

TIME TABLES FOR EARTHQUAKES

POPULAR MECHANICS

MACHINE

UNDERSTAND IT

REG. U.S. PAT. OFF.

JULY
25 CENTS
30c IN CANADA

SEE PAGE 70



The CITY that
GREW BACKWARDS



When two is company I don't make a crowd

*I'm your best friend-
I am your Lucky Strike*

You wonder what makes me a better friend. It's center leaves. I spurn the sticky, bitter little top leaves. I scorn the coarse,

grimy bottom leaves. I am made only of the mild, fragrant, expensive center leaves. I do not irritate your throat.

LUCKIES USE ONLY CENTER LEAVES
CENTER LEAVES
GIVE YOU THE MILDEST SMOKE



They Taste Better

NEW CAR ABOLISHES REAR SEAT "BOUNCING"

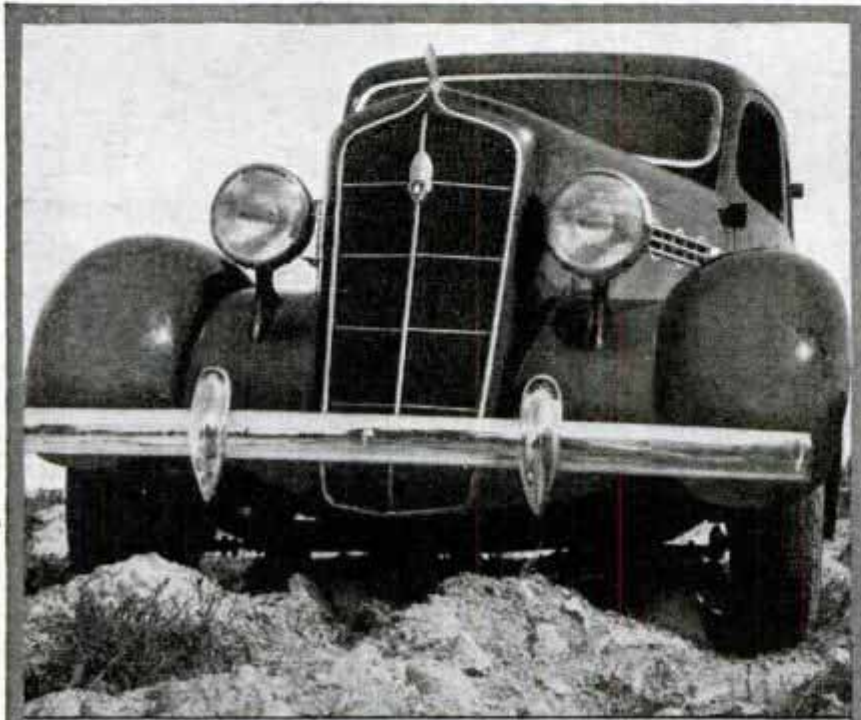

Engineers remove cause of "pitching" and bumps . . . get Floating Ride

FOR YEARS, there wasn't much comfort for any one riding in the rear seat of any car.

Then engineers discovered a new principle—which was introduced in the spectacular "Airflow" cars. Seats and engine were moved forward, equalizing the weight on front and rear springs. It ended rear seat "pitching." Now the same principle is used in the new Plymouth.

In addition, a new type of spring has been perfected—with tapered leaves, and made of special Mola steel. And a sway-eliminator has been added at the front.

The result is a miraculously smooth, restful ride. There is no bouncing or pitching. The back seat rides like the front. You can hardly believe you're riding in one of the lowest-priced cars!

Talk to your Chrysler, Dodge or De Soto dealer about this big, new Plymouth . . . now only \$510 and up list at factory, Detroit. (Convenient terms by the official Chrysler Motors Commercial Credit Plan.)



BUMP—BUMP—BUMP! This galloping, "pitching" action of the ordinary car is particularly felt in the rear seat.



FLOATING ALONG! Plymouth's smooth, Floating Ride with modern weight re-distribution and new-type springs.

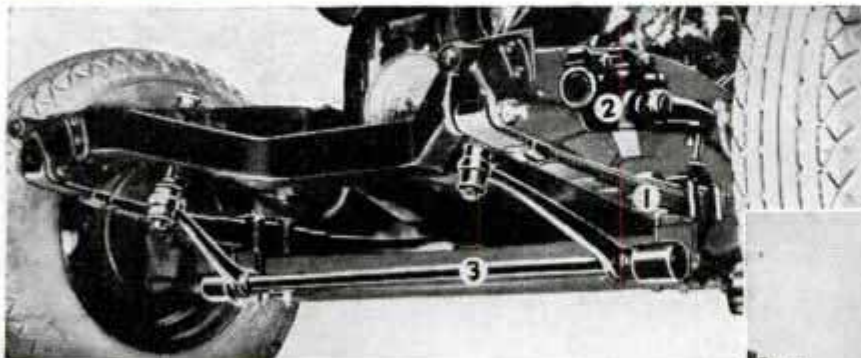

SAFE ON CURVES! Plymouth's sway-eliminator (3) holds you safe and steady on curves, even at high speeds. (Note, also, (1)—new tapered-leaf Mola steel springs; and (2)—double-action shock absorbers.)



“And only a dime?
that's *Something*”

SURE, I used to go for all those expensive pipe mixtures—thought they *had* to be better because they cost more! Then I tried Union Leader and discovered it's the *tobacco*, not the price tag, that counts. You can't buy more pipe contentment at any price than you get in this fine, *old*, mellow Kentucky Burley. So, my motto is: when you can buy the best for a dime, why part with more? (It's great in cigarettes, too.)

© P. Lorillard Co., Inc.

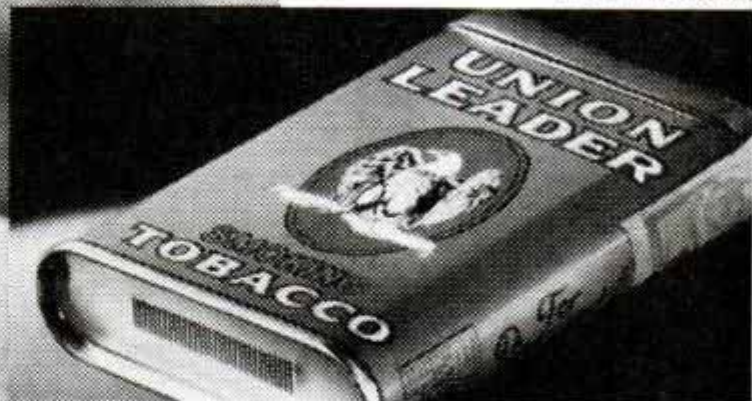
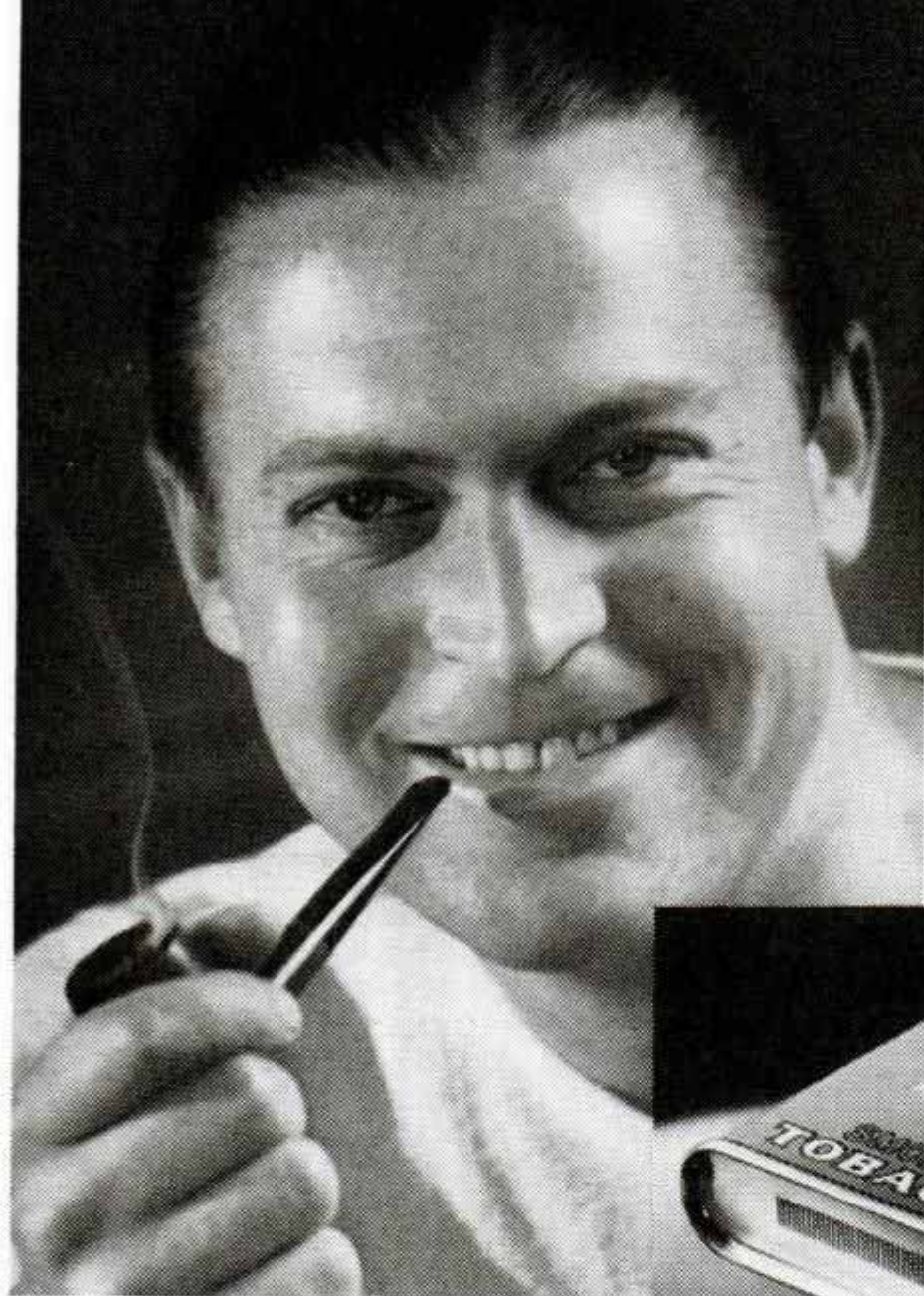

CHESTER MORRIS, Universal Pictures Star, has smoked Union Leader since 1933.

UNION LEADER
THE GREAT AMERICAN SMOKE



When writing to advertisers please mention Popular Mechanics

Popular Mechanics Magazine

H. H. WINDSOR, Founder

H. H. WINDSOR, Jr., Editor and Publisher

July, 1935

Vol. 64, No. 1

Special Features

The New Chemistry	1
Keeping Them in the Air.....	Coloroto
Painting with Fire	20
This Changing World	26
How the Weather Affects You.....	34
Hitting the Trail	40
Sculptured Sound	47
Tuning Up a Winner	50
The "G-Men" War on Crime	56
Mining a Mountain	63
Speed Boating on a Desert Sea.....	66
Where to Find the Big Ones.....	72
Dust Traps the Criminal	78
Time Tables for Earthquakes	82
The City That Grew Backwards	88
Odd Facts About Stamps	94

(Continued on next page)

What's New in the Movies

YOU may not be able to believe your own eyes and ears when you go to the movies tomorrow. Hollywood is stepping on its own heels rushing new ideas into pictures. Recent developments include a process for producing color pictures which is likely to make the black and white movies as rare as the silent film, a method of sound recording which adds the third dimension of depth to voice or music, and a new staging technique which has enabled the movies to move indoors and bring all the outdoors in with them. In next month's Coloroto section is the first of two articles describing these processes. It is illustrated by eight pages of pictures in full color.

Next Month

ARE you headed for the woods this summer, and a bit of life in the open? Well, don't come back from your camping trip with a kink in your spine, a midsummer sniffle and a memory of tantalizing mosquitoes and black flies. In the next issue Bob Becker tells how the up-to-date camper, properly equipped, can rough it in ease and comfort.

Million-Mile Pilots

JACK KNIGHT flew the mails when there was nothing but a compass, a few bonfires and some lighted villages to guide the night flyers. Now he's one of nearly two score veterans on one air line, each of whom has flown enough miles for two round trips to the moon and a couple of round-the-world journeys in addition. The first of two articles about these million-milers and their many thrilling experiences appears in the August issue.

Under-Sea Duels

CAUGHT on the ocean's floor, arms pinned in the deadly grip of an octopus. . . Attacked thirty feet below the surface by a fighting school of fifteen-pound sheepsheads—these are among the thrilling undersea adventures related in the next issue by a California diver who thinks it is sport to go down and meet the fish in their own element.

Published monthly by POPULAR MECHANICS CO., 200 East Ontario Street, Chicago, U. S. A. Single copy in United States, 25 cents; \$2.50 a year, \$4.00 for two years in United States and possessions, and countries of the Pan American Postal Union; for Canada, Newfoundland and Labrador, add 50 cents a year extra for postage; to all other countries add \$1.00 a year extra for postage. Changes in address must be reported to us immediately to eliminate delay. Entered as Second Class Matter, Sept. 15, 1903, at the Post Office at Chicago, Illinois, under Act of March 3, 1879. Entered as Second Class Matter at the Post Office Department, Canada. Copyright, 1935, by Popular Mechanics Co. in the United States, Australia and France.

So Easy!

THE NEW, IMPROVED SIMONIZ
KLEENER QUICKLY MAKES DULL
CARS SPARKLE LIKE NEW AGAIN



MOTORISTS WISE

Get a can of Simoniz and Simoniz Kleener . . . try this famous beauty treatment that all America is talking about. If your car is dull, the new, improved Simoniz Kleener will bring back all the beauty the finish had when new—and quickly. Of course, it is Simoniz that makes cars stay beautiful. Although easy to apply, it not only protects the finish, but makes it last longer and keeps it from fading. So, it doesn't matter whether your car is old or new, it should be Simonized, and the sooner the better.



(Contents—Continued)

Advertising—display case on rear of car	49
Air Conditioning—hollow-wall cooling at low cost..	38
Airplane	
parachute jumper glides on canvas wings.....	31
twin-engine, like an auto	70
Atmosphere—frame shows how much air man uses	
in hour	97
Automobile	
felt packing in valve spring saves gas	18
gun, touch-up-paint, uses air from tire	87
Automobiles	
axles for trailers fit small car wheels	87
flasher system warns of underinflation	39
seats converted into bed by adjustable hinges..	7
turret tops, giant press makes	37
Automobiles, Accessories—seat cooled by moisture	
from felt	93
Aviation—blazing trail for passenger air line to	
China	4
Baby—palm print proves identity	17
Bathing—chart of water temperature and depth . . .	35
Bicycle—locking cable inside handlebars	49
Boilers—rivet seals holes in tanks of	8
Bottle—rubber ball as seal for	25
Bridge—bid reminder attached to ash tray	55
Building Materials—made from waste	18
Camera—flash gun set off by shutter	44
Camping—bag, kapok filled, for outdoor sleeping..	77
Carpet—binder on backing, makes inlays easy....	86
Chain Letter—mathematics shows fallacy of	25
Concrete—figures depicting historical events deco-	
rate garden	7
Dogs—trip and hold fugitives	8
Drainpipe—flusher, built-in, prevents clogging....	60
Egg Breaker—separates whites and yolks	45
Electricity—"egg," metal, to shoot high voltage at	
the atom	62
Electric Light	
Battersea power station	32
fog-piercing light is produced in "smoke-box"	
tests	91
Elephants—model, hobby of New Jersey governor..	69
Engine, Steam—speedline train is steam's answer	
to Diesel	17
Express, Pony—anniversary, seventy-fifth, of in-	
auguration of	61
Eyes—photograph inner eye to help physician.....	3
Fence, Electric—power control unit makes safe....	45
Ferry—shallow water, wades on endless track.....	71
Fish and Fishing	
angling taught in public school	43
belt, inflated, fisherman floats in boots at-	
tached to	96
Flood—gauge, radio, warns of rising waters	60
Freight—cars, lightweight, carry greater loads....	39
Glass—silk, artificial, makes unbreakable	100
Golf—ball, streamline, gives player better chance..	85
Gun—anti-aircraft, mount for	45
"Gyrauto"—giant two-wheeled car	97
Hinge—door checked or closed by spring action of.	22
Household Devices	98, 99
Lightning—"thunder machine" aids in making....	32
Lightship—carried to new station on deck of ship.	76
Mask	
dust-storm, throat and lungs protected by....	49
padded, boxer protected by	91
"Memorizer"—records cement used in mixer.....	81
Metal	
"bullets" rebuild machine parts	23
castings, home foundry kit produces	44
Model—elevated railway built as hobby	85
Motion Pictures—mirrors, flickering, give depth to.	92
Motorcycle—cavalry men ride, with machine gun	
on handlebars	81
Music and Musical Instruments—piano produces	
sound of string orchestra	60
Oil Well—fire squeezed out	100

(Continued to page 6A)

metal spray gun

Chock-full



Speedy
Cruiser-

"ROAMER"-A
Outboard

to Build

Starting

BUILD YOUR OWN BOAT AT SMALL COST

Whatever type of boat you want; whether it be a speedy outboard cruiser, a racing hydroplane, a serviceable outboard runabout, snappy inboard runabout, sailing boat, flat-bottom rowboat for outboard motor, or round-bottom rowboat or canoe, the new

POPULAR MECHANICS BOAT BOOK SHOWS YOU EXACTLY HOW TO CONSTRUCT IT

The need for easily understood directions for the amateur builder of small craft has been met by actually building these boats and photographing every vital step in the construction. Thus you are shown everything just as it is done; nothing being left to guesswork. The designs used in the new Boat Book are of the very latest, up-to-the-minute craft.

THE ONE BOOK NEEDED BY EVERY BOATING ENTHUSIAST

Gives you in addition to boat building information, everything you need to know about the operation, equipment, care, repair and maintenance of boats. This includes navigation, pilot rules, handling sailing craft, government regulation of motor boats, knots, storm signals, useful boat kinks of various kinds, glossary of boating terms, tables, etc.

Sent postpaid upon receipt of price or by parcel post C. O. D. anywhere in the U. S. A.

POPULAR MECHANICS PRESS, P7-200 E. ONTARIO ST., CHICAGO

269 PAGES
(Several in Color)

PROFUSELY
ILLUSTRATED

LARGE SIZE
7x10 INCHES

CLOTH—PRICE \$3

The
BOAT
BOOK

The
BOAT
BOOK

POPULAR
MECHANICS
PRESS

POPULAR
MECHANICS
PRESS



**ONLY
GENUINE PYROIL
GIVES
PYROIL RESULTS**

It is a decided economy to use Pyroil. In new car or old, you secure added power, smoother operation and better mileage. Valves are freed. Rings are better sealed. Gears and bearings are safeguarded. Nothing finer for safe break-in.

We would like to tell you the interesting history of Pyroil. Mail the coupon below. In the meantime, ask your service station or garage attendant to add Pyroil (merely by the ounce) to your every filling of gas, oil and grease. Or, consult the local Pyroil Distributor—see phone directory. Be sure you get genuine Pyroil.

NOTE: PYROIL IS HIGHLY EFFICIENT IN SAFEGUARDING ALLOY BEARINGS, ALL TYPES. CONTAINS NO HARMFUL OILS OR ACIDS. Manufactured and guaranteed by Pyroil Company, W. V. Kidder, Pres., 57 Pyroil Bldg., LaCrosse, Wis., U.S.A.

PYROIL HAS BEEN TESTED BY POPULAR MECHANICS AND IS USED BY POPULAR MECHANICS' PRESSES AND PUBLISHING EQUIPMENT.

DISTRIBUTORS—SALESMEN

Check square in coupon below and mail for facts of one of the greatest sales and distribution Opportunities of today, for you. It will pay you to do this—at once.



Genuine Pyroil is protected by U. S., Canadian and foreign patents issued to W. V. Kidder, its inventor. Look for this signature on every can.

W. V. Kidder
Pres.

**1567 MILES IN ONE
DAY USING PYROIL**

Bob McKenzie, Transcontinental Road Champion, recently drove a Pyroil-protected Willys Sedan 1567 miles in 24 hours, on Muroc Dry Lake, California. "Pyroil gave me the same satisfactory results as in the past," says McKenzie.

Pyroil Company,
57 Pyroil Bldg., LaCrosse, Wis.

Please send me further facts of Pyroil's efficiency.
 Please send Distributorship Opportunity facts.

Name.....

Address.....

City.....County.....State.....

(Contents—Continued)

Pencil—engraving, plugs in on a.c. current.....	46
Photographs—periscope for studying makes enlarging easy	46
Photography—records, valuable, preserved by.....	54
Planimeter—area measuring made easy with	76
Poultry—chicks' markings reveal sex at time of birth	76
Radio	
problems, easy solution for	104
transceiver, two-tube, is portable.....	106
tube, metal, dissipates heat rapidly	65
Radio, Apparatus	
meter, square, for maximum scale length.....	106
pick-up arm with "electric eye"	106
Radio, Receivers—audio indicator, visual.....	101
Radio, Transmitters—power unit for 50-watt transmitter	105
Radio, Tubes	
acorn type for ultra high frequencies	106
two-tube, a.c.-d.c. portable	102
Railroad—Diesel engine train built like airship....	19
Razor, Safety—case, like fountain pen, for carrying	61
Saws and Sawing—unit with its own power plant..	71
Ships and Shipping—hospital ship for St. John's guild	24
Siding—fireproof, looks like wood	62
Snowplane—built like auto	22
Sports—soap-box races by boys	6
Stairs—metal, "put-together" for temporary building	87
Telegraphy—current carrier unit, more telegrams carried by	77
Telephone—phone and bell in same case	22
Television	
cathode ray brings to Germany	33
exchange of patents speeds	24
New Yorkers promised	8
Tractors	
boats moved over long portages by	69
pipes, giant, towed to Boulder Dam	93
Truck—Diesel, handles brick at reduced costs.....	55
Tube—slide top replaces screw cap	100
Typewriting—gauge shows amount done	25
Wagon—wheel has automobile brake	32
Window-Pane—"glass silk," light diffused by.....	96
Wood—oil, non-toxic, preserves	38
Workshop—five power tools for home craftsman... 18	

AMATEUR MECHANICS

Advertising—window display pedestals made of cardboard	140
Attic—house kept cool by ventilating	129
Bathing Cage—children protected with	129
Bathtub—force cup applied to overflow cleans drain	110
Belt—slipping, ashes cause to grip	138
Bicycle—car on side of used as "hot dog" stand... 127	
Boats and Boating	
emergency light on small boat	138
sunshade, muslin, for rowboat	126
Camping—bottle caps as reflectors on tent rope stakes	138
Canary—toenails, emery paper on perch trims.... 118	
Clothes Hanger—folding, for closets	118
Clothesline—battery clip prevents clothes moving. 120	
Croquet Wickets—wire coat hangers serve as.... 128	
Dinghy—"Skip," a pram type	107
Drawing—stipple shading produced with sandpaper. 130	
Dressing Room—portable, for the beach	119
Eggshell—names written under	118
Filing—scroll saw used for	112
Fish and Fishing	
line guides on fishing rod made from safety pins. 125	
minnow trap provides live bait	128
rod, tough enough to hold big ones	131
Fishhooks—holder, sheet-metal, for carrying	112
Furniture, Garden—canvas seats are removable.... 128	

(Continued to page 8A)



Crowds a Lifetime's Progress in 400 Days

The Amazing But True Story of LaSalle Student Brown's Career



"It's almost unbelievable—but just a year ago, I was living in a little board shack, trying to raise a family on an unskilled man's pay. I decided—since everything else had failed—to try LaSalle home study."



"I had to work 12 hours a day, studying at odd moments. I used to sneak my books to work, sensitive to ridiculing friends. They were the 'poor saps'—for not one of them has since bettered himself in life."



"The boss's eyes were sharper than I reckoned; within five months I was suddenly promoted from 'Hey, you' to 'Mr. Brown' with the title of Night Superintendent—over the heads of men twice as long with the company."



"On my new job, I immediately applied the things I had learned through LaSalle. I organized a maintenance system since adopted by other companies. A director said 'Brown knows more about handling men than any other man in the company'."



"Unexpected rewards came outside my work, as the result of reading that remarkable LaSalle booklet, 'The Second Milestone.' I have been a speaker on business methods, and urged to run for political office. My opinion is sought by men I was afraid to speak to a year ago."



"As I stand in front of my new home, I am proud that in one year I have made what is lifetime progress for many men. Now I'm buckling down to more LaSalle training to meet future opportunities."

How We Build Men

This man's career may seem amazing to you, but to LaSalle it is not so unusual. Along with Brown, thousands of others have, these past years changed poorly-paid jobs to well-paid positions of honor and trust.

Training some 825,000 men and women has taught us that Success demands three things. If you have all three, not even a major business depression can stop you from getting ahead.

First of all, *training*—the ability to do a job better than the next man. LaSalle home-study training is recognized as a quick way of acquiring such ability. Second, there must be a *Success Plan*. This, LaSalle also supplies—bringing you expert consultation on business and personal problems; helping you overcome handicaps; building confidence . . . speeding you ahead. Third, and this is vital—there must be *ambition*; the courage to stick! Given this, LaSalle can supply all else you need to win success. This coupon is your test—this minute can be the most important in your life! Why not send the coupon NOW?

LA SALLE EXTENSION UNIVERSITY

Dept. 764-R CHICAGO, ILL.

Kindly tell me about your Success Plan and training in the business field I have checked below:

- Higher Accountancy
- Law
- Business Management
- Modern Salesmanship
- Business Law
- Business Correspondence
- Expert Bookkeeping
- Industrial Management
- Business English
- Personnel Management

This One



5DSD-J21-A2Q5

LA SALLE
EXTENSION UNIVERSITY

LET THESE GREAT BOOKS
HELP YOU TO



Start Your Climb!

*"the Man
who KNOWS
is the Man who WINS"*

Easy to train yourself! These books have helped thousands—

AIR CONDITIONING Live Field; Great Future.....	\$3.50
AUTO ENCYCLOPEDIA Dyke's 16th Edition. Recent!.....	\$6.00
110-V. GENERATORS Made From Old Auto Units.....	\$1.00
BIRD HOUSES Build to Sell; Easy Designs.....	\$1.00
BOAT BOOK Power, Sail, Rowing, Paddle Plans.....	\$3.00
BOY MECHANIC Hundreds Things Boys Can Make.....	\$2.00
BUILT-IN FURNITURE Take Orders, Make Money!.....	\$2.50
CARPENTRY HANDBOOK 336 Practical Short- Cuts.....	\$1.50
CHEMISTRY, PRACTICAL Make Hundreds Things Daily Use.....	\$2.00
CONCRETE WORK 173 Uses Described, Pictured.....	\$1.00
DIESEL HANDBOOK New! Latest Informa- tion.....	\$5.00
DOG TRAINING Home, Stage, Movies, Etc.....	\$1.50
ELECTROPLATING Modern Practical Includ- ing Nickel, Zinc, Cad- mium and Chro- mium.....	\$2.25
FARMERS' BOOK 861 Kinks for Field, Home.....	\$1.00
V-8 FORDS Also "A" and "B" Models. All New!.....	\$2.50
FORMULAS 10,000 Money Mak- ing.....	\$4.00
FROG INDUSTRY New! Raise and Sell. Profits!.....	\$2.00
FURNITURE MAKING Tools, Materials, De- signs.....	\$2.50
LATHE WORK (Metal) Drilling, Threading.....	\$1.00
LOCOMOTIVE Folding Chart Shows all Parts.....	\$1.00
LOG CABINS Easy Plans; Build for Profit. Value!.....	\$2.50
MATHEMATICS Easy Guide for the Prac- tical Man.....	\$1.50

MECHANICAL DRAWING Learn Drafting; Good Salaries.....	\$1.00
MONEY MAKING IDEAS 1000 Spare Time.....	\$1.00
OCEAN LINER "EUROPA" Atlantic Speed Queen; Charted.....	\$1.00
PLUMBING 500 Facts Every Home- owner Should Know.....	\$1.50
POULTRY Breeding, Management. Protect Your Profits!.....	\$2.00
PRECIOUS METALS Identify—Buy—Sell. Only book on.....	\$1.00
PROSPECTORS' HAND- BOOK How to Mine, Appraise, Equip.....	\$3.00
RADIO Amateurs' Handbook; Circuits, Repairs, Etc.....	\$1.00
RADIO SERVICING Profit by Knowing Costs, Kinks, Etc!.....	\$4.00
REFRIGERATION Electric. Gas. Bea Service Expert.....	\$4.00
REWINDING ELECTRIC MOTORS Fractional Sizes. Value!.....	\$2.50
SHIP MODEL Entire Text, Famous "Sovereign" of 1637.....	\$1.00
SHOP NOTES LIBRARY 6 Vol. 2500 Wonderful Shop Ideas.....	\$3.00
STAMP ALBUM Modern. 400 Pages.....	\$1.00
STEEL SQUARE How to Figure Angles of Rafters, Roofs, Etc.....	\$1.00
STORAGE BATTERIES New! How to Build, Repair, Charge.....	\$2.50
TOYS For Amusement or Prof- it. Saleable Designs.....	\$1.50
UPHOLSTERY Always a Big Market. Start Own Business.....	\$1.60
WELDING ENCYCLOPEDIA All Methods; Hard Jobs Made Easy.....	\$5.00
WIRING Approved Economy Methods for Homes, Buildings.....	\$2.50
WOOD TURNING Woods, Tools, Methods; Practical Teacher.....	\$1.50
WRIGHT ENGINE Chart of "Whirlwind"; All Parts.....	\$1.00

Books sent C.O.D. anywhere in U.S.

Just check the books you want, write your name and address below, and mail the advertisement. It is your order blank. When postman hands you books, pay him the price and few cents postage. If you send remittance when ordering, please include 10 cents per book extra for postage. Write for information about books on other subjects you are interested in.

Name.....
City..... State.....
Address.....

Mail to Popular Mechanics Press,
Room JUL 5—200 East Ontario St., Chicago, Ill.

(Contents—Continued)

Ice Box—efficient for camp or cottage.....	139
Insects—home, ridding of pests.....	132
Ladder—spurs, movable, prevent sliding of.....	112
Lathe—gauge aids in turning duplicate work.....	126
Microscope—eyestrain prevented by black paper on barrel.....	138
Mitts—canning, cut from inner tube.....	128
Paint and Painting—coal tar stains covered with shellac.....	140
Porch—enclosed, adds to your home.....	121
Razor—how to keep sharp.....	114
Rolling-Pin—bottle filled with ice used as.....	130
Rubber, Crepe—many uses for.....	138
Saws and Sawing—holder on belt, handsaw carried with.....	118
Screens, Window—two ideas on repairing.....	113
Stairs—auto-wheel rims used as forms for concrete steps.....	112
Swimming—diving board, nonslip.....	130
Swing—portable, for little tots.....	111
Tent—flap locked with broomstick.....	120
Trailer—joint for hitch.....	113
Trellis—"Spider-Web," vines trained on.....	120
Windows—tar paper keeps water from running un- der.....	120

SHOP NOTES

Aluminum—melt in crucible but do not use a flux..	155
Automobiles help for the owner.....	157
method of removing fan pulley from car motor.....	159
notched washer holds bolt.....	159
pump, priming Ford fuel.....	159
radiator hose, V-block and knife blade cut.....	158
steering-gear oil gauge.....	159
tie rods of front axles used on trailers.....	158
Automobiles, Repairing brake rods, repairing rusted.....	160
catches on car doors repaired with sheet metal.....	158
generator work, button-hook serves as tool for.....	159
zerk fittings, emergency help for.....	158
Belt Sander—for the lathe.....	147
Brush—fountain, flows acid for large soldering jobs.....	150
Camera—film packs held firmly in adapters.....	156
Camping—tourists' cabins that get the business.....	151
Cattle—safety razor brands.....	146
Cleaning—paper covers, time saved in putting on garments.....	148
Cutters—milling, rule to follow when grinding.....	150
Drill Chuck—how to repair worn keyhole.....	145
Drilling—jig holds round work for.....	156
Dumb-Waiter—indicator simplifies use of.....	149
Dustpan—V-shape piece of tin improves.....	150
Fly Paper—rolled, metal clips hold.....	145
Glass—wall gauge simplifies cutting.....	154
Golf—clubs, repair your own.....	141
Hydrometer—battery, making more useful.....	149
Lathe graphite lubricates tailstock center.....	148
tool for cutting grooves and fillets.....	160
Machine, Milling cutting racks longer than crossfeed travel of.....	156
cylinder heads refaced in.....	155
Metal, Sheet—how to cut with cold chisel.....	155
Mimeograph—pictures, tracing on stencils.....	148
Moths—electric bug killer rids greenhouse of.....	146
Nails—brackets support kegs for dispensing.....	150
Nuts—castellated, slotted in milling machine.....	148
Orchard—citrus, windbreak protects.....	146
Paint and Painting brush cleaning pan saves time in shop.....	156
drab colors, mixture for.....	144
Pencil—tape holds on glove finger.....	150
Planer—holes drilled at an angle in.....	154
Pliers—hose keeps open for one-hand work.....	154
Tools kit, plywood, has individual pockets.....	145
moth balls prevent from rusting.....	160

THE TYPICAL I. C. S. STUDENT!



WHEN people refer to the International Correspondence Schools as competitors of other educational agencies, they speak from inaccurate impression and not from established fact.

Let's take a look at the typical I.C.S. student—an average of over 4,000,000 students during the past 40-odd years:

He is 27 years old. He works. (Interestingly enough, you seldom see an I.C.S. student out of work.) He is married. He is a parent. In appearance, he is a composite of office and shop worker.

He comes to I.C.S. because of a specific need for a specific kind of training.

Recognizing his own shortcomings in training, and influenced by the recommendations of his superiors and associates who know by personal experience the value of spare-time study under expert instruction, he approaches his I.C.S. course with hope and determination.

Where else, in view of his circumstances, could he turn? *This is the place of the International*

Correspondence Schools in the American educational picture—a place honored and commended by thousands of ambitious men in hundreds of professions and trades today and by educators from coast to coast!

AN INVITATION

Men who are anxious to get ahead, to earn more money, and who are willing to pay the price in hard work and sacrifice of pleasure, are invited to consider this coupon and the subject most vital to them. *But men who think some magic force of fortune goes into action in their behalf at the drop of a coupon without any further effort on their part, should save their stamps and our time! Our invitation is to the courageous.*

INTERNATIONAL CORRESPONDENCE SCHOOLS

"The Universal University"

BOX 5582-H, SCRANTON, PENNA.

★ Without cost or obligation, please send me a copy of your booklet, "Who Wins and Why," and full particulars about the subject *before* which I have marked X: ★

- | | | |
|--|---|---|
| TECHNICAL AND INDUSTRIAL COURSES | | |
| <input type="checkbox"/> Architect | <input type="checkbox"/> Heat Treatment of Metals | <input type="checkbox"/> Plumbing |
| <input type="checkbox"/> Architectural Draftsman | <input type="checkbox"/> Sheet Metal Worker | <input type="checkbox"/> Steam Fitting |
| <input type="checkbox"/> Building Estimating | <input type="checkbox"/> Telegraph Engineer | <input type="checkbox"/> Heating |
| <input type="checkbox"/> Contractor and Builder | <input type="checkbox"/> Telephone Work | <input type="checkbox"/> Ventilation |
| <input type="checkbox"/> Structural Draftsman | <input type="checkbox"/> Mechanical Engineering | <input type="checkbox"/> Air Conditioning |
| <input type="checkbox"/> Structural Engineer | <input type="checkbox"/> Mechanical Draftsman | <input type="checkbox"/> Steam Engineer |
| <input type="checkbox"/> How to Invent and Patent | <input type="checkbox"/> Machinist | <input type="checkbox"/> Steam Electric Engineer |
| <input type="checkbox"/> Electrical Engineer | <input type="checkbox"/> Patternmaker | <input type="checkbox"/> Marine Engineer |
| <input type="checkbox"/> Electric Lighting | <input type="checkbox"/> Gas Engines | <input type="checkbox"/> R. R. Locomotives |
| <input type="checkbox"/> Welding, Electric and Gas | <input type="checkbox"/> Diesel Engines | <input type="checkbox"/> R. R. Section Foreman |
| <input type="checkbox"/> Reading Shop Blueprints | <input type="checkbox"/> Aviation Engines | <input type="checkbox"/> Air Brakes |
| <input type="checkbox"/> Boilermaker | <input type="checkbox"/> Automobile Mechanic | <input type="checkbox"/> R. R. Signalmen |
| | <input type="checkbox"/> Refrigeration | <input type="checkbox"/> Highway Engineering |
| | | <input type="checkbox"/> Civil Engineering |
| | | <input type="checkbox"/> Surveying and Mapping |
| | | <input type="checkbox"/> Bridge Engineer |
| | | <input type="checkbox"/> Bridge and Building Foreman |
| | | <input type="checkbox"/> Chemistry |
| | | <input type="checkbox"/> Pharmacy |
| | | <input type="checkbox"/> Coal Mining |
| | | <input type="checkbox"/> Mine Foreman |
| | | <input type="checkbox"/> Navigation |
| | | <input type="checkbox"/> Cotton Manufacturing |
| | | <input type="checkbox"/> Woolen Manufacturing |
| | | <input type="checkbox"/> Agriculture |
| | | <input type="checkbox"/> Fruit Growing |
| | | <input type="checkbox"/> Poultry Farming |
| BUSINESS TRAINING COURSES | | |
| <input type="checkbox"/> Business Management | <input type="checkbox"/> C. P. Accountant | <input type="checkbox"/> Service Station Salesmanship |
| <input type="checkbox"/> Office Management | <input type="checkbox"/> Bookkeeping | <input type="checkbox"/> First Year College |
| <input type="checkbox"/> Industrial Management | <input type="checkbox"/> Secretarial Work | <input type="checkbox"/> Business Correspondence |
| <input type="checkbox"/> Traffic Management | <input type="checkbox"/> Spanish | <input type="checkbox"/> Lettering Show Cards |
| <input type="checkbox"/> Accountancy | <input type="checkbox"/> Salesmanship | <input type="checkbox"/> Signs |
| <input type="checkbox"/> Cost Accountant | <input type="checkbox"/> Advertising | <input type="checkbox"/> Stenography and Typing |
| | | <input type="checkbox"/> Civil Service |
| | | <input type="checkbox"/> Mail Carrier |
| | | <input type="checkbox"/> Railway Mail Clerk |
| | | <input type="checkbox"/> Grade School Subjects |
| | | <input type="checkbox"/> High School Subjects |
| | | <input type="checkbox"/> College Preparatory |
| | | <input type="checkbox"/> Illustrating |
| | | <input type="checkbox"/> Cartooning |

Name.....Age.....Address.....

City.....State.....Present Position.....

If you reside in Canada, send this coupon to the International Correspondence Schools Canadian, Limited, Montreal, Canada

When writing to advertisers please mention Popular Mechanics

FOR BETTER JOBS AND MORE PAY



Prosperity is coming. Be prepared for a bigger, better job. Get the training now!

These TOOLS and Other EQUIPMENT Given When You Start

Learn DRAFTING at home.



"I'll train you RIGHT—the practical EASY way!"

—Engineer Dobe

Now is YOUR big opportunity! Boost your pay! Get a better job. Business is picking up. Draftsmen are the first needed! I furnish you all tools and a drawing table. And I'll teach you in a very short time by mail in your spare time until you actually have a desirable draftsman's position so that you are fully satisfied with your easy work and better pay. Earn while you learn! No previous experience required. High School education not needed. Everything made plain by my practical method right from the start. You'll be amazed how quickly you can prepare yourself in your spare time for MORE PAY by my practical method—now used for over 34 years. Thousands of successful graduates, aged 16 and 18 to past 50.

JOBS OPEN NOW!

**AUTOMOBILE
MOTOR BUS
AVIATION
ELECTRICITY
MACHINE BUILDING
BUILDING
CONSTRUCTION**

After training you I help you to a job without charging you a cent for this service. For 30 years employers of Draftsmen have been writing me when they want help. Aviation, Electricity, Machinery, Auto Work, Building Work—All these industries and others, too, must have draftsmen in their offices. These industries are now growing fast; be prepared.

Start Now and get the training. Then YOU will be ready for that bigger, better pay job. Time is money. Send the coupon NOW—TODAY!

FREE BOOK COUPON

ENGINEER DOBE, Div. B337 Libertyville, Ill.

Send me your free book, "Successful Draftsmanship" and explain how you will assist me to a good position as a draftsman.

Name.....Age.....

Address.....

Post Office.....State.....

When writing please mention Popular Mechanics

Law!

LEARN AT HOME

Are you adult, alert, ambitious, willing to study? Investigate LAW! We guide you step by step—furnish all texts, including 14-volume Law Library. Training prepared by leading law professors and given by members of bar. Degree of LL. B. conferred. Low cost, easy terms. Send NOW for Free, 64-page "Law Training for Leadership."

LaSalle Extension University, Dept. 764-L, Chicago

LEARN MECHANICAL DENTISTRY

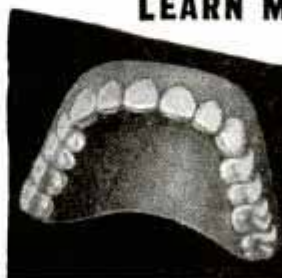

A profession that cannot be affected by machinery. Make plates, crowns, bridges, etc., for dentists—or have a business of your own. Easily and quickly learned, in day or night school. Individual instruction. No books—no classes. Write for Catalogue and FREE TOOL OFFER.

Dept. 612

McCARRIE SCHOOL
OF MECHANICAL DENTISTRY
207 N. Broad St. Phila., Pa.

RADIO PAYS!

You, too, can be in the big pay class. Trained Radio and Television men make big money in interesting work. For FREE details write First National Television, Power & Light Building, Kansas City, Missouri. Dept. AA-7

You Can Regain Perfect Speech, if you STAMMER

Send today for beautifully illustrated book entitled "DON'T STAMMER," which describes the Bogue Unit Method for the scientific correction of stammering and stuttering. Method successfully used at Bogue Institute for 33 years—since 1901. Endorsed by physicians. Full information concerning correction of stammering sent free. No obligation. Benjamin N. Bogue, Dept. 156, Circle Tower, Indianapolis, Indiana.



Learn to Write

Begin Today. Write for my Free Book, "How to Become a Good Penman." It contains specimens and tells how others learned to write in spare time. Your name elegantly written on a card if you enclose stamp for postage. Write today. F. W. TAMBLYN, 418 Ridge Bldg., Kansas City, Mo.

5¢ EACH LITTLE BLUE BOOKS

Send postcard for our free catalogue. Thousands of Bargains. Address: LITTLE BLUE BOOK CO., Catalogue Dept., Desk 490, Girard, Kansas.

MAKE MONEY

AT HOME!

Learn easy Koehn Method of coloring photos and miniatures in oil. New! No art talent needed. Big demand. Send for free booklet. Make Money At Home.

NATIONAL ART SCHOOL
3601 Michigan Ave. Dept. 135-B Chicago

NEW MEXICO SCHOOL of MINES

Practical instruction in Mining and Mining Geology. Also Metallurgy, Petroleum Geology and General courses offered by this 4-year state-owned college. Strong faculty; fine equipment; small classes. All expenses low. Healthful climate. Ask for Catalog 51.

E. P. WATSON, REGISTRAR, SOCORRO, N. M.



STUDENTS BUSY AT WORK IN GREAT COYNE SHOPS

Learn RADIO

I'll Finance Your Training

Yes, sir! I mean what I say. I'll train you in 10 weeks right here in the Great Coyne Shops — NOT BY CORRESPONDENCE — but by actual work on **Radio, Sound and Television** equipment AND YOU WON'T HAVE TO START PAYING ME BACK UNTIL FIVE MONTHS FROM THE DATE YOU START SCHOOL, AND THEN YOU'LL HAVE OVER A YEAR TO COMPLETE YOUR PAYMENTS.

This Is the Greatest Offer Ever Made by Any School

I MEAN exactly what I say. You can get a complete training by the world's oldest and largest Practical Radio School and I'll finance your Tuition. You won't have to start paying me back in small, monthly payments UNTIL FIVE MONTHS FROM THE DATE YOU START SCHOOL. I consider the fellow who is ambitious enough to want to get ahead by taking my Training, worthy of my help. MAIL THE COUPON BELOW and you can prove to me that you are willing to spend just 10 weeks in the Coyne Training Shops learning Radio. Then, I'll tell you how I finance your Tuition—give you your complete Training and let you pay me back later.

Learn By Doing In 10 Weeks

I don't care whether you are 16 or 45. It makes no difference to me if you don't know an oscillator from a spark coil. You don't need any previous experience or advanced education to master my Shop Training. Don't let lack of money stop you. Most of the students at Coyne have no more money than you have. That's why I have worked out my finance offer.

MANY EARN While LEARNING

If you need part-time work to help pay your living expenses and will tell me your problems I may be able to help you as I have thousands of others. Then, in 10 brief weeks, in the great Training shops of Coyne, you will learn on a wide variety of modern, up-to-date A. C. Superheterodyne sets, oscillators, analyzers and test instruments. Prepare for Amateur Broadcast, or Telegraph Radio Operator's License and to know all code and Dept. of Commerce rules for a government License Examination.

TRAINING By Actual Work

No dull books, no baffling charts, no classes, you get individual training . . . all real actual work with only the theory you will need. Building real radio sets, doing radio wiring and testing, trouble-shooting, re-



Auto Radio Instruction

Prepare for Jobs Like These
Here are a few of hundreds of positions in the Radio field. My free employment bureau gives you life-time employment service.
AIRCRAFT RADIO OPERATOR
SHIP RADIO OPERATOR
RADIO SERVICING
PUBLIC ADDRESS SYSTEMS
BROADCAST STATION OPERATOR
TALKING PICTURE STUDIOS
TELEVISION LABORATORY MAN



pairing and servicing. That's a glimpse of how I help to make you a Radio expert, and fit you to qualify for jobs leading to the biggest pay.

Jobs - Pay - Future

"Two weeks after graduation I received a splendid job. The main consideration given my application was that I was a Coyne Trained man," reports Harold Soucy of Illinois. "I wish to thank your Employment Manager for securing this position for me," writes Albert Yagon, "he sent me out to this Company the first day and I was employed there immediately." And I could go on quoting from hundreds of letters of successful Coyne Trained men. What they have done, you should be able to do!

Electric Refrigeration Air Conditioning

Right now I'm including my big new Electric Refrigeration and Air Conditioning course at no extra cost.

GET THE FACTS

Coyne is your one greatest chance to get into Radio. Every obstacle is removed. This school is 36 years old—Coyne training is tested—proven beyond all doubt—endorsed by many large concerns. You can find out everything absolutely free. Simply mail the coupon and let me send you the big, free Coyne Book with photographs . . . facts . . . jobs . . . salaries . . . opportunities. Tells you how many earn expenses while training and how we assist our graduates in the field. This does not obligate you. So act at once. Just mail coupon.

Get This
FREE
Book



Home of Coyne Shops

This is our fireproof modern Building wherein is installed thousands of dollars' worth of Radio equipment of all kinds. Every comfort and convenience has been arranged to make you happy and contented during your Training.

COYNE H. C. LEWIS, PRESIDENT FOUNDED 1899
RADIO & ELECTRICAL SCHOOL
500 S. Paulina St., Dept. B5-3H, Chicago, Ill.

H. C. LEWIS, President
Coyne Radio & Electrical School
500 S. Paulina St., Dept. B5-3H, Chicago

Dear Mr. Lewis: Without obligation send me your big free catalog and all details; also tell me all about your "Pay-Tuition-After-Graduation" Plan.

Name.....
Address.....
City..... State.....

BECOME A TRAINED AUTO EXPERT

GOOD JOBS—GOOD PAY

Say good-bye to layoffs and low pay! Get into the Auto Service and Repair Business... a field of opportunity where practical training has brought big pay... promotion... shops of their own... to hundreds of fellows just like you.

PRACTICAL "JOB WAY" TRAINING BROUGHT TO YOUR HOME

Whether or not you are now employed... you can get this complete training right at home in your spare time. By this simple, easy "Job Way" method you can learn—in a few short months—what it would take you years to learn by ordinary methods. And we show you how to earn extra money while you are learning... doing actual JOBS on real autos.

SPARE-TIME MONEY

MOTOR TESTING OUTFITS FURNISHED
For those who act promptly we are including complete Motor Testing equipment at no extra cost. This practical working equipment helps your training, and will enable you to start making extra spare-time money soon after you enroll.

COMMON SCHOOLING ALL YOU NEED

Men between 15 and 50 with no previous auto experience or special education, quickly master "Job Way" Training and become skilled experts in every branch of auto work. We know what training you need, and give it to you in a way that is easy to understand.



GET THE FACTS! Mail the Coupon NOW for Big FREE Auto Book, facts about "Job Way" Training. Free Employment and Consultation Service, Motor Testing equipment included with Course, and details of amazing

MONEY-BACK OFFER.

MOTOR INSTITUTE of AMERICA

2140 Lawrence Ave., Chicago, Ill., Dept. G-11

Without cost or obligation to me, send Free Auto Book, with full details of "Job Way" Home Training and your Money-Back Offer.

Name.....

Address.....

City.....

State.....

MAKE BIG MONEY!

EARN WHILE YOU LEARN AT HOME

MAIL COUPON FOR FREE AUTO BOOK

BE A RAILWAY TRAFFIC INSPECTOR



YOU CAN EARN GOOD PAY AT THE START
TRAINED MEN—16 to 50—find a well-paid place in this growing field of Railway and Bus Passenger Traffic Inspection. Complete our few weeks' home-study course, and we will help place you at up to \$135 per month, plus expenses, to start, or refund tuition. Your job is waiting for you—you'll like the work—and advance quickly with experience. Free Booklet.

Standard Business Training Institute
Div. 207 Buffalo, N. Y.

RADIO ENGINEERING

RCA Institutes offers an intensive course of high standard embracing all phases of Radio. Practical training with modern equipment at New York and Chicago schools. Also specialized courses and Home Study Courses under "No obligation" plan. Illustrated Catalog on request



RCA INSTITUTES, Inc.

75 Varick Street, New York, N. Y.
1154 Merchandise Mart, Chicago

Recognized Standard in Radio Instruction Since 1909

LEARN WATCH REPAIRING



AT HOME You can learn by our modern and original system of instruction every part of the Watch Repairing Trade at home as good or better than at a shop. You can earn money while learning and secure a well paying position or start in business after completing our course of instruction. Good watch repairers are always in demand and earn very good salaries. For particulars apply to the

Wisconsin School of Watch Repairing
524 E. Mason St., MILWAUKEE, WIS.

Learn to Dance

You can learn all the modern dances—the latest Tango steps, the new Fox Trots, dreamy Waltzes, smart Collegiate Steps, and popular Society Steps at home, easily and quickly. New chart method makes dancing as simple as A-B-C. No music or partner required. Don't be a wallflower. Learn to dance. Complete course—256 pages, 54 illustrations, sent on 5 Days' Free Trial. Equals \$20.00 course. Send no money. Pay postman only \$1.98, plus postage upon arrival. Money back if not delighted. Catalog Free.



Franklin Pub. Co., 800 No. Clark St., Dept. 9474, Chicago

TRAIN FOR A FINE

HOTEL POSITION

Come to Washington. Qualify in 4 months for well-paid opportunities in Hotels, Clubs, Schools, Restaurants, Hospitals, Institutions. Learn on modern equipment under expert instructors. National Placement Service FREE. Day Classes start Sept., Oct.

FREE book gives details. LEWIS HOTEL TRAINING SCHOOLS, Div. RLH-393, Washington, D. C.

Be an ARTIST

MAKE \$50 TO \$100 A WEEK!

Many of our successful students are now making big money. Our simple methods make it fun to learn Commercial Art, Cartooning and Designing at home, in spare time. New low tuition rate. Write for big free book "ART for Pleasure and Profit," today. State age. Address:

WASHINGTON SCHOOL OF ART,

STUDIO 127, 1115—15TH ST., N. W., WASHINGTON, D. C.



Play the Hawaiian Guitar like the Hawaiians!

FAMOUS NATIVE HAWAIIAN INSTRUCTORS teach you to play this fascinating instrument. ONLY 4 MOTIONS—No previous musical knowledge needed. OUR 52 EASY LESSONS teach you the enchanting music you hear over the radio.

GIVEN—when you enroll—a sweet toned

HAWAIIAN GUITAR, complete playing outfit and carrying case.

WRITE AT ONCE for attractive offer and easy terms.



FIRST HAWAIIAN CONSERVATORY OF MUSIC, Inc.
9th Floor, Woolworth Bldg. Dept. 250 New York, N. Y.

Approved by New York State Board of Regents

AU AVIATION

ACCREDITED

2 Yr. B. S. Degree Course in Aeronautical Engineering. Also Pilot's Ground, Master Mechanic and Administrative Courses, Days and Evenings. U. S. Approval. Write for "Aviation Facts." **AERONAUTICAL UNIVERSITY** Curtiss-Wright Bldg. Chicago, Illinois
1342 S. Michigan Blvd.

CAMPION Jesuit High School FOR BOYS

Boarding School, Highest academic standing. Prepares for all colleges and universities—and for Life. Finest, most healthful location in middle west. Beautiful, large campus. Complete, modern equipment. All sports Golf and Ice Hockey, R. O. T. C. Catalog FREE.

CAMPION BOX 20 PRAIRIE DU CHIEN, WIS.

"BECOME A LIGHTNING TRICK CARTOONIST"

Send \$1.00 for Laugh Producing Program of 23 Trick Drawings with Instructions. Catalog of Chalk Talk Supplies Free.

BALDA ART SERVICE, Dept. 1, Oshkosh, Wis.

INVENTING Now Taught for the First Time!

Home study course. Send TODAY for free literature.

TROFIMOV SCHOOL OF INVENTIVE PRACTICE, INC.
3859 Northampton Rd., Cleveland, Ohio

Learn PHOTOGRAPHY at Home

Make money taking pictures. Photographs in big demand. Commercial Photography also pays big money. Learn quickly at home in spare time. No experience necessary. Write today for new free book, *Opportunities in Modern Photography*. American School of Photography, Dept. 135-B, 3601 Michigan Avenue, Chicago.

LET OTHERS SELL FOR YOU ---

Start your own business making Cheese Chips at home. Sell through dealers—no house-to-house canvassing. Big profits, steady repeat orders. Less than \$10.00 investment is all required. A clean-cut proposition for willing workers. Write **Fluff-O, Dept. 18-G, St. Louis**

WHY NOT spend spring, summer, fall, gathering butterflies — insects?

I buy hundreds of kinds for collections. Some worth \$1 to \$7 each. Simple outdoor work with my Instructions, pictures, price list. Profit. Pleasure. Send 10¢ (not stamps) for Illustrated Prospectus, terms, before sending butterflies. **Mr. Sinclair, Dealer in Insects, Dept. 6, Box 1424, San Diego, Calif.**

Diesel Engineering Will Need Trained Workers Throughout Your Life

Why Diesels Are Fast Increasing

Diesels are fast replacing steam and gasoline engines because they have proved their efficiency, economy, and dependability under the hardest operating conditions. They use a much cheaper fuel, which is dustless and smokeless, and eliminates the gasoline fire hazard in case of accident. Equally adapted to heavy or light loads. Will drive direct or generate electric power for any purpose.



What This New Field Offers You

If you are mechanically inclined, you owe it to yourself and your dependents to investigate this new power. You will be amazed and interested to see how it is invading practically every power field. Diesel Engineering offers you a new, progressive, uncrowded line that will provide steady employment and frequent advances as long as you need to work.

Turning Spare Time into Dollars

Unveiling the Diesel Mystery

Get our Free Diesel Booklet and learn all about this newest, fastest-growing line—its opportunities and requirements. Find out what Diesel Engineering offers you—how it fits in with your present training and experience—the large number of Diesel engines and accessories being manufactured—how easily you can master Diesel Engineering by home study—how quickly our employment service can help you turn your training into dollars!

Amazing New Industry

Soon the Diesel will dominate the power field—throwing out of employment thousands of men operating other types of engines. Now is your chance to get in on the ground floor of this amazing new industry. You young men can grow up with it into important jobs; you older men now handling some other type of power can save your jobs and cash in on your experience.

Half the men and women employed today are working at jobs that did not exist 30 years ago—jobs created almost overnight by new inventions. In the same way, the Diesel Engine is building up a big new industry that will provide good jobs for Diesel-trained men throughout your lifetime.

Diesel Engineering

Newest, Fastest-Growing Type of Power and Transportation

Diesel-powered trains have staged a startling comeback for the railroads; but their performance is no more sensational than the daily work of the thousands of Diesels that have replaced steam and gasoline engines in power plants, motor trucks and busses, ships, tractors, dredges, drills, pumps, etc. This replacement is constantly going on all over the country, as the economy and adaptability of the Diesel engine become better known. And every new Diesel installation means more well-paid jobs for Diesel-trained men.

Train at Home In Spare Time

You can get the necessary training at home on all the latest Diesel developments—two- and four-stroke cycles; solid- and air-injection fuel systems; low- and high-speed and heavy-duty types; Diesel-electric generating systems, etc. Course includes all text material—with special diagrams making possible quick understanding of this new type of power.

Make the Start Now

How far you go in the industrial world depends more upon how you use your spare time than your working hours. You can learn how to do an ordinary job in a short time; and if that is all you know, that is where you stay. But if you use part of your spare time to learn how to do the better-paid jobs, that's where you will go before long. Start now to get specialized Diesel training.

Individual Employment Service Without Extra Charge

A very important part of our service is that, when the student has completed his training, we help him (without extra charge) to search out an opening in the Diesel Engineering field where he can be sure of steady advancement, with an ever-increasing reward for his foresightedness in getting training. Write today for Free Diesel Booklet. No obligation. Use coupon below.

American School, Drexel Ave. at 58th St., Chicago, U. S. A.

Asking for Information Involves No Obligation—It May Mark the Turning Point in Your Life

The American School was chartered as an educational institution, not for profit, in 1897. Exempt from Federal income tax. Special instruction material prepared by over 200 well-known Educators, Engineers, and Executives, and adopted by many resident schools and colleges, U. S. Navy, and Province of Manitoba, Canada.



American School, Dept. DB-45, Drexel Ave. at 58th St., Chicago
Send me your Free Diesel Booklet and tell me how to get ready for a well-paid job in Diesel Engineering. No obligation.

Name..... Age.....

Address.....

When writing to advertisers please mention Popular Mechanics

AUDELS Carpenters and Builders Guides 4 vols. \$6



Inside Trade Information for Carpenters, Builders, Joiners, Budding Mechanics and all Woodworkers. These Guides give you the short-cut instructions that you want—including new methods, ideas, solutions, plans, systems and money saving suggestions. An easy progressive course for the apprentice and student. A practical daily helper and Quick Reference for the master worker. Carpenters everywhere are using these Guides as a Helping Hand to Easier Work, Better Work and Better Pay. To get this assistance for yourself, simply fill in and mail the FREE COUPON below.

Inside Trade Information On:

How to use the steel square—How to file and set saws—How to build furniture—How to use a mitre box—How to use the chalk line—How to use rules and scales—How to make joints—Carpenters arithmetic—Solving mensuration problems—Estimating strength of timbers—How to set girders and sills—How to frame houses and roofs—How to estimate costs—How to build houses, barns, garages, bungalows, etc.—How to read and draw plans—Drawing up specifications—How to excavate—How to use settings 12, 13 and 17 on the steel square—How to build hoists and scaffolds—skylights—How to build stairs—How to put on interior trim—How to hang doors—How to lath—lay floors—How to paint.



THEO. AUDEL & CO., 65 W. 23rd St., New York City

Mail Audel's Carpenters and Builders Guides, 4 vols., on 7 days' free trial. If O.K. I will remit \$1 in 7 days, and \$1 monthly until \$6 is paid. Otherwise I will return them. No obligation unless I am satisfied.

Name.....
 Address.....
 Occupation.....
 Reference..... P.M.



START \$1260 to \$2100 YEAR
MEN—WOMEN—18 to 50

STEADY WORK
 Many Early Examinations Expected

Qualify at once
 Common Education Usually Sufficient
Mail Coupon Today—SURE

Franklin Institute
 Dept. T174
ROCHESTER, N. Y.

Gentlemen: Rush to me, FREE of charge, list of U.S. Government big pay jobs. Send me FREE 32-page book describing salaries, vacations, hours, work, and pointers on how to get one of these jobs.

Name.....

Address.....

When writing please mention Popular Mechanics

AUTO-MECHANICS & WELDERS

Auto Mechanics and Welders are in big demand. Complete courses in arc and acetylene welding. Pay while you learn. Enroll now at special low rates. Write today.
MICHIGAN TRADE SCHOOL
 3758 Woodward Ave., Detroit, Mich.

Write for **FREE CIRCULAR**



Learn Public Speaking

At home—in spare time—20 minutes a day. Overcome "stage-fright", gain self-confidence, increase your salary, through ability to sway others by effective speech. Write now for free booklet, *How to Work Wonders With Words*.

NORTH AMERICAN INSTITUTE, Dept. 135-B
 3601 Michigan Avenue, Chicago, Illinois

ENGINEERING



INTENSIVE PRACTICAL TECHNICAL COURSES. Non-essentials omitted. **TIME AND MONEY SAVED.** Degree in 2 yrs. Electrical, Mechanical, Structural, Architectural, Civil, Aeronautical, Highway. Also shorter courses in Electricity, Radio, Electric Refrigeration, Power Plant, Drafting, Building, Low tuition. Extensive modern equipment. Part-time work for board and room. 34 yrs. experience producing successful men, located all over U. S. and foreign lands, holding responsible positions. Approved by industry, endorsed by graduates and educators. Catalog free.

FINLAY ENGINEERING COLLEGE
 1001 Indiana Avenue Kansas City, Mo.



Enjoy a fascinating money-making business

There are big opportunities in **PHOTOGRAPHY**. We can show you more than 50 ways to make money in this growing profession—**COMMERCIAL, NEWS, PORTRAIT or MOTION PICTURE** Photography. Personal attendance and Home Study training. 25th year. Free booklet.

New York Institute of Photography
 10 West 33 St. (Dept. 49) New York City

LEARN WATCHMAKING AND ENGRAVING

BY OUR PROFIT-SHARING PLAN OUR GRADUATES SUCCEED

One of our Iowa students started in a very small way—now doing over \$30,000 a year. Another in Wisconsin, over \$10,000 the first year. Day or night classes. Call or write for **FREE BOOK**. **Chicago School of Watchmaking, Dept. 2901, 155 N. Clark St., CHICAGO.**

RADIO

ENGINEERING, broadcasting, aviation and police radio, servicing, marine and Morse telegraphy taught thoroughly. Nine months' engineering course equivalent to three years' college radio work. School established 1874. All expenses low. Catalog free.

Dodge's Institute, Ada St., Valparaiso, Ind.

LEARN CARTOONING

by the method that has developed hundreds successfully. Send name, age and 6c in stamps for chart to test your ability.

The Landon School, 1738 National Bldg., Cleveland, Ohio

MAIL FOR FREE INFORMATION

BEDFORD YMCA TRADE SCHOOL

- 1117 Bedford Ave., Dept. PM-26
 Brooklyn, New York City, N. Y.
- Auto Mechanic Talking Pictures
 - Aviation Mechanic Welding
 - Aeronautical Engineering
 - Refrigeration Machine Shop
 - Oil Burner Commercial Art
 - Air Conditioning Sign Painting
 - Electrical Window Display
 - Radio and Television Mechanic
 - Architectural-Mechanical Drafting
 - Armature Winding
 - Diesel Engines

Name.....

Address.....

"Give Me Your Measure and I'll Prove in the First 7 Days You Can Have a Body Like Mine!"

No other Physical Instructor in the World has ever DARED make such an offer!

I'll give you PROOF in 7 DAYS that I can turn you, too, into a man of might and muscle. Just think of it! Right in the first week under my guidance you will see and feel the improvement! Then as my weekly instructions arrive in your home you continue to re-build, renew and "overhaul" your body. By the end of three months you are the owner of a powerful body that you will be proud to display on the beach this summer. People will notice the ruddy glow of health in your face, the sparkle in your clear eyes, your broad shoulders, and they will seek your company. You will be the fellow who will walk off with the prettiest girl and the best job while the others wonder how you did it!

Write your name and address carefully on the coupon below. I'll send you, absolutely free, a copy of my new book, "Everlasting Health and Strength." It reveals the secrets that changed me from a 97-pound flat-chested weakling into a husky fellow who won the title of "The World's Most Perfectly Developed Man" against all comers! And it shows how I can build you into an "Atlas Champion" the same way.

Are you underweight? I'll add pounds where they are needed! Are you fat in spots? I'll show you how to pare down to fighting trim.

And with the big muscles and powerful, evenly-developed body that my method so quickly gives you, I'll also give you through-and-through health—health that digs down into your system and banishes such things as constipation, pimples, skin blotches and the hundred-and-one similar conditions that rob you of the good times and the good things of life.

I've Got No Use At all for "Contraptions"

I haven't any need for contraptions that may strain your heart and other vital organs. I don't dose you or doctor you. *Dynamic-Tension* is all I need. It's the natural, tested method for developing real men inside and out. It distributes added pounds of powerful muscles over your body, gets rid of surplus fat, and gives you the vitality, strength and pep that win you the admiration of every woman and the respect of any man.

Get my free book, "Everlasting Health and Strength"! Mail my coupon today. Gamble a stamp to prove I can make YOU a new man!

MAIL COUPON FOR FREE BOOK NOW!

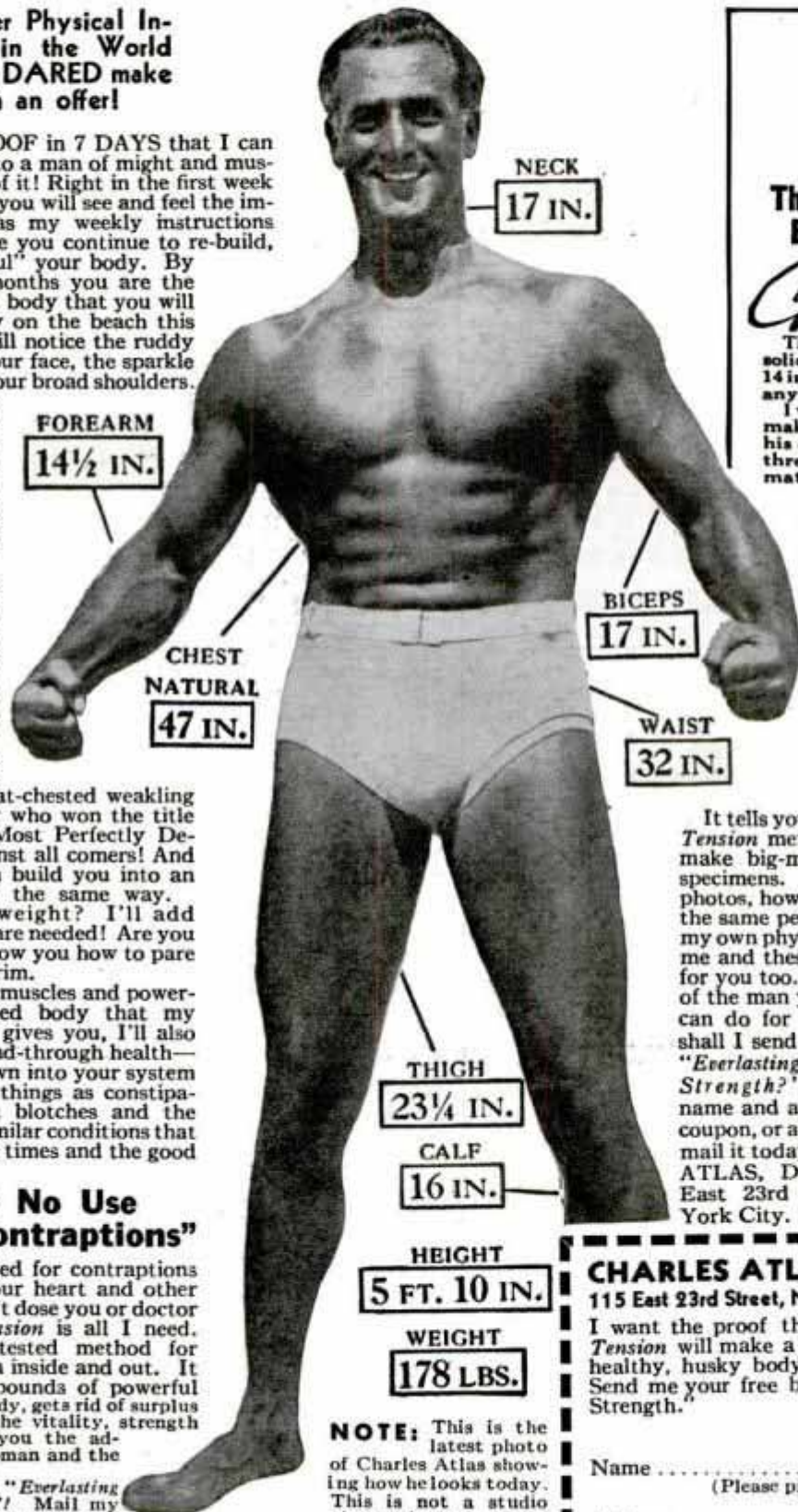

NOTE: This is the latest photo of Charles Atlas showing how he looks today. This is not a studio picture but an actual untouched snapshot.



This Sterling Silver Cup Being Given Away by

Charles Atlas

This valuable cup, made of solid sterling silver, stands about 14 inches high on a black mahogany base.

I will award it to my pupil who makes the most improvement on his development within the next three months. Therefore, no matter what your measurements may be now, you have an equal chance to win this cup for permanent possession—and with YOUR name engraved on it!

Get my free book by mailing coupon below, and WITH the book I'll send you full information about this "Atlas Championship TROPHY."

48-PAGE BOOK
FREE

It tells you all about my special *Dynamic-Tension* method, and what it has done to make big-muscled men out of run-down specimens. It shows you, from actual photos, how I have developed my pupils to the same perfectly balanced proportions of my own physique. What my system did for me and these hundreds of others it can do for you too. Don't keep on being only half of the man you CAN be! Find out what I can do for you. Where shall I send your copy of "Everlasting Health and Strength?" Put your name and address on the coupon, or a postcard, and mail it today. CHARLES ATLAS, Dept. 87, 115 East 23rd Street, New York City.



CHARLES ATLAS, Dept. 87
115 East 23rd Street, New York City

I want the proof that your system of *Dynamic-Tension* will make a New Man of me—give me a healthy, husky body and big muscle development. Send me your free book, "Everlasting Health and Strength."

Name
(Please print or write plainly)
Address
City State

© 1935 C. A. Ltd.

When writing to advertisers please mention Popular Mechanics

AVIATION

Offers **BIG MONEY** to
LINCOLN-Trained Men!



The aviation industry demands and willingly pays for well-trained pilots and mechanics. That's why there is a steady demand for Lincoln graduates.

GOVERNMENT APPROVED SCHOOL—FINEST EQUIPMENT—High wing and low wing monoplanes, biplanes, cabin planes and others are used to assure you complete flight training for Government License as Transport, Limited Commercial, Private or Amateur Pilot. Only modern, high class training planes with Department of Commerce approval are used. Government licensed instructors. Both flight and ground training under Government Supervision.

Airlines and Factories are Employing Graduates of our Master Mechanics Airplane and Engine Course. We give you practical experience in rebuilding every part of real airplanes. Also ample experience on modern motors including Whirlwind, Wasp, Cyclone and latest radial Diesel. **Lincoln is the first school to offer Diesel airplane motor training.** Airplane instruments and radio training also included.

SUCCESSFULLY TRAINING MEN FOR 25 YEARS

Thousands of men have reaped the benefits of LINCOLN training during this school's 25 years of success as a mechanics trade school, and 15 years teaching aviation. LINCOLN-TRAINED pilots and mechanics are NOW EMPLOYED by many of the best known companies in the aviation industry. Graduates satisfactorily meeting required tests are recommended for positions in the aviation industry, with which LINCOLN is in constant touch. Let Lincoln train you for aviation success. Write today for complete information. Please state age.

LINCOLN AIRPLANE & FLYING SCHOOL
206E Aircraft Bldg. Lincoln, Nebraska

How To Secure A Government Position

Why worry about strikes, layoffs, hard times? Train now for a Government job. Many examinations expected! Increased salaries, steady work, travel, good pay. Let me help you become a Railway Postal Clerk, Post Office Clerk, City Mail Carrier, Rural Carrier—or help you get into any other Government job you want. I was a Secretary Examiner of Civil Service Commission for 8 years. Have helped thousands. **Now FREE** My 32-page book tells about the jobs open—and how I help to qualify you to get one. Send the coupon for your copy TODAY.



A. R. Patterson, Civil Service Expert
PATTERSON SCHOOL, 87 Case Bldg., Rochester, N. Y.
Please send me, without obligation, your free book "How to Secure a Government Position."

Name.....
Address.....

Amazing Sensational Discovery

REFINISHES AUTOS Like NEW!



PAYS UP TO \$7.00 IN AN HOUR

Kar-Nu is a new, miracle discovery—a transparent, magic-like fluid with which anyone can refinish any color automobile easily, quickly and economically without polishing, waxing, rubbing or painting. Just wipe it on with a cloth! Immediately dullness, discoloration, shabbiness, sun fade disappear. Instantly, as if by magic, the old finish is rejuvenated and restored to the lustre, life glow and beauty of the original factory finish. As KAR-NU dries it seals the pigment and protects the finish from further wear. Lasts 8 to 12 months. **GUARANTEED.** Equal in beauty to a repaint or refinishing job which costs \$25.00 to \$75.00.

Not A Wax Polish or Paint
Lasts 8 to 12 Months
GUARANTEED

FREE SAMPLE

Enormous demand! Millions want it! W. L. Morgan of Mass. earned \$10.61 in a single hour. Sell KAR-NU to individuals, fleet owners, garages, auto accessory stores, used car dealers, etc. No experience necessary. Write for FREE sample to prove our claims and territory offer.
Distributors Wanted for Foreign Countries

KAR-NU CO., Dept. L-30, Oakley Station, Cincinnati, Ohio

CARTOON YOUR WAY TO SUCCESS!

DON'T COPY—LEARN TO ORIGINATE!



RAYE BURNS will teach you HOW TO CREATE ORIGINAL CARTOONS at home that you can SELL! Course contains 26 lessons and over 600 illustrations. All for Only **\$2.85**
Send name and address for free details.
RAYE BURNS SCHOOL, Dept. M-X, BOX 2194, Cleveland, Ohio

CRIME DETECTION SECRET SERVICE AND FINGER PRINTS

SECRET SERVICE BOOK FREE

For 30 Days Reading
No Money Down—Actual Crime Cases—
If You Act Quick!—We will send you this stirring book on Crime Detection, Secret Service and Identification Works for 30 days free reading. Send no money. If you decide to keep it, then send only \$1.00. If not, return it. **WRITE TODAY.** Not sent to boys under 17 years of age.
T. G. Cooke, Dept. B-135, 1920 Sunnyside Ave., Chicago

The man who studies gets ahead. Popular Mechanics Press will advise you what books to read to advance in your trade. 200 East Ontario Street, Chicago, Illinois.

Inventions Wanted

Patented or Unpatented

If you have a sound, practical invention for sale, patented or unpatented, write
Chartered Institute of American Inventors
Dept. 4G, Barrister Building Washington, D. C.
"World's Largest Organization of Inventors"

ELECTRICAL ENGINEERING

A broad, basic, intensive course—complete in one school year
Includes the fundamentals of Refrigeration, Air Conditioning and Electronics
Earnest, ambitious young men of limited time are prepared under skilled instructors for new opportunities in the electrical field.

THEORY AND PRACTICE COMBINED—Underlying principles emphasized. Commended by graduates, approved by educators, endorsed by industry. Bliss-trained men hold responsible technical and executive positions. 7000 graduates.

43rd year—Catalog on request



BLISS ELECTRICAL SCHOOL

"As old as the Industry"

117 Takoma Ave., Washington, D. C.

Increase Your Earning Power

Apply time and labor-saving kinks to your work. Your efficiency will soon be recognized and you will be in line for advancement.

If you do machine shop work of any kind, sheet-metal work, painting, carpentry, auto repairing, farming, concrete work, plumbing, electrical work, welding, building-glass work, general repairing, tool-making, poultry raising, masonry or home repair work, get this

LIBRARY OF 2500 TIME AND LABOR SAVING IDEAS FOR SHOPMEN AND HANDYMEN

RECENTLY PUBLISHED



SHOP NOTES

for

1935

332 Articles

721 Illustrations

224 Pages

Price 50c

See partial list of contents below

Including the new 1935 issue illustrated above, there are six volumes in the Shop Notes Library of 2500 easily understood short cuts to every-day jobs. Here are just a few of the subjects taken from the latest issue.

- | | | |
|---|---|---|
| Auto Electrical Troubles, Tests | Glass, Working with | Scroll Saw, Special Uses |
| Auto Knocks, Lousting Bandaw, Tuning Up | Hack Saw, Using | Soldering with Electric Arc |
| Belt Sander, Portable | Heat Treating of Iron, Steel, Brass, Copper, Aluminum | Streamline Bodies, Wire Mesh and Fabric for Boat and Auto |
| Boathouse Piling, Concrete | Jointer, Keeping in Shape | Taps and Dies |
| Cold Chisels, Using | Knee Action Wheels, Servicing | Toul Chest, Portable |
| Dancing Auto Wheels, Curing | Lathe, Labor Saving Ideas for | Window Attraction, Novel Store |
| Drill Press, Homemade | Leather Kinks, Simple | Wooden Displays, Mechanical, that Draw Trade |
| Drill-Press Problems, Solving | Metal Spinning | Wood Chisels, Tricks of Using |
| Electric Appliances, Repairing | Metal Turning Suggestions | Wood Joints with Hand Tools |
| Electrical Motors, Rewinding | Neon Sign, Flashing | Work Benches you can Build |
| Electricians, Short Cuts for | Paint Spray Gun | Workshop, Motorize Your |
| Forge Made from Cream Separator | Reed Baskets, Weaving | |
| | Roadside Salesman | |
| | Sander From Auto Parts | |
| | Saw, Uses in Workshop | |
| | Saw Table, Adjustable | |

Each volume contains approximately 350 articles and 500 illustrations and has 192 or more pages. This unrivaled library of shop helps may be secured for a limited time only. After the present supply of books is exhausted the offer must be withdrawn.

*** Send No Money**

POPULAR MECHANICS PRESS, 200 E. Ontario St., Room 635, Chicago, Ill.

Send me, as per your offer, the following books. I will pay postman price and small amount of postage. My money will be refunded if I am not satisfied. (Check what you want.)

- 1935 Shop Notes and Lathe Handbook, both for 98c.
- Shop Notes Library (6 vols.) \$3.00.

Name.....

Street and No.....

City.....State.....

* C. O. D. applies to U. S. and possessions only. If you reside elsewhere, remittance must accompany order.

MAKE ME PROVE that it is Easy to Learn at home to fill a GOOD JOB in RADIO



COUPON BRINGS FREE SAMPLE LESSON

Clip the coupon and mail it. I'm so sure that I can train you at home in your spare time for a good job in Radio that I'll send you my first lesson free. Examine it, read it, see how clear and easy it is to understand. Then you will know why many men with less than a grammar school education and no technical experience have become Radio Experts and are earning two to three times their former pay as a result of my training.

Many Radio Experts Make \$40, \$60, \$75 a Week

In less than 15 years, the Radio Industry has grown from a few million to hundreds of millions of dollars. Over 300,000 jobs have been created by this growth and thousands more will be created by its continued development. Many men and young men with the right training—the kind of training I give you in the N. R. I. Course—have stepped into Radio at two and three times their former salaries.

Get Ready Now for Jobs Like These

Broadcasting stations use engineers, operators, station managers and pay up to \$5,000 a year. Manufacturers continually employ testers, inspectors, foremen, engineers, servicemen, buyers, (for jobs paying up to \$7,500 a year. Radio operators on ships enjoy life, see the world, with board and lodging free, and get good pay besides. Dealers and jobbers employ servicemen, salesmen, buyers, managers, and pay up to \$100 a week. My book tells you about these and many other interesting Radio jobs. There's opportunity for you in Radio. Its future is certain. Television, short wave, loud speaker systems, police Radio, automobile Radio, aviation Radio—in every branch, developments and improvements are taking place.

Many Make \$5, \$10, \$15 a Week Extra In Spare Time While Learning

The day you enroll I start sending you Extra Money Job Sheets which quickly show you how to do Radio repair jobs common in most every neighborhood. I give you plans and ideas that have made good spare time money—\$300 to \$1000 a year—for hundreds of fellows. My Course is famous as "The Course that pays for itself."

Free 64-Page Book of Facts

Mail the coupon now. In addition to the sample lesson, I send my book, "Rich Rewards in Radio." It tells you about the opportunities in Radio; tells you about my Course, what others who have taken it are doing and making. This offer is free to any ambitious fellow over 15 years old. Find out what Radio offers you without the slightest obligation. Mail Coupon in an envelope or paste it on a penny post card. ACT NOW!

J. E. SMITH, President!

National Radio Institute, Dept. 5GP Washington, D. C.



Set Servicing

Spare time set servicing pays many N. R. I. men \$200 to \$1,000 a year. Full time men make as much as \$40, \$60, \$75 a week.



Broadcasting Stations

Employ trained men continually for jobs paying up to \$5,000 a year.



Loud Speaker Systems

Installation and service work is another growing, money-making field for Radio trained men.

MAIL NOW for FREE PROOF



J. E. SMITH, President National Radio Institute, Dept. 5GP Washington, D. C.

I want to take advantage of your offer. Send me your Free Sample Lesson and your book, "Rich Rewards in Radio." I understand this request does not obligate me.

(Please print plainly.)

NAME.....AGE.....

ADDRESS.....

CITY.....STATE.....

"R"

When writing please mention Popular Mechanics



IS THIS THE WAY YOU FEEL ABOUT YOUR JOB?

YOU will never catch any fish while sleeping — and you will never make any more money just going through the motions of your job! You've got to be wide-awake these days. The slightest nibble may be your biggest opportunity. Be alert to it and trained to take advantage of it. You need training to get opportunities! All over the world men have realized this simple truth and are acquiring training through spare-time study of I. C. S. Courses. Their example—and this coupon—suggests a definite course of self-service to you.

INTERNATIONAL CORRESPONDENCE SCHOOLS

"The Universal University" Box 5583-H, Scranton, Penna.

Without cost or obligation, please send me a copy of your booklet, "Who Wins and Why," and full particulars about the subject before which I have marked X:

TECHNICAL AND INDUSTRIAL COURSES

- | | | |
|--|--|--|
| <input type="checkbox"/> Architect | <input type="checkbox"/> Plumbing | <input type="checkbox"/> Heating |
| <input type="checkbox"/> Architectural Draftsman | <input type="checkbox"/> Air Conditioning | |
| <input type="checkbox"/> Building Estimating | <input type="checkbox"/> Steam Engineer | |
| <input type="checkbox"/> Contractor and Builder | <input type="checkbox"/> Steam Electric Engineer | |
| <input type="checkbox"/> Structural Draftsman | <input type="checkbox"/> Marine Engineer | |
| <input type="checkbox"/> Structural Engineer | <input type="checkbox"/> Civil Engineer | |
| <input type="checkbox"/> Electrical Engineer | <input type="checkbox"/> Highway Engineer | |
| <input type="checkbox"/> Electric Lighting | <input type="checkbox"/> Bridge Engineer | |
| <input type="checkbox"/> Welding, Electric and Gas | <input type="checkbox"/> Bridge and Building Foreman | |
| <input type="checkbox"/> Reading Shop Blueprints | <input type="checkbox"/> Surveying and Mapping | |
| <input type="checkbox"/> Telegraph Engineer | <input type="checkbox"/> Refrigeration | |
| <input type="checkbox"/> Telephone Work | <input type="checkbox"/> R. R. Locomotives | <input type="checkbox"/> Air Brakes |
| <input type="checkbox"/> Mechanical Engineer | <input type="checkbox"/> R. R. Section Foreman | |
| <input type="checkbox"/> Mechanical Draftsman | <input type="checkbox"/> R. R. Signalmen | |
| <input type="checkbox"/> Machinist | <input type="checkbox"/> Chemistry | <input type="checkbox"/> Pharmacy |
| <input type="checkbox"/> Patternmaker | <input type="checkbox"/> Coal Mining | |
| <input type="checkbox"/> Sheet Metal Worker | <input type="checkbox"/> Navigation | |
| <input type="checkbox"/> Heat Treatment of Metals | <input type="checkbox"/> Textile Overseer or Supt. | |
| <input type="checkbox"/> How to Invent and Patent | <input type="checkbox"/> Cotton Manufacturing | |
| <input type="checkbox"/> Gas Engines | <input type="checkbox"/> Woolen Manufacturing | |
| <input type="checkbox"/> Aviation Engines | <input type="checkbox"/> Agriculture | <input type="checkbox"/> Fruit Growing |
| <input type="checkbox"/> Automobile Mechanic | <input type="checkbox"/> Poultry Farming | |

BUSINESS TRAINING COURSES

- | | | |
|---|--|---------------------------------------|
| <input type="checkbox"/> Business Management | <input type="checkbox"/> Business Correspondence | |
| <input type="checkbox"/> Office Management | <input type="checkbox"/> Lettering Show Cards | <input type="checkbox"/> Signs |
| <input type="checkbox"/> Industrial Management | <input type="checkbox"/> Stenography and Typing | |
| <input type="checkbox"/> Traffic Management | <input type="checkbox"/> Civil Service | <input type="checkbox"/> Mail Carrier |
| <input type="checkbox"/> Accountancy and C.P.A. | <input type="checkbox"/> Railway Mail Clerk | |
| <input type="checkbox"/> Coaching | <input type="checkbox"/> Grade School Subjects | |
| <input type="checkbox"/> Secretarial Work | <input type="checkbox"/> High School Subjects | |
| <input type="checkbox"/> Cost Accountant | <input type="checkbox"/> College Preparatory | |
| <input type="checkbox"/> Salesmanship | <input type="checkbox"/> First Year College | |
| <input type="checkbox"/> Service Station Salesmanship | <input type="checkbox"/> Illustrating | <input type="checkbox"/> Spanish |
| <input type="checkbox"/> Wallpaper Decorating | <input type="checkbox"/> Cartooning | <input type="checkbox"/> French |
| <input type="checkbox"/> Salesmanship | <input type="checkbox"/> Lumber Dealer | |

Name..... Age.....

Address.....

City..... State.....

Present Position.....

If you reside in Canada, send this coupon to the International Correspondence Schools Canadian, Limited, Montreal, Canada

When writing please mention Popular Mechanics

Become an Artist for 19½¢ a LESSON!

SPECIALIZE in drawing attractive heads and figures—the highest paid and most popular branch of Art today! Anyone can quickly master the new, easy, Beechwald System! No talent necessary! You work directly from simple charts, diagrams, and figure photographs of Professional Artists' Models! 20 COMPLETE lessons, profusely illustrated—Equal to a \$100.00 correspondence course! ONLY \$3.90 Postpaid (Cloth-bound 10c extra). ORDER TODAY! Or write for FREE details.

BEECHWOLD STUDIOS, 852 Ashland Ave., N. E. Atlanta, Ga.

VOICE

100% Improvement Guaranteed

We build, strengthen the vocal organs—not with singing lessons—but by fundamentally sound and scientifically correct silent exercises... and absolutely guarantee to improve any singing or speaking voice at least 200%... Write for wonderful voice book—sent free. Learn WHY you can now have the voice you want. No literature sent to anyone under 17 years unless signed by parent.

PERFECT VOICE INSTITUTE, Studio B-135
64 E. Lake St., Chicago

don't WORRY

Why put up with years of needless discomfort and worry? Try a Brooks Automatic Air Cushion. This marvelous appliance permits the opening to close, yet holds rupture securely, comfortably—day and night.



Thousands report amazing results. Light, neat-fitting. No hard pads, metal girdle or parts to chafe or gouge. Patented in U. S. and 13 foreign countries. Try one 10 DAYS WITHOUT A PENNY'S RISK. You'll be delighted. Free book on Rupture and convincing facts mailed postpaid in plain sealed envelope. Address

BROOKS COMPANY, 111 State St., Marshall, Mich.

DIESELS

FASTEST GROWING TRADE DEMANDS TRAINED MEN

Combination Auto-Diesel Course Fully Qualifies You

Earn Room and Board

We assist students to obtain part time job during training. We allow coach railroad fare from any part of U. S. to Los Angeles.

Trained men needed. Demand for Auto-Diesel experts to service and operate trucks, tractors, trains, boats, power shovels, generating plants, etc., grows every month. To qualify for good Jobs you must first become trained. Accomplish this in a few months at the National Schools. Qualify as Diesel Engineer, Auto Mechanic, Auto Electrician, Battery Expert, Carburetor Expert, Fuel Injection Expert, Trouble Shooter, etc.

Oldest, Largest Trade School in West

Est. 1905. 30,000 graduates. Finest equipment—latest model auto, actual Diesel Engines to work on. Expert instructors.

Coupon Brings FREE Catalog

NATIONAL AUTOMOTIVE SCHOOLS
Dept. 7PMA, 4000 So. Figueroa St., Los Angeles

NAME.....

ADDRESS.....

CITY..... STATE.....

You Can Now Make More Money

Let us show you how easy it is to make special, individually fitted foot supports. New System. Supports bring ten to twenty times their small cost. No capital, machinery, or store needed. Customers come to you. Highly profitable, respected occupation, full or part time. You can learn quickly in your own home. Send your name for full information free. Address

Mr. C. W. METZDORF, American College, 50 W. Illinois St., Chicago

Correspondence Courses in RADIO & ELECTRICAL ENG.



Course No. 1: ELECTRICAL ENGINEERING—Simplified mathematics, covers complete field, easy to understand. Modern and up-to-date. Course No. 2: RADIO AND ELECTRONIC ENGINEERING—An ultra modern course in radio, public address, photo electric work. Trains you to be super-service man and real vacuum tube technician. Tuition \$25 either course. Deferred payment plan for worthy students. Free laboratory apparatus. Student publication. School pin. Run like a college. Write today for school catalog.

LINCOLN ENGINEERING SCHOOL, 855-I.S. 37th St., Lincoln, Nebr.

KILL FOR MONEY

Be a Professional Exterminator. Make up to \$50 to \$75 weekly in your own all-year-round business. Customers in every city, town, village. Five complete easy-to-learn lessons on Control and Extermination of roaches, bedbugs, rats, mice, moths, etc., in homes, apartments, stores, farms, factories, etc. Act Quick! Write NOW for FREE details. **EXTERMINATING INSTITUTE, 2650 Carmen, Dept. 7, Chicago.**

Profit from Books

Popular Mechanics Press specializes in supplying books on any subject. Look over this list. Check the books you want, and mail this advertisement as your order blank. Write for information about books on any special subject you may be interested in.

- AIR CONDITIONING SERVICE MANUAL** Just Out. \$5.00
- ARMATURE WINDING and Motor Repair** \$3.00
- AUTO RACING** How to Build Dirt Track Racers \$1.00
- AUTO REFINISHING** Latest Methods \$1.50
- BRICKLAYING** Plain and Fancy \$1.50
- CAMPS AND LOG Cabins (Building)** \$2.00
- CARBURETORS (All Makes)** New, Revised Edition. \$2.50
- CARPENTRY** All Forms \$2.00
- CHEMICAL MAGIC** Experiment, Entertain, Mystify \$1.00
- COIN BOOK** New U. S. Correct Valuations \$0.50
- DANCE** How to Teach Yourself in Private! \$2.00
- DRAWING** Freehand and Perspective \$1.50
- DRY CLEANING (Practical) and Dyer** \$3.00
- ENGINEERS' VESTPOCKET Reference Book** \$1.50
- FURNITURE REPAIRING** Finishing and Decoration \$3.00

- HYPNOTISM** Science of \$2.00
- INVENTIONS** How to Make Pay \$2.50
- LANDSCAPE GARDENING** Practical \$2.50
- LEATHER MAKING AND HOME TANNING** \$1.00
- LOCKSMITHING** Revised Edition \$2.00
- MONEY MAKING FORMULAS** 15,000 Practical \$5.50
- MUSHROOMS** Raise for Market \$1.75
- PATTERN MAKING** Excellent New Book \$1.50
- PLASTERING** Best Instruction Manual \$1.25
- RADIO PHYSICS COURSE** Most Complete \$4.00
- REFRIGERATION SERVICE Manual (All Makes)** \$5.00
- RUBBER ARTICLES** How to Make \$2.00
- SHEET METAL** Construction Work \$2.00
- STAMP COLLECTING** Why and How \$1.50
- Steam Engineer's License** How to Obtain \$2.00
- TAXIDERMY, HOME** Mount Trophies Profit, Pleasure \$1.50
- WROUGHT IRON WORK** Practical \$1.35

Books sent C. O. D. anywhere in U. S.

Just check the books you want, and mail the whole advertisement. It is your order blank. When postman hands you books, pay him the price and few cents postage. If you send remittance when ordering please include 10 cents per book extra for postage.

POPULAR MECHANICS PRESS, Room P-7, 200 East Ontario St., Chicago, Ill.

GOV'T. JOBS

SALARY TO START \$105 to \$175 MONTHLY MEN.. WOMEN Age Range 18 to 50

- Ry. Mail Clerk
- P. O. Laborer
- R. F. D. Carrier
- Special Agent
- Customs Inspector
- City Mail Carrier
- P. O. Clerk
- Matron
- Immigr' Inspector
- Typist
- POSTMASTER
- Seamtress
- Auditor
- Stenographer
- U.S. Border Patrol
- Telephone Opr.
- Watchman
- Meat Inspector
- Statistical Clerk
- File Clerk

MENTION INSTRUCTION BUREAU, Dept. 111, St. Louis, Mo.

Send me FREE particulars "How to Qualify for Government Positions" marked "X". Salaries, locations, opportunities, etc. ALL SENT FREE.

Name ..
Address ..

LEARN RADIO



HERE THEY ARE:

- Dr. C. M. Blackburn, Chief Radio Engineer, Grigley-Grover Company (Chicago)
- Donald Clough, Chief Engineer, Clough-Brengle Co. (Radio Engineers and Manufacturers)
- Earl Hazel, Chief Engineer, Zenith Radio Corporation
- Howard Hogan, Gen. Manager, Radio Station KTW, Chicago
- E. MacGregor, Service Manager and Sales Engineer, Transformer Corporation of America (Chicago)
- H. C. Tittle, Chief Radio Engineer, Stewart-Warner Corporation, Chicago Plant
- F. H. Whitman, Service Manager, Philips Radio and Television Corporation

From REAL RADIO ENGINEERS

LET THESE ENGINEERS RIGHT FROM THE HEART OF THE BIG RADIO INDUSTRY

Train You at Home for

GOOD PAY RADIO WORK
MANY R-T-I TRAINED MEN
MAKE \$35 TO \$75 A WEEK

"WE SAY THESE 40 LEADING MANUFACTURERS"
RADIO and TELEVISION INSTITUTE "HOME TRAINING"

Get out of the rut. Train now, as big radio manufacturers want you trained. Fit yourself for good-pay work in Radio—the field with a future. I'll train you quickly and inexpensively right in your own home, and in your spare time. More than 40 leading Radio Manufacturers endorse R-T-I Training and recommend it to you. The famous Radio Engineers listed above have made this Training so practical and easy that many men start to make an extra \$5 to \$10 a week soon after enrolling.

Mail Coupon for FREE Information

My free Book tells you about Radio's spare-time and full-time opportunities — about my manufacturer-endorsed Training — about the famous Advisory Board of top-notch engineers who direct and supervise R-T-I Training — about hundreds of R-T-I students and graduates who are making \$35 to \$75 a week, and more, in Radio.

My Money-Back Agreement Protects You

Get the facts about Radio's opportunities for TRAINED MEN — about the exclusive features that make R-T-I Training so outstandingly successful—about R-T-I Working Outfits and 5 Advanced Courses furnished without extra cost. Act today. Get out of the rut. Mail the coupon for my FREE Book. There is no obligation.

RAY D. SMITH, President Radio & Television Institute, Chicago

- AMERICAN TELEVISION APPARATUS DESIGN
- ARCTURUS
- BALKEIT • BRUNSWICK
- CAPEHART • CLARION
- CLOUGH-BRENGLE
- CONTINENTAL CARBON
- CROSLY • DEFOREST
- ECHOPHONE • FADA
- ERIC RESISTOR
- GENERAL INSTRUMENT
- GREBE
- HAMMARLUND
- NICKOK • HOWARD
- INTERNATIONAL RESISTANCE CO.
- KENNEDY • KEN-RAD
- KOLSTER • LYRIC
- MAJESTIC • MUTER
- MEISSNER MFG. CO.
- NATIONAL UNION
- PHILCO
- RADIO PRODUCTS
- SANGAMO ELECTRIC
- SENTINEL • SHELDON
- SILVER-MARSHALL
- STANDARD TRANSFORMER CORP.
- STEWART RADIO
- STEWART-WARNER
- STROMBERG-CARLSON
- UNIVERSAL MICROPHONE
- ZENITH



MAIL COUPON FOR FREE BOOK

RAY D. SMITH, President Radio and Television Institute (R-T-I) 2130 Lawrence Ave., Dept. 1-B Chicago, Ill.

Dear Mr. Smith: Without obligating me, send FREE BOOK about spare-time and full-time Radio opportunities and how I can train for them at home.

Name ..
Address ..
City .. State ..



»If you do **2** not add...
2 INCHES
TO YOUR BICEPS
THREE INCHES TO YOUR CHEST
... it won't cost you one cent!

Signed: **GEORGE F. JOWETT**

TWO solid inches of tough, sinuous muscle added to your biceps... three inches to your chest... or it won't cost you one penny! That's my unqualified agreement!

If I hadn't accomplished this for many others... If I wasn't absolutely sure that you could do it... I wouldn't dare make such a startling claim!

You will not only increase your biceps, but every part of your body will be developed proportionately... I'll show you how to add at least 3 inches to your chest... I'll show you how to get lithe, muscular legs that will be columns of power for speed and endurance... your whole body will vibrate with muscular energy, pep and health!

Take my full course, if it does not do all I say... if you are not completely satisfied... and you are the judge... it won't cost you one penny! I want you to try one of my test courses NOW!

Send for "Moulding a Mighty Arm"
A Special Course for ONLY 25c.

It will be a revelation to you. You can't make a mistake. The assurance of the strongest armed man in the world stands behind this course. I give you my secret methods of development illustrated and explained as you like them. Mail your order now while you can still get this course for only 25c.

I will not limit you to the arm or chest... Try any one of my test courses listed below at 25c. Or, try all six of them for only \$1.00.

Mail your order now and I will include a **FREE COPY** of "NERVES OF STEEL, MUSCLES LIKE IRON." It is a priceless book to the strength fan and muscle builder. Full of pictures of marvelous bodied men who tell you decisively how you can build symmetry and strength the Jowett Way! Reach out — Grasp this special offer!



FREE BOOK WITH PHOTOS OF FAMOUS STRONG MEN

JOWETT INSTITUTE of PHYSICAL CULTURE
 Dept. 40e 422 Poplar St., Scranton, Pa.

Send, by return mail, prepaid, the courses checked below, for which I am enclosing \$

- | | |
|---|--|
| <input type="checkbox"/> Moulding a Mighty Arm 25c | <input type="checkbox"/> Moulding a Mighty Chest 25c |
| <input type="checkbox"/> Moulding a Mighty Back 25c | <input type="checkbox"/> Moulding mighty Legs 25c |
| <input type="checkbox"/> Moulding a Mighty Grip 25c | <input type="checkbox"/> Strong Man Stunts Made Easy 25c |

All 6 Books for \$1.00.

"Nerves of Steel" included FREE

Name _____

Address _____

When writing please mention Popular Mechanics

GET OUTDOORS!

FOR THE WORLD'S BEST FUN AND ROBUST HEALTH Enjoy it 100% with safe, practical equipment! Make devices for all sports in all seasons with ordinary tools and at small cost. What fun you'll have!

NOW! A GREAT NEW BOOK FOR SPORTSMEN—POPULAR MECHANICS' "OUTDOOR SPORTS"

Practical kinks and 650 clear pictures show construction of every device. Easy! Postpaid on order; or C.O.D. in U.S. Don't fail to get this remarkable book—TODAY!

POPULAR MECHANICS PRESS
 Room 1235 200 E. Ontario St. Chicago

ONLY \$2

BEAUTIFY WITH
CONCRETE
 NOW YOU CAN BUILD YOUR OWN GARDEN & LAWN PIECES!
POPULAR MECHANICS' "CONCRETE HANDBOOK"

EASY to MAKE
 Garden Seats—Fountain and Basin—Flower Boxes and Vases—Pedestals and Bird Baths—Ornamental Pools—Sanitary Drinking Fountain—Gateposts—Auto Driveways—Sidewalks—Boat Landings and Docks—Entrance and Garden Walks—Sidewalk Flagging—Narrow Curb Walks—Curbs and Gutters—Wall Coping—Steps.

Practical methods for home, farm, shops. Describes mixtures, molds and home-made equipment. Scores of beautiful useful designs pictured. Start a business—make them to sell!

GET THIS REMARKABLE BOOK NOW! Ask us to forward; then pay postman only \$1 and postage. **ORDER IT!**

POPULAR MECHANICS PRESS
 Room 1235, 200 E. Ontario Street, CHICAGO

\$1

A PRACTICAL COURSE IN MECHANICAL DRAWING

By **WM. F. WILLARD**

An ideal book for home study. Each exercise is clinched in the mind of the student by practical application to every day practice. 160 Pages. 157 Drawings. Cloth. Price \$1.00 Postpaid.

POPULAR MECHANICS PRESS 200 E. Ontario St. CHICAGO

DIESEL POWER
A Coming American Industry



THE internal-combustion engine represents man's supreme triumph of machine power. Diesel engines are in great demand. Many

are acquiring necessary knowledge through spare-time study of this modern I.C.S. Course on Diesel engines. Free booklet!

INTERNATIONAL CORRESPONDENCE SCHOOLS

BOX 5585-H. SCRANTON, PENNA.

Please send information on course checked.

- DIESEL POWER** **ELECTRICAL ENGINEERING**
- | | |
|---|--|
| <input type="checkbox"/> Mechanical Engineering | <input type="checkbox"/> Automobile Course |
| <input type="checkbox"/> Aviation Engines | <input type="checkbox"/> Air Conditioning |

Name _____ Age _____

Address _____

THESE FREE BOOKS ARE FOR INVENTORS

AND OTHER MEN WITH IDEAS

"We're only entering the great period of inventive advancement"

—says C. F. Kettering, Vice Pres., General Motors.

SOMETIMES we hear people say: "Well, there isn't much left to invent." But Charles F. Kettering, Vice-Pres. and head of Research of General Motors, who helped develop the self-starter, Duco and many other outstanding inventions, **doesn't think that at all.** Not long ago in a published statement, he said:

"If we took half the men employed in tool making and put them to working out new inventions, new things, we could snap out of this depression in no time. Our return to normal times depends on new manufactured products that will catch the purchaser's eye, get him to buy and thus start the ball rolling. Change and buying go together. We are only entering the great period of inventive advancement."

Many Little Ideas Have Big Commercial Possibilities

Some of the world's best inventions came from men who didn't consider themselves inventors at all. The telegraph was invented by a painter, the typewriter by a farmer, the hand camera by a bank clerk, the stock ticker by a dentist. Or look at small inventions. A husband noticed his wife bending a hair pin to make it stay put. That gave him the idea of the crinkly hair pin. One day a golfer got the idea to make a wooden tee. Now wooden tees are sold by the millions every year. There are many similar examples in inventive history. That is why we say that the books shown here are for INVENTORS and Other Men with IDEAS. Whether you consider yourself an inventor or not—if you have an idea that will make money, save time, save labor, or give pleasure—find out how you can protect your rights to it.

Our Business Is To Help You

For thirty-six years, this organization has been in the business of helping inventors. During that time inventions from every corner of the country have been turned over to us to protect. Some ideas have represented complicated mechanisms; others have been small, practical articles, like a can opener or a new toy. All this has given us a wealth of experience to use for the inventor of today. Here in Washington, we maintain a large staff of experienced Patent Specialists to give you prompt and expert service. Yet because we work efficiently—our fees are low; and if desired we help you with deferred payments. But first, find out exactly what to do to protect yourself. **Decide on that today by sending for your FREE copies of the books shown above.**

Suggestions
on
WHEN
and
HOW
to Sell an
INVENTION

THESE BOOKS TELL YOU:

How the Patent Laws protect an inventor. Simple steps to take promptly, without cost, to claim your right to your idea. Kind of sketch or model needed. How you can go about selling an invention. They are full of valuable facts, simple, easily understood suggestions and interesting bits of inventive history. We gladly send them to serious men. No charge, no obligation. Write us or use the coupon below. Get that much done today.

**PATENT
PROTECTION**

VICTOR J.
EVANS & Co.

REGISTERED PATENT ATTORNEYS

MAIN OFFICE: 500-H, VICTOR BUILDING
WASHINGTON, D. C.

Other Offices: 1640-N Conway Bldg., Chicago; 1007-N Woolworth Bldg., New York; 514-N Empire Bldg., Pittsburgh; 1016-N Hobart Bldg., San Francisco; 736-N Security Bldg., Los Angeles.

Send me FREE copies of your books "Patent Protection" and "When and How to Sell an Invention." (Note: Same books supplied by any of branch offices listed above.)

Name.....

Street and No.....

City or Town.....



Become an Expert Accountant

The Profession That Pays

The demand for skilled accountants—men who really know their business—is increasing rapidly. The new national and state legislation is requiring of business—both big and small—much more in matters relating to Auditing, Cost Accounting, Business Law, Organization, Management, Finance. Men who prove their qualifications in this important field are rapidly promoted to responsible executive positions—given an opportunity to earn real salaries. The range is from \$3,000 to \$15,000 a year—even to higher income figures.

Send for Free Book—

"Accountancy, the Profession that Pays"

Why let the other fellow walk away with the better job, when right in your own home you can equip yourself for a splendid future in this profitable growing profession?

Preliminary knowledge of bookkeeping is unnecessary. Our free book on accountancy fully explains how we train you from the ground up, or from where you now are, according to your individual needs. Low cost; easy terms.

The facts about the new LaSalle training in Accountancy and the opportunities in this highly profitable field are clearly outlined in a 64-page book which LaSalle will send you free.

The man in earnest to get ahead will find this coupon a most profitable aid to progress. If you have the urge and the will to increase your income, clip and mail the coupon NOW.

LaSalle Extension University

The school that has trained over 1,200 C. P. A.'s

Dept. 764-HR Chicago

I would welcome details of the new opportunities in accounting, together with copy of "Accountancy, the Profession that Pays," without obligation.

Higher Accountancy

Other LaSalle Opportunities:

LaSalle opens the way to success in every important field of business. If interested in one of the fields below, check and mail.

- | | |
|---|---|
| <input type="checkbox"/> Business Management | <input type="checkbox"/> Law—Degree of LL.B. |
| <input type="checkbox"/> Modern Salesmanship | <input type="checkbox"/> Commercial Law |
| <input type="checkbox"/> Traffic Management | <input type="checkbox"/> Modern Business Correspondence |
| <input type="checkbox"/> Railway Accounting | <input type="checkbox"/> Stenography—Stenotypy |
| <input type="checkbox"/> Industrial Management | <input type="checkbox"/> Expert Bookkeeping |
| <input type="checkbox"/> Modern Foremanship | <input type="checkbox"/> C. P. A. Coaching |
| <input type="checkbox"/> Effective Speaking | <input type="checkbox"/> Business English |
| <input type="checkbox"/> Credit and Collection Correspondence | |
| <input type="checkbox"/> Practical Accounting and Office Management | |

Name

Present Position

Address

When writing please mention Popular Mechanics



60 ART LESSONS

Become Talented Artist with Big Income

This thorough course by Alexander Murray, famous Art School instructor, makes it easy to learn art in spare time. Teaches commercial art, cartooning, lettering, anatomy, perspective, adv. layout, etc., without bother or expense of corresponding. You get all 60 lessons at once—no waiting for next lesson. Over \$15 instruction illustrations. 125 pages of drawing paper FREE. Complete Course Only \$1.95 postpaid—or pay postman plus postage. MONEY BACK if not delighted after inspecting. Start Now turning your spare time into MONEY!

EDUCATIONAL SUPPLY CO., Dept. 101-G, Racine, Wis.

Only 95¢ POST PAID COURSE COMPLETE

QUICK WAY to make money in RADIO

Modern receivers are demanding men with modern training for service work. New training method and service equipment offer starts you earning almost at once. Up to \$3 an hour easy in a short time. Write today for FREE book of details.

Radio Training Association of America
Dept. PM-57, 4513 Ravenswood Ave., Chicago

TRAIN WITH R.T.A. NOW

900 WORKSHOP IDEAS

Why "putter" when you can make hundreds of articles for beauty, utility and dollar and cent profits?

"Make It Yourself"

INCLUDING:
Toys, Models
Furniture
Garden Equipment
Home Repairs
Sports Equipment
Auto Kinks
Radio Equipment
Workshop Tools and Machinery
Articles on Working: Wood, Metal, Leather, Glass, Etc. Etc. Etc.

Newest edition: 480 pages, 823 pictures. Size: 7x10x1 1/2 inches. Sent postpaid anywhere upon receipt of price or C.O.D. in U.S.A. paying postman price and postage. \$3

Send for it!

POPULAR MECHANICS PRESS
Room 1234
900 E. Ontario St. Chicago

MODERN REFRIGERATION

Automatic, iceless refrigeration has become a mighty important factor in our daily lives. Millions of refrigerators are in use. Many thousands are being installed every month. An entirely new industry and a new profession has sprung up in the past, few years. Already there is a

DEMAND FOR TRAINED MEN

who understand the installation, servicing and repair of refrigerators of all kinds. You can get started on a pleasant and profitable career in refrigerating work with Althouse and Turnquist's new book "Modern Refrigeration." It covers physics of refrigeration; principles of construction and operation; different types of refrigerants; automatic controls and thermostats; compression devices; condensing apparatus; electrical equipment; electric motors, etc.; use of tools with service operations; modern service practice.

An up-to-date book covering all types. Diagrams in six and eight colors. 275 pages. Fully illustrated. Flexible. Price \$4.00 Postpaid. Sent C. O. D. in U. S. if preferred. Small amount extra for postage charged. Popular Mechanics Press Room 635 200 E. Ontario St., Chicago.

Amazingly Easy Way To Learn ELECTRICITY IN 12 WEEKS AT COYNE

Don't waste your best years, waiting for the right job to find you. I'll train you in my shops for a real future in Electricity... then start you on the way to success by helping you find the job you're trained for.

I'LL FINANCE YOUR TRAINING!

You can get your training first... then I'll give you over a year to pay me back, in small monthly payments starting FIVE MONTHS from the date you start school. Mail Coupon for FREE Illustrated Book on Coyne "Learn-by-Doing" Shop Training without book study or correspondence, how many earn while learning, and Free Employment Service.



COYNE ELECTRICAL SCHOOL

H. C. LEWIS, PRESIDENT
500 S. Paulina St., Dept. B6.72, Chicago, Ill.
Send FREE Book and financing plan details.

NAME

ADDRESS

CITY

STATE

I'll bet real money you can learn to play — this easy fascinating way

YES, I mean you actually play real music—classical numbers or jazz—so that you'll be able to entertain your friends—to be popular everywhere.

You won't need a private teacher. You'll learn by yourself—right in your own home. And at only a fraction of the cost of old-fashioned methods. Why am I so sure? Simply because 700,000 others, no more gifted than you have learned to play by this modern system.

Learning to play this U. S. School of Music way is easy as A-B-C. No special talent is needed. If you can whistle a tune you can learn to play by this simple method. Everything is right before you in print and picture. First you are told how to do a thing. Then a picture shows you how to do it. Then you actually do it yourself and hear it. Instead of monotonous scales and finger exercises, you play real tunes from the start.

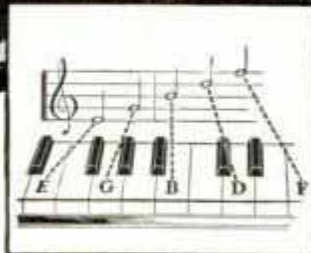

this opportunity to make your dreams come true. Fill out and mail the coupon below. Don't delay—there is no obligation whatever. U. S. School of Music, Dept. 77, Brunswick Bldg., New York City.

U. S. SCHOOL OF MUSIC
77 Brunswick Bldg., New York City

Send me your amazing free book, "How You Can Master Music in Your Own Home," with inspiring message by Dr. Frank Crane; also Free Demonstration Lesson. This does not put me under any obligation.

Name

Address

Instrument

LEARN TO PLAY BY NOTE

Piano Violin
Guitar Saxophone
Organ Ukulele
Tenor Banjo
Hawaiian Guitar
Piano Accordion
Or Any Other Instrument

Free Book and Demonstration Lesson

Our wonderful illustrated free book and Demonstration Lesson explain all about this remarkable method. You'll see how simple this home method is—how easily you can become an accomplished musician. So if you really want to learn to play—to win new friends—take

INDIANA TECH DEGREE IN TWO YEARS

B. S. Degree in Electrical, Civil, Chemical, Radio, Mechanical or Aeronautical Engineering in two years. Located in Electrical Hub of West. Earn Board. Low tuition. Enter June, Sept., Dec. Catalog. INDIANA TECHNICAL COLLEGE, 229 E. Washington St., Fort Wayne, Indiana

YOUR OPPORTUNITY—NEON and Other Gaseous Tubes

Today's biggest opportunity is in NEON or "gaseous-tube" lighting—most widely-used medium of lighted signs—the future's greatest source of illumination. Get started while it is still new!

FREE—Send name for free booklet, and excerpts of our practical, low-cost, home-study course that teaches everything! **WRITE NOW!**

COMMERCIALITE LABORATORIES, Dept. 47, Omaha, Neb.

CIVIL SERVICE

VALUABLE INFORMATION FREE
COLUMBIAN CORRESPONDENCE COLLEGE
WASHINGTON, D. C.

NEW YORK SCHOOL OF MECHANICAL DENTISTRY

Becomes a TRAINED Dental LAB Technician. We show you how! Oldest school. Practical training. Day, Eve. Easy terms. Tools FREE. Ask for Catalog P. N. Y. SCHOOL OF MECHANICAL DENTISTRY, 125 W. 31 St., N. Y. C.

Forms to cast Lead Soldiers, Indians, Trappers, Hunters, Wild and Farm Animals. 239 different forms to select from. Every form guaranteed to cast perfect figures. Send 5c stamp for illustrated catalogue.

HENRY C. SCHIERCKE Spencer Rd. GHENT, N.Y.

MAN IN EACH TOWN To Plate auto parts

reflectors, mirrors, etc., by new method; no capital or experience required. Outfits furnished. Free particulars. Write Today!

GUNMETAL CO., Ave. M, Decatur, Ill.

AGENTS Make \$380 Monthly

selling 10 CARTER WINDOW WASHERS daily. Clean, dries, polishes. No mess. Good Housekeeping approval. Restricted territory. Also ask for details of our fast selling lever spray hose nozzle. Write today.

Carter Products Corp., 998 Front Ave., Cleveland, Ohio

PHOTO ENLARGEMENTS 10c EACH

Enlargements, size 5x7 inches, made from your favorite kodak negatives (films). Send as many different negatives as you wish. They will ALL be returned. Take advantage of this AMAZING OFFER today. Address **DARMER PHOTO LAB, Enlarging Dept. 90 DES MOINES, IOWA** **3 for 25c**

High School Course in 2 Years

You can complete your High School education at home—in 2 years or less. Course meets requirements for entrance to college, business, and industry. Standard texts supplied. Diplomas awarded. Full credit for H. S. subjects already completed.

Business & Engineering

Over 200 noted Educators, Engineers, and Business Men helped prepare our special instruction material which assures you college-grade training at home for the best positions in Business and Industry.

The School was chartered in 1897 as an educational institution, exempt from Federal income tax. Instruction material used by many resident schools and colleges, U. S. Navy, and Dominion of Canada.

Home Study Prepares You for the Better Job

No matter what your inclinations may be, you can't hope to succeed without proper training. Check kind of work preferred and let us send you full details. No obligation.

American School
Dept. HB-45; Drexel Ave. at 58th St., Chicago

-- Air Conditioning	-- Drafting & Design
-- Architecture & Building	-- Electrical Engineering
-- Automotive Engineering	-- Electric Refrigeration
-- Business Management	-- Higher Account'g (C.P.A.)
-- Civil Engineering	-- High School Course
-- Complete Law	-- Highway Engineering
-- Diesel Engineering	-- Mechanical Engineering

Name

Address

When writing please mention Popular Mechanics

SAVE UP TO 50%

DIRECT FROM MIDWEST LABORATORIES



30 DAYS FREE TRIAL

ONLY RADIO COVERING 9 TO 2,400 METERS.

12,000 MILE TUNING RANGE

FOREIGN RECEPTION Guarantee

ONE YEAR Guarantee

MONEY-BACK Guarantee

TERMS as low as \$5.00 DOWN

Amazing New MIDWEST HIGHER FIDELITY 16-TUBE (ALL 5 WAVE BANDS)

EXCLUSIVE features, acting like "Invisible Hands," give magical world-wide High Fidelity reception. Before buying a radio, write for FREE 36-page 4-color catalog. Learn how thousands saved 1/3 to 1/2 by buying direct from MIDWEST.

This Super DeLuxe, 16-tube All-Wave radio gives you: High Fidelity reception, 5 wave bands, 50 advanced features, many of them exclusive . . . such as Multi-Function dial. Only Midwest offers you 9 to 1200 meters. Brings in foreign stations 12,000 miles away. Hear realistic American and SHORT WAVE programs . . . Canadian, police, amateur, airplane, ships. One-Year Guarantee, Foreign-Reception Guarantee, Money-Back Guarantee. As little as \$5.00 down. 30 days FREE Trial.

Long Range Radios \$27.50 as Low as

Mail coupon or send 1c postcard

Midwest Radio Corporation
Dept. 257A, Cincinnati, O.

MAIL COUPON TODAY! FOR FREE MINIATURE DIAL.....FREE 30-DAY TRIAL OFFER...FREE CATALOG



PHOTO-ENGRAVING LEARN IT AT HOME



We Furnish all equipment and materials including large photo-engraving camera complete with lamps, lens and screen. When you have finished the course you can establish a good paying independent business with the equipment furnished or work for others at a big salary. Photo-Engraving offers greater opportunities today than any other industry. Every picture in this issue of Popular Mechanics was engraved by the process we teach you. Earn good money while learning. Write today for our new illustrated catalog which was engraved on equipment such as we furnish. You will not be obligated in any way by writing such as we furnish. You will not be obligated in any way by writing such as we furnish. You will not be obligated in any way by writing such as we furnish.

A copper plate to print above picture size 8 by 10 inches sells for \$15.37.

Aurora School of Photo-Engraving, Dept. 175, Aurora, Mo.



REAL JOBS OPEN

For Trained Auto Mechanics

Step into Big Pay. Earn \$35 to \$75 a week. I train you in only 8 weeks at largest schools of kind in world. New practical shop plan. Learn with real tools . . . on real equipment. Write today for Big Free Opportunity Book and Special Low Tuition Offer. Address school nearest you.

FREE BOOK

McSWEENEY SCHOOLS, Dept. 10-19 Cleveland, O. or Kansas City, Mo.

New York Electrical School Established 1902
Ask for free booklet
44 West 17th St., N. Y. C.

Let us recommend the best books to study on any subject. Popular Mechanics Press, Chicago, Illinois



Learn to DIVE and SWIM

It's as easy as walking—if you follow the directions experts give in "OUTDOOR SPORTS." A new guide to happiness for all lovers of the great outdoors. 352 pages of practical, helpful suggestions for greater enjoyment in every form of sport, with directions for building necessary equipment. Prepaid \$2.00. C. O. D. anywhere in U. S. Catalog listing 5,000 other books—Free.



POPULAR MECHANICS PRESS
Room 89 200 E. Ontario, Chicago

CHEMISTRY

A CAREER OF SERVICE AND PROFIT

No FIELD of human endeavor offers greater possibilities today than chemistry. All progress is dependent upon this fascinating science. And right at home, in spare time, you can learn the fundamentals by study of the International Correspondence Schools modern course. Send for booklet.

...INVENTION—a field of opportunity for men with ideas

If you have an inventive turn of mind, this new International Correspondence Schools Course in inventing and patenting will teach you all the basic knowledge you must have in order to earn real money from your talents. Mail the coupon today.



INTERNATIONAL CORRESPONDENCE SCHOOLS

Box 5586-H, Scranton, Penna.

Explain fully about your course in the subject marked X:

- | | |
|--|---|
| <input type="checkbox"/> CHEMISTRY | <input type="checkbox"/> INVENTION |
| <input type="checkbox"/> Radio | <input type="checkbox"/> Air Conditioning |
| <input type="checkbox"/> Aviation | <input type="checkbox"/> Architecture |
| <input type="checkbox"/> Refrigeration | <input type="checkbox"/> Accountancy |
| | <input type="checkbox"/> Advertising |
| | <input type="checkbox"/> Electrical Engineering |
| | <input type="checkbox"/> Drafting |
| | <input type="checkbox"/> Show Card Lettering |

Name..... Age.....

Address.....

MIDWEST RADIO CORP.
Dept. 257A, Cincinnati, Ohio



Without obligation send me your FREE catalog, FREE Miniature Dial, and 30-day FREE trial offer. This is NOT an order.

Name

Address

Town..... State.....

Check here, if interested in Midwest World-Wide Battery Radio.
 Check here, if interested in a Midwest Auto Radio.

Travel for "Uncle Sam"

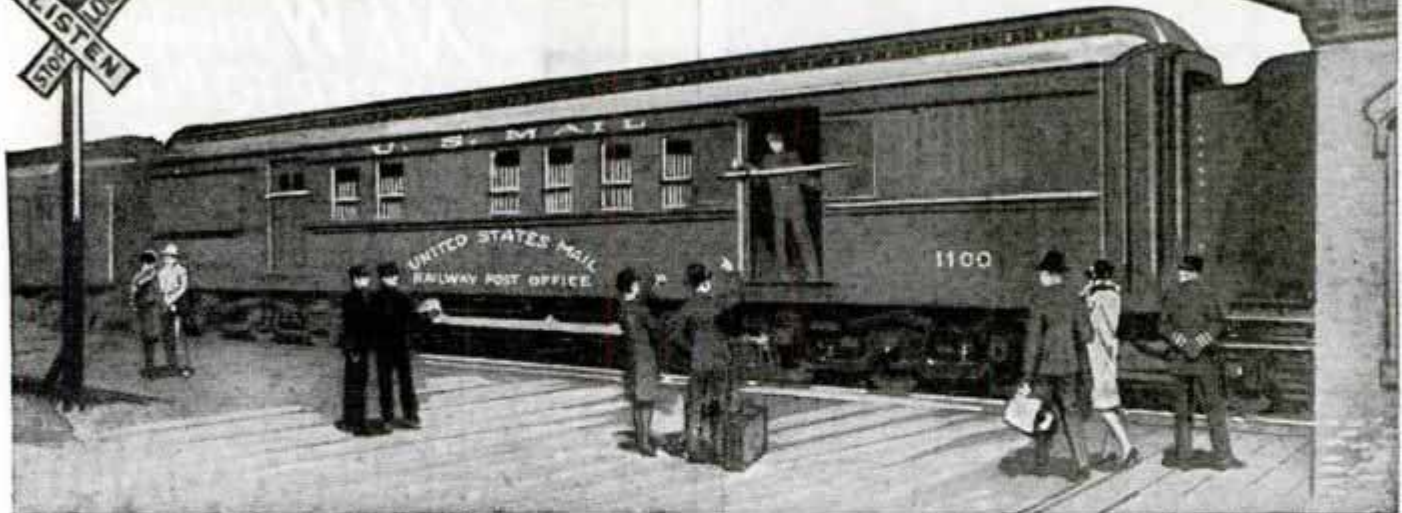

Railway Postal Clerks

MANY OTHER U. S. GOVERNMENT POSITIONS STEADY WORK
MEN—BOYS 18 TO 50

Short Hours Pleasant Work
 Rapid Advancement, Permanent Employment
MANY GOVERNMENT EXAMINATIONS COMING QUALIFY NOW

MAIL COUPON TODAY. TOMORROW YOU MAY FORGET

BE A POULTRY EXPERT

Make \$40, \$50, \$60 a Week

Free book shows how to get started quickly. You'll be surprised at the amazing profit opportunities in the poultry business. Wherever you live—whatever you do—it is easy to start on a spare or full time basis. Free book tells all. Send for "How to Raise Poultry for Profit." You learn right at home in spare time by methods endorsed by colleges and leading poultrymen. Know how to get the maximum profits from interesting, healthy work. Iron-clad agreement protects you. We have prepared hundreds for good jobs and businesses of their own. Write now for free book. No obligation. National Poultry Institute, Inc., Dept. 37, Adams Center, New York.

Wrestling Book FREE



Wrestling taught at home, by mail, by greatest of all world's champions—Farmer Burns and Frank Gotch. He a wonderful athlete. Handle bigger, stronger men with ease. Learn the secrets of experts. Jiu-Jitsu, Physical Culture. Have perfect health, fame, a perfect body admired by both sexes.

FREE 32 page illustrated prospectus, full of thrilling information, sent free. Tells how we teach expert wrestling at home. Send 2c to cover postage. Write now for your copy. State age.

FARMER BURNS SCHOOL
 B337 Elwood Bldg., Omaha, Neb.



AGENTS 500% PROFIT GUARANTEED GOLD LEAF LETTERS
 For Store fronts and office windows. Anyone can put them on. Free samples. Liberal offer to general agents.
METALLIC LETTER CO., 438 N. Clark St. Chicago



MAKE GLAZED GARDEN POTTERY
 Beautiful, colored, glazed concrete pottery made without molds. No experience needed. Use only sand and cement. 2,500 different designs birdbaths, vases, jars, etc. Big profits. Send 10c for Booklet, color plate, etc.
NATIONAL POTTERIES CO., 424 Second Ave., So., Room 21 Minneapolis, Minn.



EARN BIG MONEY AT HOME!

Grow mushrooms in your basement, cellar, garage, idle places. We buy crop. Experience unnecessary. **FREE** Book.

MUSHROOM GROWERS OF AMERICA, HA-433, N. Clark St., CHICAGO, ILL.

VALUABLE COUPON

FRANKLIN INSTITUTE, Dept. T185, Rochester, N. Y.
 Rush to me entirely free of charge (1) a full description of the position checked below; (2) Free Copy of 32-page book, "How to Get a U. S. Government Job"; (3) A list of U. S. Government Jobs; (4) Tell me how to get a Government Job.

- Railway Postal Clerk.....(Start \$1900 year)
- Post Office Clerk.....(Start 1700 year)
- City Mail Carrier.....(Start 1700 year)
- Office Clerk—File Clerk.....(Start 1260 year)
- Inspector of Customs.....(Start 2100 year)
- Immigrant Inspector.....(Start 2100 year)
- Liquor Gauger—Storekeeper.....(Start 2000 year)

Name.....
 Address.....

Use This Coupon Before You Mislay It



Know Electricity as Experts Know It—and Get an Expert's Pay!

Recovery has begun! The months ahead are charged with significance and expectation. What will you do to get the jump on the other fellow?
 Thousands of men have used

The Croft Library of Practical Electricity

The Croft Library is a complete electrical educator. It is founded on practice—on 20 years of shirt-sleeve experience—on work as it is actually done. It is jammed from cover to cover with the kind of hard-headed facts you want. Written so that the beginner can easily understand it, yet so sound, so thorough, that it is the daily guide of 50,000 highly paid electrical workers and engineers. Croft tells you the things you need to know about motors, generators, armatures, commutators, transformers, circuits, switchboards, distribution systems—electrical machinery of every type—wiring for light and power—wiring of finished buildings—underwriters' and municipal requirements—illumination in its every phase—the most improved methods of lighting—lamps and lamp effects, etc.—how to do a complete job, from estimating it, to completion.

No money down—easy payments

Fill in and mail the coupon attached and we will send you the entire set of seven volumes for ten days' Free Examination. We take all the risk—you assume no obligation. If you decide to keep the books, send \$1.50 in ten days and the balance at the rate of \$2.00 a month. Send the coupon NOW and see the books for yourself.

FREE EXAMINATION COUPON

McGraw-Hill Book Co., 330 W. 42nd St., New York

Send me for ten days' free examination the Croft Library of Practical Electricity. If satisfactory I will send you \$1.50 in 10 days and \$2.00 monthly until the price of \$19.50 is paid. If not wanted, I will return the books postpaid. (To insure prompt shipment write plainly and fill in all lines.)

Name.....
 Home Address.....
 City and State.....
 Position.....
 Name of Company..... PM-7-35



Follow this Man

Secret Service Operator 38 is on the job

FOLLOW him through all the excitement of his chase of the counterfeit gang. See how a crafty operator works. Telltale finger prints on the lamp stand in the murdered girl's room! The detective's cigarette case is handled by the unsuspecting gangster, and a great mystery is solved. Better than fiction. It's true, every word of it. No obligation. Just send the coupon and get—

FREE!

The Confidential Reports No. 38 Made to His Chief

And the best part of it all is this—it may open your eyes to the great opportunity for YOU as a well paid Finger Print Expert. This is a young, fast-growing profession. This school has taken men and trained them for high official positions. This is the kind of work you would like. Days full of excitement. A regular monthly salary. Rewards.

Can you meet this test?

Are you of average intelligence? Are you ambitious? Would you give 30 minutes a day of your spare time preparing yourself for this profession? Answer "yes" and I'll show you how it is possible for you to attain all this. Send the coupon and I'll also send the Free Reports.

INSTITUTE OF APPLIED SCIENCE
1920 Sunnyside Ave., Dept. B-135 Chicago, Illinois

Institute of Applied Science
1920 Sunnyside Ave., Dept. B-135 Chicago, Illinois

Gentlemen:—Without any obligation whatever, send me the Reports of Operator No. 38, also your illustrated Free Book on Finger Prints and your low prices and Easy Terms Offer. Literature will NOT be sent to boys under 17 years of age.

Name _____

Address _____

Age _____

NEW models EASIER TO PLAY

Find out about these sensational new Conn Band Instruments. Many wonderful, exclusive features! Today, more than ever, Conns are the "choice of the artists." You'll advance faster and take more pride in a genuine Conn—made by the world's largest manufacturer. See your dealer or write us for Home Trial, Easy Payment offer. Mention instrument.

C. G. CONN, LTD.
731 Conn Bldg., Elkhart, Ind.

WRITE FOR FREE BOOK

CONN
BAND INSTRUMENTS

YES, BOB, MOUNTING BIRDS and ANIMALS IS A GRAND HOBBY! I'VE DOUBLED MY FUN FROM HUNTING—AND AVERAGE \$14 PER WEEK, SPARE TIME, MOUNTING FOR HUNTERS—WHY DON'T YOU WRITE TO THE N.W. SCHOOL FOR THEIR FREE BOOK?

FREE BOOK!

Learn Taxidermy at home. Write today for Free Book. State age. N. W. School of Taxidermy 8337 Elwood Bldg., Omaha, Nebr.

TELEVISION

has arrived

AMERICA'S First Complete TRAINING COURSE - now ready

RECEIVING

LEARN TELEVISION ELECTRICITY RADIO all branches

BROADCASTING

Students operate actual equipment in NATIONAL STUDIOS

CONTROL

You can quickly qualify for big opportunities in the newest radio science—TELEVISION. Be a Radio expert. National Schools (est. 1905) offers several complete courses at price of one course. 30,000 graduates. Practical shop and studio instruction. Coach railroad fare allowed to Los Angeles. Earn room and board during enrollment. SEND COUPON FOR BOOK.

NATIONAL RADIO & ELEC. SCHOOLS
Dept. 7 PMR, 4000 So. Figueroa St., Los Angeles

NAME _____

ADDRESS _____

CITY _____ STATE _____

FREE Book

**WORLD'S
BEST
WANT AD
MEDIUM**

CLASSIFIED

Advertisements



Advertisements in this section, 35 cents per word, each insertion, minimum 10 words, payable in advance
To be inserted under proper classification in August issue, copy should be in our office June 14th
Popular Mechanics Magazine, 200 East Ontario Street, Chicago, Illinois

**Our Records Prove That You
Can Fill Almost Any Want
Through a Small Classi-
fied Ad in This Section**

*Mr. F. W. Johnson, Mgr., Classified Department,
Popular Mechanics Magazine, 200 E. Ontario St., Chicago, Ill.*

Dear Mr. Johnson: For more than twenty years we have used the Classified Section of Popular Mechanics Magazine on our various home study school courses without missing one issue. Cost per inquiry and per enrollment runs very low, and I am safe in saying that our advertising expenditure in your Classified Section has shown a substantial profit every year. In fact, I know of no magazine in the entire publication field that equals Popular Mechanics Classified Section in returns. Yours truly,
PAGE DAVIS SCHOOL OF ADVERTISING
J. E. Marcus, President

AUTOMOBILES

KIT Containing all necessary parts to convert Chevrolet or any belt driven Hemy generator into air-cooled for higher charging rate. Kit complete with instructions, \$2.25, post paid. Selindh Machine Company, 614 East Grand, Des Moines, Iowa.

BUILD A racer! Kuns tells how you can build 125-135 m.p.h. stock cars and speedway racers. New book fully describes mid-gets, conversions. Contains all speed records, drawings, pictures, full description record cars. \$1 postpaid, \$1.12 c.o.d. 3c tax in Ohio. Ray F. Kuns, Dept. B-10, Madisonville, Cincinnati, Ohio.

DODGE Generator quickly changed to arc welder. Welds fenders, cylinder heads, etc. Plans, drawings \$1.00. Neal Brown, Richland Springs, Texas.

DIESEL Oil for auto fuel! Extraordinary economy. True flashpoint principle of application. Blueprint and instructions \$1.00. Salesmen wanted. Panama Oil Co., Berkeley, Calif.

CHEVROLET Owner, stop that ruinous rattle by installing Spring-Saddle Anti-Rattler. Ask your auto supply house or write for circular. Price 90c. Nic Bredar's Sons Mfg. Co., Rock Island, Ill.

200 MILES 35c. Burn stove distillate in your car. Get parts in any junk yard. Complete detailed information and blueprint 50c (coin). C. C. Carmichael, 5013 2nd Ave., Los Angeles, Calif.

AUTO SUPPLIES—EQUIPMENT

AUTO Parts, supplies, for most any make. Saving up to 75% on some new parts. Send for catalogue. Special list on model T Ford parts. Auto Tire & Parts Co., Cape Girardeau, Mo.

POLICE Sirens, mechanically or motor driven. For cars, boats, aeroplanes. Particulars free. Norfolk Machine Shops, 1611 Goodfellow Blvd., St. Louis, Mo.

MICROMETER: (Outside) accurate every thousandths between 1½, 5 inches. \$1.00. Agents! Schaap, Springfield Gardens, L. I.

MOTORISTS: Save over 100%. Use Diesel or stove oil in car. \$3 installs, easy starting. Instructions one dollar. B Service Co., 403, Redding, Calif.

BIG Saving. Not great sensation, but very practical idea, tried out and improved two years, to save 25% gasoline on any motor. Send 50c and get supplies and instructions. Reimer, Dalhart, Texas.

TRAILER Drop axles and chassis to order. Carey, Palmer, Mass.

DEMONSTRATORS. Compressor, test bench, 8-hour battery charger—are welder. Guaranteed. Trial and terms. Ken's Equipment Exchange, Box M-752, Troy, Ohio.

USED Auto parts at half price for all cars. Century Parts Co., 1712 Lafayette Ave., St. Louis, Mo.

NICKEL Plating outfits, connect to your battery. No tanks used, thousands in use. \$3.00 prepaid. Gunmetal Co., Ave. J, Detroit, Ill.

TRAILERS, 4'x6'—\$27.50. Undercarriages \$15.50. Plans, utility 50c, house \$1.00. Shamrock, 12321 Turner, Detroit, Mich.

A. C. AUTO GENERATORS

TWENTY New practical changes for automobile generators. See our advertisement at bottom of page 133A. Auto Power, Inc.

FOR FORD OWNERS

FORD Owners stop that ruinous chatter by installing Bredar's Ball Shim, price 45c. Ask your auto supply store or write for circular. Nic Bredar's Sons Mfg. Co., Rock Island, Ill.

MOTORCYCLES, BICYCLES AND SUPPLIES

REBUILT Motorcycles. All makes. New and used parts. Expert repair work by factory trained mechanics. We are the authorized Harley-Davidson distributors. Send 10c for bulletin. Western, 914 E. 15th St., Kansas City, Mo.

ATTACH A Fleetwing motor to your bicycle. Ride 100 miles per gallon—30 miles per hour. Easily installed. Guaranteed. Write for circular. Hoffman Engineering Company, 500 North Craig St., Pittsburgh, Pennsylvania.

CLOSING Out all used motorcycles and parts. Save up to 90% on your repair bill. Used machines \$25 and up. Dime for lists. Tulsa Motor & Cycle Co., Tulsa, Oklahoma.

POWER Your bike with low priced Speed-bike motor. Attach in one hour. Eighty miles to gallon. Thirty miles an hour. Free folder. Guaranteed. Outboard Motors Corp., 4027 N. 28th St., Milwaukee, Wis.

HENDERSON, Excelsior, Harley, Indian, used parts, alloy pistons, catalogue and wings pin 10c. Ballak, 1115 Chestnut Street, St. Louis, Mo.

MOTORCYCLE Bargains, lowest prices, bargain sheets for stamp. Motorcycle accessories. Rochester Harley Davidson Corp., 129 West Main St., Rochester, N. Y.

SIXTY Reconditioned motorcycles. New and used parts for all makes. Whitman Motorcycle & Supply Co., 465 Southwest Blvd., Kansas City, Mo.

SEND 15c For illustrated used Motorcycle catalog. Large stock. Bargains. Indian parts. Accessories. Indian Motorcycle Sales, Kansas City, Mo.

MOTORCYCLES—Direct to you at rock-bottom wholesale prices. Rebuilt, roadtested and guaranteed Indians, Harleys, etc. Send 10c today for "Bargain Bulletin 43." Crandall Hicks Co., 780 Commonwealth Avenue, Boston, Mass.

MOTOR Bicycles \$45.00, motorcycles \$40.00, new cord tires \$3.95, used tires, \$2.50. Bicycles \$11.50. (Bicycles for two \$35.00.) Used motorcycle parts, wheels \$1.00. Chains \$1.00. Engines \$10.00 to \$75.00. Frames \$5.00, all parts. Balloon tired wheels for boys automobiles. Send 6c. Price Cutter Deninger, Rochester, N. Y.

AVIATION

LIGHTPLANE Design—Approved experts. Free literature. Korff, Box 71-M, Mt. Vernon, Illinois.

FREE Book "Airplanes and How to Fly Them," with 6-month trial subscription. Send only 50c. American Freeman, Box 1803, Girard, Kansas.

DON'T Buy anything until you get Ort's 1935 aviation catalogue. Send thin dime. Karl Ort, 539 W. Poplar, York, Pa.

NEW Aeroplanes, \$98.00; motors, \$49.99; propellers, \$2.98. Send 25c for data, information. Hibbs, Ft. Worth, Texas.

GET Into aviation. Air transport pilots get up to \$7,000 per year; mechanics, \$2,500. Learn at this government approved school. Write for complete information. State age. Lincoln Flying School, 2004 Aircraft Building, Lincoln, Nebr.

AIRMINDED Young men interested in entering the field of aviation as apprentices. Write, enclosing stamp. Mechanix Universal Aviation Service, E-13291 Ardmore, Detroit, Mich.

AEROPLANES, Motors, gliders. Colored catalog imported World War aeroplane souvenirs 6c up mailed 3c. Midget car rims \$1.75. Northrup Aeroplane Co., Minneapolis, Minnesota.

HUNDREDS Airplanes, crackups \$40 up. Directory 20c, postpaid. Used Aircraft Directory, Athens, Ohio.

BATTERIES, GENERATORS, ETC.

EDISON Storage batteries for power and lighting systems. Replace your old lead batteries with the Edison. Built like a battleship. Non-acid. Non-corrosive. Exceptionally long life. Liberal guarantees. Free illustrated literature. See Jay Battery Company, 82 Sterling Avenue, Yonkers, N. Y.

COMMERCIAL Battery chargers (20 auto battery capacity). Build and sell. Plans \$1.00. Printz Electric Co., 5296 Tireman, Detroit.

BUILD New farmlight, automobile, batteries from old. Particulars. Battery Laboratories, St. Paul, Minnesota.

PROFIT Rebuilding batteries. Make your own plates. Information 25c (coin). Wind power battery charger plans 25c. General Battery Service, 78M Glenwood, Minneapolis, Minn.

GENERATOR Propellers, expertly designed at factory prices. Hibbs, Ft. Worth, Texas.

EDISON Storage batteries for all types of lighting systems. Uses no acid. Odorless. Long life. Guaranteed. Generating plants, motor bargains. Free interesting literature. Hawley Smith Company, 22 Washington Ave., Danbury, Conn.

ELECTRIC Lights—Wind driven—You build them. Write Wind Motor Electric, Ridgway, Mont.

BUILD Your Electric plant cheap. With washer engine, automobile generator. Operates lights, washer, refrigerator perfectly. 67¢ monthly. Particulars. Battery Laboratories, St. Paul, Minnesota.

ELECTRICAL SUPPLIES—EQUIPMENT

FREE Book "Electric Energy: What It Does," with 6-month trial subscription. Send only 50¢. American Freeman, Box 1804, Girard, Kansas.

BUILD Your own electric refrigerator—or build for profit. Low cost. New manual explains theory, construction, operation, source of supplies. 40 illustrations. \$1.00 postpaid. L. R. Wright, Box 527, 5 West 63 Street, New York City.

ELECTRICAL Experimental laboratory kit—Contains alternating generator, small motor, microphone, transformer, polarized relay, condensers, electroplating chemical, carbons, electro magnets, etc. Contains 25 pieces commercial apparatus. Weight 16 pounds. Laboratory makes are furnaces, secret detector, search light, extension telephone, generates electricity, etc. Complete instructions. Educational, fascinating, useful. Original cost \$17.75. Special bargain, \$2.79. Other bargains. Stamp for catalog. Electrical Salvage Company, Box 524-AE, Lincoln, Nebraska.

LARGE Powerful floodlights. Suitable playgrounds, gas stations, etc. \$8.50. Surplus, 938 No. Homan, Chicago.

INSTRUCTIONS: Gathering data and re-winding motors. \$1.00 complete. Hoosier Service Co., Terre Haute, Indiana.

INSULATION, Wire, varnishes, supplies, etc. Send 3¢ stamp for bulletin. Autopower, 408-B Hoyne Ave., Chicago.

WELDING AND SOLDERING

200 AMPERE Welding generator. Fine order. \$130.00. Wilmot Auto Supply, 1970 Wilmot St., Chicago.

ARC-WELDING Outfit \$1.25. Weld fenders, braze, solder. Lavrow, 4368-W. Warren, Detroit. Stamp appreciated.

WELDING And brazing oxy-acetylene equipment, new and rebuilt. Superior Oxy-Acetylene Company, Hamilton, Ohio.

ARC-WELDERS, Instructions, drawings for three types, 50¢ (coln). Hildman Engineering, 459 Irvin Ave., Rochester, Penna.

PRACTICAL 200 Amp. welder made from farm light plant generator, small cash outlay, gets the job done. Blueprints, specifications \$5.00. City Electric Shop, Snyder, Oklahoma.

DEMONSTRATORS, Electric arc welders. Money-saving prices. Used by the government. Trial and terms guaranteed. Hobart Welders, M-753, Troy, Ohio.

BUILD 150 Amp. arc welder from Dodge generator. Blueprints \$1.00. "Dunn," Box 214, Middletown, Ohio.

ENGINES, MOTORS, DYNAMOS

200 NEW General Electric ¼ horse, 110 volt, 1750 alternating current motors \$5.99. Wilmot Auto Supply, 1970 Wilmot St., Chicago.

FIVE KVA 110 volt alternating generators \$89.50. Other sizes. Converters, motors. Queen City Electric, 1736 Grand Avenue, Chicago.

GOVERNORS Control auto engines—stationary or portable power uses. New big discount. No cash down. Special foreign terms. Agents wanted. Candee-Smith Governor Co., 215 North Los Angeles St., Los Angeles.

WINDING Data, 100 AC motors, various horsepower and voltage, \$1.00. Motor Data Co., 3002 Monroe, Kansas City, Mo.

MACHINERY—TOOLS—SUPPLIES

14"x6' LODGE & Shipley lathe, quick change, good condition, price \$175.00. 2" Peerless motor driven bench pipe machine, \$100.00. No. 60 Head cylinder grinder \$175.00. All sizes of machine tools. Send for catalogue listing other bargains. Terms to suit. Cincinnati Machinery & Supply Company, 27 West Second Street, Cincinnati, Ohio.

ELECTRIC Drills. Brand new. \$5.95 up. Descriptions sent. Shaw, 31-A Winchester St., Boston, Mass.

\$20.00 FLEXIBLE Shaft \$12.00—½ horse-power. Capacity 5 ft. long. Robert, 3515 N. Seeley Ave., Chicago.

LIMITED Quantity. Genuine 1" micrometers. Brand new, graduated in thousandths. Accurate. Send money order \$1.50 plus 15¢ postage. Bradley Machine Co., 6501 Epworth Blvd., Detroit, Mich.

BARGAINS. Demonstrators, electric arc welders, guaranteed, 30 days trial and terms. Write Ken's Equipment, Box M-754, Troy, Ohio.

BOATS, OUTBOARD MOTORS, ETC.

CUT-TO-FIT Kayaks, canoes, \$6.95 up. Catalog for dime, refunded with order. Boat Shop, 737P, Greenville, Pa.

DETACHABLE Canvas top for motor or rowboats. Plans 50¢. Kingsbury, 480 - 83rd St., Brooklyn, N. Y.

TWENTY Mile outboard racer complete plans 25¢. Free boat building catalog. The Rudder, 15 Murray Street, New York.

CLIPPER Outboard motors are recommended. Powerful, sturdy, dependable. Guaranteed. Write for circular and dealer's price. Hoffman Engineering Company, 500 North Craig St., Pittsburgh, Penna.

BUILD Your own boat and save ¾ cost. 38 designs. Send 10¢ for catalog. Brooks Boat Co., Inc., Box E-20, Saginaw, Mich.

KYACKS—Aluminum framework. Puncture-proof steelcoat hull. Non-sinkable, non-capsizeable. Boats and kits. Particulars. Ki-Boats, 4520-A Christiana, Chicago.

PROPELLERS, Stuffing boxes, gear pumps, bearings, etc. Wm. Baker, Pond St., Quincy, Mass.

MAKE Canvas canoe. Blueprint 30¢. Weesho-Uco, B51, Detroit, Mich.

OUTBOARD Parts—New or used—All makes—What do you need? Crandall-Hicks Company, 782 Commonwealth Avenue, Boston, Mass.

BOATS, Camps, motor camping, trailers, outdoor sports, etc. Send for list of special books on. It's free. Popular Mechanics Press, Room C35, 200 E. Ontario St., Chicago.

GUNS, FISHING TACKLE AND SPORTING GOODS

INDIAN Pack baskets; Hudson Bay blankets; sleeping bags; compasses; knives. Write for catalogue. Howe Fur Co., Box P, Coopers Mills, Maine.

MAKE Dipsies for use or sale. Free folding. Reading Instrument Co., Box 78, Reading, Pa.

FIELD GLASSES, TELESCOPES AND MICROSCOPES

TELESCOPES, Binoculars, microscopes. Bargain list free. Teeko Optical, Evanston, Illinois.

MICROSCOPES, Telescopes, binoculars. America's lowest prices. Optical catalog free. Brownscope Company, 234 Fifth Avenue, New York.

SIX Inch reflector astronomical telescope. H. E. Bussey, Atlanta, Ga.

ANTIQUES, RELICS, INDIAN GOODS

15 ARROWHEADS, Scalping knife 99¢. Spearhead, lancehead, birdpoint, skinner 99¢. Photolist 10¢. Robt. Heike, Rutland, Ill.

BAYONETS, Helmets, medals. List 10¢. Dare, 670E42, Brooklyn, N. Y.

INDIAN Relics, flint arrowhead. List, 3¢. Edward Townsend, Delmont, Pa.

INDIAN Relics. Beadwork. Coins. Curlos. Catalogue and arrow, 6¢. Vernon Lemley, Northbranch, Kans.

ANTIQUE Guns, Indian relics. List five cents. Elmer Ellis, Webster Groves, Mo.

TAXIDERM Y

TAXIDERM Y Supplies—Quality artificial eyes, teeth, genuine Jonas head forms. Tools, materials, etc. Everything for the progressive taxidermist. Send for big illustrated catalogue—Free. Jonas Bros., 1049 Broadway, Denver, Colorado.

LEARN Taxidermy. Five courses. Blue Beaver Taxidermy School, Lemont, Ill.

DOGS, BIRDS, POULTRY, ETC.

INCREASE Poultry profits. Thousands successful using proved methods of Harry M. Lamon, famous authority. Amazing home-study course trains you. Free book explains. Write today. National Poultry Institute, Dept. 167, Adams Center, New York.

COLLIES—All kinds and colors. Send for lists. Shomont, Monticello, Iowa.

POULTRY Tribune—Leading poultry magazine. Five years \$1.00; six months trial 10¢ in U. S. Poultry Tribune, Dept. C-93, Mount Morris, Ill.

BEAUTIFUL Pure white police dogs. Ansonia Kennels, Mose, N. Dak.

ROOTS, HERBS, TREES AND SHRUBS

SEND For this amazing new "Herbalist Almanac." Interesting! Instructive! Educational! Contains hundreds tested recipes for old-fashioned home remedies, salves and herb teas. Beautiful natural colored illustrations herbs and plants. Weather forecasts. When to plant and harvest. Best fishing days and baits. Recipes for cooking and baking. Weights and measures. Signs of the moon. Historical events. Valuable information on poultry and building. Many other great features. Only 10¢ postpaid. Write today! Botanics, 145 West 112th St., Chicago.

FARMS AND FARM LANDS

60 ACRE Lakeside farm once sold at \$8000 equipped; on good road, 50 acres level fields, wood and fruit; well-kept 8-room home overlooking lake, hip-roof barn 44x48, insured \$2475. Price now only \$1750, part cash; pg. 46 big catalog special bargains. Write today for free copy. Strout Agency, 255-P 4th Ave., New York City.

INDEPENDENCE, Security assured, North Dakota, Minnesota, Montana, Idaho, Washington, Oregon farms. Bargain prices, easy terms. Descriptive literature, impartial advice. Mention state. J. W. Haw, 119 Northern Pacific Railway, St. Paul, Minn.

FLORIDA: 10 To 40 acres; combination land; Peace River country. Florida's best. Terms. Foster's Florida Farms, Orlando, Florida.

RENTS And prices are low in Minnesota, North Dakota, Montana, Idaho, Washington and Oregon. Farms large or small near lakes, streams, forests. Low rates. Free book. E. C. Leedy, Dept. 857, Great Northern Railway, St. Paul, Minn.

\$5 DOWN, \$5 Monthly, 20 acres, Ozarks, \$100. Fishing, hunting, trapping. Hubbard, 216 Grossman Bldg., Kansas City, Kas.

PROFITABLE OCCUPATIONS

RAISE Rabbits for us. We pay you up to \$5.00 each. Also put you in touch with markets everywhere. Large illustrated book and catalog; also copy of the American Rabbit Farmer and monthly market bulletin showing names of buyers in various parts of America who continuously buy all rabbits offered them. All for 10 cents. Address Outdoor Enterprise Co., Box 10, Holmes Park, Mo.

IF Interested in raising frogs we guarantee to save you money. Send 10¢ for literature. American Frog Industries, Rayne, La.

PROFIT And pleasure in taxidermy. Complete guide for the preparing and mounting of animals, birds, fish, reptiles, etc., for home, den, or office. \$1.65 postpaid. Popular Mechanics Press, Room C35, 200 E. Ontario St., Chicago.

RAISE Angorra wool rabbits. Big profits. Wool brings \$3 to \$6 lb. Wool samples, catalogue 10¢. Clay Farm, Sharon, Wash.

BOOKS AND PERIODICALS

SEND Postcard for free Little Blue Book catalog. Thousands of bargains. More than 350 books at 5¢ each. Address: Haldeman-Julius Co., Box 2048, Girard, Kansas.

McDONALD'S Electrical dictionary, 192 pages, cloth, \$1.50 prepaidd; latest electrical dictionary; needed wherever electricity is used; discounts to dealers. Meador Publishing Company, 470 Atlantic Ave., Boston.

"FINDING Gold Nuggets." Book including 16 maps with instructions \$1.00. Fine Art's Engraving, 416 S. Dearborn St., Chicago.

THOUSANDS Of old magazines. List 10¢. Seeley Service, Jennings, La.

GAMES—ENTERTAINMENT

PLAYS, Operettas, musical comedies, complete minstrel first-parts with song programs, blackface skits, vaudeville acts, monologs, dialogues, recitations, juvenile plays and songs, musical readings, entertainments, make-up goods. Catalog free. T. S. Denison & Co., 623 So. Wabash, Dept. 11, Chicago.

MAGIC TRICKS, PUZZLES, JOKER NOVELTIES

BE A magician. Large professional magic catalogue of latest tricks 25c. Ireland's Magic Factory, 431 North Clark, Chicago, Illinois.

6 CARD Tricks 25c. John McCormick, Hazel Street, Norwalk, Conn.

VALUABLE Crossword puzzle contests solver, 5,000 alphabetical definitions. \$1.00 postpaid. Crosswords, Reg., Huntingdon, Pennsylvania.

250 MAGIC And card tricks, explained, illustrated. 25c. Weiss, Box 153, Chicago.

BOOKS, Novelties, incense, stamps, magic, tricks. Samples, catalog 10c. Morrelle, 159-N State, Chicago.

MAGIC Catalogue 20c. Lynn, 105 Beach, Dept. 3, Jersey City, N. J.

LARGE Professional magic catalogue, 25c. Holden, 220 W. 42nd St., New York.

AMAZE And mystify! Fool your friends—be popular. South's largest line magic, puzzles, joke novelties. "153 Tricks," 10c. "125 Card Tricks" 25c. Send stamp for illustrated catalogue. Lyle Douglas, Station A-5, Dallas, Texas.

FOR BOYS

THROW Curves! Star as pitcher on your team. Tricky hurling will surprise the boys. New copyrighted book tells exactly how big leaguers do it. Illustrated with actual photographs and diagrams. Sent postpaid for 25c. Charles Paulsen, Minden, Nebraska.

FINGERPRINTS—Instructions for etching on metal identification tags \$1.00. Instructions for fingerprint identification cards 25c. Advanced Science, Box 152, Altadena, Calif.

STAMP COLLECTING

UNUSED Jubilee. All colonies. Canada set complete 50c. 50000 varieties in stock all countries. 100 different British colonials 30c. Send stamp for bargain lists. Ontario Stamp Co., Box 444, Toronto, Canada.

FREE Prize with every Gold Nugget lot at ten cents. United States, foreign, commemoratives, airmails, dues. Surprises. You'll be amazed. I purchase in bulk, make into lots, and, Oh Boy, what you receive for your money. Wrap dime. Enclose stamp. Prize free. The Stamp Mine, 818 East 47th Street, Chicago.

PENNY Approvals by country! Stamp Exchange, Montville, N. J.

GOYA Nude stamp \$0.10 to approval applicants. "Jewels," Tamaqua, Penna.

DEFYABLE Collection including airmails, Tanganyika, Newfoundland, Gold Coast, Charkhari, and many others—only 10c with bargain approvals. Lucas Stampco, 726 No. Edgemont, Los Angeles, California.

25 DIFFERENT Japan 8c, 50 18c. David Crockett, Farmington, Mo.

CHOOSE Your premiums! Jungle stamps! Animal! Bird! Airmail! Triangle and map stamps! Pick any ten from our big approval selections. Inclose 5c postage. Stamp Importers, Akron, Ohio.

20 DIFFERENT United States stamps, (catalog value 75c). 5c to approval applicants. Carpenter's Stamp Co., Mantl, Utah.

UNITED States: 50 different 10c; 100 different 40c; 4 imperforates 10c; Park Imperforates complete 75c; 600 assorted including commemoratives 20c. Wholesale Stamp Mart, Storm Lake, Iowa.

BRITISH Turkislands—Also Congo's, Montecarlo, Nigercoast, Uganda, Djibouti, Ecuadorian, Ivorycoast, Ubangi, countries collectors need. Free for 5c postage. Empire-stampshop, Dept. PM, Toronto, Canada.

1897 NEWFOUNDLAND Commemorative—superb mint Cabot commemorative selling everywhere for at least 15c. Also—Brunel, Turks Caeos Islands, \$5 U. S., and imperforate "Park." Everything only 5c to approval applicants. Extra! Genuine Baden free with each order. Viking Stamp Co., One Hanson Place, Brooklyn, N. Y.

HAILE Selassie King of Kings. Ethiopian Emperor, scenes from his domain, prowling tigers, ponderous rhinoceros, ungainly ostriches, gentle giraffes, graceful kudu, are shown on valuable Abyssinian set in Midwest's big packet different stamps from many countries only 5c to approval applicants. Midwest Syndicate, Box 91-F, Linwood Sta., Detroit, Mich.

MOZAMBIQUE, Jamaica, Portugal, British Colonials—30 different, 5c. Depraw, Ocean Park, California.

WHOLESALE Most liquidate surplus stock quickly and cheaply. 1000 well assorted United States, 1887-1919, 50 varieties unpicked, \$1.00. Randall, 431 South Dearborn, Chicago.

UNITED States! Reasonable to serious collectors. Box 835, Minneapolis, Minn.

FREE! 100 Different stamps with approvals. Postage 3c. Aladdin, 1550 Carroll, St. Paul, Minn.

FREE 50 Different stamps to approval applicants. Hoyt, 42 Cornhill, Boston, Mass.

WISE Collectors consider future value! Particulars free! Peegee, Station H, New York.

30 DIFFERENT U. S. commemoratives only 25c. Standard Sales, Harlan, Iowa.

SURPRISE Stamp assortment: Ships, animals, 6c; approvals. Blue lantern, Fullerton, Calif.

50 DIFFERENT Stamps 3c with approvals. W. Keyer, Irvington, N. J.

PHILATELIC Mail 3c. We mail 15c hundred. 10600 Thru, Cleveland.

GIGANTIC Collection containing stamps from fifty different countries only 10c with approvals. Walker, 471 Witmer, Los Angeles, Calif.

LONDON. Send 50c in unused U. S. stamps for magnificent introductory assortment foreign stamps worth ten times this amount. Stamps are cheap in London. Bileski, 38 Myddleton Square, London E. C. 1, England.

A BIG Bargain—All for only 55c. Stamp album, providing spaces for 2200 stamps with 700 illustrations, packet of 500 different stamps, 500 hinges, and millimeter measure. Free with each order our pamphlet which tells "How To Make A Stamp Collection Properly," and our price list of albums, supplies and hundreds of bargains in sets and packets. Queen City Stamp Company, Room 36, 604 Race Street, Cincinnati, Ohio.

MALAYAN 300 \$1.00. Cheahkimchow, 70 Irving Road, Penang, Straits Settlements.

200 MIXED Stamps 5c with approvals. Yakima Stampco, Yakima, Washington.

4 SETS: Georgia, Japan, Russia, Roumania. Approval applicants only, 5c. Butler-Care, Plainfield, New Jersey.

BARGAINS In one cent approvals. 22 Strathearn Blvd., Toronto, Canada.

BEAUTIFUL New Guinea Bird of Paradise airmail, smallest stamp, Zanzibar, Siam airmail, etc., (no Europe) in wonder packet 40 different stamps, 10c to approval applicants. Bargain Co., Box 39P, Station H, New York.

SCARCE Spain and Chile airmails! Highly prized Spain and Chile airmails; also scarce Abyssinia in fine packet of 61 different stamps from Siam, Ecuador, Andorra, British and French Colonies, etc., and illustrated lists. All for 5c to approval applicants. Gulf Stamp Co., Dept. 43, College Station, Texas.

FREE To applicants for my low priced foreign and United States approvals a packet of 100 different stamps. David A. Swenson, South Mountain, Franklin County, Penna.

PENNY Approvals, that satisfy. Neil Gronberg, Box 5441-P, Philadelphia, Pa.

CANADA Catalog only 10c, with 50 diff. Canada 25c. World specials—500 diff. 30c, 1000 diff. 85c, 2000 diff. \$2.50. Approvals with each order. Victoria Stamp Company, London 4, Canada.

40 U. S. Stamps. Cat. value \$4.00—25c. Ray Erick, 2402 4th, Hibbing, Minn.

TRANSVAAL! We include a stamp, guaranteed genuine, from this distant and rare country, along with a complete Russian commemorative set; complete Denmark Ancient-Ship set; 3 classic stamps of the world, all over 50 years old; and a complete set of the most historic issue in existence, "The Bosnian Assassination, the Spark That Set the World Afire," all guaranteed genuine, for only 10c! Pearson Bros., 68 Nassau St., Dep't 19, New York.

DUPLICATE Pocket stamp wallet, with valuable stamps. All for 5c, with approvals. Alden Stampco, Springfield Gardens, N. Y.

CANADA—32 Different mint \$2.50, including commemoratives. Summers, 47 Bloomfield Ave., Toronto, Canada.

WEEKLY Stamp magazine, thirteen weeks, 10c. Stamp Journal, Kalamazoo, Mich.

ILLUSTRATED U. S. list, price 50c, large complete U. S. price list free. Stanley Gibbons, 38P Park Row, N. Y.

300 DIFFERENT 20c; 1,100, \$1; 2,000, \$2.50. Fred Onken, 630 79th St., Brooklyn, N. Y.

NEWFOUNDLAND, 15 different 5c with approvals. Hudson Co., Plainfield, N. J.

25 CHINA 10c; 25 Luxemburg 15c; 25 Egypt 10c; 40 Japan 10c. To approval applicants. Ancher Stampco, Rutherford, N. J.

SOUTH Rhodesia (Victoria Falls), Zanzibar, Yemen, 15 fine stamps 5c approvals. L. W. Hudson, 87 Nassau, New York City.

GOOD Cover, with 15c stamp packet. Box 71, Oneida, New York.

166 U. S. including commemoratives, airmails—10c, 500—25c. Box 457, Newark, New Jersey.

MAMMOTH Mystery packet of rare stamps for only 10c to serious approval applicants, also valuable free premiums with every selection afterwards. Our stamps are better and our service is different. Fair-Play Stamp Service, 1215 Browning Blvd., Los Angeles, California.

SURPRISE Package! \$10 catalog value for dollar bill. Guaranteed. Davenport's, 15180 Monica Ave., Detroit, Mich.

50 DIFFERENT Stamps from 50 different countries. Only 10c to approval applicants. R. S. Allen, 1053 N. Stanley, Hollywood, California.

CANADA, Silver jubilee complete, six unused 53c; 30 Canada, 10 Kenya, 15 Egypt, all three 25c. Approvals. Westminster Stampco, 5060, London, Canada.

SURPRISE Gifts with approvals—6c postage. Weston Stampco, Fort Logan, Colorado.

ASCENSION, Grenada, pictorial commemoratives. Also other scarce islands 10c. Provided you desire approvals. Grandstamps, 919 South Grand, Los Angeles, California.

111 ALL Different foreign only 5c with approvals. Johnson, 69 W. 102nd, New York.

40 DIFFERENT South and Central America, including airmails, commemoratives, bi-colors, pictorials; 10c with approvals. Bell, 4401-M Ethland, Baltimore, Md.

200 DIFFERENT Including 50 different British with Fiji, Newfoundland, Cyprus, Canadian commemoratives 10c, approvals included. Mantle Stamp Company, London, Canada.

SPECIAL—To secure approval customers—10 different Canada 3c. Avalon Stampco, 1133 E. 82nd, Chicago.

30 FRENCH 10c To approvals. Arvid Fagerberg, 908 Lee St., Rockford, Ill.

FREE Gorgeous packet including Spanish airset, triangle, ships, maps, and animal stamps. Only 3c postage to approval applicants. Imperial Stampco, Fontana, Calif.

ARABIA, Mongolia, Schleswig, 50 other stamps with approvals 6c. Ransom, 1333 Pontiac, Ann Arbor, Mich.

FD COVER. Scarce naval cancellation. 5c. Approvals. Horace Rush, Benning, D. C.

GIVEN! Borneo, Flume, Kedah, Iceland, Azerbaijan, Danish-West Indies and 100 other different stamps, also special gift for only 10c to approval applicants. Paramount Stamp Co., 4225 Broadway, Chicago, Ill.

FREE! Packet cataloging 80c. 3c postage. Approvals. Clifton English Co., Nashua, New Hampshire.

3000 MIXED From world \$1.00. Longacre, 108-P West 42nd, New York.

FREE!!! 50 Varieties beautiful stamps, copy big Collector's Magazine—Postage, etc. 6c. R. Smith, 914 Watson, Flint, Michigan.

CASH For common stamps. We pay 20c each some present issue used United States. Catalog 25c. Universal, Box 71, Pelham, New York.

\$5 CATALOG Value for \$1. 25, 50 or 100 different stamps from personal collection. Riedell, Greensburg, Penna.

GIVEN—A pleated and stitched pocket stamp wallet with 100 different stamps for 10c to applicants for 1/2c up approvals. Elsing, 768-M Fox Street, New York.

SEND Ten cents for full particulars and samples for making money and big prizes representing the largest monthly philatelic magazine. Stamp and Cover Collecting, Cary St., Richmond, Va.

70 NIGER, Siam, Venezuela, etc., 5 cents. Lufbery, 213 Pine, Middletown, Connecticut.

YOU'VE Tried the rest—now get the best! "Challenge Collection" including Cape Goodhope, triangle, Thessaly octagonal, etc., 10c with approvals. Free airmail collection, additional premiums given regular customers. Bargain Stamp Service, 1332 South Hope, Los Angeles, California.

AGENTS Wanted selling stamps to junior collectors. Sparacia, 1315A Jefferson Ave., Brooklyn, N. Y.

UNITED States Missions 50c, Canada 75c, foreign \$1.00 lb. Mission Co., 4512 North Racine, Chicago.

DEALERS: 164 Page wholesale catalog for 50c deductible on first purchase. Grossman Stamp Co., 102-P West 42nd, New York.

FREE!!! Russia ethnographic set. Postage 3c. Roberts, 901F Fourth, Baycity, Michigan.

50 STAMPS 1c, Mostly obsolete. Album 3c. Bullard, 446 Tremont, Boston.

FREE!! Three sets French Colonies to serious approval applicants. Bargains—beauties. Postage 3c. Kumler, Cherry, Lancaster, Ohio.

110 DIFFERENT Stamps only 3c to approval buyers. Badger Stampco, Milwaukee, Wisconsin.

STAMP Dealers, your ad here will bring wonderful returns. Ask me for proof. F. W. Johnson, Manager, Classified Advertising, Popular Mechanics Magazine, 200 E. Ontario St., Chicago.

STAMPS Sent on approval. 50% discount. Fred Herzberg, 197 Grantley Ave., Elmhurst, Illinois.

200 DIFFERENT 10c. Big 50% approvals. Covert Stamp, 39 State, Rochester, N. Y.

SCARCE Airmail and triangle. Beautiful Uruguay "flying horse" airmail and scarce Guatemala triangle (smallest in the world) are included in our big packet of 60 different stamps from Alouites, Grand Liban, Venezuela, British and French Colonies, etc. All for 5c to approval applicants. Big illustrated lists free with each order. Write today! Mystic Stamp Co., (Dept. 80), Camden, New York.

AIRMAILS—Brazil, Chile, Columbia, Ecuador, Mexico—all for 10c with double premium penny approvals. Progress Stamp Service, Franklin Park, Ill.

THIS Ad worth 25c. If you send for our approvals and buy 50c worth or more—large selection of U. S. and foreign—reasonable prices. Morton Stamp Co., 1121 Olive, St. Louis, Mo.

UNITED States stamps—40 different with pricelist 10c. Seidenberg, Baroda, Mich.

SCARCE Morocco airmail, Eritrea camel stamp, maps of stamp countries, watermark detector, hinges, perforation gauge, stamp album, many scarce stamps, 5c with approvals. Superior Stampco, Box 8276, Palms Station, Los Angeles, California.

MAGNIFIER, Stock book, stamp album, hinges, watermark detector, perforation gauge, millimetrescale, packet scarce stamps. Price 5c with approvals. Atlas Stampco, Box 4025, Culver City, California.

FREE Dollar packet with penny approvals. Harlan, 5307 South Marshfield, Chicago.

KOOKABURRA Bird!! Bolivia triangle! Packet of unusual stamps containing rare Kookaburra Bird, scarce Bolivia triangle, famous money stamp (printed on cardboard and also used as currency); airmails from Mexico and Brazil; map, ship, animal, commemorative, etc. No Europe. Only 10c to approval applicants. DeSoto Stamp & Coin Co., 105 No. Clark St., Chicago, Ill.

IMPERFORATE National Park, 2 diff. and 33 U. S., including early issues; high values; commemoratives; airmail; envelopes; special delivery; postage due; revenues cataloging over 85c. All for 7c to approval applicants. Illustrated pricelist free. Curhan Stamp Co., Dept. P, Gloucester, Mass.

105 DIFFERENT, Hyderabad, Congo, Guinea, etc. 3c to approval applicants. Extra—Airmail set free with above. Hunziker, Box 225-P, Minneapolis, Minn.

ILLUSTRATED Album, spaces 4000 stamps; or 19 beautiful Andorra; or 30 Algeria to approval applicants 20c. Swan Stamps, 604 Swan, Dunkirk, N. Y.

FIFTH Wholesale Review—mailed every dealer, trader, storekeeper. Greatly enlarged. Free. Empire Stampco, Toronto, Canada.

FREE—25 Different United States stamps to approval applicants. Brownie Stamp Shop, Flint, Mich.

STAMPS: 100 Different catalogue over \$2.00 with catalogue 10c. Norman Shultz, Salt Lake, Utah.

SCARCE Zeppelin and triangle. Famous Russia Zeppelin stamp and beautiful Lithuania airmail triangle; also big packet of 53 different stamps including Azerbaidjan, Epirus, new Martinique, etc., and illustrated lists—all for 5c to approval applicants! World-Wide Stamp Co., Box 600, Camden, New York.

5 DIFF. Confederate states (facsimiles), 8c; 12 diff. 25c. Satisfaction guaranteed. Approvals sent. Tatham Stampco, Springfield-125, Mass.

RARE COINS

UP To \$400.00 paid for dime, dated before 1890. Liberty head nickels \$75.00. Pennies \$50.00. Send 15c for coin book. Phillips Coinco, West Springfield, Mass.

INDIAN And Lincoln head pennies wanted. Will pay up to \$2 each if over ten years old. Certain pennies worth \$53. Latest listing 10c. American Coin Co., Box 219, Grand Rapids, Mich.

A GOOD Collection, 20 different coins for 25c postpaid. Hubert Carcaba, St. Augustine, Fla.

50,000 COINS, Medals, paper money. Lists free. Nagy, 8P South 18th, Philadelphia, Penna.

OLD Money wanted. Will pay fifty dollars for 1913 Liberty head nickel (not buffalo). I pay cash premiums for all rare coins. Send 4c for large coin folder. May mean much profit to you. B. Max Mehl, H Mehl Bldg., Fort Worth, Texas.

CONFEDERATE, State, bank bills, continental, colonial paper money, coins, old newspapers, etc. Lists free. Lester White, West Newton, Mass.

OLD Coins, unused postage stamps, old gold bought. Coin book, 15c. William Barker, 1522 Fourth Ave., York, Pa.

\$\$\$ FOR Pennies! \$50 each for Indian heads! \$2 each for Lincolns! 10c brings buying catalog. Nationwide Coin Exchange, 130-B West 42nd, New York.

10 FOREIGN Coins, 10 bills, and price list 25c. Lenz, 50 Station L, New York City.

WE Buy 1907 Indian head cents. Full information one dime (coin). New Miss Mattick Co., Box 3450, Altoona, Pa.

WANTED Indianhead pennies. Everyday purchased. Particulars free. Specialty Stampco, Box 681, Rockford, Illinois.

WE Purchase all Indianhead pennies and rare coins. Purchasing catalogues 10c. Barkley, 287 Broadway, New York.

COIN Collectors: Read "The Numismatist," published monthly since 1888. Latest news, interesting articles. Trial subscription six months \$1.00. Introductory booklet free with subscription. American Numismatic Association, Suite P, 95 Fifth Avenue, New York.

FREE! Foreign coin, banknote, and large illustrated coin catalogue. Send 4c postage. Coin approvals sent. Tatham Coinco, Springfield-125, Mass.

TEXAS, Maryland, Kentucky commemorative half dollars \$1.50 each. 3c piece and selling catalogue 10c. Norman Shultz, Salt Lake, Utah.

SPECIAL Prices on United States commemorative half dollars in uncirculated condition; Columbian 69c; Lincoln \$1.23; Pilgrim \$1.19; Grant \$1.23; Monroe \$1.19; Lexington \$1.29; Stone Mountain 89c; Bennington \$1.29; bargain selling price list and California 50c gold token 25c. Arcy, Box 483, Muskogee, Okla.

RARE United States, foreign coins, war medals. Catalogue 10c. Mengelle, Colorado Springs, Colorado.

UNITED States. Large cent, 2c bronze, 3c nickel and bargain list, 25c. Thirteen dates large cents, \$1.00. George P. Coffin, Augusta, Maine.

\$5.00 To \$500.00 Each paid for old coins. Keep all old money. Send 10 cents for illustrated coin value book. 4x6. Guaranteed prices. Buying and selling. Coin Exchange, Box 5, Le Roy, N. Y.

11 DIFFERENT Coins, 3 bills and catalog, 25c. Creamer's, 1112 Somerset, Baltimore, Md.

CAMERAS, PHOTO SUPPLIES

CAMERAS And supplies. Big bargain book free. Offers tremendous savings on cameras, lenses, photographic apparatus, etc. Still and movie. All listed and illustrated in our new, big, complete bargain book. Write for your copy of this free book now. Central Camera Company, 230 South Wabash Avenue, Dept. K-7, Chicago, Ill.

MAKE Money in photography. Learn quickly at home. Spare or full time. New plan. Nothing like it. Experience unnecessary. American School of Photography, Dept. 343-B, 3601 Michigan Avenue, Chicago.

FREE Book "Photography Self-Taught," with 6-month trial subscriptions. Send only 50c. American Freeman, Box 1790, Girard, Kansas.

AMATEUR Photographers wanted for news service. Box 159, Alton, Ill.

POWERFUL Floodlights. Take beautiful pictures. \$3.75. Surplus, 938 No. Homan, Chicago.

HAVE You a camera? Send ten cents for recent number of our big magazine, showing how to make better pictures and earn money. American Photography, 116 Camera House, Boston, 17, Mass.

INCOME From your camera instead of expense. Low cost home course teaches you to make photographs for magazines, newspapers, advertisers. Tremendous demand. Earn good money wherever you live. Free book. Universal Photographers, Dept. 104, 10 West 33rd St., New York.

PHOTO FINISHING

20 REPRINTS 25c. Films developed, 16 prints 25c. Enlargements 8x10—25c; 5x7—10c. Low Photo, 2657 Neva, Chicago.

FILM Developed and 8 Super Sheen prints 20c. North Chicago Film Service, North Chicago, Ill.

FILMS Developed 2 prints of each 25c; 20 reprints 25c. Pine Photo, 5134 Nevada, Chicago.

20 REPRINTS 25c. Roll developed 2 sets prints 25c. Enlargement coupons. Photo-shop, Sweetwater, Texas.

PRINT Snapshots on handkerchiefs, note-paper, etc., sensitized with photoprint fluid. Dark room unnecessary. Washable, permanent. Send 50c for fluid to print 100 pictures. Park Specialty, 219 Park Place, Brooklyn, N. Y.

SENSATIONALLY Beautiful enlargements on silver or gold metallic paper. Colored 8x10 50 cents. Lerometallic, 2618 N. Halsted, Chicago.

FLORENTINE Royal oil colored silk enlargements, 8x10 size 48c. Three different \$1.10. 11x14—60c. Two 11x14—\$1.05. Four 6x8 or 5x7—\$1.10. 16x20—\$1.50. Made from any size photo, snapshot, or negative. Originals returned. C.O.D. orders filled. Monarch Studios, McAdoo, Penna.

ROLL Developed, eight perfectone prints and two beautiful double-weight professional enlargements, 2c. Barkley Photoservice, 287 Broadway, New York.

HAND Colored enlargement with each roll 25c. 40 reprints 50c. Colorgraph, Dunning Station, Chicago.

KODAK Enlargements 5x7, 10c, 3 for quarter, coin. Send best negative (film). Nint Photo Lab., Dept. 5, Cedar Rapids, Iowa.

EIGHT Guaranteed prints and two professional double weight enlargements. 25c. Perfect Film Service, LaCrosse, Wis.

ROLL Developed and 8 prints 25c, reprints 3c. Five by seven enlargements 10c. Square Deal Studio, Dept. K, Huntington, Indiana.

BEAUTIFUL 5x7 Enlargements 10c, 3 for quarter or 7 for half. Send your best negatives (films) now. Bill's Photo Studio, McAdoo, Penna.

YOUR Money never bought more quality and prompt service. Roll developed, 8 prints and two enlargements 25c. Excel Photo Service, Dubuque, Iowa.

YOUR Favorite kodak pictures enlarged, size 5x7. 10c. Three for quarter, coin. Send best negatives (film) today. Address Darmer Photo Lab., Enlarging Dept. 9, Des Moines, Iowa.

ENLARGEMENTS 4x6 Five for 25c. 5x7 three for 25c. 8x10 three for 35c. Special hand colored easel mounted 4x6, 25c. Enlargers, 1652 North Western, Chicago.

FINER Finishing. Rolls developed and printed. Colored enlargement, or two double professional enlargements all for 25c (coin). Genuine, nationally known. Moentone superior quality. Moen Photo Service, Box P-867, LaCrosse, Wis.

BEAUTIFUL Colored enlargement with each film 25c. Speedy service. Satisfaction guaranteed or money refunded. LaCrosse Film Company, LaCrosse, Wis.

BETTER Photos easily made! Particulars free! Peegee, 76-4, Station H, New York.

TRIAL Roll developed free. Prints 3c each. Feather, Weston, Ohio.

★ HEMPHILL DIESEL SCHOOLS ★

play an important part
in the growth of the
DIESEL INDUSTRY

HERE ARE THE REASONS

1. Hemphill **SELECTS** its students. Only those applicants are accepted whose character references pass investigation and whose natural abilities show obvious promise of developing, through proper training, into capable Diesel men.
2. Hemphill **TRAINS** its students ON **DIESEL ENGINES**. Each Hemphill School is equipped with a **LARGE ASSEMBLAGE OF DIESEL ENGINES**. Hemphill instructors [both Theory and Shop] are particularly qualified for their work.
3. Hemphill **ISSUES** its Certificates only to those selected students who, during their specialized training, pass exacting tests and practical examinations.
4. Hemphill **RECOMMENDS** for responsible positions in Diesel Installation, Operation, Maintenance and Sales Work only those men whose reliability, sincerity of purpose and school record prove them worthy of accepting the responsibilities to which they are assigned.

Not only in these ways but also in widely publicizing the uses of Diesel power, the Hemphill Diesel Schools are contributing actively to the solid growth and nation-wide development of the Diesel Industry.



Hemphill Schools Waukesha Comet recently broke the world's Diesel speed record at Daytona Beach, Florida, thus helping to make Diesel history and increasing public interest in Diesel development.
(Official A. A. A. World's Record)



★ **NEW YORK SCHOOLS**
3128 Queen's Boulevard
Long Island City, N. Y.



★ **CHICAGO SCHOOLS**
1253 Diversey Parkway, Chicago, Ill.



★ **LOS ANGELES SCHOOLS**
2121 San Fernando Rd., Los Angeles



★ **SEATTLE SCHOOLS**
503 Westlake North, Seattle, Wash.

★ **VANCOUVER SCHOOLS**
1365 Granville St., Vancouver, B. C.

Write or visit the nearest Hemphill School for information about Day, Night, and Combination Home Study Courses. A copy of "Diesel News" is free on request.

HEMPHILL DIESEL SCHOOLS

NEW YORK CHICAGO LOS ANGELES
SEATTLE VANCOUVER, B. C.

Caution: We operate Schools ONLY at the locations listed above and are in NO WAY connected with any other schools.

AMERICA'S ORIGINAL EXCLUSIVE DIESEL TRAINING SCHOOLS



Learn Air Conditioning. Be one of the far seeing men to get in early and take advantage of the many new opportunities. Thousands of installations have been made and are being made. Air Conditioning means not only comfortable living, but, in industry, the perfecting of ideal conditions for the manufacture of many products. The creation and control of indoor weather is

AMERICA'S NEXT BIG INDUSTRY

Get your start with the new book by E. W. Riesbeck, International authority. It is complete, non-technical; tells what A. C. is; difference between complete conditioning and cooling; humidification and filtration; all methods and types of equipment; how to figure requirements; make installations; adapt present heating plants to new systems; equip old buildings; use of ozone, etc. 300 Pages. Illustrated. Flexible. Price \$3.50 postpaid. Sent C. O. D. in U. S. if preferred. Small amount extra for postage charged.
Popular Mechanics Press Room 635 200 E. Ontario St., Chicago.

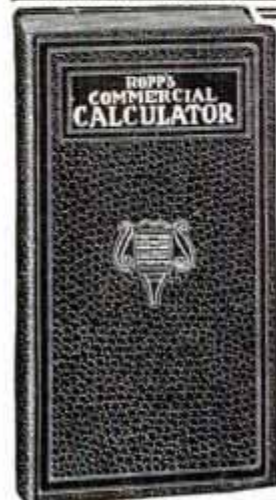

Mathematics Made Easy by ROPP'S CALCULATOR AND SHORT-CUT ARITHMETIC

Shows the Answer as Quickly as a Watch shows the Time to all Problems likely to occur in the Office, Store, Shop, Bank, Farm, or Factory.

Over 2,000,000 Sold
Explains and simplifies every principle in Arithmetic, Mechanics, and Mensuration.

- PRICES POSTPAID
- Desk Size, Flexible Keratol Binding... \$2.00
 - Pocket Size, Art Leather Binding... \$1.00
 - Pocket Size, Cloth Binding... \$0.50

POPULAR MECHANICS PRESS
Room P-7 200 E. Ontario St. CHICAGO

When writing please mention Popular Mechanics

BE AN ARTIST

WE CAN TEACH YOU DRAWING in your own home during your spare time. Thirty-five years of successful teaching proves our ability. Artists receive large salaries.

Write today for Art Year Book
SCHOOL OF APPLIED ART
Dept. 105B, 10 E. Huron St., Chicago, Ill.



GO TO HIGH SCHOOL



IN BEDROOM SLIPPERS!

If you feel the need of a high school education — regardless of your age — you can acquire it in the privacy of your own home after your day's work is done. Mail this coupon for information about our modern and widely recognized high school course. Thousands of adults are studying it every night!

INTERNATIONAL CORRESPONDENCE SCHOOLS

Box 5587-H, Scranton, Penna.

Explain fully about your course in the subject marked X:

- HIGH SCHOOL SUBJECTS
- Automobile Course
 - Concrete Construction
 - Civil Engineering
 - Electrical Engineering
 - Architecture
 - Radio
 - Chemistry
 - Aviation Engines

Name..... Age.....

Address.....

NOW - You Can Really Afford

Automatic OIL HEAT At It's Best

New Improved LACO—\$60 Under Usual Prices!
Burns Cheap Oil New Way—LESS THAN COAL!

Here's an astounding new-type Oil Burner—offered at the World's Lowest Price—that will heat your home perfectly—for **Less Than You Pay For Coal!** Many users report fuel savings of 25% to 50%!

Now you can get away forever from the drudgery of starting furnace fires—handling dirty, costly coal or wood—carrying out ashes!

This new LACO "Model F" is built—and sold on a positive Money-Back Guarantee—by the world's largest manufacturer of oil burners, exclusively. It's a full size, full capacity burner, approved by the Underwriters' Lab. Embodies many new features that eliminate servicing cost—make it the safest—give it utmost durability. Over 50,000 LACOs in use.

Works Automatically Heat turns "on" and "off," without the slightest attention, to keep your home at exactly the temperature you want, constantly. Is magically responsive to changes in temperature.

How It Saves! Burns "heavy" oil which costs less, yet contains more heat! New patented "High Pressure Carburetor" uses 96% AIR, only 4% cheap OIL—mixes them perfectly—creates a Quiet-blast Flame that burns very slowly—to get every bit of heat from every drop of oil.

Fits all furnaces. Is very easy to install. Get Free Book, Low Price, and Special Offer! See if LACO isn't just what you want for your home. Send NOW!

L. A. Cocklin, Pres., LACO OIL BURNER CO., 175 Union St. Griswold, Iowa



DEALERS: Thousands interested in LACO's Low-Cost Oil Heat! Get these easy profits! Have me ship you a Sample Burner—subject to examination—WITHOUT OBLIGATION! Write today for plan.

Home Owners: Have your local LACO dealer quote you the very low price. If he does not carry LACO, write for Free Book and Low Price. Send NOW!



AUTO BOOKS SENT FREE



CAN YOU FIX IT?

These wonder books tell step by step HOW to take out "play" in differential—to kill the shimmy in steering—to set TIMING—how to put your finger instantly on engine trouble and then the quick expert way to FIX it. Newest improvements fully covered. Equal to a complete trade course at less than a fourth the cost.

6 Big Volumes 1935 Edition

2500 pages, 2000 illustrations, wiring diagrams, etc., including Marine Engines, Aviation Motors, Diesel engines, etc. De Luxe edition, gold-stamped flexible binding.

AMERICAN TECHNICAL SOCIETY,
 Drexel Ave. & 58th St., Dept. AB19, Chicago, Ill.
 I would like to see the new 6-volume edition of your AUTO BOOKS. I will pay the few cents delivery charges only, but if I choose to, I may return them express collect. If after 10 days use I prefer to keep them, I will send you \$2 and pay the balance at the rate of only \$3 a month, until \$24.50 is paid. Please include free consulting membership as per your offer above. Send brand new 1935 edition.

Name.....
 Address.....
 City..... State.....
 Attach letter stating age, occupation and name and address of employer and at least one business man as reference.

on approval. Just mail the coupon and we'll send you a set of these remarkable auto books, just off the press. Whether you are a mechanic or helper, expert or apprentice, auto owner or driver, if you're interested in knowing all about automobile mechanics, then take advantage of this FREE OFFER.

DON'T SEND A PENNY!

A better job—in the gigantic auto industry. BIGGER PAY—a chance to go into business for yourself and get a share of the huge profits are waiting for any man who even half tries to improve himself. Learn auto engineering with these wonder books a new way—without studying or memorizing. Simply use the JIFFY INDEX to look up the answer to any auto problem. Built by eleven of America's greatest automobile engineers, and written in simple language so you can understand it. Very newest cars, all covered.

FREE! Privilege of consulting Automobile Engineers of American Technical Society for one year without cost if you mail coupon immediately.

AMERICAN TECHNICAL SOCIETY
 Drexel Avenue & 58th Street
 Dept. AB19, Chicago, Ill.

"Why VOICE Students Fail"

SENT FREE No Obligation to Buy

If you act quick!—we will send postpaid—for 30 days' free reading—new Voice Book disclosing startling VOICE FACTS that may save hundreds of dollars to every man or woman seeking a strong, rich voice for either singing or speaking. 30 days' free reading—then send \$1.00. Otherwise, return it—that's all!

PROF. E. FEUCHTINGER Studio B-135
 64 E. Lake St. Chicago

ARTISTS MAKE MONEY

Find out your ability. Send name, age, occupation and address for Free Vocational Art Test.

Federal Schools, Inc., 7135 Federal Schools Bldg., Minneapolis, Minn.

\$25 A WEEK FOR YOU

and work 12 hours a week. Great plan (illustrated) to breed PR Royal squabs. Ask for new free Library 4, send 3-ct. stamp for mailing. Get details, learn what, why, how, where, 1935 facts.

Plymouth Rock Squab Co., 633 H. St., Melrose, Mass.

RAISE RABBITS FOR US

WE PAY YOU UP TO \$5.00 EACH. ALSO PUT YOU IN TOUCH WITH MARKETS EVERYWHERE. Large illustrated book and catalog, also copy of the AMERICAN RABBIT FARMER and monthly market bulletin showing names of buyers in various parts of America who continuously buy all rabbits offered them. All for 10 cents. Address:

OUTDOOR ENTERPRISE CO., 101 Main Street, NEW CITY, N. Y.

No JOKE TO BE DEAF

—Every deaf person knows that—

Mr. Way made himself hear his watch tick after being deaf for twenty-five years, with his Artificial Ear Drums. He wore them day and night. They stopped his head noises. They are invisible and comfortable, no wires or batteries. Write for TRUE STORY. Also booklet on Deafness.

Artificial Ear Drum
THE WAY COMPANY
 729 Hofmann Bldg. Detroit, Michigan

TRI-STATE COLLEGE

ENGINEERING DEGREE IN 2 YEARS



Courses in Civil, Electrical, Mechanical, Chemical, Aeronautical, Radio Engineering. Essentials of engineering training included and non-essentials eliminated. B.S. Degree granted upon completion of course. For ambitious, earnest students. Those who lack high school training may make up required work. Graduates compete successfully with those of 4-year schools. Technical instruction at lowest cost and in least time consistent with thorough training.

Intensive instruction in accord with individual ability. Courses also in Business Administration and Accounting. Students from all parts of the world. Tri-State graduates make good. Located in picturesque hill and lake region. Tuition, living expenses low. 52nd year. Enter September, January, March, June. Write for catalog. 475 College Ave., Angola, Ind.

When writing to advertisers please mention Popular Mechanics

Become an ENGINEER



Save time and money on your training. **OR DRAFTSMAN ACCREDITED ELECTRICAL, MECHANICAL, CIVIL, ARCHITECTURAL.** Opportunities to partly earn living expenses. B.S. Degree Course 3 years (27 mos.). Also shorter courses. Send for FREE 80-PAGE "BLUE BOOK".

CHICAGO TECH COLLEGE
Dept. H78, 118 East 26th St., Chicago, Ill.

\$1.50 Deal Sells for 49c

AGENTS WANTED to introduce

No. d73 deal consisting of 10 blue steel safety razor blades, 1 tube of shaving cream, 1 styptic pencil and 1 Goodrich hone, all quality merchandise. It's the outstanding seller of the day. At 49c it's a sell out. FREE, wholesale catalog. Send for a copy.

SAMPLE DEAL 29c Postpaid
Doz. 21c ea. deal, Gr. 19c ea. deal
Spors Co., 5-35 Main St., Le Center, Minn.



\$ MONEY-MAKING \$ OPPORTUNITIES

For those who need larger incomes or must seek new occupations.

The following workable, tested plans are adaptable both to the needs of the country or city dweller either for part time development or principal income source.

Every idea set forth in these books has been used by others for profit. They are well worth your consideration.

Plan No. 1—\$50 a Week with Car and Camera. Paul G. Holt tells you how he made a daily average of \$11.30 profit. Price \$1.50.

Plan No. 2—Radio Servicing. Let an expert teach you how to engage in this money making business. Price \$4.15.

Plan No. 3—Refrigeration Service. Official manual covers all makes. Good service men are needed. Price \$5.00.

Plan No. 4—Automobile Refinishing. Start a lucrative business of your own. Fine possibilities here. Excellent new instruction book. Price \$1.50.

Plan No. 5—Outdoor Opportunities. The raising of small animals, birds and plants for profit. Price \$2.00.

Plan No. 6—10,000 Money-Making Formulas. Complete instructions for the making of commodities at small cost that may be sold at a handsome profit. Price \$4.00.

Plan No. 7—How to Make Money at Home. 100 successful ways for women to make money. Price \$2.00.

Plan No. 8—100 Civil Service Examinations. Covering steady Government jobs. All types of positions. Better business means thousands of new jobs. Prepare now by studying this new book. Price \$5.00.

Plan No. 9—Making Poultry Pay. The proper breeding and management of fowls for higher egg production. Price \$2.00.

Plan No. 10—Fur Farming for Profit. Complete instructions that enable the beginner to succeed from the start. Price \$4.00.

Plan No. 11—Rabbits for Food and Fur. A complete guide to the successful rearing and breeding of rabbits. Price \$2.00.

Plan No. 12—The Frog Industry. Should be considered more as a side line than as a major means of income. Price \$2.00.

Plan No. 13—How to Live on a Subsistence Homestead. Facts and figures on how one family fled from the city and found security and independence. Price \$2.50.

Plan No. 14—New Ways to Make Money. Roger Babson points out to young men and women the profit possibilities in 50 fundamental industries. Price \$2.50.

Any of the above mailed postpaid upon receipt of price or sent C.O.D. anywhere in U. S. Pay postman price and few cents postage.

POPULAR MECHANICS PRESS
Room 137 200 E. Ontario St. Chicago, Illinois

FREE How To Secure A Government Position

Tells About These and Other Positions

RAILWAY POSTAL CLERKS \$1850 to \$2700 a year

POSTMASTER \$1200 to \$2500 a year

POST OFFICE CLERK \$1700 to \$2100 a year

R. F. D. MAIL CARRIER \$1800 to \$2300 a year

FREE BOOK tells how I can help you get a Government Job.

For 8 years I was Civil Service Examiner—have helped thousands. If citizen 18 to 50, you may qualify. Get ready NOW for a Government position. Send for free book. Write or mail coupon TODAY.

A. R. PATTERSON, Civil Service Expert, 87F Case Bldg., Rochester, N. Y. Please send me your free book "How to Secure a Government Position."

Name.....
Address.....



MECHANICAL ENGINEERING

—A Field with a Future



This course has meant advancement to hundreds of ambitious men, mechanics, draftsmen, blacksmiths, foundrymen, patternmakers, apprentices, and mechanical engineers—men who wanted to get ahead and to earn more money. You will find, as they have found, that enrolling for an I. C. S. Course is an investment in a Bigger Future. Use the coupon!

ELECTRICAL ENGINEERING

—A Great Industry with a Great Future

The new course in Electrical Engineering covers this fascinating field thoroughly. If you are just starting or are partly on the way to a real paying position in this industry, this new course brings the broader knowledge necessary for advancement. The coupon brings complete information.



DIESEL POWER

A Coming American Industry



The internal-combustion engine represents man's supreme triumph of machine power. Diesel engineers are in great demand.

Many are acquiring necessary knowledge through spare-time study of this modern I. C. S. Course on Diesel engines. Free booklet!

AUTOMOBILE EXPERTS

are always in demand

The rapid progress in manufacture and service of the modern automobile brings new opportunities to thousands of ambitious and forward-looking men. There's always a demand for trained men. The new I. C. S. Automobile Course will make you a trained man! The time to act is now. Use the coupon.



INTERNATIONAL CORRESPONDENCE SCHOOLS

BOX 5584-H, SCRANTON, PENNA.

Without obligation, send me full information on subject checked below:

- MECHANICAL ENGINEERING
 ELECTRICAL ENGINEERING
 DIESEL POWER AUTOMOBILE COURSE
- | | | |
|--|---|--|
| <input type="checkbox"/> Architecture | <input type="checkbox"/> Drafting | <input type="checkbox"/> Accounting |
| <input type="checkbox"/> Concrete Construction | <input type="checkbox"/> Good English | <input type="checkbox"/> Salesmanship |
| <input type="checkbox"/> Reading Shop Blueprints | <input type="checkbox"/> Advertising | <input type="checkbox"/> Show Card Lettering |
| <input type="checkbox"/> Civil Engineering | <input type="checkbox"/> Civil Service | <input type="checkbox"/> High School Subjects |
| <input type="checkbox"/> Diesel Engines | <input type="checkbox"/> Air Conditioning | <input type="checkbox"/> Inventing and Patenting |
| <input type="checkbox"/> Gas Engine Operating | <input type="checkbox"/> Aviation Engines | |
| <input type="checkbox"/> Refrigeration | | |
| <input type="checkbox"/> Chemistry | | |
| <input type="checkbox"/> Highway Engineering | | |
| <input type="checkbox"/> Poultry Farming | | |

Name.....

Address.....

When writing please mention Popular Mechanics

NEW KIND OF MOTOR OIL ENDS STUCK VALVES, LEAKY RINGS!

**FINEST PENNSYLVANIA OIL, NOW REFINED BY NEW SOLVENT
PROCESS, BRINGS BIG SAVINGS ON OIL, GAS AND REPAIRS**

HOW NEW PENNZOIL

1. Cuts oil consumption up to 50%
2. Saves up to 15% on gasoline
3. Cuts valve and piston ring troubles 75 to 90%

ORDINARY motor oils can't stand today's increased speeds and higher temperatures. These oils contain damaging elements that break down under engine heat and cause *sludge*. This collects on valves and piston rings and wastes power, oil and gasoline.

But now comes New Pennzoil, refined by a revolutionary solvent process that *removes* these sludge-forming elements. Result? An utterly new *kind* of oil that saves you money in three different ways! Valve and piston ring repairs are reduced 75 to 90% . . . there is no sludge to cause valves to stick or piston rings to leak. With sludge eliminated, New Pennzoil's tough film is *tougher*—doesn't burn up—cuts oil consumption up to 50%. Because valves and piston rings work freely, you get better compression—more power, speed and pick-up. You save up to 15% on gasoline!

New Pennzoil costs not a penny extra. Just ask any bonded Pennzoil dealer for the correct grade of new Pennzoil for *your* car.



"Ab" Jenkins, in his Pierce Arrow, broke 11 major world's speed records with New Pennzoil.



Note sludgy deposits from *plain* oil on (A) valves (B) piston rings, causing them to stick and leak. Compare with *clean* valves (C) and *clean* piston rings (D) lubricated with New Pennzoil

Faulty Lubrication can ruin your car!

At least 7 different lubricants are vital to your car—and Pennzoil "Safety System" dealers are skilled in how to apply them. Every dealer who displays this sign (shown at right) can give your car the 7 special lubricants it needs—and save costly repair bills later.



TOUGH-FILM

New PENNZOIL

THE OIL THAT GOES FARTHER... FASTER... SAFER



Member Penn. Grade Crude
431 Assn. Permit No. 8

The
PENNZOIL CO.
Executive Offices:
Oil City, Pa.
Los Angeles, Cal.
British-American
Oil Co. Ltd.
Canada

Popular Mechanics Magazine

REGISTERED IN U. S. PATENT OFFICE AND CANADA

WRITTEN SO YOU CAN UNDERSTAND IT

Vol. 64

JULY, 1935

No. 1

THE NEW AGE CHEMISTRY

of

TEN thousand chemists met recently in New York at the three hundredth anniversary of the American Chemical industry and told stories that rival the greatest fiction and fantasy ever conceived by man.

Is there any limit to what men can do in chemistry? After listening to these stories, one feels that chemistry has just begun its amazing conquest of materials and forces, and that it is rapidly giving men greater and greater power over their destiny.

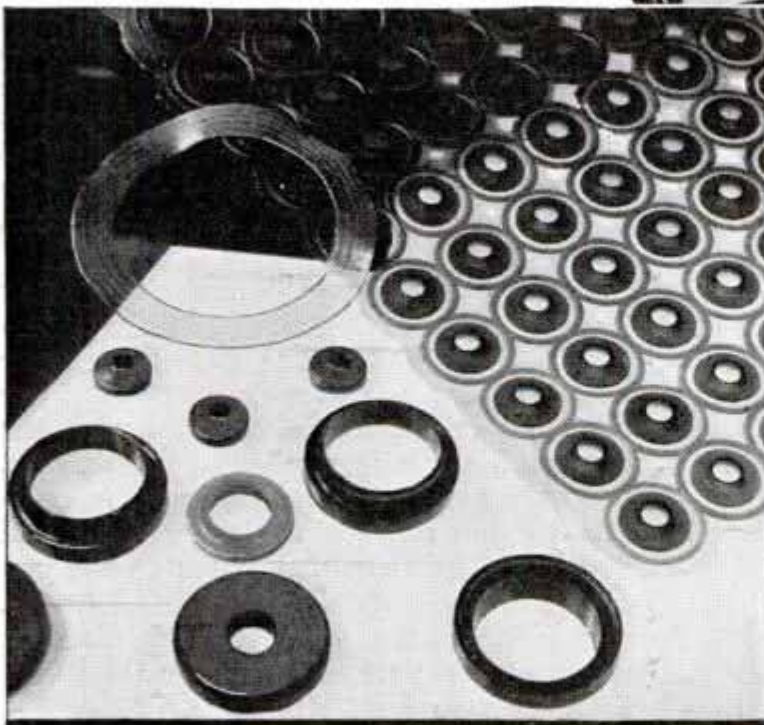
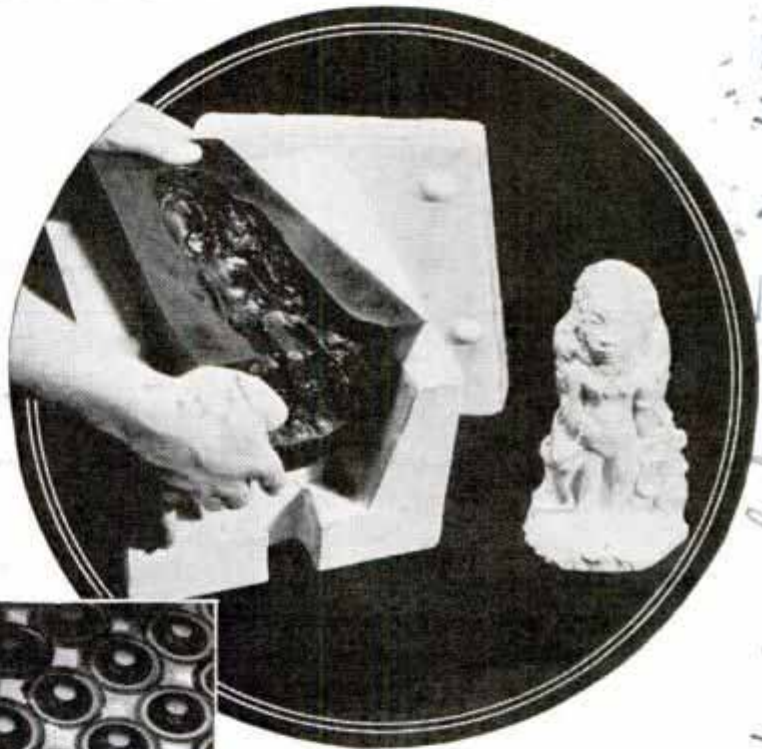

Samples of Products Molded with the Aid of a New Rubber Plastic Material Known as Koroseal

For the most part, the recent chemical discoveries have immediate and direct application to our pressing problems. Human life, health, comfort and prosperity are proper themes for the modern chemist. There is scarcely one field of human endeavor which does not feel the effect of chemical research.

In a single year, American chemists make discoveries that would fill an encyclopedia. Chemists are not always concerned with such materials as can fit into test tubes and retorts. One of the most recent inventions by a chemist is

B. Filsoodrich Rubber Co.

Chester Ohio

Cont. Don Salamoni, 4 W. 105th St. New York

E 528.



Dr. E. O. Lawrence of the University of California, Discoverer of a Process to Make Radium from Common Salt, and Some of His Laboratory Equipment

an amazing machine which can multiply the force of gravity a thousand times. The inventor, Dr. Walter J. Podbielniak, calls it a "centrifugal super-contactor." The true function of this device is to speed up gravity to such a degree that it can do the work of much more elaborate apparatus.

Under the force of gravity, an object travels only thirty-two feet during the first second of its descent; but this new device accelerates gravity to a speed of 32,000 feet per second. This invention will have a far-reaching effect on industrial production. Operating on the principle of centrifugal force, it can do strange and diverse things. Ordinarily it takes four to eight years of "aging" to get rid of the "hangover" in whisky. Dr. Podbielniak's invention can do it in a few minutes. It can separate petroleum into several hundred fractions, some of them pure hydrocarbons which never before have been recovered in the pure state. In present-day refining practice, petroleum is separated into only nine parts in a single distillation. It also simplifies the process of air-conditioning the interiors of automobiles and boats and reduces the space and volume occupied by refrigerating equipment.

Chemistry is looking into our food supply with an eye to the future. The evidence, according to C. F. Schnabel, indicates that in the near future we will make grass the most important part of our diet. This will come out of the full realization that young cereal grasses, such as oats, wheat, barley and rye, when grown in rich soil and cut just prior to jointing, have a health value from 200 to 500 per cent greater than any of twenty common vegetables, including spinach, carrots, lettuce, and endive.

When eating grasses, the important thing is to harvest them before the jointing process. If they are cut one week late, their health-giving qualities decrease fifty per cent. The dried material from these grasses is palatable, tasting similar to malted milk. Only ten per cent of these grasses in bakery products gives them an improved taste. Mr. Schnabel estimates that if you feed a hen one pound of this dried grass a month, it will increase her production ten dozen eggs a year, and on less total feed than she would eat otherwise.

One pound of "grass meal" contains more vitamins and greens than fifty pounds of fresh head lettuce, which sells for about

65
222 E. Superior, Chicago
% Industrial Research and
Analytical Laboratories

1026 Keith Ave. Berkeley, Calif

see July 1940 - 10. Oct. 1940 - 609

90 Fairfax Airport
Wilmington, N.C.

ten cents a pound. On this basis, grass meal is worth about five dollars per pound, but actually sells for much less.

A commercial process for manufacturing "heavy" water has been announced by Dr. D. S. Cryder and his colleagues at Pennsylvania State college. The first commercially produced heavy water cost \$80 a gram or about sixteen drops. Penn State can make it for \$20 a gram; but within the last month New York has received heavy water from Norway at two dollars per gram. Two and a half tons of ordinary water contain one pound of heavy water.

The process evolved at Penn State will, if developed commercially, bring down the price of American-made heavy water to two dollars per gram. It is planned to link the manufacture of heavy water to steam boilers in power plants. About one trillion pounds of steam are generated in the power and light industry of the United States annually. If only one per cent of the heavy water in this steam were extracted, it would amount to 2,000,000 pounds a year. At the Norwegian price, 2,000,000 pounds of heavy water would be worth nearly a billion dollars. As yet no commercial use has been found for heavy water.

Edward Bartow, president of the American Chemical Society, says that farm products now disposed of as sewage will soon be made to yield vitamins of importance to human health. The chemist has already learned how to save ninety-nine per cent of the kernel of corn. The same is true of sugar cane, which yields molasses as a source of industrial alcohol, a solvent, a fuel, and fiber board.

What bothers us in summer is the humidity, not the heat. Why then, ask F. R. Bichowsky and Gilbert A. Kelley, chemists, cool the air? That is how they hit on the idea of conditioning air by removing the humidity. They have discovered that a strong solution of lithium chloride will

(Continued to page 114A)

Secrets of Inner Eye Revealed By Special Camera



Top, Photographing the Inner Eye with Special Camera; Bottom, Photo of Eye Showing Minute Blood Vessels

Photographs of the inner depths of the eye may be taken with a new camera at the Stanford University school of medicine as a means of helping the physician record the progressive treatment of various diseases. The outfit is a Zeiss-Nordensen ophthalmoscopic camera. By use of the photographic prints, a detailed study may be made of the arteries and veins of the retina, as well as the optic nerve, over which visual impressions are carried to the brain. The camera has an indirect system of lighting, a device that functions like a flash bulb giving light only for an instant as the picture is snapped. Subdued lighting prevents injury to the eyes.

Carl Zeiss, 485 Fifth Ave New York.

Pal Alto Calif
Dr. L. R. Chandler

Go Surface Combustion
2375 2nd Ave

Clipper Conquers Pacific on Hawaiian Hops



Giant Thirty-Two Passenger Sikorsky, Pan-American Clipper, in Flight over Los Angeles Shortly Before History-Making Round Trip from the United States to Hawaii; Powered by Four Engines, the Ship Set a New Record on the West-Bound Hop, Then Conquered Headwinds on Its Twenty-One Hour East-Bound Flight over the Pacific; the Trip Blazed the Trail for Air Service to China; Below, Capt. Edwin Musick, the Clipper's Commander (Right) and Pilot R. O. D. Sullivan Coming Ashore



Pan American Airways
 135 & 42 nd
 newford

Blazing Trail for Passenger Air Line to China

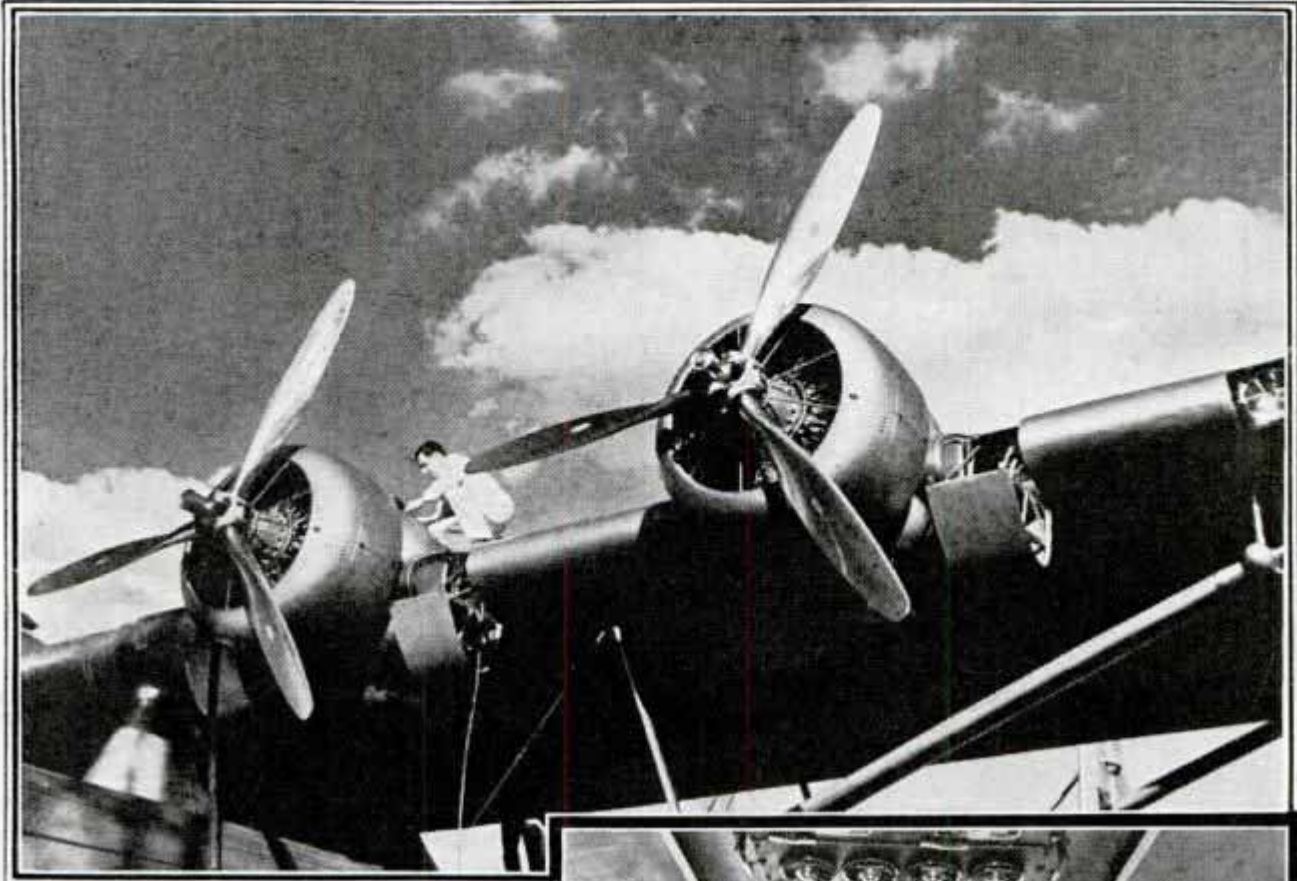

Top, Tuning Up the Giant Motors of the Clipper for Flight to Hawaii; This Photo Shows Two of the Four Engines Which Give the Ship a Speed of 150 Miles per Hour with a 3,000-Mile Cruising Range; Right, Capt. Edwin Musick, Left, and Pilot R. O. D. Sullivan Take It Easy While a Mechanical Device, the Gyropilot, Flies the Clipper; Two Small Gyroscopes Spinning at 13,000 Revolutions per Minute, Acting through Hydraulic Power Unit, Control Ailerons, Elevators and Rudder

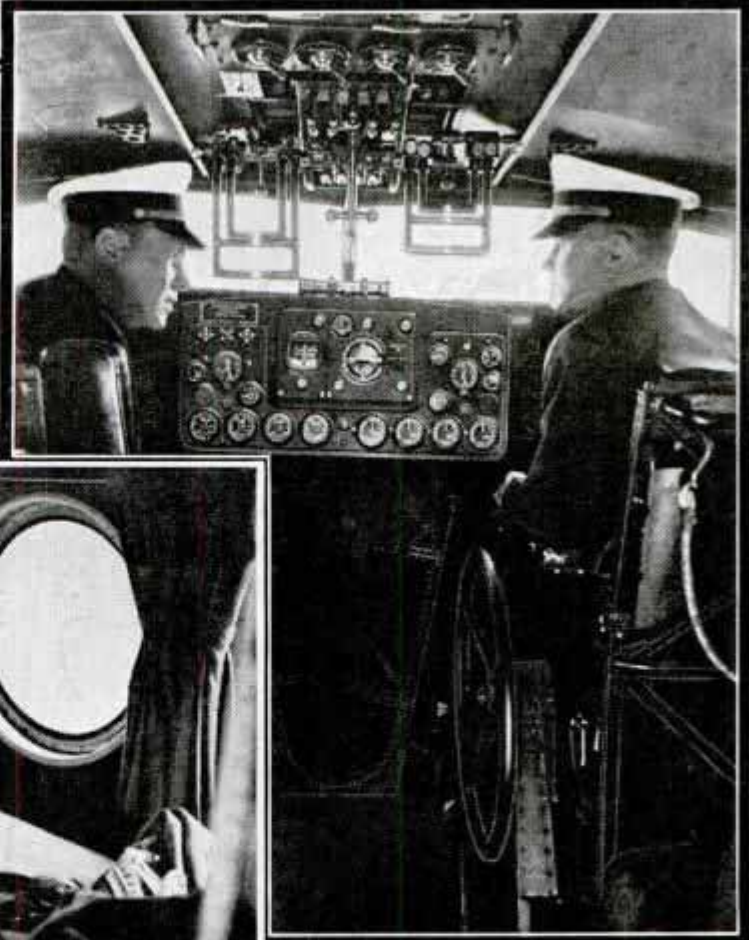

Left, One of the Four Sleeping Bunks in Clipper Which Were Used by Members of the Crew on Round-Trip Flight from U. S. to Hawaii

6
 500

Soap-Box Races Test Skill of Boy Engineers

Fashioning four-wheeled vehicles from pieces of iron and wood, several hundred thousand boys will compete this year in the elimination contests and finals of the All-American Soap Box Derby, which has developed into a nation-wide annual event. In 100 cities, elimination races will be conducted under the sponsorship of as many

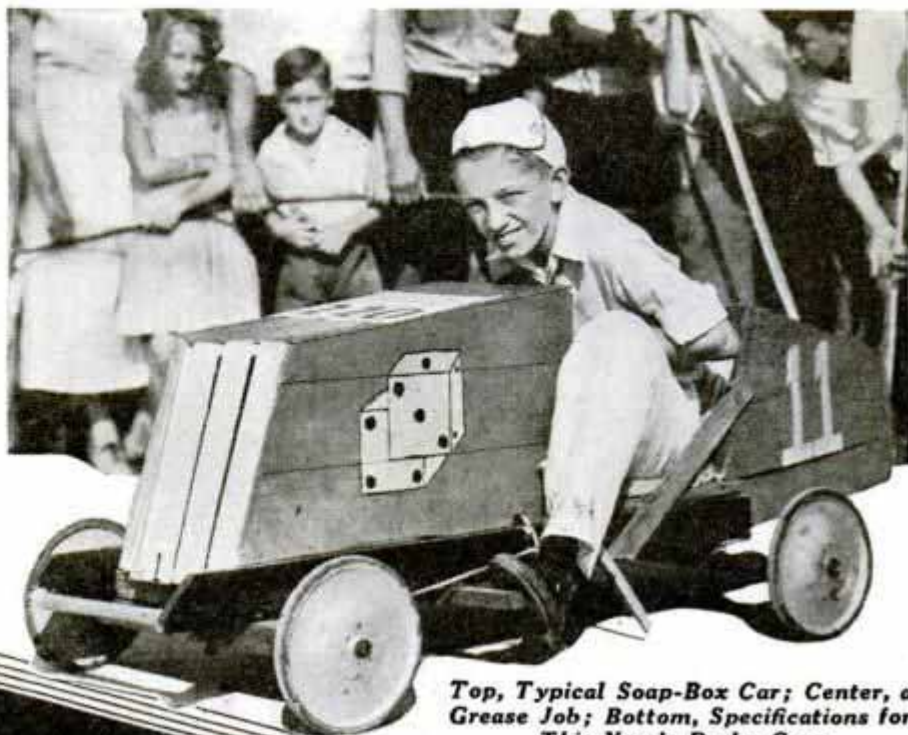

Top, Typical Soap-Box Car; Center, a Grease Job; Bottom, Specifications for This Year's Derby Cars

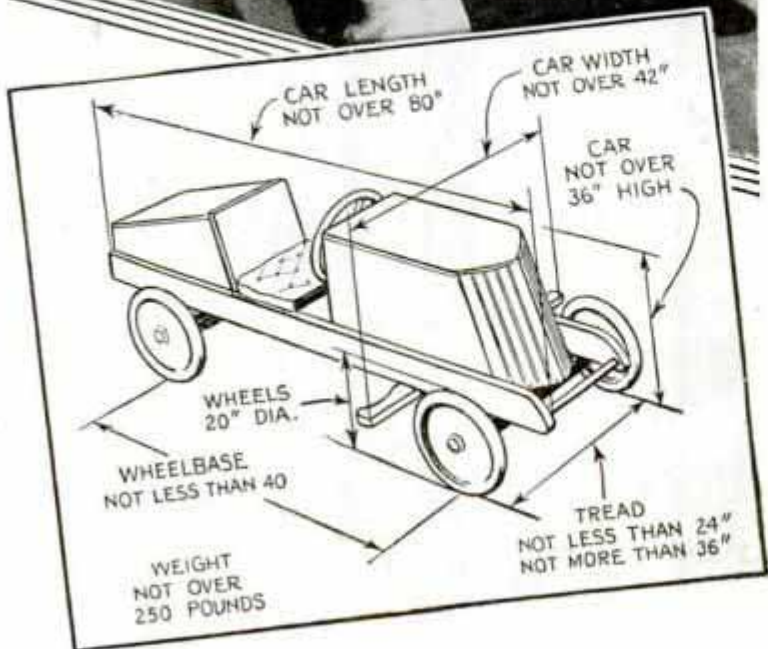
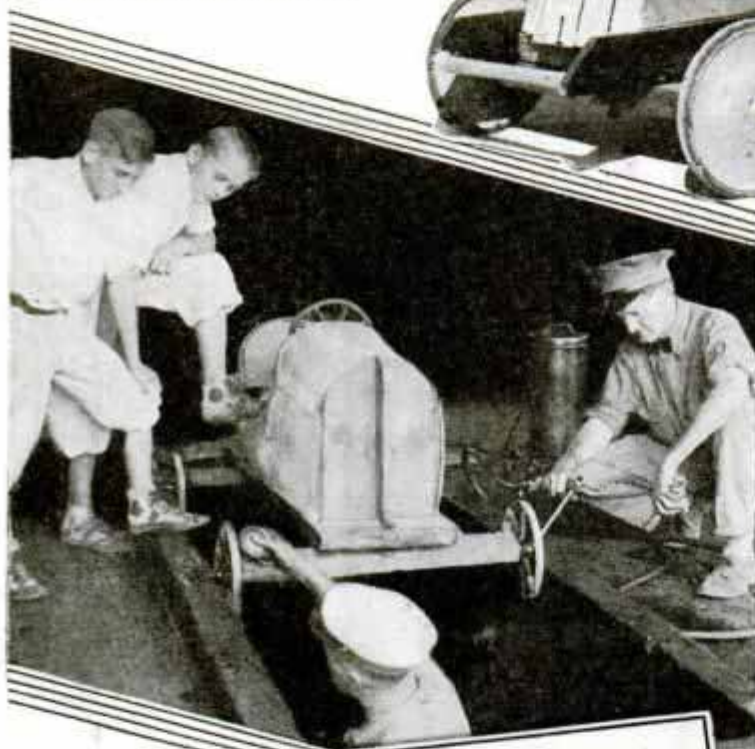

newspapers to determine winners who will compete in the final contests on August 11. The national contest, fast becoming one of the greatest amateur racing events in the world, is co-sponsored by the Chevrolet Motor company, with a list of rewards for winners. In constructing their racing cars according to rules formulated by a technical committee, the boys' ingenuity and ability are taxed to devise ways to make the cars run fast down hill without being pulled or pushed. Of course, the "soap box" vehicles have no engines. Specification limits are fixed so that no car will be longer than eighty inches, wider than forty-two inches and higher than thirty-six inches, exclusive of the steering wheel. Any type of wheel bearing and any type of tire may be used, so the individual builder is free to select plain, roller or ball bearings and hard or pneumatic tires if he decides that one or the other will increase the speed. Any safe steering equipment and any safe brake may be used. To make the races still safer, the grade of the 1,800-foot course

42-0 W.
 Milwaukee

on which the boy drivers compete is limited to not more than ten per cent. So skillfully are some of the cars constructed, automotive engineers have made plans to "scout" the 1935 finals for the purpose of picking up ideas that might be applied to the automobile. For instance, in last year's derby, one young driver wheeled his mount down the course at a speed of fifty-six miles per hour in a demonstration of how far even a "boy engineer" may go to eliminate friction and to attain balance in a four-wheeled vehicle. Other racing cars, less skillfully built and equipped with fewer aids to speed, chalked up a general average of about twenty-six miles per hour. There will be three classifications, or divisions, in this year's races:

class A will include drivers aged six through nine; class B, drivers aged ten through twelve, and class C, drivers aged thirteen through sixteen. Winners in each bracket will be determined. Then these three drivers will race for the local championship and for the right to represent their city in the national event.



© Planet News
 Figures Made of Concrete Depicting a Highwayman Holding Up a Stagecoach; the Group Forms Part of the Decoration of a Garden

FIGURES MADE OF CONCRETE DECORATE HOME GARDEN

One Englishman who fashions concrete models as a hobby has decorated his garden with groups of figures depicting historical events. One shows a highwayman holding up a stagecoach, all the miniature figures being made of concrete.

CAR SEATS MADE INTO BED BY ADJUSTABLE HINGES

For the tourist, hunter, fisherman, salesman and other travelers, adjustable hinges are available for converting the seats of the sedan automobile into a bed. The hinges permit the back of the front seat to be lowered to the level of the front and rear seat cushions, thus making a bed. Installed on the inside of the seat arm, the hinges are invisible and self-supporting. Adjustments are made easily.

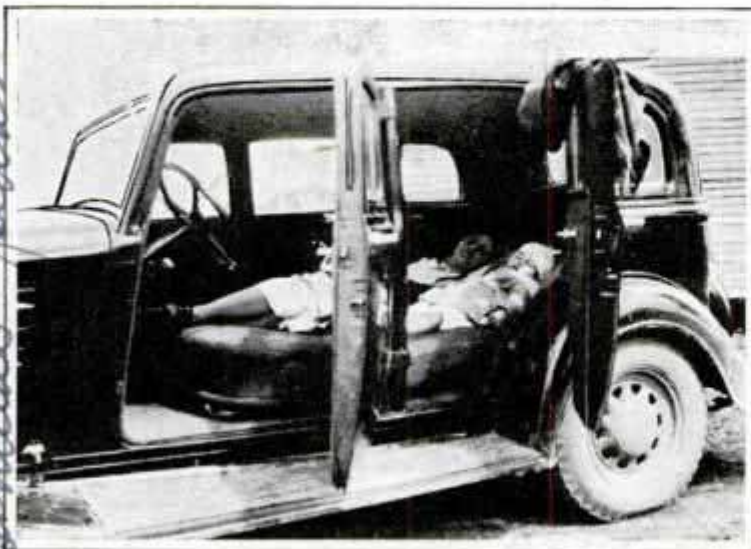

Showing Hinged Seats in Position for Resting or Sleeping on Tour; Adjustment Up or Down Is Accomplished Quickly

see April 1932 -
 similar plans

H. Scott Spring
 Essex, England

8505
 Lyle Esrander
 Edenville Mich

*Lyle Esrander
 Edenville Mich.*

5/7/35

8
E 490

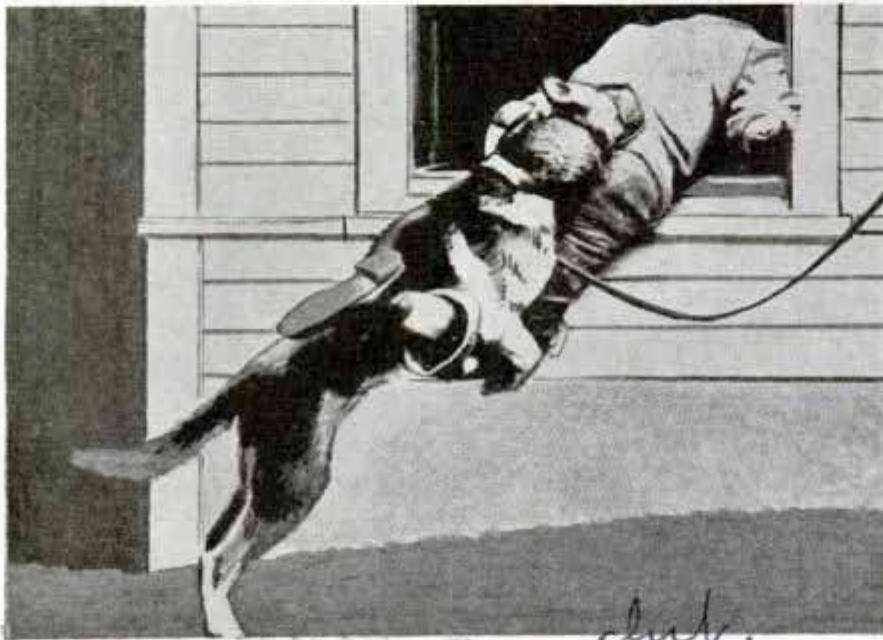
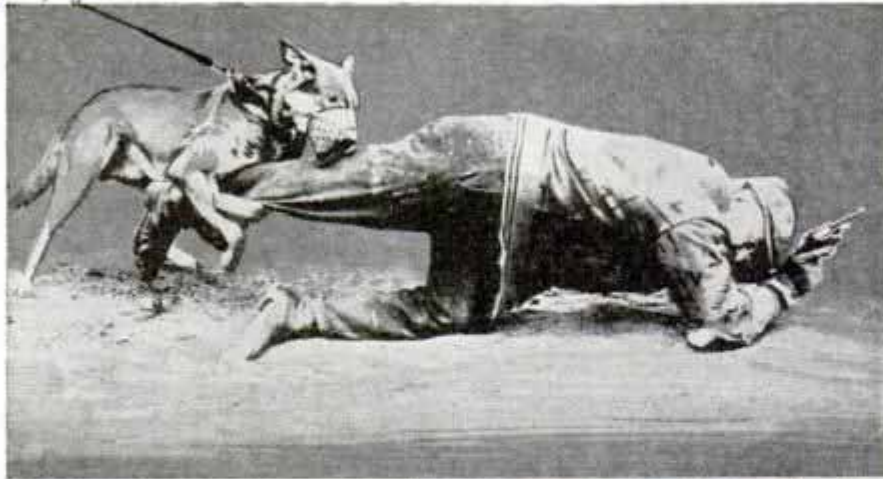

Top, Dog Holding "Criminal" After Tripping Him; Bottom, Dragging "Burglar" from Window by Using Legs and Paws Like Arms and Hands

TRAINED DOGS TRIP CRIMINALS WITH THEIR FRONT PAWS

Almost human in action, the trained dogs of the New York police department chase, trip and hold fugitives. In training, the dogs are taught to chase a man marked as a criminal. Using their front paws as hands, they trip the fugitive and then lock their front legs around his leg, arm or body to hold him. The dogs also are trained to drag prowlers from windows.

TELEVISION FOR NEW YORKERS PROMISED BY TEST STATION

Television with ten times the detail shown in the crude experimental pictures of a few years ago will be broadcast within twelve or fifteen months in the New York metropolitan area. David Sarnoff, president of Radio Corporation of America, has

announced that \$1,000,000 will be invested in a transmitting station, in the manufacture of receiving sets and in a program service. American television already is prepared to deliver pictures superior in detail to those being broadcast in Europe, further progress awaiting the move from laboratory to field. At present television pictures with 343 lines to the inch are available, compared with the thirty-line pictures of a few years ago. What can be seen with television, Mr. Sarnoff said, is "comparable with what one sees of a parade from the window of an office building, or a world series baseball game from a near-by roof, or of a championship prize fight from the outermost seats of a great arena." Transmission at first will be limited to a twenty-five mile radius and it is emphasized that wire facilities are not available for wide distribution, and such mass broadcasting is neither here nor "around the corner."

tion, and such mass broadcasting is neither here nor "around the corner."

EXPANDING RIVET SEALS HOLES IN TANKS OR BOILERS

Made with a lead alloy mushroom head, an expanding rivet is available for repairing holes in tanks, boilers, air compressors, pipe lines and other metal surfaces. As the nut is turned up on the bolt, a brass former causes the lead alloy head to take a mushroom shape that plugs the hole. The device also can be used as an expansion bolt or anchor bolt in concrete, brick and tile.



the hole. The device also can be used as an expansion bolt or anchor bolt in concrete, brick and tile.

multi seal mfg co, merchandise mark, nos 3900, Chicago

E 568

50 Rockefeller Plaza

A vintage Boeing transport airplane, likely a Boeing 247, is shown in flight, banking to the right. The aircraft is dark-colored with the word "BOEING" visible on the upper surface of the left wing. It is flying above a thick layer of white and pinkish clouds. In the background, a snow-capped mountain peak, identified as Mount Rainier, rises above the cloud layer. The sky is a mix of blue and white. Below the clouds, a grid-like pattern of land, possibly a city or airport, is visible. The overall scene is a classic aviation advertisement illustration.

LATEST type of Boeing transport flying above the clouds with Mount Rainier showing in the background.

KEEPING THEM
in the
AIR



AIR passengers soon tire of looking at the scenery and must seek other pastimes. Here two of them are enjoying a game of checkers above the clouds.

THE thousands of passengers who travel millions of miles annually by plane usually credit the success of air transportation to the veteran pilots who sit at the controls. But the nation's airlines could not pile up a total of 55,000,000 miles annually without the aid of a group of earth-bound men who know nothing about flying a ship. For each pilot in the air there are ten men on the ground engaged in keeping the transport planes flying.

It is the skilled hand of the experienced engine mechanic, the watchful eye of the airplane inspector and the careful and painstaking work of other experts on the ground that make it possible for the pilot to write an "All O.K." report at the end of his run.

United Air Lines, operating coast-to-

coast and border-to-border, flies 1,350,000 miles per month, and the mainspring of this far-flung air network is an airplane "round house" at Cheyenne, Wyo. Here, on the roof of the continent, is the world's largest airplane overhaul and repair base manned by 500 expert plane mechanics, engine mechanics, instrument technicians, sheet-metal workers, machinists, riggers, battery men, radio experts, seamstresses, inspectors and foremen. To this base, built on a mile-square airport more than a mile above sea level, comes each of United's fleet of fifty-five transports for complete overhaul and repair after each 350 hours of flight duty. Five days later, the ship goes back on the line, virtually as fit mechanically as the day it was delivered from the factory.

The mobility and flexibility of airline

operations have given aviation an advantage over earth-bound transportation agencies and have enabled United Air Lines to consolidate its overhaul and repair activities at one point nearly 2,000 miles from New York and more than 1,000 miles from San Francisco. Here the airline erected a plant larger than the average airplane factory and just as well equipped to build planes from the drawing board to flight tests. It staffed this plant with the cream of aviation's crop of ground men. Supervisory jobs were filled by veterans of ten years and more of experience in air transportation; but among the mechanics are progressive young men, trained in the best aeronautical schools, whose qualifi-

36040 R
New York



SERVICING and testing the hundreds of spark plugs at the air transport "round house" at Cheyenne, one of the many operations involved in overhauling and repairing the transport planes. Left, testing a directional gyro which has been removed from one of the transports for inspection and service.

281

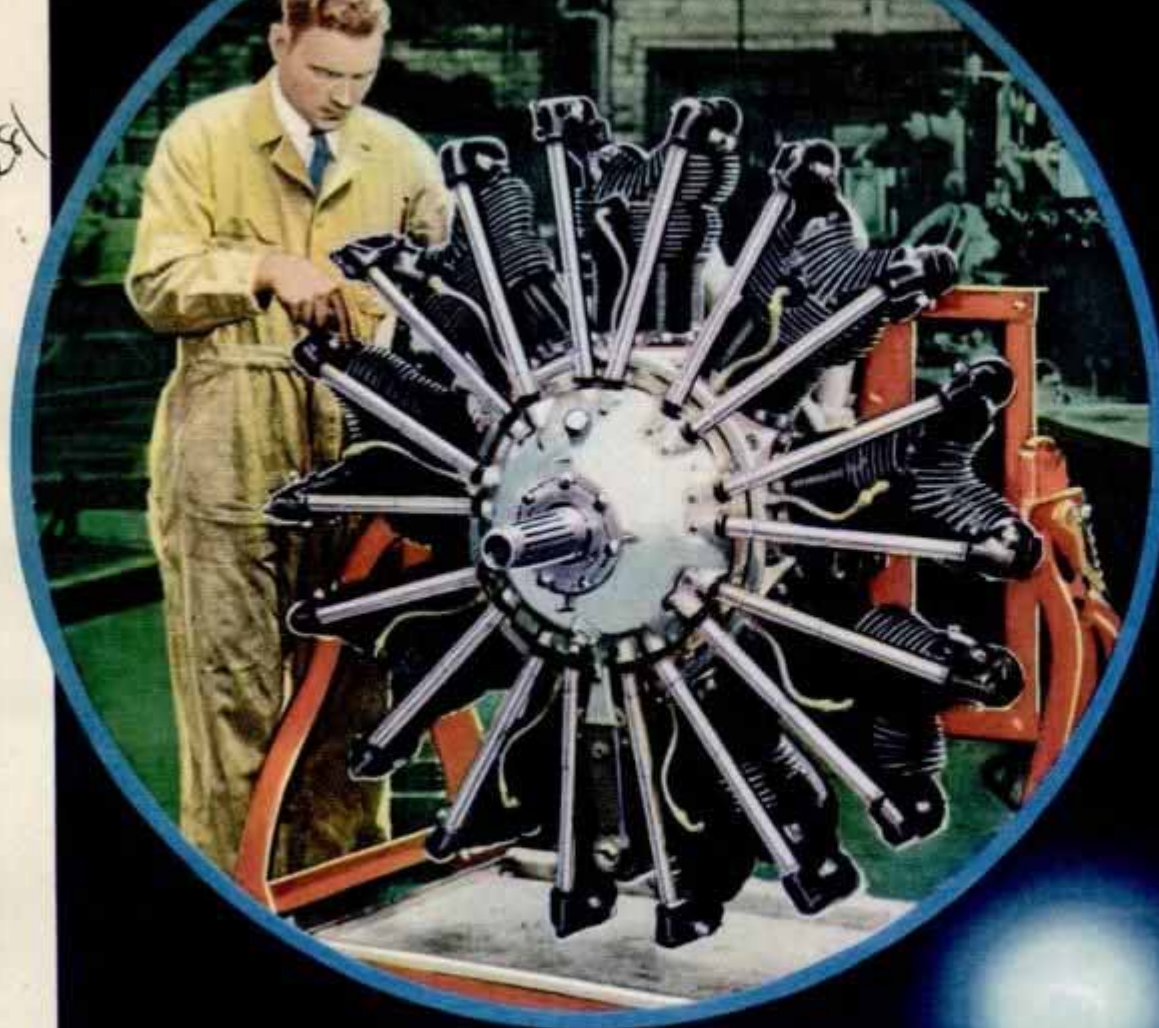

TRANSPORT plane standing in front of the Union Air Terminal, Los Angeles, before its midnight departure for the north Pacific coast cities. Left, preparing an overhauled engine for a several hours run on the test block at Cheyenne.



8281



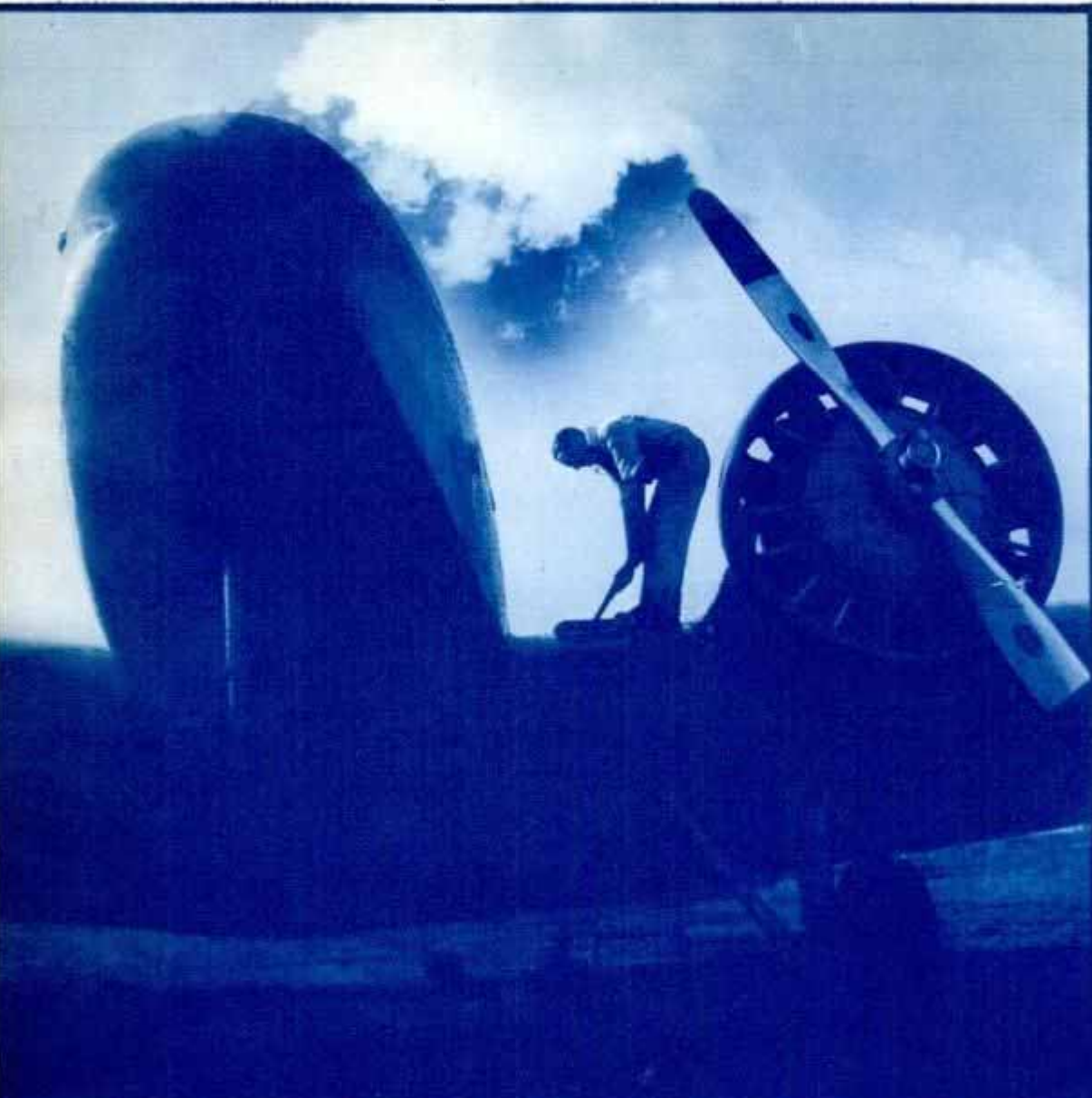

REFUELING a big transport plane during one of its few stops on a coast-to-coast run. Below, examining bearings under a microscope to detect flaws, one of the many painstaking tests of the parts of a plane being overhauled at Cheyenne.



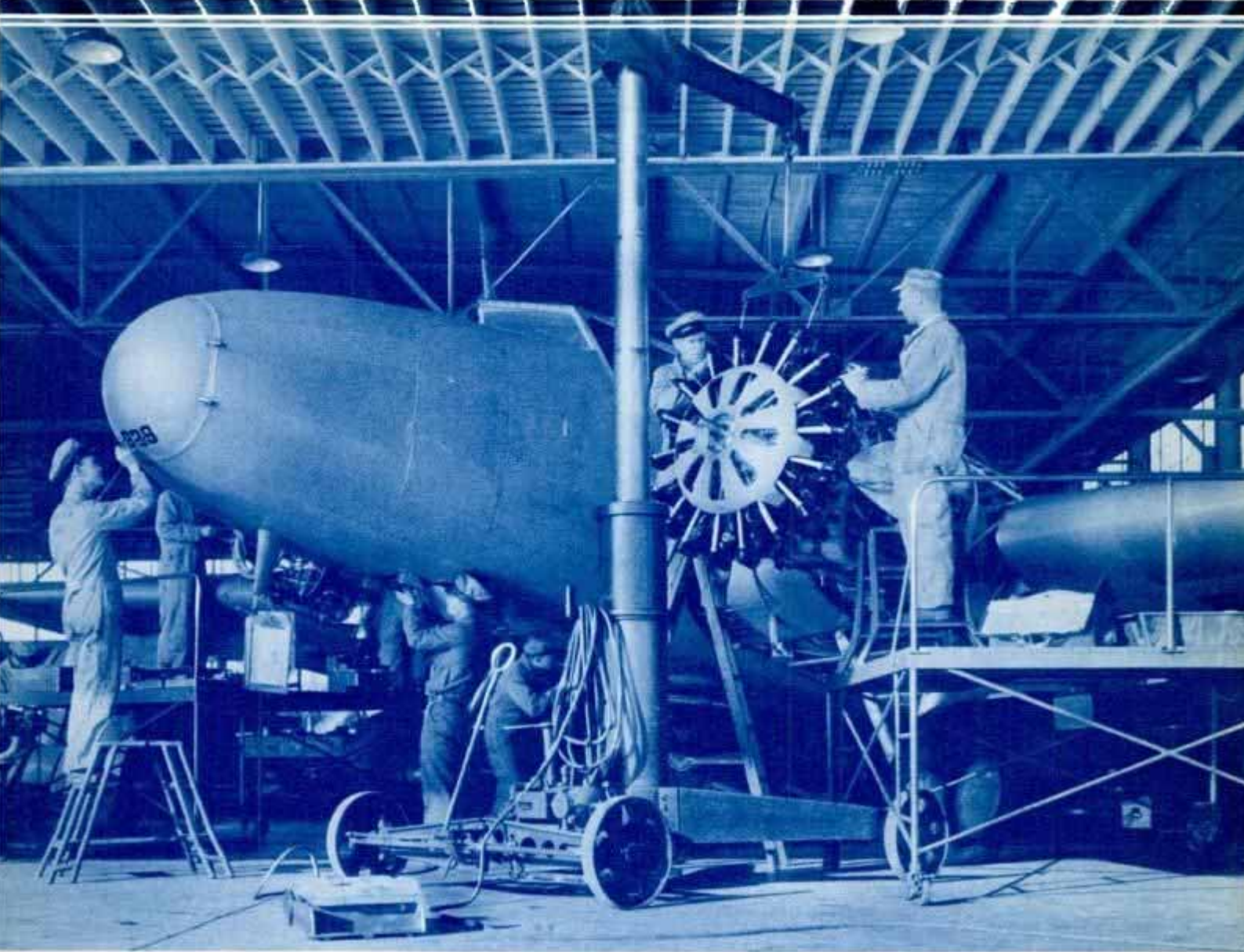

INSTALLING motor in an overhauled ship at Cheyenne. This motor was operated for several hours on a test block after it was reassembled.

ations have been certified by government license. This Cheyenne staff represents one-third of the company's 1,500 employes.

This plan of eliminating guesswork from the mechanical operation of an airplane, which reaches its zenith at the Cheyenne overhaul base, is carried out along the entire 6,000-mile system. After every scheduled flight made by a transport plane, it is inspected at the terminal, where mechanics make 190 different checks on engines, propellers, fuel system, electrical system, fuselage, controls, landing gears, instruments and other parts. After each forty hours of service the ship is given a more thorough inspection. At the eighty-hour period spark

plugs are changed, electrical accessories are serviced and changed and brakes are overhauled. The forty and eighty hour overhauls are continued until the airplane has flown 300 hours when it is withdrawn from its particular route and transferred to the Salt Lake-Cheyenne-Chicago sector. It is flown on this run until it reaches 350 hours, when it is landed at Cheyenne and turned over to the overhaul and repair station.

Immediately the maintenance crews begin to function like clockwork. First, the airplane is given a thorough bath of soap and water so dirt and grease cannot mask flaws. The engines are removed by hydraulic hoists and conveyed to the engine overhaul department, the propellers



A TRANSPORT plane leaving the Cheyenne "round house" after a complete overhaul, ready to go back into service on the coast-to-coast run.

being routed to the propeller department. Radio apparatus goes to the radio service crew. The cabin is stripped of its furnishings for cleaning and necessary replacements. A crew of inspectors examines every inch of the fuselage and wings. Portions of the wings are removed so examination of the interior construction can be made. The inspectors check the different parts of the plane on charts, and where service or replacement is necessary, the work is assigned to specialists in the different fields. Fuel lines and oil lines are removed and replaced with new systems, control wires are checked, and the flying

instruments are removed from the cockpit and assigned to the instrument overhaul and repair shop. Landing wheels are removed and the shock-absorber units are serviced, brakes tested and tires are examined and changed if necessary.

The three-bladed controllable pitch propellers, weighing 242 pounds each, are taken apart, the blades are ground with special buffers, and then dipped in an acid bath which reveals flaws. The blades are examined under microscopes and slight nicks are ground away carefully to prevent them from developing

(Continued on page 126A)

Shenectady, N.Y.

Speedline Engine Is Steam's Answer to Diesel

Meeting the challenge of the streamline Diesel powered train and the conventional steam locomotive, the Chicago, Milwaukee, St. Paul and Pacific railroad has entered the traffic race between Chicago and St. Paul with a speedline train drawn by a medium-weight locomotive designed for great speed. Its builders claim for its power plant the ability to drive seven-foot wheels, largest driving wheels on any American locomotive, at better than 120 miles an hour. The Milwaukee road's "Hiawatha" will travel the 410-mile route in 390 minutes, matching the running time of the Burlington line's Diesel driven, lightweight articulated twin "Zephyrs" and the Chicago and North Western railway's heavy type "400." Like the latter, the "Hiawatha" is an oil-burner, develops 300 pounds steam pressure and is so friction-proofed by roller bearings and lubricating systems as to obviate operating stops. The six coaches, parlor cars and cafe cars of steel welding

840 rpm & labor. Chicago



Trim Lines for Speed Feature the Medium-Weight Oil Burning Steam Locomotive of the Milwaukee Railroad's "Hiawatha"

construction are about one-third lighter than the ordinary type, and present an unbroken line from the wind-cleaving nose of the locomotive to the beaver-tail of the last car, which closely simulates the rear of the streamline automobile. Passenger cars introduce new features in equipment and are air-conditioned.

BABY'S PALM PRINT PROVES IDENTITY

Palm prints of newborn babies proved an unflinching method of identification in 2,700 cases studied by an Illinois physician in conjunction with the Northwestern University crime laboratory. Dr. Gilbert P. Pond, who directed the experiments, said the footprint identification scheme commonly in use is of value only two weeks because of changes in the creases and folds of the baby foot. Finger and toe prints were too small. With prints of the palm Dr. Pond said he could establish identity in three to twelve minutes. Permanent identification records have been made even with the palms of prematurely born infants, since the palm ridges remain unchanged through life.

657/

Chicago Daily News 5/9/25

510 Oct 1935

Cal Park, Ill. 703 991 12

8486

Berlin Germany

RUBBISH MADE INTO MATERIAL
USEFUL IN BUILDING



Acme

Slab of Building Material Made from Waste; Cost of Manufacture Is Low

Constructed by a chemical process, a building material made of rubbish has been introduced in Germany. The material, which is fireproof, can be used for partitions. It is much cheaper to produce than ordinary materials for which most of the raw products must be imported.

FELT PACKING IN VALVE SPRING SAVES GAS FOR AUTOIST

Improved valve action and reduced gasoline consumption are two results claimed for felt packing that is installed inside the

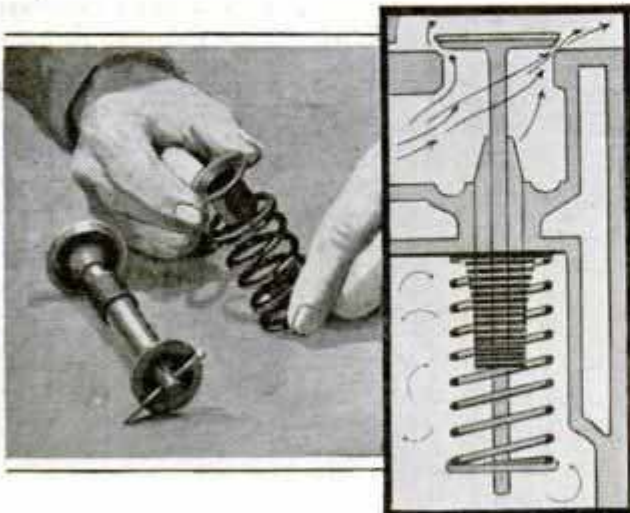

Spring with Felt Packing Seals in the Oil and Keeps Air from Entering Cylinder

valve spring. Essentially a coil spring with a circular felt washer within it, the packing acts as a seal to keep in oil and to prevent air from getting into the cylinder around the valve stem. Air leakage destroys the balance of the gas mixture and results in a sluggish motor and increased consumption of gasoline. The felt acts as an oil wiper, increasing the vacuum and drawing the oil from the valve chamber to lubricate the stem. The spring automatically takes up wear in the packing.

8456

COMPLETE HOME WORKSHOP CONTAINED IN ONE UNIT

Five power tools for the home craftsman are contained in a single compact unit suitable for both metal and wood work. The machine includes a lathe, jig saw, drill press, sander and grinder. The same

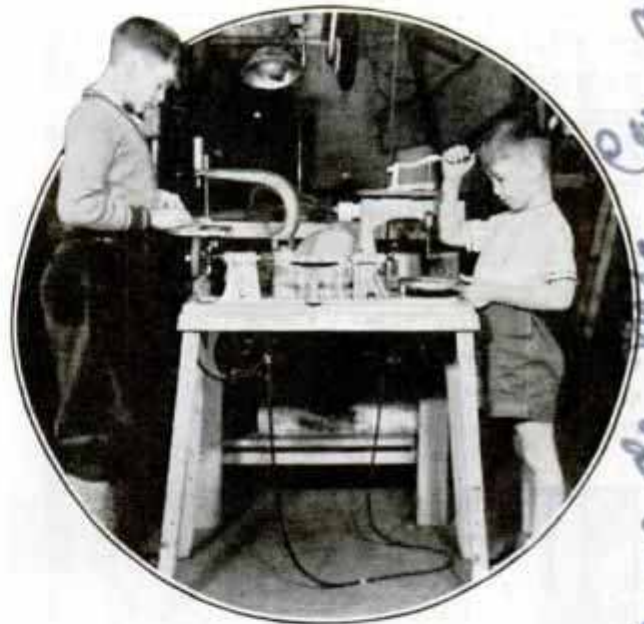

Compact Home Workshop Unit Containing a Lathe, Jig Saw, Drill Press, Sander and Grinder

V-belt operates each unit, the electric motor being turned into position and the belt changed quickly from one part to another. When the operator is using one tool, the others do not interfere with the work. A mounting plate for a one-fourth, one-sixth or one-eighth horsepower motor is furnished as is a four-step motor pulley and V-belt. The lathe has an eight-inch swing and turns fifteen inches between centers and the jig saw uses standard plain end saw blades. The drill press can be used on both metal and wood and the disk sander is eight and one-half inches in diameter.

Arca de 1937. Co. 310 Ave. de Arca. 210 Ave. de Arca. 210 Ave. de Arca. 210 Ave. de Arca.

8499

Del. Cent. 7087

Lindendoll Corp.
228 N. La Salle.

Latest Diesel-Engine Train Built Like Airship

Powered by two 400-horsepower engines, the latest train will carry passengers over the forty-three mile stretch between Boston and Providence in forty-five minutes. The three-car train, built in the factory that produced the airships "Akron" and "Macon," has features borrowed from the airship and the airplane. It is the same at both ends and capable of operation in either direction. One engine will drive the train. Speed in ex-



Top, Interior of Passenger Coach; Center, the Train on Test Run; Bottom, One of the Two Powerful Diesel Engines That Drive the "Comet"

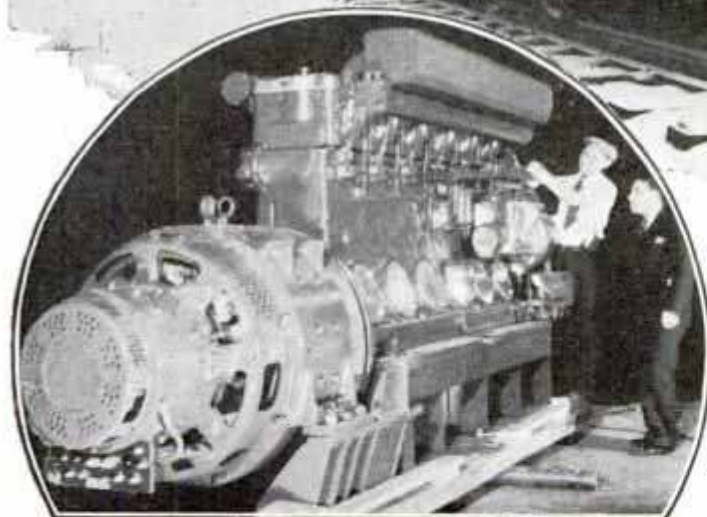
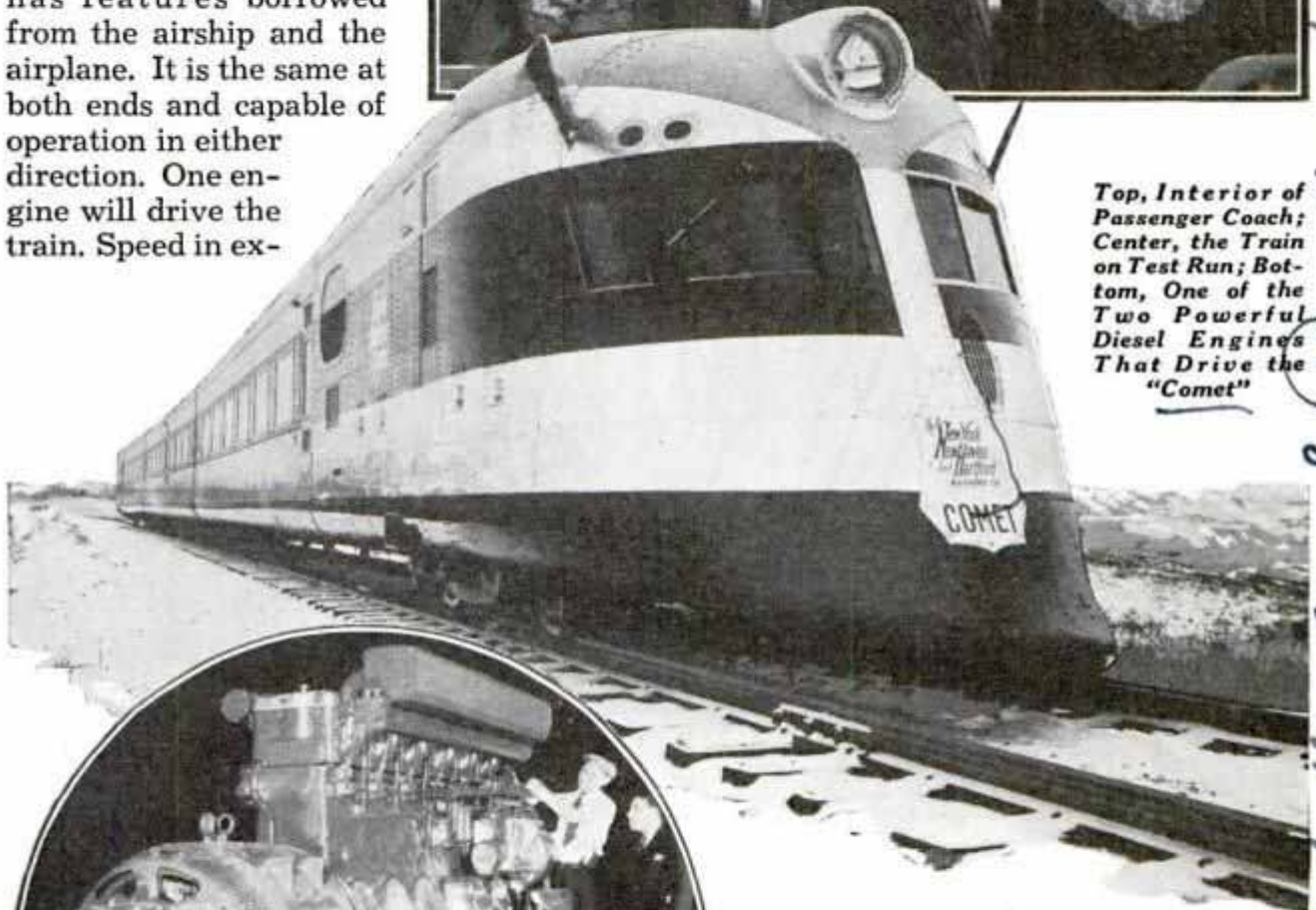

cess of 100 miles per hour is possible, but the "rail Zeppelin" will not be operated above ninety miles per hour. There are accommodations for 160 passengers in the air-conditioned cars. One idea taken from the airship is in the construction of the cars. Each car is essentially a metal tube with two "skins," an inner and an outer covering. Between them is a network of

beams and girders made of aluminum alloy. Another airship idea is found in the four keels running from one end of the car to the other at the corners. These serve as strengthening members and the upper ones house ducts used in air conditioning, and support illuminating equipment. The influence of the airplane is seen in the hydraulically controlled spring shock absorbers that take the place of leaf springs. They are installed so the cars literally float above the tracks. Rubber is used in large quantities to increase riding comfort and reduce noise. Weighing 126 tons, the train is slightly less than 208 feet long.

Isoragyan... Akron, Ohio... 10.8.2 Florida... Comb. Walter & Burton Akron, Ohio

8 355

10555 - Holman Ave
Los Angeles Calif

PAINTING

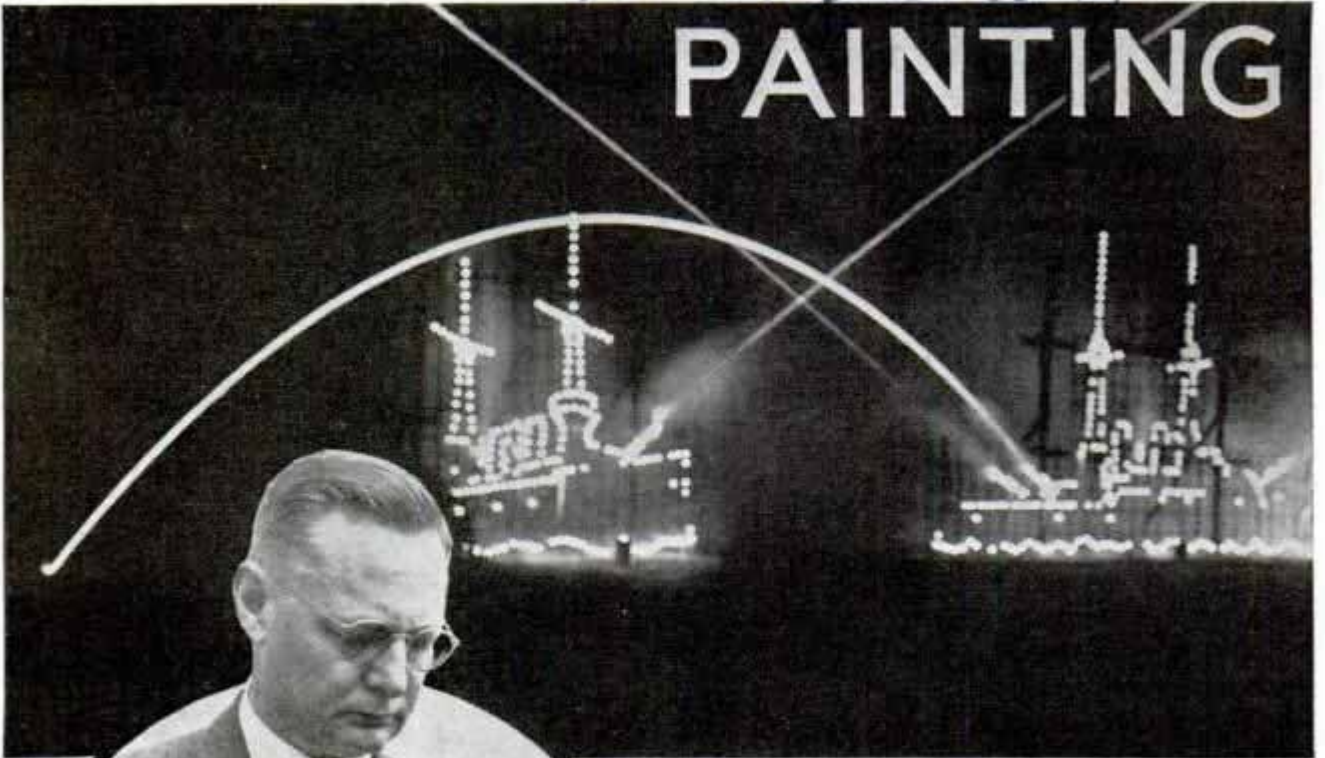

IN an inferno of sound and glaring lights mysterious figures faintly visible through clouds of red fog darted under a skeleton framework and pulled levers with robot-like motions. In the foreground men clustered around a mortar, rammed home another shell and touched off the fuse. A second later the ground shook as the projectile roared toward the sky. An airplane, every detail etched in

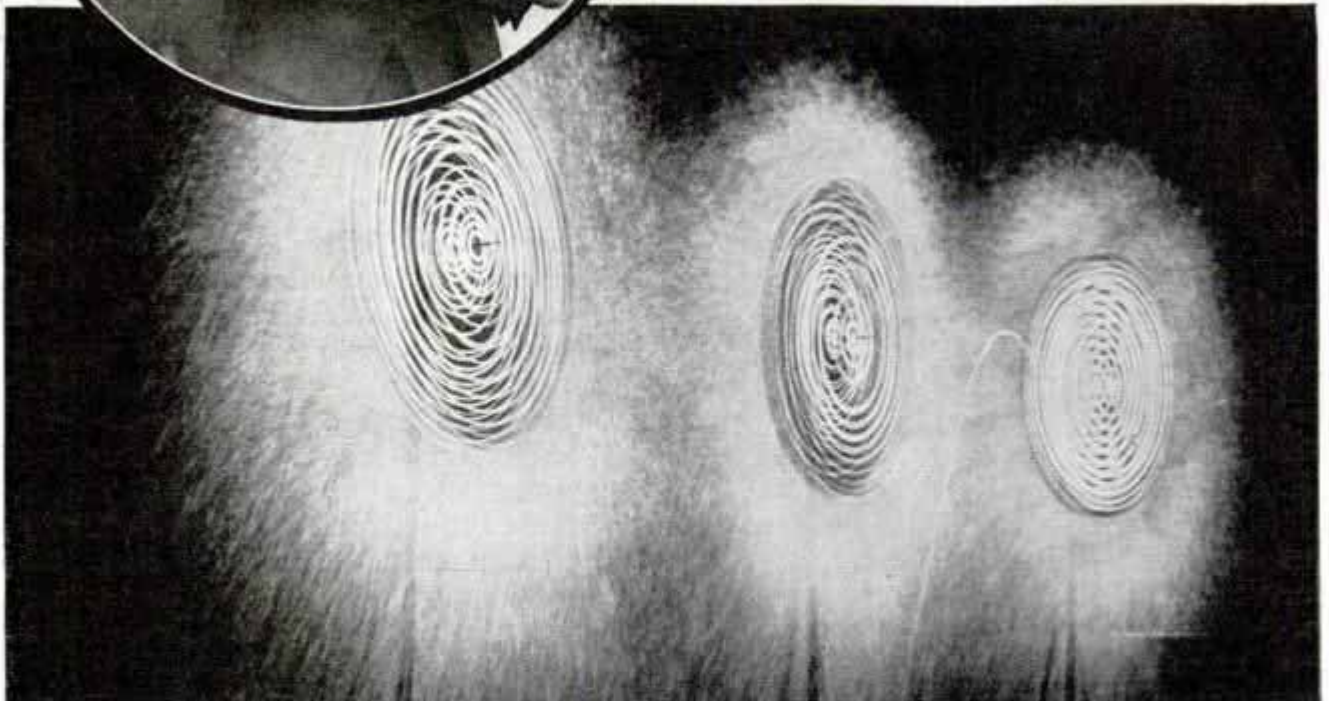

Top, Fireworks Display Showing Battleships Firing Roman Candles at Each Other; Center, Comet Shell with Fuse for Firing from Mortar; Bottom, Pinwheels That Spin and Whistle

C.A. Cronkite, (22 W) [E 355]
Third St. Los Angeles Calif

WITH FIRE

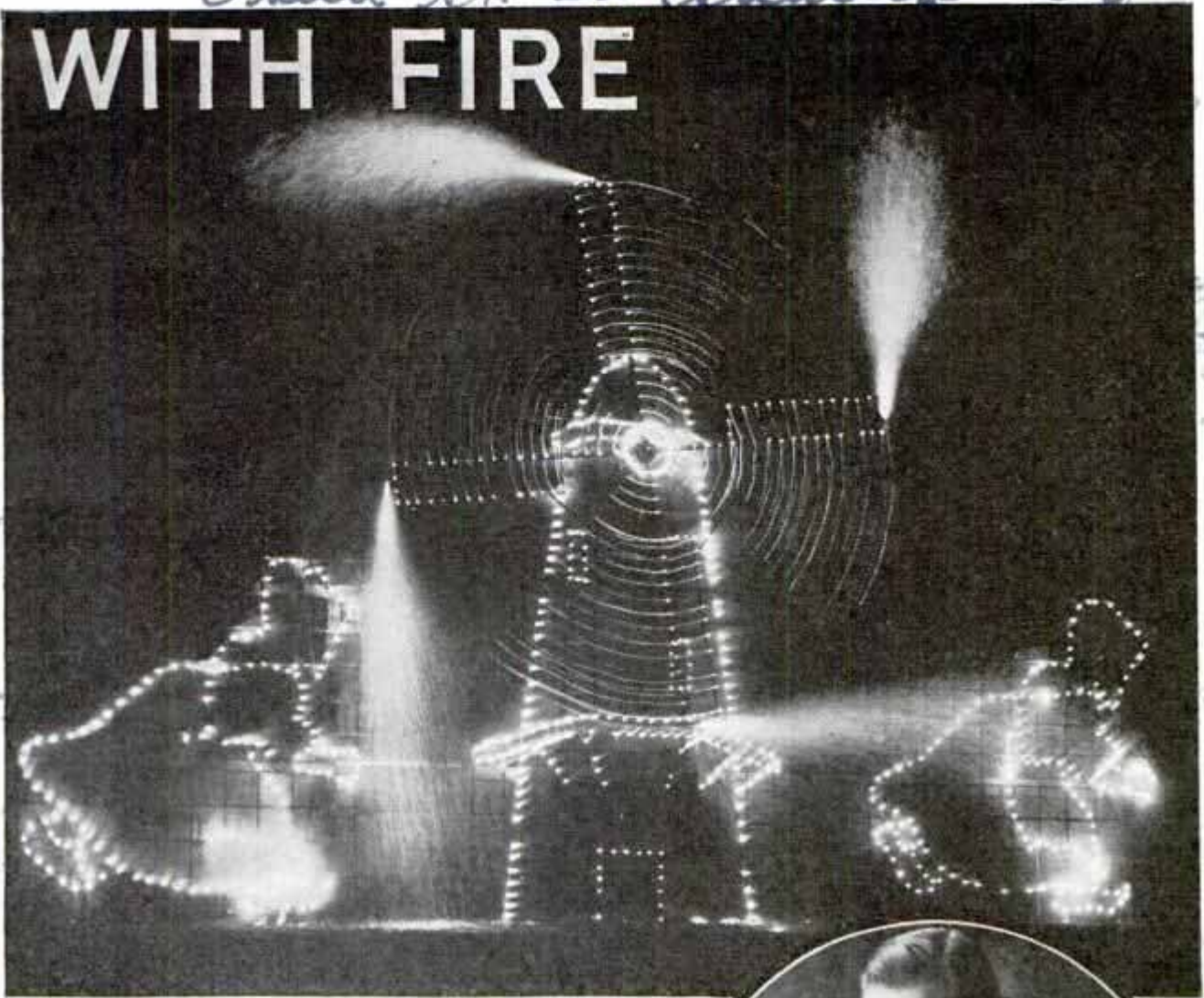

fire, rocketed to the ground and crashed in flames. A star shell spread its eerie glare over the scene.

Instead of lighting up a battle-scarred scene the star shell revealed 50,000 spectators watching a pyrotechnic display which made them alternately gasp and laugh. For their entertainment a mammoth elephant outlined in amber flares thrust its trunk into a water tub and shot a spray of silver fire at the figure of its keeper.

The scene died in darkness and was replaced by a fleet of battleships. Then began a spectacular naval engagement. The battleships were replaced by a Dutch windmill, by huge "clown" pinwheels that burst into rainbow colors and revolved at dizzy speeds, and finally by a red, white, and blue American flag that appeared to ripple in the wind.

Outdoor pyrotechnic spectacles are far removed from the penny torpedoes and crackers for which the public spends millions of dollars every Fourth of July but the materials



Dutch Windmill Outlined in Fireworks, and Shells Containing Colored Fire Composition

(Continued to page 124A)

PHONE AND BELL IN SAME CASE TO DISCARD WALL BOX



Using Latest Telephone Which Eliminates Bell Box on the Wall or Desk

With the bell enclosed in the same case with the latest telephone, the unsightly wall or desk box is eliminated in home and office. The phone has a heavy base that prevents it from sliding while dialing.

HINGE CHECKS OR CLOSES DOOR BY SPRING ACTION

Acting as a combined door closer and door check, a new hinge operates silently. The door is closed by strong, double-acting springs sunk in both the door and the

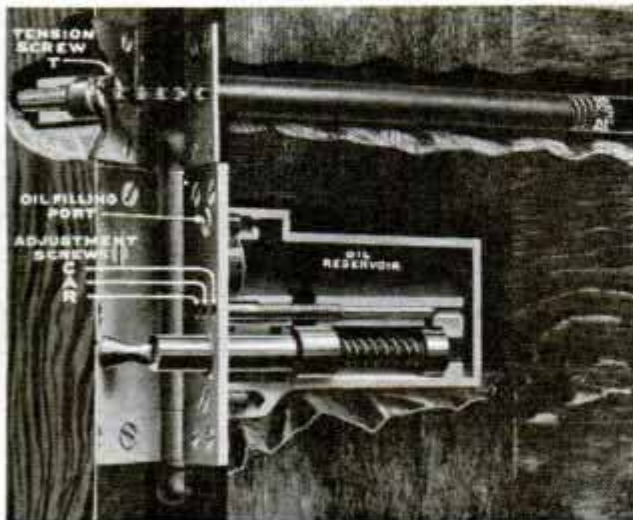

Cutaway of Combined Door Check and Door Closer Shows Method of Installation

door jamb. A hydraulic bumper checks the force of the springs, giving a cushioning effect. Tension can be adjusted by a set-screw to hold the door open or at any angle desired from ninety to 180 degrees. At this set point, the door is dead center. Opened a little beyond the dead center, the door is swung back against the wall in wide-open position. Swung slightly inside dead center, the door is closed by the springs. All the mechanism is concealed when the door is closed and hardly noticeable when it is open.

SNOWPLANE BUILT LIKE AUTO TRAVELS AT HIGH SPEED

Snowplanes as comfortable and almost as speedy as automobiles are now being used in northern Canada. The vehicles

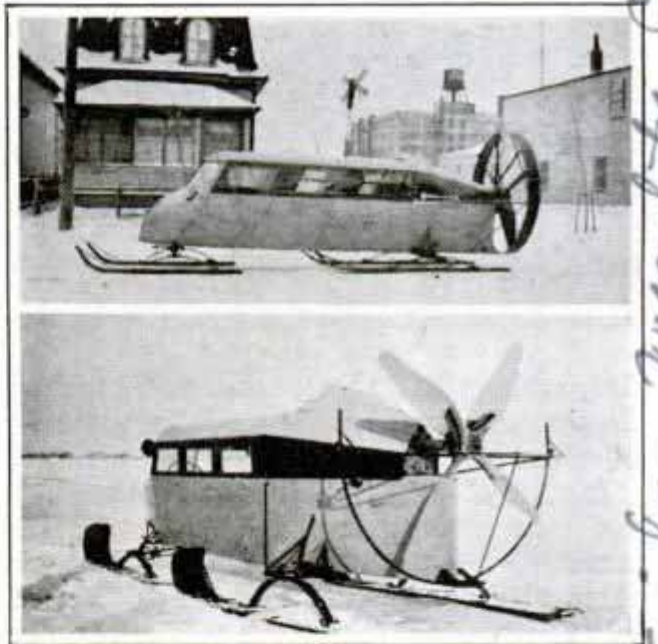

Two Types of Snowplanes, with Comfortable Bodies and Driven by Push-Type Propellers

are being made with closed bodies seating from three to six passengers and the cars, streamline in design, have glass windshields, mechanical brakes, lights, heaters and other conveniences. The bodies are of welded steel tubing covered with aluminum, runners have carbon steel shoes and the push-type propeller is operated by a Ford automobile engine. The snowplanes will travel anywhere there is snow, they can climb hills, negotiate drifts, will speed up to fifty miles an hour when roads permit and their gasoline consumption averages fourteen miles per gallon.

American Automatic Electric Sales Co. 1033 W. 10th Ave. Minneapolis, Minn.

517

Rippenhagen Bros 4115 - Ravenswood

Eggertson Snow Plane Co

Canada Manitoba Winnipeg St. Clayton 587

Hot Metal "Bullets" Rebuild Machine Parts

Fired at the speed of a rifle bullet, particles of hot metal rebuild worn machine parts by a new method. Screw threads are cut into the surfaces to be repaired and then the metal is sprayed on the grooves and ridges in such a way as to "freeze" and become a part of the metal under treatment. The spraying is done with an electrically operated gun that "shoots" the metal particles through a tiny hole in the nozzle at 2,700 feet per second. The rebuilt parts are smoothed and polished with abrasives, giving long wear. Piston rods, cylinder walls, shafts, bearings and turbines are among the parts treated successfully.

OUTPUT OF INVENTORS IS SPEEDED UP

After working 121 years for their first million patents, American inventors speeded up and obtained the second million in the last twenty-four years. The first American patent was granted in 1790, the millionth in 1911—and No. 2,000,000 was issued recently to Joseph Ledwinka, chief engineer for the Edward G. Budd Manufacturing company, for an improvement on pneumatic tires for railway cars. In 1899 he won his first patent on a "means of propulsion of vehicles by electricity."

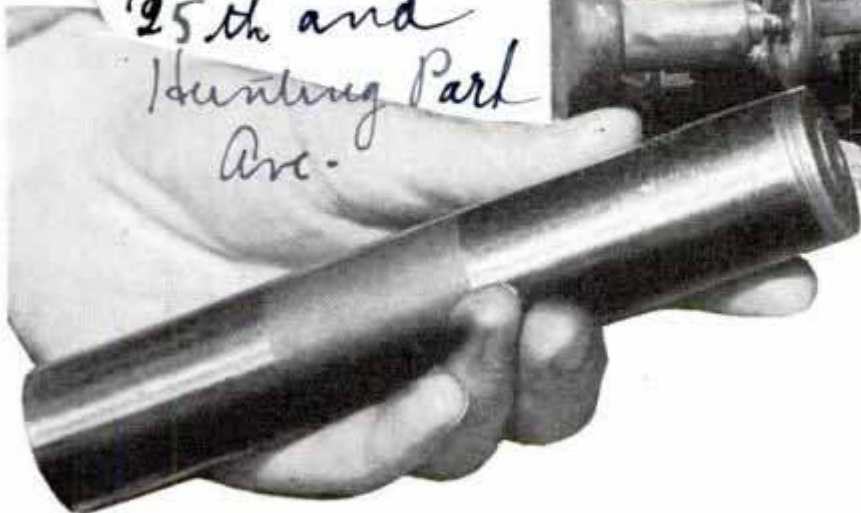
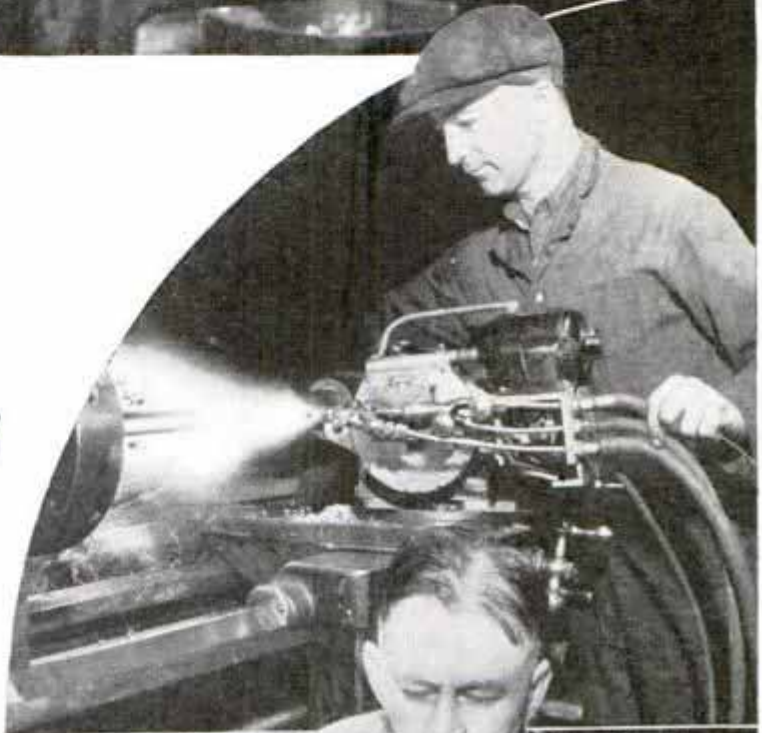

25th and
Hunting Park
Ave.

Top, Worn Machine Part Being Grooved or Threaded; Second from Top, Spraying Metal Particles at Rifle Bullet Speed into the Grooves; Third, Preparing to Smooth Off and Polish Rebuilt Section; Bottom (Left), Sample of Rebuilt Part after Completion of Polishing; Its Strength Is Said to Be as Great as When the Part Was New

2847 N. Park Ave
Phila

Exchange of Patents Speeds Home Television

549 Museum St

Agreement upon an interchange of television patents and technique between Farnsworth Television Incorporated of Philadelphia and San Francisco, and Fernseh, A. G., of Germany, brings home television in America a step nearer.

Already, in Germany, a Berlin station sends television programs several hours daily, equipment for a second station is ready and Dr. R. Moeller, chief research engineer for the German company,

Above, Tuning in Television Receiving Set; Camera and Lighting Arrangements in Broadcasting Studio Are Shown Below; Right, Tube Which Projects Image upon Screen



asserts television is a reality. By virtue of the patent agreement 100 receiving sets will be ready for showing in Germany by August, and by next January, sets will be available to the public for about \$200.

A lack of sending stations in the United States now retards development of tele-

vision here. Funds have been set aside and plans made for the erection of ten television stations in Germany. These stations will be connected with cables which are already in operation experimentally, and by wireless relay stations. The huge cost of this special cable has been put forth

as a barrier to television, but when it is considered that aside from television uses, one of these cables could carry the entire telephone traffic between San Francisco and New York, it will be seen that the cost is not such a great factor. The cable cannot be used, at present, for television and telephone simultaneously, but it can carry telephone traffic while not being used for television, and thus will be economical.

The small Farnsworth projecting receiving tube is a significant feature of the new sets. Previously the Farnsworth tube was large and the image appeared on the end of the tube. Now the tube is small and the image is projected upon a screen, set up in the cabinet.

By use of the Farnsworth multipactor—a cold cathode tube—only five tubes will be necessary for the television reception and five more for the sound reception, ten tubes in all, as against the twenty or more in television sets hitherto shown

Not the least important development in television sending apparatus is the "tele-cine," apparatus for sending out motion pictures. The new studios will be equipped with facilities to send out both still scenes from life, and also motion pictures, thus giving both stage and screen amusement.

The multipactor is a cold cathode tube, which means that it will not be necessary for the tubes to heat, as in present tubes, in order to get reception. In fact it is the inefficiency of the present tube which causes it to heat.

8-553
FALLACY IN "SEND-DIME" CHAIN SHOWN BY MATHEMATICS

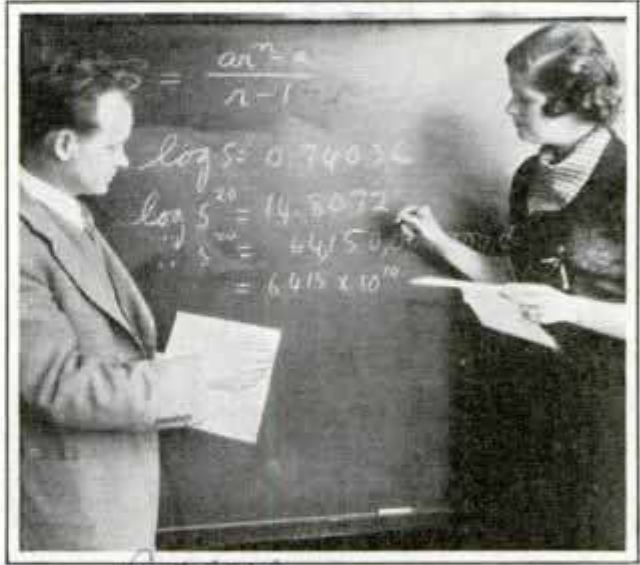

Logarithms Presented by Prof. Steed Show Fallacy of Get-Rich-Quick Chain-Letter Scheme

Prosperity can't travel very far over the "send-a-dime" chain-letter route. The scheme started in Denver, and post offices there and elsewhere were deluged with letters containing five names and asking the recipient to mail a dime to the top name, add his own at the bottom and send a copy of the letter on to five more. When the sender's name reached the top, it was theorized he would receive \$1,562.50. But Prof. D. Victor Steed, of the University of Southern California, has demonstrated mathematically that wealth cannot be multiplied by the chain method. It takes 15,625 persons to make up the \$1,562.50 in dimes for the name at the bottom of the original list. Before these 15,625 can collect a similar sum, 244,140,625 other persons—more than twice the national population—would have to dig up a dime each.

Los Angeles, Calif.

8433

AUTOMATIC LINE GAUGE SHOWS AMOUNT OF TYPING DONE



Lines of type-writing are recorded accurately by a line gauge which can be adjusted in one of two ways. A dial can be set to indicate the number of lines written

or it can be adjusted to show the number of unwritten lines from the point at which the machine is working to the bottom of the page. When a letter is completed, a whirl of a knob adjusts the counter for the next one.

41 Lichers on 41 Newark N.J.

Chas. H. W. Postman, c/o A. W.

8516

RUBBER BALL AS BOTTLE SEAL SNAPS ON OR OFF

Easily snapped on or off with a push of the finger, a rubber ball seal for bottles is intended to replace corks and screw tops. The ball is pushed to the side of the bottle for easy pouring.



Isard on 110 E 23rd New York

8395

4 W 10 and St
New York

This CHANGING WORLD

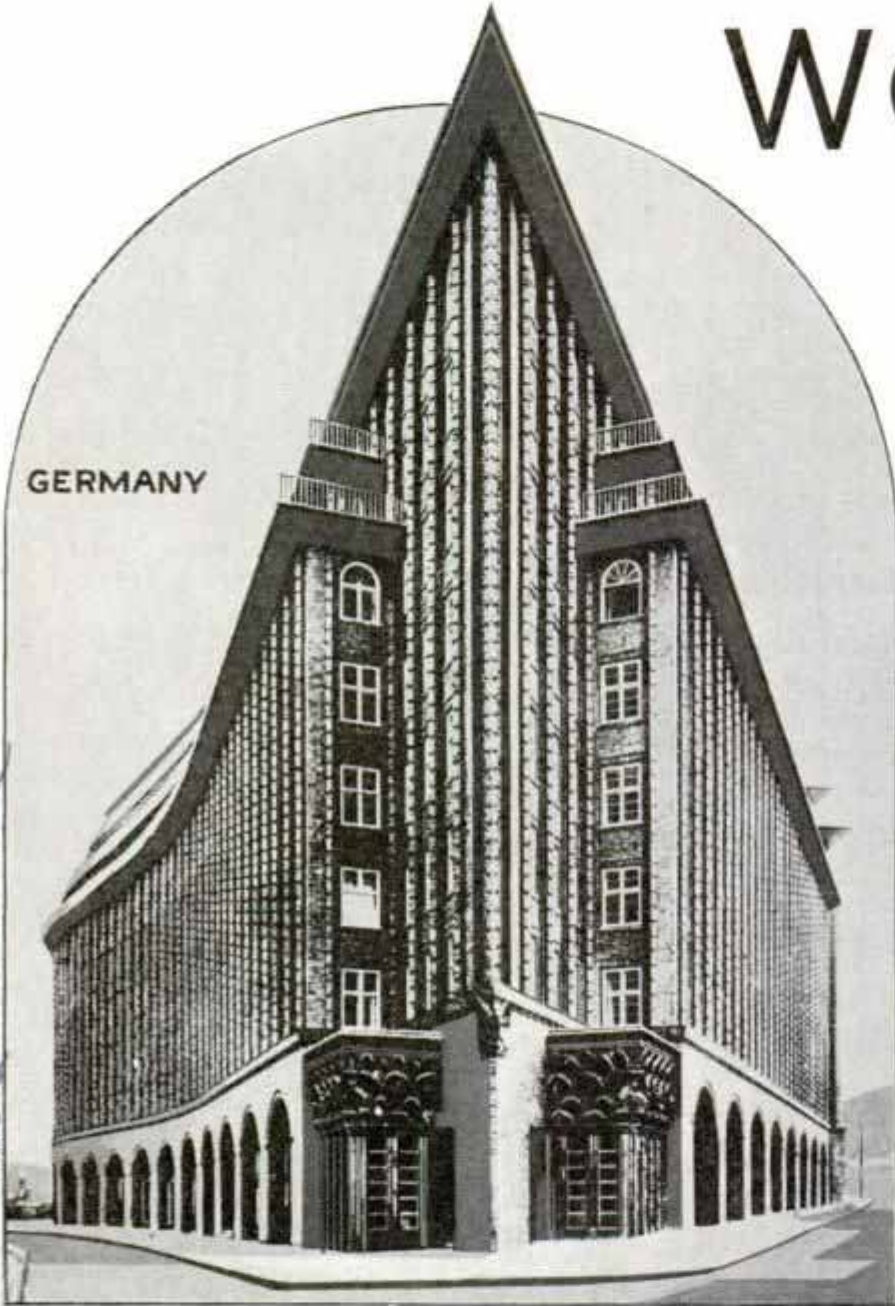

Chute House

House Built in Hamburg to Honor Seafarers; It Is Intended to Resemble a Head-On-View of a Speeding Ocean Liner

indelible mark on civilization. The new architecture is closely allied with the machine age, which has standardized building materials and made possible the mass-production house.

Our age gives the architect compressed sheets of fiber board, fireproof partitions, steel beams, hollow tile, glass sheets and metal fittings, all cut to their proper sizes at the factory. The humblest home now becomes a problem within the province of the engineer, who collaborates with the architect in the design of human shelters as safe and sensible as modern steel bridges.

Useless ornament, decoration, and adaptations from Greek, Roman and Spanish architectural styles are strictly taboo these days. Architects have decided that a modern man can't live in an Italian Renaissance house or mid-Victorian flat and

THE machine age is tackling a long-neglected job—modernizing the exteriors of homes and buildings.

With steel, stone, concrete and glass, architects the world over are designing and building structures to remind people that they are living in the day of streamline trains and air transports.

The job of making multiple houses, commercial and public buildings harmonize with the spirit of our time has spread all over the world and promises to leave an

feel that he belongs to the twentieth century. The new architecture is being received as enthusiastically as the new streamline trains.

The machine age has made possible the first international style in architecture. For the first time, all nations are adopting a single style of building because the automobile, the airplane, and the radio have brought them all into closer contact and made possible the rapid spread of ideas from one country to another.

6575
See page 70 Jan. 1935
Joren



Kindergarten Providing Plenty of Light and Plenty of Under-Cover Play Space When It Rains; Below, Unusual Apartment Building Recently Constructed in Rotterdam

6575

Unusual Apartment Building

See p 75 Jan. 1933

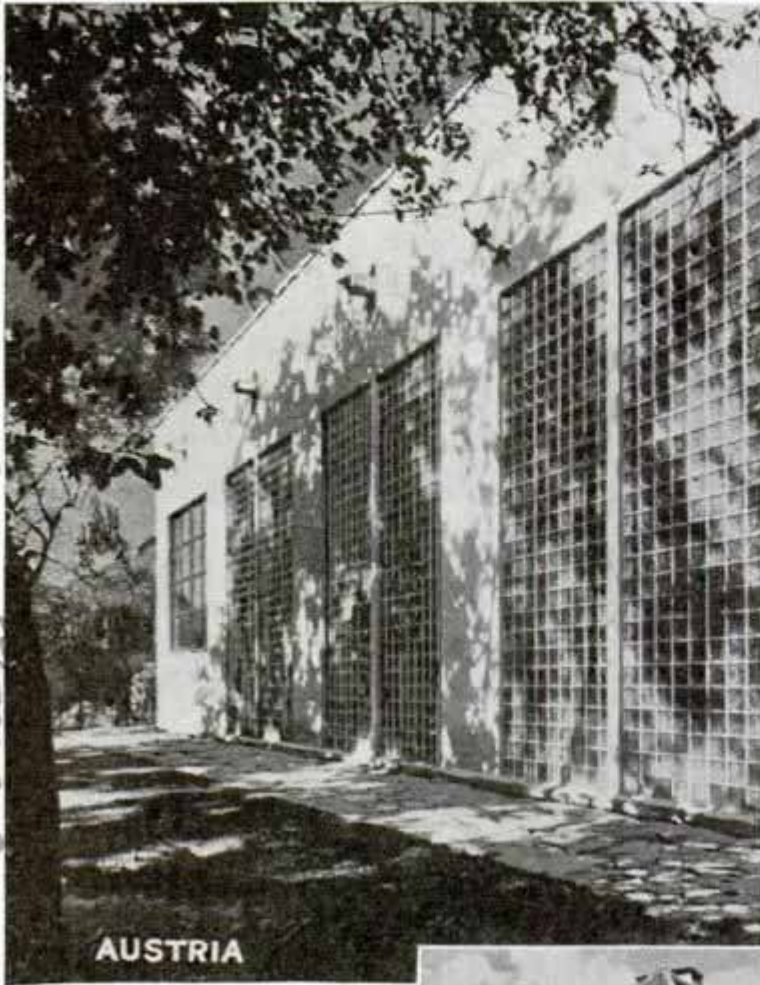

AUSTRIA

At present, modern architecture may be seen in every civilized country, and is rapidly spreading to very remote districts. It is most evident in Holland, Germany, Switzerland, France, Russia, and in the Scandinavian countries. The United States has only within the last several years taken up modern architecture quite seriously, but all signs point to a great activity in the near future.

Oddly enough, this architecture received considerable impetus from the design of industrial buildings in America, most notably from our grain elevators. American factory design has also influenced foreign architects. Without even attempting to create a new movement in architecture, but aiming only at the most practical grain elevators, American industrial architects made something so honest and faithful to the ideal of the machine

age that their work aroused profound admiration abroad.

Foreign architects were quick to grasp the meaning of Louis Sullivan's pioneer work with steel construction in the skyscraper. In his famous buildings around Chicago, Sullivan first showed how to illuminate the usual dark interiors with walls of glass. He did not try to hide the supporting steel; he tried to make it plain to the eye that the building was standing on steel columns. Sullivan's pupil, Frank Lloyd Wright, conceived and executed the famous prairie house and the house of pre-cast concrete blocks. Few of these ideas, which originated on American soil, were taken up here as they were in Europe.

The trend in American home architecture is toward the pre-fabricated house. This, a special product of the machine age, is now on the market and may be



SWITZERLAND

Top, Shadows Provide Ornamentation for This Wall of Glass and Stucco; Below, Type of Low-Cost Housing Favored in Switzerland

purchased in convenient payments by the home owner, just as he would buy an automobile. One of the latest pre-fabricated houses consists of panels of cement and asbestos, formed under tremendous pressure, and designed to be bolted to a steel frame. It can be assembled and later taken apart and moved to a new site. In line with modern practice, the flat roof is an integral part of the home. It is the family's outdoor

American Houses

480 See p 75 Jan. 1933



On the installment plan, the price is \$6,800, with payments of \$38 per month over a period of fifteen years. There is no down payment or mortgage on the property. The price includes fire and life insurance; if the owner dies, the title reverts to his heirs without further payment.

A buyer has the choice of twelve models, ranging up to nine rooms and three baths. The cash price for the largest house available is only about \$10,000. The procedure of buying consists of going

Top, Note the Abundance of Light Provided for This British School; Below, Modern Dining Room Designed by Walter Dorwin Teague

living room. The construction is so solid that the mass-production house can withstand a hurricane of 120 miles an hour, or support a snowpile twenty feet deep on the roof. Tentatively, the price for a four-room dwelling is placed at about \$3,800, with all necessary mechanical appliances.

to a show room, picking out your model and signing a contract. The house is delivered by a single giant truck. Two expert house builders arrive with the truck, which is their home while the house is under construction. They obtain the help of four or five local laborers, and within

2419 Dec 1934

Handwritten notes: *flooring made by...*
Proletar Corp.
42 Market
Kemliworth, 719
GERMANY

Frankfurt. on. Main



Flats for Workers as Provided in Germany Today; Note the Plain Surfaces, the Glass-Enclosed Top Story and the Little Balconies at the Corners

two or three weeks the house is ready for occupancy.

The steel frame does all the supporting work and the owner can make one huge room out of the interior or divide it to suit his convenience. The house has some admirable conveniences and innovations. The floors are made of a compressed fire-proof hardwood. Every room is air-conditioned summer and winter, and the builders guarantee that you can control temperature within one or two degrees at any season of the year. The casement windows may be opened or closed without interference from screens. Electric clocks are built into the walls; a radio is built into the living room wall.

The heart of the house is a "moto-unit," which contains the operating machinery. Here one finds the air-conditioning equipment, electric refrigerator, hot-water heater, dish and clothes washing machines, etc. Much of the pre-fabricated house's economy is based on the fact that all the service machinery is built into one unit. The American home of the future, as it was recently depicted by hundreds of entries to General Electric's national home design competition, makes the composite house

appear with flat roof and thoroughly modern lines. The tendency is for the garage to be placed at the front of the house with kitchen adjoining, and the living room across the rear. The recommended materials are concrete, stucco and brick.

Frank Lloyd Wright has completed a model of a modern self-contained community which he calls "Broadacre City." It is built along horizontal lines and covers four square miles of countryside. The families in Broadacre City would be served by a through highway which carries slow and fast traffic. Streamline monorail trains run down the center of the highway. Small shops and factories, as well as garden plots, are attached to the homes. Electric power is "shipped" in, and there are no chimneys to pollute the air. Each family owns its plot of land, which ranges from one acre up, depending upon the size of the family.

The movement in modern architecture has been making enormous strides in countries which heretofore had their national styles. Architecture has become internationalized, and you may see the same principles practiced on buildings from the tip of Italy to the tip of Norway.

see June 1935
805

American Houses due.
670 Fifth Ave

Parachute Jumper Glides on Canvas Wings



High above the airport soars the tiny speck that spectators know is an airplane because they have watched it climb steadily for several minutes. Now a thin, almost invisible white line appears, leading downward from the ship, and a few seconds later, the form of a man suddenly is outlined, with strange "wings" flapping. Head first the "bird man" comes, then into a series of loops and spirals, the wings seeming to control and retard his downward movement. As he nears the earth, ballooning white cloth spreads above him into the shape of a parachute and he slowly completes his daring flight, in safety. This is the story of Clem Sohn's latest leap from a plane to demonstrate how closely man can imitate the bird by spreading wings attached to his arms and webbing sewed between trouser legs. The wings are made of airplane fabric fastened to a frame on the jumper's body and arms. Steel ribs make possible their control as Sohn moves his arms back and forth in a manner to change direction



Sohn and His "Wings"; Top, Left, After One 'Chute Failed, Sohn Pulled Ring of Second and Both Chutes Opened

of the glide. After stepping off into space from the plane at about 10,000 feet, Sohn performs his spirals and loops through a retarded drop of nine thousand feet, then pulls the ring of his parachute at 1,000 feet. Once, Sohn pulled the ring of the 'chute on his back, but nothing happened. Then he pulled the ring of his front 'chute. Both opened at the same time.

**BIG FLOODLIT POWER STATION
MONUMENT TO PROGRESS**

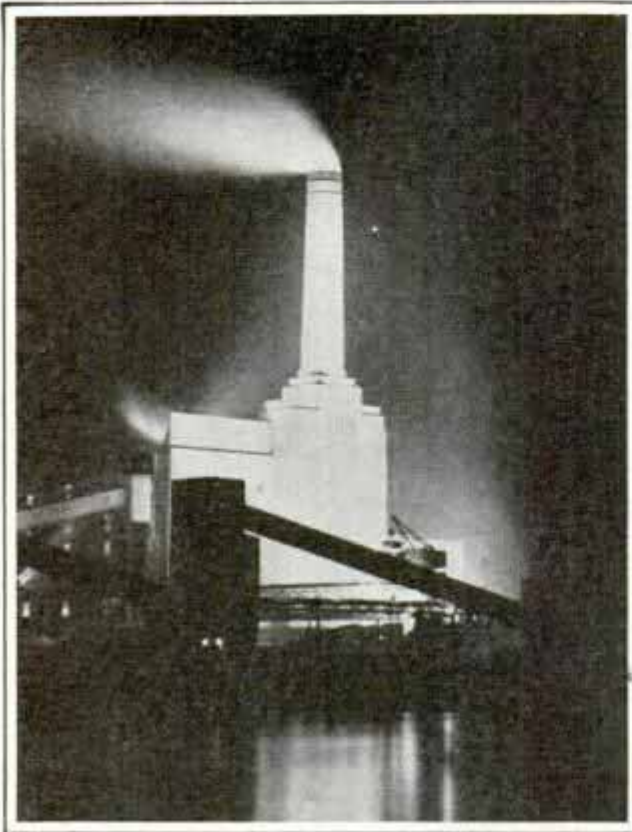

Startling in Its Brilliance, This Power Plant Supplies a Large Part of London Area

White in the brilliance of floodlights that turn its smoke to silver, the Battersea power station across the Thames river from London stands as a monument to progress. It is one of the key sources of supply for electricity that turns night into day for many of the public and private buildings in that part of England. The big plant is illuminated the year round by batteries of high-voltage lamps.

**PNEUMATIC WHEEL FOR WAGON
HAS AUTOMOBILE BRAKE**

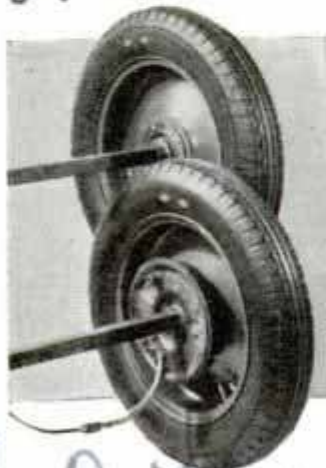

Delivery wagons are now being equipped with pneumatic tires, disk or wire wheels, steel alloy axles, two-shoe automotive type brakes, brake cables, roller-bearing hubs and the necessary parts for installation.

*The B. F. Goodrich Co
Aberon Ohio*

The wheels can be fitted on almost any type of wagon. The casing is subjected to little actual wear and no overheating, but is made particularly to resist deterioration from long exposure in all kinds of weather, and the side walls are made very tough to resist chafing. The low drawbar and the roller bearings make the wagon equipped with such wheels easy to start and much easier to pull, while the rubber tires permit bolts to stay tight, reducing upkeep.

**"THUNDER MACHINE" TESTS
LIGHTNING PROTECTORS**

Engineers at the California Institute of Technology are manufacturing man-made lightning with the aid of a huge "thunder machine." This apparatus generates million-volt bolts which are directed at lightning arresters and other protective devices atop model homes, oil tanks and power lines. The experiments are aiding in developing protectors to eliminate the lightning-storm hazards faced by houses, oil and gas tanks and power lines.

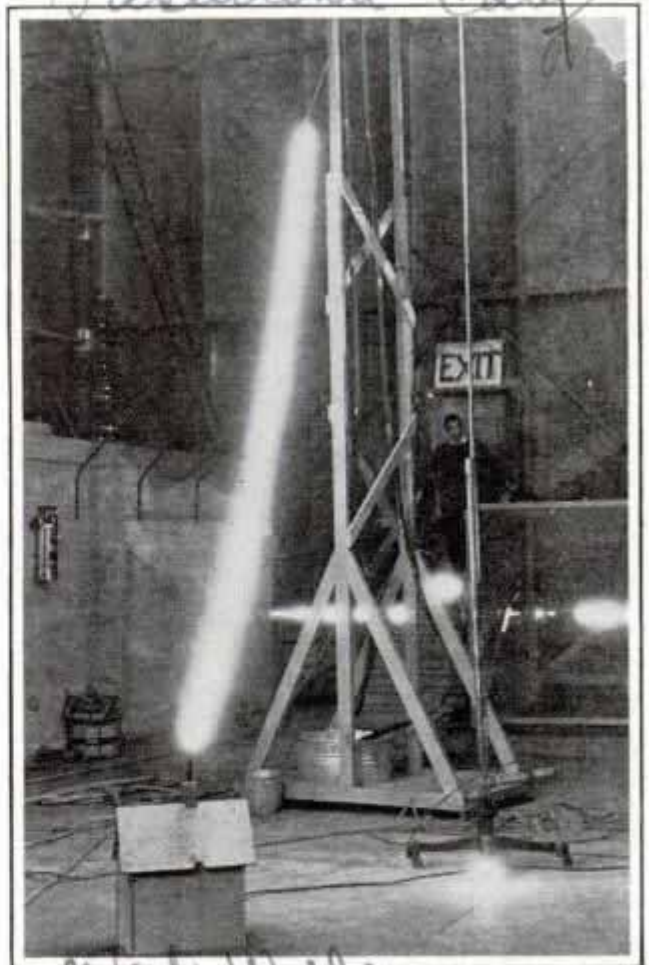

"Thunder Machine" Shooting a Bolt of Man-Made Lightning at Arrester Atop Model Building

*4, Egerton Isaacs
London, S.W.3, Eng.*

2474

2439

Pasadena Calif

W. H. Wall

Cathode Ray Brings Television to Germany

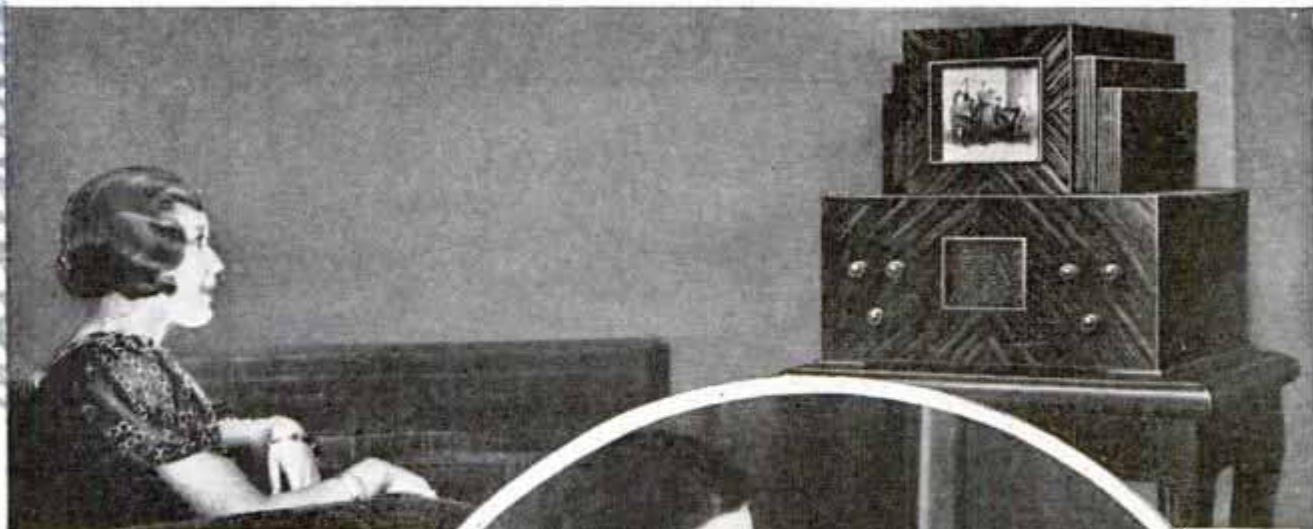

Above, Television Receiving Set in Operation in German Home; Right, a Similar Set with Cathode-Ray Tube Lifted from Cabinet to Show Area on Which Image Appears



Cathode-Ray Tubes Now Bring Television Right into the Parlor of German Homes; on the Face of the Tube, Framed by a Cabinet, Appear the Pictorial Programs Being Broadcast Regularly in Berlin; at the Left Is the Antenna Mast from Which the State Broadcasting Company Sends Pictures on Ultra-Short Waves; Right, a Cathode-Ray Tube Is Being Evacuated, and Below It a Receiving Set Is Shown Assembled, Ready for Its Cabinet

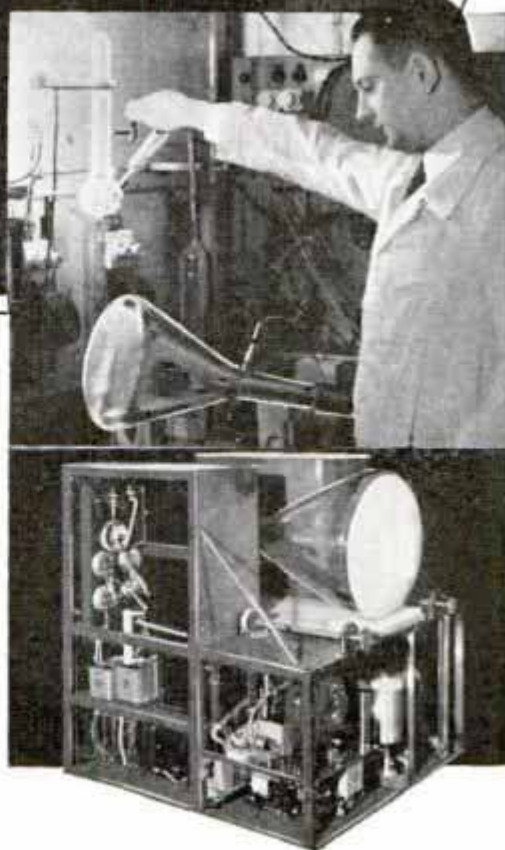

Cont. Hans J. Kutschbach, Berlin, highlights

Gesellschaft, (State) Broadcasting Co.

8254. - Mr. Chas. J. Calman,
% Pictogram Co
Box 682, Washington, D.C.

How the WEATHER and



feel. Human sensations are a better gauge of weather than the thermometer. Strong sunshine can make the weather hot when the thermometer says it is cold. Mountaineers encounter hot weather on sunny days when the air temperature is below freezing. A windy day in dry Arizona is cool when the thermometer reads as high as ninety.

The man in the street may explain the discomfort of a hot wave with the sententious observation, "it's not the heat, but the humidity." Yet he

DURING a very hot or very cold spell, the weather breaks into the newspaper headlines. Then we find temperature readings intended to tell us just how hot or cold the weather has been—but they do nothing of the kind.

Perhaps we read that in St. Louis it was 103, and in Kansas City it was 107, indicating it was hotter in Kansas City than in St. Louis. Perhaps it was, and perhaps it wasn't.

The figures are readings of shaded and ventilated thermometers designed to show how hot the air got. But they do not tell us how hot human beings, animals, plants or pavements got, and it is such effects we think of when we say "hot weather." We think of the way such weather makes us



Above, the Kiosk Thermometer Tells only Part of the Story during a Hot Spell; Below, Measuring Mountain Sunshine Which Can Make You Hot When the Thermometer Is Below Freezing

consults a thermometer to learn its intensity and never thinks of consulting an instrument that measures humidity.

But more than air temperature and hu-

Makes You HOT COLD

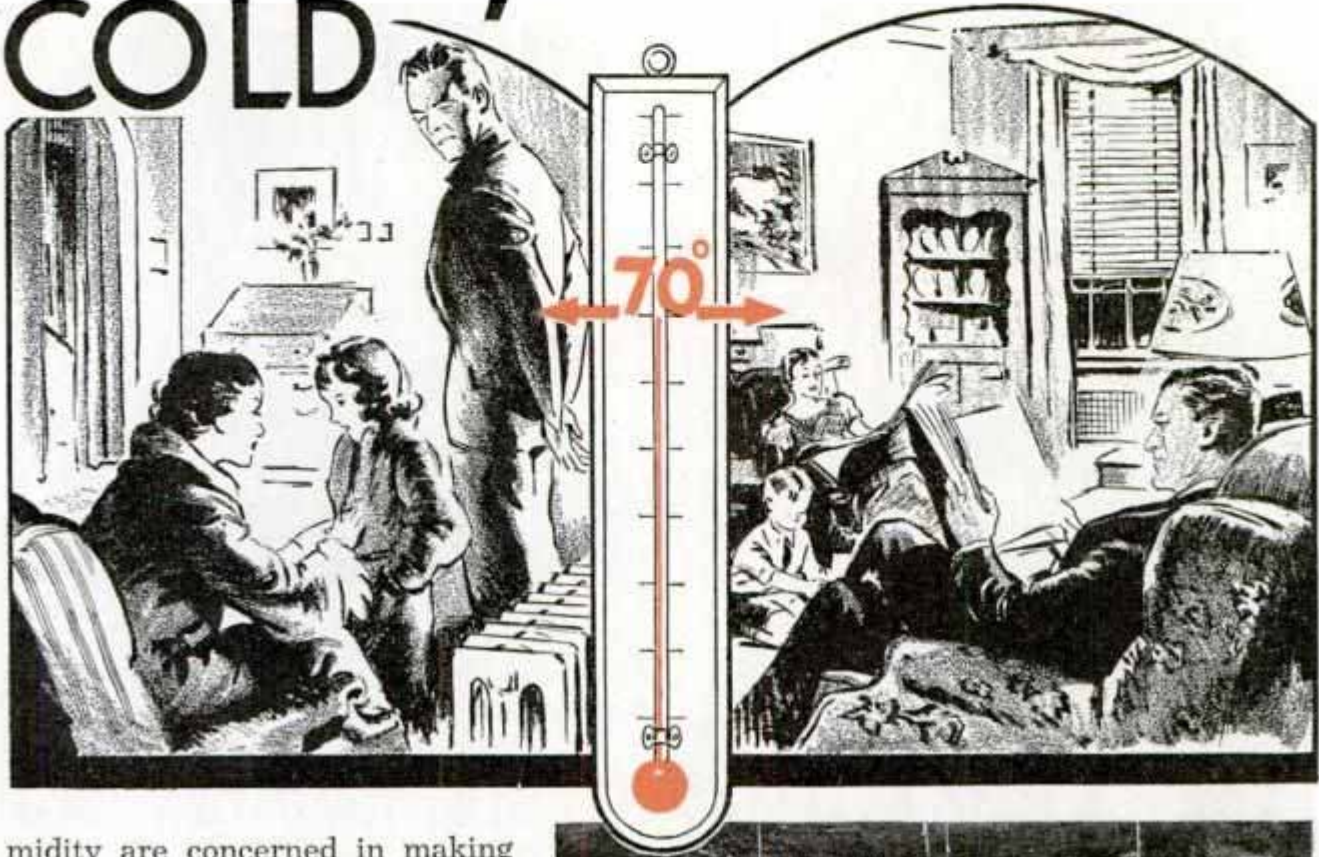

midity are concerned in making the weather hot or cold. Much attention now is given to the study of what is called "atmospheric comfort," the various factors that affect the comfortableness of the air, both outdoors and indoors.

Human sensations that we think register temperature really register something else. The temperature of the healthy human body never varies, except at the surface, more than a fraction of a degree from "blood heat," regardless of weather, clothing or other external conditions. The body is a furnace that constantly produces heat from food. This heat must be given off as fast as produced.

The mechanism by which the body maintains a steady outflow of heat is sometimes compared to a thermostat, but these devices usually maintain a uniform temperature by shutting down the heater from time to time. The human furnace is never shut down, though its activity varies somewhat and is regulated to a certain extent by the thermostatic apparatus of

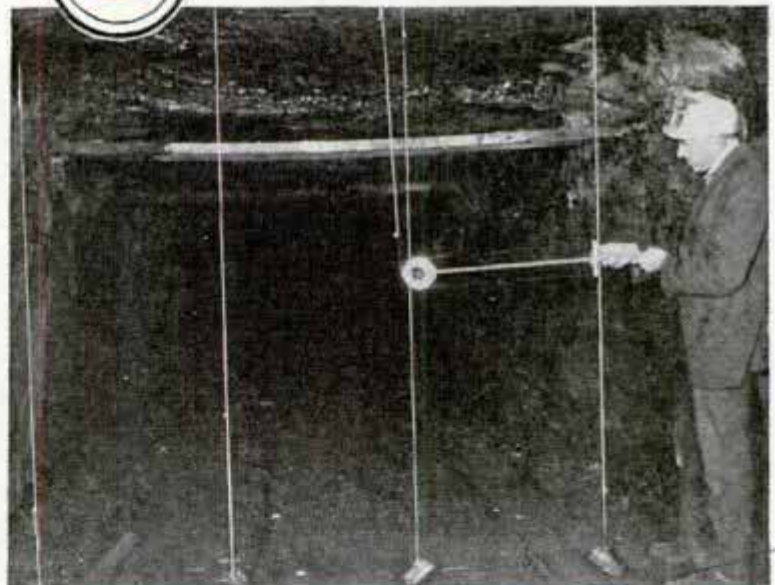

Drawing Courtesy Carrier-Lyle Corp.

Top, the Temperature in Both Homes Is the Same, but the Air in the One at the Right Has Been Humidified; Below, Measuring Speed of Air Current in Mine

the body. The chief function of this apparatus, however, is to eliminate surplus heat at the right rate to keep the internal temperature constant, despite varying external conditions, by varying the blood supply at the surface of the body and controlling the action of the sweat glands. The feelings of comfort and discomfort that we describe

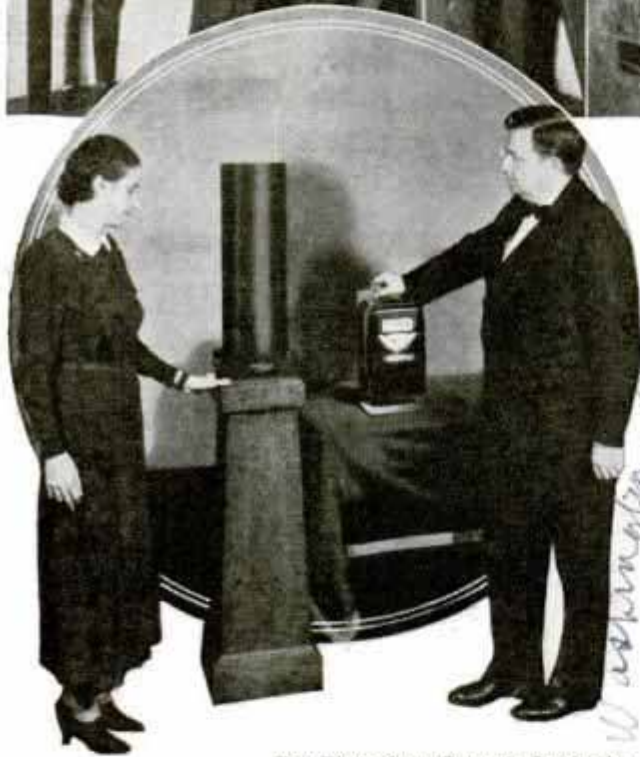
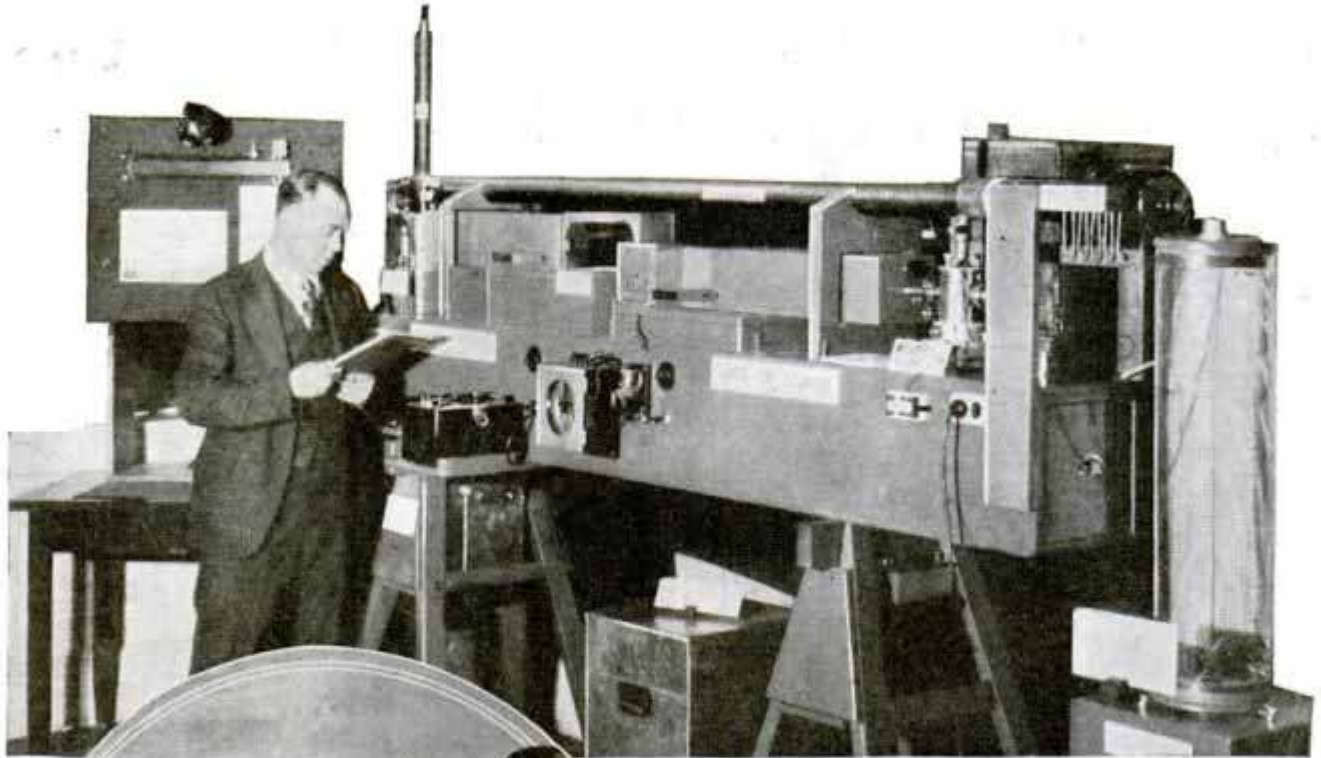

Top Photo from Carnegie Institution

Top, Ion Counter Which Measures Tiny Carriers of Electricity in Air; Below, Cylinder Is Kept at Body Temperature and Rate of Heat-Loss Is Measured

in terms of temperature actually indicate the ease or difficulty with which this regulation of heat-loss is accomplished.

Besides clothing, four conditions are involved in making the weather feel hot—air temperature, air movement, humidity and radiation. Air temperature affects the rate at which heat passes from the body into the air by conduction. Air movement carries away air heated by contact with the body and replaces it by cooler air except when the temperature of the air is above blood heat. Another effect of air movement is to promote evaporation. The hu-

midity of the air also affects heat-loss by controlling evaporation. In dry air, evaporation is rapid; in humid air, it is slow.

The body constantly radiates heat to objects about it and they, in turn, radiate heat to the body. The great importance of radiation in the heating of buildings has only lately been recognized. In the new process of "panel heating" electrically heated walls, ceilings or screens radiate heat to the occupants of rooms. In order to counteract the effect on the rate of heat-loss from their bodies, the air is kept colder than would be comfortable in houses heated by other methods.

When our bodily machinery cannot get rid of excess heat fast enough, we feel uncomfortably hot. When it has difficulty in preventing heat-loss, we feel cold. There has been controversy over why damp cold air feels colder than dry cold air. Some believe it is because when the humidity is high our skin and clothing become moist and are better conductors of heat, so there is more cooling by conduction.

A fan does not cool the air, but increases its cooling power by increasing its movement. In all kinds of weather our comfort, so far as temperature sensations go, depends upon the cooling power of the air; hence the many methods devised for measuring atmospheric comfort really measure atmospheric cooling power. More than twenty different instruments have been

(Continued to page 140A)

Giant Press Makes All-Steel Top for Autos

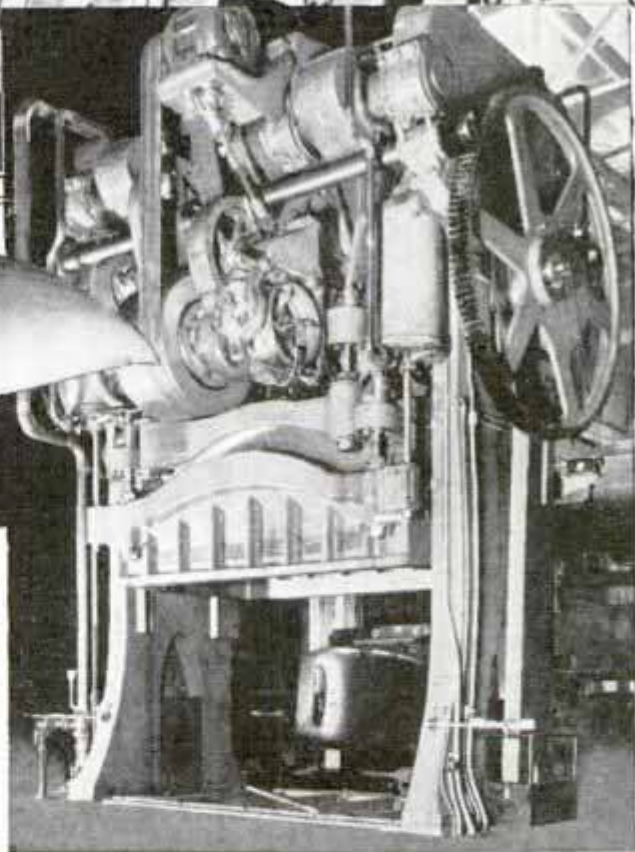

Top, Unusual View of Factory Ventilators; Left, One of the All-Steel "Turret Tops"; Right, Powerful Press in Which Steel Auto Tops Are Formed

More than four stories high and weighing 500 tons, a giant press for producing all-steel tops for automobiles has been developed. One of eighteen to be installed in the Fisher body plants, it exerts a pressure of 1,950 tons, or 3,900,000 pounds. Each top passes through four of the mammoth presses, a total pressure of 5,200 tons, or 10,400,000 pounds, being necessary to draw and form the solid steel roof. An electric motor drives the largest press, turning a ten-ton flywheel at a constant

speed of 375 revolutions per minute. A manually controlled air brake stops the flywheel in two minutes. If the brake were not used, the tremendous momentum of the flywheel would cause it to rotate for an hour or more after shutting off the power, holding up production and resulting in loss of time.

Hollow-Wall Cooling for Home at Low Cost



Diagram Showing Built-In Cooling System; Top, Left, Basement Made Comfortable in Winter by Conducting Warm Air under Its Hollow Tile Floor; Top, Right, How Wall Is Closed

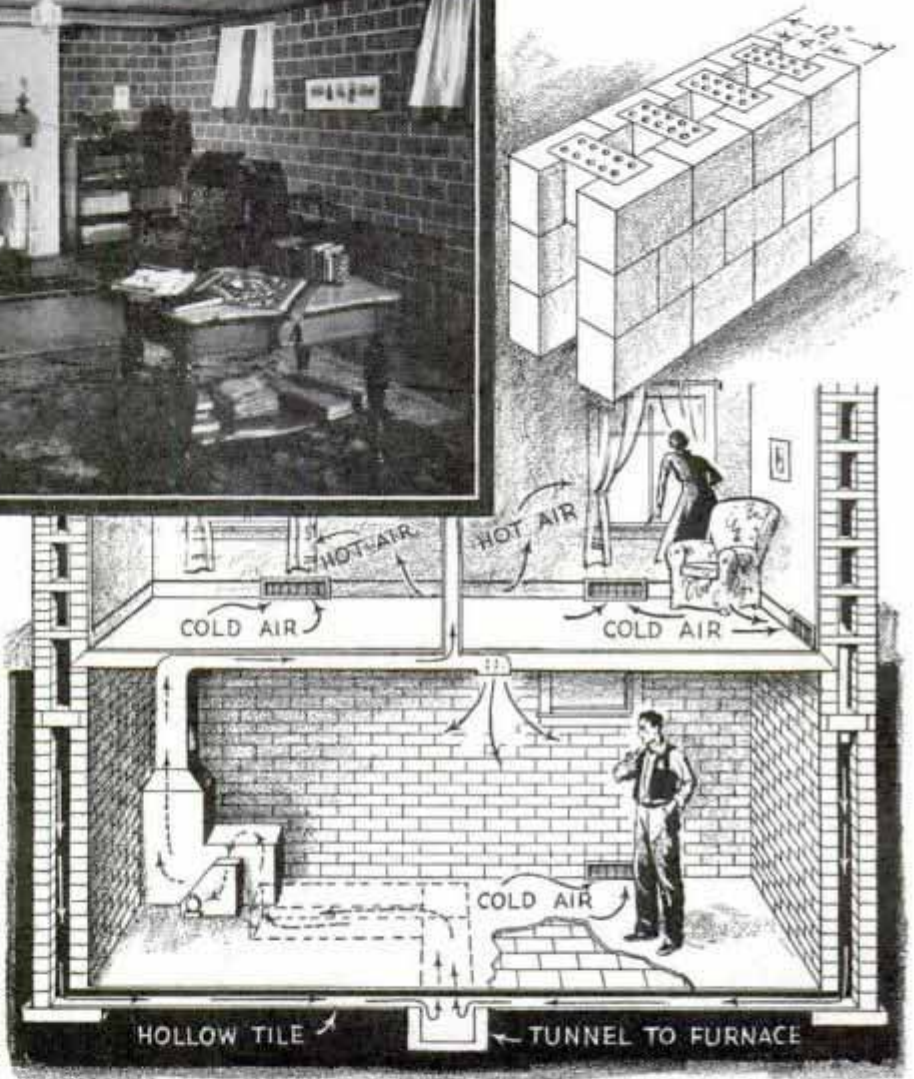

Cooling the home without refrigerating machinery is possible by employing the natural earth insulation which surrounds the wall of the basement. The method, built into new houses at low cost, has been tested successfully in the middle west. A hollow wall of brick, with a four-inch air space between the outer and inner walls, comprises the foundation wall. It has no continuous mortar joints, hence excludes all moisture. Closures of solid brick at the first-floor line and at a point thirty inches below grade line seal off the inner space. The regulation hot-air heating plant, with blower or fan for forced circulation, completes the equipment. The air is conducted through the cool basement walls and hollow tile beneath the basement floor, then forced into the upper floors at a much lower temperature than that at which it was taken into the cold-air ducts. The difference between outside and inside temperatures is about sixteen degrees. In winter, the heating plant is operated as usual, the hollow wall

helping to warm the basement as the air is drawn from the upper rooms into the furnace through the wall ducts.

WOOD IS PRESERVED LONGER BY NON-TOXIC OILS

Unusual protection is given wood by a treatment with non-poisonous oils ob-

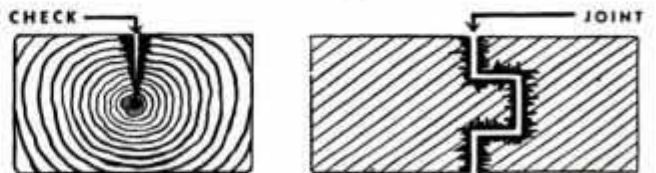

Sketches of Cross-Sections Show Places Most Susceptible to Attack from Fungi

Tennessee Eastman
 Prob. H. Woodcock

Western Brick & Supply Co., 1911-12 St. Lincoln, Neb.
 Wm. Julian Ehrhart.

8475

Mr. Julian Ehrhart, 35 1/2 Maryland Lincoln, Neb

tained by destructive distillation of hardwood. The new oils, however, are more toxic against fungi than are coal-tar oils, according to governmental agencies which have made tests. So penetrating that wooden barrels cannot be used for shipping the hardwood oils, the product has a great affinity for wood, following the fibers and becoming fixed. Wood treated with the preserver is little affected by exposure to weather. The oil is applied with a brush, by immersion, by spraying or by pressure. Frequently used for railway ties, the pressure method consists of pumping the hot oil into the timbers while they are enclosed in a large cylinder.

*charge
to another*

**LIGHTWEIGHT FREIGHT CARS
CARRY GREATER LOADS**

Increasing the payload is possible with lightweight freight cars designed to reduce costs and damage hazards. Displayed by the Baltimore and Ohio railroad, the cars are built of corrosion-resistant materials and equipped with shock-absorbing appliances. All are constructed of lightweight alloy, double-strength metals. Some of the eight cars exhibited have rounded roofs. An aluminum hopper car, having two sawtooth hoppers at the center, can discharge its load across the track. One car has doors in the floor center that slide downward and another has doors that slide upward. It will be possible to carry greater loads in the cars, because of the sturdy construction, without adding to the train load.

8 494

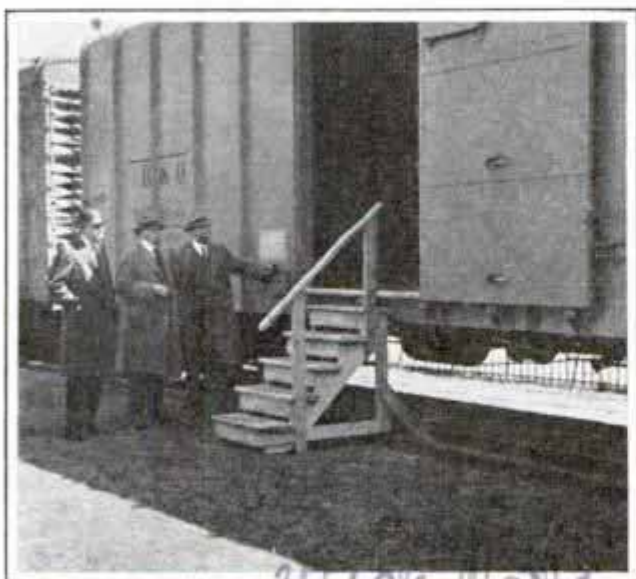

Officials Inspect Latest Freight Car Built of Light but Strong Metal Alloys

**TIRE GAUGE FLASHER ON DASH
WARNS OF LOW PRESSURE**

pal Bend.

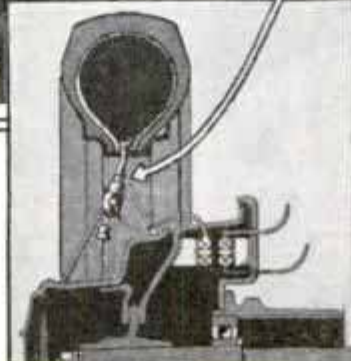
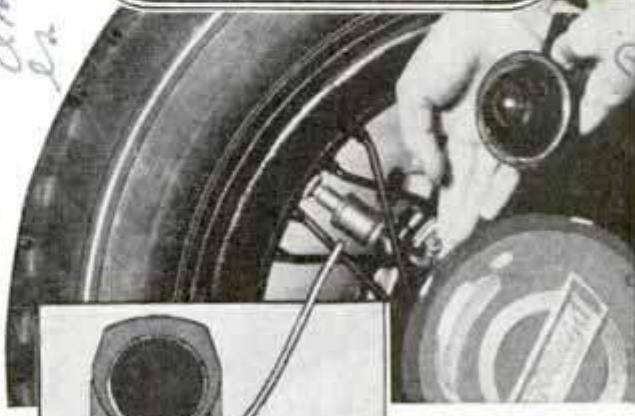
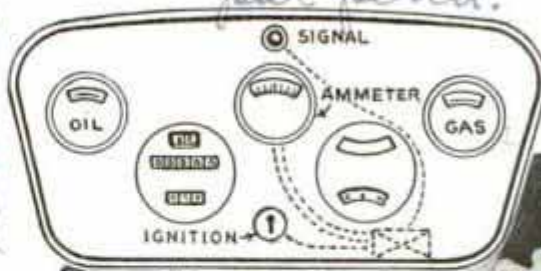

Photo and Diagrams Show Flasher System That Connects to Tire Valve to Warn of Under-inflation

When air pressure is low in tires of the automobile, truck or bus equipped with a new-type gauge, a red light flashes on the instrument panel to warn the driver. The device functions through a series of magnetic coils operated by electricity from the car battery through a valve attached to the tire valve stem to the signal on the dash. Screwed into place on the valve stem, the device resembles an oversize valve cap. A small diaphragm in the valve closes a circuit when pressure drops below a predetermined point, perhaps twenty-five pounds, and causes the flasher to signal the driver. The gauge works while the car is moving, due to the coils which carry the electricity through the brake drums to the instrument board. One coil is bracketed to the inside of the revolving brake drum, the other to the inside of the stationary drum, and each has contact points. Thus, one set delivers the current and the other receives it as the wheel revolves. The equipment is expected to save time in checking tire pressure and to save money by preventing rim cuts.

*The General Mfg. Co.
421 N. W. Cincinnati, Ohio*

W. W. Wood

8,429. Mrs. 157 Carhart St. Marion, Ohio

Covered Wagon Co
7 118 55 E. Selman



HITTING



Top, Interior Showing Kitchen; Circle, Top, Parked in Pleasant Spot; Circle, Left Center, Dining in Comfort; Circle, Bottom, Reading in Bed

FROM the prairie schooner to the modern trailer coach is a vast step forward. More surprising is this prediction of Roger W. Babson, able statistician: "Within twenty years, more than half the population of the United States will be living in automobile trailers!"

In some of the large trailer colonies of the south and the Pacific coast may be found a thousand trailers, averaging three persons per trailer, registered at one time. They stay for a week or two and then "hit the trail."

A little over one dollar a week reserves space for the tourist's car and coach, and entitles him to free electricity and water. Inside the coach is the spick-and-span kitchen with an ice box, then the lavatory and up front the comfortable full-size berths with inner-spring mattresses. Mechanically, the



Trailer
Trailer
Trailer
Ohio

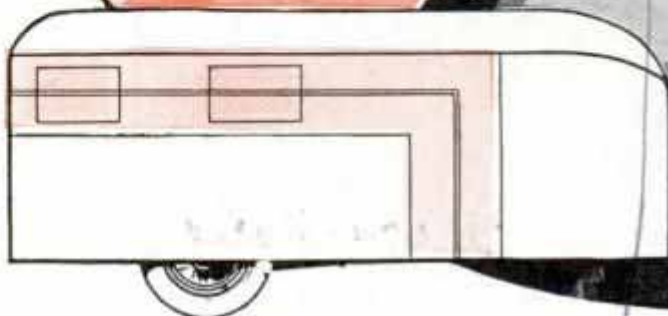

Wife Bodies 441 Wash. St. Columbus, Ohio

Covered Wagon Co
118 55 E. Selman

Conceded wagon...
 E. Jefferson are Detroit
 much

THE TRAIL

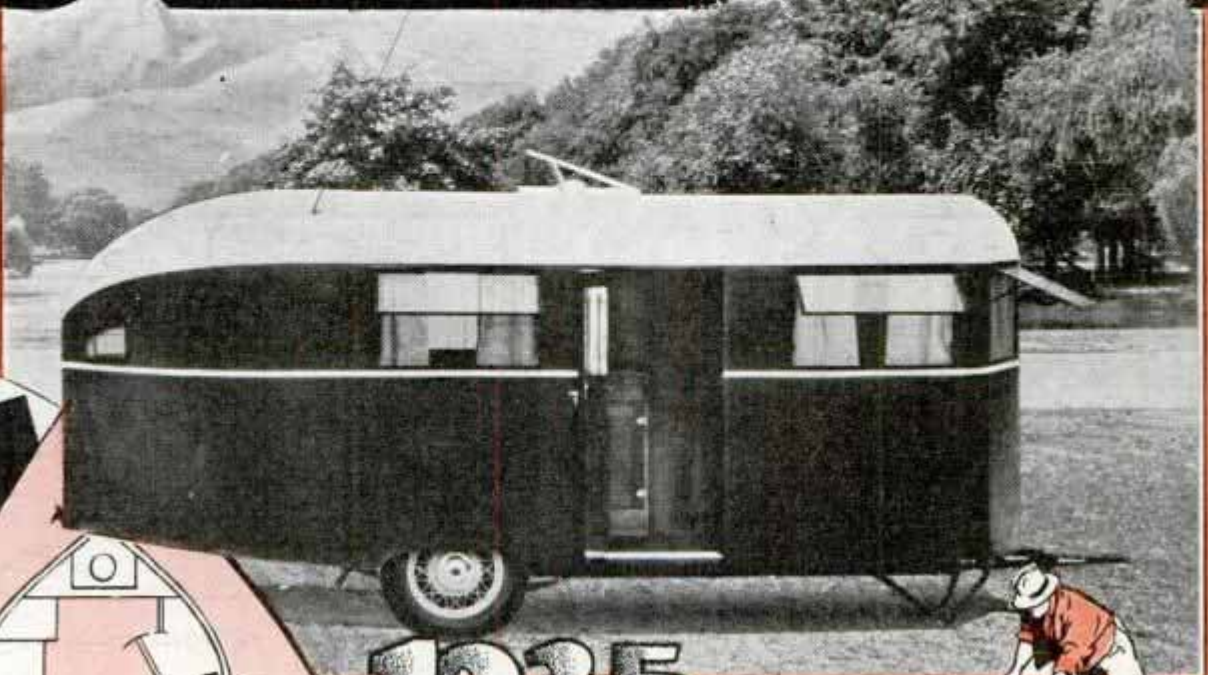

1935
 Style

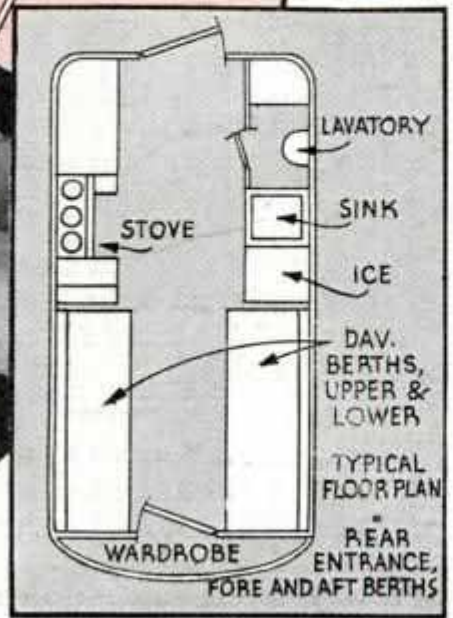
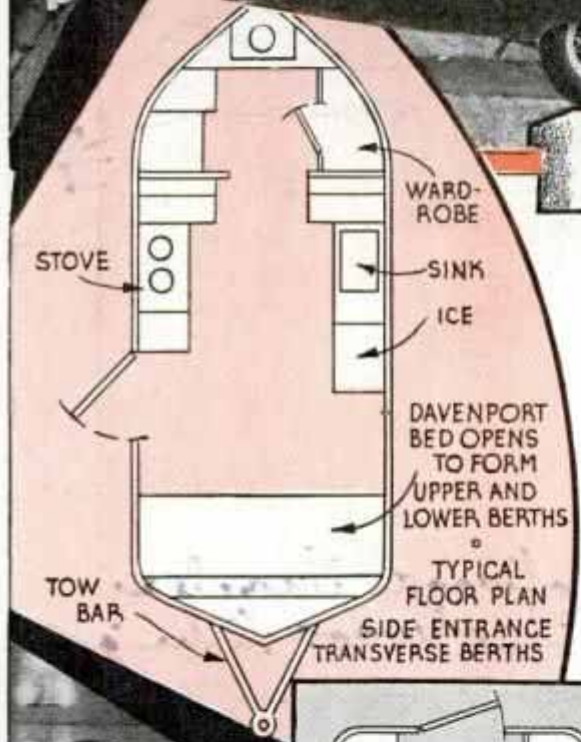

Top, at Home on Any Camp Site; Left, Diagrams of Two Styles of Berth Arrangement; Bottom, Left, Berth Made Up for the Night

trailer is as sound as the car that pulls it. Structurally, the trailer is like a modern home, insulated against summer's heat and winter's cold, and having practically every convenience which makes for good and comfortable living.

Trailers range from thirteen to eighteen feet long. Width and height must be sufficient to allow the "six-footer" headroom while standing and leg room when sleeping. An average dimension is seventy-six inches for the interior height and width, while the over-all height is approximately seven and one-half feet. All of these dimensions are from twenty to forty per cent within the limits as defined by law in most states. In one style trailer the berths are placed crosswise, usually at the head end. In another style, the berths run fore and aft along each side. Both make use of the davenport bed, which is a seat



Trailer Styles to Suit Any Owner; Right, Center, Comparison of Gas Consumption; Just Below, Trailer Insulated against Cold; Bottom, Cottage-Type Trailer Folds into Compact Box

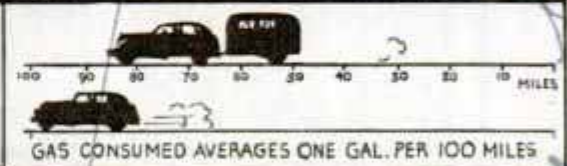
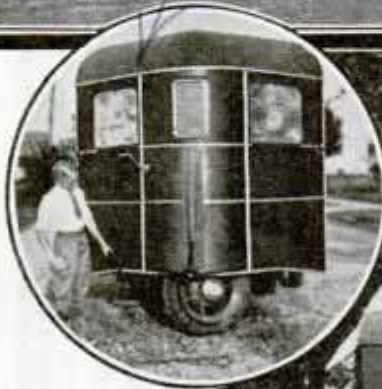

by day and unfolds into upper and lower berths by night.

The kitchen is usually in the center of the coach, in close proximity to the open section of floor space, which, with a folding table and chairs, makes the dining room. Other features of the interior are as many and as varied as well-designed homes. All are marvels of compactness. The first look inside gives an impression of ample room, yet in this limited space you will find everything from kitchen sink and ice box to lavatory.

Viewed from the outside, the trailer is far ahead of the boxlike structures which roamed the highways a few years ago. Sweeping lines and a beautiful finish make them as attractive as the 1935 car ahead, while even the smallest and least expensive unit shows many refinements over previous designs. Streamlining is much in evidence, but largely for beauty alone since wind-resistance is practically nil at the speed which the average man favors—a top of fifty miles per hour.

Gas consumption usually is of interest to the prospective buyer of a trailer coach. It has been accurately determined that a fully equipped trailer, about 1,800 pounds, takes one gallon of gasoline for each 100 miles traveled. If five gallons of gasoline are good for 100 miles with the car alone, the same five gallons would last from eighty-five to ninety miles with trailer attached—an increase in fuel consumption of from ten to fifteen per cent. Other costs

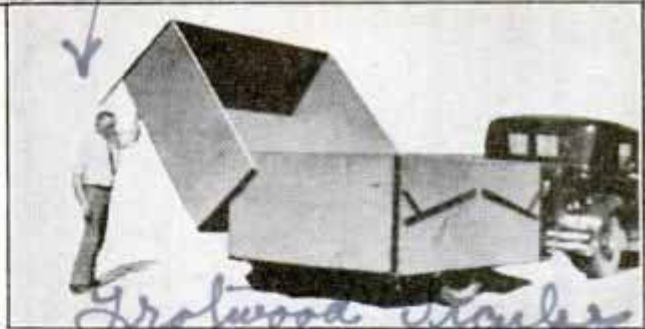

which are of interest to the buyer are the initial purchase price—\$300 to \$1,000—and the trailer license fee, about seventy cents for each 100 pounds of weight. The last-named item varies in different states, as do also various rulings affecting the operation of a trailer upon the highway. Legislation is under way to standardize lighting, load limits and structural soundness of chassis and body, the latter to outlaw many of the unsafe home-built units now on the road.

Names and addresses of manufacturers and dealers in articles described in this magazine will be furnished by our Bureau of Information upon request accompanied by stamped, self-addressed envelope.

Hammerblaw Cool Co. Chicago, Wis

Groffwood trailers Groffwood, Ohio

8701 Tracy Ave.
Kansas City, Mo.

Tricks of Angling Taught in Public School



Top, the Fishing Class on Bank of Stream Gets Practical Instructions in Casting; Bottom, Left, Chart Used in Teaching Habits of Fish; Right, Instructor Shows How Line Should Be Handled

Scientific phases of angling, usually acquired through the "trial and error" method over a period of several years, were taught in a course offered by a Kansas City, Mo., public school recently. More than 100 students completed two ten-week semesters sponsored by the recreational department of adult education. Class periods were one and one-half hours long, in which research, history and a practical work-out in casting were featured. The pupils brought pencils, notebooks and rods. The first lesson included a thirty-minute lecture on the antiquity of angling, practice in casting and discussion. Doormats were used as targets for casting and by the end of the course many of the students

could cast accurately at distances up to eighty-five feet. Kinds of fish were studied, with considerable detail concerning fish anatomy, locale, habits and response to certain lure, weather conditions, the signs of the zodiac and phases of the moon. Frank DeCou, regarded as an expert angler, hunter and guide, was the instructor. In discussing the need for such a course, Mr. DeCou pointed out that in 1934, nearly ten million hunting and fishing licenses were issued, indicating the widespread interest in angling. And there are many more fishermen than licenses, since a few states do not require permits under some circumstances. The fishing classes will be continued during the next school year.

Home Foundry Kit Produces Metal Castings

49.50 - e. o. l.

see ad P. 139.



Making Castings with Small Foundry Outfit; This Photo Shows Metal Being Poured into the Casting Mold

Particularly adapted to the home workshop, a small foundry kit is available for castings of aluminum, silver, gold and other metals, forgings, assaying and experiments. Heat treating and case hardening of steel can be accomplished at temperatures as high as 2,400 degrees Fahrenheit. The kit operates on the regular gas supply and 110-volt electric current at about one cent per hour. The furnace starts cold and melts aluminum in seven minutes. The kit includes the furnace, fire-clay crucibles, crucible tongs, flask, graphite, molding sand, refractory lid for high temperatures, insulating lid to prevent escape of heat and complete instructions.

6 446

FLASH GUN ON CAMERA SET OFF BY SHUTTER

When the aperture is the widest, the shutter of a speed-graphic camera sets off the flash bulb in perfect synchronization, resulting in better pictures. The arrangement, invented by Harry Grogin of Brooklyn, N. Y., also re-

No Overcoats Needed for These Jobs

SOME miners and other industrial workers habitually labor in temperatures well above 100 degrees Fahrenheit. In some of the coal pits in England, the temperature is 103 degrees and in a Brazilian gold mine, the mercury stands at 117 degrees at 7,000 feet. This mine is cooled by special apparatus but the temperatures are so high the miners can work for short periods only. Drillers for oil in Vera Cruz cool the drill with ice because it goes down to a depth of 10,585 feet, where high temperatures are encountered. The temperature in the melting room of the United States mint is around 106 degrees, in many gas works it ranges from 112 to 118 degrees and in the stokeholds of ships crossing the Red sea, sometimes it runs up to 140 degrees.

Emb. H. P. Behrman 19186 Storer Ave Detroit, Mich



Ready to Snap a Picture; When Shutter Opens to Widest Point, It Sets Off Flash Bulb

Art Director

1669 S. Peabody St.
Milwaukee, Wis.

relieves the photographer of the tedium of trying to press the flashlamp button and operate the camera shutter at the same time. As the shutter starts opening, a contact point rises to touch off the flash bulb when the aperture is largest. This is done at a speed of one two-hundredths of a second. The flash gun is fitted into a handle by which the camera is held for focusing.

RAPID EGG BREAKER SEPARATES THE WHITES AND YOLKS



Reed
Egg Breaker Which Handles 3,600 Eggs per Hour and Separates Whites and Yolks

ELECTRIC FENCING MADE SAFE BY POWER CONTROL UNIT

By using a control unit that cuts the current off and on at five-second intervals, the farmer and rancher may install electric fencing that will be harmless to human beings and live stock, yet will protect their property. The unit makes it possible to send a sharp shock as far as four miles on the fence wire in any weather. Current from the ordinary outlet is reduced by the unit from 110 to ninety volts and less than one

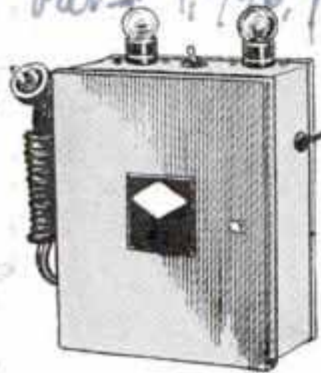

ampere, far below the point of danger. Should an accident occur, the one-ampere fuse would blow, cutting off the power from the fence. In tests, the operating costs for 200 acres amounted to about ten cents per month. With attachments, the unit can be used on thirty-two volt house plants.

Eggs are broken and the whites and yolks are separated by an automatic breaker which handles 3,600 eggs per hour compared with less than 650 which can be broken by hand in the same period. As each egg comes to the breaking position, the action of the breaker is halted momentarily to allow all the contents to escape.

MOUNT FOR ANTI-AIRCRAFT GUN IS LIKE FORT ON WHEELS

To combat air attacks in time of war, Uncle Sam is adding modern three-inch anti-aircraft guns to the equipment of some units of the coast artillery. One of these guns, mounted for duty, resembles a steel fort on wheels as it rumbles along on its rubber-tired wheels. Despite the great size and weight, the gun can be transported at a good rate of speed where its route is over improved roads.

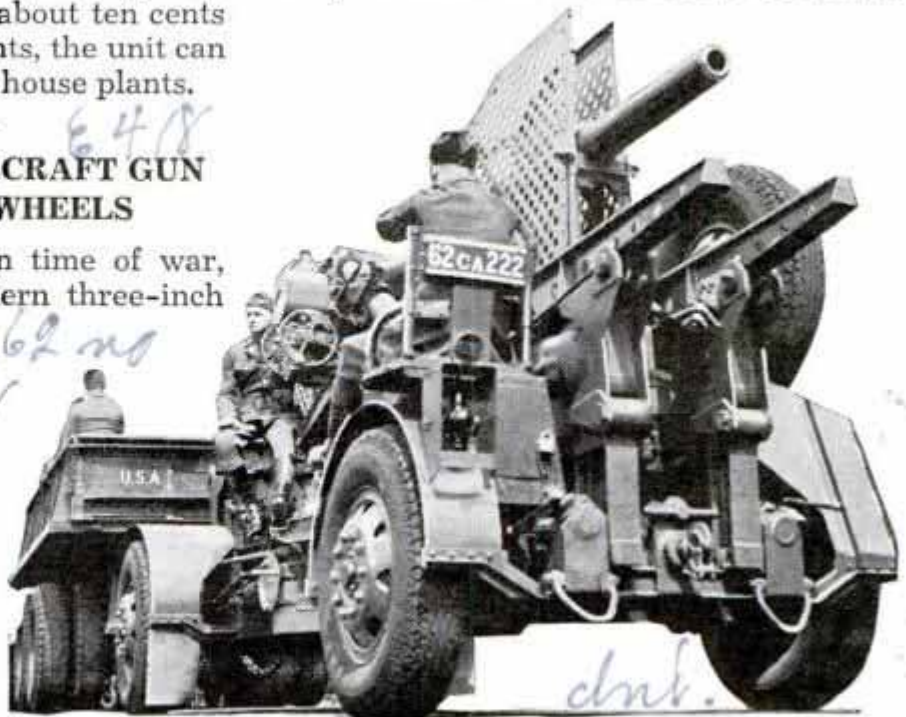

62 no
Three-Inch Anti-Aircraft Gun Mounted for Duty; the Heavy Gun Can Be Transported at a Fair Rate of Speed; Note the Rubber-Tired Wheels

Battery B.

Reed Automatic Egg Breaker and No other separator Co. Los Angeles, Calif.

made by Reese Patent Corp. 354 S. Spring St. Los Angeles

6435

648

dnk.

Periscope to Study Photos Makes Enlarging Easier

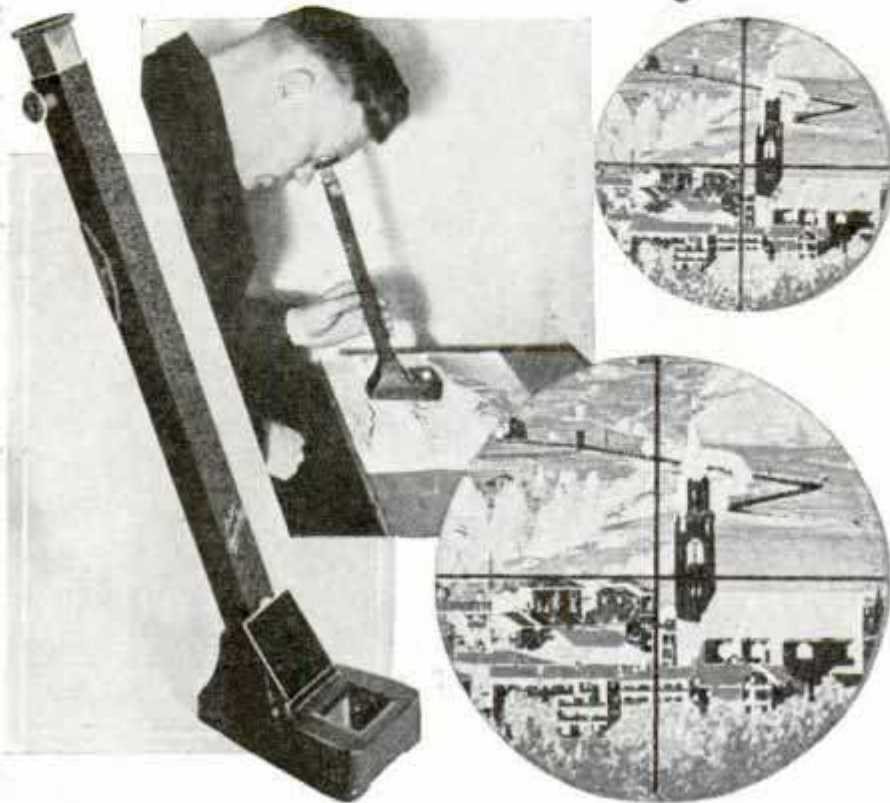

Left, Photo Periscope; Center, the Instrument in Use; Right, How Photo Appears under the Glass; Each Part Can Be Studied Easily

For gauging and accurate setting of enlargements, a periscope has been produced in Germany to aid in studying photographs. The instrument is placed on the projection surface and can be used in the cover frame. Thus, the picture is on a level with the eyes, appearing very clearly through a dulled disk. Any part of the picture can be studied at leisure for the purpose of judging whether it is suitable for enlargement. The instrument also is useful for examining and judging the negative generally, an aid to the professional or the amateur photographer.

PROPELLER FLAWS ARE FOUND BY TESTS WITH SAND

Army air corps engineers have solved the problem of failures in metal airplane propellers. It was found that the vibration of the blades is similar to that of reeds. The critical points on the blades were located by a unique method. Fine wood dust or sand was sprinkled on the blades. When a resonant vibration was set up, it was found that the sand was shaken off except

at the critical points. In tip failures, the weakness was near the critical point closest to the top. Further study indicated most propeller failures occur on engines having crankshafts in which a natural frequency can be excited by engine explosions. As a result, engineers can prevent many propeller failures by restricting engines to a specified range of operation or by changing to another type of propeller.

ENGRAVING "PENCIL" PLUGS IN ON A. C. CURRENT

For engraving on gold, silver, brass, copper, aluminum and other metals, as well as bakelite, catalin, ivory and hardwoods, a plug-in tool that is used like a pencil is available.

No pressure is required, the operator writing or printing as with a pencil. The tool cuts rapidly with a chisel-like stroke. The powerful little motor operates on 110-volt, a.c. circuits, the standard lighting current used in homes. The engraver fits the hand.

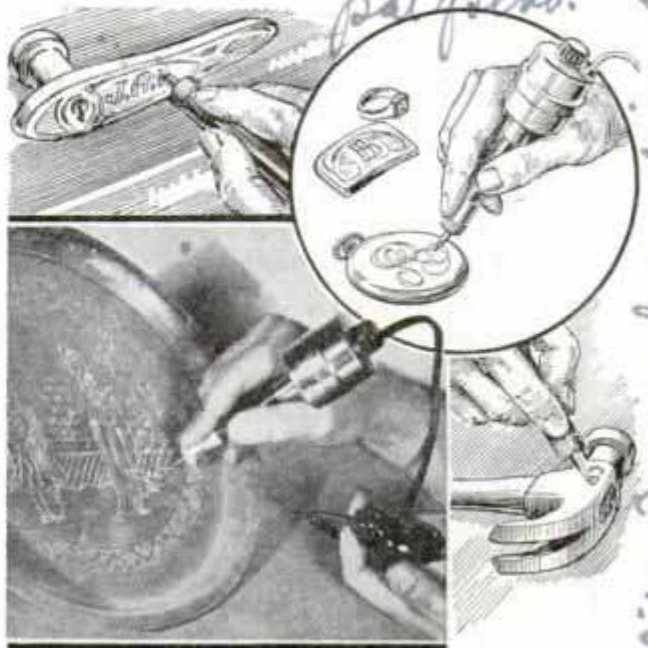

Several Views of the Engraving Instrument in Use; Note Simplicity of Operation

E 412. Esmb. H, Barbarasta 20, Freiburg, Germany

No. U. S. Agent known

E 477 Army Corps of Engineers, Dayton, Ohio

Lincolnwood Ill. Quality Merchandise Co., 2306

4 W. 103rd St
New York City.

SCULPTURED SOUND

Whizzes by Ear like Bullet

IF you could hear 10,000,000 people talking at once or an orchestra of 1,000 musicians playing their loudest, you would get a fair notion of what sound volume can come from the newest loud speakers developed in the Bell Telephone laboratories, for use with a new three-way sound transmission system. *463 West St.*

"I don't dare to 'shoot the works,' with these loud speakers," said Dr. Harvey Fletcher, director of acoustical research. "Something might give way."

Nobody doubted what he said, for at only a fraction of their full volume, the thunder from the loud speakers made the windows and fixtures of a modern building shake and rattle as if there were a typhoon blowing outside. With such apparatus Dr. Fletcher could hurl sound waves like bricks, and bring

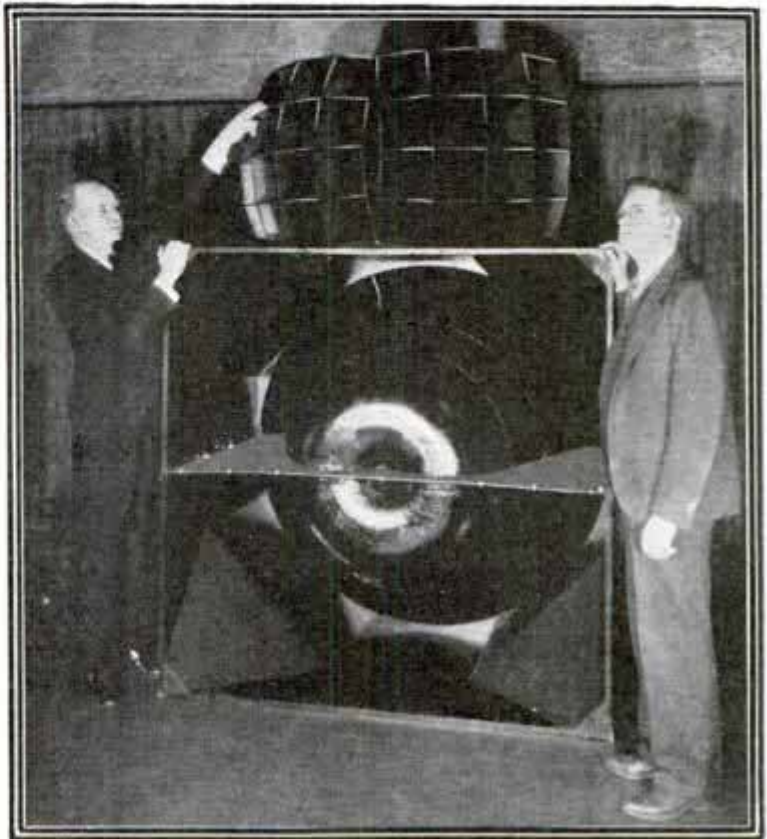

High-Frequency Loud Speakers Used for the Reproduction of Music in Auditory Perspective

the walls crashing down on our heads—if he had a mind to do it.

The result of the new sound transmission system is music that is "solid, sculptured, and dimensional." Now we know what a real "loud" speaker sounds like. It



A Broadcast of Three-Dimensional Sound; Note the Three Microphones Necessary to Produce the Sculptured Relief Effect and Give Depth to the Music

Further data from Paul B. Dindley

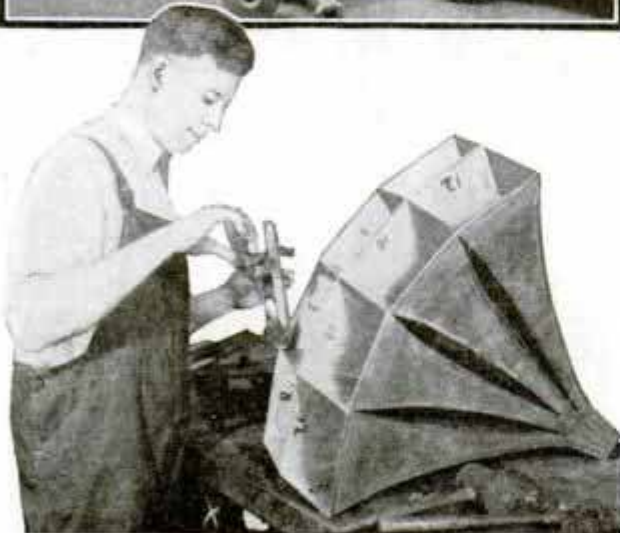
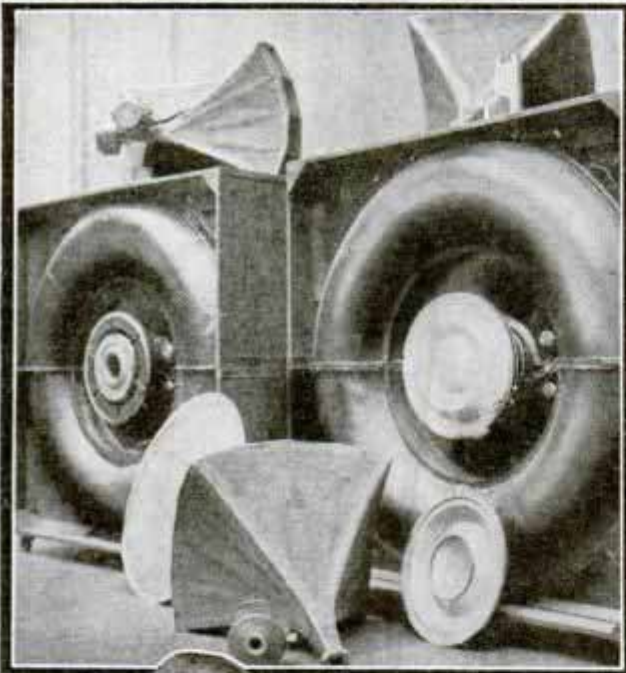
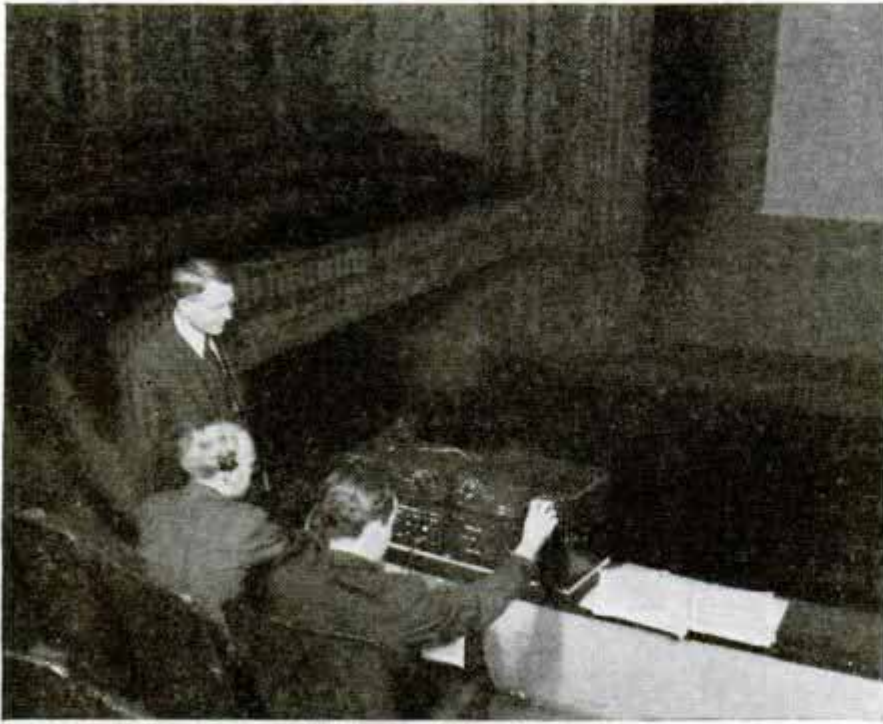

Control Board of Sound System, and Some of the Huge Loud Speakers Used in Reproducing Music in Three Dimensions

has an efficiency of about sixty per cent, as compared with a two-per-cent efficiency for other types of speakers.

"These are good loud speakers, better, we think, by a considerable margin than any which have been built before," said Dr. Fletcher. "They will radiate continuously more than 100 watts of sound power, and for short intervals, as much as one-half kilowatt of sound power."

But their ability to produce man-made thunder is not their only distinction. They can radiate

sounds having frequencies covering a range of 15,000 cycles; and an additional characteristic is that of distributing sound uniformly at all frequencies in different directions from the loud speakers to different points of the room.

"These speakers," said Dr. Fletcher, "will produce a much better distribution of the musical sounds, without distorting them, than would be produced if an orchestra were actually playing before you, on a stage. And whereas the usual loud speakers convert two per cent of the electrical current into sound power and waste ninety-eight per cent, these convert sixty per cent of the electrical power into sound power. They also add one and one-half octaves of tone to the low register and two octaves to the high register, which cannot be heard by the usual speaker."

Dr. Fletcher can produce any sound or sound variation which it is possible for your ears to stand. It is all mystifying and terrifying. You imagine that you are actually "feeling" and "touching" and even "seeing" sound. The waves come at your ears from odd and unexpected places. Dr. Fletcher waves his wand of magic and you hear the roar of an airplane overhead. A musician walks off the stage but his music remains—and then the music marches off in the opposite direction.

This form of sound reproduction is made possible by a new three-way transmission

(Continued to page 146A)

2309 Archer Ave
Chicago

**BICYCLE HAS LOCKING CABLE
IN THE HANDLEBARS**

Concealed in the handlebars, a cable lock for bicycles is attached to any convenient "hitching post" to make it impossible for a thief to carry a bicycle away and saw the lock at his leisure. When the bicycle is being used, the lock remains attached to the frame while the cable disappears within the handlebars, making it unnecessary to carry a lock on the person or have it dangling from a chain on the vehicle. The lock portion of the device is a chromium-plated steel shell enclosing the lock itself. It is permanently attached



Demonstrating the Dust Masks; Note How the Nose and Mouth Were Protected

**MASKS WORN IN DUST STORMS
GUARD THROAT AND LUNGS**

Protection of the nose, throat and lungs during the dust storms that swept several western states in the spring of 1935 was afforded by masks. Worn over the nose and mouth, the devices prevented the dust particles from reaching delicate membrane. Hundreds of cases of dust-pneumonia were reported while the storms raged.

**DISPLAY CASE ON REAR OF CAR
E 394 ADVERTISES GOODS**

Something new in advertising has been introduced by a Berlin merchant. It is a traveling showcase, really a display window set up on the back of an automobile. Within the case are goods offered by the merchant. Since it is glass enclosed, the case protects the merchandise from dust as the car moves through the city's streets.

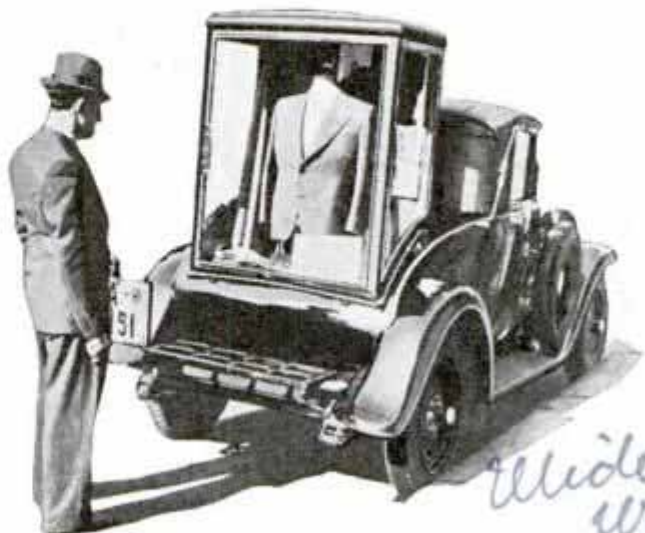

This Showcase on Wheels Attracts Attention as It Moves Along Berlin's Streets



Locking Cable for Bicycle Which Is Concealed Inside the Handlebars When Not in Use

to the under side of the frame between the steering post and the seat. The cable is installed in the handlebars by removing the right grip. Special fixtures make it virtually impossible to detach the cable from inside the handlebars, once it is installed. It is tested to withstand a pull of 1,000 pounds. The grip is re-attached after the cable is installed, the hole in its end being reamed larger so the cable will slide through it. A safety device attached to the steering post makes it impossible for a thief to remove the handlebars. To lock the bicycle, the cable is pulled out, placed around a tree or post and its end is inserted in the lock shell.

☐ The greatest known depth of the Atlantic ocean is about 44,000 feet.

Clarity News Almanac

8150.

10555-5 Holman Co. I
Los Angeles, Calif

TUNING UP

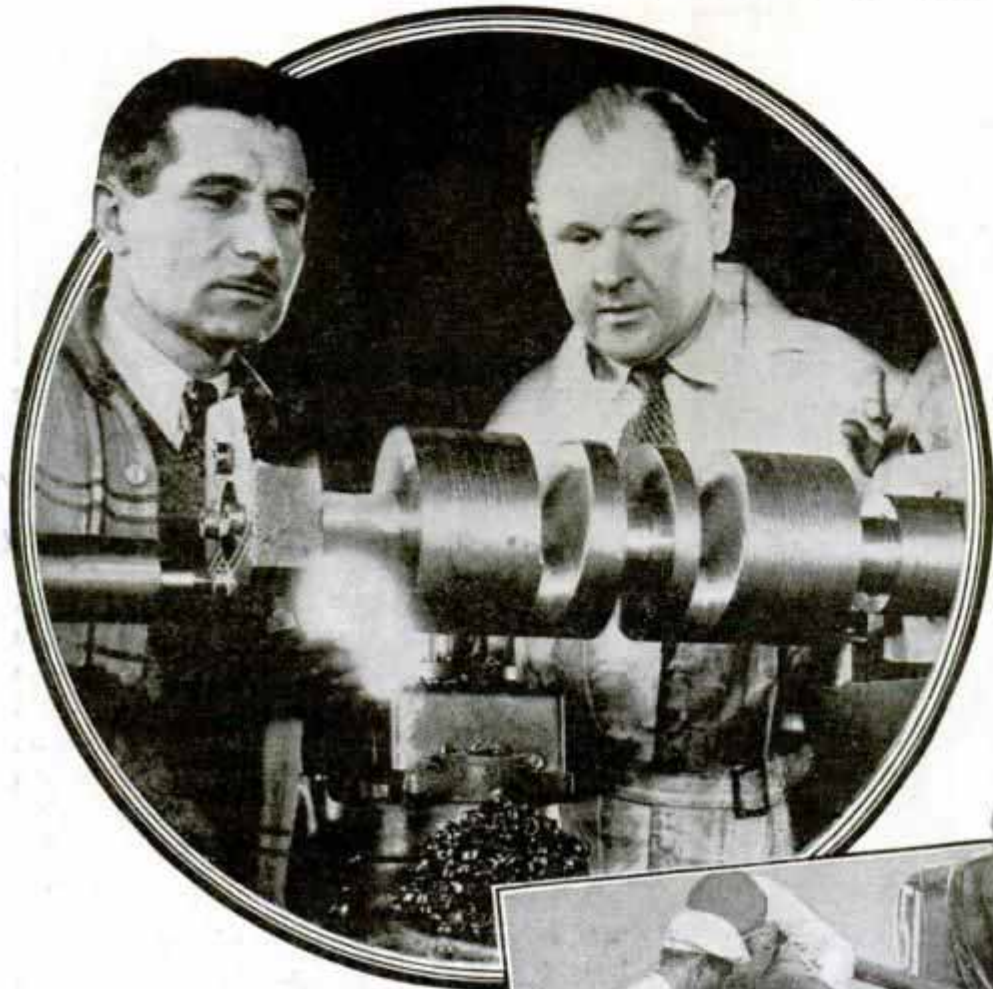

Jean Marcenac and Fred Offenhauser Watching a New Crankshaft for a Racing Car as It Is Being Cut; Below, When a Racer Pulls into the Pits, It Is Up to the Pit Crew to Get It Back into the Race as Quickly as Possible; Here a Tire Is Being Changed



SWAYING wildly as it lost speed, the car with the flat tire wobbled down the track and drew into the pits. Then, just as the pit crew went into action, clouds of smoke and the odor of burning rubber rose from the car. A few seconds later, while the spectators stood up in their seats, the fire had been extinguished, the tire changed, and the car was back in the race. The flat tire had caught fire from the intense heat of rolling down the track and when the car stopped the clouds of smoke made it seem to the onlookers that the entire car was in flames.

Two dare-devils ride each car in an Indianapolis race but in addition nearly a dozen men are needed on the track to keep each car going. Every car is allowed a pit crew of five men, skilled mechanics who sit idly by during most of the race but who work with superhuman speed and skill

when their car pulls into the pits. No matter whether the car has developed serious trouble or merely needs more fuel, they attend its wants and get it back in the race without delay.

Jean Marcenac has groomed cars for fourteen Indianapolis races. Ralph de Palma, Tommy Milton, Harry Hartz, Joe Boyer, Frank Lockhart, and Cliff Durant have all depended on Marcenac to tune up their racing mounts. Marcenac has had mechanical charge of four Indianapolis winners and all his other cars, except three that

a WINNER



failed to finish the race, placed in the money.

"During a race the mechanics in the pits do their best to remain cool because they never know when they will be called upon for help," Marcenac says. "When their car does stop every second counts and there must be no lost motions. If there's something wrong a good mechanic tries to do his trouble shooting by ear before the car stops.

"But they must make haste slowly enough to do everything right. I've seen a nervous pit man jerk a gasoline funnel from the car's tank before all the fuel had drained in, spilling several quarts over the back of the driver. A couple of laps later the driver was out of the race nursing a raw back. The gasoline, evaporating rapidly under the hot sun, burned his back and then the chafing against the back of the seat took the skin right off.

"Other pit men have neglected to tighten the fuel tank cap and after the car had gone down the track a few feet it stalled, causing a delay until the cap could be put on, pressure pumped up in the tank, and the engine started again. A little carelessness like not tightening up the oil drain plug has allowed a car to spill all its oil on the track, piling up several others in a

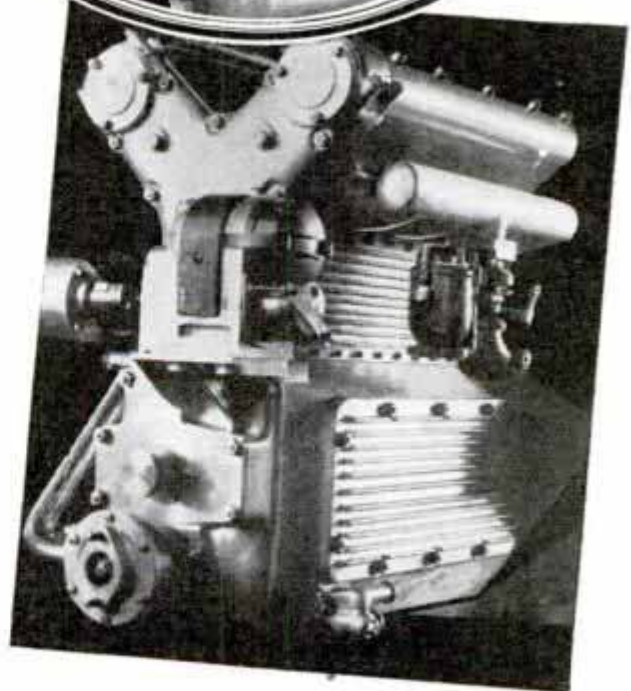

Top, Pit Crew Servicing Car; Center, Tuning Up Motor of a Race Car; Below, Racing Engine Fitted with One Carburetor

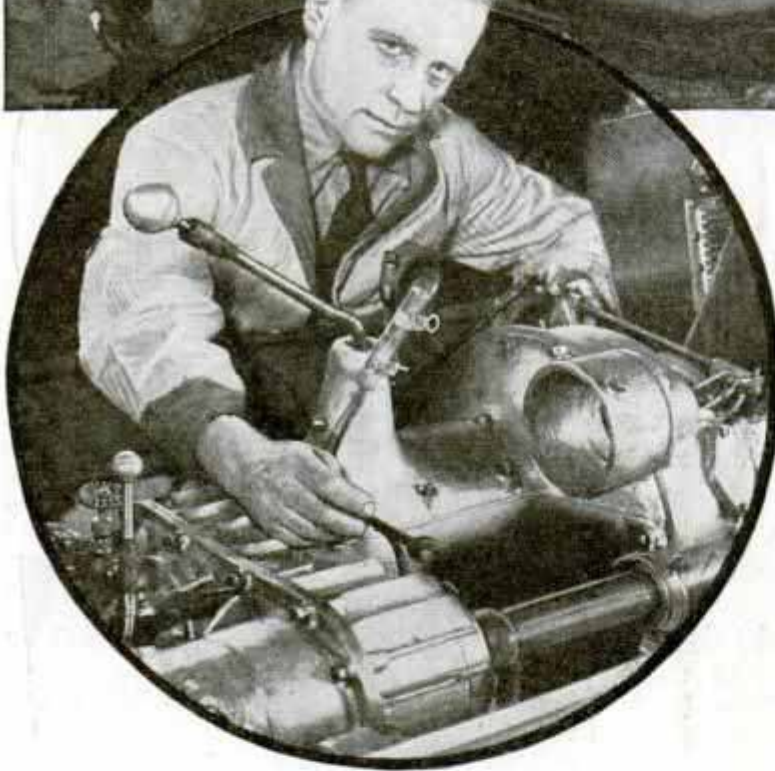

Top, Track Officials Checking Car in Pits; Below, Note How Drive Shafts Are Set Parallel with Engine

disastrous wreck and disqualifying itself.

"We usually practice tire changes the night before the race, one man running the jack under the car while I remove the cap. Eleven or twelve seconds is plenty of time for making a tire change.

"In 1930, when Billy Arnold had a three lap lead at the 110th lap he came into the pit for what amounted to an overhaul. We gave him thirty-five gallons of fuel, changed three tires, added water, put in a gallon of oil, got approval from the pit inspector, and the driver and riding me-

chanic had drinks of water, all in one minute and twenty-seven seconds. Arnold pulled out of the pits still in the lead."

Two years later Marcenac had charge of the pit for Fred Frame and Frame won the race in spite of six stops. The water pump forced water through the overflow pipe, allowing the car to overheat. The pit crew knew what was coming each time and was pouring water almost before the car stopped.

"Fifteen years ago we sometimes made major repairs to a car during a race," Marcenac says. "In 1921 at Indianapolis we took enough time out to change a cylinder head. In those days

even valves were changed or new connecting rods were placed in a car that developed trouble. Today, there isn't time. Even a ten-minute pit stop during the last half of an Indianapolis race would mean the loss of several places and probably end the chances of getting in the money.

"So we don't stock up in the pits with a lot of equipment. A fire extinguisher, two front and two rear tires already mounted on spare wheels, a set of hand tools and tire-changing tools, a spare magneto, several sets of spark plugs, and odds and ends

like wire and hose are about all we take. If the repeated shocks break an oil or fuel line we make a temporary repair with a section of small hose, or plug up small radiator leaks with chewing gum. But in case of a major breakage, like in 1933 when the timing gear of Fred Frame's car stripped while he was in the lead, we don't try to repair the damage because it would take so long that the driver wouldn't have a chance to regain his place.

"We keep a careful check on the laps run so we can signal before it is necessary to make a pit stop for fuel. Running out

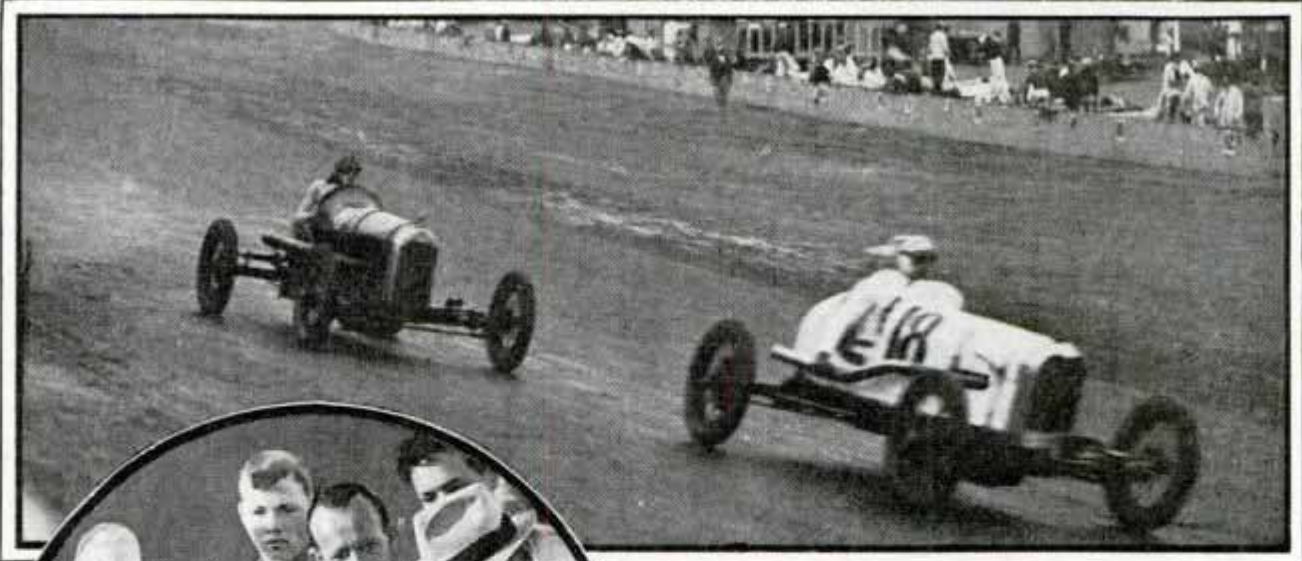
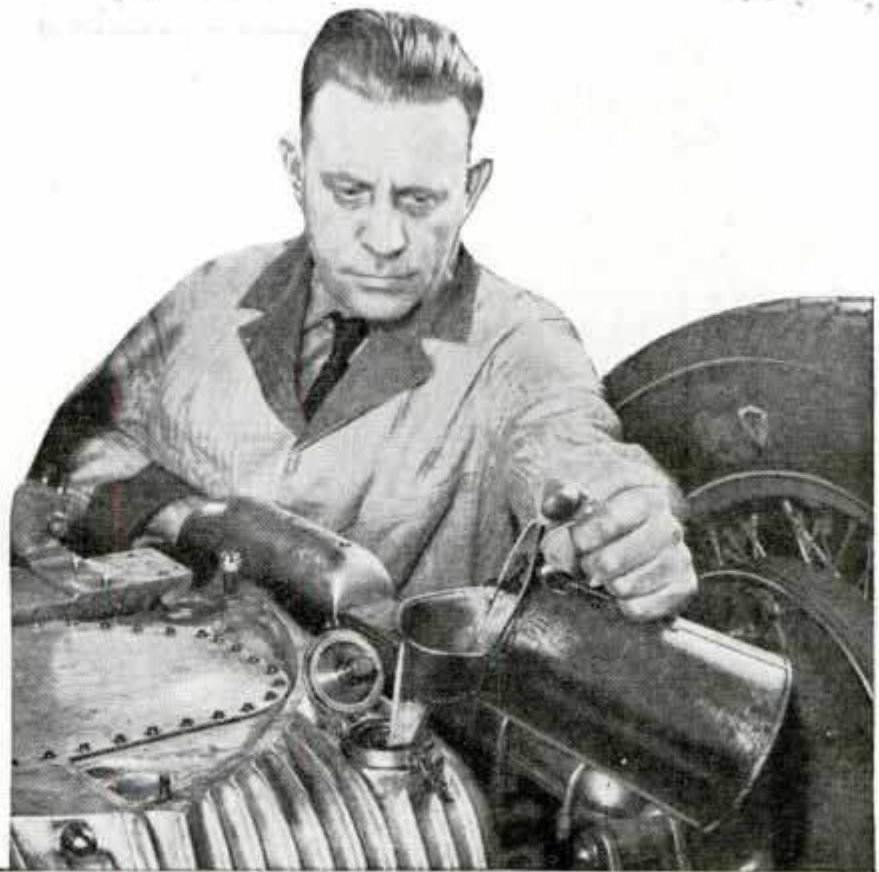

Top, Adding Oil to Front Drive Car; Center, Coming Out of Turn; Below, Driver Receiving Instructions Before the Start of a Race

of gas is dangerous, not only because of the time lost in carrying fuel to the car, but also because it almost ruins the engine. The excess air taken into the combustion chambers overheats the engine and warps the valves, reducing the peak engine speed possibly 1,000 revolutions per minute.

"One of the most exasperating things is to service your car in a few seconds and then discover it won't start. Usually the fuel in the combustion chambers and the intake manifold is so hot that it's too thin to fire. Rules forbid towing or pushing a

(Continued to page 128A)

Records kept. 350 Madison Ave New York

Valuable Records Preserved by Photography

Important historical records, newspapers and even books are now being preserved by photography. With the aid of a special photographing machine, the pages of a newspaper are photographed consecutively on a sensitized film similar to that used in moving-picture cameras. These photographed pages may be projected by means of a special viewing apparatus which produces an image one and one-half times the size of the original printed page.

The machine takes pictures at the rate of thirty pages a minute and is almost wholly automatic. A camera is synchronized with a revolving drum and the pages or forms are fed in much as papers are put into a mimeographing machine. They are carried at high speed along the circumference of the drum through the photographic field and are photographed in motion. Illumination and focus adjustments are set, and all the operator does is feed the forms

into the apparatus. One hundred feet of film carries between 825 and 850 newspaper pages. For reading, the film is mounted on a carrier on top of the viewing device, and is unwound and rewound as desired with the aid of a crank. If a print of one page is desired, it is made from the negative like an enlarged photographic print is produced. Should the original film begin to wear out, another print can be made from the negative. The film method of preserving records not only saves valuable filing space but makes it easy to look up any particular record. Some banks now record every check passing through for payment on a roll of moving-picture film, one roll of film recording about 7,500 checks. The picture of any check can be thrown onto a



Making Photographic Records of Newspaper and Bank Statements for Future Preservation; the Film Serves as a Permanent Record and Saves Valuable Filing Space

screen or a reproduction of it, taken from the negative, can be furnished to be used as evidence in court. The photographic machine also produces monthly statements of accounts. More than 3,000 such statements can be printed on one roll of film. At the end of the month, two photographs are taken simultaneously of every statement of account on separate rolls of film. The original statement, after the ledger and analysis section has been torn off, is sent to the depositor, and the two rolls of film are filed. Records of depositors' transactions thus can be preserved indefinitely. Merchants are also employing the photographic method for keeping an accurate daily record of accounts receivable.

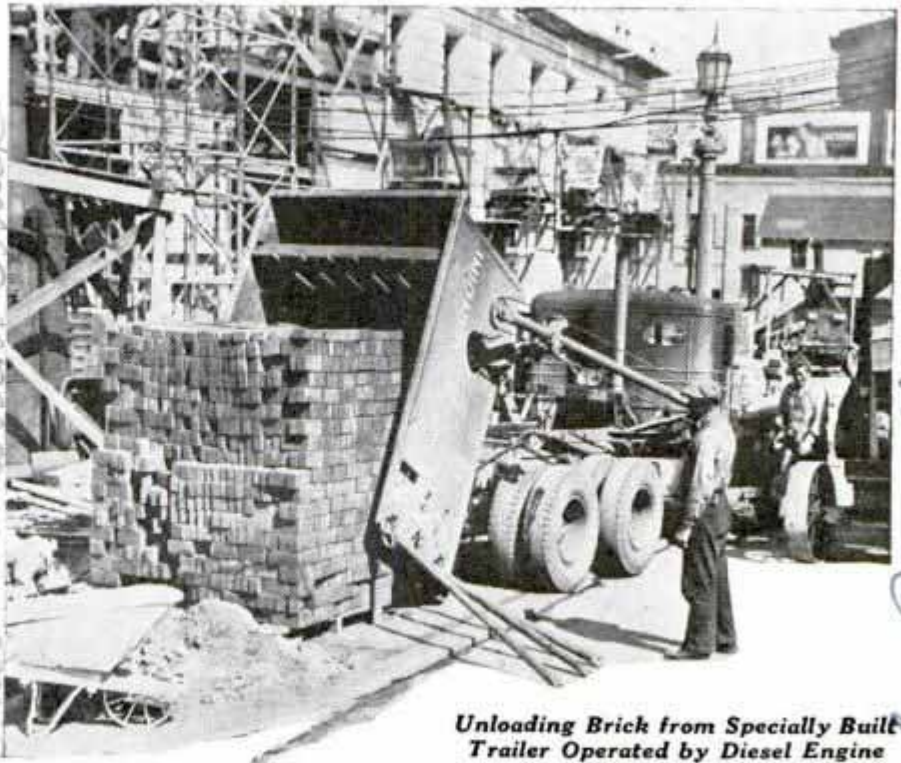

Unloading Brick from Specially Built Trailer Operated by Diesel Engine

DIESEL TRUCK HANDLES BRICK AT REDUCED COSTS

Fitted with a special body, a Diesel truck is reducing the costs of handling brick on the Pacific coast. The driver can pick up a load of eighteen and one-quarter tons of brick at the kiln in seventeen minutes with the assistance of only one man. At the delivery point, the driver unloads without aid. In picking up and setting down these brick containers, power is taken from the engine to shove the load back, tilt it and set it down. The truck attains a speed of forty-five miles per hour.

8402

BID REMINDER IN BRIDGE GAME ATTACHED TO ASH TRAY

As a reminder of the bid, a clock-like device attached to an ash tray is handy for the bridge table. When one of the players has won the bid, the dealer sets the hands or pointers on the dial to indicate the correct suit and the number of tricks. For instance, on a bid of seven spades, one hand would point to "7" and the other to the symbol of the spade suit.

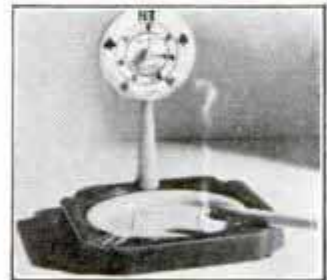

CHART OF WATER TEMPERATURE AND DEPTH AIDS BATHERS

Greater safety for bathers at Santa Monica, Calif., beach is attained by providing complete information about water temperature, depth and the tides. A chart showing this data is set in front of the beach guard headquarters each morning. Light-guards direct attention to the chart.

8409



This Chart Tells All the Bathing Beach Patron Needs to Know About the Water

Operated by - Remillard-Landini Co. Oakland, Calif.

Original novelty Co
2924 Carroll Ave

Mr. John ...
3107 - 19th St. N.W.
Washington, D.C.

The "G-MEN"



IN MEMORY OF
SPECIAL AGENTS
OF THE
DIVISION OF
INVESTIGATION
WHO HAVE LOST THEIR
LIVES IN LINE OF DUTY

EDWIN C. SHANAHAN OCT. 11, 1925

PAUL E. REYNOLDS AUG. 9, 1929

ALBERT L. INGLE NOV. 24, 1931

RAYMOND J. CAFFREY JUNE 17, 1933

RUPERT V. SURRATT OCT. 8, 1933

W. CARTER BAUM APRIL 23, 1934

H. E. HOLLIS NOVEMBER 27, 1934

S. P. COWLEY NOVEMBER 28, 1934

A NEW force for law and order has entered American police circles. The "G-men" of Washington, federal operatives of the department of justice, have stepped into a new role as a result of recent legislation.

There are 528 of these men, chosen from every walk in life, but all educated in the law or accountancy. They have been lifted from private life and trained specially by the department of justice to wage relentless war on crime. Not only do they know how to analyze a crime situation but they know how to shoot as well. The special training begins with their acceptance by the department as members of this exclusive anti-crime body. All are between the ages of twenty-five and thirty-five.

Before he is accepted to be a "G-man," an applicant is investigated from every angle. A special agent has visited the place of his birth and residence and gone carefully into his whole past life. Members of his family have been questioned as to his habits, companions and attendance at school. His grades at school have even been scrutinized.

If the applicant has been in business, that business and his conduct of it has been investigated. Does he pay his bills promptly? Is he honest in all his deal-

"G-Men" on the Rifle Range, and a Roll of Honor of Special Agents Killed in Line of Duty in the Past Ten Years

WAR *on* CRIME

ings? Did he ever have trouble with anybody? In addition to passing this scrutiny, he is required to stand a rigid physical examination.

More stress is placed on the education and character of these super-sleuths of Uncle Sam than on their ability to shoot straight because they are destined to be investigators rather than hard-riding, hard-shooting minions of the law. In fact, "taking to the gun" is the last thing they do. And this only as a last resort, as in the case of "Pretty Boy" Floyd and the Barker criminals of Florida.

Relentless pursuers of fact are these "G-men." Their special aptitude is

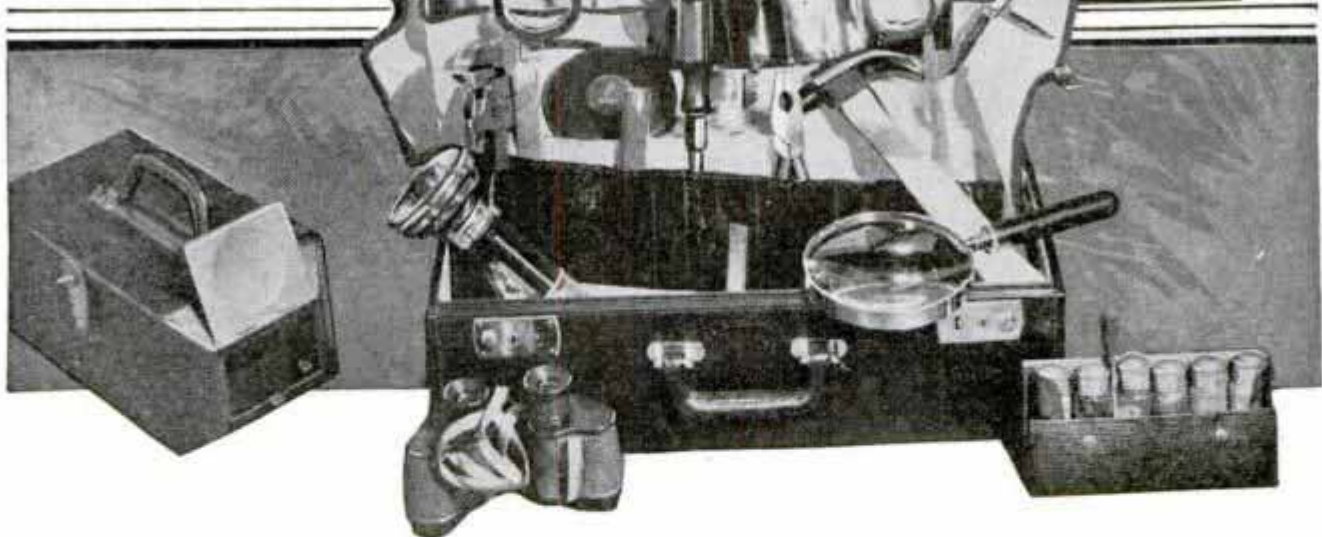

A Special Kit Carried by the "G-Men" in Their Investigation Work, and One of the Special Agents Using a Submachine Gun on the Pistol Range in the Department of Justice Building

digging up clues, tracing them out to an end and fitting the conclusions together into one picture puzzle solution. To be able to do this, they are trained under "old timers" in the art of sleuthing and taught how to "break a case." "Here are two pieces of thread," the recruit is told. "Do they mean

anything to you?" The recruit examines them, studies them under the microscope and concludes they are somewhat similar. Then the old timer swings into action.

He too, examines the strands under the microscope. The twist of the thread is the same, the color is the same, save for one

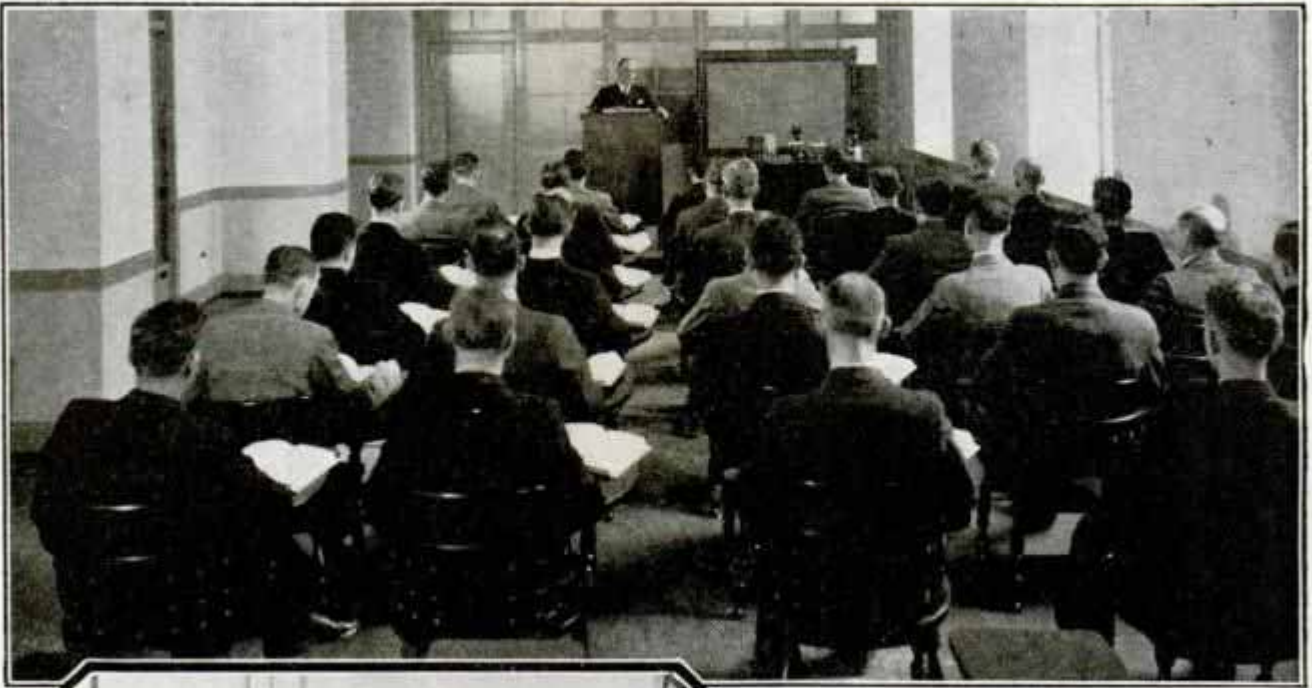

Special Agents in School, and Examining Evidence in Crime Scene

tiny spot, the weight is the same. The spot is resolved by a chemical and is found to be blood. One piece of thread has been torn from a colored shirt, the other has come from an identical shirt. They are burned and the ash is analyzed. Finally, these pieces of thread are sent through a great scientific mill and when they come out they are pronounced the same kind of thread from the same kind of garments. Result: the man who owned the shirt from which one piece of thread was taken is held for murder.

The same goes for ink, for dirt from under the fingernails, for typewritten impressions, or penmanship. Everything that has been recovered around a scene of crime is picked up by these "G-men," trained to observe and to collect, and subjected to exhaustive testing. For months an expert will work on a piece of

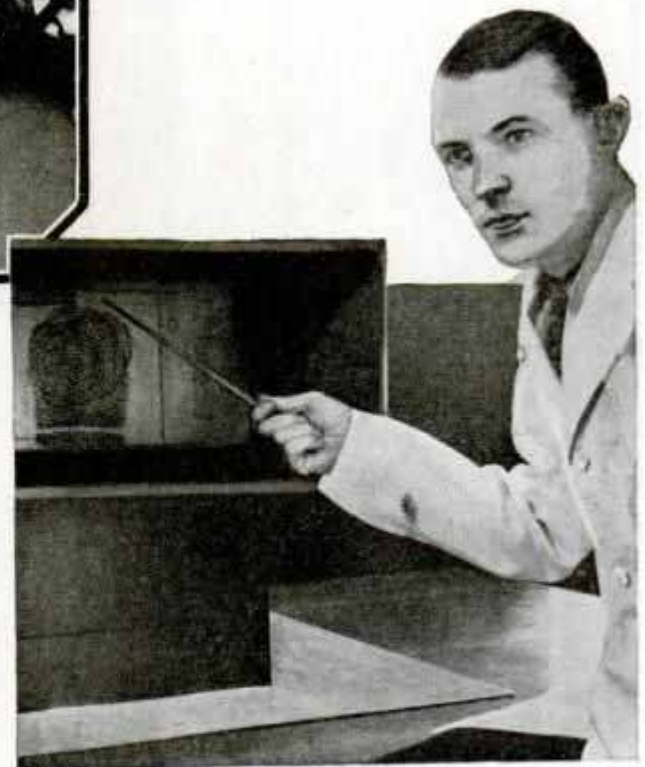

Apparatus in Which Enlarged Images of Two Fingerprints Are Thrown on Screen for Comparison

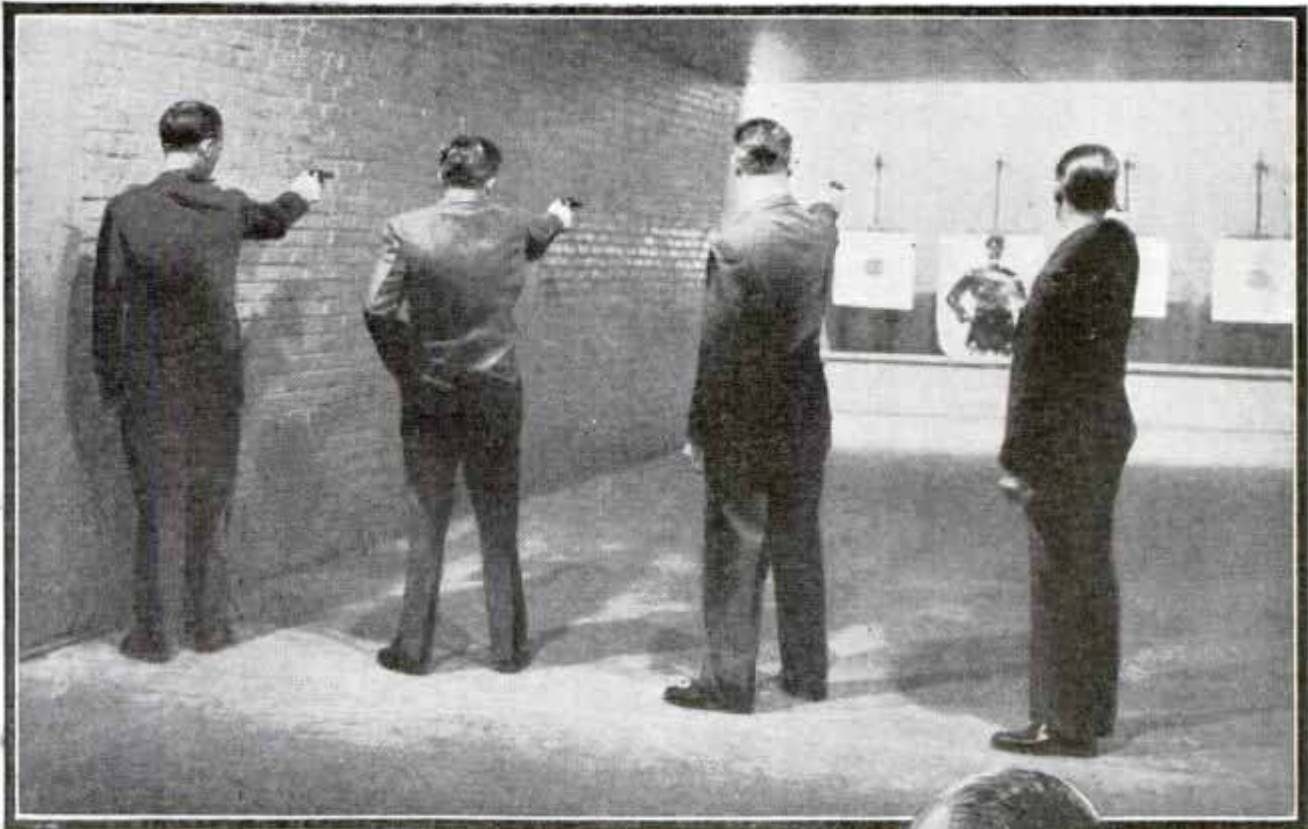

wood, take shavings and sawdust residue from it and, under the microscope, acids, fire and scales tell him not only the kind of wood it is, but the section of the country from which it came. This "G-man" carries a kit with him. It looks like an ordinary suitcase but it contains binoculars, a hammer, file, magnifying glass, pincers, screwdriver, knife, fingerprint powders, brush, tape, a camera and a pair of handcuffs.

Can you imagine a machine that will tell you the man you want before you know yourself? The "G-men" have such a machine in the bureau of investigation in Washington. This machine looks like a series of post-office boxes mounted on an iron frame to which is attached a motor. A man may change his name but seldom is it possible for him to lose his nickname. "Red" Scott is always "Red" no matter whether he calls himself Smith or Jones. And criminals have a flair for nicknames—look at "Baby Face" Nelson, "Pretty Boy" Floyd, "Red"



Special Agents Engaged in Pistol Practice, and Ultra-Violet Ray Apparatus Used in Studying Messages in Invisible Ink

Connors. When the mind of the fingerprint expert is baffled by the "Red" aliases the robot comes to his rescue. From the police circular the fingerprint expert knows the age, build, the color of the hair and eyes of the man he wants, together with a few peculiar physical characteristics. These facts he feeds into his robot by turning a few knobs and setting a few catches. Then into the machine he piles all the "Red"

(Continued to page 142A)

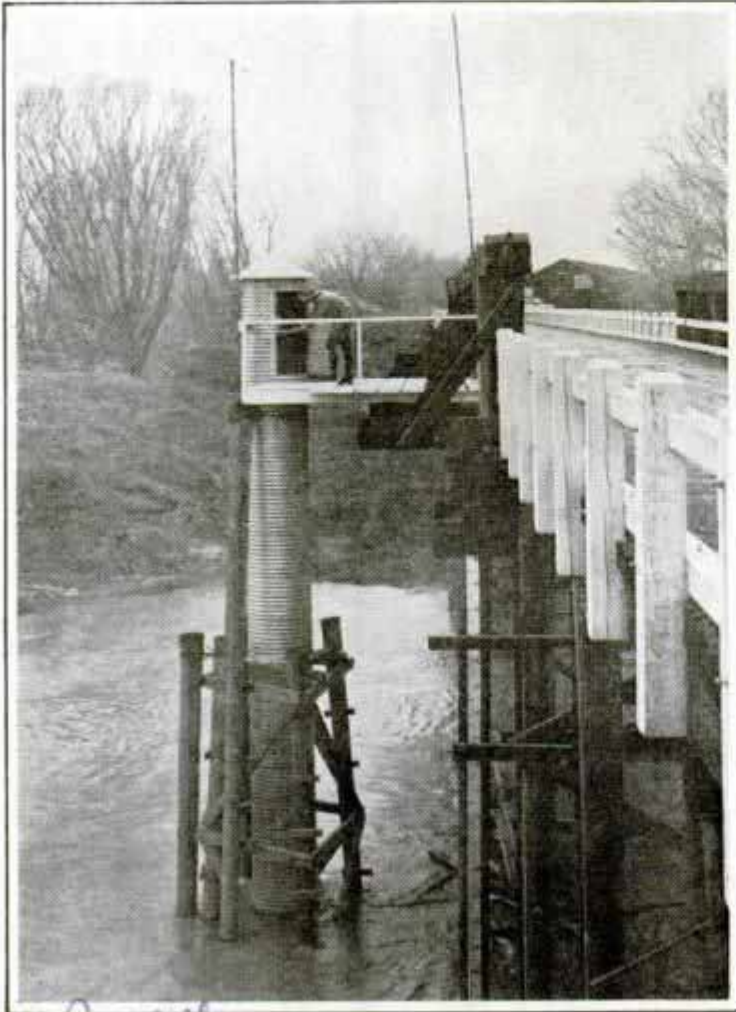

Station at Which River Level Readings Are Taken and Transmitted by Radio to Weather Bureau Office

RADIO GAUGE WARNS OF FLOOD AS WATER RISES

Long before flood level is reached, an automatic radio gauge now in use in California warns of rising water. A new aid in flood control, the gauge transmits water-level readings at frequent intervals.

FLUSHER TO CLEAN DRAINPIPE PREVENTS CLOGGING

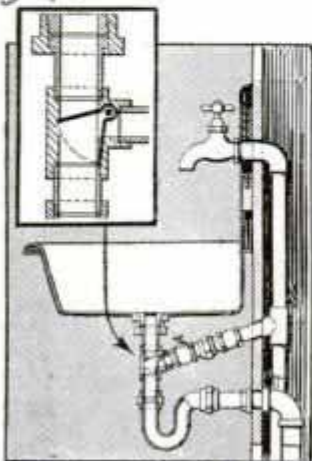

Clogging of drainpipes can be prevented by a built-in flusher that directs the full pressure of the city water system against accumulations. It consists of a short slanting pipe with "T" connections on both ends, connecting

the main line water pipe with the waste pipe, and a valve and safety gate. Turning on the valve releases the full flow of city water down the drain, the safety gate being raised to a horizontal position by the force of the water. Thus, the safety gate prevents water from gushing up into the sink or washbowl. When the valve is closed, the water drains out of the slanting pipe and the gate drops back to vertical position. The flusher can be installed in new or remodeled drainpipe outlets.

PIANO PRODUCES SOUND OF STRING ORCHESTRA

By producing the bowed tones of a violin, cello and viola at the same time as the percussion note on a piano, a Tulsa, Okla., musician gives the effect of a string orchestra simply by playing the piano. Linen cords are attached to one string of each group for a single piano note. At the other end they are attached to a terminal which tips with the striking of the respective piano key. The strings are brought against a rosined roller revolved by a small electric motor. A knee push regulates the speed of the roller and the volume of the bowed instrument tone.

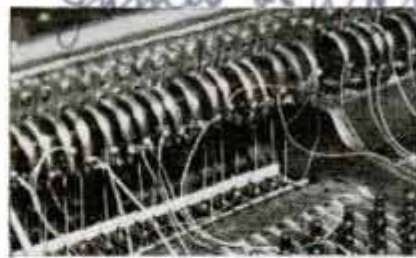

Piano Which also Produces Bowed Tones of Violin, Cello and Viola When Keys Are Struck

Henry Drainpipe
Flusher Co 705 W 45th St

Tulsa Okla.
Tulsa Tribune
James L. Warner
Emb. Hugh H. Y. Haddock of Tulsa Tribune

Striking the piano key produces the piano note on two strings of a group and the bowed instrument tone—violin, viola or cello, depending on the register—on the third.

Eleven-Hour Plane Equals Eleven-Day Pony Express

LIGHT SAFETY RAZOR CARRIED IN A CASE LIKE FOUNTAIN PEN

When collapsed in its case, a lightweight safety razor looks very much like a fountain pen and can be carried in a pocket or purse. One end of the cylindrical case holds the razor and the other end has room for five spare blades. The bulbous end of the razor handle is the knob on one end of the case and a separate knob closes the other end. The head of the razor snaps flush with the handle when not in use. To assemble, it is unsnapped like a glove and screwed to the end. The blade is of standard length but somewhat narrower and the razor itself is a little smaller than the usual safety model. This razor saves space while traveling, is exceptionally lightweight and comes in several colors.

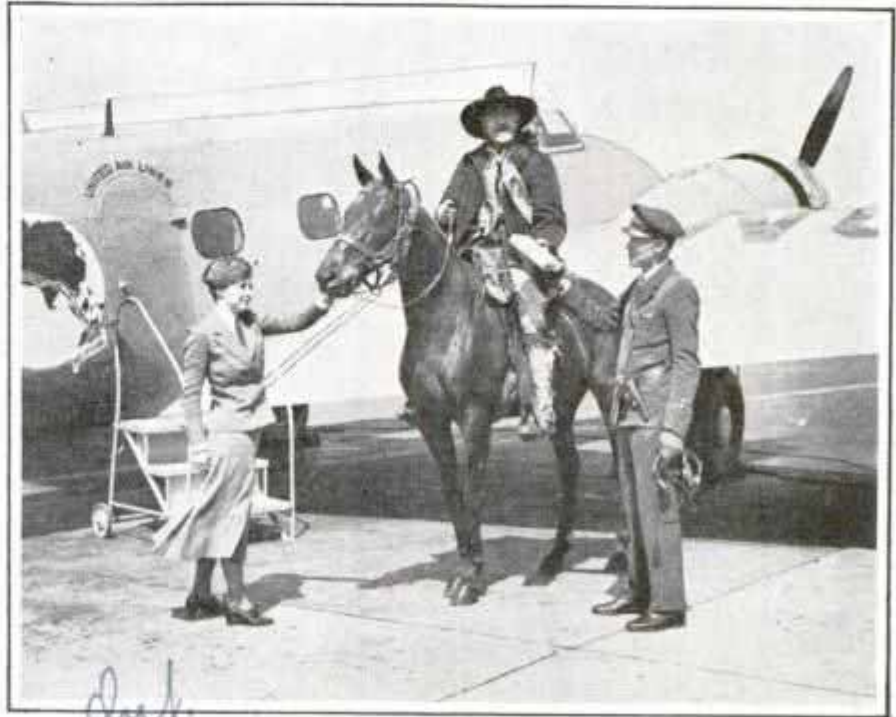

Veteran Pony Express Rider as He Handed Copy of His Autobiography to Pilot to Be Carried Swiftly across Country

On the seventy-fifth anniversary of the inauguration of the Pony Express Service, a message of good will was sent by mail plane from St. Joseph, Mo., to Sacramento, Calif., in eleven hours, a trip that required eleven days by pony. At New York, on the same day, "Broncho" Charlie Miller, the last of the pony express riders, handed the first copy of his autobiography to Pilot Hi Miller of the United Airlines for delivery by plane to the governor of California. Thus did the survivor of the first type of mail delivery in the old west use the most modern means of mail transportation. The pony express was started before the west had trains or telegraph service. The riders, young men selected for light weight, nerve and general fitness, received \$400 a year and maintenance. The equipment of the horse was a light riding saddle and bridle, with saddle bags of leather. These bags contained the mail. For each letter \$5.00 for one-half ounce or less was charged in addition to regular postage. Letters were wrapped in oiled silk to protect them from moisture.

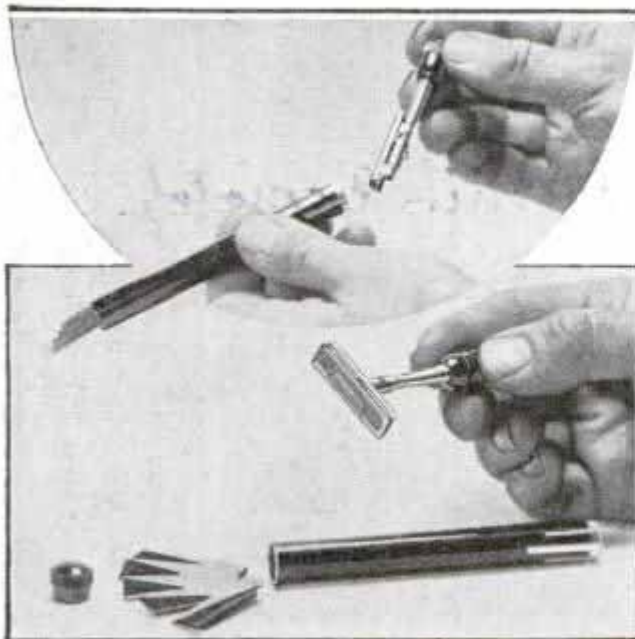

Small Safety Razor and Narrow Blades Which Fit into Cylindrical Case Like Fountain Pen

Ⓜ A filter which transmits "cold light," virtually without heat, has been developed.

Elgin American Co

*Bureau of Standards
Physics, Colorimetry section*

6-401

Giant Metal 'Egg' to Shoot High Voltage at the Atom

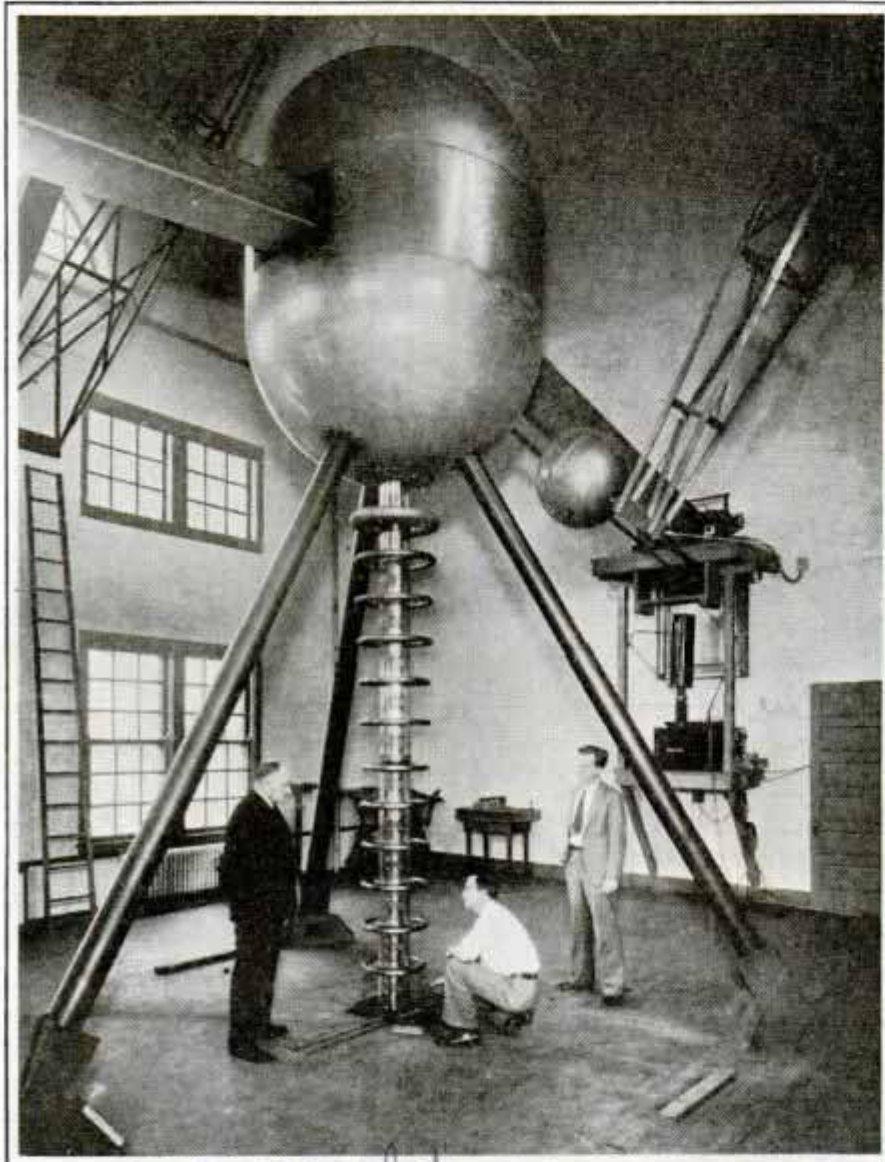

Wide World

© Harris & Ewing

Apparatus for Producing High-Voltage Electricity Is Another Means by Which Science Seeks to Solve Mystery of the Atom

For an assault upon the atom, high-voltage equipment has been constructed at the Carnegie Institution in Washington, D. C. One piece of the apparatus, made of metal, resembles a giant egg. It will be used to "shoot" powerful electrical currents at the nucleus of the atom in an attempt to discover information that science may put to some useful purpose. Whether the breaking down of the atom releases vast energy has puzzled scientists for many years and this vast equipment was constructed to carry on experimental work that may answer it, and other questions. The "egg" was built by the department of

terrestrial magnetism at the institution. Dr. M. A. Tuve, in charge of the apparatus, could produce no sparks for photographic purposes, he said, because such sparks would indicate a leak of electricity, a weakness that would forestall success in the experiments.

6403

FIREPROOF SIDING LOOKS LIKE WOOD

Textured like weather-aged natural wood, siding shingles made of two indestructible materials are available for permanently re-siding an old house or applying to a new one. Furnished in three rich "wood" colors, cypress brown, silver green and silver gray, the siding needs no painting. Mixed with the Portland cement and asbestos fibers that give fireproof and long-wearing qualities are mineral oxides that produce the colors. The top of the shingle is cut pointed and is covered by the shingle above. Thus, approximately thirty per cent of the material is saved without changing the appearance.

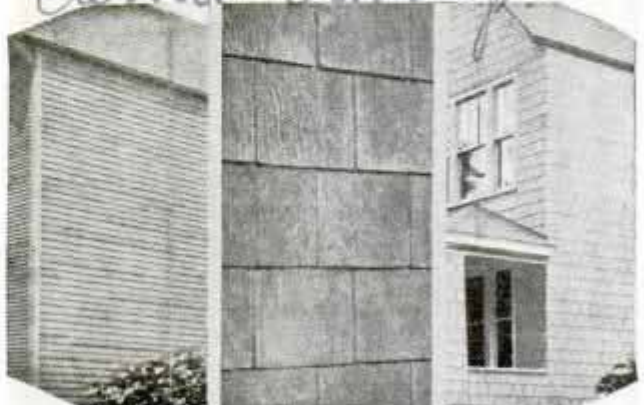

Left, House with the Usual Side Boards; Center, Closeup of Cement Siding; Right, How New Siding Improves Appearance

Plasteroid Co. 70 Madison Ave

MINING A MOUNTAIN

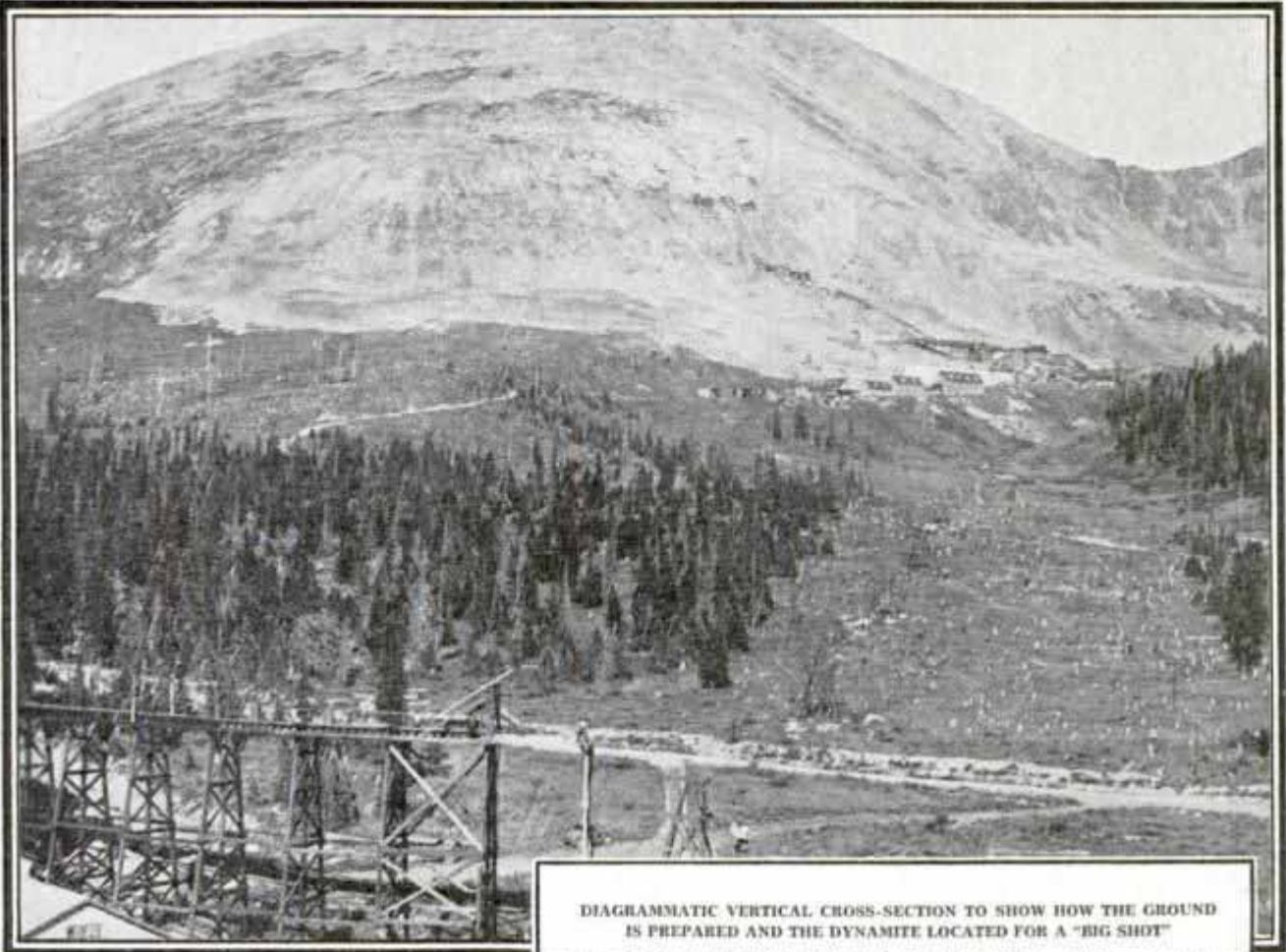

By **DR. P. G. WORCESTER**

Head of the Department of Geology
University of Colorado.

Boulder Colo
THE little mining town of Climax, Colo., perched precariously atop the Continental divide, twelve miles northeast of Leadville, boasts proudly of three distinctions besides its altitude. It supplies the world with most of its molybdenum, it produces man-made earthquakes and its citizens are engaged in the serious business of moving a mountain and manufacturing earthquakes in the process by setting off 100,000 pounds of black powder and dynamite at a shot. They are literally tearing a mountain to pieces and hauling it away at the rate of 4,000 tons a day to recover the metal it contains.

"If you ever want to know how big is a mountain," says one of these Climax miners, "just try to tear one down some time—

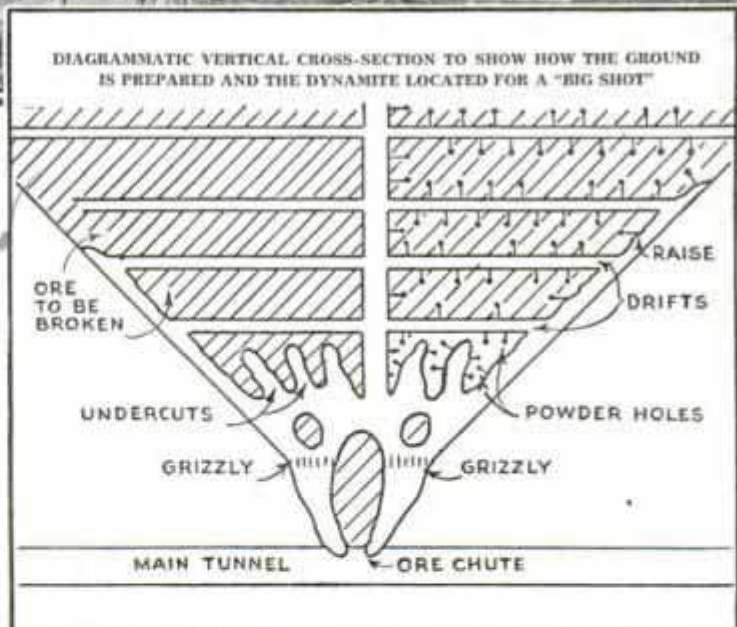
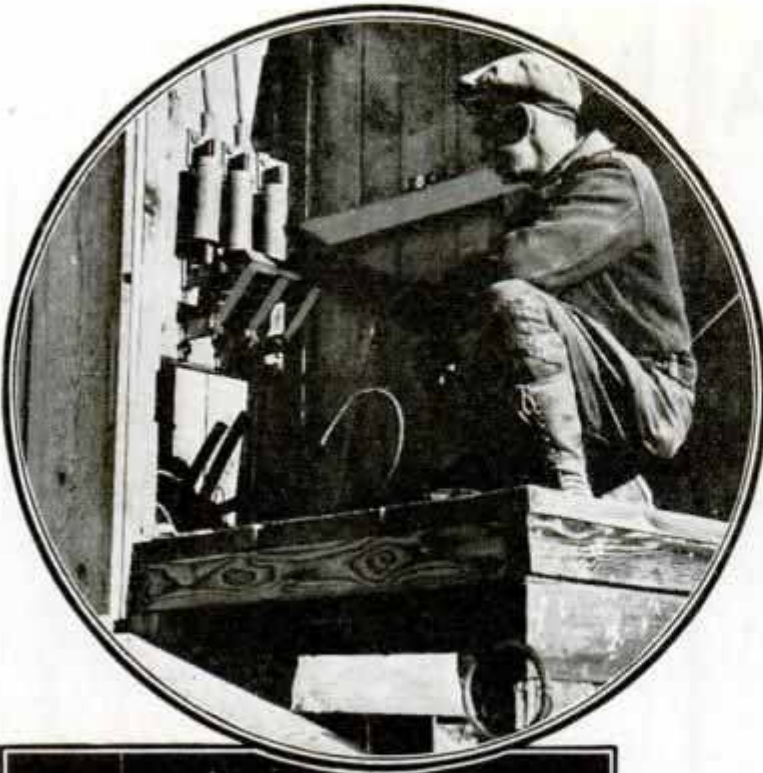

Photo Courtesy William J. Coulter

Top, Bartlett Mountain, Virtually One Solid Mass of Ore, and Diagram of Underground Mining Operations

even a little one." And Bartlett mountain, towering above Climax, and the scene of operations of these mountain wreckers, is not little. It is majestic, even in a land of big mountains. Its base is at timberline and it rears a snow-capped summit into the clouds 13,500 feet above sea level. De-



Above, Closing the Switch for the Big Shot, and a View of the Tunnel Lined with Icicles; Right, One of the Trains Hauling Ore from the Mine to the Crushing Plant

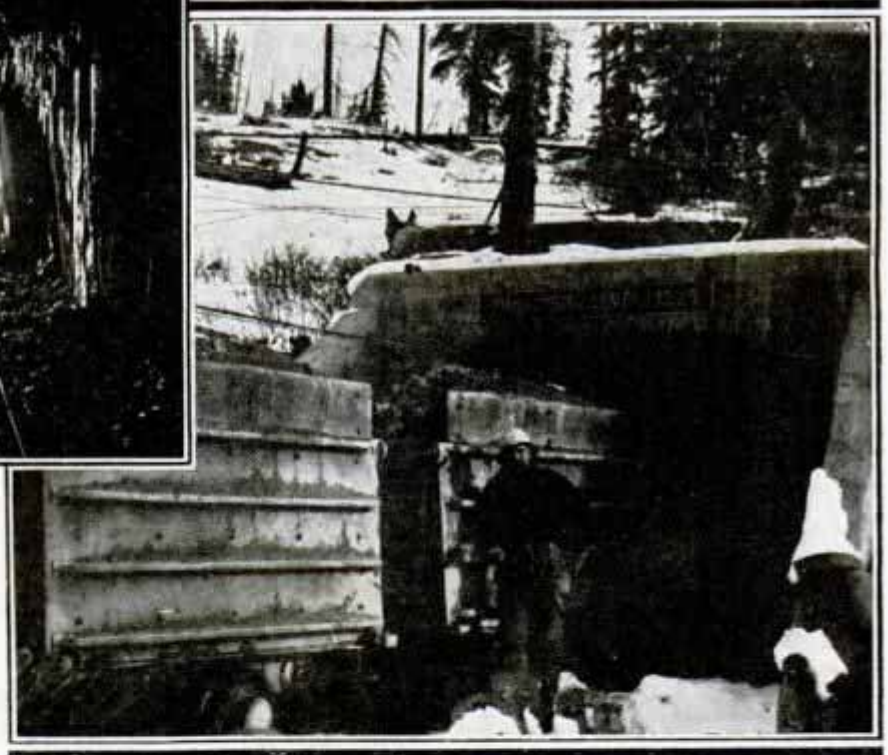

and an ability to withstand high temperatures and corrosion. Molybdenum steel began to go into heavy machinery, forgings and ordnance pieces. Further investigation showed molybdenum improved the properties of iron, nickel, chromium, vanadium and other metals.

Over night the demand for molybdenum soared and a worldwide search for it was started. And old Bartlett, part of the backbone of America, was found to be virtually one solid mountain of molybdenum ore. By surface study, diamond drilling and underground development, it was proved that the whole southwest side of the mountain, an area one and one-half by three miles—and

fiant of time and the elements, Bartlett might have remained just something for tourists to look at if metallurgists had not become molybdenum-conscious.

They had known about this metal for years but no one had considered its possibilities. Then the age of alloys dawned and they began mixing one metal with another. Someone found that when molybdenum was combined with steel, even in a proportion of less than one-half of one per cent, it imparted extra hardness, toughness

no one knows how deep—was mineralized, and that the mountain contained more than 100,000,000 tons of ore.

But mining engineers shook their heads when they inspected this mountain of metal. It could scarcely have been in a more inaccessible place. High above timberline in a land of perpetual snow and bitter cold, Bartlett and the wealth of metal locked in its bosom challenged the ingenuity of the miner. Surface mining was impossible because the weather was too

severe most of the year for work in the open. Any kind of mining required transporting all equipment above timberline before it could be attempted.

Finally an underground attack on the mountain was decided on. The Climax Molybdenum company was formed, the town of Climax was established at the base of the peak, and machinery was dragged by the little narrow gauge railroad up the Continental divide over Fremont pass to the foot of old Bartlett. The first step was to dig a horizontal tunnel into the mountain at an altitude of 11,450 feet. This tunnel is large enough to admit an electric train and is three-fourths of a mile long.

Through the roof of this tunnel shafts were driven upward for sixty feet. In these chutes were set huge "grizzlies," heavy steel rails weighing 350 pounds to the yard. These rails, placed three feet apart, served as screens for the ore, passing all pieces less than three feet long. The shafts were then extended upward another forty feet—and the wreckers were ready to begin the serious business of tearing down a mountain.

At the tops of these shafts, immense "rooms" 150 feet high, 425 feet long and 150 feet wide were opened up. A cross section of the operation shows these shafts and rooms are in the shape of a great fan or outspread hand. Into the main tunnel and up the shafts to the room thousands of pounds of black powder and dynamite were carried. For several weeks the work of honeycombing the mine with explosives proceeded.

At last more than 110,000 pounds of powder had been placed in the mine. More than 6,000 electric blasting caps were attached and thousands of feet of wire were strung to connect up the fuses for each cache of powder, all the wires terminating at a switch on the side of the mountain.

Finally the ticklish work of disposing of 100,000 pounds of powder was completed. Wires, fuses and blasting caps all were in place. Climax was ready to set off its 100,000-pound "firecracker." Miners were ordered out of the tunnel and the entrance was blocked. Officials, engineers and miners gathered one May morning at the electrical control to "view the remains," as one man expressed it. What would result when

(Continued to page 122A)

METAL RADIO TUBE DISSIPATES HEAT VERY RAPIDLY

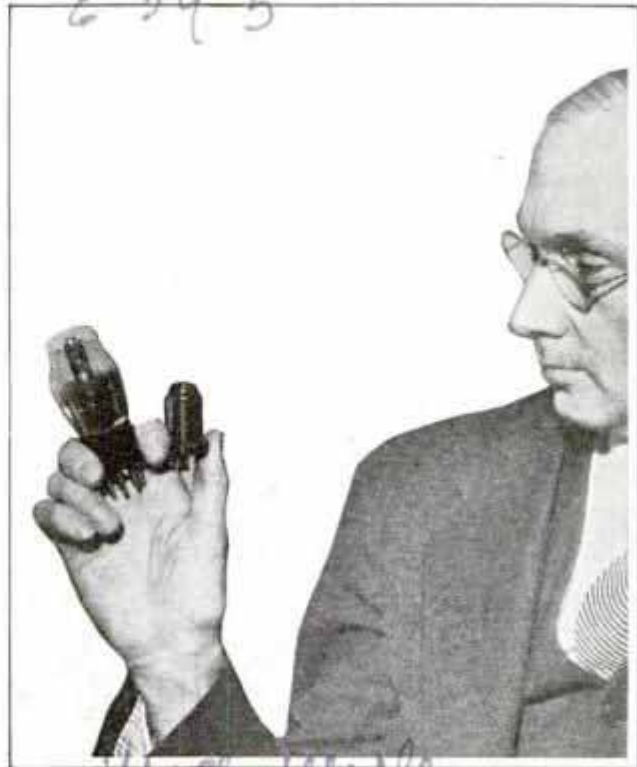

Comparing the Glass Radio Tube (Left) with Smaller and Sturdier Metal Tube

Metal radio tubes which dissipate heat rapidly have been introduced by the General Electric company after exhaustive tests. Smaller and more sturdy than glass, the metal tube has its own shielding, a metal shell that is an efficient heat conductor and radiator. The tube is particularly useful in the short-wave field, giving excellent reception. Short leads on the tube permit great amplification at the higher frequencies and the efficient shielding insures stability. The tubes are cylindrical, some in reduced diameter at the top. Others have a terminal at the top.

AUTO PROPELLED BY WOOD GAS FROM SMALL GENERATOR

So small that it takes up less space than a trunk, a wood-gas generator suitable for small passenger automobiles has been designed in Germany. It produces a gas with quick combustion qualities, enabling a motor with a high number of revolutions to utilize wood as fuel. The car is started on gasoline, but is switched to the wood gas after slightly more than a mile of operation. In trial runs, the motor reached the same speed as when using gasoline.

Press memo - 4/19/35

Wicks Wall
Schedady
ing

Report from Yusei Enami.
A. H. S. Tevnie, Hamburg
A. H. S. Tevnie, Hamburg

Witcox 232 Maryland Bldg.
Washington, D.C.

SPEED BOATING



Some of the Salton Sea Racers as They Appear under the Desert Sun, Preparing to Take Off on This Fast Body of Water

IN and out through purple sage and spiny cactus the thing winds its way. Across long vistas of shimmering sand it moves, this crawling, serpent-like thing, almost as gray as the desert floor. It is one of the strangest sights ever seen on the great Colorado desert.

It is a caravan of motorboats, on its annual pilgrimage to the Salton sea for the

running of the Desert Speedboat Sweepstakes. The event, staged each year, is rapidly becoming famous in boat-racing annals. Every type of craft is there to take part, from high-powered inboards to tiny racers of the smallest classes.

All the boats, motors protected from sand by canvas coverings, are aboard trailers or trucks, some hauled by cars and some by burros. It is a toilsome journey through a land which has blistered for centuries without water. There could be no more incongruous place to find a caravan of motorboats.

The main highway across the desert is fairly simple going for the cars with trailers. But once this is left for the narrow sand road, the horse and burro come into their own. If some luckless driver, unfamiliar with the trickery of the desert, departs by less than twelve inches from the two well-traveled ruts, the desert has him. Beneath a broiling sun shovels are wielded and it is here that the burro looms like an angel on the horizon.

The mecca for all this effort, discomfort and expense is the Salton sea, 250 feet below sea level, where there is not one comfort to which the average speedboat king is accustomed. It is an unusual body of water. Ages ago the Gulf of California extended 150 miles farther northwest than it does now. The Colorado river, busy carving the Grand Canyon, deposited its silt

on a DESERT SEA



on the east side of this arm and built a delta so far out into the gulf that it finally constructed a dam clear across. The river cut a channel southward, and the body of water to the north of the delta dam gradually dried up under the intense heat, creating the Salton sink. More than 250 feet below sea level, the sink was also below the channel of the river.

Each year or so, in one of its sudden rises, the river discharged some of its surplus water into the sink, which dried up as soon as the river receded. In 1891 two



Above, Trucking the Speedboats across the Desert Sands; Center, Dick Loynes Piloting "Miss California"; Bottom, Some of the Members of the Girls' Speedboat Club of California



Loretta Turnbull, Girl Champion, and a Section of the Boat Camp beside the Salton Sea in the Middle of the Desert

canals were cut from the Colorado river into part of the sink, which became highly productive. This area today is known as Imperial valley. But these ranchers reckoned without the Colorado silt. In 1905 one of the canals began to scour rapidly, due to the silt, and in a short time the whole Colorado was pouring down again into the Salton sink. Hundreds of miles of irrigated lands, homes, railroad tracks and other improvements were threatened. Thousands of men toiled for many months, a dam was built and the river was turned back into its old channel.

This left what is now the Salton sea, a fifty-mile long body of salt water which, from time to time, recedes, due to evaporation, but the progress backward is comparatively slow.

Some enthusiast tried out an outboard on the sea some years ago. He was amazed at the result—more punch to the motor, more propeller resistance in the water due to the heavy salt content, and the boat rode like a cork. Official trials indicated the sea is perhaps the fastest body of water for speedboating in the world. The low altitude, meaning more oxygen to the cubic foot of air, aids combustion. The heavy salt content not only furnishes propeller resistance, but eliminates propeller slip. Thus the first desert classic started.

(Continued to page 130A)

8-10 S. Stockton, H. Treiston, N.J.

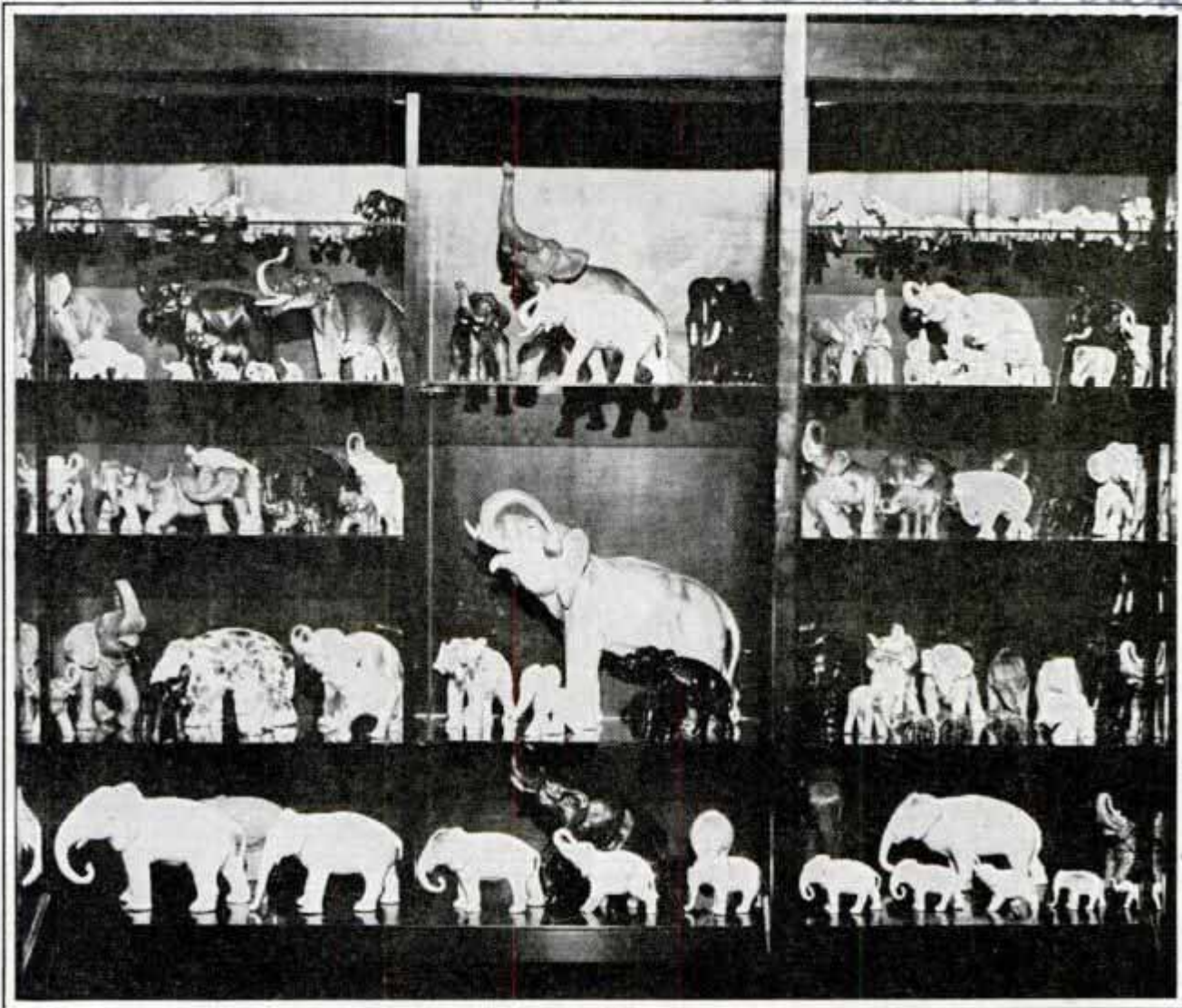

Vertical handwritten notes on the right margin, including 'N.J.' and '8-10 S. Stockton, H. Treiston, N.J.'.

Some of the Model Elephants in Governor's Collection; in Many Sizes, the Models Range through Various Colors between White and Black and They Are Made of Many Different Materials

MODEL ELEPHANTS A HOBBY OF JERSEY GOVERNOR

Hundreds of miniature elephants, made of wood, metal, porcelain and a variety of composition materials, have been collected by Governor Hoffman of New Jersey. The

model animals range from less than one inch to several feet in size. In a display case which the governor uses for his hobby, the elephants attract considerable attention. The miniatures are of many colors, white, black, green, red, and every species of elephant is represented.



Tractor Pulling a Scow over a Sixteen-Mile Portage at Fort Smith in Canada

Handwritten number '8432' next to the section header.

TRACTORS MOVE HEAVY BOATS OVER LONG PORTAGE

All boats, from small canoes to scows and river passenger craft, must be portaged for sixteen miles at Fort Smith, in Canada, to overcome the rapids of the Slave river. Tractors are now used for this work and it is not at all unusual on the portage road to see several boats moving on the highway, each towed by a tractor.

Alkaline ink is less damaging to paper on which permanent records are to be written.

Handwritten signatures and notes at the bottom of the page, including 'Capt. James Montague' and 'Dept of Commerce'.

TWIN-ENGINE PLANE LIKE AN AUTO

Streamline Four-Passenger Cabin on Fast "Flying Wing"

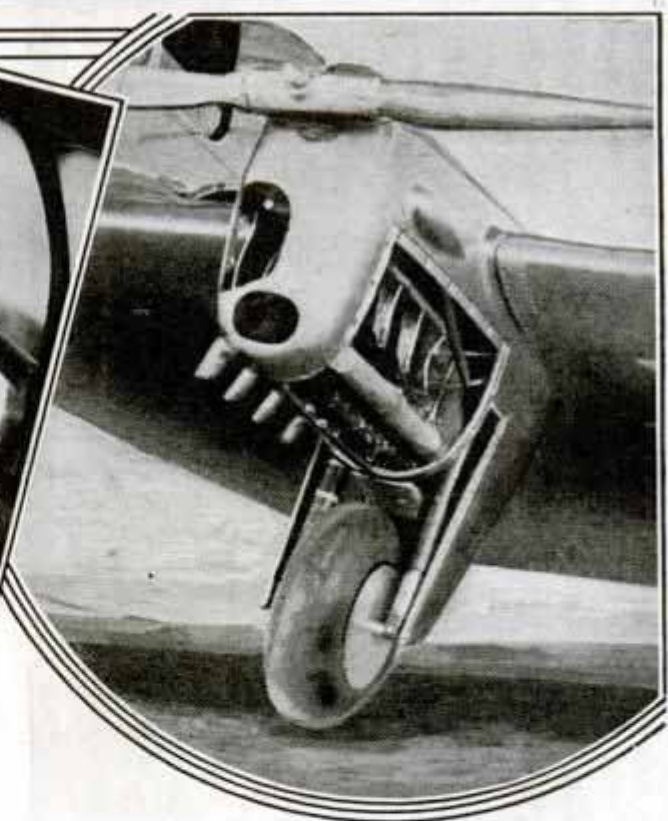
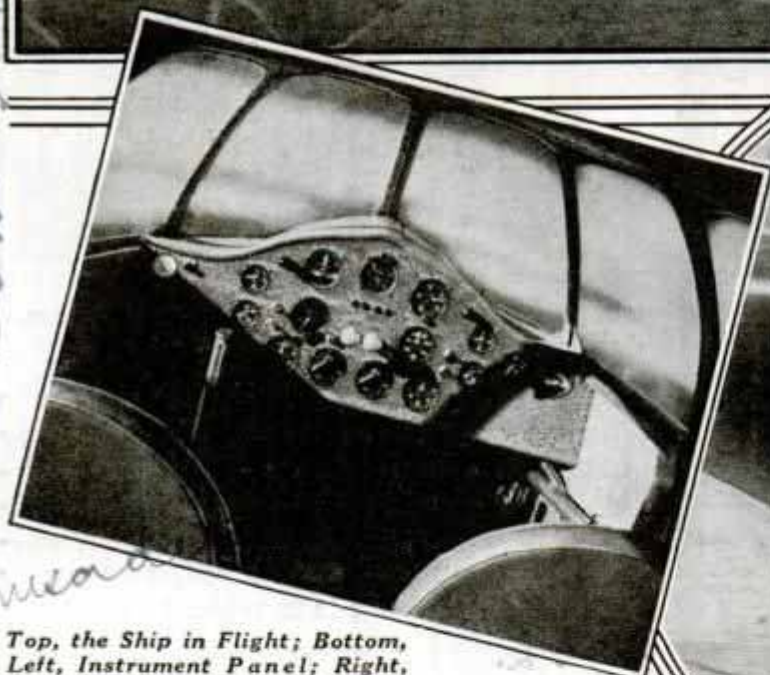

Top, the Ship in Flight; Bottom, Left, Instrument Panel; Right, One of the Two Engine Nacelles

Resembling in many respects the latest streamline automobile, a new four-place cabin monoplane has been developed for the private owner or airline operator. It has twin engines, rated at 125 horsepower and supercharged to develop 156 horsepower at sea level, and its top speed is 233 miles per hour. Its cruising speed is 210 miles per hour and high speed on one engine is 150 miles per hour. The ship is all metal with the exception of wing tips and control surfaces. The center section,

which embraces the engine nacelles, landing gear, fuel tanks and cabin compartment, occupies twelve feet of the wing's thirty-six foot span. In the event of damage, two outer wing panels may be removed from points outboard of the engine

*American Gyro Co., Bentham Bldg
Denver, Colo
Crescent
Measco*

Wilmington, Del.

nacelles and new panels bolted in place. One-eighth inch Plastecele is used for windows, its advantages being that it is inexpensive to replace as compared to glass, and it can be molded readily to fit smoothly into the streamline body. The wheels are retractable and the ship has hydraulic brakes. The horizontal and vertical control surfaces are supported at the end of two exceptionally stiff, taper elliptical duralumin tubes that fair neatly into the wing behind each engine nacelle. The instrument panel is illuminated for night flying. Controllable pitch propellers are available as optional equipment. Known in its early design stages as the Shelton Flying Wing, the craft has been tested successfully in wind tunnels.

E 461

FERRY FOR SHALLOW WATER WADES ON ENDLESS TRACK

England boasts a sea ferry which wades through the water instead of floating on it. It operates between the mainland and an island a quarter of a mile distant and is in the form of a tractor running on an endless track, the passengers occupying a raised platform above the conveyance which plows through the shallow water between the island and the mainland at a pace of two or three miles per hour.

at Highbury, Devon England

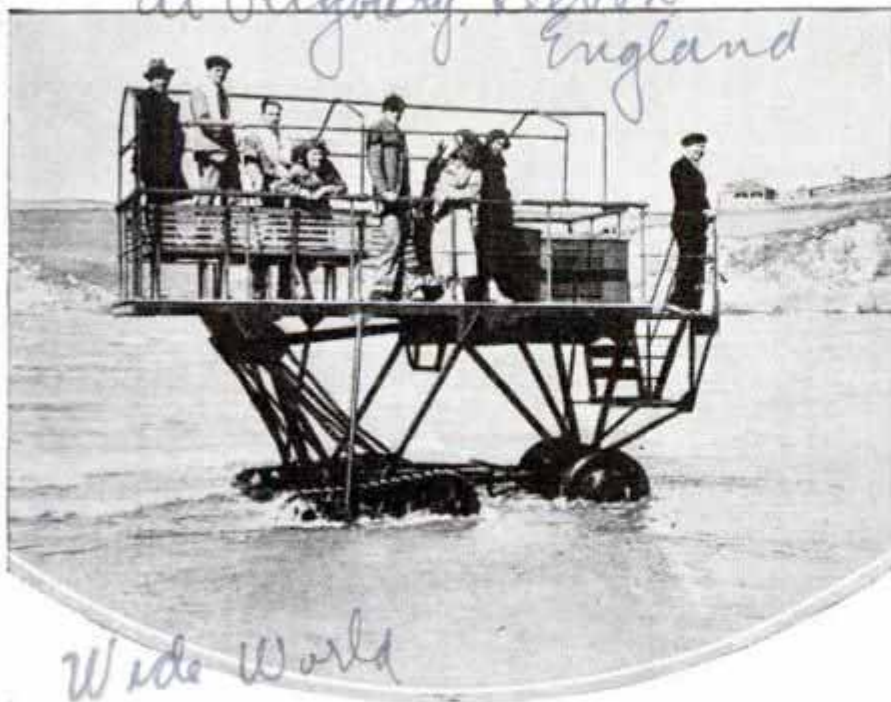

Wide World

Sea Ferry in the Form of a Tractor Which Wades through Shallow Water on an Endless Track, Carrying Passengers on Raised Platform

PORTABLE WORKSHOP SAW UNIT HAS ITS OWN ENGINE

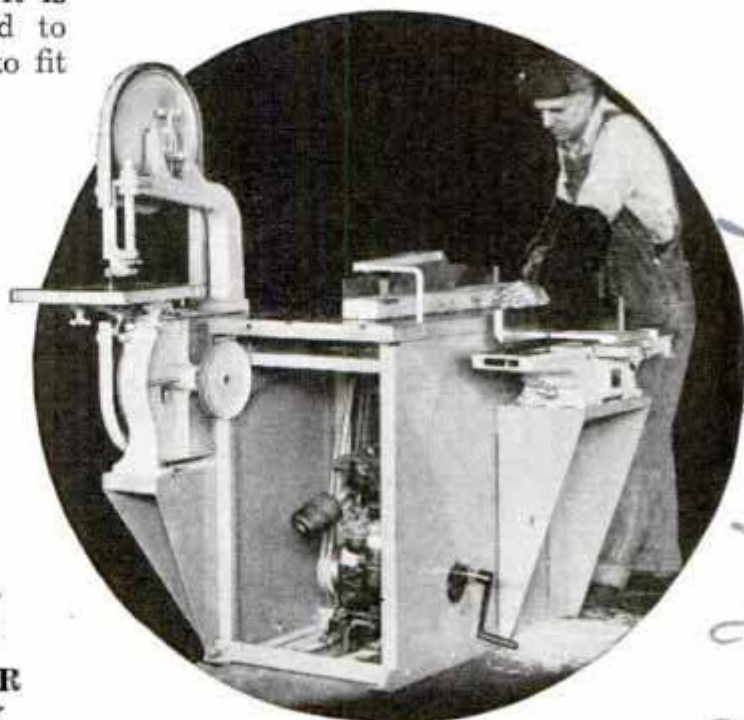

Saw Unit with Its Own Power Plant Serves Many Purposes; It Can Be Moved Easily

Equipped with its own power plant, a new saw unit designed for the home workshop is readily portable. A two or three-horsepower gasoline engine drives the saw by means of V-type silent and slipless belts. The unit consists of a band saw, rip saw and jointer, all mounted on a central table made of steel angles and sheets. An automatic guard protects the operator from injury. The band saw is the fourteen-inch size. Other attachments can be supplied, including a handy unit for boring, mortising, grooving, counterboring and sanding. Emery wheels can be mounted on the saw arbor. Four men can work on the machine at the same time. The unit can be transported on auto or truck.

Inquiries as to makers of articles described in Popular Mechanics, will be answered by our Bureau of Information on receipt of return postage.

E. I. Lee de Nemours & Co. Chicago. E 430
C. H. and E. H. H. Co. Chicago. E 430
120 E. Milwaukee Ave. Milwaukee, Wis.

8270.

WHERE to FIND

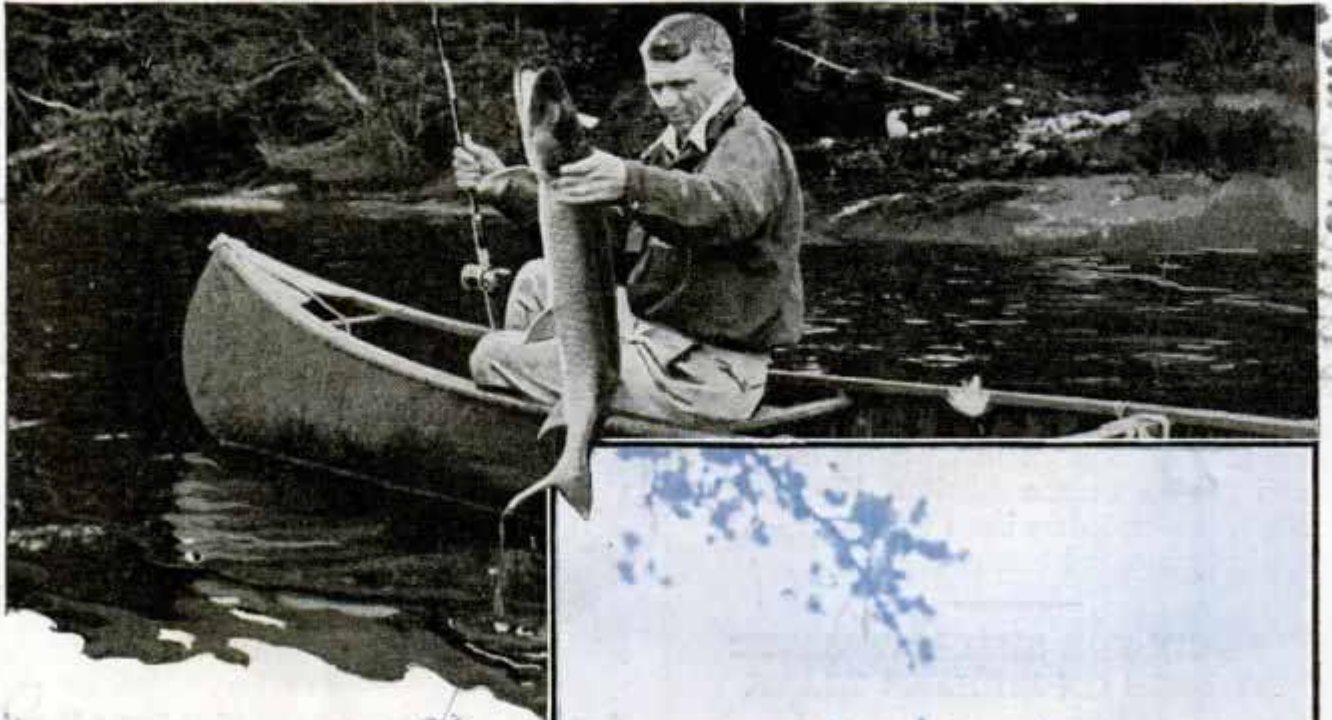

Chicago Tribune. Chicago
 By **BOB BECKER**

THE sport of fishing, which attracts some 10,000,000 devotees to lakes and streams every summer, is more than manual labor involving the use of rods, reels, a boat and oars, and a lot of wrist and arm exercise. It is brain exercise as well because the wise fisherman must use his head to gain a knowledge of fish habits and fish preferences.

Here are some practical tips on where to find the big ones. The largest number of game fish and the biggest specimens are usually found where natural food is most abundant—where minnows, frogs, crawfish, aquatic insects and other forms of life can be gobbled up. Therefore the smart fisherman throws his lures around natural havens for such food.

Lily pads in from four to ten feet of water provide both food and cover for fish. Bass especially like to loaf in the shade of the big pads. For casting into beds of lily pads a favorite artificial lure is a weedless hook and a pork chunk to imitate the jump and splash of a live frog. Cast the lure into a pocket in the pads, retrieve it slowly, jerk it up on a lily pad and then make it wriggle through

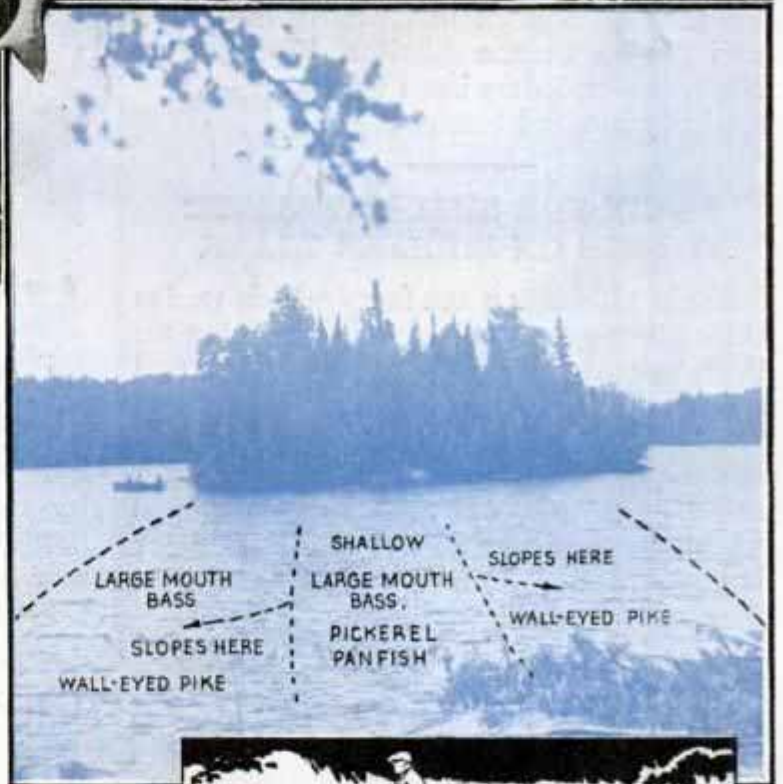

Top, a Muskie Taken by Casting a Shore Line with Lots of Snags and Logs; Center, Lake Plotted to Indicate Where the Big Ones Are; Dotted Lines Show Boundaries of an Underwater Plateau or Bar; You Must Know the Bed of Your Fishing Waters to Find the Fish

the BIG ONES



Fish Gather Below a Rapids or Waterfall Because Both Are Apt to Bring Food; Lily Beds, the Mouth of a Creek or Shoals Are All Good Locations



MOUTH OF CREEK



SHOALS IN MIDDLE OF LAKE



BED OF LILY PADS

the vegetation. The pickerel fisherman must not overlook a single big log or snag, because the big fellows often lurk in the shadows. If the snags are close to shore with an underwater weed bed out a few feet, you probably have found a fish heaven. Almost every kind of natural food will be discovered in this type of cover.

The strategy calls for several kinds of lures here. If the water is fairly clear,

diving, wobbling plugs, spinners, pork rinds and various underwater metal lures will trick the pickerel. Weedless lures brought through the weed beds fool the bass, too. Just at the edge of the weed beds or in pockets will be found sunfish, bluegills and perch. If a large tree has fallen with its tip extending out from the shore, the fisherman should work this carefully. In live-bait fishing, you can

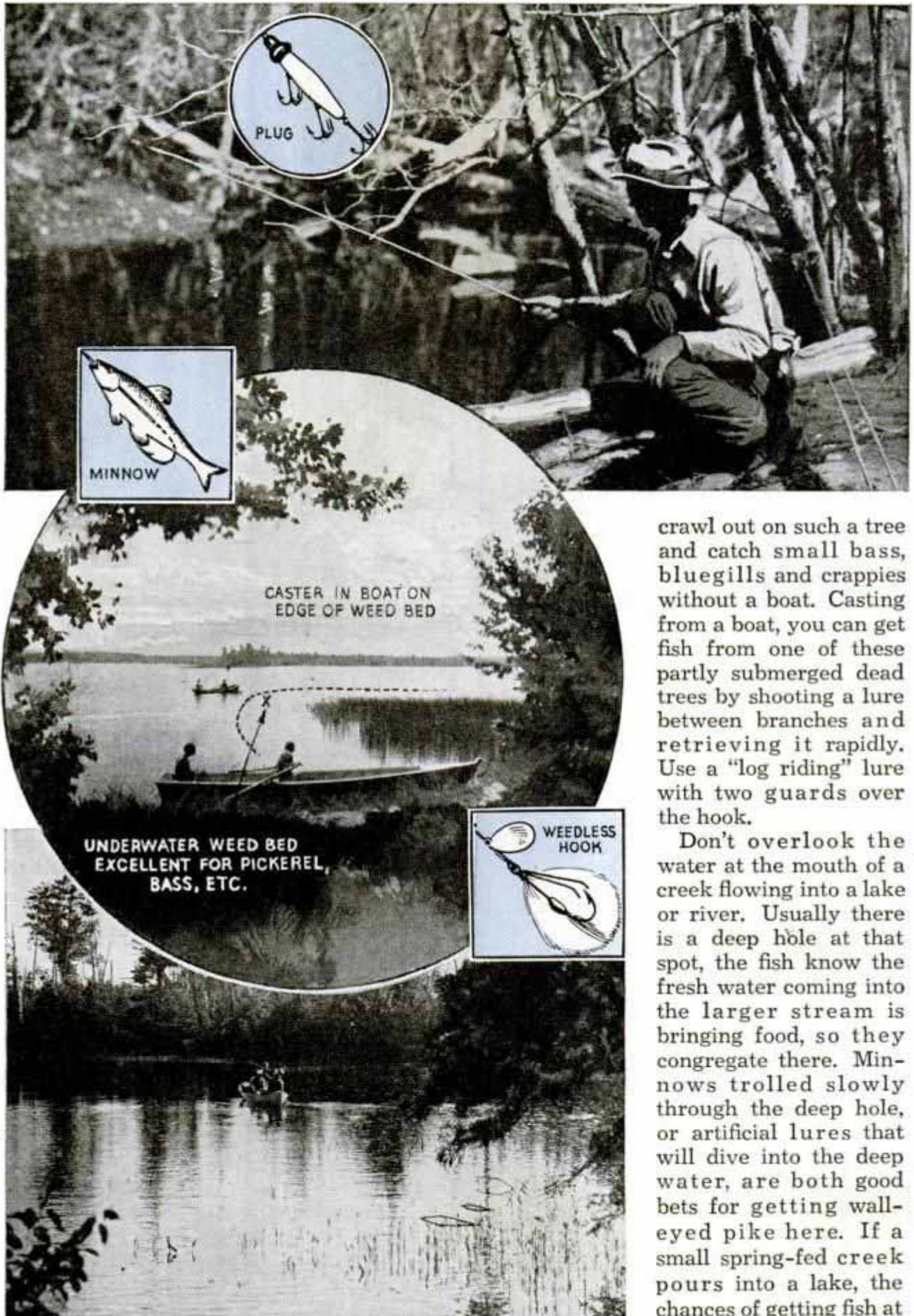

crawl out on such a tree and catch small bass, bluegills and crappies without a boat. Casting from a boat, you can get fish from one of these partly submerged dead trees by shooting a lure between branches and retrieving it rapidly. Use a "log riding" lure with two guards over the hook.

Don't overlook the water at the mouth of a creek flowing into a lake or river. Usually there is a deep hole at that spot, the fish know the fresh water coming into the larger stream is bringing food, so they congregate there. Minnows trolled slowly through the deep hole, or artificial lures that will dive into the deep water, are both good bets for getting wall-eyed pike here. If a small spring-fed creek pours into a lake, the chances of getting fish at the mouth of the stream are almost 100 per cent.

Top, Fishing a Deep Hole; Center, Casting from Boat on Edge of Weed Bed; Bottom, a Likely Corner of a Deep Lake

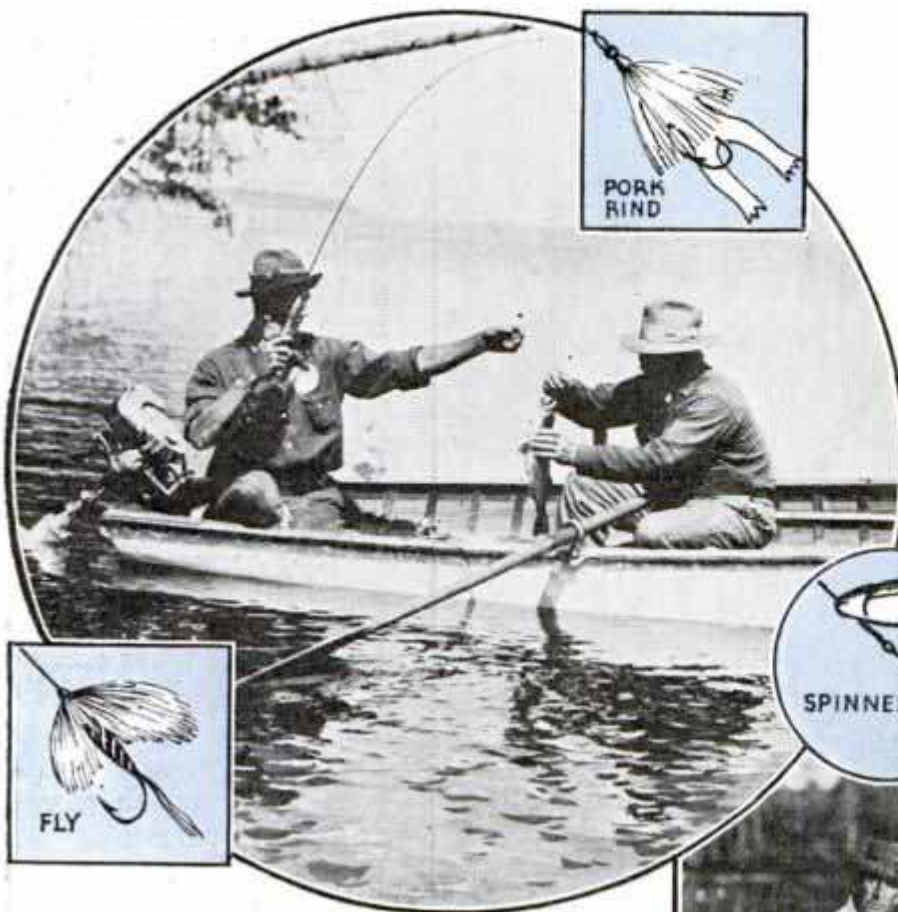

in this part of the lake. The trick is to know exactly where the ledge drops into deep water. Frequently small-mouth bass and wall-eyes loaf in the cool water just off the edge of the plateau where it slopes down into the very deep water.

In midsummer some of the finest sport I have

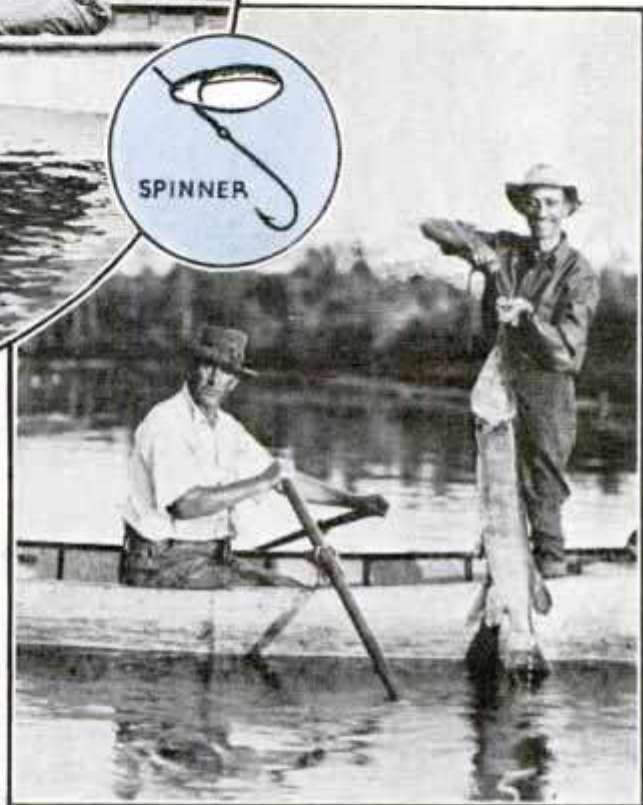

A Muskie That Stayed around a "Woodpile" Too Long, and a Pike Caught over Gravel Bar

In hot midsummer weather when the water becomes warm, the brook trout will usually "migrate" to the mouth of a cool feeder creek flowing into the main part of the trout stream.

"Plateaus," or bars out in the lake, are usually big producers, especially in hot weather. There are two kinds of plateaus. One is the island type from which a rock bar slopes off into deep water. The other is the sand, gravel or mud-bar type which usually grows luxuriant beds of weeds. In the hot days of midsummer when the fish retreat from shallow shore-line waters, these bars are the place to fish. You may have to ask a native to locate these choice fishing spots, but by all means find them.

Here the bass find crawfish and aquatic underwater insects. Around the weedy bars there are minnows and other foods. If the weed growth is thick, almost every species of fish will be found there. I have caught wall-eyed pike at the edges of the weed beds by trolling deep with artificial lures or minnows. Keeping the boat away from the weeds I have cast muskie lures over these weedy spots and hooked some nice ones. Bass will stay around this location and so will pickerel. And don't forget many a bluegill, crappie and sunfish lives

had with bluegills has been around the weed beds growing up from these bars. By using small wet flies and a fly rod you can have great sport.

If you fish a lake with a tiny island in it or a very small rocky reef devoid of weeds, you have a good bet for muskellunge, pickerel, bass and pike. Every lake fisherman must learn where there are underwater plateaus, rock bars, reefs and weed beds if he wants to cast his lures "where they are" in midsummer. And the smart angler will change his lures to fit the conditions, using weedless lures for some places, deep-diving fish foolers in

(Continued to page 132A)

University

£ 327

Bahrein for Bahrein Island

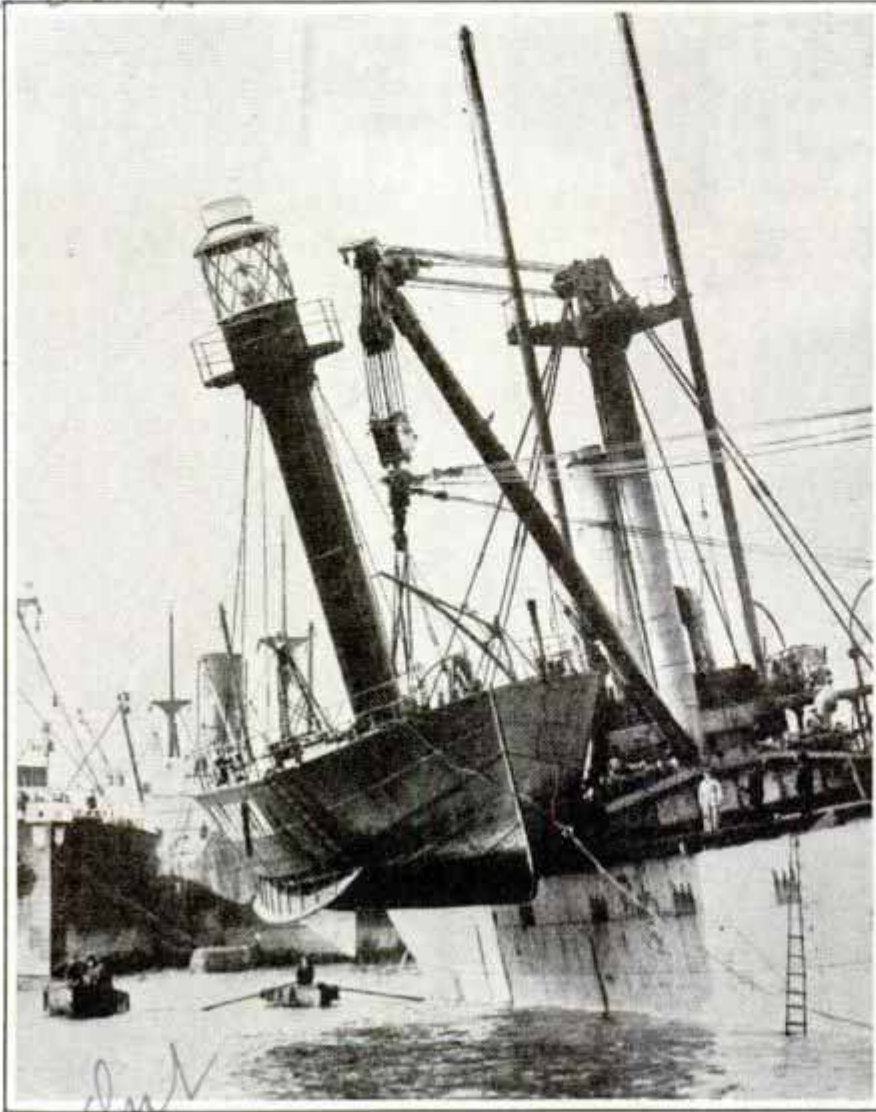

Note the List as Lightship Was Hoisted from the Water to Be Carried to New Location; Lightship Weighs 120 Tons

BIG LIGHTSHIP LOADED ON DECK OF ANOTHER SHIP

Weighing 120 tons, a lightship recently was loaded on the deck of another ship and carried to a new station. As the lightship was hauled out of the water, the other ship, the S.S. "Belmoira," took on a fifteen-degree list. Powerful hoisting equipment was necessary for the job, which was accomplished without accident at the lower Charlton buoys in the Thames river.

CHICKS' MARKINGS REVEAL SEX AT TIME OF BIRTH

Markings on baby chicks of a new species of fowl reveal their sex. The male and the female chicks are marked differently, a great advantage to the poultry industry because chicks travel safely and well only during the first two days of their life. The

new breed is called Cambar and was developed by Dr. R. C. Punnet at Cambridge, England, by application of Mendelian principles. By use of the Canadian barred plym-outh rock, both silver and golden Cambars have been evolved. They are prolific layers of large colored eggs.

£ 45

AREA MEASURING MADE EASY WITH PLANIMETER

Irregular areas up to 500 square inches can be measured without subdivision by a compact instrument known as a planimeter which gives readings directly in square inches. It weighs less than four ounces and folds into a size about equal to that of a slide rule. A transparent tracer arm, resting flat on a drawing, facilitates curve tracing and makes visible the portion of the curve near the tracer arm. All

parallax is avoided by using a fine tracer point lightly inscribed on the under side of the transparent arm and direct reading values for any scale drawing are possible

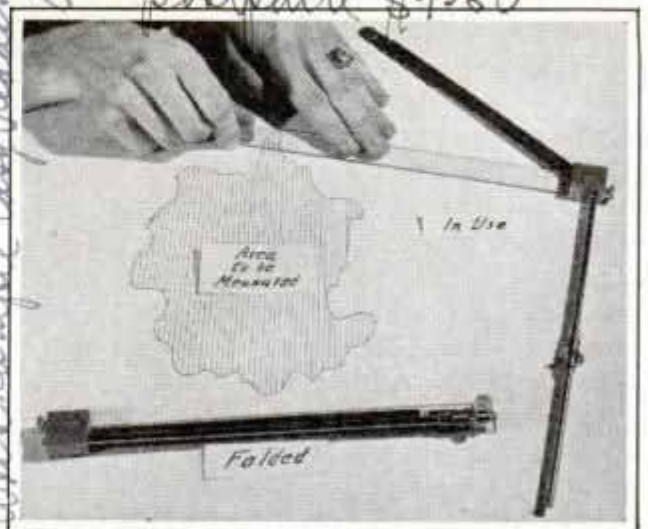

Planimeter Which Makes It Easy to Measure Irregular Areas Up to 500 Square Inches

£ 479

Weschampf Case Readers

Comp. Francis Lickley
"The Fox" Heriot Bag.

Silson Slide Rule Co. 1007

*The Western Union
Telegraph Co.
New York City*

Portable Set Adapts Wire To Carry More Telegrams

by inscribing a new tracer point on this arm. The tool is used most frequently to determine the areas of water surfaces, cuts and fills, but it can also be used to get the center of gravity of odd-shaped figures and the strength of wood and steel beams. An extra tracer arm near the head of the instrument permits closer readings on small areas.

2466

KAPOK-FILLED BAG FOR OUTDOOR SLEEPING

For protection in all kinds of weather, a kapok-filled sleeping bag has been developed. Light, soft, vermin-proof, cold-proof and resilient, the kapok permits the bag to "breathe." Perspiration exhaled through the kapok evaporates through tiny pores in the covering of the bags, promoting sound, healthful sleep. Double waterproofed, the bags have canopy tops for protection of the camper against rain, sleet or snow. Patented mosquito netting attachments may be obtained to keep out insects in summer.

La-Pak Co

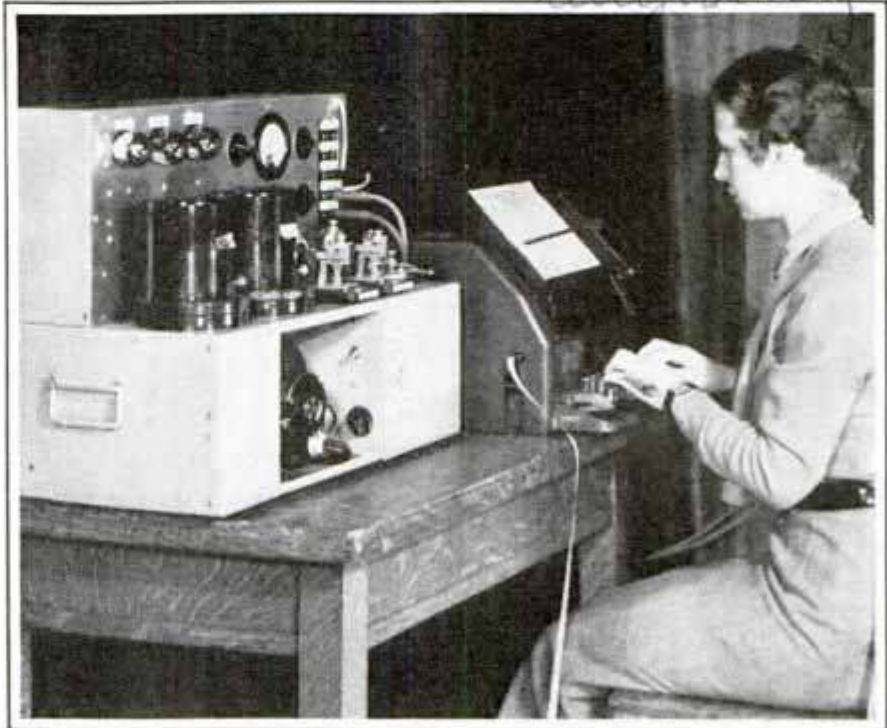

Current Carrier Unit Shown on Table (Left) Greatly Increases Capacity of Wire; It Can Be Transported Easily to Meet Emergencies

Designed for emergencies, a portable carrier current system developed by Western Union engineers adapts existing wires to carry a larger number of messages. The set, weighing only seventy-five pounds and small enough to install on a table, provides an extra two-way circuit for telegraph operation over distances up to 150 miles. It will be found useful when floods or storms curtail the number of wires into an area or when vacation resort activities, sports events, trials or other news occurs at points where there are few wires. By sending the portable set to the place where it is needed, the capacity of any two wires reaching that point may be increased.

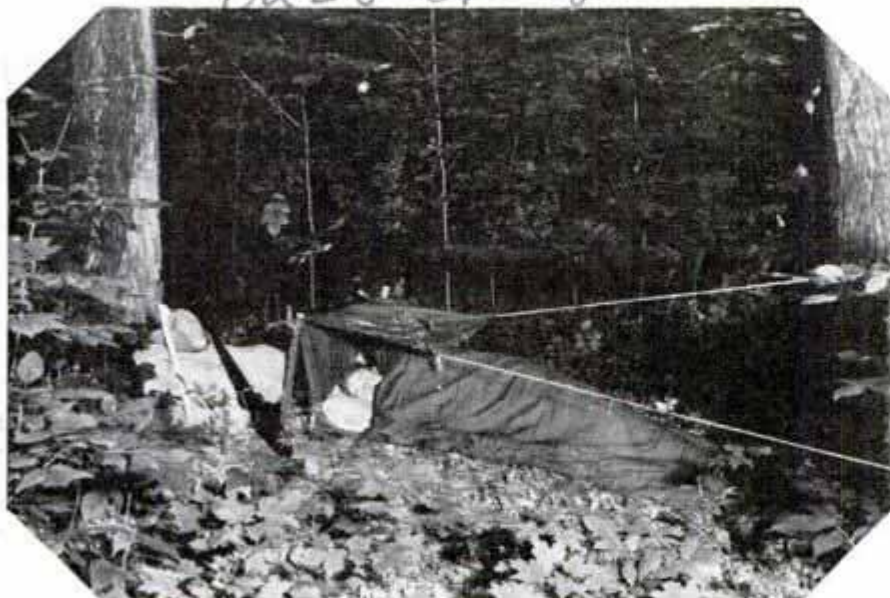

Camper in Sleeping Bag Rests Comfortably, Protected from Rain and Wind by the Small Canopy for the Head

When you wish to know more about any article in this magazine, write our Bureau of Information, inclosing return postage.

*American Pad & Textile
Greenfield, N.H.*

D/263.

DUST *Traps*

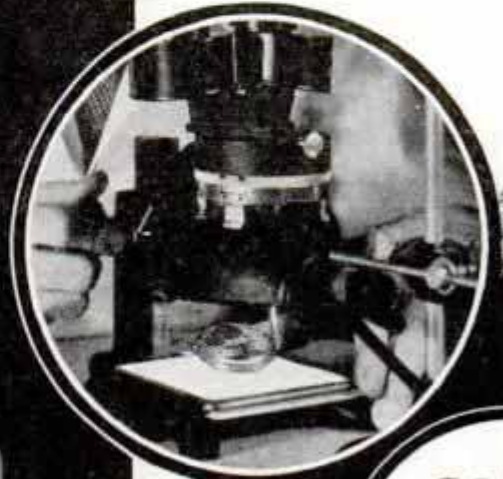

DIRT UNDER FINGERNAILS



dust.
By H. W. MAGEE

EVENTUALLY all matter tends to revert to dust.

This simple fact is being utilized today to catch and convict criminals by a new type of crime investigator—the dust detective—a modern Sherlock Holmes who solves crimes by analyzing common dust.

He works on the theory that it is virtually impossible for a person to commit a crime without leaving microscopic evidence to identify him. By studying these minute clues, the dust sleuth attempts to learn facts concerning the criminal which will aid in capturing and convicting him.

In the "empty" pockets of your coat, for instance, one of these dust detectives may

M. Edwin O'Neill, Authority on Dust Analysis, Weighing Dust Particles and Examining a Knife and a Watch under the Microscope in a Search for Debris

find an amazing variety of material—hairs, cloth fibers, epidermal scales, seeds, spores, tobacco fragments, paper fibers, bits of wood and even food. Each substance, when identified, may reveal to the

the CRIMINAL

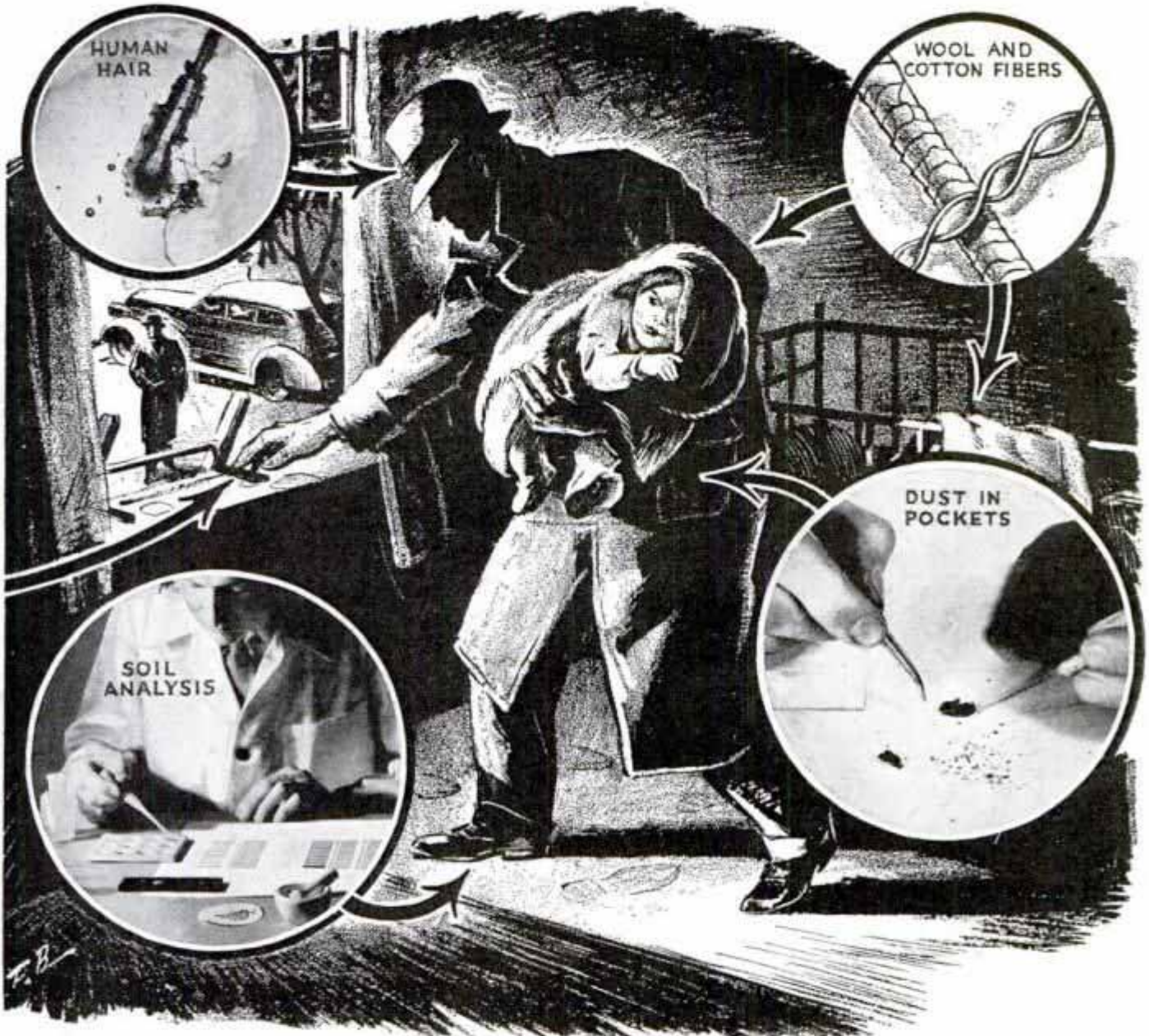

This Kidnaper May Be Convicted by Such Seemingly Insignificant Clues as a Hair, a Few Cloth Fibers, Soil from His Shoes, or Debris in His Pockets or under His Fingernails

investigator something about your habits, occupation and environment.

M. Edwin O'Neill, microscopist in the Scientific Crime Detection Laboratory of Northwestern University and a pioneer in this new field of crime research, explains that criminologists long have used microscopy and chemistry in studying such things as poisons, inks and gunpowder, but the dust detective is concerned with much more obscure things—the dirt collected under your fingernails, the dust contained in the wax of your ear, the accumulation of foreign material in the meshes of your

clothing. That such seemingly trivial material actually solves crimes and convicts criminals is attested by police records.

For instance, the body of a woman was found in a field. She had been strangled with a red and blue silk handkerchief which the slayer left twisted about her neck. A man who had been employed in a sand pit and later in a gas works was arrested as a suspect, but stoutly maintained his innocence and there was little specific evidence to connect him with the crime.

Then a dust detective was summoned. All dust and dirt were carefully removed

Evanston, Ill.

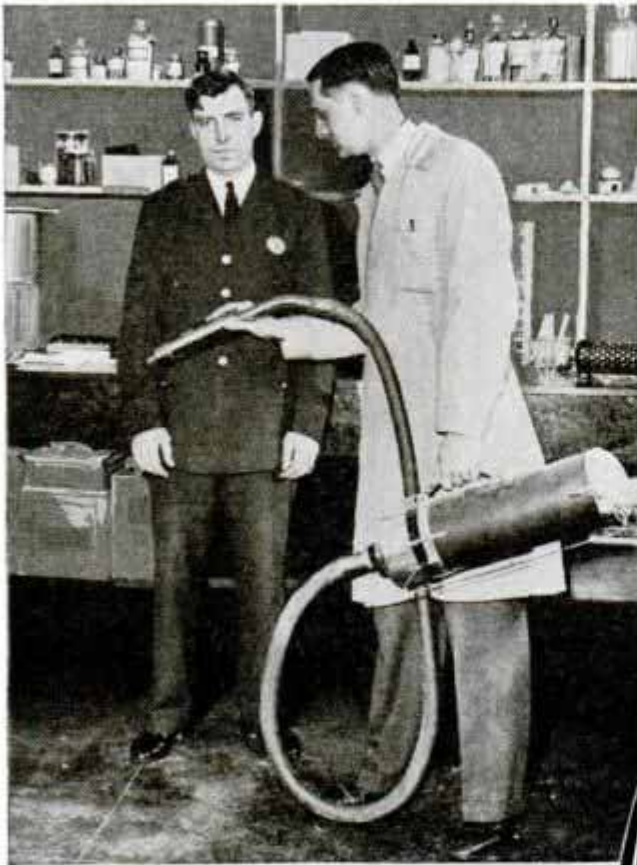

from the woman's clothing and the debris was examined under a microscope, particle by particle. Telltale bits of coal and coke, scales of mica, grains of sand of an unusual kind and fragments of tobacco were identified. Dust from the suspect's clothing was subjected to the same painstaking examination—and the eye of the microscope revealed similar particles.

Was this mere coincidence? The suspect said it was, so scrapings from under his fingernails were examined. These disclosed bits of mica and sand similar to the other specimens, fibers identified as from his clothing—and tiny strands of red and blue silk like those in the handkerchief wrapped around the woman's neck. Later the man, confronted with this evidence, confessed the slaying.

This illustrates how dust in the clothing or on the person of either a victim or a suspect may aid in solving a crime. Particularly in homicides or assault cases involving a personal encounter, the victim is likely to carry on his person dust particles giving a clue to his assailant.

A woman was held up while walking through a park at night and struggled with her assailant, but because of the darkness, was unable to see him. A microscopic ex-

amination of scrapings from her fingernails revealed fragments of hair and skin indicating the man was a negro, and an examination of tiny fragments of cloth found on her coat showed he wore a suit of a certain kind and color. So the police concentrated their search for a negro wearing this type of suit and bearing scratches and other evidences of the encounter. Eventually a youth answering

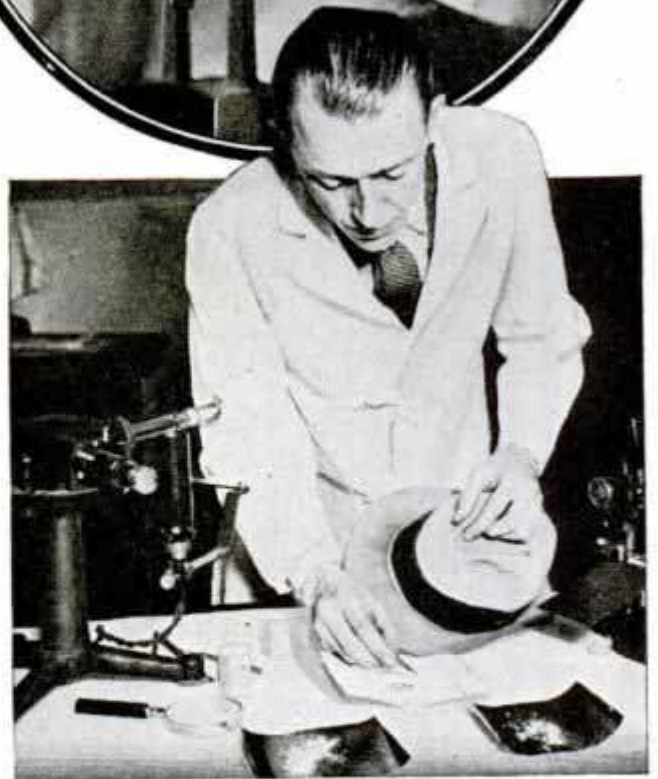

Top, Special Vacuum Cleaner for Removing Dust from Clothing; Center, Measuring Diameter of Hair; Below, Removing Dust from Hat for Analysis

Portland, Oregon

"MEMORIZER" FOR CEMENT MIXER PREVENTS HUMAN ERRORS

2452

these qualifications confessed. The dust detective operates in a dust-proof laboratory and his tools are powerful microscopes, delicate scales and a variety of chemicals for analyzing the minute clues he gathers. By studying wax from the ear or dust from the clothing he may determine a person's occupation. Particles of coal, for instance, would indicate you were a miner, while metallic dusts of rare metals would show you were a jeweler.

By analyzing soil from the shoes of a suspect, the dust detective is often able to tell whether the person was in the neighborhood where a crime was committed. The muddy shoes of a man accused of breaking into a flour mill were submitted to one investigator. The mud, carefully removed, was found to be in two layers, divided by a white material in the form of a paste. This paste was identified as wheat starch. Thus the shoes themselves told a story of having walked over muddy ground, having encountered some wheat starch, and later having retraced their steps over the same ground, thus strengthening the police case against the accused.

Most of the dust and debris productive

(Continued to page 116A)

8417

MACHINE GUN ON MOTORCYCLE USED BY CAVALRY UNIT

One of Uncle Sam's cavalry units is now experimenting with motorcycles, instead of horses, for mounts. On the handlebars of the motorcycle is a light machine gun, making the vehicle a deadly weapon, both because of its speed and the effectiveness of the machine gun as compared with the rifle or other hand weapon.



Cavalryman Riding a Motorcycle, Instead of a Horse; Note Machine Gun on Handlebars

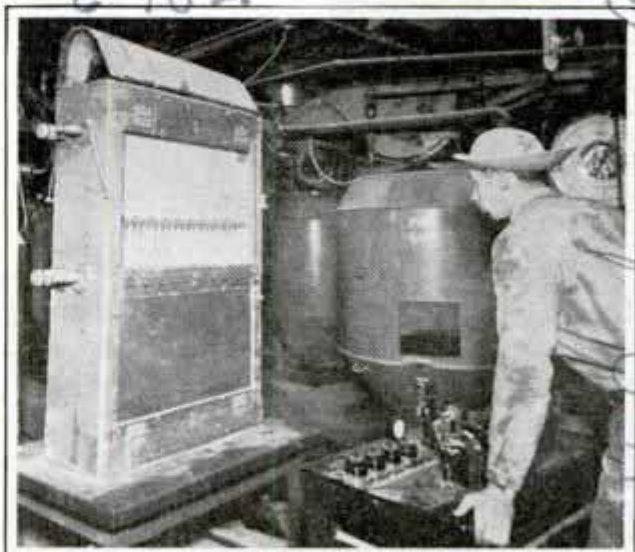

Graphic Recorder Which Keeps Track of Every Batch of Cement Used on Bonneville Dam Project

Thousands of cubic yards of concrete are being poured on the Bonneville dam project without error, due to the assistance of a mechanical "memorizer" which checks the human operations. The sand, gravel and cement meet at the top story of a batching plant and are run into the "batchers" where they are automatically weighed and drop through a chute to the mixers below where water is added. One man controls the whole operation of mixing and dumping into shuttle cars. Through windows in the sides of his station and in the floor he sees the mixers, watches the cars in their trips to the loading platform, sees the cableway bucket take the concrete and finally dump the contents into the forms hundreds of feet below. The human element is discounted by an interlocked electrical control system. The man in charge cannot dump a batch of aggregate to a mixer until it has discharged the previous mix and returned, he cannot discharge the batchers until the weight has been recorded and he cannot dump a mixer onto the ground. In front of him is a graphic recorder, a thirty-inch roll of paper on which a series of pens mark on a time scale every mixer charge, indicate the kind of concrete, its consistency and, by means of collateral records, the exact spot where it is finally placed.

There are more than 3,000,000 miles of roads in the United States.

Early News Almanac 1925 P 333

E. H. Johnson Co. Chambray, Ill. made by

10555 Holman Ave
Los Angeles Calif

TIME TABLES *for*



penmanship are learning that surprising things happen when the solid earth goes on a spree.

At the Carnegie seismological laboratory in Pasadena earthquakes are being studied in the hope that accumulated knowledge may lead eventually to foretelling when a major shock is due. Somewhere in the United States this century a very destructive earthquake is likely to occur although no one yet can put his finger on the time and place, for science has no means at present of predicting even to within a decade when a temblor will occur.



IN the gloom of a reinforced concrete underground vault in Pasadena recently tiny pencils of white light stabbed through the dark, glanced off quivering mirrors, and began to etch jagged lines on sheets of photographic paper. As the shrill note of the automatic alarm buzzer sounded scientists gathered and watched the light beams trace the history of a heavy earthquake. That evening the newspapers told, under Pasadena date lines, of a damaging temblor that had rocked part of New Zealand, news confirmed next day by word from the stricken area itself.

Recording earthquakes that happen 6,500 miles away is only part of the work of the sensitive optical-photographic machines. Each earthquake writes its own individual signature and men who can interpret the

Jagged Lines Recording Earthquake, and Measuring a Distance Taken from Seismogram Records to Learn Location of Temblor

Millions of perceptible shocks will rock the world this year. Hardly an area will escape, past records suggest, although few of the tremors will be serious. Possibly twenty will be true world shakers. Many of the quakes occur in uninhabited regions

Richter, Carnegie
Seismological Laboratory, 220

EARTHQUAKES

H. Jan
Raphael

Pasadena, Calif



or under the sea and are recorded only on the instruments.

Earthquakes result from rupturings in the earth, sudden slippings between blocks of rock down to forty miles below the surface. Blame for the strains that cause these readjustments may be laid to tidal forces, erosion and deposition, and possibly to the wobbling of the earth on its axis. At Harvard university studies are being conducted that may link earthquakes definitely to the moon, infinitesimal movements of the earth's crust already having been traced to the daily movement of the tides in the ocean miles away. The shifting of tremendous quantities of water causes a give and take in the earth along the coast equal to the tilting of a sixty-five-mile pole one inch at one end.

Dr. Harlan T. Stetson and Dr. A. L.

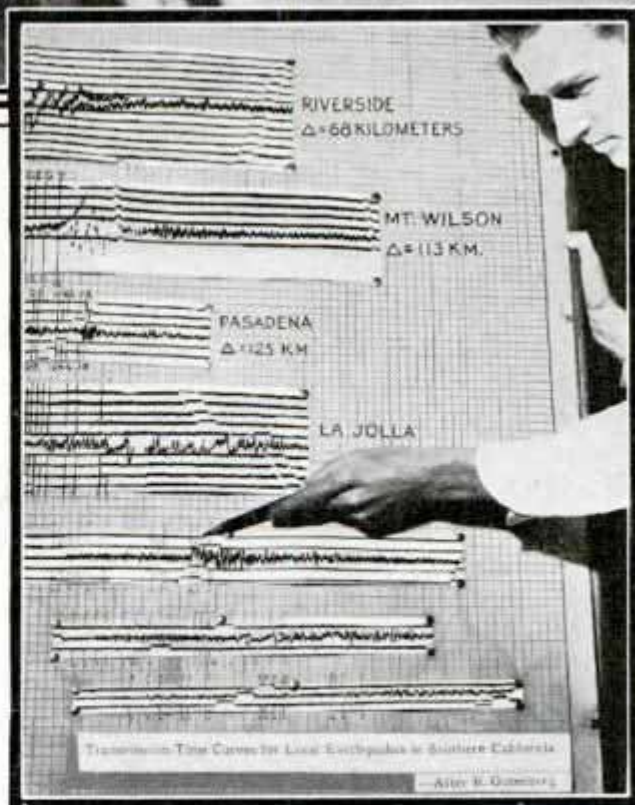

Records of Same Quake Made at Different Stations, and Vertical Seismometer in Underground Vault



heavily faulted regions are constantly active while other areas seem to have spells of action.

The seismologists think that study of the minor shocks may lead to anticipation of the time or place when a greater upheaval is due. In some cases a major earthquake seems to be preceded by an increasing number of small preliminary tremors. In spite of the tremendous forces involved in an earthquake the actual motion of the ground

Loomis at Harvard are checking the position of the moon at the times when 2,000 quakes occurred in the last several years. Aside from the responsibility for ocean tides, the moon exerts a measurable gravitational pull that causes the crust of the whole earth to expand and contract. In California some investigators have found a definite relationship between some earth movements and certain phases of the moon.

Japanese seismologists advanced a theory that the surface of a region assumes a tilt during the hours preceding a quake. In the United States sensitive instruments have recorded violent "tilt storms" that change ground contours as much as an inch per hundred feet in a few hours but these temporary movements are mostly regarded as being caused by shifting temperatures at the surface or by the amounts of water in the ground instead of being connected to any deep-seated condition that might result in an earthquake.

At the Pasadena laboratory eleven seismographs are recording the characteristics of every tremor that occurs and this nest of machines is linked through radio time signals to a network of outlying stations in southern California. From the mass of records the seismologists have observed a shifting pattern of activity. Frequent quakes in one section seem to be followed by lulls during which more quakes occur in adjoining regions. During the last seven years the scientists have found that some



Above, Checking Instruments with Radio Time Signals at Earthquake Station; Below, Machine for Making Physical "Spectrum" of Earth Shocks

usually is slight. In the Long Beach quake of two years ago, described by scientists as a moderate tremor, the shock was manifested by a series of sharp jiggings almost too small to measure, accompanied by slow swaying motions that moved the ground back and forth about an inch. Even this was enough to cause great damage

(Continued to page 114A)

8423

New York

Model of Elevated Railway Built as a Hobby

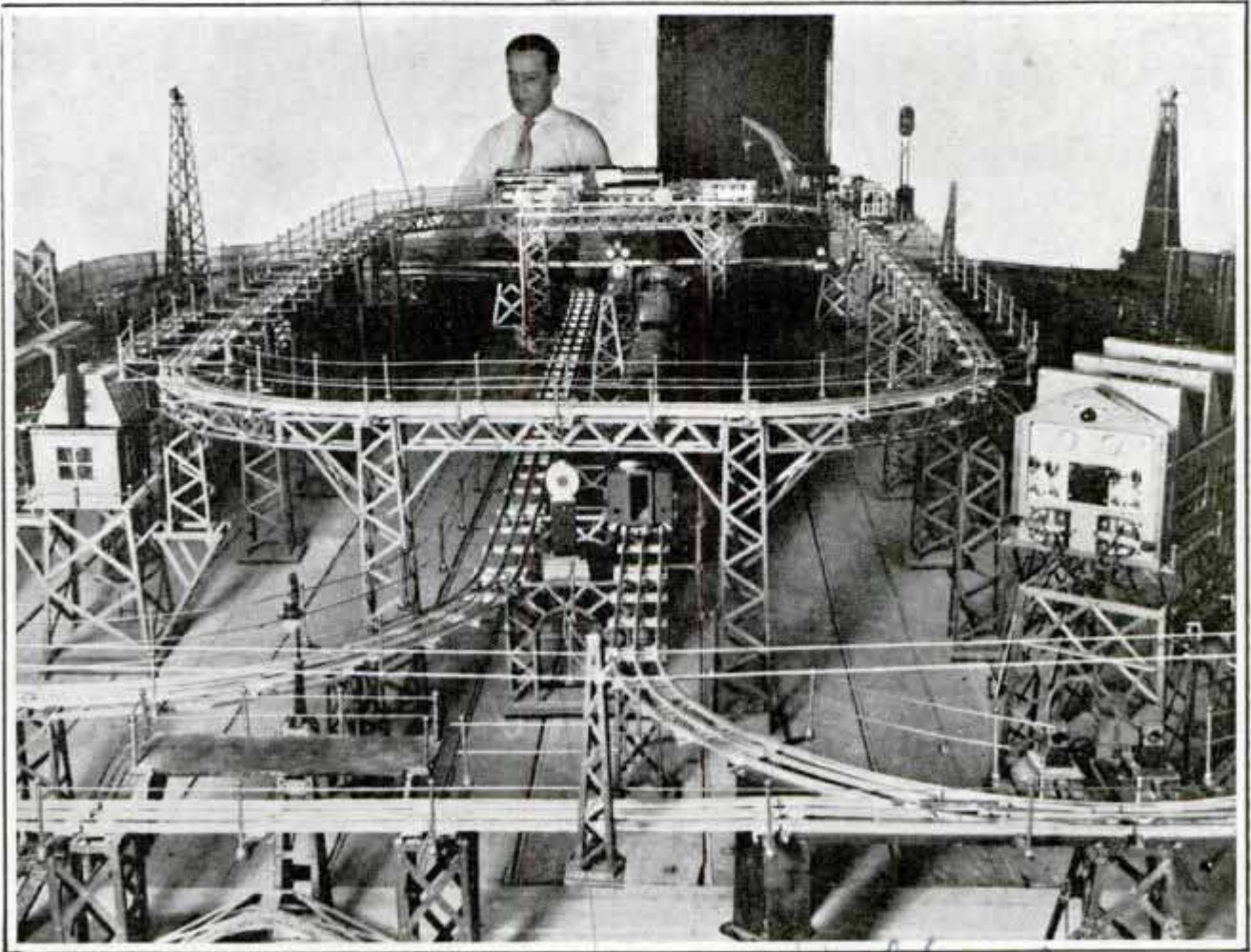

Model Elevated Railway System Built as a Hobby and Which Fills an Entire Room; Note the Two-Level Tracks, the Signal Towers, Power House and Switching-Control House

One employe of the New York elevated lines has spent his leisure time for the past seven years building his own elevated system in his home. His railway is a miniature which fills all of one large room. It is built of brass and 10,000 rivets hold it together. The tracks, built on two levels, would stretch over a city block if laid in a line and the structure is strong enough to support the weight of a man. Everything is elevated, including a tiny power house and switching-control house. There is also a miniature floodlighting system which, through the medium of small towers supporting automatically revolving lights, illuminates the entire line. An automatic signaling system permits the running of many trains at one time without danger of a collision.

☐ Destructive waves soon may be forecast with the aid of a new machine that records intensity and direction of ocean currents.

"STREAMLINE" GOLF BALL GIVES PLAYER BETTER CHANCE

Less opportunity for hooking and slicing, and a better chance of making a true shot are claims made for a "streamline" golf ball, the outer surface of which consists of a series of wavy grooves instead of the usual squares. In a slice or hook the curve in the flight of the ball is caused partly by uneven packing of the air on one side due to the hollow squares, each of which sets up resistance to the air currents, thus tending to draw the ball from its course. The makers claim grooves will act as escape valves for the air.



Woodward - Slow -

8422
Newlin List
Boston Mass
Wm. W. Channing
Durban (inventor)

no data

Sold by Edison J. Hughes, 1270

Binder on Carpet Backing Makes Inlays Easy

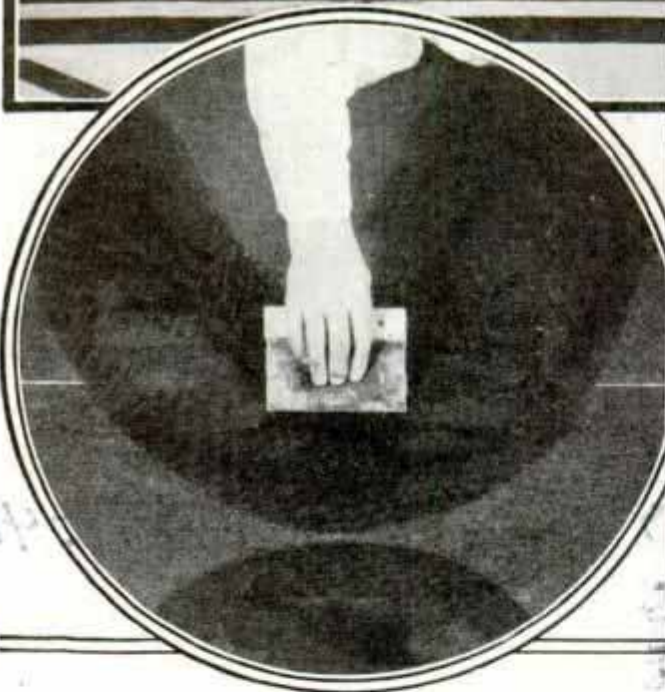
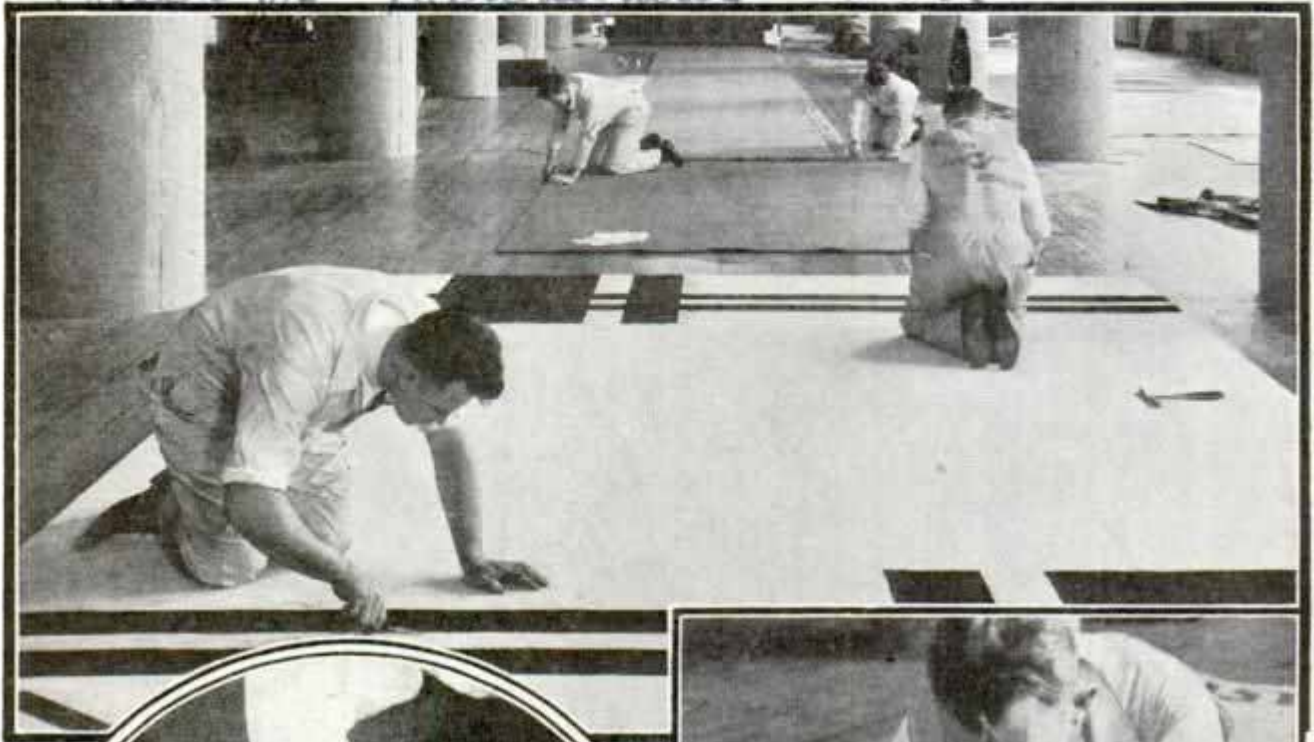

Three Steps in Preparing Latest Carpet for Inlays; Process Simplifies Decorative Work

New opportunities for floor decoration are offered by a carpet that can be inlaid with simple designs of one or more colors quickly and without expensive loom-setting costs. The carpet is produced with a binder, a superior type of pyroxylin, that holds the warp and weft threads together. The process is that of "doping" the back of the carpet with this binder so the tufts are locked into the fabric, forming a natural selvage wherever a cut is made. A fabric with tufts that go through to the back is used so the "dope" may bind the tufts to

the warp and weft threads. Thus, the carpet is easy to cut and there is no danger of raveling. Since two pieces can be bound together simply by sticking a tape to the back of the carpet along the seam, worn or burned spots can be removed and new sections put into the carpet. It can be cut or fitted to any size room with a minimum amount of expense. The seams lie flat and are practically invisible, yet three times the strength of sewn seams is claimed. To

Lachweave.

Wrightson - 136 Madison Ave. New York 17

Chas. M. Merchandise - Mail

cut and inlay a design is similar to precision pattern making. A template is rowel cut in heavy paper. Through the pin point holes, powder dusts the design on the reverse side of the carpet. The cutting tools are mounted razor blades, squares and long, weighted rules. In the ordinary designs, such as block figures, straight lines and angles, the tufts are not sacrificed and only a few are cut in curved patterns. The carpet is tacked to the floor to assure fixed position. Once the designs are in place, the taping holds them firmly without showing the usual seam lines.

8396

**TOUCH-UP PAINT GUN FOR AUTO
USES AIR FROM TIRE**

Designed for retouching scratched and worn spots on the automobile, a paint-spray gun made for use with a special retouching enamel is operated by air from the tires of the car. The gun, with its six-foot hose, is attached to the paint can and connected to the tire valve. Pressing a trigger on the gun causes the compressed air to force out the paint in a fine spray that dries with a glossy finish. If tires are inflated to slightly more than normal pressure, using the gun will not cause an appreciable drop in pressure. The gun can be used for other paint and spray jobs.



Spraying Fender with Paint Gun Operated by Air Taken from Tire, as Shown in Picture

*E. J. du Pont
nemours & Co., Inc.*

**"PUT-TOGETHER" METAL STAIRS
FOR TEMPORARY BUILDING**

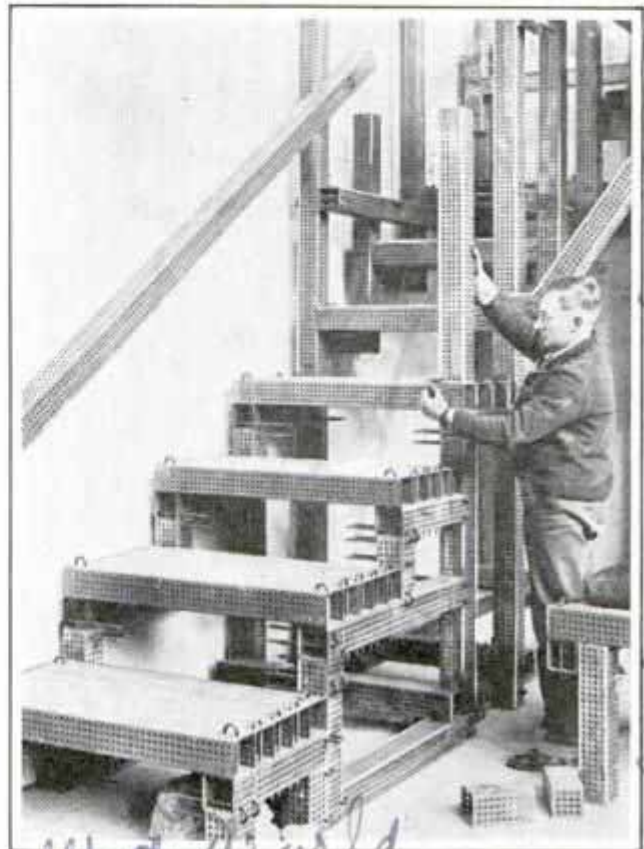

Constructing Metal Stairway with "Put-Together" Pieces; It Speeds Up Work

Designed to facilitate the erection of temporary buildings, metal forms have been developed in Germany. A staircase can be put together quickly by using the metal bars and special hooks that hold the bars in place. The forms are similar, except in size, to toy construction sets.

8389

**AXLES FOR BUILDING TRAILER
FIT SMALL CAR WHEELS**

For building trailers, an axle made to accommodate the wheels from low-priced automobiles is available. It is offered in either straight or six-inch drop shaft, for either Ford or Chevrolet front wheels. The two ends are drop forgings, with a heavy piece of tubing in the center, electrically welded to these forgings. Intended primarily for the repair shop and garage, the axle can be used by anyone constructing his own trailer.



*W. O. Foreman
5353 S. State*

*Mr. J. S. Waddy, Self. Hollander
Technical University*

C 193
The George Wythe House,
Williamsburg, Va

The CITY that

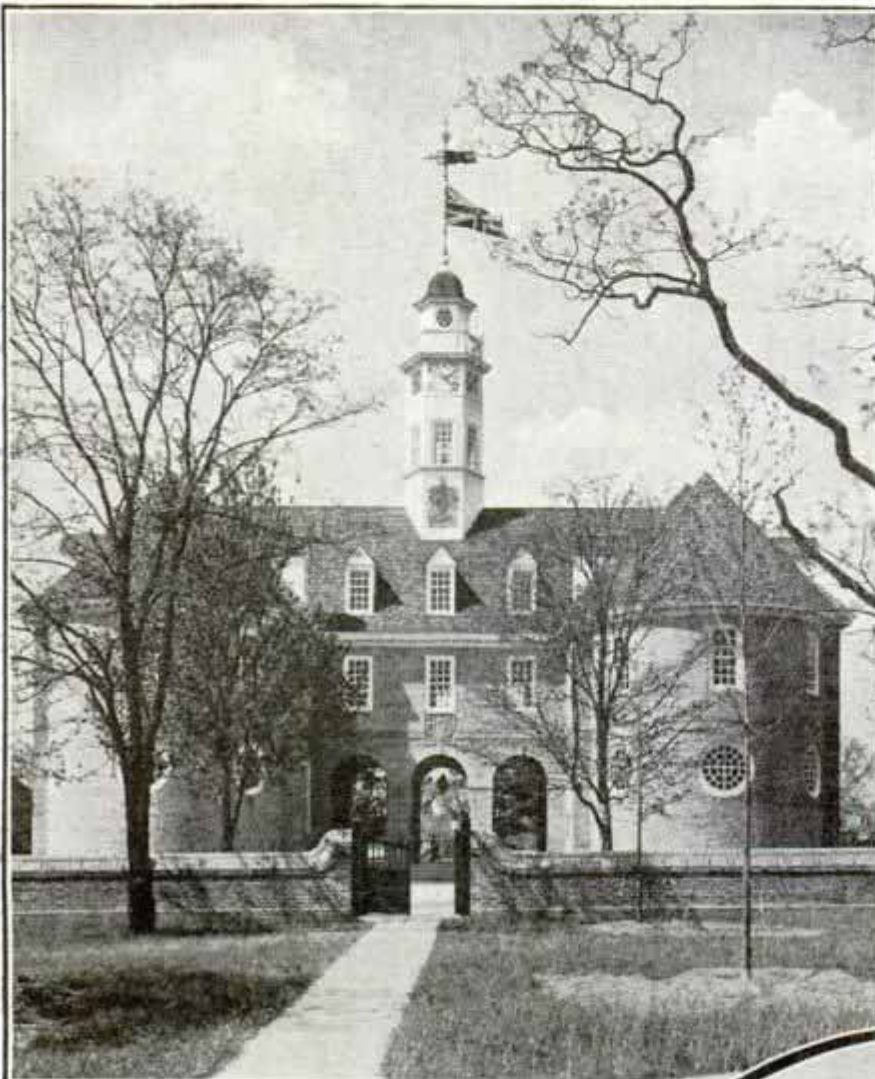

days was the capital of the region where now are the states of Virginia, West Virginia, Kentucky, Ohio, Indiana, Illinois, Michigan, Wisconsin, and a part of Minnesota. Before the Revolution people came to Williamsburg from this vast territory to have their cases tried in the general court in the capitol where the House of Burgesses and the King's Council also met, to buy things freshly imported from England, or to enter their sons in the College of William and Mary.

It was the first city in America built according to an officially authorized plan. The main thoroughfare was named the Duke of Gloucester street. It was one mile long. At

COLONIAL America boasted four important cities—New York, Boston, Philadelphia, and Williamsburg, Va. Three of them flourished with the development of the republic and became world famous centers of commerce. The fourth went to sleep.

Today Williamsburg, the Rip Van Winkle town which slumbered for 150 years, has awakened and become famous again—this time by growing backwards. The town of 3,000, the only one of the four early cities unspoiled by modern progress, has been restored to its appearance during the years from 1699 to 1781 when it was the capital of colonial Virginia. Williamsburg in colonial



Above, the Restored Capitol of 1705, and Rear View of Governor's Palace, Showing Use of Glazed-End Bricks.

Conservation and Development C. F. S.
R. 891, 914 Capitol St. Richmond, Va.

Grew BACKWARDS

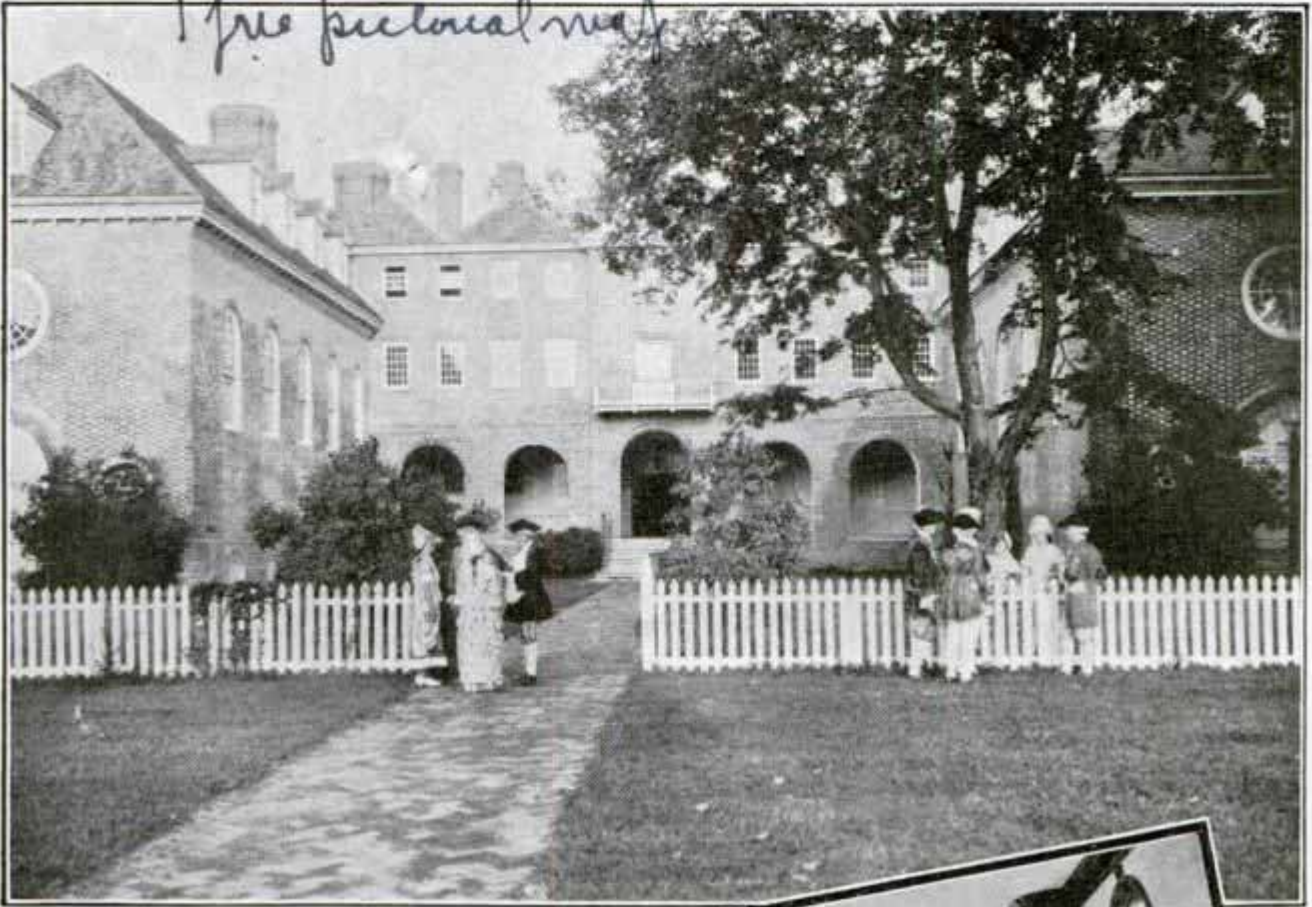

one end stood the college and at the other the capitol. Midway between them was the palace green, at the north end of which was erected the palace of the English colonial governors. At the corner of the Duke of Gloucester street and the palace green stood Bruton parish church, erected in 1710. Here, on Sundays, the governor sat in a velvet canopied pew and around him sat the members of the House of Burgesses and the King's Council. Below the palace green was the spacious court green and the market square. Facing on these greens and the three parallel streets of the colonial city were the simple beautiful homes of the people and the taverns and inns.

Visitors who could afford it stopped at the Raleigh tavern, the most famous resort



All Photos © Williamsburg Restoration, Inc.

Wren Building of 1693 at the College of William and Mary, and Hall of House of Burgesses in the Restored Capitol

of colonial Virginia. Here the great banquets and balls were held to welcome the governors sent over from England. Here also the House of Burgesses met when Patrick Henry or George Wythe or George Mason or George Washington said things and sought to enact laws which caused the royal governors to dissolve the assembly.

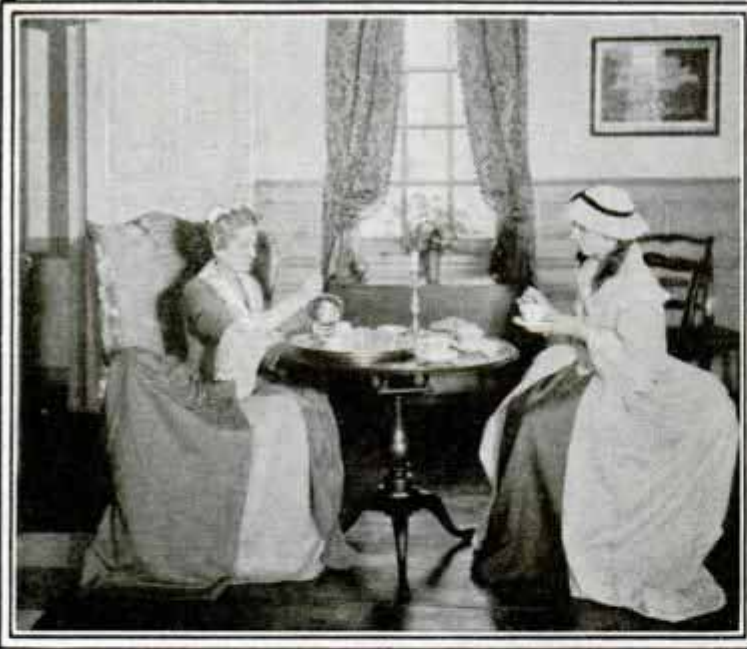

Hostesses in Colonial Costume in Raleigh Tavern, and the Restored Christopher Wren Building

Though dissolved they continued to resolve to be free, and after Patrick Henry's "Cæsar had his Brutus" speech in the capitol, they were dissolved again and organized the Revolution.

When, in 1928, John D. Rockefeller, Jr., decided to restore colonial Williamsburg, at the suggestion of Dr. W. A. R. Goodwin, rector of Bruton parish church, he enlisted

the services of historians, architects, landscape architects, and engineers, expert in the life of the colonial period. The problems involved the restoration and preservation of the old buildings which remained; the rebuilding on their original sites of the capitol, the palace, and the Raleigh tavern; the restoration and reconstruction of colonial homes, and the removal of many modern buildings which would have been out of place in the restored city.

Historians collecting information about colonial Williamsburg, searched every known public and private source in America. Then research was undertaken in England. After the Revolution, French soldiers had been stationed in Williamsburg for a year, so the search also led to France.

Important assistance came from both countries. In 1782 a French soldier, stationed in Williamsburg, had paced off and drawn a map of Williamsburg as it ap-

(Continued to page 119A)

Padded Mask Guards Boxer from Injuries

Padded masks for boxers have been developed to prevent such injuries as cauliflower ears and broken noses, thus permitting those who like this sport to indulge in it without fear of disfiguration. The masks are strong enough to withstand a blow by a hammer or to support the weight of a person while being worn. The nose, chin, ears and eyes are protected although the masks do not interfere with seeing or breathing.



Boxers Wearing Padded Masks Which Protect Ears, Noses and Eyes from Injuries

Fog-Piercing Light Is Produced in "Smoke-Box" Tests

How to make existing artificial light sources penetrate fog and smoke or dust clouds has been discovered by "smoke-box" tests in the Westinghouse Lamp company's laboratory. By working lamps overvoltage, visibility was increased more than double in some instances. Overvoltage means operating the lamps at a voltage higher than their normal rating. This

shortens the life of the lamp, of course, but can be offset somewhat by working the lamp below its rated voltage when there is no fog. The tests were made by Gjon Mili, Westinghouse engineer. A footcandle meter, placed at a known distance in a chamber filled with smoke or artificially created fog, measured the change in beam intensity as the voltage across the lamp or the

degree of atmospheric turbidity was varied. Increasing the voltage resulted in extension of visibility for distances of half a mile in a night fog of medium intensity. Such a fog is one in which the outline of objects may just be discerned at a distance of approximately 400 feet in the daytime.

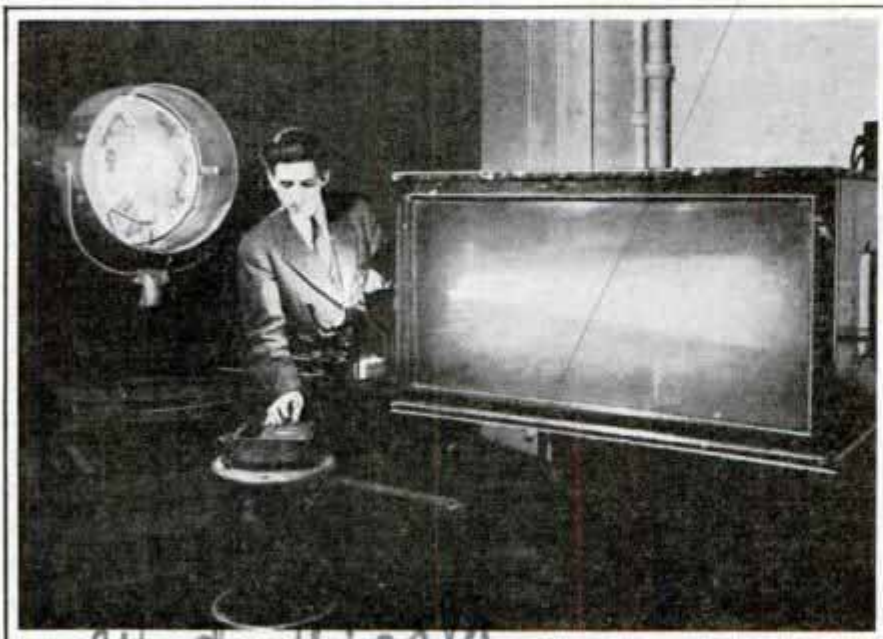

Passing Light Beam Through Smoke-Filled Cabinet to Show How Increased Voltage Helps to Penetrate Fog or Smoke Clouds

Whenever you find that you wish to know more about any article in Popular Mechanics Magazine, write our Bureau of Information, inclosing a stamped, self-addressed envelope.

Westinghouse Lamp Co

6438
 Andrew Jackson Heights, New York
 3746 P 3rd St.

Flickering Mirrors Give Depth to the Movies

J. Alder, 1183
Mariposa, Pasadena, Calif.
J. W. Williams
see Nov. 1934, p. 701

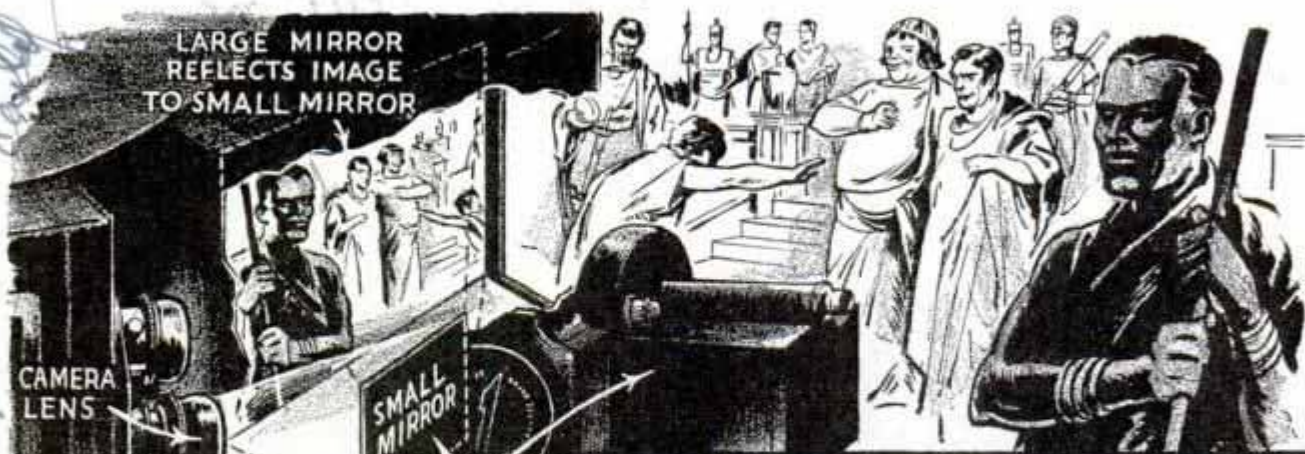

MOTOR MOVES SMALL MIRROR IN AND OUT CHANGING POSITION ON CAMERA LENS

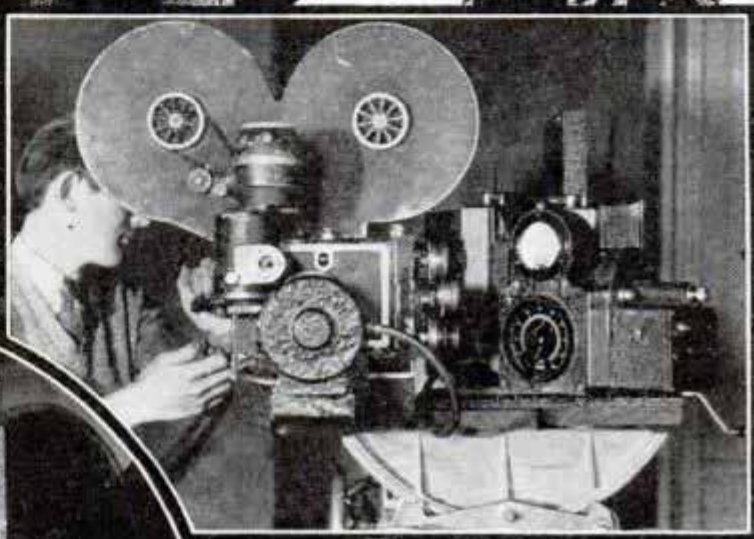

Sketch Shows How Three-Dimension Camera Works; Photo, Right, the Camera; Circle, Bottom, Inside View of Equipment

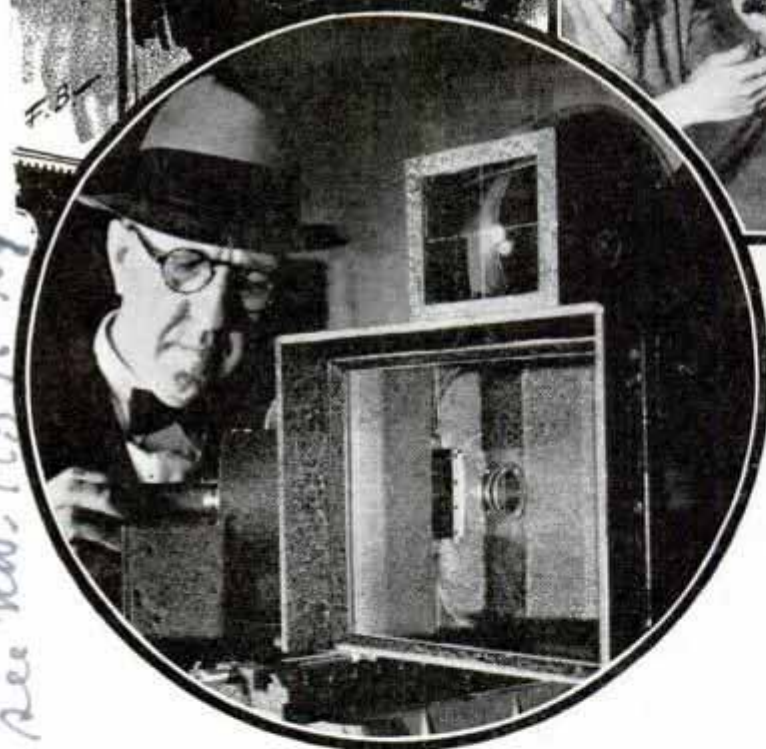

audience viewing these pictures the impression that the images actually stand out in relief. Besides possessing the quality of "third dimension," these natural-vision pictures have eliminated "side-seat distortion," but what endears them most to those who have seen them is the fact that they not only do not cause eyestrain, but actually rest tired eyes.

After twenty years of research and experiment, third dimension, or natural vision, photography has come into its own in motion pictures.

This has been accomplished by a device which causes the motion-picture camera to which it is attached to "shoot" film with qualities which permit the projection on the screen of pictures with stereoscopic relief, or depth.

So decided is this effect that it gives an

These results are accomplished by what is called a tri-dimensional poly-scope, and is, bluntly, a gadget that jiggles the image being photographed in the lens of the camera. It accomplishes this by the use of two mirrors, one of which catches the image to be photographed and passes it on to the second, which reflects it into the camera lens and displaces, or wiggles, it as it does so.

"Way back in 1912, when I was cameraman for the American Film company, I

made some shots from a moving automobile which brought directors and executives to me to learn how I obtained my stereoscopic qualities," says William F. Alder, the inventor. "At first I didn't know, but then I discovered it was because I had made my shots from a moving vehicle, and that movement gave depth.

"While shooting a serial of Ruth Roland, I tried manipulating my camera, and secured quite startling depth. At that time everybody called me a 'camera cuddler' because I wrapped my arm about my camera as I cranked. They could not see that I was rocking the camera back and forth in a sidewise movement.

"The resolving power of the human eye, is, of course, the ability to separate objects one from another. At a distance of a mile two telephone poles standing sixteen and one-half inches apart would look like a single pole to the human eye, because at that distance the human eye cannot resolve them into two objects. This power of the human eye is seventy seconds of arc. If I kept my movement within that the eye would not notice the movement on the screen, and yet that degree of displacement in each frame or film or 'shot' would permit motional perspective.

"To get this I tried moving a camera back and forth. I got my depth, but the process was too cumbersome. Then I tried moving the lenses in the camera. The vibration resulting from moving the camera lens sixteen times to every foot of film and 1,440 times to the minute of exposure was disastrous to the lenses.

"So I concluded I must keep my lens still and move my images. I finally discovered that the only way to do this would be to reflect the image I was to photograph on a mirror and then move the mirror.

"By moving the mirror I could displace my images on the lens and secure the same effect as that obtained by the motion-picture director when he 'dollies' his camera for depth."

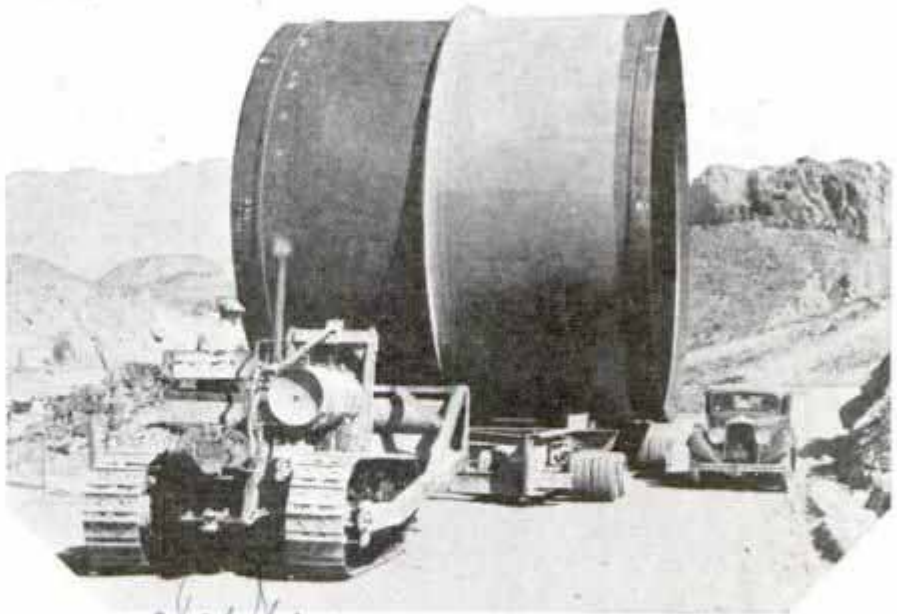

Transporting a Giant Penstock Is No Easy Job; Note Tractor Hauling the Big Steel Pipe While Motor Car Travels Alongside

TRACTORS TOW GIANT PIPES TO BOULDER DAM

When Boulder Dam was in readiness for installation of the giant penstocks to be used at the power house, tractors were called into service to tow the big steel pipes to the base of the great concrete structure. The penstocks are used to convey water into the turbines which will generate electric power for millions of customers in the west.

£ 386

AUTO SEAT IS SELF-COOLING AS WET FELT DRIES

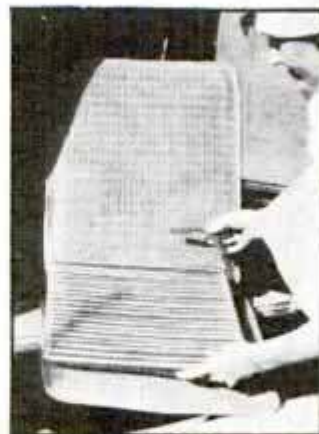

Cooled by the evaporation of moisture from felt in the interior, the latest auto seat keeps the driver or passenger comfortable on long rides. The seat, resembling the pads used to protect upholstery, produces a better

ride, absorbing unevenness in rough roads, and preventing breaking down of cushion springs. The frame containing the felt is removed from its cover, dipped into water and replaced after all excess moisture has been shaken out. The seats are made in a number of different sizes.

Box 1112, Cisco, Texas.

*Self-Cooling Seat
2808 Main St*

D1523.

619 E. Woodland Park
Chicago

ODD FACTS *about*

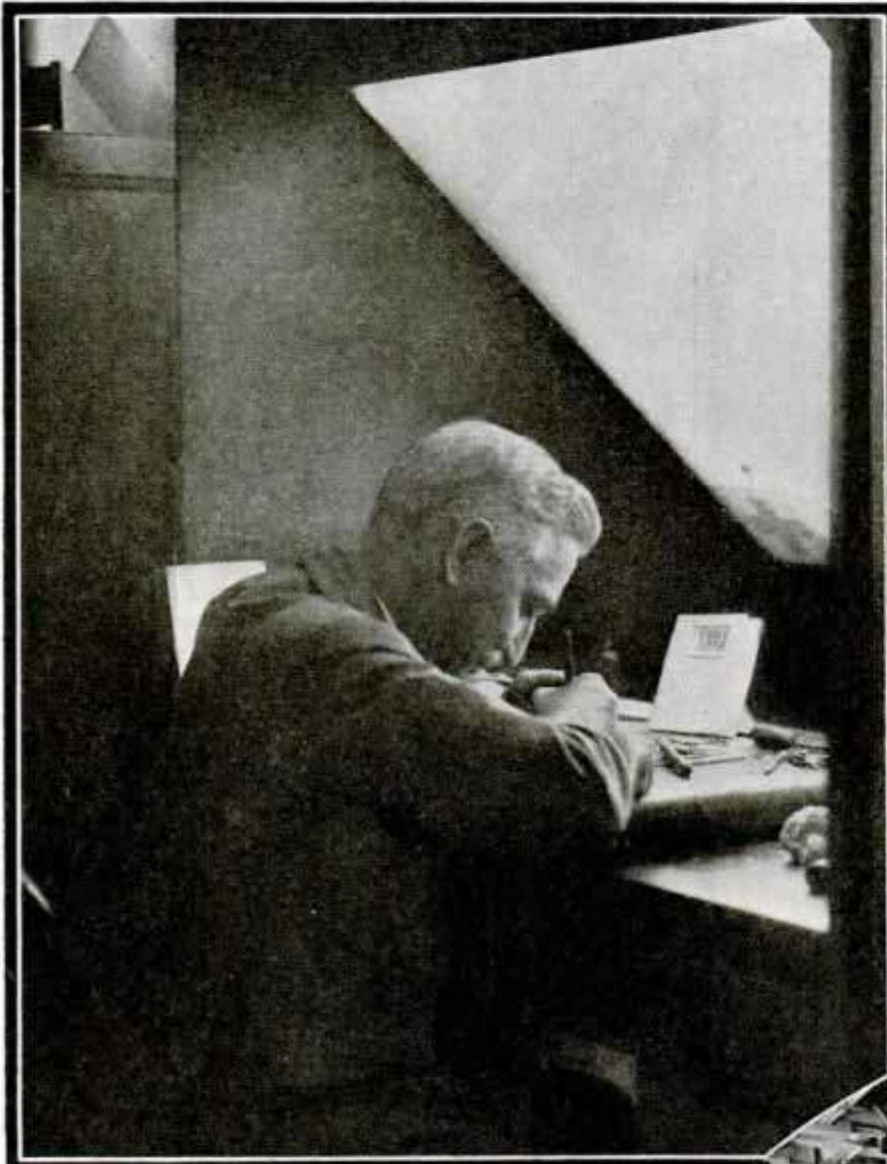

the Carolinas with ink from Missouri minerals and gummed with tapioca starch—not glue—from the cassava fields of Java.

They are printed on presses which, in one continuous operation, wet the paper, ink and wipe the stamp plate, print the stamps, dry them, apply the gum, dry it, and wind the finished product on rolls. A device on the presses also will pre-cancel the stamps. The rolls are cut into smaller rolls for vending machines, into sheets for post offices and made into stamp books.

A numbering machine prints a serial number each time 400 stamps are run off. At night each sheet must be accounted for. If any are missing

A POSTAGE stamp—the bit of gummed paper you stick on a letter—is about the most intricate document in the world. And stamp collecting today is a world business running into millions of dollars. It is the occupation, form of investment or hobby of one out of every fourteen persons you meet on the street.

Into one postage stamp go the products of mines, forests and distant fields, and the skill of the industrial arts. Uncle Sam manufactures from twelve to fifteen billion stamps yearly, enough to reach from the earth to the moon. They are printed on paper from

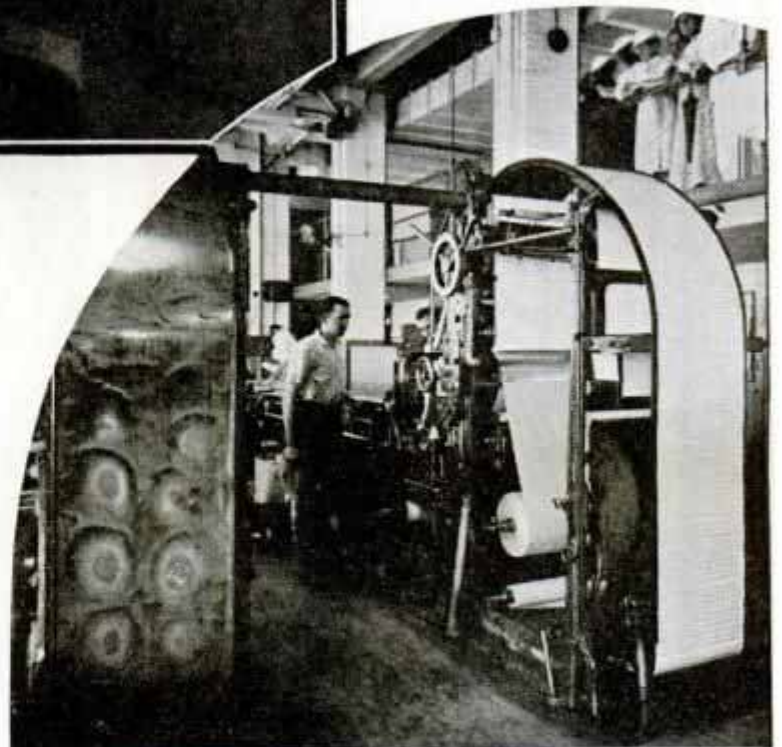

Press Which Prints Stamps by the Millions, and Steel-Plate Engraver at Work with Diamond-Pointed Tool Making Plate for a New Stamp

POSTAGE STAMPS

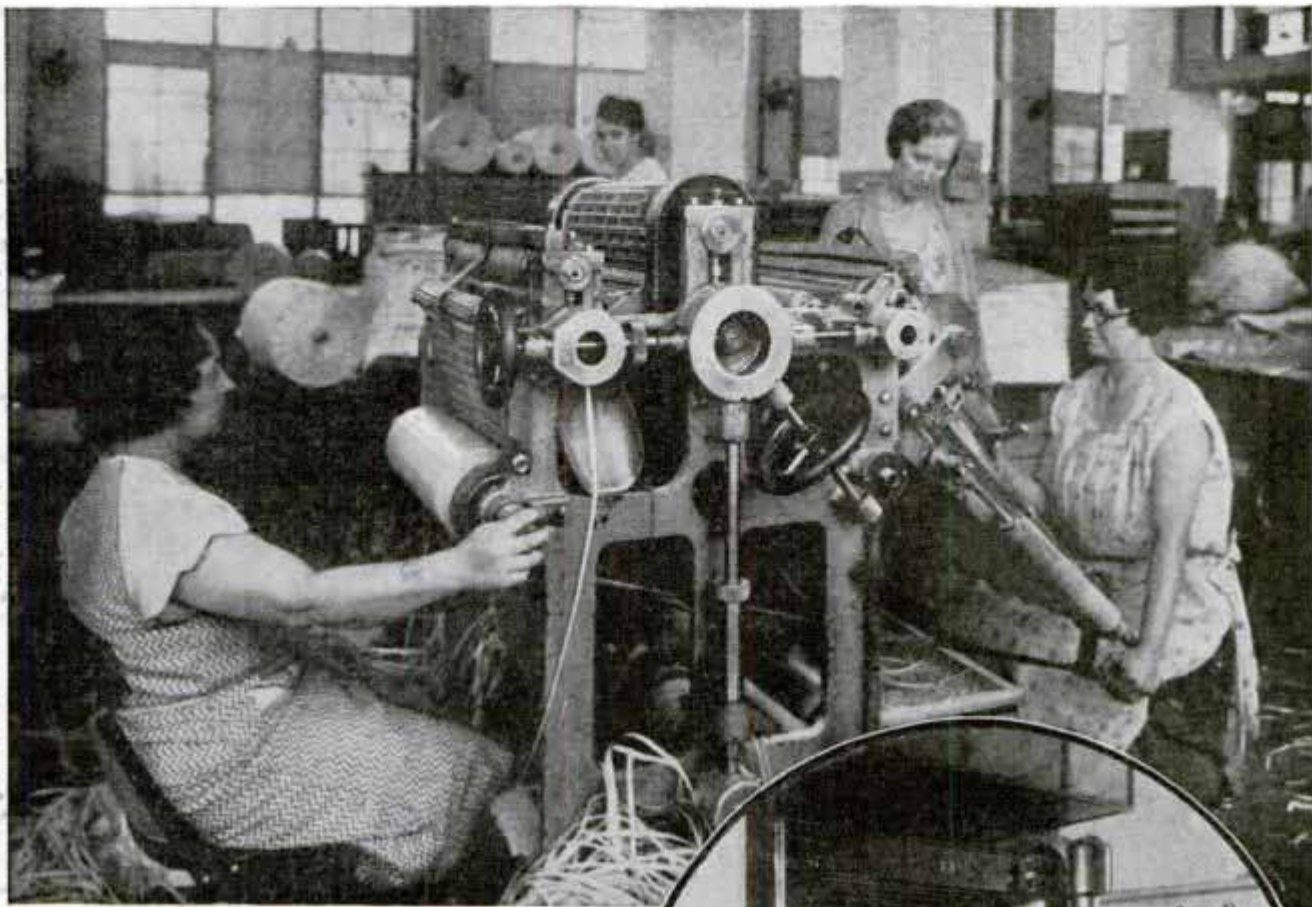

the person to whom the batch was assigned is held accountable. And there never has been any loss, a testimonial to the personnel of the bureau of printing and engraving. The tapioca starch used in gumming is just as edible as any that goes into tapioca pudding and enough is used yearly on stamps to make a pudding for all of greater New York.

The base of all inks used is barytes, derived from a mineral, sulphate of barium, mined chiefly in Missouri. Aniline colors are used mostly in printing. The ink division of the bureau turns out more than 5,000,000 pounds of ink annually at the astonishingly low price of about ten cents per pound. The paper is made of bleached chemical wood fiber derived from pine trees and comes mostly from North Carolina.

Stamp engraving is probably the most intricate of all such processes. A picture of a new stamp is first drawn on cardboard. This picture, about three by four inches, then is photographed in miniature—



Perforating Rolls of Stamps after They Are Printed, and Vault Where Stamps Are Stored

the exact size of the stamp. This is pasted in the center of another piece of cardboard and now is ready for the steel engraver, some of whom have worked at the art for decades. Slowly and laboriously, with magnifying glass and steady nerve, in silent surroundings, they trace the design with sharp instruments on soft steel. Two or three engravers may work on the same

(Continued to page 120A)

Fisherman Floats in Boots Attached to Inflated Belt

to obtain a boat to reach a likely location. So lightweight is the outfit, the wearer experiences no discomfort even after several hours of fishing.

LIGHT IS DIFFUSED BY "GLASS SILK" IN WINDOWS

Threads of glass so finely drawn that a bundle of them looks like a wisp of silk, are woven into one piece and sandwiched between two sheets of ordinary glass to form a window-pane that diffuses light evenly. This results in more efficient lighting of the home or office. Another desirable feature is that the health-giving ultra-violet rays pass through this glass. The ordinary window glass obstructs passage of the rays. The "glass silk" panes can be produced in several different colors.



Weighing only ten pounds, an air compartment attached to the latest hip boots will keep the fisherman afloat in deep water when inflated. Somewhat resembling the old-fashioned hoop skirt, the air belt fits around the wearer's waist. A rubberized vest affords protection to the upper part of the body. The fisherman can propel himself through the water by means of a flap attached to the sole of the boot. When the air compartment is deflated, it folds into a small parcel for easy carrying. The floating boots allow the fisherman to get away from snags along the shore without bothering

Top, with Belt Inflated, the Fisherman Prepares to Enter the Water; Note Paddling Device on Sole of Boot; Bottom, the Angler Wades and Then Floats into Deep Water to Make His Catch

Sold by Bauer's Sport Shop, Seattle Wash. Descend Ave & Seneca

885

8465

Dept. of Commerce 4/10/33

1, Albemarle St. Piccadilly London, W.1

American Concrete General. London

Alta... engineers
97
annual
locate

**SPEEDY "GYRAUTO"
 HAS TWO WHEELS**

With its motor, controls and two seats located between two giant wheels, the latest automobile in Europe can attain speeds above 100 miles per hour. It is called the "gyrauto." The huge wheels on the car are rubber-tired.



© Planet News *Acme*
 Ready for a Spin in This Giant Two-Wheeled Car; a Small Motor Propels the Odd-Looking Vehicle at High Speed

**BIG FRAME SHOWS
 AIR MAN USES
 IN AN HOUR**

How much air is required by one person in sixty seconds is demonstrated by a large wire frame constructed in Germany. A wire form outlines a man's body, while the frame, inclosing thirty cubic meters of space, gives a comparison between the size of the man and the air supply for one hour. The exhibit is a part of the Berlin show, "Wonders of Life."



Acme
 Here's as Much Air as a Man Breathes in Sixty Minutes; Note Outline of Body (Lower Left)

**UNUSUAL USES FOR "DRY ICE"
 FOUND IN INDUSTRY**

This year marks the one hundredth anniversary of the discovery of solid carbon dioxide—the Dry Ice used so extensively by ice-cream manufacturers. Many other industrial applications also have been found for the substance. Diamonds and pearls can be distinguished from imitations by a characteristic rattle or squeak when touched with Dry Ice, and quartz lenses can be distinguished from glass in the same manner. Metal bars and tuning forks are excited by touching them with the substance. The overtones of metal bars can thus be distinguished and the method is used in tuning musical instruments. Brittle materials can be set in vibration by bringing Dry Ice in contact with them. If a piece of carbon dioxide is held against a bicycle bell, there will be a "chatter" or singing sound almost like a ring. This is caused by the sudden flow of heat from the bell to the Dry Ice. This substance also is used in the automobile industry to obtain "shrink" fits of parts. It also has been found that Dry Ice is more effective than ordinary ice in preserving flowers. The gas is said to arrest deterioration.

843!
Dry Ice Corp 205 E 42nd St New York
cm. sec. it... are...
natural English Feb 23, 1935
Mar 23, 1935

New CONVENIENCES



Above, Footboard of Latest Bed Contains Built-In Dressing Table with Disappearing Mirror; Shoe Rack Holds Nine Pairs; Shelves Are for Toilet Accessories and Small Articles; Vanity Top Measures Twelve by Fifty-Seven Inches; Mirror Is Adjustable to Any Height



Above, Spoon with Hood Automatically Measures Proper Dose of Medicine; It May Be Held Vertical without Spilling; Below, Fireplace Screen Is Opened or Closed by Pulling Handles at Side; Mesh Channel Has Rollers Controlled by Chain Pulls

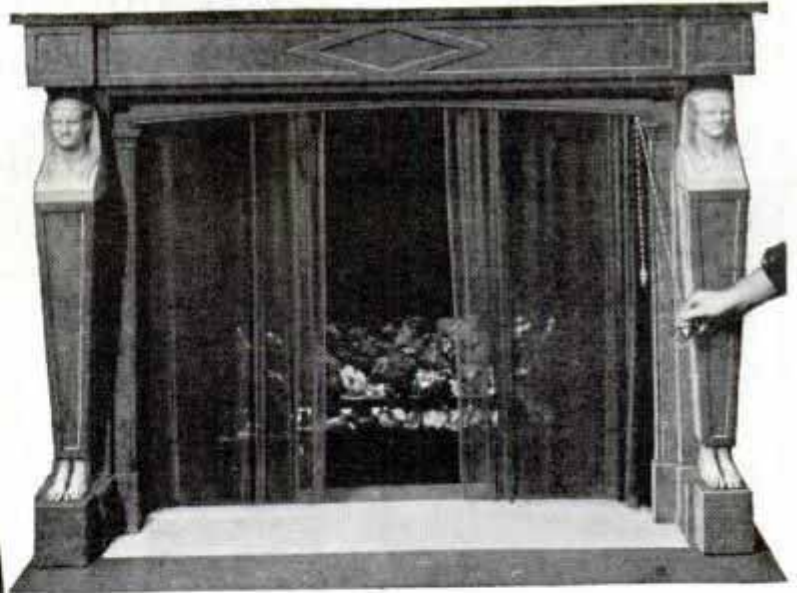

Left, Combined Carry Bag and Shopping Bag; Folding Frame Reduces Bag to Small Size for Shopping Purposes and Opens It Out for Work; Right, Combination Mop and Brush; Upper Section Is Made of Sterilized Horsehair and Has a Thirteen and One-Half Inch Spread; Bottom Part Is Soft Cotton with a Spread of Eighteen and One-Half Inches; in Cleaning Walls, the Brush Loosens Dust and the Wider Cotton Section Catches It



for Your HOME

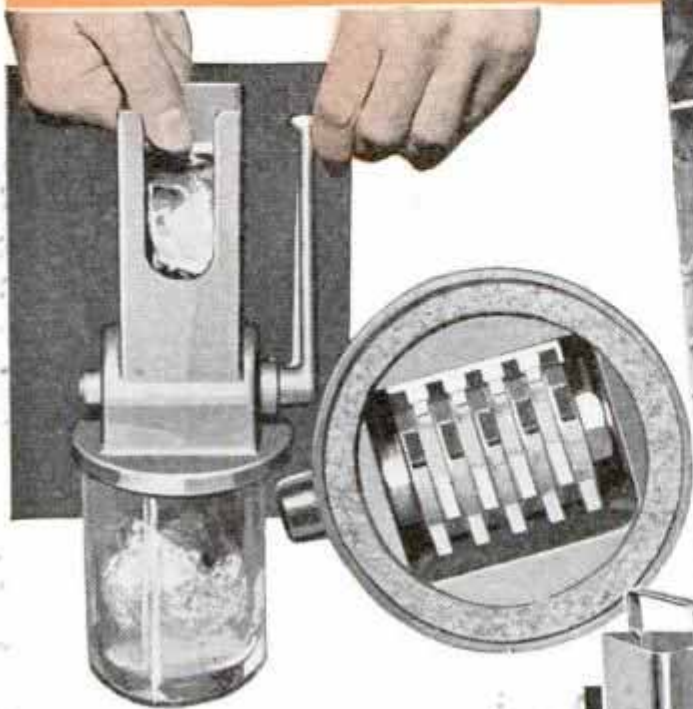

Above, Ice-Shredding Machine Utilizes Standard Ice Cubes; Shredder Fits over Round Lip of Glass into Which the Ice Falls as It Is Chipped; Below, Teeth of This Kitchen Tool Break Fibers of Steaks, but Save the Juices; the Device Eliminates Pounding



Above, Vegetables Can Be Sliced Perfectly with This Machine; Turning a Screw Adjusts Thickness of Slice; After Hopper Is Filled with the Vegetable, Swinging the Handle Back and Forth Produces the Slices



Right, Inexpensive Mechanical Refrigerator Requires No Gas or Electricity; Two Metal Balls Run It; Connected by U-Shaped Pipe, These Balls Are Prepared in Morning by Placing One over Small Oil Stove, the Other in Tub of Water; Heat Forces Refrigerant from "Hot" Ball over Stove to Cold Ball in Water; Replaced in Cabinet, Refrigerant Vaporizes Gradually and Returns to Ball outside the Cabinet; This Action Keeps Inside of Refrigerator Uniformly Cool; Shelf Area Is Four and Two-Tenths Square Feet, for Small Home, Farm or Apartment; There Are No Moving Parts; Cost of Operation Is about Two Cents per Day



Erving Tulsa

1140 Laird Ave
Salt Lake City, Utah

E 353

OIL-WELL FIRE "SQUEEZED OUT" AS JAWS CLOSE CASING

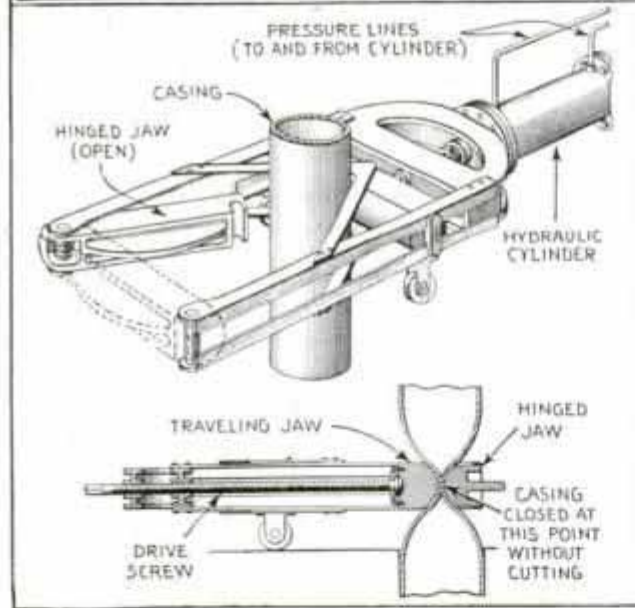
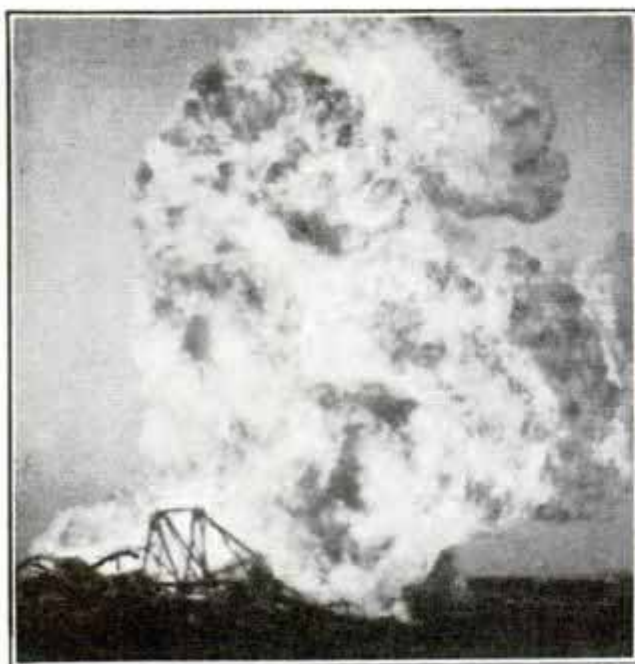

Top, Raging Flames at Oil Well; Bottom, Sketch of Giant Clamp That Closes Casing

Oil-well fires can be extinguished mechanically by equipment that squeezes together the sides of the casing and shuts off the flow of oil. The equipment consists of a heavy steel frame. At one end is a gate that closes under spring power. The other end has a movable steel jaw that moves forward under screw propulsion so that the two jaws form a heavy clamp. An angled iron at the top centers the casing of the well directly between the jaws. In an emergency, the device, which can be mounted on wheels, is drawn by cables against the casing of the burning well and clamped into place. Workmen then squeeze

the casing by turning the screw. Extension rods can be provided to protect workmen from the heat. For permanent installation, hydraulic power might be used.

E 388

SLIDE TOP FOR CREAM TUBE REPLACES SCREW CAP

Attached to the neck of the tube so there is no danger of losing it, a slide top for shaving cream or toothpaste tubes replaces the conventional screw cap. The device is attached when the tube is made, being inserted firmly into the neck of the tube. Pushing one side of the slide arrangement opens the tube, pushing it back closes the aperture through which the cream is squeezed.

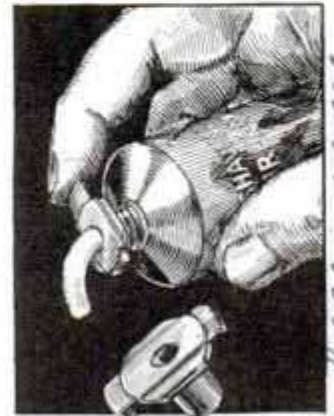

E 363

ARTIFICIAL SILK USED IN GLASS TO MAKE IT UNBREAKABLE

Unbreakable glass, the secret of which has been lost for many years, has been produced by a German scientist who uses artificial silk in its manufacture. It is claimed that the glass will not burn, proof that it will withstand high temperatures. How to make unbreakable glass was discovered in the time of the Roman emperor Nero, but the formula later was lost.

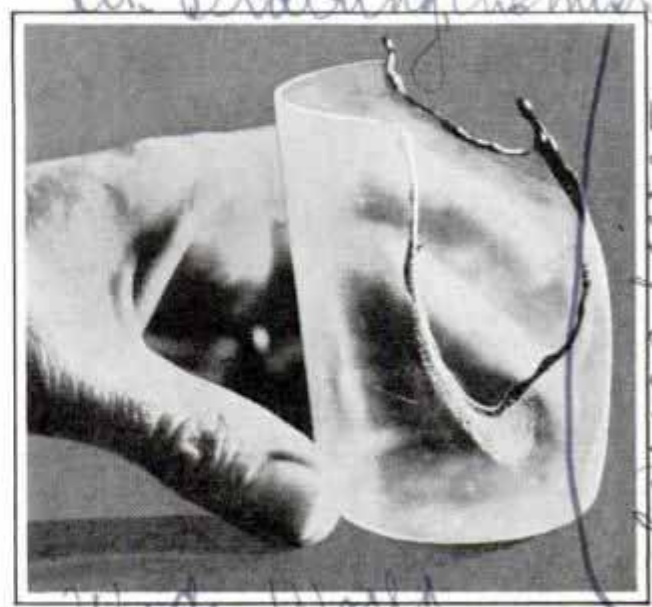

It's a Silk Glass but It Resists Flame

0 Berlin Germany
Dr. Brating Chemist
Krombeerenstrasse 31

R A D I O . . .

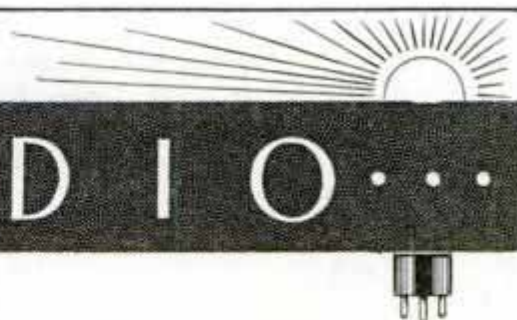

VISUAL AUDIO INDICATOR

HERE is a practical audio indicator that will enable you to balance up that new homemade receiver or bring back the original punch in the old set. Any receiver will gradually lose its knife-edge selectivity and sensitivity over a period of time. Service men and experimenters will find this a very useful addition to the tool kit.

The case, from a discarded transformer, is $4\frac{1}{8}$ in. high, $2\frac{3}{4}$ in. deep and 3 in. wide. A metal strip, $1\frac{1}{2}$ in. wide and $2\frac{1}{2}$ in. long, is bent up $\frac{3}{4}$ in. at one end to form the supporting bracket for the small porcelain socket. The transformer is a 33 to 1 ratio push-pull output to voice-coil type, mounted and connected as shown in Figs. 1 and 2. This transformer steps up the signal voltage across the speaker voice-coil windings to a value sufficient to flash the $\frac{1}{4}$ -watt neon lamp.

If an oscillator, or signal generator, is not available the receiver can be lined up with broadcast station signals, beginning at the first R.F. stage and continuing straight through. With an oscillator begin at the first I.F. stage, line these up in rotation backing off the potentiometer each time until the lamp dims. It will then flash only when maximum gain is obtained. Now move the oscillator to the antenna and line up the trimmers in the R.F., detector and oscillator stages.

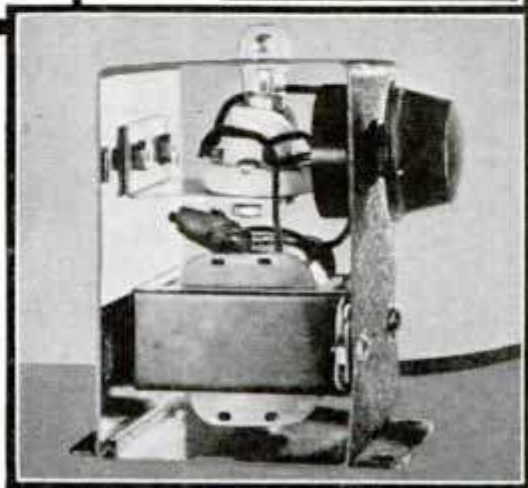
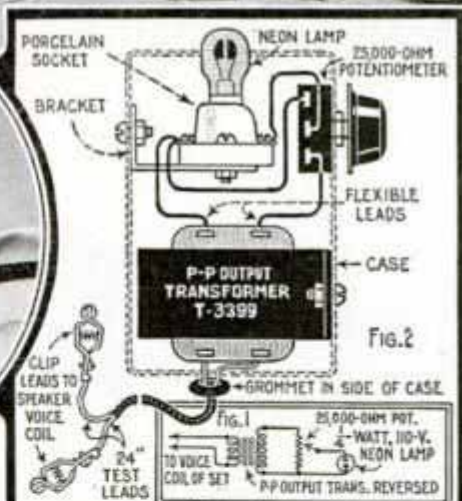
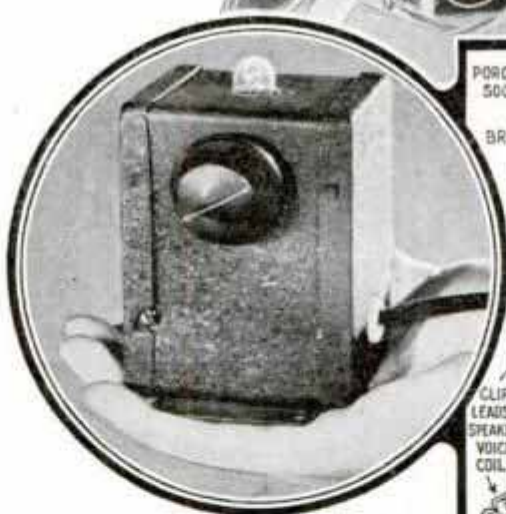

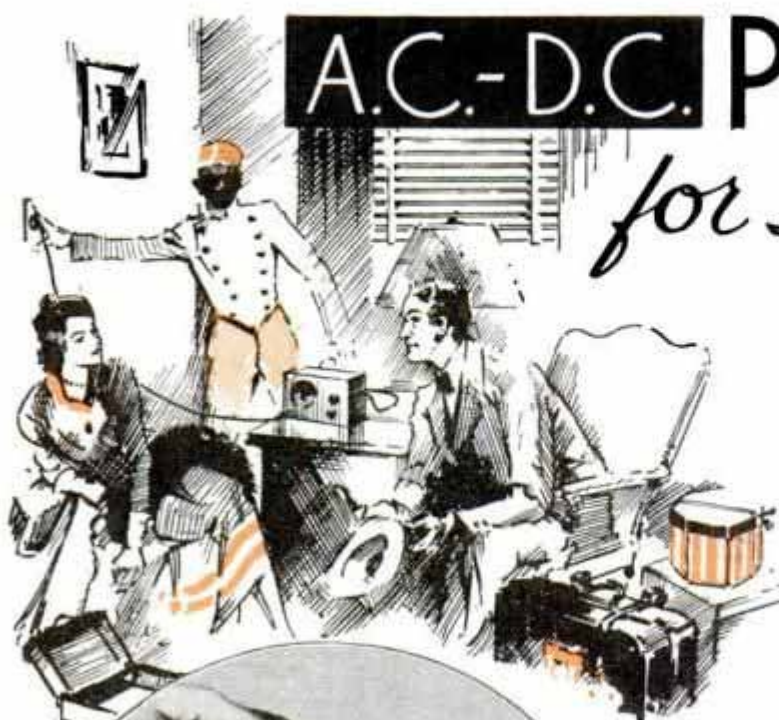

A.C.-D.C. PORTABLE *for Travelers or*

By PERRY S. GRAFFAM

NO expensive cabinet or metal chassis is required for the construction of this little 2-tube broadcast receiver. Cardboard boxes are utilized for the purpose and the dimensions may be varied slightly to suit the material at hand. You can build the set with very few tools; the model shown in the photos was assembled on the kitchen table with a soldering iron, screwdriver, hand drill, hacksaw and a pair of shears.

Operating on 110 volts either a.c. or d.c. and using practically any kind of make-shift antenna, this compact little set is ideal for the traveling man, tourist or summer home. Complete with dynamic speaker, it weighs only five pounds and may be carried in the suitcase or traveling bag.

Although only two tubes are employed, the tone, volume and range equal that of many 4 and 5-tube sets. This unusual performance is due to two dual-purpose tubes that have recently appeared on the market.

The cardboard chassis is 8 1/4 in. long, 5 1/4 in. deep and 2 in. high. This may be made from heavy cardboard and given one or two coats of clear shellac for further stiffening. The base plate is 1/16-in. sheet aluminum, or similar metal, to cover the bottom of the box. The parts are arranged on the metal plate as shown in the various

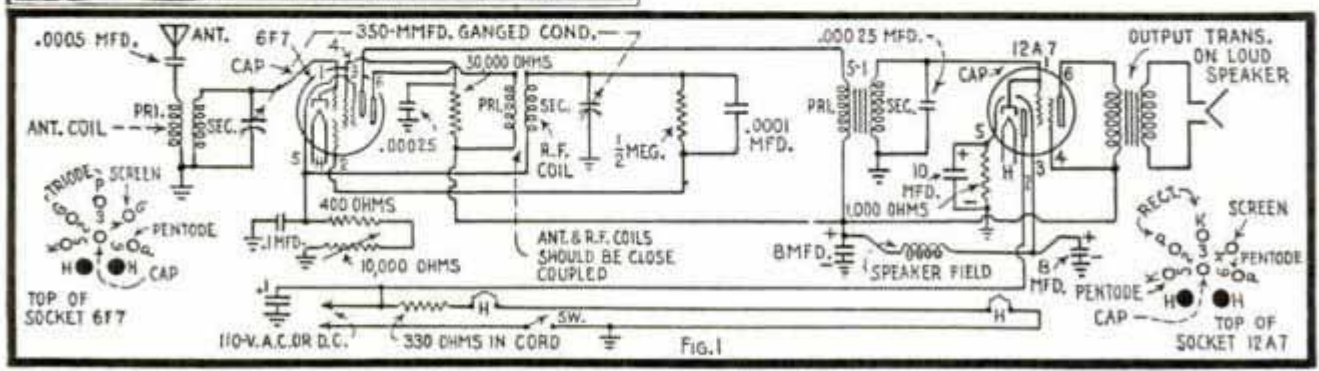
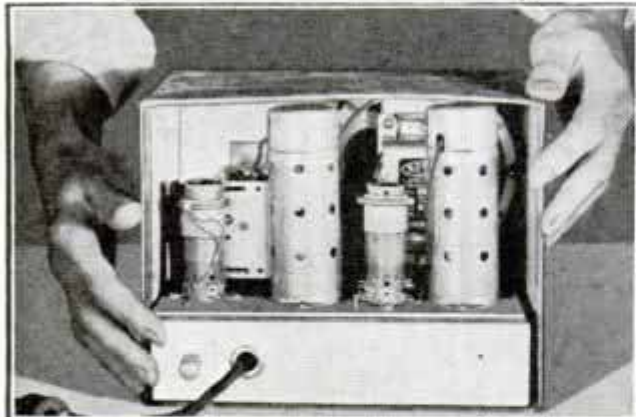
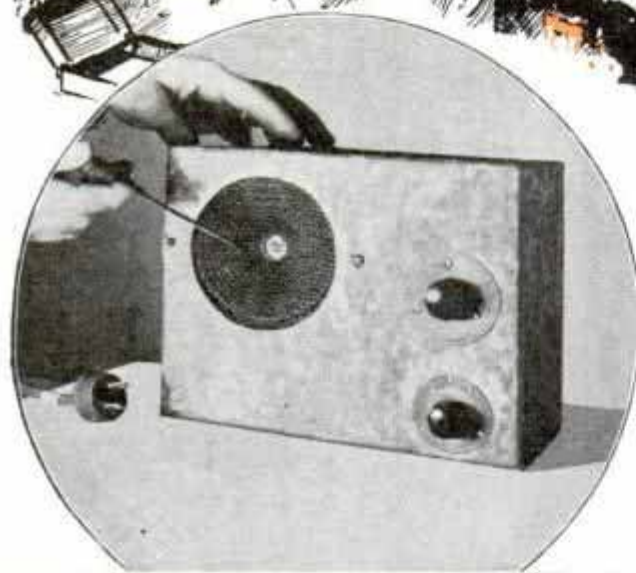

TWO-TUBE *Summer Home*

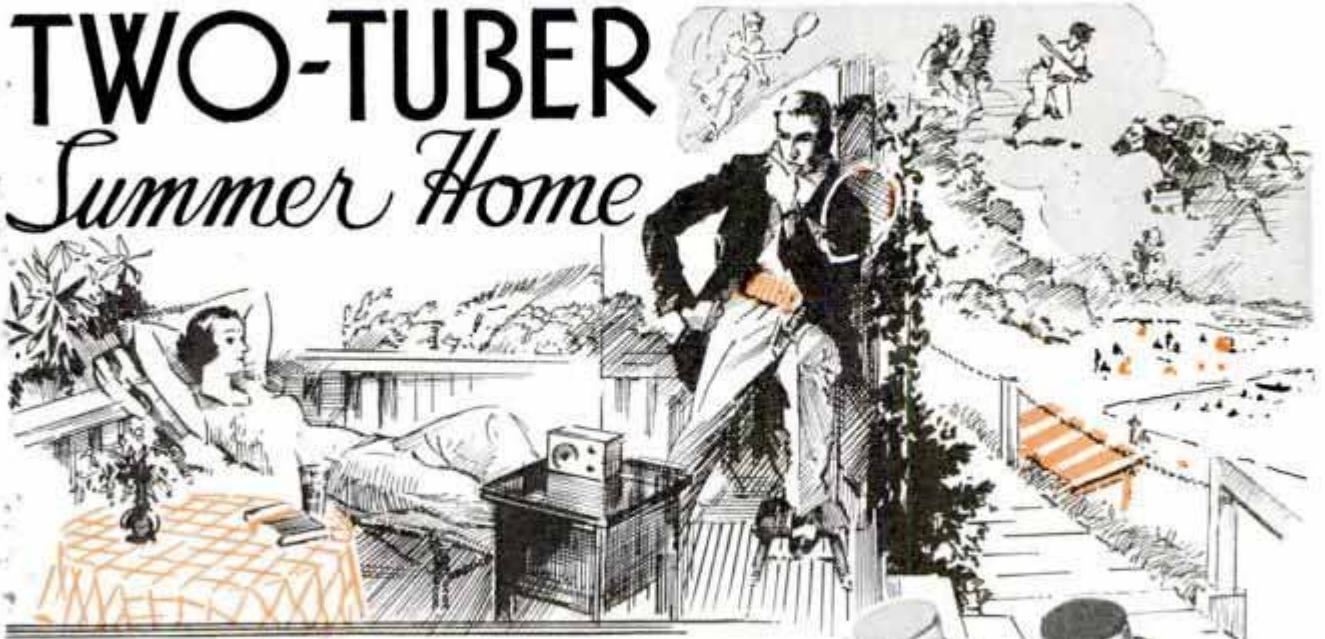

photos and simplified wiring diagram, Fig. 2. Two 1¼-in. holes are cut in the plate for mounting the wafer-type tube sockets; these holes may be made by drilling a series of small holes around a penciled outline, and finished with a half-round file. The socket-hole centers are located 1⅜ in. in from the rear edge and spaced 3⅝ in. apart. This allows room for mounting the standard Sickles antenna and r.f. coils on each side of the type 6F7

(Continued to page 134A)

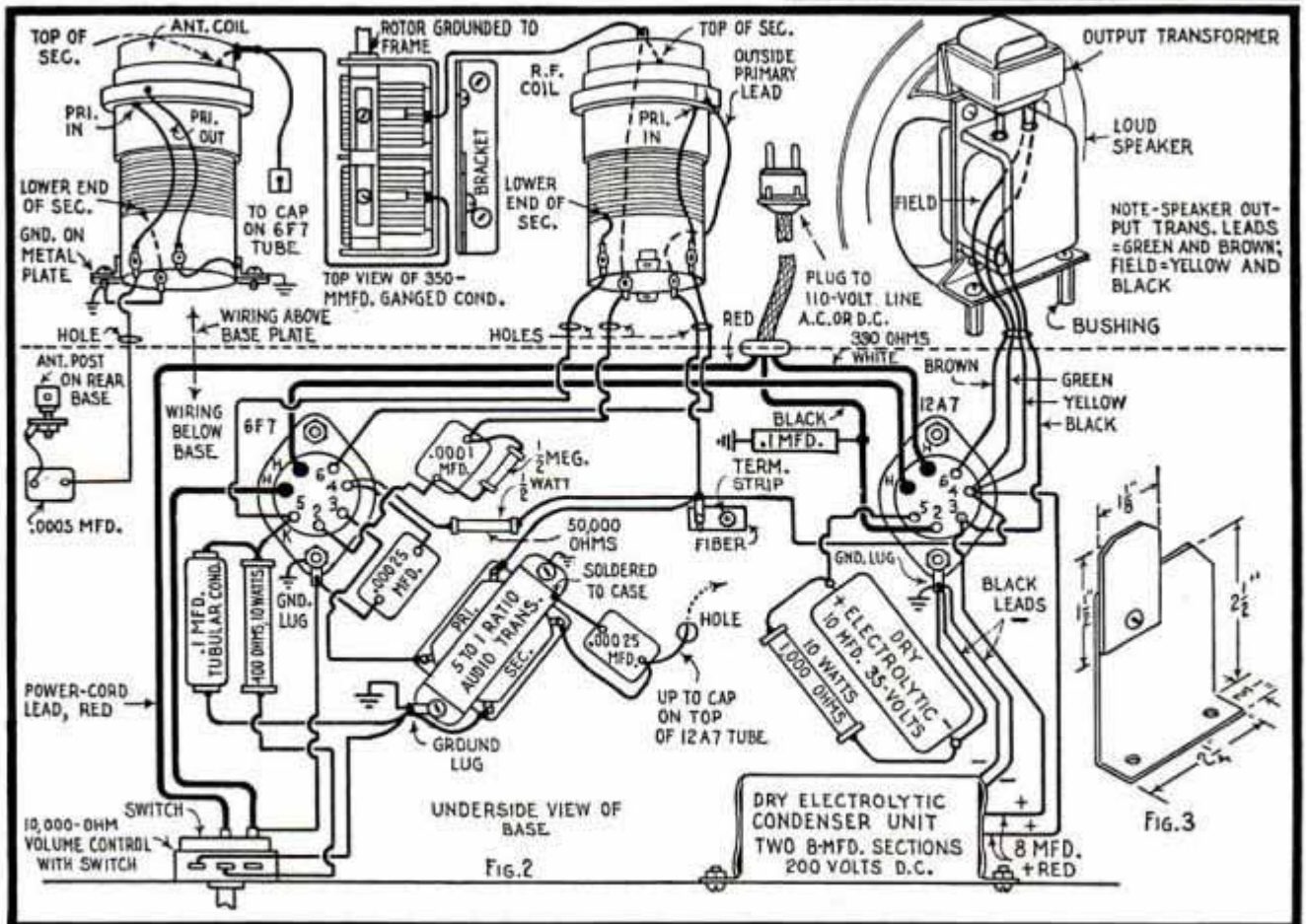
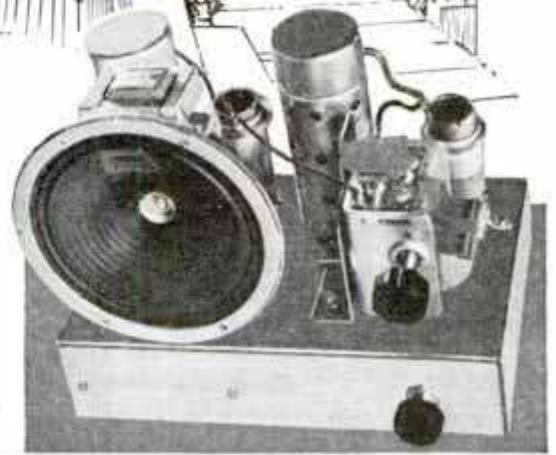

Easy Solutions for Everyday Radio Problems

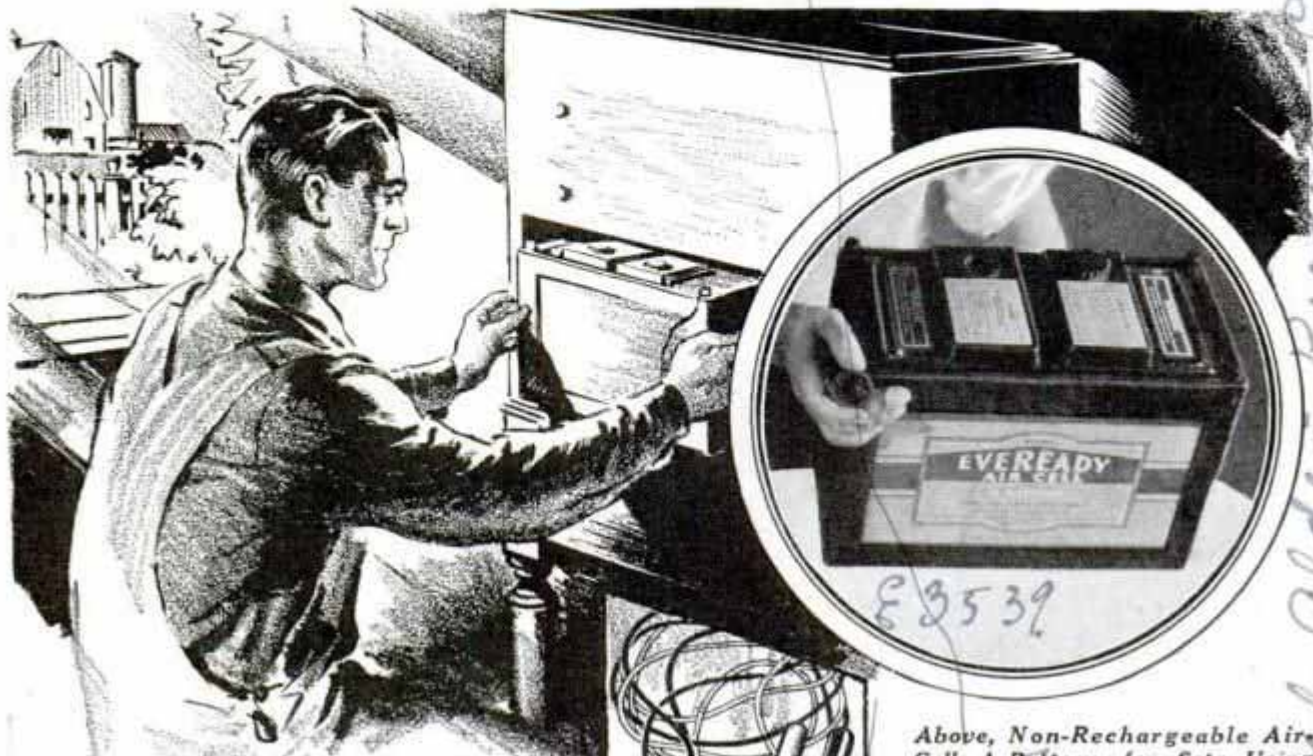

Above, Non-Rechargeable Air-Cell A-Battery, for Sets Using 2-Volt Tubes, Has 600-Ampere Capacity; Operates Standard Air-Cell Sets 1,000 Hours; Left, Rubber-Insulated Combination Test Leads Supplied with Removable Phone-Tip Points and Spare Needle Points in the Handle

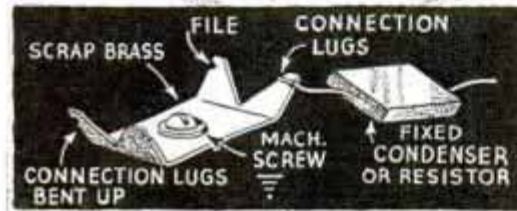

Grounding Lug, Made from Scrap Brass, Is Fastened to Metal Chassis for Handy Multiple Connections

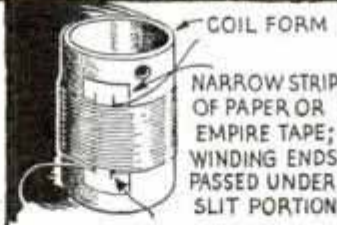

Strip of Insulating Material Provides Easy Method for Fastening Coil Ends Instead of Drilling Holes

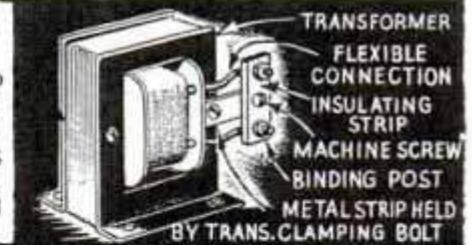

Insulated Terminal Block, Made from Scrap Bakelite and Brass Strip, Is Fastened under Core-Clamping Bolt for Transformers or Filter Chokes Commonly Supplied with Flexible Leads Only

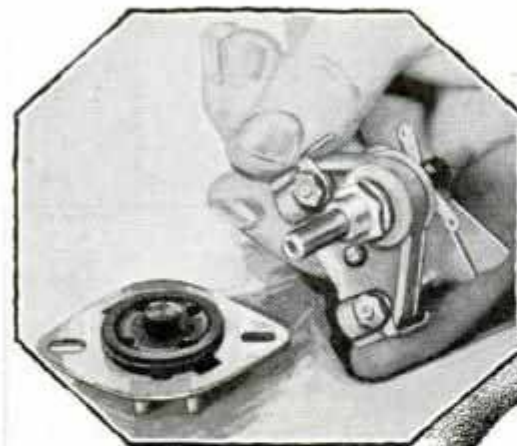

Above, Molded Chassis Plug for Use on Auto Sets, Short-Wave Receivers or Amplifiers, May Also Be Used with Standard Wall Plates; Plug Is Dead When Connector Is Removed; Right, Low-Loss Midget Variable Condenser for Short-Wave Sets Has Silver Pressure Contact on Rotor



Small Homemade Emergency Tip for Electric Soldering Iron Simplifies Operation in Awkward Chassis Locations; Close-Wound No. 10 Copper Wire Is Substituted for Regular Tip

19 E 41 st. New York!
The Alderly Product Co. Boston, Mass.
The Alderly Product Co. Boston, Mass.
715 Center, Brockton, Mass.

Simple Power Unit for 50-Watt Transmitter

PART II

ALTHOUGH this power-supply unit was primarily designed for the compact crystal-controlled, 20-meter C.W. transmitter described in the June issue, it is also suitable for use with any low-powered rig. It will furnish 500 volts of well-regulated plate voltage; the filament supply for all tubes except the rectifier is obtained from separate transformers as shown in Fig. 2. To resume the description of the transmitter layout, a Cardwell type 157-B, 210-mmfd. split-stator condenser is mounted directly on the bakelite front panel, with the shaft $4\frac{1}{8}$ in. from the top. The plate coil, L_5 , is supported firmly on the stator terminals. Two 4-prong sockets and the filament by-pass fixed condensers are mounted on the small shelf at the right. Two double-spaced 20-mmfd. maximum,



midget-type neutralizing condensers for the 210 tubes, are mounted directly on the stator terminals.

Drilling template diagrams for the bakelite shelves and front panel are given in Figs. 3 and 4. The first shelf is mounted 10 in. above the baseboard; the second shelf is $6\frac{3}{4}$ in. higher and the small shelf

above, is just 5 in. below the top of the front panel.

All coils, with the exception of L_5 , are close-wound on standard plug-in coil forms $1\frac{1}{2}$ in. outside diameter. The coil-winding data are as follows: L_1 consists of 12 turns of No. 20 d.c.c. wire; L_2 has 5 turns and L_3 is center tapped and has 8 turns of the same size wire. The grid coil, L_4 , consists of 6 turns of No. 22 d.c.c. wire and is also tapped at the center. Four-prong sockets and coil forms are used for L_1 and L_2 ; L_3 and L_4 require 5 prongs. The 3-turn link coupling coils are wound on L_3

(Continued to page 136A)

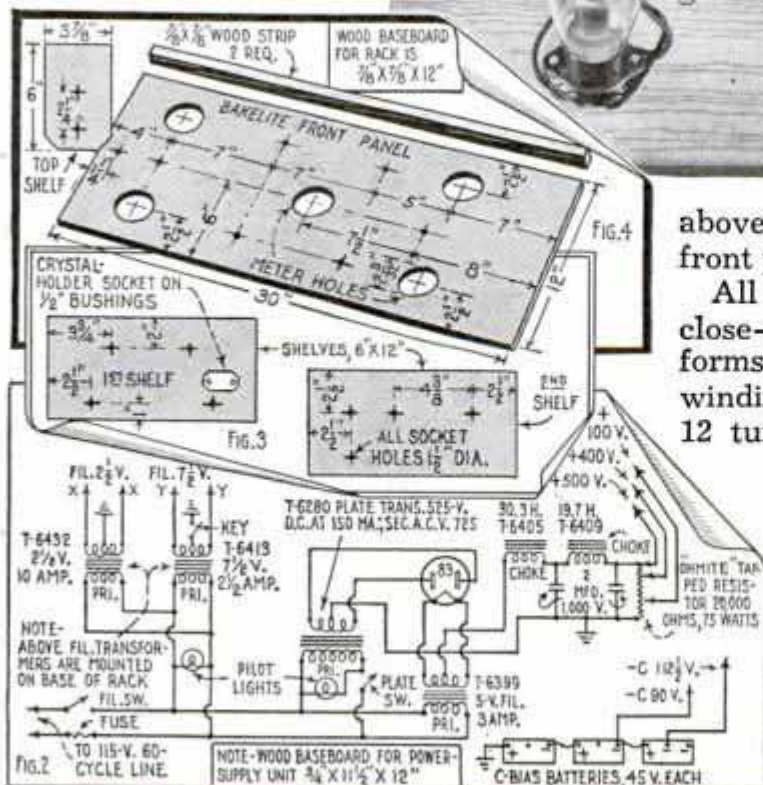

Es mb. H., Hamburg

Instrument Co

D 4666 Germany
Phonograph Pick-Up with "Electric Eye"

Bluffton Ohio

no U.S. Agent

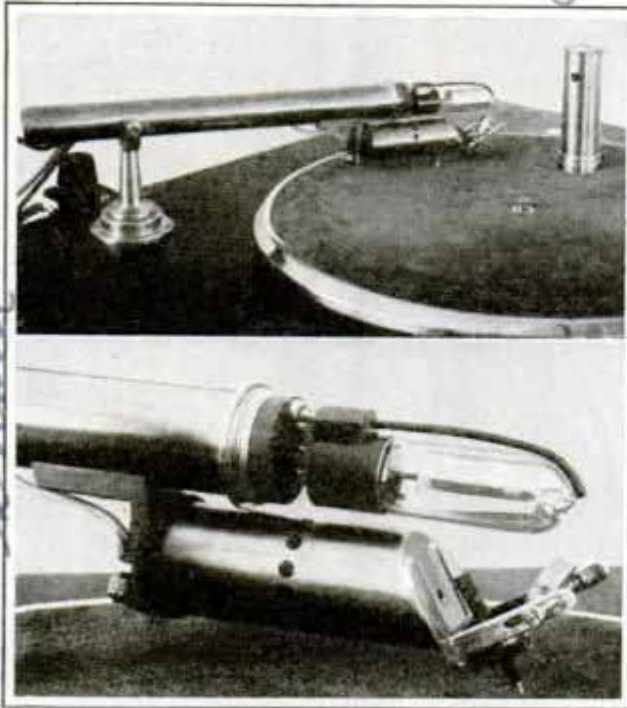

Pick-Up Arm on Turntable with Metal Cover Removed from Photo Cell; Below, Close-Up of Lamp and Mirror Assembly, with Cell Above

This pick-up arm, recently developed by a German engineer, is equipped with a hooded lamp and small vibrating mirror fastened to the armature. As the needle follows the record, a varying beam of light is reflected to a photo cell and audio amplifier, reproducing sound in a manner similar to that employed in talking pictures. Used with ordinary records, greatly improved tone is claimed.

D 4631

Two-Tube Transceiver Is Portable

Designed primarily for portable use on five meters, this de luxe combination re-



Portable Transceiver Assembly; All Parts, Including Handset and Batteries, Are Housed in Wood Case Provided with Carrying Strap

ceiver and transmitter is housed in an oak carrying case. Type-30 and 33 tubes are employed and provision is made for using either a single wire or doublet antenna.

Square Meter for Maximum Scale Length

Although this meter is 4 in. square, only a 2 3/4-in. round mounting hole is required. It provides the same scale length that is offered in a 5-in. instrument yet it occupies one inch less panel space. These meters are available in all popular ranges and varieties



Acorn-Type Tubes for Ultra-High Frequencies

Miniature tubes, resembling an acorn in shape and size, are now available for experimental uses. They offer new possibilities for the amateur and experimenter and provide needed tools for exploration and practical applications in the ultra-high frequency bands. The type RCA-955 tube, at the right, is rated for a maximum



Small Vacuum Tubes Designed for Ultra-Short Waves, Compared in Size with a Golf Ball

plate voltage of 180 volts. It will amplify, detect and oscillate at frequencies not practical with ordinary tubes. The type 954, at left, is a pentode which provides gains of three or more at one meter, and 10 at 3.5 meters. Higher gains are of course attainable at longer wavelengths.

Blueprints covering radio construction articles can be obtained for 25 cents each; further information and material lists are available from our Radio Department, without charge, upon receipt of postage.

National Co. Chicago

R.C.A. Mfg. Co. Harrison N.J.



AMATEUR MECHANICS

"SKIP" A Pram-Type DINGHY

flat bottom

Ease of construction, portability and light-load carrying capacity, make this dinghy highly popular with yachtsmen and fishermen for widely differing reasons. Yachts less than 38 ft. in length require tenders that are easy to tow and small enough to take little deck space. Fishermen, on the other hand, consider portability and ease of rowing almost equally important

By W. E. STEWART

"SKIP" is 8 ft. long, has a 40½-in. beam, and a 13¼-in. depth. The forefoot is given enough "lift" to cause planing when in tow at any speed above four knots. The bluff ends make the dinghy easy to stow on fore deck or cabin top, as well as increase carrying capacity for length. Correct location and elevation of oarlocks combined with extreme lightness make "Skip" easy to row. The boat weighs less than 100 lbs. and therefore may be carried readily on top or on the luggage rack of most automobiles. The total cost for lumber, fastenings, and paint for the boat shown was less than \$10.

All wooden parts except the oarlocks, which are white oak, are No. 2 white pine or cedar. The stem, transom and corner braces are cut out of a 1½ by 14-in. by 6-ft. board. Sides, keelson and fender-



wales are cut from five pieces of ½ by 10-in. by 10-ft. material. The bottom, seat braces, and frames are made from two 10-ft. and two 12-ft. lengths of ¾ by 5-in. planks. The seats come from one ¾ by 10-in. by 8-ft. piece, and the chines are



while the planking is applied. A third spacer, 2 ft., 10 in. long, is placed 3 ft., 8 in. from the bottom of the stem and parallel to it to spread the garboard planks. Make a loop of sash cord around the forward ends of the two garboard planks and draw them in place against the stem. Then, simultaneously draw the opposite ends until they fit against the transom. The cross spacer should strike at the edge of the planks. Fasten the planks to the stem and transom with $1\frac{1}{4}$ -in., No. 6 flat-head brass screws, which are not to be countersunk. Turn the form right side up and bend and fasten the sheer planks in the same manner. These should overlap the garboards $1\frac{1}{4}$ in. The rowing seat, nailed to the top edge of the garboards, will be an additional spacer.

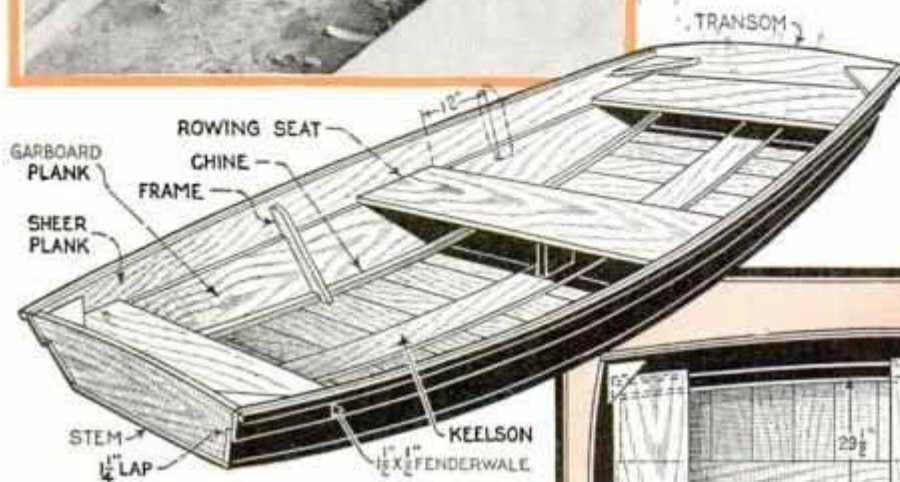

two pieces $\frac{3}{4}$ by $1\frac{3}{4}$ in. by 8 ft. Construction is much simplified and costly mistakes are eliminated by working exactly to plan. You will need a clear floor space at least 8 ft. wide and 12 ft. long. In this space chalk to full scale all the lines shown in the plan view except those of the seats and braces. Lay out and cut the stem and transom, keeping the saw perpendicular to the material. It is better to cut the bevel with a plane or drawknife afterward. To determine the correct bevel, place the stem and transom on their respective chalk lines, extend the side lines onto them and add $\frac{1}{16}$ in. more at the outside. The extra $\frac{1}{16}$ in. is for calking. Fasten the bottoms of stem and transom temporarily to a spacer, making their outside surfaces 7 ft., 5 in. apart, then incline them until the distance between tops is 8 ft. Do this with the parts inverted over the chalked outline, giving a 5-in. displacement to the stem and 2 in. to the transom. Another spacer tacked to the tops will hold the ends in correct position

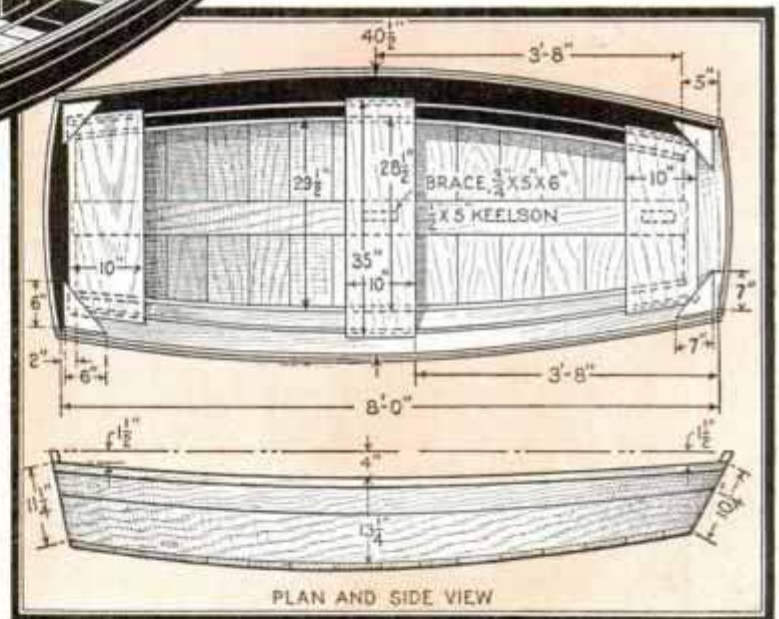

Garboard and sheer planks may be fastened together with screws, clinched nails, or copper rivets. Of these the rivets are undoubtedly best. The rivets are really small copper nails and washers, and may be obtained at most hardware stores. Drill a small lead hole, then drive the nail from the outside, place a washer over it on the inside, cut it off about $\frac{1}{16}$ in. from the washer, and rivet it over with a special tool or a ball-peen hammer, while a helper holds a heavy hammer against the head. You will be able to draw the two planks together very tightly by careful riveting. Space the rivets 3 in. apart and $\frac{5}{8}$ in. from

the plank edge. The sheer planks are to be 6 in. wide at a point 4 ft., 1 in. from the top of the stem. Bend a thin strip from stem to transom through this point and mark the line. Saw off the excess material above this line, leaving about $\frac{1}{4}$ in. for planing. Measure the garboard planks $7\frac{1}{4}$ in. wide at a point 3 ft., 8 in. from the bottom of the stem. From this point bend a strip to the bottom edge of the transom and mark the line. Without the strip, continue this line forward in a smooth curve to the bottom of the stem. Saw away the excess material, as before, leaving about $\frac{1}{4}$ in. for planing. Save the strips which have been removed to be used later for fenderwales. If the planks are not of the same stiffness, it may be that at this stage, the structure will not be true to its lines. However, it may be squared easily by stretching a cord tightly between the cen-



ters of the stem and transom. A square held against either should fit exactly against the cord. If it does not, run a rope loop diagonally around stem and transom and tighten until the cord lines up with the square. At this stage fit in the corner braces and the fore and aft seats so that further operations will not pull the hull out of shape. All of these are fastened with $1\frac{1}{2}$ -in., No. 8, flat-head brass screws. Always drill lead holes for screws.

The chines should be soaked in water

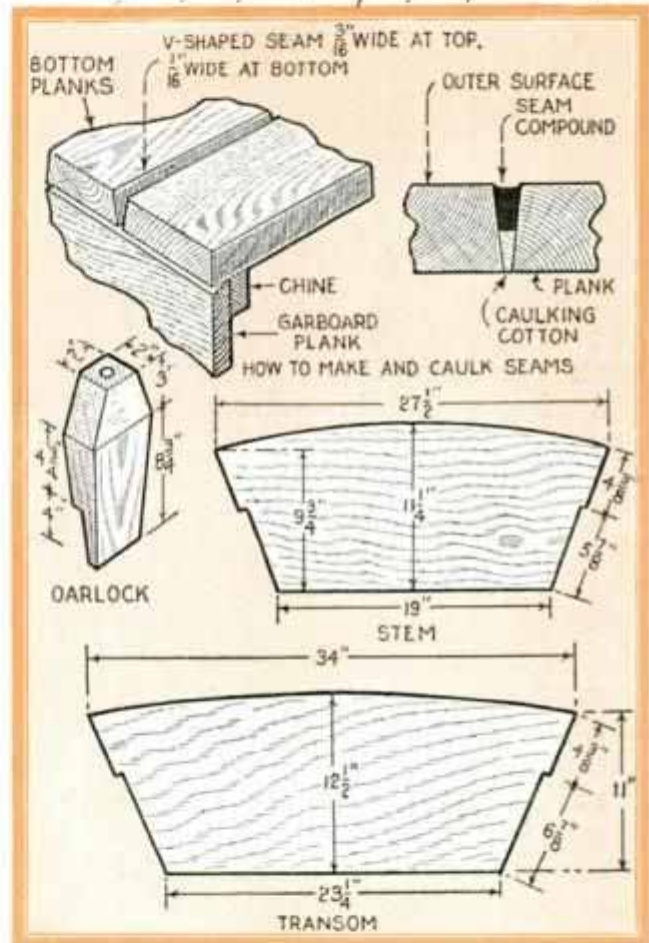

overnight or saturated with scalding water before bending in place. Determine the correct length by measuring with a thin, pliable strip, and cut the chines so that they will fit snugly against both stem and transom. Insert them from the top of the boat, and exercise care to avoid breaking while drawing them in place with carpenters' clamps. Fasten them from the outside with $1\frac{1}{4}$ -in., No. 6, flat-head brass screws spaced about 8 in. apart. Lay a straight plank across the bottom of the boat and plane the chine and garboard until it lies flat on them. Plane a $\frac{1}{16}$ -in. outward bevel to the garboard to form a



calking seam. Before applying the bottom planks plane a $\frac{1}{16}$ -in. bevel in each edge. Nail the planks on before sawing and saw at an angle in line with the sides of the boat. Use three 2-in. copper nails for one end of each plank, and smooth up the sawed edges with a plane. The addition of the keelson completes the bottom. Fasten it with $1\frac{1}{2}$ -in. copper nails, five to a plank, clinched outside. From the leftover side planking make two fenderwales $1\frac{1}{2}$ in. wide. Rivet them to the top edges of the sheer planks, plane down to a smooth surface, and bevel all edges. Make two frames to fit, one on each side, about midway between the rowing and forward seats. Use the $1\frac{1}{8}$ -in. material, and fasten with brass screws from the outside.

The oarlocks are elevated above the gunwales so that the oarsman will have ample room for his hands when lifting the blades from the water for the return stroke. Make them from 2 by 4-in. white oak to the dimensions shown, and fasten with $1\frac{1}{2}$ -in., No. 8, flat-head brass screws from the outside. Finishing the seams is one of the most vital parts of boat building. Leave sufficient spacing between the planks, and calk with regular calking cotton, not wicking, until the seam is one-third filled. Put the cotton in by hand with a putty knife. Under no circumstances use a hammer. The cotton must remain soft enough to permit the planks to swell without buckling. Fill the remainder of the seam with a good grade of

boat-seam compound. About 1 lb. will be sufficient for the entire boat. Then apply three coats of varnish or paint. Allow time for the varnish to dry, and sand the surface before applying the next coat.

Force Cup Applied to Overflow Cleans Bathtub Drain

Due to the difficulty of sealing the overflow opening of a bathtub against escape of air, it is sometimes almost impossible to clean the tub drain with a plumbers' force cup. However, if the stopper is put in place in the bottom of the tub and held firmly with a weight, the cup may be used effectively by holding it against the overflow opening as shown.



Bathtub Drain Cleaned by Using Plumbers' Force Cup at Overflow Opening

Homemade Swing for Little Tots Is Portable

Here is a substantial swing for a small child that anyone can make, and it can be used inside a house, on a porch or outdoors. The dowels forming the back and sides are either glued or bradded in place in the seat and rails. Note the method of attaching the swing rope. This is threaded through holes in the seat and the side and

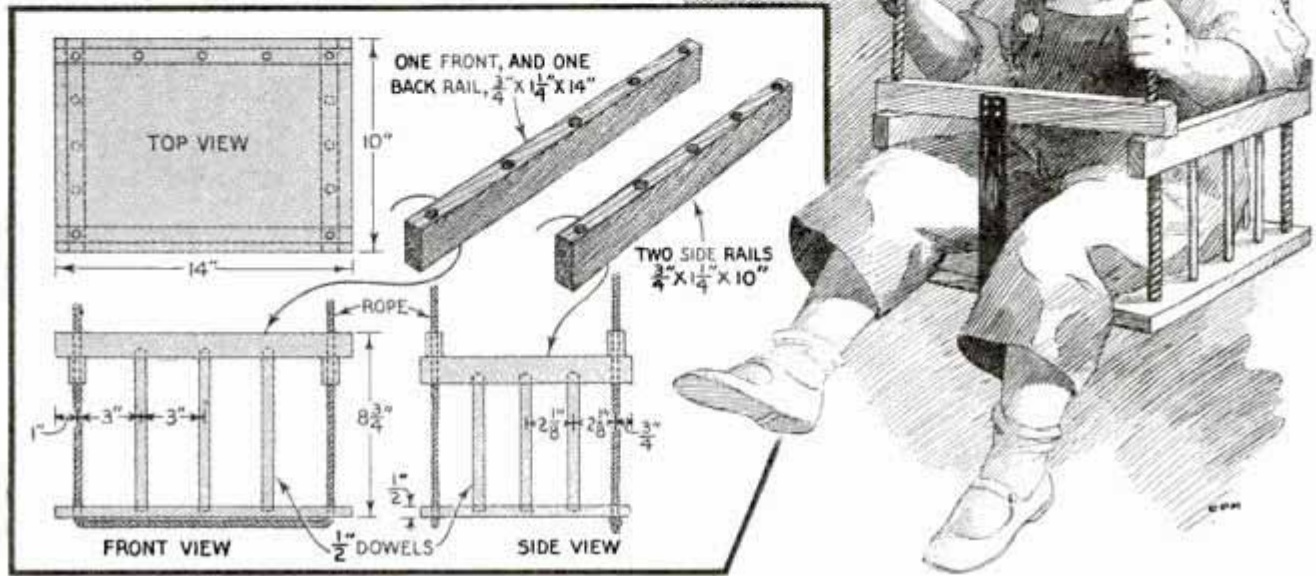

back rails, then back through the front and side rails, through and under the seat. The same procedure is followed for the other side of the swing. With this method, the swing is supported at each corner to

prevent tipping. If the swing is to be moved from place to place, heavy harness snaps may be attached at the ends of the rope to engage strong screw eyes driven into suitable overhead beams.

Ladder for Picking Fruit Made from Split Hardwood Pole

The usual hard job of manipulating a ladder among tree limbs, when picking fruit, is made less difficult by using this ladder. Split an oak or hickory pole about three-fourths of its length, after which the sides, or rails, are drilled to take hickory rungs. An iron band prevents the pole from splitting out to the end, which is pointed. If a suitable pole is not available, a ladder of the same shape may be made from two-by-fours. These are beveled at the upper ends and nailed or screwed to a block. It is a good idea to use an iron band to further strengthen the joint.

☞ When a three-cell flashlight battery becomes too weak to use, substitute a two-cell lamp; the cells can then be used and the lamp will give good light.

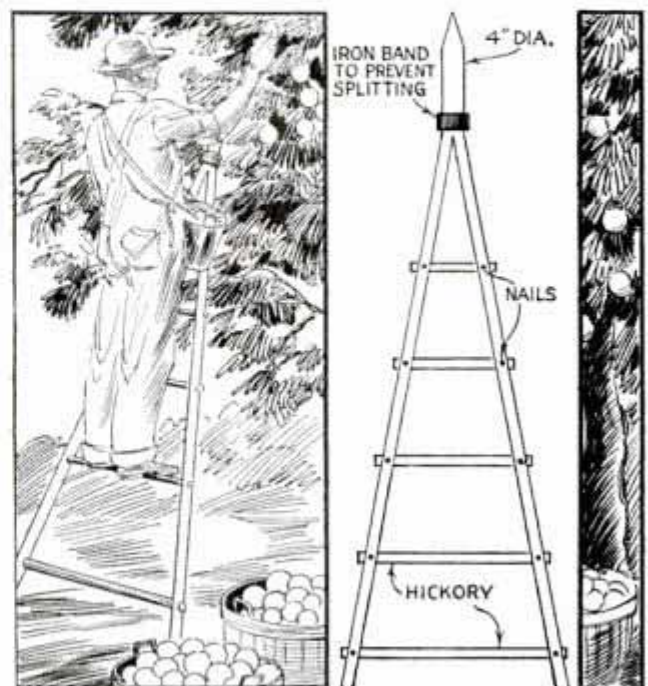

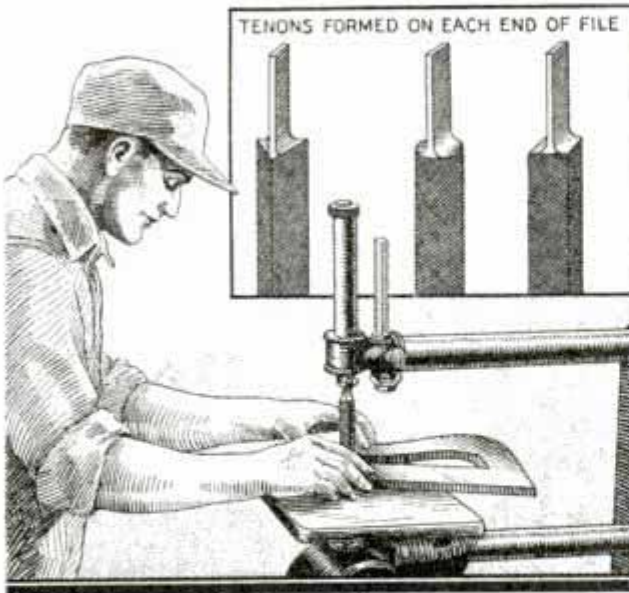

Small Files with Tenons Ground at Ends Used in Scroll Saws to Do Filing

Filing with a Small Scroll Saw

Although most small motor-driven scroll saws are not equipped with universal chucks to hold files, you can do this type of work by grinding tenons at the ends of small hand files so that they can be put in the machine like saw blades. Small, round, three-corner and half-round files can be used, but they must be broken off to the right length and ground flat at the ends. In doing this, take care to keep the ends in perfect alinement. A large felt washer should be fitted over the lower plunger to keep the metal filings out of the bearing if the saw is not already equipped with one.

Movable Spurs Prevent Ladder from Sliding

To prevent a ladder from sliding when set on hard ground or gravel, take a couple of short iron rods, point the lower ends with a file or grinder and form hooks on the upper ends. Then fasten them to the ladder rails near the lower ends with flat steel guides so that the spurs can be pushed into the ground. When not in use, the spurs are pulled up and fastened over L-hooks driven into the ladder rails.



Sheet-Metal Holder to Carry Fishhooks

To keep your fishhooks safe and prevent them from becoming entangled, make this holder in which to carry them. It consists of a piece of sheet metal, $9\frac{1}{2}$ in. long and about $2\frac{1}{2}$ in. wide, across one end of which is soldered a piece of angle brass or copper so that an opening is left to take the points of the hooks. A short length of light coil spring is stretched across the other end of the holder and the ends tacked to the metal with solder. The spring holds the hook leaders.—C. E. Packer, Chicago.

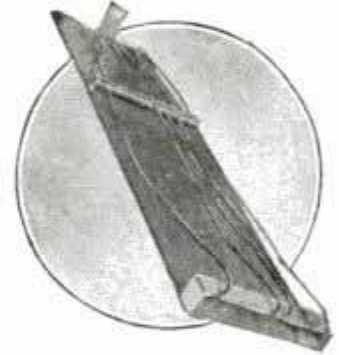

Auto Rims Make Economical Forms for Concrete Steps

While in search of some cheap forms with which to make concrete steps at a boat landing, one man used discarded auto-wheel rims. These were set in a shallow trench excavated in the bank, after which the concrete was poured into them, thus making neat, semi-circular steps.



Auto-Wheel Rims Set in Bank Make Neat Steps to Boat Landing at a Summer Cottage

Two Ideas on Repairing Window Screens

The job of getting your window screens ready for summer will be easier by following these ideas: Below is a simple stretcher for use when applying new screen to the frames. It is a thin board nailed to a bench, and has a row of brads projecting through one side. In use, the wire and frame are placed over the block so that the brads engage in the meshes of the wire, which has been tacked at one end. It is a simple matter to push against the bottom of the frame and stretch the wire sufficiently without damaging it. The right-hand detail shows a method of refin-

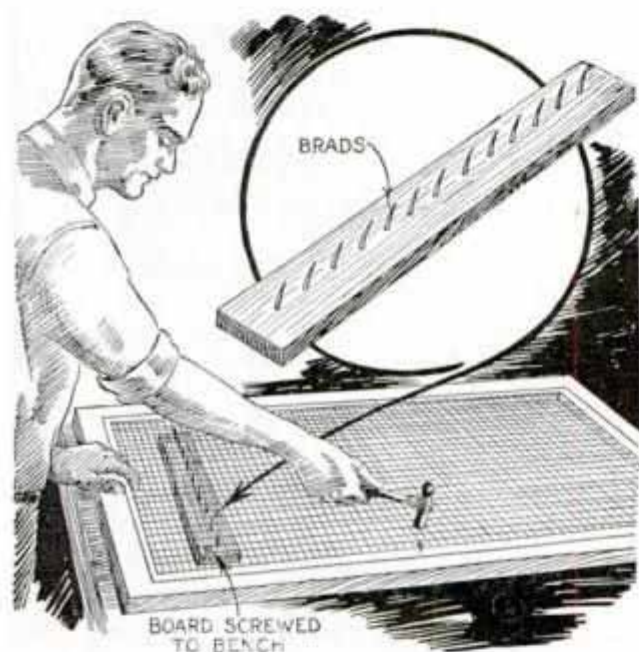

ishing the screens, which will save time and paint, as well as prevent clogging the meshes of the wire. A large block, which has been padded with burlap and screwed to a bench or table, is placed under the wire and the painting is done directly over it, the screen being moved about as the work progresses. Excess paint is absorbed by the pad.

Easily Made Universal Joint Improves Auto-Trailer Hitch

Made from model-T Ford parts, this trailer hitch will enable you to travel over rough roads, and take sharp curves with ease. The axle is cut at a point two-thirds of its length and the wheel spindle is removed with a hacksaw, as indicated. The whole arrangement has proved to be sturdy and flexible. An extension tongue for hauling boats, and other long objects, can be made from 2-in. pipe and fittings.—R. Windberg, Brockton, Mass.

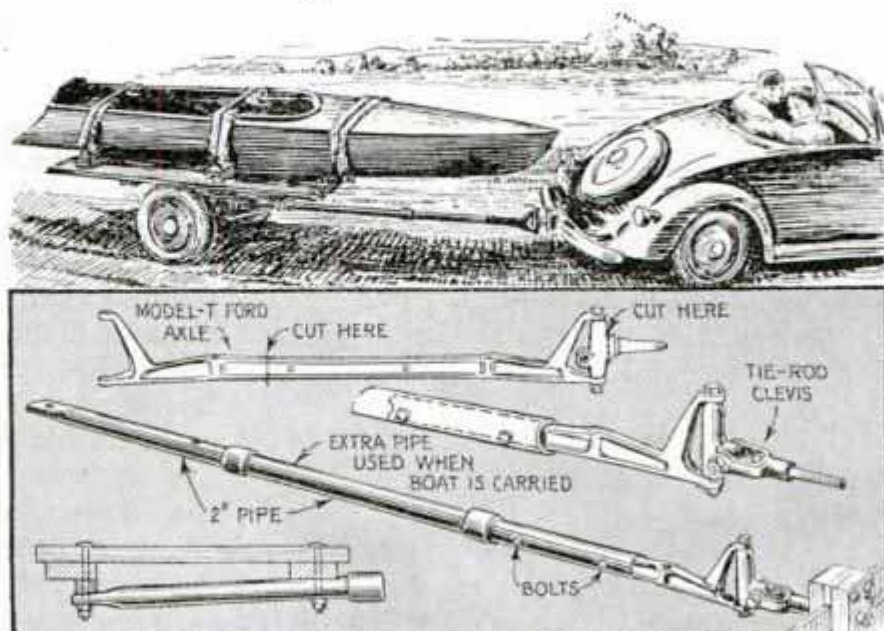

KEEPING *Your*



MAGNIFIED EDGE OF SAFETY-RAZOR BLADE IMMEDIATELY AFTER SHAVING



EDGE OF SAME BLADE AS IT APPEARS AFTER A CAREFUL STROPPING



① EDGE OF NEW SAFETY-RAZOR AS IT APPEARS BEFORE USING



STROP SHOULD NOT BE HELD TAUT WHEN STROPPING EITHER STRAIGHT RAZOR OR SAFETY RAZOR OF TYPE SHOWN

LEATHER STROP

THE edge of your razor blade is one of the keenest and also one of the most delicate cutting edges known. The upper photo in Fig. 1 shows how the edge of a blade appears under the microscope after you have finished shaving. Though it looks anything but sharp it is, in fact, still very keen. This is because only the extreme edge has been blunted slightly by the cutting action. The bevels are still perfect. From the second illustration you will see how a very light stropping restores the edge, but note especially the marked difference between these two edges and that of a new blade.

Either the straight or the safety-razor blade consists of an infinite number of extremely minute projections or fibers. On a

new blade the shape, and incidentally the backing of the edge, is formed by three bevels as in Fig. 7. In shaving, the cutting action bends the tiny fibers back and over, resulting in a condition similar to the set teeth of a saw. Each time you use the blade without honing or stropping, this condition becomes more pronounced until it results in an extremely fine wire edge. Then the blade loses its smoothness and begins to pull. Even though many razor strops are impregnated with a very fine abrasive, stropping alone gives practically no direct abrasive action. Rather the object of stropping a blade is to bend the bulged and bent fibers back in line, and for this reason stropping does not sharpen the cutting edge by direct abrasive action on the metal. As an example, if you have a safety blade that has been used a number of times you can restore the edge to a fair degree of keenness by simply stropping the blade with a straight stroke on the inside of a large glass tumbler. Here there is practically no abrasive action, the effect being merely that of straightening the bent-edge fibers.

Preservation of the bevels originally

*Dep't Perkins Campbell Co / Cincinnati
Shop Dept 1309 Edward St / Ohio*

*Solo
America*

RAZOR SHARP

ONE TYPE OF HOLDER USED FOR STROPPING SAFETY BLADE. ACTION IN STROPPING IS SAME AS SHARPENING STRAIGHT RAZOR.

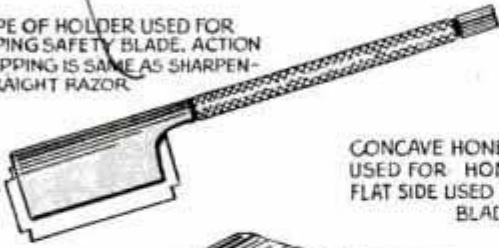

CONCAVE HONE, CONCAVE SIDE USED FOR HONING SAFETY BLADE. FLAT SIDE USED FOR STRAIGHT BLADE

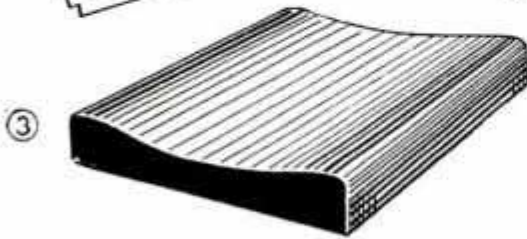

FLEXIBLE HONE WITH FINE AND COARSE SIDES FOR SHARPENING STRAIGHT BLADES



*100% American Home Co. N.Y.
Clean*

by W. Clyde Lamme

ground on a new blade is practically impossible because they are so small that you cannot see them with the unaided eye. But we can, nevertheless, preserve the thickness of the edge by use of the proper methods of honing and stropping. There is a simple, yet very important detail in this connection. When you strop either a self-stropping safety razor, like that in Fig. 2, or a straight blade, as in Fig. 5, there always should be a certain amount of slack in the strop, that is, the strop should never be taut. A slack strop supports the blade at the correct angle and at the same time gives a rubbing or wiping action at the extreme edge. This straightens the bent fibers effectively and also avoids wearing down the bevels.

In both theory and practice the amount of stropping and honing necessary to keep a blade in condition should be about equal, though this statement will not apply to all blades, as they vary greatly in quality. Long continued stropping without honing tends to round over the edge and does not take sufficient metal off the bevels to maintain the proper angles. If you hone such a blade to a sharp edge you must



TWO TYPES OF SAFETY RAZORS IN MOST COMMON USE WITH SINGLE & DOUBLE-EDGED BLADES

necessarily remove considerable metal and as a result you are apt to get the edge too thin. Excessive honing without stropping produces the latter effect until finally the blade reaches a point where ordinary stropping and honing are no longer effective. This is particularly true of the straight blade and the two-edged safety blade held in the device shown in Fig. 3 and sharpened on a straight hone. When you strop or hone a safety-type blade in the holder shown in Fig. 3, the effect on the edge is essentially the same as on a straight blade. On the other hand, when you sharpen a safety blade on a concave hone, the flexing

portant that you lift the blade directly off the hone without sliding or moving it in any way. If you slide the blade off the hone you will ruin the edge. Fig. 9 shows the edges, highly magnified, which are produced by the straight, lateral and circular strokes. The lateral stroke is to be used only when the blade has been lightly nicked or otherwise damaged, as the position of the hone causes it to cut down the bevels much faster. The metal hone produces a very smooth edge as in Fig. 9 but as yet this hone is not universally available. To preserve the edge and keep it in condition, it is important that you keep your razor and hone and also the strop in a dust-proof container while not in use. A hone covered with dust particles is useless. It will help if you dip the blade in hot water immediately before shaving. A few drops of light oil on the blade at in-

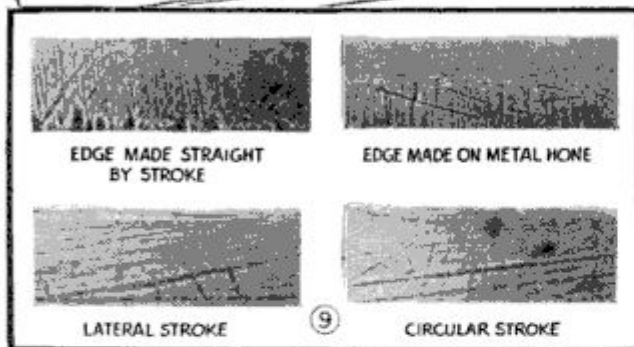
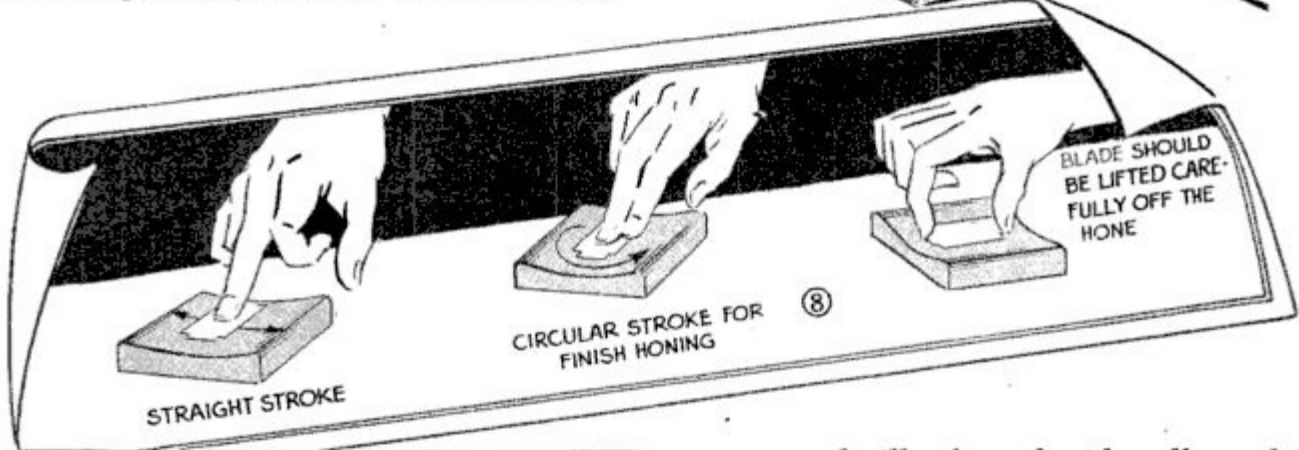

tervals will prevent rust. Before you use a strop give it a brisk rubbing with the palm of your hand. A few drops of light oil on the corrugated rolls of the automatic stropper shown in Fig. 6 will help to retain the flexibility of the leather.

How to Preserve and Mount Fish Heads

Anyone can preserve and mount large fish heads. To do this, first cut off the head just behind the gills and remove the eyes,

tongue and gill rakers, besides all surplus flesh. Then gouge a channel from the top of the head, at the rear where the vertebra is exposed, to the eye sockets. Next, cover the inside and outside surfaces of the head with a mixture of equal parts of arsenic and powdered alum. Also, fill the cavity from the vertebra to the eye sockets with the powder, and then prop the mouth wide open with a short stick. The head is now ready for mounting. Lay it on the base with the part below the gills flush to the boards and nail it down with short brads at either side of the head above the gill opening. Then spread the lower end of the gill covers well out to the sides and tack the tips down. Glass eyes can be placed in the eye sockets when the head has cured and dried completely. When dry, dust the head off and decorate the base with whatever design you wish. Then finish the job by giving the base and the head three separate coats of clear varnish.



Holder for Handsaw Leaves Both Hands Free When Climbing or When Working on a Ladder

Holder to Carry Handsaw on Your Belt

Many serious and fatal falls from trees and ladder tops have resulted from trying to climb with a saw held in one hand. To leave both hands free and help avoid an accident, carry the saw on your belt with this holder, which is made from a strip of inner tube cut to the shape shown. A slit at each end permits attachment to the belt, after which the rubber is inserted through the handle and brought up over it as indicated in the detail. This operation is done easily with one hand.

Writing under an Eggshell

If you want to mystify your friends at a party, just write the guests' names on some eggs with a solution consisting of alum, 1 oz., and water, 1 pt. Allow the writing to dry and then boil the eggs for about 20 min. All evidence of the writing will have disappeared from the shell, but when the latter is removed, the writing will be found on the egg.



Emery Paper on Perch Keeps Canary's Toenails Trimmed

Instead of attempting to cut or file a canary's toenails, glue a strip of coarse emery paper to the lower side of the wood perch in its cage. As the bird moves back and forth along the perch, the emery paper will tend to keep its nails worn down to their natural lengths.—G. E. Hendrickson, Argyle, Wis.



Folding Clothes Hanger for Closets

If space in your closet does not permit installing a rod on which to hang a number of garments, this folding one may help solve the problem. It is a length of broomstick having several screw hooks driven into it to take coat hangers, one end being provided with heavy wire loops for attaching it to a coat hook as shown. To drop the

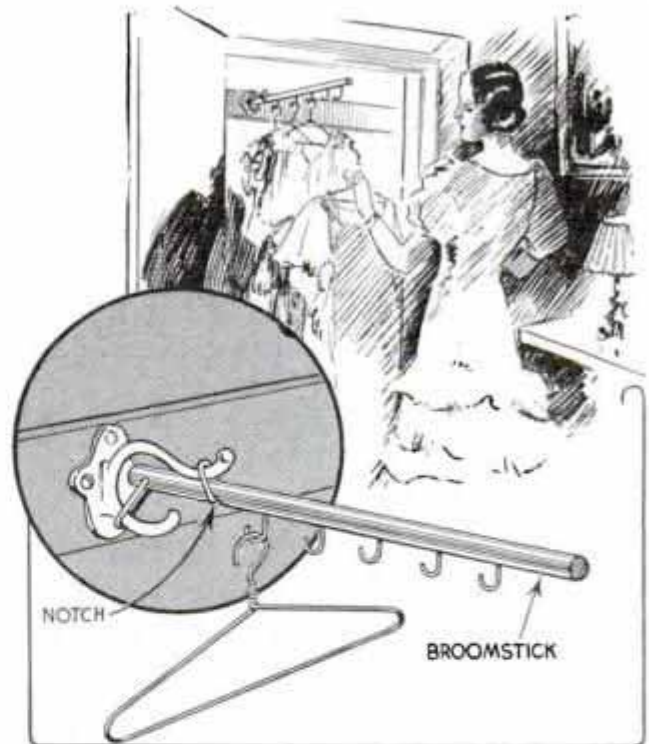

Folding Hanger for Use in Small Closets and Pantries Where Space Is Limited

hanger out of the way, merely slip the small loop off the upper end of the hook. This idea is also applicable in pantries for hanging utensils.—Chas. Tyler, Chicago.

Portable DRESSING ROOM

-folds flat

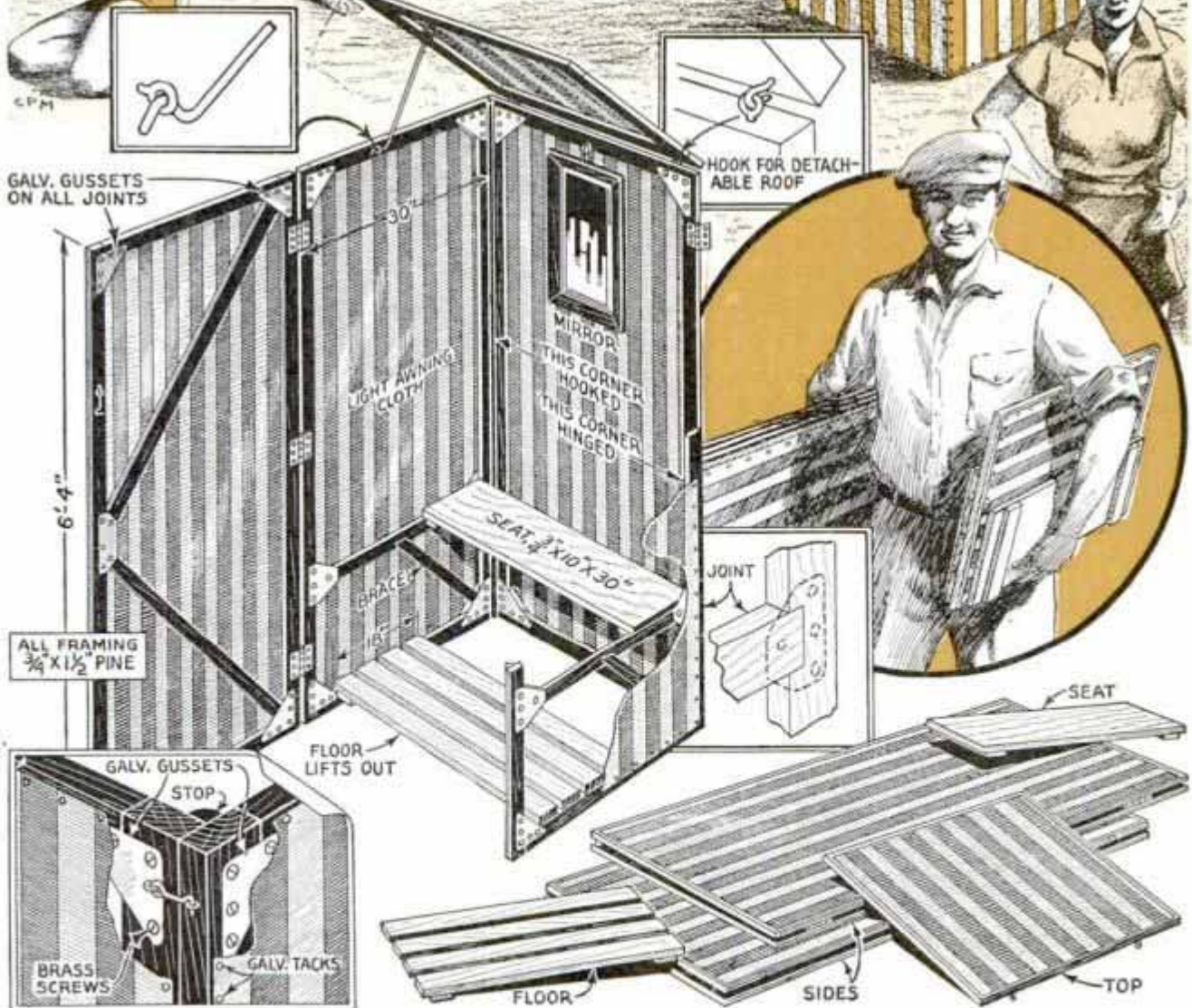
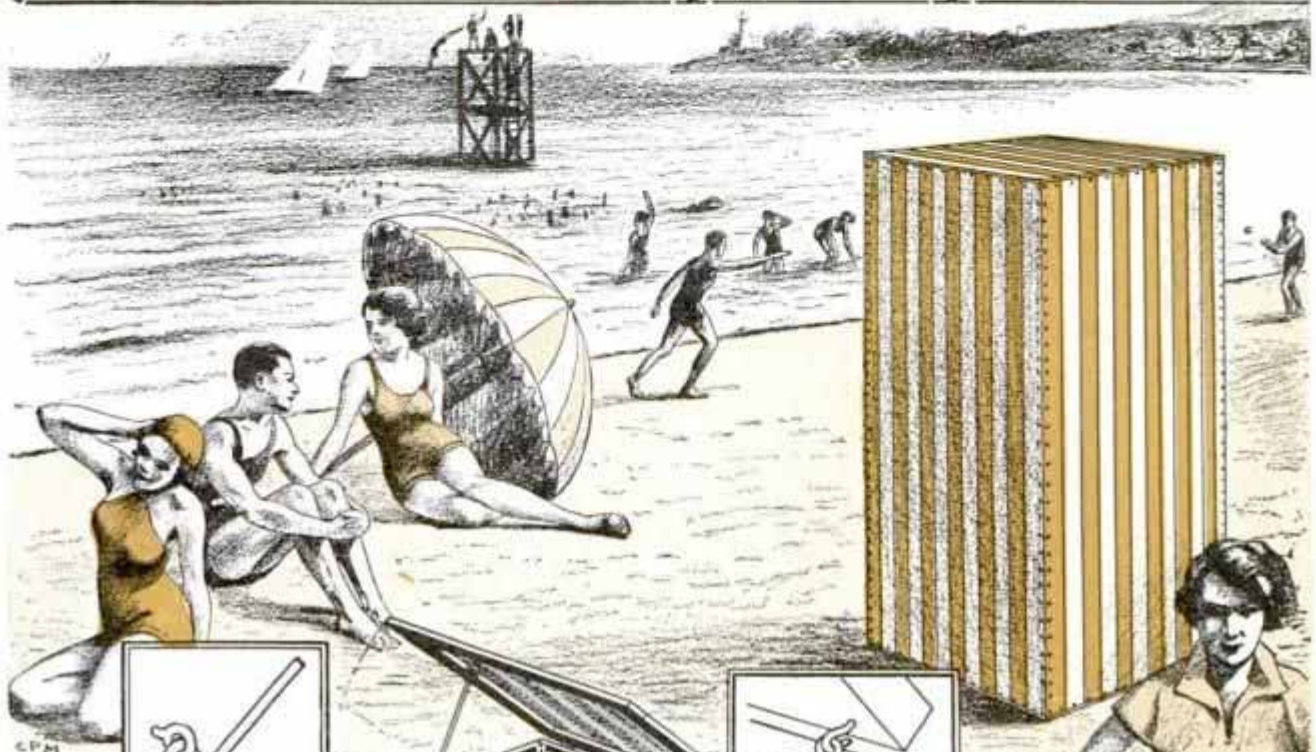

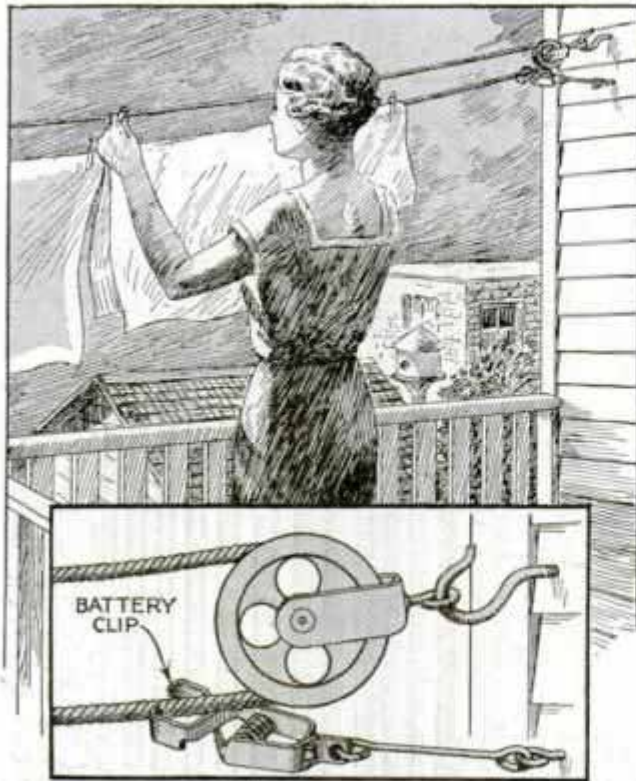

Battery Clip Holds Double Clothesline So That Wind Cannot Blow Clothes against Building

Battery Clip Prevents Clothes Moving on Double Line

Clothes hung on a double clothesline are often damaged or soiled when a heavy wind causes them to be pulled toward the house or post to which the pulleys are attached. To avoid this, fasten a large battery clip below the pulley in such a position that it will hold the line as shown.

Tar Paper Keeps Water from Running under Windows

If water runs under your windows and soils the wallpaper, the trouble is caused probably by the saddle, which sometimes pulls away from the casing, permitting the wind to drive rain under it. To prevent this, remove the saddle and lay a strip of tar paper under it as shown, first coating the underside with a good, flexible roofing cement. Then re-



place the saddle and the job will be waterproof.—L. H. Georger, Buffalo, N. Y.

Tent Flap Locked with Broomstick

To prevent the loose flap of his tent from blowing open in the wind, one sportsman inserted a length of broomstick in the lower hem of the canvas, allowing the end to project several inches past the center pole. By driving a short stake near this pole, as shown, the broomstick could be dropped down in the slot thus formed to hold the flap closed.

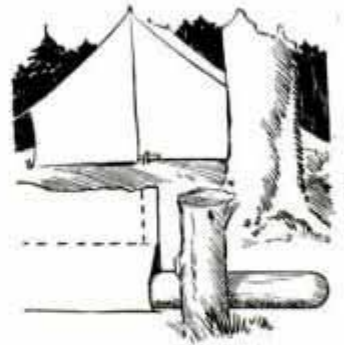

Vines Trained on "Spider-Web" Trellis

A resident of southern California has built an unusual flower trellis, in the form of a huge spider web, on the side of his house. The strands of the web are made of wood lath, and the spider's body is



Large "Spider Web" of Lath Makes Unusual Flower Trellis for the Side of a House

carved from a piece of white pine, and has long legs of rattan. The web is stained brown, and the spider is painted a bright yellow or other suitable color.

☞ A piece of tire patching cemented into the backs of oxfords will help protect the heels of your socks.

An ENCLOSED PORCH *adds to Your Home*

By R. O. BUCK



"THIS is a wonderful porch you have, so light and sunny, I wish that we could enclose ours like this but suppose it would be pretty expensive, wouldn't it?"

The Browns were spending a pleasant evening with their neighbors, the Kinsleys. Mr. Kinsley is a contractor and has made his own home the acme of convenience and comfort during the dull seasons.

"Quite to the contrary Brown, enclosing a porch, especially of the type you have, is neither difficult nor expensive. Why don't you do the work yourself? I would be glad to give you a few pointers on how to go about it and having only the material to consider, I am sure that you could keep the cost pretty low."

The following evening the men were looking over Brown's porch, which was roomy but old style, with open rail and baluster. Kinsley, note book in hand, was enumerating the changes that would be necessary to make the improvement.

"Well Brown, here are the things you will have to do. After removing the old railing, your first problem is the floor. Considerable pitch is required on an open-porch floor so that water will drain off, but this slope is rather uncomfortable, as you have perhaps noticed, to sit on unless your chairs are in line with the slope and even



then rockers will 'travel.' As this slope is unnecessary on an enclosed porch, I would suggest that you take up this flooring and re-lay it level. Sounds like a big job,

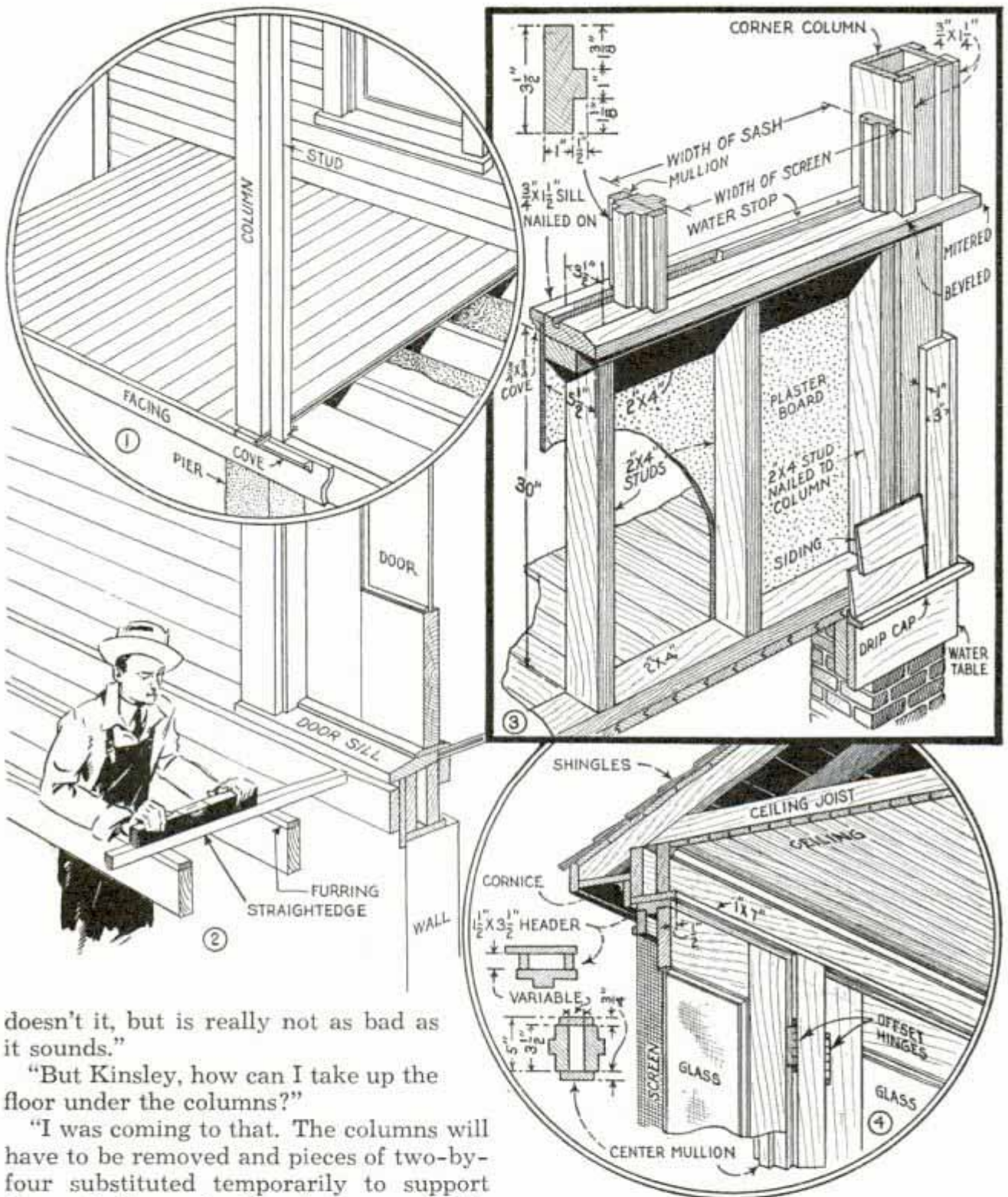

doesn't it, but is really not as bad as it sounds."

"But Kinsley, how can I take up the floor under the columns?"

"I was coming to that. The columns will have to be removed and pieces of two-by-four substituted temporarily to support the roof. Supposing I make you a sketch (Fig. 1) to show this step. First remove the flooring to a column, then set up a stud resting on the joist before removing the column. The opposite procedure is followed when replacing the columns on the level floor. You will find it almost impossible to take up the flooring without breaking some of the tongues but as you will probably want to cover the floor with linoleum after the porch is finished, this need not concern you too greatly. After all of

the flooring has been removed, strips of furring of various thicknesses are nailed along the tops of the joist to bring each joist up to the level of the one nailed to the house, Fig. 2. The flooring then may be replaced, the columns cut off and reset and the two-by-four supports removed. The next step is to saw off the ends of the flooring flush with the joist. Be sure not to saw off the pieces where the doorway is to be, as this should be allowed to over-

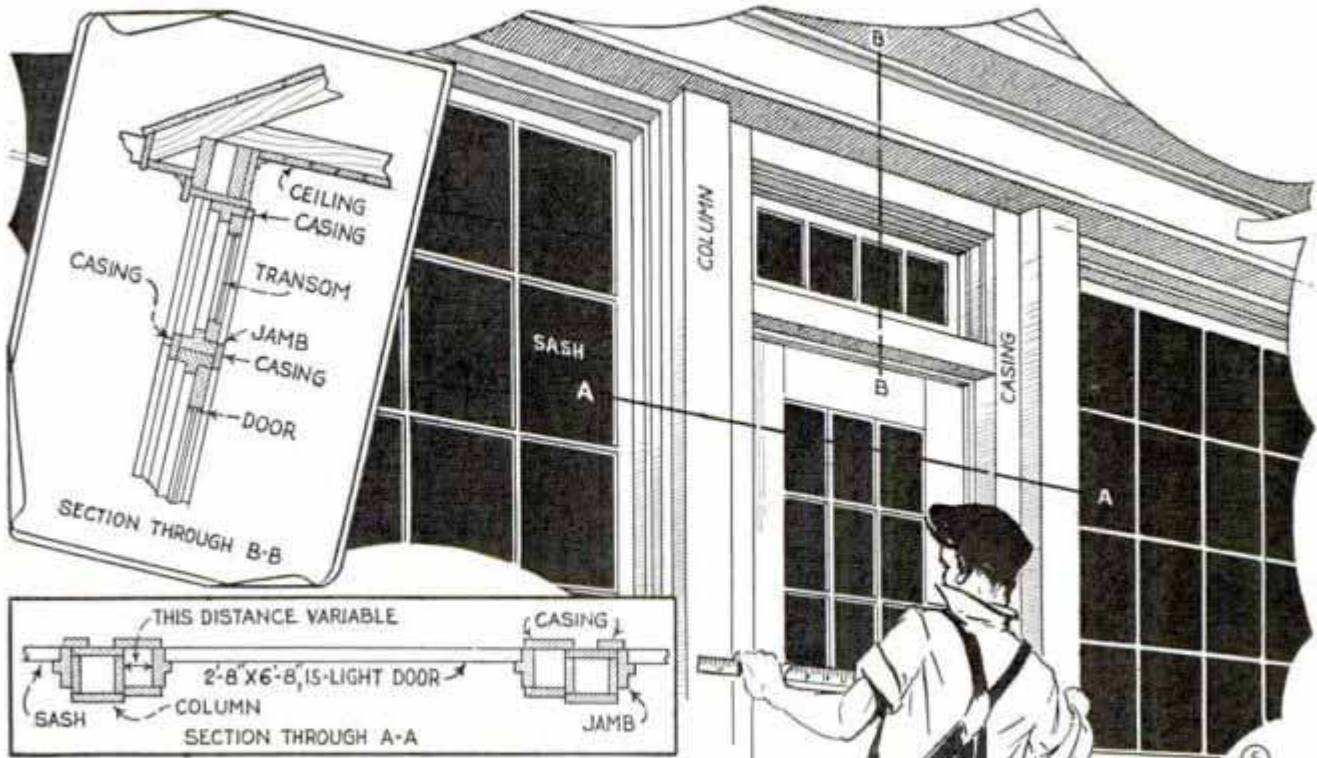

hang as on an open porch. Another thing, the steps will have to be raised a bit. Do this by adding to the height of the footing under the bottom step as the variation in the height of the riser is less noticeable there."

A few nights later Kinsley stopped in to note the progress and found Brown just resetting the last column and anxious to get started on the new work.

"It is fortunate that those columns are square, round ones would have to be replaced or the job considerably complicated. Well, I guess you are all ready for the framing, below the sill (Fig. 3). The columns and studs are to be placed on a line with the outside of the joist and ends of the flooring. Also notice how the corner is framed and finished, the wall sided and the drip cap and water table installed. I am not figuring on any sheathing under the siding as the plaster board on the inside will make the job wind and weather tight."

With these instructions Brown was able to complete the entire enclosure below the sill but was confronted with the problems of how to frame the windows and door and what type of sash to use.

"Well Kinsley, I have built up to the 'water line' but have run into several snags. You suggested using standard-size porch sash, because they are cheaper, but I find that none of the sizes listed in your

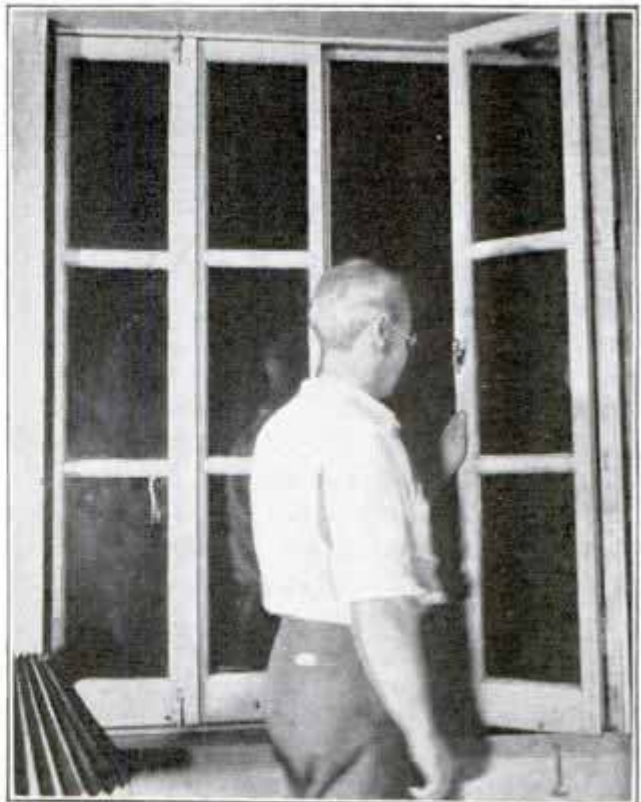
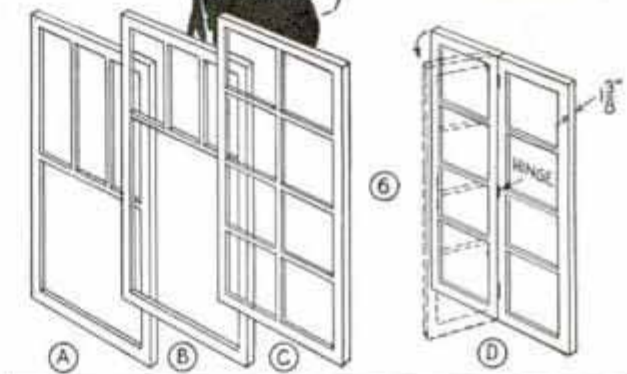

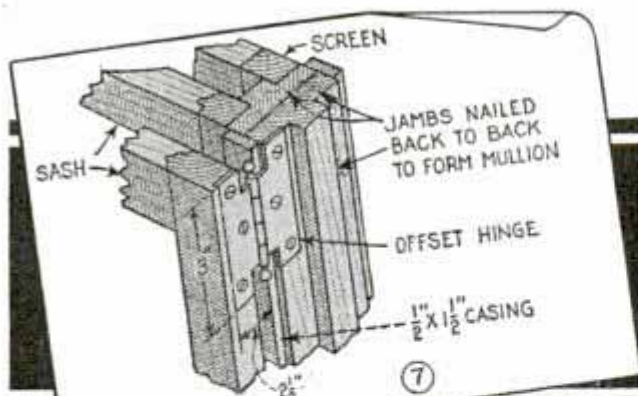

be D. These are half-width sash like those I have on my porch. They are hinged at the center in pairs so that the halves fold against each other. They do not extend out into the porch so far and are less likely to sag than the other types. If the full-width sash are used, special 'offset' hinges are required to allow one sash to fold against the other, and still allow space for a shade." (See Fig. 7.)

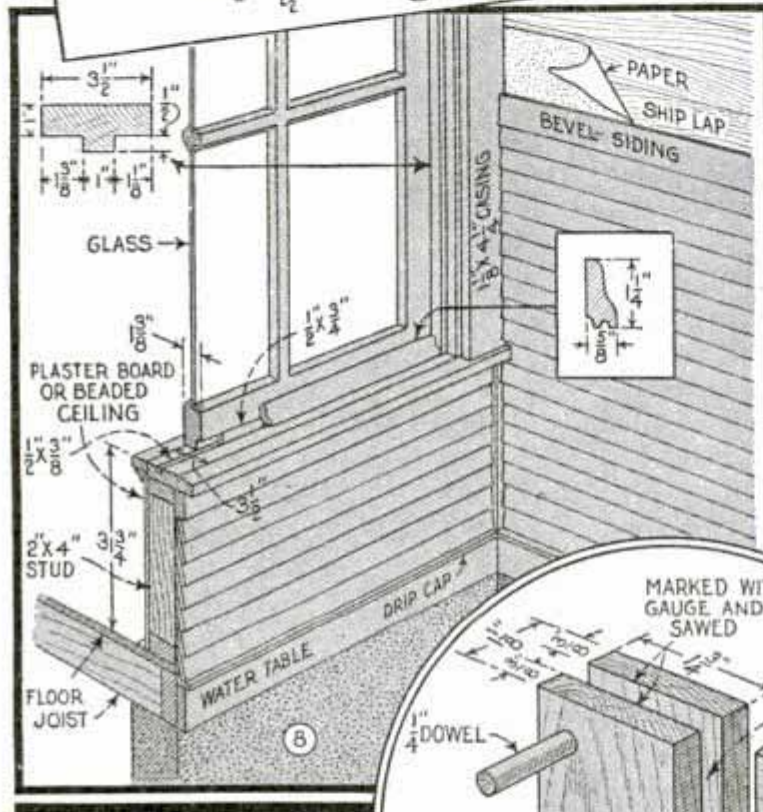

"Just one thing more, I have always heard that hinged windows were not water-tight. Do you ever have trouble with yours?"

"No, two separate devices are made to prevent rain from driving under casement windows, both of which should be used. A drip cap is fastened to the outside of the sash and a water stop set into the sill to fit into a rabbet cut into the lower edge of the sash." (See Fig. 8, which also shows how to finish up the corner next to the house.)

A few weeks later Brown stopped at the Kinsley home with a snapshot in hand.

"Well, Kinsley, I have finished the job, except for the screens, and here is a picture to prove it."

"That is fine, I surely

catalog work out on my job."

"I guess you didn't notice the type of jamb I suggested in Fig. 3. By using two such jamb pieces for your center mullions you can space them any required distance apart to compensate for the width of the sash. The height of a standard sash may be wrong also, but this can be taken care of by boxing the head jamb. (See Fig. 4.) Then there is the door frame which can be made of the same stock jamb material (Fig. 5). No sill is required for the door frame but a threshold should be used so that the door will not scrape on the floor."

"Well, that takes care of the sash spacing and door frame, what about the type of sash?"

"There are four types of porch sash in general use. We will call them A, B, C, and D in Fig. 6. Any of these would be suitable for your home but my choice would

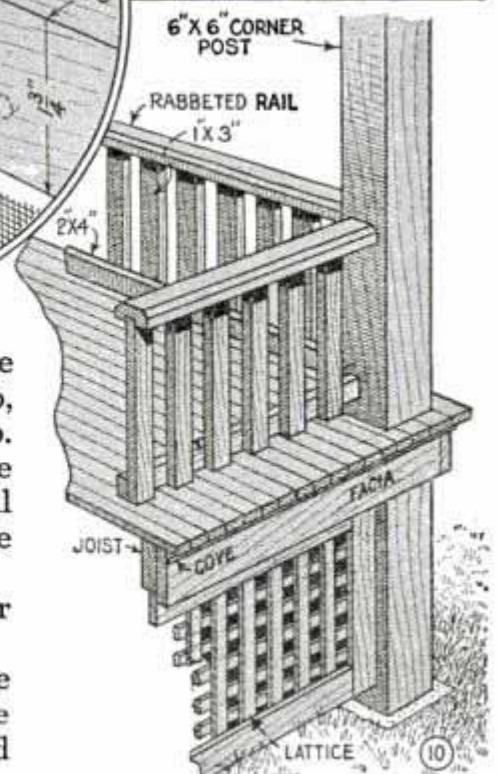
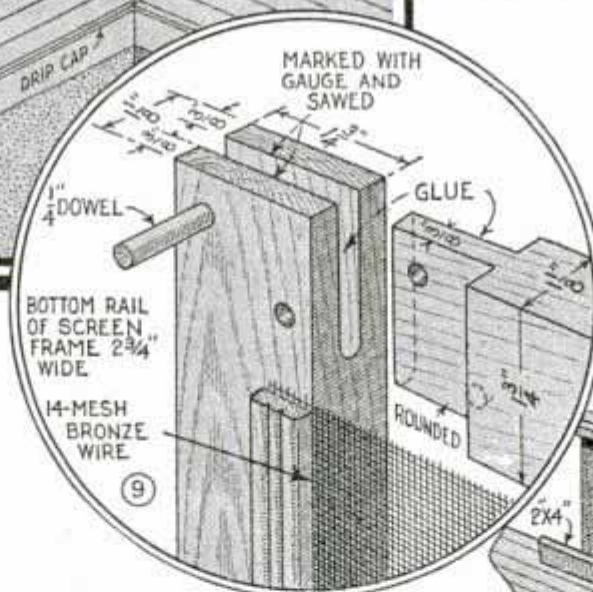

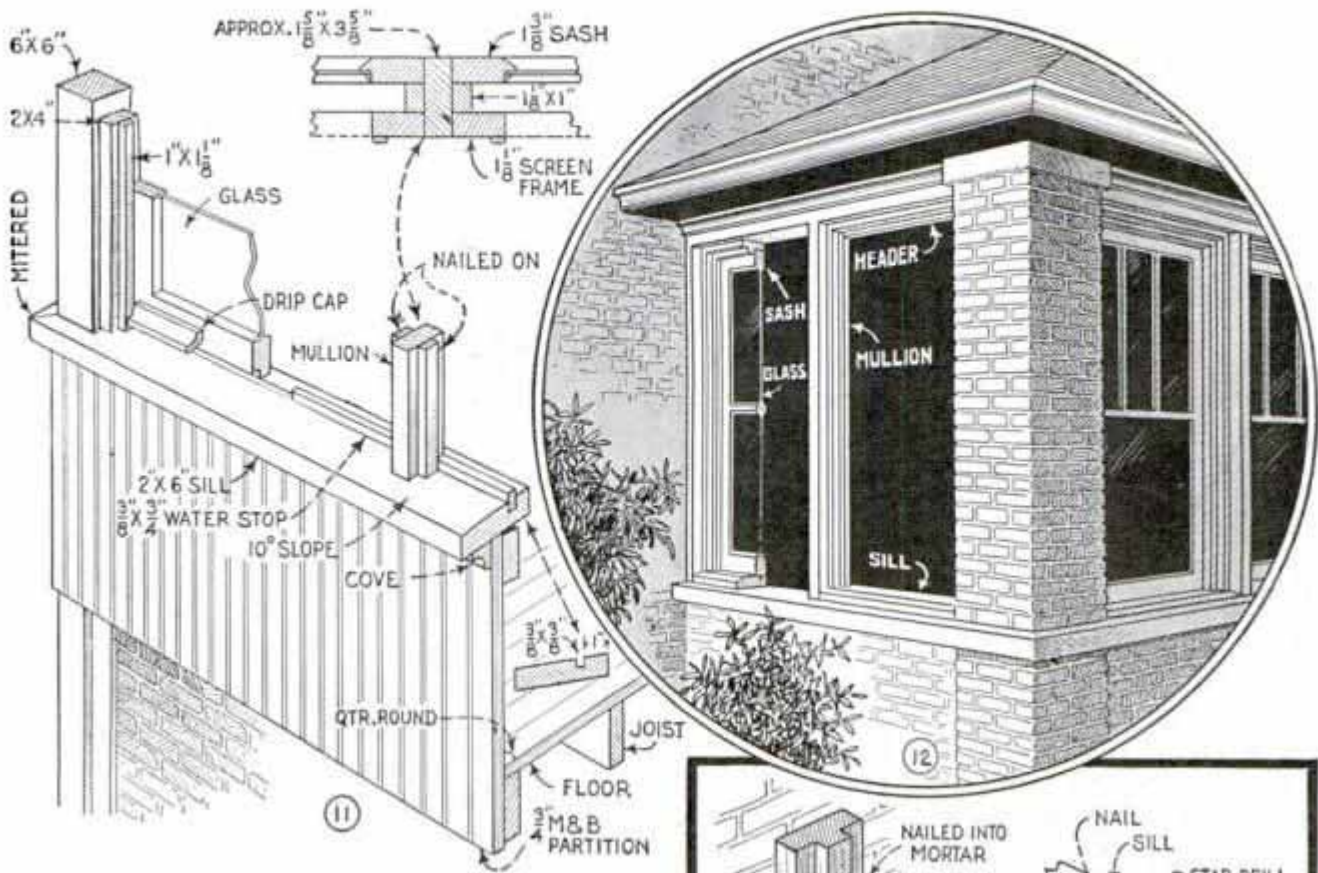

will be over. The screen frames are easily made with stock material. Simple slip mortise joints are probably the easiest for you to make with limited equipment, so I will just make a sketch to show you how this joint is made (Fig. 9). I guess that makes our porch enclosure complete doesn't it?"

"Not on your life, old man! If you don't mind my bothering you, I would say we have just started. The wife wants the back porch enclosed now, and even mother has been hinting about my enclosing the porch on that brick bungalow of hers."

"You seem to have acquired a full-time job. Well, with the experience you have had that back porch should be a snap. As I recall, your back porch is constructed as in Fig. 10, and you simply change it over to the arrangement shown in Fig. 11. That brick bungalow job for your mother would be the easiest of all for it is bricked up to the sill and only requires the installation of the sill and jambs besides some fitting around the brick work." (See Fig. 12.)

"How do you fasten the wood pieces to the brick wall and cement cap?"

"Jambs are usually fastened to brick walls simply by nailing into the mortar joints (Fig. 13). Holes must be drilled into the cement cap with a star drill, Fig.

14 shows, and wood plugs driven into these holes to receive the nails or screws. I would suggest that you set your sills on a thin layer of rich cement and also carefully calk the cracks between the brick wall and the jambs with plastic calking material to make a wind-tight job."

Line Guides on Fishing Rod Made from Safety Pins

If you need line guides for your fishing rod, and none are at hand, they can be improvised from safety pins. Just cut off the head of the pin, straighten the sides, and whip the pin to your rod with silk thread as shown. The looped end of the pin then provides a neat, effective guide.—William Magginiti, Alhambra, Calif.



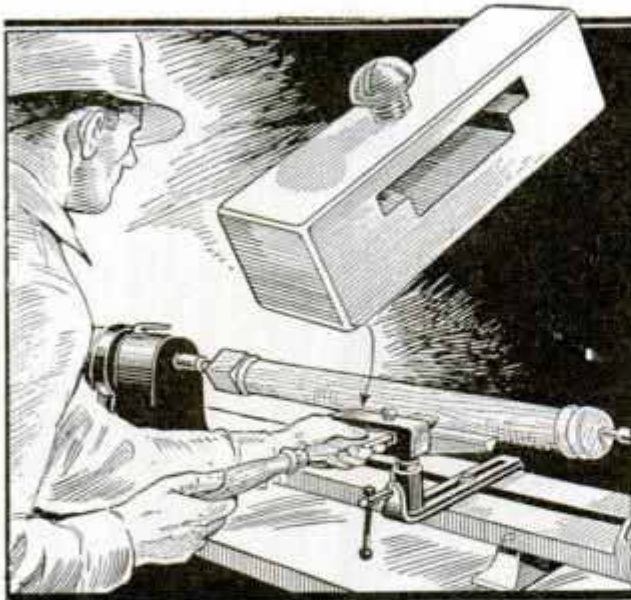

Frequent Calipering of Work Is Unnecessary When Turning Duplicate Pieces if This Gauge Is Used

Chisel Gauge Aids in Turning Duplicate Work in Lathe

By using this gauge, when turning duplicate parts in a lathe, it is unnecessary to caliper the work at frequent intervals to get all parts the same size. The gauge is a small steel block, which is slotted through the center and fitted with a set screw for attaching it to the chisels. One piece of the work is turned to size, after which the gauge is set on the chisel so that it will touch the tool rest when the next piece is turned to the same diameter.

Use metal lath for arched doorways; it is easier to form than wood.

Rowboat Sunshade Made from Muslin

Short fishing trips by rowboat are often accompanied by painful sunburn, which can be avoided at small expense, by providing your boat with this sunshade. It is merely a sheet of unbleached muslin stretched over four strips of bamboo as shown. The muslin is hemmed to take the strips, which are arched, and the ends inserted in staples in the sides of the boat.

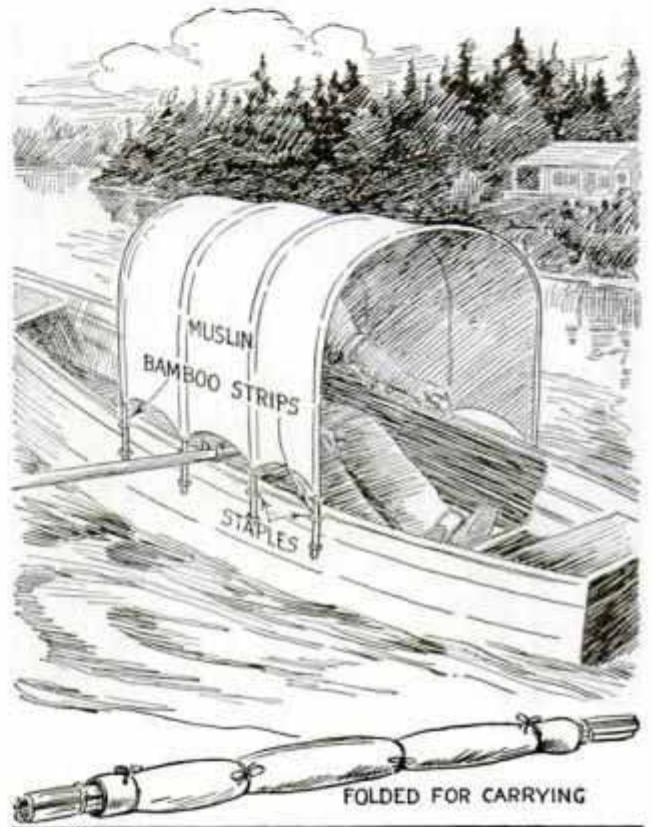

Muslin Stretched over Arched Strips of Bamboo Makes Portable Sunshade for Your Rowboat

Build Your Own Speed or Pleasure Boat

Popular Mechanics Blueprints Show Every Detail of Construction



The photo shows one of our boats, "Roamer" —a 16-ft. cabin cruiser. It has a 66-in. beam and goes about 28 m.p.h. with a large outboard motor. A set of six prints showing how to make it costs you only \$1.00. When ordering specify "Roamer," Nos. 765 to 770. Or, would you like a 14-ft. family runabout? Then send for "Hi-Ho," six prints, 840 to 845, also for \$1.00. Besides these, there are many other speed and pleasure boats, rowboats, sail boats, boat trailers, etc., listed in our 80-pp. book called "What to Make," which will be sent upon receipt of 12 cents.

POPULAR MECHANICS MAGAZINE
Blueprint Dept.

200 E. Ontario St., Chicago, Ill.

Making your Bicycle PAY DIVIDENDS

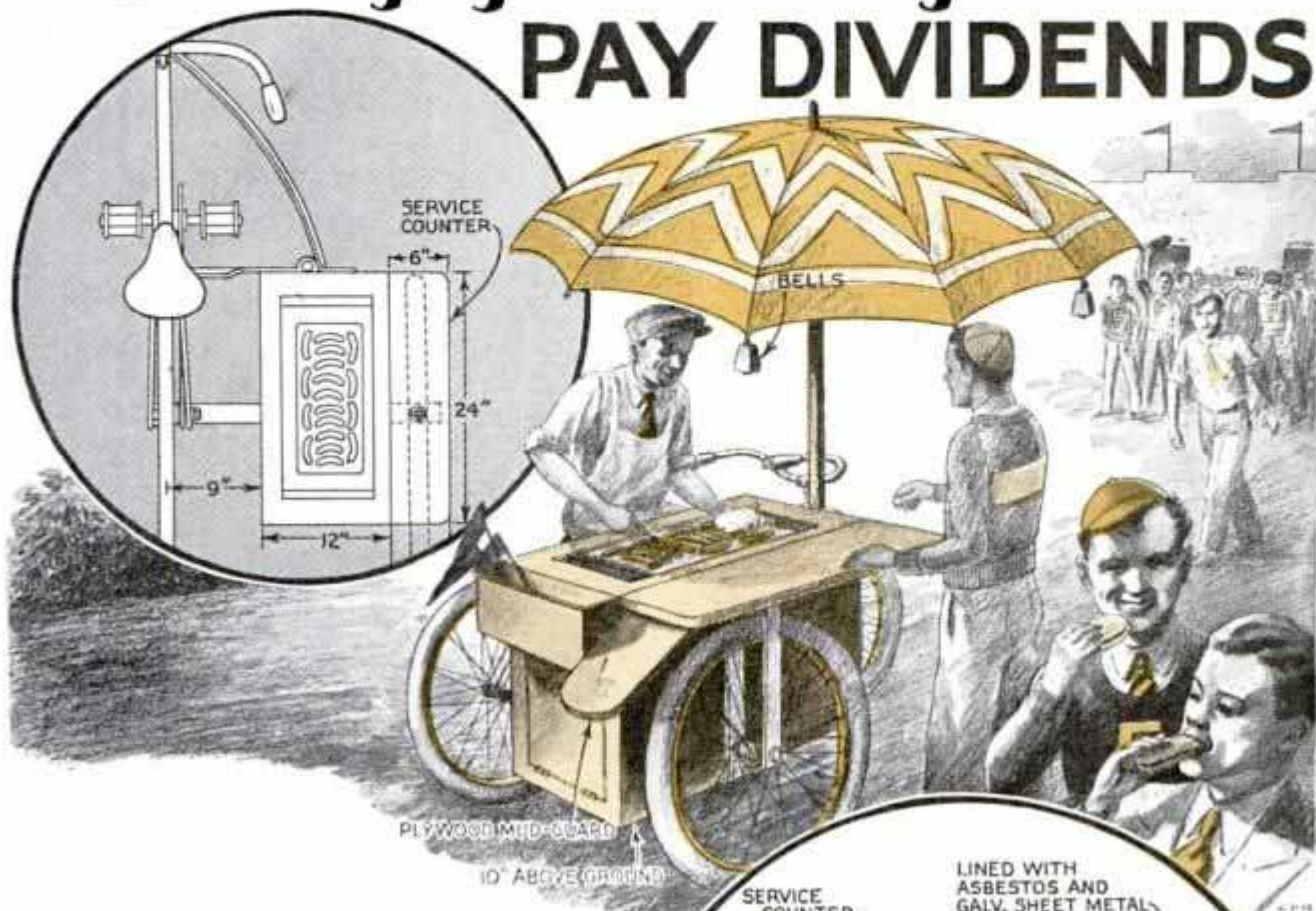

With this light side car on your bicycle, you can pull up to the curb and sell "hot dogs," pop corn, soft drinks or small novelties. A large umbrella will make it quite conspicuous besides providing shade for the owner. The arrangement shown is designed for hot dogs or hamburgers, but with slight alterations, the outfit can be adapted to dispensing ice-cream cones and cool drinks. If the contents are to be kept cold, install a small galvanized-iron ice box inside of a compartment that is lined with insulating board. With a little care, you can easily build this whole outfit yourself

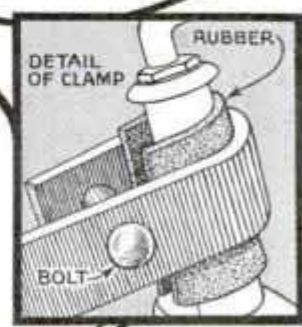
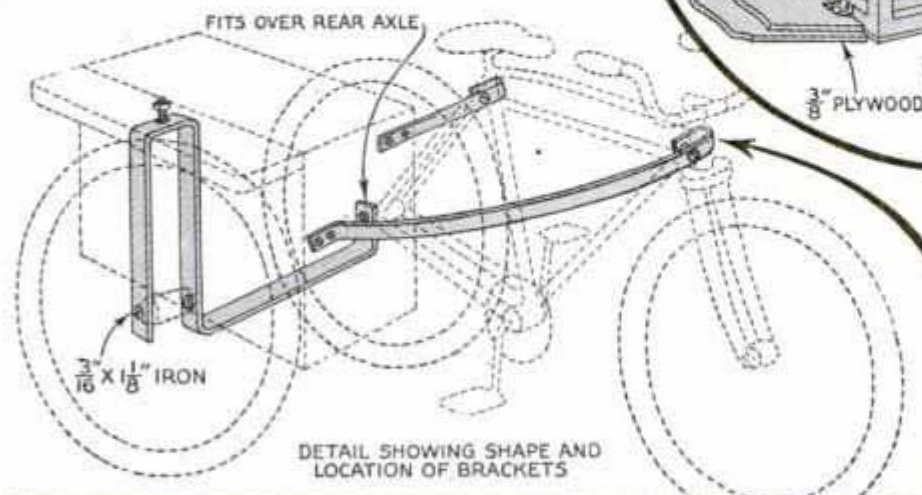
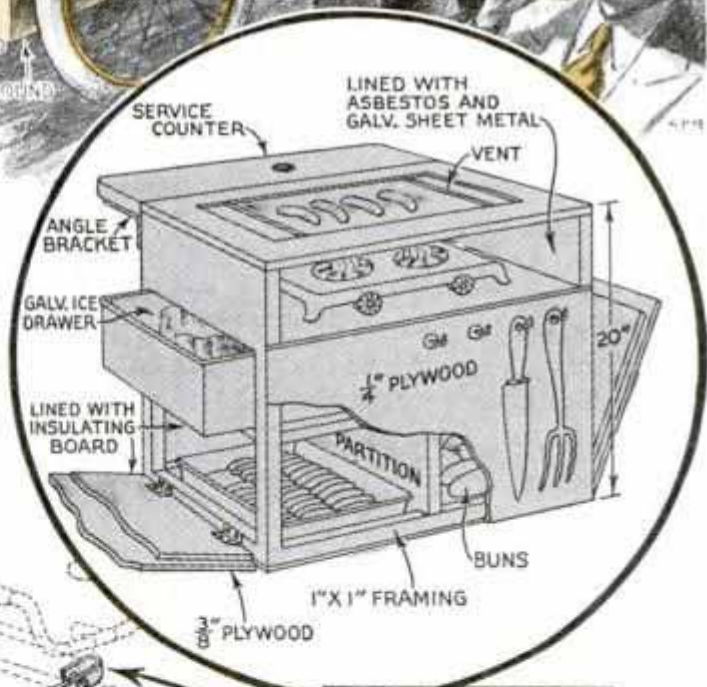

DETAIL SHOWING SHAPE AND LOCATION OF BRACKETS



Minnow Trap Suspended into Water from Side of Fishing Boat Assures Supply of Live Bait

Minnow Trap Provides Supply of Live Fish Bait

You will have live fish bait at hand without any effort on your part if this minnow trap is suspended from the side of your boat. The trap is a glass fruit jar having a screen-wire cone fitted in the mouth as shown, where it is held with the lid. The top is cut out of the lid, leaving a narrow rim around the edge to hold the cone. A rubber band around the center of the jar is attached to a stout line which allows the trap to hang in the water.

Removable Porch and Lawn-Chair Seats

If you alter your canvas-seated porch and lawn chairs like the one shown, the cloth can be removed easily and laundered when it becomes soiled. Instead of tack-

ing the canvas to the top rung on the back of the chair as is usually done, put a large hem in the end, bring it over the top of the rung and insert a length of broomstick.



This is screwed between the chair rails just below the rung to hold the canvas. The bottom end of the canvas, where it fastens to the chair seat, is treated in the same manner. It is now a simple task to take out the screws and remove the canvas.—N. S. Trout, Norwood, Ohio.

Wire Coat Hangers Serve as Croquet Wickets

The next time you are short a croquet wicket, get a wire coat hanger, cut off the twisted end and bend it to shape as shown in the photo.



The enamel on the hanger will protect the metal against rust for at least one season.

Rubber Canning Mitts Cut from Old Inner Tubes

To protect the hands from hot fruit jars and lids, and to provide a strong friction grip for tightening the lids when canning, cut a pair of mitts from an old inner tube. A piece of rubber about 9 in. long and 6½ in. wide will be about the right size for each mitt. In the center of one mitt, cut two slits to provide a strap to slip over the hand and hold the mitt for tightening a jar lid. The mitt used to hold the bottom of the jar will not need a strap.



Mitts Cut from Inner Tube Save Time and Protect the Hands When Sealing Fruit Jars

Ⓛ Before driving screws into hardwood, coat them with soap to minimize friction.

Safety Bathing Cage Protects Small Children

As it keeps little tots from wading out into deep water unobserved, this safety bathing cage will afford more security for them. Another advantage is that it can be towed out away from shore where there is less

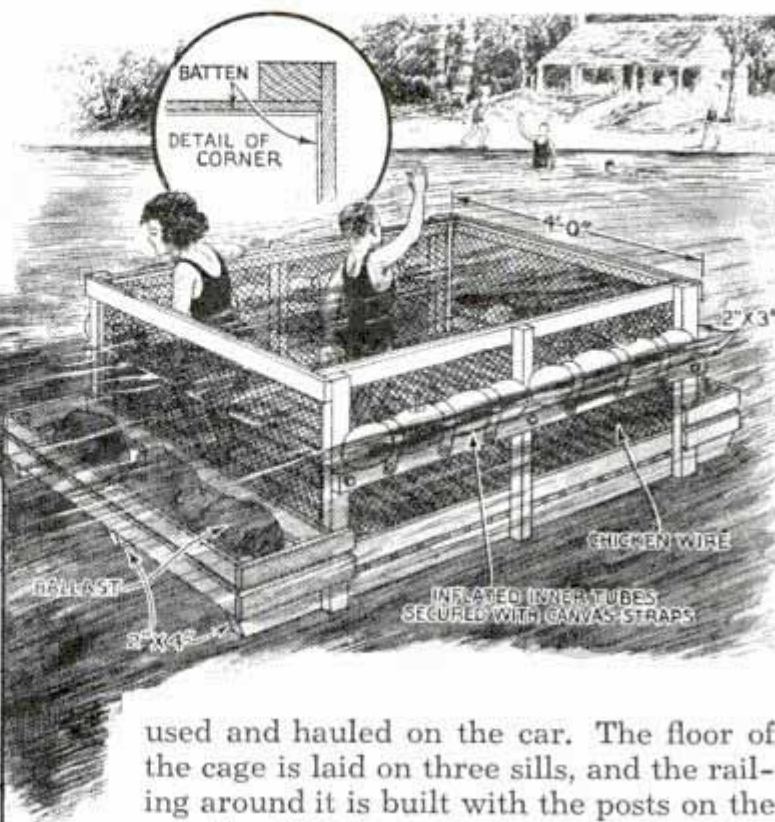
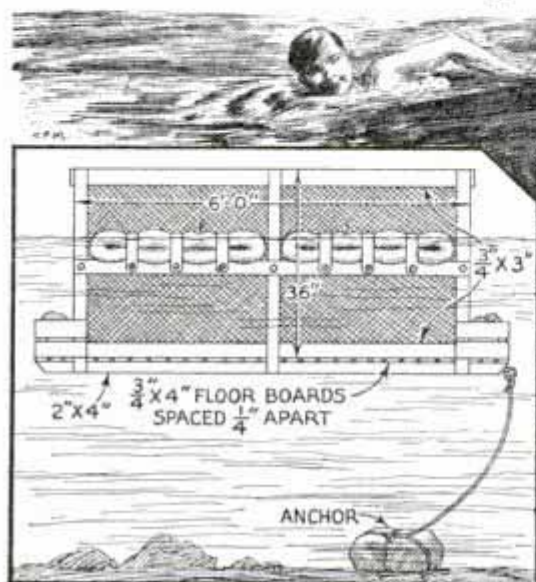

danger from contaminated water. The little ones will also get the thrill of being in deeper water, while safe in the cage. If you live some distance from a beach, a smaller cage, which is portable, may be

used and hauled on the car. The floor of the cage is laid on three sills, and the railing around it is built with the posts on the outside. Chicken wire is stretched tightly over the railing on the inside, with battens over the edges. Corners of the battens and top rail should be rounded to avoid splinters. Boxes for stone ballast are built on each end, and inner tubes are fastened to the center rails.

Ventilating Closed Attic to Keep House Cool on Hot Days

If you live in a low-roof house where the attic is not ventilated during the hot summer months, you can lower the temperature several degrees in the rooms below by using one of the methods shown. One method consists of installing a vent pipe in the roof and providing a screened opening in the ceiling so that air can circulate up through the attic. If you care to, a small fan can be mounted in the bottom of the vent pipe to accelerate the air movement. Another method consists of cutting openings under the eaves, where the roof extends over the side of the house, as shown in the right-hand detail. This method may be used in combination with the vent pipe, or it can be used by cutting the openings on

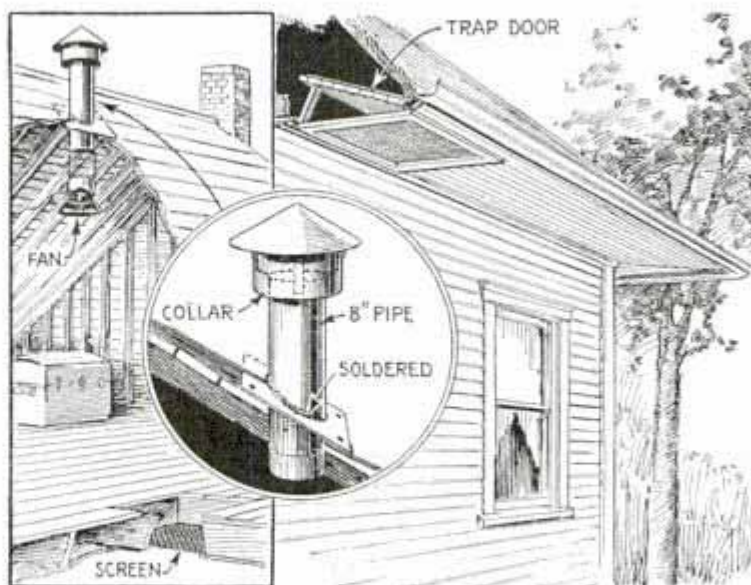

opposite sides of the house so that air enters at one side, circulates through the attic, and comes out at the other.



Large Bottle Filled with Cracked Ice and Water Makes Ideal Rolling-Pin for Hot Weather

Refrigerated Rolling-Pin

In hot weather when dough has a tendency to stick to a rolling-pin, take a large bottle and fill it with cracked ice and water. This can be used as a rolling-pin, and the dough will not adhere to it. Also, the cold bottle will tend to cool the dough and improve the finished pastry.

Drawings Stippled with Sandpaper

To produce stipple shading on drawings rapidly, place a small piece of carbon paper over the desired area, and upon this, put a piece of coarse sandpaper, rough side down. By rubbing over the sandpaper with the blunt end of a fountain pen or other instrument, shading will be produced as shown. If a large surface is to be shaded around other objects in the sketch, cut a mask from plain paper to protect these portions.

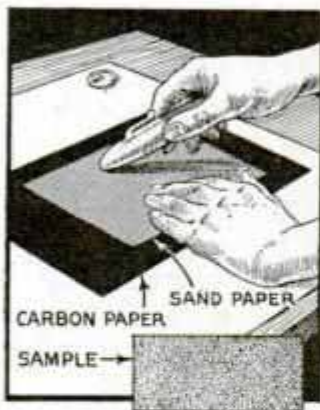

city of Long Beach, Calif., have been in service for more than a year of hard usage. —Ray Chapin, Long Beach, Calif.

☐ Chimney soot can be removed by throwing a handful of equal parts of sulphur and powdered saltpeter into the fire.

Nonslip Diving Board Surfaced with Paint and Sand

Surfacing a diving board with paint and sand is an effective and economical method of making the board nonslip. The first step is to procure a quantity of fine, dry sand. If this contains small stones or shells, it should be sifted through a fine mesh. The board is then given a coat of the best marine deck paint. While the paint is wet, the sand is applied about 1 in. deep over the top surface of the board. This is left to dry for about three days after which loose sand is lightly brushed off. The board is then placed in the sun for another four or five days while paint containing the sand particles hardens. After the entire operation has been repeated three times the board is ready for use. Several diving boards treated in this manner by the recreation commission of the



Liberal Coatings of Paint and Sand Give Diving Board Nonslip Surface to Prevent Accidents

☐ To blacken aluminum, clean it thoroughly and apply a mixture of the following chemicals: Sulphate of iron, 1 oz., white arsenic (poison), 1 oz., hydrochloric acid, 10 oz., and water, 12 oz.

This Tough Fishing Rod Holds the Big Ones



For as little as 50 cents and a few hours work, you can make a fishing rod from a 25-cent bamboo pole that has the appearance of the best of them, and one that can really "take it." I have seen rods of this type used along the Florida coast, and come back unscathed from battles with tarpon, amberjack and barracuda. To make a rod, get a closely jointed pole that has a slick, glossy appearance, a reasonably fast taper, and one that is fairly springy when whipped up and down. A pole that has a yellow color is preferable, and it should be free of rotted specks and tiny air splits. Cut the pole to the length that best suits you, cutting 2 in. above a joint at the small end, and snugly below a joint at the large end. With a sharp knife, round off the joints, but not between them, and finish them with fine sandpaper. Plug the small end snugly with a hardwood rod, cementing it in place, and fit your metal tip, but do not cement it. Now comes the wrapping. Start and finish this as indicated in the detail. These wrappings should not be longer than 4 in. If you desire the rod wrapped its entire length, do it in 4-in. sections. I wrap the entire sections from the butt up to a point a little beyond the reel for the sake of appearance. Beyond this, wrap only about half of each section squarely in the center between the joints.

Here is where you can use up your old fishline, heavy on the sections at the large end, a little lighter on the center sections, and still lighter line, or even shoe thread, up to the tip. Hold the newly wrapped rod as though you were actually fishing. Note that each section is slightly flattened on one side, and that the flattened portions are staggered. These should be edgewise to the bend. Holding the pole in this way, the guides and reel should go on top, in perfect alinement. Then set the tip accordingly, using either varnish or rod cement. The rod is now ready for varnishing. Use a high-grade, flexible varnish. This should be applied sparingly to the bare portions of the rod, and liberally on the wrappings. When the varnish has dried, rough the surface with sandpaper where the reel is to be placed, and wrap it on extremely tight. Then varnish this wrapping heavily. —John Bennett, St. Petersburg, Fla.

Ⓛ Don't plane or sand off edges of doors when the weather is damp; simply rub the edges with soap or melted paraffin.

Ridding the Home



Flytrap of Barrel Hoops and Screen with a Week's Catch on a Farm

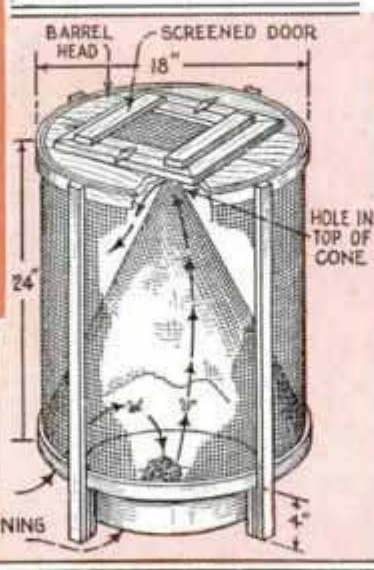

PAN CONTAINING BAIT

Take 2 lbs. of rosin and 1 pt. of castor oil; heat together until it looks like molasses. Take an ordinary paint brush and smear while hot on any kind of paper. A cheap and convenient fly poison is made by adding three teaspoonfuls of commercial formalin to a pint of milk sweetened with a little brown sugar. Partly fill a tumbler with the solution; cut a piece of white blotting paper to proper size and place in a saucer or plate. Place this over the glass and quickly invert the whole, inserting a toothpick under the edge of the glass. As the solution evaporates, the supply is automatically renewed from the glass.

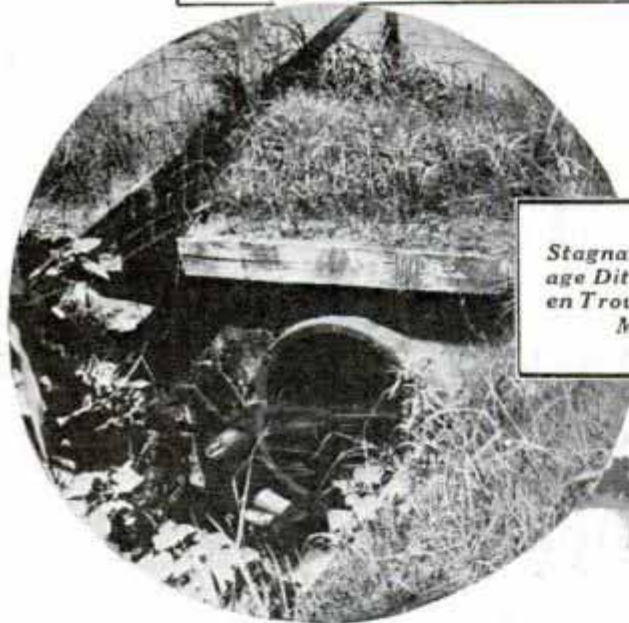

Stagnant Water in Drainage Ditches and Old Wooden Troughs Assures a Good Mosquito Crop



Illustrations by Courtesy of the U. S. Department of Agriculture

BESIDES being an annoyance, the ordinary house fly is a menace to health through its ability to spread disease germs. Its presence is always an indication of unsanitary conditions and improper disposal of the substances in which it breeds, and its extermination becomes a community rather than an individual undertaking. Absolute cleanliness and the proper disposal of garbage and animal excreta would eliminate the fly in a short time. However, by the use of screens, poisons, fly paper and traps, a person can keep his own home comparatively free from this pest. A dozen sheets of sticky fly paper may be made for one cent by the following formula, prepared by the Kansas state board of health:

An efficient and durable flytrap may be constructed for about 75 cents. Details are shown in one of the drawings. Two barrel hoops are bent into a circle 18 in. in diameter on the inside and nailed together, the ends being trimmed to give a close fit, to form the bottom of the frame. Two other hoops similarly treated form the top. The top of the trap consists of a barrel head with the bevel edge sawed off so that it will fit tightly into the hoops. A 10-in.

of INSECT PESTS

square, cut in the center, forms the door. Wood strips, 1 in. wide, nailed $\frac{1}{2}$ in. from the opening, hold the barrel top together and form the door jamb. The door is a narrow frame covered with screen and well fitted into the jamb, where it is held in place by two turnbuttons. The top is nailed inside the top hoops, and the sides are formed by tacking screen on the outside of the hoops. It will take 61 in. of screen 24 in. wide to cover the sides, which are supported by four laths nailed to the hoops outside the wire. The laths project $4\frac{1}{2}$ in. below the bottom hoops to form the legs. The cone is cut from a piece of screening 41 in. long by 26 in. wide. It is best to make a pattern of heavy paper before cutting the wire. The overlapping edges are soldered together and the apex is cut off the cone to give an opening one inch in diam-



Argentine Ants Poisoned in Simple Tin-Can Traps; Birds and Animals Cannot Get at Them



Above, Ring of London Purple, Correctly Used, to Exterminate Red Harvester Ants

Right, Close-Up of Shelter Tube Constructed by Termites to Bridge Masonry So They Can Get at Wood; Below, Types of Sheet-Metal Shields That Protect Buildings against Termites

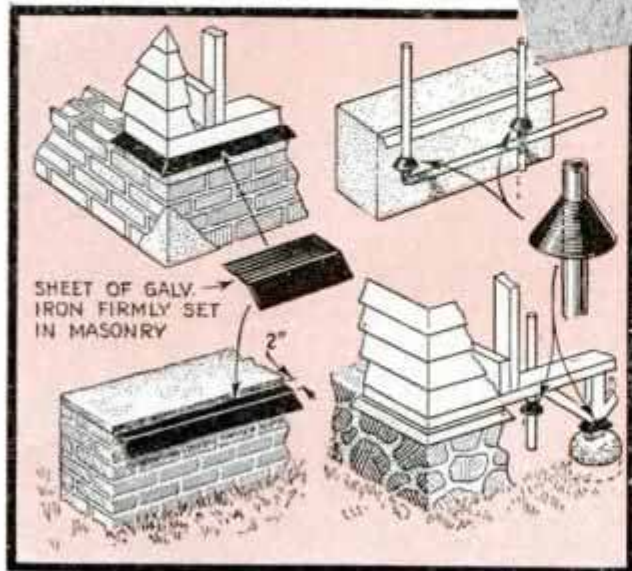
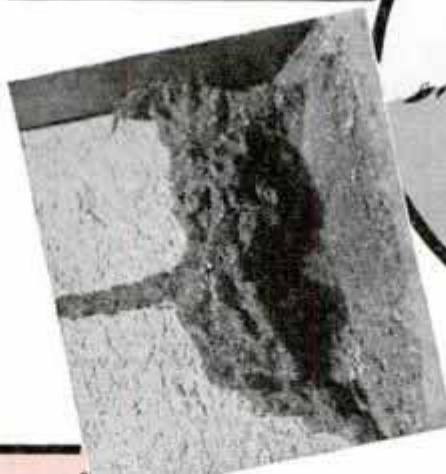

eter, after which the cone is inserted in the frame and closely tacked to the lower hoop. To bait the trap, fill a shallow pan about 14 in. in diameter with a solution consisting of one part of molasses and four parts of water. Place a sponge or a few chips in the center of the pan so that more flies will have room to feed, and place the pan under the trap. The trap should be placed where flies naturally congregate and the pan kept well filled with bait. Empty the trap weekly after immersing it in hot water to destroy the flies.



Right, Typical Barren Spots That Surround a Nest of Harvester Ants; Left, Termites Have Eaten Up through a Floor to Get at This Shoe

Above, Damage to a Book Which Was Caused by Termites; Right, This Was Once a Fur Helmet but Moth Larvae Have Eaten Off all the Fur; Below, Ready to Moth-proof Contents of Trunk with Chemicals

but must come to the surface to breathe. Marshes, ponds, pools of rain water, hollow trees, rain barrels, roof gutters, tin cans, bottles, in fact any hollow receptacle that will hold water a few days will serve as a breeding place. To eradicate this pest marshes must be drained. Lakes and ponds must be oiled or stocked with minnows. In the latter case, vegetation must be trimmed closely around the edges so that the minnows can reach every portion of the surface. Casual pools of water should

be sprayed with oil, roof gutters should be examined to see that they are not clogged, holes should be punched in cans before they are discarded, and water should not be allowed to stand

Effective Method of Using Carbon Tetrachloride to Keep Moths Out of Trunks and Closets; This Chemical, Obtainable at Any Drug Store, Is Non-Inflammable and a Quantity Is Poured into a Shallow Dish Placed in the Trunk or Closet, After Which the Latter Is Tightly Sealed; upon Evaporating, the Fumes of the Chemical, Being Heavier Than Air, Will Permeate the Clothing

The eradication of mosquitoes is also a community project, for until breeding places have been abolished, any efforts to keep the insects out of the home must be continuous during the summer. Mosquitoes lay eggs in still water. When these hatch the larvæ swim about in the water,

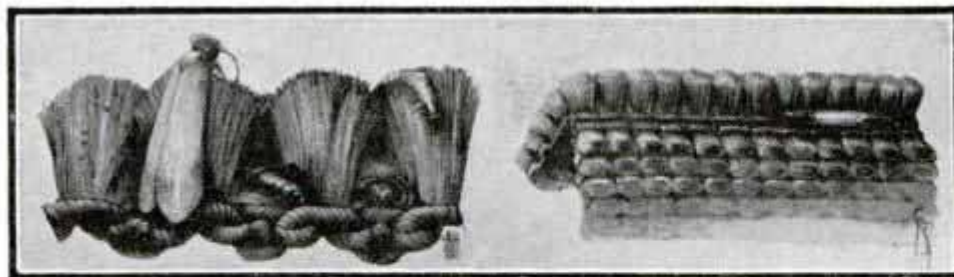

By Folding a Rug or Carpet Carefully to Inspect It, the Presence of Moth Larvae May Be Determined

undisturbed in any receptacle for more than a day or two at a time.

Tightly fitted screens, 18 meshes to the inch, will keep out most mosquitoes. Lightly painting the screens with kerosene or oil of citronella will prevent any from making their way through. Pyrethrum powder, moistened and heaped into a little pyramid, will burn slowly, and the smoke will stupefy any mosquitoes in the room if the air is fairly still. A little of the powder placed on a metal screen above the chim-



Above, Damage to Rug Caused by Moths; Right, Some Brushes Make Good Breeding Places for Moths; Below, Even Feathers Are Not Immune

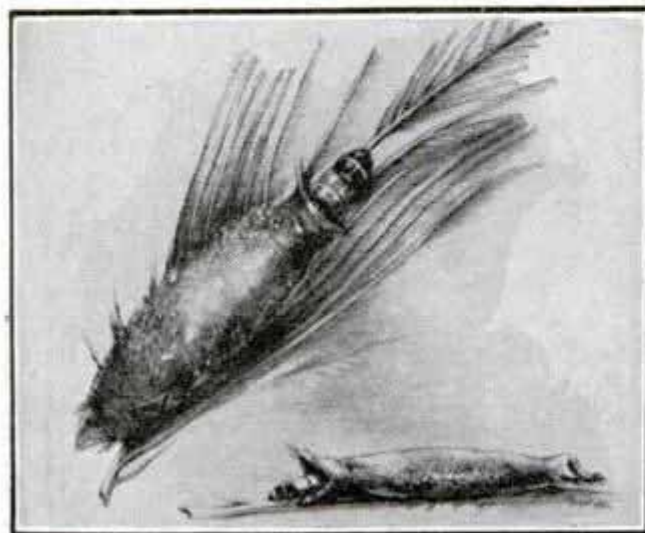

ney of a kerosene lamp is even better. To rid a house of mosquitoes, one pound of powder must be burned for every 1,000 cubic feet of space. A solution of one part oil of cedar, two parts spirits of camphor and two parts oil of citronella, if rubbed on the face and hands, will keep mosquitoes away for several hours. A few drops of the solution placed on a bath towel hung over the head of the bed will enable a person to get some sleep in a mosquito-infested room. A little moist toilet soap, rubbed gently on a mosquito bite, will soon relieve the irritation.

House ants are attracted by food, especially meat, bread, cake, sugar and sirup. Keeping all food in ant-proof containers and ice boxes, and promptly cleaning up all crumbs after meals, will do much to abate the nuisance. Sodium fluoride powder, mixed with flour and dusted in runways, will kill all ants coming in contact with it. Dusting this chemical is also the most effective way of combating roaches. A wash of common laundry soap, using $\frac{1}{2}$



Above, Damage by Moth Larvae on Overstuffed Furniture; Right, Type of Construction That Keeps Out Moths; Below, Slip Covers Permitted Moth Larvae to Feed Unmolested in Darkness

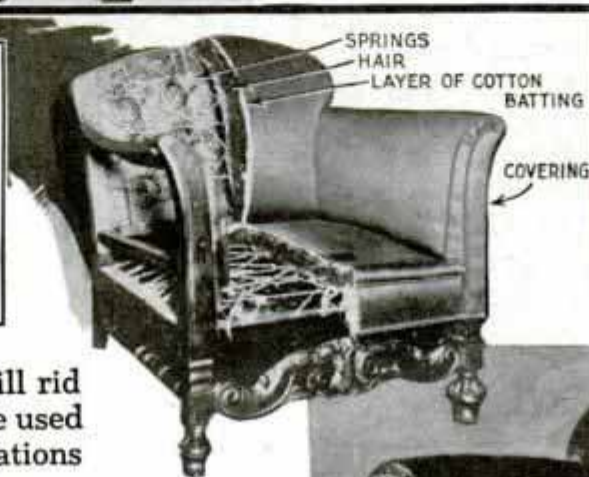

lb. to a gallon of water will rid a lawn of ants. It should be used as a spray. Several applications usually will be necessary.

Argentine ants, which are small and dark brown, are found in scattered localities throughout the South. These pests are intolerable in badly infested places, even going so far as to cause homes to be vacated. They invade bed chambers and have attacked babies with serious results. A bite from their mandibles is extremely painful. The most effective means of combating this ant is with poisoned sirup. A special formula, prepared by the department of agriculture, consists of 9 lbs. of granulated sugar, 6 grams of crystallized tartaric acid, and 8.4 grams of benzoate of soda boiled slowly for 30 min. in 9 pts. of water. Allow this to cool. Then dissolve 15 grams of sodium arsenate (C.P.) in $\frac{1}{2}$ pt. of hot water and let it cool. Add this solution to the sirup and stir well. Then add $1\frac{1}{4}$ lbs. of honey and mix thoroughly. The best containers for this poison are made from $\frac{1}{2}$ -lb. baking-powder tins having friction covers. Indent each can deeply on opposite sides and replace the cover. If kept in an upright position this container is weather-proof, and there is ample room between the top of the can and the cover to permit the entrance of the ants. Two

gills of sirup to each can will last several months. A piece of sponge should be placed in the can, where it will float on top of the sirup and provide room for the ants to feed in large numbers. A piece of wire 6 in. long may be bent to form a handle that will permit the can to be hung on trees, fences or the walls of houses. These ants prefer to climb for their food.

The red harvester ant does not usually invade the home, but when it infests lawns it makes their use for recreational purposes almost impossible, for it invariably gets on people and bites and stings or both. It also attacks live stock and is especially annoying to cows, often reducing milk production. This ant may be



identified by the large barren area around its nest. A ring of London purple, placed in a complete circle $1\frac{1}{2}$ in. wide and not more than 2 in. from the entrance to the nest, is most effective. If the ring is too far from the entrance, the ants will shake off the powder before entering the nest. If it is placed directly over the hole, or the ring is too deep, the ants will dig another entrance. Three or four applications are usually necessary to exterminate a colony.

Complete insulation from the ground of all untreated woodwork is the only insurance against ravages of termites or white ants. Foundations should be of stone, brick, concrete, or of wood treated with coal-tar creosote. No sleepers, stringers, beams or porch supports of untreated wood should be in contact with the ground. When termites cannot gain access to wood

directly they often build shelter tubes over the face of stone, concrete or brick foundations. A sheet of galvanized iron, firmly inserted in the face of the masonry, will form a shield that will cut off the termites' connection with the ground. The metal should be allowed to project horizontally for 2 in. and should then be turned downward at an angle. When all wood is so insulated, termites in the building will die.

Fumes of burning sulphur are effective for killing bedbugs, but are likely to cause damage to wallpaper and fabrics. A pound of sulphur is needed for each 1,000 cu. ft. of space, and the building should be closed tightly for at least 6 hrs. The sulphur is burned in a dish which is placed in a larger one as a precaution against fires being started by overflow. Liberal appli-

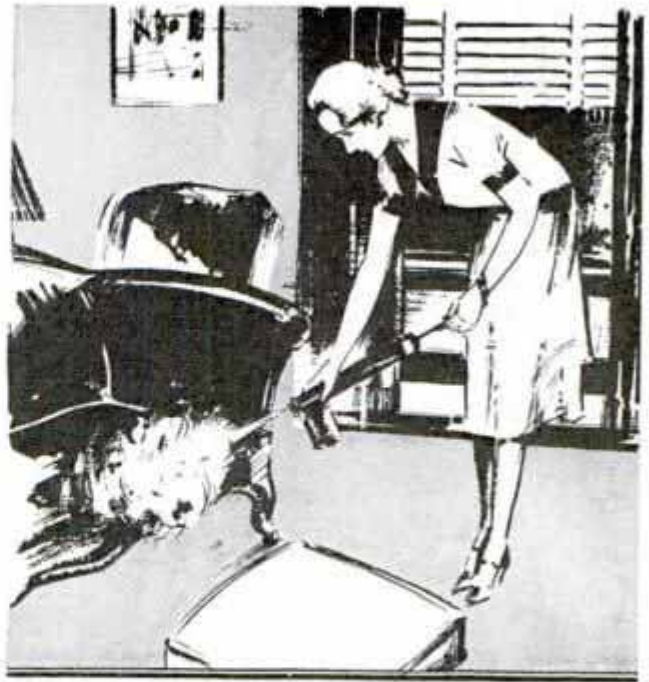

Upholstered Furniture Cleared of Moths by Spraying with Chemical Solution Which Is Non-Inflammable and Will Not Stain the Fabric; Subjecting the Furniture to a Continued Heat of 130° Fahr. for a Few Hours Will Kill Both Moths and Moth Larvae; an Electric Heater Enclosed in a "Tent" of Comforters Will Do the Trick

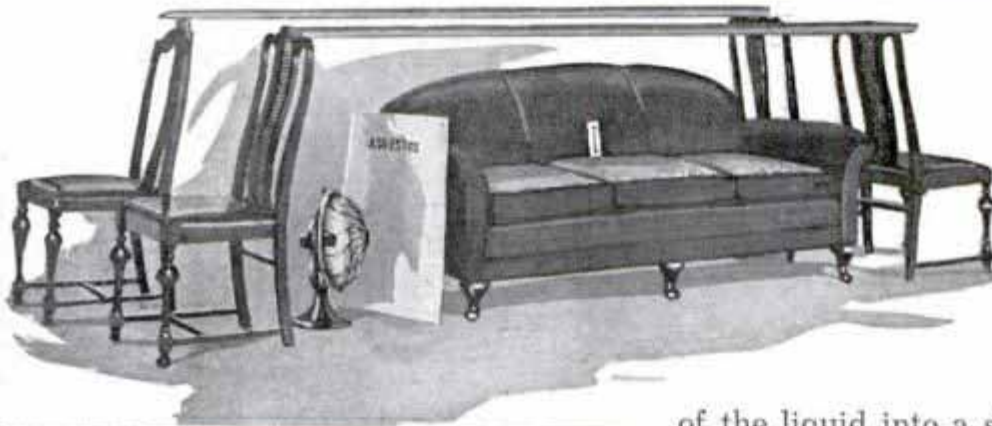

cations of kerosene, applied with a brush to all crevices in walls, furniture and mattresses, are usually adequate with slight or recent infestations. Since the bugs and eggs are destroyed at temperatures of 113° Fahr., it is quite simple to rid the house of bugs in summer by turning the central heating plant to full blast on a hot day.

Frequent cleaning, brushing and exposure to sunlight of fabrics will do much to prevent damage by clothes moths. Clothing to be stored should be wrapped tightly in paper containing naphthaline crystals. Carbon tetrachloride will keep moths out of closets or trunks. Merely pour a little

of the liquid into a shallow dish, place it on top of the trunk or closet shelf, then seal the door or lid. The liquid will evaporate, and being heavier than air it will sink and permeate all the clothing. Cedar chests give effective moth protection if only fabrics that have been cleaned recently and thoroughly are placed in them.

By maintaining a dry heat of 130° for an hour or more, so that all articles reach that temperature, all moths, eggs and larvæ in the home can be killed. This superheating, in fact, is one of the simplest and best ways of ridding a house of all pests during hot months.

Upholstered furniture which has become infested with moths may be cleared of them by spraying with a solution made by dissolving paradichlorbenzene, 1 part, in ethylene dichloride, 75 parts, and carbon tetrachloride, 25 parts. This solution is non-inflammable and will not leave a stain on the fabric. Paradichlorbenzene crystals placed in an open container on a clothes-closet shelf will keep moths away.



Black Paper over Barrel of Microscope Enables Amateur Microscopist to Keep Both Eyes Open

Black Paper on Microscope Helps to Prevent Eyestrain

Microscopists avoid eyestrain by keeping both eyes open while using a microscope, and have learned, through long practice, to suppress vision in the eye not being used. The amateur, of course, cannot do this, but he can keep both eyes open and get practically the same result if a piece of black paper is slipped over the barrel of the microscope as shown.

Uses for Crepe Rubber

Crepe rubber that is sold in small rolls for bandages and finger stalls is adapted readily to many other purposes around the home. It can be used for covering almost any small article that needs protection, and, as the surplus rubber can be removed without the edges separating, a neat job can be done. Also, it can be used for noiseless



bumpers and protection sleeves to prevent marring furniture, varnished walls, etc.

Bottle Caps Serve as Reflectors on Tent-Rope Stakes

After several members of a camping party had stumbled over the tent stakes in the dark, one suggested the use of bottle caps as warning reflectors on the tips of the stakes. The lacquer was scraped from each cap to expose the shiny surface of the tin. In all but utter darkness, the caps can be seen easily.



Emergency Light on Small Boat

While fishing in navigable waters, I stayed too long and had to row back in the dark without a light on my boat. To avoid this happening again, I made a small light that could be stored in the boat for such an emergency. An auto dash-lamp bulb and socket were mounted on the end of a stick, which was fitted with a clamp for attachment to the side of the boat. Dry cells were used to light the bulb.—Geo. J. Oslaender, Richmond Hill, N. Y.

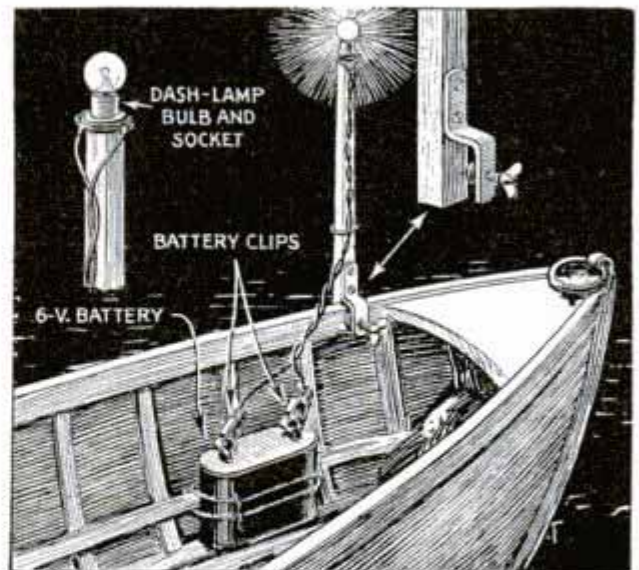

Auto Dash Lamp Mounted on Stick Serves as Emergency Light for Small Boat

☐ When no rosin is at hand, a glazed and slipping belt can be made to grip by throwing a handful of ashes on it.

An Efficient Ice Box for the Camp or Cottage



You need have no worries about food spoilage at your camp if this ice box is used. The secret of its efficiency lies in its adequate insulation and close-fitting lid, which has an air-cooled top as further protection if the box must be exposed to the

sun on an open porch. Construction is simple. The only extra precaution necessary is to see that the lid fits perfectly. Note that the sills "A" are nailed flush with the bottom, and the corner pieces "B" and "C" rest on them. After filling the hollow walls with insulating board and crumpled paper, the piece "D" is applied to seal the compartment. Do not shred the paper, but tear it in half sheets so that air pockets will be formed.



Sheets of Colored Cardboard Rolled into Cylinders to Make Neat Window-Display Pedestals

Cardboard and Embroidery Hoops Make Neat Display Fixtures

A merchant, finding himself short of pedestals on which to display merchandise in his windows, made some neat substitutes from colored cardboard and embroidery hoops. The cardboard was cut into sheets of various sizes, which were rolled into cylinders and held with the hoops. The small hoop of each pair was fitted inside of the cylinder, and the large one outside. The upper ends of some cylinders were closed by placing a sheet of heavy paper under the outside hoop.

☞ Coal tar stains paint, and therefore it is necessary to insulate it with shellac. Remove as much of the tar as possible by scraping, and apply a thin coat of brown shellac. Paint will adhere to shellac, and the stain will not penetrate it.

“WHAT TO MAKE”

Popular Mechanics Craftsman's Guide

This 80-page book will be sent to you, postpaid, upon receipt of 12 cents

Check full of illustrations showing hundreds of useful and interesting things you can make, besides valuable and practical information that every home craftsman should have at hand. Whether you are interested in making things for the home, in building boats, models, toys or garden furniture, this standard reference book will be found indispensable. Also tells how other craftsmen have built up spare-time efforts to money-making enterprises.

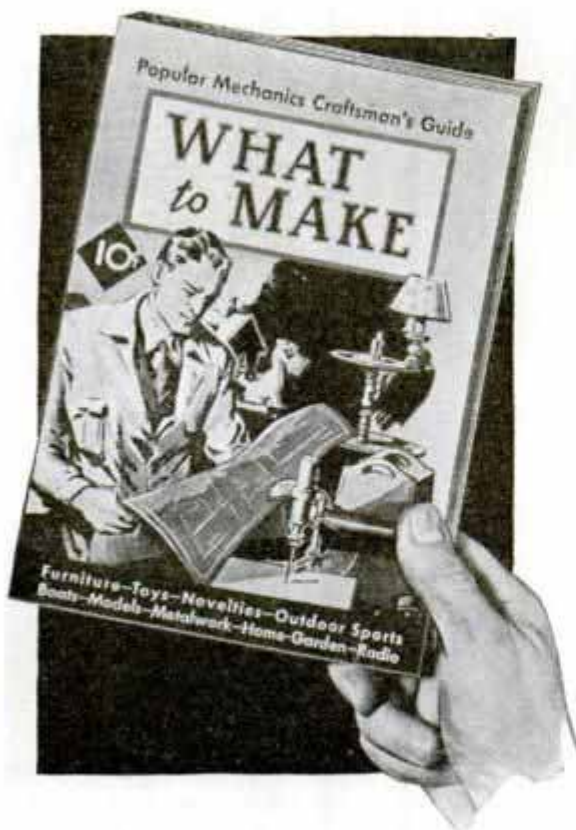

WHAT THIS BOOK OFFERS YOU

VITAL WORKSHOP REFERENCE DATA such as workbench construction, proper selection of tools, sharpening tools, taking correct measurements, motorizing your workshop, etc.

WHERE TO PURCHASE “HARD-TO-GET” MATERIAL AND SUPPLIES such as rare woods, fancy inlays, furniture ornaments and fittings, special hardware, Nichrome wire, tools, etc.

COMPLETE LISTING OF POPULAR MECHANICS WORKSHOP BLUEPRINTS, showing a picture of nearly every article as it will look when finished—383 things to make—ornamental shelves, tables, chests, chairs, hall clocks, cabinets, bird houses, lawn chairs, fences, trellises, arbors, toys, novelties, ship and train models, radios, rowboats, outboard racers and pleasure boats, metal work, electrical projects, home workshop machines, etc.

POPULAR MECHANICS MAGAZINE, Dept. B.P.C.
200 E. Ontario Street, Chicago, Ill.



REPAIR *Your Own* GOLF CLUBS

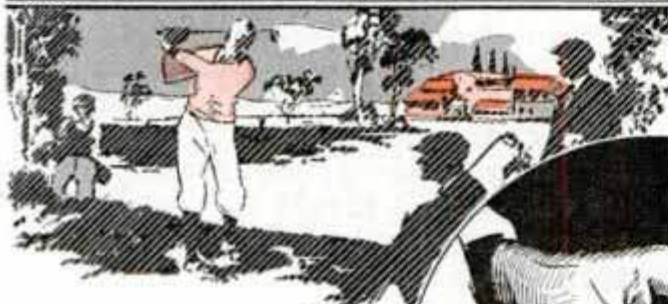

By
ELDRED C. JACKSON

THERE is nothing complicated in repairing your own golf clubs at home and the work can be done without much expense. Replacing loose or missing whippings, used on all clubs, is perhaps the most common repair. These whippings, used to finish off and hold the ends of the leather grip and as a covering and to strengthen the joint of the hosel of the club head and the shaft, are of pitched linen thread, which you can get from any shoemaker if you cannot find it elsewhere. Either 3 or 4-ply thread is the correct size and strength. Silk fishing line may be used and makes an excellent job. To start the whipping, make a sharp right-angle bend in the thread $\frac{1}{8}$ in. from the end. Lay this bent part parallel with the shaft and pointing in the direction you intend to wrap on the whipping. It is always best

to wind from the smallest diameter to the largest.

Hold the thread in position with the forefinger of the left hand as in Fig. 1, and commence turning the club away from you, guiding the strand with your right hand. When one complete turn has been made, see that the wrap is over the small bent portion and is on the side toward which the wrapping is to be wound as in Fig. 2. Guide the thread with considerable resistance to lay snugly against the previous turn as you continue turning the club, wrapping on all but six turns of the required amount. At this point, hold your left thumb on the last turn. Allowing your-

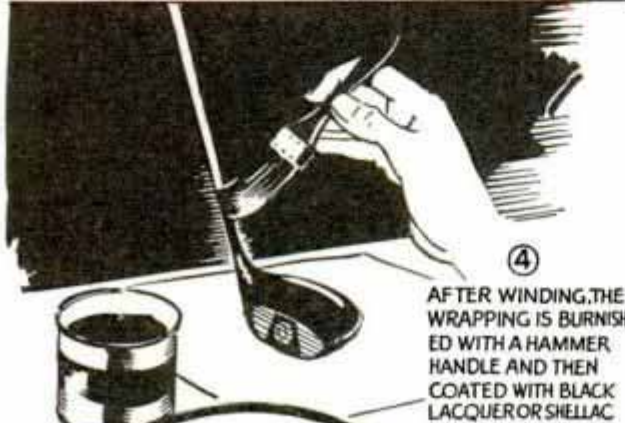
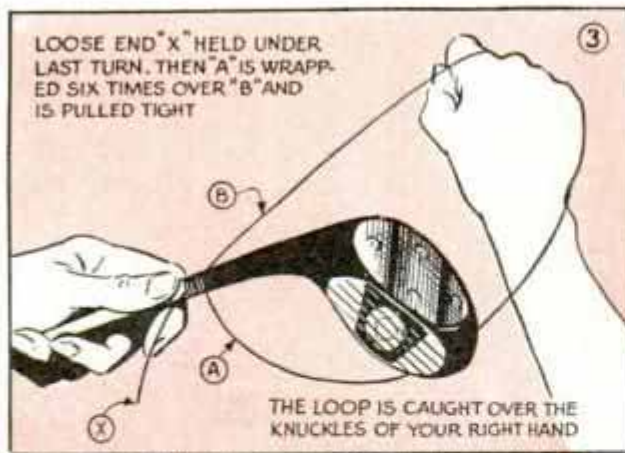

self plenty of slack, about two and one-half times the length of the club extending beyond the point at which you are working, place this point of the strand at right angles to and over the whippings, and under the thread projecting from under your left thumb. Now catch the loop of thread over the knuckles of your right hand as in Fig. 3. The strand in contact with your index finger is now loosely wrapped three times around the club by extending the hand to the limit of the loop, to beyond the end of the club. Pull the thread tightly as three more wrappings are wound on. Be sure the

whipping is wrapped over the thread laid at right angles to the wrap. The previously made loose wraps, you will see, have been eliminated. Pull the strand that is now under the whippings, being careful that no kinks or knots develop, which may break the thread or prevent a smooth finish. After all the slack is pulled through, you will see that the thread has overlapped itself and can now be cut flush with the whipping. When completed, burnish firmly with a hammer handle or similar smooth, rounded object. A light coat of clear or black lacquer or shellac, as in Fig. 4, adds finish and prevents chafing. This is the method used in the manufacture of golf clubs and is suitable for every whipping used on a golf club.

If the finish on your wood clubs—driver, brassie, spoon, cleek—has become scarred and whitened, you will find this a simple method to make them look like new. The old finish should be removed entirely. This is easily done by soaking the whole head of the club in acetone as in Fig. 5. As the wrinkled-up substance accumulates on the head, it should be wiped off and soaking continued until all the old finish is removed. Then go over the head thoroughly with No. 0 sandpaper or No. 00 steel wool, Fig. 6. Paint the face with clear lacquer or shellac. The color of the head will be somewhat lighter now than previously, which may be deepened with either shoe dye (ruby) which does not streak

when painted on, or potassium permanganate dissolved in water to the proportion of a pound to a gallon of water, into which the head of the club is dipped and allowed to stand for about ten seconds. A second application of either stain may be applied to bring the color sufficiently dark. When the head is thoroughly dry, apply mahogany colored wood filler. When it turns gray, wipe off thoroughly and rub lightly with steel wool. You are now ready to finish the head after the face and sole plates have been cleaned. Use steel wool to clean the plates. To clean the face, place the club head in a vise between two pieces of leather about 2 by 3 in. square and at least $\frac{1}{4}$ in. thick. A piece of belting or large scraps from the shoemaker will do nicely. Use a fine flat file on the face to clean down to the bare wood. With a 14-in. bastard file held flat on the club head face, move it back and forth parallel with the sole of the head as in Fig. 7. Be careful to move the file in the same grooves and to score equally deep and definite over the whole



⑧ RECONDITIONING THE LEATHER GRIPS

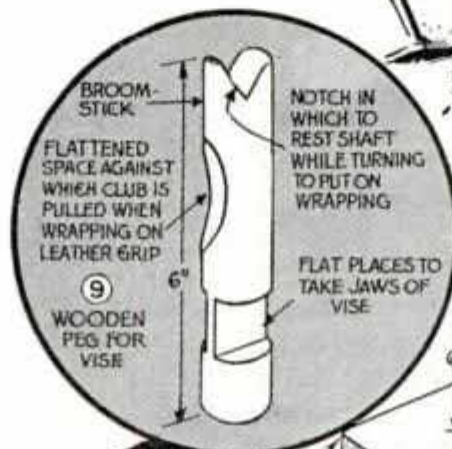

⑨

WOODEN PEG FOR VISE

6"

BROOMSTICK

FLATTENED SPACE AGAINST WHICH CLUB IS PULLED WHEN WRAPPING ON LEATHER GRIP

NOTCH IN WHICH TO REST SHAFT WHILE TURNING TO PUT ON WRAPPING

FLAT PLACES TO TAKE JAWS OF VISE

BROOMSTICK

6"

18"

ROUNDED CORNERS

4"

6"

WOODEN ROLLER FOR GRIPS AND UNDERLISTING

⑩



⑪

face. Double scoring may be achieved by moving the file across the face at the proper angle to make diamond-shaped spaces between the scores. Then wrap a piece of fine sandpaper around a small file and go over the whole face lightly and also take down any sharp edges on the sole plates.

You are now ready to varnish or lacquer the head. If varnish is to be used, outside spar is best, which may be brushed or sprayed on. Two coats give best results. If you wish to bring out the stampings on the head, put white water color or powdered zinc white, made into paste form with a little water, into the indentations between the two finishing coats. Wipe off the excess of white when dry with a moist cloth. Also go over the surface lightly with No. 00 steel wool between coats after which the head should be wiped off thor-



oughly with a clean cloth before the second coat. If clear lacquer is to be used, it may be brushed, dipped or sprayed and gives a fine finish, but great care must be taken so that the face and sole plates do not become stained. Two coats give best results. Except to put white in the stampings, do not touch the head between coats. When the finish is thoroughly dry, go over with auto-finish cleaner on a cloth, which takes off the shine and gives a satiny finish. A whipping over the joint of the hosel and shaft completes the job.

You may find it necessary or desirable to recondition the leather grips on some or all of your golf clubs. The job is not difficult and your clubs will feel much better in your hands. The leather must be taken off carefully, starting at the lower end by cutting the old whipping. Unwrap completely, taking care not to break the leather at the very last where it has been fastened by a tack, which should be pried out. Unless the leather is very badly out of shape, it may be used again. Otherwise a whole new leather grip will be needed. If hollow places show up in the underlisting or foundation material onto which the leather is wrapped, pieces or strips of tire tape should be wrapped on and cut cleanly where the piece stops, and the edges filed by a pulling stroke. Of course, the tape is wrapped on in a spiral the same as the grip. You will do a better job with the assistance of a wooden peg, for your vise, and a roller, as shown, Figs. 8 to 10 inclusive. The roller should be used now on the underlisting to make it smooth and

free from bumps before starting to replace the leather. The leather is started by putting a tack, one with a very small, flat head so the head won't wear through the overlapping part of the grip, in the end of the tongue of leather, which should be placed flush with the top of the shaft or end plug and on the back. Slightly thinned glue will be needed to hold the leather as it is wrapped on. After the tack has been put into place, brush glue on the underlisting for about 6 in., covering all around. Hold the shaft in the left hand and against your left hip, resting the free end of the shaft against the peg in the vise as in Fig. 11. Manipulate the leather with your right hand. Turn the shaft away from you. Guide the leather with quite strong resistance and pinch the sides to buckle it slightly as it rolls onto the shaft. Pay particular attention that the edge against the previous wrap is tucked in neatly and smoothly. After the first two turns are on, considerable pull against the wrap should be applied to make a good tight job. Apply more glue in advance of the wrapping. When the last of the leather or enough of it has been wrapped on, put a piece of tire tape around to hold it from unwinding and to free your hands for putting on a whipping. The grip may be a trifle shorter than it was previously. The extra space may be covered with thread, a fragment of other leather, colored leatherette or any flexible, durable material. The whipping is started at the lowest point, several turns made and then a long sweep of the thread to a point just below the leather, and regular whipping put on from there until at least $\frac{1}{2}$ in. of the leather is covered. Wipe the excess glue off the grip with a damp sponge and roll smooth with a wood-block roller as in Fig. 12. A light coating of lacquer or shellac on the whipping completes the job.

Clubs with shafts having other than chromium-plated finish may be cleaned and made to look like new by rubbing with No. 00 steel wool followed by a brisk polishing with floor wax on a piece of thick, moderately hard felt. Iron heads of clubs may be kept bright by scouring them with ordinary household scouring powder.

☛ Burnt umber with white and orange-chrome yellow will give a variety of clear, warm drab colors.

Kit of Plywood Has Individual Tool Pockets

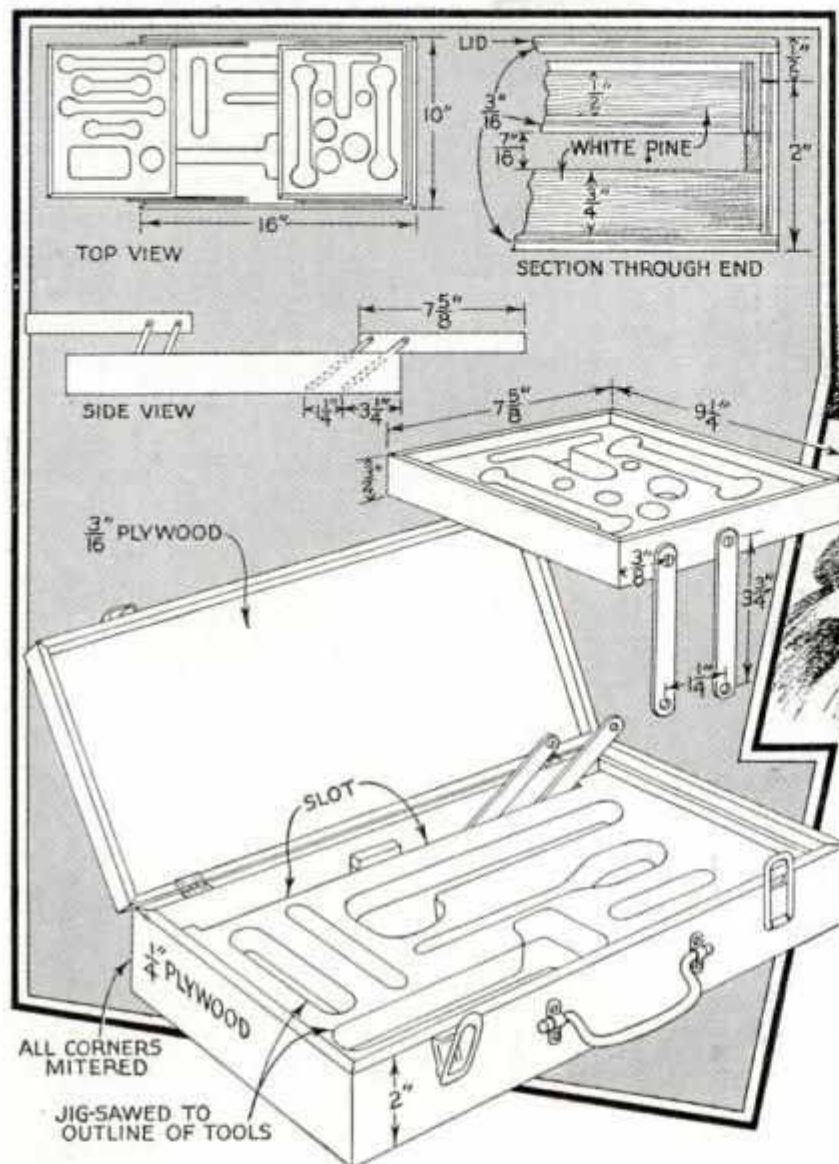

The latter tray is slotted at the back to accommodate the arms, which are pivoted to it. Each tray is filled with a pine block in which slots or pockets are cut to take the tools, each pocket being cut to the contour of the particular tool

Workmen who must carry a number of small tools to their work will find this light, compact tool kit handy. It consists of a mitered plywood case containing three trays, two of which swing upward on flat-iron arms when open, and rest on top of the third tray in the bottom when closed.

it is to hold. In this way, there is little possibility of any tool being forgotten as an empty pocket will be noticed when closing the case. Installing a couple of strong trunk fasteners to hold the lid and a handle with which to carry the kit completes the job.

Metal Clips Hold Sticky Fly Paper in Roll



Loose sheets of fly paper, when spread about on showcases and counters, or even in the home, are generally a source of annoyance and embarrassment

which can be avoided if the sheets are rolled, with the treated side in, and the ends held with metal paper clips. The heavy clips prevent the sheets from rolling about, and a piece of candy or sugar inside the cylinder will serve as a bait.

When the keyhole in the end of a drill-chuck screw is worn, drill a hole in the other end of the screw and broach or cut it out square to fit the key.

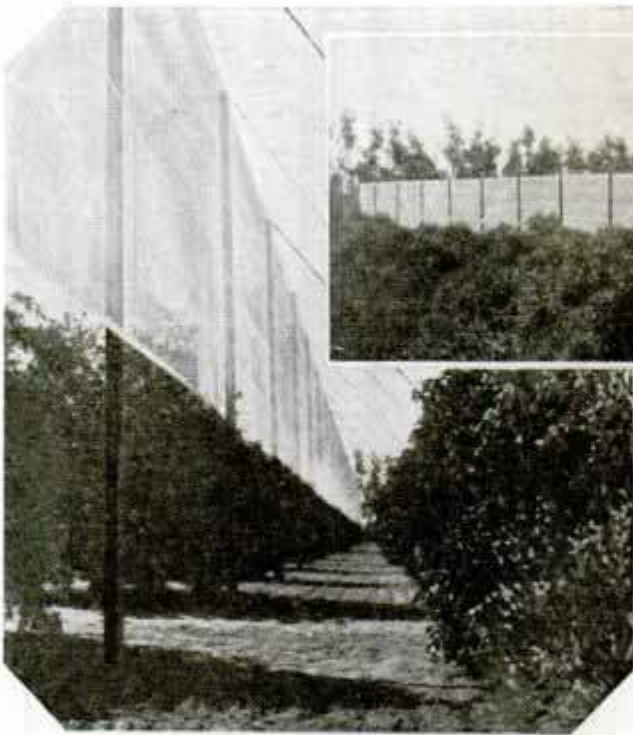

Huge Windbreaks of Wire Mesh Fastened to Tall Posts Protect This Orchard against Strong Winds

Wire-Mesh Windbreak Protects Citrus Orchard against Wind

Running across an orchard at 330-ft. intervals, these huge wire-mesh windbreaks are used by a farmer in the citrus-fruit belt of southern California to protect his trees against high winds that blow in from the Mojave desert. The windbreaks consist of heavy $\frac{1}{2}$ -in. wire mesh fastened to 4 by 6-in. pine posts, which extend 29 ft. above the ground. The wire reaches from the top of the posts to within 9 ft. of the ground. To withstand the strain of the wind, which at times reaches 70 m.p.h., the posts are slanted slightly toward the wind, and set 3 ft. into the ground.

Electric Bug Killer Rids Greenhouse of Moths



Based on the fact that bugs are attracted to a bright light at night, this bug killer is constructed for use in greenhouses and conservatories to destroy moths and small butterflies whose eggs pro-

duce leaf-eating larvæ. A square baking tin is fitted with a vertical baffle plate in the top of which is cut an opening to take a 100-watt electric lamp. Two hooks of heavy wire are soldered at the top of the opening and rubber-insulated wire is looped through them and passed

around the top of the light socket for support, brace wires being soldered to the pan and baffle plate. In use, the pan is partly filled with kerosene in which the bugs fall when they fly against the baffle plate while circling the light.—Paul E. Rimbey, Roodhouse, Ill.

Safety Razor Brands Cooperative Shippers' Cattle

Members of a Wisconsin cooperative shipping association who often had difficulty in separating their stock upon arrival at the city market, on account of the stamped or painted brands being obliterated, used a safety razor to clip or shave



Brand Shaved on Hip Identifies Cattle Handled by Cooperative Shipping Association

the brands on the animals' hips. The corners of the razor blade were ground off as shown in the illustration to cut off a narrow width of hair.

A BELT SANDER *for the Lathe*

FOR a few cents and a little work, you can have a belt sander that can be fitted to your lathe in a few moments, ready to finish either flat or curved work. Some inexpensive pipe fittings and a bicycle pedal are all you need. Construction is simple as shown in the photos and drawing. The general assembly is much neater if fittings without flanges are used. The

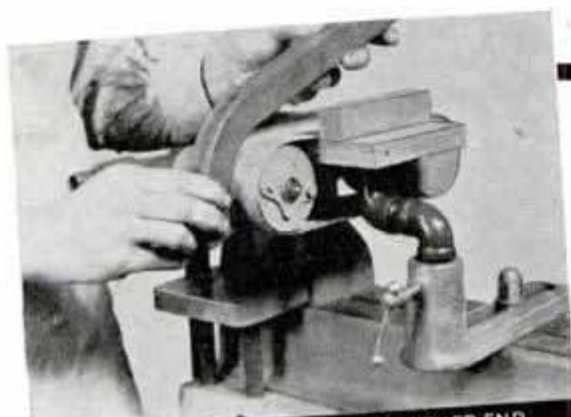

CURVED WORK READILY SANDED AT EITHER END

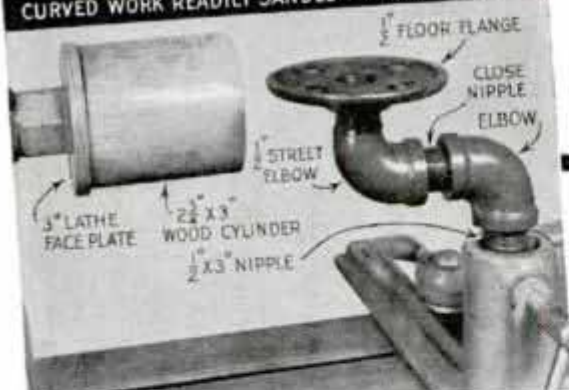

SANDING TABLE SUPPORT MADE OF 1/2" PIPE FITTINGS



BICYCLE PEDAL PROVIDES A BALL-BEARING SPINDLE

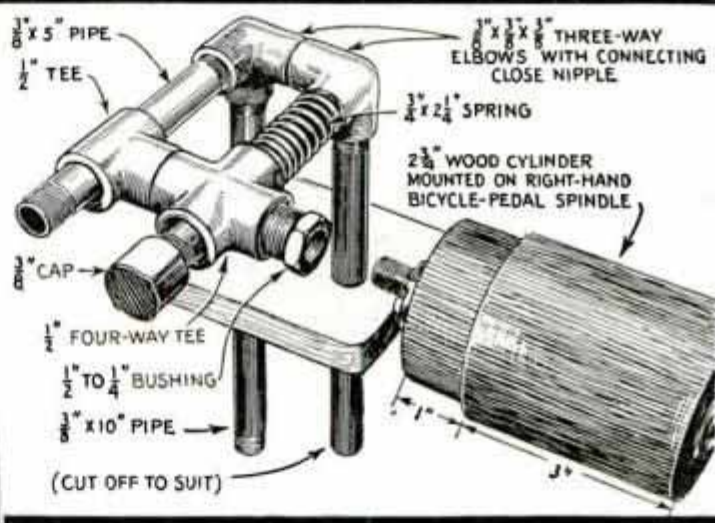

sanding table is supported in the lathe tool post, and one of the wooden rollers, which carry the belt, is screwed to a lathe face-plate, the other roller being supported by the pipe-fitting assembly. This roller is mounted on the bicycle pedal. The 1/2-in. tee and the 1/2-in. four-way tee, which carry the roller, are connected with a close nipple. These two fittings are a sliding fit over the 3/8-in. pipe arms, tension on the belt being supplied with a compression spring. The bushing reducer at the outer opening of the four-way tee will take the threaded end of the bicycle-pedal spindle. The whole unit is arranged to slip into holes drilled in the lathe bench. The block over the vertical supports presses against the lathe headstock and prevents any side play or end movement.

Time Saved in Putting Paper Covers on Dry-Cleaned Garments



Large Bag Holder Screwed to Wall Keeps Paper Covers Handy for Dry-Cleaned Garments

I have found that one of the simplest methods of putting dry-cleaned garments inside paper covers is to fasten a number of the covers on a wall with a large paper-bag holder of the type shown. Then, by using a yardstick with a hole drilled in one end to take the hanger hook, a garment can be inserted into the cover very easily by holding the bottom open with one hand and pushing the garment into it with the other one. Then a jerk will pull the cover loose from the holder.—Wm. T. McKenna, Los Angeles, Calif.

Simple Method of Tracing Pictures on Mimeograph Stencils



In many offices, where mimeographing machines are used, occasions sometimes arise where an illustration would enhance the value of the literature, and no reflector or copying device is at hand. In such a

case, the picture may be traced easily by placing the stencil over it and holding the assembly against an outside window so the picture shows through the stencil.

Graphite Lubricates Tailstock Center

When it is desirable to prevent staining the end of a piece of wood, which is being turned in a lathe, use paste graphite instead of oil to lubricate the tailstock center. The graphite will not stain the wood as deeply as oil so that the stained portion can be sanded off easily.

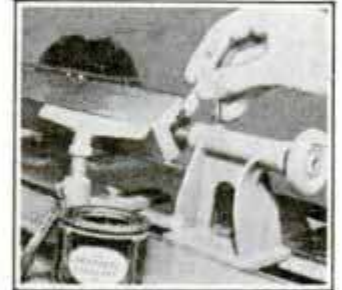

Slotting Castellated Nuts

Having a large quantity of castellated nuts to slot, which did not warrant making a fixture for the purpose, the work was done in a milling machine with the aid of an indexing-head chuck as shown. Instead of slotting one nut at a time, as is generally done, seven were held in the

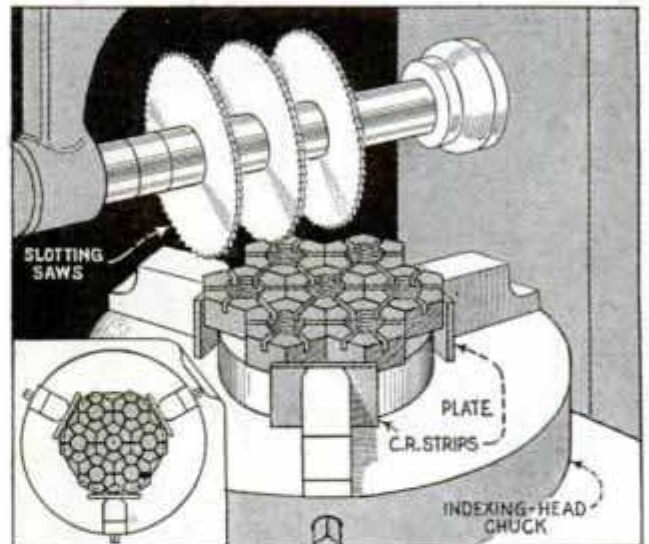

Indexing-Head Chuck Holds Several Castellated Nuts to Slot Them in Milling Machine

chuck and three saws used in the machine. A plate was placed under the nuts to raise them above the chuck so that they could be slotted without the saws coming in contact with the jaws. The work was indexed for three divisions as usual.—Charles Kugler, Philadelphia, Pa.

Indicator Simplifies the Use of a Dumb-Waiter

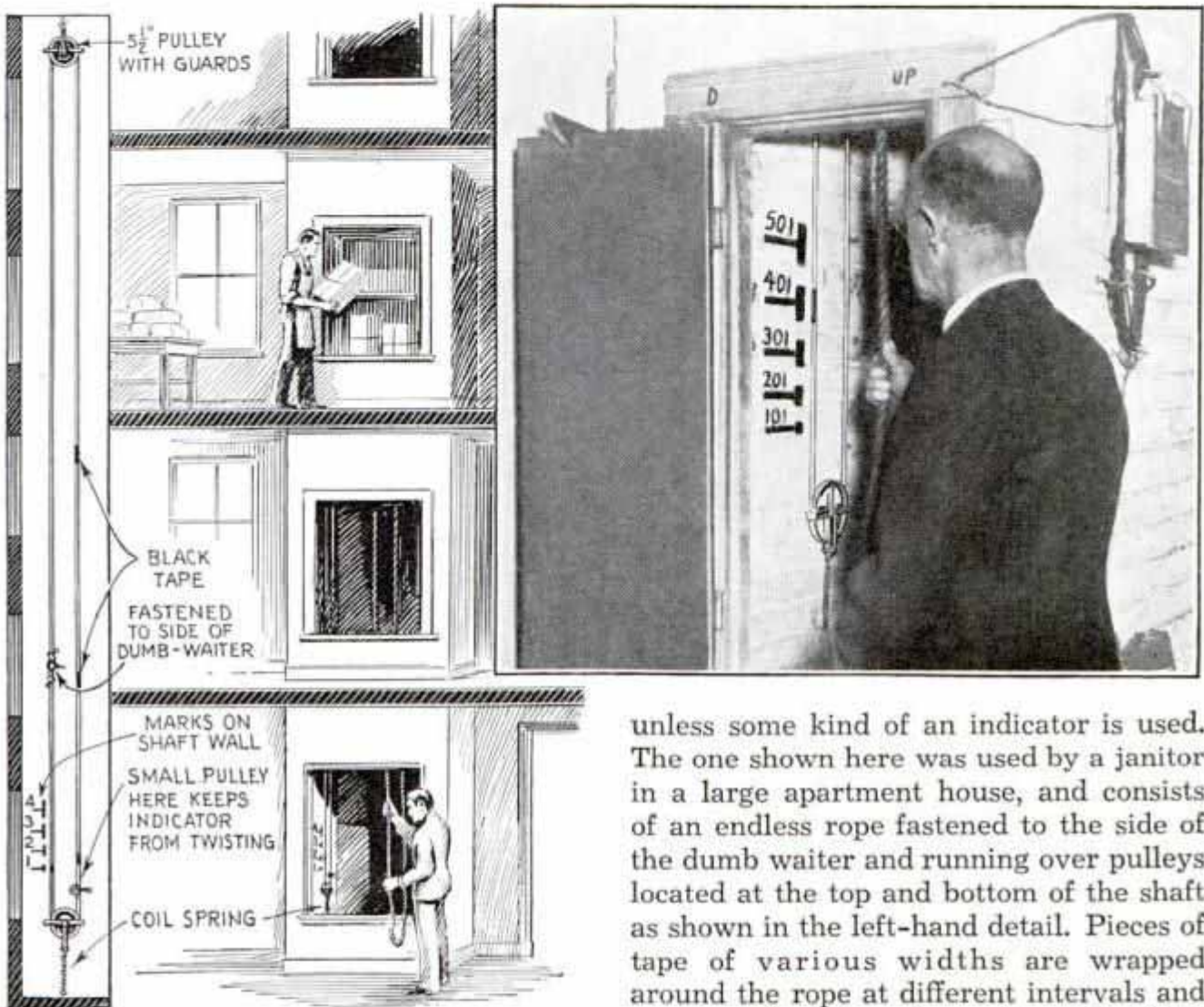

When a dumb-waiter is installed in a building and operated from the basement to make deliveries to the floors above, difficulty is often experienced in determining when the waiter reaches the various floors,

unless some kind of an indicator is used. The one shown here was used by a janitor in a large apartment house, and consists of an endless rope fastened to the side of the dumb waiter and running over pulleys located at the top and bottom of the shaft as shown in the left-hand detail. Pieces of tape of various widths are wrapped around the rope at different intervals and correspond with marks on the wall at the basement entrance of the shaft. When the dumb-waiter has reached a certain apartment, the width of the tape on the rope is opposite a mark of equal length.— J. W. Ainge, Jersey City, N. J.

Making a Battery Hydrometer More Useful

Mounting house-lighting batteries on shelves instead of stepped tiers is a space-saving arrangement, but tends to make testing the electrolyte a difficult job as hydrometers do not read accurately when held at an angle. This difficulty may be overcome by slipping a short length of rubber tubing of a suitable size over the rubber tip of the hydrometer. This added length makes it possible to reach the battery cells easily while holding the barrel of the hydrometer in a vertical position.





Kegs Supported by Brackets Take Place of Bins Ordinarily Used in Dispensing Nails in Stores

Kegs Supported to Dispense Nails

To save time and labor, a merchant supported his nail kegs at an angle by means of brackets so that he could dispense the contents to his customers directly from the kegs. The brackets were made from iron or steel rods bent to the shape shown. Besides supporting the kegs, the brackets also served as runners on which the kegs were slid under the counter, thus occupying space used ordinarily for nail bins.

Fountain Brush Flows Acid for Large Soldering Jobs

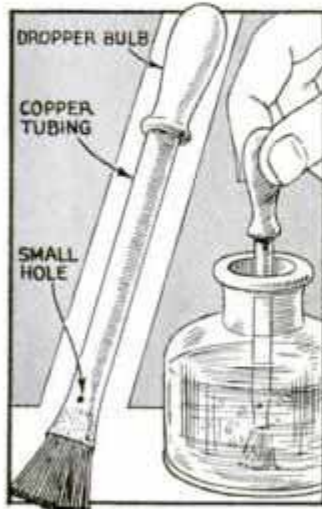

On soldering jobs, such as eave troughs and other sheet-metal work, where a quantity of flux must be applied to a single joint, this fountain brush will save both time and labor. To make the brush, insert coarse strands of rope into one end of a small copper

tube, and flatten the end to hold them securely. Then drill a small hole through

the side of the tube just above the bristles, and slip a medicine-dropper bulb over the opposite end. The brush is filled in the same way that you would fill a medicine dropper, after which the flux runs slowly out of the hole onto the bristles.

Tape Holds Pencil on Glove Finger

Annoyed by the difficulty of picking up a pencil when wearing gloves, a shipping clerk attached it to the index finger of the glove by means of a piece of adhesive tape. This leaves the hand free for moving crates or boxes, yet the pencil may be grasped readily between the thumb and forefinger when there is writing to do.



Shop Dustpan Improved with V-Shaped Strip of Tin

Metal turnings and small pieces of scrap material that accumulate on the shop floor, are often difficult to sweep up because they roll out of the dustpan as fast as they are swept into it. To avoid this trouble, solder a V-shaped strip of tin across the bottom of the pan at an angle as shown. This will help to retain the sweepings and will not interfere with filling the pan.

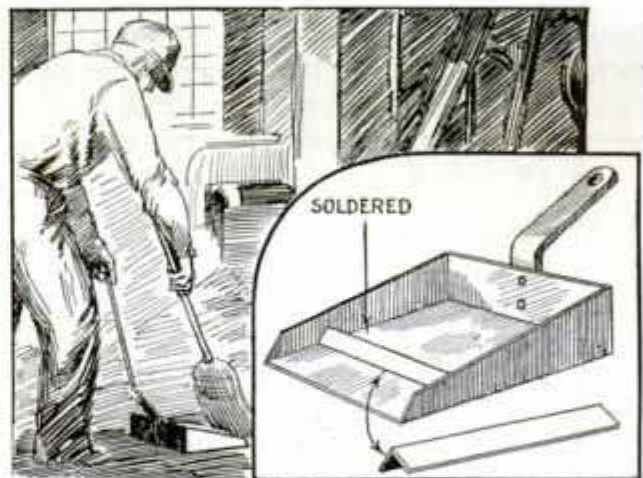

Tin Strip Soldered to Bottom of Dustpan Aids in Sweeping Up Scraps on Shop Floor

☐ A good rule to follow when grinding milling cutters is to allow 7° clearance for roughing, and 5° for finishing, the cutters.

TOURISTS' CABINS



that get the business

IF you live near a well-traveled highway, or can lease space near one, a few low-cost tourists' cabins of the attractive type shown will afford you a substantial income during the summer months. If the cabins are erected in a well-kept grove where there is an adequate supply of pure, fresh water, so much the better. Also, electric lights are an added inducement to tourists.

Figs. 1 to 5 show a neat, inexpensive cabin that will accommodate a double bed, a small table and two chairs. In the forward corners triangular shelves

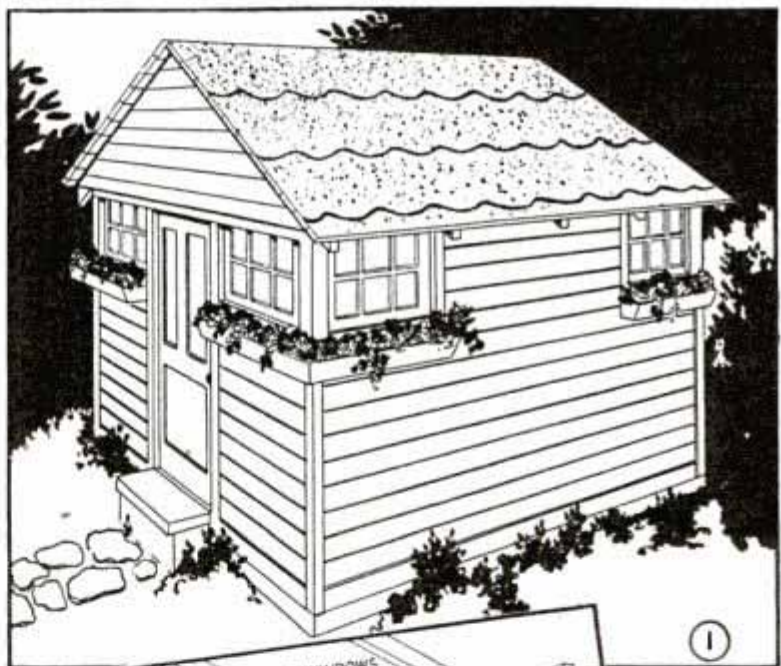

An Inexpensive Cabin That Is Compactly Arranged to Comfortably Accommodate Two People; All Windows Open Inward to Afford Good Cross Ventilation

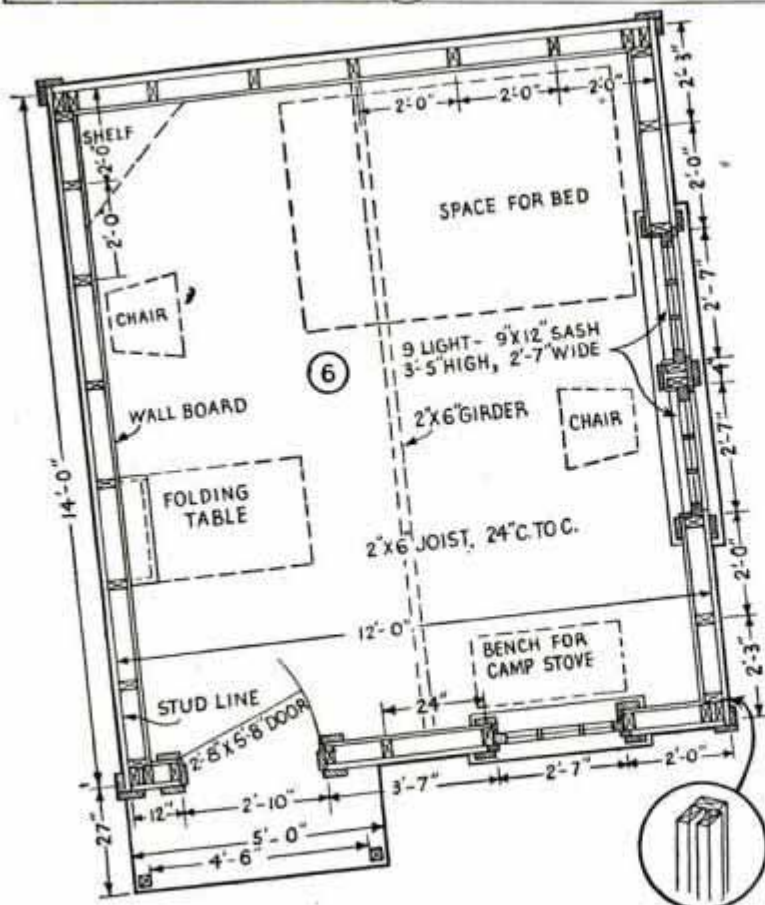
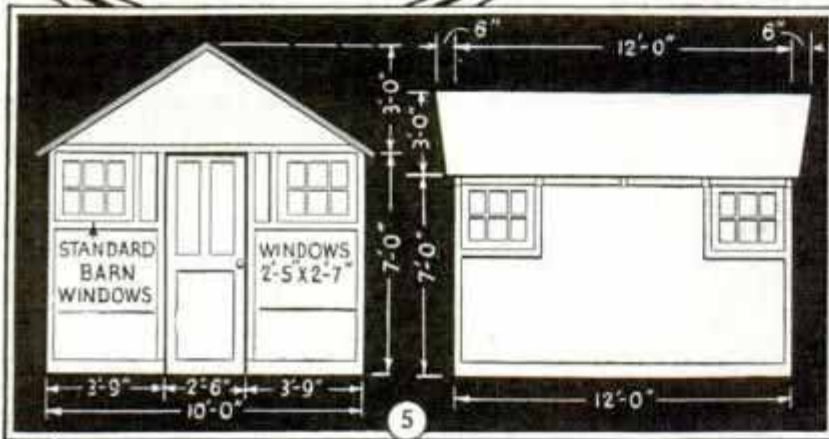
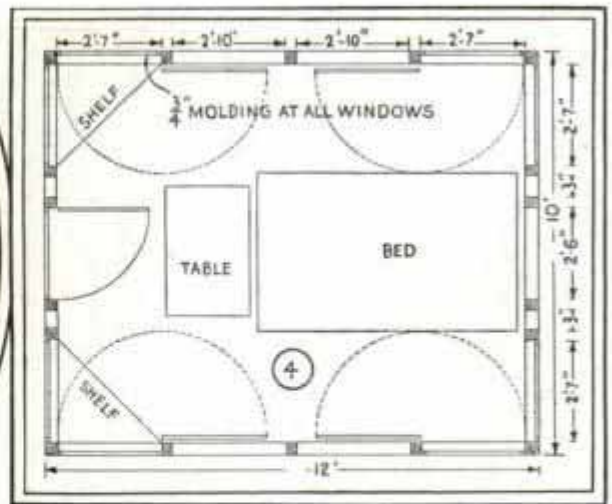
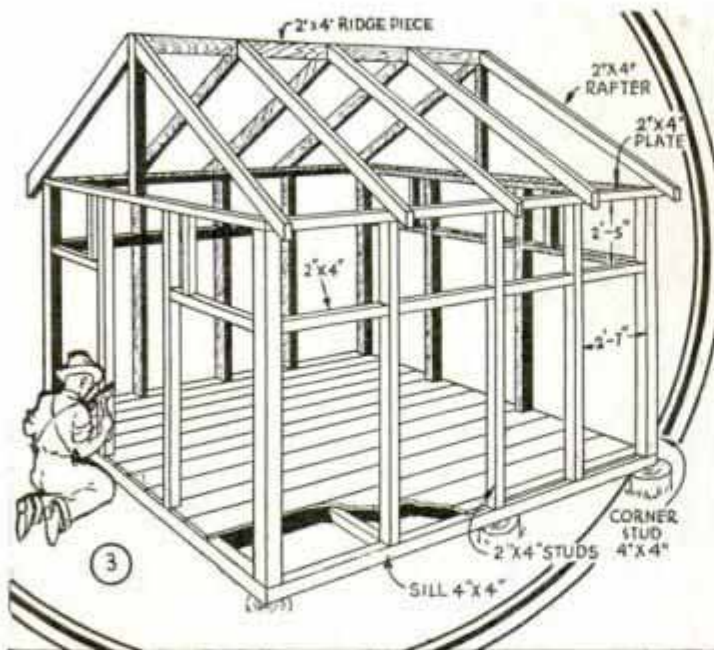

are placed low enough to permit opening and closing the windows, yet high enough from the floor to support clothes on hooks which are screwed to their undersides. The studs of the cabin are spaced to accommodate the windows, which are standard sash hinged to swing inward so that they can be opened and closed from the inside. The cabin may be covered with clapboards, log siding or other sheathing and then painted.

Any good roll roofing may be used. For protection from summer insects, screen wire can be stretched across the outside of the window frames before the molding is nailed on, and a screen door hung outside the regular one. A porch lantern placed over the door, and flower boxes hung just below the window sills will effectively dress up the exterior of the cabin.

The cabin pictured in Figs. 6 to 11 is a little different in that it is finished inside with wall board, and has a small porch over the door. The porch is a continuation of one corner of the roof, and is very simple in construction as shown in Fig. 9. Also, it has a built-in cabinet, the door of which folds down to provide a table. This is covered with oil cloth or other waterproof material for easy cleaning.

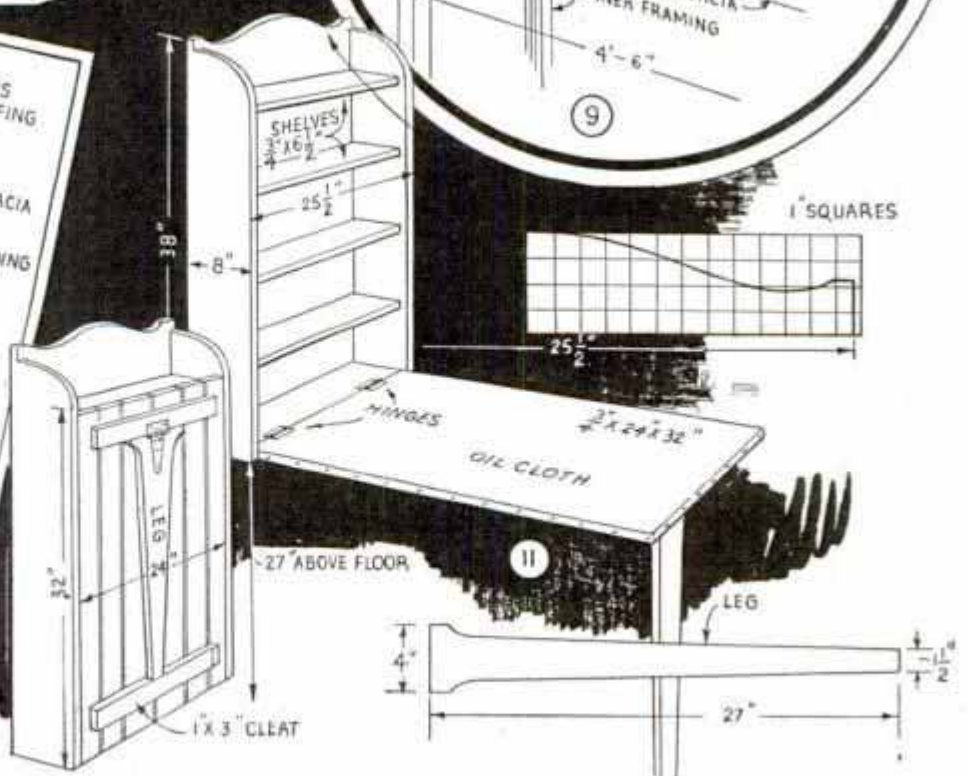
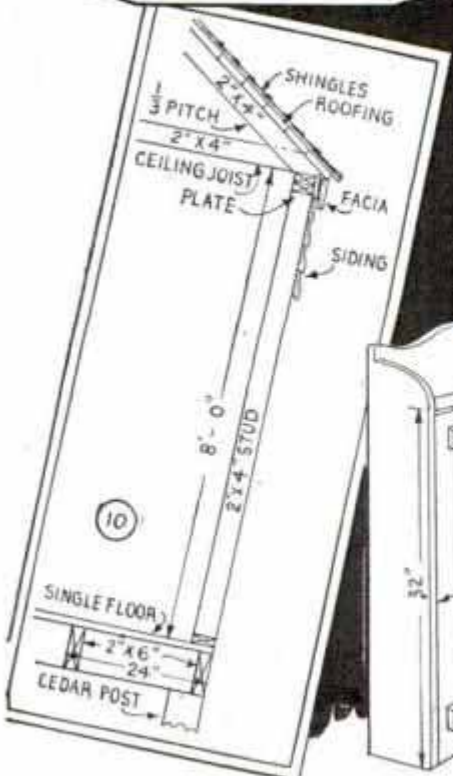
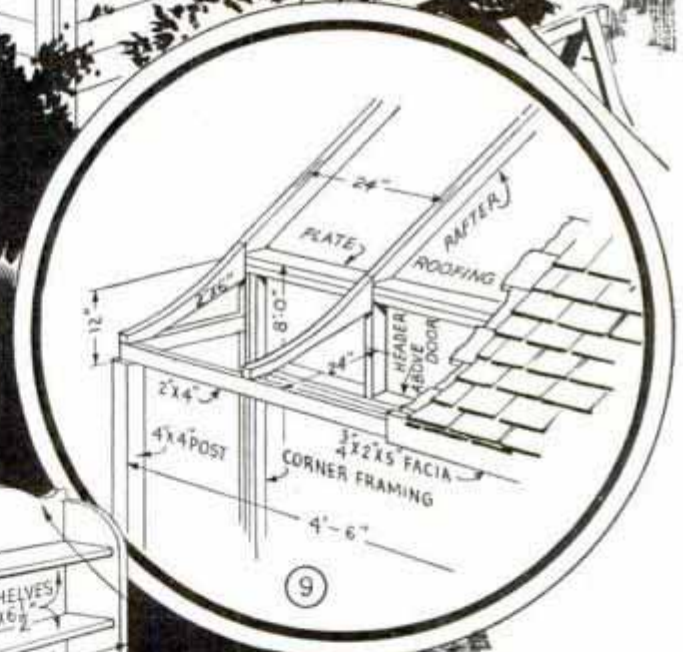
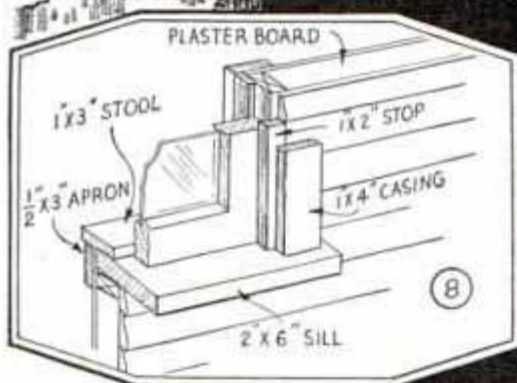
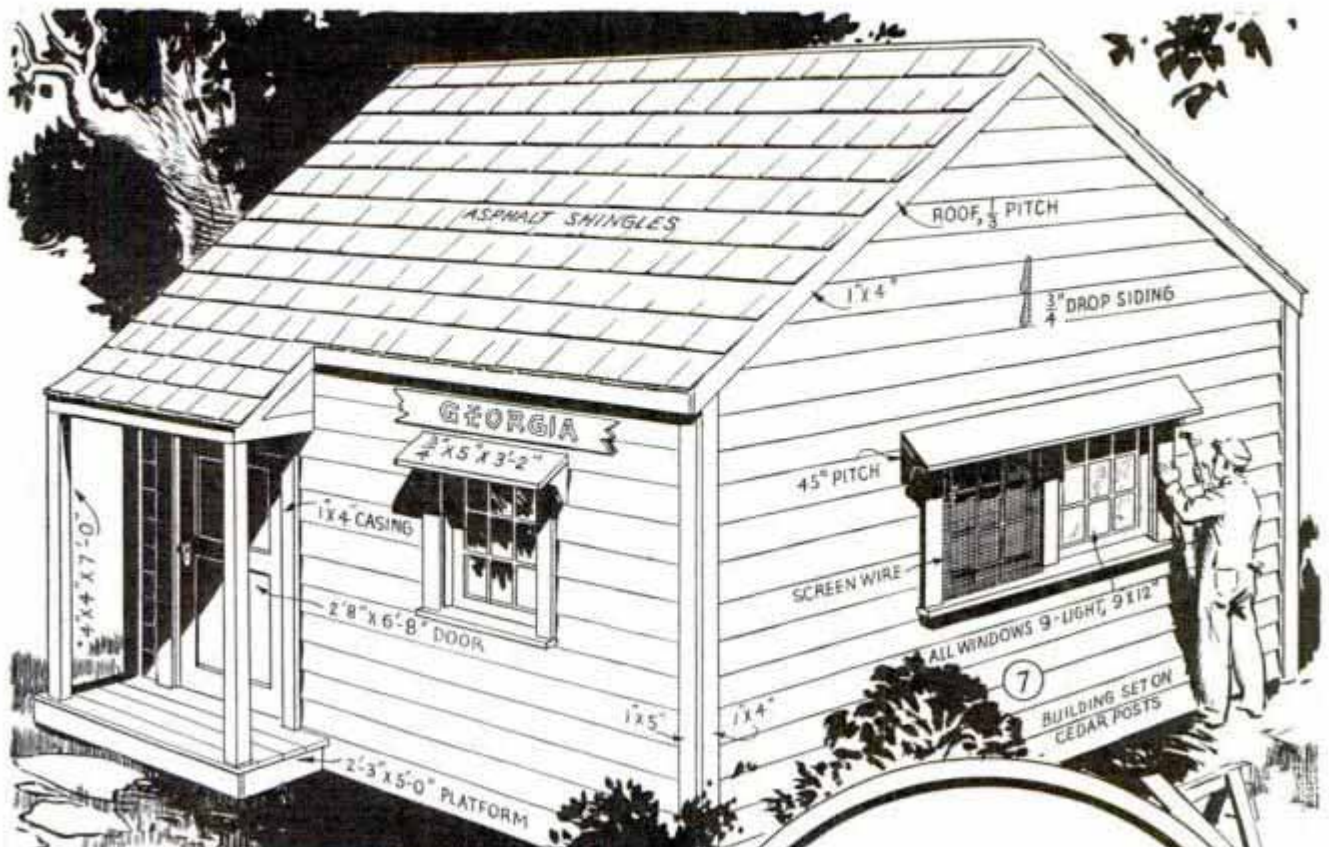

Wall Gauge Simplifies Glass Cutting

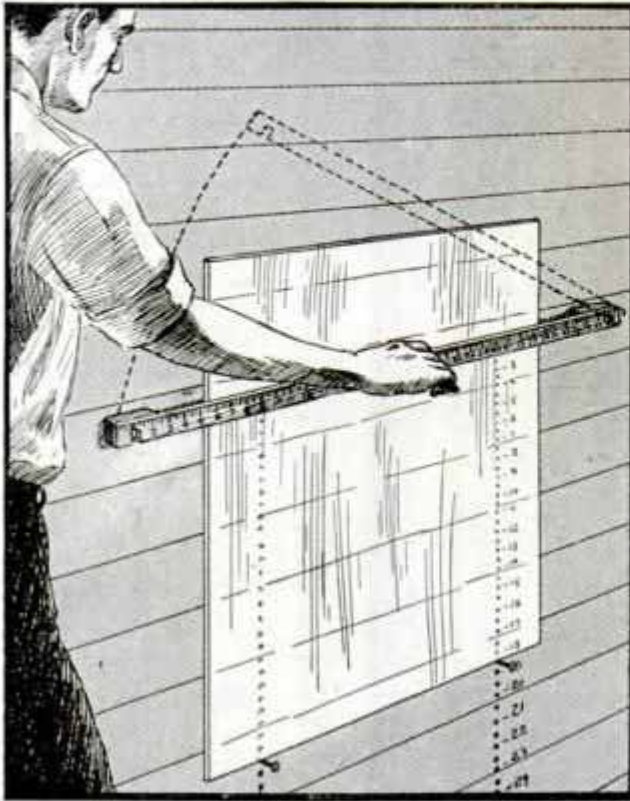

Gauge on Wall Aids in Cutting Glass in Shop or Store Where Bench Space Is Limited

In a store or workshop, where bench space is often limited, a simple measuring gauge may be made for cutting glass on the wall. Two blocks are screwed to the wall and a yardstick is pivoted to one of them, while the other carries a screw, which projects to engage a slot in the free end of the stick. Below the blocks, a number of small holes are drilled in the wall at $\frac{1}{2}$ -in. intervals to take a couple of heavy nails, which serve as stop pins to support the glass to be cut. These holes are scaled in inches so that it is a simple matter to set the glass on them, drop the yardstick in place, and cut off a piece of glass to a specified size.

Rubber Hose Keeps Pliers Open for One-Hand Work

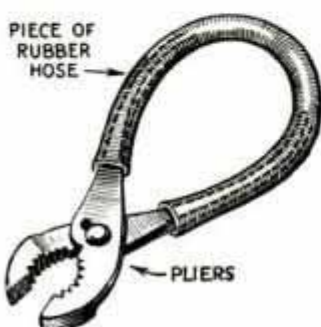

Garage mechanics, who are frequently inconvenienced in their work by trying to operate a pair of pliers with one hand, will find that a short piece of

rubber hose slipped over the handles helps to solve the problem. The hose tends to keep the jaws open, when the pliers are not gripped, so that they can be manipulated easily with one hand.

Holes Drilled at an Angle in Planer

For drilling a number of small holes at an angle in work under certain conditions, a planer will answer the purpose when regular equipment for this work is not available. A length of shafting was recently brought into our shop to have a V-groove planed in it. Also, ninety holes, 1 in. apart, were to be drilled on each side of the groove as shown. The entire job was machined and drilled in the planer at one setting in the following manner: A piece of steel was welded on each end of the shaft so that it could be clamped on the planer table. The clapper was removed and an electric drill was clamped to the clapper box. It is important that the center line of the drill be parallel with the line of motion of the down feed, the hand

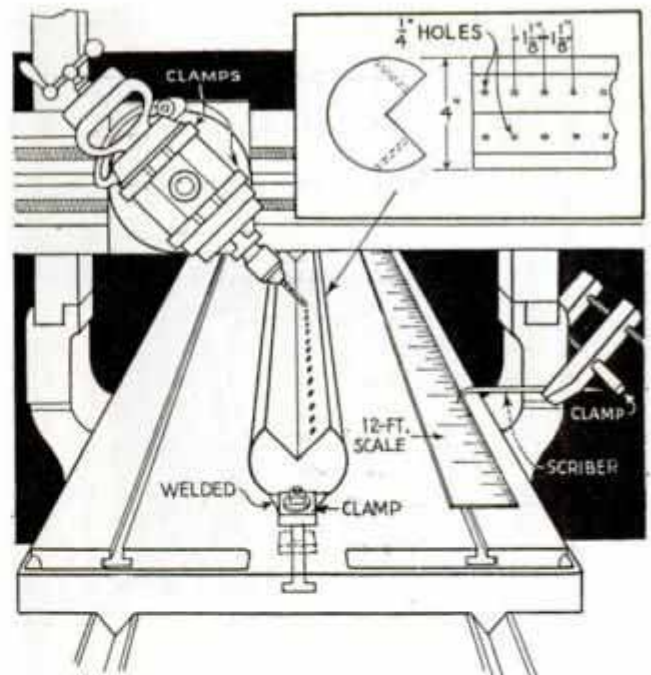

Long, Steel Shaft Grooved and Drilled in a Planer at One Setting

feed being used. For drilling the holes the correct distance apart, a 12-ft. scale was clamped to the planer bed, after which a scriber was clamped to the planer housing as shown. The table was moved by rotating the drive pulley by hand.—Chas. Kugler, Philadelphia, Pa.

Cylinder Heads Refaced in Milling Machine

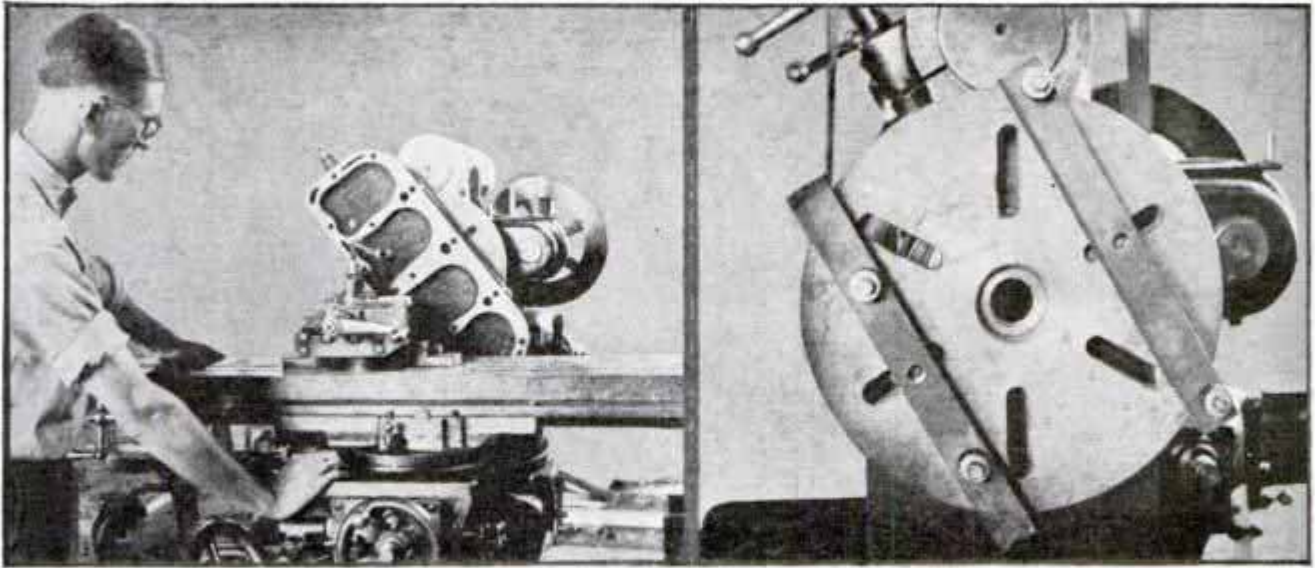

When it is necessary to reface a cylinder head in a shop where none of the machines are large enough to swing it, the job may be done in a milling machine by converting a faceplate to hold the head as shown. The faceplate is machined to screw on the milling-machine spindle, and has two 1½-in. steel bars bolted or clamped to it. These are drilled to take four locating pins, which are carefully matched to fit in the stud holes to turn the motor head. The latter

is clamped to the faceplate with two cap screws properly threaded to screw into the spark-plug holes. In use, the slide-over arm of the milling machine is backed into the clear, and the work rotates as the cut is made. Work up to 36 in. in diameter has been handled with a set-up of this kind. Also, wheel hubs may be bored out in a milling machine by clamping the wheel to the faceplate in a similar manner.—Jos. C. Coyle, Phoenix, Ariz.

Making Smooth Cuts in Sheet Metal with a Cold Chisel

When using a cold chisel to cut sheet metal, clamp the work in a vise so that the scribed line, where the metal is to be cut, is flush with the top of the vise jaws. Then, by holding the chisel as shown in the right-hand detail and tapping it with a hammer, you get a shearing effect that produces a clean-cut edge. Start the cut at the right side of the work with the chisel held at an angle so that it points to the left, and downward, with the short bevel resting flat against the top of the vise. A series of light hammer blows will be found more effective in producing a smooth edge than a few heavy ones. A cold chisel is often preferred to a tinsmith's snips because you can handle heavier metal and can cut more intricate shapes.

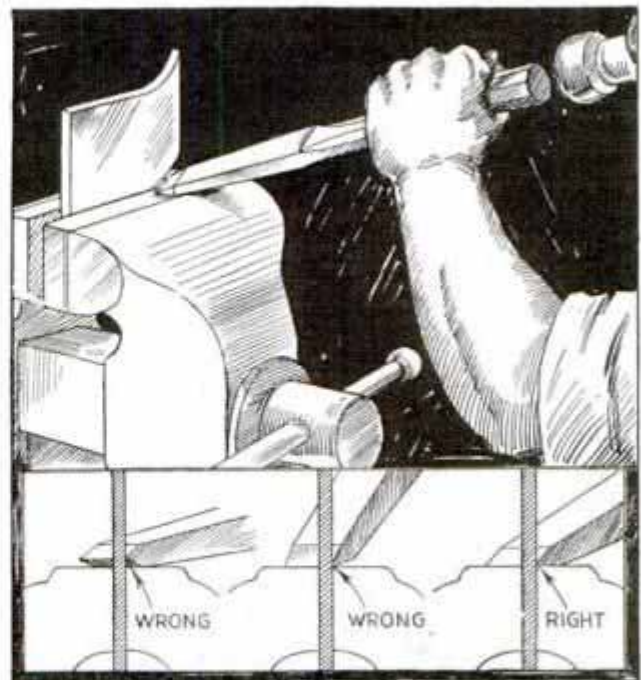

Sheet Metal Clamped in Vise so That Scribed Line Is Flush with Jaws to Make Smooth Cut with a Cold Chisel

☐ Aluminum can be melted in an ordinary crucible, but a flux should not be used, as a chemical combination will likely result.

Jig Holds Round Work for Drilling

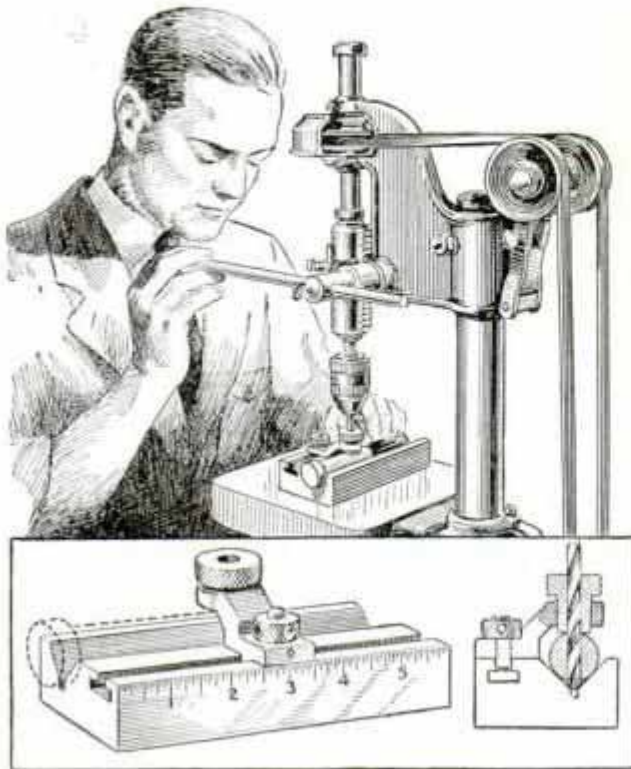

Adjustable Jig Made from a V-Block Simplifies the Job of Drilling Small, Round Work

In our shop, where we often have various sizes of screws and shoulder pins to drill cotter keys, this adjustable jig was made to hold them in the drill press. It is a V-block having a T-slot milled along one side of the top surface, in which a bracket is clamped to hold the drill guide. The latter is threaded and screwed into the bracket where it also serves as a set screw to hold the work steady in the block. A number of the guides are kept on hand for various sizes of work.—Elmer Felske, Cleveland, Ohio.

Brush-Cleaning Pan Saves Time in Paint Shop



To encourage care of expensive paint brushes in his workshop, a contractor soldered a piece of heavy screen wire across the top of a stewpan and kept this filled with a brush-cleaning liquid. By dipping

used brushes into the fluid and wiping the bristles across the screen the workmen may clean them in a few moments.

Holding Film Packs Firmly in Adapters

Most camera film packs do not fit an adapter snugly enough to prevent them from moving slightly, which tends to spoil the focus on one end of the picture. To eliminate this trouble, I shel-lacked two rubber strips inside the adapter cover as shown. Friction between the rubber and the pack tends to prevent the latter from moving.—W. Edward White, Plymouth, N. H.



Cutting Racks Longer Than Cross-Feed Travel of Milling Machine

Mechanics, in shops where there is no attachment for cutting racks that are longer than the cross-feed travel of the milling machine, will find that they can do this work by using two or more cutters to cut equal portions of the rack. This method, of course, requires careful spacing of the cutters so that all of the rack teeth will be spaced equally when the job is finished.—Chas. Kugler, Philadelphia, Pa.

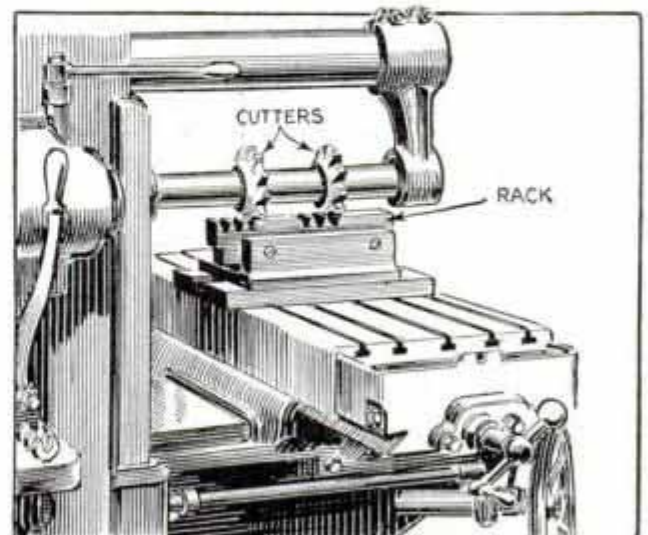

Two or More Cutters Used to Cut Racks Longer Than the Cross-Feed Travel of a Milling Machine

HELPS for the AUTO OWNER



Bugs and other foreign matter will come off a windshield easily if it is scraped with a pine block that has been soaked thoroughly in water. This idea is especially useful at filling stations if the block is kept in a bucket of water within convenient reach. Left, a short person will find that a wood block placed under the rear supports of a coach seat enables him to reach the pedals with more comfort than when a cushion is placed at his back. Below, two C-clamps will be helpful in mounting tires on drop-center rims. The clamps are spaced on the tire about 8 in. apart and then screwed on tightly to bring the beads together so that they will fit into the drop center

Above, a length of iron rod hooked over the short arm on a brake or clutch pedal, and connected to the car frame by means of a coil spring as shown, will keep a tension on the pedal and prevent it from rattling. Right, a piece of tape wrapped around an auto fuse and then cut off to provide a finger grip

Simple Repair for Worn Catches on Car Doors

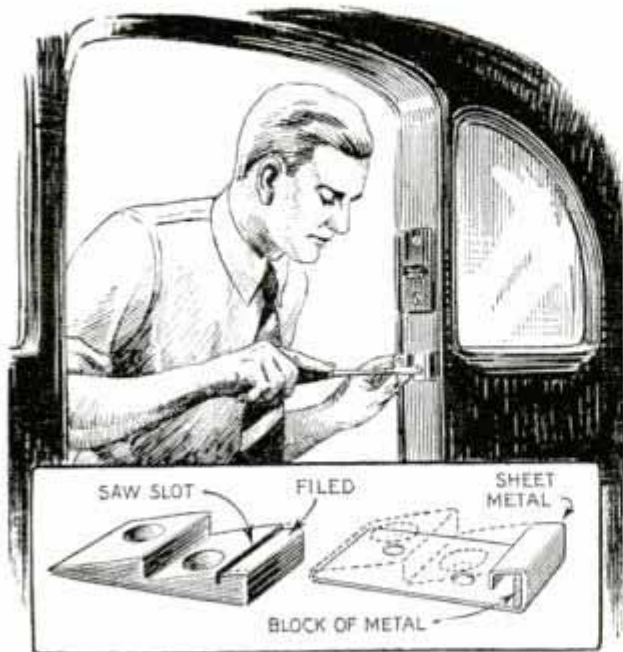

Worn Car-Door Catches Repaired with Sheet Metal Bent over the End to Take Up Play

An efficient method of compensating for wear in the door catches of your car, where there is no provision for adjustment, is to bend a piece of sheet metal over the end of the catch as shown in the detail. To do this, a saw slot is cut across the catch about $\frac{1}{8}$ in. from the end, after which the metal between the slot and the end of the catch is filed down an amount equal to the thickness of the sheet metal. One end of the latter is inserted into the slot and is bent over the end of the catch, after which it is folded over the back and drilled to correspond with the screw holes in the catch. If one thickness of sheet metal is not enough, a thin, metal block may be inserted at the end of the catch.—Walter N. Purdy, Chicago.

Cloth Serves as Emergency Repair for Damaged Zerk Fittings



When a Zerk fitting becomes nicked or slightly damaged in any way, it is almost impossible to grease the part with a gun as the lubricant squeezes out around the

nick when pressure is applied. As an emergency repair, I have found that a piece of cloth placed over the end of the gun serves nicely. The cloth is stretched tightly and is punctured by the end of the fitting, thus allowing the grease to pass, but effectively sealing the nick in the fitting.—V. Winemann, San Francisco, Calif.

V-Block and Knife Blade Cut Lengths of Radiator Hose

To do a smooth job of cutting different lengths and sizes of radiator hose, a repairman found the tool shown highly effective. To make it, two wood blocks are nailed together to provide a trough, which is fastened to the wall or workbench. A stout, sharp knife blade is then driven through one side of the trough at an angle. In use, the hose is forced down into the trough so that the blade is driven through the hose wall at the desired point. By turning the hose against the blade, the cut is quickly made around the entire circumference.

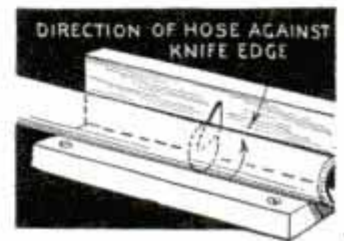

Locking Tie Rods of Front Axles Used on Trailers

When the front-axle assembly of a car is used for a trailer chassis, a good method of locking the wheels in proper alignment is to cut the tie rod in the center and bolt

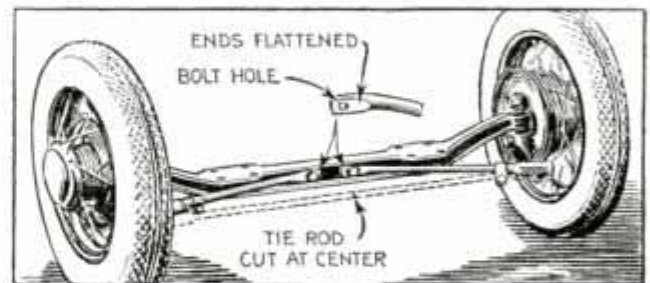

Simple Method of Locking Wheels in Alignment on Front-Axle Assemblies Used as Trailer Chassis

the ends to the axle as shown. Before bolting the tie rod, align the wheels so that they will be as straight as possible, allowing no toe-in. If the axle has adjustable king-pins, draw them up tight after the wheels have been aligned.

Notched Washer Holds Bolts

When repairing a car, it often happens that a bolt head cannot be reached to hold it while turning on the nut. In these cases, a notched washer is quite effective in holding the bolt from the end on which the nut is driven.



Three sharp notches are filed on the inner edge of the washer as shown, after which it is slipped over the threaded end of the bolt and a screwdriver held against it to make the teeth bite into

the threads as the nut is screwed down.—
E. T. Gunderson, Jr., Humboldt, Ia.

Button-Hook Serves as Tool for Generator Work

If you are working on an auto generator and have no tool at hand to lift the brushes, a button-hook will serve the purpose nicely. The tool is also handy to hold up the spring when installing a new brush. It may be necessary to alter the end of the hook slightly to fit the various generator-brush assemblies which may be encountered.



Priming Ford Fuel Pump

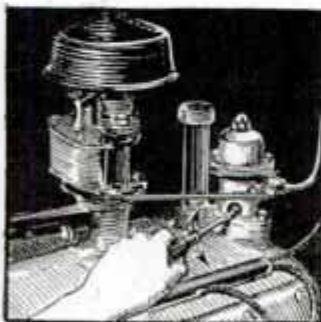

If it is necessary to prime a Ford fuel pump, this can be done very easily by inserting the blade of a small screwdriver through the vent hole under the pump and working

the spring up and down. Do this until the spring does not come down when it is raised, which is an indication that the pump is filled with gasoline.

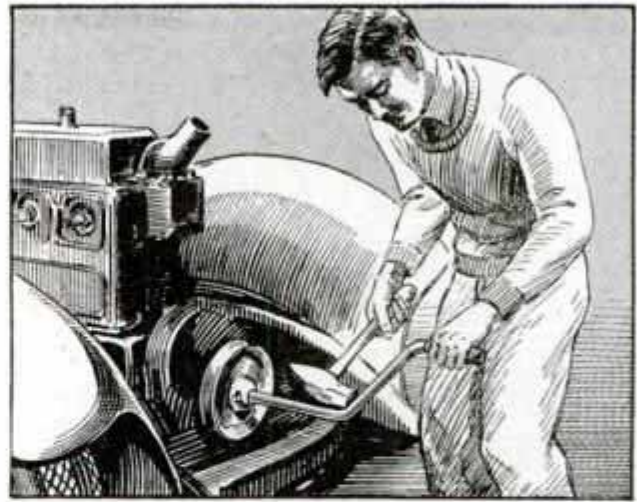

Fan Pulley Removed from Crank Shaft of Car Motor with Crank and a Hammer

Emergency Method of Removing Fan Pulley from Car Motor

Sometimes it is almost impossible to remove a fan pulley from a crank shaft because the proper tools are not at hand for this work. In such cases, I find that the job can be done by using the crank and a heavy hammer. The radiator is removed, after which the crank is put in place and struck a few sharp blows to loosen the pulley. The pulley can be replaced by striking the crank on the opposite side.—
Robert B. Powers, North Bennington, Vt.

Steering-Gear Oil Gauge

On most steering gears there is no way of telling how much lubricant is in the gear housing. If too much grease is pumped into it, the lubricant will force its way out at the top of the steering tube, thus causing dust to collect and get on the clothes. A gauge to show the level of lubricant in the gear housing may be made by drilling a $\frac{1}{4}$ -in. hole in the steering tube about 1 in. above the housing.

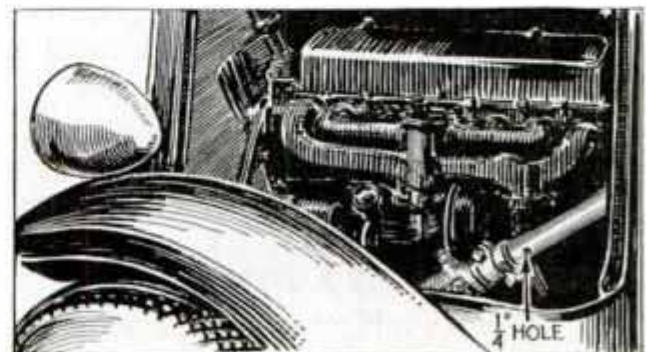

Hole Drilled in Steering Tube to Serve as Lubricant Gauge for Steering Gears

Lathe Tool for Cutting Grooves and Fillets

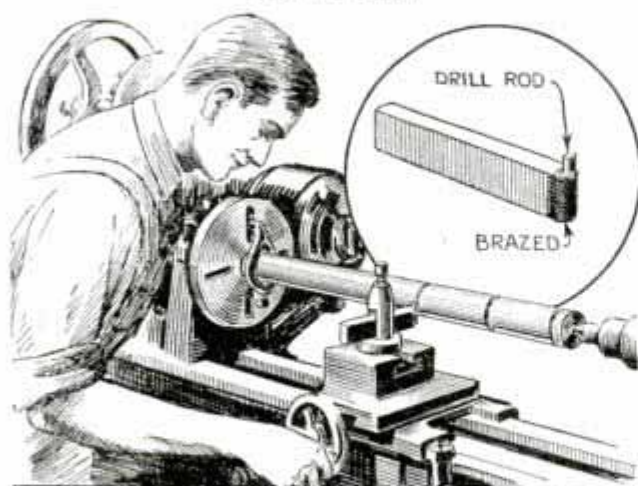

If a Number of These Tools Are Kept on Hand, You Can Save Time in Cutting Grooves and Fillets

Here is a tool that makes the turning of grooves and fillets of an exact radius an easy and inexpensive process. The tool consists simply of a piece of drill rod welded vertically to the end of a piece of steel which fits in the tool post. The upper end of the drill rod is ground to the proper cutting edge, and its diameter, of course,

determines the size of groove that will be cut. It is a good idea to make up various sizes of these tools and keep them on hand. —M. L. Lowrey, Livermore, Calif.

Repairing Rusted Brake Rods

The threaded ends of brake rods often rust so badly that it is impossible to keep the clevis yokes tight, even with a lock nut. In such cases, after adjusting the brakes carefully, drill a small hole through each clevis and rod to take a cotter key as shown. While this method is not recommended as a permanent repair, it does serve in an emergency, and will hold the clevises until the rods have to be readjusted.

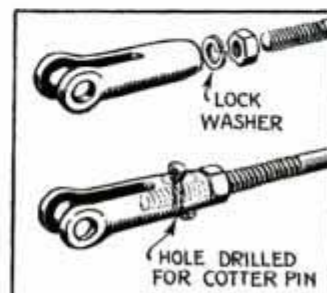

☐ A few moth balls in each drawer of your tool box help prevent tools from rusting.

The Next Issue

GET THE MOST OUT OF YOUR CAMPING TRIP

Five pages full of helpful information gathered by a camper over a period of 15 years. Tells how to care for your gas stove, lantern and other equipment, besides what to take along, where to pitch the tent, and what to avoid.

THERE'S CHARM IN WHITE FURNITURE

Step-by-step description of how you can improve the appearance of your home by refinishing old furniture in white, ivory and antiqued-ivory.

LIGHTING UP YOUR SUMMER CABIN

Inexpensive electric-light plant to operate six 30-watt lamps. It is made from a ¼-hp. motor driven by a small gas engine. Also, a self-starting, 6-volt job.

SKIM OVER THE WATER

Homemade racing shell especially designed for the amateur who requires a boat to develop skill with the oars. Has a sliding seat to aid in rowing.

BOY'S MIDGET AUTO

Simple, midget car that gives you lots of fun. Powered by any small gas engine, and equipped with pneumatic tires. One lever works clutch and brake.

NORTH AMERICA



At the **TWIST**
of the
throttle

Make North America your playground. California's glorious scenery — Canada's rugged lands and shimmering lakes — the east from Maine to Florida — the great Middle West — the hospitality of the Southland — or Mexico with its sunshine and romance. All are yours at the twist of the throttle when you own a 1935 Harley-Davidson. Its world famed dependability will never fail you. No time tables — no set schedules — just go when and where you please.

See the new Harley-Davidsons at your dealer's store. Let him give you a free ride — ask about his Easy Pay Plans — and send in the coupon.

MAIL THIS COUPON
HARLEY-DAVIDSON MOTOR CO.
Dept. P, Milwaukee, Wis.
Interested in motorcycling. Send illustrated literature.
Postage stamp is enclosed to cover mailing cost.

Name _____

Address _____

My age is 16-19 years, 20-30 years, 31 years and up, under 16 years. Check you age group.

Vacation
with a

HARLEY- DAVIDSON

THE NEW AGE OF CHEMISTRY

(Continued from page 3)

do the work. When moisture-laden air comes in contact with this chemical, it is dried by chemical action. They have also found it is cheaper to cool pre-dried air than wet air. Also the capacity of an air-conditioning apparatus can be increased two and one-half times by pre-drying the air. In most cases air can be conditioned without cooling it.

Chemists of the B. F. Goodrich company have compounded a new rubber plastic material which they call koroseal. Its natural color varies from amber to brown. As matrix material for molding plaster-of-Paris and cement ornaments it is excellent. It also makes good gasket material.

Gustav Egloff, oil chemist, says motor fuels now under development will help to raise the cruising speed of airplanes up to 500 miles per hour. He expects that a new process called "polymerization" may eventually produce gasoline capable of giving aircraft engines much more power.

Dr. Gordon W. Kline, of the bureau of standards, has discovered a chemical that will reduce the fire hazard in airplanes. The airplane cloth is "doped" with cellulose acetate after it has been treated with a boric acid-borax solution. Gasoline spilled on a wing so doped is burned off without setting fire to the fabric; ordinary airplane fabric, coated with cellulose nitrate, is instantly ignited by a match.

A billion barrels of oil are saved every year through the technological advances made by chemistry in the past twenty years. If it were necessary to produce our present consumption of 17,000,000,000 gallons of gasoline by the refining methods of 1917, we would require about 1,000,000,000 barrels more crude oil than now used.

Chemistry is doing significant work in building glass. Glass bricks, glass wool, and glass silk are now extensively used by the building industry. Glasses of the protective type are developing rapidly. Laminated safety glass, bullet-resisting glass, and laminated safety sheet glass are some recent developments. A new type of heat-strengthened glass has just been made for use as fire-wall material.

Today, after three centuries of continuous effort, chemistry has shifted to machines some of the heaviest burdens which the early Americans had to bear.

TIME TABLES FOR EARTHQUAKES

(Continued from page 84)

since the jiggles loosened things and the swaying caused them to fall. Almost all heavy earthquakes are followed by a series of diminishing settling shocks at longer and longer intervals for several months.

Scientists use the different kinds of waves generated by a quake to measure its distance from a recording station. The first jiggling wave that compresses the earth ahead of it moves at from three and one-half to eight miles a second and the sheer waves that cause swaying travel three-fifths as fast. Both are recorded at the same station and the interval between their reception allows the distance they have traveled to be figured. A third and longer wave moves around the earth's surface at about two miles a second.

Aside from the damage earthquakes cause, they sometimes do strange and spectacular things. A heavy temblor in India in 1897 tossed stones into the air and shot posts out of their holes. Earthquakes that cause shifts in the ground along fault lines have played tricks on property owners like shifting the front walk to a house fifteen feet beyond the front porch.

Contrary to popular belief, the earth doesn't open up and swallow houses or people. Large fissures are rarely opened up by quakes and these almost invariably remain open. There is no typical "earthquake weather" and most quakes do not occur in the evening as many believe. Minor shocks are noticed in the evening because people are quiet and are more apt to feel them. There is no assurance that an area that has experienced a major shock will escape another for a long time.

Since there is no indication that quakes will ever cease, architects and engineers are developing types of construction that would be damaged least when earthquakes do occur. Generally speaking, damage is greatest to buildings erected on "made" ground or loose natural alluvium, and the same quake exerts less force in areas having firm, rocky foundations. Water-soaked ground seems to intensify the force. On the whole, rigid units of construction that have little if any "give" appear to receive less damage than loosely built buildings that weave in moderate tremors. In case of a tremendous shaking a rigid building probably would suffer more.

LENS SPEED...what it is...how to use it

THE faster the lens on your camera, the less light you need to take pictures. And the less light you need, the greater the variety of snapshots you can take.

Lens speed is denoted by an "f" rating—such as *f.4.5* and *f.6.3*. The smaller the "f" number, the larger the diameter of the lens . . . hence, an *f.4.5* lens admits more light—is bigger, therefore *faster*—than an *f.6.3* lens when fully open.

When you buy a camera, get one with a good fast lens. It will let you take pictures at higher shutter speeds . . . and even indoors at night with Mazda Photoflood bulbs. It will increase your fun in picture taking many fold.

Of course, you won't take all your pictures with the lens wide open—but, like a high-powered automobile, it's nice to have the extra power when you need it.

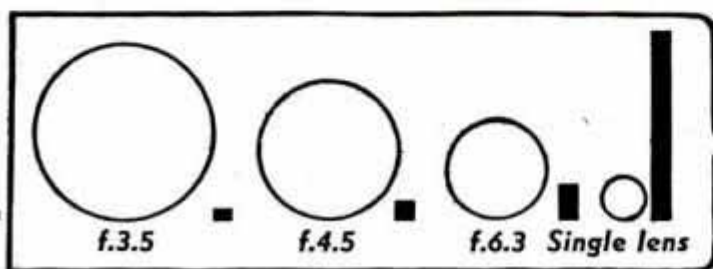

CIRCLES indicate relative openings of various lenses. Bars indicate relative times of exposure necessary. The bigger or faster the lens, the shorter the exposure that is needed. Notice that an *f.3.5* lens is *16 times* faster than an ordinary single lens . . . thus, you can take action pictures at 1/400 second with an *f.3.5* camera where a 1/25-second exposure would be required with an ordinary camera.



f.3.5 KODAK DUO
(above)

. . . the miniature Kodak that makes a larger picture. In the rain . . . indoors . . . almost anywhere . . . at night with Photoflood bulbs, the crisp, sharp *f.3.5* lens lets you take pictures. And the Compur shutter gives you speeds up to 1/300 second—fast enough to "stop" an express train.

Takes sixteen pictures on a roll of 620 Kodak Film. And each picture is $1\frac{1}{4} \times 2\frac{1}{4}$ inches, large enough for your album. Complete with depth-of-focus scale . . . Kodak Duo Six-20 costs \$52.50.

Kodak "SS" Film adds speed to any camera

Kodak Super Sensitive Panchromatic Film is a high-speed film for high-speed cameras—but it opens new picture possibilities to any camera.

Try a roll or pack of "SS" Film—you'll find it helps get the pictures you may have missed before.



f.4.5 KODAK SIX-16

(right)

Kodak Six-16 with *f.4.5* lens will instantly appeal to those who know fine photographic equipment. It takes a standard-size picture— $2\frac{1}{2} \times 4\frac{1}{4}$ inches.

Its fast Kodak Anastigmat lens (*f.4.5*) and the Compur shutter with its speeds from 1 to 1/250 second give you mastery of light and "action." Conventional and eye-level finders. Built-in self-timer. Focuses down to 4 feet. Costs \$40.

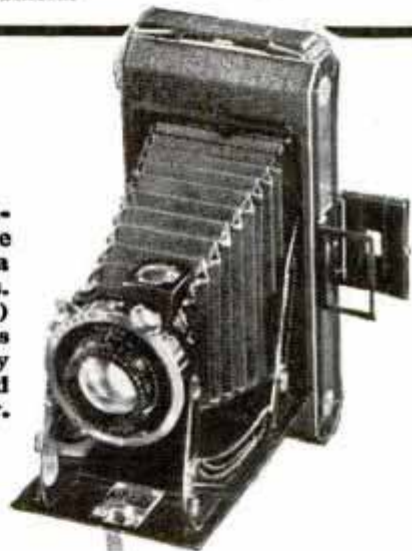

f.3.5 KODAK RETINA
(left)

This miniature Kodak is built for speed. A 1/500-second Compur shutter gives you command of action—and the keen *f.3.5* anastigmat lens admits ample light for high-speed exposures in difficult light.

Thirty-six pictures, approximately $1 \times 1\frac{1}{2}$ inches, at a loading.

And it's a real camera bargain. Complete with optical view finder—Kodak Retina costs about half as much as cameras of similar range—only \$57.50.



FREE! THE NEW KODAK CATALOG

16 pages of information on Kodaks and photographic equipment. It's yours for the asking. Eastman Kodak Co., Rochester, N. Y.

Name _____

Address _____

City _____ State _____

P. M. 7-36

Dust Traps the Criminal

(Continued from page 81)

of evidence is obtained from the person, clothing and personal effects of the victim of a crime or of the suspect. The common sources are pockets, trouser cuffs, seams and folds of clothing and meshes of cloth, dirt from the fingernails, wax from the ears, dirt from shoes and dust accumulated in watches, knives and other objects carried on the person. The more common particles found and identified by microscopic or chemical analysis are fibers of cloth, hairs, both human and animal, seeds, spores, pollen, mineral and rock particles, fragments of tobacco, paper fibers, wood shavings and wood dust, metal filings and particles of food, flour, soot and coal.

Some particles have well-defined structural characteristics and can be identified by microscopic methods. Others irregular in form must be examined microchemically. Debris from the pockets is removed with forceps or carefully brushed out on a sheet of glazed paper. Dust embedded in the clothing is beaten out by placing the garment in a closed container or is collected by using a miniature vacuum cleaner or a dust pump. Wax from the ears and dirt from the fingernails are removed with tiny instruments, and knives or other personal effects are studied directly under the microscope, or dust particles are removed with tiny forceps or by suction.

The debris thus collected is carefully sorted and each minute particle is examined separately and identified. Such a seemingly insignificant item as a human hair may tell a trained investigator much concerning the person from whose head it came. It is an easy matter, of course, to determine the color, but this hair also may indicate something of the age of the individual by the very absence of color, and a microscopic study will reveal whether the hair fell out or was pulled out and whether the owner has had a recent haircut. Such facts are often important.

A discarded cigaret likewise may reveal clues which later may trap a guilty suspect. The dust detective can determine, for instance, whether the person uses a domestic or foreign tobacco and whether he smokes cigaretts containing drugs, as many criminals do. When it comes to textiles, the dust detective is able to identify

a microscopic fiber of cloth quite definitely as linen, cotton, silk or wool of a particular kind. He does this by burning tests, fluorescence analysis and microscopic and chemical analysis. Thus it is possible for him to describe the clothing of a man who has committed a crime with a fair degree of accuracy from only a textile fiber.

The dust detective also is able frequently to trace the movements of an automobile by studying the dirt it has collected. A man who had committed a crime escaped in a car, driving over a road covered with mud of a peculiar red color and type. More than 100 miles from the scene he stopped, had the car washed and then was picked up on suspicion. He maintained he had not been near the scene of the crime. Dust experts examined his freshly washed car, found traces of the red mud and showed that this mud was like that near the scene of the crime but entirely different from soil where the man said he had been. He later was convicted.

Another motorist fled after striking and killing a boy. A witness jotted down his license number and the man was arrested but maintained his innocence. Dust clinging to the under side of a fender was examined and fibers of cloth similar to those in clothing worn by the boy were found. Confronted with this, the driver confessed.

Mr. O'Neill, who has developed many of the methods employed in this new field of scientific crime detection, is making the procedure available to police agencies throughout the country. Once the details are understood, any technician familiar with a microscope and possessed of an elementary knowledge of biology and chemistry is able to analyze dust evidence.

"This should make it possible," says Mr. O'Neill, "for every police unit to have its own dust experts. Sometimes such evidence is more important than the clues visible to the naked eye. Often dust analysis represents the only logical approach to the solution of a crime. In other cases it limits the field of investigation or directs it to the most promising channels. The criminal may conceal fingerprints but he can't keep his hair from falling out or his clothing from disintegrating. Sometimes a hair or fiber may catch or convict him."

Here's where
**PENNSYLVANIA
 MOTOR OILS**
 are vital

And here's the VITAL SPOT THEY COME FROM



PHOTO BY BRUEHL

DEEP IN THE mechanism of your car are the steel muscles that drive it forward—the crankshaft. At this vital spot raw power is transformed into smooth speed. Here, trustworthy lubrication is essential.

The map shows another spot vital to motorists. It is the area where Nature stored her finest crude oil, Pennsylvania Grade Crude. From this crude are refined all the motor oils sold under the insignia of the Pennsylvania Grade Crude Oil Association. They are *better oils from the ground up*.

They are better for every vital spot in your motor, wherever one piece of metal must slide over another—at high speed—in intense heat. Your motor oil must get on the job, instantly, and stay on the job tenaciously. It must defy heat and cold, hold its body, and not degenerate into sludge.

That's a lot to ask of any oil. But Pennsylvania motor oils have been doing it for 40 years.

You hear a lot these days about "new oils" and "new processes." Of course, Pennsylvania refiners have access to all the latest methods of refining, just as others have. But they have one big advantage that is *exclusive*—the natural superiorities of the crude itself. For your car's sake, insist on an emblem-protected Pennsylvania motor oil!

Pennsylvania Grade Crude Oil Association,
 Oil City, Pennsylvania

Copyright 1935, Pennsylvania Grade Crude Oil Assn.



What This Emblem Means!

This emblem is the badge of membership in the Pennsylvania Grade Crude Oil Association. You are protected when you buy oils sold under this emblem, because it assures you that (a) they are made 100% from Pennsylvania Grade Crude, (b) they meet or exceed the high minimum standards set by the Association to assure proper lubrication of modern motors. Safeguarding these assurances are: (1) the research laboratory of the Association at State College, Pa., (2) a national field force, and (3) each member's individual surety bond.

BETTER OILS FROM THE GROUND UP!

When writing to advertisers please mention Popular Mechanics



What an Athletic Director of Indiana University did for his daughters

It was back in 1922, when Mary was eight and Catherine was five. Their father felt his responsibility strongly. He wanted to make sure that no matter what the future held, his daughters would have funds for a college education. He naturally turned to life insurance.

An Equitable agent helped him work out Educational Fund policies providing that, when the girls reached eighteen, the proceeds would be paid to them, over a four-year period.

The father lived only fifteen months after the policies were issued.

Mary is now in her third year in the School of Journalism at a mid-west State University. Catherine will enter an art school in Chicago next fall.

Because of their father's thoughtfulness and foresight, both these girls will be soundly equipped to face the world.

* * *

This insurance program is but one of thousands which Equitable agents, trained in the Case Method of life insurance planning, have put into effect for far-sighted people.

Let an Equitable agent suggest an insurance program especially adapted to your own conditions.

"and I wouldn't be able to go to art school"



To The Equitable Life Assurance Society of the U. S.
393 Seventh Avenue, New York, N. Y.

Please mail a copy of your booklet describing the Equitable Case Method of life insurance planning.

67PM

NAME

ADDRESS

AGE



THE EQUITABLE

FAIR - JUST

LIFE ASSURANCE

SECURITY - PEACE OF MIND

SOCIETY

MUTUAL - COOPERATIVE

OF THE U.S.

NATION-WIDE SERVICE

Thomas I. Parkinson, *President*

When writing to advertisers please mention *Popular Mechanics*

The City That Grew Backwards

(Continued from page 90)

peared at that time, showing the location of every building, the shape of the wide city greens, and the direction and width of the streets. This map was used by the restoration architects.

At Oxford university in England an old copperplate made about 1740 was discovered showing the three major buildings of the restoration—the capitol, the palace, and the Wren building at the college of William and Mary. A radiophoto of the copperplate was sent to the architects.

All the colonial foundations were excavated. By sifting the dirt, twenty tons of archaeological material were obtained. Pieces of Wedgwood, English glass, silverware, pottery, marble, iron and bricks were found, giving a vivid picture of the domestic utensils of the time.

With historical data accumulated the restoration work commenced, and for seven years it has continued. Four hundred and fifty-eight modern buildings have been torn down or removed, sixty-one colonial buildings have been restored; eighty-nine colonial buildings reconstructed, and two business blocks of thirty-three shops and stores, a post office and a fire house, erected.

Several old houses were moved from outside into the colonial section, and houses of colonial design were erected upon excavated and measured foundations to fill in the gaps where colonial houses had once stood. Boxwood trees and bushes were brought in to again border the flower gardens. Holly, crepe myrtle, dogwood, and cedar trees were planted.

Roofs of restored houses were covered with fireproof shingles made of asbestos-slate, copied from old moss-covered wooden shingles taken from the colonial buildings. The reproduction was so perfect that the insurance men coming to Williamsburg announced that the rates would be raised because of wooden shingles. At the Wren building of the college, the time-weakened walls were reinforced by hidden steel and concrete. Complete fireproof construction methods and materials were used in restoring the college and in erecting the capitol and governor's palace.

Layers of white paint were scraped off woodwork. Underneath the brilliant colors of the eighteenth century were brought

to light, and the colonial greys, blues, greens, and yellows were reproduced on interiors. In some of the interiors the natural woodwork has been left unpainted.

Old hardware and hand-wrought nails were used whenever possible. Butterfly and strap hinges have been fastened to doors and shutters, and old iron and brass locks placed on doors. When new hardware was necessary it was hammered out by hand at the forge of a local blacksmith.

Bricks were needed to repair old buildings and to erect new ones. Some were obtained from old houses, but not enough. So a brick kiln was set up, old-time brick-makers were brought in to supervise the work, mules were imported to grind the clay, handmade brick molds were constructed and glazed-end bricks were made as they had been in colonial days.

The concrete roadway and sidewalks of the Duke of Gloucester street were torn up. In its place a bituminous bound gravel roadway has been laid, the edges bordered by cobblestone. The old brick and flagstone sidewalks have been restored.

Telephone poles have been taken down and the wires laid underground. Old-time lamp posts now support antique lighting fixtures. More than 7,000 lineal feet of streets have been resurfaced, 11,000 feet of sidewalks have been replaced and 59,000 feet of cable and wire undergrounded.

The capitol, the palace, the Raleigh tavern and the Paradise house have been furnished with antiques, and are open to the public at a reasonable maintenance cost. These exhibition buildings are presided over by hostesses who wear the costumes of the eighteenth century. The restored homes are rented or occupied by private families who, because of ancestral associations, were granted life tenure in their homes when they were purchased by the restoration. These homes are opened only on special occasions. The exhibition buildings do not have modern conveniences, but the private homes are equipped with electricity and with plumbing.

The project has cost \$15,000,000 to date and has shown how the brains, skill and ingenuity of the twentieth century have been able to transform an entire town to the architecture of 150 years ago.

Odd Facts about Postage Stamps

(Continued from page 95)

stamp, each doing a particular portion. This steel, known as a die, forms the basis of a "relief die" which does the actual plate engraving. It is hardened, by heating and cooling, then over it is rolled a soft steel cylinder under tremendous pressure. The pressure forces the soft steel into the cut die, producing the stamp impression in relief. This raised impression is hardened and becomes the working tool of the plate maker who uses it to cast 400 impressions of the stamp on a steel sheet which is hardened and curved to fit the press.

Stamp collecting, started as a hobby, today has become a business so profitable that buyers far outnumber sellers. If you possessed one copy of every stamp listed in the world catalogue, you would be one of the world's richest men. If you had only one copy of each of the first 350 stamps listed in the United States section of the catalogue, you would be worth \$200,000.

In the last fiscal year, the philatelic agency of the post office department filled 96,000 orders totaling \$811,723 for various current or recent stamp issues from dealers or collectors—virtually clear profit since the stamps were not used on letters but went into collections. It is estimated sales this year will double. In addition to the United States philatelic agency, there are at least 130 foreign ones.

Values in stamps for collectors are regulated mostly by their rarity. There is only one known copy of a one-cent, magenta, British Guiana stamp issued in 1856 and it is in a very poor state of preservation. Yet this stamp, a decrepit little rectangle of paper, is the most valuable in the world. It is worth \$50,000.

In recent years the executors of the estates of wealthy men have found that their stamp collections represented the quickest and most liquid assets, and in many cases such collections have been sold for a profit whereas other assets had depreciated.

The stamp treasures of the world are far from exhausted although the intensified hunt for them today by millions of new collectors is narrowing the undiscovered field. Treasures sometimes turn up in brand new issues but finding them is a matter of knowledge and observation. A postmaster lamented to a friend that he

had no luck finding valuable stamps despite the thousands which passed through his office. The very same day the friend bought three stamp booklets from this office, each containing the rare plate number from which the stamps were printed.

Some stamps issued this year may become valuable before the year ends. The 1934 Mother's Day stamp is already rare and is likely to advance in price. Age is far from being the only requirement.

The first copies of old and famous issues are, of course, the crown jewels of the stamp empire. Before the post office department issued the first gummed stamps in 1847, postmasters made provisional issues—their own stamps, stamped envelopes, cancellation marks or autographed franks for matter mailed from their post offices. Some of these today are worth thousands of dollars.

Sometimes the printer makes an error, and if the stamps get out before the error is detected, the philatelic fireworks start. The classic mistake of the airplane printed upside down on a few stamps a few years ago is an example. The upside-down plane stamps are worth \$3,500 each today. In printing the 1854-1857 western Australia four-pence blue, a graceful swan in the center design was stood on its head, thereby becoming a \$5,000 bird as far as collectors are concerned. In the same year, on the other side of the world, a printer stood Queen Victoria on her head in a stamp printed in India and it is quoted at \$5,000 today. Sometimes a sheet of stamps is turned over accidentally and re-run, thus becoming a valuable "impression on both sides." When too many errors occur in any country, however, collectors become suspicious that they are not "genuine" mistakes and prices drop accordingly.

The huge traffic in stamps naturally has resulted in many dishonest practices. The best safeguard against buying trash, repaired stamps, forgeries or counterfeits is to make purchases from reputable dealers or direct from the approved philatelic agencies of governments. Knowledge of stamps gained by study is an essential to serious collecting. Then you realize why one stamp may be cheap at \$2,000 and another may be expensive at twenty cents.

D1523

Why do men in the Tropics look old at forty?



GREEK GODS at twenty-five, old men at forty. That's the penalty of living down near the equator.

"Why is it that people who live in the tropics show the wrinkles and lines of old age in the very prime of life?" asked Edwin C. Hill with his insatiable curiosity.

Reason enough, said the experts. The burning tropical sun dries up the natural oils of the skin, leaving the face like parchment, which wrinkles easily.

Women know that a dry skin wrinkles easily. That is why they use creams and gentle oils to keep their complexions youthful.

Men who do not want to look older than they are maintain the natural oils in their skins by using Barbasol. They know its bland soothing oils keep the skin fresh, and the whole face looking alert and youthful.

You see, Barbasol doesn't dry out the skin. It's so soothing that thousands use it to relieve wind-burn and chapping.

It gives you a smooth quick shave, no ingrown hairs. And its bland oils leave your face in the pink of condition.

No brush, no lather, no rub-in. Just wet your face, spread on good old Barbasol and shave.

Why look older than you are?

BARBASOL BLADES now 5 for 15¢

For only fifteen cents you can now buy 5 of those scalpel-keen Barbasol Blades that make shaving a joy.

They're going like hot cakes, men. Step up and get yours today.

Shave the Barbasol way. Soften your whiskers with Barbasol Shaving Cream and mow 'em down with Barbasol Blades. It's the perfect shaving combination.

Tune in Singin' Sam—the Barbasol Man—every Friday evening over WOR, New York; WLW, Cincinnati; WXYZ, Detroit; and WGN, Chicago. (See your newspaper for local time.)



For Modern Shaving:
No Brush • No Lather • No Rub-In

Mining a Mountain

(Continued from page 65)

the big shot was fired? Would the blast knock down tons of ore as expected and planned, or would it wreck the mine? No one knew the answer.

The chief electrician stood before a switch on which the eyes of the spectators were riveted. Last minute inspections were completed. The last wires were connected. Those who had worked for months creating this giant shot were about to see what would happen when 100,000 pounds of powder let loose inside old Bartlett.

"All clear, let 'er go," finally ordered the superintendent. The electrician's hand went out to the switch and shoved it home as the faces of the onlookers tensed. There was a rumble like distant thunder, a faint vibration—then silence. Had the blast failed? Could it be possible that the twenty-eight billion foot-pounds of energy in the powder would be released so gently?

At last it was considered safe to enter the mine. In the main tunnel the exploring party found electric-light bulbs intact and planks and boards undisturbed on the ground. But in the huge rooms above the shafts overhead a different scene greeted their eyes. The contours of these great underground chambers had changed. The powder, enough to have destroyed the greatest skyscraper or ocean liner ever built by man, had broken down thousands of cubic yards of rock—850,000 tons of it, or eight tons of ore for each pound of powder set off. The first shot in the work of undermining a mountain was a success!

In a few weeks the ore was being moved out of the mine at the rate of hundreds of tons a day. Production was speeded up until 4,000 tons of ore per day were going out, virtually all of it "untouched by human hands." Down through the "grizzlies" or screens tumbled the great blocks as the gates of the chutes were operated by compressed air. Pieces too large to pass the three-foot screens were smashed with small charges of powder. In the main tunnel the ore fell through the chutes into fifteen-car electric trains, each hauling 150 tons and requiring less than five minutes to load.

At the mill, a mile distant, the cars were dumped automatically into giant crushers. On endless belts the wealth of old Bartlett

moved to other smaller crushers and through ball mills until it was reduced to dust. Then it went into flotation cells, long tanks filled with water, each equipped with a pump which forced air through the water. Overhead automatic sprinklers sprayed a light pine oil into the mixture. The air and oil combined with the metal to form a froth on top of each flotation cell and an automatic skimmer removed the froth which passed into a thickener. Then a vacuum pump removed the water and the metal passed to dryers after which it was ready for loading.

This process has been going on for many months with the ore from this first big shot. Soon the mill will have consumed the 850,000 tons of ore knocked down by the giant blast and the powder men are preparing another giant "firecracker." In all 100 shots probably will be required to knock down the ore known to exist above the tunnel level. If each shot requires 100,000 pounds of powder and if each knocks down 850,000 tons of rock, the final figures reach staggering proportions.

The world supply of molybdenum jumped from 28,000 pounds in 1922 to more than 4,000,000 pounds in 1930. This country produces eighty per cent of the world supply—and most of it comes from Climax. A ton of old Bartlett's ore contains about seventeen pounds of molybdenum and of this amount, about fourteen and one-half pounds are recovered. But a few pounds go a long way, for molybdenum steel contains an average of about three-tenths of one per cent of molybdenum. So Bartlett mountain is likely to supply the world with molybdenum for scores of years to come. And when the millions of tons of ore have been removed from this underground mine on a mountain top with the aid of hundreds of tons of powder its sides will be caved and scarred but the summit of old Bartlett will still remain the same to all outward appearances—as big and as imposing as ever.

¶ Names and addresses of manufacturers and dealers in articles described in this magazine will be furnished by our Bureau of Information upon request accompanied by stamped, self-addressed envelope.



WHO'D BELIEVE I WAS
SKINNY AND
LONELY
 A FEW WEEKS AGO



**Thousands Are Quickly Gaining
 5 to 15 Lbs. This New Easy Way**

DON'T think you're "born" to be skinny and friendless. Thousands with this new, easy treatment have gained husky pounds, new good looks—in just a few weeks!

Doctors for years have prescribed yeast for health. But this new yeast tablet discovery gives *double* results—health, and solid, new flesh—and *far* quicker.

Not only are thousands quickly gaining good-looking pounds, but also clear, smooth skin, freedom from constipation, indigestion and nervousness, glorious new strength and pep.

Concentrated 7 times

This amazing new product, Ironized Yeast is made from special brewers' ale yeast imported from Europe—the richest yeast known—which by a new scientific process is concentrated 7 times—made 7 times more powerful.

But that is not all! This marvelous, health-building yeast is ironized with 3 kinds of iron.

Day after day, as you take Ironized Yeast tablets, watch flat chest develop, skinny limbs round out attractively. Skin clears of blemishes, new health comes—you're an entirely new, good-looking person.

Results guaranteed

No matter how skinny and weak you may be, this marvelous new Ironized Yeast should build you up in a few short weeks as it has thousands. If not delighted with the results of the very first package, your money will be instantly refunded.

Special FREE offer!

To start you building up your health *right away*, we make this absolutely FREE offer. Purchase a package of Ironized Yeast tablets at once, cut out the seal on the box and mail it to us with a clipping of this paragraph. We will send you a fascinating new book on health, "New Facts About Your Body." Remember, results guaranteed with very first package—or money refunded. At all druggists. Ironized Yeast Co., Inc., Dept. 537, Atlanta, Ga.

*Posed by
 professional
 models*

Painting with Fire

(Continued from page 21)

and chemicals used are essentially the same. Gunpowder is the basis of nearly all fireworks. One scene in a night pageant may consume fifty pounds of chemicals and usually it lasts no longer than a child's sparkler.

Putting on a fireworks show takes weeks of preparation. The pyrotechnic engineers bend thin rattan canes on wooden frameworks to the outlines of the figures to be shown, then attach their lances to the rattan. Lances are paper cases resembling thin firecrackers and contain concentrated colored fire composition. Strips of quick match fuse that burn inside paper wrappers at forty feet a second are pinned to the lances and one end of the fuse is led to wires that connect with an electrical firing board at the control station. Pinwheels get their motion from "turning cases" filled with rocket compounds.

"The public likes to see fireworks burned rapidly with no delays," says C. E. Cronkite, fireworks expert, "and this takes a skilled crew since some of the sets must be operated mechanically. When I press the electric firing button for the elephant set, for instance, the flame in the fuse whips around through the set and lights all of the lances in a few seconds. Then the blazing figure of the keeper bends down to empty a bucket of water in the tub and the elephant in turn dips its trunk into the tub and sprays the keeper. All these motions are directed by men behind the sets who pull the wires and levers at the right times. The crashing airplane slides along a wire."

Increasing in popularity are the spectacular aerial shows in which shells are fired 1,000 feet into the air and explode in bursts of colored stars and streamers. A twelve-inch shell bursts with the spread of a city block and may be visible for twenty-five miles around. The shells, consisting of the fireworks compounds and a propelling charge of gunpowder, are fired from heavy steel mortars embedded in the ground. One type of comet shell discharges blazing stars that leave trails of glowing fire behind them. An "octopus" shell carries paper tubes that glow and wriggle above the spectators.

Pyrotechnic engineers use strontium

chemicals for red fire, barium compounds for green, sodium mixtures for yellow, copper compounds for blue, and magnesium compounds for white fire. Iron and steel filings mixed into the compounds provide the glowing sparks. Brilliant stars and glowing balls are all compounded from the same materials, the difference in effect resulting from the proportions in which the chemicals are mixed.

Railroad fuses and marine signaling flares and rockets are manufactured by the same companies that turn out packages of flash crackers. During the world war, "E" floats that give off quantities of dense smoke when thrown overboard were developed to assist merchant vessels to escape from submarines. Recently the navy has experimented with new upper altitude star shells that are fired from anti-aircraft guns and illuminate the sea for miles around. Attached to a parachute, the illuminating charge floats in the air for considerable periods.

Motion-picture war scenes depend on fireworks for the smoke and flash of exploding shells and mines. Fireworks even supply the whine of bullets for the sound men since the whistle emitted by burning picrate sounds like the noise of a passing missile. Practically all battle scenes as well as encounters between fleets are photographed in miniature and a few handfuls of fireworks compound are enough for creating scenes of devastation.

Most fireworks ingredients are harmless chemicals in themselves but form dangerous compounds when mixed. Unless extreme care is used some of the compounds may explode even in the mixing process. Workers in pyrotechnic factories carry no matches in their pockets and abide by the same rigid rules that apply in plants that make high explosives. There are no "safe" fireworks mixtures that can be recommended for amateur experimenters since even a slow burning compound may turn out to be a high explosive if a slight mistake is made in the proportions. Even trained engineers don't always escape burns and injuries in staging a fireworks spectacle and their first word of warning for the Fourth is, "Don't hold anything in your hands."

£355

126 W. 3rd St. Los Angeles Calif

HANDEE

Tool of 100 Uses

Grinds, routs, drills, carves, sharpens, cuts, engraves. Over 100 wheel shapes available. Fits the hand perfectly. Weighs 1 pound. For use at home, in the shop or take to the job. Do away with slow hand work! A.C. or D.C., 110



Plug
in any
light
socket

\$10.00

and up
Postpaid
U. S. A.
with 3 wheel
shapes Free.
Order today.

Order on 5-day
trial. Satisfaction
guaranteed.
Ask for FREE
booklet.

New MASTER CRAFTS-
MAN'S SET
17 useful accessories to
grind, drill, polish, sand, cut,
carve, engrave, etc. Prepaid \$5.00

CHICAGO WHEEL & MFG. CO., 108 S. Aberdeen Street, Chicago, Ill.



LOW COST RACING CRAFT

Make winning sailboat in a few hours. Hull already shaped and hollowed. Only a little work and she's ready to launch! Instructions and all parts furnished.

25c and up. Buy at dealer or send money-order for 7' solid hull kit, 25c; 15' hollow hull kit, \$1.00; 22' hollow hull kit, \$2.50. Sent prepaid in U. S. A.

SEND FOR
FREE
BOOK

THORNECRAFT
Dept. 7, 2518 Montrose Ave., Chicago

EARN MONEY RE-STRINGING RACKETS AT HOME



Coins CASH for YOU!

SET OF
PERMA-TEX SILK STRINGS
with directions,
guide, all prepaid

85c

This great opportunity, plan now to make \$100 to \$200 each this season. QUICK—write for FREE details! (Get my Free Catalog of tennis equipment.)

W. A. BICKEL, 809 W. Madison, Dept. B-135, Chicago, Ill.

ONE-MAN SAWMILL FARM MODEL 49

TURN TREES INTO MONEY WITH A BELSAW! Makes lumber, shingles, lath, ties, crates, boxes, cases, all forms lumber.



Three capacities: 10, 14 and 20 feet. Accurate set works, positive dogs. Full or one-way type power feed runs on low power—many owners use old auto engine.

Pays for itself quickly—thousands in commercial service, everywhere. Write for free lumber handbook and catalog of mills, supplies, tools, saw tables, and woodworking equipment.

BELSAW MACHINERY CO.

811-D Davidson Bldg., Kansas City, Mo.

COMPLETE ELECTRIC PLANTS



ONAN A.C. PLANTS furnish the same current as city service. Operate Radio, Water System, Refrigerator, all Appliances.

SIZES 350 WATTS UP

Have A.C. Current anywhere. Models \$110 and up. Easy to install. Available from stock. Ideal for farms, camps, lake homes, commercial purposes—anywhere electricity is needed.

D. W. ONAN & SONS

849 Royalston Ave., Minneapolis, Minn.



GERSTNER Tool Chests are Splendid Values! Machinists — Toolmakers — Write for Free Catalog.

GERSTNER TOOL CHESTS

443 Columbia St., Dayton, Ohio

BURN YOUR NAME ON TOOLS

WITH THE
ARKOGRAF

PROTECT YOUR TOOLS FROM THEFT
Write with electricity any name or design on the hardest and finest tools and instruments, or any metal, like writing on paper with pen or pencil. Complete Outfit \$3.50—Prepaid Anywhere. Interesting illustrated circular free. Write today. Agents wanted.

ARKOGRAF PEN CO., 3927 S.E. Stark St., Portland, Ore.



SHALL I ADD OIL OR CHANGE IT ?

Which is right? Conflicting recommendations by car manufacturers, oil refiners, service stations, and other motorists have caused millions of car owners to wonder. Some say: "Just keep on adding oil." Others advise: "Drain and refill twice a year" or "Change oil every so many miles." But, in the meantime, the automobile repair bill of the nation continues to increase.

There are very sensible reasons why oil should be completely changed at regular intervals. Oil at work in your motor is contaminated with many things: dirt and dust, fuel residues, moisture, and minute metal particles.

It is true that oil filters help to prolong the useful life of your oil.

It is also true that Quaker State has been able to eliminate the "light-end" material found in ordinary oil—thus increasing materially the efficiency of the oil. But even this advance in oil refining doesn't remove the necessity for regular crankcase draining.

How often you should add oil or change it depends upon the conditions under which you drive your car and the brand of oil you use. Some oils go to pieces under the terrific heat of your motor long before the accumulation of dirt, etc., would normally cause you to change.

There is only one safe and truly economical rule: use the best oil you can buy—use Quaker State—and drain and refill your crankcase at safe and regular intervals. Quaker State Oil Refining Company, Oil City, Pennsylvania.

"First choice of Experience"

**QUAKER STATE
MOTOR OILS**

WOOD IN CANS SEALS CRACKS AROUND TUBS



Permanent — Waterproof

For sealing around pipes—permanently replacing loose tiles—repairing damaged toilet seats—loose towel racks, glass holders—1001 other household uses.

Plastic Wood is the scientific marvel of the age—wood in putty form that dries to hard, permanent, waterproof wood.

It adheres to any clean, dry surface—wood, metal, glass, stone, porcelain—can be painted, varnished or lacquered—can be worked with any wood-working tools; can be planed, sawed, sanded, turned on a lathe—will hold screws and nails firmly—will not split or crumble. Get your can or tube at any hardware, paint or department store.



Plastic Wood also comes in white which is ideal for bathroom repairs.

FREE

Write The A. S. Boyle Co., Inc., 1934 Dana Ave., Cincinnati, O., Dept. PM-7 for booklet "200 Things to Do."

PLASTIC WOOD

Earn Money with Leathercraft

Complete Leathercraft Set (not a toy). Everything you need including tools, leather patterns, work blocks, etc. with full directions. Make your own belt, purse, card case, gun holster, hat band, etc. of tooled leather. Sell them at good prices. No experience needed. Ask for ENJOY Complete Leathercraft Outfit by name. Only \$2. First time a complete outfit with full directions sold at this price. At your Dealer or direct postpaid from E. A. Sweet Co., Inc. 148-P State St., Binghamton, N. Y.



Make furniture, toys and novelties in your spare time. Earn extra money. Easy to operate. You can start a shop for \$10.00. Mfrs. of Leathers, Jit Saws, Band Saws, Drill Presses, Planers and Bench Saws. Write for Free of Page Catalog.

Walker-Turner Co. Inc., Dept. P5, Plainfield, N. J.

KEEPING THEM IN THE AIR

(Continued from Coloroto Section)

into serious flaws. The intricate assembly of the hubs, which contains the controllable mechanism for setting the pitch of the blades, is examined carefully, the bearings are inspected under microscopes, and parts showing wear are replaced. The propeller is then reassembled and placed on a balancing stand where perfect balance is obtained. After checking the angle with protractors, it receives the final examination from the chief of the department.

The 887-pound Wasp engines are cleaned with a special compound in steam vats, then routed into the overhaul department. Here they are torn down and the component parts are placed on large portable racks on rollers, each large enough to accommodate all the parts of one engine. The parts are examined for wear, and some, such as crankshafts, are magnetized and then dusted with special metal powder. The pattern the powder takes clearly reveals hidden flaws. Engine cylinders are re-bored, then enameled and the finish is baked on in special electric ovens.

Spark plugs, one of the biggest items of engine maintenance, are inspected carefully. From 2,000 to 3,000 spark plugs are handled every week. Dynamotors, starters, generators and other electrical accessories also are tested with special equipment. The overhauled engine goes to the test block for ten hours before it is ready to go back in the ship. In the instrument department are experts whose talents rank with those of skilled watchmakers. In one section, the men disassemble, inspect and service the artificial horizons and directional gyros. Another section handles compasses, rate-of-climb indicators and turn and bank indicators.

An important part of the airplane fuselage and wing overhaul and repair work is handled in a sheet-metal department. Samples of every consignment of gasoline and oil also are carefully analyzed. The overhaul is completed when the various units are returned to the main assembly hangar where the engines, propellers, instruments and other parts of the plane are put back in place. For several hours the test pilot puts the airplane through its paces. When satisfied with the performance, he signs the test report and the ship is ready for 350 more hours of service.

EARN MONEY WITH PERFECTED
TENNIS
 ENJOY CHEAPER TENNIS
 RESTRINGING VISE



Newly perfected Tennis Vise invention enables anyone to re-string tennis rackets at big savings or for BIG PROFITS. Just follow simple instructions. Save on your own tennis...earn money too! Write for Free details.

BUY Factory-Fresh-Strings *Save Cash*

Now you can buy genuine GUT strings direct-from-factory-to-you. High quality, low cost! SILK strings, too. Our Free Tennis Equipment Catalog will **SAVE YOU MONEY**. For your FREE copy today, and details of Perfected tennis vise invention!

WRITE

H. E. WILLS CO.
 1047 W. 47th ST. Dep. B-128 CHICAGO, USA

FREE TENNIS CATALOG
 MFR. OF QUALITY GUT STRINGS

A QUALITY KAYAK FOR \$9.20

Everyone can now own a Fellowcraft Kayak. Practical, rugged, fast sporty lines. Last year's boating sensation. Perfectly engineered. Finest materials. Seaworthy. Safe. Weight 15 lbs. Carried by hand or auto. Quickly assembled at home. Full instructions. Complete Kit for 8 ft. Kayak containing all parts ready-to-assemble, \$9.20; 10 ft. Kayak (shown here) \$14.60; 8½ ft. Square End Dinghy (shown here) \$17.90. Make good tenders. Prices F. O. B. Cash with order or C. O. D. Every customer enthusiastic. Assembled Kayaks also available. Plans only, \$1 per model. Descriptive folder. Order now.

FELLOWCRAFTERS, INC.
 64 Stanhope St., Boston, Mass.
 Dept. F.P., Boston, Mass.



AMAZING AUTO COMPASS



Don't lose time and money by taking the wrong road and going many miles out of your way. This new AIRPLANE TYPE COMPASS constantly tells your direction of travel. Sticks to windshield. Base 1½" diameter. ONLY \$1.95 POSTPAID, including Compensator. **SATISFACTION GUARANTEED** or your money refunded if returned within ten days.

DEALERS WANTED!
HULL MFG. CO., Box 246-D, WARREN, OHIO

GET YOUR TRACTOR AT FACTORY PRICE



3 Speeds Forward and Reverse. Runs 4 to 8 hours per gal.

Amazing money maker for farms, truck gardens, orchards, nurseries, poultry ranches, country homes, etc. Plows, discs, harrows, cultivates, mows lawns, cuts weeds, runs belt machinery, 1 to 5 H.P. riding or walking types. Write for **FREE CATALOG, Low Factory Prices and 10 Day Trial Plan.** Address Nearest Office.

SHAW MFG. CO. Desk 4507
 Osceola, Kans., or Columbus, Ohio,
 or 5812 Magnolia Ave., Chicago, Ill.

SHAW DU-ALL TRACTOR

Air Tires or Steel Wheels

GENUINE FORD PARTS

are the best replacement parts for Ford cars and trucks. They are made by the same men—on the same machines—by the same precision methods that built your Ford originally.

\$1 VALUE FOR 50c



Get **FACTS** on trailer design. This 50 page book can save you 100 times its cost. Order direct from author. Money back if not satisfied. 2c tax in Ohio.

RAY F. KUNS, Dept. 108, Madisonville, Cincinnati, O.

ENGINES

DIESEL-GASOLINE-KEROSENE

Enclosed • Self-Oiling • Roller Bearing



A size and style for every purpose. Most economical power for farm or factory. Put one to work and watch it pay for itself. **Sold Direct from Factory to You!** Write today for **FREE Catalog and Literature.**

WITTE ENGINE WORKS
 1748 Oakland Ave., KANSAS CITY, MO. 2150 So. 2nd St., HARRISBURG, PA.



National Model CONTEST

S.S. "NORMANDIE"

BUILD AN EXACT SCALE, ELECTRICALLY LIGHTED MODEL—18 INCHES LONG

4 BIG PRIZES!
 AND MANY OTHER PRIZES

1. A Round trip to France
2. A Round trip to France
3. A Long Cruise
4. A Short Cruise

Every one entering the contest will receive a beautiful commemorative medal.

SPECIAL MODEL KIT, \$1.50

● A complete kit has been specially designed to simplify building. It includes a hollowed hull easily assembled from factory-cut Balsa wood parts. All other materials are provided such as wood for the superstructure, mast, rudder, paints, brush, sandpaper, electric lights, wire, model builder's knife and cement—nothing else to buy. Life boats, anchors and propellers furnished fully finished.

● Full-sized plans are included, showing all steps in construction, and a picture of the *Normandie* in full colors. Any one handy with a knife can complete a realistic model.

● Entry blank, contest rules, list of prizes and judges' names included in each set.

NO AGE LIMIT—OPEN TO BOTH SEXES—Contest started April 15, 1935—closes February 15, 1936. . . . Model kits may be bought at department stores, sporting goods dealers, and hobby shops. Or direct from us (\$1.50 plus 25 cents for postage and packing).

MODEL BUILDERS' GUILD
 DEPARTMENT H, HEMPSTEAD, NEW YORK

Tuning Up a Winner

(Continued from page 53)

car and the engine has to be cranked by hand or with the starter until it goes."

The mechanical campaign to win an Indianapolis race begins the winter before, although in emergencies builders have rushed a \$15,000 race car from blueprints to the finished article in ten hectic weeks. In the case of a car already built, Marcenac, the owner, and the driver get together months ahead and decide what changes they will make to increase the car's performance. The engine is taken down, the changes made, every part is inspected and checked for wear, and finally the engine is reassembled and placed in the chassis. Then test runs are made on nearby tracks or the car is taken to some dry lake bed where it can be raced at top speed. Many cars being raced today are five or six years old and have been improved each year by minor changes.

The car is shipped to the track two or three weeks before the race for its final tuning up. Day after day it is driven over the course, testing different oils, fuels, and spark plugs. Nearly all the cars use special mixtures of fuel, most of them consisting of three quarters gasoline and one quarter benzol, with ten cubic centimeters of tetraethyl lead per gallon. Getting the engine in tip-top shape is comparatively easy but it is harder to bring out the best riding and handling qualities. Four or five sets of springs and shock absorbers may be tried and discarded, and the distribution of weight changed half a dozen times to get the best balance.

One slight change may enable the driver to speed around the course four or five miles an hour faster with less strain on himself. On the day before the qualifying runs the motor is torn down for its final inspection. Each wheel is taken off and trued up in a balancing machine. The mechanics get little sleep during the week before a race.

Such is the perfection of modern motors that few changes were made this year. Of two new cars built for the Indianapolis race, one was powered with a conventional four-cylinder Miller design engine having 255 cubic inches displacement, turning up to 5,500 revolutions per minute, with a compression ratio of eleven to one. The

bore is four and one-quarter inches and the stroke four and one-half inches. The engine has conventional timing on the intake and exhaust valves. Practically the only addition to standard auxiliary equipment is an oil temperature gauge on the oil tank. The other car, also built by Fred Offenhauser, is a front-drive powered by a new four-cylinder Miller of 220 cubic inches displacement, with two updraft carburetors, having the same compression ratio, but turning up to 6,000 revolutions per minute. Bore is four and one-sixteenth inches and the stroke is four and one-quarter inches. The engine is mounted in a semi-streamlined body with streamline underpanning, having a 100-inch wheel base and weighing 1,950 pounds empty. The chief improvement is a new method of mounting the front springs at an angle closer to the wheels, to improve the handling qualities of the car and afford better traction with the front end transmission.

It will be some time, mechanics expect, before engines of higher compression ratios are used in spite of the fact that more power is developed as the compression is increased. The trouble is that carburetion is extremely critical at the higher ratios and conditions are likely to change so much during a single race that overheating and burned valves result.

Several cars this year were equipped with new kinds of bearing metals but so far no ideal alloy has been found. Several drivers discovered that the new standard proportions of copper and lead cut their shafts at high speed and now they are trying bearings in which the lead proportion is increased.

Because motors already are capable of greater speeds than are safe on present tracks, designers and engineers are concentrating on improving the riding qualities of the cars to give the drivers better control, and in obtaining better balance to improve traction, which in the long run leads to better gasoline mileage. Next year, some believe, cars in the Indianapolis race will be limited to forty gallons of gasoline, two and a half gallons less than this year for the 500-mile race, and economy will be more important than it has been in former races.

"This Stuff Is Liquid Gold"



A great railroad system ordered a barrel of a new kind of oil. An old engineer gave one disgusted look at the open barrel and said, "It's nothing but tar." But after he had tested the oil on a day's run he remarked, "This stuff is liquid gold . . . the old iron horse never ran so smoothly."

Fifty-four years have passed since that engineer acclaimed the peculiar, rich lubricating quality of this first engine oil made from Bradford, Pennsylvania crude. But that same "liquid gold," carefully refined and hermetically sealed in cans, is famous among motorists today as Veedol, "the oil you can't break down."

Veedol is still refined from Bradford, Pa., crude oil. It still makes "iron horses" and modern, high-speed automobiles run more smoothly. And because Tide Water is the largest and most experienced refiner of Pennsylvania lubricants, Veedol is still unsurpassed as "the world's finest motor oil."

Bootleggers Foiled Again!



The makers of Veedol Motor Oil have put bootleggers on the spot again . . . by placing

two spots of red on all Veedol cans. Oil racketeers had developed a new racket: cutting tops off sealed cans of oil, replacing the good oil with a "bootleg" product and resealing the cans with new tops. But the operation required cutting down the sides of the cans an eighth or a quarter inch.

Ever on the alert to safeguard the public, the Tide Water Oil Company placed a red circle over a white background at the top and bottom edges of all Veedol cans. Now if the top is taken off, the bootlegger must break into that red circle and his tampering is immediately detected. Another victory for Veedol! Another assurance that when you buy Veedol you actually get Veedol . . . "the world's finest motor oil."

AMAZING VEEDOL FACTS

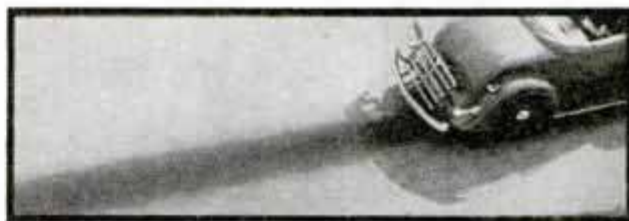

"Streaking" Over Highways

Those two dark streaks you've noticed on concrete highways aren't just from excess grease thrown from chassis lubrication points. Automobile engines turn at enormous speeds today and thrash ordinary crankcase oil into a foaming vapor. Evaporation and loss of oil take place through the engine's breather pipe . . . and the concrete pavement soaks up the oil that should be lubricating your motor. The makers of Veedol Motor Oil carefully remove the lighter constituents in refining the rich Bradford, Pennsylvania crude oil, and the result is a motor oil that retains its body and lubricates perfectly, whether your engine is idling or rushing you over the highway at race track speed.

NOTE: Oil dealers! Good profits come easy selling this easy-to-sell motor oil—either wholesale or retail. For an interesting proposal, communicate immediately with—Tide Water Oil Company, 17 Battery Place, New York City.



A DIRTY or clogged radiator overheats the motor, robs power, wastes money. It's unnecessary. Sani-Flush removes rust and scale from radiators. Not caustic. Can not harm aluminum cylinder-heads or cooling-system. You can use it in a few minutes for a few cents. Simple directions are on the can. Clean your radiator twice a year with Sani-Flush. Sani-Flush is used in thousands of homes to clean toilet bowls. Sold by grocery, drug, and hardware stores—25c and 10c sizes. The Hygienic Products Co., Canton, Ohio.

Sani-Flush KEEPS
RADIATORS CLEAN—NON-CAUSTIC

FIX IT YOURSELF
AND CUT YOUR REPAIR BILLS



Are You
Suffering from
DRAFTY WINDOWS & DOORS?
LEAKY ROOF FURNACE GASES?
CRACKED PLASTER WALLS?

Save money on repairs by writing today for our illustrated folder telling how you can do the small but important jobs about the house yourself—easily, quickly.

FREE
FOLDER

Pecora Paint Company, Inc.
Dept. 7, 4th and Venango Sts. Phila., Pa.

SPEED BOATING ON A DESERT SEA

(Continued from page 68)

When a caravan arrives here, miles from the nearest habitation or nearest supply of drinkable water, it finds the little club house built by the Salton Sea Boat Club. Camp is pitched like that of a tribe of Arabs. The roar of muffled motors is like music to the ears of these water kings. There are women speedboat drivers along, members of the Girls' Speedboat Club, only organization of its kind in the United States. All camp in the open. Everyone carries water, brought in by tank trucks.

The races, covering three days, are known as the Annual Desert Speedboat Sweepstakes, sanctioned by the American Power Boat Association, and its officials are on hand to ratify all records made. Here many of the world's most famous drivers attempt to add to the more than twenty world records which already have fallen on this course.

There is twenty-year old Loretta Turnbull, international girl champion, with her fleet of "Sunkist Kids," to which she has added "Sunkist XI." There is Rodney Pantages of Hollywood with his boat, the "Little Shot." Adding to the din is Martin C. Martin, also of Hollywood, one of the country's outstanding drivers.

Some unusual things happen during these races. Two drivers, out in early morning when the highest speed is often attained, slammed into a flock of ducks, thousands of them, at rest on the lake. The drivers were blinded by the shower of feathers. They had two smashed boats as a result of hitting a feather fog.

There is an audience to these speedboat races. From the reservation of the Sobobas and Coahuilas, sheltered under mighty San Jacinto, come chiefs and tribesmen, followed by squaws and many papoose. They peer at the roaring, flashing boats from behind the fringe of brush, curious but fearful. There are cowboys, people from the irrigation districts, movie people from Hollywood, women of the desert in gingham and sunshade hats, prospectors, miners and desert rats.

After the roar of the motors is quieted, the moon sails over the Chocolate mountains and camp fires fade. The huge desert becomes normal until the morrow when speeding boatmen again will try to lower marks on this desert sea.

Hit the Trail with a Covered Wagon Trailer

All America beckons to the owner of a Covered Wagon . . . unblazed trails . . . virgin forests and better fishing grounds. Now you can go farther, stay longer in greater comfort. Spacious and roomy for a family of 4. Davenport type beds; kitchen with enamel sink, water tank, ice box, stove, pantry, cupboards, dish racks, clothes closet, mirror, dresser, toilet, etc. Hook it to your car—travel for less than ¼ cent a mile extra. America's greatest values at **\$375 and \$825**

COVERED WAGON COMPANY
11904 E. Jefferson Avenue, Detroit, Michigan

FOR CAMPING, FISHING AND TOURING

Two streamline models—the standard and de luxe—give you the Perfect Home on the Open Road. Some dealer territory open.



FREE — ILLUSTRATED TRAILER TRAVEL BOOKLET — FREE

NEW DIESEL BOOK

Diesel Handbook by Rosbloom is universally used by Engineers and Schools. A practical book for the man who depends upon practical information.

The World's Standard Book on Diesel Operation
Get Diesel Handbook, new edition, covering all latest Diesel developments. Treats thoroughly all fundamentals and principles. Question and answer form. Contains Tables, Latest Formulae, Practical Instruction on Diesel Engines of High and Low-speed, Auxiliaries and Accessories for Land, Marine, Locomotive, Automotive, Aero and Portable Services.

A standard book. Strictly authentic. 544 pages. Profusely illustrated. Flexible Cover. Price \$5.00 Postpaid. Sent C. O. D. in U. S. if preferred. Small amount extra for postage charged.
Popular Mechanics Press, Room 735, 200 E. Ontario St., Chicago

Handbook for Farmers

861 discoveries by practical farmers, telling how to make, repair or improve the various devices and machines used about a farm or garden. 683 illustrations. "The Most Remarkable Book Ever Published for Farmers," says one authority. **Send No Money.** When the postman delivers the book to you, hand him \$1 plus the few cents postage.

POPULAR MECHANICS PRESS
Popular Mechanics Building, Room 735, Chicago, Ill.



For Economy BUY—For Income SELL

The **FIFEL-GEARED PIERRENCH KIT**

● 2 New Pocket Machine Shops . . 7" and 8½" . .

Each with 3 INSTANTLY Changeable Jaws—No. 1, for all Pliers, Wrench, and Small Vise & Clamp work; No. 2, for all PIPE work, "chewed" nuts, etc.; No. 3, for all WIRE, Chain, Spring-making, Fence work . . with astounding POWER and SPEED!

● They Give you a 10-to-1 Power-gear, 1-TON Grip; Instantly a Million sizes 0"—1¾"; 4-Way V-GRIPS, 12-Point Automatic Grip-LOCK Ratchet Wrench, Etc.
● A \$50 Super-Tool Service at the Cost of One Tool!

● Mail this Part of Ad Today with your address (on a Postcard will do) Get **FREE—7-Edge, End-&-Angle Screwdriver, 101-Picture Manual of Mechanics, with . . .** User Offer, Or, With . . . Distributor, Territory and **FREE KIT Offer!**
● Be a Plierench Man, They're making \$35 to \$85 Weekly!

AMERICAN PIERRENCH CORP'N GPM-4809 N. Ashland Ave. CHICAGO, ILL.

new Invention SAVES GAS!

CUTS GASOLINE COSTS up to 30%

Creates New Mileage Records
It's Here! **VACU-MATIC—"The Carburetor That Breathes!"** AUTOMATIC CONTROL guarantees constant peak performance. More power, smoother running, quicker starting. Fits all cars; installed in a few minutes.

Don't wait! Just send name and address for details about VACU-MATIC and our **FREE TRIAL OFFER.** Write Today! **AGENTS WANTED**

VACU-MATIC CO., 7617-101 W. State St., Wauwatosa, Wis.

Raise Giant Frogs

A NEW INDUSTRY!



Nuford Giants

Weigh up to 3 lbs.

MAKE BIG MONEY raising giant frogs. Breeder lays 10,000 eggs each year. Bull-frogs sell \$1 to \$5 dozen. Biggest money-maker you can raise. *Back-yard ponds start you.* Any climate suitable. Our **FREE** book "A Fortune in Frogs" explains everything. Write today.



FREE BOOK

AMERICAN FROG CANNING CO.

(World's Largest Frog Market)

Dept. 133-M

NEW ORLEANS, LA.

AUTOMATIC AIR SERVICE • \$12 MONTHLY

This dependable outfit brings business right to your door. Extra profits from grease, oil, gas will pay for it. Upright, beltless, space saving, fully automatic. Our liberal trial plan lets you see how profitable it can be, before you buy. Ask for details.

9 HR. BATTERY CHARGING • ONLY \$10 MONTHLY

Earn \$50 to \$100 monthly profit with this charger. Puts your shop above competition. Cuts electric bills in half—no expensive bulbs to replace. Recommended by leading battery makers. Liberal Trial at our expense. Ask for details.



ARC WELDING • EASY MONTHLY TERMS

You can earn \$300 to \$400 monthly profit on garage and general repair work with simplified Arc Welding. No special experience required. Electric, gas engines or belt drive. 30 Days Trial—at our expense to prove its profit making ability. Write for details.

20 MINUTE CAR WASHING • \$10 MONTHLY

Rig profits washing cars. Saves two-thirds time, does better job. Savings pay for it. Tear out and mail this ad, checking items of interest to

HOBART BROS.
Box M751
TROY, OHIO

DOUBLE YOUR PROFITS... 30 Days Use to Prove it NO INVESTMENT TERMS Write Today

SHOOTING HOLIDAYS ARE HERE AGAIN!



New pictures—135 sparkling photos; new inspiration; shooting celebrities; club scenes; rifle ranges, trap shooting and skeet fields; hand trap; pistol marksmanship; 24-page rotogravure tabloid, sent FREE!

MODEL 69
New .22 cal. Winchester Repeater—bolt action, box magazine, 6 shots.



MODEL 42
.410 bore Repeating Shotgun shoots the sensational 3-inch shell. Light. Quick handling. For shooters of all ages.

HAPPY DAYS! Healthy days! Days of fascinating informal or organized competitive sport. Get out your gun and have some fun. Or get yourself a new Winchester—a smart, new, 1935, amazingly low-priced Model 69 Repeater, for example. Greatest gun value for the money Winchester has ever offered. An inexpensive, full-size, accurate all-round .22 repeating rifle for men, women, juniors.

Or get yourself a racy, light Winchester Model 42 Repeating Shotgun. The .410 gun that has put SMALL-BORE shotgun shooting square in the middle of the spotlight. World record maker in Skeet. Light report. Little recoil. Powders hand-trap clay pigeons like a 12 gauge. The FAMILY shotgun for shooting holidays.

See These Popular Winchesters

TODAY. Look them over . . . also the other famous Winchester Great Guns for shooting holidays. At your dealer's. For rotogravure tabloid and folders, send coupon below.

WINCHESTER REPEATING ARMS CO.
Box 46-C NEW HAVEN, CONN., U. S. A.

Sure thing! Mail me FREE your 1935 "Shooting Holidays" and folders on Models 69 and 42.

NAME.....

ADDRESS.....



WORLD'S LOWEST PRICED FULL SIZED ARC WELDER

PORTABLE—HANDLES UP TO 3/16TH INCH ROD

Here's the ideal Arc Welder for all general shop work. Welds lightest materials and heaviest castings and forgings with ease. Large capacity—185 amperes.

MAKE BIG WELDING PROFITS!

This new Welder brings you wonderful money-making opportunities. Write at once for details of special introductory offer for your territory. No obligation.

TATRO BROTHERS INCORPORATED
Dept. PM Decorah, Iowa



FULLY LICENSED!

WHERE TO FIND THE BIG ONES

8270 (Continued from page 75)

water with no vegetation, and surface lures over the weed beds around evening.

In a stream the fish avoid shallow, straight stretches devoid of trees, snags, logs or deep holes. So watch for the holes, large boulders or any other kind of cover along the bank. If you come to a shallow rapids, walk right past, but fish the pool below. The big fellows are facing the flow of the stream and watching the current for food that may be washed down to them. If you come to a big pile of old logs or snags tossed against the bank by the high water of spring, prepare to "camp" there for a while. If you are still fishing, try to get close to the log jam, making as little disturbance as possible.

When you find a natural aquatic "den" of fish be sure to change lures, if necessary. If you do not get a strike on one kind of muskie lure, try something else. Although you have located fish in a certain place early in the season, don't be surprised if they have moved later on, due to a change in food supply. This is another reason for devoting plenty of time to learning the fishing water thoroughly.

If you locate a natural rendezvous for game fish, around a weed bed or elsewhere, don't be surprised if during the heat and the sunshiny part of the day business is slow. During the summer many game fish are inactive until evening. Around sundown they move from deep, cool spots to hunt for frogs, minnows and other food. The brown trout is a famous night feeder. It is necessary to start around evening and continue through the dark to fool the big fellows.

Although there are a few species that go into very deep water in midsummer, the average fisherman should ignore water which is marked "very deep." I have taken lake trout in 100 feet of water during the summer, but as a rule our common species care nothing for such water.

By learning the fishing water so that the location of weed beds, underwater plateaus, rocky reefs, sand and gravel bars and other features are known, and then "thinking like a fish," the angler can outwit the finny tribe much more easily. A good student of angling will get a nice string invariably, when the fellow who doesn't attempt to study fish habits will fail.

LOOK! AMAZING FISHING ROD OFFER!

Mail Coupon at Once for Parts-Kit! Supply Limited!

BUILD THIS DURABLE FISHING ROD WITH THESE PARTS



Only \$1.50 Pre-paid

(United States only)

Kit Consists of:

- | | |
|--------------------|-----------------|
| 1. Solid Steel Rod | 7. Reel Lock |
| 2. Top Tip | 8. Drop Handle |
| 3. Guide | 9. Forward Grip |
| 4. Guide | 10. Hand Grip |
| 5. Winding Wire | 11. Butt Plate |
| 6. Solder | |

ACCEPT THIS AMAZING OFFER! Make popular style one-piece solid steel fishing rod for only \$1.50. Kit contains everything you need. Easy to do with instruction furnished. Take advantage of this introductory offer. Satisfaction guaranteed. Mail coupon at once!

MAIL THIS COUPON NOW! AVOID DELAY!

GEPHART CO. (Steel Rod Specialists), 222 W. Illinois St., Chicago, Ill. Enclosed find Money Order for \$1.50 (\$1.75 West of Denver) for Geph-Kit, as shown. 4 1/2 ft. 5 ft. 5 1/4 ft. Check length wanted.

Name.....
Address.....
Dealer's Name.....

TYPEWRITER

only 10¢ a Day

Not used or rebuilt. A new Remington Portable. Carrying case free. Use 10 days without cost. If you keep it, it's yours for only 10¢ a day. Write today. Say: Tell me how I can get a Remington Portable on 10-day free trial offer for only 10¢ a day. Remington Rand Inc., Dept. 152-7, 205 E. 42 St., N.Y.C.



BIG 3 1/2 FOOT TELESCOPE Count Cattle 10 Miles away. 5 sections. 10-Power. Brass Bound. Eye-Piece for viewing Sun, FREE. Makes good Microscope. Postpaid \$1.90, C. O. D. 20¢ extra. Guar. **BENNER & COMPANY** T-490 **TRENTON, N. J.**



Famous Museum Model

You'll be proud to **BUILD HER!**

"SOVEREIGN OF THE SEAS"

Now—begin the BEST model ever published, great man-o-war of 1637! Modelers say, "build her and you can build them all!" A masterpiece.

WONDERFUL NEW BOOK WITH FULL DIRECTIONS ILLUSTRATES EVERY DETAIL AND PART — ONLY

Step-by-step stages. Even a beginner can complete her with ordinary tools. 80-page DeLuxe book shows how to mold "Craftmat" carvings; history, etc. Marvelous value at

Sent postpaid upon receipt of price by **POPULAR MECHANICS PRESS**

Room 1234, 200 E. Ontario St., Chicago.



When You Build the **"SOVEREIGN"** You Can Build Them All

Complete book on building Popular Mechanics Famous Museum Ship Model "Sovereign of the Seas." Price \$1.00 postpaid. **Popular Mechanics Press** 200 E. Ontario St., Chicago

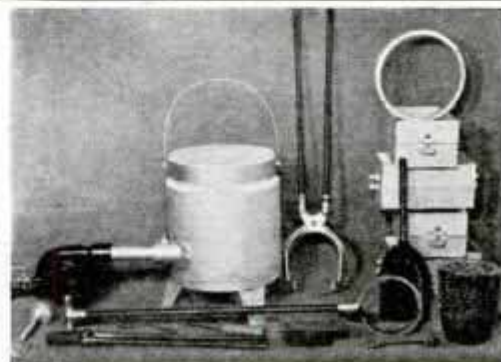

Brass Bronze and Aluminum Castings \$47.50 Complete Set

Make them in your workshop with this complete foundry set with instructions. Send for descriptive folder.

W. F. ANDERSEN

P. O. Box 142

ALAMEDA, CALIFORNIA

Electric Paint Sprayer

ONLY \$14.50 Complete Outfit and Spray Gun

Startling offer! Famous spraying outfit includes pressure internal mix spray gun, adjustable, non-clogging, fan and round spray nozzles. Ideal for spraying paint, varnish, enamel, lacquer, shoe dyes, aluminum paints, insecticides, etc. The power way saves time and labor and does better work.

Outfit complete with spray gun, National Compressor with sealed piston, (cannot pump oil) heavy duty Westinghouse motor, 110 volt, 60 cycle, A.C., plug and cord, safety valve, 15 ft. air hose. Just plug into light socket and it is ready for operation. \$14.50 complete. Send \$5.00 deposit, balance C. O. D. Shipping weight, 30 lbs. Sold on money-back guarantee basis.

NATIONAL ELECTRIC TOOL CO.

560 Washington Blvd.

Dept. 347

Chicago, Ill.

TENNIS

Get our sensational low prices on strings. Our famous animal tendon string now only 80¢ a set. It's tougher and faster than gut. We have sheep gut and silk too. Sample cuttings free.

Crescent Tennis Works 1472 So. Robertson Blvd. Los Angeles, Cal.

Let us recommend the best books to study on any subject. **Popular Mechanics Press**, Chicago, Illinois.

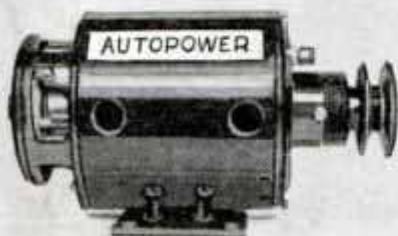

TURN SCRAP INTO MONEY

The new and revised edition of "Auto Power" with all the ten original specifications and ten new ones is now off the press. Convert old generators into A. C. and D. C. generators and motors with voltages of 6 to 400 volts, for power, light, welding, and radio operation. Create new generators adaptable for home, automobiles, or trucks. They can be driven by fan belt, wind, or water. This book, with complete illustrations, tells you how easily and economically these changes can be made. Also instructions for rewinding auto armatures. 350 definitions of electrical terms, etc. Already used and endorsed by thousands. Price, \$1. Postpaid. **AUTO POWER, Dept. B, 410 S. Hoyne Ave., Chicago**



PULVEX

FLEA POWDER

Actually Kills Fleas instead of Merely Stupefying them



The world's biggest selling flea powder because it lives up to its money-back guarantee to "kill them off — keep them off." It not only kills all the fleas and lice present but its deadly killing action continues for days, preventing reinfestation. Harmless, even if swallowed. Odorless. Non-irritating. At leading pet shops, drug and department stores, 50c, or direct, William Cooper & Nephews, Inc., 1950 Clifton Avenue, Chicago, Illinois.



GIVEN with every Can of PULVEX Flea Powder

GUARANTEED ONE YEAR



FREE

1935 MODELS

Benjamin Super Single Shot Air Rifles—Bolt Action—Hammer Fire

—Hair Trigger—Shoot lead or steel BB shot and 177 or 22 pellets and darts. Illustrated and described in New "BB Magic" Free—Write Today—get full details of Benjamin 25 Shot Repeater and New Benjamin Air Pistol

—Free Targets—SPECIAL INTRODUCTORY and TRADE-IN OFFERS. BENJAMIN AIR RIFLE CO. 697 N. Broadway St. Louis, Mo., U. S. A.



BIG MONEY Assembling NEW KI-YAK IN 3 DAYS

Make big money on each 20 lb. Mead KI-YAK you easily assemble at home in 3 days from complete "cut-to-it" Klt at amazing LOW COST! Seaworthy. Fast! Snappiest thing afloat. (Complete Sailing Rig, a few dollars extra.) Rush 10c for illustrated folder and \$6 Paddle GIFT OFFER! MEAD GLIDERS, 15 S. Market, Dept. B-7, CHICAGO, ILL.

GIVEN!
\$6 Double-blade Paddle now given with your Ki-Yak ... if you hurry!

MAKE IT.. FLY IT!



FREE BLUEPRINTS FOR MODEL CURTISS FALCON

MAKE THIS NEW MODEL TO LAST with strong, quick-drying, easy-to-use Du Pont Duco Cement. Favorite with model builders everywhere. Send green carton or red disc from 25c tube for free working plans. DU PONT, Dept. B-1, Wilmington, Del. **TRANSPARENT • WATERPROOF**



A.C.-D.C. PORTABLE TWO-TUBER

(Continued from page 103)

tube. Note that the primaries are pushed near the top of the coils for close coupling. When mounting the tube sockets under the base, be sure that the large heater termi-

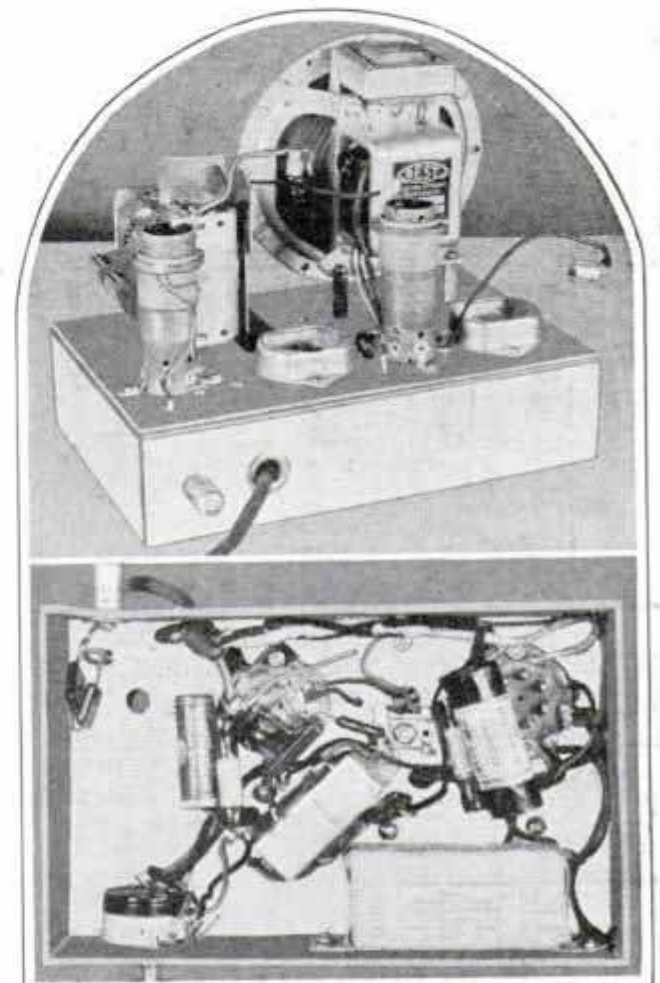

Above, Chassis Assembly with Tubes and Shields Removed; Below, Underside View of Base

nals are in the positions shown in Fig. 2. Both coils are provided with mounting brackets and small holes are drilled for these brackets and the various leads that are to be brought down through the base from the coil terminals. The 2-section ganged 350-mmfd. variable condenser is a small variety, about 2¼ in. long, 2¼ in. wide and 1½ in. thick. It is mounted on the metal bracket detailed in Fig. 3; the small tab is an additional shield and extends above the rear section of the condenser. Another shield, made of thin copper sheet, ¾ by 1¼ in., is soldered to the top of the center shield in the condenser. However, this is optional and may not be required. After all holes are drilled in the base plate, it is used as a template for

(Continued to page 138A)

Adjustable Stop for Spring Collets

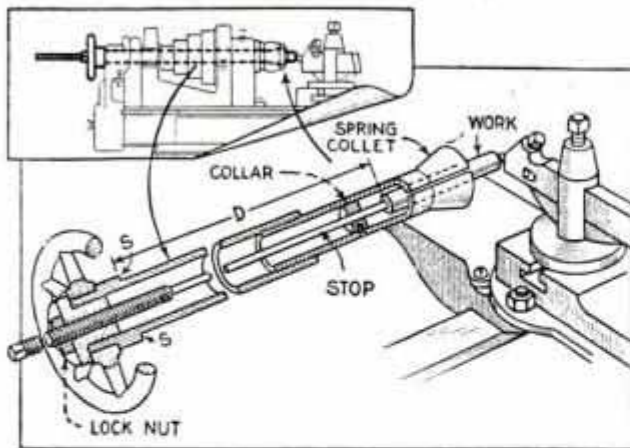

Adjustable Collet Stop That Eliminates Guesswork When Machining with a Lathe

Lathe operators can save time and material when machining work that is held in a collet by using this stop, which eliminates guesswork in getting all pieces a uniform length. To make the stop, tap the end of the draw-in tube and fit it with a plug, which has been drilled and tapped to take the threaded end of the stop, using a lock nut to hold the adjustment. A collar or bearing should be provided inside of the tube to prevent the stop from vibrating when the lathe is in motion. As the shoulder "S," always comes in contact with the rear end of the lathe when the tube is tightened, the distance "D," will always be the same.—Charles Kugler, Philadelphia, Pa.

Finishing Moldings with a Split Sander Belt

If you have been using a belt sander for finishing moldings, and have found it a hard job to avoid knocking off sharp corners, the trouble probably is caused by the belt being too wide to bend down into the hollows without taking off the higher points. The way to avoid this trouble is to split the belt into parts, which may be anywhere from $\frac{3}{4}$ in. wide up to ribbons twice that width. However, never try to make up a number of narrow widths and place them on the pulleys afterward as they will not run straight because they are not exactly equal in length. The trick lies in first making up a belt of regular width and then splitting it afterward. In this way all the pieces will be exactly the same length and will have equal bearing on the pulleys.

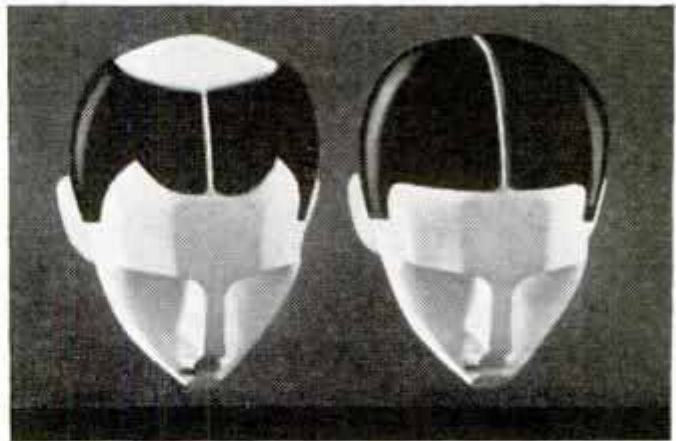

The Post Institute Presents A Revolutionary Hair Discovery

After twelve years of research, the Post Institute presents ULTRASOL, a new hair discovery, based on a new theory. Although Ultrasol has won most enthusiastic endorsement from distinguished users, the ethics of the Institute preclude exaggerated claims. Intelligent men and women, intent upon hair improvement, are invited to send for the treatise on Ultrasol, which will be mailed without cost or obligation.



POST INSTITUTE
Dept. M7, 105 E. 16th St.
New York, N. Y.



Saw Filing PAYS!

Steady growing business, all cash, no canvassing. Start in spare time. No experience needed. No eyestrain. With a **FOLEY Automatic Saw Filer** you can file hand, band and circular saws, easily, quickly, accurately! Small investment. Send postcard for **FREE PLAN** and Special Offer. No obligation.

FOLEY MFG. CO., 716-5 Foley Bldg.
11 Main St., N. E., Minneapolis, Minn.



Chucks for Small Lathes

Lowest Prices Ever Offered



A quality tool, accurately made. Send draft or money order. If not entirely satisfied, return chuck in 5 days and we will refund your money.

5 inch Chuck \$6.87

6 inch Chuck \$8.67

JOHN L. ALEXANDER, 424 Superior St., Detroit, Mich.

EXPLORE THE WONDERS

OF
GRAPHITE

WITH **DIXON'S**
GRAPH-AIR GUN



NEW CLEAN WAY OF APPLYING the most extraordinary lubricant known—**MICROFYNE POWDERED GRAPHITE**. Won't burn, gum, drip. Proof against acids, alkalis and brine. Thousands of uses in your car, home, shop and play. Write for descriptive circular and name of nearest dealer.

JOS. DIXON CRUCIBLE CO., Dept. 26-CG, JERSEY CITY, N. J.

- 1 Novel nozzle control
- 2 Handy burner attached
- 3 More power from motors
- 4 Lubricates locks
- 5 For everything that slides



UNION MADE **TUB-TEST**
Signal OVERALLS
 REG. U.S. PAT. OFF.



I'LL SAY THEY'RE STRONG

They outwear any two ordinary pair. Famous for their superlative quality for 50 years. Triple stitched and bar tacked at points of strain make them rip-proof. Large, roomy, comfortable to work in and good-looking. Made of best quality shrink-proof denim — especially woven for Signals.

See Signals at Your Dealer's

If he does not handle them, please send us his name.

JOHN RISSMAN & SON

Makers of the Famous SIGNAL Work Shirts

841 Blue Island Avenue CHICAGO, ILLINOIS

FREE RADIO CATALOG

Write for our big new 112 page catalog—the leading Radio Supply Guide. Packed with Build-Your-Own Radio Kits, New World-Wide sets, Battery and Auto Radios, Sound Systems and thousands of parts at lowest prices. Write now!

ALLIED RADIO CORPORATION

833 W. Jackson Blvd. Dept. K Chicago, Ill.



BIG 1935 LEADER

Genuine Leather Ties, 4-In-Hands and Bows;—Men's and Boys'. New fancy patterns in colors. Look like silk. Cleaned with a damp cloth. Durable; won't wrinkle. **SELL ON SIGHT.** Big profits; repeat orders. Be independent; have your own business. Young man sold 23 one night after school. No sales ability needed. Send 50c or stamps for sample and kit. *Information free.*

CENTURY TIE CO., Dept. 2, 2333 W. Grand Blvd. DETROIT, MICH.

Catch Fish!

Eels, Mink, Muskrats, with our new folding galvanized **STEEL WIRE TRAP.** Write for our **FREE TRAP OFFER** and Bargain Catalog. \$1 Box of our famous Fish Bait **FREE** to introduce our traps. **WALTON SUPPLY CO., 3509 JUNIATA AVE., ST. LOUIS, MO.**

LUCKY TIGER

For Hair and Scalp!

A single application stops that miserable itching... a single bottle corrects annoying scalp irritations... a real dandruff remover for more than two decades...



delicately perfumed... safe for adults and children... among the world's largest sellers... costs little at druggists and barbers.

GUARANTEED

SIMPLE POWER UNIT FOR 50-WATT TRANSMITTER

(Continued from page 105)

and L₄ forms; below the first winding on L₃ and above on L₄. These windings are separated about 1/8 in. and all coil ends are brought down and soldered in the coil-form prongs. All leads from the sockets should be as short as possible. The plate coil, L₅, consists of 6 turns of 1/4-in. copper tubing; the inside diameter is 27/16 in., and the turns are spaced the diameter of the tub-

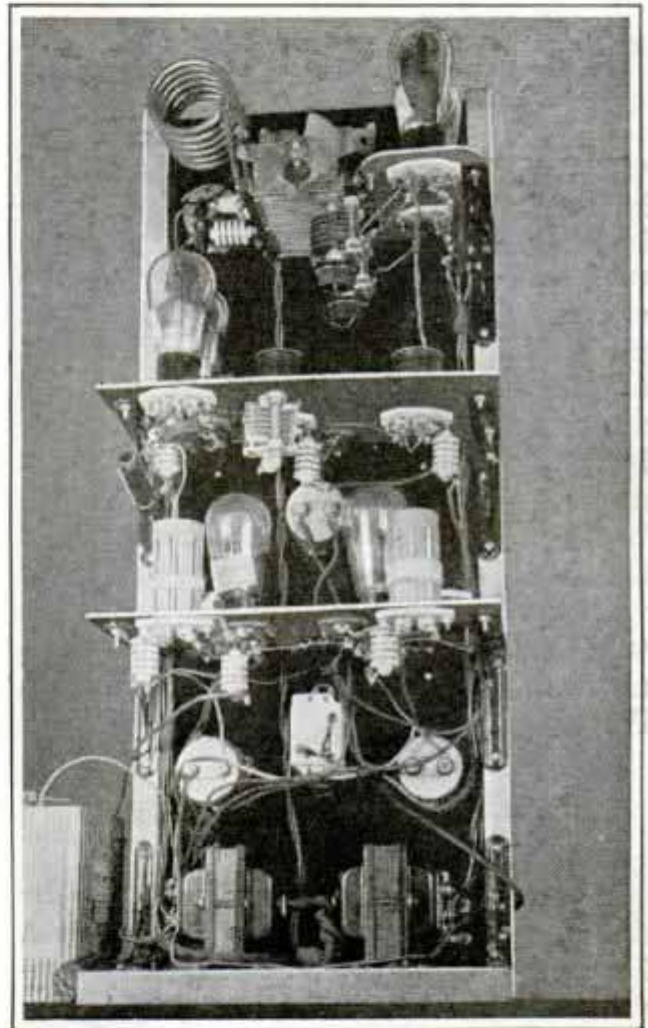

Crystal-Controlled 20-Meter C. W. Transmitter Showing Filament Transformers and Underside View of Shelf Arrangement

ing. Two 4-in. supporting lengths of this tubing are flattened at the ends and drilled to take short machine screws through the coil ends which are also flattened. The .002 mfd. by-pass condenser and r.f. choke are supported by means of a small porcelain stand-off insulator mounted on the split-stator condenser directly under L₅. The lead to the center of the tank coil is provided with a small spring clip. A com-

(Continued to page 138A)



A Really GOOD Lathe \$35⁵⁰ TO \$87⁵⁰

UNIT PLAN—You can start with a small lathe and build it up, part by part, as your needs increase. Final step is the back-geared, screw-cutting 10' lathe shown above. Does all lathe jobs. Used in production in many large plants.

24" WORK — 10' swing. Large capacity for a small shop bench lathe. 16 speeds. Cuts 4 to 72 threads per inch.

.001 ACCURACY—Running tested before shipment for .001 accuracy. Buy on 2 weeks' trial, money back unless satisfied. Easy terms. This is a REAL lathe built to expert machinists' standards of quality and accuracy.

Send for FREE illustrated catalog.

ATLAS PRESS COMPANY

1843 N. Pitcher St., KALAMAZOO, MICH.

When in Chicago, see our complete display at
ATLAS SALES CO., 35 E. Wacker Drive, Chicago

ATLAS QUALITY

Shop Equipment Since 1911

CASH INCOME DAILY RESILVERING MIRRORS; REFINISHING METAL Plated articles; autoparts, reflectors, tableware, etc., Making Chipped Glass Name Plates, Signs, etc.,—Portable Outfit—Write! SPRINKLE, PLATER, 129, MARION, INDIANA

MAKE MONEY PRINTING

letter and billheads, circulars, cards for friends, spare time. Easy to learn, easy to get jobs. **Printing Presses \$12**; new type faces, complete supplies, lowest prices. Send stamp for catalog. PEIFFER CO., 46-A; 6 Columbia St., Newark, N. J.

BUILD YOUR OWN FANS. 20 inch aluminum propellers for aeroplane fans \$3.85. Shipped collect. Michael Electric Co. Fort Worth, Texas



NEW TYPE CHEAP OIL BURNER

COOK and BAKE Without Coal or Wood
Slips into Any Old Stove, Range or Furnace. No Ashes, Dirt—Twice the Heat, HALF THE COST.

COOKS A MEAL for 1¢

Beats any oil burner ever gotten out for low cost, perfect performance. Slips into any old stove, range or furnace; burns cheap oil a new way, without generating or clogging up. Instant heat instantly by Simple Turn of Valve.

Try At Our Risk
30 DAYS' TRIAL

Prove it ends drudgery and dirt of coal or wood; cuts fuel bills in half, pays for itself quickly by what IT SAVES.

FREE SAMPLE FOR AGENTS

offered to one energetic man or woman in each locality who will demonstrate and take orders. Write quick, be first to learn how to make REAL MONEY right now, spare or full time—mail 1c postcard today.

UNITED FACTORIES, J-751 Exchange Bldg., Kansas City, Mo.

**Quick Heat at
TURN OF VALVE**

**AGENTS
Salesmen
BIG MONEY**

It's sweeping the country. Clark of Ind., sold 93 in 30 days. O'Tools of Mass., sold 164 in July. Get YOUR OWN oil burner FREE and make REAL Money. Write quick.



**COOLER KITCHEN
IN SUMMER**

BEAUTIFY YOUR GARDEN

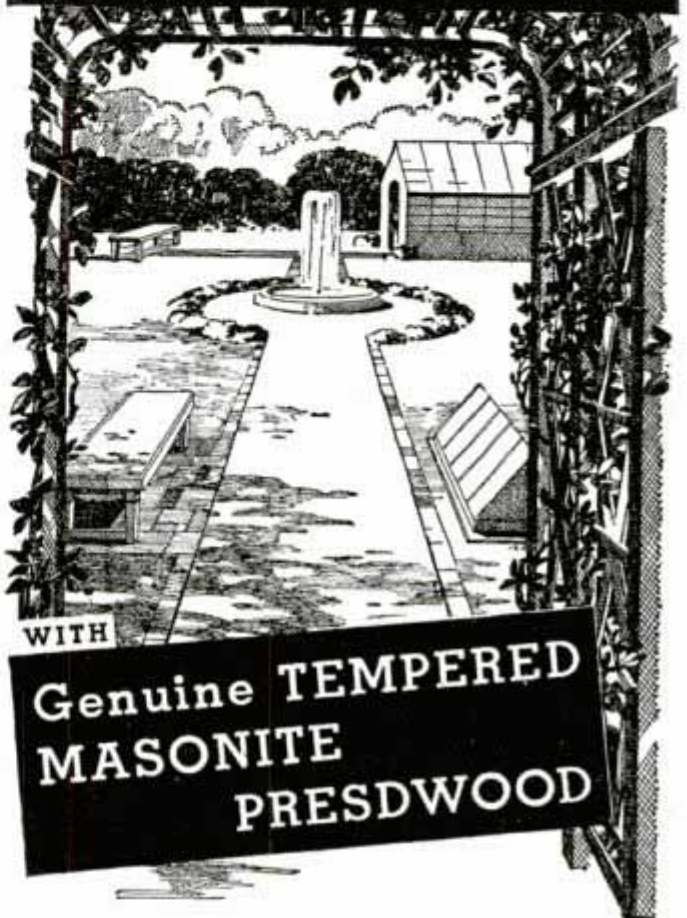

WITH

**Genuine TEMPERED
MASONITE
PRESWOOD**

Genuine Tempered Masonite PRESWOOD is an ideal material for outdoor use. Garden furniture, birdhouses, pergolas, fences, arbors, cold frames and hundreds of other permanent garden fixtures can be made entirely of this grainless material. Also splendid for concrete forms in building fountains, pools, walks, greenhouses, birdbaths.

PRESWOOD defies wind and weather. Moisture-resisting, it will not warp, chip or crack. Natural warm brown finish blends beautifully with foliage and soil. Or it can be varnished, painted, lacquered or enameled with any standard application.

PRESWOOD comes in light, durable boards, 1/8", 3/16", 1/4" thick. Can be cut or sawed to any size or shape without damage to tools. Reasonable price and long life make it a money saver wherever used.

Let PRESWOOD go to work in your own garden. Send in the coupon today for a free sample and more information about this wonder material.

MASONITE CORPORATION

PM-7

111 W. Washington St., Chicago, Ill.

Please send me a sample of Tempered Masonite PRESWOOD, and additional literature.

Name _____

Address _____

City _____ State _____

When writing to advertisers please mention Popular Mechanics

Interested in SHORT WAVE? Then you need this

FREE SHORT WAVE MANUAL

Here between the covers of this 32-page book you will find the complete descriptions of all that is best in short wave receiver design. Thirteen sets are fully described and illustrated—every one a top notcher—the "cream" of the 1935 crop!

Over 70 illustrations and diagrams make it an outstanding book which anyone needs who wishes to construct a simple yet efficient set for s. w. reception!

Here at SHORT WAVE HEADQUARTERS, where we collaborate with every leading manufacturer, we can supply you with any standard parts for any kit described in the Hammarlund Short Wave Manual, Popular Mechanics, Radio Craft, Short Wave Craft, Radio News and many others.

Consult us before you build! **SAVE MONEY!** by buying from us at **lowest WHOLESALE prices!**

The most outstanding All-Wave Super Het of 1935 is the **BROWNING "35"**

Praised by Engineers and Editors everywhere. We can supply the complete Kit of parts at **Lowest WHOLESALE Prices!** Free tabloid on request.

WHOLESALE RADIO SERVICE CO.

100 SIXTH AVENUE - NEW YORK, N. Y.

CHICAGO, ILL. 242 S. Dearborn St. ATLANTA, GA. 150 W. Peachtree St. N.W. NEWARK, N. J. 110 Central Ave.

Wholesale Radio Service Co.
100 Sixth Ave., Dept. PM 75, New York, N. Y.

Send me your FREE S. W. Kit Manual for 1935.
Send me FREE tabloid on the Browning "35."

Name.....
Address.....
City..... State.....

BUILD IT YOURSELF

JIM DANDY CABIN TRAILER

Classy! Roomy! Easy to build at low cost! Plans and instructions only \$1.00—including all Diagrams, Sketches, Photos, Material List, etc. Big Value! Mail Dollar Bill to Jim Dandy, Box 125-A, Wausau, Wis.



SALESMEN

Why expect Politics to bring Prosperity? We don't believe it ever has or ever will. Make prosperity selling METLMACHES, the match that lights 1000 times or more, and was sold around the World in 90 days. One man sold 3000 gross in six months. Can you? If you do, you will make \$6480 commission.

PEOPLE HAVE MONEY & BUY WHAT THEY WANT
Will you work hard for big money? Write us for salesman's terms free. Samples 15¢ or better still, send \$1 for 15 METLMACHES, sell them at 10¢ each, make 50% profit and convince yourself that this is a red hot seller.

METALMATCH CORPORATION, 115 Water St., Warsaw, Illinois

EARN MONEY Stringing Tennis Rackets

STRINGING TENNIS RACKETS PAYS UP TO 140% PROFIT PER RACKET!

String your own racket and Save Money!
String for Tennis Players and Earn Money!

It's easy—we teach you how to string—Show you how to get business. Your success is assured with our backing.
Covers next to nothing to start. Write for "Play & Profit"—gives all details.

FREE FOLDER
"Play & Profit" tells you how to earn money stringing rackets.
Low prices. Buy direct-from-factory! Price list of TOMGUT "Court-Tested" Tennis Strings and Stringing Equipment included.

New "Tension-Master"
racket stringing machine enables you to do expert stringing or over-measures correct tension in No experience needed! Machine weighs 10 lbs. Brings bigger profits. If you can do home work than the best professional. Easy to use! Low Cost! Write for folder.

THOMPSON MFG. CO., 4535 Packers Ave., CHICAGO, ILL.
Makers of Tomgut "Court-Tested" Tennis Strings and Restrunging Equipment

A.C.-D.C. PORTABLE TWO-TUBER

(Continued from page 134A)

marking the holes to be drilled in the box.

The speaker is mounted on the base by means of two 7/8-in. metal bushings and machine screws. The front of the speaker should be flush with the edge of the base, and the condenser unit is mounted 5/8 in. back from the edge. Fig. 1 shows the schematic diagram. A complete material list can be obtained from Popular Mechanics radio department upon application, without charge. The cardboard case is 9 in. long, 5 1/4 in. deep and 7 1/8 in. high. This is given a coat of shellac. A hole is cut for the speaker and backed with a piece of heavy screen wire. An enlarged blueprint diagram of the layout, wiring diagram and drilling template is available; those who wish it should specify blueprint R-211.

To balance the set, connect the antenna to the insulated post on the rear of the base and plug the cord-ohm power cord in a wall socket. If line supply is d.c. it may be necessary to reverse the plug in the socket. Turn the condenser plates about 3/4 of the way out, with no station heard, and adjust the trimmer condensers on top with a screwdriver for loudest noise, after which the set is ready for operation.

SIMPLE POWER UNIT FOR 50-WATT TRANSMITTER

(Continued from page 136A)

plete material list with tuning data, may be obtained upon application, without charge.

The baseboard for the power-supply unit is 3/4 by 12 by 13 1/2 in. As shown in the photo, the arrangement from left to right at rear is as follows: Thordarson power transformer, swinging input choke and filter choke. Two oil-filled Aerovox transmitting condensers are mounted directly in front of the chokes and the tapped voltage divider is at the right. A type-83 rectifier tube and its 5-volt filament transformer are at the left. Fairly heavy rubber-covered stranded wire is used for all connections. An enlarged blueprint of all layout and wiring diagrams is available, those who wish it should specify blueprint R-212. The power unit is connected to the transmitter with a 5-ft. cable. No adjustments should be made in the power unit without first removing the plug from the wall socket.



100 PAGE BOOK
Full of Beautiful things you can make. Lists and pictures 76 blueprints, designs, scroll patterns, beautiful furniture inlays, etc. The most useful book of its kind.

only 10¢ Craftsman Wood Service Co.
We ship all over the world
2728 Mary St. CHICAGO

UNIVERSAL · LATHE · CHUCKS

Self centering—Reversible Jaws.	3" —	\$ 8.00
Sturdy—Dependable.	4" —	9.00
A "Precision Product"	5" —	11.50
Send Draft or Money Order.	6" —	14.00

If not entirely satisfied, return in 5 days and we will refund your money.

Postpaid
JOHN L. ALEXANDER 424 Superior Street
DETROIT, MICH.

Make Money at Home!

GROW MUSHROOMS in your cellar or shed. Exclusive new process. Bigger, better, quicker crops. More money for you! Enormous new demand. Write for Free Book.

American Mushroom Industries Ltd., Dent. 319, Toronto, Ont.

Print Your Own

Cards, stationery, circulars, tags, labels, advertising, etc. Save money. **Print for Others; Big Profits;** easy rules sent. Will do popular Raised Printing like Engraving. Junior press \$5.95, job presses, \$11 up, power \$149. Send for free catalog and all details.

THE KELSEY COMPANY, B-37, MERIDEN, CONN.

NEED A BETTER GRIP ON MATHEMATICS?

SEND for a copy of "Mathematics for the Practical Man," only \$1.50. By common sense methods it removes the mystery and difficulties so that algebra and even calculus are made simple.

Assuming your knowledge is limited to arithmetic you quickly and easily gain a working knowledge of Algebra, Geometry, Trigonometry and Calculus. Simply pay postman price of book plus the postage when he hands you the package.

Popular Mechanics Press
Room P12
200 E. Ontario Street, Chicago

NEW BUSINESS IS MONEY-MAKER FOR MEN WHO ARE HANDY WITH COMMON TOOLS

Unemployed? Dissatisfied? Start your own business! Others making money—why not you? Full details in **"BUILT-IN FURNITURE"**

SIMPLY TAKE ORDERS—BUILD—AND GET PAID! Popular Mechanics' big new book pictures and describes modern built-in furniture, closets, cabinets, safes, cupboards, shelves, etc., to utilize waste home spaces. Every owner interested in these practical improvements. You need only fractional amount for standard materials; profits depend on your efforts. Postpaid, \$2.50—order!

POPULAR MECHANICS PRESS
200 E. Ontario St. Room 734 CHICAGO

\$150 to \$300 Profit Monthly with "Build Your Own" Simplified Arc Welder

This new "Build Your Own" Welder unit lets you have modern portable welding equipment at \$300 to \$500 savings. Puts you in big paying business of your own—lets you go to the big jobs where profits are large. Low prices and long terms lets you pay for it out of increased profits.

30 DAYS TRIAL AT OUR RISK MONTHLY TERMS

HOBERT BROS.
Box M75 Troy, Ohio

Shops everywhere have found that this unit puts them back in the big money class—they are cashing in on the profitable jobs and construction work it lets them handle. Comes to you complete with instructions for assembling into gas engine drive, portable unit. Write us today for new low prices and complete data on HOW TO BUILD YOUR OWN WELDER. No obligation.



They Said I Couldn't Do It. But Here It Is my 1935 OFFER

WEAR A WATCH OR DIAMOND

30 Days FREE!
then Make Your Own Terms



My confidence in YOU; my confidence in my standard, dependable watches and beautiful genuine diamonds, and my confidence in business conditions cause me to make this unheard of offer. I am going to place as many watches and diamonds in the hands of men and women throughout the land as possible in 1935 NO MATTER WHAT THE SACRIFICE, because each watch and diamond will act as a salesman to sell another.

Direct-to-You, Rock Bottom Prices on Nationally Advertised Watches, Diamond Rings and Silverware

What an offer! Nationally advertised watches, diamonds and silverware offered at lowest direct-to-you prices! For nearly a half century we have sold highest quality jewelry all over the world. And now this remarkable offer.

Send for Beautiful FREE CATALOG

Write now—before this offer is withdrawn and get the beautiful FREE Catalog. Select the watch or diamond you want, wear it, examine it, and then write us the terms you desire.

SANTA FE WATCH COMPANY
76 Thomas Bldg., Topeka, Kan.
We Buy OLD GOLD and STERLING SILVER

AT LAST! A REAL POCKET RADIO

Can actually be carried in pocket or purse! No tubes—batteries—nothing to wear out. NO Crystals to adjust! Simply clip to any metal object as desks, beds, telephones, etc., for clear reception locally! One control—gets all stations 50 up to 100 miles under favorable conditions. **Short Wave and police calls also!** No complicated hookups. Fool-proof—and practical—great novelty. Can be used ANYWHERE ANYTIME—in auto, etc. Complete with tiny phone—NOTHING else to buy—ready to listen to! Send only \$1 and pay postman \$1.95 plus postage or send \$2.50 (M.O. Currency Check.) Ideal gift. Complete Ina. Included, Guaranteed. Order now! At all the better Department and Radio stores.

TINY TONE RADIO CO., Dept. P7 Kearney, Nebraska

FOUNDRYETTE Inventors and Craftsmen

Make your own castings of aluminum, copper, bronze, nickel brass. Outfit contains gas furnace with 110 volt, 60 cycle motor blower, moulding sand, crucibles, tongs, rubber hose flask, parting materials and instructions for use. For making models, trays, dishes, art objects, tools, shop equipment, etc.; also used for forging, case hardening and heat treating. Crucible capacity 6 cubic inches. Price of outfit complete \$9.50 f.o.b. K. C., weight approximately 25 lbs. Check or money order acceptable, express charges C.O.D. Write for Free Circular.

KANSAS CITY SPECIALTIES CO.
P. O. Box 6022 Kansas City, Mo.

Information on any book free. Write Popular Mechanics Press, Chicago, Ill.

\$150 to \$300 Profit Monthly with "Build Your Own" Simplified Arc Welder

Shops everywhere have found that this unit puts them back in the big money class—they are cashing in on the profitable jobs and construction work it lets them handle. Comes to you complete with instructions for assembling into gas engine drive, portable unit. Write us today for new low prices and complete data on HOW TO BUILD YOUR OWN WELDER. No obligation.

30 DAYS TRIAL AT OUR RISK MONTHLY TERMS

HOBERT BROS.
Box M75 Troy, Ohio

Write today for FURTHER INFORMATION - Get our FREE BOOK!

**This easy test
will show you
which polish to
use . .**



Compare DuPont Polish with any other make

First, polish one half of your car with Du Pont Duco Polish. Second, polish the other half with any other make.

Now you can see why Du Pont Polish is called "Speed Blend." It's easier to use—quicker in action. Makes your car shine brighter and longer. That's why it's the most popular liquid polish you can buy.

- TRIAL OFFER**— You can try Du Pont Polish at our expense. Get a generous sample FREE. Tear out this advertisement and send it with your name and address to DUPONT, Dept. M-53, Wilmington, Del. Enclose 6c in stamps to cover postage.

(Offer good only in U. S. and Canada.)



**DU PONT
DU CO
POLISH**



HOW WEATHER AFFECTS YOU

(Continued from page 36)

devised for this purpose. They belong to two general classes.

Typical of one class is the katathermometer, a special form of thermometer, the bulb of which is heated by dipping in hot water after which the rate at which the mercury falls is observed with the aid of a stop watch. The "wet kata" has its bulb covered with cotton mesh to retain the moisture so as to include in its measurement the cooling due to evaporation.

Instruments of the other class imitate the behavior of the human body by maintaining a constant temperature and are designed to measure the rate at which heat is lost. The eupatheoscope, or "good feeling indicator," consists of a hollow cylinder of copper, the outside of which is painted dull black. The cylinder contains an electric heating unit, a thermostat and the bulb of a thermometer. The thermostat will keep the temperature constant. The electric energy consumed by the instrument shows the rate of heat-loss.

Measurements of the cooling power of the outdoor air as a gauge of comfort are now made at several places in Europe. In years to come it will probably be customary during hot and cold waves to publish figures that will give an accurate idea of how people feel instead of the present misleading records of thermometers.

Clean air is more comfortable to breathe than dusty air. The rarity of the atmosphere causes discomfort at high altitudes. The chemical composition of the air may affect our comfort, and some believe it would be possible to supply an air-conditioned building with a "synthetic atmosphere" better for our comfort and efficiency than the one provided by nature. Years ago it was suggested that the uncomfortable condition experienced by many people when hot, dry mountain winds are blowing, is due to the electrical state of the air.

Evidence that minute electrified particles in the air, known as "ions," are the principal cause of a fresh invigorating atmosphere is now being sought. Some believe the relative freshness or "deadness" of air and perhaps also some of its health-controlling properties depend upon the quantity and kinds of ions present. Instruments for regulating the ion content of indoor air are already on the market.



Don't let DIRTY SPARK PLUGS STEAL YOUR GAS!

Car makers will tell you that dirty spark plugs rob you of as much as 1 gallon of gas in 10. The sure remedy is spark plug cleaning—at any Registered AC Cleaning Station. Be guided by the sign of the "Plug-in-the-Tub." Replace worn plugs with new ACs. Now 60c.

AC SPARK PLUG CO.
Flint, Mich. St. Catharines, Ont.



30 Days' Trial

On all Mead bicycles. New RANGER models now ready for delivery direct to rider. Many recent improvements. Astonishing new prices and terms.

\$19.95 buys a genuine Mead bicycle. Rangers cost a few dollars more. Lamps, horns, wheels, parts, equipment, and repairs at half usual price. Established 44 years.

Mead CYCLE COMPANY
DEPT B-115, CHICAGO



Write us today for free catalog

BUILD YOUR OWN

Streamlined Trailer at little cost. Send dollar for plans and blueprints of two models—the light Standard and the Deluxe Model as shown. Mail a dollar to D. VAN OOSTVELDT, 111 MARSTON, DETROIT, MICHIGAN.



Catalog No. 35 Illustrating Electrical, Mechanical and Model Makers' Supplies, Small Steam & Gasoline Engines, Motors, Generators, Lathes, Drill Presses, Bench and Band Saws, etc., 16 & 32 Dyna-Motors, Rebound Projects, Engine Castings, Motor Parts, etc., Books, Blue Prints, Brass and Steel Tubing, Gears, Pulleys, Hangers, Experimental Material.
Big Copy. Mailed anywhere for 20 cents. 25 cents Canada, refunded first order.
LOOMIS ELECTRIC COMPANY
2822 N. California Ave. Chicago, Ill.

RENEW OLD BUILDINGS WITH PLASTIC STUCCO

New process—Fuses a plastic, waterproof mixture on any surface. Renews old buildings with a permanent overcoat in any thickness desired and in 30 colors. Proven over six years actual use in practically every climate.
HIGH EARNINGS OFFERED—Operators report profits of 10c to 30c per sq. yd. covered. Machine capacity 40 sq. yds. surface per hour. One job often pays for machine. Enjoy the profits connected with big government renovating campaign. Machine furnished on free trial, easy payments. Write today for complete details.

COLORCRETE INDUSTRIES, Inc.
570 Ottawa Ave., Holland, Mich.



HOME OWNERS:— This was written for you and is sent



DO your own simple home, auto and motorboat repairing and be independent of outside repair men. You will avoid delays, save much money, and have the satisfaction of knowing that the work is well done.

The booklet contains clear diagrams and directions for correct procedure for hundreds of common jobs, and enables any home worker to get dependable results, *easily*, on any of the following:

- Stopping leaks in pipes, heaters, boilers, tanks, radiators, air ducts, smoke pipes, pails, etc., at connections, seams, cracks, rivets or holes.
- Tightening or anchoring loose hinges, locks, handles, screws, bolts, nuts, bases, stems, tops, casters, etc.
- Making waterproof joints at skylights, roof cracks and flashing.
- Making wet cellars dry from the inside, making concrete floors hard, water and oil proof, and non-dusting, making masonry walls waterproof.
- On the car:—Stopping leaks in the radiator at hose connections, or in oil and gasoline lines, patching cracked water jackets, crank, gear and differential cases, tightening loose rivets, mud guards, lamp standards, hub caps and lubricator connections, loose moulding screws, etc.

Smooth-On Iron Cement with which this work is done is applied without heat, without special tools, and so easily and inexpensively that half a dollar to half a hundred dollars is saved in each instance. Smooth-On has been widely used in industrial work for over 35 years and its use is standard practice by power plant engineers and repair men.



Get the booklet by mailing the coupon and buy Smooth-On No. 1 in 7-oz., 1-lb. or 5-lb. can from your hardware store or if necessary from us.

Do it with SMOOTH-ON

SMOOTH-ON MFG. CO., Dept. 37
574 Communipaw Ave., Jersey City, N. J.

Please send the free Smooth-On Repair Book.

Name.....

Address.....

7-35.....

JUST GREAT for PICNICS

Camping and Fishing Trips

The Master Picnic Grill enables you to have a hot, even-burning fire almost with a "twist of the wrist" . . . so simple, so easy. Spacious cooking surface will accommodate steaks, wieners, hamburgers, fish and coffee for a large party. Burns charcoal or wood.

QUICK, CLEAN, EVEN HEAT

No loose parts to assemble or get lost. Very strong and durable, yet light and easy to carry. Cooking surface 11 inches wide by 18 inches long. Folds to 1 1/2 inch thickness; compact and clean because sidewalls protect grill inside; prevents soiling. Complete with folding, removable windshield; conserves all the heat. Master Picnic Grills will be on sale at all hard-

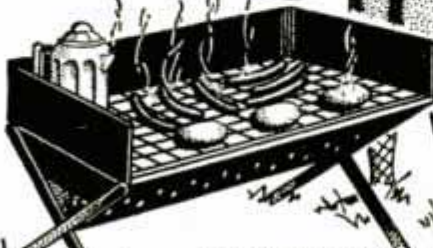

FULLY COVERED BY PATENTS

No Fuel or Ashes Can Fall Through Bottom

ware, sporting goods and department stores as soon as distribution can be effected. Order yours today or, if you prefer, we will send one postpaid for \$2.00—(\$2.25 West of Mississippi River and in Southern States—\$2.50 in Pacific Coast States—\$2.75 in Canada, from our Canadian plant). If not entirely satisfied with Grill, return it within 10 days and your money will be refunded.

MASTER METAL PRODUCTS, INC.,
355 Chicago St., Buffalo, N. Y.

Send me, postpaid, one Master Picnic Grill complete with windshield. Enclosed find (check) (money-order) for \$.....

Name.....

P. O. Address.....

City..... State.....

No C. O. D. orders accepted.



BUILD DUTCH WINDMILLS

Great Fun from Our Detailed BLUEPRINTS. Make Money Selling to Others. Model BIG Hexagon Windmill 30 in. high 75c. LAWN FIGURES (approx. 20 in.) Dutch Schoolboy, Tulip Girl, Holland Pair, Sunbonnet Girl patterns 35c ea. All 4—\$1.00. "KEEP OFF THE GRASS" Policeman pattern 35c. Send 10c for CATALOG illus. over 25 models.

RAFTSMAN'S MODEL CO., Dept. P20, 2030 N. 41st St., MILWAUKEE, WIS.

HIGH POWERED TELESCOPE

GENUINE BROWNSCOPIES AT AMAZING PRICES

Most powerful in America for the money! 15 power long range telescope. Can see moon's craters or time on pocket watch a block away. 5 sections. Approx. 3 ft. long. Fine lenses. Brass bound. Can be used as powerful microscope. Vol. magn. 512X. Only \$1.69 postpaid. C. O. D. 24c extra.

\$1.69



\$1.98

Special Super-Power 30X Telescope.

Similar to above but more powerful.

Guaranteed to see 900 times larger in surface and 30 times closer. 31 mm. objective 4 powerful lenses. Large field. Includes powerful microscope feature. Only \$1.98 postpaid.

BROWSCOPE CO. Dept. 47 234 Fifth Ave., New York, N. Y.

SHIP MODELS

Priced from 10c to \$2. "Seth Parker" pictured. Visit our dealer or write for catalogue to

MEGOW'S

Howard & Oxford Sts., Phila.



ITCHING

TORTURE STOPPED in one minute!

For quick relief from the itching of pimples, blotches, eczema, rashes and other skin eruptions, apply Dr. Dennis' cooling, antiseptic, liquid D. D. D. PRESCRIPTION. Its gentle oils soothe the irritated and inflamed skin. Clear, greaseless and stainless—dries fast. Stops the most intense itching instantly. A 35c trial bottle, at drug stores, proves it—or money back. Ask for—

D.D.D. Prescription

THE "G-MEN" WAR ON CRIME

(Continued from page 59)

cards in the bureau files. These are all punched as to the physical description of the man whose record they constitute. Then the motor is turned on.

Slowly the machine begins to grind out the cards into the separate compartments lined along the top. Two fall here, three there, four in another receptacle and one falls alone into a certain receptacle. The holes in that card fitted the punches set at the beginning by the operator. He is the "Red" who is wanted. The expert now goes to the fingerprint file, gets his man's fingerprint record and from it is able to tell the police department wiring in who the suspect actually is, his past criminal record, and whether he is wanted elsewhere in the United States.

"G-men" are taught in the federal criminological institute not only how to split a bullet and match the two halves, microscopically, with other split bullets from a suspected gun, but how to use a gun themselves. Before congress passed a law making it a federal crime to kill a federal officer, "G-men" did not carry guns and did not have the power to make an arrest. They did not have any means of chasing criminals save with old automobiles salvaged from the prohibition area. Such long-range and multiple firing guns as they were able to muster had been taken from kidnapers and gangsters themselves.

Now these men are equipped with the latest type of machine guns, rifles and gas bombs. They also have fast automobiles. As yet no armored cars are theirs but these will come in time. All "G-men" are trained in the use of firearms and gas grenades. Each is required to be an expert shot because life may depend on it.

This training is a part of the regular eight weeks schooling given the "G-men" in all branches of investigation work. The rifle range where they practice is one of the finest in the country and the best rifle shots and machine gunners instruct them.

The government "spotlight" on a gangster means one of two things today—apprehension or death. There is no alternative. Witness the record. Since the Lindbergh kidnap law of 1932, federal agents have investigated thirty-two cases of kidnaping or plots to kidnap. And there have

(Continued to page 144A)

Just Out FREE BOOK for INVENTORS

**48 PAGES
ON PATENTS
AND HOW TO MARKET
INVENTIONS**
Over 100 Illustrations

Tells How to Patent an Invention

Describes method of obtaining Patent—advantages of being first in applying for a patent—how patent protects you—what it covers—part it plays in marketing invention—danger of delay in applying for patent. Many facts on Patents are revealed for the first time in this book.

How to Market an Invention

This section describes different fields of invention—how to go about marketing your invention, type of inventions best suited to today's needs, how to place your invention before the public after securing patent. Practically everything brought out here is the result of recent analysis of market conditions.

How to Commercialize Your Invention

How to arrange for partnership—organizing your own company—securing finances—arranging for royalties—types of contracts . . . information you should have right now if you wish to obtain practical success for your invention.

How to Judge Marketability of Invention

After reading this book you can judge to some extent the worth of your idea. Is it an improvement—is it novel enough to warrant patent protection—is there a demand for it? A well known authority gives you his experienced judgment on these questions. You will learn from reliable sources many facts about patents that are vitally important to you **Right Now!**

Make These Tests

In this book you will be told how to apply tests to your invention. You will be shown what qualifications it must meet—both in respect to obtaining a patent and in obtaining a market for it afterwards. You will be told the merit U. S. Patent Examiners will require your invention to have—and the demands the commercial market will make upon it afterwards if success is to be obtained.

No Obligation—Mail Coupon Today

This 48-page book is doubly valuable and interesting because it is brand **NEW!** Every page is packed with latest information of interest to you as an inventor, and calculated to guide you in furtherance of the protection by patent of your invention. Get the very latest information—learn the things you don't know about getting a patent and commercializing your invention.

CLARENCE A. O'BRIEN

Registered Patent Attorney

708 Adams Bldg., Washington, D. C.

Mail coupon for this New Free Book and Record of Invention Blank **TODAY!**

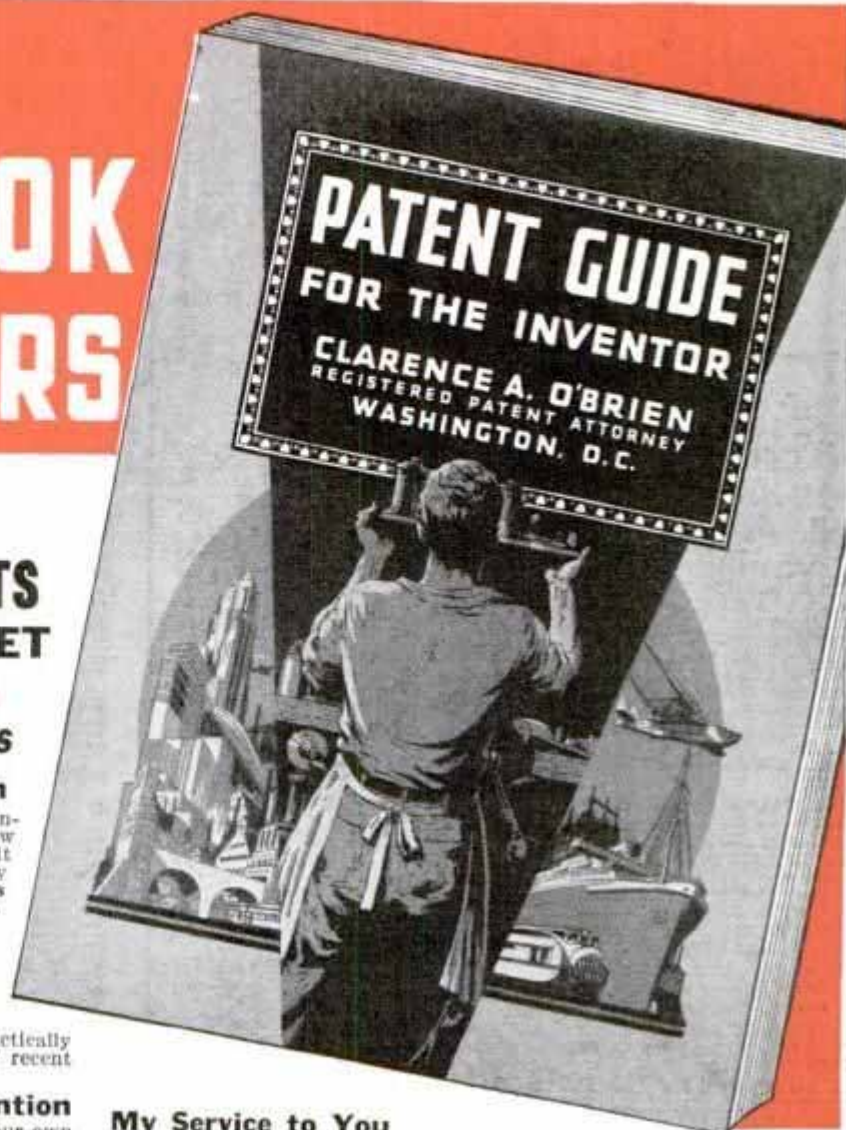

My Service to You

I have secured patents for inventors located in every State in the Union. My organization is a large and efficient one. My practice is confined entirely to Patents, Trade-Marks, and Copyrights. I have had years of experience in patent matters. When you place your idea in my hands, I am in position to proceed at once to secure protection for you. My fees are reasonable, and if you desire, I can arrange convenient terms of payment.

Free Record of Invention Blank

This **FREE** Record of Invention Blank enables you to make in convenient form a sketch of your idea and have it witnessed in a manner of value to you should the occasion for evidence arise.



CLARENCE A. O'BRIEN
REGISTERED PATENT ATTORNEY
708 ADAMS BUILDING
WASHINGTON, D. C.

Please send me your **FREE** BOOK, "Patent Guide for the Inventor," and your "Record of Invention" form, without any cost or obligation on my part.

NAME.....

ADDRESS.....

(Important: Write or print name plainly)

Write for **FREEBOOK**

Start a POTATO CHIP BUSINESS

IN YOUR KITCHEN and MAKE MONEY!

Buy Potatoes for **2c A POUND**
Sell Them as **Hi-Hat Chips for 35c A POUND**



THERE'S big money in potato chips for any man or woman who wants a business capable of paying as much as \$23.50 a day in profits. Just think of it. You can install the wonderful new machine in your kitchen—just manufacture and sack a sensational new kind of "Greaseless" Potato Chip—and let the stores sell them for you. Only \$2.50 invested in raw materials brings back \$10.00 in cash.

EVERYTHING FURNISHED You don't have to have a lot of money to start this business. A small investment in the machine puts you in a big profit business of your own. I send you everything including speed-slicer, cooker, oil-extractor (for making new "GREASELESS" chip) a big supply of printed bags and free advertising material. No experience is needed as I send complete, simple instructions showing how to make a profit the first day. Prices, pictures, and complete plans will be sent free for the asking.

DON'T BUY ANYTHING Just send your name and address on a post-card for all this Free information including the "Secret of Making Greaseless Potato Chips." No obligation, but hurry and you may become independent as so many others have done with these fast selling new "Greaseless" Chips. Address your card to

J. H. Miller, 325 W. Huron St., Dept. 57, Chicago, Illinois



5-DAY TRIAL OFFER

MARVEL All Aluminum WINDOW CLEANER with WATERFLOW CONTROL VALVE, with one filling cleans, dries, and polishes in 1-3 time, 30 to 40 large windows. Sent prepaid for \$1.95 introductory price (Regular \$2.25). Send check or M. O. Agents Wanted.

MARVEL WINDOW CLEANER, Inc.
5003 Euclid Avenue Cleveland, Ohio

WEAVING MATERIALS BAMBOO RATTAN

Reed, Colored Raffle, China Grass, Chair Caning, Chair Frames and Stools, Basketry and Furniture Weaving. Send 10c for Catalog. Instructions Free. **AMERICAN REEDCRAFT CORPORATION** Dept. P 130 Beekman Street New York, N. Y.



HOME AUTOMATIC CIGARETTE MACHINE

Have YOUR OWN Monogrammed Cigarettes. Put tobacco and block of papers on machine, TURN THE CRANK—PRESTO—CIGARETTES. Easy—simple. All metal construction. Guaranteed. No cloth ribbons! no special tube or gummed papers required. **ASK FOR FREE ILLUSTRATED FOLDER.** AUTOMATIC CIGARETTE MACHINE WBS., PM-7, 1055-57 Devon Ave., Chicago, Ill.

New Motor-Driven "DELTA" SHOP TOOLS



PRACTICAL, efficient and compact—the new "Delta" quality tools are in use today in many thousands of home workshops and factories all over the world. Ideal for hobby work, spare-time money-making or production work. The Delta line includes: **Circular Saws, Drill Presses, Band Saws, Lathes, Scroll Saws, Jointers, and full line of accessories.** Priced within the reach of all. Write for complete Delta catalog.

Write for CATALOG!

DELTA MFG. COMPANY
3775 N. Holton St. Dept. B635 Milwaukee, Wisc.

THE "G-MEN" WAR ON CRIME

(Continued from page 142A)

been exactly thirty-two solutions. As a result, seventy-four persons are serving combined sentences totaling more than 1,186 years. Twenty-two others are awaiting trial. Of the seventy-four convicted, sixteen are doing "life." And others have been killed when they elected to "shoot it out" rather than surrender.

The "G-men" have other duties than those of running down criminals. They are taught criminal procedure in federal courts, application of the national bankruptcy act, the motor theft law, mail frauds, what constitutes crime on the high seas on government property and Indian reservations—in fact they receive instruction in what constitutes violation of the criminal statutes of the United States. Hence the preponderance of lawyers and accountants in the personnel, though other professions are represented. For any particular type of crime, there is one special agent who can handle it better than any other because he happens to have a background which fits into the background of the crime—he knows Indians, can speak their language, has been a mechanic, a dentist, doctor, soldier, sailor. All these former occupations give to a "G-man" special qualifications.

So the "G-men" are fast becoming the pride of the nation. Tradition is marking them as it already has marked Scotland Yard. Under their withering fire, keen analytical powers and superb leadership gangland in America is fast learning that crime "does not pay."

PLANE MADE FIRE-RESISTANT BY "DOPE" ON WINGS

By "doping" the fabric in a new manner, airplanes can be made more fire-resistant. In Bureau of Standards tests, gasoline poured on a wing can be burned off without injuring the cloth. The treatment consists of impregnation of the cloth fibers with a boric acid-borax mixture and then coating the cloth with cellulose acetate instead of cellulose nitrate as now used. The acetate burns only one-fifth as fast as the nitrate. Thus, the fire hazard is reduced to twenty per cent, while the fire-resistant treatment of the fibers decreases the danger still more.

829
508
Washington
Announced by

PATENTS

Booklet Free **Highest References**
Promptness Assured **Best Results**
 Send drawing or model.

ALL BUSINESS GIVEN PROMPT AND PROPER ATTENTION

Listed Patent Lawyer in the latest editions of the Rand-McNally Directory of Bankers and Bank-Recommended Attorneys, published by Rand-McNally & Co., Chicago, Ill.; The Baggott & Ryall Directory of Guaranteed Attorneys, published by Legal Directory Corporation, Boston, Mass.; Flugel's Law List, published by Legal Directory Publishing Co., St. Louis, Mo.; American Lawyers Annual, Cleveland, Ohio; Bankers Service Legal Directory, Bankers Service Co., Boston, Mass.; Eyre's Law List, 9 Park Place, New York City, and the Central Guarantee Co., Bankers and Lawyers Directories, Empire State Bldg., New York City.

WATSON E. COLEMAN,
 REGISTERED PATENT LAWYER

Victor Building, 724 Ninth Street, N. W.,
WASHINGTON, D. C.

PATENTS—TRADE MARKS

All inventions submitted held confidential and given personal attention by members of the firm.
 Form, "Evidence of Conception" and instructions, "How to Establish Your Rights"—FREE!

LANCASTER, ALLWINE & ROMMEL
 Patent Law Offices

412 Bowen Bldg. Washington, D. C.

INVENTORS PATENT YOUR IDEAS

SEND FOR FREE BOOK

HOW TO OBTAIN A PATENT

Written by a Former Member of the Examining Corps (1922-24) of the U. S. Patent Office. If you want to profit by your idea, you should take steps to apply for a U. S. Patent at once. Your first step is to get this Free Book. This interesting illustrated book contains valuable information you should have. It tells you fully how to obtain a patent on your idea in the quickest way. With this Free Book you will also receive a "Record of Invention" form on which you can easily record your idea. Personal and Confidential Service: Your case will be personally handled only by a Registered Patent Attorney who is also a Former Member of the Examining Corps of the U. S. Patent Office. All communications confidential. MAIL COUPON TODAY for FREE PATENT BOOK and RECORD OF INVENTION Form.



CARL MILLER

REGISTERED PATENT ATTORNEY
 FORMER MEMBER EXAMINING CORPS U. S. PATENT OFFICE

1638 Woolworth Bldg., Dept. 75A, New York City
 MILLER BUILDING, Dept. 75A, WASHINGTON, D. C.

Please send me your Free Book, "How to Obtain a Patent," and your "Record of Invention" form.

NAME.....

ADDRESS.....

INVENTORS

who derive largest profits know and heed certain simple but vital facts before applying for patents. Our book, Patent-Sense, gives those facts; sent free. Trade Marks—Copyrights. LACEY & LACEY, Est. 1869, 635 F St., N. W., Dept. 5, WASHINGTON, D. C.

DEAFNESS IS MISERY



Many people with defective hearing and Head Noises enjoy Conversation, Movies, Church and Radio, because they use Leonard Invisible Ear Drums which resemble Tiny Megaphones fitting in the Ear entirely out of sight. No wires, batteries or head piece. They are inexpensive. Write for booklet and sworn statement of the inventor who washed himself deaf.



A. O. LEONARD, Inc., Suite 699, 70 5th Ave., New York

BUCHSTEIN'S FIBRE LIMB



is soothing to your stump—strong, cool, neat, light. Easy payments. Braces for all deformities. Agents wanted. D. BUCHSTEIN CO. 810 3rd Ave., So., MINNEAPOLIS, MINN.

Send for Catalog Today

ARMY AND NAVY SUPPLY CO.

Bargains—Army, Sport Goods, Firearms, Clothes, Shoes, etc. Send 10c for new catalog, to be redeemed on first order

Army & Navy Supply Co. 4772 Lester St. Richmond, Va.

Get These Tricks on CAMPING



Now—before you start touring, camping, vacationing, get this book that tells HOW to enjoy each minute: How to avoid hardships, discomforts, disappointments. Every sport enthusiast will welcome this book, "OUTDOOR SPORTS."

352 PAGES—650 PICTURES of time and labor-saving camping suggestions. Fishing, Fly Casting, Boating, Canoeing, Swimming, and hundreds of helpful ideas for making outdoor sports enjoyable. Price \$2.00. Sent prepaid or C. O. D. anywhere in U. S. Catalog listing 5,000 other books Free. Popular Mechanics Press, Room P7, 200 E. Ontario, Chicago



WILL YOU WEAR THIS SUIT



and Make up to \$12 in a Day!

Let me send you this fine all-wool tailored suit FREE OF COST. Just follow my easy plan and show the suit to your friends. Make up to \$12 in a day easily. No experience—no canvassing necessary.

Send for Samples—FREE OF COST
 Write today for FREE details, ACTUAL SAMPLES and "sure-fire" money getting plans. Send no money. H. J. Collin, Progress Tailoring Co., Dept. U-216 500 S. Throop St. Chicago, Ill.

DO YOU

WANT a new business profession of your own, with all the trade you can attend to? Then become a foot correctionist, and in a few weeks earn big income in service fees,—not medical nor chiropody—easy terms for home training, no further capital needed, no goods to buy, no agency. Established 1894. Address Stephenson Laboratory, 1 Back Bay, Boston, Mass.

To PROTECT Your INVENTION—Use this coupon, NOW

Delays are dangerous and may be very costly. My personal service assures prompt action, strict confidence, and a minimum of expense. I suggest that you send me a model or drawing, or sketch and description of your invention, and \$5.00. I will make a search and report

promptly as to its patentability and send you a copy of my 72-page booklet. Or, if you prefer to read my booklet first, mail the attached coupon at once. I will also send my "Record of Invention" form. (Over 37 years experience as a Registered Patent Attorney.)

L. F. Randolph, 302-D Victor Bldg., Washington, D.C.

Please send me at once, free of charge, your 72-page booklet and "Record of Invention" form.

Name.....

Address.....

A PERSONAL CONFIDENTIAL PATENT SERVICE

SCULPTURED SOUND

(Continued from page 48)

line which conveys the "sculptured" sound effects between any two points. In giving sound what Dr. Fletcher describes as "perspective," the recording is similar to that in a radio studio, save that three microphones are scattered about. Each of these is sensitive to a given set of frequencies and no other, and each transmits on a separate channel. Hence, the system requires three channels and is appropriately called "three-way" sound transmission.

In reproducing the sound, the special loud speakers are placed exactly in the same relative position as the microphones in the distant studio. In this way, engineers have arrived at sound perspective, which gives a more faithful reproduction of music than any other known form. Dr. Fletcher can produce startling effects with electrical filters which can separate and amplify, in turn, the upper and lower registers of an orchestra. He can send a revolver shot whistling past your ear with such fidelity that you instinctively duck, then he can make the shot reverse itself and end where it started.

Without apparent effort, Dr. Fletcher succeeded in populating an empty stage with the voices of actors who were not present. These phantom voices moved around the stage as if they came from the mouths of real people. It is a new kind of entertainment, the exact opposite of the silent movies. The silent movies were entirely visual; the new type of entertainment is entirely vocal.

"If you listen directly to real music with one ear stopped up so no sound is heard through it, only two dimensions, quality and volume, are perceived," declared Dr. Fletcher. "When you listen with two ears, perspective, or a sense of depth is added, which plays no small part in the over-all artistic effect."

"The enormous variety of tone color that is possible in music depends on the varying intensity of overtones, reaching as high as 15,000 cycles in a second—and the whole range of this is possible with three-way transmission," says Dr. Leopold Stokowski, the well-known orchestra conductor. "The sensation of space is important in music. Sometimes dim sounds seem to come from a great distance, and this remoteness gives them a particular mys-

tery and unearthly beauty."

In its present form, three-dimension sound is not directly applicable to the limited dimensions of the home. With the movies, the additional cost is also a consideration. Two microphones would be necessary and two sound tracks. This leaves orchestral reproduction in a large auditorium as the principal commercial use for sculptured sound at present.

THE Smooth WAY TO "ROUGH" IT

Self-Built DeLuxe House Trailer gives you economical travel-convenience. Complete interiors—4 models. Progressive Buying Plan. Any workman can build. Beautiful new Trailer Builders' Guide, 100 illustrations: famous Ball and Socket Hitches; Combi-Chase axles; Parking Legs; Sinks; Stoves; Inner Spring Beds. Send only 50c for Trailer Builders' Guide.



Full Size Blueprints FREE With Parts.

HAMMERBLOW TOOL CO. Dept. 17, 606 Third St. Wausau, Wis.

RACKETS

Save money stringing your own racket. Earn extra money stringing for others. String, tools, and instructions \$1.50 C. O. D., 15c extra. Free catalog of our new tennis strings, rackets, balls. OLYMPIC SPORTING GOODS CO., 6 E. Sidney Ave., Mt. Vernon, N.Y.



Earn Cash at Home!

Grow fancy giant mushrooms in cellar, attic, barn. Easy, odorless method. We show you how, furnish guaranteed materials and buy crops. Valuable big book, pictures free if you write quickly. (Est. 1908.) UNITED CO. 3648 Lincoln Ave. Dept. 127 CHICAGO

FOR YOUR HOME WORKSHOP

If you like to make things, you will enjoy this new book just published by Popular Mechanics entitled



Make It Yourself

The home mechanic, whether young or old, amateur or professional, will take pride and delight in making many of the things described therein.

Both father and son will find fascination and an association of interest in making useful and ornamental articles for mother to admire upon their completion.

900 Articles All Different

There are attractive ship models, a great variety of toys that operate themselves by means of an ingenious application of mechanical principles, novel amusement devices for indoors and outdoors, for both water and land, unique designs in furniture for children, scores of useful appliances for the home, things of beauty and utility for lawn and garden, etc.

Special articles instruct the amateur mechanic in the care and use of tools, special tools for special purposes, how to read and use plans, how to solder, the making of a handy work bench, cuts, joints and methods in woodworking, automobile repairing, installing radio equipment, house wiring, fixture hanging, working in glass, leather, metal, celluloid, lathe work, utilizing parts of old machines to make equipment that would be expensive to buy, etc.

480 Pages—823 Illustrations. Size 7x10x1 1/2 in. Cloth Binding

Price \$3.00

Mailed Postpaid upon receipt of price anywhere in the world. If you reside in U. S., Hawaii, Porto Rico, Alaska or Mexico, we will send the book by mail C. O. D. if you prefer.

POPULAR MECHANICS PRESS (ROOM P-5)
200 East Ontario St. Chicago, Ill.

Crystal Radio Detector 25c

COMPLETE WITH CRYSTAL RECEPTION POSITIVELY GUARANTEED

This Detector is a complete radio in itself, as it is possible to get reception with it alone, provided you are within 25 miles of a broadcasting station (or up to 100 miles under very favorable conditions). All you need is an aerial and an ear phone and you are all set. It is completely assembled and wired, all ready for use. It has two posts, making connection much easier, also making it possible to make changes quickly. Everything complete, including the stand, crystal cup, arm with catwhisker and necessary screws, an ultra sensitive crystal of the finest grade, two terminals for wire connections mounted on handsome base—**EVERYTHING COMPLETE FOR ONLY 25 CENTS POSTPAID.** Send coin or stamps. Every set tested and reception positively guaranteed.

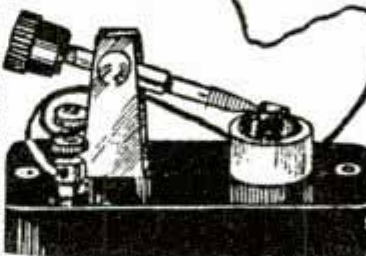

**No Tubes
No Batteries
No Noise
No Distortion**

BOOK ON RADIOS 10c

Add 10c and we will send you a book called "EFFICIENT RADIO SETS." Tells how to make inexpensive radio receiving sets, crystal as well as electrical, how to make short wave set, etc. Fully illustrated. **Price 10c Postpaid.**

JOHNSON SMITH & CO., Dept. 851, RACINE, WIS.

BOYS! THROW YOUR VOICE

Into a trunk, under the bed or anywhere. Lots of fun fooling teacher, policeman or friends.



THE VENTRILO

a little instrument, fits in the mouth out of sight, used with above for Bird Calls, etc. Anyone can use it. Never fails. A 64-page Book on Ventriloquism and the Ventrilo. **ALL FOR 10c POSTPAID.**



LEARN JIU-JITSU

25c DON'T BE BULLIED. Learn to protect yourself under any circumstances without any weapons whatsoever. Jiu-Jitsu has been proved to be the BEST science of self-defence ever invented. Jiu-Jitsu, meaning "muscle-breaking," is the Japanese method of physical training, and has been practised for three thousand years. It has long been acknowledged as the most wonderful of all systems, giving power over an adversary that counts for more than strength. Anyone well trained in Jiu-Jitsu can meet and defeat the best expert at all points. This book gives the fullest instructions enabling you to learn Jiu-Jitsu in the privacy of your own home. Fully illustrated. **PRICE 25c Postpaid.**

JOHNSON SMITH & CO., Dept. 851, Racine, Wis.

THE ART OF DANCING

Learn the Carlo, Continental, Rhumba, Kiss Dance, Etc.



LEARN TO DANCE THE LATEST STEPS. Be popular this season. Really good dancers are always admired—always popular guests. Partners welcome them eagerly. With the aid of this book you can learn the newest, smartest steps without a teacher and become a dancer who is sought after. After following the instructions in this new book you won't need to make excuses when the dance music starts. Besides you'll get lots more fun out of parties and dances. If you want to become a perfect dancer, learn to dance at home this new, easy way.

WHAT THE BOOK TELLS: How to develop poise and control, how to improve your dance steps, the art of holding, how to walk to music, how to lead, how to do the latest Fox Trot Steps, Natural and Reverse Turns, the Reverse Wave and Change of Direction Steps, the Quickstep, swaying to music, how to waltz, Backward Changes, how to do the Continental, the famous Kiss dance, the Manhattan Dance, the College Rhumba, the Carlo, the Veyo, etc., etc. Nearly 100 illustrations are given, and everything is made so plain that you'll be dancing before you know it. **PRICE 25c POSTPAID.**

Learn to be a Tap Dancer

Why envy the easy rhythm and fascinating grace of Step'n Fetchit, Fred Astaire and others? Now you can learn to tap dance in **ONLY 6 HOURS** by a new, simplified course of lessons by Prof. Hawley Wilson. No special ability needed.

PRICE 25c Be smart! Learn tap dancing. Everybody's tapping. The whole town is tapping. Learn to beat out a tune with your feet. Hostesses love it. Friends adore it. It's fun and you'll thoroughly enjoy the lessons. Besides, tap dancing is not only an invigorating and entertaining accomplishment, but it is also an invigorating and health-giving exercise for making the limbs supple and giving a "springy" feeling of fitness to the whole body. It promotes slimmness—nature's way, without pills, drugs or dieting. Here is what some of our readers say: "... wonderful benefit. Thank you for adding tap dancing to my accomplishments."

And another: "My friends were amazed. I dare not recommend your course for fear of competition." **PRICE 25 cents. JOHNSON SMITH & CO., Dept. 851, Racine, Wis.**

Boy Electrician with 75 illustrations for making Batteries, Dynamos, Motors, Telegraph apparatus, Telephone, Lights, Bells, Alarms, Coils, "Wireless" Current Reverser, Electric Engine, Radio, etc. **Price 10c Postpaid.**

BLANK CARTRIDGE PISTOL

REVOLVER STYLE

Three new models now out. 25c, 50c and \$1.00. Well made and effective. Modelled on pattern of latest type of Revolver. Appearance alone enough to scare a burglar. Takes 22 Cal. Blank Cartridges obtainable everywhere. Great protection against burglars, traps, dogs. Have it lying around without the danger attached to other revolvers. Fine for 4th of July, New Year's, for stage work, starting pistol, etc. **SMALL SIZE 4 in. long 25c. MEDIUM SIZE 5 in. long 50c. LARGE SIZE 6 in. long \$1.00. BLANK CARTRIDGES 50c per 100. HOLSTER (Cowboy type) 50c. Shipped by Express only not prepaid. Big novelty catalog 10c. JOHNSON SMITH & CO., Dept. 851, Racine, Wis.**



JOHNSON SMITH & CO.
Dept. 851 RACINE, WIS.

A copy of our NEW CATALOG mailed on receipt of 10c., or the De Luxe Edition with cloth binding 25c. Bigger and better than ever. Only book of its kind in existence. Nearly 600 pages of the latest tricks in magic, the newest novelties, puzzles, games, sporting goods, rubber stamps, unusual and interesting books, curiosities in seeds and plants, etc., unobtainable elsewhere. Remit by Coin, Money Order, or Stamps, for all articles listed above. If by Check, add 15c for exchange. Canadian money and stamps, and British P. O. Orders accepted.

South Bend 9" x 3' WORKSHOP Precision Lathe

**A High Quality
Back-Geared, Screw Cutting
Metal Working Lathe**
RECOMMENDED FOR

- MANUFACTURING PLANTS
- MACHINE SHOPS, ALL TYPES
- U. S. GOV. LABORATORIES
- AUTO SERVICE SHOPS
- ELECTRICAL SHOPS
- HOME WORKSHOPS
- INVENTORS
- SCHOOL SHOPS
- WASHING MACHINE
and REFRIGERATOR
REPAIR

This Lathe
TURNS, BORES, FACES,
CUTS SCREW THREADS,
DOES CHUCKING,
REAMS, FILES,
POLISHES, DRILLS
AND DOES HUNDREDS
OF OTHER MACHINE
OPERATIONS



**LATHE
WEIGHS
300
POUNDS**

9 1/2" swing x 3' bed Workshop Lathe with Horizontal Countershaft, 1/4 h.p. reversing motor, reversing switch, and belting. **\$24.00 Down, \$7.00 a Month. \$94.00**
11 Months to Pay. (Special tools extra.) For other sizes see prices below.

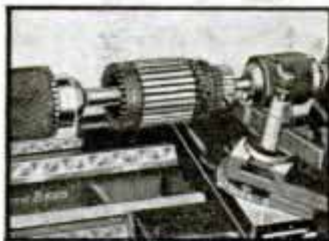

Truing an Armature.

Lathe Machines Metals, Woods, Compositions, Etc.

The 9" x 3' Workshop South Bend Lathe is the greatest value we have ever offered in our 28 years of lathe building. It is practical for making and servicing mechanical devices of every kind. Recommended for all classes of accurate machine work, wood turning, radio, auto and electrical repair; also for model, tool and instrument work. This precision lathe performs all general machining operations on cast iron, steel, other metals, woods, hard rubber, fibre, bakelite, and similar compositions.

FEATURES: The 9" Workshop Lathe is a rigid, powerful, accurate, modern lathe. It is constructed entirely of cast iron and steel and all gears are machine-cut and tested. Has six spindle speeds; cuts screw threads 4 to 40 per inch; has automatic longitudinal feed to carriage; 3/4" hole through spindle; graduated compound rest; micrometer graduations on feed screws; reverse for threads and feeds; three V-ways and one flat-way on bed. Can be fitted with 38 practical attachments.

30-DAY TRIAL. Send in your order and down payment today and try this genuine South Bend Lathe for 30 days in your own shop. The lathe will be shipped immediately. Satisfaction guaranteed or your money back.

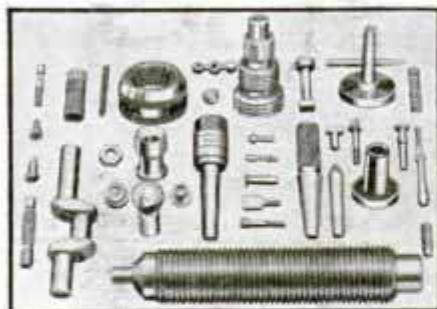

Metal Parts Machined in this Lathe.

EASY PAYMENT PRICES 9-inch WORKSHOP LATHES—10 to 12 Months to Pay											
Size of Lathe			Lathe Less Countershaft				Lathe with Motor Drive				
Swing Over Bed	Length of Bed	Distance Between Centers	Wgt. Crated Lbs.	Net Factory Price	Down Payment	Monthly Paym'ts Each	Wgt. Crated Lbs.	Net Factory Price	Down Payment	Monthly Paym'ts Each	
9 1/2"	3'	18"	240	\$ 75	\$19	\$6.50	300	\$ 94	\$24	\$7.00	
9 1/2"	3 1/2'	24"	265	87	21	7.00	325	106	28	7.00	
9 1/2"	4'	30"	290	99	24	7.00	350	118	29	8.00	
9 1/2"	4 1/2'	36"	340	116	29	8.00	400	135	31	9.00	

MAIL COUPON FOR BULLETIN No. 5-W FREE

SOUTH BEND LATHE WORKS 6-35
607 E. Madison St., South Bend, Ind., U.S.A.
Please send me free quotation and illustration on the following lathe:
Swing.....Length of Bed.....
 Countershaft Drive Motor Drive
My work is.....
 9-inch "Workshop" Lathe Bulletin No. 5-W (free)
 How to Run a Lathe (160 Pages) (25c)
Name.....
Address.....
City.....State.....



WRITE FOR BULLETIN 5-W—FREE

Bulletin No. 5-W fully describes and prices the 9" Workshop Lathe in its various sizes together with all its accessories and attachments. This 20 page bulletin mailed free postpaid to any address. Send coupon now.

If interested in larger size lathes, write for Catalog No. 94, which shows South Bend lathes from 9" to 18" swing inclusive. Catalog mailed free postpaid.

SOUTH BEND LATHE WORKS
607 East Madison St., South Bend, Ind., U. S. A.
Lathe Builders Since 1906—Users in 97 Countries

South Bend Lathes are Displayed in over 400 Cities of the U. S. A. also in Principal Cities throughout the World.

IT'S A REVOLUTIONARY NEW KIND OF SUMMER OIL

Lasts far longer
than any oil you ever
used before

HAVE YOUR CRANKCASE filled with this Summer Mobiloil. Watch. You'll notice a new responsiveness in your engine. Listen. It hums a sweeter tune.

Drive 1,000 miles with Mobiloil and you'll say, "I can't afford to use anything else." You go farther . . . yet consume *less* oil!

Stick to this new Mobiloil all Summer . . . and next Fall you'll find your engine more like new than you'd believe possible!

Why take less than this for your money? Change to this new Summer Mobiloil now.

SOCONY-VACUUM OIL CO., INC.



THERE'S ABSOLUTELY no advance in price for this new kind of Mobiloil. It's the first Summer oil made by Socony-Vacuum's famous Clearosol Process . . . *thoroughly cleansed* of impurities that have always defied refining. In grades A, AF, B, BB . . . for all makes of cars.



100 HOURS on ordinary oil leaves engine dirty.

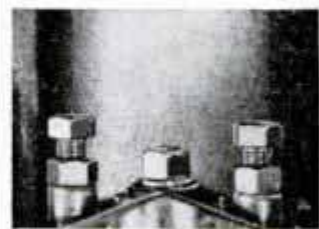

AFTER 100 HOURS on new Mobiloil, engine is clean.

Mobiloil



SOLD AT THE SIGN
OF THE
FLYING RED HORSE

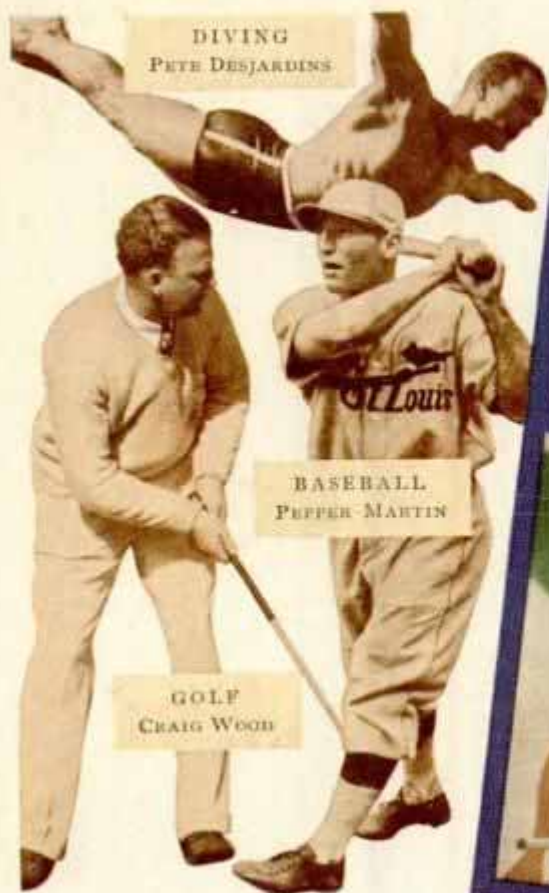

DIVING
PETE DESJARDINS

BASEBALL
PEPPER MARTIN

GOLF
CRAIG WOOD



PETE DESJARDINS
famous Olympic diver

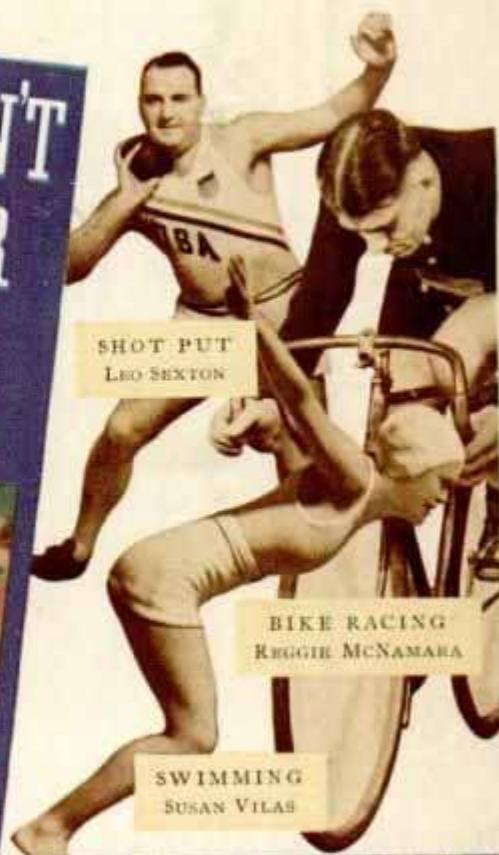

SHOT PUT
LEO SEXTON

BIKE RACING
REGGIE McNAMARA

SWIMMING
SUSAN VILAS

There's more pleasure in this mild cigarette... approved by athletes!

When athletes in all leading sports agree upon one cigarette, its mildness is placed beyond question.

Pete Desjardins, famous Olympic diver, says: "Camels are so mild that I can smoke as many as I like and still keep my wind in perfect condition."

Pepper Martin, fleet-footed St. Louis Cardinal, says: "Camels are mild—don't cut down my speed or wind."

Reggie McNamara, "Iron Man" bike racer, adds: "I've smoked Camels for ten years—showing that Camels don't get the wind." And Reggie is backed up by Leo Sexton, Olympic shot-put record holder; Craig Wood, the golf star; and Susan Vilas, of swimming fame!

More enjoyment for you in this mild cigarette!

You'll find you can smoke Camels all you want! For athletes say that Camel's costlier tobaccos don't tire their taste—don't upset their nerves or get their "wind."

© 1935, R. J. Reynolds Tob. Co.



IT'S IMPORTANT TO YOU, too, to keep "in condition." Camels, with their costlier tobaccos, never upset your nerves. And remember—athletes say "Camels never get your wind!"



Camels COSTLIER TOBACCOS!

● Camels are made from finer, MORE EXPENSIVE TOBACCOS—Turkish and Domestic—than any other popular brand.

(Signed) R. J. Reynolds Tobacco Co., Winston-Salem, N. C.