

PHANTOM RAIDERS OF THE AIR

POPULAR MECHANICS

MAGAZINE

WRITTEN SO YOU CAN UNDERSTAND

REGD. TRADE MARK, GREAT BRITAIN, NO. 4042E

JUNE
25 CENTS
30c IN CANADA

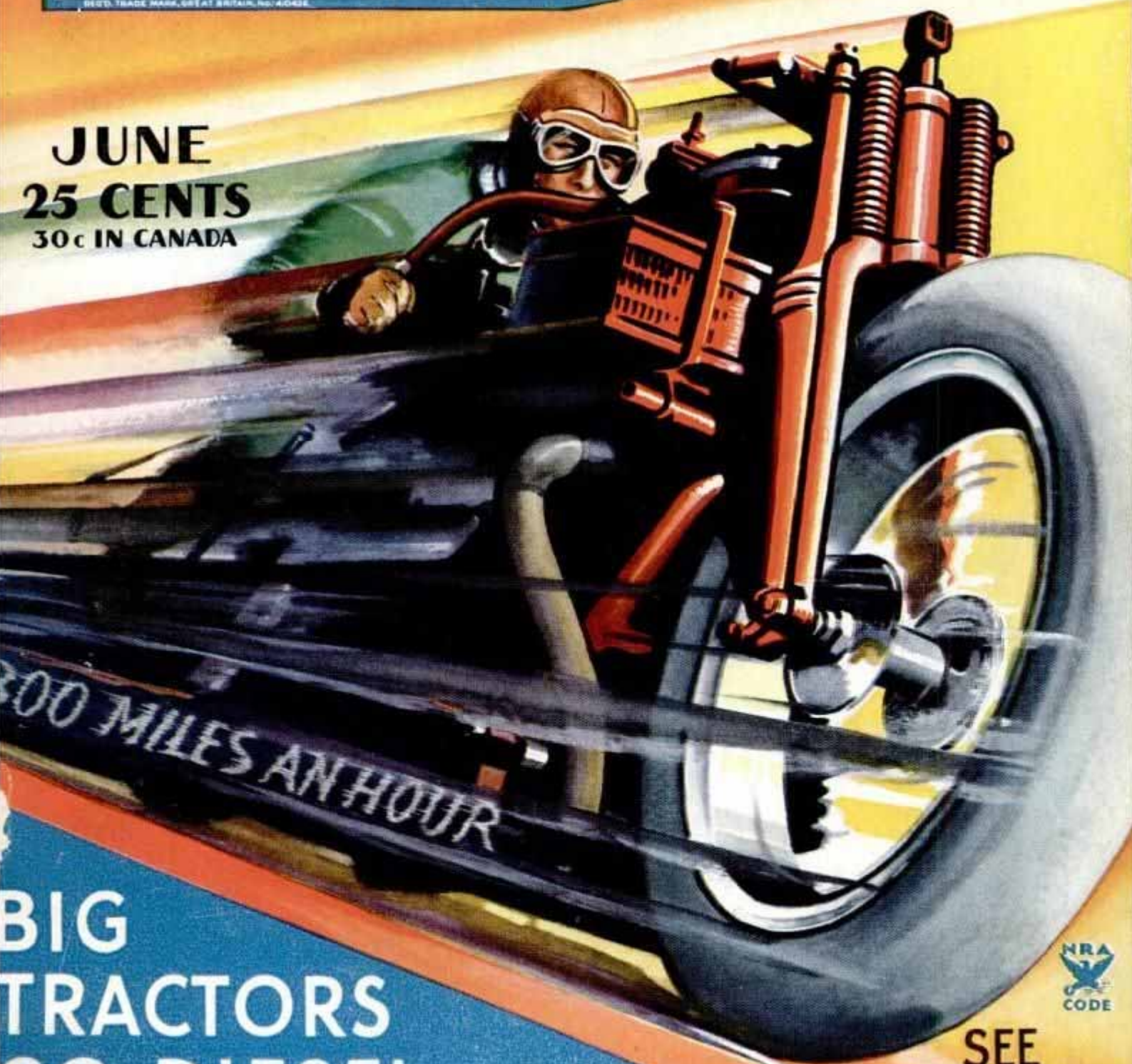

**BIG
TRACTORS
GO DIESEL**



SEE
PAGE 838

"I'd Rather Fight Any Man
Alive Than Have Another
Blow-out"

Says JIMMY McLARNIN
POPULAR WELTERWEIGHT

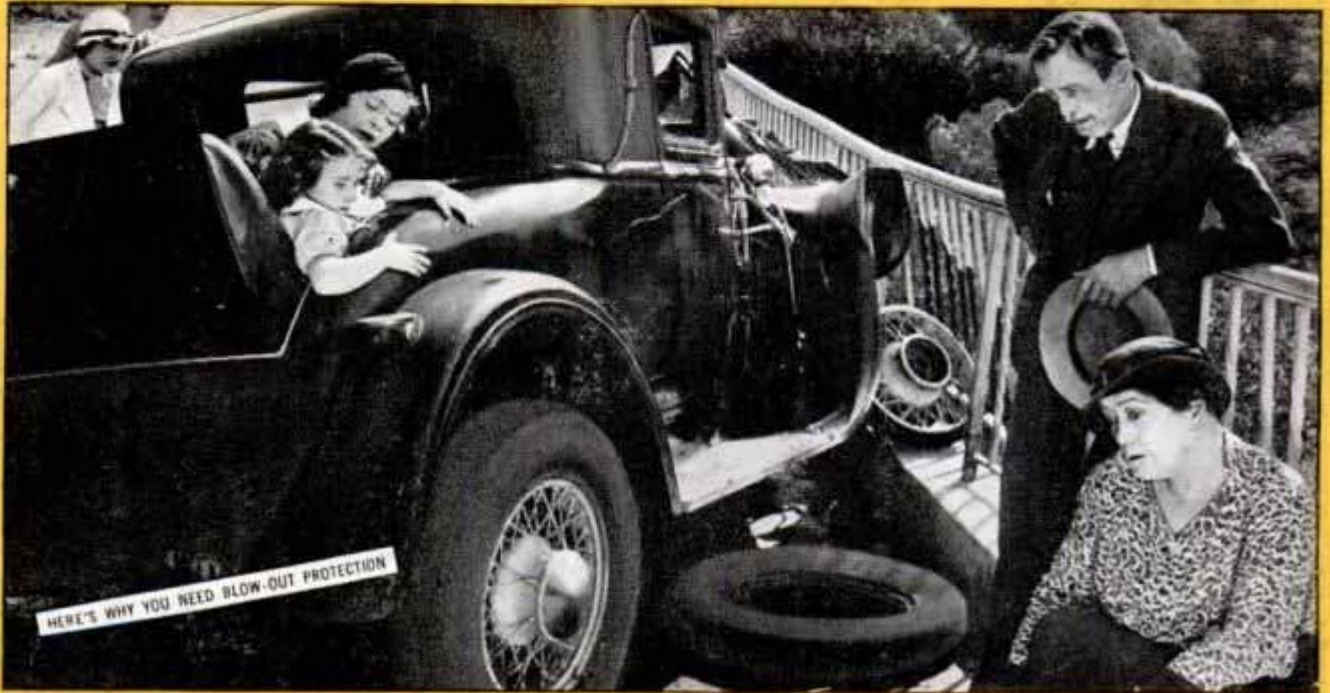

New Tire Invention is a Life Saver!

HEAT CAUSES BLOW-OUTS—
THE LIFE-SAVER GOLDEN PLY
RESISTS HEAT—PREVENTS
THESE BLOW-OUTS



DON'T MISS THIS RADIO TREAT



**Circus Night
in Silvertown**
starring **JOE COOK**
with B. A. Rolfe and others

Every Friday Night N.B.C. Blue Network

"I WAS driving to Seattle, Washington, when my left front tire blew out," says JIMMY McLARNIN. "My car hurtled across the highway and plunged off the road. If anything had been coming the other way, you could have counted me out. A punch may knock you out, sure—but it takes only one blow-out to finish you off. So now I'm playing safe—I have Goodrich Silvertowns on all four wheels."

* * *

Today's faster driving generates terrific heat inside a tire. Fabric and rubber separate. A blister starts and keeps growing—until sooner or later, BANG! A blow-out! And it

takes plenty of luck to save you. To prevent this great, unseen cause of high-speed blow-outs, every Silvertown has the Life-Saver Golden Ply with a secret Goodrich compound which resists heat—stops high-speed blow-outs before they start.

Another Safety Feature

Goodrich Silvertowns also have an extra-thick, husky-cleated tread that gives you maximum protection against dangerous "tail-spin" skids. If you want the utmost in tire safety and tire mileage—equip your car with Goodrich Silvertowns. Silvertowns cost not a penny more than other standard tires.

Copyright, 1935, The B. F. Goodrich Co.

The **NEW Goodrich Safety Silvertown** WITH LIFE-SAVER GOLDEN PLY

HOW MODERN ENGINEERING MAKES MOTORING MORE FUN

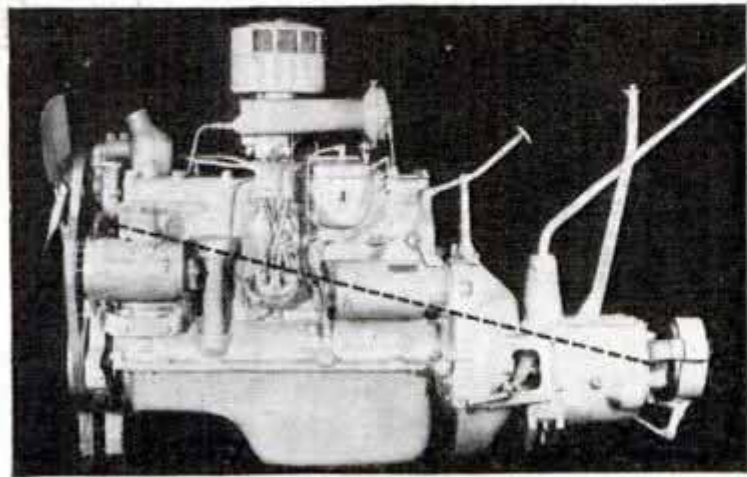

FLOATING POWER engine mountings hold the engine in perfect balance yet permit it to "rock" so that vibration is dissipated. There is no other way to keep engine vibration away from driver and passengers.



JUST TOUCH THE PEDAL...air-cooled clutch needs 30% less pedal-pressure. Hydraulic brakes need only a touch for safe stopping.

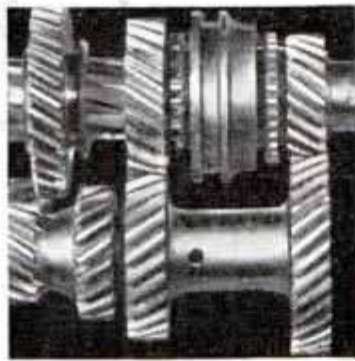

ALL SPEEDS QUIET—costly helical gears for every speed. Syncro-silent transmission...shifting is easy and noiseless at any speed.

Everything easier for the driver...and passengers all have more room and comfort...in the big New Plymouth

"SO EASY a child could drive it!"—that's literally true of a car as modern as this.

With a worm-and-roller type steering gear, and *three* anti-friction roller bearings, a slight wrist motion controls the wheel. Cross-steering keeps the wheel free from "road shock."

The clutch is ingeniously *air-cooled*. Facings have longer life. The pedal requires 30% less pressure! Genuine hydraulic brakes, of course, need only a touch to stop you quickly, without swerving.

A synchronizing device brings gears to the same rotating speed. You can shift quietly at any driving speed. Helical gears throughout keep the gears quiet.

Weight is scientifically distributed. New tapered-leaf springs of Mola Steel are far softer-acting. There's a sway-eliminator.

Find out how much *more* fun the new Plymouth is. Prices now only \$510 and up, list at factory, Detroit. Ask your Chrysler, Dodge or De Soto dealer about the official Chrysler Motors Commercial Credit Plan.

CORRECT WEIGHT DISTRIBUTION BASED ON THE FAMOUS "AIRFLOW" CARS



SEATS AND ENGINE moved forward... give more room as well as smoother riding...no more bumps or bouncing.



THRILLING SPEED AND POWER... more power and acceleration than ever...on 12% to 20% less gas and oil.



**MORE
THAN A**

Million People
**OWN OR OPERATE
THE BELL SYSTEM**

THE Bell System furnishes a nation-wide telephone service to a great and populous country—a service used for 59,000,000 talks a day. Telephone conversations per capita in this country are more than nine times as many as in Europe.

It takes 275,000 trained people to build and operate the switchboards, wires, cables, and other apparatus that make this service possible. It has taken the savings of 850,000 people to pay for the plant and equipment of the Bell System. Six hundred and seventy-five thousand own stock in the American Telephone and Telegraph Company, and in many instances other Bell securities. Another 175,000 own Bell System bonds or stock in the operating telephone companies.

No other business organization is so widely owned by so many people.

It is owned by the people, and it is run by wage-earning men and women. Their incentive is pride in performance; in doing a good job come recognition and promotion.

Since its beginning more than 50 years ago, the Bell System has rendered a constantly improving service more and more indispensable. Usefulness to the public is the motive that keeps the telephone business going. In the true sense of the word, this is a democracy in business.

More than half the stockholders of the American Telephone and Telegraph Company, the parent company in the Bell System, are women. Nobody owns as much as one per cent of the stock.



BELL TELEPHONE SYSTEM

When writing to advertisers please mention Popular Mechanics

Popular Mechanics Magazine

H. H. WINDSOR, Founder

H. H. WINDSOR, Jr., Editor and Publisher

June, 1935

Vol. 63, No. 6

Special Features

Trees Tell the Truth	801
Inside Story of Rodeos	Coloroto
How to Feed Your Dog	820
Queen of the Seven Seas	826
Riding Race Cars for a Living	834
Flying the Fog Patrol	840
"LZ-129," the Latest Airship	846
What Price Speed Records?	850
One Man Against the Deep	856
Flying the Pacific	862
Big Tractors Go Diesel	866
Horse Racing Up to Date	872
Heroes of the Switchboard	882
Phantom Air Raiders	888

(Continued on next page)

Keeping Them in the Air

THE nation's airlines could not pile up 55,000,000 miles of flying annually without the aid of a group of earth-bound men who know nothing about flying a ship. For each pilot in the air, there are ten men on the ground engaged in keeping the transport planes flying. It is the skilled hand of the experienced engine mechanic, the watchful eye of the airplane inspector and the painstaking work of other experts which keep the ships in the air. In an airplane "round house" at Cheyenne, Wyo., all the ships of one great airline come regularly for overhaul and inspection. An article in the July issue, illustrated with eight pages of pictures in color, describes the work of a crew of 500 experts at this big air base on the roof of the continent.

Next Month

THE man had an armload of expensive rods, reels, lines and lures. The boy had a cane pole, some string and a few hooks. The man came back empty-handed, the boy returned with a nice catch. The boy knew where to look for fish; the man didn't. Next month Bob Becker gives you some tips on where to find the big ones.

Tuning Up a Winner

TWO dare-devils ride each car in an Indianapolis race, but they rely on their pit crew to win the race. The pit men loaf most of the time but work with almost superhuman speed when their car develops trouble. The pit mechanics also labor for weeks preceding the race tuning up the car they service on race day. An article next month describes how races have been won in the pits.

Dust Solves Crime

COMMON dust today is supplying the clues to catch and convict criminals. From the "empty" pockets of your coat the dust detective extracts hairs, cloth fibers, seeds and other microscopic debris. Each substance, when identified, may reveal to this scientific crime investigator something about your habits, occupation and environment. A story next month tells how this modern Sherlock Holmes solves crimes by studying microscopic evidence.

Every CAR NEEDS SIMONIZ!



The new improved Simoniz Kleener quickly restores the lustre



Wipe with a dry cloth and it sparkles as bright as ever



Simoniz not only protects the finish and makes it last longer, but keeps cars beautiful for years



MOTORISTS WISE

SIMONIZ

You're sure to get more pleasure out of driving your car if it is Simonized . . . for then the finish will stay beautiful. With practically no effort at all, the new, improved Simoniz Kleener quickly brings back all the lustre your car had when new. Although easy to apply, Simoniz is hard for weather to wear off. It not only gives perfect protection to the finish, but makes it last longer. So, new or old, the sooner you Simoniz your car the better.

(Contents—Continued)

Air Cleaner—removes harmful particles	831
Air Conditioner—fits under window sill	885
Airplane	
bomber, French, also transports troops	876
flyer resembles "man of Mars"	880
picture shows iron monster	887
Automobiles	
exhaust gas causes "sleepy drivers"	818
forerunners of today's	892
German, are ultra-streamlined	895
Automobiles, Accessories	
brakes, electric, operated by battery	886
generator control on dash	845
ram straightens car frame	849
Awning—copper, folds like Venetian blind	844
Bags—waxed paper, sealed without adhesive	837
Bicycle—gearless and chainless	839
Bird Cage—automatic cups for	870
Blowpipe—cutting machine is portable	832
Boats and Boating—automobile used to salvage	844
Braces—screens, shaky, made firm with	830
Bus, Motor	
has front and rear engine	865
herringbone seating used in	825
Cactus—electricity illuminates at night	894
Calking Gun—plastic compound cartridge used in	877
Camera	
small size reflex	844
squad-car, has own flash	825
tailor takes measurements with help of	843
Camping	
auto, folding tent on top of	819
rail-cars for	818
Cellophane—fabric made of	839
Chapel—mountain, in Angeles national forest	832
Clock	
candle employed as, made in segments	897
world's, has moving dial	854
Continent, Lost—sea-floor model shows	896
Cream—air-bubble mixer whips fluffier	838
Damper—automatic, gas heat saved by	897
Divining Rod—road materials below earth located by	849
Egg Rack—for the refrigerator	893
Elk—antler monument in Yellowstone National Park	831
Faucet—water shut off when bucket is full	877
Film—color photos produced by using	870
Fingerprinting	
citizens safeguarded by	833
dog teams, to prevent race fraud	837
Fireflies—secret of flicker revealed	823
Fish and Fishing—lure has spinners on hinges	861
Flowers	
Cellophane box gives better display	887
metal stems, device for attaching	843
Fruit Jar—cap, match loosens for removal	876
Garage—door, open or shut, holder locks	845
Grinder—high speed, weighs less than two pounds	887
Heating Plant—circulator for hot-water plant	894
Horsehair—eight-pound pull required to break	861
Horses—wild, shod in special rig	871
Household Devices	896, 899
Hunting—indicator, electric, measures scent for	877
Ice Cream—bars, dipping outfit for	817
Lamb—hybrid, has both hair and wool	823
Lamps—odd-shaped filament used in signs	900
Lifeboat	
non-sinkable and self-bailing	854
oarless, hand-operated levers propel	861
Lighthouse—basket elevator used at	886
Locomotives—new design in rail speed race	860
"Memory Machine"—auto license-plate numbers checked by	819
Models	
houses put together like block puzzle	817
refinery, carved as profitable hobby	830

(Continued to page 6A)

closed trap 853

CHEVROLET'S PRESSURE STREAM OILING

forces oil to the bearings at the rate of 120 miles per hour when the car is traveling at 40



Pressure Stream Oiling—employed in the 1935 Chevrolet—is as simple in operation as it is efficient in results. Oil is forced *under pressure* along the path of each connecting rod dipper from the direction opposite that of the connecting rod rotation. Result: A veritable deluge of oil on the bearings—efficient lubrication at all engine speeds.

 Think of it! . . . When your Chevrolet is traveling 40 miles an hour, oil is forced to the connecting rod bearings at the rate of 120 miles an hour. . . . And the Chevrolet oil pump forces 8.5 quarts of oil per minute! Pressure Stream Oiling—*exclusive to Chevrolet in its price class*—means that the oil is sent under pressure along the path of each connecting rod

Compare Chevrolet's low delivered prices and easy G.M.A.C. terms. A General Motors Value

dipper from the direction *opposite* that of the connecting rod rotation . . . thereby assuring an adequate supply of oil at all engine speeds. Much of the smooth operation and long-lived reliability for which Chevrolet cars are noted is due to this *extra-efficient* oiling system. See the new Chevrolets—*drive them*—and choose *Chevrolet* for quality at low cost. CHEVROLET MOTOR CO., DETROIT, MICH.

CHOOSE CHEVROLET FOR QUALITY AT LOW COST

FEATURES

Turret-Top Body by Fisher
(with Fisher Ventilation System)
Blue-Flame Valve-in-Head Engine
with Pressure Stream Oiling
Improved Knee-Action Ride
Weatherproof
Cable-Controlled Brakes
Shock-Proof Steering



When writing to advertisers please mention Popular Mechanics

2498 PUNCTURES WITHOUT A FLAT TIRE

NEW PUNCTURE-SEALING TUBE BANISHES FLAT TIRES

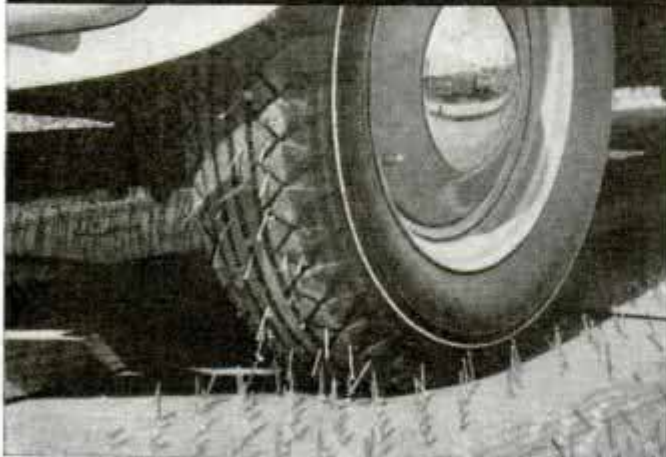

Here's one of four test tires going over torture road—punctured many times—without a flat.

SEIBERLING introduces a new Sealed-Air tube—which actually seals punctures on running wheels. This new invention—novel in design—is built like a battleship—with bulkheads packed full of plastic puncture-sealing gum.

The Seiberling Sealed-Air tube gives you more protection from punctures than any other tube. In addition it gives tire economy. Proper tire inflation means longer mileage. By assuring uniform pressure, the Sealed-Air tube increases mileage—lowers tire cost. See your Seiberling dealer for an interesting demonstration or write for information.

THE SEIBERLING RUBBER CO.

Akron, Ohio, U. S. A.

Seiberling Rubber Company of
Canada, Ltd. • Toronto, Canada



As nail punctures tube note how adhesive gum clings to nail, sealing puncture on inside.



As nail is withdrawn note how gum clings to nail, sealing tube on outside.



Puncture plugged with rubber rivet. Bulkhead holds plastic material in place... hole disappears.

SEIBERLING SEALED-AIR TUBES

FREE

Tire dealers are invited to write for big free book telling all about this new puncture-sealing tube invention. Address Dept. W.

(Contents—Continued)

Motor	
base, portable, saves time	892
heater for warming up airplane	896
Motorcycle—auto engine drives	838
Music—characters printed by hand	897
Outboard—has protective hood	896
Paint and Painting—trap catches excess paint from brush	839
Parachute—jumping from tower latest thrill	845
Photography—ladder-scaffold, down shots of trees made from	859
Planetarium—Los Angeles, has three domes	881
Plant—insects destroyed by	839
Racing, Horse—males faster on track	860
Radio	
coils, plug-in, for short-wave receivers	906
driver communicates with home from auto	824
fifty million receiving sets in the world	817
globe with broadcast receiver built in	906
hints for experimenters	905
microphone, small ribbon type	906
phonograph records played through receiver	906
transmitter, crystal-controlled CW	904
Wheatstone bridge, inexpensive to build	901
Radio, Receivers—amplifier for small short-wave	902
Railroad—car driven from roof of cab	871
Scooter, Water—swimmer helped by	870
Scraper—has three interchangeable blades	885
Screws—fiber anchor locks in brick	900
Sharpener—triple oilstone, produces honed edges	838
Ski-Skates—speedy over snow and ice	886
Smokestack—"electric eye" in, warns of waste	861
Snowmobile—mile-a-minute, has safety brakes	853
Staircase—etched-glass rail, lighted, is novel	855
Steel	
amount housewives, American, use	845
lanolin mixture keeps bright	897
Sunshine—artificial, for apartments	832
Tacks—double-pointed, keep pictures straight	823
Television—camera, electron, shoots images	878
Tent—air tubes, inflated, used to erect	897
Toys—barking dog, bellows and sound box in	848
Trailer—big log, is steered from rear	876
Trap—insect, for indoors or out	853
Trucks—	
army, forty-five per cent hill tests	900
house carried from factory to home site	880
Vault—flyers for high-altitude work tested in	837
Washing Machine—locking wedge keeps level	894
Water Cycle—paddle wheel drives	865
Weeds—burner, portable, throws hot flame	894
Windows—skyscraper, nerve required to wash	818
—	
AMATEUR MECHANICS	
Awning—adjustable, for open porches	917
Balloons, Toy—hydrogen gas generated for	910
Barometer—steam gauge converted into	913
Beach Rest—"lazyback," folding	918
Bicycles—rental booth for	921
Boats and Boating	
stuffing box for propeller shaft	935
ten hints to boat owners	929
Cement—bicycle tires mounted with	918
Clocks—electric, novel cases for	914
Dandelions—retarding growth of	935
Door—dessert plates used as lights in	920
Fire—grass, skid chain on rake extinguishes	930
Fireplaces—built for comfort and utility	936
Fish and Fishing	
fishhooks, knots to use when tying	909
fishhooks, snagged, how to loosen	920
Flies—peppermint odor keeps away from door	921
Floor—attic, false joists support	934
Fruit—grapefruit cutter slices and removes core	909
Furnace—hot-air, utilized as cooling system	940
Furniture—barrow chair for garden	911
Golf—repairing your clubs	932

(Continued to page 8A)

MONEY—\$\$\$—what will YOU do for it?

Have you—like most men—said to yourself at one time or another—

“I’d do almost anything for money”?
And did you really mean what you said
—are you ready to back word with action?

If so—read on. If not—turn the page.

If you want something out of life, you’ve got to pay for it—in one way or another.

Money—business success—prestige—position—these things don’t come for a wish—you have to pay for them.

To earn more—you must learn more—know more—be able to do more.

Your spare time—spent in training—under the LaSalle Problem Method—is a short cut to this larger ability.

But even this short cut requires its price—calls for initiative, ambition, extra effort. Consequently, the many pass it by—continue vainly to hope for luck or pull or “something” to bring their desired success.

But the few who are really in earnest—and there have been more than three-quarters of a million of them in the twenty-six years of LaSalle’s history—find in LaSalle training their pathway to promotion, to a business of their own, to prestige, to money.

Take, just for example, these four cases:

IN 1924, a Bookkeeper— IN 1927, Vice-President

Mr. A—— of Indiana was marking time in a bookkeeper’s job back in 1924—after a fine war service and various attempts to find himself in farming, in managing a truck line, and in other jobs. With his enrollment in LaSalle came the change upward.

First he became office manager of a cannery firm, then entered the automobile field, and in 1927 became vice-president of one of the large automobile sales agencies of the Middle West. He says, “Spare time invested in study with LaSalle pays compound interest.”

GETS the Last Laugh!

“Mr. C. P. A.”—that’s what the boys at the bank jokingly called Fred Williams when he enrolled with LaSalle. The idea of a 21-year-old trying to learn—by home study—a branch of business as specialized and highly paid as Higher Accounting!

But Williams got the last laugh. Not only did he pass the C. P. A. examination—but today, just nine years later—he is head of his own Chattanooga firm, and clearing—on the average—\$9,000 a year. The men who once laughed at his ambition are coming to him for jobs.

Mr. Williams writes: “Your representative told me when I enrolled that I would receive \$50 for each hour of study, but I have far exceeded that figure a number of times.”

CLIMBS Out of 20-Year Rut—

The future looked bright when Arthur Griffin—“just a kid”

—went to work as a railroad clerk twenty years ago. A year passed—then another—and another—and, to his horror—he gradually realized that he was caught in a rut, with his best years almost gone. Perhaps you know how helpless he felt.

Courageously, this Washington, D. C. man looked the facts in the face—saw that while faithful service often goes unrewarded, the man who makes himself more valuable always gets higher pay and promotion. He invested his spare time in Traffic Management training.

Today he writes, “My recent appointment as a tariff examiner with the Interstate Commerce Commission is due to LaSalle . . . My progress started as I studied with you, and now I am not only in a position that pays a much greater salary (100% greater) than I was getting, but my future looks bright.”

FROM \$12.00 a Week to \$6,000 a Year!

Bachman wanted to get into Law but his chances looked mighty slim. Nothing better than an average education behind him—a family to support on \$12 a week—no money, no time and no law school within hundreds of miles of his home!

It looked impossible—yet today E. A. Bachman is a successful lawyer in Chattanooga, Tennessee, and his income tax reports show earnings as high as \$6,000 a year.

No wonder that today he writes, “It is due to LaSalle training that I hold my present position. I certainly can recommend your law training to anyone. It is as thorough as any resident course.”

TWO FREE BOOKS

Tell You How to Get Money

We could go on and on—through hundreds of similar cases of LaSalle members who wanted success, and got it.

But you have had enough proof. What is needed now is—action.

Two books will give you all the facts you need to start—one, a 64-page book outlining the requirements and opportunities in the business field that most appeals to you; the other, “Ten Years’ Promotion in One.” LaSalle will send them both to you free.

If you really mean what you say when you tell yourself that you want more money—fill in, clip and mail the coupon NOW.

LaSalle Extension University

THE WORLD’S LARGEST BUSINESS TRAINING INSTITUTION

----- Find Yourself Through LaSalle! -----

LA SALLE EXTENSION UNIVERSITY, Dept. 664-R CHICAGO

I would welcome your booklet on the business field I have checked, together with a copy of “Ten Years’ Promotion in One,” all without obligation.

- Business Management
- Higher Accountancy
- Expert Bookkeeping
- C. P. A. Coaching
- Modern Salesmanship
- Traffic Management
- Railway Station Management
- Modern Business Correspondence

- Stenotypy
- Paper Salesman’s Training
- Law: LL. B. Degree
- Industrial Management
- Modern Foremanship
- Personnel Management
- Banking and Finance
- Railway Accounting

- Credit and Collection Correspondence
- Business English
- Commercial Law
- Effective Speaking
- Telegraphy—Railway and Commercial



Name

Address

This One



ESHE-HTW-7ZQA

When writing to advertisers please mention 1

LOST BY A NOSE!

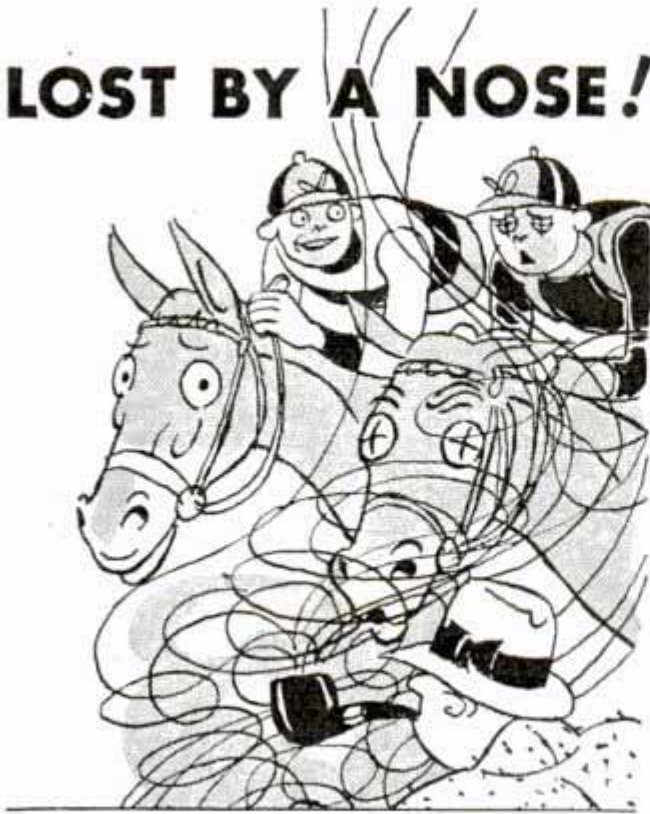

THE race was neck and neck—up to the moment Railbird Ralph let loose a puff of hoosegow tobacco from his never-curved pipe.

It's the horselaugh for you now, Friend Ralph. But you can easily make yourself choice company for man and beast. Sluice out the old briar. Get it really clean and sweet. Then tamp it full of Sir Walter Raleigh Smoking Tobacco. You've heard men praise its mildness. You've heard women extol its fragrant aroma. Now try a tin. See if this ever-so-mild blend of gentle Kentucky Burleys in a well-kept pipe isn't a combination that wins any race. Particularly the human.

Brown & Williamson Tobacco Corporation
Louisville, Kentucky. Dept. P-56



FREE BOOKLET

tells how to make your pipe taste better, sweeter. Write for a copy.



It's 15¢
—AND IT'S
MILDER

(Contents—Continued)

Grain—incubator used as oats sprouter	913
Hats—straw, bleaching discolored	928
Heater, Solar—gas bills reduced by	918
Hose, Garden—reel drains while winding	912
Ice Box—running board, has air-cooled lid	931
Incense Burner—"Mother Goose Cottage" made from gourd	928
Knife—rips seams without cutting cloth	932
Lamp—sailboat, has rudder light control	933
Mirror—frame for hanging circular	928
Models	
aeroplane, front propeller bearing for	917
flags for ships made to drape naturally	939
Nails—holder for driving in tight places	935
Nuts—pour boiling water over before cracking	909
Oil Can—spout protected by tubular rivet	927
Pie—vent in crust prevents overflow of juice	910
Play-Ship—"Treasure island" story inspiration for	907
Rack—smoker's pipes held in	928
Razor Blades—sharp edges destroyed by placing in sulphuric acid	931
Refrigerator—glass prevents escape of cold air	920
Sanding Block—grooves in, assure true edges	913
Saws and Sawing—rubber hose on blade protects fingers	918
Screen Door—hook improved by short coil	912
Screw Hooks—attachment for driving	927
Sink—risers, correct way of connecting	912
Soap—grated on wash boiler lid	920
Spectacles—cork pads cushion nose pieces	910
Switch—wall, plates improved by decorating	932
Tank—roll films developed inexpensively	931
Tennis—clamp to re-string rackets	912
Thermos Jug—water kept cool for drinking	910
Trailer—build a utility type	922
Veneer Work—cauls, waxed, aid in gluing	927
Weeds—removing from lakes	917
Wheelbarrow—pitchfork tines cleaned by pickets on	935

SHOP NOTES

Agriculture—Bordeaux spray mixture, preparing	944
Automobiles	
bearings, loose, cause noisy timing gear	958
cylinder compression, tool to test	959
horn, grease preserves diaphragm	958
how to tell right or left spring	959
oil jars, air vent helps empty	959
spark plugs, emergency test for	959
tire-deflating tool made from nail	958
Camera—stand for the studio	945
Cigarette Lighter—bunsen burner improved by	947
Clamp—tripod, for the photographer	944
Corks—bottles fitted over drawer pulls of	960
Drill, Electric—model makers find ideal	949
Files—slender, how to use	950
Flytrap—Cellophane sack and funnel used as	948
Fountain, Drinking—pipe and fittings used for	950
Garage—inner tube on wall protects car door	958
Gun, Grease—Alemite, repairing	958
Labels—moistener for	948
Live Stock—feed boxes made from oil drums	948
Machine—threading, made from car parts	947
Micrometer—truing anvil and spindle	955
Padlock—boat cleat provides holder for	950
Plants—muslin tents protect young	954
Poultry—pail as swinging hopper holds feed	956
Pump—barrel-a-minute, has many uses	955
Sanding Block—piece of hose used as	948
Saws and Sawing—bandsaw, homemade	951
Screwdriver—grooves in blade prevent slipping	944
Shellac—sealing wax improves	960
Signs—sidewalk, anchored with weights	944
Tape, Friction—reel for holding	950
Telephone—can amplifier for bell extension	948
Tools	
modelmaker's requirements	941
threading, set without center gauge	949
Tubing—copper, two methods of forming	956



"SELDOM SEE AN I. C. S. GRADUATE OUT OF A JOB"

"IN ALL THE YEARS I have known of the International Correspondence Schools, I have seldom seen one of your graduates jobless."

A business executive made this statement in a recent letter commenting on the I. C. S. men in his employ and expressing regrets that it was necessary to reduce his personnel.

"However," he added, "all I. C. S. graduates and students will be retained, for I

fully realize their value in my business."

The reason so many I. C. S. men have jobs is because they are *trained men!* A recent investigation into the working conditions of 1000 I. C. S. students revealed only 10 unemployed. You, too, can be an I. C. S. man.

Mark the coupon and mail it today! It has been the most important act in the lives of thousands of men.

INTERNATIONAL CORRESPONDENCE SCHOOLS

"The Universal University"

BOX 5576-H, SCRANTON, PENNA.

★ Without cost or obligation, please send me a copy of your booklet, "Who Wins and Why," and full particulars about the subject *before* which I have marked X: ★

TECHNICAL AND INDUSTRIAL COURSES

- | | | | | |
|--|---|--|--|--|
| <input type="checkbox"/> Architect | <input type="checkbox"/> Heat Treatment of Metals | <input type="checkbox"/> Plumbing | <input type="checkbox"/> Steam Fitting | <input type="checkbox"/> Bridge Engineer |
| <input type="checkbox"/> Architectural Draftsman | <input type="checkbox"/> Sheet Metal Worker | <input type="checkbox"/> Heating | <input type="checkbox"/> Ventilation | <input type="checkbox"/> Bridge and Building Foreman |
| <input type="checkbox"/> Building Estimating | <input type="checkbox"/> Telegraph Engineer | <input type="checkbox"/> Air Conditioning | | <input type="checkbox"/> Chemistry |
| <input type="checkbox"/> Contractor and Builder | <input type="checkbox"/> Telephone Work | <input type="checkbox"/> Steam Engineer | | <input type="checkbox"/> Pharmacy |
| <input type="checkbox"/> Structural Draftsman | <input type="checkbox"/> Mechanical Engineering | <input type="checkbox"/> Steam Electric Engineer | | <input type="checkbox"/> Coal Mining |
| <input type="checkbox"/> Structural Engineer | <input type="checkbox"/> Mechanical Draftsman | <input type="checkbox"/> Marine Engineer | | <input type="checkbox"/> Mine Foreman |
| <input type="checkbox"/> How to Invent and Patent | <input type="checkbox"/> Machinist | <input type="checkbox"/> R. R. Locomotives | | <input type="checkbox"/> Navigation |
| <input type="checkbox"/> Electrical Engineer | <input type="checkbox"/> Patternmaker | <input type="checkbox"/> R. R. Section Foreman | | <input type="checkbox"/> Textile Overseer or Supt. |
| <input type="checkbox"/> Electric Lighting | <input type="checkbox"/> Gas Engines | <input type="checkbox"/> Air Brakes | <input type="checkbox"/> R. R. Signalmen | <input type="checkbox"/> Cotton Manufacturing |
| <input type="checkbox"/> Welding, Electric and Gas | <input type="checkbox"/> Diesel Engines | <input type="checkbox"/> Highway Engineering | | <input type="checkbox"/> Woolen Manufacturing |
| <input type="checkbox"/> Reading Shop Blueprints | <input type="checkbox"/> Aviation Engines | <input type="checkbox"/> Civil Engineering | | <input type="checkbox"/> Agriculture |
| <input type="checkbox"/> Boilermaker | <input type="checkbox"/> Automobile Mechanic | <input type="checkbox"/> Surveying and Mapping | | <input type="checkbox"/> Fruit Growing |
| | <input type="checkbox"/> Refrigeration | | | <input type="checkbox"/> Poultry Farming |

BUSINESS TRAINING COURSES

- | | | | |
|--|---|---|--|
| <input type="checkbox"/> Business Management | <input type="checkbox"/> C. P. Accountant | <input type="checkbox"/> Service Station Salesmanship | <input type="checkbox"/> Railway Mail Clerk |
| <input type="checkbox"/> Office Management | <input type="checkbox"/> Bookkeeping | <input type="checkbox"/> First Year College | <input type="checkbox"/> Grade School Subjects |
| <input type="checkbox"/> Industrial Management | <input type="checkbox"/> Secretarial Work | <input type="checkbox"/> Business Correspondence | <input type="checkbox"/> High School Subjects |
| <input type="checkbox"/> Traffic Management | <input type="checkbox"/> Spanish | <input type="checkbox"/> Lettering Show Cards | <input type="checkbox"/> College Preparatory |
| <input type="checkbox"/> Accountancy | <input type="checkbox"/> Salesmanship | <input type="checkbox"/> Stenography and Typing | <input type="checkbox"/> Illustrating |
| <input type="checkbox"/> Cost Accountant | <input type="checkbox"/> Advertising | <input type="checkbox"/> Civil Service | <input type="checkbox"/> Cartooning |
| | | <input type="checkbox"/> Mail Carrier | |

Name.....Age.....Address.....

City.....State.....Present Position.....

If you reside in Canada, send this coupon to the International Correspondence Schools Canadian, Limited, Montreal, Canada

When writing to advertisers please mention Popular Mechanics

For MORE PAY learn DRAFTING FROM AN ENGINEER

Learn by mail at home



Prosperity is coming. Be prepared for a bigger, better job. Get the training now.

These TOOLS and Other EQUIPMENT Given When You Start



Write

for my valuable book, "Success in Draftsmanship"—free. See coupon below.

I'LL TRAIN a number of selected students as practical Draftsmen. Yes, I furnish you all tools and a drawing table. And I'll teach you in a very short time by mail in your spare time until you actually have a desirable draftsman's position so that you are fully satisfied with your easy work and better pay.

Trained men needed now; jobs pay \$50 a week or more; be prepared!

"I will train you by mail at your home."

Engineer Dobe Est. since 1900

Keep the job you have now while training. I'll tell you how to start earning extra money a few weeks after beginning my training. Get started now. Send coupon.

Jobs Open NOW!

in these and many other great industries.

Automobile industry is experiencing a wonderful improvement.
Motor Bus building is becoming a leading world industry.

Aviation is expanding to enormous proportions.

Steel Construction is upward bound.

Electricity is getting a bigger market every day.

Machinery building faces revival. No machinery can be built without plans drawn by a draftsman.

Building of stores, homes, factories, office buildings. No structure can be erected without plans by a draftsman.

START NOW and get the training. Be ready. Send the coupon NOW.

FREE BOOK COUPON

ENGINEER DOBE, Div. A337, Libertyville, Ill.

Send me your free book "Successful Draftsmanship" and please explain how you will assist me to a good position as a draftsman.

Name..... Age.....

Address.....

FREE LESSON Home Art Crafts

GOOD MONEY FOR SPARE TIME

A new easy way. Art novelties in big demand. Get free lesson and quickly learn to decorate Gifts, Bridge Prizes, Toys, etc. No experience necessary. Anyone can succeed with simple "3-step" method, and you earn as you learn. Everything furnished, including supply of Novelties for you to decorate and Home-crafter's Outfit.

NO CANVASSING
Just sit at home and make up to \$50 a week spare time or full. Write today for big illustrated book and FIRST LESSON FREE. Absolutely not one cent to pay. Lesson is free. Openings in every locality. Write quick.

FIRESIDE INDUSTRIES
Dept. 66-G, Adrian, Mich.

You Can Regain Perfect Speech, if you STAMMER

Send today for beautifully illustrated book entitled "DON'T STAMMER," which describes the Bogue Unit Method for the scientific correction of stammering and stuttering. Method successfully used at Bogue Institute for 33 years—since 1901. Endorsed by physicians. Full information concerning correction of stammering sent free. No obligation. Benjamin N. Bogue, Dept. 155, Circle Tower, Indianapolis, Indiana.

BE A RAILWAY TRAFFIC INSPECTOR

YOUR OPPORTUNITY—GET THE FACTS NOW
WRITE for Free Booklet which explains our 16-yr. record in training and placing our graduates as Railway and Bus Passenger Traffic Inspectors at up to \$140 per month, plus expenses, to start. Complete our short, home-study course and we will help place you or refund tuition. Plenty of opportunity for rapid advancement with experience. Interesting, outdoor work; travel or stay near home. Costs little; terms, STANDARD BUSINESS TRAINING INSTITUTE, Div. 206 Buffalo, N. Y.

VOICE

100% Improvement Guaranteed
We build, strengthen the vocal organs—not with singing lessons—but by fundamentally sound and scientifically correct silent exercises... and absolutely guarantee to improve any singing or speaking voice at least 70%... Write for wonderful voice book—sent free, Learn WHY you can now have the voice you want. No literature sent to anyone under 17 years unless signed by parent.
PERFECT VOICE INSTITUTE, Studio A-135
64 E. Lake St., Chicago

Learn to Dance

You can learn all the modern dances—the latest Tango steps, the new Fox Trots, dreamy Waltzes, smart Collegiate Steps, and popular Society Steps at home, easily and quickly. New chart method makes dancing as simple as A-B-C. No music or partner required. Don't be a wallflower. Learn to dance. Complete course—256 pages, 54 illustrations, sent on 5 Days' Free Trial. Equals \$20.00 course. Send no money. Pay postman only \$1.98, plus postage upon arrival. Money back if not delighted. Catalog Free.

Franklin Pub. Co., 800 No. Clark St., Dept. 9473, Chicago

CIVIL SERVICE

VALUABLE INFORMATION FREE
COLUMBIAN CORRESPONDENCE COLLEGE
WASHINGTON, D. C.

LEARN WATCH REPAIRING

AT HOME You can learn by our modern and original system of instruction every part of the Watch Repairing Trade at home as good or better than at a shop. You can earn money while learning and secure a well paying position or start in business after completing our course of instruction. Good watch repairers are always in demand and earn very good salaries. For particulars apply to the Wisconsin School of Watch Repairing
524 E. Mason St., MILWAUKEE, WIS.

NOW-GET INTO ONE OF THESE BIG PAY FIELDS! PAY FOR YOUR TRAINING AFTER YOU GRADUATE



Practical work on real
Electrical machinery



Student working on Television
transmitter in
Coyne Radio Shops

Amazingly Easy Way to Get Into ELECTRICITY

Dissatisfied with your job? Not making enough money? Then let me show you an easy way to get into **Electricity**, where thousands of Trained Men are drawing down Big Pay envelopes every week. Coyne has been training men for the Electrical Industry since 1899. **12 WEEKS' TRAINING HERE IN MY SHOPS WILL GIVE YOU THE START YOU NEED.**

WHY I CAN DARE TO MAKE THIS SENSATIONAL "PAY AFTER GRADUATION" OFFER

You can take Coyne Training without starting to pay for your training until **2 full months** after your regular Training Period, and then I give you over a year to complete your payments! That's my **LATEST, GREATEST OFFER!** I can dare to do this because the type of man who really wants to get ahead, is honest. If you're ambitious enough to send in the coupon below, I believe you'll make good!

Practical Work in COYNE SHOPS

It's **EASY** to learn a **BIG-PAY TRADE** with my "Learn-by-Doing" method. Not by books, not by correspondence, but by **ACTUAL PRACTICAL WORK JUST LIKE YOU WOULD DO ON THE JOB.** That's why many concerns endorse **Coyne** and prefer **Coyne Trained Men.**

Many Earn While Learning

If you're short of funds, don't let that stop you. My plan makes it possible to get Coyne Training with very little money. Many students

Learn RADIO TELEVISION TALKING PICTURES

Prepare for jobs in Service Work, Broadcasting, Talking Pictures, Wireless Operating, etc. Get in on the ground floor of Television! Radio has grown in a few years from a mere experiment to a **Billion Dollar** industry. There are many opportunities for the trained man. **PREPARE FOR THEM NOW BY 10 WEEKS OF ACTUAL SHOP WORK AT COYNE!**

earn all or a large part of their living expenses doing part-time work while here. We'll help you—and then give you **Lifetime Employment Service** after graduation. **Coyne Employment Service produces amazing results. You receive this service absolutely FREE as my graduate.**

REAL JOBS—GOOD MONEY—QUICK!

"Coyne boosted my pay from \$20 to \$50 a week," writes D. Ellsworth, North Carolina. "Got this fine job on shipboard, thanks to Coyne Training, and now make \$350 a month," says G. P. Vautrot, California. Hundreds of successful men boost Coyne. What they have done, you, too, should do!

Get Pay-Raising Facts FREE

Select the field you like best, then mail one of the coupons below. Let me send you either my **BIG FREE ELECTRICAL BOOK** or **MY BIG FREE RADIO-TELEVISION BOOK.** No cost or obligation. Do it today.

MAIL ONLY THIS COUPON FOR FREE ELECTRICAL BOOK

H. C. LEWIS, President
COYNE ELECTRICAL SCHOOL, Dept. A5-72
500 S. Paulina Street, Chicago, Illinois

Gentlemen: Please send me your big Free Electrical Book, with 151 illustrations and details of your "Pay After Graduation" offer. This does not obligate me in any way.

Name.....

Address.....

City..... State.....

MAIL ONLY THIS COUPON FOR FREE RADIO BOOK

H. C. LEWIS, President
RADIO DIVISION, COYNE ELECTRICAL SCHOOL
500 S. Paulina St., Dept. A5-3H, Chicago, Ill.

Gentlemen: Send me your Big Free Radio, Television and Talking Picture Book and details of your "Pay After Graduation" offer. This does not obligate me in any way.

Name.....

Address.....

City..... State.....



High School Course in 2 Years

Business—To be valuable in any Business capacity, you must be able to write clear, accurate letters and reports—make business calculations—understand geography, economics, etc. Most firms require all applicants to be High School graduates.

Industry—Advancement in Engineering or Manufacturing depends on your knowledge of High School mathematics, physics, chemistry, mechanical drawing, etc. Your employment application shows definitely for what job you're fitted.

College Entrance and the Professions

—Colleges, Universities, Engineering and Professional Schools require entering students to have a High School education, because College work begins where High School leaves off.

Business

College and Professions

Industry

You Can Complete Your High School Education at Home—in 2 Years or Less

Our course meets all requirements for Business, Industry, the Professions, and College Entrance. Standard High School texts supplied, supplemented by our own time-saving study instructions. Diplomas awarded. Full credit given for High School subjects already completed. Send for Free Bulletin TODAY. No obligation.

American School, Dept. HA-45, Drexel Avenue at 58th Street, Chicago, Illinois

Choose AVIATION and Learn at LINCOLN

There's a place for you in Aviation—if you have complete, proper training. That's the kind of modern, high class training you get at Lincoln. That's why Lincoln-trained Pilots and Mechanics are now employed by many of the best concerns in the Aviation Industry. You can be one of these big pay men in aviation!

Government Approved School with skilled Government Licensed Instructors. Only training planes with Dept. of Commerce approval are used. Both flight and ground training under Government Supervision.

All Flight Courses Offered including Transport course. Flight curriculum includes night flying, flying by instrument, cross country flying, acrobatics and all other phases to produce highest type of pilot.



Master Airplane and Engine Mechanics course gives you complete, practical training under experienced supervision. Practical factory methods used. You overhaul and rebuild actual airplanes and motors.

- 25 years success as a mechanics trade school and 15 years successful teaching of aviation recommends Lincoln training to you.
- Lincoln is in constant touch with the Aviation Industry and recommends graduates who meet required tests for the good pay job.
- Part time work offered for board and room.
- Now is the time for you to start training at Lincoln, for the good pay Pilots and Mechanics jobs of the future. Write! Please state your age.

LINCOLN AIRPLANE & FLYING SCHOOL
205E Aircraft Bldg. Lincoln, Nebraska

FOR BIG PAY SUCCESS



FREE 1935 CATALOG OF Practical and Mechanical Books

New 1935 catalog. Tells all about hundreds of practical, mechanical and scientific books on Aviation, Automobiles, Air Brakes, Alloys, Electricity, Formulas, Clock Making, Heating, Hydraulics, Machinery, Model Making, Metallurgy, Radio, Ship Models, Soaps, Perfumes, Recipes, Plumbing, Inventions, Tanning, Television, etc. Send name and address for FREE descriptive catalog. Write NOW.

Norman C. Henley Publishing Co., 2 W. 45th Street, New York



Learn Public Speaking

At home—in spare time—20 minutes a day. Overcome "stage-fright", gain self-confidence, increase your ability to sway others by effective speech. Write now for free booklet, *How to Work Wonders With Words*.

NORTH AMERICAN INSTITUTE, Dept. 135-A
3601 Michigan Avenue, Chicago, Illinois

Be an ARTIST

MAKE \$50 TO \$100 A WEEK!

Many of our successful students are now making big money. Our simple methods make it fun to learn Commercial Art, Cartooning and Designing at home, in spare time. New low tuition rate. Write for big free book "ART for Pleasure and Profit," today. State age. Address:

WASHINGTON SCHOOL OF ART,
STUDIO 126, 1115-15TH ST., N. W., WASHINGTON, D. C.



5¢ EACH LITTLE BLUE BOOKS

Send postcard for our free catalogue. Thousands of Bargains. Address: **LITTLE BLUE BOOK CO., Catalogue Dept.,** Desk 489, Girard, Kansas.

Play the Hawaiian Guitar like the Hawaiians!

FAMOUS NATIVE HAWAIIAN INSTRUCTORS teach you to play this fascinating instrument. ONLY 4 MOTIONS—No previous musical knowledge needed. OUR 52 EASY LESSONS teach you the enchanting music you hear over the radio.

GIVEN when you enroll—a sweet toned

HAWAIIAN GUITAR, complete playing outfit and carrying case.

WRITE AT ONCE for attractive offer and easy terms.



FIRST HAWAIIAN CONSERVATORY OF MUSIC, Inc.,
9th Floor, Woolworth Bldg. Dept. 250 New York, N. Y.

Approved by New York State Board of Regents

RADIO ENGINEERING, broadcasting, aviation and police radio, servicing, marine and Morse telegraphy taught thoroughly. Nine months' engineering course equivalent to three years' college radio work. School established 1874. All expenses low. Catalog free.
Dodge's Institute, Ada St., Valparaiso, Ind.

YOUR OPPORTUNITY—NEON and Other Gaseous Tubes

Today's biggest opportunity is in NEON or "gaseous-tube" lighting—most widely-used medium of lighted signs—the future's greatest source of illumination. Get started while it is still new!
FREE—Send name for free booklet, and excerpts of our practical low-cost, home-study course that teaches everything! **WRITE NOW!**
COMMERCIAL LABORATORIES, Dept. 47, Omaha, Neb.

MODERN BOOKKEEPING in 12 Easy Lessons

by an expert. Learn easily by mail, to open, keep and close books. **SMALL EASY PAYMENTS.**

THE FRAZEE METHOD, 46A Wayne Place, NUTLEY, N. J.



**"BET YOUR LIFE IT'S Fun"
WHEN YOU PLAY THE HARMONICA**

**-AND HERE'S
YOUR CHANCE
FELLOWS, TO BECOME
AN EXPERT PLAYER
Free**

● Don't envy other boys and girls who get in on all the good times and are the center of attraction wherever they go. There's no reason why you can't have just as much fun yourself. Good looks or athletic ability are not needed. In fact, you don't need any special talent whatever. Anyone who wants to can learn to play the harmonica—and once you're an expert you can't help but be always in the limelight.

This is an accomplishment that fits you into all kinds of gatherings. Boys and girls who once were worse off than you are now doing the entertaining at parties, outings, church affairs, scout meetings, etc. Many more are to be found in harmonica bands that have been organized in thousands of schools and scout groups throughout the country. What these others have done, YOU also can do.

Here's How To Learn

Even if you do not know a single note, you can learn to play the harmonica quickly and easily the Hohner way. Our new book: "The Art of Playing the Harmonica"—full of easy diagrams and simple lessons—tells the whole remarkable story of how to play this most fascinating of in-



A lot of big boys love the Harmonica too. Here's what Dizzy Dean, the famous St. Louis pitcher, says: "Do I play a Harmonica? You bet I do. I've played a Hohner Marine Band for years and it's a winner."



struments. The Hohner book is sent absolutely without cost or obligation. Follow its simple directions carefully and in a short time you will be able to give your friends the surprise of their lives.

Hohner Harmonicas "The World's Best"

The kind of harmonica you use can make all the difference in the world in the quality of your playing. Hohner Harmonicas have a world-wide reputation for beauty, accuracy of tone, and perfect standards of construction. They are the choice of leading professionals for stage and radio work—and of thousands of harmonica bands in all sections of the country. Make sure that the instrument you buy is a HOHNER and you can be sure of absolute satisfaction. Accept no "just as good" makes. Look for the name HOHNER on the box and instrument itself.

**Take First Step to Popularity Now
Send for FREE Instruction Book**

So if you're sick and tired of staying at home—and if you really want to step out as one of the leaders in your crowd—don't lose another minute. Tell us where to send your FREE copy of "The Art of Playing the Harmonica." Once you have this book you'll see how easy it is to be a real entertainer—how easy it is to get your share of fun and good times. Send the coupon below—NOW!

**M. HOHNER, INC.
351 Fourth Avenue New York City**

FREE Illustrated Harmonica Instruction Book

M. HOHNER, Inc., Dept. 975F
351 Fourth Ave., New York City

Please send me without cost your free instruction book, "The Art of Playing the Harmonica."

Name..... PLEASE PRINT

Address.....City.....State.....

Please address Canadian inquiries to Hough and Kohler, Ltd., 468 King St. West, Toronto, Canada.

300 Prizes GIVEN



Mail the Coupon

O H, BOY! Here's a bike that is a bike. And it can soon be yours! Comes to you fully equipped as shown, with headlight, coaster brake, horn, platform carrier, etc. Latest deluxe motorbike model. Swift as a comet. Sturdy as an Indian pony. As classy a bike as you've ever looked upon. Get it for your very own—without one cent of cost. Mail the coupon printed below. Do it today!

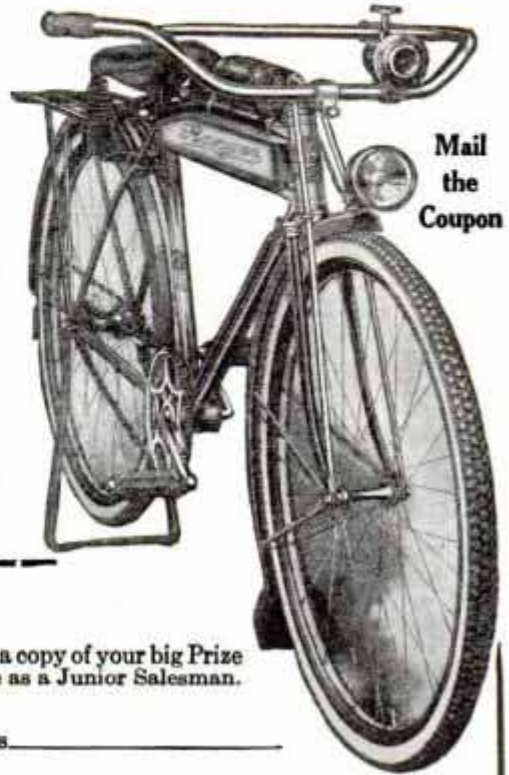

Mail the Coupon

YES, SIR! You can get this bicycle—and your choice of 300 other prizes, including 'most anything from a marble to a movie camera. You can make MONEY, besides. It's easy! Just deliver our 3 fine magazines to customers in your neighborhood. Will not interfere with school or play. Gives you valuable business training. Mail the coupon and we'll start you earning money and prizes.



Mr. Jim Thayer, Dept. 507
The Crowell Publishing Co., Springfield, Ohio

Dear Jim: I want to earn MONEY and PRIZES. Send me a copy of your big Prize Book showing 300 prizes that can be mine, and start me as a Junior Salesman.

Name _____ Address _____
City _____ State _____ Age _____

BECOME A TRAINED AUTO EXPERT

GOOD JOBS—GOOD PAY

Say good-bye to layoffs and low pay! Get into the Auto Service and Repair Business... a field of opportunity where practical training has brought big pay... promotion... shops of their own... to hundreds of fellows just like you.

PRACTICAL "JOB WAY" TRAINING BROUGHT TO YOUR HOME

Whether or not you are now employed... you can get this complete training right at home in your spare time. By this simple, easy "Job Way" method you can learn—in a few short months—what it would take you years to learn by ordinary methods. And we show you how to earn extra money while you are learning... doing actual JOBS on real autos.

SPARE-TIME MONEY

MOTOR TESTING OUTFITS FURNISHED

For those who act promptly we are including complete Motor Testing equipment at no extra cost. This practical working equipment helps your training, and will enable you to start making extra spare-time money soon after you enroll.

COMMON SCHOOLING ALL YOU NEED

Men between 15 and 50 with no previous auto experience or special education, quickly master "Job Way" Training and become skilled experts in every branch of auto work. We know what training you need, and give it to you in a way that is easy to understand.

HOW TO BECOME AN AUTO EXPERT

GET THE FACTS! Mail the Coupon, NOW, for Big FREE Auto Book, facts about "Job Way" Training, Free Employment and Consultation Service, Motor Testing equipment included with Course, and details of amazing MONEY-BACK OFFER.

MOTOR INSTITUTE OF AMERICA

2140 Lawrence Ave., Chicago, Ill., Dept. F-11

Without cost or obligation to me, send Free Auto Book, with full details of "Job Way" Home Training and your Money-Back Offer.

Name _____
Address _____
City _____ State _____

When writing please mention Popular Mechanics

MAKE BIG MONEY!
EARN WHILE YOU LEARN AT HOME
MAIL COUPON FOR FREE AUTO BOOK

Be a DENTICIAN

Learn at home to make Crowns, Plates, Bridgework, etc., for Dentists. Easy, practical way to learn mechanical dentistry at home in spare time. Full equipment of tools and materials included with course FREE. Low tuition. Easy terms. Write for FREE BOOK about this money-making profession that is not affected by "machine age."

McCARRIE SCHOOL OF MECHANICAL DENTISTRY
207 N. Broad St., Dept. 611, Philadelphia, Pa.

SECRET SERVICE BOOK FREE

For 30 Days Reading No Money Down—Actual Crime Cases—If You Act Quick!—We will send you this stirring book on Crime Detection, Secret Service and Identification Work for 30 days free reading. Send no money. If you decide to keep it, then send only \$1.00. If not, return it. WRITE TODAY. Not sent to boys under 17 years of age.

T. G. Cooke, Dept. A-135, 1920 Sunnyside Ave., Chicago

Learn PHOTOGRAPHY at Home

Make money taking pictures. Photographs in big demand. Commercial Photography also pays big money. Learn quickly at home in spare time. No experience necessary. Write today for free book, *Opportunities in Modern Photography*. American School of Photography, Dept. 135-A, 3601 Michigan Avenue, Chicago.

"BECOME A LIGHTNING TRICK CARTOONIST"

Send \$1.00 for Laugh Producing Program of 31 Trick Drawings with Instructions. Catalog of Chalk Talk Supplies Free. **BALDA ART SERVICE, Dept. 1, Oshkosh, Wis.**

WHY NOT spend spring, summer, fall, gathering butterflies — insects?

I buy hundreds of kinds for collections. Some worth \$1 to \$7 each. Simple outdoor work with my instructions, pictures, price list. Profit. Please. Send 10¢ (not stamps) for Illustrated Prospectus, terms, before sending butterflies. Mr. Sinclair, Dealer in Insects, Dept. 6, Box 1424, San Diego, Calif.

IT'S HARD TO BELIEVE
THEY ONCE CALLED ME
SKINNY!



It's a shame to be
SKINNY

When This Special Quick Way
Adds 5 to 15 Pounds . . . Fast

Astonishing gains with new double tonic. Richest imported brewers' ale yeast concentrated 7 times and iron added. Gives 5 to 15 lbs. in a few weeks

THOUSANDS who were "skinny" and friendless have gained solid, attractive flesh this new easy way—in just a few weeks!

Doctors for years have prescribed yeast to build up health. But now, with this new yeast discovery in pleasant little tablets, you can get far greater tonic results than with ordinary yeast—regain health, and also put on pounds of firm flesh—enticing curves—and in a far shorter time.

Not only are thousands quickly gaining beauty-bringing pounds, but also clear, radiant skin, freedom from indigestion, nervousness and constipation, new pep.

Concentrated 7 times

This amazing new product, Ironized Yeast, is made from specially cultured brewers' ale yeast imported from Europe—the richest yeast known—which by a new scientific process is now concentrated 7 times—made 7 times more powerful.

But that is not all! This super-rich yeast is ironized with 3 kinds of strengthening iron.

Day after day, as you take Ironized Yeast tablets, watch flat chest develop, skinny limbs round out attractively, constipation go, skin clear to beauty—you're an entirely new person.

Results guaranteed

No matter how skinny and weak you may be, this marvelous new Ironized Yeast should build you up in a few short weeks as it has thousands. If you are not delighted with the results of the very first package, your money back instantly.

Special FREE offer!

To start you building up your health right away, we make this absolutely FREE offer. Purchase a package of Ironized Yeast tablets at once, cut out the seal on the box and mail it to us with a clipping of this paragraph. We will send you a fascinating new book on health, "New Facts About Your Body," by a well-known authority. Remember, results are guaranteed with the very first package—or money refunded. At all druggists. Ironized Yeast Co., Inc., Dept. 536, Atlanta, Ga.

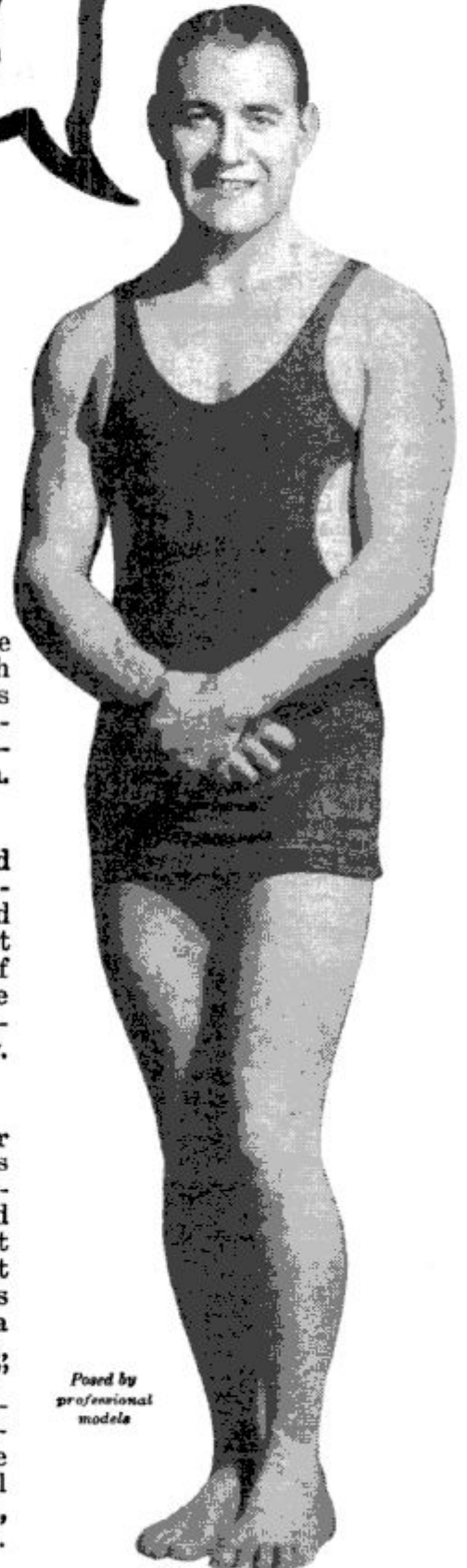

Posed by professional models

THE ONLY MAN



WHO COULD TALK TO THE SUPERINTENDENT

"Soon after I began studying," a student wrote to us the other day, "we had a change in management at our plant. I certainly was glad then that I had decided to study in my spare time. For, thanks to my I. C. S. Course, I was the only man in the organization who could talk to the Superintendent in his own language. As a result, I was promoted over men who had been here many years longer than I."

That's a true story of what just one I. C. S. student has done. This is proved by letters from satisfied students telling of promotions and increases in salary due directly to spare-time study.

One hour a day, spent with the I. C. S. in the quiet of your own home, will help prepare you for success in the work you like best. *Yes, it will!* Put it up to us to prove it.

INTERNATIONAL CORRESPONDENCE SCHOOLS

"The Universal University" Box 5580-II, Scranton, Penna.

Without cost or obligation, please send me a copy of your booklet, "Who Wins and Why," and full particulars about the subject before which I have marked X:

TECHNICAL AND INDUSTRIAL COURSES

- | | | |
|--|--|--|
| <input type="checkbox"/> Architect | <input type="checkbox"/> Plumbing | <input type="checkbox"/> Heating |
| <input type="checkbox"/> Architectural Draftsman | <input type="checkbox"/> Air Conditioning | |
| <input type="checkbox"/> Building Estimating | <input type="checkbox"/> Steam Engineer | |
| <input type="checkbox"/> Contractor and Builder | <input type="checkbox"/> Steam Electric Engineer | |
| <input type="checkbox"/> Structural Draftsman | <input type="checkbox"/> Marine Engineer | |
| <input type="checkbox"/> Structural Engineer | <input type="checkbox"/> Civil Engineer | |
| <input type="checkbox"/> Electrical Engineer | <input type="checkbox"/> Highway Engineer | |
| <input type="checkbox"/> Electric Lighting | <input type="checkbox"/> Bridge Engineer | |
| <input type="checkbox"/> Welding, Electric and Gas | <input type="checkbox"/> Bridge and Building Foreman | |
| <input type="checkbox"/> Reading Shop Blueprints | <input type="checkbox"/> Surveying and Mapping | |
| <input type="checkbox"/> Telegraph Engineer | <input type="checkbox"/> Refrigeration | |
| <input type="checkbox"/> Telephone Work | <input type="checkbox"/> R. R. Locomotives | <input type="checkbox"/> Air Brakes |
| <input type="checkbox"/> Mechanical Engineer | <input type="checkbox"/> R. R. Section Foreman | |
| <input type="checkbox"/> Mechanical Draftsman | <input type="checkbox"/> R. R. Signalmen | |
| <input type="checkbox"/> Machinist | <input type="checkbox"/> Chemistry | <input type="checkbox"/> Pharmacy |
| <input type="checkbox"/> Patternmaker | <input type="checkbox"/> Coal Mining | |
| <input type="checkbox"/> Sheet Metal Worker | <input type="checkbox"/> Navigation | |
| <input type="checkbox"/> Heat Treatment of Metals | <input type="checkbox"/> Textile Overseer or Supt. | |
| <input type="checkbox"/> How to Invent and Patent | <input type="checkbox"/> Cotton Manufacturing | |
| <input type="checkbox"/> Gas Engines | <input type="checkbox"/> Woolen Manufacturing | |
| <input type="checkbox"/> Diesel Engines | <input type="checkbox"/> Agriculture | <input type="checkbox"/> Fruit Growing |
| <input type="checkbox"/> Aviation Engines | <input type="checkbox"/> Poultry Farming | |
| <input type="checkbox"/> Automobile Mechanic | | |

BUSINESS TRAINING COURSES

- | | | |
|---|--|---------------------------------------|
| <input type="checkbox"/> Business Management | <input type="checkbox"/> Business Correspondence | |
| <input type="checkbox"/> Office Management | <input type="checkbox"/> Lettering Show Cards | <input type="checkbox"/> Signs |
| <input type="checkbox"/> Industrial Management | <input type="checkbox"/> Stenography and Typing | |
| <input type="checkbox"/> Traffic Management | <input type="checkbox"/> Civil Service | <input type="checkbox"/> Mail Carrier |
| <input type="checkbox"/> Accountancy and C.P.A. | <input type="checkbox"/> Railway Mail Clerk | |
| <input type="checkbox"/> Coaching | <input type="checkbox"/> Grade School Subjects | |
| <input type="checkbox"/> Bookkeeping | <input type="checkbox"/> High School Subjects | |
| <input type="checkbox"/> Secretarial Work | <input type="checkbox"/> College Preparatory | |
| <input type="checkbox"/> Cost Accountant | <input type="checkbox"/> First Year College | |
| <input type="checkbox"/> Salesmanship | <input type="checkbox"/> Illustrating | <input type="checkbox"/> Spanish |
| <input type="checkbox"/> Service Station Salesmanship | <input type="checkbox"/> Cartooning | <input type="checkbox"/> French |
| <input type="checkbox"/> Wallpaper Decorating | <input type="checkbox"/> Lumber Dealer | |
| <input type="checkbox"/> Salesmanship | | |

Name.....Age.....

Address.....

City.....State.....

Present Position.....

If you reside in Canada, send this coupon to the International Correspondence Schools Canadian, Limited, Montreal, Canada

When writing please mention Popular Mechanics

ELECTRICAL ENGINEERING

A broad, basic, intensive course

Complete in One School Year

Includes the fundamentals of Refrigeration, Air Conditioning and Electronics

PREPARATION under skilled instructors for new opportunities in electrical field. Approved by educators, endorsed by industry. 42 years' successful experience.

Theory and Practice Combined

Theory and practice are closely interwoven in classroom and laboratory. Fireproof dormitories, dining hall, laboratories and shops.

Prepare Now

Bliss men hold responsible technical and executive positions. Catalog on request.



BLISS ELECTRICAL SCHOOL
116 Takoma Ave., Washington, D. C.



Learn to Write

Begin Today. Write for my Free Book, "How to Become a Good Penman." It contains specimens and tells how others learned to write in spare time. Your name elegantly written on a card if you enclose stamp for postage. Write today. F. W. TAMBLYN, 416 Ridge Bldg., Kansas City, Mo.

LEARN WATCHMAKING AND ENGRAVING

BY OUR PROFIT-SHARING PLAN
OUR GRADUATES SUCCEED

One of our Iowa students started in a very small way—now doing over \$30,000 a year. Another in Wisconsin, over \$10,000 the first year. Day or night classes. Call or write for FREE BOOK. Chicago School of Watchmaking, Dept. 2801, 155 N. Clark St., CHICAGO.

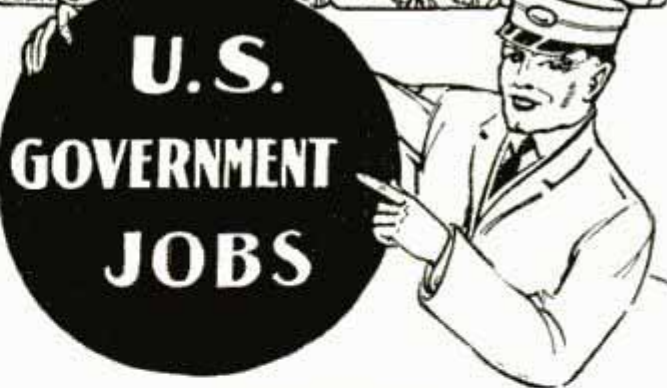

START \$1260 to \$2100 YEAR
MEN—WOMEN—18 to 50
STEADY WORK

Many Examinations Coming
Common Education Usually Sufficient
Mail Coupon Today—**SURE**

Franklin Institute
Dept. S174
Rochester, N. Y.

Gentlemen: Rush to me. FREE of charge, list of U. S. Government big pay jobs. Send me FREE 32-page book describing salaries, vacations, hours, work. Tell me fully how to get one of these jobs.

Name.....

Address.....

Amazing New 7-TUBE, 5-WAVE BAND SUPERHETRODYNE

WORLD-WIDE RECEPTION

HERE'S today's most sensational radio value—a 7-tube, 5-wave band Superheterodyne... at a saving of 30% to 50%—on 30 days FREE trial. Only 7-tube all-wave radio covering 9 to 2400

ONLY **\$27.50** COMPLETE WITH DYNAMIC SPEAKER AND TUBES

30 DAYS FREE TRIAL

meters. Has 20 advanced 1935 features. Five full wave bands bring in realistic American and Foreign Short Wave programs... Canadian, police, amateur, airplane and ship. Write for FREE 36-page, 4-color catalog. Money Back Guarantee.

TERMS AS LOW AS **75¢ A WEEK**



MIDWEST RADIO CORP.

DEPT. 238-A - CINCINNATI, OHIO, U. S. A.

Established 1920 Cable Address Miraco... All Codes

Operator No. 38



FOLLOW THIS MAN

Secret Service Operator No. 38 is on the job! Running down dangerous Counterfeit Gang. Tells finger prints in murdered girl's room.

Free The Confidential Report Operator No. 38 made to his chief. Write for it. Earn a Regular Monthly Salary

YOU can become a Finger Print Expert at home, in your spare time, at small cost. Write for confidential full report and details. Literature will NOT be sent to boys under 17 years of age.

INSTITUTE OF APPLIED SCIENCE

1920 Sunnyside Ave. Dept. A-135 Chicago, Ill.



FASTEST GROWING TRADE DEMANDS TRAINED MEN

Trained men needed. Demand for Auto-Diesel experts to service and operate trucks, tractors, trains, boats, power shovels, generating plants, etc., grows every month. To qualify for good Jobs you must first become trained. Accomplish this in a few months at the National Schools. Qualify as Diesel Engineer, Auto Mechanic, Auto Electrician, Battery Expert, Carburetor Expert, Fuel Injection Expert, Trouble Shooter, etc.

Oldest, Largest Trade School in West

Est. 1905. 30,000 graduates. Finest equipment—latest model autos, actual Diesel Engines to work on. Expert instructors.

Coupon Brings FREE Catalog

Combination Auto-Diesel Course Fully Qualifies You

Earn Room and Board

We assist students to obtain part time job during training. We allow coach railroad fare from any part of U. S. to Los Angeles.

NATIONAL AUTOMOTIVE SCHOOLS

Dept. 6PMA, 4006 So. Figueroa St., Los Angeles

NAME _____

ADDRESS _____

CITY _____ STATE _____



Be a RADIO EXPERT



Learn at Home to Make \$40, \$60, \$75 a WEEK



\$500 a Year in Spare Time

"Doing spare time Radio work only, I have averaged about \$500 a year in addition to my regular income. Full time Radio work would net me many times that amount."

Edward H. Fawcett, Slough Rd., Ladner, B. C., Canada.



\$6,000 in 2 Years

"Soon after the depression started, I found myself without a job, but I was well protected with N. R. I. training. I swung right to full time Radio Servicing and made over \$6,000 in a little over 2 years."

William Spartivent, Sparty Radio Service, 93 Broadway, Newark, N. J.



Mets About \$50 a Week besides Sales

"I have been getting along fine. I net about \$50 a week, not counting profits on sales. I have serviced almost every make of set and

have earned more than I ever expected. I owe my success to the N. R. I." Bernard Costa, 150 Franklin St., Brooklyn, N. Y.

Get my FREE book about the opportunities in Radio. Mail the coupon now. Get the facts about this field with a future. N. R. I. training fits you for jobs making, selling, servicing short and long wave Radio sets, to have your own business; to operate Radio apparatus on board ships, in a broadcasting or commercial land station; for television, aviation, police Radio, and many other branches. My FREE book gives full information and tells how you quickly learn at home in spare time. Stop struggling along in a dull job with low pay and no future. Start training now for the live-wire Radio field. I have doubled and tripled salaries of many.

Many Make \$5, \$10, \$15 a Week Extra in Spare Time While Learning

Hold your job. I'll train you in a few hours of your spare time a week. The day you enroll I start sending you Extra Money Job Sheets which quickly show you how to do Radio repair jobs common in most every neighborhood. I give you radio equipment that teaches you to build and service practically every type of receiving set made. Fred J. Duhquan, 19 Church St., Oswego, N. Y., wrote: "I have made about \$1200 in a little over two years' spare time Radio work."

Get My Book—FREE—Now

My book has shown hundreds of fellows how to make more money and win success. It's FREE to any ambitious fellow over 15 years of age. Investigate. Find out what Radio offers; about my Course; what others who have taken it are doing and making; about my Money Back Agreement, and the many other N. R. I. features. Mail coupon NOW.

J. E. SMITH, Pres.
National Radio Institute, Dept. 5FP
Washington, D. C.

MAIL NOW for FREE PROOF

J. E. SMITH, President
National Radio Institute
Dept. 5FP
Washington, D. C.
Dear Mr. Smith:

Without obligating me, send free book about spare time and full time Radio opportunities, and how I can train for them at home in spare time. (Please print plainly.)

NAME.....AGE.....

ADDRESS.....

CITY.....STATE.....



When writing please mention Popular Mechanics

The Diesel Engineer

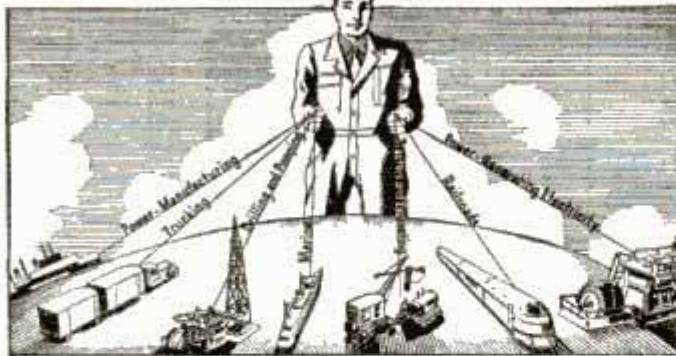

Diesel Engineering offers you a chance to get into a field that is on the upgrade and continually expanding — one that will require more and more Diesel-trained men for the next 25 years, or as long as you need to work. A very important part of our service is that, when the student has completed his training, we help him search out an opening in the Diesel Engineering field where he can be sure of steady advancement, with an ever-increasing reward for his foresightedness in getting training. Write today for free Bulletin. No obligation.

American School, Department DA-45, Drexel Avenue at 58th Street, Chicago

AUDELS Carpenters and Builders Guides 4 vols. \$6



Inside Trade Information for Carpenters, Builders, Joiners, Building Mechanics and all Woodworkers. These Guides give you the short-cut instructions that you want—including new methods, ideas, solutions, plans, systems and money saving suggestions. An easy progressive course for the apprentice and student. A practical daily helper and Quick Reference for the master worker. Carpenters everywhere are using these Guides as a Helping Hand to Ease Work, Better Work and Better Pay. To get this assistance for yourself, simply fill in and mail the FREE COUPON below.

Inside Trade Information On:

How to use the steel square—How to file and set saws—How to build furniture—How to use a mitre box—How to use the chalk line—How to use rules and scales—How to make joints—Carpenters arithmetic—Solving mensuration problems—Estimating strength of timbers—How to set girders and sills—How to frame houses and roofs—How to estimate costs—How to build houses, barns, garages, bungalows, etc.—How to read and draw plans—Drawing up specifications—How to excavate—How to use settings 12, 13 and 17 on the steel square—How to build joists and scaffolds—skylights—How to build stairs—How to put on interior trim—How to hang doors—How to lay floors—How to paint



THEO. AUDEL & CO., 65 W. 23rd St., New York City

Mail Audels Carpenters and Builders Guides, 4 vols., on 7 days' free trial. If O.K. I will remit \$1 in 7 days, and \$1 monthly until \$6 is paid. Otherwise I will return them. No obligation unless I am satisfied.

Name.....

Address.....

Occupation.....

Reference..... P.M.

NEW MEXICO SCHOOL of MINES

Practical instruction in Mining and Mining Geology. Also Metallurgy, Petroleum Geology and General courses offered by this 4-year state-owned college. Strong faculty; fine equipment; small classes. All expenses low. Healthful climate. Ask for Catalog 51.

E. P. WATSON, REGISTRAR, SOCORRO, N. M.

Train for a Well-Paid Hotel Position

COME TO WASHINGTON

Good positions for trained men in hotel, club, restaurant and institutional field. Previous experience unnecessary. Quality in **FOUR MONTHS**—learn on real hotel equipment, under expert instructors. National Placement Service FREE of extra charge. New Day Classes start Sept. and Oct. **Catalog FREE!**

LEWIS HOTEL TRAINING SCHOOLS
Division RLG-334 Washington, D. C.

MAKE MONEY with Your CAMERA

Magazines, newspapers, advertisers, BUY 134,000 photos a week from people who know how to take the kind of pictures wanted! Let us teach you how to make real human-interest pictures that SELL!

LEARN AT HOME

Our personalized home-study Course—the most complete training in Journalistic Photography ever offered—prepares you to make good money in this fascinating field—quickly, at low cost, in spare time. Write now for **FREE BOOK!** UNIVERSAL PHOTOGRAPHERS Dept. 76, 10 W. 33rd St., N. Y. C.

Why VOICE Students Fail

SENT FREE No Obligation to Buy

If you act quick!—we will send postpaid—for 30 days' free reading—new Voice Book disclosing startling VOICE FACTS that may save hundreds of dollars to every man or woman seeking a strong, rich voice for either singing or speaking. 30 days' free reading—then send \$1.00. Otherwise, return it—that's all! PROF. E. FEUCHTINGER Studio A-135 64 E. Lake St. Chicago



Correspondence in RADIO & ELECTRICAL ENG.



Course No. 1: ELECTRICAL ENGINEERING—Simplified mathematics, covers complete field, easy to understand. Modern and up-to-date. Course No. 2: RADIO AND ELECTRONIC ENGINEERING—An ultra modern course in radio, public address, photo electric work. Trains you to be super-service man and real vacuum tube technician. Tuition \$25 with course. Deferred payment plan for worthy students. Free laboratory apparatus. Student publication. School pin. Run like a college. Write today for school catalogs.

LINCOLN ENGINEERING SCHOOL, 855-H S. 37th St., Lincoln, Nebr.

HOW TO WIN PRIZE CONTESTS

This book can make you rich, or at least help you make a good living. The purpose of this book, "How to Win Prize Contests," is to help you win by setting forth the best-known principles and methods. Send 25c to HALDEMAN-JULIUS CO., Box 774 GIRARD, KANSAS

ARTISTS MAKE MONEY

Find out your ability. Send name, age, occupation and address for Free Vocational Art Test.

Federal Schools, Inc., 6135 Federal Schools Bldg., Minneapolis, Minn.

TIRES MADE as low as 40¢



Make UP TO \$6.85 AN HOUR

NO-FLATZ Sensational, new discovery ends flat tires forever! Just squirt it into tubes through valve stem. Be safe at any speed. No-Flatz seals holes made by nails, tacks, glass, air-tight *Instantly* and *Permanently*. Increases life of tires and tubes. Quick! Easy! Low priced! Lifetime Guarantee.

FREE SAMPLE: Rush name and address for Free Sample Offer and Money-making details. Make up to 203 per cent profit. Act now!

Opportunities for Distributors in Foreign Countries
NO-FLATZ CO., Dept. K-369, Cincinnati, Ohio

Increase Your Earning Power

Apply time and labor-saving kinks to your work. Your efficiency will soon be recognized and you will be in line for advancement.

If you do machine shop work of any kind, sheet-metal work, painting, carpentry, auto repairing, farming, concrete work, plumbing, electrical work, welding, building-glass work, general repairing, tool-making, poultry raising, masonry or home repair work, get this

LIBRARY OF 2500 TIME AND LABOR SAVING IDEAS FOR SHOPMEN AND HANDYMEN

RECENTLY PUBLISHED

SHOP NOTES for 1935

332 Articles
721 Illustrations
224 Pages
Price 50c
See partial list of contents below



Including the new 1935 issue illustrated above, there are six volumes in the Shop Notes Library of 2500 easily understood short cuts to every-day jobs. Here are just a few of the subjects taken from the latest issue.

- | | | |
|---------------------------------|---|---|
| Auto Electrical Troubles, Tests | Glass, Working with | Scroll Saw, Special Uses |
| Auto Knocks, Loosening | Hack Saw, Using | Soldering with Electric |
| Bandaw, Tuning Up | Heat Treating of Iron, Steel, Brass, Copper, Aluminum | Are |
| Belt Sander, Portable | Jointer, Keeping in Shape | Streamline Bodies, Wire Mesh and Fabric for Boat and Auto |
| Boathouse Filing, Concrete | Knee Action Wheels, Servicing | Tape and Dies |
| Cold Chisels, Using | Lathe, Labor Saving Ideas for | Tool Chest, Portable |
| Dancing Auto Wheels, Curing | Lathe Kinks, Simple | Window Attraction, Novel Store |
| Drill Press, Homemade | Metal Spinning | Window Displays, Mechanical, that Draw Trade |
| Drill-Press Problems, Solving | Metal Turning Suggestions | Wood Chisels, Tricks of Using |
| Electric Appliances, Repairing | Neon Sign, Flashing | Wood Joints with Hand Tools |
| Electrical Motors, Rewinding | Paint Spray Gun | Work Benches you can Build |
| Electricians, Short Cuts for | Reed Baskets, Weaving | Workshop, Motorize Your |
| Forge Made from Cream Separator | Roadside Salesman Sander From Auto Parts | |
| | Sand, Uses in Workshop | |
| | Saw Table, Adjustable | |

Each volume contains approximately 350 articles and 500 illustrations and has 192 or more pages. This unrivaled library of shop helps may be secured for a limited time only. After the present supply of books is exhausted the offer must be withdrawn.

* Send No Money

POPULAR MECHANICS PRESS, 200 E. Ontario St., Room 635, Chicago, Ill.

Send me, as per your offer, the following books. I will pay postman price and small amount of postage. My money will be refunded if I am not satisfied. (Check what you want.)

- 1935 Shop Notes and Lathe Handbook, both for 98c.
- Shop Notes Library (6 vols.) \$3.00.

Name.....
Street and No.....
City..... State.....

* C. O. D. applies to U. S. and possessions only. If you reside elsewhere, remittance must accompany order.

BE A RADIO EXPERT



Kendall Clough
Chief Engineer,
Clough-Brenzle Co.

E. E. Gramer
Chief Engineer,
Standard Transformer Corp.

Karl E. Hassel
Chief Engineer,
Zenith Radio Corp.

H. C. Tittle
Chief Radio Engineer,
General Household Utilities (Grunow).

F. D. Whitten
Service Manager,
Chicago Branch, Philco Radio & Television Corp.

Dr. C. M. Blackburn
Radio Engineer,
P. R. Mallory & Co., Mfrs. of Radio Apparatus.

LEARN AT HOME FROM THESE REAL RADIO ENGINEERS

Learn Radio from these men! Just see who they are! All top-notch engineers—selected by the great Radio concerns they work for to supervise and direct your Training. Learn Radio the way Big Radio Firms want you to learn it—the Shop way—the practical way—the real money-making way. Only the Radio & Television Institute can offer you this chance to learn Radio from real Radio Engineers working right in the heart of the Radio Industry.

MANY R-T-I TRAINED MEN
Earn \$35 to \$75 A Week

Get out of the rut. Fit yourself for good-pay work in Radio—the field with a future. My FREE book tells how real engineers train you quickly and inexpensively right in your own home and in your spare time.

Turn Your Spare Time Into Money

Many R-T-I students make \$5, \$10, \$15, and more, a week in spare-time work soon after enrolling. I send you instructions which you should master quickly for doing Radio jobs common in most communities—plans and ideas which have helped hundreds of my "boys" pay for their R-T-I Training with spare-time earnings.

Good - Pay Opportunities Everywhere

Broadcasting Stations, Factories, Dealers and Distributors and others all use "trained" men, and pay up to \$5000 a year. Air Craft and Short Wave Radio, Photo Cells, Public Address Systems and Sound Pictures have created thousands of good-pay jobs. This is a big year for Radio. New developments in receivers alone, demand up-to-date trained technical men. Get the facts in my free book.

RAY D. SMITH, President
Radio & Television Institute (R-T-I)
2130 Lawrence Ave., Dept. 1-A
Chicago, Ill.

MAIL YOUR FREE COUPON FOR BOOK

RAY D. SMITH, President
Radio & Television Institute (R-T-I)
2130 Lawrence Ave., Dept. 1-A
Chicago, Ill.

Without obligating me, send FREE BOOK about spare-time and full-time Radio opportunities and how I can train for them at home.

Name.....
Address..... Age.....
City..... State.....

When writing please mention Popular Mechanics





Attention

MEN WHO WANT TO GET MARRIED!

Most likely your income has been reduced. And yet —

You and that girl of your dreams have the precious hope of facing life together!

The obstacle is money—more money.

Listen: Thousands of men, even in these times—men who faced the same problem that now troubles you—have learned the secret. They're making themselves more valuable on their present jobs, preparing themselves for the bigger opportunities ahead!

They're doing it by devoting a portion of their spare time to study—by mastering International Correspondence Schools Courses that are modern and practical in their training. Many of today's business leaders started this very way.

You can do the same thing—and realize that hope you hold so dear. It takes work and sacrifice—what worth-while thing doesn't? The coupon will bring you good news—mail it today!

INTERNATIONAL CORRESPONDENCE SCHOOLS

"The Universal University" Box 5577-H, Scranton, Penna.

Without cost or obligation, please send me a copy of your booklet, "Who Wins and Why," and full particulars about the subject before which I have marked X:

TECHNICAL AND INDUSTRIAL COURSES

- | | | |
|--|--|--|
| <input type="checkbox"/> Architect | <input type="checkbox"/> Plumbing | <input type="checkbox"/> Heating |
| <input type="checkbox"/> Architectural Draftsman | <input type="checkbox"/> Air Conditioning | |
| <input type="checkbox"/> Building Estimating | <input type="checkbox"/> Steam Engineer | |
| <input type="checkbox"/> Contractor and Builder | <input type="checkbox"/> Steam Electric Engineer | |
| <input type="checkbox"/> Structural Draftsman | <input type="checkbox"/> Marine Engineer | |
| <input type="checkbox"/> Structural Engineer | <input type="checkbox"/> Civil Engineer | |
| <input type="checkbox"/> Electrical Engineer | <input type="checkbox"/> Highway Engineer | |
| <input type="checkbox"/> Electric Lighting | <input type="checkbox"/> Bridge Engineer | |
| <input type="checkbox"/> Welding, Electric and Gas | <input type="checkbox"/> Bridge and Building Foreman | |
| <input type="checkbox"/> Reading Shop Blueprints | <input type="checkbox"/> Surveying and Mapping | |
| <input type="checkbox"/> Telegraph Engineer | <input type="checkbox"/> Refrigeration | |
| <input type="checkbox"/> Telephone Work | <input type="checkbox"/> R. R. Locomotives | <input type="checkbox"/> Air Brakes |
| <input type="checkbox"/> Mechanical Engineer | <input type="checkbox"/> R. R. Section Foreman | |
| <input type="checkbox"/> Mechanical Draftsman | <input type="checkbox"/> R. R. Signalmen | |
| <input type="checkbox"/> Machinist | <input type="checkbox"/> Chemistry | <input type="checkbox"/> Pharmacy |
| <input type="checkbox"/> Patternmaker | <input type="checkbox"/> Coal Mining | |
| <input type="checkbox"/> Sheet Metal Worker | <input type="checkbox"/> Navigation | |
| <input type="checkbox"/> Heat Treatment of Metals | <input type="checkbox"/> Textile Overseer or Supt. | |
| <input type="checkbox"/> How to Invent and Patent | <input type="checkbox"/> Cotton Manufacturing | |
| <input type="checkbox"/> Gas Engines | <input type="checkbox"/> Woolen Manufacturing | |
| <input type="checkbox"/> Diesel Engines | <input type="checkbox"/> Agriculture | <input type="checkbox"/> Fruit Growing |
| <input type="checkbox"/> Aviation Engines | <input type="checkbox"/> Poultry Farming | |
| <input type="checkbox"/> Automobile Mechanic | | |

BUSINESS TRAINING COURSES

- | | | |
|---|--|---------------------------------------|
| <input type="checkbox"/> Business Management | <input type="checkbox"/> Business Correspondence | |
| <input type="checkbox"/> Office Management | <input type="checkbox"/> Lettering Show Cards | <input type="checkbox"/> Signs |
| <input type="checkbox"/> Industrial Management | <input type="checkbox"/> Stenography and Typing | |
| <input type="checkbox"/> Traffic Management | <input type="checkbox"/> Civil Service | <input type="checkbox"/> Mail Carrier |
| <input type="checkbox"/> Accountancy and C.P.A. | <input type="checkbox"/> Railway Mail Clerk | |
| <input type="checkbox"/> Coaching | <input type="checkbox"/> Grade School Subjects | |
| <input type="checkbox"/> Bookkeeping | <input type="checkbox"/> High School Subjects | |
| <input type="checkbox"/> Secretarial Work | <input type="checkbox"/> College Preparatory | |
| <input type="checkbox"/> Cost Accountant | <input type="checkbox"/> First Year College | |
| <input type="checkbox"/> Salesmanship | <input type="checkbox"/> Illustrating | <input type="checkbox"/> Spanish |
| <input type="checkbox"/> Advertising | <input type="checkbox"/> Cartooning | <input type="checkbox"/> French |
| <input type="checkbox"/> Service Station Salesmanship | <input type="checkbox"/> Lumber Dealer | |
| <input type="checkbox"/> Wallpaper Decorating | | |
| <input type="checkbox"/> Salesmanship | | |

Name.....Age.....

Address.....

City.....State.....

Present Position.....

If you reside in Canada, send this coupon to the International Correspondence Schools Canadian, Limited, Montreal, Canada

A frank man PATENTS SELLING

THE world of invention moves on. The Patent Office clerk who resigned his job back in 1833, because he said there was nothing left to invent, now stands out as one of the funniest men in American History. Think what's happened in the last 100 years! Why, only recently the papers carried a notice that an obscure worker, Hans Wach, has invented a device to utilize exhaust steam on steamboats. Already, the report states, the steamship lines have saved more than \$15,000,000 in fuel bills with his invention. Almost in the same breath the Dept. of Commerce announces a new, non-crashable aeroplane, that the average man can learn to fly in a day, that will travel at 110 miles an hour and sell at the price of a cheap automobile. A Seattle man has invented a robot to go 5,000 feet under the sea and recover millions and millions of dollars worth of gold.

Many Little Ideas Have Big Commercial Possibilities

But remember this: For every outstanding big invention there are thousands of small, simple ones. Little articles like you find on the counters of a 10-cent store, hardware store, drug store, toy and novelty shop. A person finds something he's using doesn't work right, or it's clumsy, or costs too much. He gets an idea. He improves the old Article and Patents his improvement. That's the way that many men have reached financial comfort, independence and even wealth. Most of the things

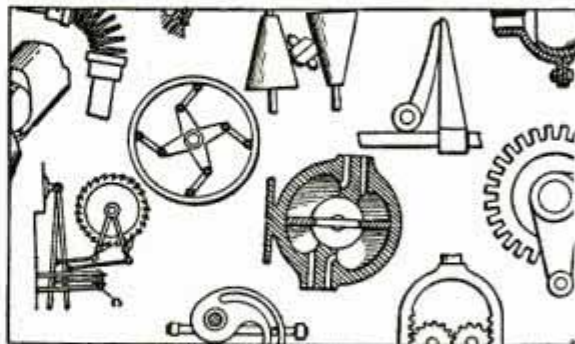

Our Book Shows You

Besides many other features, facts and inter-mechanical movements in the big, 48-page idea you need to solve some mechanical prob-

READ AND MAIL

When writing to advertisers please mention Popular Mechanics

to man talk about

INVENTIONS INVENTIONS

we use didn't come from the brains of engineers and physicists. They came from the mind and maybe the crude home work bench of Mr. Average Man. Poor men who have no thought of invention now will be financially well-fixed in a few years because of a happy thought that the world could use to advantage.

Can You Answer These Questions?

Ask yourself these questions: How do the Patent Laws protect me? What easy steps can I take, without cost, to put myself in position to support my belief that I am the first man to think of my invention? How have other inventors secured protection? Is a Patent worth the cost? Do I need a model? Should I try to sell my invention before I have it Patented? Is there any safe, business-like way to secure financial help? How shall I reach people who can market my invention? Can I protect and sell an improvement on some invention that has already been patented? These questions usually confront the average man. You need the answers! YOU CAN HAVE THEM, without cost, without trouble, without delay.

Our Business Is to Help You. Write Us Today

For thirty-six years, we have helped men with an inventive turn of mind. We maintain a large staff of trained, experienced specialists—Registered Patent Attorneys, Draftsmen, and Searchers. Fees are reasonable. Deferred payments frequently arranged. Questions promptly answered. Write us frankly; what you say will be treated with strictest secrecy. But FIRST, send for the FREE BOOKS shown here. They may save you time, expense, EVEN LATER DISAPPOINTMENT. Simply fill in the coupon. No charge, no obligation. Write us TODAY.

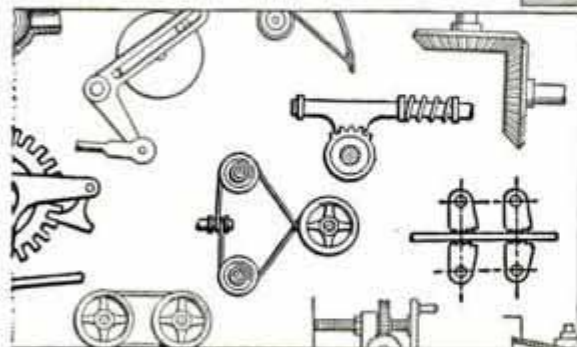

115 Mechanical Movements

esting illustrations, there are 115 different Book shown above. Maybe there is just the lem. Use the coupon or write us a card or letter.

A NEW BOOK About Selling Inventions

So far as we know, the facts in the booklet shown below have never before been published by any Patent Attorney. Remember that there are two sides of every inventive success: The inventive side and the commercial side. This NEW booklet deals with the commercial angle. Both books sent with our compliments to serious, interested men. **To save time, use the convenient coupon.**

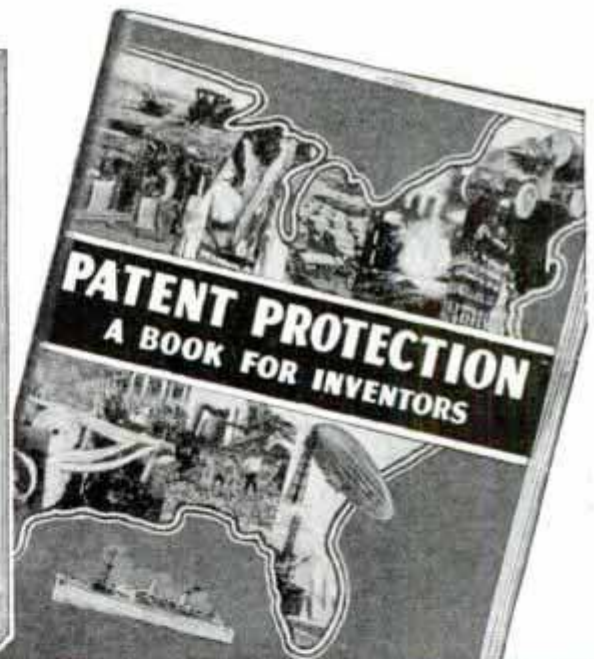
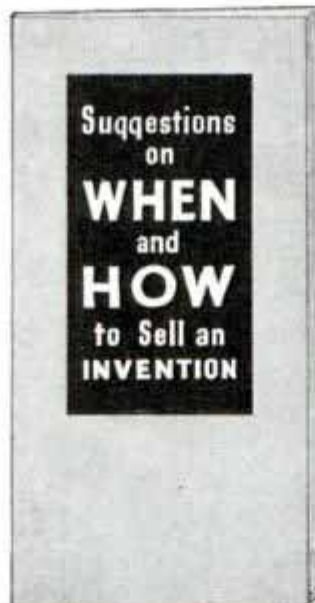

**NOW READY
FOR YOU**

**2 FREE
BOOKS**

**68 PAGES
of Facts and
Pictures!**

VICTOR J.
EVANS & Co.

**REGISTERED PATENT ATTORNEYS,
MAIN OFFICE: 500-G, VICTOR BUILDING,
WASHINGTON, D. C.**

Other Offices: 1640-N Conway Bldg., Chicago; 1007-N Woolworth Bldg., New York; 514-N Empire Bldg., Pittsburgh; 1010-N Hobart Bldg., San Francisco; 736-N Security Bldg., Los Angeles.

Send me FREE copies of your books "Patent Protection" and "When and How to Sell an Invention." (Note: Same books supplied by any of branch offices listed above.)

Name.....

Street and No.....

City or Town.....

THIS COUPON

When writing to advertisers please mention Popular Mechanics

This is 1935 FIGHTING Talk



IF YOU'RE a quitter you won't read far in this advertisement. If you're not—if you have the courage to face facts—you want to know who is responsible for your not getting ahead faster. It's YOU. The man who won't be licked *can't* be licked. If you're a drifter you'll always wish for success but never do anything about it. The earth is cluttered with that kind.

If you're a fighter you *will* do something about it. You'll get the special training that fits you for advancement, and you'll go on to a bigger job.

In spare time, right at home, you can get the training you need through the home-study courses of the International Correspondence Schools. Thousands of other men have lifted themselves out of the rut and into well-paid, responsible positions by I. C. S. study. Are they better men than you?

The time for action is *this minute*. Find out about this practical educational method that lets you learn while you earn. Check the subjects that interest you in the coupon below and mail it today. It doesn't obligate you in any way to ask for full particulars, but that one simple act may make all the difference between failure and success. *Do it now!*

INTERNATIONAL CORRESPONDENCE SCHOOLS

"The Universal University" Box 5581-H, Scranton, Penna.

Without cost or obligation, please send me a copy of your booklet, "Who Wins and Why," and full particulars about the subject before which I have marked X:

TECHNICAL AND INDUSTRIAL COURSES

- | | | |
|--|--|--|
| <input type="checkbox"/> Architect | <input type="checkbox"/> Plumbing | <input type="checkbox"/> Heating |
| <input type="checkbox"/> Architectural Draftsman | <input type="checkbox"/> Air Conditioning | <input type="checkbox"/> Steam Engine |
| <input type="checkbox"/> Building Estimating | <input type="checkbox"/> Steam Electric Engineer | <input type="checkbox"/> Marine Engineer |
| <input type="checkbox"/> Contractor and Builder | <input type="checkbox"/> Civil Engineer | <input type="checkbox"/> Highway Engineer |
| <input type="checkbox"/> Structural Draftsman | <input type="checkbox"/> Bridge Engineer | <input type="checkbox"/> Bridge and Building Foreman |
| <input type="checkbox"/> Structural Engineer | <input type="checkbox"/> Surveying and Mapping | <input type="checkbox"/> Refrigeration |
| <input type="checkbox"/> Electrical Engineer | <input type="checkbox"/> R. R. Locomotives | <input type="checkbox"/> R. R. Section Foreman |
| <input type="checkbox"/> Electric Lighting | <input type="checkbox"/> R. R. Signalmen | <input type="checkbox"/> Chemistry |
| <input type="checkbox"/> Welding, Electric and Gas | <input type="checkbox"/> Coal Mining | <input type="checkbox"/> Pharmacy |
| <input type="checkbox"/> Reading Shop Blueprints | <input type="checkbox"/> Navigation | <input type="checkbox"/> Textile Overseer or Supt. |
| <input type="checkbox"/> Telegraph Engineer | <input type="checkbox"/> Cotton Manufacturing | <input type="checkbox"/> Woolen Manufacturing |
| <input type="checkbox"/> Telephone Work | <input type="checkbox"/> Agriculture | <input type="checkbox"/> Fruit Growing |
| <input type="checkbox"/> Mechanical Engineer | <input type="checkbox"/> Poultry Farming | |
| <input type="checkbox"/> Mechanical Draftsman | | |
| <input type="checkbox"/> Machinist | | |
| <input type="checkbox"/> Patternmaker | | |
| <input type="checkbox"/> Boilermaker | | |
| <input type="checkbox"/> Sheet Metal Worker | | |
| <input type="checkbox"/> Heat Treatment of Metals | | |
| <input type="checkbox"/> How to Invent and Patent | | |
| <input type="checkbox"/> Gas Engines | | |
| <input type="checkbox"/> Diesel Engines | | |
| <input type="checkbox"/> Aviation Engines | | |
| <input type="checkbox"/> Automobile Mechanic | | |

BUSINESS TRAINING COURSES

- | | |
|---|--|
| <input type="checkbox"/> Business Management | <input type="checkbox"/> Business Correspondence |
| <input type="checkbox"/> Office Management | <input type="checkbox"/> Lettering Show Cards |
| <input type="checkbox"/> Industrial Management | <input type="checkbox"/> Signs |
| <input type="checkbox"/> Traffic Management | <input type="checkbox"/> Stenography and Typing |
| <input type="checkbox"/> Accountancy and C.P.A. | <input type="checkbox"/> Civil Service |
| <input type="checkbox"/> Coaching | <input type="checkbox"/> Mail Carrier |
| <input type="checkbox"/> Bookkeeping | <input type="checkbox"/> Railway Mail Clerk |
| <input type="checkbox"/> Secretarial Work | <input type="checkbox"/> Grade School Subjects |
| <input type="checkbox"/> Cost Accountant | <input type="checkbox"/> High School Subjects |
| <input type="checkbox"/> Salesmanship | <input type="checkbox"/> College Preparatory |
| <input type="checkbox"/> Advertising | <input type="checkbox"/> First Year College |
| <input type="checkbox"/> Service Station Salesmanship | <input type="checkbox"/> Illustrating |
| <input type="checkbox"/> Wallpaper Decorating | <input type="checkbox"/> Spanish |
| <input type="checkbox"/> Salesmanship | <input type="checkbox"/> Cartooning |
| | <input type="checkbox"/> French |
| | <input type="checkbox"/> Lumber Dealer |

Name.....Age.....

Address.....

City.....State.....

Present Position.....

If you reside in Canada, send this coupon to the International Correspondence Schools Canadian, Limited, Montreal, Canada



EASY

You'll advance faster with an easy playing Conn. Choice of the world's greatest artists. Many exclusive features yet they cost no more. Home trial, Easy payments. See your dealer or write for free book. Mention instrument.

C. G. CONN, Ltd.
631 Conn Bldg., Elkhart, Ind.

CONN
World's Largest
Manufacturers of
BAND INSTRUMENTS

PHOTO-ENGRAVING LEARN IT AT HOME



A copper plate to print above picture size 8 by 10 inches sells for \$15.37.

We Furnish all equipment and materials including large photo-engraving camera complete with lamps, lens and screen. When you have finished the course you can establish a good paying independent business with the equipment furnished or work for others at a big salary. Photo-Engraving offers greater opportunities today than any other industry. Every picture in this issue of Popular Mechanics was engraved by the process we teach you. Earn good money while learning. Write today for our new illustrated catalog which was engraved on equipment such as we furnish. You will not be obligated in any way by writing.

Aurora School of Photo-Engraving, Dept. 165, Aurora, Mo.



REAL JOBS OPEN

For Trained Auto Mechanics

Step into Big Pay. Earn \$35 to \$75 a week. I train you in only 8 weeks at largest schools of kind in world. New practical shop plan. Learn with real tools... on real equipment. Write today for Big Free Opportunity Book and Special Low Tuition Offer. Address school nearest you.

McSWEENEY SCHOOLS, Dept. 10-18
Cleveland, O. or Kansas City, Mo.

FREE BOOK

Wrestling Book FREE



Wrestling taught at home, by mail, by greatest of all world's champions—Farmer Burns and Frank Gotch. Be a wonderful athlete. Handle bigger, stronger men with ease. Learn the secrets of experts, Jiu-Jitsu, Physical Culture. Have perfect health, fame, a perfect body admired by both sexes.

FREE 32 page illustrated prospectus, full of thrilling information, sent free. Tells how we teach expert wrestling at home. Send 2¢ to cover postage. Write now for your copy. State age.

FARMER BURNS SCHOOL

A337 Elwood Bldg., Omaha, Neb.

AMAZING PARLOR CARD TRICKS

Be popular, entertain your friends—pep up any party. Easy System makes many tricks simple. Send \$1 now, for Easy System and tricks!

Direct Sales Co., P. O. Box 2, Oak Park, Ill.



\$25 A WEEK FOR YOU

and work 12 hours a week. Great plan (illustrated) to breed **PR Royal squabs**. Ask for new free Library 4, send 3-ct. stamp for mailing. Get details, learn what, why, how, where, 1935 facts.

Plymouth Rock Squab Co., 633 H. St., Melrose, Mass.

RAISE RABBITS FOR US

WE PAY YOU UP TO \$5.00 EACH. ALSO PUT YOU IN TOUCH WITH MARKETS EVERYWHERE. Large illustrated book and catalog, also copy of the AMERICAN RABBIT FARMER and monthly market bulletin showing names of buyers in various parts of America who continuously buy all rabbits offered them. All for 10 cents. Address

OUTDOOR ENTERPRISE CO., 101 Main Street, NEW CITY, N. Y.

TEAR GAS Protection DEVICES

Send Today for B 9 Illustrated Catalog showing complete line of Tear Gas devices for protection of life and property. AGENTS Wanted for this quick-selling long-profit non-competitive line. LACHRYTE CORP. P. O. Box 1719 Dept. D162, Chicago, Ill., U.S.A.

When writing to advertisers please mention Popular Mechanics

Over 700,000 People have learned music this easy way

You, too, Can Learn to Play Your Favorite Instrument Without a Teacher

Easy as A-B-C

MANY of this seven hundred thousand didn't know one note from another—yet in half the usual time they learned to play their favorite instrument. Best of all they found learning music *amazingly easy*. No monotonous hours of exercises—no tedious scales—no expensive teachers. This simplified method, perfected by the U. S. School of Music, made learning music as easy as A-B-C.

From the very start you are playing *real* tunes perfectly, by *note*. Every step, from beginning to end, is right before your eyes in print and picture. First you are *told* how to do a thing, then a picture *shows* you how, then you do it yourself and *hear* it. And almost before you know it, you are playing your favorite pieces—jazz, ballads, classics. No private teacher could make it clearer. The cost is surprisingly low—averaging only a few cents a day—and the price is the same for whatever instrument you choose.



Free Booklet and Free Demonstration Lesson. These explain our newly perfected method fully and show you how easily and quickly you can learn to play at little expense. U. S. School of Music, 76 Brunswick Bldg., New York City.

U. S. School of Music,
76 Brunswick Bldg., New York City

Send me your amazing free book, "How You Can Master Music in Your Own Home," with inspiring message by Dr. Frank Crane; also Free Demonstration Lesson. This does not put me under any obligation.

Name.....

Address.....

Instrument.....

LEARN TO PLAY BY NOTE

Piano	Violin
Guitar	Ukulele
Organ	Saxophone
Tenor Banjo	
Hawaiian Guitar	
Piano Accordion	
Or Any Other Instrument	

Learn now to play your favorite instrument and surprise all your friends. Change from a wallflower to the center of attraction. Musicians are invited everywhere. Enjoy the popularity you have been missing. Start now!

Free Booklet and Demonstration Lesson

If you really do want to play your favorite instrument, fill out and mail the coupon asking for our

FULLY PATENTED
AND PATS. APPLD.
FOR IN ALL LEADING COUNTRIES



Astounding Invention

URNS JUNK AUTO TIRES INTO MONEY

5¢ Tire Makes \$2.00 MAT

The Most Sensational Business Opportunity Since 1929

Gigantic National Market running into Millions. And you can now supply it with JUNK TIRES as your raw material. What a Business. What an unheard of profit. Schools, stores, clubs, factories, public buildings, homes, offices, grab this good looking, springy, long wearing FABRIX Mat. No limit to market. And the profits are so big that you can easily afford to hire helpers, hire salesmen, and still have a fabulous margin on every mat.

ONE HANDY MACHINE KEEPS FOUR HELPERS BUSY

Here is a new business. The product is so unusual that it has opened up a new market. Don't confuse FABRIX with a "Door Mat." It has a hundred INDUSTRIAL uses in factories. Your sales for home use will be the least part of your business. Here is an opportunity for one man in each community. Under our license you can establish a local manufacturing plant. The investment required is reasonable.

COSTS NOTHING to get complete facts. Rush your name and address and we'll send complete description of simple machine that quickly slices

old tires into uniform strips; show you how patented method forms strips into springy, long-wearing FABRIX Mats; how you can turn a 5¢ tire into a \$2.00 mat; how you can start on a reasonable investment and build a business so big, so fast, that it will take your breath away. Capable men, responsible men, big men, are the ones we want in this enterprise. If you are that kind don't delay a minute. Write, air mail or wire today. All information is free.

FABRIX, INC., 325 West Huron St. Dept. 76 Chicago, Ill.

MAIL COUPON for FREE FACTS

Responsible men dropping everything to enter this New Field.

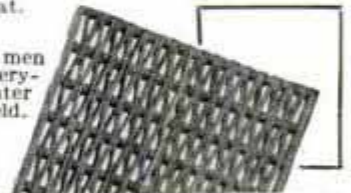

FABRIX, Inc., Dept. 76 325 West Huron St., Chicago, Ill.
Send full information at once. No cost to me, no obligation.

Name.....

Address.....

City.....State.....

Acquire LAW nights AT HOME

THOUSANDS of men today, who never intend to practice before the bar, are studying law.

They realize that the law-trained man is a leader—that law training makes keen, clear, quick, correct thinking—that there is a real reason why legally-trained men head many of America's greatest corporations.

PRACTICAL Law Through Home Study

The home study Law training offered by LaSalle has proven itself practical and valuable far beyond the time and money cost.

In certain permitted states every year LaSalle-trained men pass bar examinations with high honors.

But many, many more men, take their LaSalle law training to use in business and find in it a quicker, surer key to success and leadership—to the avoidance of pitfalls and the picking of the sure and certain paths of progress.

A MOST UNUSUAL Law Library

The basis of LaSalle law instruction is a fourteen-volume library compiled by leading professors and authorities.

This library might well be called—"Law Simplified and Condensed"—for it covers the whole basic field of law in an orderly, classified and simple manner. In many resident universities, the LaSalle Law Library is the reference work most used by students. In one of the greatest resident law schools, fourteen sets of LaSalle's Law Library are at the student's disposal and constantly used.

Supplementing this great library, are lectures and personal instruction of the highest grade, all under a definite, clear plan involving continual use of the Problem Method, where you train in law by dealing with actual legal problems—learn by doing the work—not by memorizing rules.

To get the whole story, you must investigate. And the coupon below is the easy way to start that.

La Salle Extension University

The World's Largest Business Training Institution

Dept. 664-LR Chicago

I would like to have full information about your law training, together with copy of "Law Training for Leadership," all without obligation.

Law: Degree of LL. B.

Other La Salle Opportunities:

If more interested in one of the fields indicated below, check and mail now.

- | | |
|--|--|
| <input type="checkbox"/> Business Management | <input type="checkbox"/> Personnel Management |
| <input type="checkbox"/> Modern Salesmanship | <input type="checkbox"/> Business Correspondence |
| <input type="checkbox"/> Higher Accountancy | <input type="checkbox"/> C. P. A. Coaching |
| <input type="checkbox"/> Traffic Management | <input type="checkbox"/> Business English |
| <input type="checkbox"/> Banking and Finance | <input type="checkbox"/> Commercial Spanish |
| <input type="checkbox"/> Commercial Law | |
| <input type="checkbox"/> Industrial Management | |



Name.....

Present Position.....

Address.....

TRI-STATE COLLEGE

Degree in 2 Years

B. S. Degree in Civil, Electrical, Mechanical, Chemical, Radio, Aeronautical Engineering; Business Administration and Accounting. World famous for technical two-year courses. Work intensive and courses complete. Non-essentials eliminated. Tuition and living costs low. For ambitious, earnest students. Those who lack high school training may make up required work. Students from all parts of the world. Graduates successful. Enter September, January, March, June. Write for chart, "Does a Degree in Engineering Pay?" Also catalog. 465 College Ave., Angola, Ind.

SCHOOL OF
ENGINEERING
52ND YEAR

CARTOON YOUR WAY TO SUCCESS!



DON'T COPY—LEARN TO ORIGINATE!

RAYE BURNS will teach you HOW to CREATE ORIGINAL CARTOONS at home that you can SELL! Course contains 26 lessons and over 600 illustrations. All for Only...

\$2.85

Send name and address for free details.

RAYE BURNS SCHOOL, Dept. M-X, BOX 2194, Cleveland, Ohio

RADIO ENGINEERING

RCA Institutes offers an intensive course of high standard embracing all phases of Radio. Practical training with modern equipment at New York and Chicago schools. Also specialized courses and Home Study Courses under "No obligation" plan. Illustrated Catalog on request



RCA INSTITUTES, Inc. Dept. PC-35
75 Varick Street, New York, N. Y.
1154 Merchandise Mart, Chicago

Recognized Standard in Radio Instruction Since 1909

• HOW TO SOLVE MECHANICAL PROBLEMS •

Only book of its kind. Covers friction and efficiency, levers, wheels and pulleys, inclined planes, gears, screws, wedges and horse power. By Prof. Barrett. Illustrated. Send only 30c to HALDEMAN-JULIUS CO., Box 1335, Girard, Kan.



AT HOME!

Learn easy Koshus Method of coloring photos and miniatures in oil. New! No art talent needed. Big demand. Send for free booklet. *Make Money At Home.*

NATIONAL ART SCHOOL

3601 Michigan Ave. Dept. 135-A Chicago



BOW LEGS?

THIS GARTER (Pat'd)
Makes Trousers Hang Straight
If Legs Bend In or Out

Free Booklet—Plain Sealed Envelope

THE T. GARTER CO., Dept. 2
Niles, Mich.

How To Secure A Government Position

Why worry about strikes, layoffs, hard times? Train now for a Government job. Many examinations expected! Increased salaries, steady work, travel, good pay. Let me help you become a Railway Postal Clerk, Post Office Clerk, City Mail Carrier, Rural Carrier—or help you get into any other Government job you want. I was a Secretary Examiner of Civil Service Commission for 8 years. Have helped thousands.

Now FREE My 32-page book tells about the jobs open—and how I help to qualify you to get one. Send the coupon for your copy TODAY.



A. R. Patterson, Civil Service Expert

PATTERSON SCHOOL, 86 Case Bldg., Rochester, N. Y.

Please send me, without obligation, your free book "How to Secure a Government Position."

Name.....

Address.....

★ HEMPHILL DIESEL SCHOOLS ★

play an important part
in the growth of the
DIESEL INDUSTRY

HERE ARE THE REASONS

1. Hemphill SELECTS its students. Only those applicants are accepted whose character references pass investigation and whose natural abilities show obvious promise of developing, through proper training, into capable Diesel men. 2. Hemphill TRAINS its students ON DIESEL ENGINES. Each Hemphill School is equipped with a LARGE ASSEMBLAGE OF DIESEL ENGINES. Hemphill instructors [both Theory and Shop] are particularly qualified for their work. 3. Hemphill ISSUES its Certificates only to those selected students who, during their specialized training, pass exacting tests and practical examinations. 4. Hemphill RECOMMENDS for responsible positions in Diesel Installation, Operation, Maintenance and Sales Work only those men whose reliability, sincerity of purpose and school record prove them worthy of accepting the responsibilities to which they are assigned. Not only in these ways but also in widely publicizing the uses of Diesel power, the Hemphill Diesel Schools are contributing actively to the solid growth and nation-wide development of the Diesel Industry.



★ NEW YORK SCHOOLS
3128 Queen's Boulevard
Long Island City, N. Y.



★ CHICAGO SCHOOLS
1253 Diversey Parkway, Chicago, Ill.



★ LOS ANGELES SCHOOLS
2121 San Fernando Rd., Los Angeles



★ SEATTLE SCHOOLS
503 Westlake North, Seattle, Wash.

★ VANCOUVER SCHOOLS
1365 Granville St., Vancouver, B. C.

Write or visit the nearest Hemphill School for information about Day, Night, and Combination Home Study Courses. A copy of "Diesel News" is free on request.

HEMPHILL DIESEL SCHOOLS

NEW YORK SEATTLE CHICAGO LOS ANGELES
SEATTLE VANCOUVER, B. C.

Caution: We operate Schools ONLY at the locations listed above and are in NO WAY connected with any other schools.



Hemphill Schools Waukesha Comet recently broke the world's Diesel speed record at Daytona Beach, Florida, thus helping to make Diesel history and increasing public interest in Diesel development.
(Official A. A. A. World's Record)

AMERICA'S ORIGINAL EXCLUSIVE DIESEL TRAINING SCHOOLS

QUICK WAY to make money in



RADIO

Modern receivers are demanding men with modern training for service work. New training method and service equipment offer starts you earning almost at once. Up to \$3 an hour easy in a short time. Write today for FREE book of details.
Radio Training Association of America
Dept. PM-56, 4513 Ravenswood Ave., Chicago

INDIANA TECH DEGREE IN TWO YEARS

B. S. Degree in Electrical, Civil, Chemical, Radio, Mechanical or Aeronautical Engineering in two years. Located in Electrical Hub of West. Earn Board. Low tuition. Enter June, Sept., Dec. Catalog. INDIANA TECHNICAL COLLEGE, 229 1/2 E. Washington St., Fort Wayne, Indiana

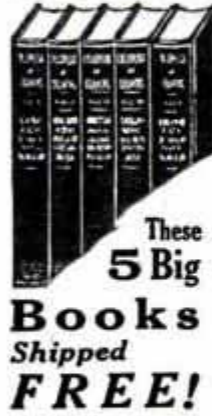

Be a Draftsman Make BIG PAY

Only 15 minutes a day with these WONDER BOOKS will prepare you for a good drafting job in less than a year. Mechanical and architectural drafting from simple straight lines to important complex plans. A step at a time! Built especially for beginners, for men with only grammar schooling. Drafting room practice, PLUS ENGINEERING, made easy and clear. Includes complete course in blue-print reading.

Competent draftsmen are urgently needed right now in all building and manufacturing lines at \$30.00 to \$75.00 a week. That's just the beginning—FOR DRAFTSMEN HAVE THE BEST CHANCES FOR ADVANCEMENT. Pleasant, fascinating work, easy to learn and do. Learn quickly with these books. Complete set of drawing instruments if you send for these drafting books NOW.

American Technical Society, Drexel at 58th St., Dept. DA-19, Chicago, Ill.
Send for 10 days' free use. New 5-volume set of drafting. I will pay the few cents delivery charge. If I wish, I may return the books in 10 days and owe you nothing, but if I decide to keep them, I will send \$2.00 after 10 days, then only \$3.00 a month until \$24.80, the special introductory price, is paid. Send latest edition and include drawing instruments.
Name.....
Address.....
Attach letter stating age, occupation, employer's name and address and that of at least one business man as a reference.



Know Electricity as Experts Know It—and Get an Expert's Pay!

Recovery has begun! The months ahead are charged with significance and expectation. What will you do to get the jump on the other fellow?
Thousands of men have used

The Croft Library of Practical Electricity

The Croft Library is a complete electrical educator. It is founded on practice—on 20 years of shirt-sleeve experience—on work as it is actually done. It is jammed from cover to cover with the kind of hard-headed facts you want. Written so that the beginner can easily understand it, yet so sound, so thorough, that it is the daily guide of 50,000 highly paid electrical workers and engineers. Croft tells you the things you need to know about motors, generators, armatures, commutators, transformers, circuits, switchboards, distribution systems—electrical machinery of every type—wiring for light and power—wiring of finished buildings—underwriters' and municipal requirements—illumination in its every phase—the most improved methods of lighting—lamps and lamp effects, etc.—how to do a complete job, from estimating it, to completion.

No money down—easy payments
Fill in and mail the coupon attached and we will send you the entire set of seven volumes for ten days' Free Examination. We take all the risk—you assume no obligation. If you decide to keep the books, send \$1.50 in ten days and the balance at the rate of \$2.00 a month. Send the coupon NOW and see the books for yourself.

FREE EXAMINATION COUPON
McGraw-Hill Book Co., 330 W. 42nd St., New York
Send me for ten days' free examination the Croft Library of Practical Electricity. If satisfactory I will send you \$1.50 in 10 days and \$2.00 monthly until the price of \$19.50 is paid. If not wanted, I will return the books postpaid. (To insure prompt shipment write plainly and fill in all lines.)
Name.....
Home Address.....
City and State.....
Position.....
Name of Company..... PM-6-35

When writing please mention Popular Mechanics

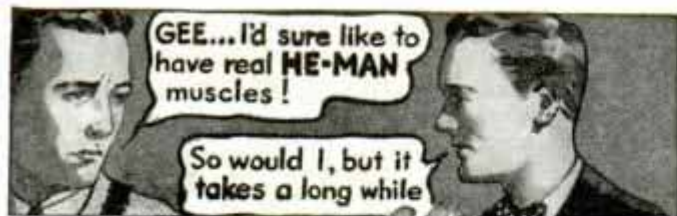

—says Charles Atlas
Holder of title, "World's Most Perfectly Developed Man" won in national and international contests.

"Bunk!"

I'll Prove in the first 7 days YOU can have a Body like Mine!"

DON'T get the idea that it takes a lot of time and hard work for you to get smashing strength and powerful muscles! Don't think you need dumbbells, springs or any other contraptions!

Both these ideas are all bunk—and I have PROVED it. All I need is 7 days to prove what I can do for you! And I don't need any apparatus either. In fact, I don't believe in artificial methods that may strain your vital organs for life!

NATURAL Methods Are All I Need

Above you see an actual photo of how I look today. No muscles have been "painted on." This is the camera's honest proof of what I did for MY body. Now I'm ready to prove what my secret of Dynamic Tension can do for YOURS!

A few years ago I was a physical wreck, a 97-pound weakling—flat chested, arms and legs like pipestems. I was worried. I studied myself. Then I found a new way to build myself up. A way that was simple, natural, quick, and sure! "Dynamic Tension" is what I called it. In a short time I had the body that has twice won the title of "The World's Most Perfectly Developed Man."

Get My FREE Book

Thousands of others now know from their own personal experience what Dynamic Tension has done for them. My interesting booklet, filled with pictures tells my story—and theirs.

This little coupon brings you my free book, which tells all about it. No cost or obligation.

I just want to give you proof that I can do for you what I have done for so many others; give you broad, powerful shoulders, biceps that bulge with smashing strength, a chest which stands out solid and muscular, and an evenly developed body that will make others look like dwarfs next to you. Mail this coupon TODAY! CHARLES ATLAS, Dept. 86, 115 East 23rd St., N. Y. C.

CHARLES ATLAS, Dept. 86
115 East 23rd Street, New York, N. Y.

I want the proof that your system of Dynamic Tension will make a New Man of me—give me a healthy, husky body and big muscle development. Send me your free book, "Everlasting Health and Strength."

Name.....
(Please print or write plainly)

Address.....

City..... State.....

© 1935, C. A. Ltd.



FREE BOOK

Gamble a stamp today. Mail coupon for free copy of my new book, "Everlasting Health and Strength." It shows you from actual photos how I have developed my pupils to my own perfectly balanced proportions. Where shall I send your copy?

at last CARTOONING MADE EASY

NEW, ORIGINAL, COMPLETE COURSE, especially prepared by one of today's cleverest newspaper and magazine Cartoonists. Full of punch and interest. 50 fascinating lessons; Hundreds of step-by-step Cartoons. **EX-TRIMELY EASY**. Learn quickly right from the start, either for fun and spare money or to become a professional Cartoonist! Money Back Guarantee. Or, send for Free Details. Don't delay.

Complete COURSE only \$2.75

AMERICAN SCHOOL OF CARTOONING
Dept. 165 614 West Austin Ave. Chicago, Ill.

New York Electrical School Established 1902

Ask for free booklet **School**
44 West 17th St., N. Y. C.

LEARN TO DANCE AT HOME

With Radio or Phonograph Music. Latest Broadway Steps—Waltz, Fox Trot, One Step, CONTINENTAL, TANGO. Write Today for full particulars.

IRVING SCOLNICK
1474 Broadway New York

INVENTING Now Taught for the First Time!

Home study course. Send TODAY for free literature.
TROFIMOV SCHOOL OF INVENTIVE PRACTICE, INC.
3859 Northampton Rd., Cleveland, Ohio

\$17.95 AUTO-RADIO

Amazing reception—distance and tone. Unheard of low price—tubes and remote control included. Install in 30 minutes—no batteries. Enormous profits to be made. Write quick for territory and terms.

M. C. WILCOX, 308 W. Randolph St., Chicago AGENTS WANTED

AGENTS Make \$380 Monthly

selling 10 CARTER WINDOW WASHERS daily. Cleans, dries, polishes. No mist. Good Housekeeping approval. Restricted territory. Write today.
Carter Products Corp., 998 Front Ave., Cleveland, Ohio

MAN IN EACH TOWN To Plate auto parts

reflectors, mirrors, etc., by new method; no capital or experience required. Outfits furnished. Free particulars. Write Today!

GUNMETAL CO., Ave. M, Decatur, Ill.

DIVORCE EYE CRUTCHES!

Get Rid of the Spectacle Handicap
The Natural Eyesight System tells how to do it at home. Full information FREE.

NATURAL EYESIGHT INSTITUTE, Inc.
Dept. 56-F Los Angeles, Calif.

The man who studies gets ahead. Popular Mechanics Press will advise you what books to read to advance in your trade. 200 East Ontario Street, Chicago, Illinois.

Get These Tricks on CAMPING

Now—before you start touring, camping, vacationing, get this book that tells HOW to enjoy each minute; How to avoid hardships, discomforts, disappointments. Every sport enthusiast will welcome this book, "OUTDOOR SPORTS."

352 PAGES—650 PICTURES of time and labor-saving camping suggestions. Fishing, Fly Casting, Boating, Canoeing, Swimming, and hundreds of helpful ideas for making outdoor sports enjoyable. Price \$2.00. Sent prepaid or C. O. D. anywhere in U. S. Catalog listing 3,000 other books Free.

Popular Mechanics Press, Room C9, 200 E. Ontario, Chicago

When writing to advertisers please mention Popular Mechanics

NOW - You Can Really Afford

Automatic OIL HEAT At It's Best

New Improved LACO—\$60 Under Usual Prices!

Burns Cheap Oil New Way—LESS THAN COAL!

Here's an astounding new-type Oil Burner—offered at the World's Lowest Price—that will heat your home perfectly—**for Less Than You Pay For Coal!** Many users report fuel savings of 25% to 50%!

Now you can get away forever from the drudgery of starting furnace fires—handling dirty, costly coal or wood—carrying out ashes!

This new LACO "Model P" is built—and sold on a positive Money-Back Guarantee—by the world's largest manufacturer of oil burners, exclusively. It's a full size, full capacity burner, approved by the Underwriters' Lab. Embodies many new features that eliminate servicing cost—make it the safest—give it utmost durability. Over 50,000 LACOs in use.

Works Automatically Heat turns "on" and "off," without the slightest attention, to keep your home at exactly the temperature you want, constantly. Is magically responsive to changes in temperature.

How It Saves! Burns "heavy" oil which costs less, yet contains more heat! New patented "High Pressure Carburetor" uses 96% AIR, only 4% cheap OIL—mixes them perfectly—creates a Quiet-ised Flame that burns very slowly—to get every bit of heat from every drop of oil.

Fits all furnaces. Is very easy to install. **Write!** Get Free Book, Low Price, and Special Offer! See if LACO isn't just what you want for your home. Send NOW!

L. A. Cocklin, Pres., LACO OIL BURNER CO., 165 Union St. Griswold, Iowa



ENGINEERING



INTENSIVE PRACTICAL TECHNICAL COURSES. Non-essentials omitted. **TIME AND MONEY SAVED.** Degree in 2 yrs. Electrical, Mechanical, Structural, Architectural, Civil, Aeronautical, Highway. Also shorter courses in Electricity, Radio, Electric Refrigeration, Power Plant, Drafting, Building, Low tuition. Extensive modern equipment. Part-time work for board and room. 34 yrs. experience producing successful men, located all over U. S. and foreign lands, holding responsible positions. Approved by industry, endorsed by graduates and educators. Catalog free.

FINLAY ENGINEERING COLLEGE
1001 Indiana Avenue Kansas City, Mo.

BE A POULTRY EXPERT

Make \$40, \$50, \$60 a Week

Free book shows how to get started quickly. You'll be surprised at the amazing profit opportunities in the poultry business. Wherever you live—whatever you do—it is easy to start on a spare or full time basis. Free book tells all. Send for "How to Raise Poultry for Profit." You learn right at home in spare time by methods endorsed by colleges and leading poultrymen. Know how to get the maximum profits from interesting, healthy work. Iron-clad agreement protects you. We have prepared hundreds for good jobs and businesses of their own. Write now for free book. No obligation. **National Poultry Institute, Inc., Dept. 36, Adams Center, New York.**

LEARN CARTOONING

by the method that has developed hundreds successfully. Send name, age and 6c in stamps for chart to test your ability.

The Landon School, 1738 National Bldg., Cleveland, Ohio

Learn ADVERTISING at Home

Greater opportunities now in advertising. Learn easily and quickly in spare time. Practical work. No text books. Old established school. Low tuition—Easy terms. Send for free booklet of interesting information. **Page-Davis School of Advertising Dept. 135-A, 3601 Mich. Ave., Chicago**

WANT \$1900 A YEAR?

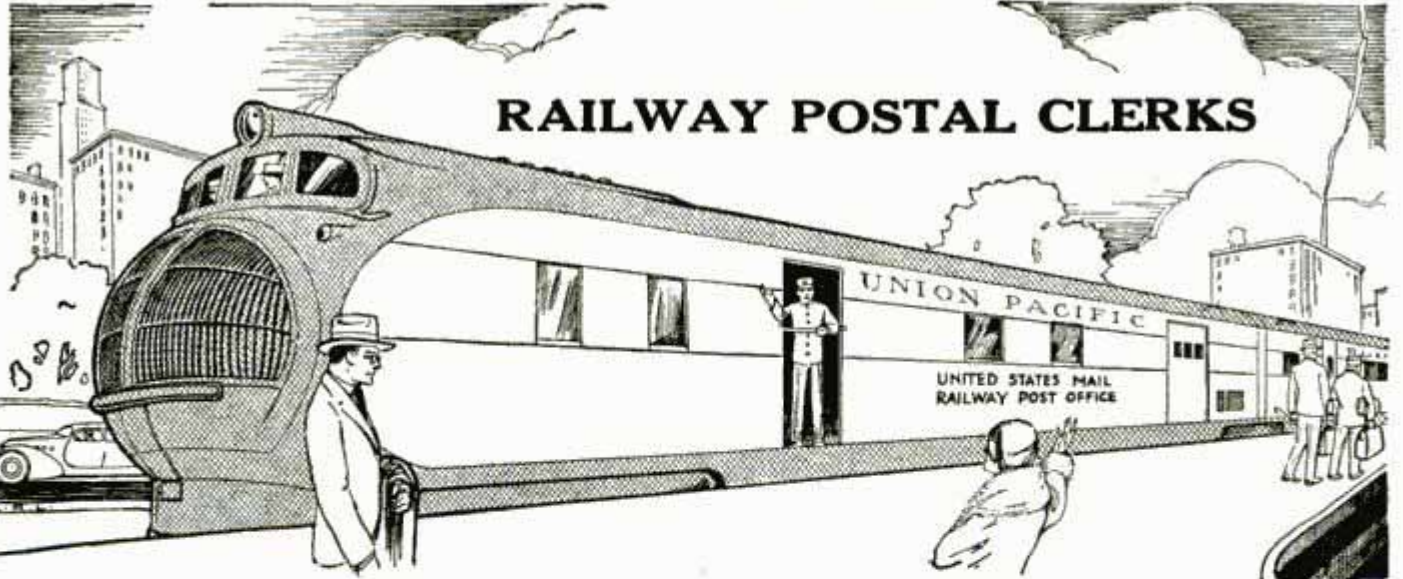

MANY OTHER U. S. GOVERNMENT POSITIONS STEADY WORK

MEN—BOYS 18 TO 50

Short Hours Pleasant Work Rapid Advancement, Permanent Employment

MANY GOVERNMENT EXAMINATIONS COMING QUALIFY NOW

MAIL COUPON TODAY. TOMORROW YOU MAY FORGET

FRANKLIN INSTITUTE, Dept. S185, Rochester, N. Y.

Rush to me entirely free of charge (1) a full description of the position checked below; (2) Free Copy of 32-page book, "How to Get a U. S. Government Job"; (3) A list of U. S. Government Jobs; (4) Tell me how to get a Government Job.

VALUABLE COUPON

- Railway Postal Clerk..... (Start \$1900 year)
- Post Office Clerk..... (Start 1700 year)
- City Mail Carrier..... (Start 1700 year)
- Office Clerk—File Clerk..... (Start 1260 year)
- Inspector of Customs..... (Start 2100 year)
- Immigrant Inspector..... (Start 2100 year)
- Liquor Gauger—Storekeeper..... (Start 2000 year)

Name.....

Address.....

Use This Coupon Before You Mislay It

When writing to advertisers please mention Popular Mechanics

GO TO HIGH SCHOOL



IN BEDROOM SLIPPERS!

If you feel the need of a high school education—regardless of your age—you can acquire it in the privacy of your own home after your day's work is done. Mail this coupon for information about our modern and widely recognized high school course. *Thousands of adults are studying it every night!*

INTERNATIONAL CORRESPONDENCE SCHOOLS

"The Universal University" Box 5578-H, Scranton, Penna.

Without cost or obligation, please send me a copy of your booklet, "Who Wins and Why," and full particulars about the subject before which I have marked X:

TECHNICAL AND INDUSTRIAL COURSES

- | | | |
|--|--|--|
| <input type="checkbox"/> Architect | <input type="checkbox"/> Plumbing | <input type="checkbox"/> Heating |
| <input type="checkbox"/> Architectural Draftsman | <input type="checkbox"/> Air Conditioning | <input type="checkbox"/> Steam Engineer |
| <input type="checkbox"/> Building Estimating | <input type="checkbox"/> Steam Electric Engineer | <input type="checkbox"/> Marine Engineer |
| <input type="checkbox"/> Contractor and Builder | <input type="checkbox"/> Civil Engineer | <input type="checkbox"/> Highway Engineer |
| <input type="checkbox"/> Structural Draftsman | <input type="checkbox"/> Bridge Engineer | <input type="checkbox"/> Bridge and Building Foreman |
| <input type="checkbox"/> Structural Engineer | <input type="checkbox"/> Surveying and Mapping | <input type="checkbox"/> Refrigeration |
| <input type="checkbox"/> Electrical Engineer | <input type="checkbox"/> R. R. Locomotives | <input type="checkbox"/> Air Brakes |
| <input type="checkbox"/> Electric Lighting | <input type="checkbox"/> R. R. Section Foreman | <input type="checkbox"/> R. R. Signalmen |
| <input type="checkbox"/> Welding, Electric and Gas | <input type="checkbox"/> Chemistry | <input type="checkbox"/> Pharmacy |
| <input type="checkbox"/> Reading Shop Blueprints | <input type="checkbox"/> Coal Mining | <input type="checkbox"/> Navigation |
| <input type="checkbox"/> Telegraph Engineer | <input type="checkbox"/> Textile Overseer or Supt. | <input type="checkbox"/> Cotton Manufacturing |
| <input type="checkbox"/> Telephone Work | <input type="checkbox"/> Radio | <input type="checkbox"/> Woolen Manufacturing |
| <input type="checkbox"/> Mechanical Engineer | <input type="checkbox"/> Machinist | <input type="checkbox"/> Agriculture |
| <input type="checkbox"/> Mechanical Draftsman | <input type="checkbox"/> Patternmaker | <input type="checkbox"/> Fruit Growing |
| <input type="checkbox"/> Machinist | <input type="checkbox"/> Toolmaker | <input type="checkbox"/> Poultry Farming |
| <input type="checkbox"/> Patternmaker | <input type="checkbox"/> Boilermaker | |
| <input type="checkbox"/> Sheet Metal Worker | | |
| <input type="checkbox"/> Heat Treatment of Metals | | |
| <input type="checkbox"/> How to Invent and Patent | | |
| <input type="checkbox"/> Gas Engines | <input type="checkbox"/> Diesel Engines | |
| <input type="checkbox"/> Aviation Engines | | |
| <input type="checkbox"/> Automobile Mechanic | | |

BUSINESS TRAINING COURSES

- | | |
|---|--|
| <input type="checkbox"/> Business Management | <input type="checkbox"/> Business Correspondence |
| <input type="checkbox"/> Office Management | <input type="checkbox"/> Lettering Show Cards |
| <input type="checkbox"/> Industrial Management | <input type="checkbox"/> Stenography and Typing |
| <input type="checkbox"/> Traffic Management | <input type="checkbox"/> Civil Service |
| <input type="checkbox"/> Accountancy and C.P.A. | <input type="checkbox"/> Mail Carrier |
| <input type="checkbox"/> Coaching | <input type="checkbox"/> Bookkeeping |
| <input type="checkbox"/> Secretarial Work | <input type="checkbox"/> Railway Mail Clerk |
| <input type="checkbox"/> Cost Accountant | <input type="checkbox"/> Grade School Subjects |
| <input type="checkbox"/> Salesmanship | <input type="checkbox"/> High School Subjects |
| <input type="checkbox"/> Service Station Salesmanship | <input type="checkbox"/> College Preparatory |
| <input type="checkbox"/> Wallpaper Decorating | <input type="checkbox"/> First Year College |
| <input type="checkbox"/> Salesmanship | <input type="checkbox"/> Illustrating |
| | <input type="checkbox"/> Spanish |
| | <input type="checkbox"/> Cartooning |
| | <input type="checkbox"/> French |
| | <input type="checkbox"/> Lumber Dealer |

Name..... Age.....

Address.....

City..... State.....

Present Position.....

If you reside in Canada, send this coupon to the International Correspondence Schools Canadian, Limited, Montreal, Canada

Amazing Sensational Discovery REFINISHES AUTOS Like NEW!



Not A Wax
Polish or Paint
Lasts 8 to 12 Months
GUARANTEED

PAYS UP TO \$7.00 AN HOUR

Kar-Nu is a new, miracle discovery—a transparent, magic-like fluid with which anyone can refinish any color automobile easily, quickly and economically without polishing, waxing, rubbing or painting. Just wipe it on with a cloth. Immediately dullness, discoloration, shabbiness, sun fade disappear. Instantly, as if by magic, the old finish is rejuvenated and restored to the luster, life glow and beauty of the original factory finish. As KAR-NU dries it seals the pigment and protects the finish from further wear. Lasts 8 to 12 months. GUARANTEED. Equal in beauty to a repaint or refinishing job which costs \$25.00 to \$75.00.

FREE SAMPLE

Enormous demand! Millions want it! W. L. Morgan of Mass. earned \$10.61 in a single hour. Sell KAR-NU to individuals, fleet owners, garages, auto accessory stores, used car dealers, etc. No experience necessary. Write for FREE sample to prove our claims and territory offer.

Distributors Wanted for Foreign Countries

KAR-NU CO., Dept. K-30, Oakley Station, Cincinnati, Ohio

BECOME AN EXPERT

ACCOUNTANT

Executive Accountants and C. P. A.'s earn \$3,000 to \$15,000 a year. Thousands of firms need them. Only 12,000 Certified Public Accountants in the U. S. We train you thoroughly at home in spare time for C. P. A. examinations or executive accounting positions. Previous experience unnecessary. Personal training under supervision of staff of C. P. A.'s including members of the American Institute of Accountants. Write for free book, "Accountancy, the Profession that Pays."

LaSalle Extension University, Dept. 664-H Chicago
The School That Has Trained Over 1,200 C. P. A.'s

TELEVISION

has arrived

AMERICA'S
First Complete
TRAINING
COURSE
-now ready



RECEIVING

Students operate actual equipment in NATIONAL STUDIOS



CONTROL



LEARN
TELEVISION
ELECTRICITY
BROADCASTING
RADIO all branches

You can quickly qualify for big opportunities in the newest radio science—TELEVISION. As a Radio expert, National Schools (est. 1905) offers several complete courses at price of one course, 30,000 graduation. Practical shop and studio instruction. Coach railroad fare allowed to Los Angeles. Earn room and board during enrollment. SEND COUPON FOR BOOK.

NATIONAL RADIO SCHOOLS

Dept. 6 PMR, 4006 So. Figueroa St., Los Angeles

NAME.....

ADDRESS.....

CITY.....

STATE.....

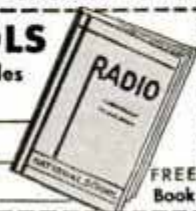

FREE Book

When writing please mention Popular Mechanics

Classified Advertisements

WORLD'S BEST WANT AD MEDIUM

Advertisements in this section, 35 cents per word, each insertion, minimum 10 words, payable in advance
To be inserted under proper classification in July issue, copy should be in our office May 14th
Popular Mechanics Magazine, 200 East Ontario Street, Chicago, Illinois

**Our Records Prove That You
Can Fill Almost Any Want
Through a Small Classi-
fied Ad in This Section**

Popular Mechanics, Chicago, Ill.

Dear Sirs:—We have advertised in Popular Mechanics for many years and we are quite safe in saying that our cost per reply is the lowest, in your magazine, out of over 25 in which we place advertisements. We might say also, that the business is not seasonal; July and August producing as many replies as January and February. You may count on us as long as we remain in business. This is our 44th year.

(Original letter on file in our office)

Yours truly,
VICTORIA STAMP COMPANY

AUTOMOBILES

DODGE Generator quickly changed to arc welder. Welds fenders, cylinder heads, etc. Plans, drawings \$1.00. Neal Brown, Richland Springs, Texas.

BUILD A racer! Kuns tells how you can build 125-135 m.p.h. stock cars and speedway racers. New book fully describes mid-gets, conversions. Contains all speed records, drawings, pictures, full description record cars. \$1 postpaid, \$1.12 c.o.d. 3c tax in Ohio. Ray F. Kuns, Dept. B-9, Madisonville, Cincinnati, Ohio.

DIESEL-IZE Any engine. Improved low-cost alteration. Instructions, drawings \$1. L. M. Inman, 542, Aberdeen, Washington.

200 MILES 35c. Burn stove distillate in your car. Get parts in any junk yard. Complete detailed information and blueprint 50c (coin). C. C. Carmichael, 5013 2nd Ave., Los Angeles, Calif.

AUTO SUPPLIES AND EQUIPMENT

NICKEL Plating outfits, connect to your battery. No tanks used, thousands in use. \$3.00 prepaid. Gunmetal Co., Ave. J, Decatur, Ill.

TRAILERS, 4'x6'—\$27.50, Undercarriages \$15.50. Plans, utility 50c, house \$1.00. Shamrock, 12321 Turner, Detroit, Mich.

AUTO Parts, supplies. Wholesale catalog 10c, refunded first order. Russell Auto Supply, 1018P Monroe, Toledo, Ohio.

L-J RACING Equipment Co. Parts made to specification. 2225 Fulton Rd., Cleveland, Ohio.

FLEXSEAL Gasket paste! Mechanics soap! Profits! Agents! 75c money order gets samples, refunded with order. Automotive Chemical Laboratories, Box 101, Sacramento, California.

USED Auto parts at half price for all cars. Century Parts Co., 1712 Lafayette Ave., St. Louis, Mo.

MICROMETER: (Outside) accurate every thousandths between 1½, 5 inches, \$1.00. Four jaw Pick-Up tool 30c. Agents! Schaap, Springfield Gardens, Long Island.

SAVE 70% Oil costs. Reclaim used oil. Safe, practical. Used by big concerns. 20 gallon home treatment, \$1.00 postpaid. Guaranteed. Fike Laboratories, 4637 - 58th Street, Maywood, California.

DEMONSTRATORS. Compressor, test bench, 8-hour battery charger—are welder. Guaranteed. Trial and terms. Ken's Equipment Exchange, Box M-652, Troy, Ohio.

TRAILER Axles and chassis, any size or design to order. Carey, Palmer, Mass.

MOTORCYCLES, BICYCLES AND SUPPLIES

MOTORCYCLE Bargains, lowest prices, bargain sheets for stamp. Motorcycle accessories. Rochester Harley Davidson Corp., 129 West Main St., Rochester, N. Y.

DIME Secures sample Speedway Racing Magazine, catalog English motorcycles, crash helmets, speed books, supplies. Overhead speed heads for Fords. Clymer, 434 W. Pico, Los Angeles, Calif.

HENDERSON, Excelsior, Harley, Indian, used parts, alloy pistons, catalogue and wings pin 10c. Ballak, 100 N. 12th, St. Louis, Mo.

FLEETWING Bicycle motor—now the newest in economical transportation. A husky dependable motor that puts wings on your bicycle. Travels 100 miles per gallon—speed range up to 30 miles per hour. Rear mounted. Positive chain drive controlled by disc clutch. 45 minutes to install. \$39.50 complete, ready for mounting. A post card will bring circular and information. Hoffman Engineering Company, 500 N. Craig St., Pittsburgh, Penna.

SIXTY Reconditioned motorcycles. New and used parts for all makes. Whitman Motorcycle & Supply Co., 405 Southwest Blvd., Kansas City, Mo.

SEND 15c For illustrated used Motorcycle catalog. Large stock. Bargains. Indian parts. Accessories. Indian Motorcycle Sales, Kansas City, Mo.

MOTORCYCLES—Direct to you at rock-bottom wholesale prices. Rebuilt, roadtested and guaranteed Indians, Harleys, etc. Send 10c today for "Bargain Bulletin 43." Crandall Hicks Co., 780 Commonwealth Avenue, Boston, Mass.

PARTS. Send 10c for 24 page Handbook of Information, listing new and used parts, accessories, batteries, tires, for Indian, Harley, Henderson, Excelsior. Bootz, 622 E. Grand, Des Moines, Iowa.

BIKE Parts for less. New, used. List, stamp. Foreman's, Racine, Wis.

CLOSING Out all used parts and motorcycles. Save up to 90% on your repair bill. Used machines \$25 and up. Bicycles from \$7 up. Tulsa Motor & Cycle Co., Tulsa, Okla.

MOTOR Bicycles \$45.00, motorcycles \$40.00, new cord tires \$3.95, used tires, \$2.50. Bicycles \$11.50. (Bicycles for two \$35.00.) Used motorcycle parts, wheels \$1.00. Chains \$1.00. Engines \$10.00 to \$75.00. Frames \$5.00, all parts. Balloon tired wheels for boys automobiles send \$6.00. Price Cutter Deninger, Rochester, N. Y.

POWER Your bike with low priced Speedbike motor. Attach in one hour. Eighty miles to gallon. Thirty miles an hour. Free folder. Guaranteed. Outboard Motors Corp., 4026 N. 28th St., Milwaukee, Wis.

A. C. AUTO GENERATORS

TWENTY New practical changes for automobile generators. See our advertisement at bottom of page 137A. Auto Power, Inc.

FOR FORD OWNERS

NEW Ford repair book for 1935 V-8 and model A. Includes data taught in Ford training schools. Answers 600 mechanical and electrical questions in non-technical language. Used in hundreds of Ford garages. 144 pages, many charts and diagrams. Sold on money-back guarantee. Price \$1.00, postage prepaid. Trade Press Publishing Co., Montgomery Building, Milwaukee, Wis.

AVIATION

NEW Aeroplanes, \$98.00; motors, \$49.98; propellers, \$2.98. Send 25c for data, information. Hibbs, Ft. Worth, Texas.

GET Into aviation. Air transport pilots get up to \$7,000 per year; mechanics, \$2,500. Learn at this government approved school. Write for complete information. State age. Lincoln Flying School, 2004 Aircraft Building, Lincoln, Nebr.

AIRMINDED Young men interested in entering the field of aviation as apprentices. Write, enclosing stamp. Mechanix Universal Aviation Service, E-13291 Ardmore, Detroit, Mich.

USED Airplanes \$40 and up. Literature 10c. Continental Sales, Box 344U, Indianapolis, Ind.

AEROPLANES, Motors, gliders. Colored catalog imported World War aeroplane souvenirs 6c up mailed 3c. Midget car rims \$1.75. Northrup Aeroplane Co., Minneapolis, Minnesota.

GENERATOR Propellers, expertly designed at factory prices. Hibbs, Ft. Worth, Texas.

HUNDREDS Airplanes, crackups \$40 up. Directory 20c, postpaid. Used Aircraft Directory, Athens, Ohio.

BATTERIES, GENERATORS, ETC.

EDISON Storage batteries for all types of lighting systems. Uses no acid. Odorless. Long life. Guaranteed. Generating plants, motor bargains. Free interesting literature. Hawley Smith Company, 22 Washington Ave., Danbury, Conn.

ELECTRIC Lights—Wind driven—You build them. Write Wind Motor Electric, Ridgway, Mont.

PROFIT Rebuilding batteries. Make your own plates. Information 25c (coin). Build an arc-welder, instructions 50c. Coil and condenser tester 25c. All for \$1.00. Wind driven charger plans 25c. General Battery Service, 78M Glenwood, Minneapolis, Minn.

32 VOLT Wind electric, propellers, slow speed generators, circulars 10c. 6 volt charger plans, circulars, 25c. Propeller Man, Kindred, No. Dak.

BEFORE Building your wind battery charger, write, Bracket Co., Bonilla, S. Dak.

ELECTRICAL SUPPLIES—EQUIPMENT

ELECTRICAL Experimental laboratory kit—Contains alternating generator, small motor, microphone, transformer, polarized relay, condensers, electroplating chemical, carbons, electro magnets, etc. Contains 25 pieces commercial apparatus. Weight 16 pounds. Laboratory makes arc furnaces, secret telephone, search light, extension telephone, generates electricity, etc. Complete instructions. Educational, fascinating, useful. Original cost \$17.75. Special bargain, \$2.79. Other bargains. Stamp for catalog. Electrical Salvage Company, Box 524-AD, Lincoln, Nebraska.

POWERFUL Floodlights 1000-1500 watt. Suitable playgrounds, gas stations, etc. \$8.50. Morelite, 938 No. Homan, Chicago.

COMPLETE Simplified instructions re-winding fractional AC motors. \$1.00. Guaranteed. Hoosier Service Co., Terre Haute, Indiana.

MOTOR Mounting \$1.00! For fractional h.p. motors. Permits motor to be moved from one machine to another in 30 seconds with proper belt adjustment, hammer the only tool. Complete mountings for two machines \$1.00 postpaid. Returnable if desired. Mounting for four direction hook-up of motor and reversing without switch \$2.00. William S. Foster, 321 North Third St., Muskogee, Okla.

INSULATION. Wire, varnishes, supplies, etc. Send 3c stamp for bulletin. Autopower, 408-B Hoyne Ave., Chicago.

RADIOACTIVITY And cosmic rays detected with new instrument made from old radio, electrical parts. Plans, instructions \$2.00. Advanced Science, Box 152, Altadena, Calif.

WELDING AND SOLDERING

200 AMPERE Welding generator. Fine order, \$130.00. Wilmot Auto Supply, 1970 Wilmot St., Chicago.

BLOWTORCH—Gasoline automatic, 1900 Fahrenheit, guaranteed, 45c each. Grant Labo atories, Independence, Missouri.

DEMONSTRATORS, Electric arc welders. Money-saving prices. Used by the government. Trial and terms guaranteed. Hobart Welders, M-653, Troy, Ohio.

ARC-WELDING Outfit \$1.25. Weld fenders, braze, solder. Lavrow, 4368-W. Warren, Detroit. Stamp appreciated.

WELDING And brazing oxy-acetylene equipment, new and rebuilt. Superior Oxy-Acetylene Company, Hamilton, Ohio.

MACHINERY, TOOLS, SUPPLIES

KELLOGG Air compressors. Excellent condition. \$6.00. Taylor, 105 East 102nd Street, New York.

SHOP Outfit. Punches, lathes, Swiss gear cutter. Clarence Gayle, Frankfort, Ky.

FINE Enclosed ball bearing shafts. Build your own power tools. 1/2" or 3/4" x 10". One end threaded, with clamp nuts. Pulley included. \$5.35. Cox Electric, Route 8, Box 237, Phoenix, Arizona.

BARGAINS, Demonstrators, electric arc welders, guaranteed, 30 days trial and terms. Write Ken's Equipment, Box M-654, Troy, Ohio.

BANKRUPT—Stocks, shop supplies, specialties, merchandise. Nichrome. List 10c. Kostka, 2350-T South Crawford, Chicago.

12"x5" **WILLARD** Lathe, three step cone drive, price \$190.00 refitted. 12" Hendey shaper \$75.00; No. 60 Heald cylinder grinder \$175.00; all sizes and types of machines tools. Send for catalogue listing other bargains. Terms to suit. Cincinnati Machinery & Supply Co., 27 W. 2nd St., Cincinnati, O.

ENGINES, MOTORS, DYNAMOS

200 **NEW** General Electric 1/4 horse, 110 volt, 1750 alternating current motors \$5.90. Wilmot Auto Supply, 1970 Wilmot St., Chicago.

WANTED—Motors, gas engines, lathes. McBrady, 836 South Paulina, Chicago.

SAW-MOTORS, 3600 r.p.m., Repulsion-induction, 1/2 hp.—\$14.50, 3/4 hp.—\$12.25. Kirkhof Electric, 344 Commerce, Grand Rapids, Mich.

LIGHT Plants \$25 new, 32v, 500w. Electrolite Sales, Security Bldg., Portland, Ore.

FIVE KVA 110 volt alternating generators \$89.50. Other sizes. Converters, motors. Queen City Electric, 1736 Grand Avenue, Chicago.

GOVERNORS Control auto engines—stationary or portable power uses. New big discount. No cash down. Special foreign terms. Agents wanted. Candee-Smith Governor Co., 215 North Los Angeles St., Los Angeles.

WINDING Data, 100 AC motors, various horsepower and voltage, \$1.00. Motor Data Co., 3002 Monroe, Kansas City, Mo.

FOR Sale—Small elec. motors, high speed, 1/10 h.p., 110 volts. Reworked. \$1.50 postpaid. L. McConnell, 1619 Edgewood Ave., Racine, Wis.

REWINDING Motors and 330 other valuable articles in Shop Notes for 1935—50 cents postpaid. Popular Mechanics Press, Room C35, 200 E. Ontario St., Chicago.

FOR BOYS

FOR Pastime make engines. Illustrated catalog 25c. Howardo, 2417 N. Ashland Ave., Chicago, Ill.

FINGER-PRINTING—Make identification cards for yourself and friends. Inexpensive method. Send 25c for instructions. Advanced Science, Box 152, Altadena, Calif.

BOATS, OUTBOARD MOTORS, ETC.

BUILD This 14 foot folding boat yourself. Takes outboard. Inexpensive, safe, punctureproof. Actually fits in your car. Plans, instructions, material prices for \$1.00. Anyone can build it. Milwaukee Folding Boat Co., Wauwatosa, Wis.

CUT-TO-FIT Kayaks, canoes, \$6.95 up. Catalog for dime, instructions for quarter. Boat Shop, 737 P. Greenville, Pa.

"CLIPPER." Unquestionably the highest quality outboard motor value in the American market today. Powerful, sturdy, dependable. Guaranteed. Manufactured in 4 sizes—2 horsepower \$45.50; 4 horse power \$59.50; 6 horsepower \$69.50; 16 horse power \$109.50. Write for free circular and information. Hoffman Engineering Company, 500 North Craig St., Pittsburgh, Penna.

BUILD Your own boat and save 1/2 cost. 38 designs. Send 10c for catalog. Brooks Boat Co., Inc., Box E-20, Saginaw, Mich.

BUILD Your own boat. Our fabricated frames save you 2/3s. Describe requirements and let us quote. Illustrated catalog 100 boats 10c. Bay City Boats, Inc., 1552 Adams, Bay City, Mich.

KYACKS—Aluminum framework. Puncture-proof steelcoat hull. Non-sinkable, non-capsizable. Boats and kits. Particulars. Ki-Boats, 4520-A Christiana, Chicago.

NEW Boats and motors at bargain prices. Regular retail prices smashed. Marine Equipment Store, Sac City, Iowa.

PROPELLERS, Stuffing boxes, gear pumps, bearings, etc. Wm. Baker, Pond St., Quincy, Mass.

MAKE Canvas canoe. Blueprint 30c. Weesho-Uco, B51, Detroit, Mich.

OUTBOARD Parts—New or used—All makes—What do you need? Crandall-Hicks Company, 782 Commonwealth Avenue, Boston, Mass.

BOATS, Camps, motor camping, trailers, outdoor sports, etc. Send for list of special books on. It's free. Popular Mechanics Press, Room C35, 200 E. Ontario St., Chicago.

GUNS, FISHING TACKLE AND SPORTING GOODS

MAKE Dipsies for use or sale. Free folder. Reading Instrument Co., Box 78, Reading, Pa.

BOWS—Arrows—for everybody. Chicago headquarters at B439 So. Wabash Ave. Catalogue free. Archery Sales Co.

AMAZING New repeating slingshot holds 150 B.B. shot. Shoots through ordinary 100 page magazine. Send 25c to Slingo Corp., Toledo, Ohio.

FISH Bite like hungry wolves with my amazing dough balls. Tested formula \$1.00. Free alarm bell with order. Baer, 5907 Magnolia, Chicago.

"SLING-ARROW," Kills small game, shoots 150 yards. Sling and six arrows \$1.00. Thomas Gaskins, Arcadia, Florida.

FIELD GLASSES, TELESCOPES AND MICROSCOPES

MICROSCOPES, Telescopes, binoculars. America's lowest prices. Optical catalog free. Brownscope Company, 234 Fifth Avenue, New York.

ANTIQUES, WAR RELICS, INDIAN GOODS

16 **ARROWHEADS,** Lancehead, spearhead 99c. Scalping knife, birdpoint, scraper 98c. Poison arrowhead, wampum, skinner, drillhead 99c. Photolist 10c. Robt. Heike, Rutland, Ill.

INDIAN Relics. Beadwork. Coins. Curios. Catalogue and arrow, 6c. Vernon Lemley, Northbranch, Kans.

DOZEN Arrowheads, fair 50c; fine \$1.00. Repaired ancient pot, \$1.00. Paul Summers, Sagerton, Texas.

ANTIQU Guns, Indian relics. List five cents. Elmer Ellis, Webster Groves, Mo.

TAXIDERM

TAXIDERM Supplies—Quality artificial eyes, teeth, genuine Jonas head forms. Tools, materials, etc. Everything for the progressive taxidermist. Send for big illustrated catalogue—Free. Jonas Bros., 1049 Broadway, Denver, Colorado.

LEARN Taxidermy. Five courses. Blue Beaver Taxidermy School, Lemont, Ill.

DOGS, BIRDS, POULTRY, ETC.

COLLIES—All kinds and colors. Send for lists. Shomont, Monticello, Iowa.

POULTRY Tribune—Leading poultry magazine. Five years \$1.00; six months trial 10c in U. S. Poultry Tribune, Dept. C-93, Mount Morris, Ill.

BEAUTIFUL Pure white police dogs. Ansonia Kennels, Mose, N. Dak.

PUPS—Bostons, Scotties, Wires, Chows, Pomeranians, Pekingese, Spitz, Collies, Shepherds, Rat and Fox Terriers. Berg, Tourist Camp, Hendrum, Minn.

POINTER Puppies, beauties, eligible, \$20.00. R. P. Millikan, Newcastle, Ind.

ROOTS, HERBS, TREES, SHRUBS

AMERICA'S Biggest value! New "Herbalist Almanac" sent for only 10c postpaid. Includes hundreds tested herb medicine recipes, fishing dates, best times for planting and other valuable information. Beautifully illustrated in natural colors. Needed every home. Botanics, 145 West 112th St., Chicago.

FARMS AND FARM LANDS

RENTS And prices are low in Minnesota, North Dakota, Montana, Idaho, Washington and Oregon. Farms large or small near lakes, streams, forests. Low rates. Free book. E. C. Leedy, Dept. 857, Great Northern Railway, St. Paul, Minn.

\$5 DOWN, \$5 Monthly, 20 acres, Ozarks, \$100. Fishing, hunting, trapping. Hubbard, 216 Grossman Bldg., Kansas City, Kas.

INDEPENDENCE, Security assured, North Dakota, Minnesota, Montana, Idaho, Washington, Oregon farms. Bargain prices, easy terms. Descriptive literature, impartial advice. Mention state. J. W. Haw, 119 Northern Pacific Railway, St. Paul, Minn.

STROUTS May-June catalog—Up-to-the-minute bargains in many states. Operating income-farms, tourist places, all rock-bottom prices. Write today for free copy. Our 35th year. Strout Agency, 255-P 4th Ave., New York City.

PROFITABLE OCCUPATIONS

FORTUNES In frogs. Literature, magazine, 5c. Moyer, B-241-P, Milton, Pa.

MAKE Extra money mailing circulars. Psychoscope Company, Box 1164, Portland, Oregon.

IF Interested in raising frogs we guarantee to save you money. Send 10c for literature. American Frog Industries, Rayne, La.

RAISE Rabbits for us. We pay you up to \$5.00 each. Also put you in touch with markets everywhere. Large illustrated book and catalog; also copy of the American Rabbit Farmer and monthly market bulletin showing names of buyers in various parts of America who continuously buy all rabbits offered them. All for 10 cents. Address Outdoor Enterprise Co., Box 10, Holmes Park, Mo.

PROFIT And pleasure in taxidermy. Complete guide for the preparing and mounting of animals, birds, fish, reptiles, etc., for home, den, or office. \$1.65 postpaid. Popular Mechanics Press, Room C35, 200 E. Ontario St., Chicago.

BOOKS AND PERIODICALS

"FINDING Gold Nuggets." Book including 16 maps with instructions \$1.00. Fine Arts Engraving, 416 S. Dearborn St., Chicago.

BIG Mails. Magazines, catalogs, propositions, etc. Send 10 cents. Anderson Press, Box 3177, Miami, Fla.

THOUSANDS Of old magazines. List 10c. Seeley Service, Jennings, La.

FREE! Handbook of useful tables. This indexed book gives all long, square, cubic, liquid and dry measures; metric, time, miscellaneous tables; specific gravities; decimal fractions; squares; square roots; cube roots; arithmetical formulas, etc. Copy free, pre-paid, with 6-month subscription; send only 50c. The American Freeman, Box 835, Girard, Kansas.

SEND Postcard for free Little Blue Book catalog. Thousands of bargains. More than 350 books at 5c each. Address: Holdeman-Julius Co., Box 2047, Girard, Kansas.

STAMP Sent "Us, San Jose, Cal." buys famous "Letterseal-Bookmender."

ASTROLOGY; Occult; all religions—Book lists free. Occult, Box 1286, Providence, Rhode Island.

PICTURES AND POSTCARDS

NEW York views—20 different new colored cards; 25c coin. Kane's, Whitehall Street, New York.

SPECIAL Photographs—Campbell's Bluebird 25c. Atkinson, 619 Tanglewood, Daytona Beach, Fla.

GAMES—ENTERTAINMENT

PLAYS, Operettas, musical comedies, complete minstrel first-parts with song programs, blackface skits, vaudeville acts, monologs, dialogues, recitations, juvenile plays and songs, musical readings, entertainments, make-up goods. Catalog free. T. S. Denison & Co., 623 So. Wabash, Dept. 11, Chicago.

THE Psychoscope "tells fortunes," "receives messages," "answers questions." No study, skill, practice. Illustrated circular free. Psychoscope Company, Box 1164, Portland, Oregon.

HOMEMADE Gas sends aloft rubber balloons. Entertains old and young. Target practice, night fireworks, sending messages, flying model dirigibles. Booklet—send thirty cents. Adams, Tyrone, Penna.

MAGIC TRICKS, PUZZLES, JOKER NOVELTIES

MAGIC Catalogue 20c. Lynn, 105 Beach, Dept. 3, Jersey City, N. J.

LARGE Professional magic catalogue, 25c. Holden, 220 W. 42nd St., New York.

"125 CARD Tricks" 25c. Spelzer Service, 417 Altamont, Schenectady, N. Y.

NOVELTIES For sale cheap. Send for free lists. Marker Billingsley, Nashville, Tennessee.

MOST Baffling trick, ever devised. Make things vanish right before the eyes. Instructions \$1.00. Cesapp, 101 3rd St., Peoria, Ill.

TRICK Catalogue, Illustrated, 10c. Oaks Magical, Dept. 548, Oshkosh, Wis.

AMAZE And mystify! Fool your friends—be popular. South's largest line magic, puzzles, joke novelties. "153 Tricks," 10c. "125 Card Tricks" 25c. Send stamp for illustrated catalogue. Lyle Douglas, Station A-5, Dallas, Texas.

FREE Tricks! Join Magicians' Fraternity. Monthly magazine, sample 10c. International Magicians, Mt. Morris, Ill.

SIX Comic novelties and catalog 25c. Variety Stores, Decherd, Tenn.

NEW Base ball game. Free information. Charles Wood, Highland, N. Y.

BIG Catalog; magic, stamps, formulas, tricks, mystery. 25c. Price refunded first order! Becker, 300N Graham Avenue, Brooklyn, N. Y.

STAMP COLLECTING

SEYCHELLE Islands, Brunei, Charkhari, Turks Caicos Islands, \$5 U. S., genuine Baden, and imperforate "Park"—absolutely free to approval applicants enclosing 3c postage. Viking Stamp Company, One Hanson Place, Brooklyn, N. Y.

UNITED States missions 50c, Canada 75c, foreign \$1.00 lb. Mission Co., 4512 North Racine, Chicago.

FREE—Beautiful airmails from six countries, to approval applicants enclosing postage. Green & Co., Norwood, Ohio.

DEALERS: 164 Page wholesale catalog for 50c deductible on first purchase. Grossman Stamp Co., 102-P West 42nd, New York.

FREE!!! Russia ethnographic set. Postage 3c. Roberts, 901F Fourth, Baycity, Michigan.

50 STAMPS 1c, Mostly obsolete. Album 3c. Bullard, 446 Tremont, Boston.

ENGLAND. Stamps on old album leaves, colonials, pictorials, sets, etc., are all found in our famous \$2 lots. Absolute satisfaction or money refunded. Slip \$2 bill into envelope today. F. Hughes, Peterborough, England.

FREE!! Three sets French Colonies to serious approval applicants. Bargains—beauties. Postage 3c. Kumler, Cherry, Lancaster, Ohio.

FREE \$1.00 U. S. stamp with request for 48 page illustrated price-list of U. S. and foreign stamps. Also fine stamps on approval. Reference necessary. Packet \$10.00 value only \$1.25. New Hussman Stamp Co., 1122 Pine Str., St. Louis, Mo.

110 DIFFERENT Stamps only 3c to approval buyers. Badger Stampco, Milwaukee, Wisconsin.

30 DIFFERENT Angola, Cape Verde, Guinea, Portugal, Mozambique, St. Thomas—5c. Depraw, Ocean Park, Calif.

STAMP Dealers, your ad here will bring wonderful returns. Ask me for proof. F. W. Johnson, Manager, Classified Advertising, Popular Mechanics Magazine, 200 E. Ontario St., Chicago.

STAMPS Sent on approval. 50% discount. Fred Herzberg, 197 Grantley Ave., Elmhurst, Illinois.

200 DIFFERENT 10c. Big 50% approvals. Covert Stamp, 39 State, Rochester, N. Y.

AMAZING Value—35 different U. S. early commemoratives, air mail, etc., 10c to approval applicants. Stamp Shop, 809 Holland Bldg., St. Louis, Mo.

SCARCE Airmail and triangle. Beautiful Uruguay "flying horse" airmail and scarce Guatemala triangle (smallest in the world) are included in our big packet of 60 different stamps from Alouites, Grand Liban, Venezuela, British and French Colonies, etc. All for 5c to approval applicants. Big illustrated lists free with each order. Write today! Mystic Stamp Co., (Dept. 80), Camden, New York.

AIRMAILS—Brazil, Chile, Columbia, Ecuador, Mexico—all for 10c with double premium penny approvals. Progress Stamp Service, Franklin Park, Ill.

THIS Ad worth 25c. If you send for our approvals and buy 50c worth or more—large selection of U. S. and foreign—reasonable prices. Morton Stamp Co., 1121 Olive, St. Louis, Mo.

FREE Outfit! Pocket wallet, hinges, watermark detector. Packet stamps from South America, Asia, Africa, etc. Postage 6c. Approvals. Maxwellton Stampco, Piedmont, California.

200 DIFFERENT Stamps, triangle, airmail, etc., 10c. R. H. Carlton, 209 W. Fourth, Los Angeles, Calif.

CANADA \$1.00 "Mountain"—rare, and 30 other Canada only 30c. World specials—500 different 30c; 1000 different 85c; 2000 different \$2.50. Approvals with each order. Canadian catalog 10c. Victoria Stamp Company, London, 4, Canada.

UNITED States stamps—40 different with pricelist 10c. Seidenberg, Baroda, Mich.

GORGEOUS Packet 3c. Approval applicants only. Harvey Teeple, Decatur, Ind.

SCARCE Morocco airmail, Eritrea camel stamp, maps of stamp countries, watermark detector, hinges, perforation gauge, stamp album, many scarce stamps, 5c with approvals. Superior Stampco, Box 8276, Palms Station, Los Angeles, California.

MAGNIFIER, Stock book, stamp album, hinges, watermark detector, perforation gauge, millimetrescale, packet scarce stamps. Price 5c with approvals. Atlas Stampco, Box 4025, Culver City, California.

SCARCE Egypt and Roumania airmails; giant Belgium balloon; packet British Colonies including rare Borneo, Congo, Charkhari, San Marino; perf. gauge, watermark detector. 6c to approval applicants. Eureka Stampco., Burbank, Calif.

LIBERIA Snake triangle, Guatemala triangle, 50 other stamps, 5c. Crowder's, Carroll, Baltimore, Md.

50 DIFFERENT Stamps 3c with approvals. W. Keyser, Irvington, N. J.

FREE—100 United States, scarce triangle, stamp cataloging \$1.00. Only 10c mailing charges! (Approvals.) Clifton English Co., 54, Nashua, New Hampshire.

GRAND Comoro Archipelago (No. 1) plus used Empress Jingo set (which catalogues \$9.00 unused), only 10c to approval applicants. 1000 (unpicked) American or world-wide 25c. Rio Stampco, 3280 Rochambeau Ave., New York.

1000 U. S., including bicentennials, parks, precancels and \$5.00 stamp, only 35c. Lee, Bridgeport, N. Y.

FREE Dollar packet with penny approvals. Harlan, 5307 South Marshfield, Chicago.

MAMMOTH Mystery packet of rare stamps for only 10c to serious approval applicants, also valuable free premiums with every selection afterwards. Our stamps are better and our service is different. Fair-Play Stamp Service, 1215 Browning Blvd., Los Angeles, California.

SPECIALIZED Album pages—Ships, maps, birds, locomotives, explorers. Handsomely lettered—Printed in two colors, each set complete with illustrated title page and index sheet. Fit any standard 8 1/2 x 11 three ring loose-leaf cover. Price 35c per set postpaid. Lake Publishing Company, 4440 N. Ashland Ave., Chicago, Ill.

KOOKABURRA Bird!! Bolivia triangle! Packet of unusual stamps containing rare Kookaburra Bird, scarce Bolivia triangle, famous money stamp (printed on cardboard and also used as currency); airmails from Mexico and Brazil; map, ship, animal, commemorative, etc. No Europe. Only 10c to approval applicants. DeSoto Stamp & Coin Co., 105 No. Clark St., Chicago, Ill.

YOU'VE Tried the rest—now get the best! "Challenge Collection" including Cape Good Hope, triangle, only existing octagonal stamp, etc., 10c with approvals. Free airmail collection and additional premiums to regular customers. Comparison proves conclusively the superiority of "Bargain Stamp Service," 1332 South Hope, Los Angeles, California.

UNITED States stamps on approval. Huber, 3 South 8th, Minneapolis.

70 STAMPS From 70 countries 15c with approvals. B. Roberts, 5437 N. Sawyer, Chicago.

FREE Ascension, Grenada pictorials, commemoratives, also other scarce islands. Provided you desire approvals. Grandstamps, 919 South Grand, Los Angeles, California.

U. S., Canada, Mexico—56 different—Commemoratives, pictorials, etc., with approvals. 10c. Sibley, 3630 Childress, St. Louis, Missouri.

PENNY Approvals loaded with real bargains. Taylor, 6122 Woodlawn, Chicago.

AFRICA—Wierd mystic continent. 50 diff. stamps 10c with approvals. Ransom, 1333 Pontiac, Ann Arbor, Mich.

200 DIFFERENT Including 50 different British with Fiji, Newfoundland, Cyprus, Canadian commemoratives 10c, approvals included. Mantle Stamp Company, London, Canada.

IMPERFORATE National Park, 2 diff. and 33 U. S., including early issues; high values; commemoratives; airmail; envelopes; special delivery; postage due; revenues cataloging over 85c. All for 7c to approval applicants. Illustrated pricelist free. Curhan Stamp Co., Dept. P, Gloucester, Mass.

25 AFRICA 5c With approvals. Tulla, Box 76, Flatbush, Brooklyn, N. Y.

BEAUTIFUL Polish, Brazilian, Hungarian airmails. 3c to approval applicants. Merit Stamp Shoppe, Guilford, Conn.

FREE. Canada map stamp 1898. Sarajevo assassination commemorative issue. Approvals. 5c postage. Cornwall Stamps, Cornwall, Ontario, Canada.

TWO U. S. \$5.00 stamps—10c! Twenty stamps cataloging \$20.00—\$1.00. Vanvoorhis, Hyndman, Penna.

SALVADOR Diamond shaped stamp, airmail, triangle, 25 others (no Europe) 6c with penny approvals. Lejac, 902 1/2 South San Pedro, Los Angeles, Calif.

CHOOSE Your premiums! Jungle stamps! Animal! Bird! Airmail! Triangle and map stamps! Pick any ten from our big approval selection. Inclose 5c postage. Stamp Importers, Akron, Ohio.

BEAUTIFUL New Guinea Bird of Paradise airmail, smallest stamp, Zanzibar, Siam airmail, etc., in wonder packet 40 different stamps, 10c. (No Europe.) Bargain Co., Box 39P, Station H, New York.

GET Latest newest foreign stamps even before dealers list them. Send 25c for 100 stamps, all different. Many valuable surprises. Details of amazing different stamp service free. Alfred, 1858 Taft, Cincinnati, Ohio.

THE Beautiful Byrd South Pole stamp and the imperforated set of Park Stamps were not issued for ordinary postal use. Very few saw postal duty. In consequence these issues are more valuable used than unused. We offer the perforated Byrd and the imperforated 1c and 3c Parks used, lightly cancelled in superb condition for only 10c to approval applicants. Globus Stamp Co., 268 - 4th Ave., Dept. 50, New York, N. Y.

THE World in a packet—105 different stamps from 105 different countries, including Abyssinia, Afghanistan, Brunei, Falkland, Zanzibar, and others from Africa, Asia, South America, West Indies, etc. Our pamphlet which tells "How to Make a Stamp Collection Properly," together with our large bargain list of albums, packets, sets, etc., all for only 28c. Queen City Stamp Co., Room 36, 604 Race St., Cincinnati, Ohio.

ANDORRA, Latakia, Inini, Kouangtcheou, many others in big packet, 54 stamps from 54 countries, 5c to approval applicants. Midwest Syndicate, Box 91, Linwood Station, Detroit, Michigan.

600 DIFFERENT Foreign stamps, actual catalog value \$13.00, only \$1.00. Eisenmeier, 3700 Frankford, Baltimore, Md.

FREE 50 Different stamps to approval applicants. Hoyt, 42 Cornhill, Boston, Mass.

QUALITY Stamps, scarce 19th, 20th century. Import new lots weekly. Packets \$2.00 catalogue, also surprise 25c with approvals. Paine, 52 Redington, Swampscott, Mass.

CAPE Triangular 4 \$10.00; Afghanistan 50 \$2.00; natives 300 \$3.00. Ponchaji, Wimbridge, Grant Rd., Bombay.

105 DIFFERENT, Hyderabad, Congo, Guinea, etc. 3c to approval applicants. Extra—Airmail set free with above. Hunziker, Box 225-P, Minneapolis, Minn.

FREE! Airmail set and 10 U. S. commemoratives with approvals. Postage 3c. Aladdin, 1550 Carroll, St. Paul, Minn.

BR. Honduras, 10 diff., 45c. Mexico, airmails, 10 diff., 45c. Both pkts., 75c. E. Chanona, Belize, B. H.

REGULAR 10c Set and packet hinges, 5c to approval applicants. Highland Stampco, Salamanca, N. Y.

ZANZIBAR—Also Sudan, Somaliland, Tigerstamps, Togoland, Caribbean, Archer, Algerian, Centralamericans, Britishcolonials. This magnificent collection free for 5c postage. Graystampshop, Dept. PM, Toronto, Canada.

HAWAII—Included; 200 different foreign, 20c. United States mixtures, unpicked, 1 pound \$1.00. Write for approvals. Hawaii Stamp House, Honolulu, Hawaii.

ILLUSTRATED Album, spaces 4000 stamps; or 19 beautiful Andorra; or 30 Algeria to approval applicants 20c. Swan Stamps, 604 Swan, Dunkirk, N. Y.

SENSATIONAL Penny approval values. Bargains galore. Thomas Flood, Clinton, Michigan.

NYASSA Triangle, Spanish commemorative, French colonial pictorial, etc., all included in packet of 25 different for 5c to approval applicants. Sierra Stamp Co., Box 73, Fontana, Calif.

5 DIFF. Confederate states (facsimiles), 8c; 12 diff. 25c. Satisfaction guaranteed. Approvals sent. Tatham Stampco, Springfield-125, Mass.

FIFTH Wholesale Review—mailed every dealer, trader, storekeeper. Greatly enlarged. Free. Empire Stampco, Toronto, Canada.

100 DIFFERENT United States 36c. Postage issues only. Includes over 33 air mails and commemoratives. Approvals at reasonable prices. Chase Stampco, Haverhill, Mass.

FREE—25 Different United States stamps to approval applicants. Brownie Stamp Shop, Flint, Mich.

BIG Bargain: Old United States including commemoratives, also Grenada, Seychelles, Fiji, St. Lucia and many other dandies. Everything only 10c to approval applicants. Gateway, 4837 Hutchinson St., Chicago, Ill.

EXCHANGE Stamps, postcards by "Exchangers," 51 Passage Bureau, Paris, 126, France. Information free.

STAMPS: 100 Different catalogue over \$2.00 with catalogue 10c. Norman Shultz, Salt Lake, Utah.

AGAIN Available, Cavell Mountain dollar stamp with 24 other Canadian varieties only 25c to approval applicants. Ralph Lynch, Box 56, Peoria, Illinois.

40 GREECE 10c, 10 Epirus 10c, 25 Luxemburg 15c, 25 Egypt 10c. To approval applicants. Acher Stampco, Rutherford, N. J.

SOUTH Africa "Voortrekker" 2 var. with 15 fine stamps 10c approvals. L. W. Hudson, 87 Nassau, New York City.

ILLUSTRATED U. S. list, price 50c, large complete U. S. price list free. Stanley Gibbons, 38P Park Row, N. Y.

NEWFOUNDLAND, 15 Different 5c with approvals. Hudson Co., Plainfield, N. J.

300 DIFFERENT 20c; 1,100, \$1; 2,000, \$2.50. Fred Onken, 630 79th St., Brooklyn, New York.

COIN Collectors: Read "The Numismatist," published monthly since 1888. Latest news, interesting articles. Trial subscription six months \$1.00. Introductory booklet free with subscription. American Numismatic Association, Suite P, 95 Fifth Avenue, New York.

ROMANIAN Boy Scout issue. 5 beautiful mint varieties. 25c to approval applicants. Krogh, 6711 Paschall, Philadelphia, Pa. Specialist in sets.

FREE—Watermark detector. Approvals. Baylis, 148 Indiana, Providence, R. I.

FREE Set to approval applicants. Bill Stadler, Vineland, N. J.

UNITED States—Br. Col. approvals! Reasonable prices! Box 822, Minneapolis, Minn.

30 CANADA, 15 Newfoundland, 15 Egypt, 10c each, 3 for 25c. 200 different British Colonies 70c. Ask for British Colonial approvals. Westminster Stampco, 5060, London, Canada.

ECUADOR 20 Different, commemoratives, airmail, only 10 cts. with approvals. Dependable Stamps, 716 North Kilkea, Los Angeles, California.

STAMP Collecting. Ten easy lessons including Philatelic dictionary; 50 different stamps. Illustrated circular. Complete 25c. American Stamp Company, 217 Sanders St., Rockford, Illinois.

ADDRESSES Of stamp collectors in 150 different countries who are willing to exchange stamps of their countries for stamps of yours. 25c (coin). Lanier, 509 - 15th St., Denver, Colo.

HEAP Of stamps given from every corner of the world. Includes old U. S. airmails, British Colonies, French Colonies, Belgian Colonies; also other countries as Panama, Fiume, Spanish Guinea, Liberia, Abyssinia, etc. A real grand lot. All for only 10c to approval applicants. New York Stamp & Coin Exchange, 246 Fifth Ave., Dept. U-6, New York.

NAT. Park bicentennials 7c to approval applicants. Donald Riesburg, Hutchinson, Minnesota.

SCARCE Zeppelin and triangle. Famous Russia Zeppelin stamp and beautiful Lithuania airmail triangle; also big packet of 53 different stamps including Azerbaijan, Epirus, new Martinique, etc., and illustrated lists—all for 5c to approval applicants! World-Wide Stamp Co., Box 600, Camden, New York.

THE Queerest stamps. Our special packet includes world's largest airmail stamp; smallest stamp ever issued; scarce triangle from Bolivia; Japanese "earthquake" stamp; Newfoundland map; weird Afghanistan, Manchuko—and many others. (No Europe.) Price only 10 cents to approval applicants. R. M. Stamp Co., Box 112, Port Chester, New York.

120 DIFFERENT Including United States commemoratives 10c with approvals. Tricity Stampco, Davenport, Iowa.

FREE—Free—Free—Free—100 mint stamps from 100 different countries. Free to approval applicants. David A. Swenson, South Mountain, Franklin County, Pennsylvania.

25 U. S. Before 1900 10c, 500 \$1.00. Ebert Hale, Palestine, Texas.

55 DIFFERENT United States commemoratives, Civil War revenues, airmails, etc. 15c with approvals; 120 different 50c; 200—\$1.00. Illinois Stampco, Rockford, Ill.

RARE COINS

OLD Money wanted. Will pay \$100.00 for 1894 dime, S. mint; \$50.00 for 1913 Liberty head nickel (not buffalo). I pay big premiums for rare coins. Send 4c for large coin folder. May mean much profit to you. B. Max Mehl, H Mehl Bldg., Fort Worth, Tex.

UNCIRCULATED Half dollars, Lincoln, Monroe, Lexington, Sesquicentennial, Maryland, @\$1.40 post-paid. Hubert Carcaba, St. Augustine, Florida.

INDIAN White cent and list 10c. Greenclay, 1626 Washington, Denver, Colo.

25 GOOD Coppers with ancient and historical before 1800 named in separate envelope different. 25 crisp notes and catalog 35c. Geo. Best, Cedar Rapids, Iowa.

COMPLETE Premium list of U. S. small cents, 10c. Walter F. Allgeyer, Box 192, Newark, N. J.

FREE! Foreign coin, banknote, and large illustrated coin catalogue. Send 4c postage. Coin approvals sent. Tatham Coinco, Springfield-125, Mass.

OVER \$300.00 Paid for dime, dated before 1890. Liberty head nickels \$75.00. Pennies \$50.00. Send 15c for coin book. Phillips Coinco, West Springfield, Mass.

TEXAS, Maryland, Kentucky commemorative half dollars \$1.50 each. 3c piece and selling catalogue 10c. Norman Shultz, Salt Lake, Utah.

U. S. COIN Book—Guide to values, just issued. Many special features. Order Burt's, the leader among American coin books, only 50 cents postpaid. Popular Mechanics Press, Room C35, 200 E. Ontario St., Chicago.

SPECIAL Prices on United States commemorative half dollars in uncirculated condition; Columbian 69c; Lincoln \$1.23; Pilgrim \$1.19; Grant \$1.23; Monroe \$1.19; Lexington \$1.29; Stone Mountain 89c; Bennington \$1.29; bargain selling price list and California 50c gold token 25c. Arcy, Box 483, Muskogee, Okla.

UP To \$300.00 paid for dimes dated 1894; Liberty head nickels \$200; Colonial coins \$300; 1909 cent \$10.00; various \$5000, etc. Send 15c complete 1935 catalogue. National-coin Company, (PM) Springfield, Mass.

TWENTY Assorted coins 25c. 100 coins \$1.00. Otto Oddehon, Williamstown, Kans.

PENNIES Wanted!! Indianheads up to \$65.00 each, every date purchased. Lincolnheads up to \$2.00, uncirculated, large cents \$2000.00, certain 1909 cent \$10.00, others to \$2000.00. Send dime, two latest purchasing lists. Coinmart, MF-20 Jeffrey, Chicago.

RARE United States, foreign coins, war medals. Catalogue 10c. Mengelle, Colorado Springs, Colorado.

UNITED States. Large cent, 2c bronze, 3c nickel and bargain list, 25c. Thirteen dates large cents, \$1.00. George P. Coffin, Augusta, Maine.

HIGHEST Prices paid for Indian head pennies. Send dime for list of those wanted. Coin Shoppe, Box 407-PM, Ottawa, Ill.

\$2000.00 FOR 1c. We pay the world's highest prices for old coins, encased postage stamps and paper money. Large cents up to \$2000.00 each, half cents \$250.00, 1909 cent \$10.00, Indian head cents \$50.00, half dimes \$150.00, 25c before 1873 \$300.00, 50c before 1879 \$750.00, silver dollars before 1874 \$2500.00, gold dollars \$1000.00, trade dollars \$250.00, 1822 \$5 gold \$5000.00, old paper money \$26.00, encased postage stamps \$12.00, certain foreign coin \$150.00, etc. Send dime for large illustrated list. Romano-coinshop, Dept. 424, Springfield, Mass.

WE Buy 1907 Indian head cents. Full information one dime (coin). Mattick, Box 3450, Altoona, Pa.

\$5.00 To \$500.00 Each paid for old coins. Keep all old money. Send 10 cents for illustrated coin value book. 4x6. Guaranteed prices. Buying and selling. Coin Exchange, Box 5, Le Roy, N. Y.

11 DIFFERENT Coins, 3 bills and catalogue. 25c. Creamer's, 1112 Somerset, Baltimore, Md.

PHOTO FINISHING

ROLL Developed, two prints each negative 25c. Reprints 2½c. Enlargement coupon. Willard's, Box 3535-A, Cleveland Heights, Ohio.

ROLL Developed and 16 prints 25c. Smart Photo, Winona, Minn.

BEAUTIFUL Colored enlargement with each film 25c. Speedy service. Satisfaction guaranteed or money refunded. LaCrosse Film Company, LaCrosse, Wis.

FREE Reprints as samples. Send two negatives. Adams Photo, 11-D2 Lincoln, Dorchester, Mass.

ROLL Developed, printed, and two enlargements 25c coin. Reprints 3c. Immediate service. Twin City Photo Mill, Box 629Z, Minneapolis, Minn.

ROLLS Developed—Printed 25c. Mail your films to the biggest and best! Rolls developed and 8 good prints guaranteed plus 8x10 inch enlargement coupon only 25c. Reprints, any size, 3c each. Geppert Studios, Dept. 130, Des Moines, Iowa.

TRIAL Offer. Roll developed and 8 prints 25c. Reprints 3c each. Beautiful 10-inch enlargement 25c. Young Photo Service, 405 Bertha St., Albany, N. Y.

ROLL Film developed and printed on deckle edge paper in neat album 25c. Swan Photo Co., Dept. X, Box 975, St. Louis, Mo.

SPECIAL Trial offer! Your next Kodak film developed 5c, prints 2c each. Moser & Son, Dept. 23, Walnut Hills, Cincinnati, O.

20 REPRINTS 25c. 100 Reprints \$1.00. Rolls developed with 16 prints 25c. Photo-shop, 4, Maywood, Ill.

30 BEAUTIFUL Guaranteed kodak prints from your negatives only 25c. Rapid Film Service, Unionville, Mo.

ROLLS Developed. Two beautiful double-weight professional enlargements and 8 guaranteed Never Fade Perfect Tone prints. 25c coin. Rays Photo Service, LaCrosse, Wisconsin.

FILMS Developed 5c per roll; prints 3c each. Ask for special bargain list. Roanoke Photo Finishing Company, 161 Bell Ave., Roanoke, Va.

20 REPRINTS 25c. Films developed, two prints each negative, 25c. Skrudland, 4118-8 Overhill, Chicago.

KODAK Pictures enlarged, 5x7 10c, 3 for 25c. Send negative film. Stanley Studio, Des Moines, Iowa.

PROFESSIONAL Enlargement 10c. Three 5x7 enlargements and catalog 25c. coin. Unique Art, 550 W. 144th, New York City.

ROLL Developed, 8 beautiful double deckle prints, 5x7 enlargement, 25c. Quick service. Quality guaranteed. Elkhart Photo Service, Elkhart, Ind.

20 REPRINTS 25c—Films developed, 16 prints 25c. Enlargements 8x10—25c; 5x7—10c. Low Photo, 2657 Neva, Chicago.

INTRODUCTORY Bargain—Film developed, 2 prints each 25c; 20 reprints 25c. Quality Photo, Hutchinson, Kan.

ENLARGEMENTS, 4x6 Five for 25c. 5x7 three for 25c. 8x10 three for 35c. Special hand colored easel mounted 4x6, 25c. Hand colored enlargement or two crystal stiple enlargements with each roll developed and printed 25c. Enlargers, 1652-8 North Western, Chicago.

ROLLS Developed. Two sets guaranteed prints and enlargement coupon 25c, reprints 3c each, over 19, 2 1/2c. Jones Studios, Davenport, Iowa. "Where the West Begins."

ROLL Developed and 8 prints including two enlargements, 25c coin. Super Snapshot, Winona, Minnesota.

FILM Developed, printed 20c coin. Mack Co., 15 Mechanic, Canton, New York.

FILMS Developed 2 prints of each 25c; 20 reprints 25c. Pine Photo, 5134 Nevada St., Chicago.

21 REPRINTS 25c. Roll, 16 prints 25c. Smartshop, Albany, Wis.

FILMS Developed. Any size. 25c coin, including 2 enlargements. Century Photo Service, Box 829, LaCrosse, Wisconsin.

ROLLS Developed, two beautiful Nu-border enlargements, eight Nu-border prints, guaranteed fadeless, 25c coin. Giant Snapshots, Inc., Dept. A, Greenbay, Wis.

TWO Professional enlargements with each roll developed and printed 25c. Eight reprints, two enlargements 25c. Hyglass, 8, River Grove, Ill.

FILMS Developed. 25c coin. Two 5x7 enlargements, 8 High Gloss Never Fade prints. Club Photo Service, LaCrosse, Wis.

SAVE Money and enjoy a real thrill—develop and print your own photos. Complete outfit for all sizes including 2 1/2x4 1/4—trays, printing frame, chemicals, paper, etc., only \$1.59 postpaid. Not a toy. Film Craft, 4869 N. Talman Ave., Chicago.

FIFTH Avenue Art Film Photo, 210 Fifth Ave., New York. Complete roll with art photos 20c. Individual photos 3c.

ROLL Developed, 8 prints, oil painted enlargement, also valuable coupon on 8x10 hand painted enlargement, 25c. Quick service. Guaranteed work. Individual attention to each picture. Janesville Film Service, Janesville, Wis.

YOUR Favorite kodak pictures enlarged, size 5x7, 10c. Three for quarter, coin. Send best negatives (film) today. Address Darmer Photo Lab., Enlarging Dept. 8, Des Moines, Iowa.

INDIVIDUAL Photo album free with original orders. Roll developed and 8 Panel-Art snapshots 25c, or 8 or more reprints, 3c each. Prompt service. Album Photo Service, Box 119-PM, Rockford, Illinois.

2 PORTRAIT Enlargements, roll printed, or 8 reprints and enlargement 25c coin. Griffin's, Winona, Minn.

KODAK Prints 1c each. Imperial Film Service, Unionville, Mo.

ROLLS Developed. Quick service. Two enlargements, eight prints expertly finished 25c. Electric Studios, Department A, Eau Claire, Wis.

2 BEAUTIFUL Enlargements suitable for framing with roll developed, printed 25c. Photofilm, P-2424 North Ave., Chicago.

ANY Size kodak film developed 2 prints of each negative and two free enlargement coupons, 25c. Reprints 2c each. Summer's Studio, Unionville, Mo.

ROLL Finished or 12 reprints, including two free enlargements, 25c. Bulows Photo-shop, Armstrong, Iowa.

BEAUTIFUL Art-panel enlargement with "Trial Order." Roll developed and 8 prints 25c coin. Ideal Photo Service, Box 2255, Paterson, N. J.

CAMERAS, PHOTO SUPPLIES

CAMERAS And supplies. Big bargain book free. Offers tremendous savings on cameras, lenses, photographic apparatus, etc. Still and movie. All listed and illustrated in our new, big, complete bargain book. Write for your copy of this free book now. Central Camera Company, 230 South Wabash Avenue, Dept. K-6, Chicago, Ill.

MAKE Money in photography. Learn quickly at home. Spare or full time. New plan. Nothing like it. Experience unnecessary. American School of Photography, Dept. 3432, 3601 Michigan Avenue, Chicago.

POWER 12" Floodlights. Take beautiful pictures inside. \$3.75 complete. Morelite, 928 No. Homan, Chicago.

4 FOR 10c Photo outfits, complete \$140.00. Wabash Photo Supply, Terre Haute, Indiana.

EASTMAN \$5 Cameras, our price \$2.75. Hornstein Co., 29 E. Madison St., Chicago.

WRITE For free booklet "New Discovery in Photography." International Research Laboratories, 2618 N. Halsted St., Chicago.

HAVE You a camera? Send ten cents for recent number of our big magazine, showing how to make better pictures and earn money. American Photography, 116 Camera House, Boston, 17, Mass.

INCOME From your camera instead of expense. Low cost home course teaches you to make photographs for magazines, newspapers, advertisers. Tremendous demand. Earn good money wherever you live. Free book. Universal Photographers, Dept. 104, 10 West 33rd St., New York.

NEW Kodaks and cameras at bargain prices. Regular retail prices smashed. Catalogue free. Camera Store, Sac City, Iowa.

MOTION PICTURES AND SOUND EQUIPMENT

16 M. FILM Exchange. Large list. Exchange, 210 Armstrong Ave., Jersey City, New Jersey.

16MM FILMS:—Art 10c foot. Mickey-Mouse, Chaplin, Silly Symphony 5c foot. Big features rented anywhere \$5.00. Lists. Thousand feet 35mm \$1.00. Features \$7.50. Projectors, cameras \$5.00 up. Waldo Films, Box 524, Cincinnati.

16 MILLIMETER Club reels. Blackstone Exchange, 515 South Laflin, Chicago.

FREE—16 mm. 8mm Bargain lists. Films 35c up. Projectors \$3.75 up. Art sample 25c. Home Movies, Box 32, Easton, Penna.

100 FEET 35mm Film 27c. Lists 3c. Hoffman Film Service, 57 Broad, Albany, New York.

WORLD'S Greatest "Passion Play" 16 MM. (new) 5 reels. Rent or purchase. Write Hemenway Film Co., 37 Church Street, Boston, Mass.

35-MM FILMS. Projectors. Stamp for lists. Box No. 6, Rosedale, Kans.

NEW Movie Maker camera \$3.79. 400' capacity, 100 watt projector \$6.79. Kodacolor filter, 2 density filters for Cine Kodak models, \$7.50 complete. Victor, B&H \$11.50. Sept camera with magazines, case \$22.50. DeVry 35mm still camera \$5.95. Projector for same \$8.95. Used 16mm features and single reels \$3.75. Film library, free membership, lists. Mogull Bros., 1944-J Boston Road, New York City.

16MM FILMS Exchanged \$1.00 400 ft. Sold 2c foot. We buy, sell cameras, projectors. Send stamp. Robert Block, 1451-P Broadway, New York.

16MM FILMS \$2.20; Silly Symphony \$3.10; exchanges 45c; catalogue 3c. Riedel Films, Euclid, Ohio.

8MM FILMS: Mickey Mouse, travel, others. List for stamp. Lincoln Film Service, Box 293-A, Saginaw, Mich.

BASS Offers immediate delivery on the remarkable 100 ft. Keystone camera, seven speeds including slow motion, F:3.5 lens, now \$44.50. Write for full description and information. 100 ft. Dupont 16 mm. Mono film including reversing at \$2.95. 200 watt Keystone Special projector, motor driven, at \$23.75. 400 watt biplane Ampro Model A projector at \$99.50. Send for Bass Bargain-gram No. 215, standard of values, money back guarantee. Library service, silent and sound films, available in 22 states. Send for free catalog to Cine Headquarters. Bass Camera Company 179 W. Madison St., Chicago, Ill.

MOVIE Film. Half price. Film Service, 10125 Champion, Cleveland, Ohio.

8MM OWNERS: New, economical film, new accessories, new ideas for better pictures. Information free. Write: Corpe, Box 177A, El Monte, Calif.

BARGAINS: 16—8MM Films, supplies, equipment. Lists. G. Taylor, Bx-234, Corning, N. Y.

16MM FILM Subjects—50% saving. Rental library. Catalogue, two "end" titles sent for dime. Eastin Films, Dept. 39, Galesburg, Illinois.

16MM PROJECTORS Converted into sound film reproducers. Sound Products, Inc., 567 Seventh Avenue, New York.

LEARN Motion picture theatre business. Catalog. Theatre Institute, Elmira, N. Y.

USE 3/4c Foot 16mm safety film. Easy reversal processing instructions \$1. W. Truman, E. Wareham, Mass.

8MM—16MM MOVIE Equipment. "Easy terms." Send stamp for catalogue. Elder, Dept. B-12, Chelsea, Mass.

POWERS DeVry projectors with professional films \$75. Caesar Entertainments, Frankfort, Indiana.

35MM 100 FEET 25c Plus postage. Features, projectors. Marsala Company, Hillsdale, New Jersey.

DEVELOP Your own movies, reversal and negative-positive process, \$1.00. Millo, 620 Myrtle Ave., Brooklyn, N. Y.

RADIO, SUPPLIES, INSTRUCTIONS

RADIO Engineering, broadcasting, aviation and police radio, servicing, marine and Morse telegraphy taught thoroughly. All expenses low. Catalog free. Dodge's Institute, Ames St., Valparaiso, Ind.

RADIO Experimenters and set builders. Parts and kits of parts for the Six Tube 32 Volt Farm Set, Economy Three Tube, Five and Four Tube Little Giant, Auto Radio and Portable Battery Set described by Popular Mechanics. Short wave kits, complete line of radios. Lund Mfg. Co., Dept. PMJ, 1730 Foster Ave., Chicago.

ONE Tube, DX radio, \$1.00. Long distance crystal set. Completely assembled, 25c. Cumberland Radio, Knoxville, Tennessee.

NEW B-Less—Uses one battery. No-cost sample. 2x J-20th Century Co., Kansas City, Mo.

AUTO Radio noise eliminated. Special filter, easily installed. Agents \$2.00 postpaid. State Radio Service, R-2002 State Street, Chicago.

RADIO. All phases. Amateur, shortwave, experimenting, set building, broadcasting, servicing, etc. Complete list recommended books free. Popular Mechanics Press, Room C35, 200 E. Ontario St., Chicago.

MUSIC AND MUSICAL INSTRUMENTS

LEARN Hawaiian guitar easily. Demonstration lesson free. Buckley Studio, 2144 N. Maplewood, Chicago.

ORIGINAL Melody to your words, \$1.00. Henry O'Connell (writer of "Night Wind"—Orch. 25c silver), 9 Homeside Ave., West Haven, Conn.

PIANOSCORES From melody, \$2.00. Lee, 109 Judson, Syracuse, N. Y.

AMATEUR Songwriters, let the writer of many "hits" send you free pamphlet "How to Cash in on Song Talent." Address Larry Conley, Suite 811-P, 113 West 57th Street, New York.

COMPOSERS, Verse—Music. Brilliant opportunity. Write immediately. Vanburen, 19 McClurg Bldg., Chicago.

JAZZ Piano course. Modern, simple, successful. Complete, sent prepaid for \$1. Spencer Music School, 2504-B East 4th Street, Chattanooga, Tenn.

GUARANTEED Music arranging. Piano-vocals, \$2.00. Lee, 109 Judson, Syracuse, New York.

MELODY To your words, \$1 complete. Professional Composer, Sausalito, California.

SUCCESSFUL Songwriters receive large financial returns. Send for free booklet "How to Write Songs" by famous Broadway composer. Songwriters Institute, 330C Wadsworth Ave., New York.

WANTED: Original poems, songs. It will pay you to get our proposition first. MMM Publishers, Studio Bldg., Portland, Ore.

"SONGWRITERS Professional Plan." Edward Madden, 1017 Danforth St., Syracuse, New York.

NEW Deal. Write Sequoia Songwriters Service, Sherman Branch, Los Angeles, Calif.

SONGWRITING. Good money being made from songs through talking pictures, radio, phonograph, music publishers. "Hit" writers revise, arrange, compose music to your lyrics, lyrics to your music. We submit to studios and other markets. Free reading. Send for booklet. Universal Song Service, 671 Meyer Bldg., Hollywood, Calif.

MUSIC Composed to words. Wonderful proposition. Bauer Bros., Oshkosh, Wis.

SONG Writers. Send for our "Publishing Agreement." McKinley Music Printers, 1501 E. 55th St., Chicago.

SONG Poems wanted, free examination, 50-50 plan. Song Bureau, Salem, Ind.

DUO-FLEX Reeds for clarinets, and saxophones eliminate your reed troubles. Write for circular. Duo-Flex Reeds, 1204 1st Ave., Evansville, Ind.

BUSINESS OPPORTUNITIES

RESILVER Mirrors. Plate auto fixtures, tableware. Portable outfits. Metalcraft, Arcade Bldg., St. Louis, Mo.

MANUFACTURE Soap—All kinds. Best quality. Write. Grinstead, Edwardsville, Illinois.

PROFIT With new products. Make, sell, repeat. Guaranteed formulas, special prices, leads. Biggest catalog free. Gibson, Chemist, BD-4702 No. Racine, Chicago.

MAKE Money in your own business. Our successful plans will increase your income. Details 3c stamp. Stewart Morse, 1009 Oak St., Elmira, N. Y.

"TURN Ideas into cash." Free details. Martinez-PM, San Bernardino, Calif.

CASH Income daily resilvering mirrors; replating metalware; making glass signs. Portable outfit. Sprinkle, Plater, 127, Marion, Ind.

ARTIFICIAL Marble sanitary flooring, instructions covering wood or cement flooring 1/2 inch thick, fireproof, all colors, low cost, ornamental casting, concrete, plaster, papier-mache, garden furniture, statuary, flexible molds, particulars free. Chris. Mahler, Elmout, N. Y.

I WANT To send you proof of the wonderful pulling power of Popular Mechanics Magazine's classified pages. What's your proposition? Write me today. F. W. Johnson, Manager, Classified Advertising, 200 E. Ontario St., Chicago, Ill.

PLASTEX Industries offers industrious men an opportunity to start a business of their own, manufacturing art goods, novelties, souvenirs, etc., in Plastex and marble imitation. 5c material makes \$1 articles. Rubber moulds furnished for speed production. Small investment brings big returns. You are just in time for the big 1935 business. Write for interesting booklet mailed free. Plastex Industries, Dept. A, 1085 Washington Ave., New York.

MAIL Order business is your opportunity. Many began small, now earn thousands yearly. No personal contact. Boundless opportunities. Have had over 30 years experience; will help you succeed. Send 25c for valuable booklets, none free. B. Breniser, 257 South 21st, Philadelphia.

FREE Booklet describes 87 plans for making \$20-\$100 weekly, in home or office, business of your own. Elite Co., 214 Grand St., New York.

CHEMICAL Expert will furnish formulas and trade secrets. All lines. Lists free. W. L. Cummings, Ph. D., 228 Gordon Ave., Syracuse, N. Y.

MAKE Your own products. Employ agents yourself. Toilet articles, soap, extracts. We furnish everything. Valuable book free. National Scientific Laboratories, 1950W Broad, Richmond, Va.

SELL By mail. Books, novelties. Bargains! Big profits. Particulars free. B. Elco, 525 S. Dearborn, Chicago.

START Little business anywhere. Everything furnished. No canvassing. Maywood, PM-923 Broadway, New York.

"SCHEMER Magazine." Alliance, Ohio, prints schemes, ideas, business starters, formulas; winners—\$10,000 to \$50,000 reported. 37th year. \$1. Subscribe now. Six months special, only 30c.

OPEN A key-making shop. Start a permanent profitable business with a small sum. No skill necessary. Write for particulars. Belsser Mfg. Co., 411 E. Fort, Detroit, Michigan.

FREE Circulars describing how you can make big money in mail order business at home in spare time. Write today. Mail Order Institute, 669-H Marcy Avenue, Brooklyn, N. Y.

CHARTERS: Delaware; best, cheapest; free forms. Colonial Charter Co., Wilmington, Del.

LIQUID Marble—Anyone can make! Colorful, glazed! Molded, brushed, sprayed. Rubberlike molds. Composition flooring. Big money making these! Particulars free. Marbleizing Service, Edwardsville, Ill.

CHEMICAL Expert furnishes manufacturing formulas with complete working directions. Reliable individual service. Charges reasonable. Dr. Van Heeden, 4721 Lakepark, Chicago.

MAKE—Sell products yourself. Write Allied Research, 2217 N. Kilbourn, Chicago.

BIG Paying mail order business in your own home. Write. Dixie Mailers, King, North Carolina.

GET Lots of mail. Your name in 10,000 opportunity directories, 25c. Rosco, 4627 Glenshade, Cincinnati.

BOYS, Men, \$5, \$6 a day re-edging razor blades! No machinery needed! Instructions 40c. A. Lopes, Box 175, Pleasantville, N. Y.

MAKE Money selling by mail! Typewriter ribbons, carbon paper. Advertising furnished. Sample ribbon 35c. 100 sheets 8 1/2 x 11 carbon paper \$1.25. Midwest, 2710 North Whipple, Chicago.

MAKE Big income in the collection agency business. Easily and quickly learned. Write Cole & Associates, Tower, Syracuse, N. Y.

START Profitable home manufacturing; mailorder businesses. Money making literature free. Duffy, Covington, Ky.

MAKE Name plates and other glass signs. Instructions free with 25c sample. Progressive Sign Works, Station U, New York City.

SURE Money. No experience. Small multicolor spray rented 50c per month for sign-making, showcards and decorating. Cut-out letters supplied. Stamp brings information. New Spray Co., Box 226, Berkeley, Calif.

600% PROFIT. Make new emulsion automobile polish. Formula, source supply \$1.00. Paramount Products Company, St. Petersburg, Fla.

SELL Business opportunity books by mail. Imprinted your name as publisher. Good profit. Sample and source of supply, dealers budget, copy of Winner advertisement, all three 25c and razor sharpener free. W. Drain, 5315 Walton Ave., Philadelphia, Pa.

SUCCEED With your products. Learn how. Formulas, Processes, Analytical service. Catalog free. B. Thaxly Co., Washington, D. C.

MAKE Money in your business. 3 fast selling products. Formulas 25c coin. Satisfaction guaranteed. Cooney, Box 114, Dormont, Pittsburgh, Pa.

AMAZING Money making plans. Write; Fauls Specialties, 4519-P 49th St., Woodside, N. Y.

ACREAGE Calculator. Agents money-maker. Particulars, rush postage. Carmean, Anthony, Kansas.

OPERATE Home mail order business, selling our products. Everything furnished. Superior Specialties, Springfield, Ill.

MAKE Fast selling products, from superior formulas. Write, H. Newman, Box 58, Chicago.

TWENTY New successful mailorder propositions. J. Home, 3949 Metropolitan, Chicago.

SUCCEED. Make your own exclusive perfumes. Write, Youth Products, 509 Fifth Ave., New York.

MANUFACTURE Profitable products! Specialty Manufacturer's Bulletin—25c. C. Terrone, 1107 Broadway, New York.

PROFITABLE Home enterprise. We back you—furnishing everything. United Buyers, 224 Terry Road, Syracuse, N. Y.

FOR Real success in business get Library of Business Opportunities. 36 page booklet explains. Mailed free. Horake, 724 N. Sweetzer, Hollywood, Calif.

SWAP! Buy! Sell! Anything!! Anywhere!!! 4 months 10c. Traders-Exchange, Brookings, S. Dak.

OPERATE Chain world's fastest money making penny vending machines. Displays—sells four kinds merchandise—same time. Start small, grow fast. Large profits immediately. Particulars free. Penny King, 3445 Park, St. Louis.

INDEPENDENT Business, easily carried by automobile, re-leveling butcher's chopping blocks. Heath Company, 210 Lafayette Street, New York, builds portable electric machines that re-levels all sizes and shapes of wood blocks.

GROW Mushrooms right now—a steady income—in cellar, shed or stable. Exclusive new process. Bigger, better, quicker crops—more money for you! We buy. Book free. American Mushroom Industries, Dept. 304, Toronto, Ont.

CAST Beautiful novelties in rubber moulds. Secret cement formulas. Samples 3c. John A. Payn, 945 Grande Vista Avenue, Los Angeles, Calif.

INVESTIGATE Frog raising—a profitable side line. New book explains and illustrates every phase of subject. Covers very latest developments such as plans of constructing ponds, combination frog feeder and fly traps, getting other live food electrically, also the goly poly, a new mechanical feeder. \$2.00 postpaid. Popular Mechanics Press, Room C35, 200 E. Ontario St., Chicago.

LEARN Synthetic rubber mold making. Inexpensive. Cold process. Equals pure rubber for flexibility, toughness, longevity. All branches marbleizing taught. Dime brings mold and cast; marble powder and rubber material for testing; assorted samples. Expensive gift offer. Cowell Institute, Grayling, Michigan.

UNUSUAL Opportunities, for cash, spare or full time. No canvassing. Details free. Nelson Specialty Co., Venice, Calif.

FREE—Copy "Goshar's Startling Information Bulletin." Goshar, 141 Rockview Terrace, Rochester, New York.

SURE Ways to make money—Home, anywhere. Details 3c stamp. George Douglass, Fort Johnson, New York.

MEN, Women, interested earning money home, details free. Rapid Sales Co., P. O. 8645, Tampa, Florida.

\$500 A YEAR Raising canaries—Stamp brings circular. Missouri Aircraft Studios, Box 302, Sullivan, Mo.

MANUFACTURE World's greatest sellers from chemist's perfect unequalled formulas. New valuable literature, free! You'll make money with my service. Miller, Chemist, 1706-J, Tampa, Florida.

ALL Sales by mail! No canvassing. Enclose 25c for details. Guaranteed—absolutely! Stanley Organization, 112-114 Queen St., Lancaster, Pa.

EARN Quick cash raising mushrooms in cellar, shed, attic. We buy crops. Guaranteed materials furnished. Easy, odorless method. Book free. United, 3848-EM Lincoln Ave., Chicago.

YOUR Letter reproduced exactly as if typewritten—500, \$2. Free samples. Carol Co., 15 Beekman St., New York City.

LEARN Floor refinishing. Send for "My 20 years experience finishing floors." 25c Floor Renovator, 175 3rd St., Newark, N. J.

BARGAINS—Paint spray outfit, gasoline engine drive. Terms—trial. Helmick Paint Spray Exchange, M-655, Troy, Ohio.

EARN Extra money making three useful products. Formulas 25c. Beever, 407 Main St., Richmond, Ind.

HANDYMEN: New, practical, individual business; profitable anywhere; protected territory. Write F. Sargent, Grundy Center, Iowa.

TURN Scrap into money. Convert old auto generators into A.C. generators for auto radio, camp and home lighting, power and other uses. Complete instructions \$1.00 postpaid. Popular Mechanics Press, Room C35, 200 E. Ontario St., Chicago.

FORMULAS AND TRADE SECRETS

SEND For special formula list. Free. D. Ackerman, 2829 Lawton Ave., Bronx, New York.

FORMULAS, All kinds, Guaranteed best. Catalog, "Special Offer Free." Kemico, 32, Partridge, Ill.

BEAUTY Formulas, twelve, \$1.00. Charles, 1863 Liliha Street, Honolulu, Th.

22 FORMULAS For manufacturing automobile polishes, top dressings, tire repair compound, etc. Set \$2.00. Chemical Laboratories, Wingdale, New York.

ANYTHING Analyzed. Efficient service. Modern formulas, processes. Free consultation. Diamond Laboratories, Rushville, Ind.

SUCCEED With your products. Learn how. Formulas, Processes, Analytical service. Catalog free. B. Thaxly Co., Washington, D. C.

ANALYZE Fast sellers to get fast sellers. Write. Associated Chemists, Indianapolis, Indiana.

3,000 FORMULAS, Facts, processes, trade secrets in Dr. Brown's Book of Formulas—380 pages. Price, postpaid \$1.00. Ozilite Publishing Co., 57 Rose Street, Dept. 25, New York.

FORMULAS, Plans, ideas, literature free. Belfort, 4042 N. Keeler, Chicago.

NEWEST Guaranteed formulas. Biggest catalog free. Special prices, leads. Gibson, Chemist, BD-4702 No. Racine, Chicago.

NEW! Specialty Manufacturer's Bulletin—25c. Terrone, 1107 Broadway, New York.

FORMULAS, 25c each, by master chemists. Kay Laboratories, 2443 1/2 Brooklyn, Los Angeles.

ANY Formula \$1.00. Remedies, cosmetics, insecticides, etc. Completed samples sent. 25c each. Miessene Products, Box 372, Columbus, Ohio.

RECOVER Gold and silver from plated articles. Formula 50c. Joseph Dorsney, Station J, Box 2614, Philadelphia, Pa.

400 GUARANTEED \$1-\$100 Formulas (duplicate all kinds popular preparations); 42 sections expose secrets of profitable mail order successes—home businesses! "Twentieth Century Business Encyclopedia," \$1.00. Money making literature for stamp. Fuller, Box 1144-B, Kalamazoo, Michigan.

ANY Formula, trade secret or recipe, 50c each. Guaranteed, individual attention. Start your own business. We furnish advice on request. Asperen Formula Co., Box 169, Grand Central Annex, New York, N. Y.

ANY Cosmetic formula \$1. Guaranteed best. Johnson Co., Box 392, Brookport, Ill.

ANY Formula 25c or money refunded. Bradford Laboratories, Jackson, Tenn.

TESTED Formulas—Largest, most complete line. Newest—guaranteed. Catalog free. Grinstead Laboratory, Edwardsville, Illinois.

VALUABLE Formula, graphite lubricant for automobile oil, 25c. Easily mixed. Johnson Laboratories, Elwood, Ind.

FALSE Teeth cleaner. Improves suction. Eliminates film, odor. Formula \$1.50. Douglas Sales Co., Crete, Nebraska.

CORRECT. Technically-tested, practical formulas for easily producing newest products, quickly selling; paying handsome profits. Save time and money here. Valuable literature free! Miller, Analytical Chemist, Tampa, Florida.

MIRRORS! Electro-plating. Make portable outfits. Astonishing disclosures. O'Cluster, Mirror-Craftsman, HP-224 Highland, Detroit, Mich.

50 SPLENDID Formulas automobile specialties 30c. Dorsey, Box 2, Louisville.

FREE: "One Illustrated Formula." Descriptive literature—listing. Formulas all kinds. Superior Formula Institute, Rome, Georgia.

THREE Moneymaking formulas 10c. Mars Lab., 47 Pleasant, Concord, N. H.

CHEMISTRY

CHEMICALS And apparatus for your home laboratory. Send 10c for catalogs. Save money! Kemkit Chemical Corp., 135P Johnson St., Brooklyn, N. Y.

SEND For new big catalog. Chemical sets, microscope outfits, laboratory, biological and chemical supplies. Approved by experimental laboratories. Special 30 day offer now open. Send 10c now! Winn Co., Dept. 405, 124 West 23 St., New York.

CHEMISTRY Students' slide rule saves time, prevents failure. For details write MWC Company, 508 Andrus Bldg., Minneapolis, Minn.

CHEMICALS. Laboratory glassware and apparatus. Catalog CP. Biological Supply Co., 1176 Mt. Hope Ave., Rochester, N. Y.

CHEMICAL Analysis, industrial problems, and mineral assays. Estimates free. Lowell Bunting, Consultant Chemist, Royal Oak, Michigan.

HANDBOOK For chemical experimenters, revised and illustrated, 50c. Experiment booklet 15c. Chemical catalogue 5c. Scientific booklet free. Reading Scientific Co., Reading, Pa.

CHEMICALS In small quantities. Exceptionally low prices. Send stamp for price list. Century Chemical Co., Portland, Mich.

CHEMICAL Set. Performs 35 different experiments. 20c. Fleischer's Laboratories, Everett, Mass.

PRACTICAL Everyday chemistry—How to make what you use. 2342 practical workable formulas of widely used products. Save 4%. Start a paying business of your own. \$2.00 postpaid. Popular Mechanics Press, Room C35, 200 E. Ontario St., Chicago.

MONEYMAKING OPPORTUNITIES

HOME Manufacturing enterprises—Ten sections: Woodcraft, metalcraft, leathercraft, toys, plastics, baskets, rubber, plaques, lawn furniture, pottery. Illustrated. 25c with trial subscription to Home Industries magazine. 32 pages. Two copies magazine, 10c. Home Industries, B84, Irvington, Nebr.

STUDY Journalism! Make excellent money anywhere. Twenty lesson course complete \$1.00. Satisfaction guaranteed. Associated Management Girard Trust Bldg., Dept. 493, Philadelphia, Pa.

EARN Money at home. Unusual opportunities—No canvassing. National Sales Service, Box 1773-PMM, Roanoke, Virginia.

MILLIONS Unemployed! Supply them amazing information—how man, long jobs, got 76 openings; other priceless help. Supplies, plan, 60c. Satisfaction guaranteed. Co-Operative Service, 77 Swan, Buffalo, New York.

FIFTY Money making formulas, 25c. Gulco, Box 422M, Gadsden, Alabama.

MAKE Extra money mailing circulars. Psychoscope Company, Box 1164, Portland, Oregon.

BIG Money hand engraving rubber printing plates. Instructions 25c. Large, illustrated, descriptive catalog; dime. Becker, 300H Graham Avenue, Brooklyn, N. Y.

BIG Money electrifying spring clocks and building cases. Dime brings drawing and "How" book. Klocksters, Guttenberg, Iowa.

NECKTIES—Jobbers, salesmen—Exclusive \$1.75 dozen. Write Capitol Neckwear, Norwich, Conn.

MAKE Money—Big profits—No canvassing. Details free. Howland's Laboratories, 17 South Cranston, R. I.

CASH Income daily resilvering mirrors; replating metalware; making glass signs. Portable outfit. Sprinkle, Plater, 287, Marlon, Ind.

HOW To make your spare time profitable—two thousand words of wisdom that will help you. Also information of dozens of spare time occupations and businesses. All 10c, none free. Publishers Sales Company, Box A78, Nelson, Ga.

BIG Money at home plating auto parts, reflectors, mirrors, chandeliers; by new method; experience unnecessary. Outfits furnished. Gunmetal Co., Ave. N, Decatur, Ill.

FREE Booklet describes 87 plans for making \$20-\$100 weekly. In home or office, business of your own. Elite Co., 214 Grand St., New York.

HOME Work plans—Legitimate, dignified, profitable! Prospectus 10c. Simpsons, 618P Vickers, Durham, N. C.

HOW To identify and determine value of old precious metals. Where to buy. To whom to sell. Reliable and up-to-date information. Complete instructions only \$1.00 postpaid. Popular Mechanics Press, Room C35, 200 E. Ontario St., Chicago.

AGENTS WANTED

NEW Different pinless curtain stretcher—Curtains attached in 30 seconds. Low priced—100% profit. Pocket-size sample furnished. Evans Mfg. Co., MX49, Cincinnati, Ohio.

DISTRIBUTORS For "Ramo" wanted. Every lady a prospect. Send 15c for sample. Ramo, 34 Elmwood Road, Rochester, N. Y.

500% PROFIT! Gold and colored sign letters for windows, offices, trucks, signs. Monograms. Easily applied. Neonite, Akron, Ohio.

AGENTS—Engraved name plates, number plates, signs, etc., easily sold, profits large. Brett Bros., Winthrop, Mass.

STRANGE Ironing cord. Saves electricity. Abolishes scorching and kinking. For telephones also. 150% profit. Sales guaranteed. Big free offer. Neverknot, Dept. 6A, 4503 Ravenswood, Chicago.

500 SALES Representatives wanted. We sell to merchants, jobbers, consumers. We broadcast daily. Bur-Lite, Hudson, Ohio.

DRAIN Pipe, straw hat and special cleaners, corn remedies, cements, special lacquers and chemicals. Chemical Specialties, 311 Broadway, Somerville, Mass.

MAKE Your own products. Guaranteed formulas for fast sellers. Catalog free. Kemco, 45, Parkridge, Ill.

GET Our offer for a real surprise. Earn \$5.00 daily in your spare time. Full time workers make much more. Mail postal for details. No obligation. A. Kennedy Co., Kokomo, Indiana.

MAKE Big money; commissions advanced; sell Goodyear raincoats, jackets; union made; latest style. Lowest prices; experience unnecessary; outfit free. Goodyear, LZ-1133 Milwaukee, Chicago.

AGENTS Sell 5 glasses California orange jelly, 25c. 200% profit. 5 glass sample 25c. Cutter Company, 1138E Hyde Park, Inglewood, Calif.

TIES, Pens, pearls, razor blades, etc., all big sellers. Get our list. Hell Premium Co., M2, Gaylord, Minn.

1000 SUMMER Specialty formulas; business starting plans. D-Duffy, Covington, Ky.

\$6.00 HOURLY. Amazing Karnu refinishes auto like new without rubbing, polishing, waxing or painting. Wipes on with cloth. Lasts 8 to 12 months. Free sample. Karnu, Dept. K-108, Cincinnati, Ohio.

SELL Stickers and labels for us. Proposition free. Settle's Labels, Bowdoinham, Maine.

MARRIED Man with spare time to distribute free samples coffee, flavoring, food products and make customers. Must devote at least two hours daily and be satisfied with up to \$3 in an hour. Permanent. Blair, Dept. 321-F, Lynchburg, Va.

CASH Paid for butterflies, insects. See Sinclair Display Advertisement on page 14A.

PORTRAIT Agents—Sell large size framed feather pictures tropical birds. Sample, terms, \$1.00. Zuckerman, 1311 E. 46 St., Brooklyn, N. Y.

AGENTS Sell furs—jackets, coats \$7.50 up. Summer average \$40 weekly. Many own shops from original \$7.50 investment. Knoblocks—Furs, New Castle, Pa.

STEADY Cash income making chipped glass name plates, signs, checkerboards, mirrors. Outfit furnished. E. Palmer, 512 Wooster, Ohio.

SELL, New food specialty. Spicy butter. Colavit's Co., Perkasie, Penna.

"WINDOW-RITER"—Magic pencil writes on glass, red, white, blue, green, yellow. Storekeepers buy on sight. Big profits. Repeat business. Free sample. Lake Chemical, Dept. 6-PM, 6 E. Lake, Chicago.

MAN Wanted—Manufacturer established 45 years will finance responsible man with complete stock of guaranteed finest foods, groceries, good health products, toiletries, farm and home necessities—you pay when sold. Mighty attractive plan. Excellent opportunity for good living right from the start with steady increase for industrious man. Pays better than most occupations. Anderson of Utah sold over \$330 and Jack of Wisconsin sold over \$308 in one week. Pleasant work. Experience unnecessary. No slack seasons or layoffs. Write for No-Investment offer. McCannon and Company, Room 66FS, Winona, Minn.

SUCCEED With your products. Learn how. Formulas, Processes, Analytical service. Catalog free. B. Thaxly Co., Washington, D. C.

SELLS Like hot cakes. Big profits. New laundry soapflakes, perfumes clothes lastingly when washing. Territory given. Sunset Laboratories, Lynbrook, N. Y.

MARVELOUS Kitchen tool. Lifts pie tins, etc., from hot ovens. Also, get our 1935 canning set. Will mail samples. 20c each. National Sales Corporation, Portland, Oregon.

AMAZING 3Way product, hand cleaner, dirt preventive, household utility, something new. 15c postpaid. Particulars free. Eastern Co., 717 N. Eutaw, Baltimore, Md.

MAKE Extra money! Write for our special offer and catalog of household deals, cosmetics, extracts, etc. Make big money selling your friends and neighbors. Clyde Collins Chemical Co., Dept. 15E-1, Memphis, Tenn.

WHOLESALE Catalog free. 500 best sellers. Paty Co., 1167 Broadway, Somerville, Massachusetts.

APPOINT Agents for us. Commissions. Repeats. Working literature, 50c. Amsa, Box PM-22, Station B, Brooklyn, N. Y.

EARN Up to \$10 daily while learning and building your own business. Cooperative plan. Outline free. Mashken, 923B Milwaukee, Chicago.

MAKE Your own products!! Formulas supplied! 50 pages opportunities; formulas 10c!! Galluzzo, Wilkesburg, Pa.

OPPORTUNITY To earn substantial profit selling complete line of RCA licensed radios for auto and home. Broadcaster Radio Company, 37 South Desplaines, Chicago.

MEXICAN Feather pictures. Great profit. Send 25c (stamps) for \$1.00 worth sample and details. Mexican Art, Apartado 1593, Mexico City.

SELL Neckwear, 100% profit. Quick sellers. Low wholesale prices. Free catalog. Artstyle Neckwear, Elmira, New York.

FREE Literature outlining mail order and other profitable business plans. J. Haddock, 4617 Nevada, Chicago.

DISTRIBUTORS: A few quick easy sales daily nets you \$58.00 weekly. Represent manufacturer—Latex—Amazing selfsealing bandage that breathes. Wonderful demonstrator. Irresistible appeal. Exclusive territory. Neway, 39-E South Clinton, Chicago.

SELL America's finest razor blades. Big profits. Excellent sideline. Send 10c for samples or write for prices. Swedish Steel Products, P-702 East 63rd, Chicago.

AGENTS—Write for proposition on our line of toilet, household, food products, etc. Trout Products, BPM35, Hickory, Ky.

IF You want to get your groceries and household supplies at wholesale, and a wonderful chance to make \$9.50 a day besides, write me immediately. Send no money; details mailed free. Albert Mills, 8063 Monmouth, Cincinnati, Ohio.

AGENTS—Make \$25.00 week selling Yankee Duster; 100% profit. Scheff, 3748 North Lawndale, Chicago.

AMAZING Zipper pinless clothesline. Instant demonstration. Sure sale every home. Free guarantee sales plan. Dunn Bros., Hempstead, N. Y.

CALIFORNIA Flower beads sure fire fast sellers. Big profits. Low prices. Catalog free. Mission No. 16, 2328 W. Pico, Los Angeles, Calif.

450% PROFIT Magic gas lighter. No flint or flame. Lights gas instantly. Retail 27c. Costs you \$1.00 a dozen or 15 dozen for \$9.00. Sample 10c. New Method Co., Desk PMG-28, Bradford, Pa.

AMAZING Profits selling colored folks. Hair preparations, bleach creams, perfumes, incense. 300 products. Write for free samples. Valmor, 5249-SN Cottage Grove, Chicago.

AT Last a home treatment for pyorrhea. Distributors wanted. Supreme Laboratories, 1700 South Ogden, Los Angeles, Calif.

ENGRAVED Initial plates, nameplates, signs, numbers. Enamel finish, five colors, big profit. Hilton Specialty, 29 Portland, Providence, R. I.

SALESMEN—Distributors—Sensational profit with amazing new automatic striping tool. Works like magic! Anyone can use it. Does perfect striping work—any width—on autos, bicycles, furniture, walls, signs, etc. Sells on sight. Write today. Midwest Sales, 1337-C Monadnock Bldg., Chicago.

BIGGEST And quickest sales are made in brushes. Write for proposition. Wire-Grip Sanitary Brush Corporation, 45 East Eleventh Street, New York.

GREATER Money-maker. Quality electric water heater. Retail \$1.95, wholesale 65c, agent's sample \$1. "Realproducts," 8608 Phillips, Chicago.

PROFIT With new products. Make, sell, repeat. Guaranteed formulas, special prices, leads. Biggest catalog free. Gibson, Chemist, BD-4702 No. Racine, Chicago.

FREE Literature describing many money making plans. Belfort, 4042 N. Keeler, Chicago.

PENNY Each. Mirror finish window sign letters. Free samples. Atlas, 7941 Halsted, Chicago.

REGULAR Income—Quick returns—No canvassing. McArthur Co., Desk 5, Butte, Montana.

PENNY Each. Large sizes. Non-tarnishable window sign letters. Free mirror finished samples. Atlas, 7941 Halsted, Chicago.

100% PROFIT In the mystery cigar lighter. No flint or friction. What makes it light? No wind can blow it out. Retail 35c. Sample and sales plan 25c. New Method Company, Desk PM-28, New Method Bldg., Bradford, Pa.

CASH Income daily resilvering mirrors; replating metalware; making glass signs. Portable outfit. Sprinkle, Plater, 128, Marion, Ind.

SOMETHING New in photo medallions and sterling silver photo rings. Big profits. Free catalog. Gibson Photo Jewelry Co., Inc., 835 McDonald Avenue, Brooklyn, N. Y.

MAKE More money taking orders. Shirts, ties, underwear, dresses, hosiery, raincoats, coveralls, pants, uniforms. Outfit free! Nimrod Company, Department 8, 4922-28 Lincoln Avenue, Chicago.

NEW Cleaner! Washes clothes quickly. Cleans everything. Premium deals. Free sample. Bestco, 5007 Irving Park, Chicago.

BIG Money applying gold initials on automobiles. Easiest thing today. No experience needed. Free samples. "Ralco," 1084 Washington, Boston, Mass.

AGENTS: Smash go prices. Santos coffee 12c lb. 4-oz. vanilla 8½c. \$1.00 size tonic 11c. Razor blades 10 for 8½c. 100 sticks chewing gum 12c. 150 other bargains. Experience unnecessary. Write Carnation Co., P.O. St. Louis, Mo.

PROFITABLE Home business. Legitimate. No canvassing. Maywood Publishers, P-923 Broadway, New York.

SILVERING Mirrors made easy and 460 other useful articles in Shop Notes. Volume 28—50 cents postpaid. Popular Mechanics Press, Room C35, 200 E. Ontario St., Chicago.

AGENTS: Stamping names on pocket-key protectors. Sample check with your name, address. 25c. Stamping outfits, Emblem checks, check-fobs, name plates. Hart Mfg. Co., 303 Desraw St., Brooklyn, N. Y.

100 PROFITABLE Mail order and local business plans. A. Pruitt, Elburn, Ill.

GENUINE Gold letters for store windows. Easily applied. Free samples. Liberal offer to general agents. Metallic Letter Co., 438-B North Clark, Chicago.

AGENTS—Opportunity to make money; book containing 87 successful business plans; home or office; send for free introductory booklet. Elite Co., 214 Grand St., New York.

"HOW To Secure Agents," a specially prepared booklet, tells of one of the most inexpensive methods in which to secure good live producing agents. It is free; write for your copy today! F. W. Johnson, Mgr., Classified Advertising, Popular Mechanics Magazine, 200 E. Ontario St., Chicago, Ill.

BIG Money and fast sales. Every owner buys gold initials for his auto. You charge \$1.50; make \$1.45. Ten orders daily easy. Write for particulars and free sample. American Monogram Company, Dept. 40, East Orange, N. J.

PORTRAIT Agents throughout the world. Lowest prices, portraits, frames. Catalog free. Picture Man Friedman, 528 Cornelia, Dept. 9, Chicago, Ill.

MAKE Your own products. Employ agents yourself. Toilet articles, soap, extracts. We furnish everything. Valuable book free. National Scientific Laboratories, 1950W Broad, Richmond, Va.

MAN In each town to plate auto parts, reflectors, bathroom fixtures, refinish beds, mirrors, chandeliers; by new method. No capital or experience required. Simple plan of manufacturing at home starts you in big money-making business. Outfit furnished. Free particulars and proofs. Gun Metal Co., Ave. H, Decatur, Ill.

15,000 PROFIT Making formulas. Following and many others: Accidents and emergencies, agriculture, alloys and amalgams, artist's materials, beverages, cements, glues, pastes, mulligans, bleaching, renovating, coloring metals, dyeing glass, heat treatment of metals, household formulas, ice cream, confectionery, chewing gum, lapidary work, exterminating vermin, lubricants, paints, varnishes, photography, condiments, canning formulas, rubber, soap, candles, soldering, toilet preparations, perfumes, waterproofing, fireproofing, writing materials. \$5.50 postpaid. Popular Mechanics Press, Room C35, 200 E. Ontario St., Chicago.

HIGH-GRADE SALESMEN

WAGON Jobbers sell Pres-On battery charging connectors. Write Simpson Bros., Auburn, N. Y.

SALESMEN: To sell well-known line coin wrappers, bill straps, bank supplies. Abbott Coin Counter Company, New York, N. Y.

MAKE Big money steady. High grade coveralls, shopcoats, pants, shirts, summer suits. Advertising on back. Fast sellers. Free outfit. Strong Mfg. Co., 901 West Jackson, Dept. N-5, Chicago.

HERSHEYS, Baby Ruth, Oh Henry candy deals. 1c—5c display and punch deals. Living scale. Steady employment. Casterline Bros., 1920 Sunnyside, Chicago.

AUTO Accessory salesmen. Free deal for dealers. Irresistible appeal. Complete line auto accessories priced right. 25% commission daily. Exclusive territory. Outfit free. National, 1916-CM Wentworth, Chicago.

MAN—Handle regular store route. Place nationally advertised 5c-10c counter card mds. New aspirin deal—6 tablets 5c. 85 other fast sellers. 100% profit. No investment. Samples free. World's Products Co., Dept. 6810, Spencer, Ind.

SALESMEN: Acquainted with garages, filling stations, to handle local business. Write Colgra, 2632 N. Third St., Milwaukee, Wisconsin.

SELL Salesbooks. 100 printed \$3.75. Big commission. Victory Press, Dover, Mass.

DON'T Be a job hunter—Start your own business on our capital. No hard times; no lay-offs; always your own boss. Hundreds average \$5,000 to \$5,000 annual sales year after year. We supply stocks, equipment on credit. 200 home necessities. Selling experience unnecessary. Wonderful opportunity to own pleasant, dignified, profitable business backed by world wide industry. Write Rawleigh, Dept. F-U-PPM, Freeport, Ill.

NEW Invention softens water from faucet instantly; sensational demonstrator. Softette, GG-751 Kansas City, Kansas.

SALES People sell Havana cigars; big commission. Sullivan Cigar Co., Tampa, Fla.

SALESMEN: Sell complete line gummed labels, calendars, memo books, and business stationery. Special features. Free deals. Write quick. Big commission daily. Attractive sales portfolio free. Willens, Dept. CD, 2132 Gladys, Chicago.

BIG Money in tire patches. Sell new auto tire patch to service stations, garages, etc. Tiger-Grip patches guaranteed 10,000 miles. \$75 weekly for salesmen or distributors. Protected territory. Write Economy Rubber Co., 753 Burkhardt, Dayton, Ohio.

NEW Low price steak machine. Butchers amazed, competes expensive cubers. Big profit. Federal Engineering Co., Minneapolis, Minn.

AUTO Radio—World's cheapest. No-cost sample. J-20th Century Co., Kansas City, Missouri.

MYSTERY Pig. Has everybody laughing and mystified because eyes, ears, snout, tail move without mechanical or human aid. Funniest, biggest selling novelty. Act quick. Samples 60c more convincing than any letter. Money back guarantee. Novelty Toy Crafters, Manufacturers, MP-328 So. Franklin, Chicago.

HANDSOME Profit selling Neoprinting! Printing without type or engravings! Illustrated catalog, sales data. 25c. Becker, 390L Graham Avenue, Brooklyn, N. Y.

SALESMEN—Familiar with garage and car dealer trade. Sell new specialty for every motor. Necessity, K & G, Box 2050, Birmingham, Ala.

SELL Stores or homes. Big new line. Over 60 items. Up to 600% profits. Repeats. Superba Co., S411, Baltimore, Md.

PENNY Each. Mirror finish window sign letters. Free samples. Atlas, 7941 Halsted, Chicago.

NEW Federal, state tax and code laws force, under severe penalties, the keeping of proper business records. Immense demand for our officially approved tax record. Sells at sight. Repeat commissions without call-backs. Men selling 5 to 25 daily. \$3.50 cash profit every sale. Commonwealth Publishing Co., 508 So. Dearborn, Chicago.

SELL Process embossed printing \$3.95 thousand, with free cut service. Worth \$6.00. Nothing like it! Commission \$1.00, advanced. Experience unnecessary. Outfit free. United Engravers, F-6155 South State, Chicago.

START A business of your own! Become a subscription representative for "Popular Mechanics." No capital required. Liberal commissions. Monthly bonus. Write for details. V. D. Angerman, Circulation Manager, 200 East Ontario Street, Room 235, Chicago.

BRAND New grab-bag deal. Going big everywhere—big profits—swift sales—fast repeats. No restrictions. All dealers buy. Act! K&S, 4373 Ravenswood, Chicago.

SALESMEN—Sell collection systems. 400% commission. Sayers Systems, 2801-123 Sheffield, Chicago.

NEW Specialty—Sells every business and professional man. Four \$15 sales daily pay \$280 weekly. Foyer cleared \$4920 in three months. Write, F. E. Armstrong, President, Dept. PM, Mobile, Ala.

SALES Demonstrators. U-Kan-Plate with pure silver. 1 oz. polish 20c, 8 oz. \$1. Justice, 904 Walnut, Philadelphia.

MAKE More money taking orders. Shirts, ties, underwear, dresses, hosiery, raincoats, coveralls, pants, uniforms. Outfit free! Nimrod Company, Department 65, 4922-28 Lincoln Avenue, Chicago.

SELL Punchboards direct to dealers from world's leading punchboard factory. Wholesale prices. Enormous profits. Big commissions. Sales kit free. Harlich Co., 1407 Jackson, Chicago.

FREE Booklet describes 87 plans for making \$20-\$100 weekly, in home or office, business of your own. Elite Co., 214 Grand St., New York.

OUTDOOR Sports for everyone—Enjoy them all year round with aid of book published by Popular Mechanics. Hundreds of ideas for new and popular sports for every season; complete instruction for making necessary equipment at small cost. 350 pages and 650 illustrations. \$2 postpaid. Popular Mechanics Press, Room C35, 200 E. Ontario St., Chicago.

HELP WANTED

"HANDS Up!" But don't worry! "Mystery" trouser belt with secret pocket defies thieves, conceals and protects money and valuables. No betraying zipper. Looks exactly like any fine leather belt. Men eager to own it. Startling demonstration sells it. Customer's name, monogram engraved free. Tremendous profits. Free sample offer. Halvorsen, 605 W. Washington, Dept. F-81, Chicago.

GROW Mushrooms right now—a steady income—in cellar, shed or stable. Exclusive new process. Bigger, better, quicker crops—more money for you! We buy. Book free. American Mushroom Industries, Dept. 305, Toronto, Ont.

GO INTO wholesale business without investment. Call on stores with biggest line self-selling counter displays: Aspirin, razor blades, handkerchiefs, breathlets, household cement, 79 different items. Up to 125% profit for you. Experience unnecessary. Write for catalog and plans. Procopax, Dept. 36-KD, 1956 S. Troy, Chicago.

TEACHERS: Many vacancies reported to you by new cooperative placement plan. Treweeke, 599, Wichita, Kans.

BIG Money growing mushrooms, cellar, idle places. Supplies furnished. We buy. Free book. Mushroom Growers, FV-433 N. Clark, Chicago.

I WANT Men for local tea and coffee routes paying up to \$42.50 a week. No capital or experience needed but must be willing to give prompt service to approx. 200 families. I furnish everything. Write Albert Mills, 8957 Monmouth, Cincinnati, Ohio.

EARN Quick cash raising mushrooms in cellar, shed, attic. We buy crops. Guaranteed materials furnished. Easy, odorless method. Book free. United, 3848-EN Lincoln Ave., Chicago.

CASH Paid for butterflies, insects. See Sinclair Display Advertisement on page 14A.

MAKE Extra money mailing circulars. Psychoscope Company, Box 1164, Portland, Oregon.

AGENTS—Mosco corn and callous remover will build you a steady repeat business. Send today for pocket-size trial outfit. The Moss Company, 54 Searle Bldg., Rochester, N. Y.

LEARN Air conditioning—America's next big industry. Thousands of opportunities for far seeing men. Get your start with complete new book by E. W. Riesbeck, \$3.50 postpaid. Popular Mechanics Press, Room C35, 200 E. Ontario St., Chicago.

EDUCATIONAL AND INSTRUCTION

WOODCARVERS! Latest up-to-date figure-carvings—complete instructions \$1.00. Hallsthammar's School of Wood Sculpture, 1620 Farwell Ave., Chicago, Ill.

LATEST Developments in arithmetic easily learned. Frederick A. Smith, 2410 Smalley Court, Chicago.

SECRET Service. Valuable information free. International Secret Service Institute, PM-65 Hoboken, N. J.

LEARN Newspaper reporting. Good pay. Course by mail \$10.00. Southern Journalism School, Box 11, Jacksonville, Fla.

WORK For "Uncle Sam." Start \$105.00—\$175.00 month. Early examinations expected. Steady work. Men-women, 18-50. Common education usually sufficient. Qualify immediately. Full particulars, list positions and sample tests—free. Write today sure. Franklin Institute, Dept. 83, Rochester, New York.

LEARN Lettering, poster art and design. Free booklet. Emerson Studios, 127 No. Dearborn, Chicago.

AUCTIONEERING—Rochester Correspondence School of Auctioneering, approved, also personal courses. 34 Atkinson, Rochester, New York.

EASY To learn, developing, printing, and coloring of photographs. Instructions \$1.00. Fred Carpenter, Hamlin, Texas.

REVISE Your own short stories. Chart free. Stamp. Thomas Powis, Libertyville, Illinois.

HOME Study courses leading to degrees: Arts and sciences, philosophy, education, law, letters, theology, psychology, engineering, chemistry, business and commerce. Many others. McKinley-Roosevelt University, Chicago.

MODERN Refrigeration. New industry needs trained men for installing, servicing, repairing. If you seek a new field with larger opportunities get latest book by Alt-house and Turnquist, \$4.00 postpaid. Popular Mechanics Press, Room C35, 200 E. Ontario St., Chicago.

LEARN Chiropody. Complete course by correspondence. Evans Foot Inst., Montgomery, Ala.

LEARN Machinist trade, tool and die making, designing, automatic and hand screw machines. Get experience on actual jobs. Leading shops approve our methods and employ our men. Steady demand for skilled men. Days—evenings. Send for free book. Allied Screw Machine Company (School Div.) 601 W. Lake St., Chicago.

GET U. S. government job—start \$105-\$175 month. Men-women, age 18-53. Are you eligible for eligibility test? Get our free questionnaire—find out. No obligation whatever. Instruction Bureau, 101, St. Louis, Missouri.

U. S. GOVERNMENT Positions, \$1700-\$1900 and up a year. Let our expert (former government examiner) prepare you for a position in the railway mail service, rural carrier, post office, customs and other branches. Write today for free booklet. Dept. S, Paterson School, Rochester, N. Y.

LEARN Diesel engineering. Rapidly expanding field. Good pay for Diesel-trained men for next 25 years. Home training possible. Get latest and right up-to-date Diesel Handbook. Authentic, \$5.00 postpaid. Popular Mechanics Press, Room C35, 200 E. Ontario St., Chicago.

CARTOONING—COMMERCIAL ART

CARTOONING Course:—30 lessons, 500 illustrations with drawing pens and pencils. \$1.00 complete. Scovell Studios, Box 610-P, Hollywood, Calif.

AMATEUR Cartoonists can earn \$35.00 weekly, spare time, duplicating cartoon advertisements. 3-M Syndicate, Argyle, Wis.

MAKE Money. Sketching. Duplicating. Send for free plans. Paisley, 421-P Kinloch Bldg., St. Louis, Mo.

CARTOON Your way to prosperity. Write Straley, 13 1/2 Main, Springfield, Ohio.

ADVERTISING AGENCIES

ADVERTISING Placed anywhere. Helpful, free service. Rate guide book free. Baker Advertising Agency, 189 W. Madison, Chicago.

FREE—New Advertisers Rate Guide, 44 pages. Includes everything. Lowest rates. E. H. Brown Advertising Agency, 140 S. Dearborn, Chicago.

ADVERTISE Profitably: \$15 reaches 6,000,000 Sunday newspaper readers with 24 word ad. Newspaper, magazine rate-guide, free. Chicago Union Agency, 20 West Jackson, Chicago.

LEARN Advertising quickly at home. New easy practical plan. No text books. Interesting booklet free. Page-Davis School of Advertising, 3601 Michigan, Dept. 3431, Chicago.

INCH Display advertisement 30 magazines, year \$24. Wood's Popular Services, Atlantic City, N. J.

FOR ADVERTISERS

30 WORDS Printed 10,000 advertising-circulars and mailed to prospects \$1.00. Lee Agency, Sheridan, Ark.

ADVERTISE: 24 Words in 250 newspapers \$10. Lists free. Advertising Service Bureau, 4650 Drexel, Chicago.

24 WORDS 50 Newspapers \$2.00. Good-all Adv. Company, Box 1592, San Francisco.

BUSINESS SERVICE

COMPLETE Office routine service. All essentials business without office. Mail address, desk, bookkeeping, correspondence, typing, notary. From \$2. Frederic, 507 Fifth Ave., New York.

COLLECT Your own bad accounts. Our prize series money-getting collection letters, \$1. Collectors Systems, Rutland, Vt.

EFFECTIVE Collection letters, five for \$1.00 Ernest Poulin, Rumford, Maine.

DELAWARE Charters; fees small; free forms. Chas. G. Guyer, 901 Market St., Wilmington, Del.

RUBBER STAMPS AND OFFICE SUPPLIES

NAME, Address, 2 lines 25c; 3 lines 35c. Stamp Works, Auburn, Nebr.

CUSHION Mounted, one or two lines, 25c. Three 3 1/2 colin. Stamp Works, 814 Bradley, Peoria, Ill.

PRINTING, MULTIGRAPHING, MIMEOGRAPHING, GUMMED LABELS

500 WATERMARKED Bond standard size letterheads, envelopes, billheads, statements \$1.75. 1000 cards \$1.40. Illustrations. Bradshaw, 3214 Huron, Chicago.

100 BUSINESS Letterheads and envelopes \$1.00; 225, \$2.90. Richards, 133 Maple Road, Stow, Ohio.

ENGRAVURE Printing. Lowest possible prices. Samples free. Sunko, Mohawk, N. Y.

CLEAN! Guaranteed mimeographing, 250 8 1/2 x 11 \$1.50. 1000 \$3.50. Superior printing, 250 each 6 1/2 envelopes, 8 1/2 x 11 letterheads \$2.00. 1000 each \$6.50. Typewriter ribbons 75c. Mail address \$1.25 month. Stationery, supplies, lists free! Seejay Office Supply Service, 2459 Station Street, Chicago.

1000 3 1/2 x 6 BLANK Back circulars \$3.00. Clark, 262 Eulalie, Oshawa, Canada.

1000 BOND Billheads, 5 1/2 x 8 1/2—\$2.00. Frederic Mahon, 231 79th Street, Rockaway Beach, N. Y.

200 EACH, Letterheads, envelopes, \$1.75 delivered. Ledlin, 1017 Greenfield, Milwaukee.

PARTICULAR? Near-Gravure processed stationery. Distinctive! Unique! Samples. Sollidays, Knox, Indiana.

BETTER Labels for less. Samples. Labelers, 6618A Quinby, Cleveland, Ohio.

NEW Type 29c font. Catalogue dime. National Type Company, Jackson, Michigan.

SOMETHING New—Bookform paneled business and personal cards, 4 books 50c. Agents wanted. Anderson Co., 12612 Greenwood, Blue Island, Ill.

2000 BUSINESS Cards neatly printed \$1.50. Atlas Distributing Co., 1814 Bedford Ave., Pittsburgh, Pa.

500 LETTERHEADS, Envelopes, etc., \$1.75. Wimpee, Box 62, Lyerly, Ga.

5000 ELEGANT Colored envelope slips, \$3.90 prepaid. All printing low prices. Samples. Goodprint, Harrisonburg, Va.

200 QUALITY Envelopes, letterheads or statements \$1.00. 1000 cards \$1.50. Press, Commodore, Penna.

REDUCE Your printing bills! Neoprinting reproduces printing without type or engravings! Illustrated catalog 25c. Becker, 300M Graham Avenue, Brooklyn, N. Y.

ENVELOPES Printed \$1.95—1000. Good letterheads \$2.50—1000. Wilson Printing Co., 1931P 7th St., Long Beach, Calif.

1000 BLOTTER Business cards \$1.75. Superior Printing Co., Springfield, Missouri.

250 LETTERHEADS, Bond, 8 1/2 x 11, \$1.25; 250 envelopes, \$1.00 postpaid. Quick. You'll want more. Lewis Press, Malvern, Ohio.

1000 BUSINESS CARDS, card case, \$1.50. Miller, Printer, Ambler, Pa.

STATIONERY, Circulars, checks, loose-leaf, ruling, binding. Commercial Press, Batavia, Ohio.

BETTER Grade printing, reasonable priced. Free samples. Economic Press, Leonia, N. J.

PRINTING OUTFITS AND SUPPLIES

BARGAINS, Presses, type. List 3c. Exchange D11 22 Orient, Meriden, Conn.

HAND Press, type and complete printers' supplies. Advise equipment you need and we quote prices; or send stamp for catalog. P. Pelifer, 43-A; 6 Columbia St., Newark, New Jersey.

PRINT Your own cards, stationery, circulars, advertising, etc. Save money. Easy rules furnished. Print for others, big profits. Junior press, \$5.90; job presses, \$11, power \$149. Write for details. Kelsey Co., Y-11, Meriden, Conn.

PHOTO Engraving equipment. Easy cut making process. Andercamco, 12612 Greenwood, Blue Island, Ill.

PRINT Your own circulars, envelopes, with home made press costing less than \$1.00. Illustrated instructions 10c. Carl Edquist, Odessa, Minn.

PRINTING Outfits—Presses, type supplies, type novelties. Send stamp for catalog. Model Press, York, Penna.

BARGAINS Used presses, type. Send stamp. Box 15, Cambridge, Mass.

TYPEWRITERS, DUPLICATORS, OFFICE DEVICES

TYPEWRITER \$12. Multigraph, mimeograph, and other office machines. Write 816 Pruitt Bldg., 170 North LaSalle, Chicago.

A ROTARY Stencil duplicator \$15.50 comp. All metal construction guarantees clean copies in typewriting, handwriting or drawing. Beco, 860-p Newark, N. J.

TYPEWRITER Bargains—Genuine late model Underwoods, Royals, Remingtons, L. C. Smiths refinished \$100 office models at 60% saving. Fully guaranteed—10 day trial—easy terms—10c a day. Free catalog. International Typewriter Exchange, Dept. A-601, 231 West Monroe St., Chicago.

NEW \$4.75 Automatic adding machine. Fully guaranteed. Bassett, 1458J Hollywood Avenue, Chicago.

INCREASE Business. "Excellograph" rotary stencil, clay and film duplicators \$3.85 to \$37.50. Prints anything. Typewritten, penned, drawn, traced. Colors. Folder free. Pittsburgh Typewriter Supply, Suite 518, Pittsburgh, Pa.

NEW Booklet—"The Trick of Touch-Type-writing. Let Your Fingers Do It." 10c. Island Press, 8236 Cornell Ave., Chicago.

PATENT ATTORNEYS

INVENTORS: Send immediately for your copies of our new free books, "Patent Protection" and "Suggestions on Selling an Invention." Sixty-eight pages of interesting facts. They tell how Patent Laws protect you; kind of sketch or model needed; simple steps to take without cost; how successful inventors have secured financial assistance; show interesting inventions; illustrate important mechanical movements. With book we also send free Evidence of Invention form to help establish date of disclosure. Prompt service, reasonable fees, special deferred payment plan. Strictest secrecy. Thirty-six years' experience. Highest references. Write us today. The facts in our books are worth money to the man with a good invention. Address: Victor J. Evans & Co., Registered Patent Attorneys, 400G Victor Building, Washington, D. C.

PATENTS. Booklet free. Highest references. Best results. Promptness assured. Watson E. Coleman, Patent Lawyer, 724 Ninth St., Washington, D. C.

A BETTER Deal for inventors: valuable manufacturing and sales suggestions combined with skillful patent protection. My fee to secure patent \$50.00. Trade-marks registered \$35.00. Copyright \$6.00. 22 years patent, engineering experience. J. J. O'Brien, 108 West 42nd, New York.

POSTAL Brings full information about patents and their cost. Shepherd & Campbell, Patent and Trade-Mark Attorneys, 512 Victor Building, Washington, D. C.

HAVE You an invention? Want to know how to develop them? A novel invention may produce something saleable. Secure patent protection. Write today for my free book "Patent Guide for the Inventor." It illustrates scores of inventions, many of them the foundation of commercial success. Clarence A. O'Brien, Registered Patent Attorney, 58-Z Adams Building, Washington, D. C.

PRACTICAL Inventions now saleable before patenting. What have you? Chartered Institute, Dept. 4C, Barrister Building, Washington, D. C.

PATENTS Procured; trade marks registered—preliminary advice furnished without charge. Booklet and form for disclosing idea free. Irving L. McCathran, 700A International Bldg., Washington, D. C.

L. F. RANDOLPH, 302-B Victor Building, Washington, D. C. Low cost. Book and information free.

PATENTS. Instructions "How to Establish Your Rights" and form. "Evidence of Conception"—sent free! Lancaster, Allwine & Rommel, 411 Bowen Building, Washington, D. C.

INVENTORS—Send for free booklet "Patent-Sense." Information based on 64 years experience. Lacey & Lacey, Dept. 5A, 635 F St., Washington, D. C.

ECONOMY For inventors. Write for booklet. Thos. H. Johnston, 635 F St., N. W., Washington, D. C.

"INVENTOR'S Guide," 100 mechanical movements, free; advises on patenting, selling inventions. Fk. Ledermann, 154 Nassau Street, New York.

FOR INVENTORS

IDEAS Developed, research, information, etc. American Research, Box 817, Muncie, Indiana.

DESIGNING, Drawings, blueprints, working models, commercial development of inventions. Reasonable. Satisfaction guaranteed. Engineering Service, 1519 Crescent, Ft. Wayne, Indiana.

INVENTORS: Send immediately for your copies of our new free books, "Patent Protection" and "Suggestions on Selling an Invention." Sixty-eight pages of interesting facts. They tell how Patent Laws protect you; kind of sketch or model needed; simple steps to take without cost; how successful inventors have secured financial assistance; show interesting inventions; illustrate important mechanical movements. With book we also send free Evidence of Invention form to help establish date of disclosure. Prompt service, reasonable fees, special deferred payment plan. Strictest secrecy. Thirty-six years' experience. Highest references. Write us today. The facts in our books are worth money to the man with a good invention. Address: Victor J. Evans & Co., Registered Patent Attorneys, 401G Victor Building, Washington, D. C.

BEGINNERS, Helpful information including idea protection method 25c. Patent searches conducted. Box 48, Newport, Ky.

WE Make models and samples for inventors. Send for catalog of supplies. The Pierce Model Works, Tinley Park, Ill.

UNPATENTED Ideas can be sold. I tell you how and help you make the sale. Free particulars. (Copyrighted.) Write W. T. Greene, 944 Barrister Bldg., Washington, D. C.

TO Inventors: We are in the market to purchase a good patent, preferably in the automobile accessory line. Will purchase outright or on royalty basis. Purchasing Agent, 241 Front St., New York, N. Y.

HAVE You a patent to sell? You'll be interested in my proposition. Write now for free particulars. F. W. Johnson, 200 E. Ontario St., Chicago.

COPY Of any patent sent for \$1.00. R. Burch, 904 F St., Washington, D. C.

INVENTIONS Suitable national distribution exhibited June 24-28. Write National Inventors Congress, Hotel Sherman, Chicago, immediately for details.

HAVE You an invention? Want to know how to develop them? A novel invention may produce something saleable. Secure patent protection. Write today for my free book "Patent Guide for the Inventor." It illustrates scores of inventions, many of them the foundation of commercial success. Clarence A. O'Brien, Registered Patent Attorney, 58-Z Adams Building, Washington, D. C.

INVENTORS—New lists of ten wanted inventions and ten recent patent buyers for twenty-five cents; chemical, radio, general, automotive and aero-marine. All five for \$1.00. E. Mitchell, 586 Seiden, Detroit, Michigan.

HAVE You a sound, practical invention for sale, patented or unpatented? If so, write Chartered Institute, Dept. 4D, Barrister Bldg., Washington, D. C.

I SELL Patents. Established in 1900. Charles A. Scott, 773PM Garson Ave, Rochester, N. Y.

INVENTORS: "Making Inventions Pay," our 32-page illustrated book, mailed upon receipt of 3c postage. Crescent Tool Company, Dept. Z, Cincinnati, Ohio.

PATENTS. Low cost. Book and information free. L. F. Randolph, 302-C Victor Building, Washington, D. C.

INVENTIONS WANTED

SMALL Inventions wanted. Stanley Hull, 7829 Euclid Avenue, Cleveland, Ohio.

INVENTIONS Wanted—Patented, unpatented. If you have an idea for sale, write Hartley's, Inc., Box 928-E, Bangor, Maine.

PATENTS FOR SALE

MANUFACTURERS Looking for new inventions should write W. T. Greene, 939 Barrister Bldg., Washington, D. C.

AIR Cooler. Manufacturing cost \$10.00. D. J. Besse, 231 East 6th St., San Angelo, Texas.

PIPE Pusher, light, convenient, efficient, powerful. Sale or royalty. Box 4, Hartford, Michigan.

MANUFACTURING

WOODEN Novelties manufactured. All kinds. Send specifications. Kauffman Novelty Works, Paris, Ill.

MANUFACTURING Dies and models made at low cost. J. J. O'Brien, Patent-Development Engineer, 106 West 42nd, New York.

METAL Articles developed and manufactured. Model making. Reasonable price and first class workmanship. W. F. Meyer Company, Bedford, Indiana.

INVENTIONS Manufactured in any quantity at low cost. Stampings, dies, models, etc. Estimates and free catalog. Crescent Tool Co., Dept. X, Cincinnati, Ohio.

MODELS AND MODEL SUPPLIES

LET Us solve your mechanical problems. We have served inventors and manufacturers for 35 years. Special machinery, devices, models and parts. Clyde Engineering Company, Inc., 1460 North Market Street, St. Louis, Mo.

RAILWAY Model supplies—Track, signals, locomotives, cars. List 10c. Crovan Railway Models, Stamford, Conn.

MODEL Makers—Brass, copper, fibre, steel and aluminum in all shapes. Also castings, gears, screws, fittings. Catalog 10c. Experimenters Supply House, Dept. P, Box 19, Station Y, New York.

BRASS Gears and model supplies. Send for catalog. The Pierce Model Works, Tinley Park, Ill.

THE Modelmaker. The magazine for those interested in building model railroads, boats, engines. Send 15 cents for copy. Model-maker Corp., 98P East Main St., Bay Shore, New York.

MODELS—Your ideas developed into practical working models. 30 years' successful experience; thousands of satisfied customers. Confidential service guaranteed. Bank references. Send 3c postage for 32-page book—"Making Inventions Pay." Crescent Tool Company, Dept. Y, Cincinnati, Ohio.

SHIP Models—Build 18" Flying Cloud, Constitution or Galileo. All materials including full-sized plans only \$1.50 from Hancock, 323 Douglass Ave., Portsmouth, Virginia.

EVRAY'S Engine catalog (No. 34) or supply catalog (No. 35) postpaid 20c. Evray-mesco, 28 N. Clinton, Chicago.

MECHANICAL Models, new and novel. Popular Mechanics has developed accurate models in the mechanical field. Those now ready are Wright "Whirlwind" Airplane Engine, Ocean Liner "Europa" and Modern Passenger Locomotive. Every part clearly shown and the name given. Invaluable to students and all who are mechanically inclined. \$1.00 each postpaid. Popular Mechanics Press, Room C35, 200 E. Ontario St., Chicago.

HOME CRAFTSMEN

MAKE Miniature pottery novelties. Instructions 10c. Curtis, 3329 Lafayette St., Denver, Colo.

SEND 5c Catalogue, samples. Leathercraft Supply Co., Station "B," Long Beach, Calif.

FOUNDRY. Make castings, forgings, heat treat, case harden with home outfit, free circular. Kansas City Specialties Company, Box 6022, Kansas City, Mo.

LLR (Liquid Live Rubber) is self vulcanizing. Use it for making flexible molds, rubber articles, insulating tool handles, etc. See page 657 May issue of Popular Mechanics. 1/2 pint LLR \$1.00, quart \$3.00. Postpaid with instructions. Stewart's LLR, 2102 West 19th, Chicago.

BUILD Purple Martin houses. Twelve plans 50c. J. A. Walsh, Barrington, Ill.

MAKE It Yourself. Hundreds of practical and useful devices described in our big book. Plain instructions and illustrations show you how to make them. Save money on things for yourself or make profit selling to others. 900 articles of great variety. 480 pages. 825 illustrations. \$3 postpaid. Popular Mechanics Press, Room C35, 200 E. Ontario St., Chicago.

THINGS YOU CAN BUILD

LAWNMOWER Shops—Save 1/2 the time required to sharpen and repair lawnmowers by using our lawnmower stand. Holds any lawnmower rigidly and firmly. Sharpen the bed knife and make all repairs without removal. Any mechanic can build it. Blue prints and instructions only \$1.00 postpaid. Tax included. Engle and Wirt, West Burlington, Iowa.

BOY Mechanic—Famous library of 4 volumes covers the building of almost everything a boy might want to make. A great boon to parents and teachers. Actually covers 4,000 different articles. Each volume 460 pages, fully illustrated. Cloth. Price \$2.00 each or set of 4 vols.—\$7.00 postpaid. Popular Mechanics Press, Room C35, 200 E. Ontario St., Chicago.

WATCHES, JEWELRY, PRECIOUS STONES

JEWELRY—Learn how to make and repair. Write for information. John Mack, 55 E. Washington St., Chicago.

RING Offer—Dazzling, brilliant. \$150 diamond replica; 15c with ad. Gem Co., 221 W. Fourth, Los Angeles, California.

WALTHAM—Elgin pocket watches. Seven jewel, rebuilt, unconditionally guaranteed—\$5 postpaid. Kane's Jewelry, Whitehall Street, New York.

OLD GOLD WANTED

\$5 PER Ounce for gold teeth, watches, jewelry. 100% full cash value mailed day shipment received. Satisfaction guaranteed or articles cheerfully returned. Licensed by United States government. Information free. Chicago Gold Smelting & Refining Co., 300-P Champlain Bldg., Chicago.

FOR THE HOME

FINEST Michigan peppermint. Sample bottle 10c. Mint Co., Baroda, Mich.

TOBACCO

SUBAC—The wonder smoking tobacco, blending Virginia grown Gold Leaf, Burley and Turkish tobaccos, 3 lbs. \$1.10 postpaid. Belmont Farms, Box 44, Chatham, Va.

POSTPAID: Guaranteed very finest 28 inch, sweet, juicy redleaf chewing, 10 lbs. \$2.00. Extra smoking \$1.50. Ernest Jolley, Dresden, Tennessee.

BETTER Quality! Lighter, milder, golden yellow smoking or rich ripe chewing. Two pounds, postpaid, 50c. Riverside Ranch, 201, Hazel, Ky.

RAZOR BLADES—SHARPENING

GILLETTE Razor and 50 blades, 98 cents. Gross Printo, Sibley, Illinois.

TATTOOING

AMATEUR Tattooing outfits, free list. Removing facts and formulas 15c. Chicago Tattoo Supply House, 651A South State, Chicago.

TATTOOING Outfits, supplies, 1935 illustrated list. "Waters," 965 Put-nam, Detroit.

SURVEYING INSTRUMENTS

GUARANTEED Factory rebuilt instruments for rent (with purchase option) or sale (cash or terms). Largest selection in United States. Ten day free trial. Liberal allowance for old instruments. Save money by buying now. Write for new list M-96. Warren-Knight Co., 136 North 12th St., Philadelphia, Pa. Surveying Inst. Mfgs. and Headquarters for Repairs to any make instruments.

FOR SALE OR EXCHANGE

1,000 **SWAPS** in Trader's Bulletin. Sample copy, 10c. 190 N. Wells, Chicago.

WANTED—MISCELLANEOUS

CASH For used microscopes, slide rules, drawing sets, scientific, engineering, dental and medical instruments, portable typewriters. Highest prices paid day shipment received. Satisfaction guaranteed or shipment cheerfully returned. Elman's, 23023 Van Buren, Chicago.

1,000 **PEOPLE** With cameras. Stamp brings information. Gannon-Service, Muskegon, Michigan.

WANTED: Suitable articles to sell by mail. Mirtle McCormick, Streator, Ill.

\$5,000 **EACH** Will be paid for certain old books (as late as 1927), magazines, letters, newspapers; a single school book, travel book, story book or poetry book, etc., in your home may bring \$10, \$50, \$100 or more in cash; send 10c for big list of books wanted. Act now. American Book Mart, Dept. 113, 140 S. Dearborn, Chicago, Ill.

I PAY Big cash for all your photos, snapshots, drawings. I buy thousands. Send dime for big lists wanted. Robert Wells, Box 108, Madison Square Station, New York City.

PERSONAL

THE Psychoscope "tells fortunes," "receives messages," "answers questions." No study, skill, practice. Illustrated circular free. Psychoscope Company, Box 1164, Portland, Oregon.

BUNIONS Actually reduced without pain booklet free. Eugene Eaton, D-106, Bandon, Oregon.

INDIAN And Lincoln head pennies wanted. Will pay up to \$2 each if over ten years old. Certain pennies worth \$53. Latest listing 10c. American Coin Co., Box 219, Grand Rapids, Mich.

MISCELLANEOUS

ELECTRIC Or gasoline portable lamp kills insects automatically, indoor or outside. \$1.75 up. Literature free. Sauer Bros., East Oakland, California.

WATERPROOF Cement for attaching fabrics to auto trunks, trailers, boats, gun cases, piazza roofs, use Ferdico Canvas Cement—it's waterproof. L. W. Ferdinand & Co., 599 Albany St., Boston, Mass.

ATTENTION, Refrigeration service men. Service sheets available on opening and servicing Majestic hermetically sealed unit. Price \$2.00. Interstate Machine Works, 111 So. 11 St., Boise, Idaho.

TECHNICAL Glassblowing. Write for particulars. Glastube Products, P. O. Box 446, Sta. C. Los Angeles, California.

DOORBELL Nameplates make beautiful gifts! Silver engraved, any name 50c. Gilbert Means, San Bernardino, Calif.

CUTS—Make them yourself. Simple, inexpensive etching process. Information free. Hughes Products, 64 Miami, Terrace Park, Ohio.

LOCATE Gold, silver, oil. Twenty scientific ways. Book, two radio finder plans, \$3.00 mineral rod, all for \$3.00. Cloughart, Grayling, Michigan.

RADIOACTIVE Treasure finder plans, fifteen foot depth range, \$1.50. Three foot range \$1.00. Information stamp. John Segee, Dover, N. H.

ROMANTIC, Practical, simple! International language Esperanto. Widely used. Instructions, 10c (coin). Webber, Laurain Apartments, Bismarek, North Dakota.

CASH Paid for butterflies, insects. See Sinclair Display Advertisement on page 14A.

ACREAGE Very easily calculated. Particulars for postage. Carmean, Anthony, Kansas.

YOUR Family coat-of-arms 11x14" oil painted \$12.50. Descriptive color sketch 5½x7", \$1.00. Selden, Heraldic Artist, 1500 Laburnum Ave., Richmond, Va.

FOR Census and war records your ancestors. A. Bell, 2002-F St., N. W., Washington, D. C.

SCIENTIFIC Electric machines for locating buried metals. Tommy White, Greenville, Miss.

MOULD Marbiene art goods, novelties, toys. Rubber moulds furnished; or make "Rubberlastic" Moulds yourself! Particulars free. Marbleizing Service, Edwardsville, Illinois.

NEWEST Hobby sensational bookmatch covers. Free premiums and magazine. International Bookmatch Club, 516 Fifth Avenue, New York.

BEAUTIFULLY Painted "Farm Set." 33 metal pieces. Fences, trees, bushes, hens, chickens, cow, horse, goose, ducks, rabbit, girl, man. \$1.00 postpaid. Geo. Calhoun, 602 Bennington, East Boston, Mass.

PAINT—Enamel, red, green, some black. Sherwin-Williams products. From big combine factory. General purpose for implement, industrial, house, barns. While it lasts \$1.15 gallon, 5-gallon container \$5.00. Worth and costs lot more. Dealers, jobbers can get big discounts. Other colors and brands; white, ivory, cream, gray, 85c gallon, 5-gallon container \$4.00. Don't overlook this big money saving. Wire or write Paint Exchange, 1413L Grand, Kansas City, Mo.

BALSA Wood—Usable strips, sheets, blocks. Big bag 20c postpaid. Tropical Wood Importers, 8637 Tampa, Florida.

FENCING. World's finest sport sweeping country! Real fun for whole family, young and old, indoors and outdoors. Finest spring steel bladed foil (sword) equipped with rubber button on tip making it perfectly safe, only \$1.49 postpaid. Fencing instructions free. Masks, body shields also for sale. Brownscope, 234 Fifth Ave., New York.

16 **DUPLICATE** Contract bridge boards \$1.13. Duplicate Board Co., Syracuse, N. Y.

THROW Away your glasses. Rid yourself of their expense and annoyance. I did, after wearing them nine years. My easily applied Eyesight System for doing away with glasses costs little. Guaranteed. Satisfied customers in every state. Send no money—just ask for particulars. A. E. Jacobson, Box 80, Pasadena, California.

TREASURE Buried. Send for free literature, photographs. Fisher, Palmer Building, Hollywood.

CAN You use tools? Build your own perfected treasure finder. High efficiency assured. This one really works. Full details free. Famous booklet "Successful Prospecting" mailed for only thirty cents. Write. The Goldak Co., Western Pacific Bldg., Los Angeles, Calif.

TREASURE Seekers—Make your own gold finders. Wyss, 104½ Frances, St. Joseph, Missouri.

CASH Income daily resilvering mirrors; replating metalware; making glass signs. Portable outfit. Sprinkle, Plater, 288, Marion, Ind.

HERR Fire alarms, operate, electric, doorbell; 75c each. Collinsville, Ill.

BRONZE Tablets, desk plates, wall plates, memorials, grave markers. Bronze, brass and aluminum casting. Wandkey Pattern & Foundry Co., Anderson, Ind.

CUTS Anybody can make. Zinc etching process. Specimens, particulars, testimonials, for stamp. J. C. Day, Windfall, Ind.

GARDENING. Flower growing, lawn making, landscaping, house repairing, etc. Send for free list of books on. Popular Mechanics Press, Room C35, 200 E. Ontario St., Chicago.

AUTO-MECHANICS & WELDERS

Auto Mechanics and Welders are in big demand. Complete courses in arc and acetylene welding. Pay while you learn. Enroll now at special low rates. Write today. **MICHIGAN TRADE SCHOOL** 3758 Woodward Ave., Detroit, Mich.

Write for **FREE CIRCULAR**

BE AN ARTIST

WE CAN TEACH YOU DRAWING in your own home during your spare time. Thirty-five years of successful teaching proves our ability. Artists receive large salaries.

Write today for Art Year Book **SCHOOL OF APPLIED ART** Dept. 105A, 10E, Huron St., Chicago, Ill.



Let us recommend the best books to study on any subject. **Popular Mechanics Press, Chicago, Illinois.**

GOV'T. JOBS

SALARY TO START \$105 to \$175 MONTHLY MEN WOMEN Age Range 18 to 50

- | | |
|--|---|
| <input type="checkbox"/> Ry. Mail Clerk | <input type="checkbox"/> POSTMASTER |
| <input type="checkbox"/> P. O. Laborer | <input type="checkbox"/> Seamstress |
| <input type="checkbox"/> R. F. D. Carrier | <input type="checkbox"/> Auditor |
| <input type="checkbox"/> Special Agent | <input type="checkbox"/> Stenographer |
| <input type="checkbox"/> Customs Inspector | <input type="checkbox"/> U.S. Border Patrol |
| <input type="checkbox"/> City Mail Carrier | <input type="checkbox"/> Telephone Opr. |
| <input type="checkbox"/> P. O. Clerk | <input type="checkbox"/> Watchman |
| <input type="checkbox"/> Matron | <input type="checkbox"/> Meat Inspector |
| <input type="checkbox"/> Innig's Inspector | <input type="checkbox"/> Statistical Clerk |
| <input type="checkbox"/> Typist | <input type="checkbox"/> File Clerk |

GOVERNMENT INSTRUCTION BUREAU, Dept. 111, St. Louis, Mo. Send me **FREE** particulars "How to Qualify for Government Positions" marked "X". Salaries, locations, opportunities, etc. **ALL SENT FREE.**

Name.....
Address.....

The MACHINISTS' Home-Study Course helps men get ahead

A man can go just so far in machine shop work with only his every-day experience to aid him. The men who get ahead are those who equip themselves with knowledge—who prepare to take advantage of the breaks. Many have done so with these practical books; you can too.

AMERICAN MACHINISTS' LIBRARY

6 volumes—2000 pages—2,500 illustrations

(A combined home-study course and reference library)

This library of machine shop practice was written for practical men. It gives you the best methods for every kind of machine shop work. It explains machine tools and their operation, tool work, gears and grinding, jigs and fixtures, automatic screw machines, their tools, punches, dies, etc. Plainly written—completely illustrated—the best kind of help to the machine-shop man who wants to advance himself.

Free
T
R
I
A
L



No money down—
only 7c
a day

FREE EXAMINATION COUPON

McGraw-Hill Book Co., Inc., 330 W. 42nd St., NEW YORK

Send me for 10 days' free examination the AMERICAN MACHINISTS' LIBRARY. If satisfactory I will send \$1.00 in 10 days and \$2 monthly until the special price of \$17.50 is paid. If not wanted, I will return the books postpaid.

Name.....
Address.....
City and State.....
Position.....
Company..... P. M. 6-35

60 ART LESSONS

Become Talented Artist with Big Income

This thorough course by Alexander Murray, famous Art School instructor, makes it easy to learn art in spare time. No bother or expense of corresponding. Teaches commercial art, cartooning, lettering, anatomy, perspective, adv. layout, etc. You get all 60 lessons at once—no waiting for next lesson. Over \$15 instruction illustrations. 125 pages of drawing paper FREE. Complete Course Only \$1.95 postpaid—or pay postman plus postage. MONEY BACK if not delighted after inspecting. Start Now turning your spare time into MONEY!

Only
\$1.95
POST
PAID
COURSE
COMPLETE

EDUCATIONAL SUPPLY CO., Dept. 101-F, Racine, Wis.

AMATEUR CHEMISTS—SCIENTISTS!

Every issue of Home Laboratory Journal has loads of experiments, spicy scientific news, queries department, facts on chemical sciences, laboratory suggestions, formulas, humor, etc. Adds pleasure to working chemical experiments. Send for special six months' subscription at 25c for limited time only and receive your first copy by return mail.

THE CHICAGO PRESS, Dept. 303, 158 Carroll Ave., Chicago

Big Chance for ELECTRICAL ENGINEERS

NOW

Here's great news for anybody interested in Electricity. BRAND NEW edition of Applied Electricity brought right down to date with every NEW Electrical subject fully covered. 10 big volumes and all shipped FREE for examination.

Big Field—Big Demand—Big Pay

Men who understand electricity are urgently needed right now in thousands of industries. Autos, airplanes, machine shops—practically every industry depends on electricity and men who know this subject make big money. Pleasant, fascinating work, easy to learn and do; learn quickly with these books. Send coupon for a set for FREE examination and see for yourself.

10 Big Books Shipped FREE FOR EXAMINATION

American Technical Society, Drexel at 58th St., Dept. EA-19, Chicago

Send for 10 days' free use, BRAND NEW 10 volume set of Electrical Engineering. In return for mailing this coupon promptly send free certificate of membership in the American Technical Society entitling me to full consulting privilege for one year. I will pay the few cents delivery charges on the books. If I wish I may return them in 10 days and owe you nothing, but if I keep them I will send \$2.00 after 10 days, then \$3.00 a month until the special price of only \$29.50 is paid

Name.....
Address.....
City..... State.....
Attach letter stating age, occupation and name and address of employer and at least one business man as reference.



FUN!

Learn Taxidermy. It's Fun, and You Can Make Good Money in Your Spare Time, Too.

Learn to mount and preserve all kinds of birds, animals, and fish. Tan skins and make them into rugs and robes. Take COMMON SPECIMENS like rabbits, squirrels, frogs, etc., and make them into ash trays, mirrors, lamps, etc. They sell at sight. Malcolm Greany made \$25 while learning. Save your trunks and decorate your room. This great new hobby for men and boys will delight you.

FREE BOOK! Send AT ONCE—TODAY—for this beautiful new FREE BOOK which tells how you can learn Taxidermy at home. No cost. No obligation. Contains hundreds of fine game pictures. It's FREE! Write for yours TODAY. State your AGE.
N. W. School of Taxidermy, Dept. A 337, Omaha, Nebr.

RADIO PAYS!

You, too, can be in the big pay class. Trained Radio and Television men make big money in interesting work. For FREE details write First National Television, Power & Light Building, Kansas City, Missouri. Dept. AA-6

Free DRAFTING TRIAL LESSON



Get ready now for new money-making opportunities in Drafting. Clean, well-paid work. Send post card for FREE TRIAL LESSON in Drafting. Shows how easy to learn at home by C.T.C. method. We furnish all tools. Write today. CHICAGO TECHNICAL COLLEGE 6206 Tech Bldg., 110 E. 26th St., Chicago, Ill.

COMPLETE ELECTRIC PLANTS



ONAN A. C. PLANTS furnish the same current as city service. Operate Radio, Water System, Refrigerator, all Appliances.

SIZES 350 WATTS UP

Have A. C. Current anywhere. Models \$110 and up. Easy to install. Available from stock. Ideal for farms, camps, lake homes, commercial purposes—anywhere electricity is needed.

D. W. ONAN & SONS
947 Royalston Ave., Minneapolis, Minn.

Men & Women Earn Cash at Home!



Grow fancy giant mushrooms in cellar, attic, barn. Easy, odorless method. We show you how, furnish guaranteed materials and buy crops. Valuable big book, pictures free if you write quickly. (Est. 1908.) UNITED CO. 3848 Lincoln Ave. Dept. P-6 CHICAGO

NEW YORK SCHOOL OF MECHANICAL DENTISTRY



Become a TRAINED Dental LAB Technician. We show you how! Oldest school. Practical training. Day, Eve. Easy terms. Tools FREE. Ask for Catalog P. N. Y. SCHOOL of MECHANICAL DENTISTRY, 125 W. 31 St., N. Y. C.

MAIL FOR FREE INFORMATION

BEDFORD YMCA TRADE SCHOOL

1115 Bedford Ave., Dept. PM-25
Brooklyn, New York City, N. Y.

Auto Mechanic Talking Pictures
 Aviation Mechanic Welding
 Aeronautical Engineering
 Refrigeration Machine Shop
 Oil Burner Commercial Art
 Air Conditioning Sign Painting
 Electrical Window Display
 Radio and Television Mechanic
 Architectural-Mechanical Drafting
 Armature Winding

Name.....
Address.....

Just Out
FREE BOOK
for **INVENTORS**

48 PAGES
ON PATENTS
AND HOW TO MARKET
INVENTIONS
Over 100 Illustrations

Tells How to Patent an Invention

Describes method of obtaining Patent—advantages of being first in applying for a patent—how patent protects you—what it covers—part it plays in marketing invention—danger of delay in applying for patent. **Many facts on Patents are revealed for the first time in this book.**

How to Market an Invention

This section describes different fields of invention—how to go about marketing your invention, type of inventions best suited to today's needs, how to place your invention before the public after securing patent. Practically everything brought out here is the result of recent analysis of market conditions.

How to Commercialize Your Invention

How to arrange for partnership—organizing your own company—securing finances—arranging for royalties—types of contracts . . . information you should have right now if you wish to obtain practical success for your invention.

How to Judge Marketability of Invention

After reading this book you can judge to some extent the worth of your idea. Is it an improvement—is it novel enough to warrant patent protection—is there a demand for it? A well known authority gives you his experienced judgment on these questions. You will learn from reliable sources many facts about patents that are vitally important to you **Right Now!**

Make These Tests

In this book you will be told how to apply tests to your invention. You will be shown what qualifications it must meet—both in respect to obtaining a patent and in obtaining a market for it afterwards. You will be told the merit U. S. Patent Examiners will require your invention to have—and the demands the commercial market will make upon it afterwards if success is to be obtained.

No Obligation—Mail Coupon Today

This 48-page book is doubly valuable and interesting because it is brand NEW! Every page is packed with latest information of interest to you as an inventor, and calculated to guide you in furtherance of the protection by patent of your invention. Get the very latest information—learn the things you don't know about getting a patent and commercializing your invention.

CLARENCE A. O'BRIEN

Registered Patent Attorney

707 Adams Bldg., Washington, D. C.

Mail coupon for this New Free Book and Record of Invention Blank TODAY!

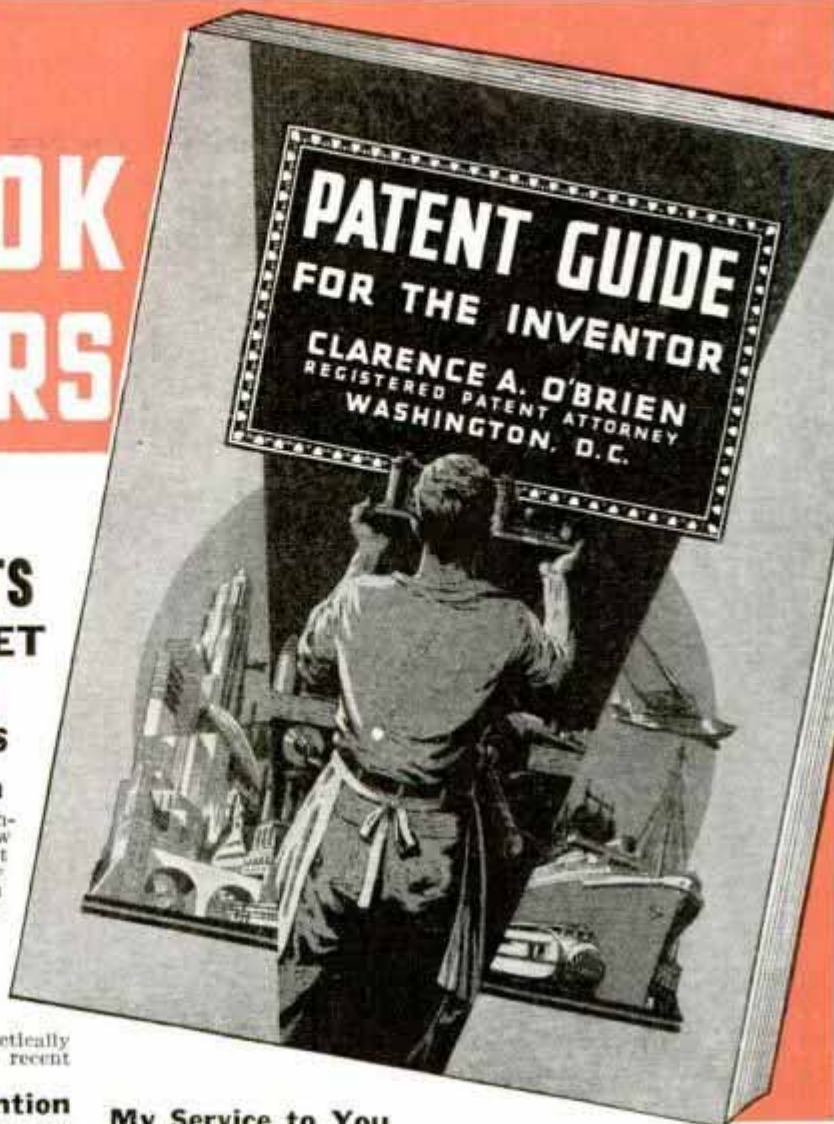

My Service to You

I have secured patents for inventors located in every State in the Union. My organization is a large and efficient one. My practice is confined entirely to Patents, Trade-Marks, and Copyrights. I have had years of experience in Patent Matters. When you place your idea in my hands, I am in position to proceed at once to secure protection for you. My fees are reasonable, and if you desire, I can arrange convenient terms of payment.

Free Record of Invention Blank

This FREE Record of Invention Blank enables you to make in convenient form a sketch of your idea and have it witnessed in a manner of value to you should the occasion for evidence arise.



CLARENCE A. O'BRIEN
REGISTERED PATENT ATTORNEY
707 ADAMS BUILDING
WASHINGTON, D. C.

Please send me your FREE BOOK, "Patent Guide for the Inventor," and your "Record of Invention" form, without any cost or obligation on my part.

NAME.....

ADDRESS.....

(Important: Write or print name plainly)

Write for **FREEBOOK**

PATENTS

Booklet Free Highest References
Promptness Assured Best Results

Send drawing or model.

ALL BUSINESS GIVEN PROMPT AND PROPER ATTENTION

Listed Patent Lawyer in the latest editions of the Rand-McNally Directory of Bankers and Bank-Recommended Attorneys, published by Rand-McNally & Co., Chicago, Ill.; The Baggott & Ryall Directory of Guaranteed Attorneys, published by Legal Directory Corporation, Boston, Mass.; Flugel's Law List, published by Legal Directory Publishing Co., St. Louis, Mo.; American Lawyers Annual, Cleveland, Ohio; Bankers Service Legal Directory, Bankers Service Co., Boston, Mass.; Eyre's Law List, 9 Park Place, New York City, and the Central Guarantee Co., Bankers and Lawyers Directories, Empire State Bldg., New York City.

WATSON E. COLEMAN,
REGISTERED PATENT LAWYER

Victor Building, 724 Ninth Street, N. W.
WASHINGTON, D. C.

INVENTORS PATENT YOUR IDEAS

SEND FOR FREE BOOK →

HOW TO OBTAIN A PATENT, written by a Former Member of the Examining Corps (1922-24) of the U. S. Patent Office. If you want to profit by your idea, you should take steps to apply for a U. S. Patent at once. Your first step is to get this Free Book. This interesting illustrated book contains valuable information you should have. It tells you fully how to obtain a patent on your idea in the quickest way. With this Free Book you will also receive a "Record of Invention" form on which you can easily record your idea. Personal and Confidential Service: Your case will be personally handled only by a Registered Patent Attorney who is also a Former Member of the Examining Corps of the U. S. Patent Office. All communications confidential.

MAIL COUPON TODAY for FREE PATENT BOOK and RECORD OF INVENTION Form.

CARL MILLER

REGISTERED PATENT ATTORNEY
FORMER MEMBER EXAMINING CORPS U. S. PATENT OFFICE

1638 Woolworth Bldg., Dept. 65A, New York City
MILLER BUILDING, Dept. 65A, WASHINGTON, D. C.

Please send me your Free Book, "How to Obtain a Patent," and your "Record of Invention" form.

NAME.....

ADDRESS.....

don't WORRY

Why put up with years of needless discomfort and worry? Try a Brooks Automatic Air Cushion. This marvelous appliance permits the opening to close, yet holds rupture securely, comfortably—day and night.



ABOUT RUPTURE

Thousands report amazing results. Light, neat-fitting. No hard pads, metal girdle or parts to chafe or gouge. Patented in U. S. and 13 foreign countries. Try one 10 DAYS WITHOUT A PENNY'S RISK. You'll be delighted. Free book on Rupture and convincing facts mailed postpaid in plain sealed envelope. Address **BROOKS COMPANY, 111 State St., Marshall, Mich.**

PATENTS—TRADE MARKS

All inventions submitted held confidential and given personal attention by members of the firm. Form, "Evidence of Conception" and instructions, "How to Establish Your Rights"—FREE!

LANCASTER, ALLWINE & ROMMEL
Patent Law Offices

412 Bowen Bldg. Washington, D. C.

PATENTS As one of the oldest patent firms in America we give inventors at lowest consistent charge, a service noted for results, evidenced by many well known Patents of extraordinary value. Book, Patent-Sense, free. **LACEY & LACEY, 635 F St., N. W., Dept. 5, Washington, D. C.** Established 1869.

No JOKE TO BE DEAF

—Every deaf person knows that—Mr. Way made himself hear his watch tick after being deaf for twenty-five years, with his Artificial Ear Drums. He wore them day and night. They stopped his head noises. They are invisible and comfortable, no wires or batteries. Write for TRUE STORY. Also booklet on Deafness.



THE WAY COMPANY
729 Hofmann Bldg. Detroit, Michigan

Try This On Your Hair 15 Days



Let Your Mirror Prove Results. Your hair need not thin out, nor need you become bald. This Different Method stops thinning out of hair, lifeless hair, itching, dandruff, threatened or increasing baldness by strengthening, prolonging the life of hair for men and women. Send your name now before it's too late for free 15-day test offer. **JUEL DENN, 207 N. Michigan Ave., Dept. A-49, Chicago, Ill.**



BUCHSTEIN'S FIBRE LIMB

is soothing to your stump—strong, cool, neat, light. Easy payments. Braces for all deformities. Agents wanted. **D. BUCHSTEIN CO.** 610 3rd Ave., So., MINNEAPOLIS, MINN.

Send for Catalog Today

Electroplating with Gold & Silver

and other plating information in Shop Notes for 1933. Illustrated. 50 cents, postpaid. **Popular Mechanics Press, 200 E. Ontario Street, Chicago**

Let us recommend the best books to study on any subject. **Popular Mechanics Press, Chicago, Illinois**

To PROTECT YOUR INVENTION Use this coupon, NOW

Delays are dangerous and may be very costly. My personal service assures prompt action, strict confidence, and a minimum of expense. I suggest that you send me a model or drawing, or sketch and description of your invention, and \$5.00. I will make a search and report

promptly as to its patentability and send you a copy of my 72-page booklet. Or, if you prefer to read my booklet first, mail the attached coupon at once. I will also send my "Record of Invention" form. (Over 37 years experience as a Registered Patent Attorney.)

L. F. Randolph, 302-D Victor Bldg., Washington, D.C.

Please send me at once, free of charge, your 72-page booklet and "Record of Invention" form.

Name.....

Address.....

A PERSONAL CONFIDENTIAL PATENT SERVICE

LET THESE GREAT BOOKS
HELP YOU TO
Start Your Climb!
"the Man
who KNOWS
is the Man who WINS"
Easy to train yourself! These
books have helped thousands—

- AIR CONDITIONING**
Live Field; Great Future.....\$3.50
- AUTO ENCYCLOPEDIA**
Dyke's 16th Edition, Recent!.....\$6.00
- 110-V. GENERATORS**
Made From Old Auto Units.....\$1.00
- BIRD HOUSES**
Build to Sell; Easy Designs.....\$1.00
- BOAT BOOK**
Power, Sail, Rowing, Paddle Plans.....\$3.00
- BOY MECHANIC**
4000 Things to Make, 4 Vols.....\$7.00
- BUILT-IN FURNITURE**
Take Orders, Make Money!.....\$2.50
- CARPENTRY HANDBOOK**
336 Practical Short-Cuts.....\$1.50
- CONCRETE WORK**
173 Uses Described, Pictured.....\$1.00
- DIESEL HANDBOOK**
New! Latest Information.....\$5.00
- DOG TRAINING**
Home, Stage, Movies, Etc.....\$1.50
- ELECTROPLATING**
Modern Practice Including Nickel, Zinc, Cadmium and Chromium.....\$2.25
- FARMERS' BOOK**
861 Kinks for Field, Home.....\$1.00
- V-8 FORDS**
Also "A" and "B" Models, All New!.....\$2.50
- FORMULAS**
10,000 Money Making.....\$4.00
- FROG INDUSTRY**
New! Raise and Sell Profits!.....\$2.00
- FURNITURE MAKING**
Tools, Materials, Designs.....\$2.50
- GARDEN GUIDE**
Every phase. New edition. 576 pages.....\$2.50
- LATHE WORK (Metal)**
Drilling, Threading.....\$1.00
- LOCOMOTIVE**
Folding Chart Shows all Parts.....\$1.00
- LOG CABINS**
Easy Plans; Build for Profit. Value!.....\$2.50
- MATHEMATICS**
Easy Guide for the Practical Man.....\$1.50

- MECHANICAL DRAWING**
Learn Drafting; Good Salaries.....\$1.00
- MONEY MAKING IDEAS**
1000 Spare Time.....\$1.00
- OCEAN LINER "EUROPA"**
Atlantic Speed Queen; Charted.....\$1.00
- PLUMBING**
500 Facts Every Homeowner Should Know.....\$1.50
- POULTRY**
Breeding, Management, Protect Your Profits!.....\$2.00
- PRECIOUS METALS**
Identify—Buy—Sell, Only book on.....\$1.00
- PROSPECTORS' HANDBOOK**
How to Mine, Appraise, Equip.....\$3.00
- RADIO**
Amateurs' Handbook; Circuits, Repairs, Etc.....\$1.00
- RADIO SERVICING**
Profit by Knowing Costs, Kinks, Etc!.....\$1.75
- REFRIGERATION**
Electric. Gas. Be a Service Expert.....\$4.00
- REWINDING ELECTRIC MOTORS**
Fractional Sizes. Value!.....\$2.50
- SHIP MODEL**
Entire Text, Famous "Sovereign" of 1637.....\$1.00
- SHOP NOTES LIBRARY**
6 Vol. 2500 Wonderful Shop Ideas.....\$3.00
- STAMP ALBUM**
Modern. 400 Pages.....\$1.00
- STEEL SQUARE**
How to Figure Angles of Rafters, Roofs, Etc.....\$1.00
- STORAGE BATTERIES**
New! How to Build, Repair, Charge.....\$2.50
- TOYS**
For Amusement or Profit. Saleable Designs.....\$1.50
- UPHOLSTERY**
Always a Big Market. Start Own Business.....\$1.60
- WELDING ENCYCLOPEDIA**
All Methods; Hard Jobs Made Easy.....\$5.00
- WIRING**
Approved Economy Methods for Homes, Buildings.....\$2.50
- WOOD TURNING**
Woods, Tools, Methods; Practical Teacher.....\$1.50
- WRIGHT ENGINE**
Chart of "Whirlwind"; All Parts.....\$1.00

THE WORLD IS MOVING!

These days it takes a sprinter to keep up

★ **CRASH**
... there goes a tradition.

★ **BANG**
... it's the end of a regime.

★ **BOOM**
... another fallacy passes.



You can't stand still today! Things are happening. *Old ways* are losing out. *New methods* are coming in.

And this applies to you—and your job!

What are you doing about it—just standing still?

Wake up, get in action! Equip yourself today—in spare time—for the sprint that leads to success—to security—to a better job—to more money!

The race is on. Many of your competitors (they may be close friends, too, but they're earnest competitors, don't forget) are in serious *training*—they're devoting every possible moment to the mastery of International Correspondence Schools Courses. This is real *training*—it's not for slow-pokes and quitters! Only men who mean business in a fast-moving world need apply. The coupon is *your* application blank.

INTERNATIONAL CORRESPONDENCE SCHOOLS

"The Universal University" Box 5579-H, Scranton, Penna.

Without cost or obligation, please send me a copy of your booklet, "Who Wins and Why," and full particulars about the subject before which I have marked X:

TECHNICAL AND INDUSTRIAL COURSES

- | | | |
|--|--|--|
| <input type="checkbox"/> Architect | <input type="checkbox"/> Plumbing | <input type="checkbox"/> Heating |
| <input type="checkbox"/> Architectural Draftsman | <input type="checkbox"/> Air Conditioning | <input type="checkbox"/> Steam Engineer |
| <input type="checkbox"/> Building Estimating | <input type="checkbox"/> Steam Electric Engineer | <input type="checkbox"/> Marine Engineer |
| <input type="checkbox"/> Contractor and Builder | <input type="checkbox"/> Civil Engineer | <input type="checkbox"/> Highway Engineer |
| <input type="checkbox"/> Structural Draftsman | <input type="checkbox"/> Bridge Engineer | <input type="checkbox"/> Bridge and Building Foreman |
| <input type="checkbox"/> Structural Engineer | <input type="checkbox"/> Surveying and Mapping | <input type="checkbox"/> Refrigeration |
| <input type="checkbox"/> Electrical Engineer | <input type="checkbox"/> R. R. Locomotives | <input type="checkbox"/> Air Brakes |
| <input type="checkbox"/> Electric Lighting | <input type="checkbox"/> R. R. Section Foreman | <input type="checkbox"/> R. R. Signalmen |
| <input type="checkbox"/> Welding, Electric and Gas | <input type="checkbox"/> Chemistry | <input type="checkbox"/> Pharmacy |
| <input type="checkbox"/> Reading Shop Blueprints | <input type="checkbox"/> Coal Mining | <input type="checkbox"/> Navigation |
| <input type="checkbox"/> Telegraph Engineer | <input type="checkbox"/> Textile Overseer or Supt. | <input type="checkbox"/> Cotton Manufacturing |
| <input type="checkbox"/> Telephone Work | <input type="checkbox"/> Woolen Manufacturing | <input type="checkbox"/> Agriculture |
| <input type="checkbox"/> Mechanical Engineer | <input type="checkbox"/> Fruit Growing | <input type="checkbox"/> Poultry Farming |
| <input type="checkbox"/> Mechanical Draftsman | | |
| <input type="checkbox"/> Machinist | | |
| <input type="checkbox"/> Patternmaker | | |
| <input type="checkbox"/> Boilermaker | | |
| <input type="checkbox"/> Sheet Metal Worker | | |
| <input type="checkbox"/> Heat Treatment of Metals | | |
| <input type="checkbox"/> How to Invent and Patent | | |
| <input type="checkbox"/> Gas Engines | | |
| <input type="checkbox"/> Diesel Engines | | |
| <input type="checkbox"/> Aviation Engines | | |
| <input type="checkbox"/> Automobile Mechanic | | |

BUSINESS TRAINING COURSES

- | | |
|---|--|
| <input type="checkbox"/> Business Management | <input type="checkbox"/> Business Correspondence |
| <input type="checkbox"/> Office Management | <input type="checkbox"/> Lettering Show Cards |
| <input type="checkbox"/> Industrial Management | <input type="checkbox"/> Signs |
| <input type="checkbox"/> Traffic Management | <input type="checkbox"/> Stenography and Typing |
| <input type="checkbox"/> Accountancy and C.P.A. | <input type="checkbox"/> Civil Service |
| <input type="checkbox"/> Coaching | <input type="checkbox"/> Mail Carrier |
| <input type="checkbox"/> Bookkeeping | <input type="checkbox"/> Railway Mail Clerk |
| <input type="checkbox"/> Secretarial Work | <input type="checkbox"/> Grade School Subjects |
| <input type="checkbox"/> Cost Accountant | <input type="checkbox"/> High School Subjects |
| <input type="checkbox"/> Salesmanship | <input type="checkbox"/> College Preparatory |
| <input type="checkbox"/> Advertising | <input type="checkbox"/> First Year College |
| <input type="checkbox"/> Service Station Salesmanship | <input type="checkbox"/> Illustrating |
| <input type="checkbox"/> Wallpaper Decorating | <input type="checkbox"/> Spanish |
| <input type="checkbox"/> Salesmanship | <input type="checkbox"/> Cartooning |
| | <input type="checkbox"/> French |
| | <input type="checkbox"/> Lumber Dealer |

Name.....Age.....

Address.....

City.....State.....

Present Position.....

If you reside in Canada, send this coupon to the International Correspondence Schools Canadian, Limited, Montreal, Canada

Books sent C.O.D. anywhere in U.S.

Just check the books you want, write your name and address below, and mail the advertisement. It is your order blank. When postman hands you books, pay him the price and few cents postage. If you send remittance when ordering, please include 10 cents per book extra for postage. Write for information about books on other subjects you are interested in.

Name.....

City.....State.....

Address.....

Mail to Popular Mechanics Press, Room JUN 5-200 East Ontario St., Chicago, Ill.

NEW KIND OF MOTOR OIL ENDS BIG CAUSE OF LOST POWER!

Finest 100% Pennsylvania Oil, Refined by New Process, Cuts Oil Consumption Up to 50% . . . Saves Up to 15% on Gasoline . . . Reduces Valve and Piston Ring Troubles 75 to 90%

THE introduction of New Pennzoil offers motorists a new kind of Pennsylvania oil that solves the last big problem of safe motor lubrication!

Until now all motor oils contained damaging elements impossible to remove by previous refining methods. These elements break down under engine heat and form sludge . . . that gummy substance that forms in *plain* oil after it has been run for a time. It collects on valve and piston rings, and wastes power, oil and gas. . . sends cars to the repair shop often.

Saves Money 3 Ways

But now comes New Pennzoil, refined by a revolutionary process that *removes* these sludge-forming elements . . . and *saves you money 3 important ways:*

First, with sludge-forming elements removed, New Pennzoil cuts valve and piston ring repairs 75 to 90%—there is no sludge to cause valves to stick or piston rings to leak. *Second*, with sludge eliminated, New Pennzoil's tough film is *tougher*—doesn't burn up under engine heat—cuts oil consumption up to 50%. *Third*, because valves and piston rings work freely, you get better compression, more power. Speed and pick-up are increased. You save up to 15% on gasoline!

New Pennzoil costs nothing extra—so get it today from any bonded Pennzoil dealer. Just ask for the correct grade of New Pennzoil for your car.



At left, note sludgy deposits on piston, valves and rings, due to impurities from *plain* oil. Compare with clean piston at right, lubricated with New Pennzoil. No sludge to cause valves to stick and piston rings to leak.



Faulty Lubrication ruins more cars than smash-ups

Look out where you say, "Change the oil and grease the car." Those few words cost car owners more money . . . ruin more cars . . . than smash-ups. At least 7 different lubricants are vital to different parts of your car—and Pennzoil dealers, who specialize in the Pennzoil "Safety System" of lubrication are skilled in how to apply them.



FOR COMPLETE "SAFETY SYSTEM" LUBRICATION, LOOK FOR THIS SIGN

Every dealer who displays it can give your car the 7 special lubricants it needs—and save you costly repair bills later on.

TOUGH-FILM
New **PENNZOIL**
THE OIL THAT GOES FARTHER... FASTER... SAFER



Member Penn Grade
Crude Oil Ass'n Permit No. 2

Popular Mechanics Magazine

REGISTERED IN U. S. PATENT OFFICE AND CANADA

WRITTEN SO YOU CAN UNDERSTAND IT

Vol. 63

JUNE, 1935

No. 6

TREES Tell the TRUTH



In the United States forest products laboratory at the University of Wisconsin, at Madison, government technologists solve crimes and perplexing legal tangles by analyzing tree-ring markings and making microscopic studies of the grains of countless woods.

These men, who view a tree not merely as wood to be used for commercial purposes, but as a complex structure of cellulose, lignin, starches, gums, sugar, tannin and coloring materials, repeatedly outdo the exploits of fictional sleuths by their accomplishments in the field of wood identification.

This was demonstrated at the trial of Bruno Richard Hauptmann, convicted of murdering the Lindbergh baby, when Arthur Koehler, expert of the laboratory, not only traced the Ponderosa pine in the kidnap ladder from South Carolina to the Bronx, but offered evidence to show that one of the uprights of the ladder was made of a plank taken from a floor in the attic of the defendant's home. Through Koehler's testimony, the public became

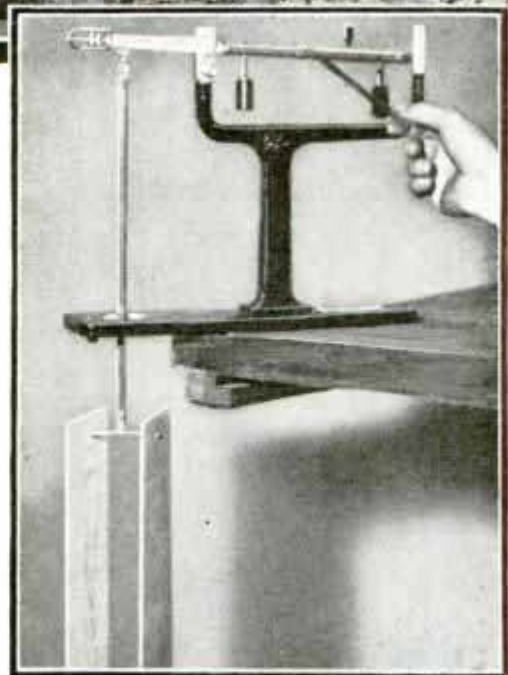

Forest Officer Making Cast of Incendiary Footprints in a California National Forest and, Below, Wood Moisture Balance Developed by the Forest Products Laboratory to Show Equilibrium Moisture Content of Wood in Lumber Storage Sheds

*Cont. James W. Booth Arlington
Hotel Washington D.C.*



the floor, but tucked away back of the workbench, the wood technologists found a single shaving. That shaving brought about the carpenter's conviction. Not only was it of white elm, but the microscope revealed that its cellular structure was identical with that of the box fragments.

In another case, shreds adhering to the tip of an auger saved an innocent man from conviction on a burglary charge. The wood experts proved that the shreds were not of the same kind of wood as a door which had been drilled by the burglar.

The tools of the sleuths in crime detection laboratories—the binocular microscope, calipers, powerful lights, wide-field magnifying glasses—are also the tools of the experts in wood identification. But they also have numerous devices of their

(Continued to page 120A)

acquainted with the crime detection value of wood identification. The field is not a new one, however.

There is the case of the Wisconsin bomb maker, intent upon killing a drainage commissioner, who reckoned without the wood technologists of the forest products laboratory. He left the bomb, packed in a white elm box, in his intended victim's mail box, and there the commissioner's wife found it. It was shortly before Christmas and, believing it was a present, she opened it. The bomb exploded, killing her.

The slayer, who was a carpenter, was suspected, but there appeared to be no proof. The bomb's container had been blown into splinters, and the police saw no clues in them. Not so the wood experts. They made careful microscopic studies of the cellular structure of the fragments of the box. Then they visited the suspect's workshop. It had been carefully swept out. The usual litter of shavings was gone from

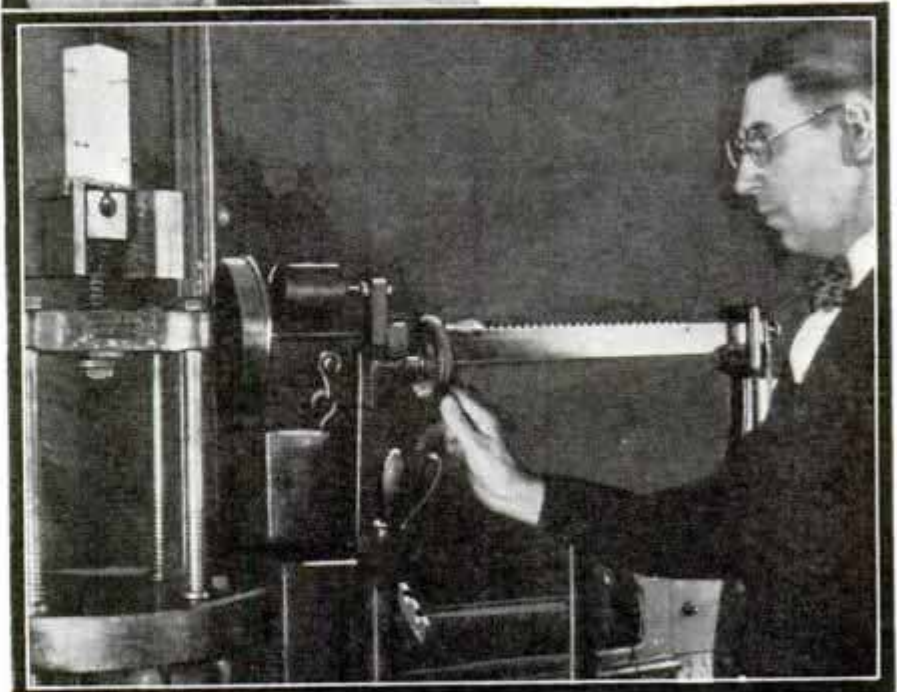

Top, Instrument for Measuring Tree Increment Cores; Center, Hanging Coated Wood Panels in Humidity Chamber to Test Moisture Resistance; Below, Testing Nail-Holding Capacity of Specimen

Arnold's Flagship Raised on Old Tar Drums

8326

How Sunken Hulk Was Raised by Pumping Air into Old Tar Barrels; Circle, the "Royal Savage" as It Appeared Before Being Captured and Burned

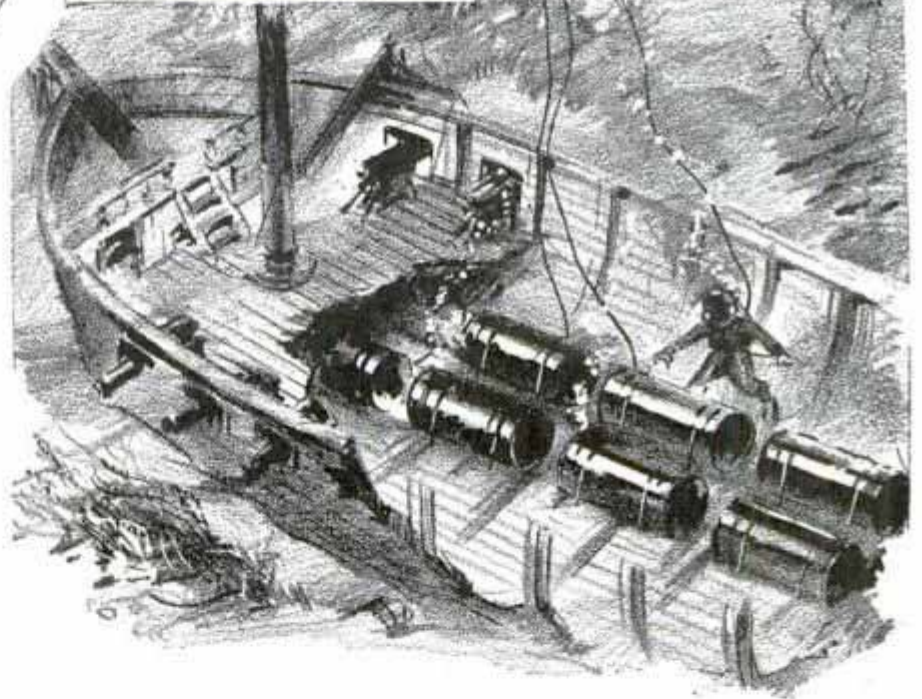
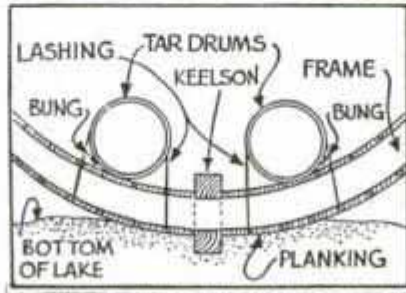
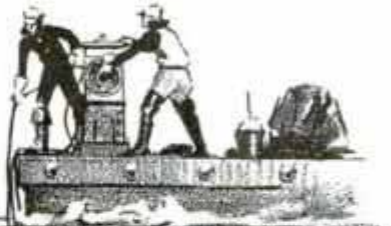

CAPTURED and burned to the water's edge by the British in the fall of 1776, the schooner "Royal Savage," Gen. Benedict Arnold's flagship, has been recovered from the bottom of Lake Champlain by simple salvage methods. Capt. L. F. Hagglund, a marine salvor, located the sunken wreck in 1932, then returned later to refloat the hulk. His only equipment was a diving dress, several lengths of air hose and a hand-operated compressor. Lacking surface salvage facilities, the captain towed to the scene twenty empty tar drums that had been discarded. One by one, the drums were filled with water and guided into place, one row on each side of the wreck. The next job was to fill the drums with air, but Capt. Hagglund's compressor would not supply enough air for his diving dress and the cylinders at the same time. So, he had to go underwater with spare hose, insert the lower end of the line in the open bunghole of a drum and return to the surface. Then the upper end of the hose was

connected to the air pump, replacing the diver's air line. Air was then forced into the tank until all water was displaced. When bubbles began to rise from the bunghole, which was turned downward to prevent losing the air, the diver again connected his air line to the pump, went to the lake bottom and plugged the bunghole. When all the drums were filled with air, the wreck floated to the surface and was towed to shore. The timbers of the craft, all numbered properly, have been taken apart, treated with a preservative and stored for assembly later when a suitable setting has been made available.

384. Merion, Pa.

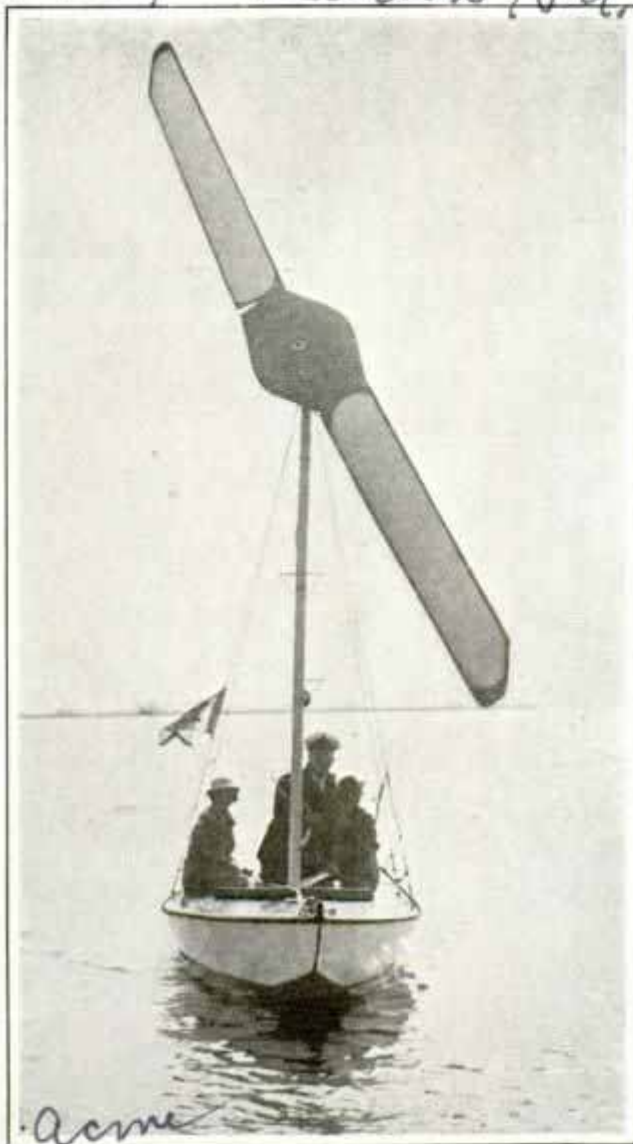

Small Craft with Propeller-Like Arrangement Attains Fair Speed without Motor

GYRO BLADES PROPEL BOAT INSTEAD OF SAILS

Rotating blades mounted on a revolving mast replace sails for propelling a boat invented by E. Burke Wilford. The blades pull the boat through the water, being moved to various positions to take advantage of the wind. The hull is a standard "star" racing craft. Made of duralumin frames with a covering of thin sheet duralumin, the blades give the boat a speed of about seven knots. No motor is used. Trial runs have been successful.

Popular Mechanics Magazine does not publish the name of the maker of, or dealer in, any device described in its pages, but this information will be furnished by our Bureau of Information upon request, accompanied by stamped envelope.

COLORED MOVIES EASY TO MAKE WITH AID OF NEW FILM

8404.

Any amateur photographer who can take sixteen-millimeter black and white pictures can now take colored moving pictures just as easily by using a special film developed for the purpose by the Eastman Kodak company. All practical processes of color photography depend upon the division of light into three components, red, green and blue-violet. Pictures are taken by these three components and then combined by some method to give color to the finished picture. By the latest method, known as the Kodachrome process, the separation of the light into the three components is a matter of depth. The film is coated five times. Nearest the base an emulsion is coated which is red-sensitive. This is over-coated with a gelatin layer containing some dye to act as a filter. Next comes a green-sensitive emulsion, then another layer of gelatin and finally there is a top coat which is blue-sensitive. When a picture is taken on such a film, the three components are automatically separated in the depth of the coating, the red component being formed in the emulsion nearest the base, the green in the middle layer and the blue component forming the image of the top layer. To obtain a color picture it is necessary to transform each component image of the negative into a positive image consisting of a suitably colored dye. This is accomplished by a complex processing system. The images in the three layers are first developed, as with ordinary film. By a series of treatments these images then are transformed to positives formed in the dye. Finally all the silver salts are removed and the image consists of three superimposed dye pictures.

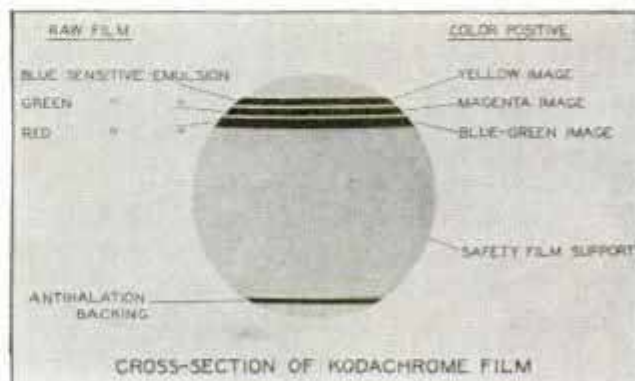

Cross-Section of Film for Making Colored Movies, Showing Layers of Color-Sensitive Emulsions

Eastman Kodak Co
Rochester N.Y.

6485
578
Grand Central Terminal
#80 Lexington
670 Fifth Ave
New York City

new
displayed at John Wanamaker
29th and Broadway York

The HOUSE that RUNS ITSELF

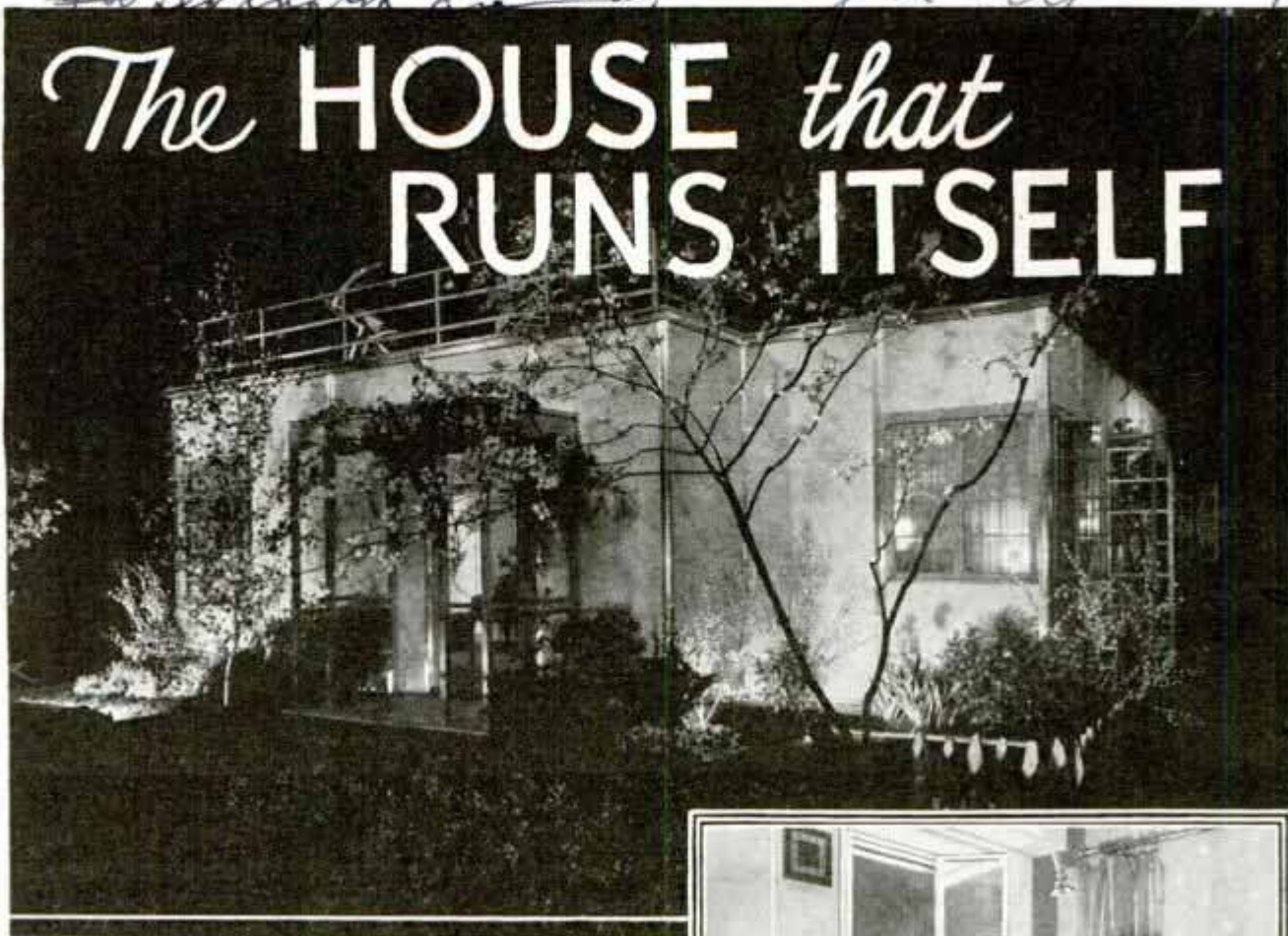

Acme *Motohome*
WITH a mechanical "heart" that runs everything necessary for comfortable living, the "packaged home" no longer is a dream. Right now, a limited number can be delivered to owners in a giant truck, unwrapped from their Cellophane covers, set up and anchored to foundations in about two weeks—real homes, solidly built and fireproofed.

Prices range from \$3,800 for a five-room bungalow to \$9,900 for a two-story house, with fifteen models available. Extra rooms can be added as needed, a feature that adapts the "motorized home" to the average American family.

The house is a marvel of mechanical and electrical arrangement. Its motor unit, the "thing that helps run the home," contains all the plumbing, heating, cooking, lighting and air-conditioning devices. All equipment for the kitchen is located on one side of the unit, with all bathroom fixtures on the other, including a patented wash basin large enough for the baby's bath.

Dreams of only yesterday are brought to full reality by the air-conditioning apparatus. All air breathed by the occupants of the house will be filtered, washed and



The "Motohome"; Bottom, View of Bathroom; Note Basin Shaped for Baby's Bath

heated or cooled before being circulated through a duct system extending to the various rooms. All the work is done by the motor unit without the dirt of furnace operation, the expense of extra cooling equipment and the trouble of attending to separate units. Gas, oil, coal or electric heat can be used in the small but highly

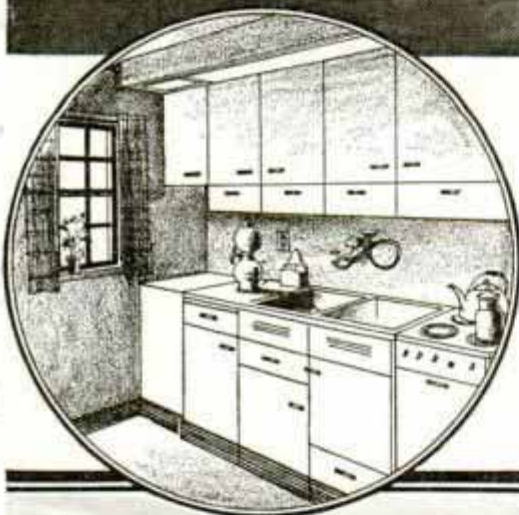

efficient heating plant, thus enabling the home owner to choose the fuel best suited to his needs and to the contents of his purse.

Imagine, if you can, the delight of the woman who steps into her "ready made" house and finds the kitchen already equipped with electric refrigerator, dishwasher, sink, electric or gas stove, built-in clock, abundant cupboard space—and even a two-day supply of groceries on the shelves. And

she never will be bothered by cooking odors because an electric exhaust quickly removes smoke, dust and fumes from the kitchen. In addition to the windows, indirect lighting gives plenty of illumination for her work in the compactly designed room.

In the bathroom, this same housewife will find bathtub complete with shower and anti-splash curtain, the large basin that also may serve as the baby's bathtub, triple adjustable mirrors for her husband's morning shave and an extra electric heater for warming up the room quickly. The conditioned air issues from grills set into the wall near the floor and a built-in clock tells the "man of the house" just how long he has before his train or street car comes



Top, Another Model of the Mechanical Home, with Two Stories, Sun Deck and Double-Car Garage; Center, Sketch of Conveniently Arranged Kitchen; Bottom, the Living Room of One of the Mechanical Homes

(Continued to page 148A)

Willow Grove
Small Gyroplane May Bring Flying for All

Undergoing tests by the U. S. Bureau of Air Commerce as a possible means of private flying for everybody, a small autogiro has folding rotor blades that permit taxiing like an automobile and storage in a backyard hangar. By controlling the pitch



clm
 Showing How Rotor Blades Can Be Folded for Taxiing Like Auto

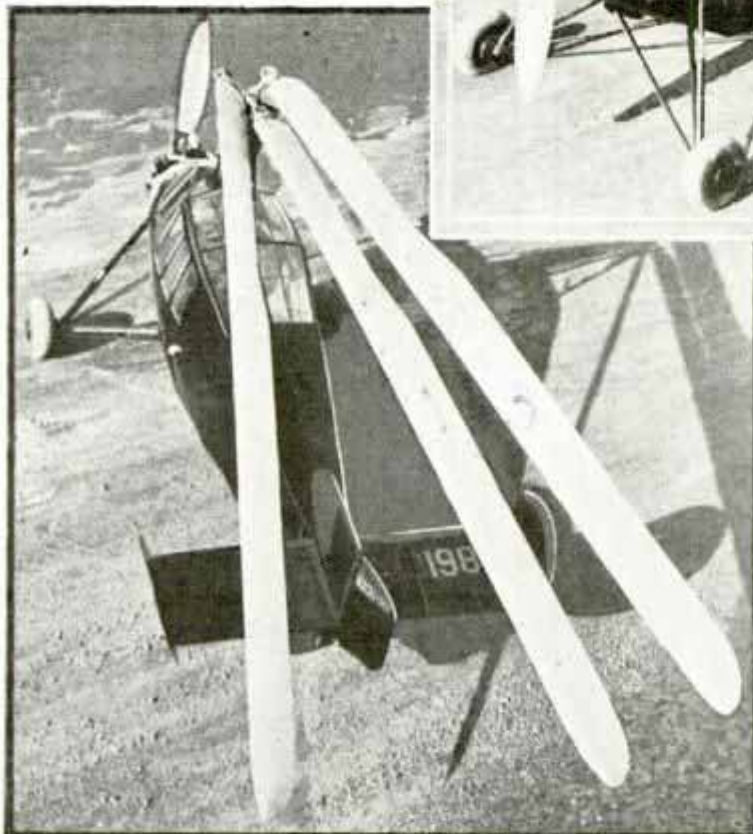

up the nose sharply. Patented hubs for the rotor blades adjust these forces automatically and make the actual flying comparatively simple. By controlling the rotor blade pitch within eight degrees, the plane can be made to "hug" the ground when high winds are blowing at takeoff. The gyroplane can be flown, landed and taken off like a normal airplane. There is space in the ship's enclosed cabin for the pilot and one passenger.

of the rotor blades, the operator can "jump" the craft into the air, then start its forward flight. The takeoff is simple. With wheel brakes locked, the rotor blades are spun rapidly at 400 revolutions per minute without positive pitch. Then, as the pitch is varied for normal lifting flight, the rotor speed falls to about 220 revolutions per minute and the plane rises vertically fifteen to twenty-five feet. During this operation, only twenty horsepower is being transferred to the tractor propeller. At about twenty feet in the air, the propeller gives the craft its full flying speed. In addition to the elevator controls on the tail, the tilting of the rotor to the left makes the nose go down by gyroscopic action, while tilting the rotor to the right brings

E 369
DROPPING HOSE STOPS WATER AND PREVENTS WASTE

Water consumption can be reduced sharply by an automatic hose valve that shuts off the flow when the hose is dropped. Picking up the hose starts water flowing again. The device fits any standard water-hose connection. It will save money at wash racks and other places where water is permitted to flow while attendants perform other duties.



Heintz Mfg. Co. Chicago
Chicago

6 225

Portages Easy If You Carry Canoe Properly



Steps in Preparing for a Portage: Top, Lashing Paddles to Center Thwarts; Second, Grasping Canoe by Center Thwarts, Preparatory to Lifting; Third, Canoe Half-Raised to Shoulders; Note Position of Hands in Relation to Paddles; the Carrier's Head Is Very Nearly in Place between the Paddles; Bottom, Set Properly on the Shoulders, with Hands Grasping Paddles, the Canoe Is Ready for a Journey to the Next Body of Water

How to carry a canoe over portages is information that every camper, fisherman and hunter should know, since it will save time and trouble on both short and long journeys from one stream or lake to another. If a person is unfamiliar with the fundamentals of portage practice, he loses much time and exhausts himself unnecessarily on overland trips. The procedure is simple. First, the paddles are lashed to the thwarts to aid in carrying the canoe and to keep them from being lost. Second, the canoe is grasped by the center thwarts. Third, the canoe is swung upward and over the head to be balanced properly for the trip across land. In the final position, the canoe can be carried for miles without undue fatigue.

E410

RED LIGHT WARNS PILOT IN "CONE OF SILENCE"

The "cone of silence," a dead space directly above the transmitting towers of a radio range beacon and the one indication to an airman following a radio beam and endeavoring to orient himself, that he is directly over the sending station, may now be identified in the pilot's cockpit by a red light on the instrument board as he passes through this zone. The department of commerce has announced that D. M. Stuart, radio engineer, has developed a method of identifying this important land mark to a pilot flying blind who needs to know the whereabouts of the radio beam transmitter before he can determine the location of the airport. A high-frequency transmitter projects a vertical beam in the cone of silence area. To receive this signal the plane requires only a small receiver which is tuned constantly to one frequency and will receive the special signal from any radio beacon so equipped.

Bureau of Air Commerce Washington

E 115

INSIDE STORY *of the* RODEOS

by **ANDREW JAUREGUI**
CHAMPION TEAM ROPER

THIS broncho, intent on getting rid of its rider, is doing what is known as a side-slip. The pony was successful and the man was unseated in a few seconds.



Chamber of Cal
R. Bone 665
Andrew Jauregui
Champion Team Roper

6-115



TAMING a wild horse in one sitting is quite a task as the man on the animal seems to be finding out for himself. Once the animal is mastered and gives up, the rider's troubles probably will be over. Below, view of the opening of a typical rodeo in California. Right, bulldogging a steer. In this contest, the cowboy straddles the head or left horn and twists the nose upward. A good man can throw an animal seven seconds after it has left the chute.





FOR thirteen years I have been doing "setting-up" exercises —attempting, more or less successfully, to remain in leather on a plunging broncho or Brahma steer or to rope and tie elusive, wriggling bundles of calf meat. I am a rodeo performer and, with other cowboys, move from rodeo to rodeo each season, risking sound bones and excellent health for the roar of the crowds and the reward of gold.

Everywhere we hear these three questions: Isn't it dangerous to ride wild horses? How do you stay in the saddle? What are the tricks of rodeo riding?

There is danger and, of course, there are tricks. Some have learned the fine points that enable them to ride to a championship in at least one division. Most of us specialize in one subject. Mine is roping. Some choose to ride bare-back on Brahma steers, others prefer bucking bronchos, minus bridle, or wild horses, without benefit of saddle or bridle. We take every precaution, but danger from the unforeseen stalks us always.

Although we use strong saddles with fourteen-inch swells directly in front of the legs to help us hang on during the plunging, these are of little help

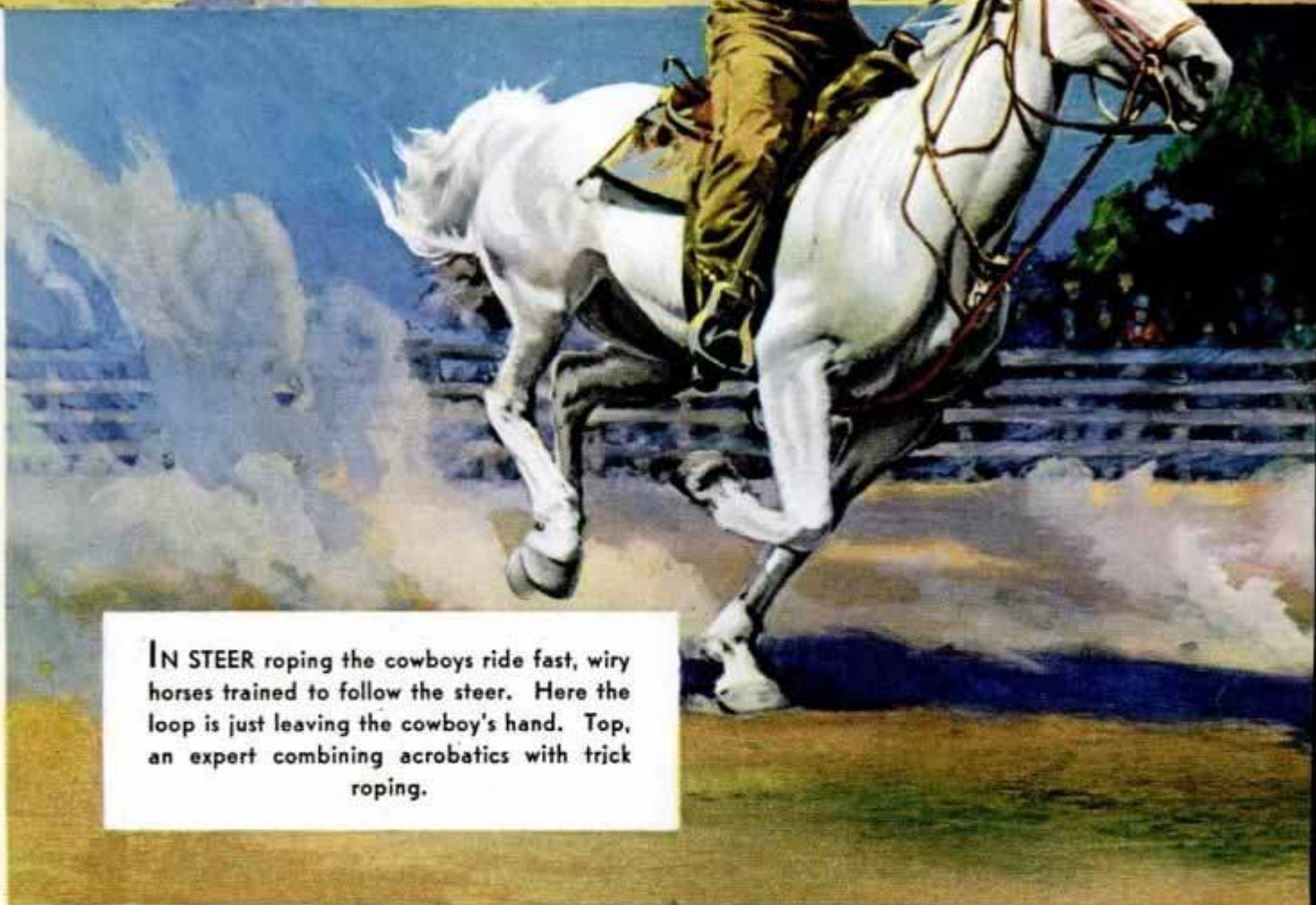
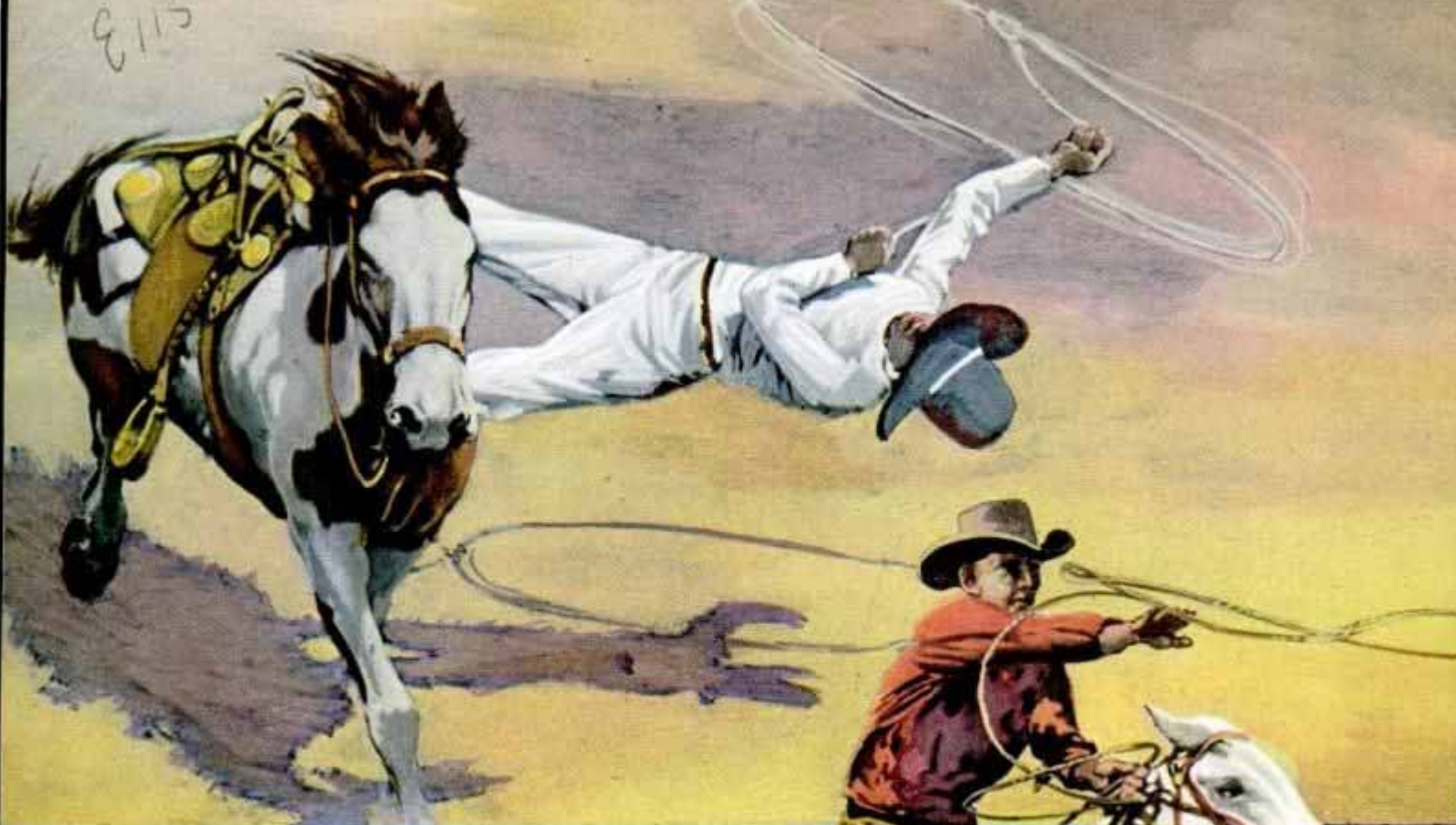

IN STEER roping the cowboys ride fast, wiry horses trained to follow the steer. Here the loop is just leaving the cowboy's hand. Top, an expert combining acrobatics with trick roping.

Top Photo Copyright R. R. Doubleday

under some circumstances, such as fighting a horse in the chute. When I ride this kind, I slip into the saddle quickly and draw the bucking rein, a heavy rope leading to one side of the halter, back short. This pulls the pony's chin in close

to his chest and keeps him from rearing up.

There's a very smart trick in riding these untamed animals—swaying with the horse while keeping balance by leaning back against the rope. Oddly, the

8115
THIS is a simple way to go through your "setting-up" exercises and have it all over in just a few seconds.



worst buckers are bronchos of several years' rodeo experience.

No matter how mean the horse or how tough the going, we must observe a few rules to the very letter. We must wave one hand in the air—to touch leather

with this one is to be disqualified. We must continue scratching with our spurs. Our only safety lies in keeping a steady and tight hand on the bucking rein, keeping our balance in the saddle if possible, or pulling ourselves back as we start to

8115



JO MORA, California artist and his \$5,000 statuette of silver, presented to the champion cowboy at Salinas each year. Right, steer riding is considered by some cowboys to be more dangerous than trying to stay aboard a bucking broncho. This rider is just about ready to leave his perch.



fly through space. For ten long seconds during what seem like a thousand bucks skyward and back again, we must stay aboard these heaving mountains, then slide out of the saddle as best we can. Some bronchos continue bucking after the final gun barks, while others heed the signals and calm down. Since we draw mounts by lot shortly before each event, unless we get a broncho we know by rep-

utation, we must be prepared for anything.

But riding a wild horse! There's excitement. Imagine straddling a bundle of mixed thunder and lightning bareback, with no bridle, and hanging onto a rope passed around its middle as it plunges, bucks, races, storms and kicks. Thanks to the Rodeo Association of America, the organization that rules



these events, we don't have to change our spurring position on the barebacks. So every rider who is wise sets his feet out ahead and scratches along the shoulders and doesn't change that position. Meantime, he must keep a hand free to wave his sombrero, he must not change hands on the loose rope and he must maintain a pleased expression for the benefit of the customers.

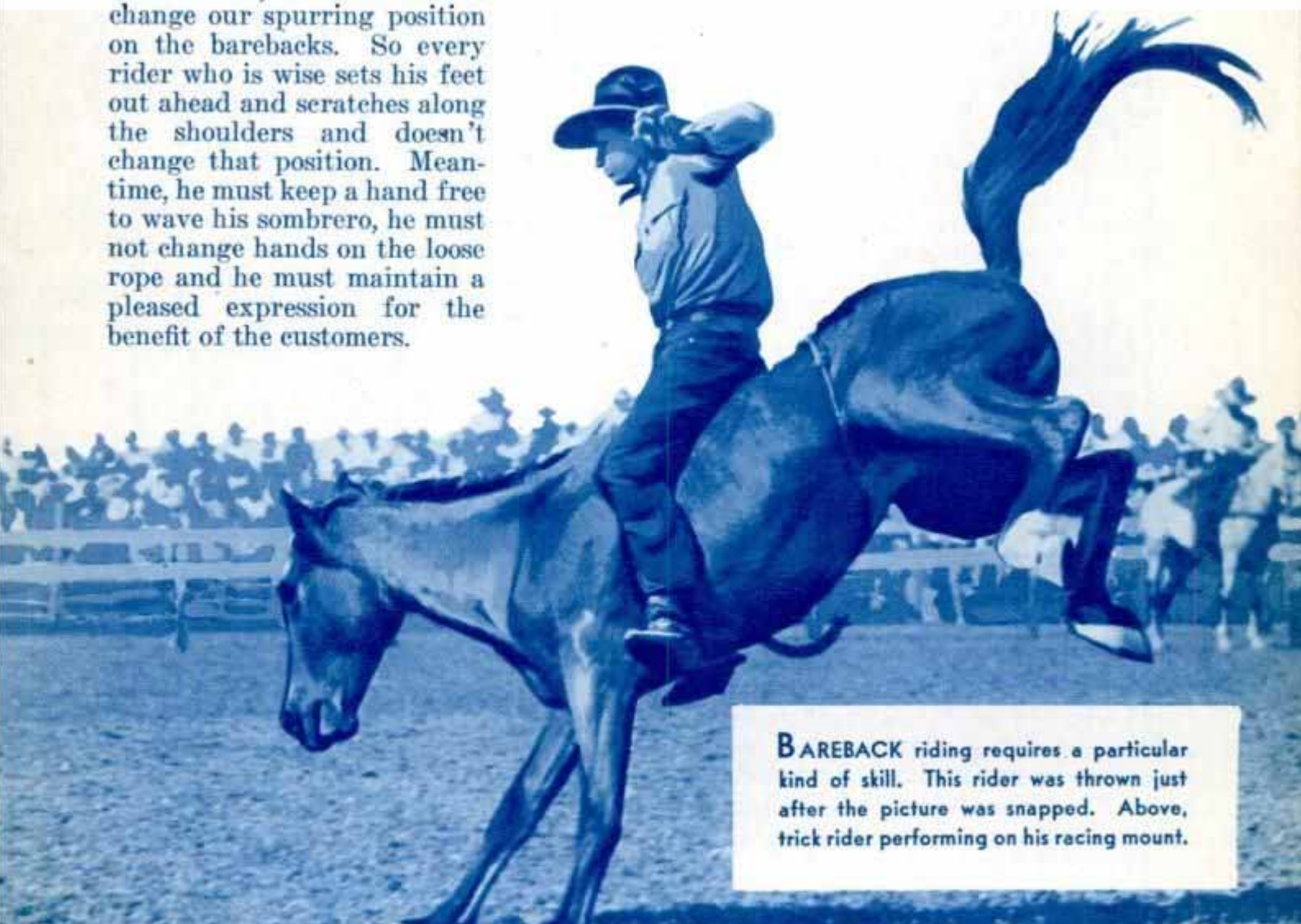

BAREBACK riding requires a particular kind of skill. This rider was thrown just after the picture was snapped. Above, trick rider performing on his racing mount.



8115
6115

HOLDING the bucking rein on a horse and riding a bucking steer. The rider must keep one hand aloft, for touching the animal disqualifies him.

Dangerous as are the wild bronchos, riding them is less hazardous than boarding, riding and departing from the rolling back of a cantankerous Brahma. They are a cross between India's sacred cow and the Texas Longhorn. Their

flesh rolls, their horns are sharp and they take keen delight in goring a rider once he is thrown. They give more action and are smarter in some respects than the bronchos. Although they look smaller, (Continued to page 126A)

£ 334

Wela Park, Cleveland Ohio

Model Homes Assembled Like Block Puzzle

An unusual method of planning houses has been evolved by T. W. Freh, who serves the General Electric company in an advisory capacity. Dividing the home into distinct units, each designed to serve certain needs of the family, Freh has prepared a set of plans which can be combined in various ways to produce houses for families of different sizes and habits. The plan is demonstrated by miniature units which can be put together like block puzzles. Among the combinations possible are a one-story house with three bedrooms, a two-story house with five bedrooms and a house with the garage opening at the side or at the front. Freh's plans include a living unit, containing kitchen, dining room, living room, main hallway and service room; several bedroom units for large or small families, and basements extending under all of the house or only part.



Model House Put Together in Units, with the Roof Being Lowered into Place; the Model Demonstrates a New Idea in Building Practice

not on market

And Walter E. Burton 1082 Florence Ave. Akron

Ice-Cream Bars Are Made Easily with Dipping Outfit

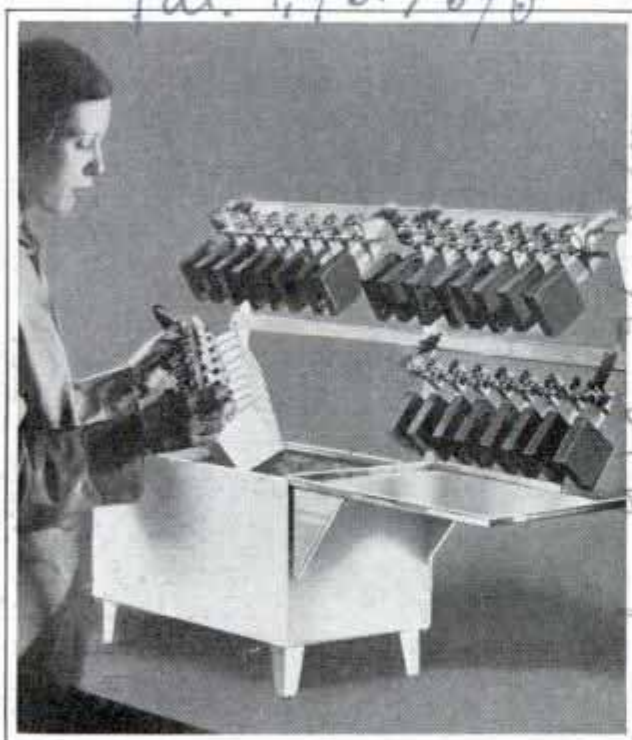

Preparing to Dip Ice Cream Bars in Chocolate

Less expensive than some other equipment on the market, a new ice-cream bar maker has several desirable features. One is a spreader that holds the bars, with the flat, wooden sticks inserted, in position for dipping in chocolate or similar coating mixture. After dipping, the bars are hung on a rack to dry, the spreader and dipping apparatus being arranged for this purpose. The dipping tank has a 110-volt heater for keeping the chocolate at the proper temperature. A cutting guide with a chilled base to prevent the ice cream from melting, assures that each bar will be the same size. Standard ice-cream bricks are used in the equipment. The small size outfit is designed to produce between forty-five and sixty dozen bars per hour, while the large size makes 125 to 150 dozen per hour.

More than fifty million radio receiving sets are in use throughout the world.

The Ellwood Co.

Dept. of Commerce June 13, 1935

It Takes Nerve to Wash Skyscraper Windows



Window Washers at Work Near the Top of a Lofty Skyscraper; Note Safety Belts Attached to Lugs in Sides of Windows

It takes more than a cake of soap, a bucket, one wet cloth and one dry one to make a window washer. It also takes nerve. Seven or eight floors is not so very far up when you are standing inside a window, but when you are standing outside it's a long way down. But, as far as results are concerned, an accident outside a third floor window is likely to be just as disastrous to the window cleaner as one outside a thirty-third floor window. So he takes the same precautions on the mezzanine floor that he takes when working near the tower at the top. He wears a stout safety belt which is attached to lugs embedded in the building itself, and the first rule of safety he learns is to be sure the belt is attached to the lugs before stepping out on a ledge. He also tests the lugs, but sometimes one which appears safe will snap off or pull out, leaving the window cleaner dangling by his safety belt and the remaining lug. Unless help is at hand, the man in such a predicament must know how

to pull himself to safety by grasping the sill and inching his way up the wall. After such an experience, the window washer usually takes the rest of the day off, but is back on the job again next morning ready to wash more windows.

Rail Cars for Camping

RAILWAY coaches fully equipped for camping are to be made available to the British public at a relatively small charge to increase passenger traffic. The sites for the "camping" coaches will be selected with regard to scenic and other advantages. The rental is about \$20 a week. The only additional charge is the minimum number of four "monthly return" tickets to the site where the coaches are located. The cars are old equipment, refitted for the purpose.

CRASHES OF "SLEEPY DRIVERS" CAUSED BY EXHAUST GAS

Many accidents resulting from drowsiness at the wheel are caused by carbon monoxide mixed with air breathed by the automobile driver. F. M. VanDeventer, of Cities Service company, has found that three parts of carbon monoxide, or exhaust gas, in 10,000 parts of air will cause thirty-per-cent blood saturation if the mixture is

Dept. of Commerce
Press memo 3/23/35

Cont. U.S. Wilcox 292 Maryland
Bldg. Washington D.C.

290.396
Talk before SA. E
New York

Southern Railway
Great Western Railway
60 Wall St. New York

breathed for an hour. Tests of closed cars after accidents reveal that in most cases, the proportion of carbon monoxide is far above the danger point, sometimes as much as forty parts in 10,000 of air. Fifteen parts in 10,000 of air, if breathed for an hour, will cause death. Drivers may lessen the danger by making certain that combustion is as near perfect as possible and by sealing car bodies against the gas.

E-67

FOLDING TENT ON TOP OF CAR HELPS AUTO CAMPERS

Motorists who take to the open road with a camping outfit will be interested in the arrangement for carrying such equipment devised by a California physician. He has made a stout frame which extends above the top of the car and which encloses a space large enough for a collapsible camping outfit. A canvas cover which also can be used as a tent protects the equipment when on the road.



Camping Outfit for the Motorist Which Includes a Folding Tent, Carried on Top of the Car, and Collapsible Chairs and Table

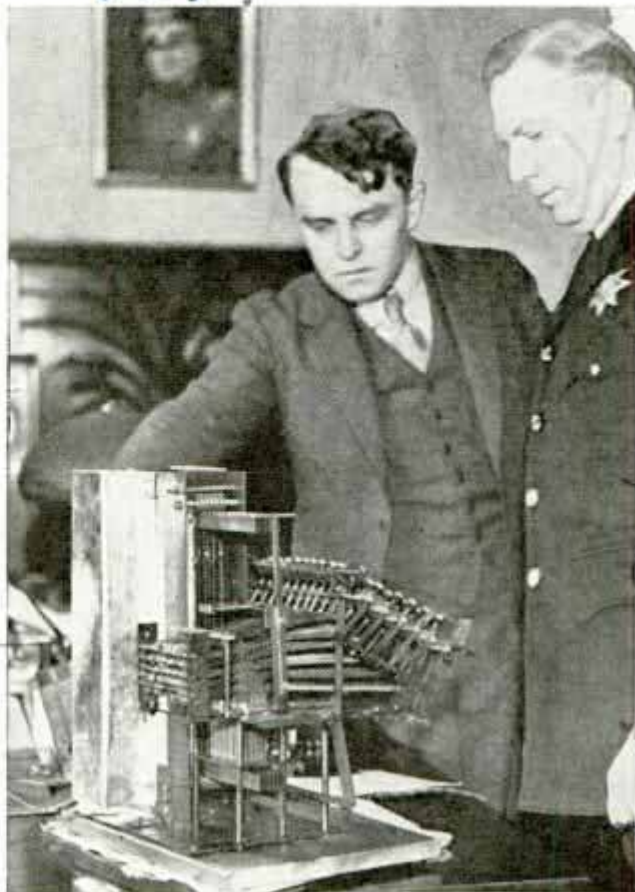

Demonstrating Machine That Signals When Number to Be "Remembered" Appears

"MEMORY MACHINE" KEEPS TAB ON NUMBERS FOR POLICE

Once "told" to remember, a new machine gives a "reply" in less than two seconds, helping police to keep tab on automobile license-plate numbers, serial figures on money and fingerprints. To use it, the operator punches out a pattern containing the number which is to be "remembered"

by the machine. Then, if the number is that appearing on the license plate of an automobile, an officer stationed at any location desired manipulates the eight rows of keys. The license number of each car passing is recorded. When the automobile for which the police are hunting appears, and its license number is registered, the machine rings a bell and flashes a lamp. In fingerprint work, the device compares suspects' fingerprints with every print on file.

Highstone, Oakland, Calif. 2066 High St. Harold

Wade Watts
Mr. E. H. Crane California Portable Auto
Blindwood Calif Camp C. 201 Central

8156

How to FEED

This Scottie and the Pointers Have a Good Start in Life; Whether They Will Grow into Healthy Dogs Will Depend to a Considerable Extent on Feeding

c/o Chicago Tribune Chicago



By **BOB BECKER**

THE problem of feeding a dog is one that troubles hundreds of thousands of families. It is great fun for the grown-ups and the children to go to a kennel, look at the little puppies that are so friendly and appealing, and finally make a selection. When it comes to feeding the furry little newcomer, however, mistaken kindness often ends in disaster for everybody.

A veterinarian who has specialized on dog nutrition states that the mistakes the average owner makes in feeding his pet are serious, because too many owners do not know how to provide the right food for a canine. Also the average owner is likely to overfeed and underexercise his pet. Then he wonders why his dog is not vigorous and healthy.



English Setter Pups Lined Up for the Dinner Gong; They Will Continue Healthy if Fed Correctly

Your DOG

Here are some common-sense tips on feeding your dog. They include the important suggestion that your dog must be trained to eat what is good for him, not just what he likes. One nationally known veterinarian has said:

"Your dog should be taught to eat what he needs, what is good for him. A dog is much like a child. Turn a youngster loose in a bakery shop and he will pick out the rich fancy foods and pastries in preference to wholesome, digestible food every time. A dog will do the same thing if you let him. No dog owner should ever allow his pet to dictate what it wants to eat. The pup should be trained to eat what is good for it."

First, let us consider the puppy's diet. Here, all too frequently, the



Above, the Dog, Like the Child, Should Be Fed What Is Good for It Rather Than What It Likes

puppy owner is cruel to his pet through ignorance. What foods are good for a puppy, eight or ten weeks old, that has just come from the kennel?

Here is an approved list of foods which will develop a healthy, normal pup because the list represents a balanced diet.

First comes meat. A dog must have meat. Don't let anybody tell you that raw or cooked meat makes a dog mean or savage. That's nothing short of ridiculous. In fact, it's a wonder dogs don't get savage because they are deprived of meat in so many homes! An eight or ten weeks old puppy should have raw or cooked beef,



scraped or chopped fine, cooked lamb or cooked mutton, cooked or raw liver and also raw meat bones on which to chew. Cooked meat as put up in the form of canned dog food is excellent, provided the canned food is a wholesome, nourishing meat food, and not just a cheap food consisting of "filler" and almost worthless ingredients.

So don't be afraid to give that puppy plenty of meat. The dog is by inheritance a carnivorous animal, and meat is an essential part of his diet. It is true that our house dogs of today are eating most of the foods that we eat and are therefore more nearly omnivorous than carnivorous. Nevertheless the dog likes meat and needs meat.

But meat isn't a complete food for a dog, so we supplement it with other foods in order to give the dog vitamins and minerals. Therefore we have cereals as food classification number two. Among the approved cereals for your puppy or grown dog is graham, bran or whole-wheat bread toasted. For the puppy the toast can be soaked in milk. A good dog biscuit has a

number of valuable food elements in it besides cereal. Shredded-wheat biscuit is excellent. Cooked cereals, like cream of wheat and oatmeal, are good if well cooked. Most wise dog owners feed some dog biscuits, called dry foods, to their pets, especially brands that have a fairly high meat content in them.

We now have the approved meats and good cereals for the puppy. We still have two classes of foods which must be considered for the pup. One of these is vegetables.

Vegetables should be considered as subsidiary or supplementary food in a dog's diet. I am not suggesting that you feed the dog like a live rabbit, by throwing him a head of cabbage. That isn't the idea at



You Can't Raise a Healthy, Happy and Active Beagle or Irish Wolfhound Unless You Feed It Properly

all. A dog needs vegetables in small portions, and mixed with his other foods. From vegetables he gets food elements that are just as essential to his health as they are to ours. Among the approved vegetables are cooked mashed onions, cooked mashed spinach, cooked mashed asparagus left over from the table, carrots cooked and mashed, cabbage and tomatoes or tomato juice. If fresh cooked vegetables are not always available it is possible to supply this food to the dog by giving him vege-

(Continued to page 124A)

Cross-Bred Lamb Has Both Hair and Wool

Covered with both hair and wool, a strange-looking animal has developed from the crossbreeding of a mountain sheep and a domestic ewe. The lamb has many characteristics of the mountain sheep, frequently jumping high fences or leaping to the roofs of low buildings on the Wyoming ranch of Charles Belden. It has horns about six inches long. Wool grows on part of the body and hair on the other.

Answer.

PICTURE HELD RIGID BY TACKS WITH DOUBLE POINTS

Pictures can be kept in perfect alinement on the walls by double-pointed tacks. One point is pressed into the lower left-hand corner of the back of the frame. Then, when the picture is hung, the other point is eased gently into the wall, preventing vibration from moving the frame. The tacks are made in a variety of sizes and shapes.

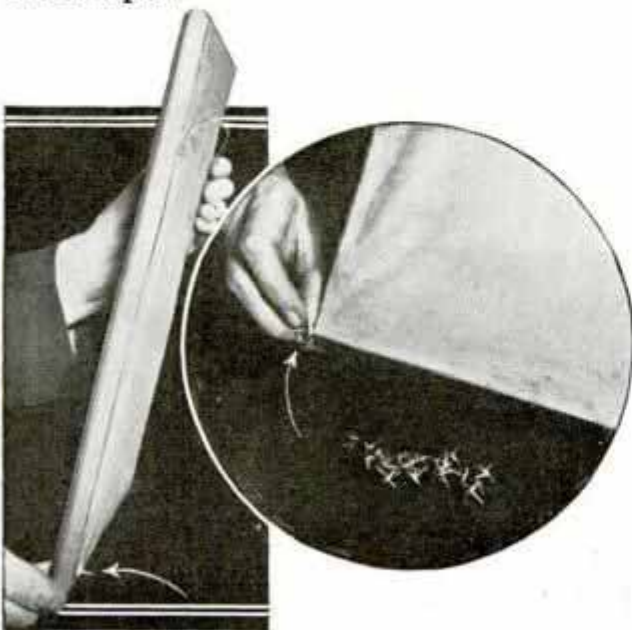

Two Views Demonstrating How Double-Pointed Tack Is Used to Keep Picture Straight

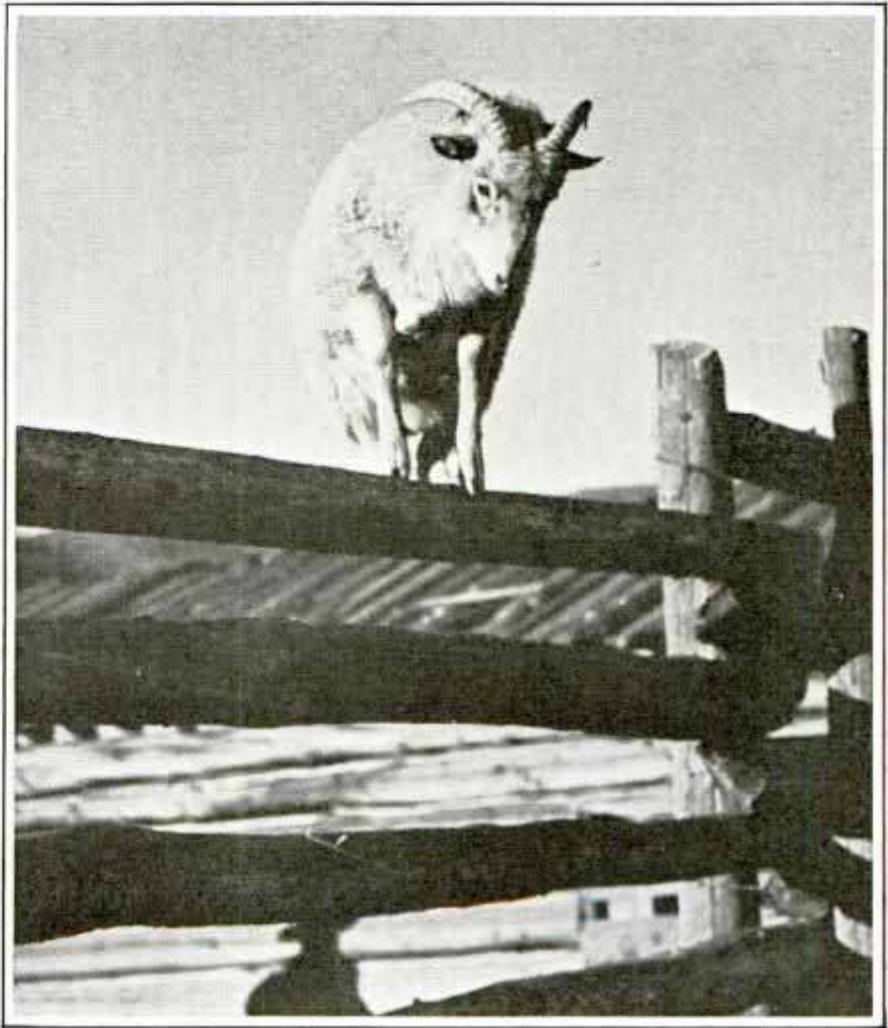

Hybrid Lamb with the Characteristics of a Mountain Sheep Is Shown Here Leaping over Fence; It Has Both Hair and Wool on Its Body

Test-Tube Fireflies

WHY the firefly flickers, long one of nature's secrets, has been revealed by the General Electric research laboratory. A chemical equivalent of a gigantic firefly's luminescence has been produced in tests, a cold light appearing blue-green and prolonged rather than intermittent. A mixture of Luminol and sodium hydroxide, to which water is added, is placed in the test tube. When a second mixture of potassium ferrocyanide and hydrogen peroxide is allowed to run into the tube, the luminous light appears. It costs the laboratory twenty-five dollars to produce a lumen-hour of "firefly light," due to the costly chemicals involved.

Scientific Development Schenectady, N.Y.

Cont. News. Sydca. A. Hooper
255 Loma Ave
Long Beach Calif
 Driver Chats on Radio with Family at Home



receiver promptly at 5:30 p.m. each day that dad is away on business.

When Mr. Wallace was about twelve years old, he became interested in radio as a hobby, but it later developed into business, and is now his life work. In the world war, he became a naval radio operator and at eighteen years of age, was chief operator on the U.S.S. "George Washington," which carried President Woodrow Wilson to the Peace Conference at Versailles. He arranged the first presidential broadcast in history, President Wilson's Fourth of July address aboard ship to other vessels of the American navy. One of the most widely known amateur radio operators in the world, Mr. Wallace has talked from his home, in Long Beach,

4214 Country Club Drive
 Two-way radio equipment in his home and his automobile enables Don C. Wallace, of Long Beach, Calif., to communicate with his family while he is on business trips. Near Santa Ana he may discover that he will be late for dinner. He presses a button on the floor of his car and this signal flashes through the ether: "W6AM, W6AM mobile, W6AM."

Quickly comes the voice of his son, Bill, in the Long Beach home: "Hello, dad, where are you now? Dinner is about ready. How soon will you be home?" Another kick on the button and "dad" replies: "I was delayed in Riverside, and am just east of Santa Ana now, making about forty-five miles an hour. I think I can reach home shortly after 6:00 p.m. How's everyone?"

"Okeh, dad, everyone's fine. We're waiting dinner for you, so step on it."

Bill is twelve years old, and is under contract with his father to be at the home



Top, Talking on Short-Wave Radio from Auto; Bottom, Son Receives His Father's Call on Radiophone Set in Home

with stations in more than one hundred countries. During Admiral Byrd's first Antarctic expedition, Mr. Wallace talked with the explorer regularly each week. Mrs. Wallace also has a government operator's license.

The government has allocated the five-meter wave length to amateur operators exclusively, but only licensed operators are permitted to install two-way equipment.

Small Camera for Squad Car Has Own Flash

Designed for police use in the war on crime, a small camera with flash-lamp equipment attached is handy for the squad car. Flash-light shield and bulb holder are fastened to the top of the camera. Four small batteries set off the bulb in synchronization with the shutter. The camera also can be used for taking pictures of suspects, since it can be concealed easily in the office of police commissioner or chief of detectives. A "remote control" disk, which sets off the flash light and opens the shutter simultaneously, can be hidden under a rug or near the operator's foot, making it possible to get the picture before the suspect can cover his face. With the camera concealed near a safe and the disk hidden under a rug, anyone stepping on the disk takes his own picture. Inexperienced burglars probably would be frightened away by the flash, but not until the camera had made its record for the police.



Preparing the Camera with Its Flash; Inset, Hiding the Disk That Would Make Burglar Take His Own Picture

£ 320

"Herringbone" Seating for Bus Gives More Visibility

Improved visibility for each passenger is one feature of the latest German-built motor coach with accommodations for twenty-three persons. The seats are set

in a herringbone arrangement instead of side by side and are placed low to bring the passenger's eye on a level with the lower half of the window.

At the rear of the bus are two full-length seats, running transversely and facing each other. All of the seats are attached directly to the frame, with a gangway or walkway sunk on each side. The body proper is simply a shell set around the seats and attached to the frame. Rated at seventy-five miles per hour, the vehicle has two tail fins designed to reduce air vibrations at high speed, thus increasing speed. Duralumin is used in the construction of the bus.

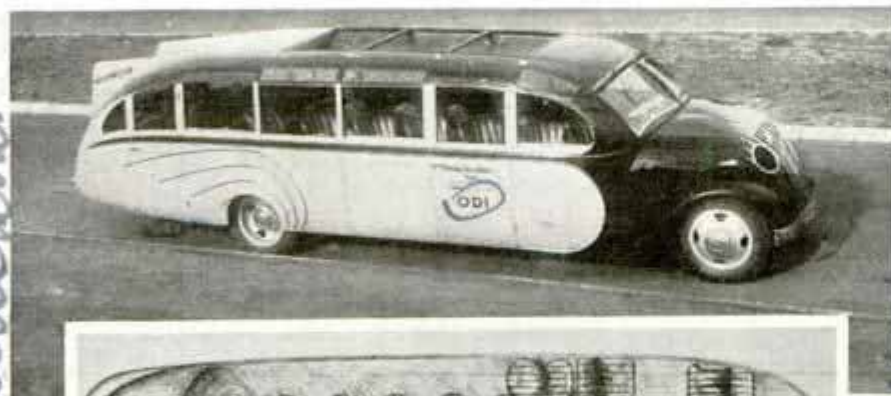

Latest Style Bus Attains High Speed; Note the "Herringbone" Seating That Is Used to Increase Visibility for All Passengers

Karosserie fabrik
199 2 17
Lsebt. Ludwig

Cont. Weich

no 7 2 17

Coen, Loeman

E284 Cont. New Massman
4 W. 103rd St.
New York

The QUEEN of



The Giant French Liner, "Normandie," as It Would Look if Placed Beside the Capitol in Washington; Its 1,029 Feet of Length Far Exceeds the 751 Feet of This Famous Building

THE 79,280-ton "Normandie," a ship that dares comparison, is about ready for the supreme test of a transatlantic crossing.

Described as the largest moving unit ever built by man, the vessel sets a standard difficult to equal. Her plan and decoration reach a high-water mark in maritime history. No such ultra-modern interiors have ever been seen on an ocean vessel. The outside strikes a complete harmony with the inside. Her low rakish hull rides gracefully on the water, while her clipper bow and streamline funnels give her all the earmarks of the greyhound.

All the usual comparisons seem vain. Her power plant alone would supply electricity for a city of 300,000.

Almost any view of the ship commands admiration. Her decks are unusually free and clear of ventilators, chains, and other gear. She can toss smashing waves off her "whaleback" bow. With immense power in reserve, the "Normandie" may establish a ninety-six-hour schedule across the Atlantic, leaving and arriving with the min-

ute hand of a watch. Winds, tides, shoals, gales, and heavy seas—nothing is likely to keep her from appointed schedules.

Next to her size, the most startling thing about the "Normandie" is her interior design and decoration. In addition to lighting and color harmony, the combination and fabrication of materials appear fresh and new to the eye. Rare and common woods from all parts of the world; soft and cunningly woven fabrics; works of art that give atmosphere and refinement to the surroundings; furniture that is not only comfortable, but pleasant to behold—everything leads one to believe that in this ship man displays the best proof of his attainments in the last century.

Here are the figures relating to the vessel: Gross tonnage, 79,280 tons; length, 1,029 feet; beam, 119 feet and six inches; draft, thirty-six feet and seven inches; height from keel to top of navigating bridge, 128 feet; crew of 1,339; propulsive machinery, turbo-electric, generating 160,000 horsepower; cruising speed, about thirty knots.

the SEVEN SEAS

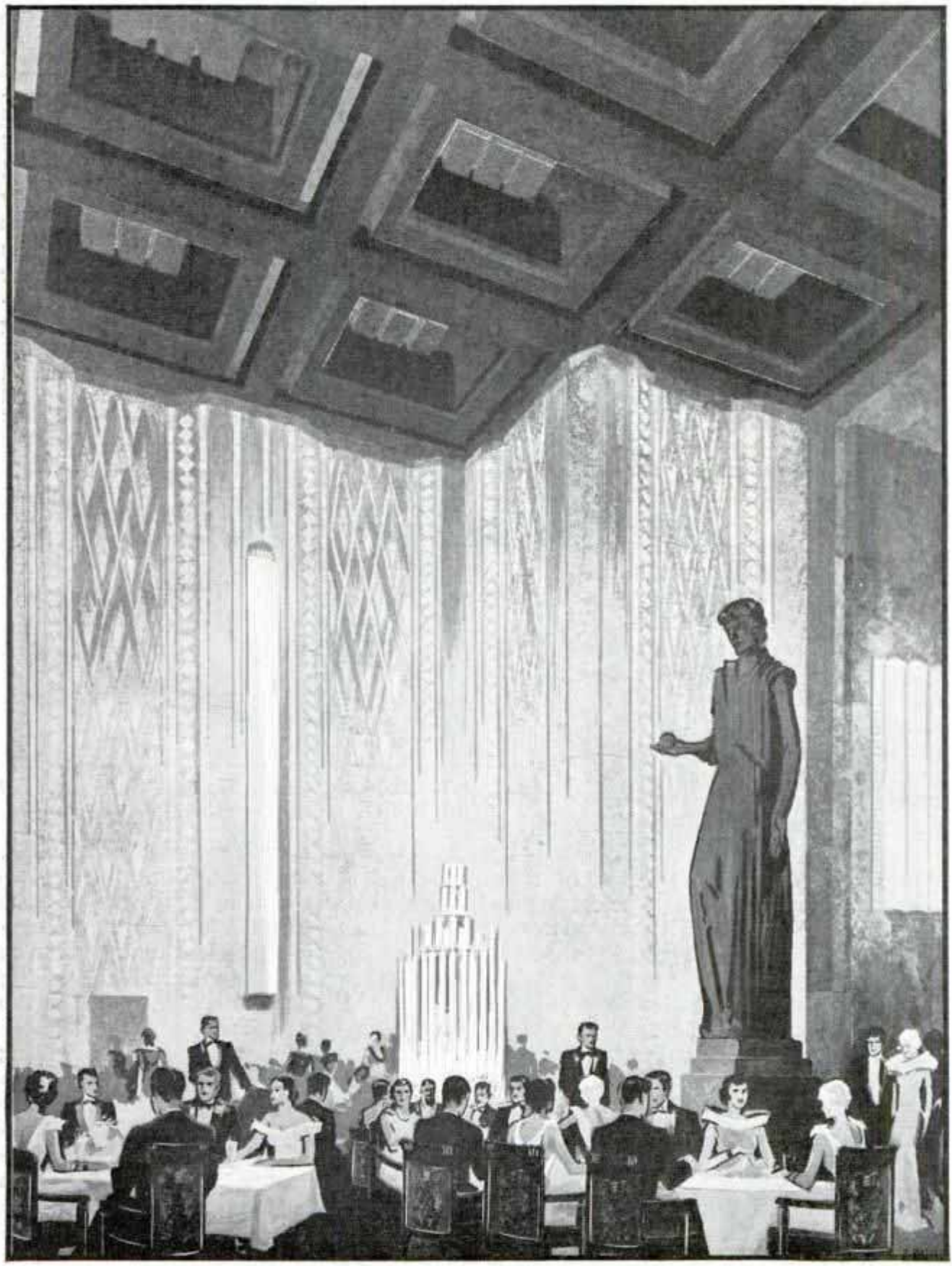

First Class Dining Salon Which Is 300 Feet Long and Three Decks High, Making It One of the Largest Dining Rooms in the World, Either Afloat or Ashore

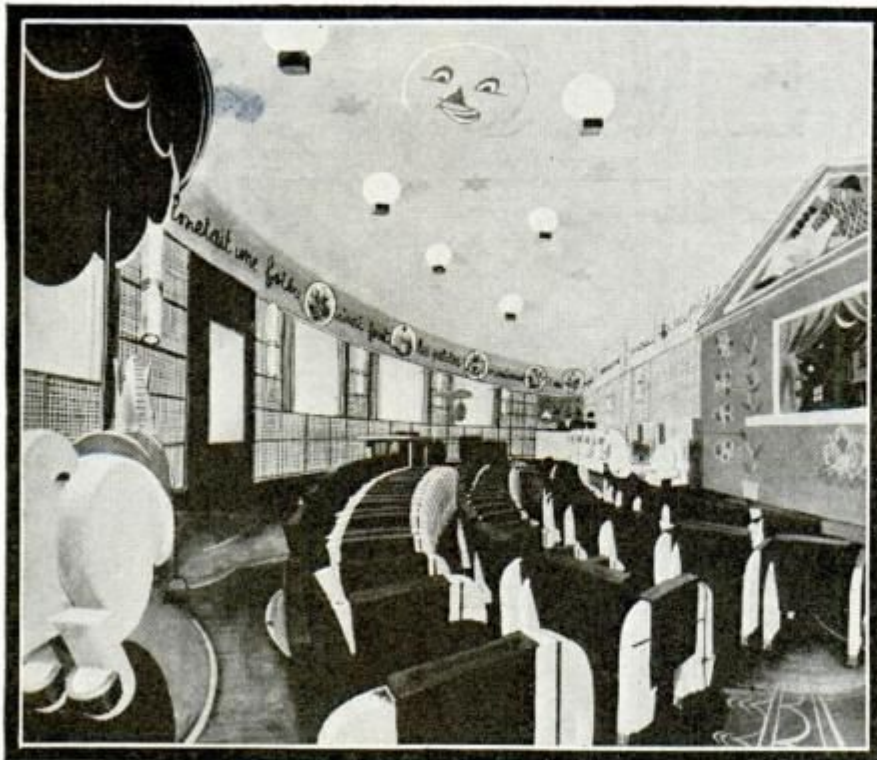

seventy-five feet in width. It is unobstructed by ship gear and offers sufficient room for almost any outdoor sport.

A winter garden in the first class is 112 feet long and thirty-nine feet wide. The grand foyer is ninety-five feet long and three stories high and from it, elevators will carry passengers to any one of the ship's eleven decks. The theater seats 350 and can be used either for sound movies or regular plays. The swimming

If you were "stranded" for life on this floating island, there is scarcely a thing you would miss, for this ship provides food, shelter, medical care, libraries, theaters, gymnasiums, swimming pools, newspapers, radio reception, barber shop, hairdresser, tailors, art galleries, and dozens of amusements. You could purchase a complete wardrobe in the "Normandie's" shopping center. And by mingling among the widely traveled passengers, you could learn the important languages of the world. It required the labor of thousands over a period of five years to make this ship possible. Passenger accommodations set new standards of luxury in travel. The "Normandie" boasts two suites, each with its own private deck thirty by eighteen feet, and twelve suites with private verandas. There are children's play rooms, card rooms, a shooting gallery, a massage salon, three hospitals, florist shop, photographic studio, therapeutic, electric vapor and steam baths, a garage for 100 autos, dog kennels, dog washing pool and a dog promenade.

The ship's third class is placed near the stern instead of within the narrow confines of the bow, and the sun deck is large enough to be used as an airplane landing field, measuring 300 feet in length and

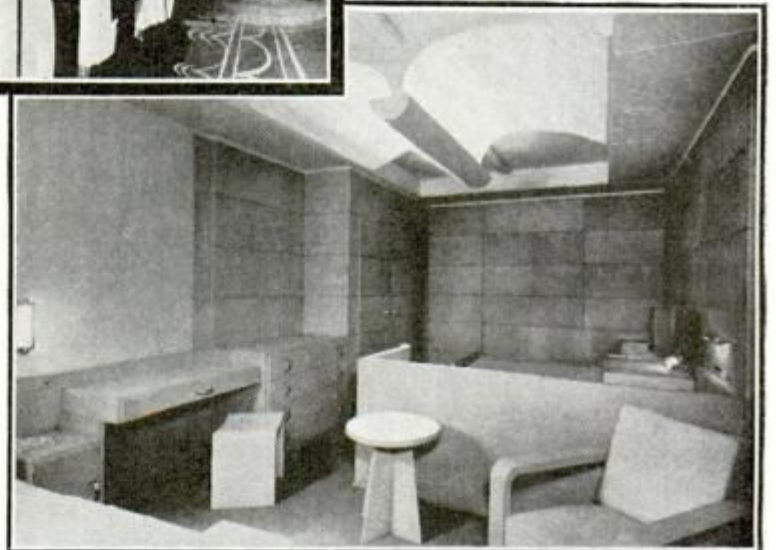

A View of the Children's Theater Aboard the "Normandie" and One of the Luxurious Passenger Staterooms

pool is 112 feet long and thirty feet wide, with a graduated depth. Diving and swimming contests can be held here without difficulty. In addition to eight private dining rooms, the first class dining salon is 300 feet long and three decks high, making it one of the largest dining rooms in the world, afloat or ashore.

With automatic alarms and fire-fighting equipment, the "Normandie" will carry a special squad of professional firemen. The security officer who commands the firemen, has nothing to do but maintain a constant vigil against fire. All walls and cabin partitions are rendered fire-resisting by a sheet of duralumin between layers of asbestos. Placed between the outside wall covering, this metal sheet and asbestos act

(Continued to page 140A)

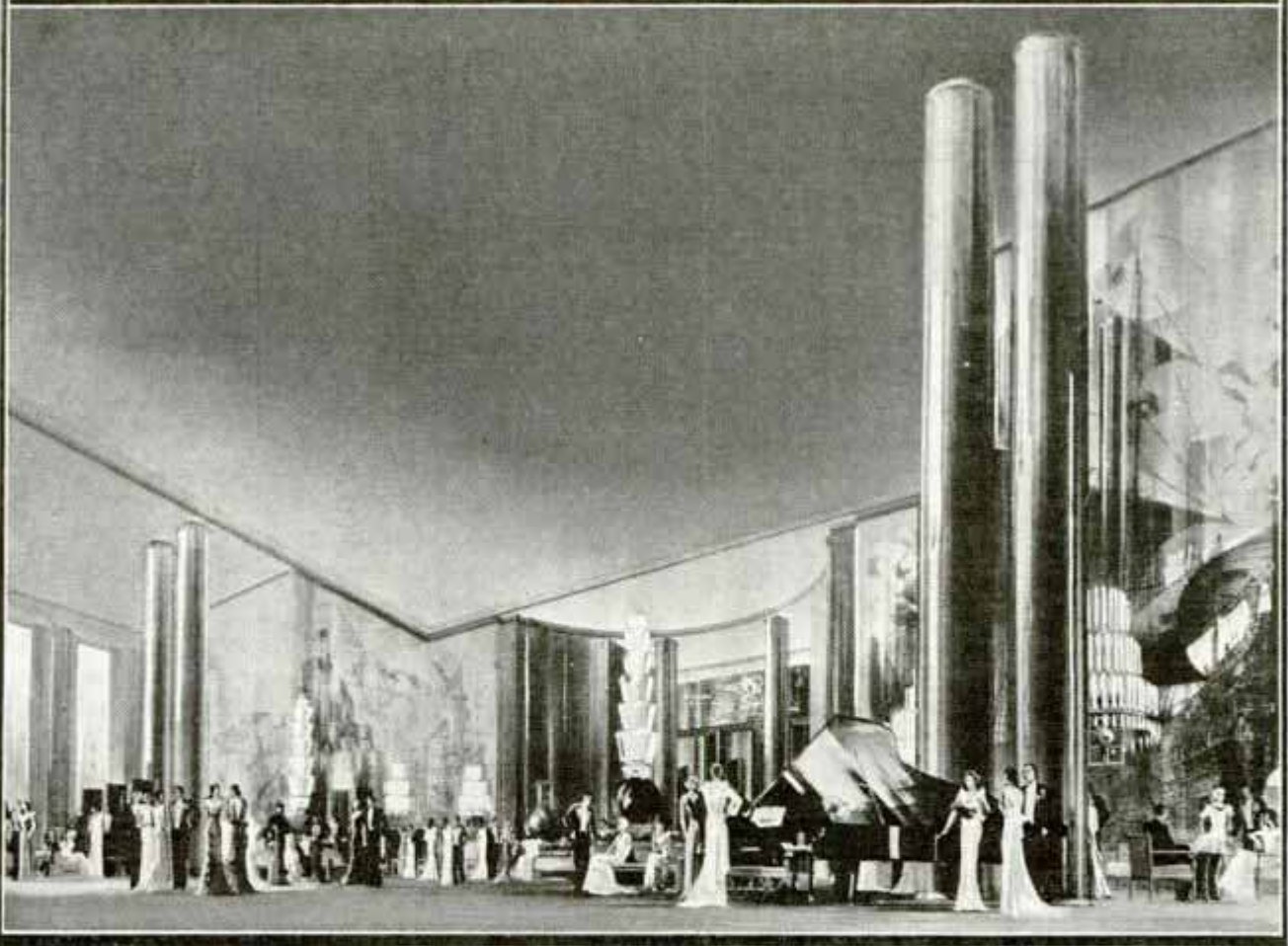
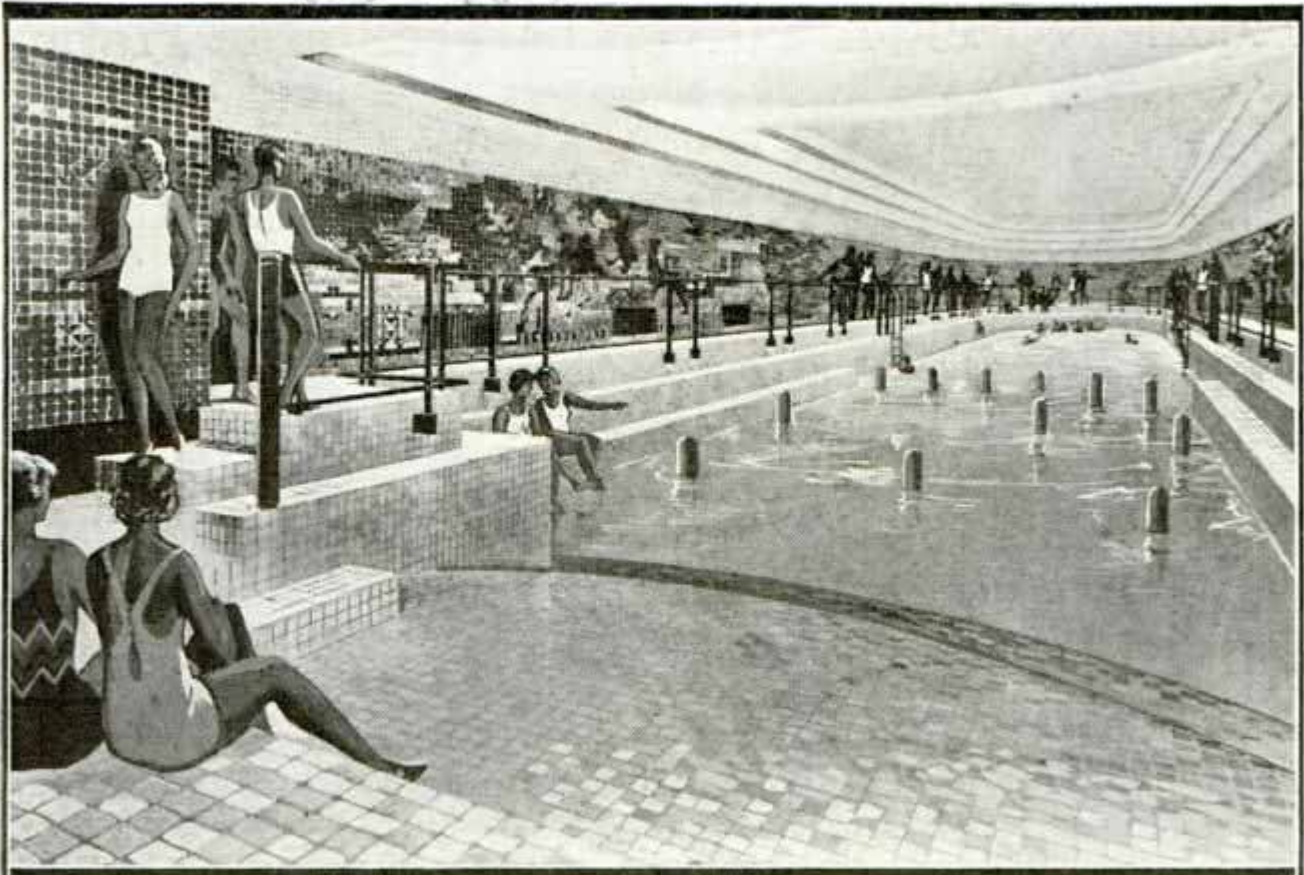

The Largest Swimming Pool Afloat, 112 Feet Long and Thirty Feet Wide, with a Graduated Depth and Plenty of Room for Diving and Swimming Contests; Below, the Grand Salon of the First Class, Giving an Idea of the Colossal Proportions of the Vessel and Its Appointments; It Has a Sun Deck Big Enough for an Airplane Landing Field

830
8339

Com. ...
1923 S. Peoria
Tulsa, Okla.

Refinery Model Carved as Profitable Hobby

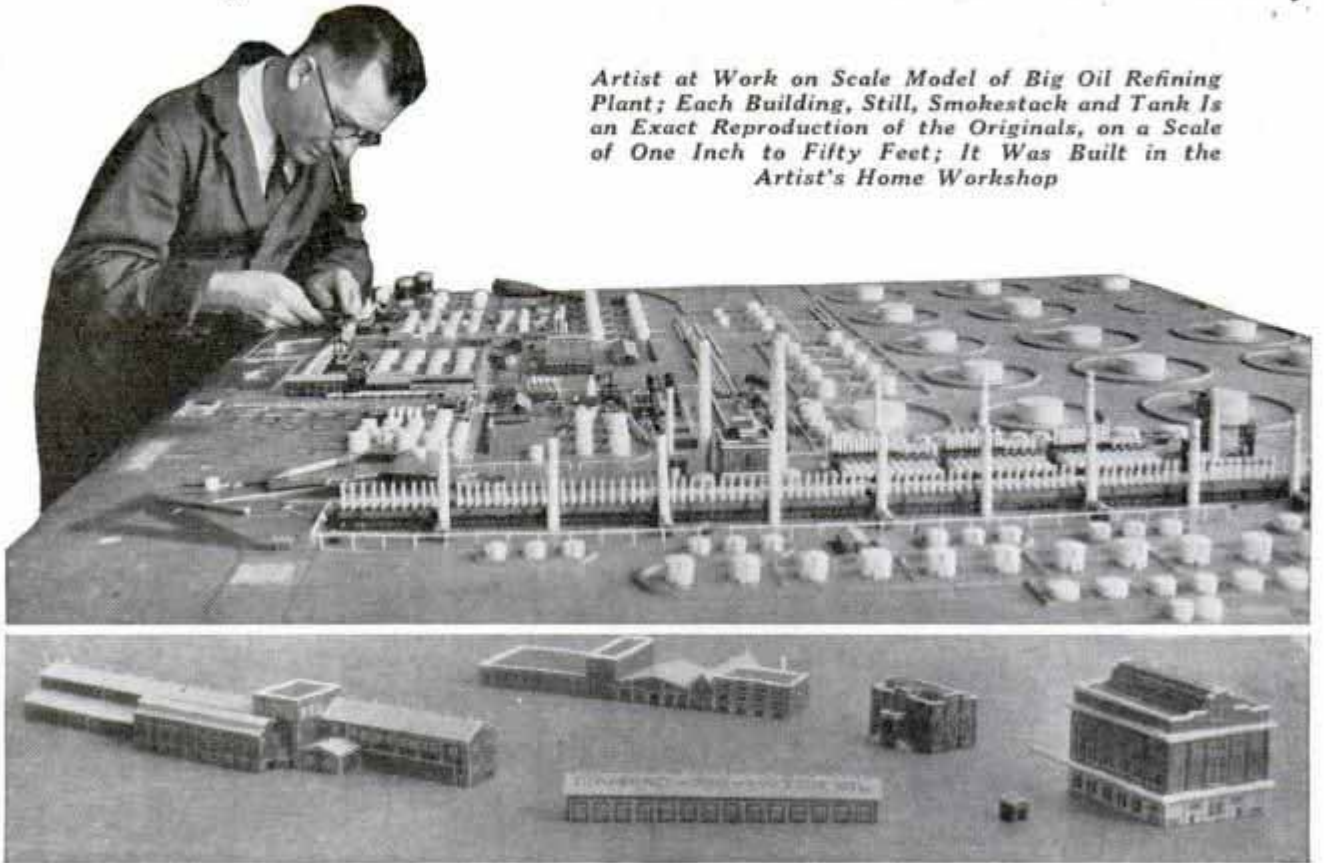

Artist at Work on Scale Model of Big Oil Refining Plant; Each Building, Still, Smokestack and Tank Is an Exact Reproduction of the Originals, on a Scale of One Inch to Fifty Feet; It Was Built in the Artist's Home Workshop

Tulsa, Okla.

After nine months of spare-time work, Henry H. Krueger, commercial artist, has completed and sold a carved wooden miniature of one of the world's largest oil refineries. An idea of making a model for his own satisfaction came to the artist on an airplane flight over the 800-acre plant. When he sought permission to enter the grounds and take measurements, the superintendent of the refinery surprised Krueger by placing him under contract to carve the miniature for use in an advertising campaign. The model was built to scale, one inch to fifty feet, and for convenience of handling in Krueger's small home workshop, it was constructed in two sections, which, when assembled into one piece, measured ten feet long and seven feet wide. The base or foundation is composed of five-ply laminated wood, seven-eighths of an inch thick. As each piece was carved in accordance with the scale, it was glued to a permanent position on the base. White pine, oak, walnut and cypress blocks were used. The carvings include: five buildings, 150 gasoline stills, thirty smokestacks, 400 tank cars and 600 tanks, 350 of the tanks for outdoor storage being shown in the open. Several hundred feet

of wire represent the network of pipe lines, while single strands of window-screen wire are used in the model as iron ladders leading from the ground to the top of storage tanks. Mirrors represent water in the refinery's spray ponds. All the objects are painted the same color as the originals. Black letters, one on each of several tanks, spell out the name of the city where the plant is located. The artist may be able to cash in on his hobby to a greater extent, since other companies have expressed interest in his work.

BRACES FOR SHAKY SCREENS

SAVE MONEY IN HOME

\$1.80 dozen

Strong, durable frames can be constructed easily by using steel corners. A piece of lumber of the proper dimension is inserted in each end of the corner to be nailed in rigid position. Nail holes are punched in the corners at the factory. The bridge-truss de-

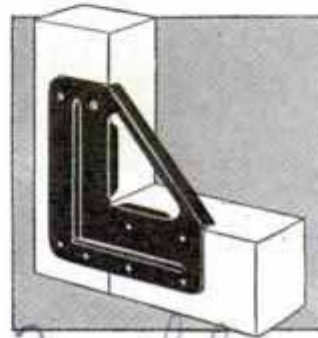

Micklin Mfg Co
Chicago, Neb.

sign of the corners assures permanency and prevents sagging and wobbling. One use is reinforcement of shaky window and door screens and porch screens. The corners are made of heavy, long terne steel, for one and one-eighth inch or seven-eighths inch lumber.

**PILE OF ANTLERS
A MONUMENT
TO THE ELK**

Elk antlers have been gathered and formed into an unusual monument in Yellowstone National Park. The monument, which is twelve feet high, marks the place where thousands of elk once roamed, before the large herds were wiped out by hunters. Rangers in the park are responsible for this tribute to the departed elk.



Ranger beside Pile of Elk Antlers Collected by National Park Staff

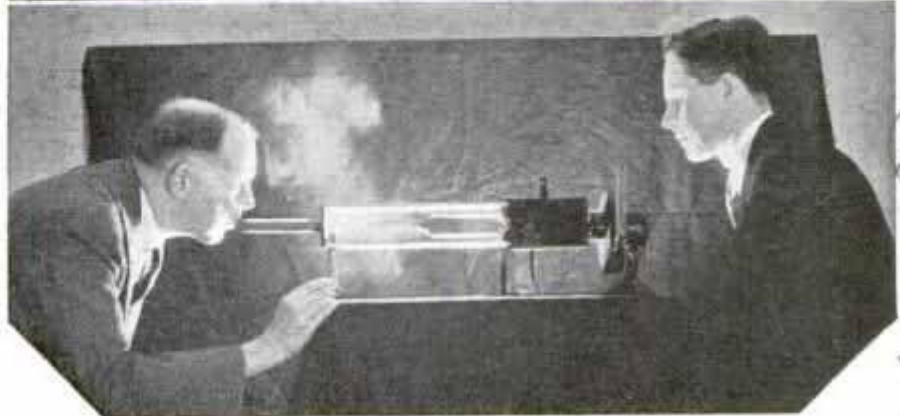
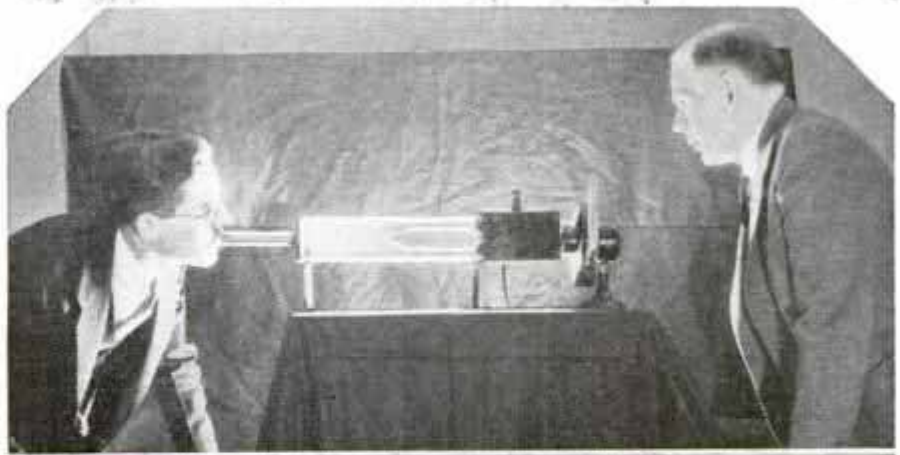

Showing How Air Cleaner Quickly Eliminates Smoke as It Is Blown into Test Apparatus; It Is Operated by Electricity

**ELECTRIC UNIT CLEANS AIR
OF HARMFUL PARTICLES**

Experimental models of an electrical unit to remove dust, soot, pollen and other solid and liquid particles from the air are being tested by Westinghouse Electric and Manufacturing company. Data are being gathered by physicians who are using similar units in treatment of patients afflicted with various types of asthma or pollen fevers. The unit is arranged to draw particle-filled air past two small wires, suspended horizontally. Connected to a power pack, which raises their voltage, these wires "charge" all air particles in their vicinity. This is called "ionizing" the air. Next, the ionized particles are drawn through a series of plates which also are charged. The plates have opposite polarity, with the result that the air particles move and cling to the plate, just as a needle jumps over to a magnet. Thus, air is made to clean itself. In addition, a film of oil covers each plate to make certain the particles stick to the plates. The air, freed of particles, then is sent into the room by a fan. The unit requires no more current than an ordinary electric lamp.

East Pittsburgh, Pa.

203

The Switzerland Chapel

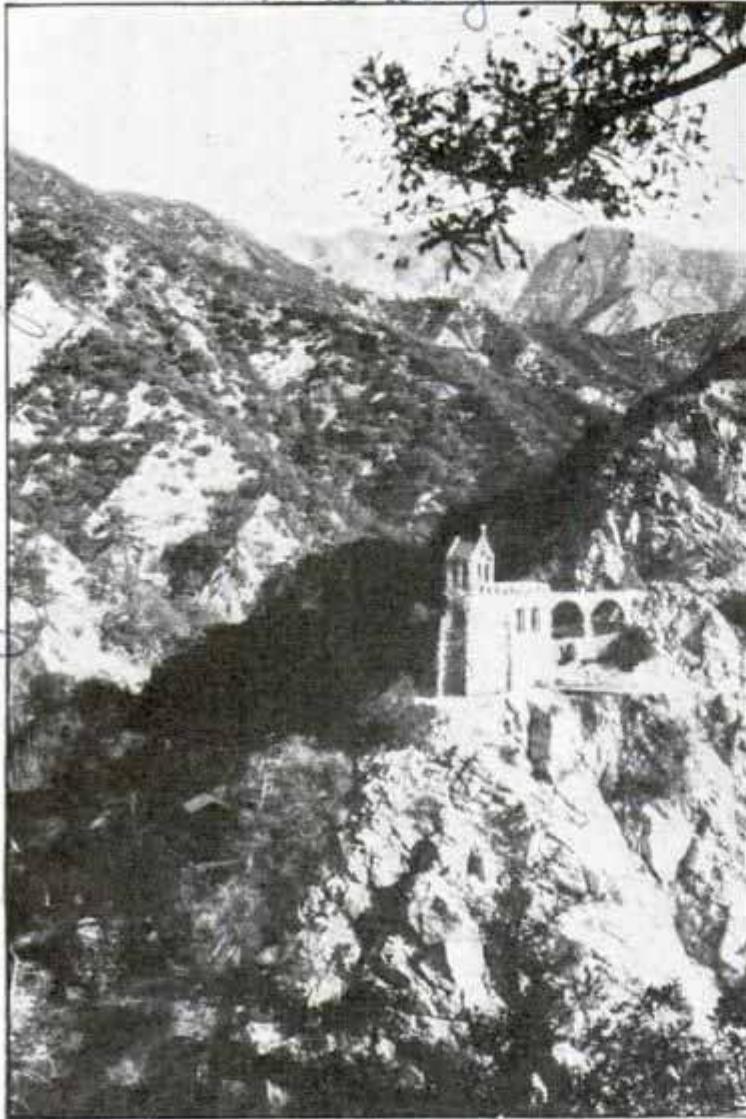

Tiny Stone Chapel Erected in Mountains Near Pasadena, Calif.; Services Are Held in It Each Sunday

TINY CHAPEL IN MOUNTAINS ATTRACTS MANY VISITORS

Angeles national forest boasts a tiny stone chapel which stands remote and lonely in the mountains near Pasadena. It is situated high on a rocky ledge and was constructed of stone gathered near by. Many visitors are attracted to the little mountain church and services are held there each Sunday.

833

BLOWPIPE CUTTING OUTFIT EASILY PORTABLE

Weighing only forty-three pounds, the latest cutting machine produces high-quality work. It consists of a blowpipe mounted on an electrically driven chassis. The machine has a direct drive and runs on an angle iron track or relatively smooth plate. When operated on the track, it does straight-line cutting automatically. For automatic circle cutting, a center and radius rod are used. The machine can be guided with a hand grip in cutting simple shapes. The blowpipe can be adjusted vertically, horizontally and to cut bevels up to forty-five degrees. A universal motor operating on 110 or 220-volt circuits drives the

machine, which produces work so clean that machining frequently is unnecessary.

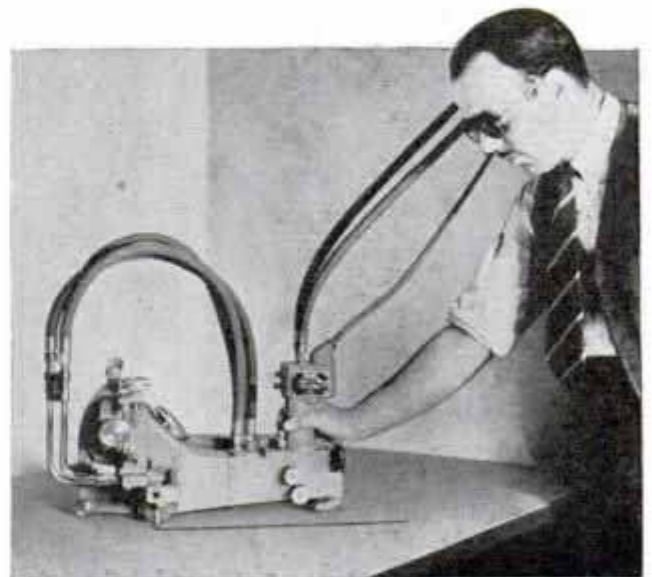

Showing How Easily This Cutting Machine Is Operated; It Produces Clean Work

Linde Air Product Co
205 E 42nd New York

Cmt. Mabel Little 336 d Olive St. Los Angeles, Calif

247

Artificial Sunshine for Apartments

ARTIFICIAL sunlight is created for apartment dwellers by installing eighteen floodlamps in the ventilating shafts, or "wells," at the ninth-floor level of a fourteen-story building in New York. These lights operate from eight to twelve hours a day. With the lights on and window shades halfway down, the similarity to sunlight is startling. Time switches prevent a sudden burst of illumination, the artificial suns requiring fifteen minutes to "rise" on the ninth-floor horizon. It is a General Electric company installation.

Schenectady, NY

Fingerprinting All Safeguards Each Citizen

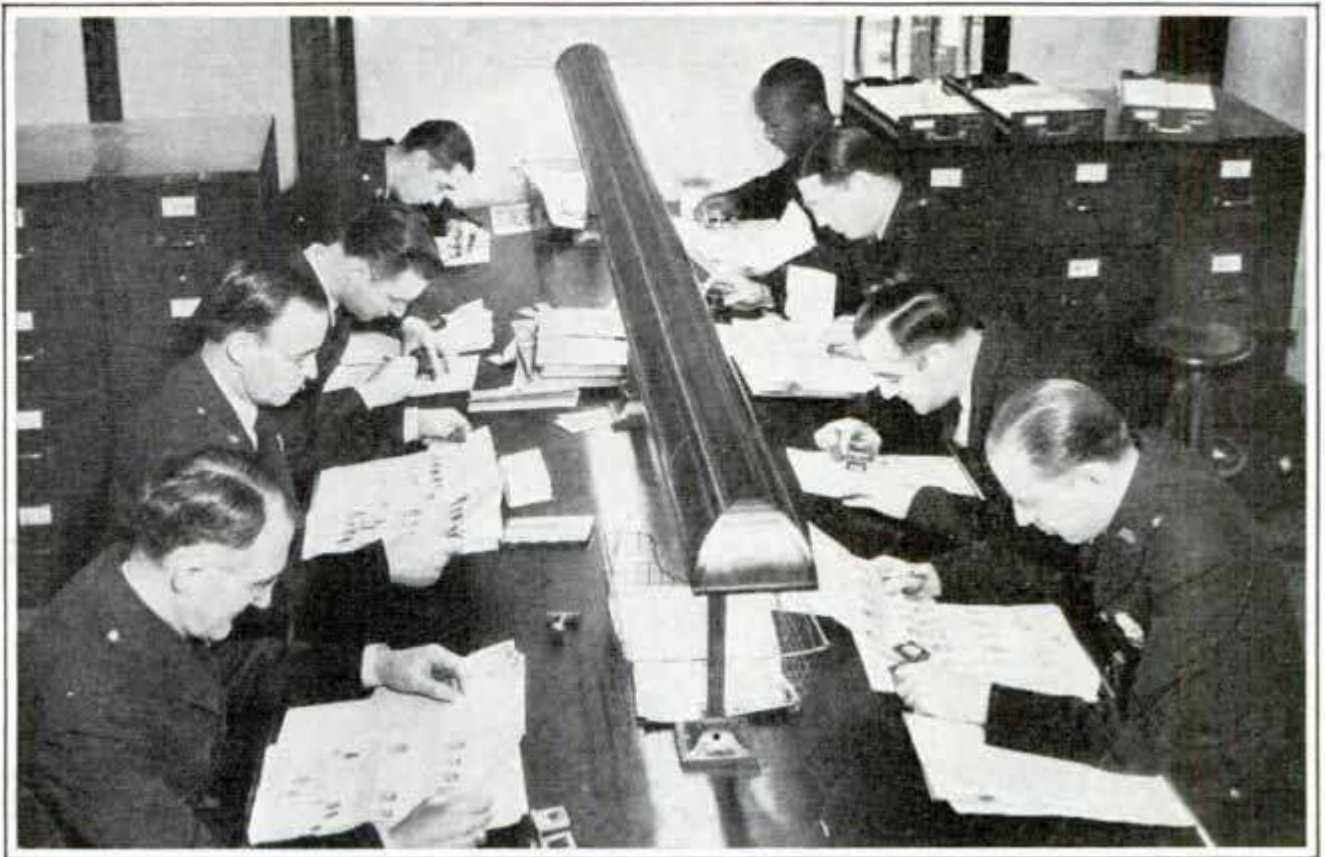

Examining Fingerprint Records in New York's Police Bureau of Identification; Classification System Speeds Up Work of Finding One Particular Set of Prints in the Large File

Fingerprints of citizens are being made by state and federal agencies at the rate of tens of thousands per month, as a result of the Department of Justice plea that every law-abiding person in the United States volunteer for the work. A complete file would contain 125,000,000 sets of fingerprints. J. Edgar Hoover, director of the federal bureau of investigation, points out that fingerprint records help authorities in making speedy identification of persons rendered unconscious in accidents, persons suffering from loss of memory and persons who die with no identifying papers or marks in their clothing. Many maternity hospitals are using this means of avoiding mistakes in identifying babies. If all employes were fingerprinted, Mr. Hoover says, it would be almost impossible for criminals to gain positions of trust. When the United States civil service began to route all applicants' fingerprints through the Department of Justice, it was found that one of every thirteen applicants had a criminal record. No means of identification is more reliable than fingerprints. The courts recognize such records. There is

not one chance in 1,000,000,000,000,000,000,000,000,000,000 (pronounced "one undecillion") that one person's fingerprints will be exactly like those of anyone else. For that reason, fingerprints are more satisfactory than a signature for documents, important papers, valuable records and certificates. Signatures can be forged, but not a fingerprint. To speed up the search for a particular set of fingerprints, a system of classifying them by certain whorls, lines and other marks has been evolved. In a recent test, the exact record of an unidentified person's fingerprints was located within three minutes in a file containing more than 1,500,000 records. The New York city police department has been collecting citizens' fingerprints for several years. Between 15,000 and 20,000 persons volunteer each month. Other cities are taking up the work. The Department of Justice in Washington is the clearing house for most fingerprints. The master criminal file contains 5,000,000 records. The civilian file will be separate. Instead of a stigma, the record will be a form of personal protection.

6 69.

Com. Thomas G. Sturmes Jr.
10555 Hollywood Ave
Los Angeles, Calif

Riding RACE



By "SPIDER" MATLOCK
Famous Riding Mechanic

I'M the passenger who rides beside the driver of a race car, holding down a job that plays a big part in winning races. I've been taken for lots of rides on the race track but I don't know yet whether there's a thrill in going 125 miles an hour, because usually I've been too busy to look at the scenery.

I know, though, that the mechanic's seat is too hot for some. One chap became frightened when the car went into a turn pretty fast. He reached over and snapped off the ignition switch, right in the middle of a lot of traffic that was going better than 100 miles an hour. Another fainted from fright during an Indianapolis race and the driver in desperation pushed him down on the floor boards so he could reach over and keep the fuel pump going himself until he pulled into the pits.

A few years ago at Indianapolis a mechanic looked back and saw a car coming toward him in a skid. That was too much

"Spider" Matlock and Al Gordon, Driver; Mechanic Signaling to Pass, and Working Fuel Pump

c/o Mudge's Racing Assn
1030 S. Broadway

CARS *for a* LIVING

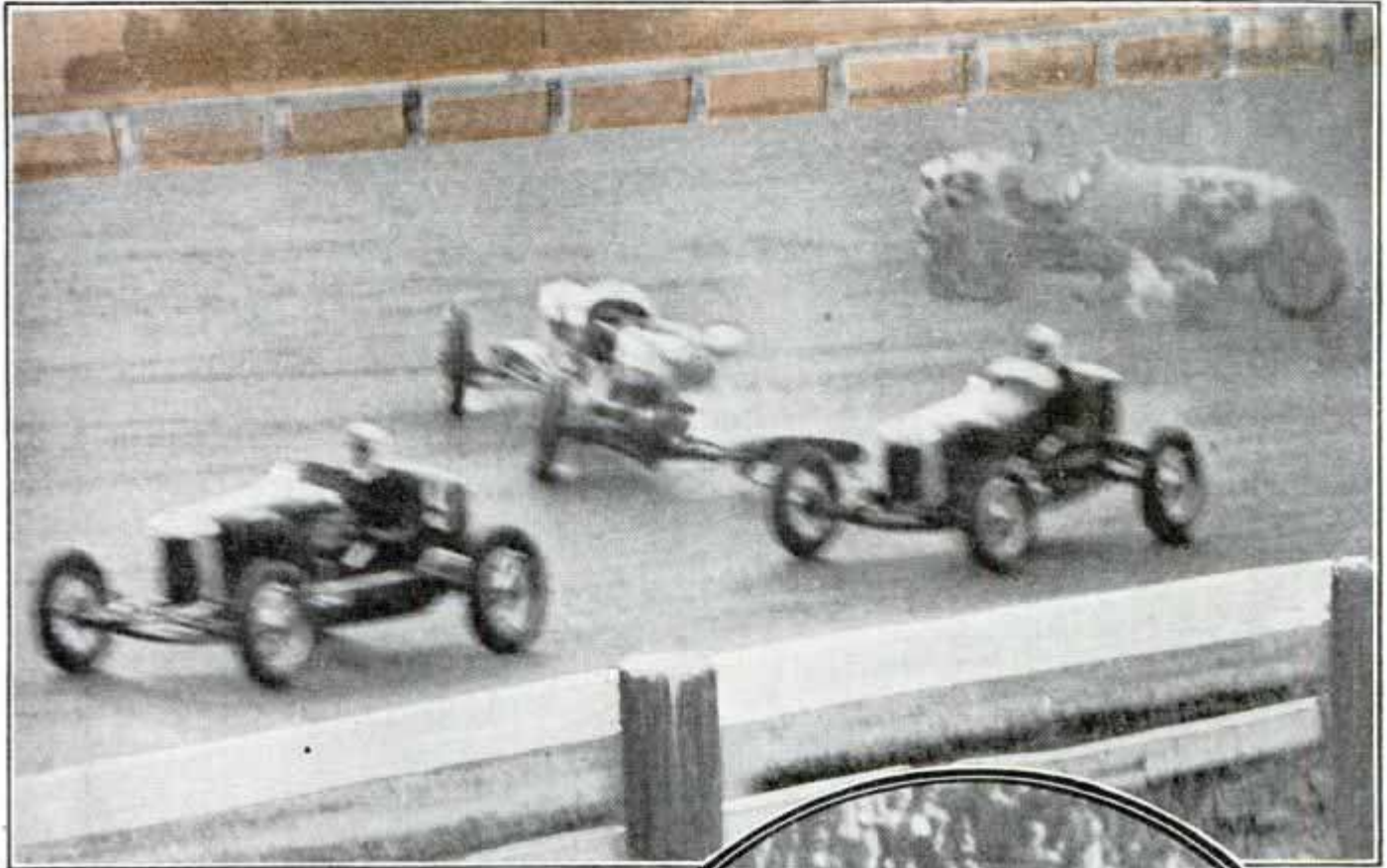

for him and he wrapped his arms around the driver's neck. The car crashed through the concrete retaining wall, but even then it was still rolling and the driver had to pitch the mechanic out before he could bring it under control.

When I say a riding mechanic has much to do with winning a race, I mean it's his duty to relieve the driver's mind of most of the worries except driving. The mechanic must keep up gasoline pressure, regulate oil pressure, estimate the condition of the tires, signal to other cars, watch for signals from the starter's booth, and just plain hold on when he has a chance. One mechanic at Indianapolis cost his driver \$2,500 in lap money because he forgot to keep up the fuel pressure and, when the motor sputtered, signaled his driver that they were out of fuel. It took twenty-five laps for the driver to regain

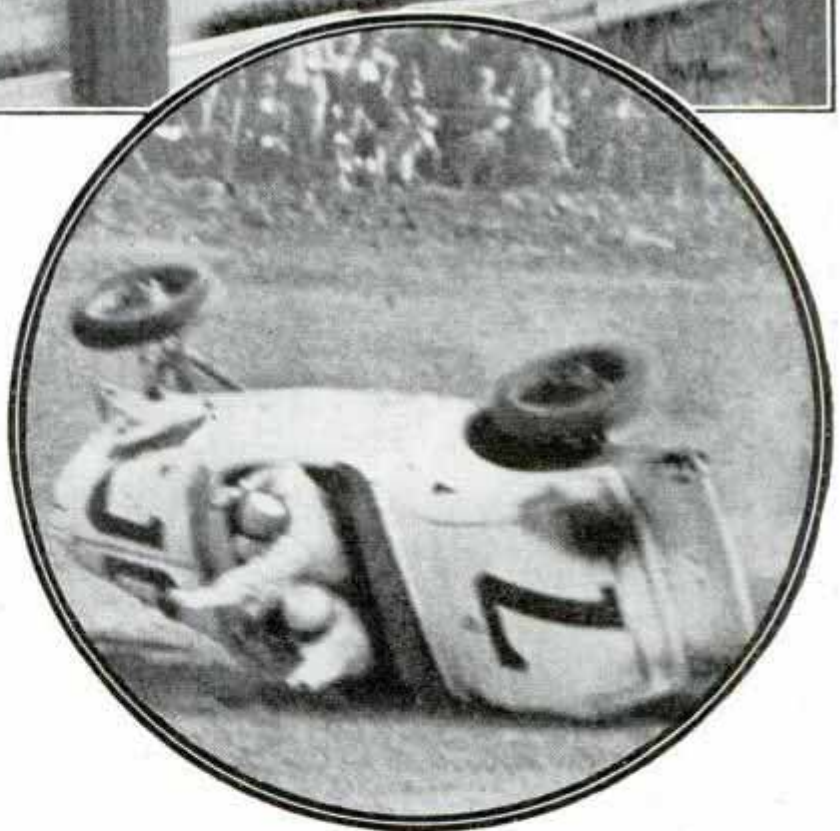

Drivers Dodging Two Cars Still Moving after Collision, and Car Rolling over in Dirt-Track Race

his lead. I've been in twelve major crack-ups and have spent three of the last seven years in hospitals, recovering from injuries received on the track. At various times I've had 250 broken bones, including a

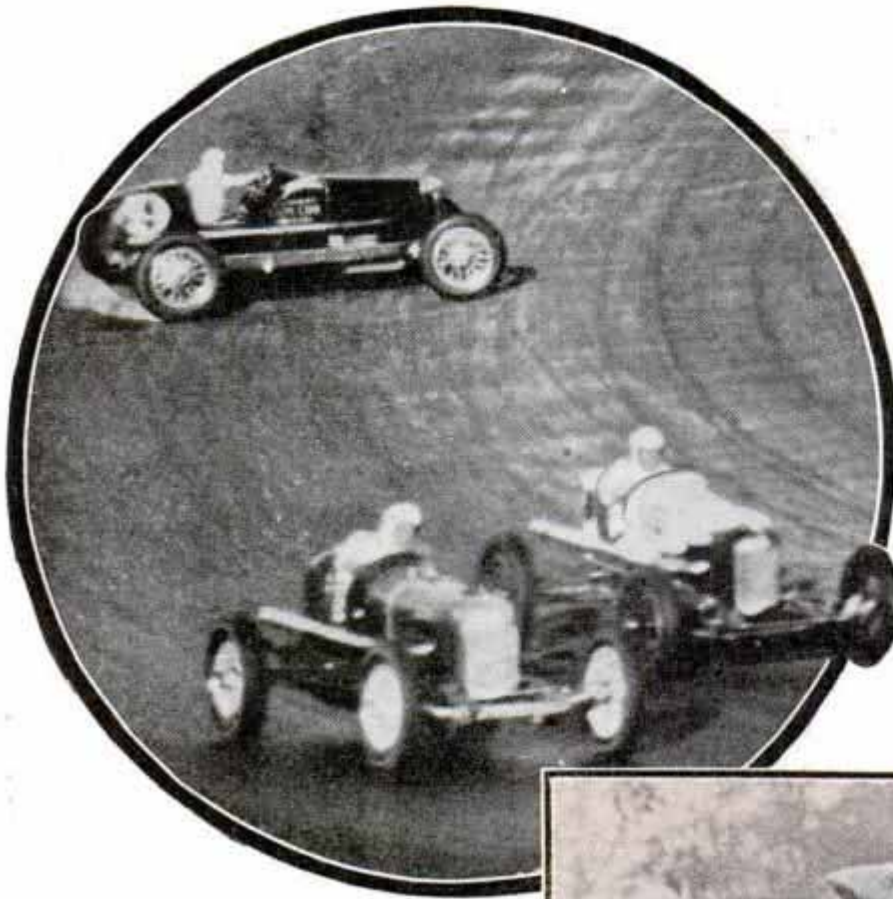

ner. Coming out of a turn the tires skated on a new pool of oil, spinning us around and sending us backward down the track until we were struck by another car. The impact tore our engine to bits, breaking off the manifold and setting the car on fire, and tossed us against the wall. Arnold was pinned in the wreckage but I was torn loose and thrown 258 feet, landing in the grass alongside the grandstand. Just as I was leaving the car the bottom fuel tank exploded and threw out sheets of flame that en-

double basal fracture of the skull, but of all my injuries, a broken thumb is the only one that has bothered me since. I got that when we tossed a connecting rod through the crankcase, locking the engine and rear end and going into a slide in which we were hit by another car.

I got the skull fracture in 1932 riding with Billy Arnold at Indianapolis, a couple of years after he and I had collected \$72,000 in prize money during the racing season. At the 150-mile mark, after we had piled up a two-lap lead, another car went into a spin in front of us. Billy's only chance was to pass below it, so he took his foot off the throttle to slow down. We were in a front-drive car and the rapid deceleration of front end swung the rear around, causing us to spin and throwing us over the concrete wall tail first. The car hung on the wall and dropped me out, then came crashing down on top of me. Arnold was badly hurt also.

The year before, at Indianapolis, we had a six-lap lead at 425 miles and it began to look like we were going to bring in a win-

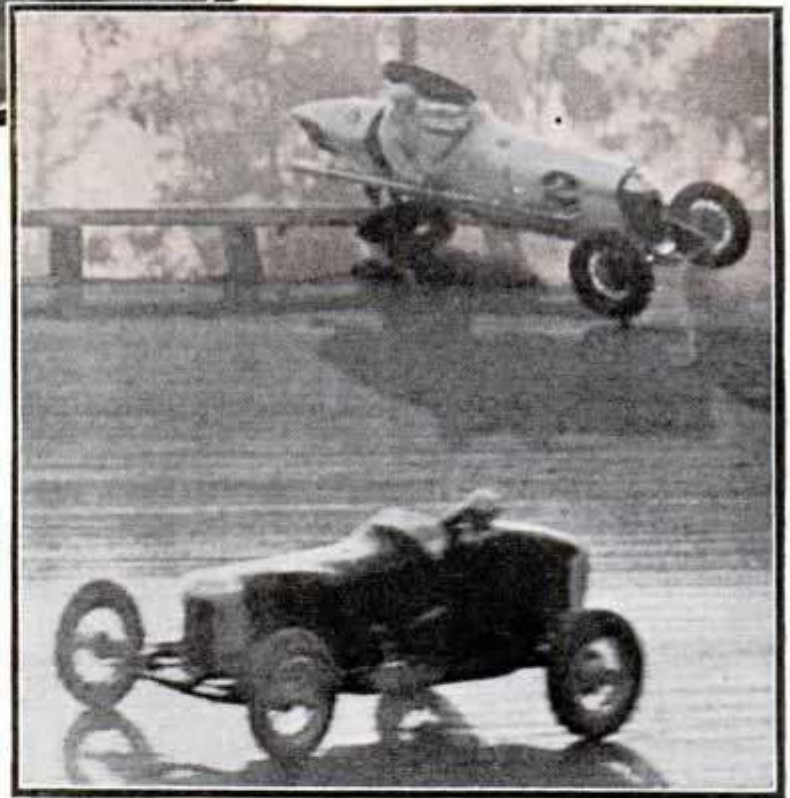

Top, Too Much Speed Causes Rear Car to Spin in Turn; Below, Race Car Caught as It Spun into Fence

veloped me in the air. Both of us were in the hospital for months.

In the 1933 race, I was asked to act as relief for "Monk" Jordan, who was riding with Les Spangler. Spangler was flagged from the pit to stop for me on the next lap and I sat on the fence to wait. As I waited, traffic was piled up on the backstretch by

(Continued to page 134A)

Vault Tests Flyers for High-Altitude Work

Tests in all stages of flying are given students at an indoor flying field without subjecting the inexperienced pilots to dangers aloft. A huge experimental chamber is a part of the equipment. In this vault, which is closed by a giant door, students are tested for respiration in "high altitudes." Thus, the instructors are able to learn the student's reaction to thin air without sending him on a hazardous flight. The indoor flying field is located at the army aviation school in Italy at Monticello

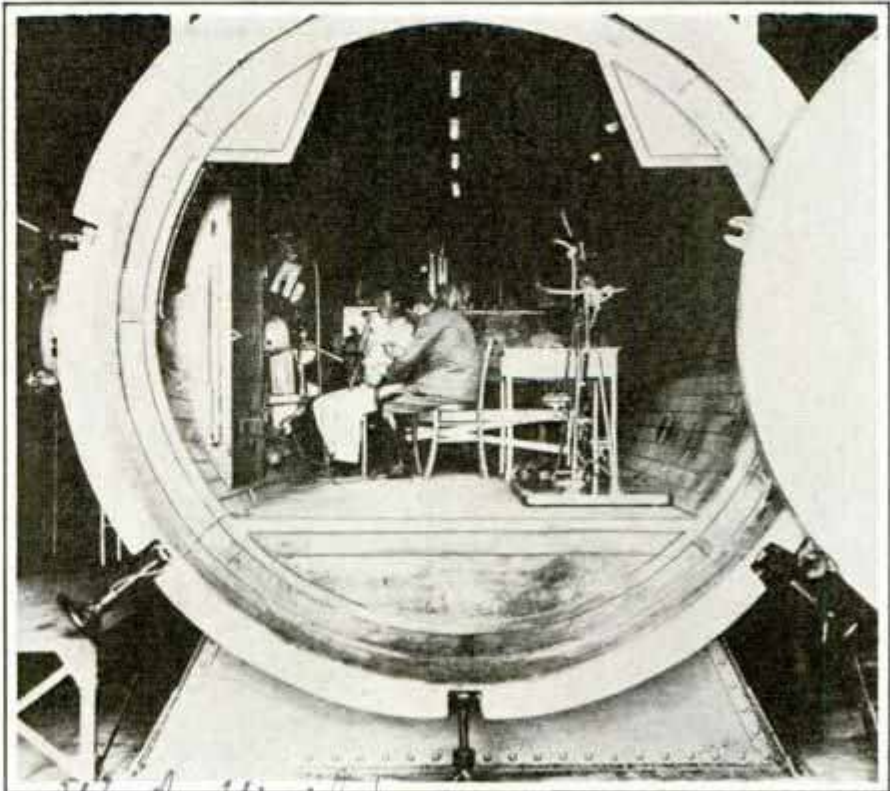

Right, Flying Test Vault Before Giant Door Is Closed and Sealed

Waxed Paper Bags Sealed Quickly without Adhesives

Quick sealing of waxed, glassine or Cellophane bags without adhesives is accom-

plished by a small foot-operated machine for the home or small factories. It is heated electrically, a thermostat holding the temperature at the level for best performance. The open lips of the bag are placed between jaws which crimp and close the bag when the pedal is depressed. The heat softens the paper or Cellophane sufficiently so that the lips remain closed tightly after release of the jaws.

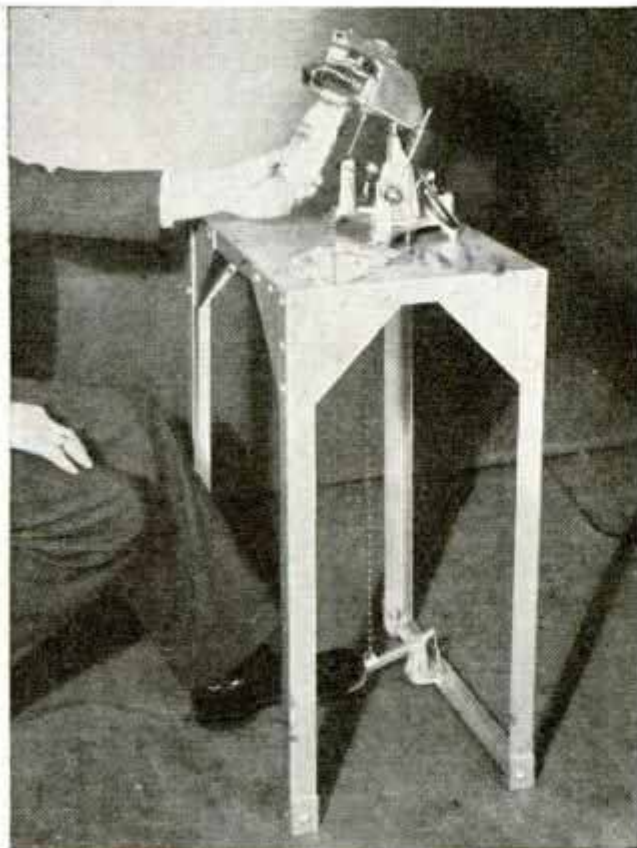

Simple Arrangement for Sealing Bags without Using Any Form of Adhesive

"FINGERPRINTING" DOG TEAMS PREVENTS RACE FRAUD

As a means of preventing fraud, the "fingerprints" of dog teams entered in derby races in Canada are taken. A small tuft of hair at the base of each dog's tail is pressed between two soft wads of sealing wax and left to harden. In the process, the fingerprints of the thumb and index finger of the judge doing the marking are imprinted in the wax. This makes it impossible to substitute fresh dogs for those starting the race, since the seals are examined carefully when each team finishes the race. The wax is applied so that it is not easily broken or scraped away.

Heat Seal. T & Co. 3836 W. Lincoln Ave. Chicago, Ill.

Wide World

E-268

E 27 7

Heat Seal. Co. 3836 W. Lincoln Ave. Chicago, Ill.

Process originated by Serah. Mergetts. Royal Canadian Mounted Police. Illinois. Hull. leatherman. Best Day

Auto Engine Drives Motorcycle at High Speed

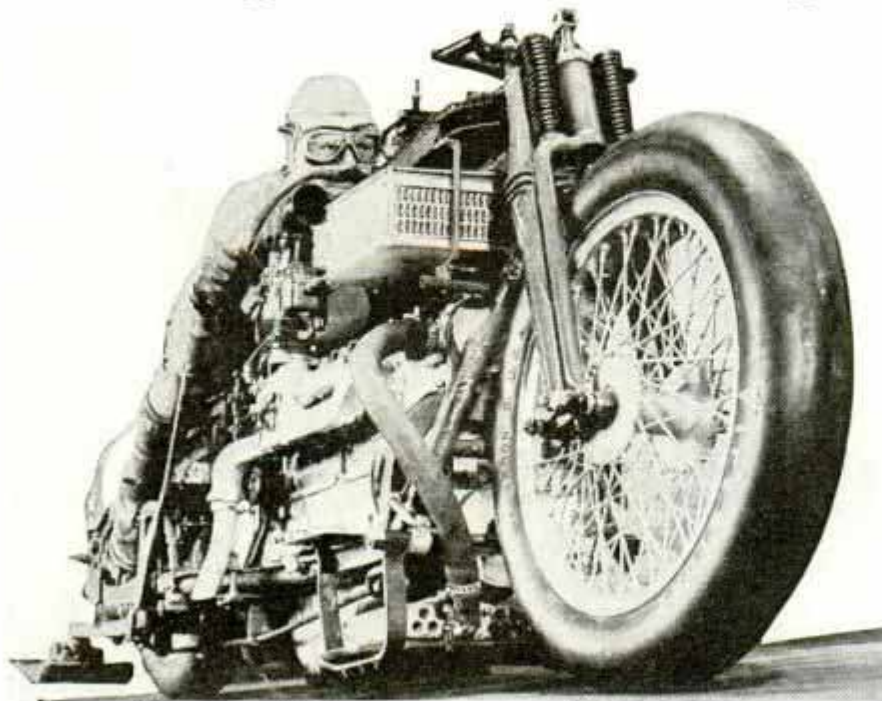

This "Hybrid X" Racing Machine, Motorcycle Powered by Auto Engine, Is Expected to Attain Speeds above Five Miles per Minute

Assembled especially for establishing a world's record of more than 300 miles per hour, an over-size motorcycle powered with an automobile engine has been making speed tests on the Pacific coast. The motorcycle, weighing 1,500 pounds, is powered with a six-cylinder Plymouth automobile engine with fan and generator removed. With special timing and carburetor jets, the engine makes 4,100 revolutions per minute. The wheel-base is eighty-five inches and the over-all length is 115 inches, a standard motorcycle frame being

CREAM IS WHIPPED BETTER BY AIR-BUBBLE MIXER

By introducing thousands of air bubbles, a new mixer produces more than three quarts instead of the usual two quarts of



whipped cream from the original one quart. The result is a fluffier and more easily digested cream. The whipper is a bucket-like container resting on a motorized base. At the bottom of the container are aerating disks held in place by a central stem. Each disk is scored on each side with tiny grooves or air tracks, which direct the minute air bubbles from the motor-driven compressor through the cream. No blades are used.

Names and addresses of manufacturers and dealers in articles described in this magazine will be furnished by our Bureau of Information upon receipt of a stamped, self-addressed envelope.

lengthened and reinforced with steel tubing. Two large sprockets connected by a three-quarter inch chain facilitate steering, the handlebars having been moved back several inches from their original position. Two steel plates, one on each side in front of the rear wheel, serve as brakes by actual contact with the ground or track. They can be raised or lowered by a lever.

TRIPLE OILSTONE SHARPENER PRODUCES HONED EDGES

2. stone \$12.00.



3. stone \$16.00
Sharpening Knife on One Surface of Multi-Oilstone Unit; the Stones Are Reversible

Containing three oilstones, the latest sharpener produces honed edges on a great variety of tools, knives and instruments.

Behr-Manning Corp.
219-3-3 S. Broadway

1212 W. Sloman
8289
Hobart Mfg. Co. 112 Mitchell Ave. Troy Ohio

Plymouth Lev. Chrysler Corp. Detroit Mich.
3-4-1 Masbachetts

Hunters Point
POPULAR MECHANICS

The stones, which are pre-filled with oil at the factory, are reversible for use of both sides. The stone in use is elevated, preventing cuts and grazed knuckles. The three oilstones are set on a rigid base in an enameled case.

al manley
TRAP CATCHES EXCESS PAINT DRIPPING FROM BRUSH



£228
 Excess paint is trapped by a pliable rubber guard that fits on a new non-drip brush. Somewhat cup-shaped, the guard has a rim lip that prevents escape of paint until the user is ready to empty it through a drain notch. Another brush has a drip-trap ferrule of "washboard" design. This ridged construction retards the flow of excess paint from the bristles toward the painter's hand.

£300
GEARLESS AND CHAINLESS BIKE DRIVEN BY BODY BOUNCE

Functioning on the principle of an eccentric rear wheel, the latest bicycle has neither gears nor a chain. Invented by Phil Huyseng of Chicago, the bike is propelled by a bouncing motion of the body.



Carl Gardner Jr. Wilson Cass Hotel
Latest Bike in Use; Note Rear Wheel Is Off Center, Providing Means of Propulsion

Designed by Miss Ruth Reeves, Carnegie Institution
"CELLOPHANE" USED IN FABRIC OPENS UP NEW FIELD

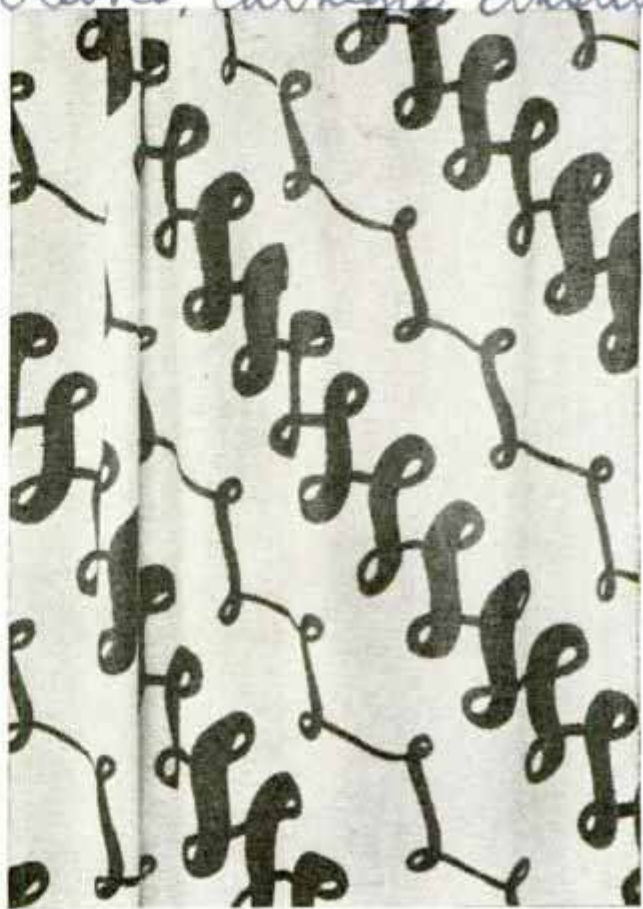

National Alliance of Art and Industry, 30 Rockefeller Plaza, New York
Looped Braid Design on New "Cellophane" Cloth; the Fabric Offers Many Possibilities

Possibilities of increasing use of Cellophane are held out by a beautiful piece of drapery exhibited recently in New York. The drapery is a fabric, known as "Luvet," made entirely of Cellophane slit cellulose film and cotton. An unusual design, printed diagonally in cochineal red across the cloth, is a feature. It consists of a looped braid, similar to that worn by the court guard of honor of King Charles V of Spain.

£312
PLANT THAT TRAPS INSECTS DESTROYS MANY SPIDERS

Science Service 2/11/35
 Termed by Darwin "the most wonderful plant in the world," the Venus flytrap is responsible for destroying many insects. Prof. Robert F. Griggs of George Washington University has found that the largest single class of its victims is the spider. Examinations of hundreds of its traplike hinged leaves showed that spiders formed twenty-eight per cent of the catch, flies were second with twenty-four per cent and other prey included beetles, ants, roaches and even one tiny toad.

Washington DC

668

FLYING

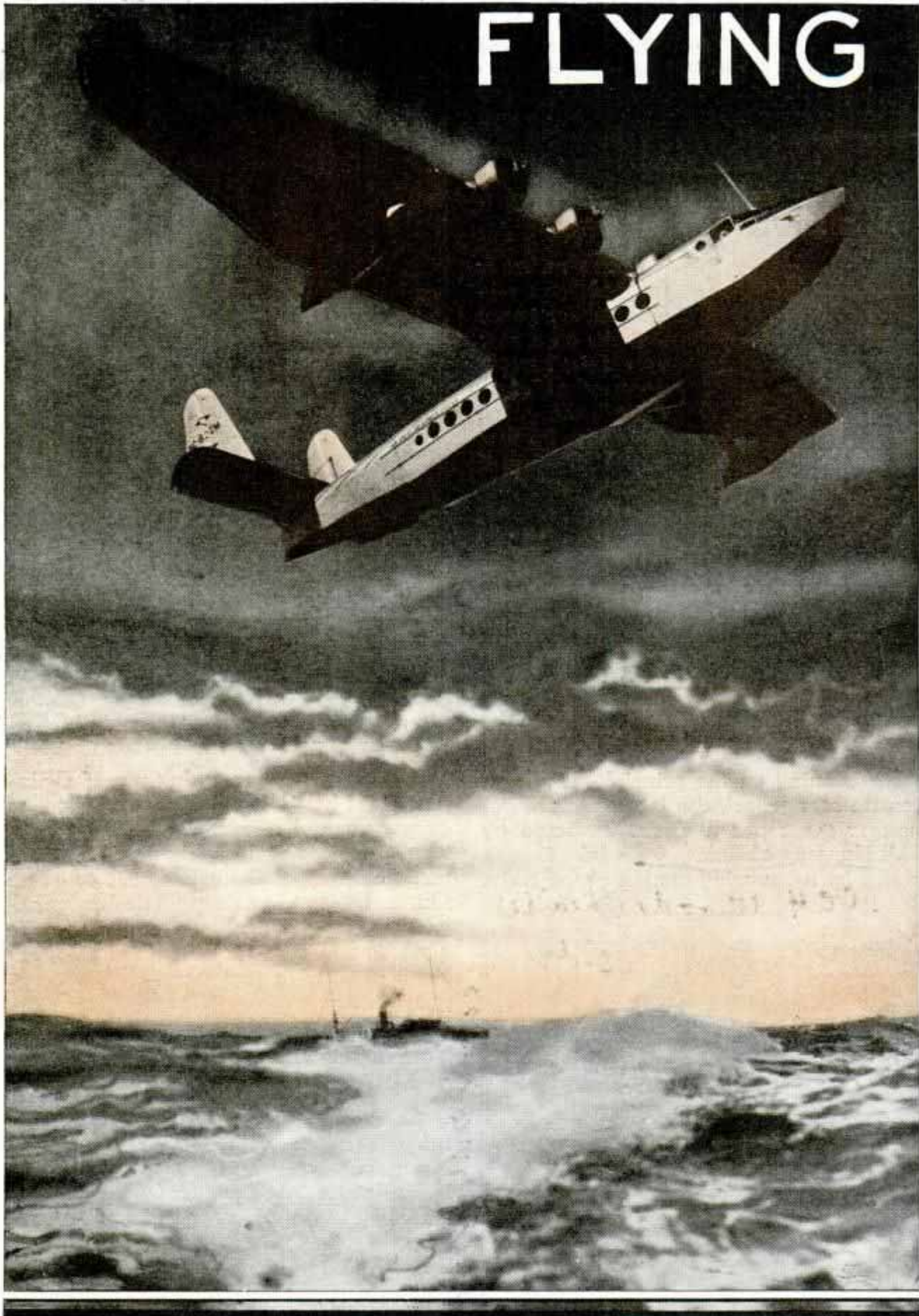

The Fog Patrol, by Obtaining Advance Weather Data, Makes Possible Safe Flights of Commercial Airliners Such as This, and the Flashing of Storm Warnings to Ships at Sea

Mr. Mitchell C. Schmitt, 668
22 & 69 H H
necessar!

the FOG PATROL

"HELLO—109 calling WO9—
109 to WO9—now at altitude
of 17,000 feet. The temperature is
forty below zero. Observation
completed. Coming down."

"WO9 calling 109—WO9 to 109
—ceiling 500 feet—you can make
it down now."

Sometimes between darkness
and dawn, under weather condi-
tions which have grounded all
other airplanes, Lieut. David H.
Baker, flying the fog patrol, has



see data

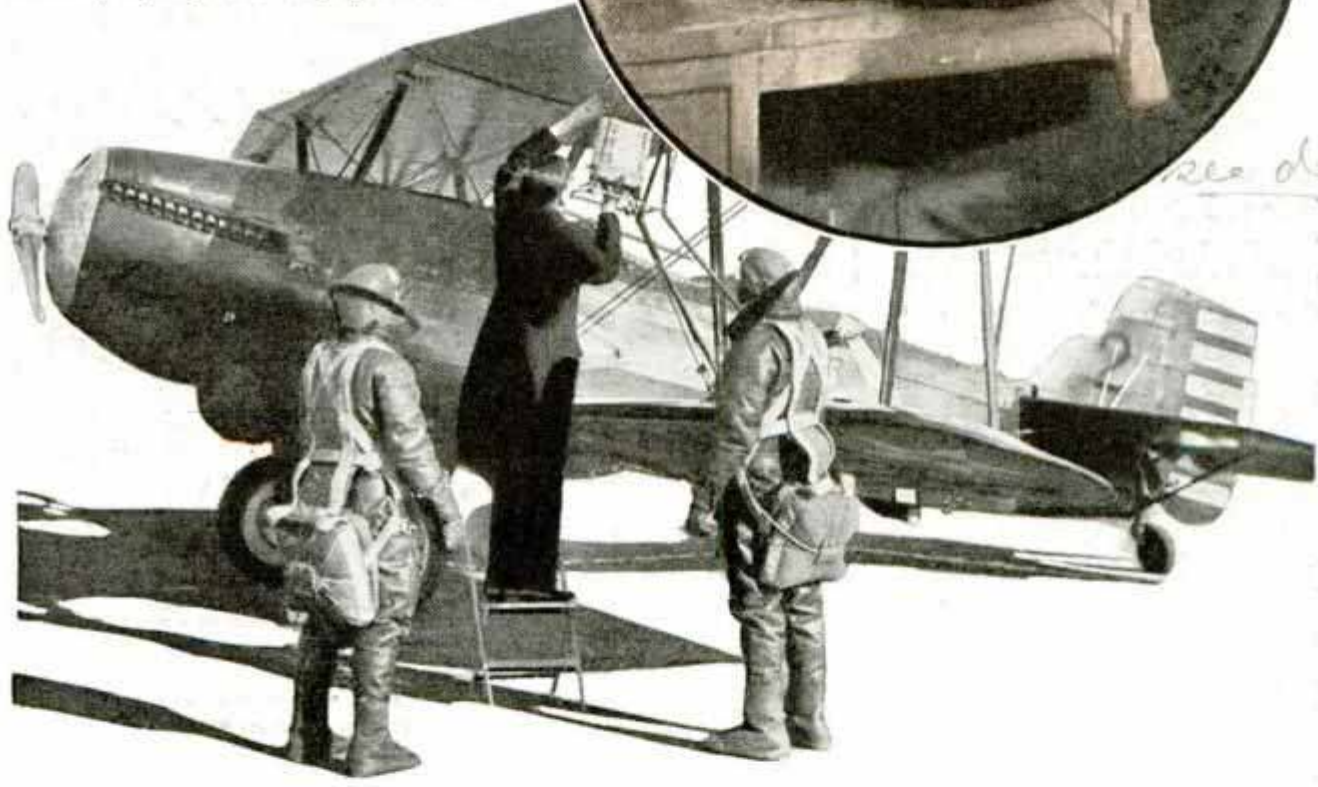

Weather Observer Detaching Recording Instruments from Fog Patrol Plane after Flight and the Radio Operator Who Maintains Contact with Pilot of One of Fog Patrol Ships

phoned his base at Mitchell Field by short wave and has received an answer.

With a strong wind trying to blow his ship out over the Atlantic and with a ceiling that offers a sporting chance for landing safely, Lieut. Baker is flying in the interests of a newly developed science for speeding up weather reports and making them more accurate. Although yet in its infancy, this science already has saved many lives and much money, and is destined to play an important part in your own daily life if your activities are influ-

enced by weather conditions. This new system of weather forecasting is called air-mass analysis. It was developed in the United States by Joseph George, chief meteorologist of Western Air Express, and Dr. Irving P. Krick of the California Institute of Technology, who states that all that is needed for 100-per-cent accuracy is 100-per-cent reports of conditions on which the new forecasts are based.

"Air-mass analysis in forecasting can be used effectively only if certain data not heretofore available are provided, includ-

Pasadena, Calif. ⁸⁴¹



ing particularly detailed information concerning temperature, humidity and air movement above the earth's surface," says W. E. Gregg, chief of the weather bureau.

"Full use of air-mass analysis is not yet possible but to the extent that it is now employed in the weather bureau, it has been found to aid materially in forecasting thunderstorms and their probable movements, precipitation in general, the probable occurrence and strength of vertical convection, maximum temperatures, in establishing the probable 'ceiling' or height of clouds, and in forecasting the occurrence of ice formation on aircraft."

While Lieut. Baker is in the air other members of the fog patrol are also flying at no less than twenty-three strategically located points throughout the United States, so when you awake in the morning to board a commercial airplane, or ocean liner, or even plan a day's outing, you may know to a certainty what sort of weather is in store for you.

Why is it called the fog patrol? Because fog conditions encountered in the east, where the weather ship has been flying since last July, have been considerable, at

times paralyzing steamship traffic and grounding commercial airplanes. At Newark airport, for example, weather bureau reports from July, 1933, to June, 1934, show there were 1,226 hours of fog and 2,352 hours during which the visibility was less than two and one-half miles. In spite of such conditions, the fog patrol flies.

About 4:30 a.m. Lieut. Baker and his radio mechanic take off in their observation plane and climb at 300 feet a minute, leveling off at 1,500 feet and at every additional 3,000 feet so that the aerometeorograph hooked in a cage to the upper right wing, may record

(Continued to page 122A)

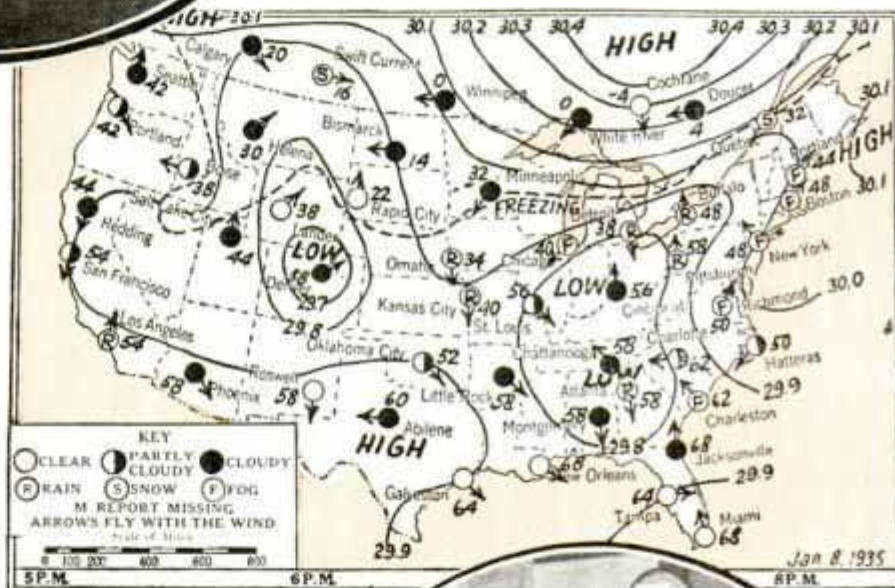

Top, Looking over Recordings of Fog Patrol Instruments; a Typical Weather Map, Made More Accurate by the Patrol, and Operator Teletyping Patrol Data to Weather Bureau



Wide World
Taking Measurements for Suit Is Made Easy by Using Small Camera; Note Tapeline Attached to the Customer as He Stands Before Chart; Camera Records Measurements and Posture Quickly

CAMERA HELPS THE TAILOR TAKE MEASUREMENTS

More accurate measurements can be taken if a camera is added to the custom tailor's equipment. With the customer standing before a scale with tapes adjusted to his body, the tailor snaps the picture that shows exact measurements and details of posture and appearance. The tailor works from the photograph in making the suit, which often can be finished without calls for fitting. The usually long job of measurement is reduced to about one minute by using the camera.

E 298.

METAL STEMS FOR FLOWERS LATEST AID TO FLORIST

Fastening metal stems to flowers or leaves to facilitate their insertion into mossed frames or designs, a new machine aids the florist. It holds several hundred stems or picks, automatically feeding one out and clamping it around the flower stem. This method replaces the old way of tying a wooden stick to the stem with a piece of wire.



pat. pend.

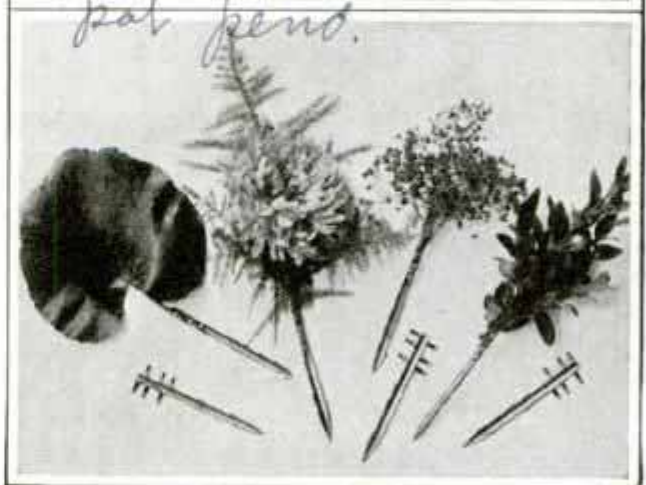

Device for Attaching Metal Stems to Flowers

The Herwan Co. 719 W. 28th St. New York

Sinking Boat Saved by Auto Driving a Pump



Auto Is Shown Pumping Water from Sinking Boat; Note the Pump Located between the Car and the Boat; This Unusual Means of Salvage Saved the Boat after Ice Had Punctured a Hole in Its Hull

When a sixty-five foot fishing craft began to sink amid the ice of a Canadian stream recently, an automobile was used to salvage the boat. The car was driven

out on the ice to furnish power for a large suction pump that soon emptied the boat of water. A hole in the hull was plugged and the boat towed to drydock.

Copper Awning Can Be Folded Like a Venetian Blind

Awnings made of copper instead of fabric are now being produced. The metal

awnings fold like Venetian blinds and can be used both winter and summer since they are not affected materially by rain, snow, sleet or sunshine. Such awnings also eliminate the fire hazard always present when cloth awnings are used. Similar awnings are being made of aluminum and corrosion-resisting steel.



This Awning Made of Copper Folds Like a Venetian Blind and Can Be Used the Year Round

SMALL-SIZE REFLEX CAMERA HAS ULTRA-FAST LENSES

Equipped with ultra-fast lenses, a small reflex camera is available for night photography and "candid camera" work. It is of the twin-lens type, the upper lens showing the image in a ground glass while the lower lens takes the picture. Film changes are automatic.



*Metal Awning Corp
19 E. 47 St., New York*

*U.S. - Burleigh
Brooks 127 at 42nd*

£ 237

£ 154

8243

GENERATOR CONTROL ON DASH REGULATES CHARGING

Control of the generator charging rate is placed at the auto driver's fingertips by a system operated from the dash. A variable



resistance, an all-metal pack, is introduced into the generator shunt field. Encased in heavy brass, the pack is connected to a hard rubber knob installed on the instrument panel of the car. Turning this knob sets the generator at the charging rate desired. The resistance pack

controls the output of the generator instead of being hooked up in the main electric circuit. Installation requires only a few minutes, as only two holes and two connections are necessary.

Chubasaw Ave Cleveland Ohio

\$2.58

1916 Island Ave

GARAGE DOOR HOLDER LOCKS IN OPEN OR SHUT POSITION

Locking the garage door in open or shut position, a new inexpensive holder is available to the automobile owner. A plunger with a spring is forced into a slot at one end of a long rod upon opening the garage door. This holds the door open.

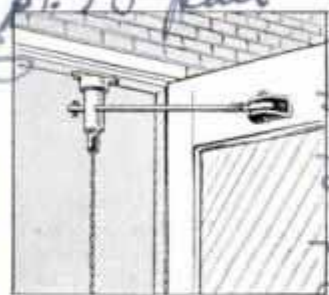

Pulling a chain releases the plunger and permits the door to be closed. When the door is shut, the plunger is forced into a slot at the other end of

the rod, locking the door. Thus, if the garage has a side or service door, no padlock is required on the larger door. If there is no service door, installation and operation are different, but the holder still does its work of holding the door in either position.

Hold up to 190 lbs

Lock

American housewives own and use an average of 600 pounds of steel in their homes, according to recent estimates.

Steel Facts

Iron and Steel Institute

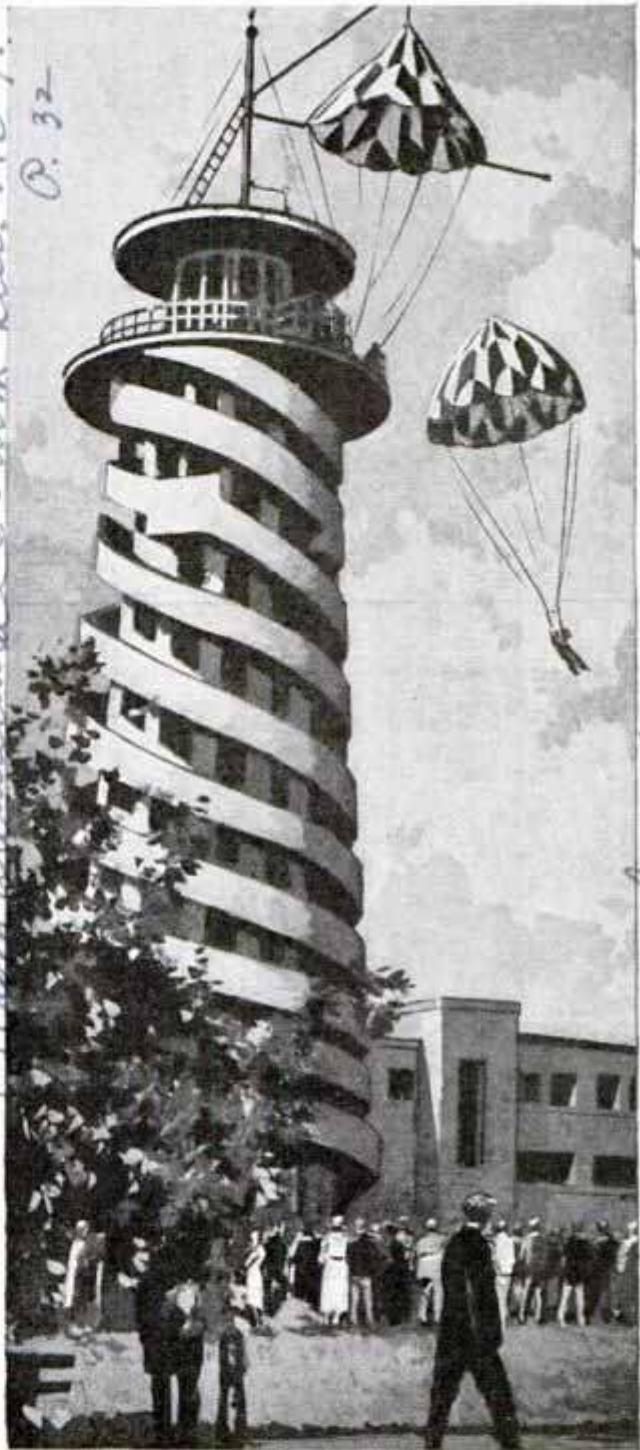

Giant Tower Erected for Parachute Jumping; Note How 'Chute Is Held Open before Jump

'CHUTE JUMPING FROM TOWER IS LATEST THRILLER

Parachute jumping for the novice is the latest thrill-producer in one of Moscow's parks. The person desiring to make a jump climbs a spiral ramp to the top of a tower, attaches the parachute harness and floats to earth when the 'chute is released from its frame. There is no waiting for the parachute to open, because it is held in spread position by its frame before it is released, thus making it safer for patrons.

at Max in Rocky Central Park of Culture and Rest.

at

8-2-41

1000 Bertram
Wheeler Co.
Kansas City, Mo.

1700 Architecture & Design Bldg. 1934

P. 32

8272

Emb. Dir. Maschinen
4 W. 103rd St.
New York City

LZ-129

The

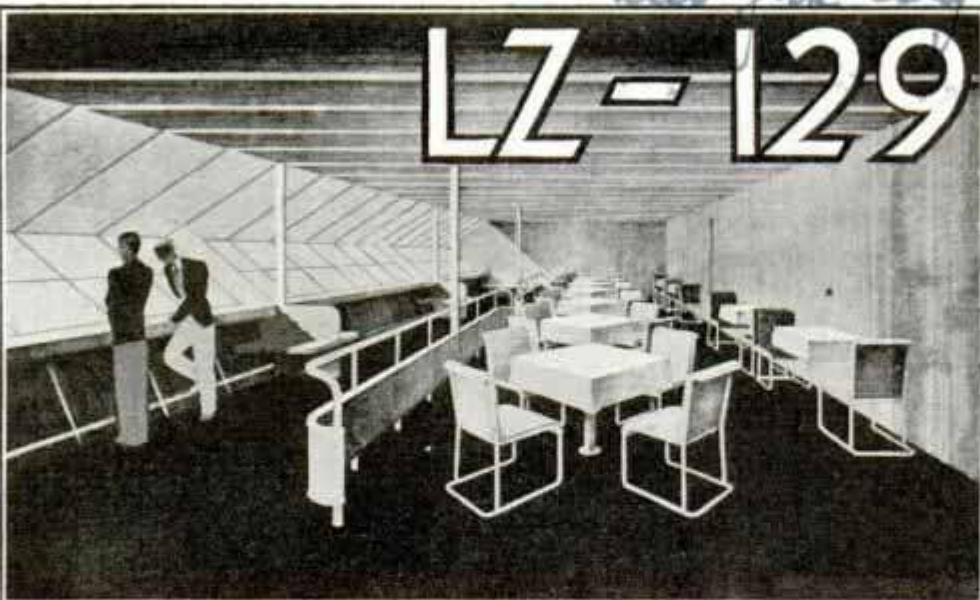

Promenade Deck of the New German Dirigible, and Dining Room Designed by Prof. F. A. Breuhaus, Berlin Architect; Note the Slanting Windows Which Give Passengers a View of the Panorama Below



One of the Lounge Rooms of the Dirigible Where Passengers Assemble for Social Gatherings; Note the Light but Sturdy Metal Furniture Designed Especially for the Dirigible

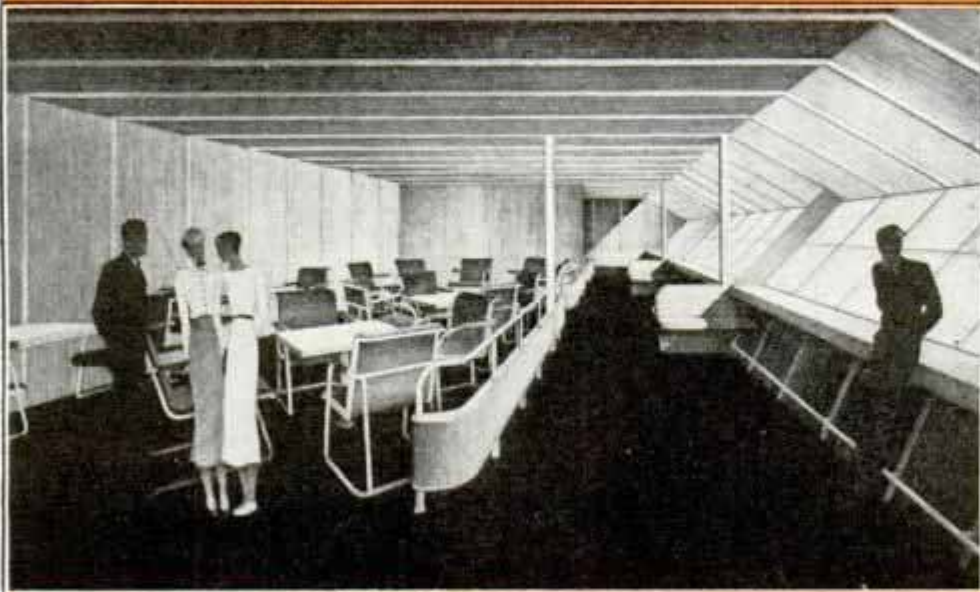

This Is One of the Promenades and Lounging Rooms of the Giant Airship Which Has Accommodations for Fifty Passengers and a Crew of Thirty-Five Persons

Latest AIRSHIP

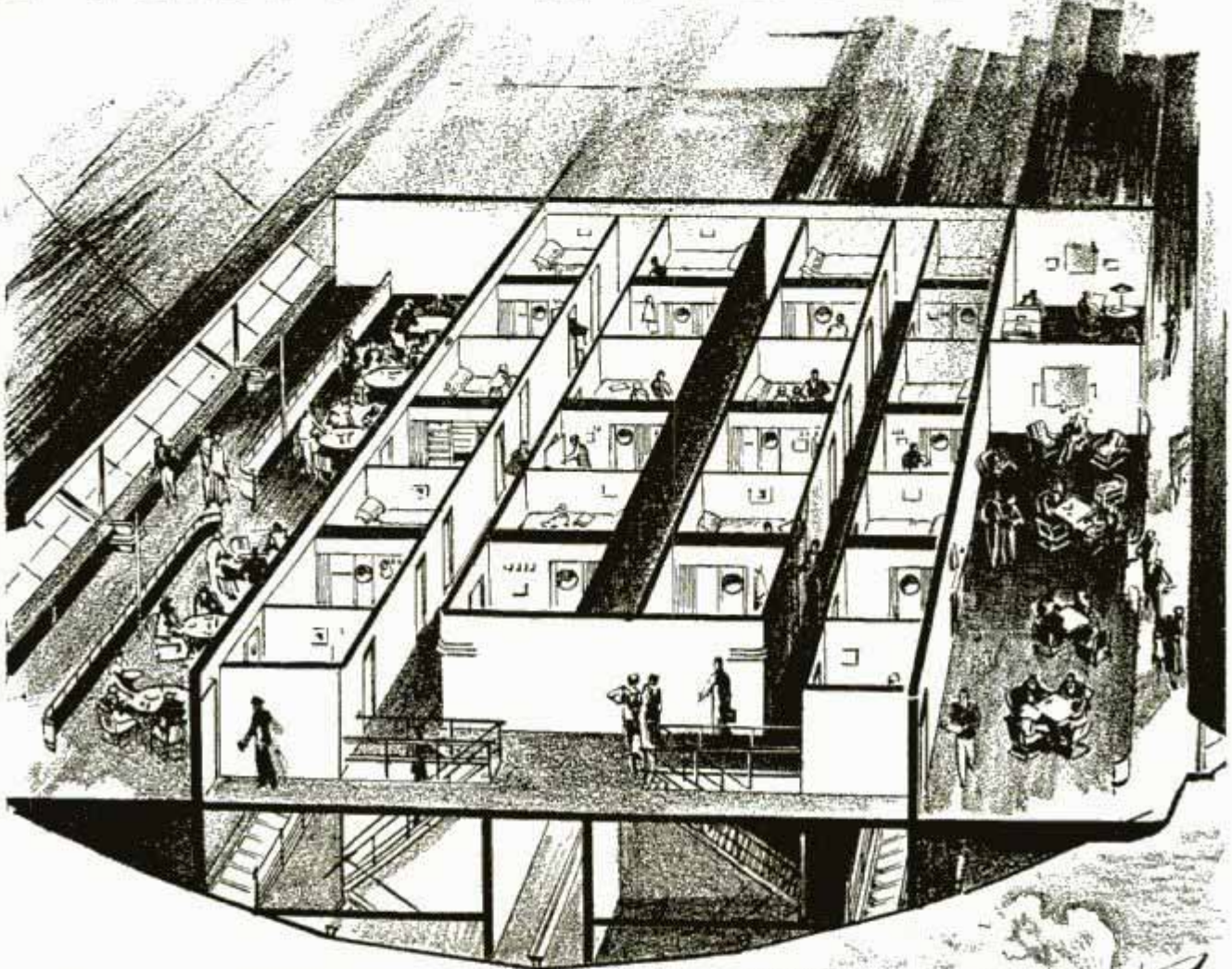

DR. HUGO ECKENER'S latest venture with rigid airships promises to unfold endless possibilities of traveling safely and swiftly through the air in modern luxury. The "LZ-129," under construction since February, 1932, is about to make her maiden trip across the Atlantic, with Dr. Eckener as her master.

Here are the main facts about the ship: Length, 812 feet; greatest diameter, 137 feet; gross lifting capacity, 418,000 pounds; pay load twenty-five to thirty tons; fuel load, 130,000 pounds; cruising speed eighty miles per hour, which will carry it across the Atlantic in about two days.

Passenger accommodations are superior to those on any previous aircraft. The designer, Prof. F. A. Breuhaus, created an "architecture of the air" in the interior decoration. He designed chairs, tables and beds as an engineer would design a bridge.

Because so much dead weight was saved

Diagram of Passengers' Quarters, Showing Dining Room, Lounge and Cabins in Center

in the design, it is possible to accommodate fifty passengers and a crew of thirty-five in the ship's twenty-five staterooms, each with hot and cold running water. In addition, the ship will carry considerable express and mail.

There are two groups of parlors, including two promenade decks, giving a total floor space of 5,380 square feet, of which one-half is available for social gatherings.

The passengers will be permitted to smoke, a luxury denied on the "Graf Zeppelin." The social salons and promenades

(Continued to page 138A)

J. S. Heyman 719 S. Los Angeles
Los Angeles Calif
 Bellows and Sound Box in 'Barking' Toy Dog

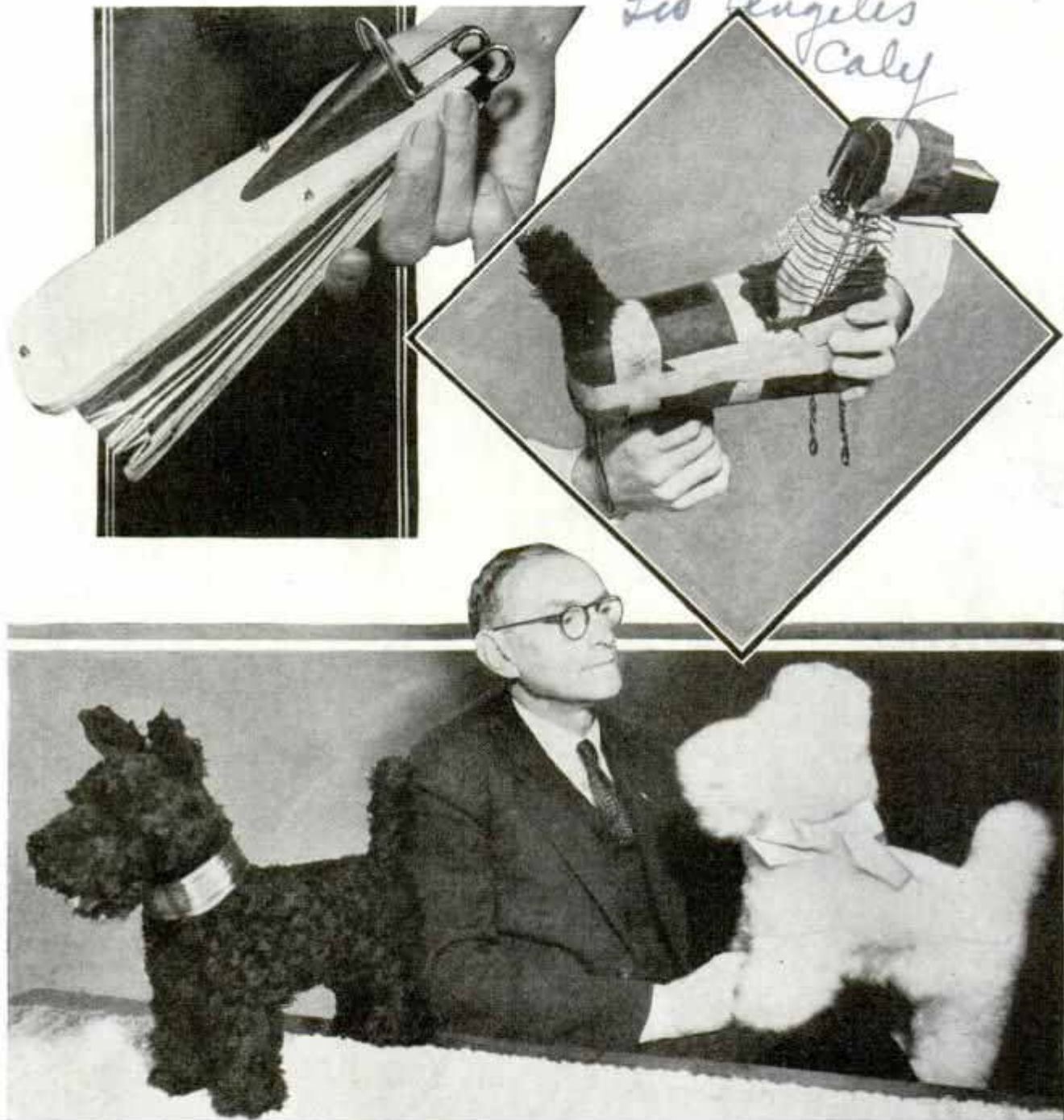

Top, Left, Bellows Arrangement for Producing Dog's Bark; Right, Toy Dog Before Frame Is Covered with Rabbit Fur; Bottom, Two Realistic Looking Toy Dogs That "Bark" until a Spring Runs Down

Producing a noise that closely resembles a natural bark, the latest toy dog is equipped with a spring-driven bellows that pumps air into a sound box. The coil spring that works the bellows also opens and shuts the dog's mouth and wags its tail. A single winding of the spring operates the mechanism for two minutes to produce about twenty-five barks. By using the bellows and sound-box arrangement, the inventor claims that he can imitate vocal noises peculiar to almost any

animal. The use of air syringes is discarded in favor of the bellows. Made of welded metal bodies covered with rabbit fur, the toy dogs will withstand hard usage.

☐ Popular Mechanics Magazine does not publish the name of the maker of, or dealer in, any device described in its pages, but this information is kept on file and will be furnished by our Bureau of Information upon request, accompanied by stamped envelope.

ROAD MATERIALS ARE FOUND BY DIVINING ROD

Sand and gravel deposits for building roads can be located below the earth's surface by a new electrical divining rod. From a truck equipped to generate the necessary power, a long electric cable extends, enabling the operators to survey areas of about three acres at each shift of the truck. The instrument looks like a combination of a radio and an airplane instrument board. Four electrodes are pegged into the ground at intervals. The earth gives up its secrets when circuits between the electrodes are measured for resistance of the formations through which the current passes from one electrode to another. Stanley W. Wilcox, Minnesota highway engineer, points out that stone, sand, gravel, silt, loess, wet or dry, have different resistances to current, making it possible to determine what formation is hidden under the surface. The divining rod saves the highway department considerable time and money, since it eliminates the digging of test holes to find sand and gravel. A supervisor and a crew of three men are required to operate the truck and its equipment.

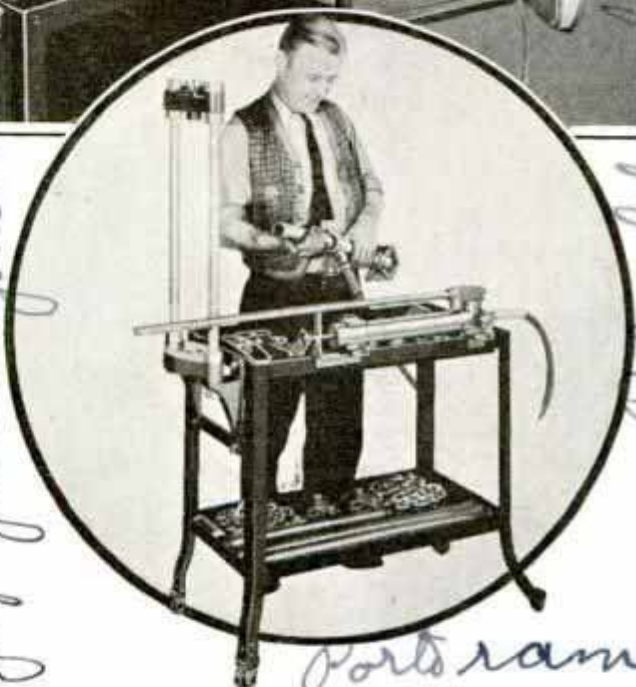

Top, How Frame Straightener Is Used on Auto; Bottom, Note Compactness of the Equipment

RAM STRAIGHTENS CAR FRAME BY HYDRAULIC POWER

Mounted on a compact wheeled stand, a combination hydraulic ram and jack is available for straightening auto frames, bodies and fenders. The pump and ram are separate units connected by a flexible hose, permitting the ram to deliver full power in any direction. The ram is threaded on both ends for attachment of thirty accessories in any combination to fit the individual repair job. The jack can pull, push, press, lift, spread, clamp or straighten with seven-ton pressure. A press at one end of the portable stand can be converted into a power press by using the ram as the power unit.



Sensitive Equipment Indicates Formation Below Surface; It Is Shown in Use

Uses such - Roonly four electrode earth resistivity

medal, 33 40 Blaydell Ave
state
Cml. George

Blackhawk Wyo to Milwaukee Wis
116 h B roadway Wyo

8962

2548

geophysical engineer

port ram

St. Paul, Minn

303.

Com. Low ...
4 W. 103rd St. New York

WHAT PRICE

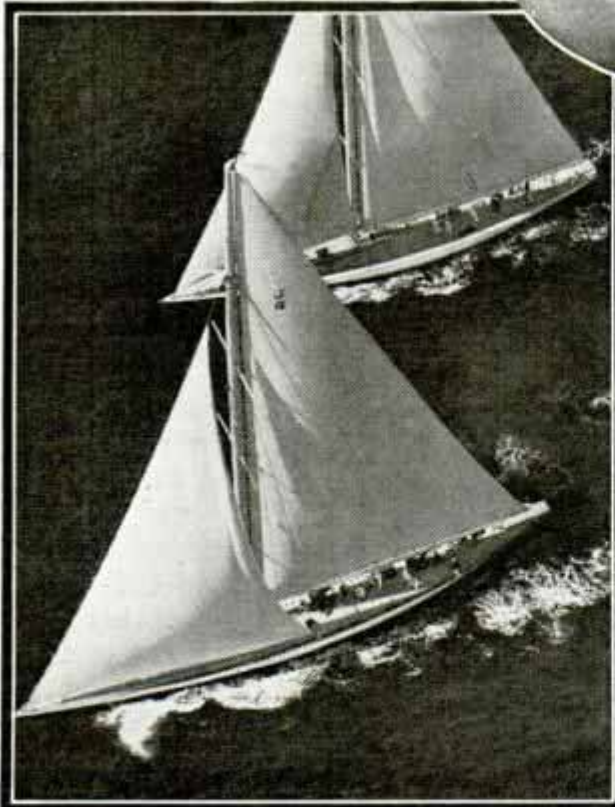
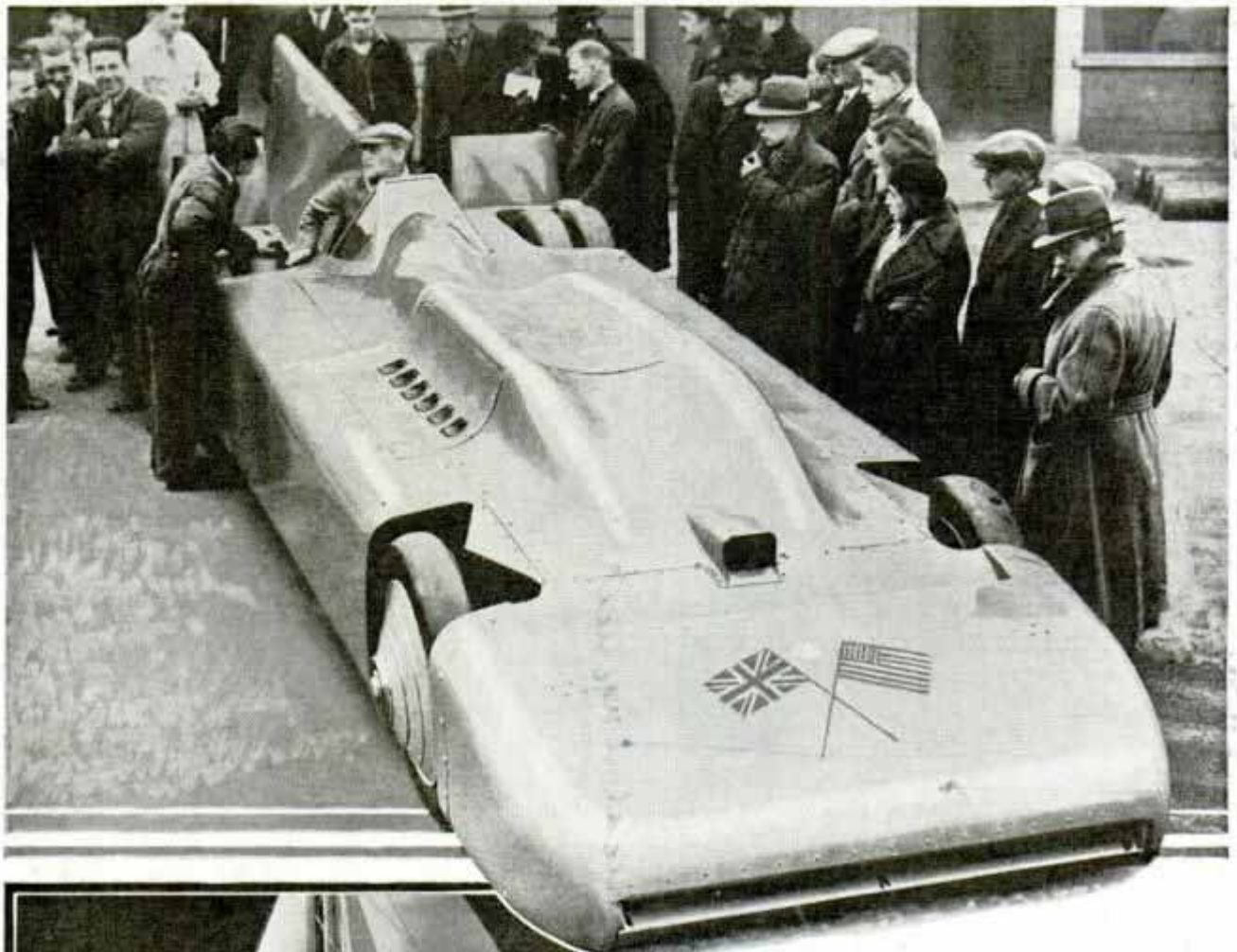

Sir Malcolm Campbell's Record-Breaking "Bluebird" and Two of America's Fastest Racing Yachts, the "Rainbow" and the "Weetamoe"

BEFORE you attempt to break a speed record you ought to inquire about the price of one. Speed records cost from nothing to millions of dollars.

The most expensive speed races are those between transatlantic passenger vessels. The construction costs of the super-ships, "Normandie" and "Queen Mary," were \$30,000,000 each. The additional expense of outfitting basins, special piers, and drydocks brings their combined costs to about \$100,000,000.

When 1,000-foot giants speed across the Atlantic they consume money at an extraordinary rate. Aside from the expense of a crew of 1,300, the engines burn fuel at more than a barrel a minute. The fuel cost of an extra two or three knots in speed of a 50,000-ton vessel amounts to thousands of dollars for a single crossing. At her regular speed of twenty-six knots, the "Rex" burns 650 tons of oil daily. But on a record-breaking dash, when the ship

SPEED RECORDS?



A Race of Fast Swimmers; Swimming Is the Slowest Form of Human Muscular Locomotion, the Maximum Speed Being About Four Miles per Hour

speeds up to twenty-nine knots, the oil consumption is about 1,100 tons daily. Hence, the cost of three extra knots per day is \$4,500; and for a record-breaking dash of four and one-half days the cost of three extra knots is \$20,250.

Train speed records do not cost nearly as much as passenger ship speed records, but the price is far beyond the average man's purse. The actual operating cost of Union Pacific's record-breaking streamline train is comparatively low. In crossing the continent, the Union Pacific streamliner consumed 2,079 gallons of crude oil, costing \$83. This is slight in comparison with the \$200,000 construction cost of the train.

Airplane speed records also come fairly high. As early as 1912 the Frenchman, Jules Vedrines, came to America with a 140-horsepower monoplane in which he

covered 124.3 miles at a speed of 105 miles per hour, winning the airplane speed record. The cost of the experimentation and construction of his monoplane was reported as \$600,000.

The costliest air records are undoubtedly those which have been won in the Schneider cup races. The principal participants, England and Italy, have spent more than \$2,000,000 in the experimental work necessary for building seaplanes that can travel in excess of 400 miles per hour. The commercial Douglas transport plane, which flew from coast to coast in slightly more than twelve hours, was developed at a cost of more than \$300,000. But the individual planes can now be reproduced for about \$80,000.

The racing automobiles brought to this country by the famous British drivers, Sir Henry Segrave, Kaye Don, and Sir Mal-

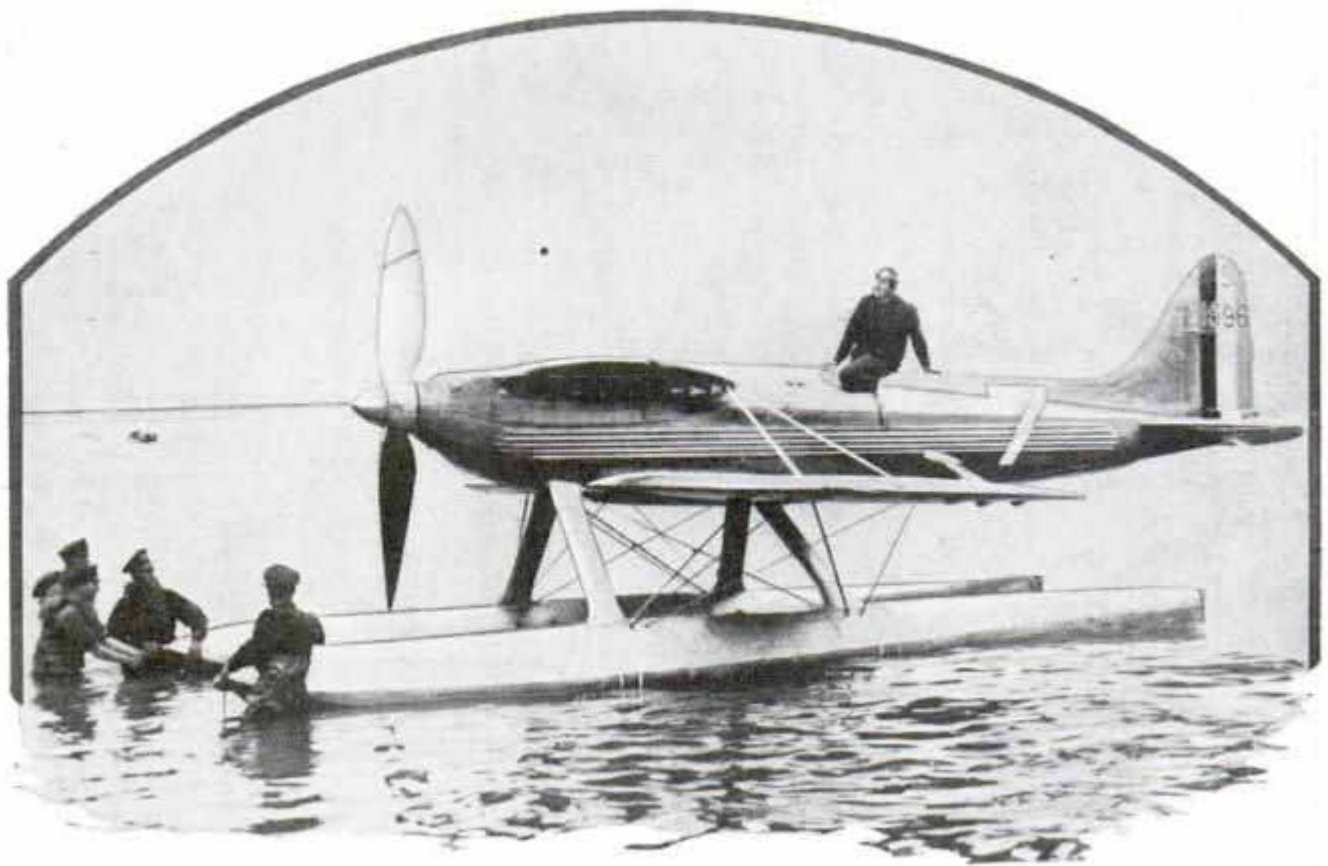

A Man and His Record-Breaking Machine; This Is Flight Lieut. G. H. Stainforth of the British Schneider Cup Team Who Piloted This Plane at a Speed of More Than 400 Miles an Hour

colm Campbell, cost their backers considerably more than \$100,000 each. It takes from six to nine months for a staff of automotive experts to design and build a superspeed automobile. The mere cost of building is figured at about \$75,000. But there are very few places where it is safe to drive an auto at a greater speed than 200 miles per hour.

Every time an English built racer comes to Daytona Beach, it is accompanied by a crew of mechanics. The cost of transportation amounts to about \$1,000 per man. Hence, when the car finally returns to England, after a Daytona speed trial, the total cost usually runs above \$100,000. The "Silver Bullet," the "Golden Arrow," the "Mystery 'S'," and finally Sir Malcolm Campbell's "Bluebird" cost anywhere from ten to twenty-five dollars per pound to build. The principal cost goes to overcome the effects of high wind resistance. If it were not for the wind, a 400-mile per hour racing car could be built for as little as \$25,000.

In general, it may be said that the cost of winning speed records is mounting. The early international cup yacht races were run for a mere fraction of the present-day

costs. The Vanderbilt syndicate spent no less than \$500,000 in the race against the British challenger, "Endeavour." Altogether, the cost to challenger and defender of an international cup yacht race may be figured at about \$1,000,000.

The cost of motorboat racing has also jumped in price. Sir Henry Segrave, who was drowned while breaking a speed record, was piloting a motorboat that had cost his backers tens of thousands of dollars to develop and to build. Gar Wood, the present motorboat record holder, has also spent tens of thousands of dollars in the experimental work necessary to build "Miss America."

Jules Verne set the world agog with an account of an imaginary journey around the world in eighty days. He figured the cost of this trip at about \$100,000. That is one speed record that was and still can be beaten for less. In 1910 one could have traveled around the world with a servant in forty days or less for about \$2,000. Starting from New York, one can now travel around the world by steamship for less than \$1,000.

When Nellie Bly traveled around the

(Continued to page 136A)

Mile-a-Minute Snowmobile Has Safety Brakes

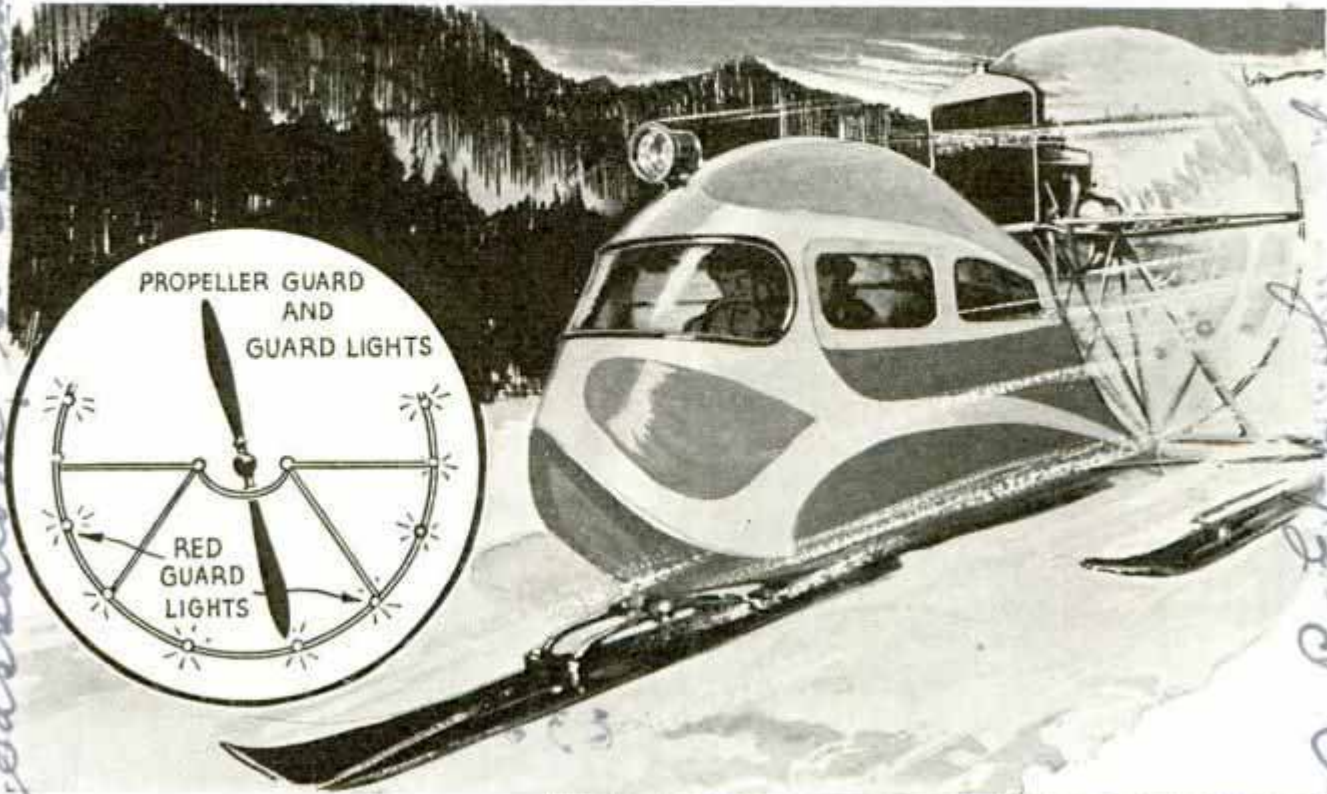

Motor Sled with Lighted Propeller Guard (Circle) and Braking System (Bottom)

Designed for safety and comfort as well as speed, the latest snowmobile is capable of sixty miles per hour. It has "knee-action" runners with retractable brakes, assuring positive braking in loose or hard snow, red warning lights around the propeller guard and a large headlight for night driving. Power, lights and heat are supplied by a Ford model-A engine equipped with starter. Motor and the "pusher" propeller are mounted at the rear, back of the driving compartment. The safety brake has a spring that causes the braking rod to retract within the main runner when the driver releases the brake pedal. Applying pressure causes the rod to dig into the snow, greatly retarding the snowmobile's speed and finally bringing it to a halt. Controls are located on a dashboard panel inside the cab. Streamlining gives the machine a pleasing appearance and reduces air resistance.

Whenever you find that you wish to know more about any article in this magazine, write our Bureau of Information, inclosing return postage.

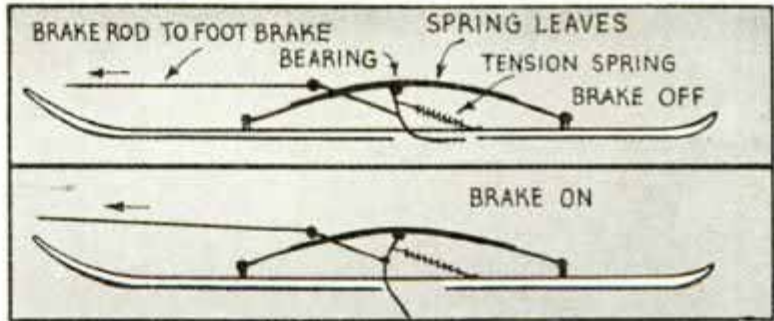

ELECTRIC-LAMP INSECT TRAP WORKS INDOORS OR OUT

Efficient indoors or out, the latest insect trap has no moving parts. It attracts the insects to an electric lamp, ranging from sixty to 500 watts. The insects accumulate

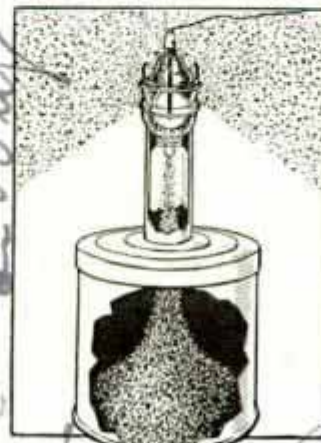

in the trapping bowl, which can be detached, cleaned and replaced quickly. The trap screws into any light socket like an electric bulb. The bulb is then screwed into the trap. For outdoor use, larger bulbs and trapping bowls are used.

Cmd. Harry F. Dimmock 327 Ave. E. South, Sashalton Sask Canada

C. P. Epp. Pangham, Sask Canada

San Leandro, Calif.

8-318

2000

Sauler Bros. 5230 E. 12th St.

519 Harbour Commission
Bldg Toronto & Ont. Can

Mr. John H. Willis, Southwell Lodge
Spruce Road Norwich England



Top, Inventor with the World Clock; Bottom, Close-up of Clock; Its Dial Revolves

CLOCK TO TELL WORLD TIME HAS MOVING DIAL

Designed to tell time at all points on the earth simultaneously, an inexpensive clock for the home has been introduced in England. Instead of moving hands, it has a dial that revolves counter-clockwise past stationary pointers representing all the time areas of the world. The dial is calibrated in five-minute periods and a glance tells the time anywhere. The moving hand on a small dial below gives the exact minutes past the hour. The clock never needs altering, either on ship or aircraft. During daylight saving months, a person in the Chicago area may use the mountain zone time pointer. For use with

error - maintain time is slow

short-wave radio, the clock enables the listener to tell at a glance the exact time at which a call or program originates on the other side of the globe. The clock is the invention of John H. Willis, amateur horologist of Norwich.

£ 398.

ESKIMOS TREK FARTHER NORTH

Eskimo families are being moved by the Canadian government from Baffin island and the Hudson straits region to the more northern Arctic islands, some within 700 miles of the north pole, because game is more plentiful. Most of the Eskimos depend on hunting for subsistence, or work at some of the northern outposts, trading their labor for food, clothing and ammunition. The Canadian government is making an effort to save the Eskimos as a race by aiding in moving them to better locations as civilization encroaches on them.

£ 366

LARGE NON-SINKABLE LIFEBOAT IS SELF-BAILING

Claimed to be non-sinkable, a large lifeboat that is self-bailing has been tested successfully. It will be used by the U. S. coast guard off the New Jersey coast where the "Morro Castle" and the "Mohawk" sank with heavy loss of life.

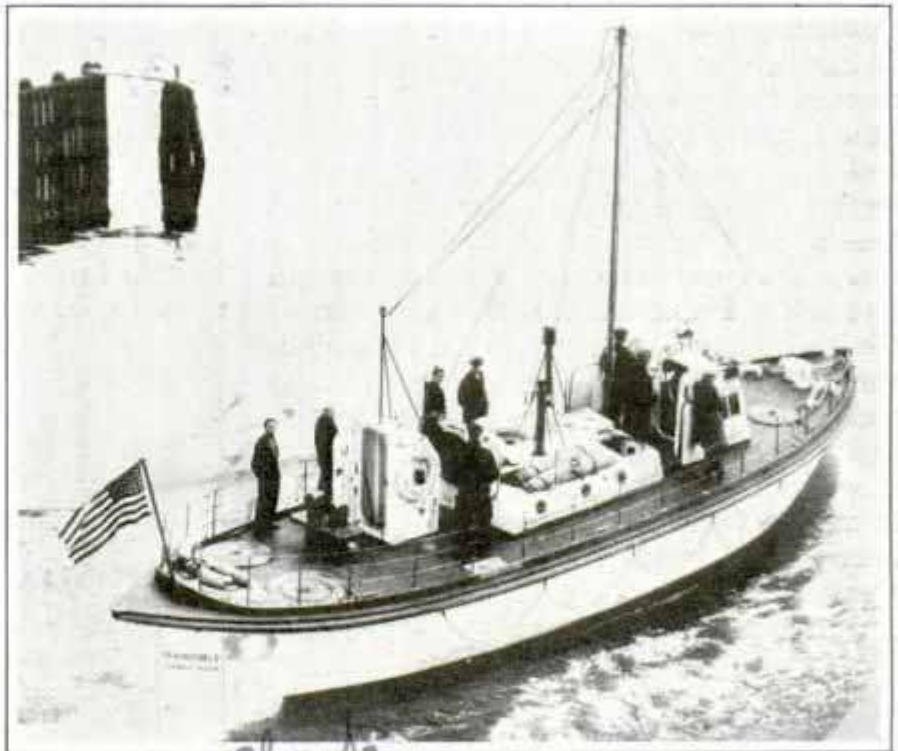

Unsinkable Boat for Use of U. S. Coast Guard as It Returned from Successful Test; It Will Go into Service Off the New Jersey Coast

Lighted Glass Stair Rail Gives Novel Effect



Main Staircase Hall of New Building of Royal Institute of British Architects, Showing Etched-Glass Stair Rails, Illuminated by Tubular Lights Concealed in the String

6/15/3

Mr. William Reed
205 E. 42nd St. New York

ONE MAN *Against*

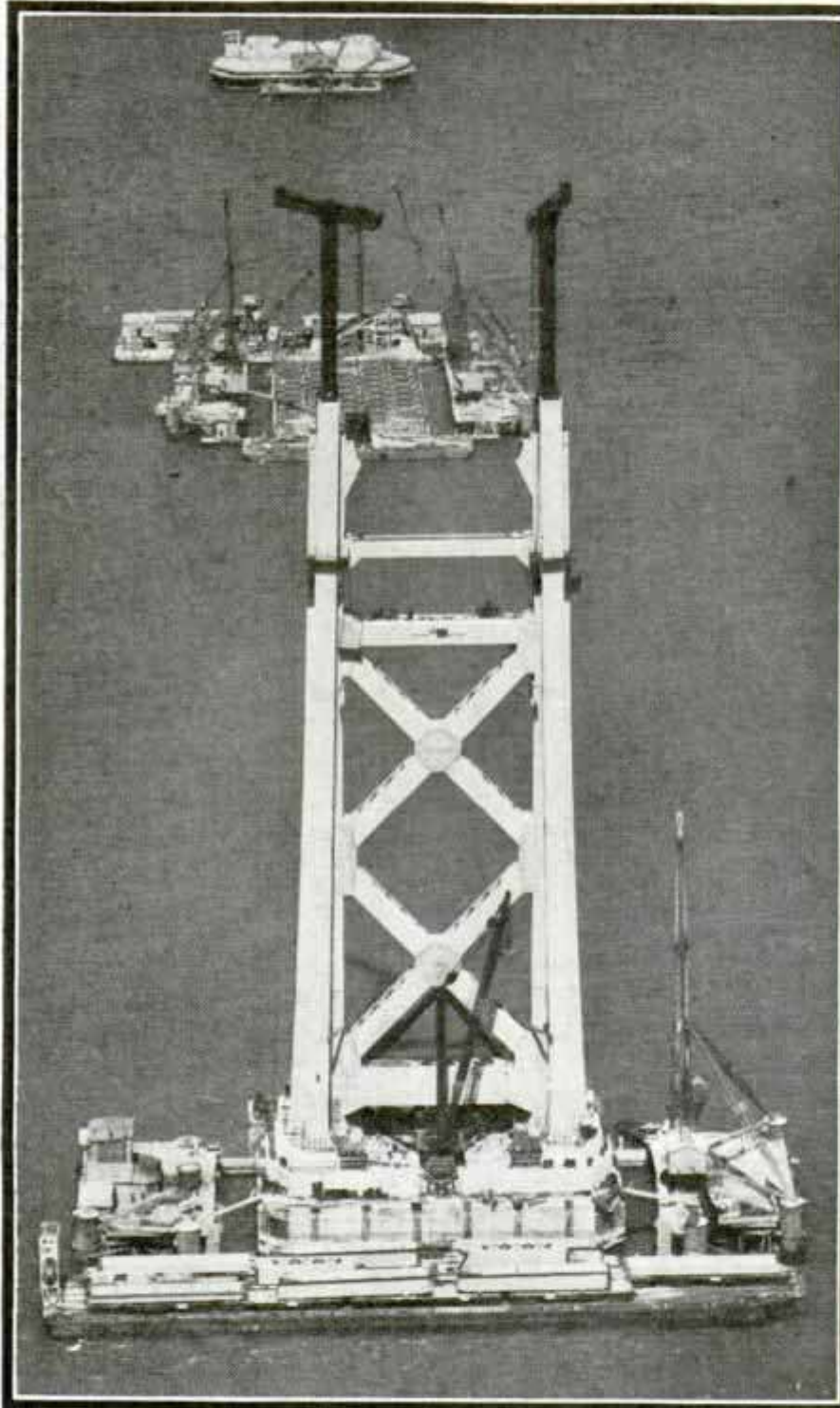

Concrete Islands from Which Rise the Suspension Towers of the Giant Bridge Connecting San Francisco and Oakland

© Associated Oil Co.

ous job is just about done. Soon he will be looking for another just as hazardous. His specialty is the underwater job that no one else can handle.

William Reed's high-sounding title is chief submarine inspector of the San Francisco-Oakland Trans-Bay bridge. The story behind it is this.

Five men sat around a big mahogany table in a director's room in San Francisco.

They had just been handed \$76,000,000 with which to build the world's greatest bridge.

Their immediate job was to dump about one-third of that huge sum into San Francisco bay, sight unseen.

The dumping had to be done in exactly the right way so that the result would be a chain of concrete islands capable of supporting the towers and the superstructure of the enormous bridge.

Nothing like that had ever been done. Never had engineers undertaken to build piers from the

surface of the water down. Never had men tried to erect them in water so deep. It was over 100 feet to the mud at the bottom of the bay, another 100 through the mud to the rock below on which the piers must rest. "Sand hogs" had never worked that deep below the surface.

To make matters worse, tides raced in and out of the bay eleven hours out of every twelve with such velocity that they

By **FRANK J. TAYLOR**

IT'S the toughest, meanest, most dangerous job on earth, but Bill Reed thinks it's swell.

Day after day, for months on end, Reed has dived into the treacherous tides of the Pacific to flirt with death, then returned grinning to the land of the living.

His main regret today is that the peril-

the DEEP

swept every loose object in their wake.

Furthermore, the icy water was full of silt and inky black below the ten-foot depth. Even if men could work on the bottom they could not see their hands six inches in front of their eyes. No light known to man would penetrate that watery blackness.

Nevertheless, \$25,000,-

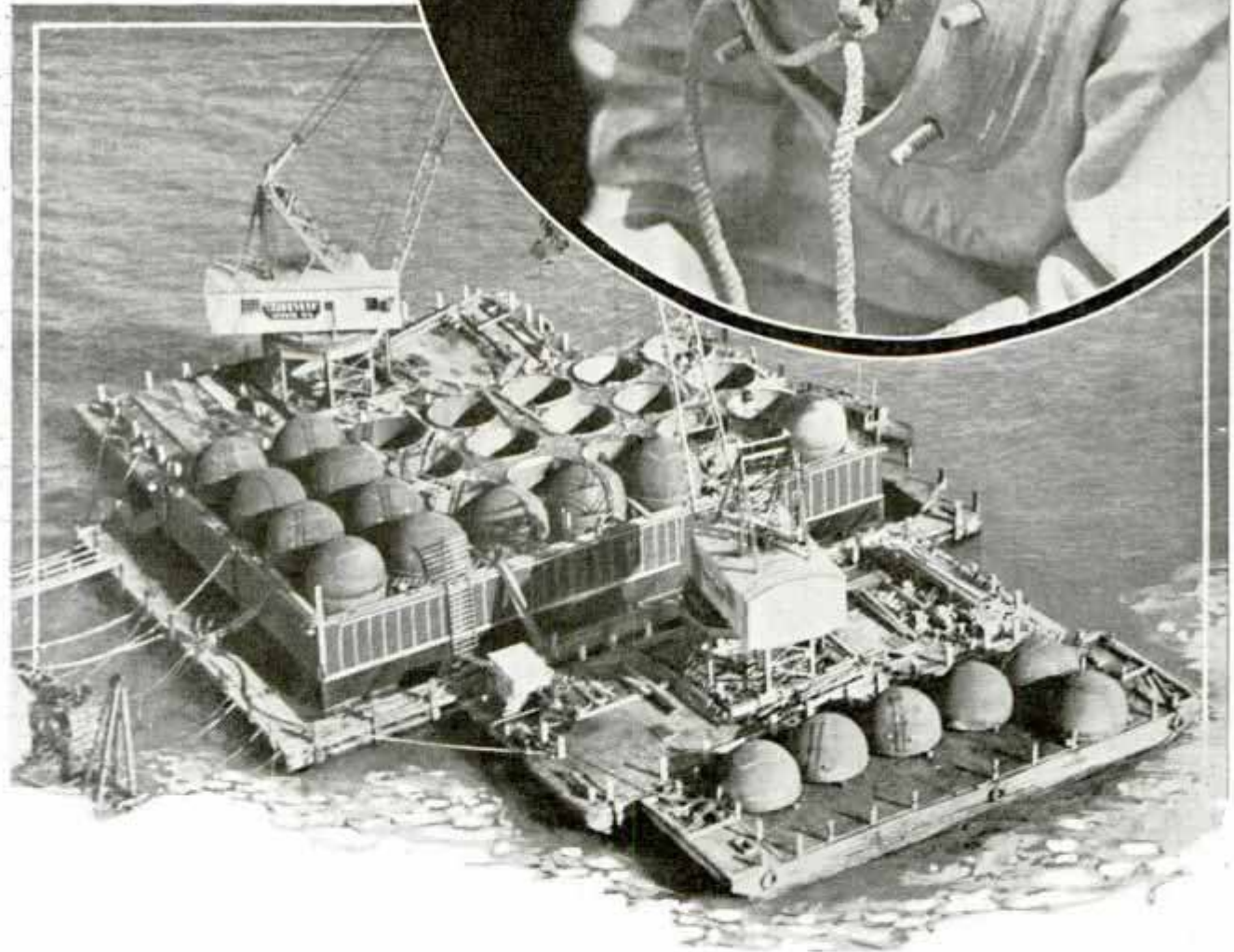

A Caisson with Some of Steel Caps Removed so Bill Reed, Above, Could Dive Down to Bottom and Inspect the Foundations 200 Feet Below the Water and Mud

000 worth of concrete had to be dumped in the bay, just so, and it must support another \$50,000,000 worth of steel and cables that formed the huge bridge.

The five men around the table included

some of the greatest engineers in the land. They agreed that it called for more than smart engineering brains to push that concrete overboard properly.

So they sent for William Reed. He lis-



but watch him for a few hours as he wagers his life against the tides. Then see if you would care to earn eighty "grand" as Reed is earning his.

Reed first purchased a small barge. On one end of it was a small cabin, equipped with a stove, shelves for dishes and food. Midway in the barge, Reed installed his "iron doctor," an invention of which he is exceedingly proud. The

tened to their story and said he would tackle the job.

Now, Bill Reed is no engineer. He has no college education. He left school as a kid and went to work with a bridge construction gang. He couldn't figure a stress or strain to save his life. But Bill Reed's name is fame wherever bridge engineers gather. When he left the director's room, he was the highest paid of 3,000 employes on the bridge project, for two reasons.

One is that Bill Reed is a "Handy Andy under water," and the other is that he "has eyes in his fingers," as the engineers put it.

Reed's contract was unique. It assured him a retainer of \$15,000 a year, plus "deep money." Every time he dove twelve inches or more beyond the 100-foot depth he received a bonus of a dollar a foot. That's deep money.

Altogether, the world's most risky job will net Reed about \$80,000 when it's done. Offhand, that looks like a lot of money,

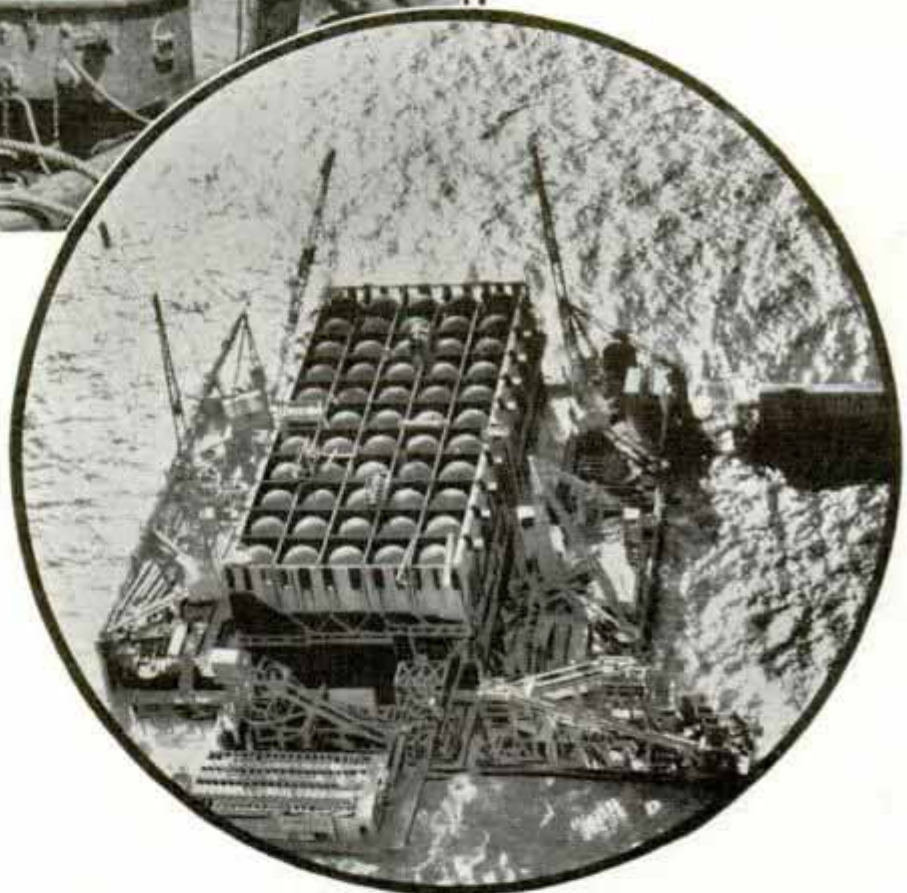

Cluster of Steel Tubes Forming the Caissons by Means of Which the Concrete Islands Are Built from Surface Down, and Diver Reed Talking Things Over with His Telephone Man

"doctor" is a huge pressure tank of heavy steel divided into two compartments. One is large enough to hold two cots, a radio, a telephone and a few bottles of stimulants. The other is barely big enough to accommodate a man standing up.

The doctor lies on its side amidships. Behind it is a compressor motor. In his iron doctor Reed decompresses slowly for two hours after each dive, the compression being reduced gradually from that of the

8153

8237

Wood Hally

Santa Barbara

Calif.

nether world, with its pressure of 100 pounds per square inch, to the condition on the earth's surface, where the pressure is only sixteen pounds per square inch.

The balance of Reed's paraphernalia includes a regulation diver's suit, a bronze helmet, lead shoes, 300 feet of rubber air-line hose, a submarine telephone outfit, sundry ropes, and "Spud" O'Donnell, tender of the life line.

So equipped, Bill Reed was all set—one man against the deep.

The first task they handed him was exploring the bottom of the bay along the five-mile course of the bridge. The engineers had to clear the path before pouring the concrete for the piers.

For two months, fed with air from the barge above, Reed lurched around against the tides, leaning into the drifting currents at an angle of forty-five degrees. In spite of the weight of his 185-pound diver's suit, with bronze helmet and metal shoes, plus his own 200 pounds, he had to fight to stay on his course. On the bottom he found junk and debris, dumped in bygone years, relics of sunken ships, boulders, lost anchors, and cables. He hitched hawsers to the worst obstructions, so they could be towed away before he tackled his next job.

That was to walk around on the bottom with a magnetic detector to locate the telephone cables connecting San Francisco with Oakland. They were exactly on the line of the bridge piers. Reed's task was to find a cable, cut it in two with a hack saw, fasten hawsers to the ends, so they could be pulled up to the work barge, spliced and lengthened, and moved.

The cables had sunk too deep in the mud to be pulled out without breaking. So the men on the barges lowered a "washing machine," a little vehicle about the



Photo Associates

Photographer Takes a Downward "Shot" in Orchard While Two Assistants Hold This Unusual Scaffold and Ladder Rig

"DOWN" PHOTOS OF TREES MADE FROM LADDER-SCAFFOLD

Making downward "shots" of trees and other subjects is made easier for the photographer by a combination ladder and scaffold designed by a Californian. The scaffolding supports the ladder in upright position so that the photographer may climb to the top for his "shot." To speed up the process of taking the pictures, two assistants steady the rig when the photographer is ready with his camera. The cross-bracing is so pegged that the entire scaffolding is mobile. When it is desired to remove the ladder to another location, the cross-bracing is strapped to the ladder, which in turn can be placed on trailer wheels and towed by automobile.

Names and addresses of manufacturers and dealers in articles described in this magazine will be furnished by our Bureau of Information upon receipt of a stamped, self-addressed envelope.

(Continued to page 118A)

Faster Locomotives Built in Rail Speed Race

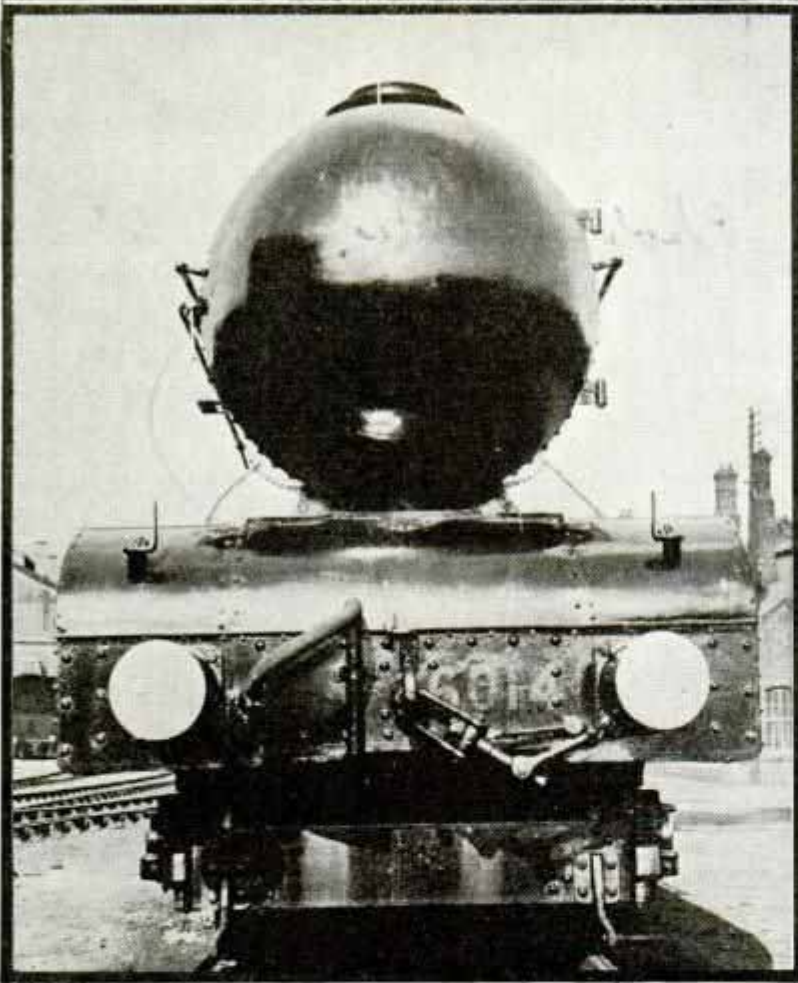
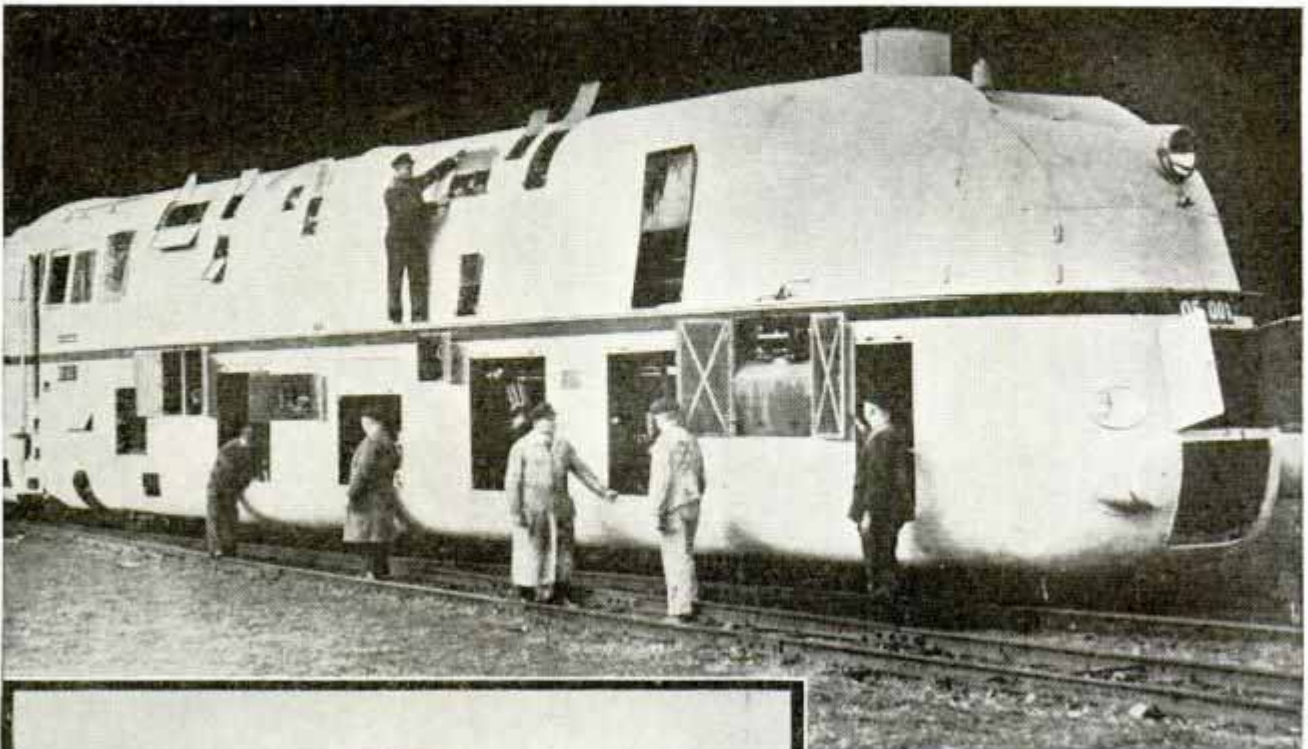

Top, Preparing Streamline Locomotive for its Trial Run on a German Railway; Note How the Smooth Metal Covering Shields All Working Parts against Wind Drag; Bottom, Latest Steam Engine in England, as Viewed from the Front, Has a Rounded Nose Designed to Increase its Speed; Both Engines Are Expected to Attain 100 Miles per Hour or More

Acme © Planet News

Streamline locomotives of many sizes and designs are being constructed in Europe's race for speed on rails. In Germany a steam engine built in accordance with the latest ideas of aerodynamics has been undergoing tests before challenging the world's record. Speeds around 100 miles per hour are expected. An engine on a regular run of an English railroad recently attained a speed of 108 miles per hour. England's latest locomotive is a streamline, bullet-nosed engine. Built for the Great Western railway, it will pull the crack express, "King Henry VII."

MALE HORSES FASTER ON RACETRACK

Prof. Calvin P. Stone of Stanford University reports that only twenty-two per cent of the winners in stake races in the period of 1923 to 1929 were mares and fillies. Eighty-six per cent of all racing records established from 1908 to 1932 were made by stallions and geldings, the survey also shows.

Journal of Comparative Psychology

Source same

Stanford P.C. Case

**HAND-OPERATED LEVERS
PROPEL LIFEBOAT
WITHOUT OARS** £231

Hand-operated levers, instead of oars, are pulled to propel a type of lifeboat recently demonstrated in New York. The levers are connected to a shaft which in turn operates a propeller. It is claimed such a craft can be lowered more readily, operated easier and can be maneuvered closer to the scene of an accident than a lifeboat operated with oars as no room for moving the oars is required.

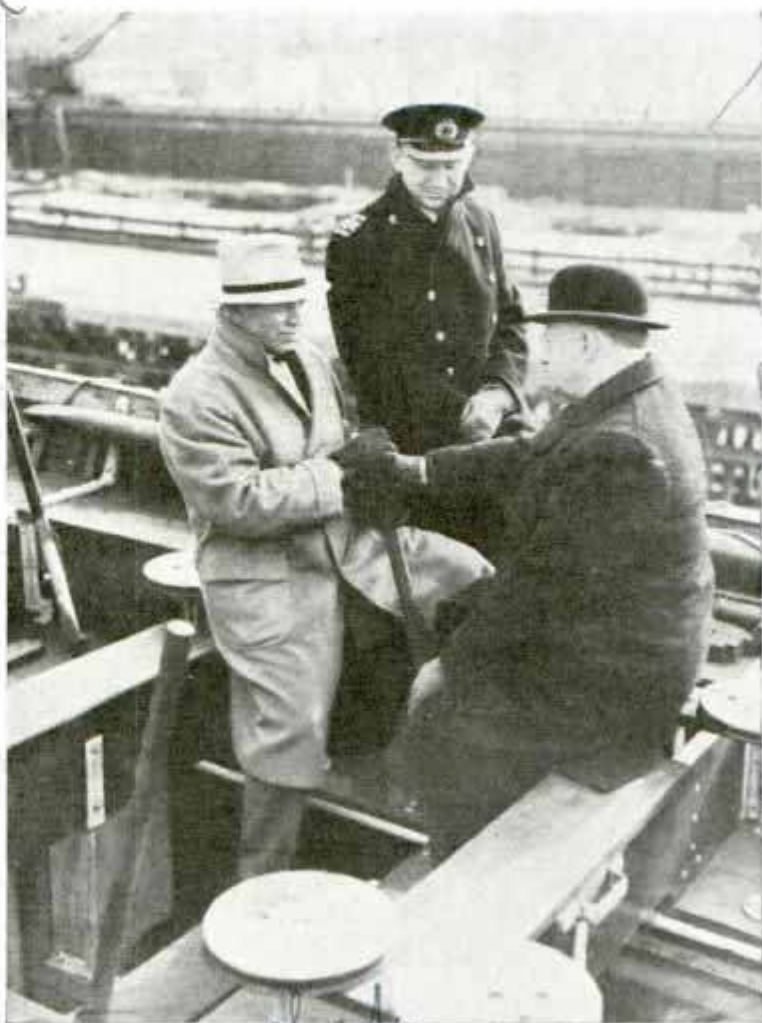

Oarless Lifeboat Propelled by Hand-Operated Levers Attached to Shaft Which Operates a Propeller

£352
**"ELECTRIC EYE" IN STACK
WARNS OF WASTE**

When a chimney or the smoke-stack of a factory smokes, indicating waste of fuel, a photo-cell relay will give an immediate warning. In a demonstration recently, the "electric eye" flashed a signal when the stack of a model factory became filled with smoke. This equipment is intended to reduce costs of operation.



Model of Photo Cell in Chimney

**LIFELIKE AUTOMATIC LURE HAS
SPINNERS ON HINGES** £330

Functioning automatically while submerging in any position, a new fish lure has a lifelike appearance that induces strikes. It has a hinged bail to which are attached swivels and two spinner blades. Casts may be made with deadly accuracy because no feathers or buck-tail are used. The body is cast from special treated metal, balanced to make casting easy. Regular baseball thread protects the metal casting.

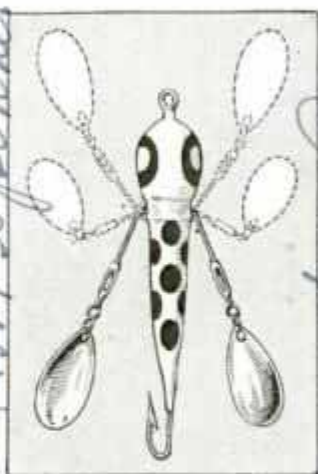

Tests show that a pull of eight pounds is required to break a horsehair.

Steamboat Navigation Service

*Mr. J. R. Fleming
Water Co. 734
London, England*

*1819/4
J.A. Clyburn
Los Angeles, Calif.
Echo Park Ave.*

Is In Laboratories

*Weekly News
Almanac 1935*

8357

410, 103rd, near York

WINGS Over the

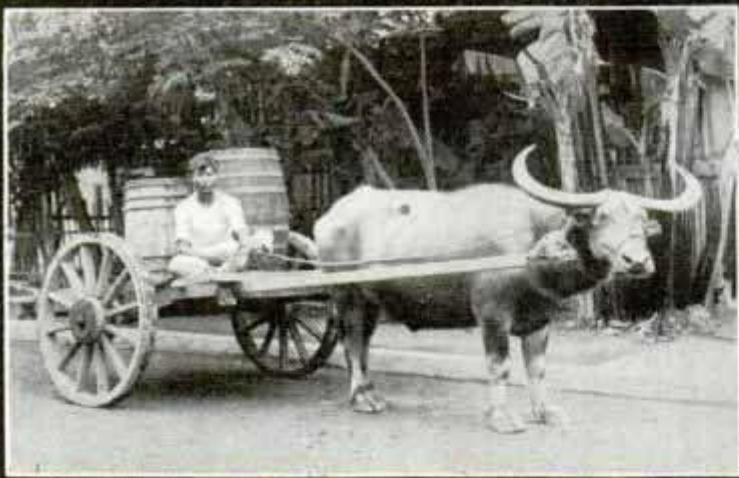

San Francisco Harbor, Possible Terminus of Pacific Airline; a Philippine Ox Cart and Street in Canton, China

AMERICAN engineers, inventors, pilots and airplane builders will claim the honor of being first to heave an airline across the largest body of water on the map—the mighty Pacific ocean, 68,000,000 square miles in area.

A brand new airway 8,678 miles long, one-third of the way around the globe, will be in operation by Pan American Airways before the end of 1935.

What formerly required months on a sailing vessel, and even now takes three weeks on a steamship, will be covered in about four days by a fast fleet of clippers cruising at 150 miles per hour.

Not even the Orient is remote any more. If you have 100 hours to spare and a desire to see a good bit of the world from the air, you may soon hop aboard a Pan American clipper at a California port and speed across the blue Pacific faster than a trade wind.

With the same energy and re-

135 E 42nd
New York

See China Clipper
Jan 19 31. 30 2357

PACIFIC



sourcefulness with which it conquered the Caribbean sea, Pan American is proceeding on this new venture, one of the most audacious and courageous in maritime history. To weave an airway net over the jungles of South and Central America is no mean undertaking, but to blaze a commercial air trail across the greatest water body on the map is something that until recently appeared foolish and next to impossible.

But these engineers go about it with an assurance and confidence that overcomes every obstacle. They are now somewhere in the Pacific ocean wastes, laying foundations, erecting radio towers, surveying harbors, and assembling machinery where such things were scarcely known heretofore. On Wilkes island, for instance, they are establishing an airway base and the first human settlement, so far as is known.

By a fortunate coincidence, it happens that all the islands necessary for air bases are under the jurisdiction of the United States. Except for the last stop, Canton, China, the entire airway covers territory controlled by the United States. At the

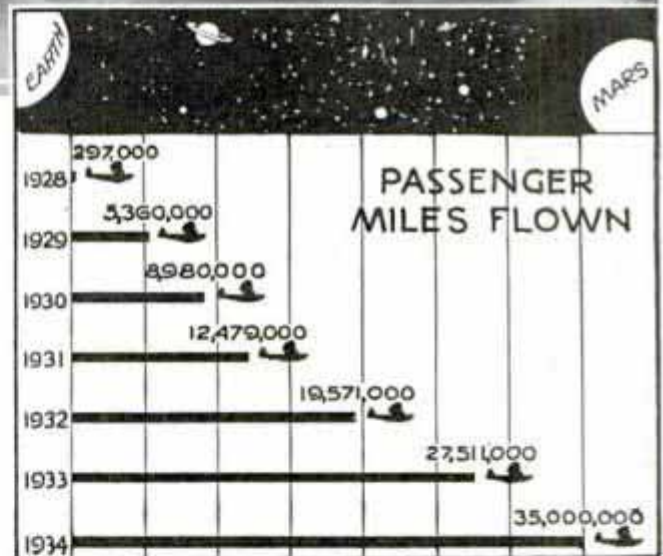

Sketch of Nineteen-Ton Trans-Pacific Clipper Ship, and Chart Showing Increase in Passenger Miles Flown by Pan American in Seven Years

present state of aviation it would be virtually impossible for a foreign nation to establish a competing airway across the Pacific without the consent of the American government.

The "North Haven," a 15,000-ton vessel chartered by Pan American Airways, is the supply ship for the crew now engaged in establishing the five bases on Pacific islands. In addition to a construction crew of seventy-four, the "North Haven" carries a staff of forty-four technicians who have received intensive training in Pan

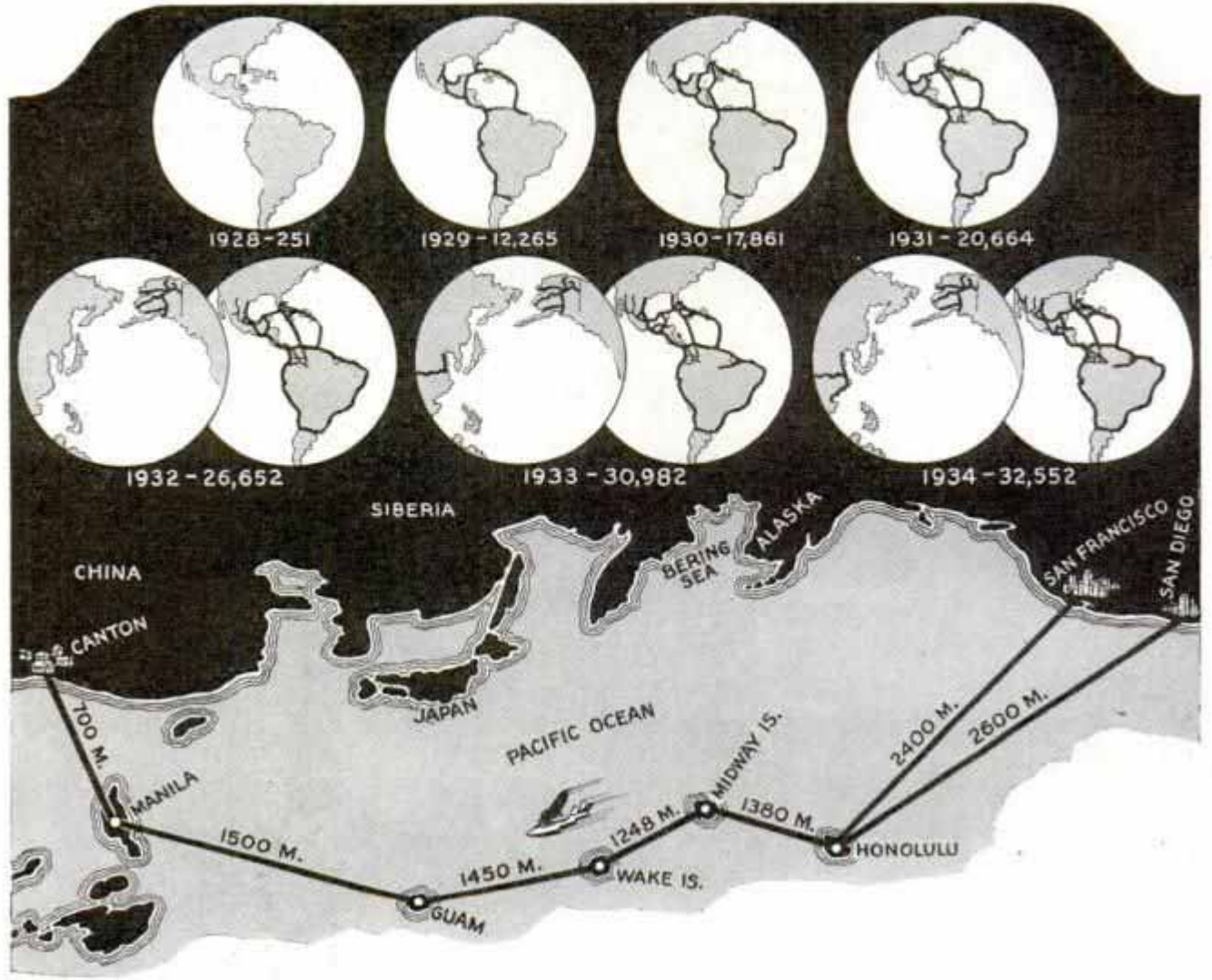

Route to Be Flown on Trans-Pacific Airline with Island Airports Where Stops Will Be Made and Charts Showing Growth of Airway Route Mileage of Pan American Airways

American's ocean flying school in the Caribbean sea.

Preparations for establishing the trans-Pacific service have been going on for more than two years, and the crews of the clippers and staffs of the island bases are now prepared to meet almost any contingency. The company has accumulated masses of geographic and meteorological material relating to the Pacific. It has developed a system of radio communication that keeps every ship in the air in constant touch with the personnel on land. All members of the marine personnel have received three years of training in ocean navigation and long-range flight technique.

The new short-wave radio direction system developed by Pan American engineers has a range of more than 1,800 miles. Traveling on the beam, pilots will find it difficult, if not impossible, to lose their way.

The Pacific airway may have its Ameri-

can base at either Los Angeles, San Francisco, or San Diego, Calif. From there, the rest of the route is virtually certain. The first stop is Honolulu, 2,400 miles from San Francisco; the second stop is Midway island, 1,380 miles from Honolulu; then Wake or Wilkes island, 1,248 miles from Midway island; Guam, 1,450 miles from Wilkes island; Manila, 1,500 miles from Guam, and finally Canton, 700 miles from Manila. Only five stops for a total of 8,678 miles!

In China, the Pacific service will connect with the 3,000-mile system of the Pan American Chinese Airlines, which covers strategic trade areas in the Far East.

This will make the Pan American system by far the greatest air transportation service in the world. Its system now includes 33,000 miles of scheduled airways touching thirty-three countries, but it does not operate within continental United

(Continued to page 144A)

£ 304

Fast Motor Bus Has Front and Rear Engines

no U.S. agent known



Streamlined and capable of speeds up to seventy-five miles per hour, the latest German-built bus has two engines, one at the front and the other at the rear. Each engine produces 140 horsepower. There are seats for forty-four passengers, the driver and two mechanics in the bus, which is heated by radiators connected to both engines. Other improvements include pendulum rear axles, corresponding to independently sprung wheels now used on American automobiles, but with an addi-

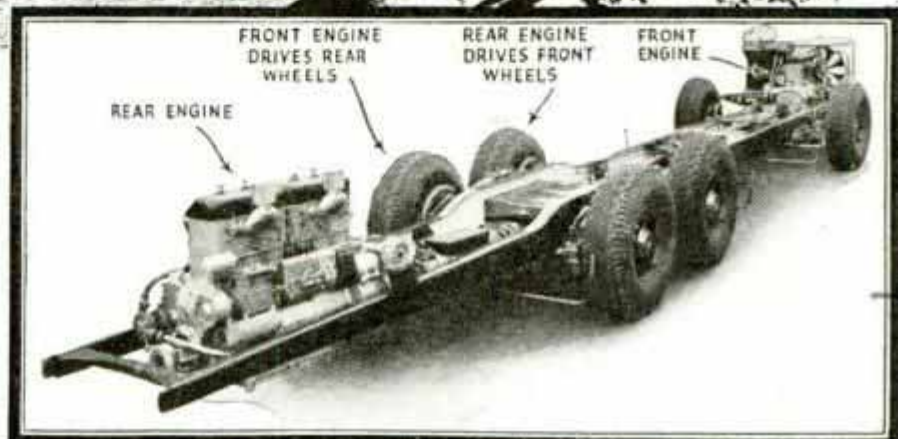

Chassis of Latest Motor Coach with Engines at Front and Rear; Drive Shafts Are Arranged in Unusual Manner to Get More Power

tional spring that acts as a stabilizer. The bus was constructed especially for use on a new high-speed highway now nearing completion in Germany.

Water Cycle on Pontoons Is Driven by Paddle Wheel

£ 246



Pontoons Replace Wheels on This Water Cycle; a Speed of Ten Miles per Hour Is Possible by Pedaling the Craft Like a Bicycle

Built for exercise or sport, the latest water craft is propelled by a paddle wheel driven by pedaling. The operator sits on a frame resembling that of a bicycle. Pontoons of rustless metal support the cycle. Carrying two passengers, the craft can attain a speed of ten miles per hour. It has shallow draft and can buck strong currents. The cycle is easier to handle than a boat.

Wm. S. Luzern Custer

Prunswick, Germany
119 F. raschlin, Clayton, Ohio
cmd. Hans Jr. Kutechbuch
Molthe strasse 2, Berlin-Steglitz, Pse

E-144

Cummins-Wright Bros Mineral Wash.
Big Tractors
Caterpillar - Diesel 75



*John Deere Cutter,
Caterpillar 22.*

Pacific Logging Congress

Diesel Tractors Thrive on Heavy Work; Above, a Diesel Being Used for Logging on the Slopes of the Cascades; Below, Harvesting Guayule Which Later Is Transformed into Rubber

*American Rubber
Produce Co. Salinas
Calif.*

THE astounding success of the Diesel tractor in three depression years since it was offered the public is one of the mileposts in that modern combination of invention, manufacturing and merchandising known as manufacturing.

Prof. Hobert Beresford, of the University of Idaho, sums up the case for the Diesel engine today as he sees it after

three years study in the Pacific northwest: "The saving in fuel consumption and fuel costs by the Diesel engine comes through the fact that Diesel fuel oil contains from 500 to 850 more B.T.U.'s per pound than does ordinary gasoline and that because of this difference in molecular structure, which provides the added heat energy, the Diesel oil weighs more per gallon than

Chas. C. Dale Higgins E-144.
Mt. Loutas Aero.
Piedmont, Calif

Go DIESEL

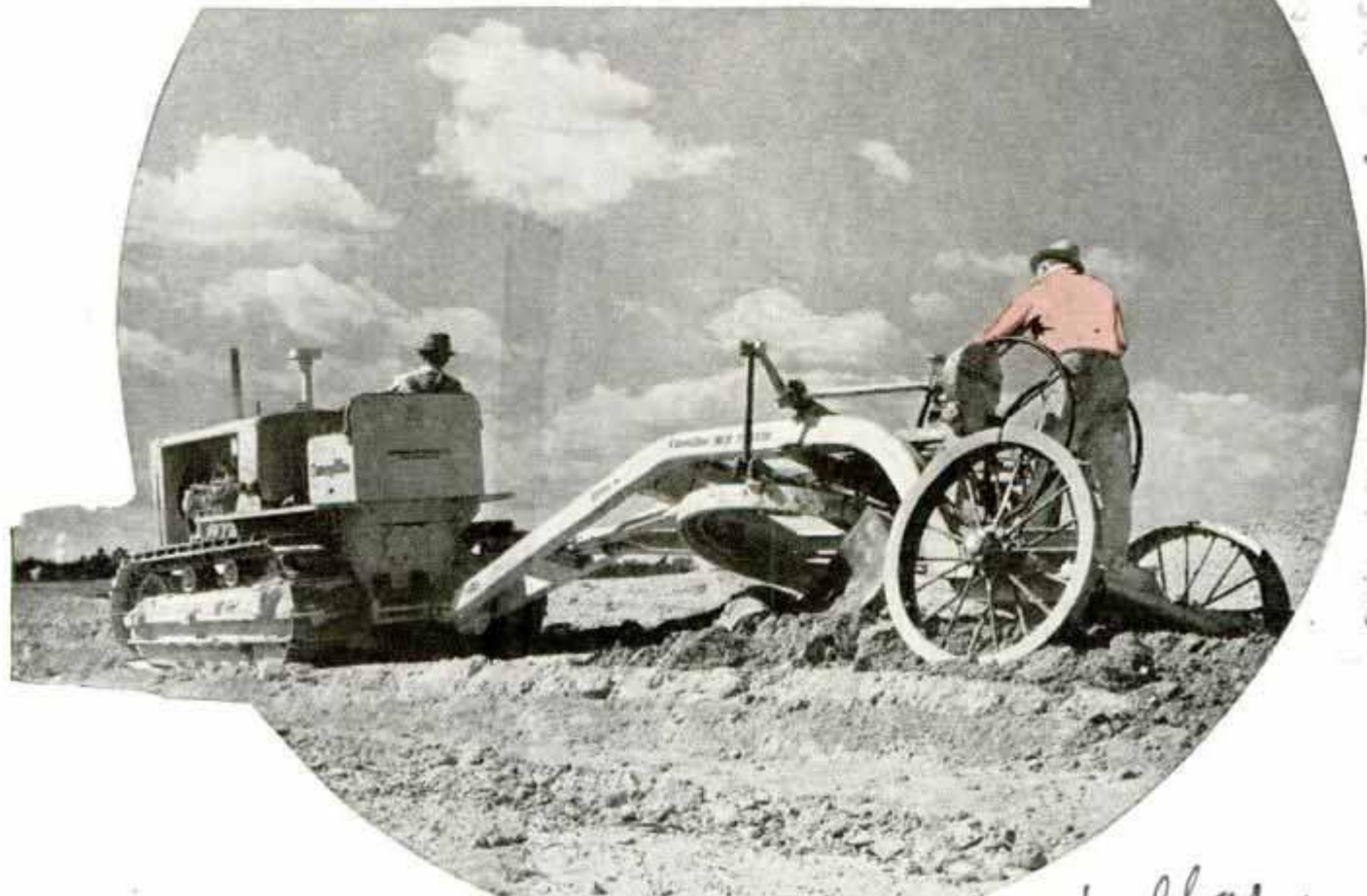

Caterpillar 35 and Caterpillar Terracer.

Here a Diesel Tractor Is Doing Its Bit to Prevent Soil Erosion in Georgia by Pulling a Terracer Which Plows Up Banks of Earth and Stops Gullying

U.S. Soil Erosion Service Cobb County

does gasoline, with the result that a gallon of Diesel oil may contain as much as 30,000 more B.T.U.'s than a gallon of gasoline. In addition to this, the thermal efficiency of the Diesel engine is usually from one-third to one-half greater than the efficiency of the gasoline engine."

Already, in California, Arizona, Oregon, Washington and Idaho, the cost of the fundamentals of agriculture—plowing, disking, harrowing, weeding, seeding, harvesting—have been cut in half by the advent of the Diesel tractor. Professors Gilmore of Oregon State College, Bosworth of the University of Idaho, Johnson of Washington State, and County Agricultural Agent McKennon of Gilliam County, Oregon, agree with H. W. Putnam, Oliver branch manager for California and Arizona on that statement.

In this great wheat area, fields are rare-

ly less than 160 acres and frequently over 1,000 acres in extent. Tractor operators work night and day during the season, a Diesel pulling nine sixteen-inch plows and covering from eighty to ninety acres in twenty-four hours. A depth of six inches is about standard here, says County Agent McKennon. He figures a farmer with less than 1,000 acres of grain cannot afford to own his own Diesel tractor; hence, practically all owners do some custom work for neighbors.

In the Salt River valley of Arizona, the plowing job is heavier. There, according to Mr. Putnam, quoted prices have dropped from three dollars an acre to \$1.50 with the arrival of the Diesel, and he adds the custom operators are making money at those figures. Over in the Imperial Valley of California and Mexico, where the big disk plows are going down eighteen inches

Vertical handwritten text on the right edge of the page.

Installation at Valley
POPULAR MECHANICS
Isin by Valley, S. C.

Engin running at 700 rpm
pulling 4 stands 80. each
bullet
Gins.



to find fleets of tractors averaging 3,000 to 3,500 hours per year work, and there are tractors that can prove over 6,000 hours work inside a twelve-month period!

So California now has over 1,000 Diesel tractors and is adding them as fast as purchasing power returns with profitable prices in the areas where acreage, hours or custom work warrant them. The eight western states have taken close to 2,000 Diesel tractors up to the end of last year. Colorado has forty-two, according to Colorado Agricultural College estimates, and

Valley Express

deep, the rate is \$2.50 to three dollars for Diesels where it has been five to six dollars for gasoline rigs.

Although now the Diesel tractors only come in the larger sizes, ranging from thirty-five to eighty horsepower, at any moment they may appear in reduced sizes. Even now, the smaller tractors are burning second-grade fuel, low-grade distillates, "stove tops," or butane, to bring farm tractor power costs to a new low level never approached before and undreamed of before the depression.

To get the tractor picture of California's lead in rushing to the Diesel tractor, remember that the western farmers began hooking the imported English "road steamers" to their plows back in the early 70's and have never stopped tractor farming since. Census figures have shown California leading the nation in number of tractors per 100,000 acres of cultivated land; nearest to horseless farming of all the United States. It is nothing uncommon



The Diesel Engine Is Equally at Home as a Power Plant for the Farm or for the Heavy-Duty Truck on the Highway

Diesel-Cummins.
from there east, practically every state has one or more on some large farm holding, with many others scattered in heavy construction work like the Mississippi river levees or road building.

All up and down the Pacific coast, from Seattle to San Diego, the Diesel engined truck and the butane-burning truck have been fighting the battle of lower cost transportation fuels for freighting. While the

Caterpillar D 7700
P... ..

routes are mountainous and long, modern highway building cuts down grades, straightens curves and makes it tougher and tougher for the railroads to hold their freight business.

There is a single firm, the Pacific Freight Lines, in Los

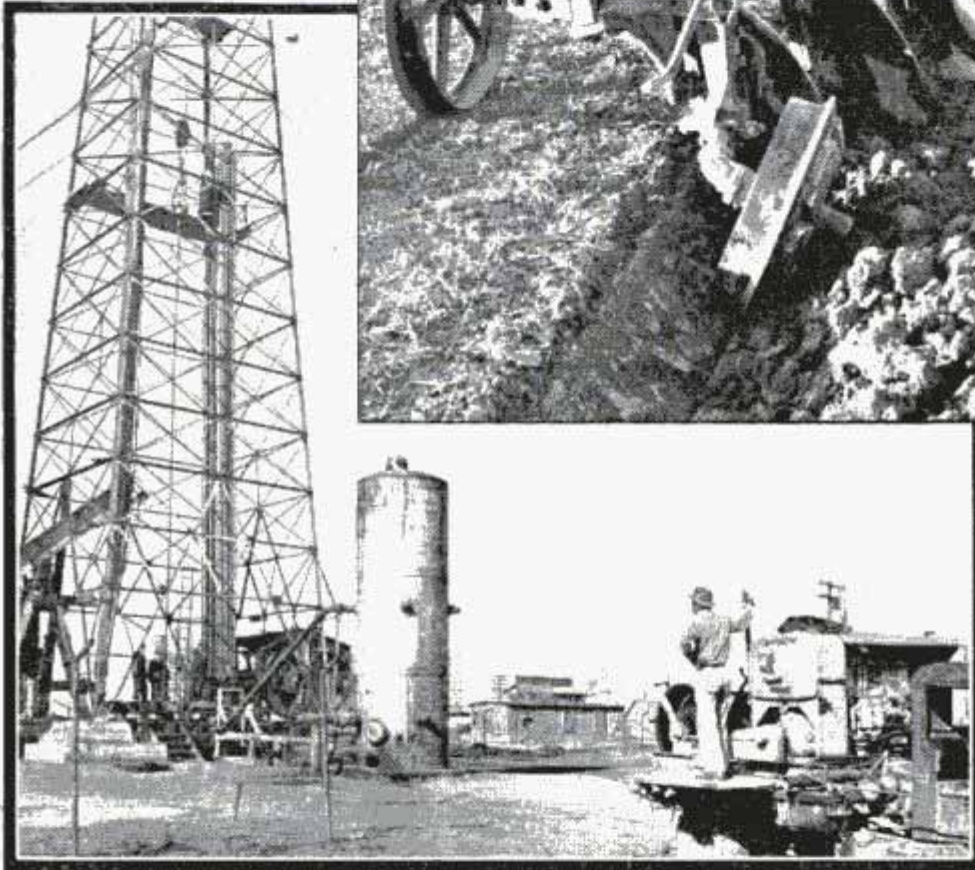
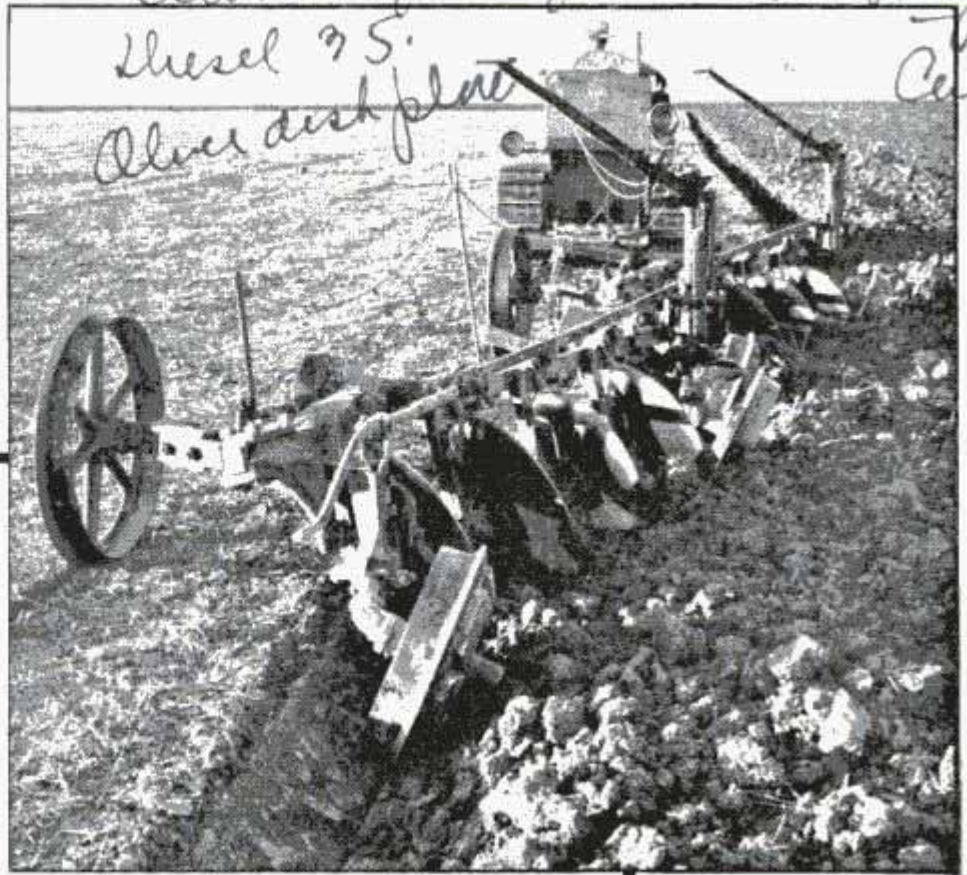

saving than does the Pacific—about seventy-five per cent, they figure. With first cost so high, however, they do not expect to see the Diesel truck sweep all opposition away overnight. Like the tractor, the truck must get in a lot of hours and miles of work to pay out the extra cost.

The Farmer Above Covers a Lot of Ground in a Day with This Diesel Tractor; Below, Diesel Power Unit Mounted on a Truck for Use in the Oil Fields

Angeles, now running seventy-five Diesel engined trucks. According to L. V. Branch, office manager, the Diesels have cut operating costs of trucks 2.78 cents a mile. This firm bought its first Diesel in June, 1933. Now, there is a rival firm across the street with fifteen Diesel trucks and they say they could use as many more. Business is again profitable to the Diesel engined truck where it's questionable on much of it with old equipment.

Savage Transportation Co., San Francisco, which pioneered the Diesel truck on the coast, buying its first in October, 1932, now has 175,000 miles on each of five Cummins engined trucks. They claim a bigger

There are only 800 Diesel trucks in the country today, due perhaps to the high first cost. In the tractor field, the Diesel has been a big success and the farmer in a position to keep large tractors busy has been the gainer, as also has been the hauler of long-distance freight who operates twelve months of every year.

What's around the corner in Diesels for light trucks and small tractors is in the laboratories and test fields of some of the big manufacturers at this very minute, perhaps. They are all working on it. So are the auto engineers of firms with names that are household words.

Caterpillar D 7 100. Power Unit
Indian Territory Oklahoma City Okla

Owner - John Jones - Fairbaugh Calif.

SCOOTER TO HELP SWIMMER IS BUILT FROM KIT



Two Views of Water Scooter in Use; Top, Note How Easily It Can Be Handled

For water sport, learning to swim or life-saving, a lightweight craft is available in kit form. It is the kind of scooter that will support a 300-pound swimmer and can be used for riding the surf, racing and some forms of aquaplaning. A double-V bottom gives it speed and steadiness in surf or still water. The scooter is non-sinkable. Weighing only fifteen pounds, it can be handled easily in the water.

FILM MAKES COLOR PHOTOS IN ANY SIZE CAMERA

Natural color photographs can be produced in any size camera by using a new type film that requires no special equipment. A precise machine prints three primary colors, red, green and blue, on the film support, bleaches and then dries it. The colors are applied in criss-cross lines, resulting in a mosaic of colors, but the pattern is extremely minute. In a single square inch of film surface, there are more than 1,500,000 interstices between the color lines. These "holes" act as lenses which admit white light and produce blends of

the three colors in addition to reproducing whites or blacks. By reversal from negative to positive during the developing process, the image becomes a colored transparency which may be projected in natural color by any standard still or motion-picture projector. The tri-color screen is so fine that color separation negatives may be made directly for gravure or half-tone reproduction without screen interference. Printing the films on ordinary white paper, such as is used for snapshots, has not been developed to its highest efficiency and further research is necessary before perfect reproductions can be made on print paper. The film, called Dufaycolor, is available for Leica, Contax, Nettel and similar cameras, and will be offered in thirty-five and sixteen millimeter sizes for movies, and in commercial photography sizes up to eight by ten.

8316

BIRD FED IN OWNER'S ABSENCE BY AUTOMATIC CUPS

Automatic food and water dispensers for bird cages make it possible for owners to leave their canaries at home without attention for several days. The fountain, working on a vacuum principle, keeps the water in the trough at the same level as long as the connecting glass bulb is filled. Made of pure iron, the trough introduces tonic iron into water passing through it, keeping the birds healthy. The granary cup supplies seeds automatically.



Cage with Automatic Fountain, Right, and Grain Cup, Left, for Feeding Canaries

Chicago

St. George's Inf. Co. Redzie Av. 215 S.

Dufaycolor, Inc. Rochester Center New York

6271. *Armstrong Siddleley Co*
Covers for Works
England - Mull & agents.
Rubber-Tired Rail Car Driven from Roof Cab

Riding smoothly and almost without noise, the latest rail car is equipped with sixteen pneumatic-tired wheels. Its driver occupies an observation tower or cab built into the roof to give a clear view of the track. Powered by a gasoline engine, the car has a top speed of seventy miles per hour. It can be accelerated to fifty miles per hour in 1,000 yards or stopped in 120 yards. Constructed in France, the car has been tested for fast inter-city rail service in England. The new rubber-tired car is another entry in Europe's race for fast transportation at low cost.

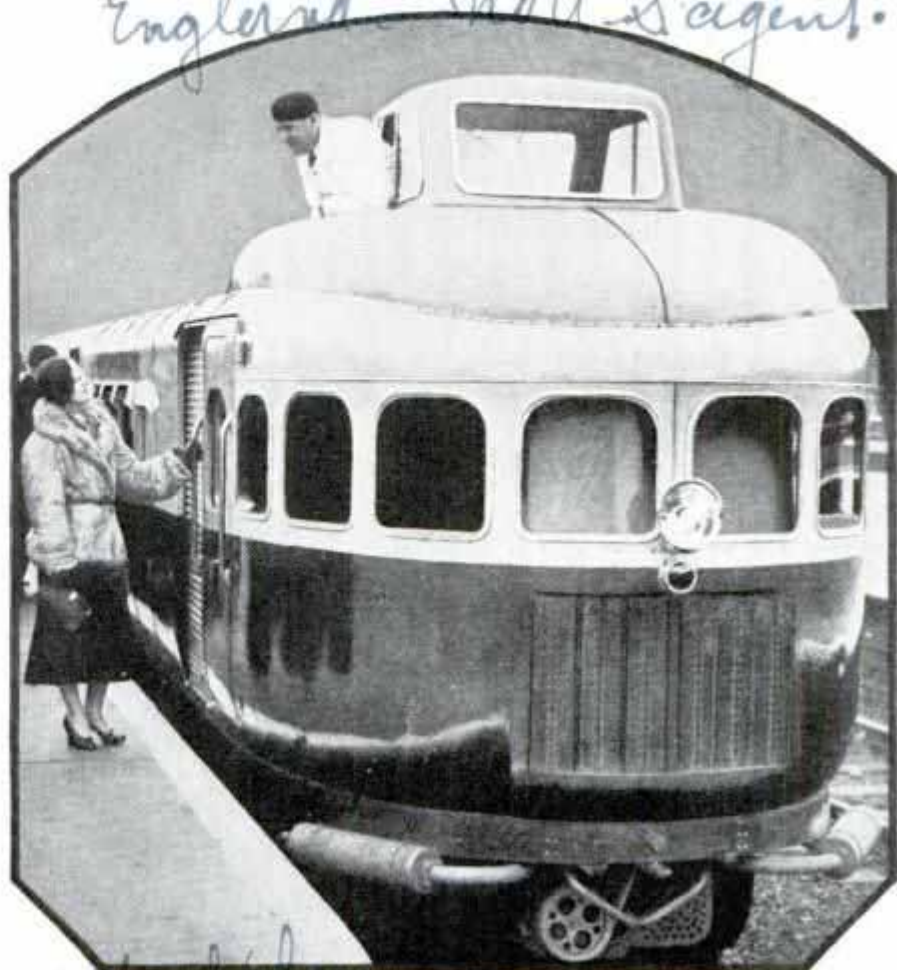

Em
Driver in Cab Atop Latest Rail Car Prepares to Open Door for Passenger; Capable of High Speed, This Car Can Be Stopped Quickly in Emergencies

The Sphere, Feb 23, 1935
Smithy on Wheels Shoes Wild Horses in Special Rig

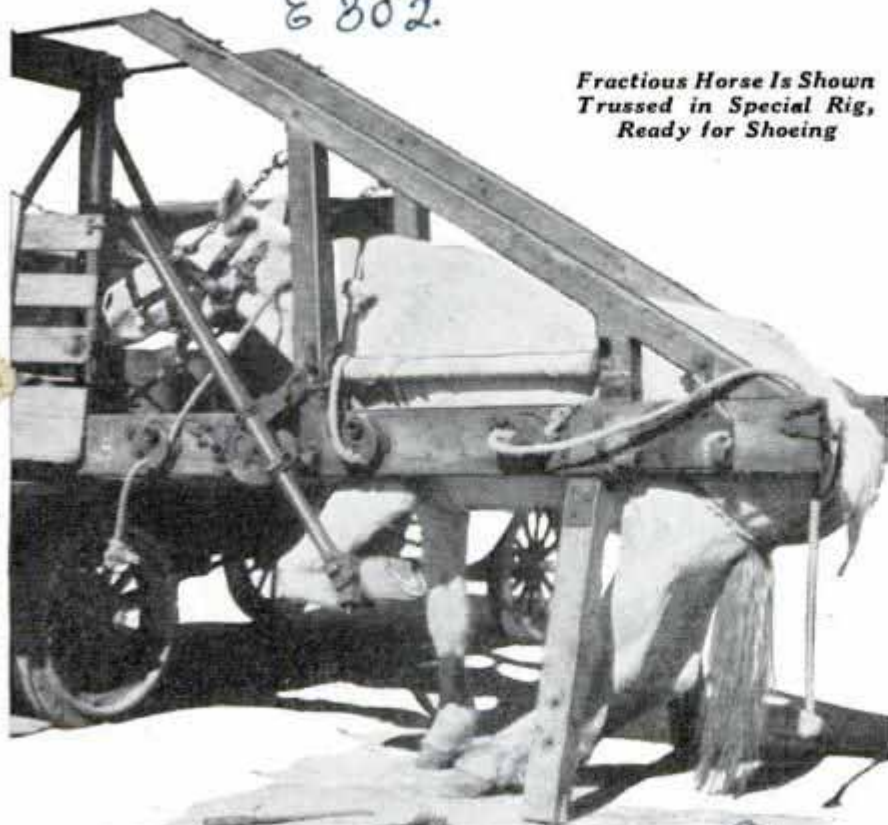

Fractious Horse Is Shown Trussed in Special Rig, Ready for Shoeing

How to shoe wild horses without injury to the animal or handlers is the problem solved by the inventor of a blacksmith shop on wheels. The smithy is equipped with a rig into which a fractious horse is trussed before the blacksmith goes to work with hammer and anvil. A combination of gears, lifts and pulleys holds the animal securely. In addition, the shop, mounted on a truck, contains bellows, charcoal and other equipment. It is operated in California, where the owner makes the rounds of the ranches after periodic roundups of range horses.

Owner - W. M. Oralston 3602

6157 Mr. John O. Marcy,
Box 292, Hollywood, Calif.

The SPORT of KINGS

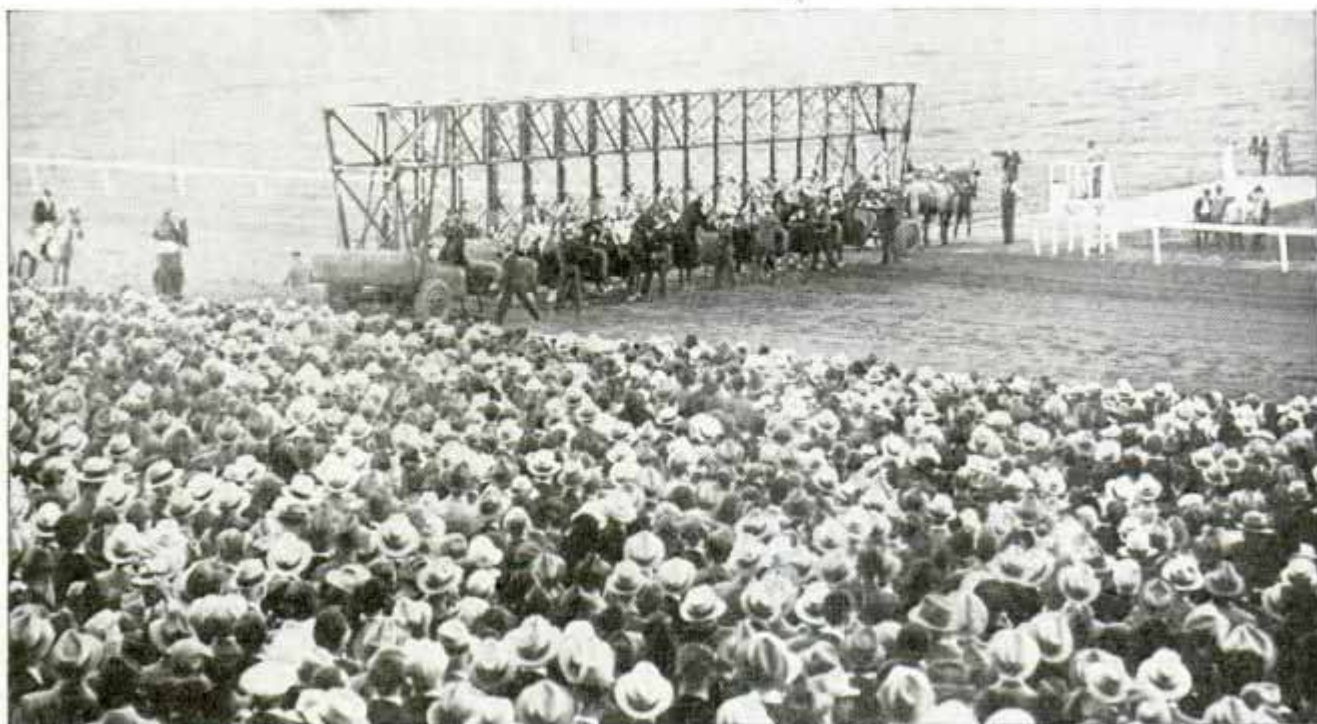

"THEY'RE at the post! They're off!"

The response from the crowd when the horses break from the stalls and pound down the track in one of the oldest of sports is the same today as fifty years ago. But there's a difference now.

Modern science has come to the aid of horse racing. The start, the race, the finish—even the betting—are guided and controlled by mechanical devices.

Timing is no longer left to the stop watch, accurate to only about one-fifth of a second, but is checked by an electric clock actuated by photo-electric light cells. When, closely bunched, the horses flash across the finish line, the result is judged from photographic records taken at split-second intervals. The betting is entirely mechanically controlled; each ticket sold is added to the total and automatically the odds against the particular horse are changed.

The real start of a race is not when the horses leave the starting gate. Fifty to 150 feet in front of the gate is the first light ray across the track. When that is broken by the leading horse a clock mechanism is started, a picture of the time reading is automatically taken, and the race has begun.

The purpose of the starting gate is to



An Evenly Matched Pair, and the Line Up of the Horses in the Starting Gate

give the starter a chance to get the restive thoroughbreds into some kind of a line, and give the horses a "running start" for better speed records. No tapes spring up these days, no barriers are raised—just a

... UP *to* DATE



Race Horses Move at a Speed of About Fifty Feet a Second, Making It Almost Impossible for the Human Eye to Pick the First Four in a Bunched Finish

shrill tone simultaneously from three electric bells, and the horses are off. Then the gate is rolled out of the way to be hauled to its position for the next race.

The photo-electric ray broken at the starting line makes the first of a series of accurate timing records in each race. Oth-

er rays at each sixteenth-mile post are broken in turn and the clock reading photographed. Thus "form" information accurate to within one-thousandth of a second is made available. These form records are important to the owners and judges as well as to the public. Horses differ. One may



This Is "Twenty Grand," Going Places in a Hurry; Note the Position of the Jockey in Encouraging His Mount

high-speed motion-picture camera, focused on the finish line, and the pictures catch the horses at approximately every six inches. Going a step farther, a Western Electric camera timer takes more than 100 double frames per second, to provide a record about every two inches.

At the Santa Anita track in California, the camera is located on the roof of the grandstand, 200 feet from the track. At the end of each "take," the film is sent to the developing room and in two minutes or less it has been developed, and two views of each of the first four horses, wet enlarged under hypo, are shot

take things easy until he comes to the home stretch, and then begin to show his real speed; another may have a tendency to expend all his energy at the start. Then too, if the records show a certain horse covered part of the course in far better time than his rivals and yet finished far back of the leaders, the judges know something is wrong. Probably the horse belonged in a better class, and was being held back to "build up" the betting odds on him.

Race horses run a mile in a minute and forty seconds or better—that means they move fifty feet a second. When a bunch comes thundering across the finish line at that speed, often with two or three leaders neck and neck, trying to pick them by eye in the right order is a tough job. It is not only the winner that has to be noted, but the second and third horses, which pay "place" and "show" bets, and the fourth, which pays the stable and jockey part of the purse. Most errors in judging formerly were made on the third and fourth.

Now, as the horses near the finish, an auxiliary light ray is broken to start a

down on a wire carrier to the judges' stand. The records of the timing clock appear on the edge of each print, eliminating any question as to the order in which the horses finished. Two views of each horse are provided because, even with a camera



Note the "Tote" Board in the Background Which Automatically Registers Betting Totals and Odds

that takes photos at two or three inch intervals, it is seldom that one shows a horse's nose right on the line. The first view may show it an inch from the line, the other an inch or two over.

The results of a race are not "official" until several minutes after the finish, when

the jockeys have finished weighing in and the judges have given the final word. Formerly, they compared notes and agreed on a decision; now they examine the photos. In close decisions, the enlarged prints are sometimes posted so spectators may see for themselves just what happened. There is no questioning a

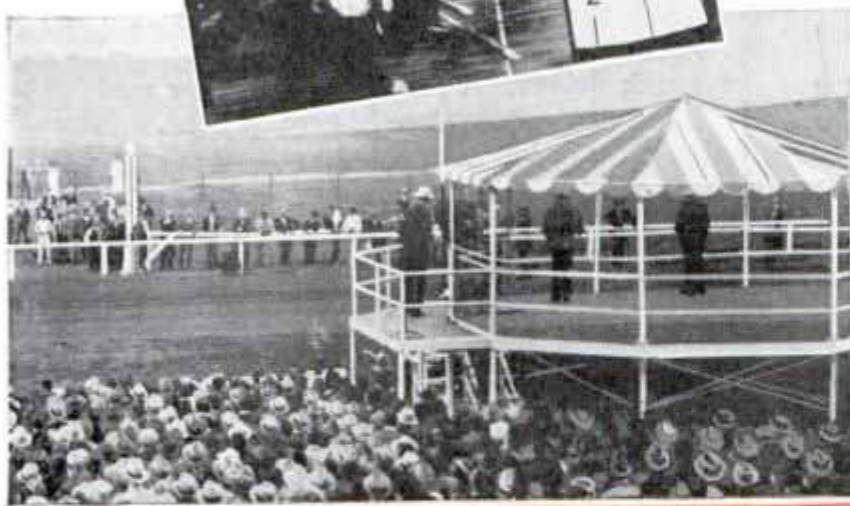
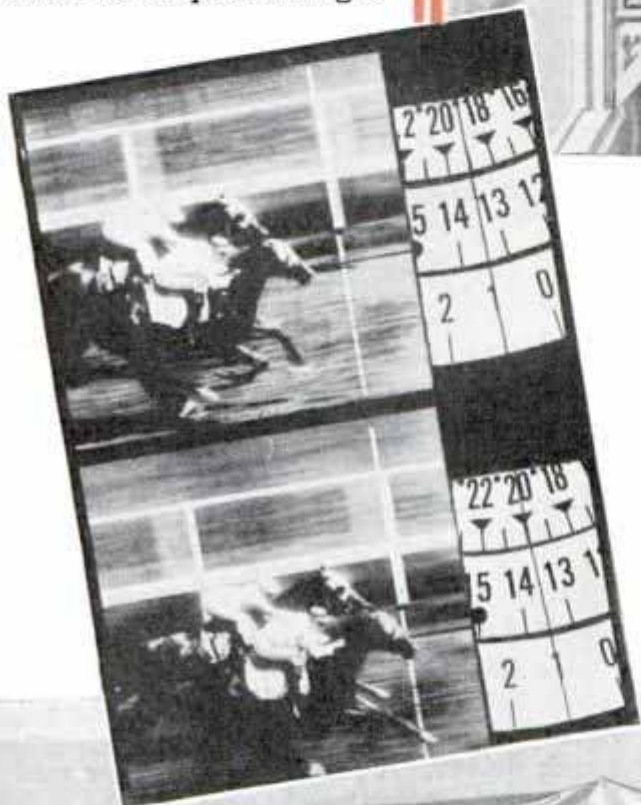

A Close Finish Seen through the Camera's Eye, and the Camera Room at One of the Tracks

set of photographs showing the clock readings along one side.

The totalizator, a huge all-electric "cash register" that automatically keeps track of the betting and posts the changing results, came as a result of pari-mutuel wagering. In this method of betting control, the pub-

lic bets into a pool and thereby makes its own odds. From the total of all bets a percentage is deducted for taxes and management expenses, and the holders of the winning tickets divide the balance.

When a clerk presses on his ticket machine the number of the horse called for, an impulse flashes to a "tote" room where an electrical distributor whirls around to the right slot, and the bet is added to the total wagered on that horse. Every few seconds a large indicator board changes its lighted figures to show the new results.

The tote could be so regulated that each bet would show instantly on the board, but this would cause a flickering of the figures and make reading them difficult.

Better starting, more accurate timing, and mistake-proof judging of finishes, together with mechanical handling of betting, are doing away with much of the public's distrust of the way racing is conducted. Even where strict honesty was the policy, the human eye was no infallible judge of anything as close as the finish of a horse race can be; and without accurate form information, picking the right horse in the betting

was at best no more than a good guess.

Now all the guesswork has been eliminated in selecting the winners, and the making of odds, formerly distrusted because of the opportunities for dishonesty, is likewise mechanical. Thus science has helped elevate the sport of kings.

Huge French Bomber Also Transports Troops



Photo Courtesy of L'Aeronautique
This Huge Bombing Plane, One of the Latest to Be Completed in France, Is Similar to Giant Freight Ships in Use in Some Countries; the Bomber Has Space for Transporting Soldiers in Emergencies

Closely resembling a big freight or express plane, one of the latest French bombing aircraft has space to carry a large number of troops. It is powered by two engines. Fighting platforms have roofs and sides of armor plate, with bullet-proof

glass. One feature is the machine gunner's post in the nose of the giant fighting ship, a compartment with plenty of windows to give full visibility. The machine gun can be swung in a wide arc to give protection to the front surfaces of the plane.

Big Trailer for Hundred-Foot Logs Is Steered from Rear

Designed for hauling 100-foot logs, the latest trailer is steered from the rear, facilitating the movement of truck and trailer over narrow roads, around sharp curves and down steep hills. The trailer has four

wheels. Pivots in the bearings of the load make it easier to negotiate curves. A man riding a small seat at the rear of the trailer steers the front wheels. Wires to the horn of the truck enable him to signal the truck driver. A rear-vision mirror and a hand brake complete his equipment.



Top, Truck and Big Log Trailer; Bottom, Rear End Steering for Turning Curves

MATCH LOOSENS FRUIT-JAR CAP FOR EASY REMOVAL

Nothing except a match is needed by the housewife to loosen a fruit-jar cap used to close jars containing food packed in a vacuum. A rubber sealing ring, a small rubber valve ring and a metal spring clip, together with the cap itself, make up the unit. Atmospheric pressure exerted against the diaphragm of the cap compresses the rubber valve against



Armstrong Cork Co
Lawrence, Pa

Emb. Wilbur R. Buley
1508 E. Duval St
Bellingham Wash

Mr. Harold J. Williams, Capt
Columbus 29 Bean Road
Berkeley Beach, Md. Landon

225

the clip. Inserting the match in the top of the cap presses down on the spring clip, releasing the valve and admitting air into the chamber. With the vacuum broken, the cap can be removed with the fingers. The cap is not injured by removal and affords an effective reseal until the contents of the jar have been used.

8-288.

FAUCET SHUTS OFF THE WATER WHEN BUCKET IS FULL

Fitted with an attachment for holding the bucket, the latest water faucet automatically shuts off when the bucket is full.

A horizontal stem contains a spring which stops the flow after three gallons have passed through the outlet, this being sufficient to fill the standard water bucket. The spring can be adjusted to a lesser or greater flow. A hose attachment is provided for a steady flow.

In the home, the faucet is handy for the housewife drawing water for the laundry. Filling station attendants also will find the attachment a convenience.



Pat. Ap. 8276

CALKING GUN USES CARTRIDGE OF PLASTIC COMPOUND

Consisting of a strong metal frame into which is placed a cartridge of plastic, a new calking gun operates under high pressure. When full, its weight is such that it can be operated quickly with one hand.

It holds twice as much calking compound as some hand guns and develops many times the pressure through its gear and rack-driven piston. The cartridges are filled and sealed at the factory, making it possible to carry extra ones in the clothing.

When the workman empties one cartridge, he inserts a fresh one without leaving the job, resulting in a saving of time.



Pecora Paint Co. 35-11 2 4+1 St

SCENT MEASURED FOR HUNTER BY ELECTRIC INDICATOR



Pictograph
Scent Indicator in Use; Information Obtained with the Device May Aid Hunters

To aid in studying the relations of weather conditions to scent, H. M. Budgett, English hunter, has devised an electric scent indicator. This instrument registers the difference in temperature between the air and the ground. It shows that any sudden fall in the air temperature causes the scent to be good, while a sudden rise causes it to be bad. Scent is usually bad when the sun is shining brightly, it is uncertain when a high wind is blowing and obliterated by heavy rain, according to the indicator. The equipment also shows that scent is good on snow that has fallen before a freeze. Information obtained by the experimenter is expected to aid hunters.

Names and addresses of manufacturers and dealers in articles described in this magazine will be furnished by our Bureau of Information upon receipt of a stamped, self-addressed envelope.

Remort mfg Co Oakfield, Wis

8292. England
H. M. Budgett
Kirtlington Park Oxford

Electron Camera "Shoots" Television Images

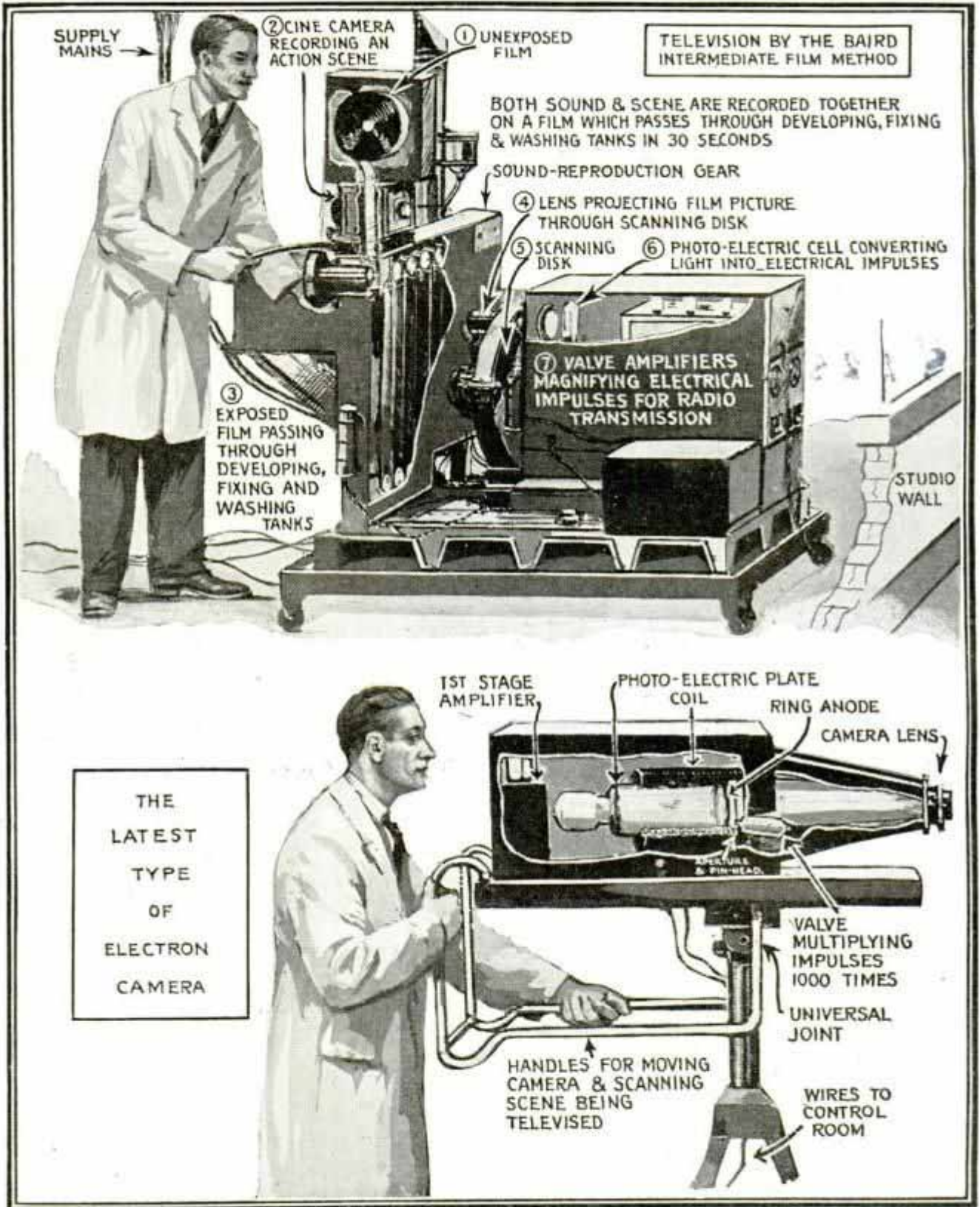

Television Will Be Made Available to 10,000,000 People This Year by a London Station Which Will Alternate the Baird and Marconi Systems of Transmission; the Baird System Uses Four Types of Transmitters; the Intermediate Film Apparatus Records Both Sound and Scene on One Film, Which Is Projected through a Lens by Light from an Arc onto a Photo-Electric Cell Which Converts the Light Impulses into Electrical Impulses for Transmitting by Short-Wave Radio; a Television Disk Transmitter Accommodates Ordinary Sound Films and a Spotlight Transmitter, Used for Close-Ups, Projects a Spot of Light onto the Person Being Televised, This Spot Traveling Rapidly over Face and Figure, Reflected Shades of Light Impinge on Photo-Electric Cells Which Convert the Light Tones into Electrical Impulses That Are Amplified and Sent by Radio

*J. & Baird, 22 Finsbury St
London, W. 1*

London Station to Serve Ten Million People

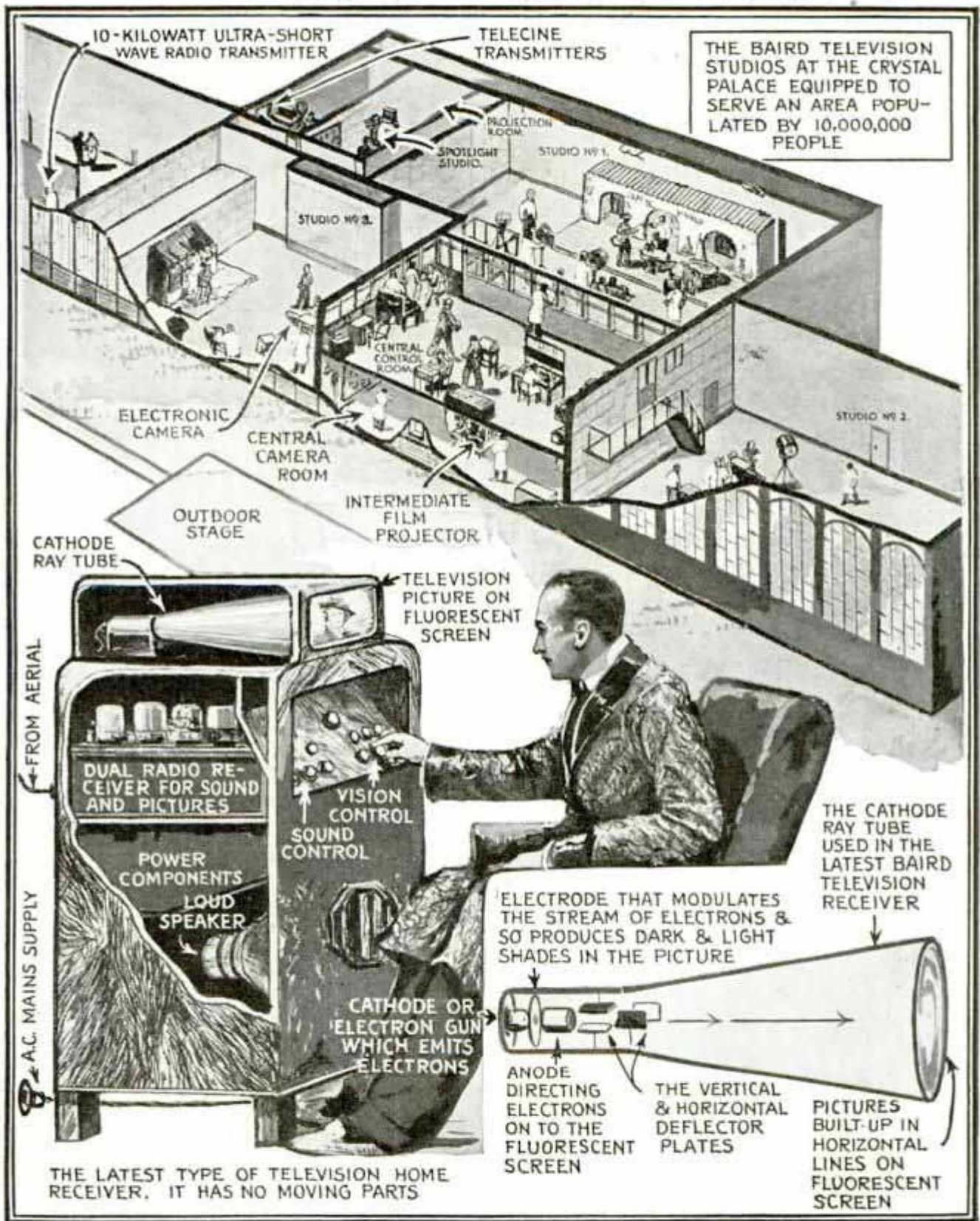

The Electron Camera Is the Greatest Advance in This System of Transmission; It Has No Moving Parts; the Scene Is Recorded through a Camera Lens and Impinges on a Photo-Electric Plate for Conversion into Electrons; the Electrons Are Vibrated, Pass a Small Aperture, Strike a Metal Pin-head, and Set Up Minute Electrical Impulses Varying with the Light Tones Received; These Are Broadcast by Ultra-Short Waves and Reconverted into the Scene Televised; the Cathode-Ray Tube Is Used in the Latest Type of Home Receiver; It Receives the Signals at Its Narrow End and Fires Them in a Stream of Electrons onto a Disk-Electrode; an Anode Directs the Stream onto a Fluorescent Screen at the Wide End of the Tube and as the Electrons Strike the Screen, They Become Points of Light and, with Great Rapidity, Reconstruct the Picture

Giant Truck Will Carry "Mail Order" House

Grand Central Palace

480 lbs weight per unit

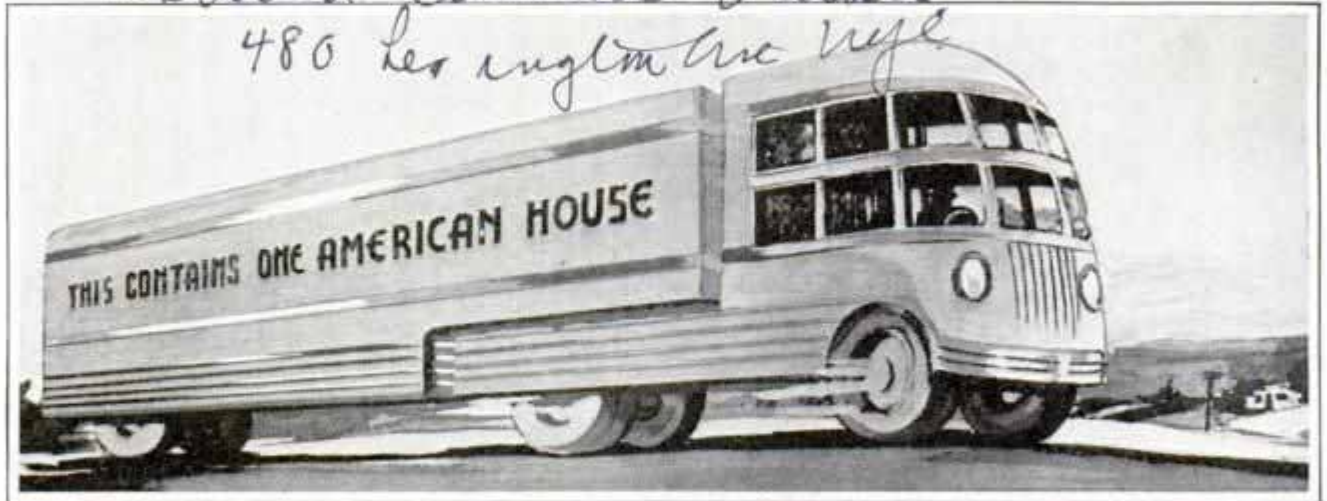

Sketch of Proposed Truck and Trailer for Transporting Ready-Cut House from Factory to Home Site; Note the Double-Decked Driving Compartment in Which Crew Is Housed

For the delivery of complete prefabricated houses to all parts of the United States, a special tractor-trailer unit is planned. The trucking arrangement is intended to serve a house manufacturing

company in which Alfred P. Sloan of General Motors and other industrialists are interested. According to plans, each of the 1,500 proposed vehicles will carry one complete house ready for assembly, two

drivers, a master mechanic and a building supervisor. Sleeping accommodations above the seat will enable the crew to travel night and day, speeding up the movement from one site to another. Local labor will erect the houses, supervised by the crew from the factory or distribution point. The houses, which will be low-cost, modern residences, can be completely assembled, ready for occupancy, in two weeks.

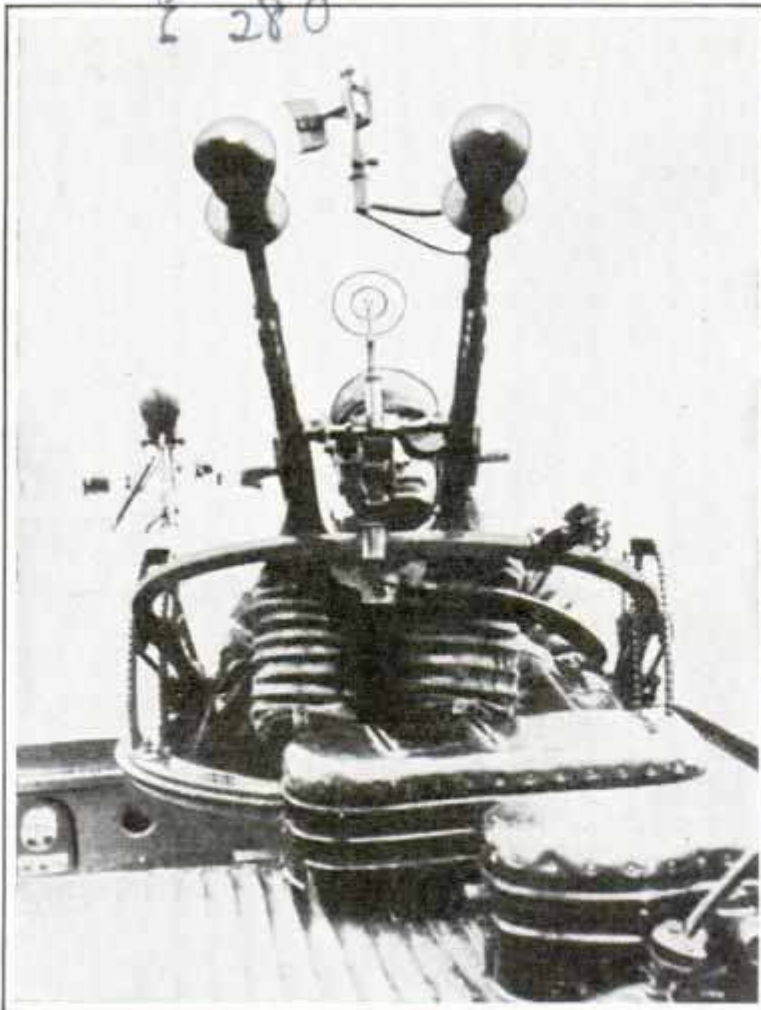

Closeup of Gunner Aiming Twin Barrels in Plane; Angle of Photo Produces Strange, Warlike Appearance

FLYER RESEMBLES GRIM "MAN OF MARS" AS HE AIMS GUNS

Photographed at an unusual angle as he trained the barrels of his machine gun on an imaginary foe, a member of the Soviet air force appeared to resemble the mythical "man from Mars." The twin barrels of the gun seemed to be antennae attached to the head of the Martian visitor, giving the pilot's face a strange grimness. The range finders, swivels and other trappings of the plane's guns indicate the progress that is being made by the Soviet air force.

from Motor, March 1930

6377

American Houses Inc.

670 - Fifth Ave

Neugal

error

280

280

Club

Latest Planetarium Topped by Three Domes

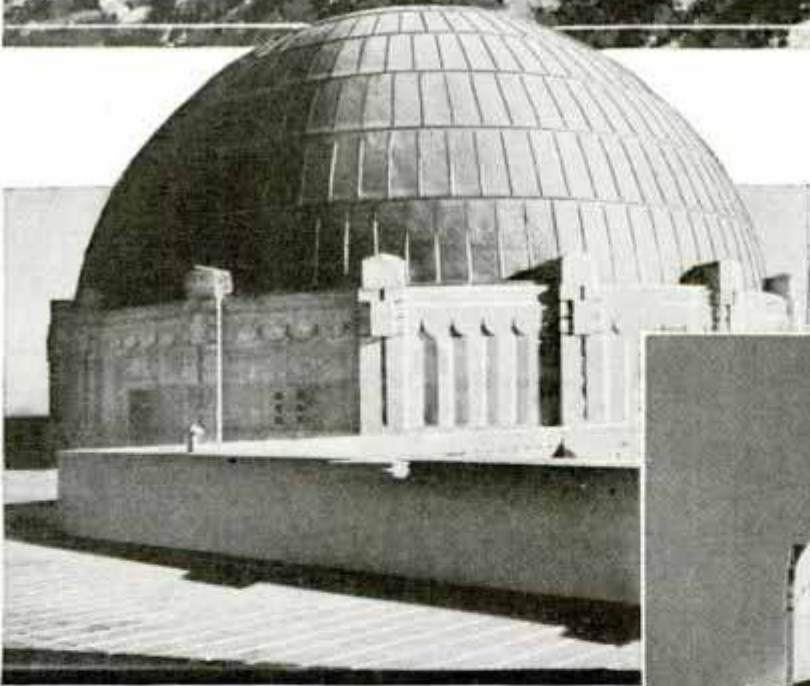
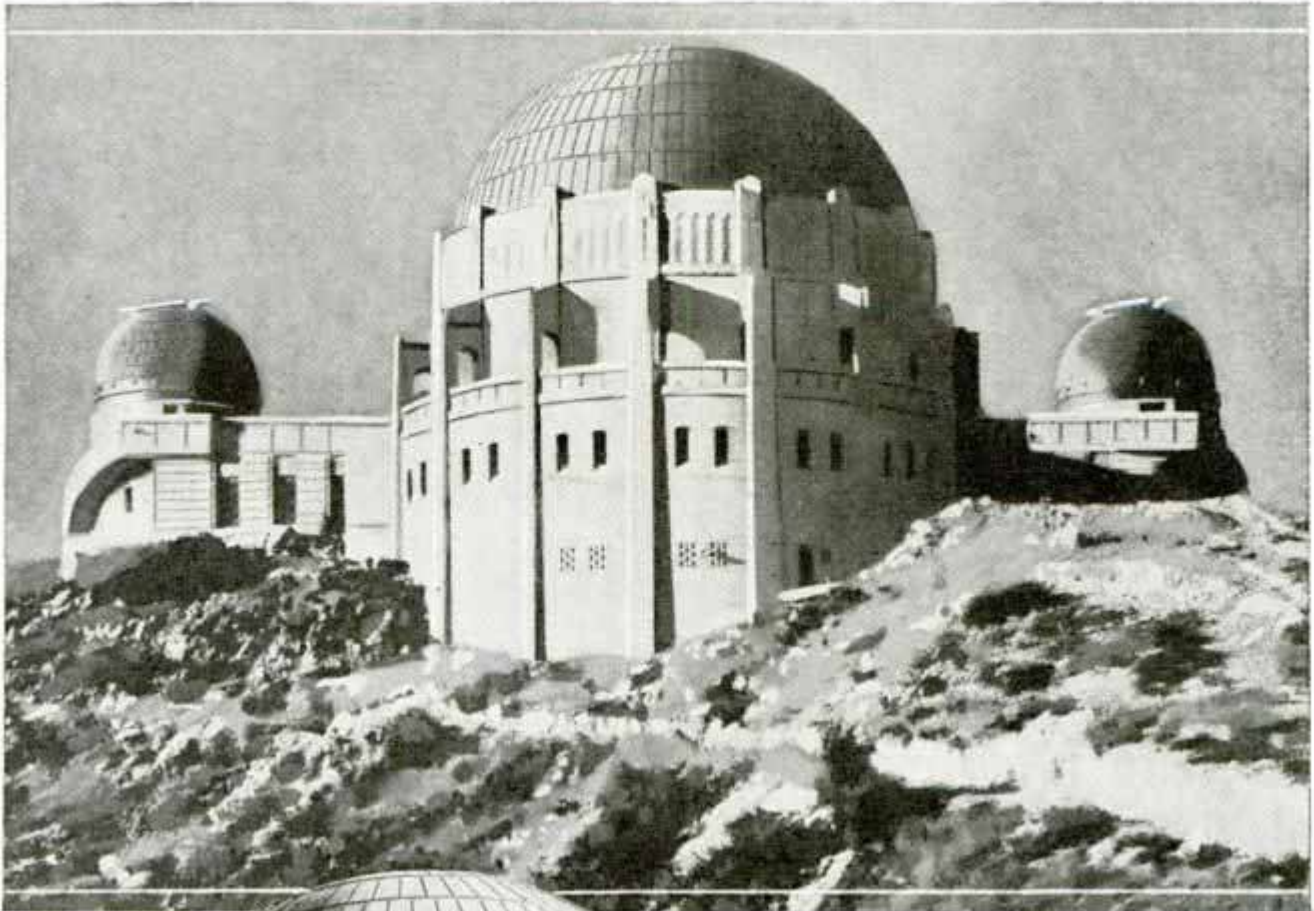

Scriffith
 Top, New Los Angeles Planetarium, Third Completed in America; It Contains Many Features, Including an Observatory with Twelve-Inch Refracting Telescope, a Coelostat (Mechanical Driven Mirror for Holding Image of Star) and Pendulum for Demonstrating Earth's Rotation

Scriffith Park

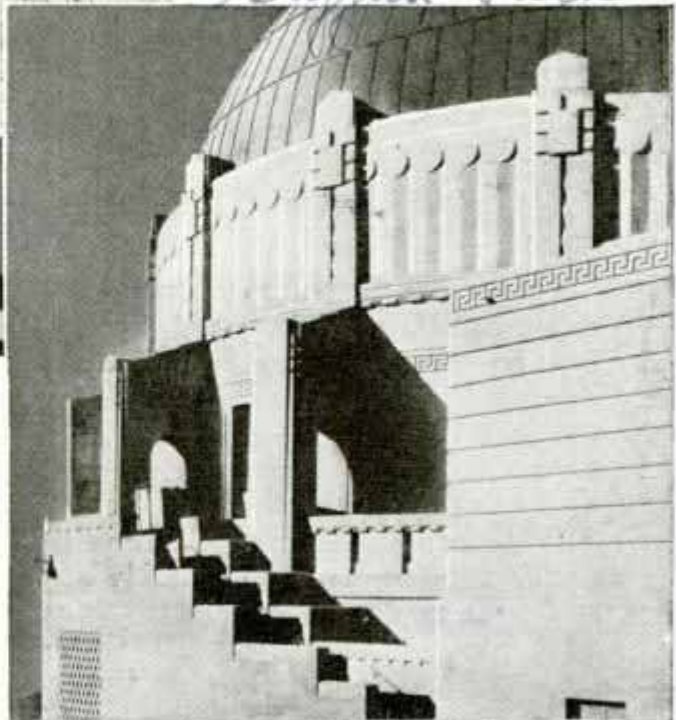

Above, Planetarium Dome and Roof Terrace; the Ceiling of This Dome, One of Three Topping the Structure, Is Plaster Hung from Steel and Concrete Frame of Outer Dome; Silhouette around This Dome Represents Mountain and Sea Scenery of California; Lighting Troughs Permit Simulation of Sunrise or Sunset; Light Pockets Are Arranged to Make It Appear That Stars Actually Pass behind the Mountains; Right, Stairs Leading to Observation Promenade around Great Dome; Reinforced Mass Concrete Construction Is Used to Increase Resistance to Earthquakes

875

Com. John U. Macey
Box 292, Hollywood, Calif

HEROES

of the

Myron Dresser, a Telephone Lineman, Who Worked during the St. Francis Dam Disaster Repairing Broken Lines Although He Knew His Home Was in the Danger Area and His Family Was Threatened; His Home Was Swept Away but His Family Was Saved



stuck to their posts and kept the lines open, greatly facilitating the rescue work, while more than 120 persons died around them. In the wake of the fire, explosions shook the building. Poisonous chemical fumes billowed through the halls. Gladys Gibson, branch exchange operator, stayed at her position calling ambulances and the fire and police departments. Rescuers found her crumpled over the switchboard. The cords plugged into lines throughout the building bore mute witness to her efforts to spread the alarm, while a window a few feet away provided a means of escape, had she preferred to take it. The usual award of the phone company for valiant action

FIRES, floods, earthquakes, tornadoes—these are some of the hazards that bring drama into the work of telephone employes. Keeping communication lines open during disasters is a vital matter. As long as nature behaves herself, as long as things go along normally, the work of the lineman, the operator, and the man on the test board is routine, but when trouble begins heroes are made.

When fire swept through the Cleveland Clinic, in 1929, the telephone employes

was used to erect a fitting memorial.

Gerald Mahaffey, Walton Turner, Benjamin Spaeth, James Roonan—these are names of other telephone employes on the Cleveland Clinic roll of honor. Dampened handkerchiefs over mouths and noses, they went again and again into the building, carrying out victims and keeping up communication service from the switchboard.

Saticoy, Calif., was in the path of a wall of water sweeping down from the bursting St. Francis Dam. Mrs. Althea Marks,

E 75

Switchboard *and* Phone Lines



warned of the disaster, stayed at her switchboard calling residents of the threatened Santa Clara valley, sending messengers to those she could not reach by phone. After the flood had subsided, she continued for three days and two nights without respite to direct the relief workers in the stricken area. In the same disaster a lineman swam through the flood, a line end tied around his waist, to reestablish a broken circuit. Another worked on for hours although he knew his own home and family were in the danger area, and might have been swept away.

The Bell Telephone company recognizes heroic acts of individual employes by giving gold, silver, or bronze medals and cash awards from the Theodore N. Vail

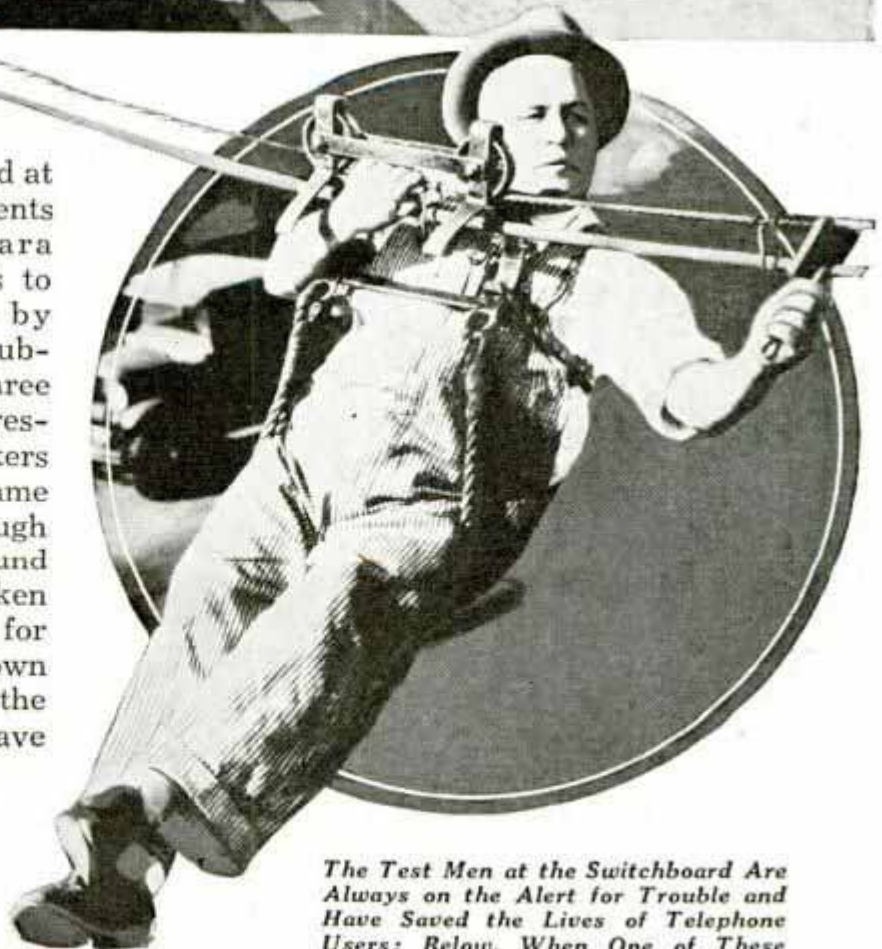

The Test Men at the Switchboard Are Always on the Alert for Trouble and Have Saved the Lives of Telephone Users; Below, When One of These Cable Cars Contacted a Trolley Wire, Another Hero Was Made



memorial fund, but when southern California was rocked by earthquakes in 1933, practically all employes in the area performed outstanding service, and a group award of a special plaque was made. Typical of the spirit shown was an incident in an exchange in the center of the disturbance. A call had been sent out for volunteers to aid harrassed operators. Among many others one woman, a former employe, responded and was assigned a station. Some time later the superintendent noticed she was so nervous she could hardly go ahead with the board. He learned she had left her baby ill at home, in the care of its bedfast and helpless grandmother. She was excused.

At the Long Beach toll office, a water tank on the roof had been turned over by the first tremor and volumes of water were pouring down through the operating room. A chandelier crashed, narrowly missing some of the operators. Falling debris littered the floor. In the darkened room, with only the switchboard lights to provide illumination, and with hastily thrown up

timbers supporting the walls, the operators worked until finally ordered to leave the building.

Major disasters like these sometimes bring the work of the telephone employes to public notice. But day in and day out scattered instances of the same type occur and are recorded only in the company reports. A woman, succumbing to the effects of leaking gas, groped her way to the phone and knocked it over before she collapsed. A telephone patrolman, always on the alert for trouble, cut in on the line to learn why the receiver was off. Turning in a powerful set of batteries, he amplified the sound on the open line until the labored breathing of the woman became clearly audible. Minutes later a repair man, with the help of a neighbor, broke into



A Lineman at Work, the Vail Medal Award Plaque and Mrs. Althea Marks, Who Stuck to Her Post during the St. Francis Dam Disaster

the house and rescued the woman. Sometimes it is the operator who senses trouble. Alarmed by a woman's weak voice and her failure to hang up the receiver, an operator had the test board man cut in with the "howler tone," a gradually increasing sound that calls the subscriber's attention to the fact that the line is open. Getting no response, she called a doctor, who arrived in time to save the woman, suffering from an overdose of medicine.

The work of telephone linemen and repairmen, in spite of safeguards, is not always safe. High-voltage lines near by are an ever-present hazard. One repairman was inspecting overhead cables when the cable car in which he was riding came into contact with a trolley wire. A fellow workman, on the ground nearly fifty feet away, heard his cry in time to run beneath and catch the man as he fell, saving him from possible death.

Another lineman, encumbered with a heavy tool box and climbers, fell into a flood-swollen river. His companion jumped from a twenty-foot trestle, brought the victim to the surface and fought his way through floating debris to the river bank but, with his helpless burden, he was unable to reach firm ground. Climbing on the submerged branches of a tree, he hauled the unconscious man out of the water, cast off the equipment and swam with him to where some logs had lodged against a tree. There he applied artificial respiration, restoring the man to consciousness, and together they made the shore.

All linemen are trained in the principles of first aid and artificial respiration, and many times this knowledge has been used to save lives. And not always is it a fellow workman who benefits. In Boston, James Geagan was laying conduit near a drawbridge under which a diver was working. Hearing cries for help, Geagan ran to the

(Continued to page 132A)

SCRAPER IS HANDY FOR HOME OR THE WORKSHOP

Useful in the home or workshop, a small scraper with three interchangeable blades is on the market. The blades can be removed and their edges restored.

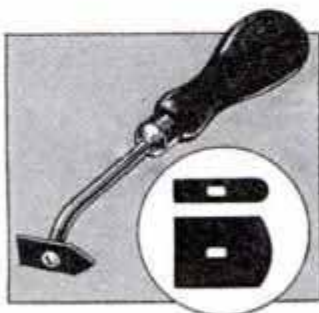

One blade at the time is used, each being reversible, and the three blades give six scraping edges, three straight, one "V" and two curved. The tool is invaluable for removing paint, varnish, grease or any foreign substance from furniture, cabinet work, carvings, moldings and picture frames.

ROOM-SIZE AIR CONDITIONER FITS UNDER WINDOW SILL

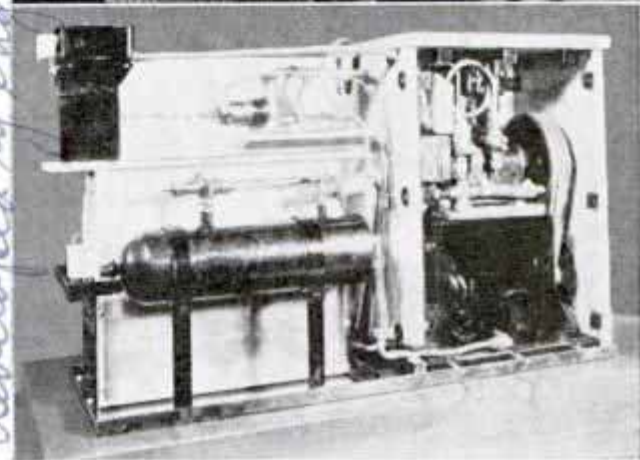

Top, Latest Room Air Conditioner; Bottom, Conditioner with Cabinet Removed

Compact and so low in height that it fits below the window sill of the average home or office, a self-contained air-conditioning unit is ready for the market. Its capacity is sufficient for one large room. Semi-portable, it can be moved from place to place if a change of residence is desired. The unit is practically noiseless. Motor and compressor are mounted on a separate frame from one supporting the coils, and the entire unit is mounted on a cork base. Quantities of rubber, springs and sound-absorption material are used to insure quietness. Switches on top of the cabinet make operation easy. Almost at the "touch of a button," it is possible to have the air cooled, dehumidified, circulated and filtered. Installation is comparatively simple. Water taps and drains may be utilized for water circulation. House current supplies the power. At slight extra cost, coils can be installed to produce warm air in winter, the connection being made to the standard heating system.

Miller Falls Co. Greenfield Mass.

air temp. line. Chrysler Bldg. New York

developed by engineers of Chrysler Motors

8 308

D 154 S

Champion Electric Brake Co. 1801 S. Hope St. Los Angeles

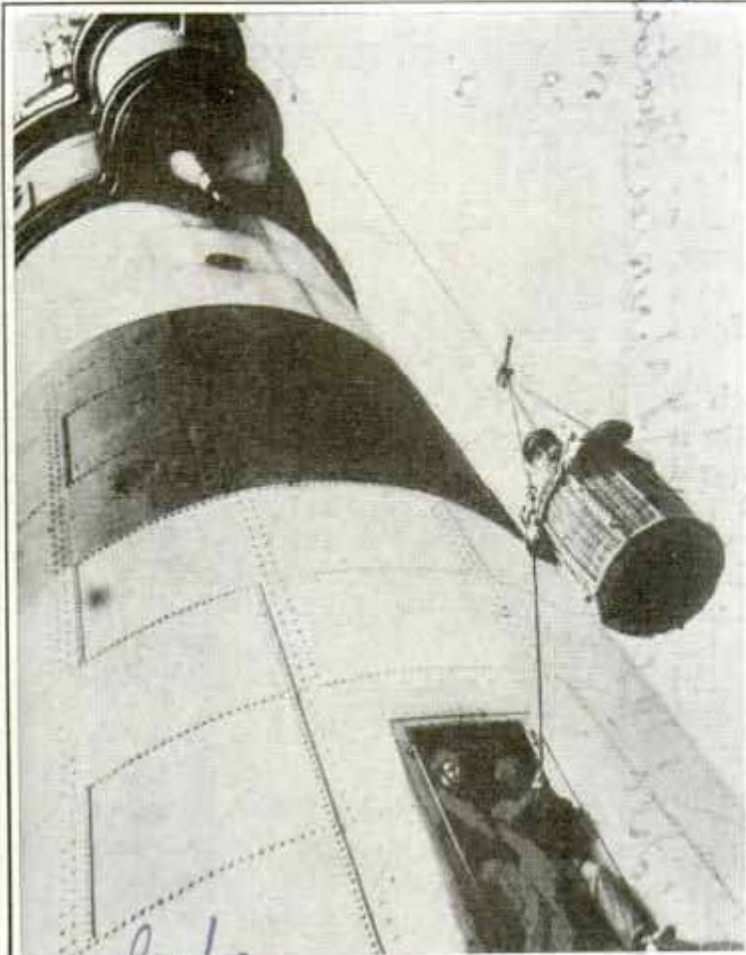

Lighthouse Keeper Taking a Ride in Basket Elevator Used to Haul Up Provisions from Supply Ship

BASKET ELEVATOR LOWERS LIGHTHOUSE KEEPER

Lighthouse keepers at the "Red Sand," one of the best known lighthouses in the North sea, take a ride in a basket elevator every two months when a supply ship arrives to change crews. The lighthouse stands on a lofty rock and the basket is used to lower the crew from the tower to the supply boat and to carry the relief men to their posts from the ship. The same basket also raises supplies from the boat to the lighthouse.

SKI-SKATES GIVE SPEEDY RIDE OVER SNOW AND ICE



One of the latest winter sports in Switzerland is ski-skating. Ski-skates are shaped like small skis with turned up points and are clamped to the



Pointing to Magnet Which Sets Brakes When Brake Pedal Releases Battery Current

shoes like skates. They have an ice contact surface about two feet in length and give an exceptionally speedy ride on the ice and snow-covered slopes.

8238

ELECTRIC AUTO BRAKES OPERATED BY CAR BATTERY

Electromagnetic brakes that work off the battery have been developed for the automobile. In tests, the brakes have drawn from one to five amperes of current while in use, not enough to impair the battery's efficiency. The brake consists of an internal expanding brake unit, inside of which a powerful electromagnet is suspended at the end of a yoke. Depressing the brake pedal reduces resistance in a rheostat, allowing the current to energize the magnet and clamping it against a steel plate that is mounted integral with the brake drum. As the magnet is pulled in the direction of the revolving wheel, the fulcrum yoke on which it is mounted operates a cam that expands the brake. Only light pressure on the brake pedal is necessary. The system has been found capable of

stopping a car traveling twenty miles per hour in five feet. The brakes operate even when there is not enough current to turn the starter. In case of battery failure, the system draws power from the generator.

Paich Photos

St. Marty

Colman's

Picture of Airliner Shows an Iron Monster

When a photographer began snapping pictures of mechanics as they worked on one of the airliners of Transcontinental and Western Air, he had no idea of obtaining a view of a man-eating monster. But when he developed one of the negatives showing a mechanic cleaning the metal nose of one of the 200-mile-an-hour Douglas ships, he found to his amazement that the photograph, when it was turned upside down, showed the mechanic about to be swallowed up by a monster with glaring eyes, a blunt nose and a huge mouth, as seen in the accompanying picture.



Turn This Picture Upside Down and You Will Obtain an Odd Illusion of an Iron Monster Swallowing a Man in One Big Gulp

Handy High-Speed Grinder Weighs Less than Two Pounds

Rated at 50,000 revolutions per minute, the latest electric grinder weighs slightly less than two pounds. It develops one-quarter horsepower. In addition to grinding, it is adapted to milling, circular filing, reaming, routing, carving and other work. Equipped with straight or spiral mills, it

cuts oil grooves without burring the bearing surfaces. As a portable unit, the grinder is very useful to the die maker. Lubrication is automatic.

FLOWERS IN "CELLOPHANE" BOX GIVEN BETTER DISPLAY

Flowers, or other contents, can be displayed to better advantage in a box constructed with Cellophane top and sides. Known as "peek-pack," the box gives full view of its contents, a desirable feature for advertising purposes or for decoration. Flowers packed in such a box can be seen and enjoyed without unpacking, until ready for wearing or arranging in vase. The transparent paper composing top and sides is supported by cardboard bottom and cardboard ribs. Boxes of this type can be made up in collapsible form.



Lightweight Grinder in Use; Its High Speed Makes It Efficient on Many Jobs



Answer Machine
 1111 3900 Palmer

Helmer V. Swenson
 Pa. 1841 111 Palmer

8/68

Com. Logan A. Olears
145 W. 45 St. New York

Solemn L. Martin Co
Osborne, Ind

PHANTOM RAIDERS

CONCEALED by nothing but their coloring, two camouflaged planes on the ground eluded the vigilant eyes of the crews of six observation planes sent up to search for them during a test at the army air corps base in Hawaii. The observation ships spent one and one-half hours in hunting and not one spotted the camouflaged aircraft.

The camouflaging of aircraft is one of the finer arts of aerial warfare. It contemplates not only the hiding of planes on the ground, but the hiding of them in the sky from anti-aircraft guns and other planes. Planes thus camouflaged become real "phantom raiders of the air."

The color depends upon the purpose. Bombers, attackers, pursuits and observation planes have different duties. Attack planes fly low and bombers fly high. Pursuits are chasers and observation planes ferret out enemy positions. Attack planes are camouflaged against earth background so they cannot be seen from above, bombers against a sky background and darkness, for air raids at night, pursuits against the sunlight and observation planes against daylight.

The purpose of color camouflage is to decrease the visibility. If the plane is finished in only one color this objective cannot be realized. Camouflage means the breaking up of the outline so that it is impossible for a gunner to silhouette the plane against the sky, clouds or ground. The irregular figures he sees destroy the true shape and outline of the plane.

The upper and lower surfaces are camouflaged, one against the terrain, the other against the sky. For the upper surface the best colors are tan, blue-green and mauve purple. These blend with the earth colors, the tan running in with plowed fields and roads, the blue-green with the foliage of trees and growing crops, while purple,

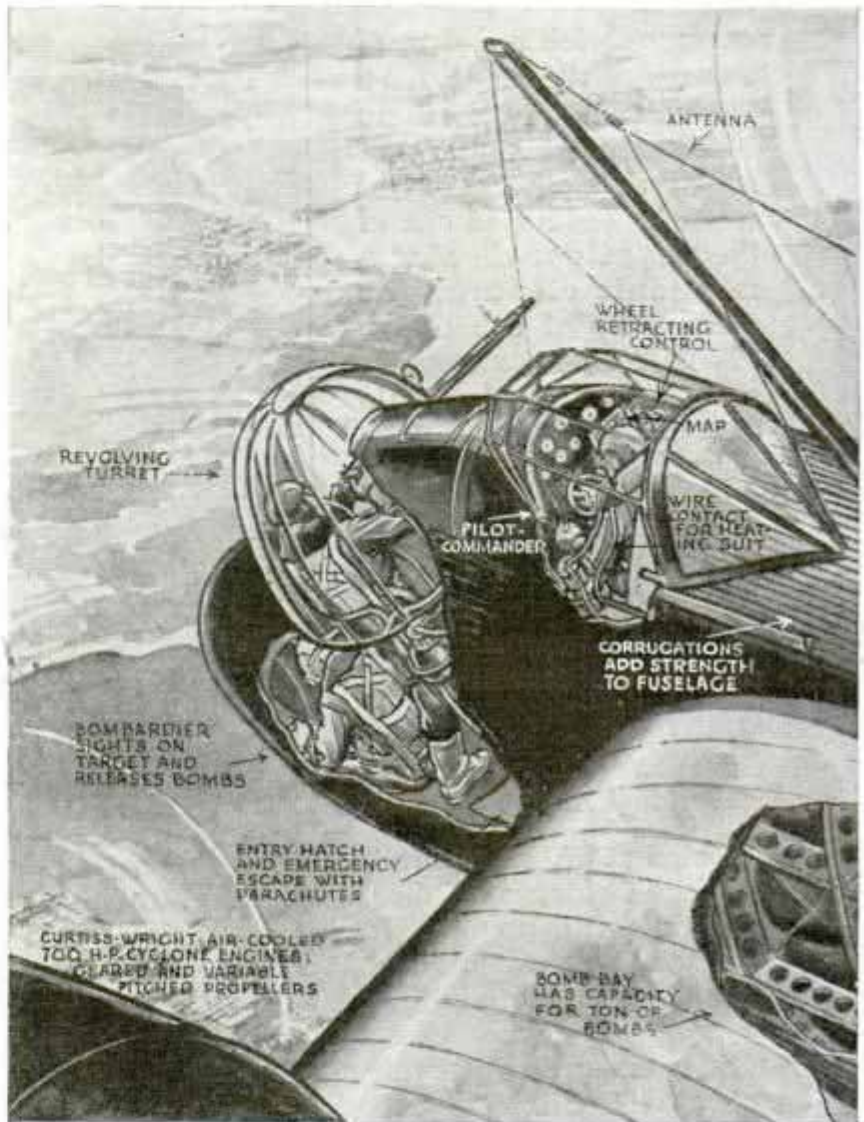

which has a low visibility rating, blends with the falling shadows of evening and the aspects of the earth after rain.

The upper surfaces of the top and lower wings are earth simulated. This is accomplished by dividing the surfaces into three irregular sections, with large curving outlines. To these sections the three colors are applied. They are brought back along the upper part of the fuselage to the tail surfaces. This mottled effect reduces the visibility of a plane from above. The tan section blends with the earth colors and leaves only the darker sections discernible. Their irregularity finishes the job of confusion. The plane's outline is lost to the eye of the detector.

In camouflaging planes to deceive the eye from the ground, the sky, instead of

2/88

of the AIR ...

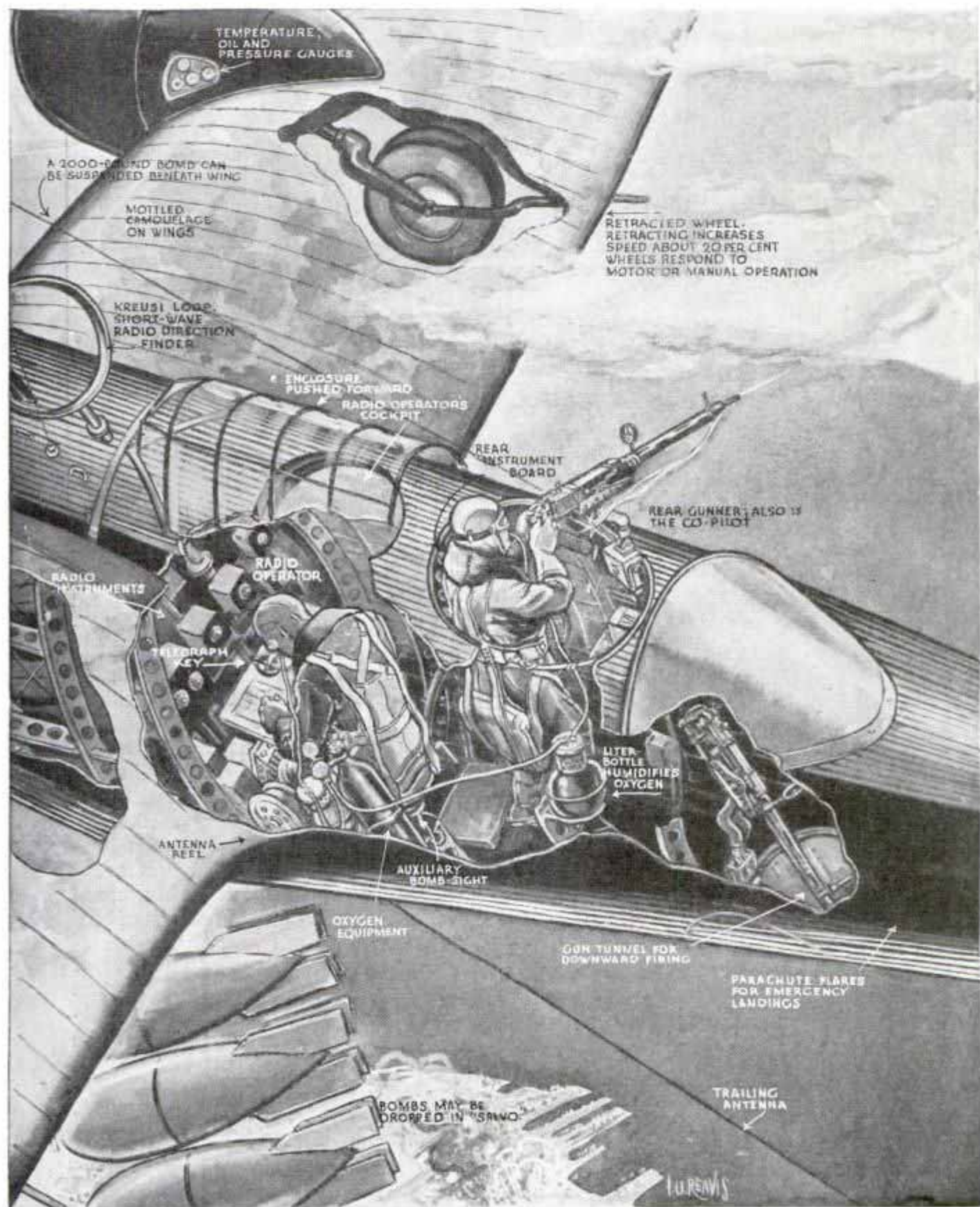

Drawing Executed through Courtesy Army Air Corps Officials
Details of One of Army's Camouflaged Martin Bombers Which Can Ascend to High Altitude with Ton of Bombs, Shut Off Motors and Attack Before Its Presence Is Discovered

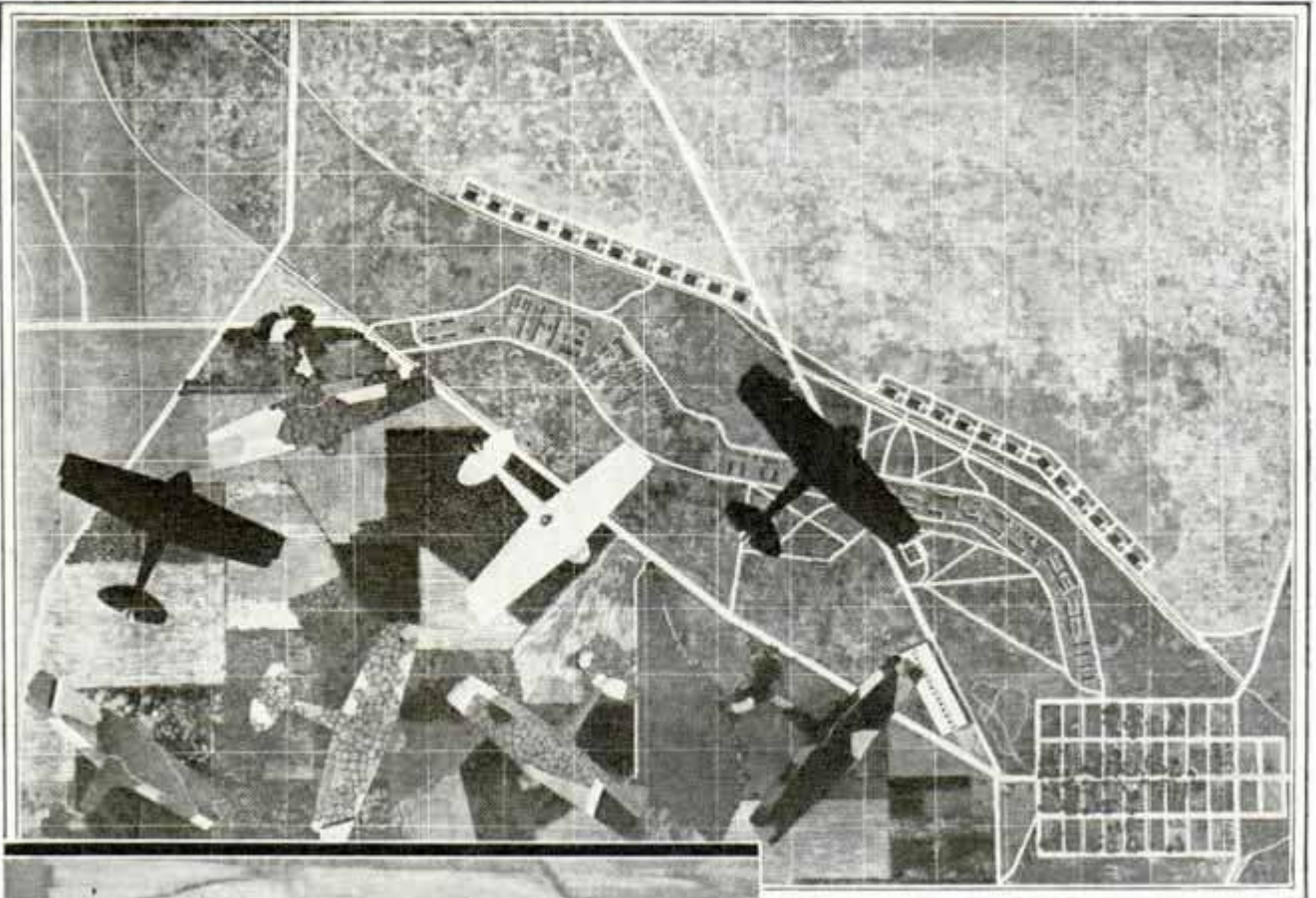

Top, Models of Camouflaged Planes against Various Backgrounds; Note How the Ships Blend with Their Surroundings; Below, Bombers Camouflaged to Fly over Terrain

the earth, is the background to be filtered against. Flying against the blue sky, a plane presents a solid silhouette. To blot out its visibility to anti-aircraft gunners on the ground, burnished aluminum, light blue, light purple and white are used. The aluminum reflects light and brightens the under surface. The white assists in this while the light blue and light purple carry out the sky dissimulation. The under surface combinations are put on in small areas which, quite remarkably, blend into a solid color at heights of half a mile. This has the effect of lightening the under surfaces of the plane when projected against the background of the sky. Shadows, formed by the wings on the fuselage, are taken care of by brightening the plane at this point with aluminum finish. The landing gear is touched up also.

Planes so treated become invisible at heights of 10,000 feet. Those not treated are visible at 17,000 feet. This means decreasing the

(Continued to page 130A)

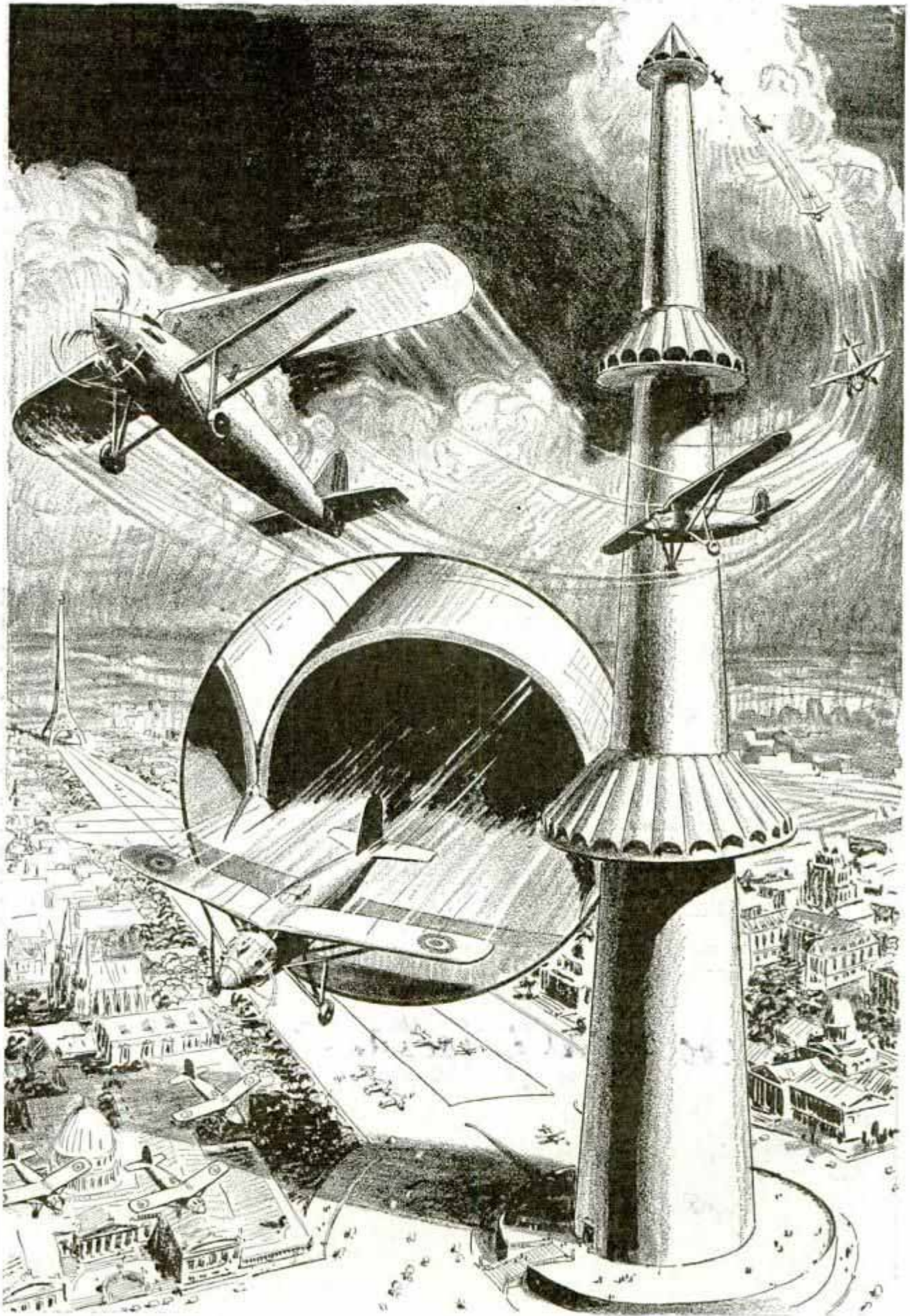

Proposed Tower More Than a Mile High with Platforms from Which War Planes Could Be Launched at Various Heights; Elevators Would Carry the Ships to the Launching Chutes

at University of Padua, Italy



nardi, Italian scientist and inventor, built several types of self-propelled vehicles, two of which are shown here. One was a bicycle pushed by a third wheel revolved by a gasoline engine. Some of the principles he employed are still considered good practice. The spark plug in his engine is similar to those used today. The three-wheeled vehicle had a single control which enabled the driver to go from top speed to braking and stop, all in one operation.

8259
**PORTABLE BASE
 FOR MOTOR
 SAVES TIME**

Eliminating the need for line shafts, hangers and loose belts, an inexpensive portable motor base saves time and money in the workshop. The motor can be shifted easily to drive the circular saw, the planer, the lathe and other equipment. These changes are made

acme
Two Forerunners of the Automobile Built More Than Forty Years Ago; Each Had Features Incorporated in Cars Today

FORERUNNERS OF TODAY'S AUTO HAD MODERN FEATURES

Some of the earliest "horseless carriages," while crude in appearance, had features incorporated in today's cars. More than forty years ago, Prof. Enrico Ber-

by simply lifting the motor and changing its position on the bench rail fastened to the workbench. Changing pulleys or changing belt center requires only a few seconds. The belt tension can be adjusted by means of the notches cut in the motor base rails.

\$1.00 - West of Rockies - Canada \$1.25

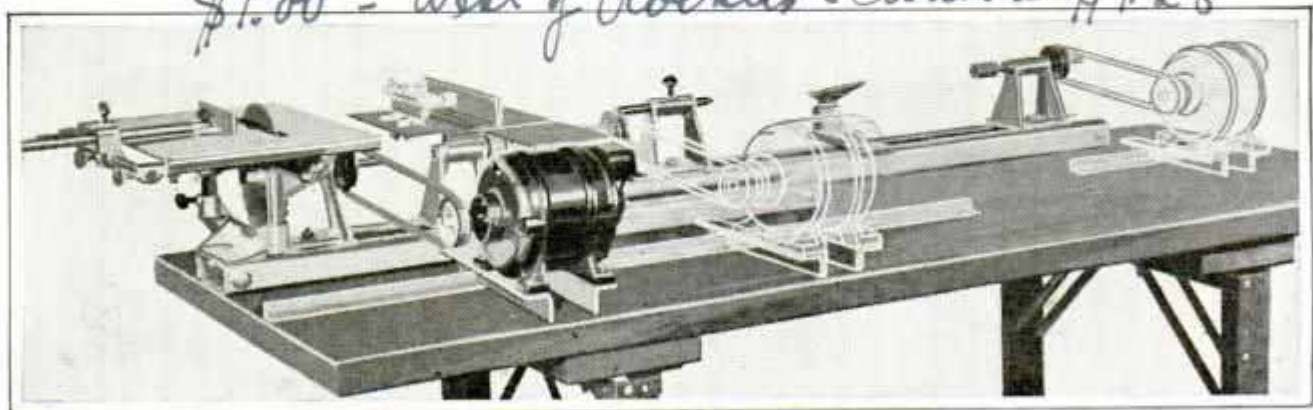

Motor on Portable Base Is Shown in Black; Phantom Views Show Other Applications Possible Only by Using Portable Base; Tension of Belts Can Be Adjusted by Means of Notches in Base Rails

*Atto Königslow Mfg. Co Cleveland
 3610 Perkins Ave.*

Home Craftsman Starts Egg-Rack Business

Top, Right, Craftsman in His Home Workshop; Note Model of Egg Rack, One of Many He Tried Out; Left, Egg Rack in the Icebox; Bottom, Right, How the Eggs Are Placed in Rack for Storage; the Device Is a Handy Space Saver; Increasing Demands for It Keep the Inventor Busy

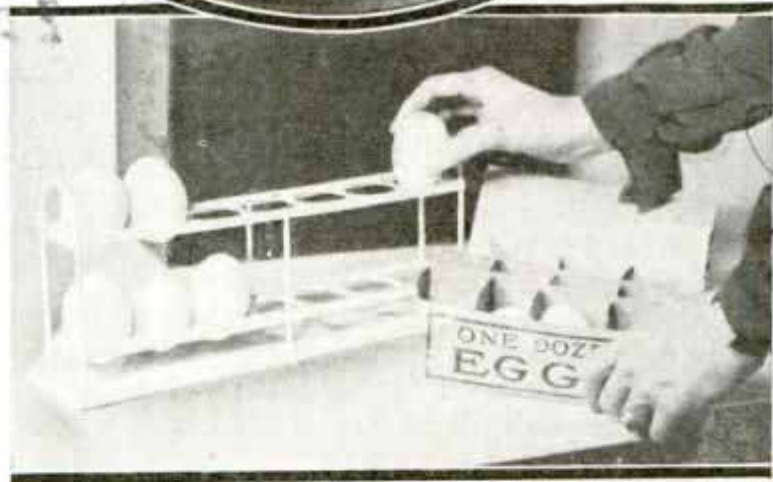
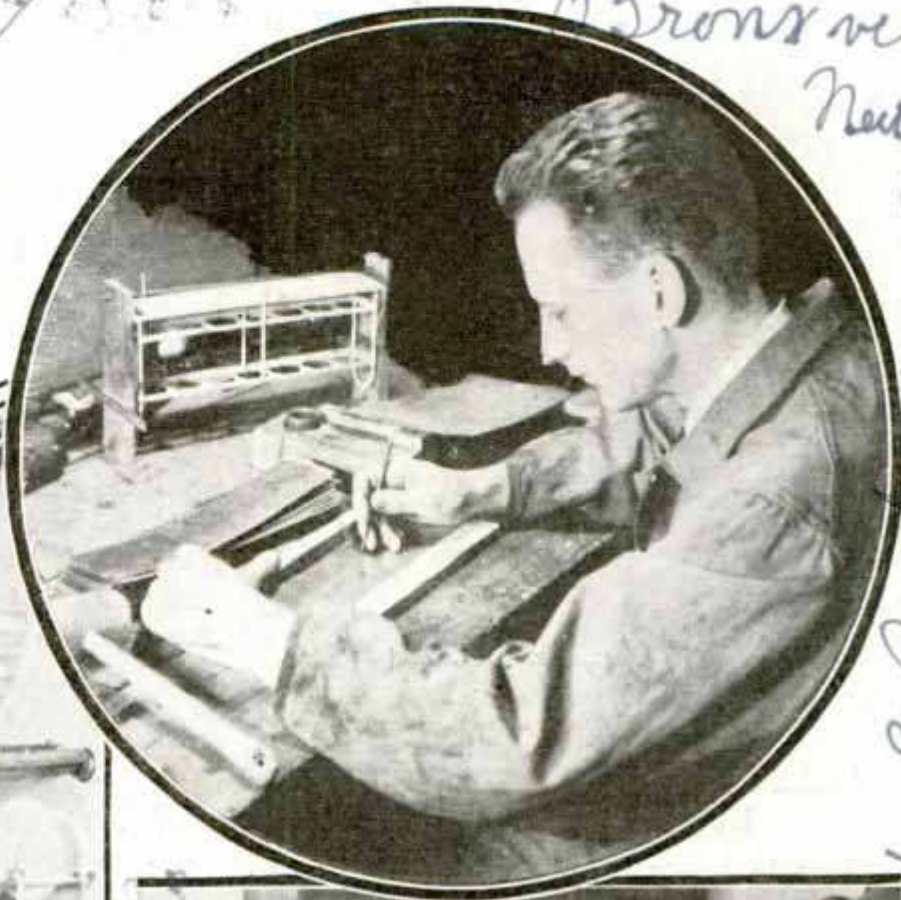

When Cranston Jones heard his wife complaining about the amount of space taken up in the refrigerator by a bowl, wire basket, paper bag or cardboard box of eggs, he began experimenting in his home workshop. After trying many different styles of egg holders, he evolved a double-decked rack that pleased his wife. Relatives and friends saw it and put in orders. Churches and other organizations began to demand the handy racks and a profitable business developed in the workshop. The inventor frequently has to em-

ploy assistants to help fill rush orders, and special jigs, tools and paint-dipping machines have been devised to speed up operations. The rack, holding fourteen eggs, measures thirteen inches long, two and one-half inches wide and five and one-half inches high. It is made of brass coated with white porcelain enamel.

Popular Mechanics Magazine does not publish the name of the maker of, or dealer in, any device described in its pages, but this information will be furnished by our Bureau of Information upon request, accompanied by stamped envelope.

Cranston Jones
Brooklyn Ave
Dronsville,
New York
Emp. Auth. E. Cushman
325 W 212 nd. New York

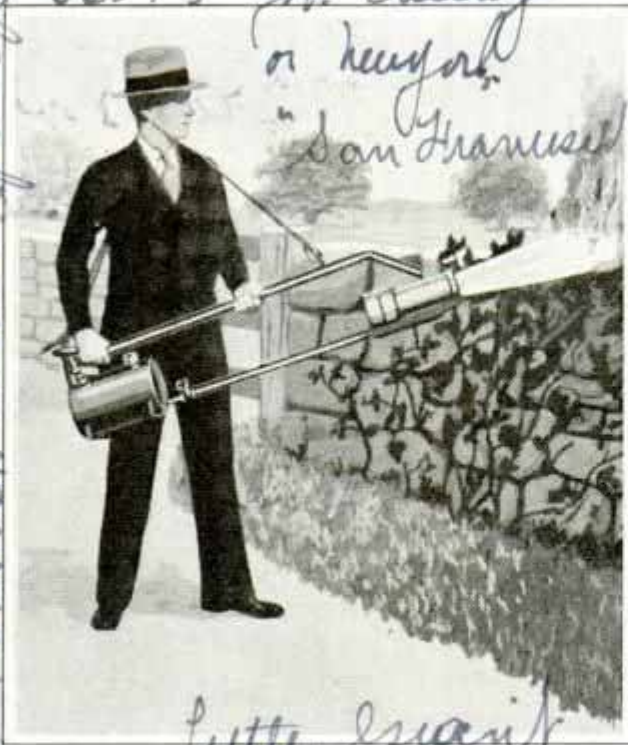

Clearing Away Vines from Wall by Portable Weed Burner That Throws a Hot Flame

WEEDS DESTROYED BY BURNER IN PORTABLE UNIT

Easy to carry from place to place, a weed burner solves the problem of clearing land. It throws a fan-shaped flame that mushrooms against the ground, stone wall or rock pile to "melt" every growing plant within its range. One model of the burner is self-contained for one-man operation. It has a tank that holds oil for one and one-half hours' work. The handle is constructed for attachment of a shoulder strap or webbing to facilitate carrying. The torch also can be used for sterilizing poultry houses, dog kennels and stables.

WASHING MACHINE KEPT LEVEL BY LOCKING WEDGE

Washing machines can be locked in level position by a simple cupped wedge that requires no lifting of the washer. Since it prevents crawling or creeping of the machine, the wedge reduces vibration, assures quieter operation, and prolongs the life of the washer.

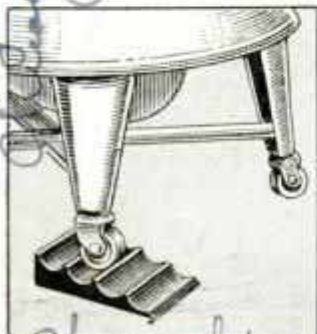

8260

HOT-WATER CIRCULATOR SAVES ON HOME HEATING BILLS

Speeding up heat delivery, a circulator for the hot-water heating plant increases efficiency and reduces the fuel bill. The faster flow through the piping minimizes the loss of heat during transmission from the boiler to the radiators in distant parts of the home. Its forced circulation tends to overcome the disadvantages of inadequate pipe sizes and small radiators. The circulator consists of a centrifugal type pump driven by an electric motor turning 1,725 revolutions per minute. Especially designed for quiet operation, the motor is free from radio interference. The pump is made of steam bronze.

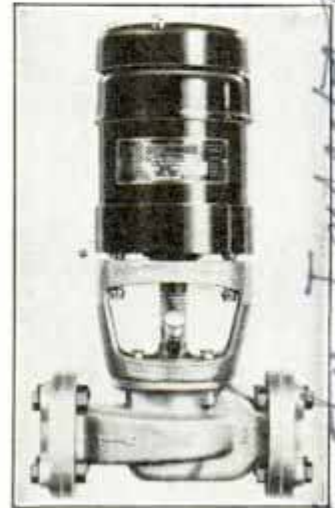

8273

CACTUS SET GLOWING AT NIGHT BY ELECTRICAL MAGIC

Magic of electricity is employed to turn a giant cactus into a glowing thing of beauty at night in Phoenix, Ariz. Located in the center of the city's business district, the growing cactus is illuminated to welcome visitors.



Night View of Illuminated Cactus

Hauck Mfg. Co. 126-48th St. Brooklyn, N.Y.
H.O. Jones, 2339 W. Albany Ave.

Penberthy Injector Co. Detroit, Mich. 1242

Phone Spaulding. 8362

Wide World

German Cars Streamlined from Stem to Stern

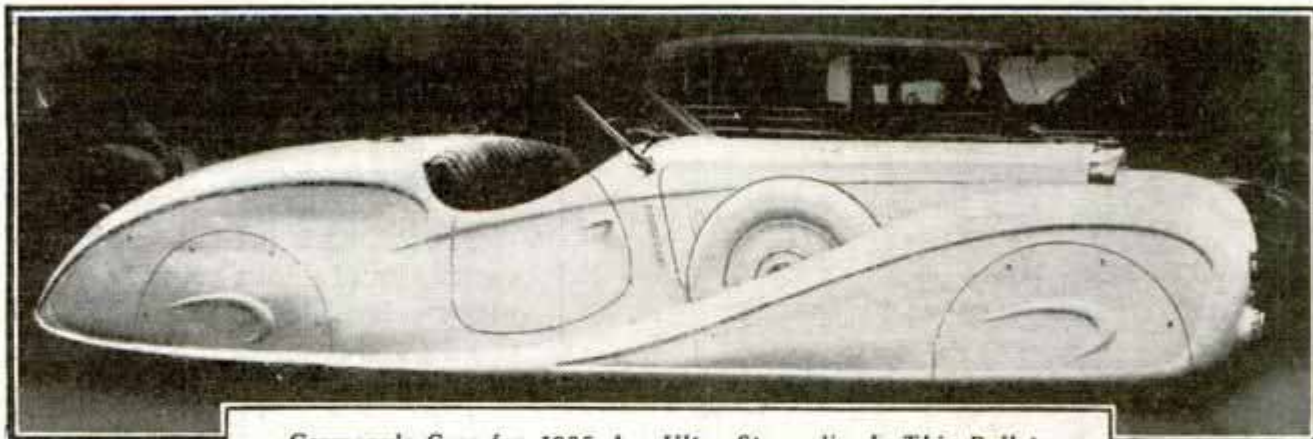

Germany's Cars for 1935 Are Ultra-Streamlined; This Bullet-Shaped Creation Is a Mercedes Roadster Exhibited at the International Auto Show in Berlin

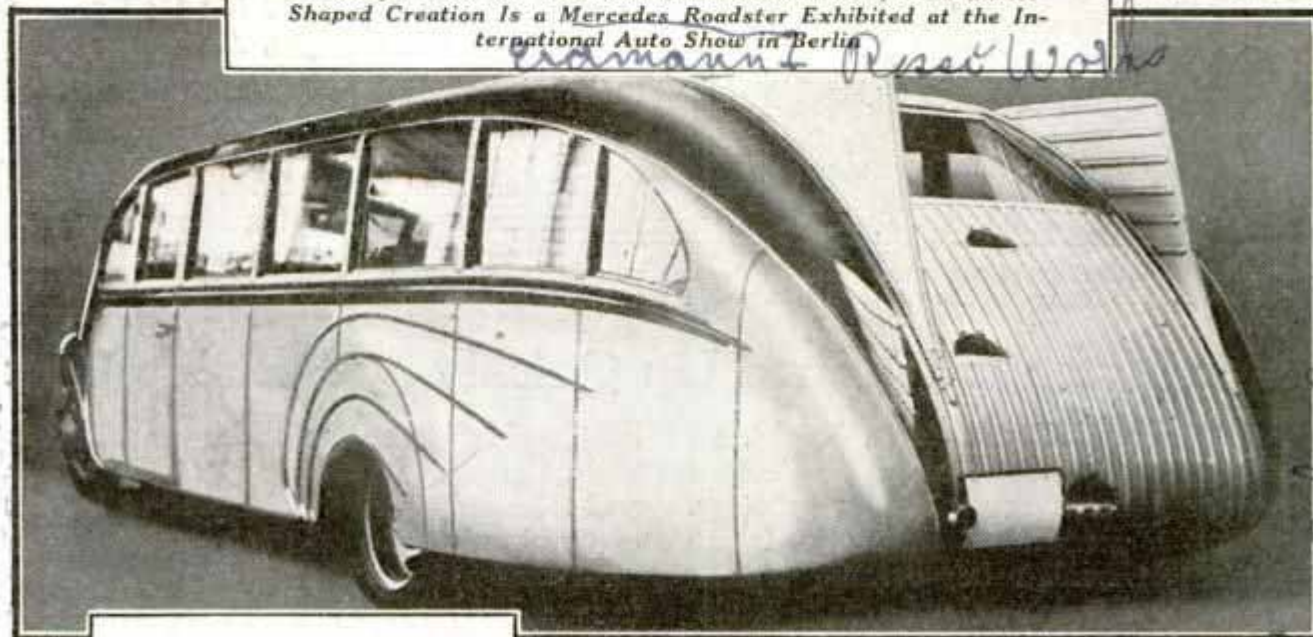

Here Is a Well-Streamlined Bus for Cross-County Operation, a Product of the Opel Works; Note How the Flowing Lines Have Been Carried to the Fins at the Rear and over the Rear Wheels

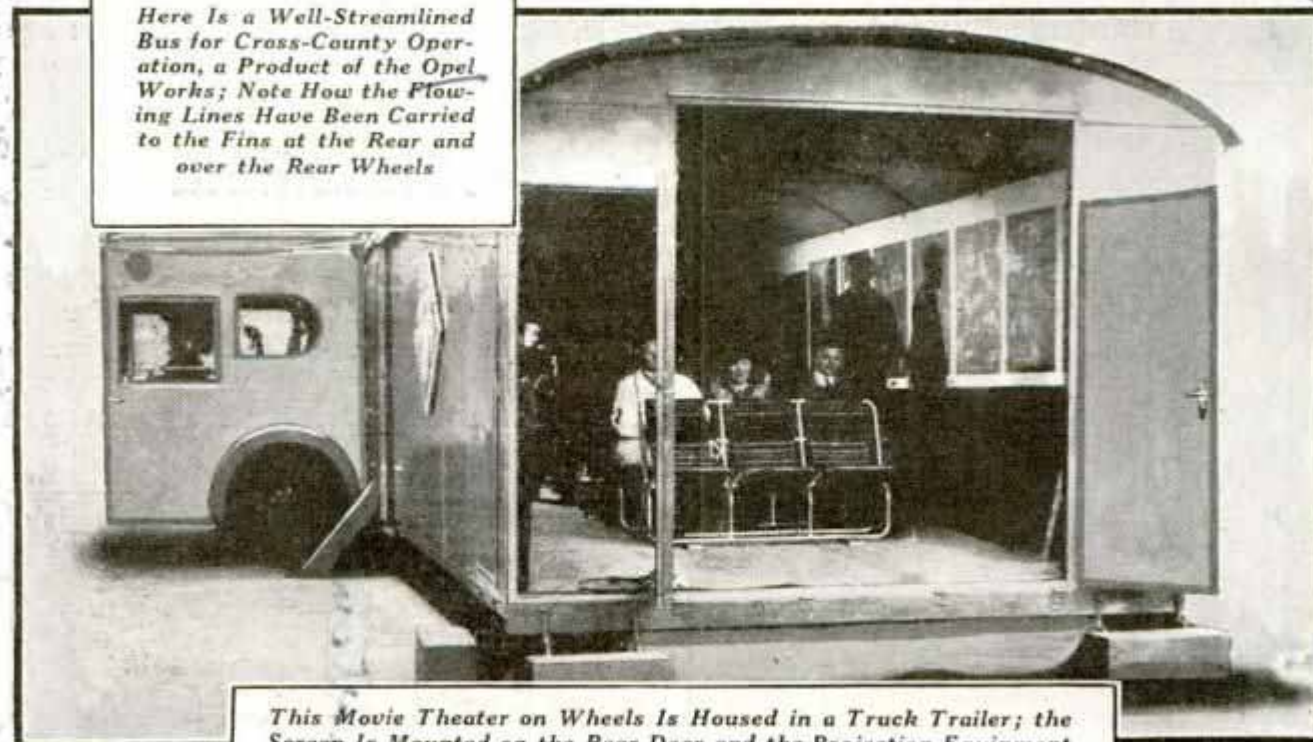

This Movie Theater on Wheels Is Housed in a Truck Trailer; the Screen Is Mounted on the Rear Door and the Projection Equipment Is at the Front

Mercedes Automobile Co. N.W. U.S.A. Opel Adam Opel Gesellschaft. Germany-Kommande Gesellschaft. Hüsselheim a. Main. Hüsselheim

no longer

Staff of U.S. Navy Command of Capt. Claude B. Mayo

"Lost Continent" Shown on Sea-Floor Model



Students Examining Model of Ocean Floor; Its Formations Are Believed to Represent the "Lost Continent of Mu"

Portraying for the first time the mythical "lost continent of Mu," an unusual hydrographic map and model has been constructed as a result of 17,239 sonic soundings of the bed of the Pacific ocean. The "lost continent" is the vast underwater mountainous country which many scientists believe bridged the Pacific from China to Mexico about 13,000 years ago. The theory is that this lost land submerged as the result of flood or severe volcanic changes. Anthropologists have considered it as the possible explanation for the baffling presence of the American Indian on this continent. The relief map was made by naval authorities. The soundings were taken with the aid of special instruments.

to be displayed at California Pacific International Exposition

Plane Motor Is Warmed Up Quickly by Portable Unit

Portable and adjustable in height, an electric-and-gas heater has been devised for quickly warming up airplane motors. The unit is suspended in a light frame mounted on small roller-bearing wheels. When a plane is scheduled to make a trip, the heater is pushed to the front of the motor, the shutters adjusted to direct the

heat, and left in operation for ten minutes. Then the pilot is able to start the motor and take off at once. The process is that of fanning hot air onto the motor, at the same time heating the oil in the crankcase to seventy or eighty degrees. Since it eliminates the old half-hour "warming up" period, the heater is said to prolong the life of the motor.

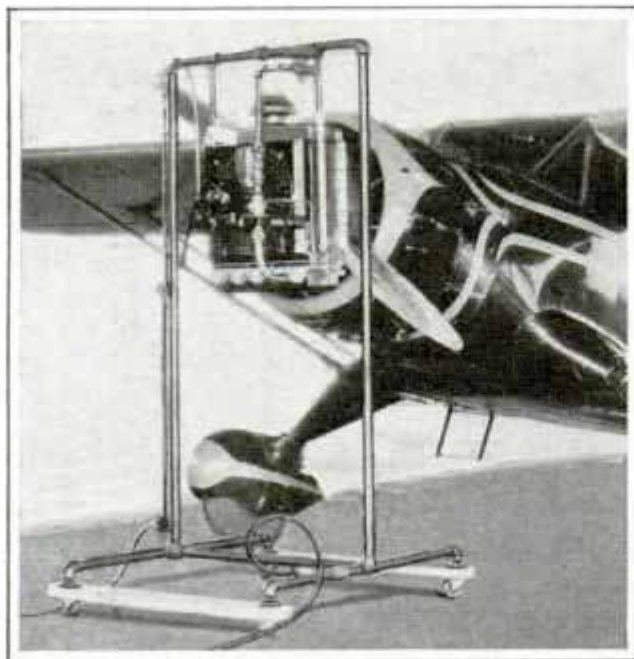

Latest Type Heater in Place for Warming Up Airplane Motor; Heater Is Portable

OUTBOARD LIGHT IN WEIGHT HAS PROTECTIVE HOOD

Weighing only twenty-four and one-half pounds, the latest outboard motor is easy to carry to and from the boat. Developing one and one-half certified brake horsepower, it runs two hours on less than one gallon of fuel. Constructed with a hood that encloses engine, ignition system, carburetor intake and flywheel, the motor is protected against rain, spray and breakage. Its low first cost is another feature.



4/43 N. 27 Mrs. Outboard Motors Corp. Milwaukee Wis

Dr. C. W. Short Jr. Municipal Airport

**DAMPER TO SAVE ON GAS HEAT
WORKS AUTOMATICALLY**

Installed in the flue to prevent the escape of heat, an automatic damper reduces the cost of operating the furnace with gas.



When the gas burners start, the damper opens to permit the passage of flue gases. When the burners stop, the damper closes and prevents the loss of heat out the chimney. The damper replaces a four-inch section

of the flue pipe. One connection to the boiler or furnace control line completes the job.

**STEEL KEPT BRIGHT BY COATING
OF LANOLIN MIXTURE**

Bright steel parts of stored machinery can be kept from rusting by a coating of lanolin mixture containing about eight pounds of lanolin per gallon of solvent. The solvents are white spirit and naphtha. A little more lanolin is used with naphtha.

**MUSIC EASILY PRINTED BY HAND
WITH SIMPLE OUTFIT**

Music characters can be printed by hand with an inexpensive outfit. It includes the "manutype," a small printing instrument that fits the hand, a staff stamp, transposition chart, ink pad and ink. The manutype is especially designed for writing music, saving time, patience and eye strain.



Hand-Fitting Music Writer Is Shown in Use; It Is Designed to Save Musician's Time



Candle-Clock Made in Segments, Each of Which Requires Fifteen Minutes to Burn

**CANDLE EMPLOYED AS A CLOCK
IS MADE IN SEGMENTS**

In the time of King Arthur, candles were used to measure the passing of time and one of these candle-clocks was exhibited recently in this country. The candles were made in segments and one segment required fifteen minutes to burn. The passing of the quarter hour thus was indicated as the flame flickered at the end of the period, showing one section of the candle had been burned away.

**TENT ERECTED BY AIR TUBES
INFLATED WITH PUMP**

Erecting a tent with compressed air is made possible by pumping up the rubber tubes encased in the corners of a tent for which Lee Burrows, of California, is seeking patents. The rubber tubes are contained in canvas tubes with zipper fasteners. When the tubes are inflated with a tire pump, the tent takes shape and is held erect. Guy ropes at the corners give additional rigidity. Five to ten pounds of air is sufficient. The four air tubes are connected with a by-pass arrangement so that one valve will serve all.

Chicago People's Gas Co. (Murphy and Alden)

17825 St. Clair Ave. Cleveland, O.

at Western Spales Jewelry Show - Los Angeles

The manutype

Lee Burrows, Murphy, California

Making HOME TASKS



Hassock with Rounded Pillow Which Serves as an Arm, or Back Rest, and Book Holder Consisting of Chromium-Plated Scroll Spring; When Book Is Removed, Spring Comes Forward to Hold Remaining Volumes



Left, Venetian Blind Brush with Adjustable Wool Fingers Which Fit between Slats; It Can Be Washed; Right, Thermometer Which Tells When Roast Is Rare, Medium or Well Done; It Is "Cooked" with the Meat

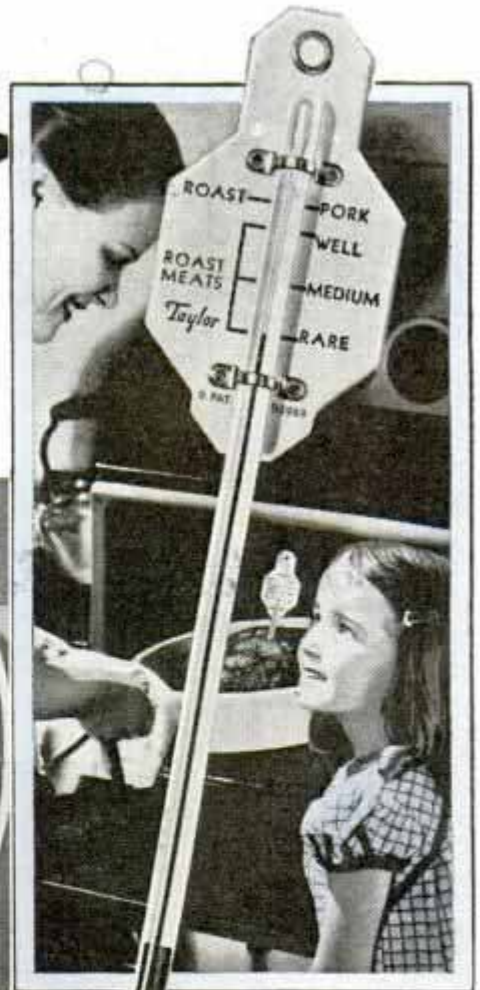

Waterproof Shampoo Shade Which Keeps Soap and Water Out of the Eyes While Washing Hair; It Stretches to Fit Any Head

a PLEASURE



Left, Fruit-Jar Cap Sealer Which Straightens Flange of Lid When Sealing; It Is an Octagon Shell with Four Beveled Rollers



Chest of Drawers with a Desk Section and a Sliding Writing Panel Board Concealed in the Top; the Desk Is Exposed by Lifting the Top, but When Closed, the Top Is Flat and the Desk Is Hidden; Left, Baby Basket with Two Handles Which Fold over Each Other, Keeping the Baby Upright but Preventing It from Climbing or Falling Out

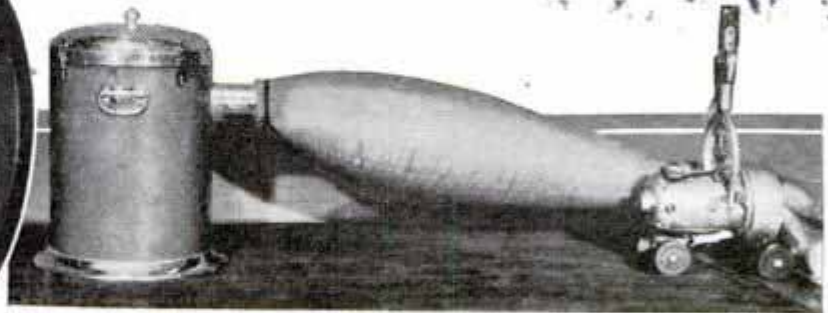

Left, Porous Rubber Mop for Sweeping or Scrubbing; Folding Hinged Clamps Make It Possible to Wring Mop without Getting Hands Wet; Above, Tank for Emptying Vacuum Cleaner Bag; Bag Is Connected to Tank and Electric Sweeper Is Turned on to Empty; Sweepings Go into Special Container and Are Burned; Current of Air Passes through Receiving Bag and Is Forced through Filter and Out through Holes in Top

Forty-Five Per Cent 'Hill' Tests Army Trucks

Rigid service tests, including one in which a forty-five per cent incline made of heavy timbers is used, are required before acceptance of trucks for the U. S. army. The trucks are made to run up and

down the man-made "hill" under full load, simulating road conditions that might be encountered during peace-time maneuvers or actual warfare. The trials also provide that the brakes hold a fully loaded truck

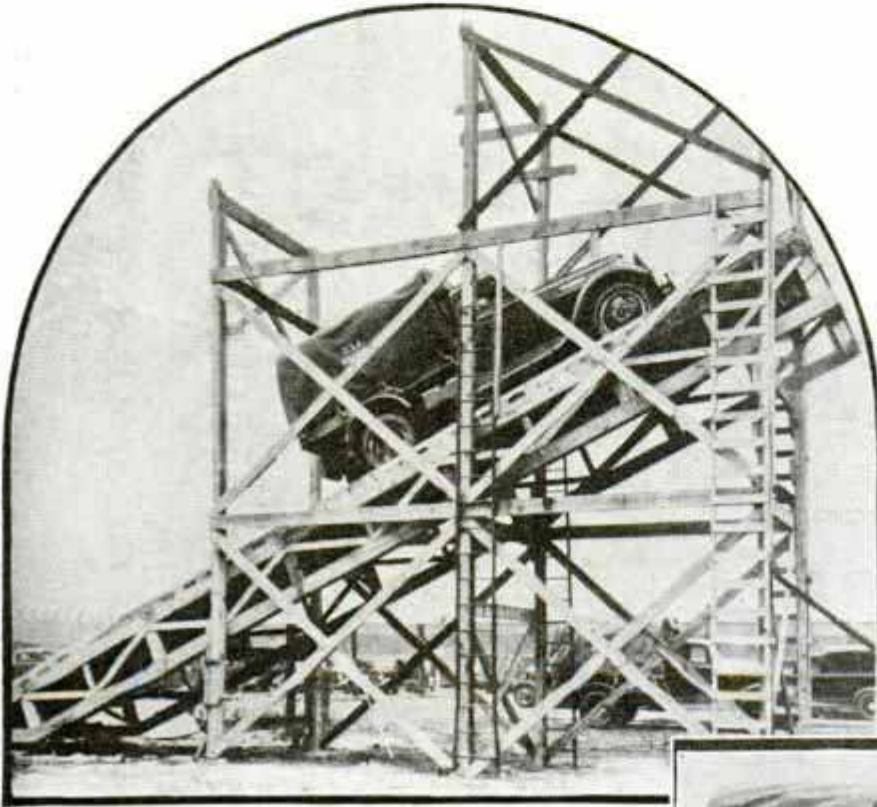

on the forty-five per cent grade, as well as bring the vehicle from a speed of twenty miles per hour to a stop in twenty-five feet. One of the latest trucks delivered to the army by Dodge Brothers corporation is equipped with a heavy metal guard that protects radiator and headlamps against damage. Installed between the front fenders, the grill acts as a bumper for the radiator, absorbing much of the shock of collision. Another innovation is the four-wheel drive, which gives more power.

Army Truck Climbing Steep Incline; Right, Note Stout Grill Protecting Radiator



FIBER ANCHOR LOCKS SCREW IN CONCRETE OR BRICK

Screws can be locked in stone, concrete, brick, plaster or other material by inserting them in a non-split fiber anchor. Unaffected by moisture or temperature, the plugs are practically indestructible. Installation is easy. First a hole is drilled in the material, then the fiber plug is inserted and finally the screw is driven into the plug with a screwdriver. The anchors are made of hemp, braided and interwoven with copper wire.

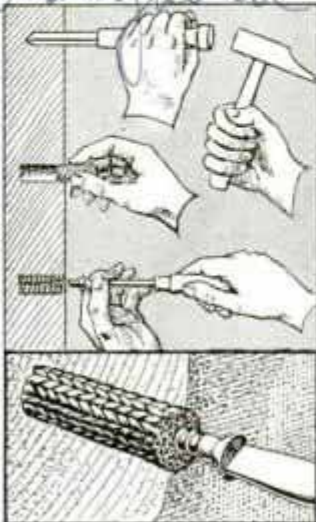

ODD-SHAPED FILAMENT LAMPS USED IN SIGNS

Straight, curved and odd-shaped incandescent lamps with filaments are being used in signs and other places where a diffused light of low brightness is needed. Of the tubular type with filaments running the entire length of the tube, the lamps are useful where the high voltage required for gas or neon tubes is undesirable. The lamps, which can be operated in standard sockets at standard voltage, are expected to open up a new field of architectural and decorative lighting.

Palatine Industrial Co
ill. H. C. Newell
illuminating Engineers
Feb. 1935 - P. 6! Englan

267

prices vary

stronghold

278

mazda

1000 lbs
Caracas, Pa
Wellrock Hill
suggested lamp made by General Electric
inla Park Cleveland, Ohio



INEXPENSIVE UNIVERSAL BRIDGE

ANYONE can build this simple universal Wheatstone bridge. Experimenters, service men, set builders and students all require some means for accurately measuring the values of resistors and condensers as labels often are missing from such parts or the color-code bands may be charred or faded.

This simplified bridge, assembled from a standard kit of parts, has been designed to meet the requirements at low cost. Tested in Popular Mechanics radio laboratory, a corner of which is shown in the upper photo, the instrument was found to be satisfactory in every respect. The range covers resistance measurements from .01 to one million ohms and capacitance from .0001 mfd. up to the highest values used in radio work.

All mathematics, other than simple multiplication, have been eliminated. The voltage source is a small filament-lighting transformer; however, a battery and buzzer may be used in d.c. districts to provide the necessary interrupted voltage source. The kit of parts includes operating instructions.

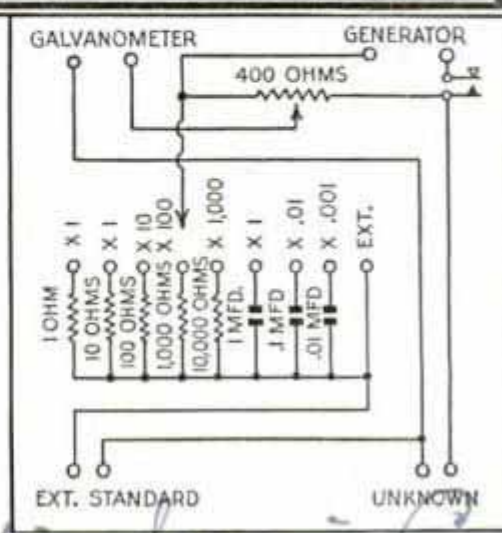
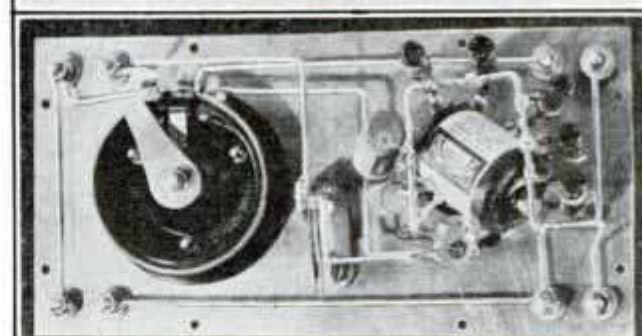
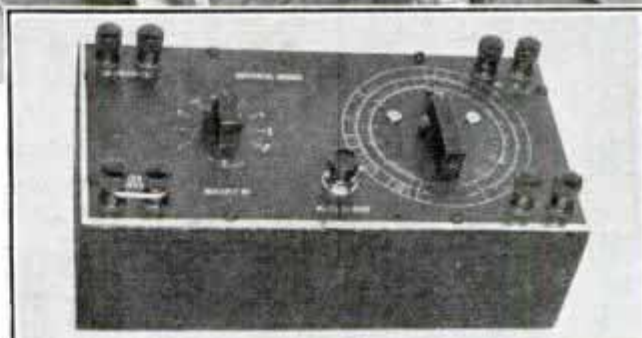

*Wholesale Radio Service Co. 901
100-6th St. New York*

AMPLIFIER *for*

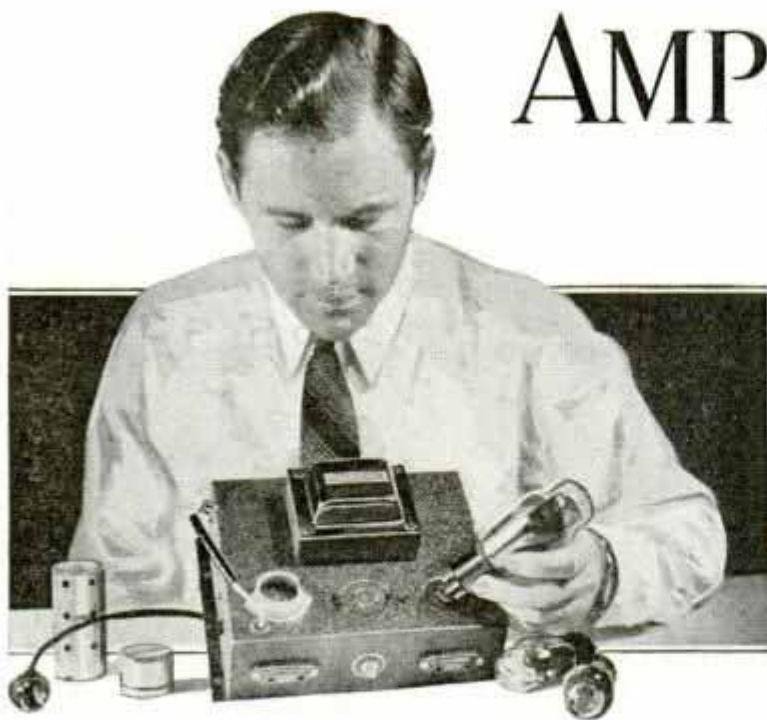

By **FRANK LESTER**

OWNERS of small 2 and 3-tube short-wave, or broadcast, receivers who desire more volume for the operation of a dynamic speaker, will find this compact midget amplifier very effective. The increase in volume brings in distant stations with good strength which formerly were just audible in headphones. It also makes a fine public-address amplifier for small halls, or club rooms, as it can be used with

a microphone, phonograph pick-up or to amplify a regular broadcast receiver. Amateurs will find this 3½-watt unit handy for modulating low-power phone outfits.

It is complete with its own power supply, and provision has been made for optional speaker-field connections so that practically any type of speaker may be used. The unit is assembled easily and the parts are within the range of limited pocketbooks. A completely drilled black-lacquered steel base is available; however, all dimensions appear in the sketch on the opposite page for those who wish to make their own. A schematic diagram is given in Fig. 1, and Fig. 2 shows the simplified wiring diagram looking at the unit from the underside. The first tube is a type-57 pentode, resistance-coupled to a type-2A5 pentode amplifier tube. A full-wave type-83 rectifier tube is used in the power supply, which furnishes 300 volts of well-filtered plate voltage. A complete list of materials can be obtained upon application, without charge.

It will be noted that the type-57 tube is shielded to protect it against outside pick-up. The input and output connections to and from the amplifier depend on the kind of receiver with which it is to be used and the type of available loud speaker. Self-powered speakers, such as the special short-wave variety shown in the upper photo, may be plugged directly into the output

jacks. If a magnetic speaker is on hand it should be connected as shown in Fig. 1A. The choke coil is hooked directly across the output posts of the amplifier, with a .5 mfd. condenser in series with the plate lead to the speaker. The other speaker lead is

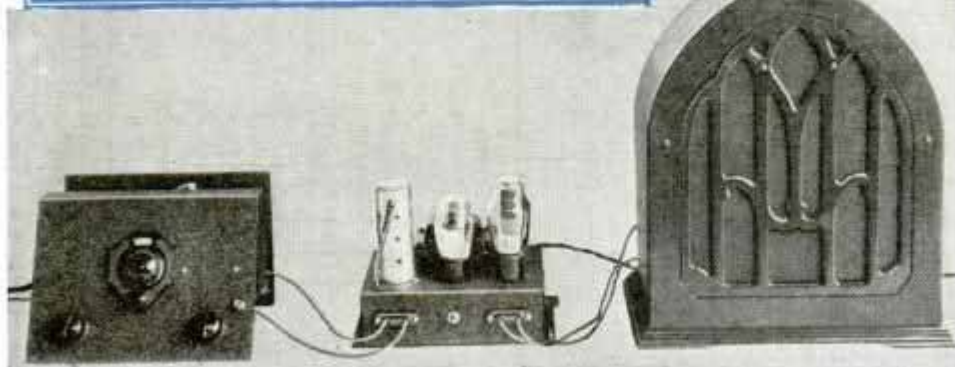
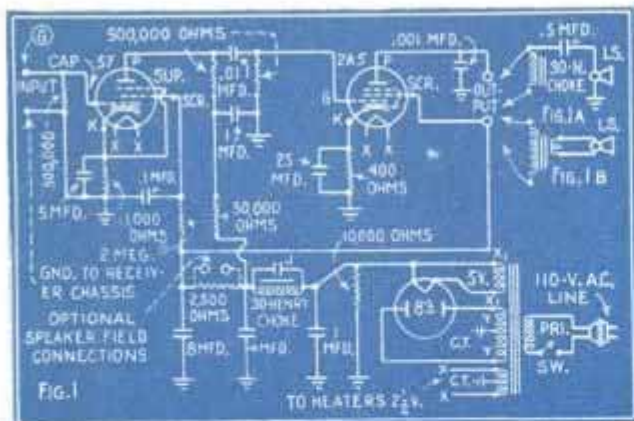

Small Short-Wave Receivers

grounded to the frame of the amplifier.

A dynamic speaker is recommended as it will handle more volume than a magnetic type. These speakers are available with built-in output transformers to match the 2A5 output tube; if your speaker does not have a coupling transformer of this description, one should be provided and connected as shown in Fig. 1B. The field of the speaker may be excited conveniently by the power pack of the amplifier by merely removing the 2,500-ohm resistor and substituting the speaker-field connections as indicated in Fig. 1. An enlarged blueprint of all wiring and layout diagrams is available, those who wish it should specify blueprint R-210.

To connect the amplifier to any short-wave receiver of the popular regenerative types, as shown in the photos, it is merely necessary to

(Continued to page 128A)

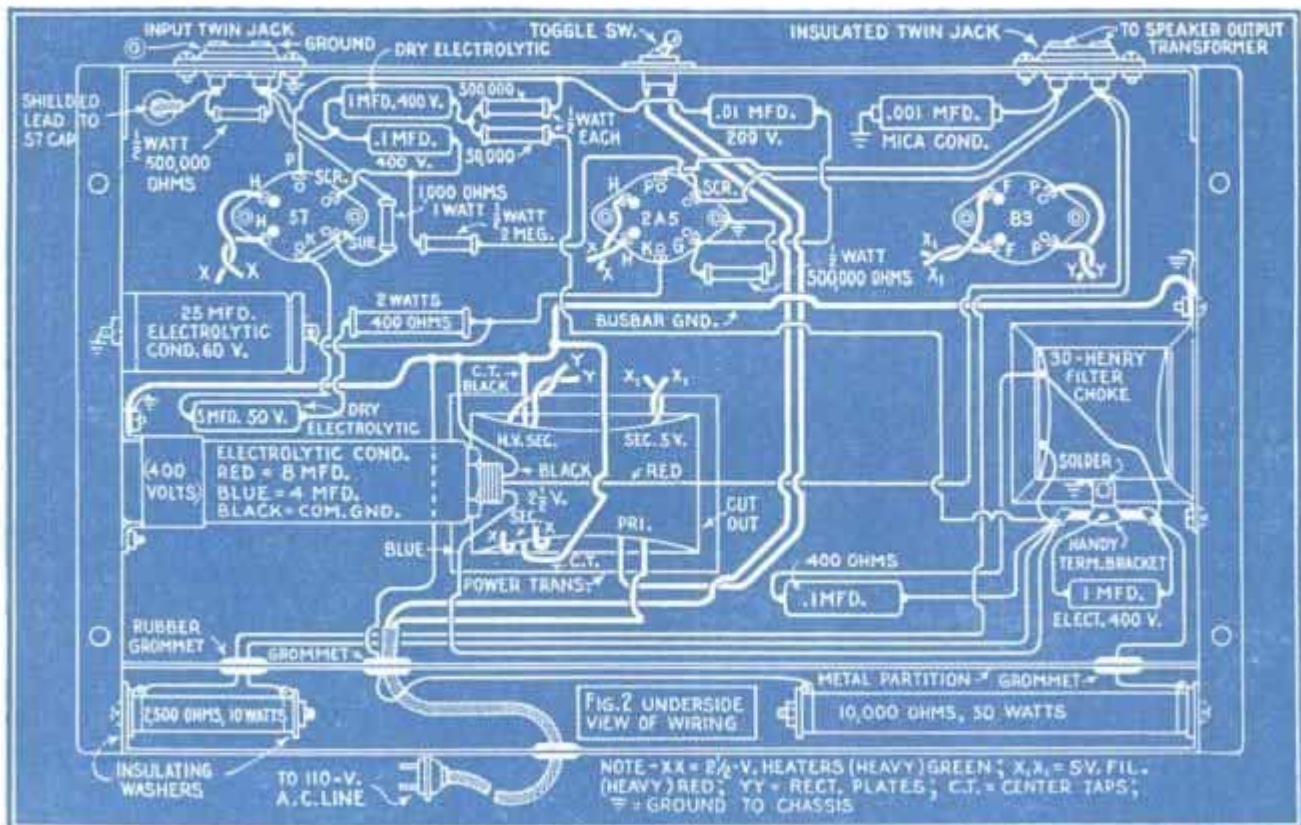
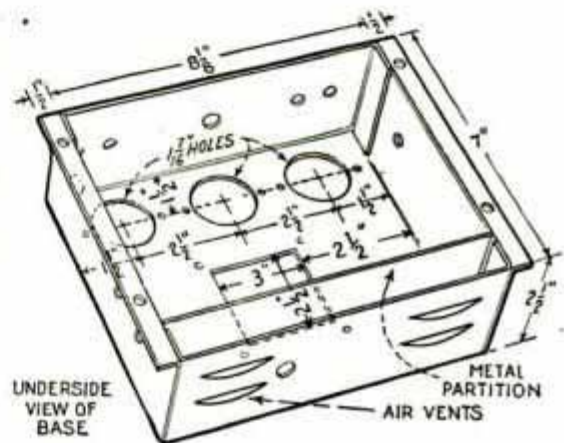

Compact Crystal-Controlled CW Transmitter

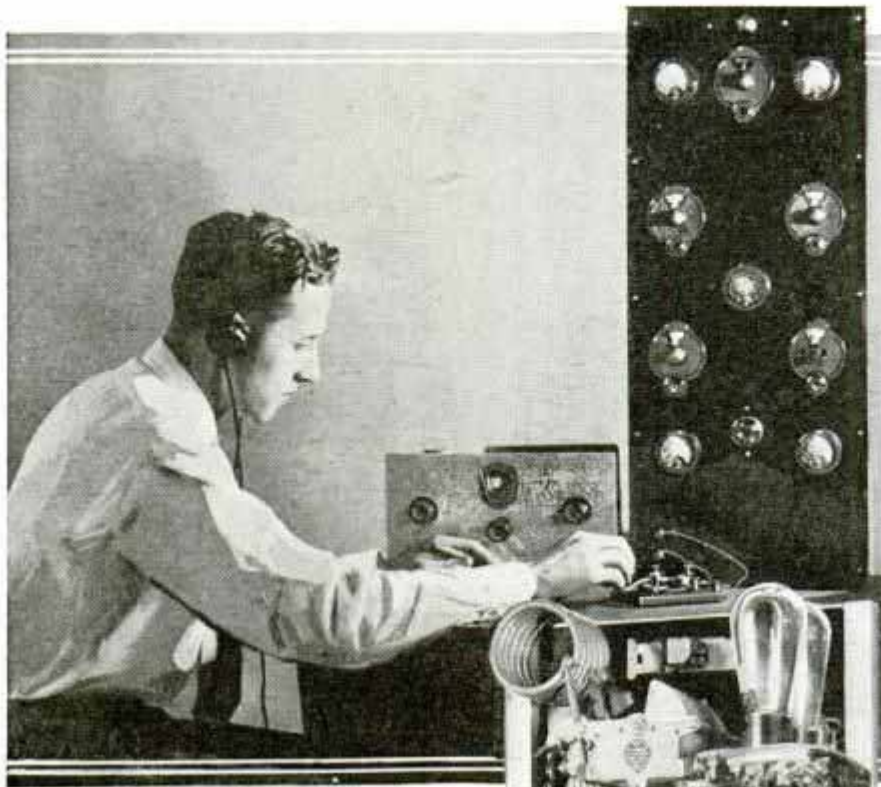

PART I

BEGINNERS will find this unusually compact 20-meter key transmitter easy to build. It employs inexpensive tubes and the parts have been selected carefully for economy and high-grade performance. For the more advanced amateur it will serve as a stand-by transmitter in high-powered stations for use when full power is not required or where 20-meter operation is not provided for otherwise.

Although the builder may alter the arrangement to suit his particular needs, the simple rack assembly shown in the

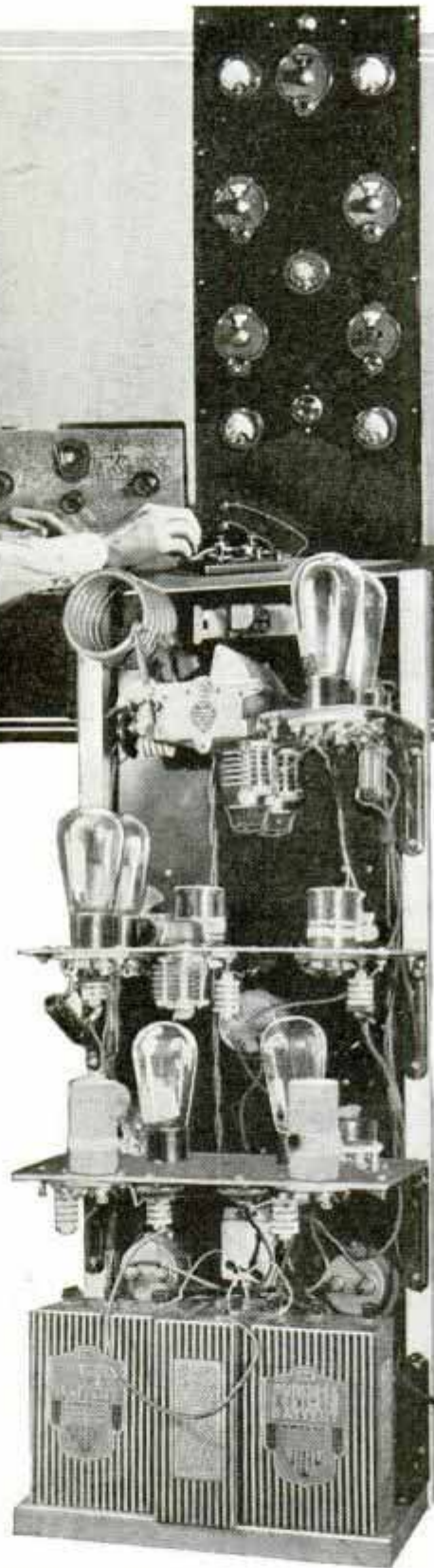
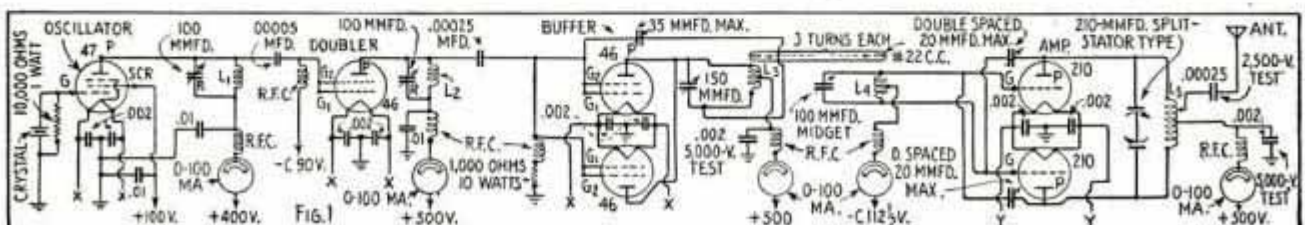

photo occupies very little space on the operating table. There is nothing unusual about the circuit, Fig. 1; however, the tube line-up is exceptionally good for DX work on 20 meters as a 40-watt output is obtained easily.

The $\frac{3}{16}$ -in. bakelite front panel is 12 in. wide and 30 in. high, and two $\frac{7}{8}$ by $\frac{7}{8}$ -in. wood strips, 30 in. long, form the uprights which support the panel at rear. The wood baseboard is $\frac{7}{8}$ by $6\frac{7}{8}$ by 12 in. Cutouts are made at the front corners to take the uprights, which are fastened with long wood screws through the front panel. The panel is supported further by means of 3-in. shelf brackets screwed to the baseboard at each side. Five more of these brackets are used to mount the three shelves above; most of them are shown in the rear-view photo. Scrap bakelite is employed for shelves. Two pieces $\frac{1}{8}$ by 6 by 12 in., and one piece $\frac{1}{8}$ by $3\frac{7}{8}$ by 6 in. are required. It will be noted that the small upper shelf is supported by a 3-in. shelf bracket on one side, the other side being fastened to the split-stator tank condenser frame by means of two small angle brackets.

A 2½-volt filament
(Continued to page 116A)



HINTS FOR RADIO EXPERIMENTERS

Right, Sheet-Metal Punches, Now Available in Four Sizes, Enable Experimenters and Set Builders to Cut Instrument Mounting Holes Quickly; Three Necessary Steps Are Illustrated in A, B and C; Hole Is Drilled to Fit Guide Pin Snugly; Metal Sheet and Punch Are Placed over Pin on Firm Surface When Driving Punch through Stock



Above, Handy Indicator for Neutralizing and Balancing Sets, Made from a Short Length of Wire; Below, Heavy-Duty Antenna Insulator Made of 1-In. Porcelain Coated with a Smooth Glaze to Prevent Collection of Dirt



Right, Noise Rejector Unit, Improves All-Wave Doublet-Antenna Systems; Installed Near Ground and Antenna Posts of Receiver, Two Short Leads Connect with Set; Screw Terminals Take the Twisted Downlead Cable of Doublet Antenna



Fused Connecting Lead on Battery Nearest Negative End Protects B-Batteries

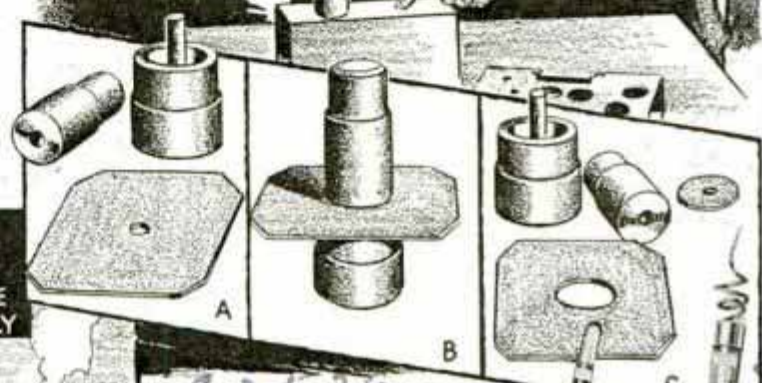

Right, Miniature Neon Voltage Fuses, or "Tattletales," Protect Radio Equipment against Excessive Voltages, Whereas Regular Fuses Protect against Excessive Currents; They Work by Shunting Out the Overload; Other Practical Uses Include Testing for Blown Fuses and Set Checking

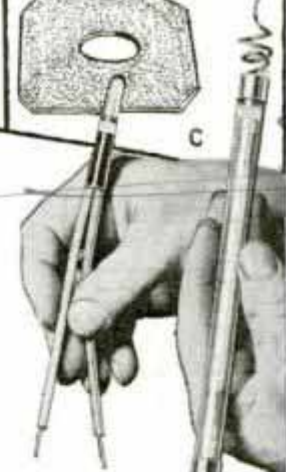

Homemade Clamp Used to Repair Old Dials Where Setscrew Is Lost or Threads Are Badly Worn; a Short Length of Brass Strip Is Bent and Drilled to Just Pass Shaft; Hacksaw Cut Is Made Lengthwise of Strip through Holes as Shown; Machine Screw Locks Clamp to Shaft



Technical Appliance Corp. 119 S. Broom St. Madison, Wis.

Littlefield Laboratories Chicago 1772 Washington Ave.

83527

D4697

83524

83526

Four-Tube Receiver in World Globe



Globe with Broadcast Receiver Built In; Tuning Knob Is Shown at Front

Built into a 12-in. washable globe, this self-contained receiver works on either a.c. or d.c. and employs a full floating dynamic speaker. The set has good tone and tunes from 175 to 550 meters.

Play Records through Your Receiver

This inexpensive record player transforms your a.c. radio set into an electric phonograph. The turntable is driven electrically and plays either 10 or 12-in. records. It may be operated at any distance



Record Player Showing Pick-Up Arm in Position

from the receiver, depending on the length of connecting cord selected. A volume control, provided on the instrument, is independent of the controls on the receiver.

Miniature Ribbon-Type Microphone

£ 3533 for Public Speakers

Although only about the size of a match box, the output of this little mike is said to be equal to that of standard microphones. Suspended by a ribbon around the neck, the response is constant with any position of the speaker's head. It can be used also as a hand mike.



£ 3540

Ready-Wound Low-Loss S-W Coils

Four complete and highly efficient short-wave coils, covering the entire range from 17 to 270 meters, are available now to ex-

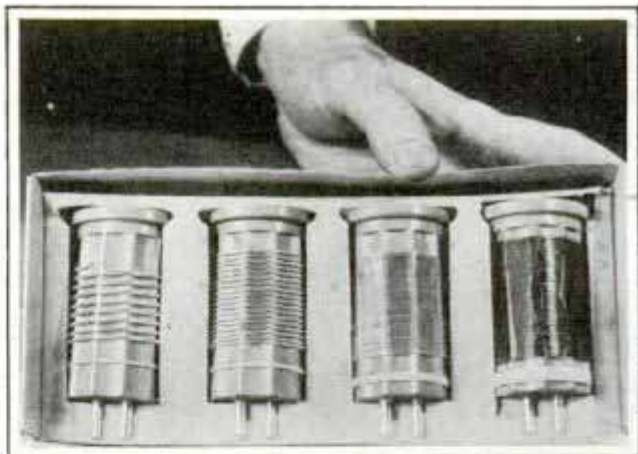

Plug-In Coils for Short-Wave Receivers

perimenters. Wound on low-loss Hammarlund plug-in coil forms, the secondaries of the first two coils are wound with heavy silver-plated wire to reduce skin-resistance losses. An additional coil is supplied for the broadcast band.

Blueprints covering radio construction articles in past issues can be obtained for 25 cents each; further information and material lists are available from our Radio Department, without charge, upon receipt of postage.

Hammarlund Mfg Co
424 W-33rd St

Balchick Radio Corp
561 Broadway
Chicago

R.C.A. Victor Co.
Camden, N.J.



TREASURE ISLAND

Play-Ship and Tool House . . .

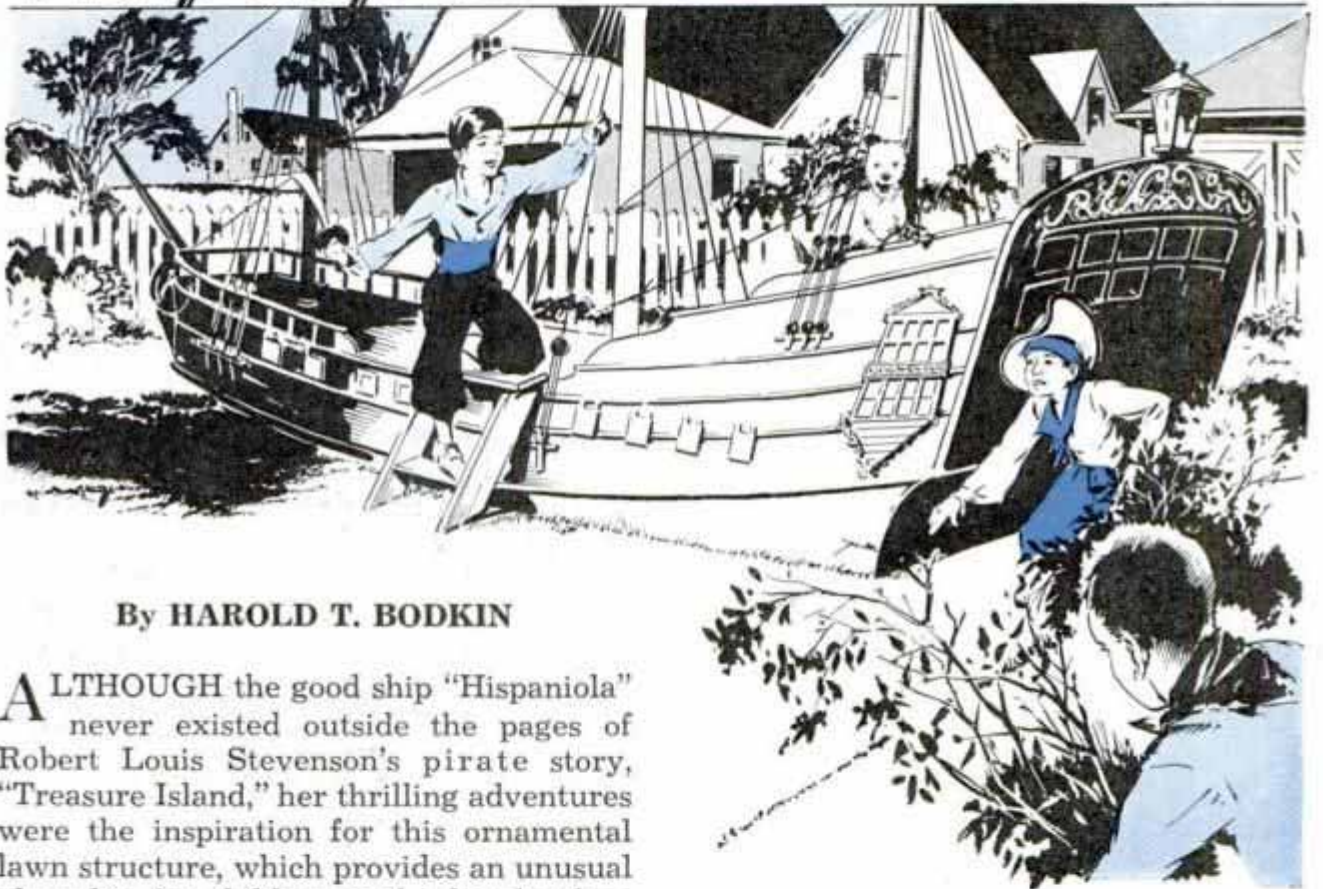

By HAROLD T. BODKIN

ALTHOUGH the good ship "Hispaniola" never existed outside the pages of Robert Louis Stevenson's pirate story, "Treasure Island," her thrilling adventures were the inspiration for this ornamental lawn structure, which provides an unusual play-ship for children, and a handy place to keep garden tools.

As the ship rests on the ground, the foundation is started first. To do this, a chalk line is stretched between two stakes driven into the ground about 10½ ft. apart to represent the centerline of the boat. At the stern end, two more stakes are driven so that another line between them is at a 90° angle to the first one, the stakes being set 1½ ft. from the centerline on each side. About 5 ft. aft of the bow stake, another pair of stakes are driven, each being 2 ft. outward from the centerline. When so placed, the stakes outline the bow, the

width at the stern, and the widest part of the boat amidships along its "waterline." Next, a long limber stick is tied to the bow stake, bent in a curve around one of the midships stakes, and then inward, where it is tied to one of the side stakes at the stern. The bow in the stick will determine the horizontal curve of the hull. This done, lengths of ¾-in. boards are laid on the ground under the curved stick to conform roughly to its arc. Using the stick as a guide, the curve is marked on the ground boards, after which they are taken up and sawed to shape. These are laid in place

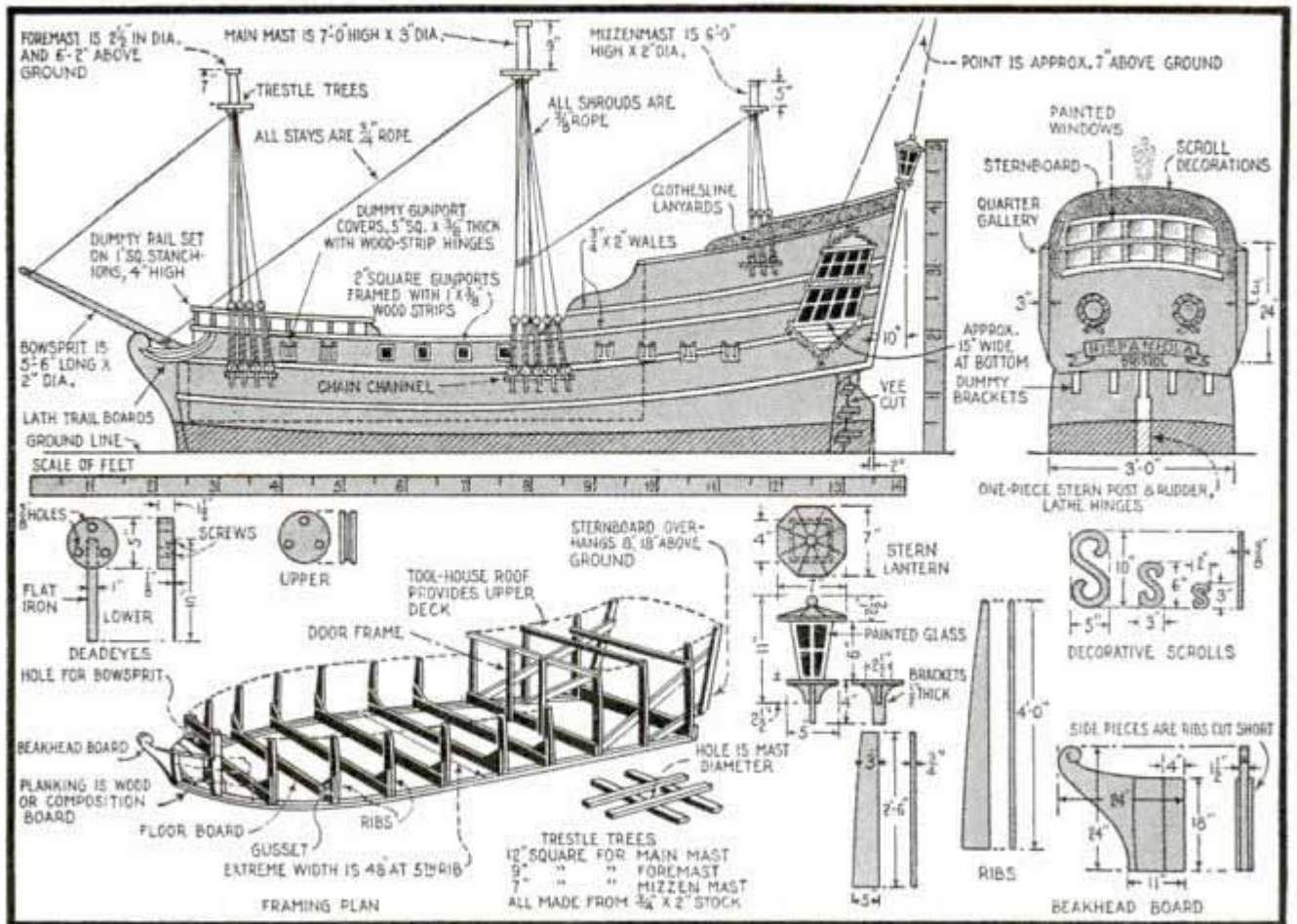

and fastened by wooden pegs driven through holes in them and into the ground.

When the foundation is finished, the ribs are next, six long ones and sixteen short ones, two of which are nailed to the beakhead board. These are sawed from $\frac{3}{4}$ -in. stock and are spaced about 1 ft. apart, flush with the ground boards. The forward frame is about 3 ft. above the ground, and the rearmost frame ribs are full length to provide for the sweep of the rail.

The beakhead board is cut now, using two pieces battened together with two short ribs, one on each side. The two upright frame pieces at the extreme stern are set at a 10° angle aft, their tops being about 4 ft. 4 in. above the ground.

The planking of the hull can be of light material or composition board, the combination rudder and sternpost being nailed over the planking. The illusion of the hull curves, as viewed from the side, is accomplished by application of the curved wales. Dummy window ledges and columns on the sternboard can be made from 2 by $\frac{3}{4}$ -in. stock or lengths of lath, while the open ports amidships are cut through the planking and framed with wooden strips. The

dummy rail forward now is put on, also the trail boards, which start at the sides and curve in and downward to fasten on the beakhead board.

Decorative scrolls are sawed out in numbers sufficient to decorate the sides and sternboard. The stern wreaths also are sawed. The masts are made by roughly rounding square stock with a spoke shave, while the deadeyes are formed from two disks cut from $\frac{3}{4}$ -in. stock. Those for the fore and mizzenmasts should be slightly smaller than those for the mainmast. After nailing the trestletrees in place on the masts and fastening the respective stays and shroud lines in place, the masts are erected by sinking their lower ends into holes in the ground on the centerline of the ship in the locations shown. The masts should be adjacent to a floor board so that they may be bolted or screwed to it.

Two coats of paint will protect the boat. The rails, wales, gunport covers and frames, background of scrolls, trail boards and all window framing are painted dull dark brown. Except for the space below the waterline, which is painted a dull white, the balance of the hull is black.

York, Mt. Carmel, Conn.

Grapefruit Cutter Slices and Removes Core

This grapefruit cutter slices the fruit and removes the core in one operation. It consists of eleven 2 by 1 5/8-in. steel cut-

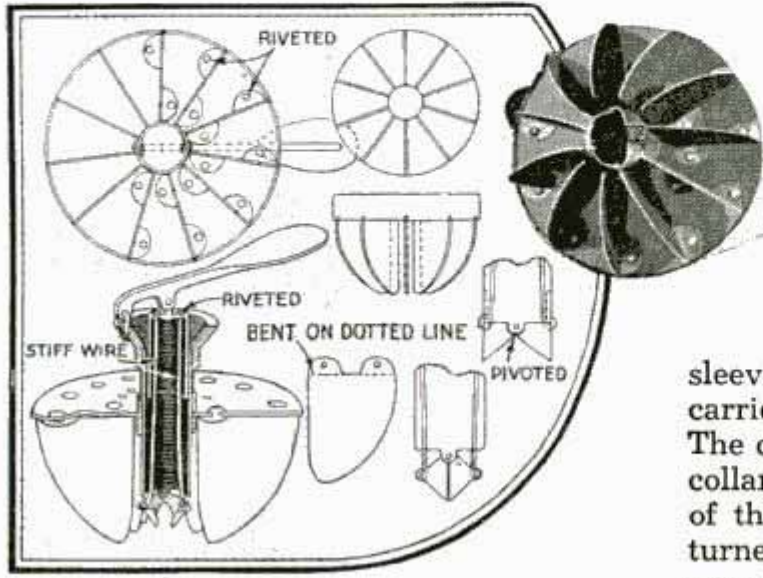

ters, riveted to a 4 1/2-in. brass disk, which has a hole in the center for the coring assembly. This consists of a short brass tube with two coring jaws pivoted to the bottom end and a flared sleeve at the top to which one of the handles is pivoted. Slipping inside of the tube, is a short

sleeve that is pivoted to the handle and carries two stiff wires to operate the jaws. The coring assembly is held by two brass collars soldered to the tube on each side of the disk so that the assembly can be turned with the handle to remove the core thoroughly from the fruit. A similar idea is used in making an orange slicer. In this case no coring assembly is needed, and the cutters are forced into narrow slots cut in a hardwood block. The orange is peeled and cut in halves. The slicer is then forced through it leaving evenly cut pieces—Charles Tyler, Chicago.

Turner. Design by G. J. ...

Strong Knots to Use When Tying Fishhooks and Leaders

Have you ever had a big fish break the line close to the hook? If so, perhaps the trouble was due to the knot used in attaching the hook or leader to the line. Tests have shown that some knots reduce the strength of a line as much as 30 per cent. One of the strongest knots is the fishermen's bend, while the timber hitch is good also and is tied easily. The latter, when drawn tightly, pulls double through the swivel or hook eye. The slip, or jam knot, and the bowline are often used but have a tendency to cut the line when a large fish pulls on the hook. The fishermen's loop perhaps is the weakest of all of them, although it does have one advantage—it forms a double line of several inches behind the hook or leader.

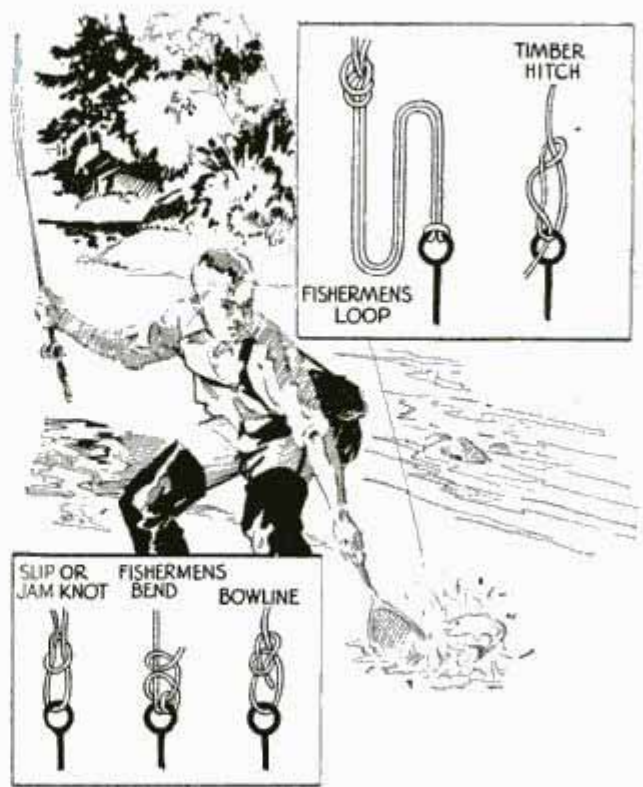

☛ Boiling water poured over nuts before cracking them will tend to make the meats come out clean and whole.

Generating Hydrogen Gas to Fill Toy Balloons



Toy Balloons Inflated with Hydrogen Gas Generated by Dropping Strips of Zinc into Muriatic Acid

It is no trick to generate hydrogen gas with which to inflate toy, rubber balloons. Just get a fair-sized bottle, pour a little muriatic acid into it. Then, when you are ready to fill the balloon, drop a few pieces of zinc into the acid and immediately stretch the neck of the balloon over the neck of the bottle. The acid acting on the zinc generates hydrogen gas, which quickly inflates the balloon.

Cork Pads Cushion Nose Pieces on Your Spectacles

If your spectacles are fitted with rigid nose pieces, which sometimes irritate your skin, try relieving this condition with a couple of small oblong cork pads. These are cut along one edge with a razor blade so that they can be slipped over the nose pieces, after which they are glued in place with ambroid cement. To assure correct alignment of the pads, wear the spectacles

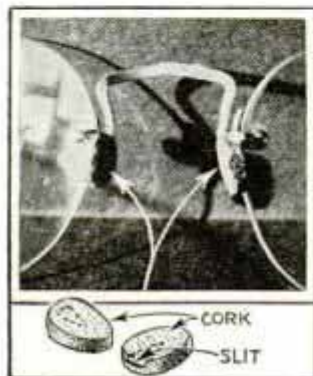

the spectacles while the cement is drying so that the corks will adjust themselves automatically to your nose.—C. E. Packer, Chicago.

while the cement is drying so that the corks will adjust themselves automatically to your nose.—C. E. Packer, Chicago.

Vent in Pie Crust Prevents Overflowing of Berry Juice

When berries containing an abundance of juice are baked in double-crust pies, the steam accumulating within often causes the liquid to overflow between the edges of the crust. This may be overcome by punching a few holes around the base of a small funnel spout and inserting this in the center of the pie. The formation of steam within the pie will force the juice up into the spout instead of causing it to burst through the edges of the crust.—G. E. Hendrickson, Argyle, Wis.



Homemade Thermos Jug Keeps Drinking Water Cool

Here is an inexpensive thermos jug that will be found handy when it is necessary to carry drinking water and keep it cool for several hours. First, get a can or pail, fitted with a lid. It should be large enough to hold a quart or half-gallon glass fruit jar so that there is at least a 2-in. clearance between them on all sides. Fill this space with sawdust or other insulating material, and then cut a hole in the can lid to fit the top of the jar snugly. If possible, pack a little of the material under the lid, although it is better to use a few layers of sheet asbestos. After the jug has been insulated thoroughly, solder the cover in place.—James Vick, Mannboro, Va.



B.P. 924

BARROW CHAIR *for the* GARDEN

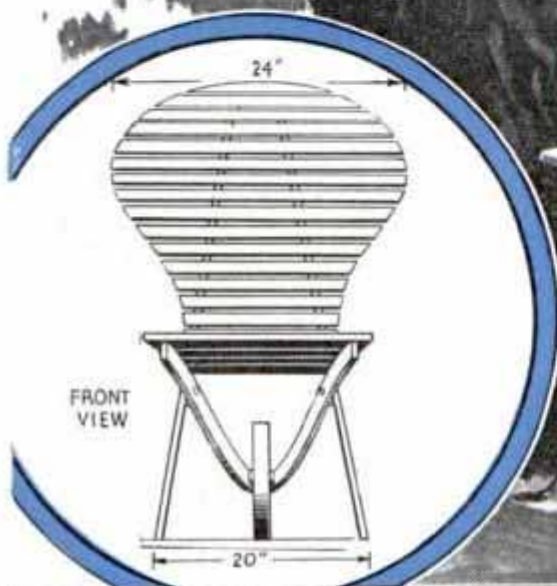

FRONT VIEW

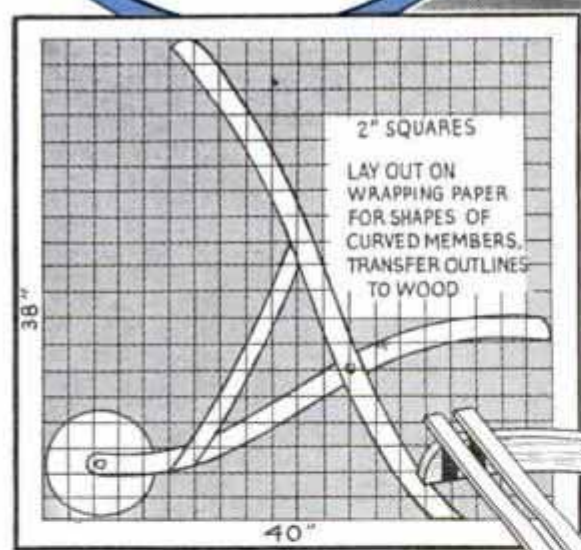

THIS CHAIR IS SURPRISINGLY COMFORTABLE, AND THOUGH STRONGLY BUILT, CAN EASILY BE MOVED ABOUT

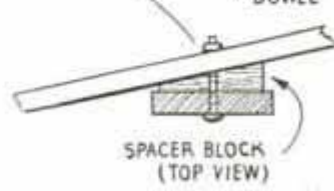
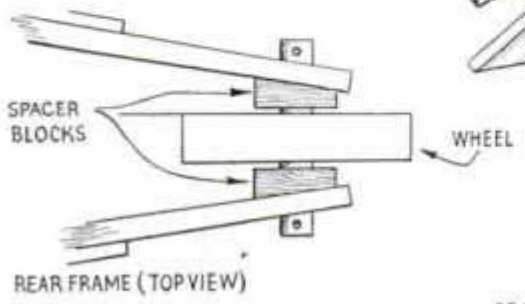
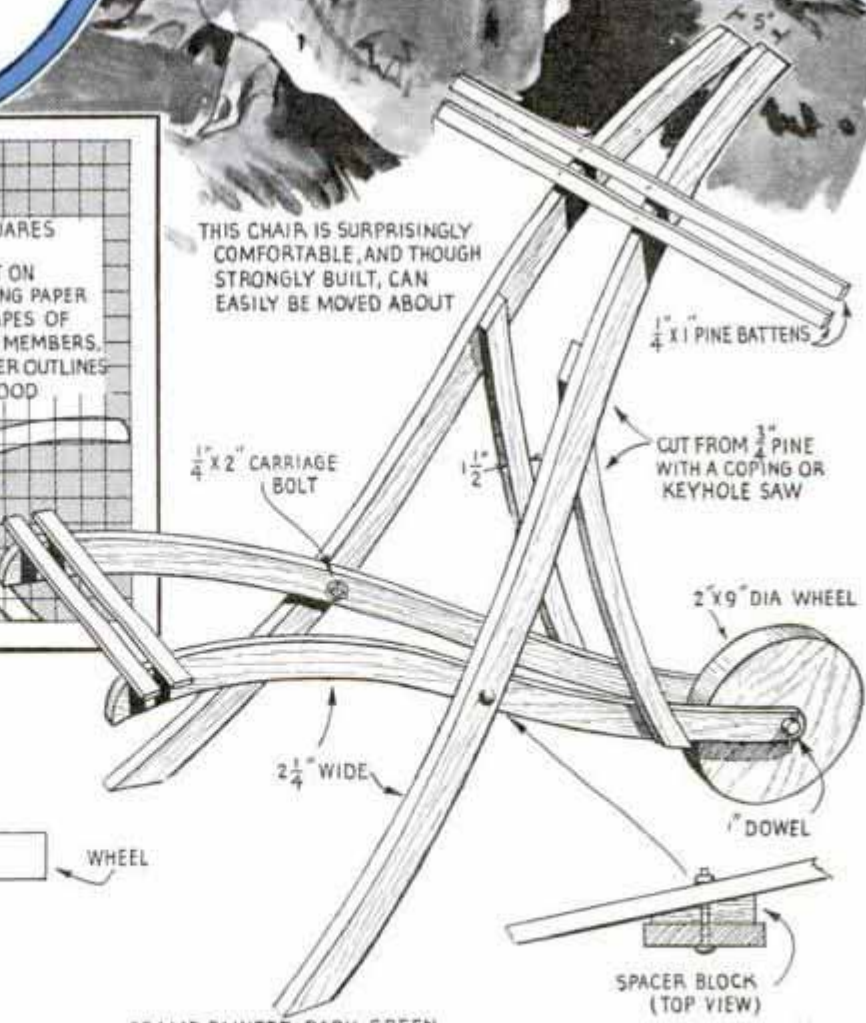

FRAME PAINTED DARK GREEN, WHEEL AND BATTENS LIGHT GREEN

Reel Drains Garden Hose



A Garden Hose Will Drain Thoroughly If Wound in One Layer on a Vertical Reel

It has been my experience that a rubber hose will last much longer if it is drained thoroughly before it is put on a reel. With the reel shown, the hose is drained as it is wound on the drum. The reel is mounted vertically, and the drum is large enough to take the hose in one layer.—W. F. Schaphorst, Newark, N. J.

Correct Method of Connecting Water Risers to Kitchen Sink

Water leaks at a kitchen sink sometimes are caused by vertical expansion and contraction of the hot-water riser, the continued action of which often cracks the

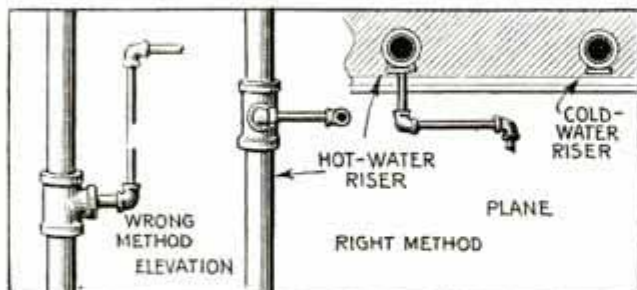

How to Connect Your Sink to Prevent Leak Caused by Contraction of the Hot-Water Riser

small pipe leading from the riser to the sink when the connection is made as shown in the left-hand detail. A better method of making the connection, and one that will eliminate this trouble, is shown in the

right-hand detail. Instead of attaching the S-shaped pipe assembly, leading to the sink, in a vertical position, attach it in a horizontal position. In this way, any slight vertical movement of the riser, caused by expansion or contraction, is taken care of in one of the threaded connections instead of twisting the small connecting pipe.—L. H. Georger, Buffalo, N. Y.

Short Coil Spring Improves Screen-Door Hook

Inserted between the eye of a screen-door hook and the screw eye to which it is usually attached, a short length of fairly strong coil spring will compensate for any swelling or shrinking of the wood, which often makes it almost impossible to fasten the hook. The spring maintains a tension to hold the door snugly, yet allows the hook to be fastened easily.

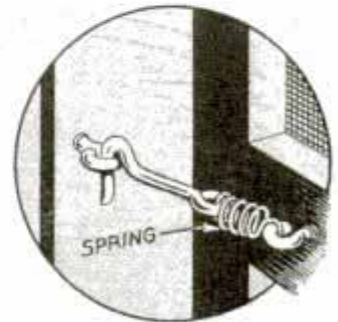

Clamp to Re-String Tennis Rackets

When re-stringing a tennis racket, a good clamp to pull in the sides of the racket, so that the cross strings will be taut when the job is finished, is made from a small turnbuckle as shown in the photo. These are obtainable at dime stores, and, when fitted with a couple of hooks made from a small iron rod, they are fitted readily to the sides of a racket. One hook is V-shaped to help prevent the clamp from slipping off the curved sides of the racket.—Perry S. Graffam, Waverly, Mass.

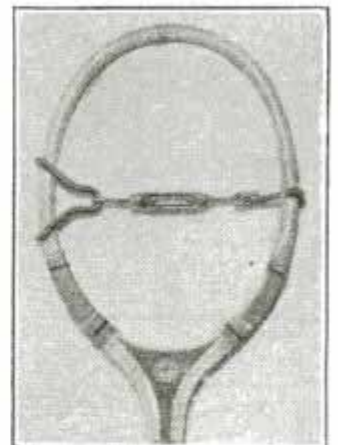

Manicurists' emery boards are handy for sanding in tight places, especially many places on models where ordinary sandpaper is difficult or awkward to use.

Old Steam Gauge Converted into Barometer

Unlike aneroid and mercurial barometers, this homemade weather indicator is not affected by either altitude or temperature. It is made from an old steam gauge and an "A" violin string of gut. As these strings have a tendency to twist when ex-

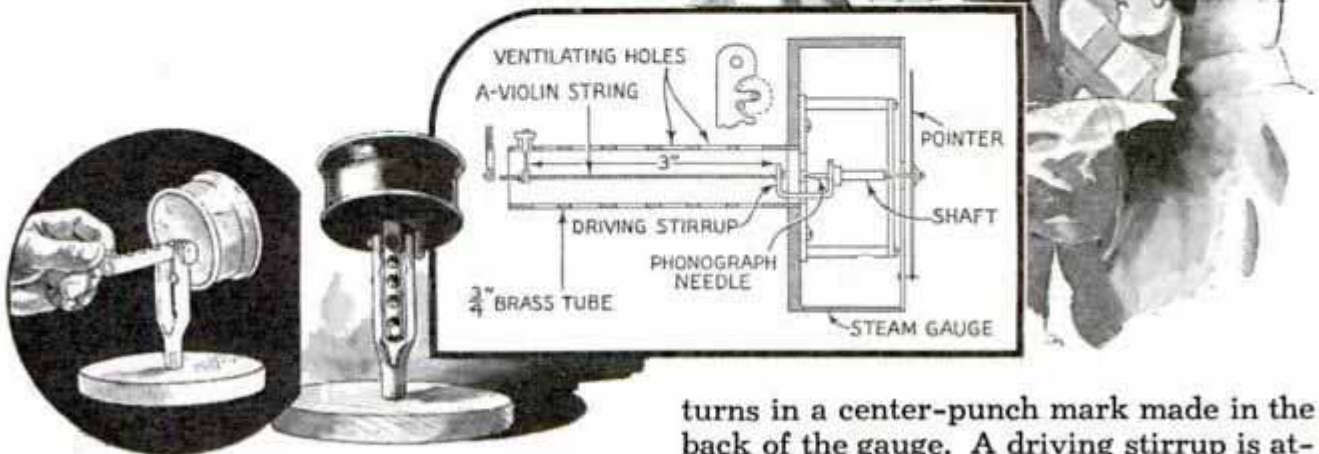

posed to moisture, humid air, which usually precedes a storm or unsettled weather, causes the string to twist and move the gauge pointer. Only the frame of the gauge is used, together with the pointer and pointer shaft, which is altered to reduce friction to a minimum. This is done by using a phonograph needle, inserted into the end of the shaft so that the point

turns in a center-punch mark made in the back of the gauge. A driving stirrup is attached to the end of the shaft, a small portion of the gauge back first being cut out as indicated in the detail, to permit it to turn. After fastening the string to the free end of the stirrup, a brass tube, with several ventilating holes drilled through its walls, is centered over the stirrup and soldered to the gauge. At the open end of the tube is an adjustable fastener to hold the free end of the string.

Grooved Sanding Block Assures True Edges on Boards

Sanding the edges of boards so that they will remain true and square is accomplished easily with this special sanding block. It has grooves of various widths cut deeply into one side to fit over the edges of work of different thicknesses. Strips of sandpaper are fastened to the bottoms of the grooves with rubber cement.

Old Incubator Used as Oats Sprouter

On account of the almost universal practice of buying chicks from commercial hatcheries, many poultrymen have small incubators on hand that may be used profitably as grain sprouters during the winter months when green feed is not available. The egg trays of the machine are divided into sections which are filled with oats. The grain is moistened daily and the incubator lamp operated at a low temperature.

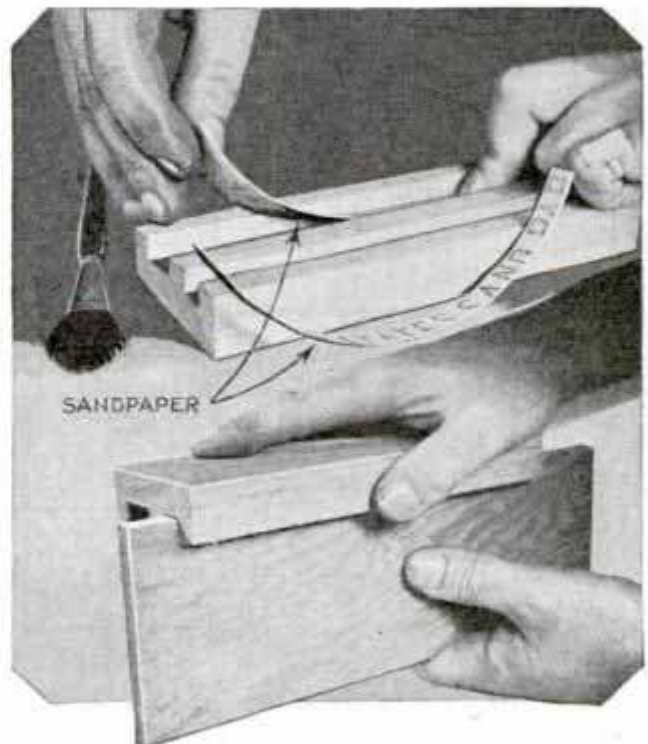

Novel CASES for

By W. CLYDE LAMMEY

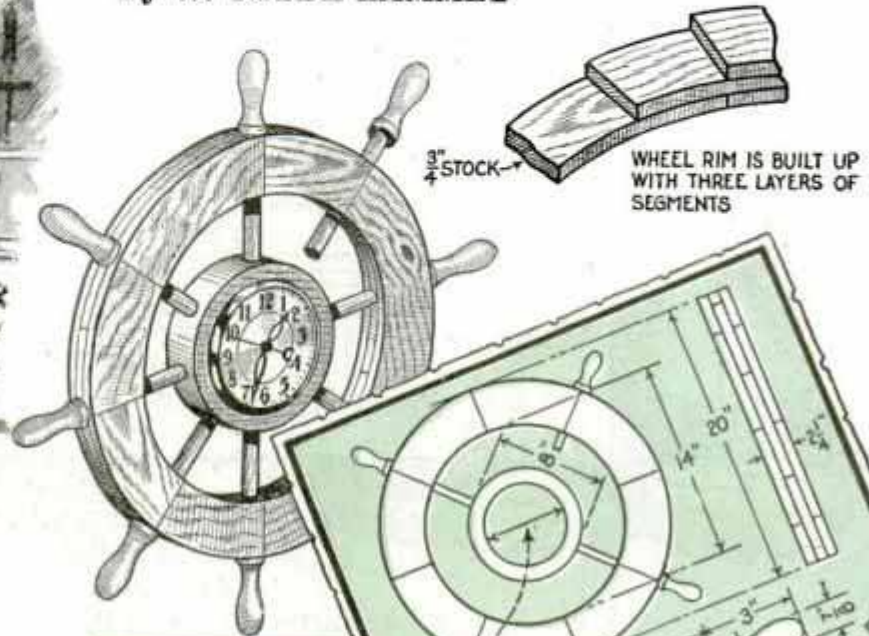

SHIP'S WHEEL CLOCK CASE, SUITABLE FOR ANY NON-STRIKE ELECTRIC MOVEMENT

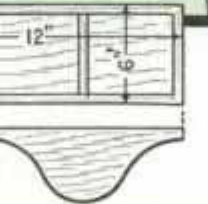
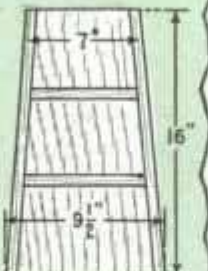
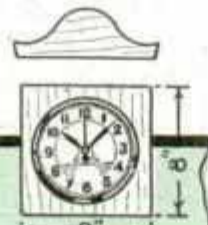
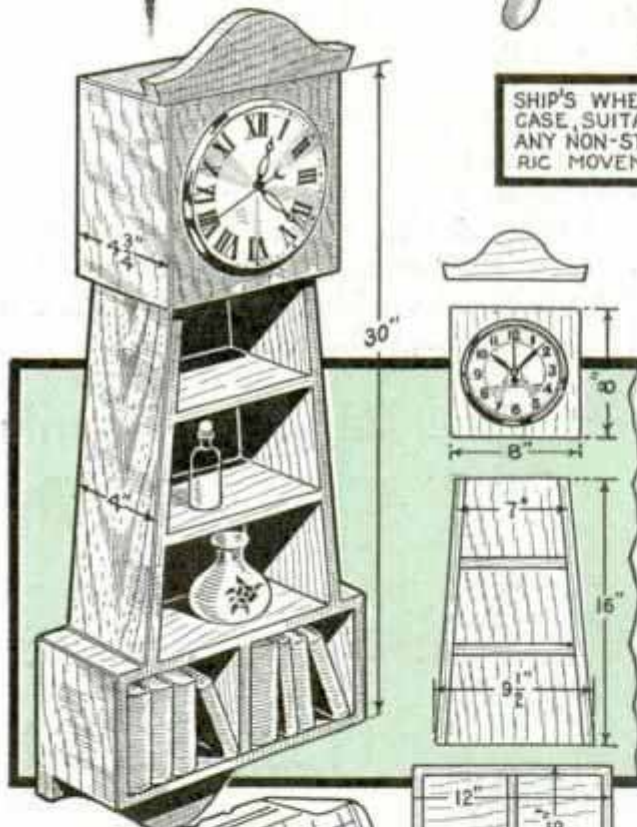
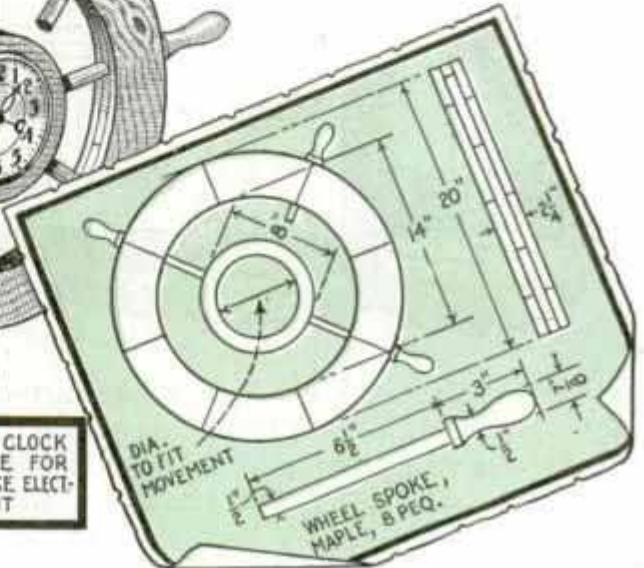

COLONIAL WALL CLOCK, BANJO TYPE, WITH WOOD DIAL AND OPEN FACE

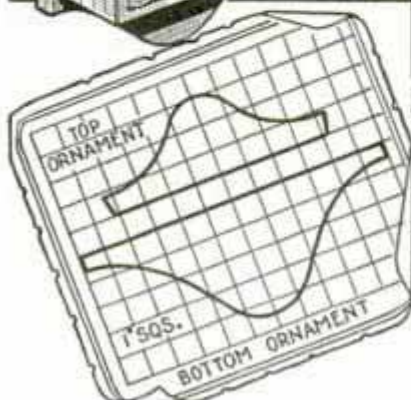

DISTINCTIVE designs in clock cases that can be built in your home workshop, help to bring out that touch of individuality you desire in your home. Electric movements fitted with various styles and sizes of dials can be purchased inexpensively, and the installation involves no difficulty.

An exceptionally novel clock case is one that resembles a ship's wheel as shown above. For the rim and the hub, you will need a few small pieces of good-quality plain mahogany. With these cut into segments, glued up and turned in your lathe, you have the rim and hub of the wheel, after which six pieces of maple, each 1 in. square and 10 in. long are turned to form the handles and spokes of the wheel. Carefully spaced holes through the rim and hub take the combined spokes and handles, which are glued in place, after which the movement is fitted in the hub.

Perhaps you prefer a banjo-type clock that incorporates a wall case, which is easily made with a few hand tools. You can turn a thin wooden disk and glue it to the front pieces for a suitable dial, or you can

ELECTRIC CLOCKS

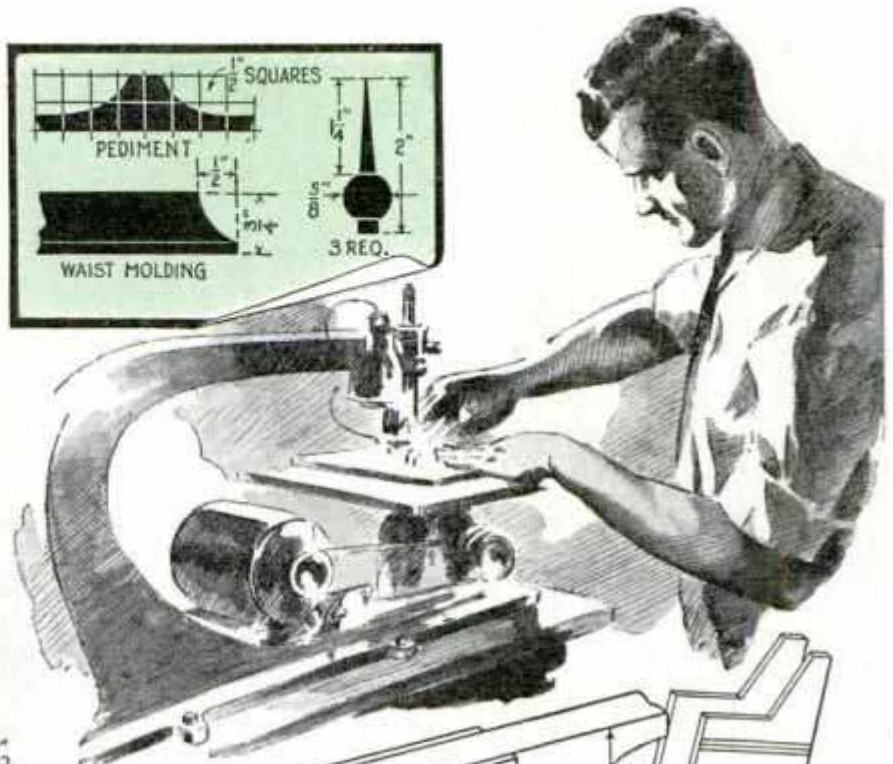
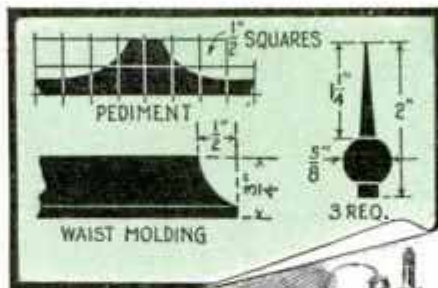
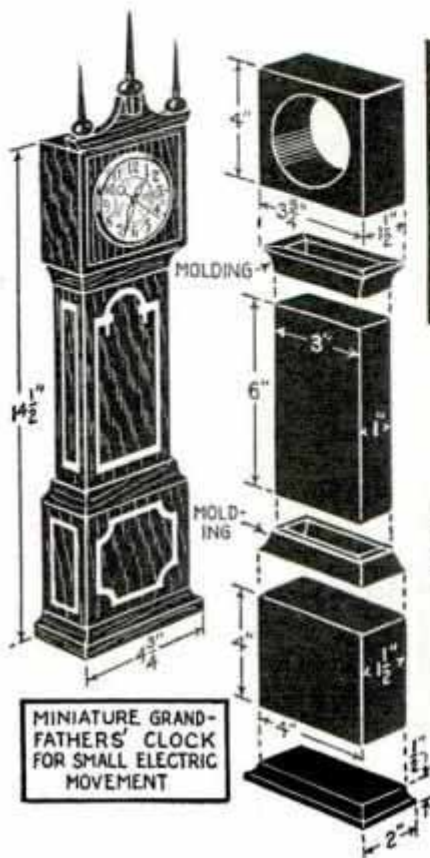

omit the dial, and simply score a heavy line directly on the wood to represent the minute circle, and fasten the numerals to the wood with small brads. Your jeweler can obtain suitable numerals, or, if you wish, you can make them from thin, sheet brass by marking the outline with a pattern and cutting out with a jeweler's saw.

The cases for the miniature grandfather's clock and the desk clock are likewise simple woodworking jobs. The first consists of solid blocks cut to the size given, and glued together with waist moldings in the corners. Veneer overlays of contrasting colors complete the front of the case. Details give the size of the top ornament and the single turning, which may be turned out of solid brass and then polished and lacquered. Construction of the desk clock is shown clearly. It may be made with one or two cigarette compartments.

If you want an accurate timepiece that is always handy, put a small electric movement in a pediment on the top of the hall mirror. This can be done on any large-size rectangular mirror as can be seen from the drawings. Again, if you need a

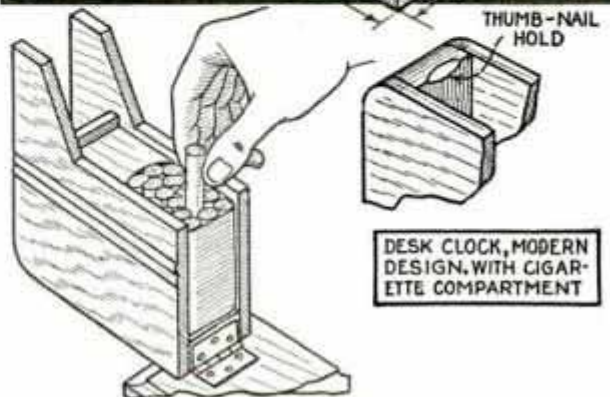
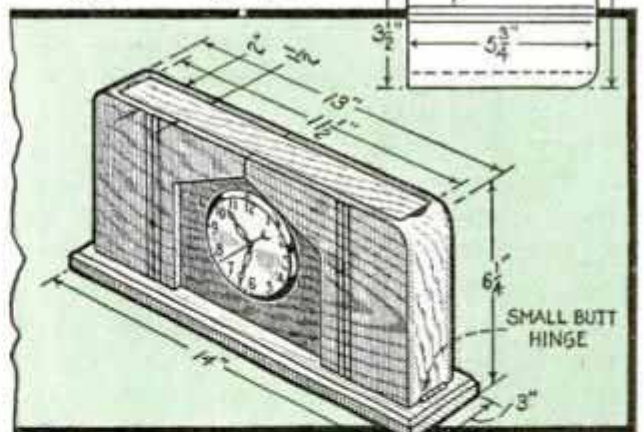
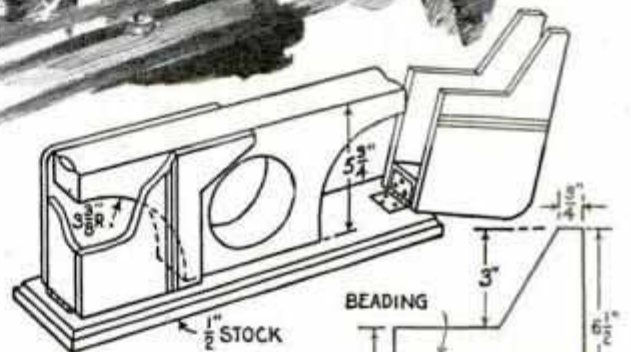

Adjustable Awning to Cover Open Porches

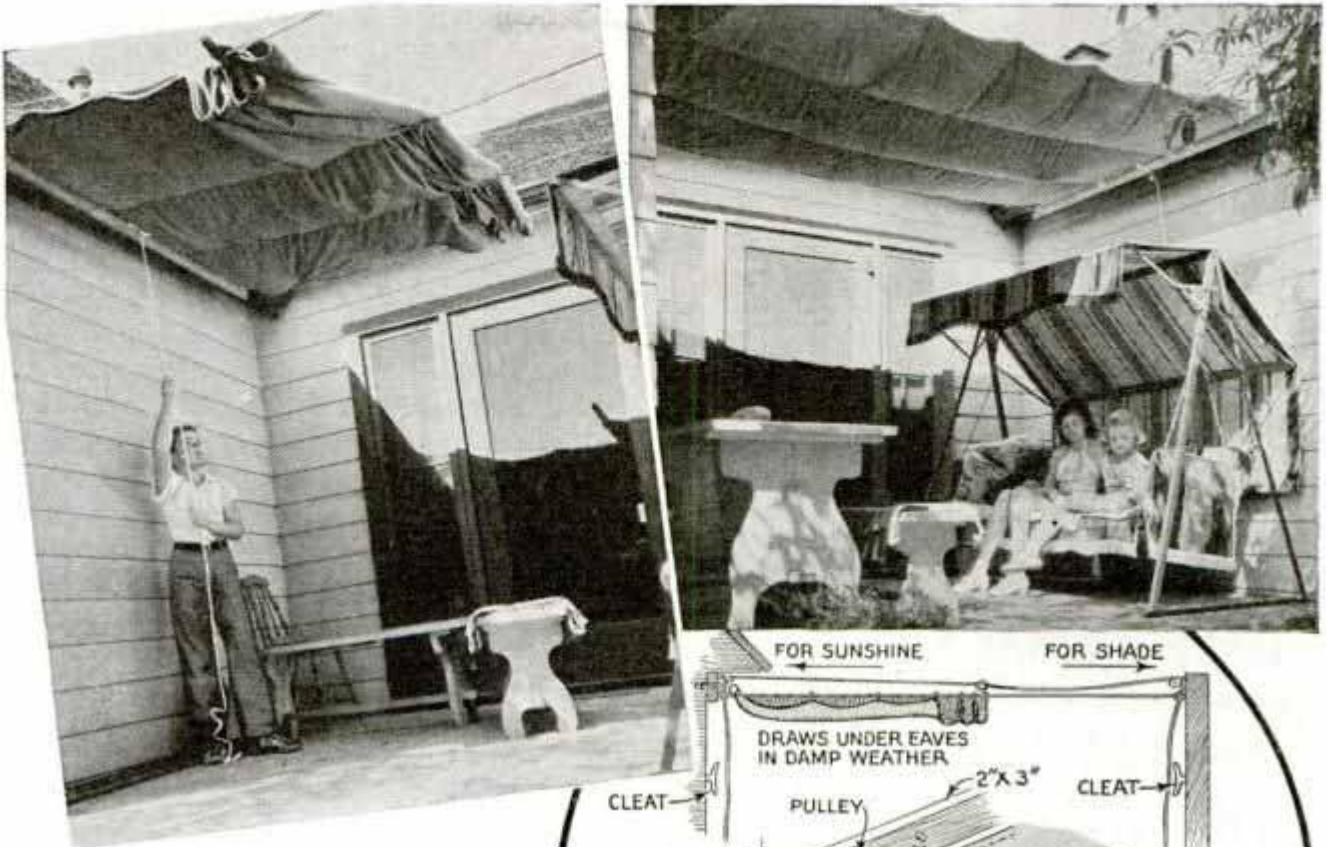

For large, open porches or for a piazza, an overhead awning can be arranged to slide on horizontal wires suspended between suitable, sturdy supports. With this arrangement, it is a simple matter to pull the awning out to provide shade. Canvas or colorful awning cloth may be used. The best construction is to fit the awning with rings which slide on the wires. A simpler method is to use rings at the end wires only, and let the canvas rest on the other supporting wires. A turnbuckle should be provided at the end of each wire to keep it taut. The pulley arrangement shown in the detail makes it easy to arrange the awning in any desired position by manipulating a rope.

Removing Weeds from Lakes

The following method of removing sea weeds from shallow lakes and lagoons where bathing beaches are maintained will be found more effective and much quicker than the customary use of a rake. A coil of barbed wire is mounted on the

rear of a boat and one end is attached to a tree. Then the boat is rowed slowly in an arc at the edge of the area from which the weeds are to be removed and the wire is payed out so that it will sink to the bottom. The free end of the wire is attached then to a car and, when it is driven slowly away from the shore, all weeds within the area will be torn loose and dragged out.

☞ The small brass tip from a discarded generator of a gasoline lamp or stove makes a good front propeller bearing for a model aeroplane; a needle may be used to enlarge the hole to the right size for the propeller shaft.



Piece of Rubber Hose Slipped over Heel of Bucksaw Blade Prevents Pinching Your Fingers

Rubber Hose on Saw Prevents Injuring the Fingers

Slipped over the heel of a bucksaw blade, a short piece of rubber hose will prevent injury to the fingers from being squeezed between the saw handle and the work on the downward stroke. When the hose is stretched over the blade, the teeth will penetrate the rubber and hold it in place. —Kenneth Murray, Sturgis, Mich.

Folding "Lazyback" for the Beach

Here is a simple "lazyback" that anyone will appreciate when spending a day at the beach. The sides and rear support of the

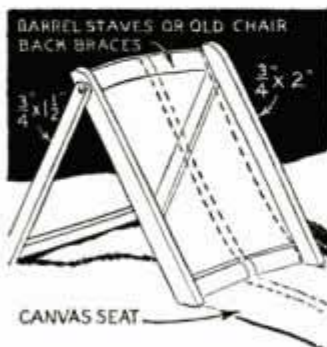

back can be made of pine for lightness, while the cross braces are cut from a couple of barrel or keg staves, preferably the latter, which have a more pronounced curve. Between these,

canvas is stretched to form a comfortable back, and is extended on down to form a seat when sitting on the sand.

Solar Heater Reduces Gas Bills

During the warm summer months this solar heater will keep your reservoir full of hot water whenever the clouds do not interfere. Although the original was found highly successful in California, it should work equally well in temperate zones. Not only the box itself, but the circulating pipes exposed outside should be insulated thoroughly. Make three sash with double panes, as shown in Fig. 2. When the panes are installed, the upper ones should be puttied carefully to make the joints water tight. The shallow box to receive the heating coils is a matter of simple carpentry. Fig. 3 shows how the various layers are built up. First is the 2 by 4-in. supporting frame, set at a 30° angle, then tongue-and-groove sheathing or flooring, several layers of newspapers laid flat, and on top of this, thick insulating board. Cover with black tar paper, and paint all exposed wood side members a dull black to prevent loss of heat by reflection. Install the 5/8-in. galvanized pipe, which should be painted dull black. All pipes should have a slight incline so that warm water will circulate freely toward the highest level as shown in Fig. 4. A 1/4-in. vent hole in a side member will allow for expansion and contraction of air inside following changes in temperature. The sash should fit snugly all around. Fasten them to the box with screws so that any one may be removed in case of broken glass. If the heater is in an exposed place accessible to children, dogs, etc., it will be well to protect it with a stout frame covered with galvanized wire mesh. A good location for the heater is directly against the south side of the house, as close to the indoor reservoir as possible.

Cement to Mount Bicycle Tires

Bicycle tires may be mounted on wood or steel rims with a cement made by dissolving crude rubber, 2 lbs., and rosin, 2 lbs., in carbon disulphate, 1 gal. The latter is very inflammable and should not be handled near an open flame or while smoking. This cement will keep if stored in screw-cap bottles or sealed cans. To use the cement, clean the rim and apply with a brush. A light coat should also be applied to the rim surface of the tire.

SOLAR HEATER ...

reduces Gas Bills

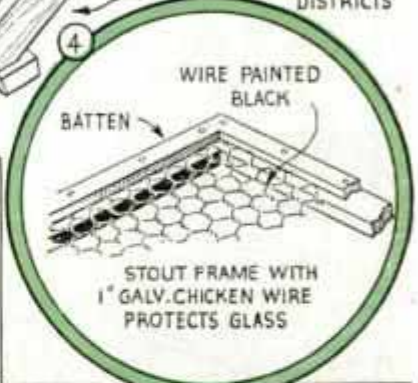
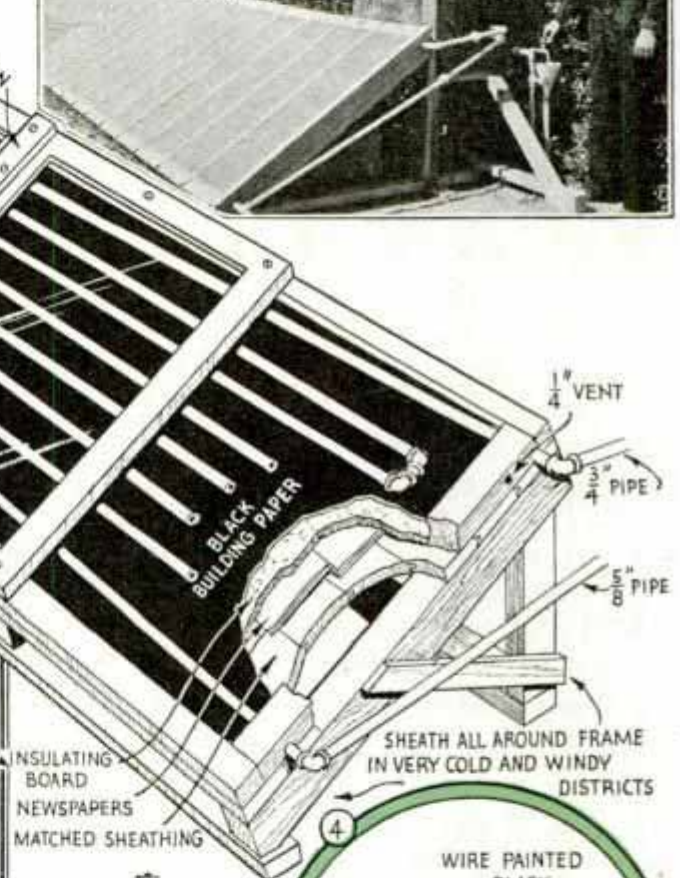
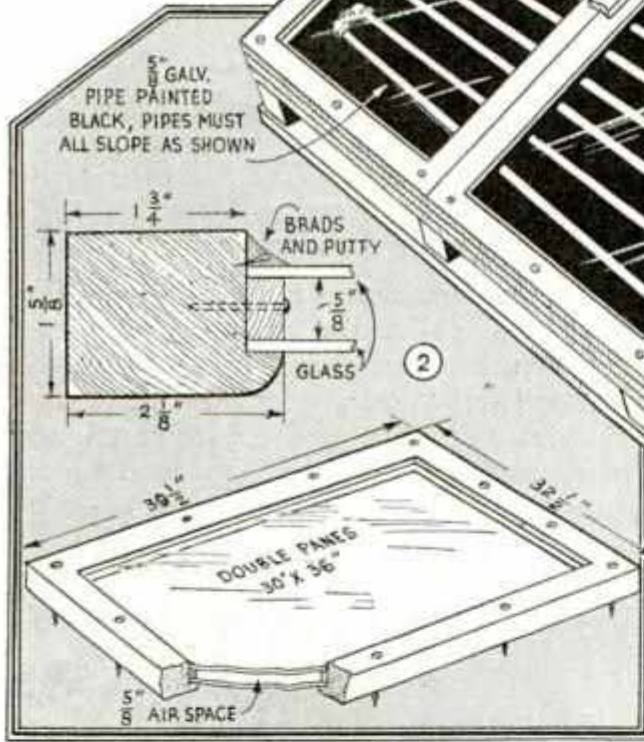
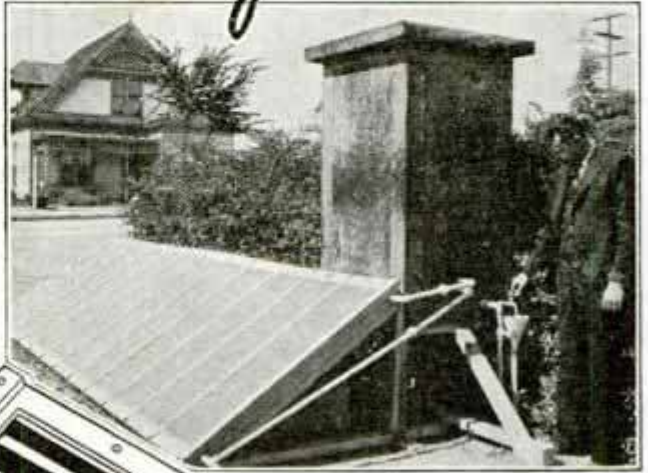
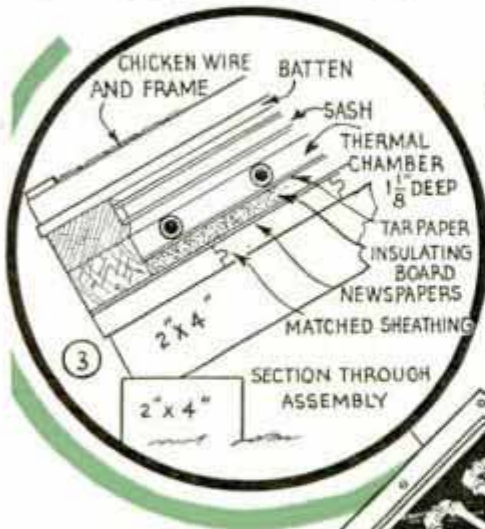

If located against the south side of your house, as close to the hot-water tank as possible, this heater will keep the water very warm when exposed to a fair amount of sunshine. The heater can be constructed easily and inexpensively, but the box, as well as the exposed pipes leading to the tank, must be well insulated to assure efficiency

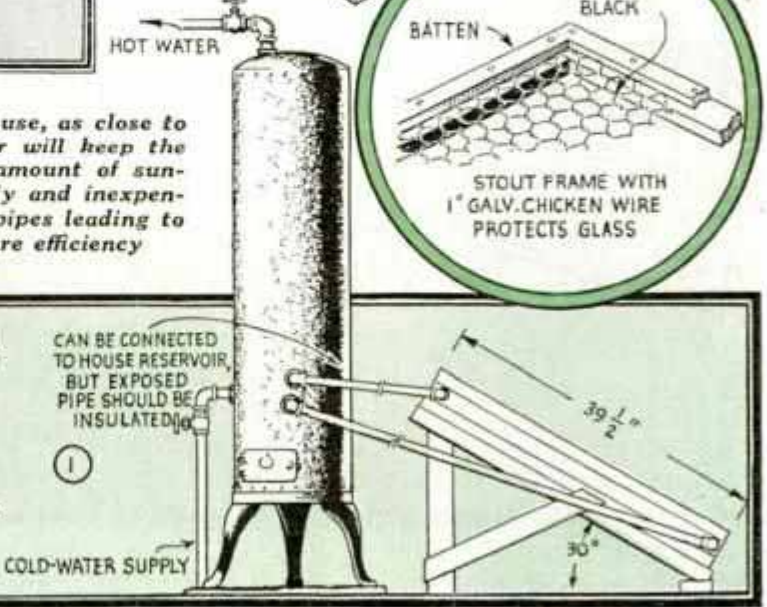
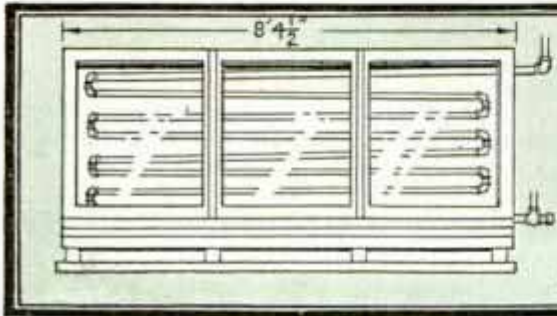

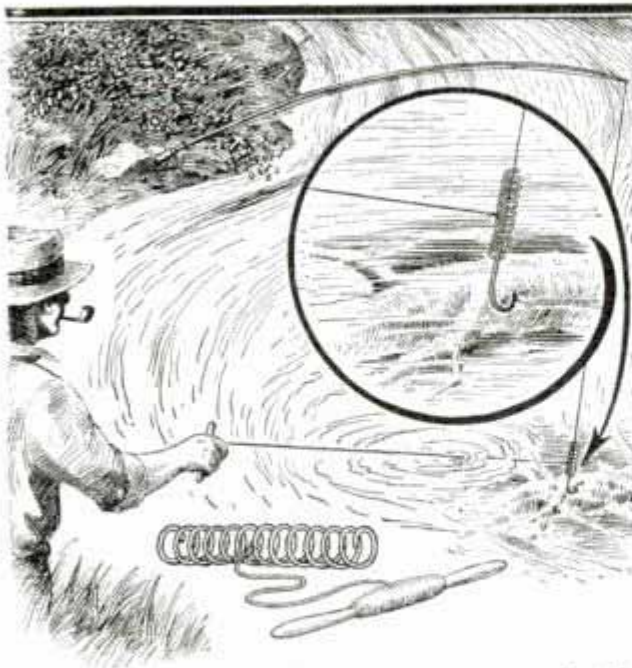

Fishhooks Caught on Sunken Logs Loosened with Large Spring and a Long Cord

Loosening Snagged Fishhooks

To loosen fishhooks that have become snagged on a submerged log, or entangled in debris, the method shown here has proved very effective. A heavy coil spring, with a strong cord attached, is slipped over the pole and allowed to slide down to the hook. If the force of the dropping spring does not dislodge the hook, usually it can be loosened by pulling on the cord as shown in the illustration.

Soap Grated on Wash-Boiler Lid

You can save time on wash day if a number of holes are drilled through the lid of your wash boiler, and one edge of each hole slightly raised so that when a



LID OF WASH BOILER

cake of soap is pushed over them thin chips will be scraped off. After drilling the holes, the lid is turned upside down on a hardwood block and the edges of the holes are raised with a short length of iron rod. This is

done by setting the end of the rod on the edge of the metal, so that about half of the rod overlaps the hole, and then striking it a sharp blow with a hammer.—A. H. Waychoff, Tempe, Ariz.

Glass Helps Prevent Escape of Cold Air from Refrigerator

Much of the cold air that escapes from a refrigerator when the door is opened can be conserved by closing the lower part of the opening with a piece of glass. The method of installing the glass will depend on your particular type of refrigerator, but if space permits, brass, copper or wood slides may be provided inside the opening as shown. Then, by drilling a couple of finger holes in the glass near the upper edge, it can be raised to give access to the lower shelves when necessary.—J. L. Robinson, Chatham, New Jersey.

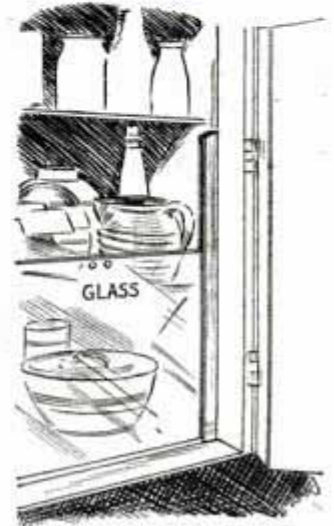

Dessert Plates Used as Door Lights

Produce Pleasing Effect

Glass dessert plates have been installed in the door panel of a home in California, and furnish a very pleasing effect, as well as admit light and give a view of callers. The plates are laid on the door panel, and their positions marked with a lead pencil, after which a portion of the panel is sawed

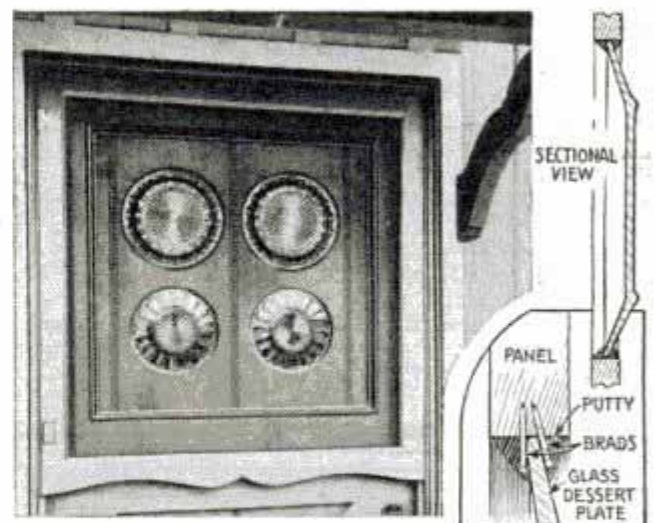

Set in Outside Doors, Glass Dessert Plates Admit Light and Help Make the Door Attractive

out and the plates set in place with brads and putty. The panels should not be less than $\frac{1}{2}$ in. thick.

Bike Rental Booth Is Accessible on All Sides

Large enough to accommodate ten bicycles, this rental booth is designed to occupy a minimum amount of space. It is

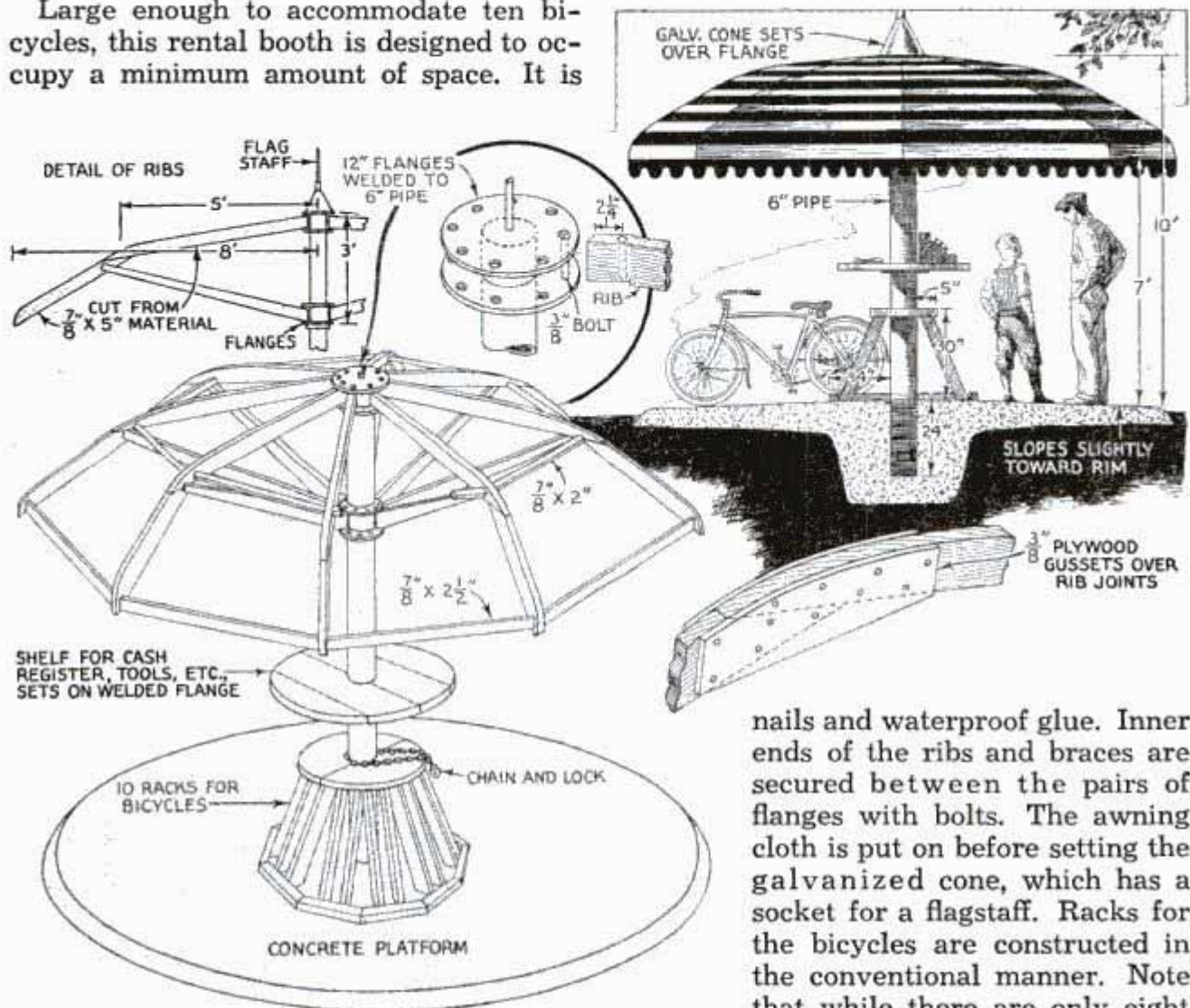

nothing more than a 16-ft. umbrella supported by a single pipe standard, set in concrete, the latter being extended to form a platform 14 ft. in diameter. The umbrella is made of wood and is covered with bright, striped awning cloth. Before setting the standard, it is a good idea to drill a few 1-in. holes near the lower end so that it will be anchored firmly in the concrete. Four pairs of flanges should be welded to the standard as indicated; one pair at the top for the inner ends of the ribs, another pair 3 ft. lower down for the braces. The third pair is welded 40 in. from the floor to support a shelf, while the fourth pair is placed 30 in. above the platform to hold the top of the bicycle rack. After the concrete has been poured, the umbrella is assembled. Each rib is made up of two pieces, which are lapped at the joint and reinforced with plywood gussets,

nails and waterproof glue. Inner ends of the ribs and braces are secured between the pairs of flanges with bolts. The awning cloth is put on before setting the galvanized cone, which has a socket for a flagstaff. Racks for the bicycles are constructed in the conventional manner. Note that while there are only eight ribs, there are ten racks evenly spaced. Three or four chains with padlocks will serve to lock the wheels in groups, or individually.

Starting Outboard Motor Easily

Outboard motors of the two-cylinder opposed type often may be started easier by simply shorting one spark plug to the cylinder block in such a manner that the short can be removed immediately after the motor has been started. Because of the series wiring of the spark coil secondary through both spark plugs, shorting one plug allows a hotter spark to occur in the one remaining cylinder at a much lower cranking speed.

☛ The pungent odor from bunches of peppermint hung near the top of screen doors will prevent flies from collecting on them.

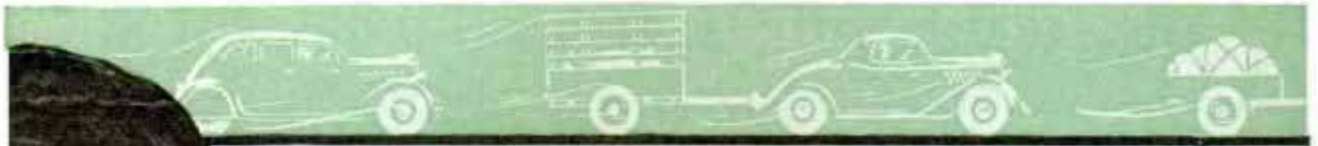

BUILD A



TWO-WHEEL utility trailers hold first place in the trailer field, both in numbers and in general all-around usefulness. The particular types described in this article are typical examples of present-day practice—useful vehicles capable of high speed with loads up to 2,000 lbs.

The first consideration in making one of these trailers is the matter of axle and springs. Most

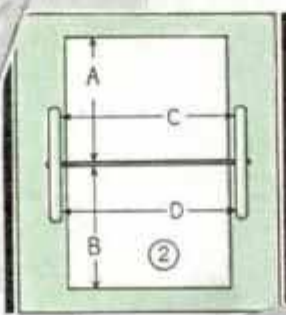

THE FLOORING CAN BE NAILED, SCREWED OR BOLTED IN PLACE

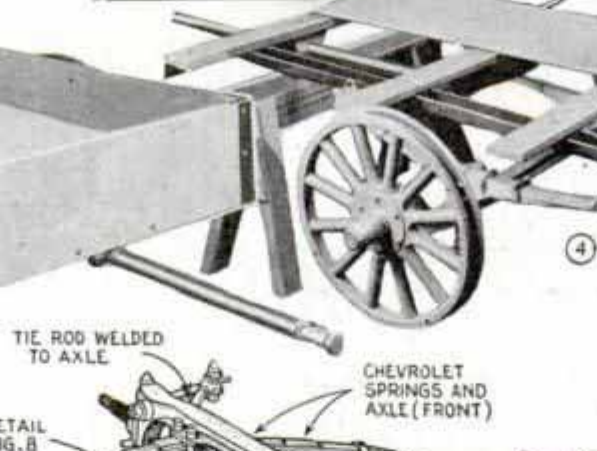
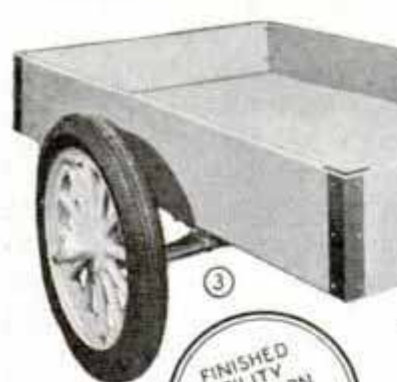

FINISHED UTILITY TRAILER ON CHEVROLET AXLE AND SPRINGS

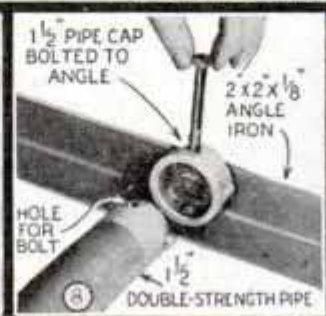
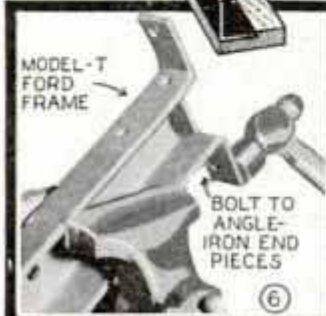
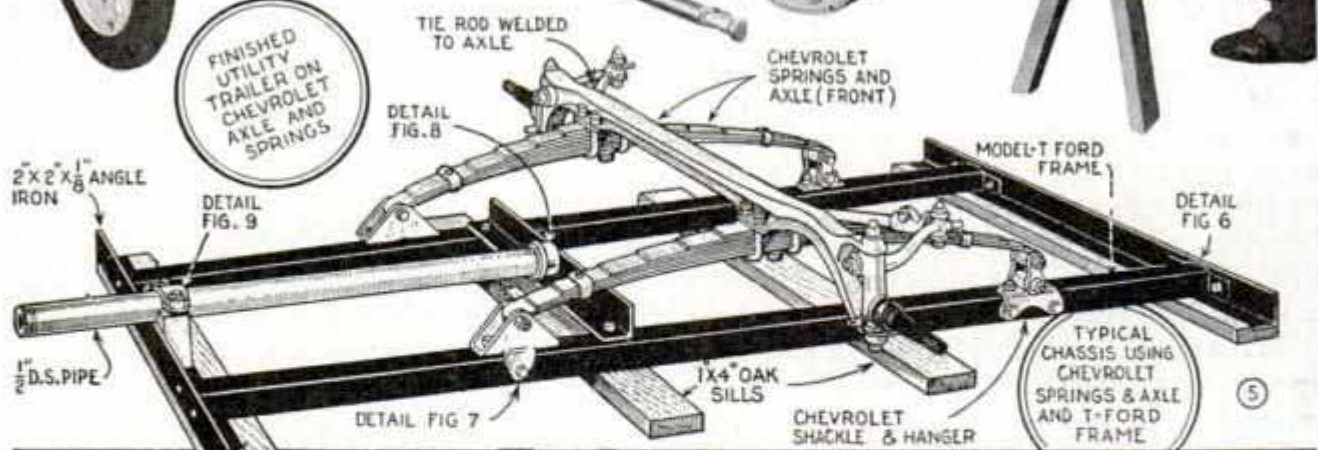

TRAILER UTILITY TYPES

builders prefer the Chevrolet front axle and springs because such units are obtainable readily at any junkyard, and are converted easily for trailer use. Front or rear-axle assemblies from any other light car can be used with equally good results. The construction, in every case where a front axle is used, starts with the locking of the spindles. On most cars, this is done easily by welding the tie rod to the axle, as shown in Fig. 1. The same result is achieved by flattening the tie rod and bolting it to the axle. This op-

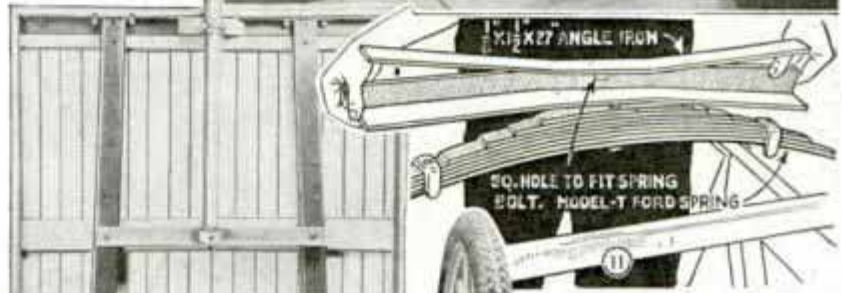
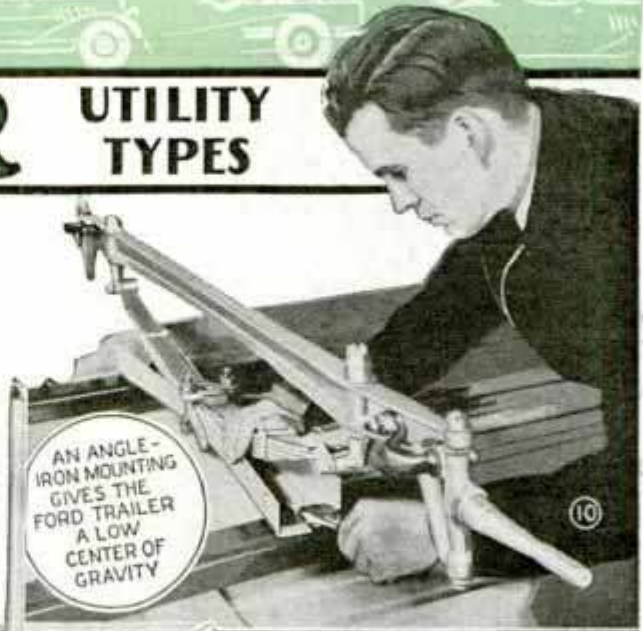

eration, whatever the method, demands careful measuring so that the distance "C,"

Fig. 2, will equal the distance "D." A small amount of toe-in (not over 1/8 in.) is permissible but not necessary. Referring to Fig. 2 again, "A" should equal "B." That is, the trailer is a balanced unit. The axle can be pushed back, if desired, but the balanced job works out to best advantage for light hauling.

Fig. 5 shows a typical chassis, and the detail photos should aid in making the

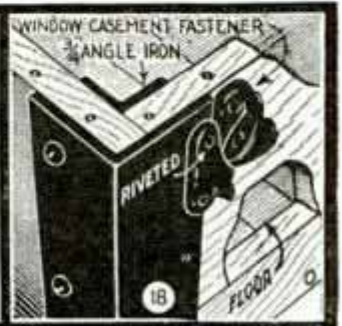
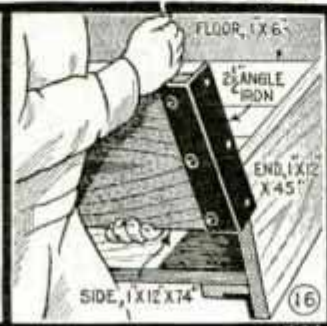
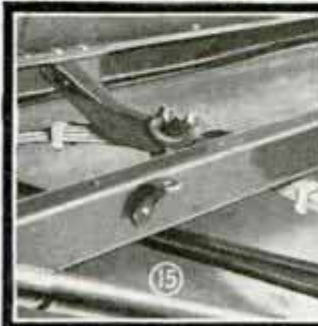

Ball and Socket Most Efficient Type of Hitch

Hammerblow Tool Co. 606 3rd St Wausau, Wis

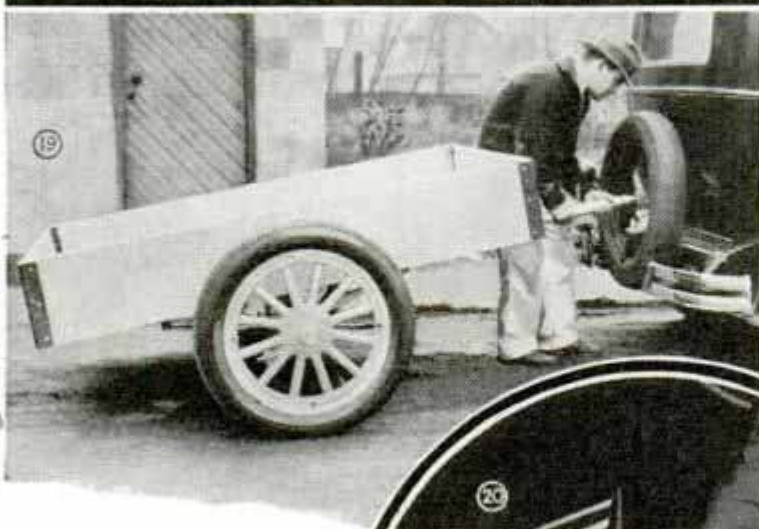

construction clear. You will notice that your purchase of an axle and springs should include also shackles and spring hangers. Other automobile parts include the wheels and rims, a model-T Ford frame, and a suitable size connecting rod cap to hold the forward end of the pipe tongue. The chassis can be made any reasonable length desired, while the width of the two Ford frame sections is automatically fixed when the springs are bolted in place. Cross members will average 43 to 46 in. long.

Fig. 12 shows this same chassis as adapted for a model-T Ford front axle and spring. A low center of gravity is obtained by using the angle iron mounting shown in Figs. 10 and 11, but the standard method of mounting (Ford frame on edge and the front frame moved back to the center, as in Fig. 15) can be used if desired. In both cases, the Ford radius rod can be left in place for additional stiffness, but is not necessary with a good fit at the center. Figs. 13 and 14 show the standard method of locking Ford spindles. Details of the simple box body shown in Figs. 3, 4, 12 and 19 are pictured in Figs. 16, 17 and 18, the latter being a detail of a drop end gate, held in place by window casement fasteners at either end.

Proper hitching of the trailer to the tow-

ing car is important. Best results are obtained from a ball-and-socket joint, and an excellent hitch of this nature can be made from a drag link and steering ball taken from a heavy-duty truck. Fig. 21 shows the drag-link assembly as it comes from the truck. Fig. 22 shows a cutaway view of the trailer hitch as made from the drag-link parts. When the cam lever is down, the ball is locked securely in place; when the cam lever is pulled up, the ball is free and can be removed

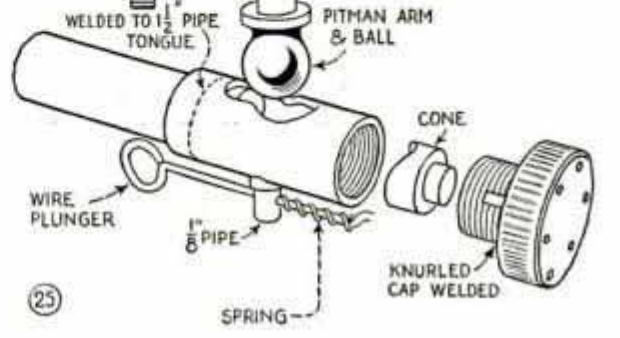
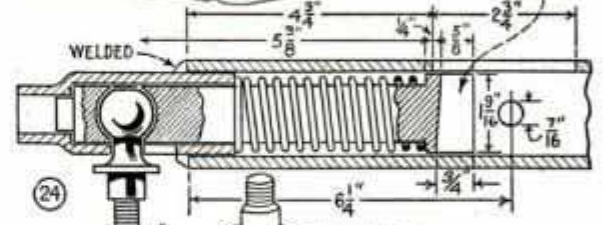
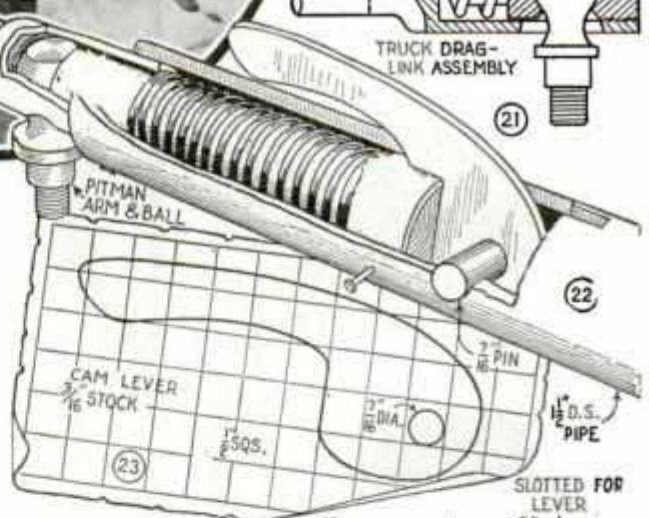

Farm Trailer Fitted with Underslung Springs

easily. Fig. 24 is a plan of the construction. You will notice that there is a metal plunger to be turned on the lathe, the heavy end of this being slotted on an angle to take the thickness of the cam lever, while the opposite end is cupped to fit around the ball. The ball itself is $1\frac{1}{16}$ in. in diameter, and should be the old-style variety with a shoulder and straight shank. Later types have no

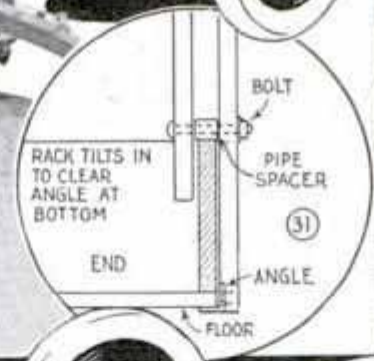
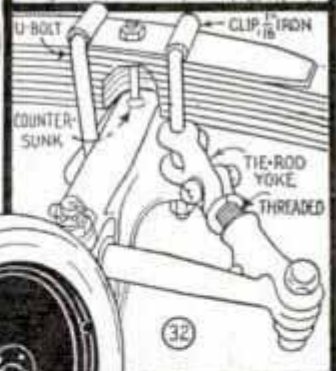
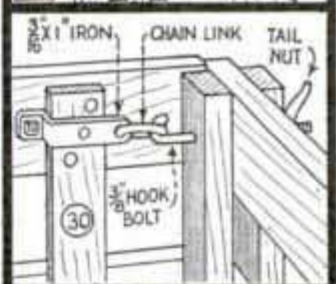
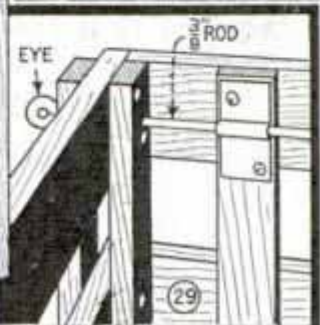
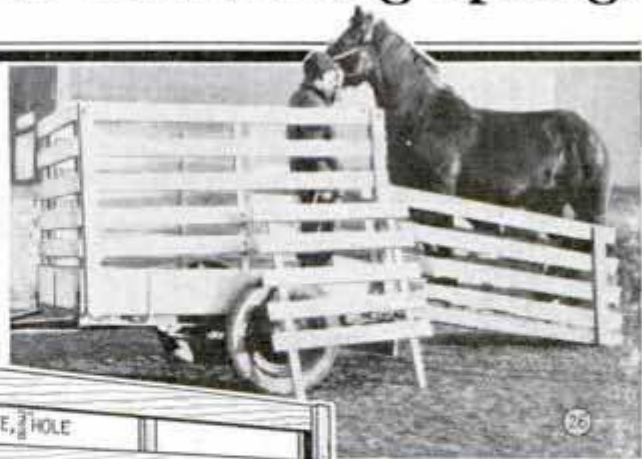

shoulder and have a tapered shank. This style can be used, but is harder to fit, necessitating the drilling of a corresponding tapered hole in the car towing plate.

A simpler type of hitch using the truck drag-link assembly is shown in Figs. 20 to 25 inclusive. The assembly is used just as it comes from the truck, with the exception of the small spring which you will find behind the inner cone. This is removed, and the parts put

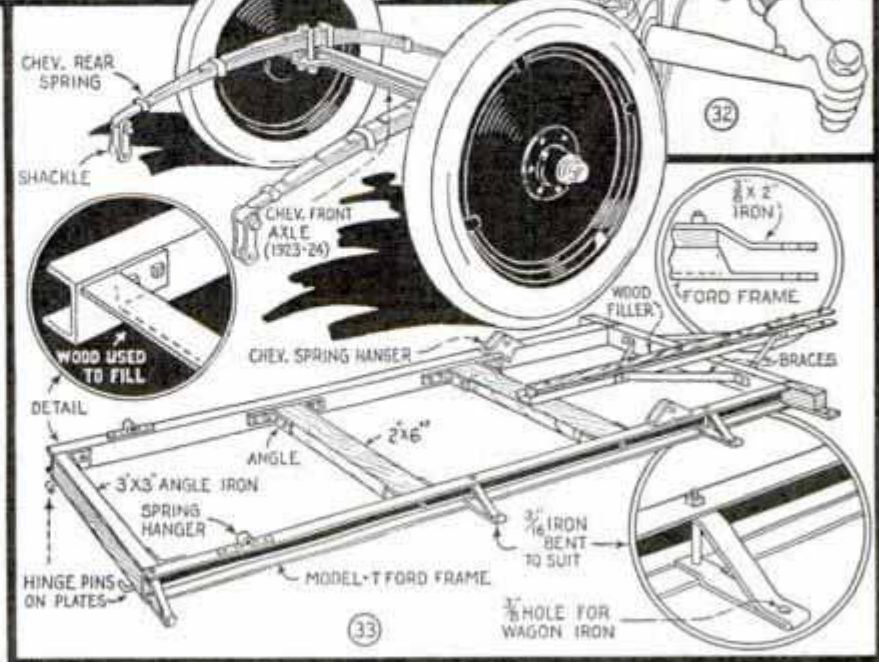

Variations in Chassis and Body Construction



Above, a Simple Chassis Made by Bolting the Forward Frame Section of a Car to a Wood Frame; in Circle, Typical End Gate and Body Construction; Below, Two Boat Trailers from Ford Parts

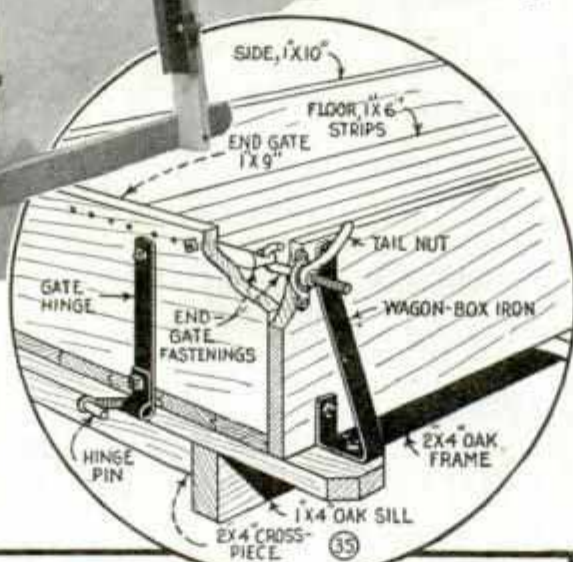

together again. A knurled cap is welded to the adjusting screw so that this can be turned readily in or out to engage or disengage the ball. The cap is fastened in place by a simple wire plunger working through a hole in a 1/8-in. pipe fitting, the pipe being screwed into the hole originally occupied by the grease fitting. For an even simpler job, you can fasten the ball in place permanently, uncoupling at the threaded shank which fits through the tow bar. These drag-link hitches should not be used for continuous heavy duty. If you are hauling regularly over 1,500 lbs., it

would be advisable to purchase a suitable ball hitch. In lieu of this, any of the simple clevis-and-pin hitches, made from heavy flat iron, can be used with good results.

Figs. 26 to 33 inclusive show the construction of a heavy-duty trailer especially suited for the farm. The heavier and longer rear springs of a passenger car are used instead of the front springs, and the springs are underslung for additional stability. Chevrolet parts are used. The older style of Chevrolet front axle is suited especially for this trailer because of the extreme width between the spring seats.

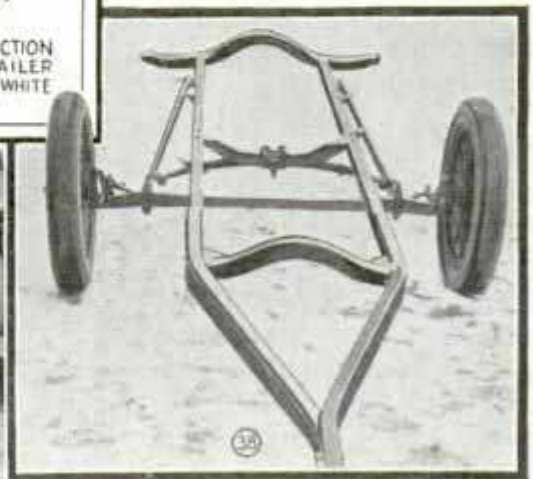
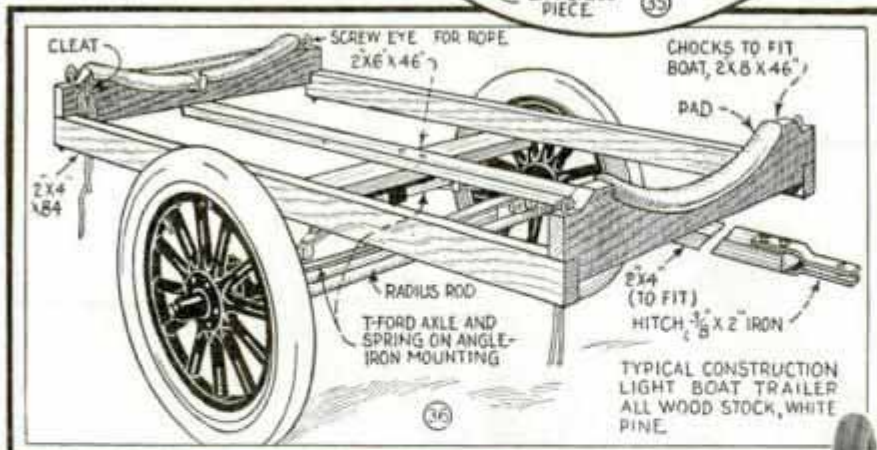

This is not a balanced trailer. The axle is set well back to overcome the natural tendency of live-stock cargo crowding to the rear. The chassis and body construction is much the same as already described, with the exception that it is heavier and better braced and fastened all the way around. The plan of the cattle rack, Fig. 27, shows one end and one side in place, the other end and side being exactly the same. The two sides are put in place first when the rack is used, the ends being held securely between them. Fig. 29 shows the manner of fastening at the front end, while Fig. 30 shows how the rear corners are hooked together. The hardware shown here and in Fig. 35 comprises stock items which can be purchased at any hardware store handling farm supplies.

Fig. 34 shows a simple method of chassis construction for the light trailer. The forward portion of the car frame carrying hangers, shackles, springs, etc., is simply bolted to a wooden frame and the job is ready for the box. A standard form of construction for this or any other chassis is shown in Fig. 35. Fig. 36 shows the construction of a typical boat trailer using a Ford axle and spring as pictured in Fig. 37. The framing will vary with the size of the boat, and any of the previously described chassis can be adapted. Fig. 38 shows another type of Ford construction, two frames being welded together in this case, with the transposed front member carrying the spring in the usual manner.

Handy Attachment for Driving Screw Hooks

When a number of screw hooks are to be driven into woodwork, the task may be simplified by flattening a short piece of

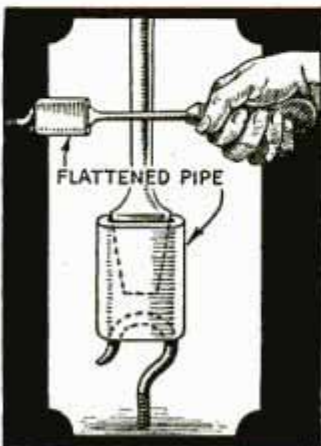

small pipe or tubing and slipping it over the point of a screwdriver. By inserting the screw hook into the opposite end of the attachment, it may be driven with very little difficulty. Screw eyes may be driven in the same manner.

Waxed Cauls Aid in Gluing Veneer Work



Cauls Impregnated with Wax Are Handy When Clamping Up Several Pieces of Veneer Work

When gluing up veneered material, time can be saved if more than one piece is put in the clamps at one time, but this often results in ruined work because the glue oozes out and runs down on the piece underneath. To prevent this trouble, use cauls and impregnate them with paraffin wax, or a preparation consisting of equal parts of paraffin and tallow melted together. Any glue that has run down on the cauls can be scraped off after the job is done so they can be stored for future use.

Tubular Rivet Protects End of Oil-Can Spout

To prevent the spout of an oil can from getting clogged with dirt and grease, or to prevent the oil from spilling if the can is upset, slip a small tubular rivet over it as shown.

The inside surface of the rivet may be tapered slightly at the end with the point of a round file to make it fit snugly over the end of the spout.





Discolored Straw Hat Bleached by Fumes from Flowers of Sulphur Confined under a Can

Renewing Your Old Straw Hat

Your old straw hat that has become slightly discolored can be bleached and given a new appearance by subjecting it to fumes from burning flowers of sulphur under an air-tight container. First brush and clean the hat with gasoline and let it dry. Then dampen the straw thoroughly by means of a wet cloth, and place it under a large can with the flowers of sulphur, which has been ignited. This work should be done outdoors or in a well-ventilated room, and will take 2 or 3 hours. —R. H. Wampler, Roanoke, Va.

Wall Rack Holds Smoker's Pipes

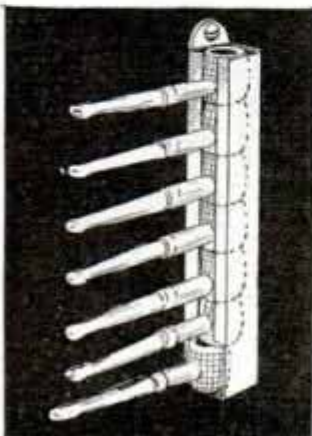

Here is a pipe rack that will automatically rotate seven corn-cob pipes, and, if a change is made daily, it will assure the smoker a dry pipe for each day of the week. It hangs on a wall and is made from strips of thin wood

or sheet metal. Used pipes are inserted at the top opening, and the dry ones are removed from the bottom. With slight changes, the rack may be made to accommodate pipes of other types.

A Novel Incense Burner

Resembling a "Mother Goose Cottage," this novel incense burner is made from a gourd. The window openings should be just large enough to supply the proper amount of air to give a good draft up the "chimney." This can be determined by cutting the openings one at a time. The incense burns on a tile block. A wood block, scribed and painted to resemble a brick walk, placed in front of the door, adds a touch of novelty.

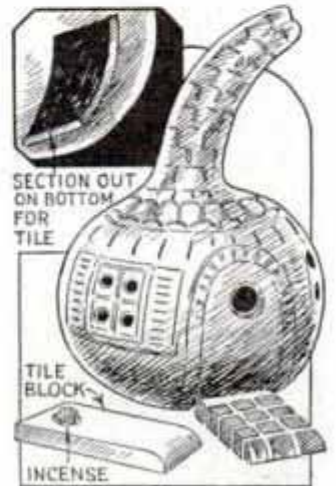

Hanging a Circular Mirror

Here is a modern, inexpensive cradle frame for hanging a circular mirror above a sideboard, hall stand or a vanity dresser. It is made by gluing together three pieces of hard pressed board, which have been cut to the shape shown. The middle piece is cut narrower so that a groove, in which the mirror rests, will be left extending along the inside curve of the frame. The assembly is hung by a strip of fabric.

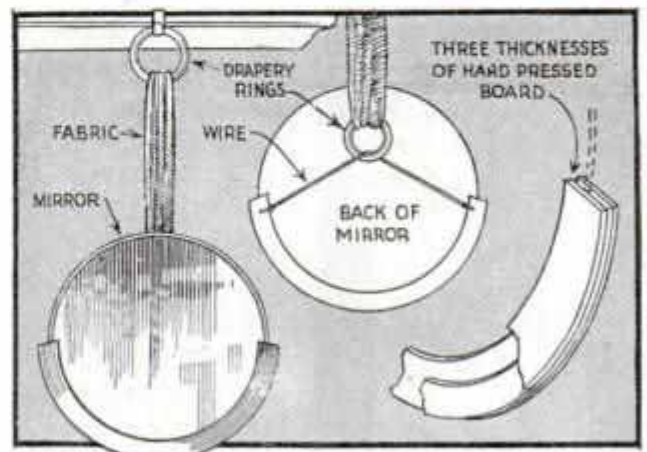

Frame Made of Hard Pressed Board for Hanging a Circular Mirror above Dresser or Sideboard

TEN HELPFUL HINTS

for the Small-Boat Owner

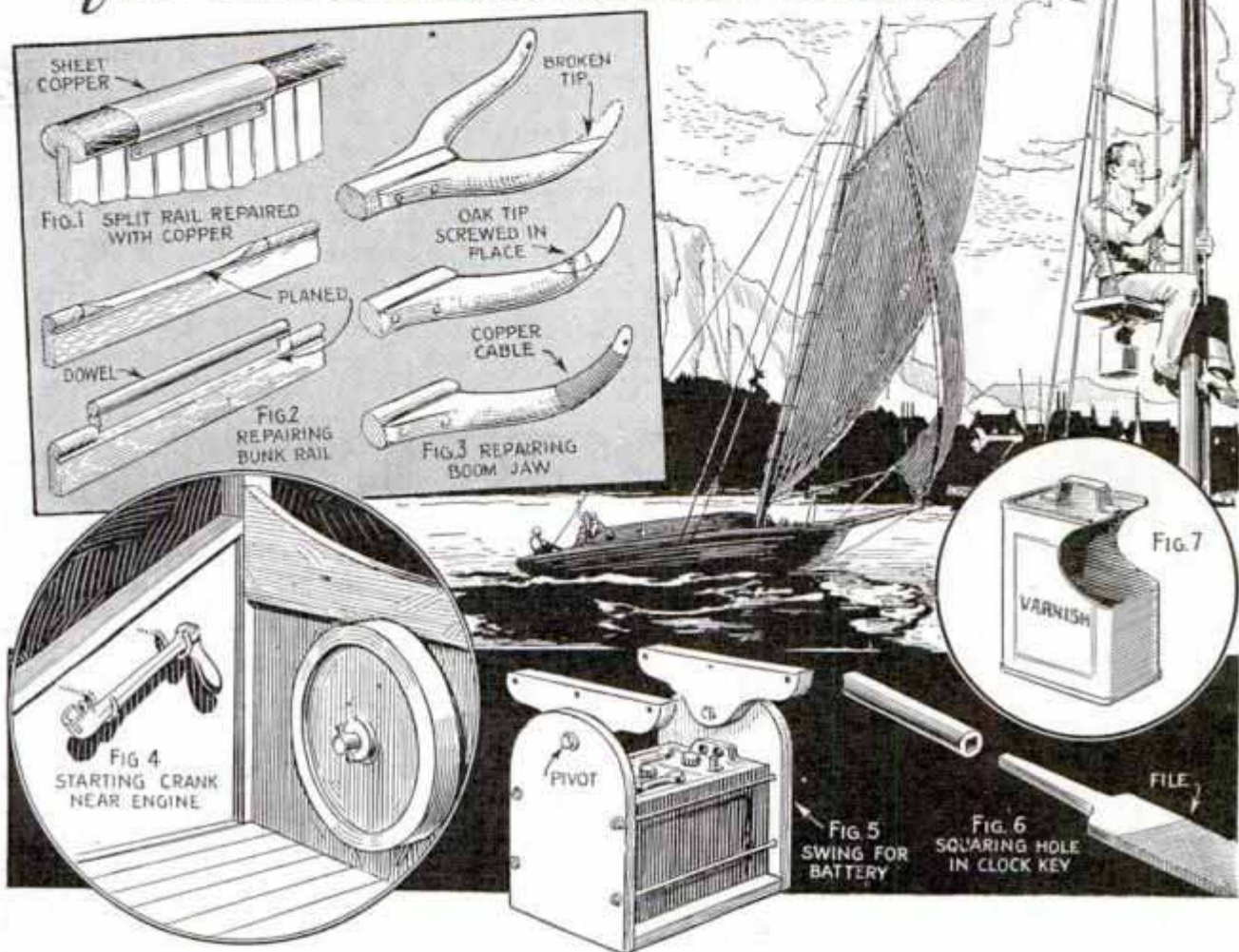

MANY owners of small boats usually spend a few weeks in repairing, varnishing, painting and doing dozens of small jobs to get the craft in readiness for the coming season. With this overhauling job in view, there are a number of simple, effective "kinks" that are worth remembering.

In case of a splintered rail, which you would rather repair than renew, take a sheet of thin-gauge copper, bend it to fit snugly around the rail and tack it underneath the combing as shown in Fig. 1. Sharp edges should be dressed down with a file. Two coats of paint will help to fill the slight space between the metal and wood, and to make the repair scarcely noticeable. Where molding is used to hold cabin mattresses in place, and part of the molding is split off, a repair can be made by gluing and tacking in a piece of dowel rod as in Fig. 2.

On one occasion, the gaff of the mizzen had a broken jaw. Replacement meant an extensive forming job, so a new section of oak was spliced to the tip, as shown in Fig. 3. The broken edge was planed smooth at an angle, and a new tip fitted, after which it was drilled for long wood screws, used to join the pieces together securely. Then the long splice was wound tightly with small-diameter copper cable—of the kind used for radio antennas—and the finished job was varnished heavily.

The crank of an auxiliary engine may be kept at hand conveniently and ready for instant use, if it is hung on a couple of screw hooks driven into the side of the engine housing as shown in Fig. 4. Where a small storage battery is used for starting or lighting, the electrolyte may be spilled out of the battery if it tips far enough when the boat heels over in a stiff breeze. To avoid this, make a swinging cradle for

the battery as in Fig. 5. If the rods on each side are slid in place, they are removed easily to facilitate taking the battery out of

handle of the right size. This is placed into the hollow rivet and driven down with a wooden mallet as in Fig. 8. It often happens that the steel strap, fastened over the tip of the bowsprit and provided with an eye at its lower end for the bobstay, rusts through just below the bowsprit. To make a permanent repair without removing the forestay, jib, etc., take a length of 1/4-in. galvanized steel cable, thread it through the eye and over the tip of the bowsprit as many times as the eye in the end of the turnbuckle will permit. Then pull it up as tightly as possible and fasten with two cable clamps. The turnbuckle then is tightened to take the strain as in Fig. 9.

On a small boat without a cabin, it is often quite a problem to arrange a suitable cover for sleeping on inclement nights while on a cruise, and at the same time provide a head-high cover that can be used during the day under the same

weather conditions. Such difficulty is solved by the cover shown in Fig. 10. Small sockets are screwed to the sides of the cockpit to hold steam-bent oak ribs. These are spaced at the top with a stretcher bar that can be slipped out. A canvas cover then is fitted over this framework. For a daytime cabin, the whole assembly may be held on the mast as indicated by the dotted lines. A strip of canvas between the cockpit coaming and the suspended canvas cover will form a small, but comfortable cabin in a drizzle.

the cradle. When the winding stem of the ship's clock has become worn so that the key slips, take a small piece of steel rod, drill a hole lengthwise into one end and then square the hole by driving a file tang into it, the tang having been ground previously to the proper square shape as in Fig. 6. In doing this, the rod should be red hot, and a mallet should be used to drive the file; otherwise the hard metal of the file may chip off and endanger the worker's eyes. The opposite end of the rod is slotted and the key handle driven into it. For varnishing the mast, a handy can, cut from a 1-qt. varnish can as in Fig. 7, will be helpful as it is within easy reach, will not tip over, and is closed at the top to protect the contents from sand, dust and shavings while scraping and sanding the mast.

In making up sail covers, the difficulty of getting the grommets to spread evenly can be overcome by using a metal faucet

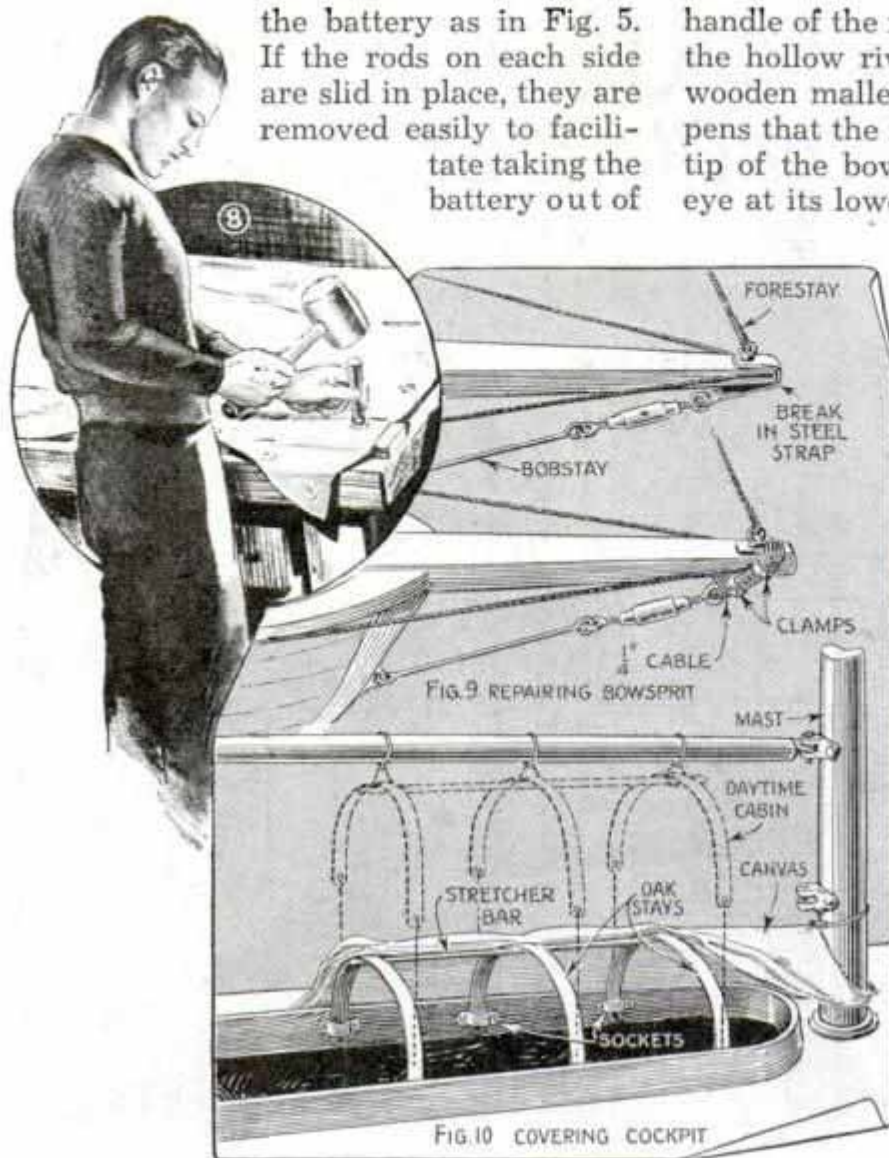

Skid Chain on Rake Extinguishes Grass Fire

Instead of using wet sacks or blankets on a garden rake to extinguish grass fires, take an old auto skid chain and entangle it in the rake teeth. The chain will cover a wide surface and its weight makes it effective in raking out flames.

Running-Board Ice Box Has Air-Cooled Lid

Your food will be kept cool when touring on a hot day, if stored in this running-board ice box, which is well insulated and has an air-cooled lid to permit maximum circulation. Light plywood or insulating board is used for the double walls, between

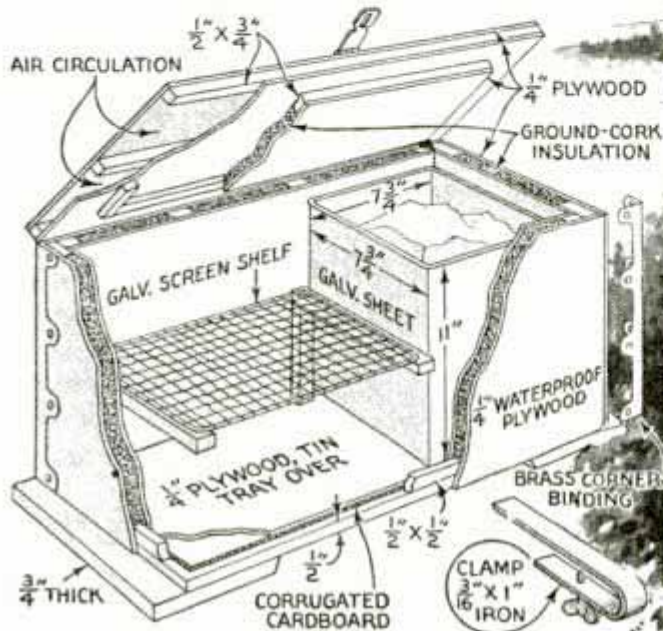

which ground cork, sawdust or powdered asbestos is stuffed. A shallow tin tray is fitted in the bottom over a piece of corrugated cardboard, and the galvanized ice tank, which occupies about half of the interior, is set in the tray so that the latter will catch moisture that condenses on the

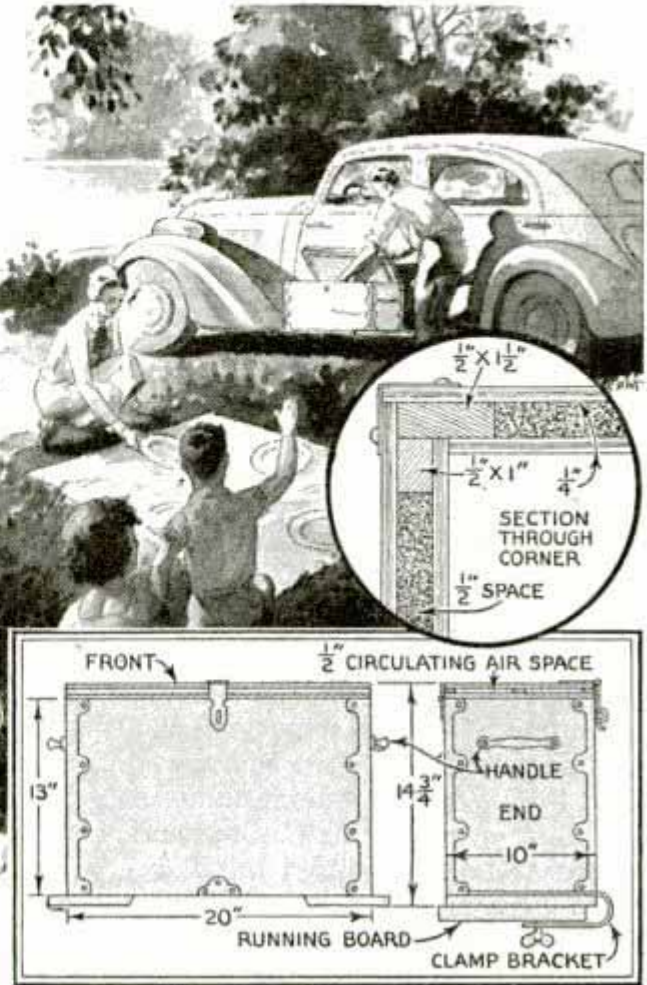

outside surface of the tank. No drain is provided in the tank as the cool water from the ice, collecting in the tray, helps to keep the temperature down.

Tank to Develop Roll Films with Small Amount of Fluid

With this homemade tank, roll films are developed easily in a small amount of developer. First make a wood paddle as shown, on which to place the film, and then construct a box to take the paddle. Impregnate the inside surface with wax to make the box waterproof. In use, one end of the film to be developed is tacked to the upper end of the paddle, emulsion side out, and then brought down under the other end and tacked to the opposite side. A rubber band stretched across the two longer sides of the box, prevents the paddle from floating in the fluid.

ⓘ If used safety-razor blades are placed in a jar of sulphuric acid, they will corrode and the sharp edges will be destroyed.

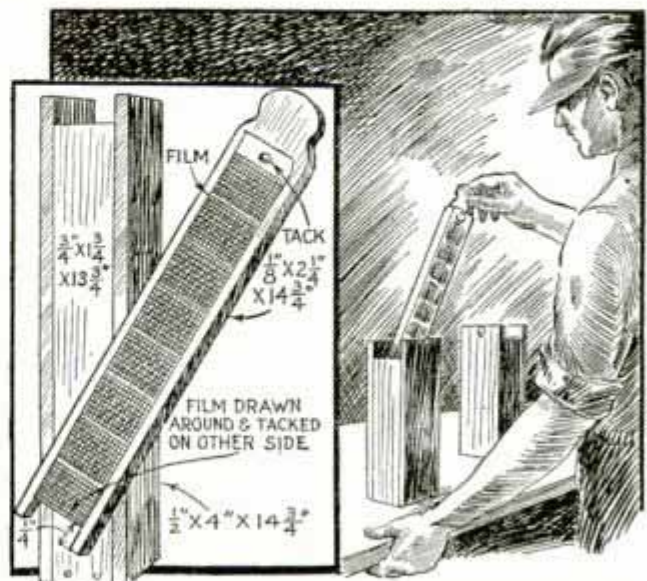

With This Simple Tank, You Can Develop Your Own Roll Films Inexpensively

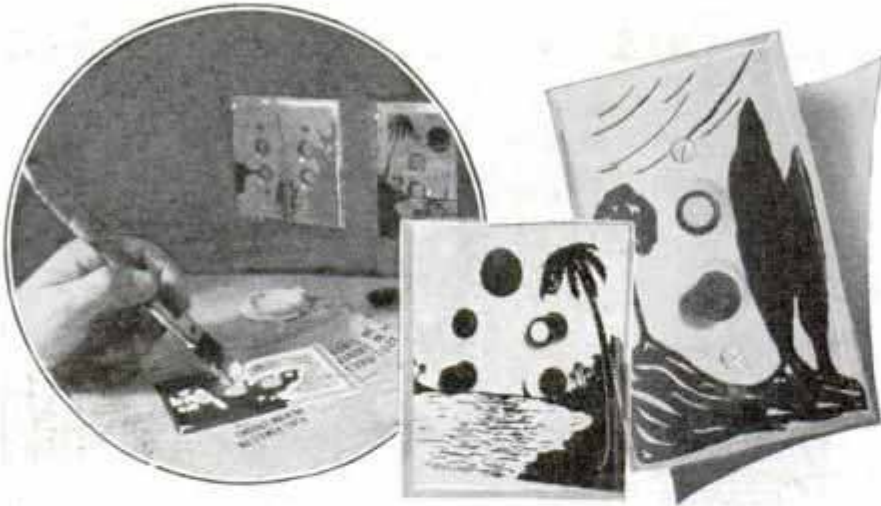

Appearance of Wall Switch Plates Greatly Improved by Painting Scenes of Landscapes Clipped from Magazines

An Improvement in Wall-Switch Plates

By painting landscapes or figures to match the surrounding wallpaper on the plates of wall switches, they are made more attractive and the work of polishing them is eliminated. If you are not adept at painting, pages of catalogues or magazines will provide a variety of landscape scenes, the outlines of which can be traced on the plates and then painted in. To make the work easy, paint the plates white and trace the scene on this, painting the details in black to give the picture depth. This produces neat effects as indicated in the two right-hand photos. Or, if you want to imitate the wallpaper figure on the plates, use colors that correspond to those in the paper. A coat of clear varnish will protect the completed work. A better job can be had if a glass switch plate is used. In this case, the picture is painted on the back of the plate in black, after which the white background is painted over it.

Keeping Your Golf Clubs in Repair

It is a good idea to test wood-shafted golf clubs occasionally for looseness by twisting the shafts against the necks of the heads. If moderately loose, stand the clubs in light oil overnight with the necks submerged. If a club is extremely loose, remove the head and wrap the end of the shaft with fine waxed, linen thread and then force it back into place. To put a beautiful finish on wood shafts, sand off the old surface and wet them slightly to swell the grain. When thoroughly dry, sand them again and wipe with a clean

cloth. Then polish with a cloth saturated with a mixture of shellac, 60 parts, and machine oil, 40 parts. If you desire the grain to show clearly, add a little powdered charcoal to the mixture. Steel-shafted woods may be tightened by removing the screws in the heads and swelling the holes in the metal by tapping them with a hammer until they fit the screws snugly. In smoothing out

nicks and dents on the sole of iron clubs, tap them into line with a hammer as much as possible. It is best not to grind them unless absolutely necessary, as this removes the metal and may destroy the balance of the clubs. When clubs are not in use, lay them flat. If they stand on end, the weight of the heads may warp the shafts.

Handy Knife for Ripping Seams

Seams in cloth can be ripped easily by using this knife, which is made from a 3-in. length of old hacksaw blade, and fitted with a suitable handle. Two slightly curved pieces of spring brass are riveted

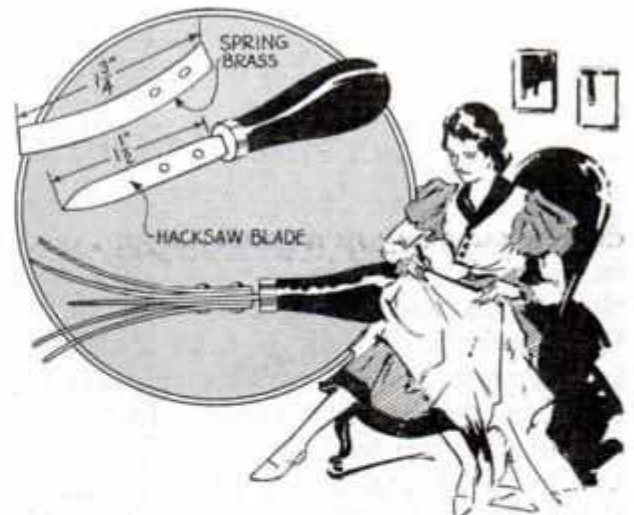

Improvised Knife Rips Seams without Cutting the Cloth or the Operator's Fingers

to each side of the knife and project about $\frac{1}{4}$ in. beyond the point of the blade. In use, the edges of the cloth at the seam are inserted between the two little flat springs on each side of the blade after which the knife is pulled along the seam.

SAILBOAT LAMP

Has Rudder Light Control

LIGHT UP" with this novel sailboat lamp means "Port your helm," with the rudder arm and rudder, which controls the toggle switch to turn the light on and off. The light itself is enclosed within a parchment shade, which is shaped around wire frames at top and bottom to resemble a ship's sail.

Most of the construction concerns the hull of the boat. As shown in Fig. 1, the bottom part of the boat is a separate piece, while the upper part and the cabin are cut from a single thickness of 2-in. stock. By band-sawing the deck line carefully, the cabin will fit into place perfectly. Shaping of the hull sides is accomplished by simply tilting the band-saw table to an angle of 83°. A few strokes with a plane will round off the forward

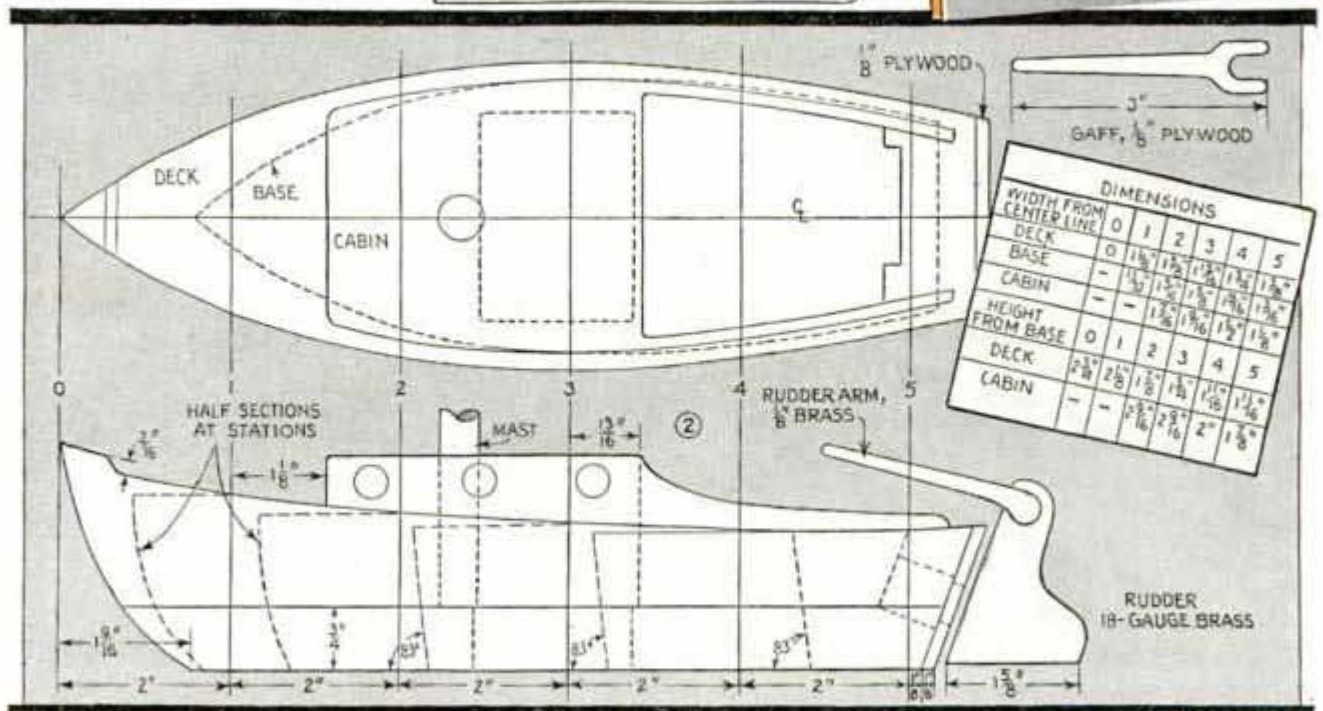
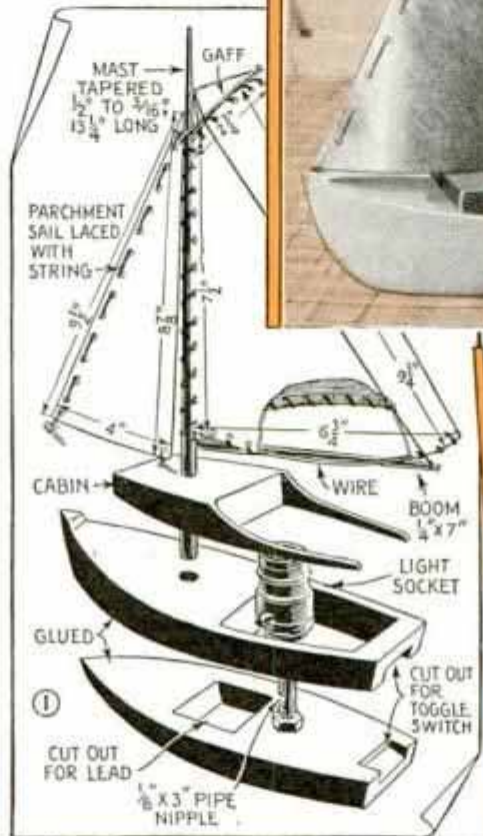
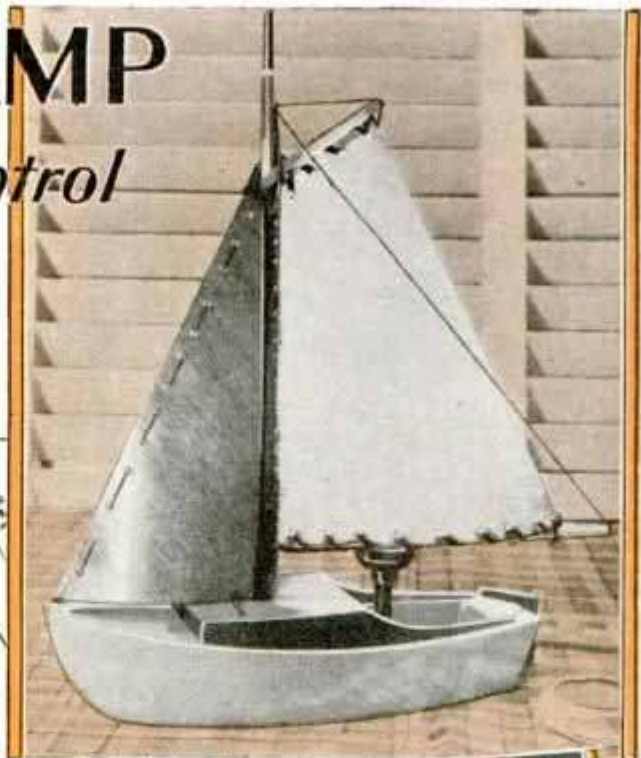

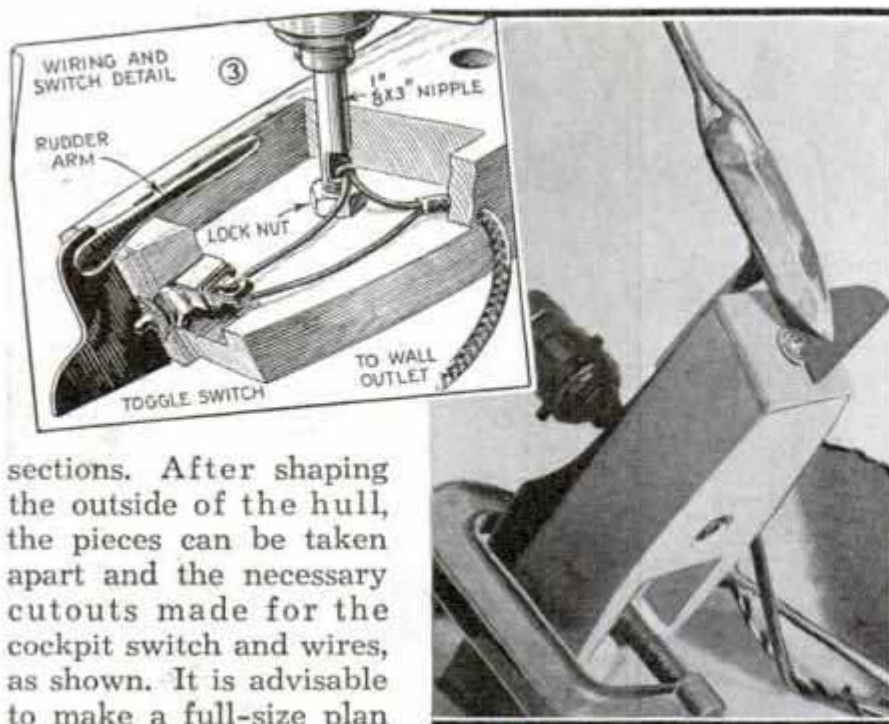

sections. After shaping the outside of the hull, the pieces can be taken apart and the necessary cutouts made for the cockpit switch and wires, as shown. It is advisable to make a full-size plan of Fig. 2, erecting the station lines on 2-in. centers, before commencing the actual construction.

The sail is made from parchment paper, which may be purchased flat or cut from a discarded shade. It is laced around wire loops at the top and the bottom, and then can be laced to the $\frac{1}{2}$ -in. dowel which serves as a mast. The jib sail is merely a triangular piece of parchment, cut to the size shown, and suspended on a string running from the mast to the bow of the boat. The boom and the gaff are made

easily, and add to the sail-boat motif while helping to hold the shade securely in place.

Fig. 3 shows the switch detail. This is made by slotting the arm of a small toggle switch so that the brass rudder can be soldered in place. The rudder arm, which is made of $\frac{1}{8}$ -in. brass, is soldered to the rudder, the whole unit serving as the light switch. The light socket is carried on a $\frac{1}{8}$ by 3-in. pipe nipple, which is held to the base of the hull by means of two locknuts. The pipe is cut near the lower end to allow the

wires to be connected with the switch.

Additional finishing touches can be added if desired, such as port holes, a small anchor, mooring line, etc. As shown in the heading photo, the hull is done in white pine with a colorful lacquer finish. A varnish finish on hardwood would make up nicely also. The lead in the lower part of the hull makes the lamp "stay put," but could be omitted if desired. The bottom should be covered with felt to prevent the wood from marring polished surfaces.

Attic Floor Laid on False Joists to Protect Ceiling Plaster



False Joists Support Attic Floor and Prevent Plaster on Ceiling from Being Cracked

There is enough spring in long 2 by 10-in. joists to crack ceiling plaster of the room below if the attic floor is laid directly on them. To prevent this, one home owner installed a set of false joists between the regular ones, resting the false joists on elevating blocks on the plates, which raised them above ceiling joists. The attic floor then was nailed to the false joists.

Sandpaper Prevents Slipping of Belt on Sewing Machine

Instead of applying a sticky dressing to a sewing-machine belt, which may soil the work, rough the inside surface of the belt with medium-grade sandpaper. This can be done by holding the paper against the belt while the machine is in motion.

Stuffing Box for Propeller Shaft on a Motor Boat

A stuffing box made and installed as shown, has been used in a 22-ft. motor boat with excellent results. In order to get the hole for the box through the keel at the correct angle, it is best to make a guide for the drill bit. This can be done by drilling a hole through a block of wood and then sawing it in two at the correct angle. Use a bit $\frac{1}{8}$ in. smaller than the outside diameter of the pipe. After drilling the hole, thread the pipe with the dies opened to cut a very light thread. Spread a thick coat of marine glue or white lead on the pipe and inside the hole and then screw the pipe through the keel. Screw on a pipe coupling and ream a reducing bushing to the size of the propeller shaft. All water pipe has a larger inside diameter than indicated. For example, the inside diameter of a 1-in. pipe is actually $1\frac{1}{8}$ in., so a 1-in. shaft can be used easily.

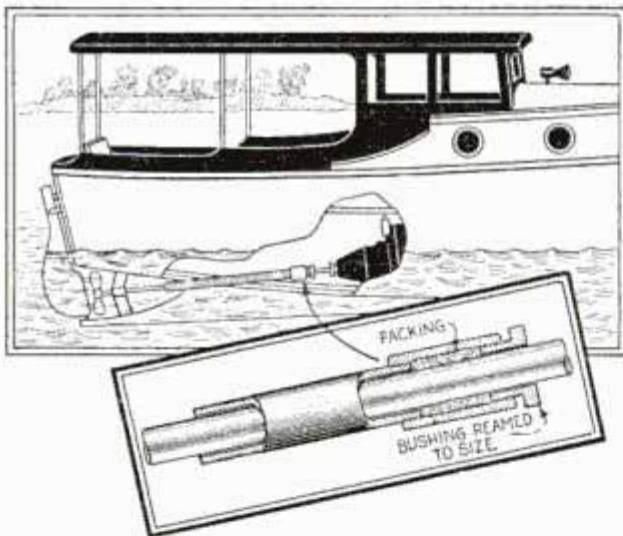

Stuffing Box for Boat-Propeller Shaft Made of Pipe and Fittings Is Easily Installed

Retarding Growth of Dandelions

According to lawn experts at the state college of Iowa, dandelions can be controlled by spraying a lawn with a solution consisting of ammonium sulphate, $\frac{1}{2}$ lb., and water, 1 gal. Apply one gallon of the mixture to each 100 sq. ft. of lawn two or three times each year. This will retard the growth of the dandelions and promote the growth of lawn grasses.

☐ A toy flour sifter is handy for sprinkling powdered sugar over cakes, pastries, etc.

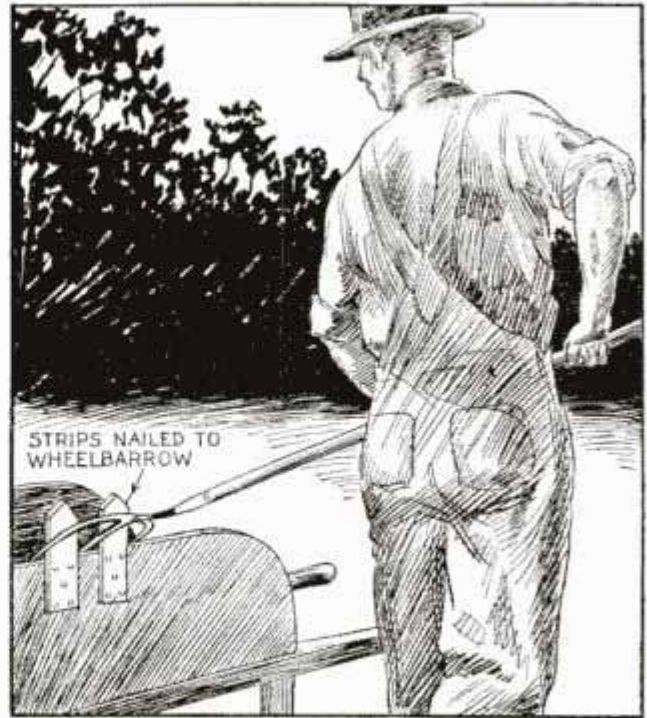

Pointed Wood Strips on Side of Wheelbarrow Aid in Removing Litter from Tines of Pitchfork

Pickets on Wheelbarrow to Clean Pitchfork Tines

The difficulty of keeping a pitchfork from clogging with straw and leaves, when loading such litter into a wheelbarrow, can be overcome by nailing a couple of wood strips on one side of the barrow. Then by inverting the fork over the strips and pulling it toward you, the litter is removed from the fork tines easily.

Holder to Drive Nails in Tight Places

I have found the tool shown very handy for driving nails in places difficult to reach with the hands. It consists of a length of $\frac{3}{8}$ -in. pipe and a $\frac{1}{4}$ -in. iron rod a little longer than the pipe. A narrow slot is sawed in the side of the pipe at one end to receive a spring clip, which is soldered in place to hold the nail as shown.

In use, the nail is held in place with the tool and then driven by striking the end of the rod with a hammer.—Benj. Nielsen, Aurora, Nebraska.

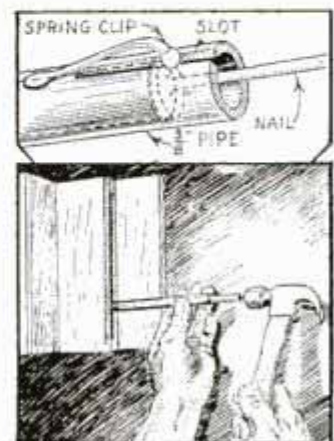

FIREPLACES *built for*

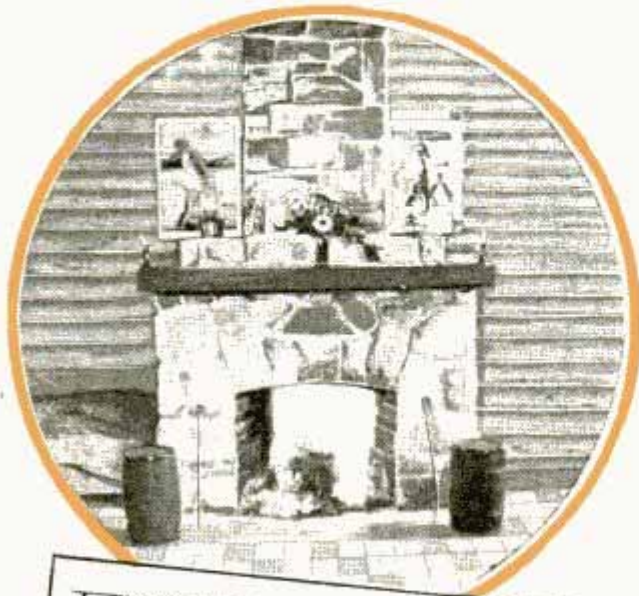

WHEN the night fog rolls in from the lake, or when the crisp spring or fall air filters into the cottage, there are few luxuries more desirable than a comfortable fireplace of good design. In many localities suitable stone may be had for the trouble of gathering it, and by following the details of this article, the average person can build a good fireplace. If you purchase the stone and hire a mason to do the work, the cost should be well under a hundred dollars, varying, of course, in different sections of the country, according to local cost of labor and material.

Figs. 1 and 2 show plans for a fireplace having an opening 36 in. wide and 30 in. high, which is recommended for the average living room of a summer cottage. However, if you desire a larger or smaller size, refer to the chart, from which dimensions are given for fireplaces of various sizes. It will be seen also in Fig. 1 that the over-all width of the stonework is 64 in. A word of

explanation regarding this detail: It was thought that most of the fireplaces built from these plans would be placed in cottages already erected, and, as the studs in such structures are generally placed 24 in. from center to center, an over-all size was adopted that would require the removal of only two studs. However, if you have the space, you may increase the width of the face of the front walls from 14 in., as shown, to 18 in., which will make your total over-all width exactly 6 ft. If you build a fireplace with an opening wider than 36 in., the width of the side walls should be increased to preserve an artistic balance.

Before you build, it will be necessary to decide

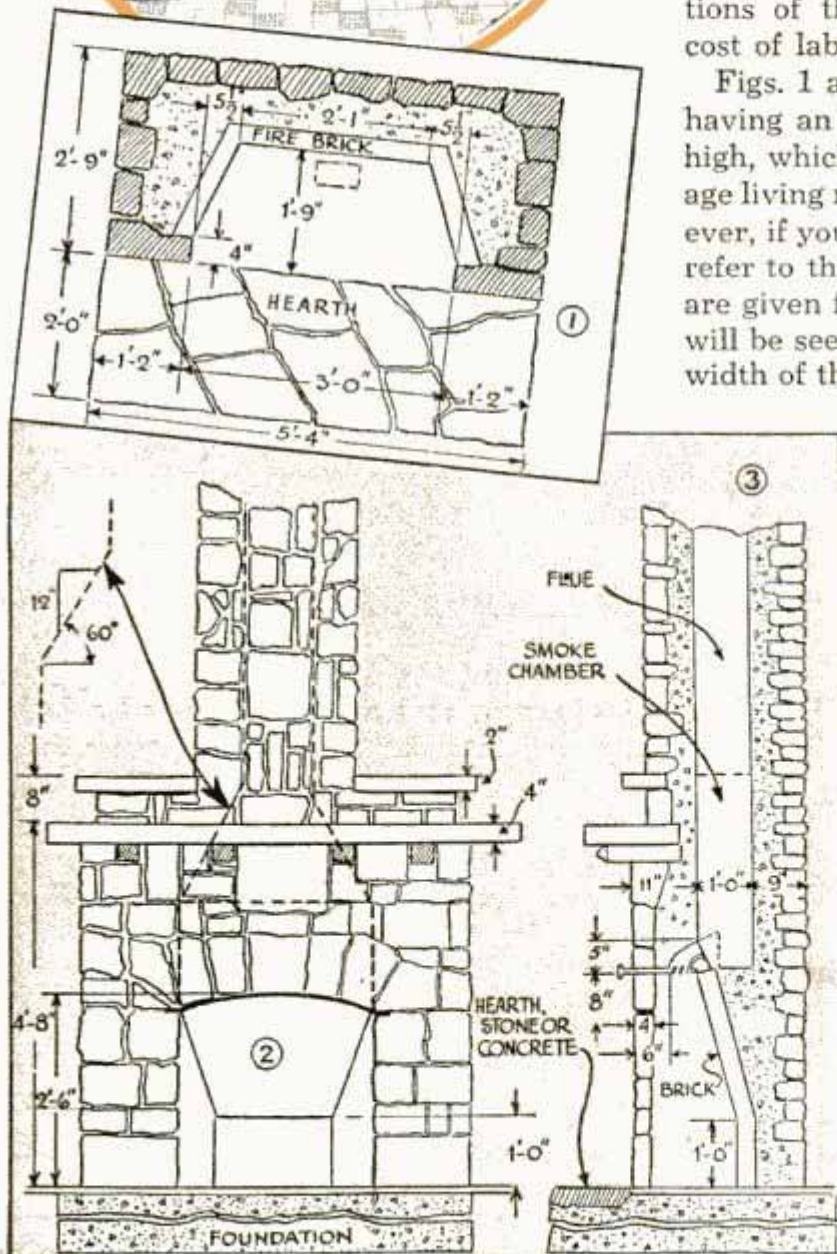

Comfort and Utility



by
J. B. TEMPLE

whether or not a damper is to be used. Fig. 3 shows a sectional detail with a standard dome damper in place, while Fig. 4 gives the proper throat construction, if no damper is used. We strongly advise the use of a damper, which should be the full length of the throat and set as near to the front as is practicable. A damper up in the flue is worse than useless. You can purchase a suitable device from any builders' supply house at a very small cost. A dome damper controls the draft, when the fireplace is used, helps to support the masonry and, if closed, prevents a draft from going either up or down the chimney when the fire is not lit, thus keeping insects, squirrels, mice, etc., from coming down the chimney when the cottage is closed and unoccupied. In ordering the damper, mention the width of the opening (in the detail shown this width would be 36 in.) and specify cast-iron frame and rotary-controlled type with operating rod, preferably at one side and not in the center. If the rod or handle comes in the center, the damper may have to be moved up or down

to avoid drilling the keystone. As the stones on either side of the keystone are smaller, the rod can be placed in a mortar joint more easily if the operating mechanism is not in the center.

Before starting the actual work, it will be necessary to arrange for the materials. We will now lay out an approximate bill of material. This bill may vary a little according to the depth of the foundations, the height of the chimney, or any other modifications of this design, which may be necessary or desirable in particular cases. For our list we will assume that you are going to build a fireplace of the size which has an opening 36 in. wide and 30 in. high as detailed in the plans.

BILL OF MATERIAL

- 1 36-in. fireplace rotary-control damper
- 1 3 by $\frac{1}{2}$ -in. steel arch bar
- 16 bags Portland cement (for average height)
- 120 fire bricks (or hard-burned common brick will do)
- 3 to 4 tons stone (field stone preferred)
- Mantel shelf—wood, stone, cement, or choice
- Material for forms
- Sharp sand for concrete

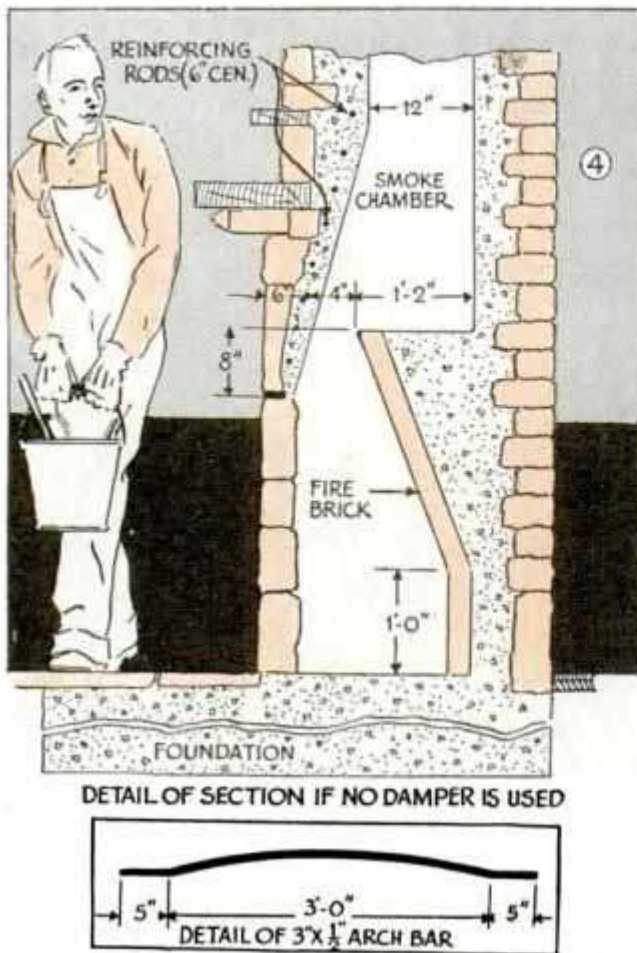

DETAIL OF SECTION IF NO DAMPER IS USED

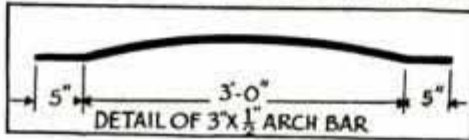

We are now ready to consider the details of construction step by step:

The foundations should be carried down to a solid bed below the frost line. If you are building on wet or soft ground, spread the base and use reinforcing rods in the same. These rods are not necessary if you have good bearing soil. Carry the footing almost up to the floor of the building leaving space to later finish up the hearth with tile or cement at top-floor level.

Field stone is less likely to crack from the heat than stone taken from the water. Also split stone is more satisfactory than cobbles. Attractive designs may be obtained by matching up various faces, colors and textures of stone.

When the foundation is completed, build a wooden form to the inside shape of your firebox, Fig. 1, and start laying up the outside shell of stone. Lay up the fire bricks against your form and fill in between these bricks and your outside wall with concrete. When you reach the top of the opening, place the 3 by $\frac{1}{2}$ -in. steel arch bar, below Fig. 4, and build a removable wooden form back of the arch to the height of the damper (or if no damper is used, up to the

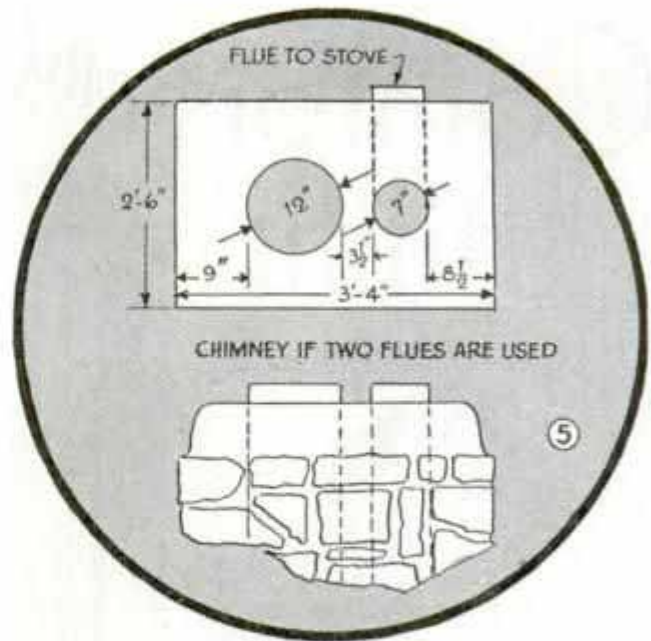

CHIMNEY IF TWO FLUES ARE USED

throat). Continue the stonework outside, backing the inside with concrete, and set the damper in place.

All wooden forms should be made so that they can be removed progressively from the inside of the fireplace. Use small nails and do not clinch them. It is bad practice to depend on burning out the forms. They should be dismantled as soon as the cement is set.

We now come to a very important part of the detail. The smoke chamber and shelf have two important functions, first to stop down-draft, and second to prevent too much heat from going up the chimney. You will note that the smoke chamber at its bottom is the full width of the opening and that you are to taper it up on a bevel of 7 in. to every 12 in. to the flue size (see Figs. 2 and 6). The actual horizontal depth of the smoke shelf is not important, but it should be at least 9 in. (see Fig. 3). Build your forms to these details, and lay up your stonework to the base of the flue.

A circular flue is considered to be more efficient than a square flue, but if it is easier for you to build the latter do not hesitate to do so, provided that you give it sufficient area in cross-section. A rule for figuring the size of the flue for wood-burning fireplaces is to make it about one-tenth of the area of the fireplace opening. A satisfactory size for the fireplace detailed would be a circular flue 12 in. in diameter or a square flue 10 by 10 in. If you are going to use the former get a length of 12-in. sheet-iron pipe and punch

PROPORTIONS FOR FIREPLACES OF VARIOUS SIZES					
Width of Firebox	Height of Opening	Depth of Firebox	Size of Flue		Width of Throat if no damper
			If Round	If Rectangular	
24"	24" to 28"	16" to 18"	9"	8" x 8"	4"
30"	26" to 28"	16" to 20"	10"	9" x 9"	4"
36"	30" to 32"	18" to 24"	12"	10" x 10"	4"
42"	30" to 32"	20" to 24"	12"	12" x 10"	5"
48"	32" to 34"	21" to 26"	13"	12" x 12"	5"
54"	32" to 36"	21" to 28"	15"	12" x 15"	6"

In all cases splay smoke chamber and sides of firebox to the bevels shown on plan. Depth of smoke shelf may vary from 9" up to 18."

a couple of holes near one end of it for placing a $\frac{1}{2}$ -in. pipe or rod diametrically through it for a turning handle. Set this pipe in place and use it as the interior form, moving it upward as you proceed with the work. If you prefer the square flue you may use lumber for the form. Clay flue linings may be obtained also, which can be left permanently in place. These make an excellent job, but they are comparatively expensive.

It is often necessary that the fireplace chimney should serve as chimney for a cook stove. A 7-in. stovepipe or thimble can be placed through the flue wall at the desired height for the smoke pipe from the stove. However, it is considered better practice to build a separate flue in the chimney to take a stovepipe as shown on Fig. 5. When the flue reaches the roof line, flash with galvanized sheet iron or copper by inserting the metal about 3 in. into the chimney, then extending and lapping it about 10 in. over the adjoining roof. Continue the chimney to at least 2 ft. above the peak, and cap with cement.

When your stonework has been completed, do not light a fire in your fireplace for at least one week. It takes some time for the concrete, which is not exposed to the air, to dry out, and if the moisture is driven out by excessive heat, cracks are likely to develop. It is very important that all details as explained should be followed carefully; without going into the theory of fireplace design, you may be assured that there are very good reasons for the various slopes, bevels and areas shown on the drawings. If you can handle stonemason's tools in splitting the stone, in pointing or raking out the exterior joints, or in coloring the mortar to contrast with the stone, you can obtain pleasing decorative effects.

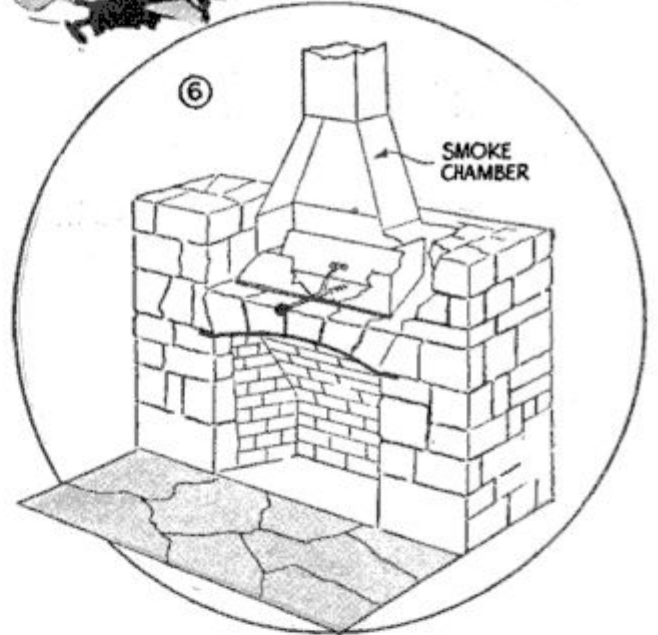

How to Make Ship-Model Flags Drape Naturally

Even though ship-model flags are made from very thin fabric, they tend to appear stiff and unnatural if attached in place without treatment to make them drape naturally. This can be done by attaching the flag to its staff and holding it in the steam from a tea-kettle spout for a few minutes. While still damp, the staff is put in place on the model, and, when the fabric dries, the flag will remain in a naturally draped position. If the flag is attached directly to a mast, the same effect is achieved by leading the steam through a rubber hose from the kettle spout.

Hot-Air Furnace Utilized as Cooling System

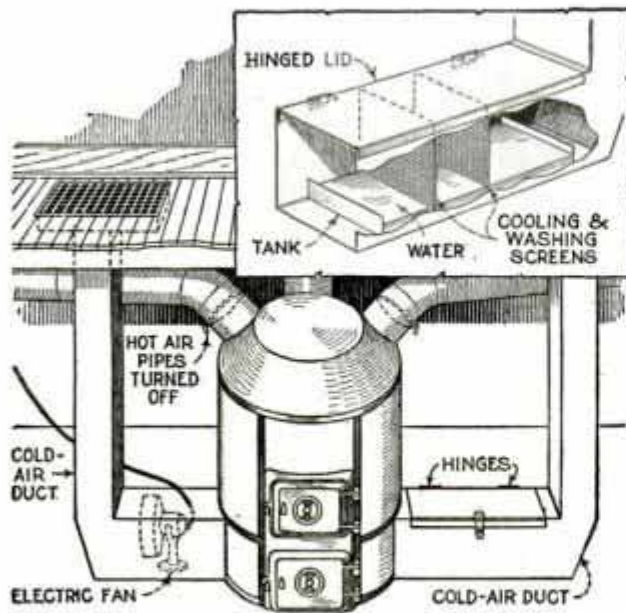

Small Unit Installed in Cold-Air Duct of Furnace Washes and Cools Air

If your home is equipped with a hot-air furnace, you have the rudimentary parts, that need little changing, for installing a cooling and air-washing system for the summer months. First close the dampers in the hot-air pipes, as only the cold-air

ducts are to be used. Then loosen one of the ducts from the furnace jacket and insert the cooling unit shown in the detail. This consists of a shallow water pan and two copper screens to which a coarse mesh cotton cloth is fastened. Be sure the unit fits snugly against the bottom and sides of the duct. If the latter is round, make the screens and pan accordingly. Next cut out the upper section of the duct over the screen and hinge a tight-fitting lid over the hole to permit access to the unit. After fastening the duct to the furnace jacket, loosen the other one and install a large electric fan as shown. Filling the pan in the unit with water completes the job. When the fan is started, air will be drawn through the wet screens and circulated through the house. As air circulates through the system, the screens will filter out the dust and the air will evaporate the water in them, which will tend to cool it. Be sure to keep the water pan filled, and inspect the screens often, changing the cloth when it becomes filled with dust.

☞ Sifted coal ashes help to keep clay soil loose so that plant roots can get air.

Making Your Workshop Pay Dividends

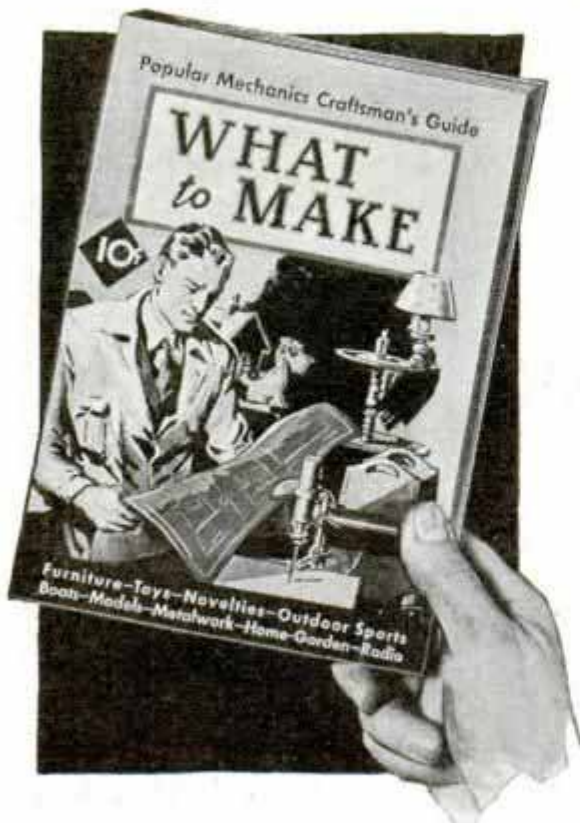

Do you want to make your workshop pay profits? Many other craftsmen have built up their spare-time efforts to large money-making enterprises! Or, do you want suggestions to make things for your home? Then, don't fail to get Popular Mechanics Craftsman's Guide.

This new 80-page guide pictures hundreds of completed items made in the home workshop—ornamental shelves, tables, stands, chests, chairs, cabinets and other useful furniture; bird houses, garden chairs, fences, trellises, arbors, bird baths, toys, novelties, ship and train models, radio, and many other things everybody wants to build.

A REAL GUIDE FOR CRAFTSMEN

Besides giving an elaborate list of plans, this valuable book tells where to purchase hard-to-get materials, such as rare wood, fancy inlay strips, Nichrome wire, etc. It also contains articles on correct workbench construction, what tools you need, how to file saws, make wood joints, motorize your workshop, sharpen wood-turning tools, tricks of metal spinning, correct measurements, mounting work in lathe, etc.

Send 12c in stamps for your copy to
POPULAR MECHANICS MAGAZINE

Dept. BPB, 200 East Ontario Street, Chicago



TOOLS for the *Modelmaker*

GREATLY increased interest in model making has raised the question among beginners as to just what tools are required to follow this interesting and economical hobby. Fortunately, only a small outlay of tools is necessary for this work and these can be obtained at a very reasonable cost.

For those who have plenty of space available, a good substantial workbench may be constructed in the basement. A bench 6 ft. long, 2 ft. wide and 30 in. high is preferred by many model makers. This should be covered with linoleum, or a suitable substitute, and be provided with adequate lighting both from a window and by an adjustable electric light. However, for those who must work in restricted space, such as an apartment affords, a portable table bench is satisfactory. The working surface can be made from a single plywood panel, the best being surfaced with maple. The assembly is clamped quickly in place on a convenient table or, when not in use, can be stored

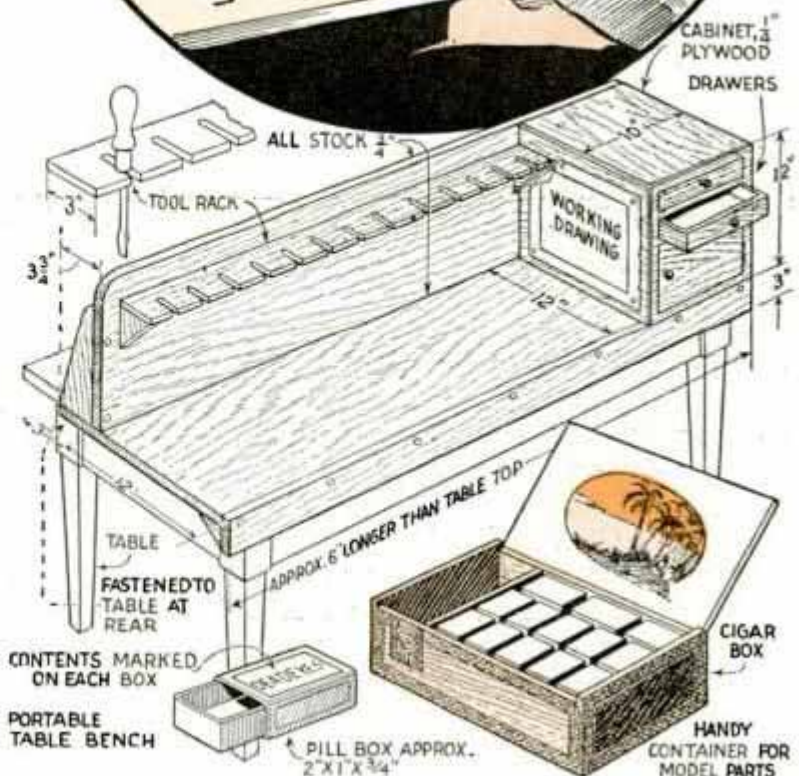

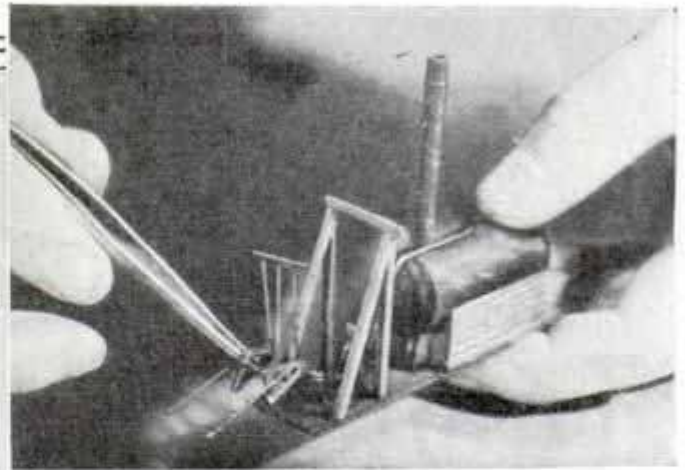
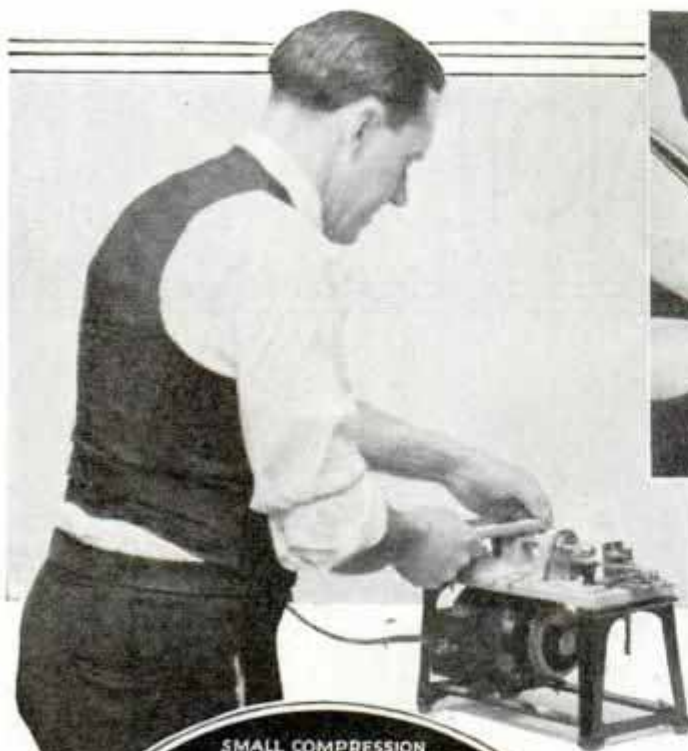

set of small wood-carving chisels and ordinary carpenters' flat chisels in $\frac{1}{4}$, $\frac{1}{2}$ and 1-in. sizes. In addition, a block plane, a 2-in. spokeshave and a good jackknife should be purchased. A 6-in. steel machinists' scale, a pair of small outside calipers and a pair of dividers will take care of most measuring. Sandpaper of different grades may be purchased as needed.

The suggested list of tools will serve for almost all average model projects in wood and for many operations in soft metals, such as soft brass, tin and steel. In model-railway construction, however, a small screw-cutting bench lathe is necessary. For grinding tools and stock, a double shaft bench grinder—with coarse and fine wheels—is essential. Likewise, the accuracy and speed of a bench drillpress will more than balance the modest price at which a good standard make can be purchased. Other metal-working equipment includes a machinists' hammer and some assorted files.

There has been placed on the market recently another machine for working wood and soft metals that entirely eliminates many tedious hand operations and delivers accurate work in a fraction of the time ordinarily required to make and duplicate model parts. As illustrated, this midget machine combines a small, high-speed circular saw and a miniature wood-turning lathe on a common base. A light jig saw, a drillpress, disk sander, planer, extension rest (for turning ship-model spars) and a routing device also are available as attachments with this machine. Thus equipped, the model maker has practically a universal assortment of power machinery suitable for making a wide variety of

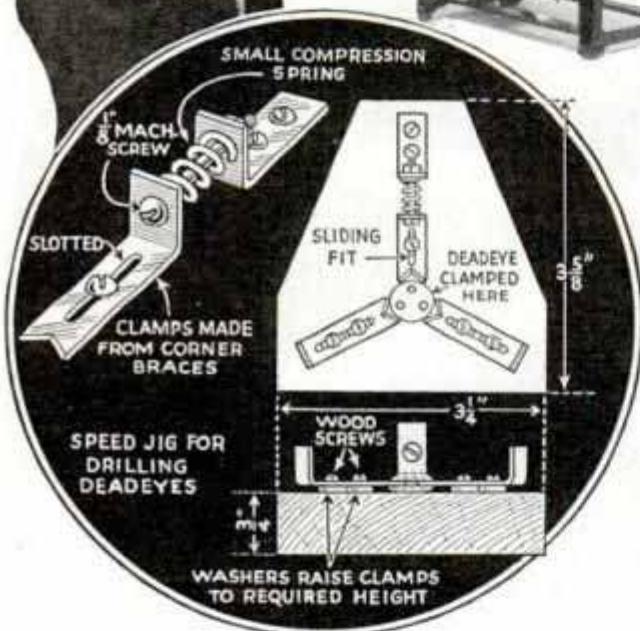

in a closet. The dimensions given are only approximate and the individual can make the unit either larger or smaller according to his requirements. A vise can be clamped on one of the projecting bench ends.

An assortment of hand tools includes a 4 or 6-oz. ball-peen hammer, a jewelers' saw with assorted blades, electric soldering iron, light tin snips, small needle-nose pliers, 4-in. machinists' tweezers, a fine nail set and twist drills from $\frac{1}{4}$ in. down to about No. 80. A lightweight hand drill and one or two sizes of pin vises should handle most drilling operations. Die sinkers' files in a variety of teeth and shapes are very useful for reaching into corners where a larger file cannot be used. Cutting tools for woodwork are covered by a

Wm C. Roemey.com

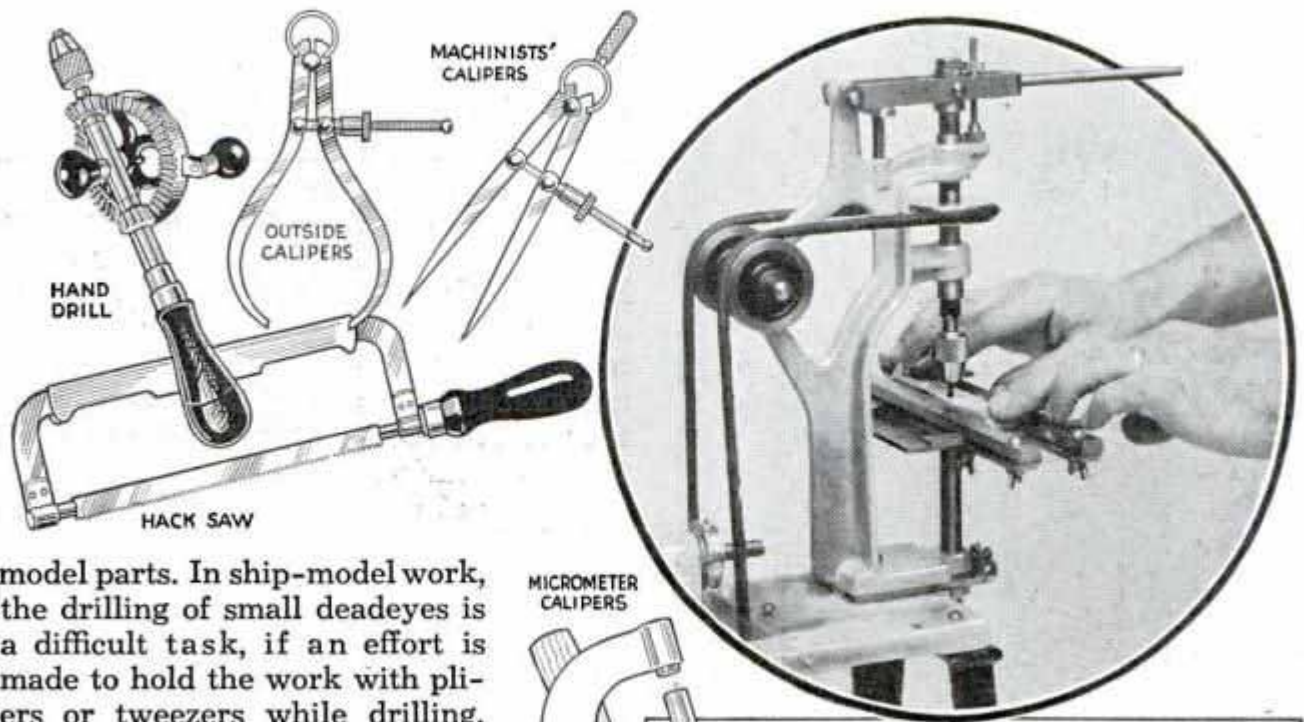

model parts. In ship-model work, the drilling of small deadeyes is a difficult task, if an effort is made to hold the work with pliers or tweezers while drilling. The simple speed jig illustrated, provides a solution to the problem and is constructed easily. As will be seen, the jig is adjustable both horizontally and vertically to accommodate the most-used sizes of deadeyes and, once set for a given size, it assures faster and more accurate work even though the drilling is done by hand. The same jig is suitable for drilling blocks and other parts by replacing the clamps

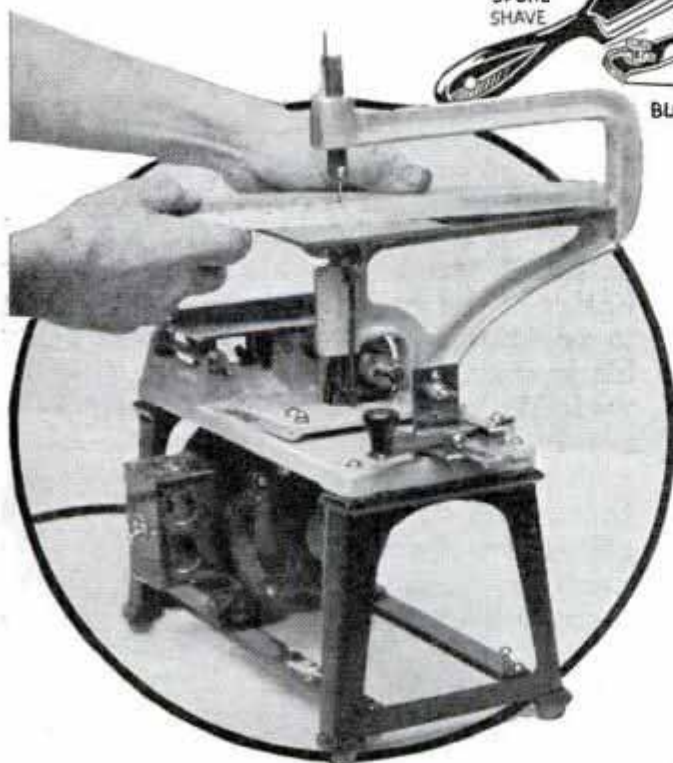
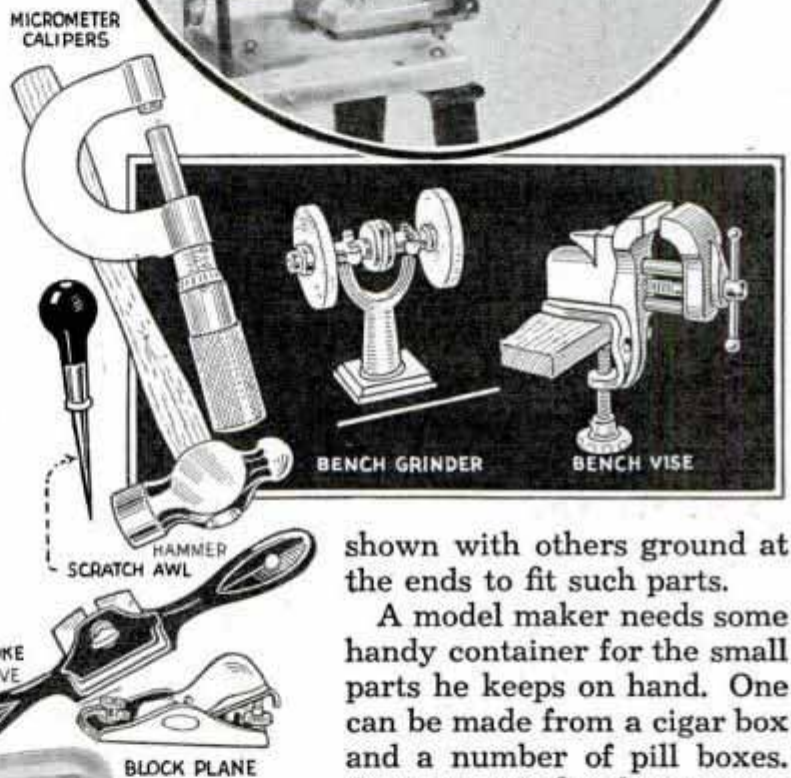

shown with others ground at the ends to fit such parts.

A model maker needs some handy container for the small parts he keeps on hand. One can be made from a cigar box and a number of pill boxes. A partition is fitted across one end of the cigar box—the location depending upon how many of the pill boxes are used—to provide a compartment for materials that are too large to be placed inside the small boxes. The tops of the pill boxes are lettered to identify their contents. When buying tools other than those suggested, the model maker should be careful not to over-specialize by purchasing items restricted to one or a few uses. Likewise, if choice is optional between a large tool that will do reasonably fine work and a small tool suitable for the work only, the former is preferred. In this way, a tool assortment is available for other larger jobs that a craftsman may want to do between model projects.



Process Developed at the University of Minnesota Enables You to Prepare Bordeaux Mixture Quickly

Preparing Bordeaux Spray Mixture

By a new process developed at the University of Minnesota, you can prepare Bordeaux mixture more quickly and with less equipment than by the old method. To make it in a 100-gal. tank, first fill the tank one quarter full of water. Then put finely pulverized copper sulphate, 8 lbs., in the intake strainer so that the inflowing water will wash it into the tank. While the water is being added, agitate the solution by means of a suitable lever or paddle. When the tank is three-quarters full, add dry, chemically hydrated lime (containing 70 to 73 per cent calcium oxide), 8 lbs. This is done by pouring it through the intake strainer with flowing water while the contents are being agitated. Where calcium arsenate, Paris green or arsenate of lead is to be added, for controlling chewing insects, it should be made into a thin paste and added to the mixture in the amounts recommended on the package. Water is added until the tank is full, after which the mixture is agitated one minute longer. The spray then is ready for use, and, as it deteriorates rapidly after the sulphate and lime solutions are united, it should be used as soon as possible.

Use of a lathe bed as a substitute for an anvil quickly destroys its accuracy.

Grooves in Screwdriver Blade Prevent Slipping

If a screwdriver slips when driving large screws, take a three-cornered file and make several shallow grooves across the blade as shown. Practically the same result may be had by roughing the blade with the point of a center punch, making a number of depressions on each side of the blade to raise the metal.

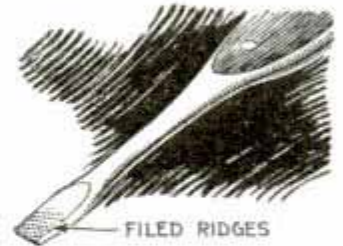

Quick-Acting Tripod Clamp

This clamp will save much time for the photographer, as one single movement of the handle will either lock or unlock it. The side pieces are formed from a piece of thin steel about $\frac{3}{4}$ in. wide and the lever arms are made from $\frac{3}{16}$ -in. steel rod. The eccentric may be made from $\frac{3}{8}$ -in. brass rod. The holes in the brass pieces must be drilled perfectly true and slightly off center as the eccentric action forms the lock.

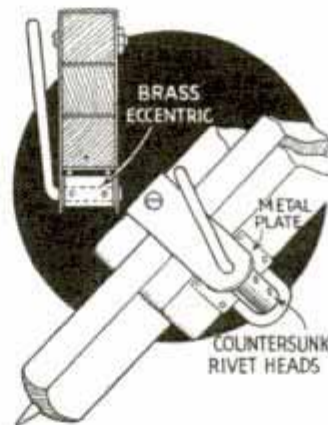

Sidewalk Signs Anchored with Weights

Having no further need for a pair of cast-iron weights to hitch his delivery horses at the curb, a merchant used them to prevent his sidewalk signs from being blown over. As the weights were already provided with rings for attachment of tie straps, it was only necessary to drive a screw hook into the bottom of each sign frame to hold the weight as shown.



All-Purpose STUDIO CAMERA STAND

By W. J. REED

IN my daily use of the well-known type of three-castered camera stand, with which so many photographic studios are equipped, I made a few improvements that greatly increased its utility to meet modern requirements.

The stand originally was made to permit a camera height of 4 ft., but by adding extensions on the two parallel uprights, a full range of adjustment up to 9 ft. was obtained. To do this, first remove all devices under the camera bed except the shaft with gears, which is attached to the hand wheel. Then attach two thin steel plates, drilled for six screws, to the

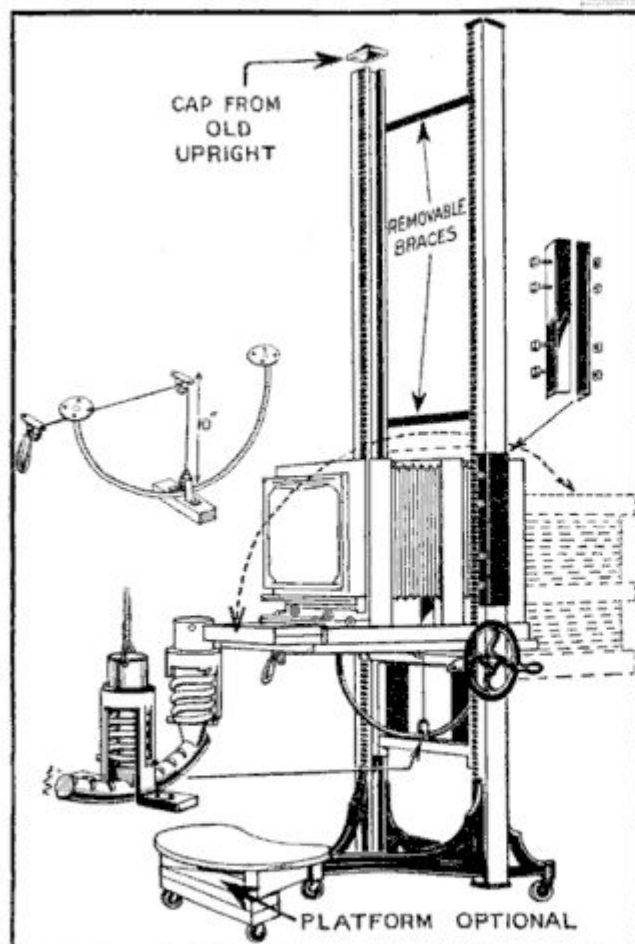
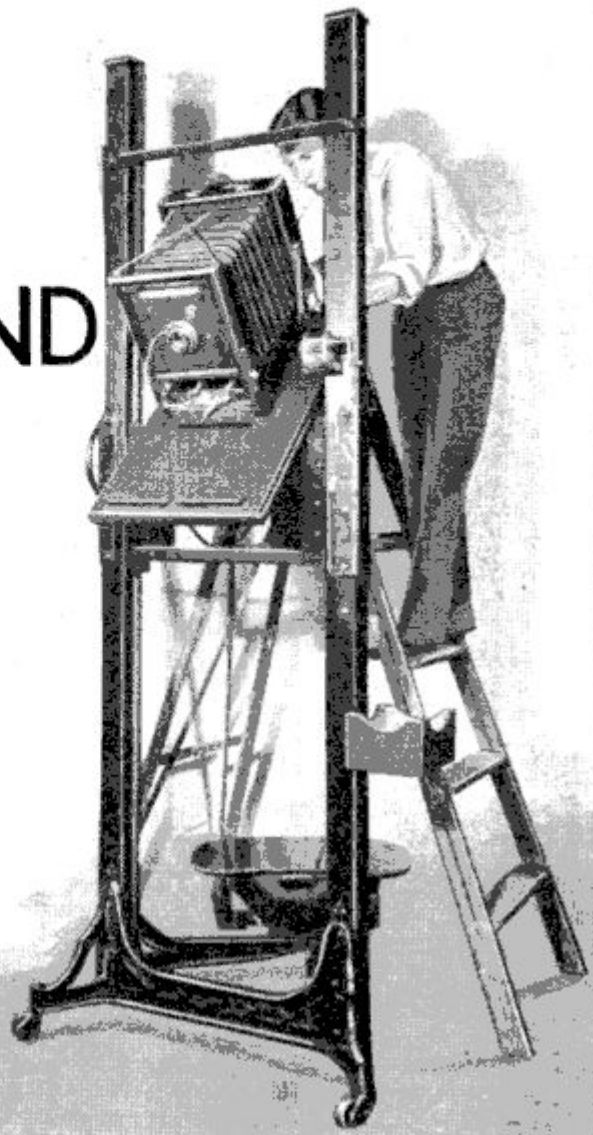

sliding frame to make it more rigid. To lengthen the upright, have two pieces of wood grooved and trimmed to the same size as the uprights. You can make these extension pieces any required length; 40-in. pieces will give a range of height up to 7½ ft. They are attached with 14-in. lengths of 2 by 2-in. angle iron, drilled for bolts as shown in the detail. When attaching the extensions, remove the caps from the old uprights. These can be used to finish off the new ones. Two racks, with which the gears engage, are purchased from a supply house. These should be just as long as the extensions, and must be mounted carefully so that the gears will track easily. Strips of paper may be used to shim the racks at points where the surface of the wood varies. To increase the rigidity of the extension pieces, flat-iron braces are attached with thumbscrews.

To turn the camera in a vertical position for photographing objects on the floor, you

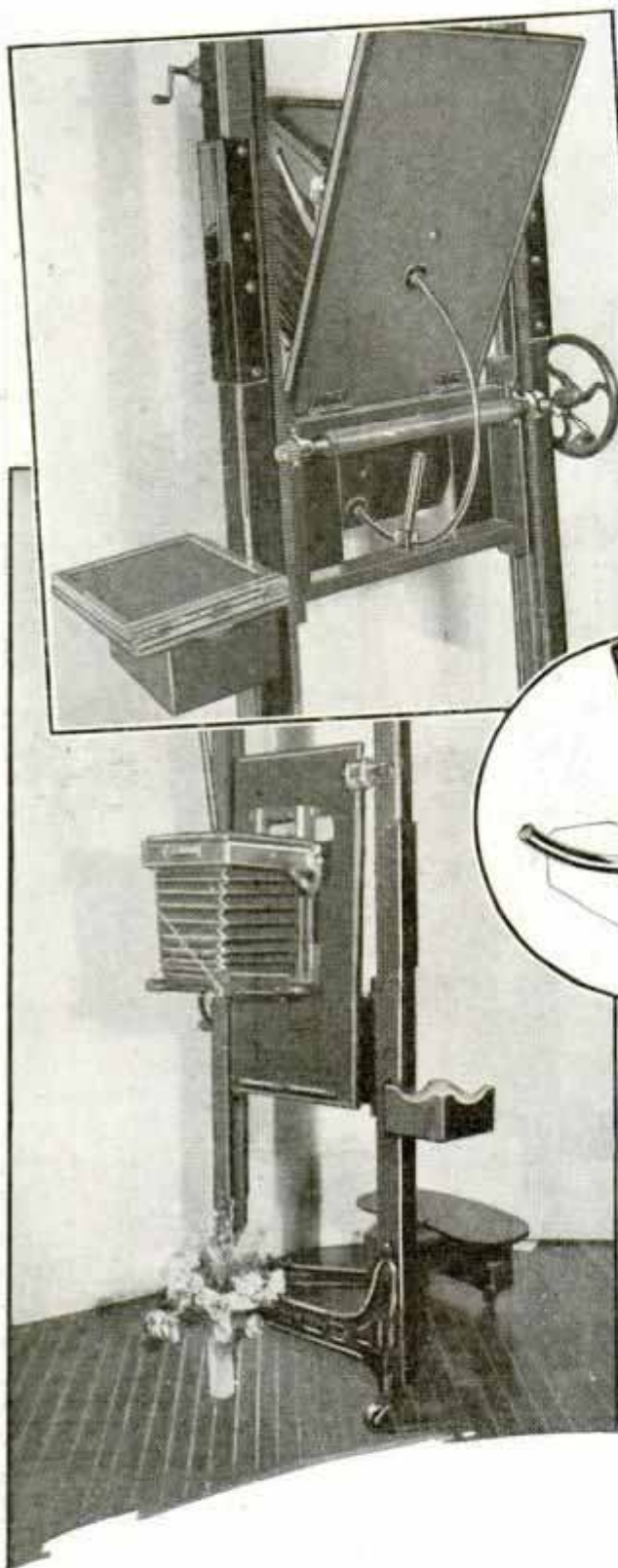

can make a tilting attachment. It consists of a piece of $\frac{1}{2}$ -in. iron rod bent to a semi-circle having a 10-in. radius. The ends are fitted with flanges to facilitate attachment to the bed of the camera stand. To hold the camera at any desired angle, notches, spaced $\frac{1}{4}$ in. apart, are filed in the rod as indicated, and a stationary finger, under spring pressure, is arranged on a cross-piece to fit the notches. The finger is a

steel rod ground or filed to an edge to fit the notches. It is held in a piece of pipe cut as shown, with the ends bent at right angles and drilled for screws, with which it is attached to a crosspiece located just below the notched rod. A small coil spring retained by a pin, forces the finger against the rod. A length of wire is attached to the top of the finger and is carried over two small pulleys to a handle. When this is pulled, it lifts the finger and allows the camera to be tilted.

How to Prevent Wood Rot

As moisture is a common cause of wood rot, the prevention is to keep it out, or, if this is not possible, to provide good air circulation around the wood so that the moisture will evaporate. When making a wood frame that is to be exposed to the weather, coat the insides of the joints with white lead before assembling in order to seal them against moisture. The outer surfaces, of course, should be kept painted. The bot-

tom ends of screen and sash stiles, where end grain is exposed, should be protected with paint. In building a porch, always be sure to provide for air circulation underneath the floor when it is finished. When setting porch columns, a better job will be had if the bases are cut out at the bottom so that they rest on a small part of the column at each corner, which should be coated with white lead at the points of contact. In cold weather, moisture condenses on window-panes inside the house and runs down between the glass and the wood, where it causes rot. If the panes are bedded in a small amount of putty when placed in the sash, water will be kept out. On the outside of a house where the bottom rail of the sash contacts the window sill, be sure the sash fits tightly on the inside, leaving a $\frac{1}{8}$ -in. space between the outer edge of the sill and the rail. The reason for this is that it is not possible to fit a rail so tightly that water cannot enter under it, therefore the space allows air to enter and evaporate the moisture.—John Hyler, Peoria, Ill.

Threading Machine Is Made from Car Parts

A used Chevrolet transmission and other auto parts, plus a few hours labor, provided the owner of a repair shop with a three-speed threading machine at a very slight cost.

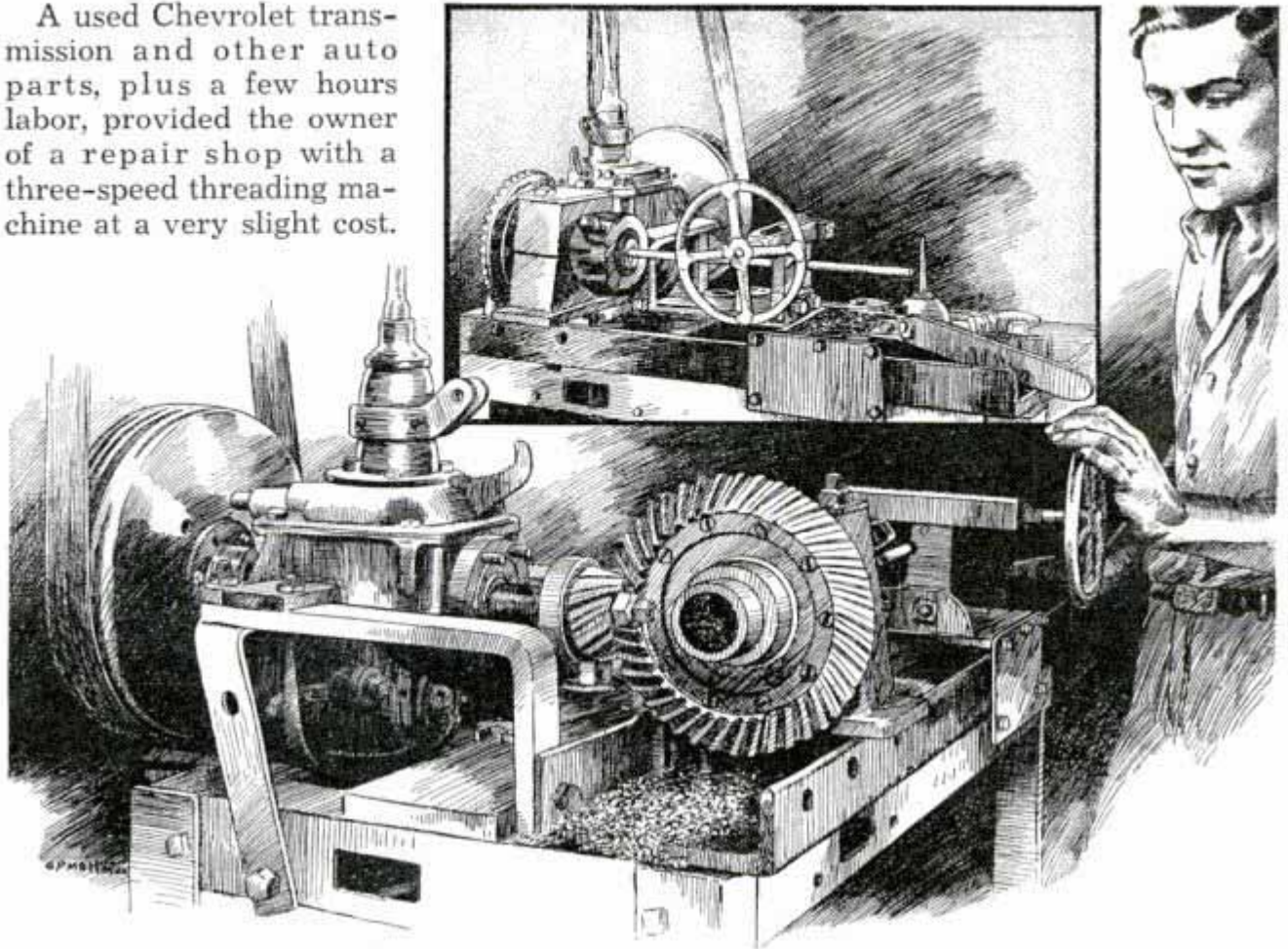

The shaft ahead of the transmission is fitted with a pulley, which was made from a brake drum, the latter being wound with tape to give proper friction with the drive belt, while the drive shaft at the other end of the transmission was cut off near the pinion, and the latter section welded to the transmission shaft, leaving out the universal joint. The pinion meshes with the ring gear, which is riveted to a die chuck made from the hub of an old tractor. The threading unit turns in a hardwood bearing, the bolts of which extend through a section of 8-in. channel iron forming a track for a moving clamp that holds the work to be threaded. The clamp is made of $\frac{1}{2}$ -in. iron and fits over the flanges of the channel iron. To the top of the clamp is bolted loosely an 8-in. U-shaped bar, through which a small hand-wheel is threaded with which to set the clamp bars. This gives quick adjustment and release of the work. A small cog bar then is bolted to the base of the channel beneath the carriage, which has a drop latch for moving the work forward.

Cigarette Lighter Improves Bunsen Burner

If you have an old cigarette lighter lying around, it can be used to good advantage as a lighter for your bunsen burner. The top part of the lighter, comprising the flint and scratch wheel, is removed and is soldered to a clamp made of sheet metal. This is fastened to the burner near the top so sparks from the lighter will ignite the gas.

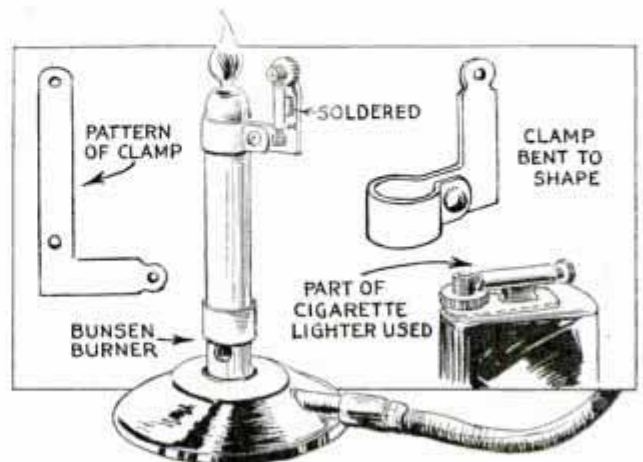

Old Cigarette Lighter Soldered to Clamp Provides Good Lighter for Your Bunsen Burner



Feed Boxes That Can Be Moved Where Needed Are Made Easily from Small Oil Drums

Portable Feed Boxes for Live Stock

Made from small oil drums, these feed boxes are sanitary and will be found convenient for feeding cattle and horses outside of the barn. Drums of 5 or 10-gal. capacity are cut as indicated by the dotted lines, one half of each end being removed, and one side bent to hook over a fence board, or other support. The other side is rolled to eliminate the sharp edge.

Piece of Hose Serves as Sanding Block

A short piece of garden hose will serve as a sanding block for finishing work of almost any shape.

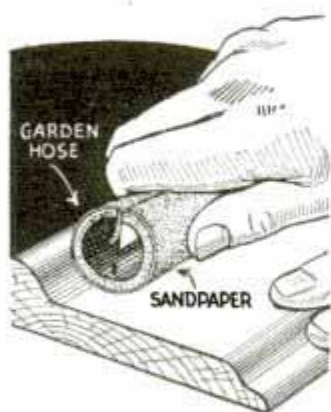

The hose is split along one side, after which a piece of sandpaper is wrapped around it and the ends folded down into the slot, where they are held by squeezing the hose together. A sander of this kind has an

advantage over the usual type in that the paper can be changed, or shifted quickly, to expose an unused portion to the work.

Emergency Label Moistener

When it is necessary to affix a number of gummed labels or stamps, and no moistener is at hand, place an ink bottle in a shallow can cover that has been half filled with water. The bottle will roll easily in the pan and the labels or stamps may be moistened rapidly on its rotating surface as shown in the accompanying illustration.



Can Amplifier for Extension Phone Bell

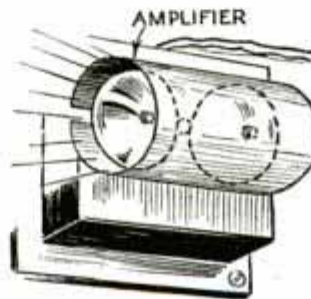

In garages or shops, where an extension telephone bell is placed in the workroom, the noise of machinery sometimes prevents the call from

being heard. This trouble may be eliminated by cutting a slot in a baking-powder can and slipping it over the bell as shown.

"Cellophane" Sack and Funnel Used as a Flytrap

An emergency flytrap may be made from a tin funnel, a Cellophane sack, and a few spring-type clothespins.

The sack is inverted over the funnel spout as shown, and drawn down snugly around the cone part, where it is held with short strips of tape or gummed paper. The clothespins are clipped around the rim of the inverted funnel to raise the trap so that flies can enter to get the bait, which may be sirup or sweetened water.

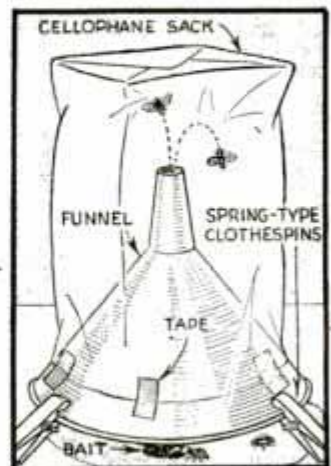

Homemade Electric Drill for Model Makers

Chicago
Pedersen Bros. Tools Supply
625 W. Washington
Chicago



Assembled from a small electric motor, such as one taken from a fan, mixer, movie projector or other device, this small, electric drill is ideal for model makers. Motors of this size are not suitable for heavy work, but will handle drills up to $\frac{3}{16}$ in. in size. Parts for the handle usually can be found in any workshop. In this case, the handle consists of two lengths of flat iron cross-braced with a U-shaped piece and screwed to the sides of the motor, a wood grip being riveted between the upper ends. A standard 110-volt toggle switch, available at a radio store, is mounted on the handle within convenient reach. The drill is equipped with a three-jaw chuck, which may be purchased

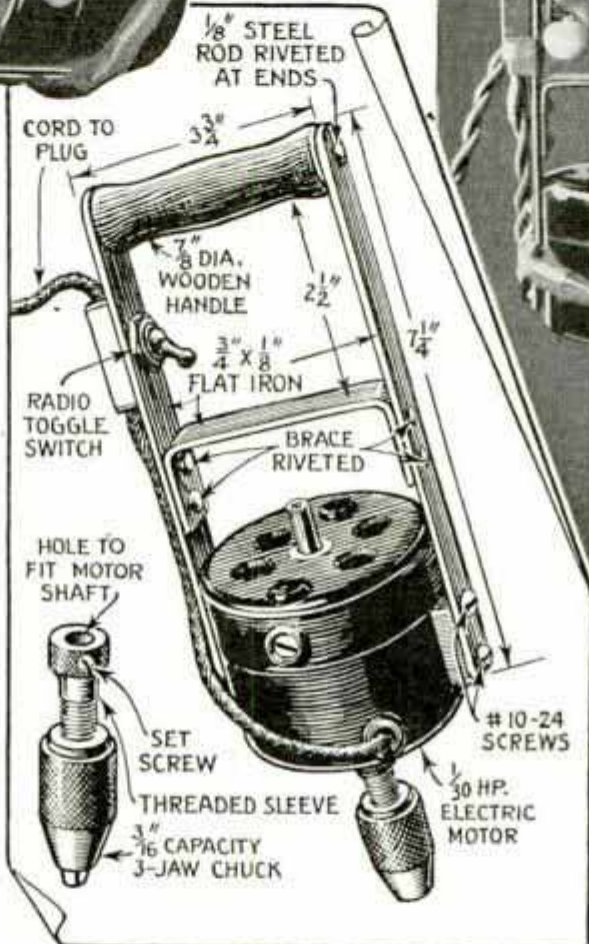

at low cost from stores dealing in machinists' tools. It is attached to a sleeve which fits on the motor

shaft and is held in place with a set screw, as shown in the lower detail.

Threading Tool Is Set in Lathe without a Center Gauge

When a center gauge is not at hand to set a threading tool in a lathe, try the following method: First, set the compound rest at a 60° angle, run in the cross feed, and adjust the threading tool so that one tapered side of the point rests snugly against the tailstock spindle, as shown in the illustration, with no light showing between them. Then tighten the tool and set the compound rest at zero.

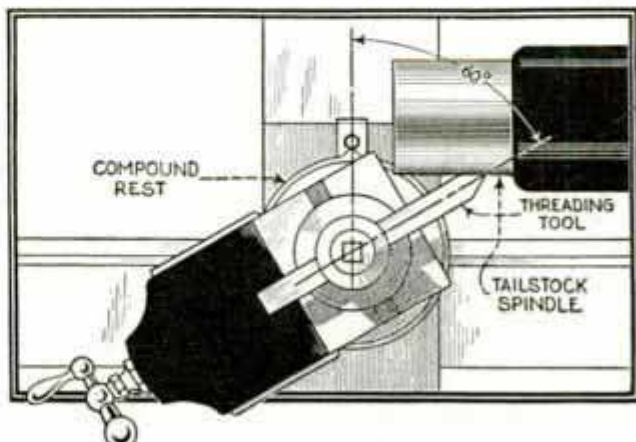

Simple Method of Setting a Lathe Threading Tool When No Center Gauge Is at Hand

☛ Corn meal will be found helpful in removing grease from the hands if rubbed on after working up a lather with soap.

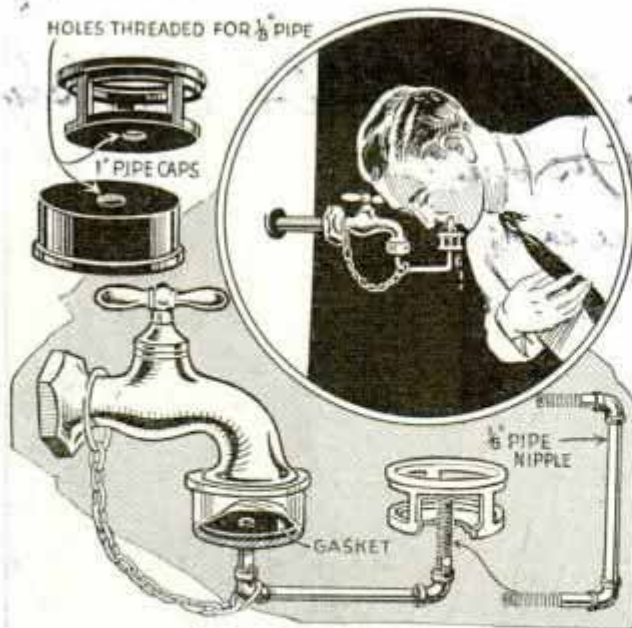

Owner of Filling Station Improvises Drinking Fountain from Pipe and Fittings for His Customers

Sanitary Drinking Fountain Made of Pipe and Fittings

Needing an inexpensive drinking fountain to accommodate his customers, the owner of a filling station made one from pipe nipples, elbows and two caps. After sawing out three sections from the sides of one cap, both of them were drilled and tapped to screw on the threaded ends of the nipples as in the above illustration.

A Hint on Using Slender Files

When using a slender file, the work is ruined sometimes because the necessary pressure that must be put on the ends of the file to make it cut bows it slightly in the center, thus causing the edges of the work to be rounded. To remedy this trouble and enable the work to be done with full strokes and a maximum pressure, the file may be grasped as shown. The pres-

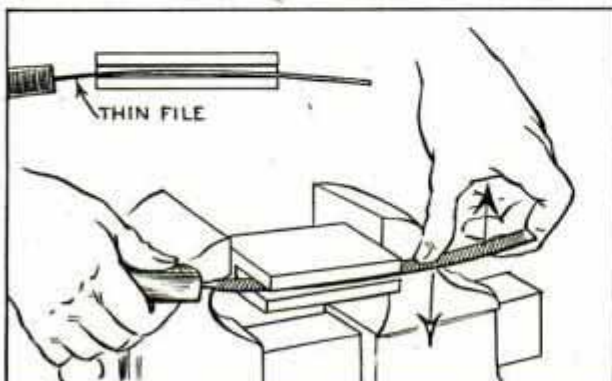

How to Hold a Slender File to Prevent It from Bowing Up in the Center

sure of the forefinger and thumb being exerted in the direction shown by the arrows, bends the file to a sweep or curve, thus causing it to file flat across the work.

Boat Cleat Provides Handy Holder for a Padlock

When a padlock is used on a door that must be left open at intervals, the problem of what to do with the lock, while the door is open, is solved with a small boat cleat. This is screwed to the door casing within convenient reach, and when the lock is removed from the door, it is snapped over the cleat where it will be kept safely until needed.



Reel to Hold Friction Tape

To simplify unrolling and tearing off strips of friction tape, one may use a wire reel of the type shown. A wooden cylinder, drilled to receive the wire hub, is inserted through the core of the tape to make it roll smoothly, and a piece of sheet metal, crimped at the edges and drilled to slip over the handle, is held against it for tearing strips of desired length.

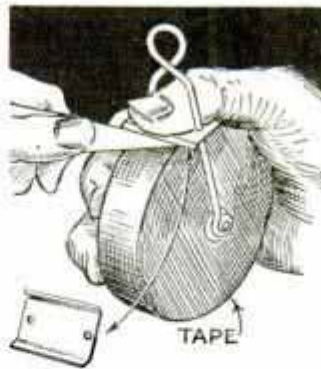

Opening a Shellac Jar

It often is difficult to open a jar of shellac after it has been used and re-sealed. To prevent this trouble, put the jar on a bench or table, bottom side up. Then with a straw or dropper, let a few drops of grain alcohol run inside the edge of the metal cover. The alcohol dissolves the dried shellac so that the top can be turned.

*Plumber - Carpenter -
Woodworker Tool Works,
222 S. Jefferson
Chicago.*

Homemade BANDSAW

from Pipe Fittings and Auto Parts

By R. E. MYERS

YOU can build this efficient ball-bearing bandsaw easily from standard iron-pipe fittings, two discarded model-T Ford front wheels, a single piston from the same car, and a few other pieces of scrap materials. The frame is assembled from 2-in. pipe fittings as in Fig. 1. First drill and tap the tees and the single elbow for $\frac{1}{4}$ by 1-in. set screws, placing these as in Fig. 8 to prevent the parts of the frame from shifting out of line. Screw the parts to-

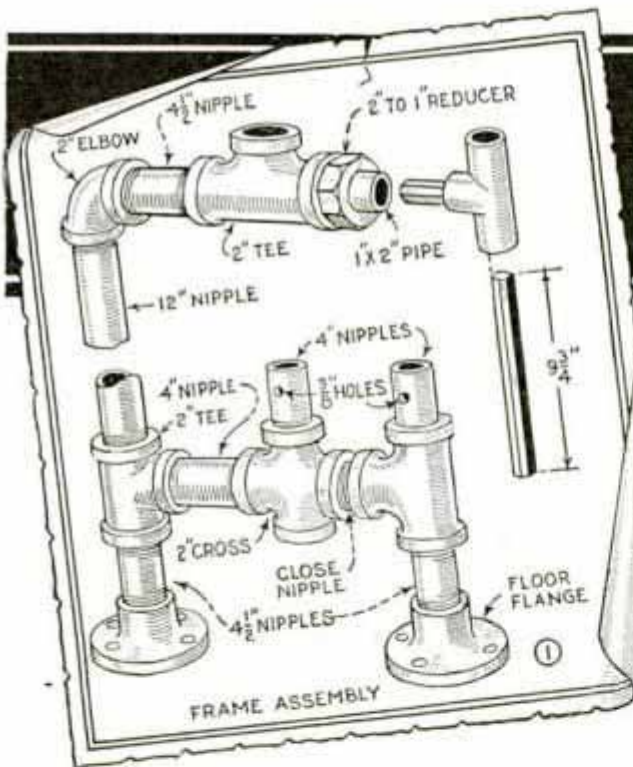

gether tightly, line up the upper arm with the lower cross member, and then tighten the set screws.

Next, you remove the spokes from the hubs of the two model-T Ford front wheels. Drive the outer flange up to the inner flange on both hubs, then with a hacksaw cut the spindle-bolt housings as shown by the dotted lines in Fig. 4. The exact size of the remaining portion of the housings is not important as filing will be necessary in fitting the spindles to the frame and the



upper slide. Two disks are cut from 1-in. birch plywood, each $12\frac{1}{2}$ in. diameter, and the center is bored out to fit over the wheel hub as in Figs. 6 and 8. Remove the hubs from the spindles and bolt the disks in place.

Now bolt the lower spindle to the frame as in Fig. 8. Make sure that the spindle is square with the frame both ways so that the wheel will run true. This will likely require some filing on both the spindle and the frame. Then fit the upper slide as in Fig. 8, from which you will see that a single bolt passes through the slide bar with a nut on each side; a set screw is tapped through the tee from the opposite side and bears against the lower end of the slide bar. Polish the bar so that the slide will move freely up and down. Fig. 3 dimensions the two parts of the slide which carries the upper wheel when assembled as in Figs. 5 and 8. Flat iron $\frac{1}{8}$ in. thick is used for both pieces. Bend the slide over a piece of $\frac{3}{8}$ by 2-in. iron to get the proper size and fit. Smooth the corners with a file

*Delta Specialty Milwaukee Wisc
1/66 1001011*

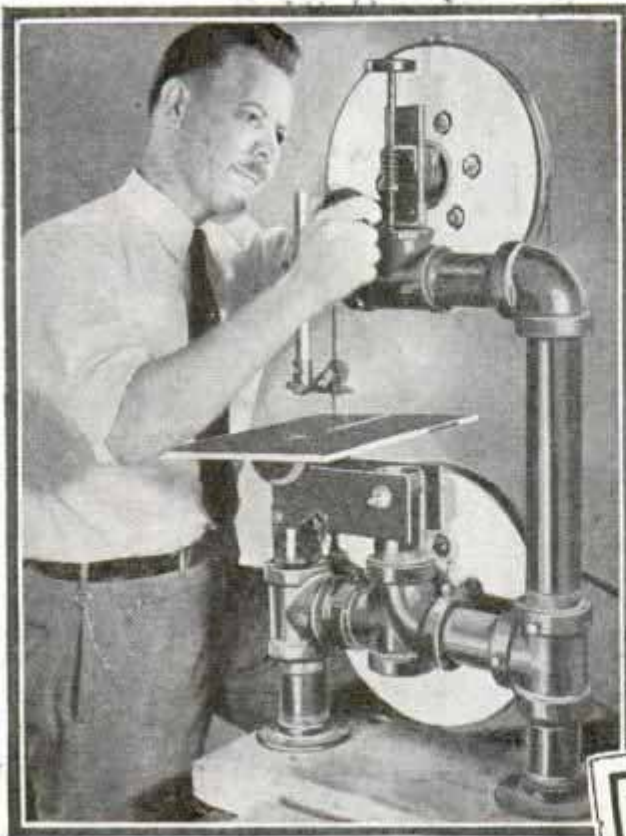

until the part slides easily on the bar that has been attached to the upper arm of the frame. The slide should fit the bar snugly so that there is no side play. Unless otherwise indicated, all holes drilled in these two parts are $\frac{3}{8}$ in. in diameter. The assembly complete ready for mounting is shown in Fig. 5. Two short lengths of $1\frac{1}{4}$ by $1\frac{1}{4}$ -in. angle iron are riveted to the back of the slide to form lugs for the handwheels. To make the latter, turn out two hardwood disks and drive these onto $\frac{1}{16}$ -in. carriage bolts. Or, you can use a rod of the same diameter and bend the end to form a crank. In either case the threaded length of the tension screw should be 7 in. and the tilting screw 4 in. The tilting screw is tapped through the angle-iron lug and is provided with a nut to lock the setting. The lower end of the tension screw bears on a spur attached to the bolt holding the slide bar as in Fig. 8. The tension spring is $2\frac{1}{2}$ in. long. The upper wheel spindle is attached to the yoke with a $\frac{3}{8}$ -in. cap screw tapped into the end of the spindle, and also a $\frac{3}{8}$ -in. stud, which is tapped into the flat section of the yoke as in Fig. 5. It is likely that some filing will be necessary to assure a true fit of the spindle housing against the yoke.

When the spindles are in place and lined up, mount the drive pulley on the lower wheel as in Fig. 6. The pulley should be turned from hardwood with a V-groove slightly less in width than the V-belt, which is used to drive. Belt to the motor and improvise a rest for a wood-turning chisel so that you can turn the wheel disk to a diameter of exactly 12 in., and crown the face slightly. Then attach the pulley to the upper wheel in the same way and turn to the same diameter, with the same degree of crown on the face. Replace the pulley permanently on the lower wheel. Cover the face or tread of each wheel with a 1-in. rubber band fastened on with the special cement made for this purpose. Both bands and cement may be purchased ready.

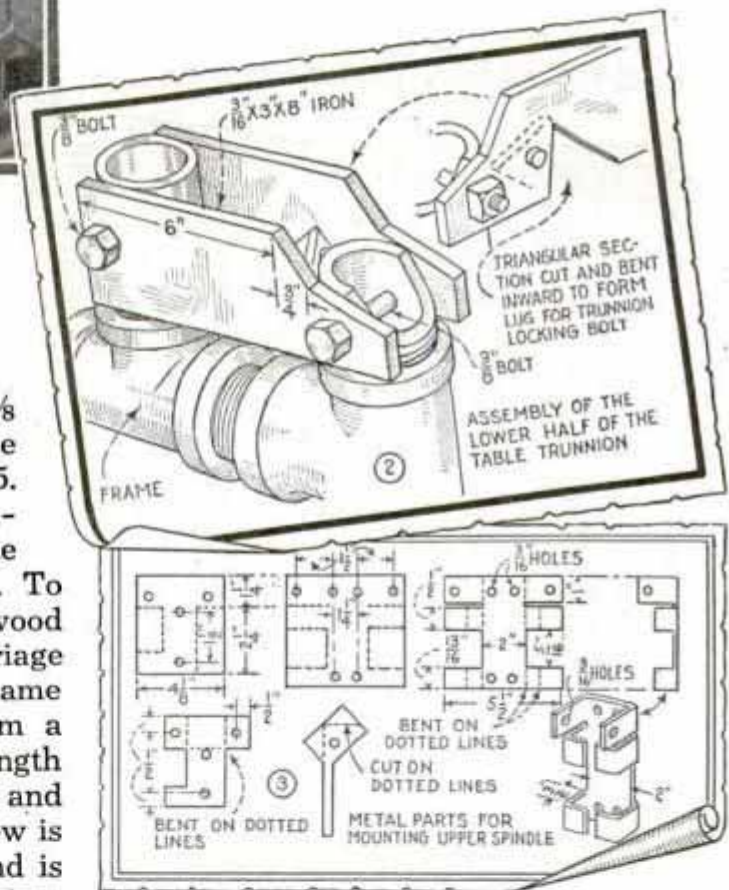

for use. The table trunnion, Figs. 2, 7 and 8, consists of two flat plates and a section cut from a model-T Ford piston as in Fig. 8. These three details show the construction of the trunnion clearly. The important thing is to position these parts so that when the table is tilted, the blade will remain in the center of the slot. To do this you first drill the plates at the ends, cut the piston and slot it as indicated, then clamp the whole table assembly in posi-

tion on the frame. Provide a wing nut for the trunnion screw so that you can loosen it quickly and easily when necessary to tilt the table. By placing a blade on the wheels you then can determine the correct location of the holes for the bolts holding the plates. Though not essential, it is better to cover the plywood table top with a sheet of 1/8-in. aluminum. This is slotted for insertion of the blade and is held in place with countersunk screws. If desired, the table may be made larger than indicated in Fig. 7.

Figs. 8 and 9 show the type of blade guides used above and below the table. The roller guide, Fig. 9, may be used also below the table in place of the pin guide shown. The upper and lower guides and the upper guide bracket shown in Fig. 1

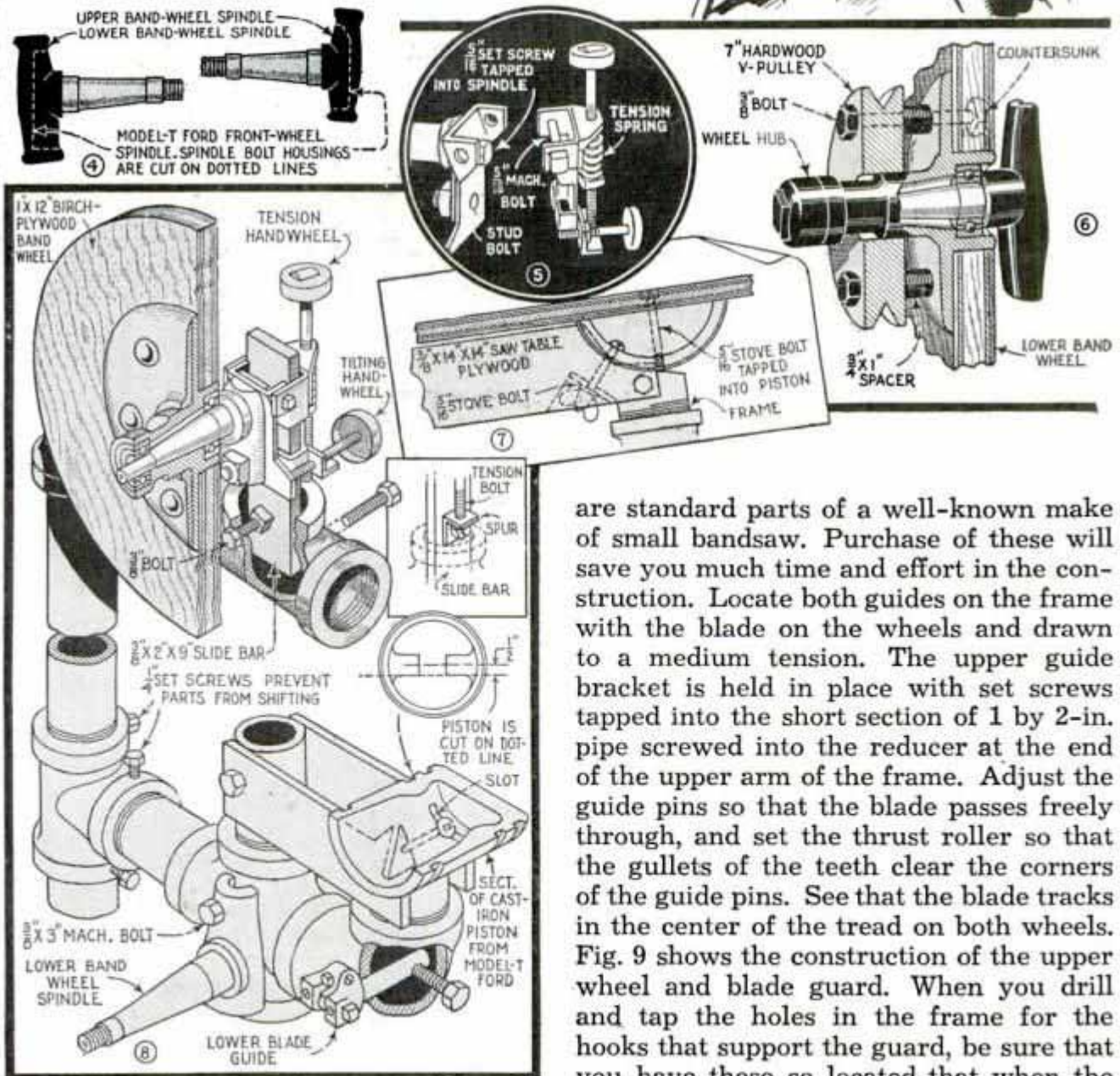

are standard parts of a well-known make of small bandsaw. Purchase of these will save you much time and effort in the construction. Locate both guides on the frame with the blade on the wheels and drawn to a medium tension. The upper guide bracket is held in place with set screws tapped into the short section of 1 by 2-in. pipe screwed into the reducer at the end of the upper arm of the frame. Adjust the guide pins so that the blade passes freely through, and set the thrust roller so that the gullets of the teeth clear the corners of the guide pins. See that the blade tracks in the center of the tread on both wheels. Fig. 9 shows the construction of the upper wheel and blade guard. When you drill and tap the holes in the frame for the hooks that support the guard, be sure that you have these so located that when the

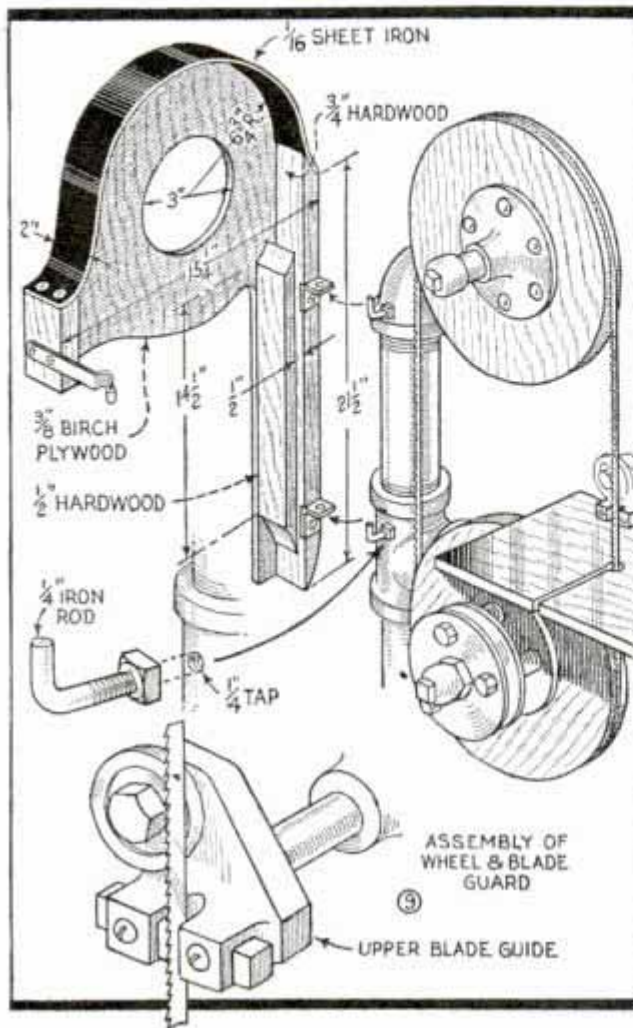

guard is in position the top will clear the upper band wheel by at least 1 in. This will allow sufficient space for the necessary up-and-down movement of the wheel. Blades for the standard 12-in. bandsaw can be used on this machine. These are 78 in. long, measured around the wheels, and come in widths from $\frac{1}{8}$ to $\frac{1}{2}$ in. Your machine should be mounted on a solid bench or stand and should be driven with a $\frac{1}{4}$ -h.p. motor of 1,750 r.p.m. Use a 2-in. V-pulley on the motor to give proper blade speed. When using the machine, the blade should be drawn just tight enough to prevent its vibrating when the machine is running. To get the proper tension adjustment, start the motor and draw up slowly on the tension screw until the blade runs smoothly through the guides.

An Effective Hole Filler

Having a number of small, irregular holes through the clapboards and outer wall of a building that I desired to close and make as inconspicuous as possible, I

filled them with a plastic cement made by mixing equal parts of Portland cement and asbestos boiler covering with water, to form a thick paste. This was rolled into a ball and forced into the holes. After allowing it to set for 12 hrs., it was smoothed off by scraping with a putty knife, and left to dry thoroughly. The asbestos and magnesia in the boiler covering tempered the cement and made it work smoothly and adhere firmly.—Charles A. Allen, Whitinsville, Mass.

Muslin Tents Protect Young Plants

Instead of using cans, jars and boxes as covers over young plants to protect them against either the sun or frost, make up a number of small muslin tents, which can be rolled up and stored when not in use. Strips of the muslin about 12 in. wide are hemmed at the ends and a V-cut made through the center of each hem. This permits the use of two small stakes at each end. When pushed into the ground at a wide angle, the stakes spread the muslin over the plants like a tent.



Strips of Muslin Stretched Tent-Fashion over Young Plants to Protect Them against Sun and Frost

¶To lower the freezing point of carbon tetrachloride in fire extinguishers to be used in cold climates, use chloroform, 10 parts, and carbon tetrachloride, 90 parts.

This Barrel-a-Minute Pump Has Many Uses

Anyone who has use for a small electric pump where the water does not have to be raised higher than 15 or 20 ft., can make one inexpensively from old auto parts. The pump may be used for draining small pools or for pumping water from shallow wells

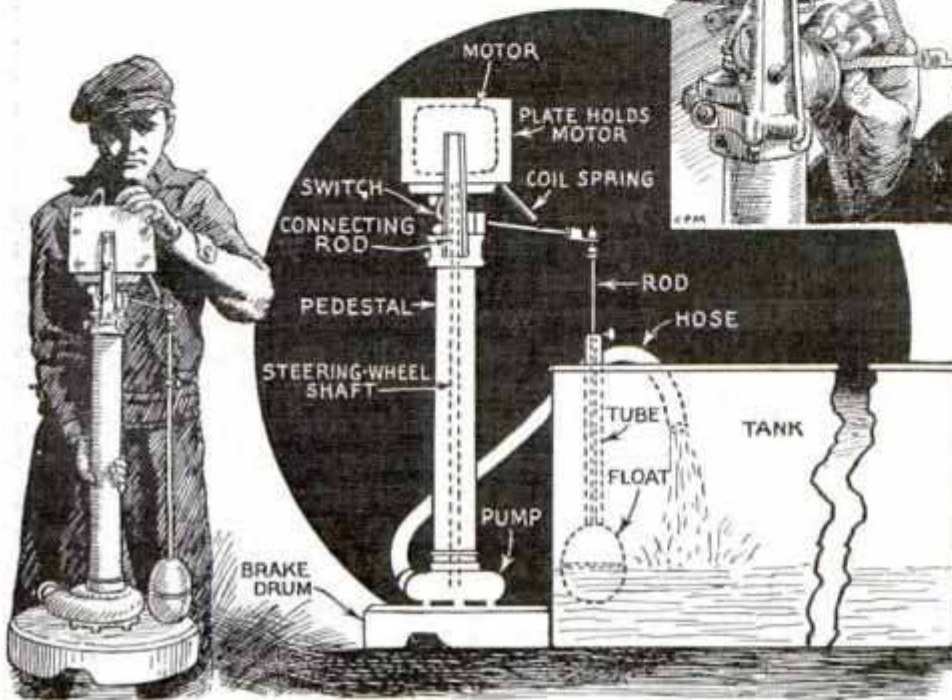

electricity is not available, as it can be driven with a small gasoline engine if a pulley is substituted for the motor, and a bearing provided for the drive shaft. Aside from the motor, the main part of the outfit is a water pump from a Buick car of the years 1918 or 1919. Other car pumps

and springs, and, as it is provided with a switch controlled by a float, it can be adapted to automatically keep basements drained in homes where there are no sewers to carry away the water during wet seasons. In addition to this, many uses for the pump can be found on farms where

will do, but are not as effective as this type, which has the impeller blades running close to the pump housing. In assembling the pump, it is attached to a pipe standard, and the motor is mounted vertically at the upper end. The motor is connected to a shaft which drives the pump.

Micrometer Anvil and Spindle Trued with Lapping Tool

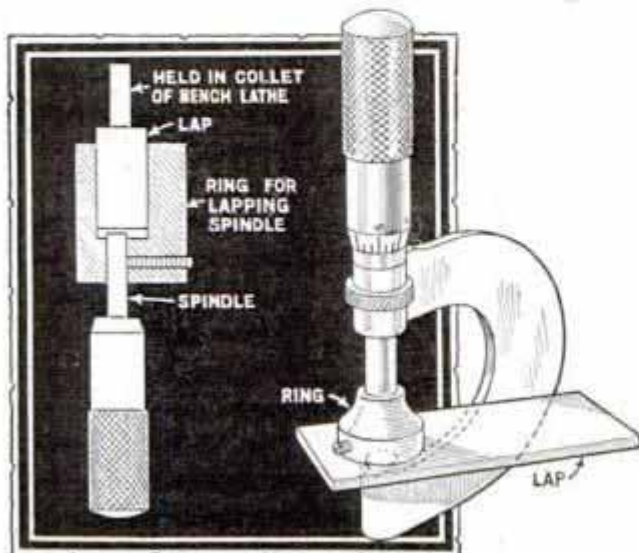

Unless the ends of the spindle and anvil of a micrometer are true so that they butt together perfectly, accurate measurements cannot be taken. To test for wear, bring the two parts together and sight between them. If they are worn, they may be lapped to true them up. For the spindle, the work is done in a lathe, using a steel ring and a lapping tool as shown in the detail. The anvil will have to be trued by hand. This is done with another ring and a flat lapping tool as shown. If the rings and lapping tools are made absolutely true, the repaired micrometer will be accurate. —Charles Kugler, Philadelphia, Pa.

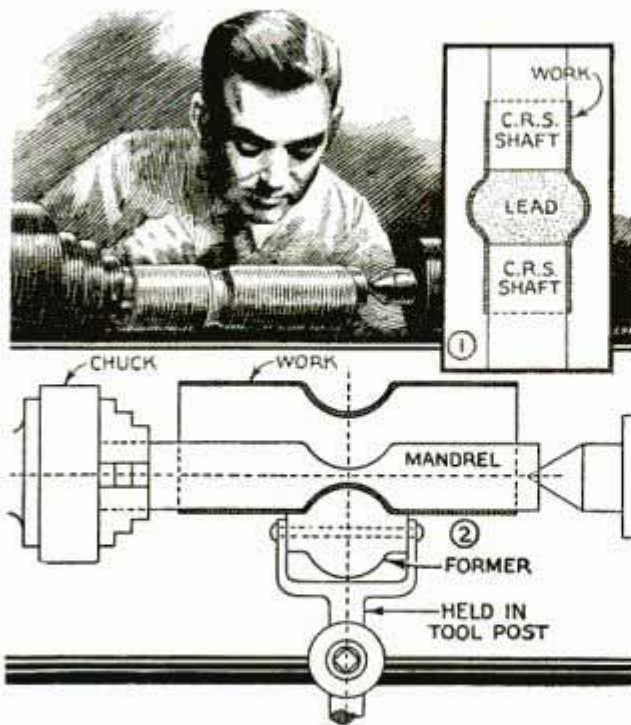

Methods Used by a Machinist for Forming Bulges and Grooves in Copper Tubing

Two Methods of Forming Copper Tubing

Here are two methods used by a machinist in forming copper tubing. Fig. 1 shows how a bulge is made by compressing lead inside the tube, between the ends of two steel shafts. One shaft is clamped in a vise after which the other is struck with a hammer until the desired bulge is obtained. The lead is removed by melting it. A depressed groove is made in the tubing by means of a former as shown in Fig. 2. The tubing is slipped over a small mandrel, especially made up for this purpose, and then chucked in a lathe, after which the forming tool, held in the tool post, is fed into the work until the required depth of groove is obtained. As the diameter of the mandrel is smaller than the tubing, there is no difficulty in removing the work. It is a good idea to anneal copper tubing by heating and quenching it in water before forming it.

Eliminating "Ring" in a Field Drum

The ringing sound that can sometimes be heard when using a field drum, can be eliminated with a small piece of friction tape. It is placed under the drumhead so that it forms a chord, in relation with the drum shell, and is fastened in position by pressing the flesh hoop over it.—Sherwood Jones, Northampton, Pa.

Accurate Brake Tester

If you are to have full control of your car and avoid bad skids or accidents, it is necessary that the brakes work equally on all four wheels. This can be assured only by adjusting them frequently, which you can do at no cost with the homemade tester shown on the opposite page. It consists of two pieces of hardwood pivoted together in the center, the ends of which are provided with adjustable, tapered handles. These are fastened to the pieces at right angles, as shown. A 40-lb. coil spring is fastened between the pivoted edges at one end, while a 16-in. scale, or a length of yardstick, is provided at the other. The scale, which is fitted with a "slider," is pivoted to one piece and slides through a screw eye driven into the other piece. To use the tester, adjust one set of handles to fit inside the wheel rim between the spokes and push the slider against the screw eye. With brake pedal depressed, and the wheel jacked up, put the tester in place and turn the wheel with it. Then note the scale reading as indicated by the slider. Follow this procedure on the other three wheels, adjusting the brakes so that all four will show the same scale reading.

Pail Serves as Swinging Hopper to Feed Poultry

In order to keep rodents from getting into dry mash fed to poultry, shallow pails and pans often are suspended a few



inches above the floor, but such containers have the disadvantage of being open at the top so that the chickens scratch litter into the mash. A better container, and one that will keep out rats, is made by cutting long slits in opposite sides of a pail an inch or two above the bottom. The metal above the slits then is bent in, as shown, to provide two openings from which the mash is accessible to the poultry.

Accurate BRAKE TESTER easy to make

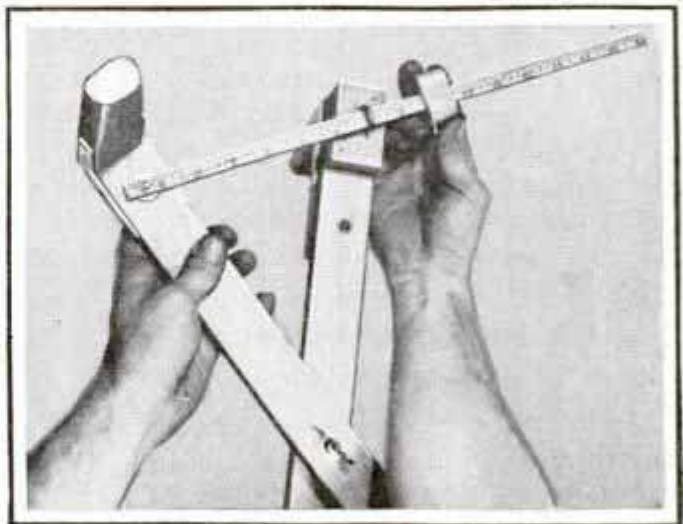
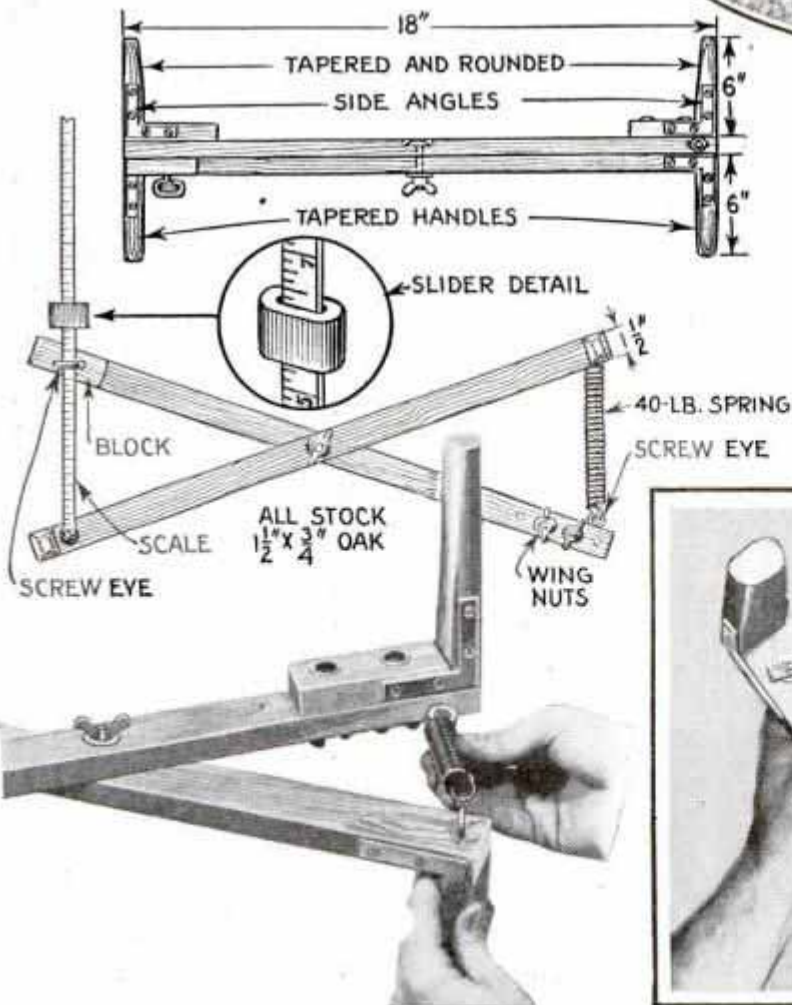
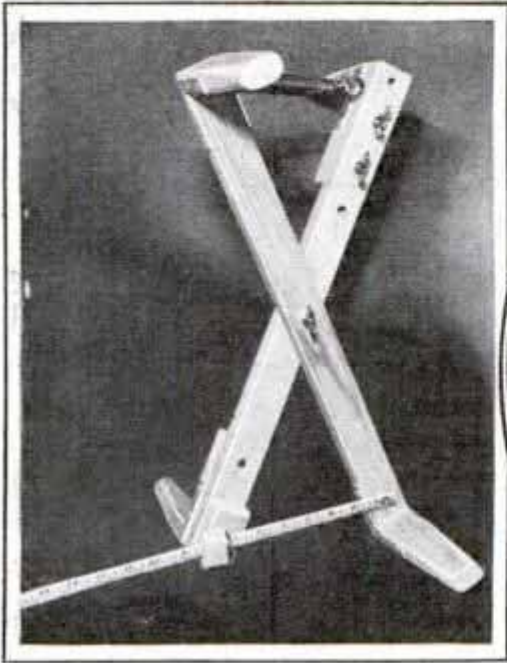

Old Inner Tubes on Garage Wall Protect Car Door

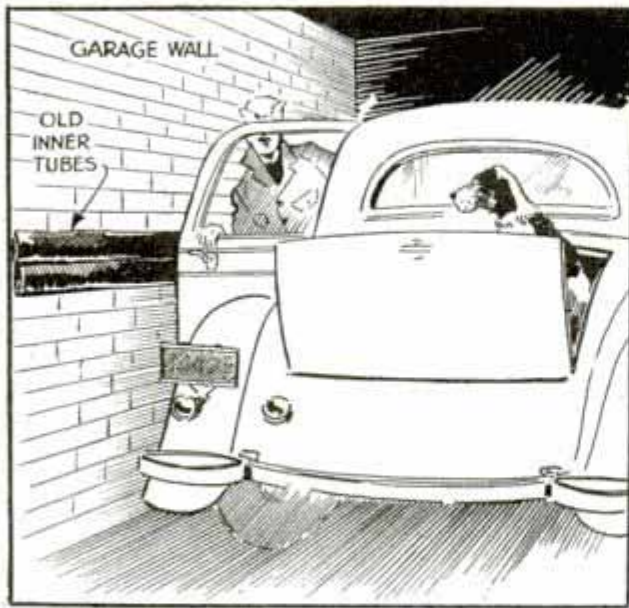

*Inner Tubes Stretched on Wall Protect Car Door
When Opened in Narrow Garage*

If your garage is narrow, or it is necessary to park the car close to a wall where the door sometimes strikes when it is opened, stretch two or three old inner tubes horizontally along the wall at the point where the door strikes. The tubes will provide a cushion for the door to strike against so that the finish will not be damaged.—A. H. Waychoff, Tempe, Ariz.

Repairing an Alemite Grease Gun

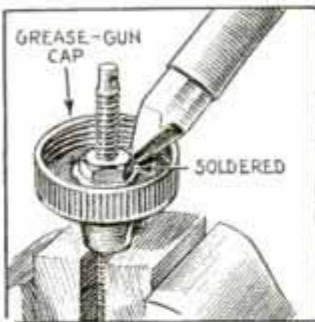

When the threads on the cap and plunger rod of an Alemite grease gun become worn, a repair may be made cheaply. The plunger is removed from the rod and a die is used to deepen the threads slightly, after which a nut is run on the rod to fit snugly against the inside surface of the cap, where it is soldered in place.

Loose Main Bearings Cause Noisy Timing Gears

Noisy timing gears are sometimes caused by worn main bearings which allow the crankshaft to drop slightly below its proper position in the motor. This causes an

increased amount of play in the teeth of the gears, permitting them to rattle, and in many cases, causing a distinct knock. Taking up the bearings removes this play, often quieting the gears to the point where a replacement will not be found necessary. The amount of play remaining in the gears after the bearings have been adjusted can be checked easily, from underneath, by grasping the camshaft with a pair of heavy pliers and rocking it back and forth.

Grease Preserves Horn Diaphragm

Car horns often rust on the front side of the diaphragm and prevent a clear, loud sound being produced. This is especially true of horns that are mounted outside the hood. Rusting can be prevented by applying a light coat of waterproof pump grease to the diaphragm each year. If the diaphragm is rusted already, clean it with fine sandpaper before applying the grease.

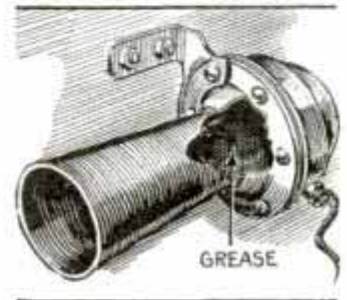

Tire-Deflating Tool Made from Nail

Mechanics in a tire-repair shop will find this simple deflating tool a timesaver when patching inner tubes. Besides deflating the tube, it serves to mark the location of the puncture until the patch is prepared. The tool is a large nail cut off near the head and pointed at the end. A hole drilled through one side intersects a second hole drilled through the nail transversely to let air escape from the tube.



The latch and catch of the much-used right front door on most cars is interchangeable with the one on the left rear door, which, in most cases is used very little, thus doubling the life of the one on the front door at no cost.

Emergency Test for Spark Plugs

A spark plug that fires perfectly when laid on top of the cylinder block and tested in the usual way, sometimes fails to fire under compression in the cylinder. A better method of testing a plug is to insert a strip of mica between the points to increase the gap. The mica must be perfectly dry and thick enough to be puncture proof from sparks. Still another method is to increase the gap an amount proportional to the compression pressures in the motor and then test the plug on top of the cylinder in the usual manner. Thus, if normal compression is 75 lbs., as shown by a gauge, add 15 lbs. in order to get the absolute pressure, and divide by 15 to determine the number of times the gap must be increased. In this example, the gap must be increased to six times its normal clearance, which in most cases is .025 in., making a gap of .150 in. If the plug fires regularly in open air at this setting, it is reasonably certain that it will fire in the cylinder when reset to .025 in.

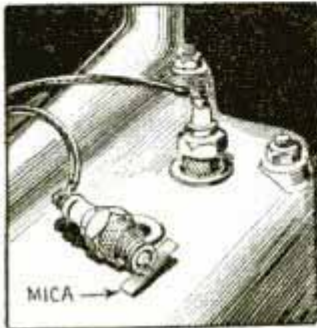

absolute pressure, and divide by 15 to determine the number of times the gap must be increased. In this example, the gap must be increased to six times its normal clearance, which in most cases is .025 in., making a gap of .150 in. If the plug fires regularly in open air at this setting, it is reasonably certain that it will fire in the cylinder when reset to .025 in.

How to Determine Whether Starter Spring Is Right or Left Hand

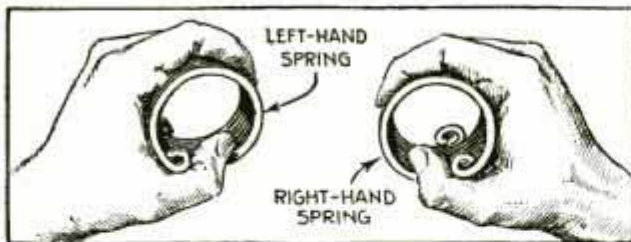

Broken Starter Spring Grasped in Hand, to Tell Whether It Is a Right or Left-Hand Spring

A broken Bendix spring on a starter sometimes causes doubt as to whether it is a right or left-hand spring. To determine this, grasp it in either hand, and if the loop on the end of the spring turns with the thumb of the right hand, it is a right-hand spring, but if it turns with the left thumb, it is a left-hand spring.

☞ Car radiator cleaners containing caustic alkali damage aluminum cylinder heads.

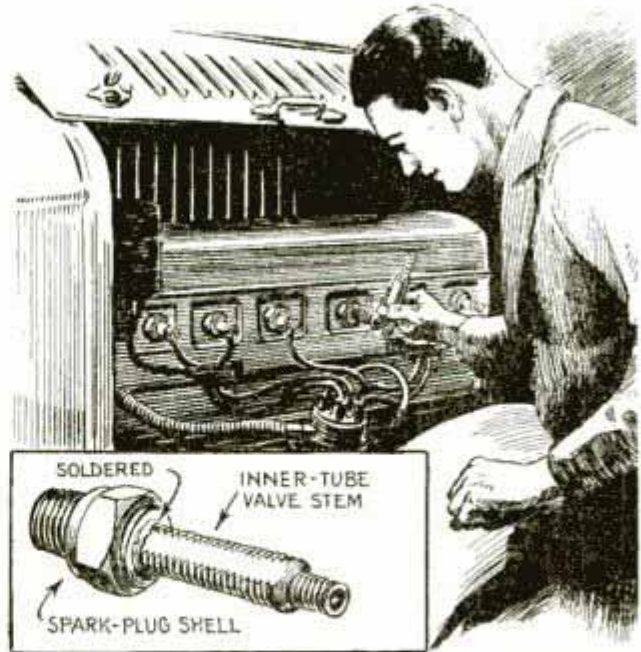

Valve Stem Soldered to Spark-Plug Shell for Testing Cylinder Compression with a Tire Gauge

Improved Tool to Test Compression of Auto Motor

If you suspect that some of the cylinders in your car motor have low compression, you can check them with this tool, which is made by soldering a valve stem into a spark-plug shell. In use, the tool is substituted for the spark plug in the suspected cylinder, and the compression is checked with a tire gauge as the motor is turned over with the hand crank. While this method is not absolutely accurate, it does serve to show up weak cylinders.

Air Vent Helps Empty Oil Jars Used at Filling Stations

Time can be saved in servicing cars at filling stations if an air vent is provided in the oil jars so that the contents will drain quickly. The vent is a small tube having one end extended almost to the bottom of the jar, and the other soldered over a small hole drilled through one side of the spout.

A few drops of oil may run out of the tube when the jar is first turned upside down, but this will run down the outside of the spout into the motor.

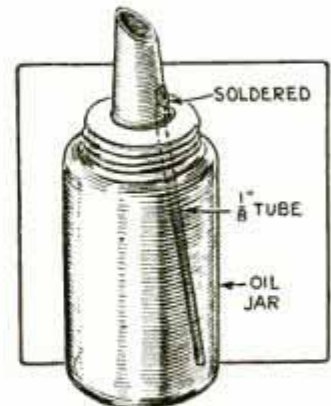

Bottles Fitted over Drawer Pulls to Get Correct Cork Size



Druggist Saves Time in Fitting Bottles with Corks by Using Latter as Drawer Pulls

To save time in opening a number of drawers to fit a bottle cork, one druggist uses corks of different sizes for the drawer pulls and tries the bottle over these to

determine the correct size. The corks are drilled lengthwise for wood screws, with which they are fastened to the drawers.

Sealing Wax Improves Shellac

By dissolving one or two sticks of good sealing wax in each pint of white shellac, the latter will take on a different character. When dry, it will be firm and not easily marred, yet it will retain its toughness. If special colors of sealing wax are used, the shellac makes a unique finish for objects ordinarily finished with enamel.



High-speed reamers will often work in metal so refractory or tough that carbon-steel reamers would fail utterly.

The Next Issue

RIDDING YOUR HOME OF INSECT PESTS

Ants, mosquitoes, moths and other common insect pests exterminated by simple and effective measures. Especially intended for the home owner, this article tells what preventive means are best, what preparations to make, how to make and bait traps, how to use gases, etc.

KEEN-EDGE RAZOR BLADES GIVE YOU PLEASURE

You won't mind the chore of daily shaving if you keep a real keen razor edge. Wrong stropping will ruin a blade, but—this story tells the right way.

TOURISTS' CABINS THAT GET THE BUSINESS

Comfortable and good looking, these light, airy cabins are just the thing that brings in tourist trade, and they can be built at a moderately low cost.

KEEPING GOLF CLUBS IN TIPTOP SHAPE

Keep your golf clubs in perfect condition! It's such an easy job to repair them yourself. Expert tells you methods of polishing, whipping and refinishing.

LIGHT, COMPACT FISHING BOAT

An 8-ft. dinghy, for fishing on week-end trips, that can be hauled on your car to lakes and rivers where boat-renting facilities are lacking.

MAKE
VACATION
DAYS
Travel days!



See the country's glorious beauty spots and famous historical places. Visit our great National Parks. Cross the Appalachians or the Rockies. Explore the battle fields where our heroes fought and died. Select your own routes — travel when you feel like roving — linger when you wish — with no set time tables or schedules to follow.

You'll be surprised how much ground you can cover at so little cost when you own a 1935 Harley-Davidson. You'll thrill to its speed, stamina and style. Don't wait — see your nearest Harley-Davidson dealer NOW!

Ask him for a Free Ride — let him explain his Easy Pay Plans — and send in the coupon.

MAIL THIS COUPON

HARLEY-DAVIDSON MOTOR CO., Dept. P, Milwaukee, Wis.

Interested in motorcycling. Send illustrated literature. Postage stamp is enclosed to cover mailing cost.

Name.....

Address.....

My age is () 16-19 years, () 20-30 years, () 31 years and up, () under 16 years. Check your age group.

Vacation with a
**HARLEY-
DAVIDSON**

When writing to advertisers please mention Popular Mechanics

SQUASH RACQUETS
JOHN L. SKILLMAN

DIVING
GEORGIA COLEMAN

SCULLING
BILL MILLER

**“THEY DON'T
GET YOUR
WIND”
ATHLETES SAY**

GENE SARAZEN, championship golfer, who has smoked Camels for years

The mild cigarette the athletes smoke is the mild cigarette for YOU!

• A cigarette so mild you can smoke all you want—that's what athletes say about Camels. And when a champion talks about "condition"—"wind"—healthy nerves—real tobacco *mildness*—he knows what he's talking about.

Listen to Gene Sarazen. "Traveling and playing as much as I do—I have to keep in condition. I smoke Camels steadily. They're so mild they never get my 'wind' or nerves."

Other athletes back him up. "I smoke all I want and yet keep in top condition; I smoke Camels and only Camels," says Mel Ott, home-run hitter of the

When writing to advertisers please mention Popular Mechanics

New York Giants. Georgia Coleman, Olympic champion diver, says: "Camels don't cut down on my 'wind.'" Bill Miller, outstanding oarsman; Jim Lancaster, N. Y. U.'s 1934 basketball captain; John Skillman, squash champion—hundreds of sports stars smoke Camels regularly and report that Camels never get their "wind."

What this mildness means to you!

It means you can smoke Camels all you want. Athletes have made this discovery: Camel's costlier tobaccos are so mild, they can smoke them as often as they please, without disturbing their "wind" or nerves.

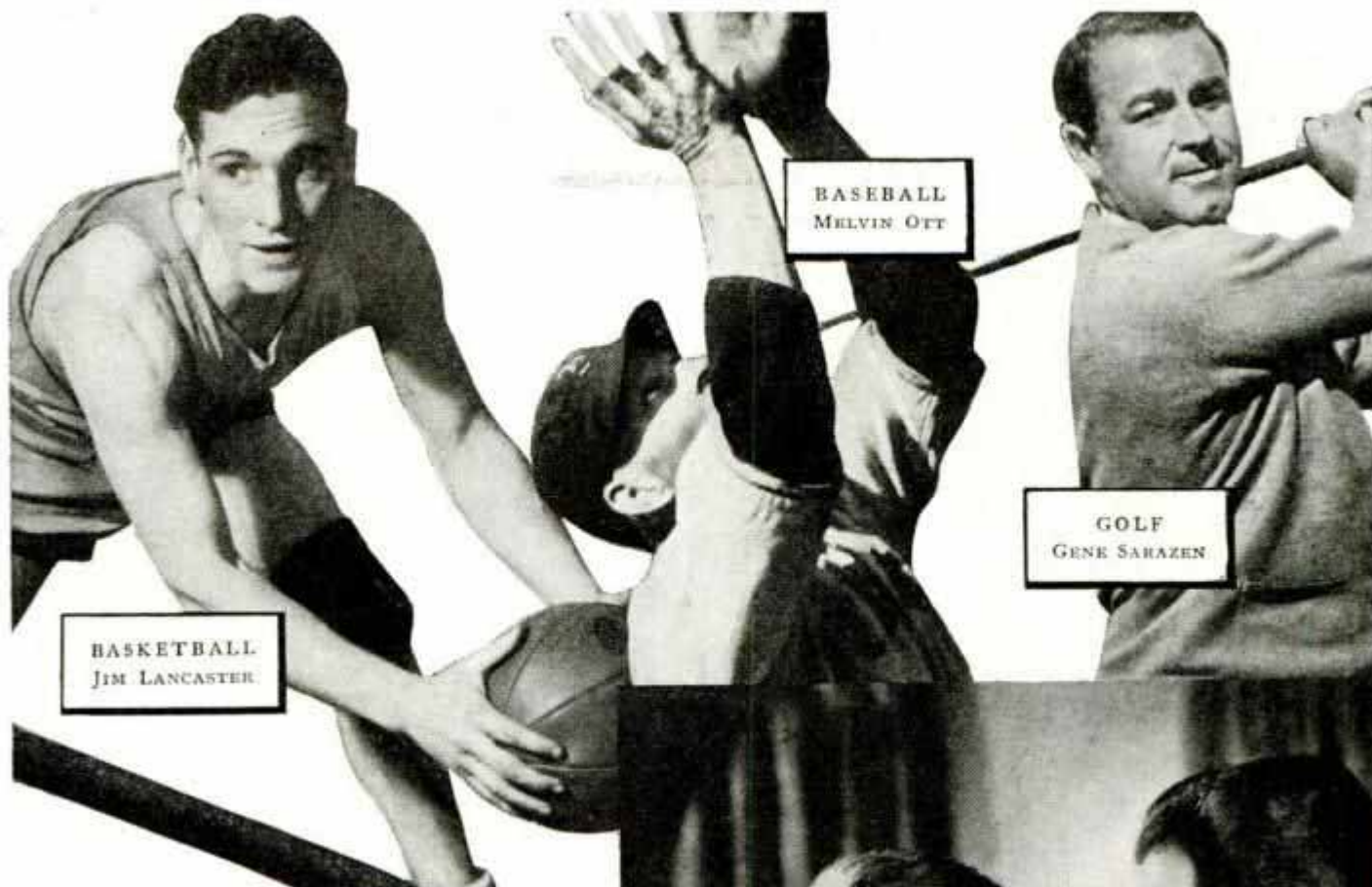

BASKETBALL
JIM LANCASTER

BASEBALL
MELVIN OTT

GOLF
GENE SARAZEN

CONDITION IS IMPORTANT TO YOU — on vacation, in the office, at home. You can keep "in condition," yet smoke all you please. Athletes say: "Camels never get your wind."

SO MILD
YOU CAN SMOKE
ALL YOU WANT!



© 1935, R. J. Reynolds Tob. Co.

Camels COSTLIER TOBACCOS!

- Camels are made from finer, MORE EXPENSIVE TOBACCOS — Turkish and Domestic — than any other popular brand.

(Signed) R. J. REYNOLDS TOBACCO COMPANY, Winston-Salem, N.C.

When writing to advertisers please mention *Popular Mechanics*

TRAINS UNRULY HAIR

—to stay put!

**Costs but a few
cents to use—**

IS YOUR HAIR difficult to keep in place? Does it lack natural gloss and lustre?

It is very easy to give your hair that rich, glossy and orderly appearance so essential to well-groomed boys. Just rub a little Glostora through your hair once or twice a week—or after shampooing, and your hair will then stay, each day, just as you comb it.

Glostora softens the hair and makes it pliable. Then, even stubborn hair will stay in place of its own accord.

It gives your hair that natural, rich, well-groomed effect, instead of leaving it stiff and artificial looking as waxy pastes and creams do.

Glostora also keeps the scalp soft, and the hair healthy by restoring the natural oils from which the hair derives its health, life, gloss and lustre.

A bottle lasts for months

Try it!—See how easy it is to keep your hair combed—any style you like—whether parted on the side, in the center, or brushed straight back.

A bottle of Glostora can be bought for a trifle at any drug store and will last for months.



Glostora
FOR THE HAIR



COMPACT CRYSTAL-CONTROLLED CW TRANSMITTER

(Continued from page 904)

transformer for the oscillator, doubler and buffer tubes, and a 7½-volt transformer for the filaments of the final amplifier tubes, are mounted on the baseboard directly back of the panel in front of the three 45-volt, C-bias batteries.

The meter and dial arrangement on the front panel is shown clearly in the upper photo. Five 2-in. Triplett-type 0 to 100 d.c. milliammeters, five National type "BM" 3-in. dials, two pilot lights and two small binding posts are required. A small pilot light near the top indicates that the 115-volt a.c. line-supply switch is on and that all tube filaments are lighted. This lamp may be hooded to illuminate the front panel if desired. The lower pilot light is provided with a red jewel glass and is lighted only when the high-voltage plate switch is thrown to place the transmitter in operation. Panel drilling dimensions, further data and construction details for a simple power unit will appear in Part II of this article, next month. A complete list of all parts used in the transmitter and power unit may be obtained immediately upon application without charge. These parts are all standard and available from radio supply houses at the usual discount to amateurs.

The sockets for the 40-meter crystal holder, oscillator tube and plug-in coil, L₁, are located at the right on the lower shelf; the 20-meter doubler tube and L₂ coil sockets are at the left. Two 100-mmfd. Hammarlund midget condensers are mounted on the shelf at front. The associated r.f. choke coils, fixed condensers, and 10,000-ohm resistor are mounted under the shelf by means of soldering lugs and short 6-32 machine screws.

Sockets for the parallel buffer tubes, and the link-coupled plug-in coils, L₃ and L₄, are located on the next shelf above. The 150-mmfd. condenser across L₃, mounted directly in front of the tubes, is a Cardwell type 405-B; L₄ is tuned with another 100-mmfd. Hammarlund midget. A double-spaced Hammarlund midget neutralizing condenser, type MC-35, is mounted under the shelf at rear together with the r.f. choke coils, fixed condensers and 1,000-ohm biasing resistor for the buffer tubes.

(To be continued)

RECOMAR the all-purpose Kodak for Fans

SPEED snapshots, portraits, copies, wide-angle and telephoto pictures—this one camera makes them all. Kodak Recomar has a high-speed Compur shutter that splits seconds to 1/250 (1/200 on the "33")... a built-in self timer. And the brilliant *f*.4.5 Kodak Anastigmat lens lets you make snapshots in difficult light.

Completely equipped, the Recomar has double-extension bellows... micrometer screw focusing... hooded ground-glass back... rising front... both eye-level and reflecting finders... spirit level. Supplementary wide-angle and long-focus lenses extra.



Model "18"—for 2¼ x 3¼-inch pictures, \$54
... model "33"—for 3¼ x 4¼-inch pictures, \$63.



A WIDE CHOICE OF FILMS... every Recomar uses film packs, cut film or plates. Ideal for snapshots at night with "SS" Film and Photoflood bulbs. For extreme speed, Hypersensitive plates are available.

Three supplementary lenses are available for the Recomars. These lenses require no adjustments... merely slip on over the regular lens. Cost, \$3.50 each.

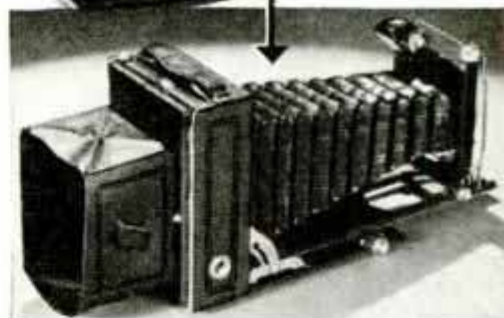

The long, double-extension bellows allows you to make close-ups... copies. The hooded ground-glass back insures micrometer-sharp focus.



The wide-angle supplementary lens increases the angle of view 23% on the Recomar "33"... 17% on the "18."



Normally—the Recomars cover this field. The Recomar "33" has a 135 mm. lens... the "18"—105 mm. lens.



With supplementary lens A—Recomar "33" gives a 33% increase in the image size... the "18," a 28% increase.



With supplementary lens B—Recomar "33" gives a 70% increase in the image size... the "18," a 62% increase.

JUST OFF THE PRESS—1935 KODAK CATALOG



Complete information about Kodaks, enlargers, dark-room outfits, equipment. Send for your copy today. Eastman Kodak Company, Rochester, N. Y.

Name _____
Address _____
City _____
State _____

PM-6-35

When writing to advertisers please mention *Popular Mechanics*

E 153

ONE MAN AGAINST THE DEEP

(Continued from page 859)

size of a baby buggy with a nozzle in front. From this nozzle, by means of a hose and a pump on the barge, Reed squirted water under 100 pounds' pressure into the mud. Day after day he trundled the washing machine on the bottom until he had hydraulicked the cables out of the silt.

One day while cutting a cable, the tide turned against him. Reed swung one leg over the cable and continued his sawing. When he finished, he discovered his life line was afoul one end of the cable which was slowly sinking back into the mud. The cable weighed many tons. It was pulling him into the mud with it. Seizing his knife, he cut the life line and called by telephone to his tender to pull him up by the air-line hose, a dangerous procedure indeed. Luckily, the air line swung free of the cable. Reed made it to the surface.

Meanwhile, the engineers were lining up a real job for him. In a near-by drydock they had fabricated clusters of huge steel tubes each topped with a round, airtight dome. Into these tubes they pumped air under pressure until each cluster floated. Then it was barged out into the bay and anchored along the bridge right of way.

These clusters were the caissons by which it was proposed to build piers from the surface of the water down to the rock far below, instead of vice versa, as in the old order of things. The caissons resembled giant honeycombs, as they floated about on the water, particularly the large one for the center pier. Sixty tubes were clustered in this caisson.

Between the tubes and the outer shell, tons of concrete were emptied from the barges. The caissons slowly sank. As they touched the water level the round domes were removed, new tubes were welded on top and then pumped full of air.

Thus, as the bottom of the caisson dropped down into the mud, it was built up on top, and more concrete added. The bottom of the outer wall was a steel cutting edge, a giant knife blade ten feet across. Clam-shell dredging buckets were dropped inside the opened tubes and the mud was scooped out. Hydraulic sprays, dropped through the tubes, sluiced the mud away from the cutting edge.

Sight unseen, this work went on with astonishing precision, on a dozen piers at

once. Sight unseen, except for Bill Reed's fingers which were the eyes of the engineers. As the cutting edges sank into the mud, Bill was sent down daily to feel along the edges inside the caisson. With his fingers and his iron pike staff, he examined the foundation conditions.

Pressure down there at the 200-foot depth was terrific, more than 100 pounds to the square inch. To appreciate what that means, if Reed's flesh were caught by accident in a fold in his diver's suit, it sliced the flesh off as if a knife blade had cut him. That happened several times.

Down in the darkness, he could stand it but ten to fifteen minutes at a time. He had to do his work with unerring instinct and lightning speed, then ascend to the forty-foot depth, decompress for a few minutes, to get part of the air bubbles out of his blood stream, then rise to the surface, dash to the iron doctor on the barge, and slowly reduce pressure.

One big caisson, near Yerba Buena island, tilted slowly one day until it looked as though it would topple over. It stopped in time, teetered like an underwater leaning Tower of Pisa. A million dollars worth of concrete and steel hung in the balance.

Call for Submarine Inspector Reed. A risky job it was, descending into the tilting tubes to the bottom, to inspect the cutting edge, one side of which had hit a boulder. Bill Reed took down dynamite, carefully wrapped in waterproof covering, dug a nest for it beside the boulder, strung the wires to set off the explosive, then returned to his barge. The boulder blown out of the way, the caisson returned to plumb.

For the first year Reed practically lived in his little barge, alternating between the tiny cabin, his hefty diving suit, and his iron doctor. Sometimes he dived by day, sometimes by night.

There came a day when the concrete crest of the last of the piers piled up above the waves, and the great red steel towers rose high above three of the piers. The "deep money" work was practically done, and Reed could rest on his laurels for a time, knowing that his diving had made possible the caisson method of pier building, which had not only saved years of time and millions of dollars but probably the fate of scores of sand hogs who might have laid down their lives for the bridge, had the usual methods been attempted.

Ask your wife if this isn't so . . .

A DRY SKIN MAKES YOU LOOK OLDER THAN YOU ARE

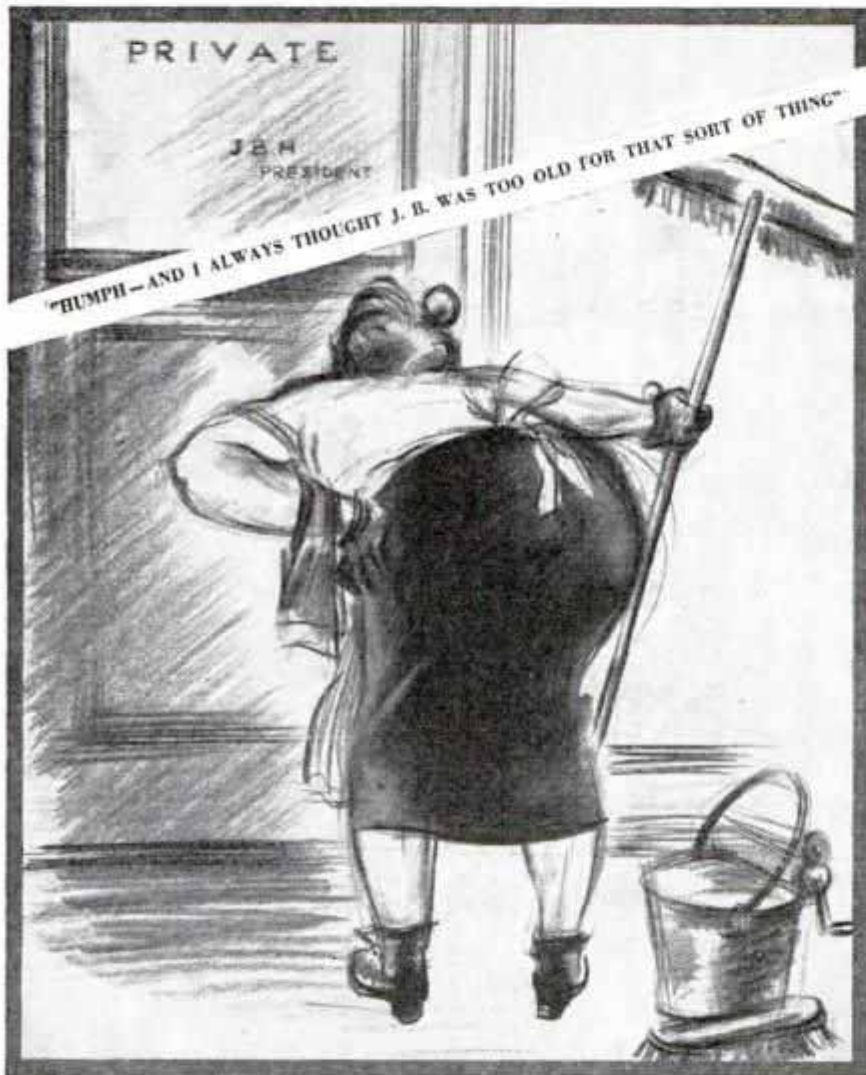

NO MAN in his sane moments really wants to look older than his age. In this competitive world of ours youth gets the breaks. Old age is a handicap at every turn.

Women all know that a dry skin wrinkles easily—and that cold winds dry out the skin, leaving it chapped and brittle. So they avoid alkaline soaps and use creams and bland oils to keep their complexions youthful.

Men who shave with alkaline soap every morning rob their skin of natural oils and invite old age to come right into the bathroom.

Throw away that messy brush and start shaving with Barbasol if you want to keep your skin in the pink of condition.

Barbasol is a latherless cream that gives you the fastest, smoothest, cleanest shave you've ever had. It is so soothing and refreshing that many people use it for sunburn, windburn and chapping.

No more ingrown hairs. Barbasol holds the whisker steady to the razor, insuring a clean cut at the base.

And the natural oils in Barbasol keep your face looking young.

That's why Barbasol is America's most popular shaving cream.

BARBASOL BLADES now 5 for 15¢

For only fifteen cents you can now buy 5 of those scalpel-keen Barbasol Blades that make shaving a joy.

They're going like hot cakes, men. Step up and get yours today.

Shave the Barbasol way. Soften your whiskers with Barbasol Shaving Cream and mow 'em down with Barbasol Blades. It's the perfect shaving combination.

Tune in Singin' Sam—the Barbasol Man—every Friday evening over WOR, New York; WLW, Cincinnati; and WGN, Chicago. (See your newspaper for local time.)



**For Modern Shaving:
No Brush • No Lather • No Rub-In**

TREES TELL THE TRUTH

(Continued from page 802)

own design, including instruments for measuring tree increment cores, determining moisture content of lumber, testing the nail-holding capacity of wood, and reckoning the wood-moisture balance of timber.

Just as no two fingerprints are alike, the wood technologists know that no two trees have identical ring markings. If tree-ring markings match point to point in the cut ends of two pieces of wood, the technologists know that the two pieces came from the same piece. In short, that they were once one piece. For duplicate details of tree rings, the experts have found, can belong only to one piece of wood, and only to one place in that piece.

Nature is responsible for this. Each spring when water is plentiful in the soil, the living cells beneath the tree's bark lay down a layer of tubes to carry rising sap. In the summer when the water becomes scarcer and the tree slows its growth rate, a layer of smaller tubes is manufactured. Running lengthwise, these tubes appear as grain in a piece of timber, those laid down in the spring being wider and lighter in color than those formed in the summer.

The cycle of tube manufacture continues year after year and, because of it, the wood experts are not only able to determine the age of a piece of wood, but also, to establish where the tree grew and under what climatic conditions.

Because no two trees manufacture their tubes under precisely the same conditions—there are always slight variations in the water supply and other life experiences—the cut ends of no two pieces of wood are the same. Always there is a difference in the width of the tubes. Sometimes it is only a tiny difference. So tiny that the human eye would not notice it. But the difference is there just the same and under the microscope it can easily be discerned. When there is no difference, as was the case of the upright in the Lindbergh kidnap ladder and the flooring in the Hauptmann attic, the wood expert knows instinctively that the two pieces of wood were once one.

It was an almost insurmountable task that faced Koehler when he was called upon by the New Jersey state police to trace the yellow pine of the kidnap ladder. But scientist that he is, the task intrigued

him. He took the ladder to the forest products laboratory, at Madison, and there he commenced one of the most amazing accomplishments in the realm of scientific detection. He sawed a notch in a rung of the ladder and saved the sawdust. The process was repeated with an upright. The little chips were weighed, the specific gravity was measured and they were bathed in acids, stained with dyes and burned so the ash could be studied.

He took the ladder apart, piece by piece, and reckoned its tensile strength and density. X-rays and enlarging cameras were used, as well as nameless machines invented by Koehler himself. Finally, he learned a certain high-speed planing mill had trimmed the lumber, finishing the surfaces with a grain particularly its own. He circularized some 40,000 mills to learn where such a planer had been used. He made trips to the pine and spruce forests of Oregon, to Great Lakes mills and, eventually, in South Carolina, found a neighborhood mill with a high-speed cutter.

The surfacing done by this plane served Koehler as well as the whorls and loops serve the fingerprint expert. But his travels were not over. They continued until finally he walked into a mill in the Bronx, where Hauptmann had purchased lumber, and found bits of Ponderosa pine planed by the same unique cutters.

It is not always in crime detection that Koehler and his colleagues employ their expert knowledge. They are called upon in numerous civil actions, and many times their testimony is needed by the federal trade commission in cases of fraudulent misrepresentation. One civil action decided by Koehler's testimony involved two painters who fell from a scaffold when the rung of a ladder broke. It snapped off on both ends where the rung entered the uprights. Both men were injured and brought suit against the manufacturer for damages, claiming the ladder was defective. Koehler subjected the ladder to various tests and testified the break was not due to brittleness, but had been brought about by frequent dropping of the ladder.

Again in a civil suit brought by the city of Cincinnati against a contractor as a result of the collapse of park bleachers, his testimony helped win the suit when he proved the lumber used was not leaf pine, as called for in the specifications.

IT'S THE MOST TALKED ABOUT OIL IN AMERICA!

*This Revolutionary New
Summer Mobiloil*

Enables you to drive farther
and faster . . . yet use less oil

DO YOU BELIEVE that most mo-
tor oils are pretty much alike?
Then consider these facts:

The new Mobiloil was tested
with another large-selling oil.

First, for consumption. The new
Mobiloil showed 98% resistance
. . . the second motor oil, 88%.

Then gumming. Mobiloil scored
100% resistance . . . Oil Two, 68%.

Finally resistance to thinning
was tested. Mobiloil registered
100 plus . . . its competitor, 38!

Here is the scientific reason for
this improvement: *The Clearosol
Process cleanses crude oils of im-
purities that have always resisted
refining!*

You buy oil anyway. Why not
enjoy the benefit of refining's lat-
est development? Why not get this
new Mobiloil for your money?

SOCONY-VACUUM OIL CO., INC.



NO ADVANCE in price for
this new Mobiloil. It comes
in Grades A, AF, B and BB
. . . for all cars. Sold at the
Sign of the Red Gargoyle or
the Flying Red Horse.



100 HOURS on ordinary oil
stuck pistons with gum.



100 HOURS on new Mobiloil
. . . pistons were clean.

Mobiloil



MADE BY THE SOCONY-VACUUM CLEAROSOL PROCESS

E 68

FLYING THE FOG PATROL

(Continued from page 842)

the pressure, temperature and humidity.

Lieut. Baker performs no tricks in the air. It is a job that calls for a steady hand, a cool head and lots of patience so the weather reports will be accurate. Any stunts the fog patrol pilot resorts to are done to save his life. Ice may form on the wings, fog may close in, or terrific cold or tremendous winds may be encountered.

When a fog patrol plane lands, a weather observer detaches the aerometeorograph, compiles the information it contains and sends it by teletype to the weather bureau at Washington. That same day in your newspaper the weather map gives you a full report of the fog patrol's findings.

"These reports are of great value in providing information concerning current conditions and in giving data that are of great aid in the bureau's forecast work," explains Mr. Gregg. "In order that the data can be readily visualized, they are plotted on special charts, showing the temperature, humidity and other data obtained. Of special importance are the curves that show the extent, both horizontal and vertical, of masses of relatively cold, dry air and other masses of warm humid air. It is along the boundary planes where these differently constituted masses of air meet that most of our stormy weather occurs. The charts showing the temperature and humidity conditions together with the upper-air wind charts, give the forecaster a more complete picture of the structure of the upper air than has ever been available heretofore, but the number of stations where airplane soundings are made is still far too few to give as complete information as is needed."

The fog patrol has been of particular benefit to the commercial airline pilot. Before it started, weather forecasting revealed to commercial pilots only the length and breadth of atmospheric disturbances. The fog patrol has added a third dimension, giving a vertical distribution of weather disturbances. The air-transport pilot needs to know at what level clouds are formed; whether they extend to heights impossible to fly over; whether the clouds are close to the ground; when and where turbulent conditions exist, so that he can avoid them by landing or flying around them; and what effect moun-

tains and other terrain in his vicinity will have on the air masses. It is also necessary to know at what levels smooth air will be found; when and where a pilot may expect to find icing conditions, and where on his route "cold" and "warm" fronts exist. This information can be ascertained by the fog patrol.

The new method of weather prediction resulted in an increase of twenty per cent in completed schedules on one airline, and a forty-per-cent safety factor was added to air transport operations, \$35,000 in operating expenses was saved and on-time schedules increased forty-five per cent.

Science is now assigning an added duty to the pilots of the fog patrol. During the past few months the flying speed of commercial airplanes has gone up. The new Douglas airliners on the Atlantic seaboard run have stepped up from a cruising speed of 125 miles to 185 miles an hour, flying in a fast changing weather territory where tropical air and north Atlantic air masses meet to form the violent storms known along the coast. To maintain such a speedy schedule between New York and Miami, it was necessary for the fog patrol to gather the data to allow meteorologists to forecast fog and weather movements with precision, a fact now being achieved as much as twelve hours in advance.

Capt. Charles W. France, superintendent of operations of Eastern Air Lines, believes the number of completed trips has increased by twenty-five per cent since installation of the air-mass method of weather forecasting and within the next six months, when more details of operation are completed, the airline will be able to fly all schedules giving 100-per-cent operation. So important has the work of the fog patrol and the air-mass analysis method of forecasting become that Dr. R. A. Millikan, the eminent scientist, and Dr. Theodor von Karman, director of the Guggenheim Laboratory and of the Airship Institute at Akron, have established a course of instruction at the institution where men will be trained to meet future demands of aircraft operators. The course will pave the way for a new profession whose members may, when more fog patrol planes have been added to the existing service, be able to route a plane from coast to coast so that only perfect weather conditions will be encountered.

Keep HAPPY
with
COOL shaves

There's no such thing as a hot shave for any man who uses Ingram's Shaving Cream and a good blade. Every shave is *cool* and comfortable.

Three special ingredients of this rich, foamy lather take out all the stings and jabs, tone the skin, and shield it against scuffing and rawness. No burning, no smarting, no need for a lotion. Your face feels fine without it.

Your first tube or jar will convince you that an Ingram's shave is the world's best. And inexpensive, too. Ingram's lathers so freely that you need far less cream to tame your whiskers. Prove it with a *trial tube*.

TUBE OR JAR



1 FOR YEARS THIS FACE WAS ON THE SPOT—

2 EACH SHAVE WOULD LEAVE IT RAW AND HOT!

3 BUT NOW COOL SHAVES HAVE SAVED ITS SKIN

4 WITH INGRAM'S YOU CAN SHAVE AND GRIN

TRY THE WORLD'S COOLEST SHAVE

BRISTOL-MYERS CO., Dept. E-65
110 Washington St., New York, N. Y.

I'm hot about cool shaves. Let me try a 10-shave tube of Ingram's, free.



Name _____
Street _____
City _____ State _____

INGRAM'S SHAVING CREAM

When writing to advertisers please mention Popular Mechanics

8 15 6

HOW TO FEED YOUR DOG

(Continued from page 822)

tables in dehydrated form. It is worthy of note that many English dog authorities give their dogs some finely chopped lettuce or chopped cabbage occasionally. One Irish dog breeder and trainer recommends this procedure and always feeds his dogs a small amount of raw green stuff. I do the same thing, especially if my big Labrador seems to have a craving for something green. The lettuce, for example, is chopped very fine. The dog likes it and apparently thrives on it.

If you offer some mashed vegetables to your dog he may refuse them if he is a rather finicky eater. That's not surprising. If a dog hasn't been fed vegetables he may turn up his nose at the first taste, but don't decide that he won't eat vegetables. Take his food dish in which you have placed the meat or whatever you are feeding, and mix a tablespoonful of the mashed vegetables. See that the dog is hungry and he will eat it without much hesitation. At the next feeding increase the amount of vegetables in the combination. You feed a very small amount of vegetables to the puppy even after the pup decides it likes the green stuff.

Now we come to the last classification of foods, the miscellaneous kind. Right at the top is milk. Here is your standby in feeding an eight or ten weeks old pup. It's an almost perfect food containing not only protein and fat, but also mineral salts, carbohydrates and vitamins. Don't let anyone tell you that milk causes worms in dogs. That's another myth which is so ridiculous that it hardly need be mentioned. Every healthy pup needs milk those first weeks he is in the home. He can get milk on cooked cereal, milk on bites of toast, milk with a small amount of canned dog food, milk with biscuit, and in other ways.

Buttermilk also is excellent and cottage cheese is a good food. Raw eggs also stand high in this miscellaneous list. The yolk of an egg is rich in protein, calcium and iron and also has vitamins. The raw white of an egg is not very easy for the dog to digest, so it is a good idea to beat up the eggs. Any mutton broth with barley which might be left over from the table is good for the pup. Beef broth also is good. Cream cheese in moderate amounts is ex-

cellent for your dog, too, after he has grown up.

A valuable adjunct to your dog's diet is cod-liver oil, especially if the pup is acquired in the fall or winter. I usually start with a half or three-fourths of a teaspoonful every other day and gradually increase the amount as the pup grows older. Cooked boned fish is another food that is good for the dog.

The final question concerns the number of times per day that the pup should be fed. A dog eight or ten weeks old should be fed four meals a day. In other words, feed small amounts often. When a dog is three to seven or eight months old, reduce the meals to three a day. After that, feedings twice daily are sufficient. Grown dogs usually do best on a very light meal in the morning and the real meal at night although some owners feed their pets only once a day. I usually give my dogs a light breakfast consisting of dog biscuit and milk, possibly some cooked cereal and milk, or whole-wheat toast, a few dog biscuits, or some similar combination.

There are certain foods which never should be given to a dog. Chicken or rabbit bones are taboo. The same holds true of any small splintery bones which may be swallowed and injure the animal. I do not recommend pork, either. Candy, highly spiced foods, rich pastries, raw potatoes, fried eggs, peanuts, corn, and similar foods are not dog foods.

Many dog owners say their pets seem to like the taste of raw apples and grapes, and fruit in moderation is not harmful to dogs. Every dog I have owned in recent years seemed to like grapes and I have given them a few. My Labrador is fond of apples and is allowed to have one or two small pieces. Bananas that are well ripened may be fed in moderation. The point is—a little raw fruit, although not a staple in a dog's diet, can be eaten by a dog and, in moderation, will not harm him.

Here are a few good general tips on feeding your dog involving procedure rather than individual items in his diet.

Feed your dog in one place only. Train him to expect his food at that place every day. Try to establish a routine of feeding so that the dog is usually fed at the same time each day.

If he doesn't eat all his food, do not

(Continued to page 126A)

again **FISHER BODY** leads the way
to greater safety with a new solid steel
"TURRET TOP"*

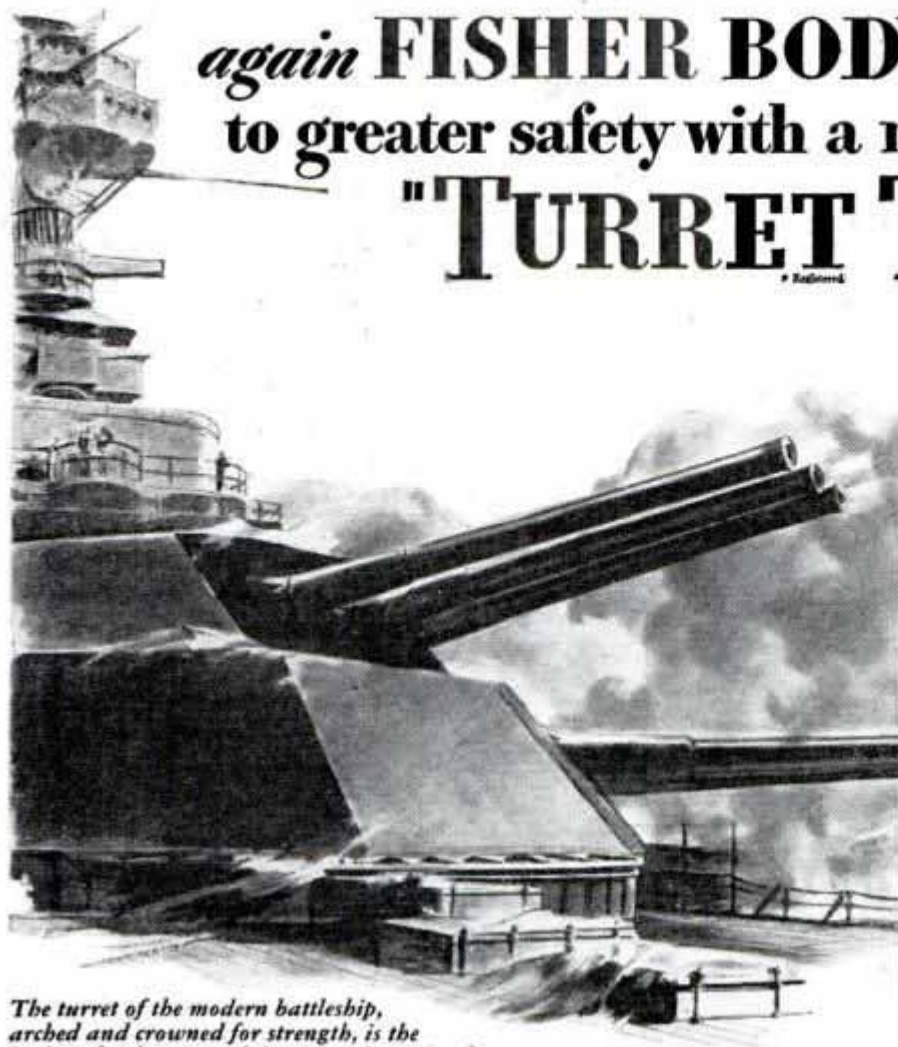

The turret of the modern battleship, arched and crowned for strength, is the highest development of the principles utilized by Fisher in the new solid steel "Turret Top" for closed cars



Note the smart lines of the new solid steel "Turret Top" Body by Fisher. It's scientifically insulated against rumble and drum, heat and cold, too — thanks to years of experiment both in the laboratory and at the great General Motors Proving Grounds

Featured on all

CHEVROLET (Master De Luxe Series), **PONTIAC**

OLDSMOBILE, and LA SALLE

Closed car models for 1935

THIS remarkable new solid steel "Turret Top" Body by Fisher—now featured on 1935 Chevrolet (Master De Luxe Series), Pontiac, Oldsmobile and La Salle closed cars—is a solid protective roof of seamless drawn steel—steel braced with steel like the modern battleship turret from which it takes its name. It is supported by steel-roof-bows and is welded to the steel body panels. For the first time, it successfully provides the safety of solid steel *over your head*.

By rounding the corners, the principles of sphere construction are employed to give maximum

over-all rigidity and strength — as well as lower wind resistance and enhanced appearance.

Moreover, it is scientifically insulated against drum and rumble; and comparative tests, using "Turret Top" cars and cars with the conventional type roofs, conducted at Key West, Florida, under the sanction and supervision of the American Automobile Association, proved conclusively that the "Turret Top" can be depended upon for maximum coolness under hot-weather driving conditions.

Other advantages in Body by Fisher for 1935 include greatly improved Fisher No Draft Ventilation, full streamlining, more luggage room, windstream V-type windshield, wider seats, more head room, bigger doors and many other vital advancements.



BODY BY FISHER on GENERAL MOTORS CARS ONLY: CHEVROLET • PONTIAC • OLDSMOBILE • BUICK • LA SALLE • CADILLAC

8115 INSIDE STORY OF THE RODEOS

(Continued from Coloroto Section)

they are really heavier than horses. And they're quick as the wind. Tex Palmer was tossed from a Brahma at Oxnard, Calif. Hardly had he hit the ground before the steer attacked. When the battle ceased, the Brahma had shoved Palmer all around the arena, leaving him bruised and, of all things, with two black eyes.

The only protection the boys have is provided by tipping the horns on the worst animals with round, brass knobs. These may cause considerable pain, but they're not apt to plunge through the body.

I like roping for real scientific precision and action. In team roping, we work in pairs, one rider taking the head, the other the heels. Each of us sits beside the chute, until the steer crosses the "dead line," thirty feet distant. Then we give chase on horses trained to follow the animal.

If I'm playing head man, I toss the first rope. As the loop settles over the steer's head, my horse comes to a dead stop. Quick as a flash, the heeler ropes the steer by the heels, then we move in opposite directions and force him to fall. Then I dismount and tie his heels with a three-foot pigging string, one end tucked in my belt and the other in my mouth.

All we need for roping is a good horse, a sturdy roping saddle and a twenty-five-foot length of seven-sixteenths-inch Manila rope. The pony must be sturdy, very fast and schooled not only to stop from a gallop on a dime, but to back up and keep the rope taut while you tie up the steer. The roping saddle has a low cantle board, which enables the roper to get off quickly and which will stand hard jerks of the lasso which is tied to the pommel.

Bull-dogging has lost favor in some states, while roping has gained. In bull-dogging, the rider leaps from the saddle at a gallop, falls on the steer's head and twists him down by pulling the nose into the air as the cowboy walks backward. Some consider this a cruel practice. In its place, "decorating" is practiced. This is the same, except that the "decorator" slips an elastic band over the animal's nose.

The stars of the rodeo game must keep in fit condition the year round. They train as faithfully as any other athletes, for theirs is a hard lot, and some may appear in thirty rodeos in a year.

8156 HOW TO FEED YOUR DOG

(Continued from page 124A)

leave the pan where he can get at it. He won't starve by not getting a full portion at this meal. Just as it is good for us to go easy on food sometimes when we are not feeling perfectly fit, so it is good for a dog to be underfed sometimes rather than overfed without sufficient exercise.

Don't disturb the dog when he is eating. You may have the most affectionate pet, one that thinks the world of you, but when eating he may feel the old primeval urge that has been inherited from his wild ancestors, and turn on anyone who tries to interfere with his food and his eating. Therefore, don't blame the dog if he snaps or growls at you when you disturb him while he is eating. He can't help it. Wild dogs had to fight for every mouthful of food, hence we have this instinct in our modern dogs.

Don't feed your dog in a dirty, unwashed dish. You want him to be clean and have good manners. You can at least give him a clean food dish.

Don't get the idea that a dog likes his meat "ripe" because he buries a bone and then digs it up later. This burying of a bone is another inherited trait from the dog's wild ancestors who were not always sure of having a meal every day. So when they killed an animal they ate their fill and buried what was left for tomorrow's meal.

Don't worry because your dog doesn't chew his meal like you and I masticate our food. Your dog is a gulper and there is nothing you can do about it. He will be healthy if he get's good food even though it is gulped instead of chewed thoroughly. The reason he cannot chew food thoroughly is because his teeth are not made that way. They do not present smooth grinding surfaces.

Don't feed your dog mushy or sloppy foods as a regular diet. It's a good thing to give your dog liquids like milk or broth on some of his food, but don't feed him a "swimming mixture" day after day.

Try to give him smooth bones to chew on—ones that will not splinter and catch in his mouth. If your dog starts to roll his tongue around the roof of his mouth and give signs of distress, examine his mouth for bone splinters. Despite care in the kind

(Continued to page 128A)

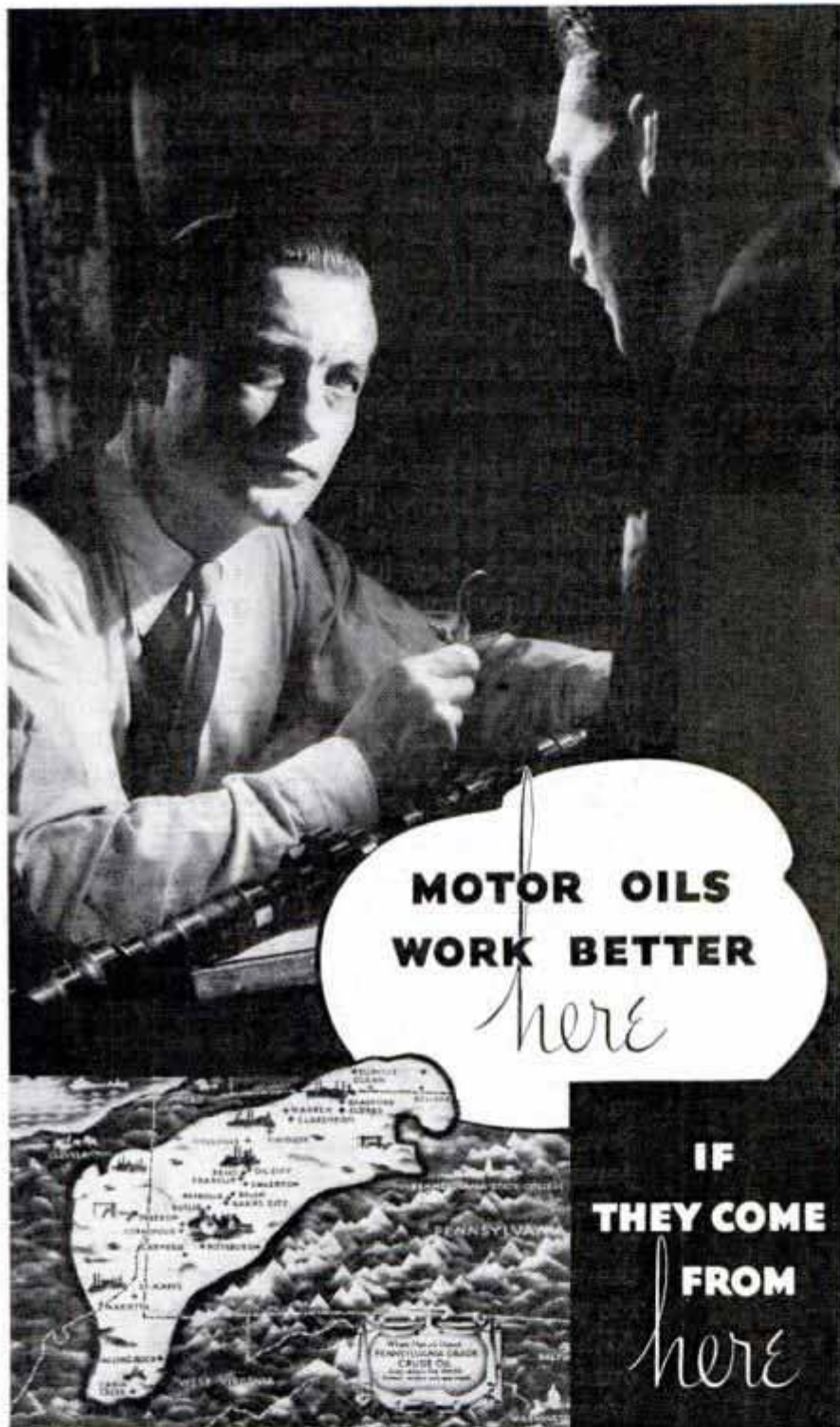

Photograph by ANTON BRUEHE.

THE PICTURE...

THE object at the left is of vital importance to your car. It is a camshaft. Every motor has one. To get the utmost performance from your car, this and other inner working parts must be lubricated by a motor oil that has definite superiorities. And that's where the map comes in...

THE MAP...

This area is the only place in the world where Nature stored her richest crude oil—Pennsylvania Grade Crude. Nature gave this crude special qualities. From this favored crude are refined all the motor oils sold under the emblem of the Pennsylvania Grade Crude Oil Association. They are *better oils from the ground up*.

THE EMBLEM...

The emblem is the badge of membership in the Pennsylvania Grade Crude Oil Association.

You are protected when you buy oils sold under this emblem, because it assures you that (a) they are made 100% from Pennsylvania Grade Crude, and (b) they meet or exceed the high minimum standards set by the Association to assure proper lubrication.

Safeguarding these assurances are: (1) the research laboratory of the Association at State College, Pa., (2) a national field force, and (3) each member's individual surety bond.

There are no vital secrets about refining. Pennsylvania refiners can and do use all the latest scientific methods in processing their motor oils. The *real* exclusive advantage—the *real* secret—is Nature's own.

Pennsylvania Grade Crude Oil Assn.
Oil City, Pennsylvania

Copyright 1935, Pennsylvania Grade Crude Oil Assn.

6 ways Pennsylvania Motor Oils save time and money**YOU GET...****BECAUSE...**

- | | |
|---|---|
| 1. More power for quicker pickup. | Pennsylvania oils have rich "body," sealing maximum power above the piston rings. |
| 2. Less strain on the battery. | With Pennsylvania oils, there is less "drag" at the start. |
| 3. A "sweeter" motor, less friction and repairs. | Their film is thicker, stronger. Less affected by heat and cold. |
| 4. Fewer extra quarts needed between oil changes. | Pennsylvania oils have more ability to stay on the job. |
| 5. Better protection, for your motor, against heat. | They do not thin out so much under fierce heat of engine. |
| 6. Less sludge. | Pennsylvania oils are naturally pure. The chemical structure is stable. |



BETTER OILS FROM THE GROUND UP!

AMPLIFIER FOR SMALL SHORT-WAVE RECEIVERS

(Continued from page 903)

isolate the plate circuit of the detector tube and bridge this to the input side of the amplifier. The upper hook-up shown in Fig. 3 is a commonly used variety; the second type-30 tube is removed entirely and the G input connection to the amplifier is clipped to the point indicated. The other input amplifier connection must be run to the metal chassis of the receiver, or to B-negative, in order to complete the

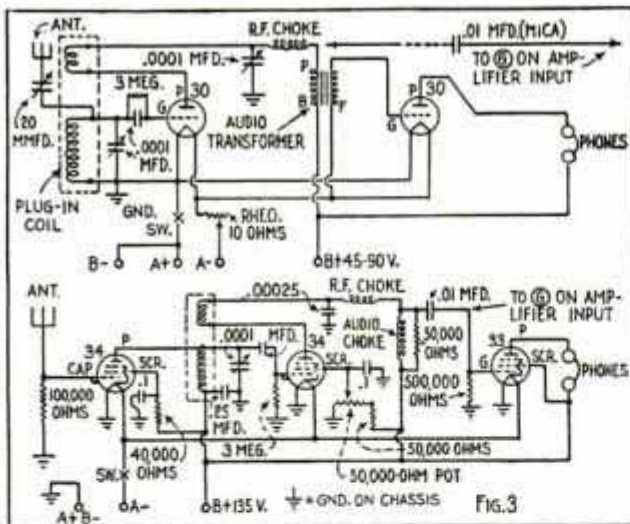
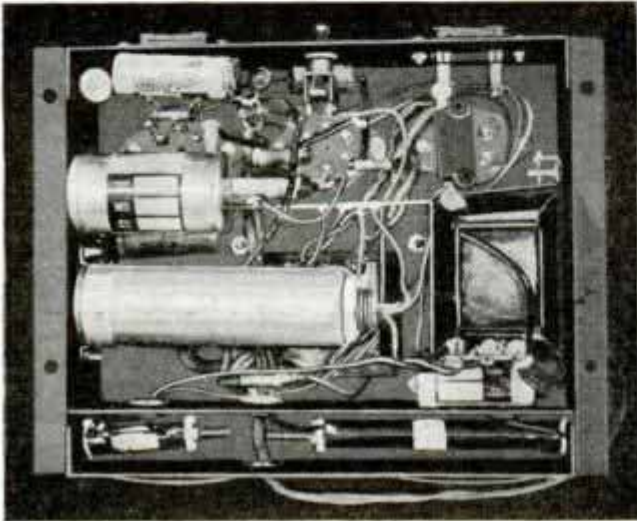

circuit. In the 3-tube circuit shown below, the .01 mfd. coupling condenser is already in the circuit, therefore the G connecting lead may be fitted with a small phone-cord tip, instead of a clip, and inserted in the grid hole of the socket from which the output tube is removed. The other input connection is made to the set chassis or B-negative as before and in neither case is it necessary to disturb the wiring of the receiver.

HOW TO FEED YOUR DOG

(Continued from page 126A)

of bones given dogs, one sometimes gets a splinter in the roof of the mouth.

Don't feed your dog and then exercise him a great deal immediately after his meal. And above all, don't overfeed. Thousands of dogs have to be treated by veterinarians every year due to overfeeding and lack of exercise. Digestive troubles, skin troubles and other dog ailments can be traced to improper feeding or overfeeding.

Don't take icy cold food from the refrigerator and serve it to your dog, if you want him to keep well. Dogs do not want, nor should they have hot foods. Neither should they have foods that are thoroughly chilled. Don't feed your dog a lot of rich gravies, sauces and other greasy things if he can't take care of them. A dog getting plenty of exercise as, for example, a hunting dog, can digest things that a canine leading a quiet, sedentary life cannot.

Don't feed your dog too much during hot weather. During extremely hot summer weather most of us eat lightly and thrive by doing so. The same holds true of dogs. In the winter when you need more body heat, your dog naturally needs more food than he does in the summer.

Don't let your canine get the habit of raiding garbage cans for food. He may develop a case of ptomaine poisoning if he persists in that habit.

To solve the question of how much food to give, the owner watches two things—the amount of flesh that covers the ribs of his pet, and the way the dog eats his food. Although one may prescribe so many ounces or so many pounds for a certain breed, dogs of the same breed differ so much in their food requirements that what will fatten one, keeps another in good shape. So the dog owner must use his own judgment on the amount of food to be given. A dog in good flesh will have his ribs covered but not buried by flesh, a sheen on his coat, and be full of life. A dog that is round like a barrel, slow, sluggish, and not eager for the evening meal is obviously overfed and underexercised.

☐Inquiries as to makers of articles described in Popular Mechanics, will be answered by our Bureau of Information upon receipt of return postage.

“What a surprise party I got
for a **dime!**”

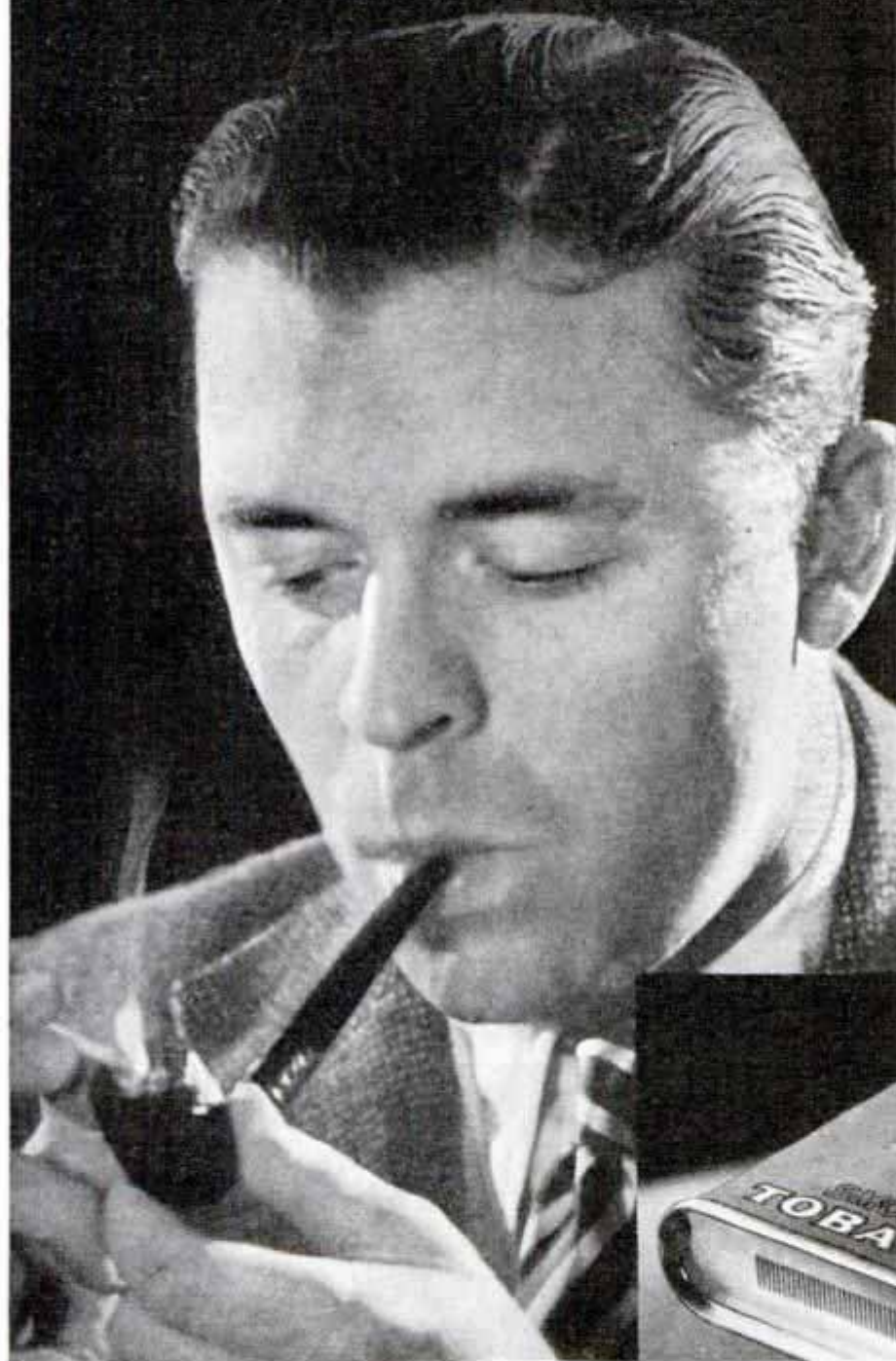

MY FIRST pipeful of Union Leader tobacco gave me the surprise of my life. It cured me of the prejudice that expensive pipe mixtures are always best. You simply can't beat the fragrant, mellow, full-flavored *old* Kentucky Burley in this grand old brand. It's head and shoulders above any pipe tobacco I've ever smoked. And that dime-a-tin price adds a lot of profit to my pleasure. (It makes a grand cigarette, too.)

© P. Lorillard Co., Inc.

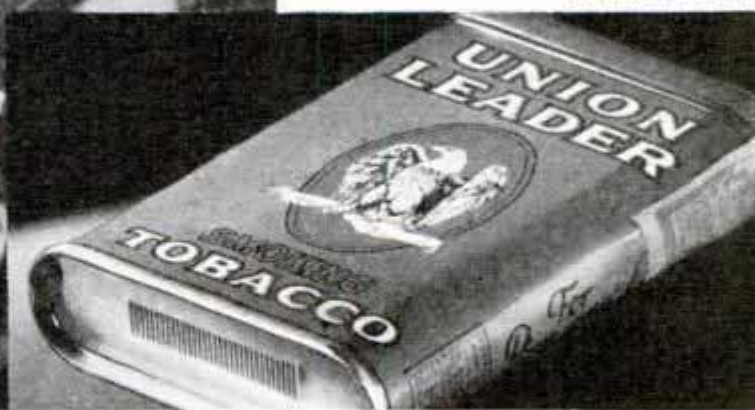

LYLE TALBOT . . . Warner Bros. Star, Union Leader smoker since 1924

UNION LEADER

THE GREAT AMERICAN SMOKE



When writing to advertisers please mention Popular Mechanics

8/68 PHANTOM RAIDERS OF THE AIR

(Continued from page 890)

service ceiling of the plane through camouflage by 7,000 feet. At this lower ceiling greater weight can be carried and the plane really looks as if it were at the higher altitude—a fact which fools the anti-aircraft gunners. Bombers are also black-winged for night raiding.

A novel method of hiding war planes, although leaving them ready for instant use, has been developed by a French engineer, Henri Lossier, and Faure-Dujarric, an architect. Their plan is a huge concrete tower with circular housing platforms. These platforms would be covered and divided into crypts, each of which would care for a plane. One hundred or more planes could thus be housed, the planes being lifted to their respective positions by elevators. The planes thus housed would be like great eagles, hidden from view and protected by covering, but ready, at an instant's notice, to attack.

This mass of concrete would be 6,500 feet high. The three platforms enveloping it would be built at 2,000, 4,000 and 6,000 feet. They would project 500 feet out from the side of the column. Runways would be established from them to the center of the column where the planes would be delivered by elevators. The column would be 700 feet in diameter at the base and 130 feet at the top. The great value of such a tower lies in the fact that planes would not need to climb to the respective heights of the platforms before beginning combat.

Future air tactics for the United States call for the concentration of an air fleet at various camps throughout the country, available on instant notice for combat, either defensive or offensive. In event of war, however, the planes would scatter, rendering it impossible for the fleet to be attacked as a whole. Camouflaged, they would rest in some far corner of a commercial field by night, only to rise with the dawn and, hidden by their many colors, to go forth to the attack.

Phantom fleets also are being concealed by governments in underground air bases. There are reports of such a base at Singapore, the orient base of the British navy, and of another at Vladivostok, the great Russian fighting base. Here all the war paraphernalia of the air is kept and secret battle plans are formed.

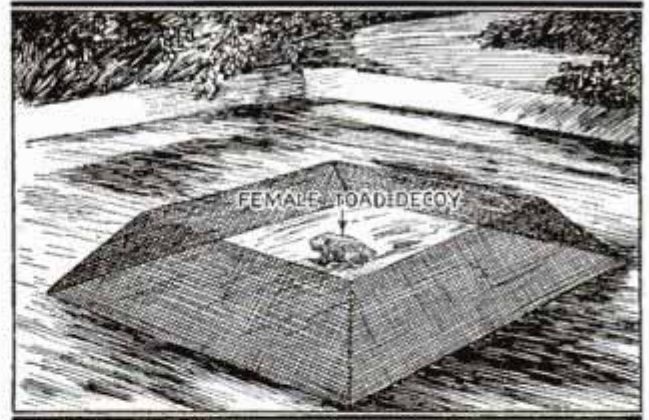

Simple Trap to Catch Toads before They Lay Eggs in Your Fish Pool

Trap to Rid Your Fish Pool of Toads

A fish pool offers an inviting place for a female toad to deposit its eggs, with the result that some pools are soon thickly infested with little black polliwogs that keep the water muddy. Many fish fanciers use varied traps and devices to catch the polliwogs after they have hatched, but if this trap is used, you can often catch the toads before the eggs are laid. The trap is a wood float having sloping sides of screen wire on which the toads climb.

Pipe Makes Folding Flag Bracket

A flag bracket, which may be removed easily, or swung against the side of the house, out of the way, when not in use, may be made from a length of pipe as shown. The bracket is held in place on the window casing by means of steel clips, the lower clip and the lower end of the pipe being drilled to receive a cotter key, which may be inserted to hold

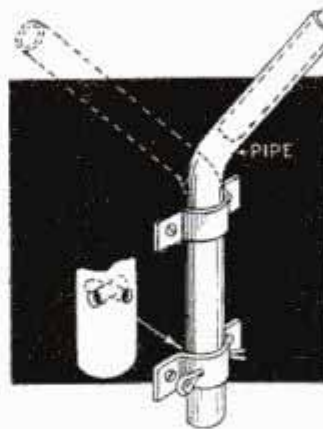

the pipe either extended, or in position flat against the wall.

☞ To find just where a door is sticking, rub the sides with blue chalk, and then open and close it a few times.

THE VITAL SPARK

★ THE accurate timing and control of the spark—and maximum intensity—are essential to high efficiency in engine performance. To make it easy for Ford owners to keep the electrical system in top-notch condition, the Ford Motor Company includes vital electrical units in the low-cost Ford Parts Exchange Plan.

The owner of a V-8 can obtain a Ford factory-reconditioned distributor for only seven per cent more than it would cost to have new ignition points installed. The exchange unit has been completely rebuilt with new ignition points. Worn parts are replaced—all working parts have the same close tolerances as in a new distributor.

Ford owners can also secure a Ford factory-reconditioned generator which is installed for actually less than what it would cost to replace the armature, field coils and brushes

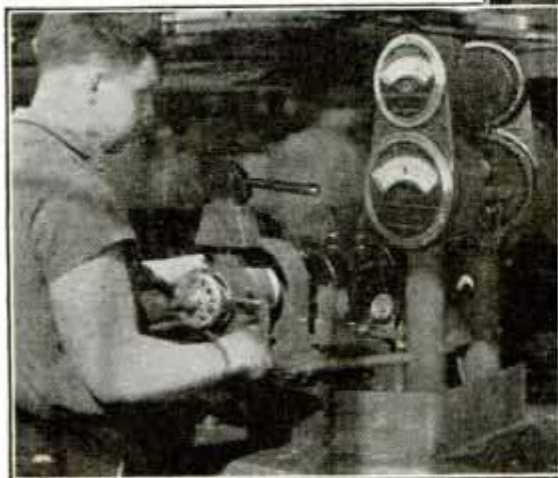

Testing Generator for Current Output

*Checking the Fit of
Distributor Housing
Front Bearing*

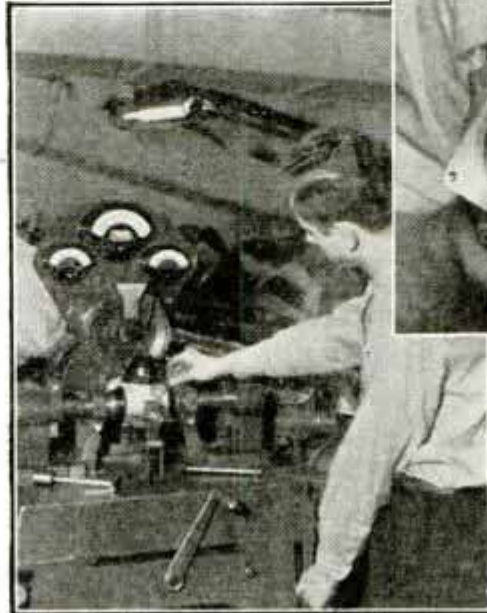

*Adjusting Distributor Vacuum Brake
on Final Test*

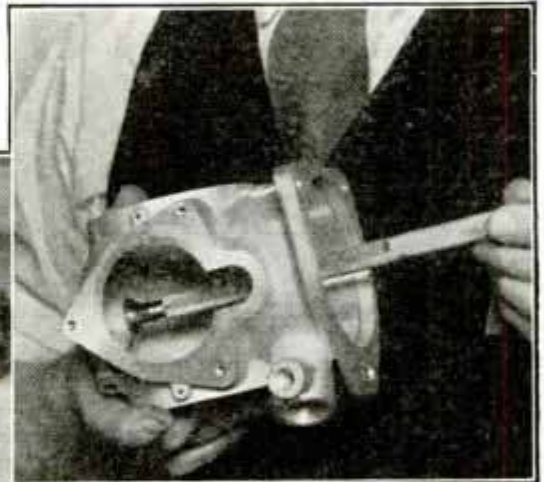

*Assembling Reconditioned
Generators*

alone. And every detail of the exchange generator has been accurately checked.

In most cases the armature is new. The rear bearing must measure within the same one-thousandth of an inch limit as a new one or it is replaced. The new bearings are accurately sized in a 4-ton press—an exclusive factory operation. The tapered-roller front bearings are carefully inspected and adjusted. Brushes are new and the springs are tested for tension. The factory-reconditioned generator has the same efficiency as a new generator.

The Ford Parts Exchange Plan includes the Engine Cylinder Assembly and many other units. It not only saves money for the owners of Ford cars and trucks but it helps them maintain the high standard of Ford performance.



FORD MOTOR COMPANY • DEARBORN • MICHIGAN

When writing to advertisers please mention Popular Mechanics

HEROES OF THE SWITCHBOARD AND PHONE LINES

(Continued from page 885)

water and found that the boat from which the diver had been working was attached to the underspan of the bridge and had been lifted up when the bridge raised, spilling the diver's assistants, air pump and equipment into the water. Geagan jumped in, found the lines attached to the diver, and pulled him to the surface. At that moment, the ropes holding the boat suspended broke and the boat, in falling, struck Geagan's outstretched hands, knocking the lines loose. The diver began to sink again and to make matters worse, one of the assistants, still struggling in the water, accidentally kicked and broke the window of the diver's helmet, sinking him like a plummet. Geagan climbed to some piling and dived, but failed to locate the lines. Once more he dived and when almost exhausted, he found the diver, brought him to the surface, swam to a raft, and there helped to pull the unconscious man out of the water. Although dizzy and bleeding from the nose, he alternated with a fellow employe for nearly an hour in applying artificial respiration before the diver regained consciousness.

It is not heroism alone that is recognized with a Vail award. Hazel Haase, chief operator at Clinton, Ind., learned that five bandits had robbed a bank in her town and were making their escape in an automobile with the police in pursuit. She notified the county sheriff and the authorities of all the towns in the direction taken by the bandits' car. Then she broadcast a description of the car to citizens of the countryside and requested them to keep her informed of the bandits' movements. Though the bandits commandeered other cars and frequently changed their course, she immediately relayed such information to the authorities. After a pursuit of more than fifty miles they were surrounded, three of them killed, two captured and the loot was recovered.

Thus the story unfolds daily of these modern Paul Reveres whose voices travel the countryside to warn of impending danger or to bring help where needed. Like modern Horatios, the telephone men and women stick to their posts with fire, crumbling walls, or rising water about them and count it all part of the day's work.

Centralizing a Gear Cutter

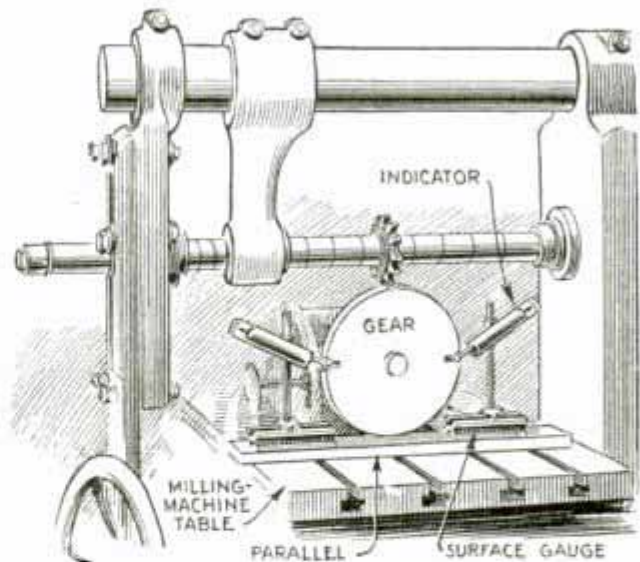

An Accurate Method of Setting Up the Work to Cut Teeth in a Gear Blank

In cutting gears that must run quietly, it is necessary to set the cutter centrally with the blank, which is done easily by the following method: First set the gear blank as close to central as possible by the usual method. Then cut a tooth, but not to the full depth, and rotate the blank 180°, or one half of a turn, using the indexing head for this purpose. Then cut another tooth and rotate the blank 90°, which brings the gear in the position shown. Now check the highest points on the blank of the teeth with an indicator. One half of the difference between the height of opposite teeth is the distance to move the cross slide so the cutter is in the center of the gear.

Simple Fishhook Extractor

Fishermen, who dislike the idea of tearing a swallowed hook from the throat of a fish, will find this simple extractor a great convenience. It is a piece of stout wire bent as shown, with the end loop bent at right angles to the shaft. By causing this loop to engage the line, and sliding it down to the position indicated, it may be manipulated to disengage the hook.

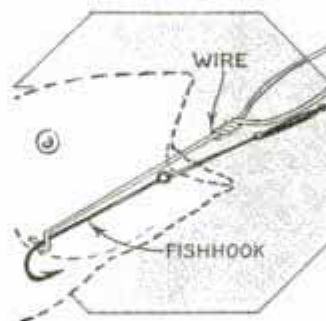

Screen wire that has eighteen meshes to the inch keeps out mosquitoes and most small bugs.

"The Devil's After Us"

ONE of the most dramatic incidents in the building of the first oil pipe-line from the Pennsylvania Fields to the Seaboard, occurred in the early days of 1880. As the work progressed, sticks, stones and pieces of rope mysteriously appeared in the pipe and stopped the flow of oil. To remove these, a scraper was invented which revolved as the flow of oil forced it through the pipe-line.

Farmers, hearing the rumble of the scraper as it bumped along under their fields, thought the devil was after them. And they nicknamed it the "Go-Devil". At first, the Go-Devil was an arrangement of leather and sheet iron washers strung on a bolt. The perfected device consisted of a series of revolving knives which loosened and scraped off the dirt and sediment clinging



to the pipes. The creation of this instrument was just one of the many achievements of the Tide Water pioneers who built the pipe-line that to this day carries the rich Bradford crude oil that is refined into Veedol, "the world's finest motor oil."

Graf Zeppelin Writes New Air History

A recent dispatch received from the Chief Engineer of the Graf reads in part, "One of the engines of the Graf went through the whole flying year of 1934 without overhauling. It was faultlessly lubricated with Veedol for 2,200 flying hours, which means a distance of over 220,000 kilometers (over 135,000 miles)."

Since its maiden take-off in 1928, this historic airship has made 71 ocean crossings, has carried tons and tons of mail, thousands and thousands of passengers, and has flown over 1,000,000 kilometers (over 600,000 miles). On every one of its record flights around the world, in the Tropics as well as in the Arctic, Veedol Motor Oil has been used exclusively.



AMAZING VEEDOL FACTS

300,000 lbs. per square inch

Did you know that recent tests on automobile rear-axles prove that old-fashioned greases are absolutely unfitted to lubricate the gears of new model cars? The specific pressure on the contact surface of the rear-axle driving gears reaches the almost unbelievable figure of 300,000 pounds per square inch. . . . For the past five years the makers of Veedol Motor Oil have been ready to meet this new problem. Veedol *Extreme Pressure Lubricants* are built to protect your car and your pocketbook too!

NOTE: You will be surprised to learn how small an investment it takes to start a profitable oil business selling Veedol, the world's finest motor oil. With your first order you get every sales and merchandising help. For details write—Tide Water Oil Company, 17 Battery Place, New York City.



National
Model
CONTEST

S.S. "NORMANDIE"

BUILD AN EXACT SCALE, ELECTRICALLY
LIGHTED MODEL—18 INCHES LONG

4 BIG PRIZES!

AND MANY OTHER PRIZES

1. A Round trip to France
2. A Round trip to France
3. A Long Cruise
4. A Short Cruise

Every one entering the contest will receive a beautiful commemorative medal.

SPECIAL MODEL KIT, \$1.50

● A complete kit has been specially designed to simplify building. It includes a hollowed hull easily assembled from factory-cut Balsa wood parts. All other materials are provided such as wood for the superstructure, mast, rudder, paints, brush, sandpaper, electric lights, wire, model builder's knife and cement—nothing else to buy. Life boats, anchors and propellers furnished fully finished.

● Full-sized plans are included, showing all steps in construction, and a picture of the *Normandie* in full colors. *Any one handy with a knife can complete a realistic model.*

● Entry blank, contest rules, list of prizes and judges' names included in each set.

NO AGE LIMIT—OPEN TO BOTH SEXES—Contest started April 15, 1935—closes February 15, 1936. . . . Model kits may be bought at department stores, sporting goods dealers, and hobby shops. Or direct from us (\$1.50 plus 25 cents for postage and packing).

MODEL BUILDERS' GUILD
DEPARTMENT B, HEMPSTEAD, NEW YORK

RIDING RACE CARS FOR A LIVING

(Continued from page 836)

a wreck. Spangler and Jordan were killed. I would have been in the car myself a few seconds later.

Some have called me a clown because I thumb my nose at other cars or offer them cigars as we pass. I do things like that because a race is a long, tough grind and anything I can do to keep my driver cheerful or make him smile now and then, helps our chances of winning. Occasionally I duck under the cowl and light a cigaret for him, or feed him sticks of gum or lemon drops. Toward the end I may reach over and take the wheel going down the backstretch to give him a chance to relax and rest his arms. By the end of a race, our hands are cracked and bleeding, his from gripping the wheel and mine from keeping up fuel pressure with the pump.

Scarcely a minute goes by during a race without my checking the tires, for if one starts to go bad it may last only a few seconds. Usually I can see tire trouble long before the driver feels it with the wheel. You would understand just how much punishment tires receive if you should sit where I have and watch them sliding sideways across the bricks in a turn, with clouds of smoke and sparks shooting up from the rubber on each wheel.

I carry a tin palm for my riding glove with which I can reach out and feel the right rear tire, which gets the most of the punishment, to detect a blister before it gets too large. Now and then the tread pulls away from the casing and I get the first warning of this by watching the tops of the tires. As long as the tire is round across the top all is well, but if it begins to peak up in the middle the tread is pulling off and I nudge the driver and point. That means slow speed and a pit stop. A thin white line down the middle of the tire indicates it is worn down too much for safety. The thin line widens as more of the tire is worn away.

Before every race my driver and I work out some simple gestures so I can let him know when trouble develops and just what the trouble is. Usually a nudge and then a hand pointing to the cause is all that is necessary. Also, we have other signals between the car and the pit that we try to keep secret so the boys in the other pits won't know how we stand.

EXTRA RANGE FOR .22 RIFLES

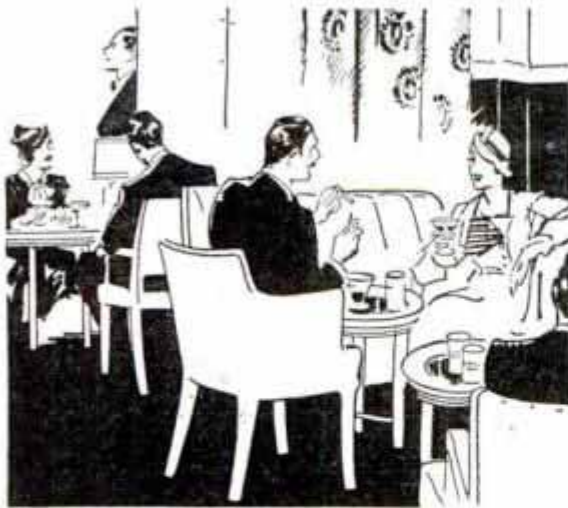

You don't have to be fussy about hotels to appreciate Hotel Cleveland » » »
But if you are, you will.

HOTEL CLEVELAND

SHIP MODELS

Get this dandy catalog of true-scale models of Flying Cloud, Viking, Blue Nose, Golden Hind deluxe fittings. Send 15c (in coin) for your copy. ROY HANCOCK, 323 Douglas Ave., Portsmouth, Virginia

RITZY STANDARD
Ezee Auto Axle with Low Mounting Idea. Size 8"x10". Get all materials in your Home Town.

BUILD A RITZY CABIN TRAILER
Plans & Specifications by Registered Prof. Engineer. Save 20% with these plans.

RITZY AIR GUTTER
MAIL DOLLAR TO-DAY for all three Plans to THE RITZY CABIN TRAILER Box 202 & WAPARONETA, OHIO

EARN MONEY Stringing Tennis Rackets

STRINGING TENNIS RACKETS PAYS UP TO 140% PROFIT PER RACKET!

String your own racket and *Save Money!* String for Tennis Players and *Earn Money!*

It's easy—we teach you how to string—show you how to get business. Your success is assured with our backing.

Costs next to nothing to start. Write for "Play & Profit"—gives all details.

FREE FOLDER

"Play & Profit" tells you how to earn money stringing rackets.

Low prices. Buy direct-from-factory! Price list of TOMGUT "Court-Tested" Tennis Strings and Stringing Equipment included.

New "Tension-Master"
racket stringing machine enables you to do repair stringing at once. No expensive contract tensioning machines. Contract tensioning machines measure stringing errors. You can do better work than the best professional. Easy to use. Low Cost! Write for folder.

THOMPSON MFG. CO., 4535 Packers Ave., CHICAGO, ILL.
Makers of Tomgut "Court-Tested" Tennis Strings and Restringing Equipment



SMACKO! A Kleanbore Hi-Speed bullet strikes 100 yards from the gun. Instantly delicate instruments measure the striking force. *110 foot pounds of energy!* More power than ordinary .22's develop at the muzzle!

Why do these Hi-Speed space sizzlers outshoot all others? Simply this: They're built like big game cartridges—solid brass case; extra-hard bullet, specially lubricated; Hi-Speed powder, and the one and only Kleanbore priming!

Test this amazing .22 ammunition yourself. We promise it will put new pep and power in any rifle. No increase in price. Buy and try a box today. Remington Arms Company, 1763 Seaview Avenue, Bridgeport, Conn.

Remington
DU PONT

ORDINARY .22's
102 FT. POUNDS ENERGY AT THE MUZZLE

KLEANBORE HI-SPEED .22's

When writing please mention Popular Mechanics

Make this test on your car!



*Compare Du Pont Polish
with any other make*

POLISH *one half* of your car with Du Pont Duco Polish. Polish the *other half* with any other make. See for yourself if Du Pont Polish isn't the easiest, quickest polish you ever tried.

This polish is a liquid...Is easy to apply. Rubs off with a flick of the rag. Removes grimy traffic film...leaves your car sparkling with beauty.

TRIAL OFFER. Get a generous sample of Du Pont Polish FREE. Tear out this advertisement and send it with your name and address (and 6c in stamps for postage) to DU PONT, Dept. M-52, Wilmington, Del. Try this polish at our expense.

(Offer good only in U. S. and Canada)



DU PONT DU CO POLISH



WHAT PRICE SPEED RECORDS?

(Continued from page 852)

world in seventy-two days and six hours, the cost was figured at less than \$10,000. In 1931, when Wiley Post and Harold Gatty toured the world in less than nine days, the cost was far less than Jules Verne estimated. And there is a good probability that before the end of 1935 anybody with \$2,000 can arrange an air tour of the world in about two weeks.

Although speed records in mechanical locomotion have gone up, there are others which are virtually stationary, although millions have been spent in attempts to better them. While we do not attempt to break the speed record of light, we do try to find out how fast it travels. And the cost of these experiments has gone beyond \$200,000. Dr. Michelson, before he died, spent \$60,000 for a metal tube three feet in diameter and a mile long, with pumps to suck out the air.

The speed of horses has increased only slightly, although millions have been spent in trying to improve it. Thoroughbred racers are worth fortunes because they have great earning capacity. For instance the winnings of "Sun Beau" amounted to more than \$375,000 and those of "Zev" to more than \$300,000. And yet, the speed record of the running horse remains almost stationary at about forty miles per hour.

Both man and the animals are bound by speed limitations. By ingenious breeding, man has developed the fleet greyhound. At his best, the greyhound can touch more than forty miles per hour, while man, at his best, travels about twenty-one miles per hour. A champion walker covers about nine miles an hour. The fastest walker can make a mile in about six minutes. For a hundred-mile race, the champion runner can average only seven and one-half miles per hour. Elaborate and costly training for athletes has not meant any appreciable reduction of previous records.

Swimming is man's slowest form of muscular locomotion. A fast swimmer can go up to four miles an hour for 100 yards, but for a long distance he cannot average better than two miles per hour. Man's best speed records are made in ice skating and roller skating, where the maximum is about twenty-three miles an hour. But on a bicycle, a man has traveled as fast as a mile a minute.

CRITICAL MOMENTS NO 3

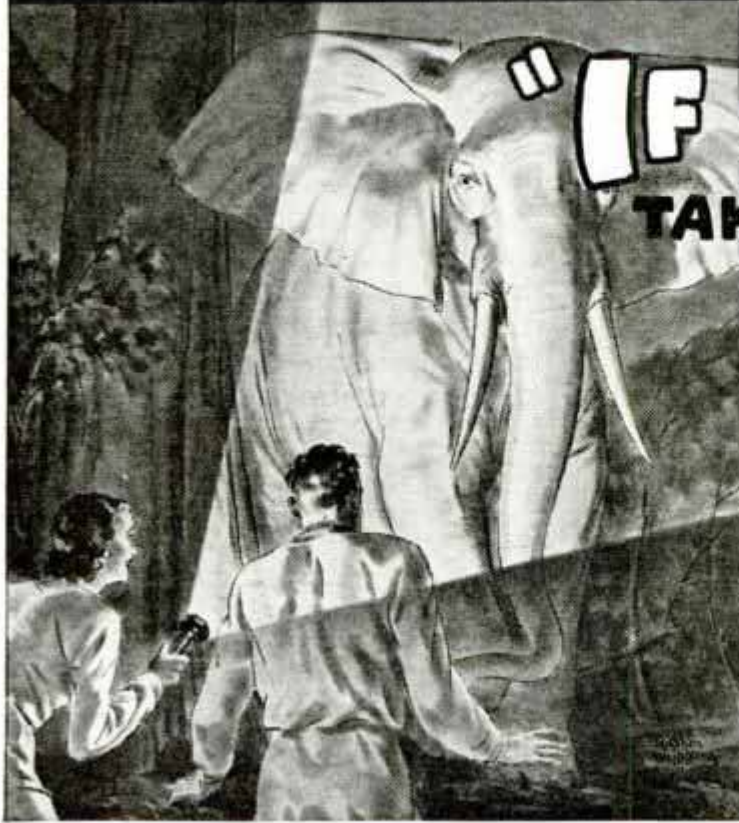

**"IF MARTIN HAD
TAKEN ANOTHER
3 STEPS!"**

**SAID
MRS. MARTIN JOHNSON**

"Martin was waiting in the dark for me to bring our Eveready Flashlight. I shot its beam past him... and *there*, barely ten feet off, was a huge elephant!"

OSA JOHNSON
(Excerpt from an actual letter)

AT TIMES LIKE THIS
...YOU'RE GLAD THEY'RE
FRESH
LOOK FOR THE "DATE-LINE" →

Batteries tend to "go stale," if left over-long on dealers' shelves. Uniform, dependable, long-lived service *only* comes from FRESH batteries. The "Date-Line" on all Eveready Batteries guarantees FRESHNESS and UNIFORMITY... National Carbon Co., Inc., New York, N. Y.



ESKANOE KAYAK **READY TO ASSEMBLE \$15**

Complete kits including **FREE PADDLE**, with simple plan for self-assembling. No experience needed, safest boat for children.

Also cedar and folding KAYAKS, carry 1 to 4 persons, 10 to 20 ft. For paddling, sailing, hunting & fishing, non-sinkable, light, portable. Expert Kayak designer and builder since 1924.

Send 10c
Postage for catalog illustrating 16 models & new self-assembling plan.

KAYAK BOAT CO., 147 East 84th Street, N. Y. C.



AMAZING AUTO COMPASS

Don't lose time and money by taking the wrong road and going many miles out of your way. This new AIRPLANE TYPE COMPASS constantly tells your direction of travel. Sticks to windshield. Base 1 3/4" diameter. **ONLY \$1.95 POSTPAID**, including Compensator. **SATISFACTION GUARANTEED** or your money refunded if returned within ten days.

DEALERS WANTED!
HULL MFG. CO., Box 245-D6, WARREN, OHIO



TURN SCRAP INTO MONEY

The new and revised edition of "Auto Power" with all the ten original specifications and ten new ones is now off the press. Convert old generators into A. C. and D. C. generators and motors with voltages of 6 to 400 volts, for power, light, welding, and radio operation. Create new generators adaptable for home, automobiles, or trucks. They can be driven by fan belt, wind, or water. This book, with complete illustrations, tells you how easily and economically these changes can be made. Also instructions for rewinding auto armatures. 350 definitions of electrical terms, etc. Already used and endorsed by thousands. Price, \$1. Postpaid.

AUTO POWER, Dept. B, 410 S. Hoyne Ave., Chicago





**REMOVE RUST
The Easy Way—
Dissolve It with
RUSTICIDE!**

RUST-I-CIDE dissolves rust! It's just the thing you need to brighten up those bumpers that show the signs of winter weathering. Abrasives scratch and mar—but RUST-I-CIDE simply melts the rust away in three short minutes. Just dab it on—then wipe away the rust.

Another important use for RUST-I-CIDE is the removal of rust before touching up fenders and running boards. Touch-up enamel cannot stay on unless you remove all the rust. Leading manufacturers of fender enamels recommend RUST-I-CIDE for the perfect preparation of rusted surfaces.

There are dozens of other uses for RUST-I-CIDE in every home. Removes stubborn stains from bath tubs, toilets and sinks. Every household should keep a bottle on hand.

For Sale by hardware, automotive accessory and department stores. Also by Firestone and Western Auto stores.

ASK YOUR DEALER. IF HE HAS NONE IN STOCK, USE THIS COUPON

RUSTICIDE PRODUCTS CO., 1919 E. 19th St., Cleveland, Ohio
Enclosed find 25c for one bottle of RUST-I-CIDE 5
Please rush this order postpaid.

Name _____
Address _____ City _____ State _____

HAVE YOU TRIED "CREATIVE WHITTLING" ?



Arthur Dayton, Whittler

THOUSANDS of people who knew nothing about whittlin' until last year are now experts . . . They sent a 3c stamp for Remington's fascinating Whittlin' Book—and what they learned from it started them on a **NEW HOBBY!** Have you tried to carve anything of wood lately? It's great sport. Send for the book today...then get a razor-sharp Remington Knife (or better still, the Whittlin' Set) —and go to it!



SEND 3c FOR WHITTLIN' BOOK

Remington Arms Company, Inc., Cutlery Division, Dept. E-5, Bridgeport, Conn.

Please send me your Whittlin' Book. I enclose 3c stamp.

Name
Address
City State

6292
LZ-129 THE LATEST AIRSHIP
(Continued from page 847)

are in the sides of the ship to enable passengers to have a full view of the panorama. Living quarters are in the interior of the ship. All cabins are windowless, air-conditioned, and lighted for comfort.

There is even enough room for certain deck games. Passengers will eat in comfort in a dining room with thirty-eight chairs and equipped with long tilted windows. The living quarters are in two decks, one above the other, connected by a broad staircase. The galley, with its electric stove and other equipment, is on the lower deck. Here also are the bathrooms, steward's office and crew's quarters.

In order to offset the coldness of metal furniture, the public rooms are decorated in soft pleasing colors. Wall paintings show the history and development of the airship, a bird's-eye panorama of the route traveled, and the constellations in both northern and southern hemispheres.

The engines will develop 4,400 horsepower in all. For the first time an airship will have the advantage of Diesel engines. They are hung on the outside, as on the "Graf," and each operates independent of the rest. The "LZ-129's" immense cruising range, 8,000 miles, enables her to travel around the world with only two refueling stops. The ship is equipped with an apparatus for extracting water vapor from the surrounding atmosphere at a rate of about 150 gallons per hour.

Clark Howell, chairman of the federal aviation commission, recently pointed to the value of dirigibles in commerce.

"Dr. Eckener," he said, "has made thirty-seven voyages across the ocean and circumnavigated the earth without missing a schedule in the 'Graf,' covering more than 625,000 miles without a serious accident.

"If the Germans can do it, we can. The record of the 'Graf Zeppelin' should be an object lesson and we should leave nothing undone to see to it that, whatever may be the shortcomings, either in construction or operation, of lighter-than-air craft, they can and will be surmounted."

Commander Charles E. Rosendahl, a veteran of many airship flights, said: "The loss of 282 airships since 1919 was due almost entirely to naval and military operations. No attempt to cross the ocean by airship has ever come to grief."

BOOK FORM CARDS

NOW COST YOU

About HALF!

THE latest development in **raised letter printing** puts these attractive business and social cards on a basis with the most expensive. Unless you are an expert, the only difference to you will be the price.

Run your fingers over them, and you can actually **feel** the raised letters. Look at them on the back, and you won't find the type punched through. You will have a hard time convincing others of how little they cost.

Send us 10c in stamps for postage and packing, and we will send a selection of these astonishing business and social cards. If you wish to order some for yourself, you may deduct this 10c from our estimate.

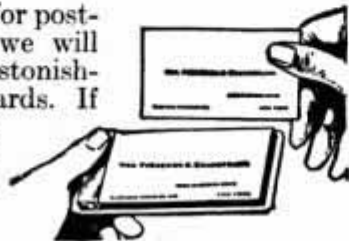

MODERN CARD COMPANY
2351 No. Racine Avenue - CHICAGO

A QUALITY KAYAK FOR \$9.20

Everyone can now own a Fellowcraft Kayak. Practical, rugged, fast sporty lines. Last year's boating sensation. Perfectly engineered. Finest materials. Seaworthy. Safe. Weight 15 lbs. Carried by hand or auto. Quickly assembled at home. Full instructions. Complete Kit for 8 ft. Kayak containing all parts ready-to-assemble. \$9.20; 10 ft. Kayak (shown here) \$14.60; 8 1/2 ft. Square End Dinghy (shown here) \$17.90.

Make good tenders. Prices F. O. B. Cash with order or C. O. D. Every customer enthusiastic. Assembled Kayaks also available. Plans only, \$1 per model. Descriptive folder. Order now.

FELLOWCRAFTERS, INC.
64 Stanhope St., Boston, Mass.
Dept. F.P., Boston, Mass.



BUILD YOUR OWN FANS. 20 inch aluminum propellers for aeroplane fans \$3.85. Shipped collect. Michael Electric Co. Fort Worth, Texas



EARN MONEY WITH PERFECTED
TENNIS
RESTRINGING
VISE
ENJOY CHEAPER TENNIS

Newly perfected TennisVise invention enables anyone to re-string tennis rackets at big savings or for BIG PROFITS. Just follow simple instructions. Save on your own tennis...earn money too! Write for Free details.

BUY Factory-fresh-Strings Save Cash

Now you can buy genuine GUT strings direct-from-factory-to-you. High quality, low cost! SILK strings, too. Our Free Tennis Equipment Catalog will SAVE YOU MONEY.

WRITE for your FREE copy today and details of Perfected tennis vise invention!

H. E. WILLS CO.
1047 W. 47th ST. Dep. A-135 CHICAGO, U.S.A.

FREE TENNIS CATALOG
MFR. OF QUALITY GUT STRINGS

WHY DO SOME NEW CARS AGE SO QUICKLY?

From the moment you get behind the wheel of that bright and shining new car, you enter a race against *wear and depreciation*.

The car maker has supplied you with a motor that gives you more power, more speed, with less consumption of gasoline than engineers thought possible a few years ago. But in reaching this stage of perfection the motor builder has used new alloys, new bearings—has *fitted* the wearing surfaces closer and closer together. And all these things create a new and serious problem in lubrication.

Oil now has only a fraction as much space in which to flow—and is subjected to greater heat and tension. Therefore, the opportunity for *quick* damage is greater than ever before.

Thus, the question of "why do some new cars age so quickly" is definitely related to the selection of the right oil and the care used in "breaking-in" the motor.

Car makers, generally, are recommending the use of light oil (SAE10 or SAE20) to "break-in" the motor; and several suggest lighter grades of oil for general driving, even in Summer. However, the following warning is given: "*one of the most important factors is the quality of the oil.*"

That's why you will hear so many experienced motorists say today: "I don't experiment with motor oils—I buy Quaker State." Quaker State Refining Company, Oil City, Pa.

"First choice of Experience"

**QUAKER STATE
MOTOR OILS**

When writing please mention Popular Mechanics

INSIST ON THE

Genuine



for PERMANENT REPAIRS

Genuine Plastic Wood is actual wood that comes in cans and tubes—can be moulded with the hands—when dry it is hard, permanent wood that can be sawed, planed, sanded, drilled, turned on a lathe—will hold nails and screws without splitting, cracking or crumbling—can be painted, varnished and lacquered perfectly—it is water-proof and weather-proof.

Plastic Wood will adhere to any clean, dry surface—wood, metal, glass, stone.

Get your can or tube of genuine Plastic Wood (made by The A. S. Boyle Co., Inc., Cincinnati, Ohio) at all hardware, paint, department stores.

PLASTIC WOOD

INFECTION

Always Dangerous!



Avoid infection from insect bites, blisters, cuts, abrasions, fire and sun burns, scratches and skin irritations by using

**LUCKY TIGER
ANTISEPTIC OINTMENT**

Instant relief. Tested according to accepted standards.

FREE

Generous sample Free upon request.
Lucky Tiger Mfg. Co., Kansas City, Mo.

THE QUEEN OF THE SEVEN SEAS

(Continued from page 828)

as a fire wall. Each cabin has a fire detector which, when the temperature of the room reaches an abnormal degree, rings an alarm in the central fire station, and automatically closes all ventilators in that section of the ship. The electric circuit in most of the cabins is independent of the others; and in the ceiling of each cabin is a hole, accessible to firemen in emergency. If the power fails, the passengers will see their way with the aid of phosphorescent signs. Several radio transmitters operate independently of the ship's power plant.

The amazing thing about this vessel is that so few men are required to operate it. Actually, only 400 men are needed to keep her running continuously. The other members of the crew are for the service of passengers. But if human hands were required to do the work performed by the instruments on the captain's bridge, a small army would have to be enlisted. The bridge has telegraph and telephone equipment, gyroscopic compass repeaters for the watch officers and helmsman, an automatic gyro-pilot, which keeps the ship on her charted course, and hydraulic telemotor apparatus.

In the chart room are the sonic depth finder, speed-indicator logs, radio-direction finder, indicator for the closing of bulkheads, indicator for the closing of portholes, and numerous other devices. All these constitute the "brains" of the "Normandie." The officers and crew merely direct the brains.

Squeaking and creaking have been virtually banished by the use of fireproof flannel between uprights and in the partitions. The flannel not only eliminates squeaks, but insulates cabins against noise.

In terms of food, the "Normandie" will be a connoisseur's delight. The ship's galley has facilities for feeding an army. All cooking will be done by electricity. The range weighs twenty tons, which includes eight tons of sheet iron and five tons of insulating brick. The thirty roasting ovens can handle 768 chickens at one time.

When she comes across the ocean on her maiden trip, the "Normandie's" funnels will discharge 150 tons of smoke! But thanks to wind-tunnel tests and careful designing, this smoke will be wafted into the air and not into the faces of passengers.

Thompson BEATS the World on BOATS



**Better Built
Lower Prices**



Canoes \$45 and up

Rowboats \$36 and up

Outboards \$42 and up

Very fast utility model

**Only Boats With
Full Length Spray Rails**

Keep passengers perfectly dry—even at high speeds. Catalog also shows snipe sail boat complete with sail for \$185. Two big factories. Prompt shipment.

CATALOG FREE
Write for your copy. State kind of boat in which you are interested.

THOMPSON BROS. BOAT MFG. CO. (77)
213 Ann St., PESHIGO, WIS. (Write to either place) 113 Elm St., CORTLAND, N. Y.

new- READY SHAPED LOW COST RACING CRAFT



Sensational Sailboat Kit

Make winning speed models in a few hours. No hard work. Hull already shaped and hollowed. You smooth it down, paint, adjust rigging, etc., and she's ready to launch! Watch her go! Easy-to-follow instructions and all necessary parts in kit.

Kits as Low as 25c

Get Racing Craft at dealer. If he can't supply, send money order for 7" solid hull kit, 25c; 15" hollow hull kit, \$1.00; or 22" hollow hull kit, \$2.50. Sent prepaid in U. S. All materials guaranteed. Free book shows larger sailboats, Runabout and the Buck Rogers Strait-O-Sphere Balloon.

**SEND FOR
FREE
BOOK**

THORNECRAFT

Dept. 6, 2518 Montrose Ave., Chicago

ENGINES

**DIESEL-
GASOLINE-KEROSENE**
Enclosed • Self-Oiling • Roller Bearing



A size and style for every purpose. Most economical power for farm or factory. Put one to work and watch it pay for itself. Sold Direct from Factory to You! Write today for FREE Catalog and Literature.

WITTE ENGINE WORKS

174A Oakland Ave., KANSAS CITY, MO. 215F So. 2nd St., HARRISBURG, PA.



QUALITY Tool Chests!

Built for long Service. The Favorite of Machinists, tool, die and patternmakers. Free catalog.

GERSTNER TOOL CHESTS

442 Columbia St. Dayton, Ohio

MAKE MONEY! STRING TENNIS RACKETS



Why pay \$5.00 for a stringing job? Do it yourself. It's easy. We send complete instructions: 37 ft. factory fresh string, any popular color; and length of trim. Money back guarantee. **SAVE MONEY ON YOUR RACKET — EARN MONEY STRINGING FOR OTHERS.** Sent post paid for only \$1.00.

ACE TENNIS STRING CO.
Box 155, Brighton, Mass.



GET YOUR TRACTOR AT FACTORY PRICE

3 Speeds Forward and Reverse. Runs 4 to 8 hours per gal.

Amazing money maker for farms, truck gardens, orchards, nurseries, poultry ranches, country homes, etc. Plows, discs, harrows, cultivates, mows lawns, cuts weeds. Runs belt machinery. 1 to 5 H.P. riding or walking types. Write for **FREE CATALOG, Low Factory Prices and 10 Day Trial Plan.** Address Nearest Office.

SHAW MFG. CO. Desk 4506
Galesburg, Kans., or Columbia, Ohio,
or 5812 Magnolia Ave., Chicago, Ill.

SHAW DU-ALL TRACTOR

Air Tires or Steel Wheels

When writing to advertisers please mention Popular Mechanics



10c

WILL SAVE THEM

Dip these two caked-up brushes into a magic bath of Savabrush and . . . you won't know them! For Savabrush's main mission in life is to redeem the "toughest" citizens of Brushland. A 10c carton will save several brushes; loosen every bit of paint, varnish, shellac, enamel; make the bristles soft, pliable, good-as-new, overnight! No matter how old or hopeless they look Savabrush cleans 'em right down to the heel. Ask your paint or hardware dealer; if he is not supplied use this quick-action coupon.

NAME

ADDRESS

This coupon and 10c, mailed to Schalk Chemical Co., 354 E. 2nd St., Los Angeles, will bring you a postpaid package of Savabrush.

SAVABRUSH

BURN YOUR NAME ON TOOLS

WITH THE ARKOGRAF

PROTECT YOUR TOOLS FROM THEFT
Write with electricity any name or design on the hardest and finest tools and instruments, or any metal, like writing on paper with pen or pencil. **Complete Outfit \$3.50 — Prepaid Anywhere.** Interesting illustrated circular free. Write today. Agents wanted. **ARKOGRAF PEN CO., 3927 S.E. Stark St., Portland, Ore.**



HANDEE

Tool of 100 Uses

Grinds, routs, drills, carves, sharpens, cuts, engraves. Over 100 wheel shapes available. Fits the hand perfectly. Weighs 1 pound. For use at home, in the shop or take to the job. Do away with slow hand work! A.C. or D.C., 110 volt, 13,000 r.p.m.



Plug in any light socket

\$10.00
and up Postpaid U. S. A. with 3 wheel shapes Free. Order today.

Order on 5-day trial. Satisfaction guaranteed. Ask for **FREE** booklet.

New MASTER CRAFTSMAN'S SET
17 useful accessories to grind, drill, polish, sand, cut, carve, engrave, etc. **Prepaid \$5.00**

CHICAGO WHEEL & MFG. CO., 108 S. Aberdeen Street, Chicago, Ill.

Amazing ENAMEL

LEAVES NO BRUSH MARKS



WHEREVER you want a tough, long-lasting finish... wherever wear is hardest... that's the place where *Steelcote Rubber Enamel* brings best results. Autos, steam radiators, refrigerators, porch furniture hold their beauty and new appearance when finished with *Steelcote*.

Contains Rubber Plasticizer
Steelcote leaves no brush marks. The rubber plasticizer levels the paint and smoothes out all brush marks or laps. The most inexperienced can obtain a factory-like finish with ease... a finish that alcohol, steam, oil or grease will not mar.

SEND FOR FREE COLOR CARD
 Thousands know and insist on *Steelcote*. Good dealers everywhere have it. If your nearest hardware, paint or auto accessory store can not supply you, write for color card and prices.
 Steelcote Manufacturing Company
 3460 Gratiot Street, St. Louis, U.S.A.



Steelcote

RUBBER ENAMEL

Free ROAD MAPS

for your vacation trip

Also Illustrated Travel Books
and Hotel & Camp Directories!



Just write us, telling where and when you want to go. We will send you complete travel service for trip anywhere in North America—free of charge and postpaid. No obligation. Service includes elaborate road maps of all States you visit, with your best route and latest road conditions marked. Hotel and camp directories, with location and rates. Illustrated booklets on scenic and historic sights. Conoco Passport, with identification card and expense record. Fishing and sport information sent if requested. A service of Continental Oil Company. Write now to—

CONOCO TRAVEL BUREAU
 DEPT. 94 DENVER, COLORADO

Collect BIG PROFITS in Advance

Something that every man wants... **INDIVIDUAL BUCKLE AND BELT.** Every buckle different, made to personal order. Initials or name in raised letters and colors... non-tarnishable, lasting finish. Including genuine cowhide leather belt with famous "Hook-Fast" catch.

Volume orders easy from Schools, Lodges, Clubs, etc. Many sales from friends, neighbors. Write today for Special Offer.

HOFMANN "HOOK-FAST" SPECIALTIES, INC.
 P. O. Box 1425 Dept. 71 Providence, R. I.

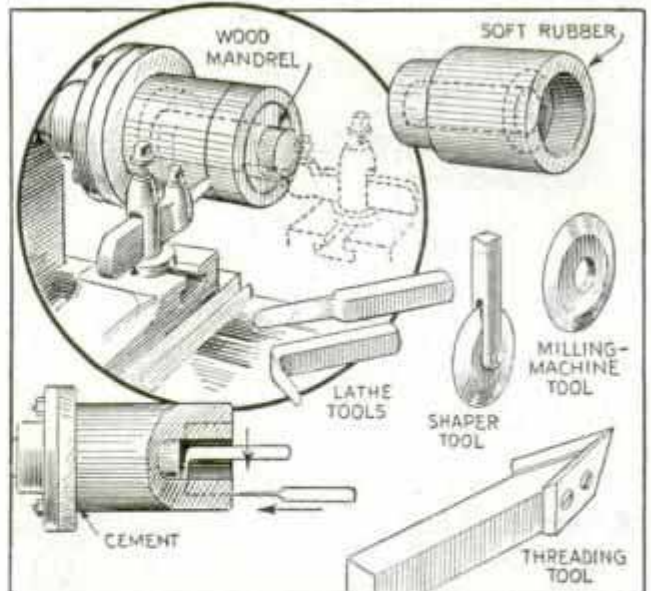

Machining Soft Rubber in a Lathe Is a Comparatively Simple Task When the Right Tools Are Used

Machining Soft Rubber

On first thought, the machining of soft rubber may seem difficult, but it is a comparatively easy task if the right tools are used. The tools shown will be found adequate for ordinary work. The method of setting up the rubber in the lathe will depend on the type of machining to be done, the main idea being to support the rubber so that it will not distort under pressure of the tools. Wood forms are used for this purpose, and their shape varies according to the work at hand. The rubber is cemented to the form, which is attached to the faceplate with a mixture of equal parts of rosin and beeswax melted together. The drawing shows three simple operations in machining a piece of soft rubber in a lathe. Also, this work may be done in a shaper or milling machine. Glycerine is a good cutting fluid for machining rubber, although lard oil, and even soap and water are sometimes used.—Charles Kugler, Philadelphia, Pa.

Soldering Leaks in Radiator

To easily repair a leak in a honeycomb radiator, remove the latter from the car and clean the surface of the metal around the leak. Then coat the cleaned surface with soldering flux, and whitewash the metal around the edge of the flux. The whitewash will keep solder from adhering to the metal where it is not wanted. If the radiator is set in a slanting position, molten solder can be poured over the flux-coated surface and the leak sealed permanently.

AMAZING TYPEWRITER BARGAIN

New Remington Portable only 10¢ a day!

10-DAY FREE TRIAL OFFER

Only 10¢ a day buys this latest model machine. Not a used or rebuilt typewriter. Not an incomplete machine. A beautiful brand new regulation Remington Portable. Standard 4-row keyboard; standard width carriage; margin release on keyboard; back spacer; automatic ribbon reverse; every essential feature found in standard typewriters. Carrying case and typing course free . . . absolutely the biggest typewriter value ever offered! Try it in your home or office 10 days free. If you do not agree that it is the finest portable at any price, return it at our expense. Don't delay. We pay cost of shipment direct from the factory to you. You save on the purchase price and you do not risk one penny. Write today!



FREE HOME TYPING COURSE

Write Remington Rand Inc., Dept. 152-6, 205 E. 42nd St., N.Y.C.

9 HOURS TO BUILD NEW SPORTSMAN'S BOAT!

MEAD Sportsman's Ki-Yak is the most sensational boat development in years. Exclusive new structural features set a new standard for lightness, strength, durability, beauty and ease of assembly. Easily portable. Low introductory price! Don't deny yourself the pleasure of knowing all about it. Rush 10¢ for Catalog. \$6 Paddle now given with your Sportsman's Ki-Yak Kit—if you hurry!

MEAD GLIDERS 12 So. Market Dept. B-6 **CHICAGO**

For **FISHING CAMPING HUNTING SAILING**

FREE METLMACH THE MODERN MACH.

This amazing new mach sent free (to salesman) if you enclose 10c for packing, mailing, etc. The biggest sensation in Mach industry. A mach made of metal—lights 1000 times or more. Fire and water proof. The new—safe way to light fires, cigarettes, cigars, pipes, etc. Take advantage of free Metlmach offer, or send \$1 for 15 METLMACHES, sell them at 10¢ each, make 50¢ profit. \$1 invested today may mean your future independence. METALMATCH CORPORATION, 115 WATER STREET, WARSAW, ILLINOIS

DO YOU WANT a new business profession of your own, with all the trade you can attend to? Then become a foot correctionist, and in a few weeks earn big income in service fees,—not medical nor chiropody—easy terms for home training, no further capital needed, no goods to buy, no agency. Established 1894. Address Stephenson Laboratory, 1 Back Bay, Boston, Mass.

WILL YOU WEAR THIS SUIT and Make up to \$12 in a Day!

Let me send you this fine all-wool tailored suit **FREE OF COST**. Just follow my easy plan and show the suit to your friends. Make up to \$12 in a day easily. **No experience—no canvassing necessary.** Send for Samples—**FREE OF COST** Write today for **FREE** details, **ACTUAL SAMPLES** and "sure-fire" money getting plans. Send no money. H. J. Collins, Progress Tailoring Co., Dept. T-216 500 S. Throop St. Chicago, Ill.

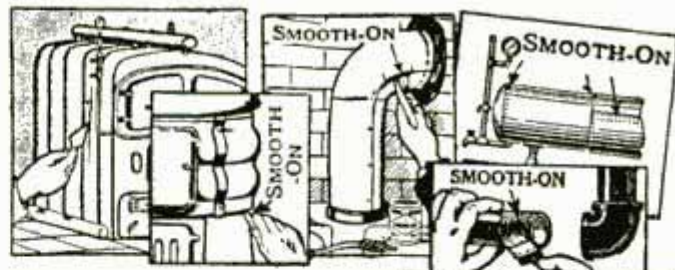

BE THRIFTY! Do your own repairing with SMOOTH-ON No. 1

THIS cement hardens into metallic iron, costs little, is easy to apply and makes dependable permanent and emergency repairs that save the householder big sums.

By following directions in the Smooth-On instruction booklet you can stop steam and water leaks from joints or cracks in the boiler, heater, piping and radiators, stop leaks from gas lines, stop leaks of fumes from air furnaces, ovens and smoke pipes, in every instance avoiding a big labor bill and often the cost of a renewal part.

Smooth-On No. 1 is also excellent for resetting loose screws, nuts, rivets, hooks, hinges, locks, handles, drawer pulls, casters, etc., anchoring bolts and pipe posts in concrete, plugging holes or seam openings in tanks, troughs and pails, tightening loose bases, etc.

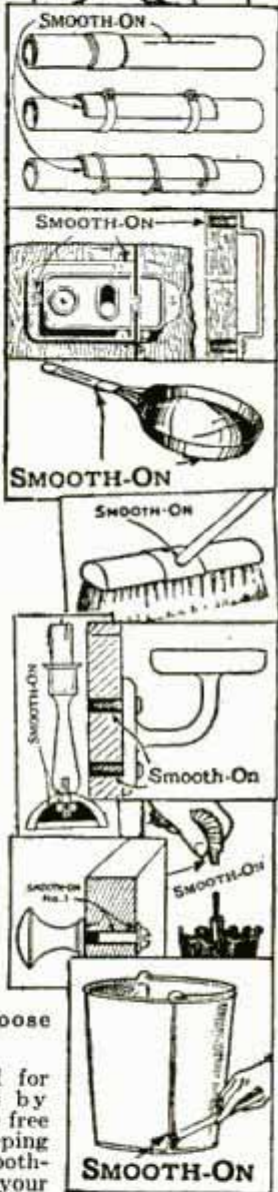

Be prepared for emergencies by sending for the free book and keeping a can of Smooth-On No. 1 in your workshop. Get Smooth-On No. 1 in 7-oz., 1-lb. or 5-lb. can from any hardware store, or if necessary from us direct.



Write for **FREE BOOK**

SMOOTH-ON MFG. CO., Dept. 37, 574 Communipaw Ave., Jersey City, N. J. Please send the free Smooth-On Repair Book.



Name.....
Address.....
6-35.....

Do it with SMOOTH-ON

When writing please mention Popular Mechanics



You know by experience that no job turns out well if part of it is slighted. So 3-in-One does *extra work* to do a perfect job of lubrication. As it *oils* it keeps moving parts *cleaner*, and *prevents rust*. Saves trouble, saves repairs, saves your workshop equipment. Handy cans and bottles.

3-IN-ONE OIL

*This much more
in a Shelvador*

EXCLUSIVELY IN

CROSLEY

ELECTRIC REFRIGERATORS

Good Housekeeping Institute

WINGS OVER THE PACIFIC

(Continued from page 864)

States. It is distinctly an international undertaking.

The cargo of the supply ship, "North Haven," weighs 6,000 tons and is equivalent to that of 300 railroad freight cars. The list of equipment reads like a catalog of what any modern Robinson Crusoe would like to have were he taking up a settlement in mid-Pacific. Each air base will have a small library of books, including standard works on various phases of aviation and engineering; also books of reference and books of fiction.

The station at Midway island will be stocked with 2,500 pounds of frozen meats and a like quantity of smoked meats, 500 pounds of chicken, 700 pounds of butter, 450 dozen eggs, and canned goods sufficient to stock a grocery store. The heavy cargo of the "North Haven" includes Diesel engines for power plants, radio poles, lumber, floodlights, 1,000-gallon fuel tanks, anchors, car wheels, cable, wire, paints, screens, carpenter tools, and plumbing equipment.

For the amusement of the staffs at the airway bases, the "North Haven" carries baseball outfits, tennis balls, chess, checkers, and puzzles. Each air base will have long and short wave receivers. Each canteen will be stocked with sundries, cigarettes, candles, shaving equipment, chewing gum, sunburn cream, shoe polish, writing paper, and toilet articles. The "North Haven" also carries full kitchen equipment, and prefabricated parts for the small buildings necessary to each station.

Both for recreation and food, the personnel on the islands will take up gardening. They will add to the variety of their diet, raising such staples as coconuts, celery, cauliflower, cabbage, beets, squash, tomatoes, lettuce, onions, cucumbers, peas and spinach. Seeds for these plants will be delivered by the supply ship.

It is expected that the "North Haven" and her construction crew will complete their initial work of establishing the bases in less than 100 days. According to present plans, the ship will return to the United States by the end of July. After that, the air bases and clipper ships will be ready for the first experimental flights.

Five men already have been assigned to

(Continued to page 146A)

*Eslen L. Martin Co
Baltimore Md*

**MAKE MONEY!
INSTALL YOUR OWN BURNER**

At last! A quality burner in the low priced field. Our burners bought by U. S. Govt.! Now you can buy direct at one low price complete with full set of electric controls, wire, etc., plus complete instructions for making your own installation. Write for amazing low price and free literature today!

CHALMERS OIL BURNER CO.
1248 Central Ave., Minneapolis, Minn.



FREE LITERATURE
... SEND TODAY!



GOOD BLUE PRINTS and GOOD TOOLS characterize GOOD CRAFTSMANSHIP for good cross-hatching THE NELSON SECTION LINER ask your dealer or write for folder.

THE NELSON SECTION LINER
727 N. 7th St., De Kalb, Ill.
New York Office, F. P. Mehm, Mgr.
1133 Broadway, New York City



\$1 VALUE FOR 50c

Get FACTS on trailer design. This 50 page book can save you 100 times its cost. Order direct from author. Money back if not satisfied. 2c tax in Ohio. RAY F. KUHS, Dept. 105, Madisonville, Cincinnati, O.

CASH INCOME DAILY RESILVERING MIRRORS; REFINISHING METAL Plated articles; autoparts, reflectors, tableware, etc., Making Chipped Glass Name Plates, Signs. Portable Outfit, Write! **SPRINKLE, PLATER, 129, MARION, INDIANA**

Catch Fish!

Eels, Mink, Muskrats, with our new folding galvanized STEEL WIRE TRAP. Write for our FREE TRAP OFFER and Bargain Catalog. 51 Box of our famous Fish Bait FREE to introduce our traps. **WALTON SUPPLY CO., 3509 JUNIATA AVE., ST. LOUIS, MO.**

TYPEWRITER 1/2 Price

Now Only

10¢ a Day

AFTER 10 Day FREE Trial

No Money Down



Fully GUARANTEED

Positively the greatest bargain ever offered. A genuine full sized \$100.00 office model Underwood No. 5 for only \$39.90 (cash) or on easy terms. Has up-to-date improvements including standard 4-row keyboard, backspace, automatic ribbon reverse, shiftlock key, 2-color ribbon, etc. The perfect all purpose typewriter. Completely rebuilt and FULLY GUARANTEED.

Learn Touch Typewriting Complete (Home Study) Course of the Famous Van Sant Speed Typewriting System — fully illustrated, easily learned, given during this offer.

Lowest Terms—10 Cents a Day Money-Back Guarantee

Send coupon for 10-day Trial —if you decide to keep it pay only \$3.00 a month until \$44.90 (term price) is paid. Limited offer—act at once.

INTERNATIONAL TYPEWRITER EXCHANGE
231 West Monroe St., Chicago, Ill., Dept. 601
Send Underwood No. 5 (F. O. B., Chicago) at once for 10-days trial. If I am not perfectly satisfied I can return it express collect. If I keep it I will pay \$3.00 a month until I have paid \$44.90 (term price) in full.

Name..... Age.....
Address.....
Town..... State.....

**YOU CAN OWN THIS
POTATO CHIP
BUSINESS**

Sweep the Market with the Sensational New Chip Now Made Possible by This Inexpensive Machine
300% PROFITS

Never before such an opportunity as this for making big money quickly in a business of your own. Millions of pounds of Potato Chips sold weekly. Now a sensational invention turns out a "Greaseless" Potato Chip (every bit of excess oil extracted right after cooking) and it is so delicious, so dry and crisp, so digestible, that the public is wild about it. Everywhere it is introduced it sweeps competition like wildfire. This big profit food can now be turned out in large quantities by a wonderful new machine. The cost of this machine and the complete business is so low that any man or woman can now start this profitable business at home.

Everything Furnished

You manufacture and deliver to stores. No canvassing or peddling as stores do your selling for you. Just on a wholesale business the capacity of this wonderful machine makes it possible to make \$23.00 a day in cash profits. I send you everything—machine, scoop, speed slicer, oil extractor, a big supply of printed bags, free advertising matter, and complete directions for you to follow. Write to me quickly. Send no money—just your name and address. I'll send you complete instruction, descriptions, prices and terms by return mail. Don't delay a minute. All information is free. This is the biggest proposition you've seen in many a day.

J. H. MILLER, Dept. 56, 325 W. Huron St., Chicago, Ill.



Hire a Girl to Manufacture — You Deliver and Collect—Cash every day.



J. H. Miller, 325 West Huron Street Dept. 56, Chicago, Illinois

Send instructions and free information with prices and terms and order blank.

Name.....

Address.....

City..... State.....

SANI-FLUSH WILL FIX THAT!



A CLOGGED radiator overheats automobile engines . . . saps power . . . causes expensive trouble. Don't let rust and scale stop-up the delicate tubes in the cooling system of your car. Clean out your radiator regularly with Sani-Flush. It's quick. Thorough. Sani-Flush is non-caustic. Cannot harm aluminum cylinder-heads or cooling system.

Just pour Sani-Flush in the radiator. Run the motor. Drain. Flush. And refill. (Directions on the can.) You'll find Sani-Flush in most bathrooms. Women use it to keep toilet bowls sparkling clean. Or you can buy Sani-Flush at any grocery, drug, or hardware store—25c and 10c sizes. The Hygienic Products Co., Canton, Ohio.

Sani-Flush

KEEPS
RADIATORS CLEAN—NON-CAUSTIC

FIX IT YOURSELF AND CUT YOUR REPAIR BILLS



Are You
Suffering from

DRAFTY WINDOWS & DOORS?
LEAKY ROOF FURNACE GASES?
CRACKED PLASTER WALLS?

Save money on repairs by writing today for our illustrated folder telling how you can do the small but important jobs about the house yourself—easily, quickly.

FREE
FOLDER

Pecora Paint Company, Inc.
Dept. 7, 4th and Venango Sts. Phila., Pa.

WINGS OVER THE PACIFIC

(Continued from page 144A)

establish an airway weather and radio communication station at Honolulu. The first cargo discharge from the "North Haven" was at Midway island, at the end of the Hawaiian island group. Here, an airway crew of ten were landed and the working crew of seventy-four men assisted them in the building project.

The second cargo stop for the "North Haven" was Wilkes island. The third stop was Guam. A crew of five men has already been assigned to work at the Philippine air base. On the return trip from Guam, the "North Haven" deposited the supplies and provisions necessary to operate the island bases.

The amazing speed of establishing these bases was possible only because everything had been planned and calculated in advance. The designs of all structures had been reduced to blueprints, which governed the construction of every detail. A typical island air base has a shallow lagoon protected against high waves, and is ample in size to accommodate a nineteen-ton flying clipper. The ship will be moored to a dock, enabling the passengers to walk ashore. As one steps ashore, the underground fuel storage tanks will be on the right. Then one passes the power house. Beyond that is the radio transmitter. At a still greater distance beyond will be the transmitter of the radio direction-finder.

Going toward the main part of the island station, one sees a group of white frame buildings on concrete piers. On the right is the radio receiving station, with the office of the airport opposite it. Further along, and arranged around a circle, are staff quarters, consisting of a house for the seaport's manager, and sleeping quarters for the crews of incoming clipper ships. Outside the circle of staff houses, one sees the kitchen and servants' quarters.

The staff of each base consists of a seaport manager, a radio officer and assistants, a chief mechanic and two mechanic's helpers, and five men in the service staff; cook, steward, mess boy and two cabin boys. On Wilkes island, there will be, besides those mentioned, a staff physician.

Our Bureau of Information will answer questions regarding articles in this magazine, if accompanied by return postage.



Have you had your Spark Plugs cleaned lately? **SAVE GAS** by the **AC** plug cleaning method

Spark plugs can cause serious gasoline waste because driving crusts them with Oxide Coating, soot, and carbon. To stop this waste, let a Registered AC Spark Plug Cleaning Station thoroughly clean your plugs in the AC Cleaning Machine. The sign of the "Plug-in-the-Tub" identifies these stations. **Replace worn plugs with**



THE QUALITY SPARK PLUG
NOW 60c (in Canada 75c)

AC SPARK PLUG CO.
Flint, Mich. St. Catharines, Ont.



**SPARK PLUGS
CLEANED
AND ADJUSTED
WHILE
YOU
WAIT 5 C
EACH**



BIG 1935 LEADER

Genuine Leather Ties, 4-In-Hands and Boys'. New fancy patterns in colors. Look like silk. Cleaned with a damp cloth. Durable; won't wrinkle. SELL ON SIGHT. Big profits; repeat orders. Be independent; have your own business. Young man sold 23 one night after school. No sales ability needed. Send 50c or stamps for sample and kit. Information free.
CENTURY TIE CO., Dept. 2, 2333 W. Grand Blvd. DETROIT, MICH.



Forms to cast Lead Soldiers, Indians, Trappers, Hunters, Wild and Farm Animals. 239 different forms to select from. Every form guaranteed to cast perfect figures. Send 5c stamp for illustrated catalogue.

HENRY C. SCHIERCKE Spencer Rd. GHENT, N.Y.

BUILD THIS Ocean Cargo Steamer



Popular seale model of old time tramp steamer, from shipbuilder's plans. Only one of many models covered in our 32-page catalog of blueprints, construction sets and fittings. Send 10c for this catalog today. A. J. Fisher, 1002-1 Etowah Ave., Royal Oak, Mich.



MAKE GLAZED GARDEN POTTERY

Beautiful, colored, glazed concrete pottery made without molds. No experience needed. Use only sand and cement. 2,500 different designs birdbaths, vases, jars, etc. Big profits. Send 10c for Booklet, color plate, etc.
NATIONAL POTTERIES CO., 424 Second Ave., So., Room 21 Minneapolis, Minn.

COMPLETE ELECTRIC PLANTS



ONAN A.C. PLANTS furnish the same current as city service. Operate Radio, Water System, Refrigerator, all Appliances.

SIZES 350 WATTS UP

Have A.C. Current anywhere. Models \$110 and up. Easy to install. Available from stock. Ideal for farms, camps, lake homes, commercial purposes—anywhere electricity is needed.

D. W. ONAN & SONS
948 Royalston Ave., Minneapolis, Minn.

MAKE YOUR "Home-work" EASY WITH

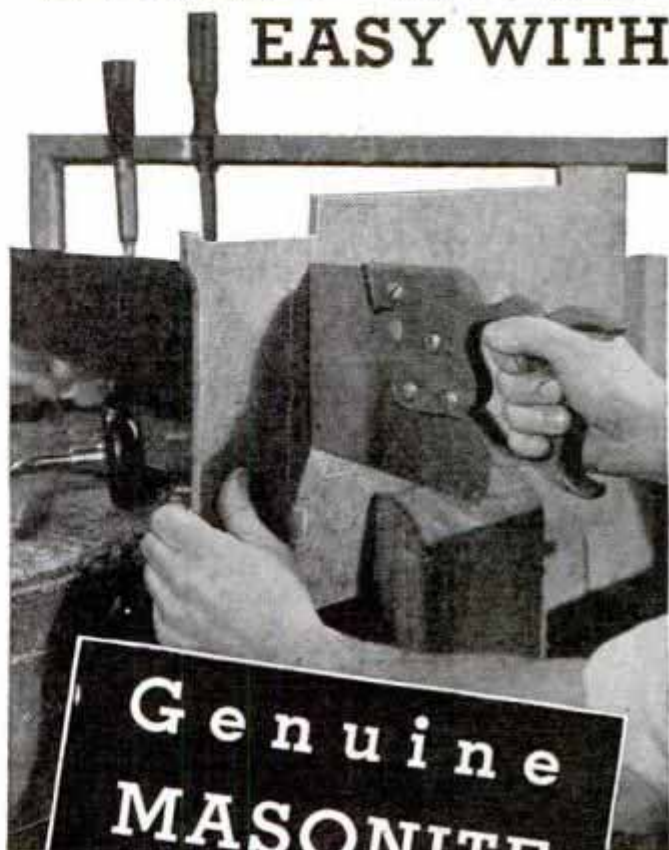

PRESWOOD is the ideal material for jobs around the house. It makes hard jobs easy, because it won't chip, crack or split. And when you do a job with PRESWOOD the job stays done, for PRESWOOD doesn't warp out of shape. You can finish it any way you want to or leave it unfinished. Its grainless, warm brown surface will take any kind of paint or varnish, but it looks well without any.

And if your home-work is your hobby, you need PRESWOOD even more. Cabinet-workers and model-builders find many uses for it. Although it's strong, PRESWOOD won't dull your tools. It contains no glue or binder.

PRESWOOD is available in 1/8", 3/16" and 1/4" boards at leading lumber dealers everywhere. The prices are very reasonable. Mail the coupon for a free sample of PRESWOOD and a booklet describing some of the many ways you can put it to work in your home.

MASONITE CORPORATION
111 W. Washington St., Chicago, Ill.

PM-6

Please send me a free sample of Genuine Masonite PRESWOOD and a free descriptive booklet.

Name _____

Address _____

City _____ State _____

When writing please mention Popular Mechanics

UNION MADE **TUB-TEST**
Signal SHIRTS
REG. U.S. PAT. OFF.



*Styled For Better
Appearance . . .*

There is a "feel" of being better dressed in a SIGNAL that you do not get from any other work shirt.

Every SIGNAL is made to exact size with real neck and armhole comfort . . . long-wearing fabrics specially woven for SIGNAL . . . fast colors guaranteed not to fade or shrink . . . choice of neckband or collar-attached styles.

**See Signals at
Your Dealer's**

If he cannot show you the newest patterns in plain colors, stripes and dots, please send us his name.

JOHN RISSMAN & SON

Also Makers of Signal Superlative Quality Overalls
841 Blue Island Ave.
CHICAGO, ILL.

**SIGNAL
SUPERIORITY**

1. Complete Comfort.
2. Will not Shrink nor Fade.
3. Finest Workmanship.
4. Style.

Everybody buys PRINTING

Sell our complete line of printed Business Necessities, Advertising Novelties, etc., thru our "SURE-FIRE, EASY-SALE" plan.

**New Attractive Line of
CALENDARS, FANS and MENUS**
Priced to Sell on Sight

FULL OR PART TIME • Send for
Elaborate Free Sales Portfolio today

PRINT-RITE, INC.

640 STINSON BLVD. MINNEAPOLIS, MINN.

**LARGE
FREE
CUT
SERVICE**

Wow! What a Sharpener

SALESMEN WANTED!

KEEN-EDGE — The knife sharpening sensation of a lifetime. Four easy strokes puts razor-keen edge on any size knife. Positively amazing. Housewives surprised, delighted, buy quick. Needed by millions of housewives, restaurants, butchers, barbecue stands—wherever knives are used. Sharpens everything from pocket knives to biggest butcher knives and cleavers. Low price, big value means quick sales, big profits for agents. Sample postpaid 25c. Write for full details and quantity prices—a postal will do.



Hurry!

Don't miss this chance. Get your home territory. Be first to introduce KEEN-EDGE and get cream of the profits. Exclusive territory if you prefer. Send name on postal for details—Now!



THE KEEN-EDGE CO.
Dept. 3-6 Minneapolis, Minn.

THE HOUSE THAT RUNS ITSELF

(Continued from page 806)

along. The packaged home is prefabricated, having a steel frame and walls of asbestos-cement, a material that looks like stucco. That means that it is fireproof, termite-proof, practically earthquake and hurricane proof and protected against lightning. Scientific insulation not only assures the owner of getting his money's worth out of his fuel, but it combines with acoustical ceiling materials to give the extra advantage of soundproofing. The house is built on a cement foundation with three feet of air space below the first floor. Since the motor unit does all the work, a basement is unnecessary.

Set into the corners of the rooms are steel windows operated by a crank, like those of an automobile. The location of the windows, which are the casement type, permits full use of wall space for attractive arrangement of furnishings. The walls have washable coverings, available in a wide range of designs. Doors also are cut in the room corners for the same reason that the windows are so placed. Since there is no need for opening the windows, due to the air-conditioning system, curtains and draperies will remain clean for much longer periods than now is possible. Lighting is accomplished with thoroughly modern electrical units.

Furnishing the home is entirely up to the owner. He can spend much or little, but the expense can be kept low. A New York department store exhibiting one of the mechanical homes filled its five rooms with furniture, draperies, rugs, wall decorations, in fact, everything to make it comfortable, at a cost of less than \$1,200. The furnishings were designed especially for the house, modern, attractive, but inexpensive.

A special crew that delivers the ready-made home by truck to the purchaser's lot in any part of the country also supervises its erection, assuring that it will be put together properly.

The house brings to the low and middle income group conveniences not now found even in many millionaires' homes.

☐ Inquiries as to makers of articles described in Popular Mechanics, will be answered by our Bureau of Information upon receipt of return postage.

The Old Reliable Credit Jewelers

LOFTIS

JEWELRY COMPANY EST. 1858

Dept. A994
30 No. State St.
Chicago, Ill.

Send for **FREE** Catalog
Use your Credit!

CASH OR CREDIT GENUINE Diamonds GUARANTEED

Rings are Solid White Gold, artistically engraved

No. 31 \$7.60 \$1.50 a Week

Blue-White Diamonds! **A Buy!**

No. 28 \$100 \$2.50 a Week

No. 39-- Solid White Gold Wedding Ring; 5 Diamonds \$14.95 50c a Week

No. 38 \$50 \$1.25 a Week

Man's Elgin Strap Watch Very special bargain. Excellent timekeeper. \$16.95 \$1.69 Down--50c a Week

Bulova "Dolly Madison" New--exquisite. Natural yellow gold or white. \$29.75 \$2.97 Dn., \$1 a Wk.

Our References: Any Bank or Banker in the U. S. A.

HIGH POWERED TELESCOPE

GENUINE BROWNSCOPIES AT AMAZING PRICES

Most powerful in America for the money!
15 power long range telescope. Can see moon's craters or time on pocket watch a block away. 5 sections. Approx. 3 ft. long. Fine lenses. Brass bound. Can be used as powerful microscope. Vol. magn. 61X. Only \$1.69 postpaid. C. O. D. 24c extra.

\$1.69

Special Super-Power 30X Telescope. Similar to above but more powerful. Guaranteed to see 900 times larger in surface and 9 times closer. 31 mm. objective 4 powerful lenses. Large field. Includes powerful microscope feature. Only \$1.98 postpaid.

\$1.98

BROWNSCOPE CO. Dept. 46 234 Fifth Ave., New York, N. Y.

HANDY ELECTRIC GRINDER

Every home work bench needs this all-purpose electric grinder and sharpener, for knives, saws, chisels, drills, tools, etc. Plans in any light socket. 105-115 v. 50-60 cycle AC. 3300 RPM hi-speed fan-cooled motor. Heavy duty shaft and bearings. Complete with cord, grinders, On-Off switch as illustrated. **Warranty Guarantee.** Quantity production permits price cut to only \$3.15 plus 25c for mailing and packing. Remit in full, or send only \$1 and we ship C.O.D. for balance plus postage. Order TODAY.

\$3.15

COOPER ELECTRIC CO.
10506 S. State, Dept. P65, Chicago

DEAFNESS IS MISERY

Many people with defective hearing and Head Noises enjoy Conversation, Movies, Church and Radio, because they use Leonard Invisible Ear Drums which resemble Tiny Megaphones fitting in the Ear entirely out of sight. No wires, batteries or head piece. They are inexpensive. Write for booklet and sworn statement of the inventor who washed himself deaf.

DRUM

A. O. LEONARD, Inc., Suite 699, 70 5th Ave., New York

TRAILER COMPLETE \$39.50

Ready for road, wt. 175 lbs.; load 1/2 ton. Fit any car. Attaches to bumper bolts. 4" pneumatic tire Body 52x42x9". No side sway. Detach one minute.

Write for FREE Literature

A. C. Kar-A-van 308 W. Randolph St., Chicago

Men & Women Earn Cash at Home!

Grow fancy giant mushrooms in cellar, attic, barn. Easy, odorless method. We show you how, furnish guaranteed materials and buy crops. Valuable big book, pictures free if you write quickly. (Est. 1908.)

UNITED CO. 3648 Lincoln Ave. Dept. PM-6 CHICAGO

AUTO RADIOS

Guaranteed. Lowest Prices.

Latest 1935 features. All electric. Super Het. R.C.A. Licensed. Easy to install. Complete, ready to play. 4 sales plans. No stock investment. 100% profit.

ALSO 14 OTHER MODELS FOR HOME OFFICE & FARMS

(Check here if interested in 14 models: cash less free)

Sales Card—Punch Board Men! Write for Plan giving Radios Away

BERKSHIRE RADIO CO., 130 No. Wells, Dept. P8, CHICAGO

FREE TRIAL!

SEND NO MONEY

Mail Coupon for Details



NEW ROYAL PORTABLE with TOUCH CONTROL

Nothing like it on the market. The key tension is instantly, *visibly* adjustable to everyone's individual finger pressure! Many other exclusive improvements. Try the New Royal Portable. Even if you have never typed, you can use it immediately, and without training. If not pleased, it may be returned without question.

Lowest Prices—Monthly Terms

Unusual new sales plan places amazing convenience of the New Royal Portable easily within reach of every reader of this magazine. Use coupon for full information.

A Better Job?

One of the best ways to improve your position is to learn to type efficiently. This will increase your usefulness, or lead to other opportunities. With a Royal Portable you can easily acquire real typing speed in your spare time at home.

This is Your Opportunity!

Students, Parents, Teachers, Business People! Sign and mail the coupon below. No obligation. The New Royal Portable is made and guaranteed by the world's largest manufacturer of typewriters exclusively. Smooth, rhythmic action of an office-sized machine. Try it!

FREE! Typing Course ... Carrying case included



TOUCH CONTROL... Most revolutionary improvement ever presented.



FINGER COMFORT KEYS... Scientifically designed to minimize eye-strain.



PROTECTED for lifetime against dust and dirt.

Royal Typewriter Company, Inc., Dept. PM-6
2 Park Avenue, New York City.

Please send me complete information concerning special sales plan on the New Royal Portable Typewriter with TOUCH CONTROL, also details of FREE TRIAL OFFER.

NAME.....

STREET.....

CITY..... STATE.....

New Invention... ENDS MITERING and MORTISING

MICKLIN CORNERS *Save...*
TIME • LABOR • MONEY

WHY worry about mortise and tenon joints? Forget about mitering! Use Micklin *Dual* Corners and make true, rigid, right angle joints on screens, shelves, tables, cello-glass frames, lawn furniture, etc. Easy to use. Simply insert ends of lumber into the strong steel corners and drive nails through punched holes.

Repair Screens, Shelves, Tables, Etc.

Saggy and wobbly screens, etc., can be quickly repaired and strengthened with Micklin *Single* Corners. Bridge-truss design guarantees life time strength. Ask your lumber or hardware dealer about Micklin Corners TODAY!

MICKLIN MFG. CO., Dep't 9, OMAHA, NEBR.

Write for ILLUSTRATED CIRCULAR





**IVER JOHNSON
BICYCLES**

Always
Ahead
in Beauty
— Safety
— Strength
and Easy Riding

Be out in front! Flash by with the leaders—the boys who rate the best; they ride Iver Johnson Bicycles—the only bicycles of their grade. Balloon or standard tires and the latest equipment. From \$27.50.
Have you sent for folder 66B, showing models, colors—and all details?
Shipped direct if no dealer nearby.

Iver Johnson's Arms & Cycle Works

21 River St., Fitchburg, Mass.	Chicago
New York	108 W. Lake St.
85 Chambers St.	Montreal
San Francisco	Coristine Bldg.
731 Market St.	



**Brass
Bronze
and
Aluminum
Castings**

\$47⁵⁰

Complete
Set

Make them in your workshop with this complete foundry set with instructions. Send for descriptive folder.

W. F. ANDERSEN

P. O. Box 142

ALAMEDA, CALIFORNIA

NEW BOOK ABOUT BICYCLES

"Bicycle Repairing Simplified" tells how to true a wheel, adjust coaster brakes, etc. 24 pages, 40 pictures. Repair own bike. Book will pay for itself. **Only 25c.** Send coin, money order, or stamps to

COMMERCIAL EDITORS, 657 Grand Ave. AURORA, ILL.

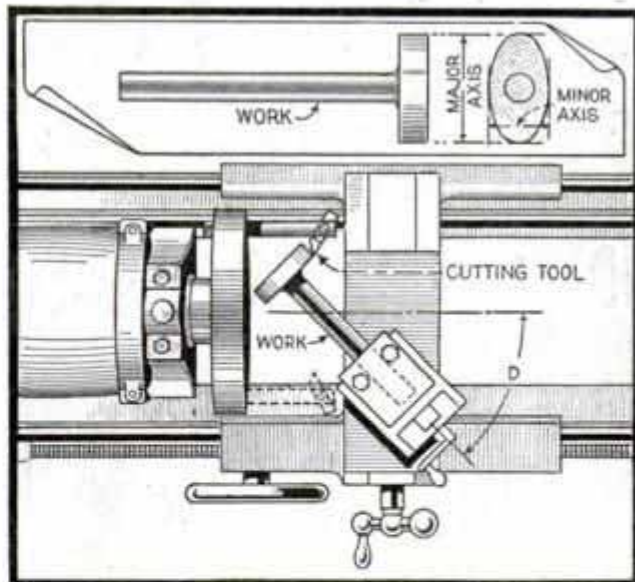

With This Arrangement, It Is Possible to Turn Elliptical Work in a Metal-Turning Lathe

Elliptical Turning in a Lathe

With this set-up, it is possible to turn elliptical work accurately in a lathe. The work is clamped in a hardwood block, which has been drilled transversely and sawed in half, and then bolted to the tool-post saddle. Attaching a boring tool to the faceplate completes the job. In use, the work is set so that the ellipse will be in the center of the shaft. To do this, an indicator is clamped to the tool post, the lathe is turned by hand, and the carriage is moved until the indicator registers the same as it touches both sides of the work. The angle "D," to which the rest must be set, can be determined by referring to any handbook that contains a table of natural functions. As can be seen in the upper sketch, the major axis is determined by the diameter of the circle generated by the tool, and the minor axis is determined by the angle at which the compound rest is set.

Skew-Pointed Brush to Paint in Corners on Models

When parts for ship, coach and other wooden models must be assembled before they can be painted, thus leaving corners that cannot be reached with an ordinary brush, a narrow flat one may be cut on a 45° angle from the ferrule to one corner of the bristles. This will provide a point and a squared edge with which any odd-shaped surface can be reached. It is advisable to use a brush with rather stiff bristles for this purpose to assure accurate guidance in close corners.

OWN A Potato Chip Factory

COMPLETE

NEW "HOME FACTORY" MAKES PERFECT POTATO CHIPS—DONUTS—SALTED NUTS

Stop looking for something difficult. Turn potatoes into cash. I show you just how with my newly perfected outfit. Start anywhere. Very little cash needed. Exclusive location. Profits pour in. No experience needed. I furnish the plans. Begin anywhere—village, small town, city or suburb. A big opportunity is waiting. Business permanent.

MAKE UP TO 500% PROFIT ON RAW MATERIALS

Raw materials are plentiful and cheap. Highly perfected outfit and confidential plans make operation simple, with startling profits certain.

WE HELP FINANCE YOU

and locate you. Send no money, just name, for book of facts and free opportunity.

Newly perfected, rapid, direct-to-fat slicer with outfit at no extra charge.

LONG-EAKINS COMPANY

628-S. High St.

Springfield, Ohio

AT LAST! A REAL POCKET RADIO



Can actually be carried in pocket or purse! No tubes—batteries—nothing to wear out. NO Crystals to adjust! Simply clip to any metal object as desks, beds, telephones, etc., for clear reception locally! One control—gets all stations 50 up to 100 miles under favorable conditions. Short Wave and police calls also! No complicated hookups. Fool-proof—and practical—great novelty. Can be used

ANYWHERE ANYTIME—in auto, etc. Complete with tiny phone—NOTHING else to buy—ready to listen to! Send only \$1 and pay postman \$1.95 plus postage or send \$2.99 (M.O. Currency Check.) Ideal gift. Complete Ins. Included. Guaranteed. Order now! At all the better Department and Radio stores. TINYTONE RADIO CO., Dept. P6 Kearney, Nebraska

BUILD IT YOURSELF

JIM DANDY CABIN TRAILER
Classy! Roomy! Easy to build at low cost! Plans and instructions only \$1.00—include all Diagrams, Sketches, Photos, Material List, etc. Big Value! Mail Dollar Bill to Jim Dandy, Box 125-A, Wausau, Wis.



TENNIS

Get our sensational low prices on strings. Our famous animal tendon string now only 80c a set. It's tougher and faster than gut. We have sheep gut and silk too. Sample cuttings free.

Crescent Tennis Works 1472 So. Robertson Blvd. Los Angeles, Cal.

New Motor-Driven "DELTA" SHOP TOOLS



PRACTICAL, efficient and compact—the new "Delta" quality tools are in use today in many thousands of home workshops and factories all over the world. Ideal for hobby work, spare-time money-making or production work. The Delta line includes: **Circular Saws, Drill Presses, Band Saws, Lathes, Scroll Saws, Jointers, and full line of accessories.** Priced within the reach of all. Write for complete Delta catalog.

Write for CATALOG!

DELTA MFG. COMPANY
3775 N. Holton St. Dept. A635 Milwaukee, Wisc.

Buddy's last excuse is gone
Mother put some Wet-Pruf on
And water can't
hurt Wet-Pruf



NEW
BAUER & BLACK
Wet-Pruf
ADHESIVE
TAPE

● An adhesive tape that's 100% Water-proof, snow white. Washes clean. Non-ravelling, soft, kid-like finish that resists soiling. Yet costs no more than ordinary adhesive! Get Wet-Pruf today. Comes in all widths and lengths.



NEW!



Aero-built 300

WORLD'S SMALLEST
ALL-PURPOSE FULL-POWER TWIN

NOT a feature lacking—**EVERYTHING** you need. 30 important, modern outboard motor developments!... The difference in cost for this deluxe type of outboard motor is so little, and the difference in performance, long life and final trade-in value is so great, it is a mistake to consider anything that offers less. Write for new illustrated **HANDY CHART** of motor sizes and specifications, describing this and the five other great motors **FREE!** in the 1935 SEA-HORSE line.

JOHNSON MOTOR CO. 400 Pershing Road, WAUKEGAN, ILL.
Canadian Johnson Motor Co., Ltd., Peterboro, Can.

JOHNSON
Sea-horse OUTBOARD MOTORS

IS HE LISTLESS?

When your pet won't play, is off his food and listless, he needs attention. **GLOVER'S CONDITION PILLS** stimulate the appetite, exert a tonic effect and aid in restoring him to



GLOVER'S Kennel and Flea Soap removes D. O. (doggy odor). Promotes healthy skin. Kills fleas.

good health. **GLOVER'S NEW FREE DOG BOOK** is a valuable aid in the Care, Training and Feeding of your Dog. Contains handy symptom chart. Write today to **GLOVER'S**, Dept. Y, 468 Fourth Ave., New York

GLOVER'S ANIMAL MEDICINES

SAVES HAIR!

Use Glover's Mange Medicine and Glover's Medicated Soap regularly. Famous for results it gives in cases of excessive Falling Hair and Dandruff. Get it at your dealer's or have your barber give you this treatment.



GLOVER'S MANGE MEDICINE

BENCH SAW ONLY \$345

Most Amazing Bargain Ever Offered!

Compares with saws that sell for many times the price. Ideal for job or home workshop—rips, GROSS CUTS, MITRES—Oversize bronze bearings. Overall height 9 in., width 8 in. Shipping weight 12 lbs. Threaded and equipped with flanges and nut on both ends of shaft. By raising the table can be used for grinding. Tool rests furnished FREE. Send \$1.00, balance C. O. D., F. O. B. Chicago.

BALCO ELEC. MOTOR & SUPPLY CO.
10 S. Clinton St., CHICAGO, ILL.

Comp. with comb. Rip Cross Cut Blade.



FOUNDRYETTE Inventors and Craftsmen

Make your own castings of aluminum, copper, bronze, nickel brass. Outfit contains gas furnace with 110 volt, 60 cycle motor blower, moulding sand, crucibles, tongs, rubber hose, flask, parting materials and instructions for use. For making models, trays, dishes, art objects, tools, shop equipment, etc.; also used for forging, case hardening and heat treating. Crucible capacity 6 cubic inches. Price of outfit complete \$9.50 f.o.b. K. C. weight approximately 25 lbs. Check or money order acceptable, express charges C.O.D. Write for Free Circular.

KANSAS CITY SPECIALTIES CO.

P. O. Box 6022

Kansas City, Mo.

BUILD YOUR OWN RADIO

FREE CATALOG

Send for ALLIED'S new 1935 Spring and Summer Catalog. Over 100 value-packed pages, featuring kits and parts for building every type of Radio Receiver or Transmitter. Also new 5 Meter Amateur kits, tools, test equipment, Sound Systems—everything in Radio at lowest prices. Write for our valuable FREE BOOK.

ALLIED RADIO

ALLIED RADIO CORPORATION
833 W. Jackson Blvd., Chicago, Ill., Dept. K.

Send me your FREE 1935 Spring & Summer Catalog.

NAME.....

ADDRESS.....

Centering Jig Aids Machinists to Cut True Radii

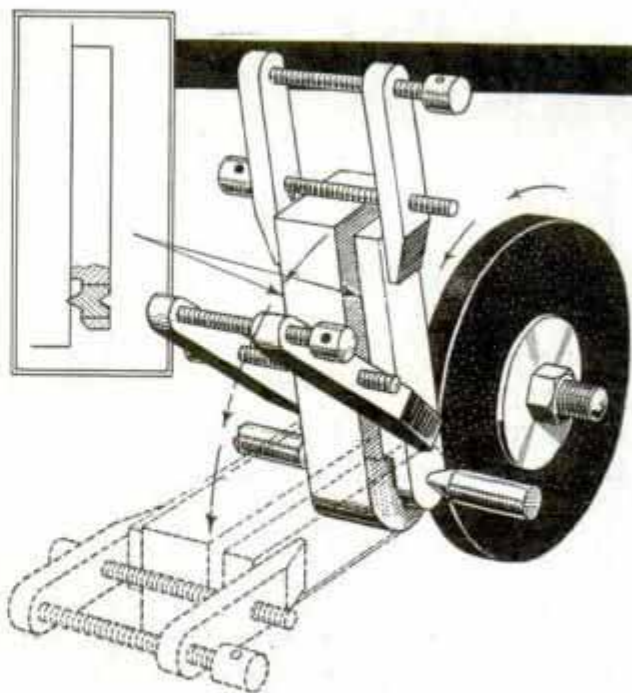

Adjustable Jig Clamped to Work Pivots It for Grinding Radii of Almost Any Size

Used in connection with a power grinder, this adjustable centering jig will enable you to grind radii of almost any size. The jig consists of two pieces of $\frac{3}{4}$ -in. steel, which are recessed at one end and then drilled and fitted with short bushings of drill rod. These have both male and female centers as shown in the detail. In use, the work is center punched to take the male centers of the bushings, the jig being clamped to it, after which the assembly is placed between centers in front of the grinding wheel. If your machine is not fitted with centers, they can be supported by blocks, which have been screwed to the bench and carefully aligned with the machine.—Walter Wells, Newark, N. J.

"Cellophane" Helps to Synchronize Dual Ignition

Strips of Cellophane will aid in synchronizing dual ignition systems, or distributors with more than one set of points. Adjust one set to the proper time in relation to the motor, and then put a strip of Cellophane between each set of points. Crank the motor until the adjusted set has just started to open so that the Cellophane may be pulled out with a slight drag. Then adjust the other set until there is the same tension on the strip as it is removed.—D. F. MacLachlan, Palo Alto, Calif.

FOR Real FUN Play.
A Soprani
ACCORDION



● If you want to be *really* popular, have *all* the fun, be the *whole* show and the center of attraction everywhere, just learn to play this thrilling instrument from Italy. A complete band or orchestra in itself, romantic organ tone, and so easy to learn to play. You'll master this *easier* Soprani in *no* time, and you'll have real fun from the start. Don't delay. Big future. Send postal for beautifully illustrated literature. No obligation. Easy terms. Write today sure.

SOPRANI, INC. 24
 630 S. Wabash Ave., Dept. 629, Chicago, Ill.

Easy TO PLAY

RENEW OLD BUILDINGS WITH PLASTIC STUCCO



New process—Fuses a plastic, waterproof mixture on any surface. Renews old buildings with a permanent overcoat in any thickness desired and in 30 colors. Proven over six years actual use in practically every climate.

BIG EARNINGS OFFERED—Operators report profits of 10c to 30c per sq. yd. covered. Machine capacity 40 sq. yds. surface per hour. One job often pays for machine. Enjoy the profits connected with big government renovizing campaign. Machine furnished on free trial, easy payments. Write today for complete details.

COLORCRETE INDUSTRIES, Inc.
 570 Ottawa Ave., Holland, Mich.



EARN MONEY AT HOME
Business of Your Own Making Novelties

HOME MFG. ENTERPRISES: 1. Novelties of wood. 2. Metalcraft. 3. Leathercraft. 4. Tin toys. 5. Plastic molds. 6. Baskets. 7. Rubber articles. 8. Plaques. 9. Lawn furniture. 10. Pottery. Illustrated. 25c for all ten sections with trial subscription to Home Industries Magazine. Trial subscription, 10c. Describes all kinds of profitable plans for a business of your own. 32 pages.

NEW OPPORTUNITY—Make floor mats from old tires with simple home made equipment. Illustrated instructions, \$1.00.

HOME INDUSTRIES BOX 64 **IRVINGTON, NEBR.**

600 POWER MICROSCOPE \$8.50
Triple Objective Brownscope "Professional"



THE NEW SUPER-POWER 100X to 600X BROWSCOPE. The QUALITY microscope satisfying the demand for ultra-high power at low cost. Substantially and precisely made. Nickel tube and machined brass parts. Compound lenses. Large concave mirror. Heavy base tilting any angle. Fine rack and pinion focusing with TWO adjusting wheels. Power 100X to 600X in six steps. Power is varied by rotating the dust-proof 3 objective nose-piece, or by adjustment of the eyepiece. Comes complete with fine wood carrying case, prepared and plain slides, instruction book, and elaborate 6 piece set of dissecting instruments mounted in carrying case. Only \$8.50 postpaid.

BROWSCOPE CO. Dept. 46, 234 Fifth Ave. NEW YORK, N. Y.

METAL CUTTING LATHE *a precision tool*
Unbelievable Value · Amazing Bargain only



Fastest selling tool in America! Startling value! An exclusive National product. Furnished complete with compound side rest, 4 jawed 3 in. chuck and 4 in. face plate. Hollow spindle, large oversized bronze bearings. Centers, standard Morse tapers, 20 in. bed, 5 in. swing, 13 in. between centers. Accurately turned and machined. Only \$7.95 (without chuck), \$3.50 extra for chuck. \$11.45 complete with chuck. Same lathe furnished with 26 in. bed, \$1.00 extra. Shipping weight 30 lbs. Unquestionably the most amazing Metal Cutting Lathe bargain ever offered. Send \$2.00 deposit—balance C. O. D. Be wise. Order at once. Sold on Money back guarantee!

We Invite Dealer Distributors

NATIONAL ELECTRIC TOOL CO., 560 Wash. Blvd., Dept. 346, Chicago

\$7.95
Less Chuck

Information for Shooters

NOW Enjoy a NEW .22 WINCHESTER



MODEL 69 REPEATER

Get a 1935 All 'Round REPEATER

YOU, too, will want the new Winchester Model 69 .22 Repeating Rifle. Such a remarkably good buy at its surprisingly low price. Send today for your FREE Shooting Holidays envelope—contents as above. Rub shoulders with famous marksmen in all target shooting branches. Scores and scores of photographs in your big, beautiful 24-page 1935 "Shooting Holidays" rotogravure tabloid. Information, too. Read all the interesting details on Model 69 in its special folder. Look up all types of rifles, shotguns, in the 1935 Winchester Pocket Catalog—64 pages. Mail coupon NOW.

FREE "Shooting Holidays," Model 69 Folder, and Pocket Catalog

.22 rim fire. Bolt action. Standard target box magazine. Six shots. Take down.

Model 69 shoots both Winchester Staynless and Super Speed .22 Short, Long and Long Rifle cartridges. Full size, with 27 1/2" sighting radius. Peep or open rear sight. Covered bead front sight. Self-cocking safety bolt action.



WINCHESTER REPEATING ARMS CO.
 Dept. 46-C NEW HAVEN, CONN., U. S. A.

Yes, send me FREE your 1935 "Shooting Holidays," Model 69 Folder, and Winchester Pocket Catalog.

NAME.....

ADDRESS.....

HOME AUTOMATIC CIGARETTE MACHINE
 Have YOUR OWN Monogrammed Cigarettes.



Put tobacco and block of papers on machine. TURN THE CRANK—PRESTO—CIGARETTES. Easy—simple. All metal construction. Guaranteed. No cloth ribbons; no special tube or gummed papers required. **ASK FOR FREE ILLUSTRATED FOLDER.** AUTOMATIC CIGARETTE MACHINE WKS. PM-6, 1056-57 Sheridan Rd., Chicago, Ill.

STEP INTO THE *Spotlight*



FREE LESSONS... A YEAR TO PAY

Banish Boredom... Earn Extra Money START TO PLAY VERY FIRST DAY

Picture the joy of playing a snappy foxtrot, dreamy waltz or mellow old favorite on the Xylorimba. No reason why you shouldn't! Xylorimba is easiest of instruments to play and yet the most spectacular. In constant demand by orchestras, radio stations, at lodge meetings and parties. Marvelous opportunity to increase popularity, make big spare-time money. No bothersome practice or exercises. With Free easy lessons you actually Start to Play Very First Day.

BIG FREE BOOK tells all about Deagan line, liberal trial offer and easy payments. Send coupon today for your free copy.

J. C. Deagan, Inc., Dept. A-845, 1770 Berceau Ave., Chicago
Send me, without obligation, full details of Free Trial offer and easy-payment plan on the Deagan Xylorimba.

Name.....

Address.....



Catalog No. 35 Illustrating Electrical, Mechanical and Model Makers' Supplies, Small Steam & Gasoline Engines, Motors, Generators, Lathes, Drill Presses, Bench and Band Saws, etc., 16 & 22 Dyna-Motors, School Projects, Engine Castings, Motor Parts, etc., Books, Blue Prints, Brass and Steel Tubing, Gears, Pulleys, Hangers, Experimental Material.
Big Copy. Mailed anywhere for 20 cents. 25 cents Canada, refunded first order.
LOOMIS ELECTRIC COMPANY
2822 N. California Ave. Chicago, Ill.

GUARANTEED ONE YEAR **FREE BB MAGIC**

1935 MODELS
Benjamin Super Single Shot Air Rifles—Bolt Action—Hammer Fire
—Hair Trigger—shoot lead or steel BB shot and 177 or 22 pellets and darts. Illustrated and described in New "BB Magic" Free—Write Today—get full details of Benjamin 25 Shot Repeater and New Benjamin Air Pistol
—Free Targets—SPECIAL INTRODUCTORY and TRADE-IN OFFERS.
BENJAMIN AIR RIFLE CO. 697 N. Broadway St. Louis, Mo., U. S. A.

DRIVER POWER TOOLS

Make furniture, toys and novelties in your spare time. Earn extra money. Easy to operate. You can start a shop for \$12.25. Kits of Lathes, Jig Saws, Band Saws, Drill Presses, Planers and Block Saws. Write for Free 48 Page Catalog.
Walker-Turner Co. Inc., Dept. 95, Plainfield, N. J.

NO "HUMPS" **FELT CUSHION ALL METAL SANDER**

Sanding surface always even. Beats any sander made. Just what you need. Shapes, Grinds, Sharpens, Polishes metal, wood, leather, etc. Use on drill press, lathe, motor, chuck or shaft. \$2.75 with 3/8" dia. spindle, postpaid, \$3.00 C. O. D. Other size spindles on request. P.U'd sandpaper lock eliminates costly sleeves. Sanding cloths 40c. doz. postpaid. Agents Wanted.

MASID CO., 180 N. Wacker Drive, Chicago, Ill.

Every Wood Craftsman Should Have This 100 Page Book No. 8 It is full of beautiful things that you can easily make—hard to find material such as foreign woods—lovely crotch, butt, burl, fiddle back, etc. Veneers, Panels and Solid Woods. Lists and illustrates 76 Blue Print Designs for Scroll Patterns, Inlay Table Tops, etc.

only 10¢ **Make Beautiful Period Furniture at a fraction of store cost.** If you are handy with tools you will value this book. It will save you money and make available exactly the kind of material you want.

CRAFTSMAN WOOD SERVICE CO.
We Ship All Over The World
2728 MARY STREET CHICAGO

NEW TYPE CHEAP OIL BURNER

COOK and BAKE Without Coal, Range or Furnace; Beats Coal or Wood; No Dirt or Ashes; HALF THE COST.

COOKS A MEAL for 1¢
Amazing oil burner which experts and 15,000 users say beats any ever gotten out burns cheap oil a new way, without generating or clogging up: gives intense heat at HALF COST by turn of valve. One free to one person in each locality who will demonstrate and act as agent. Write quick, be first to learn how to end drudgery of coal and wood and make big money, spare or full time—mail 1c postcard today.

AGENTS Salesmen BIG MONEY
It's sweeping the country. Clark of Ind., sold 98 in 30 days. O'Toole of Mass., sold 164 in July. Get YOUR OWN oil burner FREE and make REAL Money. Write quick.



THE Smooth WAY TO "ROUGH" IT

Self-Built DeLuxe House Trailer gives you economical travel-convenience. Complete interior—4 models. Progressive Buying Plan. Any workman can build. Beautiful new Trailer Builders' Guide, 150 Illustrations; Famous Bull and Socket Hitches; Comb-Chain axle; Parking Log; Sink; Stoves; Inner Spring Beds. Send only 50c for Trailer Builders' Guide.



HAMMERBLOW TOOL CO. Dept. 16, 606 Third St. Wausau, Wis.

LONG RANGE TELESCOPE

You will enjoy using this 6 power terrestrial telescope. Fine 1 1/4 inch objective lens. ALL BRASS body over one foot long. Folds to pocket size! Easy draw. Special eye-cup feature aids vision. C. O. D. 15c extra.

For only \$1.00 We Pay Postage

SEND FOR CATALOG BINOCULARS, FIELD GLASSES MICROSCOPES, AIR GUNS, ETC.
DWIGHT CARLSON LABORATORIES
175 Fifth Ave. New York, N. Y.

LET YOUR MOTOR PAINT YOUR CAR IN ONE HOUR ALSO FURNITURE

"**AUTO SPRAY**"—a professional needs valve spray gun, 40 lb. capacity compressor fits all cars, water trap, enough hose to reach around car and enough 10-minute-drying, high-dose, best-grade auto enamel (any color) to paint whole car. \$6.90 postpaid. Auto Spray with out enamel \$4.95. Fully Guaranteed. 40-page book, "Painting Secrets for the Amateur", FREE with each outfit. Send for FREE circular and ENAMEL COLOR CARD.
AUTO SPRAY CO., 132 E. Palmer, Compton, Calif.

\$19.95 Now buys a genuine **MEAD Bicycle**

RANGERS cost a few dollars more. Do not buy until you get our astonishing new prices and terms.

30 Days' Trial We ship on unsatisfied after trial return the bicycle at our expense.

Tires lamps, wheels, equipment at half usual prices. Write for marvelous new prices and terms.

Mead CYCLE COMPANY Write us today for free catalog
DEPT. A-115 CHICAGO

Make Money at Home!

GROW MUSHROOMS in your cellar or shed. Exclusive new process. Bigger, better, quicker crops. More money for you! Enormous new demand. Write for Free Book.

UP TO 25¢ A WEEK

American Mushroom Industries Ltd., Dept. 303, Toronto, Ont.

FUN! BIG PAY EASY for YOU



WITH an easy-playing, sweet-toned Buescher you play tunes right away. Be a social "hit," win new friends; popularity; increased income. Opportunities for good-pay jobs. You can qualify quickly.

FREE on trial, any Buescher instrument. Write now for details and handsome Free Book. Mention instrument: saxophone, cornet, trombone, etc.

BUESCHER
BAND INSTRUMENT CO.
610 BUESCHER BUILDING
ELKHART INDIANA

The NEW Tark ELECTRIC RAZOR



NEW—LATEST RAZOR

No. H315. Electric razor whisks off the beard like magic. It does not irritate the skin—but leaves it smooth and refreshed. The latest in razors—A Sensational Seller. Comes complete with cord and one blade; ready for use. Guaranteed against any mechanical or electrical imperfections. Suggested selling price \$1.50 to \$2.00.

SAMPLE 89c, DOZ. \$9.60 Plus Postage

FREE Wholesale catalog of 3000 Fast Sellers. Send for a COPY TODAY.

SPORS CO., 4-35 Main Street, LE CENTER, MINN.



OH BOY! WHAT FIREWORKS!

FREE CATALOG AND COUPON

Return coupon with order for Fireworks and get big 35c box of SALUTES FREE

SPENCER FIREWORKS CO., P.O. Box P. M. 150 POLK, OHIO

SAW 25c

filng is imperfectly understood, even by expert filers. The result is 50% efficient saws. My booklet **THE ART OF SAW FILING and THE FILING MODEL** will help you to get a much better saw. Send 25 cents. A. P. SHEBEL, 730 S. 2nd St., Milwaukee, Wis.

BUILD YOUR OWN



Streamlined trailer at little cost. Designed by experienced automobile draftsman. Send \$1 for plans and blueprints of De Luxe Model as shown. Big value. Mail a Dollar to—**D. Van Oostveldt, 111 Marston, Detroit, Mich.**

S AGENTS 500% PROFIT GUARANTEED GOLD LEAF LETTERS

For Store fronts and office windows. Anyone can put them on. Free samples. Liberal offer to general agents.

METALLIC LETTER CO., 438 N. Clark St. Chicago

Inventions Wanted Patented or Unpatented

Increased interest now being shown in sound, practical inventions by our manufacturer-clients. What have you?

Chartered Institute of American Inventors
Dept. 4F, Barrister Building Washington, D. C.
"World's Largest Organization of Inventors"



NOW I CARRY ONLY ONE PENCIL—

NORMA

THE SENSATIONAL 4-COLOR Instant Shift PENCIL for EFFICIENT MEN and WOMEN

Takes the place of four ordinary colored pencils . . . a flick of the thumb changes color with no delay in your work. Saves time, effort and money . . . pays for itself. Ideal for gifts.

Four colors—red, green, blue, black. Shifts with trigger speed. Standard leads procurable anywhere. Beautiful, sturdy barrel. Guaranteed against mechanical defects.

Silmi—handsome, silverlike finish	\$3.50
Rolled Gold plate	5.00
Sterling silver	6.50
14K Gold Filled	12.00

Try Norma 10 days free. If at the end of that time you are not thoroughly satisfied we will refund your money.

4 COLORS IN ONE PENCIL 4 PENCILS IN ONE . . .

If your dealer cannot supply you, mail coupon today

Norma Pencil Corp., Dept. 17
150 Broadway, New York City

Please send me Norma for 10 days free trial. Enclosed is my money order for to be returned promptly if I am not satisfied.

Name
Address
City State

Red Green Blue Black.

HARD TO GET HARDWARE

TOOLS AND MATERIALS FOR ALL CRAFTSMEN

Model Builders, Wood Carvers, Art Metal workers will find our stock a ready and economical source for tools, materials and metals in odd shapes, sizes and lengths. Many items unavailable elsewhere can be had from us. We issue no catalog. Write us what you need. We will quote our prices.

PATTERSON BROTHERS 25 Park Row, NEW YORK

EARN MONEY RE-STRINGING RACKETS AT HOME



Coins CASH for YOU!

SET OF PERMA-TEX SILK STRINGS with directions guide, all prepaid **85c**

"Yes, you can easily earn up to \$1 an hour at home stringing tennis rackets! No experience needed! LEARN HOW TO EARN in a few minutes. Your home is your office! Grab this great opportunity, plan now to make \$100 to \$200 cash this season. QUICK—write for FREE details!" (Get my Free Catalog of tennis equipment.)

W. A. BICKEL, 809 W. Madison, Dept. A-135, Chicago, Ill.

GENERATORS - CHEAP! \$10.00 Down

Make your own light plant or battery charging outfit, using engine, windmill, water wheel or other power. These new generators (made by Robbins & Myers) are 1000 watts, 32 volts, D.C., Ball Bearing, built-in motoring coils to self start a gas engine. Wt. 100 lbs. Regular price \$90.00. While they last, \$25.00 cash or \$10.00 down, \$3.00 per month for 6 months.

VICTOR MFG. COMPANY Money-back Guarantee
Adrian, Michigan





They Said I Couldn't Do It. But Here It Is my 1935 OFFER

WEAR A WATCH OR DIAMOND

30 Days FREE!
then Make Your Own Terms



My sole aim during the year 1935 is to place as many watches and diamonds as I can in the hands of men and women throughout the world **no matter what the sacrifice!** I have cut prices to **Rock Bottom**, and in addition I am allowing you to **Make Your Own Terms**. I know that if I can distribute 5000 of these standard dependable watches and beautiful genuine diamonds through this unusual offer, that every watch and diamond will be a salesman to sell another watch or diamond. I am making this startling and unheard of offer to those who will tell their friends of this remarkable value if they find the watches and diamonds to be all, and more, I claim them to be.

Alonzo S. Thomas, President Santa Fe Watch Co. **THINK OF IT!** You can buy nationally advertised watches and diamonds—

Hamilton, Illinois, Elgin and Bulova Watches. Beautiful genuine perfectly mounted **Diamond Rings at Direct-to-You, rock bottom prices!**

You can wear one of these watches or diamonds **Thirty Days FREE**, and then you can **Make Your Own Terms**. Have you ever heard of a more astonishing jewelry offer, and from one of the country's **Largest Jewelry Firms** which has sold **High Quality watches**

and diamonds for nearly a **Half Century!** People all over the world will be amazed by this offer.

ACT AT ONCE

Here's all you have to do to cash in on this remarkable sales drive. Clip the coupon below and mail it. I will send you one of my beautiful watch and diamond catalogs **FREE**. You select the watch or diamond you want, and then write me personally, and you and I, just between us, will fix terms to suit you. **DON'T DELAY—SEND NOW** When these Watches and Diamonds are gone I will withdraw this offer.



Santa Fe Watch Co.

66 Thomas Building, Topeka, Kansas
We Buy Old Gold and Sterling Silver

SANTA FE WATCH CO.
66 Thomas Bldg., Topeka, Kansas
Please send me the catalog I have checked.
Railroad and Dress Pocket Watches
Ladies' and Men's Wrist Watches
Ladies' and Men's Diamond Rings

Name.....
Address.....



Let us recommend the best books to study on any subject. Popular Mechanics Press, Chicago, Illinois

BABY CALCULATOR
CHANGING & ADJUSTABLE FOR
ADDITION
SUBTRACTION
MULTIPLICATION
DIVISION

VEST POCKET ADDING MACHINE
Adds, Subtracts, Multiplies, Divides. Does work of costly machine. Not a toy. Million dollar capacity. Simple and accurate. Guaranteed 5 years.

FREE TRIAL \$2.50
—SEND NO MONEY—
Total Cost

Just name and address. We will ship Calculator immediately. On delivery pay postman \$2.50 (plus few cents postage). (If outside U. S. send cash.) 10c additional in Leatherette Case. If not satisfied after 10 days' trial you get your money back. **THOUSANDS OF SATISFIED USERS.** Write for Agents' Proposition. **CALCULATOR MACHINE CO. (Intrs.)**
P. O. Box 1118, Dept. 31, CHICAGO, ILLINOIS

PANTS MATCHED TO ANY SUIT

DON'T DISCARD Your OLD SUIT
Wear the coat and vest another year by getting new trousers to match Tailored to your measure. With over 100,000 patterns to select from we can match almost any pattern. Send vest or scrap of cloth today, and we will submit **FREE Sample** of best match obtainable.

MATCH PANTS CO.
20 W. Jackson Blvd., Room 1150, CHICAGO

EARN MONEY with this WONDERFUL NEW INVENTION

BLOW TORCH & SOLDERING IRON IN ONE!

AGENTS! Make quick, steady PROFITS with amazing NEW invention—sells on "flash" demonstration. Main or side line, part or full time. Opens big, new market. **WRITE**—get established for exclusive territory. Hurry! **Justrite Mfg. Co., 2061 Southport, Dept. A135, Chicago**

BUILD DUTCH WINDMILLS
Beauty Your Garden—Make Money Selling to Others

Easy to build from **BLUE PRINTS**, Model B10 (Hexagon style 20" high) 75c. Model B25 attractive Dutch Windmill operating **DUTCH GIRL CHURNING BUTTER** 50c. **Knock Down Kit** for Model B25 only \$4.00. Lawn cut out patterns subannet girl, Dutch boy, Tulip Girl and Holland pair. 25c each. 4 for \$1.00. For Catalog send 10 cents. **Craftsman's Model Co., Dept. P6, 2030 N. 41st St., Milwaukee, Wis.**

MAKE MONEY PRINTING

letter and billheads, circulars, cards for friends, spare time. Easy to learn, easy to get jobs. **Printing Presses 512;** new type faces, complete supplies, lowest prices. Send stamp for catalog. **PEIFFER CO., 44-A; 6 Columbia St., Newark, N. J.**

EARN BIG MONEY AT HOME!

Raise mushrooms in your basement, cellar, garage, idle places. We buy crop. Experience unnecessary. **FREE Book.**

MUSHROOM GROWERS OF AMERICA, FN-433, N. Clark St., CHICAGO, ILL.

Balance as above with 1-50; 1-20; 2-10; 1-5 and 2-2 gram weights base 4" x 9"—\$4.75. Catalog with 3000 illustrations of laboratory apparatus sent for 50c. Catalog listing 10000 chemicals, drugs, flavors, etc. and 1700 scientific books sent for 25c.

Laboratory Materials Company, 639 E. 71st St., Chicago, Ill.

GO INTO BUSINESS Make 100% to 300% Profit!

Sell new and used clothing direct from your home, auto or store. Undersell all competition. **EASY SALES—FAST REPEAT ORDERS!** We furnish everything and show you how. Handsome profits every day in the year. No selling experience necessary. Satisfaction guaranteed. Write at once for our Big Money Catalog—It's **FREE.** **LIQUIDATION MERCHANDISE CO., 550 East 43rd St., Dept. D-111, Chicago, Ill.**

BEFORE YOU BUY OR BUILD A TRAILER

Let us send you our illustrated folder on building Airstream trailers (4 models), and sample copy of the 22-page English trailer magazine illustrating many trailers inside and out. Packed full of trailer ideas and information. All for 25c. **AIRSTREAM TRAILER CO., 134 So. St. Andrews Place, Los Angeles, Calif.**

ARMY AND NAVY SUPPLY CO.

Bargains—Army, Sport Goods, Firearms, Clothes, Shoes, etc. Send 10c for new catalog, to be redeemed on first order

Army & Navy Supply Co. 4772 Lester St. Richmond, Va.

\$150 to \$300 Profit Monthly with "Build Your Own" Simplified Arc Welder
SAVINGS UP TO \$500

This new "Build Your Own" Welder unit lets you have modern portable welding equipment at \$300 to \$500 savings. Puts you in big paying business of your own—lets you go to the big jobs where profits are large. Low prices and long terms lets you pay for it out of increased profits.

30 DAYS TRIAL AT OUR RISK MONTHLY TERMS

HOBART BROS.
Box 885 Troy, Ohio

Shops everywhere have found that this unit puts them back in the big money class—they are cashing in on the profitable jobs and construction work it lets them handle. Comes to you complete with instructions for assembling into gas engine drive, portable unit. Write us today for new low prices and complete data on **HOW TO BUILD YOUR OWN WELDER.** No obligation.

Write today for FURTHER INFORMATION - Get our FREE BOOK!

Crystal Radio Detector 25c

COMPLETE WITH CRYSTAL RECEPTION POSITIVELY GUARANTEED

This Detector is a complete radio in itself, as it is possible to get reception with it alone, provided you are within 25 miles of a broadcasting station (or up to 100 miles under very favorable conditions). All you need is an aerial and an ear phone and you are all set. It is completely assembled and wired, all ready for use. It has two posts, making connection much easier, also making it possible to make changes quickly. Everything complete, including the stand, crystal cup, arm with catwhisker and necessary screws, an ultra sensitive crystal of the finest grade, two terminals for wire connections mounted on handsome base—**EVERYTHING COMPLETE FOR ONLY 25 CENTS POSTPAID.** Send coin or stamps. Every set tested and reception positively guaranteed.

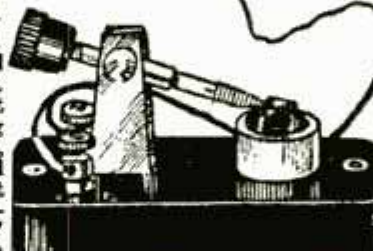

**No Tubes
No Batteries
No Noise
No Distortion**

BOOK ON RADIOS 10c

Add 10c and we will send you a book called "EFFICIENT RADIO SETS." Tells how to make inexpensive radio receiving sets, crystal as well as electrical, how to make short wave set, etc. Fully illustrated. Price 10c Postpaid.

JOHNSON SMITH & CO., Dept. 850, RACINE, WIS.

BOYS! THROW YOUR VOICE

Into a trunk, under the bed or anywhere. Lots of fun fooling teacher, policeman or friends.



THE VENTRILO

a little instrument, fits in the mouth out of sight, used with above for Bird Calls etc. Anyone can use it. Never fails. A 64-page Book on Ventriloquism and the Ventrilo. **ALL FOR 10c POSTPAID.**



THE ART OF DANCING

Learn the Carlo, Continental, Rhumba, Kiss Dance, Etc.



25 CENTS Postpaid

LEARN TO DANCE THE LATEST STEPS. Be popular this season. Really good dancers are always admired—always popular guests. Partners welcome them eagerly. With the aid of this book you can learn the newest, smartest steps without a teacher and become a dancer who is sought after. After following the instructions in this new book you won't need to make excuses when the dance music starts. Besides you'll get lots more fun out of parties and dances. If you want to become a perfect dancer, learn to dance at home this new, easy way.

WHAT THE BOOK TELLS: How to develop poise and control, how to improve your dance steps, the art of holding, how to walk to music, how to lead, how to do the latest Fox Trot Steps, Natural and Reverse Turns, the Reverse Wave and Change of Direction Steps, the Quickstep, swaying to music, how to waltz, Backward Changes, how to do the Continental, the famous Kiss dance, the Manhattan Dance, the College Rhumba, the Carlo, the Veyo, etc., etc. Nearly 100 illustrations are given, and everything is made so plain that you'll be dancing before you know it. **PRICE 25c POSTPAID.**

LEARN JIU-JITSU

The Art of Self Defence

FEAR NO MAN. Learn to protect yourself under any circumstances without weapons. Jiu Jitsu has been proved to be the BEST Science of defence ever invented.



With the aid of this book you can learn in the privacy of your own home. Complete course of lessons in fully illustrated book. **PRICE ONLY 25c POSTPAID.**

JAPANESE ROSE BUSHES

The WONDER of the WORLD Will Bloom Six Weeks After Planting

Perpetual Rose Bushes bloom all the year around. Just think of it. Six weeks after planting the seed the plants will be in bloom. It may not seem possible, but we positively guarantee it to be so. They will bloom every ten weeks, Winter or Summer, and when three years old the bush will be a mass of roses, bearing from five hundred to a thousand roses on each bush. The flowers are in three shades—white, pink and crimson. The plants will do well both in and out of doors. Send for a packet and have roses all the year round. We guarantee at least three bushes to grow from each packet of seed. **PRICE ONLY 10 CENTS Packet, three packets for 25 CENTS POSTPAID.**



10 Cts.

Boy Electrician with 75 illustrations for making Batteries, Dynamos, Motors, Telegraph apparatus, Telephone, Lights, Bells, Alarms, Coils, "Wireless" Current Reverser, Electric Engine, Radio, etc. **Price 10c Postpaid.**

BLANK CARTRIDGE PISTOL

REVOLVER STYLE

Three new models now out. 25c, 50c and \$1.00. Well made and effective. Modelled on pattern of latest type of Revolver. Appearance alone enough to scare a burglar. Take 22 Cal. Blank Cartridges obtainable everywhere. Great protection against burglars, tramps dogs. Have it lying around without the danger attached to other revolvers. Fine for 4th of July. New Year's, for stage work, starting pistol, etc.



**25c
50c
\$1.00**

SMALL SIZE 4 in. long 25c. MEDIUM SIZE 5 in. long 50c. LARGE SIZE 6 in. long \$1.00. BLANK CARTRIDGES 50c per 100. HOLSTER (Cowboy type) 50c. Shipped by Express only not prepaid. Big novelty catalog 10c. JOHNSON SMITH & CO., Dept. 850, Racine, Wis.

JOHNSON SMITH & CO.

Dept. 850 RACINE, WIS.

A copy of our NEW CATALOG mailed on receipt of 10c., or the De Luxe Edition with cloth binding 25c. Bigger and better than ever. Only book of its kind in existence. Nearly 600 pages of the latest tricks in magic, the newest novelties, puzzles, games, sporting goods, rubber stamps, unusual and interesting books, curiosities in seeds and plants, etc., unobtainable elsewhere. Remit by Coin, Money Order, Check or unused U. S. Postage Stamps, for all articles listed above. Canadian money, stamps, Postal Notes and British P. O. Orders accepted.



ATLAS QUALITY

Shop Equipment Since 1911



A GOOD Lathe
\$39⁵⁰ TO \$87⁵⁰

UNIT PLAN—You can start with a small lathe and build it up, part by part, as your needs increase. Final step is the back-gear, screw-cutting 10" lathe shown above. Does all lathe jobs.

24" WORK — 10" swing. Large capacity for a small shop bench lathe. 16 speeds. Cuts 4 to 72 threads per inch.

.001 ACCURACY—Running tested before shipment for .001 accuracy. Buy on 2 weeks' trial, money back unless satisfied. Easy terms. This is a REAL lathe built to expert machinists' standards of quality and accuracy.

Send for **FREE** illustrated catalog.

ATLAS PRESS COMPANY

1843 N. Pitcher St., **KALAMAZOO, MICH.**
 When in Chicago, see our complete display at **ATLAS SALES CO., 35 E. Wacker Drive, Chicago**

WRIST WATCH

GUARANTEED 3 YEARS

No. V296 watch — a smart looking and accurate timekeeper, dependable as a high priced watch. Has a non-breakable crystal and a non-tarnishing case. Size — suitable for ladies or men. Fitted with metal or leather wrist band. Money back if not pleased. Sells for \$3.75. **SAMPLE \$1.98, DOZ. \$1.69 EACH.**

SPORS CO., 4-35 Pine St., Le Center, Minn.

AUTOMATIC AIR SERVICE

\$12 MONTHLY

This dependable outfit brings business right to your door. Extra profits from grease, oil, gas will pay for it. Upright, beltless, space saving, fully automatic. Our liberal trial plan lets you see how profitable it can be, before you buy. Ask for details.

8 HR. BATTERY CHARGING

ONLY \$10 MONTHLY

Earn \$50 to \$100 monthly profit with this charger. Puts your shop above competition. Cuts electric bills in half—no expensive bulbs to replace. Recommended by leading battery makers. Liberal Trial at our expense. Ask for details.

★ POWERFUL ★

FIELD GLASSES
\$1.00
POST PAID

Just the thing to help you get more out of your out-of-doors pleasures. Accurate adjustment screw. Made in U. S. A.

6 Power--3 Fold
TELESCOPE
75^c

65^c
 If ordered with Field Glasses

LUDLOW LABORATORIES
 Dept. M, 1822 Ludlow St., Phila.

GENUINE EVINRUDE
OUTBOARD MOTOR

Enjoy vacations, weekends as never before with this amazing new Evinrude motor. Drives row-boats, skiffs, canoes at excellent speed, runs 2 hours on less than gallon of common gasoline. Smooth, quiet, easy to start. World's lightest outboard — 24½ lbs. Famed Evinrude quality throughout. Send for free Catalog — address **EVINRUDE, 4466 N. 27th Street Milwaukee**

CATALOG FREE

EVINRUDE

Print Your Own

Cards, stationery, circulars, tags, labels, advertising, etc. Save money. **Print for Others; Big Profits;** easy rules sent. Will do popular Raised Printing like Engraving. Junior press \$6.90, job presses, \$11 up, power \$149. Send for free catalog and all details. **THE KELSEY COMPANY, B-37, MERIDEN, CONN.**

DOUBLE YOUR PROFITS... 30 Days Use to Prove it NO INVESTMENT TERMS Write Today

RAISE GIANT FROGS

UP TO 1000% PROFIT!

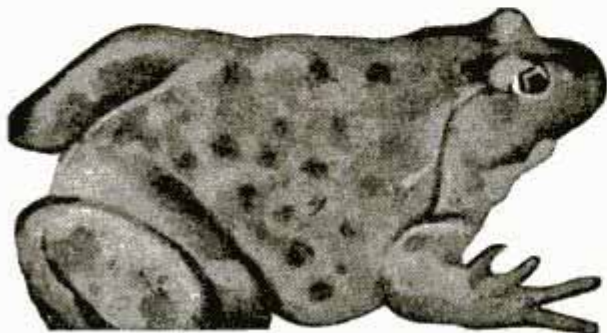

Breeder lays 10,000 eggs (833 dozen) each year. Bullfrogs sell \$1-\$5 dozen. Biggest money-maker you can raise. No experience necessary. *Backyard pond starts you.* Any climate suitable.

Get the facts on this new industry. Our big **FREE** book explains everything.

AMERICAN FROG CANNING COMPANY
 Dept. 133-H (Originators of Canned Frog Legs) **NEW ORLEANS, LA.**



Largest Frog Market in the World

New INVENTION

3 TO 7 MILES MORE PER GALLON
MOTORIST SAVES \$180.00 a YEAR



Saves up to Thirty Per Cent On Gas.
 Provides Faster Pick-Up—More Power—
 Greater Mileage and Smoother Running.

GET FREE INFORMATION

VACU-MATIC

the Carburetor Control that "BREATHES"

AT LAST! Automotive engineers have smashed down the barriers to perfected combustion! The new VACU-MATIC solves the secret of greater power! With almost magical action, this amazing invention instantly puts new life and pep in any motor. It adds mileage to every gallon of gasoline . . . produces split-second pick-up, sensitive accelerator response, greater speed and smoother running

New—Automatic—Nothing Like It!

The self-starter—four wheel brakes—knee action—streamlining . . . and now VACU-MATIC! The greatest motor improvement of recent years! With it, engineers have achieved a practical means of balancing air and gasoline automatically for all speeds. Vacu-matic is entirely different! It is AUTOMATIC and allows the motor to "breathe" at the correct time, opening and closing automatically as required. No idling troubles—no carburetor adjustments necessary. Just put it on and forget it! Sharply cuts fuel wastes, saves dollars in gas costs, reduces carbon and gives your engine new pep, greater power and longer life.

Fits All Cars

VACU-MATIC is constructed of six parts, assembled and welded into one unit, correctly adjusted and sealed at the factory. Nothing to regulate. Any motorist can attach VACU-MATIC in ten minutes. Once in, its only reminder is the surge of instant power and speed it gives to the motor and the savings it affords your pocketbook.

Agents and Salesmen

If you are interested in earning unusual profits, check coupon. Exclusive territories are now being granted.

The VACU-MATIC Co., Wauwatosa, Wis.

SAVES GAS!

CHRYSLER

Have tried the Vacu-matic and it sure is fine. Better pick-up with a 30% gas saving.—John C. Martin, Pa.

PLYMOUTH

I am amazed at Vacu-matic performance. It's giving me 5 more miles per gallon.—Walter Zielinski, Ill.

FRANKLIN

With Vacu-matic I have increased my mileage from 10.1 to 14.2 miles per gallon. I figure I save over \$75.00 a year in gasoline. R. K. Radtke, Wis.

ALL WELL PLEASED

Enclosed find order for 12 more. Everyone I have sold is giving from 4 to 6 more miles per gallon. I have 3 more orders for V8 Ford. Every body is well pleased.—J. O. Carll, Texas.

NASH

On my Advanced 6 Nash gained 17 1/2% in mileage. The car will idle down to 3 miles an hour and then take gas without a complaint. — J. Showalter, Mo.

V-8 FORD

I installed both Vacu-matics and they work excellent. On my own V8 Ford I notice wonderful performance in pickup, get-away and gas saving. — Burt Burnett, Mich.

BUICK

Everything you claim about Vacu-matic is true. I now get 20 miles to the gallon. Before I was only averaging 15 1/2 miles.—C. Constantino, Fla.

CHEVROLET

Please send me a Vacu-matic for a Model A. The mileage on my 1933 Chevrolet jumped from 18 to 22 miles per gal. with Vacu-matic.—Paul P Haas, Mass.

MODEL A FORD

Have been using the Vacu-matic for a month. I used to get 20 to 22 miles per gal. Now I get 30 to 33 miles. It is amazing the difference it makes.—James W. Barr, Canada.

SAVES \$180 A YEAR

On my Plymouth 6 I obtained an average of 22 miles per gallon, an increase of 7 miles. This means a saving of \$15 a month or \$180 a year. F S. Peck, Calif.

DODGE

Just completed 2310 miles on 92 gallons in my 1933 Dodge 6. This figures 25 miles while before I averaged only 20 miles per gal. on trips. — Al Fruzyna, Calif.

OLDSMOBILE

I am well pleased with Vacu-matic on our Oldsmobile. A test proved it to give 18 miles per gal. Before we considered 13 good. — Arthur Williams, N. Y.

Above are just a few of the many unsolicited letters received from Vacu-matic users.

Guaranteed Gas Savings

The VACU-MATIC proves itself on every car. It is guaranteed to give worth-while gas savings, quicker pick-up, and more power or it costs you nothing. "On a test I gained an average of 4 miles on a gallon," writes Alex Wertz. "Vacu-matic is the best I have ever tried." Clarence Rutzin—"I have tried the Vacu-matic on several tests and find that I get between 5 and 6 miles per gallon increase, have more mileage, have greater pickup."

Free Details

Learn about this remarkable device that so greatly affects the entire performance of your motor. Learn why your car is costing you extra money to operate without VACU-MATIC. See why your VACU-MATIC equipped car will leap away from traffic without sputter or hesitation. Discover a new driving thrill and enjoy the savings. Get the facts! Write today!

FREE OFFER COUPON

THE VACU-MATIC COMPANY
 7617-98 W. State St., Wauwatosa, Wis.
 Gentlemen: Please send me full particulars concerning the Vacu-matic and details of your Free Offer. This of course does not obligate me in any way.

Name.....
 Address.....
 City..... State.....

Check here if interested in selling proposition.

South Bend 9" x 3' WORKSHOP Precision Lathe

A High Quality
Back-Geared, Screw Cutting
Metal Working Lathe

RECOMMENDED FOR

- MANUFACTURING PLANTS
- MACHINE SHOPS, ALL TYPES
- U. S. GOV. LABORATORIES
- AUTO SERVICE SHOPS
- ELECTRICAL SHOPS
- HOME WORKSHOPS
- INVENTORS
- SCHOOL SHOPS
- WASHING MACHINE
and REFRIGERATOR
REPAIR

This Lathe
TURNS, BORES, FACES,
CUTS SCREW THREADS,
DOES CHUCKING,
REAMS, FILES,
POLISHES, DRILLS
AND DOES HUNDREDS
OF OTHER MACHINE
OPERATIONS

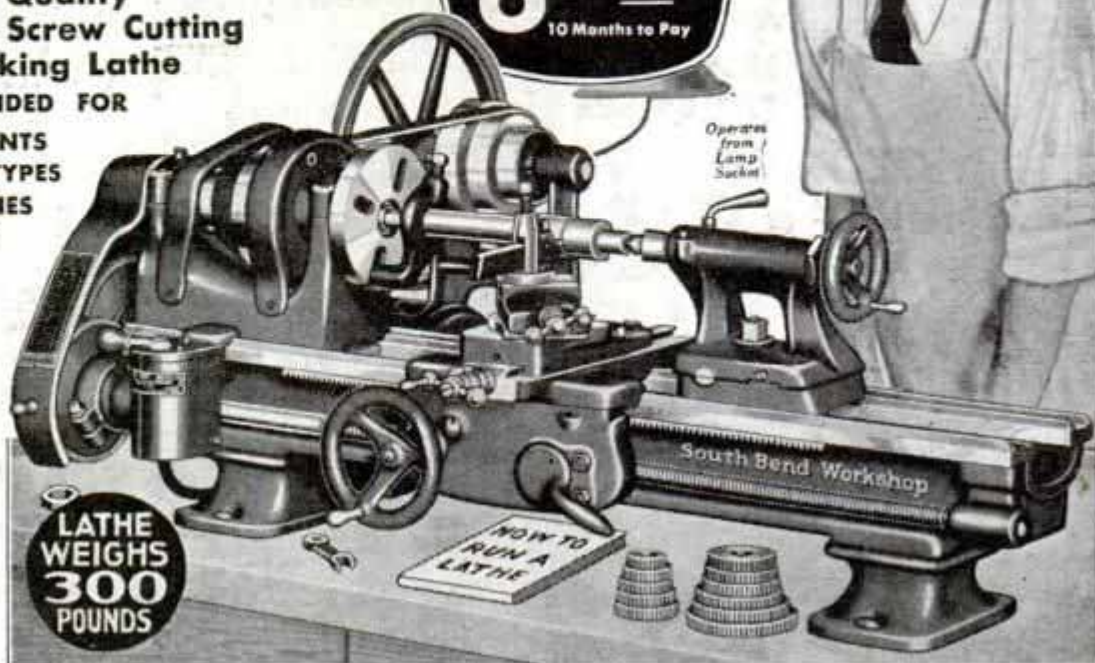

9 1/4" swing x 3' bed Workshop Lathe with Horizontal Countershaft, 1/4 h.p. reversing motor, reversing switch, and belting. \$24.00 Down, \$7.00 a Month. **\$94.00**
11 Months to Pay. (Special tools extra.) For other sizes see prices below.

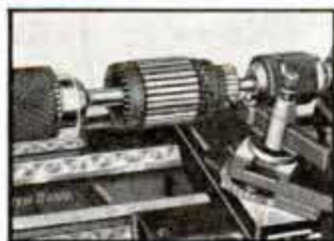

Truing an Armature.

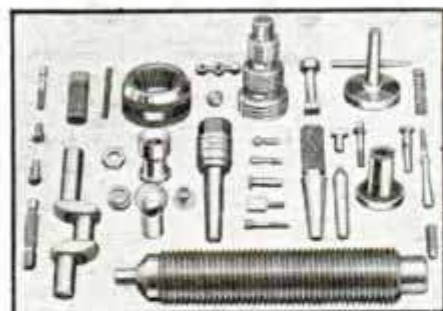

Metal Parts Machined in this Lathe.

Lathe Machines Metals, Woods, Compositions, Etc.

The 9" x 3' Workshop South Bend Lathe is the greatest value we have ever offered in our 28 years of lathe building. It is practical for making and servicing mechanical devices of every kind. Recommended for all classes of accurate machine work, wood turning, radio, auto and electrical repair; also for model, tool and instrument work. This precision lathe performs all general machining operations on cast iron, steel, other metals, woods, hard rubber, fibre, bakelite, and similar compositions.

FEATURES: The 9" Workshop Lathe is a rigid, powerful, accurate, modern lathe. It is constructed entirely of cast iron and steel and all gears are machine-cut and tested. Has six spindle speeds; cuts screw threads 4 to 40 per inch; has automatic longitudinal feed to carriage; 3/4" hole through spindle; graduated compound rest; micrometer graduations on feed screws; reverse for threads and feeds; three V-ways and one flat-way on bed. Can be fitted with 38 practical attachments.

30-DAY TRIAL. Send in your order and down payment today and try this genuine South Bend Lathe for 30 days in your own shop. The lathe will be shipped immediately. Satisfaction guaranteed or your money back.

EASY PAYMENT PRICES 9-inch WORKSHOP LATHES—10 to 12 Months to Pay

Size of Lathe			Lathe Less Countershaft				Lathe with Motor Drive			
Swing Over Bed	Length of Bed	Distance Between Centers	Wgt. Crated Lbs.	Net Factory Price	Down Payment	Monthly Paym'ts Each	Wgt. Crated Lbs.	Net Factory Price	Down Payment	Monthly Paym'ts Each
9 1/4"	3'	18"	240	\$ 75	\$19	\$6.50	300	\$ 94	\$24	\$7.00
9 1/4"	3 1/2'	24"	265	87	21	7.00	325	106	28	7.00
9 1/4"	4'	30"	290	99	24	7.00	350	118	29	8.00
9 1/4"	4 1/2'	36"	340	116	29	8.00	400	135	31	9.00

MAIL COUPON FOR BULLETIN No. 5-W FREE

SOUTH BEND LATHE WORKS
606 E. Madison St., South Bend, Ind., U.S.A.

Please send me free quotation and illustration on the following lathe:

Swing.....Length of Bed.....

Countershaft Drive Motor Drive

My work is.....

- 9-inch "Workshop" Lathe Bulletin No. 5-W (free)
 How to Run a Lathe (160 Pages) (25c)

Name.....

Address.....

City.....

State.....



SOUTH BEND LATHE WORKS

606 East Madison St., South Bend, Ind., U. S. A.

Lathe Builders Since 1906—Users in 97 Countries

WRITE FOR BULLETIN 5-W—FREE

Bulletin No. 5-W fully describes and prices the 9" Workshop Lathe in its various sizes together with all its accessories and attachments. This 20 page bulletin mailed free postpaid to any address. Send coupon now.

If interested in larger size lathes, write for Catalog No. 94, which shows South Bend lathes from 9" to 18" swing inclusive. Catalog mailed free postpaid.

SIR MALCOLM CAMPBELL ROARS TO FASTEST LAND SPEED EVER MADE, USING PYROIL



Sir Malcolm Campbell at the wheel of "Blue Bird", his \$200,000 seven-ton automobile, pictured below.

In driving "Blue Bird" at a speed of almost 300 miles per hour, Sir Malcolm said, "I used Pyroil in my Blue Bird world's record car and found it entirely satisfactory."



Thrilled and awed as never before the whole world recently watched Sir Malcolm Campbell, the English race king, thunder across the sands of Daytona Beach, Florida, at nearly 300 miles per hour. Campbell's \$200,000.00 seven-ton automobile carried him faster on land than any other man has ever gone. And in accomplishing this feat, Sir Malcolm used Pyroil.

● PYROIL is the companion of many champions. It has crossed the finish line in victory with Barney Oldfield, Boardman and Polando, Lou Meyer, Bill Cummings, Wilbur Shaw, Bob McKenzie, Fred Frame and scores of others. Such a notable record of achievement is deserved only because the Pyroil process of **protective lubrication** proves unsurpassed.

Pyroil reduces expense and safeguards all moving parts of engines, motors and machinery. Frees valves, seals rings, increases power. Saves far more than its cost. **NOTE: PYROIL IS HIGHLY EFFICIENT IN CONNECTION WITH ALLOY BEARINGS, ALL TYPES. WILL NOT HARM.**

CONTAINS NO HARMFUL OILS OR ACIDS. Mfr'd and Guar'd by Pyroil Company, W. V. Kidder, Pres., 56 Pyroil Bldg., LaCrosse, Wis., U. S. A. **PYROIL HAS BEEN TESTED BY POPULAR MECHANICS AND IS USED BY POPULAR MECHANICS PASSES AND PUBLISHING EQUIPMENT.**

DISTRIBUTORS —SALESMEN

Check square in coupon below and mail for facts of Pyroil Selling Opportunity. It will pay you to do this—at once.

Genuine Pyroil is protected by U. S., Canadian and foreign patents issued to W. V. Kidder, its inventor. Not sold under any other name. Look for this signature on every factory-sealed can.



Simply
ADD TO
GAS—OIL
& GREASE

Pyroil Company
56 Pyroil Bldg.,
LaCrosse, Wis., U. S. A.

Please send further interesting Pyroil facts.
 Please send details of the Pyroil sales opportunity for me.

Name

Address

City.....County.....State.....



*I struck a
Match in the Rain—*

*I struck a match amid the rain drops
While there we waited you and I.
A little flame revealed we both liked Chesterfield.
You know—I know—They Satisfy.*

*You smiled and said, "They do taste better"
And I replied, "They're milder, too."
Those words just fit them to the letter.
You know—I know—They're true.*

*And now we're furnishing a cottage
Where we'll be happy by and by.
Because the night we met, you held that cigarette.
You know—I know—THEY SATISFY.*

Chesterfield