

WHERE TO GO THIS SUMMER

POPULAR MECHANICS

MAGAZINE

WRITTEN SO YOU CAN UNDERST

REGD. TRADE MARK, GREAT BRITAIN, No. 410428

APRIL
25 CENTS
30¢ IN CANADA



SEE PAGE 568



"A Black Panther Isn't
Half as Treacherous
as a *Blow-out!*"

says

FRANK (*Bring Em Back Alive*) BUCK



A TYPICAL BLOW-OUT ACCIDENT—DON'T LET IT HAPPEN TO YOU

HEAT CAUSES BLOW-OUTS—
THE LIFE-SAVER GOLDEN PLY
RESISTS HEAT—PREVENTS
THESE BLOW-OUTS



FREE! Handsome emblem with red crystal reflector to protect you if your tail light goes out. Go to your Goodrich dealer, join Silvertown Safety League, and receive one FREE. Or send 10¢ (to cover packing and mailing) to Dept. 453, The B. F. Goodrich Co., Akron, Ohio.



New kind of tire protects you from dangerous, high-speed blow-outs!

"I'd rather try to 'bring back alive' a roaring lion than bring myself safely through another blow-out accident," says FRANK BUCK. "When that tire blew out—when my car plunged off the road at those rocks—there was nothing I could do to avoid the crash. Now I'm playing safe by riding on Goodrich Silvertowns."

* * *

Don't drive around on dynamite. At today's high speeds, terrific heat is generated *inside* the tire. This heat causes rubber and fabric to separate. A blister forms. It grows bigger and bigger until suddenly BANG! Your tire blows out. *Anything might*

happen. But in Silvertowns the rubber and fabric don't separate. The Golden Ply invention resists internal heat. Blisters don't form. These high-speed blow-outs are prevented before they get started.

No Extra Cost!

See the new Safety Silvertowns. Press your hand on the extra-thick, deep-grooved tread. Feel the big, husky Silvertown cleats grip. Then you'll know why they also give you maximum protection against dangerous "tail-spin" skids. Remember, Golden Ply Silvertowns cost not a penny more than other standard tires.

Copyright, 1935, The B. F. Goodrich Co.

The **NEW Goodrich Safety Silvertown** WITH LIFE-SAVER GOLDEN PLY

Straight Facts about PLYMOUTH'S Startling "FLOATING RIDE"

NEWWEIGHT re-distribution... seats and engine forward... on the principle of the "Airflow."

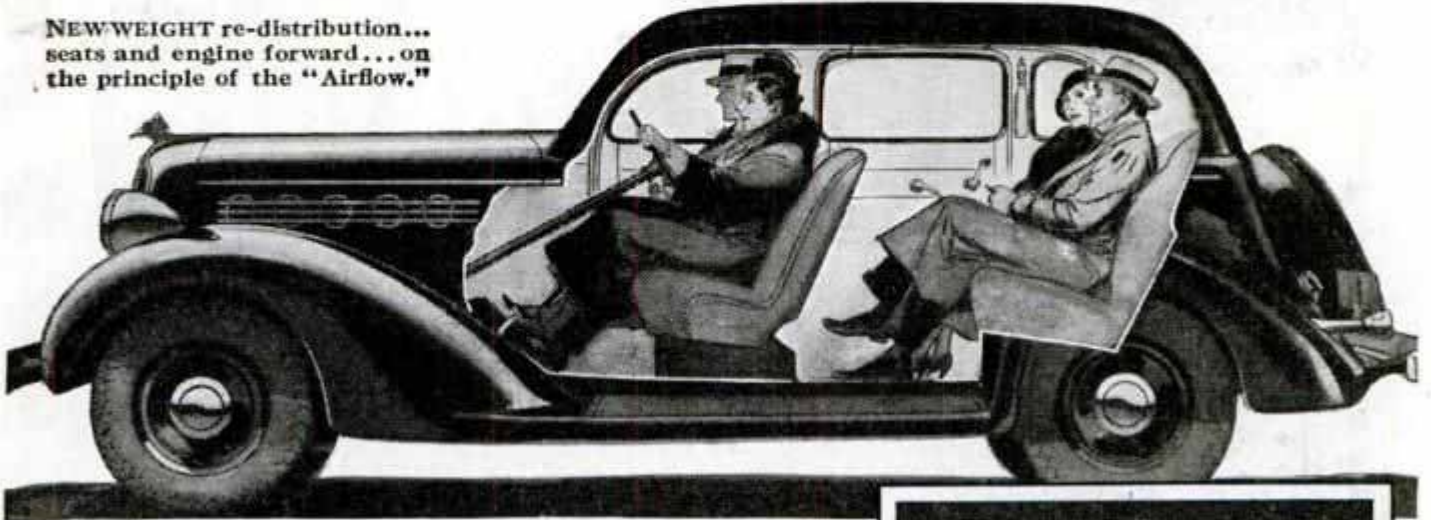

Showing How "Back Seat Bounce" and "Spring Gallop" were Outlawed by New Plymouth Engineering Principles

PLYMOUTH'S "FLOATING RIDE" is called the year's greatest advance in riding comfort. As one engineer put it—"I've never before driven a car like this. It 'glides' over bumps and ruts."

Like all outstanding engineering feats, Plymouth's "Floating Ride" started with a fundamental change in car design.

The ordinary method of placing car weight called for stiff springs in the front, where weight was less, and long, flexible springs in the rear, where weight was greater. This spring variation caused uneven, "gal-

loping" action on bumps.

Plymouth engineers began by re-distributing car weight on the principle of last year's famous "Airflow" cars. They moved engine and seats forward. Result? Back seat riders sit forward of the rear axle, away from bumps and "spring gallop." There's more leg-room.

Then Plymouth engineers developed a new kind of stronger, "livelier" front spring, made of "Mola" Steel... which aids in reducing oscillation frequency to 90 per minute, compared to 135

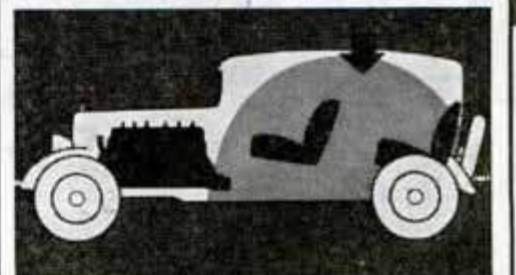

ORDINARY CAR, showing engine position. Center of weight is in rear. Back seat riders sit directly over rear axle.

per minute in an ordinary car. They added a sway eliminator at the front to give new safety on curves.

Go in to see these history-making Plymouth features at any Dodge, De Soto or Chrysler dealer. Drive it—test its "Floating Ride." Convenient purchases by the Official Chrysler Motors Commercial Credit Plan.

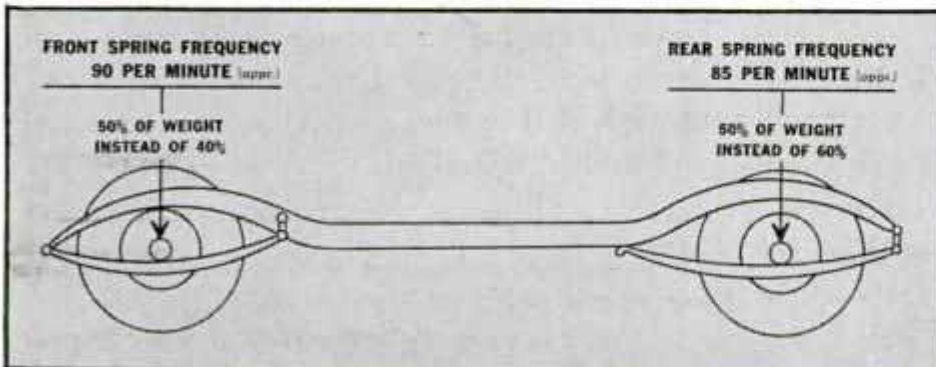

PLYMOUTH'S Correct Weight Re-Distribution divides axle load equally, brings in new spring action, makes possible a stronger, better-riding car.

Only Plymouth gives you All Four

1. HYDRAULIC BRAKES
2. WEIGHT RE-DISTRIBUTION
3. SAFETY-STEEL BODY
4. 12% to 20% LESS GAS AND OIL

NOW ONLY **\$510** AND UP F.O.B. FACTORY DETROIT



FIFTY YEARS OF PROGRESS

In 1885, fifty years ago, the American Telephone and Telegraph Company was formed.

There were few telephones then and service was slow, uncertain and limited to separate communities. In that year the largest number of telephones in any one city was 8400, in New York.

New York now has 1,500,000, Chicago 800,000, Philadelphia 350,000.

From your own Bell telephone you may talk with any one of 17,000,000 other telephones in this country and most of those in foreign lands. Today, 93% of all the world's telephones are within reach of the Bell telephone in your home or office.

This year marks also the Twentieth Anniversary of the opening of the first

transcontinental line, from New York to San Francisco, and the Eighth Anniversary of the opening of transatlantic service.

The work of improving Bell telephone communication is never ended . . . it goes on and on toward a constantly higher standard of service. Further improvements as important as those of the past half-century will come through Bell System research, manufacturing and unified operation.

To make your telephone service dependable, 94 per cent of the Bell System's 80,000,000 miles of wire is now in storm-resisting, lead-covered cable. Sixty-five per cent of it is buried beneath the ground.



BELL TELEPHONE SYSTEM

When writing to advertisers please mention Popular Mechanics

Popular Mechanics Magazine

H. H. WINDSOR, Founder

H. H. WINDSOR, Jr., Editor and Publisher

April, 1935

Vol. 63, No. 4

Special Features

Medicine Advances	481
Joys of the Open Road . Coloroto Section	
Search for a Perfect Oil	498
Hunting Lost Bonanzas	504
Newsreel of the Air	508
Adventures of the Power Explorers	516
Tackle Tips for the Fisherman	524
Fighting the Bug Smugglers	530
Secrets of the Big Leaguers	536
Stunts of the Movie Magicians	540
Dinner Table Tricks	546
Training a "Fighting Act"	552
Hazards of Creating New Colors	558
Flying Around the World	568
With the Master Bowlers	574

(Continued on next page)

Rough Riders of the Dirt Track

IF you seek the ultimate in thrills, get behind the wheel of a racer and try to keep up with the wild-eyed pack on a dirt track. The drivers do most of their steering with the foot throttle and their cars are in a skid nearly the whole distance. Piloting a dirt track racer is a hazardous and exhausting business and requires a special kind of driving skill. Winning such a contest is partly luck, partly skill and the rest is sheer nerve. Next month's Coloroto section of eight pages is devoted to the exciting adventures of the dirt track drivers and cameramen risked their lives to obtain some of the pictures which illustrate the story.

Next Month

WHEN your car balked, you used to take it to a dirty garage, surrender it to the tender mercies of a greasy man with a monkey wrench and a screw driver—and hope for the best. Today, automobile servicing has developed into an exact science. The modern service engineer, with his ingenious fact-finding and fault-correcting equipment, can give your car a thorough laboratory analysis. An article next month describes the newest servicing aids.

Going Up!

WITHOUT elevators our modern skyscrapers would be impossible and great cities could never have been built in restricted areas. In Manhattan 10,000,000 persons ride in elevators each twenty-four hours. Vertical transportation has advanced as rapidly as horizontal travel and the story of its development is a feature of the May issue.

Flying the Flyweights

MODEL plane builders who were pitching fragile toys powered with twisted rubber bands into the air a few years ago now are constructing miniature planes driven by tiny gasoline engines. These baby planes are setting records and present a fascinating new hobby. Read the article about them next month.

"SIMONIZ makes it Stay Beautiful!"



EVERY CAR NEEDS SIMONIZ TO PROTECT THE FINISH

Simoniz your car. And you can depend on it to stay beautiful for years.

New or old, the sooner you Simoniz your car the better. Simoniz not only keeps it beautiful, but protects the finish and makes it last longer. If the



finish is dull, first clean it with the new, improved Simoniz Kleener. You'll marvel how quickly it brings back all the lustre and beauty your car had when new.

Always insist on and get Simoniz and Simoniz Kleener for your car. Refuse to accept anything else.

MOTORISTS WISE SIMONIZ

(Contents—Continued)

487
Best motor picture

- Accounting—heading tab for record book 529
- Airplane, Design
 - mudguards protect landing gears 523
 - office fitted for use of company executives 557
 - wind tunnel tests for full-size 567
- Amusement Devices—loop-the-loop, self-powered . . . 514
- Architecture—unusual lighting of latest town house . 576
- Arson—smoke fingerprints to trap firebugs 528
- Automobiles, Accessories—tire guards end danger from blowouts 549
- Automobile, Tire—heavy tread gives traction 544
- Automobile, Trailer—equipped as home of student . 543
- Automobiles, Truck
 - anti-aircraft equipment mounted on 522
 - signal amplifier makes passing safer 580
- Aviation
 - flying camera, aimed like machine gun 513
 - full-size planes tested in air tunnel 520
 - high-speed cameras study fuel combustion 521
 - message in snow aids search for plane 544
- Ball Bearings—steel, magnetic mop retrieves 527
- Bench—metal, lines up pipe and fittings for welding . 519
- Bicycle
 - horn and lamp unit works on one battery 503
 - speedometer shows mileage 557
 - touring America on a 534
- Boat
 - ambulance is fast and non-sinkable 533
 - "stretched" to increase size and speed 577
- Boats, Outboard—land crew flash signals to racers . 572
- Bonneville Dam
 - model aids study of the river 539
 - sixteen tires on tractor used at 497
- Bottle—screw cap tightened with hand tool 555
- Brick—one-man machine for making 523
- Cannon—use to fire power line over ravine 503
- Canvas—made fire-resistant 571
- Carbon-Monoxide—gas, an alarm for 545
- Cloth—electrically heated 503
- Dentistry—latest aids for treating dogs 572
- Dog—six-ounce puppy fed by medicine dropper 535
- Dog Racing—rubber turf gives better footing 566
- Dolls—artist develops business, making 497
- Earth—apparatus measures tilt of, as tides change . 535
- Electrical Apparatus
 - board shows plays of bridge game 556
 - cable connector lug requires no soldering 565
 - wiring connector used without soldering 545
- Electricity
 - "seas" far above earth 566
 - spinning disks seen as source of power 576
- Exposition—flowers decorate buildings 573
- Fishing, Ice—flag tripped when bait is snatched . . . 512
- Forestry—picture helps locate fires 515
- Furnace—coal, "fireman" for 522
- Furniture—lounge built like sleigh 576
- Gas Tanks—two-man carrier simplifies handling 551
- Golf—Dry Ice inside ball causes expansion 535
- Hammer—air-pressure, smooths car fenders 577
- Hotel—pirate castle changed into 529
- Household Devices 578, 579
- Lock—twenty centuries old still working 527
- Log—cannon from, resembles a "Big Bertha" 523
- Microscope—pocket, lighted with flashlight 512
- Model—navy carved in miniature 502
- Moth—electric exterminator destroys by gas 514
- Paint—long-handled brush 515
- Pencil—writes three colors 555
- Pendulum—swinging, shows rotation of earth 533
- Photo-Cell—detector locates hidden guns 507
- Police—accident squads, give first aid, take photos . 580
- Poultry
 - anti-picking guards for hens 549
 - metal nest identifies egg-layers 561
- Pulley—speeded up by moving motor 506
- Radio
 - hints for experimenters 585
 - taste and small by, in future 567

There's so many good times

FOR THE EXPERT HARMONICA PLAYER

● Always in demand for parties, outings and social meetings of every kind are the boys and girls who are good harmonica players. They are the leaders who get the fun going—the singing and dancing that makes the affair “peppy.” They are the ones who form the Harmonica Bands that play at school functions, at community meetings, at scout rallies. And then once or

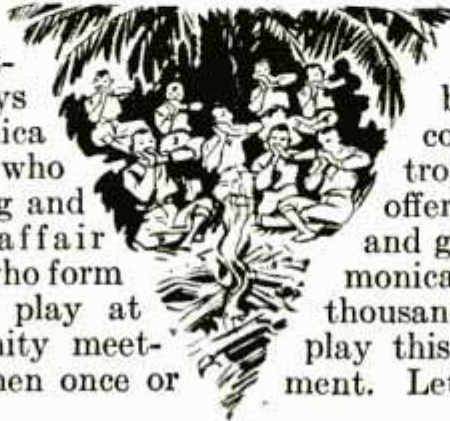

twice a year comes the big Harmonica Band Contest when bands from different schools and communities compete for the trophies and honors that are offered. All this is open to the boy and girl who learns to play the Harmonica. We have helped hundreds of thousands of boys and girls to learn to play this simple and delightful instrument. Let us help you.

So Simple to Learn

Without costing you a cent you can learn to play the Harmonica like a professional in a short time. Mail the coupon below for free Illustrated Instruction Book. You don't have to know one note from another. This book tells and shows you just what to do. Just follow the simple instructions and in a short time you'll be amazing your friends with the way you can perform.



At Parties and Dances . . . gay good times



The Harmonica Band makes a big hit



Frequent opportunities to play on the radio

Be Sure of Your Harmonica

The Harmonica is a real musical instrument, delicately tuned and beautifully made. Don't waste your money on an inferior, poorly made instrument. With a Hohner you know you have the best that can be obtained, the harmonica that for seventy-five years has been the choice of professional players for their stage and radio work.

LOOK FOR THE HOHNER NAME ON THE HARMONICA. IF IT'S NOT THERE—IT'S NOT A HOHNER. ACCEPT NO SUBSTITUTE.

Send for **FREE** Instruction Book—See How Easy It Is to Play



HOHNER IS ON THE AIR!
Listen to Carl Freed and his Harmonica Harlequins every Saturday evening on the following stations:

WOR	New York at 7:45 P.M.	—E.S.T.
WXYZ	Detroit at 7:45 P.M.	—E.S.T.
WLW	Cincinnati at 7:15 P.M.	—E.S.T.
WGN	Chicago at 6:45 P.M.	—C.S.T.

You'll enjoy listening to this superb Harmonica Band.

We want every boy and girl to know how quickly and easily they can learn to play a Hohner Harmonica. So we would like to send you, absolutely free and without any obligation to you, our complete Instruction Book “The Art of Playing the Harmonica.” Just fill in and mail the coupon, and it will be sent you at once.

M. HOHNER, Inc.
351 Fourth Ave. New York City



M. HOHNER, Inc., Dept. 975-D
351 Fourth Ave., N. Y. City
Please send me without cost your free instruction book “The Art of Playing the Harmonica.”

Name.....

Address.....

This One

W332-HRL-Z193

Please address Canadian in.

FLIES 237 miles per hour

NEW WORLD'S RECORD



Art Chester and his Pyroil-treated midget plane (weight 802 lbs.) with which he established a new world record of 237.033 m.p.h. for 100 kilometers—at Miami, Florida, Jan. 9, 1935.

Chester says, "I used Pyroil in the motor of this plane from the very first. I feel it increased my speed and is an additional factor of safety."

Aces of the air are just as enthusiastic—and sincere—about Pyroil's super efficiency as are dare devils of the motor speedway and racers of motor boats.

Pyroil puts real thrill-performance into any engine—auto, plane, boat, tractor, truck—because it controls friction. Equally effective in machinery and equipment operation.

Pyroil protects your auto engine during radical temperature changes which thin and "freeze" lubricants. Safeguards cylinder walls, piston faces, valves, bearings, gears. Saves far more than its cost.

Insist on Pyroil being added to every filling of gas, oil and grease. Sold the world over at service stations and other dealers. Mail coupon for further interesting facts. Manufactured and Guaranteed by Pyroil Co., W. V. Kidder, Pres., 54 Pyroil Bldg., LaCrosse, Wis., U. S. A.

Pyroil has been tested by Popular Mechanics and is used by Popular Mechanics' presses and publishing equipment.

DISTRIBUTORS—SALESMEN

Check square in coupon below and mail for facts of Pyroil Distributorship Opportunity. It will pay you to do this—at once.

PYROIL COMPANY
54 Pyroil Bldg., LaCrosse, Wis.

Please send me at no obligation, further interesting Pyroil facts.

Please send Distributorship Opportunity facts.

Name.....

Address.....

City.....

County.....

State.....



Genuine Pyroil is protected by U. S., Canadian and foreign patents issued to W. V. Kidder. Not sold under any other name. In factory-sealed cans only, bearing signature below. Identified by lithographed, factory-sealed cans bearing signature below. Not sold under any other name.

Simply ADD TO GAS OIL AND GREASE

(Contents—Continued)

Radio, Apparatus
cars with masts for patrol work550
homemade wrenches for special uses586
portable a.c. voltmeter aids set checking586
portable five-meter transceivers581
semi-automatic key sends code faster.....501

Radio, Application—microphone detects engine noises573

Radio, Receiver
all-wave super built with standard parts584
farm set works on 32-volts d.c.582
short-wave set is self contained586

Railroad
cab on roof simplifies control506
mirror helps find flaws in cars561

Refrigerator—Dry-Ice control for any size566

Rubber—shim for use in garage or home551

Safe—split keys prevent thefts550

Saw, Circular—attached to truck differential519

Scale
coin-in-slot reveals heart beats and weight...528
handy, three-in-one weighs accurately543

Sculpture—photos copied with aid of dual vision...507

Sea Shell—artist turns hobby into money561

Sheet Metal—nibbling tool for home workshop....519

Shooting Range—in basement, extends underground.551

Tank Heater—gas converter, makes automatic....501

Target—dummy for treasury guards507

Telephone—cord of braided elastic will not tangle..566

Tool—tri-square with rectangular head556

Toys—train delivers farmers' mail557

Traffic—roadway with four decks for city traffic...545

Watch
accuracy tested on machine544
braille, for blind has raised dots512

Weather—compact indicator forecasts changes....571

Window—automatic catch locks at any height....539

AMATEUR MECHANICS

Baking Pans—false bottom, prevents cake from sticking618

Boats—nicked propeller causes outboard motor to race593

Book Ends—pair that telescopes609

Brace—attachment aids in drilling holes vertically..609

Camera—grafx, bulb-operated shutter release for.600

Canoe—sash cord buffer protects canvas covering..618

Cements—to repair metal objects602

Cleaning—a homemade spotting brush602

Clothesline—wire rings or loop hold prop.....599

Coaster—has auto steering wheel593

Crayons—wax, how to make613

Crowbar—made from steel pipe610

Disinfectant—efficient, and deodorizer615

Electricity—experiments with bell wire and iron...601

Feathers—cleaned with vacuum sweeper598

Ferns—house, cold tea fertilizes620

Filler—inexpensive for cracks596

Funnel—device for dropping liquids into mixtures..592

Furniture
built without nails595
kitchen soap case597
reading stand that straddles your chair614

Games—cardboard horses, race on strings.....602

Garden—tile over rhubarb, makes stalks long and tender594

Glass—column lines on newspaper aid in cutting...620

Hose—rubber, used as stop on keyhole saw594

Inner Tubes—used as arm guards when pruning...594

Jigsaw—guard protects fingers615

Lawnmower—space in garage to store592

Mirrors—colonial, how to make616

Models
insulated wire used as parts590
lettered with stencil592

Moles—old razor blades rid garden of594

(Continued to page 8A)

Promoted—when others were fired!

The Story of LaSalle Student Shaw



"Since the War I have been book-keeper at \$35 a week. Married, with one baby girl, I found it harder every month to make ends meet. I was desperate!



"Last winter my wife brought me a LaSalle ad on Higher Accounting—showing how I could study in spare time for the job ahead. I investigated, and enrolled January 23. Just in time! For—



"Suddenly, orders came through to cut the force. I watched seven men in my department get the bad news and leave. Then the office boy tapped me, said I was 'next.' My heart sank as I followed him to the Front Office.

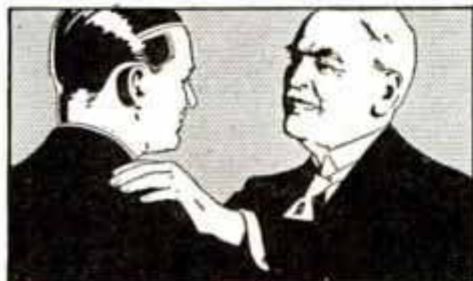

"Smiling, the boss handed me a letter. It was from LaSalle to him, announcing my enrollment and my good work on the first lesson. 'We are keeping you,' he said, 'because we like your spirit.'



"Naturally, I had more work to do, with the smaller force, but my training made it easier. I learned quickly, and when the Department Manager left, the boss moved me up.



"I have since been promoted twice, and now carry the title of Chief Accountant—at a salary several times greater. The future looks bright. If it had not been for LaSalle, I would be looking for a job right now."

BIGGER PAY FOR YOU— thru LaSalle Spare-Time Training

That's a story of what spare-time study has done for just one man. There are thousands of others like Shaw who found themselves through LaSalle. Now—how about yourself? Do you want a better position and higher pay?

You can win them, even today, if you can do the work. LaSalle experts will show you how, personally guide you step by step to success. Simply mark on the coupon the field you are interested in, and we will send you FREE, a valuable booklet about it, telling of opportunities open to you. No cost or obligation—and what you find out may put you on the road to success and financial independence.

The opportunity that is open today—right now—may not be here tomorrow. Don't put it off—but reach for your pencil, fill out, and mail today.

LASALLE EXTENSION UNIVERSITY Dept. 464-R, Chicago

Please tell me how I can take full advantage—right now—of the opportunities in the business I am checking below. And send along your free booklet on that field.

- | | |
|---|---|
| <input type="checkbox"/> Business Management | <input type="checkbox"/> Railway Accounting |
| <input type="checkbox"/> Traffic Management | <input type="checkbox"/> Business Correspondence |
| <input type="checkbox"/> Modern Salesmanship | <input type="checkbox"/> Personnel Management |
| <input type="checkbox"/> Paper Salesmen's Training | <input type="checkbox"/> Law: LL. B. Degree |
| <input type="checkbox"/> Railway Station Management | <input type="checkbox"/> Commercial Law |
| <input type="checkbox"/> Industrial Management | <input type="checkbox"/> Office Management |
| <input type="checkbox"/> Higher Accountancy | <input type="checkbox"/> Chain Grocery Management |
| <input type="checkbox"/> Expert Bookkeeping | <input type="checkbox"/> Business English |
| <input type="checkbox"/> Effective Speaking | <input type="checkbox"/> Foremanship |

Name.....

Address.....

Position.....

LASALLE EXTENSION UNIVERSITY



Follow this Man

Secret Service Operator 38 is on the job

FOLLOW him through all the excitement of his chase of the counterfeit gang. See how a crafty operator works. Telltale finger prints on the lamp stand in the murdered girl's room! The detective's cigarette case is handled by the unsuspecting gangster, and a great mystery is solved. Better than fiction. It's true, every word of it. No obligation. Just send the coupon and get—

FREE!

The Confidential Reports No. 38 Made to His Chief

And the best part of it all is this—it may open your eyes to the great opportunity for YOU as a well paid Finger Print Expert. This is a young, *fast-growing* profession. This school has taken men and trained them for high official positions. This is the kind of work you would like. Days full of excitement. A regular monthly salary. Rewards.

Can you meet this test?

Are you of average intelligence? Are you ambitious? Would you give 30 minutes a day of your spare time preparing yourself for this profession? Answer "yes" and I'll show you how it is possible for you to attain all this. Send the coupon and I'll also send the Free Reports.

INSTITUTE OF APPLIED SCIENCE
1920 Sunnyside Ave., Dept. 13-54 Chicago, Illinois

Institute of Applied Science
1920 Sunnyside Ave., Dept. 13-54 Chicago, Illinois

Gentlemen:—Without any obligation whatever, send me the Reports of Operator No. 38, also your illustrated Free Book on Finger Prints and your low prices and Easy Terms Offer. Literature will NOT be sent to boys under 17 years of age.

Name

Address

Age

(Contents—Continued)

Motion Picture—splicer and rewriter for film	615
Paint—spring handle holds small cans	610
Paper Clips—lengthen rubber bands for wrapping	596
Paste Boxes—tin strip that opens	614
Photography	
diffusing light of photoflood lamps	615
preventing splash when washing prints	618
Plaster—novelties cast in flexible molds	587
Poultry	
feed pans improvised from can lids	610
hobbles prevent scratching in flower beds	591
Seeds—tiny, sown with medicine dropper	592
Ship Models	
anchor cables from wire	618
sliding hatch covers improve	599
Skis—how to store, to prevent warping	600
Smokers' Accessories—ash tray clamped to reading lamp	591
Soap—for dry-cleaning solutions	610
Stovepipe—loose damper repaired with spring	610
Targets—rifle, old phonograph records, used as	600
Theatre—making stage sets for amateur plays	611
Tray—rubber, improvised, for acids	596
Vines—brackets hold on building	596
Vise—rubber balls cushion handle	596
Wax—how to obtain a fine finish	619
Wire—loop supports flowers	600
Wood Blocks—prevent dust gathering in stair corners	602
Yacht—"Vanja" model racing	603

SHOP NOTES

Automobiles—suggestions for repairing and care	637
Automobiles, Accessories—guard for lock buttons on car doors	639
Automobiles, Repairing	
carbon scraper from table fork	638
condenser prevents burning of contacts in headlight switch	639
exhaust-manifold gaskets, how to prevent blowing out	638
nuts to adjust bearings on connecting rods	638
rubber bands on cylinder head bolts protect hands	638
sand in carburetor causes trouble	639
set screw locks hinge pin on car door	639
sounding rod locates motor knocks	639
Automobiles, Trucks—tender for vegetable vendor	625
Bicycles—removable racks for	630
Blowtorch—lettering burned on crates with	629
Caliper—combination, for inspecting castings	630
Carpenter—sawdust pockets, as knee pads	624
Chalk Line—device levels	636
Clamp—holds two gluing jobs at one time	631
Drafting—tracing paper held with rubber cement	630
Eraser—blackboard, used as dry window cleaner	623
Files—homemade rotary, for carving wood	629
Fire Barrels—fitted with casters	626
Links—steel, attachment for grinding radii	630
Milling—template and dial indicator aid irregular	631
Milling Cutters—reground without annealing	627
Mimeograph—book covers used in making stencils	624
Models—maulstick, adjustable, aids in painting	635
Photography	
dry tissue better for fastening in folders	626
printing from wet negatives	636
wet negatives dried with rubber sponges	635
Plaster—mixed in rubber vacuum cup	625
Printing—cards dried with electric heater	640
Rivets—iron, heated without burning heads	636
Saws—hand, using your	621
Thermometer—recording, how to make	632
Tile—temporary sewer joined with inner tubes	626
Tool—for center-punching work	624
Trays—from tin cans for small parts	624
Vise—bench, utilizing as punch press	636
Wire—fence, cotter keys hold on steel posts	626
Workbench—renewing tops	629

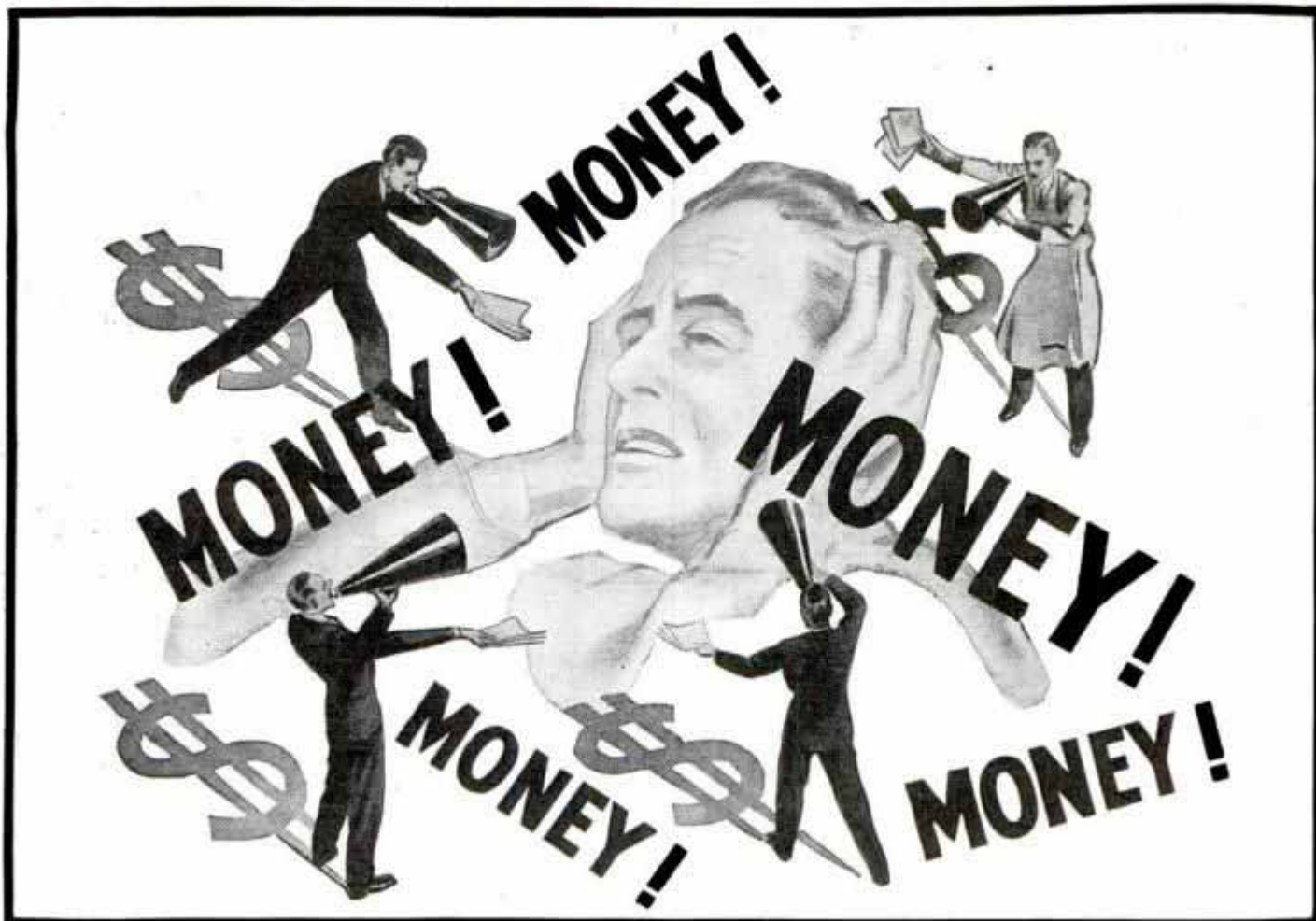

You hear it on all sides, this eternal demand for money. The butcher, the baker, the candlestick maker—*money, money, money!*

When the bills pour in and you stack them alongside your pay envelope—honestly, don't you have a sense of futility? Don't you wish you had a job that paid more money?

Well, the only way to get *that* job is to fit

yourself for it—to acquire *training* that you can convert into cash.

And you can do it! Thousands have done it. They have found the answer to their problems in spare-time study of International Correspondence Schools Courses. Perhaps modern training is the thing you need most. This coupon will bring you complete information—free.

INTERNATIONAL CORRESPONDENCE SCHOOLS

★ *"The Universal University"*

BOX 5565-H, SCRANTON, PENNA. ★

Without cost or obligation, please send me a copy of your booklet, "Who Wins and Why," and full particulars about the subject *before* which I have marked X:

- | | | | |
|---|--|---|---|
| TECHNICAL AND INDUSTRIAL COURSES | | | |
| <input type="checkbox"/> Architect | <input type="checkbox"/> Reading Shop Blueprints | <input type="checkbox"/> Automobile Mechanic | <input type="checkbox"/> Air Brakes <input type="checkbox"/> R. R. Signalman |
| <input type="checkbox"/> Architectural Draftsman | <input type="checkbox"/> Telegraph Engineer | <input type="checkbox"/> Plumbing <input type="checkbox"/> Steam Fitting | <input type="checkbox"/> Highway Engineering |
| <input type="checkbox"/> Building Estimating | <input type="checkbox"/> Telephone Work | <input type="checkbox"/> Heating <input type="checkbox"/> Ventilation | <input type="checkbox"/> Chemistry <input type="checkbox"/> Pharmacy |
| <input type="checkbox"/> Wood Millworking | <input type="checkbox"/> Mechanical Engineer | <input type="checkbox"/> Sheet Metal Worker | <input type="checkbox"/> Coal Mining Engineer |
| <input type="checkbox"/> Contractor and Builder | <input type="checkbox"/> Mechanical Draftsman | <input type="checkbox"/> Steam Engineer <input type="checkbox"/> Civil Engineer | <input type="checkbox"/> Navigation <input type="checkbox"/> Air Conditioning |
| <input type="checkbox"/> Structural Draftsman | <input type="checkbox"/> Machinist <input type="checkbox"/> Toolmaker | <input type="checkbox"/> Steam Electric Engineer | <input type="checkbox"/> Boilermaker |
| <input type="checkbox"/> Structural Engineer | <input type="checkbox"/> Patternmaker | <input type="checkbox"/> Surveying and Mapping | <input type="checkbox"/> Textile Overseer or Supt. |
| <input type="checkbox"/> Development and Protection of New Products | <input type="checkbox"/> Heat Treatment of Metals | <input type="checkbox"/> Refrigeration | <input type="checkbox"/> Cotton Manufacturing |
| <input type="checkbox"/> Electrical Engineer | <input type="checkbox"/> Bridge Engineer | <input type="checkbox"/> R. R. Locomotives | <input type="checkbox"/> Woolen Manufacturing |
| <input type="checkbox"/> Electric Lighting | <input type="checkbox"/> Bridge and Building Foreman | <input type="checkbox"/> R. R. Section Foreman | <input type="checkbox"/> Agriculture <input type="checkbox"/> Fruit Growing |
| <input type="checkbox"/> Welding, Electric and Gas | <input type="checkbox"/> Gas Engines <input type="checkbox"/> Diesel Engines | <input type="checkbox"/> R. R. Bridge and Building Foreman | <input type="checkbox"/> Poultry Farming <input type="checkbox"/> Radio |
| | <input type="checkbox"/> Aviation Engines | | <input type="checkbox"/> Marine Engineer |
| BUSINESS TRAINING COURSES | | | |
| <input type="checkbox"/> Business Management | <input type="checkbox"/> C. P. Accountant | <input type="checkbox"/> Service Station Salesmanship | <input type="checkbox"/> Railway Mail Clerk |
| <input type="checkbox"/> Office Management | <input type="checkbox"/> Bookkeeping | <input type="checkbox"/> First Year College | <input type="checkbox"/> Grade School Subjects |
| <input type="checkbox"/> Industrial Management | <input type="checkbox"/> Secretarial Work | <input type="checkbox"/> Business Correspondence | <input type="checkbox"/> High School Subjects |
| <input type="checkbox"/> Traffic Management | <input type="checkbox"/> Spanish <input type="checkbox"/> French | <input type="checkbox"/> Lettering Show Cards <input type="checkbox"/> Signs | <input type="checkbox"/> College Preparatory |
| <input type="checkbox"/> Accountancy | <input type="checkbox"/> Salesmanship | <input type="checkbox"/> Stenography and Typing | <input type="checkbox"/> Illustrating |
| <input type="checkbox"/> Cost Accountant | <input type="checkbox"/> Advertising | <input type="checkbox"/> Civil Service <input type="checkbox"/> Mail Carrier | <input type="checkbox"/> Cartooning |

Name.....Age.....Address.....

City.....State.....Occupation.....

If you reside in Canada, send this coupon to the International Correspondence Schools Canadian, Limited, Montreal, Canada

for **MORE
PAY**



LEARN DRAFTING

at HOME from an ENGINEER!



"I will train you
by mail."
Engineer Dobe



School
Established
since 1900

These TOOLS and Other
EQUIPMENT
Given When You Start

WRITE today for valuable book, "Success in Draftsmanship"—sent free. See coupon below.

I'll train a number of selected students as Draftsmen. Yes, I furnish you all tools and a drawing table. And I'll teach you in a very short time by mail in your spare time until you actually have a desirable draftsman's job or prepare you for better pay on the job you have now! Trained men on steady jobs earn \$50 a week or more; be prepared!

Keep the job you have now while training. I'll tell you how to start earning extra money a few weeks after beginning my training. Get started now. Send coupon.

Earn While You Learn!

You can start earning money a few weeks after beginning my training. I tell you how to make money.

Jobs Open NOW!

After training you I help you to a job without charging you a cent for this service. For 30 years employers of Draftsmen have been writing me when they want help. **Aviation, Electricity, Machinery, Auto Work, Building Work**—All these industries and others, too, must have draftsmen in their offices. These industries are now growing fast; be prepared. You do not need a high school education to learn by the Dobe method. No previous experience necessary. But you must have ambition to EARN MORE.

Money Back if Not Satisfied

You must be entirely satisfied with my personal training UNTIL COMPETENT and UNTIL assisted to a position OR (notice this!) you get ALL YOUR MONEY BACK.

START NOW and get the training. Then YOU will be ready for that bigger, better-pay job. Send the coupon NOW—TODAY, while I select my students for this personal, practical training to a limited number.

FREE BOOK COUPON

ENGINEER DOBE, Div. 33-74, Libertyville, Ill.

Send me your free book, "Successful Draftsmanship" and explain how you will assist me to a good position as a draftsman.

Name..... Age.....

Address.....

Post Office..... State.....

When writing please mention Popular Mechanics

Law!

LEARN AT HOME

Are you adult, alert, ambitious, willing to study? Investigate LAW! We guide you step by step—furnish all texts, including 14-volume Law Library. Training prepared by leading law professors and given by members of bar. Degree of LL. B. conferred. Low cost, easy terms. Send NOW for Free, 64-page "Law Training for Leadership."

LaSalle Extension University, Dept. 464-L, Chicago

ELECTRICAL ENGINEERING

A BROAD, basic, intensive course complete in one school year. Includes fundamentals of Refrigeration, Air-conditioning, Electronics. Approved by educators, endorsed by industry. 43rd year. Catalog.



BLISS ELECTRICAL SCHOOL

134 TAKOMA AVE., WASHINGTON, D. C.

Be a DENTICIAN

Learn at home to make Crowns, Plates, Bridgework, etc., for Dentists. Easy, practical way to learn mechanical dentistry at home in spare time. Full equipment of tools and materials included with course FREE. Low tuition. Easy terms. Write for FREE BOOK about this money-making profession that is not affected by "machine age."

McCARRIE SCHOOL
OF MECHANICAL DENTISTRY
207 N. Broad St., Dept. 609, Philadelphia, Pa.

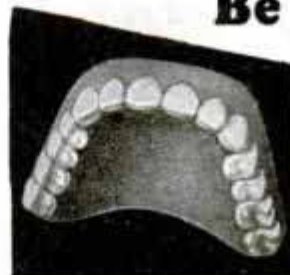

LEARN WATCHMAKING AND ENGRAVING

BY OUR PROFIT-SHARING PLAN
OUR GRADUATES SUCCEED

One of our Iowa students started in a very small way—now doing over \$30,000 a year. Another in Wisconsin, over \$10,000 the first year. Day or night classes. Call or write for FREE BOOK. Chicago School of Watchmaking, Dept. 2601, 155 N. Clark St., CHICAGO.



Learn to Write

Begin Today. Write for my Free Book, "How to Become a Good Penman." It contains specimens and tells how others learned to write in spare time. Your name elegantly written on a card if you enclose stamp for postage. Write today. F. W. TAMBLIN, 418 Ridge Bldg., Kansas City, Mo.

Learn PHOTOGRAPHY at Home

Make money taking pictures. Photographs in big demand. Commercial Photography also pays big money. Learn quickly at home in spare time. No experience necessary. Write today for new free book, *Opportunities in Modern Photography*. American School of Photography, Dept. 1354, 3601 Michigan Avenue, Chicago.

SHOES LIKE NEW AS LOW AS 2¢ A PAIR

EARN UP TO \$2 AN HOUR

SAV-AN-UPPER completely covers scuffed, discolored and faded uppers of any shoes with a wear-proof, highly polished coating and makes them look like new. Quick, easy, economical. Takes only a minute. Just brush it on! More than a polish; more than a dye. And different. Guaranteed.

FREE SAMPLE: Write today for free sample which proves all claims. Send no money. Act now! Opportunity for Distributors in Foreign Countries.

SAV-AN-UPPER CO., Dept. H-72, Cincinnati, Ohio



IT'S
EASY
Just
Brush
it
On

Absolutely new



STUDENTS BUSY AT WORK IN GREAT COYNE SHOPS

Learn ELECTRICITY I'll Finance Your Training

Yes, sir! I mean what I say. I'll train you in 90 days, right here in the Great Coyne Shops — NOT BY CORRESPONDENCE — but by real electrical work on real electrical machinery. AND YOU WON'T HAVE TO PAY ME BACK UNTIL TWO MONTHS AFTER YOUR REQUIRED TRAINING PERIOD IS OVER AND THEN YOU'LL HAVE OVER A YEAR TO COMPLETE YOUR PAYMENTS.

This Is the Greatest Offer Ever Made by Any School

I MEAN exactly what I say. You can get a complete training by the world's oldest and largest Practical Electrical School and I'll finance your Tuition. You won't have to start paying me back in small, monthly payments until 2 months after your required training period is over. I consider the fellow who is ambitious enough to want to get ahead by taking my Training, worthy of my help. MAIL THE COUPON BELOW and you can prove to me that you are willing to spend just THREE MONTHS in the Coyne Training Shops Learning ELECTRICITY. Then, I'll tell you how I finance your Tuition — give you your complete Training and let you pay me back later.

Learn By Doing In 90 Days

Lack of experience—age or advanced education bars no one. I don't care if you don't know an armature from an air brake—I don't expect you to! It makes no difference! Don't let lack of money stop you. Most of the men at Coyne have no more money than you have. That's why I have worked out my offers.

MANY EARN While LEARNING

If you need part-time work to help pay your living expenses and will tell me your problems I may be able to help you as I have thousands of others. Then, in 12 brief weeks, in the great roaring shops of Coyne, I train you as you never dreamed you could be trained . . . on one of the greatest outlays of electrical apparatus ever assembled . . . real dynamos, engines, power plants, auto, switchboards, transmitting stations . . . everything from doorbells to farm power and lighting . . . full-sized . . . in full operation every day!

TRAINING

By Actual Work

No dull books, no baffling charts, no classes, you get individual training . . . all real actual work with only the theory you will need. Building real batteries . . . winding real arma-



Prepare for Jobs Like These
Here are a few of hundreds of positions in the electrical field. Our free employment bureau gives you a life-time employment service.
ARMATURE EXPERT
SUBSTATION OPERATOR
AUTO ELECTRICIAN
INVENTOR
MAINTENANCE ENGINEER
SERVICE STATION OWNER
RADIO EXPERT

tures, operating real motors, dynamos and generators, wiring houses, etc. That's a glimpse of how we help to make you a master electrician, and fit you to qualify for jobs leading to the biggest pay.

Jobs - Pay - Future

"Two weeks after graduation I received a splendid job. The main consideration given my application was that I was a Coyne Trained man," reports Harold Soucy of Illinois. "I wish to thank your Employment Manager for securing this position for me," writes Albert Yagon, "he sent me out to this Company the first day and I was employed there immediately." And I could go on quoting from hundreds of letters of successful Coyne Trained Men. What they have done, you should be able to do!

Electric Refrigeration

Right now I'm including my big new Electric Refrigeration course at no extra cost.

GET THE FACTS

Coyne is your one greatest chance to get into electricity. Every obstacle is removed. This school is 36 years old—Coyne training is tested—proven beyond all doubt—endorsed by many large electrical concerns. You can find out everything absolutely free. Simply mail the coupon and let me send you the big, free Coyne book of 150 photographs . . . facts . . . jobs . . . salaries . . . opportunities. Tells you how many earn expenses while training and how we assist our graduates in the field. This does not obligate you. So act at once. Just mail coupon.

Get This
FREE
Book



Now In Our New Home

This is our new fire-proof modern home wherein is installed thousands of dollars' worth of Electrical equipment of all kinds. Every comfort and convenience has been arranged to make you happy and contented during your training.



COYNE H. C. LEWIS, PRESIDENT FOUNDED 1899
ELECTRICAL SCHOOL
500 S. Paulina St., Dept. 45-72, Chicago

H. C. LEWIS, President
Coyne Electrical School, Dept. 45-72
500 S. Paulina St., Chicago, Ill.

Dear Mr. Lewis:— Without obligation send me your big free catalog and all details of Free Employment Service and your new Electric Refrigeration course, also tell me all about your "Pay After Graduation Offer."

Name

Address

City..... State.....

300 Prizes GIVEN



Mail the Coupon

OH, BOY! Here's a bike that is a bike. And it can soon be yours! Comes to you fully equipped as shown, with headlight, coaster brake, horn, platform carrier, etc. Latest deluxe motorbike model. Swift as a comet. Sturdy as an Indian pony. As classy a bike as you've ever looked upon. Get it for your very own—without one cent of cost. Mail the coupon printed below. Do it today!

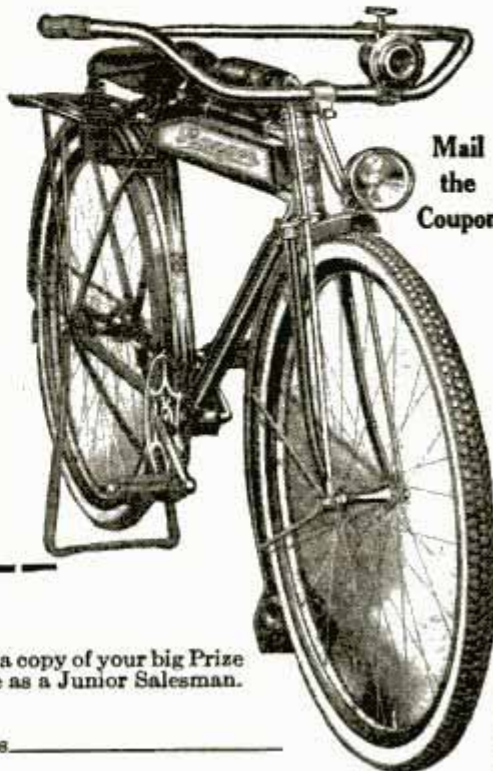

Mail the Coupon

YES, SIR! You can get this bicycle—and your choice of 300 other prizes, including 'most anything from a marble to a movie camera. You can make MONEY, besides. It's easy! Just deliver our 3 fine magazines to customers in your neighborhood. Will not interfere with school or play. Gives you valuable business training. Mail the coupon and we'll start you earning money and prizes.



**Mr. Jim Thayer, Dept. 481
The Crowell Publishing Co., Springfield, Ohio**

Dear Jim: I want to earn MONEY and PRIZES. Send me a copy of your big Prize Book showing 300 prizes that can be mine, and start me as a Junior Salesman.

Name _____ Address _____

City _____ State _____ Age _____



START \$1260 to \$2100 YEAR
MEN—WOMEN—18 to 50

STEADY WORK
Many Early Examinations Expected
Qualify at once
Common Education Usually Sufficient
Mail Coupon Today—SURE

Franklin Institute
Dept. P174
ROCHESTER, N. Y.

Gentlemen: Rush to me, FREE of charge, list of U. S. Government big pay jobs. Send me FREE 32-page book describing salaries, vacations, hours, work, and pointers on how to get one of these jobs.

COUPON

Name.....

Address.....

LEARN WATCH REPAIRING



AT HOME You can learn by our modern and original system of instruction every part of the Watch Repairing Trade at home as good or better than at a shop. You can earn money while learning and secure a well paying position or start in business after completing our course of instruction. Good watch repairers are always in demand and earn very good salaries. For particulars apply to the
Wisconsin School of Watch Repairing
524 E. Mason St., MILWAUKEE, WIS.

You Can Regain Perfect Speech, if you STAMMER

Send today for beautifully illustrated book entitled "DON'T STAMMER," which describes the Bogue Unit Method for the scientific correction of stammering and stuttering. Method successfully used at Bogue Institute for 33 years—since 1901. Endorsed by physicians. Full information concerning correction of stammering sent free. No obligation. Benjamin N. Bogue, Dept. 153, Circle Tower, Indianapolis, Indiana.

Get a Good Pay Job in AVIATION

Learn Quickly at Home in Spare Time
Earn \$30.00 to \$75.00 a Week and up. Aviation is BOOMING! My practical, up-to-date training gives you ground work you need to get a good job. Write for big FREE book. No obligation. Address Walter Hinton, Pres., Aviation Institute of U.S.A., Inc., Dept. 901-D, 1113 Connecticut Ave., Washington, D. C.

Improves Handwriting In 3 Hours

Marvelous invention. Corrects poor writing in few days. Amazing results guaranteed. No failures. Positive proof and complete outline mailed FREE. Write quickly.

MODERN BOOKKEEPING in 12 Easy Lessons

by an expert. Learn easily by mail, to open, keep and close books. **SMALL EASY PAYMENTS.**

THE FRAZEE METHOD, 46A Wayne Place, NUTLEY, N. J.
When writing please mention Popular Mechanics

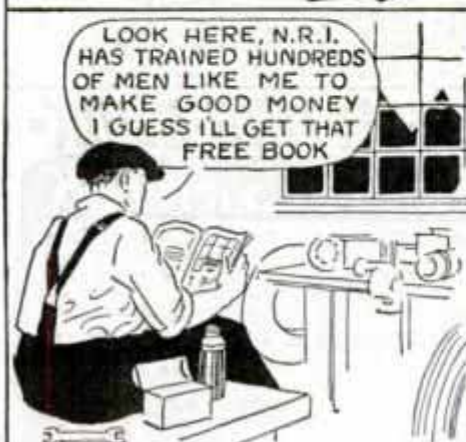

HERE'S PROOF that my training pays



New Owns Own Business

"If I had not taken your Course I would be digging ditches instead of running my own business. One week I made \$75 on repairing alone, and this doesn't count sales. If a fellow wants to get into Radio, N.R.I. is the starting point." R. S. Lewis, Modern Radio Service, Pittsfield, Ill.



Spare Time Jobs Earn \$15 a Week

"I have no trouble getting Radio work. I have the reputation of being the best Radio man in town, and average \$15 to \$20 a week for spare time only." G. Bernard Croy, 151 Washington St., Bronson, Michigan.



Owes His Success to Radio Training

"Since 1929 I have earned my living in Radio. I owe my last three jobs to N. R. I. I am now in the main control room of one of the large broadcasting chains." Serge A. De Somov, 1516 Library Ave., New York City.



I'LL TRAIN YOU AT HOME In Your Spare Time For A GOOD RADIO JOB

Mall the coupon now. Get the facts about Radio—the field with a future. N. R. I. training fits you for jobs in connection with the manufacture, sale and operation of Radio equipment. It fits you to go in business for yourself, service sets, operate on board ships, in broadcasting, television, aviation, police Radio and many other jobs. My FREE book tells how you quickly learn at home in spare time to be a Radio Expert.

Many Radio Experts Make \$40, \$60, \$75 a Week

Why struggle along in a dull job with low pay and no future? Start training now for the live-wire Radio field. I have doubled and tripled salaries. Hundreds of successful men now in Radio got their start through N. R. I. training.

Many Make \$5, \$10, \$15 a Week Extra in Spare Time While Learning

Hold your job. I'll not only train you in a few hours of your spare time a week, but the day you enroll I start sending you Extra Money Job Sheets which quickly show you how to do Radio repair jobs common in most every neighborhood. I give you Radio Equipment for conducting experiments and making tests that teach you to build and service practically every type of receiving set made. Cleo T. Retter, 30 W. Beechwood Ave., Dayton, Ohio, wrote: "Working only in spare time, I made about \$1,500 while taking the Course."

Find Out What Radio Offers

My book has shown hundreds of fellows how to make more money and win success. It's FREE to any ambitious fellow over 15 years of age. Investigate. Find out what Radio offers you. Read what my Employment Department does to help you get into Radio after graduation, about my Money Back Agreement, and the many other N. R. I. features. Mail the coupon in an envelope, or paste it on a 1¢ post card TODAY.

J. E. SMITH, President, Dept. 5DP National Radio Institute, Washington, D. C.



J. E. SMITH, President National Radio Institute

The man who has directed the Home-Study Training of more men for the Radio industry than any other man in America.



J. E. SMITH, President, Dept. 5DP National Radio Institute, Washington, D. C.

Dear Mr. Smith: Without obligating me, send your book which points out the spare time and full time job opportunities in Radio and your 50-50 method of training men at home in spare time to become Radio Experts.

(Please print plainly)

NAME.....AGE.....
 ADDRESS.....
 CITY.....STATE.....



ARE YOU JUST HOPING TO LAND IN A GOOD JOB?

HOPE without foundation is pretty futile in this competitive age! But hope *plus training* is a winning combination—and all over this country today, in all kinds of professions and trades, men are getting ahead—landing in good jobs—earning more money—because of serious and systematic study of International Correspondence Schools' courses. These courses are giving them the training they need to succeed! As for you, investigation will not put you under any obligation. Mail the coupon!

INTERNATIONAL CORRESPONDENCE SCHOOLS

"The Universal University" Box 5566-H, Scranton, Penna.

Without cost or obligation, please send me a copy of your booklet, "Who Wins and Why," and full particulars about the subject before which I have marked X:

TECHNICAL AND INDUSTRIAL COURSES

- | | |
|---|--|
| <input type="checkbox"/> Architect | <input type="checkbox"/> Aviation Engines |
| <input type="checkbox"/> Architectural Draftsman | <input type="checkbox"/> Automobile Mechanic |
| <input type="checkbox"/> Building Estimating | <input type="checkbox"/> Plumbing <input type="checkbox"/> Heating |
| <input type="checkbox"/> Wood Millworking | <input type="checkbox"/> Air Conditioning |
| <input type="checkbox"/> Contractor and Builder | <input type="checkbox"/> Sheet Metal Worker |
| <input type="checkbox"/> Structural Draftsman | <input type="checkbox"/> Steam Engineer |
| <input type="checkbox"/> Structural Engineer | <input type="checkbox"/> Steam Electric Engineer |
| <input type="checkbox"/> Electrical Engineer | <input type="checkbox"/> Civil Engineer |
| <input type="checkbox"/> Electric Lighting | <input type="checkbox"/> Surveying and Mapping |
| <input type="checkbox"/> Welding, Electric and Gas | <input type="checkbox"/> Refrigeration |
| <input type="checkbox"/> Reading Shop Blueprints | <input type="checkbox"/> R. R. Locomotives <input type="checkbox"/> Air Brakes |
| <input type="checkbox"/> Telegraph Engineer | <input type="checkbox"/> R. R. Section Foreman |
| <input type="checkbox"/> Telephone Work | <input type="checkbox"/> R. R. Bridge and Building Foreman |
| <input type="checkbox"/> Mechanical Engineer | <input type="checkbox"/> R. R. Signalman |
| <input type="checkbox"/> Mechanical Draftsman | <input type="checkbox"/> Highway Engineering |
| <input type="checkbox"/> Machinist <input type="checkbox"/> Toolmaker | <input type="checkbox"/> Chemistry <input type="checkbox"/> Pharmacy |
| <input type="checkbox"/> Development and Protection of New Products | <input type="checkbox"/> Coal Mining Engineer |
| <input type="checkbox"/> Patternmaker | <input type="checkbox"/> Navigation <input type="checkbox"/> Boilermaker |
| <input type="checkbox"/> Heat Treatment of Metals | <input type="checkbox"/> Textile Overseer or Supt. |
| <input type="checkbox"/> Bridge Engineer | <input type="checkbox"/> Cotton Manufacturing |
| <input type="checkbox"/> Bridge and Building Foreman | <input type="checkbox"/> Woolen Manufacturing |
| <input type="checkbox"/> Gas Engines | <input type="checkbox"/> Agriculture <input type="checkbox"/> Fruit Growing |
| <input type="checkbox"/> Diesel Engines | <input type="checkbox"/> Poultry Farming <input type="checkbox"/> Radio |
| | <input type="checkbox"/> Marine Engineer |

BUSINESS TRAINING COURSES

- | | |
|--|--|
| <input type="checkbox"/> Business Management | <input type="checkbox"/> Business Correspondence |
| <input type="checkbox"/> Office Management | <input type="checkbox"/> Lettering Show Cards <input type="checkbox"/> Signs |
| <input type="checkbox"/> Industrial Management | <input type="checkbox"/> Stenography and Typing |
| <input type="checkbox"/> Traffic Management | <input type="checkbox"/> Civil Service <input type="checkbox"/> Mail Carrier |
| <input type="checkbox"/> Accountancy and C.P.A. | <input type="checkbox"/> Railway Mail Clerk |
| <input type="checkbox"/> Coaching <input type="checkbox"/> Bookkeeping | <input type="checkbox"/> Grade School Subjects |
| <input type="checkbox"/> Secretarial Work | <input type="checkbox"/> High School Subjects |
| <input type="checkbox"/> Cost Accountant | <input type="checkbox"/> College Preparatory |
| <input type="checkbox"/> Salesmanship <input type="checkbox"/> Advertising | <input type="checkbox"/> First Year College |
| <input type="checkbox"/> Service Station Salesmanship | <input type="checkbox"/> Illustrating <input type="checkbox"/> Spanish |
| <input type="checkbox"/> Wallpaper Decorating | <input type="checkbox"/> Cartooning <input type="checkbox"/> French |
| <input type="checkbox"/> Salesmanship | <input type="checkbox"/> Lumber Dealer |

Name.....Age.....
 Address.....
 City.....State.....
 Occupation.....

If you reside in Canada, send this coupon to the International Correspondence Schools Canadian, Limited, Montreal, Canada

FUN!

MAKE THIS Squirrel Lamp
 Yes sir, out of a real squirrel! Also make ash-trays, book-ends, etc., using rabbits, frogs, etc. LEARN AT HOME TO MOUNT BIRDS, ANIMALS & FISH; tan skins and make rugs. Decorate your room.

It's FUN! BIG profits in spare time!
 Free book tells how.

FREE BOOK! Write TODAY for beautiful free book telling how to learn this fine hobby. Book is free. Contains many fine pictures. STATE YOUR AGE.

N. W. SCHOOL OF TAXIDERM, Dept. 3374 Omaha, Nebr.

PAID \$1.00 FOR THIS BOOK-NOW EARNS \$75 a WEEK



I have just published a new book "How to Obtain the Position You Desire Through Letters"—a valuable guide to writing convincing letters of application for high salaried executive positions, stenographic, bookkeeping and other jobs. Presents clearly, methods of **Selling Yourself to Employers**

Includes also actual letters that have obtained wonderfully profitable positions for my friends. If You Are Seeking a New or Better Position, be sure to get this valuable book at once. Salaried Jobs are ready if you know how to get them. Let me tell you how. Write name and address; send dollar bill, check or money order. Money back if not highly pleased.

HAROLD NORMAN, Employment Adviser
 700 Interstate Bldg. KANSAS CITY, MO.

ONLY \$1.00 POSTPAID

MAKE MONEY with your CAMERA

Magazines, newspapers, advertisers BUY 7,000,000 photos a year from people who know how to take the kind of pictures wanted! Let us teach you, at low cost, in your spare time, how to take real human-interest pictures that SELL! Our marketing service helps you to quick, nation-wide sales. SEND FOR FREE BOOK that tells how to earn while you learn.

UNIVERSAL PHOTOGRAPHERS
 Dept. 74, 10 W. 33 Street, New York City

Learn to Dance

You can learn all the modern dances—the latest Tango steps, the new Fox Trots, dreamy Waltzes, smart Collegiate Steps, and popular Society Steps at home, easily and quickly. New chart method makes dancing as simple as A-B-C. No music or partner required. Don't be a wallflower. Learn to dance; Complete course—256 pages, 54 illustrations, sent on 5 Days' Free Trial. Equals \$20.00 course. Send no money. Pay postman only \$1.95, plus postage upon arrival. Money back if not delighted. Catalog Free.

Franklin Pub. Co., 800 No. Clark St., Dept. 9471, Chicago

Minstrels

Unique First Parts for complete show with special songs and choruses. Make-up. Catalog Free.

T. S. Denison & Co., 623 S. Wabash, Dept. 19, Chicago

"BECOME A LIGHTNING TRICK CARTOONIST"

Send \$1.00 for Laugh Producing Program of 23 Trick Drawings with Instructions. Catalog of Chalk Talk Supplies Free.

BALDA ART SERVICE, Dept. 1, Oshkosh, Wis.

CRIME DETECTION SECRET SERVICE AND FINGER PRINTS

SECRET SERVICE BOOK FREE

For 30 Days Reading. No Money Down—Actual Crime Cases—If You Act Quick!—We will send you this stirring book on Crime Detection, Secret Service and Identification Work for 30 days free reading. Send no money. If you decide to keep it, then send only \$1.00. If not, return it. WRITE TODAY. Not sent to boys under 17 years of age.

T. G. Cooke, Book Dept. 13-54, 1920 Sunnyside Ave., Chicago

a True
SUCCESS STORY
by an **R.T.I.**
TRAINED MAN



Could you use an
EXTRA \$200
TOO?

THEN GET INTO RADIO!

WHERE MANY MEN I HAVE TRAINED ARE MAKING

\$35 TO \$75 A WEEK

My big FREE Book tells you how. Mail the coupon now. This book has shown hundreds of fellows how to quickly make more money and win success.

"It was through R-T-I Training that I got the job I now have as Radio Expert for the Oklahoma City Police and Fire Departments. The Course has been of great benefit to me in the practical work that I am doing, and a raise in salary has made me more enthusiastic than before.

"In addition to this, I have made about \$200 doing spare time radio work since I enrolled. At present, although I am very busy with my police work, I am able to make from \$5 to \$8 a week extra in this way."
J. F. BEGGS,
428 West California Ave.,
Oklahoma City, Okla.



**HE CLIPPED THE
R-T-I COUPON
WHY DON'T YOU?**

**Shows How I Train You at Home
In Your Spare Time for a
Good-Pay Radio Job**

Why struggle along in a small-pay, no-future job? Get into Radio—the field with a future. I'll train you at home, in your spare time. Keep your present job and income while training. What's more, I'll show you how to earn extra money in your spare time during your Training period.

**Many Make \$5 to \$20 a Week
Extra in Spare Time . . . While
Learning**

That's what many of my students do soon after enrolling. Delmer Grote, Greenville, Ohio, wrote, "Made my first spare-time money six weeks after enrolling. Earned over \$500 on spare-time work in ten months while studying."

**Radio Is Full of Real Opportunities
for Trained Men**

But only "trained" men can qualify. R-T-I Training fits you for Radio's glorious opportunities—to service sets—to hold a good-pay job in broadcasting, aviation, television, police Radio and many other fields rich in opportunities.

**Learn Radio from Real Radio
Engineers**

R-T-I Training is practical—proven. Famous Radio engineers, working right in the heart of the

Radio industry, direct and supervise it. You get the help and advice of these famous men. You get Radio Equipment these engineers selected and approved for conducting experiments and making tests that teach you the practical side of Radio.

**Five Advanced Courses,
Without Extra Cost**

I help you specialize for Radio's biggest jobs—and don't charge you a penny extra for the advanced training. I give you extra—FIVE Advanced Courses that are being sold right now for \$39.50 each. These take you into the latest developments of Television, Sound Pictures, Photo Cells and Public Address Systems.

**My FREE Book Gives You
All the Facts**

Tells about Radio's spare-time and full-time opportunities. About my hundreds of successful students. About my employment department. About my Money Back Agreement. About my Four Big Outfits of Radio Equipment furnished without extra cost.

Clip and mail the coupon now. Learn how you can get into a field with a real future. Learn why 45 big radio manufacturers endorse and recommend R-T-I Training . . . how the famous R-T-I Advisory Board works for you and with you while studying and after graduation.

**RAY D. SMITH,
President,
RADIO & TELEVISION
INSTITUTE,
Chicago**



R-T-I'S Famous Advisory Board of Nationally Known Radio Engineers Will Supervise and Direct Your Training

Kendall Clough
Chief Engineer,
Clough-Bronze
Company.

E. E. Gramer
Chief Engineer,
Standard Transformer
Corporation.

Karl E. Hassel
Chief Engineer,
Zenith Radio Corporation.

H. C. Tittle
Chief Radio Engineer,
General Household
Utilities (Grunow).

F. D. Whitten
Service Manager,
Chicago Branch,
Philo Radio &
Television Corp.

Dr. C. M. Blackburn
Radio Engineer,
P. R. Mallory & Co.,
Indianapolis,
Manufacturers of
Radio Apparatus.

MAIL COUPON FOR FREE BOOK

**RAY D. SMITH, President
Radio & Television Institute (R-T-I)
2130 Lawrence Ave., Dept. 14
Chicago, Ill.**

Dear Mr. Smith: Without obligating me send FREE BOOK about spare-time and full-time Radio opportunities and how I can train for them at home.

Name.....

Address.....Age.....

City.....State.....

The Diesel Engine

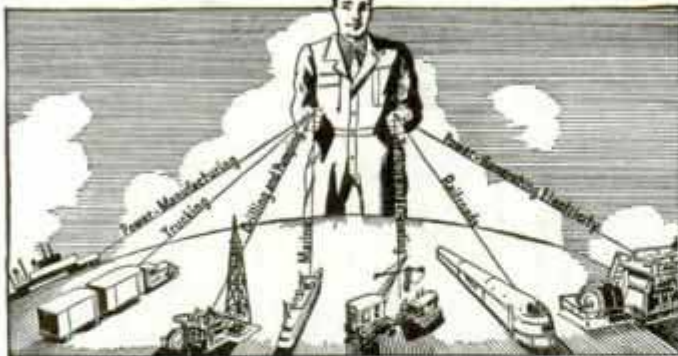

Diesel engines — because of their high efficiency, dependability and economy of operation—are fast replacing steam and gasoline engines in power plants, motor trucks and busses, locomotives and ships, tractors, dredges, drills, pumps, etc.—opening up steady, well-paid jobs for Diesel-trained men.

You can get the necessary training at home on all the latest Diesel developments—two- and four-stroke cycles; solid- and air-injection fuel systems; low- and high-speed and heavy duty types; Diesel-electric generating systems, etc. Course includes all text material—with special diagrams making possible quick understanding of this new type of power.

Diesel Engineering offers you a chance to get into a field that is on the upgrade and continually expanding—one that will require more and more Diesel-trained men for the next 25 years, or as long as you need to work. A very important part of our service is that, when the student has completed his training, we help him search out an opening in the Diesel Engineering field where he can be sure of steady advancement, with an ever-increasing reward for his foresightedness in getting training. Write today for free Bulletin. No obligation.

American School, Department D-445, Drexel Avenue at 58th Street, Chicago

Be An ARTIST



Make \$50 to \$100 a Week
Learn at Home This Amazingly Simple Way

More and more trained Artists are needed each year. 28,531 magazines, advertisers, newspapers, printing houses, etc., pay good money for art work. Our simple, proven, personalized method makes it easy to learn Commercial Art, Cartooning and Designing quickly, AT HOME, in spare time.

Big Artist's Outfit Given

Drawing board, paints, brushes and all materials you need to learn and earn come with very first lessons. Actual fun learning to draw this new way. Be an artist and make big money!

Send for FREE BOOK

Our big Free Book describes latest developments and wonderful opportunities in this fascinating field and gives full details of this quick, easy method. Tells all about our students—their successes—what they say—actual reproductions of their work—and how many earned big money even while learning. Mail coupon below or postcard today. State age. (No salesman will call.)



\$125 a Week—that's what our graduate, Miss L. F. of Brighton, Ontario, is making—selling her work in Montreal.
\$3000 for W. R. K.—of Newark, N. J. He writes that just two contracts brought him that nest sum!
\$3380 a Year—that's what our graduate R. K. K., of Michigan, is drawing as Art Director of a big engraving house.

Free Book shows how

Washington School of Art, Studio 124
1115—15th St., N. W., Washington, D. C.

Please send me, without obligation, your Free Book, "Art for Pleasure and Profit."

Name..... Age.....

Address.....

City..... State.....

Play the Hawaiian Guitar like the Hawaiians!

FAMOUS NATIVE HAWAIIAN INSTRUCTORS teach you to play this fascinating instrument. ONLY 4 MOTIONS—No previous musical knowledge needed. OUR 52 EASY LESSONS teach you the enchanting music you hear over the radio.

GIVEN when you enroll
a sweet toned HAWAIIAN GUITAR, complete playing outfit and carrying case.

WRITE AT ONCE for attractive offer and easy terms.



FIRST HAWAIIAN CONSERVATORY OF MUSIC, Inc.
9th Floor, Woolworth Bldg. Dept. 250 New York, N. Y.

Approved by New York State Board of Regents

ENGINEERING



INTENSIVE PRACTICAL TECHNICAL COURSES. Non-essentials omitted. TIME AND MONEY SAVED. Degree in 2 yrs. Electrical, Mechanical, Structural, Architectural, Civil, Aeronautical, Highway. Also shorter courses in Electricity, Radio, Electric Refrigeration, Power Plant, Drafting, Building. Low tuition. Extensive modern equipment. Part-time work for board and room. 34 yrs' experience producing successful men, located all over U. S. and foreign lands, holding responsible positions. Approved by industry, endorsed by graduates and educators. Catalog free.

FINLAY ENGINEERING COLLEGE
1001 Indiana Avenue Kansas City, Mo.

RADIO ENGINEERING

RCA Institutes offers an intensive course of high standard embracing all phases of Radio. Practical training with modern equipment at New York and Chicago schools. Also specialized courses and Home Study Courses under "No obligation" plan. Illustrated Catalog on request.



RCA INSTITUTES, Inc. Dept. PC-35
75 Varick Street, New York, N. Y.
1154 Merchandise Mart, Chicago

Recognized Standard in Radio Instruction Since 1909

BE A RAILWAY TRAFFIC INSPECTOR

A FIELD WHERE PAY ADVANCES ARE RAPID

TRAINED MEN—19 to 50—wanted in Railway and Bus Passenger Traffic Inspectors. Healthful, fascinating work; travel or stay near home. Complete our few weeks' home-study course and we will help place you at up to \$140 per month, plus expenses, to start, or refund tuition. Experience brings rapid advancement. Ambitious men find plenty of splendid opportunities. Help yourself to a real career. Write STANDARD BUSINESS TRAINING INSTITUTE, Div. 204, Buffalo, N. Y.



NEON SIGNS WHY? HOW?

Big Opportunity in the Neon Sign business! Learn all the hows and whys in this complete practical home-study course. FIVE PARTS—100 large size pages, over 150 illustrations. Covers all branches: Glassblowing—Transformers and Circuits—Vacuum Finishing—Service Work—EVERYTHING! Never before obtainable at any price—now yours at a cost absurdly low. Generous-paying Neon business needs more trained men right away! Learn it in this complete, nontechnical course—ONLY \$4.85, postpaid to your door! Send Now! Don't lose out by waiting. Mail check, express or postal money order—TODAY!

COMMERCIALITE LABORATORIES, Dept. 47, Omaha, Nebr.

GOV'T. JOBS

SALARY TO START \$105 to \$175 MONTHLY MEN WOMEN Age Range 18 to 50

- Ry. Mail Clerk
- P. O. Laborer
- H. F. D. Carrier
- Special Agent
- Customs Inspector
- City Mail Carrier
- P. O. Clerk
- Matron
- Immig't Inspector
- Typist
- POSTMASTER
- Seamstress
- Auditor
- Stenographer
- U.S. Border Patrol
- Telephone Opr.
- Watchman
- Meat Inspector
- Statistical Clerk
- File Clerk

OZMENT INSTRUCTION BUREAU, Dept. 111, St. Louis, Mo. Send me FREE particulars "How to Qualify for Government Positions" marked "X". Salaries, locations, opportunities, etc. ALL SENT FREE.

Name..... Address.....

Give me your measure and I'll PROVE You Can Have a Body like Mine!

I'LL give you PROOF in 7 DAYS that I can turn you, too, into a man of might and muscle. Let me prove that I can put layers of smooth, supple, powerful muscles all over your body.

If you are underweight I'll add the pounds where they are needed and, if you are fat in any spots, I'll show you how to pare down to fighting trim.

And with the big muscles and powerful, evenly-developed body that my method so quickly gives you, I'll also give you through-and-through health—health that digs down into your system and banishes such things as constipation, pimples, skin blotches and the hundred-and-one other ailments that rob you of the good times and the good things of life.

Here's All You Do!

Just jot down your name and address on the coupon below, mail it to me—and I'll send you, absolutely free, a copy of my new book, "**Everlasting Health and Strength.**" It reveals the secrets that changed me from a 97-pound flat-chested weakling into a husky fellow who won the title of "**The World's Most Perfectly Developed Man**" against all comers! And it shows how I can build you into an "**Atlas Champion**" the same easy way.

I haven't any use for weights or pulleys that may strain your heart and other vital organs. I don't dose you or doctor you. **Dynamic-Tension** is all I need. It's the natural tested method for developing real men inside and out. It distributes added pounds of powerful muscles over your body, gets rid of surplus fat, and gives you the vitality, strength and pep that win you the admiration of every woman and the respect of any man.

NOTE: No other Physical Instructor in the World has ever DARED make such an offer!

Charles Atlas

The 97-pound weakling who became twice holder of the title: "**The World's Most Perfectly Developed Man**"—won in open competition in the only National and International contests held during the past 15 years.



Charles Atlas As He Is Today

Gamble a Stamp—To Prove I Can Make YOU a New Man!

Gamble a stamp today by mailing the coupon for a free copy of my book, "**Everlasting Health and Strength.**" It tells you all about my special **Dynamic-Tension** method, and what it has done to make big-muscled men out of run-down specimens. It shows you, from actual photos, how I have developed my pupils to the same perfectly balanced proportions of my own physique, by my own secret methods. What my system did for me, and these hundreds of others it can do for you too. Don't keep on being only one-half of the man you can be! Find out what I can do for you.

Where shall I send your copy of "**Everlasting Health and Strength**"? Write your name and address plainly on the coupon and mail it today. CHARLES ATLAS, Dept. 84, 115 East 23rd Street, New York, N. Y.



CHARLES ATLAS, Dept. 84
115 East 23rd Street, New York, N. Y.

I want the proof that your system of **Dynamic-Tension** will make a New Man of me—give me a healthy, husky body and big muscle development. Send me your free book, "**Everlasting Health and Strength.**"

Name.....
(Please print or write plainly)

Address.....

City..... State.....

©1935 C.A.Ltd.

A better job - A future in **RADIO** WITH **COYNE TRAINING!**

Don't overlook your big chance in the field of RADIO, that young giant among the world's great industries, offering steady employment, good pay, and unlimited opportunities for Coyne-trained men.

Learn in 10 Weeks By Actual Shop Training

The remarkable Coyne training plan makes it amazingly easy for you to master Radio in its many branches and qualify as a real Radio Expert in 10 weeks. You "learn by doing" actual shop work on the finest Radio, Sound and Television equipment, with the personal guidance and individual help of expert instructors — not a correspondence course.

I WILL FINANCE YOUR TRAINING



Don't let lack of ready cash hold you back. You can get your Training first — then I'll give you over a year to pay me back. In small monthly payments starting 60 days after your required Training Period is over. Mail coupon today for complete details and my Big Free Illustrated Book on the unique Coyne Method of training . . . photographs of the great Coyne Shops . . . success stories of Coyne graduates . . . how many earn while learning . . . life-time employment service, etc.

H. C. Lewis

SEND NOW FOR FULL DETAILS!

MR. H. C. LEWIS, President
COYNE RADIO & ELECTRICAL SCHOOL
500 S. Paulina St., Dept. 45-3H, Chicago, Ill.

Send at once your Big Free Illustrated Catalog of your school and methods of training, also full details of your offer.

Name _____

Address _____

City _____

State _____

QUALIFY for GOOD JOBS

DIESEL

and AUTO TRAINING

Trained men needed. Demand for Auto-Diesel experts to operate and service trucks, tractors, trains, boats, airplanes, power shovels, etc., grows every month. To qualify for good jobs, you must first become trained. This can be done in few months at National. Qualifies you as Auto Mechanic, Auto Electrician, Battery Expert, Carburetor Expert, Diesel Mechanic, Diesel Service Man, Fuel Injection Expert, Trouble Shooter, etc.

OLDEST, LARGEST TRADE SCHOOL IN WEST

Est. 1905. 30,000 graduates. Finest equipment—late model autos and Diesel engines to work on. Expert instructors.

EARN ROOM AND BOARD

We assist students to obtain part-time job during training. We allow coach railroad fare from any part of U. S. to Los Angeles. Send Coupon For Free Auto-Diesel Book



NATIONAL AUTOMOTIVE SCHOOL Los Angeles

Dept. 4-PMA, 4006 South Figueroa St.
Send Free Auto-Diesel Book and Special offer.

Name _____

Address _____

City _____

State _____



LEARN TO PLAY THE PIANO ACCORDION



IN 5 WEEKS. CLARKE FORTNER'S FIRST 5 LESSONS \$1

Make big money! Be the life of the party. Play the Cellini Piano-Accordion—a sensational hit with boys, girls, professionals. Easy, quick to learn; Accordion is a complete band or orchestra—all in one. Easy to carry.

Send \$1.00 today for Clarke Fortner's Fortfifth of First Five Lessons, and name of our dealer nearest you where you can practice free of charge. You don't have to know how to read music. Charts show which keys to press. All practice pieces are tuneful melodies. We guarantee you can play after learning these 5 lessons. Get started now. Send \$1.00 today for this regular \$5.00 value. Money refunded if not satisfied.

Cellini Piano Accordion Division
CHICAGO MUSICAL INSTRUMENT COMPANY
Box 103, 309 So. Wabash Ave., Chicago, Ill.

TRI-STATE COLLEGE



B. S. Degree in 2 years. World famous for technical 2-year courses in Civil, Electrical, Mechanical, Chemical, Radio, Aeronautical Engineering; Business Administration and Accounting. Equivalent in technical hours to 4-year course. Those who lack

high school may make up work. Low tuition. Low living costs. Located in picturesque hill and lake region. Students from every state and many foreign countries. 51st year. Enter Sept., Jan., March and June. Write for catalog.

445 COLLEGE AVE., ANGOLA, IND.

INDIANA TECH DEGREE IN TWO YEARS

B. S. Degree in Electrical, Civil, Chemical, Radio, Mechanical or Aeronautical Engineering in two years. Located in Electrical Hub of West. Earn Board. Low tuition. Enter Mar., June, Sept. Catalog. INDIANA TECHNICAL COLLEGE, 229 E. Washington St., Fort Wayne, Indiana

5¢ EACH LITTLE BLUE BOOKS

Send postcard for our free catalogue. Thousands of Bargains. Address: **LITTLE BLUE BOOK CO., Catalogue Dept.,** Desk 477, Girard, Kansas



WHY NOT spend spring, summer, fall, gathering butterflies — insects? I buy hundreds of kinds for collections. Some worth \$1 to \$7 each. Simple outdoor work with my Instructions, pictures, price list. Profit. Pleasure. Send 10¢ (not stamp) for Illustrated Prospectus, terms, before sending butterflies. Mr. Sinclair, Dealer in insects, Dept. 6, Box 1424, San Diego, Calif.

COMPLETE ELECTRIC PLANTS



ONAN A. C. PLANTS furnish the same current as city service. Operate Radio, Water System, Refrigerator, all Appliances.

SIZES 350 WATTS UP
Have A. C. Current anywhere. Models \$110 and up. Easy to install. Available from stock. Ideal for farms, camps, lake homes, commercial purposes—anywhere electricity is needed.

D. W. ONAN & SONS
943 Royalston Ave., Minneapolis, Minn.

FREE How To Secure A Government Position

Tells About These and Other Positions

RAILWAY POSTAL CLERK \$1850 to \$2700 a year

POSTMASTER \$1200 to \$2500 a year

POST OFFICE CLERKS \$1700 to \$2100 a year

R. F. D. MAIL CARRIER \$1800 to \$2300 a year

FREE BOOK tells how I can help you get a Government Job. For 8 years I was Civil Service Examiner—have helped thousands. If citizen 18 to 50, you may qualify. Get ready NOW for a Government position. Send for free book. Write or mail coupon TODAY.

A. R. PATTERSON, Civil Service Expert, 84 Case Bldg., Rochester, N. Y. Please send me your free book "How to Secure a Government Position."

Name _____
Address _____

When writing please mention Popular Mechanics



TODAY
HEIGHT, 5 FT. 9 IN.
WEIGHT, 165 LBS.



Skinny? New easy way adds solid pounds —so fast you're amazed!

Astonishing gains with new double tonic. Richest imported brewers' ale yeast concentrated 7 times and iron added. Gives 5 to 15 lbs. in a few weeks.

NOW there's no need to have people calling you "skinny," and losing all your chances of making friends. Here's a new, easy treatment that is giving thousands solid flesh and husky good looks—in just a few weeks.

As you know, doctors for years have prescribed yeast to build up health. But now with this new discovery you can get far greater tonic results than with ordinary yeast—regain health, and also put on pounds of firm, good-looking flesh—and in a far shorter time.

Not only are thousands quickly gaining husky, handsome pounds, but also clear, radiant skin, freedom from indigestion and constipation, new strength and pep.

Concentrated 7 times

This amazing new product, Ironized Yeast, is made from specially cultured brewers' ale yeast imported from Europe—the richest yeast known—which by a new process is concentrated 7 times—made 7 times more powerful.

But that is not all! This super-rich yeast is then scientifically

ironized with 3 special kinds of iron which strengthen the blood.

Day after day, as you take Ironized Yeast, watch flat chest develop, skinny limbs round out attractively, skin clear, new pep come—you're an entirely new person.

Results guaranteed

No matter how skinny and weak you may be, this marvelous new Ironized Yeast should build you up in a few short weeks as it has thousands. If you are not delighted with the results of the very first package, your money will be instantly refunded.

Special FREE offer!

To start you building up your health *right away*, we make this absolutely FREE offer. Purchase a package of Ironized Yeast at once, cut out the seal on the box and mail it to us with a clipping of this paragraph. We will send you a fascinating new book on health, "New Facts About Your Body," by a well-known authority. Remember, results guaranteed with the very first package—or money back. At all druggists. Ironized Yeast Company, Inc., Dept. 534, Atlanta, Georgia.

Be a Civil Engineer!

It's Paying Big NOW



Cyclopedia of Civil Engineering

7 great volumes.
2,800 pages.
1,600 illustrations.
New revised edition
by twelve of America's
greatest engineers.

Includes: Surveying,
bridges, railroads,
steel structures, municipal
engineering, water supply,
road building, etc.

Spanish Grain Flexible
Covers Gold Stamped

Loaned Free!

To prove you can learn Civil Engineering at home in your spare time. And because no description here could do it justice, to let you see for yourself the scope and simplicity, the authority and quality of this great home reading course. Cost and terms are within your reach. Send no money — just mail the coupon.

Earn \$5000

a Year—and Up!

Civil engineers are wanted NOW. Enormous amounts are being spent in all kinds of public works and not a dime is spent until the Engineer has prepared plans. Then he must direct the work. It's a big job and there are not enough men to go around. Everywhere you go, you see road work going on—water and sewer systems being built—vast projects of all kinds. Here is **Your Opportunity** to get the necessary training right at home. These books are complete and simply written so anyone can understand them. Start now on our **FREE** examination plan. Mail the coupon without obligation.

American Technical Society
Dept. C419, Drexel at 58th St., Chicago

American Technical Society
Drexel at 58th St., Dept. C419, Chicago

I want to BORROW the CIVIL ENGINEERING Cyclopedia for 10 days FREE. I will gladly pay the few cents express, but I am to pay nothing for the loan of the 7 big volumes if I return them within 10 days. If I wish to keep them I will send you \$2 after the 10 days, then \$3 a month until special advertising price \$29.80 is paid. Send latest Edition.

Name.....

Address.....

(Attach letter, stating age, occupation, employer's name and address)

Write and Speak MASTERLY ENGLISH

Learn correct English with Sherwin Cody's new invention. No rules to memorize. Like a fascinating game. Sparta-time study. 15 minutes each day, quickly gives you command of English. Send for free book "How You Can Master Good English in 15 Minutes a Day." Write today, SHERWIN CODY SCHOOL OF ENGLISH, 54 Seaside Bldg., Rochester, N. Y.

AIR CONDITIONING

today's big opportunity!

AIR CONDITIONING is the next big industry. Mark that prediction! Its opportunities are as big in winter as in summer. Plumbing and

heating engineers must know Air Conditioning—the field in its broader aspects invites ambitious men. And a new, up-to-the-minute course on Air Conditioning now offered by the I. C. S. will help you qualify for advancement in this new field. Full information—free.

INTERNATIONAL CORRESPONDENCE SCHOOLS

BOX 5570-H, SCRANTON, PA.

Explain fully about your course in the subject marked X:

AIR CONDITIONING

- Chemistry
- Radio
- Aviation
- Refrigeration
- Inventing & Patenting
- Architecture
- Accountancy
- Advertising
- Electrical Engineering
- Drafting
- Show Card Lettering
- Good English

Name..... Age.....

Address.....

Increase Your Earning Power

Apply time and labor-saving kinks to your work. Your efficiency will soon be recognized and you will be in line for advancement.

If you do machine shop work of any kind, sheet-metal work, painting, carpentry, auto repairing, farming, concrete work, plumbing, electrical work, welding, building-glass work, general repairing, tool-making, poultry raising, masonry or home repair work, get this

LIBRARY OF 2500 TIME AND LABOR SAVING IDEAS FOR SHOPMEN AND HANDYMEN

JUST PUBLISHED

SHOP NOTES for 1935

332 Articles
721 Illustrations
224 Pages
Price 50c
See partial list of contents below



EASY WAYS TO DO HARD THINGS
POPULAR MECHANICS PRESS
CHICAGO

Including the new 1935 issue illustrated above, there are seven volumes in the Shop Notes Library of 2500 easily understood short cuts to every-day jobs. Here are just a few of the subjects taken from the latest issue.

- Auto Electrical Troubles, Tests
- Auto Knocks, Locating
- Bandaw, Tuning Up
- Belt Sander, Portable
- Boathouse Piling, Concrete
- Cold Chisels, Using
- Dancing Auto Wheels, Curing
- Drill Press, Homemade
- Drill-Press Problems, Solving
- Electric Appliances, Repairing
- Electrical Motors, Rewinding
- Electricians, Short Cuts for
- Forge Made from Cream Separator
- Glass, Working with
- Hack Saw, Using
- Heat Treating of Iron, Steel, Brass, Copper, Aluminum
- Jointer, Keeping in Shape
- Knee Action Wheels, Servicing
- Lathe, Labor Saving Ideas for
- Lathe Kinks, Simple
- Metal Spinning
- Metal Turning Suggestions
- Neon Sign, Flashing
- Paint Spray Gun
- Reed Baskets, Weaving
- Roadside Salesman
- Sander From Auto Parts
- Sand, Uses in Workshop
- Saw Table, Adjustable
- Scroll Saw, Special Uses
- Soldering with Electric Arc
- Streamline Bodies, Wire Mesh and Fabric for Boat and Auto
- Taps and Dies
- Tool Chest, Portable
- Window Attraction, Novel Store
- Window Displays, Mechanical, that Draw Trade
- Wood Chisels, Tricks of Using
- Wood Joints with Hand Tools
- Work Benches you can Build
- Workshop, Motorize Your

Each volume contains approximately 350 articles and 500 illustrations and has 192 or more pages. This unrivaled library of shop helps may be secured for a limited time only. After the present supply of books is exhausted the offer must be withdrawn.

* Send No Money

POPULAR MECHANICS PRESS,
200 E. Ontario St., Room 435, Chicago, Ill.

Send me, as per your offer, the following books. I will pay postman price and small amount of postage. My money will be refunded if I am not satisfied. (Check what you want.)

- 1935 Shop Notes and Lathe Handbook, both for 98c.
- Shop Notes Library (7 vols.) \$3.00.

Name.....

Street and No.....

City..... State.....

* C. O. D. applies to U. S. and possessions only. If you reside elsewhere, remittance must accompany order.

THOUSANDS LEARN MUSIC WORLD'S EASIEST WAY

No Expensive Teachers...No Bothersome Scales...No Boring Exercises

BEGINNERS PLAY REAL MUSIC FROM THE START

Yes, literally thousands of men and women in all walks of life have learned music—have won new friends, become socially popular—this quick, modern, easy as A-B-C way.

You, too, can learn to play—to entertain others—to pep up any party—just as these thousands of others are doing. And you can do this without the expense of a private teacher—right in your own home. You don't need to be talented. You don't need previous musical training. You don't have to spend hours and hours playing monotonous scales and humdrum finger exercises. You start right in playing real little tunes. And sooner than you expected you find yourself entertaining your friends—having the best times you ever had.

Easy as A-B-C

The U. S. School method is literally as easy as A-B-C. First, it *tells* you how to do a thing. Then it *shows* you in pictures how to do it. Then you do it yourself and *hear* it. What could be simpler? And learning this way is like playing a game. Practicing becomes real fun instead of a bore as it used to be with the old way.

Prove to yourself without cost how easily and quickly you can learn to play. Send today for Free Demon-

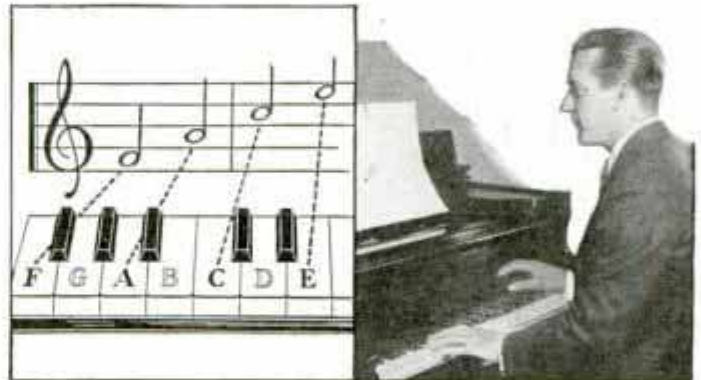

stration Lesson and Explanatory Booklet. See the simple principles around which this method is built. If you really want to learn music—if you want to win new popularity—enjoy good times galore—mail the coupon below. Don't delay—act NOW. U. S. School of Music, 74 Brunswick Bldg., New York City.

U. S. SCHOOL OF MUSIC

74 Brunswick Bldg., New York City

Send me your amazing free book, "How You Can Master Music in Your Own Home," with inspiring message by Dr. Frank Crane; also Free Demonstration Lesson. This does not put me under any obligation.

Name.....

Address.....

Instrument..... Have you Instrument?.....

LEARN TO PLAY BY NOTE

Piano	Violin
Guitar	Saxophone
Organ	Ukulele
Tenor Banjo	
Hawaiian Guitar	
Piano Accordion	
Or Any Other Instrument	

TRAVEL FOR "UNCLE SAM"

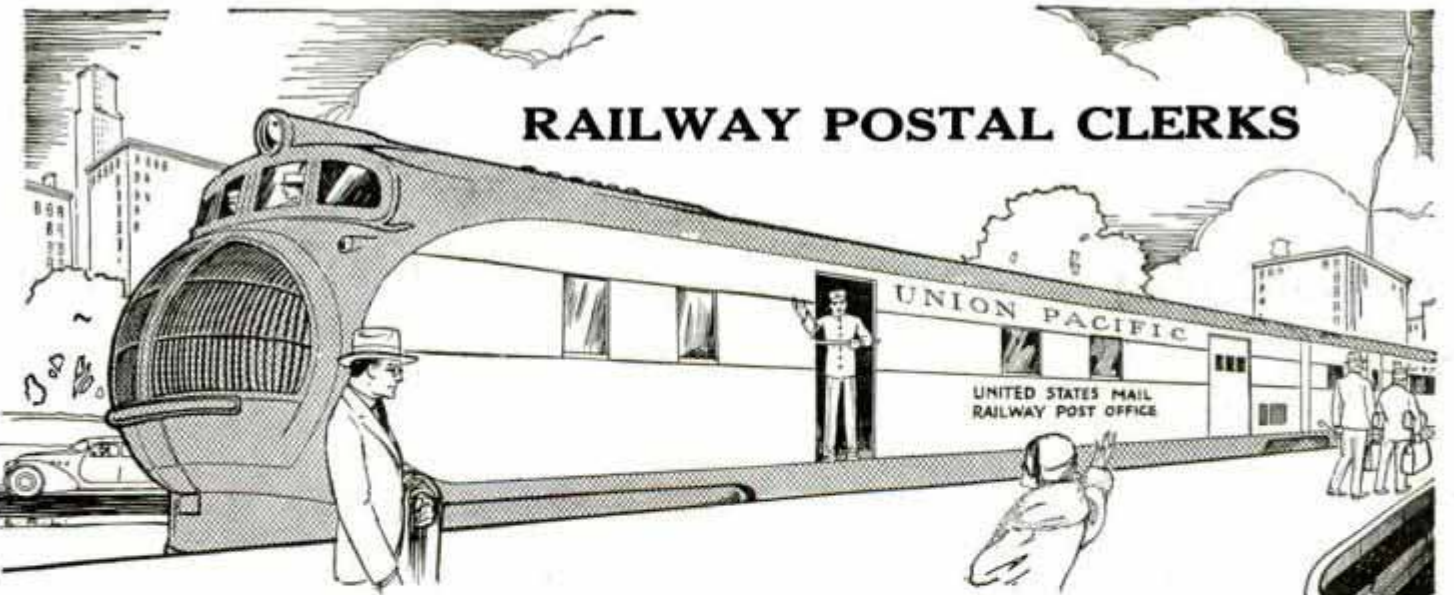

RAILWAY POSTAL CLERKS

MANY OTHER U. S. GOVERNMENT POSITIONS STEADY WORK

MEN—BOYS 18 TO 50

Short Hours Pleasant Work
Rapid Advancement, Permanent Employment

MANY EARLY EXAMINATIONS EXPECTED QUALIFY NOW

MAIL COUPON TODAY. TOMORROW YOU MAY FORGET

FRANKLIN INSTITUTE, Dept. P185, Rochester, N. Y.

Rush to me entirely free of charge (1) a full description of the position checked below; (2) Free Copy of 32-page book, "How to Get a U. S. Government Job"; (3) A list of U. S. Government Jobs; (4) Tell me how to get a Government Job.

- Railway Postal Clerk..... (Start \$1900 year)
- Post Office Clerk..... (Start 1700 year)
- City Mail Carrier..... (Start 1700 year)
- Office Clerk—File Clerk..... (Start 1260 year)
- Inspector of Customs..... (Start 2100 year)
- Immigrant Inspector..... (Start 2100 year)
- Liquor Gauger-Storekeeper..... (Start 2000 year)

Name.....

Address.....

Use This Coupon Before You Mislay It

When writing to advertisers please mention Popular Mechanics

Get Valuable **PATENT**

INVENTORS Write for

INTERESTING INVENTIONS



An Early Revolver

This early Colt revolver was patented in 1836. Samuel Colt, its originator, was known as the boy inventor. While still a lad he ran away to sea and whittled the first model of a repeating fire-arm out of wood during his leisure moments on ship-board. Colt was persevering. Three years later, in 1839, he had made improvements to produce the second revolver shown here. It was used in the Mexican War. By 1852, Colt had the largest fire-arms factory in the world. Colt died a very wealthy man.

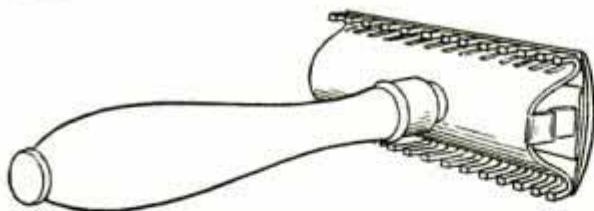

This is an early Gillette Safety Razor and the beginning of one of our greatest modern commercial enterprises. Millions of safety razors have since been sold all over the world and millions of dollars of profit have been made. For centuries men shaved with the old straight edge razor. Then came Gillette with his happy idea.

Many Little Ideas Have Big Commercial Possibilities

Look around in any direction today and see the inventor's handiwork. Many of the most successful inventions have been the small things found in ten-cent stores, drug stores, hardware stores and the like. Many inventions have come from men who did not consider themselves inventors at all. If you have an idea which in your judgment will make money, save money, save time, save labor or give pleasure—then see about protecting your rights to it. It costs you nothing to learn the facts. The Patent Laws were made to protect the poor man and the rich man alike. But you must know how to take advantage of them.

"RECEIVED your book, 'Patent Protection,' " writes an inventor, "and I am only sorry that I did not have the information contained therein some thirty years ago. I have been unfortunate enough through my ignorance to lose out in at least three major instances where understanding would have helped immeasurably."

Another inventor says: "In going through your book, one of your mechanical movements gave me an idea that I am sure I will be able to use in my invention."

We cite these statements from inventors simply to emphasize one point: Ignorance is dangerous, where Patent matters are concerned. The easiest way for an inventor to lose his rights, his possible profits, is to do nothing simply because he doesn't know **WHAT TO DO**.

That is why inventors by the hundred have welcomed the book shown on the opposite page. It tells them **WHAT TO DO**. Its facts may be the means of saving money, saving time, and most important, saving later disappointment.

Can You Answer These Questions?

How do the Patent Laws protect an inventor? What is the first simple step to take to establish a claim to an invention? What kind of a sketch or drawing is needed? When is a model needed? What can an inventor do to secure financial assistance? Why is a Patent necessary? What can be Patented? What can a competent Patent Attorney do for you? What will it cost? What is the preliminary search and why is it important?

These and other suggestions are answered in our 48-page book of facts, "Patent Protection." In it, we have put the practical, usable information which from thirty-six years' experience we know the average man requires. Among other things it shows interesting inventions, **115 mechanical movements**, views of the U. S. Patent Office, and much more. **It is yours for the asking.** We gladly send it with our compliments to serious, interested men.

HOW WE HELP INVENTORS

For thirty-six years—more than a third of a century—it has been our business to help inventors; to assist them in securing **ALL THE PROTECTION TO WHICH THEY ARE ENTITLED**. We have represented not a few inventors, or a few hundred, but **THOUSANDS** of them in their dealings with the U. S. Patent Office. We answer questions—thousands of them a year. We study each device to bring out its best Patentable possibilities; we often dissuade inventors who might have gone ahead with inventions which could not possibly have been protected. By methods of efficiency, carefully developed over a long period, we endeavor to keep expense at a minimum. We arrange deferred payments where they are needed.

FACTS • FREE

These BOOKS **THIS COUPON TO RUSH**



This is a **NEW** Book About **SELLING INVENTIONS**

There are two sides to every inventive success: there is the inventive side, which deals with the invention itself. There is the commercial side, which is the way the inventor sets about getting his invention on the market. A good invention, properly handled, can prove a failure commercially. An ordinary invention, properly handled, can be made a money-maker. In this NEW booklet we give you "Suggestions on When and How to Sell an Invention." We give you practical hints and advice on the commercial side of inventing. Write us a card, letter or use the handy coupon. Look before you leap. **KNOW THE FACTS.** They cost you nothing. They may be worth much.

STRICTEST SECRECY
 With these two booklets, we will also send you a FREE copy of our "Evidence of Invention" form, on which you can sketch and describe your invention and establish a date of disclosure. Such a dated disclosure may later prove important to you. We send full instructions. Any letters, sketches, drawings or models you send us are held in **STRICTEST SECRECY.** You can write us frankly. But get the facts. Sign and send the coupon now. **Get that much done today.**

VICTOR J. EVANS & Co.
REGISTERED PATENT ATTORNEYS
Patent and Trademark Practice Exclusively
Main Office: 500-D Victor Building, Washington, D. C.
 Other Offices: 1640-N Conway Bldg., Chicago; 1007-N Woolworth Bldg., New York; 514-N Empire Bldg., Pittsburgh; 1010-N Hobart Bldg., San Francisco; 736-N Security Bldg., Los Angeles.
 Kindly send me a FREE copy of your book, "Patent Protection" and your special booklet of "Suggestions on When and How to Sell an Invention." (Note: You can also secure the books by writing any of the branch offices listed above.)

Name.....
 Street and No.....
 City or Town.....
 State.....

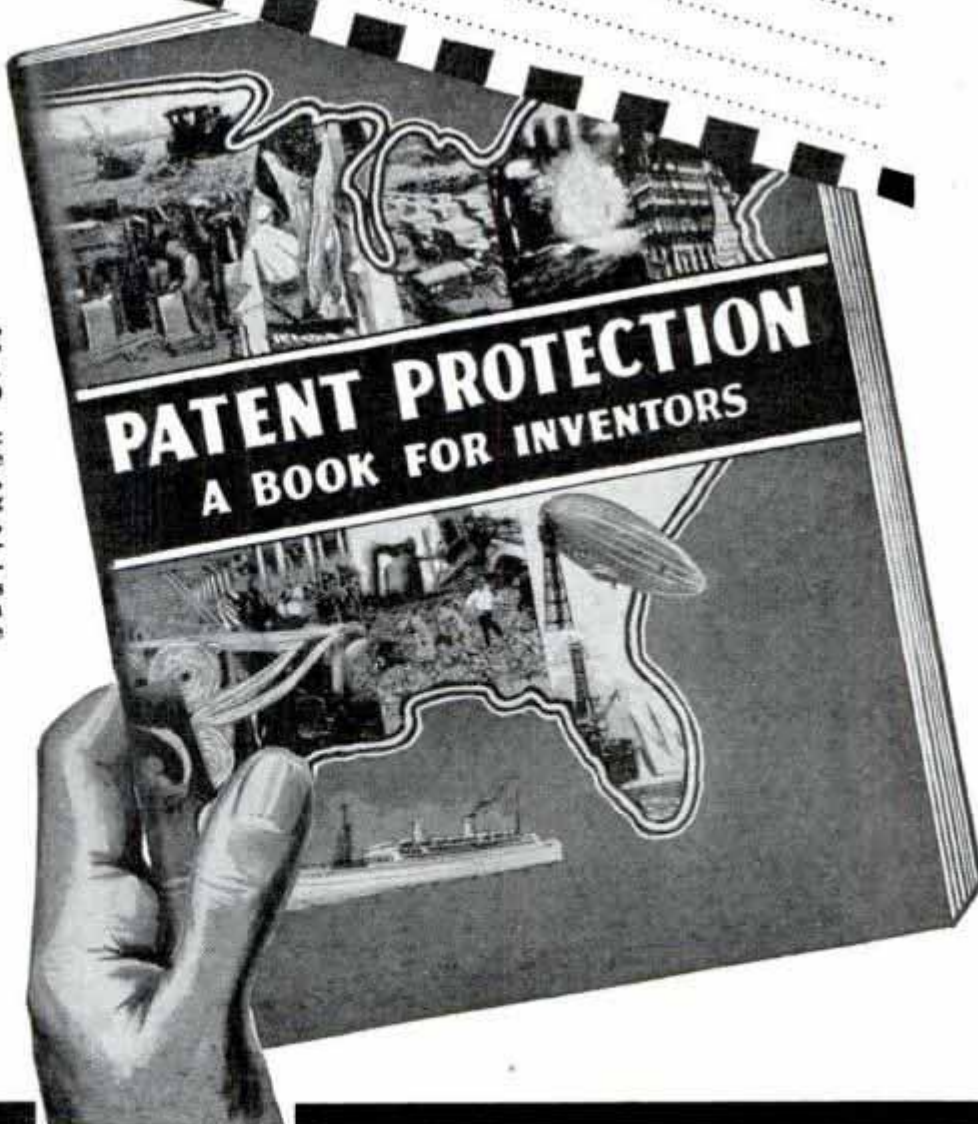

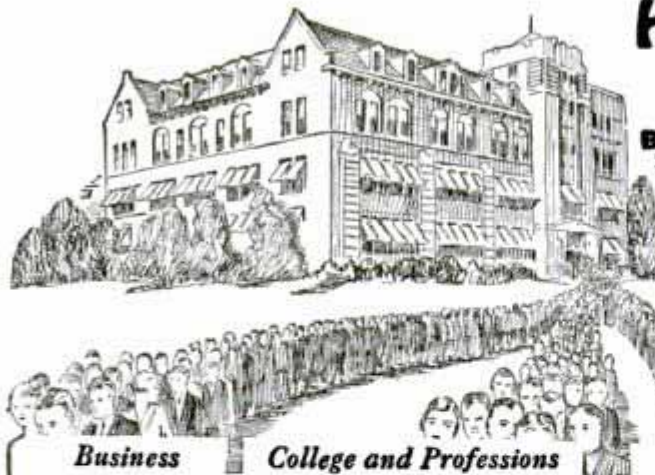

High School Course in 2 Years

Business—To be valuable in any Business capacity, you must be able to write clear, accurate letters and reports—make business calculations—understand geography, economics, etc. Most firms require all applicants to be High School graduates.

Industry—Advancement in Engineering or Manufacturing depends on your knowledge of High School mathematics, physics, chemistry, mechanical drawing, etc. Your employment application shows definitely for what job you're fitted.

College Entrance and the Professions

Colleges, Universities, Engineering and Professional Schools require entering students to have a High School education, because College work begins where High School leaves off.

Business

College and Professions

Industry

You Can Complete Your High School Education at Home—in 2 Years or Less

Our course meets all requirements for Business, Industry, the Professions, and College Entrance. Standard High School texts supplied, supplemented by our own time-saving study instructions. Diploma awarded. Full credit given for High School subjects already completed. Send for Free Bulletin TODAY. No obligation.

American School, Dept. H-445, Drexel Avenue at 58th Street, Chicago, Illinois

ACCOUNTS COLLECTED

Our national net work organization offers to credit executives everywhere a high-grade, dependable Account Collection Service. Strictly commission basis. No collection—no charge. Write TODAY (on company letterhead) for Listing Instructions and full details. No obligation.

NATIONAL BUSINESS PROTECTIVE SERVICE, Inc.
500 N. Dearborn St., Dept. 4-A, Chicago, Ill.

HOME STUDY COURSES

Home-Study Courses, leading to Degrees in Arts and Sciences; Education; Writing; Psychology; Chemistry; Business and Commerce; Law; Theology; Agriculture; Engineering; also courses in Business Training; Accounting; Advertising; Sales Management; Public Speaking; Radio. Many others. Low Cost; Easy Terms.

McKinley-Roosevelt University, 4245 Clarendon Ave., Chicago

NEW ELECTRIC LIBRARY

\$ 1.50 A VOLUME

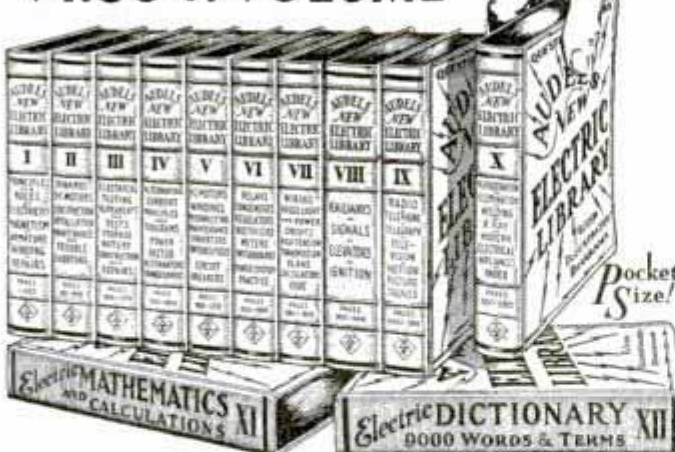

WHAT EVERY ELECTRICIAN WANTS TO KNOW!

is easily found in AUDEL'S NEW ELECTRIC LIBRARY. Electricity made simple as ABC. Up-to-date, trade dope for the expert and ALL electrical workers.

Questions, answers, diagrams, calculations, underwriter's code; design, construction, operation and maintenance of modern electrical machines and appliances FULLY COVERED.

All available at small cost, easy terms. BOOK-A-MONTH service puts this NEW information in your hands for 6c a day. You can start your subscription with any volume. Write TODAY for electric Folder and FREE TRIAL offer.

THEO. AUDEL & CO., 65 W. 23rd St., New York City

Mail Vol. I, Electric Library on 7 days' free trial. If O. K. I will remit \$1.50, otherwise I will return it. I also request you to mail one book each month on same terms. No obligation unless I am satisfied.

Name.....
Address.....
Occupation..... PM

When writing please mention Popular Mechanics

PHOTO-ENGRAVING LEARN IT AT HOME



We Furnish

all equipment and materials including large photo-engraving camera complete with lamps, lens and screen. When you have finished the course you can establish a good paying independent business with the equipment furnished or work for others at a big salary. Photo-Engraving offers greater opportunities today than any other industry. Every picture in this issue of Popular Mechanics was engraved by the process we teach you. Earn good money while learning. Write today for our new illustrated catalog which was engraved on equipment such as we furnish. You will not be obligated in any way by writing.

A copper plate to print above picture size 8 by 10 inches sells for \$15.37.

Aurora School of Photo-Engraving, Dept. 145, Aurora, Mo.

CIVIL SERVICE

VALUABLE INFORMATION FREE
COLUMBIAN CORRESPONDENCE COLLEGE
WASHINGTON, D. C.

ARTISTS MAKE MONEY

Find out your ability. Send name, age, occupation and address for Free Vocational Art Test.

Federal Schools, Inc., 4135 Federal Schools Bldg., Minneapolis, Minn.

JOURNEYS INTO THE UNKNOWN

Does the strangeness of life's profound mysteries fascinate you? Let the Rosicrucians introduce you to a world of unusual knowledge, appertaining to the intriguing subjects of time, space, the nature of consciousness, the mystery of man's being, the latent power of mind and others. Membership in this age-old fraternity brings you these astounding truths which shed new light upon the unknown. Write for free sealed book of particulars. Scribe A.T.H.

The Rosicrucians (AMORC)
ROSIKRUCIAN PARK SAN JOSE CALIF.

DIVORCE EYE CRUTCHES!



Get RID of the Spectacle Handicap. The NATURAL EYESIGHT SYSTEM makes Victory over Glasses Possible.

You are the Judge—your eyes the Jury—when the Natural Eyesight System goes on trial in your home for four months on our 100% MONEY-BACK GUARANTEE.

Full Information Mailed FREE
Natural Eyesight Institute Inc.

Dept. 54-F Los Angeles, Calif.

BE A Traffic Manager

Big Pay—Big Opportunity

Big business needs trained traffic men and pays them well. Train in your spare time for this highly profitable, growing profession. Low cost; easy terms.

Write now for valuable, interesting 64-page book—FREE.

LASALLE EXTENSION UNIVERSITY
Dept. 464-T, Chicago



VOICE

100% Improvement Guaranteed
We build, strengthen the vocal organs—not with singing lessons—but by fundamentally sound and scientifically correct silent exercises, and absolutely guarantee to improve any singing or speaking voice at least 100%. Write for wonderful voice book—sent free, but enclose 3c for part postage. Learn WHY you can now have the voice you want. No literature sent to anyone under 17 years unless signed by parent.

PERFECT VOICE INSTITUTE, Studio 93-54
308 N. Michigan Ave., Chicago



TAP DANCING

LEARN AT HOME! NEW EASY WAY. Professional Stage Method. Surprise and entertain your friends. Be popular, earn extra money. Develop hidden talent. No music or experience needed. Begin dancing first day. Beginner's fundamentals and complete Professional Tap dance included. Equal to \$40 instruction. Easy way to reduce or build up figure. For ladies or men. Send only \$3.75 money order for Complete 17-Lesson Course. Or send no money (if in U.S.) and pay postman \$3.98 on delivery. No more to pay. Try 5 days. If not delighted, money refunded. Limbering exercises free if you enroll now. **THORNTON DANCE STUDIOS** 827 Irving Park Blvd., Suite 122, Chicago, Ill.

Learn **ADVERTISING** at Home

Greater opportunities now in advertising. Learn easily and quickly in spare time. Practical work. No text books. Old established school. Low tuition—Easy terms. Send for free booklet of interesting information.

Page-Davis School of Advertising
Dept. 1354, 3601 Mich. Ave., Chicago

RADIO

ENGINEERING, broadcasting, aviation and police radio, servicing, marine and Morse telegraphy taught thoroughly. Nine months' engineering course equivalent to three years' college radio work. School established 1874. All expenses low. Catalog free.

Dodge's Institute, Ada St., Valparaiso, Ind.

GOING BALD?

Don't spend money on hair oils and tonics, etc. You may save your hair if it has not all fallen out. Dr. Dorsey's new scientific system is simple, effective. Endorsed by physicians and schools. My book on Baldness, Cause and Prevention, tells how. This book is result of dissection, craniometry and clinical investigation. Sent for 10c coin or stamps. Write Dr. B. L. DORSEY, M. D., Dept. 50, Fullerton Bldg., St. Louis, Mo.



LEARN AUTO MECHANICS

in 8 weeks!

Earn \$35 to \$75 a week as an Auto Mechanic. Never in the history of the automotive business has there been such a demand for TRAINED men. 8 weeks training fits you for a job that's waiting for you or to open your own repair shop. Read what two McSweeney trained men have done. Hundreds of others can tell you facts equally interesting. Don't look for a job! TRAIN for it!

Farrell, Pa.
Dear Mac: Please forward me your catalog. I want it to add to my traveling souvenirs. I am working in a modern garage although I have been out of school only four weeks, thanks to McSweeney Training. My best regards to all. M. Klushauk

Rector, Ark.
Dear Mac: Just a few lines which might interest you. I left your school two years ago last May. Since I left I have not seen a day I could call "hard times." I have been working ever since I left and have averaged in my earnings \$173.00 a month, in spite of the hard times. Many thanks. Thos. J. Sharp

EIGHT WEEKS of Actual Shop Training

No books or lessons the McSweeney way. First you learn the "why" of everything you do; then under competent instructors, you DO the job. You work on real equipment and machines, with the real tools of the auto expert. In eight short weeks you are TRAINED to hold down a permanent BIG PAY job. Any man 16 to 50 can learn. Write today for New Low Tuition Offer.

AVIATION GROUND COURSE

Aviation is coming and coming fast! Prepare now for the wonderful opportunities of the future. Each plane needs many mechanics on the ground.

MONEY BACK GUARANTEE!

In eight weeks of intensive training; actual shop work with real tools on real equipment; you will be qualified to accept a Big Pay Job as an Auto Mechanic. If you are not satisfied with your qualifications, your tuition will be refunded.

FREE Write today for Big Free Book on AUTOS. Get the facts about jobs; and Low Tuition Offers. Mailing the coupon does NOT obligate you. It obligates ME to tell YOU how you can train for Big Money in eight short weeks. Address Dept. 10-16

McSWEENEY SCHOOLS

AUTOMOBILE—AVIATION

CLEVELAND, OHIO or KANSAS CITY, MO.

Write Our School Nearest You

McSweeney Auto and Aviation School,
Dept. 10-16, Cleveland, Ohio or Kansas City, Mo.

Without cost or obligation, send me your Big FREE Book on Autos; also full information about your low tuition offer.

Name.....

Street.....

Town..... State..... Age.....

When writing please mention Popular Mechanics

MAIL FOR FREE INFORMATION

BEDFORD

1115 Bedford Ave., Dept. PM-23
Brooklyn, New York City, N. Y.

YMCA
TRADE
SCHOOL

- Auto Mechanic Talking Pictures
- Aviation Mechanic Welding
- Aeronautical Engineering
- Refrigeration Machine Shop
- Oil Burner Commercial Art
- Air Conditioning Sign Painting
- Electrical Window Display
- Radio and Television Mechanic
- Architectural-Mechanical Drafting

Name

Address



Know Electricity as Experts Know It—and Get an Expert's Pay!

Recovery has begun! The months ahead are charged with significance and expectation. What will you do to get the jump on the other fellow?

Thousands of men have used

The Croft Library of Practical Electricity

The Croft Library is a complete electrical educator. It is founded on practice—on 20 years of shirt-sleeve experience—on work as it is actually done. It is jammed from cover to cover with the kind of hard-headed facts you want. Written so that the beginner can easily understand it, yet so sound, so thorough, that it is the daily guide of 50,000 highly paid electrical workers and engineers. Croft tells you the things you need to know about motors, generators, armatures, commutators, transformers, circuits, switchboards, distribution systems—electrical machinery of every type—wiring for light and power—wiring of finished buildings—underwriters' and municipal requirements—illumination in its every phase—the most improved methods of lighting—lamps and lamp effects, etc.—how to do a complete job, from estimating it, to completion.

No money down—easy payments

Fill in and mail the coupon attached and we will send you the entire set of seven volumes for ten days' free examination. We take all the risk—you assume no obligation. If you decide to keep the books, send \$1.50 in ten days and the balance at the rate of \$2.00 a month. Send the coupon NOW and see the books for yourself.

FREE EXAMINATION COUPON

McGraw-Hill Book Co., 330 W. 42nd St., New York

Send me for ten days' free examination the Croft Library of Practical Electricity. If satisfactory I will send you \$1.50 in 10 days and \$2.00 monthly until the price of \$19.50 is paid. If not wanted, I will return the books postpaid. (To insure prompt shipment write plainly and fill in all lines.)

Name.....

Home Address.....

City and State.....

Position.....

Name of Company..... PM-4-35

STEP INTO THE *Spotlight*



Banish Boredom... Earn Extra Money START TO PLAY VERY FIRST DAY

Picture the joy of playing a snappy foxtrot, dreamy waltz or mellow old favorite on the Xylorimba. No reason why you shouldn't! Xylorimba is easiest of instruments to play and yet the most spectacular. In constant demand by orchestras, radio stations, at lodge meetings and parties. Marvelous opportunity to increase popularity, make big spare-time money. No bothersome practice or exercises. With Free easy lessons you actually Start to Play Very First Day.

BIG FREE BOOK tells all about Deagan line, liberal trial offer and easy payments. Send coupon today for your free copy.

J. C. Deagan, Inc., Dept. 8454, 1770 Berreau Ave., Chicago

Send me, without obligation, full details of Free Trial offer and easy-payment plan on the Deagan Xylorimba.

Name.....

Address.....

When writing please mention Popular Mechanics

How to make 33 electrical devices

ONLY ONE DIME!

Secret locks • Electro magnets

Telegraph sets • Buzzers

Complete scientifically correct instructions for making 33 interesting electrical devices that will really work. Also simple, illustrated description of principles of electricity and dry batteries.

96 pages—illustrated

Any man or boy who likes to make things needs this book. Write for your copy today. Send 10 cents (coin or stamps) to Dept. P.M. 354 Room 1328, National Carbon Company, Inc., 30 East 42nd St., New York, N. Y.



Want to be a Pilot?

Prepare yourself by studying approved text-books used by F.E.R.A. aviation ground schools. A complete treatise on subjects covered by examinations for pilots' and mechanics' licenses. Simple, practical and thorough. For old-timers as well as beginners. All for a fraction of the cost of a correspondence course. Send 10¢ today for booklet, "Plain Facts for Plane Pilots," and outline of text-books.

Send 10¢
for BOOKLET

THOMPSON AVIATION PUBLISHERS
8314 Woodward Ave. Detroit, Mich.



MULTIPLIES Your OPPORTUNITIES

We teach by mail SUPER bookkeeping that brings you the highest salary and most assured position. Hundreds of bookkeepers "just holding on" will soon be replaced by men and women who have learned the finer points of the job. If you want to be on the road to Accountancy, power, prestige and profit write for booklet.

KINMAN LETTER INSTITUTE
Box 1286 Spokane, Wash.

NEW WAY to APPLY FOR SALARIED JOBS

Are you a bookkeeper, a mechanic, a salesman or a stenographer, seeking a position? Or a young man or woman looking for a start in the business world? No matter what you are, or where you live, the **JOBSEEKER'S GUIDE** will show you where to look for the best jobs, how to apply, what to say and what to do. Send stamp for **FREE** details.

EMPLOYMENT COUNSELORS

702 East 63rd St. Dept. AK Chicago, Ill.

LEARN CARTOONING

by the method that has developed hundreds successfully. Send name, address and age for free chart to test your ability.

The Landon School, 1738 National Bldg., Cleveland, Ohio

Big Chance for ELECTRICAL ENGINEERS

NOW

Here's great news for anybody interested in Electricity. BRAND NEW edition of Applied Electricity brought right down to date with every NEW Electrical subject fully covered. 10 big Volumes and all shipped **FREE** for examination.

Big Field—Big Demand—Big Pay

Men who understand electricity are urgently needed right now in thousands of industries. Autos, airplanes, machine shops—practically every industry depends on electricity and men who know this subject make big money. Pleasant, fascinating work, easy to learn and do; learn quickly with these books. Send coupon for a set for **FREE** examination and see for yourself.

10 Big Books Shipped **FREE** FOR EXAMINATION

American Technical Society, Drexel at 58th St., Dept. E-419, Chicago
Send for 10 days' free use. BRAND NEW 10 volume set of Electrical Engineering. In return for mailing this coupon promptly, send free certificate of membership in the American Technical Society entitling me to full consulting privilege for one year. I will pay the few cents delivery charges on the books. If I wish I may return them in 10 days and owe you nothing, but if I keep them I will send \$2.00 after 10 days, then \$3.00 a month until the special price of only \$29.80 is paid.

Name.....

Address.....

City..... State.....

Attach letter stating age, occupation and name and address of employer and at least one business man as reference.

Amazing Sensational Discovery REFINISHES AUTOS Like NEW!



PAYS UP TO \$7.00 IN AN HOUR

Kar-Nu is a new, miracle discovery—a transparent, magic-like fluid with which anyone can refinish any color automobile easily, quickly and economically without polishing, waxing, rubbing or painting. Just wipe it on with a cloth! Immediately dullness, discoloration, shabbiness, sun fade disappear. Instantly, as if by magic, the old finish is rejuvenated and restored to the lustre, life glow and beauty of the original factory finish. As KAR-NU dries it seals the pigment and protects the finish from further wear. Lasts 8 to 12 months. GUARANTEED. Equal in beauty to a repaint or refishing job which costs \$25.00 to \$75.00.

**Not A Wax Polish or Paint
Lasts 8 to 12 Months
GUARANTEED**

FREE SAMPLE
Enormous demand! Millions want it! W. L. Morgan of Mass. earned \$10.61 in a single hour. Sell KAR-NU to individuals, fleet owners, garages, auto accessory stores, used car dealers, etc. No experience necessary. Write for FREE sample to prove our claims and territory offer.
Distributors Wanted for Foreign Countries

KAR-NU CO., Dept. H-30, Oakley Station, Cincinnati, Ohio

AUTO-MECHANICS & WELDERS

Auto Mechanics and Welders are in big demand. Complete courses in arc and acetylene welding. Pay while you learn. Enroll now at special low rates. Write today.
MICHIGAN TRADE SCHOOL
3758 Woodward Ave., Detroit, Mich.

Write for **FREE CIRCULAR**

CARTOON YOUR WAY TO SUCCESS!



DON'T COPY — LEARN TO ORIGINATE!

RAYE BURNS will teach you HOW to CREATE ORIGINAL CARTOONS at home that you can SELL! Course contains 26 lessons and over 500 Illustrations. All for Only... **\$2.85**
Send name and address for free details.
RAYE BURNS SCHOOL, Dept. M-X, BOX 2194, Cleveland, Ohio

FREE TRIAL LESSON in FREE DRAFTING



Get ready now for new money-making opportunities in Drafting. Clean, well-paid work. Send post card for FREE TRIAL LESSON in Drafting. Shows how easy to learn at home by C.T.C. method. We furnish all tools. Write today. **CHICAGO TECHNICAL COLLEGE**
D206 Tech Bldg., 118 E. 26th St., Chicago, Ill.

THE ORIGINAL HOME STUDY COURSE IN Practical RADIO ENGINEERING

You can learn Radio Engineering in half the usual time! School recognized by leading authorities. Catalog answers all your questions. Dept. P-4, 14th & Park Rd., Wash., D. C.
Free 44 PAGE BOOKLET On Request

NEW YORK SCHOOL of MECHANICAL DENTISTRY

Become a TRAINED Dental LAB Technician. We show you how! Oldest school. Practical training. Day, Eve. Easy terms. Tools FREE. Ask for Catalog P. N. Y. SCHOOL of MECHANICAL DENTISTRY, 125 W. 31 St., N. Y. C.
NEW WRITERS WANTED to qualify as Journalists and Authors. Write for Newspapers, Magazines. No experience. We train you spare time. Easy method. National Press Ass'n, P-3806 Beverly, Los Angeles, Cal.



Become an Expert Accountant

The Profession That Pays

The demand for skilled accountants—men who really know their business—is increasing rapidly. The new national and state legislation is requiring of business—both big and small—much more in matters relating to Auditing, Cost Accounting, Business Law, Organization, Management, Finance. Men who prove their qualifications in this important field are rapidly promoted to responsible executive positions—given an opportunity to earn real salaries. The range is from \$3,000 to \$15,000 a year—even to higher income-figures.

Send for Free Book— "Accountancy, the Profession that Pays"

Why let the other fellow walk away with the better job, when right in your own home you can equip yourself for a splendid future in this profitable growing profession?

Preliminary knowledge of bookkeeping is unnecessary. Our free book on accountancy fully explains how we train you from the ground up, or from where you now are, according to your individual needs. Low cost; easy terms.

The facts about the new LaSalle training in Accountancy and the opportunities in this highly profitable field are clearly outlined in a 64-page book which LaSalle will send you free.

The man in earnest to get ahead will find this coupon a most profitable aid to progress. If you have the urge and the will to increase your income, clip and mail the coupon NOW.

LaSalle Extension University

The school that has trained over 1,200 C. P. A's

Dept. 464-HR Chicago
I would welcome details of the new opportunities in accounting, together with copy of "Accountancy, the Profession that Pays," without obligation.



Higher Accountancy
Other LaSalle Opportunities:
LaSalle opens the way to success in every important field of business. If interested in one of the fields below, check and mail.

- Business Management
- Modern Salesmanship
- Traffic Management
- Railway Accounting
- Industrial Management
- Modern Foremanship
- Effective Speaking
- Law—Degree of LL.B.
- Commercial Law
- Modern Business Correspondence
- Stenography—Stenotypy
- Expert Bookkeeping
- C. P. A. Coaching
- Business English
- Credit and Collection Correspondence
- Practical Accounting and Office Management

Name

Present Position

Address

Each Book a Complete Course

Think of it! A muscle building course showing how to develop a definite part of your body for only 25c or six courses which show you how to develop the entire body for only \$1.00. That's my special offer. I will show you how to mold a mighty arm for a quarter or how to mold a mighty chest, mighty legs, a mighty back or a grip of steel, or I will teach you strong man stunts. Get all of the lessons in this Strong Man's Library for only \$1.00.

I show you how to add inches on your arm, how to put steel cables on your chest, how to get a back of might. I show you how to develop legs of a giant and a grip of steel. The strong man tricks which I reveal will amaze you and your friends. Molding mighty men is the business of George F. Jowett, The Champion of Champions.

RUSH COUPON—SPECIAL OFFER

All 6 books are profusely illustrated and will be sent to you by return mail, postpaid. Just slip a dollar bill in an envelope with the coupon below. For any single book, just send a quarter. I will include a free copy of my book titled, "The Thrill of Being Strong." Rush coupon now.

JOWETT INSTITUTE OF PHYSICAL CULTURE

422 Poplar Street, Dept. 4 Rc, Scranton, Penna.

Dear Mr. Jowett: Your proposition looks good to me. Send, by return prepaid mail, the lessons I am checking below and for which I am enclosing my remittance of \$.....

- All 6 Courses \$1.00
- Molding a Mighty Arm 25c
- Molding a Mighty Back 25c
- Molding a Mighty Grip 25c
- Molding a Mighty Chest 25c
- Molding Mighty Legs 25c
- Strong Man Stunts Made Easy 25c

Name.....

Address.....

LET THESE GREAT BOOKS HELP YOU TO

Start Your Climb!

the Man who KNOWS is the Man who WINS

Easy to train yourself! These books have helped thousands—

- AIR CONDITIONING**
Live Field; Great Future.....\$3.50
- AUTO ENCYCLOPEDIA**
Dyke's 16th Edition. Recent!.....\$6.00
- 110-V. GENERATORS**
Made From Old Auto Units.....\$1.00
- BIRD HOUSES**
Build to Sell; Easy Designs.....\$1.00
- BOAT BOOK**
Power, Sail, Rowing, Paddle Plans.....\$3.00
- BOY MECHANIC**
4000 Things to Make. 4 Vols.....\$7.00
- BUILT-IN FURNITURE**
Take Orders, Make Money!.....\$2.50
- CARPENTRY HANDBOOK**
336 Practical Short-Cuts.....\$1.50
- CONCRETE WORK**
173 Uses Described, Pictured.....\$1.00
- DOG TRAINING**
Home, Stage, Movies, Etc.....\$1.50
- ENGINEER-CUSTODIANS MANUAL**
Pay Raising Data for Building Superintendents and Others.....\$2.50
- FARMERS' BOOK**
861 Kinks for Field, Home.....\$1.00
- V-8 FORDS**
Also "A" and "B" Models. All New!.....\$2.50
- FROG INDUSTRY**
New! Raise and Sell. Profits!.....\$2.00
- FURNITURE MAKING**
Tools, Materials, Designs.....\$2.50
- HOME PHYSICIAN**
Modern, Complete, Authentic.....\$2.50
- HOW TO DANCE**
Teach Yourself in Private!.....\$2.00
- LATHE WORK (Metal)**
Drilling, Threading....\$1.00
- LOCOMOTIVE**
Folding Chart Shows all Parts.....\$1.00
- LOG CABINS**
Easy Plans; Build for Profit. Value!.....\$2.50
- MATHEMATICS**
Easy Guide for the Practical Man.....\$1.50
- MECHANICAL DRAWING**
Learn Drafting; Good Salaries.....\$1.00
- MONEY MAKING IDEAS**
1000 Spare Time.....\$1.00
- OCEAN LINER "EUROPA"**
Atlantic Speed Queen; Charted.....\$1.00
- PLUMBING**
500 Facts Every Homeowner Should Know.....\$1.50
- POULTRY**
Breeding, Management. Protect Your Profits!.....\$2.00
- PROSPECTORS' HANDBOOK**
How to Mine, Appraise, Equip.....\$3.00
- RADIO**
Amateurs' Handbook; Circuits, Repairs, Etc.....\$1.00
- RADIO SERVICING**
Profit by Knowing Costs, Kinks, Etc!...\$1.75
- REFRIGERATION SERVICE**
Manual (All Makes)...\$5.00
- REWINDING ELECTRIC MOTORS**
Fractional Sizes. Value!.....\$2.50
- SHIP MODELS**
Entire Text, Famous "Sovereign" of 1637.....\$1.00
- SHOP NOTES LIBRARY**
7 Vol. 2500 Wonderful Shop Ideas.....\$3.00
- STAMP ALBUM**
Modern. 400 Pages...\$1.00
- STEEL SQUARE**
How to Figure Angles of Rafters, Roofs, Etc.....\$1.00
- STORAGE BATTERIES**
New! How to Build, Repair, Charge....\$2.50
- TOYS**
For Amusement or Profit. Saleable Designs.....\$1.50
- TRICKS YOU CAN DO**
200 Sure Fire.....\$1.00
- UPHOLSTERY**
Always a Big Market. Start Own Business.....\$1.60
- WELDING ENCYCLOPEDIA**
All Methods; Hard Jobs Made Easy.....\$5.00
- WIRING**
Approved Economy Methods for Homes, Buildings.....\$2.50
- WOOD TURNING**
Woods, Tools, Methods; Practical Teacher...\$1.50
- WOODWORKING SHOP**
Motor-driven. 3 Big Volumes.....\$3.00
- WRIGHT ENGINE**
Chart of "Whirlwind"; All Parts.....\$1.00

Books sent C.O.D. anywhere in U.S.

Just check the books you want, write your name and address below, and mail the advertisement. It is your order blank. When postman hands you books, pay him the price and few cents postage. If outside the U. S. remit when ordering and include 10 cents per book extra for postage. We have many other books on these and 2,000 other subjects.

Name.....

City.....State.....

Address.....

Mail to Popular Mechanics Press, Room APR 5—200 East Ontario St., Chicago, Ill.

New DIESEL Engines!

DON'T WAIT! Diesel Power is the big, new field for greater opportunities and bigger pay. GET OUT OF THE RUT! BE AN EXPERT DIESEL ENGINEER and advance with this great new industry that is sweeping the world.

LEARN DIESELS in our big, nationally recommended DIESEL Schools and Shops. The original, exclusive DIESEL Schools of the United States and Canada . . . established many years and always ahead in training and equipment. More engines . . . more successful graduates . . . more Big Pay Jobs. Send for your FREE copy of "Diesel News," containing up-to-the-minute information about the amazing opportunities everywhere for trained DIESEL men.

Book K Explains All Practical School Courses—Day and Night
Book H Explains Home-Study Combination Course

HEMPHILL DIESEL ENGINEERING SCHOOLS, INC.
2127 San Fernando Road, Los Angeles, Calif.
1253 Diversey Parkway, Chicago, Ill.
507 Westlake N., Seattle, Wash. 1365 Granville St., Vancouver, B. C.
Nation-wide Employment Service is Free to all Hemphill Graduates

QUICK WAY to make money in

TRAIN
WITH
R.T.A.
NOW

RADIO

Modern receivers are demanding men with modern training for service work. New training method and service equipment offer starts you earning almost at once. Up to \$3 an hour easy in a short time. Write today for FREE book of details.

Radio Training Association of America
Dept. PM-54, 4513 Ravenswood Ave., Chicago

Wrestling Book FREE



Wrestling taught at home, by mail, by greatest of all world's champions—Farmer Burns and Frank Gotch. Be a wonderful athlete. Handle bigger, stronger men with ease. Learn the secrets of experts, Jiu-Jitsu, Physical Culture. Have perfect health, fame, a perfect body admired by both sexes.

FREE 32 page illustrated prospectus, full of thrilling information, sent free. Tells how we teach expert wrestling at home. Send 3¢ to cover postage. Write now for your copy. State age.

FARMER BURNS SCHOOL
3374 Courney Bldg., Omaha, Neb.

RAILWAY POSTAL CLERK



POSTOFFICE CLERK



GOVERNMENT CLERK



GOVERNMENT CLERK



**GET A
Government
JOB**

**\$1260 to \$2100
Year
to start**

**Men—Women
18 to 50
STEADY WORK**

**Many early
examinations
expected**

Qualify now

Common education usually sufficient

Mail coupon Today—SURE

Franklin Institute
Dept. P182, Rochester, N. Y.

Rush FREE, list of U. S. Government big pay LIFE JOBS. 32-page book describing salaries, hours, work. Tell me how to get a position.

COUPON

Name.....

Address.....

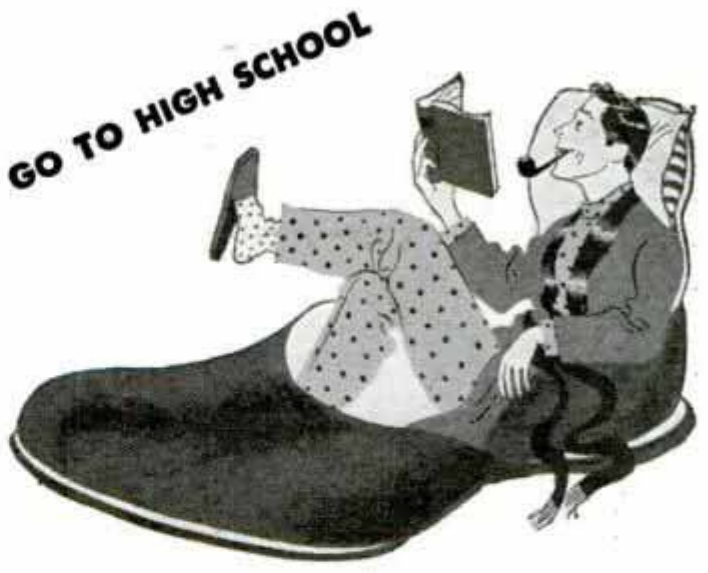

IN BEDROOM SLIPPERS!

If YOU feel the need of a high school education—regardless of your age—you can acquire it in the privacy of your own home after your day's work is done. Mail this coupon for information about our modern and widely recognized high school course. *Thousands of adults are studying it every night!*

INTERNATIONAL CORRESPONDENCE SCHOOLS

"The Universal University" Box 5567-H, Scranton, Penna.

Without cost or obligation, please send me a copy of your booklet, "Who Wins and Why," and full particulars about the subject before which I have marked X:

TECHNICAL AND INDUSTRIAL COURSES

- Architect
- Architectural Draftsman
- Building Estimating
- Wood Millworking
- Contractor and Builder
- Structural Draftsman
- Structural Engineer
- Electrical Engineer
- Electric Lighting
- Welding, Electric and Gas
- Reading Shop Blueprints
- Telegraph Engineer
- Telephone Work
- Mechanical Engineer
- Mechanical Draftsman
- Machinist Toolmaker
- Development and Protection of New Products
- Patternmaker
- Heat Treatment of Metals
- Bridge Engineer
- Bridge and Building Foreman
- Gas Engines
- Diesel Engines

- Aviation Engines
- Automobile Mechanic
- Plumbing Heating
- Air Conditioning
- Sheet Metal Worker
- Steam Engineer
- Steam Electric Engineer
- Civil Engineer
- Surveying and Mapping
- Refrigeration
- R. R. Locomotives Air Brakes
- R. R. Section Foreman
- R. R. Bridge and Building Foreman
- R. R. Signalman
- Highway Engineering
- Chemistry Pharmacy
- Coal Mining Engineer
- Navigation Boilermaker
- Textile Overseer or Supt.
- Cotton Manufacturing
- Woolen Manufacturing
- Agriculture Fruit Growing
- Poultry Farming Radio
- Marine Engineer

BUSINESS TRAINING COURSES

- Business Management
- Office Management
- Industrial Management
- Traffic Management
- Accountancy and C.P.A. Coaching Bookkeeping
- Secretarial Work
- Cost Accountant
- Salesmanship Advertising
- Service Station Salesmanship
- Wallpaper Decorating Salesmanship
- Business Correspondence
- Lettering Show Cards Signs
- Stenography and Typing
- Civil Service Mail Carrier
- Railway Mail Clerk
- Grade School Subjects
- High School Subjects
- College Preparatory
- First Year College
- Illustrating Spanish
- Cartooning French
- Lumber Dealer

Name.....Age.....

Address.....

City.....State.....

Occupation.....

If you reside in Canada, send this coupon to the International Correspondence Schools Canadian, Limited, Montreal, Canada

When writing please mention Popular Mechanics

NEW BOOK for INVENTORS

Complete Information on How To Obtain Patent and Market Inventions

If you have ideas, if you have invented something, if you're interested in inventing something, you need this new 48-page book that gives the entire Story of Patents. It tells you for the first time about new phases of invention, how others succeeded, how the patent laws protect you, how to market your invention, where to obtain finances, how to form a company, partnership, or arrange for royalties from your invention's sale.

NEW INFORMATION

This book gives you actual statements, suggestions, and ideas from famous authorities who know the inventive field thoroughly.

PRACTICAL BENEFITS

You will find 6 complete pages illustrated with simple inventions that have succeeded in six different fields of industry. Over 100 illustrations are in this book. You will read the stories of ten (illustrated) of America's most famous inventors. You will find an experienced and thorough survey of market conditions affecting the inventor—showing the possibilities for commercial invention today. Entire chapters are devoted to the value of a patent in promoting the final success of your invention. The importance of quick action in applying for patent is stressed—facts revealing danger of delay are emphasized.



FREE RECORD OF INVENTION BLANK

This FREE Record of Invention Blank enables you to make in convenient form a sketch of your idea and have it witnessed in a manner of value to you should the occasion for evidence arise.

**PATENT GUIDE
FOR THE INVENTOR**

**CLARENCE A. O'BRIEN
REGISTERED PATENT ATTORNEY
WASHINGTON, D.C.**

If you expect to realize profits from your invention you must protect it with a U. S. Patent. Otherwise you may find that all your time and labor have been lost, because it often happens that other inventors are working on the same idea. If you have an idea, an invention, or an ambition to invent—get the information on obtaining patent **AT ONCE!**

INVENTIVE FIELDS

Is your invention something for the home, the farm, the factory, the store? Would you like to know whether anything like it has ever been invented? You'll find scores of examples of patents reproduced in my

48-page book. You'll get a good idea of whether you "have something" or not. Would you like to know how you may judge the marketability of your invention? This book gives you several important tests prepared by authorities. Read of the experiences of Bell, Edison, Westinghouse, and other outstanding, successful inventors who patented and thereby protected their inventions. This book not only tells you how to obtain patent, it explains the steps that must be taken afterwards to promote the success of your invention. It answers such questions as—What is an inventive improvement? What is the worth of an improvement? How should inventor arrange for manufacture? Has an unknown inventor a chance to make money? What are the qualifications of an inventor? What happens to the patent infringer? Can local attorney handle patent case? How did other inventors get started? What pitfalls should an inventor avoid? Can inventor learn whether his idea is worth patenting?

WHAT A PATENT DOES FOR YOU

Without a U. S. Patent, you cannot expect to reap the profits that your invention may make possible. Send at once for this book. After you get that, you'll know exactly what to do to protect yourself. Anything you write me or send me is strictly confidential between us. All letters and drawings are kept in strong, steel, fire-proof files, which are open only to myself or authorized members of my staff. I have secured patents for inventors located in every State in the Union. The practice of my organization is confined entirely to Patents, Trademarks and Copyrights. I have had years of experience in patent matters. When you place your idea in my hands, I am in a position to proceed at once to secure protection for you. My fees are reasonable, and if you desire, I can arrange convenient terms of payment.

GET THIS *Guide* **FREE**
Patent
Mail Coupon Immediately - TODAY

This new **48-page** book of facts is absolutely **FREE!** You need it **NOW.** Simply fill out the coupon, and mail. The field of invention changes constantly—here is the latest information on the

most recent developments affecting inventive success. Within a very few days you will receive our Free Book, together with the Record of Invention Blank described here. Write **NOW—**

CLARENCE A. O'BRIEN
 REGISTERED PATENT ATTORNEY
 705 Adams Building
WASHINGTON, D.C.

CLARENCE A. O'BRIEN
 REGISTERED PATENT ATTORNEY
 705 Adams Building
WASHINGTON, D.C.

Please send me your **FREE BOOK**, "Patent Guide for the Inventor," and your "Record of Invention" form, without any cost or obligation on my part.

NAME.....
 ADDRESS.....
 (Important: Write or print name plainly.)

PATENTS

Booklet Free Highest References
Promptness Assured Best Results

Send drawing or model.

ALL BUSINESS GIVEN PROMPT AND PROPER ATTENTION

Listed Patent Lawyer in the latest editions of the Rand-McNally Directory of Bankers and Bank-Recommended Attorneys, published by Rand-McNally & Co., Chicago, Ill.; The Baggott & Ryall Directory of Guaranteed Attorneys, published by Legal Directory Corporation, Boston, Mass.; Flugel's Law List, published by Legal Directory Publishing Co., St. Louis, Mo.; American Lawyers Annual, Cleveland, Ohio; Bankers Service Legal Directory, Bankers Service Co., Boston, Mass.; Eyre's Law List, 9 Park Place, New York City, and the Central Guarantee Co., Bankers and Lawyers Directories, Empire State Bldg., New York City.

WATSON E. COLEMAN,
REGISTERED PATENT LAWYER

Victor Building, 724 Ninth Street, N. W.
WASHINGTON, D. C.

PATENTS

**INVENTORS - Get in touch
with this 36 Year Old Firm**

If you have an invention or an idea for one, write us today for our two books, "Patent Protection" and "Suggestions on Selling an Invention." Both Free on request. Large, highly trained, experienced staff. Highest references. Fees reasonable. Deferred payments arranged.

Victor J. Evans & Co., 501-D, Victor Bldg., Washington, D. C. (Turn at once to pages 22A and 23A for more information.)

VICTOR J.
EVANS & Co.

INVENTORS PATENT YOUR IDEAS SEND FOR FREE BOOK

HOW TO OBTAIN A PATENT, written by a Former Member of the Examining Corps (1922-24) of the U. S. Patent Office. If you want to profit by your idea, you should take steps to apply for a U. S. Patent at once. Your first step is to get this Free Book. This interesting illustrated book contains valuable information you should have. It tells you fully how to obtain a patent on your idea in the quickest way. With this Free Book you will also receive a "Record of Invention" form on which you can easily record your idea. Personal and Confidential Service: Your case will be personally handled only by a Registered Patent Attorney who is also a Former Member of the Examining Corps of the U. S. Patent Office. All communications confidential.

MAIL COUPON TODAY for FREE PATENT BOOK and RECORD OF INVENTION Form.

MILLER & MILLER
REGISTERED PATENT ATTORNEYS
FORMERLY IN EXAMINING CORPS U. S. PATENT OFFICE

1638 Woolworth Bldg., Dept. 45A, New York City
MILLER BUILDING, Dept. 45A, WASHINGTON, D. C.

Please send me your Free Book, "How to Obtain a Patent," and your "Record of Invention" form.

NAME.....

ADDRESS.....

PATENTS—TRADE MARKS

All inventions submitted held confidential and given personal attention by members of the firm.

Form, "Evidence of Conception" and instructions, "How to Establish Your Rights"—FREE!

LANCASTER, ALLWINE & ROMMEL
Patent Law Offices

412 Bowen Bldg.

Washington, D. C.

PATENTS SEND FOR
INVENTORS FREE
Protect yourself by retaining a legal firm that has been in good standing before the Patent Office over sixty years . . . Preliminary advice FREE . . . estimate of costs submitted. Write full particulars to Dept. 5-635 F St., N. W., Washington, D. C. ESTABLISHED 1869

"PATENT SENSE"

LACEY and LACEY



GEARS

In Stock — Immediate Delivery

Gears, speed reducers; sprockets, thrust bearings, flexible couplings, pulleys, etc. A complete line is carried in our Chicago stock. Can also quote on special gears of any kind. Send us your blue prints and inquiries.

Write for Catalog No. 10
CHICAGO GEAR WORKS
769-773 W. Jackson Blvd., CHICAGO, ILL.

No JOKE TO BE DEAF

—Every deaf person knows that—

Mr. Way made himself hear his watch tick after being deaf for twenty-five years, with his Artificial Ear Drums. He wore them day and night. They stopped his head noises. They are invisible and comfortable, no wires or batteries. Write for TRUE STORY. Also booklet on Deafness.



Artificial Ear Drum

THE WAY COMPANY

729 Hofmann Bldg.

Detroit, Michigan

Try This On Your Hair 15 Days -



Let Your Mirror Prove Results. Your hair need not thin out, nor need you become bald. This Different Method stops thinning out of hair, lifeless hair, itching, dandruff, threatened or increasing baldness by strengthening, prolonging the life of hair for men and women. Send your name now before it's too late for free 15-day test offer.

JUEL DENN, 207 N. Michigan Ave., Dept. 49, Chicago, Ill.

To PROTECT YOUR INVENTION - Use this coupon, NOW

Delays are dangerous and may be very costly. My personal service assures prompt action, strict confidence, and a minimum of expense. I suggest that you send me a model or drawing, or sketch and description of your invention, and \$5.00. I will make a search and report

promptly as to its patentability and send you a copy of my 72-page booklet. Or, if you prefer to read my booklet first, mail the attached coupon at once. I will also send my "Record of Invention" form. (Over 37 years experience as a Registered Patent Attorney.)

L. F. Randolph, 302-D Victor Bldg., Washington, D. C.

Please send me at once, free of charge, your 72-page booklet and "Record of Invention" form.

Name.....

Address.....

A PERSONAL CONFIDENTIAL PATENT SERVICE—

FUN! BIG PAY EASY for YOU



WITH an easy-playing, sweet-toned Buescher you play tunes right away. Be a social "hit," win new friends; popularity; increased income. Opportunities for good-pay jobs. You can qualify quickly.

FREE on trial, any Buescher instrument. Write now for details and handsome Free Book. Mention instrument: saxophone, cornet, trombone, etc.

BUESCHER
BAND INSTRUMENT CO.
410 BUESCHER BUILDING
ELKHART INDIANA

INVENTING Now Taught for the First Time!

Lev A. Trofimov, M. Sc., Development Engineer and internationally known inventor, is now offering for Home Study his complete Resident School Course. Approved by prominent educators and inventors. Teaches how to turn your ideas into cash. Thorough and intensely interesting with problems. Every phase based on practical experience. Send TODAY for free literature. No obligation.

TROFIMOV SCHOOL OF INVENTIVE PRACTICE, INC.
3859 Northampton Rd., Cleveland, Ohio

BIG MONEY in RADIO, ELECTRICITY Learn for only—\$1 Per Mo.

Write for free book, easy payment plan, on America's best home-study courses that prepare you quickly, in spare time for big-pay job in fastest-growing industry! Radio, Public Address, Photo Electronics, Electronics, Electrical-Engineering! Most complete, understandable. FREE laboratory apparatus. We help you earn as you learn. Send for full facts, TODAY!

LINCOLN ENGINEERING SCHOOL, 855-F S. 37th STREET, LINCOLN, NEBRASKA

Save Your Feet



When all else fails end your suffering with the flexible "no metal" Heefner ARCH SUPPORT

WRITE FOR FREE BOOKLET

HEEFNER ARCH SUPPORT CO. 697 M. E. TAYLOR BUILDING LOUISVILLE KY.

WANTED!

National net work collection company will employ high-grade, tactful, responsible man in each town for personal collection service work. Men accepted will be trained and bonded. (See our ad page 24A.) Write **NATIONAL BUSINESS PROTECTIVE SERVICE, Inc.,** 500 N. Dearborn St., Dept. 4-H, Chicago, Ill.

Be a Draftsman Make BIG PAY

Only 15 minutes a day with these WONDER BOOKS will prepare you for a good drafting job in less than a year. Mechanical and architectural drafting from simple straight lines to important complex plans. A step at a time! Built especially for beginners, for men with only grammar schooling. Drafting room practice, PLUS ENGINEERING, made easy and clear. Includes complete course in blue-print reading.

These 5 Big Books Shipped FREE!

Quick Way to Learn

Competent draftsmen are urgently needed right now in all building and manufacturing lines at \$30.00 to \$75.00 a week. That's just the beginning—FOR DRAFTSMEN HAVE THE BEST CHANCES FOR ADVANCEMENT. Pleasant, fascinating work, easy to learn and do. Learn quickly with these books. Complete set of drawing instruments if you send for these drafting books NOW.

American Technical Society, Drexel at 58th St., Dept. D-419, Chicago, Ill.

Send for 10 days' free use New 5-volume set of drafting. I will pay the few cents delivery charges. If I wish, I may return the books in 10 days and owe you nothing, but if I decide to keep them, I will send \$2.00 after 10 days, then only \$3.00 a month until \$24.50, the special introductory price, is paid. Send latest edition and include drawing instruments.

Name.....

Address.....

Attach letter stating age, occupation, employer's name and address and that of at least one business man as a reference.

SAVE UP TO 50% DIRECT FROM MIDWEST LABORATORIES



30 DAYS FREE TRIAL

ONLY RADIO COVERING 9 TO 2,400 METERS.

12,000 MILE TUNING RANGE

FOREIGN RECEPTION Guarantee

ONE YEAR Guarantee

MONEY-BACK Guarantee

TERMS as low as \$5.00 DOWN

Amazing New MIDWEST HIGHER FIDELITY 16-TUBE (ALL 5 WAVE BANDS)

EXCLUSIVE features, acting like "Invisible Hands," give magical world-wide High Fidelity reception. Before buying a radio, write for FREE 36-page 4-color catalog. Learn how thousands saved 1/3 to 1/2 by buying direct from MIDWEST.

\$57.50 with NEW Deluxe AUDITORIUM-TYPE SPEAKER "LESS TUBES"

This Super DeLuxe, 16-tube All-Wave radio gives you: High Fidelity reception, 5 wave bands, 50 advanced features, many of them exclusive . . . such as Multi-Function dial. Only Midwest offers you 9 to 1200 meters. Brings in foreign stations 12,000 miles away. Hear realistic American and SHORT WAVE programs . . . Canadian, police, amateur, airplane, ships. One-Year Guarantee, Foreign Reception Guarantee, Money-Back Guarantee. As little as \$5.00 down. 30 days FREE Trial.

Long Range Radios \$27.50 as Low as Mail coupon or send 1c postcard.

MIDWEST RADIO CORPORATION Dept. 150A Cincinnati Ohio

MAIL COUPON TODAY! FOR FREE MINIATURE DIAL..... FREE 30-DAY TRIAL OFFER.. FREE CATALOG

MIDWEST RADIO CORP.
Dept. 150A, Cincinnati, Ohio

Without obligation send me your FREE catalog, FREE Miniature Dial, and 30-day FREE trial offer. This is NOT an order.

Name.....

Address.....

Town..... State.....

Check here, if interested in Midwest World-Wide Battery Radio.

Check here, if interested in a Midwest Auto Radio.

EXPERIENCED MEN Get the Big Radio Jobs!

S. Q. NOEL
PRES. FIRST NATIONAL TELEVISION, INC.

"Every qualified man I train puts in actual hours at my 1,000 Watt Commercial Radio Station! When you have completed my training course, you are a tested radio and television expert—ready to step into the BIG PAY class! You have had actual experience behind you in genuine radio broadcasting work which gives you preference in any radio job. The hours you spend in my ultra-modern, "Hi-Fidelity" commercial station W9XBY and my licensed television experiment station W9XAL mean dollars to you. Never before have you been offered so great an opportunity! Tune in on "Hi-Fidelity" station W9XBY—1530 kilocycles.

GET YOUR LICENSE WHILE LEARNING

A government operator's license is a passport to a real job with a future! My students qualify for their licenses and get certified service records while learning. FREE employment service for life on graduation. No previous experience needed. Write today and let me point the way to the highest-pay radio jobs!"



MAIL TODAY

S. Q. Noel, Pres. First National Television, Inc. (Training Division)
AA-4 Power and Light Bldg., Kansas City, Mo.

Without obligation, send me postpaid FREE Illustrated Folder telling about new opportunities in radio and television. I am 17 years or older.

Name _____ Age _____

Address _____



Learn to Draw

beautiful girls' heads and figures for pleasure and profit. Be an artist and make big money. Amazing NEW easy way quickly starts you. No experience necessary. **FIRST LESSON FREE**

Any ambitious person over fifteen can have the first lesson FREE by sending name and address and only ten cents to cover mailing cost. **TRY IT FREE.** No obligation.

TOWERTOWN STUDIOS, Dept. 436
520 N. MICHIGAN AVENUE CHICAGO, ILL.

DIESEL POWER

A Coming American Industry

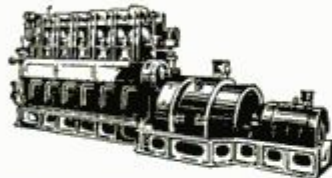

THE internal-combustion engine represents man's supreme triumph of machine power. Diesel engineers are in

great demand. Many are acquiring necessary knowledge through spare-time study of this modern I. C. S. Course on Diesel engines. Free booklet!

INTERNATIONAL CORRESPONDENCE SCHOOLS

BOX 5669-H, SCRANTON, PENNA.

Please send information on course checked.

DIESEL POWER

Mechanical Engineering Automobile Course
 Aviation Engines Air Conditioning

Name _____ Age _____

Address _____

Be Popular PLAY GUITAR

PLAY GUITAR, BANJO, or FREE!
mandolin with your friends.
Easy to learn. Have an orchestra of your own. Free book gives valuable facts.



GIBSON, INC.
1152 Parsons St., Kalamazoo, Mich.
GIBSON, INC. 1152 Parsons St., Kalamazoo, Mich.
Please send me free book showing the quick way to popularity and success.
Name _____ State _____
Address _____ Banjo _____
City _____ Guitar _____ Mandolin _____
(Check above)

Turn Cheap Oil to Gas Heat

HEATS 25% CHEAPER
Than Other Fuels!

No Work
No Dirt
No Ashes

Send name for free book on LACO'S sensational new "Mineral-Wick" automatic oil burner. World's lowest priced! Saves 25% of fuel costs. Gives hotter flame with less oil. Goodrich (Me.) says, "Saved me \$50 over coal one winter." Clean, noiseless, double safety features. 15,000 in use. **GUARANTEED.**

WRITE! Get low price, due to simpler design, low factory-costs. Get No-Risk, Trial-Offer and Free Book. **SEND NOW!**
LACO OIL BURNER CO., 145 Union Ave., Griswold, Ia.

Look Here, D. ALERS!
Lower price and fuel savings help my dealers outsell others. I'll slip you sample burner, on approval, subject to examination, no obligation. Write quick for my plan.
L. A. COCKLIN, Pres.

INFERIORITY COMPLEX

is a "disturbance centre" in subconsciousness, generating powerful negative impulses, causing self-consciousness, lack of charm, nervousness, worry, weak will, etc. To struggle against these personality-weakening forces is in vain—REMOVE THEM **ALTOGETHER** by reconstructing within yourself a powerful positive subconscious mind—vibrant, confident, resourceful! Write for **FREE BOOK.**

British Institute of Practical Psychology, Inc.
Dept. PM-54, Stamford, Conn.

\$25 A WEEK FOR YOU

and work 12 hours a week. Great plan (illustrated) to breed **PR Royal squabs.** Ask for **new free Library 4**, send 3-ct. stamp for mailing. Get details, learn what, why, how, where, 1935 facts.

Plymouth Rock Squab Co., 633 H. St., Melrose, Mass.



RAISE RABBITS FOR US

WE PAY YOU UP TO \$5.00 EACH. ALSO PUT YOU IN TOUCH WITH MARKETS EVERYWHERE. Large illustrated book and catalog, also copy of the **AMERICAN RABBIT FARMER** and monthly market bulletin showing names of buyers in various parts of America who continuously buy all rabbits offered them. All for 10 cents. Address **OUTDOOR ENTERPRISE CO., 101 Main Street, NEW CITY, N. Y.**



OLDEST BEST POULTRY PAPER 12 BIG ISSUES 25c

Paste or pin this ad on a letter with your name and address and mail it to us with 25c. (stamps or coin) for the next 12 issues. **American Poultry Journal** Chicago, Illinois



BREED CANARIES FOR US

WE SUPPLY BIRDS AND BUY ALL YOU CAN BREED

We need thousands—paying you highest prices. Breeders ship us birds from all parts of the country. Large illustrated Canary Book catalogue and list of prices sent; 10c [coin] to cover cost of mailing.

KRAFT BIRD CO., Dept. R 5 EAST 14th STREET, NEW YORK

MAKE MONEY at Home!

Exclusive new process. Bigger, better, quicker crops. More money for you! Mushroom book free. **AMERICAN MUSHROOM INDUSTRIES, Ltd.** 177 Woolnough Bldg. Toronto, Ont.



EARN up to \$25.00 A WEEK or More

BUCHSTEIN'S FIBRE LIMB

is soothing to your stump—strong, cool, neat, light. Easy payments. Braces for all deformities. Agents wanted.
D. BUCHSTEIN CO.
610 3rd Ave., So., MINNEAPOLIS, MINN.



Send for Catalog Today

Classified Advertisements

WORLD'S BEST WANT AD MEDIUM

Advertisements in this section, 35 cents per word, each insertion, minimum 10 words, payable in advance

To be inserted under proper classification in May issue, copy should be in our office March 16th

Popular Mechanics Magazine, 200 East Ontario Street, Chicago, Illinois

**Our Records Prove That You
Can Fill Almost Any Want
Through a Small Classi-
fied Ad in This Section**

Popular Mechanics Magazine, 200 E. Ontario St., Chicago, Ill.

Gentlemen:—Have been advertising steady in your paper for the last 3 years, and only wish we had 100 more papers like Popular Mechanics to advertise in.

Our replies run close to the top if not the top from your paper and we advertise in dozens of different ones.

Wishing you the best of success.

(Original letter on
file in our office)

Respectfully,

SKRUDLAND PHOTO SERVICE

AUTOMOBILES

SPEED In Auto Racing. Brand new book gives all speed records; drawings, pictures, full description of record cars. Tells how you can build 125-135 m.p.h. stock car and speedway racers. Midgets, conversions, fully described. \$1.00 postpaid; \$1.12 C.O.D. Ray F. Kuns, Dept. B-7, Madisonville, Cincinnati, Ohio.

DODGE Generator quickly changed to arc welder. Welds fenders, cylinder heads, etc. Plans, drawings \$1.00. Neal Brown, Richland Springs, Texas.

BUILD Midget airflow. Plans \$1.00. Photograph 25c. Lusk, 4841 Ogden, Cicero, Ill.

AUTO SUPPLIES—EQUIPMENT

CASH Income daily resilvering mirrors; replating metalware; making glass signs. Portable outfit. Sprinkle, Plater, 287, Marion, Ind.

"GASLINE" Auto lock—Stops car stealing. Automatically stops gas flow. Installed any fuel pump equipped car—\$3.95 C.O.D. plus postage charges. Specify if for Ford V-8—otherwise order Model X. Money back guarantee. Rice Specialty Mfg. Co., Dept. A, 1928 Ashland Ave., Toledo, Ohio.

NEW Patented automobile watch holder. Sells on sight. Fits back of steering wheel on steering post. Less than one minute to install. Sample 25c. Write for details. Powers Manufacturing Company, Dept. 5, Iowa City, Iowa.

NO-ROL-BAK Prevents your car from rolling back on hills or grades during momentary stops. Prevents riding clutch and stalling motor. Price \$2.00 postpaid. Fetter Manufacturing Co., Industrial Building, Baltimore, Md.

PORTABLE Nickel plating outfits. Particulars free. Metalcraft, Arcade Bldg., St. Louis, Mo.

WHOLESALE Prices, new auto parts, supplies. Big discounts. Catalog, stamp. Russell's, 1416 Adams, Toledo, Ohio.

MICROMETER: Accurate every thousandths between 1½, 5 inches \$1.00. Four jaw "Pick-Up" tool reaches inaccessible parts 30c. Agents! Schaap, Springfield Gardens, L. I.

DEMONSTRATORS. Compressor, test bench, 8-hour battery charger—are welder. Guaranteed. Trial and terms. Ken's Equipment Exchange, Box M-452, Troy, Ohio.

L. J. SPEED Equipment Co. Motors and Chassis, 2225 Fulton Road, Cleveland, Ohio.

NICKEL Plating outfits, connect to your battery. No tanks used, thousands in use. \$3.00 prepaid. Gunmetal Co., Ave. J, Decatur, Ill.

BUILD Your own cabin trailer and save ¼ cost. Send 3c for literature. Brooks Boat Co., Inc., Box E220, Saginaw, Mich.

MOTORCYCLES, BICYCLES AND SUPPLIES

PARTS. Send 10c for 24 page Handbook of Information, listing new and used parts, accessories, batteries, tires for Indian, Harley, Henderson, Excelsior, Bootz, 622 E. Grand, Des Moines, Iowa.

POWER Your bike with low priced Speed-bike motor. Attach in one hour. Eighty miles to gallon. Thirty miles an hour. Free folder. Guaranteed. Outboard Motors Corp., 4024 N. 28th St., Milwaukee, Wis.

HENDERSON, Excelsior, Harley, Indian, used parts, alloy pistons, catalogue and wings n/p 10c. Ballak, 100 N. 12th, St. Louis, Mo.

MOTORCYCLE Bargains, lowest prices, bargain sheet for stamp, motorcycle accessories, largest line in America, lowest prices. Largest motorcycle mailorder house in the United States. Rochester Harley Davidson Corporation, 129 West Main St., Rochester, N. Y.

We Repair bent, broken frames, forks. Scored cylinders, magnetos, generators. New and used motorcycle parts. J. B. Dahl, 3661 Archer Avenue, Chicago, Ill.

SEND 15c For illustrated used Motorcycle catalog. Large stock. Bargains. Indian parts. Accessories. Indian Motorcycle Sales, Kansas City, Mo.

MOTORCYCLES—Direct to you at rock-bottom wholesale prices. Rebuilt, roadtested and guaranteed Indians, Harleys, etc. Send 10c today for "Bargain Bulletin 43." Crandall Hicks Co., 780 Commonwealth Avenue, Boston, Mass.

BOYS Motor bicycle \$45.00. Motorcycles \$40, new. Goodyear tires \$3.95. Engines for boys automobile, sleds, boats, aeroplanes \$25.00. Wheels \$1.00. Chains \$1.00. Parts at lowest prices. Bicycles \$11.50. Send 6c. Save dollars. Price-Cutter Deninger, Rochester, N. Y.

BOYS, Learn bicycle repairing. Send quarter for Correct Way to Lace Bicycle Wheel. Foreman's, 12201 N. Wis. St., Racine, Wis.

AVIATION

"PROBLEM Of Vertical Flight"—\$1.00 postpaid. Descriptive circular. General Publishing Co., McComb, Ohio.

HUNDREDS Airplanes, \$40 up. Directory 20c. Used Aircraft Directory, Athens, Ohio.

AIRMINDED Young men interested in entering the field of aviation as apprentices. Write, enclosing stamp. Mechanix Universal Aviation Service, E-13291 Ardmore, Detroit, Mich.

QUALITY Propellers; Harley's, \$3.50; Henderson's, \$5.00; 5' auto special, \$7.00. Hibbs, Fort Worth, Texas.

USED Airplanes \$40 and up. Literature 10c. Continental Sales, Box 344U, Indianapolis, Ind.

AIRPLANES, \$50 Up. Directory 15c postpaid. Aero Bargains, Greenville, Ohio.

GET Into aviation. Air transport pilots get up to \$7,000 per year; mechanics, \$2,500. Learn at this government approved school. Write for complete information. State age. Lincoln Flying School, 2001 Aircraft Building, Lincoln, Nebr.

BATTERIES, GENERATORS, ETC.

PROFIT Rebuilding batteries. Make your own plates. Information 25c (coin). Wind power battery charger plans 25c. General Battery Service, 78M Glenwood, Minneapolis, Minn.

READY Made direct drive wind electric chargers, \$12.50. Circular—dime. Aero Electric Sales, Hart, Mich.

ELECTRIC Lights—Wind driven—You build them. Write Wind Motor Electric, Ridgway, Mont.

MAKE Automobile battery charger for dollar. Instructions 25c. Lonk, D-1613, Palatine, Ill.

EDISON Storage batteries for power and lighting systems. Replace your old lead batteries with the Edison. Built like a battleship. Non-acid. Non-corrosive. Exceptionally long life. Liberal guarantees. Free illustrated literature. See Jay Battery Company, 82 Sterling Avenue, Yonkers, N. Y.

TWENTY New practical changes for automobile generators. See our advertisement at bottom of page 144A. Auto Power, Inc.

EDISON Storage batteries for all types of lighting systems. Uses no acid. Odorless. Long life. Guaranteed. Generating plants, motor bargains. Free interesting literature. Hawley Smith Company, 22 Washington Ave., Danbury, Conn.

ELECTRICAL SUPPLIES—EQUIPMENT

ELECTRIFIED Fences reduce costs 80%. Controllers for 110 and 32 volt current. 30 days trial. Write. One-Wire Fence Co., B-25, Whitewater, Wis.

EDISON Motors, fractional horsepower. Universal current, adjustable speed, regular \$32.50, special at \$1.95. Tork eight day clocks, 15 ampere, new, \$9.00. Furnace controls: aquastats, pressurestats, new, \$3.00 each. Minneapolis Honeywell thermostats \$5.00, control motors, magnetic valves, forced draft blowers at corresponding low prices. Pioneer Air Compressor Co., 33 Warren Street, New York City.

NICHROME Resistance wire problems solved. Complete, simplified instructions. \$1.00. Details 3c. Technical Service Bureau, Inc., 6807 N. Clark Street, Chicago, Illinois.

INSULATION, Wire, varnishes, supplies, etc. Send 3c stamp for bulletin. Autopower, 408-B Hoyne Ave., Chicago.

EXPERIMENTERS. Students, home-builders, instructors, C.C.C.'s, scouts. Electrical kits free (almost). Entertaining, educational, useful. No toys. Write Engineering Service Co., 3722 "A" Street, Lincoln, Nebr.

MACHINE Costing \$24.50 changes ice-box into automatic electric refrigerator. Build it yourself. 9x12 blue print of, "how it works" illustrated by drawings 10c. Onia A. Koistinen, Lake Norden, S. Dak.

WELDING AND SOLDERING

SPEED-E-ARC Electric welder. 75 ampere. Built from automobile generator. Complete instructions and proven blueprints, \$2.00. C. A. Carlson, 2212 Grand Ave., Omaha, Nebr.

SAVE Money on new and factory rebuilt welding and cutting torches, regulators, tips, supplies. Send for current bulletin. Lowest prices. Low cost repair service. Guaranteed. Welding Equipment Service, Box 242, West Alexandria, Ohio.

DEMONSTRATORS, Electric arc welders. Money-saving prices. Used by the government. Trial and terms guaranteed. Hobart Welders, M-453, Troy, Ohio.

PORTABLE Arcwelders, (DC or AC). Drawings 50c each. Literature, magazine, dime. Wilson, Box 706, Sylacauga, Ala.

ARC-WELDING Outfit \$1.25. Weld fenders, braze, solder. Lavrow, 4368-W. Warren, Detroit. Stamp appreciated.

WELDING And brazing oxy-acetylene equipment, new and rebuilt. Superior Oxy-Acetylene Company, Hamilton, Ohio.

MACHINERY, TOOLS AND SUPPLIES

KELLOGG Air compressors, excellent condition, \$6.00. Air tanks, \$3.50. Taylor, 105 East 102nd Street, New York City.

FACTORY Closeouts! Bankrupt stocks; supplies. Years listings 10c. Kostka, 2350-P South Crawford, Chicago.

BARGAINS, Demonstrators, electric arc welders, guaranteed, 30 days trial and terms. Write Ken's Equipment, Box M-454, Troy, Ohio.

MAKE Your own workshop, motor, lathe, drill press, saw, planer, shaper. Complete specifications—\$1.00. Stark Engineering Co., P.S.S. Box 144, Erie, Penna.

SHARPEN Lawnmowers quickly, accurately, profitably, using Homcraft units. No fixture expense, alterations, damaged units. Tested, proven instructions, \$1.00. Educational Service, Wales, Wis.

12" x 7" WILLARD Lathe, three step cone drive, price \$190.00 refitted. 12" Hendey shaper \$75.00; No. 60 Head cylinder grinder \$175.00; all sizes and types of machines tools. Send for catalogue listing other bargains. Terms to suit. Cincinnati Machinery & Supply Co., 27 W. 2nd St., Cincinnati, O.

ELECTRIC Drills—Brand new, husky, powerful, 1/4-inch, \$5.95. Description sent. Shaw, 31-A Winchester, Boston, Mass.

ENGINES, MOTORS, DYNAMOS

FIVE KVA 110 volt alternating generators \$89.50. Other sizes. Converters, motors. Queen City Electric, 1736 Grand Avenue, Chicago.

MOTORS And generators at half price. Motor & Generator Supply Co., 4516 Clifton Ave., Chicago, Ill.

GOVERNORS Control auto engines—stationary or portable power uses. New big discount. No cash down. Special foreign terms. Agents wanted. Candee-Smith Governor Co., 215 North Los Angeles St., Los Angeles.

WINDING Data, 100 AC motors, various horsepower and voltage, \$1.00. Motor Data Co., 3002 Monroe, Kansas City, Mo.

BOATS, OUTBOARD MOTORS, ETC.

PROPELLERS, Stuffing boxes, gear pumps, bearings, etc. Wm. Baker, Pond St., Quincy, Mass.

RACING Fuels for outboards. Three formulas, 25c. E. Ferris, Philmont, N. Y.

BUILD Your own fishing boat. Flat bottom, thirteen foot. Blueprint, complete instructions, 50c. Saegertown Shop, Box 34, Saegertown, Pa.

CUT-TO-FIT Kayaks, canoes, \$6.95 up. Catalog for dime, instructions for quarter. Boat Shop, 737P, Greenville, Pa.

LATEST Boat sensation! New 20-lb. Mead Sportsman's Ki-Yak assembled at home easily, quickly from complete factory-cut kit. \$6 paddle now given with yours if you hurry! Rush dime for catalog. Mead Gilders, Dept. BC-4, Chicago.

BUILD Your own boat and save 1/2 cost. 38 designs. Send 10c for catalog. Brooks Boat Co., Inc., Box E-20, Saginaw, Mich.

OUTBOARD Parts—New or used—All makes—What do you need? Crandall-Hicks Company, 782 Commonwealth Avenue, Boston, Mass.

BUILD Your own boat. Our fabricated frames save you 1/2s. Describe requirements and let us quote. Illustrated catalog 100 boats 10c. Bay City Boats, Inc., 1552 Adams, Bay City, Mich.

BUILD Substantial 16 1/2 foot cedar canoe. Particulars, stamp. Arbee, 113, Bedford, O.

GUNS, FISHING TACKLE AND SPORTING GOODS

RESTRING Your tennis racket. High grade stringing outfit only \$1.50. Instructions included. Tip-Top Sports Shop, c/o Langberg, 207 Kenmore, Youngstown, Ohio.

FREE Fly tying catalog. Tack-L-Tyers, 1412CG Dempster St., Evanston, Ill.

MAKE Sinkers for use or profit. Easy. Folder free. Reading Instrument Co., Box 78, Reading, Pa.

GUNSMITHS' Secrets! Bluing, checking, engraving, etc., 25c. International Agency, P-4, Cincinnati.

FIELD GLASSES, TELESCOPES AND MICROSCOPES

MICROSCOPES, Telescopes, binoculars. America's lowest prices. Optical catalog free. Brownscope Company, 234 Fifth Ave., New York.

MINERALS—PRECIOUS STONES

SPECIAL Mineral offers for students, collectors, cutters, etc. Gem Shop, Korrs Block, Helena, Mont.

ANTIQUES, WAR RELICS AND INDIAN GOODS

INDIAN Relics, all kinds. 12 arrowheads, perfect 65c. W. B. Robinette, Pacolet, S. C.

100 **INDIAN** Flints \$2.50 postpaid. Henry Hassler, 1909 Broad, Nashville, Tenn.

STONE Age relics. Lists 60 pages, 5c. Grutzmacher, Mukwonago, Wis.

25 **CHOICE** Arrowheads \$1.00. H. L. Talburt, Calico Rock, Ark.

14 **ARROWHEADS**, Spearhead, lancehead 99c. Gempoint 38c. Scalping knife, scraper, drillhead, 98c. Poison arrowhead, birdpoint 48c. Photolist 10c. Robt. Heike, Rutland, Illinois.

INDIAN Relics. Beadwork. Coins. Curios. Catalogue and arrow, 6c. Vernon Lemley, Northbranch, Kans.

TAXIDERM Y

LEARN Taxidermy. Complete price \$1.00 catalog. Eyes and supplies free. Schoepfer-Taxidermy Studio, 134 West 32 St., New York.

TAXIDERM Y Supplies—Quality artificial eyes, teeth, genuine Jonas head forms. Tools, materials, etc. Everything for the progressive taxidermist. Send for big illustrated catalogue—Free. Jonas Bros., 1049 Broadway, Denver, Colo.

LEARN Taxidermy. Five courses. Blue Beaver Taxidermy School, Lemont, Ill.

DOGS, BIRDS, POULTRY, PETS

POPULAR Poultry Magazine—Helped thousands to success and profits in poultry raising. Sample free. Twelve issues, 35c. Four years, \$1.00. The Poultry Item, Box 71, Sellersville, Pa.

52 **BREEDS** Chicks, baby turkeys, started chicks, hybrids, pullets, cockerels; Iowa inspected, nothing finer. Beautiful poultry book free. Berry's Hatchery, Route 23, Clarinda, Iowa.

POULTRY Tribune—Leading poultry magazine. Five years \$1.00; six months trial 10c in U. S. Poultry Tribune, Dept. C-93, Mount Morris, Ill.

BEAUTIFUL Pure white police dogs. Ansoia Kennels, Mose, N. Dak.

TREES, SHRUBS, ROOTS, HERBS

COLORADO Blue Spruce—From the bluest of the blue trees. I prepay them to you for 4c—in lots of not less than 25 trees. Trees are 3 year old. I pack them so they get to you in good growing condition. H. D. Belcher, Brook Forest, Colo.

AMERICA'S Biggest value! New "Herbalist Almanac" sent for only 10c postpaid. Includes hundreds tested herb medicine recipes, fishing dates, best times for planting and other valuable information. Beautifully illustrated in natural colors. Needed every home. Botanicals, 145 West 112th St., Chicago.

MANY Roots, barks, herbs, evergreens of value in fields and forests. "Collector's Guide," 10c. Botanical, New Haven, Conn.

FARMS AND FARM LANDS

FLORIDA—5 To 40 acres; combination land; famous Peace River country. Florida's best. Terms. Foster's Farms, Orlando, Fla.

RENTS And prices are low in Minnesota, North Dakota, Montana, Idaho, Washington and Oregon. Farms large or small near lakes, streams, forests. Low rates. Free book. E. C. Leedy, Dept. 857, Great Northern Railway, St. Paul, Minn.

CANADIAN Tax sale lands for a dollar an acre and up; small monthly payments. Farms, timber, hunting and fishing camps, minerals. Limited number of properties. Write at once for free illustrated booklet. Tax Sale Service, Room 613, 72 Queen St., W., Toronto, Canada.

FARM, \$195 Month's income, 90 acres, 8-room house, big old maple shade, basement barn, hen houses. Cost \$3000 but sacrificed at \$1900, part cash. Team, cattle, 550 hens, implements, potatoes, hay, etc., included. Pg. 23 new spring catalog, the pick of 10 000 bargains. Free. Strout Agency, 255-P 4th Ave., New York City.

\$5 DOWN, \$5 Monthly, 20 acres, Ozarks, \$100. Fishing, hunting, trapping. Hubbard, 216 Grossman Bldg., Kansas City, Kas.

INDEPENDENCE, Security assured, North Dakota, Minnesota, Montana, Idaho, Washington, Oregon farms. Bargain prices, easy terms. Descriptive literature, impartial advice. Mention state. J. W. Haw, 119 Northern Pacific Railway, St. Paul, Minn.

PROFITABLE OCCUPATIONS

MAKE Keys! Write—Muller, Machinists, 207 Centre Street, New York City.

MAKE \$100 Monthly—Raise Angora wool rabbits. Wool brings \$3 to \$6 lb. Catalogue, information 10c. Clay Farm, Sharon, Wash.

RECLEAN And resell drained automobile oil. Profitable. Instructions \$1.00. Robert Hicks, Centralia, Mo.

IF Interested in raising frogs we guarantee to save you money. Send 10c for literature. American Frog Industries, Rayne, La.

RAISE Rabbits for us. We pay you up to \$5.00 each. Also put you in touch with markets everywhere. Large illustrated book and catalog; also copy of the American Rabbit Farmer and monthly market bulletin showing names of buyers in various parts of America who continuously buy all rabbits offered them. All for 10 cents. Address Outdoor Enterprise Co., Box 10, Holmes Park, Mo.

BOOKS AND PERIODICALS

DIESEL Engines, monthly publication, authoritatively and interestingly illustrates and describes application of Diesel engines to industry; to transportation, such as railroads, trucks, buses, etc.; in marine service and in airplanes. One dollar per year. (Canada and foreign \$3.00), subscribe to-day. Diesel Publications, 2 West 45th Street, New York City.

NEW Ford repair book for 1935 V-8 and model A. Includes data taught in Ford training schools. Answers 600 mechanical and electrical questions in non-technical language. Used in hundreds of Ford garages. 144 pages, many charts and diagrams. Sold on money-back guarantee. Price \$1.00, postage prepaid. Trade Press Publishing Co., Montgomery Building, Milwaukee, Wis.

"HOW To Make a High Pressure Transformer" \$1.25 and "How to Make a Low Pressure Transformer" \$1.40, by Prof. M. E. Austin. Both books in clear comprehensible English. Post paid. The College Book Store, Hanover, N. H.

"FINDING Gold Nuggets." Book including 16 maps with instructions \$1.00. Fine Art's Engraving, 416 S. Dearborn St., Chicago.

BIG Mails (national). Magazine, propositions, catalogs, 20c. International Agency, P-4, Cincinnati.

HAUPTMANN-LINDBERGH Story-Trial-Illustrated. Beautifully bound \$1.00 prepaid. American-Simplex Co., Anderson, Ind.

BIG Mails. Magazines, catalogs, propositions, etc. Send 10 cents. Anderson Press, Box 3177, Miami, Fla.

PICTURES AND POSTCARDS

WASHINGTON, D. C. views—20 different new colored cards; 25c coin. Newviews, Paeonian Springs, Va.

GAMES—ENTERTAINMENT

PLAYS, Operettas, musical comedies, complete minstrel first-parts with song programs, blackface skits, vaudeville acts, monologs, dialogues, recitations, juvenile plays and songs, musical readings, entertainments, make-up goods. Catalog free. T. S. Denison & Co., 623 So. Wabash, Dept. 11, Chicago.

FOR BOYS

FOR Pastime make engines. Illustrated catalog 25c. Howardo, 2417 N. Ashland Av., Chicago, Ill.

MAGIC TRICKS, PUZZLES JOKER NOVELTIES

BE Popular. Entertain your friends. Delightful book of unusual tricks. Defy solution. 50c. Foster, Box 134, Swarthmore, Pa.

NEW Magic trick, 50c. New list free. Eagle Magic, Minneapolis.

EIGHT Funny, instructive, interesting novelties 25c. Satisfaction or money back. Specialty House, 3835 Cambridge, Philadelphia, Pa.

PROFESSIONAL Magic catalogue 25c. Ireland's Magic Store, 431 N. Clark St., Chicago, Ill.

250 **MAGIC** Tricks—25c. Illustrated catalog included. Fraba, Cashton, Wis.

WORLD'S Fair sensation. Baffling tricks, easy to perform. Catalogue, 12 samples 25c. Nutrix, 77 W. 47th St., New York. Agents wanted.

PUZZLE—Used in leading universities as intelligence rater. Now you can rate yourself, your friends. New, unique, entertaining device. A challenge to your wits. Send 25c. Professor Green, 835 Riverside Drive, New York City.

MAGIC Catalogue 20c. Lynn, 105 Beach, Dept. 3, Jersey City, N. J.

LARGE Professional magic catalogue, 25c. Holden, 220 W. 42nd St., New York.

"125 CARD Tricks" 25c. Speizer Service, 417 Altamont, Schenectady, N. Y.

FREE Magic catalog! South's largest line. Amaze—mystify your friends. Be popular. Earn money. Lyle Douglas, Station A-5, Dallas, Tex.

STAMP COLLECTING

BETTER Grade stamp bargain. The Old Kingdom of Sardinia issued its last postage stamps 75 years ago. These classics, beautifully embossed are so scarce that many collectors have never seen any. We were fortunate to secure a few at a London auction and offer two different superb copies together with the two highest values ever issued by Brazil, numbers 278—5000 reis and 299—10,000 reis. Total catalogue value of these four stamps \$1.13. We will send all for only 10c to approval applicants. Globus Stamp Company, 268 - 4th Ave., Dept. 50, New York, N. Y.

NICARAGUA No. 3—12—Catalogs \$12.85. Net 75c. Kusmierz, 5843 Cecil, Detroit, Michigan.

YOU'VE Tried the rest—now get the best! Comparison proves conclusively the superiority of our approvals, premiums, etc. "Challenge Collection" only 10c with approvals demonstrating the distinctive advantages of "Bargain Stamp Service," 1332 South Hope, Los Angeles, California.

B - A - SPORT. Take a chance, send me a dime and see what stamps I shall send you. If not satisfied, dime refunded. A. E. Anderson, 367 Fulton St., Brooklyn, N. Y.

ZANZIBAR—Also Sudan, Somaliland, Tigerstamps, Togoland, Caribbean, Archer, Algerian, Centralamericans, Britishcolonials. This magnificent collection free for 5c postage. Graystampshop, Dept. PM, Toronto, Canada.

FREE! U. S. 30c, 50c. \$1.00 postage dues (cataloging 45c); and 40 other beauties for 3c postage. \$1.00 Lincoln memorial, \$2.00 Capitol, and \$5.00 Liberty current postage values cataloging \$2.37, only 45c. Watermark detector, 2c. 15 different Confederate prints, 10c! United States pricelist, free! Approvals with each order. Tatham Stampco, (D125), Springfield, Mass.

SCARCE New Guinea airmail and Bolivia triangle included in packet of sixty different stamps, including: Andorra, Inini, Monaco, Victoria, French-British Colonies, ship and animal stamps. Only 5c to approval applicants. Potomac Stamp Co., Dept. 104, Washington, D. C.

ILLUSTRATED Album, spaces 4000 stamps; or 19 beautiful Andorra to approval applicants 20c. Swan Stamps, 604 Swan, Dunkirk, N. Y.

WHITE Russia complete! 5c approvals. Valley Stampco, Little Valley, N. Y.

SWITZERLAND, Charity 1935, new complete issue, 3 values; pictures: Prot. sister of mercy roman-cath. deaconess, Henri Dunant the famous red-cross man. The whole issues costs only 15c and will be sent together with an interesting approval-selection franked with rare tete-beche. Atlas Stamp, Ltd., Lugano, Switzerland.

GIGANTIC Collection containing stamps from fifty different countries only 10c with approvals. Walker, 471 Witmer, Los Angeles, Calif.

FREE—25 Different United States stamps to approval applicants. Brownie Stamp Shop, Flint, Mich.

FREE Stamp outfit! Includes scarce triangle; packet handsome ship stamps; complete set airmails; watermark detector; lists and coupons! Postage 3c. Dandy approvals included. Midwood Stampco, Midwood Station, Brooklyn, N. Y.

50 DIFFERENT Unused including U. S. 10c to approval applicants. H. Hunter, Box 531, Clemson, S. C.

QUALITY: 150 Diff. 10c. Fine approvals. Ide Stamp Co., Box 1875m, Milwaukee, Wis.

SET Four Mongolia 3c to approval applicants. Merit Stamp Shoppe, Guilford, Conn.

REALIZE Thrill of filling No. 1 spaces. First stamp of sixteen countries, some old as 1868. Only 50c request approvals. Philatelic Treasure Chest, Box 888, Ventura, Calif.

U. S. And foreign mission mixture. Current and obsolete. Unpicked. 1 lb. 60c net including postage. St. Joseph Convent, Campbelsport, Wis.

ENGLAND. Stamps on old album leaves, colonials, pictorials, sets, etc., are all found in our famous \$2 lots. Absolute satisfaction or money refunded. Ship \$2 bill into envelope today. F. Hughes, Peterborough, England.

UNITED States treasure packet \$25. Casteel, Fort Sam Houston, Texas.

SUPER-WONDER Packet of 60 different stamps, containing scarce Bolivia triangle, stratosphere balloon, French, British Portuguese Colonies, Andorra, Inini, Monaco, Victoria, ship, beasts, etc. Only 6c to approval applicants. Potomac Stamp Co., Dept. 104, Washington, D. C.

A BIG Bargain—All for only 50c. Stamp album, providing spaces for 2200 stamps with 700 illustrations, packet of 500 different stamps, 500 hinges, and millimetre measure. Free with each order our pamphlet which tells "How To Make A Stamp Collection Properly," and our price list of albums, supplies and hundreds of bargains in sets and packets. Queen City Stamp Company, Room 36, 604 Race Street, Cincinnati, Ohio.

SWITZERLAND. Collection of 125 different: early new issues, jubilee charity, peace, airmail, francvalues. Price only \$1. Will be sent together with interesting approvals, franked with rare tete-beche. Atlas Stamp, Ltd., Lugano, Switzerland.

53 EXTRAFINE Newfoundland, Mexico, Canada, Salvador, Brazil only 20c. Approvals. Hart Stampco, 208 North First, St. Louis, Missouri.

FREE!! Three sets French Colonies to serious approval applicants. Bargains—beauties. Postage 3c. Kumler, Cherry, Lancaster, Ohio.

FREE!!! Russia ethnographic set or ten foreign pictorials. Postage 3c. Roberts, 901F Fourth, Baycity, Mich.

SALVADOR Diamond shaped stamp, airmail, triangle, 25 others (no Europe) 10c with penny approvals. Lejac, 902½ South San Pedro, Los Angeles, Calif.

PENNY Approvals by country! Stamp Exchange, Montville, N. J.

FREE \$1.00 U. S. stamp with request for 48 page illustrated price-list of U. S. and foreign stamps. Also fine stamps on approval. Reference necessary. Packet \$10.00 value only \$1.25. New Hussman Stamp Co., 1122 Pine Str., St. Louis, Mo.

CALLING Serious collectors. 10 scarce stamps from 10 different islands, including pictorials, commemoratives. Only 10c provided you desire approvals. Grandstamps, 919 South Grand, Los Angeles, Calif.

4 PESETA Goya Nude of Spain cataloging \$1.00 only 25c; 1 Peseta Nude 12c; 10 Peseta Nude \$1.20; complete Goya set 18 values \$2.25. Approvals included. Paramount Stampco, 66N Nassau St., New York City.

BEAUTIFUL Set—North Borneo. Hinges; approvals; 5c. Ideal Stampco, 418 Maumee, Toledo, Ohio.

ALBUM Free—Spaces for 4,000 stamps, 2,000 illustrations, free to buyers of my approvals. R. Stern, 23-56 Crescent St., Long Island City, N. Y.

BEAUTIFUL New Guinea Bird of Paradise airmail, smallest stamp, Zanzibar, Slam airmail, etc., in wonder packet 40 different stamps, 10c. (No Europe.) Bargain Co., Box 39P, Station H, New York.

\$2.00 U. S. Wine; 10 var. Canada 5c with approvals. L. W. Hudson, 87 Nassau, New York City.

500 U. S. Foreign mixed mission stamps, with approvals, 13c. Goldenrod, Harrisburg, Illinois.

PHENOMENAL Packet—Swaziland, Surinam, Inhambane, St. Pierre, Nigeria, Tunis, and over 100 different others, 10c to approval applicants. Bennett, 27P Washington Square, New York City.

105 DIFFERENT, Hyderabad, Congo, Guinea, etc., 3c to approval applicants. Extra—Airmail set free with above. Hunziker, Box 225-P, Minneapolis, Minn.

30 DIFFERENT Sweden 10c. Fred Onken, 630 79th St., Brooklyn, N. Y.

TRIANGLE And 53 different Liberia, Azerbaijan, Inini, Hyderabad, Kouang-tcheou, Gold Coast, etc. Only 6c. Gardner, 5220 Cuthbert, Baltimore, Md.

ILLUSTRATED U. S. list, price 50c, large complete U. S. price list free. Stanley Gibbons, 38P Park Row, N. Y.

FREE, To approval customers. Beautiful packet, includes airmails, and triangle. Avalon Stampco., 1133 East 82nd, Chicago.

NEWFOUNDLAND, 15 Different 5c with approvals. Hudson Ca., Plainfield, N. J.

25 EGYPT 10c; 25 Uruguay 10c; 25 Luxembourg 15c; 25 Finland 10c. To approval applicants. Ancher Stampco, Rutherford, New Jersey.

WONDERFUL Bargains, limited number. 100 different world stamps also 15 fine Cuban including unused stamp cat. 15c, all for 25c. Dale, Apartado 714, Havana, Cuba.

FREE! Inini, China, radio stamps. Postage 2c. Bremer Co., Milwaukee, Wis.

WE Pay cash for U. S. collections, accumulations, sheets. Send or quote. Justin Stamp Co., Roseville B, Calif.

MALDIVES Islands, Brunei, Charkhari, Turks, Caicos Islands, \$5 U. S., genuine Baden, and imperforated "Park"—Absolutely free to approval applicants enclosing 3c postage. Viking Stamp Co., One Hanson Pl., Brooklyn, N. Y.

25 ASIA 3c With approvals. Tulla, Box 76, Flatbush, Brooklyn, N. Y.

1000 GOOD Mixed foreign, 25c. Mailed with imperforate stamps. Mission Stamp Mart, Brookland, D. C.

U. S. \$5 postage due, 5c. Approvals. Dennie, 8103 Longworth, Detroit.

60 DIFFERENT Grottesque stamps. Odd designs; freaks; fantastic shapes. \$1.00. South Texas Stamp Co., Box 726, San Antonio, Texas.

HANDSOME Album, hinges, packet fascinating stamps only 10c with approvals. Highland Star Stampco, Salamanca, N. Y.

UNITED States! Reasonable to serious collectors. Box 114, Minneapolis, Minn.

WATCH Your change for valuable coins. We buy—Pennies bring you up to \$500.00; nickels up to \$100.00; dimes up to \$300.00; quarters up to \$300.00; half dollars up to \$750.00; other coins up to \$2500.00. Send 10c for coin list, and amounts we pay. Publix, BP-7343 Cottage Grove, Chicago.

UNITED States! Br. Col. approval service! Reasonable! Box 95, Minneapolis, Minnesota.

APPROVALS—Foreign, United States. Choice selections. Free lists. Huber, 505 Hennepin, Minneapolis.

1000 U. S., including commemoratives, precancels, high values to \$5.00, etc., 25c. Lee, Bridgeport, N. Y.

½c UP Approvals. 100 different samples 5c. Eisinger, 768 Fox Street, New York.

FREE!! Costa Rican triangle, Picard balloon, 50 others, to approval applicants. Send 3c postage. W. P. Stamp Co., 1427 Franklin Ave., Bronx, N. Y.

APPROVALS Against references. Premiums with substantial purchases. Anchor Stamps, Box 445, Battle Creek, Mich.

50 BRITISH Empire including commemoratives and pictorials 5c to approval applicants. Mantle Stamp Company, London, Canada.

EARN Cash, stamps—Sell approval books. Ellison, 2841 West 37th Street, Brooklyn, New York.

DEALERS: 164 Page wholesale catalog for 50c deductible on first purchase. Grassman Stamp Co., 102 West 42nd, New York.

GOYA Nude stamp \$0.10 to approval applicants. "Jewells," Tamaqua, Penna.

FREE Packet, 3c postage. Approvals sent. References. Murchison, 530 Chestnut, Long-Beach, Calif.

JOHORE: 6 Varieties 5c to approval applicants. Allion, Angola, Ind.

25 FINLAND, 25 Norway, 25 Switzerland, 10c each. Price lists free. John Graf, 1874 Loring Place, New York.

55 VARIETIES including Basutoland, Soruth, Lipso, Samoa, Corea and Spanish Morocco together with price list, only 5c to approval applicants. Belmont Stamp Co., 4741 Fulton St., Chicago, Ill.

BEAUTIFUL Spanish triangle given to those requesting our 3c approvals. Collectors Stamp Service, Box 118, Phoenix, Ariz.

BROBDINGANAGIAN Collection, pictorial commemoratives, including Libia, Charkhari, Eritrea, Australia, etc., 10c with approvals. Swalley Stampco, 1119 Trenton, Los Angeles, Calif.

800 U. S. including 19th century commemoratives, airmails, 25c. Wholesale Stamp Mart, Carroll, Iowa.

FREE! Pricelist. Two U. S. \$5.00 stamps 10c! No. 320—35c! Vanvoorhis, Hyndman, Pennsylvania.

22 DIFFERENT U. S. mint commemoratives, \$1.03. Parks excluded. R. A. Lynch, Box 56, Peoria, Ill.

GIVEN! Borneo, Fiume, Kedah, Iceland, Azerbaijan, Danish-West Indies and 100 other different stamps, also special gift for only 10c to approval applicants. Paramount Stamp Co., 4225 Broadway, Chicago, Ill.

FREE! Album, stamps, hinges. 10c postage. Panzers, 5339 George, Chicago.

FREE! 15 Different Peru to approval applicants, enclosing postage. Ranson, 3307 Adams, Chicago.

FREE—Beautiful airmails from six countries, to approval applicants enclosing postage. Green & Co., Norwood, Ohio.

ARABIA, Mongolia, Schleswig, 50 others 6c with approvals. Ransom, 1333 Pontiac, Ann Arbor, Mich.

BELGIAN Mourning, Greece airmail, Manchuko, others, 6c. Attractive approvals. Lists. Keating, 260 (P) Clinton, Jersey City, New Jersey.

PENNY Approvals loaded with real bargains. Taylor, 6122 Woodlawn, Chicago.

110 DIFFERENT Stamps only 3c to approval buyers. Badger Stampco, Milwaukee, Wisconsin.

MISSION Stamps, list free. Mission Company, 4512 North Racine, Chicago.

166 COMMEMORATIVES, Etc., 13c; 500, 33c; 1000, 60c. Bx. 457, Newark, N. J.

ABSOLUTELY FREE. 200 stamps. Approvals. 3c postage. Donovan Stampco, Milwaukee, Wis.

FINE Approvals United States, Philippines. References required. Philus, Geneva, New York.

\$1 TO \$10 U. S. free, with packet of 40 different—25c. Regal Stampco, 1224 North 19 St., Philadelphia, Penna.

80 ASSORTED Switzerland 5 cents. Lufbery, 213 Pine, Middletown, Conn.

FIFTY Different, including Azerbaijan, Latakia, Hyderabad, free with approvals. Bodwitch, 36 Gordon, Somerville, Mass.

PENNY Approvals, 5,000 Sudan, Congo, Nyassa, Liberia, etc. Also 15,000 averaging 1 1/2c. Philatelic Exchange, Asbury Park, New Jersey.

PACKET Manchuko, Liberia, Serbia, etc., 5c. Approvals. National Stamp Distributors, 816 Warner Avenue, Los Angeles, Calif.

3 BEAUTIFUL Sets! 105 different stamps! 10c with approvals. Aladdin, 1550 Carroll, St. Paul, Minn.

UNITED States mint, used. Single, blocks. Lists free. Leckie, 4512 North Racine, Chicago.

SCARCE Egypt and Roumania airmails; also famous Belgium Picard balloon commemorative and large packet British Colonies. All for 7c to approval applicants. Eureka Stamp Company, Box 602-P, Burbank, Calif.

30 DIFFERENT Angola, Cape Verde, Guinea, Portugal, Mozambique, St. Thomas—5c. Depraw, Ocean Park, Calif.

STAMP Dealers, your ad here will bring wonderful returns. Ask me for proof. F. W. Johnson, Manager, Classified Advertising, Popular Mechanics Magazine, 200 E. Ontario St., Chicago.

IMPERFORATE National Park, 2 diff. and 33 U. S., including early issues; high values; commemoratives; airmail; envelopes; special delivery; postage due; revenues cataloging over 85c. All for 7c to approval applicants. Illustrated pricelist free. Curhan Stamp Co., Dept. P, Gloucester, Mass.

FREE Dollar packet to one cent approval applicants. Harlan, 5307 S. Marshfield Ave., Chicago, Illinois.

BEST One cent approvals in America. F. Hand, 1117 So. 60th St., Philadelphia.

STAMPS Sent on approval. 50% discount. Fred Herzberg, 197 Grantley Ave., Elmhurst, Illinois.

200 DIFFERENT 10c. Big 50% approvals. Covert Stamp, 39 State, Rochester, N. Y.

THIRTY Large commemoratives only 10c to approval applicants. Ace Stamp Co., Erie Bldg., Cleveland, O.

SCARCE Hawaii!!! Bolivia triangle! Packet of unusual stamps containing old Hawaii, scarce Bolivia triangle, famous money stamp (printed on cardboard and also used as currency!); airmails from Mexico and Paraguay; map, ship, animal, commemorative, etc. No Europe. Only 10c to approval applicants. De Soto Stamp & Coin Co., 105 N. Clark St., Chicago, Ill.

AMAZING Value—35 different U. S. early commemoratives, air mail, etc., 10c to approval applicants. Stamp Shop, 809 Holland Bldg., St. Louis, Mo.

SCARCE Airmail and triangle. Beautiful Uruguay "flying horse" airmail and scarce Guatemala triangle (smallest in the world) are included in our big packet of 60 different stamps from Alouites, Grand Liban, Venezuela, British and French Colonies, etc. All for 5c to approval applicants. Big illustrated lists free with each order. Write today! Mystic Stamp Co., (Dept. 80), Camden, New York.

AIRMAILS—Brazil, Chile, Columbia, Ecuador, Mexico—all for 10c with double premium penny approvals. Progress Stamp Service, Franklin Park, Ill.

THIS Ad worth 25c. If you send for our approvals and buy 50c worth or more—large selection of U. S. and foreign—reasonable prices. Morton Stamp Co., 1121 Olive, St. Louis, Mo.

ECUADOR 20 Different including commemoratives, airmail only 10c. to serious collectors desiring our dependable approvals. Dependable Stamps, 716 North Kilken, Los Angeles, Calif.

FREE Outfit! Pocket wallet, hinges, watermark detector. Packet stamps from South America, Asia, Africa, etc. Postage 6c. Approvals. Maxwellton Stampco, Piedmont, California.

200 DIFFERENT Stamps, triangle, airmail, etc., 10c. R. H. Carlton, 209 W. Fourth, Los Angeles, Calif.

STAMPS: 100 Different catalogue over \$2.00 with catalogue 10c. Norman Shultz, Salt Lake, Utah.

TRIANGLE From Costa Rica, Venezuela airmail, many scarce stamps, blank album, perforation gauge, hinges, watermark detector, millimetrescale. Price 5c with approvals. Mohawk Stampco, Box 932, Mar Vista, California.

\$2.50 CONSULAR Service stamp, 5c with approvals. Chipless, 7080 Cahalan, Detroit.

SCARCE Morocco airmail, Eritrea camel stamp, maps of stamp countries, watermark detector, hinges, perforation gauge, stamp album, many scarce stamps, 5c with approvals. Superior Stampco, Box 8276, Palms Station, Los Angeles, California.

20 LICHTENSTEIN. 03c To approval applicants. Sodak Stamps, Sioux Falls, S. D.

GORGEOUS Packet 3c. Approval applicants only. Harvey Teeple, Decatur, Ind.

FOREIGN Or United States mixture \$1.00 per pound (about 4000). Sample 1/4—25c. Approvals sent. Elmer's, 192A Washington St., Boston.

MAGNIFIER, Stock book, stamp album, hinges, watermark detector, perforation gauge, millimetrescale, packet scarce stamps. Price 5c with approvals. Atlas Stampco, Box 4025, Culver City, California.

LARGEST Bi-colored United States stamp ever issued! Roger Clark commemorative and 15 different from Canada, Mexico, Newfoundland, U. S., including \$1.00 postage, \$2.00 revenue, imperforate park. All for 8c to approval applicants. Clipper Stamp Co., Dent, 7, Gloucester, Mass.

WHOLESALE Monthly—Sample copy sent free. Empirestamp, Dept. MP, Toronto, Canada.

WEEKLY Stamp magazine, thirteen weeks, 10c. Stamp Journal, Kalamazoo, Mich.

PENNY Approvals, that satisfy. Neil Gronberg, Box 5441-P, Philadelphia, Pa.

SWITZERLAND Mixture. Finest on market. Packages 3,500 for \$1.00. Satisfaction guaranteed. Charles Rose, Maywood, Ill.

GIANT Triangle and Zeppelin! World's largest triangle stamp from Spain and scarce Russian Zeppelin; also big packet of 53 different stamps, including Azerbaijan, Epirus, new Martinique, etc., and illustrated lists—all for 5c to approval applicants! World-Wide Stamp Co., Box 600, Camden, N. Y.

WHOLESALE Catalog for dealers. Illustrated. Postage 5c. Frank Company, 4900 Chalmers, Baltimore, Md.

CANADA \$1.00 "Mountain"—rare, and 30 other Canada only 30c. World specials—500 different 30c; 1000 different 85c; 2000 different \$2.50. Approvals with each order. Canadian catalog 10c. Victoria Stamp Company, London, 4, Canada.

UNITED States stamps—40 different with pricelist 10c. Seidenberg, Baroda, Mich.

50 OLD Stamps 1c. Album 3c. Bullard, 446 Tremont, Boston.

RARE COINS

TOP Prices paid for all rare coins including pennies. Join our club and receive reliable information on the value of coins. We buy for cash all old coins in demand. Send two dimes for complete buying catalog and membership card entitling you to club privileges. Mail 20c today. Reliable Coin Market, DD-702 East 63rd, Chicago.

TWENTY Assorted coins 25c. 100 coins \$1.00. Otto Oddehon, Williamstown, Kans.

RARE United States, foreign coins, war medals. Catalogue 10c. Mengelle, Colorado Springs, Colorado.

INDIAN And Lincoln head pennies wanted. Will pay up to \$2.00 each if over ten years old. Certain pennies worth \$53.00. Latest listing 10c. American Coin Co., Box 219, Grand Rapids, Mich.

10c EACH: Flying Eagle cents, large cents, Civil War cents, 2c pieces, 3c pieces, nickel cents. Lenz, 50 Station L, New York City.

PREMIUMS! We offer up to \$2500.00 each for rare coins. Big money for certain Lincolnhead cents now in circulation. Send 10c today for All American buying list. Coin-Stampmart, M6720 Jeffrey, Chicago.

15 DIFFERENT Coins, including two United States before 1866. Coin Exchange, Box 2554, Kansas City, Mo.

RARE Celebes rooster coin and lists only dime. W. Webb, Box 1854, St. Petersburg, Florida.

LINCOLN and Indian head pennies wanted: Will pay up to \$2 each if more than 11 years old. U. S. cents worth up to \$500. Send 10c for catalog. Box 731-AE, National Coin Co., Milwaukee, Wis.

OLD Money wanted. Will pay fifty dollars for 1913 Liberty head nickel (not buffalo). I pay cash premiums for all rare coins. Send 4c for large coin folder. May mean much profit to you. B. Max Mehl, H Mehl Bldg., Fort Worth, Texas.

50,000 COINS, Medals, paper money lists free. Nagy, 8 P South 18th Street, Philadelphia, Pa.

TEXAS, Maryland, Kentucky commemorative half dollars \$1.50 ea. 3c piece and selling catalogue, 10c. Norman Shultz, Salt Lake, Utah.

UP TO \$300 paid for dimes dated before 1895; Liberty head nickels \$200; pennies \$25.00. Send 15c complete 1935 catalogue. Nationaleoin Company (BB), Springfield, Massachusetts.

SPECIAL Prices on United States commemorative half dollars in uncirculated condition; Columbian 69c; Lincoln \$1.23; Pilgrim \$1.19; Grant \$1.23; Monroe \$1.19; Lexington \$1.29; Stone Mountain 89c; Bennington \$1.29; bargain selling price list and California 50c gold token 25c. Arcy, Box 483, Muskogee, Okla.

WE Purchase all Indianhead pennies. Purchasing catalogue—10c. Brownlee Numismatic, 218 Henry, New York.

UNITED States. Large cent, 2c bronze, 3c nickel and bargain list, 25c. Thirteen dates large cents, \$1.00. George P. Coffin, Augusta, Maine.

HIGHEST Prices paid for Indian head pennies. Send dime for list of those wanted. Coin Shoppe, Box 407-PM, Ottawa, Ill.

\$2000.00 FOR 1c. We pay the world's highest prices for old coins, encased postage stamps and paper money. Large cents up to \$2000.00 each, half cents \$250.00, 1909 cent \$10.00, Indian head cents \$50.00, half dimes \$150.00, 25c before 1873 \$300.00, 50c before 1879 \$750.00, silver dollars before 1874 \$2500.00, gold dollars \$1000.00, trade dollars \$250.00, 1822 \$5 gold \$5000.00, old paper money \$26.00, encased postage stamps \$12.00, certain foreign coin \$150.00, etc. Send dime for large illustrated list. Romano-coinshop, Dept. 424, Springfield, Mass.

FREE!—Foreign coin, banknote, and large illustrated coin catalogue,—4c postage. Souvenir California gold quarter size 26c; 1/2 size 53c; both 65c! Round or octagon, set of each \$1.30! Approvals with each order. Tatham Coinco, Springfield, Mass.

WE Buy 1907 Indian head cents. Full information one dime (coin). Mattick, Box 3450, Altoona, Pa.

WANTED. Old U. S. money. Walter F. Allgeyer, Box 192, Newark, N. J.

\$5.00 TO \$500.00 Each paid for old coins. Keep all old money. Send 10 cents for illustrated coin value book. 4xc. Guaranteed prices. Buying and selling. Coin Exchange, Box 5, Le Roy, N. Y.

FOUR Crisp notes, one foreign copper before 1800 with catalog 10c. Geo. Best, Cedar Rapids, Iowa.

11 DIFFERENT Coins, 3 bills and catalog. 25c. Creamer's, 1112 Somerset, Baltimore, Md.

CAMERAS, PHOTO SUPPLIES

A-1 PHOTO Finishing outfit complete, \$2.50. Everything needed; easy instructions. Fascinating hobby. Save, make money. Burnam's, 4334 Melrose, Jacksonville, Fla.

FREE Photographic bargain book listing thousands of money saving values in cameras, lenses, materials, for still or movie pictures. Complete line at lowest possible prices. Central Camera Co., Dept. K4, 230 South Wabash, Chicago.

POCKET Photo monthly, Canton, Ohio, \$1.50 year. 15c copy. Trial four months 50c. Photo contest each month. 52 pages each issue about photography—developing, printing, enlarging, selling your pictures, etc.

EARN Money with your camera. No selling. Send three dimes for new, successful, copyrighted plan. Camera System, Box 761, Tampa, Florida. No free literature.

MAKE Money in photography. Learn quickly at home. Spare or full time. New plan. Nothing like it. Experience unnecessary. American School of Photography, Dept. 3432, 3601 Michigan Avenue, Chicago.

HAVE You a camera? Send ten cents for recent number of our big magazine, showing how to make better pictures and earn money. American Photography, 116 Camera House, Boston, 17, Mass.

INCOME From your camera instead of expense. Low cost home course teaches you to make photographs for magazines, newspapers, advertisers. Tremendous demand. Earn good money wherever you live. Free book. Universal Photographers, Dept. 104, 10 West 33rd St., New York.

PHOTO FINISHING

ROLLS Developed—Printed 25c. Mail your films to the biggest and best! Rolls developed and 8 good prints guaranteed plus 8x10 inch enlargement coupon only 25c. Reprints, any size, 3c each. Geppert Studios, Dept. 130, Des Moines, Iowa.

TRIAL Offer. Roll developed and 8 prints 25c. Reprints 3c each. Beautiful 10-inch enlargement 25c. Young Photo Service, 405 Bertha St., Albany, N. Y.

"PENNY Pictures" or any photos enlarged 5x7, 20c. Negatives free. Bromar, Pontiac, Michigan.

ENLARGEMENTS 4x6. Five for 25c. 5x7 three for 25c. 8x10, three for 35c. Special hand colored easel mounted 4x6 enlargement 25c. Two crystal stipe enlargements with each roll developed and printed 25c. Enlargers, 1652-8 North Western, Chicago.

ROLLS Developed—Eight guaranteed Nu-border prints. Two Nu-border enlargements, 25c coin. Giant Snapshots, Inc., Dept. A, Green Bay, Wis.

ROLL Film developed and printed on deckle edge paper in neat album 25c. Swan Photo Co., Dept. X, Box 975, St. Louis, Mo.

ROLL Developed, two prints each negative 25c. Nutone, 1652-8 North Western, Chicago.

FREE Reprints as samples. Send two negatives. Adams Photo, 11-D2 Lincoln, Dorchester, Mass.

FREE—\$2.00 Movie star powder-perfume set with each roll developed and printed, 25c coin. P. O. Box 888, World's Finest Service, Kansas City, Mo.

COLORED Photography here—Prints in vivid fadeless colors. Any ordinary roll developed and photochrome printed, 35c coins. Reprints, 4c. P. O. Box 888, Kansas City, Mo. Sole American Producers.

BEAUTIFUL Art-panel enlargement with "Trial Order." Roll developed and 8 prints 25c coin. Ideal Photo Service, Box 2255, Paterson, N. J.

SEND 10c For "Tricks and Technique of Developing, Printing, and Enlarging." Eastern Scientific Co., Dept. P4, Box 294, Plainfield, N. J.

BEAUTIFUL 12 inch enlargement from favorite negative 35c, 3 for \$1.00, from one or three negatives. Moran Enlargement Service, 7526-P Eggleson, Chicago.

ROLL Developed, printed, and two enlargements 25c coin. Reprints 3c. Immediate service. Twin City Photo Mill, Box 2077Z, Minneapolis, Minn.

SPECIAL Trial offer! Your next Kodak film developed 5c, prints 2c each. Moser & Son, Dept. 23, Walnut Hills, Cincinnati, O.

MAKE Extra money with your kodak. Booklet describing 100 magazine markets, 25c coin. Clayton Dawson, Route 5, Coshocton, Ohio.

ROLL Developed, eight prints, and enlargement 25c. Fred Cox, Palmer, Texas.

"SUMMER'S Service Satisfies." That is why we have one of the largest studios in America. Our new modern equipment guarantees you good pictures whether your negatives are underexposed or overexposed. We develop any size kodak film, give you 2 prints of each negative and 2 free enlargement coupons for 25c. Summer's Studio, Unionville, Missouri.

20 REPRINTS 25c. 100 Reprints \$1.00. Rolls developed with 16 prints 25c. Photo-shop, 4, Maywood, Ill.

ROLLS Developed, two beautiful Nu-border enlargements, eight Nu-border prints, guaranteed fadeless, 25c coin. Giant Snapshots, Inc., Dept. A, Green Bay, Wis.

PHOTO Reproduced on ring. Send \$2.00, photo, and size. Park Specialty, 219 Park Place, Brooklyn, N. Y.

TWO Professional enlargements with each roll developed and printed 25c. Eight reprints, two enlargements 25c. Hygloss, 8, River Grove, Ill.

30 BEAUTIFUL Guaranteed kodak prints from your negatives only 25c. Rapid Film Service, Unionville, Mo.

EARN Money in spare time developing and printing pictures. Easy. No experience necessary. Professional developing set contains complete supplies for perfect results \$1.79, (C.O.D. \$1.99.) Philmore Co., Dept. P.M. 1123 Broadway, New York City.

ROLLS Developed. Two beautiful double-weight professional enlargements and 8 guaranteed Never Fade Perfect Tone prints, 25c coin. Rays Photo Service, LaCrosse, Wisconsin.

FILMS Developed 5c per roll; prints 3c each. Ask for special bargain list. Roanoke Photo Finishing Company, 161 Bell Ave., Roanoke, Va.

20 REPRINTS 25c. Films developed, two prints each negative, 25c. Skrudland, 4118-8 Overhill, Chicago.

YOUR Favorite kodak pictures enlarged, size 5x7, 10c. Three for quarter, coin. Send best negatives (film) today. Address Darmer Photo Lab., Enlarging Dept. 9, Des Moines, Iowa.

COLORED Enlargement with each film developed—a professional enlargement painted in oils and eight Gloss-tone prints. DeLux finish, guaranteed not to fade, 25c. Super quality. Speedy service. Satisfaction or money refunded. LaCrosse Film Company, LaCrosse, Wis.

FILMS Developed any size 25c coin including two enlargements. Century Photo Service, Box 829, La Crosse, Wis.

KODAK Pictures enlarged, 5x7 10c, 3 for 25c. Send negative film. Stanley Studio, Des Moines, Iowa.

MOTION PICTURE AND SOUND EQUIPMENT

BASS. Cine headquarters, offers astounding value in new special 100 ft. Keystone 16 mm. camera, seven speeds including slow motion, interchangeable lens mount, fitted with F:3.5 Anastigmat lens at \$32.95. Or with 1" Wollensak F:1.5 Anastigmat in focusing mount at \$59.95. Money back guarantee. 100 ft. Dupont Mono film including reversing at \$2.95. 200 watt Keystone Special projector, motor driven, at \$23.75. 400 watt biplane Ampro Model A projector, new latest type, \$135.00 value, complete with case, \$99.50. Willo Cinemeter, regularly \$9.50 at \$5.15. Order direct from ad. Send for latest Bass Bargaingram No. 214 of 16 mm. apparatus. Library service available in 21 states. Send for catalog. Bass Camera Company, 179 W. Madison St., Chicago, Ill.

16MM RENTALS; Catalogue 3c. Reidel, 352 East 248th, Euclid, Ohio.

DEVELOP Your own movies, reversal and negative-positive process, 50c. Millio, 620 Myrtle Ave., Brooklyn, N. Y.

16MM FILMS:—Art 10c foot. Mickey-Mouse, Chaplin, Silly Symphony 5c foot. Big features rented anywhere \$5.00. Lists. Thousand feet 35mm \$1.00. Features \$7.50. Projectors, cameras \$5.00 up. Waldo Films, Box 524, Cincinnati.

SMM FILMS: Mickey Mouse, travel, others. List for stamp. Lincoln Film Service, Box 293-A, Saginaw, Mich.

\$50,000 FILM Sale, 64-page catalog 10c. List free. Scholefield, 6801 South Carpenter, Chicago.

16 MILLIMETER Club reels. Blackstone Exchange, 515 South Luffin, Chicago.

FREE—16 mm, 8mm Bargain lists. Films 35c up. Projectors \$3.75 up. Art sample 25c. Home Movies, Box 32, Easton, Penna.

PROJECTOR And roll art film \$2.50. Catalog 16mm. movies 10c (coin). State type of movie desired. Home Movies, 22 E. Van Buren, Dept. 16A, Chicago.

SMM—16MM Movie equipment. "Easy terms." Send stamp for catalogue. Elder, Dept. B-10, Chelsea, Mass.

35MM COMPLETE Stories only. Stamp for lists. Bargains, Calderara, 5119 South St. Louis, Chicago.

SMM USERS: New economical film; new accessories; new ideas. Information free. Corne, Box 177-A, El Monte, Calif.

MOVIE-MAKER 16mm 400' Projector complete \$7.49. Camera \$3.79. Filmo projector \$75.00 like new. Victor Soundisc projector \$85.00. Soundfilm \$293.50. Library silent, sound. Catalogue camera film 100 ft. \$2.50 with processing. Mogull Bros., 1944-J Boston Road, New York City.

100 FEET 35mm Film 27c. Lists 3c. Hoffman Film Service, 57 Broad, Albany, New York.

WORLD'S Greatest "Passion Play" 16 MM. (new) 5 reels. Rent or purchase. Write Hemenway Film Co., 37 Church Street, Boston, Mass.

1000 FEET 35mm 75c. Projectors. Features. Savarese, Woodliff Lake, N. J.

35-MM FILMS, Projectors, Stamp for lists. Box No. 6, Rosedale, Kans.

16mm FILM Subjects—50% saving. Film rental library. Big catalogue, two "end" titles sent for dime. Eastin Films, Dept. 35, Galesburg, Ill.

LEARN Motion picture theatre business. Catalog free. Theatre Institute, 325 Washington, Elmira, N. Y.

RADIO SUPPLIES—INSTRUCTION

SOUND Systems—Make extra money renting amplifiers for all occasions. Hilet, Orange, N. J.

REGULAR 50c Million Point, British made, long distance radio crystals. Special offer, limited time, three for \$1.00, postpaid. Radio Supply Company, E608 Edmonton, Alberta, Canada.

FREE Electricity—6 volt wind generator for radio, lights, battery charging. Currier Mfg. Co., 402 Terminal, Minneapolis, Minn.

RADIO Experimenters and set builders. Parts and kits of parts for the Economy Three Tube, five and four tube Little Giant, auto radio and portable battery set described by Popular Mechanics. Lund Mfg. Co., Dept. PMA, 1730 Foster Ave., Chicago.

LONG Distance crystal radio easily made. Crystal and instructions, 15c. Music Sales, Independence, Mo.

DISTITE \$1.50 Pocket radio only 45c, postpaid. Music Sales, Independence, Mo.

WANTED! 100,000 Used radios. \$5.00 to \$15.00. Rush description for offer. Super Dual Radio Co., Sacramento, Calif.

NEW Long distance crystal receiver. Blueprint, 17 others 25c coin. Particulars free. Modern Radiolabs, 151-C Liberty, San Francisco.

REWIND Old meters to modern types. Instructions \$1.00. Link Laboratories, Box 437, Kirksville, Mo.

RADIO Engineering, broadcasting, aviation and police radio, servicing, marine and Morse telegraphy taught thoroughly. All expenses low. Catalog free. Dodge's Institute, Ames St., Valparaiso, Ind.

RADIOS—Farm or auto. World's cheapest. Catalog free. Sample offer. J-20th Century Co., Kansas City, Mo.

MUSIC AND MUSICAL INSTRUMENTS

PLAY Piano by ear. Complete course, \$1.00. Box 332, Washington, Ind.

NEW Deal. Write Sequoia Songwriters Service, Sherman Branch, Los Angeles, Calif.

SONG Writers. Start your song on the road to popularity. Write Al. Moquin, 22-23 37th St., Astoria, N. Y.

REBUILT Band and orchestra instruments. Honestly rebuilt—fully guaranteed. Catalog of new instruments on request. Weymann Company, Dept. M-4, 13th and Arch Sts., Philadelphia.

PIANO By ear. No notes. Twenty easy lessons including song writing. Dollar bill. Home University Press, Box 545, Dallas, Texas.

MUSIC, 8c Per copy. Send 6c for samples and catalogue. 212 Exchange Bldg., Spokane, Washington.

COMPOSERS, Verse or music. Brilliant opportunity. Write immediately. Burrell VanBuren, 1105 McClurg Bldg., Chicago.

SONGWRITING. Good money being made from songs through talking pictures, radio, phonograph, music publishers. "Hit" writers revise, arrange, compose music to your lyrics, lyrics to your music. We submit to studios and other markets. Free reading. Send for booklet. Universal Song Service, 671 Meyer Bldg., Hollywood, Calif.

MUSIC Composed to words. Wonderful proposition. Bauer Bros., Oshkosh, Wis.

SONG Writers. Send for our "Publishing Agreement." McKinley Music Printers, 1501 E. 55th St., Chicago.

SONG Poems wanted, free examination, 50-50 plan. Song Bureau, Salem, Ind.

DUO-FLEX Reeds for clarinets, and saxophones eliminate your reed troubles. Write for circular. Duo-Flex Reeds, 1204 1st Ave., Evansville, Ind.

WRITERS! Poems, music. Amazing offer. Hibbler D1, 2157 North Avers, Chicago.

BUSINESS OPPORTUNITIES

MAKE Miniature pottery novelties. Instructions 10c. Curtis, 3329 Lafayette St., Denver, Colo.

"TURN Ideas into cash." Free details. Martinez-PM, San Bernardino, Calif.

PATENTS—Before too heavy an outlay of time or money is made on an invention, a search of the Patent Office records should be made to determine as nearly as possible whether or not the same idea has been patented before. The cost of this search is small, while the value of the facts it uncovers is often considerable. We offer inventors and manufacturers a thorough, prompt, confidential search service—plus experienced counsel and assistance in every phase of Patent and Trademark practice. Write for my free book containing valuable information relating to patent procedure. Clarence A. O'Brien, Registered Patent Attorney, 58-Y Adams Building, Washington, D. C.

MAKE Big income in the collection agency business. Write Cole Associates, Tower, Syracuse, N. Y.

COMPLETE Service from development of formula to shipment of finished product under your own label. Overton Laboratories, 4648 Hollywood Blvd., Hollywood, Calif.

400 TO 500% Profit by making and bottling herb tonic, vanilla, shampoo, polish, etc., using our low priced concentrates. One sample free. John Hagen Co., Saginaw, Mich.

HOME Workers Digest—50 pages money-making plans, offers. Copy and free subscription offer 10c. Box 51-pm, East Orange, New Jersey.

DOLLARS Daily! Operate profitable mail-order business. Details. Duffy, Covington, Kentucky.

MAKE Money indexing telephone directories. Hanlan, 2911 Van Buren, Los Angeles, Calif.

CASH Income daily resilvering mirrors; replating metalware; making glass signs. Portable outfit. Sprinkle, Plater, 127, Marion, Ind.

58,000 ADDRESSES Mailorder buyers and agents. 1934 business—200, 25c; 1,000, \$1.00. Elgac Sales Co., Centralia, Ill.

WANTED—5,000 Men to buy slightly used college clothing. Business established since 1912. Free catalogue. Yale Clothing Company, Meriden, Conn.

LARGE, Steady profits. Make products yourself. Catalog free. Allied Research, 2217 N. Kilbourn, Chicago.

ARTIFICIAL Marble sanitary flooring, instructions covering wood or cement flooring 1/2 inch thick, fireproof, all colors, low cost, ornamental casting, concrete, plaster, papier-mache, garden furniture, statuary, flexible molds, particulars free. Chris. Mahler, Elmont, N. Y.

SUCCEED With your products. Formulas, Processes, Analytical service. Catalog free. B. Thaxly Co., Washington, D. C.

TWENTY New successful mailorder propositions. J. Home, 3949 Metropolitan, Chicago.

WIN Thousands cash! Send 25c. World Contests Magazine, 3 months. B949C, Seattle.

EARN Quick cash raising mushrooms in cellar, shed, attic. We buy crops. Guaranteed materials furnished. Easy, odorless method. Book free. United, 3848-BZ Lincoln Ave., Chicago.

GET Lots of mail. Your name in 10,000 opportunity directories, 25c. Roseco, 4627 Glenside, Cincinnati.

STAMP Brings clever money-making idea. "Exchange," 926 77th, West Allis, Wis.

STOP Working for others. Start profitable business at home. Key to Business Opportunities shows how free. Write. The Perry Company, 31 Bedford St., Boston, Mass.

VALUABLE Booklet describing hundreds of profitable mail order business free. Mail Order Service, S. Round Brook, N. J.

PRINT With Screenagraph. Reproduces oil paintings, designs, letters, sketches, in brilliant artists colors: on canvas, paper, wood, metal. New hobby, profession. Complete \$12.50. Beautiful sample 25c. Representatives wanted. McDaniel Co., 215 N. Fourth, Columbus, Ohio.

LEARN All about casting marble novelties in rubber molds. Cement secrets. Illustrated catalog and beautiful samples 3c. (So. Calif. business reserved.) John A. Payn, 945 Grande Vista Avenue, Los Angeles, Calif.

HOME Mailing stunts! Very fascinating and profitable. Further particulars 6c postage. National Services, Fairview, Birmingham, Ala.

FREE—Literature. Describing many money making plans. Shaw, 17 W. 125, New York.

COLLECT \$\$\$ Daily. Choice plan. Ten formulas. 50c coin. "Stonewall," 4749 - 36th, San Diego, Calif.

BARGAINS—Paint spray outfit, gasoline engine drive. Terms—trial. Helmick Paint Spray Exchange, M-455, Troy, Ohio.

24 LEGITIMATE "Home-office" profit-making plans, 25c. Free particulars. Educational-Service, 4932 Eighth, Philadelphia.

MONEY-MAKING And money-saving opportunities for you in our "Opportunity Envelope." Send 3c stamp for yours. Highlander Bros., Orange, Va.

RESILVER Mirrors. Plate auto fixtures, tableware. Portable outfits. Metalcraft, Arcade Bldg., St. Louis, Mo.

MONEY Making offers for dime. Free—Five double edged blades. Brandell, 817 1/2 Washington Ave., Des Moines, Iowa.

BETTER Business opportunities. Details, catalogue, 10c. "Nu-Era" Service, PA-140 Windemere, Detroit.

NEW Booklet—"The Trick of Touch Typewriting." Distributors wanted. Sample copy 10c. Island Press, 8236 Cornell Ave., Chicago.

CONCRETE Garden frogs. Metal mould makes hundreds quickly, 3x5 inches, \$1 prepaid. Bird bath mould \$15. Lamb grave marker. Owen Gardenware, 2500 Grinstead, Louisville, Ky.

MONEY In mail order business. 24-page book, 1935 edition, free. Midas Research League, Minneapolis, Minn.

DIME Brings big 60-page magazine spare-time money-making stunts, 3 months. Ward South, Fergus Falls, Minn.

START Mailorder business. Little capital. Guaranteed plan. 25c. Leewood, 1328 South 51st, Philadelphia.

BE Independent! Easy money-making plans 20c. Dowling, Dunellen, N. J.

FREE! Literature describing newest formulas, ideas, business plans. Barrett, 4241 Keystone, Chicago.

PROFIT With new products. Make, sell, repeat. Guaranteed formulas, special prices, leads. Biggest catalog free. Gibson, Chemist, BD-4702 No. Racine, Chicago.

SEVENTY-FIVE "Secret" opportunities, supply sources, free offers, etc., 25c. International Agency, P-4, Cincinnati.

START Your own business. Three money-making formulas with plan only 10c. Tuck, 6823 Arizona, Hammond, Ind.

STEADY Income from drained auto oil or discarded inner tubes. Instructions 25c. Charles, 12-AT, Norwood, Ohio.

BIG Money income illustrated booklet 3c. Morrow, 468 Sixth Avenue, Brooklyn, N. Y.

SWAP! Buy! Sell! Anything!! Anywhere!!! Six months subscription and 25 word advertisement once—25c. Traders-Exchange, Brookings, S. Dak.

MANUFACTURE New, fast-selling novelties, toys, preparations, wood, metal and molded items. Free list patterns, processes. Manufacturer's, 3937A Tracy, Kansas City, Missouri.

"Earn Cash at Home." \$1.00 business plan. 100 cash customers names and valuable imprint circulars all for 25c. Southern Publishers, Box 1626-PM, Savannah, Ga.

LEARN Motion picture theatre business. Catalog free. Theatre Institute, 335 Washington, Elmira, N. Y.

EXCELLENT Income opportunity for serious minded men to own and operate a ready made business. Enormous increased demand for our electric burial protection service makes territory extensions advisable. Kindly outline business experience. Standard Alarm System, Inc., 75 Pearl St., Hartford, Conn.

GROW Mushrooms all year round—A steady income indoors, in cellar, shed or stable. Exclusive new process. Bigger, better, quicker crops—more money for you! Book free. American Mushroom Industries, Dent, 178, Toronto, Ont.

SENSATION. Home operated business. New. Nothing remotely like it. No competition. No selling. Customers come to you. Every man, woman and child needs your work. No experience needed. Complete business costs you only \$18. Can be earned back in week. Sample demonstration sent. 25c, coin only. Money back guarantee. Everdry, 10A West 26th Street, Minneapolis, Minn.

FIRMS That sell wholesale. Names, addresses, 10c. International Agency, P-4, Cincinnati.

SIGNS And showcards easily painted with letter patterns. Large variety of styles and sizes. Write for free samples. John Rahn, A-2120 Neva, Chicago.

STOP! Read! Act! Money for you! Profitable ways for establishing business at home. No canvassing. Write Hetzel, 802 Garden, Hartford, Conn.

I WANT To send you proof of the wonderful pulling power of Popular Mechanics Magazine's classified pages. What's your proposition? Write me today. F. W. Johnson, Manager, Classified Advertising, 209 E. Ontario St., Chicago, Ill.

PLASTEX Industries offers industrious men an opportunity to start a business of their own, manufacturing art goods, novelties, souvenirs, etc., in Plastex and marble imitation. 5c material makes \$1 articles. Rubber moulds furnished for speed production. Small investment brings big returns. You are just in time for the big 1935 business. Write for interesting booklet mailed free. Plastex Industries, Dept. A, 1085 Washington Ave., New York.

FREE Literature describing many money making plans. Belfort, 4042 N. Keefer, Chicago.

MAIL Order business is your opportunity. Many began small, now earn thousands yearly. No personal contact. Boundless opportunities. Have had over 30 years experience; will help you succeed. Send 25c for valuable booklets, none free. B. Brenizer, 257 South 21st, Philadelphia.

FREE Booklet describes 87 plans for making \$20-\$100 weekly, in home or office, business of your own. Elite Co., 214 Grand St., New York.

CHEMICAL Expert will furnish formulas and trade secrets. All lines. Lists free. W. L. Cummings, Ph. D., 223 Gordon Ave., Syracuse, N. Y.

MAKE Your own products. Employ agents yourself. Toilet articles, soap, extracts. We furnish everything. Valuable book free. National Scientific Laboratories, 1950W Broad, Richmond, Va.

SELL By mail. Books, novelties. Bargains! Big profits. Particulars free. B. Eifco, 525 S. Dearborn, Chicago.

START Little business anywhere. Everything furnished. No canvassing. Maywood, PM-923 Broadway, New York.

"SCHEMER Magazine," Alliance, Ohio, prints schemes, ideas, business starters, formulas; winners—\$10,000 to \$50,000 reported. 37th year. \$1. Subscribe now. Six months special, only 30c.

OPEN A key-making shop. Start a permanent profitable business with a small sum. No skill necessary. Write for particulars. Beisser Mfg. Co., 411 E. Fort, Detroit, Michigan.

FREE Circulars describing how you can make big money in mail order business at home in spare time. Write today. Mail Order Institute, 609-H Marcy Avenue, Brooklyn, N. Y.

SURE Money, make 100 fine show cards per day better than artist can do them, no experience, just lay letters on card and use new invention of multi-color spray. Literature describing complete outfit with alphabet, sent free. Write today. New Spray Co., Box 226, Berkeley, Calif.

CHARTERS: Delaware; best, cheapest; free forms. Colonial Charter Co., Wilmington, Del.

LIQUID Marble—Anyone can make! Colorful, glazed! Molded, brushed, sprayed. Rubberlike molds. Composition flooring. Big money making these! Particulars free. Marbleizing Service, Edwardsville, Ill.

SOAP Making, learn at home. No machinery needed. Write Pozoraa, Station F, Milwaukee, Wis.

LEARN Rubber composition mold making. No heat. No machinery. Inexpensive, durable. Great for novelty manufacturing. Imitation marble for casts, decorating, etc. All branches marbleizing and mold making taught. Dime brings mold and cast, rubber material for testing, assorted samples. Literature. Cowell Institute, Grayling, Mich.

OVER 100,000 Articles wholesale. Directory 10c. A-Wepeco, 3705 University, Des Moines, Iowa.

CHEMICAL Expert furnishes manufacturing formulas with complete working directions. Reliable individual service. Charges reasonable. Dr. Van Heeden, 4721 Lakepark, Chicago.

FORMULAS AND TRADE SECRETS

COLORING Of cement, old or new, chemically and permanently, five formulas \$2.00. Continental Cement Coloring Co., Box No. 1, Beverly Hills, Calif.

ANYTHING Analyzed. Practical formulas. Free list. Associated Chemists, Indianapolis, Ind.

FORMULAS, All kinds. Guaranteed. Catalog free. Kemico, 32, Parkridge, Ill.

SUCCEED With your products. Formulas, Processes, Analytical service. Catalog free. B. Thaxly Co., Washington, D. C.

20 METHODS, Cleaning fabrics, metals, wood. \$1. D. Scott, Box 477, Smiths Falls, Ont., Can.

20 PROVEN Formulas 25c, special formulas lowest prices, graduate chemist. Lexico, 835 Lexington, Cincinnati.

ANY Formula 25c or money refunded. Bradford Laboratories, Jackson, Tenn.

MAKE And sell krispy "Cheese Chips," "Golden Corn Chips." Thousands others. 25c each. Guaranteed. Stanley Surler, 11301 Jos Campau, Detroit, Mich.

TESTED Formulas 30c each. List free. Ogg Laboratories, Tampa, Florida.

ANY Formula—50c!! "Luminous paint," 25c!! Higrade typewriter ribbons, three \$1.10; dozen, \$3.80!! T-S-G-Pub., Box Ten-p, Wilkinsburg, Pa.

NEWEST Guaranteed formulas. Biggest catalog free. Special prices, leads. Gibson, Chemist, RD-4702 No. Racine, Chicago.

AMERICA'S Leading formula list contains fast sellers, "hard to get" items. Unusual services rendered. Write today! Technical Service, 6805 Clark, Chicago.

WATERLESS Soap formula \$1.00, with ingredients for 1 gal. free. Missense Products, P. O. Box 372, Columbus, Ohio.

NEW Formulas, priced right. Lists. Chemist, 830 South 41 Street, Omaha, Nebr.

TWENTY Latest money-making formulas! 20c brings all! International Agency, P-4, Cincinnati.

FINEST Artificial honey, maple syrup, vanilla, lemon, purest ingredients. Filterless oil reclaiming, gallon 2c. \$1; three \$1.50. List stamp. Ralph Brooks, Arkansas, Wis.

HAIR Dye formula \$1.00. Wonderful Money back guarantee. Ernest Bennighofen, Anderson, Ind.

3,000 FORMULAS. Facts, processes, trade secrets in Dr. Brown's Book of Formulas—380 pages. Price, postpaid \$1.00. Ogilvie Publishing Co., 57 Rose Street, Dept. 25, New York.

TESTED Formulas—Newest, guaranteed. Catalog free. Grinstead Laboratory, Edwardsville, Ill.

ANY Formula or process 25c. L. Buchman, 614 E. Jefferson, Syracuse, N. Y.

FORMULAS, Plans, Ideas. Literature free. Belfort, 4043 N. Keeler, Chicago.

CHEMISTRY

SEND For new big catalog. Chemical sets, microscope outfits, laboratory, biological and chemical supplies. Approved by experimental laboratories. Special 30 day offer now open. Send 10c now! Winn Co., Dept. 404, 124 West 23 St., New York.

CHEMISTRY Students' slide rule saves time, prevents failure. For details write MWC Company, 508 Andrus Bldg., Minneapolis, Minn.

POPULAR Chemistry. Nine back issues in color, \$1.00. Swedesboro, N. J.

FASCINATING Chemistry magazine contains loads of experiments, news, problems, queries, jokes. 5 cent stamp brings sample. Chicago Press, Dept. 203, 158 Carroll Ave., Chicago.

CHEMICALS. Laboratory glassware and apparatus. Catalog CP. Biological Supply Co., 1176 Mt. Hope Ave., Rochester, N. Y.

CHEMICAL Analysis. Industrial problems, and mineral assays. Estimates free. Lowell Bunting, Consultant Chemist, Royal Oak, Michigan.

MONEYMAKING OPPORTUNITIES

EARN Money sparetime making and selling novelty ash tray. Plan 25c coin. George's Shop, Watkins, Iowa.

THREE Books, mail order business—9c—refund. Dolson Herald, 30 Liberty St., Brooklyn, New York.

MONEY. Making new streamline lawn sets. Pattern and instructions, \$1.00. Earl Callender, Milburn, Ky.

BIG Money in renovating cement and marble surface, rusty surwails and tombstones like new. This field has amazing profit possibilities with no competition anywhere. F. E. Weidlich, Pierre, So. Dakota.

BIG Money electrifying spring clocks and building cases. Dime brings drawing and "How" book. Klocksters, Guttenberg, Iowa.

AMERICAN Homemaker Magazine. 3 months' trial, plans, offers, 25c. Mallmarts, P-4, Cincinnati.

BUY Old gold. Most profitable business of the hour. Complete instructions. Buying, testing, marketing easily learned. Furnished for \$1.00. Stamps accepted. Midwest Smelting Co., 139 N. State St., Chicago, Ill.

BIG Money at home plating auto parts, reflectors, mirrors, chandeliers; by new method; experience unnecessary. Outfits furnished. Gunmetal Co., Ave. N. Decatur, Ill.

FREE Booklet describes 87 plans for making \$20-\$100 weekly, in home or office, business of your own. Elite Co., 214 Grand St., New York.

AGENTS WANTED

\$6.00 HOURLY. Amazing Karnu refinishes auto like new without rubbing, polishing, waxing or painting. Wipes on with cloth. Lasts 8 to 12 months. Free sample. Karnu, Dept. H-108, Cincinnati, Ohio.

DRUG And feed stores buy carded Kil-Rat. Small investment, big returns. Sample card 45c, refunded on first order. Farm Products, Flat River, Mo.

RUNPROOF'S Hose. Big demand. Protected territory. Dr. W. T. Abell, Alhambra, Calif.

MARRIED Man with spare time to distribute free samples coffee, flaxseed, food products and make customers. devote at least two hours daily and be satisfied with up to \$3 in an hour. Dept. Blair, Dent, 321-D, Lynchburg, Va.

MAKE Name plates and other glass signs. Instructions free with 25c sample. Progressive Sign Works, Station U, New York City.

ACTION Make big money quickly. Beautifully finished portrait of Father Chas. E. Coughlin, eleven by fourteen inches. Retail fifty cents. One dollar dozen. Sample ten cents. Eastern Sculptural Co., Slater Bldg., Worcester, Mass.

MEXICAN Feather pictures. Great profit. Send 25c (stamps) for \$1.00 worth sample and details. Mexican Art, Apartado 1593, Mexico City.

CASH Paid for butterflies, insects. See Sinclair Display Advertisement on page 18A.

CASH Income daily resilvering mirrors; replating metalware; making glass signs. Portable outfit. Sprinkle, Plater, 128, Marion, Ind.

AMAZING New cleaner, cleans everything, perfumes, disinfects, free sample. Brown Products, 2631 Barclay, Baltimore, Md.

SUCCEED With your products. Formulas. Processes. Analytical service. Catalog free. B. Thaxly Co., Washington, D. C.

\$2.00 HOURLY With new, scientific cream that mends all cloth easily, quickly, invisibly, without needle and thread. Stands laundering. Free sample. Sew-No-More Co., Dept. H-744, Cincinnati, O.

SOMETHING New in photo medallions and sterling silver photo rings. Big profits. Free catalog. Gibson Photo Jewelry Co., Inc., 835 McDonald Avenue, Brooklyn, N. Y.

500% PROFIT Making colored pencils for writing on store windows, show cases, etc. Various colors. Newest selling sensation. Repeat sales. Formula, complete instruction guide, 30c (coin). Colonial Products, Box 77, St. Catharines, Ontario, Canada.

THE Whirlwind seller—The Arrow. Sample 5c. G. M. Company, Washingtonville, O.

BE An independent local merchant. Make up to \$45 to \$60 a week supplying steady customers with groceries. I start you on no-risk trial. No capital or experience needed. Details sent free. Albert Mills, 8961 Monmouth, Cincinnati, Ohio.

MAKE Extra money! Write for our special offer and catalog of household deals, cosmetics, extracts, etc. Make big money selling your friends and neighbors. Clyde Collins Chemical Co., Dept. 15C-1, Memphis, Tenn.

450% PROFIT Magic gas lighter. No flint or flame. Lights gas instantly. Retail 25c. Costs you \$1.00 a dozen or 15 dozen for \$9.00. Sample 10c. New Method Co., Desk PMG-27, Bradford, Pa.

SELL Powdered spinach for acid conditions, weak stomach, constipation, poor blood. Sample 10c. 100% profit. Dr. McFerrin, Orlando, Fla.

INITIALING Automobiles biggest money maker today. New type requiring no varnish to apply. Write for samples. International Monogram & Transfer Co., Box 6365, Philadelphia, Pa.

BIG Money installing kitchen range oil burners. Bennett Company, Islip, N. Y.

AGENTS Look at these prices. 8 oz. Int. vanilla \$1.10 doz. 60 razor blades 40c. Box 12 aspirin tablets 30c doz. Boxes. Fix All liquid cement 75c doz. Ice box odor absorber 12c each. Bowl deodorizers 50c doz. Over 180 other products. Write, Drexall, 715 Kent Ave., Brooklyn, N. Y.

SELL Electric light bulbs, 1,000-hour guarantee. Send for new 1935 price list. Big profit. Southern Lamp Co., 1017 Seventh St., Washington, D. C.

SELLS Like hot cakes. Big profits. New laundry soapflakes, perfumes clothes lastingly when washing. Territory given. Sunset Laboratories, Lynbrook, N. Y.

100% PROFIT In the mystery cigar lighter. No flint or friction. What makes it light? No wind can blow it out. Retail 25c. Sample and sales plan 25c. New Method Company, Desk PM-27, New Method Bldg., Bradford, Pa.

WHOLESALE Catalog free. 500 best sellers. Paty Co., 1167 Broadway, Somerville, Massachusetts.

AGENTS. Amazing profits selling door controls. Sample \$1.10. Thoroughly perfected. Marvelous invention. Larson Co., 335 S. Cedar, Inglewood, Calif.

DISTRIBUTORS. Amazing 2 for 1 plan sells moth pads like wildfire. Five new moth products. Bottom prices. Patterson H-Co., 3705 University, Des Moines, Iowa.

RELIABLE Person wanted each town for your own outdoor advertising business; experience unnecessary; no selling; good pay. Dawson Service, Cane Glardeau, Mo.

STROPS All types razor blades. Many other needs for them. Easy to sell. Sample 20c. Hand-E Handle Co., Wheeling, W. Va.

RAINCOATS. Zipper jackets, \$2.95. Lowest prices. Union made. Selling fast. Commissions advanced. Experience unnecessary. Outfit free! Royal, AB-724 Roosevelt, Chicago.

30-4"x14" SIGNS For \$1.00 postpaid. Samples 25c. Zim Sign Co., 322 S. Broadway, Los Angeles, Calif.

OPPORTUNITIES Galore—400 money making plans, ideas, etc. Write A. Wolfe, 2085 Valentine, New York City.

SELL Napco's noncompetitive cleaning products homes, stores, garages, institutions. Landau, 1124 22nd N. W., Washington, D. C.

SELL Tinted cards and glass signs. Circular free. Special-Kut Letter Co., Sidney, Ohio.

QUALITY Flavors, attractive 4-bottle deal; two 4-oz., two 8-oz. Costs you 31½¢, district manager's price. Sensational \$1 seller. Favorite, 2100 Kennedy Northeast, Minneapolis, Minn.

SEND Hose size for samples and opportunity for \$20 week job. Show sensational "Anti-Snag" guaranteed hosiery to friends. Dignified, pleasant work. Everything supplied. Wilknit Hosiery, Desk D-37, Greenfield, Ohio.

DISTRIBUTORS: A few quick easy sales daily nets you \$58.00 weekly. Represent manufacturer—Latex, amazing self sealing bandage that breathes. Wonderful demonstrator. Irresistible appeal. Exclusive territory. Neway, 24-H So. Clinton, Chicago.

MAKE Big money; commissions advanced; sell raincoats, zipper jackets; union made; latest style; quality; lowest prices; experience unnecessary; outfit free. Goodyear, LZ-712 Roosevelt, Chicago.

\$45 WEEKLY Selling Firefuse firealarms. Details free. Goldenrule, Kalamazoo, Mich.

MAKE Your own products! Get proven formula list. We furnish raw materials also technical service. Chemical Bureau, 6801 Clark, Chicago.

PROFIT With new products. Make, sell, repeat. Guaranteed formulas, special prices, leads. Biggest catalog free. Gibson, Chemist, RD-4702 No. Racine, Chicago.

STEADY Employment for women demonstrating "Smooth Tex" guaranteed hosiery. About \$21 weekly. No experience or capital. Complete equipment with sample hose supplied. Send size. Betterknit Hosiery, Outfit D-237, Columbus, Ohio.

GET Our offer for a real surprise. Earn \$5.00 daily in your spare time. Full time workers make much more. Mail postal for details. No obligation. A. Kennedy Co., Kokomo, Ind.

500% PROFIT! Gold and colored sign letters for windows, offices, trucks, signs. Monograms. Easily applied. Neonite, Akron, Ohio.

FIRST Aid for mechanic's cuts, wounds. Stops pain, kills bacteria, quick healing. You sell it to friends and industrial plants. Make big profits. Send 20c in postage for trial bottle. Link Chemical Co., Emporia, Kansas.

MEN'S Neckwear exclusive \$1.75 dozen. Information free. Capitol Neckwear, Norwich, Conn.

CLEAN Up this season selling new style sparkling, tinted signs. Easter, Mother's Day, Father's Day, graduation, President Roosevelt. Cost 4c; retail 25c. Sample free! Lowy, Dept. PA, 8 West Broadway, New York.

SELL Made to measure raincoats. Outfit free. Goodyear Rainwear, 18 West 22nd, New York.

MAKE More money taking orders. Shirts, ties, underwear, dresses, hosiery, raincoats, coveralls, pants, uniforms. Outfit free! Nimrod Company, Department 8, 4922-28 Lincoln Avenue, Chicago.

HOTTEST Money-maker. Quality electric water heater. Retail \$1.95, wholesale 65c. agent's sample \$1. "Realproducts," 8608 Phillips, Chicago.

NEW Cleaner! Washes clothes quickly. Cleans everything. Premium deals. Free sample. Bestco, 5007 Irving Park, Chicago.

DOUBLE-EYED Self-threading needle packages, size 3/9. Blind people thread them. Invaluable for failing sight, necessary for good sight. Sample, particulars 10c. Agents wanted. Wm. Oglesby, Vandalia, Ill.

BIG Money applying gold initials on automobiles. Easiest thing today. No experience needed. Free samples. "Ralco," 1084 Washington, Boston, Mass.

MAKE Products yourself. Formula catalog free. Kemico, 45, Parkridge, Ill.

AGENTS: Smash go prices. Santos coffee 12c lb. 4-oz. vanilla 8½c. \$1.00 size tonic 14c. Razor blades 10 for 8½c. 100 sticks chewing gum 12c. 150 other bargains. Experience unnecessary. Write Carnation Co., P.O. St. Louis, Mo.

PROFITABLE Home business. Legitimate. No canvassing. Maywood Publishers, P-923 Broadway, New York.

100 PROFITABLE Mail order and local business plans. A. Pruitt, Elburn, Ill.

AGENTS: Stamping names on pocket-key protectors. Sample check with your name, address, 25c. Stamping outfits. Emblem checks, check-fobs, name plates. Hart Mfg. Co., 303 Degraw St., Brooklyn, N. Y.

GENUINE Gold letters for store windows. Easily applied. Free samples. Liberal offer to general agents. Metallic Letter Co., 438-B North Clark, Chicago.

AGENTS—Opportunity to make money; book containing 87 successful business plans; home or office; send for free introductory booklet. Elite Co., 214 Grand St., New York.

"HOW To Secure Agents," a specially prepared booklet, tells of one of the most inexpensive methods in which to secure good live producing agents. It is free; write for your copy today! F. W. Johnson, Mgr., Classified Advertising, Popular Mechanics Magazine, 260 E. Ontario St., Chicago, Ill.

BIG Money and fast sales. Every owner buys gold initials for his auto. You charge \$1.50; make \$1.45. Ten orders daily easy. Write for particulars and free sample. American Monogram Company, Dept. 40, East Orange, N. J.

PORTRAIT Agents throughout the world. Lowest prices, portraits, frames. Catalog free. Picture Man Friedman, 528 Cornelia, Dept. 9, Chicago, Ill.

A BUSINESS Of your own—Making sparkling glass door plates, desk plates, numbers, signs, checkerboards, mirrors. Illustrated book free. Palmer Signs, 512, Wooster, O.

MAKE Your own products. Employ agents yourself. Toilet articles, soap, extracts. We furnish everything. Valuable book free. National Scientific Laboratories, 1950W Broad, Richmond, Va.

MAN in each town to plate auto parts, reflectors, bathroom fixtures, refinish beds, mirrors, chandeliers; by new method. No capital or experience required. Simple plan of manufacturing at home starts you in big money-making business. Outfit furnished. Free particulars and proofs. Gun Metal Co., Ave. H, Decatur, Ill.

COSTS 1c—Sells 25c. Make non-explosive cleaner from Benzoyne Crystals. 1c gallon. Western Reserve Laboratories, 6615 Denison Ave., Cleveland, Ohio.

BE Independent. Own your business; experience unnecessary, selling \$10,000 accidental death, \$50 accident; \$25 sick weekly benefits—\$10.00 yearly. Other amounts proportionate. Guaranteed steady renewal income. \$250,000 deposited insurance department. Universal Policy, 716-A Lefcourt Bldg., Newark, N. J.

OVER 100,000 Articles wholesale. Large illustrated wholesale catalogs. Directory 10c. B-Wesco, 3795 University, Des Moines, Iowa.

PENNY Each. Popular sizes. Guaranteed. Window sign letters. Free samples. Atlas Sign Works, 7941 Halsted, Chicago.

REGULAR Income; home, office, no canvassing. McArthur Co., Desk 5, Butte, Mont.

HIGH-GRADE SALESMEN

FOR Dependable men—Steady sales position with fifty-year-old concern. Good line calendars, advertising specialties. Exclusive territory, good commissions. Merchants Publishing Company, Kalamazoo, Mich.

IF Figures talk with you, read these:—Jeschke sells \$36 1st 2 days; Dees \$75 1st 3½ days; Cullison \$111 1st 5 days. Established Raleigh dealers sell up to \$373 a week; best dealer averages \$320 week after week. They make these large sales because of Raleigh quality and methods. If you want to make more money, it will pay you to write Raleigh's, Box D-3-PPM, Freeport, Ill.

SALESMEN And distributors to sell battery accessory to garages, battery stations and automobile accessory stores. New item going over big. Non-Corrosive Washer Company, Rockford, Ill.

SELL Quaker's super-styled quality shirts. Big cash commissions; cash bonuses. Low prices. Ties, hose, underwear too. Complete new spring line ready. Samples free. Write Dept. P3, Quaker, Colonial Bldg., Broadway at 31st, New York.

SHOE Manufacturer's sales division wants men. Complete line includes more than 200 work, dress and sport shoes for entire family. Also special bargains at \$1.98 and \$2.98. Guaranteed quality. Good pay every day and your own shoes at wholesale prices. No experience needed. Complete outfit free. Write Consolidated Shoe System, Dept. D9, Chipewawa Falls, Wis.

MAGNETIC Cleaner—Entirely new. More effective than a vacuum cleaner. Sells for \$1.75. Make from \$5.00 to \$12.00 a day. F. S. Beveridge, Pres., Stanley Home Products, Inc., Box 453-A, Westfield, Mass.

SALESMEN: Acquainted with garages, filling stations, to handle local business. Write Colgra, 2630 N. Third St., Milwaukee, Wisconsin.

MAN—Handle regular store route. Place nationally advertised 5c-10c counter card mdse. New aspirin deal—6 tablets 5c. 85 other fast sellers. 100% profit. No investment. Samples free. World's Products Co., Dept. 4810, Spencer, Ind.

MAKE Big money steady. High grade coveralls, shopcoats, pants, shirts, summer suits. Advertising on back. Fast sellers. Free outfit. Strong Mfg. Co., 901 West Jackson, Dept. N-3, Chicago.

SELL Sanforized summer suits. No competition. Free outfit. Suit furnished. Bonus. Popular styles \$4.95 and \$2.00 commission and up. Service, E-1615 N. Damen, Chicago.

NEW Amazing portable theft-proof lock for drawers, doors (nothing like it), demonstrates instantly. Unlimited sales possibilities. Compact, attractive, genuine leather case permits carrying in vest pocket. Salesman's unusual opportunity for big money. Write now. Wonder Lock Sales, 53 West Jackson, Chicago.

100% PROFIT Big seller. New type Emerson electric water heater. Jiffy Electric Company, Hazel Park, Mich.

SALESMEN: Sell complete line gummed labels, calendars, memo books, and business stationery. Special features. Free deals. Write quick. Big comm. daily. Attractive sales portfolio free. Lionel, Dept. BC, 312 South Hamilton, Chicago.

SELL Process embossed printing \$3.95 thousand, with free cut service. Worth \$6.00. Nothing like it! Commission \$1.00, advanced. Experience unnecessary. Outfit free. United Engravers, F-6155 South State, Chicago.

NEW Sensational invention sells to men everywhere. No competition. Enormous profits. Rotofex Co., Room 511, 327 S. LaSalle, Chicago.

BIG Money in tire patches. Sell new auto tire patch to service stations, garages, etc. Tiger-Grip patches guaranteed 10,000 miles. \$75 weekly for salesmen or distributors. Protected territory. Write Economy Rubber Co., 743 Burkhardt, Dayton, Ohio.

YEAR'S Income in 3 months! New federal, state and code laws create immense demand for simplified record system every businessman must have to protect himself against fines and penalties. Millions users must buy again now. Our men selling 5 to 25 daily our officially approved, copyrighted Liberty Tax Record. \$3.50 cash profit every sale. Repeat commissions without callbacks. Live leads furnished. Big season now. Choice territories going fast. Commonwealth Publishing Company, 508 So. Dearborn, Chicago.

START A business of your own! Become a subscription representative for "Popular Mechanics." No capital required. Liberal commissions. Monthly bonus. Write for details. V. D. Angerman, Circulation Manager, 200 East Ontario Street, Room 235, Chicago.

SELL Stores or homes—Scissors sharpeners, gas lighters, razor blades, aspirin, breath gum, chewing laxative, adhesive tape, polish, handkerchiefs, polishing cloths, shoe laces, many others. Attractive displays. Catalog free. Superba Co., S-303, Baltimore, Md.

BRAND New grab-bag deal. Going big everywhere—big profits—swift sales—fast repeats. No restrictions. All dealers buy. Act! K&S, 4373 Ravenswood, Chicago.

SALESMEN—Sell collection systems, 400% commission. Sayers Systems, 2801-123 Sheffield, Chicago.

NEW Specialty—Sells every business and professional man. Four \$15 sales daily pay \$280 weekly. Foyer cleared \$1920 in three months. Write, F. E. Armstrong, President, Dept. PM, Mobile, Ala.

PENNY Each. Non-tarnishable window sign letters. Free samples. Atlas Sign Works, 7941 Halsted, Chicago.

SALES Demonstrators. U-Kan-Plate with pure silver. 1 oz. polish 20c, 8 oz. \$1. Justice, 904 Walnut, Philadelphia.

RADIOS—World's cheapest. 55% commission. Catalog free. J-20th Century Co., Kansas City, Mo.

MAKE More money taking orders. Shirts, ties, underwear, dresses, hosiery, raincoats, coveralls, pants, uniforms. Outfit free! Nimrod Company, Department 65, 4922-28 Lincoln Avenue, Chicago.

SELL Punchboards direct to dealers from world's leading punchboard factory. Wholesale prices. Enormous profits. Big commissions. Sales kit free. Harlich Co., 1407 Jackson, Chicago.

FREE Booklet describes 87 plans for making \$20-\$100 weekly, in home or office, business of your own. Elite Co., 214 Grand St., New York.

HELP WANTED

SELL Hard worsted suits \$16.95. Make \$5 profit. Extra pants at cost. Finest workmanship. Over 30 hand operations. \$25,000 bond guarantees satisfaction. Customers repeat. Complete DeLuxe sample outfit free. Actual leads furnished. Bonus sample suit. Williams Bros., 832 Broadway, Dept. PM-4, New York City.

GROW Mushrooms all year round—A steady income indoors, in cellar, shed or stable. Exclusive new process. Bigger, better, quicker crops—more money for you! Book free. American Mushroom Industries, Dept. 179, Toronto, Ont.

MONEY, Jobs, yours. Free circular gives amazing information. Tells how man, long unemployed, got 76 openings. Make money supplying employment ideas millions want. Write today. Co-Operative Service, 77 Swan, Buffalo, N. Y.

GO Into wholesale business without investment. Call on stores with biggest line self-selling counter displays: Aspirin, razor blades, handkerchiefs, breathlets, household cement, 79 different items. Up to 125% profit for you. Experience unnecessary. Write for catalog and plans. Procopax, Dept. 36-HD, 1956 S. Troy, Chicago.

CASH Paid for butterflies, insects. See Sinclair Display Advertisement on page 18A.

STEADY Money. I'll start you on a 200-family grocery route paying up to \$42.50 first week. You don't need capital. Complete outfit furnished on trial. Write quick. Albert Mills, 8955 Monmouth, Cincinnati, O.

EARN Quick cash raising mushrooms in cellar, shed, attic. We buy crops. Guaranteed materials furnished. Easy, odorless method. Book free. United, 3848-CA Lincoln Ave., Chicago.

BIG Money growing mushrooms. Cellar, idle places. Supplies furnished. We buy. Free book. Mushroom Growers, EW-433, N. Clark, Chicago.

AGENTS—Mosco corn and callous remover will build you a steady repeat business. Send today for pocket-size trial outfit. The Moss Company, 54 Searle Bldg., Rochester, N. Y.

EDUCATIONAL AND INSTRUCTION

BOYS, Girls, men. Learn to make mechanical sketches. Easy lessons for beginners. No college education necessary. Starts you on the way to a more complete course in mechanical drawing and blue print reading. Will help no matter what your occupation may be. Write for particulars. Economical School of Drawing, Box 1222, Baton Rouge, Louisiana.

WRITERS! Have you ever heard of Writer's Digest, leading, largest, and foremost writer's magazine? Contains helpful, instructive articles telling how to write fiction and articles, and where to sell them. Special three month's trial subscription, 25c. Sorry, no free samples. Writer's Digest, 1204 Jackson St., Cincinnati, Ohio.

LEARN Machinist trade, tool and die making, designing, automatic and hand screw machines. Get experience on actual jobs. Leading shops approve our methods and employ our men. Steady demand for skilled men. Days—evenings. Send for free book. Allied Screw Machine Company (School Div.) 601 W. Lake St., Chicago.

GOLDEN Future in learning the fur trade. Inexpensive. Expert personal training or correspondence courses. Address Golden Gate Fur School, Box 1049, San Francisco, Calif.

BECOME An investigator. Write former agent United States Secret Service, Joseph Kavanagh, PM-45, Hoboken, N. J.

GOVERNMENT Jobs. Start \$105-\$175 month. Men-women, 18-50. Qualify now for coming examinations. Short hours—steady positions. Common education usually sufficient. 25 coached free. Full particulars—list positions free. Write today. Franklin Institute, Dept. P3, Rochester, N. Y. (Established 1905.)

HOLLYWOOD Motion picture theatre sound-projection course. Home study. \$1.00 lesson, 50 lessons complete. Box 187, Lacsrescenta, Calif.

STUDY Law at home. Four courses; degree. Est. 1892; free catalog. Chicago School of Law, Reaper Block, Chicago.

LEARN Fast and correct figuring. New methods. Frederick A. Smith, 2410 Smalley Court, Chicago.

MONEY In feature writing. Instructions 15c. "Priggen," 377 Pine St., So. Weymouth, Mass.

PRACTICAL Engineer, 40 years experience, teaches blueprint reading, idea designing, general engineering, trigonometry, etc., for 1% of college expense. Mail \$1.00 for prints, literature, trial lesson. Fredericks Engineering Co., 68 East Goethe Street, Chicago.

PIANO Tuning learned at home quickly. Tremendous field! Have a year-around business of your own. Be independent! Information free. Empire School of Piano Tuning, 131 Rimbach St., Hammond, Ind.

GET Wise to yourself. Self testing psychologic questionnaire covering 29 vital points, including secret of mind power and control, concentration, memory, will-power. Free. Dynamal Foundation, 9304 Amesbury Ave., Cleveland, Ohio.

UNDERWOOD Portable typewriter free on completing Gregg Shorthand course; trial lesson—particulars 10c. National School, 150-P Norman Road, Newark, N. J.

BECOME A successful investigator. Experience unnecessary. Work at home or travel. Write today for free publication and particulars. National System, 340-G Electric Building, Omaha, Nebr.

LEARN New trades in your spare time—Refrigeration, oil burners, air conditioning servicing. Herkimer Institute, 1819 Broadway, New York.

GET U. S. government job—start \$105-\$175 month. Men-women, age 18-53. Are you eligible for eligibility test? Get our free questionnaire—find out. No obligation whatever. Instruction Bureau, 101, St. Louis, Missouri.

U. S. GOVERNMENT Positions. \$1700-\$1900 and up a year. Let our expert (former government examiner) prepare you for a position in the railway mail service, rural carrier, post office, customs and other branches. Write today for free booklet. Dept. 8, Patterson School, Rochester, N. Y.

BECOME A landscape architect. Easy to learn by mail. Wonderful opportunity for money-making. Earn while you learn. Write for free opportunity booklet and details. American Landscape School, 805 Plymouth Bldg., Des Moines, Iowa.

TRADE SCHOOLS

LEARN Auto top trade. Free particulars. Parsons Top School, 18 Harney, Omaha, Nebraska.

CARTOONING—COMMERCIAL ART

AMATEUR Cartoonists can earn \$35.00 weekly, spare time, duplicating cartoon advertisements. 3-M Syndicate, Argyle, Wis.

CARTOONING Course—30 lessons, 500 illustrations with drawing pens and pencils. \$1.00 complete. Scovell Studios, Box 610-P, Hollywood, Calif.

SKETCHING And painting instruction book for advanced students. 100 illustrations. Complete course 30c postpaid. Lawrence Publications, 143 West 100 St., New York.

CARTOONING Made easy! Special introductory offer, 15 easy lessons \$1.50. Ray West, School of Cartooning, Box 235, Sterling, Ill.

MODERN Cartooning methods. Cooperative Research Company, 132 West 14th Street, New York.

ARTISTS' Advisory Bureau. Information. Sales help. Criticisms. Feather, Parkville, Missouri.

ADVERTISING AGENCIES

INCH Display advertisement fifty magazines, year \$24.00. Wood's Popular Service, Atlantic City, N. J.

ADVERTISE Profitably: \$15 reaches 6,000,000 Sunday newspaper readers with 24 word ad. Newspaper, magazine rate-guide, free. Chiago Union Agency, 20 West Jackson, Chicago.

LEARN Advertising quickly at home. New easy practical plan. No text books. Interesting booklet free. Page-Davis School of Advertising, 3601 Michigan, Dept. 3431, Chicago.

FREE—New Advertisers Rate Guide, 44 pages. Includes everything. Lowest rates. E. H. Brown Advertising Agency, 140 S. Dearborn, Chicago.

ADVERTISING Placed anywhere. Helpful, free service. Rate guide book free. Baker Advertising Agency, 189 W. Madison, Chicago.

FOR ADVERTISERS

WANTED—Mail order publications. Send sample copy with rates. F. W. Johnson, 200 E Ontario St., Chicago.

ADVERTISERS. Quick! Get new 1935 advertising directory free! "Hot off the press." Lists everything. Wade-World Advertising Agency, Royal Oak, Mich.

ADVERTISE 24 Words in 50 newspapers \$2.00. Goodall Adv. Co., Box 1592, San Francisco.

25 WORDS 25 Magazines, 3 months \$1.50. One inch \$6.00. Plans. 36 Liberty St., Brooklyn, New York.

ONE Inch display, 3 months—\$3.00. Halspence Exchange-P, 509 Fifth Ave., New York City.

ADVERTISE 24 Words in 250 newspapers \$10. Lists free. Advertising Service Bureau, 4650 Drexel, Chicago.

BUSINESS SERVICE

USE Our 5th Ave. address. Secure prestige by making our offices your personal or business (New York) address. We represent you, receive mail, telegrams, telephone messages, and you call, or we reforward to you (daily). \$2.00 monthly. New York Mail Service, 210-5th Ave., or, 15 Park Row, New York.

DELAWARE Charters; fees small; free forms. Chas. G. Guyer, 901 Market St., Wilmington, Del.

PRINTING, MULTIGRAPHING, MIMEOGRAPHING, GUMMED LABELS

500 LETTERHEADS, Envelopes, billheads, (1000 cards) \$1.75. Bradshaw, 3214 Huron, Chicago.

NEARGRAVE Processed stationery. Distinctive, unique. Samples, prices. Solidays, Knox, Ind.

LETTERHEADS, Envelopes 6%, statements \$2.95 per 1000; \$1.95 per 500. 1000 business cards \$1.25. Postpaid. Palm Press, Box 33, Orange Park, Fla.

100 FINE Envelopes printed your 4-line copy. 50c postpaid. Draper Printery, Culver City, Calif.

1000 STATEMENTS 3% x 6 \$1.50, postpaid (white bond paper). Samples. Frederic Mahon, 231 79th Street, Rockaway Beach, N. Y.

PRINT Your own. Bargains presses, type. List 3c. Exchange D13, 22 Orient, Meriden, Connecticut.

2000 BUSINESS Cards \$1.80; 1000 No. 6% envelopes \$2.40; postpaid, 5th zone. Iden, 4625 Wells, Milwaukee.

2000 BUSINESS Cards \$1.50. Charles Specialty Co., 12-AS, Norwood, Ohio.

5000 ELEGANT Colored envelope slips, \$3.90 prepaid. All printing low prices. Samples. Goodprint, Harrisonburg, Va.

250 LETTERHEADS And 250 envelopes, \$1.40. Westcott, Clyde, N. Y.

ENVELOPES—Save money. 6% size. 24 lb. printed, 1,000—\$2.15, 5,000—\$7.50 (plus postage). West Co., Box 501A, St. Louis, Missouri.

TWO-COLOR Business cards. 1935 calendar on back. \$2.50, 1000; \$7.25, 5000. Jackson Printing, Independence, Mo.

GOOD White envelopes, letterheads, or billheads. Neatly printed. Postpaid. 100, 50c. Augustine, 2419 Eccles Street, Pittsburgh, Pa.

1000 BUSINESS CARDS, card case, \$1.50. Miller, Printer, Amherst, Pa.

GUMMED Labels—Your copy printed that satisfies. Wetzel, Valhalla, N. Y.

2000 BUSINESS Cards neatly printed \$1.50. Atlas Distributing Co., 1814 Bedford Ave., Pittsburgh, Pa.

STATIONERY, Circulars, checks, loose-leaf, ruling, binding. Commercial Press, Batavia, Ohio.

BETTER Grade printing, reasonable priced. Free samples. Economic Press, Leonia, N. J.

PRINTING OUTFITS AND SUPPLIES

HAND Press, type and complete printers' supplies. Advise equipment you need and we quote prices; or send stamp for catalog. P. Pfeiffer, 38-A; 6 Columbia St., Newark, New Jersey.

PHOTO-ENGRAVE Without camera. Easy, cheap process—\$1.00. Photograve, Box 63, Omaha, Nebr.

PRINT Your own cards, stationery, circulars, advertising, etc. Save money. Easy rules furnished. Print for others, big profits. Job presses, \$11.00 up. Write for catalog and full details. Kelsey Co., T-11, Meriden, Conn.

PRINTING Press 6x9 side lever. New, \$42.50. Write for circular. Brooklyn Printers Exchange, 35 York St., Brooklyn, N. Y.

NEW Type 29c font. Catalogue dime. National Type Company, Jackson, Mich.

5,000 VELLUM Die cut cards 54c thousand. Shalley, 328 Liberty Ave., Pittsburgh, Pennsylvania.

MAKE Cuts—Simple, cheap process—Halftones, line cuts, type matter. Anderson & Son, 12612 Greenwood Ave., Blue Island, Illinois.

PRINT Your own circulars, envelopes, with home made press costing less than \$1.00. Illustrated instructions 10c. Carl Edquist, Odessa, Minn.

PRINTING Outfits—Presses, type supplies, type novelties. Send stamp for catalog. Model Press, York, Penna.

BARGAINS Used presses, type. Send stamp. Box 15, Cambridge, Mass.

PRINTING Presses, type and equipment. Lists 3c. Landis, Richland, Pa.

TYPEWRITERS, DUPLICATORS OFFICE DEVICES

SUPER Wear Duratype ribbon, 45c, postpaid. State make typewriter. Wilson, 16 Elizey, Pittsburgh, 14, Pa.

TYPEWRITER Bargains—Genuine late model Underwoods, Royals, Remingtons, L. C. Smiths refinished \$100 office models at 60% saving. Fully guaranteed—10 day trial—easy terms—10c a day. Free catalog. International Typewriter Exchange, Dept. A401, 231 West Monroe St., Chicago.

STENCIL Duplicators. \$1.50 to \$6.50. Illustrated folder—stamp. Halspence Exchange-P, 509 Fifth Ave., New York City.

ROTARY Stencil duplicators \$15 to \$345. Mimeographing and supplies. Beco, 8600, Newark, N. J.

REINKING Service. Multigraphing ribbons \$3.00 doz. Typewriter \$1.20 doz. Satisfaction guaranteed. Acme, 1676 Hoffner St., Cincinnati, O.

TYPEWRITERS—\$4.99-\$17.99. Ribbons, mimeographing, 1000, \$1.99. Music, Knights, 1517 Olive, St. Louis, Mo.

TYPEWRITER \$12. Multigraph, mimeograph, and other office machines. Write 816 Pruitt Bldg., 170 North LaSalle, Chicago.

NEW \$4.75 Automatic adding machine. Fully guaranteed. Bassett, 1458J Hollywood Avenue, Chicago.

INCREASE Business. "Excellograph" rotary stencil, clay and film duplicators \$3.85 to \$37.50. Prints anything. Typewritten, penned, drawn, traced. Colors. Folder free. Pittsburgh Typewriter Supply, Suite 518, Pittsburgh, Pa.

RUBBER STAMPS AND OFFICE SUPPLIES

CUSHION Mounted, 2 lines 25c; 3 lines 35c. Coin. Stamp Works, 814 Bradley, Peoria, Ill.

NAME, Address, 2 lines 25c; 3 lines 35c. Stamp Works, Auburn, Nebr.

PATENT ATTORNEYS

PATENTS—Before too heavy an outlay of time or money is made on an invention, a search of the Patent Office records should be made to determine as nearly as possible whether or not the same idea has been patented before. The cost of this search is small, while the value of the facts it uncovers is often considerable. We offer inventors and manufacturers a thorough, prompt, confidential search service—plus experienced counsel and assistance in every phase of Patent and Trademark practice. Write for my free book containing valuable information relating to patent procedure. Clarence A. O'Brien, Registered Patent Attorney, 58W Adams Building, Washington D. C.

INVENTIONS May now be safely marketed before patenting. For information, write Chartered Institute, Dept. 4A, Barrister Building, Washington, D. C.

INVENTORS: Send immediately for your copies of our new free books, "Patent Protection" and "Suggestions on Selling an Invention." Sixty-eight pages of interesting facts. They tell how Patent Laws protect you; kind of sketch or model needed; simple steps to take without cost; how successful inventors have secured financial assistance; show interesting inventions; illustrate important mechanical movements. With book we also send free Evidence of Invention form to help establish date of disclosure. Prompt service, reasonable fees, special deferred payment plan. Strictest secrecy. Thirty-six years' experience. Highest references. Write us today. The facts in our books are worth money to the man with a good invention. Address: Victor J. Evans & Co., Registered Patent Attorneys, 400D Victor Building, Washington, D. C.

HAVE You patent matters? This firm can protect you. Avail yourself valued sound advice, long experience. Attorney-Engineer, Parish, 114 W. 44, New York.

PATENTS Procured; trade marks registered—preliminary advice furnished without charge. Booklet and form for disclosing idea free. Irving L. McCathran, 700A International Bldg., Washington, D. C.

L. F. RANDOLPH, 302-B Victor Building, Washington, D. C. Low cost. Book and information free.

PATENTS. Booklet free. Highest references. Best results. Promptness assured. Watson E. Coleman, Patent Lawyer, 724 Ninth St., Washington, D. C.

PATENTS. Instructions "How to Establish Your Rights" and form, "Evidence of Conception"—sent free! Lancaster, Allwine & Rommel, 411 Bowen Building, Washington, D. C.

INVENTORS—Send for free booklet "Patent-Sense." Information based on 64 years experience. Lacey & Lacey, Dept. 5A, 635 F St., Washington, D. C.

PATENTS—Proper service for manufacturers and individual inventors. Established 1895. Reasonable charges. Consult Chandlee & Chandlee, Patent Attorneys, 902 F. Street, Washington, D. C.

ECONOMY For inventors. Write for booklet. Thos. H. Johnston, 635 F St., N. W., Washington, D. C.

"INVENTOR'S Guide," 100 mechanical movements, free; advises on patenting, selling inventions. Fk. Ledermann, 154 Nassau Street, New York.

A NEW Deal for inventors: Combined patent attorney and development engineer service. Simple case attorney's charge \$50.00. Search \$5.00; trade-marks complete \$35.00; copyrights \$6.00. J. J. O'Brien, Patent Attorney-Engineer, Reg. 1909, 108 West 42nd St., New York City.

FOR INVENTORS

INVENTORS: Send immediately for your copies of our new free books, "Patent Protection" and "Suggestions on Selling an Invention." Sixty-eight pages of interesting facts. They tell how Patent Laws protect you; kind of sketch or model needed; simple steps to take without cost; how successful inventors have secured financial assistance; show interesting inventions; illustrate important mechanical movements. With book we also send free Evidence of Invention form to help establish date of disclosure. Prompt service, reasonable fees, special deferred payment plan. Strictest secrecy. Thirty-six years' experience. Highest references. Write us today. The facts in our books are worth money to the man with a good invention. Address: Victor J. Evans & Co., Registered Patent Attorneys, 401D Victor Building, Washington, D. C.

I SELL Patents. Established in 1900. Charles A. Scott, 773PM Garson Ave, Rochester, N. Y.

OUR Manufacturer-clients now want better inventions, patented or unpatented, to meet present industrial conditions. Write Chartered Institute, Dept. 4B, Barrister Building, Washington, D. C.

UNPATENTED Inventions wanted by nearly 1000 buyers listed in Inventors' Selling Guide—200-page book \$2 postpaid. Given ironclad methods protecting unpatented inventions, sales tips, swindles to avoid, many other topics. Free list of needed inventions, full details, on request. Donley Publishing Co., P-4, 509 Fifth Avenue, New York City.

SELL Your inventions! Patented or unpatented. Deal directly with manufacturers. 1000 prospective buyers. 25c. Hammond, 1110 Hartford Building, Chicago.

TO Inventors: We are in the market to purchase a good patent, preferably a five and ten cent store item. Will purchase outright or royalty. Purchasing Agent, 241 Front St., New York, N. Y.

PATENTS—Before too heavy an outlay of time or money is made on an invention, a search of the Patent Office records should be made to determine as nearly as possible whether or not the same idea has been patented before. The cost of this search is small, while the value of the facts it uncovers is often considerable. We offer inventors and manufacturers a thorough, prompt, confidential search service—plus experienced counsel and assistance in every phase of Patent and Trademark practice. Write for my free book containing valuable information relating to patent procedure. Clarence A. O'Brien, Registered Patent Attorney, 58-X Adams Building, Washington, D. C.

INVENTORS: "Making Inventions Pay," our 32-page illustrated book, mailed upon receipt of 3c postage. Crescent Tool Company, Dept. Z, Cincinnati, Ohio.

INVENTOR'S Universal Educator: contains 900 mechanical movements; 50 perpetual motions; instruction on procuring and selling patents and selecting an attorney, etc. Suggests new ideas. Price \$1.00 postpaid in U. S. A. Address Albert E. Dietrich, 602B Ouray Bldg., Washington, D. C.

MANUFACTURERS Everywhere seek new inventions to improve their product. List of wanted inventions sent free on request. Use our legal form for recording proof of invention. Write W. T. Greene, 944 Barrister Building, Washington, D. C.

PATENTS. Low cost. Book and information free. L. F. Randolph, 302-C Victor Building, Washington, D. C.

COPY Of any patent sent for \$1.00. R. Burch, 904 F St., Washington, D. C.

INVENTIONS WANTED

INVENTIONS Wanted, patented preferred, national contacts. Albert Apple, Monadnock Building, Chicago.

SMALL Inventions wanted. Stanley Hull, 7829 Euclid Avenue, Cleveland, Ohio.

INVENTIONS Wanted—Patented, unpatented. If you have an idea for sale, write Hartley's, Inc., Box 928-E, Bangor, Maine.

PATENTS FOR SALE

SLED Designed for cutting sharp corners. Manufacturers write Albert Erickson, 15 Parkvale, Brookline, Mass.

PATENTED Wire incinerator. Reasonable. Good money maker. James Thompson, 72 Grant, White Plains, N. Y.

FOUR in One clothes hanger, holds complete ensemble woman's clothes. Separate places, pants, vest, coat, any which can be taken off or put on as you dress or undress. Manufactured of wood, wire, stampings, plastics. Sells at 10c to dollar. Outright or royalty. A. Israelson, Hartington, Nebr.

MANUFACTURING

HEADQUARTERS For aluminum, brass, copper, monel, steel, fittings, screws, accessories, furnishing any size and quantity. Pacific Metals Company, Ltd., 1400 So. Alameda St., Los Angeles, Calif.; 3100 - 19th St., San Francisco, Calif.

DEVELOPMENT. Manufacturing, equipment, dies, stampings, transformers, etc. Kinley, Brookhaven, Chester, Pa.

METAL Articles developed and manufactured. Model making. Reasonable price and first class workmanship. W. F. Meyer Company, Bedford, Indiana.

INVENTIONS Manufactured in any quantity at low cost. Stampings, dies, models, etc. Estimates and free catalog. Crescent Tool Co., Dept. X, Cincinnati, Ohio.

DIES For stamping; models and patterns made at low cost. J. J. O'Brien, Patent-Attorney Engineer, 106 West 42nd St., New York.

MANUFACTURING. Models, dies, stampings, brasswork, moulds for castings, vulcanizing. Circular free. Baums Metal Specialties, Kansas City, Mo.

MODELS AND MODEL SUPPLIES

BRASS Gears and model supplies. Send for catalog. The Pierce Model Works, Tingley Park, Ill.

THE Modelmaker. The magazine for those interested in building model railroads, boats, engines. Send 15 cents for copy. Model-maker Corp., 98F East Main St., Bay Shore, New York.

MODELS—Your ideas developed into practical working models. 30 years' successful experience; thousands of satisfied customers. Confidential service guaranteed. Bank references. Send 3c postage for 32-page book—"Making Inventions Pay." Crescent Tool Company, Dept. Y, Cincinnati, Ohio.

SHIP Models—Build 18" Flying Cloud, Constitution or Galileo. All materials including full-sized plans only \$1.50 from Hancock, 323 Douglass Ave., Portsmouth, Virginia.

EVRAV'S Engine catalog (No. 34) or supply catalog (No. 35) postpaid 20c. Evray-mesco, 28 N. Clinton, Chicago.

PLANS, BLUEPRINTS, INSTRUCTIONS

MAKE Blueprints—Instructions and chemicals for 50 sq. ft. 50c. Box 6, Barberton, Ohio.

BLUEPRINTS Of interchangeable entrance wren-bluebird bungalows. Martin houses in many combinations. Send stamp for circular. Bex Bird Bungalows, Dept. P, Remsen, Ia.

HOME CRAFTSMEN

CRAFT Supplies: Spongex, leather belts, celluloid, craftstrips, Navajo silver, suedex, etc. Folders free. Write Craft Service, Blossom Road, Rochester, N. Y.

LEATHERCRAFTSMEN—Write for free instructions and price list of leather, tools and beginners' kits. Send 5c for sample cards. Address Wilder & Company, Dept. F, 1038 Crosby St., Chicago, Ill.

THINGS YOU CAN BUILD

DISC Type induction motor. Simple. Easily built. Runs toys, models. Blueprints and instructions 25c. Box 196, Potwin, Kansas.

WATCHES, JEWELRY, PRECIOUS STONES

WATCHES—Elgin, Walthams, Hampdens, Hamiltons, Illinois. Wonderful bargains in 7-15, 17-23 jewels \$4.98 up. Write for literature. Richfield Jewelry Co., Box 6, Richfield, Pa.

LEARN Watchmaking free. Experimental movement 50c. Catalog 5c. Stewart's, Sixth-Olive, St. Louis, Mo.

MEXICAN Orizaba rings (worn by movie stars). \$150 diamond replicas! 15c with ad. Orizabagem, 329 Broadway, Los Angeles, California. (2 for 25c.) Agents wanted. Easy money giving coupons away.

OLD GOLD WANTED

CASH For gold teeth, jewelry, watches. 100% full gold value paid day shipment received. Satisfaction absolutely guaranteed or articles cheerfully returned. Licensed by United States government. Information free. Chicago Gold Smelting & Refining Co., 357 Champlain Bldg., Chicago.

FOR THE HOME

FINEST Michigan peppermint. Sample bottle 10c. Mint Co., Baroda, Mich.

HEATING AND VENTILATING

MECHANICS—Blacksmiths—Garages. Big bargain in new and used 6" blowers with 1/10 horsepower motors. Every motor carefully checked, sold with money back guarantee. Suitable for forges, oil burners, draft booster for furnaces or boilers. Other end of motor can be used for buffer or grinder. Motor alone worth more than we ask for entire unit. Price only \$10. \$2.50 with order, balance C.O.D. plus freight. Shipping charges prepaid if full amount is sent. Order today. Oil Burner Parts Co., 1304 Washington, Chicago.

RAZOR BLADES—SHARPENING

ATTENTION—Tark electric razor. No more pulling, scraping, or sore skin. Millions in use. Guaranteed. Price \$1.59 with blades. Joe Syc, 2712 Geimer, Detroit, Mich.

FREE Gift and 10 blue steel blades 25c postpaid. Keenshaves, 175 Pinehurst Ave., New York City.

RAZOR Blades sharpened extra keen. 1c each. Petter Wetterquist, Rockford, Ill.

TATTOOING

AMATEURS Tattooing outfits for light-socket or battery. Instructions included; write Chicago Tattoo Supply House, 651A South State, Chicago.

TATTOOING Outfits, electric \$5.00, hand \$1.25. "Waters," 965 Put-nam, Detroit.

TOBACCO

QUALITY Leaf tobacco. Try our package containing 6 marked kinds, \$1.00 prepaid. Price list on request. Farmers Exchange, Edgerton, Wis.

SURVEYING INSTRUMENTS

GUARANTEED Factory rebuilt transits and levels. Sale or rent with purchase option. Terms if desired. Old instruments taken in trade. Write for list M-94. Warren-Knight Co., 136 N. 12th St., Philadelphia, Pa. Headquarters for scientific and engineering equipment, drawing room supplies and repairs to any make instruments. Estimates free.

BRAND New Hildebrandt Theodolite, \$300, worth \$800. Hugo Meyer, 245 W. 55th, New York.

WANTED—MISCELLANEOUS

CASH For used microscopes, binoculars, slide rules, drawing sets, scientific, engineering, dental and medical instruments. Highest prices paid day shipment received. Satisfaction guaranteed or shipment cheerfully returned. Eiman's, 2302G VanBuren, Chicago.

PHOTOS Wanted. Manhattan elevated steam trains before 1904, West Shore trains before 1900. C. Bissell, Wheeler Hall, Berkeley, Calif.

MAIL Us your discarded jewelry, gold crowns and bridges, watches, diamonds, silver, platinum. Money promptly mailed. Goods returned if offer refused. United States Smelting Works (The Old Reliable.) This is not a government institution. 39 So. State St., Dept. 71, Chicago.

PERSONAL

COMMERCIAL Agent. Commissions carried out. Mail. F. Gillespie, Crougha Park, Glasheen Road, Cork, Ireland.

WE Pay up to \$2000.00 each for old coins; \$50.00 for pennies. Send 10 cents for catalog. Chicago Coin Mart, 323-T South Franklin, Chicago.

POPULARITY. Success, happiness. Wonderful simple way. Free information. Flow, 6618B Quimby, Cleveland, Ohio.

FORTUNES Await unlocated heirs. 2,000 (authentic) \$1.00. International Agency, P-4, Cincinnati.

MISCELLANEOUS

METALLASCOPE Absolutely guaranteed find buried gold, silver, etc. Users all over world report finding buried treasure and valuable ore. New de luxe model five times as sensitive as any previous instrument. Operate it expertly after few minutes practice. Write for free interesting information. Metallascope Sales Co., 1031 South Broadway, Los Angeles, Calif.

CAN You use tools? Build your own perfected treasure finder. High efficiency assured. This one really works. Full details free. Famous booklet "Successful Prospecting," mailed for only thirty cents. Write. The Goldak Co., Western Pacific Bldg., Los Angeles, Calif.

ROCKWELL Kent's "How I Make a Woodcut" (5 Illustrations), 10c. Esto Publishing Company, Box 46-M, Pasadena, Calif.

MEN And women interested in joining advertising crew traveling to South America—please write. Big money making possibilities. No investment. No experience. Nothing to buy or sell in order to qualify. Health and "guts" the only requirement. Investigate this proposition thoroughly—it may pay you well! Portfolio with complete information. 15c (stamps). Wagner Advertising Service, 588, Trenton, N. J.

PROF. Magnetic mineral rods with complete placer book, \$4 value for \$1.75. Many successes. Golden B. Ray Co., 442 Market, San Francisco.

NEON Tubes any size or shape filled with rare gas. Experimental tube 8 to 12 in. \$1.00. Miller Laboratories, Latham, N. Y.

FUN—Fame—Happiness, B-241-P, Milton, Pa. Year 25c. Sample dime.

SYMBOLOLOGY Music, mathematics 50c. Hayes, 7214½ S. Broadway, Los Angeles, Calif.

"EMPIRE State" mail order catalog. Many money saving items. 15c (coins). Becker Corporation, Dept. 10, 300 Graham Avenue, Brooklyn, N. Y.

TREASURE Seekers—Make your own gold finders. Wyas, 104½ Frances, St. Joseph, Missouri.

NEWEST Hobby sensation, bookmatch covers. Free premiums and magazine. International Bookmatch Club, 516 Fifth Avenue, New York.

CASH Paid for butterflies, insects. See Sinclair Display Advertisement on page 18A.

CASH Income daily resilvering mirrors; replating metalware; making glass signs. Portable outfit. Sprinkle, Plater, 288, Marion, Ind.

TOMBSTONES Factory prices. Freight paid. Guaranteed. Free catalog. Marble Granite Company, pm, Oneco, Fla.

HERR Fire alarms, operate, electric, doorbell; 75c each. Collinsville, Ill.

BRONZE Tablets, desk plates, wall plates, memorials, grave markers. Bronze, brass and aluminum casting. Wandkey Pattern & Foundry Co., Anderson, Ind.

SWAPPER'S Friend, R4, Salline, Michigan. Interests swappers, collectors, sportsmen. 50c year, sample 10c.

TATTOOING Outfits, supplies, 1935 illustrated list. "Waters," 965 Putnam, Detroit.

CUTS Anybody can make. Zinc etching process. Specimens, particulars, testimonials, for stamp. J. C. Day, Windfall, Ind.

TRIANGLE Chart solves triangles by inspection, 15c. P. O. Box 764, Detroit, Mich.

TREASURE Buried. Send for free literature, photographs. Fisher, Palmer Building, Hollywood.

BOYS! What a joke! Magic crystals. Piece size of pinhead colors pint water beautiful purple. Harmless. Trial packet 15c. Young America Publishers, 139 N. Clark, 401, Chicago.

REFINISH Your own car. New instruction book treats all phases of painting and refinishing autos and trucks. Designed primarily for the man who wants to renew his own car, but covers also the business end of refinishing for the professional. Price only \$1.65 postpaid or sent C.O.D. by mail anywhere in U. S. Popular Mechanics Press, Room 803, 200 E. Ontario St., Chicago.



EASY

You'll advance faster with an easy playing Conn. Choice of the world's greatest artists. Many exclusive features yet they cost no more. Home trial. Easy payments. See your dealer or write for free book. Mention instrument.

C. G. CONN, Ltd.
431 Conn Bldg., Elkhart, Ind.

CONN
World's Largest
Manufacturers of
BAND INSTRUMENTS

OLD MONEY WANTED

\$2000.00 FOR 1¢

We pay the world's highest prices for old coins, encased postage stamps and paper money. Large Copper Cents up to \$2000.00 each, Half Cents \$250.00, Indian Head Cents \$50.00, 1909 Cent \$10.00, Half Dimes \$150.00, 25c before 1873 \$300.00, 50c before 1879 \$750.00, Silver Dollars before 1874 \$2500.00, Gold dollars \$1000.00, Trade dollars \$250.00, 1822 \$5.00 Gold Piece \$5000.00, Old Paper Money \$26.00, Encased postage stamps \$12.00, Certain Foreign Coins \$150.00, etc. Don't Wait! Send Dime Today for our large illustrated list.

ROMANO'S COIN SHOP
Dept. 463, Springfield, Mass.

BECOME A
RADIO
EXPERT

- RADIO**
IN ALL ITS BRANCHES
- TELEVISION**
ACTUAL BROADCASTING
- ELECTRICITY**
COMPLETE GENERAL TRAINING
- BROADCASTING**
COMMERCIAL STUDIO FACILITIES
- TALKING PICTURES**
MODERN OPERATING EQUIPMENT

Be a radio expert. Biggest opportunity in 1935. Under guidance of practical instructors you quickly qualify for expert jobs, including Radio Repair Man, Television Expert, Control Operator, Station Technician, Sound Expert, Ship-operator, Broadcaster, Electrician, etc. All courses at price of one.

Learn in Los Angeles

Enroll in oldest, largest trade school in West. Est. 1905. 20,000 graduates. Most delightful place to train. You operate actual equipment and learn by practical shop experience. Our own broadcasting studio.

Earn Room and Board

The majority of students earn living expenses during enrollment. With limited finances you can enroll.

R. R. Fare Allowed

For limited time each railroad fare from any part of U. S. to Los Angeles will be allowed.

Send coupon for Free Book and details.

NATIONAL
RADIO & ELECTRICAL
SCHOOL—Los Angeles

Dept. 4-PMR, 4006 So. Figueroa St.
Send Book and full details of Courses.

NAME.....
ADDRESS.....
CITY.....STATE.....



MARRIAGE

no trespassing!



Ask yourself this frank question—
 "Am I earning enough money to get married?"
 Then this question—
 "Is there a prospect of my ever earning enough money to marry?"
 If the answer to both questions is "no," you are in a quandary!
 Do something desperate—MAKE yourself worth more money! Many, many other bewildered men have found the answer in more training. This coupon was their very first step.

INTERNATIONAL CORRESPONDENCE SCHOOLS

"The Universal University" Box 5568-H, Scranton, Penna.
 Without cost or obligation, please send me a copy of your booklet, "Who Wins and Why," and full particulars about the subject before which I have marked X:

TECHNICAL AND INDUSTRIAL COURSES

- | | |
|---|--|
| <input type="checkbox"/> Architect | <input type="checkbox"/> Aviation Engines |
| <input type="checkbox"/> Architectural Draftsman | <input type="checkbox"/> Automobile Mechanic |
| <input type="checkbox"/> Building Estimating | <input type="checkbox"/> Plumbing <input type="checkbox"/> Heating |
| <input type="checkbox"/> Wood Millworking | <input type="checkbox"/> Air Conditioning |
| <input type="checkbox"/> Contractor and Builder | <input type="checkbox"/> Sheet Metal Worker |
| <input type="checkbox"/> Structural Draftsman | <input type="checkbox"/> Steam Engineer |
| <input type="checkbox"/> Structural Engineer | <input type="checkbox"/> Steam Electric Engineer |
| <input type="checkbox"/> Electrical Engineer | <input type="checkbox"/> Civil Engineer |
| <input type="checkbox"/> Electric Lighting | <input type="checkbox"/> Surveying and Mapping |
| <input type="checkbox"/> Welding, Electric and Gas | <input type="checkbox"/> Refrigeration |
| <input type="checkbox"/> Reading Shop Blueprints | <input type="checkbox"/> R. R. Locomotives <input type="checkbox"/> Air Brakes |
| <input type="checkbox"/> Telegraph Engineer | <input type="checkbox"/> R. R. Section Foreman |
| <input type="checkbox"/> Telephone Work | <input type="checkbox"/> R. R. Bridge and Building Foreman |
| <input type="checkbox"/> Mechanical Engineer | <input type="checkbox"/> R. R. Signalman |
| <input type="checkbox"/> Mechanical Draftsman | <input type="checkbox"/> Highway Engineering |
| <input type="checkbox"/> Machinist <input type="checkbox"/> Toolmaker | <input type="checkbox"/> Chemistry <input type="checkbox"/> Pharmacy |
| <input type="checkbox"/> Development and Protection of New Products | <input type="checkbox"/> Coal Mining Engineer |
| <input type="checkbox"/> Patternmaker | <input type="checkbox"/> Navigation <input type="checkbox"/> Boilermaker |
| <input type="checkbox"/> Heat Treatment of Metals | <input type="checkbox"/> Textile Overseer or Supt. |
| <input type="checkbox"/> Bridge Engineer | <input type="checkbox"/> Cotton Manufacturing |
| <input type="checkbox"/> Bridge and Building Foreman | <input type="checkbox"/> Woolen Manufacturing |
| <input type="checkbox"/> Gas Engines | <input type="checkbox"/> Agriculture <input type="checkbox"/> Fruit Growing |
| <input type="checkbox"/> Diesel Engines | <input type="checkbox"/> Poultry Farming <input type="checkbox"/> Radio |
| | <input type="checkbox"/> Marine Engineer |

BUSINESS TRAINING COURSES

- | | |
|--|--|
| <input type="checkbox"/> Business Management | <input type="checkbox"/> Business Correspondence |
| <input type="checkbox"/> Office Management | <input type="checkbox"/> Lettering Show Cards <input type="checkbox"/> Signs |
| <input type="checkbox"/> Industrial Management | <input type="checkbox"/> Stenography and Typing |
| <input type="checkbox"/> Traffic Management | <input type="checkbox"/> Civil Service <input type="checkbox"/> Mail Carrier |
| <input type="checkbox"/> Accountancy and C.P.A. | <input type="checkbox"/> Railway Mail Clerk |
| <input type="checkbox"/> Coaching <input type="checkbox"/> Bookkeeping | <input type="checkbox"/> Grade School Subjects |
| <input type="checkbox"/> Secretarial Work | <input type="checkbox"/> High School Subjects |
| <input type="checkbox"/> Cost Accountant | <input type="checkbox"/> College Preparatory |
| <input type="checkbox"/> Salesmanship <input type="checkbox"/> Advertising | <input type="checkbox"/> First Year College |
| <input type="checkbox"/> Service Station Salesmanship | <input type="checkbox"/> Illustrating <input type="checkbox"/> Spanish |
| <input type="checkbox"/> Wallpaper Decorating | <input type="checkbox"/> Cartooning <input type="checkbox"/> French |
| <input type="checkbox"/> Salesmanship | <input type="checkbox"/> Lumber Dealer |

Name.....Age.....
 Address.....
 City.....State.....
 Occupation.....
 If you reside in Canada, send this coupon to the International Correspondence Schools Canadian, Limited, Montreal, Canada

FOR Real FUN Play. A Soprani ACCORDION



● If you want to be really popular, have all the fun, be the whole show and the center of attraction everywhere, just learn to play this thrilling instrument from Italy. A complete band or orchestra in itself, romantic organ tone, and so easy to learn to play. You'll master this easier Soprani in no time, and you'll have real fun from the start. Don't delay. Big future. Send postal for beautifully illustrated literature. No obligation. Easy terms. Write today sure.

Easy TO PLAY

SOPRANI, INC. 24
 630 S. Wabash Ave., Dept. 429, Chicago, Ill.

BE AN ARTIST

WE CAN TEACH YOU DRAWING in your own home during your spare time. Thirty-five years of successful teaching proves our ability. Artists receive large salaries.

Write today for Art Year Book **SCHOOL OF APPLIED ART**
 Dept. 145, 10 E. Huron St., Chicago, Ill.



60 ART LESSONS Only 1.95 POST PAID COURSE COMPLETE

Become Talented Artist with Big Income! This thorough course by Alexander Murray, famous Art School instructor, makes it easy to learn art in spare time. No bother or expense of corresponding. Teaches commercial art, cartooning, lettering, anatomy, perspective, adv. layout, etc. You get all 60 lessons at once—no waiting for next lesson. Over 815 instruction illustrations, 125 pages of drawing paper included. Only \$1.95 postpaid—or pay postman plus postage. **MONEY BACK** if not delighted after inspecting. Start now turning your spare time into MONEY!
 EDUCATIONAL SUPPLY CO., Dept. 101-D, Racine, Wis.

RADIOS 2 SENSATIONAL PLANS for making big money quickly. (PLAN NO. 1) Give radios away through our famous Sales Card Plan. (PLAN NO. 2) Become our Agent-Distributor selling radios at wholesale prices. 10 models for home, office, farm; also foreign reception, and All-Electric, All-In-One-Unit Auto Radios. Write quick for exclusive territory.
BERKSHIRE COMPANY, 130 No. Wells St., Dept. P, Chicago, Ill.

EARN BIG MONEY AT HOME!
 Raise mushrooms in your basement, cellar, garage, idle places. We buy crop. Experience unnecessary. **FREE Book.**
MUSHROOM GROWERS OF AMERICA, EE-433, N. Clark St., CHICAGO, ILL.

ARMY AND NAVY SUPPLY CO.
 Bargains—Army, Sport Goods, Firearms, Clothes, Shoes, etc. Send 10c for new catalog, to be redeemed on first order
Army & Navy Supply Co. 4772 Lester St. Richmond, Va.

STUCCO SPRAYING MACHINE

FUSES A PLASTIC MIXTURE ON TO ANY MASONRY SURFACE. It waterproofs and fills all cracks. It can be applied in any thickness desired and 30 colors. For over six years in use under all conditions and in practically every climate.
OFFERS BIG EARNINGS Operators report costs of 8c to 10c per sq. yd. Sell for 20c to 35c. The profit on one order often pays for machine. Start now and get your share of large profits offered in your territory by increasing demand for color and big government renovating campaign. Machine furnished on free trial and easy payments. Territory protected. Write today for complete details.
Colorcrete Industries, Inc.
 570 Ottawa Ave. Holland, Mich.



BE A POULTRY EXPERT

Make \$40, \$50, \$60 a Week

Free book shows how to get started quickly. You'll be surprised at the amazing profit opportunities in the poultry business. Wherever you live—whatever you do—it is easy to start on a spare or full time basis. Free book tells all. Send for "How to Raise Poultry for Profit." You learn right at home in spare time by methods endorsed by colleges and leading poultrymen. Know how to get the maximum profits from interesting, healthy work. Iron-clad agreement protects you. We have prepared hundreds for good jobs and businesses of their own. Write now for free book. No obligation. National Poultry Institute, Inc., Dept. 34, Adams Center, New York

at last CARTOONING MADE EASY



NEW, ORIGINAL, COMPLETE COURSE, especially prepared by one of today's cleverest newspaper and magazine cartoonists. Full of punch and interest. 20 fascinating lessons. Hundreds of ten-by-ten Cartoons. EXTREMELY EASY. Learn quickly right from the start, either for fun and spare money or to become a professional cartoonist! Money Back Guarantee. Or, send for Free Details. Don't delay. **AMERICAN SCHOOL OF CARTOONING** Dept. 145 614 West Austin Ave. Chicago, Ill. **Complete COURSE only \$2.75**

BUILD YOUR OWN

Streamlined Trailer at little cost. Engineered to suit you. Send a dollar for plans and blueprints of a Standard or Deluxe Model as shown. Big Value. Mail a Dollar to D. Van Oostveldt 111 Marston, Detroit, Mich.



MAKE GLAZED GARDEN POTTERY
Beautiful, colored, glazed concrete pottery made without molds. No experience needed. Use only sand and cement. 2,500 different designs birdbaths, vases, jars, etc. Big profits. Send 10c for Booklet, color plate, etc. **NATIONAL POTTERIES CO., 424 Second Ave., So., Room 21 Minneapolis, Minn.**

ELECTRICAL EXPERIMENTAL KIT only \$2.79

SAVE \$14.90! Complete electrical home-laboratory exper. kit. guaranteed original cost of parts \$17.75—now only \$2.79! Contains hand-driven 110 volt AC generator—polarized test ringer—ultra violet and arc furnace carbons—microphone-transformer—condensers—test receiver—Skindriverken element—electro-plating bath—electro magnets, etc. Illustrated manual. Make motors, relays, detectors, extension telephones, electro plating, etc. Wt. 16 lbs. All high grade apparatus, assembled from surplus stocks of leading Mfgs. Order direct—send only \$2.79. Stamp for catalog.

ELECTRICAL SALVAGE COMPANY Box 524-AB, Lincoln, Nebr.



and a Successful Aviation Career

Men who train at LINCOLN know in advance that the aviation industry will quickly recognize their ability . . . and that counts for a lot when you are seeking a big pay job in aviation. LINCOLN has won recognition as the Government Approved School that turns out high class, properly trained pilots and mechanics.

Complete Training—Modern Equipment

Offering all flight courses including Transport course. Flight curriculum includes night flying, flying by instrument, cross country flying, aerobatics and all other phases to produce highest type of pilot. Master Airplane and Engine Mechanics course gives you complete practical training under experienced supervision. Factory methods used. You overhaul and rebuild actual airplanes and motors. Both flight and ground school under Gov't Supervision. **25 Years' Success as a mechanic's trade school and 15 years' teaching aviation. Lincoln-trained pilots and mechanics are now employed by many of the best known companies in the aviation industry. Graduates satisfactorily meeting required tests are recommended for positions in the aviation industry, with which LINCOLN is in constant touch. Let Lincoln put you a step ahead in Aviation with recognized finest training. Write today. State your age.**

Lincoln Airplane & Flying School
203E Aircraft Bldg. Lincoln, Nebr.

FULLY PATENTED
AND PATS. APPLD.
FOR IN ALL LEADING COUNTRIES



ASTOUNDING INVENTION TURNS JUNK AUTO TIRES INTO MONEY

5¢ Tire Makes \$2.00 MAT

The Most Sensational Business Opportunity Since 1929

Gigantic National Market running into Millions. And you can now supply it with JUNK TIRES as your raw material. What a Business. What an unheard of profit. Schools, stores, clubs, factories, public buildings, homes, offices, grab this good looking, springy, long wearing FABRIX Mat. No limit to market. And the profits are so big that you can easily afford to hire helpers, hire salesmen, and still have a fabulous margin on every mat.

ONE HANDY MACHINE KEEPS FOUR HELPERS BUSY

Here is a new business. The product is so unusual that it has opened up a new market. Don't confuse FABRIX with a "Door Mat." It has a hundred INDUSTRIAL uses in factories. Your sales for home use will be the least part of your business. Here is an opportunity for one man in each community. Under our license you can establish a local manufacturing plant. The investment required is reasonable.

COSTS NOTHING to get complete facts. Rush your name and address and we'll send complete description of simple machine that quickly slices

old tires into uniform strips; show you how patented method forms strips into springy, long-wearing FABRIX Mats; how you can turn a 5c tire into a \$2.00 mat; how you can start on a reasonable investment and build a business so big, so fast, that it will take your breath away. Capable men, responsible men, big men, are the ones we want in this enterprise. If you are that kind don't delay a minute. Write, air mail or wire today. All information is free.

FABRIX, INC., 325 West Huron St. Dept. 74 Chicago, Ill.

MAIL COUPON for FREE FACTS

Responsible men dropping everything to enter this New Field.

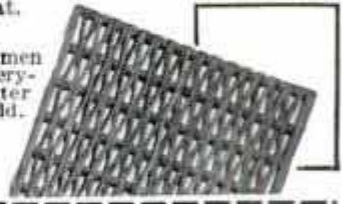

FABRIX, Inc., Dept. 74
325 West Huron St., Chicago, Ill.
Send full information at once. No cost to me, no obligation.

Name.....
Address.....
City..... State.....

FRANK McHUGH

Won long-term Warner Brothers contract after first picture in 1928. Now playing in "Gold Diggers of 1935." Has smoked Union Leader since 1932.

"If you're matching tobacco dimes I'll bet on this one!"

THOSE fancy tobacco mixtures don't get a tumble out of me since I discovered Union Leader. And it isn't the dime-a-tin price that pleases me *most*. It's the extra pipe-pleasure I get out of this grand, *old*, mellow Kentucky Burley. It's gentle as moonbeams—smooth as old sherry. Believe me. There's a tobacco education in this 10¢ tin. (Fine in cigarettes, too.)



UNION LEADER

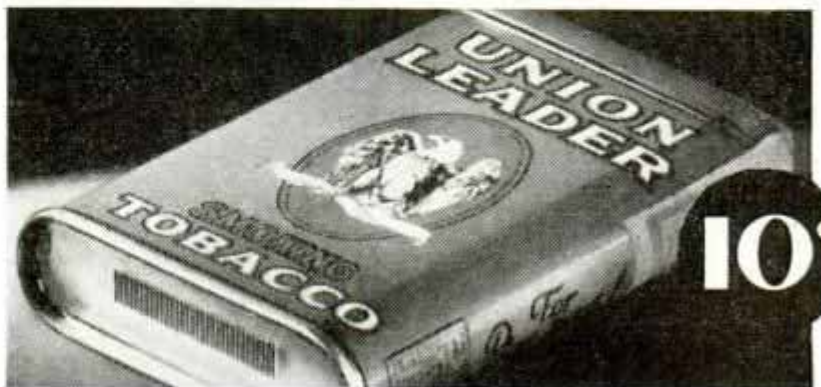

THE GREAT AMERICAN SMOKE

© P. Lorillard Co., Inc.

When writing to advertisers please mention Popular Mechanics

Popular Mechanics Magazine

REGISTERED IN U. S. PATENT OFFICE AND CANADA

WRITTEN SO YOU CAN UNDERSTAND IT

Vol. 63

APRIL, 1935

No. 4

The LENGTHENING SPAN of LIFE

By Morris Fishbein, M. D.

Editor, Journal American
Medical Association

GLANDS have been the center of medical interest, particularly during the last ten years.

It has been established that they are an interlocking chain, and that the action of one may influence others. A remarkable piece of work has been the isolation from the cortex of the adrenal gland of another glandular principle, called cortin. By its use cases of Addison's disease, or bronze diabetes, are now saved when formerly death was inevitable.



Above, Patient Reclining on Motor-Controlled Tilting X-Ray Couch with Shock-Proof Tubes; Below, Apparatus Using Short Radio Waves to Produce a Bodily Fever

But probably the most significant of all recent work on glands has been the establishment of the fact that the liver and the wall of the stomach contain a substance vital to the building of red blood cells. The use of this substance permits a return to health of people with pernicious anemia, a condition formerly fatal.

The most important single observation of last year was the determination that the body develops not only hormones but also anti-hormones. In other words, as excess amounts of various glandular principles are poured into the body, the organs and tissues responsible for counteracting

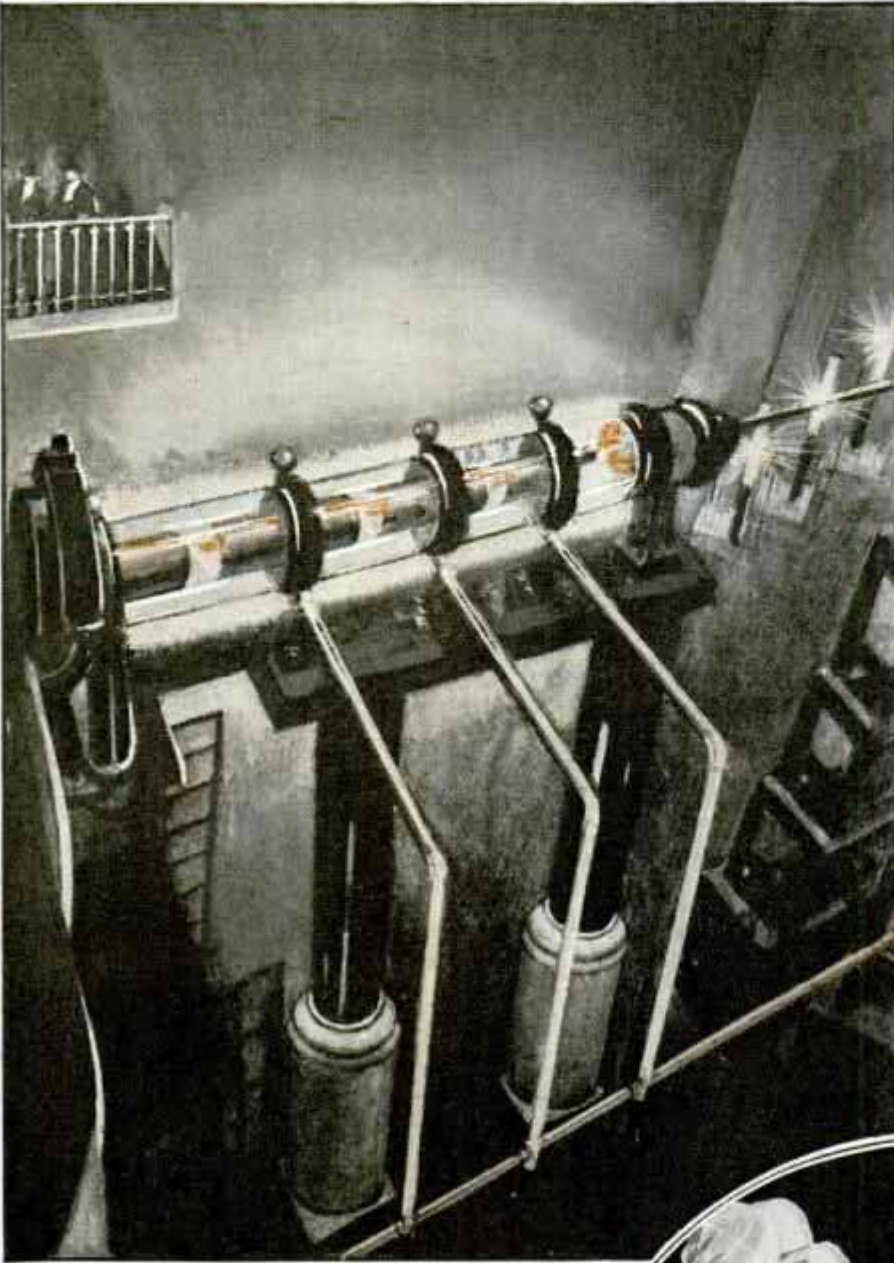

Once upon a time we thought of food simply as fuel to make the body go. Today we know it provides also the vitamins necessary for growth and the prevention of disease. More than anything else, these researches have shown the importance of mineral substances for the health.

The vitamins now include A, B, C, D, and E. Vitamin A has been shown to be necessary for the maintenance of healthful tissue and for the general resistance. Its absence results in the appearance of a disease of the eyes called xerophthalmia. A relative deficiency of this vitamin results in a breaking down of the mucous membranes, particularly in the breathing tract, and this deficiency is therefore associated to some extent with the common cold and various

these effects produce anti-substances which limit the action of the hormones and keep the body constantly balanced. These observations emphasize the basic principle that the human body is essentially a self-regulating mechanism, and that under normal conditions it is impossible to get too acid, too fat, or too thin, too big, or too small. However, under abnormal conditions, such as result from disease or deficiency, or from destruction of any vital portion, the balance is broken and strange conditions result.

Next most significant after the discoveries related to glands have been the advances in our knowledge of nutrition.



An 800,000-Volt X-Ray Tube in Chicago Hospital, and Demonstrating Radio Surgical Knife on Piece of Beefsteak

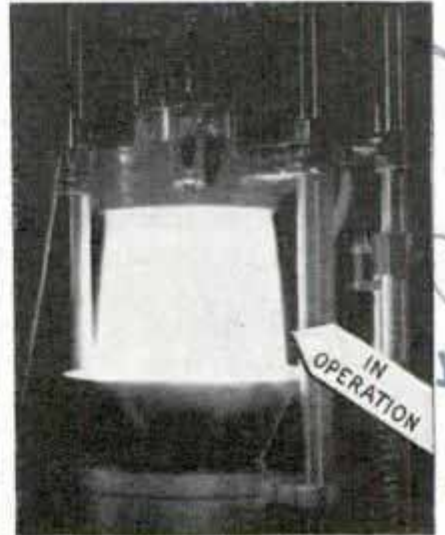
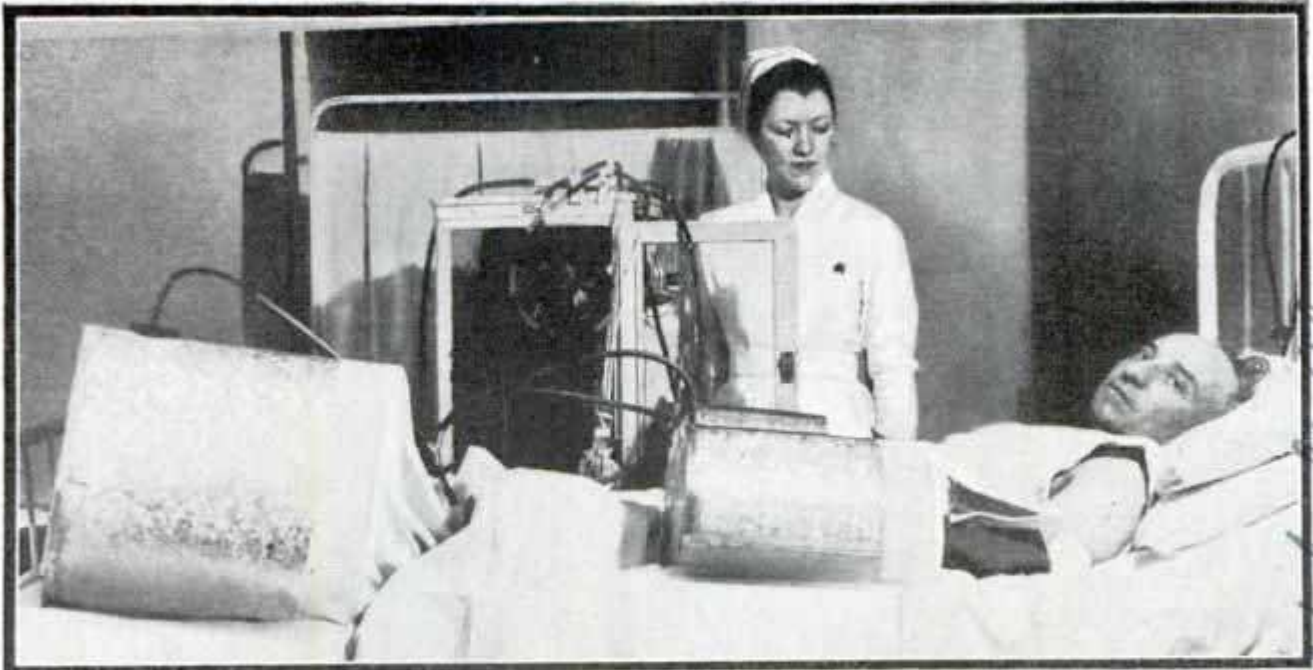

Above, Apparatus Used to Revive Frozen Limbs by Alternating a Vacuum and Normal Pressure; Below, Irradiating Milk; Note Gas-Tight Film of Water between Carbon Arc and Milk

427 Randolph St. Chicago

respiratory disorders. Its deficiency is also associated with the development of certain skin diseases.

Vitamin B, when absent, results in the appearance of pellagra, for one portion, and of beriberi, for the other. It has also been found associated with disturbances of the gastro-intestinal tract and with loss of appetite.

When vitamin C is absent, scurvy develops. The absence of vitamin D results in rickets.

Among the most significant of discoveries in recent years has been the isolation in pure form of these vitamins. Thus, the isolation of vitamin C was first announced in 1934 as was the development in pure form of vitamin A, known as carotene, after it had been shown that the

yellow coloring material in carrots was among the richest substance known in this vitamin. At the same time, it was established that the halibut liver is the richest of all fish livers in vitamin A. Thus halibut-liver oil, added to cod-liver oil, produces the richest natural preparation of vitamins A and D. Cod-liver oil is the richest natural substance in vitamin D. Also it was shown that the ultra-violet rays of the sun, acting on the human skin, produce vitamin D in the human body out of a substance existing in the skin. Thus the use of the ultra-violet rays came into prominence and artificial sources of sunlight were developed.

Continuing these investigations, it was found that various food substances can be exposed to ultra-violet rays so as to cause

Machinery, Chevy-Burrell Corp.

600

them to contain vitamin D. Eventually it became possible to produce vitamin D in milk and bread. Because rickets is primarily a disease affecting infants and children, vitamin D in milk is considered to be one of the best ways of giving the children the vitamin that they need.

Rickets did not appear among human beings to any extent until window glass came into vogue. Ordinary window glass shuts out ultra-violet rays. The incandescent lamp provides no violet rays. If, however, a new type of lamp is used, it becomes possible to light the home or school and to provide enough ultra-violet rays to have a beneficial effect on rickets.

Rickets, it should be remembered, is a disease in which the long bones do not develop properly and in which there are deficiencies of other bones and teeth. Vitamin D controls the use of calcium and phosphorus in the human body and is in this way related to many convulsive disorders, as well as to rickets.

Since Pasteur established the germ causation of disease around 1890, the causes of many infectious diseases have been determined, modes of transmission established, and these diseases have thus been eliminated. Yellow fever, plague, cholera and smallpox are seldom seen in any civilized community. Typhoid fever is so rare as to be a medical curiosity. Diphtheria and scarlet fever are being brought under control. Yet even today the exact cause of measles, infantile paralysis, epidemic encephalitis or American sleeping sickness, mumps and chicken pox are not definitely known. However, investigations during recent years have greatly advanced our ability to control these diseases.

New studies of the germ of tuberculosis have developed new ways of attacking this disease. Particular attention has been given to inoculations of children with living

(Continued to page 134A)

ICE CUBES EJECTED FROM TRAY BY HANDY LEVER

Among the features of the latest Westinghouse electric refrigerator is a tray that ejects its ice cubes. A lever raises the cube separators above the tray so that the cubes can be removed easily. Another feature is a handy-jack ice-tray release that



Showing Easy Removal of Ice Cubes

makes it easy to remove trays that have become frozen in the chilling compartment.

WINDSHIELD IS CLEARED OF ICE BY SALT HOLDER ON WIPER

Ice can be kept off the windshield by a defroster consisting of a wiper to which is attached a receptacle containing salt. Rain dissolves some of this salt and carries it along the wiper blade to the windshield, lowering the freezing temperature. Frosting occurs when the temperature is just below freezing and rain is falling. Under such conditions the salt clears the glass.



Cone of Salt on Wiper Keeps Windshield Clear

69

Westinghouse
the sure

11-1-35

42

Electric Mfg. Co. Pa.

second wiper

Applied Arts Corp.
3/15

Trans-Pacific Air Liners to Touch at Islands

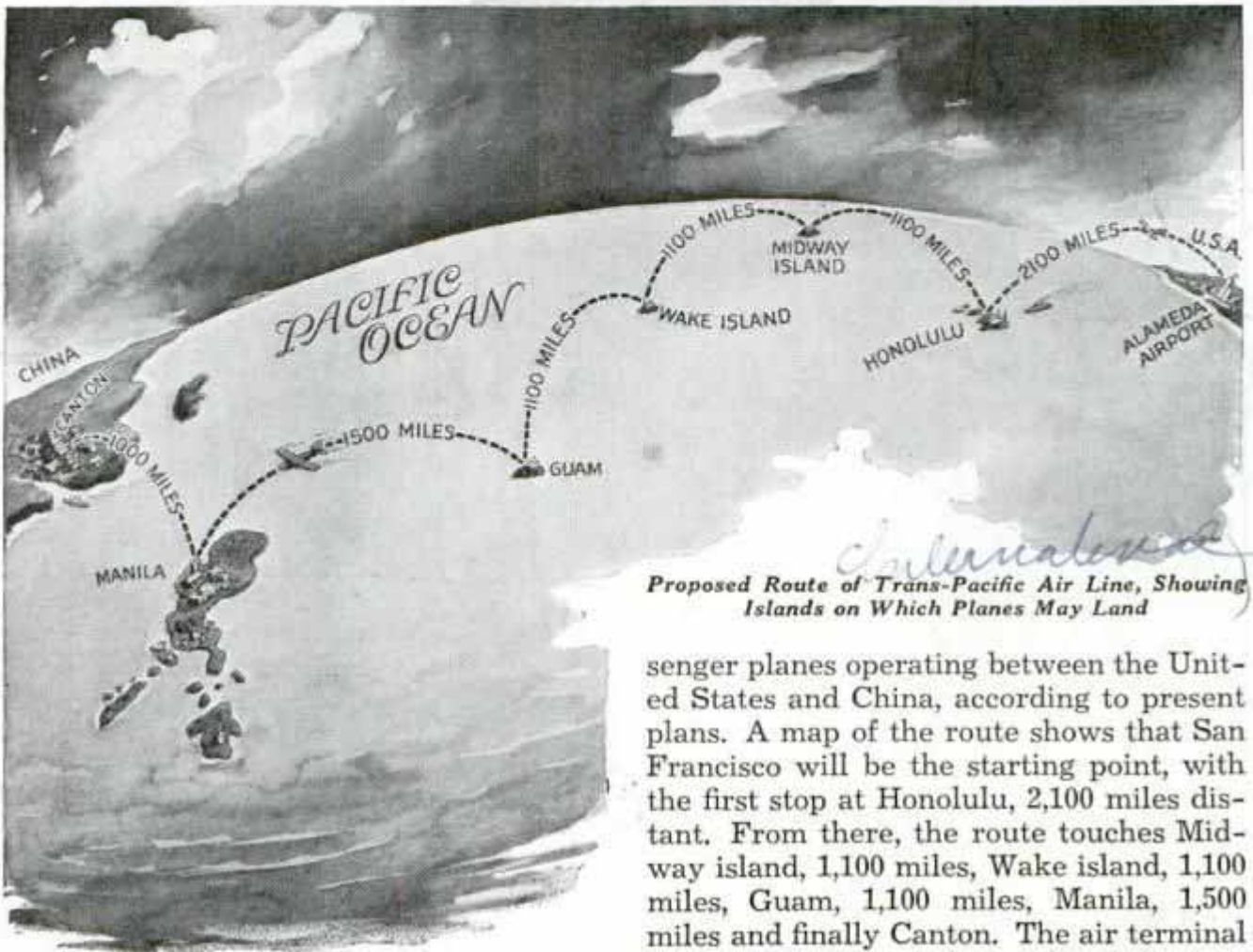

Proposed Route of Trans-Pacific Air Line, Showing Islands on Which Planes May Land

senger planes operating between the United States and China, according to present plans. A map of the route shows that San Francisco will be the starting point, with the first stop at Honolulu, 2,100 miles distant. From there, the route touches Midway island, 1,100 miles, Wake island, 1,100 miles, Guam, 1,100 miles, Manila, 1,500 miles and finally Canton. The air terminal on the American side will be Alameda, Calif. The navy department has been asked to build landing facilities on Wake island.

Several islands will be used as landing fields for the Pan-American Airways' pas-

Jack for Streamline Car Can Be Operated While Standing

Overhanging fenders of streamline cars and the independent wheel suspension on some of the modern automobiles often make jacking up a car a difficult task. As a result a jack has been developed which can be used on any car but which is suited particularly to the streamline models. This jack is operated from a standing position and is placed under a front or rear bumper. It has a detachable steel base and steel clamp screw, the brackets are heavy malleable castings and the gearing is machine cut to insure easy operation. It raises any car under 3,500 pounds with a few turns of a universal-joint handle.

Ⓢ A chemical product developed for the quick, emergency repair of automobile cylinder cracks is placed in the radiator.



Jack Which Is Placed under a Bumper and Operated Easily from a Standing Position

Phone Kildan 9606.

Charles W. Johnson & Co.
500
Plex Seal 807 car

Standup
\$3.50
Iversen & Haynes, Inc.
109 N. Harbor

921 Front St.
E 128 Bismarck

See 130
No information.
2/16/30
Wed / Jan

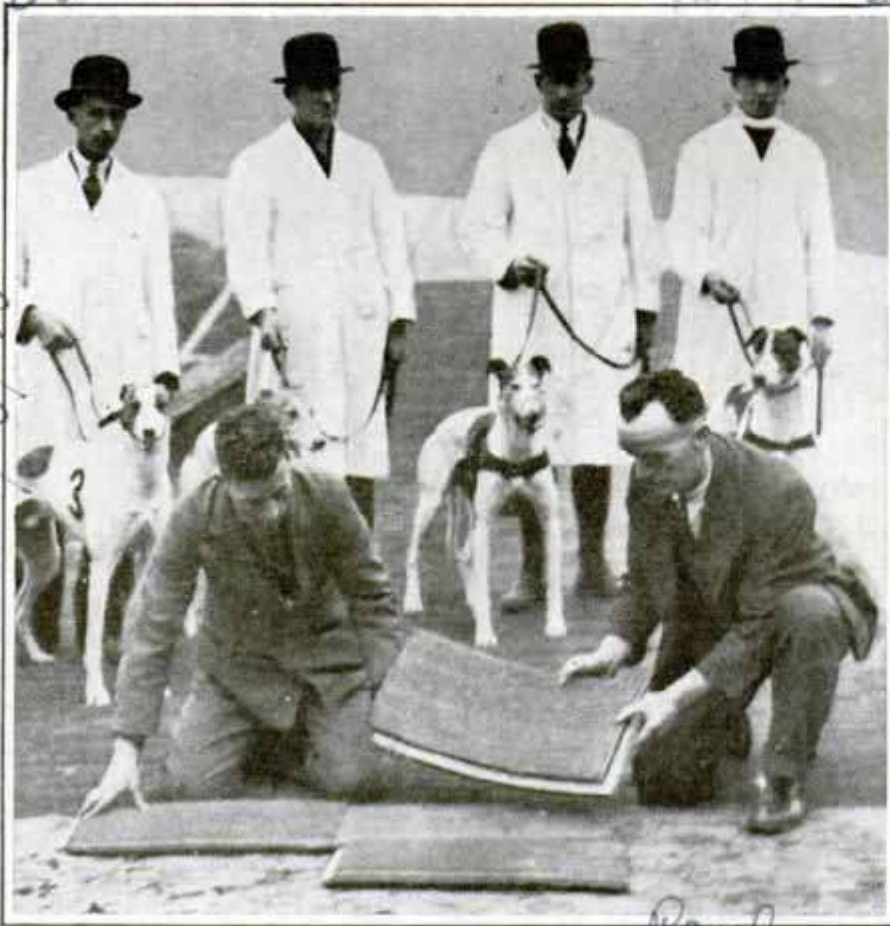

Laying Rubber Turf on Dog Track While the Racers Are Held on Leash; the Material May Be Used on American Football Fields

RUBBER TURF FOR DOG TRACK GIVES BETTER FOOTING

Tested at a stadium near London, rubber turf is being used to surface the track on which greyhounds race. It is claimed that the material gives better footing after a rain than grass. The rubber turf also will be tested on football fields.

HANDY CABLE CONNECTOR LUG REQUIRES NO SOLDERING



Installed without soldering, a new electric cable lug provides a positive connection. The only tool required is a socket-head wrench to turn a hollow set screw in the lug. The powerful leverage of the wrench tightens the screw to give a good connection. There are eight sizes of the lugs to care for all wire sizes from 1,000,000 c.m. to No. 14, each size lug being adjustable to several wire sizes.

METAL OVERSHOES ON SKATES ENABLE WEARER TO WALK

Changing from street to skate shoes on arrival at the ice pond is no longer necessary if you are equipped with a pair of metal overshoes for your skates. The shoes are in the form of lightweight braces made of sheet steel, and rubber soles and heels give good traction on icy pavements. They clip around the soles of the skate shoes and fasten at the heels with a single strap around each ankle. They are high enough to clear the skate runners and form pockets in which the skates rest. By using the overshoes, the skater can walk from his home to the ice with skate shoes and skates on, removing the metal overshoes while skating and attaching them again when leaving the ice.

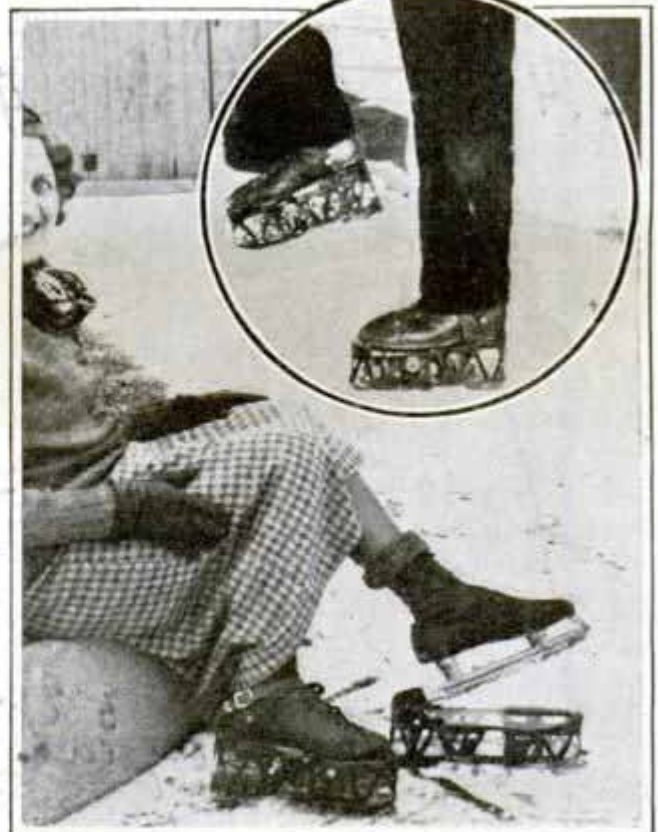

Metal Overshoes Which Are Donned over Skates

Branches - Newcastle & 13
Channing St. - Detroit - Phil
Boston - Portland

Crumble Electric Mfg Co

1930

Streamline Bus Is Like Dirigible on Wheels



White 10-ton truck

Some unique ideas in streamlining are incorporated in an ultra-modern bus constructed by three Los Angeles body shops and used as one of the "props" for a motion picture made by Paramount Productions. The script called for a daring and gaudy vehicle in which a featured orchestra was to do its cinematic traveling, and the bus which was designed is unlike anything ever built before. The multiple-wheeled vehicle looks like a dirigible on wheels. It is forty-seven feet from bumper to bumper. The driver is ensconced fifteen feet above the road in a glass-enclosed crow's nest jutting out from the roof, and below him the front of the bus is rounded and grilled like the modern streamline train. In the "cabin" are Pullman seats for thirty passengers and there is room for six more on the rounded observation platform. A tailpiece like an airplane rudder and elevator assembly juts out at the rear and the steel plate body is painted a battleship gray.

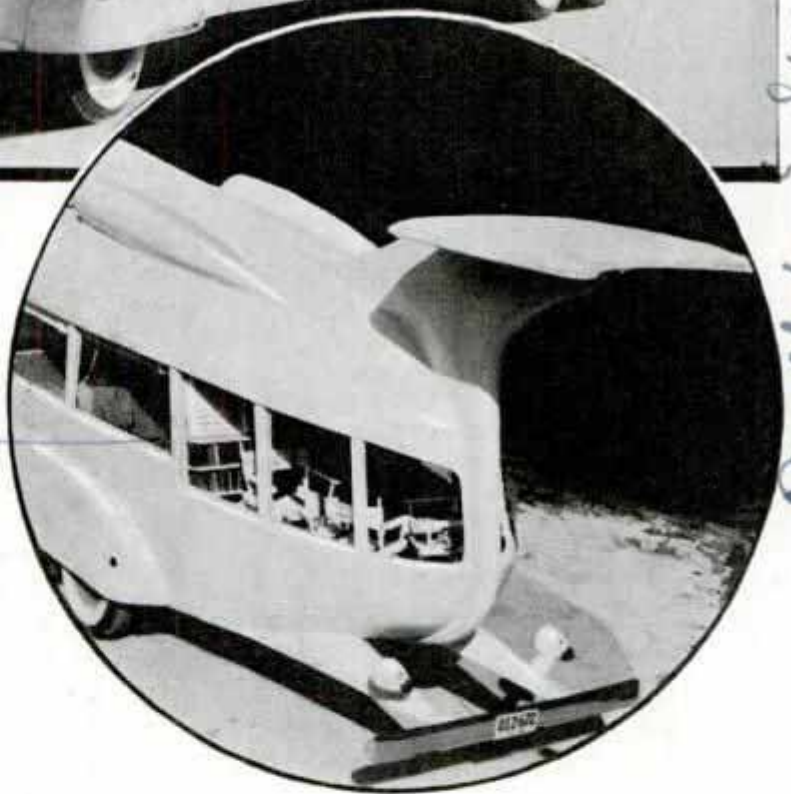

© Paramount Productions, Inc.
Front and Rear of Forty-Seven-Foot Bus Built for Movies; Note Crow's Nest for Driver

The seats can be converted into berths and the interior contains a small piano and a soda fountain. The chassis is that of a high-speed truck with two transmissions giving fifteen speeds forward and three in reverse. The driver uses extension rods to shift gears and the bus has a speed of nearly seventy miles an hour.

Used in carrying Green U.S. Marines in "Stolen Harmony"
Designed by Langdon Carney Works
717 S. Grand Ave. Los Angeles, Calif.
1935

4 W. 10 3rd St
New York

'Fabric' Inner Tube Lessens Blowout Hazard

Lifeguard

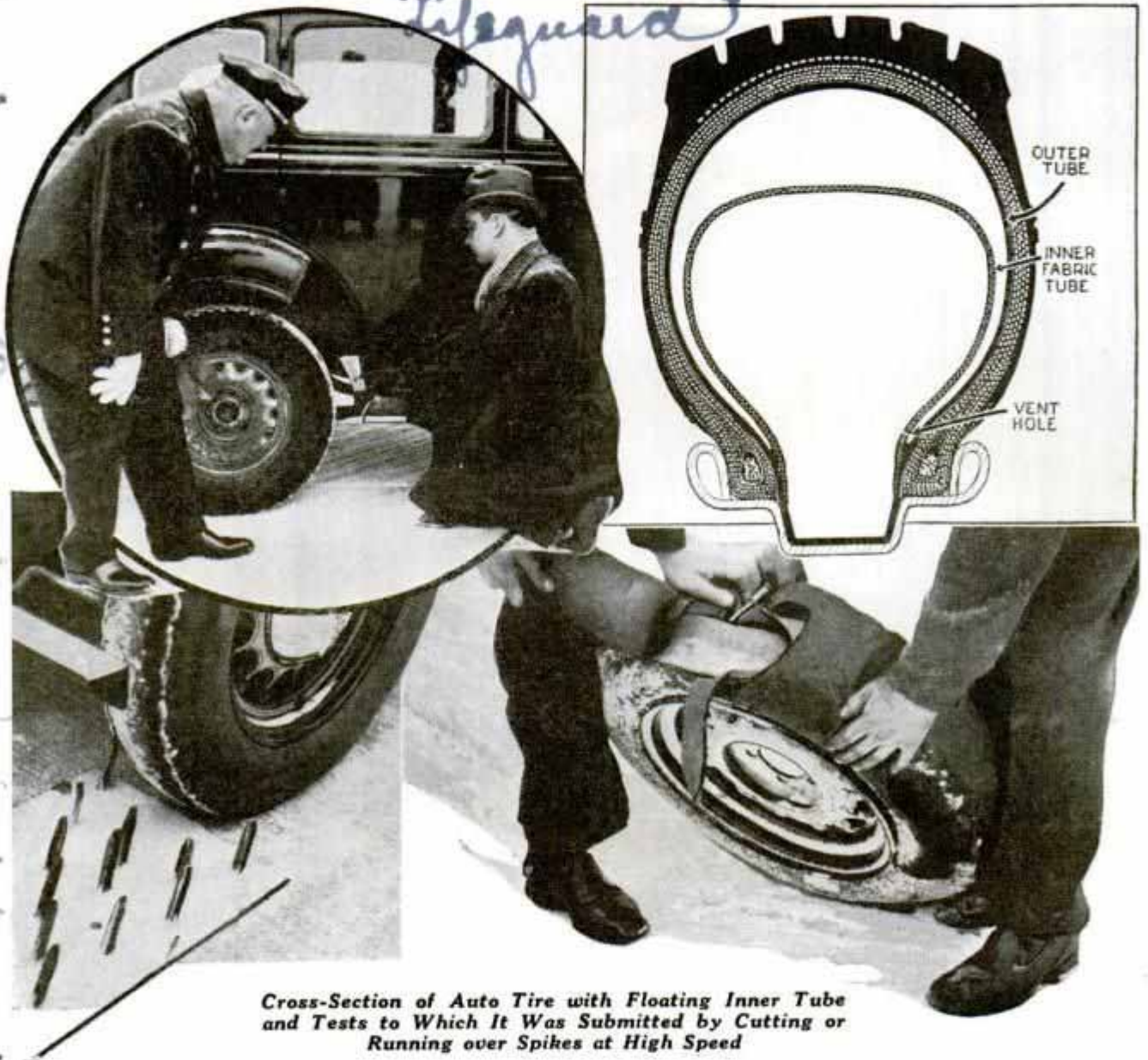

Cross-Section of Auto Tire with Floating Inner Tube and Tests to Which It Was Submitted by Cutting or Running over Spikes at High Speed

Development of an automobile tire with a "floating" inner tube has removed much of the danger of a serious accident from a blowout when traveling at high speed. The tire consists of a double tube, one inside the other and joined at the base, a single vent hole connecting the two air chambers. The outside tube is similar in function and appearance to an ordinary tube and fits against the inside of the casing, while the inside tube or "lung," built of two plies of fabric, floats free without chafing. When the tire is inflated, the vent permits the air to pass from the inner to the outer chamber, so that in ordinary service the inner carcass is under no strain. When a blowout occurs the air escapes from the outer chamber immediately but can escape from the inner one only through the small vent.

Thus only a portion of the air is lost in the blowout and the tire drops down slightly to ride on the inner fabric carcass which loses its air slowly. This permits the car to continue under control, giving the driver plenty of time to come to a gradual stop. Thus the tube, in effect, converts a blowout into a slow leak. Such tires have been blown out with dynamite caps, cut with a knife or run over railroad spikes at high speed and in each case the driver was able to bring the car to a stop under complete control.

Names and addresses of manufacturers and dealers in articles described in this magazine will be furnished by our Bureau of Information upon receipt of a stamped, self-addressed envelope.

*John & County. 3109-12th
New Washburn
22 C*

JOYS of the OPEN ROAD

WHERE TO GO THIS SUMMER

D/632.

VIEWING the mountain
crag and snow of Glacier
national park, often re-
ferred to as the "Switzer-
land of America."

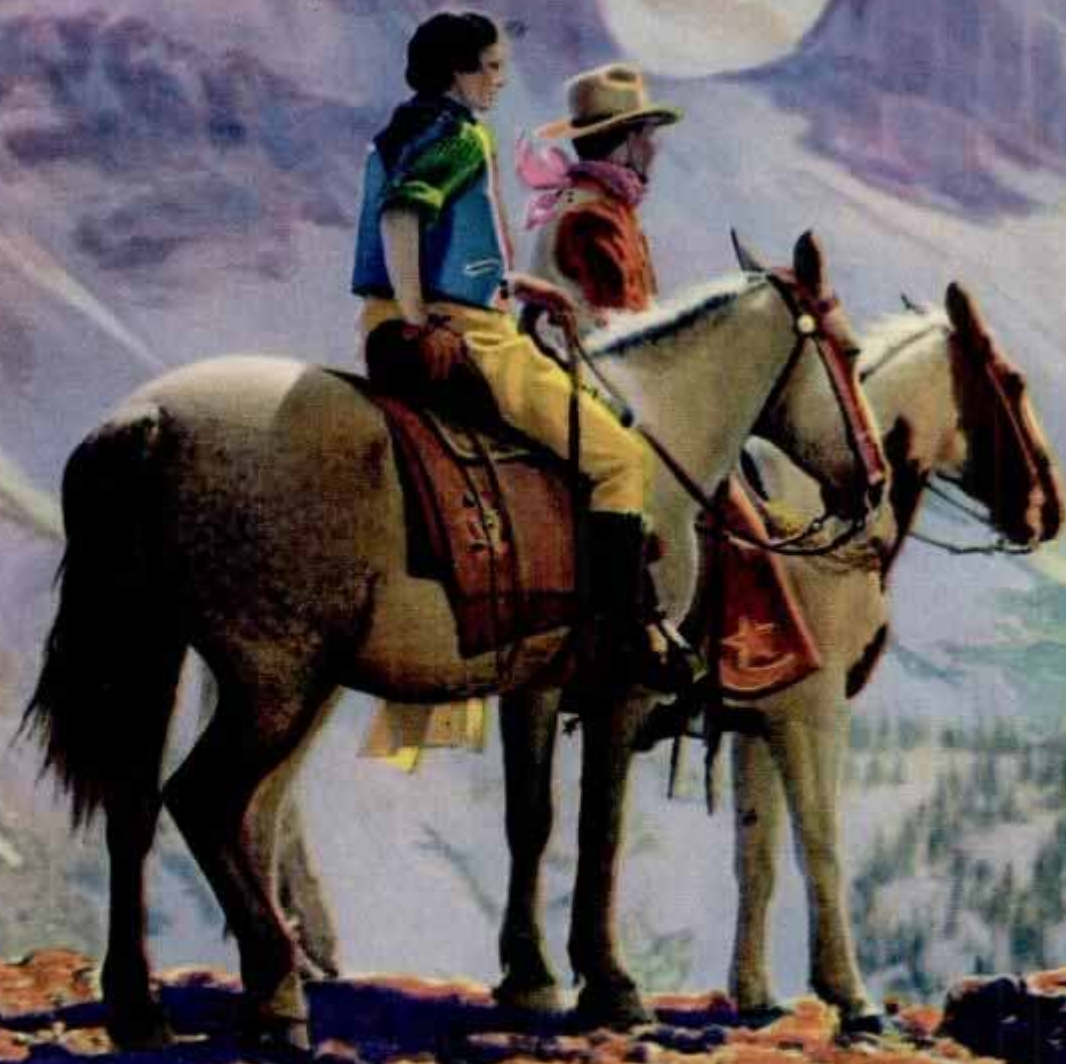

D1362.

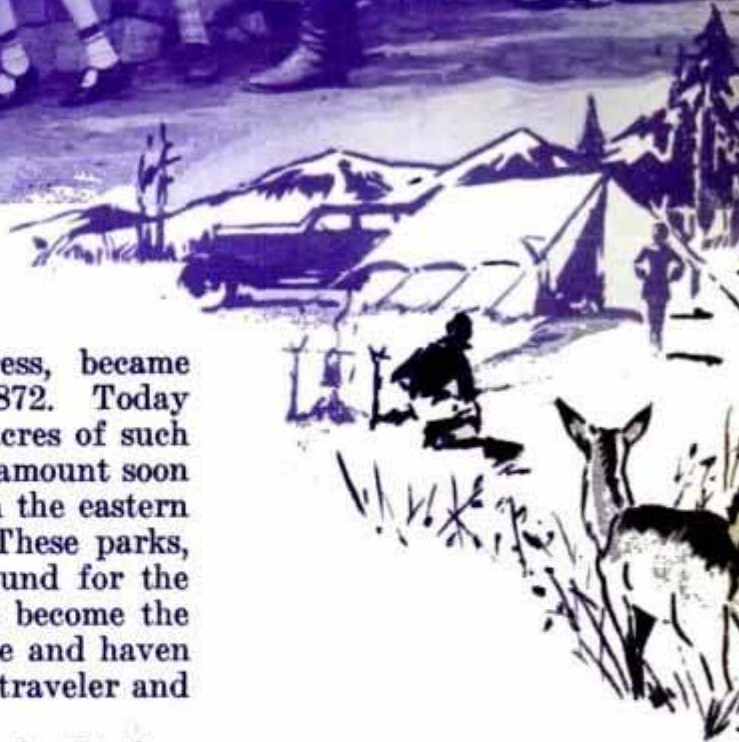

YELLOWSTONE, by act of congress, became America's first national park in 1872. Today there are approximately 8,500,000 acres of such parks in the United States and this amount soon is to be augmented by some 200,000 acres in the eastern and east central portions of the country. These parks, set aside by congress as "a pleasuring ground for the benefit and enjoyment of the people" have become the public playgrounds of the nation, the refuge and haven of bird and beast, the scenic highway of the traveler and the paradise of the jaded and tired.

Our national parks are a typical American institution. No other country in the world has set aside for posterity such marvelous areas of natural beauty and historic interest. It was left to free, democratic America to consecrate to the use and enjoyment of all mankind thousands of acres of the most beautiful and awe-inspiring scenery that can be found anywhere in the world.

This national park system ranges the eastern seaboard from Maine to the Carolinas; the west from Canada to

ENJOYING the view at Lookout Point on the loop trail north of Sunrise in Mount Rainier national park, famous for its glacier system.

P136A

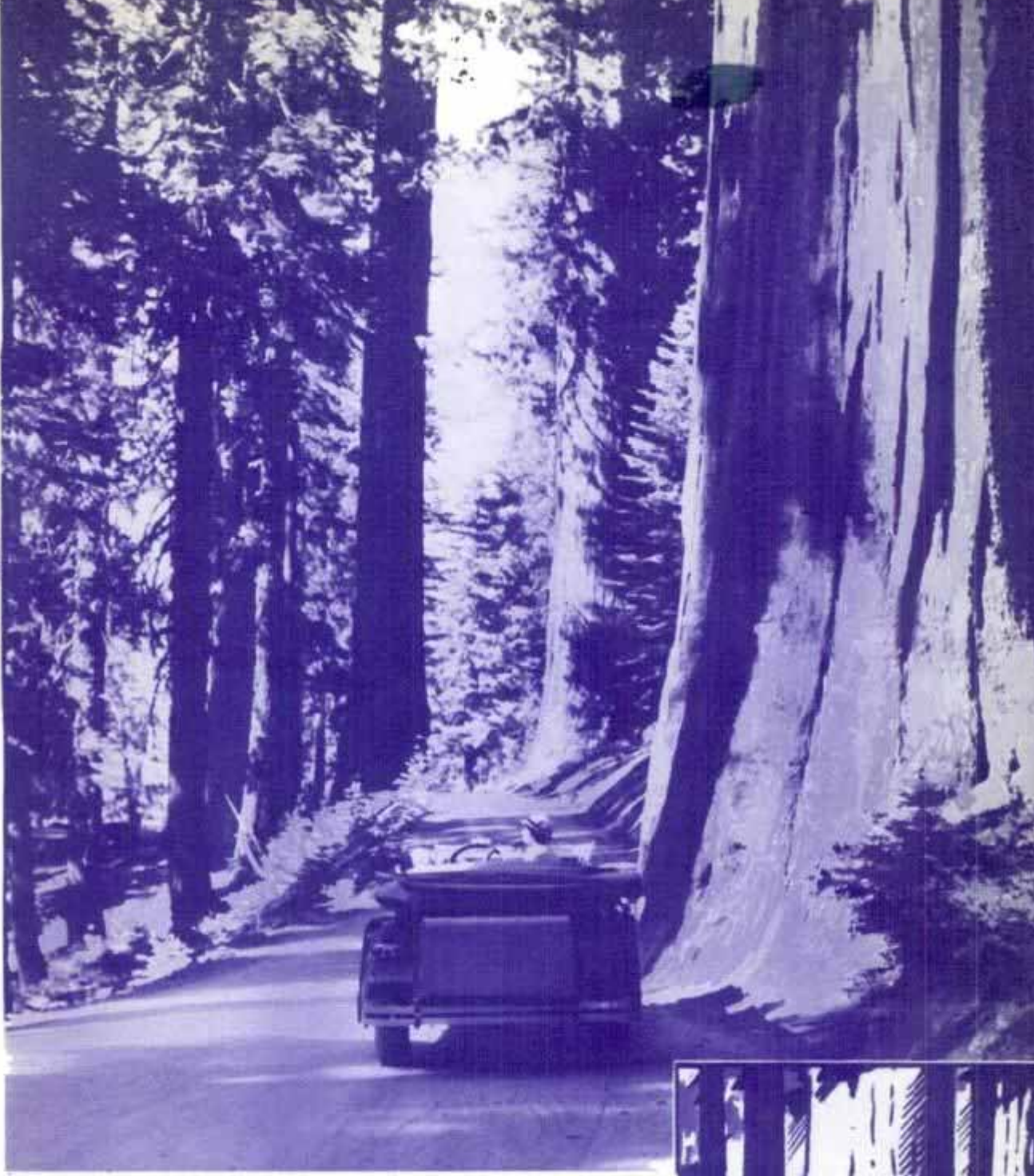

Old Mexico. Before a national park area can be set up it must measure up to a certain high standard of natural beauty and uniqueness, for nothing save the spectacular and extraordinary in nature can lay claim to national park privilege. For this reason each of our national parks is different.

Yosemite national park in California is noted for its romantic scenery, its gorgeous waterfalls, its mountains and valleys and the far-famed Valley of the Yosemite itself; Glacier park, on the boundary between Montana and Canada, for its great glaciers nestling close to its mountain crags; Mesa Verde in Colorado for its prehistoric Indian remains; Rocky Mountain for its sublime view as a part of the great Continental divide; Sequoia and General Grant in California for the giant trees, many over 3,000 years old; Crater lake for its marvelous lake of blue nestling in an extinct volcanic crater; Lassen for its active volcano; Carlsbad for its amazing caverns; Zion and Bryce in southern Utah for their wonderland of color; Hot Springs for its curative waters; Mount McKinley, for its tremendous game herds and faraway Hawaii for its tropical grandeur and volcanic wonders.

ONE of the beautiful drives in Sequoia national park in California, noted for its giant trees, some of them thousands of years old and one with a diameter exceeding forty feet.

Yosemite

D136

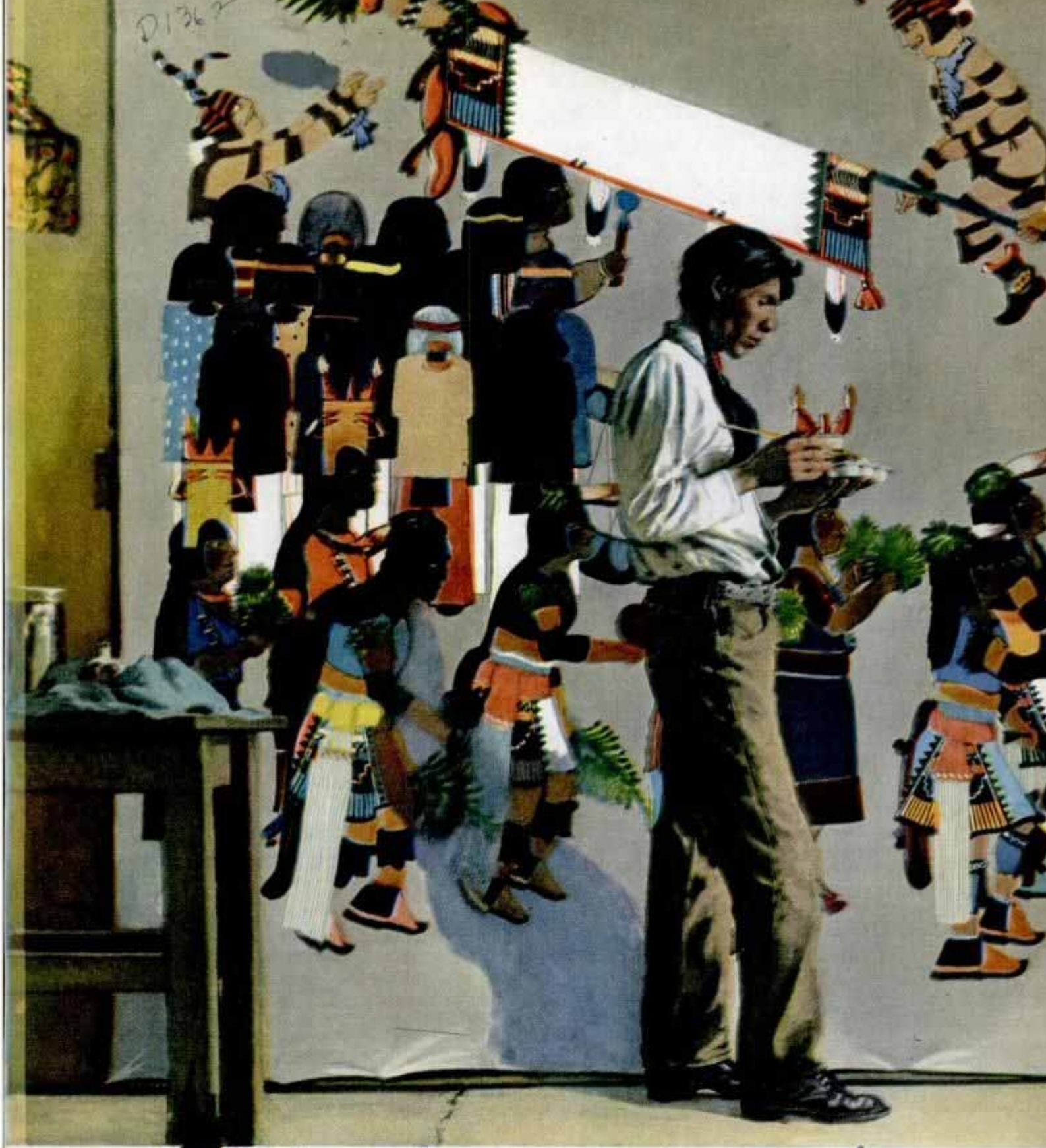

Agua Prieta, San Ildefonso Pueblos.

AN INDIAN artist in New Mexico and some of his work. Right, above, scene in the Carlsbad caverns where mountains, bottomless pits and huge amphitheatres are found 700 feet beneath the earth's surface. The caverns have been described as "like a Grand Canyon underground." Right, below, a natural "castle" in one of the western parks.



Carlshad Carans

Deal
Castle
Bryce
Park
Utah

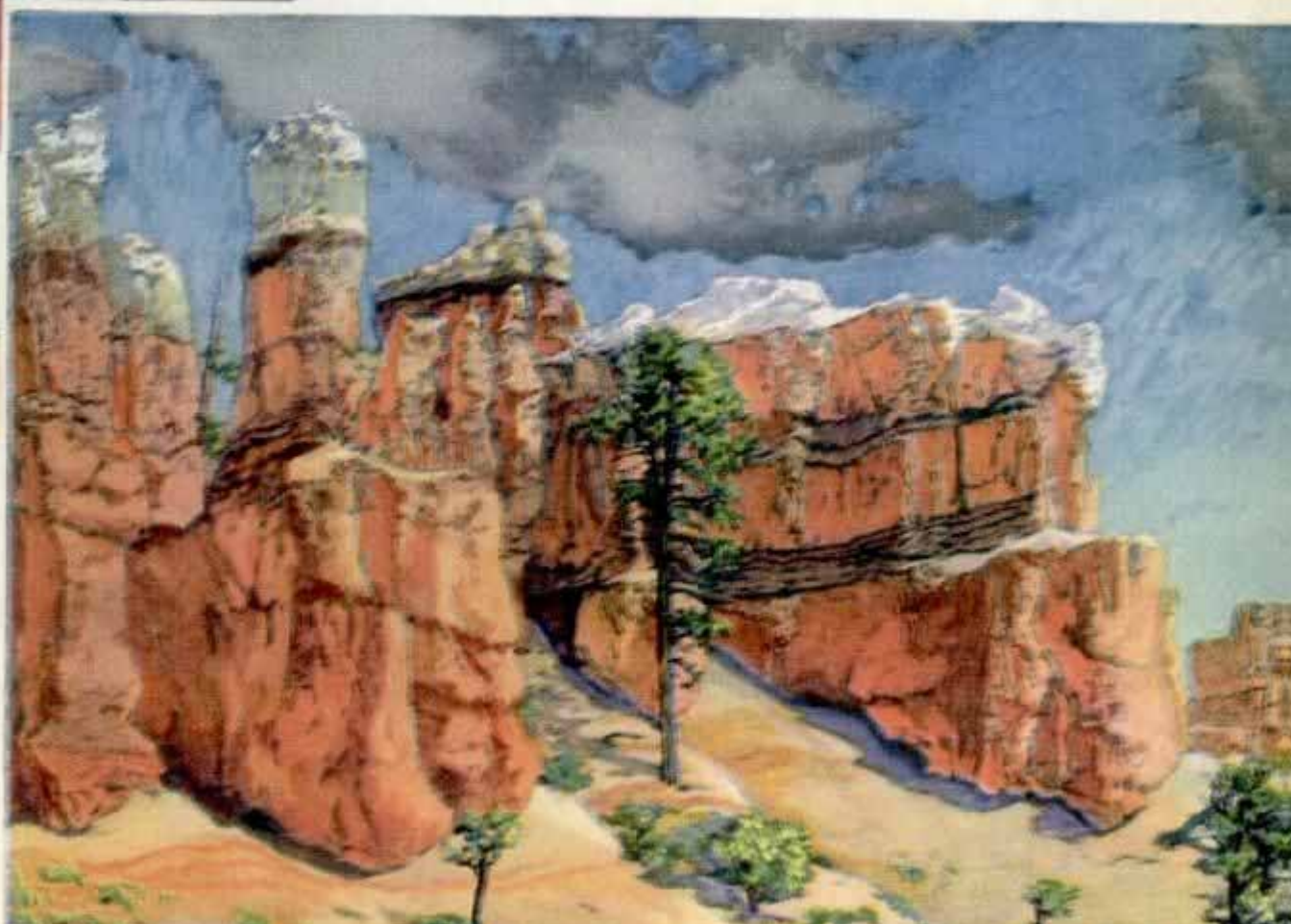

D1362

MESA VERDE national park is noted for its prehistoric Indian remains and this is the entrance to one of the homes carved out of the rocky mountain sides by the ancient cliff-dwellers.

*Keba
in Spruce
Tree House*

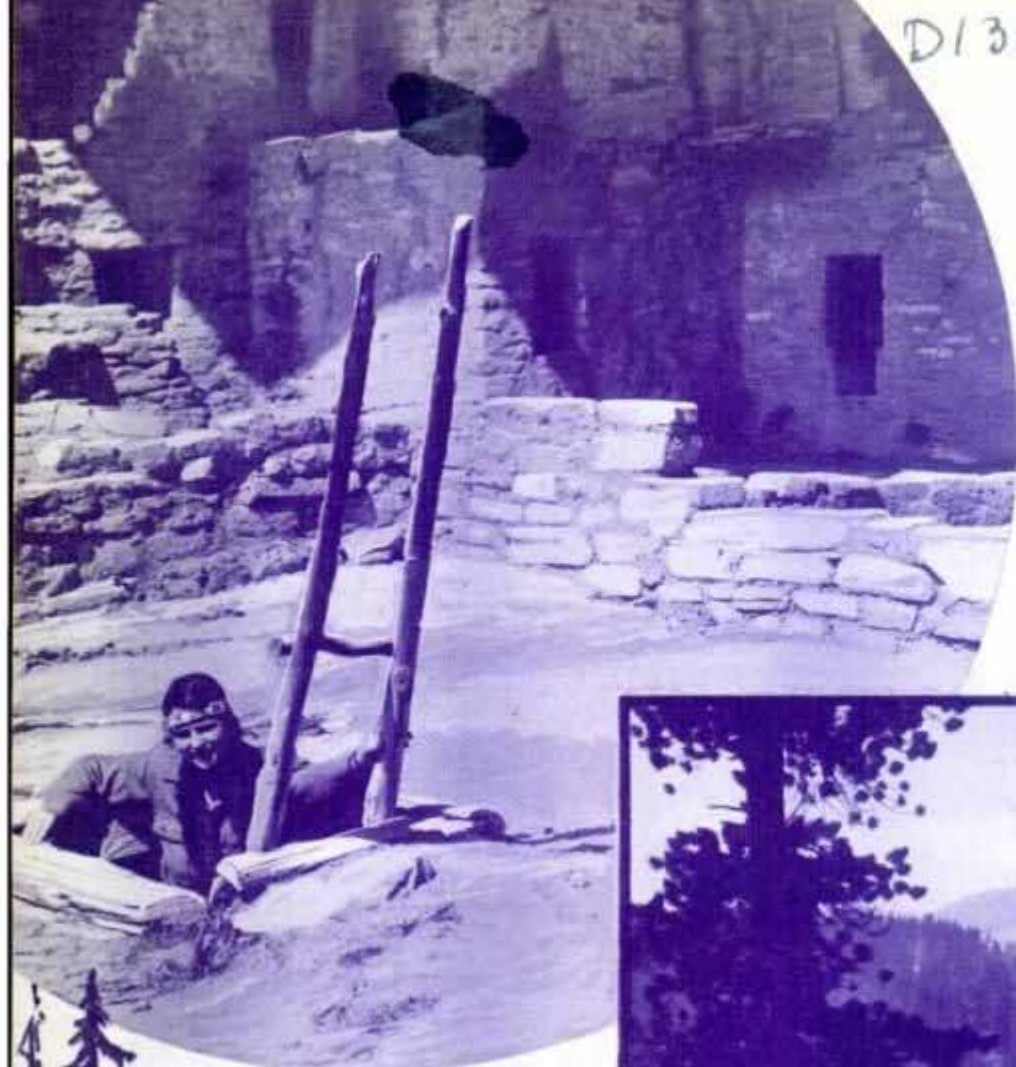

WATERFALL in Yellowstone park which contains nearly 3,500 square miles and is the largest of our national parks. This park is overflowing with amazing natural phenomena, not equalled in any other area in the world. Charming bits of water, woods and mountain scenery are discovered on every hand.

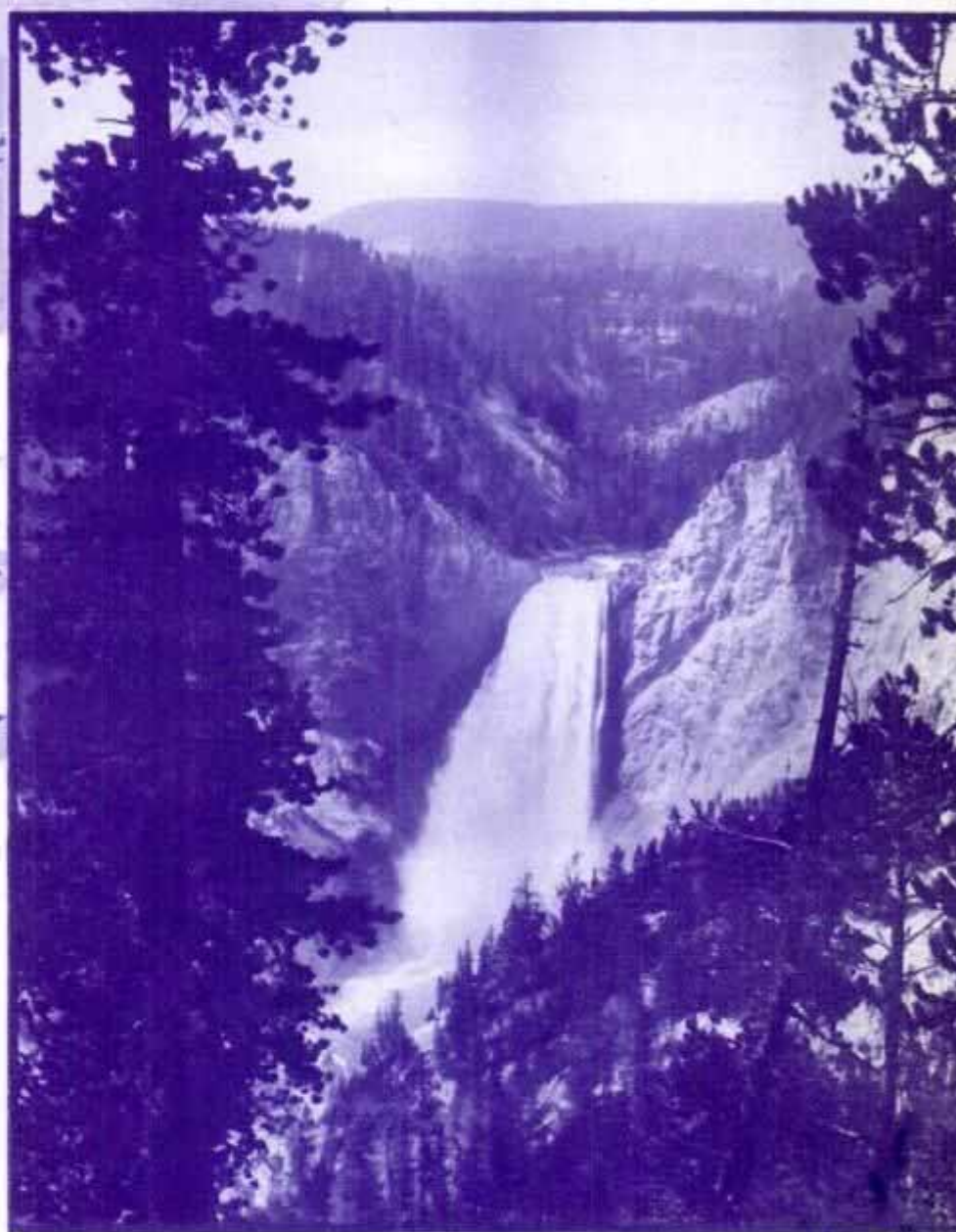

Mount Rainier, with its glacier system exceeding in size, interest and impressive beauty that of any other country, may be seen for 150 miles, and Yellowstone with its charming bits of water, woods and mountains everywhere, is re-

plete with great natural phenomena, not equalled in any other area in the world. But of all the long list of twenty-four parks none compares with the Grand Canyon of the Colorado. There is nothing like it anywhere in the world.

*Yellowstone
National Park
Grand Canyon
of the Colorado*

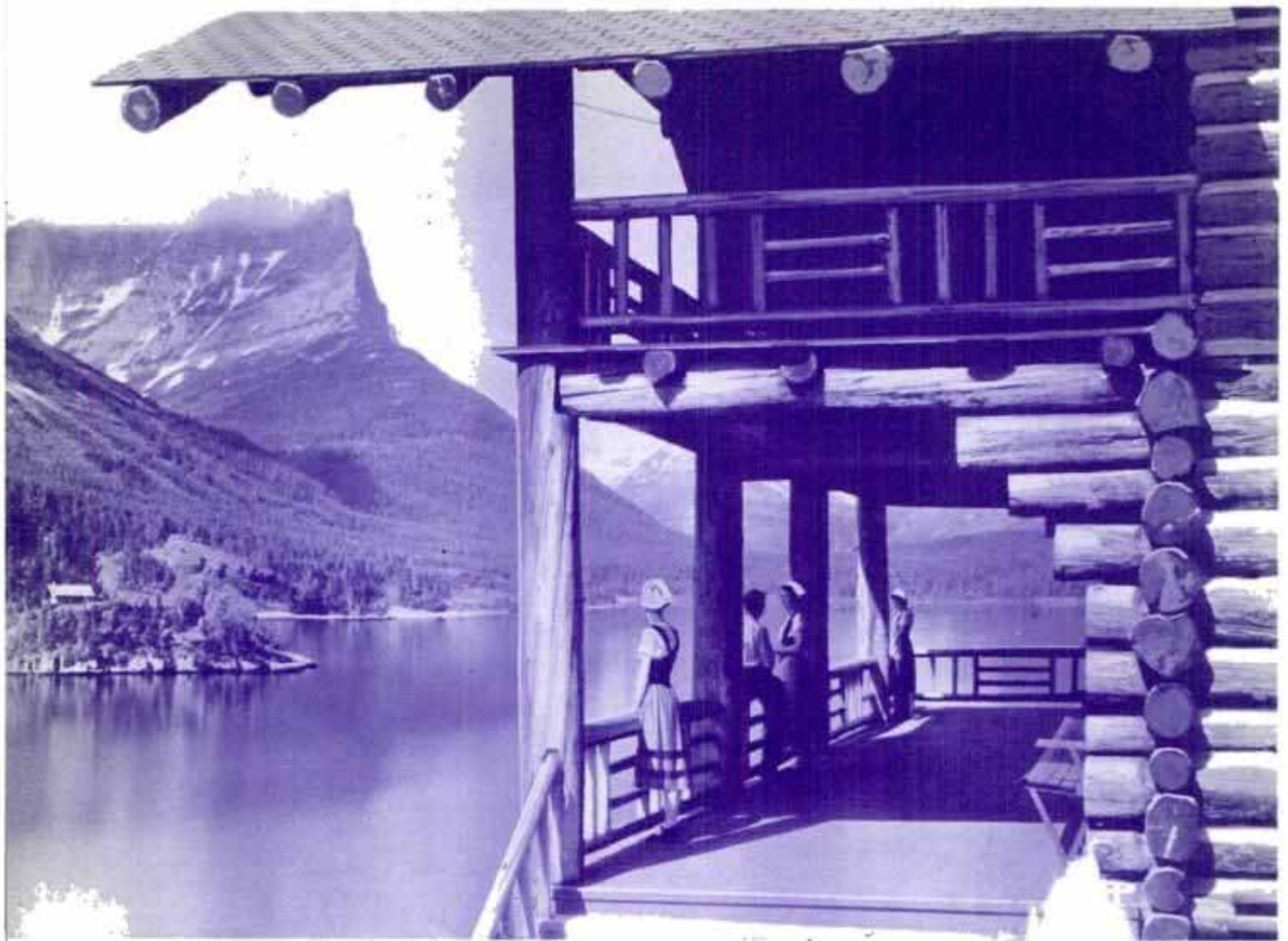

Its carvings and erosions are on a continental scale, etched against the background of a planet, showering color and mist impossible of description.

The west has until recently been the national park area of the United States but now the eastern half of the country is developing a series of parks that will rival in beauty and charm those of the west. Acadia national park in Maine heads the eastern list, a combination of picturesque mountain and rough seacoast. Further down the Atlantic chain is Morristown national historical park, less than a year old, where Washington and his troops spent much time during the revolution.

And down in Virginia, now being ceded to the federal government, is the Shenandoah national park, lying along the historic and beautiful Blue Ridge chain. Further down is the Great Smoky national park, the most picturesque mountain section of the east. Yet to be acquired is the Everglades national park in Florida, a bill for which is now pending before congress, and Isle Royale park in Michigan.

Although the national parks were established and are maintained for the benefit and pleasure of the people, they are also important factors in conservation of wild life. Elk and buffalo winter in Yellowstone. In Acadia are *(Continued to page 128A)*



VIEW from the main veranda of Going-to-the-Sun chalets in Glacier national park. It makes little difference what kind of sport you prefer—fishing, hiking, boating, horseback riding—all are offered in the millions of acres of national parks and you can select accommodations to fit your purse.



CLIFF palace in Mesa Verde national park in Colorado. Do not be misled into believing that if you have seen one of our national parks, you have seen them all. Each park lays claim to its own spectacular and extraordinary features, and each is different from the others.



Playing with Dolls Becomes Real Business



Artist with Collection of Dolls and Materials from Which She Makes Them; Note the Resemblance of Some of the Puppets to Certain World-Famous Individuals

Dolls are a hobby with Lucille Fink, artist, and she has become so expert in making them that the hobby is turning into a business. Some of the dolls are used in staging marionette and puppet shows for which she writes her own plays, while others are used as subjects for her still life paintings. Heads and features of the various dolls are fashioned from ordinary woods, plastic wood or clay, and the bodies are made of mattress stuffing and cotton. Suits, dresses and special costumes are sewn from castoff clothing.

on the Bonneville power and navigation project on the Columbia river. The tires are twenty by forty-six by ten inches and carry air at forty pounds per square inch. The tires serve as wheels, fitting over small hubs of the "buggy."

miss 477 Hermyng Place Chicago

see Jan. 1935-36

D/627

SIXTEEN DOUGHNUT TIRES MOVE HUGE LOADS OF EARTH

Sixteen big pneumatic tires of the doughnut type insure light bearing pressure for a giant tractor-hauled "buggy" having a load capacity of thirty cubic yards. This equipment is being used in moving earth



Sixteen Doughnut Tires Support This "Buggy" Which Has a Capacity of Thirty Cubic Yards

Tractor - Oils due

D 1494

Mr. Low
4 W. 103rd St
New York

The SEARCH for a



vantage to know the grade and viscosity of the oil which goes into the crankcase.

The modern car is capable of attaining ninety and 100 miles per hour, and this grueling pace causes the pistons to travel at the rate of 3,100 feet per minute, while flame velocities past the exhaust valve stems reach 100 miles per hour and the heat of the valve stems reaches 700 degrees. The strain of such speeds and heats are transmitted from the metal parts to the lubricants. If the lubricants can't absorb the strain, something cracks.

Several years ago Standard Oil of Indiana initiated the practice of refining oil by the use of a chemical, propane, also

HIGH-SPEED automobiles raise high temperatures and the combination is likely to cause trouble for your car unless you give some thought to lubrication.

On the firing line of research, many talented men are pursuing the mysteries of auto lubrication. A vast sum is being spent to gain more information about the properties of black petroleum and finding the ideal method for subtracting undesirable substances from crude oil.

Oil refining today is one of the most exacting and painstaking operations; it is chemistry and physics playing the part of mother and nurse to the automotive industry. It was recently established that fewer than one driver in ten knows the grade of oil prescribed for his automobile for various seasons. But if you intend to operate your car efficiently and economically, it is certainly to your ad-

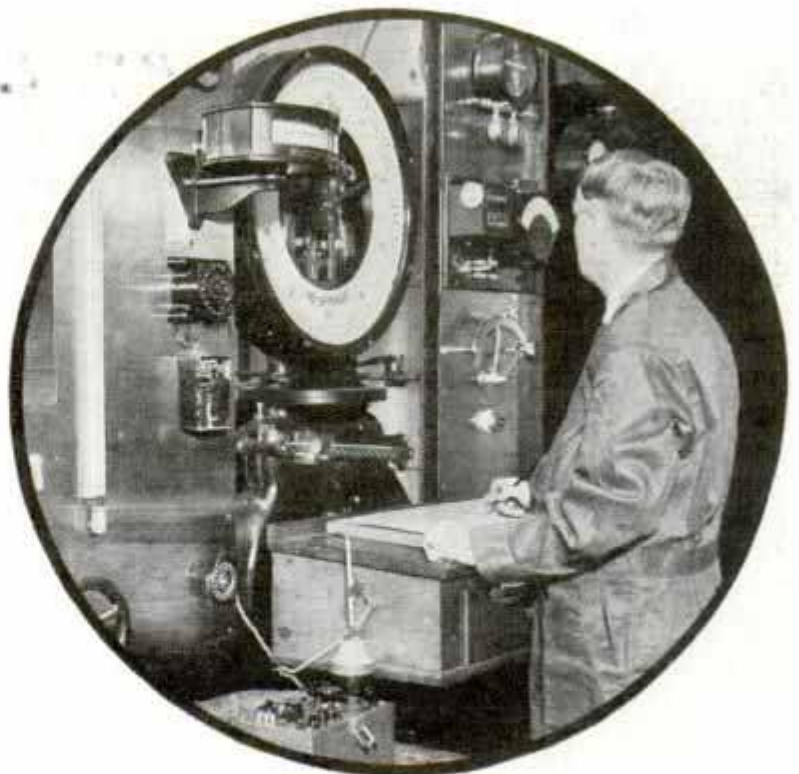

Above, Testing Effect of Low Temperature on Two Grades of Oil; Below, Scale Shows Load on Nearby Auto Engine

D 1494

PERFECT OIL

made from petroleum. That started a virtual revolution in the industry. Propane as a solvent removes certain harmful substances from the oil by "washing" them out, and not by any chemical action.

The first American refiner, Hiram B. Everest, of Rochester, N. Y., started with a crude still in which the gasoline and kerosene were boiled off the oil, yielding an oozy substance which passed for engine lubricant. Sulphuric acid refining marked a great improvement in Everest's process, but the acid residue created a problem

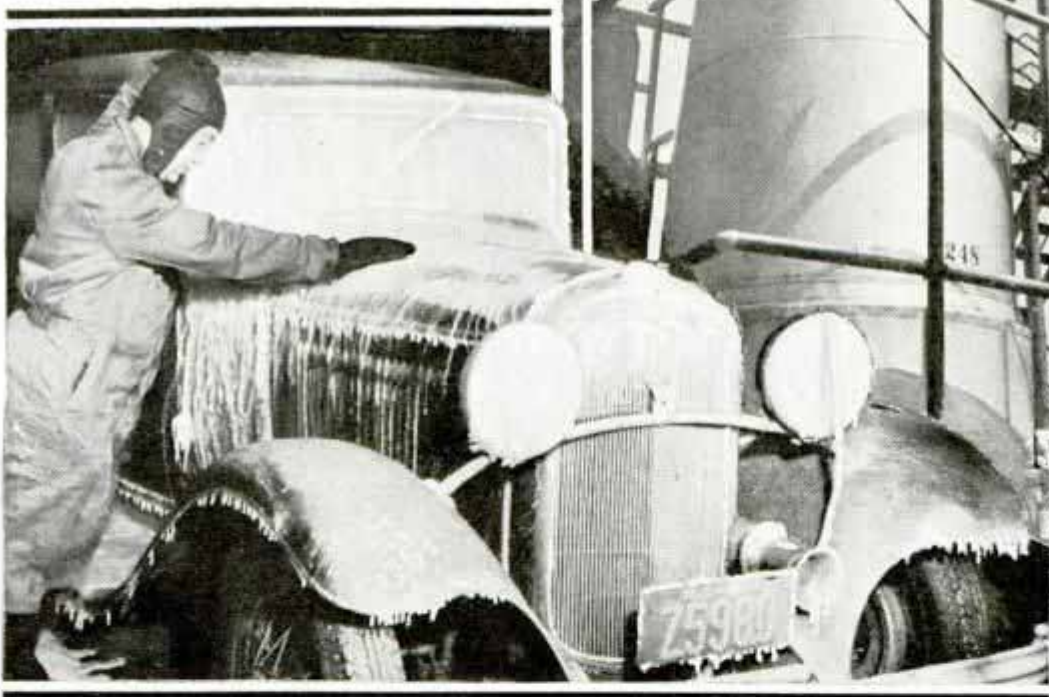
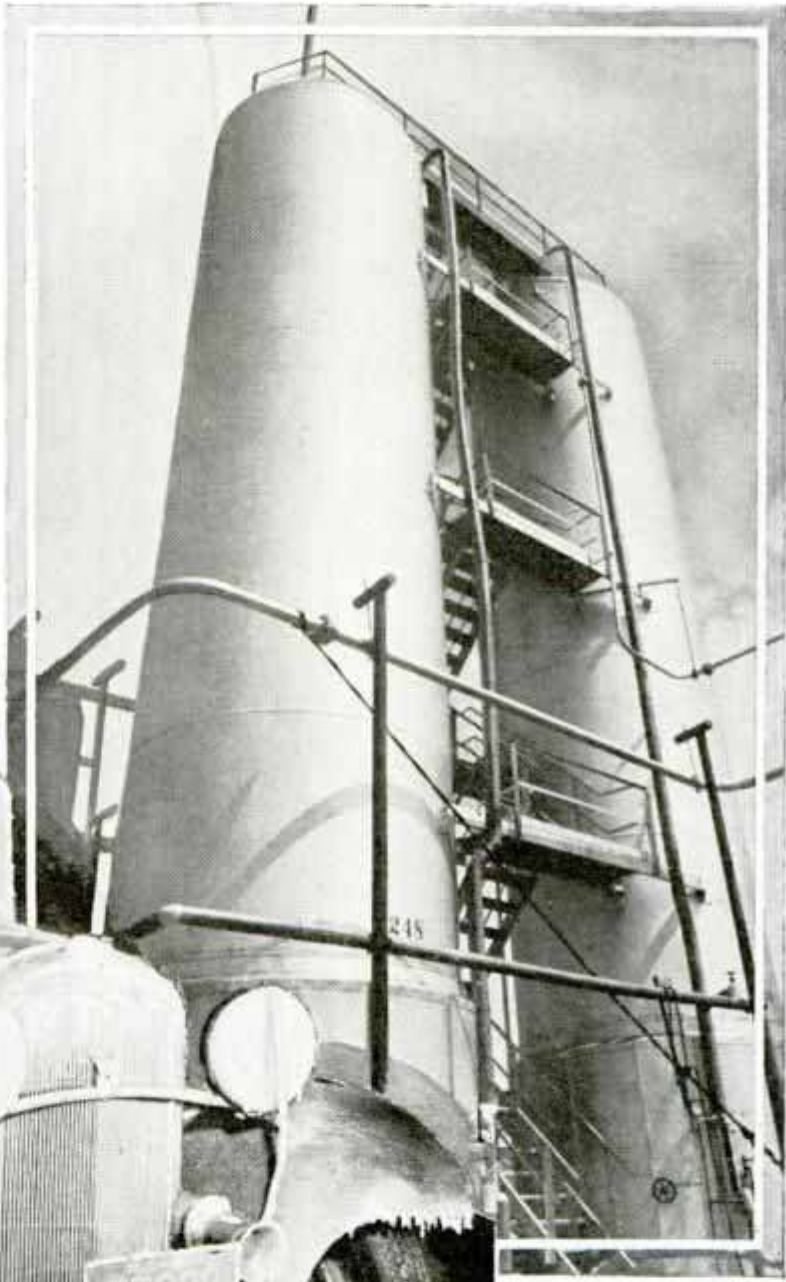

Testing Motor Oil in a Room Where the Temperature Is Forty Below Zero and the High Propane Towers of a New Jersey Oil Refinery

because the refiners did not know how to get rid of it. Clay refining came after sulphuric acid.

Clay and acid refining were responsible for most of our lubricating oil until solvent refining came into the picture. It is now widely used and the process is subject to many variations by different companies. The latest development in solvent refining was recently announced by the Socony-Vacuum Oil company, which spent \$3,000,-

000 in developing what it claims is the first oil refining process to make use of two solvents, propane and cresylic acid. One solvent washes away all substances which tend to form carbon; the other removes substances which tend to increase the viscosity at variable temperatures. In a transcontinental test run by Harry Hartz, the auto racer, only two and one-half quarts of the new Socony "clearsol" refined oil were consumed over a distance

Paulsboro

D-1494

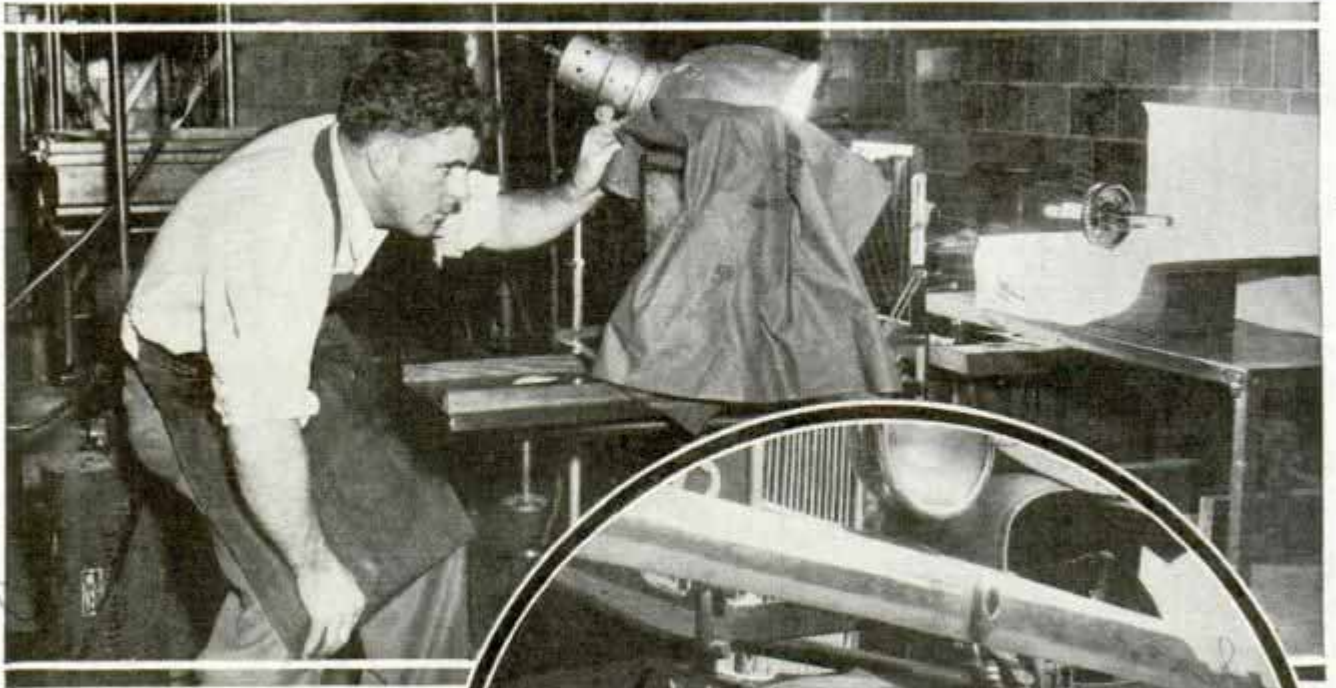

Top, Photographing Gear as Part of Oil Test; in Circle, Using Lubrication Chart; Below, Test Car in Canada Used to Prove Best Grade of Oil

of 3,188 miles. Also to meet the requirements of modern autos, Standard Oil of New Jersey adopted the hydrogenation process. By adding hydrogen, chemically combining it with the crude oil, you actually increase the volume of the resultant lubricant. With hydrogenation, it is possible to make an auto lubricant out of coal, as is done in Germany today.

In refining crude oil, the Texaco company employs a de-waxing process, then it rids the oil of certain impurities by adding a solvent called "furfural," made out of rice hulls. Similarly, Standard Oil of Indiana starts with a de-waxing process and ends with a purification process in which "chlorox" is the solvent. The Imperial Oil Refinery, of Canada, uses phenol or carbolic acid as its selective solvent.

The Tide Water Oil company uses a fractionation process of distillation. The necessary apparatus is a furnace for turning the liquid crude into crude vapor, and a fractionation tower where the vapors are

allowed to cool and settle in the different sections of the tower according to their volatility. The lubricating fraction is drawn off and chilled to a low temperature before being pumped through a filter press which separates the bulk of the crystalline wax from the oil.

The Texas Co
1352 42nd Street
190 Battery Place
New York

[Handwritten scribbles]

29 W. 59 St
New York

The Society of Automotive Engineers has undertaken to educate the public away from the so-called heavy oils, and has advised refiners to stress the advantages of light oils. The use of lighter oils means an increased consumption, of course; on the other hand, the use of heavy oil accounts for an increased gasoline consumption. Before long such inexact terms as light, medium, and heavy oil are likely to disappear. Hereafter, the most convenient way to refer to an oil's body viscosity will be by the number system adopted by the Society of Automotive Engineers.

This method of choosing a motor oil is as follows: You receive instructions as to the proper oil from the automobile manufacturer. For ordinary weather conditions, this oil will serve your car adequately. But suppose a man in Chicago needs a change of oil on January 10. Since the temperature at that time of the year runs around twenty degrees, he should ask for 20-W oil. If, after changing, he should see a forecast of sub-zero weather, he is advised to change his oil or to dilute it with ten per cent of kerosene.

Between thirty-two and 100 degrees Fahrenheit, the S.A.E. recommends S.A.E. 30. For traveling at high speeds, or for temperatures higher than 100 degrees, it recommends S.A.E. 40 and S.A.E. 50. The designations 10-W and 20-W refer to special winter oils.

The oil which was sold on the market in 1925 would be the ruination of modern automobiles. The improvements in refining have leaped ahead with automotive engineering. It is plain that the high speeds and high temperatures developed by modern cars would greatly increase oil consumption were it not for the automobile's mechanical improvements. Hence, increased speeds have not added to the cost of giving a car the proper lubrication.

In tests with gears, one refiner discovered he could make two metal surfaces "seize" each other if he polished them very smooth and flat. Evidently, a very powerful cohesive force can exist between two clean metal surfaces brought close enough together. The new high-pressure lubricants have the property of forming a layer other than oil between the gear teeth. As to the real nature of this mysterious layer, little is definitely known.

FASTER KEY SENDS RADIO CODE AT FIFTY WORDS A MINUTE



High-Speed Key Designed to Increase Rate of Transmission of Radio Code

Between fifty and sixty words per minute can be transmitted by a semi-automatic key designed to speed up the sending of radio code. The key now used by the United States navy is said to be capable of transmitting only thirty to thirty-five words a minute. The new sending equipment was invented by T. R. McElroy, champion telegraph speed sender.

HOT WATER GAS CONVERTER MAKES TANK AUTOMATIC

Conversion of a range boiler into an automatic hot water storage tank is made



easy by a small gas heater about the size of a thermos bottle. The unit has no coils, a fin-type construction giving a heating efficiency of eighty per cent. An adjustable thermostat is provided to assure an extra supply of hot water when desired.

The burner has an automatic cutoff to guard against the flame being extinguished accidentally. Gas consumption is low, the maximum about six cubic feet per hour for heating five gallons of water.

23 Bay side St.
Worcester, Mass.
Mrs. J. J. Astor

Chicago
United American

D-15-92
502

Mr. Bob Oushant
12 29 Ahmsted St
Long Beach, Calif

'Navy' Carved in Miniature by Boy Whittler

California School Boy and Some of the Boats of His Miniature Navy Which He Carved with a Knife; He Has Turned His Hobby for Whittling Scale Models of Battleships into a Profitable Business; the Boats Are Made of Soft Pine Wood

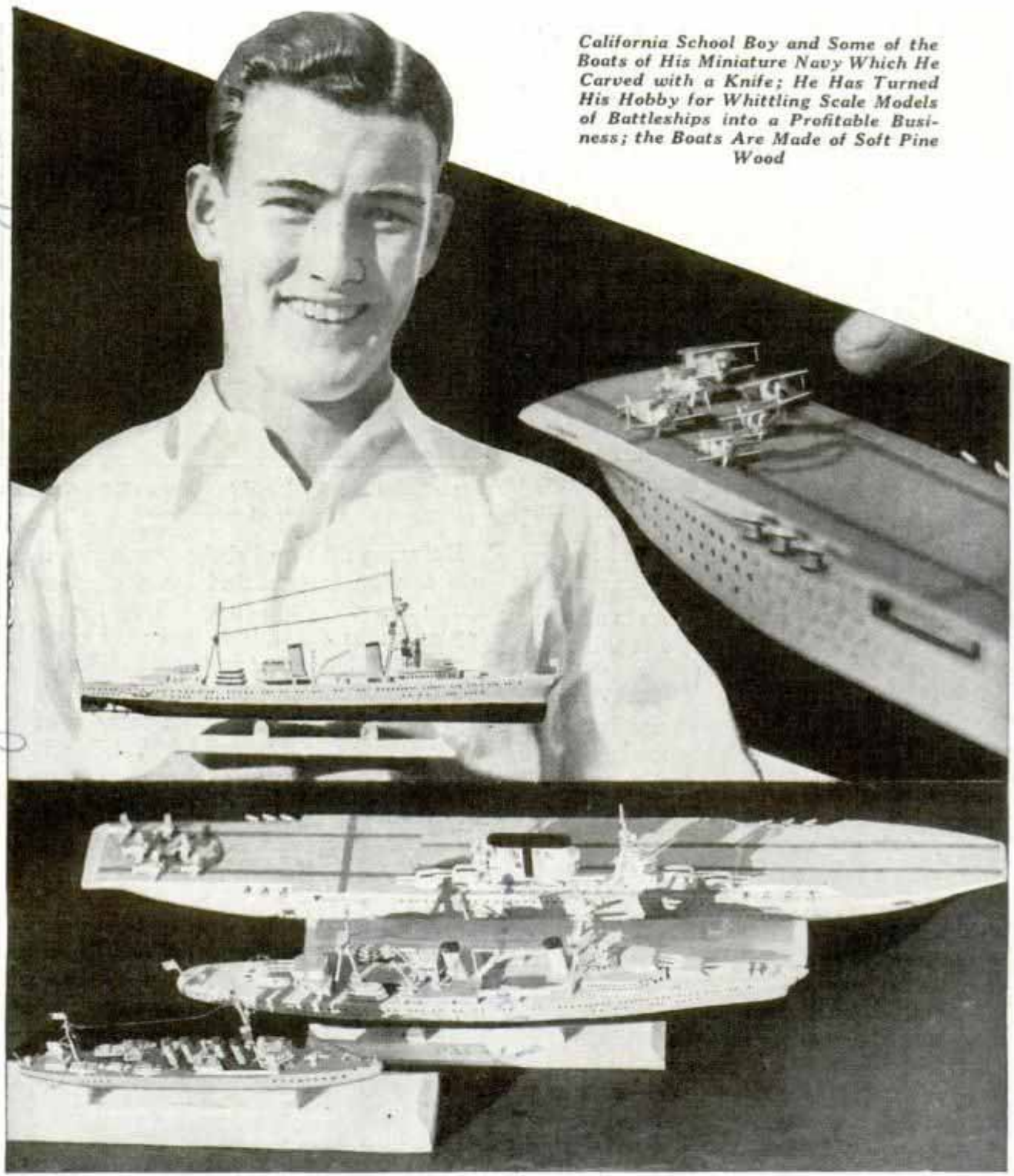

3351 Alta way, Long Beach, Calif

When the fleet anchored off Long Beach, Calif., Jack Rittmayer, a high school boy, turned a penchant for whittling into a profitable hobby. He began carving models of the entire fleet to scale dimensions of one inch for fifty feet. He completed fifteen ships, working two or three weeks in spare time on each. Navy folk and marine enthusiasts began hearing of the models and now the boy finds a market for

boats as fast as he can turn them out. He uses soft pine wood and his tools are a small penknife and a block plane.

Ⓢ Popular Mechanics Magazine does not publish the name of the maker of, or dealer in, any device described in its pages, but this information will be furnished by our Bureau of Information upon request, accompanied by stamped envelope.

Cannon Used to Fire Power Line over Ravine

In constructing a California power line it was necessary to string the conductors across several canyons and heavily wooded areas. The usual method for placing power lines is to lay them on the ground, then lift them into place on the towers or poles. This method, however, would have required clearing the trees from the right of way, so linemen used a cannon to do the work. The cannon was similar to those used to shoot lines to stranded ships and the projectile was a piece of steel shaft fitting loosely in the cannon and equipped with an eye-bolt to which a line was attached. This projectile trailed as much as 1,500 feet of rope and after some practice the workmen often shot the rope directly over the cross arms of the towers. It was then a simple matter to draw the conductor line into place.

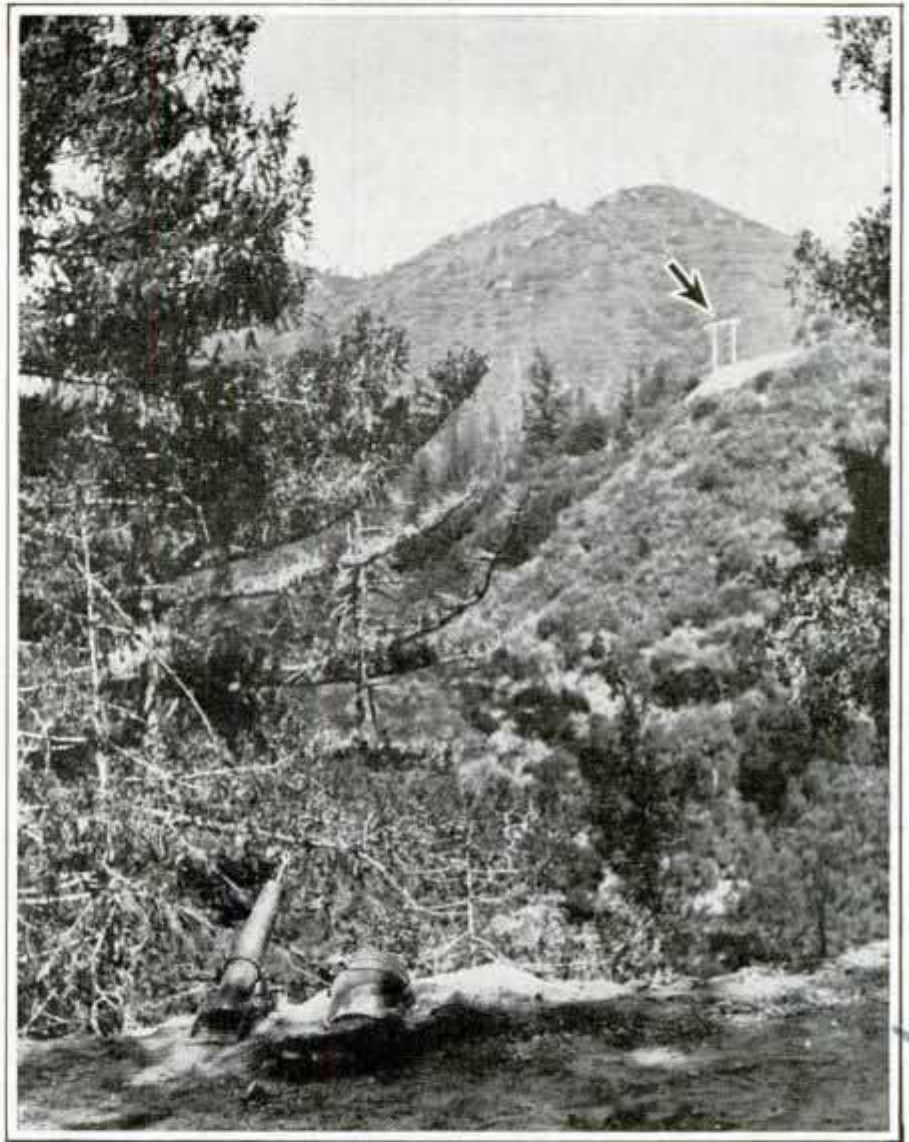

Cannon Which Shoots Power Line over Heavily Wooded Areas; Arrow Indicates Tower at Which the Gun with Its Line Is Aimed

BICYCLE HORN-AND-LAMP UNIT WORKS ON ONE BATTERY

Operating on one standard No. 6 dry cell, a combination horn and headlight for the bicycle is designed for center mounting on top of the truss fork rods. The outfit is complete with battery case, all wiring and button for sounding the horn. A slide switch controls the headlamp. Scientific construction makes the lamp highly efficient when a Mazda No. 19 bulb, one and one-half volts, is used. Lamp and horn are



chrome finished, with a red finish showing through cross-bars over the mouth of the horn to give an attractive appearance.

ELECTRICALLY HEATED CLOTH

Cloth which can be warmed by electric current recently has been produced. Copper wire is inter-spun with cotton, silk, wool or rayon into threads which can be woven or knitted without special machinery. The fine copper wire is lacquered before spinning and fabrics containing the wire do not stretch or shrink. It has many possibilities including its use in rugs which might be connected to a light socket to warm a room and as a fabric for airplane wings, which could be heated to prevent ice formation, and for heated clothing.

Delta Electric Co.

Baswell & Anderson, Inc.

Baswell & Anderson, Inc.

D13 7/11
 Box 4693, Kansas City, Mo

D1645

D1582

De Luxe

celme - Berna 12/10/34

\$4.95

D 1422

54 1/2 Islander Plots
Los Angeles Calif



Bonanzas *the* FORTY-



Working an Old Digging, Panning Gravel and the Remnants of a Location Notice Filed on an Old Claim

A FEW months ago, a Nevada storekeeper shoved a pile of groceries across his counter—traditional prospectors' staples.

"Here's your grubstake, boys, and I hope you find a million!" he told the four men gathered there.

Today he is a fifth owner in a mine which is yielding tons of rich ore assaying as high as two dollars a pound.

Tired of combing the country for a new prospect, the four men went into the Chiquita mine, abandoned many years ago by owners who thought the vein exhausted. They tunneled through solid rock until they encountered a "stringer" leading to great values. The new owners had no trouble in finding capital to back them.

Now, in electrically-lighted tunnels, power machines are driving into the rock far faster than pick and shovel.

Are the old diggings exhausted? That's the question being discussed in mining centers of the west. Miners will tell you about old Frank Shore, who took 175 ounces of gold from a single pocket in the side of an old drift that missed the deposit by only six inches; or of the man who



NINERS Overlooked

Loading Burros with Sacks of High-Grade Ore, Ready to Be Shipped to the Smelter



Mining Camp from Which Prospectors Go into the Surrounding Hills to Work Old Diggings

drove his pick into the blank end of an abandoned tunnel and took out a twenty-four-ounce nugget, worth \$840.

Why didn't the old-time prospectors find all the gold?

One reason is that many were looking for gold in simple forms that could be easily smelted and readily recognized. Frequently they lacked the advantage of thorough assaying, or had to pass by low-grade ore on account of the cost of transportation. Then, too, few prospectors were scientifically trained.

Forty years ago, for example, the vein at the Stray Horse mine suddenly ran into a "fault," where the earth had slipped abruptly. An "expert" was called and reported that the slip was to the south. The owners tunneled southward 140 feet in barren rock and quit. Recently a new group went into the mine and drifted north. Within twelve feet, the original vein was struck and the miners loaded their first car with ore that returned \$27.58 per ton in gold.

(Continued to page 120A)

D1324

Construction, 114 rue
POPULAR MECHANICS

de la gare, Saint Denis
Seine St. Denis

Cab on Roof of Rail Car Simplifies Control

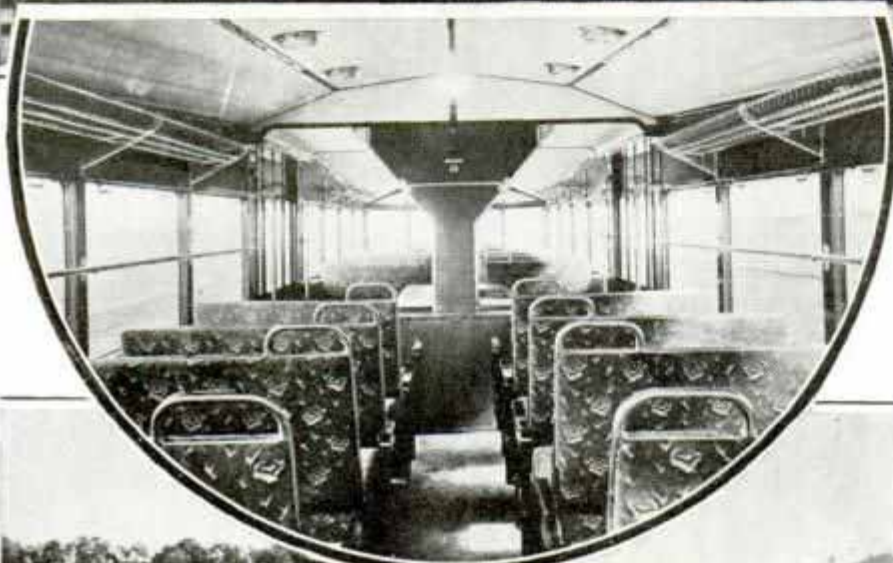
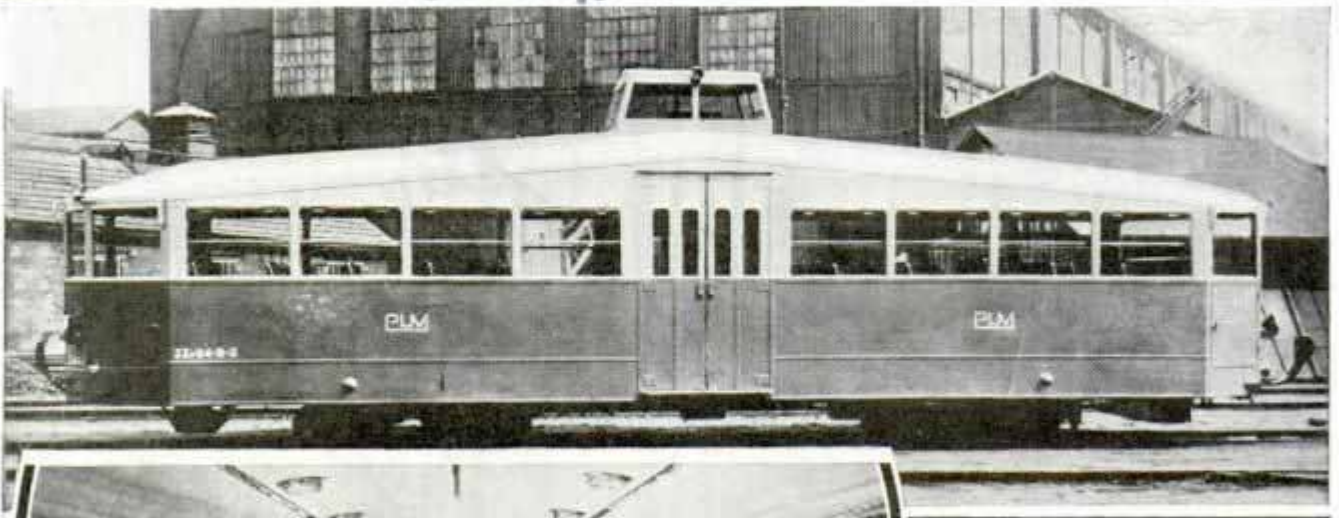

Top, Rail Car with Cab on Top; Center, Looking Forward; Bottom, View of Track from Driver's Cab

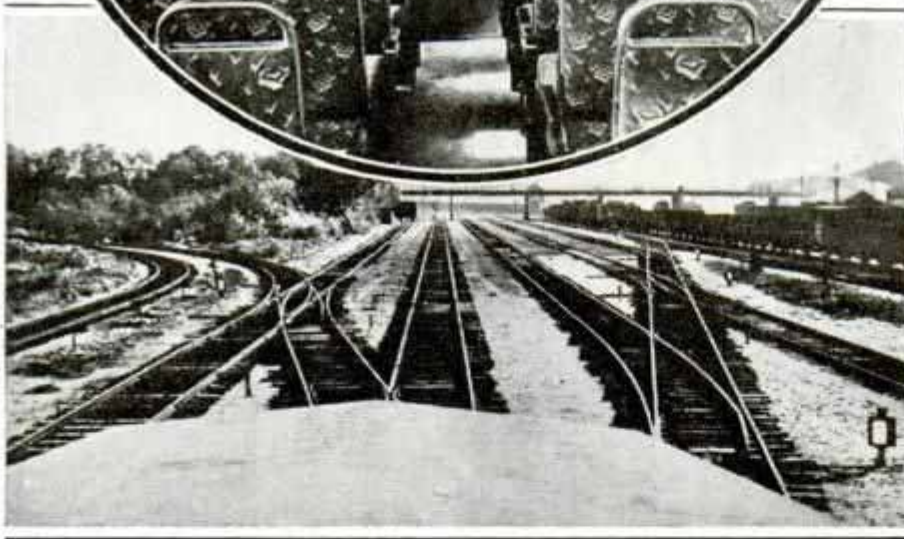

there is no driving compartment at the front. The engineer's cab affords a full view of the track.

D1656

PULLEY SPEEDED UP BY MOVING MOTOR

By moving the motor base, the speed of driven machines can be increased or decreased through the automatic change in driving circumference of a new variable speed pulley. The pulley consists of two half pulleys with slotted faces permitting them to interlock and

Simplified control of a new French rail car is attained by raising the engineer's cab above the level of the car roof in the center of the vehicle. From that position, the engineer operates the Diesel engine and gears, in addition to opening and closing the doors for passengers. The doors are visible to the engineer through small windows in the cab. Since the car has reversible gears, the engineer merely reverses his seat at the end of the run and starts the return trip. Passenger seats are reversible also. Exceptional visibility for passengers is one feature of the car, since

give a drive effect to the entire pulley. Moving the base of the motor causes the half pulleys to approach each other and increase the circumference of the entire pulley or to separate and decrease the circumference. The variation in speed results from ability of the V-belt to drive from any diameter resulting from movement of the pulleys.

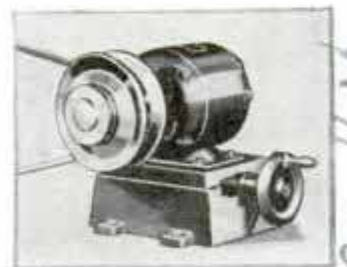

New York

Winfield H. Smith, Inc.
Manufacturers of Variable Speed Pulleys

PHOTOS ARE COPIED IN MARBLE WITH AID OF "DUAL VISION"

Making marble bas-reliefs from photographs has been made possible by a method developed by Albert H. Bumstead, of the National Geographic Society. The customary procedure is to make a wax, plaster or clay impression and then to copy on a marble slab. The new method utilizes a "dual vision" device which consists of a prism with two reflecting surfaces mounted on a steel arm clamped to the bench. The picture to be copied is held on a movable frame in front of the slab of marble. Lights mounted close by bring out the re-

D/650

make engraving

Washington D.C.



Searching a Jail Visitor for Hidden Weapons by Subjecting Clothing to Detector

The Courts Call to Shelby Ohio
Chicago - 8/2
W. March Ave
Thomas J. Hornaday



Marble Sculptor Using "Dual Vision"; Inset, Finishing Bas-Relief from Photo

... relief as it is cut in the marble. The sculptor marks identification points on the photograph and then, swinging the prism into position, gazes through it until he can see the image of the photograph reproduced on the marble. This usually necessitates adjustment of the picture or marble until the desired dual vision is established. The known marks on the photograph are then reproduced on the marble, being used as "base marks" of the bas-relief. After the rough outlines have been sketched on the marble, the artist completes the bas-relief from the photo.

D/615

SMALL DETECTOR FINDS GUNS HIDDEN IN CLOTHING

Weapons hidden in the clothing of visitors to some jails are detected by a small photo-cell device super-sensitive to metallic substances. Applied to visitors, the de-

vice indicates the presence of weapons and prevents smuggling them to prisoners.

D/664

DUMMY SERVES AS A TARGET FOR TREASURY GUARDS

Treasury guards at Washington are being encouraged to improve their marksmanship with a large dummy of a man serving as a target. Numbers on the target enable the accurate checking of hits and the scoring of the marksmen.



Dummy Used as Target by Treasury Guards

club

also Sletnick Carb
27 4 54
revised

one made by Paul W.

701610
228 69th
newsreel

"On the Spot" with the

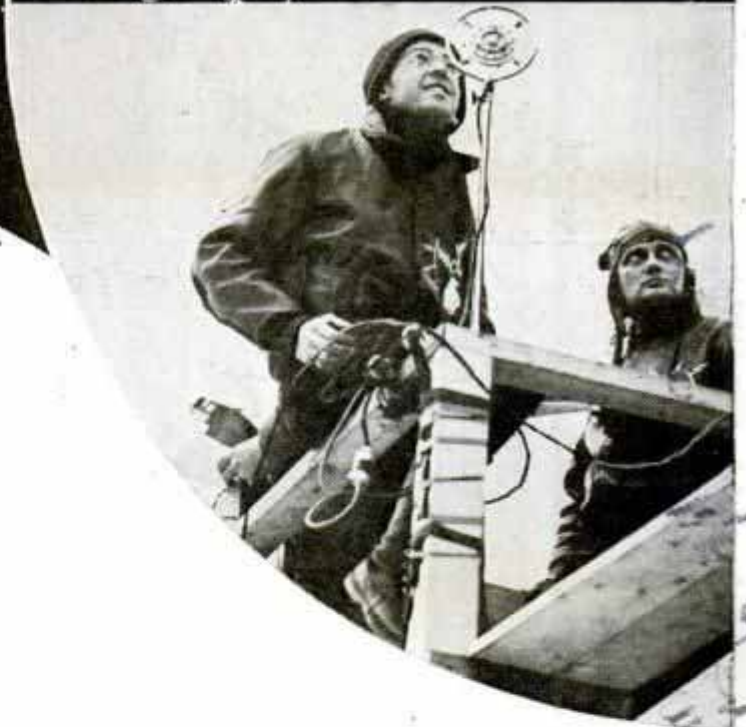
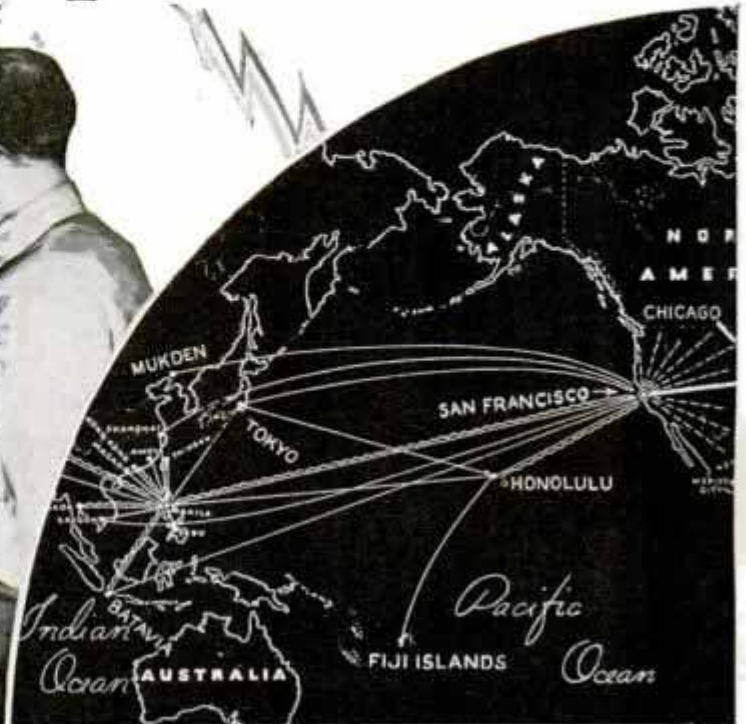
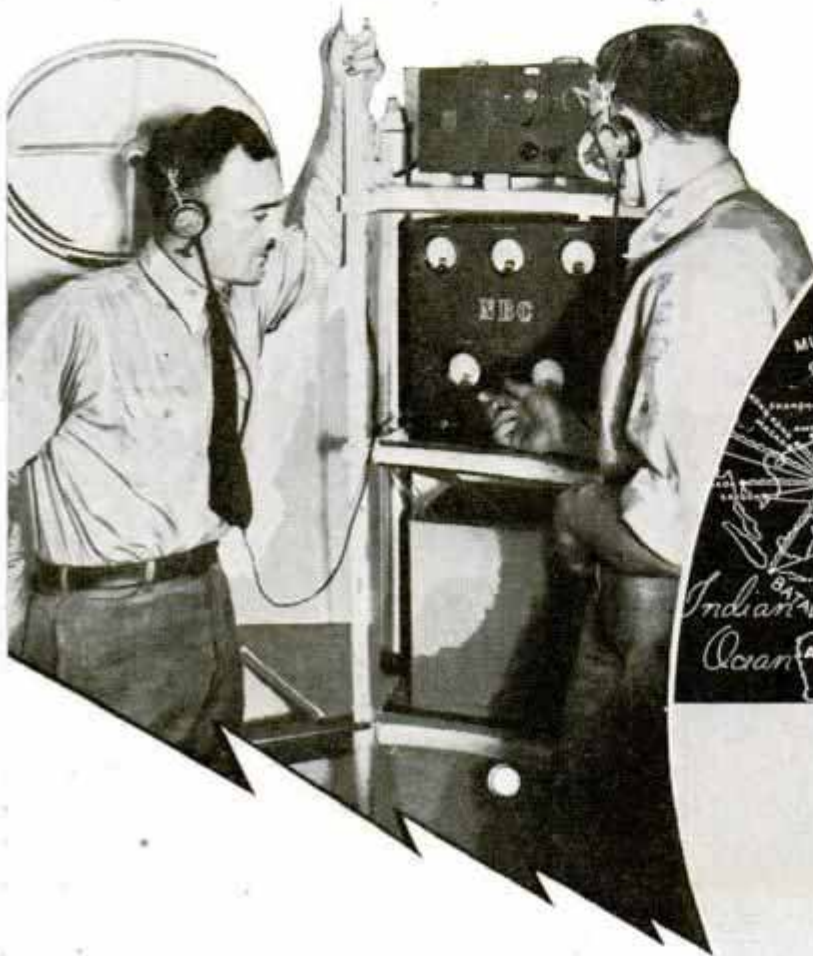

TUNE in your radio on almost any important American broadcasting station, and you may hear the actual eruption of a volcano in Hawaii, a king speaking to his subjects on the other side of the world, an announcer broadcasting from a submarine or some other event which you will read about in tomorrow's newspaper or see in this week's newsreel.

This new radio science brings you events as they happen, not in a broadcasting station but on land and sea, in the air, and beneath the surface of the ocean. During the past five years, science has harnessed the radio short waves until they have become the important vehicle which carries news and other features of interest into the studio of your favorite radio station which rebroadcasts to you. And this rebroadcasting is done so rapidly that you may hear an event as it occurs.

Previous to 1929, although there were occasional broadcasts of "on the spot" events, they were broadcast by announcers

Above, Short Wave Equipment in Stratosphere Gondola; Below, Broadcasting Ski Meet by Short Wave

whose voices traveled over telephone wires from the scene to the broadcasting station and the possibility of an eye-witness description was limited to the availability of the telephone "pipeline." Today the short waves have greatly supplanted the need for the telephone line, thus increasing the possibilities of "on the spot" broadcasting.

D160

SHORT WAVES

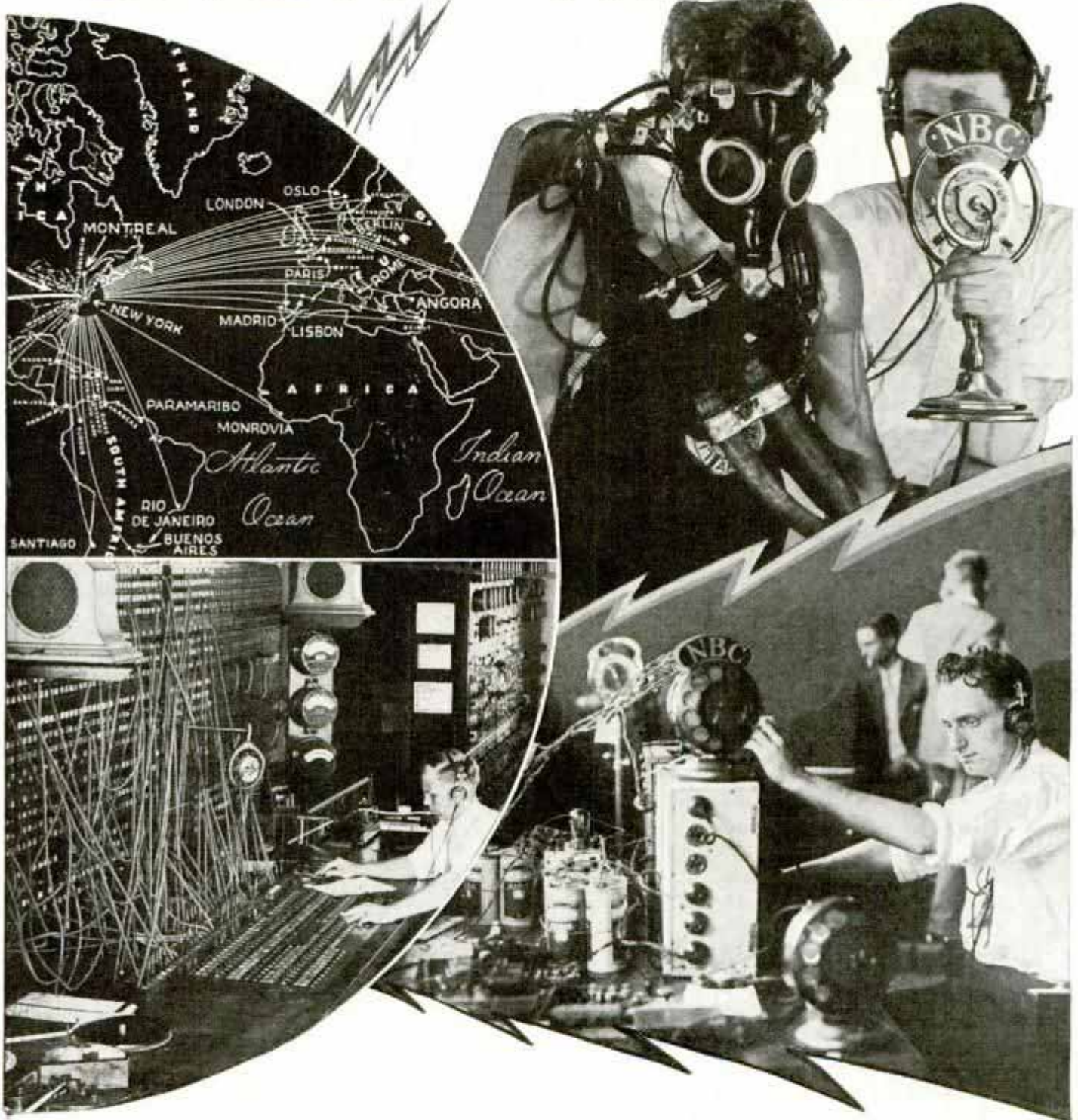

Switchboard over Which Foreign Broadcast Is Relayed by Wire, Map Showing Some of Points Reached by Short Wave, Broadcasting by Short Wave and Field Station Where Broadcast Is Relayed

"So insistent have become the demands of radio listeners for 'on the spot' descriptions of outstanding events that during the past year we have had 322 rebroadcasts from sixty-three foreign countries and more than 225 rebroadcasts originating within the United States," states Burke Miller of the National Broadcasting com-

pany. "These rebroadcasts, constituting a veritable 'newsreel of the air,' have varied from an interview with the Russian ambassador aboard a tugboat entering New York harbor, to a running description of the presidential naval review as seen by observers at nine separate points; and from a description of the trial run of the

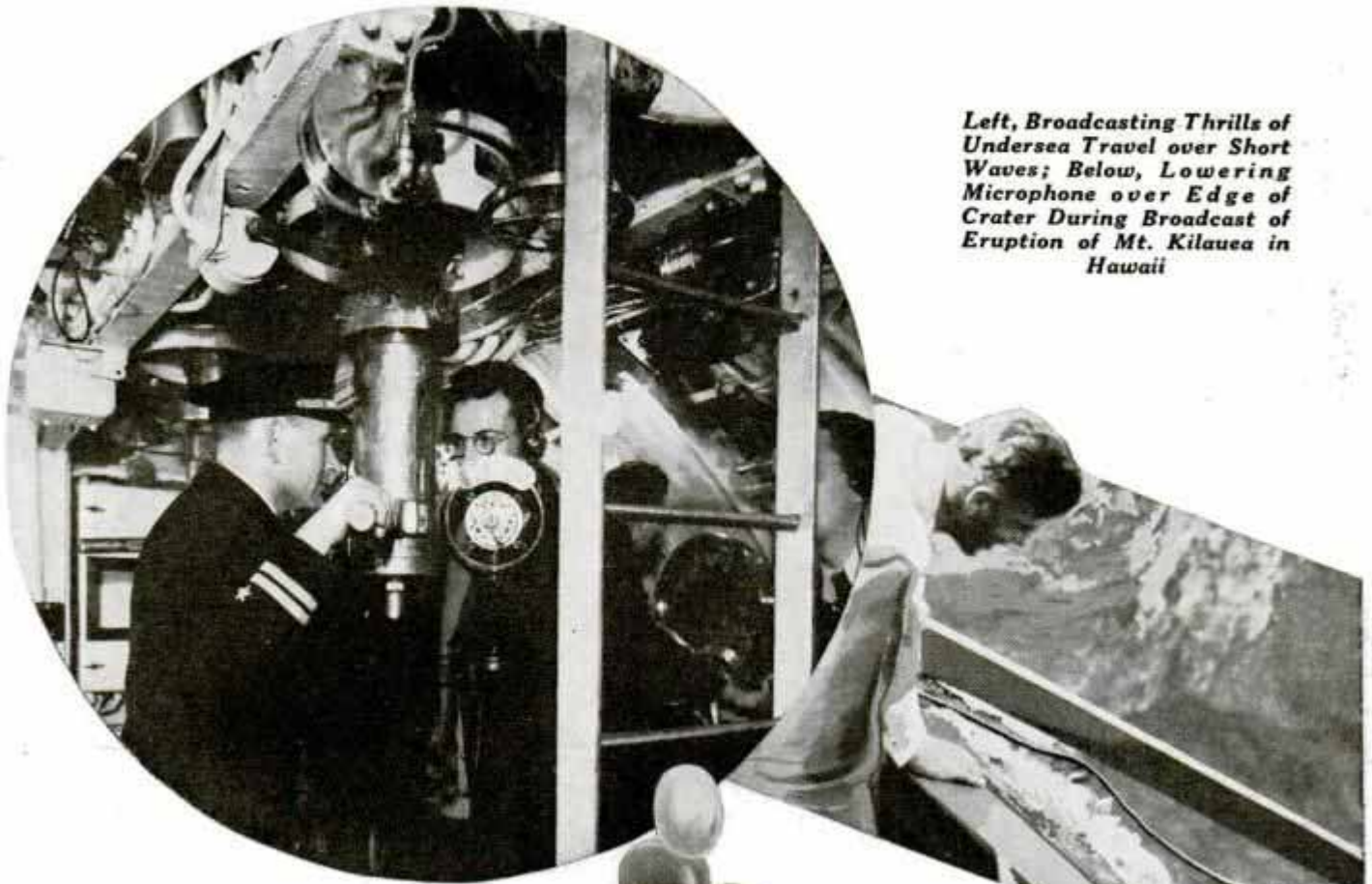

Left, Broadcasting Thrills of Undersea Travel over Short Waves; Below, Lowering Microphone over Edge of Crater During Broadcast of Eruption of Mt. Kilauea in Hawaii

Burlington Zephyr to the navy flight from San Francisco to Hawaii."

The science of rebroadcasting has fallen into two general classes. The first includes broadcasts from foreign countries which are received here and rebroadcast by the radio network on its regular domestic wave lengths. The second class includes short wave broadcasts by announcers of the broadcasting companies within the United States. These announcers and their engineers either carry portable short wave transmitting sets or ride in cars which carry these sets to broadcast to their parent station, which in turn rebroadcasts..

The broadcasting station orders its programs in advance from a radio communication company and they are "delivered" to the station just as a radiogram would be. R.C.A. Communications, Inc., with a transatlantic receiving station at Riverhead, Long Island, and transmitting station at Rocky Point, a transpacific receiving station at Point Reyes, Calif., and transmitting station at Bolinas, is the medium through which the program is received from or sent to a foreign country.

"If the National Broadcasting company



Balloons Supporting Antenna of Mobile Radio Unit; Their Use Is No Longer Necessary



or the Columbia System wished to receive a program from England," states William A. Winterbottom of R.C.A. Communications, Inc., "the program usually is ordered days or weeks ahead for delivery to the studios. We provide a point-to-point service, just as in the transmission of com-



Above, a Short Wave Crew Ready to Take the Field; Right, Ready for a Broadcast from the Life-Saving Apparatus Known as the Momsen Lung

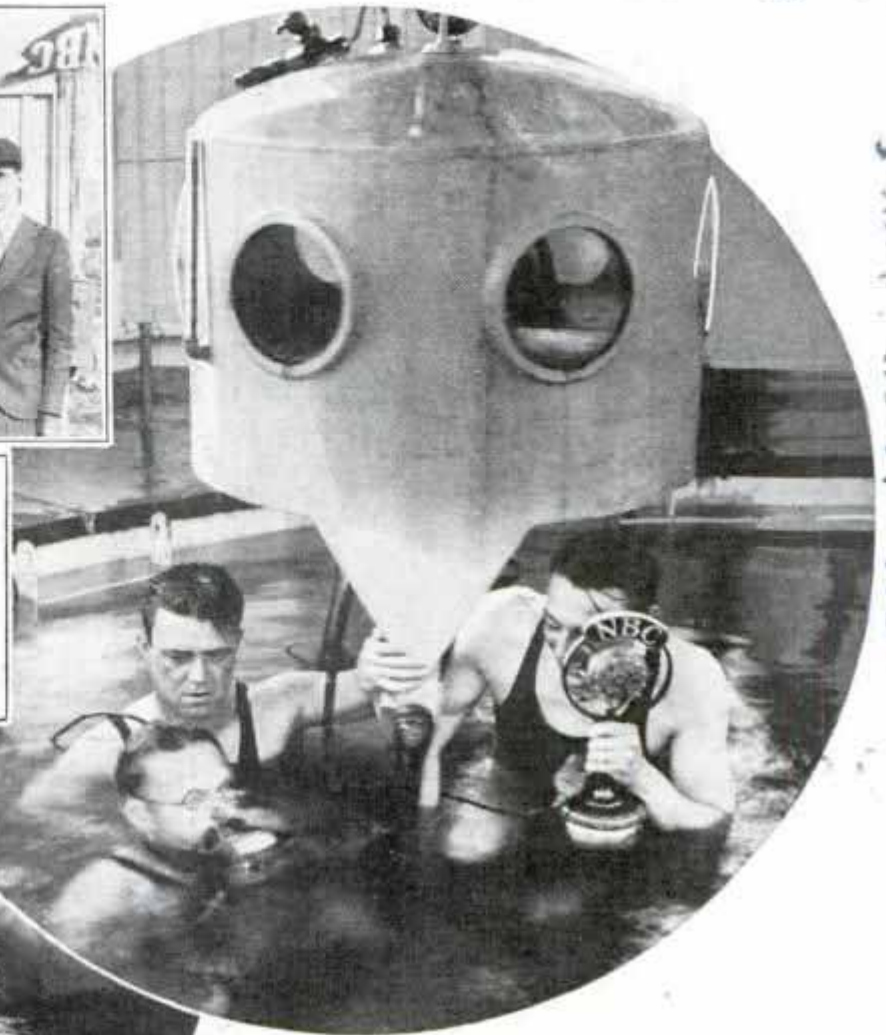

mercial radiograms, except that the 'addressed program' is delivered to the broadcasting company's studio from our central operating office over high quality wire circuits, and is charged for on a time basis.

"One of the most important achievements in short wave development is known as 'diversity reception,' an R.C.A. development which to a large extent overcomes the 'fading' occurring on short waves. Diversity reception equipment consists of three antennæ spaced about 1,000 feet apart in triangular arrangement, each connected to a separate receiver. The outputs of the three receiving sets are added together with the result that, when the program to which the receivers are tuned fades out on any one antenna-receiver combination, the other two continue to

receive it clear and strong. The received program is passed along as an audio frequency signal by special wires to the central radio operating office of R.C.A. Communications. From there it is connected through a control board to the American network to which it is addressed."

The second class of rebroadcasting, that of an announcer broadcasting in the field to his own local station or network for rebroadcast constitutes one of the most thrilling modern professions.

"Almost any broadcast has been made possible by the rebroadcasting of short waves," says Mr. Miller. "The microphone now goes to the scene of action. The world is the limit! Science has been developing practical short wave transmitting apparatus until portable sets have become so compact that they have been used to broadcast from a descending parachute."

Of the portable sets, the "transient transmitter" offers a wide range of flexible possibilities. It weighs only twenty-four pounds. The transmitter proper is con-

(Continued to page 126A)

BRILLE WATCH FOR THE BLIND HAS RAISED TIME DOTS



"Face" of Watch for the Blind; Raised Dots Replace Hour and Minute Hands

Raised dots replace the hands on a watch designed for the blind. The dial with the dots revolves under an opening, the top portion of which tells the hour and the bottom the minutes. The watch is fitted with a case to prevent damage to the dial.

FLAG FOR ICE FISHING TRIPPED WHEN BAIT IS SNATCHED

Lines do not become frozen or tangled in ice fishing if a tip-up, or tilt, with under-water construction is used. The reel

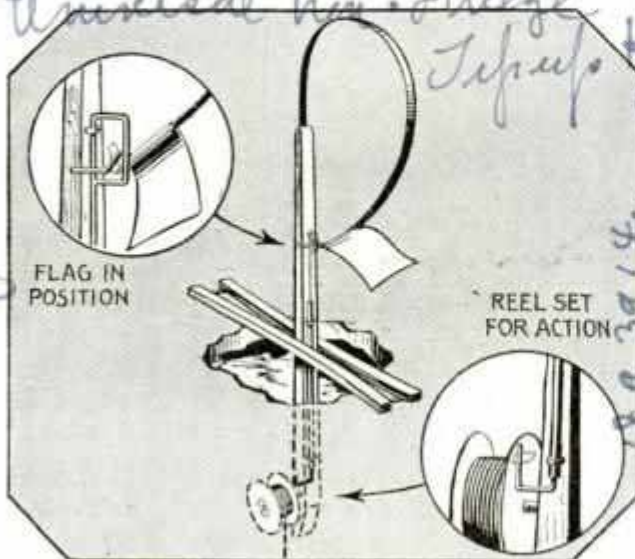

Tackle for Ice Fishing Which Prevents Lines from Becoming Frozen or Tangled

and line both are under water where they are unaffected by freezing temperatures. The mechanism causing the flag to spring up when there is a strike is enclosed in a brass tube permanently filled with a non-freezing lubricant. Thus, it is unnecessary to keep the water from freezing around the tip-up as with ordinary tackle. The equipment folds compactly for carrying.

POCKET MICROSCOPE LIGHTED WITH SMALL FLASHLIGHT

Only a small flashlight of the fountain-pen type is required to illuminate a portable pocket microscope, a tube projecting obliquely upward from the base acting as a socket to hold the light, the beam of which is directed into the hemispherical base. The instrument is designed for the



Light Is Furnished for This Pocket Microscope by a Fountain Pen Flashlight in Base

rapid inspection of paper, metal and other objects of flat, granular or irregular shape by mechanics, inspectors, students and engravers. Four different magnifications can be obtained. To examine an object, it is placed on a flat surface and the microscope is rested on top of it, the hollow base enclosing the small portion to be examined. The flashlight illuminates this portion, and light is intensified by the white enameled interior of the base. Focusing is done in the usual manner.

75¢. 5 for \$2.50

The Fishcrafters, Worcester, Mass. Esartner Corp. 1201 Wrightwood Chicago

D. 1688
to United Air Lines
United Airport, Burbank
'Flying Camera' Aimed Like a Machine Gun
Calif

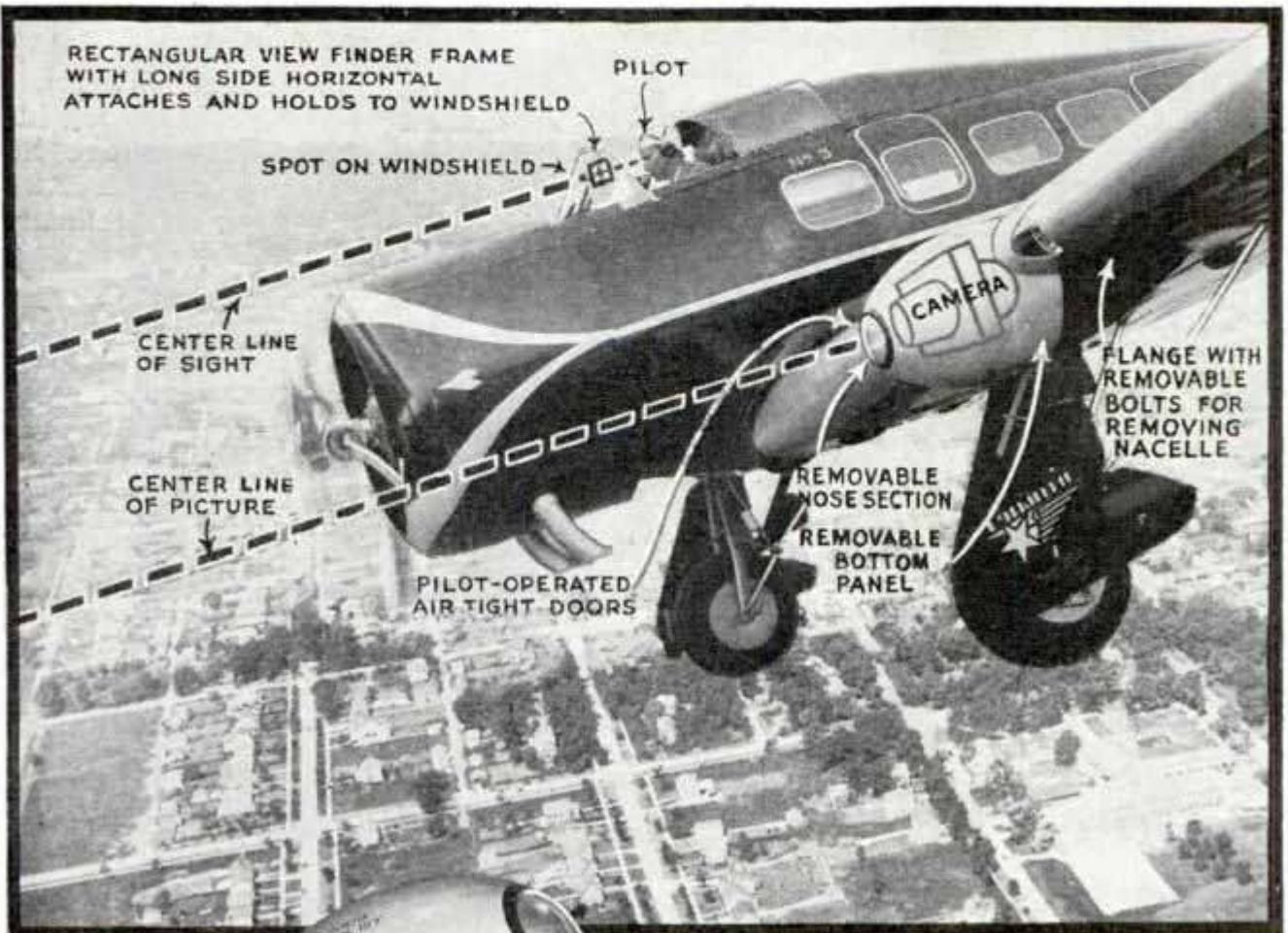

Top, Photo-Diagram of Camera Plane Showing Location of Camera in One Wing; Bottom, Installing Film Magazine in Camera Compartment Preparatory to Taking Aerial Pictures

Containing cameras that take pictures ahead, behind and straight down, a 300-mile-an-hour plane recently was completed by the Lockheed Aircraft corporation. One camera, built into the leading edge of one wing, about eight feet from the cabin, is aimed by pointing the nose of the ship at the subject to be pictured. A gunsight on the pilot's windshield serves as viewfinder. Then, as the plane speeds toward the subject, the pilot presses a button on the control stick, causing the automatic camera to snap a picture every two seconds. Auxiliary cameras are located conveniently for "shooting" pictures straight down and to the rear. These also work automatically. The cameras contain the finest aerial lenses obtainable. An automatic pilot device has been installed to allow the pilot-cameraman complete freedom to take pictures. The plane is rated at 300 miles per hour at 30,000 feet and can be equipped for either land or water service. Its cabin has seats for three passengers. The "flying camera" will be used by the Detroit News.

Burbank, Calif

Self-Powered Loop-the-Loop Is Latest Ride

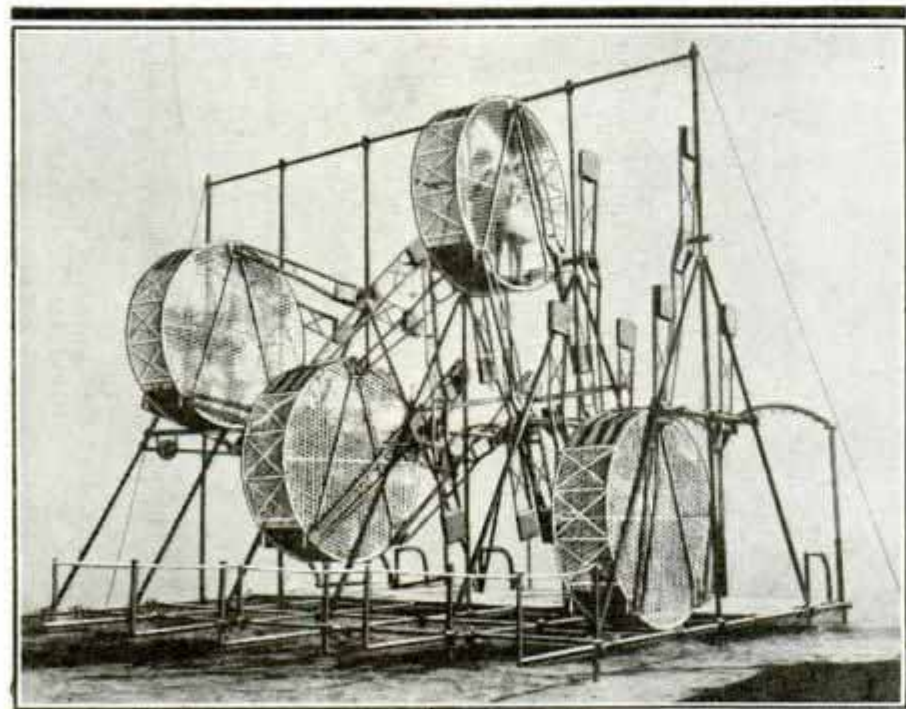

then on, the car operates like the old rope swing, the rider providing momentum by moving his body. The more he swings, the more the car moves until it finally makes a complete revolution and loops the loop. The cage always is in upright position, assuring riders of complete safety. Several cages may be set up in the same framework and operated singly or simultaneously.

Top and Right, Latest Amusement Ride; Cages Remain Upright Even While Looping-the-Loop under Momentum Provided by Rider

Operated almost entirely by the rider, a new loop-the-loop amusement device has been introduced. Most of the mechanism consists of six arms extending above circular-shaped cars and equipped with heavy counterweights. When the rider steps into the car, an electric motor starts it. From



Electric Moth Exterminator Destroys Pests by Gassing

All forms of moth life are destroyed within twenty-four hours, it is claimed, by an electric exterminator consisting of an electrical unit with a controlled heating element and a metal container of liquid chemical. The heat generates a harmless and odorless gas in suffi-



cient concentration to destroy the moth eggs as well as other stages of moth life. The unit can be used in closets or small rooms. The electrical unit is plugged in and placed on a shelf, the container of fluid is placed on the electric unit and the cap removed. The exterminator then is allowed to operate for about twenty-four hours, the closet or room being sealed as tightly as possible for this period. The treatment is harmless to fabrics and when the closet is opened no offensive odor remains in the garment or the closet.

2-58

*Moth King Corp
759 W. 2nd Ave*

Panoramic Pictures Help Locate Forest Fires

Next summer, whenever a lookout observer in Lassen Volcanic National Park "spots" a fire, he will report something like this:

"Hello, calling the dispatcher at Park headquarters. This is the lookout on Mt. Harkness. Got a fire for you. The reading is 276 and vertical minus nine."

The dispatcher refers to a map, notes the location of the fire and on photographs, determines the nearest ranger or fire guard and calls him, repeating the information and within four minutes the fire fighters are on the way. The two readings contain the key to a simple system recently developed. Here is how it operates:

At the dispatcher's office and at each ranger or fire-guard station there are a map and set of photographs. The map shows each lookout point which is circled by a 360-degree protractor. The lookout spots a fire, determines the location on a finder by means of azimuth readings and phones the reading to the dispatcher who, on map protractors locates the direction of the fire from the lookout. Should two lookouts report, the point at which the readings intersect will be its location.

Frequently, however, two lookouts cannot see the smoke. Then all that is known is that the fire is somewhere on a line in a given direction from the lookout who can see. This lookout must supplement the reading by stating the fire is on a certain ridge or in a known canyon. This often is impossible so a new method has recently been developed.

By this method, panoramic photographs are taken of the country covered by each lookout. Copies of the photographs are in each station. On each copy, a horizontal base line is drawn, and graduations marked on a celluloid scale give degrees above and below this base line. A fire is located on the photograph automatically by the fire-finder instrument. The number of degrees below the base line that the fire occurs is phoned to the dispatcher who relays this

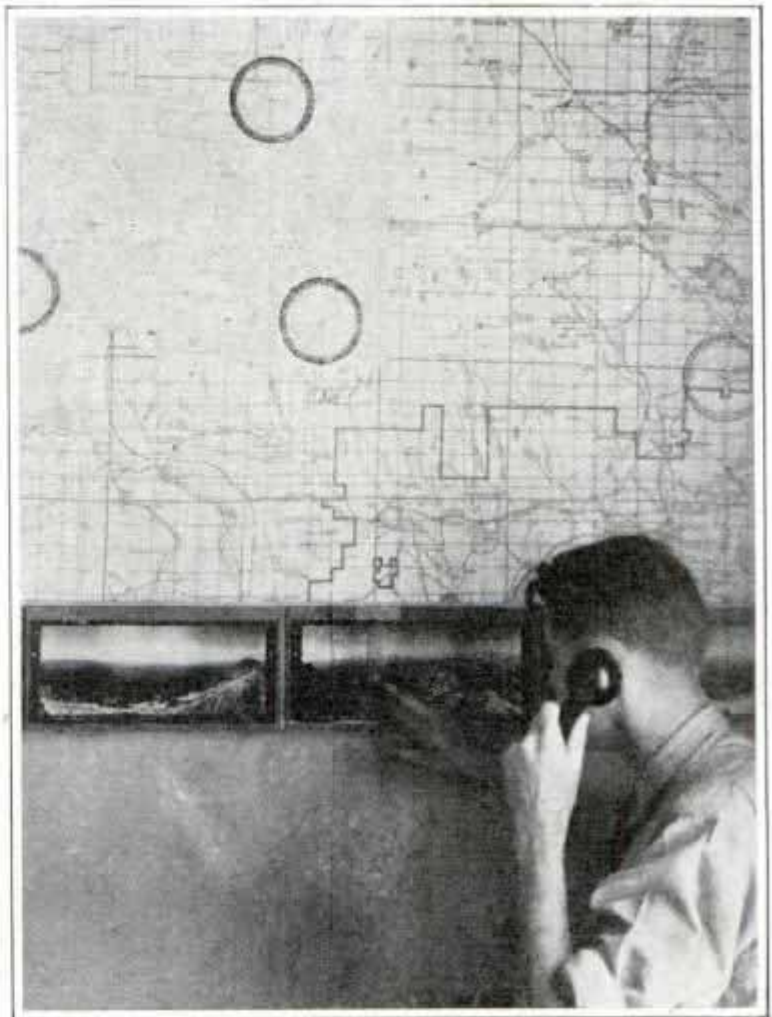

Locating Forest Fire with Panoramic Photos of Region after Lookout Has Told Direction of Fire from Him

information. The suppression crew take their photographs, run the scale to the azimuth reading and note the country indicated by the vertical reading. This is the location of the fire, and the men are able to "see" the country almost as well as the lookout himself.

LONG-HANDLED PAINT BRUSH



Varnish, shellac, liquid wax or paint can be applied easily on the floor by using a brush equipped with a four-foot handle. The finish can be spread evenly and four times faster

with the six-inch brush and the long handle makes it unnecessary to stoop.

Super Clean Applicator
60.
29 Swabach
De Vol & Clay holds
111 49th New York

ee 17

Cent. Leon Glassman
4 W. 103rd St. New York

ADVENTURES of the

see - Feb 1934 - 176

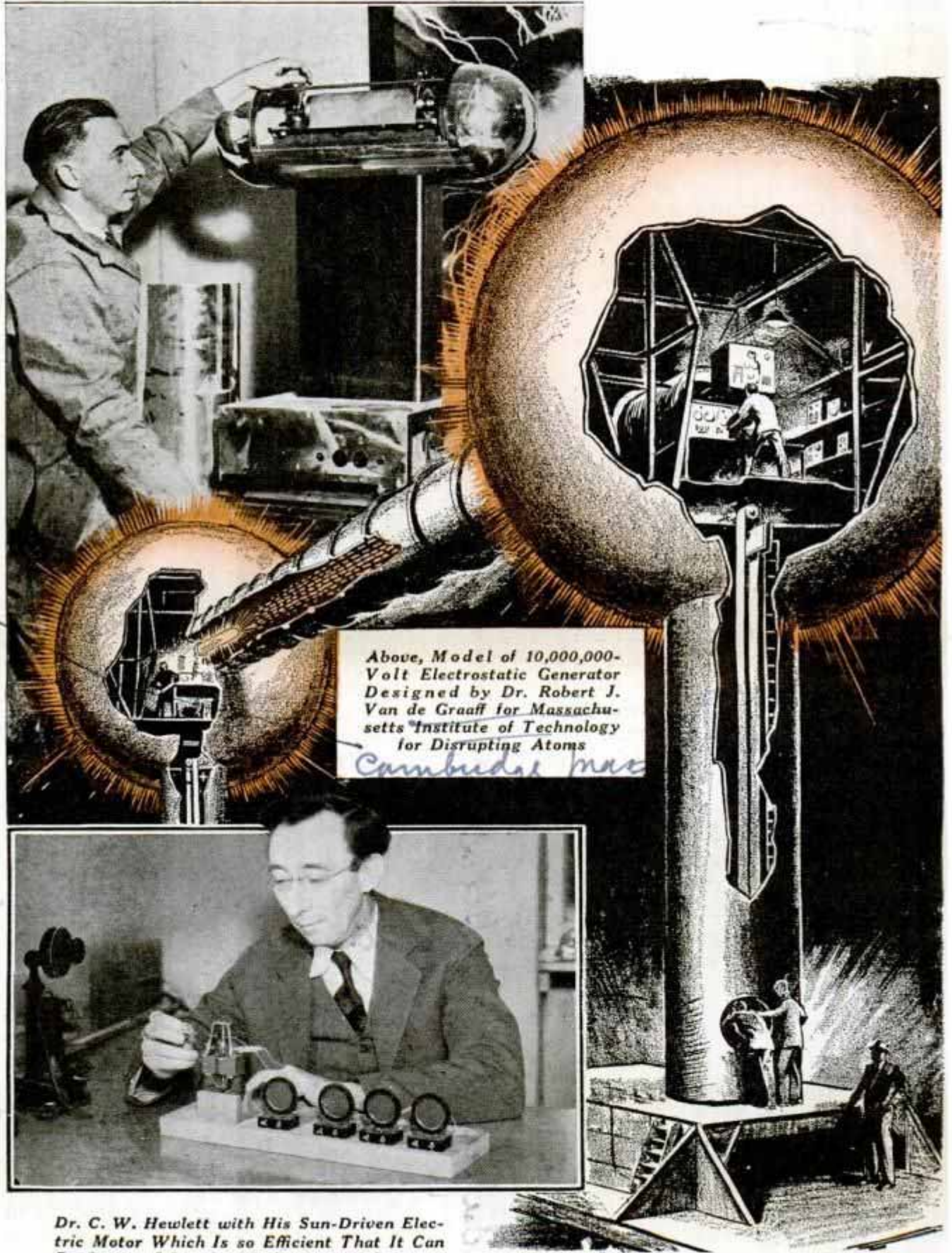

Above, Model of 10,000,000-Volt Electrostatic Generator Designed by Dr. Robert J. Van de Graaff for Massachusetts Institute of Technology for Disrupting Atoms
Cambridge Mass

Dr. C. W. Hewlett with His Sun-Driven Electric Motor Which Is so Efficient That It Can Be Operated by the Light from a Seventy-Five-Watt Lamp; It Is Rated at Four Ten-Millionths of a Horsepower

Diagram of Van de Graaff Generator, Showing Cylinders Mounted on Trucks and Aluminum Spheres

POWER EXPLORERS

WILL the Golden Age of mechanics and invention collapse for lack of power?

The power requirements of homes and industries are increasing at a rate which alarms fuel conservationists. The world consumes about 1,300,000,000 barrels of petroleum a year, while coal is being burned at the rate of about 1,500,000,000 metric tons yearly.

What will industry do when the ever-increasing demand for fuel

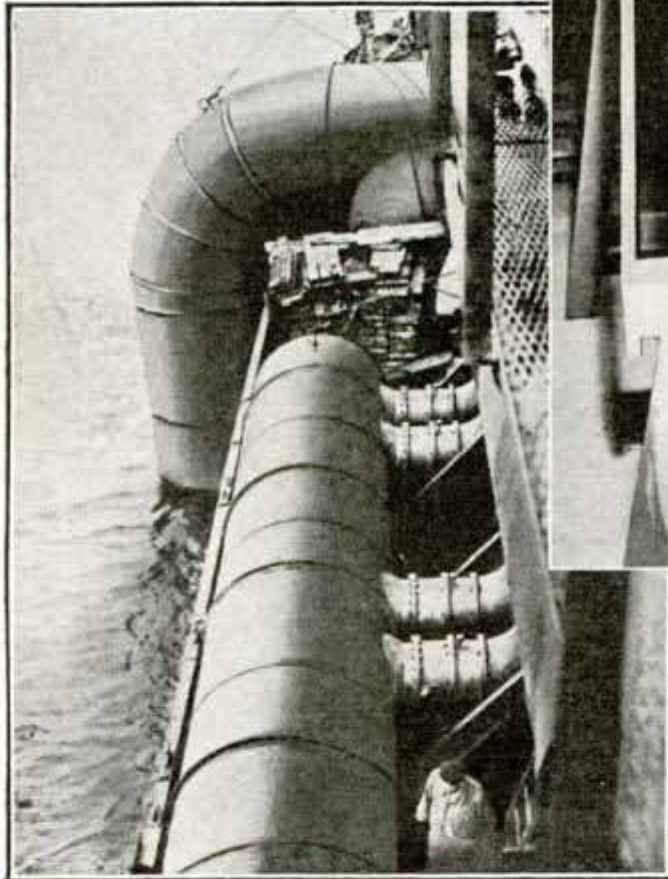

Above, Dr. Charles G. Abbot's Solar Cooker Which Concentrates the Sun's Rays to Develop a Temperature of 400 Degrees Fahrenheit in Twenty Minutes; Left, Ship Factory with Which Prof. Claude Expects to Produce Ice from Tropical Waters

see Jan-19 35-12

sends prices skyrocketing and makes uneconomical the operation of furnaces and engines which now do the hard work of mankind?

To answer this question some renowned men have turned their energies to power exploring. Dr. Charles G. Abbot, of the Smithsonian Institution, recently displayed a sun-cooker which puts to shame many fuel-burning devices. Within twenty minutes, Dr. Abbot's "solar heat collector,"

can reach 400 degrees Fahrenheit and more. He can either generate steam or supply heat to a cook stove that is odorless, clean, and economical in the extreme.

Dr. Abbot's sun engine is not, of course, intended for a region where the sun has a habit of hiding behind the clouds, but in southern countries, where the sun shines steadily, it can be used to good advantage.

As far north as Idaho, on a midsummer day, the sun rains 33,000,000 horsepower

Washington, D.C.

see June 1932 P. 51

Julius Madaras at Motor of His Rotor Power-Plant and One of Revolving Cylinders; Below, Low-Temperature Steam Boiler Which Utilizes Temperature Difference between Wet and Dry Air

at West Burlington

Julius D. Madaras, Pres. Madaras Rotor Power Co. 2146 Broadway, Newark, N.J.

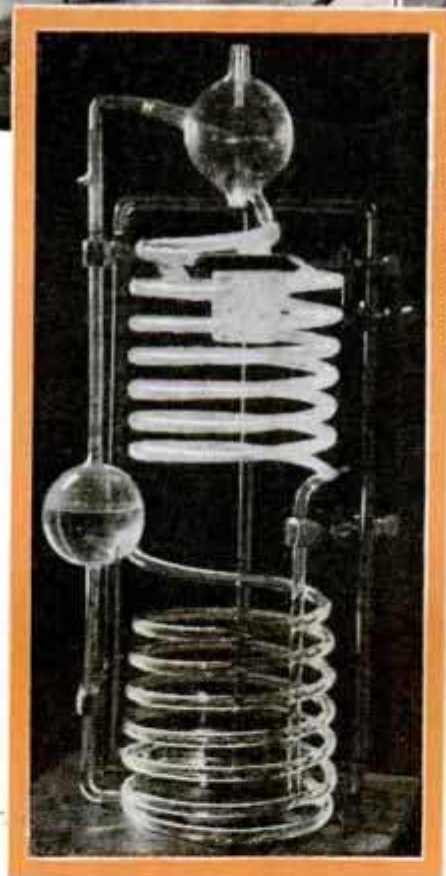
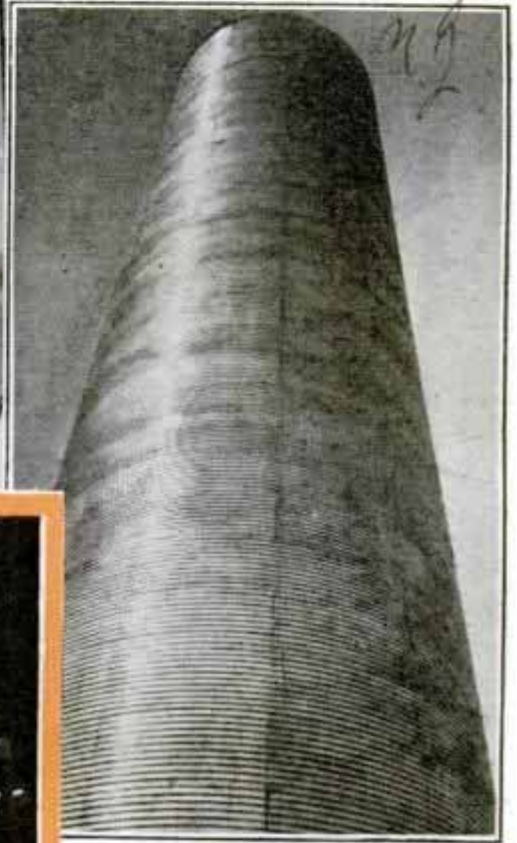

hours of energy on each square mile. And 1,800 times more horsepower falls on the Sahara desert in one year than is contained in all the coal mines on earth. If the earth were embalmed in a layer of ice 424 feet thick, the sun would melt it within one year.

Another power explorer, C. W. Hewlett, of the General Electric company, has developed an electric motor, rated at four ten-millionths of a horsepower, which takes its energy directly from the sun. The device which makes the sun power available to the motor is a super-sensitive photo-electric cell which converts ordinary sunlight into electricity. Even the light from a seventy-five-watt lamp is sufficient to run the motor. The efficiency of Hewlett's new generator photo cells is such that one watt of power can be obtained from about twenty square feet of cell area in direct sunlight.

That veteran power explorer, Georges

Claude, after proving the principle of a thermal ocean power plant, has embarked on a second power-exploring expedition, which takes him to the tropical waters off South America. This time he is attempting to utilize the sun's energy to convert water into ice at a very low cost. The freighter "Tunisie" has been converted into a floating fac-

tory, which will pump cold water from the ocean bottom through a tube 2,100 feet long. This cold water will be used to make the warm surface water boil, producing low-temperature steam. The steam will drive turbines, and the turbines will drive ice-making machinery.

At Burlington, N. J., another power explorer, Julius D. Madaras, is building a \$2,000,000 rotor power plant to make use of

Wide World

any breeze better than six miles an hour. This, too, is an attempt to harness the sun directly, for the sun generates "tides" of air.

Fifty heavy railway carriages, each carrying a rotor, will travel around a circular track and grind out the current simultaneously. Once started by power from the outside, the rotors are to be kept spinning by connection with the wheels.

The sun bows respectfully to the moon in another power-development scheme, sponsored by a prominent power explorer, Dexter P. Cooper. He plans to harness the roaring fifty-foot tide at the Bay of Fundy, off the coast of Maine. The possibility of developing large quantities of power on this site has been studied for years by Cooper and his staff, who have made plans which are approved by the war department's engineers.

Half a million dollars have already been spent on the preliminary surveys, and no doubt remains that a tidal power station is entirely practical. The Bay of Fundy tide will generate 200,000 horsepower if the power project is confined to the American side. If the project takes in the Canadian side, it will generate 600,000 horsepower.

Those are some of the solutions which inventors and engineers are presenting in an attempt to maintain the progress of industry even in the face of a diminishing fuel supply.

HANDY METAL NIBBLING TOOL FOR HOME WORKSHOP

Handy for garage or the home workshop, a small hand-operated tool is available for shearing and nibbling sheet metal and for cutting rod stock without sawing.

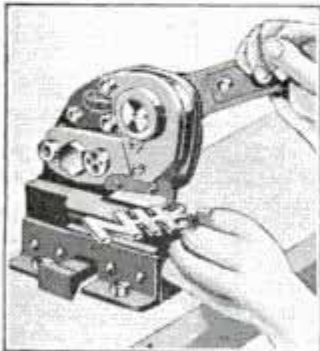

Held in a machine vise, it will cut templates, designs and letters in any shape desired in one-tenth the time required for such work with ordinary methods. Two special blades are supplied for nibbling, one for inside and one for outside. The capacity of the rod cutter is five-sixteenths of one inch.

national machine tool Co. Boston, Mass.

CIRCULAR SAW IS ATTACHED TO TRUCK DIFFERENTIAL



Circular Saw Being Operated from Truck Differential

Power to operate a circular saw is supplied by the car which hauls it by attaching the tool directly to the differential of the machine. By means of a clutch, the saw can be thrown out of gear, allowing the vehicle to use the engine for motive power.

METAL BENCH LINES UP PIPE AND FITTING FOR WELDING

Pipe, fittings and flanges can be lined up for welding by using a new metal bench. Four legs support a main bed consisting of two metal beams. An end plate to support the pipe is located at each end. The fitting to be attached to the main section of pipe is supported on a swivel table supported on a cross piece, the table being raised or lowered as desired.

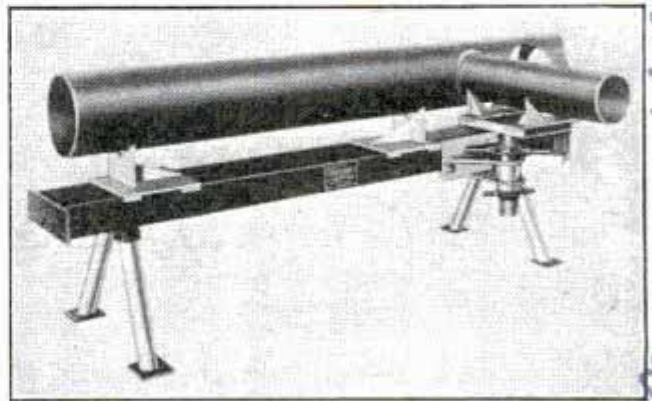

Pipe and Fitting Ready for Welding

Oster. Williams 2057 861 ab

Handwritten notes at the top of the page: "Kositsin", "Box 485, Berkeley, Calif.", "D. 16 31", "Suggested truck power take off", "Feb 19 1920", "no reply to letter", "4/11/25".

D 16 48
520

Full-Size Planes Tested in Big Air Tunnel

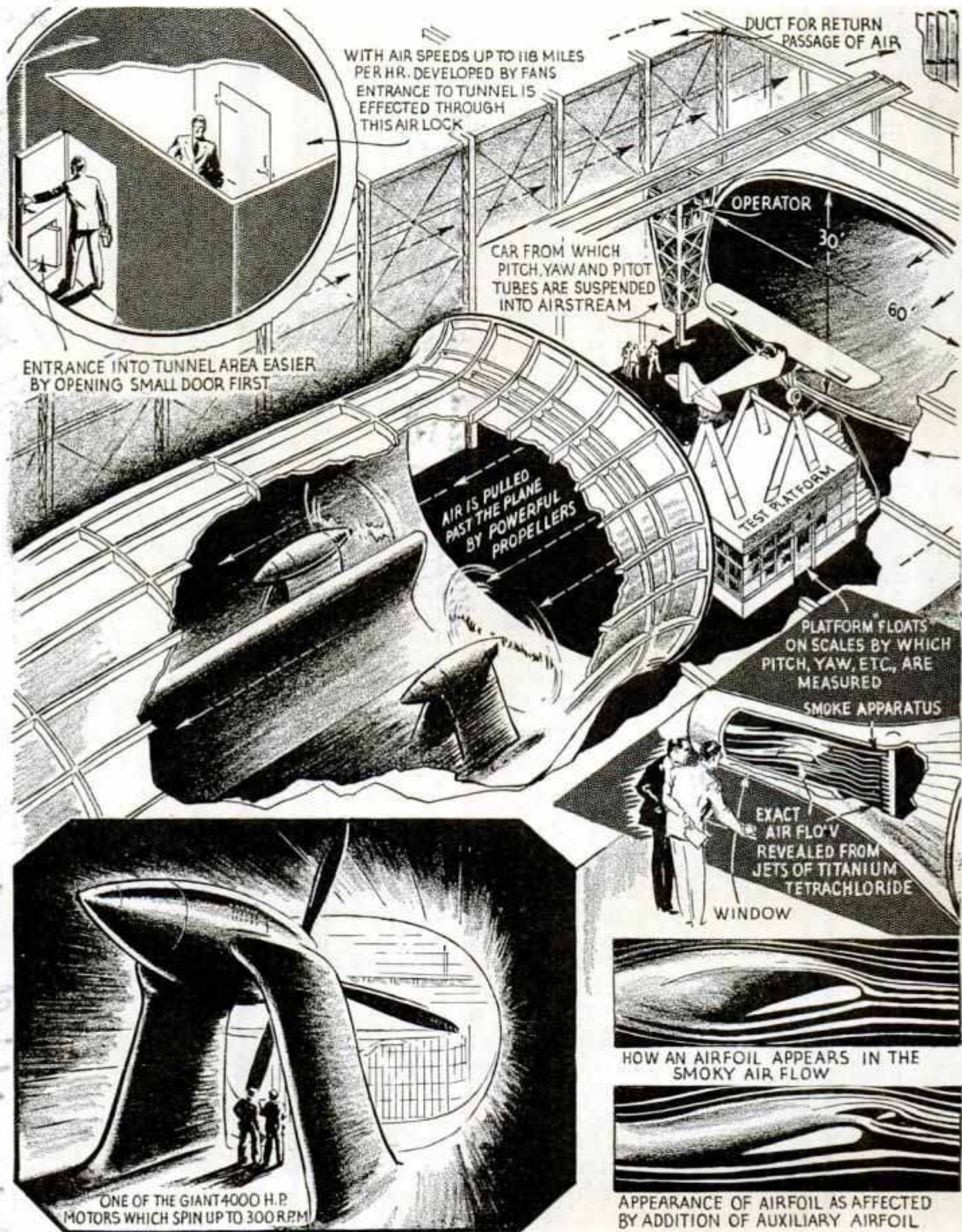

Drawings Courtesy National Advisory Committee on Aeronautics

Airplanes with a Wing Spread Up to Fifty Feet Can Be Tested in This Giant Wind Tunnel of the Langley Memorial Aeronautical Laboratories; Note Vanes Which Smooth Out Air Flow

Washington, D.C.

High-Speed Camera "Sees" Fuel Combustion

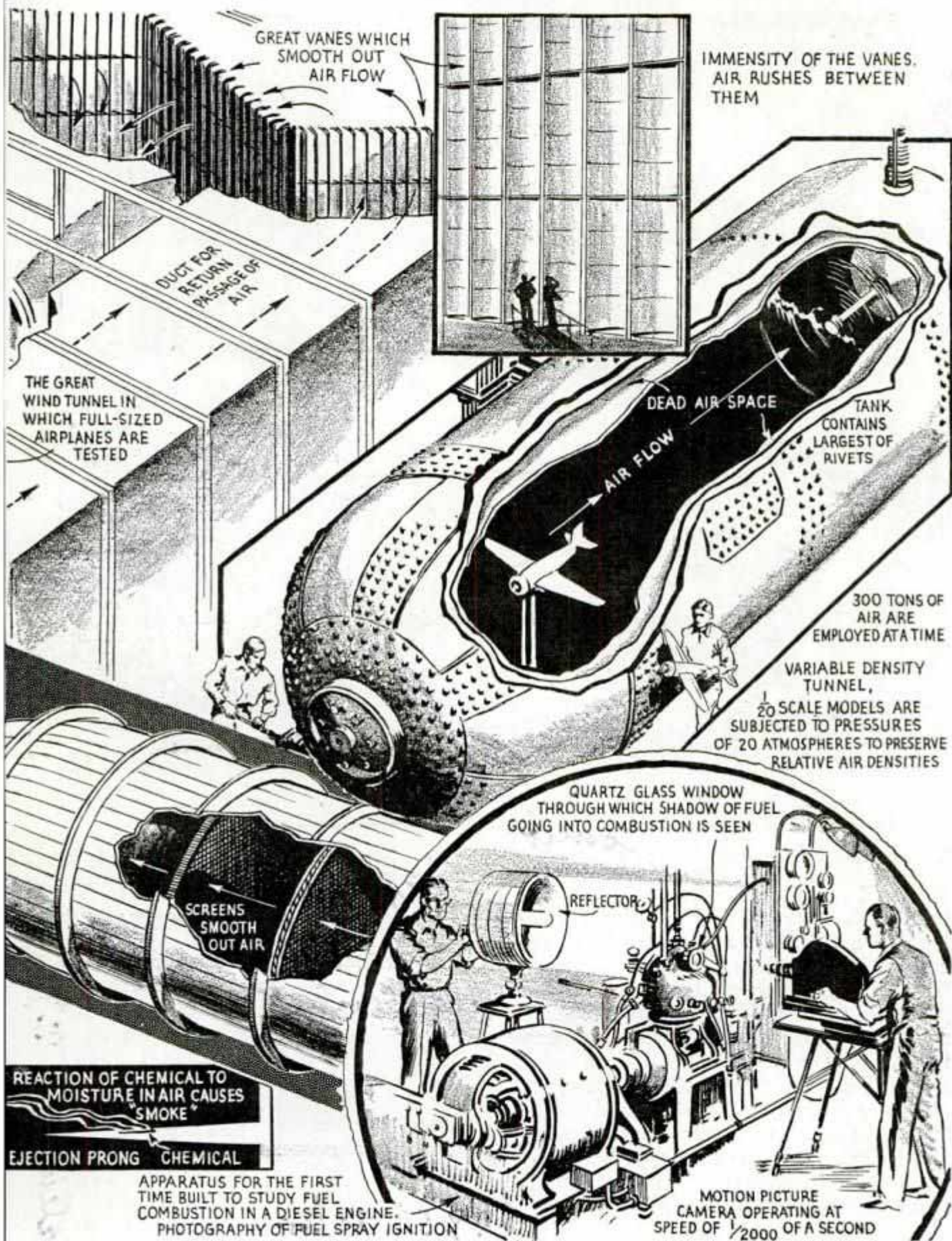

Variable Density Tunnel Where Models Are Tested at Pressures of 300 Pounds to the Square Inch and Drawing Showing How High-Speed Cameras Are Employed to Study Fuel Combustion

Trucks Bear 'Ears' and 'Eyes' to Spot Planes

*from Chevrolet Motor Co.
420 W. Milwaukee
Detroit, Mich*

D 1518

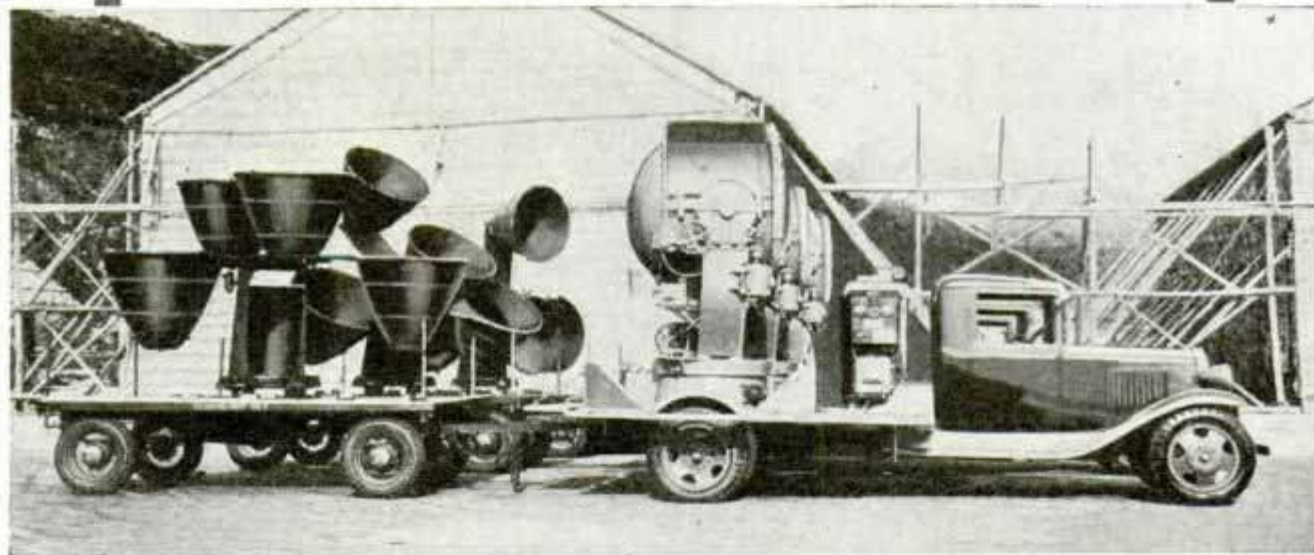
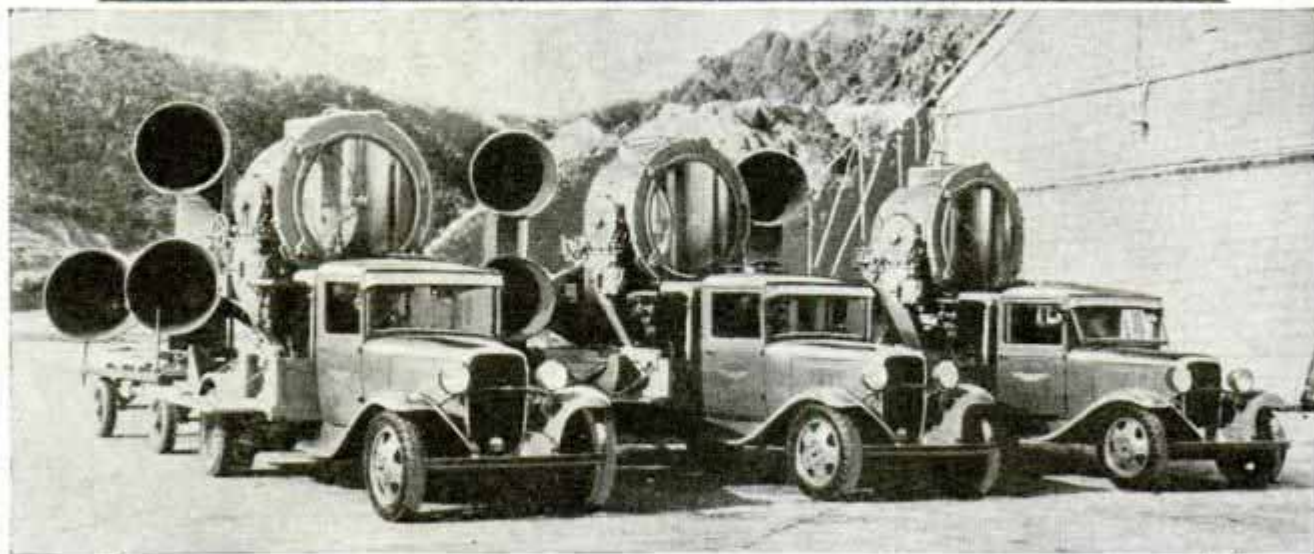

Anti-Aircraft Equipment Used in China Includes These Great Searchlights and the Electric Sound Detectors and Direction Indicators to Locate Enemy Planes

China is prepared to combat an air attack with the most modern anti-aircraft equipment, including a fleet of American trucks carrying powerful searchlights and generators to supply power to the lights and to their motor-driven elevating and transversing mechanisms. With each searchlight truck goes a trailer bearing an elaborate system of electric sound detectors and direction indicators, by means of which listeners learn of the approach of an airplane long before it comes within range of the lights or the anti-aircraft artillery.

E-53

"FIREMAN" FOR COAL FURNACE

Cheaper fuel can be burned in the coal furnace by using an inexpensive firing unit



\$47.50 dealer

that comes complete with room thermostat and automatic switch for controlling boiler pressure or hot water. It is operated by a sixty-cycle, alternating-current motor that is entirely inclosed. Buckwheat coal, smaller and cheaper than that used ordinarily, can be burned by the "fireman."

Germany is experimenting with a type of Diesel engine which burns oil produced from hard-coal tar.

*Dept. of Commerce
12/14/34*

*Report from American
Chrysler Technics*

*J. Randolph
46 330 Leaden*

"BIG BERTHA" MADE FROM LOGS LOOKS LIKE REAL CANNON

All the menacing appearance of a wartime "Big Bertha" is incorporated in a cannon made of giant Ponderosa pine logs which stands in the Chelan national forest in the state of Washington. The wood cannon, mounted on a dummy tractor also made of logs, is the work of some ingenious members of the civilian conservation corps who fashioned the big gun in their spare time.



This Is a Wooden Gun, But It Is Too Large to Be Called a Toy; the "Big Bertha" Is Made of Logs and Is Mounted on a Log Tractor

BRICKS MADE AUTOMATICALLY BY ONE-MAN MACHINE

Fifteen hundred bricks per hour can be manufactured by an automatic machine

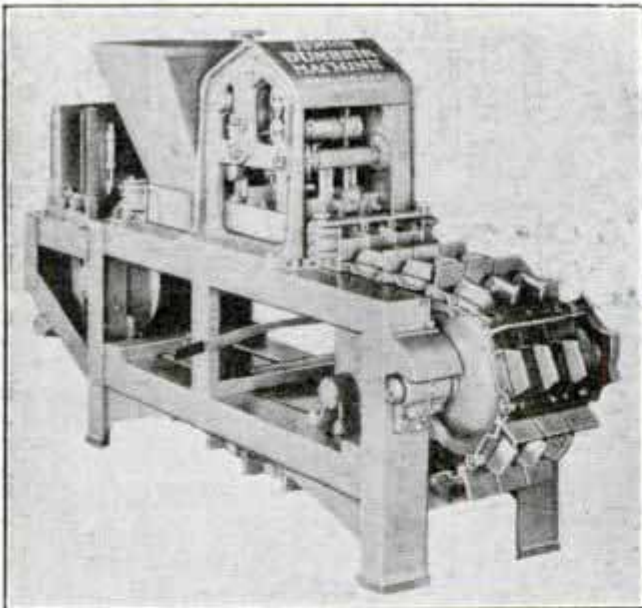

Brick-Making Machine, Showing Molds on "Endless Chain"; One Man Can Operate It

that requires the services of only one man to remove the bricks as they are delivered at the end of the machine. The brick is semi-hollow and has a water-repelling surface. By removing two dividing plates, double and triple brick can be produced as easily as standard single brick. The material is fed from a hopper into all-steel mold boxes in the form of a continuous chain. This chain passes under a packer

that compresses the material to the hardness desired. A two-horsepower motor drives the machine.

MUDGUARDS ON PLANE WHEELS PROTECT LANDING GEAR

Mud and gravel tossed up by a plane's landing wheels often jam the retractable landing gear, making it impossible to lower or raise the wheels. To overcome this hazard, Lockheed Electra airliners now are equipped with bicycle type mudguards which are placed over the wheels. The guards keep mud from flying into the landing gear and when the wheels are retracted, they fold back out of the air stream with the rest of the gear assembly.



These Mudguards Protect Plane's Retractable Landing Gear from Flying Mud and Gravel

W. E. Huntley & Co
Lockheed Aircraft

1666

D/6/1

E-18

Miss Emma H.
Morton, Oct 4/37
Cnd

of 22
 ...
 ...
 ...

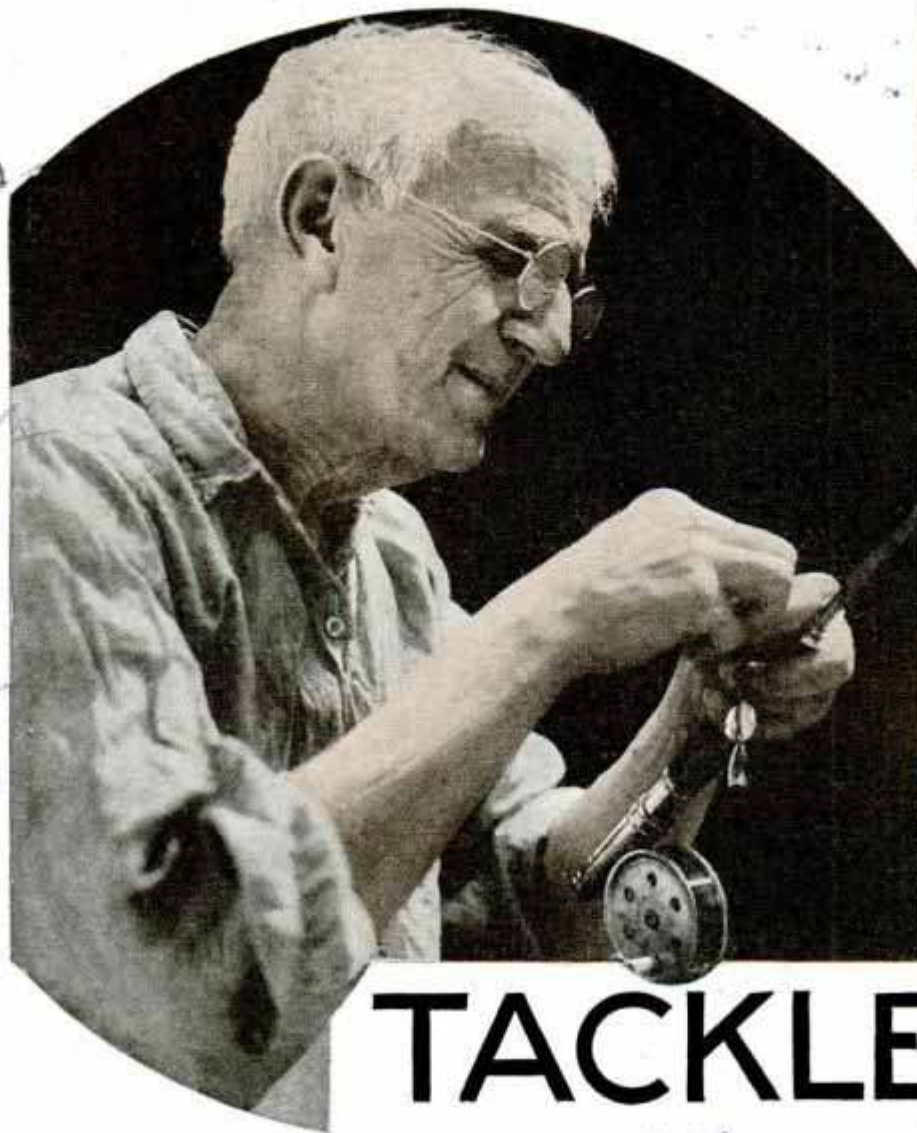

TACKLE TIPS

By **BOB BECKER** *of Chicago Tribune Tribune Square Chicago*

WHEN spring approaches, the average fisherman has several hours of "home work" in order to put his outfit in top condition for the coming season. To the real angler, these chores are more pleasure than work.

Invariably, a bamboo bait-casting, or fly-casting rod will show the need of work on wrappings, guides, ferrules and varnish.

First, take off the guides. An old razor blade is handy for cutting the windings. If the ferrules are loose, remove them for cementing. If one sticks, heat will loosen it.

Casting and fly-casting rods are apt to be badly nicked and the windings worn through. So remove both the varnish and the windings from the entire rod and start fresh from the bamboo. This is the only way to get a good-looking job and it gives you a chance to change the colors of the silk.

To remove the old varnish it is necessary to scrape the rod. A large, rather heavy blade is better than something smaller. Scrape with long strokes, up and down the rod. But if you bear down too hard you will dig into the thin protecting coating on the bamboo strips. Then use a fine

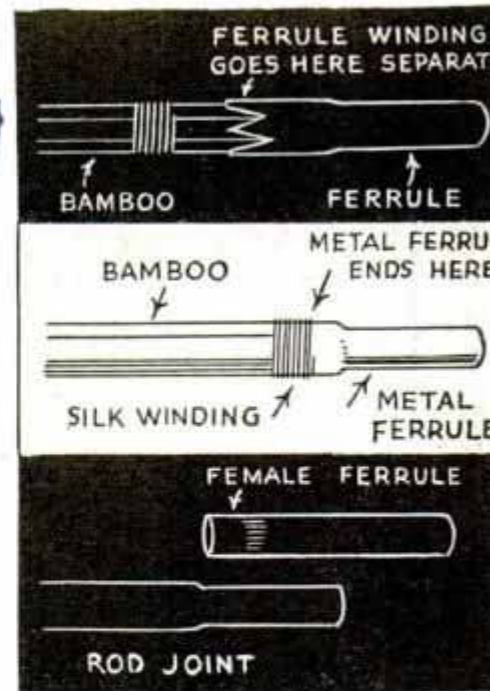

Spring Overhauling for Your Rod May Require Rewinding, Revarnishing and New Cement at the Joints Where the Ferrules Go



for the **FISHERMAN**



You Can't Land the Big Ones if Your Equipment Is in Poor Condition for the Contest of Strength

grade of sandpaper for rubbing down the whole rod. Next, clean the parts to which the ferrules are glued. Be sure and get all the old cement off.

Now we have "Old Faithful" slick and clean for the next step. To keep dampness out of the wood at the extreme joint ends—those that receive the female ferrules—apply varnish to the ends. Just a light coat will do. Failure to waterproof wood at the ferrules has much to do with breaks at these points.

A standard brand of ferrule cement comes in stick form and to use it you need a candle, or gas flame. Hold the stick in the flame until it softens and then dab a little on the wood. Then heat the cement and the joint carefully. Keep turning it around and when the cement flows, direct it evenly over the sur-



the invisible knot isn't a knot at all. It is a trick of burying the end of the silk under the final turns in order to keep it out of the way, and to keep the silk from unwinding.

As you start to whip the guide, or any part of the rod, turn in one end of the silk so three or four turns are over it. As you wind, keep pressing the silk tightly into place. At the finish you are ready for the invisible knot stunt. Here is how it is done:

When near the end of your winding, press your thumb on the last tight coil of silk. Cut the silk so you have several inches left. With this end, take

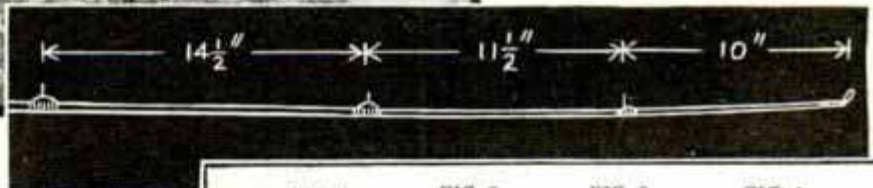

face with a match. Quickly slip the ferrule over the wood, press it down tightly and again heat the ferrule over the flame for just a second or two. Excess cement oozing out can be wiped off while still warm.

Next we are ready to beautify the bamboo rod. Put a light coat of thin shellac on the wood. Brush it out well and you are ready for the winding of the rod, fitting the guides, and the final task of varnishing. There are endless color variations for winding that can be worked out. As to quality, I select a Grade A silk, which can be found almost anywhere. It is an unwaxed silk, and not the finest grade used in windings but Grade A is serviceable and not too heavy for most of us.

To wind the rod, use silk thread and wind evenly toward the center of each guide. Every fisherman must learn the way to start winding, and the secret of invisible knotting, or whip finish. Actually

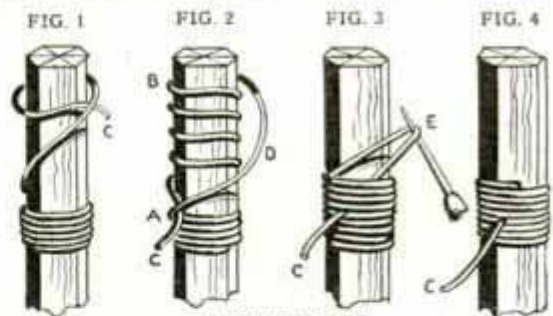

- 1 The start of the trick to bury the thread end under the final turns of a circular winding.
- 2 Pulling several loose coils (B) around the rod. (C) the free end, is inserted under the coil (A)
- 3 After loose coils are laid up tightly against the winding the loop (E) is held tight.
- 4 The loose end (C) is pulled through and snipped off.

Schedule to Location of Guides on Short Bait-Casting Rod, and Steps in Rewinding a Rod

several turns in the same direction you did before. These coils will be loose but winding back toward that last tight whip around the rod. Slip the end of the thread under that last tight coil and transfer the final loose coils into tight ones and have them laid up against the completed section of the winding. Stick a small instrument,

8. 22

D 1640

such as a large pin, through the loop of the thread and pull it through the windings. The final flip is done by withdrawing the pin from the loop, and pulling the thread sharply. You are pulling the thread that comes out of the tight windings right underneath and out of sight. When that is completed, cut off next to the windings.

This method may be used for every solid winding. When the windings are in place, apply the final varnish. See that the ends are all snipped clean, then apply one or two coats of shellac to them. I use ordinary white shellac thinned slightly with alcohol. This is a regular rod varnish obtained from any sporting goods store.

To insure an even flow, warm the varnish in a pan of hot water. Brush it on smoothly, and after each coat—you will want to apply four or five—look out for dust. While the varnish is drying, hang the rod in a place free from dust.

Use rottenstone to rub down each coat of varnish. Do this lightly after the first coat so as not to injure the wrappings. After the third coat, you can apply more pressure and build up a glossy finish.

You now have a bamboo rod with firm, well-cemented ferrules, beautiful colored windings, and completely waterproofed and strengthened.

Now take out your reels. As you take a reel apart examine each part. There is nothing but sand and carelessness to worry about. Wash the parts in gasoline, rinse and put a tiny dab of grease on the moving parts. This grease comes in tiny capsules. Be sure the sand is out before you re-assemble the reel. Oil each part carefully as you put it together with a regular reel oil. Now adjust the reel and whirl it to be sure it is running freely.

Now is a good time to test the old line. Every fisherman knows about the amount of pull his favorite line will stand. Wrap it around your hands and pull. Perhaps it is stout enough, but usually it is an excellent precaution to put a new line on the spool.

Open the tackle box and empty everything out. Most of us find a little brown rust creeping around the edges. Wash it thoroughly with soap and water, then sandpaper off the rust spots. Take an oily cloth and go over the trays lightly, leav-

(Continued to page 120A)

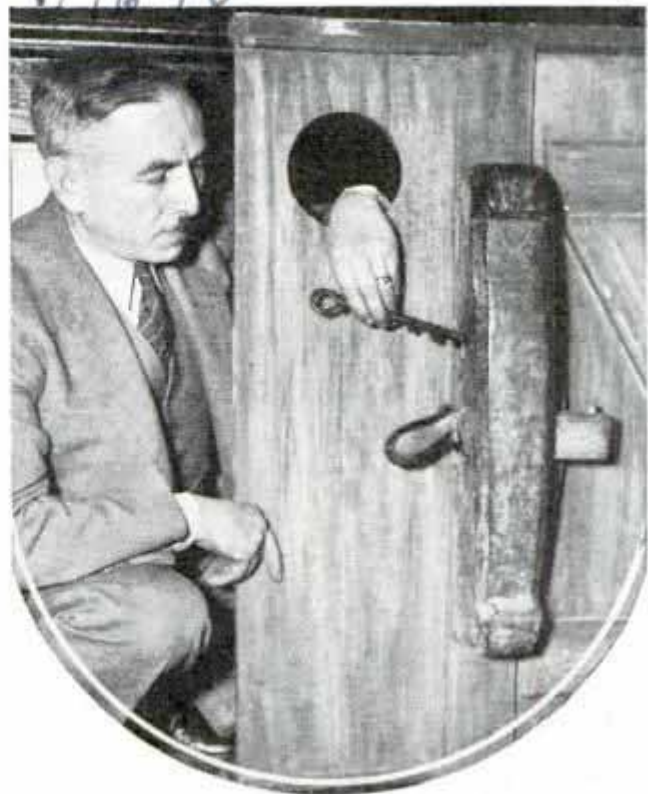

Wooden Tumbler Lock with Key of Forged Iron Which Was in Use 2,000 Years Ago

LOCK TWENTY CENTURIES OLD STILL IN WORKING ORDER

One of the prized possessions of Charles Courtney, New York locksmith, is an ancient lock in use some 2,000 years ago on the entrance to a public bath in Jerusalem. It is still in working condition today. It is a wooden tumbler lock and the key is of forged iron.

5 30 W. 125th St

"MAGNETIC MOP" RETRIEVES STEEL BALL BEARINGS



Steel ball bearings and shot are retrieved in the General Electric research laboratories with the aid of a magnetic mop. Large quantities of the bearings are used and often spill on the floor.

So an ordinary mopstick was equipped with a brass hopper, soft iron pole pieces and a sliding magnet controlled by a wire on the handle. When the magnet is down the pole pieces pick up the shot and when it is lifted the shot drop off the hopper into a receptacle.

Schenectady

Squad, Los Angeles City
POPULAR MECHANICS

D1587

Smoke "Fingerprints" Used to Trap Fire Bugs

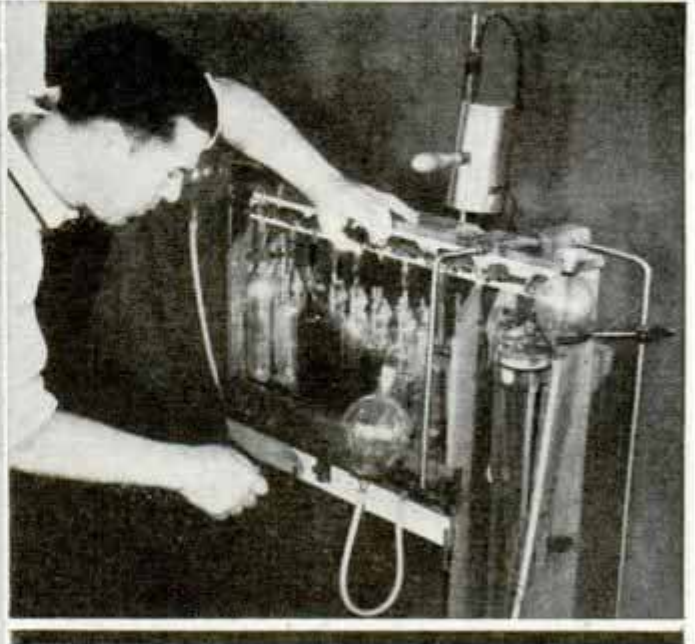

Fireman Obtaining a Sample of Smoke and Chemist Analyzing Sample in Suspected Arson Case

Smoke from a burning building is being used by the arson squad of the Los Angeles fire department to determine whether the blaze was of incendiary origin. A sample of smoke is trapped by a fireman in a vacuum bottle and submitted for chemical analysis. A gas analyzing apparatus "fingerprints" the smoke, indicating what materials were burned to produce it. The presence of petroleum oils, alcohol, or other inflammables can thus be detected. If such a substance is not normally stored in the building, an investigation is started. The fire detectives also are investigating the fluorescing characteristics of the burned residues of inflammable oils under an ultra-violet light. By exposing a sample of the charred timbers where a fire started to the ultra-violet rays, they try to determine if any chemical was used.

form of a notched wheel above the delicate weighing spring. By synchronizing the action of this wheel on a lighted indicator, the person being weighed can watch his own heart beats. A measuring rod enables the patron to obtain his height.

D1667

COIN-IN-SLOT SCALE REVEALS HEART BEATS WITH WEIGHT

Heart beats, height and weight all are recorded by a coin-in-the-slot scale now available. The instrument is so sensitive that it not only indicates the rate of the heart beats but the intensity as well. This is accomplished by an oscillograph in the



Scale Which Indicates Rate and Intensity of Heart Beats at Same Time It Registers Weight

Fairbanks, Morse & Co
Wabash

D. 1965
John F. Cook
3109-14 St. N.W.
Washington, D.C.

Blackbeard's Pirate Castle Is Now a Hotel

Famous as the place where lived one of the most notorious pirates of the old Spanish Main, Blackbeard's Castle at St. Thomas, Virgin islands, has been turned into a tourist hotel by the United States government. The

Reader says this is old Spanish fort, not castle.

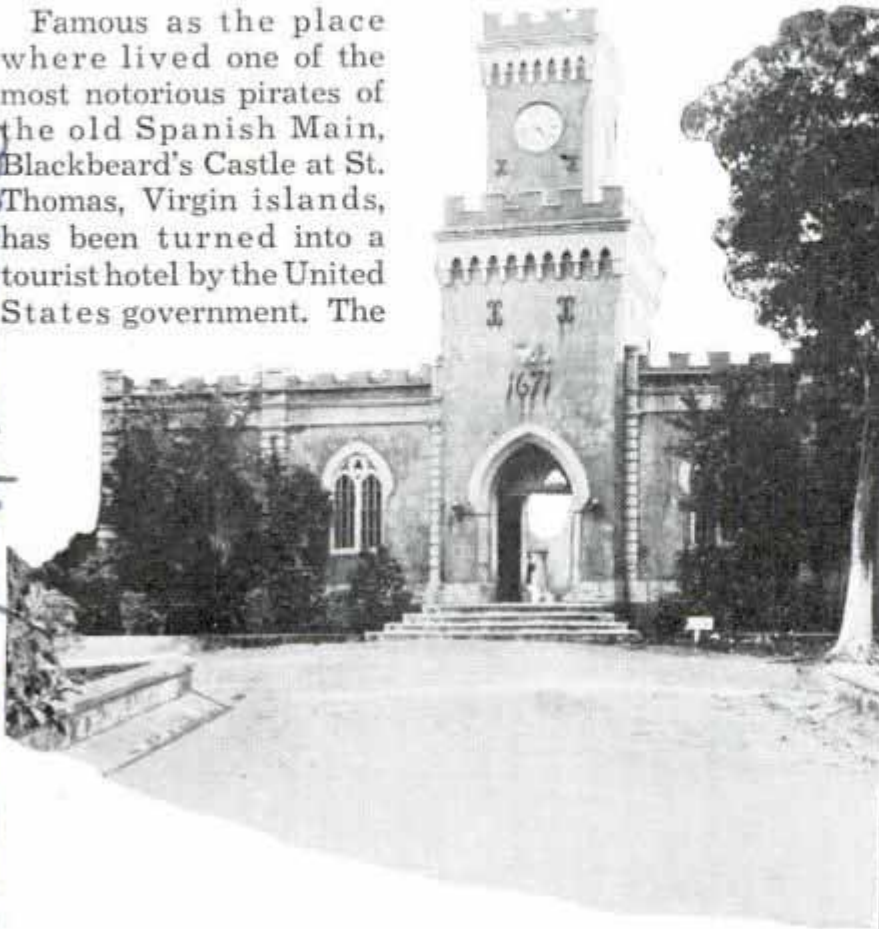

Two Views of Pirate's Castle in Virgin Islands; Photo at Left Shows Tower After Restoration as Inn for Tourists; an Excellent View of Incoming Ships Is Afforded by the Tower

pirate was Edward Teach, popularly known as "Blackbeard," but who called himself "Captain James Thatch." Teach is said to have engaged in privateering during the war of the Spanish succession. In 1717, he captured a large French merchantman and converted it into a warship of forty guns. From that time, he committed piratical outrages in the Spanish main, the West Indies and on the Carolina coast. His winter quarters were in an inlet of North Carolina. In November, 1718, Blackbeard was killed in a fight with two sloops sent by the governor of Virginia to rid the seas of the pirate craft. The tower in which Teach lived on St. Thomas held a commanding position over the sea. It originally was a Danish watch tower. A narrow room running the full length of the castle quarters above the first floor once was the dungeon in which were kept the negroes seized on slave-trading ships and later sold by Teach. In preserving the pirate castle, the government has retained all its pic-

turesqueness and charm. Five wings added to accommodate tourists were planned carefully to harmonize with the tower and tropical scenery. A dining terrace overlooks the harbor.

HEADING TAB FOR RECORD BOOK

Easily attachable to fly-leaf or backing of check register, journal or other type of columnar record book, an instant heading tab saves time on entries. After attachment, all pages are constantly headed. The tab also serves the purpose of an instant index and finder.

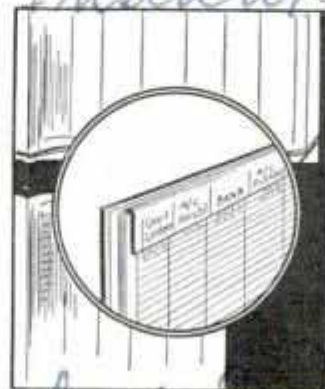

Handwritten note: ...with Am. Seath...

Handwritten note: J. W. Merrick
2100 ... 1903

D/657
36
D/657
Candy
Chicago
36
North Avenue 53
Los Angeles Calif

Fighting the



insects or plant diseases can generally be traced to some one willing to sell his plants regardless of the peril to the nation's food supply. Ignorant and innocent introductions by tourists and ships' companies on steamships and aircraft are to some extent condoned, though carefully guarded against, as are introductions on the gear of trains and automobiles and even on shoes and clothing. But the clever hiding of infected plant material with which border and seaport inspectors have had to contend has forced them to theorize that forces not so innocent are also at work.

C. E. Bellis, chief inspector at Nogales, Ariz., hints at a typical danger,

DR. HAROLD COMPERE, of the California University college of agriculture, expert on insect parasites, asserts flatly that "almost all of the serious depredators in the United States have been introduced from foreign lands."

"Insistent craftiness," are the words used by department of agriculture officials in a recent report on the amazing scope of their work against the smugglers, to describe a type of smuggler the inspectors have to outwit—and they are not at all certain, with their limited forces, that they are always successful.

The mildest thing quarantine inspectors say about deliberate insect and plant disease introduction, is that it is attempted and often accomplished by "cranks," of the same type often accused of incendiarism in the oil fields and our national forests.

Attempted commercial introduction of

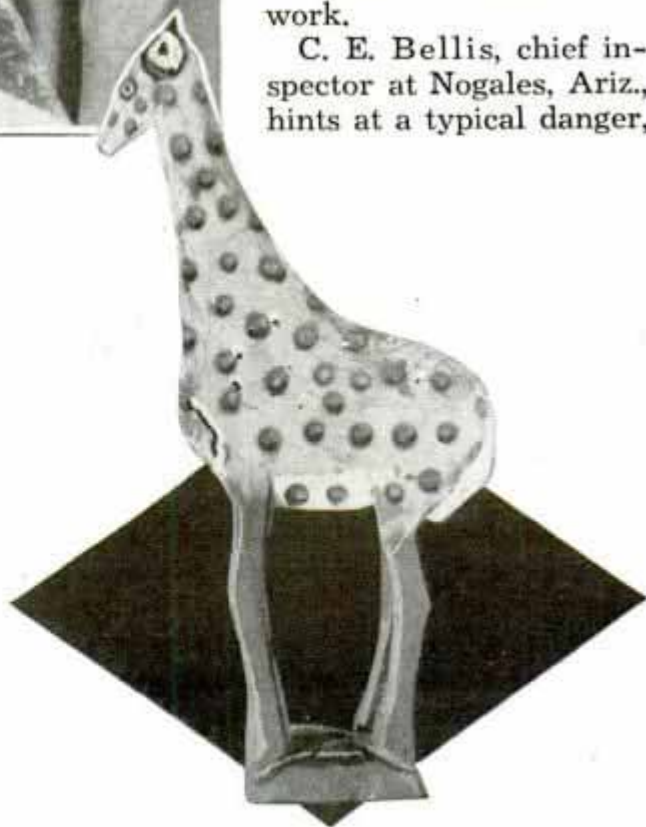

Above, Inspecting Airplane Baggage for Forbidden Fruit; Below, Imported Toy with Holes Indicating It Was Victim of Wood Borer

BUG SMUGGLERS



in a report to the department of agriculture. He says:

"On inspection of the Pullmans which crossed from Mexico on January 30, restricted plants were found concealed in the Mexico City-Los Angeles car. Twenty-one specimens were found in five packages, concealed in the following manner: two in a dark recess above the switchboard compartment in the vestibule which necessitated standing on the doorknob and using a flashlight; two on a high ledge in the ladies' dressing room; and another behind the ceiling ventilator in the toilet.

All but four passengers had detrained on the Mexican side of the line. These re-



Top, Examining Shipment of Roots from Abroad; Above, Imported Doughnuts and Pretzels Containing Infested Rice Straw and Cotton; Left, Borer Found on Imported Date Palm Plant

maining four all denied ownership of the material."

A. C. Fleury, chief quarantine officer of California, reports an incident that probably was an innocent one, but which reveals a threat nevertheless to the California and Louisiana rice-growing industries.

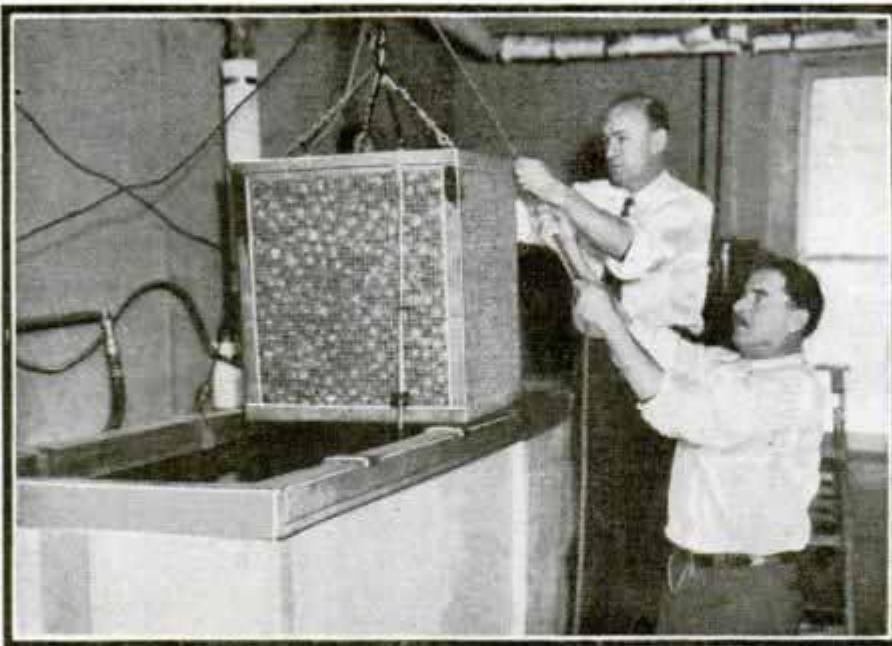

Insect Death Chamber; They Are Immersed in Hot Water

He says: "Four interceptions of the rice borer in rice straw packing around earthenware carried as cargo on Japanese freighters have been made in the past few weeks."

Since there are few foreign nations, except those contiguous to us, which care much whether the agriculture of the United States flourishes or not, we have to depend on our own inspection efficiency.

Of the apparently criminal type of smuggler, here is an instance. The S. S. "Columbia" arrived at New York with passengers from Caribbean ports. Inspector C. G. Latham, who was assigned to the vessel, was summoned to inspect some sour limes and avocados found in the baggage of one of the passengers, and during the examination he saw a shiny individual soap container accidentally

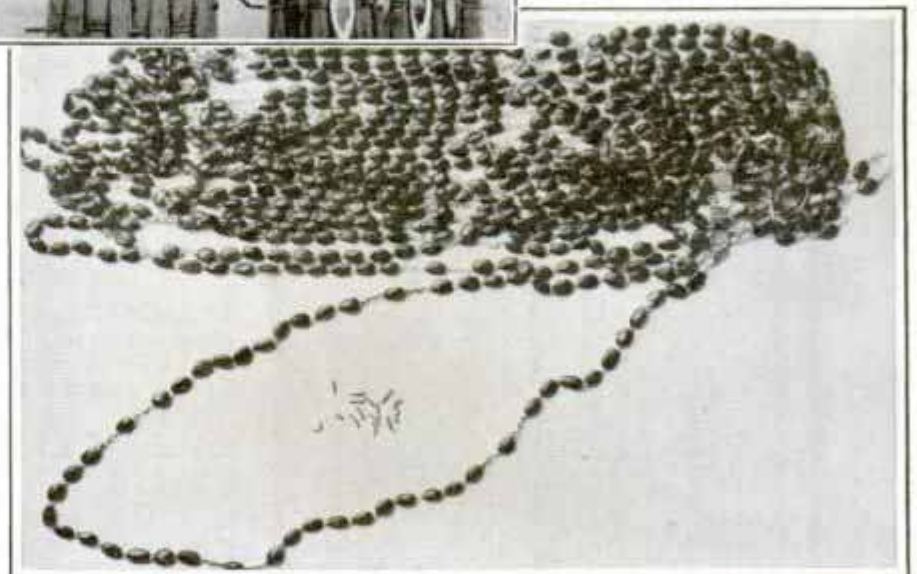
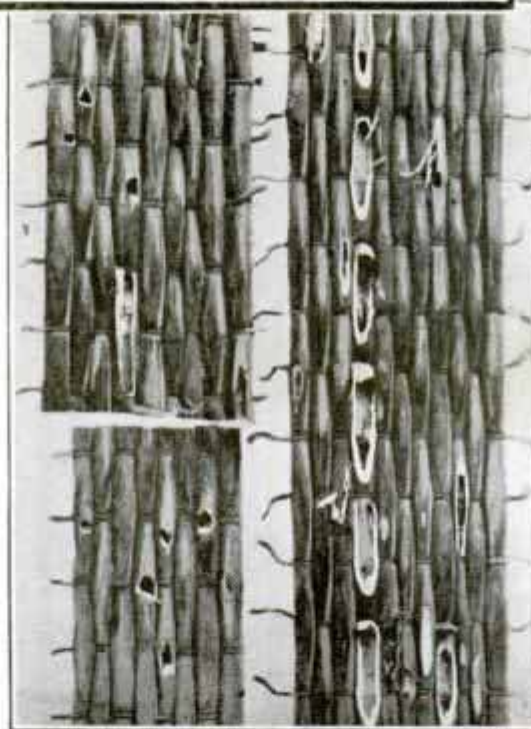

Center, Part of Imported Basket Infested with Boring Beetle; Bottom, Beads Made of Seeds Which Contained Dangerous Insects; the Vigilance of an Inspector Detected the Pests

come open. The soap was carefully wrapped in newspaper and was of such a peculiar shape that a closer examination was made. The "soap" proved to be a mango, and rigid examination of the baggage revealed two more specimens of the same fruit. They were infested with fruit fly larvæ.

Federal and state inspectors do not hope to keep out noxious insects and plant diseases forever. They do hope to delay the entry and to create a condition that will restrict that entry to as few points as possible, so that, immediately the new insect is discovered operating on our food supply, we can get it in check and delay its progress as long as possible. Once in, it is fought all along the line. However, before it gets in, entomologists go where it is known to exist and study methods for combating it with poison and insect parasites.

Swinging Pendulum Shows Rotation of Earth

on Mt. Hollywood.

One of the pieces of apparatus in the Griffith observatory in California is a Foucault pendulum, the swinging of which demonstrates the rotation of the earth. This big pendulum actually was evolved from experiments originally conducted by Galileo. A verger in the cathedral at Pisa filled a lamp and left it swinging from the roof. Galileo, then eighteen, saw the lamp swaying back and forth as did hundreds of others. But Galileo got from the swinging lamp the idea of applying the swinging movement to measurements of time and devoted fifty years to completing his pendulum theory which has been of inestimable value in

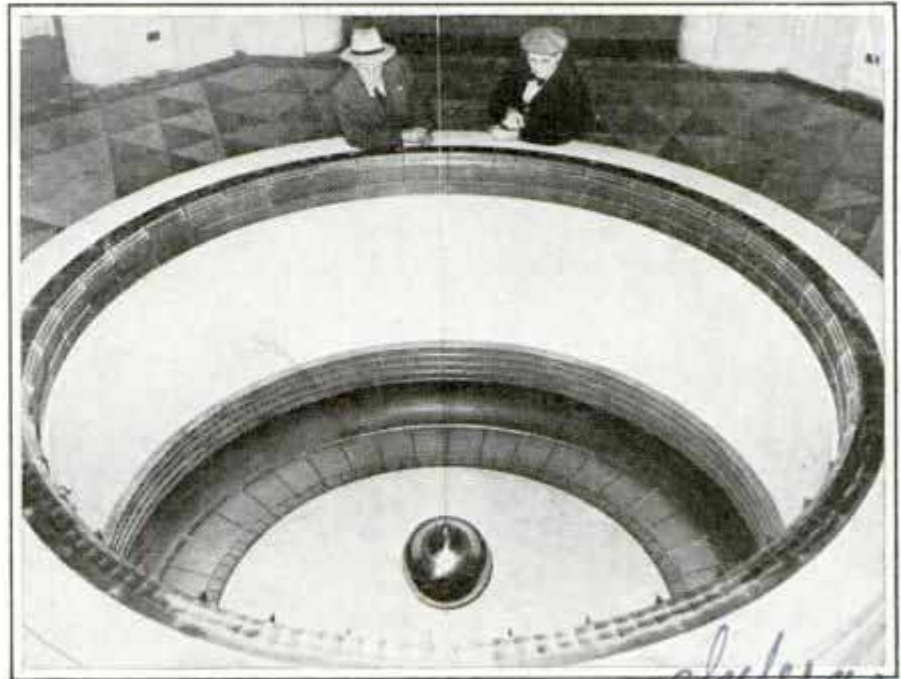

Large Pendulum in Griffith Observatory, the Swinging of Which Is Used to Demonstrate the Rotation of the Earth

measuring time and in astronomical calculations through the years since he announced the result of his experiments.

Ambulance Boat Like a Plane Is Fast and Non-Sinkable

Said to be non-sinkable, a new ambulance boat has been constructed for the Portland, Ore., police patrolling the harbor. Embracing principles of the airplane, the craft's cruising speed is rated at forty miles per hour and its top speed above fifty-five. The boat is designed to skim the water at full speed. When motionless, its draft is less than twelve inches. A siphon system that is effective when the boat

V-8 motor provides the power through an intermediate and high-gear transmission, one of the first installations of an intermediate gear in boats. This gear, in addition to providing quick acceleration, is for use at slower speed to facilitate maneuvering. High gear is for use only at higher speeds. The hull consists of a series of air-foil sections or "wing-stub ends," so designed as to afford the greatest amount of lift above and below the sections, an arrangement by which the craft is partially supported in air while traveling at top speed. The boat is twenty-four feet long and six feet in height with a beam of eight feet. It has accommodations for driver, doctor and two persons on stretchers. A special rack holds the stretchers when not in use. Respi-

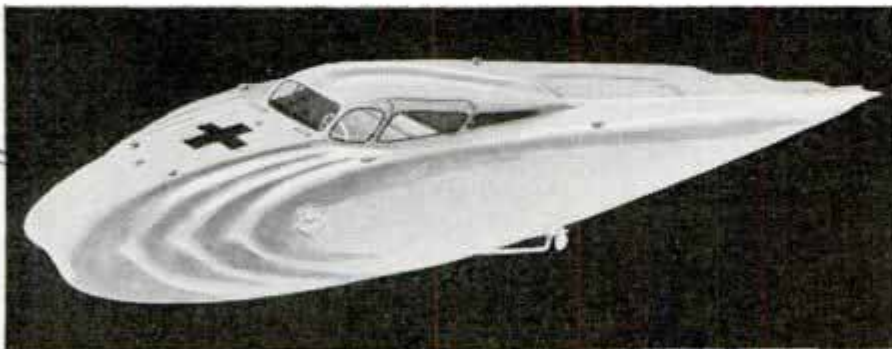

© Pacific Feature Service
Design of Speedy Craft That Will Be Used in Harbor Ambulance Work; Note Air-Foil Sections of Hull

is in operation keeps the craft dry in any weather. A marine adaptation of the Ford

ratory and first-aid equipment and oxygen tanks are carried for emergency work.

or ch. w. Victor W. Grode,

See April 1933 573

857

Oct. 19 36 - 519

Substantive

D 1568

Bike Camping Trip from Pacific to Atlantic

% Explorers Club, 10 W. 72nd St. New York

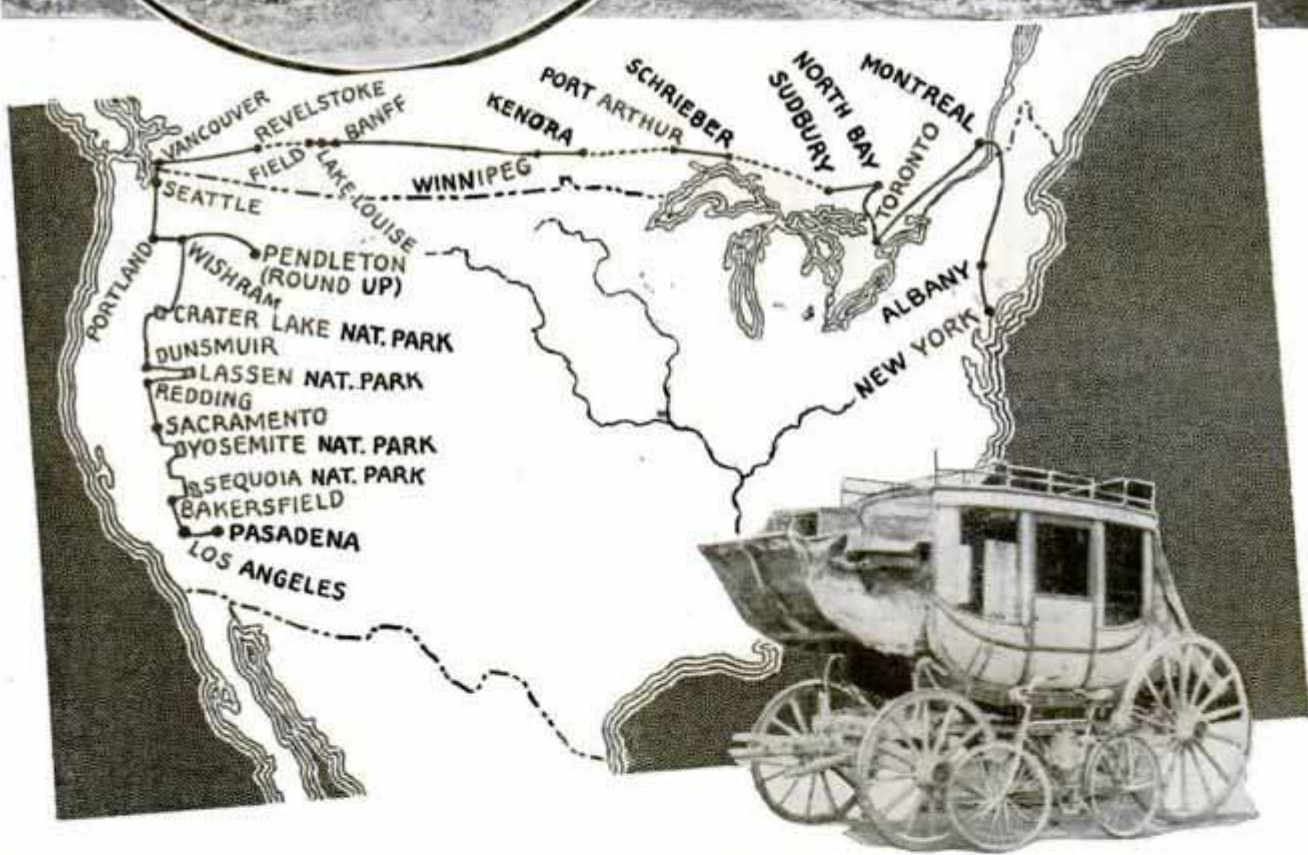

Top, Left, Preparing Meal in the Rain; Right, Along the Road; Bottom, Route of the Journey; Right, the Bike Beside Old Stage Coach

Touring America on a bicycle has been accomplished recently by Lewis R. Freeman, author and explorer. He assembled a camping outfit, including cooking utensils, tent, blankets, camera, binoculars and typewriter, lashed it on his bicycle and started north from Los Angeles. Right to Vancouver he pedaled, with side rides to

Sequoia, General Grant, Yosemite, Lassen, Crater Lake and Rainier National parks, and the Pendleton round-up. From the foot of the Canadian Rockies, hard gravel road was used to Revelstoke, where a train was taken to cross a range. Riding was continuous from Field to Banff, Calgary, and across to Winnipeg. The train



was taken across the Lake-of-the-Woods wilderness beyond Kenora, but from Fort William there was pavement nearly to Nipigon. The train was used from Schrieber to Sudbury, but from there an excellent road carried him to Toronto, and finally over pavement to Peterboro, Montreal, and down along Champlain and the Hudson to New York. The distance was more than 3,500 miles. One of the best day's rides was 120 miles. The highest altitude reached was 8,500 feet on Mt. Lassen highway loop. The bicycle was a stock model weighing thirty-five pounds. The rider weighed 235 pounds and the luggage fifty pounds. Not one cent was expended for repairs. For bedding, Freeman carried a light blanket and a waterproof poncho. A balloon fabric slicker doubled as bed-spread and shield against wind and rain when in the saddle. Complete changes of clothing were carried. For riding, an ankle-high pair of moccasins were used, with a light pair of white buckskins which were used as a "spare."

TILT OF EARTH IS MEASURED AS THE TIDES CHANGE

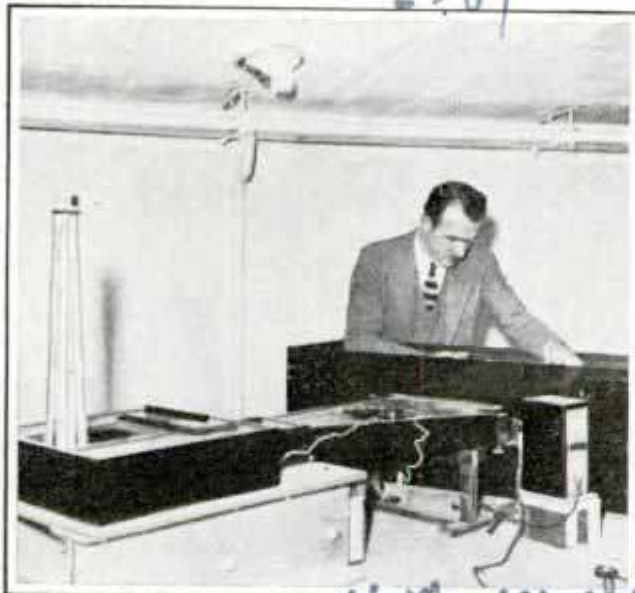

Apparatus Which Records the Tilt of the Earth with Each Change of the Tides

Tilt of the earth with each high tide is measured by a seismograph at Harvard university. The instrument records the tilt twice every twenty-four hours and keeps a photographic record. This record is preserved on a drum equipped with photographic paper and filed for future reference to aid in research work.

SIX-OUNCE PUPPY GETS DINNER FROM MEDICINE DROPPER



Six-Ounce Boston Bull Puppy Resting in Cup as It Gets Its Dinner from Medicine Dropper

Just large enough to stretch its neck over the rim of a teacup, a Boston bull puppy owned by a California man has taken its dinner since birth from a medicine dropper. The puppy, tipping the scales at six ounces when a month old, was the smallest of six normal brothers and sisters. Hand feeding saved its life.

"DRY ICE" INSIDE GOLF BALL CAUSES EXPANSION

Longer and more accurate shots are claimed for a golf ball containing a core of Dry Ice such as is used to preserve ice cream. The Dry Ice center is obtained by dropping a pellet of the substance into a heavy liquid center enclosed by a rubber sac. Around this are wrapped thousands of yards of stretched rubber band and the tough hard rubber cover is applied. The Dry Ice attempts to return to gaseous form and expands, thus "pumping up" the center. This uniform expansion increases the tension of the winding and tends to produce better centering, it is claimed.

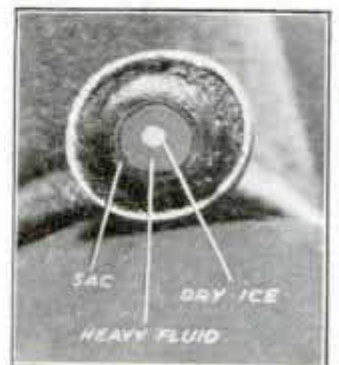

Seismograph taken Crawford Inc, Esregor

A.W. Robinson Hospital Emergency

Dayton, Ohio

Chas. Harold M. Jackson
1928 Southwest 13th St
Miami, Florida

D1588

INSIDE STUFF of the

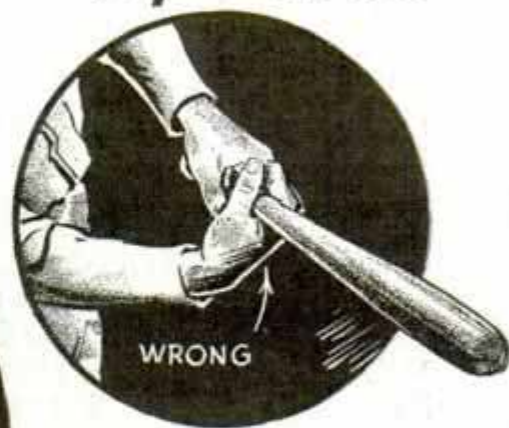

By **MAX CAREY**
Former Big League Manager

SPECTATORS at a baseball game don't care how a player bats the ball as long as he lines out a base hit. They applaud him whether he makes the hit correctly or incorrectly.

But unfortunately games cannot be won consistently unless the plays are faultless. And the plays cannot be faultless unless each is performed by the application of certain methods. There are a few exceptions, of course, among the "natural" mighty men of baseball who have their peculiarities, but for the average person there are definite rules to be followed.

Consider for instance, the correct hand grasp on the bat. The upper hand, or pow-

Right and Wrong Way to Hold Bat and Run Bases; Man at Left Is Running Correctly

er hand, is placed on the handle of the bat and rests in the groove formed by the thumb and forefinger. The handle rests across the middle of the palm so the power of the swing will find the forearm and wrist straight. This puts the maximum weight of the body into the swing. The result of a direct hit will be a line drive.

A correct stance at the plate requires

BIG LEAGUERS

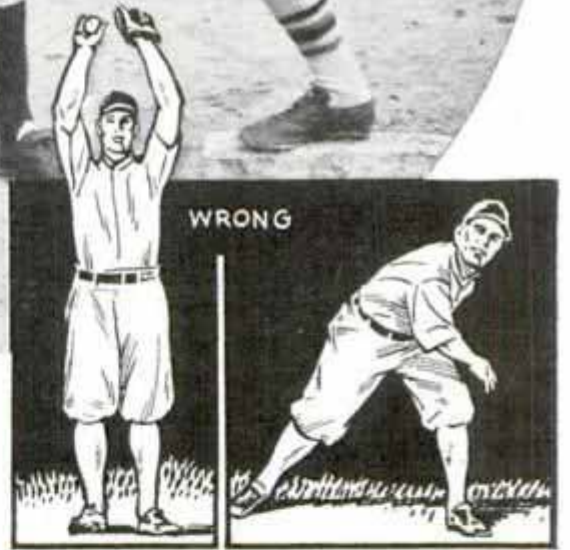
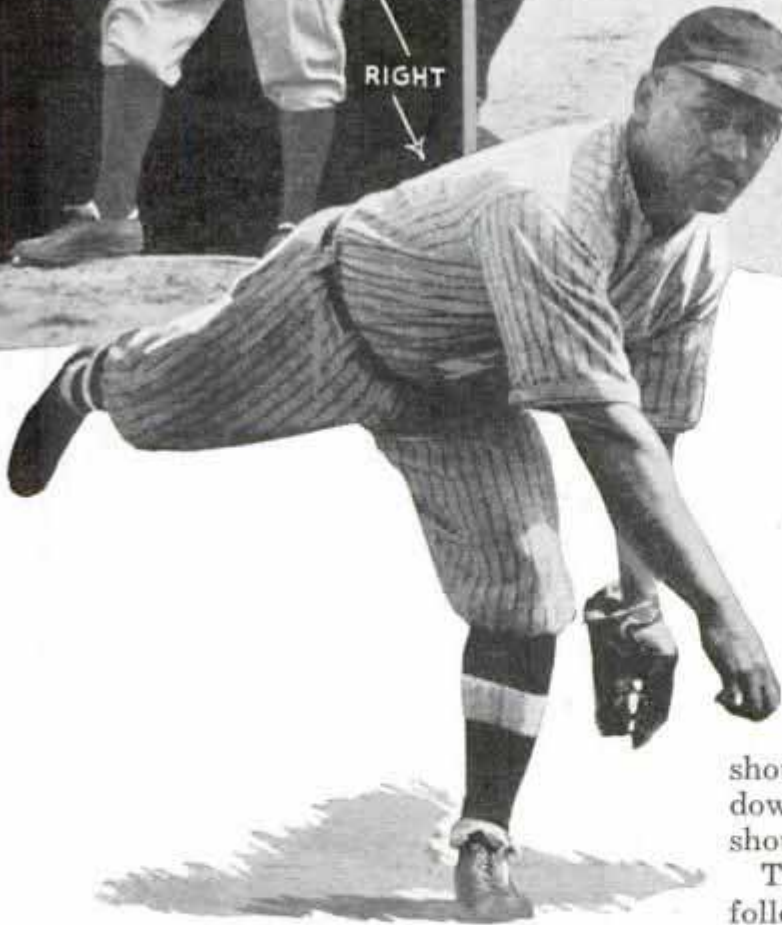

Right and Wrong Way of Starting and Delivering a Pitch; Above, Correct Stance for Delivery

that the batter be entirely at ease and relaxed. The feet must be squarely on the ground to insure balance. The side of the body should be toward the pitcher, the belt

line level, the body erect, not militaristic, but upright and restful. The head should be turned to look in the pitcher's direction. The shoulders should be level with only a slight pressing downward of the front point of the right shoulder as the bat is cocked to swing.

There is also a right and wrong way to follow through in batting. The right way is to step into the ball and swing the bat with a snap which resembles the cracking of a whip. Pivot the weight of the body from the rear leg to the front leg as the bat meets the ball. The muscles are re-

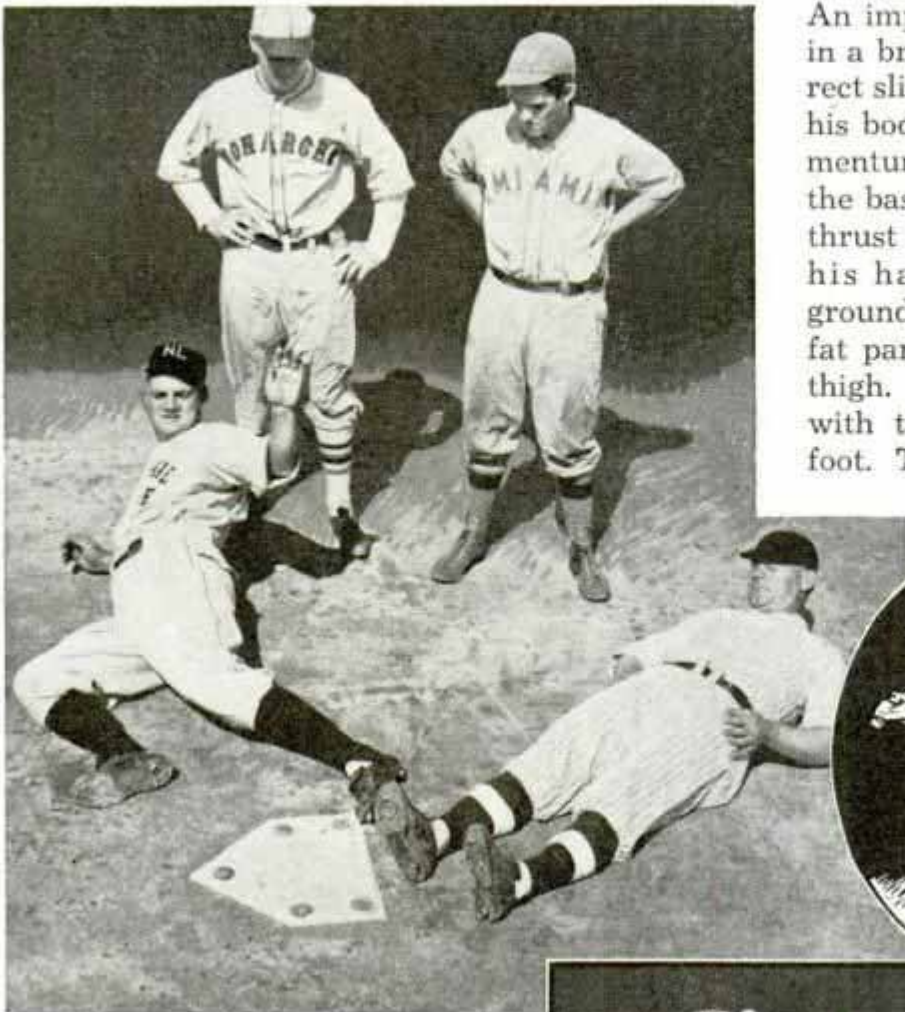

An improper slide also can result in a broken foot or leg. In a correct slide the player should throw his body out of line with the momentum directly he slides into the base. His shoulders should be thrust either to left or right, with his hands up away from the ground. The slide is made on the fat part of the lower leg, side or thigh. The base should be tagged with the top or "instep" of one foot. The other foot, missing the



laxed during this pivoting but they contract the moment of impact. The power behind the swing allows the bat to follow through naturally. The incorrect method involves a faulty step with the weight remaining on the rear leg. Here is loss of power. The bat swings up causing fly balls. There is lack of coordination and smooth swinging. This type of batter is an easy prey for pitchers.

The man who knows base running circles first base and advances toward second by swerving out. This brings him on the straightest and shortest distance between the bases and he gains additional speed in rounding first. When a player runs on a straight line into first base and then attempts to round first for second base, his momentum pulls him away from the shortest distance between first and second. He must almost stop at first to continue to second.

An improper slide often times costs a team the victory when the game is close.

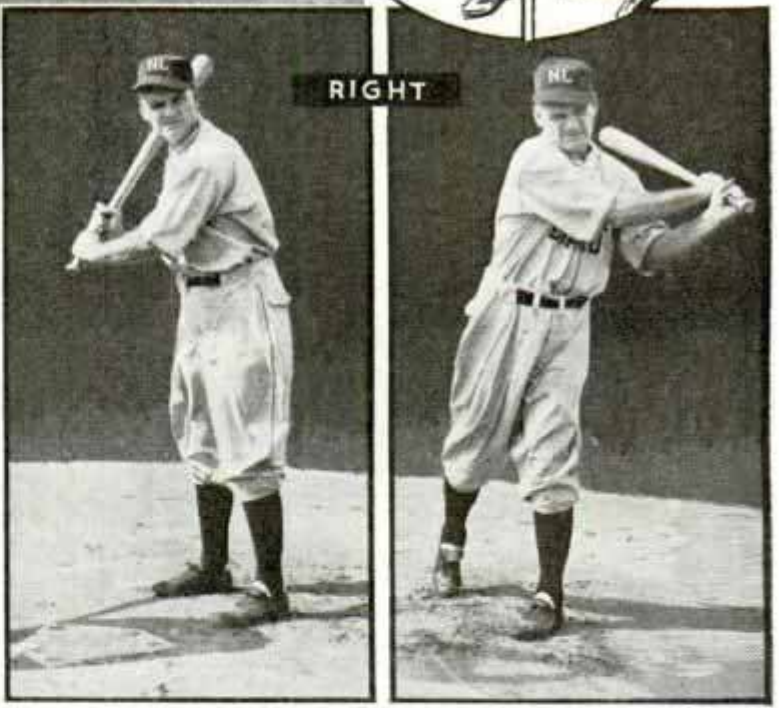

Above, Man at Left Is Sliding Correctly; Below, Right and Wrong Way to Stand at Plate and Follow Through

base, should be slid on its side. The spikes should never be toward the base as they are apt to catch the base and turn or break the ankle and the slider should never dive straight into the base.

A pitcher should maintain a balance of

(Continued to page 131A)

D/609 *Mr. Perry W. Young*
2636 2nd & Market
Model of Bonneville Dam Aids Study of River
Portland Oregon

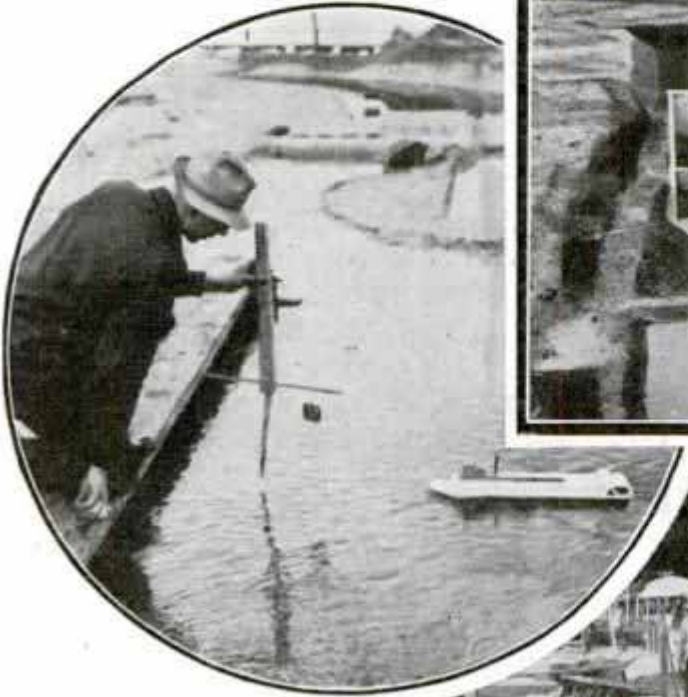

see Jan. 1935 - 38

Three Views of Experiments Conducted with Large Model of Bonneville Dam and River; the Model Enables Engineers to Study River Currents That Probably Will Be Created by Construction; Daily Measurements Are Made in Testing the Model under All Conditions



near Portland Oregon.

Probably the largest and most complete model of a river section ever constructed is being studied by engineers working out plans for the huge Bonneville dam on the Columbia river. The model is 325 feet long, representing a five-mile stretch of the river and showing every rock, ledge, islet and major obstruction. Daily readings and measurements of the midget river are made with two objectives. First is the removal of obstructions in the river bed, which will result in reducing unnecessary back-water effect and still produce the same water levels at the dam. Second, the engineers are seeking data that will help in constructing the cofferdams in the main channel. For this work, a thorough knowledge of the river currents is necessary. Another model shows three bays of the eighteen to be built in the spillway of the dam. Water for the tests is taken from the Willamette river and pumped into a res-

ervoir above the models. The work is under direction of the United States Engineers' office, with Col. T. M. Robins, division engineer, Maj. C. F. Williams, district engineer and C. I. Grimms, chief civilian engineer of the Bonneville project.

240

AUTOMATIC WINDOW CATCH LOCKS AT ANY HEIGHT

Equipped with a rubber tip that prevents slipping, an automatic catch holds a



window at any height. Thus, the window may be locked up or down permitting air to enter but keeping out marauders. The device also prevents rattling of windows.

Automatic Window

D 1183
10555 Holman Co
Los Angeles, Calif

Latest STUNTS of the

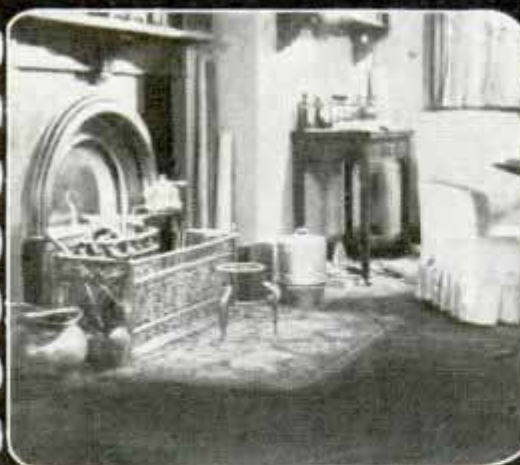

MODERN magicians perform tricks on the movie screen for your entertainment that match the most fantastic myths. Before your eyes an actor changes to a stone statue while another dissolves into the air. Absurd impossibilities occur as a matter of course and on the screen, seeing is no longer believing.

Rival trick men and photographers are still puzzling over how John P. Fulton and Frank Williams screened the "Invisible Man," a story in which a young chemist discovers a drug that makes him completely invisible. On the screen the man's head actually disappears as he removes the bandages in which he wrapped himself. His clothes appear to move around the room entirely unsupported. A hat placed on his head seems to hang in the air. When he removes his clothes and dashes from the house, his flight can be traced only by the footprints that appear in the snow.

The way in which an actor was given substance and invisibility at the same time was accomplished by using new film emulsions sensitive only to certain colors. First the actor, in front of a pale blue background, with his head and hands covered with blue masks of the same shade, was

Below, Using Miniature Devised by Don Jahrans in Filming a Railroad Siding Scene

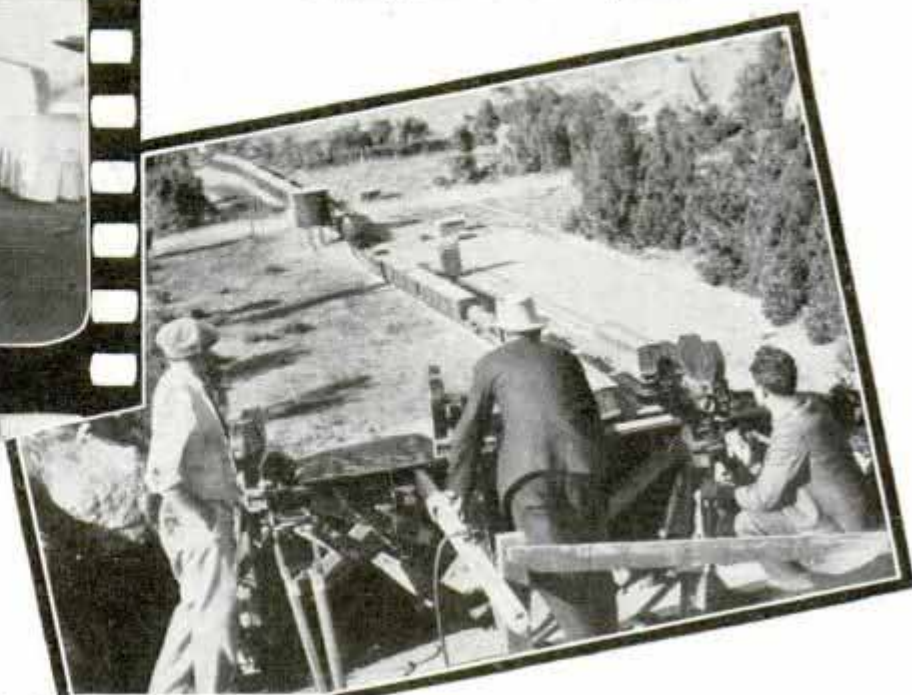

Dummy Head of John P. Fulton's Invisible Man and Same Character Disrobing; Below, Background Scene over Which Film Is to Be Printed

MOVIE Magicians

Close-Up of Model Boat and Mechanical Crew, and the Craft as It Appeared on the Water



Even in Miniature, This Train Wreck Appears Realistic Although Only Model Cars and Engine Are Used

photographed with a camera that exposed a bi-pack containing two strips of panchromatic film, one of which registered the blues as whites and the other as blacks. One of these films was used to mask or matte off parts of another film containing the background and the other actors and then this first composite film was printed over the other from the bi-pack, trans-

ferring only the actor's clothes to the finished film and eliminating his head and hands.

"The most difficult part was directing the actor," says Mr. Fulton. "In some shots he had to work blind behind the wrappings, with air supplied by concealed tubes as in a diving suit. Inside his helmet and bandages, it was sometimes impossible for

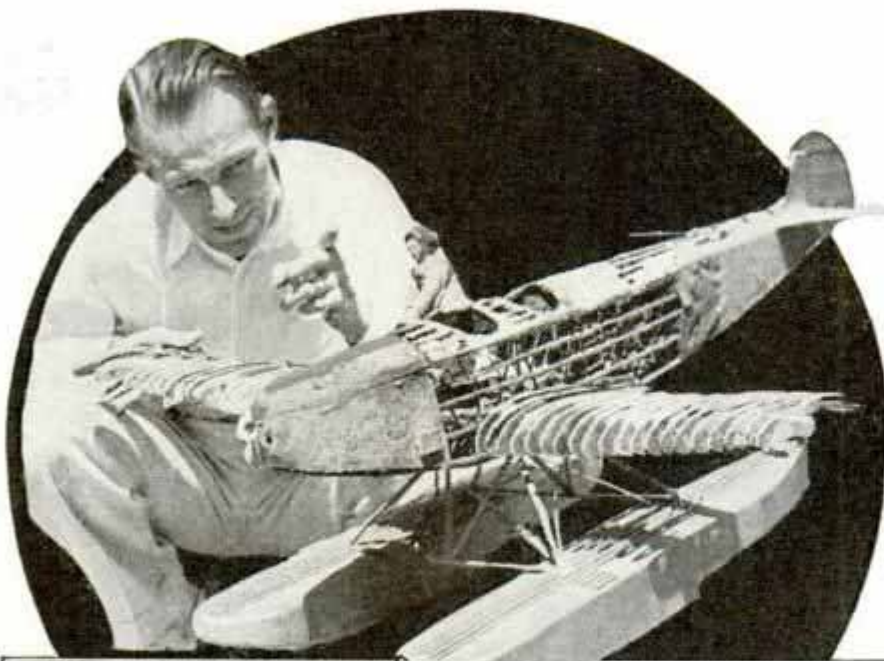

forms dropped away, giving us perfect footprints that mysteriously appeared in the snow.

"The final shots of the picture were interesting—and also difficult. The invisible man is shown lying in a hospital bed with the effects of the drug slowly wearing off. On the screen, looking straight down at the bed, we can see at first only the depression made in the pillow by the invisible head and the shape of

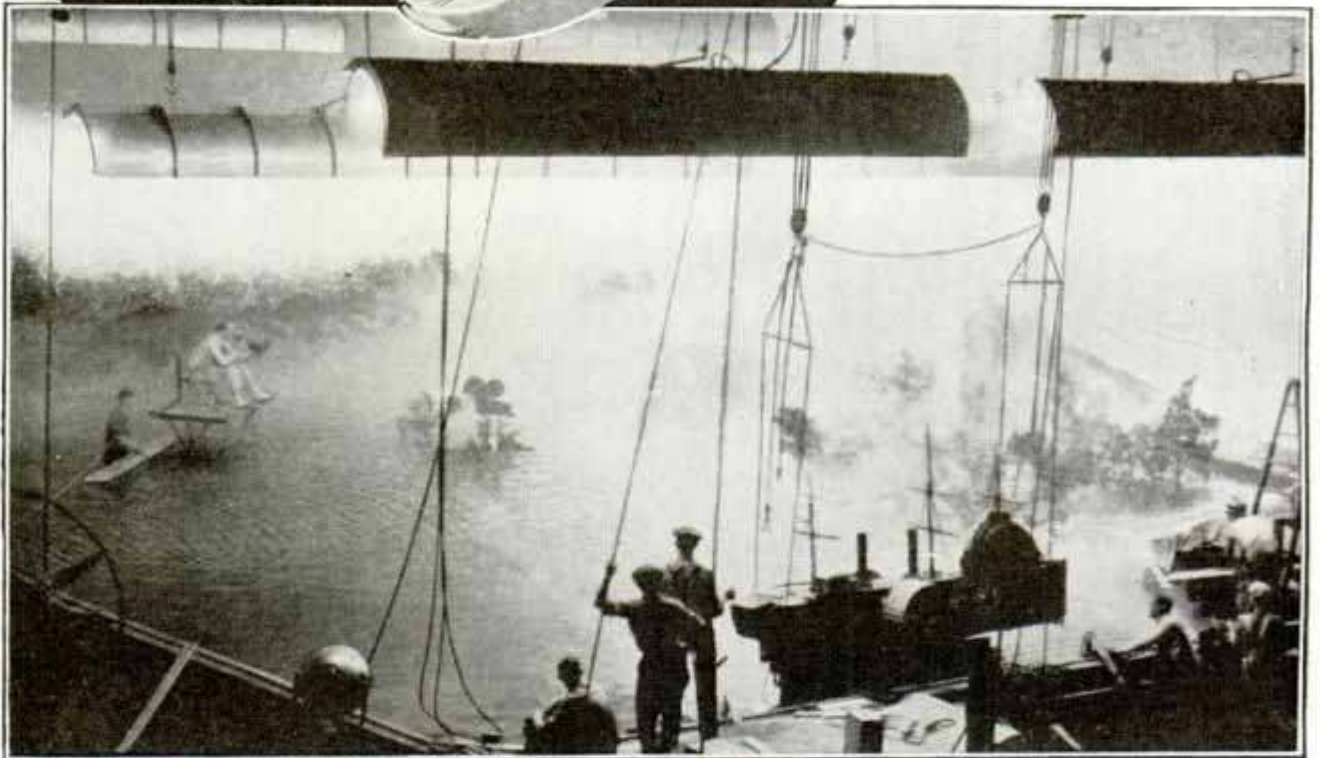

Miniature Plane after It Had Crashed and Burned; It Was Manipulated with Wires During the Crash; Below, Fog on a Model Water Set Used in the Movies

him to receive instructions. When I used a large megaphone and shouted he could just hear a faint murmur. Once, when the air supply failed, he fainted in the middle of a scene.

"We made the invisible man run across the ground by digging a trench and covering it with a board in which footprints had been cut. The wooden footprints, supported on pegs attached to a rope in the trench, were placed back in the openings in the board and the board was then covered with snow material. By pulling on the rope attached to the pegs the wooden

the sheets over the unseen form. Slowly a suggestion of bone structure appears—then a full skeleton—then slowly traces of flesh—then skin—and finally we see the man himself.

"This was done directly by the camera. The pillow, indentation and all, was made of plaster, and the sheets of papier mache. A long, slow lap-dissolve revealed the skeleton, a real one, by the way; another lap-dissolve replaced the skeleton with a roughly sculptured dummy that suggested the contours of the real actor, and a further series of such dissolves, each time

D/183

using a slightly more finished dummy, brought us to the actor himself."

The trick of slowly changing an actor into a stone statue is done by filming him through two color wheel filters, one red and the other green. The start is shot through the red filter on film that registers the actor and his clothes in normal shades, then the green filter slowly replaces the red and as it does so the color values change until the actor resembles gleaming white stone. Of course, the color of everything else on the set would be changed at the same time, so the actor is filmed by himself against a black background and this film is then printed over another that contains the desired background and the other actors. The Williams' traveling matte process, which combines the desired parts of two separate films, is also used to film such difficult effects as a tiger jumping on an elephant's back.

Miniature sets and full-size backgrounds that consist of motion pictures projected on a screen behind the actors, two standbys of the special effects departments, are now combined in many different ways. Photographing a miniature and then "blowing it up" to full size on a background screen is the latest combination. Instead of building an old fashioned train to full size, the miniature builders construct a scale model. Then a motion picture of the train is made and is thrown on a screen while live actors scurry to and fro in front of it.

Willis H. O'Brien, a specialist in combining projected backgrounds and miniature sets, has developed the art so that actors appear to move around freely in sets that would really come up only to their knees. Of course, the finished picture shows everything in the right proportion. If O'Brien wishes to show explorers at the walls of a ruined city he first constructs a miniature of the city's wall, leaving a hole at the place the actors are to appear. Then a film is made of the actors as they perform against a background having the same tint as the miniature. This film is projected on a small screen behind the miniature city and is visible to the camera through the hole in the wall. By carefully gauging distances and lighting values the finished picture seems perfectly natural.

(Continued to page 124A)

E 28

HOUSE ON WHEELS IS HOME OF COLLEGE STUDENT



Traveling Home in Which College Student Lives; the Wood Is Painted to Resemble Brick

One student at the University of Utah has solved his housing problem by building a home on wheels in which he lives and travels between his own home at Paris, Idaho, and the school at Salt Lake City. The house is twelve feet long, six and one-half feet wide and contains a stove, a bunk for two, a folding table, collapsible chairs, medicine cabinet, clothes closet, hat and book racks, typewriter stand, wash basin and other conveniences. It is built of wood, painted outside to resemble brick and well insulated. On the road it is towed as a trailer behind the student's automobile.

Albert J. Jensen,
J. Washburn.

E 59

HANDY THREE-IN-ONE SCALE WEIGHS ACCURATELY

Giving accurate weights by three systems, avoirdupois, apothecaries and metric,



a new scale is handy for the home, school and travel. The dial chart is calibrated into the three systems. The scale can be adjusted by set screws so the pointer may be set at zero to balance scoop or container.

It is three inches wide, six and one-half inches long and seven and three-eighths inches high.

Wanson Scale Co.

Message in Snow Aids Hunt for Missing Plane



Note "G E 1000" Outlined in Snow in Upper Part of Photo; Also the Arrow Pointing in Direction of Disabled Plane; the "Writing" Was Done with Snowshoes

Huge letters and figures, "feathered" into the snow by men on snowshoes, formed a message that helped rescuers in their search for a plane that was forced down in the mountains of New York state. The message, which could be seen easily from the air, was intended to direct searching parties aloft and on the ground. An arrow indicated the location of the lost plane. State troopers at Gray, N. Y. "wrote" the message for the searchers.

ACCURACY OF WATCH TESTED 99.9% IN FEW SECONDS

Developed to check the gain or loss of time in a few seconds, a watch tester records the difference on ruled paper. This permits the operator to make adjustments



Testing Watch on Latest Machine; Dots on Cylinder at Left Show Whether It Is Accurate

HEAVY TREAD ON "SNOW" TIRE GIVES BETTER TRACTION



Designed especially for winter use, a new tire is equipped with a heavy tread that gives better traction in snow and on ice. Developed by Firestone Tire and Rubber company, the scientific

design provides easy steering, firm grip in snow and smooth riding on pavement.

and recheck the watch quickly. Vibrations from the watch balance wheel are transmitted to the machine and registered as dots on a drum. If the dots are irregular, the watch should be adjusted.

848
1400 d
Main B.

Firestone Tire & Rubber

27

Roadway with Four Decks for City Traffic

Offered as a means of solving metropolitan traffic problems, a four-deck roadway has been designed. The multiple-deck arrangement is said to accomplish four times the transportation in a given amount of street space as existing systems. The top deck provides landing space for airplanes, the two middle decks contain rapid transit tracks and the bottom deck is for pedestrians. One feature is that traffic may continue at top speed in winter, the runways being inclosed and heated. In addition, power and telephone lines are in safe, dry housings, eliminating poles.



Sketch of Four-Deck Roadway as It Might Appear in City Street; Note Ramps Leading from Sidewalk to the Pedestrian Level

D/628

CARBON-MONOXIDE GAS ALARM

When the amount of carbon monoxide in the air reaches the danger point, a new alarm rings an electric gong. The alarm operates from a standard electric circuit. A small fan pulls air samples into the device constantly. If the concentration of carbon monoxide reaches .02 per cent, a point at which a few hours exposure would produce symptoms of poisoning, the alarm rings.

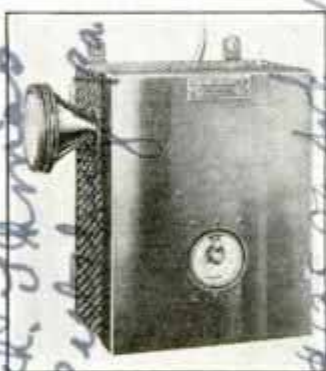

ELECTRIC WIRING CONNECTOR USED WITHOUT SOLDERING

Providing a positive and permanent contact, a new solderless connector for electric wiring replaces the conventional solder lug. It can be used for either solid or

stranded conductors. It consists of a copper cup with inclosing sides and raised lip at the wire entrance, a specially designed hexagon nut and a stud. The nut, which can be turned with either a screwdriver or wrench, presents a smoothly rounded surface to the conductor. The nut crowds the wire strands into the recess of the cup and compresses them to form a tight bond. The design eliminates loosening by vibration. Since the connector fits into the same place as a solder lug, it can be used on standard switches without exceeding electrical clearances.



Mine Safety Appliances Co. Inc. 132 Wallis Ave. Electr. Mech.

8-43

Electr. Mech.

Square D Company



DINNER TABLE TRICKS

By HARRY BLACKSTONE



DINNER-TABLE magic is a diversion rather than a mystery. The cigaret is an excellent item to open proceedings. The demonstrator extends a pack to a friend. Before the recipient can reach for one, the performer makes passes with his fingers while he holds the pack in his other hand. Immediately a cigaret arises of its own accord.

This trick is made easy by the Cellophane wrapping around the pack. The performer uses a half-filled pack. He previously removes one cigaret and inserts it between the outside of the pack and the encircling Cellophane. When he takes the pack from his pocket, he keeps the outside cigaret from view. He holds the pack in his left hand, fingers in front, thumb

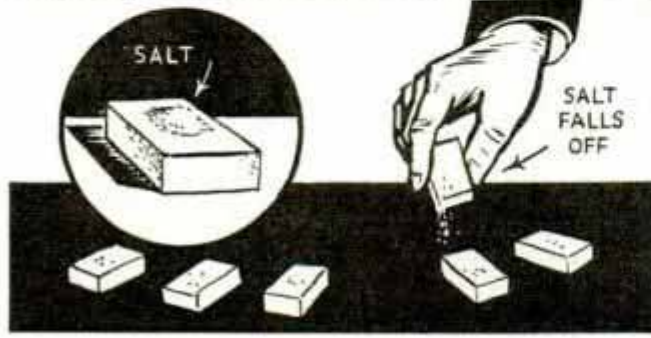

Left, Lumps of Sugar Treated with Salt in Order to Distinguish Any Lump Handled; Right, How Cigarette Inserted between Wrapper and "Cellophane" Is Made to Rise



in back. While the right hand makes its passes, the left thumb pushes through the Cellophane and forces the cigaret upward. To all appearances, the cigaret comes out of the pack itself.

With four or five lumps of sugar, the magician presents a real perplexity. He places the lumps on the table, then turns his back and gives instructions.

"Move them about," he suggests. "Then pick up any lump, clench it in your fist and hold it to your forehead. Now, replace the lump with the others."

Turning about, the performer touches each lump in turn. He lifts one and announces it is the selected lump. Before he presents this trick, he arranges the lumps in special fashion. He pours some salt into the napkin in his lap and while toying with the lumps, he drops a pinch of salt on each. Since both salt and sugar are white, no one notes the salt. When a spectator lifts a lump, the salt falls from it, unnoticed. After the lump is replaced on the table, the magician can pick it out at first glance. The whiteness of the tablecloth obscures any spilled salt.

Excellent tricks for the dinner table are those which spectators try to duplicate, only to be outdone by the performer. Here is one such trick with a cigaret and a plate.

The performer sets a cigaret in the center of a plate. After a few experiments, he manages to make the cigaret stand upright. Others try to do the same stunt. Some one suddenly succeeds. The laugh is on the magician. Then he calmly raises his plate from the table, moves it about and replaces it, keeping the cigaret upright all the while. His imitator tries to do the same but fails. The magician has prepared his cigaret by pushing a large-headed



Top, the Coin and Water Trick and Making a Cigaret Stand on a Plate; Below, Note the Concealed Thumb

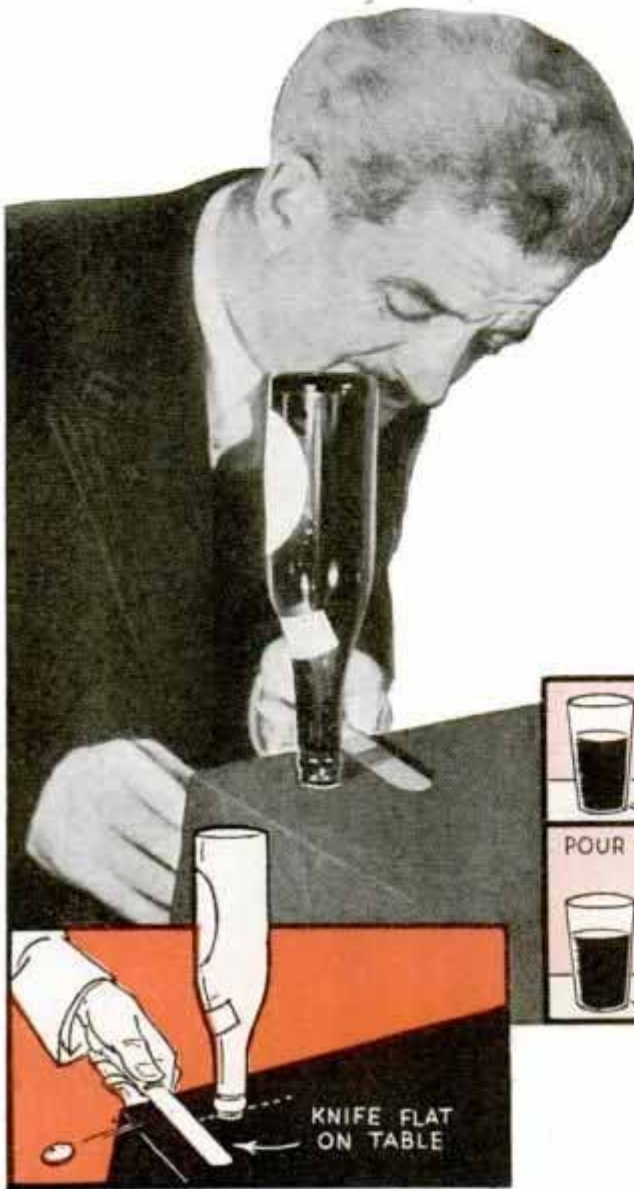

glass of the empty group; then replaces the original glass back between two full ones. Every odd glass is full; every even one is empty.

The next trick is one that some people will not believe possible even after they have seen it. First, a quarter is placed on the table. Next, an empty ginger ale bottle is inverted and carefully set upon the coin. The bottle seems ready to fall at the slightest jar.

The magician takes a table knife, holds the blade flat against the table and delivers a side stroke with considerable force, cutting the coin from under the bottle. The bottle still stands upside down upon the table.

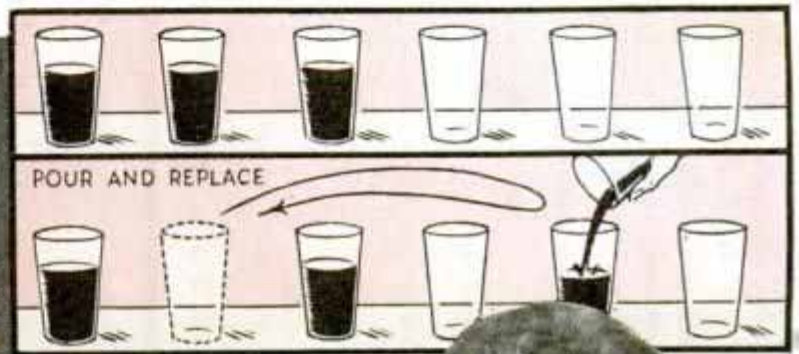

tack into one end. A cigaret thus arranged will balance with ease.

Here is one that always pleases. Six glasses are placed in a row; three tumblers are filled; three are empty. The full glasses are at one end of the line; the empties at the other. The trick is to move only one glass, yet finish with the glasses alternating full and empty, no two of the same sort being side by side. The spectators study the problem. Some declare that it can be done in two moves. A single move, however, sounds impossible, especially when the magician stipulates that he will touch but one glass.

When all have given up, the magician picks up the center glass of the three full ones. He pours the water from it into the center

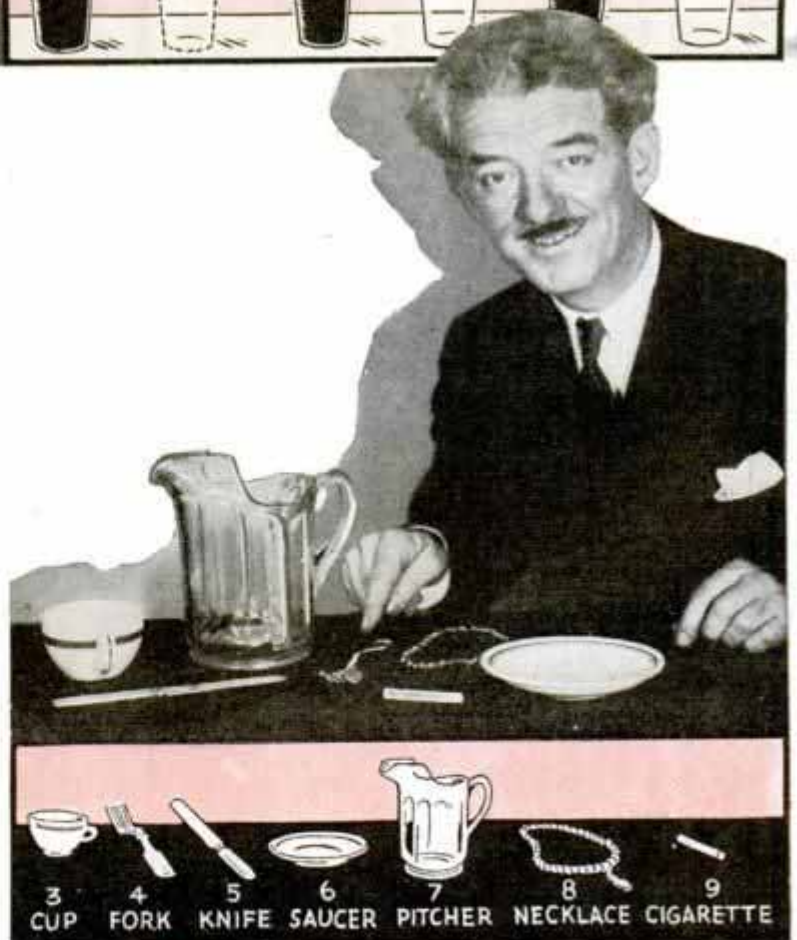

Above, Using a Knife to Flip a Coin from under an Inverted Bottle, and the Solution of the Water Glass Trick; Below, the "Props" for the Mind-Reading Stunt

The trick works on a tablecloth as well as a wooden surface, provided the cloth is large enough not to scuff when the stroke is made. All that the magician must remember is to keep the blade flat, strike cleanly and carry through. The bottle will scarcely waver as it drops into place.

When a trick does not seem too miraculous, the onlookers can frequently be kept from spotting some very simple ruse. The balancing of a dinner plate is proof of this. Done in a laborious fashion, as though very difficult, the trick will catch the wisest watchers.

The magician tries to balance a dinner plate by setting it upright on the back of his left hand. He is careful to catch the plate each time it topples. Finally he holds his hand palm upward and sets the plate on edge, trying from that position. The hand is held quite flat, allowing no purchase; nevertheless, the balance is gained at last. The performer must be careful to have all the spectators in front of him. The attempt to balance the plate on the back of the hand is merely a preliminary step, to give excuse for turning the hand palm upward.

The observers watch the plate, forgetting about the balancer's left thumb. The plate rests on edge just below the fingers; the fingers are pointed toward the spectators. Up comes the thumb out of sight behind the plate. The magician allows the plate to tilt slightly backward. The thumb serves as a rest and the plate appears to be balanced. To conclude the trick, the performer tilts the left hand slightly forward. As the plate begins to topple, he grabs it with his right hand. The left hand draws away and the right passes the plate for examination.

The trick of picking out the coin is excellent for the dinner table, because it requires a variety of items, all of which are available. The magician begins with a saucer and glass of water. He pours some water in the saucer, then drops a coin into the water. He then declares he will remove the coin openly without dampening his thumb or fingers. Yet he promises not to lift the saucer, and adds that the water will still remain in it at the finish.

He tears a corner from a sheet of paper,

(Continued to page 118A)

**PERMANENT TIRE GUARD ENDS
DANGER FROM BLOWOUTS**

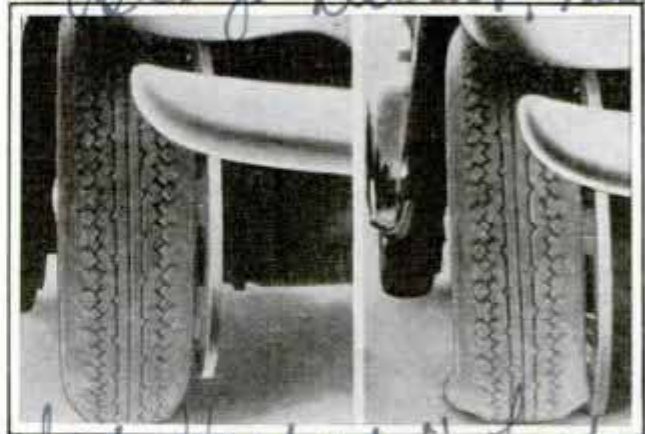

Left, Guard with Tire Deflated; Right, Guard Supporting Wheel and Deflated Tire

Permanently attached to the wheel, a tire guard ends the danger of wrecks after blowouts. It is a hubless, spokeless inner wheel of smaller circumference than the wheel with tire fully inflated, but large enough to support the wheel when the tire is deflated. If necessary, the motorist can drive for miles on the guards without damage to wheel, tire or tube. When a blowout occurs at high speed, the guard takes the drop created by the deflation and keeps the car on the road.

**CANNIBALISM OF HENS STOPPED
BY ANTI-PICKING GUARDS**

Protection of the flock from the tendency of chickens to pick each other at certain times is provided by two devices, the first of which is attached through the chicken's nostrils. When the hen puts her head down to eat, the device raises, being properly balanced. But when she raises



her head to pick at another chicken, the guard falls over the beak and prevents picking. The second device prevents the chicken from seeing when she looks up. In order to do damage

to other birds, the chicken must look up. If she wants to eat, she looks down and the device is no obstacle.

Poultry Tribune

Radio Cars with High Masts Do Patrol Work



Acme

Radio Cars Equipped with High Aerial Masts Which Were Used to Maintain Communication between Various Military Units Policing the Saar During the Recent Plebiscite

Radio cars with lofty aerial masts are used for military patrol work in Europe. A fleet of such cars, each manned by a driver and radio man aided in policing the

Saar during the plebiscite there, making possible continuous communication between the various military units engaged in the work.

Split Keys in Two Sections Prevent Thefts from Safes

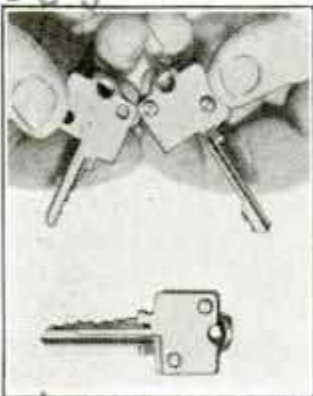

In order to divide the responsibility of the custodians of money and other valuables, a split key for cylinder locks has been developed. When the two sections of the key are joined, they form a master key for the lock on the safe or strong box. The master key is simple in construction. A single long control section can be paired

with any of several shorter main sections, each of the latter being different. The main section is kept by the cashier or other attendant in immediate charge of the money and the control section is retained by the proprietor of the business or the person who collects the money. The keys are virtually non-duplicative since they have a special grooving which does not appear on the blanks sold to locksmiths, requiring the owner to obtain a duplicate from the factory. A collector need carry only one control key in making the rounds of several stores or stations, each establishment having its own main section.

Revanee Safe Co. Revanee, Ill.

ADHESIVE-BACK RUBBER SHIM FOR HOME OR GARAGE

Many uses in the home or garage can be found for a rubber shim available in strips of ten or fifty feet. The strips have an adhesive on one side covered with a cloth backing. Attachment to wood, glass or metal is easy, the cloth simply being pulled off and the adhesive side pressed firmly on any clean surface. The material is invaluable for insulating purposes, for

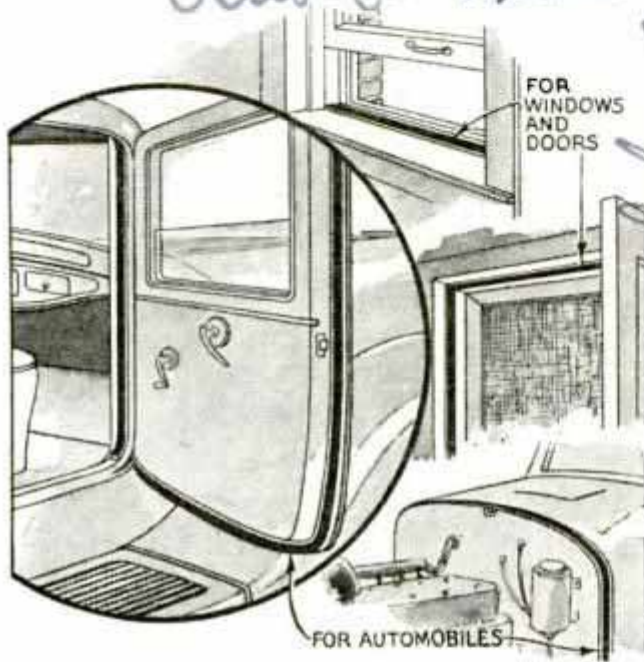

Several Uses of Rubber Shim; It Is Easy to Apply in Auto and in the Home

weather-stripping and for preventing rattles. Three-eighths of an inch wide, the strips may be obtained in three thicknesses.

TWO-MAN CARRIER SIMPLIFIES HANDLING OF GAS TANKS

Tanks used to hold oxygen, acetylene and other forms of gas can be handled easily by two men with the aid of a simple carrying device operating on the cantilever principle. It consists of two wooden handles connected by metal loops. The bands enclose a circular opening and to place the carrier in position the handles are lowered to enlarge the opening and the bands are slipped over the top of the tank. The handles then are raised to a horizontal position. This causes the bands to tighten and the butt ends of the handles are brought against the tank, making it impossible for the tank to slip. The carrier

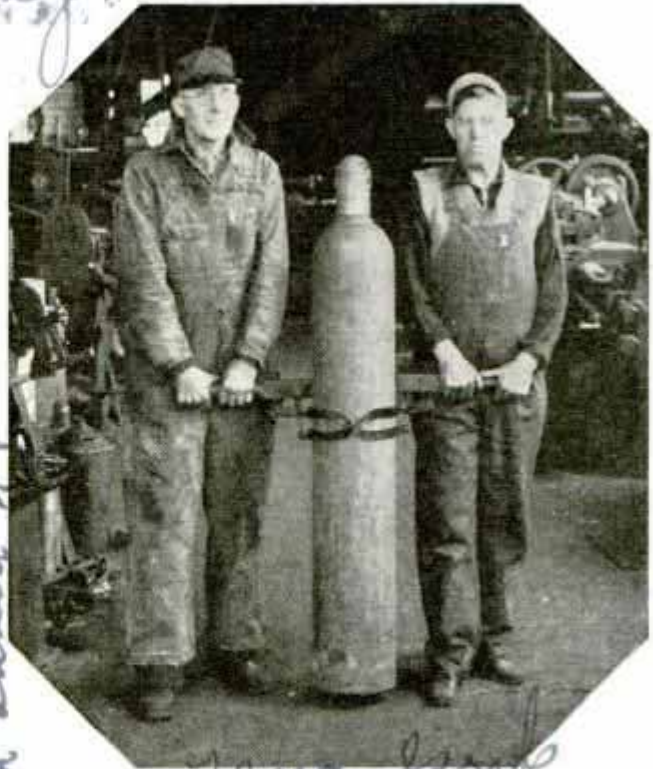

Two-Man Carrier Which Makes It an Easy Matter to Transport Tanks of Oxygen or Carbonic Gas

is provided in three sizes and a model with hooks is used with traveling cranes.

SHOOTING RANGE IN BASEMENT EXTENDS UNDERGROUND

When a New Jersey man remodeled his basement, he installed a shooting range in the lounging room. To make it safer than the usual basement range, he extended a hole through the basement wall for twenty feet and placed the target at the far end. When not in use, the aperture is covered with a plaque decorated like the walls.

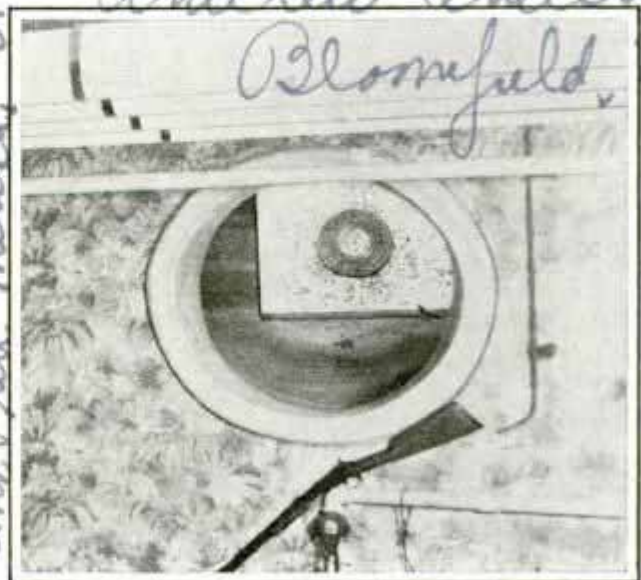

Safe Shooting Range Installed in Hole in Basement

Van Cleef, 220 S. Woodlawn Ave
7-8-36 Chicago

Auto. St. Show

Emb. Fred mensh 31 Cassare Ave Pompton Lakes, N.J.

Jona Joff

E. 65

Andrew Anderson, Bloomfield, N.J.

A. H. Moore Co. Broad Ald

8.14.

2500 Eastwood Ave

Evanston, Ill.

Behind *the* Scenes in a



excite the lion or get him rebellious in the wrestling stunt. The lion's patience and power of attention are short. He has less intelligence than the most stupid dog. He cares nothing for the man's approval. He does automatically what he has been taught. If a tame lion is allowed to mix with ordinary beasts he quickly becomes just a lion.

The spectacular lion and tiger shows are the "big

TRAINERS know only two kinds of lions—those you can put your hands on and those you can't.

There are two kinds of cat acts. In the small "trick acts" you see a huge, black-maned monarch of the veldt allow the trainer to sit on him or open his jaws and let the man put his head between them.

This lion was reared as a pet from the time it was a fluffy kitten. As a small cub it had a doll's head put in its mouth. If it closed its teeth the baby lion was tapped on the nose with a buggy whip. Every day it held in its mouth dummy heads, bigger as the lion grew.

You will notice that the trainer keeps his head in the jaws only a few seconds. He is careful not to

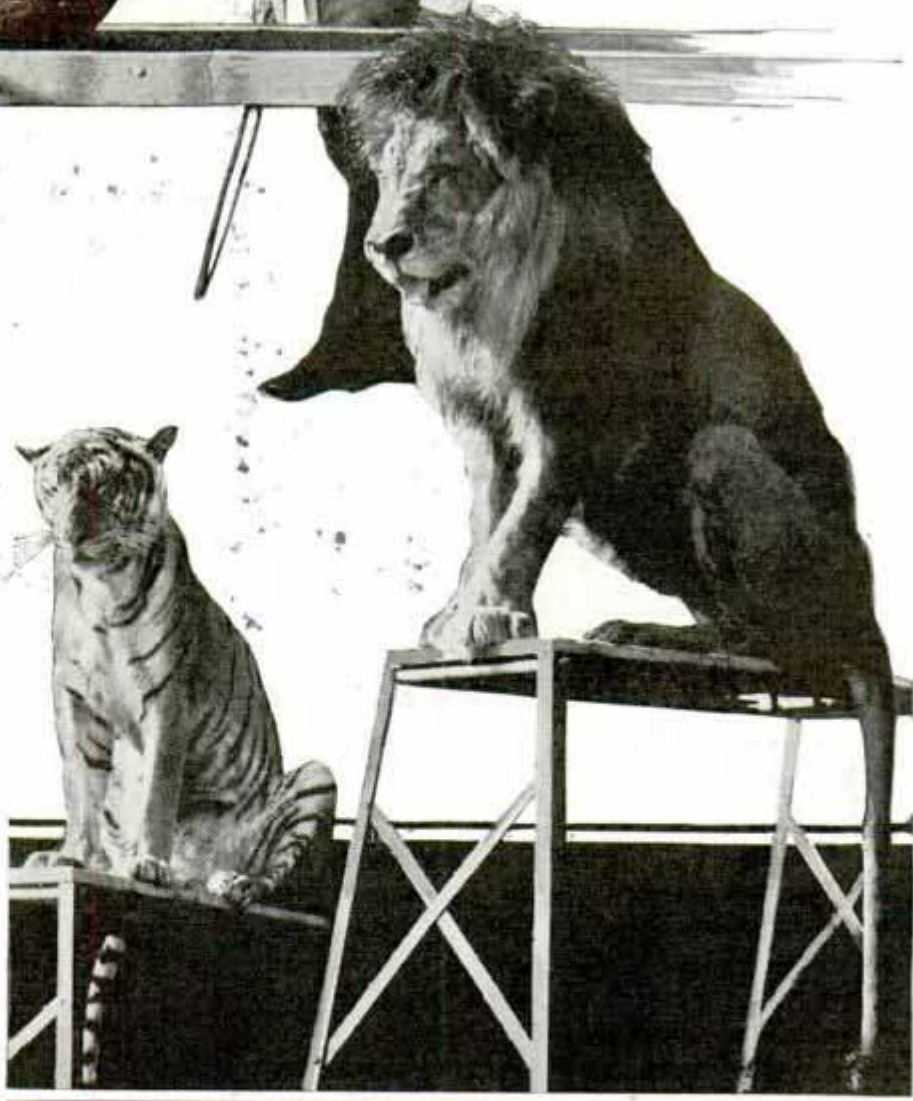

Allen King, Trainer, Teaching a Tiger to Roll a Ball and, Below, an Old Troupier Sitting Unconcernedly on His Perch Waiting for the Signal to Return to His Cage

8-1-4

Allen King

"FIGHTING ACT"

fighting acts" which have twenty to thirty beasts in the arena at once. For these acts lions and tigers are trained when two and one-half to four years old. Savagery rather than education is emphasized. For the big acts, animals that have been captured full-grown are preferred to those reared on breeding farms. Let us watch a training session.

Behind the row of cages is a wooden-barred tunnel big enough for one animal at a time to pass along it. A movable runway leads from this to the arena gate. When the trainer is ready, the door behind the lion's cage is pulled up and he is prodded out with long poles.

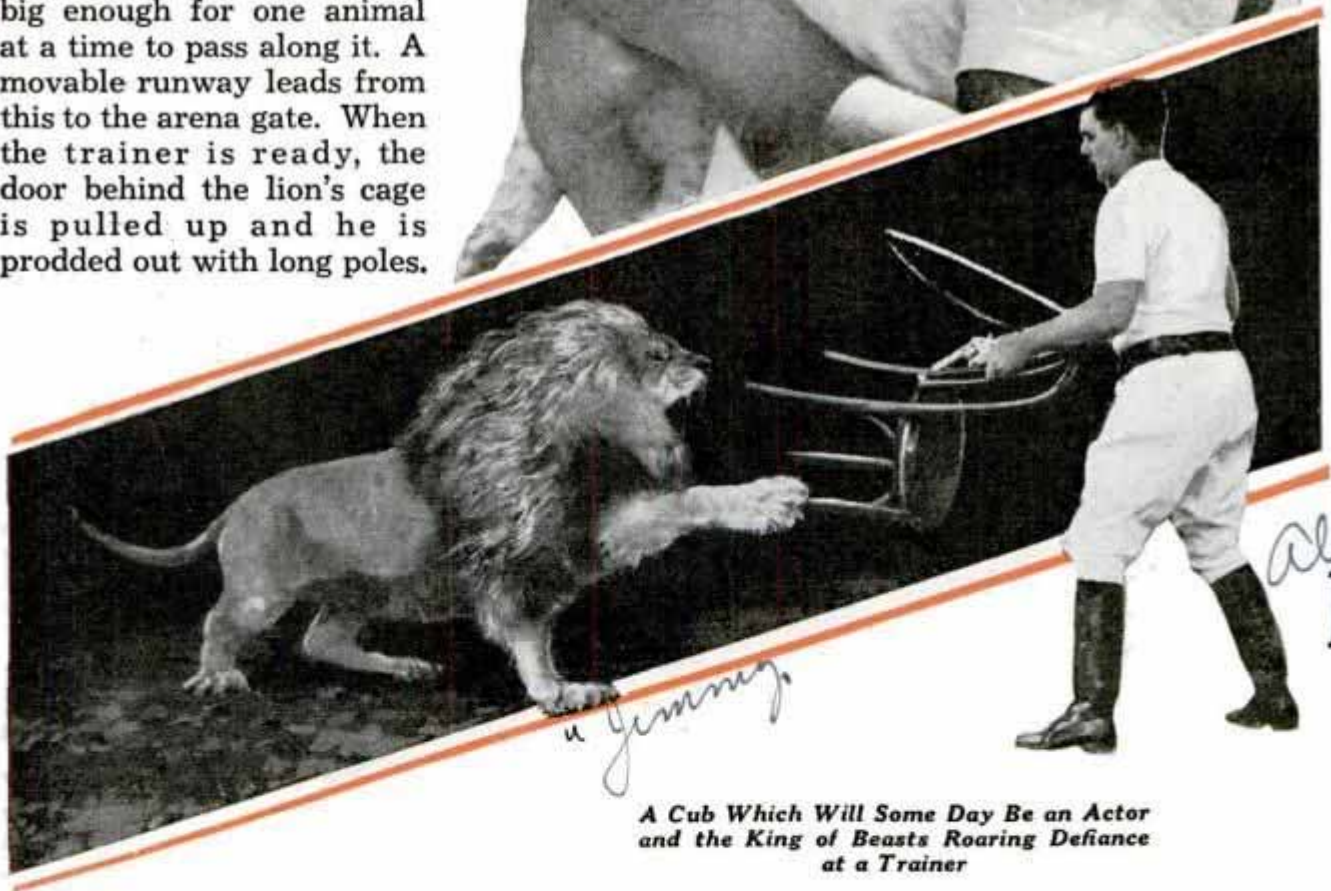
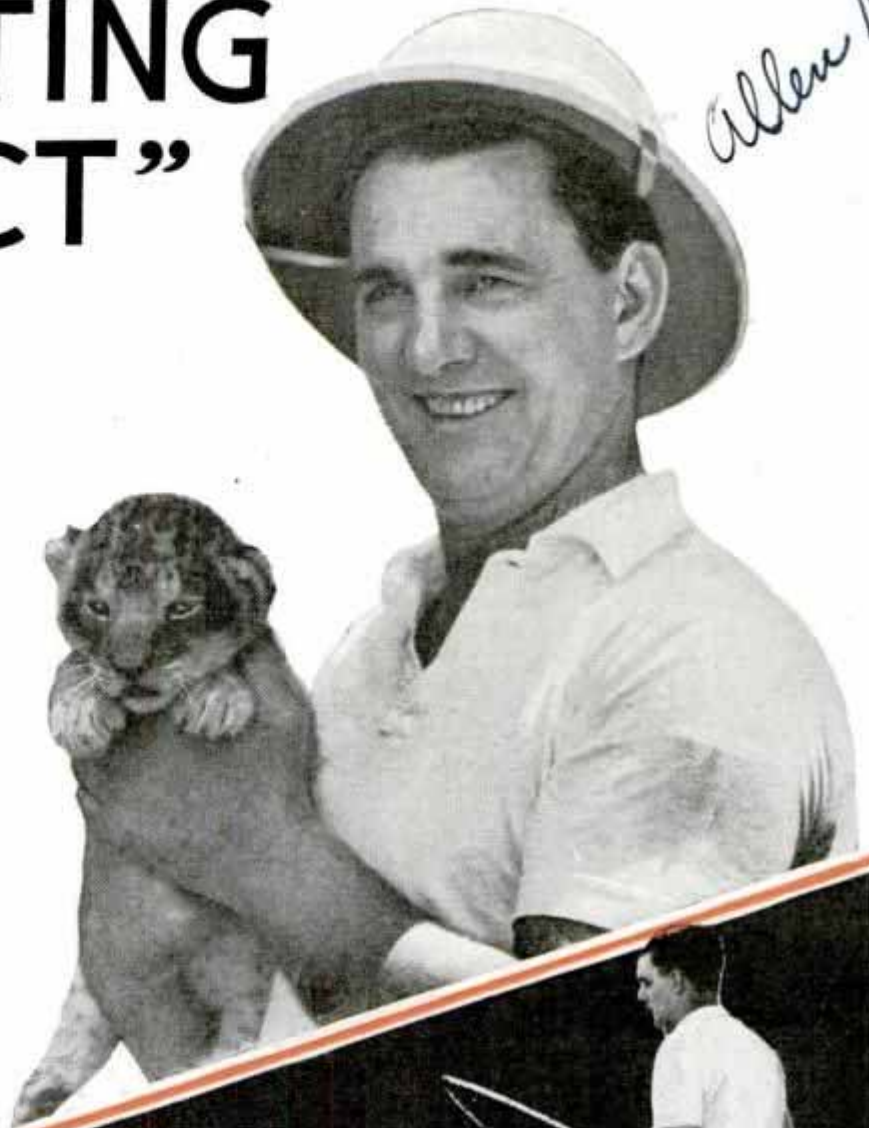

u Jimmy

Allen King

A Cub Which Will Some Day Be an Actor and the King of Beasts Roaring Defiance at a Trainer

A minute later the trainer is alone with a wild lion.

The arena is a steel-barred circle, thirty to forty feet in diameter. It has several double-door emergency exits. The same arenas are used in winter quarters and in

the shows. Training and rehearsing go on all the time. Around the arena at various heights are small platforms clamped to the bars. The object is to force the lion or tiger to get up on one of these perches and sit there until ordered down. Most of

Allen King



Forcing a Tiger to Change Perches and the Trainer and One of His Lions at a Moment When an Armistice Had Been Declared

the animals never learn anything else. That is the limit of their mental capacity.

For weapons the trainer has a long-lashed whip, a long, heavy pole and a revolver loaded with blanks—never bullets. A wounded lion would never stop until he killed or was killed. The man also holds a common wooden chair with his left hand. In preparation for its schooling the lion has had a heavy trace chain fastened around its neck in its cage by catching the animal with loops of rope. There is a loud banging of clubs on the runway and yells of "Get going!" The beast leaps out on the tan-bark, two feet of the chain whipping its fore legs, and glares around the arena, paying no attention to the man.

It immediately begins to gallop around the circle, looking for a way out. The

trainer follows, shouting and cracking his whip, trying to get the animal's attention. To the animals, the arena is a detestable, unnatural place. Sometimes a lion, in a rage to get out, will scramble up to the top, hang a moment, then fall like a sack.

Around the outside of the bars are half a dozen cage men with iron hooks and coils of three-quarter inch rope. The trainer keeps after the lion. When he annoys it too much it turns on him in a snarling rush.



The man backs away and protects himself by shoving the legs of the chair in the beast's face. The animal vents its anger by chewing a chair leg and giving it a few cuffs with its mighty paws. The fundamental, stupid good-nature of the lion tribe is shown here. All the animal wants is for that incomprehensible, two-legged creature to stop bothering him.

The lion won't go on the perch. The trainer checks him a second close to the bars. One of the men outside hooks the chain through. Two men drag the lion close to the bars. Another snaps a rope on the chain. The end of the rope is passed over a cross bar eight feet above a perch. As soon as the hook is off the lion makes great leaps out into the arena. The rope jerks him to a stop in midair and he falls on his side like a lassoed steer. Then two men on the rope drag him back to the perch. To ease the choking of the chain he crawls up on the little platform and sits, dazed, tongue hanging out and ribs pumping. The trainer rewards him by kind words and stroking, at eight feet distance, with the end of the pole.

A lion may be seat-broken at one lesson. It may take a year. In a busy session the trainer may take on one animal after another until half a dozen novices are roped on the perches. For training specially promising animals to do specialties, like balancing on a ball, or jumping from place to place, the chain is used in the same way. Tigers are slightly more intelligent and give up much easier than lions. They may often be seat-broken without the chain.

The trainer works an animal only a few minutes at a time. Wild beasts can stand nothing like the steady grind of a domestic animal, mentally or physically. Capt. W. K. Bernardi, a trainer, says that if a lion escaped and ran sixty yards at its top speed it would be completely bushed.

Obviously animals so trained are more than half wild. In the performance the trainer will come near and tease them on their perches so they will show their savagery by snarls and cutting at him, but he keeps his distance. When he is putting an animal through an act he stands well out of reach. The reason they don't leave their places to attack is that it is not the nature

(Continued to page 130A)

810.

SCREW CAP EASILY TIGHTENED WITH SMALL HAND TOOL

1.954, 422



Wooden Handle with Composition Band in Hole in End Used for Tightening Screw Caps

Tightening screw caps on bottles is made easy with a wooden handle containing a composition band which is inserted into a hole drilled in one end. To tighten a cap the handle is pressed on the top and turned to the right. To loosen, the process is reversed. The band does not slip on the cap or damage it and it can be operated faster than the fingers alone can do the work.

PENCIL WRITES THREE COLORS



Serving the purpose of three pencils, an automatic pencil made of pyralin writes three colors. A flick of a thumb button changes from one color lead to another. Three separate leads are contained in the normal size barrel. Each lead is supported to the writing point.

Warren Knight Co.

*Wm. D. MacIntyre 52 Cedrus Ave
Boston
Suggested Norma Pencil*

Crowds See Bridge Game on Electric Board



Electric Board Which Enables Crowd to Watch Play and Bridge Tournament, and the Man Who Operates It

More than 500 bridge enthusiasts were able to watch the bidding and play in an inter-city contract bridge contest between Chicago and Milwaukee teams with the aid of a big electric board on which the cards held by each player were shown. This enabled spectators to follow the bidding and play just as though they were standing behind the contestants. An announcer stood behind the players and through a telephone informed the operator of the

board, known as a tele-bridge, of the progress of the game. By manipulating a series of switches the operator flashed on the board each bid and each card played. Besides indicating cards held by each player and the cards each played, the board also showed tricks lost, redoubles and who was vulnerable at any moment during the tournament.

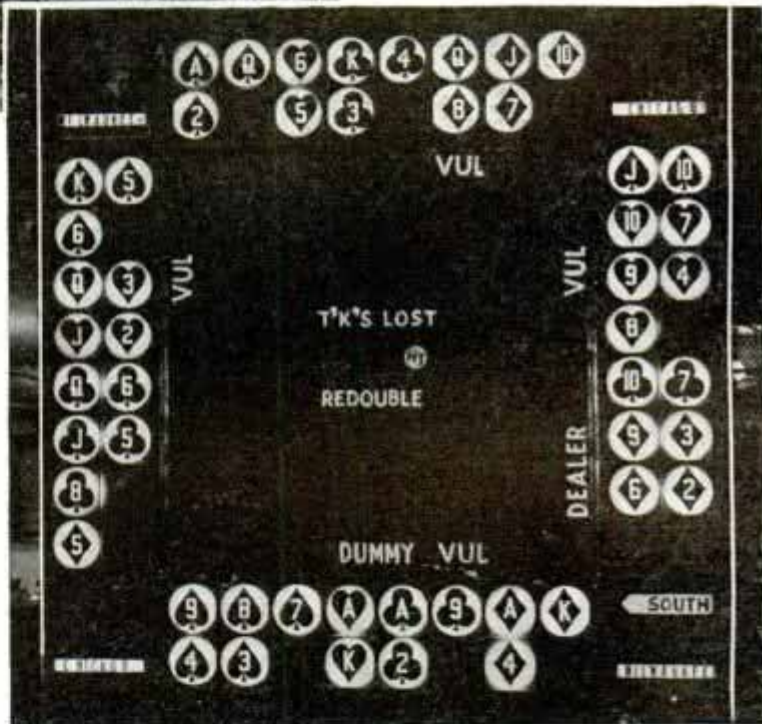

Rectangle Head Tri-Square Speeds Work of Mechanics



Designed with a rectangular head, a new tri-square can be used for inside and outside squaring without adjustment. An angle measuring arrangement is one feature, consisting of a movable arm and quadrant attachment to the head. Pressure on a slide bolt projects the arm to give the forty-five degree angle instantaneously. Angles from zero to forty-

five degrees are obtained by manipulation of the slide bolt. Quadrant faces marked for various classes of mechanics and carpenters are available. Other features include instantaneous forty-five degree miter, rule, level, plumb and scriber which screws into the head when it is not being used.

Popular Mechanics Magazine does not publish the name of the maker of, or dealer in, any device described in its pages, but this information will be furnished by our Bureau of Information upon request, accompanied by stamped envelope.

The electric board...
 The man who operates it...
 The bridge game...
 The cards held by each player...
 The bidding and play...
 The spectators...
 The announcer...
 The telephone...
 The operator...

R. Powell Co. 306 N. 11th St. Berkeley, Calif.

FLYING OFFICE SAVES TIME OF BUSY EXECUTIVES

Equipped with fine furnishings and decorated in the ultra-modern manner, the latest airplane resembles a skyscraper office, so far as the interior is concerned. It has a lounge seating eleven persons, a conference room for four, a galley, lavatory and pilot's quarters. The floor is covered with brown carpet, the ceiling with tan fabric and the paneling between windows with green finish, to match the green curtains. Metal accessories and trim are gun metal. Individual reading lights are set in the ventilating duct, while three central ceiling lights supply general illumination. The "flying office," a Douglas transport, has two-way telephone and built-in radio in the lounge. It was styled for Cities Service company.



Interior of Plane Equipped for Business Use; This Is the Lounge with Built-In Phone and Radio

TOY TRAIN DELIVERS FARMER'S MAIL

One western farmer claims he operates the world's smallest "mail train." His house



Depositing Mail in Box Pulled by Toy Engine

is some distance from the road where mail is delivered. The farmer laid a tiny track from his house to the road, obtained a toy locomotive and fitted his mail box as a "mail car." About time for the carrier to

arrive, the train is started from the house. A lever alongside the track stops the engine when it reaches the highway. The mail man deposits the letters, turns a switch and the train chugs back to the house. It is operated with small batteries.

SPEEDOMETER FOR THE "BIKE" ALSO SHOWS MILEAGE

Both speed and mileage are indicated on an accessory designed by Stewart-Warner for the bicycle.

Three and one-half inches in diameter, the speedometer head has an aluminum-finish case. The face is black with white figures that show speeds up to fifty miles per hour and mileage up to 9999.9. Only a few minutes are required for installation. The speedometer works from the front axle.



Comp. Carlton Wash. Stewart-Warner Corp. 1821...
 501 Madison Ave. New York
 E 49
 Memphis
 4.95

The HAZARDS of

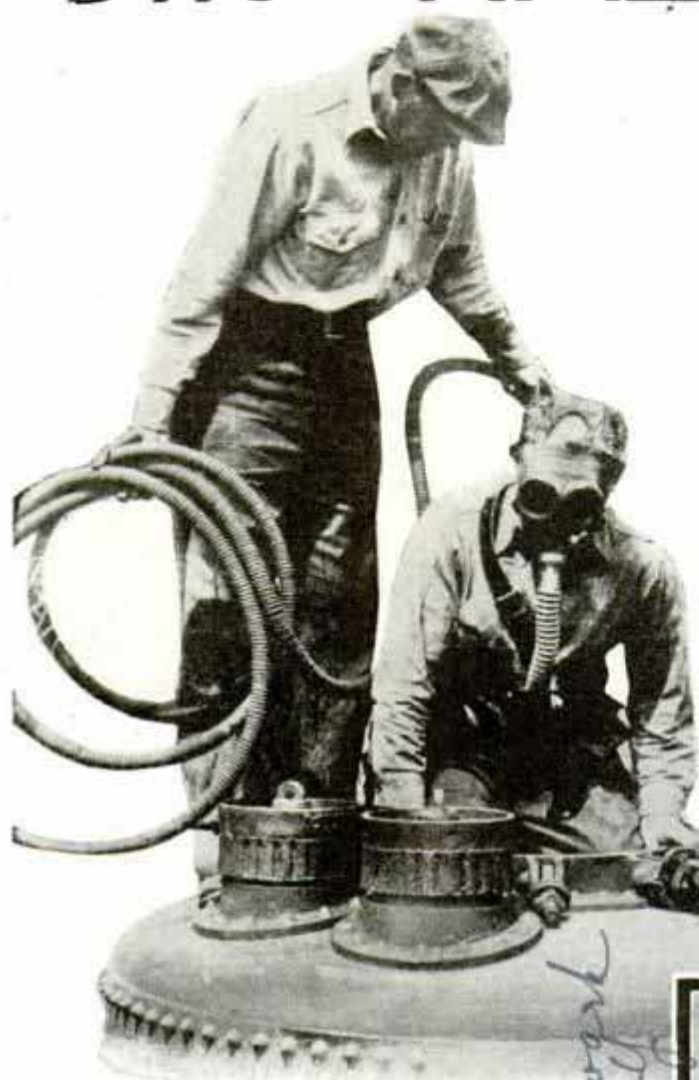

waves. So no man may number the colors; their number is infinity. In practical terms we recognize seven colors of the spectrum; red, orange, yellow, green, blue, indigo, and violet, and consider all others graduations of these. The painter recognizes only three colors, and calls these primary, for he has learned to blend them into any shade he desires save black and white, which he calls shadow and light, and not color.

But the dyestuff maker, by accurate mathematical computation, recognizes 4,000,000 colors, and each of these, he knows, is a precise chemical formula. Thousands have already been discovered and day by day the number is increasing.

In hundreds of dyestuff plants chemists labor to produce new colors and more permanent coloring materials. Their work is extremely dangerous, for from a group of 250 "intermedi-

By **WALTER E. STEWART**

WHEN W. H. Perkin, a young English chemist, attempted to make some quinine in 1856 and accidentally created the first synthetic dyestuff, aniline purple, he began an era of danger to experimenters only equaled by the development of gunpowder.

It was another English scientist who discovered the composite nature of sunlight and started the train of discovery which revealed that all non-luminous and non-fluorescent substances are dependent for their color upon the light which strikes them. A red carnation appears brilliant red in red light, and yellow in yellow light, but in green or blue light it appears black.

Colors of light are merely various frequencies of light waves, just as musical notes are various frequencies of sound



Fighting Fire Started While Making Dyestuffs and Inspecting a Pressure Mixing Chamber Used in the Manufacture of Dyes

D1575

CREATING

NEW COLORS



ates" they may derive a possible 4,000,000 or so different chemical dyes whose properties are largely unknown until discovered by experiment.

Only a few weeks ago a chemist in a laboratory near Kearny, N. J., started a reaction in a glass distillation unit. Cautiously he pushed a small bunsen burner under the glass chamber. Immediately the reaction began to accelerate, and he had just enough time to throw up his hands to protect his face before a violent detonation shattered the apparatus.

Dyes range in price from one dollar to over fifty dollars a pound, and it is not unusual for a new shade to result in a business for a small plant amounting to more than \$100,000 in a single month.

Beginning with the distillation of the coal tar and continuing to the final grinding of the dry dyestuff, every step of the process is potentially dangerous. About a year ago, near Newark, N. J., the ordinary process of recovering benzene from coal tar was proceeding when a new workman carelessly lighted a match. With a roar heard for miles a huge steel tank sailed skyward killing four persons.

A few months later at another plant in



Elle Paul Style Service

Changing Colors in the Show Windows Are the Result of the Work of Thousands of Research Chemists; the Dress Derives Its Color from a Coal Mine and the Test Tube of a Chemist



is derived from the picric acid used in gunpowder. The explosion demolished the entire end of a large building and it was only by great good fortune that the workers escaped. Accidents with this material had been so frequent that the mill was rebuilt in a bombproof shelter which was equipped with remote controls so that no one need be inside while the machinery was running.

And so the story of the creation of each new color is one of adventure and danger and high reward.

the same vicinity one of the intermediates, benzidine, was being made by adding powdered zinc to a compound of sodium hydroxide and nitro-benzene. The mixture was in a large, lead-lined, steel tank. A workman added the powdered zinc a little too fast, and when the reaction started the whole mass flashed over almost instantaneously. The resultant blast burst the heavy pressure head of the tank and sent it crashing through the heavily timbered roof.

Phosgene and chlorine, both deadly gases used in chemical warfare, are used extensively in the creation of intermediates. The chlorine is fairly well controlled, but workers around the tanks where phosgene is used always wear gas masks. A few weeks ago a foreman, checking one of the phosgenation processes, came upon a worker slumped on the floor. Only quick work in getting him out and the immediate application of an oxygen respirator saved his life. Investigation showed that the man had been knocked out by gas leaking into his mask through a tiny hole.

Many colors are themselves explosive when subjected to excessive heat. Less than a year ago a small micro-mill used for grinding and mixing the dry colors became overheated, due to friction, and exploded a batch of acid anthracine brown which was in process. This color



Above, New Fabrics Demand Hundreds of New Dye Combinations as They Are Introduced; Left, a Skein of Artificial Silk Ready for Dyeing

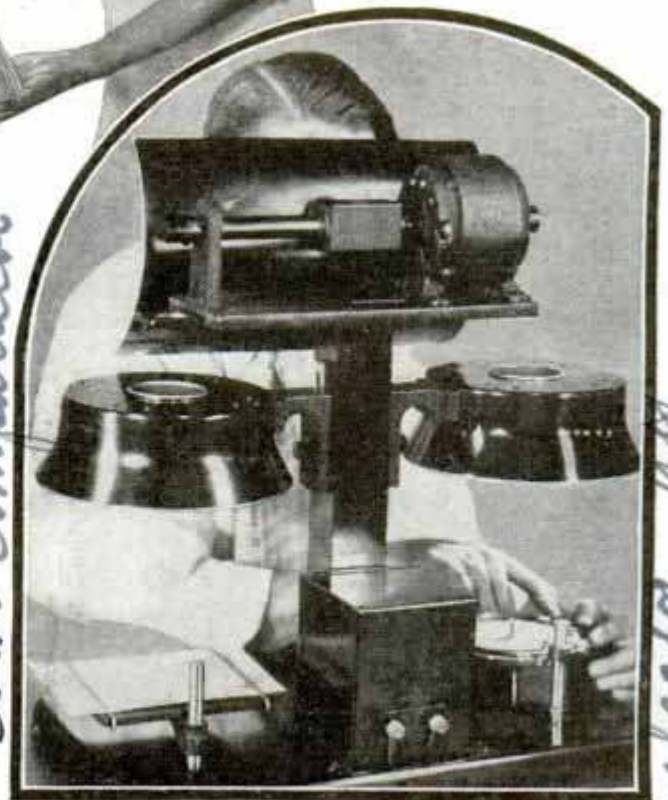

Above, an Optical Machine Which Classifies the New Colors as They Are Developed

Color Comparator
Bohler & Co.
Bausch & Lomb
optical 637 St Paul

Adam Adamick

near Ellsworth, Wash

**SEA SHELL ARTIST
TURNS HOBBY
INTO MONEY**

£-39

From a hobby of fashioning novelties out of sea shells is growing a business. A Pacific coast artist finds a demand for articles made from crab, lobster, clam, mussel, sea snail and periwinkle shells. The starfish is prepared by cleaning it thoroughly, incorporating it into a novelty and then giving the finished product a coating of shellac and varnish to give it permanency.



emb. 89 Paterson
740-11 St. Clair
north Seattle Wash

Triton Cove Resort

Artist With Some Samples of the Novelties Which He Has Made by Using Shells; Note Treatment of Starfish

**MIRROR HELPS TO FIND FLAWS
IN RAILWAY CARS**



£30

ms. 4/11/35

Car Inspector Using Mirror to Examine Arch Bar

Broken arch bars on freight cars have cost the railroads millions of dollars in damage to equipment and right of way. One of the latest methods of inspecting the arch bars at terminals is by using a specially constructed hand mirror that reflects the underside of the bars.

**NEST IDENTIFIES EGG-LAYERS
FROM NON-LAYING HENS**

£-21

Hens that lay are identified automatically from non-layers by an all-metal nest. The



Metal Nest Identifies Laying Hens; Drawing Shows How Egg Reaches Storage Basket

Forster Mfg Co 1852 Alcatraz Ave

Em. J. M. Karcher 4475 W. Paine Blvd

St. Louis Mo

U.S. Major ...
Technical Advisor to

POPULAR MECHANICS

Imperial Airways, England

Flying Boat Launches Sea Mail Plane in Air

Being built by Short Bros. Ltd. Rochester Kent England

Copyright 1934 by the McGraw-Hill Companies

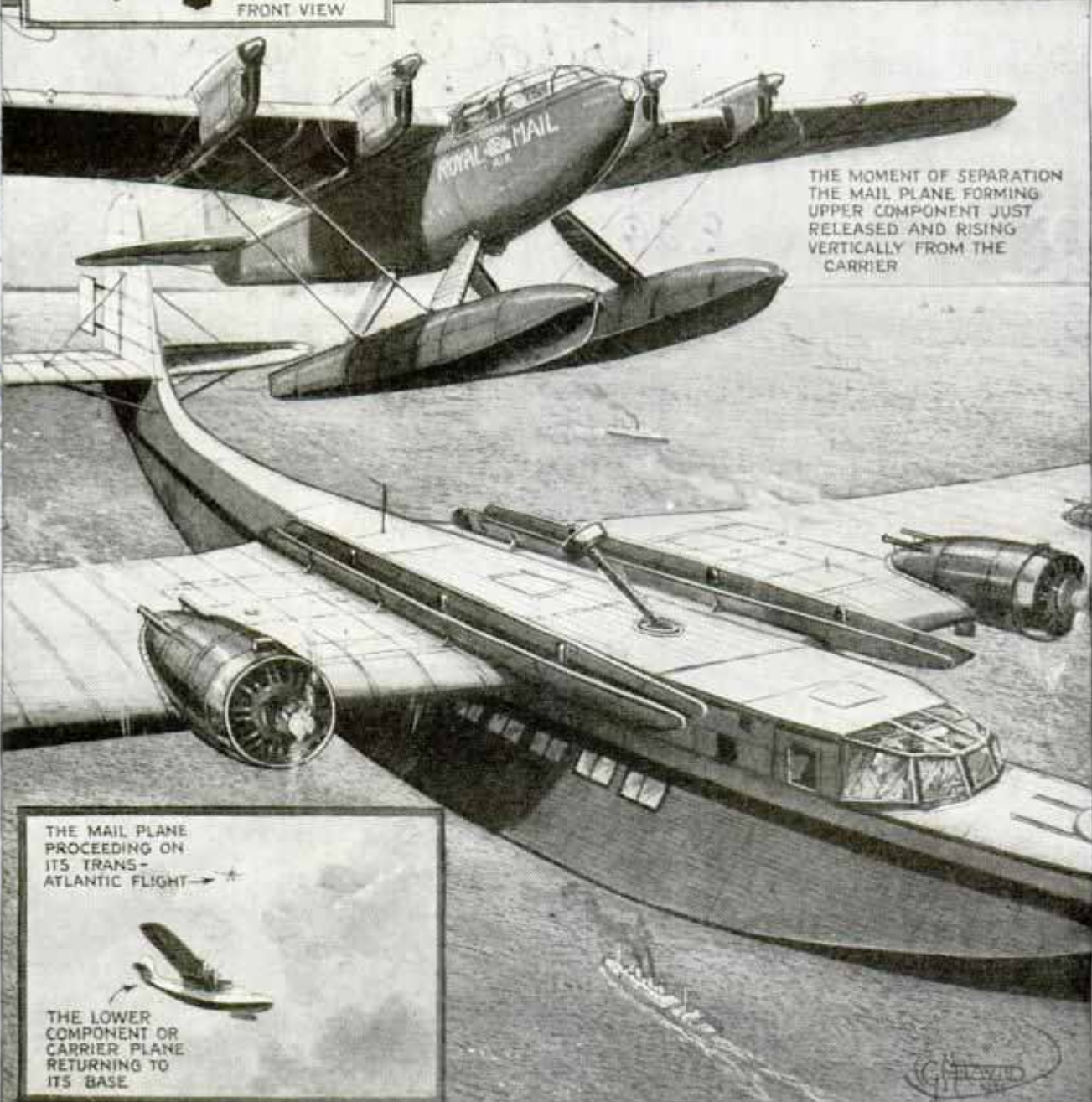
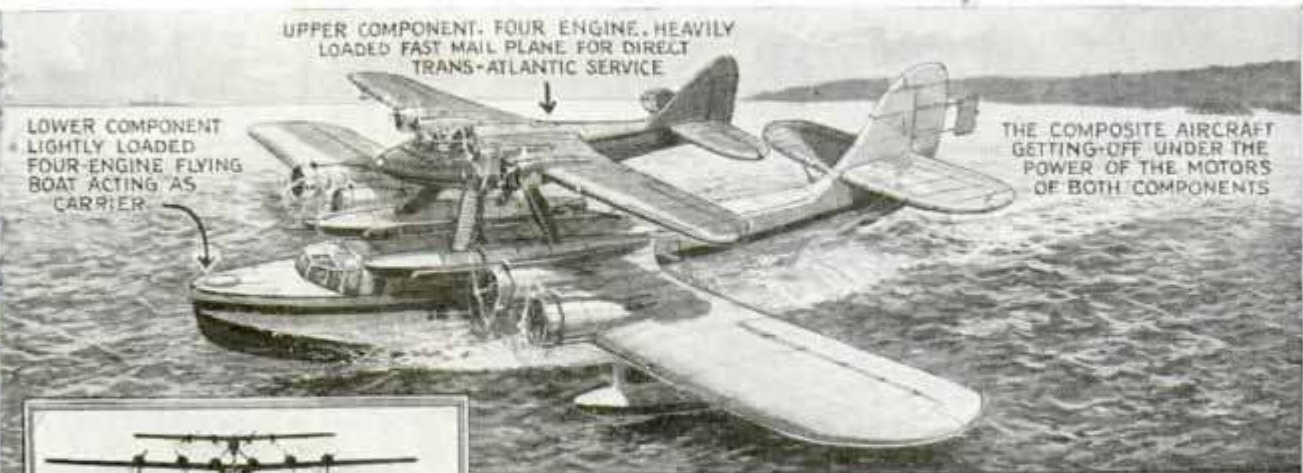

British Designer's Combination Flying Boat and Mail Plane, Each with Four Engines; Top, Mail Ship Attached to Flying Boat at Takeoff; Bottom, Launching Mail Plane in Air to Fly from England to Canada While Carrier Flies Back to Base; Mail Plane Has Floats; Composite Craft Is Being Constructured

Atos Boat Outboards Ltd. 618 London Road, Isleworth, Middlesex, Eng

RUSTPROOF STEEL BOAT RIBS DECREASE WEIGHT *8.73*

Replacing the usual timber ribs, rustless chrome-steel bars are used in a British made motor boat that is said to be about sixty per cent lighter than conventional craft of the same size. With an outboard motor, the boat attains a speed of twenty-five knots. The planks of the boat are laid lengthwise from stem to stern, with the steel bars passing edgewise through each plank. At the gunwales, the bars are fastened with nuts to press the planks tightly together. The bars are spaced three to ten inches apart to prevent changes in the shape of the hull. Painting or cleaning the interior of the craft is easy because it is smooth from keel to gunwale. The makers claim this method produces a boat that is much stronger and much easier to keep watertight.



Apparatus for Keeping Time at Ringside; It Counts Accurately in Case of Knockdowns

ping at ten and signifying a knockout. It is intended to eliminate the "long count" of past boxing bouts.

GAS IN BOTTLE WHIPS CREAM AT TOUCH OF BUTTON *8.137*

Cream can be whipped by touching the button of a gas container developed by Charles A. Getz of the University of Illinois. The whipping process is one of physical chemistry. The cream is placed in a special container made of steel, tin dipped, with an air-tight top, containing an air valve. All oxygen is forced out and nitrous oxide gas is injected into the container. The housewife is provided with a release trigger which she attaches to the "bottle." When she presses the button on top of the trigger, the gas forces out the cream in aerated or whipped form.



Three Views of Gas Bottle in Which Cream Is Whipped Almost Instantaneously

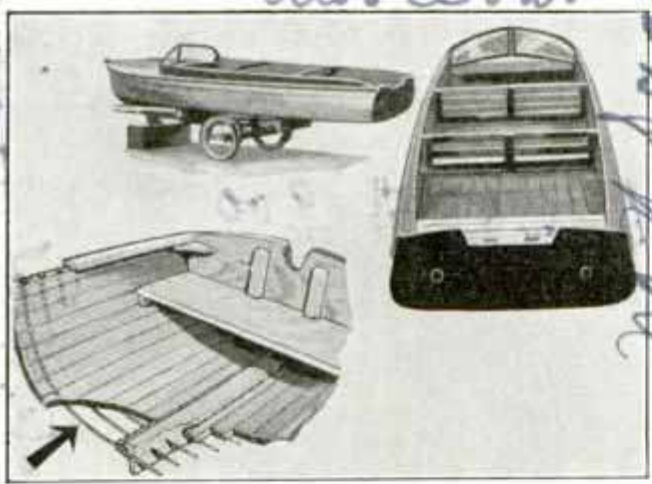

Illustrating New Boat Construction in Which Steel Ribs Replace Wood

ELECTRIC BOXING BOUT TIMER IS AID TO REFEREE *8.129*

More accurate timekeeping at boxing bouts is possible with an electric device recently installed at a Louisiana arena. After the referee gives his instructions to the fighters, the electric clock tolls off the seconds with flashes from a red-light bulb. During the rest period, the timer shows a green light for ten seconds before the fight is to be resumed, giving the handlers time to leave the ring. In the event of a knock-down, the device sounds a gong and the red light, held high above the timekeeper's head, begins tolling off the seconds, stop-

Charles A. Getz, Urbana, Ill.

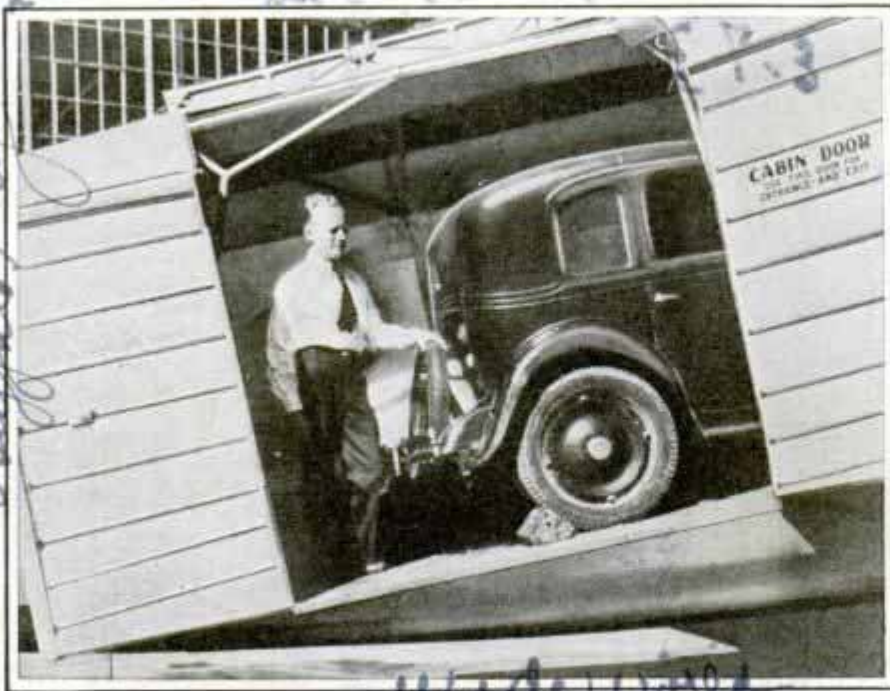

Showing Automobile Loaded in Giant Cargo Plane; Note How Fully Assembled Car Is Easily Fitted into the Compartment

CARGO PLANE CARRIES AUTO IN ASSEMBLED FORM

Automobiles in assembled form can be transported by a giant cargo plane capable of a speed of 117 miles per hour. The automobile is loaded into the cabin of the ship, a Condor. The plane also can serve as an ambulance, a troop transport or carrier of general freight, cafeteria equipment, spare engines, gasoline and other supplies. Special fittings facilitate the loading of bulky or heavy objects.

GEAR LAPPING MORE ACCURATE WITH AUTOMATIC MACHINE

Making possible the lapping of heat-treated gears to an entirely new degree of tolerances, an automatic machine has been developed to turn out smoother, quieter and more efficient spur, helical and herringbone gears. A new method called "inclined axis" is employed by the machine. By inclining the axes of the lapping members



to the work piece, the machine produces frictional or abrasive action along the normal pitch line of the gear tooth by rotary

Auto Engineering Co

motion only without increasing the sliding movement between other contacting portions of the gear teeth. The result is more thorough lapping action throughout the gear tooth surface. The machine also has the advantage of lapping one or more gears on a cluster simultaneously without adding to operation costs.

NEON AUTO LIGHTS ARE OPERATED ON SIX-VOLT BATTERY

Neon signs on automobiles, trucks, airplanes and other places where the only current is from

storage batteries have been made possible by an inexpensive transformer unit. Direct current from a six-volt battery is converted by the unit into alternating current of 10,000 volts, sufficient to operate more than twenty feet of neon tubing. Con-

\$16.50 \$19.00

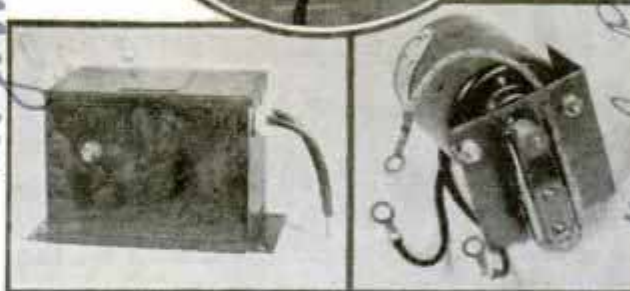

Two Views of Simple Equipment for Putting Neon Lights on Truck

sumption is only about five amperes, less than used by the average car radio. The transformer weighs only nine and one-half pounds. A special model can be used with lighting plants with thirty-volt batteries.

115 28 La Salle

Curtiss Aeroplane and Motor Corp
Vulcan Buffalo, N.Y.

Industrial Products
Merrill
Merrill

Handwritten: D1606 Carl Zeiss Co, 37-41 Marlimer St. W. London, Eng.

Diagrams Flash on Screen as Lecturer Writes

Diagrams or formulas may be flashed on a screen as the lecturer writes by a projector developed in Germany. The lecturer writes or draws horizontally on a sheet of Cellophane lying above a horizontal glass plate. Illuminated from below, this plate causes whatever is written to be projected, on an enlarged scale, on a screen. The Cellophane is arranged in the form of a strip on rollers so that it may be pushed forward as the writing space is filled. The speaker writes in normal position and faces the audience. A 500-watt lamp projects the writing, its beam passing through a water chamber which absorbs the heat rays. The projected writing does not strain the eyes. The arrangement is intended to replace blackboard work, which forces the lecturer to turn his back on his hearers.

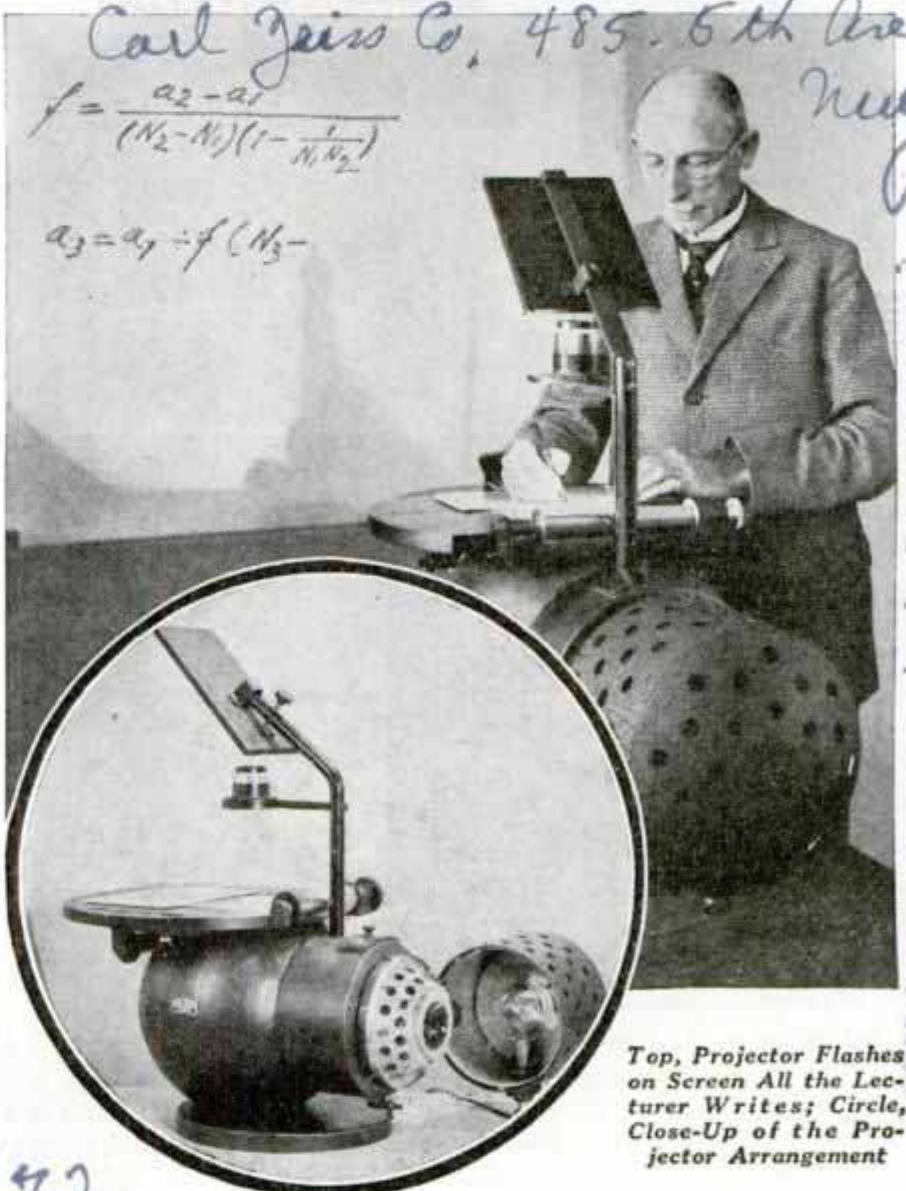

Top, Projector Flashes on Screen All the Lecturer Writes; Circle, Close-Up of the Projector Arrangement

Handwritten: E-72

Fingerprint Blurs Cleared by Matching Enlarged Images

Blurred fingerprints can be cleared up by a device recently pressed into service by the U. S. department of justice in the

war on crime. The device is plugged into an electric connection, lighting up a small screen. On this screen is projected the enlarged image of two separate sets of fingerprints. If they are identical, from the same fingers of the same hand, the lines flow together so that only one fingerprint stands out in detail. Thus may be proved the connection of a suspect with a crime, provided his fingerprints already are on file. Recently a fight occurred between department of justice agents and a band of outlaws. One of the government men was killed and the slayer escaped, leaving no trace but a pair of badly blurred fingerprints. The "unblurring" device helped to establish his identity and he was arrested.

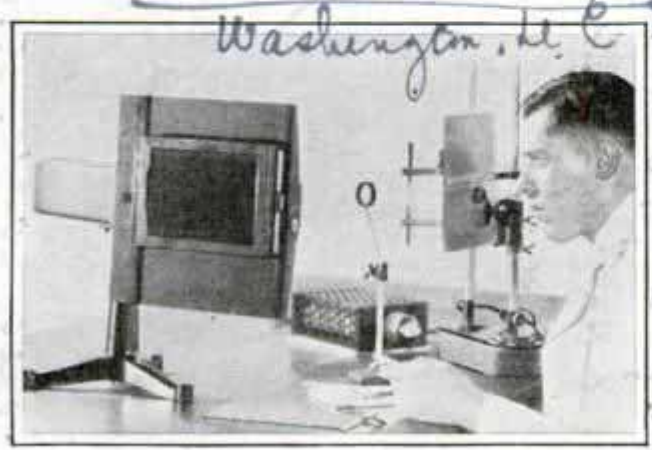

Latest Equipment for Comparing Fingerprints to Clear Up Blurred Lines

Handwritten: Washington, D.C.

Work a gentleman

D1644

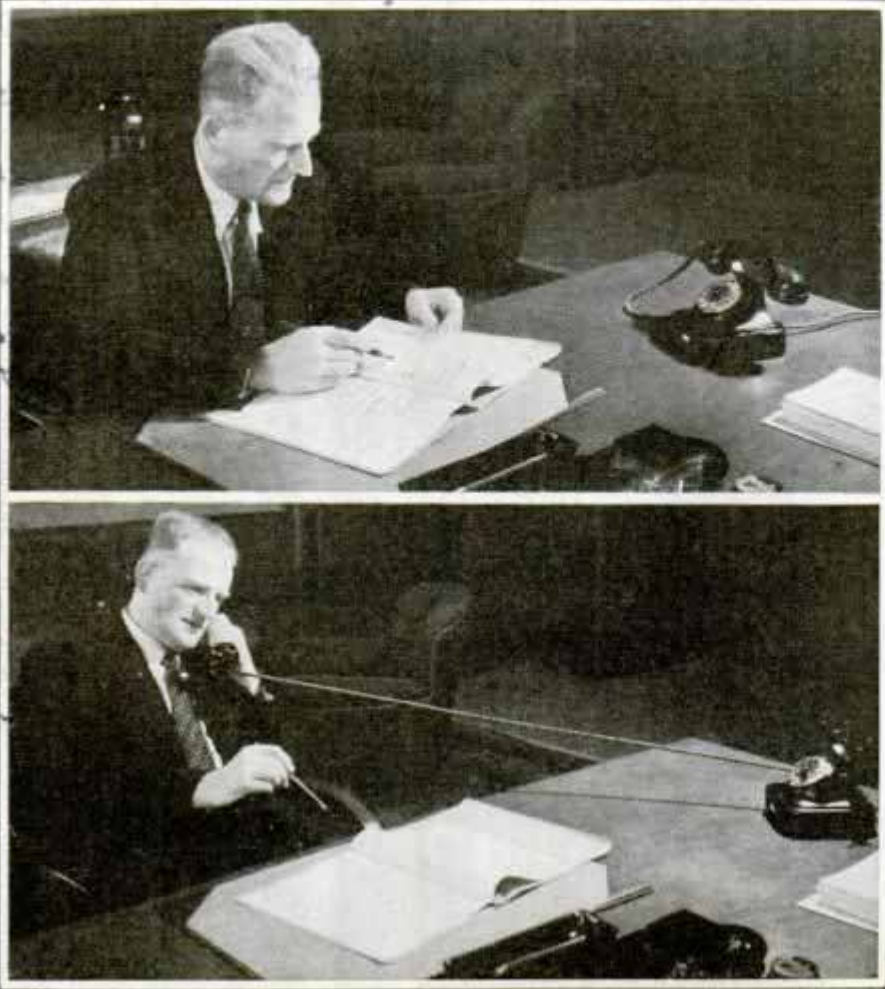

Phone Cord of Braided Elastic Which Is Out of the Way When Not in Use Although It Stretches under Tension When Receiver Is Lifted

PHONE CORD WHICH STRETCHES WILL NOT TANGLE

Germany has produced a telephone cord which stretches, thereby eliminating the bother of disentangling the cord leading from the instrument to the receiver. The double cord to the hand set is of braided elastic rubber. This allows the cords to be stretched to about four times their length when not under tension. The wires the cords enclose are pulled together when not in use and extend with the rubberized covering when the hand set is pulled.

ELECTRIC "SEAS" ABOVE EARTH

More than sixty miles above the earth oceans of electricity affect the magnetic compasses and radio reception. Radio waves are reflected by the bottom of this layer, making long-distance reception possible. Currents up to 160,000 amperes make up this sea of electricity, the effect of which on compasses is demonstrated at the Carnegie Institution at Washington, D. C.

"DRY ICE" CONTROL FOR ANY SIZE REFRIGERATOR

Control of Dry Ice temperatures inside closed spaces is achieved in a system developed for efficient refrigeration in the home, trucks and railroad freight cars. Dry Ice is solid carbon dioxide gas which has a temperature of 112 degrees below zero. When it "thaws," it turns back into dry, invisible gas. The device for controlling its temperature is a welded metal chamber having a series of tubes surrounding the inner chamber. The block of Dry Ice is placed inside the chamber and the door sealed. As the ice turns to gas, it is recirculated around the solid block. The colder gases remain near the bottom and as they absorb heat from the ice box, truck body, ice-

cream cabinet or grocer's showcase, rise to the top, similar in action to the automobile radiator. Finally, when the gases reach the temperature indicated by a control dial they escape through a valve. Fifteen pounds of Dry Ice will keep a small ice box cold for a week in summer. A unit weighing less than 200 pounds and loaded with Dry Ice will refrigerate a five-ton truck for two days.

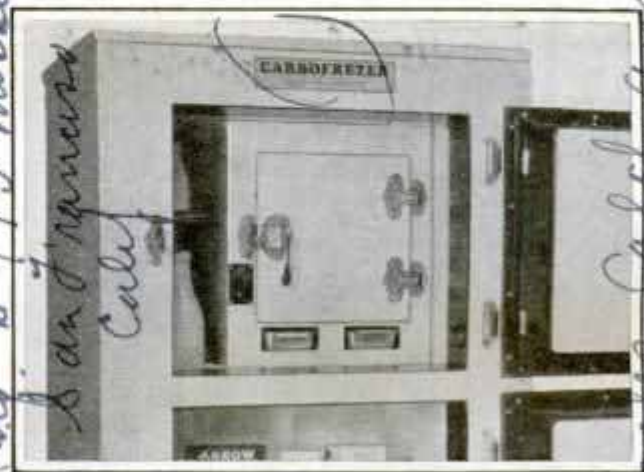

Control Unit for "Dry Ice" Keeps Ice Box Temperature at Point Indicated on Dial

Siemens & Halske, Berlin, Siemensstadt, Germany

any developed for Commerce

any of various

D1589

day 6973 museum

San Francisco Calif

Angelo. Calif. and Stan

Science Service

Holbrook Merrill

Huge Wind Tunnel to Test Full-Size Planes

Full-size airplanes will be given aerodynamic tests in a giant wind tunnel now being constructed near Paris. This tunnel is so large that actual flying conditions in the air can be approximated during the tests. From one angle the tunnel looks like a big Swiss cheese, the holes being the aspiration tubes with the supports for the motors and propellers. With the aid of this tunnel, plane designs constructed to full scale can be tested thoroughly without taking the ships off the ground. The equipment can also be used for testing boats, automobiles and other forms of transportation to which streamlining is being applied.

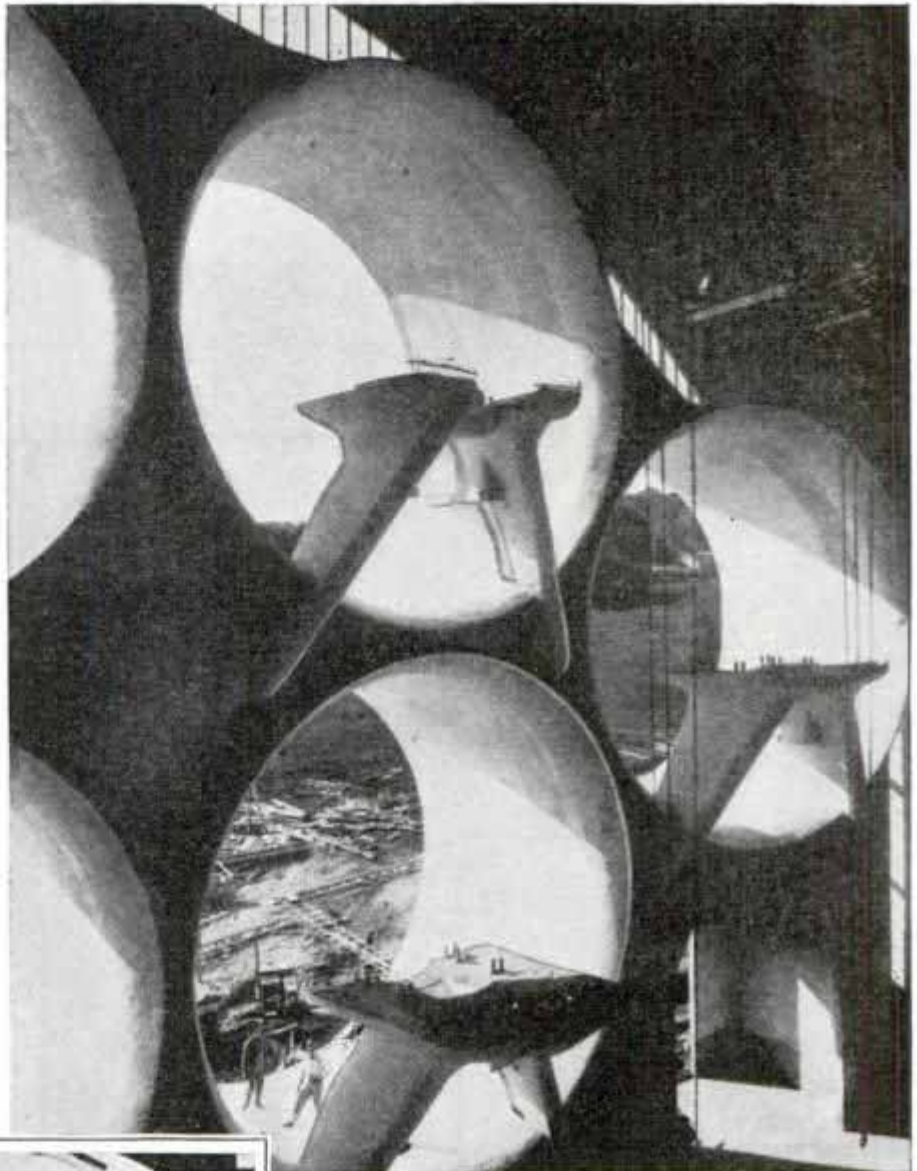

Right, Aspiration Tubes with Supports for Motors and Propellers in Giant Wind Tunnel for Testing Full-Size Planes; Below, a Part of the Tunnel; Compare Size with the Two Men

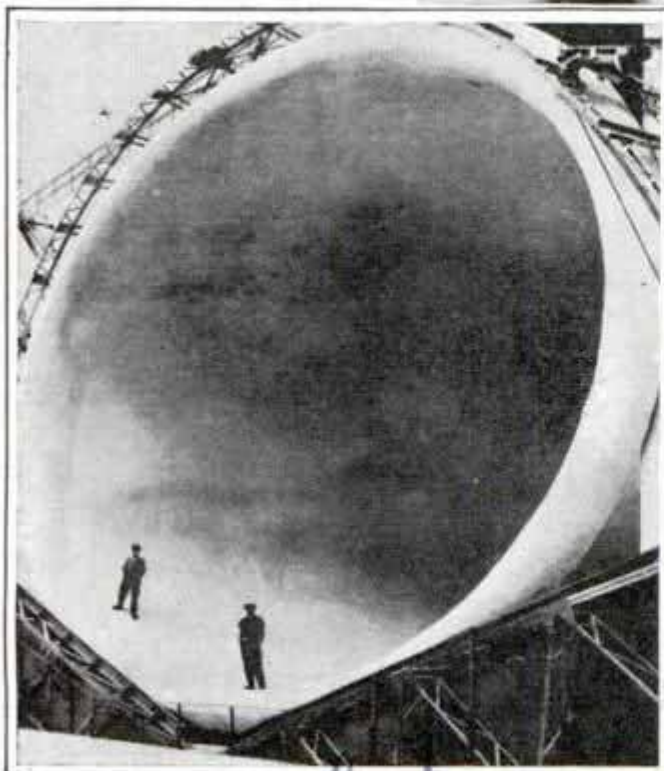

TASTE AND SMELL BY RADIO HINTED FOR THE FUTURE

Pointing out that we already hear and eventually will see by radio, Dr. Alfred N. Goldsmith, consulting engineer of the RCA Manufacturing company, suggests that in the remote future radio may appeal to man's other sense, such as taste, smell and touch. "Telegustatory Broadcasting," as he calls it, may make it possible to "taste" a fine brand of coffee by radio. The transmission of smells perhaps would be easier, he thinks, since the "telolfactory" receiver would need only to spray into the air a duplicate of the odor transmitted. Too, there is the very remote possibility of transmitting three-dimensional replicas of objects which might be touched.

Chub

Camden, N.J.

94

D1594. Cont. *Le... 40.103rd... new!*

Around the WORLD

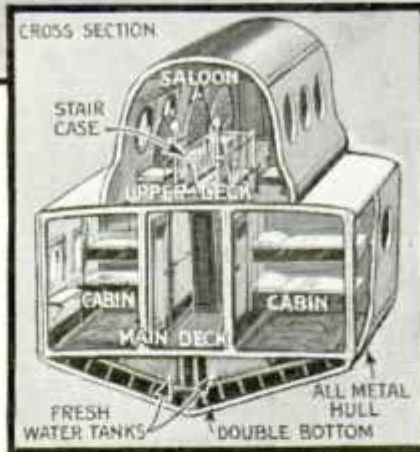
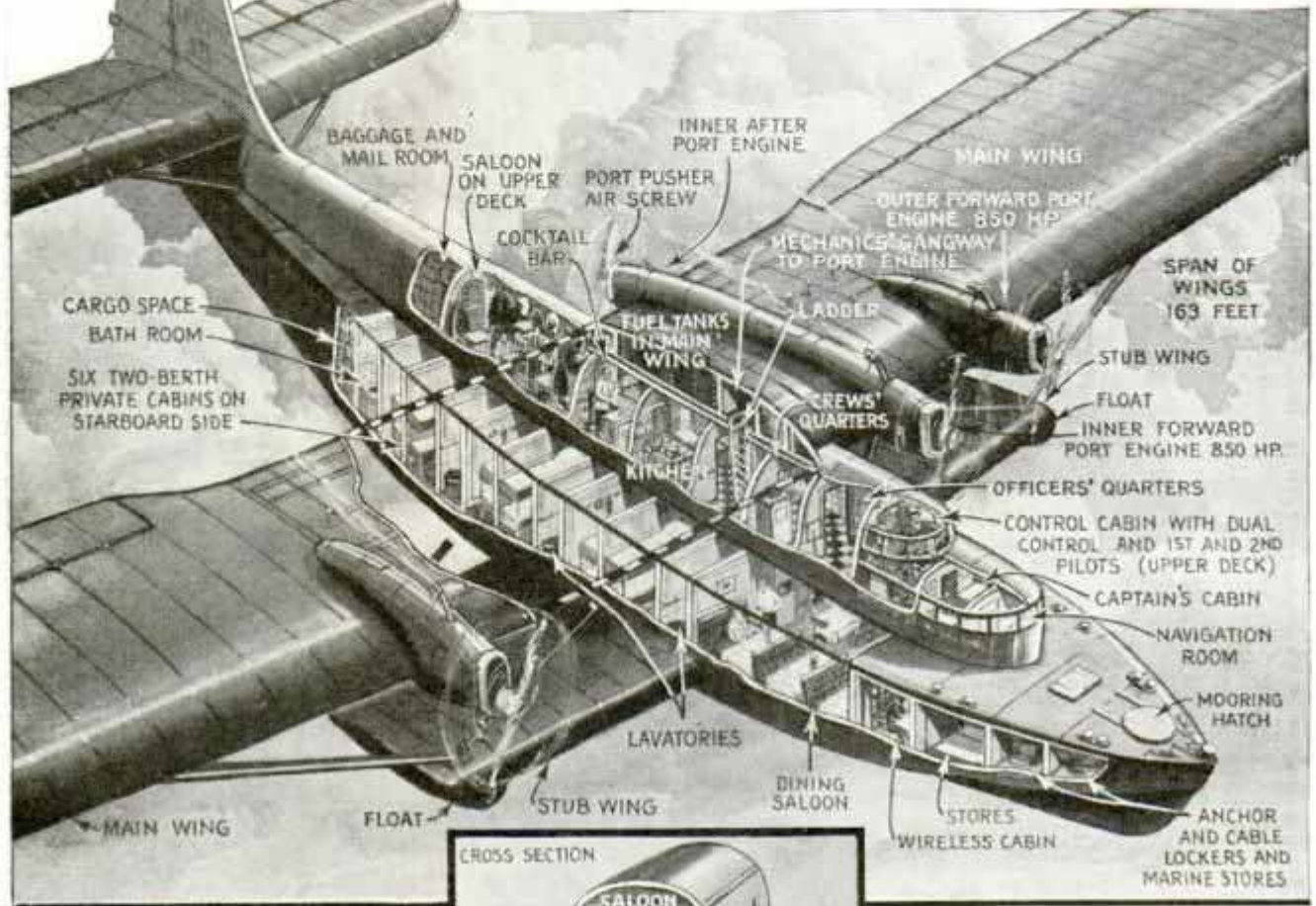

Diagram and Cross Section of Double-Deck French Flying Boat Intended for Transatlantic Service; When Fully Loaded, It Will Weigh Thirty-Seven Tons

GIANT flying whales and aerial greyhounds, built by men, are about to conquer the oceanic spaces and set new records for travel.

A ten-day tour around the world will be the immediate result of present plans to span the oceans with high-speed, multi-motored flying boats. A great boom in inter-continental communication is in prospect soon after the half-dozen or more transports pass their preliminary tests.

Five nations, the United States, England, France, Germany and Russia, have launched, or are about to launch, air transports of greater size and tonnage than any now on the world's airways. Igor Sikorsky is preparing to build a 100-passenger transatlantic clipper, while Glenn Martin has already launched the first of three Pacific clippers. Simultaneously, the French

are rushing construction on an eighty-passenger flying boat, destined for the South Atlantic run.

Under the direction of Dr. Hugo Eckener, Germany is completing the aerial greyhound LZ-129, which will have dimensions equal to some of the largest ships and comfortable accommodations for fifty passengers. The British Imperial Airways is extending

its regular service beyond India and will probably establish an eastern terminus at the Singapore naval base. Also, the company has received bids on two flying boats designed for the north Atlantic run. And Russia is now testing an eight-motored 7,000-horsepower giant capable of 240 miles per hour.

These air leviathans will change the picture of world travel beyond all recognition. Although it is now possible to buy a

D1594

in TEN DAYS ?

single ticket to carry you around the world via aircraft and steamers, the necessary time is fifty-seven days. Save for the Pacific leg, all the travel is by air. If you start from Seattle, you fly south to Pernambuco, Brazil, and transfer to the "Graf Zeppelin," which carries you to Seville, Spain; thence by plane, or plane and boat to Singapore, and across the Pacific by steamer. The actual time in transit is thirty-eight days, of which fifteen are spent in the air.

The next few months will witness a sensational reduction of the minimum time for a tour around the globe. The leg across the Pacific will be covered in a Pacific clipper and the south Atlantic leg will be optional when the new dirigible, LZ-129, starts a north Atlantic service. The new French flying boat service in the south Atlantic will cut

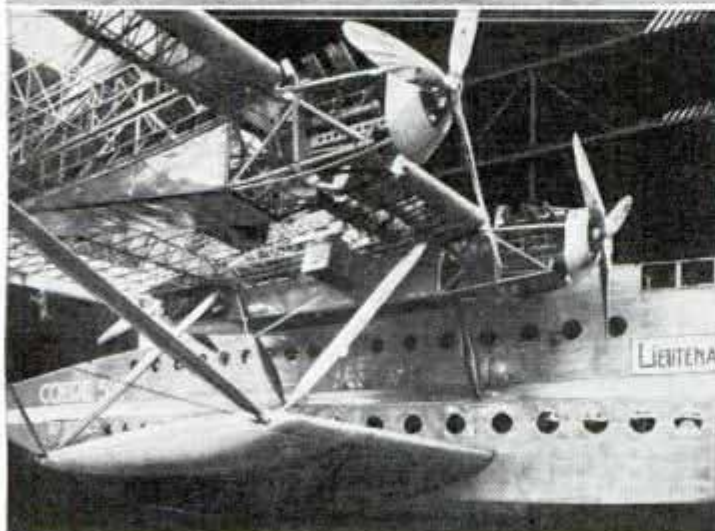
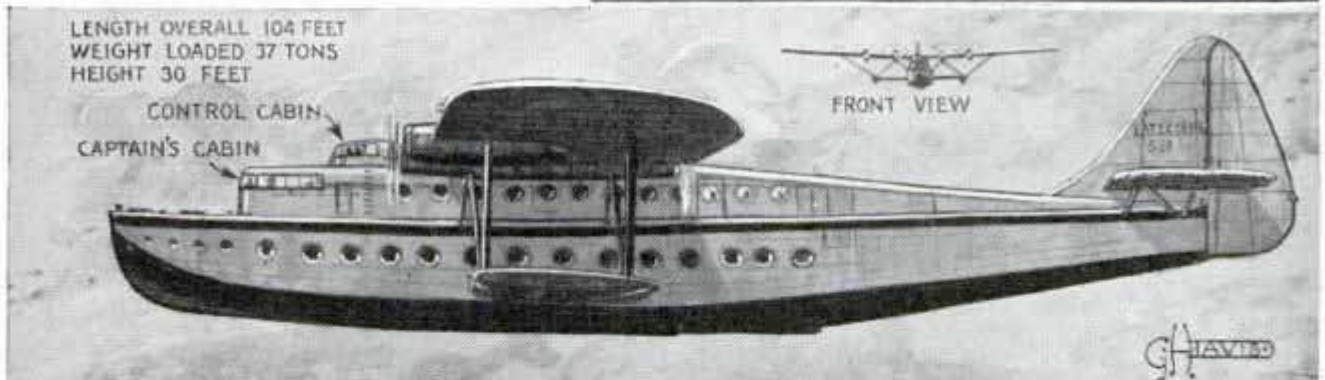
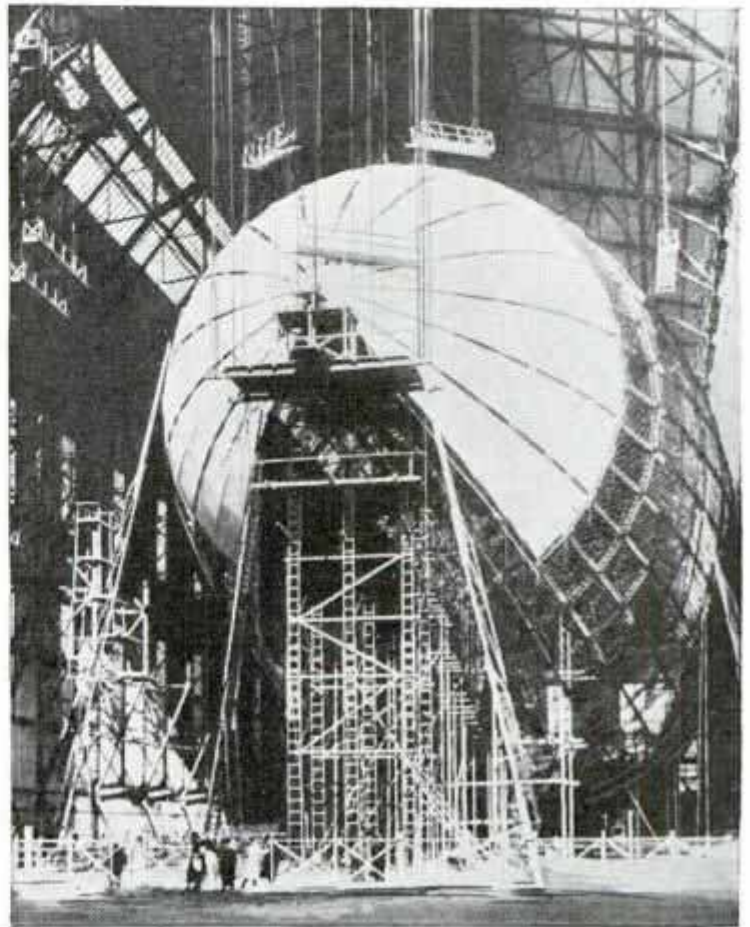

French Flying Boat under Construction and as It Will Appear When Finished; Top, This German Dirigible Will Carry a Pay Load of 60,000 Pounds

the time of the "Graf Zeppelin" in half and offer more frequent schedules. The United States navy has already granted Dr. Eckener permission to moor the LZ-129 at the Miami and Lakehurst naval stations. Tentative schedules indicate that after July, you will be able to travel from San Francisco to London in slightly more than forty-eight hours.

Commander Charles E. Rosendahl,

01574

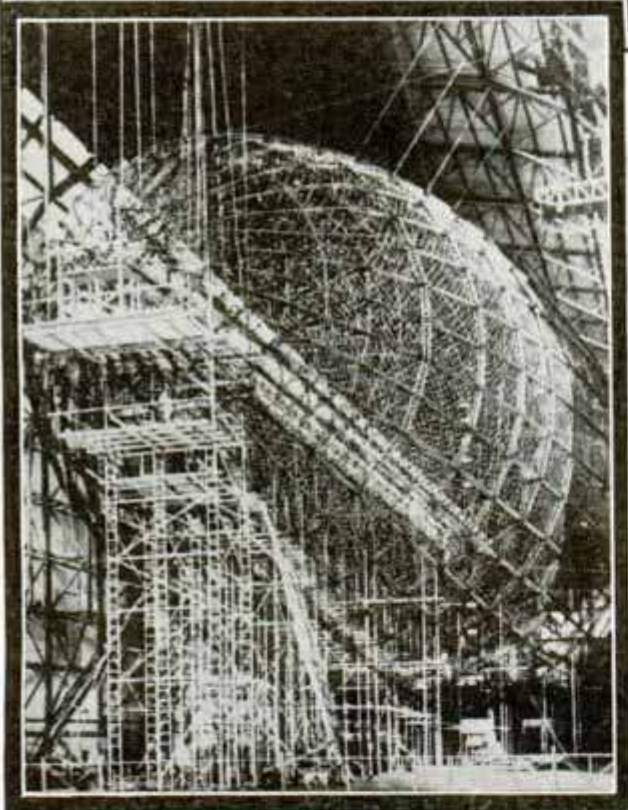

Clipper Ship for Pan-American Airways' Service, and German Airship under Construction

the navy's lighter-than-air expert, says the development of aviation makes this possible. A passenger will cross the country in an overnight trip and arrive in time to catch the transatlantic dirigible by noon. Commander Rosendahl says that mail can be assembled hours after the dirigible has started and transferred at sea from airplanes which attach themselves to the air giant with "hook-on" appliances such as are used on the dirigible "Macon."

As to the safety and dependability of transoceanic dirigible service, Commander

Rosendahl points out that no attempt to cross the ocean by an airship has ever come to grief. Pan-American Airways plans to span the Pacific with a \$2,000,000 fleet of six mammoth clippers, the first of which has already gone into experimental service. With the use of the clippers, the post office is contemplating a six-day mail service between Shanghai and New York. In other words, it will be possible to travel between Shanghai and London, via Pan American, T.W.A., and the LZ-129 on a seven-day schedule.

Imperial Airways or the Dutch Air Lines will be the connecting link between London and the orient. It seems likely that the London-Shanghai stage of the journey will be completed within three days, making possible a ten-day tour of the globe, if connections can be made without delays. This is less than one-fifth the time required at present and one-eighth the time which Jules Verne predicted.

The LZ-129 will give passengers the same comforts now offered on ocean steamers. Her length is to be 815 feet, her beam 137 feet, and her volume more than 7,000,000 cubic feet. The helium within her metal frame will have a lifting capacity of 418,000 pounds, and her pay load will be 60,000 pounds. She will carry her passengers within the ship itself, instead of in a gondola. Features include twenty-five staterooms, fifty berths, a dining salon, lounge, reading and writing room, smoker, bar and promenade.

The four Diesel engines will generate

D1594

292

4,400 horsepower giving a cruising speed of eighty-four miles per hour. Her fuel tanks will hold sixty tons of crude oil, enough to carry her at least one-third of the way around the globe without refueling. To maintain a safe ballast she will have storage tanks to conserve all the waste of the kitchen and passengers to help counterbalance the loss of weight through fuel consumption. The designers have also produced an apparatus for extracting water vapor from the air at the rate of about 150 gallons per hour. Thus, in case of serious ballast loss, it will be possible with this apparatus to increase the stabilizing load of the ship.

Glenn Martin has plans for a cantilever monoplane flying boat capable of carrying 10,000 pounds of pay load. With a range of 5,000 miles and a cruising speed of 180 miles per hour, it may make possible what Martin claims will be "an economically sound year-round service for mail, passengers and express."

"I predict," he said, "that by 1938 you will take off from New York at four p.m., have dinner aboard your plane, go to bed, and see the shore line of Europe by breakfast. You will set foot in Paris by noon."

The inventor said his super-clipper will be powered by only four engines, with a combined rating of 7,000 horsepower. This means 1,750 horsepower per engine, an unheard-of thing these days, but we have Glenn Martin's word that "such engines are well on the way experimentally."

France expects to begin operating its new flying boat on the south Atlantic run next summer. It has six water-cooled Hispano-Suiza engines rated at 850 horsepower each, and they are streamlined into the wing. Sikorsky's second record-breaking S-42 will leave shortly for experimental service in the Pacific coast area, in preparation for regular service from California to Hawaii. Supplementary service will be established from Hawaii to the Philippines and China.

British Imperial Airways are also preparing to enter the transatlantic service with flying boats. They have received bids on two larger than any they now have in service, and one of these will probably be used in the New York-Bermuda service which Imperial Airways will operate jointly with Pan-American Airways.

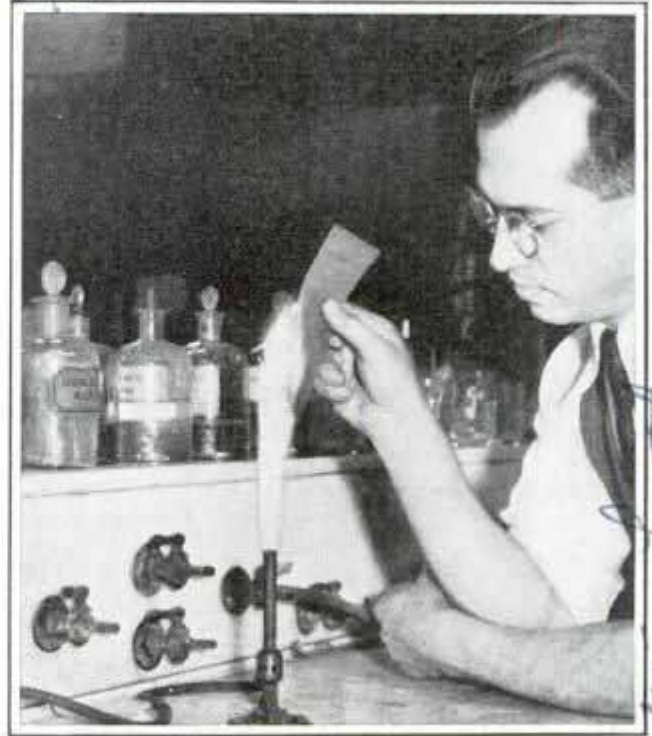

© Underwood and Underwood
Testing Sample of Awning Canvas Which Has Been Treated to Make It Fire Resistant

CANVAS MADE FIRE RESISTANT FOR USE IN AWNINGS

Canvas for awnings can be made fire resistant by a method developed by a government scientist. The treatment makes the fabric withstand repeated wetting and drying without serious deterioration.

COMPACT WEATHER INDICATOR FORECASTS CHANGES

Changes in the weather are indicated several hours in advance by a compact instrument which



includes several recordings on an upright column and a circular base. There is a barometer for measuring atmospheric pressure, a thermometer to give air temperature, a hygrometer for measuring air moisture and an indicator to show

wind direction. With the aid of these readings it is possible to make deductions concerning the coming weather.

Dr. Metzger leatherman
Washington, D.C.
Stullard, Germany

Es. Luft 22 New

"Pit" Crews Flash Signals to Outboard Racers



Signaling Outboard Boat Race Crew from Shore by Means of Placard Similar to Those Used in Communicating with Auto Race Drivers

Borrowing a trick from modern automobile racing, California outboard speedboat race drivers are catching their signals on the fly from assistants working in the "pits" ashore. The number of laps made, their position with relation to competitors, average speed and other information all are flashed to them by code characters printed on plywood boards and held aloft as they pass. The races are somewhat like automobile races in that refilling of fuel tanks and repairs are often required and this necessitates some method of communication between the drivers and mechanics and the "ground" crews.

Latest Dental Aids Are Used in Treating Dogs' Teeth

Visitors to the Humane Society's clinic in New York will find one suite of offices devoted entirely to dentistry for animals, and particularly for dogs. Here are all modern appliances and devices for dental treatment. There is also a spacious waiting room, the consulting room where dogs are brought first to have their condition determined. Next is the completely equipped operating room. But instead of the usual dentist's chair, there is a hydraulic operating table lately introduced. This has been modified and improved to suit the dog dentist's particular needs, for dog patients must lie down while being treated. In the laboratory are various curious devices necessary for the manufacture of artificial aids for broken teeth, missing teeth, etc. There are rows upon rows of artificial teeth which replace broken ones in the animal's mouth. It seems that dogs break their teeth frequently and their suffering in that case is considerable. When the dog gets false teeth, a plaster cast is made of his gums, upon which new teeth are fitted.

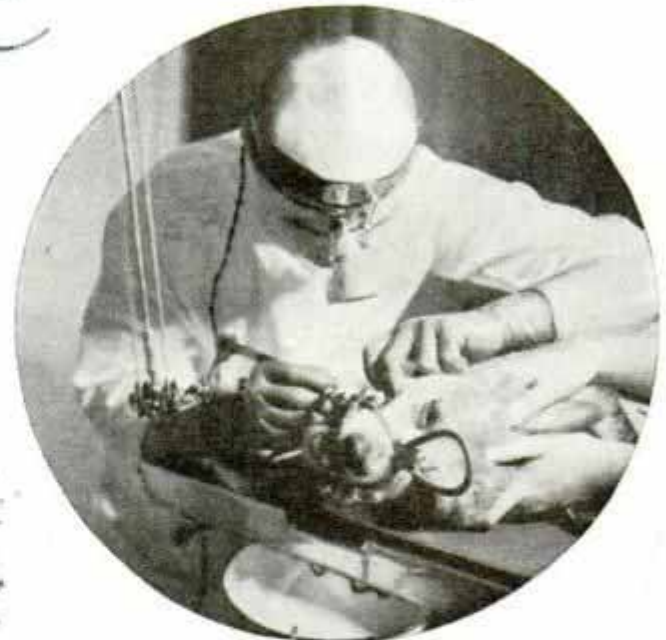

Dog Patient under Dental Treatment in Clinic Equipped with Finest Equipment

Sometimes people bring their dogs to have their teeth cleaned. Incidentally, it takes more than an hour to clean a dog's teeth because he has more than a human. Dr. William H. Dohm is in charge of the office.

Different from automobile racing - signals are flashed to drivers on the fly from assistants working in the "pits" ashore.

DL658
 737 E 5th St
 Long Beach Calif

270
 Contr. Carlos M. Washell
 1555 Homewood Street
 Altadena, Calif.

Living Flowers Decorate Exposition Buildings

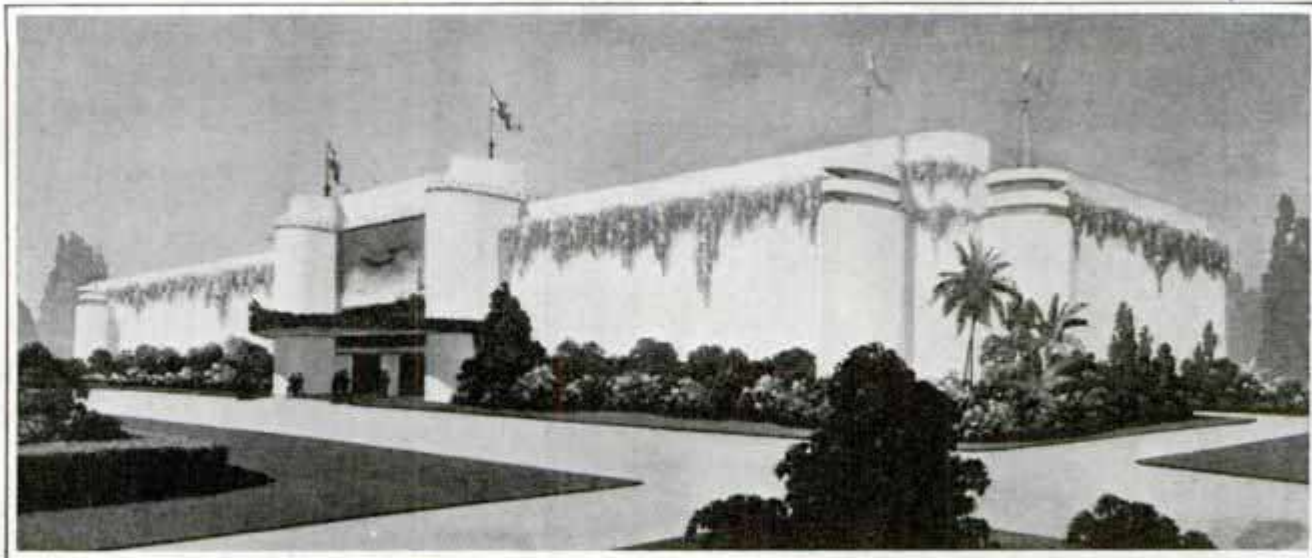

Architect's Rendering of One of Buildings for California Pacific International Exposition, Showing How Living Flowers and Vines Are Used for Ornamental Purposes

As a substitute for sculpture or other ornamental structural features, a California architect has designed a group of buildings to be decorated with living plants in bloom. From a roof-line ledge surrounding each structure, there are hanging borders of blossoming vines, adding color and life to otherwise plain wall spaces. This form of ornamentation is being employed

for buildings erected for the California Pacific International Exposition, opening in May. For each structure a different color scheme in flowers is used. For instance, from one building hang lavender trailing lantana and on the ground at the base is a border of both yellow and orange lantana. Exteriors will be illuminated at night, leading to still further color combinations.

Microphone Placed in Engine Detects Hidden Noises E 33

Experts are determining the performance of automobile engines by sounds picked up by a microphone inserted directly into the cylinder head. The noises within an engine, frequently inaudible to the driver, are measured in terms of decibels, which are units of sound. Once these hidden noises are located by the microphone, their causes can be removed to give better performance, longer life, and quieter operation. The experiments with radio equipment are being conducted in the Bohn engineering laboratory.

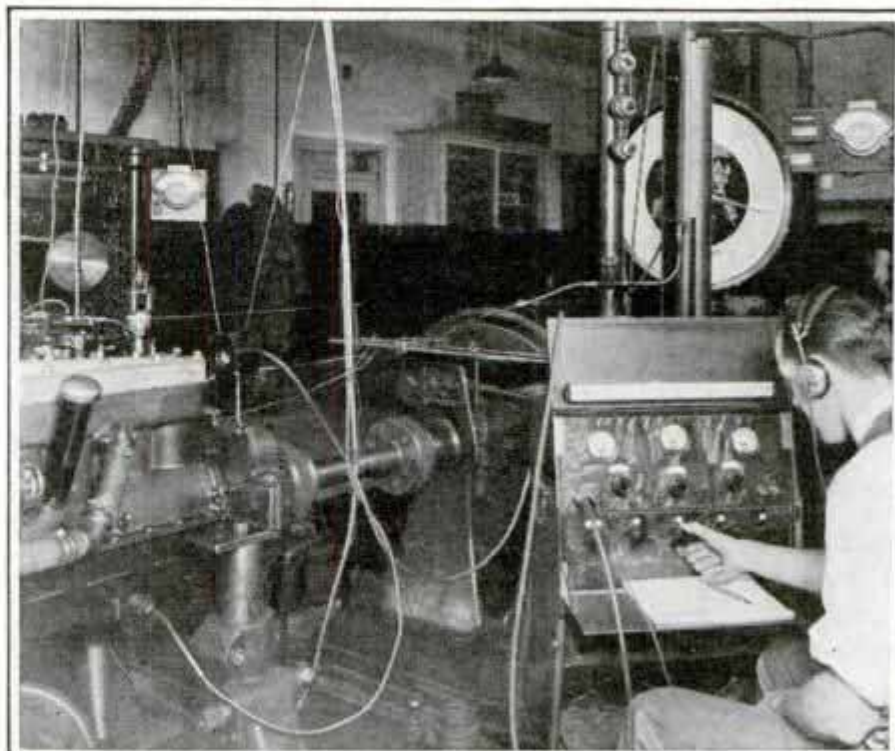

Listening to Interior Noises of Engine; Microphone Picks Up Sound from Cylinder and Carries It to Engineer's Headphones

Bohn Aluminum and Brass Castings

D7669

SECRETS of the

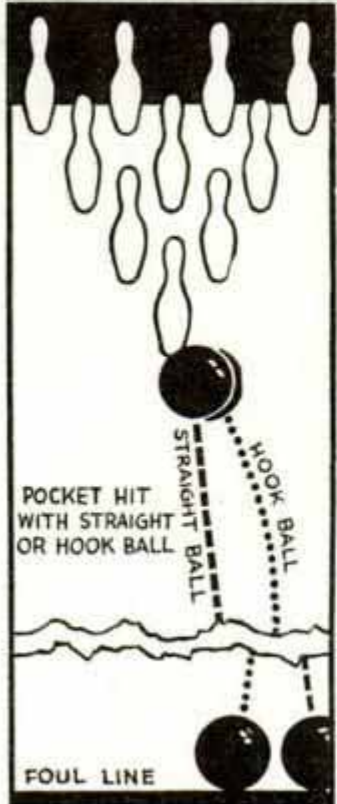
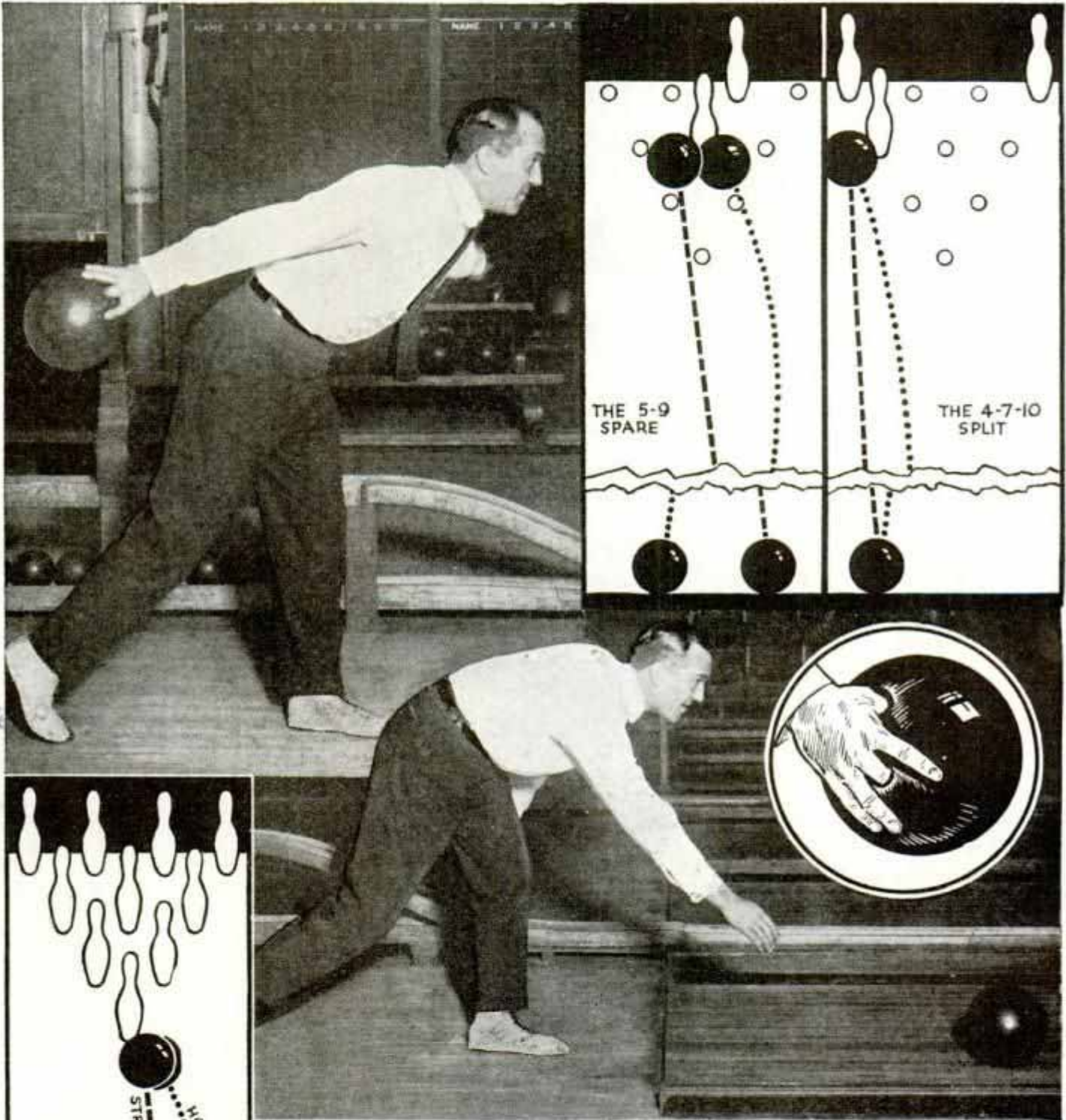

George S. Jarrett, Expert Bowler, Demonstrating the Approach, the Roll and Way to Hold Ball; Above, Right, Two Shots Which Are Difficult with Hook or Straight Ball; Left, Pocket Hit with Straight and with a Hook Ball

By **MORT LINDSEY**

THE only difference between the expert bowler and the dub is control. To roll strikes you must get the ball in the pocket, between the one and three pins, and to make spares you must hit the standing pins just right.

The biggest mistake of most beginners is

D166 Cont. Robert W. ...
1115 - 19 H St NE
Washington DC

MASTER BOWLERS

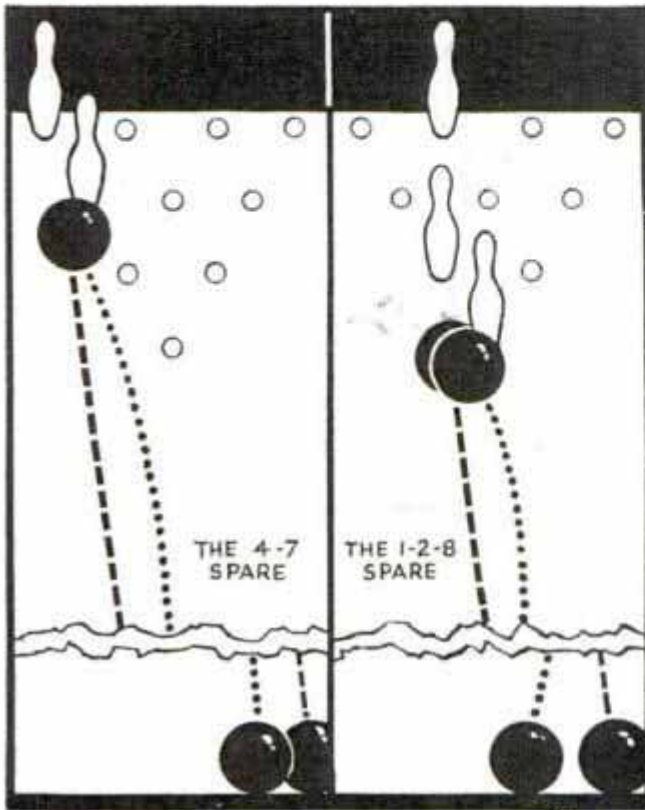

The Author and Illustration of Two Simple Spare Shots with Straight or Hook Ball



in reaching for the crayon too soon. You can see them on any alley. They pick up a ball—almost any ball—send it down the alley and wait for a lucky roll. The smart beginner forgets about the score until he has learned control. To control the ball, you must have a ball that can be controlled. The holes must be so spaced that the hand need not be stretched unnaturally, and the thumb hold must fit snugly, yet must not hang when the ball is released.

When the proper ball has been selected, lay it aside and develop your footwork. Standing ten or twelve feet back of the foul line, hold your hands in front of you as if carrying the ball and walk slowly forward, three or four steps, swinging the right arm. End the stride on the left foot, with the right foot back, the right arm completing the swing and following through.

Now try it with the ball. Hold the weight in the palm of the left hand, testing the grip with the thumb and third finger of the right hand. Now practice striding to

the foul line and releasing the ball. Make no attempt to knock down pins, but just get the ball down the alley, concentrating on your stride and swing until they are in rhythm. Try to end the stride with a short slide of the left foot, as a sudden stop will cause you to pitch the ball instead of rolling it. Don't try to copy the style of any bowler, but develop footwork and a swing that are natural and enable you to maintain balance.

Next you want to hit the one-three pocket. Most good bowlers pick out a spot near the foul line from which their natural delivery will hit the pocket, and attempt to start the ball as near this spot as possible every time. The true spot bowler picks out a spot and keeps his eyes on it until after the ball has been delivered, when he raises his eyes to watch the pins. Billy Knox, long one of the country's leading

(Continued to page 138A)

No. 11076 of 11/11/1935

Batesville, Ind

shown at Furniture Mart



acme
Latest in Lounges Is This Sled Type, Complete Even to Runners; Book and Magazine Rack at Left Matches the Lounge

LOUNGE BUILT LIKE A SLEIGH IS LATEST IN FURNITURE

Constructed along the lines of a sleigh, the latest lounge is cushioned with a white cord mattress and pillow. It even has runners, curving upward to the head of the lounge, instead of conventional legs. A magazine rack, ornamented with deer, matches the lounge.

SPINNING DISKS SEEN AS SOURCE OF CHEAP ELECTRIC POWER

Electricity generated by huge disks spinning in a vacuum and "piped" long distances along vacuum surrounded rods, thus carrying cheap energy from water-power developments or coal and oil fields to centers of population, is a possibility suggested by Dr. Karl T. Compton, chairman of the science advisory board, in a research project recommended to President Roosevelt for federal financing. The 10,000,000-volt electrostatic generator built by the Massachusetts Institute of Technology is evidence of the practicability of such a power-producing system and the transmission system proposed is an airless pipe with a rod running through it. Instead of alternating current, the proposed generators would produce direct current at about 1,000,000 volts. The big disks would be surrounded by vacuum because of the necessity of preventing tremendous

Miss. Inst. of Technology Cambridge, Mass. 1935

2113 48th St. Wash D.C.

Science Service

sparks which might wreck the equipment. If this power-production dream is realized, it will be like turning the clock back, in a sense, because the first electrical machines were of the electrostatic type, while modern generators and motors employ the electromagnetic instead of the electrostatic principle.

6-2
LATEST IN CITY HOME EMPHASIZED BY LIGHTS

Extensive use of glass is one feature of the construction methods employed in a town house completed recently in New York. An example of the modern trend, the structure lends itself to unusual treatment in lighting, the resulting brilliancy being impossible to produce in the conventional home. A photograph of the house, illuminated, offers a comparison of the old and new.

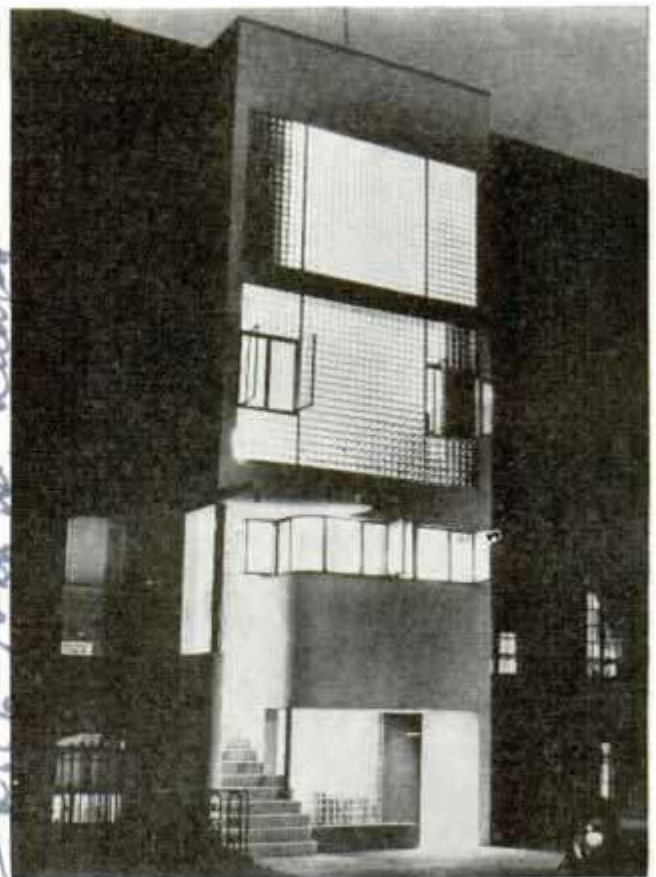

Night View of Town House Shows Effectiveness of New Methods of Illumination

Quiner. Wellman

D1642

Harbor Boat Bldg Co. plans
Owner - John Rados,
Terminal Island Calif

Boat Is 'Stretched' to Increase Size and Speed

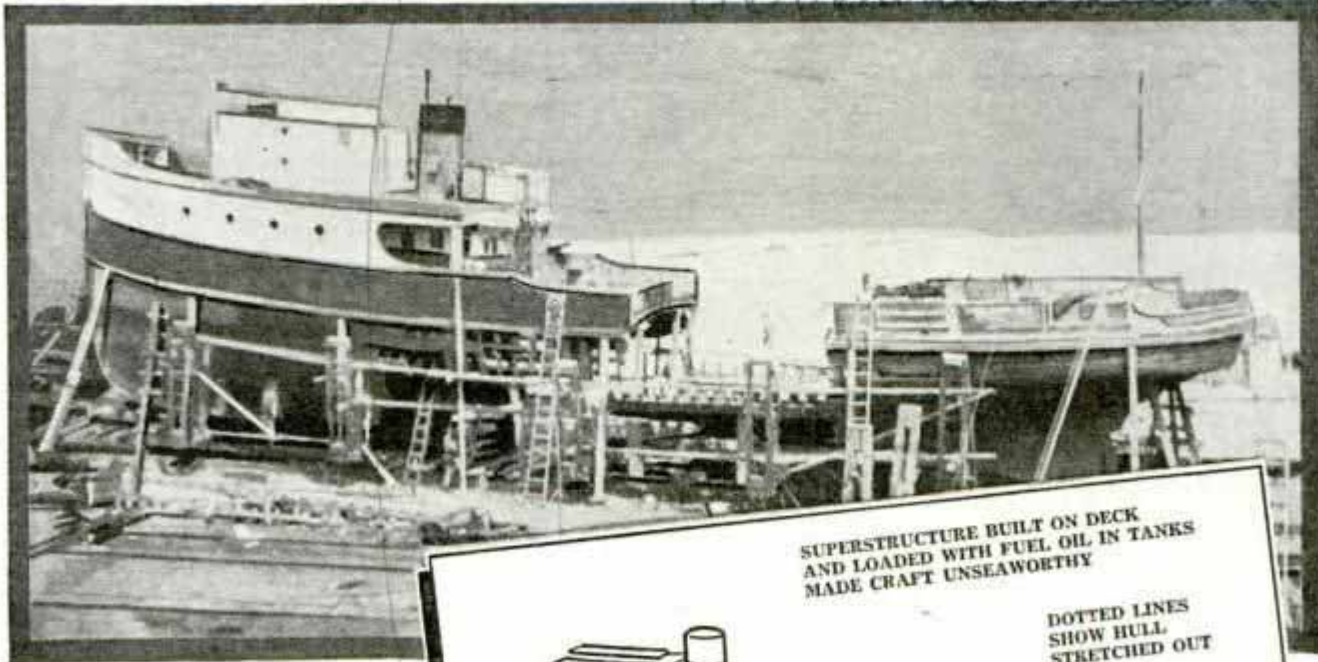

The "Rainbow" During "Stretching" Operations and Diagram Showing How It Was Cut in Two and Lengthened

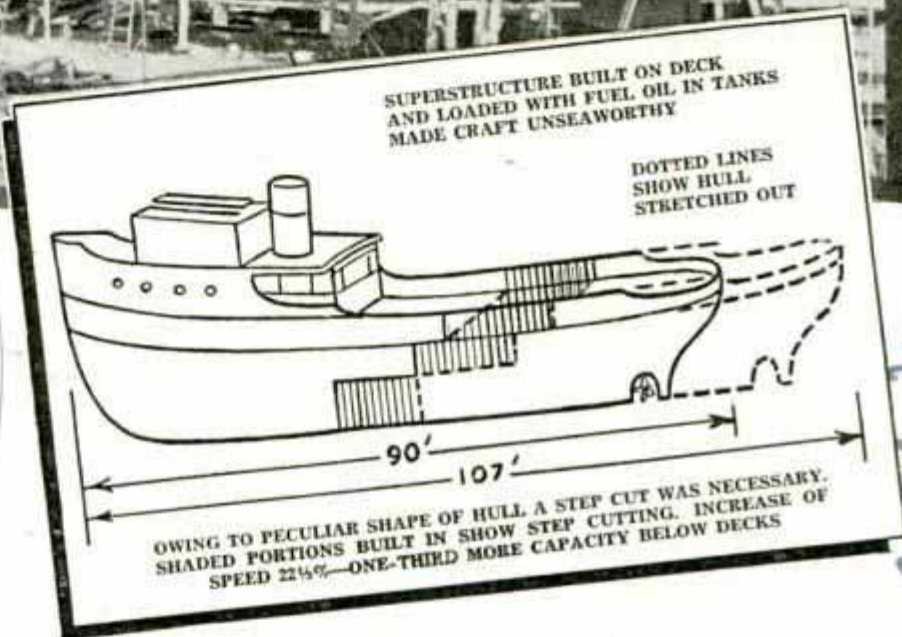

By "stretching" a ninety-foot fishing clipper, a California boat builder added seventeen feet to its length, increased its cargo space by one-third and added more than twenty per cent to its speed. The craft, the "Rainbow," capsized after a superstructure had been added to increase her cargo space. After being raised the craft was sawed in two and a new hull

section inserted in the step-like cut amidships. The boat, lengthened to 107 feet, thus was given more buoyancy and better balancing to counteract the added weight.

cmd. Max well O'Leid Island!
5 1/2' Escondido Blvd.
Los Angeles, Calif

Handy Air Pressure Hammer Smooths Out Car Fenders

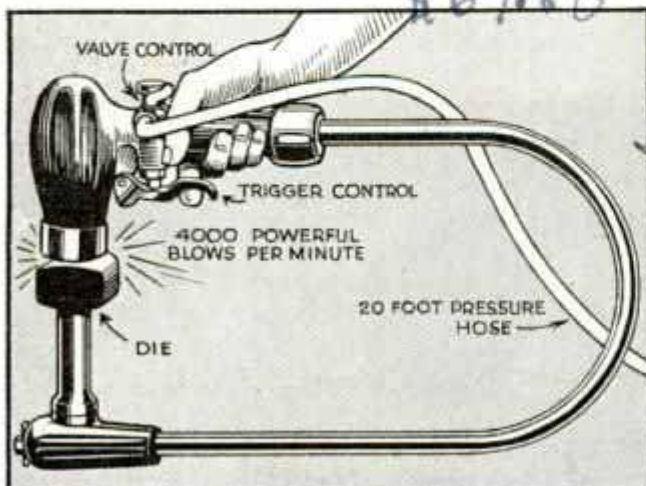

Sketch Shows Controls on New Air Hammer

Dented fenders, hood, doors and other metal surfaces of the automobile can be smoothed out by a handy air pressure hammer that delivers 4,000 regulated strokes per minute. The strokes are powerful enough to smooth out heavy sheet metal or gentle enough to handle a metal tire cover. Two arms of the tool fit all the sweeps and curves of the modern auto. Eight assorted dies are furnished for all types of curved, angular and flat surfaces. The hammer is regulated by two controls, a trigger for starting and stopping and a valve governing the air pressure, both of which are hand-operated.

Wearer Mfg Co. Springfield, Ill.

New CONVENIENCES



Left, Non-Tipping Plate for Children Holds Entire Dinner, Including Cup for Milk; Plate and Cup Are Made of Synthetic Plastic Material That Is Sanitary, Stainless and Non-Shatterable



Above, Electric Coffee Maker Percolates Beverage in Cup to Taste; Its Immersion Heater Makes Coffee in Four or Five Minutes

Right, Small Anti-Slip Pad for Rugs Is Attached by Moistening and Pressing with Hot Iron; then White Backing Is Peeled Off, Exposing Special Surface That Grips Floor; Bottom, Left, Washing Machine Drain Requires no Water Pressure to Operate; Made of Rustproof Metals, It Can Be Connected in Ten Minutes with Only a Screwdriver

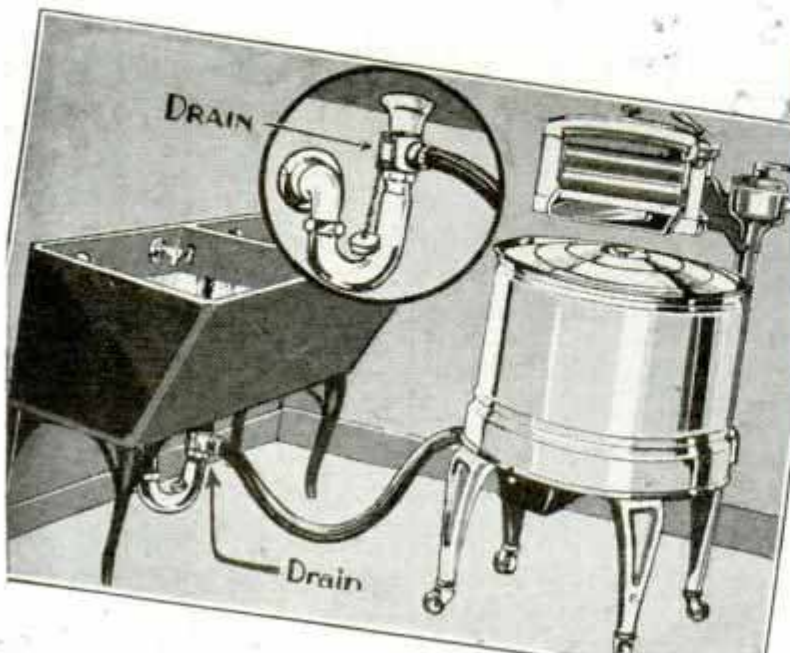

Above, Bread Box That Aids in Slicing; Loaf Is Pushed Against Adjustable Flange on Door and Knife Is Passed Through Guide Slots for Slicing; Meat or Cheese Also Can Be Sliced on This Handy Device

for YOUR HOME

Right, Portable Electric Range of Double-Steel Construction; It Can Be Moved to Convenient Socket for Cooking Entire Meal; Two Outside Burners and Oven Are Provided

Below, Thermometer Floats in the Bath and Registers Temperature of the Water; Parts Are Made of Non-Rusting Materials; Dial Is Porcelain Enamel, About Two Inches in Diameter; Thermometer Comes in Colors



Below, Center, Hot Pan Lifter Prevents Burning Hand and Arm When Handling Utensils around the Stove; It Lifts Any Pan or Dish That Has Extended Lip or Edge; Right, Modern Version of the Thermometer Also Gives the Humidity Reading; It Has Black and Chrome Case

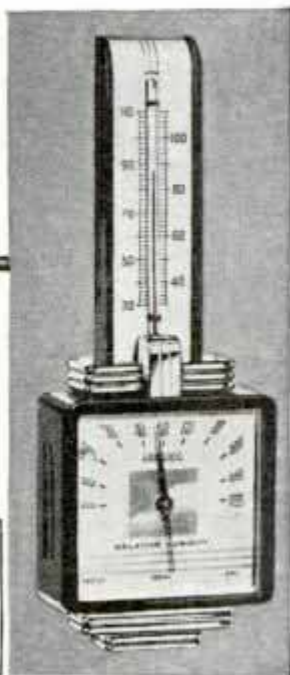
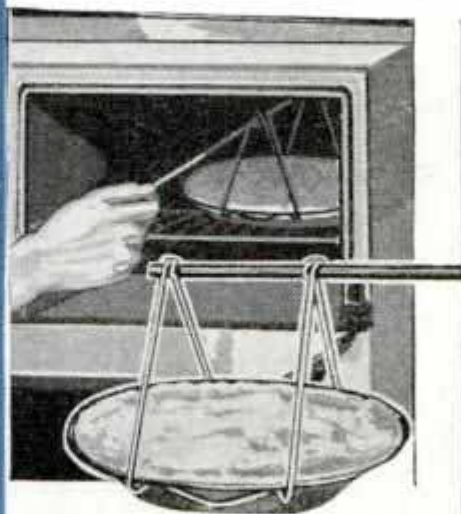

Above, Left, Floor Wax Applicator That Requires no Bending or Stooping; Can of Wax Is Attached to the Device; Wax Is Released in Even Film by Pulling Trigger Ring on Handle; After Using, Pad Can Be Removed and Washed

Auto Signal Amplifier Makes Passing Safer

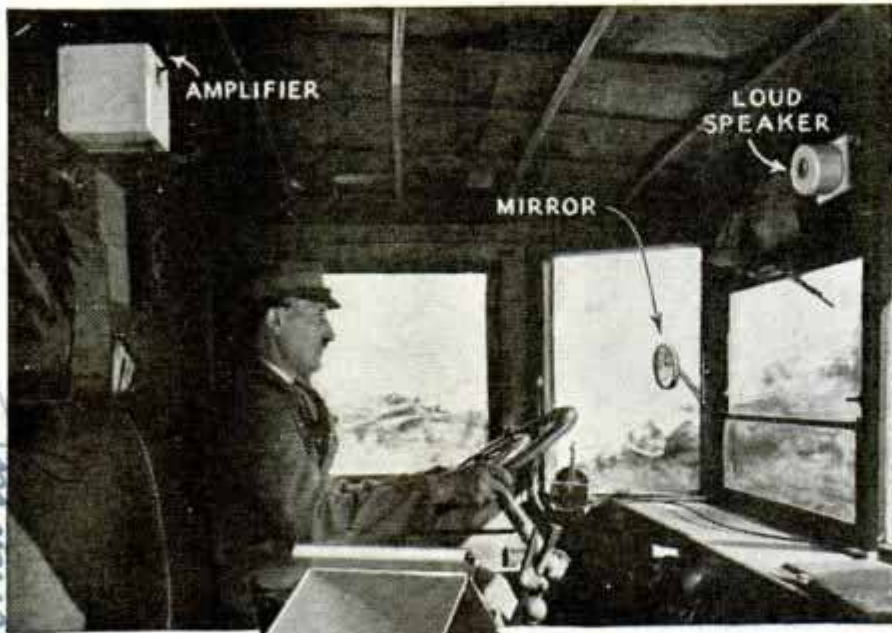

an ordinary automobile siren 100 feet behind and carry it to the ears of the bus or truck driver. A signaling device with which the commercial driver may reply that he has heard the car driver's siren can be incorporated into the system.

**ACCIDENT SQUADS
FIX BLAME AND
AID VICTIMS**

Recently organized accident squads in Berlin not only render first aid on arriving at the scene of an automobile collision but also are equipped to fix responsibility for the accident. This they do by making photographs of the cars involved, taking careful measurements of the relative positions of the automobiles and obtaining the statements of witnesses while all details of an accident are fresh in their minds. The squads were organized in an effort to decrease the number of motor fatalities in the German capital.

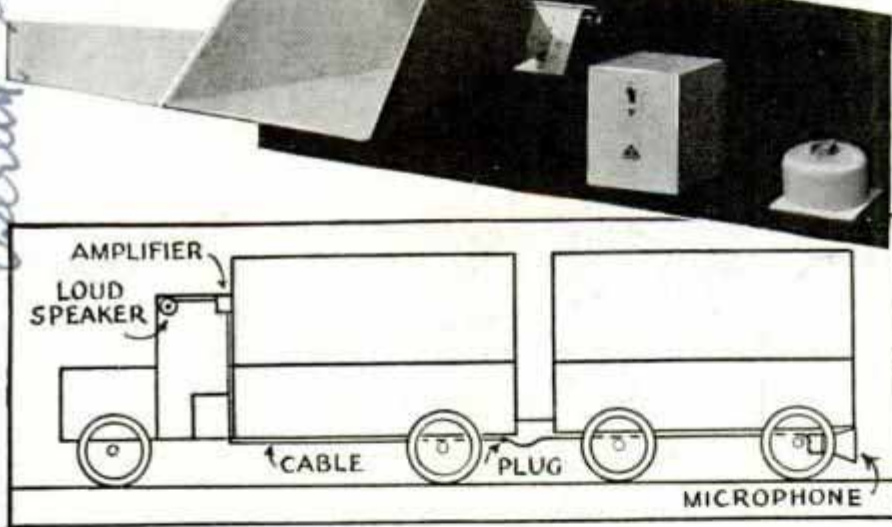

*Equipment in Truck Cab Amplifies Sound of Siren on Car Following;
Bottom, Microphone Installation on Truck and Trailer*

Increased safety for both vehicles in passing on the road is claimed for a German-made device that amplifies the signal of the car behind and carries it to the cab of truck or motor bus ahead. Electrical current from the starting battery runs a small loud speaker located in the driver's cab. The speaker is connected to a microphone box at the rear of the truck or the rear of the trailer if a two-vehicle train is being operated. The special equipment is necessary only for the commercial vehicles, since the amplifier system will pick up the signal from



Accident Squad Taking Measurements at Scene of a Collision

Messrs Siemens & Halske, Siemensstadt
 Berlin, Germany
 No U.S. agent.

D 1643

Berlin

Paul



Portable Five-Meter Transceivers

PERHAPS the most interesting piece of amateur radio apparatus is the portable 5-meter transceiver. It gets its name from the fact that it is a combination transmitter and receiver using the same tubes and accessories for both purposes.

Recent improvements in transceiver design have increased their range and portability; the new models are very compact and it is even possible to operate them in moving cars. The portable transceiver illus-

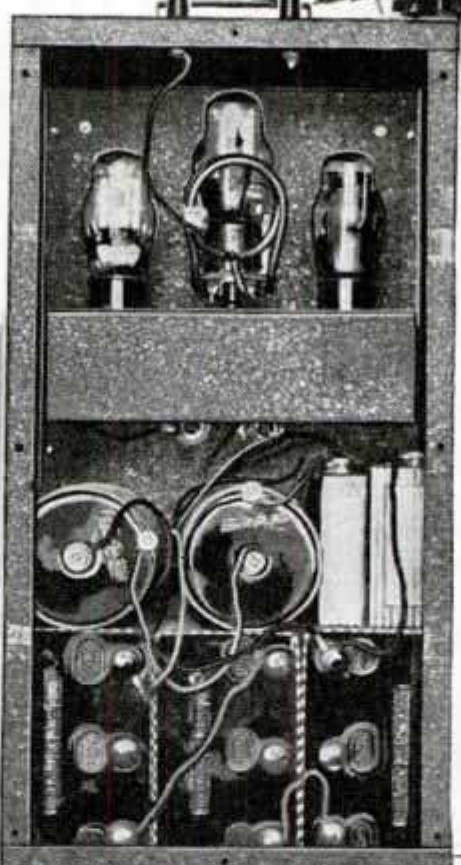

trated, is available in kit form for home assembly. One type-30 and two type-19 tubes are used in a highly efficient circuit. Two binding posts are provided on the top of the case for the antenna or feeder connections. Excellent results, however, were obtained with the 4-ft. length of aluminum tubing mounted on one of these stand-off insulators. Dry batteries are used for the power supply, one set withstood two months experimental service.

D4691
Wholesale Radio Service Co.

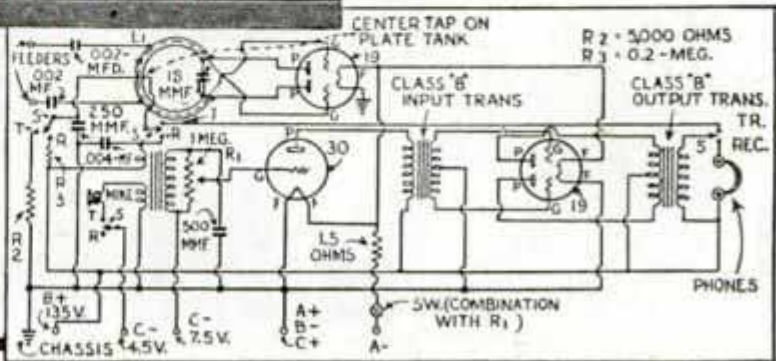



FARM SET

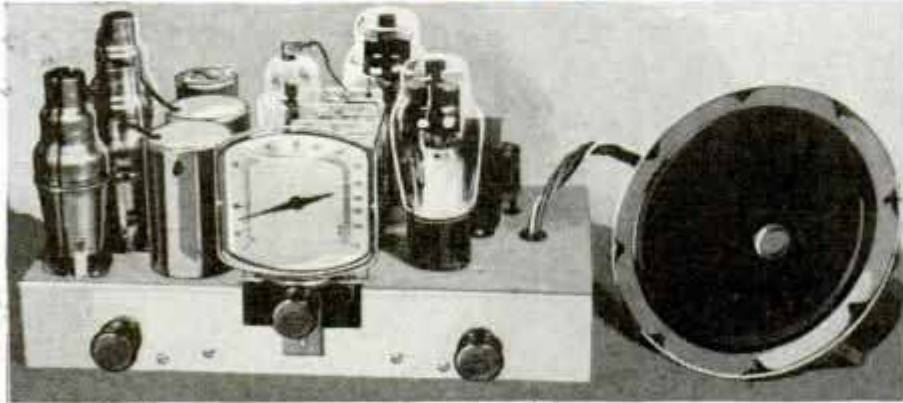

NO B-eliminator or batteries are required for this 6-tube broadcast receiver which operates directly from any 32-volt lighting plant. There are about 300,000 farm-lighting plants of this description now in use and many of the owners are depending on small batteries, or expensive converters, to operate their radio sets. All parts necessary to assemble the receiver are

available, and the construction details have been simplified so that anyone who can use a soldering iron will have no difficulty in building it.

The set has excellent volume, tone and range in spite of the fact that only 32 volts of power are required. In fact the performance equals that of many receivers employing the same number of tubes on standard power sources. Some of the outstanding features are: automatic volume control, superheterodyne circuit with tuned r.f. stage, tone control, high-gain r.f. coils, push-pull audio and a new type aeroplane dial. The secret of the unusual efficiency of this set is due to the type-48 output tubes and a specially designed super-sensitive dynamic speaker. An ordinary dynamic or magnetic speaker cannot be used. The entire cost of the parts, including the metal chassis and speaker, is less than \$15.00. Tubes are not included in the estimated cost of the construction parts. The completed receiver may be installed in practically any type of cabinet if there is sufficient room for the 6½-in. dynamic speaker. During tests, the set was used without a cabinet, the speaker being mounted behind a wooden baffle, 24 in. square and 1 in. thick.

Fig. 1 shows the dimensions of the sheet-metal base for those who wish to make their own. The holes for the wafer-type tube sockets are 1⅛ in. in diameter; the two larger holes, for the antenna and in-

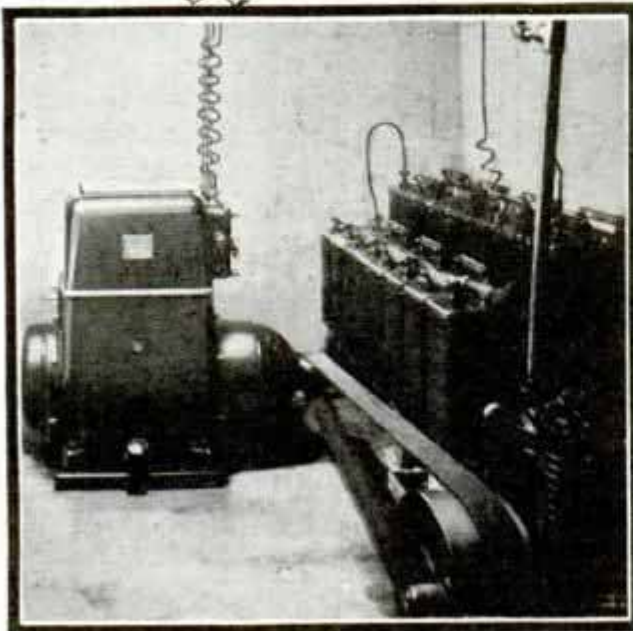
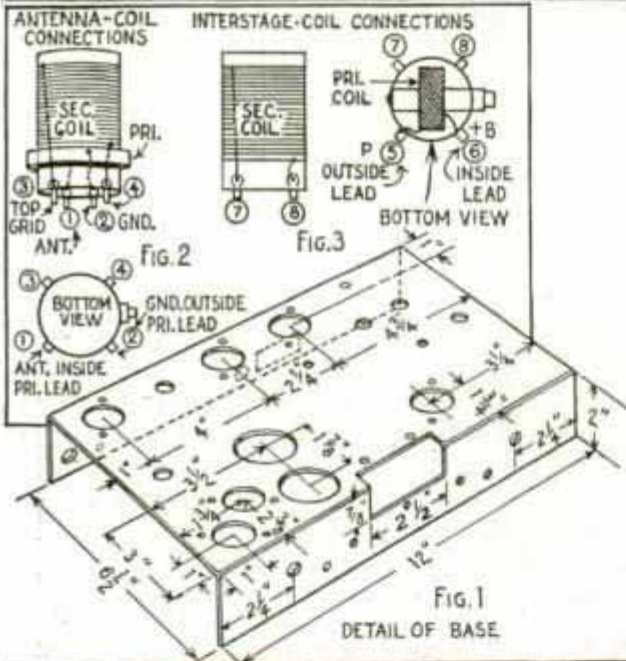

WORKS *on* 32 Volts D.C.

terstage coils, are $1\frac{3}{8}$ in. in diameter. The connections for these coils may be easily traced by referring to Figs. 2 and 3. A simplified wiring diagram is given in Fig. 4 and the schematic in Fig. 5.

It will seem odd when examining the diagrams, that positive B is also connected to the heaters of the tubes, however this is absolutely correct. No tube has more than 32 volts on the plate; series

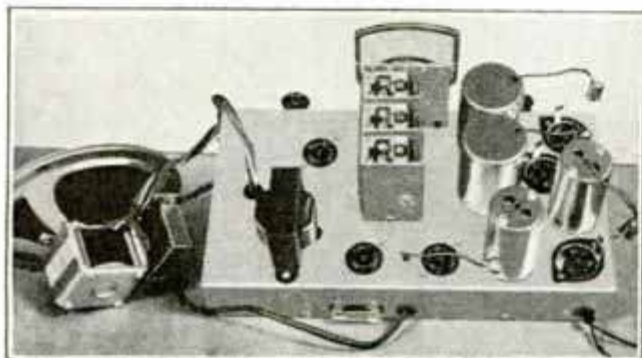

wiring provides the necessary voltage drop for all tube heaters except for the type-48 tubes which operate on the full 32 volts. Ordinary hook-up wire is used for the circuit and a 4-in. length of flexible metal shielding should enclose the leads running to the volume control. This shield must

(Continued to page 116A)

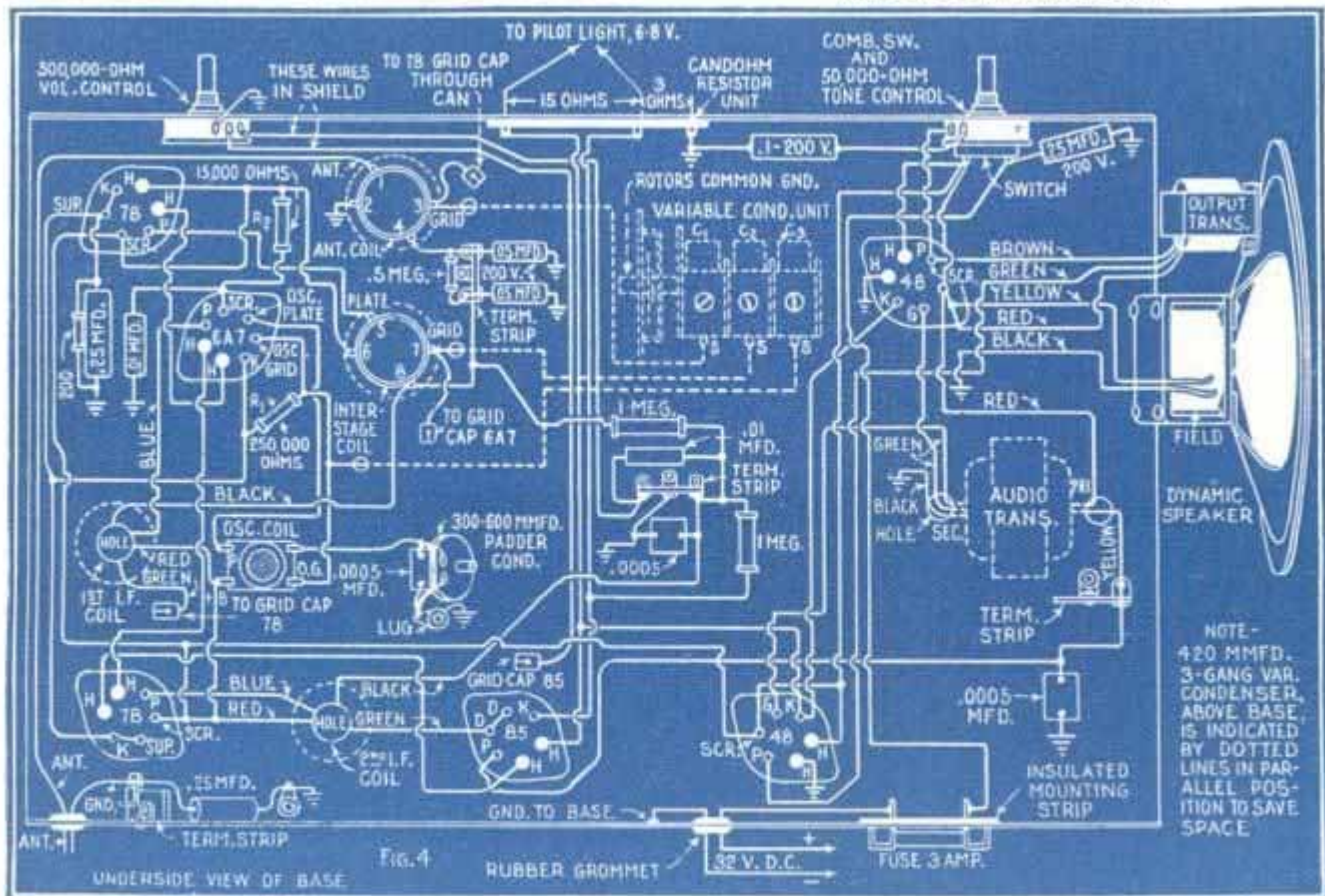

All-Wave Super Built with Standard Parts



Above, Front Panel View of All-Wave Super in Operation; Below, Rear View of Completed Chassis

THIS junior model band-spread all-wave a.c. superheterodyne receiver is the result of collective cooperation on the part of a number of the leading engineers in radio, each man a specialist in some particular radio part manufacturer's staff. Any radio experimenter, or student, can build this set in one evening on the kitchen table with a screwdriver, pliers and soldering iron.

The finished design consists of a set of plans, diagrams and a parts list. Although this is not a kit set, the designers have provided a foundation unit which consists of a drilled front and sub-panel available for \$2.25; all the remaining parts may be obtained from radio supply concerns. The experimenter with limited funds can start with the foundation

unit and purchase a few parts at a time, thus buying a complete radio receiver on the installment plan, which he assembles at leisure. This slower method often results in better workmanship and a clearer understanding and appreciation of the finished job. World-wide reception is the reward of the careful home constructor; special features not found in sets designed for the general public are built into this all-wave, all-electric receiver.

A complete itemized parts list including further necessary information, together with the names and addresses of the various manufacturers, can be obtained from Popular Mechanics radio department upon application without charge. Practically no technical knowledge is necessary to assemble the set as each step is carefully illustrated. The 5-tube superheterodyne circuit is continuously band-spread and employs a type-6A7 tube as a combination oscillator and mixer. A 6F7 pentode-triode tube works as an intermediate-frequency amplifier on a frequency of 370 k.c. The triode part of the 6F7 tube is connected as a beat-frequency oscillator, with a control switch on the front panel, as indicated by the letters B.F.O. in Fig. 1. This enables the operator to locate weak foreign stations quickly. When the switch is turned on, a whistle will be heard whenever a carrier wave is crossed while tuning. Any such carrier may be tuned easily to exact resonance, after which the beat-frequency oscillator can be switched off. A type-77 pentode detector tube is resistance-coupled to a

(Continued to page 118A)

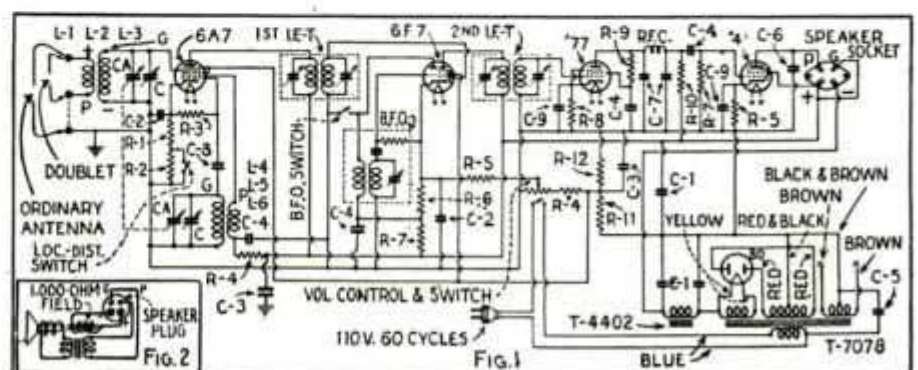

HINTS for RADIO EXPERIMENTERS

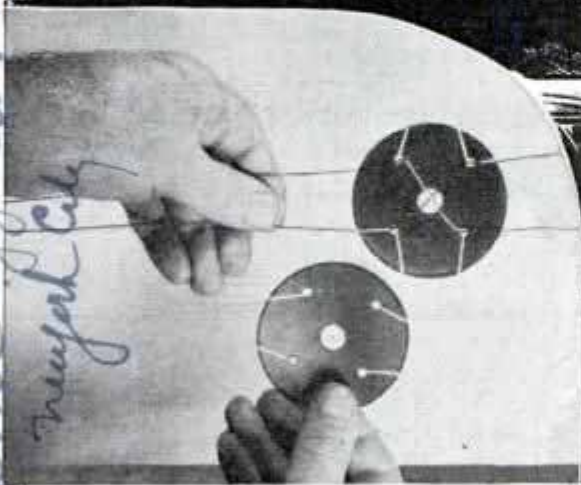

Doublet Transposition Insulators from Old Phonograph Records, Cut and Slotted on Scroll Saw



Left, Through-the-Panel Insulators for Single-Hole Mounting, Jack Types Have Soldering Lug



Left, Low-Loss Coil Form Has Threaded Shelf Inside for Mounting Variable Trimmer Condenser to Tune Coil to Fixed Frequency

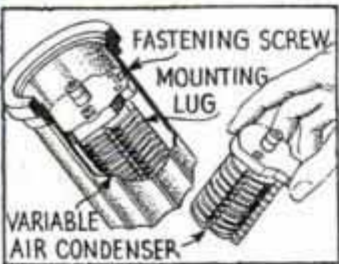

Below, Strip of Copper Screen under Fabric Tire Cover on Spare Tire, Makes Good Auto Antenna; Shield Lead to Set

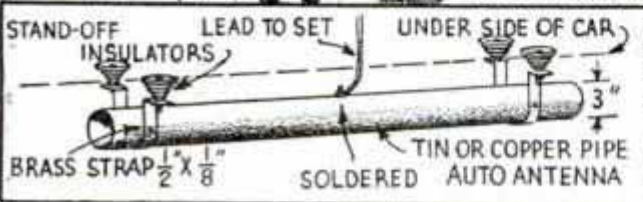

Clip for Adjusting Rod-Type 5-Meter Antenna; the Usual 40 Inches Varies More or Less for Exact Frequency

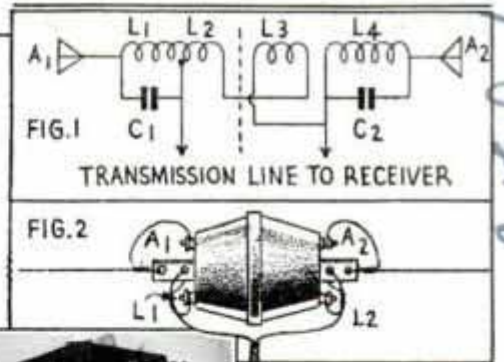

Duplex All-Wave Doublet Antenna Coupler Claimed to Be Efficient from 5 to 600 Meters; Figs. 1 and 2, Show Coil and Fixed Condenser Arrangement Housed in Bakelite Case Shown in Photo

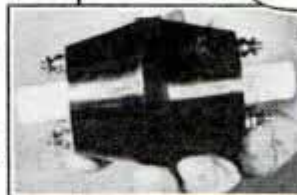

Capacity-Type Auto Antenna Made from Copper Drain Pipe, or Similar Material, May Be Easily Mounted on Stand-Off Insulators under Car

As in my book my Ca 724 41 33rd

E. F. Johnson Co. 227 Fulton St. Wash D.C.

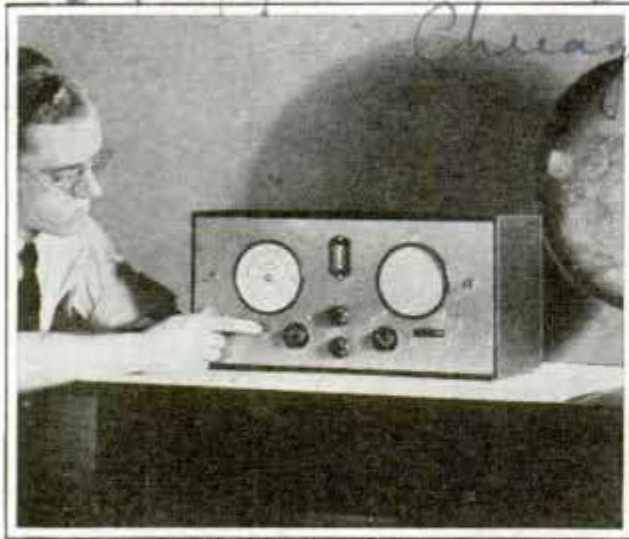

Front Panel View of Compact A.C. Short-Wave Receiver Which Employs Regenerative T.R.F. Circuit

Short-Wave Set Is Self Contained

Complete in one unit, this inexpensive regenerative receiver includes a dynamic speaker and a.c. power supply. It tunes from 13 to 200 meters and is housed in a neat metal cabinet. Tested in Popular Mechanics radio laboratory, the following features were noted: good sensitivity and selectivity with exceptionally low background noise on foreign stations. No plug-in coils are required and band-spread tuning is provided.

Homemade Wrenches for Special Uses

When small nuts are employed in out of the way places for mounting transformers and other parts, the experimenter often finds that it is difficult to reach them with ordinary wrenches or pliers. Wrenches of

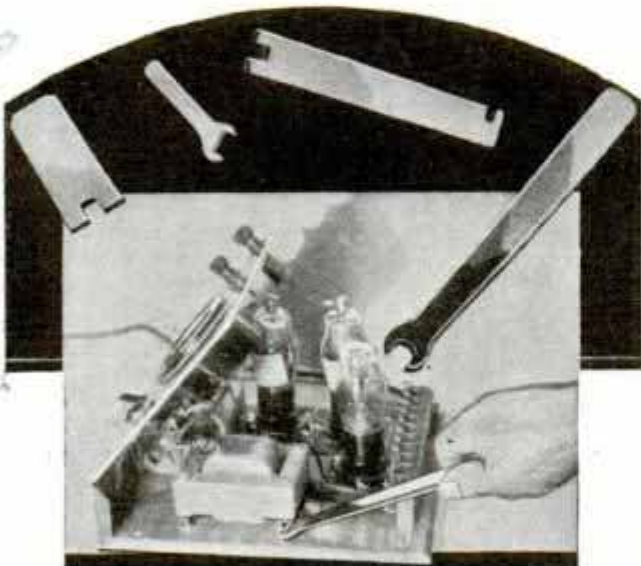

Special Purpose Wrenches Made from Scrap Metal; Handy for Tightening Nuts in Awkward Locations

suitable size and shape may be quickly made from scrap metal. A hole, equaling the diameter of the nut, is drilled near the end of the strip and two straight cuts with a hacksaw complete the tool.

D466/

Portable A.C. Voltmeter Simplifies Set Checking

One of the handiest devices available for testing a.c. operated receivers is a small portable a.c. voltmeter of the multi-range variety. These meters are provided with pin tipped 30-in. flexible cables for plug-

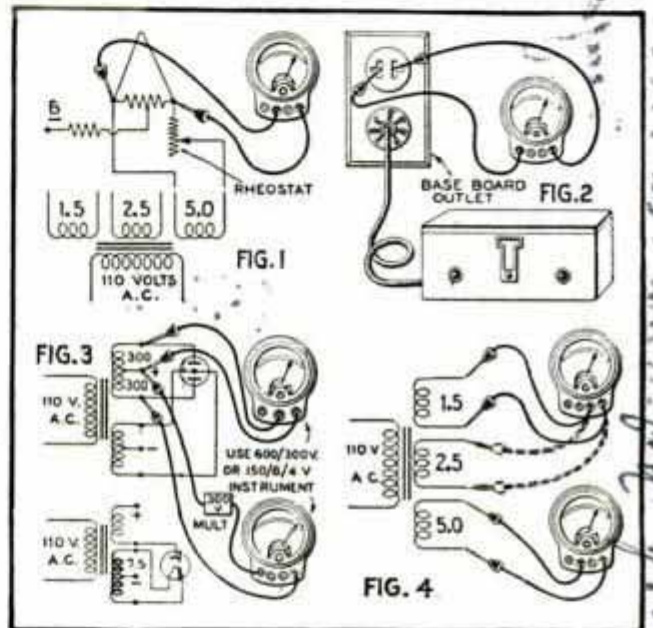

Multi-Range A.C. Voltmeter Checks Both Input Line and Output Voltages

ging into connection jacks on the instrument. Fig. 1 shows the method for adjusting a filament-voltage rheostat for correct tube operation. Line voltage, subject to fluctuation, is checked as indicated in Fig. 2. Radio amateurs and service men measure plate winding output voltages in the manner shown in Fig. 3. Critical filament winding output voltages are accurately measured by merely shifting the test leads as illustrated in Fig. 4. Designed in dual and triple ranges, these voltmeters afford an accurate check of input line voltage and the same instrument can be used for measuring ordinary secondary outputs.

Blueprints covering radio construction articles in past issues can be obtained for 25 cents each; when material lists are not included in the articles, these are available without charge on receipt of postage.

Western Electrical

6/19 of rebringsmen are new... 6/19 of rebringsmen are new...

Nicholson & Co. 79 Sudbury Boston Mass

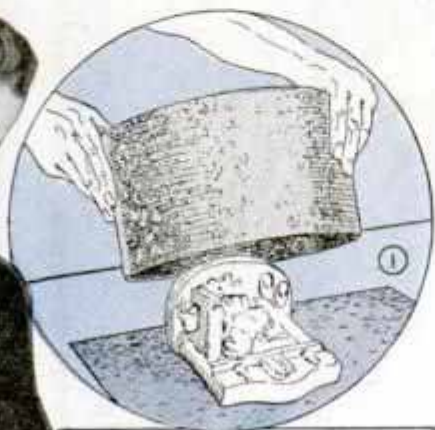

The model is placed on a sheet of tin and a tin retaining wall holds the melted molding compound, which is poured over the model

The next step is to melt the gelatin. It is melted in a double boiler, with water in the lower part. It is important to melt the gelatin slowly to avoid the formation of bubbles. Stirring occasionally while the gelatin is melting, will help. If you are doing a lot of this work, a large double boiler can be made from two pails as in Fig. 4. The inside and smaller pail has a cone, a tube soldered around a hole in the bottom, the tube passing horizontally through the side

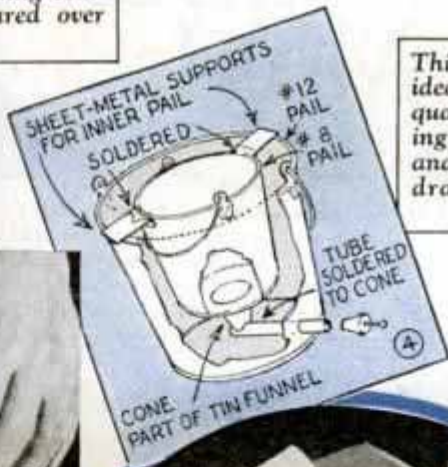

This "double-boiler" idea keeps a large quantity of the molding compound liquid and allows it to be drawn off without air bubbles



Above, after the molding compound has cooled to a stiff, jellylike consistency, the sheet-metal wall is removed. Right, when removing an intricate model from a mold, it is sometimes necessary to cut the mold with a knife, at points where the cut will meet the corners of the model



of the outer pail, where the open end is plugged with a stopper. This arrangement allows you to draw the melted gelatin from the bottom where there are less bubbles than at the surface. The large capacity of this double boiler makes it possible to fill a number of forms at one time. It is important to avoid the formation of air pockets when pouring the gelatin and for this reason it must be poured slowly.

After the gelatin has been poured to fill the form, it is al-

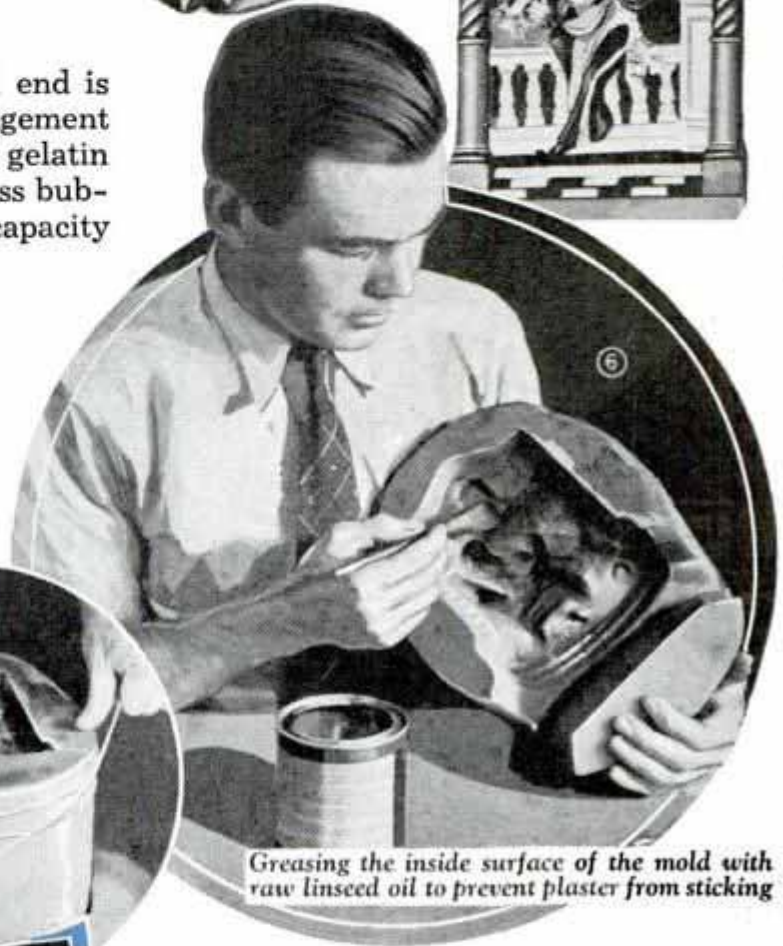

Greasing the inside surface of the mold with raw linseed oil to prevent plaster from sticking

Right, a split mold must be held together firmly with cord before the plaster is poured. Below, well-mixed plaster is slowly poured into the mold



The surplus plaster projecting beyond the surface of the mold is scraped off flush



lowed to cool, preferably overnight, in which state it will have a stiff, jelly-like consistency. The cord which holds the side of the form together is cut and the strip is pulled away as in Fig. 3. Removing the model from the bottom is next. Often simple models can be removed without the need of cutting the form, but in the case illustrated, it was necessary to cut the side of the mold at two points, Fig. 5. When doing this, make the cut at a corner of the model so that it will be less noticeable than if it were made over a flat surface.

The mold can be used for molding just as it is, in a room where the temperature is not higher than 50° Fahr. If you do the molding where the temperature is higher than this, the inside surface of the mold must be given two coats of slow drying



The molding compound can also be used to make flexible cuts of lettering and pictures

varnish, the first being allowed to dry thoroughly before applying the second. Then, when the second coat is dry, and you are ready for molding, the inside is greased with raw linseed oil as in Fig. 6, after which the mold is tied together with cord as in Fig. 7. For mixing the molding plaster (No. 1 grade molding plaster, at hardware stores), use a bowl of suitable size to hold the entire mixture, the proportions of which are, $\frac{3}{4}$ cupful of cold water to each cup of plaster. The mixture should be thick and creamy, but thin enough so that it will level itself when poured. After filling the mold level with the top, as in Fig. 8, the excess plaster is scraped off the flat, open side with a strip of tin as indicated in Fig. 9.

Now allow the plaster to set until it hardens, which will require from 20 to 45 min., depending on the amount and thickness of the mixture. Then remove the casting from mold which will be an easy matter as the latter is flexible. It can be re-greased, and used over and over again for molding as many castings as you desire. The finished castings can be left plain, coated with clear varnish, or they may be attractively painted and then given a coat of good varnish.

Another use to which the gelatin lends itself is the making of flexible stamps for printing lettering and pictures. To make the stamps place two strips of heavy cardboard or thin wood, about $\frac{1}{8}$ in. thick, on a square piece of sheet metal, after which some plaster is poured between them and smoothed down to a uniform thickness with a strip of tin as in Fig. 10. With a stylus, cut in the lettering or pictures, and then pour on some melted gelatin. When this is dry it is peeled off the plaster and glued to a block of wood.

Insulated Wire Used as Model Parts

On an architect's model of a gasoline filling station, which required measuring pumps to complete the assembly, the problem of making realistic hose for the pumps was solved by using red rubber-covered radio wire. This wire is available in many diameters and can be had in several colors, which makes it adaptable to model locomotives and other model jobs. It has the added advantage of being flexible so that it can be bent to permanent, natural curves as required.

Suggested A. Sengger & Co. 159 W. Kinzie Chicago

Small Ash Tray Clamped to Reading Lamp

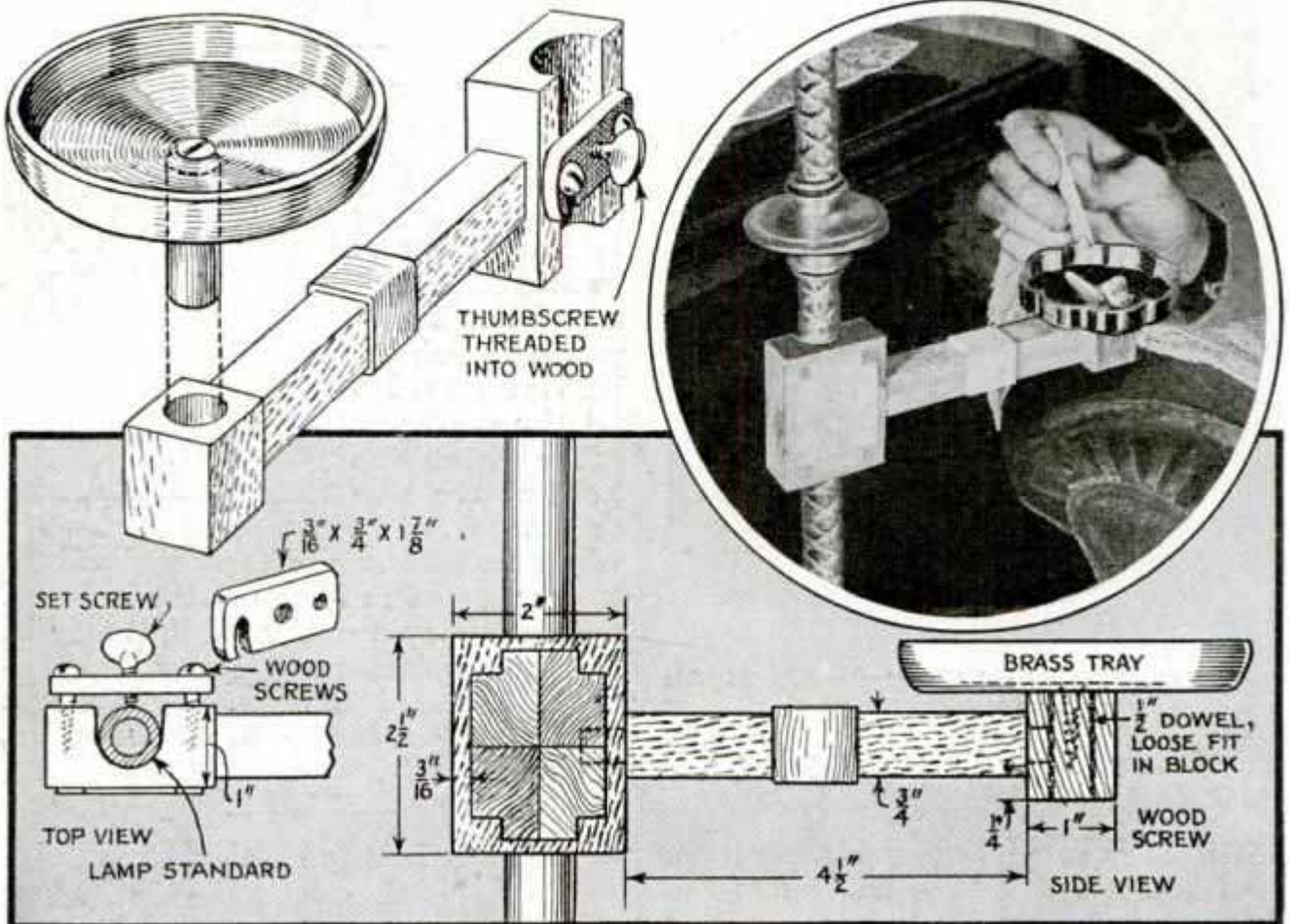

Clamped to the standard of a floor lamp by means of a decorative, wood arm, an ash tray is always at hand when reading in your favorite chair. Besides being adjustable in height, the tray can be moved from one lamp to another one. The arm and clamp may be made inexpensively from some rare wood, or you can use common wood and cover it with fancy veneer.

In this case, the arm is mahogany banded in the center with satinwood veneer. The clamp is also mahogany, and is overlaid with a design cut from satinwood. The arm is doweled to the clamp and to a wood block, which is drilled vertically for a dowel. The latter is a loose fit in the block, and is attached to the bottom of the ash tray with a wood screw.

Hobbles Prevent Chickens from Scratching in Flower Bed

When a hen must be turned loose in the yard with her brood of chicks, a piece of inner tube, cut to the shape shown, and slipped over her leg will help prevent her from scratching in flower beds. A hole of a size to fit loosely over the leg is cut in one end of the rubber. If the hen attempts to scratch, the rubber folds under her foot and has a tendency to discourage her from further scratching.

☞ A water stain should not be used on soft woods; it is better to use an oil stain or a penetrating spirit stain.

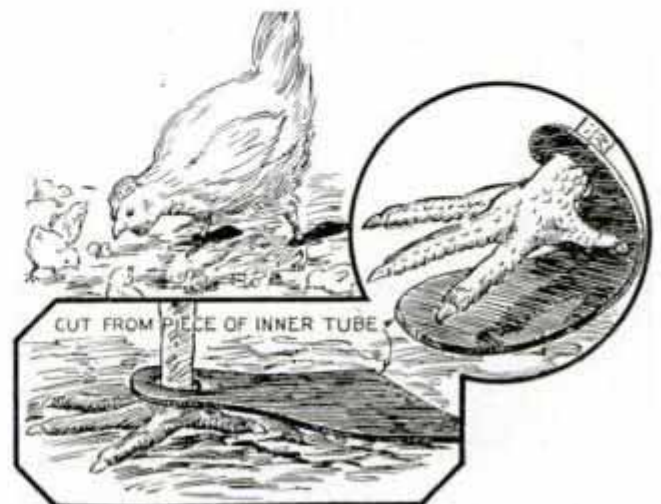



Clamped to a Mixing Bowl, This Device Adds Liquids to Mixtures a Drop at a Time

Homemade Device for Dropping Liquids into Mixtures

Riveted to a spring clamp, a small tin funnel, provided with a petcock in the spout, makes a simple device for adding oils to salad dressings or other mixtures where small amounts of liquids must be added, a drop at a time. The clamp is a piece of spring steel, which is bent at the lower end as shown to grip the edge of a mixing bowl.

Locker between Studs in Garage Holds Lawnmower

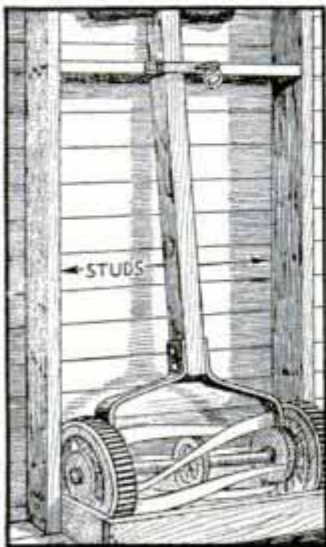

while another piece of the same material is

Built between two studs in your garage, this locker provides a good storage place for a lawnmower so that it will not be taken away if the garage doors are left open. A frame of 2 by 4-in. stock between the studs at the bottom extends out sufficiently to accommodate the mower,

nailed between the studs and notched to take the handle which is held in place with a hasp and padlock.

Sowing Tiny Seeds with Ordinary Medicine Dropper

Small seeds that are difficult to sow by hand may be planted easily with a medicine dropper. The rubber bulb is removed to fill the dropper, after which it is held above the shallow furrow in which the seeds are to be planted and the bulb squeezed to force out the seeds. If the seeds are unusually small, it may be necessary to decrease the size of the opening in the end of the dropper by heating it over an open flame.—A. S. Wurz, Jr., Rockyford, Alta., Can.

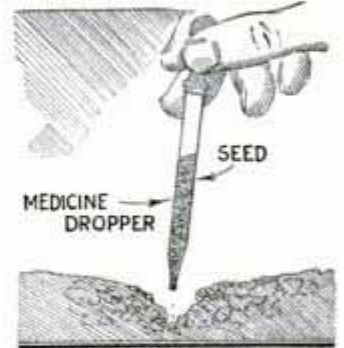

Models Lettered with a Stencil

Model makers who have difficulty in lettering their models will find that a stencil made of painters' adhesive or masking tape simplifies the work. It is best to cut



Stencil Made of Masking Tape Aids in Painting Letters or Figures on Models

the stencil on a piece of celluloid, as this permits getting a clean-cut job. The tape sticks tightly to the model so that there is no tendency of the stencil slipping, or of the paint working under the edges.

Speedy Coaster Has an Auto Steering Wheel

Here is a speedy little sidewalk coaster that can be put together in a couple of hours and if you have a set of rubber-tired wagon wheels and axles, the only extra equipment needed is a model-T Ford steering wheel and section of shaft or pipe. The steering cable is a length of sash cord wound directly around the steering post or shaft, and is fastened with a wire loop as shown. A coil spring keeps the cable taut and also acts as a shock absorber when hitting obstructions. The short wheel-base permits sharp turns and

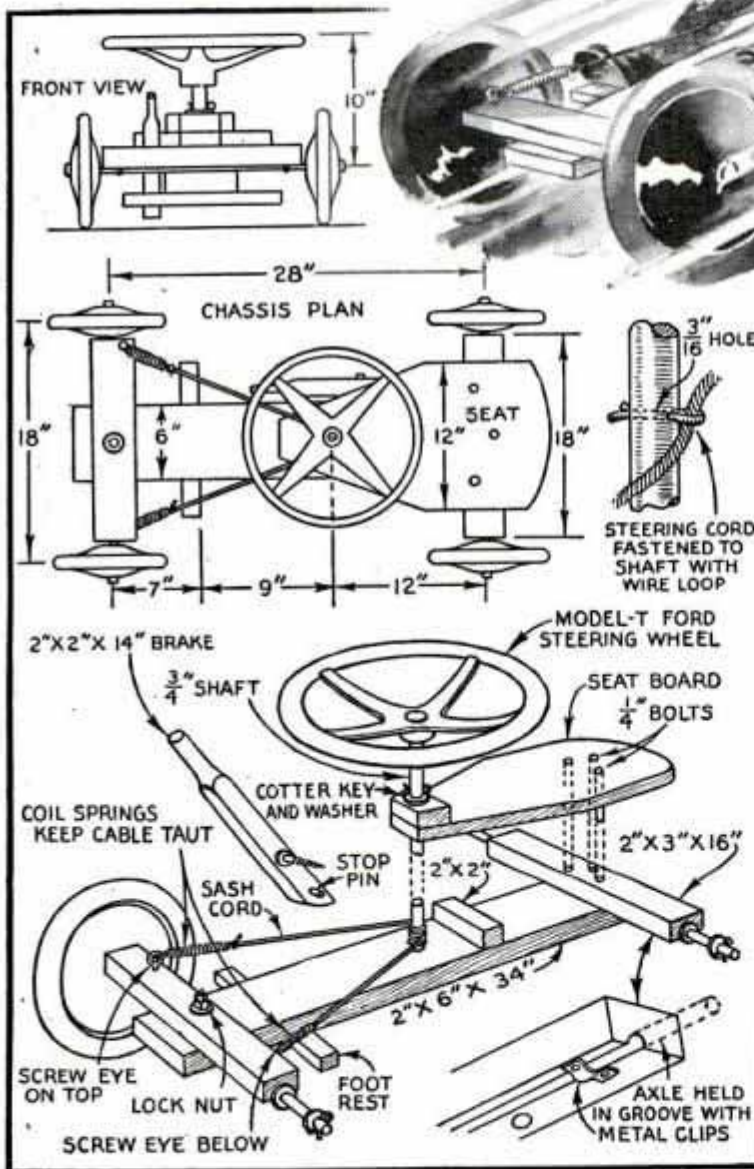

on the tires. It is pivoted to the right side of the main frame with a lag screw. A stop pin on the inside near the lower end, prevents the handle from falling too far forward when not in use.

Nicked Propeller Causes Outboard Motor to Race

Mystifying performance of an outboard motor, which reaches a normal speed, then without warning suddenly races with a slight decrease in the speed of the boat, is often caused by a damaged propeller. This is usually the result of nicking the leading edges of the blades on rocks, which narrows the effective area in such a manner that water follows the blades and assumes a circular or churning motion instead of being driven back toward the rear. This condition causes a partial vacuum to be formed in the area immediately surrounding the propeller, which allows the motor to speed up. About the only remedy is a new propeller.

the low center of gravity prevents capsizing. The brake acts directly on the sidewalk making it positive and avoiding wear

surrounding the propeller, which allows the motor to speed up. About the only remedy is a new propeller.

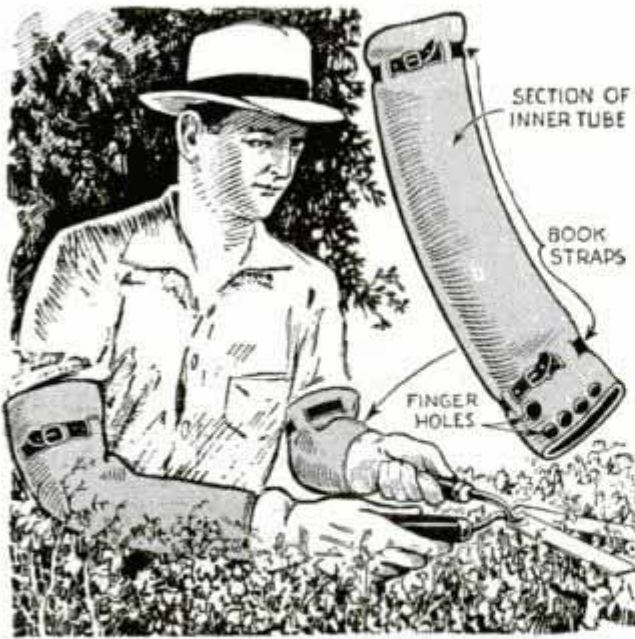

Sections of Inner Tube Slipped over the Arms to Protect Them When Pruning Thorny Bushes

Arm Guards for Pruning Hedge

When pruning a hedge or thorny bushes, slip a couple sections of old inner tube over your arms to prevent them from being scratched. Finger holes are made in one end of each section, after which they are fastened to the arms with straps, book straps being suitable for this purpose. A pair of gauntlets should be worn to protect the hands.

Old Razor Blades Rid Garden of Moles

After trying several methods of trapping moles in my garden without much success, I tried inserting old razor blades in their runways, and found that they soon left. I merely pressed down the surface of the runways at intervals, and inserted the blades about 2 in. under the ground with the sides of the blades parallel to the runways.



When a mole comes along and finds the runway blocked, he starts digging and cuts his nose on the blades. A few experiences of this kind, soon induce him to seek another feeding ground. —A. L. Flude, Pacific Grove, Calif.

Tile Placed over Rhubarb Plants Makes Stalks Grow Long and Tender

To grow long, tender stalks of rhubarb, one gardener suggests placing a drain tile over each plant as soon as it forms a few leaves. Then, when the plant grows sufficiently to bring the leaves above the tile, it is filled with rich loam and a second tile is placed on top of the first one. No dirt need be added to the second tile.

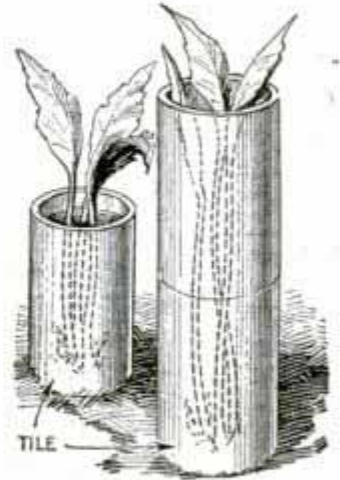

Piece of Garden Hose Used as Stop on Keyhole Saw

Slipped over the blade of a keyhole saw, a piece of garden hose was used by one home owner to limit the stroke of the saw when cutting through a floor to install wires, to avoid any possibility of sawing



Piece of Garden Hose Slipped over Blade of Keyhole Saw Serves as Stop to Limit Stroke

through the ceiling below. The hose also serves as a grip when it is necessary to hold the saw with both hands when cutting through a knot.

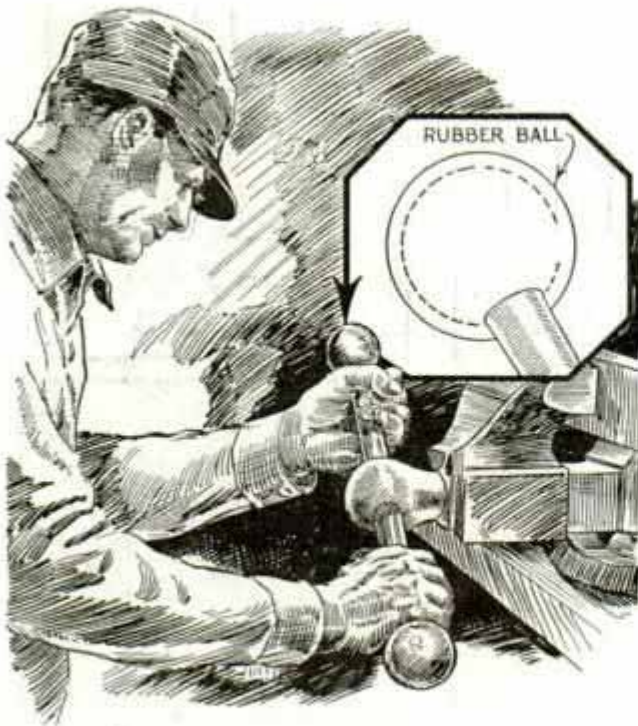

Hollow Rubber Balls Slipped over Ends of Vise Handle to Prevent Pinching Workmen's Hands

Rubber Balls Cushion Vise Handle

To avoid pinching the hands on a vise handle, slip a hollow rubber ball over each end as shown, to serve as a cushion. Holes are cut in the balls so that they can be stretched over the enlarged ends of the handle, a coat of shellac first being applied so that the balls will not slip off.—A. H. Waychoff, Tempe, Ariz.

Improvised Rubber Tray for Acids

If occasional use of acids in experimental work finds you without a rubber container in which to mix them, one can be improvised quickly from a square piece of inner-tube rubber. This is folded at the corners to form a tray, each corner being fastened with a spring-type clothespin. Tacks, driven through the bottom near each corner, hold the tray in place on a table.

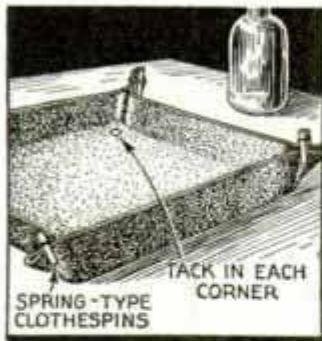

☐ A high room will seem lower if a molding is placed around the walls 16 to 24 in. below the ceiling.

Simple Brackets Hold Vines on Side of Building

To avoid driving nails into the side of a building when attaching strings or trellises to support vines, one home owner used brackets as shown. The brackets are made from lengths of stiff wire, which are bent around clothespins, the ends of the wire being bent up at right angles to slip under the siding boards of the building. By training the vines through the slots of the clothespins, they are held securely in place at a sufficient distance from the building to allow air to circulate around them.

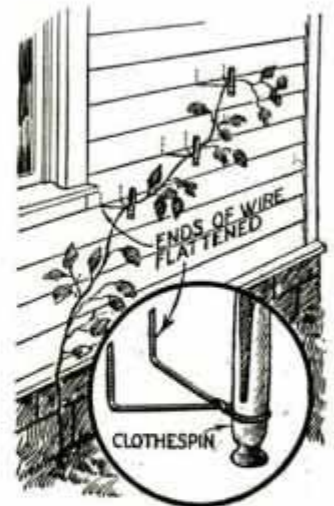

Inexpensive Crack Filler

Cracks in floors, knot and rat holes or old cuts made for wires and pipes may be permanently repaired with a filler made by mixing plaster of paris, 1 lb., precipitated chalk, 6¼ lbs., and yellow dextrine, 1 lb. Before using, enough water is added to the quantity needed to make a stiff dough. This is pressed into the cracks and troweled smooth. If a coarser grade of material is needed, fine sand may be substituted for the chalk.

Paper Clips Lengthen Rubber Bands to Reach around Packages

In an emergency, paper clips will be found handy for connecting small rubber bands together, so that they will reach around a large package. This method, besides providing a double strand of rubber around the package, is much better than looping the bands together, as the small knots formed in this way often tend to cut the rubber.



Built-in KITCHEN

SOAP CASE

BUILT into the wall above the kitchen sink, this little case provides a place where soap, cleaning powder and other dish-washing accessories may be stored. The frame of the case should be made first so that the opening in the wall may be cut to fit it. Fig. 1 gives the dimensions. At each end of the sides, a dado is cut, Fig. 3, to house the top and bottom. Also, $\frac{1}{4}$ -in. rabbets are cut in the four pieces to house the back. The assembled case is shown in Fig. 2.

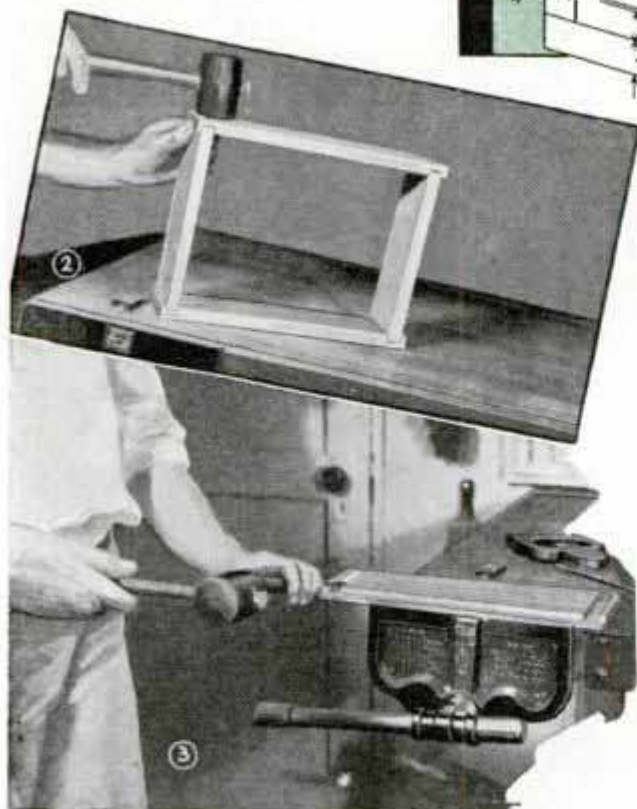

The $\frac{1}{4}$ -in. plywood backing is nailed into the rabbets to make a dust-proof joint. The casing is framed up and fastened together with long nails so that the faces will stay true even if the wall is not perfectly level. An opening for the door is made $\frac{3}{4}$ in. greater each way than the inside dimensions of the case to form a jamb.

The next step is to cut an opening in the wall between two studs for the case. To get the right location, rap on the wall. A hollow sound is produced everywhere except over a stud. Before making the cut, it is a good idea to check from the floor above, and in the basement below to be sure that there are no pipes or other obstructions in the wall. Most sinks have short risers or stubs on the pipes just above the faucets to prevent pounding; so

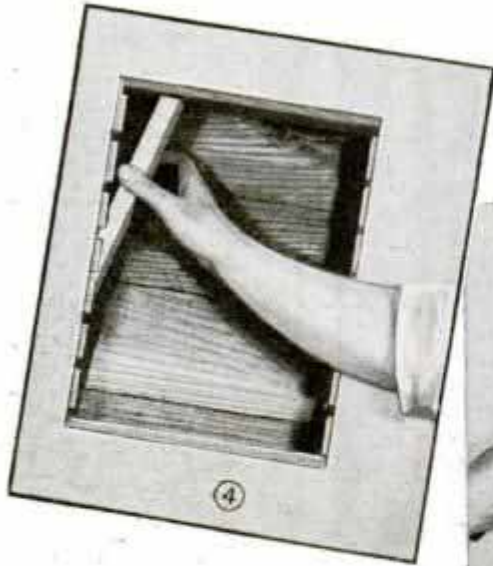

it will be best to space the bottom of the case at least 6 in. above the sink back. Obviously these directions apply only to a frame building. After laying out the opening on the wall, drill a small hole at one corner and carefully cut out the lath and plaster with a keyhole saw. Short pieces of material the width of the studs, should be slipped into the opening and forced into place at each side to support the lath, as shown in Fig. 4. Nails are then driven through the plaster

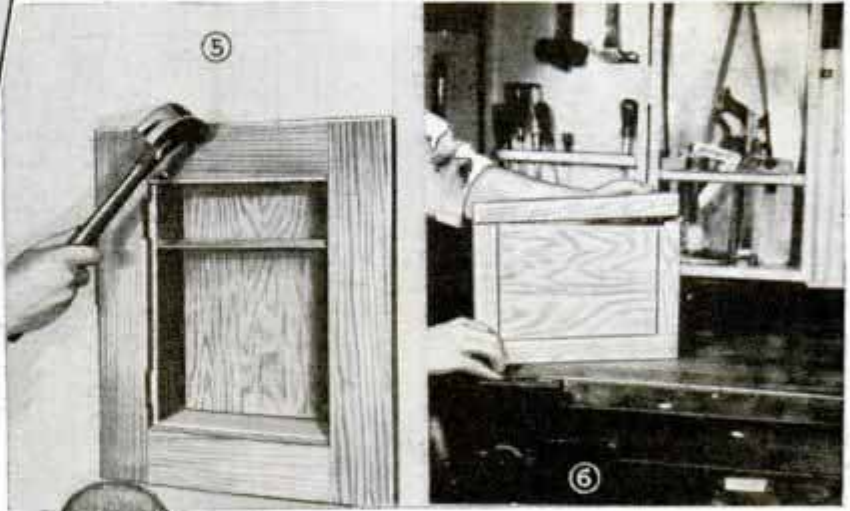

edges flush with the face of the plaster as shown in Fig. 7. After cutting the recesses for the hinges, the casing may be installed. Drive casing nails into both the case and wall, and set the heads for puttying as shown in Fig. 5. The door construction is simple. A groove to house the panel is plowed into all of the pieces, after which a tenon is formed on the rails, and stiles are mortised out to the size of the groove. This method of construction is shown in Fig. 6.

Feathers in Pillows Are Cleaned with a Vacuum Sweeper

Using a vacuum sweeper, one woman cleans the feathers in her pillows as shown in the lower detail. The feathers are spread out on a sheet laid on the floor, after which a window screen is placed over them. The sweeper is run back and forth over the screen, and draws the dust out of the feathers. After they have been cleaned thoroughly, the screen is carefully removed, the pillow case substituted for the bag on the sweeper, and the feathers picked up. Besides removing all dust from the feathers, this method assures that they will be fluffy when blown into the case.



☞ When fruit juice is spilled on table linen, sprinkle the spot at once with salt to prevent a permanent stain.

Sliding Hatch Covers Improve Ship Models

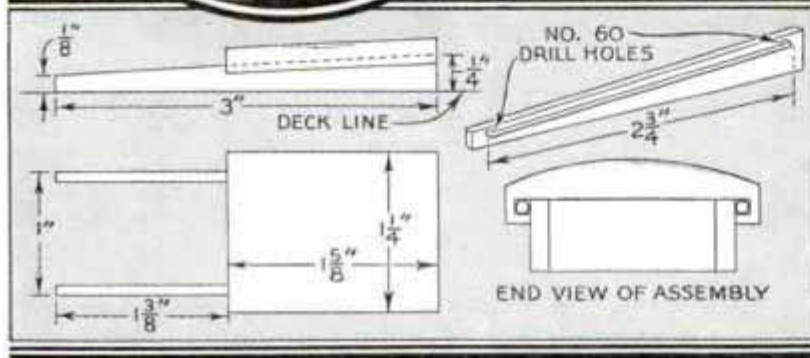
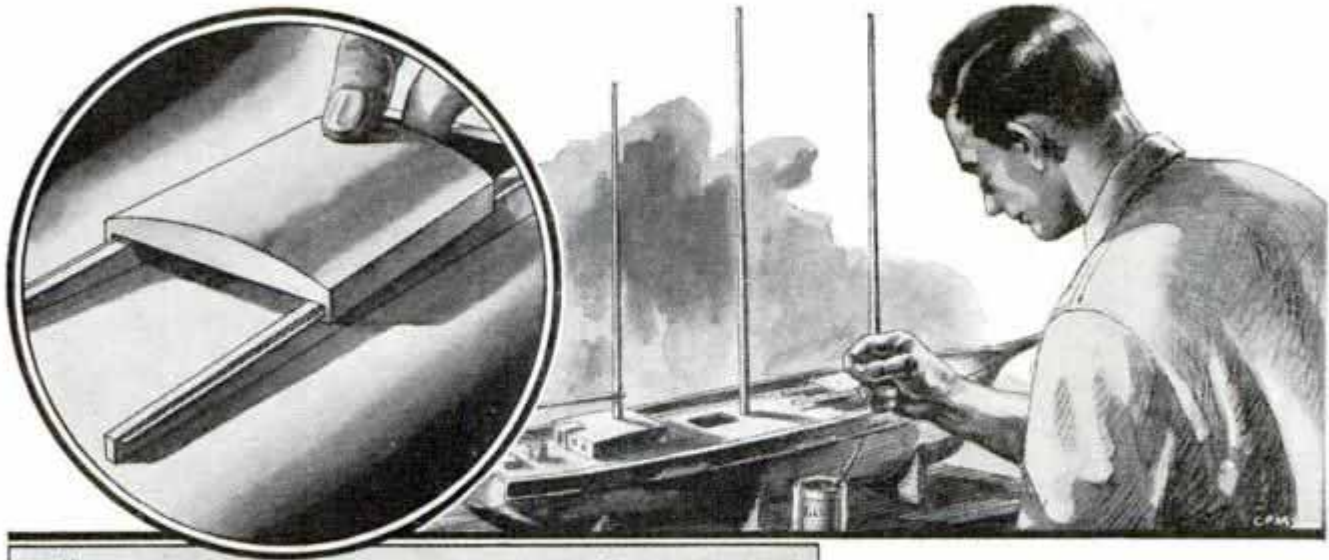

ing spaced 1 in. apart. This leaves $\frac{1}{8}$ in. on each side of the cover for grooves to take guide rods on each side of the slides. The rods were made from wire paper clips, which are straightened out and cut to length, a short portion at each end being bent at right angles to fit into tiny holes drilled in the hatch

Sliding hatch covers add considerably to the realistic appearance of ship models, although their construction is, of course, more complicated than that of stationary hatch covers. But, with the following method, the job is easy: In this case the cover was made $1\frac{1}{4}$ in. wide, the slides be-

slides. A drop of glue in each hole holds the rods in place. The next step is to glue sides to the cover, after which thin strips about $\frac{1}{2}$ in. thick are glued to the lower edge of each side to form the grooves for the guide rods. If the cover slides too easily, the rods can be sprung slightly.

Wire Rings or Loops on Clothesline Hold Prop in Place

Your clothesline prop will not slip and allow the washing to trail on the ground if wire rings or loops are attached at intervals along the line as shown. These should be permanently attached to the line and spaced about 10 ft. apart. The upper end of the prop may be tapered to fit into the rings or a hole may be drilled into the end to receive a headless spike or a length of small iron rod, which is then inserted into the rings.—G. E. Hendrickson, Argyle, Wisconsin.



☞ To prevent pictures from slipping so that they hang unevenly, hang them face to the wall, and then twist them around, making a cross in the wire.

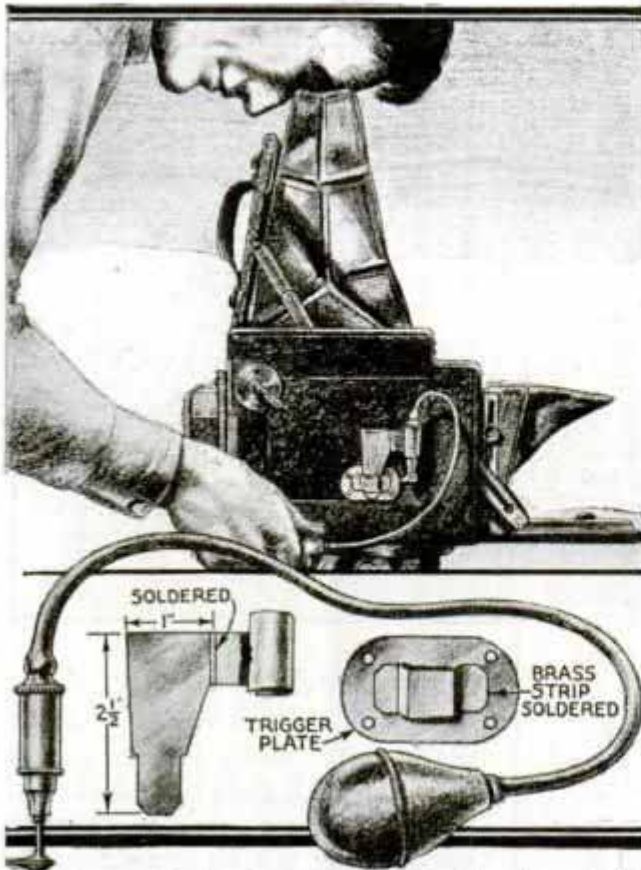

Shutter on Graflex Camera Operated by Detachable Bulb Release Held in Place with Brass Bracket

Bulb-Operated Shutter Release for Graflex Camera

Desiring a bulb-operated release for the shutter of my graflex camera, I attached one with a bracket as shown. The bracket is made from two pieces of brass soldered together. One end is bent around the end of the release, while the other end is trimmed to slip into a U-shaped brass strip soldered over the trigger plate on the camera. In this way, the assembly is readily attached or removed, and, when not in use, can be carried in the pocket where it is handy to get at when needed.—George Gilbert, Hollywood, Calif.

Old Phonograph Records Utilized as Rifle Targets

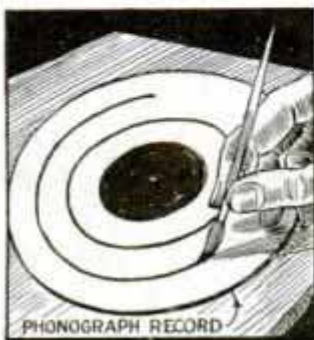

Old phonograph records are being used by amateur riflemen at Rocky Ford, Colo., for targets on their practice range. The center portion of the record is left black to form

a bull's-eye, and the recording part is painted white with a black ring halfway to the edge for the 3 and 4-in. rings. Contrary to expectations, the records will withstand many shots, the bullets leaving clean holes that may be covered with paper stickers to make them invisible.

Wire Loop Supports Flowers

Instead of using unsightly wooden stakes and barrel hoops to support flower bushes, one gardener recommends the support shown. This is merely a length of heavy wire bent at right angles near the ends, which are then inserted into the coil springs of two spring-type clothespins. In use, the wire is placed around the flower bush, after which the clothespins are clamped to a 1/4-in. rod pointed at one end and driven into the ground. To add to the attractiveness of the support, a bird cut from sheet metal may be soldered to the end of the rod, and painted a bright color.



How to Store Skis to Prevent Them from Warping

To assure that your skis will hold their shape when stored during the summer months, one man recommends tying them together with wood blocks between them as shown. A small notch is cut on the under side of each ski at the front end to take the beveled ends of a short block, a small block 1 in. square being placed between the skis midway from the ends, after which they are tied together with strong cord.

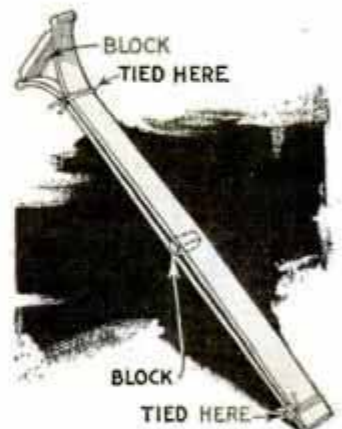

Electrical EXPERIMENTS

With Bell Wire & Iron

To demagnetize a watch, place it in coil and remove slowly

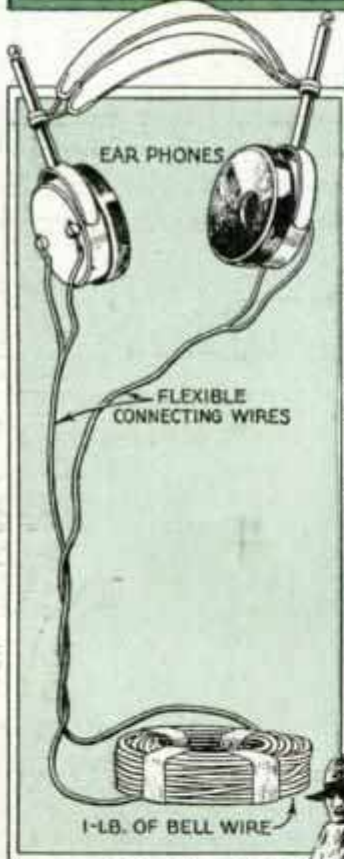
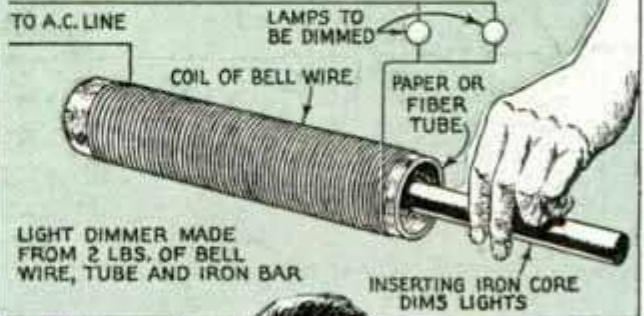
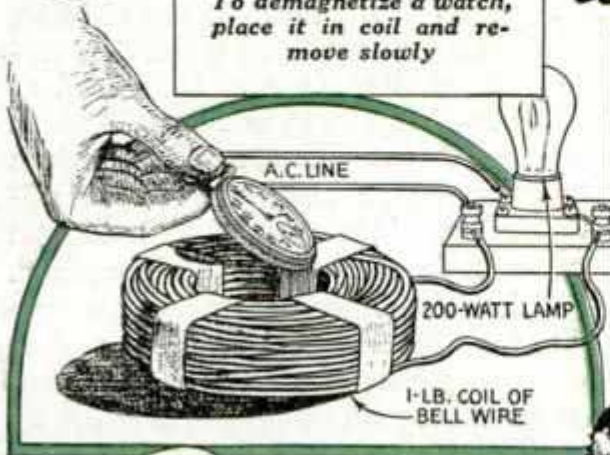

Flashlight bulb lighted without direct connection to current supply, the current in lamp circuit being produced by induction

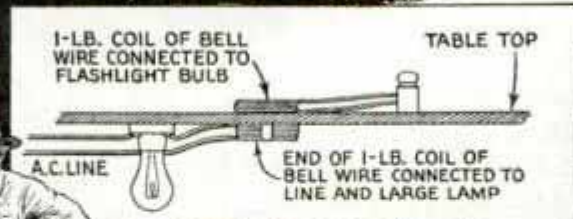

A buzzing sound in the ear phones locates buried electrical wires



TO STORAGE BATTERY

HORSESHOE MAGNET



Recharging a magnet from storage battery. Magnet is tapped with a hammer while current is flowing through the coil

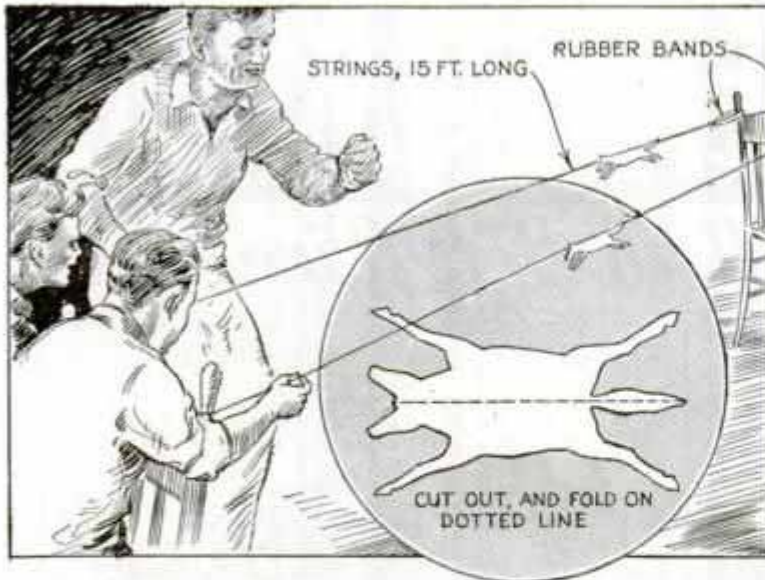

Cardboard Horses Racing over Strings in This Game Will Test Your Skill as a Jockey

Cardboard Horses Race on Strings Stretched between Chairs

Children and adults will find this race-horse game as interesting to play as it is simple to assemble. Two or more strings, provided with rubber bands at one end, are stretched horizontally between a couple of chairs. The horses, cut from a folded piece of cardboard, are placed over the strings near the rubber bands. Each jockey then races his horse by pulling the string toward him and then letting it snap back, thus leaving the horse advanced along the track.

Blocks Prevent Dust Gathering in Corners of Stairs

If small triangular wood blocks are glued into the corners of drawers and stair steps, cleaning is made easy as dirt cannot collect in the corners where it is difficult to remove. As many blocks as you need are readily obtained by sawing off the corners from pieces of scrap wood.

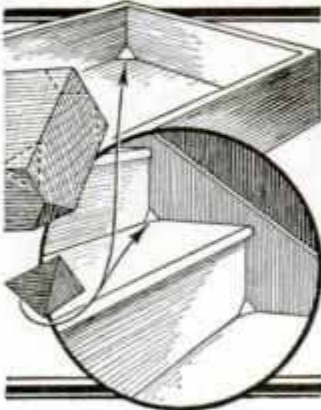

☛ Rings that are sometimes left on clothes after they have been cleaned with gasoline will often disappear when steamed over a teakettle.

Cements to Repair Metal Objects

Metal objects may be repaired by using one of the following tested preparations: Marine glue is one of the most effective cements for metal and can be made by mixing shellac with rubber cement. If the latter is not at hand, it may be made by dissolving virgin rubber, (not vulcanized or scrap) 1 part, in benzene, 10 parts. For most purposes, asphaltum may be used in place of or in addition to the shellac. This cement will keep well if tightly corked. If it becomes too thick, benzene may be added as a thinner. Another excellent metal cement that

is also useful for filling cracks is made by adding whiting to water glass until a viscous putty-like paste is formed. It dries very hard and will not deteriorate. When used as a filling material, this cement should be made very thick. It may be colored with almost any dry pigment, and if thickened with whiting, the cement may be used for modeling.

Homemade Spotting Brush

For removing spots and stains from woolens and similar fabrics, a brush may



Brush Made from Rolled Haircloth Removes Spots and Stains from Woolen Fabrics

be made from a scrap of haircloth, which is obtainable from any tailor shop. A strip of the cloth about 3 by 18 in. is rolled compactly, after which the free end is stitched down with heavy thread. Before using, one end of the brush is moistened with water and then rubbed over a cake of soap.

"VANJA"

By GEORGE BARON

PART II—Keel, Deck, Deck Fittings, Sails and Rigging

IN the last issue the construction of "Vanja's" hull was described up to the point where all the planking was completed and the molds removed. Before going further, make a cradle to hold the hull. This done, you are ready to make up the wooden pattern for the lead keel.

Making the Pattern for the Lead Keel

Glue up any number of pieces to the required size. Plane up the top, mark a center line and shape out to fit the hull. Make templates for each station from the body plan. Shape out the profile of the pattern, and mark the center line around the other side. Fasten it upside down onto a board which is marked with a center line and station lines, and cut to shape, using the templates. Plane $\frac{1}{8}$ in. off the bottom of the keel, fasten the pattern in place and finish to final contour.

Casting the Lead Keel

You can save considerable time by having the lead casting made in a foundry. This work will be done at a very nominal charge. However, if you wish to make the

Champion Class-A Model Racing Yacht

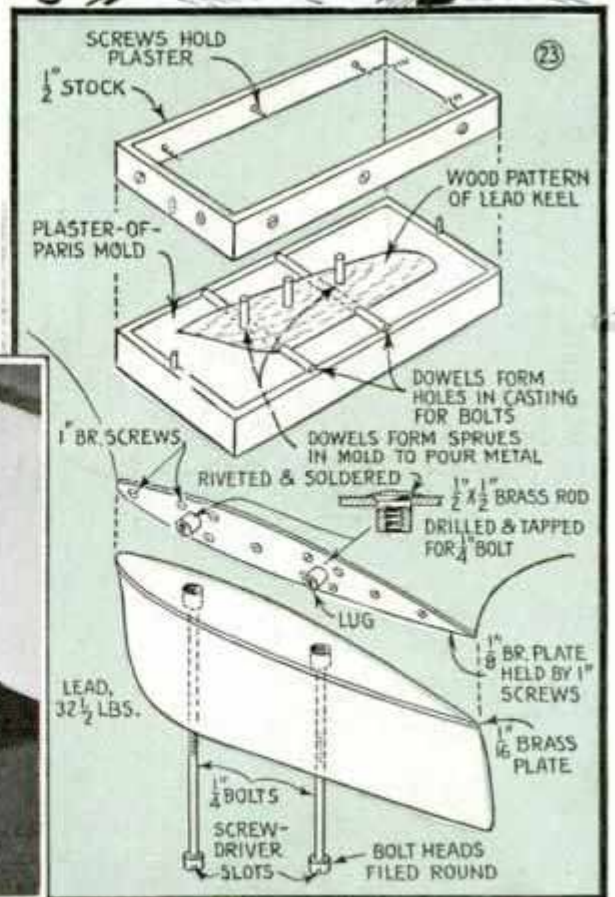
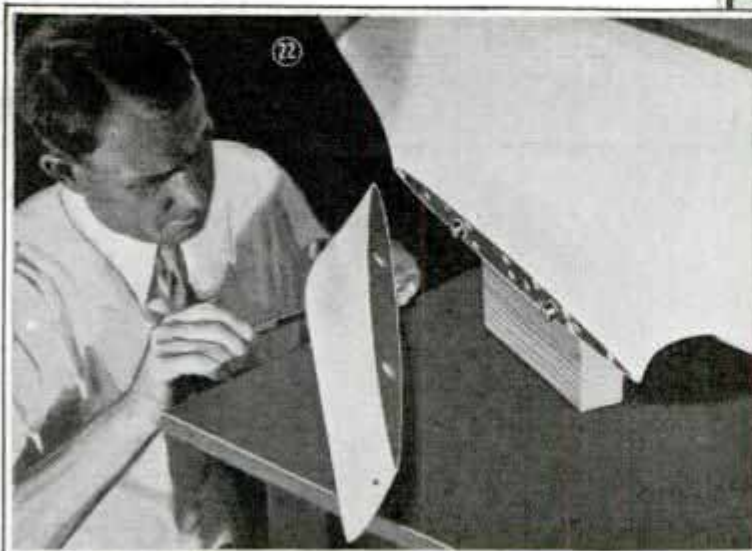

casting yourself, a method of making a plaster mold is shown in Fig. 23. The use of molder's sand is preferable, but if not obtainable, you can use plaster of paris. The molding box is made in two parts, each half 4 in. deep, 30 in. long and 10 in. wide, all inside measurements. All material should be 3/4-in. white pine joined with screws. Be careful to make both halves exactly the same size and fit dowel pins for locating the halves, one over the other. Only two pins

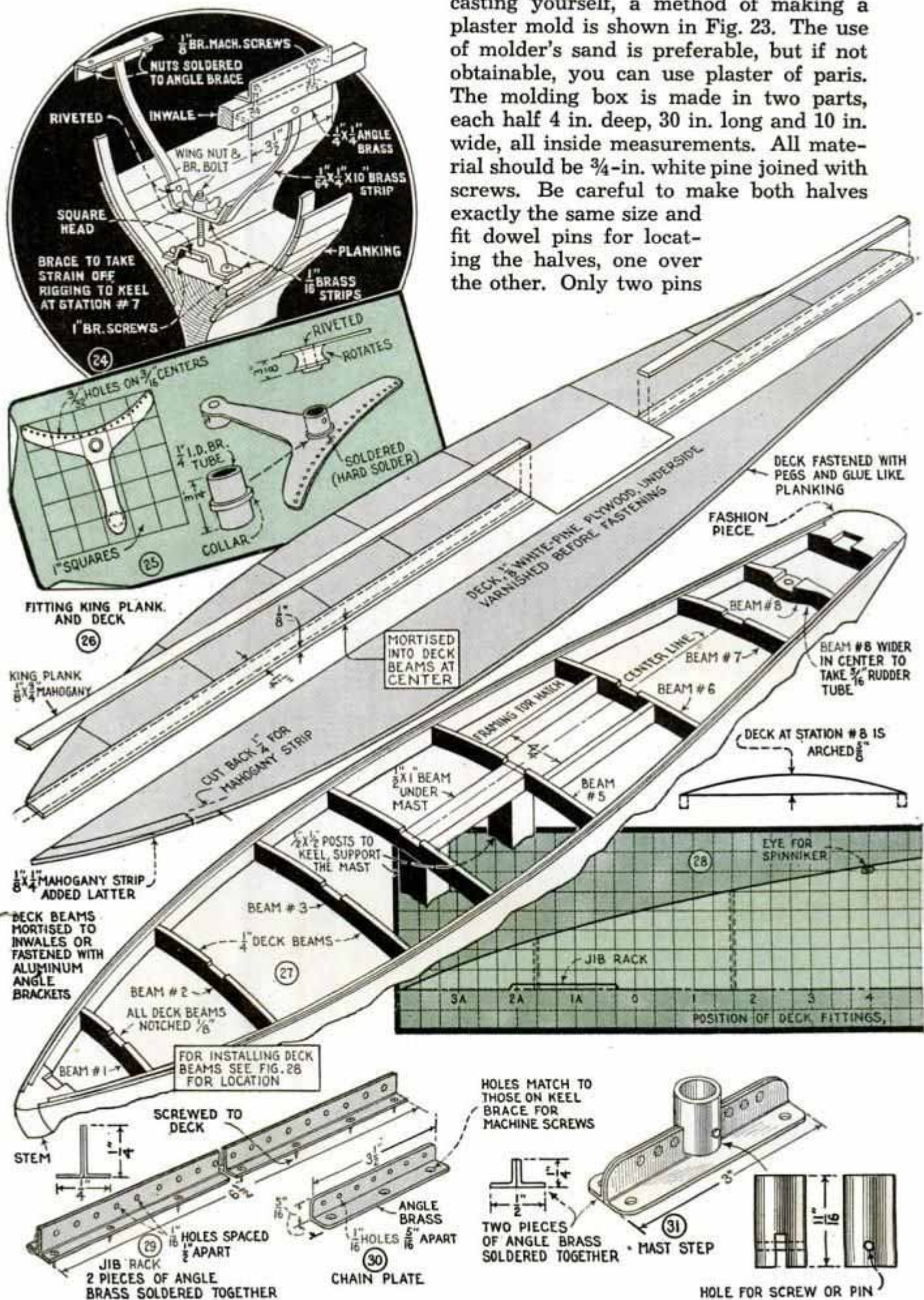

are shown in Fig. 23, but it is better to space four more, two on each side of the lower half of the box. Fig. 23 shows the pattern in place supported on two $\frac{3}{8}$ -in. dowels which fit in grooves cut in the sides of the box. These dowels are loose in the pattern and are left in the mold to form holes through the lead keel for bolts. The three vertical dowels, one for pouring and two for vents, should project beyond the top edge of the upper box. With this done, fill the lower half of the box very nearly full of plaster, grease the pattern to prevent it from sticking, and bed the pattern in the soft plaster filling in at the sides if necessary. Strike off the excess plaster flush with the top of the box and allow to

dry. Then lay a piece of waxed paper over the plaster, cutting the center away to fit closely over the pattern. Set the top half of the box in place and pack with the plaster, striking the top off flush with a straightedge. After the plaster has stiffened, prick a number of holes in the top half of the mold with a piece of wire. Sep-

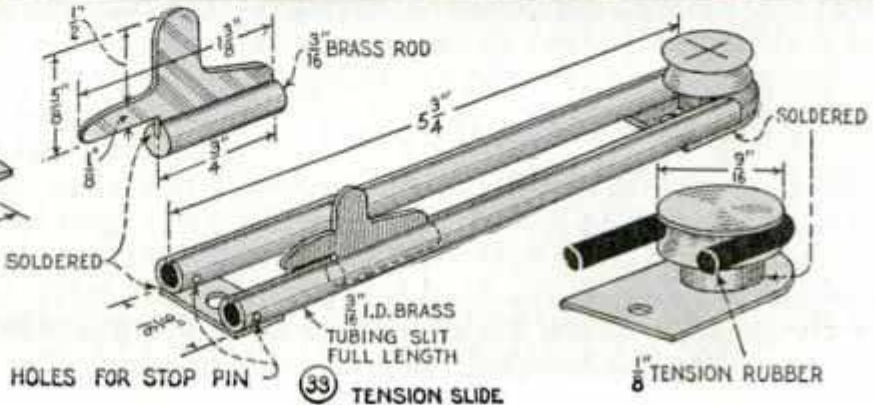
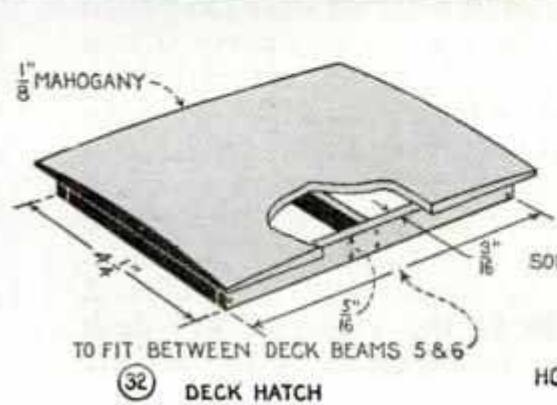
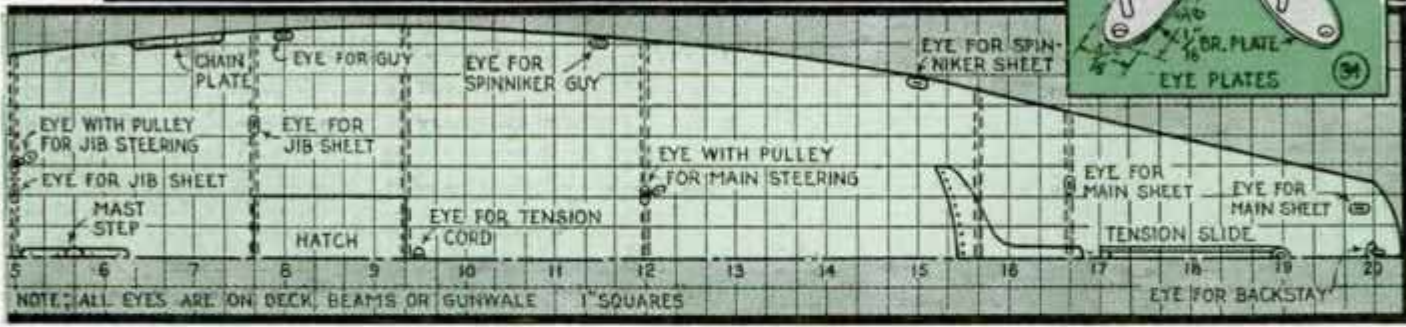
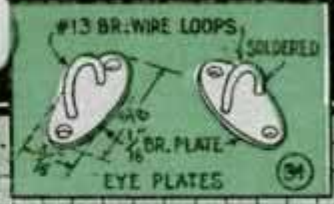
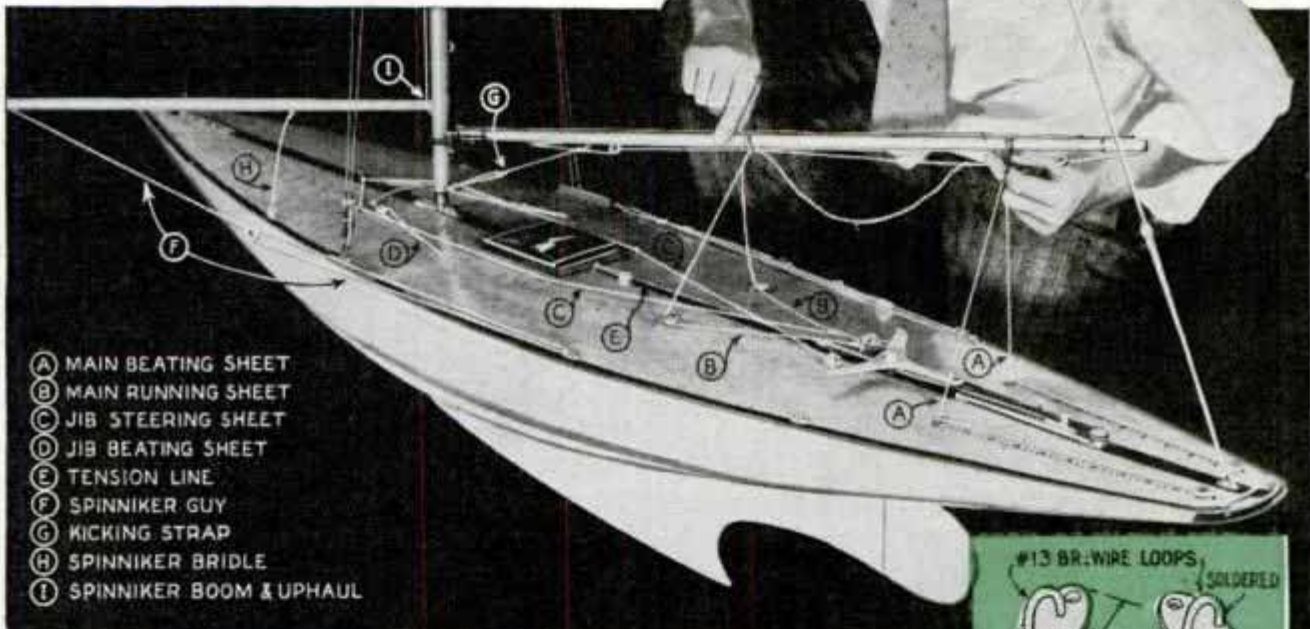

32 DECK HATCH

33 TENSION SLIDE

1/8 TENSION RUBBER

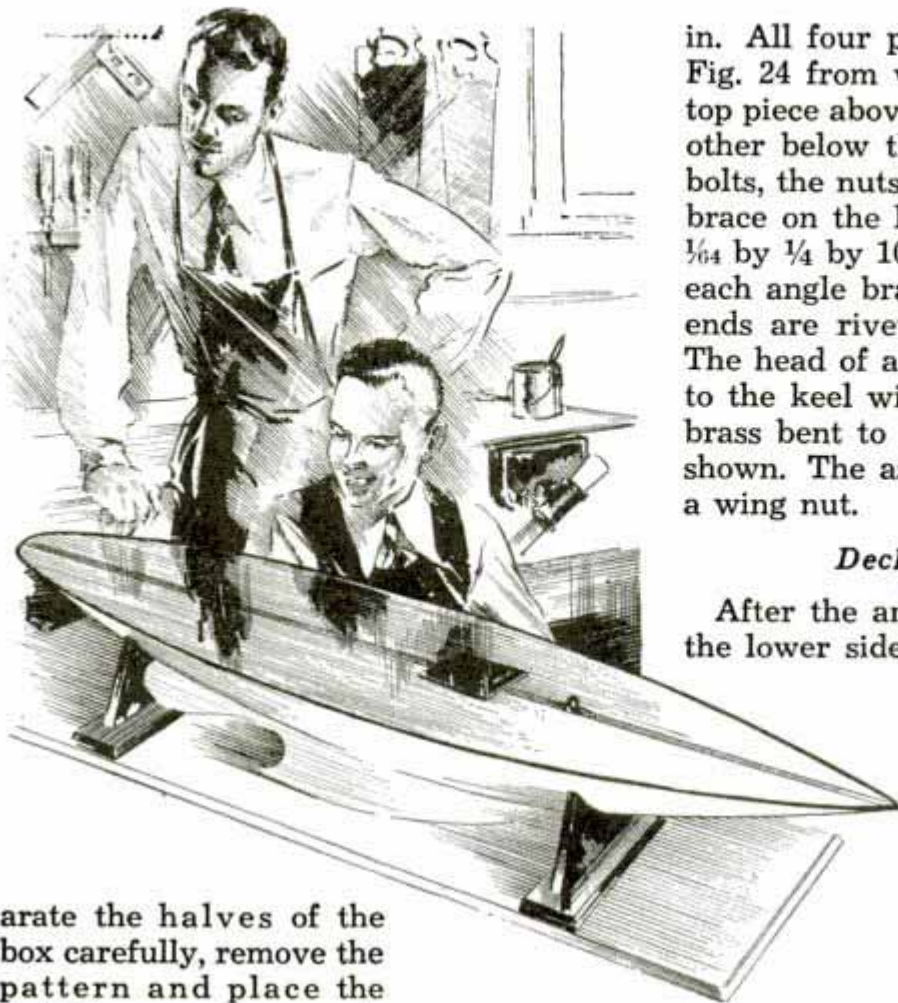

arate the halves of the box carefully, remove the pattern and place the mold in a warm room to dry. It is essential that the mold be thoroughly dry before pouring the hot lead as any moisture present when the lead is poured will turn to steam. The steam is not only likely to damage the casting, but it is dangerous. You will need about 40 lbs. of lead, which should be melted at one time in a suitable container over a gas burner. When the casting is finished, a $\frac{1}{8}$ -in. brass plate is screwed to the keel, and a $\frac{1}{16}$ -in. brass plate is soldered to the lead. The former is fitted with drilled and tapped bosses which fit into countersunk holes in the lead. Bolts through the latter screw up snugly into the bosses and hold the lead in place as in Fig. 23. The keel bolts are $\frac{1}{4}$ in. iron with the square heads rounded and slotted so that the bolts may be tightened with a screwdriver as in Fig. 22.

Chain Plates and Rigging Brace

Next, you make and fit the chain plates holding the rigging and the brace which takes the strain down to the keel. For the chain plates, Fig. 30, you need four pieces of $\frac{1}{16}$ -in. angle brass, each $3\frac{1}{2}$ in. long. The two pieces for the chain plates, which are on the deck, are filed down to $\frac{5}{16}$ by $\frac{5}{16}$

in. All four pieces are then drilled as in Fig. 24 from which you will see that the top piece above the inwale is bolted to another below the inwale with $\frac{1}{8}$ -in. brass bolts, the nuts being soldered to the angle brace on the lower side of the inwale. A $\frac{1}{64}$ by $\frac{1}{4}$ by 10-in. brass strip is riveted to each angle brace as shown and the lower ends are riveted to a $\frac{1}{16}$ -in. brass strip. The head of a $\frac{1}{4}$ -in. bolt is then fastened to the keel with a similar piece of $\frac{1}{16}$ -in. brass bent to allow room for the head as shown. The assembly is drawn tight with a wing nut.

Deck Beams and Deck

After the angles have been fastened to the lower side of the inwales with $\frac{3}{8}$ -in. screws, remove the chain plates which later are fitted on the deck. Deck beams can now be put in place, located as in Figs. 27 and 28. The beams should arch to the center of the deck, the camber being $\frac{5}{8}$ in. at the center. Make the longer beams

first out of $\frac{1}{4}$ -in. stock. Fasten deck beams to the inwales either by mortising or by means of small aluminum angle brackets. The two beams under the mast are joined by a longitudinal beam 1 in. wide and $\frac{1}{2}$ in. thick, and are further strengthened by two $\frac{1}{2}$ by $\frac{1}{2}$ -in. posts extending down to the keel as in Fig. 27. Beams No. 5 and 6 are joined by two lengthwise beams, $2\frac{1}{8}$ in. from the center line, which form a frame for the hatch, Figs. 27 and 32. Pieces of $\frac{1}{8}$ -in. mahogany, projecting $\frac{1}{4}$ in. above the deck are fastened to the frame to form the hatch coaming. Note that the No. 8 beam forms a support for the rudder post and is widened at the center to give greater strength. Run a batten over the beams and see that it takes an easy curve. Dress down any high places. Then mortise the deck beams $\frac{1}{8}$ in. deep and $1\frac{1}{4}$ in. wide at the center of the deck line and set in two pieces of wood from stem to hatch and from hatch to stern. See Fig. 26. On these lay the king plank of $\frac{1}{8}$ by $\frac{3}{4}$ -in. mahogany. Before adding the deck, bevel the gunwale to the curve of the deck beams. Also screw a handle to the keel directly under the main hatch for lifting

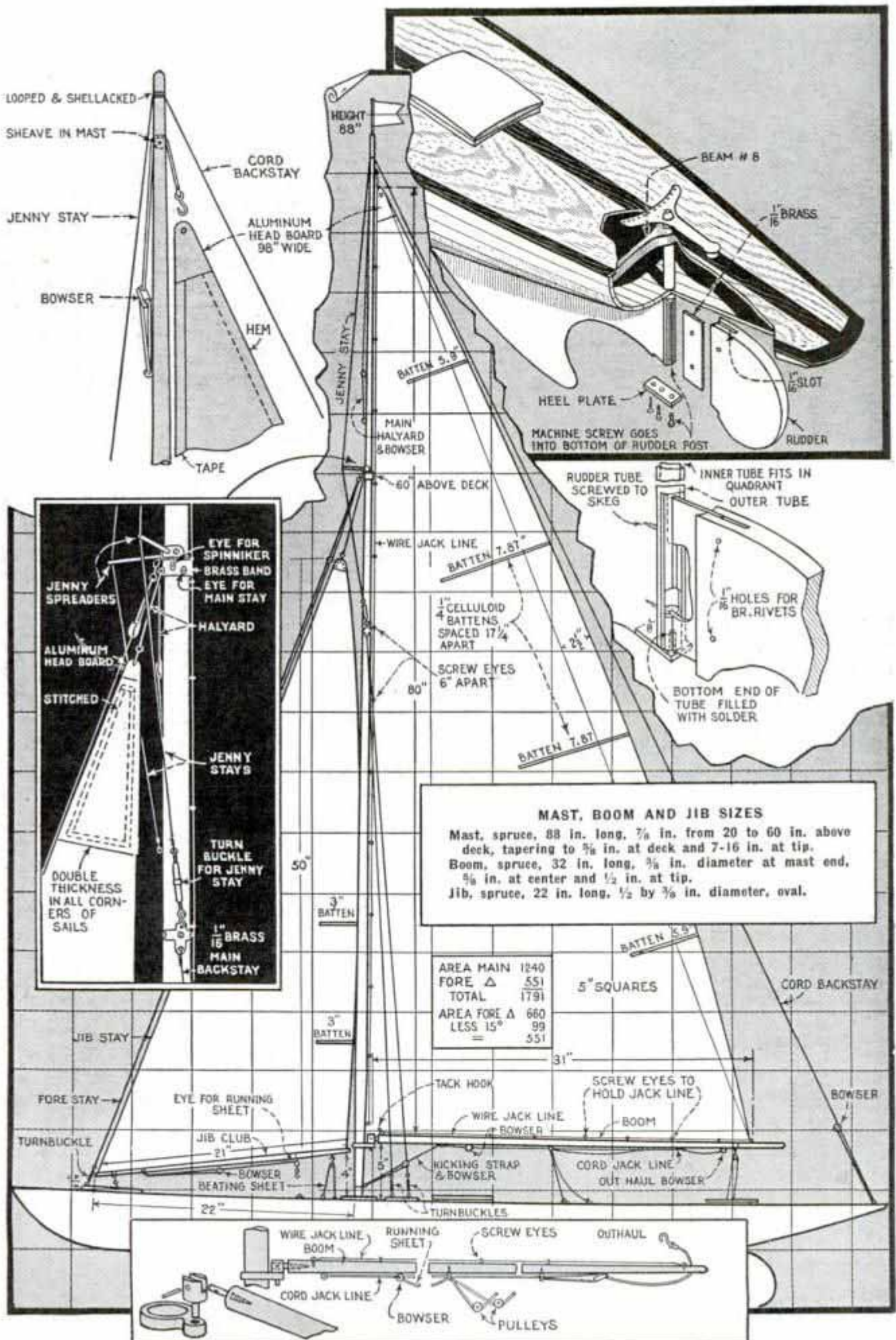

MAST, BOOM AND JIB SIZES

Mast, spruce, 88 in. long, 7/8 in. from 20 to 60 in. above deck, tapering to 3/8 in. at deck and 7-16 in. at tip.
 Boom, spruce, 32 in. long, 3/8 in. diameter at mast end, 1/2 in. at center and 1/2 in. at tip.
 Jib, spruce, 22 in. long, 1/2 by 3/8 in. diameter, oval.

AREA MAIN	1240
FORE Δ	551
TOTAL	1791
AREA FORE Δ	660
LESS 15°	99
=	551

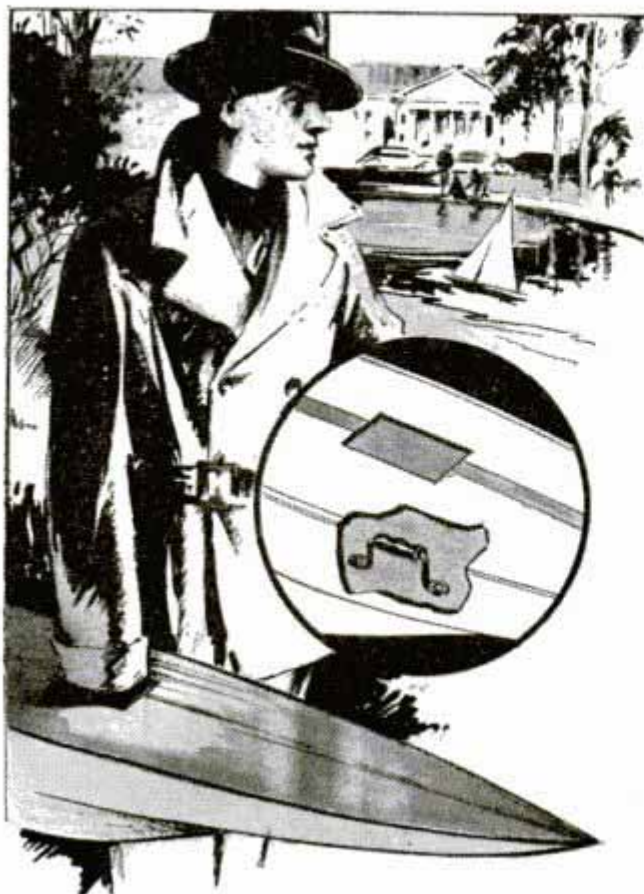

the model out of the water and carrying it conveniently. A heavy drawer or garage-door handle will do very well. The deck is made in two halves of $\frac{1}{8}$ -in., three-ply white pine. Before putting on the deck, apply two coats of spar varnish to the underside. Fit the halves to the curve of the hull, then gauge a line on the curved edges $\frac{1}{4}$ in. inward from the edge and cut down to this line. Fasten the decks on with pegs and glue and be careful to mark the position of the beams for the fittings. Finish off with a strip of $\frac{1}{8}$ by $\frac{1}{4}$ -in. mahogany around the edges of the deck. Give the deck three coats of spar varnish, sanding each coat lightly with No. 6-0 wet-or-dry paper, and finish the hull with enamel.

Quadrant, Jib Rack and Mast Step

Rigging details and the fittings are shown in the drawings. The eye plates, Fig. 34, can be made from strip brass, $\frac{1}{16}$ by $\frac{5}{8}$ in. Draw parallel lines to mark the screw holes and eye holes and mark the width and length for each plate. Drill all holes to fit No. 2 round-head brass screws, eye holes to fit No. 13-gauge brass wire. Countersink the eye holes on the reverse side of the plates and rivet and solder in the U-shaped eyes cut from No. 13-gauge brass wire. Fittings are fastened to the

deck with No. 2 brass screws, $\frac{1}{2}$ in. long. Fig. 25 shows the construction of the quadrant and the manner of attaching it to the rudder post. The quadrant collar should be turned out of solid brass leaving a shoulder to fit against the quadrant. Center-drill the collar to a close fit over the rudder post. To center the rudder, clamp two strips of wood to the skeg and the rudder, center the quadrant and drill the hole for the key pin through both the collar and the rudder post. Any minor adjustment can then be made by moving the forward end of the tension slide, Fig. 33. The construction of the jib rack and the mast step is similar and is shown in Figs. 29 and 31.

Mast, Booms and Sails

The mast is made of clear selected spruce. Dimensions are given in the rigging detail. Sails are made of light sail cloth, pre-shrunk. The luff, the edge near the mast, of the mainsail, is cut slightly hollow, the curve running into the sail about $\frac{1}{4}$ in. at the height of the third batten, then back to the straight line. The foot can be made slightly full, a curve about $\frac{1}{4}$ in. one-third its width from the mast. Tape the luff and the foot with linen tape, folding it over the edge of the sail.

Batten pockets are made of sail cloth to take celluloid battens $\frac{1}{4}$ in. wide. Angle pieces sewed on the corners and cross-stitched, keep the sail from pulling out of shape. The leech, or aft side of the sails, should be hemmed as narrow as possible. Tape the jib the same as the main sail, the luff to be straight, and the foot about $\frac{1}{4}$ in. round. Head boards of $\frac{1}{16}$ -in. aluminum are sewed to the top of both sails. Hooks are sewed to the luff and foot of the mainsail to attach it to spars by means of the wire jack lines. Also sew hooks on the luff of the jib.

Turnbuckles, goosenecks and stays can be purchased cheaply enough to be well worth the saving in time and trouble they take to make. Stainless steel wire is used for all stays and jack lines; linen lines for the running lines and backstay sheets. The mast can be moved forward or aft to trim the sails to the boat but after being measured for class racing, only $\frac{1}{2}$ in. either way is allowed. Raking the mast aft will make the boat point higher into the wind.

Unusual Pair of Book Ends That Telescope

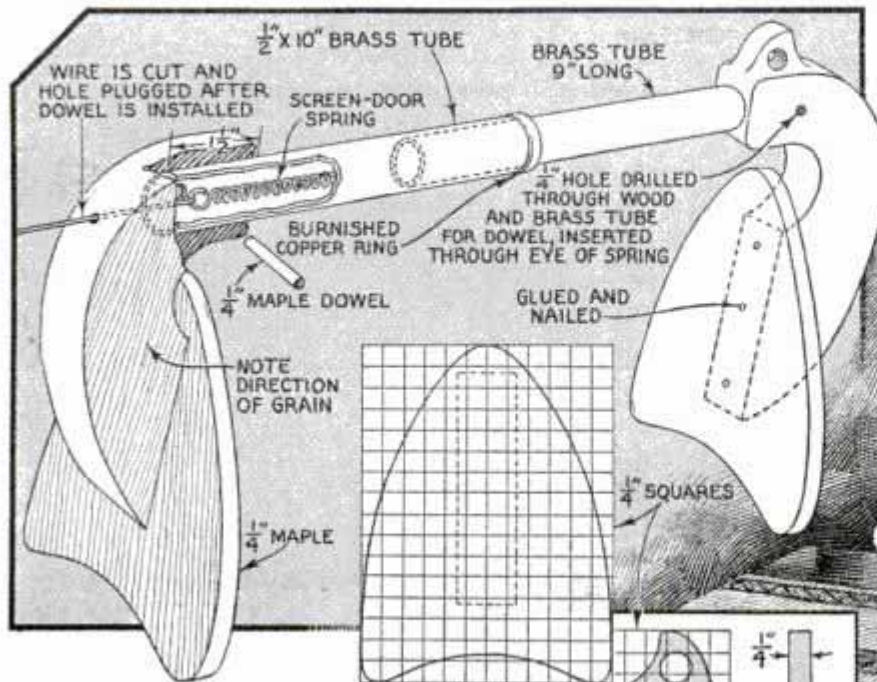

With carved panels in a wild-rose or cherry-blossom motif, and a burnished brass tube across the top, these telescoping book ends make an unusually attractive table piece. The dimensions given will permit the book ends to be extended from 10 to 18 in. It is a good idea to drill the holes in the ends of the brackets for the brass tubes before cutting them to shape, as the square stock will be easier to handle. The spring inside of the

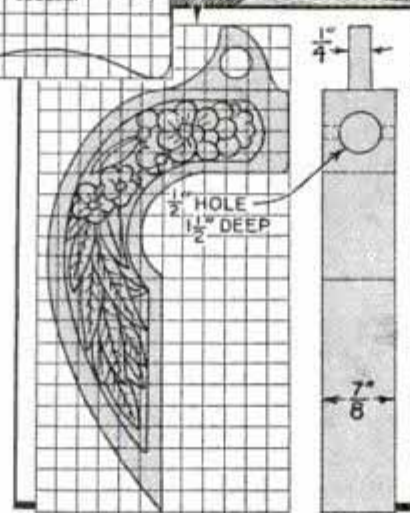

tubes is held by dowels inserted into holes drilled through the brackets and tubing. To install the spring, fasten one end in place, put the telescoping tubes together, and, with a cord or soft wire previously attached to the other eye of the spring, draw it through the tube in line with the hole in the bracket and insert the second dowel. The wire is then cut off close to the bracket.

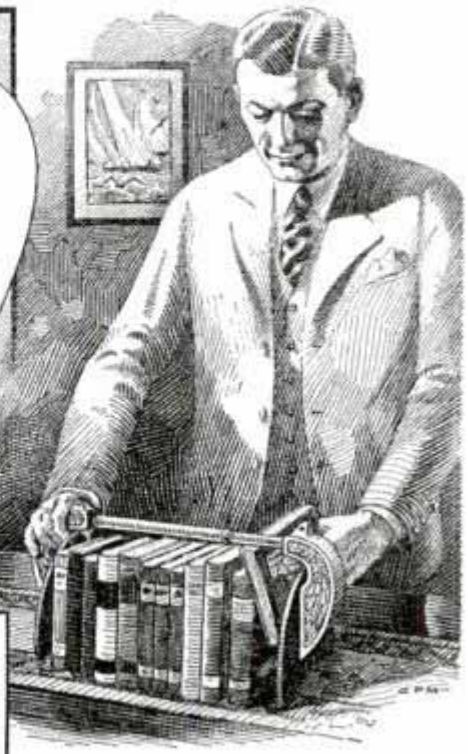

Attachment on Brace Helps in Drilling Holes Vertically

Two small pocket levels attached to a drill-bit brace with iron brackets as indicated, will be found helpful in drilling holes vertically through work. The brackets are welded to a large metal washer, which has first been drilled for screws to attach it to the underside of the brace handle. After the assembly has been screwed to the brace, the levels are fastened to the brackets with fine wire as shown. Besides being an aid in drilling holes vertically, the levels also help when drilling them at a slight angle. If the position of the level bubble is marked on the glass, duplicate holes are drilled accurately.

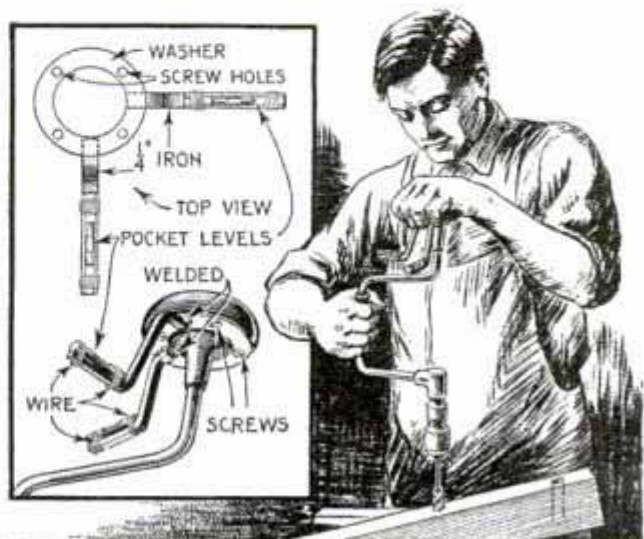



End of Steel Pipe Heated and Flattened to Make Lightweight Crowbar

Crowbar Made from Steel Pipe

I have found that an efficient crowbar can be made from a length of iron or steel pipe by heating one end to a white heat and then flattening it on an anvil. This welds the end of the pipe together, after which it is bent to shape and then filed or ground to a chisel point. A crowbar of this type has an advantage over the usual solid-iron type in that it is fairly light, yet very strong.—James E. Noble, Toronto, Ont., Can.

Baby Chicks' Feed Pans Improved from Can Lids

Instead of using wire guards to cover pans of feed and water for baby chicks,

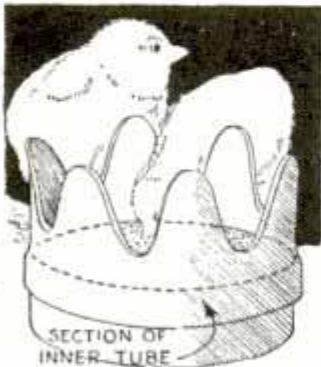

one poultryman employs can lids around which he stretches wide rubber bands cut from an old inner tube. Each piece is serrated along the upper edge as shown. With this method, the contents of the improvised pans are readily accessible to the chicks, and there is no possibility of them getting their heads caught in the rubber guards.—G. E. Hendrickson, Argyle, Wis.

Instead of using wire guards to cover pans of feed and water for baby chicks,

Loose Stovepipe Damper Repaired with Small Coil Spring

When a damper in a stove or furnace pipe loosens so that it will not stay open, slip a short coil spring over the pointed end as shown, and then provide a washer and cotter key to keep it in place. The spring provides sufficient friction so that the damper will stay in any position without being jarred loose.

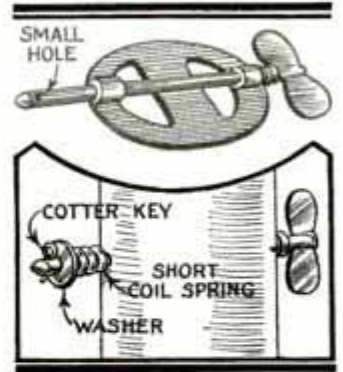

Soap for Dry-Cleaning Solutions

An excellent soap that is soluble in naphtha and can be used to add to the effectiveness of dry-cleaning solutions consists of oleic acid (red oil), 10.7 lbs., butyl cellosolve, 2.7 lbs., and dry cleaners' naphtha, 2½ lbs. This mixture is inflammable and should be heated carefully to a temperature of 140° Fahr. over a water bath. In another container, potassium hydroxide, .85 lbs., is dissolved in water, 1.35 lbs., after which triethanolamine, 1.97 lbs., is stirred into the solution. This is then heated to about 140° Fahr., and stirred vigorously into the first solution. The stirring should be continued leisurely for a half hour, or until a fairly clear solution is obtained. The amount of soap to add to a cleaning solution depends on the use for which the cleaner is intended, and may be determined by experiment.

Spring Handle Holds Small Paint Cans

When doing odd jobs of painting around the home, this paint-can handle, made from spring brass or steel, will prevent getting paint on your hands. A split ring over the handle makes it adjustable.



Making STAGE SETS for Amateur Plays

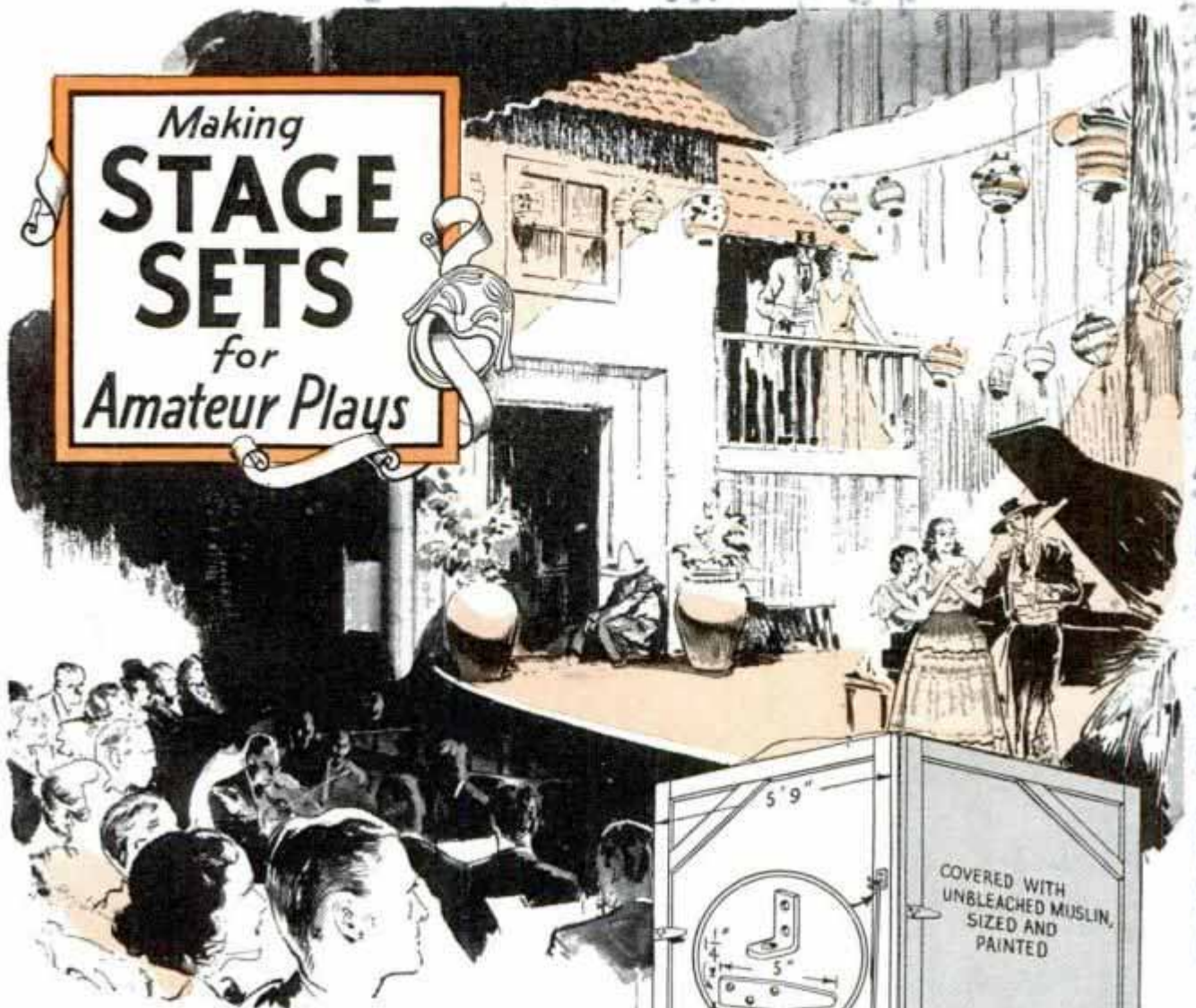

MEMBERS of schools, churches and neighborhood theaters will find it economical and instructive to build these stage sets when not too elaborate "props" are required. The simplicity of construction is well illustrated in the equipment, which was made by students of the John Muir Technical school and McKinley Junior High School of Pasadena, Calif. Indispensable to all stages are "flats" or walls for various settings, such as rooms or exteriors of a building. Fig. 1 shows two typical flats set up. These are large, but light in weight so that they are easily handled by one person. The framework is braced at one upper corner only, and is covered with unbleached muslin, which is glued and tacked to the wood. It is then sized, which stretches the cloth tightly, and painted as required. The flats are fastened

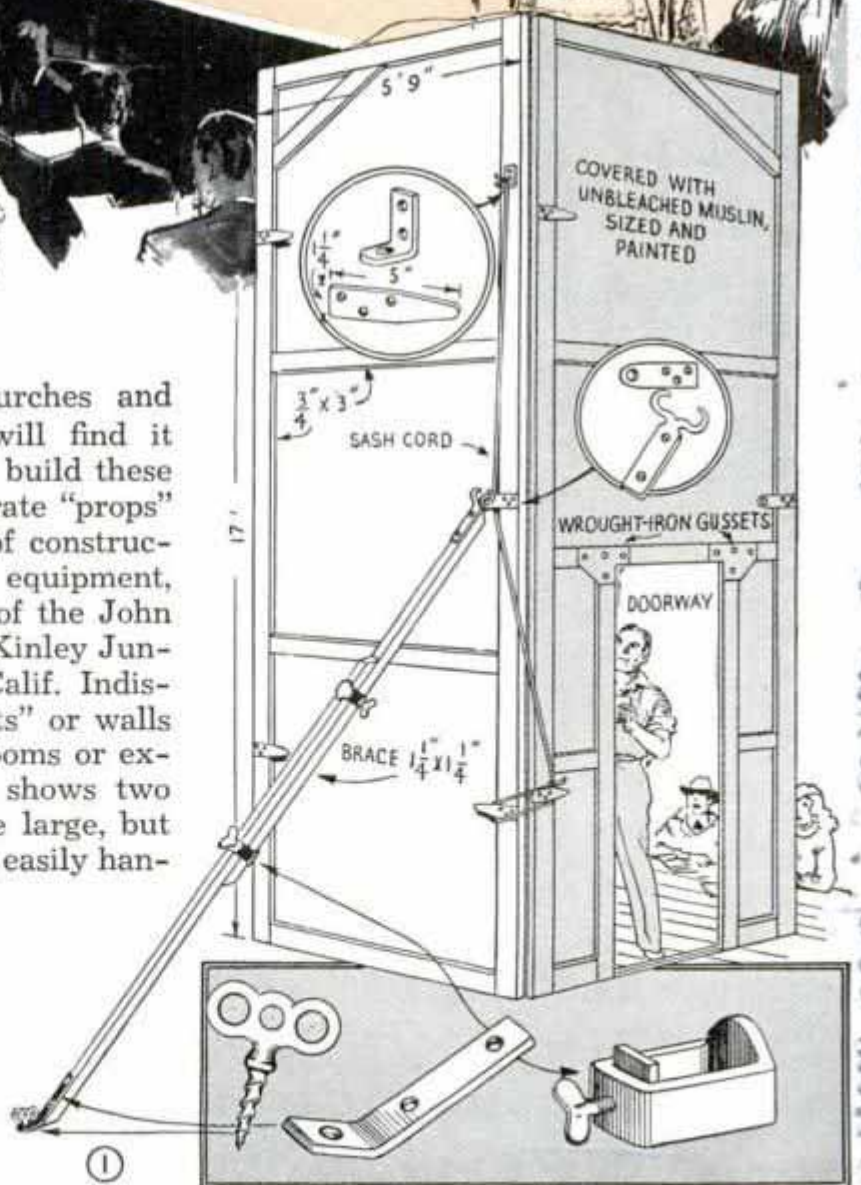

J. U. Clancy, author
247 N. Salina,
Syracuse N.Y.

James H. Chignior Corp. 1455 W. Austin Chicago
James City Scene Co. 289 N. 4th St. Minneapolis, Minn.

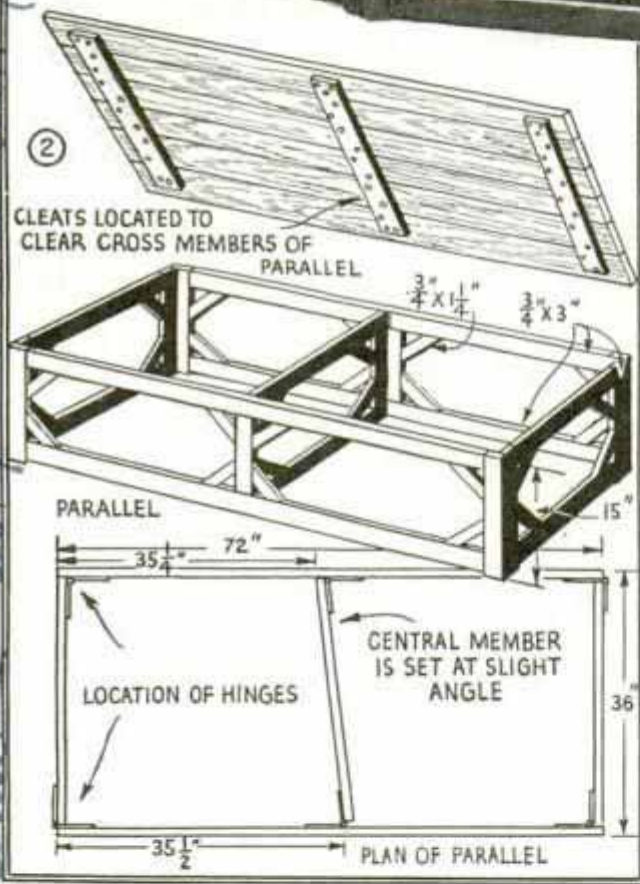
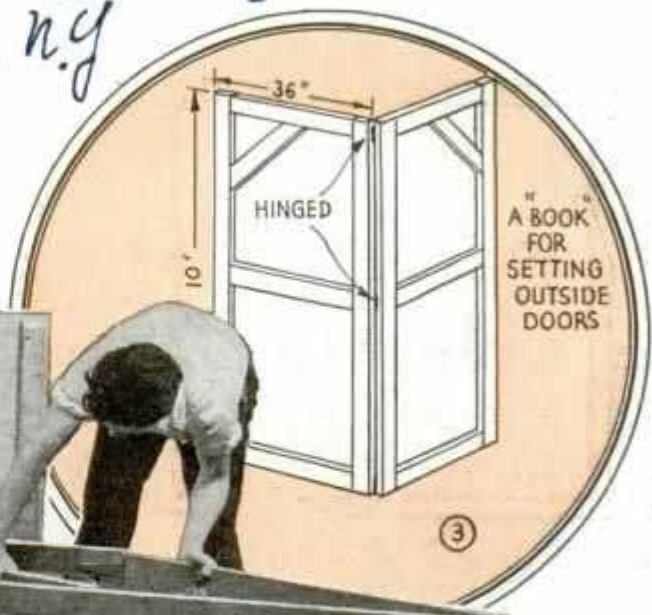
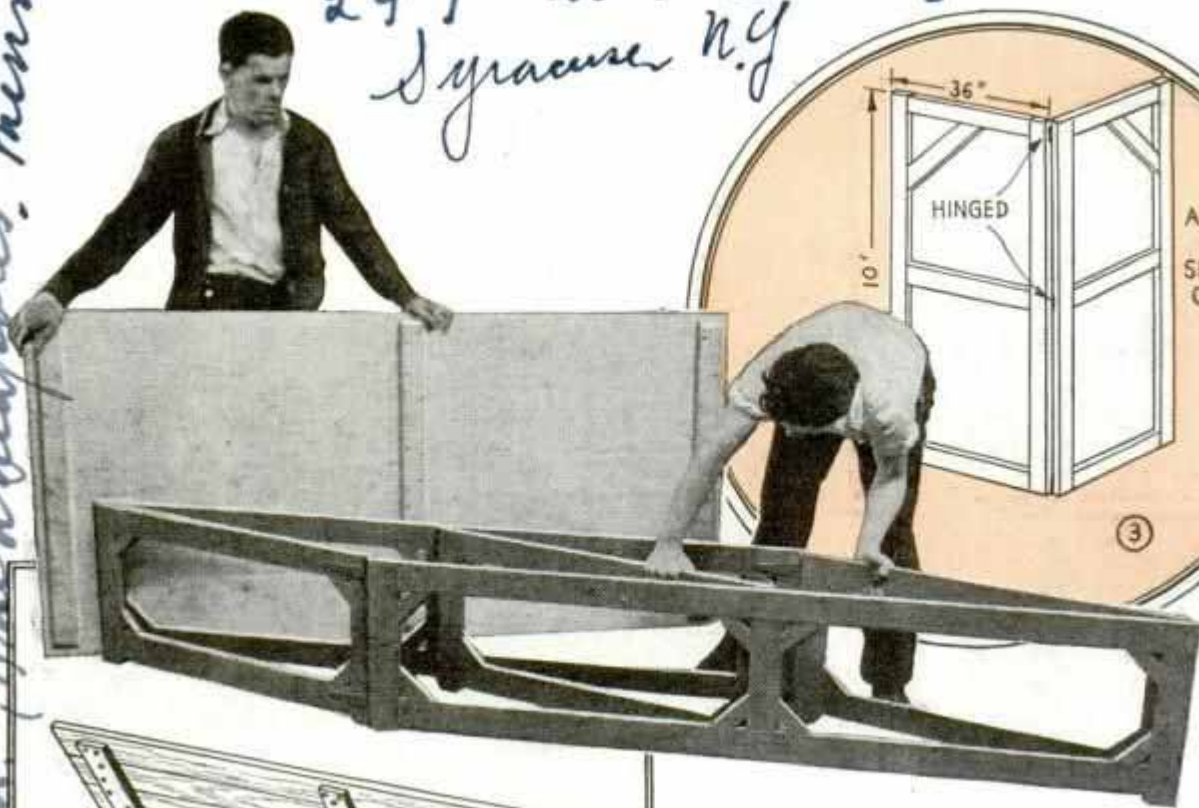

a sandbag to hold it to the floor, is shown in Fig. 8. This brace has an advantage over the standard type in that no screw is used to mar the stage floor. It is adaptable to the small flats as well as the large ones.

In addition to flats, the stage setting will require "books," Fig. 3. These are essentially two small flats hinged together and used outside of doorways so that the audience cannot see the bare stage beyond the scenery. Foliage wings, shown in Fig. 5, also have their place in outdoor settings. Windows and doors are so constructed that they can be assembled in place in a few seconds. Details of the windows are shown in Fig. 4. Sash and frame are built in a unit and set in the window opening in the flat. They are held in position by two strap hinges, which are set at an angle on the sides of the frame. When the free end of the hinge is pushed down, it tightens up on the side of the flat. To remove the window, the stage hand has but to raise the two hinge straps and lift out the entire sash and frame in a unit. The doors are installed in a similar manner.

together by means of a sash cord, which is run over brackets screwed to the side members of the framework. A standard adjustable brace supports each flat, a hook on the upper end being inserted into one of the brackets. A floor screw holds the lower end of the brace to the stage floor. It will be found less expensive to purchase all of the hardware items, which are standard equipment, than to attempt to make them. A convenient brace, which utilizes

Platforms of various heights are important items of stage equipment and consist of what is known as "parallels" and "lids," Fig. 2. In other words, they are merely a board platform supported by a parallelogram framework, which folds flat. There is, however, quite a trick in making the

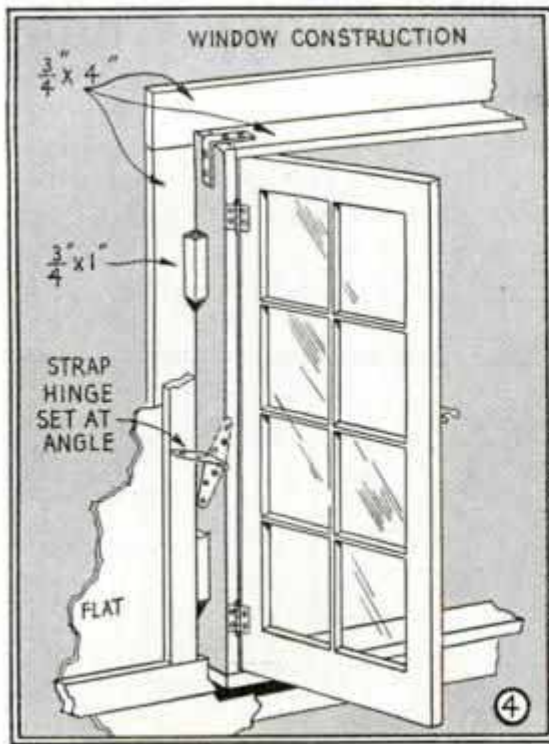

parallel. The central cross frame must be installed at a slight angle, otherwise it will not fold up easily, and the hinges must be put on exactly as shown in the drawing. The parallels may be made in several heights as the individual case demands. The cleats on the lids, of course, must be located so as to clear the cross members of the parallels. Construction of steps is shown in Fig. 6. A series of these placed around a platform make a very effective rostrum or pulpit stand, and are removed quickly when changing a scene. Tree trunks, when something more definite than foliage wings is needed, are made up of a series of sections constructed as shown in Fig. 7. Wood strips are nailed to circular wood ends, after which they are covered with cardboard and painted to resemble tree bark.

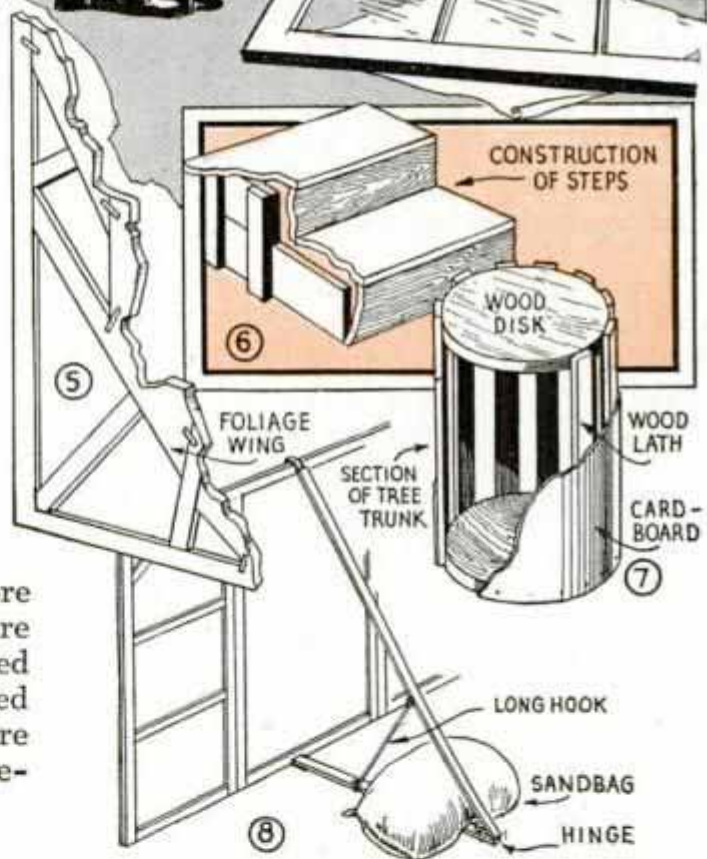

How to Make Wax Crayons

A good grade of wax marking crayons may be made in any desired color by melting together tallow, 90 parts, rosin, $2\frac{1}{2}$ parts and rosin soap, 1 part. While the mixture is molten, the coloring pigment should be stirred in. Almost any dry color may be used, such as prussian blue, red iron oxide or chrome yellow. The colored mixture is then poured into molds, which may be short glass tubes. Wax drawing

crayons may be cast from a composition made by melting together hard castile soap, 8 parts, beeswax crude, 6 parts, and crude spermaceti wax, $2\frac{3}{4}$ parts. While hot, carbon black, $1\frac{1}{2}$ parts, burnt umber, $\frac{1}{2}$ part and prussian blue, $\frac{1}{2}$ part, all by weight, are added and worked into the waxes until an even consistency is produced. The finished material is then poured into hot molds and cooled quickly by plunging into cold water.

A Reading Stand that Straddles Your Chair



making the curved braces for the rear legs, band-saw them from $\frac{3}{4}$ by 4-in. stock, making a tenon on one end, and cutting the other end at an angle for a lap joint. Use dowels and glue where indicated. Plywood is satisfactory for the magazine rack,

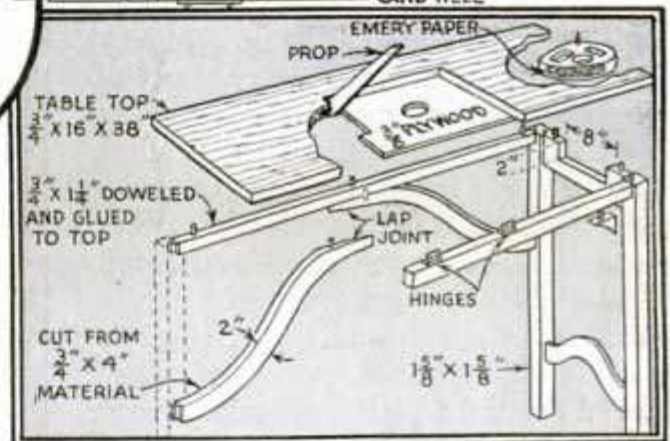
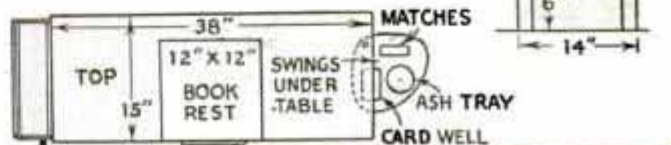
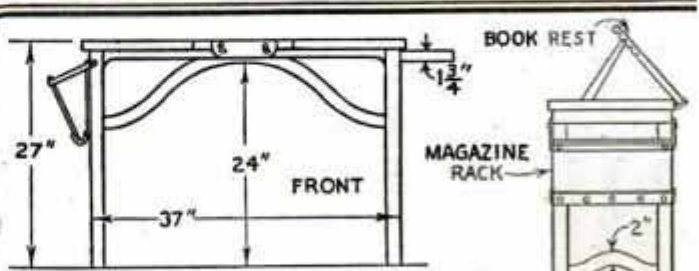
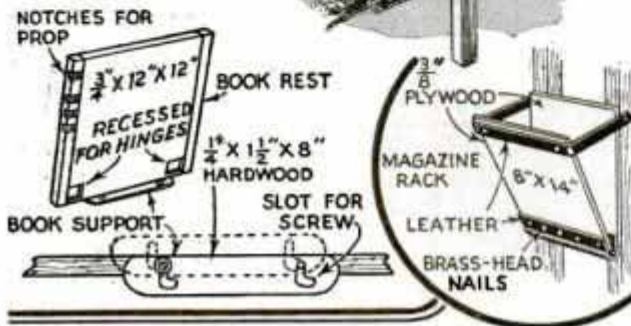

Straddling your favorite arm chair, this light table adds to the comfort enjoyed when reading, writing or playing solitaire, and it also has an ash tray within easy reach. An adjustable rest holds a book at any desired angle, and, when not in use, folds in a recess, flush with the table top. The recess is formed by sawing out a portion of the top and screwing a piece of plywood underneath, a hole being drilled in the plywood to permit insertion of the finger to raise the rest. Although not shown in the drawing, the plywood is screwed to wood strips on the underside of the table top to provide space for a $\frac{1}{2}$ -in. prop to fold under the book rest. The pivoted end, of course, must be rounded, and the prop must be shorter than the height of the rest. At the left end of the table is a magazine rack, and at the other end is a swinging shelf containing a card well, ash tray and a match box. The table top consists of two 8-in. boards glued together, sawed and trimmed to size. The legs are made in pairs, with cross members mortised and glued, the top cross member at the right end having a section cut away to receive the swinging shelf. In

which is supported by leather straps so that it will close up.

Tin Strip Opens Paste Boxes

Flat tin boxes containing paste or salve, unless provided with a patent clamp, are sometimes difficult to open. If a strip of tin is bent as shown, and then inserted in one side of the can before replacing the cover, the projecting end of the strip will, when pushed to one side, serve to lift the cover instantly.



Splicer and Rewinder for Movie Film

Two small bench-grinder heads, which are mounted on a wood base, are the essential parts of this simple home-movie splicer and rewriter. The splicer is one that comes with regular cementing kits and is mounted in the center of the base, the only addition being two hinged weights to hold down the ends of the film. These are small blocks of lead screwed to brass hinges, which are in turn screwed to the splicer. A small electric lamp mounted on the base to project above the splicer, illuminates the work when making a splice. To prevent tipping, small lead or iron bars, with felt glued on the lower sides, are screwed to the underside of the base. Painting the latter white facilitates locating the right place to make a splice.

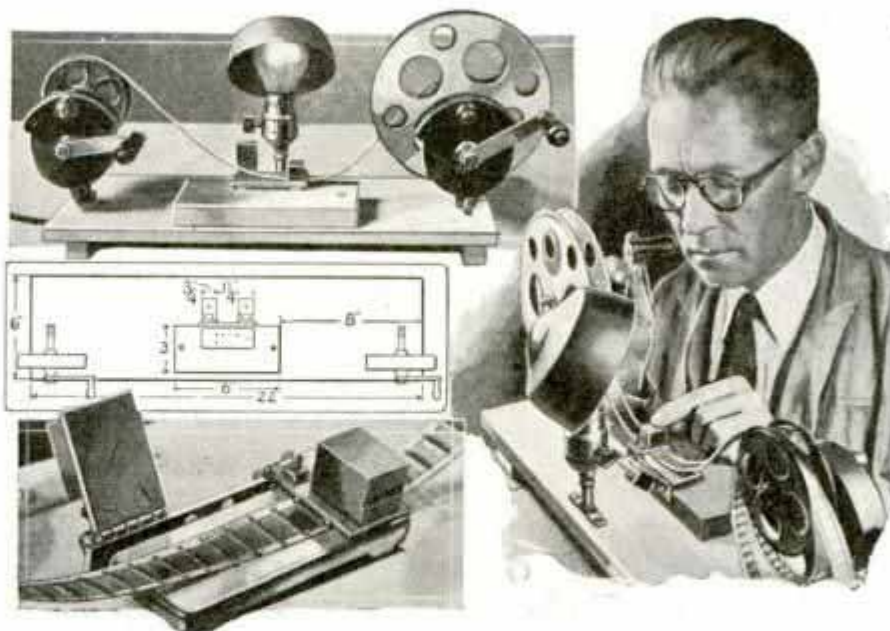

Combining a Rewinder and Splicer for Home-Movie Film, This Homemade Apparatus Has Features That Make It Exceptionally Suitable

water, 7½ gal., and again stir until evenly mixed. For use, the concentrated solution is diluted with water in the proportions of 1 part of water to 15 or 20 parts of the solution. The diluted solution has a refreshing odor of pine.

Guard on Jig Saw Protects Fingers

To prevent the fingers from being cut on a jig saw, a finger guard, formed by cutting off the looped end of a wire paper clip, can be attached to the saw guide with liquid solder. The surfaces of the clip and guide should be roughened with a file before applying the solder.



Efficient Disinfectant and Deodorizer

An inexpensive preparation having disinfecting and deodorizing properties may be made by mixing to an even consistency red oil, (oleic acid) 6 lbs., triethanolamine, 3 lb., and pine oil, 30 lbs. To this soapy mixture, slowly stir in water, 5 gal., after which 60 lbs. more of the pine oil is added while continuing to stir. When this is evenly mixed into a milky solution, add

Diffusing Light of Photoflood Lamps

Home photographers will find that the appearance of their work can often be improved greatly if the photoflood or photoflash lamps are equipped with reflectors, and a good diffusing material to soften and spread out the light. The new Cellophane cloth, which can be obtained at most department stores, has been found an ideal material for this purpose. The cloth is made in a basket weave, and while not transparent, it is very translucent, so that the exposure need not be changed from that used when the light is not diffused. The Cellophane is easily attached to the lamps with spring paper clips.



Iodine stains can usually be removed by soaking the fabric in milk and occasionally rubbing the spot.

Advance Solvents & Chemicals Corp. 28th and 5th Ave. N.Y.C.
 Chicago Sales Corp. 40 W. 40th St. N.Y.C.
 Jno. Brandt & Bros. 110 W. 40th St. N.Y.C.

Esig's Products Old

2nd DD

Colonial

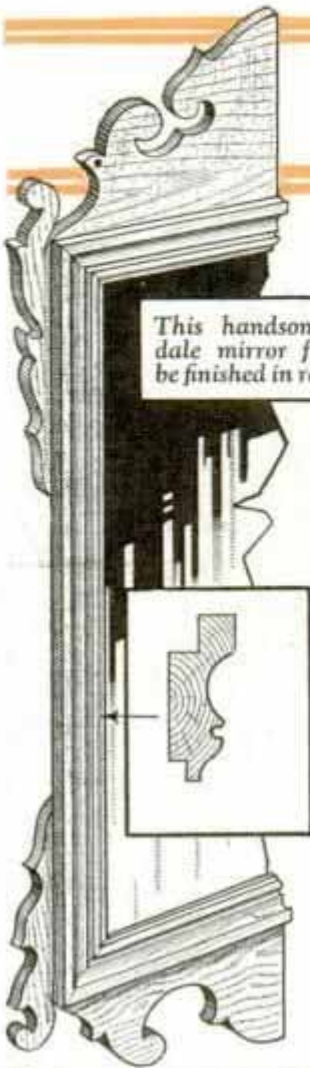

This handsome Chippendale mirror frame should be finished in red mahogany

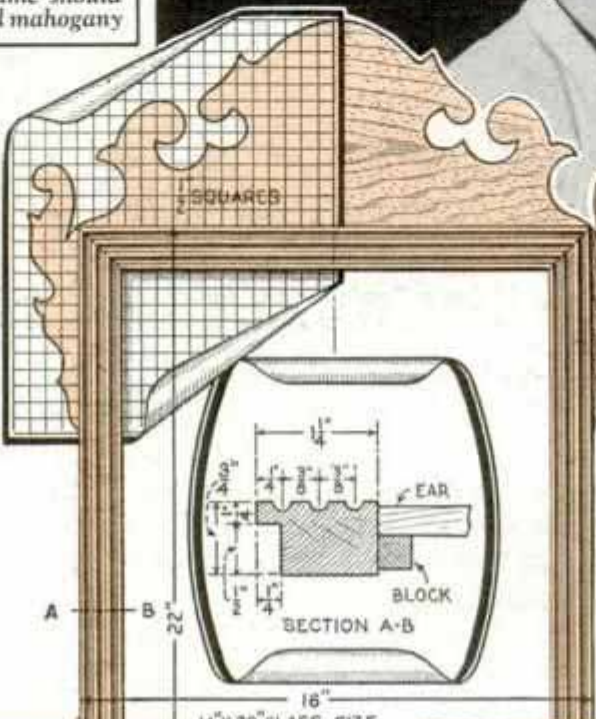

The scrolled head and ears are cut from plywood and are fastened to the frame by means of glued blocks as shown in the circular detail

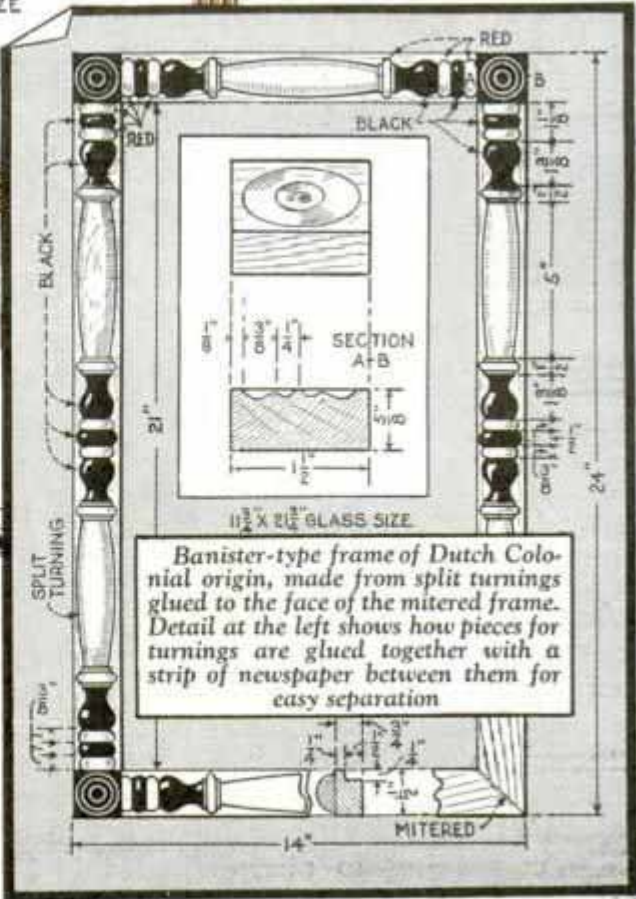
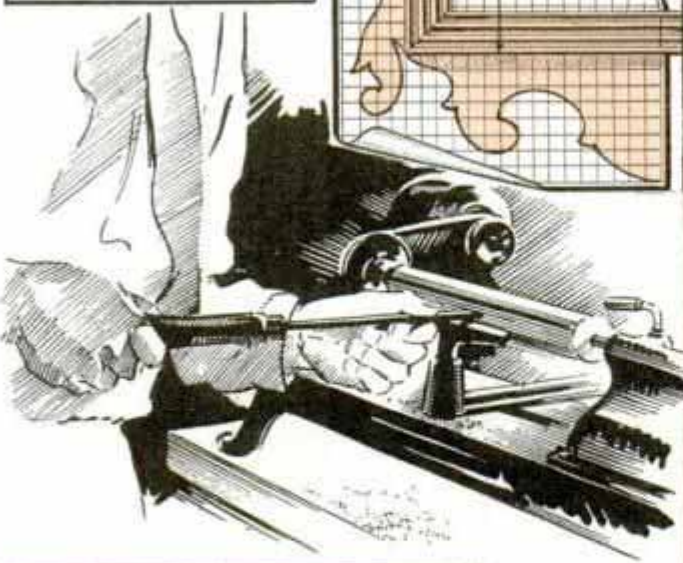

Banister-type frame of Dutch Colonial origin, made from split turnings glued to the face of the mitered frame. Detail at the left shows how pieces for turnings are glued together with a strip of newspaper for easy separation

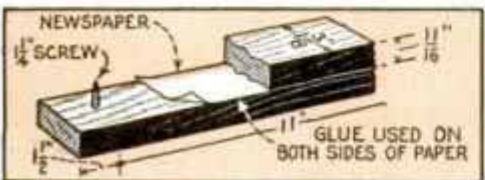

Mirrors

By R. O. BUCK
Lane Technical High School
Chicago

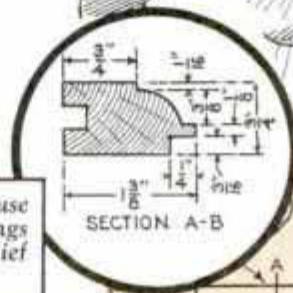
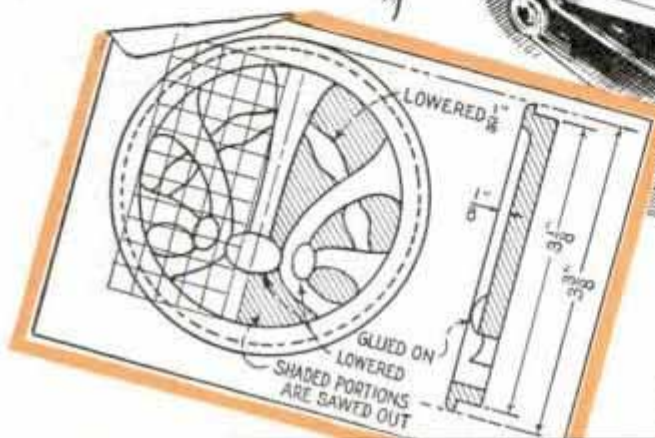
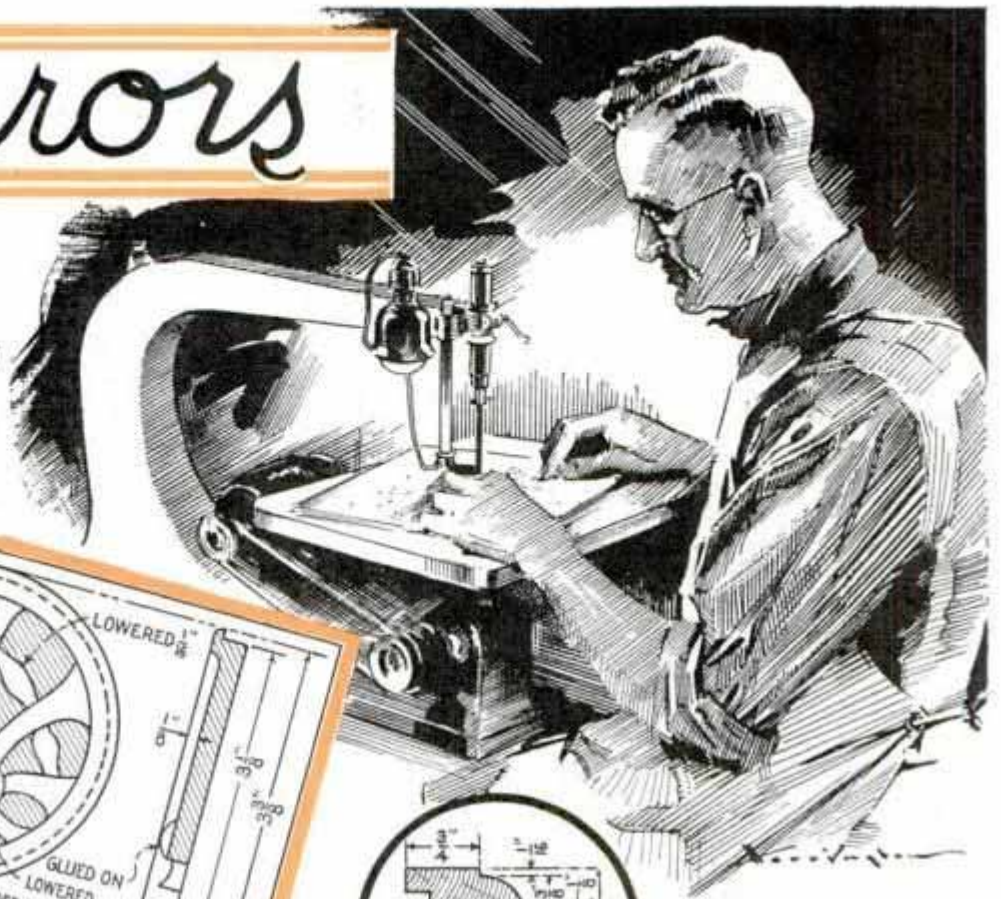

Queen-Anne style frame has cleats glued to back to house the glass. The medallion is turned on a lathe and the openings sawed out, after which it is glued over a circular hole. Relief carving helps to accentuate the design

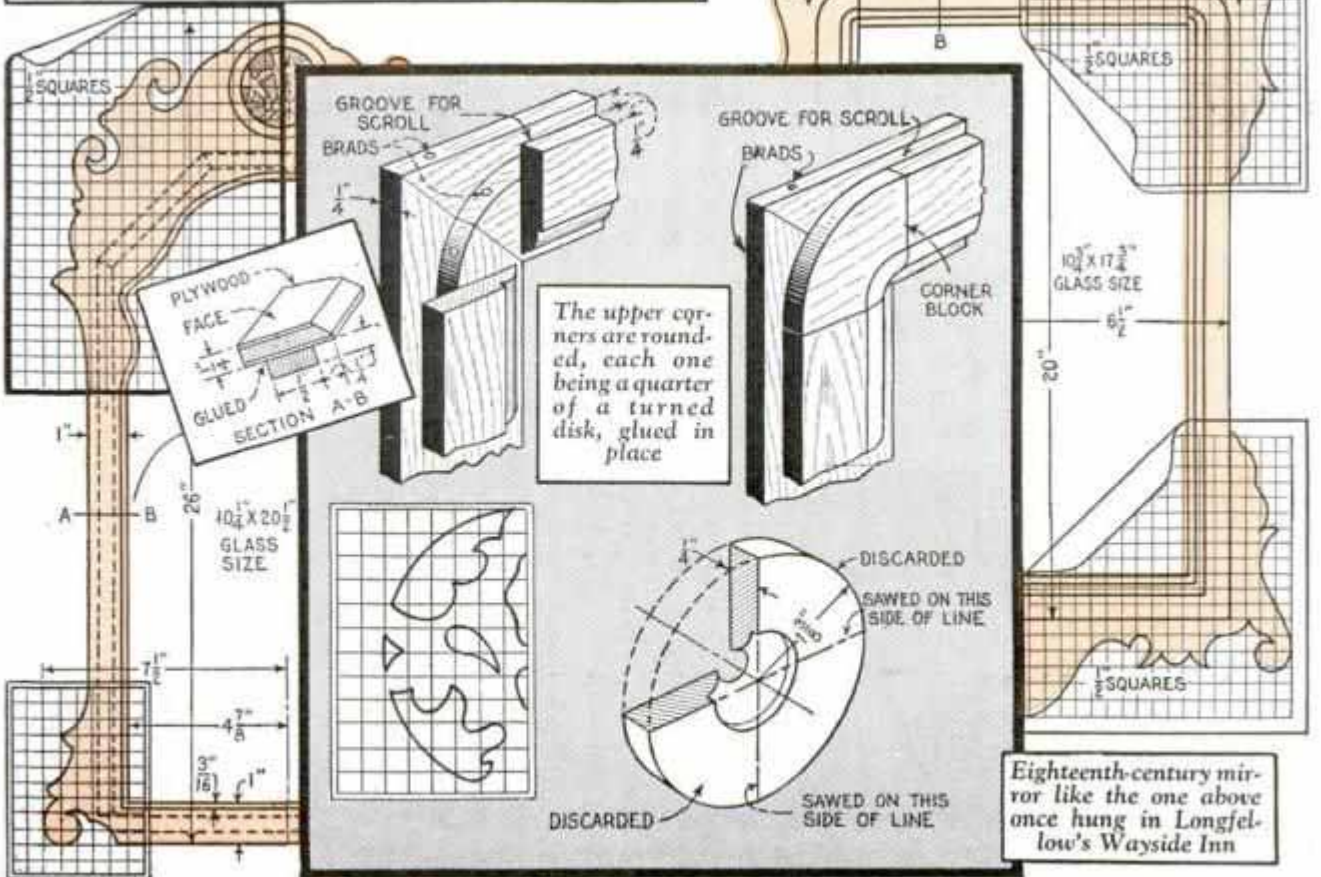

The upper corners are rounded, each one being a quarter of a turned disk, glued in place

Eighteenth-century mirror like the one above once hung in Longfellow's Wayside Inn

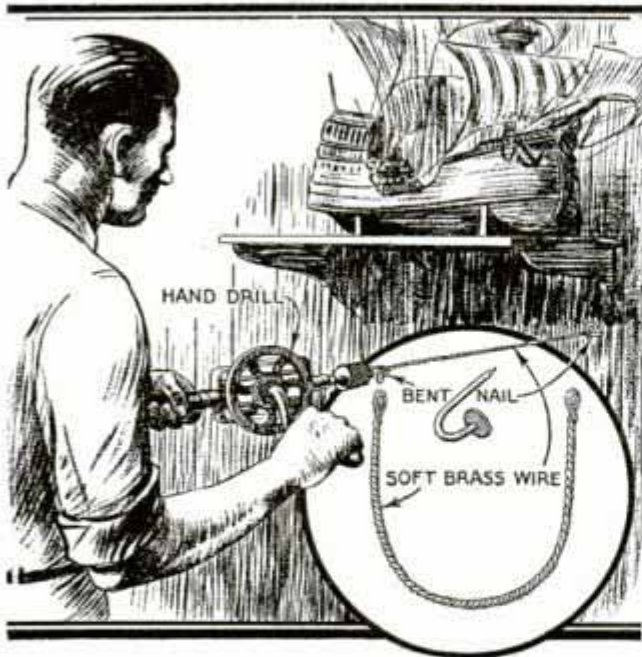

Ship-Model Anchor Cables Made of Brass Wire Drape More Naturally Than When Cord Is Used

Realistic Anchor Cables for Ship Models Made of Wire

Models of ancient sailing ships, which often require cable instead of chain, will drape more naturally if made of soft brass wire, which is better than cord. To make the cable, use wire of a size equal to one strand of the finished cable and twist several strands together. This is best done with a hand drill as shown, fastening the wire strands to the drill chuck and to a screw eye or bent nail. A coat of black or dark brown paint completes the cables.

False Bottom in Baking Pan Prevents Cake from Sticking



One woman who has experienced difficulty by having cakes stick to the bottom of deep baking pans, solved the problem by placing an aluminum disk on the bottom of the pan. The disk fits inside the pan, and is greased before pouring the cake batter. When the

cake is baked, it is turned upside down and the pan lifted off, after which the disk,

or false bottom, is removed from the cake by running a table knife under it, taking care not to damage the cake.

Preventing Splash When Washing Photo Prints under Faucet

Instead of letting water from a faucet splash on photo prints to wash them, it is better to put a string and a cork in the faucet as shown. In this way, the water follows the string, and not only can it be "led" to some extent, but splattering is prevented. The small compact stream of water also serves to keep the water in the washing pan in constant circulation.

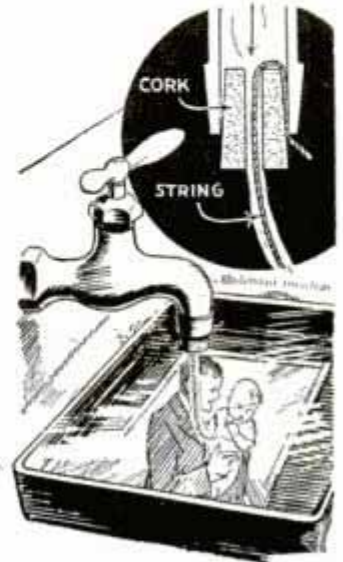

Buffers of Sash Cord Protect Canvas Covering on Canoe

Kayaks and lightweight canoes built of canvas stretched over a light framework with widely separated slats, can be made durable by putting sash-cord buffers on the outside directly over each horizontal slat. A number of such protecting cords on the bottom will prevent holes from being worn through the canvas when dragging the boat over a dock or beach.



Sash Cord Attached to Sides and Bottom of Canoe Protects Canvas Covering against Wear

The **A B C** of a FINE WAX FINISH

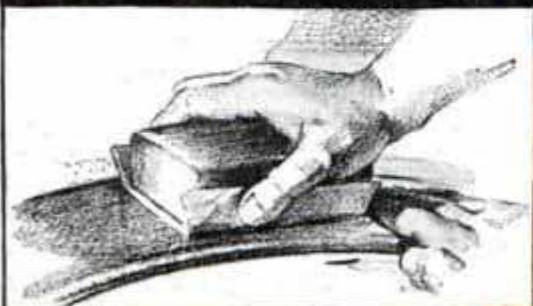

One of the best ways of obtaining a rich, satiny wax finish is to first give the work a thorough sanding with No. 00 sandpaper, and follow this with No. 4-0, always rubbing in the same direction as the grain of the wood

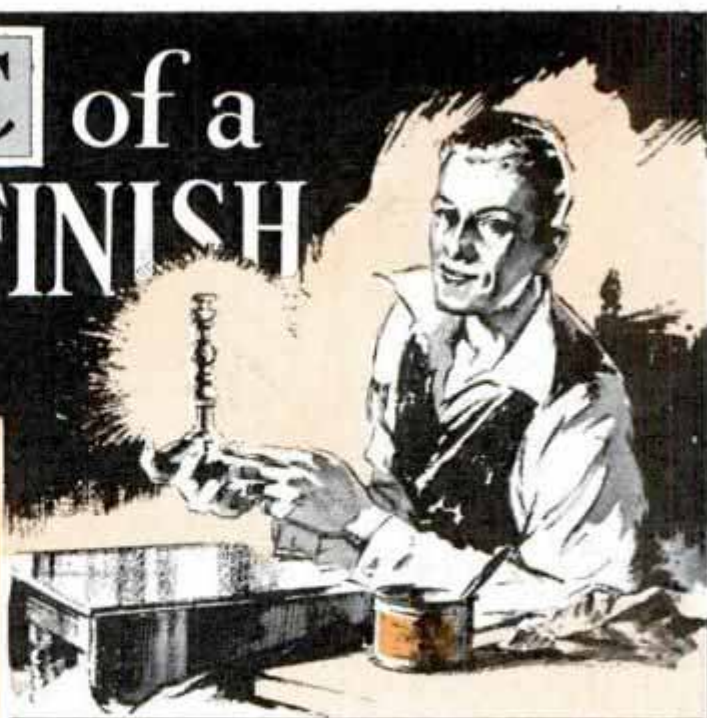

Second. The filler, which has been colored with a stain, is applied across the grain with a brush, and then allowed to stand 15 min., after which the surplus is wiped off with a cloth

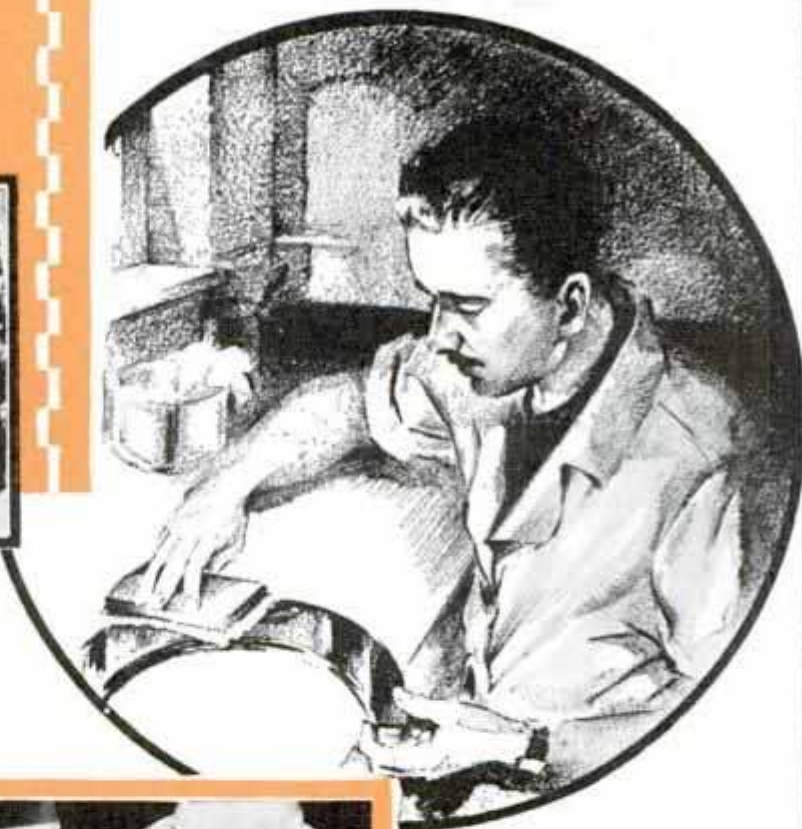

On the right is shown a sample of the finished work, which, in this case, is a wooden bag handle. This particular job is of gumwood, or Southern California eucalyptus. Wax finish is applicable to practically any wood, which may be stained in mahogany, natural wood, weathered oak, cherry or other tones of your choice



Third. After the stained work has stood for 24 hrs., use a good grade of wax, which, like the filler, is applied across the grain, allowed to stand from 3 to 24 hrs., and wiped off. The work is then polished, a shoe brush being effective for this purpose

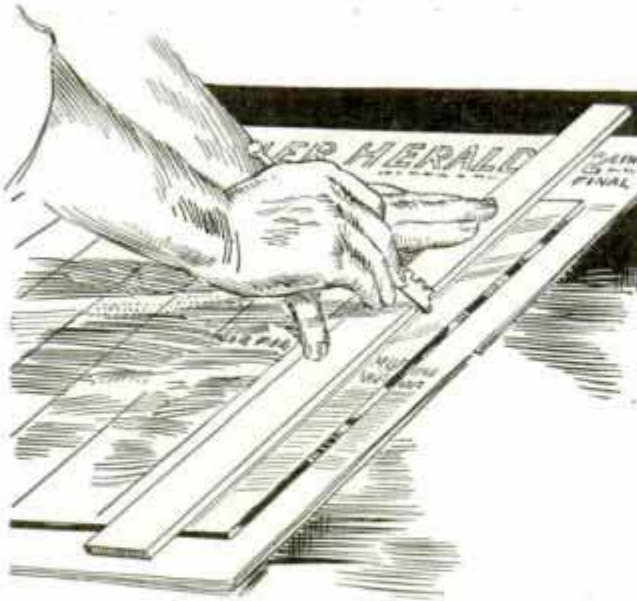

Heading and Column Lines of Newspaper Used as Guide Lines in Cutting Window Panes so That Edges Are True

Column Lines on Newspaper Aid in Cutting Glass

To aid in cutting small panes of glass, lay it over a sheet of newspaper so that the top edge is parallel with the heading line. Then cut the glass in the regular way, holding a straightedge parallel with a column line. Repeat this procedure for each cut made in the glass, and the edges of the pane will be perfectly true.

Cold Tea Fertilizes House Ferns

One woman who had unusual success in growing potted ferns, declares that the only attention given the plants is to pour cold tea over them every few days. The tea is not measured, but may be that which is left over from a meal.

BEAUTIFY YOUR GARDEN NOW



by building trellises, arbors and arched gateways. Or, perhaps you want a substantial, wooden lawn chair. And, there is nothing like an ornamental wood fence to improve the appearance of your backyard. Also, decorative window shutters are an appropriate addition to a home surrounded by a well landscaped garden. Popular Mechanics' collection of blueprints will give you many practical ideas along these lines.

Popular Mechanics 400 Blueprints

include plans for boats, models, toys, furniture, woodworking projects, as well as home-made machines for the workshop and various kinds of metal work and craft work.

Price of blueprints is 25 cents each or 6 for \$1.00. Address Blueprint Department, Popular Mechanics Magazine, 200 East Ontario Street, Chicago, Ill.

SN 636—RIDGE ROOF ARBOR AND GATE: Easily made of standard wood stock.

SN 637—CIRCULAR ARBOR AND GATE: Another beautiful style that is popular.

SN 639—FIVE LATTICE DESIGNS: Trellis types that are adaptable to any garden.

SN 715—ARBOR AND TRELLIS: A highly decorative garden unit that is easily cut and assembled.

SN 640—FIVE ORNAMENTAL WOOD FENCES: Artistic designs that can be made any length desired.

SN 635—HOW TO MAKE WINDOW SHUTTERS: Besides detailed construction hints, print includes 12 clever cutout designs.

SN 631—CONCRETE BIRD BATH: A 28-in. circular bowl mounted on a pedestal.

SN 529—LAWN CHAIR: A useful addition to your garden; plain-sawed southern style.

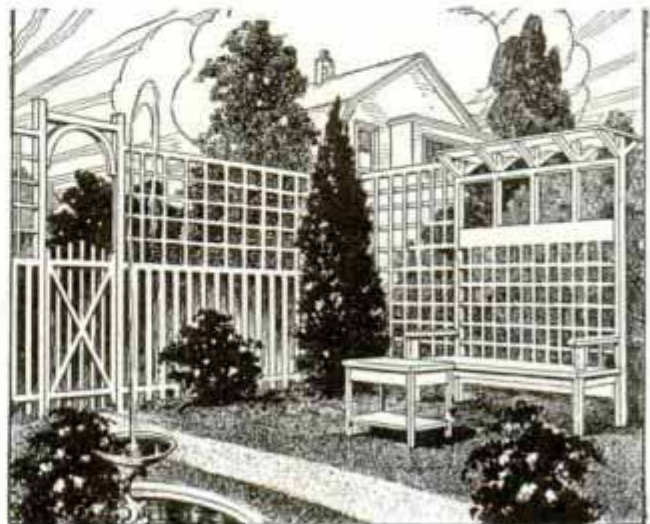



Using Your HANDSAWS



By W. CLYDE LAMMEY

CLEAN, accurate work with your handsaw is largely a matter of proper handling and selection of the tool best adapted to the work at hand. As an example, a saw with teeth filed for cross-cutting should not be used for ripping cuts lengthwise of the grain. It is essential that the teeth be filed and set for the purpose for which the saw is intended. Also, the manner in which the saw is held and started into the work determines, to a certain extent, how much or how little you are able to accomplish with it. When using either a rip or a crosscut saw, the work of moving the blade through the wood is not done with arm action alone, but by an easy swing of both body and arm. This coordination of movement is the secret of fast, accurate work. Your eye should always be in line with the blade when starting the cut, for only in this way can the angle of the blade with the work be gauged accurately. Start the saw by steadying it with the thumb, which is rested against the side of the blade. Light, short strokes will start the teeth cutting. Properly starting the blade will avoid the necessity of twisting it to hold the gauge

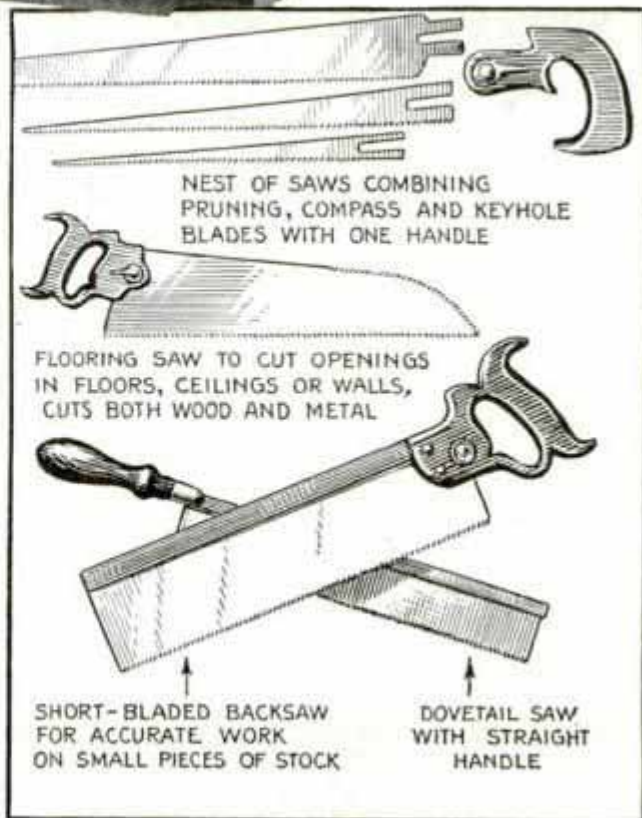



COORDINATION OF MOVEMENT BETWEEN ARM-AND-BODY ACTION IS THE SECRET OF FAST, ACCURATE WORK ON THIN STOCK

FOR CROSSCUTTING, THE SAW SHOULD BE HELD AT AN ANGLE, ABOUT 60° WITH WORK

WHEN CROSSCUTTING OR RIPPING STOCK LESS THAN 3/4" THICK, AN ANGLE OF ABOUT 40° IS PREFERABLE

THE BLADE SHOULD CUT IN THE WASTE OUTSIDE OF THE PENCILED LINE



STARTING A CUT WITH THE THUMB PLACED AGAINST THE BLADE TO STEADY IT

COPING SAW, USED FOR CURVED WORK ON THIN STOCK

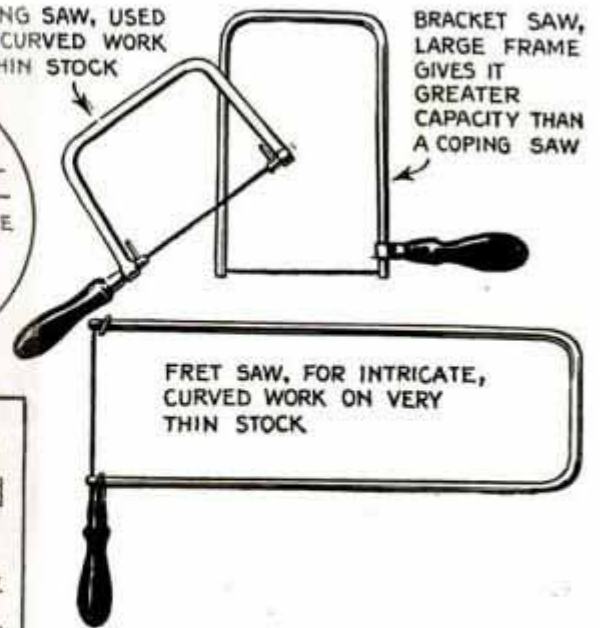

BRACKET SAW, LARGE FRAME GIVES IT GREATER CAPACITY THAN A COPING SAW

FRET SAW, FOR INTRICATE, CURVED WORK ON VERY THIN STOCK

line. This is especially necessary if you are using a saw with a very light set.

Your work should always be laid out so that the saw teeth cut outside the penciled gauge lines with the teeth on one side just cutting the edge of the line. To produce smooth work with a minimum of effort, it is essential that the saw be held at the proper angle with the wood. Ordinarily, this angle should be approximately 60° with the work. However, if you are crosscutting or ripping soft wood less than 3/4 in. thick, the saw will cut much smoother when held at an angle of 40°. The greater the number of teeth in contact with the wood, the less the necessary angle with the vertical, assuming that the work is in a horizontal position. On any special saw-

ing job, a few trial strokes will determine the angle at which the saw runs the best. Accurate line work with the handsaw cannot be done unless the work is supported at the proper height on a solid bench or table. Small, short pieces of stock are best handled in a bench hook, using a short backsaw. Sometimes it is handier to hold the work in a bench vise, especially when sawing down shoulder and cheek cuts of tenons.

The pressure applied to a saw blade should be governed by the type of saw, the kind of work, and the position in which the sawing is done. If you are cutting light stock in a bench hook, the weight of the backsaw is sufficient. As the saw moves forward, the direction of the movement, and the manner of holding the tool adds a certain amount of pressure aside from the weight of the saw. If the blade is properly sharpened it will require very little pressure of the hand to make it cut fast and smooth in any kind of wood. The strokes should always be straight and uniform. Rocking the blade and increasing the pressure just before reaching the end of the downward stroke will cause inaccurate work. The trick in making a true cut across the grain in hard or soft wood is using either a fine-tooth panel or backsaw, and holding the blade at an angle of about 30° with the horizontal. In this position, a greater length of the blade is kept in the wood, and aids materially in making an accurate

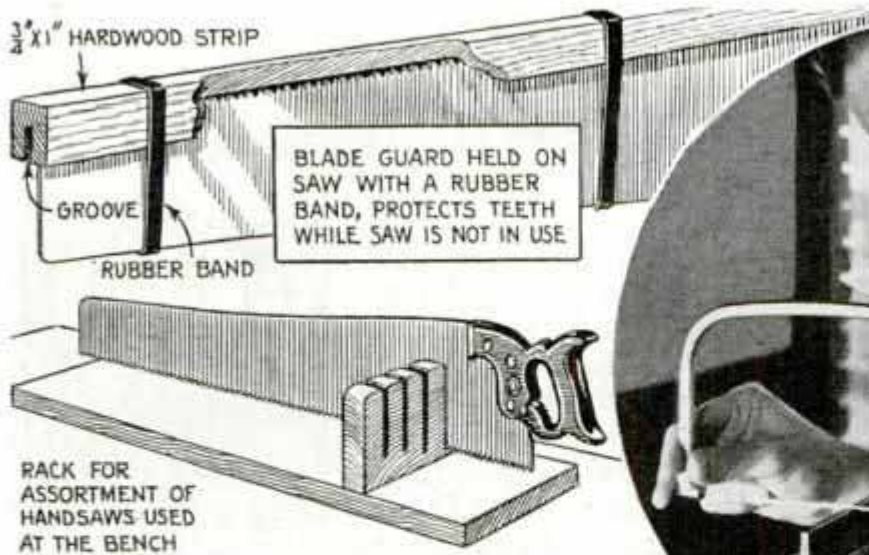

cut. The hand pressure should be just sufficient to keep the saw from chattering. Essentially, the same thing applies to compass and keyhole saws. These tools are used for cutting curves, and differ only in the width of the blades and the number of teeth to the inch. Due to the curved cut, these saws must be run with the blade very nearly at right angles to the work, and the pressure must be very light. When cutting circles of short radius, it is possible to use only the forward half of the blade with a correspondingly shorter stroke to prevent binding. Compass and keyhole saws may be purchased separately or as a "nest of saws." For cutting out sections of floors, ceilings or partitions, a flooring saw is generally used. With this tool you use the curved edge of the blade to start the cut on the line. Then the blade is turned over and the straight side used to finish to a corner, after which the procedure is repeated. The dovetail saw is used only for very fine, light work and is furnished with a straight handle, and a curved or offset handle for working on flat surfaces. Fitted with a depth gauge made from two strips clamped to the blade, the dovetail saw and the short backsaw can be used in making accurate depth cuts. Scrollwork, requiring short-radius curves on thin stock, can be cut easily with any one of several types of hand scroll saws. Bracket and coping saws differ only in the size of the frame opening, and, with the proper blades, may be used for cutting wood or sheet metal. The fret-saw frame is made especially for the very fine blades used in intricate work on thin plywood.

The important thing in using a miter

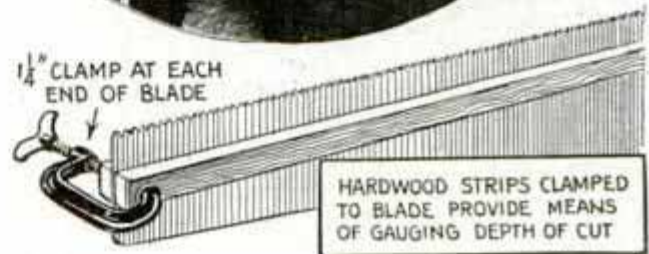

box is a straight, uniform stroke of the long backsaw, which is used in this device. A miter-box saw is not designed for fast cutting, hence it should not be crowded in an effort to speed up the work. If the blade is properly filed and set no hand pressure is necessary. If you use hand-saws exclusively at a bench, a few minutes time spent in making the bench rack shown, will save time in the frequent filing necessary to keep saws in condition if they are dropped carelessly on the bench top each time they are used. When saws are carried about in a portable tool box, a grooved blade guard will protect the teeth from damage. If saws must be stored for some time coat the blades with furniture wax to prevent rust.

Blackboard Eraser Used as Dry Window Cleaner

When cleaning windows with ordinary commercial preparations, which leave a dry abrasive powder on the glass, one may finish the task much easier and more effectively if the powder is removed with a blackboard eraser. The eraser wipes evenly and is easy to get into corners.



Embossed Book Covers Offer Varied Designs, Which May Be Utilized in Shading Mimeograph Stencils

Book Covers Utilized in Shading Mimeograph Stencils

Appearance of decorative mimeographed work is greatly improved by stippling or shading white spaces of line drawings, borders and open lettering on the stencil. Effects simulating engraving, half-tones, crosshatching, etc., may be had by placing the stencil over an embossed book cover and rubbing the surface of the portion to be shaded with a shading stylus or blunt-pointed lead pencil. Close inspection will show many variations in book covers, which can be copied on the stencil to obtain attractive shading effects.

Neat Trays from Tin Cans to Hold Small Parts



down the sides and turn over the edges as shown in the lower detail.

If only half of the tops are cut away when opening tin cans, they can be easily made into trays for small parts. Take the empty can, cut out half of the bottom and slit the side. Then bend

Sawdust Pockets Serve as Knee Pads for Carpenters

Filled with sawdust, a couple of pockets, made of denim and sewed to the knee portions of overalls, were used by a carpenter when working in a kneeling position on roofs and floors. Flaps, buttoned to the sides of the pockets, prevent the sawdust from spilling out.

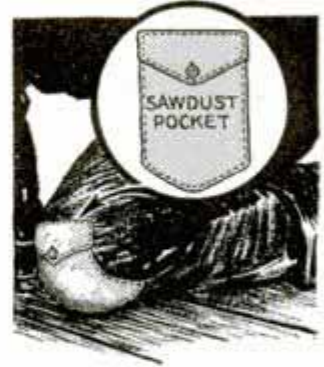

Tool for Center-Punching Work

Turned from a piece of cold-rolled steel, this tool is used by a machinist to aid in getting a center-punch mark at the exact intersection of two lines scribed 90° apart on the work. After the tool has been finished, four guide lines are marked exactly 90° apart on the beveled portion, and a hole is drilled lengthwise through the center to take the punch. It is important that

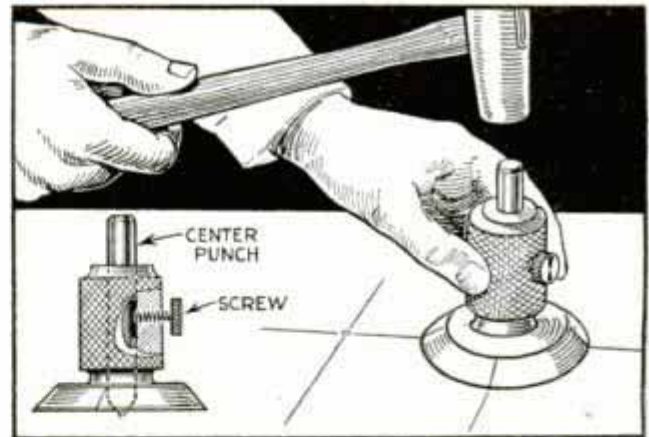

This Tool Is Handy to Accurately Center-Punch Work at the Intersection of Two Scribed Lines

the guide lines be scribed exactly central with the hole. This can be done accurately with the tool held between centers of an indexing head. The screw in the side of the tool is tightened to prevent the punch from dropping out when not in use. —Charles Kugler, Philadelphia, Pa.

☞ A little vaseline or cold cream rubbed on the hands before starting a paint job, will help make them easy to wash after the job has been finished.

Tender for Vegetable Truck Increases Sales

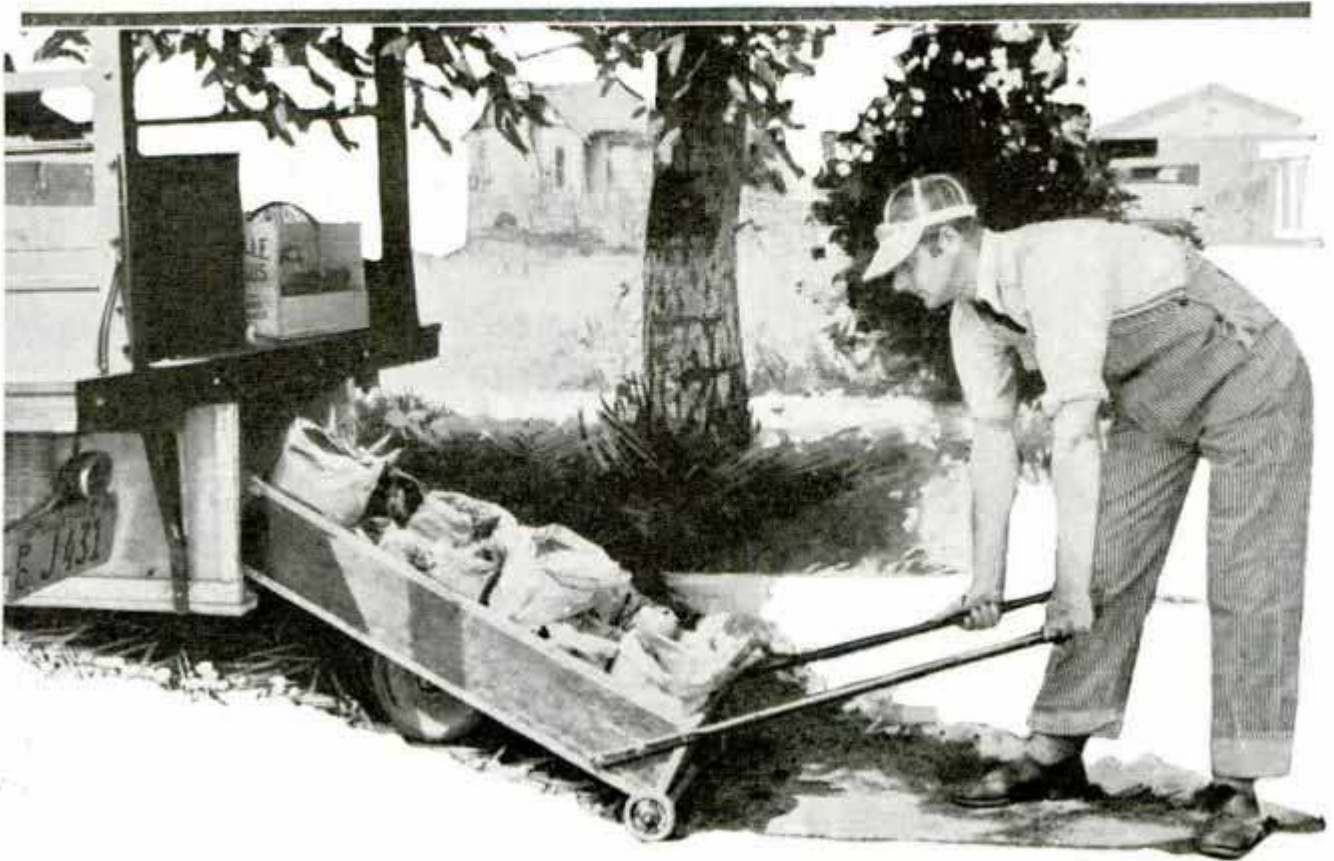

Realizing that housewives are more likely to buy fruits and vegetables if they can see them, one vendor constructed a small, rubber-tired pushcart, which he used as a tender to carry a display of his produce from the motor truck to the doors of his customers. The pushcart, when not in use, slides into a compartment built under the

body of the motor truck, and consists of a shallow box fitted with one large wheel, which is mounted on the underside slightly forward of the center, and two small ones at the rear end. A U-shaped handle, made from an iron rod and bolted to the cart at an angle, permits the latter to be pushed wheelbarrow-fashion.

Small Amounts of Plaster Mixed in Rubber Vacuum Cup

Plumbers and electricians will find a rubber vacuum cup a handy container in which to mix small amounts of plaster of paris for patching walls and ceilings. The cup can be bent or even turned inside out to crack loose the dried plaster after a job has been finished. They are convenient to handle and will make a useful addition to your tool kit.

❏ Instead of discarding sand points, used in driven wells, after they have become corroded, farmers will find that they can be cleaned with a stiff wire brush and kerosene, and used again. The points may be cleaned several times before they have to be discarded, depending, of course, on the amount of corrosion.





Set on a Frame Fitted with Casters, Fire Barrels Are Readily Pushed to Any Part of a Building

Fire Barrels Fitted with Casters

In one large warehouse, the fire barrels are mounted on hardwood frames fitted with heavy trunk casters so that in case of fire, the workmen can quickly push the barrels to any part of the building. It has been found that this method enables the men to get a volume of water to the fire much quicker than when the water has to be carried in buckets. Four casters on a rectangular frame give better support than three casters on a triangular frame.

Cotter Keys Hold Fence Wire on Steel Posts

For fastening fencing to angle-iron posts, it has been found that cotter keys are much better than short tie wires, which

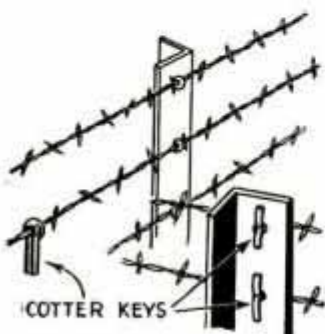

are often used for this purpose. The keys are spread and slipped over the fence wires, after which they are inserted into the holes in the posts. The keys are then clinched tightly as shown.

I have found that dry mounting tissue is better and more economical for fastening photos in folders than glue or cement, as it does not dry out and allow the photos to loosen. To use the tissue, lay a strip under the photo where you would ordinarily use cement. Then place a piece of blotting paper over the photo and press it with a hot iron to melt the tissue.—T. Perpoli, Chicago.

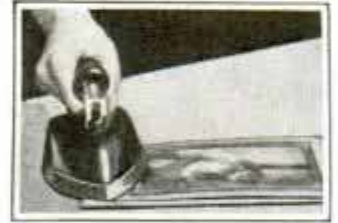

Tile in Temporary Sewer Joined with Old Inner Tubes

On a job of altering a building where a temporary sewer was needed, the contractor, instead of laying the sewer tile in cement, joined them with 12-in. sections of old inner tubes. The sewer, which was laid in a shallow trench, was in use about 30 days and was still in good condition when it was removed. The cost of laying and removing the sewer was only a fraction of what it would have been if the tile had been laid in cement, and it was much easier to take up.

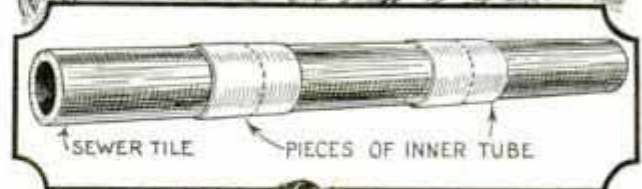

Time and Labor Saved in Laying Temporary Sewer by Joining the Tile with Sections of Inner Tubes

MILLING CUTTERS

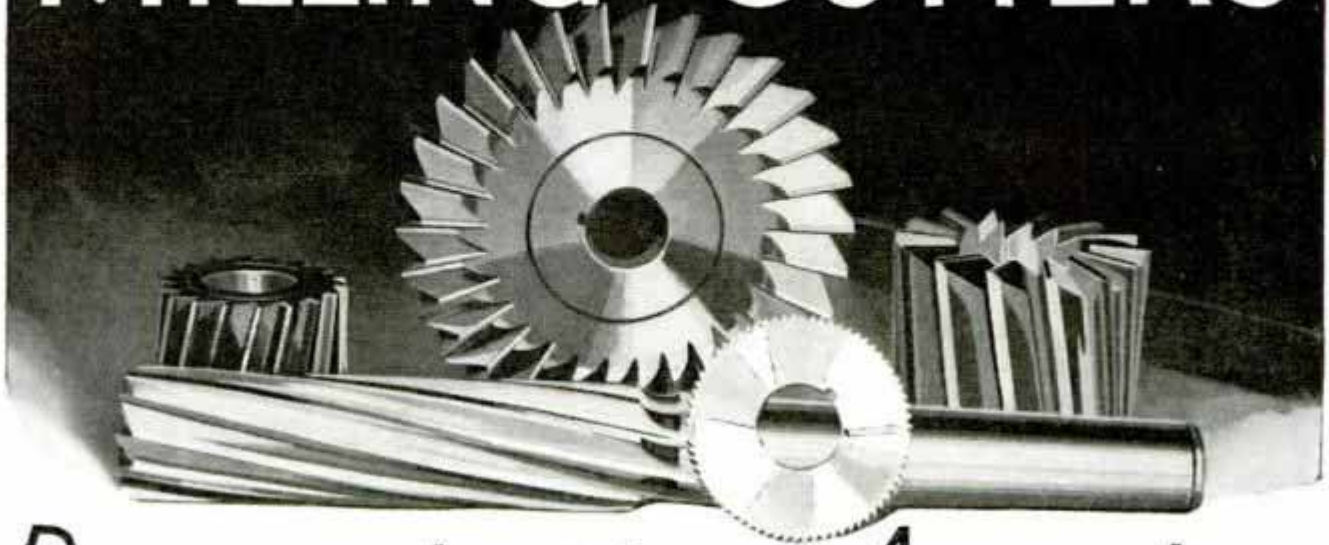

Reground without Annealing

by Fred B. Jacobs

WHILE milling cutters, of carbon steel, were reground by first annealing them and then recutting the teeth, the use of high-speed steel cutters has made it advisable to regrind them without annealing, as this process often ruins the cutters. The following grinding process, which is used successfully in many large manufacturing plants, reflects the best practice, and can be carried out by any machinist who understands the operation of cutter-grinding machines. The principle of regrinding the teeth is shown in the detail at the right, a grinding wheel being trued to the correct bevel and fed down into the teeth, one by one, to remove the superfluous metal between them.

The first step is to grind a clearance on the sides of the cutter between the teeth and the center boss with a surface grinding machine, which is fitted with a magnetic chuck and a rotary table, the wheel head being fed back and forth by hand with the turnstile handles. The cutter is

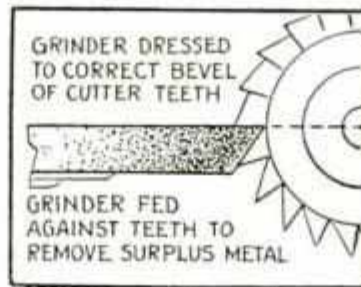

Grinding the necessary clearance on the cutter sides between the teeth and the center boss. This is done readily on a rotary-table surface grinder, which is fitted with a magnetic chuck

located accurately by slipping it over a pin in the chuck center. In this operation, enough metal is removed to give a clearance ranging from $\frac{1}{16}$ to $\frac{3}{16}$ in., depending on the size of the cutter. The side teeth are then cut on an ordinary grinder, as in the upper circular detail, the cutter being located on a head that has an angular adjustment so that it may be set to get the correct angle. The wheel face is beveled

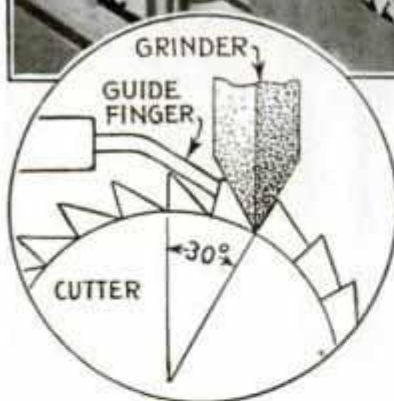
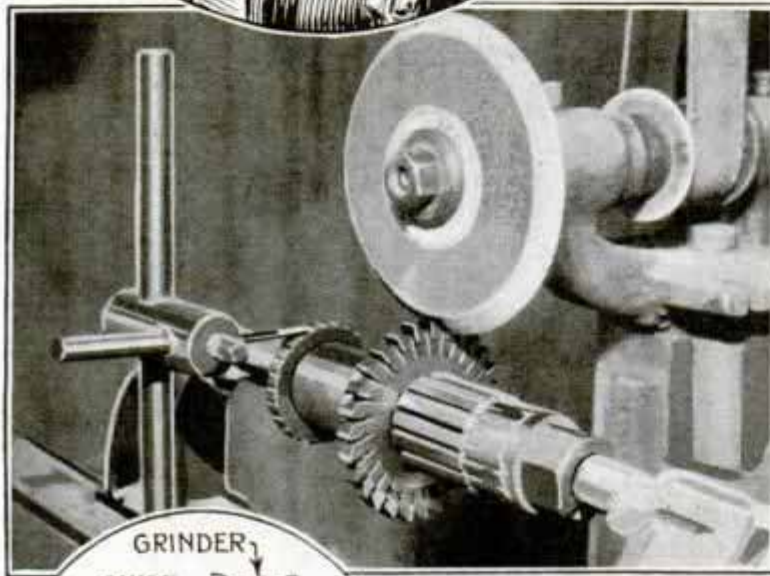
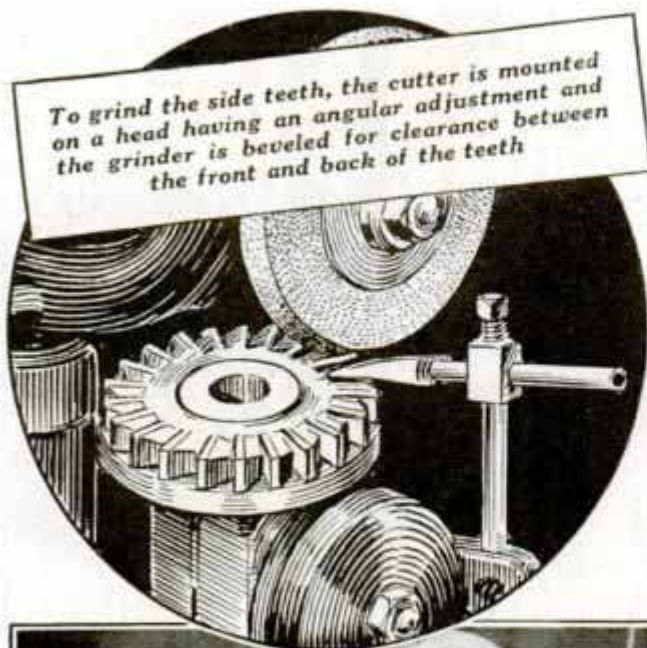

For grinding peripheral teeth, the cutter is held between collars on an arbor and correct spacing is obtained by using a guide finger. Detail at the left shows a setup for regrinding the teeth of spiral cutters

slightly to give the clearance angle between the front and the back of the teeth, the latter resting against a guide finger, which is flexible so that the teeth are readily located, one after another, and held conveniently in the grinding position.

In cutting the peripheral teeth, as shown in the photograph, the cutter is held between collars on an arbor provided for this purpose, the correct spacing between the teeth being obtained by using a guide finger with a slightly hooked end which drops into slots in a collar provided for

this purpose. See the lower, circular detail. It is necessary, of course, to provide a number of collars with different spacings to accommodate various cutters. On first thought, it would appear difficult to recut the teeth of spiral cutters, but the operation is comparatively simple if the cutter is set up correctly. The guide finger, in this case, is not flexible, and is brought to bear against the front of the tooth. The grinding wheel must have a double-angle face of about 30° at the back, while the angle at the front must be great enough to finish out the tooth correctly, and will vary with different teeth. Success or failure depends, in a great measure, on the

grinding wheels, which should be medium grade, 46 grit, $\frac{3}{4}$ in. thick, and from 6 to 8 in. in diameter, although the grade may vary, depending on the rigidity of the machine and other local conditions. However, by experimenting with wheels of various grades, those can be selected that give best results. The surface speed of the wheel may vary anywhere from 4,000 to 5,000 ft. per min. Moderately light cuts must be taken to avoid burning the work, but in grinding high-speed steel, a comparatively deep cut can be taken without burning. The wheels must be trued in a manner to keep them open so that they will cut freely. This can be done with a star-wheel dresser or a mechanical dresser incorporating an abrasive wheel, which is held at an angle against the grinder. The cutters are ground dry in every instance. It might seem that water or other coolant would help keep

down the heat, but experience has taught that dry grinding of high-speed steel is practical.

¶ Enamel letters that are used in putting the name of a firm on glass are usually cemented in place with a mixture of oil and white lead, which can be softened with ordinary paint remover so that the letters may be gently pried loose. It is generally necessary to leave the paint remover on the letters for an hour or so before they can be removed.

Homemade Rotary Files for Carving Wood

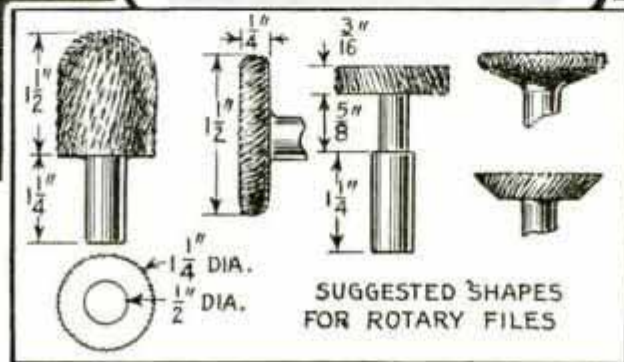
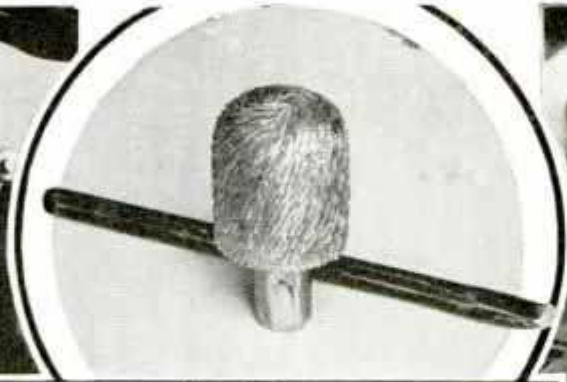

Small rotary files of various shapes are exceptionally handy for roughing out irregular shaped pieces of wood and can be made in your own shop if you have a lathe fitted for metal working. If not, you can have the files turned to shape in a machine shop at small cost. After the metal has been turned, the teeth are cut with a sharp cold chisel, and the files hardened. Exact dimensions are of little importance, except

on the shank, which should fit your drill-press routing attachment. When cutting the teeth, clamp the work tightly between two hardwood blocks, with a third block underneath to prevent the blank from being driven downward. Then grind a $\frac{1}{4}$ -in. cold chisel to a sharp, rounding edge, and, inclining it in the direction of rotation of the file, cut a series of teeth leading obliquely toward the rounded end. Make the teeth swirl in toward the center of the end. —E. M. Love, San Gabriel, Calif.

Your Initials Burned on Shipping Crates with Blowtorch

When poultry and produce crates are returned to the shippers, identification among the various dealers is sometimes difficult because the tags are often lost, or painted names are destroyed. To eliminate this trouble, one poultryman uses a sheet-metal stencil and burns his initials on the crates with a blowtorch. The stencil is mounted on a wire handle, and the lettering is outlined with punched perforations.

Renewing Workbench Tops

When the top of a workbench becomes worn, it can be renewed with a covering of quarter-sawn hardwood flooring boards. The boards should be drawn tightly together and toenailed down, after which the surface is treated with linseed oil and then given several coats of cup grease rubbed on and allowed to dry.



Owners' Initials Burned on Shipping Crates with Blowtorch and a Sheet-Metal Stencil



Tracing Paper Fastened over Drawing with Rubber Cement Instead of Thumb Tacks

Tracing Paper Held over Drawing with Rubber Cement

When it is necessary to fasten tracing paper over a drawing, try using a little rubber cement at each corner of the paper instead of thumb tacks to hold it down. This will hold the paper securely and will not mar the drawing as the cement can be removed by rubbing it with art gum.

Removable Racks Hold Bicycles

Instead of building racks in various places about the factory grounds to accommodate employees' and messengers' bicycles, the manager of the factory made individual holders for the bicycles from lengths of $\frac{1}{2}$ -in. steel rod. These were bent to a U-shape, as shown, and the ends were pointed so that they could be driven into the ground easily, permitting the racks to be moved to different locations on the grounds as necessary. Use a padlock to fasten the bicycle to the rack.



Combination Caliper for Inspecting Cored Castings

Here is a combination caliper that one machinist finds a time saver in inspecting cored castings. It is used to check the thickness of the walls and the depth of the casting in one operation. One jaw has a scale for measuring the depth of the casting, while one of the handles, which is made longer than the other one, is bent at right angles, and has a scale for measuring thickness of the walls.

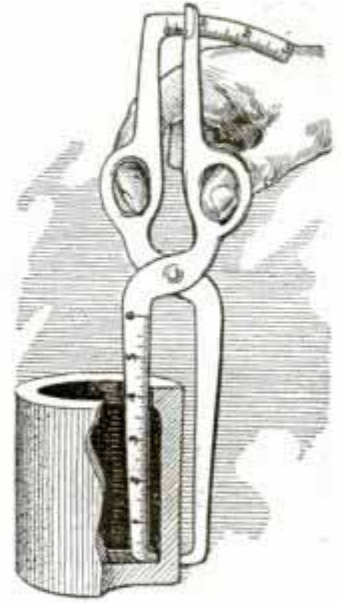

Attachment for Grinding Radii on Steel Links

For grinding radii on the ends of steel links, mechanics in a small shop, where the equipment was limited, used the at-

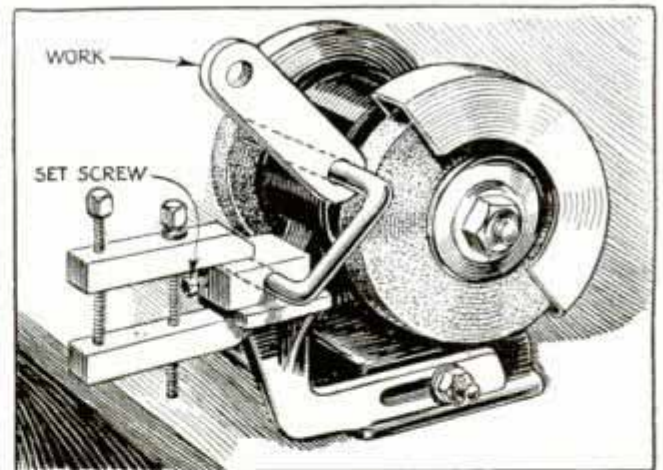

Improvised Attachment, Which Clamps to Grinding Machine for Turning Radii on Ends of Steel Links

tachment shown, which is clamped to the grinder table. It is a steel block, drilled to take a U-shaped rod, and fitted with a set screw, which holds the rod. In use, the holder is adjusted so that the work, when slipped over the rod, will be ground down to the desired radius. If the rod is securely held in place by tightening the set screw, it is an easy matter to grind a large quantity of links to the same size.

Clamp Holds Two Gluing Jobs at One Time

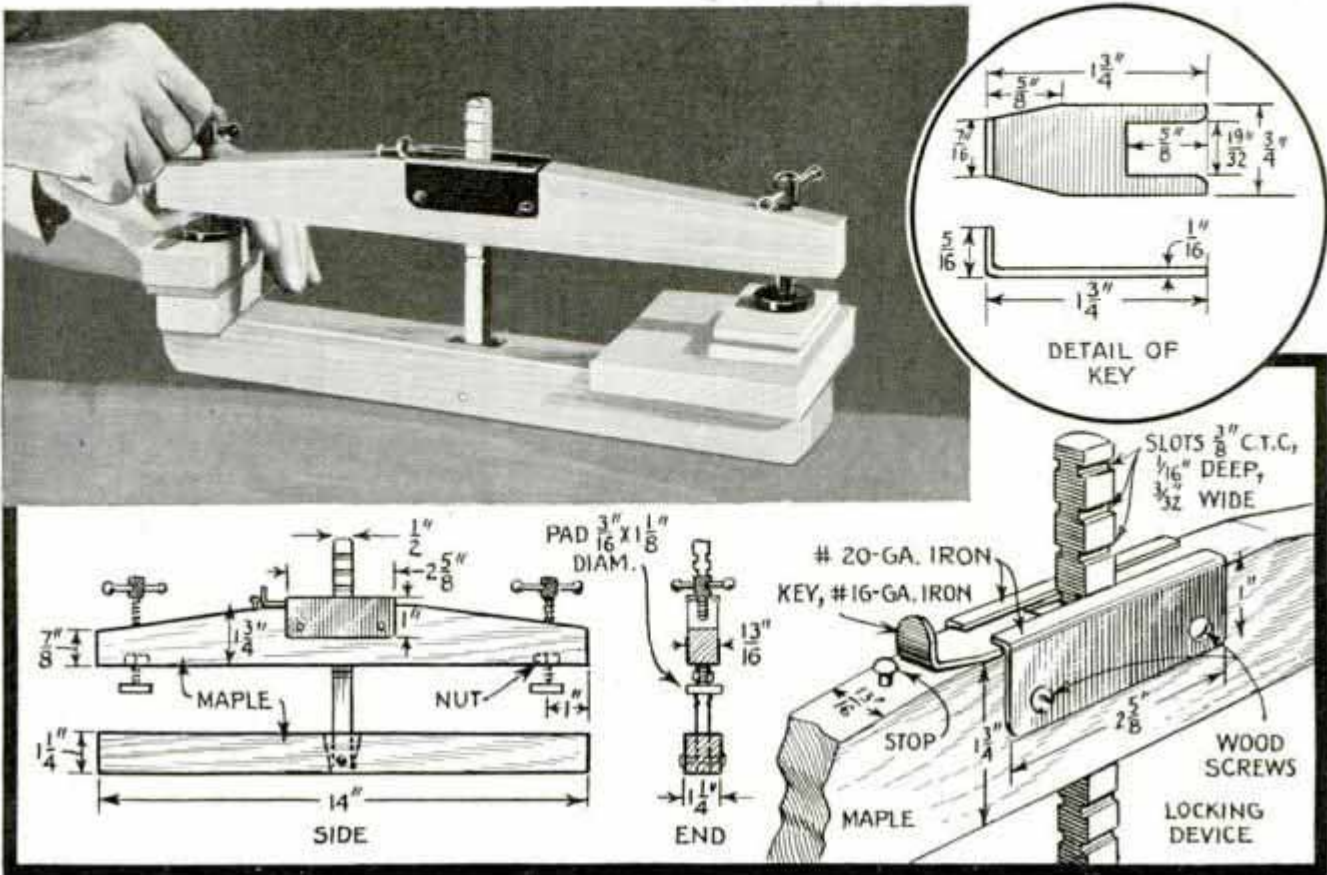

When several small gluing jobs must be done at one time, this pair of clamps will be found handy as two jobs of different thicknesses can be handled at one time. The jaws are fastened together with a square, hardwood piece, which is slotted on opposite sides and bolted loosely in a large mortise in the center of the lower jaw. A square hole in the upper jaw, through which the piece slips, is provided

with a locking device, shown in the upper and lower right-hand details, to engage the slots for spacing the jaws of the clamp. Screws near the ends of the upper jaw may be taken from broken vises or C-clamps, or they may be long bolts, screwed into nuts, which are mortised into the underside surface of the jaw. If bolts are used, they should be fitted with iron pads or disks, loosely riveted to the lower ends.

Template and Dial Indicator Aids in Irregular Milling

By using a template, cut to the desired shape of the finished work in connection with a dial indicator held on a surface gauge, irregular shapes can be milled accurately in a milling machine. The template is bolted in one of the T-slots in the machine table and the indicator is mounted as shown. With this set-up, a spherical end mill can be made to cut a groove in the work of the same contour as the template. The long automatic feed is engaged and the cross feed is controlled by hand so that the hand on the indicator remains stationary. If the work is done carefully, retouching with a file is unnecessary.

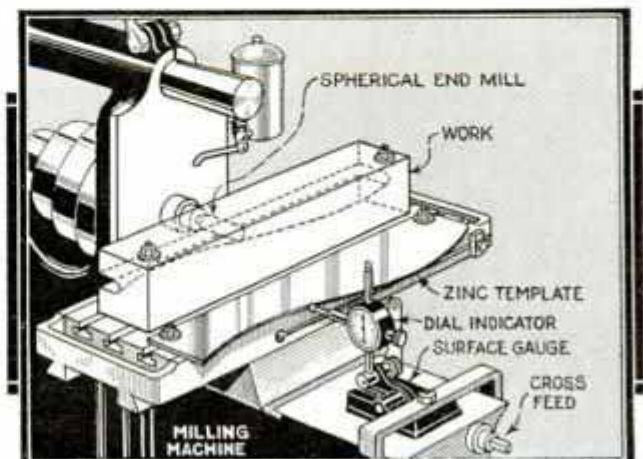

Irregular Work Cut in a Milling Machine by Using a Template and Dial Indicator

*Reader says they do not
 answer letter
 suggest also*

How you RECORDING

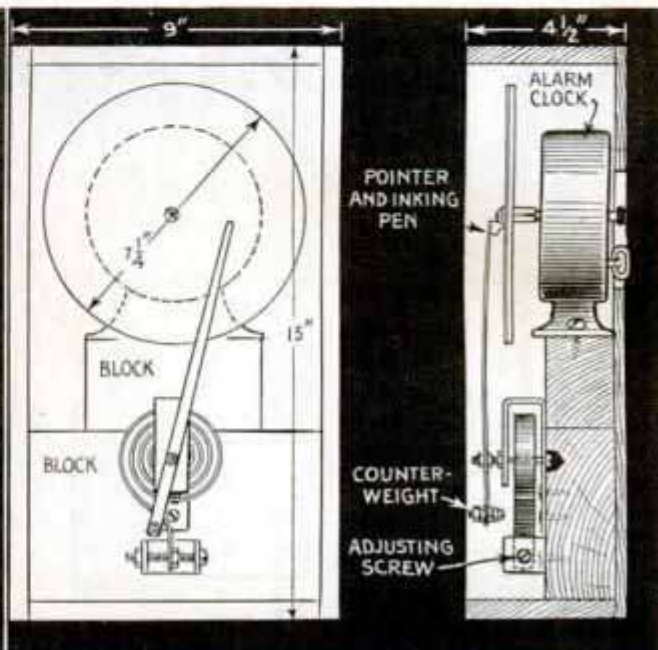
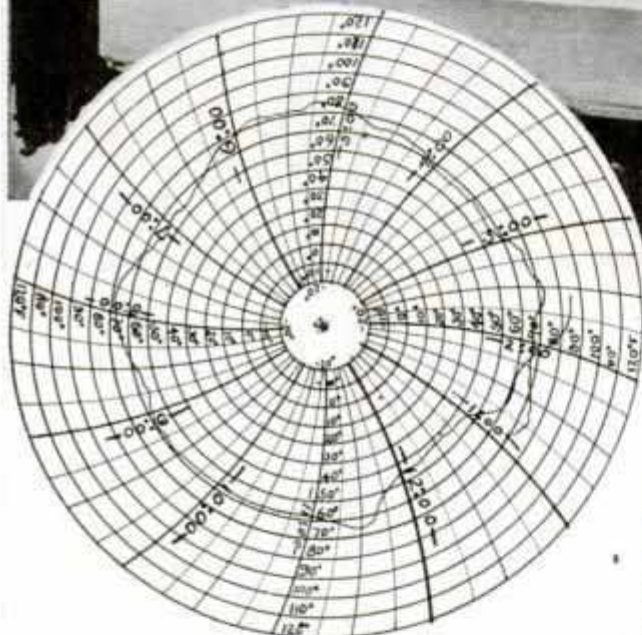

WITH this clock-driven recording thermometer, you can have a record of temperatures throughout the night, or, if you wish to check the effectiveness of your heating plant, or the insulation in your home, this simple instrument will not only do the watching, but it will write down the hourly results. The first thing required is a clock. Inexpensive alarm clocks are the simplest to work with, although any clockwork may be used with equally satisfactory results. After removing the glass from the clock face, the hands and dial are carefully taken off. On most clocks, the hour hand is attached to a piece of tubing slipped over the slender shaft to which the minute hand is attached. The rotating dial of the thermometer, to hold a paper chart

upon which the temperature is to be recorded, is attached to this tube in much the same manner as was the hour hand. This is shown in the left-hand detail on the next page. A piece of brass tubing, of such internal diameter that it can be pressed over the hour-hand hollow shaft, is cut to the length indicated and tapped at one end to take a brass machine screw, which holds the dial and the chart in place. The slot in the tube allows it to slip over the shaft readily and still bind tight enough to turn the dial without slipping. The dial is a disk of light sheet metal, such as aluminum, or better, bakelite. After the dial has been made, the next step is to build a case for the instrument and carefully locate the position at which the thermometer is to be mounted as shown above.

You are now ready to make the sensitive temperature unit, which is a strip of bi-metallic metal coiled into a spiral. This material is available at reasonable cost, and consists of two strips of metal, soldered together, one being nickel steel, which does not expand to any great extent when heated, and the other an alloy that is very sensitive to temperature changes.

5997 Mountain Ave Chicago
1/2 inch by 18 in. long.

W. M. Chace Valve Co
 4743 W. Lake Chicago
 or 1600 Broad Ave
 Allentown Pa
 by C.A. Crowley

can make a THERMOMETER

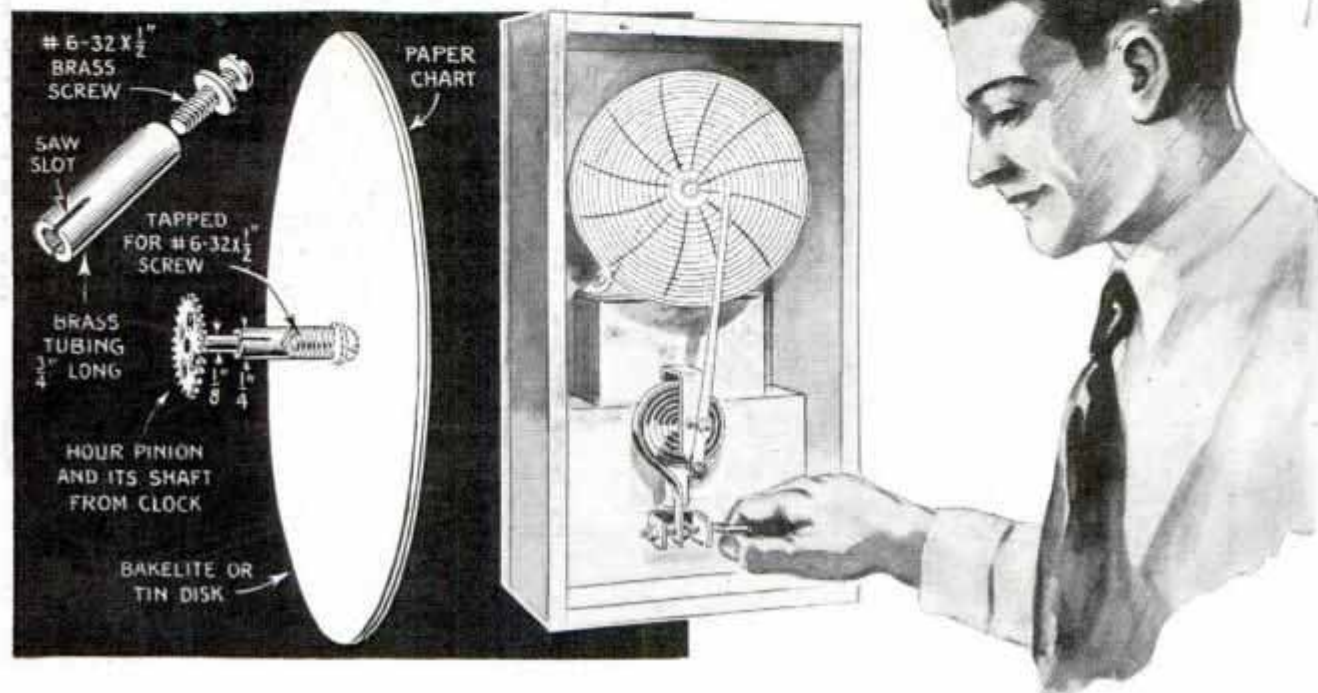

You will need a strip of this metal $\frac{1}{2}$ in. wide and about 18 in. long, as some experimenting and cutting down will be required to get the instrument to indicate accurately. The easiest way to make the spiral is to wind the strip of metal around a $\frac{1}{2}$ -in. iron rod. When released, the tight spiral will open up. When winding it, be sure that the expanding, alloy side of the strip is kept to the outside. If you are uncertain as to which is the expanding side, heat the strip cautiously over a flame and note the direction in which it curls, and then wind the spiral in the same direction. When this has been done, the ends should be bent as shown, after which the outside end should be drilled and soldered to a brass nut as shown in the lower left-hand detail on the last page.

The right-hand detail here shows a mounting bracket to hold the sensitive unit. The pivot screw is mounted in the bracket so that it turns freely. The sensitive unit is then soldered to the screw, after which the assembly is fastened to the mounting board in such a position that the end of the pivot screw is exactly $6\frac{1}{2}$ in. below the center of the dial and $\frac{1}{2}$ in. to

the right. The adjusting unit is next constructed as shown in the circular detail. The screw here is also left free to turn in the holes. The nut, which was soldered to the sensitive unit, is threaded onto the screw before pushing it through the other arm of the bracket. The holding nut may be put in place at this time, however, it should not be soldered until after all adjustments have been made.

The pointer is made next according to the details shown. It is $\frac{3}{8}$ in. wide at one end and tapered to $\frac{1}{8}$ in. The ink well is the only part which may prove troublesome. This also serves as a pen to write on the paper as the pointer moves it. The point of the well should be shaped as shown, but it should be free from burrs that might catch in the paper. The ink to be used may be ordinary red or green ink, 3 parts and glycerine, 1 part. The glycerine is to prevent evaporation. The pointer is mounted on the element shaft in such a position that its end is approximately in the center of the recording space, that is, halfway between the center of the dial and the right-hand edge.

After all of the parts have been made

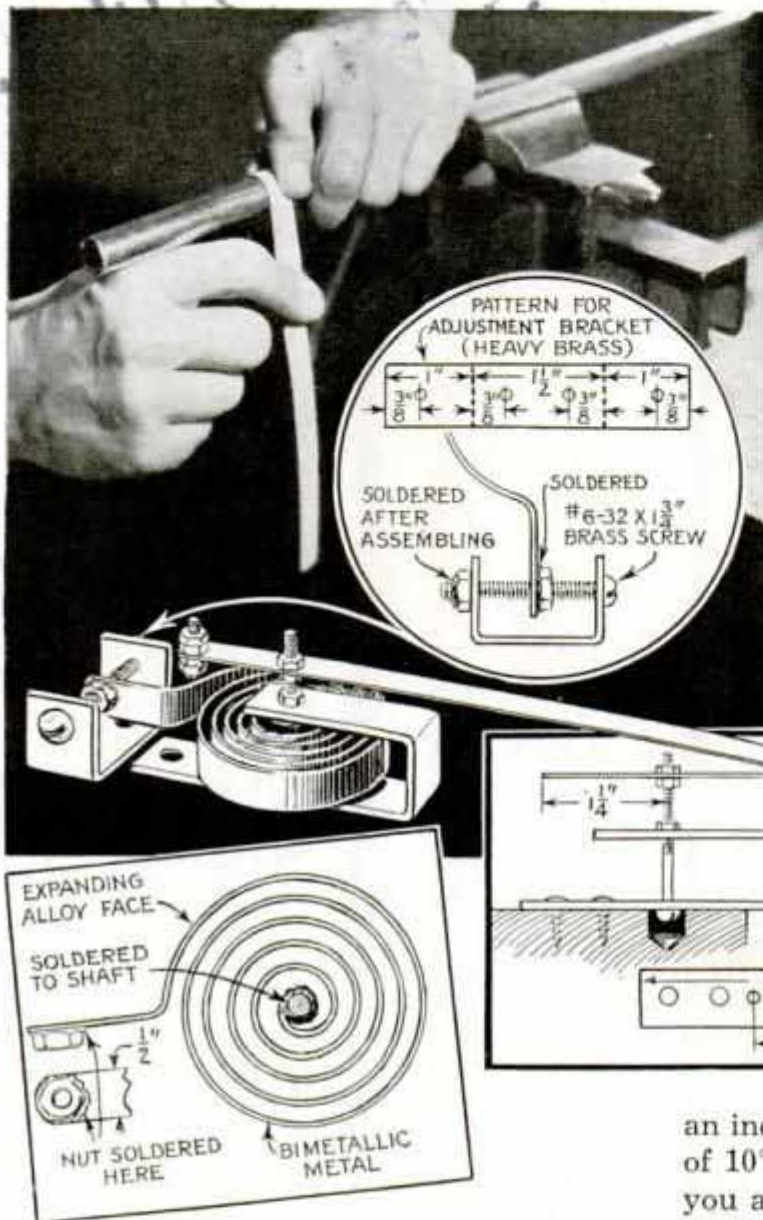

do this, place the instrument out of doors if the temperature is low outside, or in an ice box with a good thermometer. After leaving it for about 30 min., quickly read the thermometer and mark the position of the pointer on the paper. The thermometer and the instrument are next put in a warm place and allowed to remain there for another 30 min. The temperature is again read, and the position of the pointer marked. With this information it is a simple matter to measure the distance moved by the pointer and figure out how many thirty-seconds of

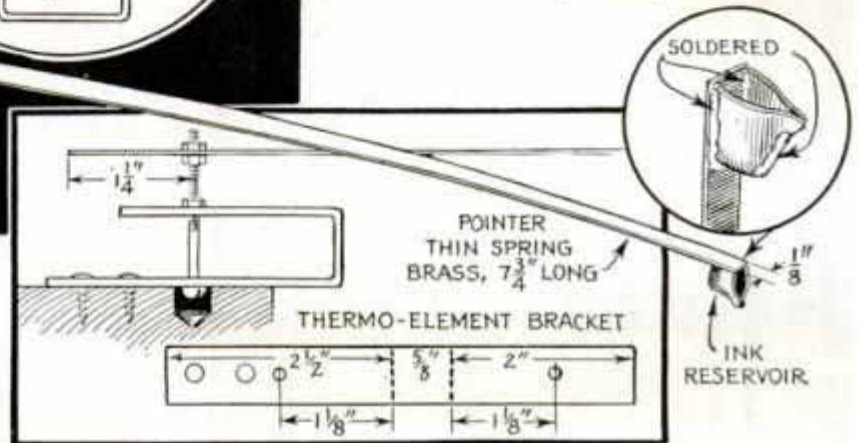

and tried out to make certain that they fit accurately, the sensitive element should be removed and placed in an oven and heated slowly to about 300° Fahr. When this temperature has been reached, the oven should be allowed to cool slowly without disturbing the element. This heating and cooling will need to be repeated three or four times before the unit is ready to use. Thermo elements of this type will not read accurately unless they are heat treated in this manner. After heat treating the unit, it may be installed into the case and given final adjustment. For this, a plain paper disk is placed on the dial, and the pen adjusted so that it will make an even line as the pointer moves slowly back and forth. Next, the paper disk should be calibrated, that is, it should be determined just how far the needle moves when the temperature increases 10°. To

an inch the pointer moves for each change of 10° in temperature. Having found this, you are ready to draw a chart for the instrument, shown on the first page. The spacing between the circles is the same as the distance the pointer moves for each 10° change in temperature. If this distance is too large, you may reduce it by cutting off part of the spiral.

When the chart has been drawn up carefully, you may have a printing plate made from it, and then have charts printed whenever they are needed. Each chart is good for 12 hours.

With a chart in place on the recorder, and the pointer held away from the paper so as to prevent ink splashes, turn the setting screw on the clock until the exact time to which the pen points on the chart is the same as indicated by your watch. Next read a good thermometer and turn the adjusting screw until the pointer of the recorder indicates the same temperature on the chart and your outfit is ready to make an accurate record.

Adjustable Maulstick Aids in Painting Models

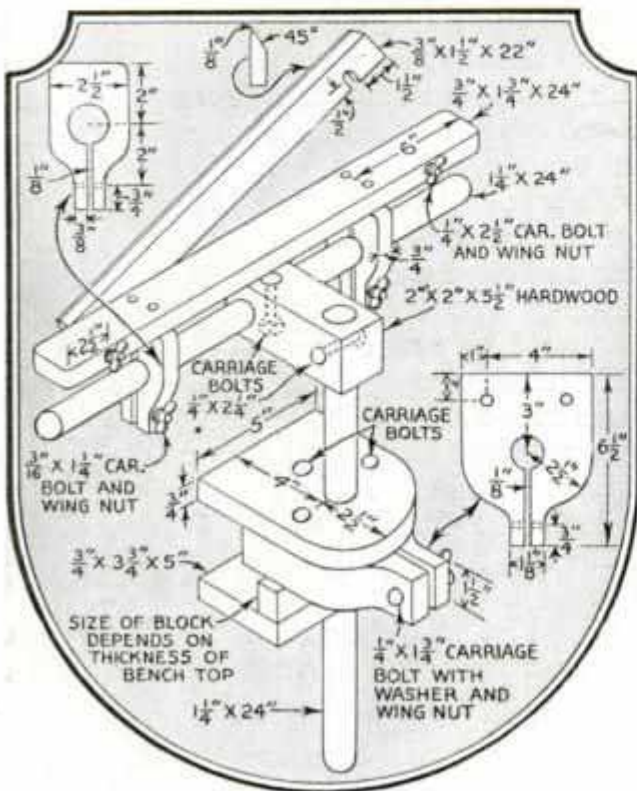

The difficulty of painting neat, straight stripes on models, owing to lack of firm support for the hand, is overcome with this adjustable maulstick. It not only assures a rigid hand rest at any convenient point, but also provides straight and curved edges as guides. Besides this, it will hold stencils for spraying details on a model. The base consists of an assembly of two wood blocks to clamp over the edge of a workbench top, and a wood clamp, or pinch clevis, the latter being used to ad-



just a standard, which supports the upper assembly. A hardwood block bolted rigidly to the upper end of the standard carries a horizontal rod, to which is clamped a hand rest by means of two clevises similar to the one in the base. With this arrangement, the rest can be shifted crosswise or inclined for working on top of the model. To the ends of the rest, a straightedge is bolted, the holes in the end of which are cut out from the lower edge so that either end may be used as a pivot without removing the bolts from the rest. To use the maulstick, stand the model on the bench top or a box, and adjust the hand rest to a convenient height and distance from the surface to be painted.

Wet Photographic Negatives Dried with Rubber Sponges

To quickly dry wet negatives, one photographer draws them between two rubber sponges. These are held in a galvanized-iron handle bent to the shape shown. The edges of the handle are bent over to form shallow channels to fit the sponges, which are held in place by strong thread. This is passed through the sides of the sponges with a needle, and brought out through small holes, drilled in the top and bottom of the handle. The sponges should be moistened with water before using them.—W. Edward White, Plymouth, N. H.

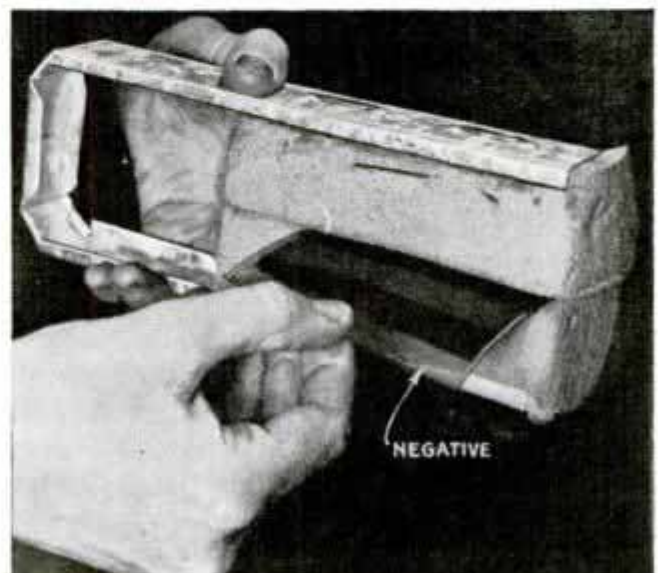

☞ Glossy enamel will dry dull if enamel undercoater is mixed with the last coat.

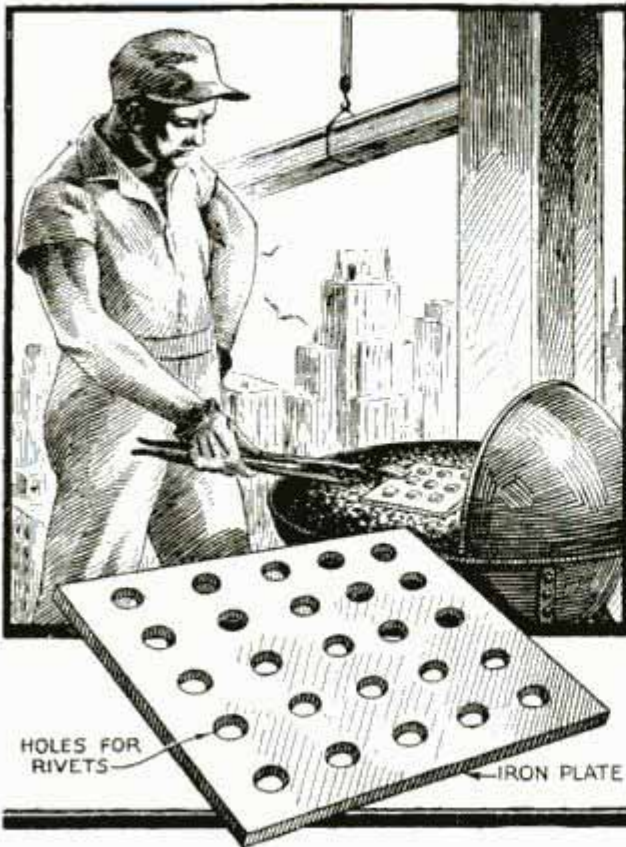

Iron Rivets Heated without Burning the Heads by Holding Them in the Fire with Iron Plate

Iron Rivets Heated without Burning the Heads

One workman who heats iron rivets used in steel construction jobs, recommends holding them in the fire with a piece of $\frac{1}{4}$ -in. iron or steel plate in which a number of holes have been drilled. He claims this method allows them to be heated without any possibility of burning the heads, which do not come in direct contact with the fire.—Don Benn Owens, Jr., Dayton, Ohio.

Simple Device Levels Chalk Line

Provided with a swinging pointer, this simple device will be found handy for getting chalk lines level. It is cut from sheet aluminum and the pointer, which is weighted at the lower end, is loosely pivoted in place. If desired, a scale to show various angles may be used. When using the device, the line must be taut.



Printing Photos from Wet Negatives

One photographer, who often had rush jobs, saved much time by printing photos while the negatives were still wet. To do this, the negatives were developed in the regular way, after which they were removed from the bath and the water shaken off. A sheet of clear Cellophane was then applied to both sides of the negatives with a squeegee so that they could be handled to make the prints. With this method, the photographer claimed he was often able to deliver rush jobs one hour after the exposure was made.



Utilizing Bench Vise as a Punch Press

In a shop where there was no punch press available, I made a quantity of brass stampings in a heavy bench vise, the jaws of which were fitted with dies machined from cold-rolled steel. The dies were used to form the center portions of the stampings, the ends being formed with a few

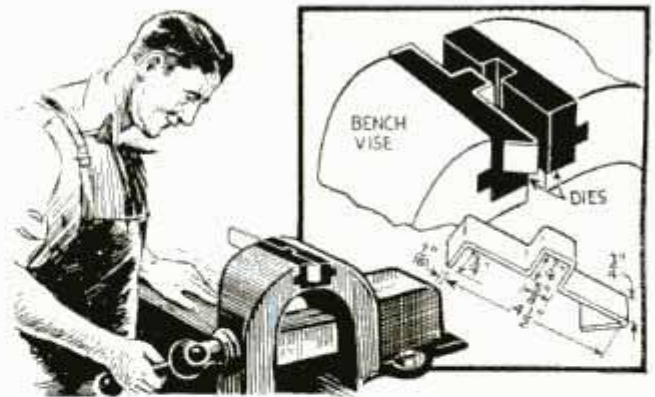

Half-Hard Brass Stampings Made in Vise Fitted with Dies of Cold-Rolled Steel

blows of a rawhide hammer while the stampings were still in the vise.—Charles Kugler, Philadelphia, Pa.

Marble and porcelain are easily cleaned by applying with a stiff brush an acid solution consisting of diatomaceous earth, 3 oz., sodium sulphate, $5\frac{1}{2}$ lbs., and sulphuric acid, 9 oz. The solution, which is corrosive, is washed off with water.

Suggestions for AUTO OWNERS

TO LUBRICATE DOOR LOCKS, FINELY POWDERED GRAPHITE IS BETTER THAN OIL, WHICH CONGEALS AND COLLECTS DIRT



INSECT-POWDER BELLOWS

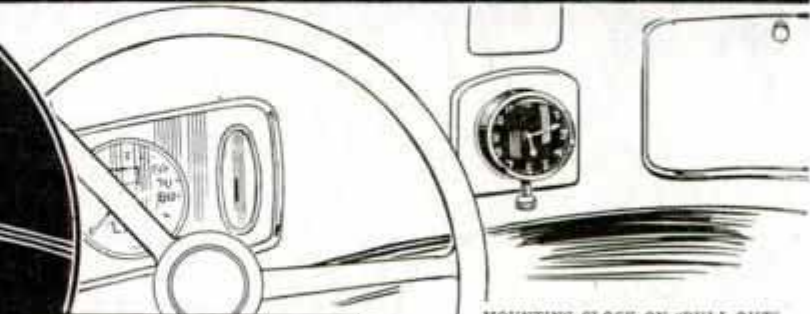

MOUNTING CLOCK ON "PULL-OUT" ASH RECEIVER. LARGE HOLE IS CUT FIRST TO TAKE CLOCK; THEN SMALL SCREW HOLES ARE DRILLED



Repairing Cracked Fender on Old Cars

CUT A CARDBOARD PATTERN TO THE FENDER CURVATURE AT THE POINT WHERE IT IS CRACKED



SAW A 2-IN. HARDWOOD BLOCK TO PATTERN CURVATURE FOR ATTACHMENT ON UNDERSIDE OF FENDER



CLAMP BLOCK AND DRILL HOLES FOR WOOD SCREWS THROUGH BOTH FENDER AND INTO BLOCK



REMOVE THE BLOCK AND COUNTERSINK THE SCREW HOLES

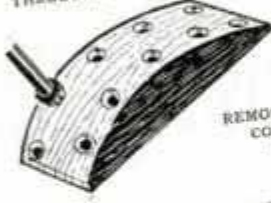

REPLACE BLOCK AND DRIVE FENDER METAL INTO COUNTERSUNK HOLES WITH A TAPERED PUNCH



DRIVE SCREWS IN PLACE. FILE HEADS OFF FLUSH WITH FENDER SURFACE AND TOUCH UP WITH PAINT

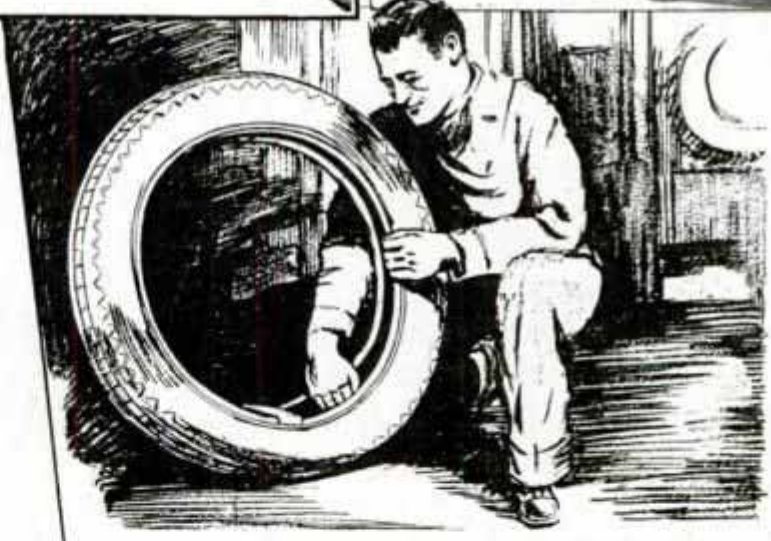
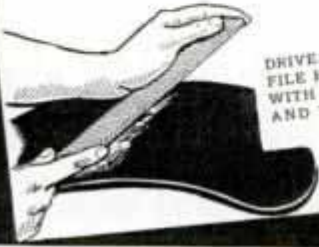

WHEN THE SOURCE OF A PUNCTURE CANNOT BE READILY LOCATED, GO OVER THE INNER SURFACE OF THE CASING WITH A PIECE OF FINE SANDPAPER SO YOU CAN FEEL THE GRIT AS SOON AS IT CONTACTS THE INVISIBLE TROUBLE MAKER



NEAT, ROUND INNER-TUBE PATCHES CAN BE CUT WITH YOUR KNIFE BY FOLLOWING THE EDGE OF A COIN



Wide Rubber Bands Stretched over Cylinder-Head Bolts Protect Hands When Working on Motor

Rubber Bands on Cylinder-Head Bolts Protect Hands

When working on an auto motor with the cylinder head removed, it is a good idea to cut wide rubber bands from an old inner tube and stretch them around the projecting studs as shown. This will help prevent cutting the hands on the threads if a wrench should slip while loosening or tightening a nut. Two or three bands will be sufficient for most motors.—Joe Gratz, Chicago.

How to Prevent Exhaust-Manifold Gaskets Blowing Out

I have found that the tendency of some cars to blow out exhaust-manifold gaskets can be overcome by using a thin, sheet-steel gasket in connection with the regular gasket. The center hole in the steel gasket is made $\frac{3}{8}$ in. smaller than the regular one so that the edges of the hole can be flanged. The gaskets are installed with the steel one next to the motor, the flanges projecting outward so that they fit inside of the opening in the manifold when it is put in place.—James W. Clift, Columbus, Ohio.

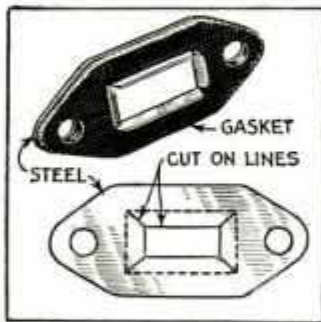

Speed Nuts to Adjust Bearings on Connecting Rods

To save time in screwing nuts on and off connecting-rod bolts, when adjusting the bearings, make up a couple of special nuts of the type shown. These are merely extra nuts to fit the bolts, and have short collars welded to them so that a bearing can be tightened without having to drive the nuts almost the entire length of the threaded portion of the bolts. After the bearing has been adjusted correctly, the special nuts are removed, and the regular ones screwed in place.

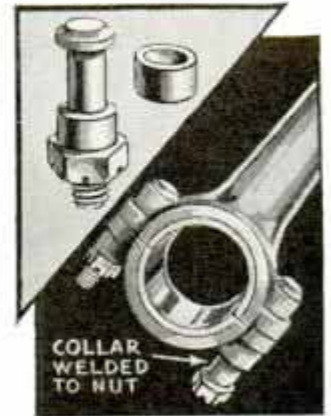

Efficient Carbon Scraper Made from Table Fork

An ordinary table fork will be found a handy tool for scraping carbon from a car motor. The tines of the fork are bent to-

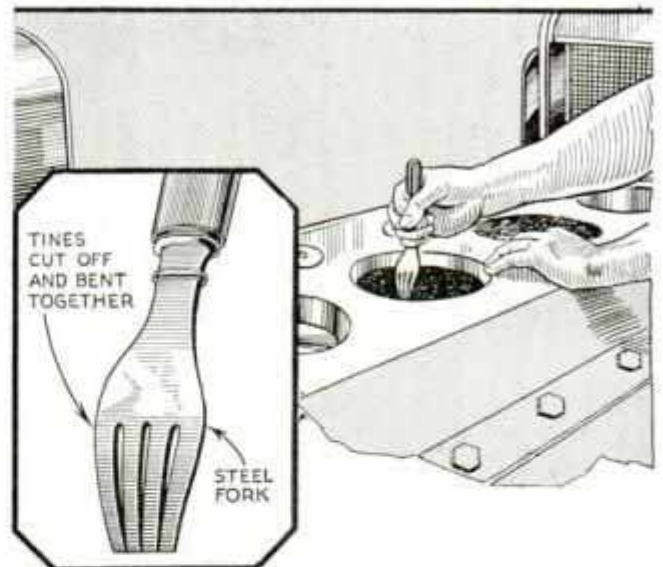

Carbon Is Readily Scraped from Smooth and Irregular Surfaces Inside Car Motor with Table Fork

gether, after which the ends are filed to a chisel-like edge. The individual cutting edges of the tines will follow the most irregular surfaces, yet they will spring back in line for cleaning smooth surfaces.

Best woods for enamel finishes are birch, poplar, white pine, whitewood or gumwood.

Condenser Prevents Burning of Contacts in Headlight Switch

The burning of light-switch or cut-out contact points may be lessened considerably by bridging a suitable condenser across them. The size of condenser required will depend on the current flow across the contacts, but in general a .5-mfd. radio condenser is satisfactory.

Guards for Lock Buttons on Car Doors

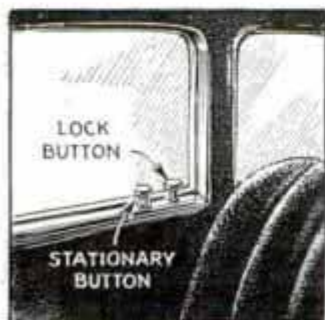

On cars that have small buttons projecting above the window ledges for locking the doors from inside, it will be found a good idea to mount an extra button in front of each lock as shown. These serve as guards to prevent the lock buttons from being bent.

Sand in Carburetor Causes Trouble

Some types of auxiliary air-valve carburetors, which employ an air dashpot control for slowing the action of the valve, are occasionally made inoperative by small particles of sand jamming the piston of the dashpot. The sand particle can be removed by anyone if care is taken to re-adjust the valve, which must be taken out for cleaning. Counting the number of turns as the valve is screwed out and then

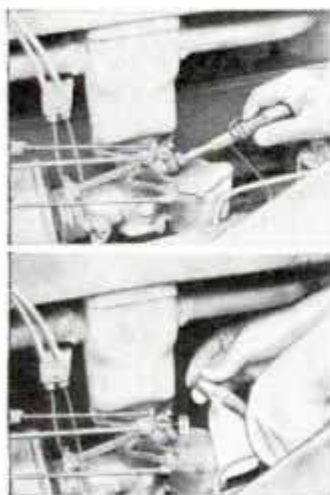

turning it back exactly the same number of turns when re-assembling, will assure the proper adjustment after cleaning. The cylinder is best cleaned with a small piece of cloth, while the piston is cleaned by spilling a small amount of clean gasoline through the hole in which it seats. The excess gas is then blown out of the cup-shaped piston, and the spring and screw re-assembled.

On cars that have small buttons projecting above the window ledges for locking the doors from inside, it will be found a good idea to mount an extra button in front of each lock



Motor-Knock Sounder Assists in Locating Knocks Made by Worn Bearings, Pistons, and Other Parts

Sounding Rod Locates Motor Knocks

A funnel soldered to the end of a metal rod makes an inexpensive but effective motor-knock sounder for locating loose bearings, piston slaps, and other operating defects. The rod is long enough to enable the funnel to be held against the ear while touching the other end to various spots about the motor.

Set Screw Locks Hinge Pin on Car Door

To prevent burglars from entering your car by removing the pins from the door hinges, drill a hole through the center portion of each hinge, and part way through the pin. Then tap the hole, and drive in a set screw as shown, first countersinking the hole so that the screw head will not interfere with opening or closing the door.

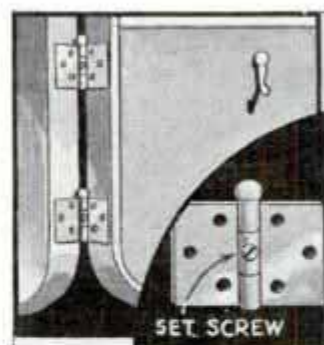

☐ If, after overhauling the rear-axle assembly of a car, a hum occurs when the motor is pulling, the ring gear and drive pinion mesh too tightly, but if the hum occurs when the car is coasting, the gears are meshing too loosely.



Ink on Printed Matter Quickly Dried by Passing It under Electric Heater

Printed Cards Quickly Dried with Electric Heater

While visiting a small printing shop, I noticed a workman taking cards from a press and placing them on an endless belt, which carried them slowly under an electric heater suspended above the belt. A workman at the other end of the belt was stacking the cards. The owner of the shop claimed that the heater dried the ink on the cards so that they could be stacked immediately, thus enabling him to get out rush jobs quickly that would ordinarily require several hours in waiting for the ink to dry.—Emil J. Novak, Omaha, Nebr.

□ An efficient hand soap for mechanics may be made by dissolving powdered soap chips in an equal amount of hot lard. Before cooling, the mixture should be poured into a shallow pan to harden.

The Next Issue

THE HOME CRAFTSMAN GOES TO SHEET METAL

Bric-a-brac shelves, flower-pot holders, shoe cabinets, vegetable bins, etc., made from sheet metal. Expert tells the tricks of forming, riveting, soldering, and making seams in metal. Also, spot welding simplifies joining.

PROFITS FROM YOUR BACKYARD GARDEN

Have you a small backyard plot you would like to use for raising vegetables? Story tells how to prepare the soil, and what to plant to get the best results.

PROJECTOR FOR THE WORKSHOP

Enlarge and project plans from magazines so that they can be traced. Quick method that eliminates the tedious job of laying out difficult drawings.

LOOK AT YOUR NEW HOME

Build a model of your proposed home to see what it looks like. A miniature offers you an opportunity to make changes before construction is started.

FURNITURE FOR BOYS

Drawing table, sea chest, and bookcase your boy will enjoy having in his room. Pieces are simple to make and have secret compartments to store treasures.

FUN ON THE SURF

Skim over the water with this graceful, slender kayak, which you can build easily. Completed boat is 17 ft. long and weighs approximately 40 pounds.

The **THRILL** OF THE *Spring Drive*

Swift streams, swollen by melted snows — tangles of smashing logs — yet those brawny, sure-footed riders of the northwoods enjoy every thrilling minute of the spring drive. But "riding the logs" isn't in it with the thrills of spring driving on a Harley-Davidson. A new 1935 Harley-Davidson will take you sweeping along — darting ahead of slower moving tangled traffic — out in the clear where the going is good. Don't sit back and merely wish you had a new 1935 Harley-Davidson. **RIDE ONE!** See your nearest dealer about the **FREE RIDE** he's offering. Ask him about his Easy Pay Plans—and send in the coupon.

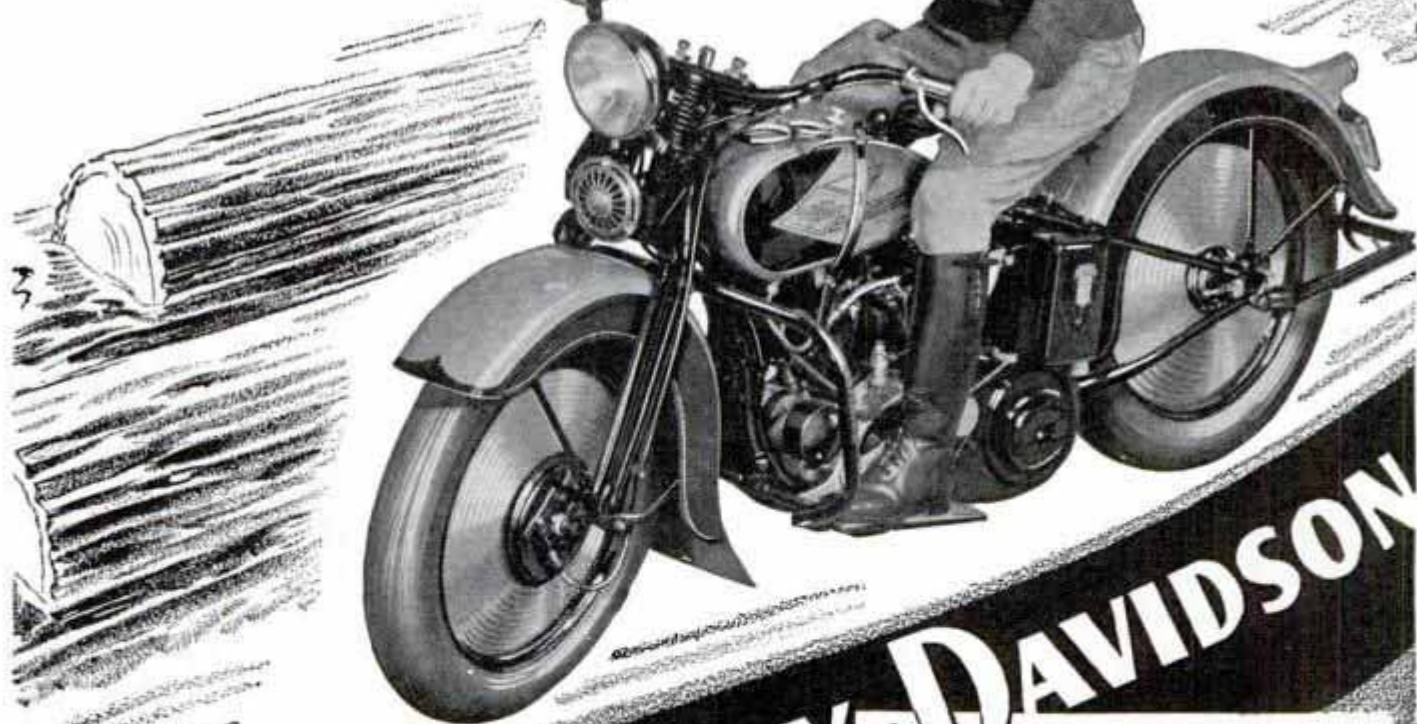

Ride a **HARLEY-DAVIDSON**

MAIL THIS COUPON

HARLEY-DAVIDSON MOTOR CO.
Dept. P., Milwaukee, Wis.

Interested in Motorcycling. Send illustrated literature.
Postage Stamp is enclosed to cover mailing cost.

Name _____

Address _____

My age is 16-19 years, 20-30 years, 31 years
and up, under 16 years. Check age group.

"STREAKING THROUGH AN ICY BOB RUN at seventy miles an hour demands infinite precision, nerves of steel, and unfailing energy! When the last heat has been run, it's mighty comforting to light a Camel. The fatigue and 'let-down' feeling fade away. As my energy is renewed, I enjoy the pleasure of smoking to the full, knowing that Camels *never* bother my nerves!"

(Signed)

RAYMOND F. STEVENS
North American Bob-Sled Champion



"WHEN I WENT TO COLLEGE, I found that smoking a Camel when you are tired makes you feel fresher."

(Signed)

MARGUERITE OSMUN



"A FACTORY Superintendent has a strenuous job. But a Camel gives me new 'pep' when tired."

(Signed) **GEORGE WEBBER**

**TO BANISH
TIREDNESS QUICKLY...**

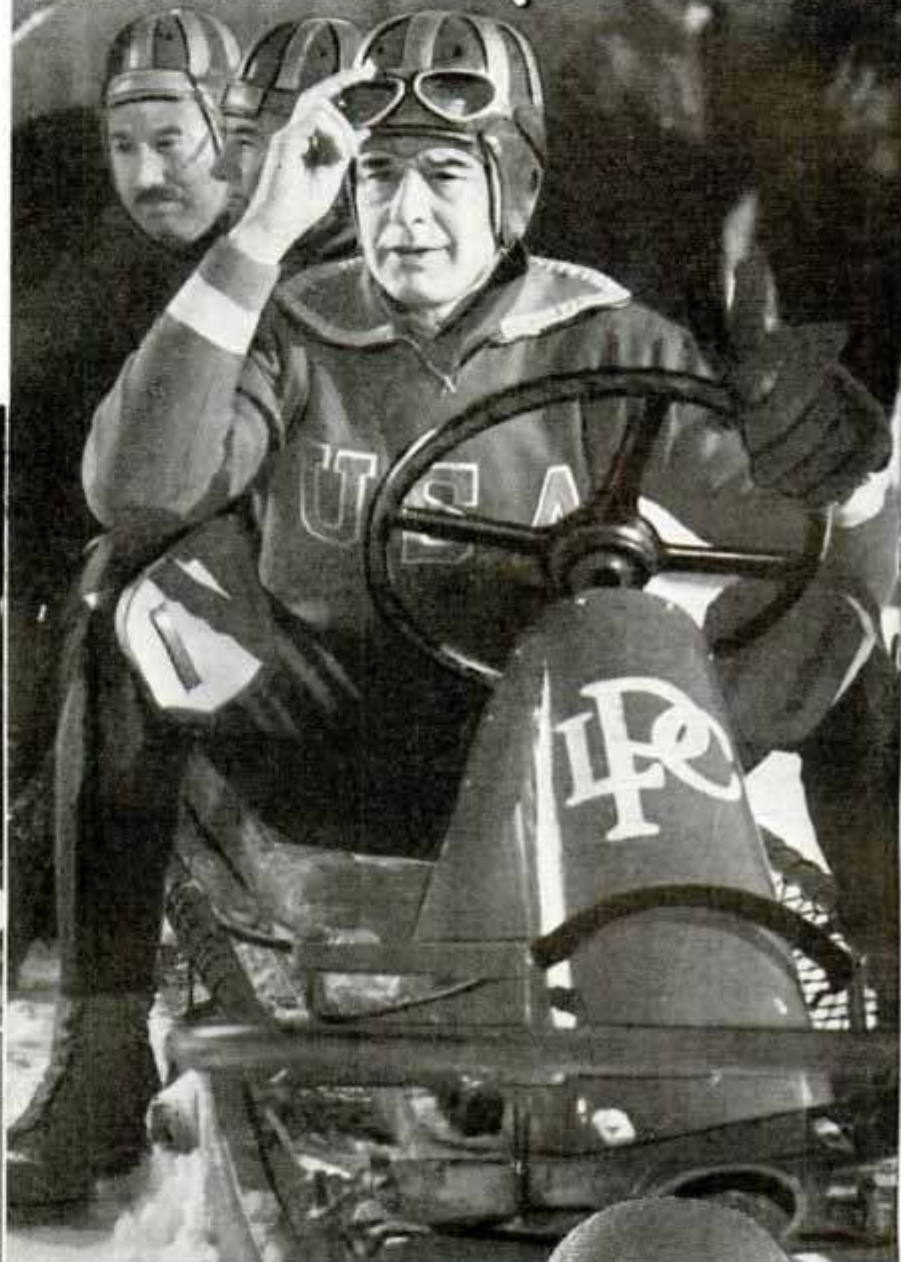

"SPEED SKATING takes an abundant supply of stamina and energy. Camels restore my 'pep' when I've used up my energy. And they taste so good, too. For sheer pleasure, there's nothing like a Camel."

(Signed) **JACK SHEA**



Camel's Costlier Tobaccos

GET A LIFT
WITH A CAMEL!



MORE EXPENSIVE
TOBACCOS IN
CAMELS...

"Camels are made from finer,
MORE EXPENSIVE TOBACCOS -
Turkish and Domestic - than
any other popular brand."

(Signed)

R. J. REYNOLDS TOBACCO COMPANY
Winston-Salem, North Carolina

LISTEN IN 

You'll like the new Camel Caravan...starring Walter O'Keefe...Annette Hanshaw...Glen Gray's Casa Loma Orchestra...over coast-to-coast WABC-Columbia Network.

TUESDAY	{	10:00 p.m. E.S.T.	THURSDAY	{	9:00 p.m. E.S.T.
		9:00 p.m. C.S.T.			8:00 p.m. C.S.T.
		8:00 p.m. M.S.T.			9:30 p.m. M.S.T.
		7:00 p.m. P.S.T.			8:30 p.m. P.S.T.



never get on your Nerves!

Make this snapshot at home *Tonight*

HERE'S ALL YOU HAVE TO DO

Use Kodak "SS" Film. Set your camera for 1/25 second—open the lens to *f.6.3*. Put 1 Mazda Photoflood bulb in lamp A—2 in lamp B. Distances as indicated. Sight the subject, click the shutter—and you've made the picture.

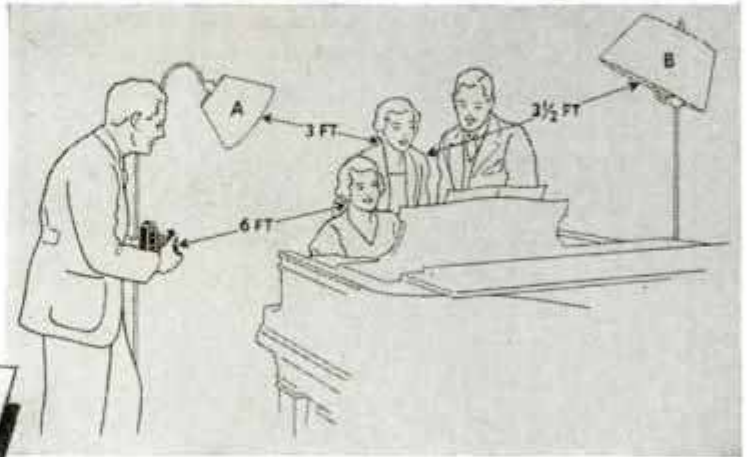

HOW many wonderful pictures you've missed because it was dark outside. Now you can get the many things that make evenings so enjoyable—you can take snapshots indoors, at NIGHT.

Just use any camera with an *f.6.3* (or faster) lens, loaded with Kodak Super Sensitive Panchromatic Film. This high-speed "SS" Film is three times as fast as Verichrome, six times as fast as ordinary film, under artificial light. Two or three Mazda Photoflood bulbs give ample light.

Hold the camera in your hands as you would outdoors, set it for 1/25 second, open the lens to *f.6.3*. Sight the subject, click the shutter. You've made a snapshot. *Indoors . . . at NIGHT.*

**ALL YOU
NEED FOR
SNAPSHOTS
AT NIGHT**



KODAK "SS"—the lightning-fast film, with the green lightning flashes on the familiar yellow box—the film that, indoors or out, in any light, improves picture quality.



MAZDA PHOTOFLOOD BULBS give brilliant light . . . last for about two hours, enough for many pictures. Cost but 25¢.



KODAFLECTOR—Inexpensive, efficient . . . makes 2 Photoflood bulbs do the work of 9. Complete with stand, reflectors, and cord, \$5.



KODAK RECOMAR "18"

—most versatile of Kodaks. With *f.4.5* Kodak Anastigmat lens . . . 1/250 second Compur shutter. Double-extension bellows for close-ups . . . long-focus and wide-angle lenses may be used. Ground-glass focusing. Uses cut film, film packs or plates. Ideal for snapshots at night. For 2 1/4 x 3 1/4 inch pictures—\$46.

**ONLY EASTMAN
MAKES THE KODAK**

FREE . . . BOOK

Here's a book you'll want in your library. Complete details about indoor pictures with Photoflood and Photoflash bulbs. Tells you how to make outdoor night pictures of lightning, lighted buildings, fireworks. How to make moonlight photos. Write to Eastman Kodak Co., Rochester, N. Y.



Name _____
Address _____
City _____ State _____

ALL-WAVE SUPER BUILT WITH STANDARD PARTS

(Continued from page 584)

type-42 power output tube; the rectifier is a standard 80 tube in a built-in power-supply unit. There are no coils to wind and the I.F. transformers are pre-tuned so that an oscillator is not required to tune up the set after it is assembled. The tuning range is from 10 to 550 meters; six pair of plug-in coils are provided for the various bands. The circuit calls for a dynamic speaker with a 1,000-ohm field and a transformer to match its voice coil to the single type-42 output tube.

Fig. 2 shows the speaker-cable and plug connections. The selection of a speaker and a baffle or housing for it, largely determines the tone quality. The larger the speaker baffle, the more efficiently the deep tones will be reproduced. A tone control is not used as it merely reduces the intensity of the desirable higher frequencies that go to make high fidelity reproduction possible. However, experimenters who desire a tone control can install an extra volume control, in series with a .05 mfd. fixed condenser across the R-10 detector plate resistor and suppress the higher audio frequencies.

Standard 110 to 120-volt, 60-cycle a.c. is the only suitable source of power; the set draws less than 60 watts from the house-lighting system. A line filter condenser in the transformer primary prevents outside interference from the a.c. line entering the receiver through the power circuit. The antenna may be a plain wire 40 to 80 ft. long and from 10 to 40 ft. above the ground or metal roofing. It should consist of one continuous length of copper antenna wire well insulated with glass or porcelain insulators. A good connection to earth by means of a ground clamp on a cold-water pipe is necessary with an antenna of this description. In noisy locations it may be necessary to use an antenna of the doublet type. This system consists of two equal lengths of antenna pick-up wire connected to a twisted-pair transmission wire lead-in which goes directly to the antenna and ground posts of the receiver; in this case the ground lead may be omitted. Noise-eliminating antenna systems employing homemade impedance-matching transformers were described in detail in the February, 1935, issue.

DINNER TABLE TRICKS

(Continued from page 549)

crumples the paper, drops it in an empty glass and ignites the paper. Just as the paper is about to finish burning, he turns the glass upside down and plunges it into the saucer. The water is sucked up into the glass. There is the coin, high and dry. The magician takes the coin from the saucer, raises the glass and the water surges back into the saucer.

As a conclusion the performer can demonstrate his ability as a mind reader. To do this, he utilizes various objects which he places conspicuously upon the table, such as a pitcher, a saucer, knife, fork and cup. A person is chosen to act as the "subject." He thinks of any one object, then turns about and faces away from the table while the performer approaches to study the articles on display.

"I want you to think of your choice," states the performer. "Begin to spell the name of the object slowly to yourself, letter by letter. As you think of each letter, say 'Go,' and I shall touch an object. After you have spelled the final letter, say 'Stop.' The others will watch to see that I make no further move."

"With each 'Go,' the magician touches an object on the table. Just after he touches the pitcher, the subject says "Stop." Keeping his hand on the pitcher, the magician asks the name of the object on which the subject was concentrating. Without turning, the subject announces that the chosen articles was the pitcher.

There is no collusion between the performer and his subject. The trick works automatically, but only the demonstrator knows it. The secret lies in the proper choice of articles. Each item must be spelled with a different number of letters as cup, fork, knife.

The magician thinks of these objects in terms of letters: cup as three; fork as four; knife as five. In touching the articles as the subject spells mentally, the performer touches at random on the first two commands to "Go"; but on the third order he touches the cup. He touches the fork on the fourth order; the knife on the fifth, and so on. Though no one realizes it, he is spelling with the person who is thinking of the object. When the person suddenly says "stop," the magician is touching the object the speller selected.

Cool your shaves with INGRAM'S

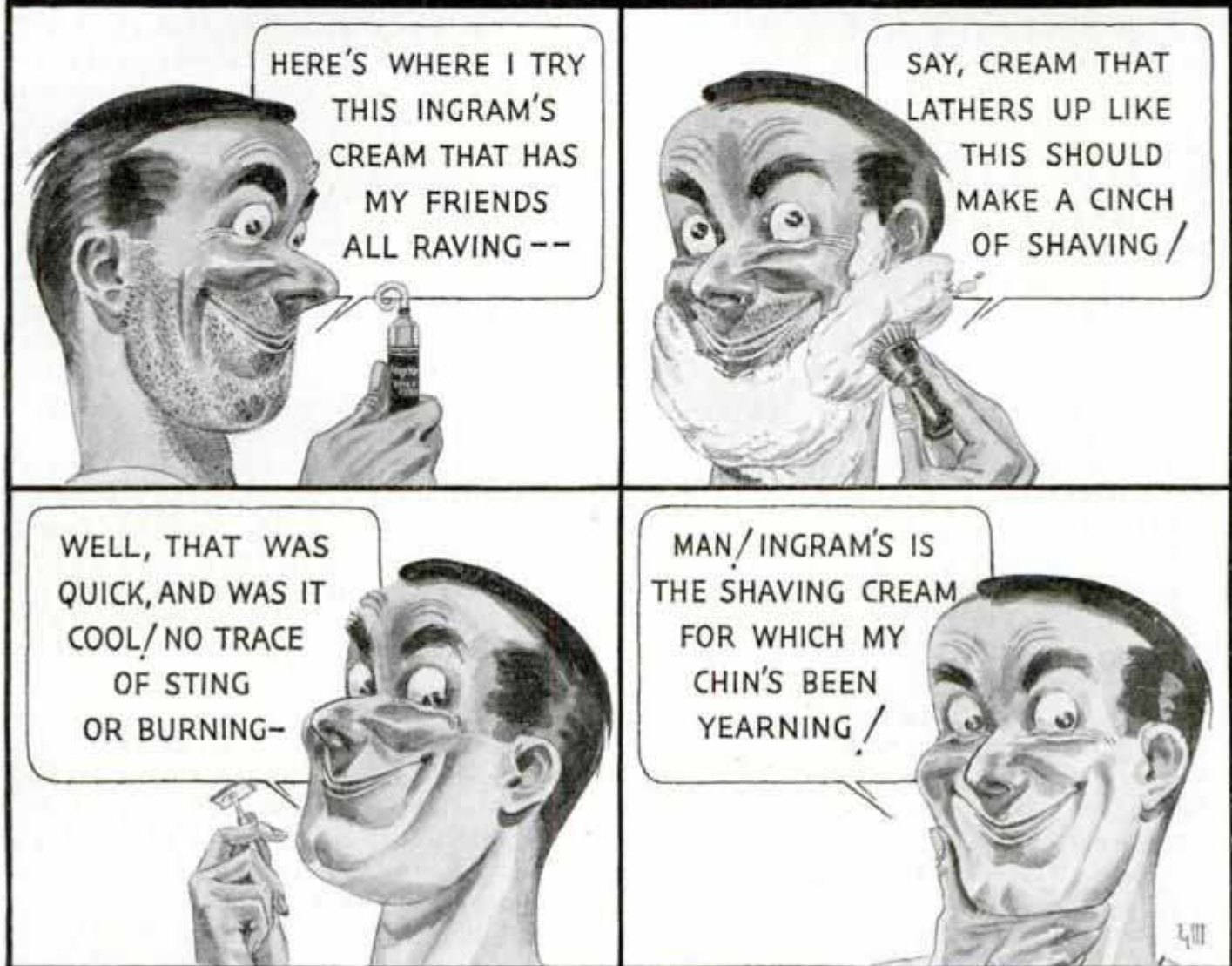

HERE'S a tip from a million happy shavers: If you want your shaves *cool* as well as *close*, use Ingram's.

Ingram's Shaving Cream softens whiskers until there's not a spark of spunk left in them. Just prey for your razor. No need to pray for your face.

It's cool while you're shaving; cool when you've finished. In this richer lather are three special ingredients that tone the skin and soothe it. No after-sting; no smarting; no call for lotion.

Ingram's SHAVING CREAM



TUBE OR JAR

TRY THE WORLD'S COOLEST SHAVE

When writing to advertisers please mention *Popular Mechanics*



BRISTOL-MYERS CO., Dept. E-3
110 Washington St., New York, N.Y.

I'm burning with curiosity. Let me try 10 cool Ingram's shaves free!

Name _____

Street _____

City _____ State _____

BONANZAS THE FORTY-NINERS OVERLOOKED

(Continued from page 505)

Geological experts say much of the west's underground wealth remains untouched.

"Take Tonopah as an example," said Letson Balliet, mining engineer and geologist. "From an area of less than 600 acres of ground, just one mine, the famous Mizpah, has produced approximately \$250,000,000. Yet not long ago a miner shipped from his lease in the Mizpah a fifty-ton car of gold and silver ore from which he received smelter returns of \$10,000. Another leaser has just uncovered two rich stringers in a section of the mine from which samples ran \$500 a ton."

Walter W. Bradley, state mineralogist of California, recently estimated California has \$600,000,000 in virgin gold easily reached; \$900,000,000 available to quartz or hard-rock miners able to follow veins 7,000 feet or more; and a total maximum amount of \$2,233,393,500 in gold recoverable in a period ending in 1950.

"Don't forget that old Mother Nature has been helping us for the past fifty years," suggests a veteran miner. "Tailings in some old mine dumps were worth a few dollars a ton to begin with. Wind and the rain have washed tons of dirt out of the heap, leaving the gold behind. Many old dumps have grown a lot richer this way."

The stamping ground of many Washington prospectors underwent a complete rejuvenation last winter. Mad torrents gouged out new channels, doing in a few days what hundreds of prospectors could not have accomplished in years. Miles of virgin ground in Idaho also have been exposed by floods.

Millions in placer wealth today rest deep beneath the burden washed down from decomposing hills. Hidden ledges never touched by the prospector's pick have lately been exposed by floods that ripped off the surface covering. Western deserts are believed to be full of deposits of gold-bearing sediments washed down from rich lodes in the surrounding mountains, and since covered by desert sands.

Sometimes strangers' eyes are keener than those of men who have lived in the country for years. Thousands of prospectors had tramped over property in the Silver City district of Nevada before a Reno

(Continued to page 122A)

TACKLE TIPS FOR THE FISHERMAN

(Continued from page 527)

822
ing a thin protecting film of oil. This attention for the tackle box is especially important if it has been near salt water. Does the box need a new coat of paint? There are some excellent rubber and aluminum paints that combine real protection with a new face for your favorite box.

While the box is drying, and all the contents are spread out on the table, is a fine time to examine plugs and spoons. Look for broken or rusted hooks. Nothing is more exasperating than losing a fish because of a rusty hook that parted during the struggle. Some of the favorite plugs will need to be touched up with a little paint, and this gives you a chance to originate your own color schemes.

Make a note of the essentials you always carry in your tackle box and may want to replace. How about the mosquito dope, and the first-aid kit, and a good knife? And that gaff, or landing net may need to be straightened and cleaned of rust. Wipe it off as you do the steel rods and the tackle box, with an oily rag.

The cork butts on your rods may be dirty and will look like new after you've gone over them with a fine sandpaper. Be careful not to sandpaper any metal trimmings but clean off the dirt and you'll be rewarded with a fresh, workmanlike appearance well worth the trouble.

And now we come to that collection of flies! Remember that the pleasant breath of spring is the time for hungry moths.

When I put flies away for the winter, I get powdered naphthaline and some glass jars that have screw tops. Put in a little of the moth chaser and turn the top tight. With this done they should go through the winter without damage. But now is a good time to look through the drawers and on the closet shelf to be sure none are lying around.

Now that you have checked your flies, and they all are safely bottled, and your tackle has been brought to top condition again, I suggest you leave that one bright red fly in that battered felt hat—the one everybody wants you to throw away—just as a gaudy, cheery reminder that the fishing season will soon be here. Any day now you'll be sallying forth with the assurance that this time that big fellow won't get away!



You can see,
I'm a
FRESHMAN.

You can SEE
that
WE'RE FRESH
TOO!



**LOOK FOR THE
"DATE-LINE!"**

Batteries are apt to "go dead" on dealers' shelves. The "Date-Line" on all Eveready Flashlight Batteries is your sure guarantee of the FRESHNESS which makes them long-lived and dependable...National Carbon Company, Inc., New York, N. Y.



**BURN YOUR NAME ON TOOLS
WITH THE
ARKOGRAF**

PROTECT YOUR TOOLS FROM THEFT
Write with electricity any name or design on the hardest and finest tools and instruments, or any metal, like writing on paper with pen or pencil.
Complete Outfit \$3.50—Prepaid Anywhere
Interesting illustrated circular free. Write today.
Agents wanted.
ARKOGRAF PEN CO., 3927 S.E. Stark St., Portland, Ore.



**Inventions Wanted
Patented or Unpatented**

Our manufacturer-clients now want better inventions to meet present industrial conditions. Write
Chartered Institute of American Inventors
Dept. 4 Barrister Building Washington, D. C.
"World's Largest Organization of Inventors"

DO YOU WANT a new business profession of your own, with all the trade you can attend to? Then become a foot correctionist, and in a few weeks earn big income in service fees,—not medical nor chiropody—easy terms for home training, no further capital needed, no goods to buy, no agency. Established 1894. Address Stephenson Laboratory, 1 Back Bay, Boston, Mass.

VEST POCKET ADDING MACHINE

Adds, Subtracts, Multiplies, Divides. Does work of costly machine. Not a toy. Million dollar capacity. Simple and accurate. Guaranteed 5 years.

FREE TRIAL \$2.50
—SEND NO MONEY— Total Cost

Just name and address. We will ship Calculator immediately. On delivery pay postman \$2.50 (plus few cents postage). (If outside U. S. send cash.) 10c additional in Leatherette Case. If not satisfied after 10 days' trial you get your money back. THOUSANDS OF SATISFIED USERS. Write for Agents' Proposition. **CALCULATOR MACHINE CO. (Mfrs.)**
P. O. Box 1118, Dept. 31, CHICAGO, ILLINOIS



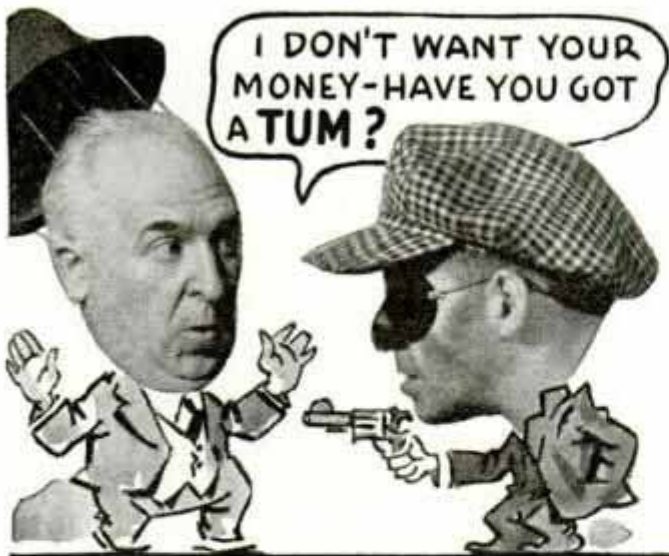

MILLIONS DEMAND TUMS FOR GAS . . . HEARTBURN

IT'S liable to happen any time—that dreaded attack of acid indigestion. That's why most sufferers keep TUMS handy for an emergency. No need to be held up by fear of heartburn, sour stomach, or that nauseating gassy fullness, when your favorite foods appear on the dinner table. Millions now know that TUMS do not contain soda or any water-soluble alkali—to over-alkalize the stomach or harm the kidneys. When TUMS correct the acid condition any excess passes off inert and unabsorbed. 10c a roll at any drug store. The 3-roll package containing handy metal pocket carrier, only 25c.

Free

1935 Calendar-Thermometer, beautifully designed in colors and gold. Also samples TUMS and NR. Send stamp for postage and packing to A. H. LEWIS CO., Dept. 21-DJJ, St. Louis, Mo.



For a laxative, use the safe, dependable Vegetable Laxative NR (Nature's Remedy). Only 25 cents. **NR**



\$1 VALUE FOR 50c

Get FACTS on trailer design. This 50 page book can save you 100 times its cost. Order direct from author. Money back if not satisfied.

RAY F. KUNS, Dept. 101, Madisonville, Cincinnati, O.



Loose Chair Rungs Fastened for All Time

HOLDEMS

Trade Mark Reg.

No Glue
No Nails

You can easily fix loose rungs and legs on chairs and tables with HOLDEMS—small metal pronged inserts that firmly grip both rung and socket. Merely remove rung, insert HOLDEM, and drive rung back. Also for mop, mallet or other handles, and any dowels. Patented. 25 cents a box of 30, assorted sizes.

AT HARDWARE STORES—or 25cts. by mail to
A & F Products, Mfrs., 3 West 37th St., N. Y.

BONANZAS THE FORTY-NINERS OVERLOOKED

(Continued from page 120A)

man recently took a sample of the unpromising looking rock and discovered an eighteen-inch vein of rich ore.

Pure chance is just as much a factor as ever. Tom Farley, small-scale miner, dug down only a foot into ground that had been panned on the surface by many prospectors, and found small streaks of gold running as high as \$1,000 a ton. Farley set up a small mill, and is now working in a shaft which has been worked and abandoned time and again.

A certain Nevada mine had been worked for years and finally, on the advice of mining engineers, was abandoned. Not long ago, a young man took a lease and started following a little streak in an old stope. He followed it a short distance, when it widened out and developed into a bonanza ore shoot, making its owner wealthy.

As one old-timer put it, "Since we have thirty-five-dollar gold, the stuff that was just country rock before, now is ore." If a man has a little capital, he can get other men to help him dig for about five dollars a shift. Materials are cheaper than in boom days. Railroad freight on supplies is only about half what it used to be. Coal, crude oil, and timber are cheaper than before; yet gold brings almost twice as much.

Many are reprospecting the old dumps in search of the gold that slipped through crude milling machinery of earlier days. From the mill dumps of the old Comstock Lode of Nevada, material has long been washing down into surrounding gullies, and now and then a miner will find a pocket of amalgam containing mercury and gold, lost half a century ago from the mills. Many who are placering small deposits are making only a dollar or less per day. But there are dozens of more experienced prospectors who have already gone back into the old diggings and found new wealth.

Then there are genuine lost mines whose lone owners never came back. Along the border on the Mexican side are some of the greatest lost mines in the world. These mines were operated by rich Spaniards, who kept them as family possessions and mined only as they needed cash. When these families were overthrown, the secret of the mines was lost. Prospectors have been looking for them ever since.

ALL ABOUT THE NEW



**Aero-built
OUTBOARD MOTORS**

NEW aero-type metallurgy and construction throughout! World's smallest all-purpose, full power twin! 30 big advanced features. Write for new illustrated Handy Chart describing this and 5 other great models in the 1935 quality Sea-Horse line... FREE!

**JOHNSON MOTOR CO., 400 PERSHING ROAD
WAUKEGAN, ILL.**
Canadian Johnson Motor Co., Ltd., Peterboro, Can.

JOHNSON
Sea-horse OUTBOARD MOTORS

SAVE PRINTING COSTS



with the COPY-STAMP

Do your own printing of typewritten or hand-written work, postcards, drawings, letters, notices, addresses, endorsements, menus, tags, labels, price lists, etc.

THE STAMP OF A THOUSAND USES

Write your copy once on the stencil paper, insert in the automatic-inking COPY-STAMP, and print instantly as many copies as wanted.

Saves not only money but the vital element of time.

Five sizes: \$5.00 and up.

The Stencil-Stamp Co., Inc., 53 Park Row, New York, N. Y.

FREE METLMACH
THE MODERN MACH.

This amazing new mach sent free (to agents) if you enclose 10c for packing, mailing, etc. The biggest sensation in Mach industry. A mach made of metal—lights 1000 times or more. Fire and water proof. The new—safe way to light fires, cigarettes, cigars, pipes, etc. Take advantage of free Metlmach offer and get money making proposition to agents.

METLMATCH CORPORATION, 115 Water St., WARSAW, ILL.

Thompson BEATS the World on BOATS



**Better Built
Lower Prices**

- Canoes \$45 and up
- Rowboats \$36 and up
- Outboards \$42 and up

Very fast utility model

Only Boats With Full Length Spray Rails

Keep passengers perfectly dry—even at high speeds. Catalog also shows snipe sail boat complete with sail for \$185. Two big factories. Prompt shipment.

CATALOG FREE

Write for your copy. State kind of boat in which you are interested.

THOMPSON BROS. BOAT MFG. CO. (7D)
213 Ann St., PESHIGO, WIS. (Write to either place) 113 Elm St., CORTLAND, N. Y.

**A MILLION PAIRS OF EYES
ARE SAYING**

"Thank you"



HERE is one of the revolutionary new lamps which is bringing new comfort and eye-protection into thousands upon thousands of homes. It is an I. E. S. Better Sight Lamp... approved by the Illuminating Engineering Society and made by many manufacturers. See one today at your department or furniture store, lighting company, or lighting fixture dealer. General Electric Company, Nela Park, Cleveland, Ohio.

FEATURES OF THE I. E. S. BETTER SIGHT LAMPS

The opal glass reflector (A) gives soft, diffused, glareless light, and reflects light to the ceiling for general illumination. The special inside reflecting surface of the shade (B) reflects twice as much useful light as an ordinary shade. The extra height insures good light, properly distributed over a wide working area. The Approval Tag shown beside the lamp identifies an I. E. S. Better Sight Lamp. Always be sure to look for this tag when you buy.



GENERAL ELECTRIC

When writing please mention Popular Mechanics

WOOD IN CANS WILL FIX THESE OLD NAIL AND SCREW HOLES



Handles Like Putty Dries to Hard Wood

Plastic Wood Becomes a Permanent Part of the Object Repaired

Plastic Wood is actual wood that comes in cans and tubes—can be moulded with the hands—when dry it is hard, permanent wood that can be sawed, planed, sanded, drilled, turned on a lathe—will hold nails—can be painted, varnished and lacquered perfectly—it is water-proof and weather-proof.

Plastic Wood will adhere to any clean, dry surface—wood, metal, glass, stone or porcelain. Sold at all paint, hardware and department stores.



FREE

Write The A. S. Boyle Co., Inc., 1934 Dana Ave., Dept. P. M. 4, Cincinnati, Ohio, for interesting booklet, "200 Things to Do With Plastic Wood."

PLASTIC WOOD

WHY BE MISERABLE WITH

Itchy Skin



When our old reliable
**LUCKY TIGER
ANTISEPTIC OINTMENT**
will stop it almost instantly? Why run the risk of bad infections when it has been proven according to standard tests that Lucky Tiger Ointment destroys such germs? **FREE** Generous sample Free upon request. Lucky Tiger Mfg. Co., Kansas City, Mo.

STUNTS OF MOVIE MAGICIANS

(Continued from page 543)

Another of O'Brien's inventions enables a studio to film fires, explosions, and gunfire by a method of double exposure that eliminates the necessity of burning up a set or firing a gun on the stage. When a stunt flyer crashed his plane in front of the camera and crawled away from the wreck, a timing device inside the plane was to set it afire a few seconds after the pilot left. The timer was broken and failed to work. Instead of making an expensive re-take, the cameraman placed the undeveloped film back in the camera and exposed it again, this time filming a motion picture of a fire that had been specially filmed against a dark background. The double exposure showed the airplane in flames exactly as had been planned.

Most shipwrecks and airplane crashes that you see on the screen are done with models. A collision at sea is made easy by mounting the miniature ships on underwater tracks so they may be pulled together by wires. Breakaway bows enable cameramen to photograph realistic disasters and a stricken ship is made to sink slowly beneath the waves by pulling a wire threaded through a pulley at the bottom of the tank. All miniature water action is shot at high speed so when the film is run at regular speed, ripples on the water look like slow swells and the ship swings smoothly instead of bobbing up and down.

The motion picture background is now so common that nearly every picture exhibited contains this special effect. You may be sure, whenever you see a close-up of the inside of a taxicab, with scenery moving by outside the window, that the cab was filmed while standing still with the scenery projected on a screen outside the window. For one thing, it would be nearly impossible to record the sounds of conversation inside a taxicab moving through city traffic.

A Hollywood invention is "fourth dimensional" sound by which voices in the theater actually come from the parts of the screen the speakers occupy. A speech seems distant or close, or from left or right, according to where the speaker stands. This is accomplished by the use of several separate sound tracks on the film, each connected to an individual loud speaker properly placed behind the screen.

Electric Drill Used for Mixing Glue

For mixing large quantities of waterproof glue, an electric hand drill has been found useful. The stirring device, which is gripped in the chuck of the drill, con-

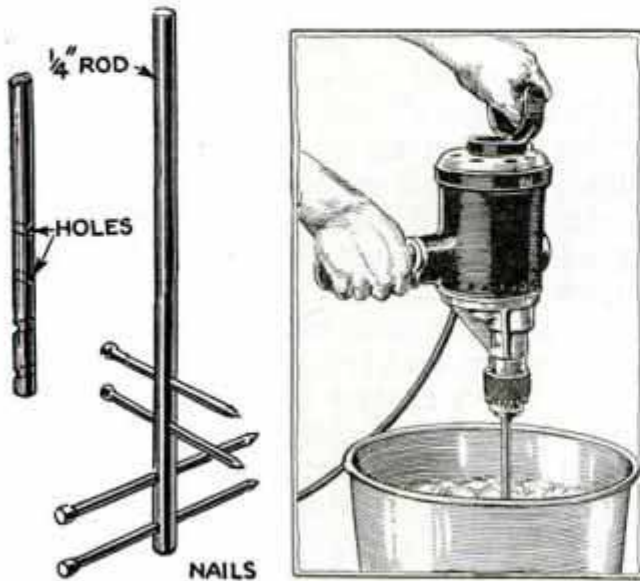

Large Quantities of Glue Can Be Quickly Mixed with the Aid of an Electric Hand Drill

sists of a short piece of $\frac{1}{4}$ -in. iron rod or steel. Two sets of slanting holes are drilled through the rod near one end to take four small finishing nails, which are driven halfway through.

Improved Gluing Clamp

A gluing clamp that is similar to a saw-horse in appearance and combines the advantages of both, has been found very useful for woodworkers. It consists of two rails notched on the underside, and supported by two legs at each end. A vise screw is securely fastened at one end and a heavy block of wood, which serves as a movable jaw, fits the rails as shown.

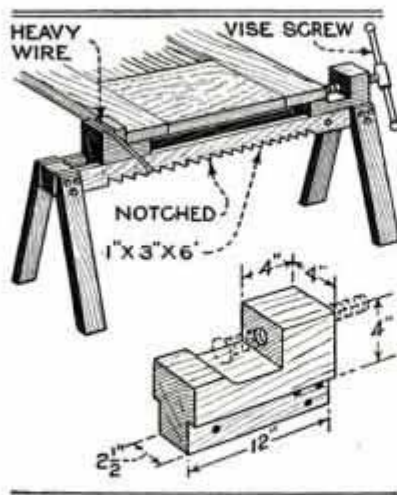

A groove is cut across the top and a heavy rod, bent to a rectangular shape, and with the ends securely twisted or welded together, is used to lock the block on the rails at any desired point.

Free THE YEAR'S FINEST HOME WORKSHOP BOOK

CASCO PROJECT BOOK

28 Prize Winning WOOD WORKING PROJECTS

BUILD THEM IN YOUR OWN WORKSHOP

BUILD THEM IN YOUR OWN WORKSHOP

Recently the manufacturers of CASCO Waterproof Glue made cash awards to the 28 homecraftsmen who submitted the best woodworking projects built with CASCO Glue during 1934.

These prize-winning articles have been assembled in the form of a most interesting and instructive book containing photographs and descriptions of these outstanding woodworking projects...inlaid card and game table, model hollow hull sailboat, unique tilt table made from cigar box wood, modern beverage set, beautifully patterned wood turned vases, lamps, smoking sets, cigarette boxes — and many others ranging from delicate wood jewelry to portable camp refrigerators.

The object of this book is to guide the homecrafter in the utilization of inexpensive pieces of wood and veneer, to build with the help of CASCO Glue, beautiful and durable articles of permanent value.

This fine book costs you nothing. Send for your FREE copy now — there's a real treat in store for you.

(Save 2c—stick it on a penny post card)

CLIP THIS NOW FOR YOUR FREE COPY

THE CASEIN MFG. CO. OF AMERICA, INC.
350 Madison Avenue, Dept. 435-B, New York, N. Y.

Please send me Free copy of the new CASCO Project Book.

Name.....
Street.....
City..... State.....



CLEAN OUT YOUR RADIATOR FOR SAFE SUMMER DRIVING

WHEN you drain out your anti-freeze, drain out the rust, scale and impurities that have collected during the winter. Give the radiator a thorough cleansing with Sani-Flush. You can do it yourself. In very few minutes. For very few cents. Absolutely safe.

Just pour half a can of Sani-Flush in your radiator. (Directions on the can.) Run the engine. Drain out the dirt that clogs the cooling system. Your car will run better. You'll save expensive repair bills.

You'll probably find Sani-Flush in your home. Thousands of women use it to keep toilet bowls glistening. If it's not there, buy a can from any grocery, drug, or hardware store—25c. The Hygienic Products Co., Canton, Ohio.

Sani-Flush 25¢
KEEPS RADIATORS CLEAN

Collect BIG PROFITS in Advance

Something that every man wants... INDIVIDUAL BUCKLE AND BELT. Every buckle different, made to personal order. Initials or name in raised letters and colors, ... non-furnishable, lasting finish. Including genuine cowhide leather belt with famous "Hook-Fast" catch. Volume orders easy from Schools, Lodges, Clubs, etc. Many sales from friends, neighbors. Write today for Special Outfit Offer.

HOFMANN "HOOK-FAST" SPECIALTIES, INC.
P. O. Box 1425 Dept. 70 Providence, R. I.



COMPLETE ELECTRIC PLANTS



ONAN A.C. PLANTS furnish the same current as city service. Operate Radio, Water System, Refrigerator, all Appliances.

SIZES 350 WATTS UP

Have A.C. Current anywhere. Models \$110 and up. Easy to install. Available from stock. Ideal for farms, camps, lake homes, commercial purposes—anywhere electricity is needed.

D. W. ONAN & SONS
944 Royalston Ave., Minneapolis, Minn.

WITH THE SHORT WAVES

(Continued from page 511)

tained within a case five inches by seven and one-half by three inches. There is a larger case with a special shoulder harness that contains a complete modulation and oscillator system with four batteries providing a higher voltage than the average home lighting circuit.

The set has an effective range of ten miles. The sending apparatus is used with a chin strap microphone which leaves the speaker's head free to turn and both hands unemployed. Signals are picked up on a short wave receiver, located near the scene of operation, and transferred to telephone wires which convey them to the broadcasting studio. Usually a thirty-foot antenna is suspended between two poles and carried about following the speaker.

The automobile "mobile transmitter" is another recent development. The car may broadcast at a speed of nearly seventy miles per hour. It has a broadcast-quality range of 100 miles when stationary and at least fifty miles when in motion. It has microphone leads ranging from fifty to 1,000 feet in length. The "mikes" are of the portable type and can be carried close to the scene of action. The transmitter can also be removed to an airplane or ship. An antenna may also be used on the roof of a truck or attached to a suitable support.

When several announcers stationed over a large territory took part in a single broadcast in the early days they had their watches set and compared with one another to assure split second accuracy. Then a schedule was prepared as to who should talk and when. But one announcer frequently repeated parts of another's talk because he had no way of hearing what another had said. To overcome this difficulty, a "cue channel" was devised which might be considered a short wave "party line," over which all the announcers, no matter where they may be, can keep in touch with one another without the audience hearing the orders and questions.

Just as the scientists and research workers improvised their rebroadcasting equipment almost overnight as the new science achieved tremendous popularity, so have the announcers and field engineers improved their technique and learned how to cope with unexpected situations so you may hear the world's news as it occurs.

Two of you AND A CANOE



ALONE in a world apart from people. . . An Old Town brings the wonder of wild outdoors. Go places easily in a canoe. Fish. Camp. Hunt.

Old Town Canoes are modeled after the Indian birch-bark. Balanced. Responsive. And sturdy to last for years of pleasure. Write for a free catalog. Many models for paddling and sailing. Sponson. Square-stern. Also many speedy outboard boats, including all-wood, sea-worthy craft for family use. Rowboats. Dinghies. Write! Old Town Canoe Co., 134 Main Street, Old Town, Maine.

"Old Town Canoes"

Standard & Walsh Garden Tractors

Flow
Seed
Cultivate
Mow Hay
and Lawns

Powerful Tractors for Small Farms, Gardeners, Florists, Nurseries, Fruit and Poultry Men.
1 & 2 Cylinder Models
Write for Free Catalog
STANDARD ENGINE CO.
3221 Como Ave. Minneapolis, Minn.



AGENTS.. Smash Go Prices!

Rantos Coffee, 12c lb. 4-oz. Vanilla, 8 1/2c. \$1.00 size Tonic 14c. Razor blades 10 for 8 1/2c. 100 sticks Chewing Gum 12c. 150 other bargains. Experience unnecessary. Write

CARNATION COMPANY PO-2 ST. LOUIS, MO.

Catch Fish!

Eels, Mink, Muskrats, with our new folding galvanized STEEL WIRE TRAP. Write for our FREE TRAP OFFER and Bargain Catalog. \$1 Box of our famous Fish Bait FREE to introduce our traps. WALTON SUPPLY CO., 3509 JUNIATA AVE., ST. LOUIS, MO.

MAN IN EACH TOWN To Plate auto parts

reflectors, mirrors, etc., by new method; no capital or experience required. Outfits furnished. Free particulars. Write Today!
GUNMETAL CO., Ave. M, Decatur, Ill.

Print Your Own

Cards, stationery, circulars, tags, labels, advertising, etc. Save money. Print for Others; Big Profits; easy rules sent. Will do popular Raised Printing like Engraving. Junior press \$3.90, job press, \$11 up, power \$149. Send for free catalog and all details. **THE KELSEY COMPANY, B-37, MERIDEN, CONN.**

BUILD YOUR OWN FANS. 20 inch aluminum propellers for aeroplane fans \$3.85. Shipped collect. Michael Electric Co. Fort Worth, Texas



S **AGENTS 500% PROFIT GUARANTEED GOLD LEAF LETTERS**
For Store fronts and office windows. Anyone can put them on. Free samples. Liberal offer to general agents.
METALLIC LETTER CO., 438 N. Clark St. Chicago

SAVE MONEY ON YOUR HOME REPAIRS

Quick, easy, dependable ways to make over 100 of the commonest emergency and routine household repairs are explained in this free booklet.



Write for FREE BOOK

Every householder has his unlucky days, when something suddenly leaks, breaks or comes apart, but—you can laugh at many such emergencies and save much money if you keep a can of Smooth-On No. 1 handy and do your own repair work!

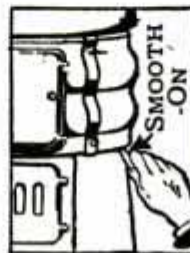

Smooth-On No. 1, applied without heat and without special tools, hardens into metallic iron and holds on any metal. It offers the simplest means of stopping water, steam or gas leaks, and is ideal for use on pipes, boilers, tanks, heating systems and automobile radiators, kitchen utensils, etc. The repairs can usually be finished before a professional fixer could arrive, and

at a very small fraction of the cost of an outsider's work.

Resetting a loose handle, lock, hinge, stripped screw, bolt or nut with Smooth-On No. 1 seldom takes more than several cents worth of material and a few minutes of time, but the repair holds like new.

Properly made Smooth-On repairs are permanent, avoid labor expense, often avoid buying a much more expensive renewal part, and you have the satisfaction of knowing that the work is well done.

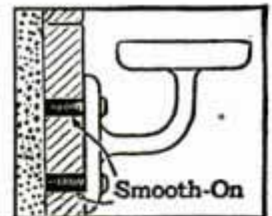

A dollar saved is a dollar earned, and the money you can keep each year by utilizing Smooth-On No. 1 at every opportunity is a substantial sum. Perfect results require only that simple instructions be followed.



Get the free booklet by returning the coupon, and buy Smooth-On No. 1 in 7-oz., 1-lb. or 5-lb. can from any hardware store or if necessary from us direct.

Do it with SMOOTH-ON

SMOOTH-ON MFG. CO., Dept. 37
574 Communipaw Ave., Jersey City, N. J.
Please send the free Smooth-On Repair Book.

Name

Address

4-35.....



TRIPLE PROTECTION FROM ONE OIL

Three-in-One Oil combines in one light, penetrating lubricant, the protective action of three different special-purpose oils.

As it *lubricates*, it keeps all working parts of tools and shop equipment *cleaner*, and *protects against rust*.

Use 3-in-One. See how its long-lasting lubrication adds to the life of shop devices, keeps them ready for use, saves repairs. At your dealer's; handy cans and bottles.

3-IN-ONE



Evenly Spaced Quick and Accurate Cross-hatching now obtainable with THE NELSON SECTION LINER. To purchase them when needed is too late—have a set on hand for the next cross-hatching job. Ask your dealer or write for folder.

THE NELSON SECTION LINER
727 N. 7th St., De Kalb, Ill.
New York Office, F. P. Mehm, Mgr.
1133 Broadway, New York City

JOYS OF THE OPEN ROAD

(Continued from Coloroto Section)

many white-tailed deer, at Bryce are many mule-foot deer and Zion also has mule-foot deer, elk and mountain sheep. At Crater lake there are deer and bears. In Glacier park deer, goats and mountain sheep roam by the hundreds and thousands. Grand Teton is noted for its moose and black bears, wolverines and deer are in Sequoia. McKinley park in Alaska has the famous Dall sheep and caribou. The parks are also a rendezvous for all kinds of migratory waterfowl which may stay unmolested by the hand of man.

Those who wish to travel in the parks may find all manner of accommodations at their disposal. This means you can spend your vacation in the parks at most any price you wish to pay—the only other expenses being transportation and a small entrance fee at some of the parks. Policing, sanitation and good water are provided. You can sleep in your own tent, cook your own food over your own campfire or avail yourself of nearby lodges, a cabin or a high class hotel. You can even rent camping equipment, such as stoves, blankets, pillows. You can roam through the parks at will in your own car or you can take a bus or travel horseback.

Rangers, hand-picked for courtesy and thoughtfulness, will guide and protect you and naturalists will explain everything of interest. Museums display exhibits peculiar to the particular park you are visiting. Everything is yours for a good time, swimming, horseback riding, golfing, tennis, hiking, fishing.

In addition to our natural parks historical objects are being preserved by the park service for the benefit of coming Americans. National monuments now are under the park service. This means that such places as Jamestown, Va., first settlement in America; Yorktown, where Cornwallis surrendered; Wakefield, the birthplace of Washington, and Monticello, the home of Jefferson, are to be preserved. Mount Vernon is already provided for.

Our largest national park is Yellowstone, containing 3,437 square miles; the smallest, Platt national park, Oklahoma, containing one and one-third square miles. Hot Springs, Arkansas, runs it a close race, it being slightly under one and one-half square miles in area.



The turret of the modern battleship, arched and crowned for strength, is the highest development of the principles utilized by Fisher in the new solid steel "Turret Top" for closed cars

AT LAST
the safety of solid STEEL
over your head
 Sensational new
FISHER "TURRET TOP"*

*Registered

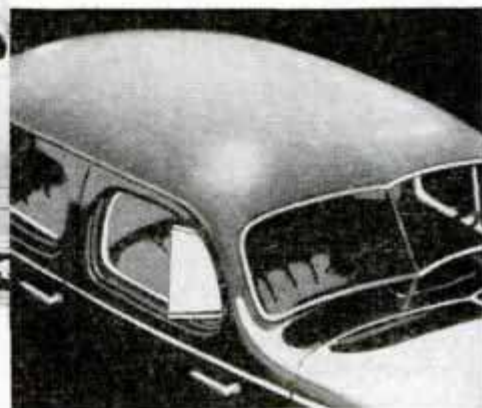

This is the way the new Fisher "Turret Top" looks—a single seamless sheet of tough drawn steel, steel reinforced with steel like a battleship turret

Featured on
CHEVROLET (Master DeLuxe Series), PONTIAC
and OLDSMOBILE
 Closed car models for 1935

AS THE largest makers of automobile bodies in the world, we have been working for years to perfect a *safety roof* of solid steel for closed cars.

No one until now ever succeeded in this and it was no simple task. It meant not only the drawing and forming of tough metal in unprecedentedly large sheets, but the designing even of the huge special presses to handle the steel.

Now, however, we are able to announce the complete success of this effort—in the new Fisher "Turret Top" closed bodies.

These bodies put over your head a safety armor of beautifully contoured solid steel, steel braced with steel like the modern battleship turret from which they take their name.

Even the steel roof is supported by steel-roof-bows and is welded to the other steel body panels.

Quiet, rugged, true, there is no rumble, drum or rattle—and you are protected from extreme seasonal heat and cold. Complete scientific insulation against *both* sound and temperature was achieved after years of work in

the laboratory, testing on the open road, consultation with car owners and exhaustive experiments at the great General Motors Proving Ground.

And the traditional eye-satisfying beauty of Body by Fisher is actually enhanced by the smooth, flowing, uninterrupted line of this modern roof.

There are many other worthwhile improvements in Body by Fisher for 1935 too—such things as full streamlining, more luggage room, windstream V-type windshield, wider seats, more headroom, bigger doors—

And, of course, time-tested and owner-approved Fisher No Draft Ventilation—more highly perfected, more efficient, more expertly engineered than ever this year.

But the biggest improvement of all is the new Fisher solid steel "Turret Top"—now featured on the 1935 Chevrolets (Master De Luxe Series), Pontiacs and Oldsmobiles—and found, like Body by Fisher, *only* on General Motors cars.

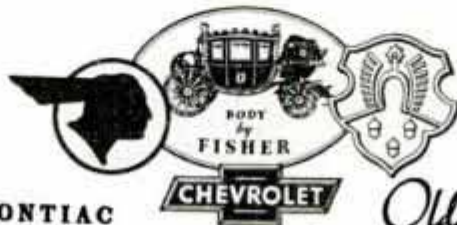

BODY BY FISHER on GENERAL MOTORS CARS ONLY: CHEVROLET • PONTIAC • OLDSMOBILE • BUICK • LA SALLE • CADILLAC

When writing to advertisers please mention Popular Mechanics

WHATEVER YOUR PROJECT



You need NICHOLSON FILES

Look through the pages of any magazine devoted to tools and their use in the home. Take a red pencil and draw a circle around the word file every time it is mentioned. We believe you will find files mentioned more frequently than any other individual tool.

Are you building a reproduction of a Colonial Chair, making toys or spending months on the construction of a tiny steam engine? Whatever your project you need Nicholson Files.

Nicholson Files are the home craftsman's most useful tools and the world's most efficient files. Sharp, durable, uniformly high in quality, Nicholson Files are made by experts and tested by experts. Moderately priced, they are the world's greatest file value in every respect.

For all home projects you need Nicholson Files. At hardware stores everywhere. Nicholson File Company, Providence, R. I., U. S. A.

Genuine

NICHOLSON FILES A FILE FOR EVERY PURPOSE

HANDEE

Tool of 100 Uses

Grinds, routs, drills, carves, sharpens, cuts, engraves. Over 100 wheel shapes available. Fits the hand perfectly. Weighs 1 pound. For use at home, in the shop or take to the job. Do away with slow hand work! A.C. or D.C., 110 volt, 13,000 r.p.m.

\$10.00
and up
Postpaid
U. S. A.
with 3 wheel
shapes Free.
Order today.

Order on 5-day
trial. Satisfaction
guaranteed.
Ask for FREE
booklet.



Plug
in any
light
socket

New MASTER CRAFTSMAN'S SET
17 useful accessories to
grind, drill, polish, sand, cut,
carve, engrave, etc. Prepaid \$5.00

CHICAGO WHEEL & MFG. CO., 108 S. Aberdeen Street, Chicago, Ill.

BEHIND THE SCENES IN A "FIGHTING ACT"

(Continued from page 555)

of lions and tigers to attack except to kill for food. The animal considered most dangerous to trainers is the black leopard, for the reason that the smaller animal fears man and is therefore a package of quenchless hate.

On the other hand the lion's magnanimity is not kindness. Making friends with a lion, says Bernardi, after thirty years experience, is pure romantic nonsense. The closest you can get to that is the total, blank indifference of an animal that knows neither fear nor hate.

If you ever are around when a lion escapes the thing to do is to keep quiet in the most open space and he probably will not give you a thought. He is looking for a dark place to get out of sight.

What to do if a lion gets you down? Capt. Bernardi says try to get up again. If you are on your feet and get away he probably won't follow. If you are down under him he may take an angry or experimental bite. A lion which has chewed a man is a lion spoiled. He must be shot or sold to a zoo.

The usual beginning of a trainer is the husky boy who joins the circus to be near the animals. There he becomes helper, whip-boy, cage hand, head keeper, assistant trainer. His chance to get on the bill usually comes when the trainer has been hurt. Then the assistant must show his mettle by going in to save him and get him out.

Breeding farms have oversupplied the market for lions. Jungle beasts require from one to two years seasoning to cage life before they can be shipped on steamers or they will die en route. Tigers also are plentiful. A good performing lion or tiger is worth up to \$1,200.

Food of performing animals averages sixteen pounds of fresh raw meat per day with six quarts of fresh milk and two dozen eggs on Sunday and a quart of cod-liver oil during the week. Seventeen to twenty years is the life span of a lion. According to Capt. Bernardi the show business is the happiest existence a lion can have. In the arenas they get abundant exercise in a few minutes. The other ninety per cent of the time they lie and loaf—the lion's idea of the life of Reilly.

INSIDE STUFF OF BIG LEAGUERS

(Continued from page 538) *D1588*

body before, during and at the finish of the wind-up. This is obtained by first placing the feet squarely upon the ground with body erect and in contact with the mound rubber. At the peak of the wind-up the ball still is hidden from the eyes of the batter.

When there is a runner on first base the pitcher's feet are placed squarely on the ground. His rear foot is braced against the rubber, front foot forward directly towards the batter with the toe pointed diagonally towards the plate. His body is erect and his shoulders level. His body is turned slightly so that the left shoulder points half way between home base and first base. The pitcher can now turn his head toward first and back again without committing a balk. The glove hand covers the hand with the ball, hiding the grasp, so he is prepared to throw to first or pitch to the plate.

Correct pitching form involves the proper balance and position of the leg kick so that the pitcher will get the maximum power behind his throw. At the peak of the leg kick, the pitcher drops his throwing arm at full length and twists the body, pivoting upon the right leg and raising his left leg upward in front and around slightly to present his back partly to the batter. At the same time he keeps his front shoulder low enough to insure clear vision on the plate.

Besides the proper stance before and during the pitch, an important fundamental is the "follow through." At the end of the throw the feet should end squarely with the plate, apart at a comfortable distance to insure a perfect balance. The eyes and head face the batter. The pitcher in this position is prepared to stop line drives, field bunted balls to the left and right, or dash to first base where he will be in a position to cover this bag when a ball is hit to his left and fielded by the first baseman.

There are right and wrong ways of playing baseball. Ninety-nine out of a hundred men who play contrary to the rules and who reach the major leagues, do not remain for a very long period. The player who applies himself step by step has the real opportunity. This type of player who reaches the major leagues has a chance of remaining in them for a good many years.

If you're a soda jerker, listen
... a **Wet-Pruf**
bandage sure does glisten!



NEW!
BAUER
&
BLACK
Wet-Pruf
ADHESIVE TAPE

Snow white—100% waterproof—soft kid-like finish—resists soiling—washes clean—non-raveling. Wet-Pruf costs no more than ordinary adhesive. All regular sizes.

ESKANOE KAYAK READY TO ASSEMBLE \$15



Send 10c

Postage for catalog illustrating 10 models & new self-assembling plan.

Complete kits **FREE PADDLE**, including with simple plan for self-assembling. No experience needed, safest boat for children.

Also cedar and folding KAYAKS, carry 1 to 4 persons, 10 to 20 ft. For paddling, sailing, hunting & fishing, non-sinkable, light, portable. Ernest Kayak designer and builder since 1924

KAYAK BOAT CO., 147 East 84th Street, N. Y. C.

BUILD IT YOURSELF

You can build this Trailer with ordinary tools easily from our step-by-step constructional sheets and large sized blueprints.

Finest designed Trailer in existence, sleeps 4. Toilet, Shower, Electric Light, etc. Save 75% of the cost by building it yourself. Send 25c for plans sheet, illustrations and details.

THE PLAN SHOP, 907 Palmolive Bldg.

Chicago, Ill.

EARN MONEY WITH PERFECTED

TENNIS
RESTRINGING
VISE

ENJOY CHEAPER TENNIS
Newly perfected TennisVise invention enables anyone to re-string tennis rackets at big savings or for **FREE PROFITS**. Just follow simple instructions. Save on your own tennis...earn money too! Write for Free details.

BUY Factory-fresh-Strings Save Cash

Now you can buy genuine **GUT** strings direct-from-factory-to-you. High quality, low cost! **SILK** strings, too. Our Free Tennis Equipment Catalog will **SAVE YOU MONEY**.

WRITE for your **FREE** copy today, and details of Perfected tennis vise invention!

H. E. WILLS CO.
1047 W. 47th ST. Dep. 13-54 CHICAGO, U.S.A.

FREE
TENNIS
CATALOG

MFR.
OF
QUALITY
GUT
STRINGS

BUILD YOUR OWN
ALL-STAR JR
ALL-WAVE Superheterodyne

A RADIO SENSATION—
ALLIED
IS FIRST
WITH THE
FOUNDATION
KIT ★★★★★



Build the famous ALL-STAR JR. low-priced All-Wave set. Tunes 10-550 meters. Features band-spread, pre-adjusted coils, beat-note oscillator, world-wide reception, fine tone, etc. Easy to build. Only \$2.25 will start you. This covers the cost of the Foundation kit which includes drilled panels, diagrams, instructions, etc. Order the ALL-STAR JR. Foundation Kit today!

SEND FOR FREE DIAGRAM

Allied Radio
CORPORATION
833 W. JACKSON BLVD., CHICAGO, ILL.

DEPT. K.

- Send me FREE Wiring Diagram and Parts list for building the ALL-STAR JR.
- My order for the Foundation Kit is enclosed.
- Send me the FREE 1935 ALLIED Catalog.

Name.....

Address.....

BUILD YOUR OWN
ALL-STAR JR
ALL-WAVE Superheterodyne



Official
Circuit and
parts list
FREE

A New Low Priced, Build-it-Yourself Superheterodyne for World Wide Reception. Designed by Eleven Leading Radio Manufacturers All-Wave, 10 to 550 meters, for reception of Phone, Code, and C. W. Beat-Frequency oscillator—brings in stations no ordinary receiver is likely to pick up. Band-Spread tuning on all waves permits amazing selectivity! All-Electric operation from 110-120 volt, 60 cycle A. C. High Fidelity reproduction on new style dynamic speaker. Standard Parts Easily Assembled! Pre-Tuned Coils, and pictorial layout diagrams. Complete instructions accompany the FOUNDATION UNIT. Performance of finished set equal to finest commercial receivers!



WRITE TO
ALL-STAR HEADQUARTERS
360 N. Michigan Blvd., CHICAGO, ILLINOIS

AMAZING TYPEWRITER BARGAIN

New Remington Portable
only 10¢ a day!
 Free Typing Course



10-DAY FREE TRIAL OFFER

Only 10¢ a day buys this latest model machine. Not a used or rebuilt typewriter. Not an incomplete machine. A beautiful brand new regulation Remington Portable. Standard 4-row keyboard; standard width carriage; margin release on keyboard; back spacer; automatic ribbon reverse; every essential feature found in standard typewriters. Carrying case and typing course free . . . absolutely the biggest typewriter value ever offered! Try it in your home or office 10 days free. If you do not agree that it is the finest portable at any price, return it at our expense. Don't delay. We pay cost of shipment direct from the factory to you. You save on the purchase price and you do not risk one penny. Write today!

FREE HOME TYPING COURSE

Write Remington Rand Inc., Dept. 152-4, 205 E. 42nd St., N.Y.C.

Saw Filing PAYS!

Steady growing business, all cash, no canvassing. Start in spare time. No experience needed. No eyestrain. With a FOLEY Automatic Saw Filer you can file hand, band and circular saws, easily, quickly, accurately! Small investment. Send postcard for FREE PLAN and Special Offer. No obligation.

FOLEY MFG. CO., 416-5 Foley Bldg.
11 Main St. N. E., Minneapolis, Minn.



GET YOUR TRACTOR AT FACTORY PRICE



Amazing money maker for farms, truck gardens, orchards, nurseries, poultry ranches, country homes, etc. Plows, discs, harrows, cultivates, mows lawns, cuts weeds. Runs belt machinery, 1 to 5 H.P. riding or walking types. Write for FREE CATALOG. Low Factory Prices and 10 Day Trial Plan. Address Nearest Office.

SHAW MFG. CO. Desk 4504
 Galesburg, Kans., or Columbus, Ohio, or 5812 Magnolia Ave., Chicago, Ill.

SHAW DU-ALL TRACTOR

Make Money at Home!

GROW MUSHROOMS in your cellar or shed. Exclusive new process. Bigger, better, quicker crops. More money for you! Enormous new demand. Write for Free Book.

American Mushroom Industries Ltd., Dept. 176, Toronto, Ont.

BUILD IT YOURSELF BUYS THE PLANS \$1



PLANS AND INSTRUCTIONS FOR BUILDING, \$1.00

Anyone handy with tools can build this classy, roomy trailer coach at low cost. Accommodates 2 to 4 people comfortably. Plans and instructions include all diagrams, floor plans, material list, how to build beds, axles, windows, top, where to get parts, etc. Can be built in any size with side or rear door. Big value for all interested in camp trailers of any kind. Thousands of satisfied users. Rush a dollar for the popular Jim Dandy trailer plans today!

Mail Dollar Bill to Jim Dandy, Box 125-A, Wausau, Wis.

OWN A Potato Chip Factory

COMPLETE

NEW "HOME FACTORY" MAKES PERFECT POTATO CHIPS— DONUTS—SALTED NUTS

Stop looking for something difficult. Turn potatoes into cash. I show you just how with my newly perfected outfit. Start anywhere. Very little cash needed. Exclusive location. Profits pour in. No experience needed. I furnish the plans. Begin anywhere—village, small town, city or suburb. A big opportunity is waiting. Business permanent.

MAKE UP TO 500% PROFIT ON RAW MATERIALS

Raw materials are plentiful and cheap. Highly perfected outfit and confidential plans make operation simple, with startling profits certain.

WE HELP FINANCE YOU

and locate you. Send no money, just name, newly perfected, rapid, direct-to-fat slicer with outfit at no extra charge.

LONG-EAKINS COMPANY

428-S. High St.

Springfield, Ohio



200 BOYS To "Road-Test" RANGERS At Home

Write quick for Mead's FREE colored Catalog, 30 Day's "Road-Test" Trial Offer, marvelous new prices. **SEND NO MONEY**—just write. Opportunity of lifetime!

Mead CYCLE COMPANY
DEPT S-114, CHICAGO

WOOD SHAPER \$3 post Loss cutters (C.O.D. or outside U.S. \$3.25)

"The Shapemaker"



Uses standard 5/16" cutters. Table is heavy gauge pressed steel, 8"x5 1/4"; stands 5 3/4" high. Base, table support and spindle adjusting slide, heavy gray iron castings. Oilless bearings. Order now or send 5c in stamps for Catalog fully describing all our equally low priced power tools and accessories, including JIG SAW, DRILL PRESS, SANDER, LINE SHAPING, LATHES, ETC., ETC.

J. & H. METAL PRODUCTS CO.

486 St. Paul St., Rochester, N. Y.



FREE CATALOG
Better, Finer, More Desirable Tool Chests for machinists, tool, die and pattern makers.

GERSTNER TOOL CHESTS
440 Columbia St. Dayton, Ohio

DEAFNESS IS MISERY



Many people with defective hearing and Head Noises enjoy Conversation, Movies, Church and Radio, because they use Leonard Invisible Ear Drums which resemble Tiny Megaphones fitting in the Ear entirely out of sight. No wires, batteries or head piece. They are inexpensive. Write for booklet and sworn statement of the inventor who wash himself deaf.



A. O. LEONARD, Inc., Suite 699, 70 5th Ave., New York

When writing to advertisers please mention Popular Mechanics



*"Mister! Do you know
why this oil filter
was put on your car?"*

"You can't keep dirt and grit and small metal particles and hard carbon from getting into the crankcase. But you *can* keep them out of the oil stream, and that's where they do all the damage . . . score cylinder walls, and break down valves and wear out bearings. That's why a Purolator was installed on your motor at the factory. Just as long as it stays on the job the close working parts are being fed with pure clean oil. *But here's the thing to remember.* After you've driven your car about 8,000 miles your Purolator is so full of this deadly sludge it won't hold any more. It must be renewed . . . replaced with a fresh clean element . . . and any service garage will do this for you in a very few minutes, and at very little expense. Then your oil will *stay clean* for another 8,000 miles."

There is just one thing we would add to this service mechanic's common sense advice. Be sure it's a GENUINE Purolator renewal. Not something "different and cheaper but just as good." Motor Improvements, Inc., Newark, New Jersey, makers of the GENUINE



PUROLATOR

The Oil Filter on Your Motorcar

LICENSED UNDER SWEETLAND PATENTS

IMPORTANT NOTICE!

Ask your servicer about the new Purolator Oil Filter especially engineered for Ford V-8s.

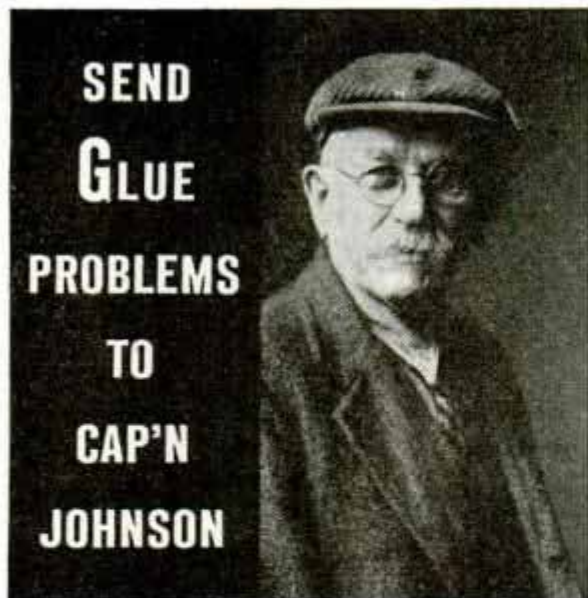

● He's the "trouble-shooter" on all glue problems for LePage's—and he ought to know glue. Born with a glue brush in his hand, he has handled all kinds for nigh on sixty years.

Capt. Johnson was a woodworker at the age of 10—then cabinet maker, blue-water sailor, ship's carpenter, captain of square-riggers, master carpenter and pattern maker.

You're invited to send your problems to Cap'n Johnson because he can tell you whether you are using the right kind of wood, the right kind of joints, a hard glue or liquid glue—or a fast or slow setting glue. He'll tell you what glues will discolor in veneering or whatever the work in hand might be. Feel free to write him on any gluing problem. Just address your letter to Capt. Oswald Johnson, Russia Cement Company, Gloucester, Mass.

RUSSIA CEMENT COMPANY

Laboratories and Factory • Gloucester, Mass.



AMAZING AUTO COMPASS



Don't lose time and money by taking the wrong road and going many miles out of your way. This new AIRPLANE TYPE COMPASS constantly tells your direction of travel. Sticks to windshield. Base 1 1/4" diameter. ONLY \$1.95 POSTPAID, including Compensator. SATISFACTION GUARANTEED or your money refunded if returned within ten days.

DEALERS WANTED!

HULL MFG. CO., Box 246-D4, WARREN, OHIO

new-READY SHAPED LOW COST RACING CRAFT



Get this sensational sailboat kit. Make authentic speed models in a few hours. All the hard work is done for you. Hull is already shaped and hollowed. Needs only smoothing down and painting. Then you "step" mast, adjust sail, rigging and rudder, and she's ready to launch! Watch her go! See her outdistance all competition. Easy to follow instructions and all necessary parts furnished.

KITS AS LOW AS 25c. Boy Racing Craft Kits at dealer or department store. If they can't supply, send money order for 7" solid hull kit, 25c; 15" hollow hull kit, \$1.00; or 22" hollow hull kit, \$2.50. Sent prepaid in U. S. All materials guaranteed. Send for Big Free Thornecraft Book. Show larger sailboats, Speed Scout Motorboats, Rotoboot, and Buck Rogers Stratosphere Balloon.

**SEND FOR
FREE
BOOK**

THORNECRAFT
Dept. 4, 2518 Montrose Ave., Chicago

THE LENGTHENING SPAN OF LIFE

(Continued from page 484)

germs of tuberculosis, made innocuous by chemical treatment. Skin tests have been developed which show very promptly whether or not a child is susceptible to tuberculosis or has the disease.

The X-ray has been improved to include the use of a new type of paper film so that large numbers of children may be X-rayed very cheaply, the condition of their lungs found out, and suitable preventive measures used early to cut down the incidence of this disease.

When the list of causes of death is studied, it is found that many of the greatest hazards to mankind in our modern life have developed with the introduction of new chemicals used in industry and in the home, and from the development of new machines, including the motor car. The six leading causes of death are heart disease, diseases of the kidneys, pneumonia, cancer, hardening of the arteries, high blood pressure and diabetes. Previous to 1900, the motor car did not appear among the causes of death. Today motor-car accidents are tenth on the list of causes of death.

New hazards to life, however, are the chemical substances already mentioned, such as carbon-monoxide gas, benzene, the aniline derivatives of various kinds, lead and arsenic. Great attention has been attracted in recent years to the fact that a chemical substance containing the benzene ring—a chemical arrangement of six carbon molecules—when taken into the body of a person who is sensitive, produces a sudden drop in the white blood cells which protect the body against infection. Among the drugs which contain the benzene ring are pyramidon, a remedy used to relieve pain, also associated with various sleep producing drugs, and also the drug called dinitrophenol, used in weight reduction.

Because of the increasing number of deaths from carbon monoxide and from mercury poisoning, chemists and physicians have combined in studies to control these two conditions. New methods in treatment of mercury poisoning have been developed which may yield eventual success. Great interest has been manifested also in the use of methylene blue as a specific antidote against poisoning with car-

(Continued to page 136A)

SCIENCE INSURES

Ford Accuracy

PISTON PINS MAY BE LITTLE THINGS—BUT LOOK HOW THEY'RE INSPECTED

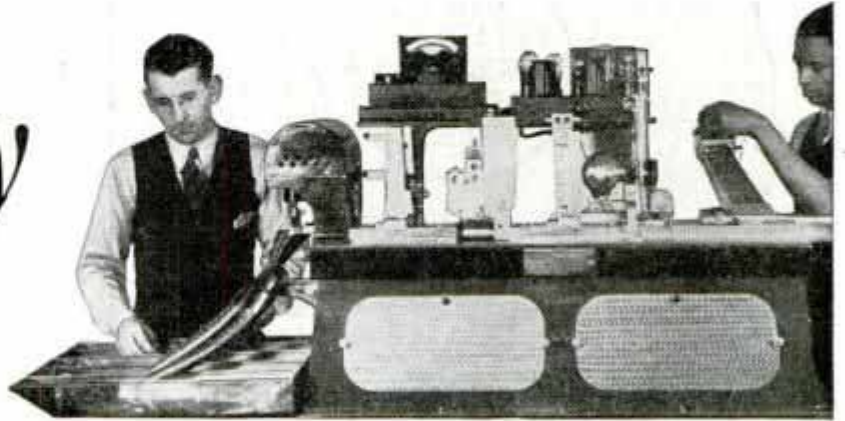

MODERN SCIENCE plays an important part in these ingenious automatic machines built by the Ford Motor Company to inspect piston pins.

The machine checks every piston pin for smoothness, hardness, straightness, roundness and diameter. One machine can check over 1500 pins an hour and those not up to the high Ford standard are automatically rejected.

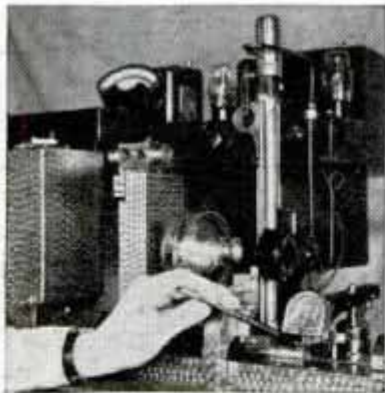

First, the pins are forced through a unit that wipes the surface clean. Then they slide under a needle on a pick-up head. Microscopic varia-

tions in surface finish set up vibrations which are amplified by a two-stage radio amplifier, and unless the pin is absolutely smooth the machine rejects it.

Next an automatic scleroscope checks the hardness. A light beam passes through an opening at the correct scale reading onto a photo-electric cell. The scleroscope hammer is released, strikes the pin, and rebounds to indicate hardness. If the pin has the right hardness the hammer rebounds and intercepts the light beam for a sufficient interval. This sets the mechanism to okeh the pin. If pin is not hard enough the hammer does not rebound high enough to intercept the beam; if the pin is too

hard the hammer goes past the opening. In both cases the mechanism rejects the pin.

The next two units of this machine inspect for straightness and roundness. A variation of only one ten-thousandth of an inch—1/30th the thickness of the average human hair—throws the pin out. That's accuracy for you!

The last unit measures the diameter and sorts the pins according to size. Pins distributed in the three center trays have passed inspection and are graded in size by one ten-thousandth of an inch. The tray on one end receives all over-size pins. The other end tray receives all undersize pins—these are scrapped.

When such machines are used for the inspection of parts there can be no compromise with accuracy. This is just one example of the painstaking efforts of the Ford Motor Company to make sure that Ford parts are right. It is one reason why it is possible to maintain such high standards of quality in Ford cars and yet sell them at such low prices. It is also a reason why Genuine Ford Parts are the best parts you can use in your Ford car or truck.

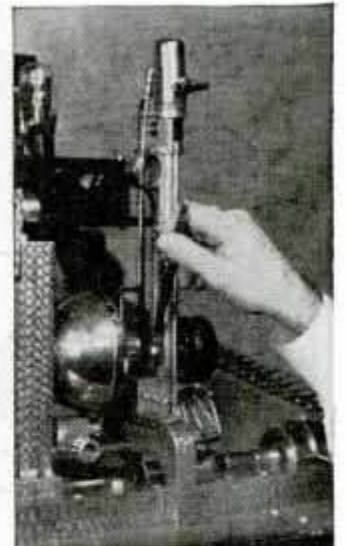

FORD MOTOR COMPANY, DEARBORN, MICHIGAN

When writing to advertisers please mention Popular Mechanics

MORE YARN TO THE INCH IN LEE JELT DENIM OVERALLS



I'M THE 1716 EXTRA FEET OF YARN IN EVERY PAIR

THAT'S WHY LEES ARE GUARANTEED TO OUTWEAR ALL OTHERS



Extra Yarn Takes the Place of Cheap Starch and Filler

BARGAIN overalls may fool the eye and the sense of "feel"—but they can never fool a wash-tub or honest hard wear! Lee Overalls resist rips and snags . . . wear and washings . . . because they're made of *genuine Jelt Denim*, with 1716 extra feet of yarn in every pair. Buy a Lee—it pays!

Kansas City, Mo.
Salina, Kan.
Trenton, N. J.
South Bend, Ind.
Minneapolis, Minn.
San Francisco, Cal.

The H. D. LEE MERC. CO., Dept. D-171

UNION-MADE

Lee OVERALLS

UNION-ALLS — SHIRTS — PANTS — PLAY-SUITS



FREE CATALOG

Just off the press

Fully illustrated, showing footwear, clothing and other specialties for Fisherman and Camper.

L. L. BEAN, Inc.
44 Main St.
Freeport Maine

Try **CASCO GLUE**!



Read what **F. L. S. of Portland, Oregon** says:

"CASCO is so easy to apply, it can be mixed in small or large quantities, thus saving waste. It is so smooth in working and gives such satisfactory results that I consider it superior to any glue that I ever used."

CASCO—now available to everyone—is the famous industrial glue used in the manufacture of fine furniture, pianos and airplanes.

The Secret of CASCO'S Great Strength

Most glues set slowly, by evaporation. CASCO sets quickly, by chemical action. This unique method gives superior, long-life holding strength. It makes CASCO heatproof, waterproof. When you want to build a project, for permanent use CASCO.

FREE! GENEROUS TEST SAMPLE & HANDY GLUING GUIDE!

32 pages, 50 illustrations, full of ideas on gluing and repairing things quickly, easily and permanently. Makes you an expert on all gluing jobs. Write name on a postcard. Say "Send free sample and copy of 'Casco Gluing Guide'".

Hardware, Paint, Lumber Dealers Sell CASCO

THE CASEIN MFG. CO. OF AMERICA, Inc.
350 Madison Avenue, Dept. 435-B, New York, N. Y.



THE LENGTHENING SPAN OF LIFE

(Continued from page 134A)

bon monoxide and with cyanides.

Progress also has been made in the fight on infantile paralysis. Maurice Brodie of New York and John A. Kolmer of Philadelphia have developed vaccines by macerating spinal cords of monkeys infected with the disease and invalidating the toxin in the cord by the use of antiseptic substances. There seems to be some reason to believe that these will be of value in immunizing children, and perhaps also in the early treatment of cases of this disease.

Research on cancer continues throughout the world, concerned principally with the nature of the cancer cells. Investigators have found out that cancer cells use sugar to maintain their growth. They have found that there is a tendency to inherit cancer when there is inbreeding in cancer types. Electrical engineers have developed X-ray apparatus more powerful than ever produced heretofore. Such X-ray apparatus is exceedingly useful in the treatment of cancers that cannot be reached in other ways. Radium is also increasingly utilized in bombs of high potency which permit shortening of the period of treatment as well as more successful treatment.

The development of new anesthetics, of new devices for cutting electrically which control hemorrhage, and of new antiseptic substances which inhibit infection, and finally, the development of technic have led to marvels in the field of surgery. There is now hardly an organ in the human body which the surgeon cannot approach successfully. As a result, one-half of the cerebrum or forepart of the brain of a human being has been successfully removed in many cases, thus saving the lives of people with cancer of the brain. In several instances one lung has been removed and life thereby saved. The heart was once considered unapproachable, but many surgeons today have performed operations which involve stitching of the heart, cutting away of portions of the sac which surrounds it, and similar procedures.

Much of our modern medical advance depends on the development of new machinery and new apparatus which aids the senses of the physician. Machines have been developed to aid in anesthetization and which give comfort and safety. New

(Continued to page 142A)

EVINRUDE SPORTSMAN

...WITH "HOODED POWER"

\$55



WEIGHS ONLY 24 1/2 POUNDS

SPEED UP TO 7 MILES

New, handsomely illustrated catalog tells all about this lightest, handiest, most portable outboard at lowest price in Evinrude history! Carries in one hand, stows easily in auto or Pullman, fits any small boat (special attachment for canoes). Embodies advanced "Hooded Power" streamline design, same as costliest models. Gallon of fuel lasts over 2 hours. Important features include Underwater Silencing, Flexo-Rubber Steering and Self-Tilting. Write today. Address: EVINRUDE, 4464 N. 27th Street, Milwaukee.



SEND FOR FREE CATALOG

BUILD DUTCH WINDMILLS

Beauty Your Garden—Make Money Selling to Others
Easy to build from BLUE PRINTS. Model B10 (hexagon style 30" high) 75c. Model B25 attractive Dutch Windmill operating DUTCH GIRL CHURNING BUTTER 50c. Knock Down Kit for Model B25 only \$4.00. Lawn cut out patterns sunbonnet girl, Dutch boy, Tulip Girl and Holland pair. 25c each. 4 for \$1.00. For Catalog send 10 cents. Free with order.
Craftsman's Model Co., Dept. P-4, 2030 N. 41st St., Milwaukee, Wis.



WORLD WIDE ALL WAVE RADIO \$1.95



Get stations all over the world with this POWERFUL radio receiver! All Wave—15 to 600 meters! Works on two inexpensive batteries! NOT a toy or attachment! **Results Guaranteed!** Ace kits include all parts mounted on attractive metal chassis and panel. Clear picture instructions. Wire it yourself! It's easy!
ONE TUBE KIT—\$1.95 • TWO TUBE KIT—\$2.85
ALL ELECTRIC 105-125 volt AC-DC two tube house current set. No batteries needed! Complete KIT \$2.65
Kits wired 75c extra. Tubes 85c ea. Double Phones \$1.25.
ORDER NOW! Send \$1. balance C.O.D. or postpaid if full remittance. Postcard brings free literature.
Free!! Large three color Map of the WORLD, valuable Short Wave data, etc.!! Send 10c for handlings. Now!
Ace Radio Laboratories
1619 Broadway
Dept. P-4, New York City



NOW I CARRY ONLY ONE PENCIL—

NORMA

THE SENSATIONAL 4-COLOR Instant Shift PENCIL for EFFICIENT MEN and WOMEN

Takes the place of four ordinary colored pencils . . . a flick of the thumb changes color with no delay in your work. Saves time, effort and money . . . pays for itself. Ideal for gifts.

Four colors—red, green, blue, black.
Shifts with trigger speed.
Standard leads procurable anywhere.
Beautiful, sturdy barrel.
Guaranteed against mechanical defects.

Silmi—handsome, silverlike finish	\$3.50
Rolled Gold plate	5.00
Sterling silver	8.50
14K Gold Filled	12.00

Try Norma 10 days free. If at the end of that time you are not thoroughly satisfied we will refund your money.

4 COLORS IN ONE PENCIL
4 PENCILS IN ONE . . .

If your dealer cannot supply you, mail coupon today

Norma Pencil Corp., Dept. 17
150 Broadway, New York City

Please send me Norma for 10 days free trial. Enclosed is my money order for to be returned promptly if I am not satisfied.

Name
Address
City State

Red Green Blue Black.

EARN MONEY RE-STRINGING RACKETS AT HOME



SET OF SILK STRINGS 95c

"Yes, you can easily earn up to \$3 an hour at home stringing tennis rackets! No experience needed! LEARN HOW TO EARN in a few minutes. Your home is your office! Grab this great opportunity, and now to make \$300 to \$500 each this season. QUICK—write for FREE details!" (Get my Free Catalog of tennis equipment.)

W. A. BICKEL, 809 W. Madison, Dept. 13-54, Chicago, Ill.

IF YOU'RE INTERESTED IN ARC WELDING PROFITS



This new Hobart "Simplified" Welder lets you start big paying business of your own—lets you make hundreds of dollars extra profit each month. Unusually low prices lets you easily pay for it out of increased profits it brings.

get this NEW Arc Welding Book FREE

30 DAYS TRIAL AT OUR RISK \$30 MONTHLY!

Thousands of shops are earning big money with Hobart—cash in on the profitable jobs and construction work it lets you handle. Comes in 125, 200, 300 and 400 ampere sizes. Electric, Belted or Gas Engine Drive. Write us today for new low prices and FREE ARC WELDER MANUAL. **HOBART BROS.** Box M-451 Troy, Ohio



Every Wood Craftsman Should Have This 100 Page Book No. 8



It is full of beautiful things that you can easily make—hard to find material such as foreign woods—lovely crotch, butt, burl, fiddle back, etc. Veneers, Panels and Solid Woods. Lists and illustrates 76 Blue Print Designs for Scroll Patterns, Inlay Table Tops, etc.

Make Beautiful Period Furniture at a fraction of store cost. If you are handy with tools you will value this book. It will save you money and make available exactly the kind of material you want.

CRAFTSMAN WOOD SERVICE CO.
We Ship All Over The World
2728 MARY STREET CHICAGO

only 10¢

Secrets of Master Bowlers Revealed by Expert

(Continued from page 575)

bowlers, claims he can start his ball every time from a spot the size of a silver dollar. The idea is to roll naturally, changing the spot rather than the delivery to make corrections.

The straight ball is the easiest to deliver and control, but unless the first ball hits the pocket accurately it is apt to carry the pins straight back without scattering them. The hook ball has a larger pocket to work in, and the spinning action of the ball throws the pins sideways, where they have a better chance to sweep the rest of the pins for a strike. Developing a good hook requires much practice, but is well worth the effort. The hook is achieved by a turning movement of the wrist and forearm from right to left just as the ball is released. The ball will roll down the alley with a fair amount of speed, and at a certain point will curve to the left.

Control is the ability to hit the one-three pocket with the first ball. Strikes, however, will not always result, and it is in picking off the remaining pins for spares that the accuracy developed by practicing trick shots will count. A good test for con-

trol is to remove all pins except the two and three. The three pin should be kept on its spot, while the two is moved three inches to the left. This will give the ball one and two-thirds inches clearance. When you can roll between these two pins four times out of five you have developed real control.

Now set up all the pins except the five, eight and nine, and attempt to pick them all off, one at a time. If you fail to get your pin, or get more than one, start over again. If you think those two shots are a bit too hard for you, try lining up the back row seven, eight, nine and ten and picking the pins off one at a time, starting over again when you miss or take two. The big trick here, of course, is to take the ten pin. It should be left until the last, unless you want to make the trick harder, for in attempting to keep out of the gutter you will tend to shave it too thin and take the nine with it. Getting the ten will be easier with a straight ball, for with a hook you must take advantage of the full width of the alley, and even then the ball must almost roll in the gutter before it breaks in order to score a hit.

"Eyes" of Automobile Are Corrected by Robot Optician

Automobile lamps can be tested and adjusted with scientific accuracy at a range of only eighteen inches, instead of the usual twenty-five feet, by employing a recently developed device which checks both the patterns of the light beams and their intensity, the latter being measured by a photronic output meter and registered as lumens. The car to be tested is placed on four flat steel plates to assure correct level. The lamp beams strike twin "aiming heads" eighteen inches distant, each head carrying three specially ground lenses which collect the light from a given area of lamp and focus it in various patterns on a target card. The latter is provided with cross lines indicating the desired shape and location of the beam patterns. The "aiming heads" can be raised or lowered to change the level of the lamp beam in steps of one inch at twenty-five feet. With the head adjusted at the required level, the car lamps then are aimed to bring their beams into proper relation with

the target cross lines behind the lenses. Differences in battery voltages and candlepower rating are compensated for by a calibrated variable resistance control. All information revealed by the tester is recorded on an analysis chart for the convenience of the customer.

Bigger Than the Great Pyramid

Grand Coulee dam, the federal project on the Columbia river, will be the largest single structure ever built by man, according to present plans. Containing three million, six hundred thousand cubic yards of concrete, it will rank first, the Great Pyramid of Egypt second and Boulder dam third. If the dam is increased in size, as suggested, its nine million cubic yards of concrete would be three times the size of the largest pyramid. These figures were given by Francis Donaldson, chief engineer for the Mason-Walsh-Atkinson-Kier company which holds the contract for the first unit of the dam.

2/106

with their limited motion device

2/106

Mason-Walsh-Atkinson-Kier Co

Esude Lamp Corp

Francis Donaldson
Chief Engineer

(Advertisement)

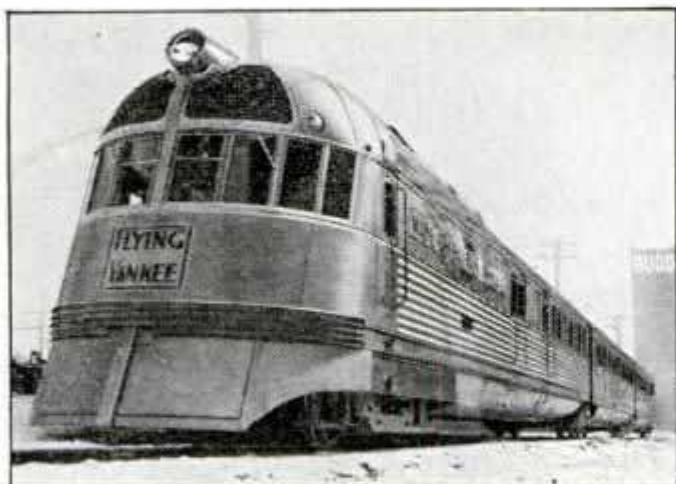
**"FLYING YANKEE" STARTS OFF
ON THE RIGHT FOOT**

Few people realize the transformation now taking place in transportation. The "Flying Yankee" typifies the radical changes that are being made in railroad equipment. This three-car streamline train weighs no more than a single pullman car. It travels over 100 M.P.H. . . . Its framework is welded together with strips of stainless steel no thicker than a dime . . . It accelerates so fast that if it raced a conventional steam train it would actually be 6 miles ahead by the time both reached 90 miles per hour.

The speed of the airways has been brought to the railways . . . And with it comes a new problem of lubrication that can only be met with a heat-proof, speed-proof motor oil. The "Flying Yankee" has solved this problem most successfully by using Veedol . . . "the world's finest motor oil."

STILL GOING TO "GRADE" SCHOOL

The man who sells Veedol Motor Oil is not only thoroughly schooled in the quality of the product, but also in the proper grade to use for each car. The text book for this "grade" school is the Veedol Lubrication Guide developed by the Tide Water Sales Engineering Department in conjunction with each motor manufacturer. Tide Water is the only major oil company that offers its own guide to the dealer.



(Advertisement)

**PIONEER PIPE-LINE
STILL GOING STRONG**

Since 1878, the pipe-line built by the Tide Water Oil Company to carry the rich Bradford crude oil from that Pennsylvania field to the great refinery at Bayonne, N. J., has done yeoman service. Today this 288-mile pipe-line is a double trunk, and still carries all the Bradford crude that is piped to New York Harbor. There, at the world's largest refinery of Pennsylvania petroleum products, the "black gold" of Bradford is processed into Veedol, "the world's finest motor oil."

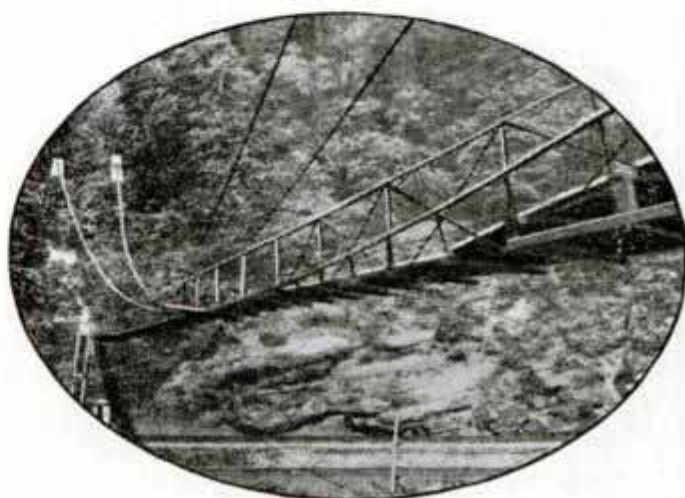
**THE LONG, LONG TRAIL THAT
ENDS IN A CAR**

Only one major oil company in the U. S. controls its production of 100% Pennsylvania motor oil from the oil well to the consumer's car. The Tide Water Oil Company transports its own rich Bradford crude oil in its own pipe-lines direct to its own



refinery at Bayonne, N. J. There the world's "oiliest" crude oil is transformed by Tide Water's own processes into Veedol, "the world's finest motor oil." Veedol leaves the great refinery in hermetically sealed cans and reaches the crankcase of millions of motor cars as pure, as fresh and as efficient as the day it was made.

ATLAS QUALITY

Shop Equipment Since 1911

1935 Model Atlas "Unit-Plan" METAL-WORKING LATHE

... designed so units may be added



\$39⁵⁰

1
Here's a lathe that meets every need economically. As your shop grows, you can add to it UNIT by UNIT until you have a fully equipped, back-gear, screw-cutting lathe, capable of every kind of lathe work—as fine a tool as a man could wish for. This first step has a precision-ground bed of heavy ribbed cast iron; hollow head-stock spindle; tail-stock; compound rest; driving belts and pulleys, etc. Takes 24 in. work between centers and has 10 in. swing.

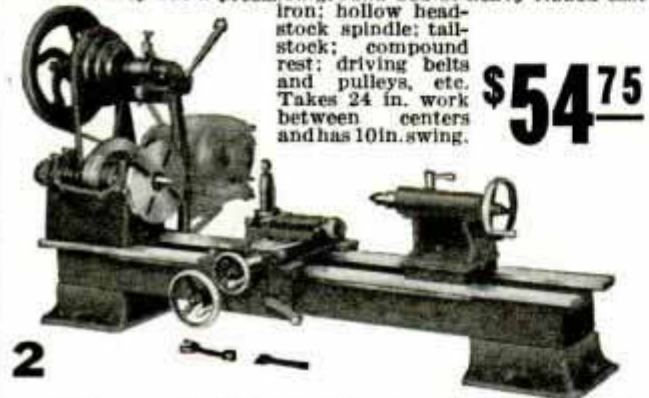

\$54⁷⁵

2
By adding countershaft assembly you get greatly increased power and wider speed selection. (\$49.25) Ideal for all small metal jobs and work on radio, armatures, valves, pistons, etc. The next step (\$54.75) substitutes different Compound Rest and adds the Carriage and Rack. This gives longitudinal feed entire length of bed without changing the Rest.



\$87⁵⁰

3
... Final additions build up, UNIT by UNIT, to this complete back-gear, screw cutting lathe. Cuts 4 to 72 threads per inch; automatic reversible feeds; 16 speeds from 28 to 2,072 R.P.M.

ATLAS DRILL PRESSES

\$13.95 to \$33.45



The ATLAS does WELL any job within its size capacity, with highest degree of accuracy and an abundance of power Sold on 2 weeks' trial, with money-back guarantee. Full line of attachments at new low prices.

ATLAS PRESS COMPANY
1843 N. Pitcher Street, Kalamazoo, Mich.
ATLAS SALES CO., 35 E. Wacker Drive, Chicago, Ill.

FREE CATALOG
Send your new FREE catalog of ATLAS metal lathes, wood lathes, drill presses, attachments, arbor presses.

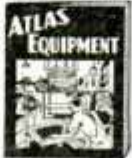

NAME

ADDRESS

CITY STATE

You get a fast clean cut



KEYSTONE K-61 HOLLOW GROUND COMBINATION SAW

—when you use the **Keystone Home Workshop Saws** that **DISSTON** makes for you. They fit your machine, suit your work, stay sharp, make good results easy. **Cross Cut, Rip, Combination; also Hollow Ground Smooth-cutting Combination.** Diameters: 6", 7", 8", 10" at \$1.00, \$1.25, \$1.40, \$1.80; Hollow Ground, \$2.50, \$3.00, \$3.60, \$4.50. In Canada, prices slightly higher.

Ask your dealer for **Disston-made**

KEYSTONE

Home Workshop

SAWS and TOOLS

Write us for valuable home workshop aid FREE—the "Disston Saw, Tool and File Manual". Henry Disston & Sons, Inc., 411 Tacony, Philadelphia, U. S. A., Canadian Factory: Toronto.

NYOIL

A MOST HIGHLY REFINED OIL

For fishing tackle, firearms, and household appliances, prevents rust. A perfect furniture polish, never gums, is odorless, stainless. A handy can, 35c, postpaid if dealer cannot supply.

Wm. F. Nye Inc. Dept. M. New Bedford, Mass.

EARN MONEY with this WONDERFUL NEW INVENTION

BLOW TORCH & SOLDERING IRON IN ONE!

AGENTS! Make quick, steady PROFITS with amazing NEW invention—sell on "flash" demonstration. Main or side line, part or full time. Opens big, new market. **WRITE**—get established for exclusive territory. Hurry! Justrite Mfg. Co., 2061 Southport, Dept. 13-54, Chicago

MAKE MONEY PRINTING

letter and billheads, circulars, cards for friends, spare time. Easy to learn, easy to get jobs. **Printing Presses \$12;** new type faces, complete supplies, lowest prices. Send stamp for catalog. **PEIFFER CO., 37-A; 6 Columbia St., Newark, N. J.**

CASH INCOME DAILY RESILVERING MIRRORS; REFINISHING METAL Plated articles; autoparts, reflectors, tableware, etc., Making Chipped Glass Name Plates. Portable Outfit.

SPRINKLE, PLATER, 129, MARION, INDIANA

Men & Women Earn Cash at Home!

Grow fancy giant mushrooms in cellar, attic, barn. Easy, odorless method. We show you how, furnish guaranteed materials and buy crops. Valuable big book, pictures free if you write quickly. (Est. 1908.) **UNITED CO. 3848 Lincoln Ave. Dept. PM-4 CHICAGO**

COMPLETE PLANS

FOR A PERMANENT
PROFITABLE BUSINESS
OF YOUR OWN *free*

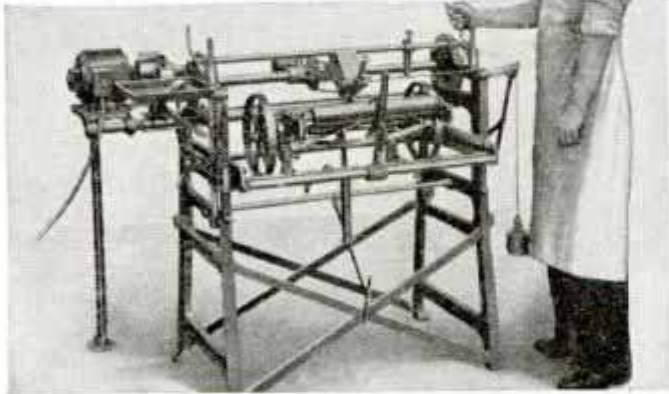

MAKE \$30 TO \$40 A WEEK

Our free plans show you how to build a successful business of your own sharpening lawnmowers. Positively no experience necessary. Most men average from \$30 to \$40 a week. J. B. Van Dien, Ridgewood, N. J., writes: "Some weeks I earned \$40 a week with my Ideal just as a side line." H. Greenlaw, Fond du Lac, Wis., writes: "In May I sharpened over 200 mowers at \$1.00 each." Niles C. Race, Rochester, N. Y., writes: "I have sharpened 785 mowers at \$1 each."

THE IDEAL LAWNMOWER SHARPENER

Makes old, dull lawn mowers cut like new. Mowers run easier, stay sharp longer—customers come back year after year. Start right at home. Attach the Ideal to your lamp socket. Sharpens any make of mower in 15 to 20 minutes—you get \$1.00 to \$1.50. Attachments for grinding skates, grass shears, hedge shears, sickles, scythes, axes, etc.

Send Post Card for FREE CATALOG
and Complete Plans

THE FATE-ROOT-HEATH CO.
435 Bell St., Plymouth, Ohio



GO INTO BUSINESS Make 100% to 300% Profit!

Sell new and used clothing direct from your home, auto or store. Undersell all competition. EASY SALES—FAST REPEAT ORDERS! We furnish everything and show you how. Handsome profits every day in the year. No selling experience necessary. Satisfaction guaranteed. Write at once for our Big Money Catalog—It's FREE! LIQUIDATION MERCHANDISE CO., 550 East 43rd St., Dept. D-111, Chicago, Ill.



BEFORE YOU BUY OR BUILD A TRAILER

Let us send you our illustrated folder on building Airstream trailers (4 models), and sample copy of our 32-page English trailer magazine illustrating many trailers inside and out. Packed full of trailer ideas and information. All for 25c. AIRSTREAM TRAILER CO., 134 So. St. Andrews Place, Los Angeles, Calif.

Make up to \$150 Weekly
GIVING AWAY
FREE  RCA LICENSED
RADIOS

RCA Licensed Automobile and Home Radio Sets for American, European and South American Reception. Beautiful World Master floor model radios. Guaranteed foreign reception. Custom made with exquisite all matched walnut cabinet, areoplane dial, twin illumination, dynamic speaker and automatic volume control. Given away absolutely FREE with our new sensational unique PUNCH SALES CARD PLAN. This is the opportunity of the year—make up to \$150 cash each week for yourself. Every home, car owner, store, office, factory, lodge, club or individual wants these marvelous new FREE RCA LICENSED RADIOS.

WRITE TODAY For OUR NEW STARTING OFFERS
Start at once making money with our unique sales plan. Write for full information how you can secure any or all of these plans.
DELUXE MFG. CO., Dept. 168, 173 W. Madison St., Chicago, Ill.

HOBBIES

BENEFIT
by the use
of

Genuine
MASONITE
PRESWOOD

FEW are the hobbies in which Genuine Masonite PRESWOOD cannot play an important part. It answers all the requirements they demand. Sturdiness, strength, permanence, lightness, versatility, workability, economy.

PRESWOOD is ideal for collectors' shelves, trays, cabinets, display cases; photographers' laboratories and equipment; radio cabinets, panels and mounting boards; game boards and hundreds of other uses.

This grainless material will not warp, chip, split or crack. Can be cut or sawed to any desired size or shape. Beautiful effects provided by its natural warm brown finish. Or it can be varnished, painted or enameled with any standard application.

Put PRESWOOD to work on your hobby. Let it make your equipment permanent and dependable . . . more useful than ever before.

Mail the coupon for sample of PRESWOOD and descriptive booklet, absolutely FREE.

MASONITE CORPORATION PM-4
111 W. Washington St., Chicago, Ill.

Please send me a sample of PRESWOOD and useful free booklet.

Name _____

Address _____

City _____ State _____

Be A Better Shot!



Here's How!

Of course you want to improve your shooting! This **NEW** free booklet will help you! Should be in the hands of every small bore rifleman. Interesting! Instructive! Gives actual experiences with Super-X Long Range .22's on game. Tells all about Super-Match, the new Western Smokeless .22 L. R. target cartridge. Mail coupon *now!*



Coupon Brings **FREE** New Booklet On Rifle Shooting

Western Cartridge Company,
Dept. D-46, East Alton, Illinois.

Mail me a copy of your **NEW** booklet on small bore rifle shooting, **FREE**. Also leaflets describing the advantages of Western small bore ammunition.

Name.....
Street.....
Post Office..... State.....

Information on any book free. Write Popular Mechanics Press, Chicago, Ill.

"Keep Out"

Says the RCA Noise Reducing World Wide Antenna To Man-Made Interference

No more need your short-wave reception be prey to every passing street car—every electrical gadget in your building! The new RCA double-doublet antenna says "No!" to man-made noises—and brings in far more foreign stations.

Ask your dealer or service engineer for a *Certified Installation*. Write for booklet, "Antenna Facts".

\$6.00 plus installation



RCA Parts Division
Dept. M
Camden, N. J.



**WORLD WIDE
ANTENNA
SYSTEM**

THE LENGTHENING SPAN OF LIFE

(Continued from page 136A)

devices for raising the temperature of the body artificially have been applied, particularly for the treatment of infections and softening of the brain. All sorts of new ways of supplying heat to the human body have been used in the treatment of rheumatic disorders.

Particularly significant was the development of the artificial lung or respirator, used to keep patients alive when their breathing muscles have become paralyzed, as occurs in infantile paralysis or when a person has been poisoned by carbon monoxide and similar poisons. An interesting device just announced maintains alternate air pressure on the limbs of the human body, said to be useful in inflammation of the blood vessels in the legs. Innumerable small devices to aid in studying the changes that go on in the body, in hearing the sounds of the heart and lungs, and in measuring the functions of the various portions of the body have been developed to aid the physician in his work.

As 1935 advances, major interest attaches itself to the new plans for economic security, including old-age pensions, unemployment insurance, sickness insurance, maternal welfare, child welfare and increased appropriations for public health.

Few people realize that medical science, through its advancement, has created new problems. When life expectancy of human beings was thirty-five years, there was no problem concerning the aged. Today the life expectancy approximates sixty years, and the care of the aged is a serious matter. The insane, the feeble-minded and the hereditary blind and the deafened were permitted to die. The workers of the population were not concerned with that problem. Today conditions of overcrowding in institutions have brought about the question of means to prevent the perpetuation of defects and to control population.

New habits of diet, and of rest, new ways of living as the development of the apartment house to take the place of the home of an earlier day, also change the nature of disease and of its care. Today American medical science is recognized as superior to that of most other nations in the world. American initiative and American opportunity if unhindered, promise still greater achievements for the future.

This much more in a Shelvador

EXCLUSIVELY IN

CROSLEY

ELECTRIC REFRIGERATORS

BIG 1935 LEADER

Genuine Leather Ties, 4-In-Hands and Bows—Men's and Boys'. Fancy patterns. Look like silk. Cleaned with a damp cloth. Durable; won't wrinkle. SELL ON SIGHT. Big profits; repeat orders. Be independent; have your own business. B. M. SOLD 30 IN 1 1/2 HOURS. No sales ability needed. Send 50c or stamps for sample and kit. Information free.

CENTURY TIE CO., Dept. 2, 2333 W. Grand Blvd. DETROIT, MICH.

HIGH POWERED TELESCOPE

GENUINE BROWNSCOPIES AT AMAZING PRICES

Most powerful in America for the money! 15 power long range telescope. Can see moon's craters or time on pocket watch a block away. 5 sections. Approx. 3 ft. long. Fine lenses. Brass bound. Can be used as powerful microscope. Vol. magn. 512X. Only \$1.69 postpaid. C. O. D. 24c extra.

\$1.69

Special Super-Power 30X Telescope. Similar to above but more powerful. Guaranteed to see 900 times larger in surface and 30 times closer. 31 mm. objective 4 powerful lenses. Large field. Includes powerful microscope features. Only \$1.98 postpaid.

\$1.98

BROWNSCOPE CO. Dept. 44 234 Fifth Ave., New York, N. Y.

READY CUT HOMES

Save \$500 or more on complete low-priced homes. \$416 and up, freight paid, ready to all and up. In addition to all assemblable. price includes Ther-mofill insulation, Spring Bronze weatherstripping, built-in ironing board, medicine cabinet. At-tractive 1-panel doors and latest hardware. Building plans, nails, lath, paint, varnish, shingles, etc. furnished. Send 25c today in full color, complete information. 80 good practical low-priced homes cottages and garages.

International Mill & Timber Co. Dept. PM-45, Bay City, Michigan

FULL COLOR CATALOG FOR ONLY 25c

Don't throw away your old paint brushes



Those stiff-necked, caked-up paint brushes huddled away in attic or workshop... Sava-brush can save them! No matter how hard or hopeless they look! For here is a pre-sto-powder that, when dissolved, loosens paint, varnish, shellac, enamel; puts new youth into stiff old bristles. A 10c carton will save several brushes. If your paint or hardware dealer is not supplied mail this.

NAME _____ ADDRESS _____

This coupon and 10c, mailed to Schalk Chemical Co., 354 E. 2nd St., Los Angeles, will bring you a postpaid package of Sava-brush. W-1

SAVABRUSH

GUARANTEED ONE YEAR

1935 MODELS

FREE BB MAGIC

Benjamin Super Single Shot Air Rifles—Bolt Action—Hammer Fire—Hair Trigger—shoot lead or steel BB shot and 177 or 22 pellets and darts. Illustrated and described in New "BB Magic" Free—Write Today—get full details of Benjamin 25 Shot Repeater and New Benjamin Air Pistol—Free Targets—SPECIAL INTRODUCTORY and TRADE-IN OFFERS.

BENJAMIN AIR RIFLE CO. 697 N. Broadway St. Louis, Mo., U. S. A.

WHAT IS THE PROPER CARE FOR YOUR PUPPY?

When should he be wormed? Training? House manners? Obedience? This and much other valuable information is given in **GLOVER'S NEW FREE DOG BOOK.**

Contains handy symptom chart. Explains Care, Training and Feeding. Tells how to administer medicine, etc. Write to **GLOVER'S, Dept. Y, 468 Fourth Ave., New York, N. Y.**

GLOVER'S ANIMAL MEDICINES

GLOVER'S Kennel and Flea Soap removes D. O. (doggy odor). Promotes healthy skin. Kills fleas.

WITTE DIESEL ENGINES

A DIESEL YOU CAN AFFORD TO OWN

Horizontal . . . Hopper Cooled . . . Solid Injection
Four Cycle . . . Easily Started . . . Entirely Self-Contained

Enclosed, Self-Oiling Timken Roller Bearing
The ENGINE that pays for itself

The small difference in price as compared to a gasoline engine is more than offset by the large saving in fuel, for the WITTE Diesel operates on non-explosive oil for about one-eighth the cost of gasoline. Where used several hours each day the savings in fuel will soon pay for the WITTE Diesel. Simple construction—few working parts, it's the last word in dependable economical power. **WRITE FOR BULLETIN Number 25.**

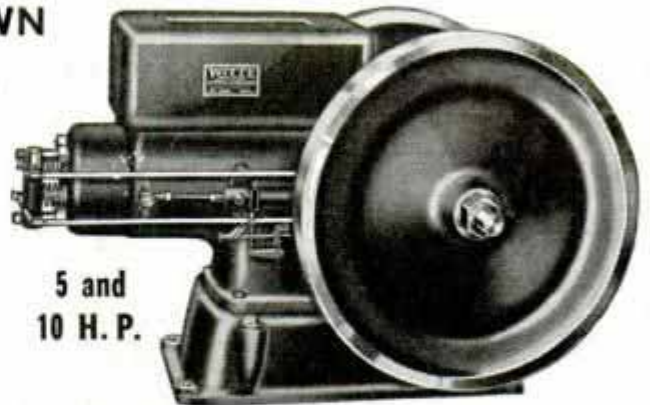

5 and
10 H. P.

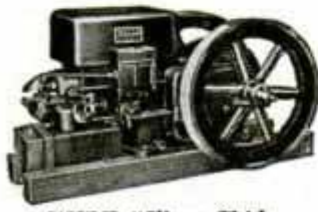

TYPE "J" on Skids

SOLD DIRECT—FACTORY TO YOU

Where the power demand does not warrant the use of a WITTE Diesel we recommend our Gasoline-Kerosene-Distillate Engines, 2 to 30 H.P. Made in two styles—one a popular priced line, the other a line of quality costing but little more. **CATALOG FREE.**

1744 Oakland Ave.
KANSAS CITY, MO.

WITTE ENGINE WORKS

215D Mulberry St.
HARRISBURG, PA.



CHICAGO FLYING SCOUT
Roller Skates
Let's Go!

Club Members

Get out your skates—watch "CHICAGO'S" lead the crowds. In cities, towns and villages they're the popular skates today. Join this SPEED Club. "Try CHICAGO'S."

No. 101 WITH FAMOUS TRIPLE-TREAD, "TRIPLE-WARE" WHEELS

Only "CHICAGO" Roller Skates have these patented steel wheels that give More Speed and More Miles at lowest cost. No. 101 shown above, Reg. Price \$2.25. Special Only \$1.95 Postpaid.

NEW Streamline Super "SILENT-FLASH"

Students and Grown-Ups prefer these high Speed, Noiseless Rubber Tire Skates with reinforced channel arch and wide toe clamps. They outwear Steel Wheels. Reg. Price \$4.00. Special Only \$3.75 Postpaid.

Send dealer's name with remittance, if he can't supply. Demand "CHICAGO'S"—name stamped on wheels.

GET CLUB PIN and FREE BOOK

Write Today! Enclose 10c if you want beautiful GOLD F. Skate Club Pin.

CHICAGO ROLLER SKATE CO.

Roller Skates with Records for over 30 years.

4414 W. Lake St.

Chicago, Ill.



PRINT—MAKE MONEY

printing letter and billheads, stationery, tickets, cards, circulars. **Start A Spare Time Business Of Your Own.** Free instruction book, learn quickly, easily. **Printing Press, \$12.00**, new type, supplies. Send stamp for list. **EXCHANGE E1, 22 Orient Street, Meriden, Conn.**

MAKE MONEY!

INSTALL YOUR OWN BURNER

At last! A quality burner in the low priced field. Our burners bought by U. S. Govt.! Now you can buy direct at one low price complete with full set of electric controls, wire, etc., plus complete instructions for making your own installation. Write for amazing low price and free literature today!

CHALMERS OIL BURNER CO.

1244 Central Ave., Minneapolis, Minn.



FREE LITERATURE TODAY!

STRING your own RACQUET

Same Quality String As in Expensive Racquets Outfit Complete with string, tools and directions \$1.65

Easy to restring racquets—better than new. Saves real money. Send for this professional outfit today. Good profits made restringing other players' racquets. 37 ft. string, colors Purple, Green, Red or White—also Scarlet and Black Spiral—with contrasting silk trim, awls, illustrated easy directions. Money back guarantee.

MAKE MONEY TOO! Send check or Money Order \$1.65 which includes Postage and Insurance. Sent C.O.D., if desired. 15c extra.

Pro Tennis String Co., Dept. Q-8, Harmon, N.Y.

AGENTS Make \$380 Monthly

selling 10 CARTER WINDOW WASHERS daily. Cleans, dries, polishes. No mess. Good Housekeeping approval. Restricted territory. Write today. **Carter Products Corp., 998 Front Ave., Cleveland, Ohio**



TURN SCRAP INTO MONEY

The new and revised edition of "Auto Power" with all the ten original specifications and ten new ones is now off the press. Convert old generators into A. C. and D. C. generators and motors with voltages of 6 to 400 volts, for power, light, welding, and radio operation. Create new generators adaptable for home, automobiles, or trucks. They can be driven by fan belt, wind, or water. This book, with complete illustrations, tells you how easily and economically these changes can be made. Also instructions for rewinding auto armatures. 350 definitions of electrical terms, etc. Already used and endorsed by thousands. Price, \$1. Postpaid. **AUTO POWER, Dept. B, 410 S. Hoyne Ave., Chicago**



Greater Power for your .22 rifle

with sensational
Kleanbore Hi-Speeds

YOU'LL take new pride in your shooting skill once you try the king of .22's—Kleanbore Hi-Speeds. How they travel—flat, straight and true. With lightning-like get-away. With a business-like z-z-zing. With a striking force 100 yards away that more than equals that of old-type low speeds at the muzzle!

These .22 speed kings are built like big game cartridges—with solid brass cases. Strong—to hold the extra power of our special Hi-Speed powder. The lubricated bullet is special, too—extra hard for greater accuracy, greater striking force (shoot hollow point Hi-Speeds if you want an expanding bullet).

The quick-action priming is patented Kleanbore—non-mercuric, another exclusive feature. No matter how hot or moist the climate, Kleanbore will not fail. Harm your rifle barrel? Never! And that means no rusting, no pitting, **NO BARREL CLEANING!**

Remington

DU PONT



KLEANBORE

HI-SPEED .22's



SEND FOR FREE folder on Remington Kleanbore .22 Ammunition or, better still, get the information from your dealer who sells Kleanbore Hi-Speed Short, Long and Long Rifle Cartridges. Remington Arms Company, Inc., 743 Seaview Ave., Bridgeport, Conn.

WHY DRAIN YOUR CRANKCASE ?

Have you ever wondered, when a service station man drains several quarts of used oil out of your car, *whether you are being wasteful?* Whether you couldn't "get by" with merely adding a quart or two of fresh oil?

There are very sensible reasons why oil should be completely changed at regular intervals. Oil at work in your motor is contaminated with many things: dirt and dust, fuel residues, water, and minute metal particles.

It is true that most cars are equipped with oil filters, and these have prolonged the useful life of your oil. But you often forget to *renew* your filter. And even if you renew it regularly, the filter cannot remove *all* of the foreign substances that collect in your crankcase.

It is also true that there are better oils on the market today. But you can't afford to take chances of motor damage. *Oil—even the best oil—is cheaper than machinery.*

How often you should drain depends on your speed and the brand of oil. Some oils go to pieces under the terrific heat of your motor *long before the accumulation of dirt, etc., would normally cause you to change.* So you should drain and refill much oftener with such an oil than with a long-lived oil such as Quaker State.

There is only one safe and truly economical rule: use the best oil you can buy—and drain your crankcase at reasonable intervals. Quaker State Oil Refining Co., Oil City, Pennsylvania.

"First choice of Experience"

QUAKER STATE MOTOR OILS



• REVOLUTIONARY IN PRINCIPLE — a single piece of brake lining **floating** between the drum and an expanding shoe—covering the entire brake drum circumference. **AMAZING IN EFFECTIVENESS**—4 times usual braking surface on **each** wheel. Eliminates grab, chatter, squeal and drum scoring. Guarantees quick, quiet brake action. Enables safer high speed stops on slippery roads.

For **FORDS** and **CHEVROLETS**

Easy to Install
Easy to Buy
\$7 DOWN — balance

2 monthly payments
Easily installed in 2 hours by average mechanically inclined car owner. Simply remove wheel and hub assembly. Slip on **HAWLEY** assembly. Put lining into place. Remount wheel and adjust brake rods. No holes to drill. No special tools necessary. A remarkable advance in motoring safety. Total cost only \$21. No carrying or finance charge. Mail coupon for full information.

COMPARE THEM YOURSELF!



THE OLD WAY

2 piece lining equal to about 50% of drum circumference—braking surface on one side only—riveted to complicated mechanism.



THE HAWLEY WAY

1 piece lining floating between drum and shoe—covers entire drum circumference—brakes on both surfaces. No rivets.

WANTED—DEALERS and DISTRIBUTORS
Many good territories still open. Write for details.

HAWLEY FLOATING LINING BRAKES

HAWLEY BRAKE CORP.
Hart Street, Corning, N. Y.

I am interested in HAWLEY FLOATING LINING BRAKES.

for my car for resale

NAME.....

Address.....

City.....

The name of a good independent garage in my community is.....



New Coin-in-the-Slot Nut Vendor Opens Field for Steady Profits in PEANUTS

Information given upon request on how to install and operate a string of these automatic salesmen in any locality. No selling. Ideal for parties with limited capital seeking to start business with a few and build up.

Hundreds of locations available. Beer parlors, dine and dance places, lunch rooms, drug stores, soda fountains, markets, groceries, filling stations.

Ask about our 30-day Money Back Test Offer

THE VENDEX CO., Dept. M
Roxbury Crossing, BOSTON, MASS.
U. S. PATENT No. 1991796

Miniature CLAMPS

“Pony” Fine Tools in miniature—quality in design, materials, finish and machining. Accurately aligned steel screws with free acting, broad-faced swivels. Malleable Iron Frames, Cadmium plated. These clamps fill a thousand needs. Look for the “Pony” mark—your guarantee of quality.

Send 50c (Plus postage on 1 lb.) for “Premier Assortment”: 4 Pony Clamps—2 No. 231 (open 1”, throat 1”) and 2 No. 232 (open 2”, throat 1”).

Check previous ads for other clamps

ADJUSTABLE CLAMP CO.
“The Clamp Felts”
421 N. Ashland Ave., CHICAGO, U.S.A.



THE Smooth WAY TO “ROUGH” IT

Self-Built DeLuxe House Trailer gives you economical travel-convenience. Complete interiors—4 models. Progressive Buying Plan. Any workman can build. Beautiful new Trailer Builders’ Guide, 150 illustrations: famous Ball and Socket Hitches; Combi-Chassi axles; Parking Legs; Sinks; Stoves; Inner Spring Beds. Send only 50c for Trailer Builders’ Guide.

HAMMERBLOW TOOL CO. Dept. 14, 606 Third St. Wausau, Wis.

Full Size Blueprints FREE With Parts.

Like Taking LIGHTED Cigarettes from Your Pocket

MAGIC CASE AMAZES EVERYBODY
Gaze in wonder while I show you a new way to smoke. LOOK! I take a beautifully enameled case from my vest pocket. I touch a magic button! There is a Spark . . . a Flame. Just one motion . . . the pressure of our finger delivers a LIGHTED cigarette to my lips. I PUFF and SMOKE! No matches or separate lighters necessary.

15-DAY TRIAL OFFER
Get a Magic Case on 15 days’ trial at our risk. Get amazing facts how this great invention can make you big money without selling.

Agent
Get facts that fairly scream big profits.

Magic Case Mfrs., Dept. D-379
4234 Cozens Ave., St. Louis, Mo.

SHIP MODELS

Get this dandy catalog of true-scale models of Flying Cloud, Viking, Blue Nose, Golden Hind, deluxe fittings. Send 15c (in coin) for your copy.

ROY HANCOCK, 323 Douglas Ave., Portsmouth, Virginia

G. E. MOTORS

made by General Electric Co., originally intended for large manufacturer. Specifications: 1-30 H. P.—4800 R. P. M. Universal A. C. and D. C. 110 volts instant reverse. Size Diameter 3 inch, length 5 inch. Shipping wt. 3 lbs. Add 25c for packing and mailing. Original price \$12.00 Bargain price, ALSO, **WIZARD TRANSFORMER**, 110 volt 60 to 133 cycle secondary voltage 6—8 volt. Special, 95c. Add 25c postage for each item.

\$2.45 Each

NATIONAL ELECTRIC TOOL CO.
560 W. Washington Dept. 324 Chicago, Ill.

Seven Tools In One

Mortising, Routing, Drilling, Carving, Sanding, Shaping and Surface Grinding



SHAPING



SANDING



BORING-DRILLING



MORTISING

THIS remarkable new "DELTA" Bench Type Drill Press performs these seven operations efficiently, conveniently and accurately. Is almost a complete workshop in one tool. Built to stand up under heavy production work—yet is priced so low as to be within the reach of every home workshop owner. A brand new "Delta" model, a quality tool throughout—with numerous interesting features. For full details mail the coupon TODAY!

A Complete Line of Motor-Driven WOODWORKING TOOLS!

"Delta" Woodworking Units are convenient, portable and compact. All are available in a large variety of combinations and at prices to fit all needs. The "Delta" line includes: Jointers, Band Saws, Scroll Saws, Circular Saws, Woodturning Lathes, Drill Presses, Boring, Routing, Sanding and Mortising Attachments—and a full line of accessories.

FREE CATALOG

Send coupon so your name will be placed on the mailing list to receive the 1935 Delta catalog without delay. Enclose only 10c at same time for Book of Practical Delta Projects. 32 pages of new and novel things to make with many blue prints, working drawings, photographs and illustrations—and complete directions.

DELTA MFG. CO., 3775 North Holton Street
Dept. A435 Milwaukee, Wis.

DELTA MFG. CO., 3775 N. Holton Street
Milwaukee, Wis., Dept. A435

I enclose 10c (stamps or coin) for which please send me one copy of "Practical Delta Projects." Also place me on your mailing list to receive 1935 Delta catalog of quality motor-driven woodworking tools.

Name.....Age?.....
Address.....
City.....State.....
 Check here if you are a Delta user now.



Pins 35¢ Rings 1.65
BIG CATALOG FREE Get Yours Today!
CLASS PINS — any letters, any year, any colors. Silver plated, 1 to 11, 40c ea; gold plated, 50c ea; sterling, 60c ea. Silver plated, 12 or more 35c ea; gold plated, 45c ea; sterling, 55c ea. Sterling silver rings as shown, 1 to 11, \$1.90 ea; 12 or more \$1.65 ea.
Metal Arts Co., Inc., Factory 44, Rochester, N.Y.

Balance as above with 1-50; 1-20; 2-10; 1-5 and 2-2 gram weights base 4" x 9"—\$4.75. Catalog with 3000 illustrations of laboratory apparatus sent for 50c. Catalog listing 10000 chemicals, drugs, flavors, etc. and 1700 scientific books sent for 25c.
Laboratory Materials Company, 639 E. 71st St., Chicago, Ill.

HOME AUTOMATIC CIGARETTE MACHINE
Have YOUR OWN Monogrammed Cigarettes.
Put tobacco and blank of papers on machine. TURN THE CRANK—PRESTO—CIGARETTES. Easy—simple. All metal construction. Guaranteed. No cloth ribbons; no special tube or gummed papers required. ASK FOR FREE ILLUSTRATED FOLDER.
AUTOMATIC CIGARETTE MACHINE WORKS, PM-4, 1088-67 Sheridan Rd., Chicago, Ill.

EARN MONEY Stringing TENNIS RACKETS

Stringing Tennis Rackets PAYS ...
\$1.75 profit on \$3.00 restringing. Easy work—we teach you how. Tennis players need new strings in their rackets two or three times a year ... every restringing means profit for you. Just see how easy it is to get in this business. Cost practically nothing to start. Get started without delay.

FREE: Write today for FREE folder "Earn Money Stringing Tennis Rackets", also FREE restringer's catalog and price list of TOMGUT "Court-Tested" Tennis Strings and Restringing Equip. Write today!

THOMPSON MFG. CO. 4535 Packers Ave., CHICAGO
Makers of TOMGUT "COURT-TESTED" Tennis Strings & Restringing Equip.

RAISE GIANT FROGS



UP TO 1000% PROFIT!

Breeder lays 10,000 eggs (833 dozen) each year. Bullfrogs sell \$1-\$5 dozen. Biggest money-maker you can raise. No experience necessary. Backyard pond starts you. Any climate suitable.

Get the facts on this new industry. Our big FREE book explains everything.

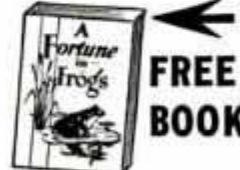

AMERICAN FROG CANNING COMPANY
Dept. 133-D (Originators of Canned Frog Legs) NEW ORLEANS, LA.

Largest Frog Market in the World

BUILD Your own RADIO

When you decide to build one of the radios or radio devices described each month in Popular Mechanics Magazine, be sure you use quality approved parts for best results. You'll save money by buying from the World's Largest Radio Mail Order House because of our lowest Wholesale Prices. Below are but 2 of the scores of kits which we can immediately supply. Ask us for **FREE** Parts List and Prices on any radio device that has appeared or will appear in Popular Mechanics Magazine.



LITTLE GIANT 5 tube A.C.-D.C. Super described in Popular Mechanics, Jan. 1935. An exceptional midget of great power. Complete Kit of approved parts with speaker, less tubes... **\$10.50**

BAND SPREAD PORTABLE described in Popular Mechanics, Dec. 1934. A truly portable S. W. Set of low cost. Easy to build. Entirely self-contained. Kit of Parts, less tubes, coils, batteries... **\$7.95**
FREE—new 136 Page Spring & Summer Catalog listing over 50,000 parts, sets, kits and accessories. Radio's greatest Bargain Book—Address Dept. P. M-45.



WHOLESALE RADIO SERVICE CO.
 NEW YORK, N.Y. - 100 Sixth Avenue
 ATLANTA, GA. 430 W. Peachtree St.

SPECIAL OFFER! GUARANTEED UNDERWOOD

Yours for **10¢ a Day**
No Money Down



Sent on **10 DAY FREE TRIAL**

\$100.00 MODEL ONLY \$39.90

Positively the greatest bargain ever offered. A genuine full-sized office model Underwood No. 5 for only \$39.90 (cash) or on easy terms. Has up-to-date improvements including standard 4-row keyboard, backspace, automatic ribbon reverse, shiftlock key, 2-color ribbon, etc. The perfect all purpose typewriter. Completely rebuilt and FULLY GUARANTEED. Lowest Terms—10¢ a Day.

Learn Touch Typewriting
 Complete (Home Study) Course of the Famous Van Sant Speed Typewriting System—fully illustrated, easily learned, given during this offer.

Money-Back Guarantee

Send coupon for 10-day Trial—if you decide to keep it pay only \$3.00 a month until \$44.90 (term price) is paid. Limited offer—act at once.

INTERNATIONAL TYPEWRITER EXCHANGE,
 231 West Monroe St., Chicago, Ill., Dept. 401
 Send Underwood No. 5 (F. O. B., Chicago) at once for 10-day trial. If I am not perfectly satisfied I can return it express collect. If I keep it I will pay \$3.00 a month until I have paid \$44.90 (term price) in full.
 Name.....Age.....
 Address.....
 Town.....State.....

Pocket PROFITS HOURLY

WITH HATS AND CAPS

Sensationally new line of personality styled Hats and Caps—latest exclusive designs—superior qualities—large selection—choice of seven spring colors—three price ranges. Caps tailored to measure and rain-proofed by secret Taylor process. Twelve luxurious fabrics in four smart styles.



WE PAY THE POSTAGE!!

Unique sales outfit sent free just for sending name. Fits in pocket. Designed to make quick, easy sales. Simply show and write up profitable orders. No experience needed. All customers' orders sent postpaid.

TAYLOR HAT & CAP MFRS.
 Dept. 12-D
 15-17 W. Sixth St., Cincinnati, Ohio

FREE HAT AND CAP OFFER

You don't invest a red cent. Everything free. We even give hats and caps to sincere salesmen. Send head size with name right now. A penny postcard will do.

ONLY \$6.95 Metal Cutting Lathe A PRECISION TOOL

Less Chuck \$3.50 extra for 4 Jawed, 3 in. Chuck



Complete with compound slide rest, 4 jawed, 3" chuck and 4" face plate. Accurately turned and machined. Ideal for machine, or home workshop.

\$6.95 without chuck, \$10.45 with chuck. Send \$2.00 deposit, balance C.O.D. Shpg. wt. 30 lbs. Money back guarantee. Same lathe furnished with 26-in. bed, \$1.00 extra.

Hollow spindle, large oversized bronze bearings. Centers standard Morse tapers. 2 1/2-in. bed, 5-in. swing, 13-in. between centers. A genuine quality tool.

Most amazing bargain ever offered in a cutting lathe. Splendid, instructive gift. Be wise. Order at once!
National Electric Tool Co., 560 Wash. Blvd., Dept. 344, Chicago

CHEAP OIL BURNER Invented

COOKS A MEAL FOR 1c



AGENTS

Big Money—It's Sweeping the Country
 Clark sold 93 in 30 days. O'Toole sold 194 in a month. Write quick for REAL money making offer.

Slips into Any Old Stove, Range or Furnace; Beats Coal or Wood; No Dirt or Ashes; HALF THE COST.

United Factories, D-751 Exchange Bldg., Kansas City, Mo., have brought out an amazing oil burner which experts and 15,000 users say beats any ever gotten out. Burns cheap oil a new way, without generating or clogging up; gives intense heat at HALF COST by turn of valve. One free to one person in each locality who will demonstrate and act as agent. Write quick, be first to learn how to end drudgery of coal and wood and make big money, spare or full time—mail 1c postcard today.

Home Manufacturing Enterprises



shows you how to make all kinds of useful novelties of wood, tin, plastics, leather, reed. List of contents—Section 1. Novelties of leather. 2. Useful items from cans. 3. Typewriter ribbons. 4. Novelties from wood. 5. Plastic molds. 6. Lawn furniture. 7. Novel baskets. 8. Reed work. Price 25c pp. with six months subscription to Home Industries free. Describes all kinds of profitable, legitimate plans, schemes, formulas, ideas, etc., 28 or more pages. 6x9 inches. Sample 5c.

HOME INDUSTRIES, Box 84, Irvington, Nebr.

\$17.95 AUTO RADIO

Amazing reception—distance and tone. Unheard of low price—tubes and remote control included. Install in 30 minutes—no batteries. Enormous profits to be made. Write quick for territory and terms.
M. A. WILCOX, 308 W. Randolph St., Chicago **AGENTS WANTED**



Forms to cast Lead Soldiers, Indians, Trappers, Hunters, Wild and Farm Animals. 239 different forms to select from. Every form guaranteed to cast perfect figures. Send 5c stamp for illustrated catalogue.

HENRY C. SCHIERCKE Spencer Rd. GHENT, N.Y.

BOYS! THROW YOUR VOICE



Into a trunk, under the bed or anywhere. Lots of fun fooling teacher, policeman or friends.

THE VENTRILO

a little instrument, fits in the mouth out of sight, used with above for Bird Calls etc. Anyone can use it.

Never fails. A 64-page Book on Ventriloquism and the Ventrilo. All for 10c Postpaid. **JOHNSON SMITH & CO. Dept. 848 RACINE, WIS.**



AUTO SCARE BOMB

The Auto Bomb is attached to the motor of your car, fastening one wire to the spark plug terminal and the other wire to any part of the motor to serve as a ground. The instant your "victim" steps on the starter, there is a shrill whistle, followed by a loud bang. The driver thinks his car has exploded. Can be attached in a few seconds. Does not harm the car. Gives you more protection than an insurance policy—catches the thief in the act.

PRICE 15c Each, 3 for 40c. Shipped by Express, not prepaid.

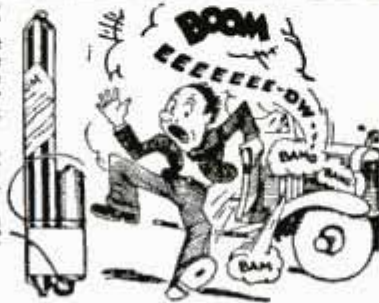

AUTO SKUNK BOMB

Works same as above. Attached to motor of car. When driver presses foot on starter the contact sets off the Skunk Bomb. A dense cloud of smoke envelops front of car; upon raising hood a violent odor greets the driver. PRICE 20c Each, 3 for 50c. Shipped Express only.

Crystal Radio

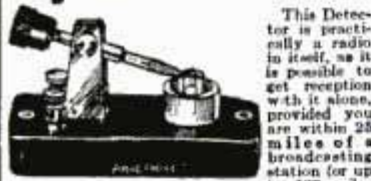

Complete with Crystal 25c. This Detector is practically a radio in itself, so it is possible to get reception with it alone, provided you are within 25 miles of a broadcasting station (or up to 100 miles under very favorable conditions). All you need is an aerial and an ear phone and you are all set. It is completely assembled and wired, all ready for use. It has two posts, making connection much easier, also making it possible to make changes quickly. Everything complete, including the stand, crystal cup, arm with catwhisker and necessary screws, an ultra sensitive crystal of the finest grade, two terminals for wire connections mounted on handsome base—**EVERYTHING COMPLETE FOR ONLY 25 CENTS POSTPAID.** Every set tested and reception positively guaranteed.

Put PHOTOS on Silk, Cloth, Wood, Paper, Linen, etc. 25c THIS EASY QUICK WAY



It is now easy to print your snapshots and other photos on any cloth or other fabric surface—cushions, pillows, handkerchiefs, scarfs, ties, bowties, underwear, paper, wood, linen, etc. The photos are washable. Will not fade or rub off—long lasting. Easy to do. Just follow a few simple directions. One bottle is good for about 50 prints in RICH TONES. Thoroughly practical.

Price for Complete Outfit, only 25 cents postpaid.

WONDERFUL X-RAY TUBE

A wonderful little instrument producing optical illusions both surprising and startling. With it you can see what is apparently the bones of your fingers, the lead in a lead pencil, the interior opening in a pipe stem, and many other similar illusions. Price 10c, 3 for 25c, ppd.



JOHNSON SMITH & CO. Dept. 848 RACINE, WIS.

A copy of our NEW CATALOG mailed on receipt of 10c., or the De Luxe Edition with cloth binding 25c. Bigger and better than ever. Only book of its kind in existence. Contains all the latest tricks in magic, the newest novelties, puzzles, games, sporting goods, rubber stamps, unusual and interesting books, curiosities in seeds and plants, etc., unobtainable elsewhere. Remit by Coin, Money Order, Check or unused U.S. Postage Stamps, for all articles listed above. Canadian money, stamps, Postal Notes and British P. O. Orders accepted.

PEA-MATIC REPEATER-12 SHOT



25c Post-paid.

Here it is, boys. You can have an immense amount of fun with this new pistol. It shoots 12 to 15 ordinary peas without reloading. All you need do is to load the gun with peas, pull the trigger and keep on firing until the barrel is empty. Then reload and fire again. It is absolutely harmless and safe. Nothing to explode. These pistols sell like hot cakes, so get yours AT ONCE. Be the first boy in your town to own one of these automatic repeating pistols and be the envy of all the other kids in the neighborhood. **PRICE ONLY 25 CENTS** Holder for Peamatic 25c.

JOHNSON SMITH & CO., Dept. 848, Racine, Wis.

The Art of DANCING



25 CENTS Postpaid

LEARN TO DANCE THE LATEST STEPS.

Be popular this season. Really good dancers are always admired—always popular guests. Partners welcome them eagerly. With the aid of this book you can learn the newest, smartest steps without a teacher and become a dancer who is sought after. After following the instructions in this new book you won't need to make excuses when the dance music starts. Besides you'll get lots more fun out of parties and dances. If you want to become a perfect dancer, learn to dance at home this new, easy way.

WHAT THE BOOK TELLS: How to develop poise and control, how to improve your dance steps, the art of holding, how to walk to music, how to lead, how to do the latest Fox Trot Steps, Natural and Reverse Turns, the Reverse Wave and Change of Direction Steps, the Quick-step, swaying to music, how to Waltz, Backward Changes, how to do the Continental, the famous Kiss dance, the Manhattan Dance, the College Rhumba, the Carlo, etc., etc. Numerous illustrations are given, in fact everything is made so plain and simple that if you follow the instructions given, you'll be dancing before you know it.

PRICE 25 CENTS POSTPAID.

JOHNSON SMITH & CO., Dept. 848, Racine, Wis.

BLANK CARTRIDGE PISTOL

REVOLVER STYLE



25c 50c \$1.00

Three new models now out. 25c, 50c and \$1.00. Well made and effective. Modelled on pattern of latest type of Revolver. Appearance alone enough to scare a burglar. Takes 22 Cal. Blank Cartridges obtainable everywhere. Great protection against burglars, tramps, dogs. Have it lying around without the danger attached to other revolvers. Fine for 4th of July. New Year's, for stage work, starting pistol, etc. **SMALL SIZE 4 in. long 25c. MEDIUM SIZE 5 in. long 50c. LARGE SIZE 6 in. long \$1.00. BLANK CARTRIDGES 50c per 100. HOLSTER (Cowboy type) 50c. Shipped by Express only not prepaid. Big novelty catalog 10c. JOHNSON SMITH & CO., Dept. 848, Racine, Wis.**



They Said I Couldn't Do It. But Here It Is
my 1935 OFFER
WEAR A WATCH OR DIAMOND

30 Days FREE!
 then Make Your Own Terms



My sole aim during the year 1935 is to place as many watches and diamonds as I can in the hands of men and women throughout the world **no matter what the sacrifice!** I have cut prices to **Rock Bottom**, and in addition I am allowing you to **Make Your Own Terms.** I know that if I can distribute 5000 of these standard dependable watches and beautiful genuine diamonds through this unusual offer, that every watch and diamond will be a salesman to sell another watch or diamond. I am making this startling and unheard of offer to those who will tell their friends of this remarkable value if they find the

watches and diamonds to be all, and more, I claim them to be.

Alonzo S. Thomas, President Santa Fe Watch Co.
THINK OF IT! You can buy nationally advertised watches and diamonds—

Hamilton, Illinois, Elgin and Bulova Watches. Beautiful genuine perfectly mounted **Diamond Rings at Direct-to-You, rock bottom prices!**

You can wear one of these watches or diamonds **Thirty Days FREE**, and then you can **Make Your Own Terms.** Have you ever heard of a more astonishing jewelry offer, and from one of the country's **Largest Jewelry Firms** which has sold **High Quality watches**

and diamonds for nearly a **Half Century!** People all over the world will be amazed by this offer.

ACT AT ONCE

Here's all you have to do to cash in on this remarkable sales drive. Clip the coupon below and mail it. I will send you one of my beautiful watch and diamond catalogs **FREE.** You select the watch or diamond you want, and then write me personally, and you and I, just bet ween us, will fix terms to suit you. **DON'T DELAY—SEND NOW** When these Watches and Diamonds are gone I will with draw this offer.



Santa Fe Watch Co.
 46 Thomas Building Topeka, Kansas
 We Buy Old Gold and Sterling Silver

SANTA FE WATCH CO.
 46 Thomas Bldg., Topeka, Kansas
 Please send me the catalog I have checked.
 Railroad and Dress Pocket Watches
 Ladies' and Men's Wrist Watches
 Ladies' and Men's Diamond Rings

Name.....
 Address.....



More Than **100,000**
 Sold—and Not One Returned

yet we said — and repeat —
"If NOT MORE THAN SATISFACTORY, your money returned immediately."

These Simplex Ball Bearing Jacks are miniatures of the larger Simplex Jacks that the good Hardware Dealer stocks.



25c post-paid

TEMPLETON, KENLY & CO. Est. 1899
 1020 South Central Avenue, Chicago, Illinois

RADIOS GIVEN

Your choice of five brand new 1935 Nationally advertised Radios given to you absolutely without cost—just for a few hours pleasant visiting among your friends and neighbors. Beautiful console and table models for **long and short wave** reception, 6 tube "Super-het," guaranteed foreign reception, and even a special radio for your car! Any one of these radios positively can be yours without a penny's cost. **Not a contest!** Write for color-illustrated circular and **Free** details of this amazing **New** plan today. **ALBERT GOULD, President, Dept. 40, 75 E. Wacker Drive, Chicago.**



NEW! SENSATIONAL SELLER

AGENTS WANTED to introduce No. d73 deal consisting of 10 blue steel safety razor blades, 1 tube of shaving cream, 1 styptic pencil and 1 Goodrich hone, all quality merchandise. It's the outstanding seller of the day. At 49¢ it's a sell out. **FREE**, wholesale catalog. Send for a copy.

SAMPLE DEAL 25c
 Doz. 21c ea. deal, Gr. 19c ea. deal
 Spors Co., 2-35 Main St., Le Center, Minn.

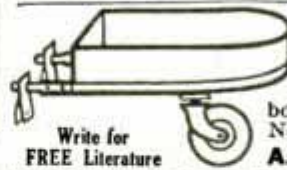

TRAILER COMPLETE \$39.50

Ready for road, wt. 175 lbs.; load 1/2 ton. Fit any car. Attaches to bumper bolts. 4" pneumatic tire. Body 52x42x9". No side sway. Detach one minute.

Write for **FREE Literature**
A. A. Kar-A-van 308 W. Randolph St., Chicago



BUILD THIS Ocean Cargo Steamer

Popular scale model of old time tramp steamer from shipbuilder's plans. Only one of many models covered in our 32-page catalog of blueprints, construction sets and fittings. Send 15¢ for this catalog today. **A. J. Fisher, 1002-1 Etowah Ave., Royal Oak, Mich.**

FLEX-O-SEAL The New *Miracle* Product for all reasonable permanent repairs for any Water Circulating System. Seals cracked Water Jackets in Automobiles. Guaranteed to do satisfying work. 8 oz. can 75¢.
ENRICH MANUFACTURING COMPANY, 3440 N. Laramie Ave., Chicago, Ill.

DOUBLE YOUR PROFITS with Modern Service Equipment!

AUTOMATIC AIR SERVICE \$12 Monthly

Brings business right to your door—profits pay for it. Beltless, space saving, always ready. Liberal trial to prove it.



8 HR. BATTERY CHARGING ONLY \$10 MONTHLY

Earns \$50 to \$100 monthly profit, puts your shop above competition. Cuts electric bills in half. Investigate now.



ARC WELDING Easy Monthly Terms

Profits \$300 to \$400 monthly with ease, using new Simplified Welder. No special experience required. Electric, belted, gas engine drive—30-Day Trial.



20 MINUTE CAR WASHING \$70 MONTHLY

Big profits washing cars. Saves two-thirds time, does better job. Savings pay for it. Tear out and mail this ad, checking items of interest to **HOBERT BROS. Box M-45 Troy, Ohio**

30 Days Use to Prove it... No Investment Terms WRITE TODAY

New INVENTION

**3 TO 7 MILES MORE
PER GALLON**

**MOTORIST SAVES
\$180.00 a YEAR**



Saves up to Thirty Per Cent On Gas.
Provides Faster Pick-Up—More Power—
Greater Mileage and Smoother Running.

GET FREE INFORMATION

VACU-MATIC
the Carburetor Control
that "BREATHES"

AT LAST! Automotive engineers have smashed down the barriers to perfected combustion! The new VACU-MATIC solves the secret of greater power! With almost magical action, this amazing invention instantly puts new life and pep in any motor. It adds mileage to every gallon of gasoline . . . produces split-second pick-up, sensitive accelerator response, greater speed and smoother running

New—Automatic—Nothing Like It!

The self-starter—four wheel brakes—knee action—streamlining . . . and now VACU-MATIC! The greatest motor improvement of recent years! With it, engineers have achieved a practical means of balancing air and gasoline automatically for all speeds. Vacu-matic is *entirely different!* It is AUTOMATIC and allows the motor to "breathe" at the correct time, opening and closing automatically as required. No idling troubles—no carburetor adjustments necessary. Just put it on and forget it! Sharply cuts fuel wastes, saves dollars in gas costs, reduces carbon and gives your engine new pep, greater power and longer life.

Fits All Cars

VACU-MATIC is constructed of six parts, assembled and welded into one unit, correctly adjusted and sealed at the factory. Nothing to regulate. Any motorist can attach VACU-MATIC in ten minutes. Once in, its only reminder is the surge of instant power and speed it gives to the motor and the savings it affords your pocketbook.

Agents and Salesmen

If you are interested in earning unusual profits, check coupon. Exclusive territories are now being granted.

The VACU-MATIC Co.,

Wauwatosa, Wis.

SAVES GAS!

CHRYSLER

Have tried the Vacu-matic and it sure is fine. Better pick-up with a 30% gas saving.—John C. Martin, Pa.

PLYMOUTH

I am amazed at Vacu-matic performance. It's giving me 5 more miles per gallon.—Walter Zielinski, Ill.

FRANKLIN

With Vacu-matic I have increased my mileage from 10.1 to 14.2 miles per gallon. I figure I save over \$75.00 a year in gasoline. R. K. Radtke, Wis.

ALL WELL PLEASED

Enclosed find order for 12 more. Everyone I have sold is giving from 4 to 6 more miles per gallon. I have 3 more orders for V8 Ford. Every body is well pleased.—J. O. Carll, Texas.

NASH

On my Advanced 6 Nash gained 17½% in mileage. The car will idle down to 3 miles an hour and then take gas without a complaint.—J. Showalter, Mo.

V-8 FORD

I installed both Vacu-matics and they work excellent. On my own V8 Ford I notice wonderful performance in pickup, get-away and gas saving.—Burt Burnett, Mich.

SAVES \$180 A YEAR

On my Plymouth 6 I obtained an average of 22 miles per gallon, an increase of 7 miles. This means a saving of \$15 a month or \$180 a year. F. S. Peck, Calif.

BUICK

Everything you claim about Vacu-matic is true. I now get 20 miles to the gallon. Before I was only averaging 15½ miles.—C. Constantino, Fla.

CHEVROLET

Please send me a Vacu-matic for a Model A. The mileage on my 1933 Chevrolet jumped from 18 to 22 miles per gal. with Vacu-matic.—Paul P. Haas, Mass.

MODEL A FORD

Have been using the Vacu-matic for a month. I used to get 20 to 22 miles per gal. Now I get 30 to 33 miles. It is amazing the difference it makes.—James W. Barr, Canada.

DODGE

Just completed 2310 miles on 92 gallons in my 1933 Dodge 6. This figures 25 miles while before I averaged only 20 miles per gal. on trips.—Al Fruzynna, Calif.

OLDSMOBILE

I am well pleased with Vacu-matic on our Oldsmobile. A test proved it to give 18 miles per gal. Before we considered 13 good.—Arthur Williams, N. Y.

Above are just a few of the many unsolicited letters received from Vacu-matic users.

Guaranteed Gas Savings

The VACU-MATIC proves itself on every car. It is guaranteed to give worth-while gas savings, quicker pick-up, and more power or it costs you nothing. "On a test I gained an average of 4 miles on a gallon," writes Alex Wertz. "Vacu-matic is the best I have ever tried." Clarence Rutzin—"I have tried the Vacu-matic on several tests and find that I get between 5 and 6 miles per gallon increase, have more mileage, have greater pickup."

Free Details

Learn about this remarkable device that so greatly affects the entire performance of your motor. Learn why your car is costing you extra money to operate without VACU-MATIC. See why your VACU-MATIC equipped car will leap away from traffic without sputter or hesitation. Discover a new driving thrill and enjoy the savings. Get the facts! Write today!

FREE OFFER COUPON

THE VACU-MATIC COMPANY
7617-82 W. State St., Wauwatosa, Wis.
Gentlemen: Please send me full particulars concerning the Vacu-matic and details of your Free Offer. This of course does not obligate me in any way.

Name.....

Address.....

City..... State.....

Check here if interested in selling proposition.

The New South Bend
9-in. x 3-ft.
"WORKSHOP"
PRECISION LATHE

A High Quality
Back Geared, Screw Cutting
Metal Working Lathe

USED BY THOUSANDS OF

- MANUFACTURING PLANTS
- MACHINE SHOPS, ALL TYPES
- U. S. GOV'T. LABORATORIES
- AUTO SERVICE SHOPS
- AUTO ELECTRIC SHOPS
- HOME WORKSHOPS
- HOBBYISTS
- EXPERIMENTERS
- INVENTORS
- SCHOOL SHOPS

THE "Workshop" is the ideal lathe for making and servicing mechanical devices of every description. It is recommended for all classes of accurate machine work; wood turning; radio, auto and electrical repair; also for model, tool and instrument work, etc.

THIS lathe turns, faces, bores, cuts screw threads, does chucking work and performs all general machining operations on cast iron, steel, other metals, woods—all kinds, hard rubber, fibre, bakelite and all other similar compositions.

FEATURES: The "Workshop" Lathe is a rigid, powerful, accurate modern lathe. It is constructed entirely of cast iron and steel and all gears are machine-cut and tested. Has six spindle speeds; cuts screw threads 4 to 40 per inch; has automatic longitudinal feed to carriage; 3/4" hole through spindle; graduated compound rest; micrometer collars on feed screws; reverse for threads and feeds; and three V-ways and one flat-way on lathe bed. Will reduce the diameter of a steel shaft 1/4" in one cut.

\$75⁰⁰ less motor drive
ON EASY TERMS
\$6⁵⁰ A MONTH
10 Months to Pay

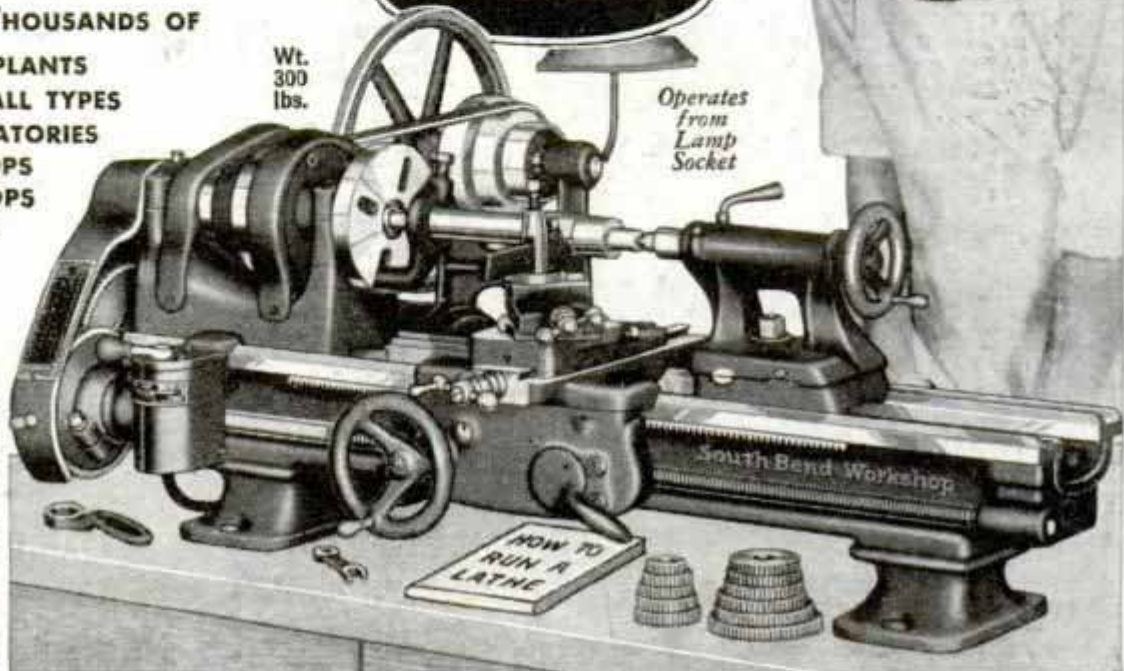

9 1/2" swing x 3' bed "Workshop" Bench Lathe Complete with Horizontal Motor Drive 1/4 h. p. reversing motor and reversing switch. Takes work 18" between centers **\$94⁰⁰**
\$24.00 Down, Balance \$7.00 a Month—10 Months to Pay.

THE "WORKSHOP" is the greatest value we have ever offered. It is accurately built and recommended for the finest precision work. May also be had in 3 1/2', 4' and 4 1/2' bed lengths, countershaft and motor drive types.

30-DAY TRIAL. Send in your order and down payment today and try this genuine South Bend Lathe for 30 days in your own shop. Lathe will be shipped immediately. Satisfaction guaranteed or your money back.

BULLETIN NO. 5-W fully describes and prices the 9" "Workshop" Lathe and all its accessories and attachments. Mailed, post paid to any address—use coupon.



Turning Down a Steel Bar.

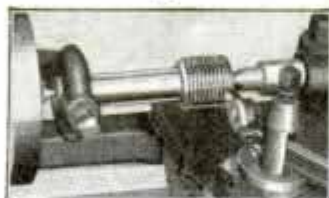

Cutting a Screw Thread.

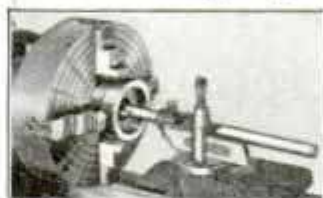

Boring Work, in a Chuck.



Turning a Wood Spindle.

MAIL COUPON FOR BULLETIN No. 5-W FREE

SOUTH BEND LATHE WORKS 4-35
604 E. Madison St., South Bend, Ind., U.S.A.

Please send me free quotation and illustration on the following lathe:

Swing.....Length of Bed.....
 Countershaft Drive Motor Drive

My work is.....
 9-inch "Workshop" Lathe Bulletin No. 5-W (free)
 How to Run a Lathe (160 Pages) (25c)

Name.....
Address.....
City.....State.....

South Bend Lathes are built in other sizes 9" to 18" swing with Countershaft Drive and Motor Drive. Prices of a few popular sizes are listed at right. Catalog No. 94 shows all sizes. Mailed free post-paid to any address in the world.

Popular Size Standard Change Gear Lathes	Mtr. Dr. Wt.Lbs. Crated	COUNTERSHAFT DR.			MOTOR DRIVE		
		Cash Price	Down Mnth. Pay't	Dr. Mnth. Pay't	Cash Price	Down Mnth. Pay't	Dr. Mnth. Pay't
16" x 6' Lathe	2195	\$480	\$100	\$29	\$622	\$125	\$34
16" x 8' Lathe	2355	520	108	31	662	135	37
13" x 5' Lathe	1440	352	75	25	485	100	29
13" x 6' Lathe	1490	367	75	25	500	100	29
11" x 4' Lathe	905	309	60	20	393	80	26
9" x 3' Lathe	461	225	45	16	244	50	17

NRA **SOUTH BEND LATHE WORKS**
604 East Madison St., South Bend, Ind., U. S. A.
Lathe Builders Since 1906—Users in 97 Countries

Big Money Assembling

Patents Pending

Mead's

New, Portable Sportsman's

Ki-Yak!

at Home •

Model CK-2

MEAD'S Sportsman's KI-YAK is the most sensational boat development in years. Exclusive new structural features set a new standard for lightness, strength, durability, beauty and ease of home-assembly. Easily PORTABLE. Lots of room. Quickly converted from paddle to sail-boat! LOW INTRODUCTORY PRICES. Don't deny yourself the pleasure of knowing all about this ideal craft for fishing, hunting, camping, sailing and auto touring! YOU can build a MEAD KI-YAK—without experience—and SAVE NEARLY ONE-HALF . . . as thousands have done. Get started NOW on special "Pay As You Build" Plan. \$6 double-blade Paddle now GIVEN with your cut-to-fit Kit or Factory-Built Ki-Yak—if you hurry! Rush dime for big color circular!

AND ↗

PAY AS YOU BUILD!

LOOK:

Write for details on Mead's convenient, easy-starting, economical PAY AS YOU BUILD Progressive Group Plan. Thousands now use it . . . brings Mead QUALITY KI-YAK within reach of all! **Hurry!**

READY!—New 20 Lb. "Baby Ki-Yak"

Presenting the new Mead CK-1 . . . "baby" paddler and sailer of the famous MEAD KI-YAK line. Tips the scales at 20 pounds! A child can pick it up—yet MEAD'S exclusive new structural features give it the strength of a giant! Extremely portable. Beautifully streamlined—as ALL MEAD Ki-Yaks. Nothing else like it . . . holds man and child or two children. 500 lb. capacity. Plenty of room. Greatest port boat out! Build yours now. **WRITE!**

WRITE NOW for These New Circulars:



A Racing Fleet of CK-1 Ki-Yaks

RUSH 10c to cover postage, handling charge on each one you want:

(1) Giant Color KI-YAK Boat Circular (2) Home Builder's Parts & Supply Book (3) Midget Auto Circular.

Send Quarter for all 3!

\$6⁰⁰
PADDLE GIVEN!

8-foot, double-blade paddle now given with your Ki-Yak—if you hurry!

Ideal for:

Fishing
Camping
Hunting
Sailing
and
Auto
Touring

Announcing
The Sensational New
MEAD MIDGET AUTO!

Ready April 1st, in kit form for HOME ASSEMBLY! Not a racer, but a sturdy, dependable little "knock-a-bout" good for 30 MPH, 75 to 100 miles per gal. Easy to build. Streamlined. Rush dime for details!



MEAD GLIDERS 15 So. Market St., **CHICAGO, U. S. A.**
Dept. B-4,



Luckies



They Taste Better