

X-RAY—MASTER MAGICIAN

POPULAR MECHANICS

MAGAZINE

TEN SO YOU CAN UNDERSTAND IT

REG. U.S. PAT. OFF.

JAN.
25 CENTS
30c IN CANADA

SEE PAGE 76

IRA
CORE



SAVE UP TO 50% by BUYING YOUR RADIO *Direct from* MIDWEST LABORATORIES

Thrill to Guaranteed World-Wide HIGH FIDELITY Performance with This Amazing New 1935 MIDWEST SUPER Deluxe **16-TUBE** ALL-WAVE Radio! (ALL FIVE WAVE BANDS)

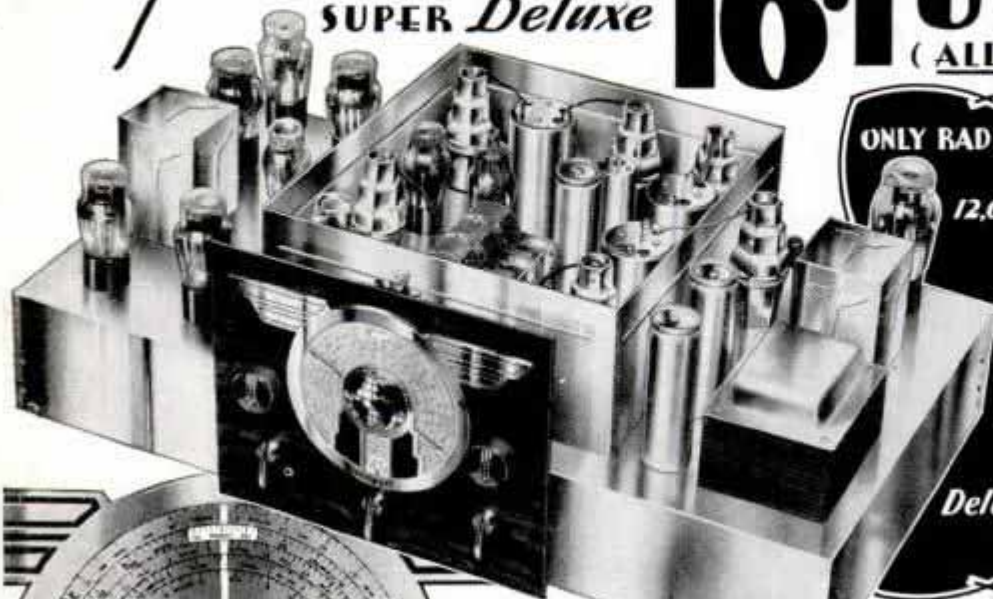

ONLY RADIO COVERING
9 TO 2,400 METERS.
12,000 MILE TUNING RANGE

WORLD'S GREATEST
RADIO VALUE

\$ **57**⁵⁰ with New
Deluxe Auditorium-Type
SPEAKER
(LAST TUBES)



30 Days FREE Trial!

TERMS
as low as
\$5.00
DOWN

BEFORE you buy any radio write for the new FREE 1935 Midwest "Fifteenth Anniversary" catalog and see for yourself the many reasons why 110,000 satisfied customers bought their radios direct from the Midwest Laboratories and saved from $\frac{1}{4}$ to $\frac{1}{2}$. Why pay more than the direct-to-you laboratory price? You, too, can make a positive saving of from 30% to 50% by buying this more economical way. Learn why Midwest outperforms sets costing up to \$200.00 and more. Never before so much radio for so little money! Midwest gives you triple protection with: **One-Year Guarantee, Foreign Reception Guarantee, Money-Back Guarantee.**

Only Midwest Gives You Multi-Function Dial

This dial was designed in keeping with the trend of the times, yet is not an airplane dial! It is a many-purpose dial that performs many functions. Now, Midwest guarantees that inexperienced persons can secure good foreign reception. Send for FREE miniature of actual rotating dial which clearly shows these outstanding advantages:

1. Dial calibrated in Kilocycles, Megacycles and Meters;
2. Call letters of American Broadcast Stations printed on dial and illuminated;
3. Slow-Fast, Smooth-Acting Tuning;
4. Station Group Locator;
5. Simplified Tuning Guide Lights;
6. Automatic Select-O-Band Indicator;
7. Illuminated Pointer Indicator;
8. Silent Shadow Tuning—Improvement on Meter Tuning;
9. Centralized Tuning.



New Style Consoles
The Midwest 36-page catalog pictures a complete line of beautiful, artistic de luxe console and chassis in four colors. Write for new FREE catalog today! Midwest long-range radios are priced as low as **\$27.50**

50 ADVANCED 1935 FEATURES

Many exclusive features include: Micro-Tenuator... Fidel-A-Stat... Separate Audio Generator... Ceramic Coil Forms, etc. Only Midwest covers a tuning range of 9 to 2400 meters (33 Megacycles to 125 KC)—enabling you to easily and successfully tune in even low-powered foreign stations up to 12,000 miles away with crystal-clear, loud-speaker reception.

All 5 Wave Bands enable you to enjoy today's finest High Fidelity American programs. In addition, you get Canadian, police, amateur, commercial, airplane and ship broadcasts and derive new delight and new excitement from un-

equalled world-wide broadcasts... England, France, Germany, Spain, Italy, Russia, Australia, etc. Send today for money-saving facts!

SENSATIONAL HIGH FIDELITY RECEPTION

This bigger, better, more powerful, clearer-toned, super selective, 16-tube radio gives you absolute realism—assures you of life-like, crystal-clear tone—unlike anything you have ever experienced before. You will hear one more octave—overtone—that cannot be brought in with ordinary radios. Now, hear every instrument, every voice, every shade and inflection of speech.



Take advantage of the amazing 30-day FREE trial offer. Send for FREE catalog.

Listeners to World-Wide Reception

Madison, Wis.—
Here are some of the stations I have heard: EAQ, Madrid; Spain—DJB, Zeehan, Germany—GSD, Giff, Daventry, England—VJIME, Melbourne, Australia—VREME, Sydney, Australia—HJZARA, HJZABE, HJZADF, Columbia, S. A., and many more. Golden Hatfield, 2202 Grand Avenue.



Peruvian Praises Foreign Reception

Lima—
Peru— We have heard the five continents with your Midwest. Have received Madagascari, Sydney, London, Paris, Vienna, Moscow, Madrid, New York, Shanghai, Tokyo and also South American transmitters. Marquis H. Bushman, Apartado 90, Plaza San Martin, 171.



DEAL DIRECT WITH LABORATORIES

Increasing costs are sure to result in higher radio prices soon. Buy before the big advance...NOW...while you can take advantage of Midwest's sensational values...no middlemen's profits to pay. You can order your 1935 High Fidelity radio from the new Midwest catalog with as much certainty of satisfaction as if you were to select it in our great radio laboratories. You save 30% to 50% when you buy this popular way...you get 30 days FREE trial...as little as \$5.00 down puts a Midwest radio in your home. Satisfaction guaranteed or money back. Write for new FREE catalog today.

SAVE UP TO 50%

MAIL COUPON TODAY! FOR AMAZING 30-DAY FREE TRIAL OFFER AND NEW 1935 CATALOG

MIDWEST RADIO CORP., Dept. B46 Cincinnati, Ohio.

Without obligation on my part send me your new FREE 1935 catalog, FREE Miniature Dial, and complete details of your liberal 30-day FREE trial offer. This is NOT an order.

User-Agents Make Easy Extra Money

Check Here for Details

Name _____
Address _____
Town _____ State _____

MIDWEST RADIO CORP.
DEPT. 846 — CINCINNATI, OHIO, U. S. A.
Established 1920 Cable Address Miraco... All Codes

New INVENTION

**3 TO 7 MILES MORE
PER GALLON**

**MOTORIST SAVES
\$180.00 a YEAR**



Saves up to Thirty Per Cent On Gas.
Provides Faster Pick-Up—More Power—
Greater Mileage and Smoother Running.

GET FREE INFORMATION

VACU-MATIC

the Carburetor Control
that "BREATHES"

AT LAST! Automotive engineers have smashed down the barriers to perfected combustion! The new VACU-MATIC solves the secret of greater power! With almost magical action, this amazing invention instantly puts new life and pep in any motor. It adds mileage to every gallon of gasoline . . . produces split-second pick-up, sensitive accelerator response, greater speed and smoother running

New—Automatic—Nothing Like It!

The self-starter—four wheel brakes—knee action—streamlining . . . and now VACU-MATIC! The greatest motor improvement of recent years! With it, engineers have achieved a practical means of balancing air and gasoline automatically for all speeds. Vacu-matic is *entirely different!* It is AUTOMATIC and allows the motor to "breathe" at the correct time, opening and closing automatically as required. No idling troubles—no carburetor adjustments necessary. Just put it on and forget it! Sharply cuts fuel wastes, saves dollars in gas costs, reduces carbon and gives your engine new pep, greater power and longer life.

Fits All Cars

VACU-MATIC is constructed of six parts, assembled and welded into one unit, correctly adjusted and sealed at the factory. Nothing to regulate. Any motorist can attach VACU-MATIC in ten minutes. Once in, its only reminder is the surge of instant power and speed it gives to the motor and the savings it affords your pocketbook.

Agents and Salesmen

If you are interested in earning unusual profits, check coupon. Exclusive territories are now being granted.

The VACU-MATIC Co.,

Wauwatosa, Wis.

SAVES GAS!

CHRYSLER

Have tried the Vacu-matic and it sure is fine. Better pick-up with a 30% gas saving.—John C. Martin, Pa.

PLYMOUTH

I am amazed at Vacu-matic performance. It's giving me 5 more miles per gallon.—Walter Zielinski, Ill.

FRANKLIN

With Vacu-matic I have increased my mileage from 10.1 to 14.2 miles per gallon. I figure I save over \$75.00 a year in gasoline. R. K. Radtke, Wis.

ALL WELL PLEASED

Enclosed find order for 12 more. Everyone I have sold is giving from 4 to 6 more miles per gallon. I have 3 more orders for V8 Ford. Every body is well pleased.—J. O. Carll, Texas.

NASH

On my Advanced 6 Nash gained 17½% in mileage. The car will idle down to 3 miles an hour and then take gas without a complaint.—J. Showalter, Mo.

DODGE

Just completed 2310 miles on 92 gallons in my 1933 Dodge 6. This figures 25 miles while before I averaged only 20 miles per gallon trips.—Al Fruzyna, Calif.

OLDSMOBILE

I am well pleased with Vacu-matic on our Oldsmobile. A test proved it to give 18 miles per gal. Before we considered 13 good.—Arthur Williams, N. Y.

Above are just a few of the many unsolicited letters received from Vacu-matic users.

V-8 FORD

I installed both Vacu-matics and they work excellent. On my own V8 Ford I notice wonderful performance in pickup, get-away and gas saving.—Burt Burnett, Mich.

BUICK

Everything you claim about Vacu-matic is true. I now get 20 miles to the gallon. Before I was only averaging 15½ miles.—C. Constantino, Fla.

CHEVROLET

Please send me a Vacu-matic for a Model A. The mileage on my 1933 Chevrolet jumped from 18 to 22 miles per gal. with Vacu-matic.—Paul P Haas, Mass.

MODEL A FORD

Have been using the Vacu-matic for a month. I used to get 20 to 22 miles per gal. Now I get 30 to 33 miles. It is amazing the difference it makes.—James W. Barr, Canada.

Guaranteed Gas Savings

The VACU-MATIC proves itself on every car. It is guaranteed to give worth-while gas savings, quicker pick-up, and more power or it costs you nothing. "On a test I gained an average of 4 miles on a gallon," writes Alex Wertz. "Vacu-matic is the best I have ever tried." Clarence Rutzin—"I have tried the Vacu-matic on several tests and find that I get between 5 and 6 miles per gallon increase, have more mileage, have greater pickup."

Free Details

Learn about this remarkable device that so greatly affects the entire performance of your motor. Learn why your car is costing you extra money to operate without VACU-MATIC. See why your VACU-MATIC equipped car will leap away from traffic without sputter or hesitation. Discover a new driving thrill and enjoy the savings. Get the facts! Write today!

FREE OFFER COUPON

THE VACU-MATIC COMPANY

7617-66 W. State St., Wauwatosa, Wis.

Gentlemen: Please send me full particulars concerning the Vacu-matic and details of your Free Offer. This of course does not obligate me in any way.

This One

Name

Address

City



BKP8-ZQP-5W9X

\$12.95 BUYS COMPLETE HOME BATTERY CHARGER

(Slightly Higher West of Rockies)

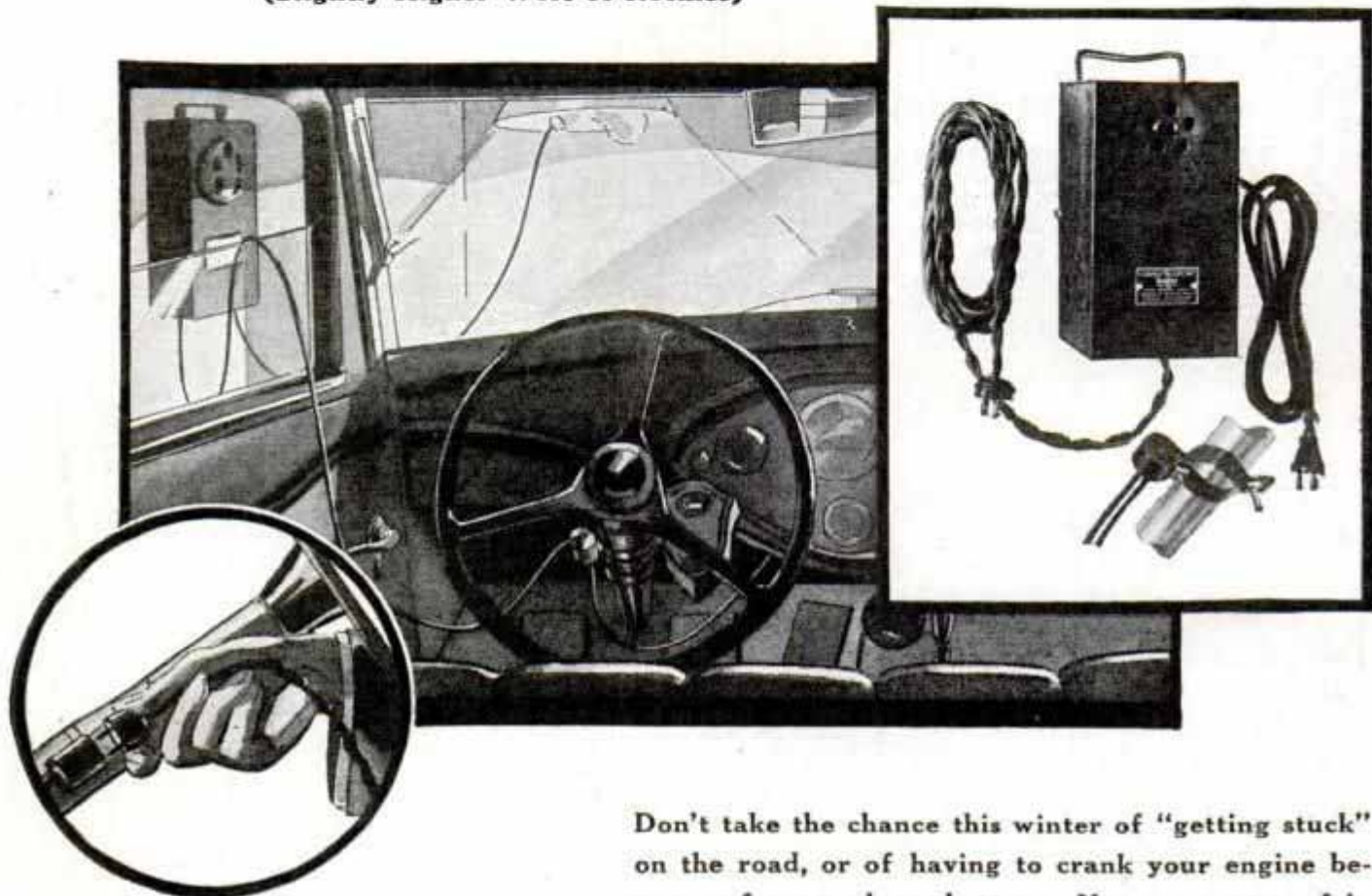

Section A-821, Merchandise Department
General Electric Co., Bridgeport, Conn.

Please tell me all about the new 5-amp.
Tungar Home Battery Charger.

Name.....

Address.....

City.....

Don't take the chance this winter of "getting stuck" on the road, or of having to crank your engine because of a run-down battery. Now, you can safely enjoy the pleasure and comfort of constant use of the car heater, cigarette lighter and radio, and also a quick start on the coldest mornings, without danger of discharging your battery rapidly. The new 5-amp. Tungar used regularly will keep your car battery fully charged the year 'round . . . in summer as in winter. With the wiring accessories furnished, it is as simple to use as any electric appliance. No lifting of dirty floorboards . . . all connections made through receptacle on steering post.

GENERAL ELECTRIC

AUTOMOTIVE PRODUCTS

MERCHANDISE DEPARTMENT, GENERAL ELECTRIC COMPANY, BRIDGEPORT, CONN.

When writing to advertisers please mention Popular Mechanics

Popular Mechanics Magazine

H. H. WINDSOR, Founder

H. H. WINDSOR, Jr., Editor and Publisher

January, 1935

Vol. 63, No. 1

Special Features

| | |
|---|----|
| Movie Magic—Part II—Coloroto Section | |
| The Comet of the Rails | 9 |
| Fighting Crime with Tear Gas | 17 |
| The Lure of Puzzle Inventing | 20 |
| The President on the Air | 28 |
| Dam Building—Waste or Progress? | 34 |
| Sikorsky Sees Daily Ocean Flights | 44 |
| Telling the World in Light | 56 |
| The Amazing Return of the "Bikes" | 62 |
| Is Your Driving Touch Modern? | 66 |
| Britain Seeks Atlantic Record | 76 |
| The Race Horse Dope Racket | 82 |
| X-Ray—Master of Magic | 90 |

(Continued on next page)

Looking Ahead with "Boss Ket"

WHAT the world needs most of all today is a whole crop of new inventions. In standardizing production, we have, unfortunately, standardized ideas. We've made over and over again the same old things when we should be constantly making new things—endlessly changing. These are the words of Charles F. Kettering—"Boss Ket" to his boys—who sees great things ahead for today's youth in tomorrow's America. Watch for Frazier Hunt's interview, in the February issue, with the head of the experimental laboratories of the General Motors company.

Next Month

EACH 1935 automobile represents the dreams, ideals, sweat and teamwork of a host of designers, sculptors, engineers, steel workers, parts manufacturers and factory officials. Eight pages of pictures in color next month depict the birth of an automobile, and a story explains the processes.

"Hams" to the Rescue

AN earthquake destroys a metropolis, a tornado rips through a populous countryside, a raging fire threatens to wipe out a city. The outside world has brief warning of the catastrophe. Then comes silence. Ordinary means of communications have broken down. When such disasters strike, radio amateurs go into action and are often the means of saving lives and property. There are 60,000 of these "hams" on the short waves today. Read of their heroic work in the February issue.

Death Cheaters

BOB ROSE, motion picture stunt man, has made 560 parachute jumps and changed planes sixty times in midair. He has dived from heights above ninety feet 150 times, he has been in 180 automobile wrecks and he has raced horses over cliffs sixty-five times. In the February issue this veteran stunt man relates his experiences and gives his recipe for cheating death while performing such feats.

**GENUINE
PYROIL**
protects
against
winter
damage



"IN TEMPERATURES OF 8° BELOW ZERO TO 110° ABOVE, ALL WITHIN 48 HOURS, PYROIL INSURED ME OF MOTOR SAFETY," SAYS BOB MCKENZIE, TRANSCONTINENTAL ROAD CHAMPION. (At left)

In cold weather, Pyroil protected motors start easily, save battery drain and escape starting damage. This is because Pyroil forms a glossy, slippery, self-lubricating surface on all frictional parts, which surface safeguards the metal until "frozen" oils and grease circulate properly.

Bob McKenzie, who holds many championships for cross country endurance driving, says: "I have broken records under all conditions and have used Pyroil in the crankcase, the transmission and differential. Pyroil will give the winter motorist better performance, easier starting and motor safety."

Use Pyroil regularly this winter. Simply add by the ounce to each filling and addition of gas, oil and grease. Saves far more than its cost. Sold the world over at service stations, garages and dealers. Mail coupon for full text of Bob McKenzie's statement and feats, using Pyroil. Manufactured and Guaranteed by **PYROIL COMPANY, W. V. Kidder, Pres., 51 Pyroil Bldg., LaCrosse, Wis., U. S. A.**

PYROIL HAS BEEN TESTED BY POPULAR MECHANICS AND IS USED BY POPULAR MECHANICS' PRESS AND PUBLISHING EQUIPMENT.

DISTRIBUTORS

A GREAT OPPORTUNITY FOR YOU WITH PYROIL. GET YOUR APPLICATION IN NOW. CHECK SQUARE IN COUPON AND MAIL FOR IMPORTANT FACTS.

GENUINE PYROIL is protected by U. S., Canadian and foreign patents issued to W. V. Kidder, its inventor. Identified by lithographed, factory-sealed cans bearing signature below. Not sold under any other name.

Simply Add TO GAS OIL & GREASE



W. V. Kidder

PYROIL COMPANY
51 Pyroil Bldg., LaCrosse, Wis., U. S. A.

Please send text of Bob McKenzie's statement and feats—also important Pyroil facts. No obligation.
 Please send Distributorship Opportunity facts.

Name.....
Address.....
City.....State.....

Genuine
PYROIL
LUBRICATION PROCESS

(Contents—Continued)

Airplane—giant carries autos to New Guinea..... 42
 Airplane Design—steel plane in one piece 72
 Archery—arrows thrown with stick 86
 Automobiles—first made in Alaska goes to museum 26
 Automobiles, Accessories
 backing light warns car behind 88
 key ejects when door is locked 81
 Automobiles, Design
 coating aluminum piston lengthens life 75
 louvers under front fender ventilate engine.... 89
 Automobiles, Driving
 fallacies of driving 69
 new menace in night driving 73
 Automobiles, Tires—coils vulcanize inner tubes... 60
 Automobiles, Traffic—signal has timer lights..... 53
 Automobiles, Truck—"pancake" motor drives.... 84
 Awning—all metal, adjusted by lever 85
 Bell Boys—dummy, aid at convention 81
 Billiard—table of concrete for outdoor play 52
 Blindness—sight restored by grafting cornea..... 60
 Bow Gun—recalls ancient warfare 24
 Brick—grooved with tie rod 65
 Camera—high-speed, takes picture of bird in flight 47
 Chimneys—revolving top for, creates better draft. 86
 Clock—desk, has a pull wind 75
 Cow—midget, is family pet 93
 Dentistry—drill held by tapered shank tool..... 19
 Diving—lamps aid hunt for sunken gold 94
 Door—bedroom, seal for, works automatically 40
 Door Check—operates without fluid 27
 Drawing—instrument has many tools in one 49
 Electrical Apparatus—pencil etches or solders.... 75
 Electricity—high voltage 25
 Fabrics—made fireproof by secret process 26
 Fish—zebra, hypnotizes victims 40
 Garbage—collected in rotating tank on truck body .55
 Gasoline Pump—gauge tests as engine runs 95
 Glass—absorbs sun's heat but admits light 85
 Grain Tanks—overcoats, keep out moisture 48
 Grease Gun
 carried on back of operator 42
 cartridge for gun 52
 Hack Saw—power, portable, has many uses 19
 Harness—hiking, holds child on wearer's back... 71
 Harpoon—gun shoots lifeline 19
 Heating—regulator replaces expansion tank..... 23
 Home—investigators of real property inventory
 show condition in 87
 Home Building—story of 54
 Household Devices 98, 99
 Ink Bottle—with pen well, prevents stained hands.. 42
 Insects
 captured in nets attached to kites 61
 city sells flies to fight earwigs 80
 Insulation—rice-hull ash blown into building 60
 Kindling—fire starter eliminates 96
 Lamp Cord—zipper action unsheaths conductors... 52
 Lamps—sodium, no auto light used on road with... 59
 Lantern—hand, double-light, works on dry batteries 93
 Lathe—adapted for milling for head attachment.... 33
 Level—all-angle, used in various positions 97
 Life Preserver—has "cabin" to protect head 24
 Lighting—accentuates beauty of Milan cathedral... 55
 Medicine—self-measuring bottle cap for container.. 48
 Metal
 non-sparking, tool, reduces hazards 81
 vulcanized to rubber 24
 Mimeograph—drawings easy to reproduce 26
 Model Making
 ancient houses built from plans..... 43
 house of cartridges made by soldering 81
 Mosaics—thousands of tints used by workers 96
 Motion Pictures—tube built to film "sand hog".... 74
 Motor—operated by sunlight produces electricity.. 23
 Motorcycle—sidecar has spare-wheel space 84
 Nail—oval, with chisel point 80
 Oiler—has forced feed and flexible spout 71
 Paddleboard—water glass finds lost articles 96

(Continued to page 6A)

Increase Your Earning Power

Apply time and labor-saving kinks to your work. Your efficiency will soon be recognized and you will be in line for advancement.

If you do machine shop work of any kind, sheet-metal work, painting, carpentry, auto repairing, farming, concrete work, plumbing, electrical work, welding, building-glass work, general repairing, tool-making, poultry raising, masonry or home repair work, get this

LIBRARY OF 3600 TIME AND LABOR SAVING IDEAS FOR SHOPMEN AND HANDYMEN

JUST PUBLISHED



SHOP NOTES for 1935

332 Articles
721 Illustrations
224 Pages
Price 50c
See partial list of contents below

Including the new 1935 issue illustrated above, there are eight volumes in the Shop Notes Library of 3600 easily understood short cuts to every-day jobs. Here are just a few of the subjects taken from the latest issue.

- | | | |
|---------------------------------|---|---|
| Auto Electrical Troubles, Tests | Glass Working with Hack Saw, Using | Scroll Saw, Special Uses |
| Auto Knocks, Locating | Heat Treating of Iron, Steel, Brass, Copper, Aluminum | Soldering with Electric Arc |
| Band Saw, Tuning Up | Jointer, Keeping in Shape | Streamline Bodies, Wire Mesh and Fabric for Boat and Auto |
| Belt Sander, Portable | Knee Action Wheels, Serrating | Taps and Dies |
| Boathouse Piling, Concrete | Lathe, Labor Saving Ideas for | Tool Chest, Portable |
| Cold Chisels, Using | Lathe Knocks, Simple | Window Attraction, Novel Store |
| Dancing Auto Wheels, Curing | Metal Spinning | Window Displays, Mechanical, that Draw Trade |
| Drill Press, Homemade | Metal Turning Suggestions | Wood Chisels, Tricks of Using |
| Drill-Press Problems, Solving | Neon Sign, Flashing | Wood Joints with Hand Tools |
| Electric Appliances, Repairing | Paint Spray Gun | Work Benches you can Build |
| Electrical Motors, Rewinding | Reed Baskets, Weaving | Workshop, Motorize Your |
| Electricians, Short Cuts for | Roadside Salesman Sander From Auto Parts | |
| Forge Made from Cream Separator | Sand, Uses in Workshop | |
| | Saw Table, Adjustable | |

Each volume contains approximately 350 articles and 500 illustrations and has 192 or more pages. This unrivaled library of shop helps may be secured for a limited time only. After the present supply of books is exhausted the offer must be withdrawn.

*** Send No Money ***

POPULAR MECHANICS PRESS,
200 E. Ontario St., Room 135, Chicago, Ill.

Send me, as per your offer, the following books. I will pay postman price and small amount of postage. My money will be refunded if I am not satisfied. (Check what you want.)

- 1935 Shop Notes and Lathe Handbook, both for 98c.
 Shop Notes Library (8 vols.) \$3.50.

Name.....

Street and No.....

City..... State.....

* C. O. D. applies to U. S. and possessions only. If you reside elsewhere, remittance must accompany order.

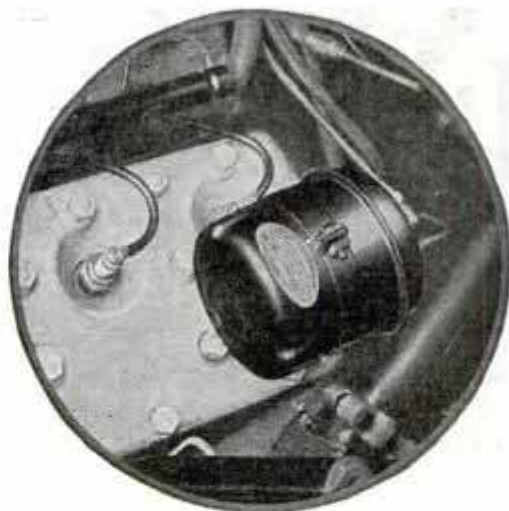

"YES!"

FORDS AND CHEVROLETS CAN HAVE PUROLATOR PROTECTION"

This is in answer to the many inquiries that come to us from Ford and Chevrolet owners.

Fords and Chevrolets are not equipped with an oil filter at the factory . . . but your own service garage is now prepared to furnish and install a Purolator Oil Filter . . . especially designed and engineered for these two jobs.

AND YOU COULDN'T MAKE A BETTER INVESTMENT

If you are using a good grade of oil a genuine Purolator Filter will keep it so clean and effective you can safely lengthen the time between crank case drainings.

Your Purolator will catch and hold the dirt and grit and fine metal particles and hard carbon that settles in crank case oil . . . will keep these grinding, abrasive substances out of the oil stream and away from your engine . . . will lengthen its life and its smoothness of operation.

It is these destructive settings that wear out bearings, score cylinder walls . . . cause costly repairs and replacements . . . send many a car to the junk heap, long before its time.

The cost of a complete Purolator Filter, especially designed for Ford and Chevrolet passenger cars or trucks and including all the necessary fittings, is only \$5.00, plus a small charge for installation.

It will pay for itself many times over . . . both in actual dollar savings and in satisfaction.

If your own favorite service garage hasn't yet been supplied with this material, just clip and mail this coupon.

We will tell you how you can be promptly served, and will also send you an "Auto Almanac" . . . an unusual booklet . . . interesting and instructive.

PUROLATOR

The Oil Filter on Your Motorcar
Licensed Under Sweetland Patents

MOTOR IMPROVEMENTS, INC.,
Newark, New Jersey.

I am interested in a Purolator for

(check here)FordChevrolet

Send me without any obligation, further detail, together with a copy of "AUTO ALMANAC."

Name.....

Address.....

City..... State.....

Note: Trucks and passenger cars take same model.

When writing please mention Popular Mechanics

FREE!

1935 RADIO CATALOG



Send for the greatest book in Radio! Over 100 amazing pages—packed with the highest quality radio equipment at unbeatable low prices. Write for this FREE book today.

- **NEW.** A great listing of Dual Wave, All-Wave, Short Wave, and Broadcast receivers—all with new Airplane Dials, Dual Purpose tubes, etc. Electric, Battery and 32 Volt models. You can now own a World-wide radio receiver at a truly low price.
- **NEW.** An amazing line of Build-Your-Own Kits! Short Wave, All-Wave, Broadcast-Superhet and TRF circuits. Includes the famous All-Star All-Wave kit, the Beginner's 2 tube S.W. set, etc. More than 20 great kits to choose from!
- **NEW.** Public Address Equipment—Amateur Short Wave Transmitting and Receiving Gear—and of course, the most complete line of Standard Quality radio parts. Let us quote you for kits for building any radio circuit described in any magazine or handbook.

BUILD RADIO

INEXPENSIVE AMATEUR 2 WAY PHONE FOR BEGINNERS

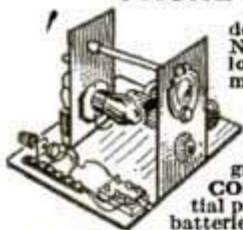

The popular Amateur 2 Way Phone described in *Popular Mechanics* for November, 1934. Easy to build—very low in cost. Equally successful as transmitter and receiver. Kit of essential parts includes condensers, resistors, tubing, socket, dial, knobs, wire, hardware, drilled bakelite panels and base, and easy-to-follow wiring diagram. Kit of essential parts

COMPLETE KIT: All essential parts together with accessories including batteries, hand microphone, headphones, and **\$4.95**

type '19 tube. Price **\$10.55**
The 2 Way Phone Kit is also available in a De Luxe model with Portable carrying case. Write for FREE parts lists.

BEGINNER'S 2 TUBE SHORT WAVE KIT

Described in *Popular Mechanics* for October, 1934. Looks and works like a professional set. Genuine "National" parts. Complete with drilled metal panel and base, all necessary parts, wiring diagram, and 5 coils tuning 13.5 to 200 meters. Less tubes, batteries, and headphones. An amazing value. Only **\$16.50**. Send for FREE Parts List.



ALLIED RADIO CORPORATION

833 W. JACKSON BLVD., Dept. K, CHICAGO, ILL.

Send me at once:

- FREE 1935 RADIO CATALOG.
- 5 Meter Essential Parts. Complete Kit.
- Beginner's 2 Tube Short Wave Kit.

Name.....

Address.....

City.....State.....

(Contents—Continued)

| | |
|---|-----|
| Pan—cover knobs attached by tapping with hammer | 33 |
| Parachute—jumper talks by radio as he falls | 47 |
| Pen—rest, guides the point | 89 |
| Piano—plays music in color on white disk | 89 |
| Pictures—plumber-artist achieves fame with hobby | 53 |
| Pig Iron—pound made into springs is fortune | 80 |
| Pipe | |
| bronze and copper, threadless fittings for | 48 |
| portable threader run by electric drill | 31 |
| rings stop tree roots from clogging sewer | 59 |
| Police—message to squad car sent by plug-in phone | 33 |
| Radio—practical suggestions | 105 |
| Radio Apparatus | |
| homemade trouble locator for power units | 104 |
| low-cost unit supplies 110 volts a.c. anywhere | 106 |
| Radio, Application—compass helps flyer find station | 86 |
| Radio, Broadcasting—how singers are made in studio | 70 |
| Radio Receiver | |
| Little Giant, 5-tube super, for a.c. or d.c. | 102 |
| set attached to belt | 100 |
| speaker designed for short-wave reception | 106 |
| Radio, Transmitter—complete for amateur | 101 |
| Radio, Tube—resembles acorn in shape and size | 106 |
| Railroads | |
| crane removes trucks from wheels | 33 |
| save millions by welding rail gaps | 94 |
| Razor—rack and blade holder clips to shelf | 85 |
| Recorder—shows vibrations in three dimensions | 97 |
| Refrigeration—simplified gas compressor for | 88 |
| Router, Electric—high speed | 59 |
| Sculpture | |
| blowtorch used instead of chisel | 88 |
| "T. R.'s" face carved on cliff by road | 96 |
| Ship Models—miniature ketch tows rowboat | 40 |
| Ships | |
| an amazing marine job | 41 |
| depth of sea bottom shown on chart | 95 |
| gas as fire alarm wakes passengers | 95 |
| iron claws grasp lifeboat and lower it into water | 72 |
| latest protective devices against fire | 50 |
| Shredder—makes excelsior of old newspapers | 80 |
| Silver—German, in name only | 40 |
| Snow Fighters—of the Cascades | 32 |
| Spectacles—rimless, mounted at top | 97 |
| Speedometer—records miles per hour on trip | 85 |
| Taxidermy—decorative and useful articles for home | 49 |
| Telephone—tag board shows location of cable reels | 86 |
| Television—aerial shaped like big wheel | 31 |
| Tennis—rubber-paved courts require no upkeep | 72 |
| Timber—salt bath seasons without kiln drying | 75 |
| Torch—adjustable, motor-propelled cutting machine | 61 |
| Trolley Car—articulated, three cars in one | 27 |
| Turbine—vacuum, to make ice, using sea water | 100 |
| Water Meter—"mitten" prevents freezing | 27 |
| Weather—forecaster shows changes on dial | 71 |
| Wire—braided, home furnishings made from | 65 |
| Wire Fence—extra zinc coating stops rusting | 31 |

AMATEUR MECHANICS

| | |
|--|-----|
| Aquarium—wall, a ⁿ lighted | 107 |
| Cardboard—strips aid in ruling special forms | 114 |
| Christmas—dress up home for | 121 |
| Clothesline—wire tool removes ice and sleet | 126 |
| Clothes Wringer—rollers renewed with hose | 118 |
| Coal Hod—improving your | 110 |
| Coat Hanger | |
| cardboard, folded over line spaces garments | 133 |
| that folds flat | 140 |
| Copper—giving articles black color | 113 |
| Door | |
| braces prevent doors from sagging | 128 |
| rasp and wedge repair sticking | 110 |
| Dowel Holes—a guide for drilling | 140 |
| Drawing Board—old toothbrush for pen cleaner | 128 |
| Drill Press—foot control for routing with | 112 |
| Fasteners—keep bolts from turning in wood | 114 |

(Continued to page 8A)

He Climbed—Out of a Mine Shaft Into a Chief Executive's Chair!

THE AMAZING STORY OF A LASALLE STUDENT*



Back in 1921 I was a laborer with nothing ahead of me, apparently, but the hard life of a laborer. Then I enrolled for LaSalle training in Accountancy. It wasn't easy to study, but discouraged, yet vaguely hopeful, I plugged away.



A year later I went to work in a copper mine, 3800 feet underground, still keeping up my study. If conditions were bad before—they were worse now! But something drove me on, and the encouraging letters from my instructors kept the light of hope burning.



When I was only half-way through I decided to go to Los Angeles and try to get a job. I had had no experience other than my training, which I found actual—not theoretical. Presenting my evidence of study and character, I was employed as assistant book-keeper.



Within the next two years I made rapid progress, and was promoted to the position of office manager, with consequent increases in salary. By this time I had completed my course—the foundation for my complete accountancy knowledge being this splendid LaSalle training.



I decided I would go further. I would be a Certified Public Accountant. I joined an accountancy firm and took the LaSalle C. P. A. coaching course. Last May I took the State examination. I passed, I was finally a Certified Public Accountant! My goal had been reached!



I shall never be able to express my gratitude for the opportunity to fight my way from a laborer's job to a C. P. A.'s desk. To any man of intelligence who wants to get out of the rut and succeed, I recommend that he enroll with LaSalle.

Spare-Time Training Promises Great Rewards Today

THIS true story illustrates what a man can do, who is resolved to get out of a rut and is willing to invest his spare time now for the sake of tremendous dividends later.

Why not take unbiased stock of *your* capabilities? Have *you* the training and knowledge needed to carry you from your present job to a highly-paid future position? If not, you must first equip yourself—to meet fast-changing business conditions that are today rich with opportunity for advancement, greater security and increased income. Not until you can do some one particular thing and do it *well*, are these prizes for **YOU**.

LaSalle experts will show you how to get

*Name gladly given on request.

La Salle Extension University, Dept. 164-R, Chicago.

Kindly send me your free booklet on the business field I have checked—and tell me how your training in that field can help me.

Business Management
 Law
 Traffic Management

Business Correspondence
 Commercial Law
 Accountancy

Salesmanship
 Business English
 Bookkeeping

Name.....

Position.....

Address.....

LA SALLE EXTENSION UNIVERSITY

When writing to advertisers please mention Popular Mechanics



**FREE
24 PAGE
BOOK**

MAKE MONEY Casting Lead Toys

Get this complete outfit. Learn how metal castings are made. It's fascinating to cast lead soldiers, animals, airplanes and other metal figures. Make all the toys you want. Junior Caster is a complete outfit for casting and coloring the largest finest toys. You can sell the toys at a good profit. Full details furnished in 24-page illustrated book.

Fascinating! Educational!



**EXTRA MOULDS, 95c
CHOICE OF 128 SUBJECTS**

All the different toys can be made with one outfit, by simply buying extra moulds. Each mould makes 3 different, large figures. For good casting results insist on genuine Junior Caster. Avoid unsatisfactory imitations. See Junior Caster at your dealers or order from the coupon below.

For Christmas!

Get a Junior Caster this Christmas. It's chock full of fun and profit possibilities.

Complete Outfit \$2.50

Includes set of moulds for making 3 different figures. Also mould handles, clamp, large supply of lead, ladle, 4 cans of paint, 2 brushes.

SEND FOR FREE ILLUSTRATED BOOK



(Contents—Continued)

| | |
|--|-----|
| Funnel —aids in baking angel food cake | 118 |
| Furnace | |
| cleaning brush has flexible handle | 140 |
| sealing ashpit door to use blower on | 114 |
| Furniture | |
| combining book racks with table lamps | 113 |
| hand-carved mahogany buffet | 115 |
| pony desk has kiddy-car seat | 129 |
| Games —shuffleboard court for game room | 111 |
| Ice Boat —a model | 127 |
| Lathe —wood, celluloid plate centers work for | 114 |
| Magnet —magnetic theater | 131 |
| Model Making —building model locomotives, Part I | 134 |
| Motion Picture —titles washed into scenes of marine | 133 |
| Paint —holder for small cans | 118 |
| Painting —drying fresh articles in oven | 130 |
| Pencil —automatic, homemade stylus points fit | 118 |
| Photography | |
| protecting photos against insects | 126 |
| using razor blade to find emulsion side | 128 |
| Ruler —novel division lines improve | 126 |
| Saw | |
| fine-tooth, for cutting thin metal | 133 |
| removing burrs from teeth of filed | 128 |
| Shelves —swinging, to keep within easy reach | 125 |
| Ship Models | |
| grating bars alined accurately | 119 |
| how to antique masts and yards | 129 |
| making strong railings | 140 |
| Shoes —white kid, cleaned with cuticle remover | 112 |
| Stove —ashes removed without raising dust | 130 |
| Suitcase —repairing worn latches with nail file | 126 |
| Teakettle —with hose, aids in watering caged pets | 112 |
| Tie Holder —rotating, a | 125 |
| Tubes, Collapsible —paste, applied with soda straw | 132 |
| Twine —windmill serves as holder | 109 |
| Vent Pipe —asbestos prevents vapor from freezing | 110 |
| Walls —solution for cleaning | 132 |
| Wire —rubber-covered removed with thinner | 110 |

SHOP NOTES

| | |
|---|-----|
| Automobiles —wiper cleans inside of windshield | 159 |
| Automobiles, Repairing | |
| floor of corrugated iron prevents punctures | 159 |
| heat control affects carburetor | 159 |
| oil grooves cut with old valve | 159 |
| Automobiles, Tires —mounting super-balloon tires | 159 |
| Barrels —old tires help when rolling | 155 |
| Belt Sander —run by drill press | 141 |
| Boiler —electric drill helps clean flues | 160 |
| Casehardening —iron and steel, simple methods of | 152 |
| Chemistry —graduates held to underside of shelf | 156 |
| Concrete —smoothed with finisher made of belting | 144 |
| Countersinking —preventing chatter marks when | 160 |
| Disks —cardboard, cut with safety-razor blade | 143 |
| Dowel Holes —substitute for drilling, in end of | |
| small round work | 150 |
| Fuses —flashlight used to test | 146 |
| Garage —ignition tester for | 157 |
| Glass —angle yardstick for cutting | 144 |
| Ladder —extension shelf on, keeps tools at hand | 155 |
| Lathe —pin cutter attachment for | 146 |
| Nail Set —fuller ball provides finger rest | 150 |
| Photography | |
| combination lens hood and filter holder | 143 |
| vest-pocket flashlight sets off bulbs | 156 |
| Pipe-Cleaner —tool made from stick and bottle caps | 150 |
| Railroad —sweeps brush off small objects | 156 |
| Safety Valve —for boilers and compressed-air tanks | 144 |
| Saw —blade wedged in bench top for slotting blocks | 150 |
| Show Card —powder puff on hand, prevents soiling | 155 |
| Signal Lamps —hoods prevent rain extinguishing | 144 |
| Soldering —corrugated cardboard spaces wires for | 146 |
| Soldering Iron —self-heating, for light work | 151 |
| Storekeepers —suggestions for | 151 |
| Windmill —built from junk parts | 145 |
| Wood-Turning —how to use tools | 147 |
| Writing Pad —held on arm | 145 |

RAPAPORT BROS.,

703 W. Ohio St., Chicago.

Enclosed find Money Order for \$..... Please send

JUNIOR CASTER Standard \$2.50 (postpaid in U. S.)
Electric \$3.25

I want the model checked: Wild West Cowboys. U. S. Soldiers. U. S. Machine Gunners. **Send FREE BOOK.**

Name.....

Address.....

City..... State.....

JUNIOR CASTER

YOU CAN REPEAT ALMOST EVERY EXPERIENCE IN LIFE

— EXCEPT

Life - itself

★

TODAY is life. Tomorrow is a hope. Yesterday is a dream. Nothing is so dead as a day that has passed. Only the trailing clouds of memory remain.

One *today* upon another *today*—how quickly a decade is built! Youth approaches manhood in high heart, embraces maturity as the period of his conquest, then “remembers with a sigh the days that are no more.”

So life goes—like that. NOW is the only opportunity. NOW is the moment of success. NOW men decide—NOW men win or fail.

Are you one of the men who are wondering today what will happen to them tomorrow? Then

remember this: *If you take care of today, tomorrow will take care of itself.* And one of the most important safeguards you can take is to be certain your *training* is modern . . . that you are adequately equipped to master the problems of 1934. Today, in almost every line of human endeavor, ambitious men are modernizing their training by spare-time study of International Correspondence Schools Courses. Their action is a guide to you—and NOW is the time to act! Complete information on any subject in which you are interested will be sent without cost or obligation. The coupon is for your convenience. Return it today.

INTERNATIONAL CORRESPONDENCE SCHOOLS

“The Universal University”

BOX 5544-H, SCRANTON, PENNA.

★ Without cost or obligation, please send me a copy of your booklet, “Who Wins and Why,” and full particulars about the subject *before* which I have marked X: ★

TECHNICAL AND INDUSTRIAL COURSES

- Architect
- Architectural Draftsman
- Building Estimating
- Wood Millworking
- Contractor and Builder
- Structural Draftsman
- Structural Engineer
- Inventing and Patenting
- Electrical Engineer
- Electric Lighting
- Welding, Electric and Gas
- Reading Shop Blueprints

- Telegraph Engineer
- Telephone Work
- Mechanical Engineer
- Mechanical Draftsman
- Machinist Toolmaker
- Patternmaker
- Heat Treatment of Metals
- Bridge Engineer
- Bridge and Building Foreman
- Gas Engines Diesel Engines
- Aviation Engines
- Automobile Mechanic

- Plumbing Steam Fitting
- Heating Ventilation
- Sheet Metal Worker
- Steam Engineer
- Steam Electric Engineer
- Civil Engineer
- Surveying and Mapping
- Refrigeration
- R. R. Locomotives
- R. R. Section Foreman
- R. R. Bridge and Building Foreman

- Air Brakes R. R. Signalman
- Highway Engineering
- Chemistry Pharmacy
- Coal Mining Engineer
- Navigation Air Conditioning
- Boilermaker
- Textile Overseer or Supt.
- Cotton Manufacturing
- Woolen Manufacturing
- Agriculture Fruit Growing
- Poultry Farming Radio
- Marine Engineer

BUSINESS TRAINING COURSES

- Business Management
- Office Management
- Industrial Management
- Traffic Management
- Accountancy
- Cost Accountant

- C. P. Accountant
- Bookkeeping
- Secretarial Work
- Spanish French
- Salesmanship
- Advertising

- Service Station Salesmanship
- First Year College
- Business Correspondence
- Lettering Show Cards Signs
- Stenography and Typing
- Civil Service Mail Carrier

- Railway Mail Clerk
- Grade School Subjects
- High School Subjects
- College Preparatory
- Illustrating
- Cartooning

Name.....Age.....Address.....

City.....State.....Occupation.....

If you reside in Canada, send this coupon to the International Correspondence Schools Canadian, Limited, Montreal, Canada

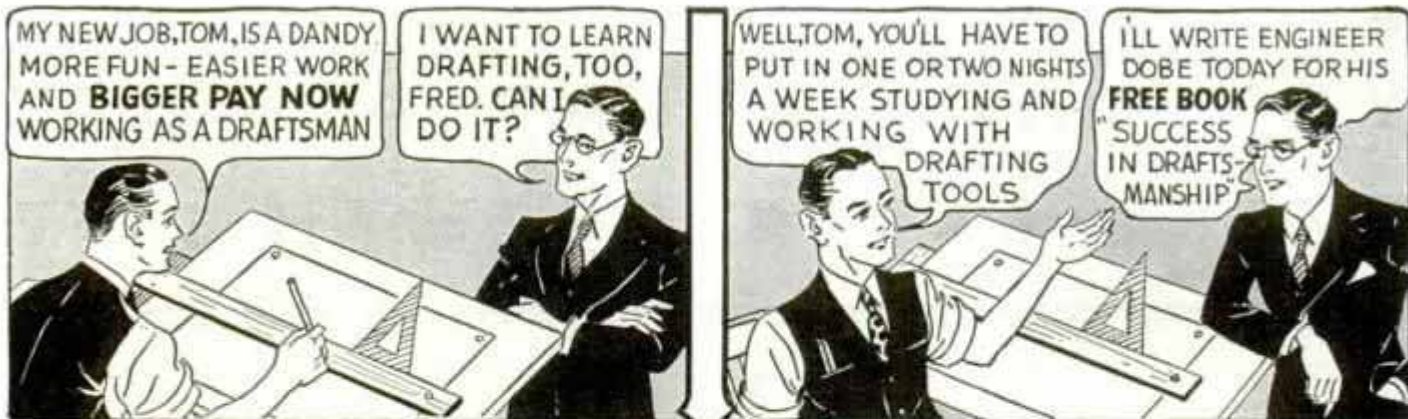

Then Tom, too, learned by mail at home

Now look at Tom at work (See next picture)



The boss asks Tom a question (See next picture)

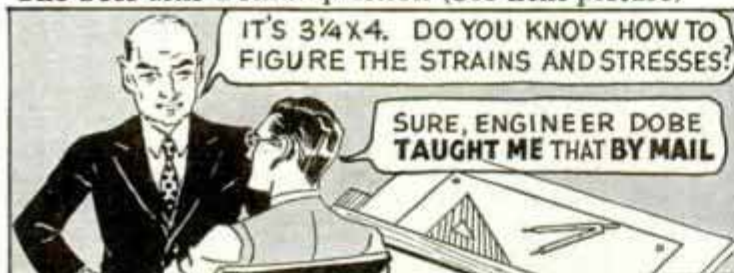

Tom's friend wants to learn, too (See next picture)

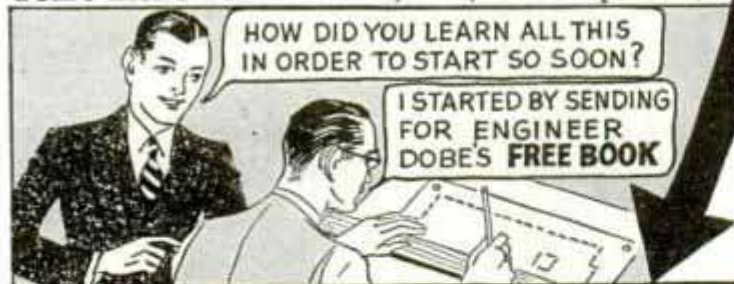

FREE BOOK

Write AT ONCE

These **TOOLS** and Other **EQUIPMENT** Given When You Start

Outfit 20x26 in.

For 34 years (since 1900) I have trained thousands of successful graduates.

Write while this offer lasts.

ENGINEER DOBE, Div. 33-71, Libertyville, Illinois

Send me your free book "Successful Draftsmanship" and please explain how you will assist me to a good position as a draftsman.

Name _____

Address _____

Age _____

If You Earn Less Than \$50 a Week MAIL COUPON

Jobs Now

in auto work, electricity, machinery, aviation and certain building lines.

Did you read in the newspaper recently that there is already an actual shortage of draftsman in an important factory town? Government Home Loans and Federal Housing have re-awakened the building industry. Remember: the draftsman is needed first of all men. First he draws the plans. Thereafter the steel mills, lumber mills and brick yards make their sales. How long before business will roll up big with jobs plentiful?

For MORE PAY Learn DRAFTING FROM AN ENGINEER LEARN BY MAIL AT HOME

IT'S high time now to prepare. You don't know how soon business will boom in many lines that will offer jobs to draftsmen. Then the big companies will take the men who have prepared. So prepare NOW! Be trained now for that better job! Jobs pay \$50.00 a week or more. I'll train you at your home in spare hours until competent and until assisted to a position—OR all your money back.

With the Dobe method, no previous experience is necessary. Every man who has a little liking for drawing lines and working with tools can quickly and easily learn drafting. It's desk work, very pleasant, profitable. Don't be too late in getting your training.

Mechanics of all branches, foremen, superintendents: Even if you never accept a job as a draftsman, you'll never read and fully understand the drawings from which all work is made unless you have learned to make such drawings yourself. Thus you get out of overall and yet draw the pay of a boss. Send coupon!

Employers: Do learn the basic plans of your business. Know what your men know. Learn Drafting.

Remember: No previous experience is necessary. You do not need to be a college man or a high school graduate. I'll train you 'til you're in a position and EARN MORE PAY at steady work. Mail the coupon!

All Tools & Drawing Table GIVEN to you if you act promptly. Send for the free book today. It explains everything. Then, if you enroll promptly, you get all those tools and other equipment at once without extra charge.

Division 33-71
Engineer Dobe, Libertyville, Ill.



Learn RADIO in 10 WEEKS

**BY ACTUAL WORK ON
REAL EQUIPMENT
PAY**

**FOR YOUR TRAINING IN
SMALL MONTHLY PAYMENTS
AFTER YOU GRADUATE**

Come to Coyne now! Get your training in the World's most fascinating, best paid profession. I train you at Coyne in a practical way so you can be prepared to take a real job and cash in quickly, and, I'LL FINANCE YOUR TRAINING. Two months after you are trained you can start paying me back in easy monthly payments from your earnings. Take over a year to pay AFTER training. Mail the coupon today for details of this plan.

REAL OPPORTUNITIES FOR THE RADIO TRAINED MAN

Prepare for jobs as Designer, Inspector and Tester—as Radio Salesman and in Service and Installation—as Operator or Manager of a Broadcasting Station—as Wireless Operator on a Ship or Airplane—as a Talking Picture or Sound Expert—HUNDREDS of Opportunities for fascinating, WELL PAID JOBS!

10 WEEKS' SHOP TRAINING AT COYNE IN CHICAGO—YOU DON'T NEED ADVANCED EDUCATION OR EXPERIENCE

I don't teach by book study. You get your training at Coyne by ACTUAL WORK on a great outlay of Radio, Broadcasting, Television, Talking Picture and Code equipment. And because we cut out useless theory, you get a practical training in 10 weeks, and that is why you don't need advanced education or previous experience.

TALKING PICTURES—TELEVISION

Talking Pictures and address systems offer great opportunities to the trained man. Television is the great new branch of Radio which is now being developed very rapidly. Be ready for your chance in Television. At Coyne you are trained on real Talking Picture and Television equipment.

Electric Refrigeration—Air Conditioning Included at NO EXTRA COST

So that my graduates may have an all around training which increases their earning capacity, I am including for a short time my big new course in Electric Refrigeration and Air Conditioning. Here is your chance to get a practical training in this great new field at no additional cost.

SPARE TIME WORK WHILE LEARNING

WHEN YOU ENROLL AT COYNE YOU GET A LIFE SCHOLARSHIP. You get Free Employment Service for Life after graduation. And if you need part-time work while at school to help pay expenses, I'll help you get it if you will tell me your problems. Coyne is 35 years old, Coyne Training is tested—You find out everything about my course and my "pay after graduation plan" free. JUST MAIL Coupon for My BIG FREE BOOK.

H. C. LEWIS, President

**Radio Div., COYNE Electrical School
500 S. PAULINA ST., Dept. 15-3H, CHICAGO, ILL.**

H. C. LEWIS, President

**Radio Division, Coyne Electrical School
500 S. Paulina St., Dept. 15-3H, Chicago, Ill.**

Dear Mr. Lewis: Send me your Big Free Radio Book and all details of your Special Introductory Offer—and your plan where I can pay my tuition in easy monthly payments after I graduate.

Name.....
Address.....
City..... State.....

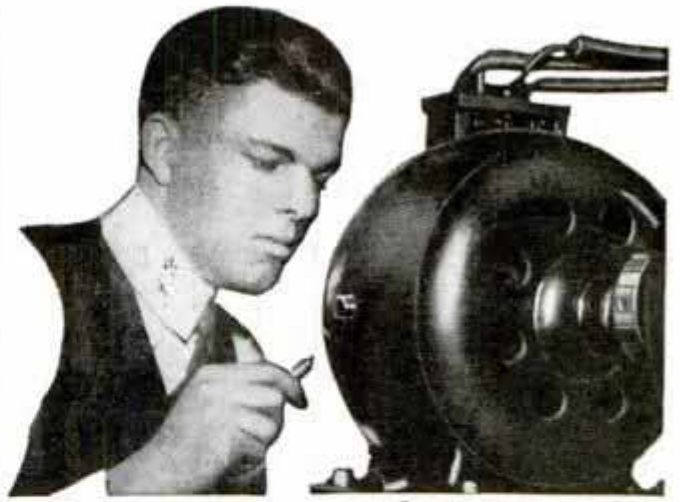

Amazingly Easy Way to Get Into ELECTRICITY

**PAY YOUR TUITION AFTER
GRADUATION**

Don't spend your life waiting for \$5 raises in a dull, hopeless job. Now . . . and forever . . . say good-bye to 25 and 35 dollars a week. Let me teach you how to prepare for positions that lead to salaries of \$50, \$60 and up a week in electricity—NOT by correspondence, but by an amazing way to teach right here in the great Coyne Shops that makes you a practical electrician in 90 days! Getting into electricity is easier than you imagine for right now I am making an offer no other school ever dared to make. **PAY FOR YOUR TUITION IN EASY PAYMENTS AFTER YOU GRADUATE.**

LEARN BY DOING — IN 90 DAYS

BY ACTUAL WORK—In the Great Coyne Shops

I don't care if you don't know an armature from an air brake—I don't expect you to! It makes no difference! Don't let lack of money stop you. Most of the men at Coyne have no more money than you have. That's why I have worked out my astonishing offers. Mail coupon below for all the facts.

EARN WHILE LEARNING

If you need part-time work to help pay your living expenses I'll help you get it and when you graduate I'll give you lifetime employment service. And, in 12 brief weeks, in the great roaring shops of Coyne, I train you as you never dreamed you could be trained . . . on one of the greatest outlays of electrical apparatus ever assembled . . . real dynamos, engines, power plants, autos, switchboards, transmitting stations . . . everything from door bells to farm power and lighting . . . full sized . . . in full operation.

ELECTRICAL REFRIGERATION

Right now I am including my big new Electrical Refrigeration Course. I train you on real electrical machinery . . . building real batteries . . . winding real armatures, operating real motors, dynamos and generators, wiring houses, etc.

GET THE FACTS Coyne is your one great chance to get into electricity. Every obstacle is removed for you don't have to pay for your tuition until after you graduate then you have ten months to pay it in small payments starting 2 months after you graduate. This school is 35 years old—Coyne training is tested—proven beyond all doubt—endorsed by many large electrical concerns. You can find out everything absolutely free. Simply mail the coupon and let me send you the big, free Coyne book of 150 photographs . . . facts . . . jobs . . . salaries . . . opportunities. Tells you how many earn expenses while training and how we assist our graduates in the field. No obligation to you. So act at once. Just mail coupon.

Big Book Free! Send for my big book containing 150 photographs telling the complete story—absolutely FREE. **H. C. LEWIS, President**

COYNE ELECTRICAL SCHOOL
500 S. PAULINA ST., Dept. 15-72, CHICAGO, ILL.

COYNE ELECTRICAL SCHOOL, H. C. Lewis, Pres.
500 S. Paulina Street, Dept. 15-72, Chicago, Illinois

Dear Mr. Lewis: Without obligation send me your big, free catalog and all details of Free Employment Service, as well as all details on your free Refrigeration Course, and how many "earn while learning." Also about your "PAY AFTER GRADUATION" offer.

Name.....
Address.....
City..... State.....

When writing please mention Popular Mechanics

LEARN AT HOME TO



I'LL TRAIN YOU QUICKLY FOR GOOD SPARE TIME AND FULL TIME RADIO JOBS

MANY MAKE \$40 \$60 \$75 A WEEK

Here's Proof



**Nets About
\$50 a Week
Besides Sales**

"I have been getting along fine. I average ten calls a week, which nets me about \$50, not counting profits on sales. I have serviced almost every make of set and have earned more than I ever expected. I owe my success to the N. R. I. and its wonderful Course."—**BERNARD COSTA**, 150 Franklin St., Brooklyn, New York.

**"\$500 a Year
in Spare
Time"**



"Although doing spare time Radio work only, I have averaged about \$500 a year extra in addition to my regular income. Full time Radio work would net me many times that amount."—**EDW. H. FAWCETT**, Slough Rd., Ladner, B. C., Canada.



**"Good Position,
Good Pay"**

"I am Chief Operator at Radio Station WSMK. This is a good position with good pay. I have advanced in Radio right along. I recommend N. R. I. to anyone who wants to be successful in Radio."—**JOHN HAJDUK, JR.**, 21 Gerard Ave., Southern Hills, Dayton, Ohio.

If you are dissatisfied with your present job—if you are struggling along in a rut with little or no prospect of anything better than a skinny pay envelope—**CLIP AND MAIL THE COUPON NOW!** Get my big 64-page **FREE BOOK** on the opportunities in Radio. Read how quickly you can learn at home in your spare time to be a Radio Expert—what good jobs my graduates have been getting—real jobs with real futures.

Real Opportunities Ahead in Radio for Trained Men

It's hard to find a field with more opportunities awaiting the trained man. Why in 1933—one of the worst depression years—the Radio industry sold \$213,000,000 worth of sets and parts! Radio set sales **INCREASED 45%**—tube sales **INCREASED 25%**! Over 300,000 people worked in the industry! It's a gigantic business, even in the worst business years. And look what's ahead! Millions of sets are going out of date annually, 18,000,000 sets are now in operation on which over \$200,000,000 are spent **EACH YEAR** for repairs, servicing, new tubes, etc. Broadcasting



stations pay their employees (exclusive of artists) approximately \$23,000,000 a year. Advertisers pay 600 great Broadcasting Stations over \$75,000,000 a year for Radio time and talent. A few hundred jobs that paid \$40, \$60, \$75 a week 20 years ago have grown to thousands. These figures are so big that they're hard to grasp. Yet they're all **TRUE!** Here's a new industry that has grown to be a commercial giant! No wonder great business leaders predict a brilliant future for the great and growing Radio industry.

Get into This Field with a Future

There's opportunity for you in Radio. Its future is certain. Television, short wave, police Radio, automobile Radio, loud speaker systems, aviation Radio, marine Radio—in every branch developments and improvements are taking place. Here is a real future for additional thousands of trained men who really know Radio. Get the Training that opens the road to good pay and success! Send me the Coupon **NOW**—and get full particulars on how easy and interesting I make learning at home. Read the letters from graduates who are today earning real money in this fascinating industry.

Learn at Home in Your Spare Time to Be a Radio Expert

Hold your job. There is no need for you to leave home. I will train you quickly and inexpensively in your spare time. You don't have to be a high school or college graduate. My Course is written in a clear, interesting style that most anyone can grasp. I give you practical experience under my 50-50 method of Training—one half from Lesson Books and one half from practical experience with equipment I give you. This unique and unequalled method has been called one of the greatest developments in home study Radio training.

Get the Facts about **THE TESTED WAY**

MAKE MORE MONEY



AS RADIO EXPERTS



Set Servicing

Spare time set servicing pays many N. R. I. men \$200 to \$1,000 a year. Full time men make as much as \$40, \$60, \$75 a week.

Loud Speakers

Installation and service work is another growing money-making field for trained Radio men.

Broadcasting Stations

Employ managers, engineers, operators, installation and maintenance men for jobs paying up to \$5,000 a year.



Many Make \$5, \$10, \$15 a Week Extra in Spare Time While Learning

My big 64-page book gives proof that many make \$5, \$10, \$15 a week extra servicing sets in their spare time soon after enrolling. I give you plans and ideas that have made good spare time money—\$200 to \$1000 a year—for hundreds of fellows. My Course is famous as "the one that pays for itself."

Money Back If Not Satisfied

I am so sure that N. R. I. can train you at home satisfactorily that I will agree in writing to refund every penny of your tuition if you are not satisfied with my Lesson and Instruction Service upon completing your Course. You'll get a copy of this agreement with my Book.

64-Page Book of Information Free

Get your copy TODAY. It's free to any ambitious fellow over 15 years old. It tells you about Radio's spare time and full time job opportunities; it tells you about my Course; what others who have taken it are doing and making. Find out what Radio OFFERS YOU—without the slightest obligation. MAIL THE COUPON in an envelope, or paste it on a penny postcard NOW.

**J. E. SMITH, President
National Radio Institute
Dept. 5AP Washington, D. C.**

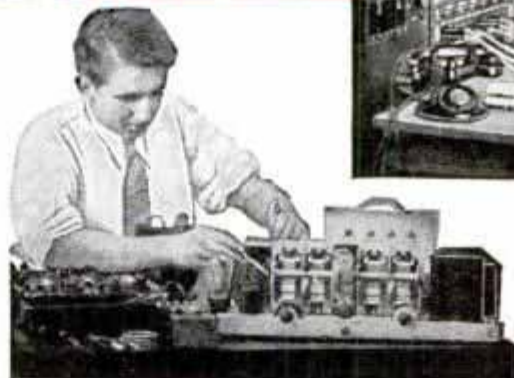

You Get PRACTICAL EXPERIENCE with Radio Equipment I Give You

I'll show you how to use my special Radio Equipment for conducting experiments and building circuits used in such well-known sets as Westinghouse, General Electric, Philco, R. C. A.-Victor, Majestic and others. You work out with your own hands many of the things you read in our lesson books. This 50-50 method of training makes learning at home easy, interesting, fascinating, intensely practical. You learn how sets work, why they work, and how to make them work.

I have doubled and tripled the salaries of . . . many

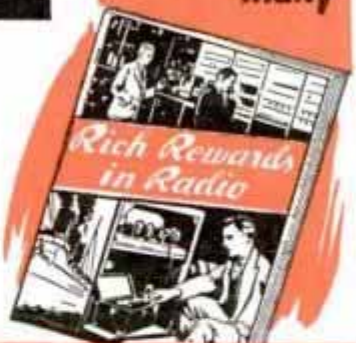

MAIL TODAY FOR FREE 64 PAGE BOOK

**J. E. SMITH, President
National Radio Institute, Dept. 5AP
Washington, D. C.**

Dear Mr. Smith: Without obligating me, send free book about spare time and full time Radio opportunities, and how I can train for them at home in spare time. (Please print plainly.)

NAME.....AGE.....

ADDRESS.....

CITY.....STATE.....

TO BETTER PAY NOW

When writing to advertisers please mention Popular Mechanics

CHEMISTRY

—a career of service and profit



No FIELD of human endeavor offers greater possibilities today than chemistry. All progress is dependent upon this fascinating science. And right at home, in spare time, you can learn the fundamentals by study of the International Correspondence Schools modern course. Today, ask us for complete information. Send for an interesting booklet — free.

..... **DRAFTING** offers opportunity to trained men

Drafting is a fascinating profession, and there is no limit to the progress you can make. Many leading draftsmen today started their careers by study of the I. C. S. Drafting Course. They recommend it to you. Let us send you complete information.



ELECTRICAL ENGINEERS are leaders in modern progress



Just as certain as electricity is the power of the future, just as certain is the part electrical engineers will play in industrial progress. Many leading electrical engineers today took their first forward step by mailing a coupon to the I. C. S. at Scranton! Why don't you follow their example?

SHOW CARD LETTERING brings quick success

Here is the very course you need if you want to get a good paying position as a Show Card Letterer or Sign Letterer.

H. L. Wood, a clerk, made more than \$700 "on the side" before he had completed his I. C. S. course and also won \$125 in prizes. William Whitman, a former wagon builder, now has a sign painting business of his own and is earning nearly three times as much as he did before enrolling with the International Correspondence Schools. Use coupon for free booklet.



INTERNATIONAL CORRESPONDENCE SCHOOLS

Dept. 5545-H, Scranton, Pa.

Without obligation, send me full information on subject checked below:

- | | |
|--|---|
| <input type="checkbox"/> Chemistry | <input type="checkbox"/> Electrical Engineering |
| <input type="checkbox"/> Drafting | <input type="checkbox"/> Show Card Lettering |
| <input type="checkbox"/> Architecture | <input type="checkbox"/> Highway Engineering |
| <input type="checkbox"/> Concrete Construction | <input type="checkbox"/> Agriculture |
| <input type="checkbox"/> Mechanical Engineering | <input type="checkbox"/> Poultry Farming |
| <input type="checkbox"/> Reading Shop Blueprints | <input type="checkbox"/> Radio |
| <input type="checkbox"/> Civil Engineering | <input type="checkbox"/> Accounting |
| <input type="checkbox"/> Aviation Engines | <input type="checkbox"/> Good English |
| <input type="checkbox"/> Diesel Engines | <input type="checkbox"/> Salesmanship |
| <input type="checkbox"/> Gas Engine Operating | <input type="checkbox"/> Advertising |
| <input type="checkbox"/> Refrigeration | <input type="checkbox"/> Civil Service |
| <input type="checkbox"/> Air Conditioning | <input type="checkbox"/> High School Subjects |

Name _____

Address _____

When writing please mention Popular Mechanics



Learn to Draw at Home

New Method Makes It Amazingly Simple

Trained artists earn from \$50 to over \$250 a week. Tremendous demand right now for good Art work. Magazines, newspapers, advertisers, printing houses, etc... all buy Art work. Become an artist through wonderful new easy method of personalized instruction—right at home in spare time. Learn Illustrating, Designing and Cartooning. Actual fun learning this way. Learn to draw and earn big money!

Send for FREE BOOK

Just printed—a new book which describes the latest developments and wonderful opportunities in Commercial Art, gives full details on this new easy method of learning to draw. Tells all about our students—their successes—what they say—actual reproductions of their work—and how many earned big money even while learning! Write for this Free Book and details of big Commercial Artist's Outfit GIVEN to all new students. Mail postcard or letter now.

Studio 121

WASHINGTON SCHOOL OF ART

1115 15th St., N. W.,

Washington, D. C.



HEALTH STRENGTH

and 10 to 25 inches solid rippling super-muscle in 30 days—or your MONEY BACK! My world-famous Stebbing 4 in 1 Course guarantees Dynamic Energy, Doubled Stamina, Virile Manhood, Robust Health, Normal Weight, 2-5 inches on Chest & Arms, Iron Will, 100% Nerve Force, Rigid Self Control, Personal Magnetism—or no cost. Complete Course only \$2.00 or particulars FREE. LIONEL STEBBING, Dept. P.M.11 Forest Hills New York



FREE

Write for illustrated booklet describing money making opportunities in PHOTOGRAPHY. Pleasant and profitable occupation. Famous N. Y. I. personal attendance or Home Study courses will enable you to earn good income as professional photographer—Commercial, News, Portrait or Motion Picture Photography. 25th year.

NEW YORK INSTITUTE OF PHOTOGRAPHY
10 W. 33 St., Dept. 49, New York

Become a Radio Expert

GOOD JOBS

Learn RADIO-TELEVISION

ELECTRICITY—TALKING PICTURES—IN LOS ANGELES
A good job awaits you if you train immediately. Enroll with National. 30,000 graduates. Qualify as a radio repair man; television expert; sound expert; broadcaster; station technician; electrician and for many other jobs. Earn room and board while learning. We help you get job. For limited time we will allow coach railroad fare to Los Angeles. Send for free book which gives full details about different jobs you can qualify for, complete course of instruction and photographs of school operation. Sign and mail coupon.

National Radio & Electrical School, Dept. 1-PMR, 4006 So. Figueroa St., Los Angeles, Calif.
Please send me your big Free Book on Television, Talking Pictures, Radio and Electricity. Also details of R. R. fare offer.

Name _____
Address _____
City _____ State _____

Prepare Quickly at Home in Spare Time



WALTER HINTON: trail blazer, pioneer, explorer, author, instructor, AVIATOR. The first man to pilot a plane across the Atlantic, the famous NC-4, and the first to fly from North to South America. The man who was a crack flying instructor for the Navy during the War; who today is training far-sighted men for Aviation. Hinton is ready to train you at home in your spare time. Get his book.

FOR A Good Pay Job IN THE Fast-Growing AVIATION INDUSTRY

My famous course trains you right in your own home—gets you ready for one of the good ground jobs—or cuts many weeks and many dollars from flight instructions. Send for my big free book today.

Don't sit back and envy the men who are in the midst of the romance, adventure and fascination of Aviation. **YOU DON'T HAVE TO.** For right in your own home, in your spare time, I'll give you the training you need to get started in this growing, well-paid industry. Get my free book. It tells *all* the facts.

**Many Make \$40, \$60,
\$75 a Week**

Through the amazingly simple method I have worked out, I can train you at home to fill many well-paid jobs in Aviation. Naturally, before you can fly, you have to take additional instruction in a plane. Even on that instruction I save you time and money. But when you graduate from my course you have the necessary foundation to fill any one of the many interesting, well-paid ground jobs. Many of my graduates quickly get into jobs paying \$40, \$60 to \$75 a week. Others, with the additional low cost flying instruction I arrange for, become pilots at \$300 a month or better.

Aviation Is Growing Fast

Get into Aviation now—when you are still getting in on the ground floor of a new industry—when you have a chance to forge ahead without having to displace lots of older men. Aviation is a young man's industry, where young men earn real money. The President of the biggest air line in the World is only 35 years old. Most famous pilots are

Here are just a few of the many well-paid jobs in the fast growing Aviation Industry:

ON THE GROUND

- Airport Superintendent
- Instrument Specialist
- Electrician
- Shop Foreman
- Hangar Crew Chief
- Traffic Manager
- Purchasing Agent
- Aerial Mail Clerk
- Motor Expert
- Radio Operator
- Airplane Mechanic
- Field Work

IN THE AIR

- Air Express Agent
- Air Mail Pilot
- Aerial Photography
- Airport Manager
- Test Pilot
- Aerial Passenger Agent
- Private Piloting
- Weather Observer
- Flight Instructor
- Commercial Pilot
- Field Manager
- Transport Pilot

in their early thirties, or even younger. It is a young man's industry, which means that there are plenty of opportunities to forge ahead. But just because it is run by young men, don't get the idea that Aviation is a small business. Millions are being spent yearly to develop and improve airways and planes. Thousands of men earn good livings from the business. And many, many thousands will enter it in the future. It is a great and growing industry, this Aviation, an industry that still brings romance, excitement, thrills—even while it is bringing big opportunities and good pay.

I Have Helped Secure Jobs for Many of My Graduates

Due to my widespread connections with aviators, plane manufacturers, airport managers, etc., I am in an especially favorable position to locate jobs for trained men. My Aviation friends know that Hinton-trained men are well qualified to fill any job for which I recommend them.

Send For My Free Book Now

Now is the time to act. Don't sit content with a humdrum job with no future. Act now—to get yourself into Aviation—the industry that is slated to grow into a giant business in the next few years. Get into Aviation. Study at home in your spare time for a well-paid job with a real future. Mail the coupon for my free book today.

Walter Hinton, Pres.
Aviation Institute
Washington, D. C.

FREE FLIGHT

"Give her the gun!"
You're off! Yes siree, as soon as you complete my course, I arrange a free flight for you at an accredited air field. It doesn't cost you a penny. It is my graduation present to you.

These Men Made Good With My Training

\$75 a Week as Instructor



Robt. N. Dobbins, a Hinton graduate, writes: "I cannot thank you enough for the assistance you gave me in getting my present position. Last week they promoted me to Chief Instructor, at a big salary increase."

Training Gives Quick Results



"I received a call from the manager of a nearby airplane factory, who understood I was taking your Course and asked if I would accept a position as chief mechanic and in his absence, act as manager." Edward F. Dick, 2203 Tuscarawas St., West Canton, Ohio.



Mail Now for Facts

Mr. Walter Hinton, President 901-A
Aviation Institute of U. S. A., Inc.
1115 Connecticut Avenue, Washington, D. C.

Please send me a Free copy of your book, "Wings of Opportunity," telling all about my opportunities in Aviation, how you will train me at home for them.

Name
(Print clearly)

Address Age....

City State.....

**Start \$1260 to \$2100 a Year
PICK YOUR JOB
MEN, BOYS — 18 to 50**

Many Winter Examinations Expected

Railway Postal Clerks get \$1,900 the first year, on regular, being paid on the first and fifteenth of each month. \$79.17 each pay day. Their pay is quickly increased, the maximum being \$2,700 a year. \$112.50 each pay day.

Railway Postal Clerks



3 Days On—3 Days Off—Full Pay

Railway Postal Clerks, like all Government employees, have a yearly vacation of 15 working days (about 18 days). On long runs, they usually work 3 days and have 3 days off duty or in the same proportion. During this off duty and vacation their pay continues just as though they were working. They travel on a pass when on business and see the country. When they grow old, they are retired with a pension.



City Mail Carriers, Post Office Clerks

Clerks and Carriers now commence at \$1,700 a year and automatically increase \$100 a year to \$2,100 and \$2,300. They also have 15 days' paid vacation.

Customs and Immigrant Inspector

Start \$2100 a year. Men 21 to 45. Work connected with examining immigrants and merchandise entering the country from foreign ports.

Winter Examinations Expected

The Government has announced that old lists of eligibles will be replaced. Many Winter examinations are expected.

Get Free List of Positions

Fill out the coupon. Tear it off and mail it today—now, at once.

This investment may result in your getting a life big-paid Government job.

FRANKLIN INSTITUTE, Dept. L-174, Rochester, N. Y.

Rush to me entirely free of charge (1) a full description of the position checked below; (2) Free Copy of 32-page book, "How to Get a U. S. Government Job"; (3) A list of U. S. Government Jobs; (4) Tell me how to get a Government Job.

- Railway Postal Clerk.....(Start \$1900 year)
- Post Office Clerk.....(Start 1700 year)
- City Mail Carrier.....(Start 1700 year)
- Office Clerk—File Clerk.....(Start 1260 year)
- Inspector of Customs.....(Start 2100 year)
- Immigrant Inspector.....(Start 2100 year)
- Liquor Gauger.....(Start 2000 year)

Name

Address

Use This Coupon Before You Mislaid It

SHOES LIKE NEW
As Low As **2 C A Pair**

PAYS YOU UP TO \$2.00 IN AN HOUR

SAV-AN-UPPER — Sensational new discovery — completely covers scuffed, discolored and faded uppers of any shoes with wear-proof, highly polished coating. Makes them look new. Quick, easy, economical. Takes only a minute. **Guaranteed.**

JUST BRUSH IT ON! Absolutely new and different. Gives glossy, good-looking, long-wearing, crack-proof finish to shoes and leather articles. **FREE SAMPLE** — Men and women representatives making tremendous profits. Unlimited demand. Write today for free sample that proves all claims, and territory offer. Send no money.

SAV-AN-UPPER CO., Dept. E-72, Cincinnati, O.

Electrical Refrigeration

Big new field — one of few that prospered during depression — offers well-paid jobs with a future to men trained in selling, installing, and servicing. Thousands of new units being sold and installed in homes, stores, offices, plants, etc. Home study will fit you for good job in 6 to 12 months. Employment service included. Send TODAY for Free Bulletin. No obligation.

American School, Dept. ER145, Drexel at 58th, Chicago

You Can Regain Perfect Speech, if you STAMMER

Send today for beautifully illustrated book entitled "DON'T STAMMER," which describes the Bogue Unit Method for the scientific correction of stammering and stuttering. Method successfully used at Bogue Institute for 33 years—since 1901. Endorsed by physicians. Full information concerning correction of stammering sent free. No obligation. **Benjamin N. Bogue, Dept. 150, Circle Tower, Indianapolis, Indiana.**

Anyone CAN LEARN

No talent or experience necessary. Fascinating work. Pays Big Money. Complete instruction book tells about: Alphabets, Colors, How to Make Points, Show Cards, Window Board and Wall Signs, Handy made letters, Gliding, Tricks of the Trade, also gives 100 Alphabets and Designs. Book bound in flexible imitation leather-gold edges, and four full bearing Show Card Pens. Sent postpaid \$3.00 (C. O. D.) 10c extra.

Ogilvie Pub. Co., 57 Rata St., Dept. 20, N. Y. City

EARN MONEY IMMEDIATELY—WE FURNISH EQUIPMENT TO START!!

PERFECT VOICE EXPRESSION

Beauty and power of perfect voice expression will be yours if you develop and strengthen your vocal organs.

100% IMPROVEMENT GUARANTEED

Our method is not an experiment but an exact science, explained in clear, simple manner that will enable you to make use of all the vocal power nature has given you. Solve your voice problem whether it is a defect in speech—your speaking voice—or lack of progress in your vocal studies. Taught by mail.

Voice Book Explaining Perfect Voice Method Sent on Request.—Learn the true possibilities of your voice. Find out about this guaranteed voice course. Entire tuition refunded if you are not satisfied.

**PERFECT VOICE INSTITUTE, Studio 93-51
308 No. Michigan Ave., Chicago, Ill.**

Finger Print Experts Get Jobs and Rewards!

You can now enter this established, young and swiftly-growing finger print profession offering genuine opportunities for a steady monthly salary, as well as sharing in Rewards. Trained men are being hired at substantial salaries with the opening of each new Identification Bureau by governments, states, cities, detective agencies, corporations and private organizations. Think of your future—investigate this opportunity for Success. Write for Free details. **Institute of Applied Science, 1920 Sunnyside Av., Dept. 30-11 Chicago.**

When writing please mention Popular Mechanics

LEARN RADIO FROM REAL RADIO ENGINEERS



HERE THEY ARE:

Dr. C. M. Blackburn,
Chief Radio Engineer,
Griesby-Grunow Company
(Majestic).
Kendall Clough, Chief Engineer,
Clough-Brengle Co. (Radio En-
gineers and Manufacturers).
Karl Hassel, Chief Engineer,
Zenith Radio Corporation.
Homer Hogan, Gen. Manager,
Radio Station WYW, Chicago.
R. MacGregor, Service Manager
and Sales Engineer,
Transformer Corporation of
America (Clarion).
H. C. Tittle, Chief Radio Engr.,
Stewart-Warner Corporation.
F. D. Whitten, Service Manager
Chicago Plant,
Philo Radio and Television Cor-
poration.



LET THESE ENGINEERS RIGHT FROM THE HEART OF THE BIG RADIO INDUSTRY Train You at Home for

GOOD PAY RADIO WORK

MANY R-T-I TRAINED MEN
MAKE \$35 TO \$75 A WEEK

If you're dissatisfied with small pay—work that's getting you nowhere—lay-offs and uncertain income—here's an opportunity that's too good to miss. At the cost of only the time it takes you to mail the coupon, you can get my big FREE book, "RADIO'S FUTURE AND YOURS." This book tells how you can learn at home to make more money almost at once in Radio—whether you want to make Radio your life's work, or use it to pick up an extra \$5 to \$20 a week in your spare time.

"RADIO IS GROWING BY LEAPS AND BOUNDS"

says *Radio Craft Magazine*. It has forged ahead even in depression years. Where only a few hundred men were employed a short time ago, thousands are employed today. Where a few years ago a hundred jobs paid \$35 to \$75 a week—there are thousands of such jobs today. And more new jobs being created all the time—full time jobs and spare time jobs. Get my book and see how easy it is to learn at home for this good-pay work.

R-T-I TRAINING IS "SHOP TRAINING" FOR THE HOME

It comes to you right from the Radio Industry—right out of the factories where Radio sets and other vacuum-tube devices are made. It was planned and prepared for you by big radio engineers IN these factories, most of whom are the Chief Engineers of these great Radio plants. And NOW these same engineers are actually supervising R-T-I Training. Which means that trained the R-T-I way, you'll be trained as the Radio Industry wants you trained—just as the Radio Industry, itself, would train you if it was doing the job.

4 BIG WORKING OUTFITS INCLUDED

These are probably the biggest and most expensive Working Outfits ever included with a home-training Course. You use them to build up testing equipment—to experiment with—to do actual Radio work. It's Shop Training for the home.

SOUND PICTURES, P. A. SYSTEMS, PHOTO CELLS, TELEVISION, ETC. ALL INCLUDED

Radio service work is just the starting point in R-T-I Training. From there we take you up through the very latest developments in Radio, and then on into the new and larger field of Electronics—Sound Pictures, Public Address Systems, Photo Cells, and Television. This feature alone makes R-T-I the outstanding home training in Radio.

YOU GET "QUICK RESULTS"

C. E. Head, 431 Third St., Alexandria, La., says: "Made my first money 11 days after starting your training—cleared \$14.25."

Frank E. Klemann, Lisle, Ill., writes: "Doubled my pay in less than six months."

Harry L. Stark, Ft. Wayne, Ind., writes: "Now making three times as much money as I was when I started your training."

AGE OR LACK OF EDUCATION NO HANDICAP

You don't have to be a high school graduate. It isn't necessary that you should have finished the grades. My Training in Radio is so simple, so easy, and so practical, that it offers every man, regardless of age, education, or previous experience, the chance to get out of a small-pay, no-future job, into good pay, big future work in Radio.

YOUR MONEY BACK IF YOU ARE NOT SATISFIED

That's my way of doing business. And I'll give you that agreement in writing—an agreement to refund every penny of your tuition if, on completion of my Training, you are not entirely satisfied. INVESTIGATE! Learn why R-T-I Training is different. Find out why R-T-I Trained men get "Quick Results" and "Big Results." Send today for my big book "Radio's Future and Yours." The book is free. Ray D. Smith, President Radio & Television Institute, Chicago

"We OK Radio and Television Institute home training"

say these **30 LEADING RADIO MANUFACTURERS**

and they are talking to **YOU**

AMERICAN TELEVISION APPARATUS DESIGN COMPANY
ARCTURUS TUBES
BALKEIT • BRUNSWICK
CAPEHART
CLOUGH-BRENGLE CO.
CROSLY • DeFOREST • FADA
ERIE RESISTOR CORPORATION
HAMMARLUND • HICKOK
HOWARD
INTERNATIONAL RESISTANCE CO.
KEN-RAD • KOLSTER • LYRIC
MAJESTIC • MUTER CO.
NATIONAL UNION RADIO CORP.
PHILCO
RADIO PRODUCTS CO.
SANGAMO ELECTRIC
SENTINEL • STEWART-WARNER
SILVER-MARSHALL MFG. CO.
STANDARD TRANSFORMER CORP.
STROMBERG-CARLSON
UNIVERSAL MICROPHONE
ZENITH



MAIL COUPON FOR MY FREE BOOK

Get your copy of "Radio's Future and Yours" today. It tells you about Radio's amazing opportunities. It describes my Course. It tells what R-T-I students are doing and making. It's FREE. Clip, sign and mail coupon RIGHT NOW!

Ray D. Smith, President
RADIO AND TELEVISION INSTITUTE (R-T-I)
2130 Lawrence Ave., Dept. 11,
Chicago, Ill.

Without obligation of any kind please send me a copy of "Radio's Future and Yours." I am interested in your home training and the opportunities you say exist in the great field of Radio for the R-T-I Trained men.

Name.....
Address.....
City..... State.....

"I Won't Be a Bookkeeper Any Longer"



how training helped A. C. Moore become a Public Accountant

For nearly 15 years A. Claude Moore sought a job with a future—doing clerical and bookkeeping work beneath his ability, cheerfully accepting salaries that were not satisfactory. Then he found it—an accounting position with a large rubber company. A bright future before him, if—

—if he prepared. The chance of a lifetime if he didn't miff it! He took no chances—he enrolled with LaSalle for home-study training in Higher Accounting.

And here's what happened: within a year he was made Chief Accountant of this two million dollar company. As Mr. Moore writes us, "Through the knowledge gained from studying your course and the splendid letters of counsel from your faculty my services had become so valuable that my salary was increased over 500%." Other honors followed. He was later made Assistant Secretary and Treasurer of his company—elected Secretary of a Finance Company, elected to the Advisory Board of the city's leading bank.

Today Mr. Moore's services are devoted to Public Accounting in the Atlas Building, Columbus, Ohio, and he is auditing for some of the largest manufacturing, finance, wholesale and retail companies in Ohio. To you and to all others who want to get ahead he advises: "At all times I unhesitatingly recommend LaSalle's course in Higher Accounting to those who want to progress rapidly in the business world, and are willing to work for it."

Have YOU Looked Into Higher Accounting?

Would you like to see if you could qualify for the \$3000—\$5,000—\$10,000 a year Accounting jobs? The coupon below will bring you two books that tell you not only what your prospects are but also the quickest way to prepare for them. Men advance fast in Accounting because it is the key to outstanding opportunities in business—and that's as true today as it was in 1929. The need for men who know business finance knows no depression. Surely if you want quick advancement, you should consider Accountancy—and especially look into the training that has prepared so many men for success in that field.

You don't need previous accounting experience or education. All that is required is normal ability and your will to succeed. We will do the rest. If you have that determination mail the coupon below—now.

LaSalle Extension University

The school that has trained over 1,150 C.P.A.'s

Dept. 164-HR Chicago

Please send me a copy of "Accountancy, the Profession that Pays," without obligation.

Higher Accountancy

Other LaSalle Opportunities:

LaSalle opens the way to success in every important phase of business. If more interested in one of the fields indicated below, check and mail now.

- | | |
|--|--|
| <input type="checkbox"/> Business Management | <input type="checkbox"/> Expert Bookkeeping |
| <input type="checkbox"/> Modern Salesmanship | <input type="checkbox"/> C. P. A. Coaching |
| <input type="checkbox"/> Traffic Management | <input type="checkbox"/> Business Correspon. |
| <input type="checkbox"/> Banking and Finance | <input type="checkbox"/> Business English |
| <input type="checkbox"/> Law—Degree of LL. B. | <input type="checkbox"/> Food Chain Store Management |
| <input type="checkbox"/> Commercial Law | <input type="checkbox"/> Stenotypy |
| <input type="checkbox"/> Industrial Management | <input type="checkbox"/> Paper Salesmanship |
| <input type="checkbox"/> Personnel Management | |



Name

Present Position

Address

When writing please mention Popular Mechanics

BE SENSIBLE

LEARN the Barber Trade



THE COMMON SENSE THING ABOUT LEARNING THIS WORK BY

Moler's New Plan

Is The Absolute Assurance of Success

The New Plan has made a wonderful business of this Industry. It has created unusual jobs in addition to regular shop work—Traveling Demonstrators—Barber Science Teachers—State Vocational Instructors and other positions not possible under the old method.

Can earn living while learning. Tools given. Write Branch nearest for Booklet B explaining the MOLER SPECIAL THIS MONTH.

MOLER SYSTEM OF COLLEGES

A National Institution

- 139 E. 23rd St., New York, N. Y.
- 59 E. Monroe St., Chicago, Ill.
- 810 N. Sixth St., St. Louis, Mo.
- 43½ Peachtree St., Atlanta, Ga.
- 81 S. Second St., Memphis, Tenn.
- 748 Prospect Ave., Cleveland, O.
- 111 W. Fifth St., Cincinnati, O.
- 839 N. Water St., Milwaukee, Wis.
- 1302 Douglas St., Omaha, Nebr.
- 1106 Canal St., New Orleans, La.
- 559 Michigan Ave., Detroit, Mich.

RADIO ENGINEERING

RCA Institutes offers an intensive course of high standard embracing all phases of Radio. Practical training with modern equipment at New York and Chicago schools. Also specialized courses and Home Study Courses under new "No obligation" plan.



Illustrated Catalog on request.

RCA INSTITUTES, INC. Dept. PC-35

75 Varick St., New York 1154 Merchandise Mart, Chicago
Recognized Standard in Radio Instruction Since 1929



GET A COLLEGE DEGREE in ENGINEERING

Special Section for mid-winter High School Graduates starts Feb. 4, 1935. Full freshman year in 6 months. Enter in the Fall of 1935 as sophomore. L. I. T. offers fully accredited degrees in all branches of Engineering. Complete, modern equipment. All college activities. Low tuition. Write Registrar today, for catalog and full information.

LAWRENCE INSTITUTE OF TECHNOLOGY
15102 Woodward Ave., Detroit, Mich.

FREE CATALOG

LEARN AUTOS and DIESELS IN LOS ANGELES

Enjoy delightful winter in California. Learn all branches Auto Repairing and High Speed Diesel operation. Trained men in demand. We teach you to qualify for good jobs. Practical shop work. Most modern million-dollar school. Big staff, individual instruction. Oldest, largest trade school in West. Est. 1905. Earn room and board while learning. Free employment service. Mail coupon for FREE BOOK.

Special Offer: Coach railroad fare allowed to L. A. from any part of U. S.

National Automotive School, Dept. 1-PMA, 4006 S. Figueroa St., Los Angeles
Send Free Book and Details of Auto-Diesel Course.

Name

Address

City

State

THIS FREE BOOK IS FOR INVENTORS

AND OTHER MEN WITH IDEAS

C. F. KETTERING

Vice Pres., General Motors,
Says This about Invention



In statement in Good Housekeeping Magazine, Charles F. Kettering, who helped develop the self-starter, Duco, and other important inventions, said: "Our return to normal times depends on new manufactured products that will catch the purchaser's eye, get him to buy and start the ball rolling. Change and buying go together. We're only entering the great period of inventive advancement."

MANY LITTLE IDEAS HAVE BIG COMMERCIAL POSSIBILITIES

SOME of the world's best inventions came from men who didn't consider themselves inventors at all. The telegraph was invented by a painter, the typewriter by a farmer; a bank clerk the hand camera, a dentist the stock ticker. Or look at small inventions. A husband noticed his wife bending a hair pin to make it stay put. That gave him the idea of the crinkly hair pin. One day a golfer got the idea to make a wooden tee. Now wooden tees are sold by the millions every year. There are many similar examples in inventive history. That is why we say that the book shown here is for INVENTORS and Other Men with IDEAS. Whether you consider yourself an inventor or not—if you have an idea that will make money, save time, save labor, or give pleasure—you should find out how you can protect your rights to it. And this interesting, FREE book, PATENT PROTECTION, will tell you.

OUR BUSINESS IS TO HELP INVENTORS

For thirty-five years, this organization has been in the business of helping inventors. During that time inventions from every corner of the country have been turned over to us to protect. Some ideas have represented complicated mechanisms; others have been small, practical articles, like a can opener or a new toy. All this has given us a wealth of experience to use for the inventor of today. Here in Washington, we maintain a large staff of experienced Patent Specialists to give you prompt and expert service. Yet because we work efficiently—our fees are low; and if desired we help you with deferred payments.

DELAYS MAY BE COSTLY— WRITE US TODAY

In inventive matters, delays can prove serious. Frequently two or more inventors work on the same idea without each other's knowledge. And the Patent Office Rules tend to favor the man who gets his Patent Application on file first. YOUR VERY FIRST STEP is to find out exactly what to do to protect yourself. Decide to do that today by sending for your FREE copy of PATENT PROTECTION.

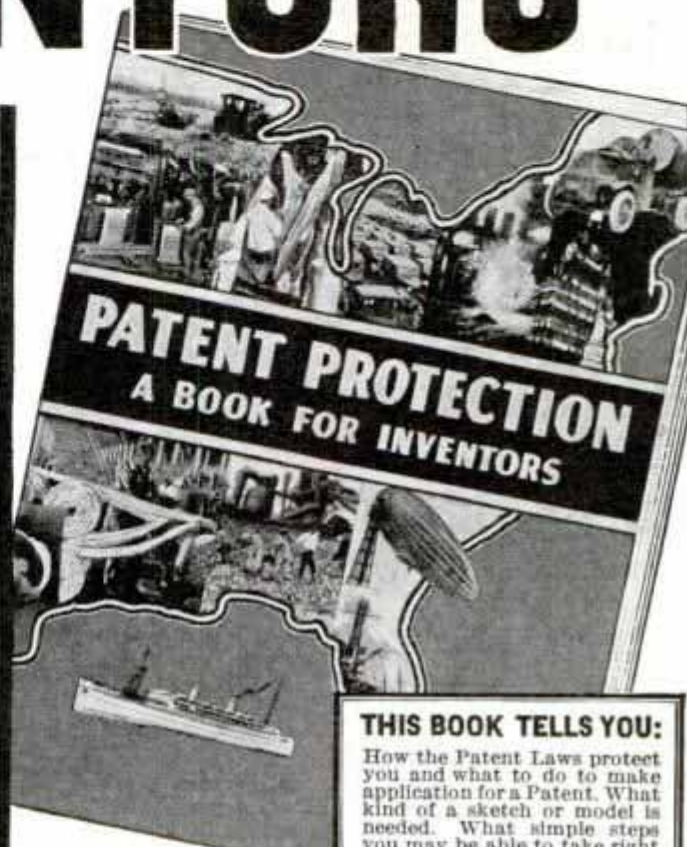

THIS BOOK TELLS YOU:

How the Patent Laws protect you and what to do to make application for a Patent. What kind of a sketch or model is needed. What simple steps you may be able to take right away to claim your right to your idea.

How some successful inventors have secured financial assistance. Tells you about interesting inventions that have proved successful and illustrates important mechanical principles and gives many other interesting facts. The very same day we hear from you—a free copy of PATENT PROTECTION will be placed in the mail to you. Sign and send the coupon. Get that much done today.

IMPORTANT

With this interesting book, you will also find an "Evidence of Invention" form, which makes it easy for you to sketch and describe your idea as a matter of record. This is an important step. Write us in confidence. The book will tell you how to use this record and why. It also comes to you without any charge or obligation.

Mail Today to WASHINGTON, D.C.

VICTOR J. EVANS & CO.

Main Office: 500-A, Victor Building,
WASHINGTON, D. C.

Other Offices: 1640 N Conway Building, Chicago—1007 N Woolworth Building, New York — 514 N Empire Building, Pittsburgh—1010 N Hobart Building, San Francisco — 736 N Security Building, Los Angeles.

I am interested in your book, PATENT PROTECTION and your Evidence of Invention form. Please send both of them FREE and without obligation on my part.

Name.....

Street and No.....

City or Town.....State.....

(Be sure to write or print name carefully)

RADIO

● holds great rewards for trained men



Almost in a decade radio has become a giant industry. The opportunities created will be enjoyed by trained men. The International Correspondence Schools Radio Course, prepared by leading authorities and constantly revised, will help make you a trained man! A fascinating book—FREE.

ELECTRICAL ENGINEERING

—A Great Industry with a Great Future

The new course in Electrical Engineering covers this fascinating field thoroughly. If you are just starting or are partly on the way to a real paying position in this industry, this new course brings the broader knowledge necessary for advancement. The coupon brings complete information.



MECHANICAL ENGINEERING

—A Field with a Future



This course has meant advancement to hundreds of ambitious men, mechanics, draftsmen, blacksmiths, foundrymen, patternmakers, apprentices, and mechanical engineers—men who wanted to get ahead and to earn more money. You will find, as they have found, that enrolling for an I. C. S. Course is an investment in a Bigger Future. Use the coupon!

AUTOMOBILE EXPERTS

are always in demand

The rapid progress in manufacture and service of the modern automobile brings new opportunities to thousands of ambitious and forward-looking men. There's always a demand for trained men. The new I. C. S. Automobile Course will make you a trained man! The time to act is now. Use the coupon.



INTERNATIONAL CORRESPONDENCE SCHOOLS
BOX 5546-H, SCRANTON, PENNA.
 Without obligation, send me full information on subject checked below:

RADIO AUTOMOBILE COURSE
 ELECTRICAL ENGINEERING
 MECHANICAL ENGINEERING

Architecture Drafting Accounting
 Concrete Construction Good English
 Reading Shop Blueprints Salesmanship
 Civil Engineering Advertising
 Diesel Engines Show Card Lettering
 Gas Engine Operating Civil Service
 Refrigeration High School Subjects
 Chemistry Air Conditioning
 Highway Engineering Inventing and Patenting
 Poultry Farming Aviation Engines

Name _____
 Address _____

When writing please mention Popular Mechanics

LINCOLN-TRAINED MEN

are Finding Good Pay Jobs in AVIATION



LINCOLN graduates are in demand. A recent report from our employment department lists ten more of our graduates who have obtained good jobs among prominent concerns in the aviation industry. These and many others have found profitable employment in aviation after completing their training in this world's best known school. This school is constantly in touch with the aviation industry, with a view of placing its graduates in trusted positions. No guess-work about your getting proper training at LINCOLN. Only modern high class training planes with Dept. of Commerce approval are used. Training given for government license as Transport, Limited Commercial, Private or Amateur Pilot. Ground and mechanics school with experienced instructors qualify you as Master Airplane and Engine Mechanic. Government Approved School. 24 years' experience as successful mechanics trade school; 14 years successfully teaching aviation. Write now. State age. LINCOLN AIRPLANE & FLYING SCHOOL, 200-E Aircraft Bldg., LINCOLN, NEBR.

Be a DENTICIAN

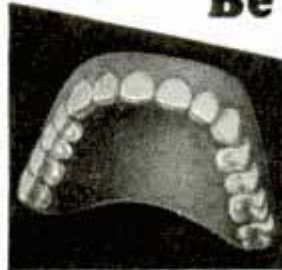

Learn at home to make Crowns, Plates, Bridgework, etc., for Dentists. Easy, practical way to learn mechanical dentistry at home in spare time. Full equipment of tools and materials included with course FREE. Low tuition. Easy terms. Write for FREE BOOK about this money-making profession that is not affected by "machine age."

McCARRIE SCHOOL OF MECHANICAL DENTISTRY
 207 N. Broad St., Dept. 606, Philadelphia, Pa.



BE A RAILWAY TRAFFIC INSPECTOR

WRITE TODAY

THIS CAN EASILY BE YOUR "BIG OPPORTUNITY"

TRAINED MEN—19 to 50—are constantly in demand by Railway and Bus Companies for Passenger Traffic Inspection work. Our short, home-study course quickly qualifies you for a position at up to \$140 per month, plus expense, to start. For 16 years we have helped secure positions for our graduates on refunded tuition. Rapid advancement with experience. Free Booklet describes our record. STANDARD BUSINESS TRAINING INSTITUTE
 Div. 201 Buffalo, N. Y.

FREE BARGAIN BOOKS

CATALOG OF BOOKS

25,000 Titles
 Our 40th Annual 320 Page Bargain Catalog of Books of all Publishers—Literature, Fiction, Juvenile, History, Scientific, etc. Illustrated, Indexed. Old favorites—new "best sellers."

Used by schools, colleges, libraries and thousands of individual customers. Write today for new 1935 catalog, "Bargains in Books."

THE BOOK SUPPLY COMPANY, Dept. 125
 564-566 West Monroe St., Chicago, Illinois

LEARN WATCHMAKING AND ENGRAVING

BY OUR PROFIT-SHARING PLAN
 OUR GRADUATES SUCCEED

One of our Iowa students started in a very small way—now doing over \$30,000 a year. Another in Wisconsin, over \$10,000 the first year. Day or night classes. Call or write for FREE BOOK. Chicago School of Watchmaking, Dept. 2301, 155 N. Clark St., CHICAGO.

GOV'T. JOBS

SALARY TO START \$105 to \$175 MONTHLY MEN WOMEN Age Range 18 to 50

- () Ry. Mail Clerk
- () P. O. Laborer
- () R. F. D. Carrier
- () Special Agent
- () Customs Inspector
- () City Mail Carrier
- () P. O. Clerk
- () Matron
- () Immig't Inspector
- () Typist
- () POSTMASTER
- () Seamstress
- () Auditor
- () Stenographer
- () U.S. Border Patrol
- () Telephone Opr.
- () Watchman
- () Skilled Laborer
- () Statistical Clerk
- () File Clerk

OZMENT INSTRUCTION BUREAU, Dept. 111, St. Louis, Mo. Send me FREE particulars "How to Qualify for Government Positions" marked "X". Salaries, locations, opportunities, etc. ALL SENT FREE.

Name _____
 Address _____

Wrestling Book

Learn at Home

FREE



Be an expert wrestler. Learn at home by mail. The greatest wrestlers of all, Frank Gotch and Farmer Burns, both world's champions have prepared the most wonderful course of lessons ever written on Physical Culture and Expert Wrestling. Be strong and healthy! Handle big men with ease. This great free book tells you how. Don't delay. Write now. State your age. Farmer Burns School, 3371 Elwood Bldg., Omaha, Neb.

Clean Air—Temperature and Humidity Control



Increasing demand for heating and ventilating engineers, builders, and salesmen trained in air conditioning offices, stores, theatres, homes, factories, coaches, etc.

Real opportunity to get in on ground floor of this fast-growing industry and grow up with it. Thorough home-study training in 6 to 12 months. Send TODAY for Free Bulletin. No obligation. American School, Dept. AC145, Drexel at 58th, Chicago

CARTOON YOUR WAY TO SUCCESS!



DON'T COPY — LEARN TO ORIGINATE!

RAYE BURNS will teach you HOW to CREATE ORIGINAL CARTOONS at home that you can SELL! Course contains 26 lessons and over 600 illustrations. All for Only... \$2.85

RAYE BURNS SCHOOL, Dept. M-X, BOX 2194, Cleveland, Ohio

SKINNY? NEW WAY ADDS POUNDS QUICK

Thousands have put on 5 to 15 lbs. in a few weeks with pleasant little Ironized Yeast tablets. Results guaranteed with first package or no cost. At all druggists.



Greater opportunities now in advertising. Learn easily and quickly in spare time. Practical work. No text books. Old established school. Low tuition—Easy terms. Send for free booklet of interesting information.

Page-Davis School of Advertising Dept. 1351, 3601 Mich. Ave., Chicago

RADIO

ENGINEERING, broadcasting, aviation and police radio, servicing, marine and Morse telegraphy taught thoroughly. Ninemonths' engineering course equivalent to three years' college radio work. School established 1874. All expenses low. Catalog free.

Dodge's Institute, Ada St., Valparaiso, Ind.

NEW YORK SCHOOL OF MECHANICAL DENTISTRY

★ ★

Become a TRAINED Dental LAB Technician. We show you how! Oldest school. Practical training. Day, Eve. Easy terms. Tools FREE. Ask for Catalog P. N. Y. SCHOOL of MECHANICAL DENTISTRY, 125 W. 31 St., N. Y. C.

Amazing New Automatic Oil Burner

SAVE 25% in Fuel Cost



Get Free Book, Special Offer!

LACO'S great new 1935 Automatic oil burner now yours for **WORLD'S LOWEST PRICE!** Saves you \$50 to \$80! Reduces fuel costs 25%! Gets more heat from cheapest oil. Quiet. Safest known. Only 1 moving part. Easy to install. Built and guaranteed by one of largest Mfrs. Approved by Underwriter's Lab. Over 15,000 in use prove it's America's finest!

Write! Send for Low Price... No-Risk, Trial-Offer plan. See how easily you can own this fine oil burner. Send NOW!

Laco Oil Burner Co., 115 Union Ave., Griswold, Ia.

I'll ship you a sample burner, on approval, subject to examination, no obligation. Write on letter-head for my plan. L. A. COCKLIN, Pres.

LEARN AUTO MECHANICS

in 8 weeks!

Earn \$35 to \$75 a week as an Auto Mechanic. Never in the history of the automotive business has there been such a demand for TRAINED men. 8 weeks training fits you for a job that's waiting for you or to open your own repair shop. Read what two McSweeney trained men have done. Hundreds of others can tell you facts equally interesting. Don't look for a job! TRAIN for it!

Farrell, Pa.
Dear Mac: Please forward me your catalog. I want it to add to my traveling souvenirs. I am working in a modern garage although I have been out of school only four weeks, thanks to McSweeney Training. My best regards to all. M. Klushauk

Rector, Ark.
Dear Mac: Just a few lines which might interest you. I left your school two years ago last May. Since I left I have not seen a day I could call "hard times." I have been working ever since I left and have averaged in my earnings \$173.00 a month, in spite of the hard times. Many thanks. Thos. J. Sharp

EIGHT WEEKS of Actual Shop Training

No books or lessons the McSweeney way. First you learn the "why" of everything you do; then under competent instructors, you DO the job. You work on real equipment and machines, with the real tools of the auto expert. In eight short weeks you are TRAINED to hold down a permanent BIG PAY job. Any man 16 to 50 can learn. Write today for New Low Tuition Offer.

AVIATION GROUND COURSE

Aviation is coming and coming fast! Prepare now for the wonderful opportunities of the future. Each plane needs many mechanics on the ground.

MONEY BACK GUARANTEE!

In eight weeks of intensive training; actual shop work with real tools on real equipment; you will be qualified to accept a Big Pay Job as an Auto Mechanic. If you are not satisfied with your qualifications, your tuition will be refunded.

FREE Write today for Big Free Book on AUTOS. Get the facts about jobs; and Low Tuition Offers. Mailing the coupon does NOT obligate you. It obligates ME to tell YOU how you can train for Big Money in eight short weeks. Address Dept. 10-13

McSWEENEY SCHOOLS

AUTOMOBILE — AVIATION

CLEVELAND, OHIO or KANSAS CITY, MO.

Write Our School Nearest You

McSweeney Auto and Aviation School, Dept. 10-13, Cleveland, Ohio or Kansas City, Mo.

Without cost or obligation, send me your Big FREE Book on Autos; also full information about your low tuition offer.

Name.....

Street.....

Town..... State..... Age.....

Okmulgee, Okla.
Hazelton, Pa.

Des Moines, Iowa
Sioux City, Iowa



Look Men!

Here's a Partial List of States, Cities and Institutions in which GRADUATES of I. A. S. were placed in positions as Finger Print Experts!

Be A Secret Service and Identification Expert!

State of Wash.
State of Michigan
State of Utah
State of Ohio
Duluth, Minn.
Detroit, Mich.
Pueblo, Colo.
Idaho Falls, Idaho
Ogden, Utah
Lorain Co., Ohio
St. Paul, Minn.
Pittsburgh, Pa.
Lincoln, Nebr.
Birmingham, Ala.
Columbus, Ohio
Havana, Cuba
New Haven, Conn.
Great Falls, Mont.
Galveston, Texas
Pensacola, Fla.
Stillwater, Okla.

Calgary, Alta., Can.
Houston, Texas
Waterloo, Iowa
Victoria, B. C.
Baton Rouge, La.
Atlantic City, N. J.
E. Lansing, Mich.
Globe, Arizona
London, Ont., Can.
Henryetta, Okla.
Seattle, Wash.
Ferndale, Mich.
McAlester, Okla.
Negaunee, Mich.
Lawton, Okla.
Crown Point, Ind.
Bay City, Mich.
Roanoke, Va.
Glendale, Calif.
Hawaiian Islands
Drumright, Okla.

Miami, Florida
Orlando, Florida
York, Pa.
El Paso, Texas
Everett, Wash.
Schonectady, N. Y.
Alhambra, Calif.
Livingston, Mont.
Saginaw, Mich.
Fort Collins, Colo.
Bedford, Ohio
Huntington, W. Va.
Salt Lake City, U.
Taft, California
Jamestown, N. Y.
Phoenixville, Pa.
Rochester, N. Y.
Media, Pa.
Dayton, Ohio
East Chicago, Ind.
Green Bay, Wis.
Nocona, Texas
Noenah, Wis.
Kingfisher, Okla.
Centralia, Wash.
Bismarek, N. D.
Bloomington, Ind.
Cuyahoga Falls, O.
Rock Island, Ill.
Philadelphia, Pa.
Astoria, Oregon
Pendleton, Ind.
St. Joseph, Mo.
State of Illinois
State of Iowa
State of Idaho
State of Colorado
Lima, Ohio
Selma, N. C.

Want a Regular Monthly Salary?

Investigate this opportunity to earn a regular monthly salary and share in Rewards—the same opportunity which appealed to those hundreds of Institute of Applied Science Graduates now holding positions in the partial list of States, Cities and Institutions shown here. And one to fifteen I. A. S. Graduates are employed on regular monthly salaries by each bureau listed. Be a Finger Print and Secret Service Operator! Write for Free details how you can train at home in spare time to enter this young, swiftly-growing profession.

FREE The Confidential Reports Operator No. 38 Made to his Chief!

Write or send coupon for Free Reports and Illustrated Finger Print Book . . . the same information requested by hundreds of I. A. S. graduates now earning a monthly salary!

**Institute of Applied Science, Dept. 13-51
1920 Sunnyside Ave., Chicago, Ill.**

Gentlemen:— Without any obligation on my part whatever, send me the Reports of Operator No 38, also your Illustrated Free Book on Finger Prints and your low prices and Easy Terms Offer. Literature will NOT be sent to boys under 17 years of age.

Name.....
Address..... Age.....

Law!

LEARN AT HOME

Are you adult, alert, ambitious, willing to study? Investigate LAW! We guide you step by step—furnish all texts, including 14-volume Law Library. Training prepared by leading law professors and given by members of bar. Degree of LL. B. conferred. Low cost, easy terms. Send NOW for Free, 64-page "Law Training for Leadership."

LaSalle Extension University, Dept. 164-L, Chicago

LEARN WATCH REPAIRING



AT HOME You can learn by our modern and original system of instruction every part of the Watch Repairing Trade at home as good or better than at a shop. You can earn money while earning and secure a well paying position or start in business after completing our course of instruction. Good watch repairers are always in demand and earn very good salaries. For particulars apply to the Wisconsin School of Watch Repairing 524 E. Mason St., MILWAUKEE, WIS.

ELECTRICAL ENGINEERING

A BROAD, basic, intensive course for men of limited time, complete in one school year. Approved by educators, endorsed by industry. Modern buildings, 41 years' successful experience. Catalog on request.



BLISS ELECTRICAL SCHOOL
131 Takoma Ave., Washington, D. C.

Why VOICE Students Fail

SENT FREE No Obligation to Buy

If you act quick!—we will send postpaid—for 30 days' free reading—new Voice Book disclosing startling VOICE FACTS that may save hundreds of dollars to every man or woman seeking a strong, rich voice for either singing or speaking. 30 days' free reading—then send \$1.00. Otherwise, return it—that's all! PROF. E. FEUCHTINGER Studio 13-51 308 North Michigan Avenue Chicago



Learn Public Speaking

At home—in spare time—20 minutes a day. Overcome "stage-fright" gain self-confidence, increase your salary, through ability to sway others by effective speech. Write now for free booklet, *How to Work Wonders With Words*.

NORTH AMERICAN INSTITUTE, Dept. 1351
3601 Michigan Avenue, Chicago, Illinois



AT HOME!

Learn easy Koehne Method of coloring photos and miniatures in oil. New! No art talent needed. Big demand. Send for free booklet, *Make Money At Home*.

NATIONAL ART SCHOOL
2601 Michigan Ave., Dept. 1351, Chicago

New Ideas now Salable Before Patenting

Inventors wanting to realize on new ideas before patenting, write

Chartered Institute of American Inventors
523A Barrister Building Washington, D. C.
"World's Largest Organization of Inventors"

Every Good Boy Deserves Fun LOOK! Easy as A·B·C to learn music this way



Just see how easy it is! The lines are always E-G-B-D-F. Memorize the Sentence "Every Good Boy Deserves Fun"—and there you are! Whenever a note appears on the first line, you know it is **e**. Whenever a note appears on the second line, you know it is **g**. And the spaces are just as easy to remember. The four spaces are always F-A-C-E. That spells "face"—simple enough to remember, isn't it?

You have learned something already! Isn't it fun? You'll just love learning music this fascinating way! No long hours of tedious practice. No dull and uninteresting scales. No "tricks" or "secrets"—you learn to play real music from real notes.

LEARN BY NOTE

- Piano
- Violin
- Guitar
- Saxophone
- Organ
- Ukulele
- Tenor
- Banjo
- Hawaiian Guitar
- Piano Accordion
- or any other instrument

So clear and simple are these fascinating "music lessons" that even a child can understand them. You do not lose a minute with unnecessary details—only the most essential principles are taught. And at an average cost of only a few pennies a day!

You simply cannot go wrong. Over 700,000 people learned to play this modern way—and found it as easy as

A-B-C. Just read the list of instruments in the panel, decide which one you want to play, and the U. S. School will do the rest.

SEND FOR FREE BOOK

Our wonderful illustrated Free Book and our Free Demonstration Lesson explain all about this remarkable method. Act NOW. Clip and mail this coupon today and they will be sent to you at once. No obligation. U. S. School of Music, 71 Brunswick Bldg., New York City.

U. S. SCHOOL OF MUSIC,
71 Brunswick Bldg., New York City.

Send me your amazing free book, "How You Can Master Music in Your Own Home," with inspiring message by Dr. Frank Crane; also Free Demonstration Lesson. This does not put me under any obligation.

Name.....

Address.....

Instrument..... Have you Instrument?.....

TRI-STATE COLLEGE



B. S. Degree in 2 years. World famous for technical 2-year courses in Civil, Electrical, Mechanical, Chemical, Radio, Aeronautical Engineering; Business Administration and Accounting. Equivalent in technical hours to 4-year course. Those who lack

high school may make up work. Low tuition. Low living costs. Located in picturesque hill and lake region. Students from every state and many foreign countries. 51st year. Enter Sept., Jan., March and June. Write for catalog.

415 COLLEGE AVE., ANGOLA, IND.



Learn to Write

Begin Today. Write for my Free Book, "How to Become a Good Penman." It contains specimens and tells how others learned to write in spare time. Your name elegantly written on a card if you enclose stamp for postage. Write today. **F. W. TAMBLIN, 418 Ridge Bldg., Kansas City, Mo.**

"BECOME A LIGHTNING TRICK CARTOONIST"

Send \$1.00 for Laugh Producing Program of 23 Trick Drawings with Instructions. Catalog of Chalk Talk Supplies Free. **BALDA ART SERVICE, Dept. 1, Oshkosh, Wis.**

5¢ LITTLE BLUE BOOKS

EACH

Send postcard for our free catalogue. Thousands of bargains. Address: **LITTLE BLUE BOOK CO., Catalogue Dept., Desk 423, Girard, Kansas.**

Minstrels

Unique First Parts for complete show with special songs and choruses. Make-up. Catalog Free

T. S. Denison & Co., 623 S. Wabash, Dept. 19 Chicago



WHY NOT

spend spring, summer, fall, gathering butterflies—insects? Profit. Pleasure. I buy hundreds of kinds for collections. Some \$1 to \$7 each. Simple outdoor work with my Instructions, pictures, price-list. First, before sending butterflies, send 10¢ (not stamps) for Illustrated Prospectus.

MR. SINCLAIR, DEALER IN INSECTS
Dept. 6, Box 1424 San Diego, Calif.



AUTO

BOOKS SENT FREE

on approval. Just mail the coupon and we'll send you a set of these remarkable auto books, just off the press. Whether you are a mechanic or helper, expert or apprentice, auto owner or driver, if you're interested in knowing all about automobile mechanics, then take advantage of this FREE OFFER.

DON'T SEND A PENNY!
A better job—in the gigantic auto industry. BIGGER PAY—a chance to go into business for yourself and get a share of the huge profits that are waiting for any man who even half tries to improve himself. Learn Auto Engineering with these wonder books a new way—without studying or memorizing. Simply use the JIFFY INDEX to look up the answer to any auto problem. Built by eleven of America's greatest automobile engineers, and written in simple language so you can understand it.

CAN YOU FIX IT?
These wonder books tell step by step HOW to take out "play" in differential—to kill the shimmy in steering—to set TIMING—how to put your finger instantly on engine trouble and then the quick expert way to FIX it. Newest improvements fully covered. Equal to a complete trade course at less than a fourth the cost.

6 Big Volumes Latest Edition
2500 pages, 2000 illustrations, wiring diagrams, etc., including **Aviation Motors**. De Luxe edition, gold-stamped flexible binding.

FREE! Privilege of consulting Automobile Engineers of American Technical Society for one year without cost if you mail coupon immediately.
If you send NOW we will include an extra volume No. 7 which covers all 1934 car improvements—knee action wheels, streamlining, booster brakes, etc.

AMERICAN TECHNICAL SOCIETY,
Dept. A119, Drexel Ave. & 58th St., Chicago, Ill.
I would like to see the new 6-volume edition of your AUTO BOOKS. I will pay the few cents delivery charges only, but if I choose to, I may return them express collect. If after 10 days use I prefer to keep them, I will send you \$2 and pay the balance at the rate of only \$3 a month, until \$34.50 is paid. Please include free consulting membership and extra Vol. 7 as per your offer above.

Name.....

Address.....
Attach letter stating age, occupation and name and address of employer and at least one business man as reference.

When writing please mention Popular Mechanics



Turns Spare Hours Into Cash!

UP TO \$40 Weekly
In Your Own Home



No soliciting! No canvassing! We show you how to make big money decorating fast-selling Giftwares. We start you with the big \$10 Artist's Outfit shown above. We supply you with \$150 worth of Giftwares free of extra charge and show you how to dispose of them without leaving your home. We give you 29 Tested Plans for making money. One Fireside Member says: "I made \$100 on furniture in one week." Another writes, "My sales were \$500 for 5 weeks. This is my first year." R. M. P., of Ill., says: "I did \$3,500 worth of business last year and over \$12,000 this year." D. W. New Mexico, reports: "I would not take \$1000 for my Course."

No Experience Needed
You too may have a **guaranteed income opportunity** with Fireside. No tiresome study. You learn by doing. No artistic ability necessary. Our easy 3-Step Method makes the work easy to learn and easy to do and fits you to make good money practically from the start.

Quick Sales in Your Home
No need to leave the house to dispose of everything you make. Our new automatic salesman does all the selling for you. Designed to quickly find cash buyers for all the Giftwares you can turn out.

No Cost Plan
Send coupon for details of new plan that pays for your Fireside Course besides putting big cash profits in your pocket. Mail coupon now while openings for new members are still being offered.

FIRESIDE INDUSTRIES
Dept. 66-A, Adrian, Mich.

Fireside Industries,
Dept. 66-A, Adrian, Mich.
Send me **FREE** Book on Home Decorating for a big steady income. Also details of plan that will pay for my Course and give me big profits besides.

FREE!
Book on decorating at home for big money. Tells how to get big assortment beautiful Giftwares free of extra charge.

NAME.....
ADDRESS.....
CITY..... STATE.....

When writing please mention Popular Mechanics

LET THESE GREAT BOOKS HELP YOU TO

Start Your Climb!
the Man who KNOWS is the Man who WINS

Easy to train yourself! These books have helped thousands—

- AIR CONDITIONING**
Live Field; Great Future..... \$4.00
- AUTO ENCYCLOPEDIA**
Dyke's 16th Edition. Recent!..... \$6.00
- 110-V. GENERATORS**
Made From Old Auto Units..... \$1.00
- AUTO TRAILER**
Fun to Tour. Make Your Own..... \$1.00
- BIRD HOUSES**
Build to Sell; Easy Designs..... \$1.00
- BOAT BOOK**
Power, Sail, Rowing, Paddle Plans..... \$3.00
- BOY MECHANIC**
4000 Things to Make. 4 Vols..... \$7.00
- BUILT-IN FURNITURE**
Take Orders, Make Money!..... \$2.50
- CARPENTRY HANDBOOK**
336 Practical Short-Cuts..... \$1.50
- CHEMICAL FORMULARY**
5000 New Formulas..... \$6.00
- CHEMISTRY, PRACTICAL EVERYDAY**
Interesting business, or Life Work..... \$2.00
- CONCRETE WORK**
173 Uses Described, Pictured..... \$1.00
- DOG TRAINING**
Home, Stage, Movies, Etc..... \$1.50
- ENGINEER-CUSTODIANS MANUAL**
Pay Raising Data for Building Superintendents and Others..... \$2.50
- FARMERS' BOOK**
861 Kinks for Field, Home..... \$1.00
- V-8 FORDS**
Also "A" and "B" Models. All New!..... \$2.50
- FROG INDUSTRY**
New! Raise and Sell. Profits!..... \$2.00
- FURNITURE MAKING**
Tools, Materials, Designs..... \$2.50
- GARDEN GUIDE**
Better Results, all Flowers..... \$2.50
- HOW TO DANCE**
Teach Yourself in Private!..... \$2.00
- LATHE WORK (Metal)**
Drilling, Threading..... \$1.00
- LOCOMOTIVE**
Folding Chart Shows all Parts..... \$1.00
- LOG CABINS**
Easy Plans; Build for Profit. Value!..... \$2.50
- MATHEMATICS**
Easy Guide for the Practical Man..... \$1.50
- MECHANICAL DRAWING**
Learn Drafting; Good Salaries..... \$1.00
- MONEY MAKING IDEAS**
1000 Spare Time..... \$1.00
- OCEAN LINER "EUROPA"**
Atlantic Speed Queen; Charted..... \$1.00
- PLUMBING**
500 Facts Every Homeowner Should Know..... \$1.50
- POULTRY**
Breeding, Management. Protect Your Profits..... \$2.00
- PROSPECTORS' HANDBOOK**
How to Mine, Appraise, Equip..... \$3.00
- RADIO**
Amateurs' Handbook; Circuits, Repairs, Etc..... \$1.00
- RADIO SERVICING**
Profit by Knowing Costs, Kinks, Etc!..... \$1.75
- REFRIGERATION SERVICE**
Manual (All Makes)..... \$5.00
- REWINDING ELECTRIC MOTORS**
Fractional Sizes. Value!..... \$2.50
- SHIP MODELS**
Entire Text, Famous "Sovereign" of 1637..... \$1.00
- SHOP NOTES LIBRARY**
8 Vol. 3600 Wonderful Shop Ideas..... \$3.50
- STEEL SQUARE**
How to Figure Angles of Rafters, Roofs, Etc..... \$1.00
- STORAGE BATTERIES**
New! How to Build, Repair, Charge..... \$2.50
- TOYS**
For Amusement or Profit. Saleable Designs..... \$1.44
- UPHOLSTERY**
Always a Big Market. Start Own Business..... \$1.60
- WELDING ENCYCLOPEDIA**
All Methods; Hard Jobs Made Easy..... \$5.00
- WIRING**
Approved Economy Methods for Homes, Buildings..... \$2.50
- WOOD TURNING**
Woods, Tools, Methods; Practical Teacher..... \$1.50
- WOODWORKING SHOP**
Motor-driven. 3 Big Volumes..... \$3.00
- WRIGHT ENGINE**
Chart of "Whirlwind"; All Parts..... \$1.00

Books sent C.O.D. anywhere in U.S.

Just check the books you want, write your name and address below, and mail the advertisement. It is your order blank. When postman hands you books, pay him the price and few cents postage. If outside the U. S. remit when ordering and include 10 cents per book extra for postage. We have many other books on these and 2,000 other subjects. Catalog free.

Name.....
City..... State.....
Address.....

Mail to **Popular Mechanics Press,**
Room Jan. 5—200 East Ontario St., Chicago, Ill.



Licensed Airmen

Pilots and Mechanics wanted for transport and commercial work. You can't fly or service aircraft without U. S. license. Our new Commercial Aeronautics Course prepares you, in short time, to pass pilots' or mechanics' written license examinations. Send TODAY for Free Bulletin. No obligation.

American School, Dept. A145, Drexel at 58th, Chicago

Learn Photo-Engraving at Home

MAKE MONEY Earn money while learning. Large photo-engraving camera, equipped with lens and screen, automatic etcher, and all other equipment furnished. Write for FREE illustrated catalogue and the facts regarding this fascinating profession.

NATIONAL SCHOOL OF PHOTO-ENGRAVING
321 Virginia Avenue, Joplin, Missouri

ARMOUR INSTITUTE OF TECHNOLOGY

A COLLEGE OF ENGINEERING AND ARCHITECTURE

41st Year. Fully accredited by North Central Assn. 4 yr. courses in mechanical, electrical, civil, chemical, fire protection

engineering, science and architecture, leading to B.S. Degree. All student activities—athletics, good living accommodations. Day and evening classes. Bulletin sent on request.

ARMOUR INSTITUTE OF TECHNOLOGY
3306 FEDERAL STREET CHICAGO, ILLINOIS

Learn to Dance

You can learn all the modern dances—the latest Tango steps, the new Fox Trots, dreamy Waltzes, smart Collegiate Steps, and popular Society Steps at home, easily and quickly. New chart method makes dancing as simple as A-B-C. No music or partner required. Don't be a wallflower. Learn to dance. Complete course—256 pages, 54 illustrations, sent on 5 Days' Free Trial. Equals \$10.00 course. Send no money. Pay postman only \$1.95, plus postage upon arrival. Money back if not delighted. Catalog Free.



Franklin Pub. Co., 800 No. Clark St., Dept. 9468, Chicago

BE A POULTRY EXPERT

Make \$40, \$50, \$60 a Week

Free book shows how to get started quickly. You'll be surprised at the amazing profit opportunities in the poultry business. Wherever you live—whatever you do—it is easy to start on a spare or full time basis. Free book tells all. Send for "How to Raise Poultry for Profit." You learn right at home in spare time by methods endorsed by colleges and leading poultrymen. Know how to get the maximum profits from interesting, healthy work. Iron-clad agreement protects you. We have prepared hundreds for good jobs and businesses of their own. Write now for free book. No obligation. National Poultry Institute, Inc., Dept. 31, Adams Center, New York

Men & Women Earn Cash at Home!

Grow fancy giant mushrooms in cellar, attic, barn. Easy, odorless method. We show you how, furnish guaranteed materials and buy crops. Valuable big book, pictures free if you write quickly. (Est. 1908.) UNITED CO., 3848 Lincoln Ave., Dept. P-1, CHICAGO

INDIANA TECH DEGREE IN TWO YEARS

B. S. Degree in Electrical, Civil, Chemical, Radio, Mechanical or Aeronautical Engineering in two years. Located in Electrical Hub of West. Earn Board. Low tuition. Enter Dec., Mar., June. Catalog. INDIANA TECHNICAL COLLEGE, 229 E. Washington St., Fort Wayne, Indiana

RAISE GIANT FROGS

BIG PROFITS IN "NUFOND GIANTS"

Breeder lays 10,000 eggs each year. Bullfrogs sell \$1.00-\$3.00 dozen. No experience necessary. Backyard pond starts you. Raised in any climate. Our FREE book "A Fortune in Frogs" explains everything. Write AMERICAN FROG CANNING COMPANY

(Originators of Canned Frog Legs and Frog a la Queens)
Dept. 133-A New Orleans, La.

When writing please mention Popular Mechanics



Start \$1260 to \$2100 a Year

PICK YOUR JOB

MEN, BOYS—18 to 50

Travel—See Your Country

Railway Postal Clerks get \$1,900 the first year regular, being paid on the first and fifteenth of each month. (\$79.17 each pay day.) Their pay is quickly increased, the maximum being \$2,700 a year. (\$112.50 each pay day.)



Travel On "Uncle Sam's" Pay Roll

3 Days On—3 Days Off—Full Pay

Railway Postal Clerks on long runs usually work 3 days and have 3 days off duty or in the same proportion. During this off duty their pay continues just as though they were working. They travel on a pass when on business. When they grow old, they are retired with a pension.

City Mail Carriers, Post Office Clerks

Clerks and Carriers now commence at \$1,700 a year and automatically increase \$100 a year to \$2,100 and \$2,300.

Customs and Immigrant Inspector

Salary \$2,100 to \$3,300. Men 21 to 45. Work connected with examining immigrants and merchandise entering the country from foreign ports.

Winter examinations expected

Many Winter examinations are expected and those wishing positions should qualify at once.

Get Free List of Positions

Fill out the following coupon. Tear it off and mail it today—now, at once.

This investment may result in your getting a life big-paid Government job.

FRANKLIN INSTITUTE, Dept. L-184, Rochester, N. Y.

Rush to me entirely free of charge (1) a full description of the position checked below; (2) Free Copy of 32-page book, "How to Get a U. S. Government Job"; (3) A list of U. S. Government Jobs; (4) Send pointers on how to get a Government Job.

- Railway Postal Clerk.....(Start \$1900 year)
- Post Office Clerk.....(Start 1700 year)
- City Mail Carrier.....(Start 1700 year)
- Office Clerk—File Clerk.....(Start 1260 year)
- Inspector of Customs.....(Start 2100 year)
- Immigrant Inspector.....(Start 2100 year)
- Liquor Gauger.....(Start 2000 year)

Name

Address

Use This Coupon Before You Mislaid It

"97 lbs. of SKIN and BONES!"

-but now The World's Most Perfectly Developed Man...



A recent photograph of Charles Atlas, holder of the title "The World's Most Perfectly Developed Man" — a title in open competition in the only national and international contests held during the past 15 years.

By
Charles Atlas

THEY thought it couldn't be done—but look at me now! I used to be a skinny, scrawny weakling weighing only 97 pounds. Only half alive; too sickly for sports; afraid to put up my fists. THEN I discovered *Dynamic Tension!*—the amazing method that gave me the body which twice won the title, "The World's Most Perfectly Developed Man." And thousands of other fellows who have put my secret to work are today the envied, he-men LEADERS in any crowd!

Proof in 7 Days that You, too, can Have a Body Like Mine!

Now I actually guarantee to show you PROOF in just 7 DAYS that I can give you a body that men will respect and women admire. Let me make you a NEW MAN—with a body of might and muscle, afraid of nothing, ready for the good things and good times of life. I'll put solid layers of rippling muscle on your back and shoulders. I can build out your chest to husky, he-man size and give your arms and legs handsome muscles of powerful strength. I'll give you vigorous new health, too—banish pimples, blemishes, bad breath, poor digestion, etc.

Send for FREE BOOK

Mail the coupon now for my valuable illustrated book, "Everlasting Health and Strength," filled with actual photos, vital body facts and full details of my "Proof in 7 Days" *Dynamic Tension* Guarantee. There's no risk, no obligation. It's FREE. Clip and send coupon TODAY to me personally: Charles Atlas, 115 East 23rd St., Dept. 81, New York, N. Y.



CHARLES ATLAS, Dept. 81, 115 East 23rd Street, New York, N. Y.

I want the proof that your system of *Dynamic Tension* will make a New Man of me—give me healthy, husky body and big muscle development. Send me your free book, "Everlasting Health and Strength."

Name.....
(Please print or write plainly)
Address.....
City..... State.....

BE A Traffic Manager
Big Pay—Big Opportunity

Big business needs trained traffic men and pays them well. Train in your spare time for this highly profitable, growing profession. Low cost; easy terms.

Write now for valuable, interesting 64-page book—FREE.

LASALLE EXTENSION UNIVERSITY
Dept. 164-T, Chicago

THE ORIGINAL HOME STUDY COURSE IN
Practical RADIO ENGINEERING

Trained men get ahead. The finest course for men serious about Radio. Catalog free.
Dept. P-1, 14th & Park Road, Wash., D. C.

Free BOOKLET
Just off the press!
WRITE FOR YOUR COPY TODAY!

CAPITOL RADIO ENGINEERING INSTITUTE

CRIME DETECTION SECRET SERVICE AND FINGER PRINTS

SECRET SERVICE BOOK FREE

For 30 Days Reading
No Money Down—Actual Crime Cases—If You Act Quick!—We will send you this stirring book on Crime Detection, Secret Service and Identification Work for 30 days free reading. Send no money. If you decide to keep it then send only \$1.00. If not, return it. WRITE TODAY. Not sent to boys under 17 years of age.

T. G. Cooke, Book Dept. 13-51 1920 Sunnyside Ave., Chicago

\$25 A WEEK FOR YOU

and work 12 hours a week. Great plan (illustrated) to breed PR Royal squabs. Ask for new free Library 4, send 3-ct. stamp for mailing. Get details, learn what, why, how, where, 1935 facts.
Plymouth Rock Squab Co., 633 H. St., Melrose, Mass.

CREDIT Given on FRUIT TREES, SHRUBS VINES, BULBS, Etc....

Small down payment books order. Easy terms on balance. Peach trees, low as 5c. Grapevines 3c, ornamental shrubs 10c. Evergreens 25c. WRITE FOR FREE CATALOG.
Benton County Nursery Co., Box 621, Rogers, Ark.

POULTRY PAPER 12 BIG ISSUES 25c

Fasten or pin this ad on a letter with your name and address and mail it to us with 25c. (stamps or coin) for the next 12 issues. American Poultry Journal
532 So. Clark Street Chicago, Illinois

RAISE RABBITS FOR US

WE PAY YOU UP TO \$5.00 EACH. ALSO PUT YOU IN TOUCH WITH MARKETS EVERYWHERE. Large illustrated book and catalog, also copy of the AMERICAN RABBIT FARMER and monthly market bulletin showing names of buyers in various parts of America who continuously buy all rabbits offered them. All for 10 cents. Address
OUTDOOR ENTERPRISE CO., 101 Main Street, NEW CITY, N.Y.

STOP Your Rupture Worries!

Why worry, suffer with that rupture? Learn about my perfected invention. It has automatic Air Cushions which bind and draw the broken parts together as you would a broken limb. No obnoxious springs or pads. No salves or plasters. Sent on trial to prove it. Beware of imitations. Never sold in stores. Write today for full information sent free in plain, sealed envelope.
H. C. BROOKS, 111-A State Street Marshall, Michigan

When writing please mention Popular Mechanics

Amazing Sensational Discovery REFINISHES AUTOS Like NEW!



**Not A Wax
Polish or Paint
Lasts 8 to 12 Months
GUARANTEED**

PAYS UP TO \$7.00 IN AN HOUR

Kar-Nu is a new, miracle discovery—a transparent, magic-like fluid with which anyone can refinish any color automobile easily, quickly and economically without polishing, waxing, rubbing or painting. Just wipe it on with a cloth! Immediately dullness, discoloration, shabbiness, sun fade disappear. Instantly, as if by magic, the old finish is rejuvenated and restored to the lustre, life glow and beauty of the original factory finish. As KAR-NU dries it seals the pigment and protects the finish from further wear. Lasts 8 to 12 months. GUARANTEED. Equal in beauty to a repaint or refinishing job which costs \$25.00 to \$75.00.

FREE SAMPLE

Enormous demand! Millions want it! W. L. Morgan of Mass. earned \$10.61 in a single hour. Sell KAR-NU to individuals, fleet owners, garages, auto accessory stores, used car dealers, etc. No experience necessary. Write for FREE sample to prove our claims and territory offer.

KAR-NU CO., Dept. E-30, Oakley Station, Cincinnati, Ohio

QUICK WAY to make money in



RADIO Modern receivers are demanding men with modern training for service work. New training method and service equipment offer starts you earning almost at once. Up to \$3 an hour easy in a short time. Write today for FREE book of details.

Radio Training Association of America
Dept. PM-51, 4513 Ravenswood Ave., Chicago

Learn PHOTOGRAPHY at Home

Make money taking pictures. Photographs in big demand. Commercial Photography also pays big money. Learn quickly at home in spare time. No experience necessary. Write today for new free book, *Opportunities in Modern Photography*. American School of Photography, Dept. 1351, 3601 Michigan Ave., Chicago.

SHIP MODELS

Get this dandy catalog of true-scale models of Flying Cloud, Viking, Blue Nose, Golden Hind, deluxe fittings. Send 15c (in coin) for your copy. ROY HANCOCK, 323 Douglas Ave., Portsmouth, Virginia

No JOKE TO BE DEAF

—Every deaf person knows that—



Mr. Way made himself hear his watch tick after being deaf for twenty-five years, with his Artificial Ear Drums. He wore them day and night. They stopped his head noises. They are invisible and comfortable, no wires or batteries. Write for TRUE STORY. Also booklet on Deafness.



Artificial Ear Drum

THE WAY COMPANY
729 Hofmann Bldg. Detroit, Michigan

How To Secure A Government Position

Why worry about strikes, layoffs, hard times? Train now for a Government job. Many examinations expected! Increased salaries, steady work, travel, good pay. Let me help you become a Railway Postal Clerk, Post Office Clerk, City Mail Carrier, Rural Carrier—or help you get into any other Government job you want. I was a Secretary Examiner of Civil Service Commission for 8 years. Have helped thousands. **Now FREE** My 32-page book tells about the jobs open—and how I help to help you qualify you to get one. Send the coupon for your copy TODAY.



A. R. Patterson, Civil Service Expert
PATTERSON SCHOOL, 81 Case Bldg., Rochester, N. Y.
Please send me, without obligation, your free book "How to Secure a Government Position."
Name.....
Address.....

AIR CONDITIONING

THE NEXT BIG INDUSTRY

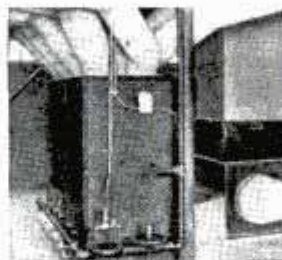

Its opportunities are as big in winter as in summer. Plumbing and heating engineers must know Air Conditioning—the field in its broader aspects invites ambitious men. Write for information on the new, up-to-the-minute course on Air Conditioning now offered by the International Correspondence Schools

... INVENTION—a field of opportunity for men with ideas

If you have an inventive turn of mind, this new International Correspondence Schools Course in inventing and patenting will teach you all the basic knowledge you must have in order to earn real money from your talents. The coupon will bring full information.



AVIATION ENGINEERS are leaders in modern progress



Aviation depends upon engines, and expert knowledge of aviation engines is a long step toward success in this rapidly growing industry. Many leading aviation engineers today took their first step by mailing a coupon to the I. C. S. at Scranton. Why don't you follow their example?

RADIO holds great rewards for trained men

Almost in a decade radio has become a giant industry. The opportunities created will be enjoyed by trained men. The International Correspondence Schools Radio Course, prepared by leading authorities and constantly revised, will help make you a trained man! A fascinating book—FREE.



INTERNATIONAL CORRESPONDENCE SCHOOLS

Box 5547-H, Scranton, Penna.

Without obligation, send me full information on subject checked below:

- | | |
|--|---|
| <input type="checkbox"/> Air Conditioning | <input type="checkbox"/> Aviation Engines |
| <input type="checkbox"/> Inventing and Patenting | <input type="checkbox"/> Radio |
| <input type="checkbox"/> Architecture | <input type="checkbox"/> Highway Engineering |
| <input type="checkbox"/> Concrete Construction | <input type="checkbox"/> Poultry Farming |
| <input type="checkbox"/> Mechanical Engineering | <input type="checkbox"/> Drafting |
| <input type="checkbox"/> Reading Shop Blueprints | <input type="checkbox"/> Accounting |
| <input type="checkbox"/> Civil Engineering | <input type="checkbox"/> Good English |
| <input type="checkbox"/> Electrical Engineering | <input type="checkbox"/> Salesmanship |
| <input type="checkbox"/> Diesel Engines | <input type="checkbox"/> Advertising |
| <input type="checkbox"/> Gas Engine Operating | <input type="checkbox"/> Show Card Lettering |
| <input type="checkbox"/> Refrigeration | <input type="checkbox"/> Civil Service |
| <input type="checkbox"/> Chemistry | <input type="checkbox"/> High School Subjects |

Name _____

Address _____

Classified Advertisements

WORLD'S BEST WANT AD MEDIUM

Advertisements in this section, 35 cents per word, each insertion, minimum 10 words, payable in advance
To be inserted under proper classification in February issue, copy should be in our office December 17th

ADVERTISING AGENCIES

ADVERTISE Profitably: Free assistance with your ads; free newspaper and magazine rate-guide. Write Chicago Union Agency (Established 1900), Great Northern Bldg., Chicago.

LEARN Advertising quickly at home. New easy practical plan. No text books. Interesting booklet free. Page-Davis School of Advertising, 3601 Michigan, Dept. 3431, Chicago.

ADVERTISE In rural weeklies. Lists free. Meyer Agency, 1602 Burd, St. Louis, Mo.

INCH Display advertisement fifty magazines, year \$24.00. Wood's Popular Service, Atlantic City, N. J.

FREE—New Advertisers Rate Guide, 44 pages. Includes everything. Lowest rates. E. H. Brown Advertising Agency, 140 S. Dearborn, Chicago.

FOR ADVERTISERS

30 WORDS Printed 10,000 advertising circulars and mailed to prospects, \$1.00. Lee Agency, Sheridan, Ark.

25 WORDS 25 Magazines, 3 months \$1.50. One inch \$6.00. Plans. 36 Liberty Street, Brooklyn, New York.

ADVERTISE, 24 Words in 45 weeklies \$2.40. Goodall Adv. Co., Box 1592, San Francisco.

10,000 CIRCULARS Printed, mailed to mailorder buyers, \$11.95. Sample? Midget, Warm Springs, Ga.

ADVERTISE: 24 Words in 250 newspapers \$10. Lists free. Advertising Service Bureau, 4650 Drexel, Chicago.

BUSINESS SERVICE

SALES, Collection and appeal letters effectively written, \$10 each. Lucian Chappell, Box 32A, Chicago.

USE Our 5th Ave. address. Secure prestige by making our offices your personal or business (New York) address. We represent you, receive mail, telegrams, telephone messages and you call, or we reforward to you (daily). \$2.00 monthly. New York Mail Service, 210-5th Ave., or, 15 Park Row, New York.

COPIES Of 5 successful mail order sales letters, 50c. Business Letter Institute, B-203 South Dearborn, Chicago.

OFFICE Address system. Mail forwarded 20 cities. \$2.00 monthly. Particulars free. Anderson, Box 3177, Miami, Fla.

DELAWARE Charters; fees small; free forms. Chas. G. Guyer, 901 Market St., Wilmington, Del.

INFORMATION

BUY Old gold. Most profitable business of the hour. Complete instructions. Buying, testing, marketing easily learned. Furnished for \$1.00. Stamps accepted. Midwest Smelting Co., 159 N. State St., Chicago, Ill.

CHISELS Make your own instructions 25c. Box 23, Sebring, Ohio.

120 WAYS To make money. Our newest book. 104 pages. \$1.00 postpaid. Anderson Press, Box 3177, Miami, Fla.

MAKE Money through my book of plans and information. Literature free. William Tresca, 318 N. 61 Street, Philadelphia, Pa.

AUTOMOBILES

SPEED In Auto Racing. Brand new book gives all speed records; drawings, pictures, full description of record cars. Tells how you can build 125-135 m.p.h. stock car and speedway racers. Midgets, conversions, fully described. \$1.00 postpaid; \$1.12 C.O.D. Ray F. Kuns, Dept. B-4, Madisonville, Cincinnati, Ohio.

AUTOMOBILE SUPPLIES

CASH Income resilvering mirrors; replating metalware; making glass signs. Portable outfit. Sprinkle, Plater, 287, Marion, Ind.

GENERATORS, Starters, distributors, magnetos or electrical parts for any auto, truck or bus. New, used and rebuilt. Save up to 75%. Write for prices. State Ignition Service, 2002 South State Street, Chicago, Illinois.

STOP Auto thieves. Device easily installed. \$1.00 postpaid. Name car, secret instructions. Radio Ignition Service, 1323 West 69th Street, Chicago, Ill.

NICKEL Plating outfits, connect to your battery. No tanks used, thousands in use. \$3.00 prepaid. Gunmetal Co., Ave. J, Decatur, Ill.

AUTO TRAILERS

BOOK Of camp trailer plans containing fifteen modern designs ranging from 8 to 16 feet. Copy sent postpaid for \$1.00. Toellen Trailer Service, Box 25, College Park Sta., Detroit, Mich.

AUTOMOBILE SERVICE EQUIPMENT

MICROMETER: Measures outside every thousandths between 2 and 5 inches. Permanent accuracy guaranteed. \$1.00. Agents! Schaap, Laurelton, Long Island.

BARGAINS Used service station, garage equipment. Fesco, 3117 W. Roosevelt, Chicago, Ill.

LEARN Auto armature rewinding. Instructions \$1. Box 42, Chillicothe, Mo.

DEMONSTRATORS, Compressor, test bench, 8-hour battery charger—arc welder. Guaranteed. Trial and terms. Ken's Equipment Exchange, Box M-152, Troy, Ohio.

A. C. AUTO GENERATORS

TEN Practical and inexpensive changes converting Dodge 12-V. Ford T. A., Chevrolet Delco 6-V generators into 100-500 watt capacity a.c. generators, or into 32-110-V d.c. motor or generator. Dodge is 500-W self-excited. All in one book illustrated with complete simplified instructions and drawings for only \$1. Autopower, 408-B, S. Hayne Ave., Chicago.

ELECTRIC Lights—Wind driven—You build them. Write Wind Motor Electric, Ridgway, Mont.

DODGE Generator quickly changed to powerful electric welder. Instructions \$1.00. Neal Brown, Richland Springs, Tex.

BATTERIES

EDISON Storage batteries for all types of lighting systems. Uses no acid. Odorless. Long life. Guaranteed. Generating plants, motor bargains. Free interesting literature. Hawley Smith Company, 22 Washington Ave., Danbury, Conn.

EDISON Storage batteries for power and lighting systems. Non-acid. Non-corrosive. Five year unconditional guarantees. 15 year life. Free illustrated literature. Plants, motors, etc. See Jay Battery Company, 82 Sterling Avenue, Yonkers, N. Y.

BUILD New batteries from old, work at home. Daily cash demand. Thousands can be put into service. Send 25c for formula, instructions, mold catalog. Home Occupations, St. Paul, Minn.

ELECTRIFY Farm with windmill! Twelve pound wooden propeller driving rebuilt auto generator supplies 500 watts 32 volts. Inexpensive, practical, scientifically correct. Step by step instructions and blue prints to build \$3.00, particulars dime. 4714 No. 41 St., Omaha, Nebr. Wind Power.

BUILD Winddriven electric plant. Plans and parts cheap. Particulars dime. Kilnsick Shop, Dept. PM, Optima, Okla.

PROFIT Rebuilding batteries. Make your own plates. Information 25c (coin). Gen. Batt. Serv., 78M Glenwood, Minneapolis, Minnesota.

DIRECT Drive wind driven battery charger and light plant. Complete plans 35c. Paul Dickson, Beaconsfield, Iowa.

MOTORCYCLES, BICYCLES AND SUPPLIES

WE Repair bent, broken frames, forks, scored cylinders, magnetos, generators. New and used motorcycle parts. J. B. Dahl, 3661 Archer Avenue, Chicago, Ill.

MOTORCYCLES \$25. New tires \$3.95, used tires \$2.50. Engines for airplanes, ice sleds, boats. Boys' automobile \$10 to \$75. Pumps, frames, forks, cylinders, crankcases, handle bars, tanks, wheels, 3 speed assemblies, chains, \$1.50. Wheels for airplanes, boys' automobiles, motorcycles \$1.00. Bicycles \$11.50. Motor bicycles \$45.00. Bike tires 80c. Save you dollars at Deninger Price Cutter, Rochester, N. Y. Send 10c for bulletin.

USED Motorcycle parts. George, 4021 Russell, St. Louis, Mo.

REPAIR With good used parts, save 1/2 or more, state parts needed, no lists. J. B. Dahl, 3661 Archer Ave., Chicago, Ill.

BICYCLE Repair book—Tells everything—Send 25c—Parts catalog free. A. H. Harwell Cycle Works, Dept. 104-A, 6267 Gravois, St. Louis, Mo.

DIME Secures sample Speedway Racing Magazine, catalog English motorcycles, crash helmets, speed books, supplies. Overhead speed heads for Fords. Clymer, 434 W. Pico, Los Angeles, Calif.

ANY Motorcycle purchased from Knuth's will give real service and satisfaction. Send 6c for bulletin. Complete stock. All models and low prices. Knuth's, 2491 W. Fond du Lac Ave., Milwaukee, Wis.

MOTORCYCLES—Direct to you at rock-bottom wholesale prices. Rebuilt, roadtested and guaranteed Indians, Harleys, etc. Send 10c today for "Bargain Bulletin 43." Crandall Hicks Co., 780 Commonwealth Avenue, Boston, Mass.

HENDERSON, Excelsior, Harley, Indian, used parts, alloy pistons, catalogue and wings pin 10c. Ballak, 100 N. 12th, St. Louis, Mo.

MOTORCYCLE Bargains, lowest prices, bargain sheet for stamp, motorcycle accessories, largest line in America, lowest prices. Largest motorcycle mail order house in the United States. Rochester Harley Davidson Corporation, 129 West Main St., Rochester, N. Y.

SEND 15c For illustrated used Motorcycle catalog. Large stock. Bargains. Indian parts. Accessories. Indian Motorcycle Sales, Kansas City, Mo.

AVIATION

HUNDREDS Airplanes, Crackups, dirt cheap. Send 20c. Used Aircraft Directory, Athens, Ohio.

SEA And air navigation instruction and equipment. Write for details, Weems System of Navigation, Annapolis, Md.

GET Into aviation. Air transport pilots get up to \$7,000 per year; mechanics, \$2,500. Learn at this government approved school. Write for complete information. State age. Lincoln Flying School, 2004 Aircraft Building, Lincoln, Nebr.

NEW Aeroplanes, \$98.00. Quality propellers, \$3.98. Photos, leather bound flying manual, 25c. Hibbs, Ft. Worth, Texas.

QUALITY Laminated propellers; 4' Harleys, \$3.50; 4 1/2' Hendersons, \$5.00; special 5' for auto motors, \$7.00. Hibbs, Ft. Worth, Texas.

TINTED Goggles, leather helmet, cost \$19, used, \$7.50. Aeronautical books cheap. Fred Buse, 720 St. Marys Street, New York.

MODEL AIRPLANES

BIG Package of model airplane samples. Send dime for packing and postage. Aero Shop, 3059 Hurlbut Ave., Detroit, Mich.

BOATS, OUTBOARD MOTORS, ETC.

BOATS—Knock down or completed. Send 10c for catalog. Dunphy Boat Co., Eau Claire, Wis.

OPERATING Scale models of U. S. air, marine and submarine fighters. Send 3 cent stamp for literature. Westlake Model Co., Erie, Pa.

12 FOOT Flat bottom rowboat—complete plans 25c. Free boatbuilding catalog. The Rudder, 15 Murray Street, New York.

CUT-TO-FIT Kayak, \$5.95 complete. Mail dime for literature or quarter for instructions. Boat Shop, Greenville, Penna.

OUTBOARD Parts—New or used—All makes—What do you need? Crandall-Hicks Company, 782 Commonwealth Avenue, Boston, Mass.

CARTOONING

CARTOONING Course—30 lessons, 500 illustrations with drawing pens and pencils. \$1.00 postpaid. Scovell Studios, Box 610-P Hollywood, Calif.

ARTISTS—Cartoonists—Amateur new publication, "How to Sell Your Art Work," tells where and how to market drawings. Send only \$1.00. Arthur J. Luchs, Studio A-1, 1115 15th St., N. W., Washington, D. C.

CHALK TALKS

BEST Trick cartoons, 1935 edition, 50c. Fred Svensson, Collins, Mont.

LAUGH Producing program, \$1.00. Catalog free. Balda, The Cartoonist, Oshkosh, Wisconsin.

FOR BOYS AND GIRLS

WANTED—Boys with metal casting sets. Join the Uncle Gas metal casting club free. A national organization of boys. Use improved "Ace" molds. Cast toys in life-like proportions (not skinny). Require no smoking. 50c each. Complete Kast-A-Toy set, \$2.00 postpaid in U.S.A. Special, machine runner mold, improved mold holder and handles, 5 bars of metal, \$1.00 postpaid in U.S.A. Free information. Uncle Gus, Dept. 3, Toledo, Ohio.

NEW Device transmits voice; code efficiently. Low cost. Circular free! Esco, Provident Bldg., Tacoma, Wash.

BOOKS AND PERIODICALS

BIG Mails. Magazines, catalogs, propositions, etc. Send 10 cents. Anderson Press, Box 3177, Miami, Fla.

BOOK Of inspirational, action-compelling, success-making poems.—35c postpaid. Carl Hansen, Brookings, S. Dak.

THOUSANDS Of old magazines. List 10c. Seeley, Box 747, Jennings, La.

GAMES, ENTERTAINMENTS AND PLAYS

PLAYS, Operettas, musical comedies, complete minstrel first-parts with song programs, blackface skits, vaudeville acts, monologs, dialogues, recitations, juvenile plays and songs, musical readings, entertainments, make-up goods. Catalog free. T. S. Denison & Co., 623 So. Wabash, Dept. 11, Chicago.

RADIO SETS AND SUPPLIES

RADIO Experimenters and set builders. Parts and kits of parts for the auto radio, Little Giant and portable battery sets described by Popular Mechanics. Lund Mfg. Co., Dept. PJ, 1730 Foster Ave., Chicago.

ASSEMBLE Radio sets in your spare time. Four tube chassis kit \$4.95 plus postage. Complete with speaker, cabinet, and tubes \$8.45. Six tube all wave kit \$15.25. Complete \$26.75. Cash with order. Plymouth Radio Company, 1307 Moorman Street, Chicago, Ill.

AUTO Radio noise eliminated. Throw away sparkplug suppressors. Special filter, easily installed, \$2.00 postpaid. State Radio Service, 2002 South State Street, Chicago, Illinois.

LONG Distance crystal radio easily made. Instructions and crystal, 15c. Music Sales, Independence, Mo.

MONEY Selling sensational \$1.50 pocket radio. Sample set, 45c postpaid. Music Sales, Independence, Mo.

"LATEST Pocket Radio," complete with phones, \$2.95 prepaid; no tubes or batteries required; distance. Walrond, 1776 West Adams, Los Angeles, Calif.

CUSTOM Build radios \$11.85 up. Guaranteed. Salesmen and dealers wanted. Orr Manufacturing Co., 1116 Berwyn Avenue, Chicago.

RADIO INSTRUCTION

RADIO Engineering, broadcasting, aviation and police radio, servicing, marine and Morse telegraphy taught thoroughly. All expenses low. Catalog free. Dodge's Institute, Ames St., Valparaiso, Ind.

MAGIC TRICKS AND JOKER NOVELTIES

BE Popular. Entertain your friends. Delightful book of unusual tricks. Defy solution. 50c. Foster, Box 134, Swarthmore, Pa.

SIX Latest, amazing professional card tricks with ordinary pack. Complete instructions 25 cents. August Becker Corporation, 300 Graham Avenue, Brooklyn, N. Y.

FREE Magic catalog! South's largest line. Amaze—mystify your friends. Be popular. Earn money. Lyle Douglas, Station A-5, Dallas, Tex.

LARGE Professional magic catalogue, 25c. Holden, 220 W. 42nd St., New York.

STAMP COLLECTING

THE Black Belgian mourning stamp for King Albert was issued in such small quantities that even now dealers scramble for it in vain. It will surely be a real rarity in the future. We offer a superb copy, together with the beautiful portrait set Brazil 1906 (5 values) and complete set Victor Emanuel commemoratives of Italy, all for only 10c to approval applicants. Globus Stamp Company, 268 - 4th Avenue, Dept. 50, New York, N. Y.

VALUABLE New complete charity set of Switzerland addressed to you free when ordering our 691 all different special including: Beautiful collection of Italian commemoratives of 17 different issues, Gabon, Spain commemoratives and airmails, Oceania, Victoria, Nicaragua, Togo, scarce Turkey, Sudan, Georgia, Somali, South Africa, Tehad, Salvador, Oubangui, Russia commemoratives, Dahomey, Persia, Egypt, Charkhari, Philippines, Austria commemoratives, Abyssinia a collection of scarce stamps, etc. The entire lot of \$17 catalogue value for only \$1 to approval applicants. Frasek, Incorporated, Lucerne 5, Switzerland.

SCARCE Indo-China and Paraguay airmails; pocket album, watermark detector and big packet stamps, only 5c to approval applicants. Penny Stampeo, 633P Maryland, Glendale, Calif.

EGYPT: 25 Different stamps from the country of pyramids, bargain at 10 cents to approval applicants. Ancher Stampeo, Rutherford, N. J.

NATIONAL Parks complete \$1.20 for 10 sets. No stamps. De Luca, 1115 45th, Brooklyn, N. Y.

50 DIFFERENT Hungary 10c. Fred Onken, 630 79th St., Brooklyn, N. Y.

STOP—Look—Ascension, Papua, Jamaica, Newfoundland, pictorial commemoratives, all only 10c providing you desire our profit-sharing foreign approvals. Swalley's Service, 1119A Trenton, Los Angeles, Calif.

U. S. \$2 Wine 8c with approvals. Arrow Stamps, Plainfield, N. J.

NEWFOUNDLAND, 15 Different 5c with approvals. Hudson Co., Plainfield, N. J.

ILLUSTRATED U. S. list, price 50c, large complete U. S. price list free. Stanley Gibbons, 38P Park Row, N. Y.

A STAMPEDE Of completion! 5 complete sets of Imperial and Soviet Russia, 1916, 1917, 1918, 1919, 1921 issues, all for 10c! Pearson Bros., 68 Nassau St., Dept. 19, New York.

50 FINE Canada-Newfoundland stamps 25c. Bargain approvals. Burt, Fairton, N. J.

SENSATIONAL Offer!! 20 different large size commemorative stamps of Italy. 10c to approval applicants. Auer, 47-17 39th Street, Long Island City, N. Y.

47 DIFFERENT U. S. 11 cents. Geo. Pilliod, Swanton, Ohio.

MAMMOTH Mystery packet of rare stamps for only 10c to serious approval applicants, also valuable free premiums with every selection afterwards. Our stamps are better and our service is different. Fair-Play Stamp Service, 1215 Browning Blvd., Los Angeles, Calif.

"FLAG Of the Race" set, Paraguay. Three beautiful tri-colored pictorials. Only 5c to approval applicants. Premiums. John McCarty, Whipple, Ariz.

FREE!! 50 Different beauties to serious approval applicants. Postage 3c. Kumlser, Cherry, Lancaster, Ohio.

RUSSIAN Collection, 50 different mint stamps (catalogue \$2.64!) for 10c to approval applicants. Harris, Legion, Texas.

FREE—100 Different to approval applicants inclosing return postage. Cardinal Stamp Company, 3417 Dodge, Omaha, Nebr.

SCARCE Paraguay Graf Zeppelin airmail triangle, pocket album, watermark detector, packet stamps from Africa, Asia, Canada, South America, etc., 6c to approval applicants. Glendale Stamp Company, 1342P Linden, Glendale, Calif.

FREE: Pricelist! Two U. S. \$5.00 stamps; 10c! Twenty varieties cataloging \$20.00—\$1.00! Vanvoorhis, Hyndman, Penna.

MALDIVE Islands, Brunei, Turks and Caicos Islands, Charkhari, \$5 United States, genuine Baden, and a U. S. imperforated "park" stamp—All these given to approval applicants enclosing 3c for postage! Viking Stamp Co., 1 Hanson Place, Brooklyn, N. Y.

FREE Stamps, including Newfoundland, Brazil, rare set Argentine with approvals. Send postage. He. Buchholz, Norwood, O.

FOR Only \$1 you receive postage stamps of Europa rarities, catalogue value \$10. Contents: Switzerland, Bosnia, Belgium, Italia, Russia, Luxemburg a.o. Same time you receive interesting approvals to moderate prices. Atlas Stamp, Ltd., Lugano, Switzerland.

SCARCE Mongolia, Inhambane, Inini, airmails, packet Africa, 5c to approval applicants. Station C, Box 391, Los Angeles.

100 PICTORIALS, 20c; 500, \$1.30; 1,000, \$3.00. J. McKee, No. 111 E. 13th, Covington, Ky.

UNITED States—Canada—Newfoundland. Where? Our "Four Star Approvals"! Nothing like them. Write today. Kessel's, Endicott Arcade, St. Paul, Minn.

SCARCE Airmail and triangle. Beautiful Uruguay "flying horse" airmail and scarce Guatemala triangle (smallest in the world) are included in our big packet of 60 different stamps from Alouites, Grand Liban, Venezuela, British and French Colonies, etc. All for 5c to approval applicants. Big illustrated lists free with each order. Write today! Mystic Stamp Co., (Dept. 80), Camden, New York.

SCARCE Hawaii!!! Bolivia triangle! Packet of unusual stamps containing old Hawaii, scarce Bolivia triangle, famous money stamp (printed on cardboard and also used as currency!); airmails from Mexico and Paraguay; map, ship, animal, commemorative, etc. No Europe. Only 10c to approval applicants. De Soto Stamp & Coin Co., 105 N. Clark St., Chicago, Ill.

WHOLESALE Monthly—Sample copy sent free. Emprestamp, Dept. MP, Toronto, Canada.

166 U. S. Commemoratives, etc., 10c, 500—25c. Box 457, Newark, N. J.

105 DIFFERENT, Congo, Hyderabad, Guinea, etc., 3c to approval applicants. Extra—Airmail set free with above. Huanziker, Box 225, Minneapolis, Minn.

25 VARIETIES Canada 5c. Approvals. Marian, 1314 Somerset, Detroit, Mich.

APPROVALS By countries, 1c and 2c. Better grade, 1/2 catalogue. Lelnert, 851 Marcy Avenue, Brooklyn, N. Y.

LISTS, Approvals, and 25 different Liechtenstein 6c. Allion, Angola, Ind.

FREE Set five Russian Ethnographies for 3c postage to approval applicants. Integrity Stamp Co., Fort Washington, Pa.

FREE United States price list. Mark G. Hanna, 335 Fifth Avenue, Pittsburgh, Pa.

CANNON! Set of stamps showing cannon, cavalry charge, battleships, firing squad, airplane, and 200 other different stamps only 10c to approval applicants. Paramount Stamp Co., 4225 Broadway, Chicago, Ill.

BRITISH Turkislands—Also Congo's, Montecarlo, Nigero coast, Uganda, Djibouti, Ecuadorian, Ivory coast, Ubangi, countries collectors need. Free for 5c postage. Empire-stampshop, Dept. PM, Toronto, Canada.

LOOK! Gorgeous packet including Uruguay (Flying Horse) airmail, Spanish airport, triangle, animal and map stamps, only 5c to approval applicants. Royale Stampeo, South Pasadena, Calif.

WEEKLY Stamp magazine. Year—10c. Harlan W. Miller, Lawrence, Kans.

ILLUSTRATED Album, spaces 4000 stamps or 10 different triangles to approval applicants 20c. Swan Stamps, 604 Swan, Dunkirk, N. Y.

STAMPS, 150 Different, with 500 hinges, 10c. Melco Stamp Co., 4024 No. Ashland Ave., Chicago, Ill.

200 DIFFERENT 10c. Big 50% approvals. Covert Stamp, 39 State, Rochester, N. Y.

1000 GOOD Mixed foreign, 25c. Mailed with imperforate stamps. Mission Stamp Mart, Brookland, D. C.

A BIG Bargain—All for only 50c. Stamp album, providing spaces for 2200 stamps with 700 illustrations, packet of 500 different stamps, 500 hinges, and millimetre measure. Free with each order our pamphlet which tells "How To Make A Stamp Collection Properly," and our price list of albums, supplies and hundreds of bargains in sets and packets. Queen City Stamp Company, Room 36, 604 Race Street, Cincinnati, Ohio.

FREE 3 Stamps for every stamp purchased from my penny approvals. Mary Labis, 745 So. 12 St., Newark, N. J.

50 DIFFERENT British colonial stamps 6c to approval applicants. H. Wilcox, Box 142, Torrington, Conn.

FREE! Swell packet with approvals. Aladdin, 1550 Carroll, St. Paul, Minn.

YOU'VE Tried the rest now get the best!! We have answered all advertisements, compared premiums, approvals, etc., and absolutely proven that ours are superior. Send 10c for "Challenge" offer with approvals. Bargain Stamp Service, 1332 South Hope, Los Angeles, Calif.

AIRMAILS—From Brazil, Chile, Colombia, Ecuador, Mexico—all for 10c with double premium penny approvals. Progress Stamp Service, Franklin Park, Ill.

CARIB Archer (Inini), map stamp, 1892 South American envelope, included in quality packet, hinges, stamp wallet, 10c to collectors desiring approvals. United Pacific Philatelists, Box 25M, Ventura, Calif.

FREE—25% Off net approvals mailed with commemoratives. Stamp Center, Route 10, Box 194, Station F, Milwaukee, Wis.

STAMPS For sale, wanted. Write C. Ritchie, Watertown, So. Dakota, U. S. A.

LIBERIA Packet free to approval applicants. Welsh, Elamere, N. Y.

FREE Outfit! Pocket wallet, hinges, watermark detector. Packet stamps from South America, Asia, Africa, etc. Postage 6c. Approvals. Maxwellton Stampco, Piedmont, California.

100 DIFFERENT For this Ad and 3c to approval applicants. Evanston Stamp Shop, 2412 Noyes, Evanston, Ill.

25 CANADA Including dollar stamp and 10 foreign 15c to approval applicants. C. A. Larson, 674 Yonge St., Toronto, Canada.

TRIANGLE From Costa Rica, Venezuela airmail, many scarce stamps, blank album, perforation gauge, hinges, watermark detector, millimetre scale. Price 5c with approvals. Mohawk Stampco, Box 932, Mar Vista, California.

MAGNIFIER, Stock book, stamp album, hinges, watermark detector, perforation gauge, millimetre scale, packet scarce stamps. Price 5c with approvals. Atlas Stampco, Box 4025, Culver City, California.

SCARCE Morocco airmail, Eritrea camel stamp, maps of stamp countries, watermark detector, hinges, perforation gauge, stamp album, many scarce stamps, 5c with approvals. Superior Stampco, Box 8276, Palms Station, Los Angeles, California.

WONDERFUL Packet free! To applicants requesting our approvals. Stampco, 8429 Island Drive, Seattle, Wash.

BEST One cent approvals in America. F. Hand, 1117 So. 60th St., Philadelphia.

SCARCE Iceland airmail triangle and fine packet of 65 different stamps including Senegal, Jamaica, Guinea, South Africa, Oceania, Nigeria, savages, maps, and animal stamps. Only 5c to approval applicants. Potomac Stamp Co., Dept. 101, Washington, D. C.

25 BRITISH Colonials 3c with approvals (1/4c). Lejac, 902 1/2 South San Pedro, Los Angeles, Calif.

AMAZING Value—35 different U. S. early commemoratives, air mail, etc., 10c to approval applicants. Stamp Shop, 809 Holland Bldg., St. Louis, Mo.

MISSION Stamps—United States 50c, Canada 75c, foreign \$1.00 a lb. Good value postpaid. Mission Co., 4512 N. Racine, Chicago.

FREE Triangle with 55 different, including Abyssinia, Guiana, Hyderabad, Madagascar, etc., with approvals 5c. Cresta Stampco, Box 2062M, Fresno, Calif.

1000 DIFFERENT Or 200 British Colonies, \$1.00; 500 different or 15 triangles, 40c. Valuable prize set and approvals with every order. Sterling, Box 725, Battle Creek, Mich.

SPECIAL Packet including mint Wisconsin 10c. Approvals. Barnes, 12731 Monica, Detroit, Mich.

TREASURE: 30 Different commemoratives 10c. Approvals. N. Begin, 48 Sous-Le-Fort, Quebec, Canada.

CHEAPEST Approvals in Canada sent to applicants with references. Bennetto, Lauderdale, Toronto.

IRAQ—10 Different 10c to approval applicants. Brownie Stamp Shop, Flint, Mich.

UNITED States—Approvals—Free list. Huber, 505 Hennepin, Minneapolis, Minn.

SETS On approval. References. Premiums. A. V. Pierce, 120 Broad St., Providence, R. I.

SPECIAL Offer: Packet guaranteed \$50.00 catalogue value, only \$1 bill. Hurry!! This bargain can't last long. Hensel, 56 West 10th Avenue, Columbus, Ohio.

FREE!! 3c Postage brings prize set, mystery packet, premium, big lists, etc., with approvals. Budie, 6929 West Greenfield, West Allis, Wis.

FREE Premium to approval applicants. L. Horowitz, 1847 Fulton, San Francisco, California.

UNUSUAL Approvals, 15 different Newfoundland to applicants. 3c postage. Ranson, 3307 Adams, Chicago.

ONE Pound! 50c. Rettig, 105 East 102nd Street, New York.

1000 STAMPS 10c, two pounds \$1.00, approvals. Jim Hale, Palestine, Texas.

100 DIFFERENT U. S. 53c. Olson & Olson, Hartford, Conn.

FREE: Two fine sets. Howard, 200 Poplar Avenue, Norfolk, Va.

BARGAIN Approvals 1/4c up. Rogers, 1205 W. Leonard, Grand Rapids, Mich.

FREE! U. S. 30c, 50c, \$1.00 postage dues (cataloging 45c); and 40 other beauties, for 3c postage! New Byrd stamp, for mail going to South Pole, 3c. Block four, 15c. Watermark detector, 2c. 15 different Confederate prints, 10c! United States price-list, free! Approvals with each order. Tatham Stampco, (D125), Springfield, Mass.

JUST What you're looking for—a business of your own handling the slickest line of quick-sellers you ever saw. Every one a winner. Take your pick or handle them all. Sell stores, homes, offices. Liberal commissions. By all means investigate. Haldon, "A16," 1837 N. Ogden, Chicago.

AUSTRALIA 1934 Centenary and 50 different free to approval buyers. Simmons Stampco, Elsie, Mich.

UNITED States stamps—40 different with pricelist 10c. Seidenberg, Baroda, Mich.

THE Queerest stamps. Our special packet includes world's largest airmail stamp; smallest stamp ever issued; scarce triangle from Bolivia; Japanese "earthquake" stamp; Newfoundland map; weird Afghanistan, Manchukuo—and many others. (No Europe.) Price only 10 cents to approval applicants. R. M. Stamp Co., Box 112, Port Chester, New York.

URUGUAY, 15 Different, 3c with attractive approvals. Garcelon, Calais, Maine.

20 LIECHTENSTEIN, 03c To approval applicants. Sodak Stamps, Sioux Falls, S. D.

FASCINATING Bargains! 1c and 2c approvals. Catalogue disregarded. Goldenrod Company, Harrisburg, Illinois.

FREE! Costa Rica triangle, scarce Turkey octagon, packet gorgeous ship stamps, complete airmail set, watermark detector, interesting lists and coupons! Postage 3c. Approvals included. Midwood Stampco, Midwood Station, Brooklyn, N. Y.

FREE!!! Russia Ethnographic set or three Spain airmails. Postage 3c. Roberts, 901 E Fourth, Baycity, Mich.

WORLD'S Most beautiful stamp, tiny triangle, 50 others, 6c with approvals. Ransom, 1333 Pontiac, Ann Arbor, Mich.

FOREIGN Or United States mixture \$1.00 per pound (about 4000). Sample 1/4—25c. Approvals sent. Elmer's, 192A Washington St., Boston.

MIGHTY Bargain: Includes Triangles, Nyasaland, Bechuanaland, set scarce Fiume, and many other dandies. Everything 10c to approval applicants. Clarke, Box 181, New Haven, Conn.

20 DIFFERENT Commemoratives, 12 different countries, 10c to approval applicants. Beverly Stamp Company, Box 866, Beverly Hills, Calif.

STAMPS: 100 Different catalogue over \$2.00 with catalogue 10c. Norman Shultz, Salt Lake, Utah.

FREE \$1.00 U. S. stamp with request for 48 page illustrated price-list of U. S. and foreign stamps. Also fine stamps on approval. Reference necessary. New Hussman Stamp Co., 1122 Pine Str., St. Louis, Mo.

THIS Ad worth 25c. If you send for our approvals and buy 50c worth or more—large selection of U. S. and foreign—reasonable prices. Morton Stamp Co., 1121 Olive, St. Louis, Mo.

110 DIFFERENT Stamps free to approval buyers. Postage 3 cents. Badger Stampco, Milwaukee, Wis.

WHOLESALE Catalog for dealers. Illustrated. Postage 5c. Frank Company, 4900 Chalmers, Baltimore, Md.

1000 DIFFERENT 95c—500, 45c; also packets, sets and singles. Price lists free. John Graf, 1874 Loring Place, New York.

COMMEMORATIVES—10 Different and 30 other Canadian only 15c. World special—500 different 30c; 1000 diff. 85c; 2000 diff. \$2.50. Approvals with each order. Victoria Stamp Company, London 4, Canada.

FREE—To approval applicants. Five beautiful airmails from five different countries. Green & Co., Norwood, Ohio.

SCARCE Zeppelin and triangle. Famous Russia Zeppelin stamp and beautiful Lithuania airmail triangle; also big packet of 53 different stamps including Azerbaijan, Epirus, new Martinique, etc., and illustrated lists—all for 5c to approval applicants! World-Wide Stamp Co., Box 600, Camden, New York.

STAMPS Sent on approval. 50% discount. Fred Herzberg, 197 Grantley Ave., Elmhurst, Illinois.

200 DIFFERENT Stamps, triangle, airmail, etc., 10c. R. H. Carlton, 209 W. Fourth, Los Angeles, Calif.

FREE Dollar packet to one cent approval applicants. Harlan, 5307 S. Marshfield Ave., Chicago, Illinois.

EXCHANGE Your duplicates! New method. Write for details. 1710H North Vermont, Hollywood, Calif.

50 OLD Stamps 1c. Album 3c. Bullard, 446 Tremont, Boston.

BYRD Commemorative and 34 different U. S. including early issues, high values, commemoratives, airmail, envelopes, special delivery, postage due and revenues cataloging over 85c. All for 7c to approval applicants. Illustrated pricelist free. Curhan Stamp Co., Dept. P, Gloucester, Mass.

PENNY Approvals, that satisfy. Neil Gronberg, Box 5441-P, Philadelphia, Pa.

RARE COINS

\$2000.00 FOR 1c. We pay the world's highest prices for old coins, encased postage stamps and paper money. Certain large cents \$2000.00 each, half cents \$250.00, flying eagle cents \$20.00, Indian head cents \$50.00, half dimes \$150.00, 20c pieces \$100.00, trade dollars \$250.00, half dollars before 1854 \$750.00, 1850 silver dollar \$2500.00, gold dollars \$1000.00, \$3 gold pieces \$1000.00, 1822 \$5 gold pieces \$5000.00, fractional currency \$26.00, Confederate bills \$15.00, encased postage stamps \$12.00, etc. Send dime for list. Romancoinshop, Dept. 424, Springfield, Mass.

FREE!—Foreign coin, banknote, and large illustrated coin catalogue.—4c postage. Souvenir California gold quarter size 26c; 3/4 size 53c; both 65c! Round or octagon, set of each \$1.30! Approvals with each order. Tatham Coinco, Springfield, Mass.

OLD Money wanted. Will pay fifty dollars for 1913 Liberty head nickel (not buffalo). I pay cash premiums for all rare coins. Send 4c for large coin folder. May mean much profit to you. B. Max Mehl, H Mehl Bldg., Fort Worth, Texas.

UP To \$300 paid for dimes dated before 1895; Liberty head nickels \$200; pennies \$25; send 15c complete catalog. Nationalcoin Company (BB), Springfield, Mass.

15 DIFFERENT Coins. Including United States before 1865. 25c. Coin Exchange, Box 2554, Kansas City, Mo.

TO \$8 For Lincoln heads; to \$78 for Indian head pennies. All dates wanted. Catalog 10c. Penny Shop, Dept. 90, Cedar Falls, Ia.

UP To \$1000.00 paid for dollars, dimes, halves and quarters \$250.00. Indianhead cents \$65.00, Lincoln cents \$2.00, etc. Also stamps. Send dime for two lists. Coin-Stampmart, M-56 West Washington, Chicago.

WE Purchase all Indianhead pennies. Pricerange 5c—\$25.00. Purchasing lists 10c. Photopennies, 100 Forsyth, New York.

ANCIENT Roman coin with list of all the Emperors and catalog 10c. Geo. Best, Cedar Rapids, Iowa.

20 ASSORTED Coins 25c. 100 coins \$1.00. Otto Oddehon, Williamstown, Kans.

\$5.00 To \$500.00 Each paid for old coins. Keep all old money. Send 10 cents for illustrated coin value book. 4x6. Guaranteed prices. Buying and selling. Coin Exchange, Box 5, Le Roy, N. Y.

HIGHEST Prices paid for Indian head pennies. Send dime for list of those wanted. Coin Shoppe, Box 407-PM, Ottawa, Ill.

UNITED States white cent and bargain selling price list 10c. Arcy, Box 483, Muskogee, Okla.

WE Buy 1907 Indian head cents. Full information one dime (coin). New Miss Mattick Co., Box 3450, Altoona, Pa.

11 DIFFERENT Coins, 3 bills and catalog, 25c. Creamer's, 1112 Somerset, Baltimore, Md.

UNITED States. Large cent, two-cent bronze, three-cent nickel and bargain list, 25c. Thirteen dates large cents, \$1.00. George P. Coffin, Augusta, Maine.

CAMERAS AND PHOTO FINISHING

NEW! Two-tone easel calendar from favorite negative. 25c each, coin. Zehr Studios, Watertown, N. Y.

CAMERAS Repaired, still and motion. Vertical Seaman, Bay City, Mich.

PROFESSIONAL Developing set. Contains complete dark room supplies. Every essential for perfect results. \$1.49 (C.O.D. \$1.69). Free: Bargain list. Philmore Distributing, PM, 1123 Broadway, New York City.

ROLLS Developed—Eight guaranteed. Number prints. Two Nu-Giant enlargements, 25c coin. Giant Snapshots, Inc., Dept. P, Green Bay, Wis.

ROLL Films, developed, deluxe printed. Colored enlargement coupon—25 cent coin. Lucas Studios, 431 North Atlantic Avenue, Daytona Beach, Fla.

NEW! Beautiful art panel prints 6c. Sample with "trial order" roll developed and 8 prints 25c; reprints 3c. Ideal Photo Service, Box 2255, Paterson, N. J.

ROLLS Finished 50c. Genuine D76-Velox. Jogolo, High Point, N. C.

FILMS Developed 2 prints of each negative and two enlargement coupons 25c. Summers Studio, Unionville, Mo.

PRINT Snapshots on handkerchiefs, note-paper, etc., sensitized with photoprint fluid. Dark room unnecessary. Washable, permanent, guaranteed. Send \$1.00 for fluid to print 200 pictures. Park Specialty, 219 Park Place, Brooklyn, N. Y.

30 BEAUTIFUL Gloss kodak prints only 25c. Rapid Film Service, Unionville, Mo.

25 BEAUTIFUL Embossed Christmas cards from your favorite Kodak negative. With envelopes to match only \$1. Films developed 16 prints finished 25c. Summers Studio, Unionville, Mo.

THREE Beautiful enlargements from your negatives 25c. Imperial Film Service, Unionville, Mo.

FILMS Developed any size 25c coin including two enlargements. Century Photo Service, Box 829, La Crosse, Wis.

TWO Crystal stiple enlargements with each roll 25c. Photoshop, 4112-8 Oriole, Chicago.

ENLARGEMENTS 4x6, Five for 25c. 5x7 three for 25c. 8x10 three for 35c. Special hand colored easel mounted 4x6 enlargement 25c. Enlargers, 1652-8 North Western, Chicago.

HAND Colored enlargement with each roll 25c. 40 reprints 50c. Colorgraph-8, Dunning Station, Chicago.

MAKE Money in photography. Learn quickly at home. Spare or full time. New plan. Nothing like it. Experience unnecessary. American School of Photography, Dept. 3432, 3601 Michigan Avenue, Chicago.

ROLL Developed, 8 prints, oil painted enlargement, 25c. Prompt service. Work guaranteed. Individual attention to each picture. Janesville Film Service, C15, Janesville, Wisconsin.

16 BEAUTIFUL Gloss prints and two enlargement coupons only 25c. Imperial Film Service, Unionville, Mo.

SUPERIOR 5x7 Enlargements, send negative, 15c coin; two, 25c. Low prices; highest quality. J. Bruff, 1475-U Grand Concourse, New York.

DEVELOP And print snapshots yourself. See advertisement on Winner Photo-Set, page 142A.

COLORED Enlargement with each film developed—a professional enlargement painted in oils and eight Gloss-tone prints, deluxe finish, guaranteed not to fade, 25c. Super quality—Speedy service—Satisfaction or money refunded. LaCrosse Film Company, Dept. 19, LaCrosse, Wis.

ROLLS Developed. Two beautiful double-weight professional enlargements and 8 guaranteed Never Fade Perfect Tone prints, 25c coin. Rays Photo Service, LaCrosse, Wisconsin.

TRIAL Offer. Roll developed and 8 prints 25c. Prints 3c each. Beautiful 10-inch enlargement 25c. Photo Christmas cards or photo calendars 10c each, 14 for \$1.00. Young Photo Service, 405 Bertha St., Albany, N. Y.

KODAK Pictures enlarged, 5x7 10c. 3 for 25c. Send negative film. Stanley Studio, Des Moines, Iowa.

20 REPRINTS 25c. Films developed, two prints each negative, 25c. Skrudland, 4118-8 Overhill, Chicago.

FILMS Developed 5c per roll; prints 3c each. Ask for special bargain list. Roanoke Photo Finishing Company, 161 Bell Ave., Roanoke, Va.

YOUR Favorite kodak pictures enlarged, size 5x7. 10c. Three for quarter, coin. Send best negatives (film) today. Address Darmer Photo Lab., Enlarging Dept. 9, Des Moines, Iowa.

INCOME From your camera instead of expense. Low cost home course teaches you to make photographs for magazines, newspapers, advertisers. Tremendous demand. Earn good money wherever you live. Free book. Universal Photographers, Dept. 104, 10 West 33rd St., New York.

ROLLS, Developed, printed, 25c. Mail your films to the biggest and best. Rolls developed and 8 good prints guaranteed plus 8x10 inch enlargement coupon only 25c. Reprints any size 3c each. Geppert Studios, Dept. 130, Des Moines, Iowa.

HAVE You a camera? Send ten cents for recent number of our big magazine, showing how to make better pictures and earn money. American Photography, 116 Camera House, Boston, 17, Mass.

MOTION PICTURES AND SOUND EQUIPMENT

LEARN The motion picture theatre business. Big opportunities for trained men. Catalog T free. Theatre Institute, Elmira, New York.

NEW 100 Ft., 16mm. subjects \$2.25, \$2.50, \$2.95. Projector, camera bargains. Film rental library. Dime brins catalogue, two "end" titles. Eastin Films, Dept. 29, Galesburg, Ill.

REELS \$1.10, 500 Ft. 75c. Jersey Films, 2075 Richland, Lakewood, Ohio.

8MM. OR 16MM. Movie cameras and projectors. Cash or terms. Elder, Dept. B-7, Chelsea, Mass.

16MM FILMS—Art 10c foot. Mickey-Mouse, Chaplin, Silly Symphony 5c foot. Big features rented anywhere \$5.00. Lists. Thousand feet 35mm \$1.00. Features \$7.50. Projectors, cameras \$5.00 up. Waldo Films, Box 524, Cincinnati.

35MM FILMS, Holiday bargains. List. Lakeshore Film Service, Michigan City, Ind.

CHRISTMAS Bargains—16mm—8mm. Listings stamp. Box 2133, Paterson, N. J.

SOUND, Silent, projector, cameras, parts, accessories, film, new, used at bargain prices. National film library trades accepted, catalogue. Mogull Bros., 1944-J Boston Road, New York City.

500-WATT 16MM Projector outfits, case, screen, film, \$110.00 value only \$79.50 new. Films 35c up. Art sample 25c. Free 16mm, 8mm bargain lists. Home Movies, Box 32, Easton, Penna.

LOWEST Prices for all kinds movie film and equipment. Free developing. Send stamp for price list. Home Movies Co., 22 E. VanBuren, Chicago.

UNUSUAL 35mm Lists, samples, 3c. Kneeland, 25 Sterling, Medford, Mass.

WORLD'S Greatest "Passion Play" 16 MM. (new) 5 reels. Rent or purchase. Write Hemenway Film Co., 37 Church Street, Boston, Mass.

EXCHANGE Library sound-on-film features, new, interesting; also 8mm and 16mm silent films of every variety. Harry Mendelwager, 182 W. 49 St., Bayonne, N. J.

1000 FEET 35mm 75c. Projectors. Features. Savarese, Woodliff Lake, N. J.

35-MM FILMS, Projectors. Stamp for lists. Box No. 6, Rosedale, Kans.

100 FEET 35mm 27c; odd reels 80c plus postage. 6 reel features \$6.00. Bargain lists 3c. Hoffman Film Service, 57 Broad, Albany, New York.

BASS Offers for a limited time brand new 100 ft. Stewart-Warner 16mm Cine camera, complete with case, F:3.5 lens, worth \$50.00, at \$18.50 each. Hundreds of other bargains in Bass Bargaingram No. 212 mailed on request. Write to Value Headquarters. Bass Camera Company, 179 W. Madison St., Chicago, Ill.

DEVELOP And print your own movies, instructions \$1.00. Millio, 620 Myrtle Ave., Brooklyn, N. Y.

TELEGRAPHY

FREE—Radio and Morse telegraphy book. Learn code in short time. New easy method. Fisher Electric Company, 3801 Riverside Avenue, Cleveland, Ohio.

BUSINESS OPPORTUNITIES

PLASTEX Industries offers industrious men an opportunity to start a business of their own, manufacturing art goods, novelties, souvenirs, etc., in Plastex and marble imitation. 5c material makes \$1 articles. Rubber moulds furnished for speed production. Small investment brings big returns. You are just in time for big Christmas business now starting. Write for interesting booklet mailed free. Plastex Industries, Dept. A, 1085 Washington Ave., New York.

(S.R.C.) Synthetic rubber molds made to order. Inexpensive, durable. Send model for estimate. We teach marbleizing and mold making in all branches. Send dime for S.R.C. testing material and miniature mold and cast, assorted marbleized samples. Cowell Institute, Grayling, Mich.

NEW Refillable punch boards sell wherever demonstrated. Big profit operating or selling outright. Currier Mfg. Co., 314 Terminal, Minneapolis, Minn.

SEE Our display advertisement on page 8A this issue. Rapaport Bros., 703 West Ohio, Chicago.

PRINT Signs, pictures, Christmas cards, etc. Outfit complete, special \$3.00. Sign House, 215 North 4th, Columbus, Ohio.

EARN Quick cash raising mushrooms in cellar, shed, attic. We buy crops. Guaranteed materials furnished. Easy, odorless method. Book free. United, 3848-CY Lincoln Ave., Chicago.

"THE Key to Business Opportunities" free. Goodall, Box 1592, San Francisco.

ARTIFICIAL Marble making puts you in paying business all your own. Easy, pleasant, profitable work. Interesting particulars free. Marble Institute, 4612-C North Hermitage, Chicago.

SIGNS And showcards easily painted with letter patterns. Large variety of styles and sizes. Write for free samples. John Rahn, A-2120 Neva, Chicago.

PROFIT With new products. Make, sell, repeat. Guaranteed formulas, special prices, leads. Biggest catalog free. Gibson, Chemist, BD-4702 No. Racine, Chicago.

SIGN Painting made easy with letter patterns. Samples free. Clark, Ellwood City, Pennsylvania.

CASH Income resilvering mirrors; replating metalware; making glass signs. Portable outfit. Sprinkle, Plater, 127, Marion, Ind.

MAIL Order book, 200 pages, tells how I built \$10,000 business. Free information. Author, 3103 E. 18th, Kansas City, Mo.

ENTER Exclusive business reinking used typewriter ribbons. New invention! \$50 required. Merit, 24 West 20th, New York.

ATTAIN Independence. Learn the collection business. Write Cole Associates, Tower PM-D, Syracuse, New York.

BIG Money at home plating auto parts, reflectors, mirrors, chandeliers; by new method; experience unnecessary. Outfits furnished. Gunmetal Co., Ave. N, Decatur, Ill.

IRISH Moss with my instructions will build you a permanent business. Sample for stamp. No postals answered. Uncle Artie, Wareham, Mass.

NEW Product; profits guaranteed. Sample \$1. Magico, 5721 Adelphi, Cincinnati.

MAILING Secretaries wanted. Experience unnecessary. Pay weekly—part in advance. Contract—details, 3c stamp. Nagel Enterprises, 1329 Olive, Indianapolis, Ind.

GENUINE Mexican opals. Perfectly cut. Edomao, Apartado 762, Mexico City.

FREE Circulars describing how you can make real, big money in mail order business at your home. Write today. Mail Order Institute, 669-H Marcy Avenue, Brooklyn, N. Y.

WIN Thousands cash. Send 10c list, legitimate contests. World Contest Magazine, 6323F 17th N. E., Seattle.

ORDER Pure spore cultured mushroom spawn from this ad. Each bottle plants 40 square feet. \$1.00 postpaid. Satisfaction or money refunded. Instructions free with order. Sterling Spawn Co., West Chester, Pennsylvania.

MAKE Your own products. Employ agents yourself. Toilet articles, soap, extracts. We furnish everything. Valuable book free. National Scientific Laboratories, 1950W Broad, Richmond, Va.

RESILVER Mirrors. Plate auto fixtures, tableware. Portable outfits. Metalcraft, Louderman Bldg., St. Louis, Mo.

SUCCEED With your products. Make-sell them. Formulas. Processes. Analytical service. Catalog free. B. Thaxly Co., Washington, D. C.

SCREW-HOLDING Screw drivers! Not magnetic! Remove, hold, insert screws in accessible places. Factories, garages, electricians, mechanics, radio, autoists buy; no competition! Quick sales, big profits. Exclusive territory; also foreign. Millicco, 5067 Winthrop Bldg., Boston, Mass.

GOOD Brick butter (not butterine) 6c lb. Particulars 25c coin. Results guaranteed or money refunded. Hallbeck Co., 6219L Wentworth, Chicago.

MONEY Making art. New, practical course. Norman Feather, Parkville, Mo.

BIND Your own books, magazines, etc. Enjoy hobby, small cost. Do bookbinding for others, rebind for libraries, nice profit. We furnish all supplies and easy rules. Complete outfit \$9.37. Write for details. Kelsey Binders Supplies, F-101, Meriden, Conn.

COPIES Of 5 successful jobwinning application letters, 25c. Business Letter Institute, A-203 South Dearborn, Chicago.

LEARN Motion picture theatre business. Catalog 8 free. Theatre Institute, Elmira, New York.

SOAP Making, learn at home. No machinery needed. Easy to start. Write I. Pozora, 3619 N. 25th St., Milwaukee, Wis.

FREE—Books, mail order business. Stamp appreciated. Dolsen Herald, 36 Liberty Street, Brooklyn, New York.

MONEY Making formulas, processes; all lines. Information free. Clore, Industrial Chemist, Crawfordville, Ind.

MAKE Concrete ornaments. Profitable winter proposition, using metal production moulds. Frog mould, 3x5 inches, makes hundreds quickly. \$1. prepaid. Owen Gardenware, 2501 Grinstead, Louisville, Ky.

OPEN A key-making shop. Start a permanent profitable business with a small sum. No skill necessary. Write for particulars. Beisser Mfg. Co., 411 E. Fort, Detroit, Michigan.

GROW Mushrooms all year round—a steady income indoors, in cellar, shed or stable. Exclusive new process. Bigger, better, quicker crops—more money for you! Book free. American Mushroom Industries, Dept. 966, Toronto, Ontario.

ADVERTISING Business of your own. Be independent. Complete instructions \$2. Cash or money order. D & H Enterprises, Box 222, Flat River, Mo.

MAIL Order industries—40 pages opportunities, plans, formulas, 10c coin. Amos Sullivan, Fairport, N. Y.

LEARN Taxidermy. Five courses. Blue Beaver Taxidermy School, Lemont, Ill.

GREATER Earnings! Home, office. No canvassing. Write for unusual opportunities. Hochman Service, 269 West First, Mt. Vernon, New York.

DOLLARS Daily: Operate; home! Mail-order business. Details. Duffy, Covington, Kentucky.

DISTRIBUTORS—Supply revolutionary corn remedy to stores. New sales plan results in landslide of orders. Up to 150% profit. Write for exclusive franchise. Reliable Specialty Corp., Buffalo, N. Y.

A FORTUNE Awaits you! New formulas for establishing business at home in spare time. Particulars free. Hetzel, 802 Garden, Hartford, Conn.

CHARTERS: Delaware; best, cheapest; free forms. Colonial Charter Co., Wilmington, Del.

LEARN All about casting marble novelties in rubber moulds. Cement secrets. Illustrated catalog and beautiful samples 3c. (So. Calif. business reserved.) John A. Payn, 945 Grande Vista Avenue, Los Angeles, Calif.

ARTIFICIAL Marble formulas. 3 for 25c. Johnson, 4520-Christiana, Chicago.

WE Buy names. Instructions 25c. Contract. Accounting Service, 9 Washington Ave., Minneapolis, Minn.

MANUFACTURE For profit. Substantial income making today's biggest-selling popular necessities—all lines—from my world famous guaranteed formulas. Get my free "eye-opening" literature. Miller, Chemist, 1708 PMB, Tampa, Fla.

"SCHEMER Magazine," Alliance, Ohio, prints schemes, ideas, business starters, formulas; winners—\$10,000 to \$50,000 reported. 36th year. \$1. Subscribe now. Six months special, only 30c.

TWELVE New successful money-makers. J. Home, 3949 Metropolitan, Chicago.

LIQUID Marble—Anyone can make! Colorful, glazed! Moulded, brushed, sprayed. Rubberlastic molds. Composition flooring. Big money making these! Particulars free. Marbleizing Service, Edwardsville, Ill.

CHEMICAL Expert will furnish formulas and trade secrets. All lines. Lists free. W. L. Cummings, Ph. D., 228 Gordon Ave., Syracuse, N. Y.

START Little business anywhere. Everything furnished. No canvassing. Maywood, PM 923 Broadway, New York.

SELL By mail. Books, novelties. Bargains! Big profits. Particulars free. B. Eilfo, 525 S. Dearborn, Chicago.

FREE Booklet describes 87 plans for making \$29-\$100 weekly, in home or office, business of your own. Elite Co., 214 Grand St., New York.

ARTIFICIAL Marble sanitary flooring, instructions covering wood or cement flooring ½ inch thick, fireproof, all colors, low cost. Ornamental casting, concrete plaster papier-mache decorations, garden furniture, statuary, flexible molds, particulars and illustrations free. Chris. Mahler, Elmont, N. Y.

MAIL Order business is your opportunity. Many began small, now earn thousands yearly. No personal contact. Boundless opportunities. Have had over 30 years experience; will help you succeed. Send 25c for valuable booklets, none free. B. Breniser, 257 South 21st, Philadelphia.

BARGAINS—Paint spray outfit, gasoline engine drive. Terms—trial. Helmick Paint Spray Exchange, M-153, Troy, Ohio.

FORMULAS AND TRADE SECRETS

TESTED Formulas 30c each. List free. Ogg Laboratories, Tampa, Fla.

ANY Formula two dimes or money refunded. Westcott, Clyde, N. Y.

FORMULAS, Processes; all lines. Individual service by experienced chemist. Clore, Industrial Chemist, Crawfordville, Ind.

500 MONEY Making formulas, 25c. Womble's, Siler City, N. C.

LABOR Saving paint and varnish remover for any surface. No scraping. Paint rubs off. Non-injurious. Costs 50 cents gallon to make. Formula and instructions \$1.00. August Becker Corporation, 300 Graham Avenue, Brooklyn, N. Y.

MANUFACTURERS Money-making formulas. Products easily made. Thermo Works, Peoria, Ill.

NEWEST Guaranteed formulas. Biggest catalogue free. Special prices, leads. Gibson, Chemist, BD-4702 No. Racine, Chicago.

"50 BEAUTY Product Formulas" and beauty culture book—\$1.00!!! T-S-G-Co., Box Ten, Wilkingsburg, Pa. (Non-evaporating anti-freeze—\$1.00!)

ANTI-MIST! Coal saver! Anti-freeze. Guaranteed. 25c each. Duffy, Covington, Ky.

FREE Formulas given! Particulars free. King Laboratory, 3223 Sixth St., Harrisburg, Penna.

FORMULAS, Analysis, free catalogue. Herstein, Chemist, 222 Ransom, Grand Rapids, Mich.

SUCCEED With your products. Make-sell them. Formulas. Processes. Analytical service. Catalog free. B. Thaxly Co., Washington, D. C.

BIG Money resilvering mirrors. Instructions 25c (coin). Charles, 12-Z, Norwood, Ohio.

FREE Formula literature, manufacture products yourself. Thomson, 7309 Pingree, Chicago.

500 MONEY Making formulas 25c. Descriptive circulars free. Harvey Teeple, Decatur, Ind.

TESTED Formulas 30c each. List free. Ogg Laboratories, Tampa, Fla.

500 FORMULAS 25c; Money-making literature free. "Ideal," 178P, Parkridge, Ill.

GUARANTEED Formulas, best science can produce for making popular, biggest-selling specialties all lines. Don't buy formulas till you've received valuable eye-opening literature. Miller, Chemist, 706-F Jetton, Tampa, Fla.

3,000 FORMULAS, Facts, processes, trade secrets in Dr. Brown's Book of Formulas—380 pages. Price, postpaid \$1.00. Ogilvie Publishing Co., 57 Rose Street, Dept. 25, New York.

FORMULAS, Plans, ideas, Literature free. Belfort, 4042 N. Keeler, Chicago.

FORMULAS, All kinds, Guaranteed, Catalog free. Kemico, 31, Parkridge, Ill.

TESTED Formulas—Newest, guaranteed! Catalog free. Grinstead Laboratory, Edwardsville, Ill.

CHEMISTRY

ULTRA-VIOLET Fluorescent materials: Filter, bulb, blueprint for building powerful black-light lamp \$2.00. 10 fluorescent specimens \$1.00. Argon lamp and 5 specimens \$1.00. Catalog 10c, free with order. Laboratory Specialties, Box 125, Wabash, Ind.

STUDENTS: Send \$2.00 for aluminum weight set, 500 to 1 milligram in paper box. Guaranteed Class 8 tolerance. Thompson Balance Co., Denver, Colo.

ANALYZE Fast sellers to get fast sellers. Pitching. Canvassing. Write Associated Chemists, Indianapolis, Ind.

HANDBOOK For chemical experimenters, revised and illustrated. 50c. Experiment booklet 15c. Chemical catalogue 10c. Scientific booklist free. Reading Scientific Co., Reading, Pa.

CHEMICAL Analysis, industrial problems, and mineral assays. Estimates free. Lowell Bunting, Consultant Chemist, Royal Oak, Michigan.

10c BRINGS You new catalog listing chemical sets, microscope outfits and laboratory supplies. Special 30-day offer to those who send immediately. Winn Co., Dept. P-12, 124 West 23 Street, New York.

CHEMICALS, Laboratory glassware and apparatus. Catalog CP. Biological Supply Co., 1176 Mt. Hope Ave., Rochester, N. Y.

CHEMISTS' Slide rule, editorial Jan. issue, saves time solving equations, gives molecular weights, shows formulas, 391 compounds. Durable precision instrument. Post-paid, complete instructions, two dollars. MWC Company, 508 Andrus Bldg., Minneapolis, Minn.

SCIENCE

SUPPLY Chemical needs in your community. Proven formulae, details 25c coin. Chas. Harker, Box 383, Jefferson, Iowa.

AGENTS WANTED

LOCAL Agents wanted to wear and demonstrate free suits to friends. No canvassing. Up to \$12 in a day easy. Experience unnecessary. Valuable demonstrating equipment, actual samples free. Progress Tailoring, Dept. N-217, 500 Throop, Chicago.

NEW Invention. Just out. Fills and drains washing machines. Opens clogged sinks. Household necessity. Brief demonstration sells housewife. Act quick for your territory. Sample 60 cents prepaid. Fill-Or-Syphon Co., 234 E. Manchester Ave., Los Angeles, Calif.

AGENTS: Stamping names on pocket-key protectors. Sample check with your name, address, 25c. Stamping outfits. Emblem checks, check-fobs, name plates. Hart Mfg. Co., 303 Degraw St., Brooklyn, N. Y.

METAL Polishing cloths. Costs 4c each, retails 25c. Free sample. Superior Specialties, Springfield, Ill.

MAKE Big money; commissions advanced; sell raincoats, zipper jackets; union made; latest style; quality; lowest prices; experience unnecessary; outfit free. Goodyear, DO-712 Roosevelt, Chicago.

LIFE-NIFE. The knife for a life time, sells itself. Big profit. Send for details or better send 20 cents for sample with sales plan. Windfeld Mfg. Co., Box 681, Sioux City, Iowa.

PROFIT With new products. Make, sell, repeat. Guaranteed formulas, special prices, leads. Biggest catalog free. Gibson, Chemist, BD-4702 No. Racine, Chicago.

CASH Income resilvering mirrors; replating metalware; making glass signs. Portable outfit. Sprinkle, Plater, 128, Marion, Ind.

SELLS Like hot cakes. Big profits. Flory Blossoms, new laundry soapflakes. Perfumes clothes lastingly, when washing. Sunset Laboratories, Lynbrook, N. Y.

AMAZING Corn remover. Big profits for distributors. Write Posco, 760 Milwaukee, Chicago.

SURE-FIRE Cigarette lighters sell themselves. Last for years. Won't blow out. Burn gasoline or naphtha. Retail 50c. Mail 50c for sample and wonderful proposition. Money back guarantee. Sales plan free. Good territories open. Act now. Bowers Manufacturing Co., Dept. M, Kalamazoo, Michigan.

SAMPLE 25c Key check for dime. Wenk-hous, Beaver Falls, Pa.

RAINCOATS, Zipper jackets; \$2.95. Lowest prices. Union made. Selling fast. Commissions advanced. Experience unnecessary. Outfit free. Royal, T-724 Roosevelt, Chicago.

MEXICAN Feather pictures. Great profit. Send 25c (stamps) for \$1.00 worth sample and details. Mexican Art, Apartado 1593, Mexico, City.

BEAUTIFUL Foil window sign letters. Penny each. Popular sizes. Easily applied. Samples, complete working equipment free. Note our ad page 130A. Atlas Sign Works, 7941 Halsted, Chicago.

SALES Kit free. Write for our free offer and catalog of household deals, cosmetics, extracts, etc. Make big money selling your friends and neighbors. Clyde Collins Chemical Co., Dept. PM-12, Memphis, Tenn.

100% PROFIT In the mystery cigar lighter. No flint or friction. What makes it light? No wind can blow it out. Retail 25c. Sample and sales plan 25c. New Method Company, Desk PM-25, New Method Bldg., Bradford, Pa.

\$2.00 HOURLY With new, scientific cream that mends all cloth easily, quickly, invisibly, without needle and thread. Stands laundering. Free sample. Sew-No-More Co., Dept. E-744, Cincinnati, O.

STRANGE Ironing cord. Prevents scorching. Saves electricity. Abolishes kinks, snarls. Approved by Good Housekeeping. For telephones also. 140% profit. Samples furnished. Neverknot, Dept. 1-A, 4503 Ravenswood, Chicago.

500% PROFIT Selling new "20-in-1" kitchen utensil. Retail 25c. Costs you \$1.00 a dozen. \$7.20 a gross. Sample 10c. New Method Co., P.M.M.-25, Bradford, Pa.

CASH Paid for butterflies, insects. See Sinclair Display Advertisement on page 23A.

\$6.00 HOURLY. Amazing Karnu refinishes autos like new without rubbing, polishing, waxing or painting. Wipes on with cloth. Lasts 8 to 12 months. Free sample. Karnu, Dept. E-108, Cincinnati, Ohio.

DISTRIBUTORS: Represent manufacturer. Sell Latex—self sealing bandage that breathes. Great demonstrator. Lowest prices. 100% profit. Good repeater. Exclusive territory. Neway, 24-H South Clinton, Chicago.

100 PROFITABLE Mail order and local business plans. A. Pruitt, Elburn, Ill.

MARRIED Man with spare time to distribute free samples coffee, flavoring, food products and make customers. Must devote at least two hours daily and be satisfied with up to \$3 in an hour. Permanent. Blair, Dept. 31-A, Lynchburg, Va.

250,000 ARTICLES Wholesale. Large illustrated wholesale catalogues. Supply sources 10c. Amazing new combination deals. Circulars free. Patterson, 3705A University, Des Moines, Iowa.

NEW; Enormous profits, year round seller everywhere; fills need; pocketful will make big day's pay. Write G. E. Cassidy, 509 Fifth Ave., New York.

WORLD'S Great novelty, Midget Bible. Smallest Bible produced. Quick seller. Everybody buys. Details, sample 10 cents. Galeo, Box 14, Hempstead, N. Y.

DISTRIBUTORS—Smashing new sales-card plan. Entirely new idea. Every punch wins! Associated Sales, 2660 N. 40th St., Milwaukee, Wis., Dept. J.

DOUBLE-EYED Self-threading needle packages, size 3/9. Blind people thread them. Invaluable for failing sight, necessary for good sight. Sample, particulars 10c. Agents wanted. Wm. Oglesby, Vandalia, Ill.

SELL Products under your own label. Big line. Low prices. Edward-Walfred, 5007-P Irving Park, Chicago.

I WANT Men for local tea and coffee routes paying up to \$60 a week. No experience required but must be willing to give prompt service to approximately 200 steady consumers. Write Albert Mills, Route Mgr., 8916 Monmouth, Cincinnati, O.

AGENTS: Smash go prices. Santos coffee 12c lb. 4-oz. vanilla 8½c. \$1.00 size tonic 14c. Razor blades 10 for 8½c. 100 sticks chewing gum 12c. 150 other bargains. Experience unnecessary. Write Carnation Co., P.O. St. Louis, Mo.

SUCCEED With your products. Make-sell them. Formulas, Processes. Analytical service. Catalog free. B. Thaxly Co., Washington, D. C.

AGENTS! Every housewife a prospect! Device cleans outside windows from inside. Earn enormous profits. Heller Products Co., 2350 Seminary, Chicago.

BIG Commissions in dignified business. Revolutionary new humidity system, practical part of air conditioning. Entirely automatic. Easily installed. Necessary in every home. Priced for every purse. Send 25 cents for blueprint, data and agency proposal. Dept. P. Moore Mfg. Co., 605 Washington Blvd., Chicago.

FOR The holidays—our Luminous Crucifix which "shines in the dark" is the most appropriate gift of all. An instant to demonstrate and the sale is made. Big profits. Hannan Co., 2539 South State, Chicago.

PORTRAIT Agents—Lowest prices, portraits, frames. Catalogue free. Picture Man Friedman, 528 Cornelia, Dept. 9, Chicago, Illinois.

GENUINE Gold letters for store windows. Easily applied. Free samples. Liberal offer to general agents. Metallic Letter Co., 438-B North Clark, Chicago.

MAKE Products yourself. Formula catalogue free. Kemico, 45, Parkridge, Ill.

REGULAR Income; home, office, no canvassing. McArthur Co., Desk 5, Butte, Mont.

FREE Literature describing many money making plans. Belfort, 4042 N. Keeler, Chicago.

BIG Money applying gold initials on automobiles. Easiest thing today. No experience needed. Free samples. "Ralco," 1984 Washington, Boston, Mass.

MAN In each town to plate auto parts, reflectors, bathroom fixtures, refinish beds, mirrors, chandeliers; by new method. No capital or experience required. Simple plan of manufacturing at home starts you in big money-making business. Outfit furnished. Free particulars and proofs. Gun Metal Co., Ave. H, Decatur, Ill.

BIG Money and fast sales. Every owner buys gold initials for his auto. You charge \$1.50; make \$1.45. Ten orders daily easy. Write for particulars and free sample. American Monogram Company, Dept. 40, East Orange, N. J.

AGENTS—Opportunity to make money; book containing 87 successful business plans; home or office; send for free introductory booklet. Elite Co., 214 Grand St., New York.

A BUSINESS Of your own making sparkling glass name plates, numbers, checkerboards, medallions, signs. Booklet and sample mailed free. E. Palmer, 512, Wooster, Ohio.

PROFITABLE Home business. Legitimate. No canvassing. Maywood Publishers, P-923 Broadway, New York.

BE Independent. Own your business; experience unnecessary. Selling \$10,000 accidental death, \$50 accident; \$25 sick weekly benefits—\$10.00 yearly. Other amounts proportionate. Guaranteed steady renewal income. \$250,000 deposited insurance department. Universal Policy, 716-A Lefcourt Bldg., Newark, N. J.

HIGH-GRADE SALESMEN WANTED

YEAR'S Income in 3 months! New federal, state and code laws create immense demand for simplified record system every businessman must have to protect himself against fines and penalties. Millions users must buy again now. Our men selling 5 to 25 daily our official approved, copyrighted Liberty Tax Record. \$3.50 cash profit every sale. Repeat commissions without callbacks. Live leads furnished. Big season now. Choice territories going fast. Commonwealth Publishing Company, 508 So. Dearborn, Chicago.

PENNY Each, popular sizes. Non-tarnishable window sign letters. Enormous profits. Free working equipment, sample. Record breaking offer. Note our ad page 130A. Atlas Sign Works, 7941 Halsted, Chicago.

GET In on the ground floor with a growing concern. Sell products needed in every home and business establishment. Territory available. Fabco, Leominster, Mass.

DISTRIBUTORS: Represent manufacturer. Sell Latex—self sealing bandage that breathes. Great demonstrator. Lowest prices. 100% profit. Good repeater. Exclusive territory. Neway, 24-H South Clinton, Chicago.

SALESMEN: Acquainted with garages, filling stations, to handle local business. Write Colgra, 2627 N. Third St., Milwaukee, Wisconsin.

STRANGE Chemical sponge cleans wallpaper like magic. Banishes housecleaning drudgery. Women amazed. Hustlers cleaning up. Outfit free. Kristee Mfg., Box 1431, Akron, Ohio.

MAN—Handle regular store route. Place nationally advertised 5c-10c counter card mdse. New aspirin deal. 16 tablets 10c. 85 more fast sellers. 100% profit. No investment. Catalog free. World's Products Co., Dept. 1819, Spencer, Ind.

SELL New Electrical tool for mechanics. Big new field. Easy convincing demonstration makes quick sales. No slack seasons. Mechanixl, 150 Franklin, Bucyrus, Ohio.

GO Into wholesale business without investment. Call on stores with biggest line self-selling counter displays: Aspirin, razor blades, handkerchiefs, breathlets, household cement, 79 different items. Up to 125% profit for you. Experience unnecessary. Write for catalog and plans. Procopax, Dept. 35-ED, 1956 S. Troy, Chicago.

DON'T Be a job hunter—Start your own business on our capital. No hard times; no lay-offs; always your own boss. Hundreds average \$3000 to \$5000 annual sales year after year. We supply stocks, equipment on credit. Over 250 home necessities. Selling experience unnecessary. Wonderful opportunity to own pleasant, dignified, profitable business backed by world wide industry. Write Rawleigh, Dept. A-U-PPM, Freeport, Illinois.

EVERYBODY Buys business stationery. New items. Highest quality. Lowest prices. Free cuts. Quickest delivery. Big commission daily. Experience unnecessary. Self selling outfit free. Willens, 2132 Gladys, Dept. S, Chicago.

AUTO Accessory salesmen: Complete line fastest sellers. Prices dealers want to pay. Big commission daily. Exclusive territory. National, 1910-BU Wentworth, Chicago.

TIGER-GRIP—New improved tire repair, specially constructed and backed with iron clad service guarantee of 10,000 miles. 100% profit—easy sales—big steady income with full line of fast-selling automobile necessities. Exclusive territory. Salesmen—distributors write. Economy Rubber Products, 731 Burkhardt, Dayton, Ohio.

SELL Process engraved printing \$3.95 thousand, with free cut service. Worth \$7.00. Nothing like it! Commission \$1.00. Experience unnecessary. Outfit furnished free. United Engravers, F-8 So. Dearborn, Chicago.

LARGE Steady profits. Make-sell amazing anti-freeze non-evaporating solution for autos. Will not freeze at 25 below. Made in few minutes for little as 10c gallon. Send only 25c today for formula. Allied Research, 2217 N. Kilbourn, Chicago.

WANTED: County salesman with car, to demonstrate and service for large Ohio manufacturer. First-class job. 242 Fyr-Fyter Co., Dayton, Ohio.

NEW Million dollar diamond mop; patented product, approved by Good Housekeeping, now appointing high grade salesmen and canvassers. Address Mop Production Dept., Box 929, New Orleans, La.

PROTECTED Territory on equipment every merchant needs. \$4.00 commission \$10.00 sale. 303 Valley Bank Building, Des Moines, Iowa.

SALESMEN Wanted—To sell brand new, patented, low-priced, non-competitive article, just being marketed. Salesmen sample 10c. Ideal Company, Racine, Wis.

NEW Specialty—Sells every business and professional man. Four \$15 sales daily pay \$280 weekly. Foyer cleared \$4920 in three months. Write, P. E. Armstrong, President, Dept. P.M. Mobile, Ala.

THOSE Having contact with large users of envelopes can add to their income by representing the Weaver Mailing Envelope Co., 715 Arch St., Philadelphia, (established fifty years)—makers of specialty envelopes in Kraft, Manila, Jute, Water-proof, Cloth-lined, and other papers.

NEWEST, Most amazing deal for stores, shops. Inexpensive. Big business increase or money back. Gold mine for salesmen. Outfit free. Stimulators, 343 Madison, Chicago.

BRAND New grab-bag deal. Going big everywhere—big profits—swift sales—fast repeats. No restrictions. All dealers buy. Act! K&S, 4373 Ravenswood, Chicago.

SALESMEN—Sell collection systems. 400% commission. Sayers Systems, 2801-123 Sheffield, Chicago.

STICK-ON Window sign letters. 500% profit. Free samples. Metallic Co., 438-A N. Clark, Chicago.

SELL Stores or homes—Scissors sharpeners, gas lighters, razor blades, aspirin, breath gum, chewing laxative, adhesive tape, polish, handkerchiefs, polishing cloths, shoe laces, many others. Attractive displays. Catalog free. Superba Co., S-303, Baltimore, Md.

HELP WANTED

IF You want to get your groceries and household supplies at wholesale, and a wonderful chance to make \$15 a day besides, send me your name immediately. No experience necessary. Albert Mills, 8915 Monmouth, Cincinnati, O.

MAN Wanted—Old established manufacturer will finance responsible man with complete stock guaranteed food products, farm and household necessities. Very pleasant work. Excellent opportunity for good living and extra money to save every week. Pays better than most occupations. O. W. Jack sold \$308, B. M. Anderson \$330 in one week. No slack seasons or layoffs. Experience unnecessary. Write for no-investment offer. McCann & Company, Room 66AT, Winona, Minnesota.

REAL Jobs open—Auto mechanical field, aviation. Earn \$35.00-\$75.00 weekly. 8 weeks' training qualifies you. Write for big opportunity book and special low tuition now. McSweeney Schools, Dept. 10-A-13, Cleveland, Ohio, or Kansas City, Mo.

EARN Quick cash raising mushrooms in cellar, shed, attic. We buy crops. Guaranteed materials furnished. Easy, odorless method. Book free. United, 3848-CZ Lincoln Ave., Chicago.

BIG Money growing mushrooms. Cellar, idle places. Supplies furnished. We buy crop. Free book. Mushroom Growers of America, BS-433 N. Clark, Chicago.

AGENTS—Mosco corn and callous remover will build you a steady repeat business. Send today for pocket-size trial outfit. The Moss Company, 54 Searle Bldg., Rochester, N. Y.

CASH Paid for butterflies, insects. See Sinclair Display Advertisement on page 23A.

EDUCATIONAL AND INSTRUCTION

EARN Regular monthly salary as secret service and finger print identification operator. Thrills, fame, travel. Write for details and "Confidential Reports Operator 38 Made to His Chief." All free. Institute Applied Science, 1920 Sunnyside Ave., Dept. 135-E, Chicago.

\$105.00-\$175.00 MONTH. Government jobs. Winter examinations expected. List jobs free. Franklin Institute, Dept. L3, Rochester, N. Y.

PARLIAMENTARY Pointer. Covers everything. No studying. Saves time. Makes humblest familiar proper procedure. Instantly available. Any emergency. Inspires confidence. Endorsed by press, pulpit and professionals. 25 cents. Gardner, 68 Arcade, Providence, R. I.

BOOKBINDING Taught by mail. For information write Hartley, 156 Malone Ave., Belleville, N. J.

IF Interested in becoming secret service agent write International Secret Service Institute, PM-15, Hoboken, N. J.

COPIES Of 5 successful jobwinning application letters, 25c. Business Letter Institute, C-203 South Dearborn, Chicago.

LAW Books 50c each. Lists sent. Maitland Milliken, Denver, Colo.

GET U. S. government job—start \$105-\$175 month. Men-women, age 18-53. Are you eligible for eligibility test? Get our free questionnaire—find out. No obligation whatever. Instruction Bureau, 101, St. Louis, Missouri.

FINGER Print instructor. Kuhne's \$3; Henry's \$1.50. Outfit \$1; in wooden case \$2. American System, 219-P West 100th St., New York.

LATEST Developments in arithmetic, easily learned. Frederick A. Smith, 2410 Smalley Court, Chicago.

LEARN Chiropody. Complete course by correspondence. Evans Foot Inst., Montgomery, Ala.

HOME Study courses leading to degrees: Arts and sciences, philosophy, education, law, letters, theology, psychology, engineering, chemistry, business and commerce. Many others. McKinley-Roosevelt University, Chicago.

GET Into aviation. Air transport pilots get up to \$7,000 per year; mechanics, \$2,500. Learn at this government approved school. Write for complete information. State age. Lincoln Flying School, 2005 Aircraft Building, Lincoln, Nebr.

BLUE Printing: Build complete outfit. Simple instructions. New processes. 35 cents. Self Help, 410 Donovan Bldg., Detroit.

MEN Wanted—To learn Machinist trade Tool and Die making, Automatic screw machine. Get experience on actual work. Employment help. Start now. Days—evenings. Write for free book. Allied Screw Machine Co., 601 Lake St., Chicago.

BECOME A landscape architect. Easy to learn by mail. Wonderful opportunity for money-making. Earn while you learn. Write for free opportunity booklet and details. American Landscape School, 805 Plymouth Bldg., Des Moines, Iowa.

U. S. GOVERNMENT Positions. \$1700-\$1900 and up a year. Let our expert (former government examiner) prepare you for a position in the railway mail service, rural carrier, post office, customs and other branches. Write today for free booklet. Dept. 8, Paterson School, Rochester, N. Y.

PRINTING, MULTIGRAPHING AND MIMEOGRAPHING

250 BOND Letter heads 8½x11 and envelopes \$1.75. Athens Press, DeLand, Fla.
1000 NEAT Business letterheads. \$1.50 per 1000. Dodds-F. Cedar Rapids, Iowa.

250 LETTERHEADS, 8½x11 Bond—\$1.00. Christmas wrapping optional. Congressional Press, 619 H St., Washington, D. C.

STATEMENTS, Letterheads and similar forms, thousand \$2.95. Deposit required, satisfaction guaranteed. New Deal, Miami, Oklahoma.

PRINTING, Mimeo-graphing, low prices. Free estimates. Hunt Co., Box 202, Trenton, N. J.

ATTRACTIVE Circulars, folders, stationery—\$2.00 thousand, quantities. Elegant samples. Goodprint, Harrisonburg, Va.

MULTIGRAPHED Letters, with printed letterheads, 500—\$3.50. Glendale Printing Company, Box 4350, Kansas City, Mo.

NEOPRINT Process reproduces anything written, drawn or printed; same size, larger or smaller, without type, cuts or engravings. Reduces printing bills materially. Send stamp for big illustrated descriptive catalog price list. August Becker Corporation, 300 Graham Avenue, Brooklyn, N. Y.

REAL Printing! Estimates and samples for stamp. Press, Commodore, Penna.

1000 CARDS \$1.40. 500 Letterheads, envelopes, billheads, \$1.75. Bradshaw, 3214 Huron, Chicago.

STATIONERY. 150 Monogrammed sheets and envelopes \$1.00. H. Palow, 2032 N. Hermitage, Chicago.

2000 BUSINESS Cards neatly printed \$1.50. Atlas Distributing Co., Roberts St., Pittsburgh, Pa.

ENGRAVURE Printing. Lowest possible prices. Samples free. Sunko, Mohawk, N. Y.

STATIONERY, Circulars, checks, loose-leaf, ruling, binding. Commercial Press, Batavia, Ohio.

BETTER Grade printing, reasonable priced. Free samples. Economic Press, Leonia, N. J.

1000 BUSINESS Cards, card case, \$1.50. Miller, Printer, Ambler, Pa.

PRINTING OUTFITS AND SUPPLIES

MAKE Cuts—Simple, cheap process. Half-tones, line cuts, typematter. Anderson & Son, 12612 Greenwood Ave., Blue Island, Ill.

MIMEOGRAPHING, Printing presses, \$4.00 up. Bargainlists, 1354 Hayden, Cleveland. (Stamp)

PRINTING Presses, type, supplies. Lawrence, 1426 South St. Francis, Wichita, Kans.

PRINTING Outfits—Presses, type, supplies, type novelties. Send stamp for catalog. Model Press, York, Penna.

PRINT Your own cards, stationery, circulars, advertising, etc. Save money. Easy rules furnished. Print for others, big profits. Junior press \$5.90; job presses, \$11; power, \$149. Write for free catalog and full information. Kelsey Co., T-11, Meriden, Connecticut.

NEW Type 29e font. Catalogue dime. National Type Company, Jackson, Mich.

STANDARD Printing presses and supplies. Lists 3c. Landis, Richland, Pa.

6 x 9 SIDE Lever presses—New—\$42.50. Send for circular. Brooklyn Printers Exchange, 35 York St., Brooklyn, N. Y.

BARGAINS Used presses, type. Send stamp. Box 15, Cambridge, Mass.

HAND Press, type and complete printers' supplies. Advise equipment you need and we quote prices; or send stamp for catalog. P. Peiffer, 25-A; 6 Columbia St., Newark, New Jersey.

REBUILT Presses, guaranteed like new, list 3c. Exchange D10, 22 Orient, Meriden, Connecticut.

DUPLICATORS AND DEVICES

INCREASE Business. "Excellograph" rotary stencil, clay and film duplicators \$3.85 to \$37.50. Prints anything. Typewritten, penned, drawn, traced. Colors. Folder free. Pittsburgh Typewriter Supply, Suite 518, Pittsburgh, Pa.

RUBBER STAMPS

2 LINES 25c. 3 Lines 35c. Free list. Stamp Works, 814 Bradley, Peoria, Ill.

REGULATION Bank style. Beautiful workmanship. Reasonable prices. Northlake, Peoria, Ill.

NAME, Address, 2 lines 25c; 3 lines 35c. Stamp Works, Auburn, Nebr.

TYPEWRITERS AND SUPPLIES

TYPEWRITERS \$7-\$27. Watches, music, adders, mimeographing 2000, \$2.50. Knight's, 1517 Olive, St. Louis, Mo.

GUMMED LABELS

PRINTED—Your copy. That catch the eye! P-Wetzel, Valhalla, N. Y.

FOR MEN

MEN'S Needs, razor blade for stamp. Moyer Supply, Milton, Pa.

RAZORS AND BLADES

E. Z. Way stropper fits any style blade, complete with 20 double edge blades postpaid \$1.00. Daniel F. Kern, Box 296, Walnutport, Pa.

ANTIQUES, WAR RELICS AND INDIAN GOODS

25 CHOICE Arrowheads \$1.00. H. L. Talburt, Calico Rock, Ark.

CATHOLICS! Unusual, antique, penmanship reproduction "Ecce Homo" 10¼x12¼" ready for framing. 2 reproductions 25c coin. Publishers, Box 6, Cincinnati.

INDIAN Relics. Beadwork. Coins. Curios. Catalogue and arrow, 6c. Vernon Lemley, Northbranch, Kans.

TOBACCO

GUARANTEED Tobacco—Natural leaf chewing and smoking, 5 lbs. \$1.00; 10 lbs. \$1.50. Cigarette Burley, 5 lbs. \$1.00. Free gift. Howards Plantation, Mayfield, Ky.

QUALITY Leaf tobacco. Try our package containing 6 marked kinds, \$1.00 prepaid. Price list on request. Farmers Exchange, Edgerton, Wis.

GUNS, FISHING TACKLE AND SPORTING GOODS

BLUE Steel finish makes old guns like new. Enough to do five guns \$1.00 prepaid. Gunmetal Company, Decatur, Ill.

FIELD GLASSES, TELESCOPES AND MICROSCOPES

MICROSCOPE Slides—Diatoms, Radiolaria, each 50c; 12, \$5.00; 25, \$9.00. Rock \$1.00 up. Wood 25c up. Used microscopes, astronomical telescopes. Rasmussen, 360 Guy Park Ave., Amsterdam, N. Y.

LIVE Micro-organisms. Send 10c for big catalog listing this and many other biological supplies. Winn Co., Dept. M-12, 124 West 23 Street, New York.

DIAMONDS, WATCHES AND JEWELRY

15 JEWEL Elgin watch, complete \$3.95. Only few left. Anderson, Box 3177, Miami, Florida.

LEARN Watchmaking free. Experimental movement 50c. Catalog 5c. Stewart's, Sixth-Olive, St. Louis, Mo.

MUSIC AND MUSICAL INSTRUMENTS

HAWAIIAN Or Spanish guitar given students taking course of home instructions. Easy as abc. Pay monthly. Paramount Conservatory of Music, 246 East 18th, Vancouver, Canada.

\$\$\$SONGWRITING\$\$\$. Good money being made from songs through talking pictures, radio, phonograph, music publishers. "Hit" writers revise, arrange, compose music to your lyrics, lyrics to your music. We submit to studios and other markets. Free reading. Send for booklet. Universal Song Service, 671 Meyer Bldg., Hollywood, Calif.

REBUILT Band and orchestra instruments. Honestly rebuilt—fully guaranteed. Catalog of new instruments on request. Weymann Company, Dept. M-1, 13th and Arch Sts., Philadelphia.

NEW Deal. Write Sequoia Songwriters Service, Sherman Branch, Los Angeles, California.

WRITERS! Poems, music. Amazing offer. Hibbler D1, 2157 North Avers, Chicago.

DUO-FLEX Reeds for clarinets, and saxophones eliminate your reed troubles. Write for circular. Duo-Flex Reeds, 1204 1st Ave., Evansville, Ind.

SONG Writers. Send for our "Publishing Agreement." McKinley Music Printers, 1501 E. 55th St., Chicago.

SONG Poems wanted, free examination, 50-50 plan. Song Bureau, Salem, Ind.

PATENT ATTORNEYS

INVENTORS: Send immediately for your copy of our big, new free book, "Patent Protection." Forty-eight pages of interesting facts. Tells how patent laws protect you; kind of sketch or model needed; simple steps to take without cost; how successful inventors have secured financial assistance; shows interesting inventions; illustrates important mechanical movements. Other men have read and profited by this book. With book we also send free Evidence of Invention form, that you can use to establish date of disclosure. Prompt service, reasonable fees, special deferred payment plan. Strictest secrecy. Thirty-six years' experience. Highest references. Write us today. The facts in our book are worth money to the man with a good invention. Address: Victor J. Evans & Co., Registered Patent Attorneys, 400-A Victor Building, Washington, D. C.

PATENTS—Before too heavy an outlay of time or money is made on an invention, a search of the Patent Office records should be made to determine as nearly as possible whether or not the same idea has been patented before. The cost of this search is small, while the value of the facts it uncovers is often considerable. We offer inventors and manufacturers a thorough, prompt, confidential search service—plus experienced counsel and assistance in every phase of Patent and Trademark practice. Write for my free book containing valuable information relating to patent procedure. Clarence A. O'Brien, Registered Patent Attorney, 58-R Adams Building, Washington, D. C.

INVENTORS: How to "safely" sell your idea unpatented. Schrieber, Nashville, Ill. \$40.00—INVENTIONS Patented. Samuel Goldstein, 275 East Gunhill Road, New York City.

INVENTIONS May now be safely marketed before patenting. For information, write Chartered Institute, 554A Barrister Building, Washington, D. C.

ECONOMY For inventors. Write for booklet. Thos. H. Johnston, 635 F St., N. W., Washington, D. C.

PATENTS—Proper service for manufacturers and individual inventors. Established 1895. Reasonable charges. Consult Chandiee & Chandiee, Patent Attorneys, 902 F. Street, Washington, D. C.

UNPATENTED Ideas can be sold. I tell you how and help you make the sale. Free particulars. (Copyrighted.) Write W. T. Greene, 907 Barrister Building, Washington, D. C.

A NEW Deal for inventors: Combined patent attorney and development engineer service. Simple case attorney's charge \$50.00. Search \$5.00; trade-marks complete \$35.00; copyrights \$6.00. J. J. O'Brien, Patent Attorney-Engineer, Reg. 1909, 108 West 42nd St., New York City.

INVENTORS—Send for free booklet "Patent-Sense." Information based on 64 years experience. Lacey & Lacey, Dept. 5A, 635 F St., Washington, D. C.

ESTABLISHED 1864. Milo B. Stevens Company. Free booklet. Patents. Trade marks. Copyrights. Offices: Monadnock Block, Chicago; American Security Building, Washington, D. C.

PATENTS. Instructions "How to Establish Your Rights" and form. "Evidence of Conception"—sent free! Lancaster, Allwine & Rommel, 411 Bowen Building, Washington, D. C.

PATENTS Procured; trade marks registered—preliminary advice furnished without charge. Booklet and form for disclosing idea free. Irving L. McCathran, 700A International Bldg., Washington, D. C.

PATENTS. Booklet free. Highest references. Best results. Promptness assured. Watson E. Coleman, Patent Lawyer, 724 Ninth St., Washington, D. C.

"INVENTOR'S Guide," valuable information free. Frank Ledermann, Registered Attorney-Engineer, 220 Broadway, New York.

L. F. RANDOLPH, 302-B Victor Building, Washington, D. C. Low cost. Book and information free.

INVENTIONS WANTED

AUTOMOBILE Inventions, devices, tools, etc., wanted. Anything that can be sold through garages and automobile parts dealers. Will manufacture or take output. Room 201, % Popular Mechanics Magazine, 200 E. Ontario St., Chicago.

INVENTIONS Wanted, patented or unpatented, any size, any material, for any purpose. Now is the time to act. Send us your ideas. A square deal assured. Bosley Mfg. Co., Torrington, Conn.

WILL Purchase outright new attractive auto accessories, household specialties, also other articles salable through mail order channels. Box 203, Popular Mechanics Magazine, Chicago.

PATENTS Wanted—We will buy, or manufacture, on a royalty basis, articles of merit made principally of wood. Give full particulars in your first letter. Weber Bros., Mfg. Co., 3147 N. 9th St., St. Louis, Mo.

INVENTIONS Wanted—Patented, unpatented. If you have an idea for sale, write Hartley's, Inc., Box 928-E, Bangor, Maine.

SMALL Inventions wanted. Stanley Hull, 7829 Euclid Avenue, Cleveland, Ohio.

FOR INVENTORS

INVENTORS: Send immediately for your copy of our big, new free book, "Patent Protection." Forty-eight pages of interesting facts. Tells how patent laws protect you; kind of sketch or model needed; simple steps to take without cost; how successful inventors have secured financial assistance; shows interesting inventions; illustrates important mechanical movements. Other men have read and profited by this book. With book we also send free Evidence of Invention form, that you can use to establish date of disclosure. Prompt service, reasonable fees, special deferred payment plan. Strictest secrecy. Thirty-six years' experience. Highest references. Write us today. The facts in our book are worth money to the man with a good invention. Address: Victor J. Evans & Co., Registered Patent Attorneys, 401-A Victor Building, Washington, D. C.

INVENTIONS Sold at National Inventors Congress, April 1-4, Hotel Tulsa, Tulsa, Oklahoma.

PATENTS—Before too heavy an outlay of time or money is made on an invention, a search of the Patent Office records should be made to determine as nearly as possible whether or not the same idea has been patented before. The cost of this search is small, while the value of the facts it uncovers is often considerable. We offer inventors and manufacturers a thorough, prompt, confidential search service—plus experienced counsel and assistance in every phase of Patent and Trademark practice. Write for my free book containing valuable information relating to patent procedure. Clarence A. O'Brien, Registered Patent Attorney, 58-R Adams Building, Washington, D. C.

TO Inventors: We are in the market to purchase a good patent, preferably a five and ten cent store item. Will purchase outright or royalty. Purchasing Agent, 241 Front St., New York, N. Y.

MODEL And inventors supply catalog 15c. Howardo, 2417 No. Ashland Ave., Chicago.

OUR Manufacturer-clients now want better inventions, patented or unpatented, to meet present industrial conditions. Write Chartered Institute, 558A Barrister Building, Washington, D. C.

INVENTORS: I'll help you with your patent problems. Consultation only. Estb. 1900. Charles A. Scott, 773PM Garson Ave., Rochester, N. Y.

INVENTORS. Sell your unpatented ideas. Highly personalized service. Write American Society of Inventors, Crosby Bldg., Buffalo, N. Y.

MANUFACTURERS Everywhere seek new inventions to improve their product. List of wanted inventions sent free on request. Use our legal form for recording proof of invention. Write W. T. Greene, 944 Barrister Building, Washington, D. C.

INVENTOR'S Universal Educator: contains 900 mechanical movements; 50 perpetual motions; instruction on procuring and selling patents and selecting an attorney, etc. Suggests new ideas. Price \$1.00 postpaid in U. S. A. Address Albert E. Dietrich, 602B Ouray Bldg., Washington, D. C.

INVENTORS: "Making Inventions Pay," our 32-page illustrated book, mailed upon receipt of 3c postage. Crescent Tool Company, Dept. Z, Cincinnati, Ohio.

PATENTS FOR SALE

SIMPLEST And most satisfying car attachment yet invented. Party with ample capital for manufacturing. Garage owners and car operators marvel at its simplicity and effectiveness. Nothing in this field to equal it. Thousands in use. Constant repeat orders. Fortune for someone. Write for our proposition. Manager, 615 Denrike Bldg., Washington, D. C.

FOR Sale—Patented novelty hairbrush. Combination military and ordinary style. Wm. H. King, Grand Central Palace, New York, N. Y.

OUTRIGHT Or royalty! New dispensable toilet article for autos and traveling kits. Martin McDonough, 560 - 60th St., Brooklyn, N. Y.

640 PROMISING Inventions to manufacture. List free to manufacturers; other 6c. Chartered Institute, 555A Barrister Building, Washington, D. C.

BRONZE TABLETS

BRONZE Tablets, hardware, desk plates, wall plates, memorials, grave markers. Bronze, brass and aluminum casting. Wand-key Pattern & Foundry Co., Anderson, Ind.

MODELS AND MODEL SUPPLIES

SHIP Model supplies, raw materials, finished fittings. Satisfaction guaranteed. List dime. Welcher, South Seventh Street, Fulton, N. Y.

SHIP Model fittings; dime for list. W. Crothers, 1639 Yewdell St., Philadelphia.

LIONEL Electric trains and replacement parts. Scale model track material, signals, motors. Illustrated catalog No. 25C free. Model Railroad Shop, Dunellen, New Jersey.

EVRAV'S Engine catalog (No. 34) or supply catalog (No. 35), either postpaid 20c. Canada 30c. Evraymesco, Box "C," 28 No. Clinton, Chicago.

RAILWAY Model supplies—Track, signals, locomotives, cars. List 10c. Crovan Railway Models, Stamford, Conn.

FAMOUS Streamline train. Boys—build your own electric streamline train. Complete blueprints and specifications only \$1.00. Model Engineering Co., 2111 Belleplaine, Chicago.

STEAM Engine 1" bore and stroke \$3.50. Stamp for circular. 2009 Hilbert St., Milwaukee.

THE Modelmaker. The magazine for those interested in building model railroads, boats, engines. Send 15 cents for copy. Modelmaker Corp., 330P West 34 Street, New York, N. Y.

SHIP Models—Build 18" Flying Cloud, Constitution or Galleon. All materials including full-sized plans only \$1.50 from Hancock, 323 Douglass Ave., Portsmouth, Virginia.

BRASS Gears and model supplies. Send for catalog. The Pierce Model Works, Tinsley Park, Ill.

MODELS—Your ideas developed into practical working models. 30 years' successful experience; thousands of satisfied customers. Confidential service guaranteed. Bank references. Send 3c postage for 32-page book—"Making Inventions Pay." Crescent Tool Company, Dept. Y, Cincinnati, Ohio.

PATENTS. Low cost. Book and information free. L. F. Randolph, 302-C Victor Building, Washington, D. C.

ELECTRICAL SUPPLIES

INSULATION, Wire, varnishes, supplies, etc. Send 3c stamp for bulletin. Autopower, 408-B Hoyne Ave., Chicago.

HEATING AND VENTILATING

BOILER Cleanser. Sample \$1. Price, 88 Lexington Ave., Bloomfield, N. J.

YOUR Heating plant automatically controlled \$19.50. G & D Control Co., 5740 N. Washtenaw Ave., Chicago, Ill.

FURNACE Fans save fuel. Quiet operating. \$22.50. Propellers \$3.75 collect. Armstrong Electric Mfg. Co., Minneapolis, Minn.

CUT Fuel bills. Increase heating efficiency. Particulars, stamp. Fuel-Saver Devices, 900 Manhattan, Dayton, Ohio.

OIL BURNERS

KITCHEN Range burners, double, \$9.00 complete. Bennett Co., Islip, N. Y.

ELECTRIC REFRIGERATION

EVERLASTING Ice for your refrigerator. Convert your present ice-box into automatic electric machine costing \$24.50. Easily made without special tools. I supply the hard-to-get parts. Complete instructions and blue prints \$1. Parts list 10c. Onia A. Kolstinen, Dept. 11-34A, Erwin, S. Dak.

ICE Cube Trays 25c. Shelving 25c. Evaporators \$1.25. Retinned like new. Retinning Mfg. Co., 3021 Greenview, Chicago, Illinois.

ELECTRICAL EXPERIMENTS

BANKRUPT Stock—Electrical experimental kits. Kit makes motors, detectophones, arc furnace, telephones, etc. Salvage price \$1.99. Other outstanding electrical values. Catalog—stamp. Electrical Salvage Co., Box 524-O Lincoln, Chicago.

HOME CRAFTSMEN

BUILD Your own hollow spindle, Timken bearing lathe. We furnish parts. Clausing, 435 Keota, Ottumwa, Iowa.

WELDING AND SOLDERING

ELECTRIC Arc welder—Build your own from automobile generator. Complete instructions and improved blueprints for 75 ampere outfit \$2.00. C. Carlson, 2212 Grand Ave., Omaha, Neb.

OXYACETYLENE Welding and cutting equipment. New and rebuilt. Instruction book, prepaid, upon receipt of \$.75. Welders Supply & Mfg. Co., Cincinnati, Ohio.

WELDING And brazing oxy-acetylene equipment, new and rebuilt. Superior Oxy-Acetylene Company, Hamilton, Ohio.

ARC-WELDING Outfit \$1.25. Weld fenders, braze, solder. Lavrow, 4368-W, Warren, Detroit. Stamp appreciated.

DEMONSTRATORS. Electric arc welders. Money-saving prices. Used by the government. Trial and terms guaranteed. Hobart Welders, M-154, Troy, Ohio.

MACHINERY

HARD To get materials plus money-making ideas for inventors, craftsmen and manufacturers. A book every thinker should have—only 10c. The most varied line available of electrical, hardware specialties, metals, bakelites, woods, chemicals, insulations, minerals, compounds and rare materials. Unusual listing of motors, belts, gears, pulleys, bearings, wheels, switches, drives, machinery, tools, flexible shafts, compressors, sprayers, blowers, fans, drills, instruments, welding material, adhesives. Get yours now. 1/20 hp. variable speed, 2 shaft, a.c.-d.c. motor \$2.95 postpaid. E. M. A. Corp., 3539-55 Fifth Ave., Chicago, Ill.

MILLING Attachment \$12.00. Tool post grinder \$17.50. Clausing, 435 Keota, Ottumwa, Iowa.

MACHINERY. Tools and supplies. Hard to get supplies. Surplus stocks, materials, bought; sold. Catalog 10c. Kostka, 2350-L South Crawford, Chicago.

BARGAINS. Demonstrators, electric arc welders, guaranteed, 30 days trial and terms. Write Ken's Equipment, Box M-153, Troy, Ohio.

ENGINES, MOTORS AND DYNAMOS

FOR Sale. 500 brand new General Electric 1/4 h.p., 110 volt, 1750 speed, alternating current motors. Weight 26 lbs., price \$5.90 each. Lots of 4—\$5.00 each. Send 33 1/2% with order, balance C.O.D. Wilnot Auto Supply Co., 1970-72 Wilnot St., Chicago.

1/2 TO 5 Horsepower, featherweight, air-cooled gasoline engines, specifications 10c. Columbia, 4020 West Lake, Chicago.

EQUIP Your fractional h.p. motor with floating power. Noiseless. \$1.00 collect. Armstrong Elect. Mfg. Co., Minneapolis, Minnesota.

1500 WATT Auto-transformers 220/110 volts \$5.00. Motors, generators, converters. Queen City Electric, 1736 Grand Avenue, Chicago.

GOVERNORS Control auto engines—stationary or portable power uses. New big discount. No cash down. Special foreign terms. Agents wanted. Candee-Smith Governor Co., 215 North Los Angeles St., Los Angeles.

WINDING Data, 100 AC motors, various horsepower and voltage, \$1.00. Motor Data Co., 3002 Monroe, Kansas City, Mo.

MANUFACTURING

MANUFACTURING. Models, dies, stampings, brasswork, moulds for castings, vulcanizing. Circular free. Baums Metal Specialties, Kansas City, Mo.

INVENTIONS Manufactured in any quantity at low cost. Stampings, dies, models, etc. Estimates and free catalog. Crescent Tool Co., Dept. N, Cincinnati, Ohio.

METAL Articles developed and manufactured. Model making. Reasonable price and first class workmanship. W. F. Meyer Company, Bedford, Indiana.

BURIED TREASURE

BURIED Treasure, send for free literature. Photographs. Fisher, Palmer Building, Hollywood.

TREASURE Seekers—Learn scientific methods. Wyss, 104 1/2 Frances, St. Joseph, Missouri.

TREASURE FINDERS

GOLD—Prospectors portable sluice and gold saver gets it. H. & C. Co., Box 260, Clinton, Okla.

TATTOOING

AMATEURS Tattooing outfits, write Chicago Tattoo Supply House, 651A South State, Chicago.

TATTOOING Outfits, supplies, illustrated list free. "Waters," 965 Putnam, Detroit.

TAXIDERMY

TAXIDERMY Supplies—Quality artificial eyes, teeth, genuine Jonas head forms. Tools, materials, etc. Everything for the progressive taxidermist. Send for big illustrated catalogue—Free. Jonas Bros., 1049 Broadway, Denver, Colo.

ROOTS AND HERBS

JUST Out! World's Greatest "Herbalist Almanac." Beautifully illustrated in natural colors. Contains over 500 old-fashioned herb medicine recipes and Indian secrets for home use. 10c (coin) postpaid. Worth dollars! Botanica, 145 W. 112th St., Chicago.

OLD GOLD WANTED

CASH For gold teeth, jewelry, watches. 100% full gold value paid day shipment received. Satisfaction absolutely guaranteed or articles cheerfully returned. Licensed by United States government. Information free. Chicago Gold Smelting & Refining Co., 357 Champlain Bldg., Chicago.

FARMS AND FARM LANDS

INVESTIGATE Maryland tobacco farms; low taxes. Leonard Snider, La Plata, Md.

\$550 FULL Price gets 20 acres, sparkling spring water, woodlot for fuel, fruit trees, 8-room house with porch, cellar, lovely views; less than hour to large city. Lifetime bargain at \$550 complete. Details Bargain Bulletin, also big catalog, both free. Strout Agency, 255-P 4th Ave., New York City.

FLORIDA Land opening; 20 acres and more. Good combination land; \$12.50 per acre; best in all Florida. Easy terms. In the famous Peace River country. Prairie Creek Farms, Orlando, Fla.

THE "New Deal"—Good farms are cheaper and rents lower in Minnesota, North Dakota, Montana, Idaho, Washington and Oregon. A small investment at unprecedented low prices today will increase as normal conditions return. Write for free book and low homeseekers' rates. E. C. Leedy, Dept. 457, Great Northern Railway, St. Paul, Minn.

\$5 DOWN, \$5 Monthly. 20 acres in Missouri Ozarks, \$100. Fishing, hunting, trapping. Hubbard, 216 Grossman Bldg., Kansas City, Kansas.

INDEPENDENCE. Security assured. North Dakota, Minnesota, Montana, Idaho, Washington, Oregon farms. Bargain prices, easy terms. Descriptive literature, impartial advice. Mention state. J. W. Haw, 119 Northern Pacific Railway, St. Paul, Minn.

POULTRY

POULTRY Tribune—Leading poultry magazine. Five years \$1.00; six months trial 10c in U. S. Poultry Tribune, Dept. C-93, Mount Morris, Ill.

DOGS AND PETS

CHRISTMAS Gifts to be remembered and enjoyed—St. Bernard puppies!!! Particulars free. Royal Kennels, Naperville, Que.

BEAUTIFUL Pure white police dogs. Ansonia Kennels, Mose, N. Dak.

RABBITS

RAISE Rabbits for us. We pay you up to \$5.00 each. Also put you in touch with markets everywhere. Large illustrated book and catalog; also copy of the American Rabbit Farmer and monthly market bulletin showing names of buyers in various parts of America who continuously buy all rabbits offered them. All for 10 cents. Address Outdoor Enterprise Co., Box 10, Holmes Park, Mo.

FROG RAISING

BIG Profits raising jumbo bullfrogs. New industry. Easy. Interesting. Send 10c for literature. American Frog Industries, Box 336, Rayne, La.

WANTED—MISCELLANEOUS

MAIL Us your discarded jewelry, gold crowns and bridges, watches, diamonds, silver, platinum. Money promptly mailed. Goods returned if offer refused. United States Smelting Works (The Old Reliable.) This is not a government institution. 39 So. State St., Dept. 71, Chicago.

CASH For used drawing sets, slide rules, microscopes, engineering instruments, scientific tools. Highest prices paid day shipment received. Satisfaction guaranteed or shipment cheerfully returned. Eiman's 2302-D VanBuren, Chicago.

PERSONAL

WE Buy Lincoln head pennies. Will pay up to \$2.00 each if over ten years old. Indian head pennies worth up to \$51.00 each. Send 10c for buying catalog. Continental Coin Co., Incorporated, HG-111 W. Jackson, Chicago.

SECRET Message coding device 25c. Mechanical principle. Details stamp. HCB Co., 1107 1/2 W. 10th St., Los Angeles, Calif.

PHYSICAL Enthusiasts! \$2 courses, muscle-building, super-defense. Now 50c. Cara's, 4728 S. Winchester, Chicago, Ill.

IMPROVE Your personality. Free information. Flow, 6618B Quimby, Cleveland, O.

HYPNOTIZE Instantaneously! New dollar book 25c. Look Institute Hypnotism, D-1613, Palatine, Ill.

USE Shortcuts in Figures. Save valuable time. The quickest ways of working all problems. Instructions for drilling yourself to become rapid with figures. Complete, yet simplicity itself. Just write a postal for "Shortcuts in Figures." Pay postman \$1.00 and postage. Popular Mechanics Press, Room 802, 200 E. Ontario St., Chicago, Ill.

MISCELLANEOUS

MEN And women interested in joining advertising outfit going to South America—please write. Wonderful money making possibilities. Adventure. No investment. Portfolio with complete information, route, etc., 15c (stamps). Wagner Advertising Service, 588, Trenton, New Jersey.

CUTS Anybody can make. Zinc etching process. Specimens, particulars, testimonials for stamp. J. C. Day, Windfall, Ind.

SWAPPER'S Friend, R4, Saline, Michigan. Interests swappers, collectors, sportsmen. 50c year, sample 10c.

ARTISTS—Manufacture signs, novelties. Samples 10c. Straley, 13 1/2 Main, Springfield, Ohio.

CASH Paid for butterflies, insects. See Sinclair Display Advertisement on page 23A.

AMATEUR Cartoonists can earn \$25.00 week, copying and duplicating for advertisers. 3-M Syndicate, Argyle, Wis.

CASH Income resilvering mirrors; replating metalware; making glass signs. Portable outfit. Snrinkle, Plater, 288, Marion, Ind.

MAKE It Yourself. Hundreds of practical and useful devices described in our big book. The plain instructions and illustrations show you how to make them. By making for your own use you save money. Through selling to others you can make a profit. 900 articles of great variety. 480 pages. 823 illustrations. Price \$3 postpaid or sent C.O.D. by mail anywhere in U.S. Popular Mechanics Press, Room 803, 200 E. Ontario St., Chicago.

Amazing NO-FLATZ Makes ALL Tires Puncture Proof! DRIVE NAILS IN TIRES! What a Demonstration!



Sensational! Breath-taking! Put NO-FLATZ, startling new invention, into tire tubes and make them Puncture and Leak Proof for life of tires! Drive over nails, glass, tacks, etc.—better yet, hammer big spikes into tires and tubes—HOLES WILL BE INSTANTLY SEALED AIR TIGHT and tire will not go flat. NO-FLATZ keeps air in tire at steady pressure. Harmless—actually lengthens life of tube. Easy to inject; can be done without unmounting tires in a few minutes. Costs only a trifle to make all five tires on any car puncture proof. Imagine—no more punctures!—no more flats! Make money hand over fist driving nails in tires and astounding every auto owner.

SENSATIONAL MONEY MAKER Get In on Ground Floor—Coin Money

NO-FLATZ is hottest money maker of your life. Millions of auto owners, fleet owners, taxi companies, bus operators and freedom from expense and trouble of flat tires. Sell to filling stations, garages, accessory stores. NO-FLATZ guaranteed to protect any tire from flats for life of tire! Customers will actually grab this product out of your hands when you make thrilling "nails in tire" demonstration. Demand here—need is great—every man (and woman) will be eager for NO-FLATZ. Thousands of customers waiting to buy NO-FLATZ from you! Big, Juicy Profits on Every Order. Be the first.

SAVE LIVES!

Prevent punctures that wreck thousands of cars and kill thousands of people every year. NO-FLATZ makes TIRES safe!

RUSH Post Card or Wire for FREE DETAILS

Send for PROOF! Facts about NO-FLATZ may change course of your life, and make you prosperous overnight. Write or Wire. FREE DETAILS and generous sample and territory offer TODAY. Act now before some one else beats you to it. Send no money. Just write or wire.

NO-FLATZ Company, Dept. E-1105, Cincinnati, O.

FREE TRIAL LESSON in Free DRAFTING

FREE TRIAL LESSON

If over 17 years of age send for this Free Trial Lesson in Drafting. Interesting and instructive. Shows how easy to learn at home by C.T.C. Method. We furnish all tools. Get ready now for money-making opportunities opening for trained Draftsmen. Write today.

CHICAGO TECH COLLEGE

A78 Tech Bldg., 118 E. 26th St., Chicago, Ill.

Train for a Well-Paid Hotel Position

COME TO WASHINGTON

Good positions for trained men in hotel, club, restaurant and institutional field. Previous experience unnecessary. Qualify in **FOUR MONTHS**—learn on real hotel equipment, under expert instructors. National Placement Service FREE of extra charge. New Day Classes start Jan., Feb. Catalog FREE!

in 4 months

LEWIS HOTEL TRAINING SCHOOLS

Division RLA-334

Washington, D. C.



Brand New Business

Make door mats out of old auto tires. Any length or width. 2c tire makes \$2.00 mat \$10.00 to \$15.00 per day profits in your home or shop. Lease hand machinery. Don't delay, write today for full particulars.

FABRIX, INC., Dept. 71
325 W. Huron St. CHICAGO, ILL.

CORRESPONDENCE COURSES



Course No. 112—ELECTRICAL ENGINEERING—Very complete and understandable. FREE laboratory apparatus. Comparable with college course.

Course No. 113—RADIO—PUBLIC ADDRESS—PHOTO ELECTRICS—ELECTRONICS—An ultra-modern course in radio, public address, photo electric, and electronic work. Graduates are true Vacuum Tube Technicians.

Lowest cost—best value correspondence courses in America. Payment Plan (\$1.00 per month). Write for Catalog.

LINCOLN ENGINEERING SCHOOL, 855-C S. 37th St., Lincoln, Neb.

PROSTATE SUFFERERS

Prostate gland acute or chronic, rheumatism, kidney and bladder sufferers send for free trial package, amazing results. Endorsed by doctors.

PROSTEX COMPANY, Dept. 15, Miami, Oklahoma

AT LAST! A REAL POCKET RADIO



Can actually be carried in pocket or purse! No tubes—batteries—nothing to wear out. Simply clip to ANYTHING made of metal for clear toned reception! One control—gets all stations to 50 miles; up to 100 miles under favorable conditions. Some users report 1,000 mile reception! Short Wave and Police Calls also! No complicated wires or hookups. Fool-proof—and practical—great novelty. Can be used ANYWHERE—while walking, riding, etc.! Complete with tiny phone. Nothing else to buy. Ideal gift. Send only \$1.00 and pay postman \$1.95 plus postage or send \$2.99 (Money Order, Currency, Check). Promptly sent postpaid. Complete Ins. Included. Guaranteed. Order now! (Foreign orders 50c extra.)

TINYTONE RADIO CO. Dept. P Kearney, Neb.



High School Course in 2 Years

You can complete your High School education at home—in 2 years or less. Course meets all requirements for entrance to college and leading professions. Standard texts supplied. Diploma awarded. Full credit for H. S. subjects already completed.

Business & Engineering

Over 200 noted Educators, Engineers, and Business Men helped prepare our special instruction material which assures you college-grade training at home for the best positions in Business and Industry.

The School was chartered in 1897 as an educational institution. Exempt from Federal income tax. Instruction material used by many resident schools and colleges, U. S. Navy, and Dominion of Canada.

Home Study Prepares You for the Better Job

No matter what your inclinations may be, you can't hope to succeed without proper training. Check kind of work preferred and let us send you full details. No obligation.

American School

Dept. H-145, Drexel Ave. at 58th St., Chicago

- .. Air Conditioning
- .. Architecture & Building
- .. Automotive Engineering
- .. Business Management
- .. Civil Engineering
- .. Complete Law
- .. Diesel Engineering
- .. Drafting & Design
- .. Electrical Engineering
- .. Electric Refrigeration
- .. Higher Account'g (C.P.A.)
- .. High School Course
- .. Highway Engineering
- .. Mechanical Engineering

Name.....Age.....

Address.....

HOW TO BUILD, TEST, AND REPAIR RADIO SETS

3 Volumes,
5 1/2 x 8—1177
pages, 561
illustrations



Radio Construction Library

Including Television, Short-Wave Receivers and Auto Radios

This practical Library includes: **PRACTICAL RADIO**—The fundamental principles of radio, presented in an understandable manner. Illustrated with working diagrams. **PRACTICAL RADIO CONSTRUCTION AND REPAIR**—Methods of locating trouble and reception faults and making workmanlike repairs. Discusses modern Short-Wave Receivers and installation of automobile radios fully. **RADIO RECEIVING TUBES**—Principles underlying the operation of all vacuum tubes and their use in reception, remote control and precision measurements.

Helps you to understand modern type receiving sets—full of construction data and practical kinks for the experimenter.

FREE EXAMINATION COUPON

McGraw-Hill Book Co., Inc., 330 W. 42nd St., N. Y. C.
Send me the RADIO CONSTRUCTION LIBRARY, charges prepaid, for 10 days' Free Examination. If satisfactory I will send \$1.50 in 10 days, and \$2.00 a month until \$7.50 has been paid. If not wanted I will return the books postpaid.

Name

Home Address.....

City and State.....

Position

Name of Company..... PM-1-35

STEP INTO THE Spotlight



Banish Boredom... Earn Extra Money START TO PLAY VERY FIRST DAY

Picture the joy of playing a snappy foxtrot, dreamy waltz or mellow old favorite on the Xylorimba. No reason why you shouldn't! Xylorimba is **easiest** of instruments to play and yet the most spectacular. In constant demand by orchestras, radio stations, at lodge meetings and parties. Marvelous opportunity to increase popularity, make big spare-time money. No bothersome practice or exercises. With Free easy lessons you actually **Start to Play Very First Day**.

BIG FREE BOOK tells all about Deagan line, liberal trial offer and easy payments. Send coupon today for your free copy.

J. C. Deagan, Inc., Dept. 8451, 1770 Berceau Ave., Chicago

Send me, without obligation, full details of Free Trial offer and easy-payment plan on the Deagan Xylorimba.

Name.....

Address.....

GO PLACES! with a

BUESCHER

Popularity... pleasure... fame... fortune... all may be yours when you play a sweet-toned Buescher Saxophone. **Easy playing** qualities and exclusive Buescher features give you quick mastery. Play tunes the first week... make new friends... **go places with a Buescher!**

FREE TRIAL; Easy Payments on saxophone, trumpet, trombone, clarinet—any instrument for band or orchestra. **Write now** for free Buescher Book—mention instrument which interests you. 1009-A

BUESCHER BAND INSTRUMENT CO.
110 Buescher Building, Elkhart, Indiana



MAKE YOUR OWN MOTORS



Model T Ford Generator makes 1/4 H. P. Motor, reversible and variable speed up to 7000 R. P. M. Dodge 12 V Generator makes 1/2 H. P. Motor. Other Generators can be used. All operate on regular or 32 volt current. Complete, illustrated and tested plans so simple a boy can use. Regular price \$2, now \$1 for a limited time only. Be sure to mention kind of Generator and current. You can sell these motors at a nice profit. Money back if plans don't work.

RAND CO., Dept. 100, 2004 Grand Ave., Kansas City, Mo.

ARTISTS MAKE MONEY

Find out your ability. Send name, age, occupation and address for Free Vocational Art Test.

Federal Schools, Inc., 1135 Federal Schools Bldg., Minneapolis, Minn.



BUCHSTEIN'S FIBRE LIMB is soothing to your stump—strong, cool, neat, light. Easy payments. Braces for all deformities. Agents wanted. **D. BUCHSTEIN CO.**
810 3rd Ave., So., MINNEAPOLIS, MINN.

EARN BIG MONEY AT HOME!
Raise mushrooms in your basement, cellar, garage, idle places. We buy (top. Experience unnecessary. **FREE** Book.
MUSHROOM GROWERS OF AMERICA, 8M-433 N. Clark St., CHICAGO, ILL.

When You Build the "SOVEREIGN" You Can Build Them All

Complete book on building Popular Mechanics Famous Museum Ship Model "Sovereign of the Seas." Price \$1.00 postpaid.
Popular Mechanics Press 200 E. Ontario St., Chicago



Mathematics Made Easy by ROPP'S CALCULATOR AND SHORT-CUT ARITHMETIC

Shows the Answer as Quickly as a Watch shows the Time to all Problems likely to occur in the Office, Store, Shop, Bank, Farm, or Factory.

Over 2,000,000 Sold
Explains and simplifies every principle in Arithmetic, Mechanics, and Mensuration.

PRICES POSTPAID
Desk Size, Flexible Keratol Binding... \$2.00
Pocket Size, Art Leather Binding... \$1.00
Pocket Size, Cloth Binding... \$0.50

POPULAR MECHANICS PRESS
Room P-1 200 E. Ontario St. CHICAGO

When writing please mention Popular Mechanics

New DIESEL Engines!

DON'T WAIT! Diesel Power is the big, new field for greater opportunities and bigger pay. GET OUT OF THE RUT! BE AN EXPERT DIESEL ENGINEER and advance with this great new industry that is sweeping the world.

LEARN DIESELS in our big, nationally recommended DIESEL Schools and Shops. The original, exclusive DIESEL Schools of the United States and Canada . . . established many years and always ahead in training and equipment. More engines . . . more successful graduates . . . more Big Pay Jobs.

Send for your FREE copy of "Diesel News," containing up-to-the-minute information about the amazing opportunities everywhere for trained DIESEL men.

Book K Explains All Practical School Courses—Day and Night.
Book H Explains Home-Study Combination Course.

HEMPHILL DIESEL ENGINEERING SCHOOLS, INC.

2127 San Fernando Road, Los Angeles, Calif.
1253 Diversey Parkway, Chicago, Ill. Box 892, Oklahoma City, Okla.
507 Westlake N., Seattle, Wash. 1365 Granville St., Vancouver, B. C.
Nation-wide Employment Service is Free to all Hemphill Graduates

Improves Handwriting In 3 Hours

Marvelous invention. Corrects poor writing in few days. Amazing results guaranteed. No failures. Positive proof and complete outline mailed FREE. Write quickly.

OZMENT INSTRUCTION BUREAU, Dept. 34, St. Louis, Mo.

LEARN CARTOONING

by the method that has developed hundreds successfully. Send name, address and age for free chart to test your ability.

The Landon School, 1738 National Bldg., Cleveland, Ohio

CIVIL SERVICE

VALUABLE INFORMATION FREE
COLUMBIAN CORRESPONDENCE COLLEGE
WASHINGTON, D. C.

GUARANTEED ONE YEAR  **FREE**

1935 Benjamin—Super Single Shot Air Rifles—Bolt Action—Hammer Fire—Hair Trigger—shoot lead or steel BB shot and .177 or .22 pellets— Illustrated and described in New "BB Magic" Free— Write Today—give your age and kind of gun you have if any— get full details of New Benjamin 25 Shot Repeater—Free Targets—Special introductory and Trade-in Offers. Watch for Benjamin Genuine Air Pistols. BENJAMIN AIR RIFLE CO., 697 N. Broadway, ST. LOUIS, MO., U. S. A.

BB MAGIC
THE SHOOTER'S DIGEST

Pins 35¢ Rings 1.65

BIG CATALOG FREE Get Yours Today

CLASS PINS—any letters, any year, any colors. Silver plated, 1 to 11, 40c ea; gold plated, 60c ea; sterling, 60c ea. Silver plated, 12 or more 35c ea; gold plated, 40c ea; sterling, 50c ea. Sterling silver rings as shown, 1 to 11, \$1.90 ea; 12 or more \$1.65 ea.

Metal Arts Co., Inc., Factory 44, Rochester, N.Y.

PENNIES WANTED Lincoln & Indian Head. We Buy. We pay up to \$20.00 per coin. Other coins up to \$500.00. Send 10c for buying list and prices.

PUBLIX COIN CO., K-7343 Cottage Grove, CHICAGO

Make Money at Home!

GROW MUSHROOMS in your cellar or shed. Exclusive new process. Bigger, better, quicker crops. More money for you! Enormous new demand. Write for Free Book.

American Mushroom Industries Ltd., Dept. 949, Toronto, Ont.

MAN IN EACH TOWN To Plate auto parts reflectors, mirrors, etc., by new method; no capital or experience required. Outfits furnished. Free particulars. Write Today!

GUNMETAL CO., Ave. M, Decatur, Ill.

MAKE GLAZED GARDEN POTTERY

Beautiful, colored, glazed concrete pottery made without molds. No experience needed. Use only sand and cement. 2,500 different designs birdbaths, vases, jars, etc. Big profits. Book, color plate, etc., 10c.

NATIONAL POTTERIES, 424 Second Ave., So., Minneapolis, Minn.



WHAT will you be doing one year from today?

THREE hundred and sixty-five days from now—

Will you still be struggling along in the same old job at the same old salary—worried about the future—never able to make both ends meet?

You recognize of course we are living in a New Day—the New Deal is a reality! Are you waiting, wondering—just hoping?

Don't do it, man—don't do it.

Choose the work you like best in the list below, mark an X beside it, and, without cost or obligation, at least get the full story of what the I. C. S. can do for you.

INTERNATIONAL CORRESPONDENCE SCHOOLS

"The Universal University" Box 5549-H, Scranton, Penna.
Without cost or obligation, please send me a copy of your booklet, "Who Wins and Why," and full particulars about the subject before which I have marked X:

TECHNICAL AND INDUSTRIAL COURSES

- | | |
|--|--|
| <input type="checkbox"/> Architect | <input type="checkbox"/> Automobile Mechanic |
| <input type="checkbox"/> Architectural Draftsman | <input type="checkbox"/> Plumbing <input type="checkbox"/> Heating |
| <input type="checkbox"/> Building Estimating | <input type="checkbox"/> Air Conditioning |
| <input type="checkbox"/> Wood Millworking | <input type="checkbox"/> Sheet Metal Worker |
| <input type="checkbox"/> Contractor and Builder | <input type="checkbox"/> Steam Engineer |
| <input type="checkbox"/> Structural Draftsman | <input type="checkbox"/> Steam Electric Engineer |
| <input type="checkbox"/> Structural Engineer | <input type="checkbox"/> Civil Engineer |
| <input type="checkbox"/> Electrical Engineer | <input type="checkbox"/> Surveying and Mapping |
| <input type="checkbox"/> Electric Lighting | <input type="checkbox"/> Refrigeration |
| <input type="checkbox"/> Welding, Electric and Gas | <input type="checkbox"/> R. R. Locomotives <input type="checkbox"/> Air Brakes |
| <input type="checkbox"/> Reading Shop Blueprints | <input type="checkbox"/> R. R. Section Foreman |
| <input type="checkbox"/> Telegraph Engineer | <input type="checkbox"/> R. R. Bridge and Building Foreman |
| <input type="checkbox"/> Telephone Work | <input type="checkbox"/> R. R. Signaller |
| <input type="checkbox"/> Mechanical Engineer | <input type="checkbox"/> Highway Engineering |
| <input type="checkbox"/> Mechanical Draftsman | <input type="checkbox"/> Chemistry <input type="checkbox"/> Pharmacy |
| <input type="checkbox"/> Machinist <input type="checkbox"/> Toolmaker | <input type="checkbox"/> Coal Mining Engineer |
| <input type="checkbox"/> Inventing and Patenting | <input type="checkbox"/> Navigation <input type="checkbox"/> Boilermaker |
| <input type="checkbox"/> Patternmaker | <input type="checkbox"/> Textile Overseer or Supt. |
| <input type="checkbox"/> Heat Treatment of Metals | <input type="checkbox"/> Cotton Manufacturing |
| <input type="checkbox"/> Bridge Engineer | <input type="checkbox"/> Woolen Manufacturing |
| <input type="checkbox"/> Bridge and Building Foreman | <input type="checkbox"/> Agriculture <input type="checkbox"/> Fruit Growing |
| <input type="checkbox"/> Gas Engines <input type="checkbox"/> Diesel Engines | <input type="checkbox"/> Poultry Farming <input type="checkbox"/> Radio |
| <input type="checkbox"/> Aviation Engines | <input type="checkbox"/> Marine Engineer |

BUSINESS TRAINING COURSES

- | | |
|--|--|
| <input type="checkbox"/> Business Management | <input type="checkbox"/> Business Correspondence |
| <input type="checkbox"/> Office Management | <input type="checkbox"/> Lettering Show Cards <input type="checkbox"/> Signs |
| <input type="checkbox"/> Industrial Management | <input type="checkbox"/> Stenography and Typing |
| <input type="checkbox"/> Traffic Management | <input type="checkbox"/> Civil Service |
| <input type="checkbox"/> Accountancy and C.P.A. Coaching | <input type="checkbox"/> Mail Carrier |
| <input type="checkbox"/> Bookkeeping | <input type="checkbox"/> Railway Mail Clerk |
| <input type="checkbox"/> Secretarial Work | <input type="checkbox"/> Grade School Subjects |
| <input type="checkbox"/> Cost Accountant | <input type="checkbox"/> High School Subjects |
| <input type="checkbox"/> Salesmanship <input type="checkbox"/> Advertising | <input type="checkbox"/> College Preparatory |
| <input type="checkbox"/> Service Station Salesmanship | <input type="checkbox"/> First Year College |
| <input type="checkbox"/> Wallpaper Decorating | <input type="checkbox"/> Illustrating <input type="checkbox"/> Spanish |
| <input type="checkbox"/> Salesmanship | <input type="checkbox"/> Cartooning <input type="checkbox"/> French |
| | <input type="checkbox"/> Lumber Dealer |

Name.....Age.....
Address.....
City.....State.....
Occupation.....
If you reside in Canada, send this coupon to the International Correspondence Schools Canadian, Limited, Montreal, Canada

Burlington's Diesel-powered "Zephyr" used only \$16.72 worth of fuel oil in its 1,015-mile non-stop run from Denver to Chicago

Photo courtesy Burlington R. R.

Diesel Engineering

The Diesel is fast replacing old-type engines in locomotives — ships — industrial and commercial power plants — motor cars and trucks — aircraft — tractors. As a result, many old jobs have been greatly changed or actually wiped out.

New Jobs For Old

Every industrial change throws many good jobs into the discard — but it creates more and better jobs. The automobile ruined scores of industries based on providing horse transportation — but the motor industry employs even greater armies of workers. Radios supplanted talking machines — electric refrigerators wrecked the iceman — air conditioning is driving out old-fashioned heating and ventilating systems.

Diesel Engineering is the great opportunity of today. The field is developing with amazing rapidity — on land and water and in the air. This is your opportunity to get in on the ground floor of a new and prosperous industry that will provide plenty of good jobs during your lifetime.

Is Your Job Safe?

There is a growing scarcity of men trained to install, operate, and service Diesel engines. New Diesel Engineering Course — just released for home study by one of America's leading educational institutions — will give you, in a short time, thorough training in modern Diesel engine practice. All texts furnished. Send TODAY for Free Bulletin. No obligation.

American School

Dept. D145, Drexel Avenue at 58th Street, Chicago, Ill.

Information on any book free. Write Popular Mechanics Press, Chicago, Ill.

MAIL FOR FREE INFORMATION

BEDFORD
YMCA
TRADE
SCHOOL

1115 Bedford Ave., Dept. PM-20
Brooklyn, New York City, N. Y.

- Auto Mechanic Talking Pictures
- Aviation Mechanic Welding
- Aeronautical Engineering
- Refrigeration Machine Shop
- Oil Burner Commercial Art
- Air Conditioning Sign Painting
- Electrical Window Display
- Radio and Television Mechanic
- Architectural - Mechanical Drafting

Name

Address

Play the Hawaiian Guitar like the Hawaiians!

FAMOUS NATIVE HAWAIIAN INSTRUCTORS teach you to play this fascinating instrument. ONLY 4 MOTIONS — No previous musical knowledge needed. OUR 52 EASY LESSONS teach you the enchanting music you hear over the radio.

GIVEN — when you enroll — a sweet toned

HAWAIIAN GUITAR, complete playing outfit and carrying case.

WRITE AT ONCE for attractive offer and easy terms.



FIRST HAWAIIAN CONSERVATORY OF MUSIC, Inc.
9th Floor, Woolworth Bldg. Dept. 250 New York, N. Y.

Approved by New York State Board of Regents

Prices Are ADVANCING Buy at BOTTOM Prices

All over the world, thrifty, far-sighted people are going to take advantage of this last chance to buy quality watches at these low prices. We bought these watches for you at bottom prices. When these are gone, even our great buying power will not enable us to continue selling these fine watches and diamonds at such low prices.

Diamond Rings Wrist Watches

Write for our New Diamond Ring of Romance and Bulova Wrist Watch Catalog showing marvelous new designs at prices which cannot be continued. Catalog sent FREE. All Watches and Diamonds Sold on Easy Payments.

Don't Delay—Send for Catalog at Once
SANTA FE WATCH CO.
Dept. 16, Thomas Bldg., Topeka, Kans.

IT'S NEW—IT'S HOT—GOODRICH SHEAR HONE



Take a pair of shears—a few strokes—zip they are sharp—the sale is made. Also sharpens pocket knives and stainless steel kitchen knives to a razor's edge. Large 3 inch stone made of sharp electric furnace abrasives.

Sample 10¢—doz. 80¢—16 for \$1.00. Postpaid.

GOODRICH CO., Est. 1864, 1502 W. Madison, Dept. PM-1, Chicago

FREE TO BOYS!

Entry blank for the great Erector Prize Contest. Gives you chance to win free auto or one of 1001 other prizes. Address The A. C. Gilbert Co., 425 Erector Square, New Haven, Conn.

MAKE MONEY Home Industries Bi-monthly AT HOME Will Show You How

Hundreds of plans, schemes, ideas and suggestions for a business of your own. Also many offers of money making books, specialties, etc. 6x9 inches, 32 pages. Six months' trial subscription, 10 cents. Home Industries, Box 84, Irvington, Neb.

\$ MONEY-MAKING \$ OPPORTUNITIES

For those who need larger incomes or must seek new occupations.

The following workable, tested plans are adaptable both to the needs of the country or city dweller either for part time development or principal income source.

Every idea set forth in these books has been used by others for profit. They are well worth your consideration.

Plan No. 1—\$50 a Week with Car and Camera. Paul G. Holt tells you how he made a daily average of \$11.50 profit. Price \$1.50.

Plan No. 2—Radio Servicing. Let an expert teach you how to engage in this money making business. Price \$1.75.

Plan No. 3—Refrigeration Service. Official manual covers all makes. Good service men are needed. Price \$5.00.

Plan No. 4—Automobile Refinishing. Start a lucrative business of your own. Fine possibilities here. Excellent new instruction book. Price \$1.50.

Plan No. 5—Outdoor Opportunities. The raising of small animals, birds and plants for profit. Price \$2.00.

Plan No. 6—10,000 Money-Making Formulas. Complete instructions for the making of commodities at small cost that may be sold at a handsome profit. Price \$4.00.

Plan No. 7—How to Make Money at Home. 100 successful ways for women to make money. Price \$2.00.

Plan No. 8—100 Civil Service Examinations. Covering steady Government jobs. All types of positions. Better business means thousands of new jobs. Prepare now by studying this new book. Price \$3.50.

Plan No. 9—Making Poultry Pay. The proper breeding and management of fowls for higher egg production. Price \$2.00.

Plan No. 10—Fur Farming for Profit. Complete instructions that enable the beginner to succeed from the start. Price \$4.00.

Plan No. 11—Rabbits for Food and Fur. A complete guide to the successful rearing and breeding of rabbits. Price \$2.00.

Plan No. 12—The Frog Industry. Should be considered more as a side line than as a major means of income. Price \$2.00.

Plan No. 13—How to Live on a Subsistence Homestead. Facts and figures on how one family fled from the city and found security and independence. Price \$2.50.

Plan No. 14—New Ways to Make Money. Roger Babson points out to young men and women the profit possibilities in 50 fundamental industries. Price \$2.50.

Any of the above mailed postpaid upon receipt of price or sent C.O.D. anywhere in U. S. Pay postman price and few cents postage.

POPULAR MECHANICS PRESS

Room 135

200 E. Ontario St.

Chicago, Illinois

When writing please mention Popular Mechanics

Easy



NEW

Improved CONQUEROR

World's largest manufacturer announces sensational improvement in Band Instruments. New patented V-CABELL revolutionizes tone effects. Easier to play. You'll develop talent fast with these new Conns. Choice of world's greatest artists. See your dealer or write today for FREE BOOK and home trial, easy payment offer. Mention instrument.

WRITE FOR FREE BOOK

C. G. CONN, LTD. 181 CONN BUILDING
ELKHART, INDIANA



BE AN ARTIST

WE CAN TEACH YOU DRAWING in your own home during your spare time. Thirty-five years of successful teaching proves our ability. Artists receive large salaries.



Write today for Art Year Book

SCHOOL OF APPLIED ART

Dept. 115, 10 E. Huron St., Chicago, Ill.

MAKE BIG MONEY

MOLDING PLAQUES, NOVELTIES, Etc.

Get your share of the XMAS business. We teach you to make your own MOLDS, mold your NOVELTIES and paint them. Sample MOLD only 25c. Write for Details on our Free Course in Mold Making.



STEWART'S STUDIO, Dept. P1
2102 W. 19th St. Chicago



3000 ITEMS! FREE

New 152 Page Catalog

showing over 3000 fastest selling high quality items at rock bottom wholesale prices—for agents, salesmen and concessionaires. Send for a FREE copy and see America's outstanding values.

SPORS CO., 1134 Main Street
Le Center, Minn.

New Streamlined ELECTRIC TRAIN

"Silver Bullet"



25c

A complete Electric Train kit for only 25c. Of course this isn't a \$20.00 train, but just listen to what you get for your quarter: the parts for a fast, peppy motor—complete base, wheels, wire, etc.—cardboard construction (shown in illustration), finished in black and silver. Needs no tracks or transformer—a big saving. And as for building it, why, some kids say they have twice as much fun building it as running it—it's so simple! This neat and flashy kit ready to assemble is only 25c, plus 10c postage and packing. Rush your order to: Interstate Electric Company, Dept. 22, Madison, Wisconsin

Be a TELEVISION EXPERT

LEARN TELEVISION with RADIO—NOW! Fine opportunity for experts in this amazing new industry. A NEW business in a NEW era offers NEW opportunities for big salaries! You learn Radio and Television from the beginning to end in our marvelously equipped labs and studios. You actually operate thousands of dollars worth of expensive equipment. You get expert instruction and skillful guidance by radio-television specialists.

Demand for Television Experts Television now perfected and ready for the market ON THE NEXT BIG BUYING WAVE. Business leaders predict new system television will require thousands of relay and broadcasting stations. Ultra-short waves will permit eighty thousand television stations in America alone. GET IN NOW and "build up" with the world's next billion-dollar industry.



FREE FOLDER

S. Q. NOEL, Pres. First National Television, Inc. Dept. AA1, Power & Light Bldg., Kansas City, Mo.

Without obligation, send me postpaid FREE Illustrated Folder, "Pictures on the Air," telling about new opportunities in television. I am 17 yrs. or older.

Name..... Age.....
Address.....



GOV'T JOBS

AND HOW TO GET THEM.

Are you ambitious? Want to get ahead? Then send coupon below and find out how to get government positions. Find out about the steady work, good pay, vacations, pensions and short hours. Starting salaries \$2100 to \$3000 a year. Nearly 100,000 men and women 18 to 50 years of age secured government positions last year. Many others will get government jobs this year. Why not you? Examinations to be given soon.

Send the coupon below at once.

-----MAIL COUPON TODAY-----

Civil Employees Training, Inc.
Dept. A, Cleveland, Ohio

Gentlemen:
Without charge send me complete particulars on how to secure a government position.

Name.....
Address.....

The MACHINISTS' Home-Study Course helps men get ahead

A man can go just so far in machine shop work with only his every-day experience to aid him. The men who get ahead are those who equip themselves with knowledge—who prepare to take advantage of the breaks. Many have done so with these practical books; you can too.

AMERICAN MACHINISTS' LIBRARY

6 volumes—2,000 pages—2,500 illustrations

(A combined home-study course and reference library)
This library of machine shop practice was written for practical men. It gives you the best methods for every kind of machine shop work. It explains machine tools and their operation, tool work, gears and grinding, jigs and fixtures, automatic screw machines, their tools, punches, dies, etc. Plainly written—completely illustrated—the best kind of help to the machine-shop man who wants to advance himself.

Free TRIAL **No money down—only 7c a day**

MACHINE TOOLS AND THEIR USE
MACHINE TOOLS AND THEIR USE
PUNCHES AND DIES
Gears
Jigs and Fixtures

FREE EXAMINATION COUPON

McGraw-Hill Book Co., Inc., 330 W. 42nd St., NEW YORK

Send me for 10 days' free examination the AMERICAN MACHINISTS' LIBRARY. If satisfactory, I will send \$1.50 in 10 days and \$2 monthly until the special price of \$17.50 is paid. If not wanted, I will return the books postpaid.

Name.....
Address.....
City and State.....
Position.....
Company..... P.M. 1-35

DRAFTING

BOOKS SENT FREE!

ON APPROVAL
5 VOLUMES BRAND NEW EDITION

For Beginners
Written so you can understand every word, by 22 famous engineers and architects. DeLuxe flexible binding, nearly 2,000 pages, 1546 blue-prints, charts and diagrams; prepares you for a good drafting job in mechanical or architectural lines. Sent for 10 days' free use if you mail coupon immediately.

Big Field Big Demand Big Pay
Competent draftsmen are urgently needed right now in all building and manufacturing lines at \$30.00 to \$75.00 a week. That's just the beginning—FOR DRAFTSMEN HAVE THE BEST CHANCES FOR ADVANCEMENT. Pleasant, fascinating work, easy to learn and do. Learn quickly with these books—send coupons for a set FREE and see for yourself.

A year's consulting membership in the American Technical Society now gives free to all readers of this famous cyclopedia of drafting. Many say that it is worth more than the cost of the books.

Complete set of drawing instruments if you send for these drafting books NOW. These instruments are made of the finest of German silver, are absolutely accurate and are packed in velvet lined leatherette pocket case. Real \$10 value, but free to you with these books.

AMERICAN TECHNICAL SOCIETY
Dept. D-119, Drexel at 58th St., Chicago, Ill.

American Technical Society, Dept. D-119, Drexel at 58th St., Chicago, Ill. Send for 10 days' free use New 5 volume set of drafting. I will pay the few cents delivery charges. If I wish, I may return books in 10 days and owe you nothing but if I decide to keep them, I will send \$2.00 after 10 days, then only \$3.00 a month until \$24.80, the special introductory price, is paid. Send latest edition and include drawing instruments.

Name.....
Address.....
Attach letter stating age, occupation, employer's name and address and that of at least one business man as a reference.

PHOTO-ENGRAVING LEARN IT AT HOME



We Furnish all equipment and materials including large photo-engraving camera complete with lamps, lens and screen. When you have finished the course you can establish a good paying independent business with the equipment furnished or work for others at a big salary. Photo-Engraving offers greater opportunities today than any other industry. Every picture in this issue of Popular Mechanics was engraved by the process we teach you. Earn good money while learning. Write today for our new illustrated catalog which was engraved on equipment such as we furnish. You will not be obligated in any way by writing.

Aurora School of Photo-Engraving, Dept. 115, Aurora, Mo.

G. E. MOTORS

made by General Electric Co., originally intended for large manufacturer. Specifications: 1-30 H. P.—4800 R. P. M. Universal A. C. and D. C. 110 volts instant reverse. Size Diameter 3 inch, length 5 inch. Shipping wt. 3 lbs. Add 25c for packing and mailing. Original price \$12.00. Barein price, while they last. **Send for Catalog of Paint Spray Equipment and General Electric Motors 3412.**

\$2.45 Each

NATIONAL ELECTRIC TOOL CO.
560 W. Washington Dept. 321 Chicago, Ill.

Ask for **FREE Catalog**

ITALIAN ACCORDIONS

OF ALL TYPES. Hand-made, best quality. Buy direct from our factory and save 1/2. Satisfaction guaranteed. Used musical instruments taken in trade. **FREE** accordion lessons.

ITALIAN ACCORDION CO.
1014 Blue Island Ave., Dept. P-3, Chicago.

SOMETHING NEW—PERPETUAL FUSE PLUG CANNOT BURN OUT CANNOT WEAR OUT (Mercury—"Liquid Metal")

Unusual opportunity to Make Big Money.
Free introductory offer — AGENTS — WRITE TODAY
EVER-NU FUSE CO., DEPT. L 120 S. LaSalle St., CHICAGO

Profit from Books

Popular Mechanics Press specializes in supplying books on any subject. Look over this list. Check the books you want, and mail this advertisement as your order blank. Catalog with lists on 2,000 subjects free.

- | | |
|--|---|
| AIR CONDITIONING SERVICE MANUAL Just Out.....\$5.00 | LEATHER WORK Artistic.....\$1.50 |
| AUTO RACING How to Build Dirt Track Racers.....\$1.00 | LOCKSMITHING Revised Edition.....\$2.00 |
| AUTO REFINISHING Latest Methods.....\$1.50 | MODEL MAKING Many Kinds.....\$3.00 |
| BRICKLAYING Plain and Fancy.....\$1.50 | MONEY MAKING FORMULAS Thousands of Ideas....\$4.00 |
| CAMPS AND LOG CABINS (Building)\$2.00 | MUSHROOMS Raise for Market.....\$1.75 |
| CARBURETORS (All Makes) New, Revised Edition..\$2.50 | PATTERN MAKING Excellent New Book...\$1.50 |
| CARPENTRY All Forms.....\$2.00 | PLASTERING Best Instruction Manual.....\$1.25 |
| CHEMICAL MAGIC Experiment, Entertain, Mystify.....\$1.00 | RADIO PHYSICS COURSE Most Complete.....\$3.75 |
| DIESEL HANDBOOK New, Latest Information.....\$5.00 | REFRIGERATION Electric Gas. Be a Service Expert!.....\$4.00 |
| DRAWING Freehand and Perspective.....\$1.50 | ROCK GARDENS How, Where, When to Make, Examples....\$1.25 |
| DRY CLEANING (Practical) and Dyer\$3.00 | RUBBER ARTICLES How to Make.....\$2.00 |
| ENGINEERS' VESTPOCKET Reference Book\$1.50 | SHEET METAL Construction Work....\$2.00 |
| FURNITURE REPAIRING Finishing and Decoration.....\$3.00 | Steam Engineer's License How to Obtain.....\$2.00 |
| HYPNOTISM Science of.....\$2.00 | WELDING ENCYCLOPEDIA All Methods.....\$5.00 |
| INVENTIONS How to Make Pay.....\$2.50 | WOOD, COLORING Finishing and Painting..\$3.50 |
| LANDSCAPE GARDENING Practical.....\$2.50 | WROUGHT IRON WORK Practical.....\$1.35 |

SEND NO MONEY

Just check the books you want, and mail the whole advertisement. It is your order blank. When postman hands you books, pay him the price and few cents postage. If outside the U. S. remit when ordering and include 10 cents per book extra for postage.

POPULAR MECHANICS PRESS, Room P-1, 200 East Ontario St., Chicago, Ill.

STOP WORRYING About Your Family



Protect them NOW
with this **GUARANTEED**

LIFE INSURANCE

Suppose your family suddenly had to face the future alone. Would you leave them Protection—or Poverty? Learn how only \$1.00 can safeguard them RIGHT NOW with standard "old line" **LEGAL RESERVE LIFE INSURANCE**. Special "Modified Life" policy, only \$1 a month for first five years, is guaranteed by assets of 29-year-old company. Includes regular cash loan, paid-up and extended insurance values.

\$1.00
a month

SEND NOW FOR FACTS

Same premium for all ages. 18 to 50

**We Have
No Agents**

Learn how Postal Life—having no salesmen—**SAVES** you usual agents' commissions. Over \$40,000,000 already paid to policy holders. Write for free information about this dollar-a-month policy. State exact date of birth, occupation. No obligation.

POSTAL LIFE INSURANCE CO.

172 Postal Life Building

New York City

62 ART LESSONS



Become Talented Artist With Big Income.

This thorough home-study course teaches **Commercial Art, Cartooning, Lettering**—anatomy, perspective, adv. layout, short cuts, tricks of profession, etc. By Alexander Murray, famous Art School instructor. **Natural ability not necessary.** Over 815 clear, concise instruction plates assure easy, rapid development. 125 sheets of drawing paper included **FREE**. Complete Course (no more to pay) only \$1.95 postpaid—or send no money, pay postman plus postage. Money back if not delighted after inspection. Turn your spare time of today into big money tomorrow.

Only **\$1.95**
POST PAID
COURSE COMPLETE

EDUCATIONAL SUPPLY CO., Dept. 101-A, Racine, Wis.

AUTO-AVIATION MECHANICS

Auto-aviation mechanics and welders are in big demand. Complete courses in arc and acetylene welding. Make good money! Enroll now at special low rates. Illustrated literature **FREE**. Write today.

MICHIGAN TRADE SCHOOL
3750 Woodward Ave., Detroit, Mich.

Write for
FREE CIRCULAR

LEARN How To Use Your VOICE

Learn to be a radio announcer—a public speaker—actor—entertainer, etc.—how to address your group or club—how to impress your words and thoughts to a spellbound audience! Amazing new book "VOICE—and how to use it" exposes professional secrets of elocution and oratory—gives complete instruction in one compact volume! Start training now. Earn while learning. Complete course postpaid for only \$1.00. Money back if not satisfied. Limited Edition—just off press. Act at once!

VOICE, 505 5th Avenue, Dept. A, New York City, N. Y.

**MEN-
WOMEN
DON'T
WORRY
ABOUT
A JOB.**

BE INDEPENDENT!

OWN YOUR OWN CLEANING AND PRESSING BUSINESS

Easy home training. Earn while learning. No experience or capital needed. Free Outfit Offer. Write for free information.

BUSINESS OWNERSHIP INSTITUTE

2400 Madison St. Dept. A-51 Chicago, Ill.



GEM-CUT PUZZLES 8 IN ONE

The biggest puzzle buy out. If he is wise give him Gem-Cuts for Christmas; then give him the laugh. Few can solve them. Send stamp for circular.

THE PUZZLE SHOP, 808-20th St., Denver, Colo.

When writing please mention Popular Mechanics

DIESEL POWER

A Coming American Industry

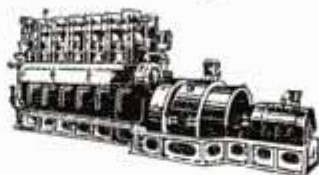

spare-time study of this modern I. C. S. Course on Diesel engines. Free booklet!

The internal-combustion engine represents man's supreme triumph of machine power. Diesel engineers are in great demand. Many are acquiring necessary knowledge through

ELECTRICAL ENGINEERING

—A Great Industry with a Great Future

The new course in Electrical Engineering covers this fascinating field thoroughly. If you are just starting or are partly on the way to a real paying position in this industry, this new course brings the broader knowledge necessary for advancement. The coupon brings complete information.



MECHANICAL ENGINEERING

—A Field with a Future



This course has meant advancement to hundreds of ambitious men, mechanics, draftsmen, blacksmiths, foundrymen, patternmakers, apprentices, and mechanical engineers—men who wanted to get ahead and to earn more money. You will find, as they have found, that enrolling for an I. C. S. Course is an investment in a Bigger Future. Use the coupon!

AUTOMOBILE EXPERTS

are always in demand

The rapid progress in manufacture and service of the modern automobile brings new opportunities to thousands of ambitious and forward-looking men. There's always a demand for trained men. The new I. C. S. Automobile Course will make you a trained man! The time to act is now. Use the coupon.



INTERNATIONAL CORRESPONDENCE SCHOOLS

BOX 5548-H SCRANTON, PENNA.

Without obligation, send me full information on subject checked below:

DIESEL POWER AUTOMOBILE COURSE
 ELECTRICAL ENGINEERING
 MECHANICAL ENGINEERING

Architecture Drafting Accounting
 Concrete Construction Good English
 Reading Shop Blueprints Salesmanship
 Civil Engineering Advertising
 Diesel Engines Show Card Lettering
 Gas Engine Operating Civil Service
 Refrigeration High School Subjects
 Chemistry Air Conditioning
 Highway Engineering Inventing and Patenting
 Poultry Farming Aviation Engines

Name _____

Address _____



hey DAD

"... There's my idea of a real present—a straight shooting—hard hitting Daisy, accurate to a hair—*put together to last* and packed full of year 'round fun. Just the ticket for a summer vacation in the woods—or in the winter, a hot competition of marksmanship at the basement target range. Boy, could I have fun with a Daisy! Say—why don't you drop in at the Daisy dealer's and look 'em over—the whole Daisy line I mean? The ones you see here are the No. 25 Daisy Pump Gun and the No. 107 Buck Jones Special. Then there's the Super Buzz Barton Special with carbine cocking action at \$2.50—the 1000 shot Buzz Barton Special with blued finish at \$1.95—the 500 shot No. 102 at \$1.50 and a single shot No. 101 at \$1.00. Boy!! who wouldn't want a Daisy—bet you'd have fun with it too."

Use Bullseye 'Coppprotect' Steel Shot for real accuracy—it's tailor-made for Daisys

No. 25 DAISY PUMP GUN

A 50 shot, pump action repeater with forced feed, micrometer type sights, sharpshooters' compound trigger action, the finest gun Daisy builds.

3⁹⁵

No. 107 BUCK JONES SPECIAL

A 60 shot, pump action repeater with Buck's name engraved on the blued steel jacket—handy compass and sundial inlaid in the beautiful hard wood stock, the last word in air rifles.

2⁹⁵



DAISY MANUFACTURING COMPANY - 270 UNION STREET - PLYMOUTH, MICHIGAN

DAISY AIR RIFLES

When writing to advertisers please mention Popular Mechanics

10555 (Holman Ave) 1057 (Holman Ave)



MOVIE MAGIC IN THE MAKING

THIRTY thousand movie "pieces of eight" glisten in the studio spotlights in this scene from Metro-Goldwyn-Mayer's "Treasure Island."

D10971

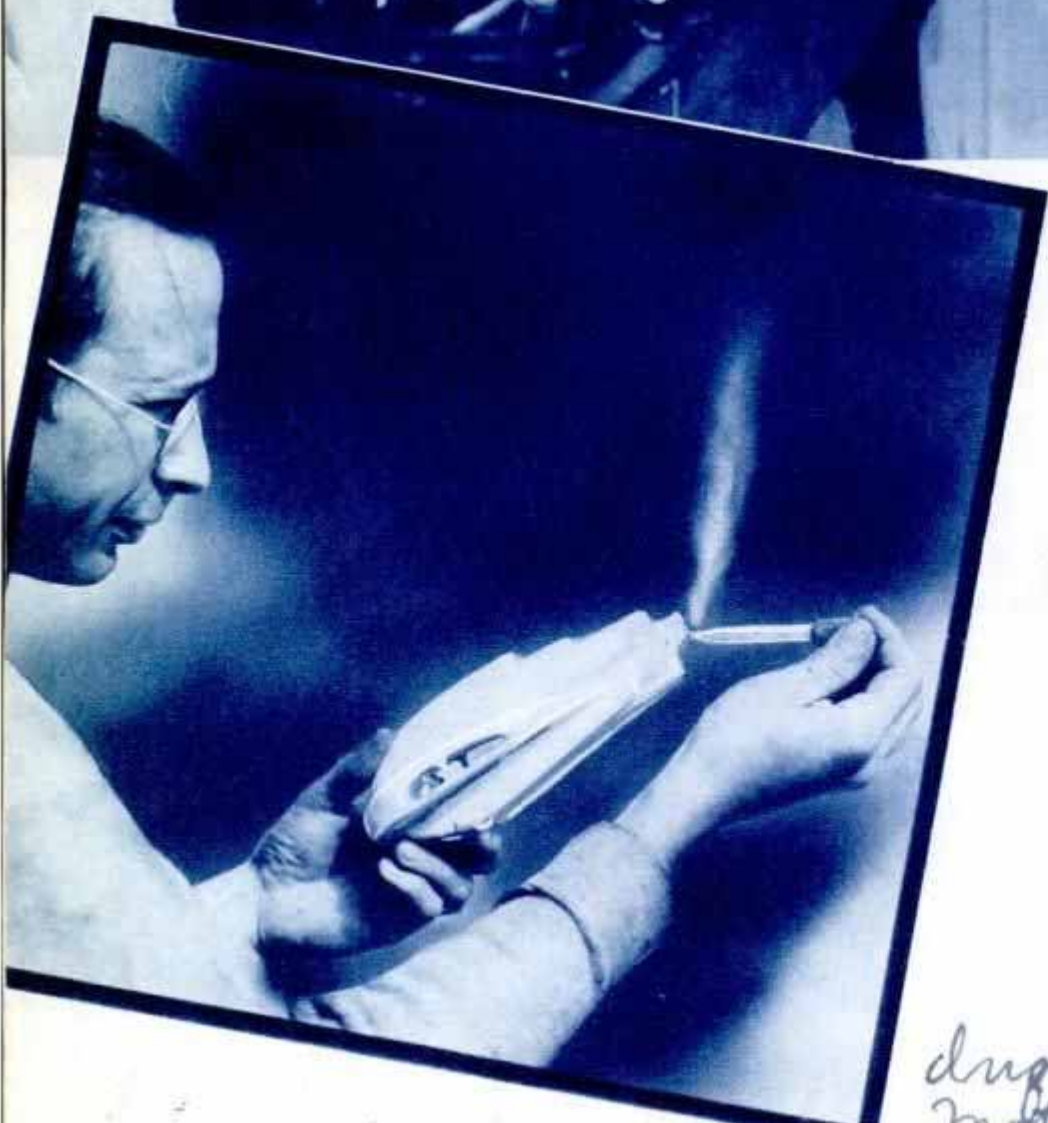
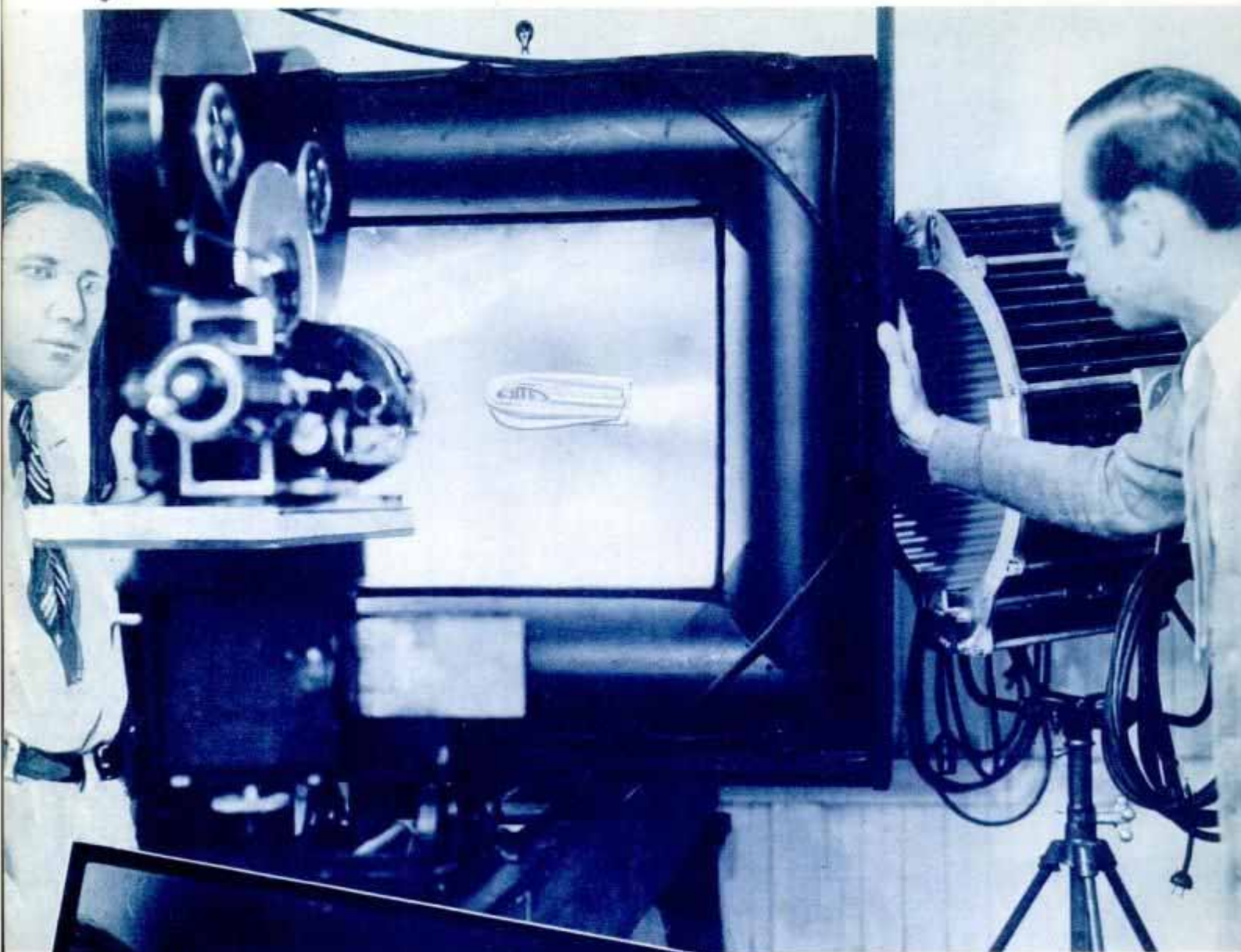

FILMING flight of rocket plane. The plane is stationary but the background of cloud moves. Left, Ray Mercer, trick man, inserting liquid smoke in plane.

PART II

HAVE you ever wondered over the rope trick in the movies in which a magician apparently tosses the end of a rope into the air and then climbs it hand over hand? On the screen part is real and part is not. The actor goes through the motions of tossing the rope into the air and you see it travel upward and stay suspended in space. That part is done in reverse, filming the rope as it hangs suspended from an invisible wire and its

*drug - Association of
M... ..*

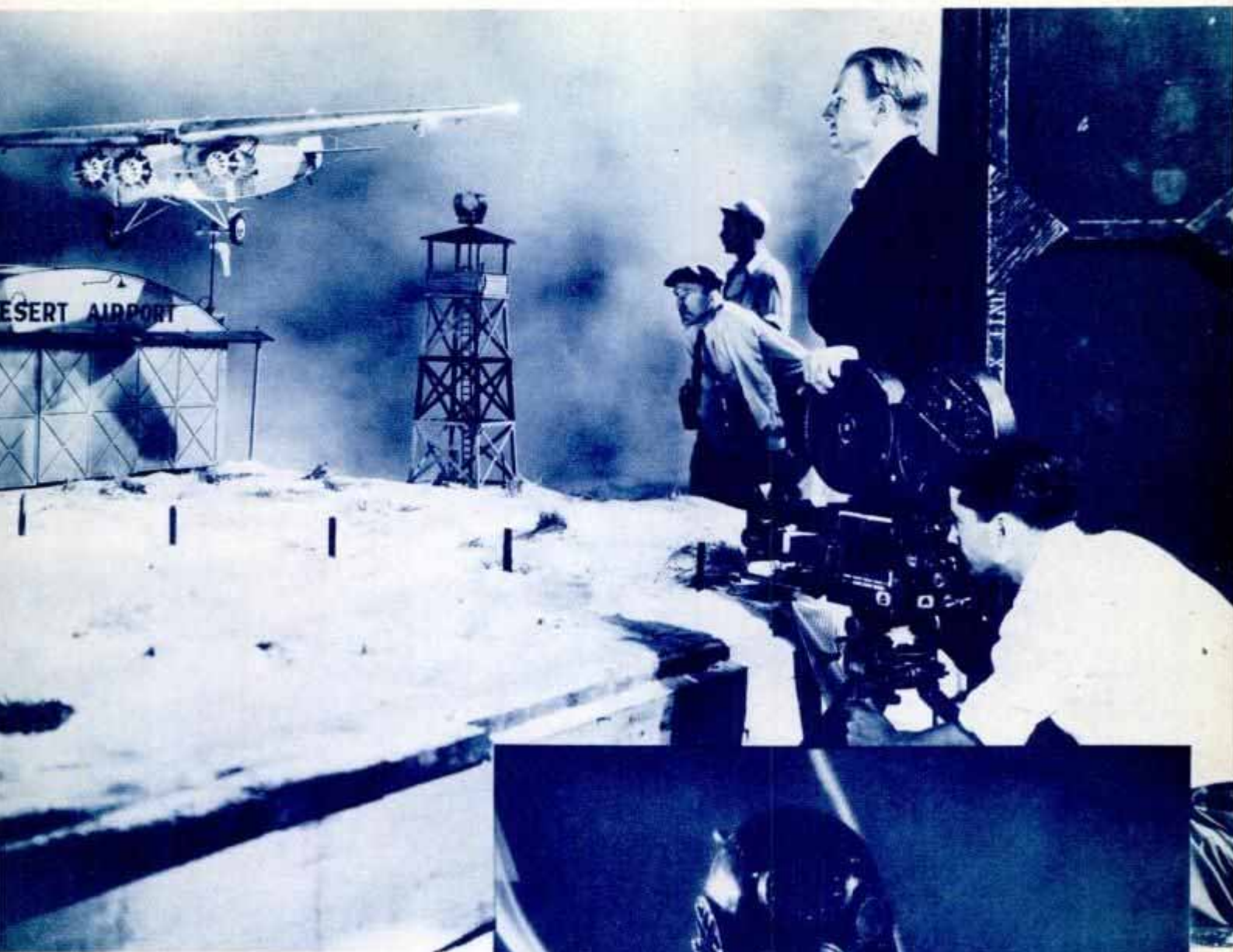

PICTURING miniature plane descending at emergency field at Universal studios. Right, using underwater camera to film a Paramount deep-sea picture.

subsequent drop when the wire is released.

Thin wires invisible on the screen are also a first aid when an inexperienced star is called upon to outline another actor against the wall by throwing knives. The star throws a knife and you see it hurtle through the air to strike and quiver in the wood a fraction of an inch from the man's throat. This, also, is shot in reverse, the knife being pulled from the wood and yanked backward by means of a wire.

Sometimes events from real life lend an air of authenticity



5304 Hollywood Blvd. Palmdale, Calif.



D1037

PREPARING to film a scene on a studio schooner. Right, here is how a stratosphere flight was filmed in a Monogram production. The gondola of the balloon, built to exact scale, is suspended from a scaffold.

to a picture that would be hard to obtain otherwise. In simulating the flight of a stratosphere balloon, the exact dimensions of the gondola were obtained and a wooden replica was built for close-up shots. Then a camera crew was sent to the middle west to film the actual take-off of the real balloon. The balance of the flight, naturally, had to be done in miniature, with the model balloon swinging and swaying on a wire while off-stage smoke pots and electric fans furnished storm clouds, an overhead needle spray

provided driving rain, and realistic lightning flashes from a flickering sun are lit up the scene.

Hardly a month passes without some mechanical improvement to pictures. When sound first came in half a dozen microphones were hidden in different parts of the set and it was the mixer's job to switch off one "mike" and switch on another as the actors moved around. Today an overhead microphone dangles from the end of a crane just out of the camera's range. Two men operate the



D 037

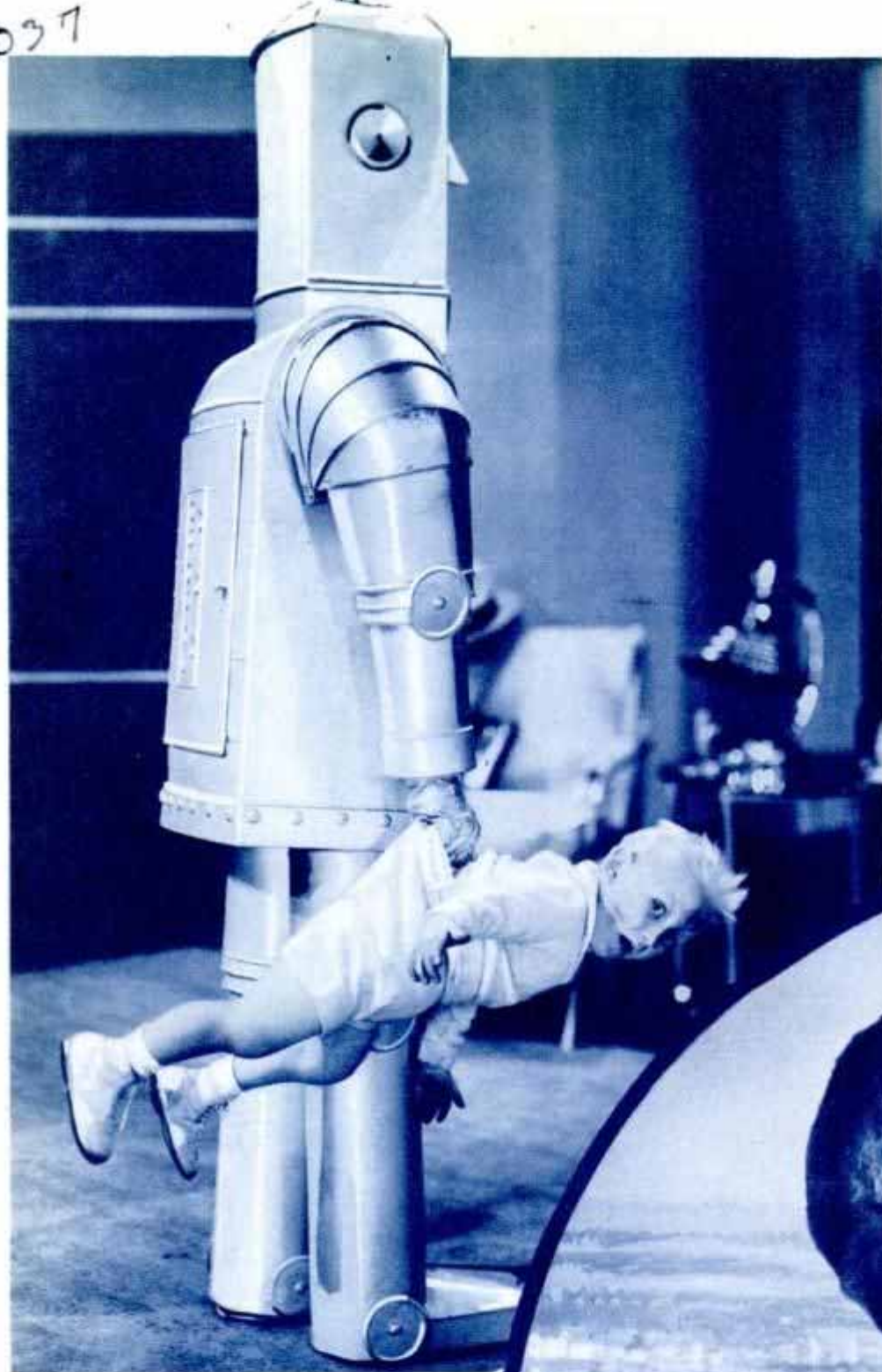

WHEN unusual figures are to be filmed, the special effects men are called in. Ray Mercer devised the robot on the left, but the mechanical man is operated by a real man inside it. Below, Willis O'Brien created this effect by using miniatures and a background painted on glass. The girl on the cupola is a motion picture projected from behind through a hole in the miniature. Right, M-G-M crew at work on "Treasure Island."

erane, shooting it in and out to stay in range of the voices, and twisting the microphone rapidly from one side to the other to catch both sides of a conversation.

Even the sound track on the side of the film has been improved and sound technicians have learned to superimpose one sound track upon another like making a double exposure with a camera. As many as half



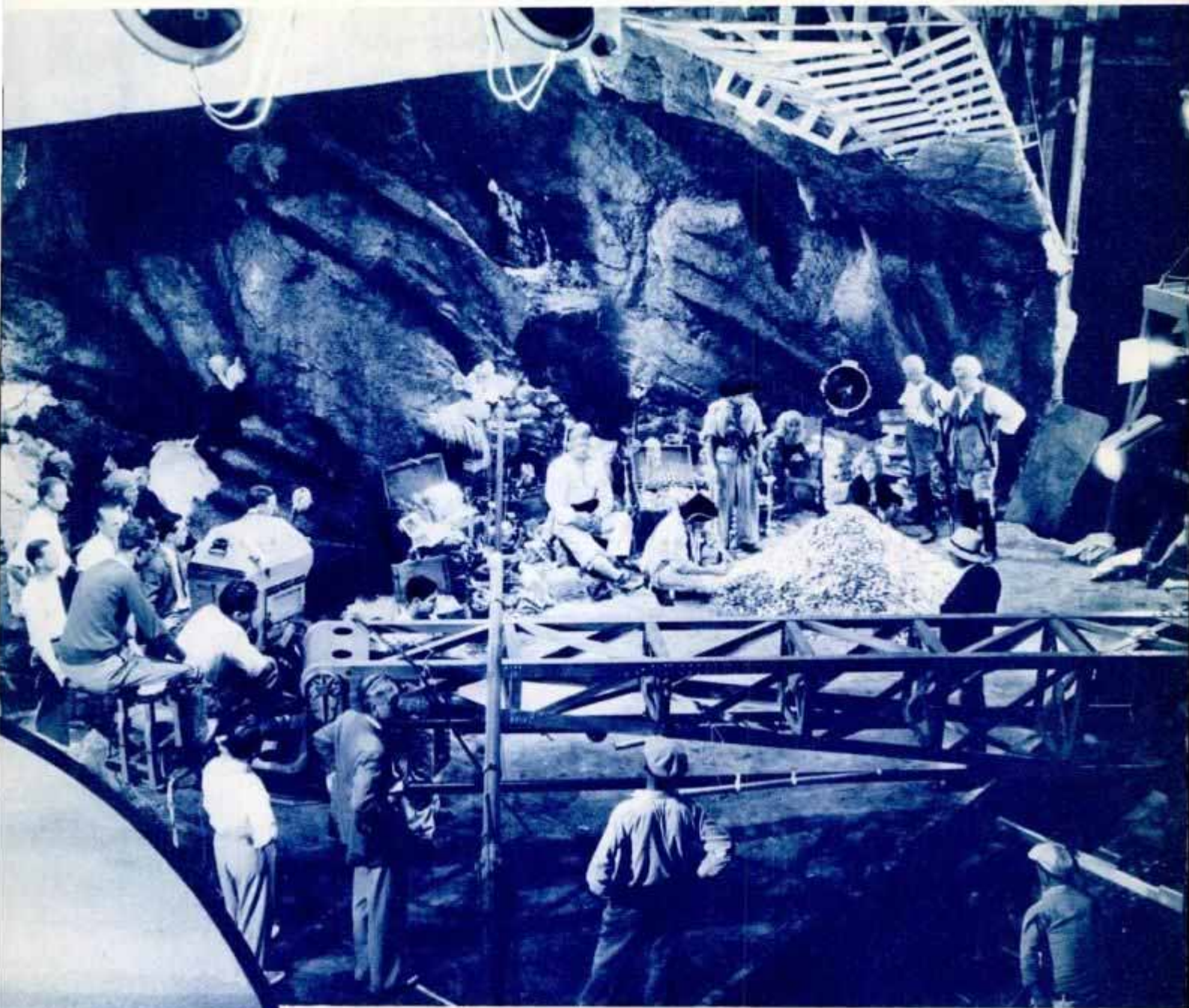

a dozen different sound tracks can be blended into one, so that to an original conversation a background of music or the swishing of surf can be added from negatives in the sound library.

Some of the things that have improved the mechanical qualities of pictures in the last twelve months include an increased frequency range in the sound track that makes for greater naturalness of sound, improved types of microphones, new silent and lighter cameras and improvements to camera booms that allow a greater variety of moving shots, the new "background" type of film negative that has an extremely fine grain, and the perfection of "soft" sets, consisting of cloth walls covered with heavy paint that reflect sounds to the microphone with greater naturalness than do the sets built of wood.

In the next ten years, motion picture technicians hope, colored films and stereoscopic pictures will come into their own. Delicate shadings and subdued colors instead of the glaring hues that fatigue the eye will be the turning point in colored pictures. Engineers (Continued to page 126A)



D1037



CLEOPATRA'S barge, a miniature ship with miniature hills in background, shown in Paramount picture. Above, at work on the sound stage.

D1364

Contr. Elmer Seaman
4 W. 103rd St., New York

COMET ON RAILS

BRINGS AIR SPEED TO EARTH

ONLY a few years ago the east and west coasts were very remote places, separated by terrible deserts, mountains, swamps, and bad lands. But how those deserts have shrunk!

The Union Pacific's streamline flyer, the first of many to come, has crossed the continent in fifty-seven hours, bringing the speed of air travel down to earth. Regulation steam trains cover the same distance in eighty hours.

If a business man in Chicago wishes to spend a busi-

A Striking Contrast between the Old and the New in Railroad Travel—the Union Pacific Streamline Train Nearing New York on Its Record-Breaking Transcontinental Run, and an Early Transcontinental Train

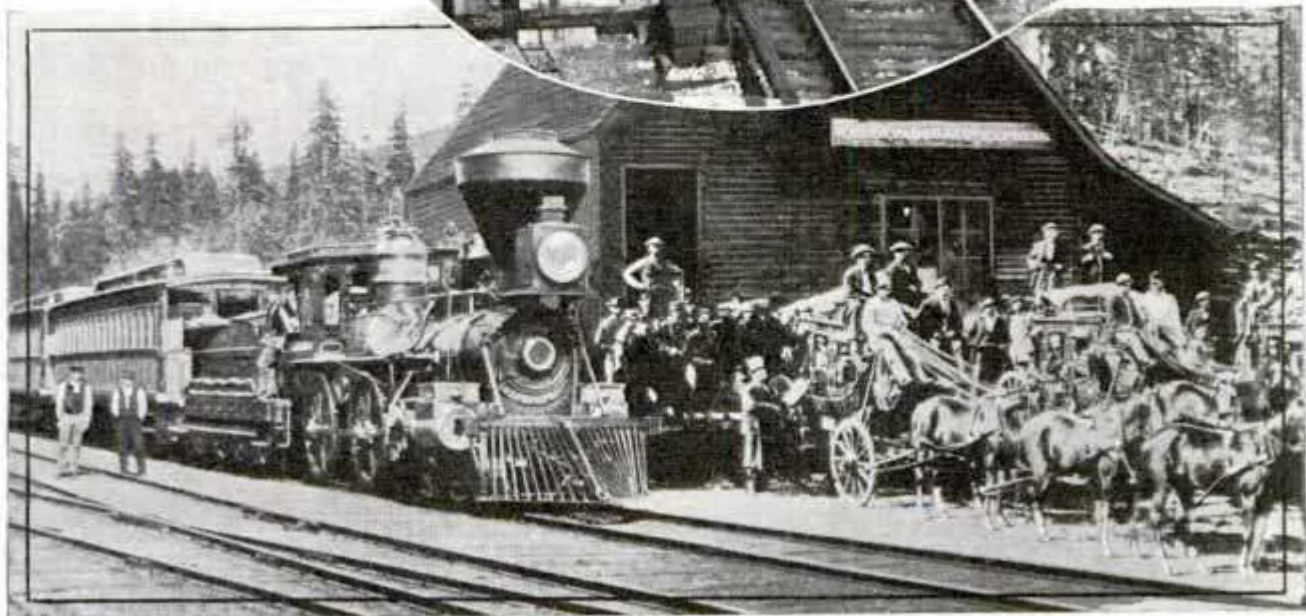
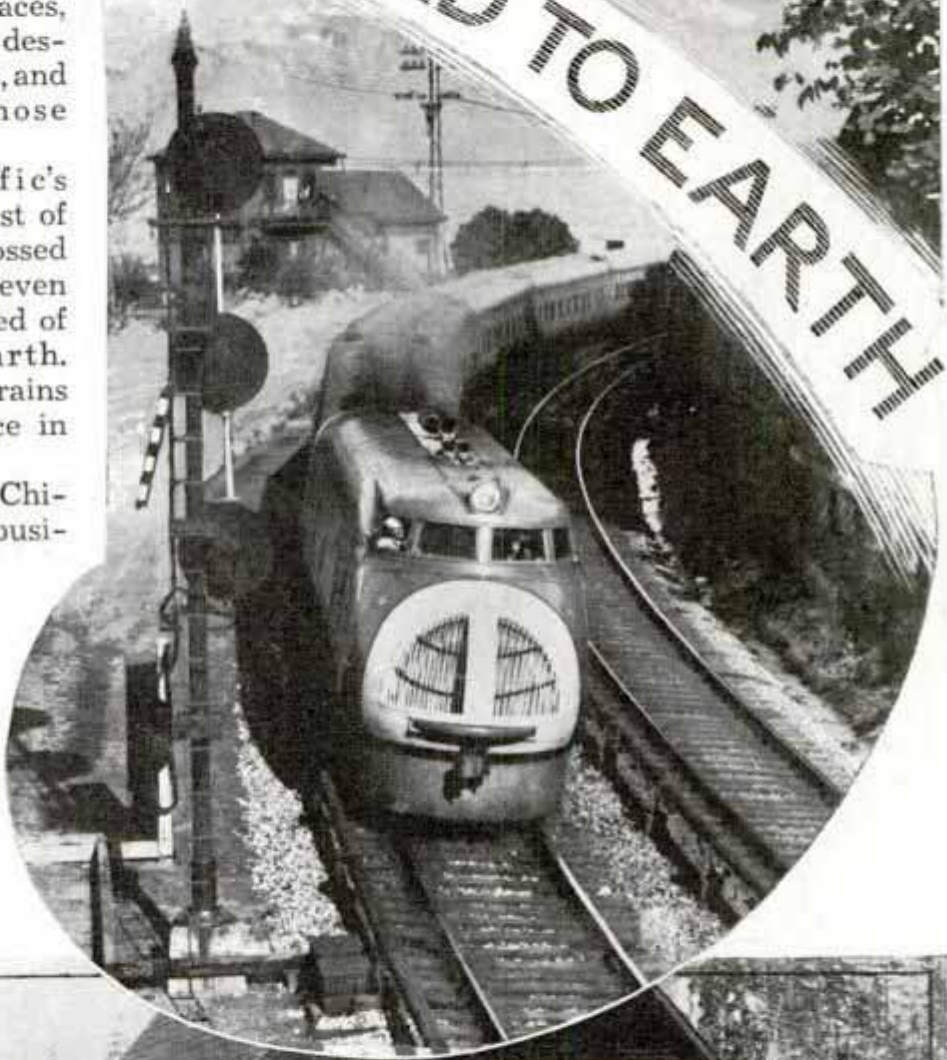



west. Rumors told of prospectors panning gold at the rate of one dollar per minute! A man and a pan often earned up to \$5,000 per day! Boys found \$1,000 nuggets on the open trail!

Who could resist such tales of gold? Men with adventure in their veins set out at once. But in the promised land it was not so easy to find the gold. The cost of living was often unbearable: ten dollars for a shovel; \$400 for a barrel of flour; three dollars for a cup of coffee, and one dollar for an old newspaper.

The covered wagon gave way to the prairie schooner, a huge vehicle drawn by six to twelve horses, and costing from \$3,500 to \$7,000. The overland freight lines, consisting of pack trains and

(Continued to page 116A)

ness day in San Francisco or Los Angeles or Portland, Ore., and return immediately, it will now take five days to make the trip using the present steam trains, while with the streamliner he will be able to make the same trip in three days, saving two whole business days or forty per cent in time.

Who remembers the day when trains of prairie schooners covered the long overland trail in the record time of six months? Look backward only a few years and recall the struggles of those pioneers who crossed on the Overland Trail. They fought up the slopes of high mountains. The streamliner surmounts these same mountains without a whimper. It skims across the Continental divide at eighty miles an hour.

The west, before the discovery of California gold in 1848, was about as well known as the Arctic is today. But the desire for gold was the flash in the pan that started the great movement from east to

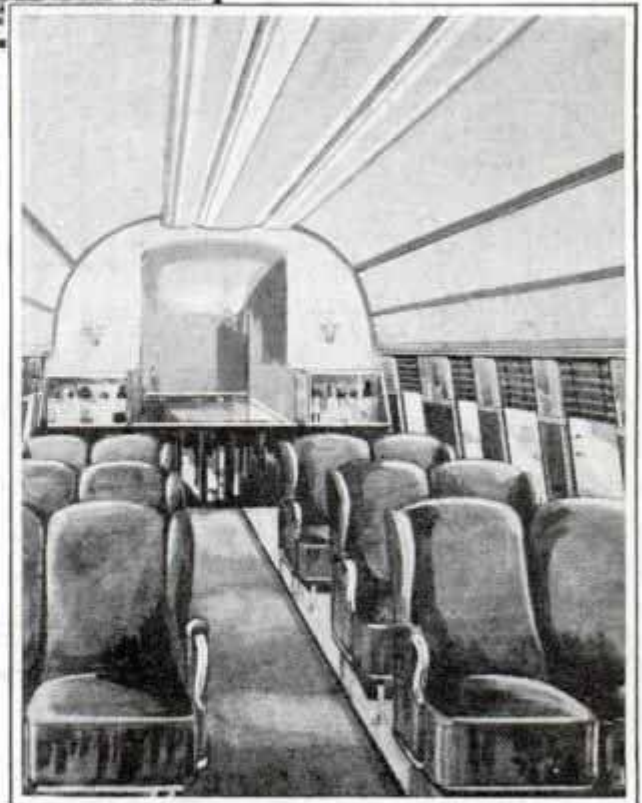

Interior of Early "Palace" Sleeper Contrasted with Coach of Union Pacific Streamline Train



Above, Rear of Buffet Car of Union Pacific Train; Below, Left, Each Seat on the New Train Is Like a Compartment in the Pullman Cars; Right, Note Upper and Lower Berth Arrangement

The new train is a...

The new train is a...

The new train is a...

D1285 refrigerating machines

see page 600

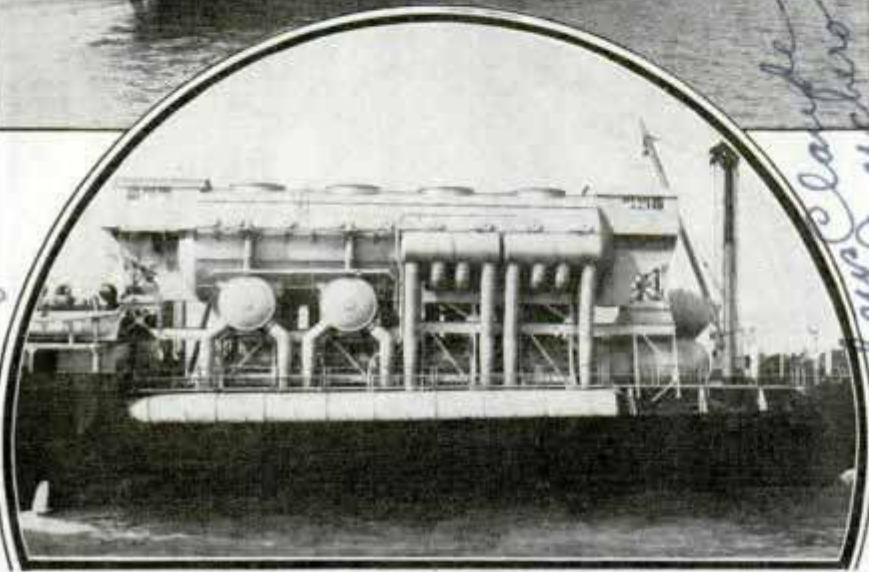

Top, Steamer at Anchor Ready to Make Ice from Tropical Sea Water; Bottom, Close-Up of Conversion Machinery on the Ship

"FLOATING ISLAND" SHIP TO MAKE ICE IN TROPICS

Two thousand tons of ice per day is the estimated output of a "floating island" ship equipped to make use of the differences between temperatures of surface water and that from the depths. The plant is a vacuum turbine, which operates on the principle that water in a vacuum will boil at unusual low temperatures. The "steam" from the vacuum boiler runs the plant. Cold water from the depths condenses the steam which returns to the boiler in the form of water. By using a ship, operators of the plant always can obtain the proper depth for most efficient production.

the test which covered about two weeks.

cently processed water-proofed Cellophane. The method is useful where speedy development is essential and prints from negatives are desired immediately.

HARD-SURFACE RUG LAID IN STREET

Laid in the center of a city street of Oklahoma, one of the largest hard-surfaced rugs in the world has been subjected to automobile and truck traffic to test its wearing qualities. The rug is 226 feet long and nine feet wide, with a delicate pattern that might be found on similar floor coverings in the home. It is made of a composition asphalt material which is water-proof and has a felt base. Used as a floor covering, the material clings to the floor without being glued or cemented. However, it was glued to the street in

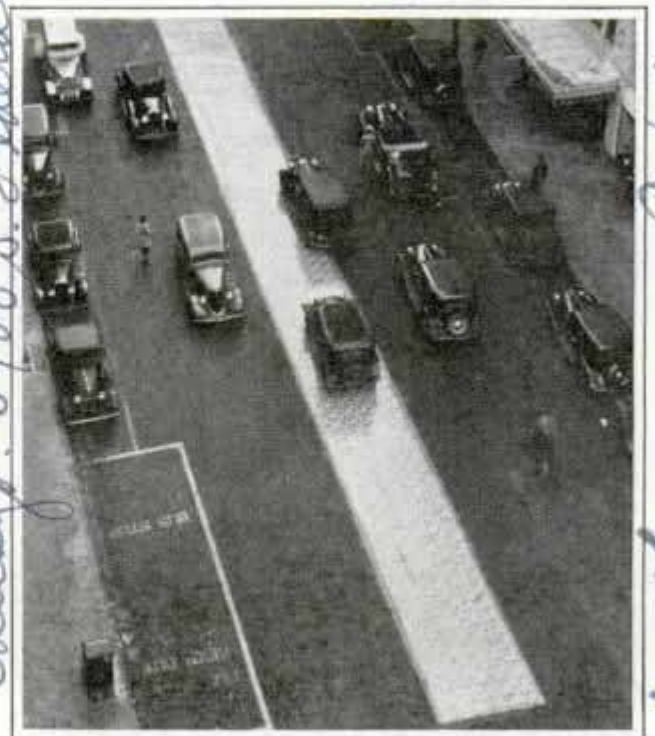

City Traffic Tests 226-Foot Hard-Surfaced Rug

Ateliers et Chantiers de France. Ingénieur en Chef. Strasbourg

Empire State

Chicago 3900 S. Federal

San Francisco, Calif

PRINTS MADE FROM WET FILM WITH AID OF "CELLOPHANE"

Photographic prints can be made from wet film or plates with the aid of a re-

Central Camera Co

Paraffine Companies

Humidity Regulator Fits Any Heating Plant

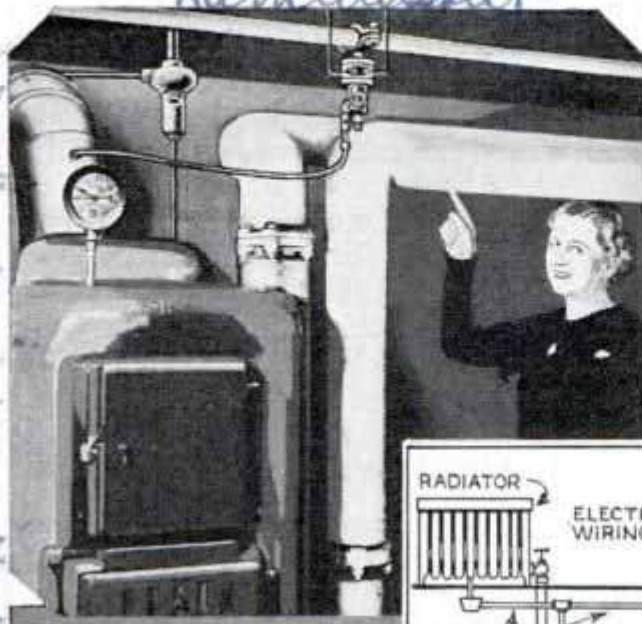

Left, Humidity Device Installed at Furnace; Center, How It Works; Right, Simple Control on Wall Regulates Humidity

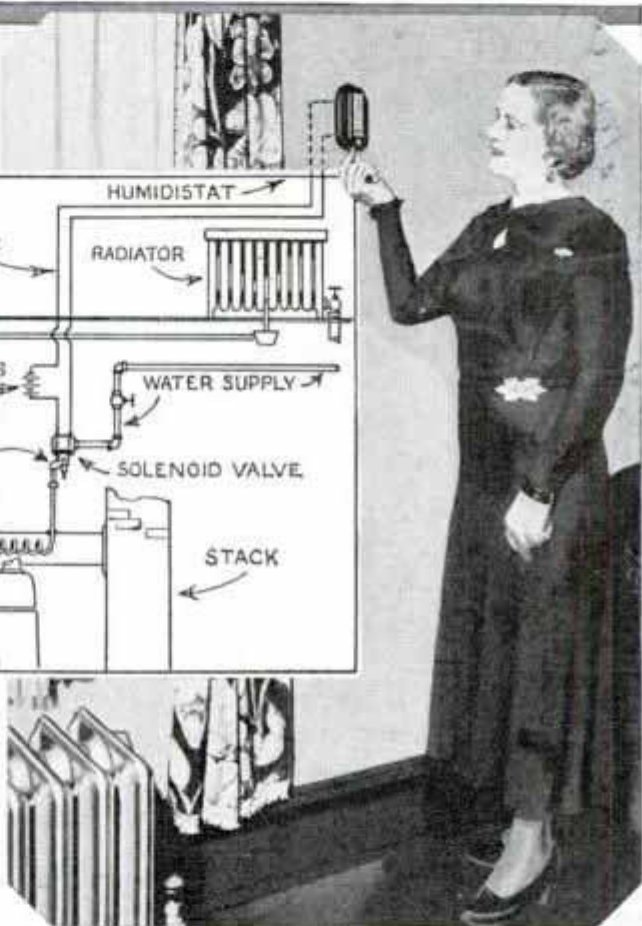
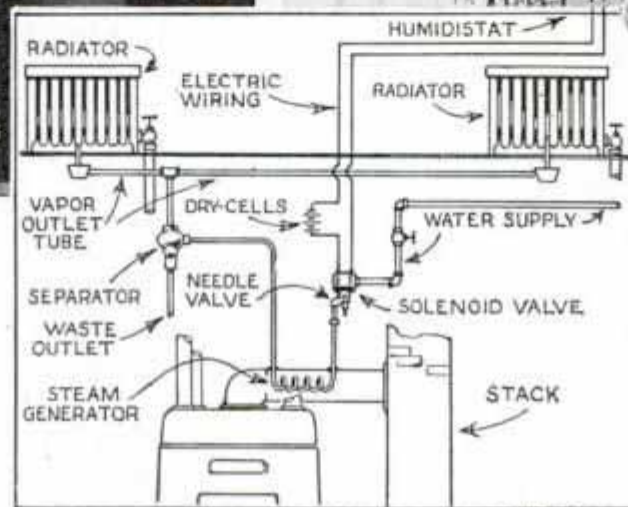

The system may be used with any heating plant. It is put up in kits.

Emergency Light for the Finger Leaves Both Hands Free

Attached to the finger with a spring clip, a handy little inspection light leaves both hands free to handle tools in making car repairs at night. A length of flexible insulated wire leads to a flashlight battery carried in the vest pocket, or the cord can be disconnected from the battery and joined to an auxiliary extension connecting with the car lighting system.

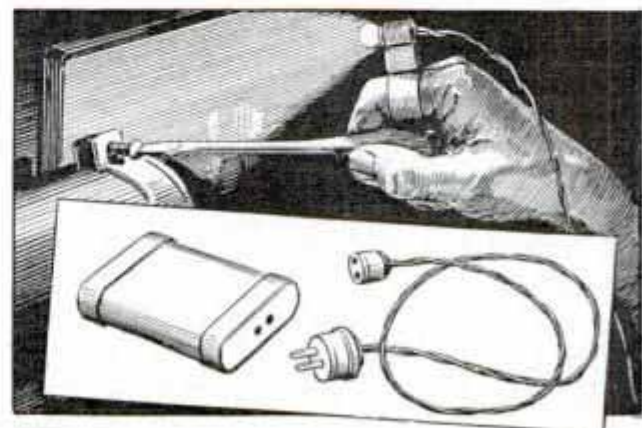

Handy Light Which Can Be Attached to Finger, Leaving Both Hands Free to Make Car Repairs

Color Seal. A sealing paint has been developed to prevent "bleeds" or discoloration of succeeding finishing coats.

The Slidder Co. Road, 11 1/2 Ave. Park

American agent, 100 West 10th St.

M. H. Richardson, Bell St. Worcester, England

D1355 The Model Eng. Co. 605 W. Washington Blvd. Chicago Ill. 738815

D13 28

Washington Monument Is Given a "Facial"

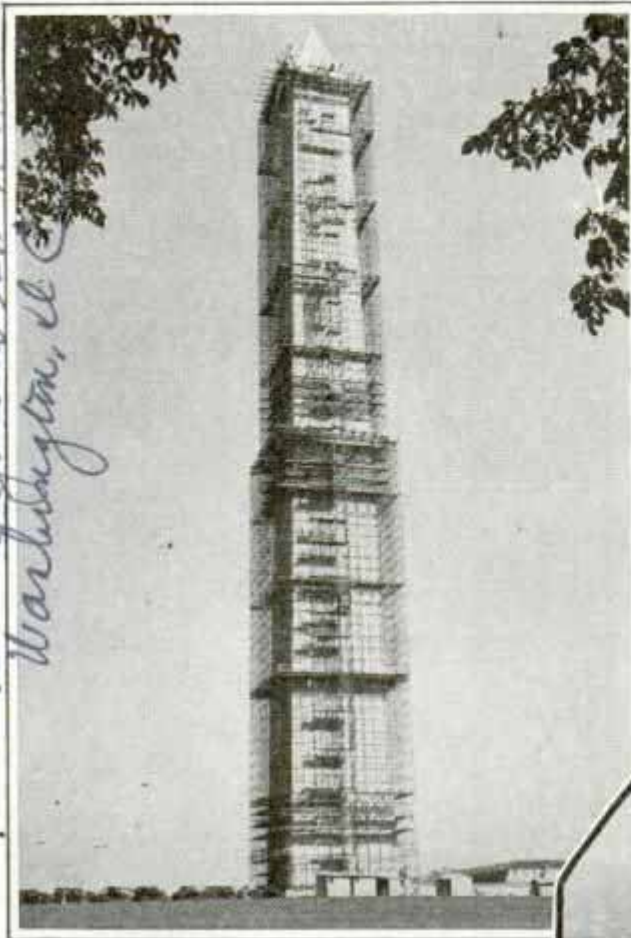

Steel Scaffold for Making Repairs to Washington Monument, and Workmen at Top of Shaft

an outside standpipe raises water to any height where it may be needed. Masons first are channeling out deteriorated mortar from between the 9,000 huge stones and filling the cracks with new pointing mortar. About 48,000 lineal feet of old mortar will be dug out and replaced with new mortar, carefully tested so its color will blend with the stone and the old mortar. When this work is finished, the whole structure is to be cleaned. The contractors plan to use old-fashioned soap, water and brushes for the cleaning. A covered passage was built over the approach to the

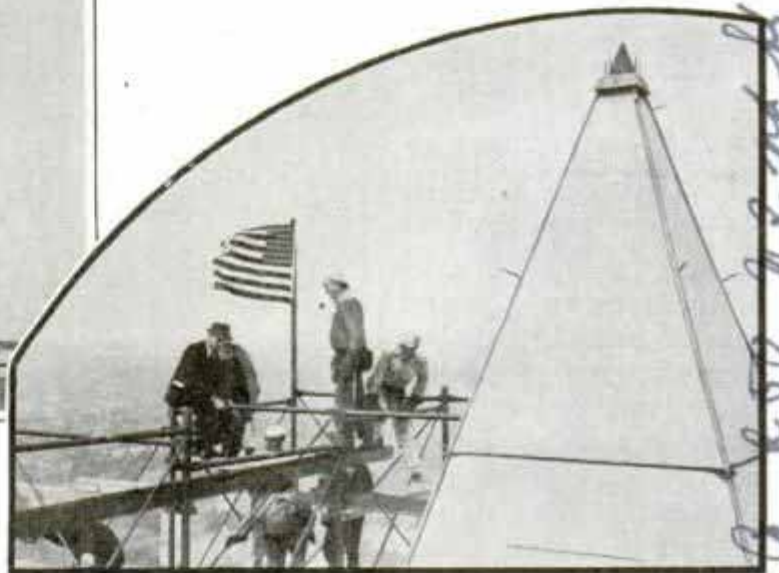

Time, the great destroyer, has attacked the Washington monument, so this shaft, a mere infant as monuments go, is getting a \$100,000 facial treatment and bath. With proper care, engineers estimate the monument may live as long as the pyramids. For the repair work, 600 tons of steel scaffolding were erected around the shaft. Made of iron pipe, the scaffolding was so placed that it could not injure the 555-foot monument. Its main supports rise perpendicularly, not parallel to the sloping sides of the monument, and it is terraced like a skyscraper. No vertical load is permitted to touch the shaft and where the framework rests against the monument at certain points for horizontal support, wooden wedges are placed next to the stone to prevent rust stains. Bolts which hold the pipe together are treated with a paraffin base product to keep them from rusting. An elevator and an iron ladder carry workmen up the scaffold and

monument entrance, so visitors can pass in and out as the work proceeds.

D1342

SCOOP SIFTS FURNACE ASHES

Unburned coal or coke is sifted from the ashes in the furnace ash pit instead of



moving it outside with the aid of a shovel. The draft in the pit carries all soot and dust up the chimney and the unburned fuel is shoveled immediately into the fire box, thus eliminating a second handling.

Chas. Margery Rice
 Cunningham Lane Apt. 113
 2127 California St. N.W.
 Washington, D.C.

W.D. New. much

Q. 200 of 2nd St

Michigan Wire Goods

D/1354 Gnt 25. H. Leavis, Esq.
 "Limners" Hillside Road.
 Middlesex England

BRITISH VICTOR IN AIR CLASSIC



THE DE HAVILLAND "COMET" IN FLIGHT WITH UNDER-CARRIAGE RETRACTED

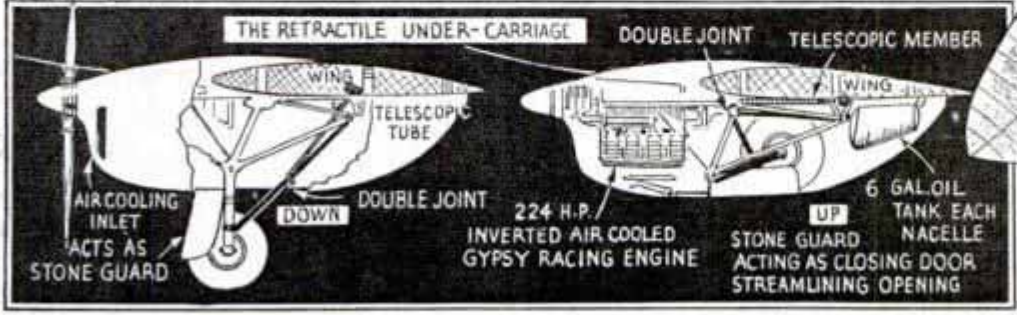
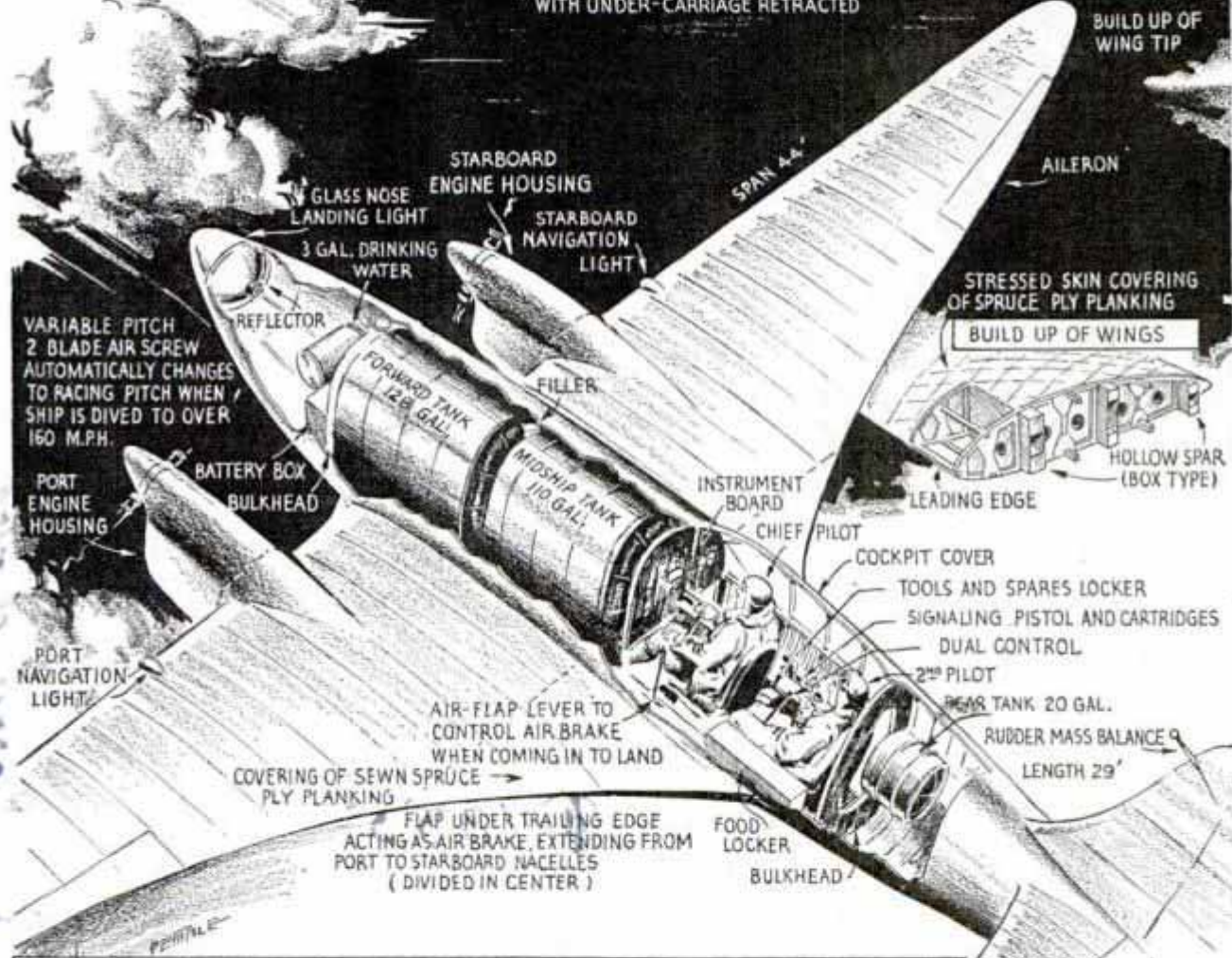

These Drawings Show Construction Details of the De Havilland "Comet" in Which the British Flyers, C. W. A. Scott and Campbell Black, Won the London to Melbourne Air Race in Two Days, Twenty-Two Hours and Twenty-Five Minutes

De Havilland Aircraft Co., Ltd.
 15
 Atlas and Aerodrome (Edwards)

England, Middlesex,

Long-Wearing Cement Paint Is Fire Resistant

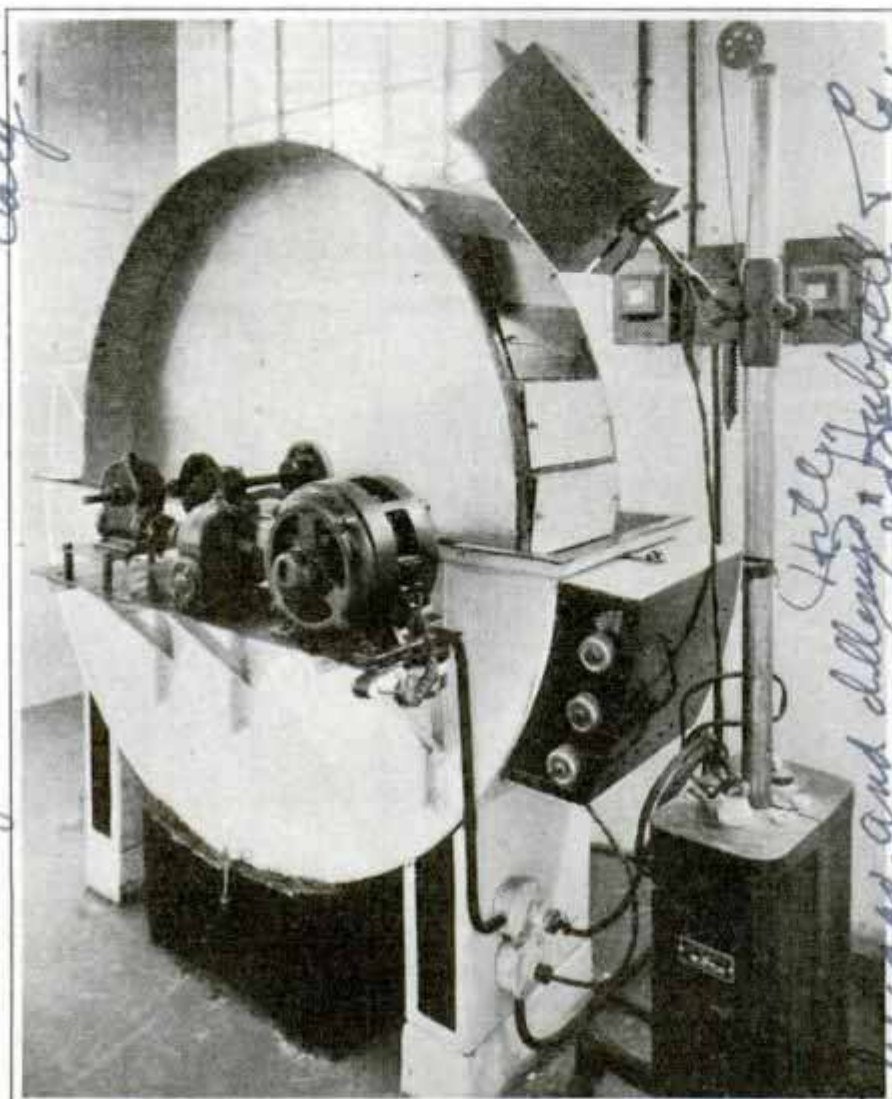

This Tester in a Short Time Exposes Paint to the Equivalent of Several Years of Ordinary Wear; Note Ultra-Violet Light Section

expansion and contraction of the metal. As it is weather and water proof, it makes an ideal coating for the under side of automobile fenders. It can be applied to new galvanized iron without using any special priming coats or chemicals and adheres firmly to all kinds of masonry surfaces. In applying it to new cement or concrete structures, the surface is first treated with a lime-proof size which can be added to the first coat of cement paint, if desired. On wood, the paint gives the soft finish now popular for decorative purposes. It can be applied with a brush or spray and thinned as desired by adding linseed oil and turpentine. The paint adheres so firmly to the surface it covers that it becomes a part of the surface rather than a film over it. Galvanized-iron sheet metal covered with the paint, for instance, can be bent double repeatedly without causing the paint to crack or chip. It dries in twelve to fifteen hours and is made in a variety of colors.

Exceptional durability and resistance to fire are only two of the unusual qualities of a general purpose paint made of Portland cement combined with pigments ground in treated oils. The result is a paint which has a filmlike cement, yet retains a high degree of elasticity, producing a close-grained flat finish which will not crack or chip. This paint has been used and tested for more than twenty years on such structures as bridges, airplane hangars, railroad stations and on stucco, concrete, cement and brick surfaces. For wood surfaces, it reduces the fire hazard without sacrificing wearing or protective qualities, as is sometimes the case with fire-retarding paints. The paint is well suited to metal surfaces since the cementlike film will not crack or chip with

repeatedly without causing the paint to crack or chip. It dries in twelve to fifteen hours and is made in a variety of colors.

D/335

TANK WAGON SALES COUNTER

Dispensing with the possibility of a human error, a gallonage counter for the tank wagon works automatically. As the valve is turned to release gasoline the counter records the number of gallons passing through the outlet.



D/368
General Paint Corp. 2627
Army St. San Francisco Calif.

Hally
Chicago and Chicago
620 Orleans St.

Perry, Iowa.

Sure Tally Co.

D 1262 Mr. Lawrence S. Harlow
 3616 E 81st St.
 Cleveland, Ohio

FIGHTING MOBS and CRIME WITH TEAR GAS...



ONLY a few years ago, a serious riot often meant the death of scores of persons. Today, thanks to recent developments in the gases first used in the World war, chemical compounds have become more effective than bullets in fighting crime and quelling mob violence.

One bullet can affect but one man, but one tear-gas shell renders many helpless. And the gas goes around corners, through cracks, into crevices and over barriers where bullets could not reach.

Lachrymal gas, as tear gas is known to chemists, is not new. As early as 1887, Prof. Baeyer, renowned organic chemist of Munich, pointed out the military value of this gas in his lectures, and chemical devices to protect bank vaults and safes were registered in the United States patent office as early as 1871.

Tear gas was used to disable troops during the World war, but after the war it was developed

so it could be used without causing permanent injury and this has made it a humane agent in suppressing mass violence. Contrary to common belief, it does not affect the tear ducts but the mucous membrane of the eyelids. It is this irritation of the lids which

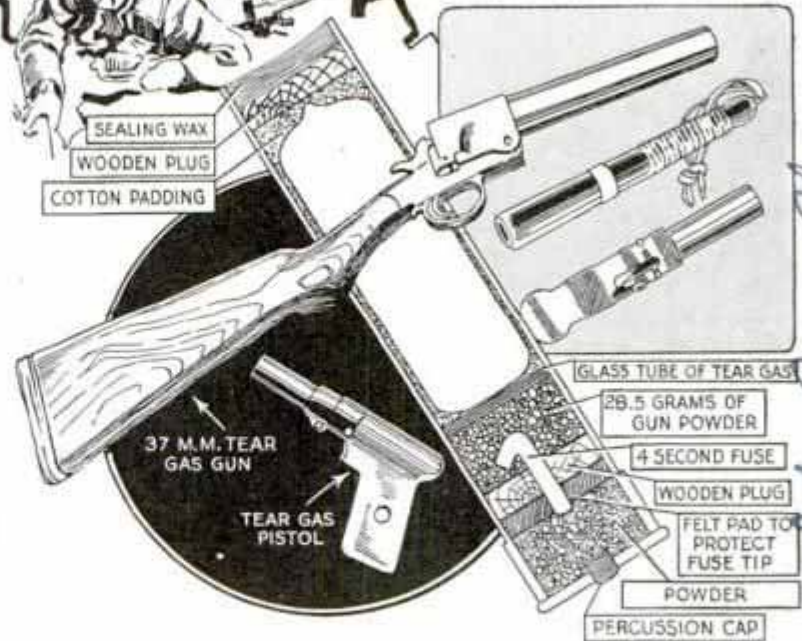

Above, Using Tear Gas to Quell Rioters; Center, Prof. Baeyer Who, in 1887, Pointed Out Military Value of Tear Gas; Below, Diagram of Tear-Gas Guns and Shell; Note the Glass Tube in the Shell Which Holds the Tear Gas

Lab. Erie Chemical Co. Cleveland, Ohio
 5806 109th Ave

W. S. Harley Co., 2810 W. Washington, Chicago



Troopers Quelling a Mob with Tear Gas; in Such a Situation Tear Gas Often Prevents Hand to Hand Encounters and Possible Loss of Life

causes tears to flow. Nausea gas is a newer chemical compound adapted to fighting the mob bent on destruction of life and property, rather than merely dispersing a disorderly crowd. Like tear gas, it causes no permanent injury, but it is much more severe than tear gas and its effects are likely to be felt for several hours after it is inhaled.

As a solid, nausea gas is a fine, bright green powder which changes to fumes of light blue with the application of intense heat. It attacks the respiratory system much like a common head cold. The faint blue haze which heralds it first causes an unpleasant tickling in the nose, followed by sneezing. Then the eyes begin to water and soon after a soreness develops in the throat. This is followed by nausea and vomiting.

Weapons for discharging these gases include pistols, fountain pens, long-range rifles, grenades and police clubs. Shells are made to fit almost any revolver, but the range of gas from such shells is only a few feet. There is also a grenade containing a

glass tube of liquid tear gas. The cylindrical metal casing has a perforated base so that, when the grenade is thrown against a wall or other hard surface, the glass tube is shattered, allowing the liquid to volatilize without an explosion and escape through the openings in the cylinder.

The long-range gas shell used today for offensive purposes is effective up to 150 yards while a similar shell used for defensive purposes has a range of about thirty yards. The former has an outer shell and inner projectile. When the pin of the shotgun hammer strikes the percussion cap, the gunpowder charge is ignited and shoots out the projectile. Simultaneously a four-second fuse in the projectile is ignited, causing a powder charge inside to explode, bursting a glass tube and liberating the gas. The projectile is made of aluminum which does not shatter but rips evenly, lengthwise. The cartridge for revolvers is an adaptation of the regular shell, a gelatine tube of tear gas replacing part of the powder charge ordinarily used.

D1319- Santa Monica Calif 19

The Dental Specialty Co. 23 2 Republica Blay Denver Colo

Within the past few years tear gas has come into wide use for protecting banks. One effective method of safe protection is designed after the present-day burglar alarm. A gas shell is placed in a barrel mounted near the top of the safe and pointing downward. The firing plunger is held back by a magnet. A wire criss-crossing the safe door carries the current to the magnet. When the surface of the door is broken, the wire is severed, this cuts off the current and the magnet releases the firing plunger which sets off the shell, shooting the gas down in front of the safe. Some banks are also equipped with gas shells mounted above tellers' windows. They are operated by electric buttons and are designed to thwart daytime robberies.

Harpoon Gun Which Also Can Be Used to Shoot Lifeline to Boat in Distress

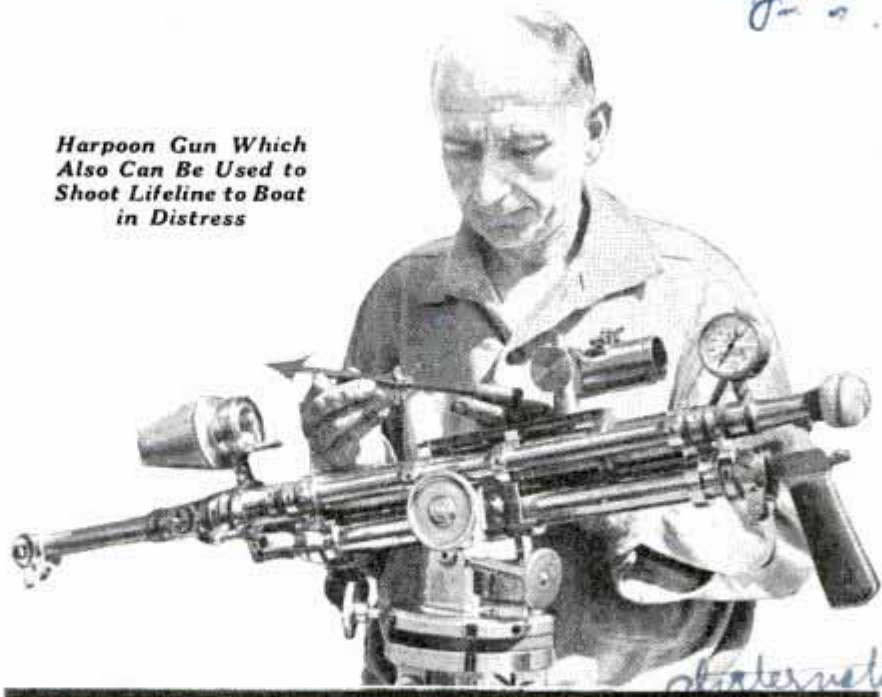

HARPOON GUN SHOOTS LIFELINE TO BOATS IN DISTRESS

Equipped with many adjustments to insure accurate shooting, a harpoon gun has been made by a California race driver, C. R. Klein, to be used in shooting swordfish, sharks and other large ocean specimens. While intended primarily for sport, this gun also can be used in emergencies for firing lifelines to boats in distress.

D1349

DENTIST'S DRILL HELD FIRMLY BY TAPERED SHANK TOOL

Greater accuracy in dental work and decreased pain for the patient are two results of using a handpiece system designed to hold the removable instruments firmly in a tapered shank tool. With this system, it is possible to use any bur, stone, mandrel or other instrument with the taper shank in either a straight handpiece or a contra-angle handpiece. The taper shank instrument has the advantage that burs and stones run true, which was not always the case with the chuck type. The burs and stones seat firmly in the tapered socket.

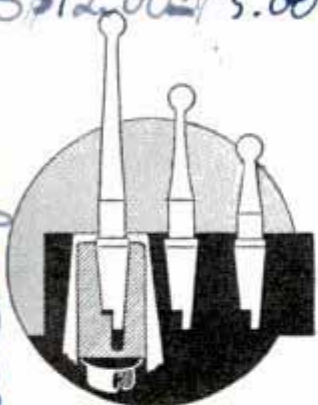

The taper shank instrument has the advantage that burs and stones run true, which was not always the case with the chuck type. The burs and stones seat firmly in the tapered socket.

A washable, waterproof adhesive tape for permanent applications can be painted to match the work to which it is applied.

Bauer & Black, 2500 S. Dearborn

PORTABLE POWER HACK SAW HAS VARIETY OF USES

Designed for bench use in tool rooms, machine shops and garages, a portable compact power hack saw permits the use of the new high-speed hand frame blades and possesses operating advantages not found in the heavier machines. Round or square stock up to three inches can be handled and a uniform feed pressure is applied during the entire cut. This equipment is mounted on a base twelve by nineteen inches and, with its one-sixth horsepower motor, weighs only fifty-eight pounds. Thus, where long heavy bars are to be cut, the saw can be moved to the work instead of moving the work to the saw.

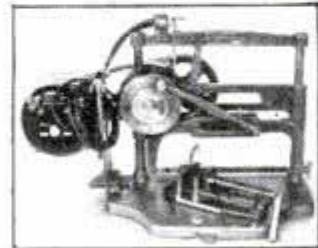

W. B. Rodgers Mfg. Co. 2381 E. 27th St. Los Angeles, Calif

D1229

The LURE of

Cont. Jacob Steeple P. 2240
500 E. 5th Ave New York
The Embroidery Co.
Albany, N.Y.

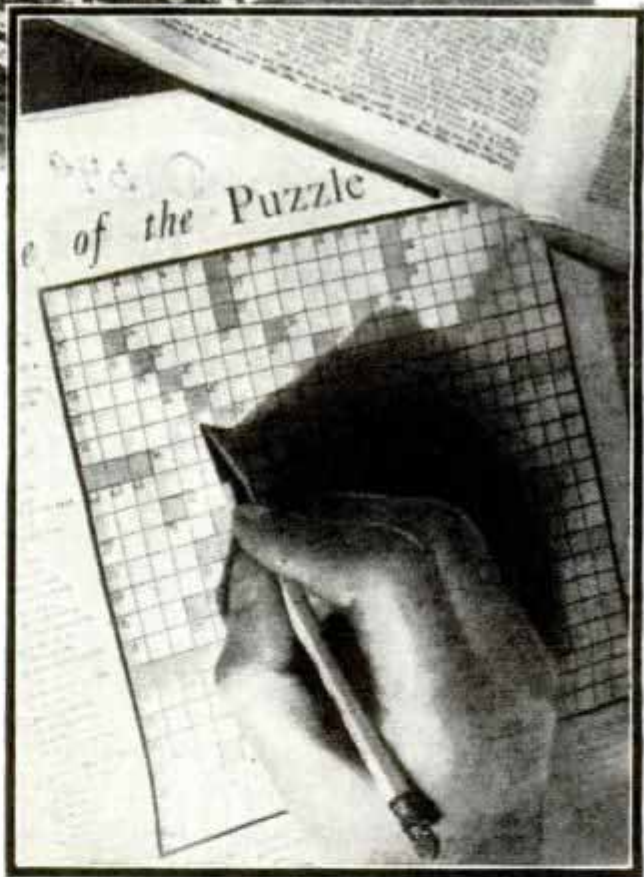
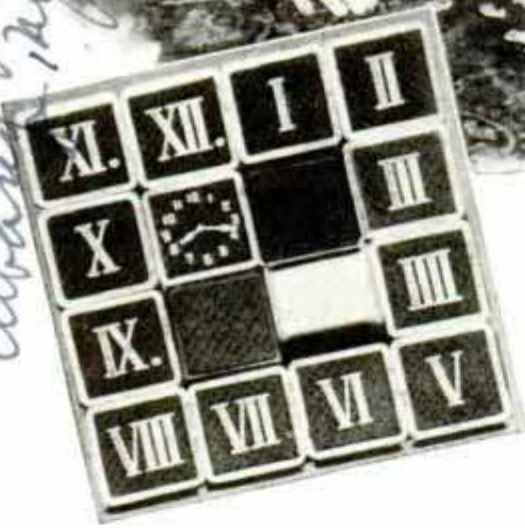

CREATE an original puzzle and you can command the world. An absolutely new puzzle is one of the rarest things in nature and will bring more people to the inventor's door than any mouse trap ever conceived. Realizing this, thousands of "part-time" puzzle inventors burn the midnight oil in pursuit of the elusive idea that may bring fame and fortune.

Puzzle inventing has become one of the most popular pastimes of the day with the result that manufacturers are constantly besieged with ideas for "new" puzzles. The reward is a royalty contract or an attractive sum for the outright purchase of the idea, but while many come few—very few—are chosen.

"There's nothing new under the sun" applies more aptly to puzzledom than al-

Jig Saws, Block Puzzles and Cross-Word Puzzles All Require Patience and Persistence

most anywhere else, for the majority of the puzzles which have enjoyed more or less popularity in modern times can be traced in some form to an ancient origin. One of the favorites that bobs up now and then is the fourteen-fifteen puzzle.

D1229

PUZZLE *Inventing*

Albany, N.Y.

Embossing Co.

Painting Portrait of Lincoln for Jig Saw; Example of Magic-Square Puzzle; Can You Rearrange the Two-Inch Matches to Enclose an Area Only Half as Large? Solution on Next Page

14-15

*Ensm -
Wreeman Co*

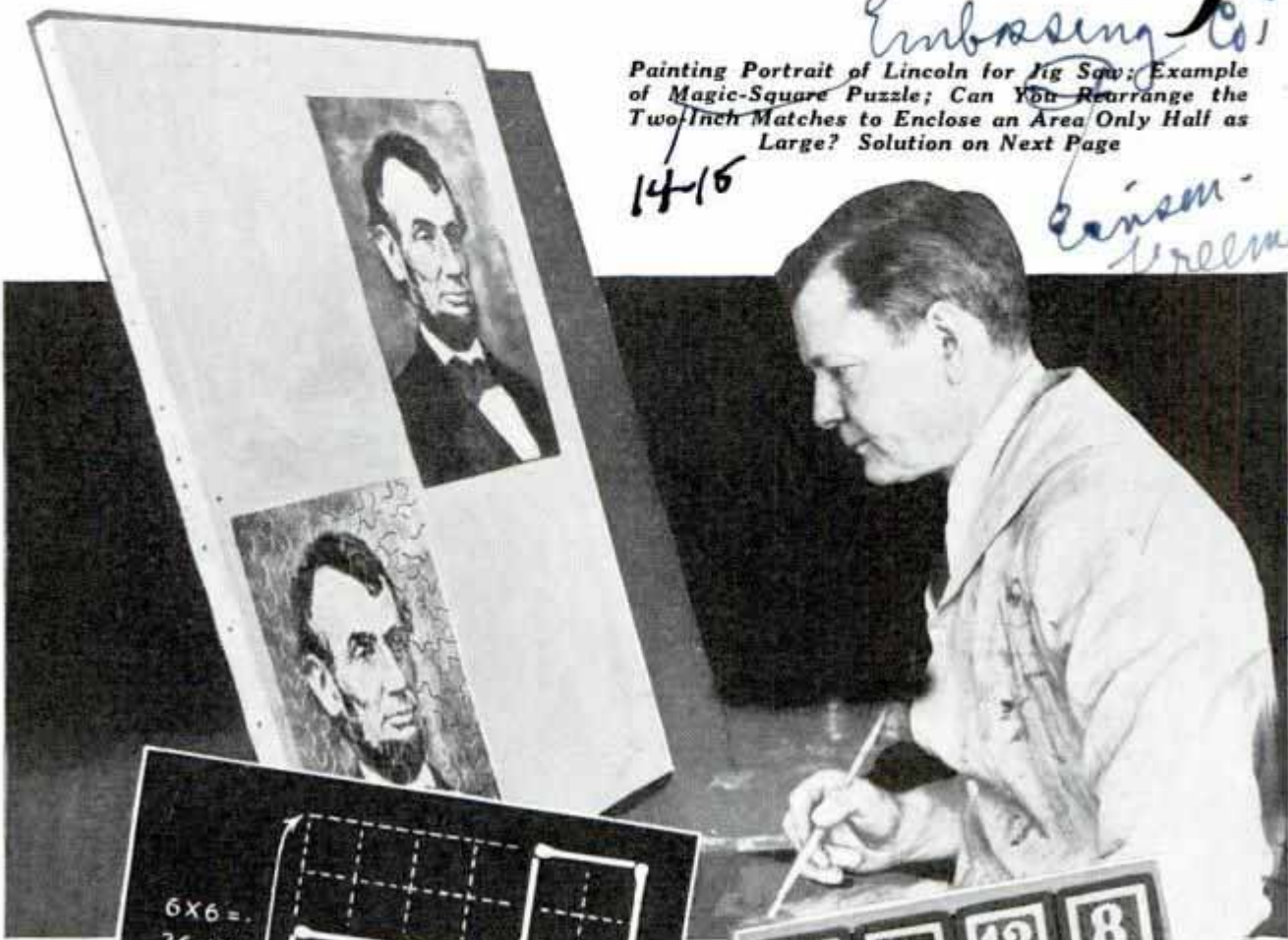

*Star + Ordinance
Long Island City, N.Y.*

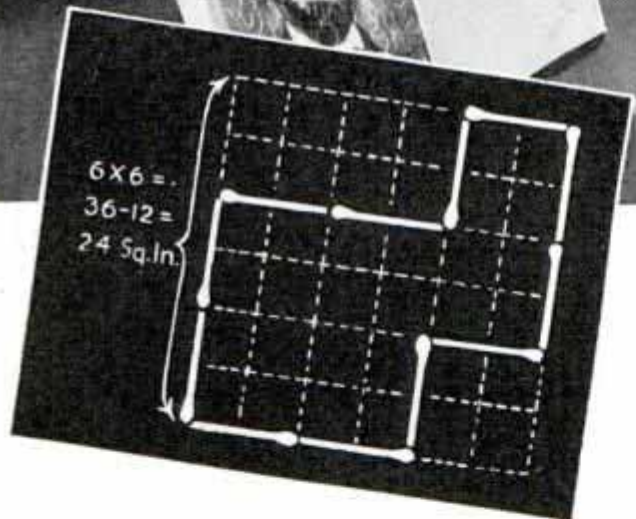

This consists of a box of numbered blocks placed in consecutively numerical order with the exception of fourteen and fifteen, which are reversed, the puzzle being to move the blocks around in the box, using for this purpose the vacant sixteenth space, until all the numbers lie in consecutive order.

This puzzle started a sensation in this country in the sixties of the last century, but, in a changed form, it is as much a sensation at the present moment when a game called "Imp," obviously the fourteen-fifteen puzzle, is absorbing the attention of the puzzle fans. The difference between the old and the latest puzzle is that the

blocks in Imp cannot be removed from the box, being engraved metal blocks which are moved about by sliding them over metal "rails" fixed in the box.

A mathematician has estimated that the fourteen-fifteen puzzle contains 1,300,000,000 possible combinations. Imp is said to have been started in 1932 in Paris when an Austrian devised the idea of making the game foolproof against the player who, exasperated at some point during the game, is strongly tempted to take the required block out of the box and put it

*West - Western
New York City*

*Modern Brands Inc.
321 11 42nd*



Anagrams and "Imp," Two Popular Types of Puzzle; Eight Persons Inherit a Piece of Land Shaped Like the Black Area Below; Divide It Evenly; Solution to This Puzzle and One on Preceding Page at Bottom

where it belongs. Within a year he was selling the game at the rate of a million a month and four factories were kept active turning them out.

An authority of many years standing says most puzzle inventions are based on the theory of inversion, that is, knowing the answer and then creating the question.

An example is the famous question propounded by the late Sam Loyd and believed by him to be his most popular puzzle:

"How old is Ann?" Here's the way it went: "The combined ages of Mary and Ann are forty-four years. Mary is twice as old as Ann was when Mary was half as old as Ann will be when Ann is three times as old as Mary was when Mary was three times as old as Ann." Now, we ask you, "How old is Ann?"

A variation of this is the problem: "I am twice as old as you were when I was as old as you are and when you are as old as I am, together we will be sixty-three." The answer is that I am twenty-eight and you are twenty-one. Breaking the proposition up, we first tackle: "I am twice as old as you were when I was as

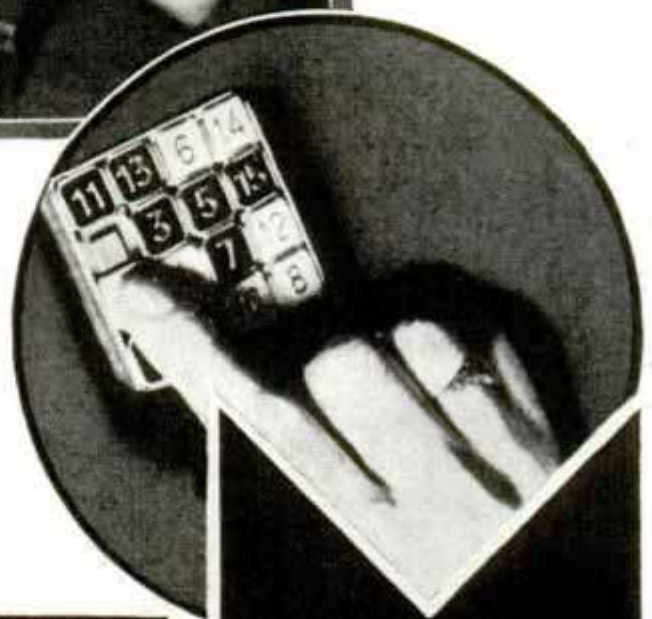

old as you are," and decide that since I am now twenty-eight I am now twice as old as you were—fourteen—when I was your present age—twenty-one, that is, seven

D 13/6 and J. Thomas
Pharmist
500 E. Woodbridge
Detroit, Mich

years ago. Now, for the second part, "When you are as old as I am, together we will be sixty-three," we find that when you, who are now twenty-one, reach my age of twenty-eight, that is, seven years hence, I'll be thirty-five and the total of our combined ages, twenty-eight and thirty-five, will equal sixty-three.

Inventing a puzzle calls for more than a pencil, a sheet of paper and an idle evening. Mathematical training, particularly in geometry and algebra, and natural mechanical leanings, as well as a habit of exact, logical thinking and natural cunning, are prime requisites of a successful puzzle inventor. Most puzzles have a mechanical basis, be it arithmetical, algebraical or geometrical, and many involve such devices as moving counters, mazes, route puzzles and "crossing river" problems. Coins, matches, string or wire are some of the materials used in puzzles of this class. There is also another type of puzzle known as the "literary" class, which includes conundrums, riddles, enigmas, charades, rebuses, palindromes, anagrams, word squares and cross-word puzzles. Puzzle fans generally belong to one group or the other; it is rarely that a puzzler excels in both.

Puzzle inventing has been described as a mixture of inspiration and science. The late Sam Loyd, reputed to have introduced more than 10,000 puzzles which reached more than 30,000,000 persons during his lifetime, believed that good puzzle ideas usually develop casually, more or less by chance, and his experience was that most people prefer puzzles calculated to inspire controversy.

Loyd's procedure in inventing a puzzle was first to decide in what general class of puzzles his puzzle "germ" belonged. If it involved pieces he shifted blocks around and around until some idea occurred to him; if he was thinking of a conundrum, he reviewed all other conundrums which already had been published; if a diagrammatic puzzle was in the making, he worked over a number of other diagrams. In all this his idea was to get the mind operating along definite lines.

The successful puzzle must be simple, yet prod the mind, and the conditions must be clear, accurate and capable of solution.

(Continued to page 128A)



Model Sunlight Motor Actually Produces Electricity; Note Sensitive Plates at Left

MOTOR OPERATED BY SUNLIGHT PRODUCES ELECTRICITY

Sunlight falling on metal plates coated with sensitive, photo-electric material is used as a source of power for a miniature motor to generate electricity. An output of four milliamperes is obtained, sufficient to spin a rotating armature four inches in diameter and weighing three ounces. The only factor that prevents wider application of this means of transforming sunlight into electricity is the expense of the coating materials for the plates. Getting sufficient output is a matter of increasing the area of surface exposed to sunlight.

HOT-WATER PLANT REGULATOR REPLACES EXPANSION TANK

Replacing the expansion tank in hot-water heating systems, an automatic control valve maintains the proper pressure with safety. Due to its sensitive diaphragm, the valve will not open until the exact pressure for which it is set is reached and it will close within a

drop of two pounds. This results in economical operation. A by-pass is provided for quickly filling the system and for making cold-water pressure tests at any time.



D 128/1
Complete \$25.00
when by order \$17.
Peerless Control Co
7522 Meade
Pittsburgh, Pa.

D1346
24

Productions, Ltd
Castroville, Cal., Canada

Owned by Clyde Brown
Los Angeles, Calif.



Widely used

Pulling Trigger of This Odd Weapon Releases the Arrow; It Was Used by the Crusaders

BOW-GUN OF CRUSADERS' DAYS RECALLS ANCIENT WARFARE

Recalling ancient means and methods of waging war, a bow-gun from the days of the Crusades has been found in a collection of weapons in California. The bow-gun first came into use on the Continent in the fifteenth century and was carried by the Crusaders to the Holy lands while England was still using the long-bow. The weapon, believed to be at least 500 years old, has a metal bow mounted on a heavy stock. The arrows are precipitated by the release of a trigger.

METAL VULCANIZED TO RUBBER

Rubber and fabrics can be vulcanized to metals and wood by a process that produces an unbreakable bond. Expected to have a wide application in the manufacturing field, the process employs thermoplastic rubber, the composition material that is subject to application of heat and at high temperatures is quite plastic. Having the characteristic of being solvent, it may

Chas. R. J. Reaney
Cottawa, Canada
1290

General
Inflated Rubber Life Preserver

be used to form lacquer, varnish or a shellac substitute. The material possesses pronounced dielectric properties. Of outstanding importance is the plan to develop a metal-reinforced rubber tire for trucks and buses. Other applications include: auto running and floor boards, power and conveyor belting, train and high-pressure hose, unbreakable battery boxes, insulated steel roofing, molded tool handles and paving materials.

LIFE PRESERVER HAS "CABIN" TO PROTECT HEAD

One de luxe life preserver recently devised is made in two sections, the upper part consisting of a "cabin" which protects the head of the user. It is of inflated rubber and if

one section becomes useless, the remaining one will keep the user afloat. On top is a pole and flag to attract attention.



Inflated Rubber Life Preserver with an Upper Section to Protect the Face and Head

General
Inflated Rubber Life Preserver
The Rubber Company

D1339

Made by O. K. Ne. W. P. G.
Lemhardt, Charlottenburg
Kresmann

HIGH VOLTAGE

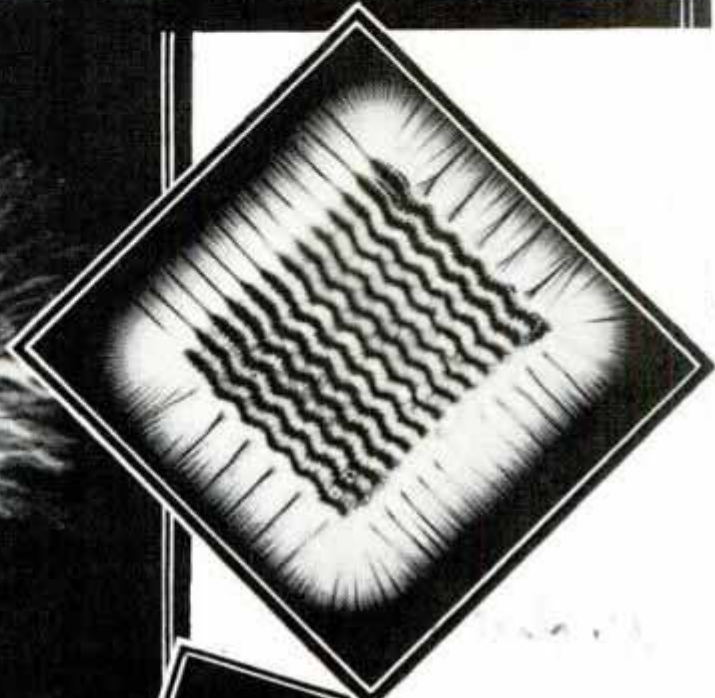
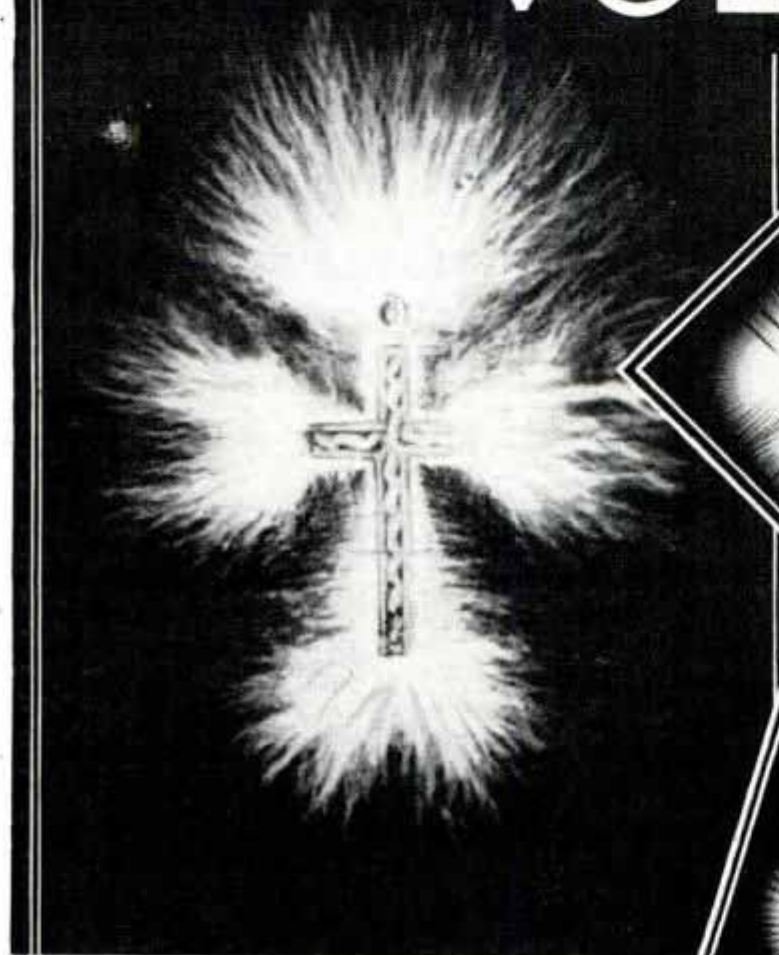

Above, Gold Cross and Its Beautiful Corona Photographed with Aid of 140,000 Volts, and Design Made by a Silver Cigaret Case



Courtesy Publishers' Photo Service

These Photographs Were Made by Passing from 140,000 to 250,000 Volts of Electrical Current through the Metal Objects Pictured; Don't Try a Similar Stunt Unless You Are Thoroughly Familiar with Electricity; at Left Are Ordinary Metal Paper Clips Exposed to 250,000 Volts, and Above Is a Gold Necklace

110 5040th
New York

D1362

3 W. 87th St
New York



This Piece of Cloth Which Has Been Fireproofed Is Being Tested by Placing It in Flame

FABRICS ARE MADE FIREPROOF BY SECRET TREATMENT

Fabrics are being fireproofed by a secret treatment which it is claimed renders them impervious to flames but does not affect their normal qualities otherwise. Fabrics thus treated have been used in building airplanes and fireproofing partitions in ships. The fireproofed cloth can also be used for clothing and for pillow cases and sheets in hospitals and on ships.

DRAWINGS EASY TO REPRODUCE ON THE MIMEOGRAPH



Blueprints, sketches, drawings, ruled forms and similar work up to eight and one-half by fourteen inches, can be reproduced accurately on a mimeograph by using a new device. Set in the frame is a sheet of translucent glass through which a light shines. An adjustable reflector can be used to vary the in-

tensity of the illumination on any part of the surface. The blueprint or drawing to be reproduced is clamped on top of the glass. A translucent, flexible writing plate is fastened on top of the blueprint or drawing and the stencil is fixed in place. When the light is turned on, every detail can be seen clearly through the stencil, making it easy to cut the stencil with the various tools provided. When cut, the stencil is run off on the mimeograph in the usual way.

D1336

FIRST AUTO MADE IN ALASKA GOES TO MUSEUM

Alaska's first homemade automobile, built from odds and ends thirty years ago, will no longer gather dust in an obscure corner of a Juneau garage. A place of honor now has been reserved for it in the Territorial museum at Fairbanks. The car was built by Robert E. Sheldon, then living at Skagway, but now postmaster at Fairbanks. Mr. Sheldon had never seen an automobile, but in 1905 he found a description and some drawings and photographs of the new invention in Popular Mechanics Magazine, and decided he would make "one of those horseless carriages." The present governor of Alaska,



Alaska's First Homemade Auto Which Was Constructed by Man Who Had Never Seen a Car

then editor of the Skagway newspaper, often saw Mr. Sheldon driving along the streets of the town, which was the gateway to the Klondike. Like the racing Panhards and Wintons of that day, the car was painted a brilliant red. The tires were made of hard rubber, and the engine was

American Clipper
Pan American Airways

A. B. Clark Co
720 W. 4th St
Juneau Alaska

71st Street
335 W. 7th St
Juneau Alaska

covered with a sheet of heavy zinc. Power was furnished by a single-cylinder, two-cycle marine engine, with a friction clutch. The car had a wooden frame, with old-fashioned buggy wheels and springs. Instead of having a steering wheel, it was equipped with a long handle.

D1359.

"MITTEN" PREVENTS FREEZING OF WATER METER

Basement or indoor water meters can be protected from freezing with metal "mittens" for covering and insulating the meters. The mitten also prevents rapid loss of heat by the water within the meter. It consists of a flexible jacket of expanded, galvanized and painted metal shaped to fit around the meter and leave space for insulating material. The insulation used is a mineral wool which is waterproof, ver-

min proof and will not decay. The jacket, with a thick layer of wool in the bottom, is placed around the meter and the sides clipped shut, then more of the wool is placed around the sides and top and pressed down. The sides of the jacket open to permit it to be slipped up over the pipe and meter couplings.



D1328

ARTICULATED TROLLEY CAR HAULS MORE PASSENGERS

Germany is experimenting with an articulated trolley car consisting of three street cars in one. The unit has only one conductor. Passengers can enter at front

Conk Welkins.

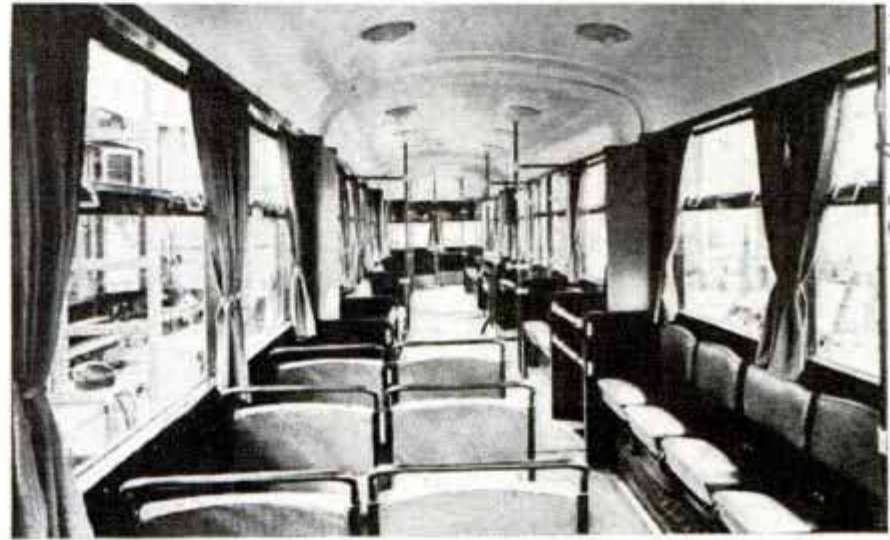
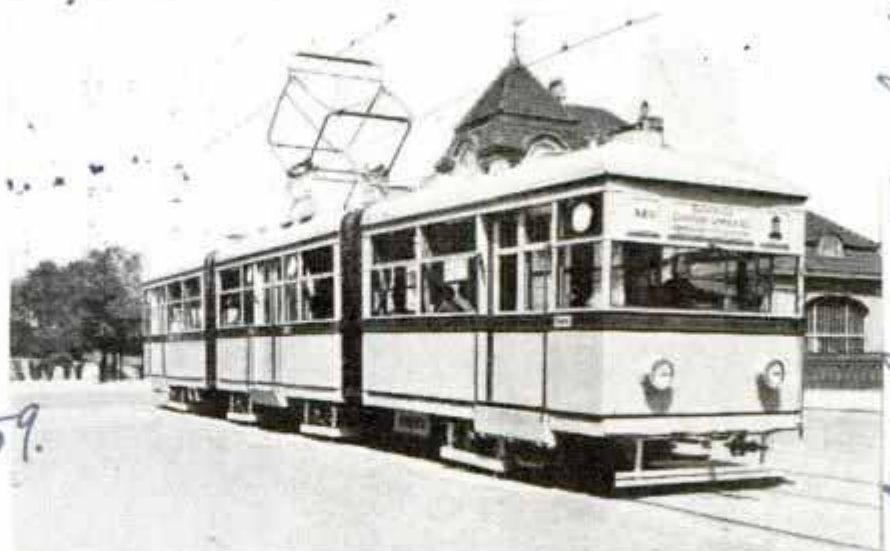

Interior and Exterior Views of Germany's Articulated Trolley, Consisting of Three Street Cars in One

or rear and leave by the middle compartment door beside which is the conductor's stand. Seats are arranged both crosswise and lengthwise.

D1302.

DOOR CHECK WITHOUT FLUID IS REGULATED BY GEARS

Regulated by gears, a new door check operates without fluids. Danger of leakage is eliminated, as is faulty operation in cold weather on account of thickening of the fluid. Inside a gear is a catch that slips when the door is opened. When the door is released, the catch engages with the gear. A governor regulates closing speed.

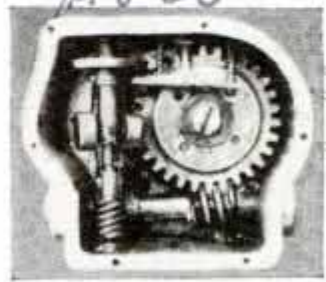

\$18.00

Allgemeine Elektrizitäts-Gesellschaft
 Berlin
 Friedrichshagen
 W. 4
 Germany
 Karl-Liebknecht-Str. 2-4

now available
 at present. 12/14/51

F. L. Kuhl, Beatrice Nebel

D 1243
Mr. Robert W. Leonard
The Infantry Journal
1115 & 17th St N.W.

The PRESIDENT

Washington, D.C.



speak. With a copy of their schedules before them, representatives of these networks get together with the President's secretary and arrange a time suitable to the President, that will interfere as little as possible with commercial programs.

A special desk for these "fireside broadcasts" has been arranged by radio technicians. It is an ordinary flat-top desk from which the drawers have

The President at the Microphone and, Left, a Sound Record of His Voice, Above, Compared with That of Ed Wynn, Comedian; Below, Broadcasting Review of Fleet

IN 1919, when President Wilson wished to appeal to the people on the League of Nations issue, he traveled 9,981 miles between September 3 and 23, making twenty-three scheduled speeches. Joseph P. Tumulty, then his secretary, estimates that on this tour, which wrecked the late President's health, 750,000 persons heard his voice.

Compare this with 1934 when President Roosevelt sat before the microphones at his desk in the White House, and in twenty-seven minutes addressed fifty million persons, all of them sitting comfortably in their own homes. "What a tragedy," comments Mr. Tumulty, "that radio could not have been developed fifteen years sooner."

When the President desires to broadcast he notifies the three great networks—Columbia, N.B.C. and the new A.B.S.—stating the approximate time he desires to

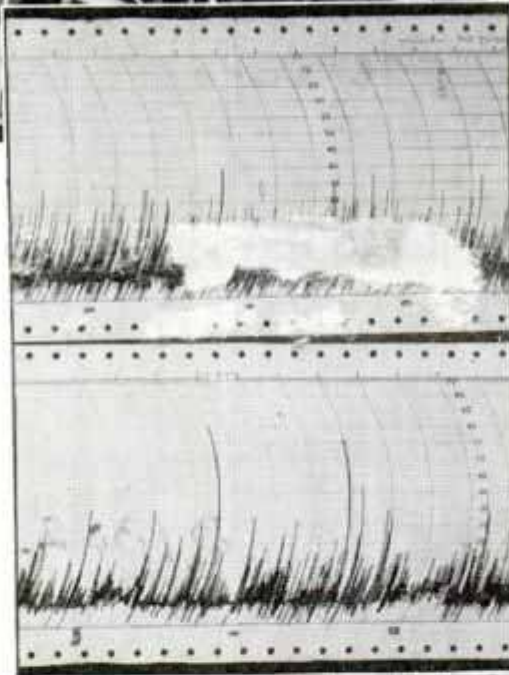

on the AIR

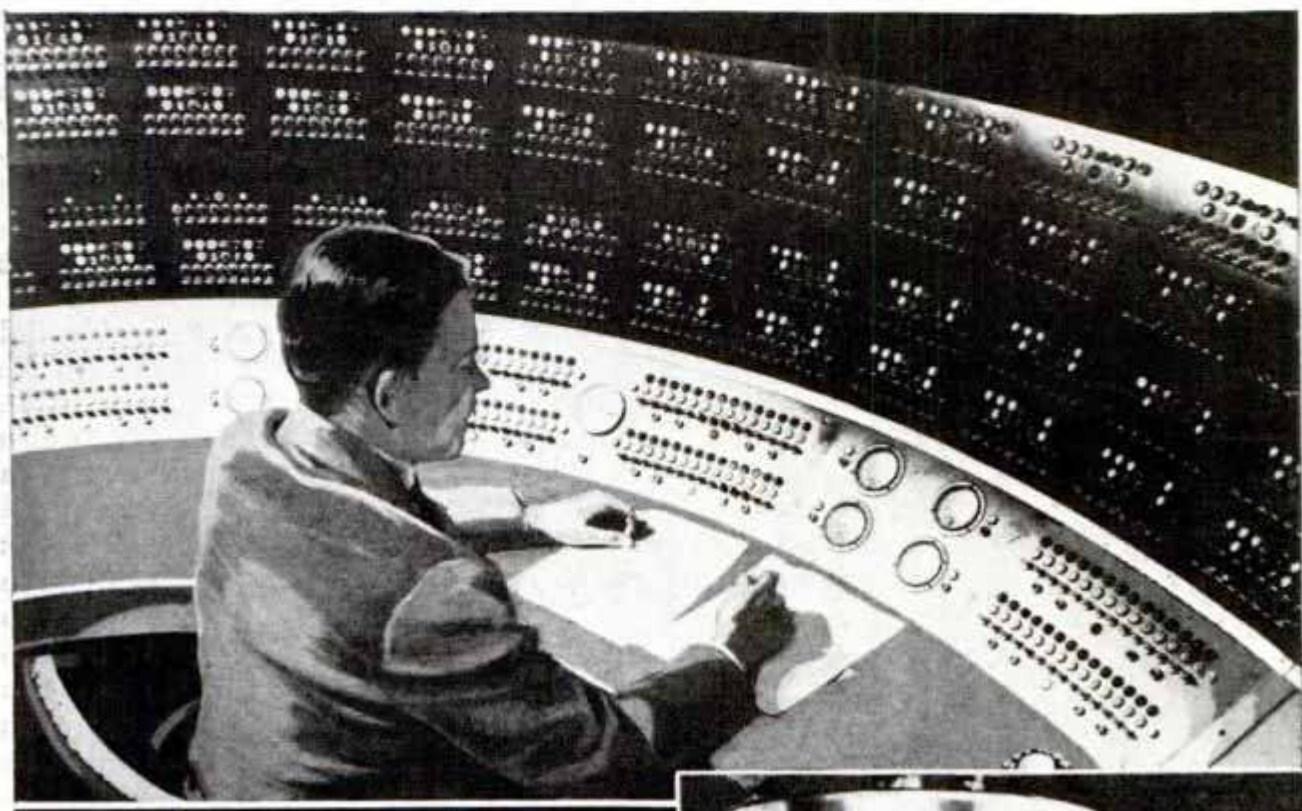

The Control Board, Heart of a National Network, and Mercury Vapor Rectifier Supplying 18,000 Volts to Radio Power Tubes

been removed. Five microphones—two for N.B.C. and A.B.S. and one for Columbia—are arranged in a semi-circle on top of the desk, which is placed in the oval diplomatic reception room of the White House. Cables from the microphones pass through two holes in the top of the desk to the floor, where they pass around the edge of the room to the portable amplifiers on the opposite side.

The telephone company arranges direct lines from the amplifiers to WRC, WJSV and WMAL, where connections are made by leased wire to the New York control rooms of the three networks. From here leased wires, leading to all stations of the networks, are plugged in. Columbia has 100 stations on its hookup, while there are eighty-seven on N.B.C. With the various independent stations plugging in at the nearest network station, there are over 250 stations ready to broadcast the President's address. As an experiment, an official of N.B.C. who possesses a radio of such range that he can select over 100 sta-

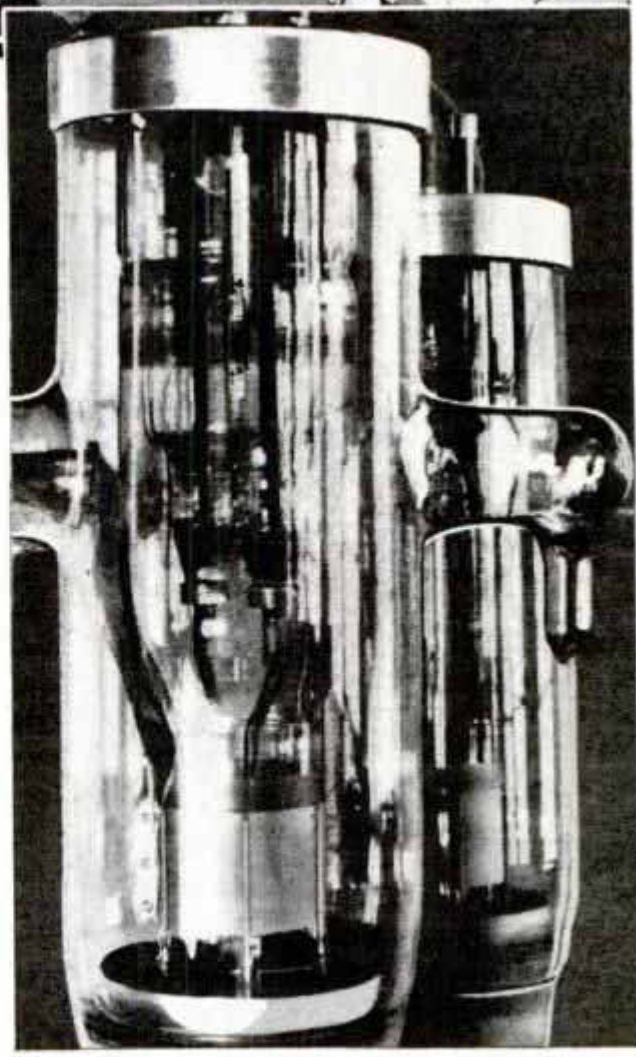



The President Broadcasting from His Radio Desk in the White House

tions, tried the complete range of his dial during the President's latest speech, and found only three stations broadcasting other programs.

President Roosevelt invariably dictates his speeches to a secretary. After they are typed he makes revisions, reading the broadcast direct from the second typing, which is identical with copies released to the press.

Carleton Smith of N.B.C. and Bob Trout of Columbia are the official presidential announcers. Each of these men composes a short introductory speech, concluding with the words, "Ladies and gentlemen, the President of the United States." Each announcer rehearses his speech aloud several times, checking with a stop watch. These times are compared, and the longer introduction is cut so that both will take approximately the same number of seconds to deliver. The announcers have their individual microphones located at opposite sides of the President's desk.

When a station is on the air there can be no vacant time; and since no requirement is made that the President speak a prescribed number of minutes or seconds, an orchestra at the New York studio stands by ready to take the air and finish out the time with music until the next scheduled broadcast.

When the Presidential broadcast is going on, the diplomatic reception room contains the two announcers, ten radio technicians, and such personal friends and members of the family as happen to be present in the White House. As soon as the speech is finished news pho-

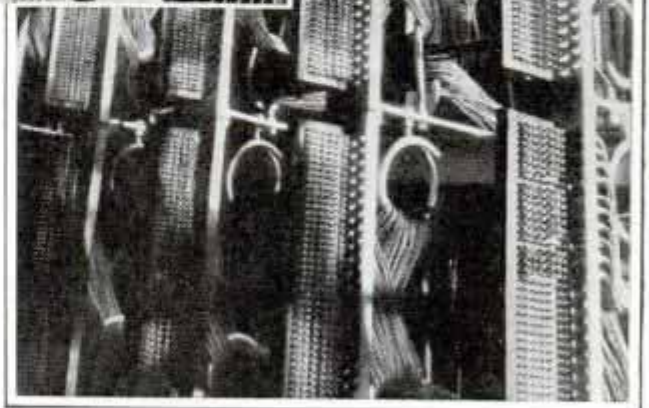
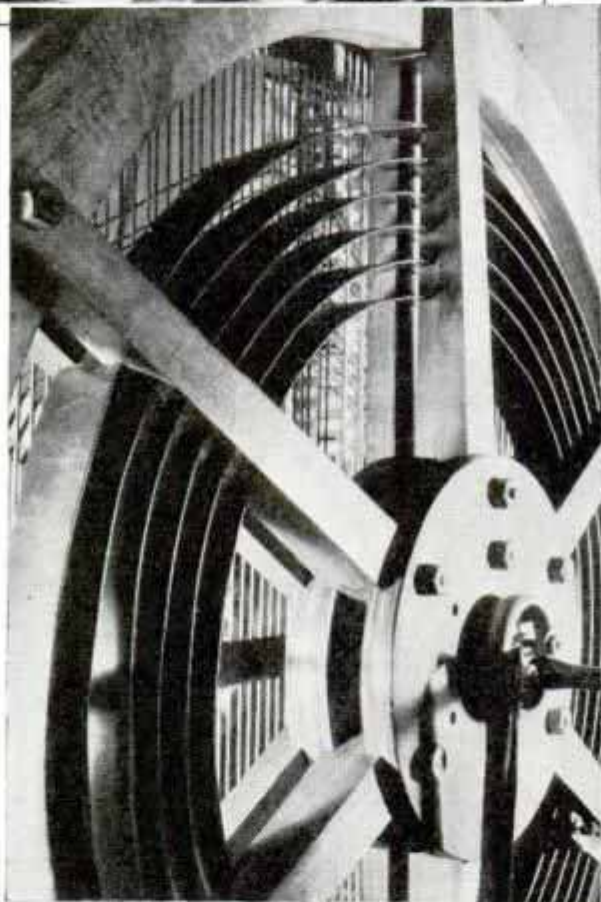

Center, High-Power Frequency Transformer; Below, Rear of Control Board of N.B.C. Network Where Hundreds of Wires Are Centered

tographers are admitted to take stills, and the cameramen grind away while the President reads the selections of his speech that will be heard by movie goers.

The magnitude of such a broadcast may be judged by the power used, 2,500,000 watts being required. This wattage would light every home in a city the size of Concord, N. H., or Greenville, S. C., for half an hour. The horsepower used is enough to lift the seventy-story RCA building in New York 1,265 feet. More than 1,500 people are necessary in order that such a hookup may go over without a hitch.

TELEVISION AERIAL IS SHAPED LIKE A BIG WHEEL

German radio engineers experimenting with television have evolved a strange form of aerial for picture transmission by wireless. This aerial takes the form of two circular frames with wire "spokes" attached to the rim of each "wheel" and leading to a central "hub." The aerial is placed horizontally atop a building.



This Wire "Wheel" Is a Television Aerial Used in Germany in Transmitting Pictures

PORTABLE PIPE THREADER RUN BY ELECTRIC DRILL

Pipe threading is simplified by using a portable threader operated by any standard make of pneumatic or electric drill.



Lightweight Portable Pipe Threader Which Can Be Operated by Pneumatic or Electric Drill

Made mostly of aluminum alloys, the threader weighs only twenty-nine pounds and the detachable base weighs sixteen pounds. It can be used with or without the base. Standard one-inch pipe fits holes in the feet of the base to form a substantial permanent work bench if desired. The operating speed of the die head is ten to fifteen revolutions per minute and the threader will cut right or left hand threads and is reversible for backing off.

EXTRA ZINC COATING ON WIRE STOPS FENCE RUSTING

Protection against rusting of wire fence is obtained by coating the wire with an extra coating of pure zinc. Every part of the wire is covered with the special galvanizing material, preventing moisture or salt air from reaching the steel wire. The process does not permit formation of the hard, brittle iron-zinc alloy with which many kinds of fence wire are covered. The brittle alloy has a comparatively short life, particularly in regions where it is subjected to the deteriorating effects of salt air.

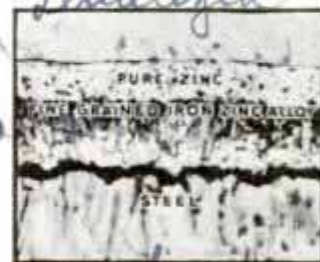

*The Burden Co
1934 Barkley
Road
Warren
Ohio*

*Beaver Pipe Tools and
Warren, Ohio*

D13/D.

D1234.

Universal

Raha

*Northwestern Barb
Wire Co. & Hardware Co.*

Highway Dept,
State of Washington

D1338



Snowplow Clearing Roads in Cascade Mountains and Short-Wave Radio Station Which Directs Operations

SNOW FIGHTERS of the CASCADES



Radio Helps Keep Mountain Roads in the Cascades Clear of Snow by Forming a Means of Communication between Snow Camps and Trucks; over the Short-Wave Set Extra Aid Can Be Summoned in Case of a Sudden Blizzard, and Slides, Weather Conditions and Breakdowns Are Reported; Above, Snowplow, Showing Radio Antenna; Right, Radio Set in Truck



740.11th Ave
740.11th Ave
Paterson, Wash.
h. Seattle, Wash.
Comb. L. &

Klauer Mfg Co (2)
Dubuque, Iowa

D/284

W. S. Clayton
Kansas City S. & R. R.

Rolling Crane Removes Trucks from Wheels

Freight-car repair work is simplified by using a small manually operated bridge crane to remove trucks from car wheels and replace them. The crane, made of two-inch pipe, bent and welded in shape, is the invention of a Kansas City, Mo., car foreman. It is easily rolled into position on its own wheels by two men. Despite its wide spread of ten and one-half feet at the base it is able to lift a weight of one-half ton from three points of suspension. The crane is moved out in raised position and when set in place over a track, the entire top framework is lowered by a series of pull jacks. When the trucks are fastened by chains, the top frame is raised and the entire device pulled from the car wheels. The crane can then carry its load any desired distance. It works equally well with the operation reversed.

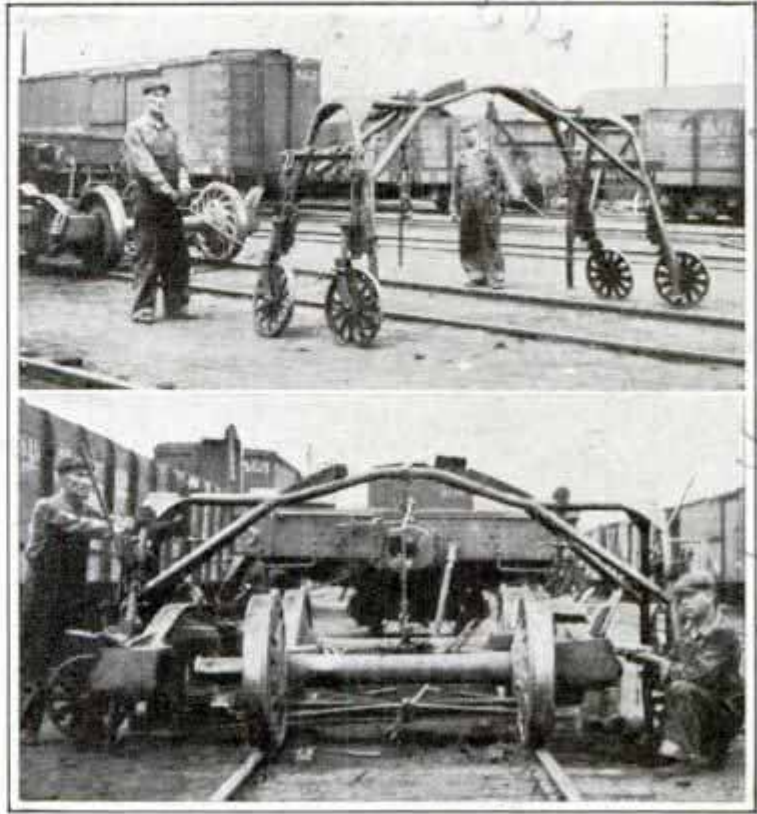

This Rolling Crane Is Used to Remove the Trucks from Freight-Car Wheels in Making Repairs

Cap. John Winter Fleming 240 Wallace Ave Buffalo N.Y.

LATHE ADAPTED FOR MILLING BY HEAD ATTACHMENT

D/250



After turning has been completed, the lathe can perform milling operations by equipping it with a new attachment that does not require removal of parts in changing from one job to the next. Spur or spiral gears can be

made with the attachment, as well as cutters and hobs for milling.

D/1315

SECRET MESSAGE TO SQUAD CAR SENT BY PLUG-IN PHONE

To prevent criminals from tuning in on police flashes to squad cars, the Buffalo, N. Y., police department has equipped its cruising cars with plug-in phones. When a secret message is to be transmitted, the police radio dispatcher asks a squad to

call headquarters. The squad car goes to the nearest patrol box, plugs in the telephone in the bottom of the box without even opening it, and receives the message.

PAN COVER KNOBS ATTACHED BY TAPPING WITH HAMMER

D/282

Pan cover knobs often become loose and drop off, leaving the covers virtually useless. Such a cover can now be repaired in a few seconds by replacing the original knob with a patented one which can be attached with a tap of a hammer. Each knob is equipped with a split rivet, the prongs of which spread when it is driven into the knob, giving a secure fastening.



It is estimated the average healthy person eats one ton of food costing about \$200 every year.

Mr. Stanley W. Todd
220 Park Ave
New York City
Baker-McMullen Co.
1100 Sweetgarden Ave
Chicago

Culver Engineering Co
1428 N. ...

636 N. Albany

D1094 Cont. John L. County
D109-1944 H 2 U

Washington
200

WASTE OR

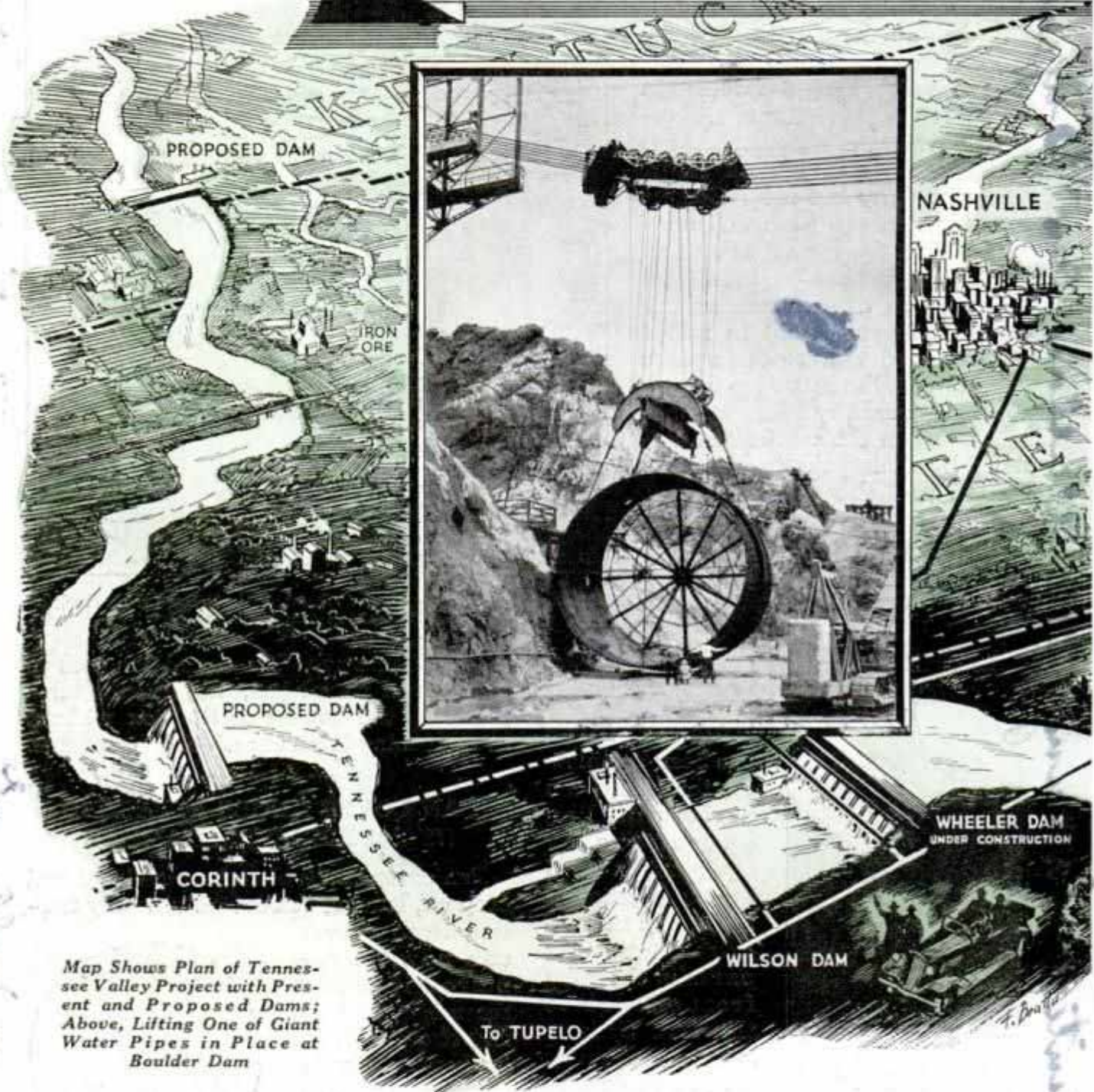

Map Shows Plan of Tennessee Valley Project with Present and Proposed Dams; Above, Lifting One of Giant Water Pipes in Place at Boulder Dam

APPROXIMATELY one billion dollars is being spent by the federal government to develop the hydroelectric resources of the nation. This vast sum is split among nine vast plants. These plants stretch from northwest to southeast and from southwest to north central United States.

The greatest is Muscle Shoals or the Tennessee valley development. Here the

government has projected an outlay of some \$300,000,000.

Boulder dam, on the California-Nevada border, draws \$165,000,000; Grand Coulee, in Washington state, calls for an expenditure of \$63,000,000; Bonneville, in Oregon, \$43,900,000; Fort Peck, in Montana, \$59,000,000; Verde, Caspar-Alcova and Owyhee, in Arizona, Wyoming and Idaho-Oregon respectively, \$49,600,000 and Loup

PROGRESS ?

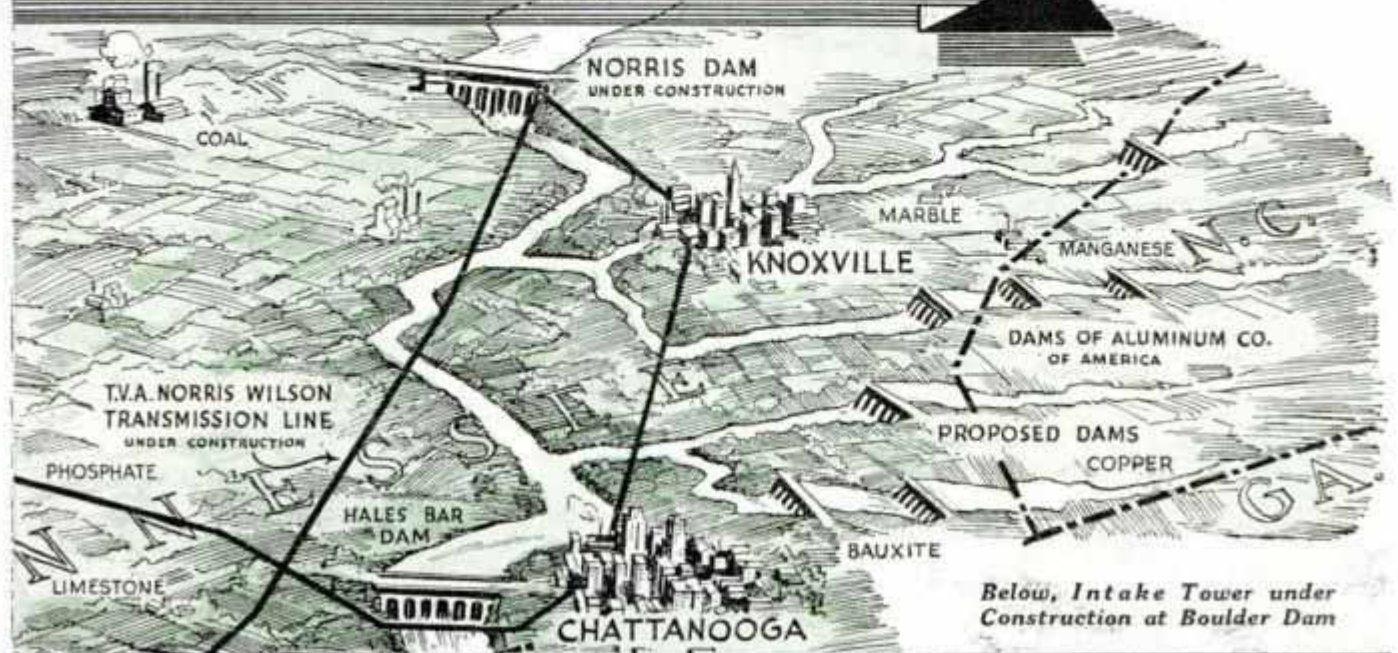

Below, Intake Tower under Construction at Boulder Dam

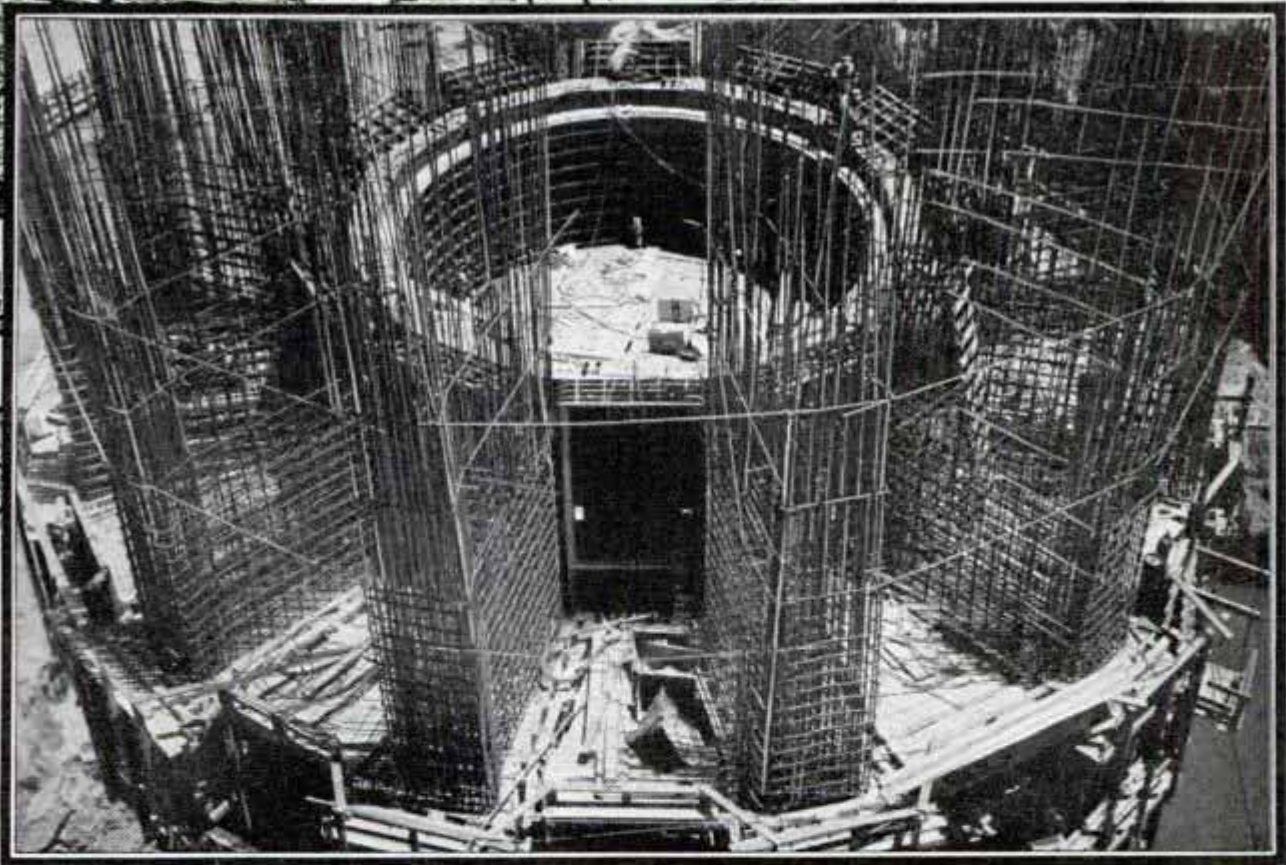

river, Nebraska, \$7,300,000. Supplement the foregoing figures with the initial cost of Muscle Shoals—\$150,000,000—and \$140,000,000 advanced to states and municipalities plus the subsidiary program cost of TVA and the total hovers around one billion dollars.

For sheer magnitude of undertaking and results expected the TVA program surpasses all the other ventures. Two great dams are being built here in addition to the one already existing—the Wilson dam. Wheeler dam, located fifteen miles above Wilson dam, will provide a storage lake

1094

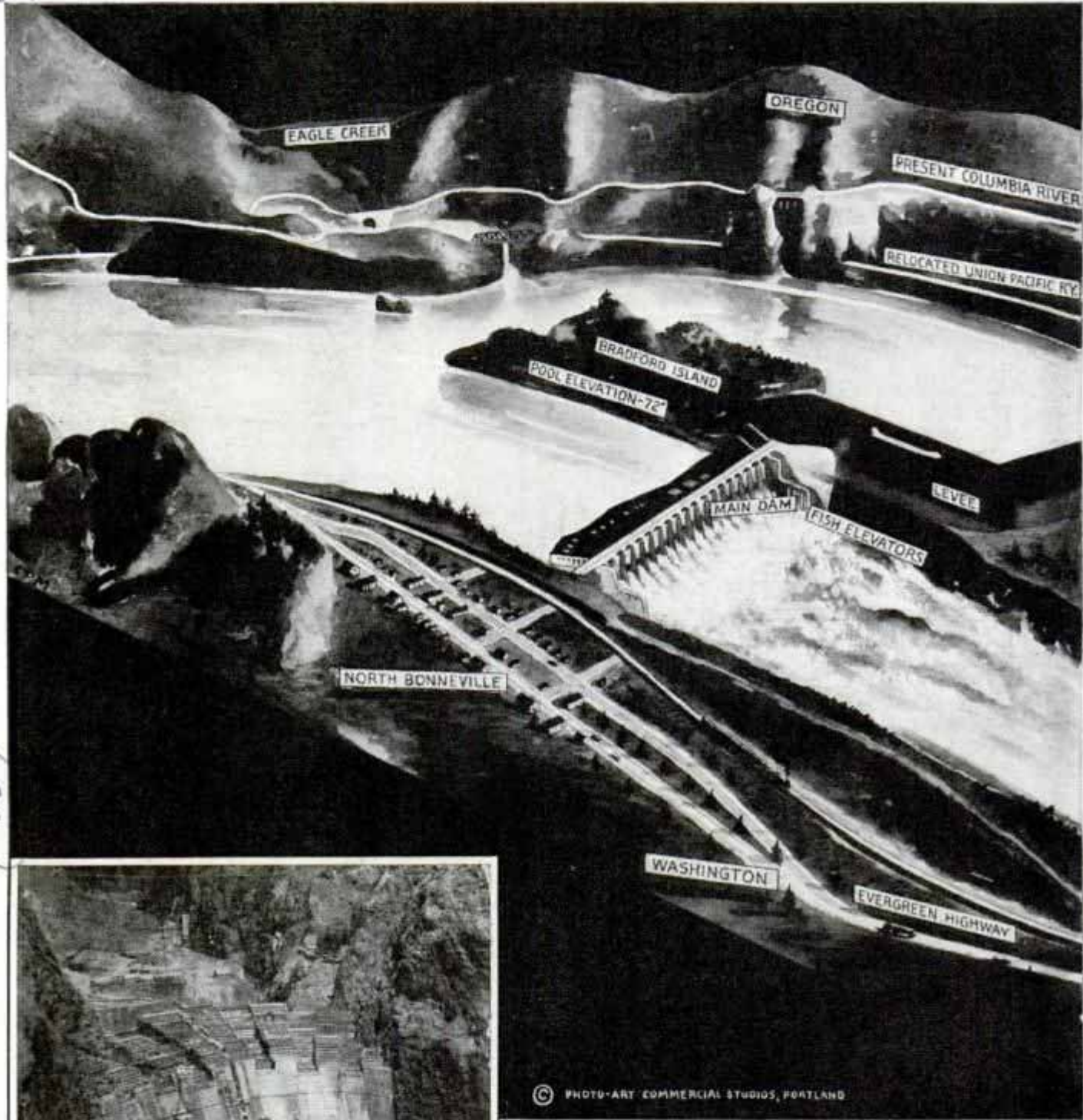

revised, 1935 - 497
539



Above, Plan for the Bonneville Dam in Oregon; Below, Boulder Dam When About Half Finished

eighty miles long. Norris dam, 400 miles distant up the river, beyond Knoxville, will span the river 1,800 feet and contribute power by transmission line to the Muscle Shoals plant.

The Grand Coulee dam in Washington represents the greatest single harnessing of hydroelectric power resources in the world. With a maximum surface elevation at 1,111 feet, the dam will back up the Columbia river about fifty miles in the vicinity of Hunters and three miles up the Spokane to near old Fort Spokane.

The BONNEVILLE DAM

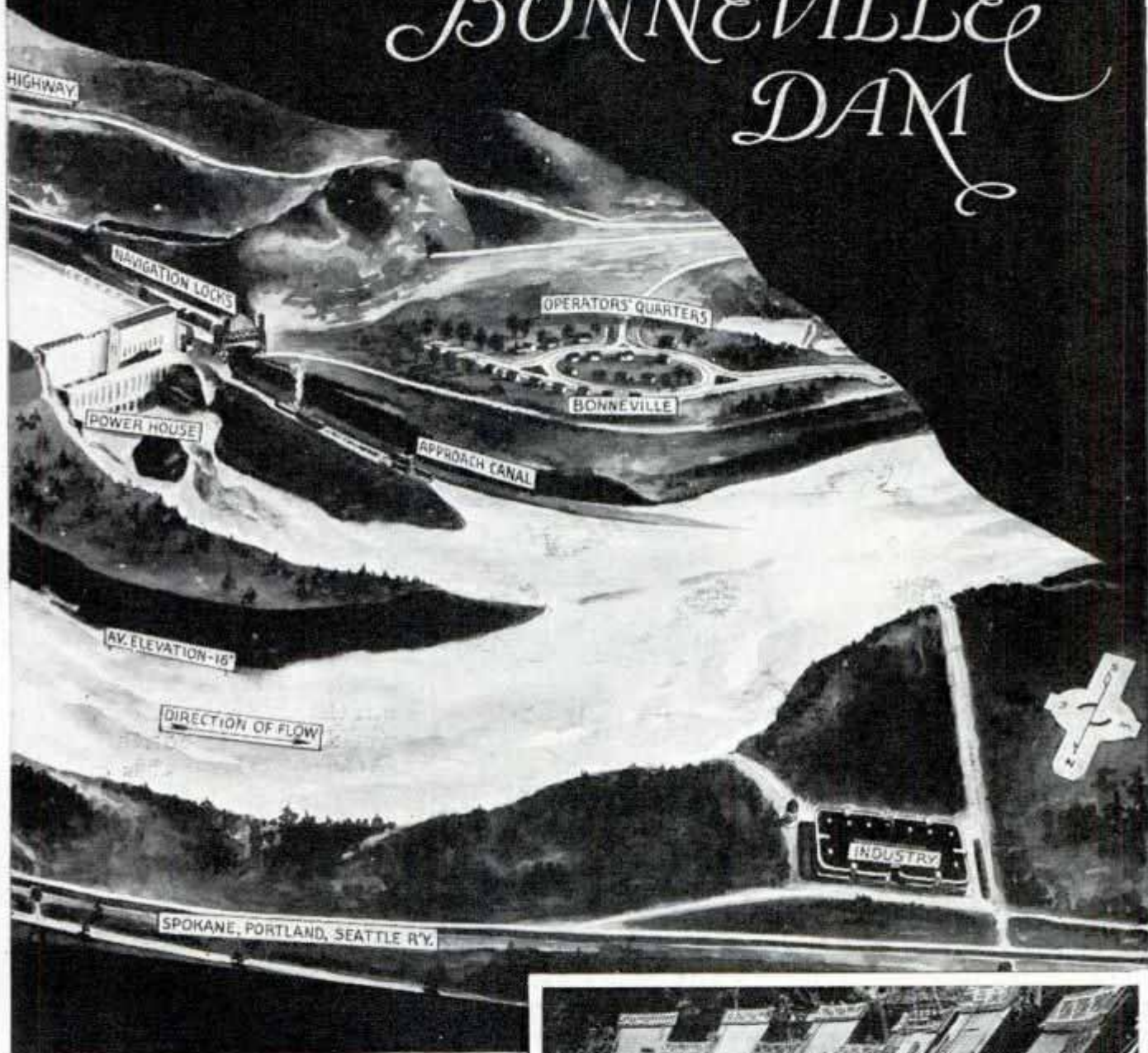

Ultimate development of this dam site calls for the construction of a single concrete gravity dam about 500 feet in height with a crest of 4,000 feet. The dam will create a reservoir of approximately 17,500 acres with a capacity of 1,200,000 acre-feet. An acre-foot is the amount of water that will cover one acre of ground one foot deep.

Boulder dam is to be the tallest dam in the world. It bars the

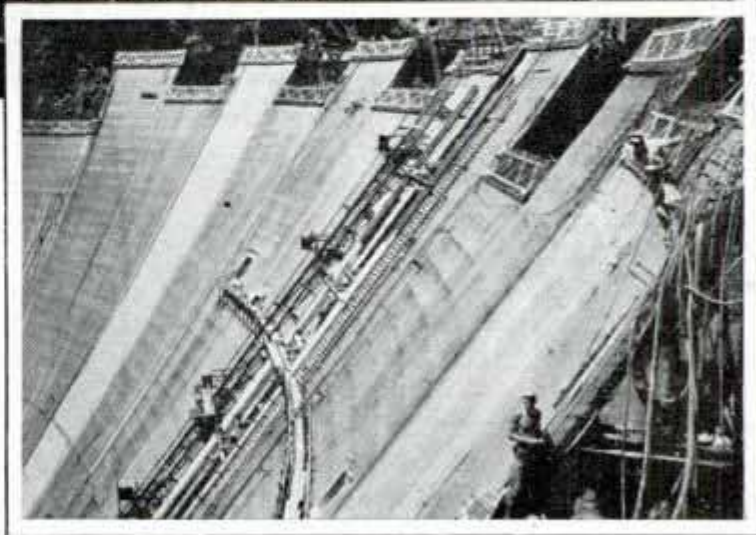

Boulder Dam, Looking across the Downstream Face at Top of Forms toward the Nevada Side

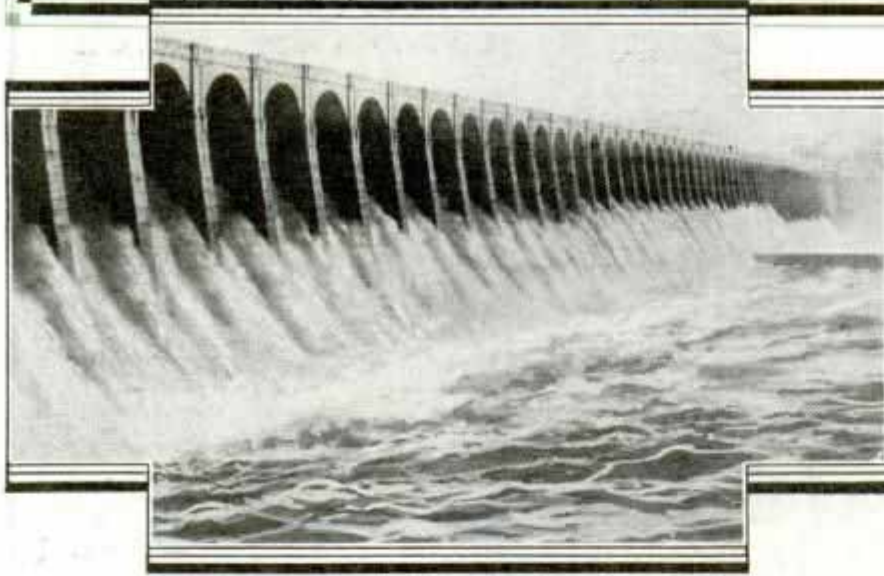
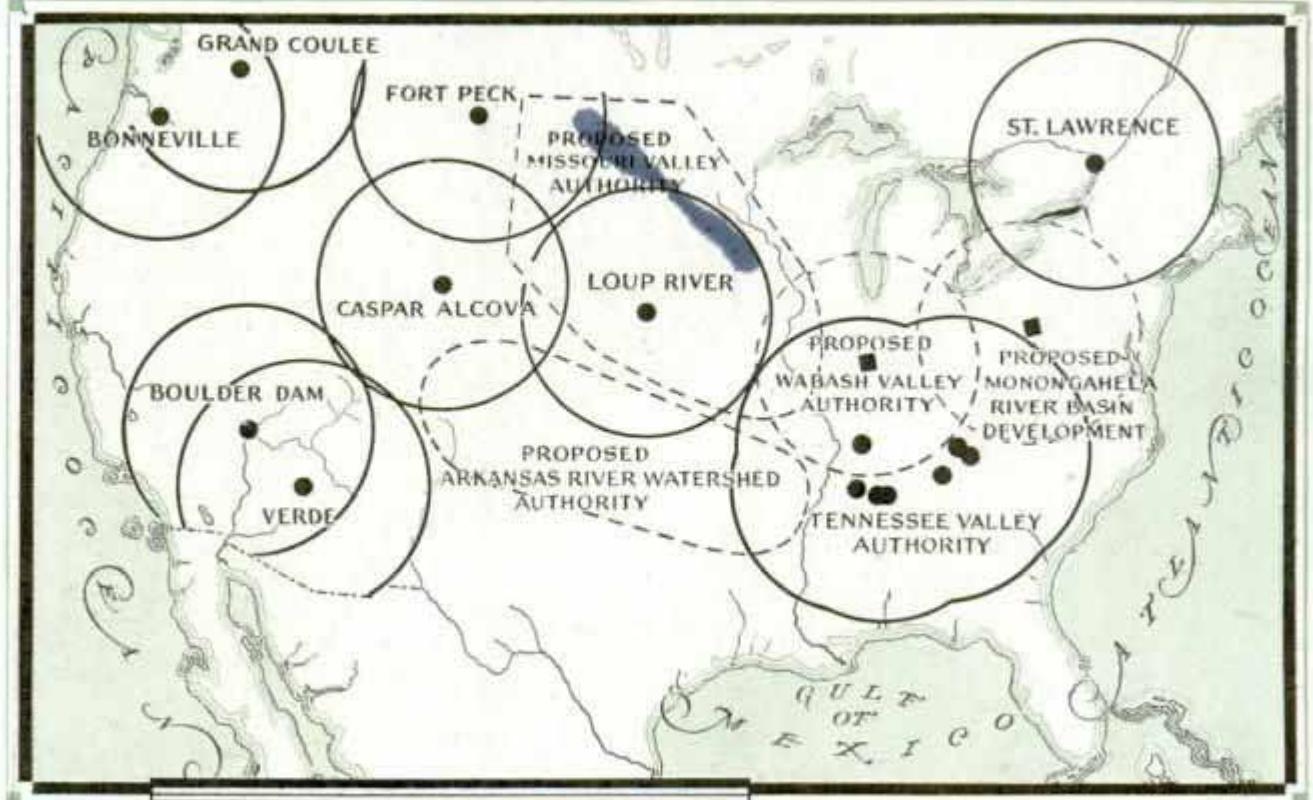

Map Showing Various Government Hydroelectric, Water Control and Irrigation Projects; Left, Wilson Dam Today

Fort Peck dam, in Montana, will be the largest earthworks dam in the world. It will contain 85,000,000 cubic yards of earth and create a reservoir in the Missouri river 175 miles long with a capacity of 19,000,000 acre-feet. The accompanying map shows the area these various dams will serve

way, for the use of man, of the narrow, twisting Colorado river as it pours through its rugged canyon. From its base the dam rises to a crest 726 feet up. Towers and parapets shoot it up another forty feet. The Sautetm now building in France, is only 446 feet high and the Owyhee, in Oregon, is only 405.

Boulder dam will raise the surface water of the Colorado river 584 feet. It will create an inland lake 227 square miles in extent, containing over 145,000 acres. This lake will hold over 10,000,000,000,000 gallons of water—30,500,000 acre-feet when full. So large will the reservoir be that the entire flow of the Colorado river for two years can be stored in it.

with electric power, the amount of power existing plants in these areas are capable of generating and the amount of additional power the government plants will create.

Existing plants in the outlined areas have a total yearly capacity of 35,089,764,000 kilowatt hours. A kilowatt hour is the amount of work one kilowatt performs in one hour of time. The government's program will add to this sum total 19,687,480 more kilowatt hours, making a grand total of power production for the areas of 54,777,244,000 kilowatt hours per year. This is three times as much power as was consumed in these areas for the fiscal year 1932. That figure is 18,481,085,500 kilowatt

(Continued to page 124A)

D 10 7 4

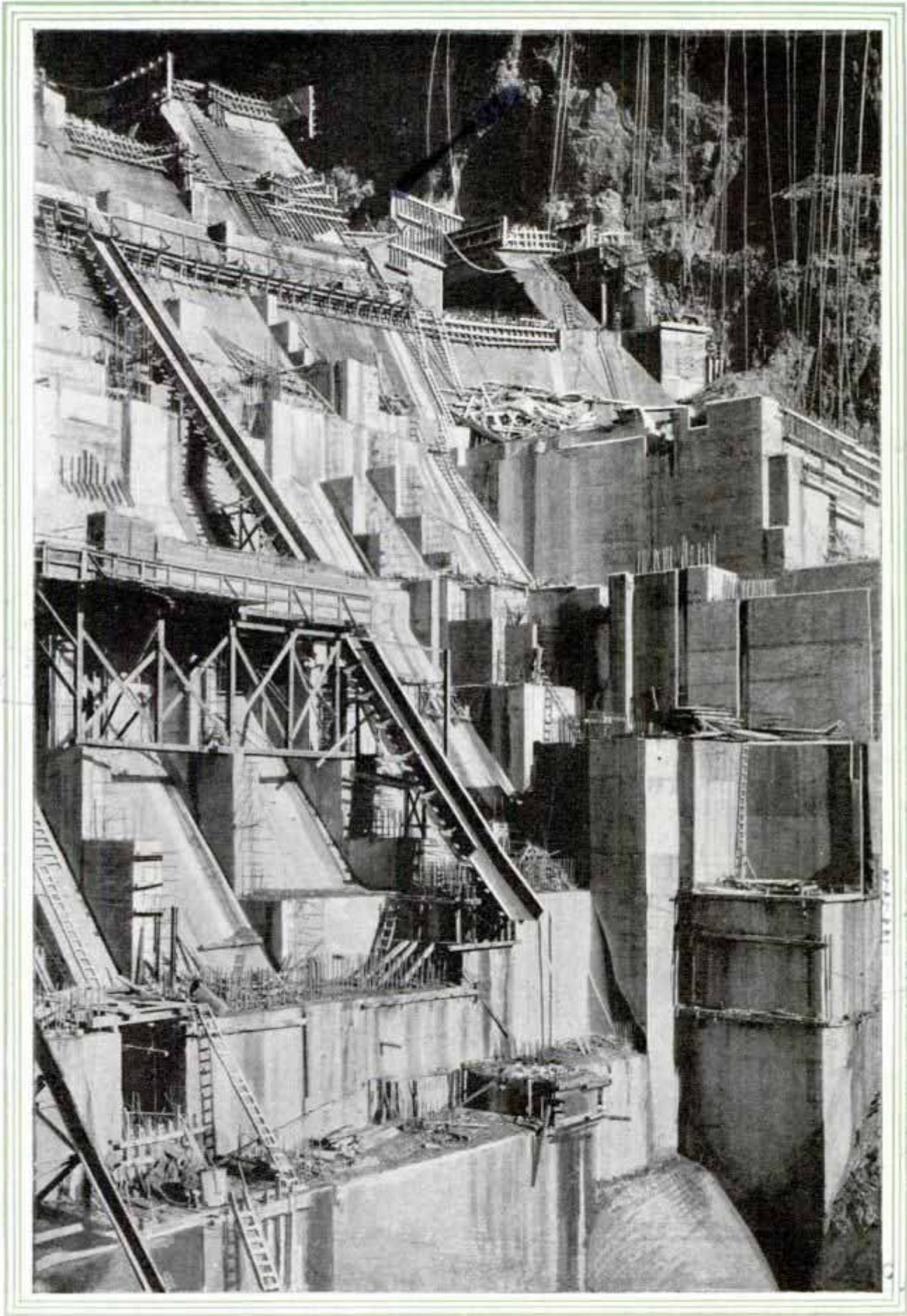

Boulder Dam in the Making; It Will Be the Tallest Dam in the World and Its Reservoir Can Store the Entire Flow of the Colorado River for a Period of Two Years

D 1888

John Lewis Elson Elson
Clevens Jr. 1112 Washington
St. Dayton Ohio

Ralph Letterier



Miniature of a Ketch Which Is Capable of Towing a Rowboat and Passengers When under Sail

Acme
MINIATURE OF SAILING CRAFT CAN TOW A ROWBOAT

Working miniatures of a ketch, a cabin cruiser and a speedboat have been built by a Los Angeles man. The six and one-half foot ketch is a miniature of a twenty-six-foot boat, and is capable of towing a rowboat and passengers when under sail.

SEAL FOR BEDROOM DOORS WORKS AUTOMATICALLY



slide in and out. Its operation is noiseless.

GERMAN SILVER IN NAME ONLY

German silver is not silver at all but the "white copper" of China which was introduced into Europe by the Germans. It is

ZEBRA FISH HYPNOTIZES VICTIMS BY WAVING ITS FEELERS

Tropical fish
Something very like hypnotism is employed by the strange tropical zebra fish in attracting victims for its dinner. It is equipped with many feelers which wave gracefully to and fro in the water but prevent rapid movement in pursuit of prey. So the striped fish approaches its victims slowly, waving its streamers to attract attention. Apparently smaller fish are fascinated by the feelers and allow the zebra fish to come close. Then there is a gulp and the little fish is gone. Recently 500 other fish were included in the same tank with two zebra fish being shipped to the New York aquarium. When the tank arrived, there were only two zebra fish left. They refused to eat anything but tropical fish and as the

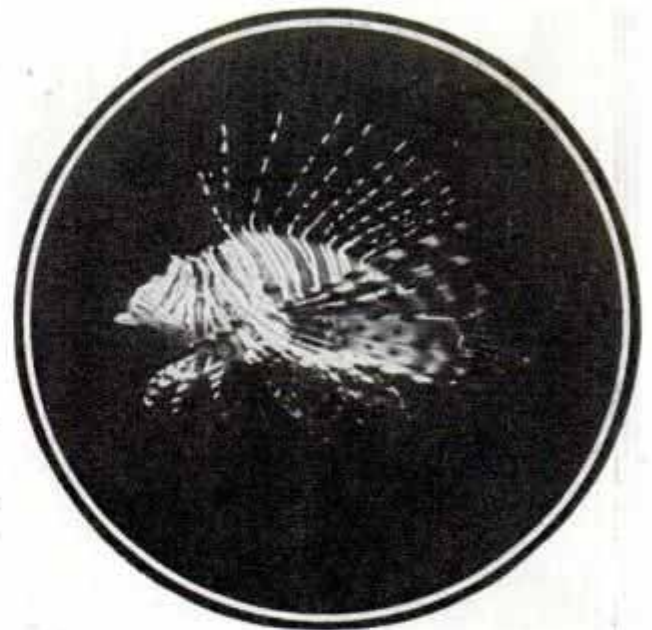

Striped Zebra Fish Which Uses Its Waving Feelers to Attract Attention of Smaller Fish

aquarium could not afford to feed the zebras a diet of tropical specimens, they went on a hunger strike and died.

A. J. Spanjers Co.
825 10th Ave. N.E.
Minneapolis, Minn.

C. W. Coates Curator

D 1314

D 1170

News Service Bureau
Box 497 Dayton Ohio

AN AMAZING MARINE JOB

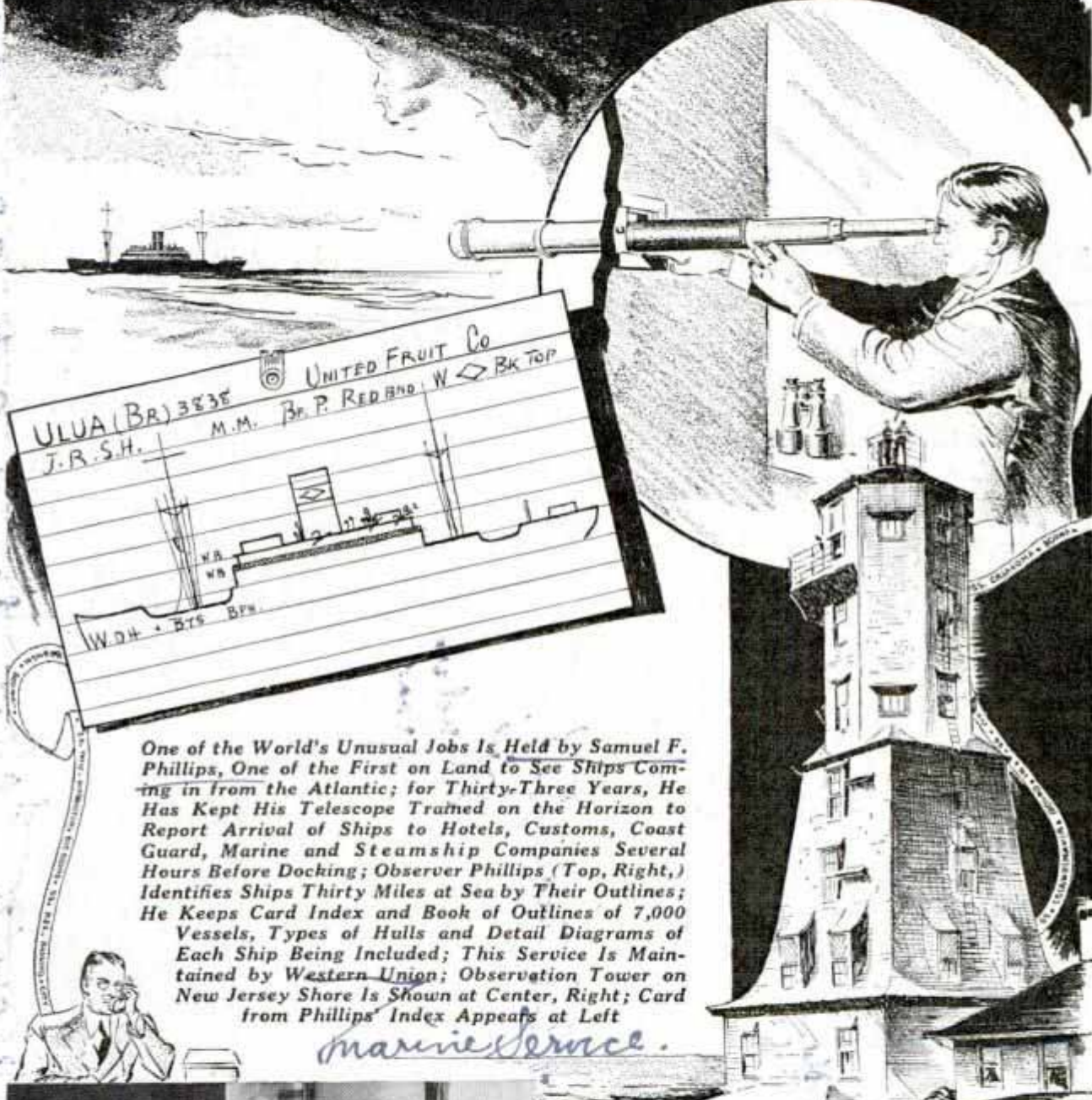

UNITED FRUIT Co
 ULUA (BR) 383E
 J.R.S.H. M.M. Br. P. RED BND. W. BK TOP
 W.D.H. DTS BPS

One of the World's Unusual Jobs Is Held by Samuel F. Phillips, One of the First on Land to See Ships Coming in from the Atlantic; for Thirty-Three Years, He Has Kept His Telescope Trained on the Horizon to Report Arrival of Ships to Hotels, Customs, Coast Guard, Marine and Steamship Companies Several Hours Before Docking; Observer Phillips (Top, Right,) Identifies Ships Thirty Miles at Sea by Their Outlines; He Keeps Card Index and Book of Outlines of 7,000 Vessels, Types of Hulls and Detail Diagrams of Each Ship Being Included; This Service Is Maintained by Western Union; Observation Tower on New Jersey Shore Is Shown at Center, Right; Card from Phillips' Index Appears at Left

marine service.

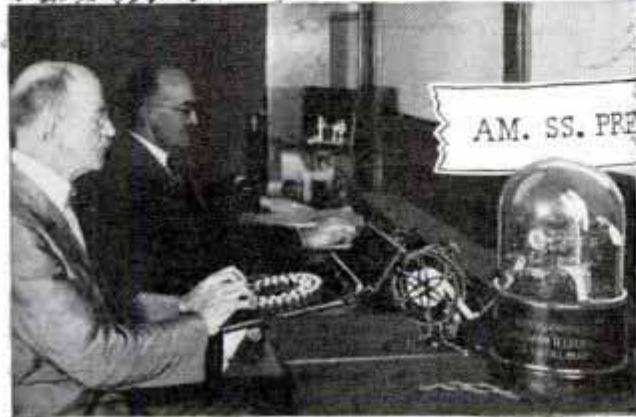

AM. SS. PREST. GARFIELD. PASSING. CITY ISLAND. BOUND. IN. AND

Bottom, Left, Telegraph Office into Which Come Observer Phillips' Reports of Incoming Ships; Immediately This Information Is Flashed to All Points Receiving the Service; Just Above, Facsimile of Ticker Tape Containing Report Telegraphed to New York Office



Bulolo Gold Dredging Co

D 1242 Bulolo, New Guinea



Auto Being Loaded into Plane for Final Stage of Trip to Interior of New Guinea; Only Windshield and Top Were Removed

GIANT AIRPLANE CARRIES AUTO TO NEW GUINEA MINES

An American made automobile recently completed its trip from Sydney, Australia, to Bulolo, New Guinea, by airplane. It was purchased in Sydney and shipped to Lae, New Guinea, by steamer. From Lae, the car, a Dodge, was transported in a large Junker plane to the Bulolo gold mines. The automobile came out of the plane practically ready to be driven away. The only parts that had to be removed to allow the car to be placed in the plane were the windshield and the top.

Shipped & Arthur & Fred, foreman of motor transport

on the under side. Restored to normal position, the well is found filled with ink.

GREASE GUN OUTFIT CARRIED ON BACK OF OPERATOR

Carried conveniently on the back of the operator, a portable grease gun has numerous attachments for doing all kinds of automobile greasing and can be used conveniently in other work to reach lubrication points which otherwise might be all but inaccessible. The grease container is filled

three-fourths full with ten pounds of grease, and is then charged with 100 to 125 pounds of air which can be applied with a hand or foot pump if an automatic air supply is not available. One filling of air empties the tank. When in operation the grease comes up to the gun head under pressure from the tank. By working the handle, the operator causes very heavy

St. Mary's Hospital

1788 Tolden Carb Service

INK BOTTLE WITH PEN WELL PREVENTS STAINED HANDS

Fingers are protected from stains in filling the fountain pen or using an ordinary pen by an ink container equipped with a special pen well. The container in which the ink is sold has a built-in compartment with a bar rest that keeps the pen holder or fountain pen barrel from touching the ink, but allows the pen point to be immersed. In use, the top is tightened and the bottle is turned over with the pen well



England, Dennison Victor Co typewriter

W. O. Sheaffer Pen Co



Portable Grease Gun Outfit Carried on Operator's Back; It Is Charged with Air Before Using

pressure to be built up in the piston chamber, thus enabling him to open the most obstinate shackles or force lubricant into the tightest bearing.

(Names and addresses of manufacturers and dealers in articles described in this magazine will be furnished by our Bureau of Information upon receipt of a stamped, self-addressed envelope.

Cherry A.D. Lightfoot, 1499 London

Specialty Sales

Models of Ancient Houses Built from Plans

Accurate in every detail, models of ancient houses have been worked out by the Museum of the University of Pennsylvania so that anyone can build them. One model, from the period of 1400 B.C., represents the home of a nobleman in the time of King Tutankhamen, while from 2200 B.C. is the model of a house at Ur of the Chaldees, the type of home in which Abraham lived. A third model is that of a cloth merchant's home in the Fifteenth Century. Blueprints and cardboard construction materials are available for building these models. Walls and furnishings are printed on water-color paper, mounted on cardboard in large sheets, ready to be colored, cut out and

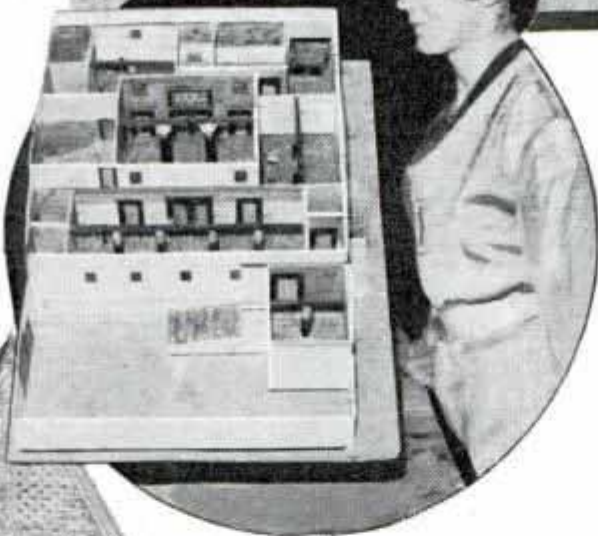

Top and Bottom, Models of Period Houses; Center, Top Removed to Show Furnishings and Decorative Treatment of Walls

set up. Complete description, color notes and directions for assembling, furniture and costume figures to scale are included with each house. The model of the house of 2200 B.C. is available in blueprint cut-out pattern form, to

be constructed of Celotex. The walls are undecorated. Since the models reflect the life of the people of the respective periods, teachers find that they increase interest of students in art, history and architecture.

D1305 COLORED NOTES FOR MUSIC AID IN QUICK READING

German musicians are trying out brightly-colored printed music as an aid in quick reading of scores. Some find the colors confusing and others claim the colored notes are more quickly read. In the colored scores, sharps are printed red, flats are green and the rest of the notes black.

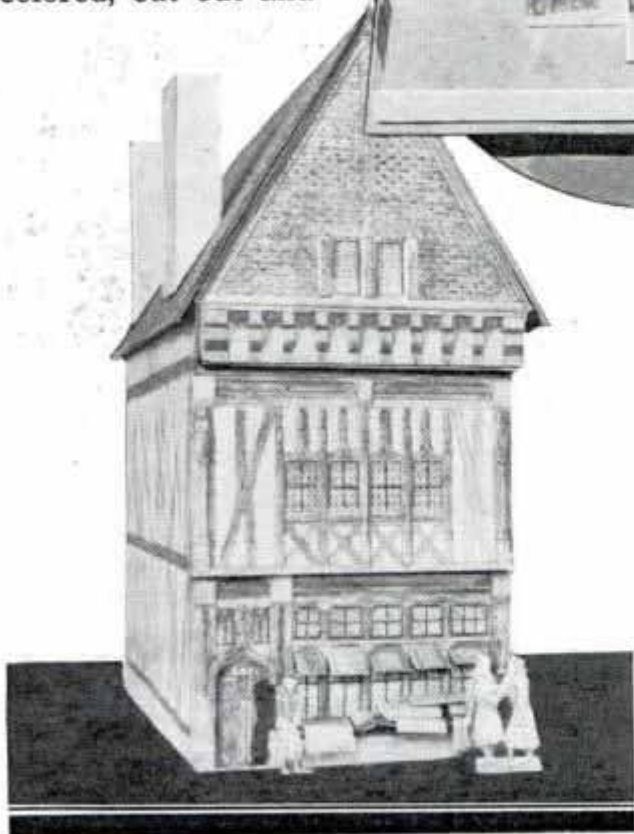

Science Service 10/4/34

Philadelphia
 20.47
 Philadelphia
 5 1/2 18 1/2
 10/4/34

D1278. Cont. Don Klasmann
4 W 103rd St. New York

SIKORSKY SEES

Dawn-to-Dusk Trans-Atlantic Flights by Airliners

I. I. Sikorsky Aviation Corp., Bridgeport, Conn.

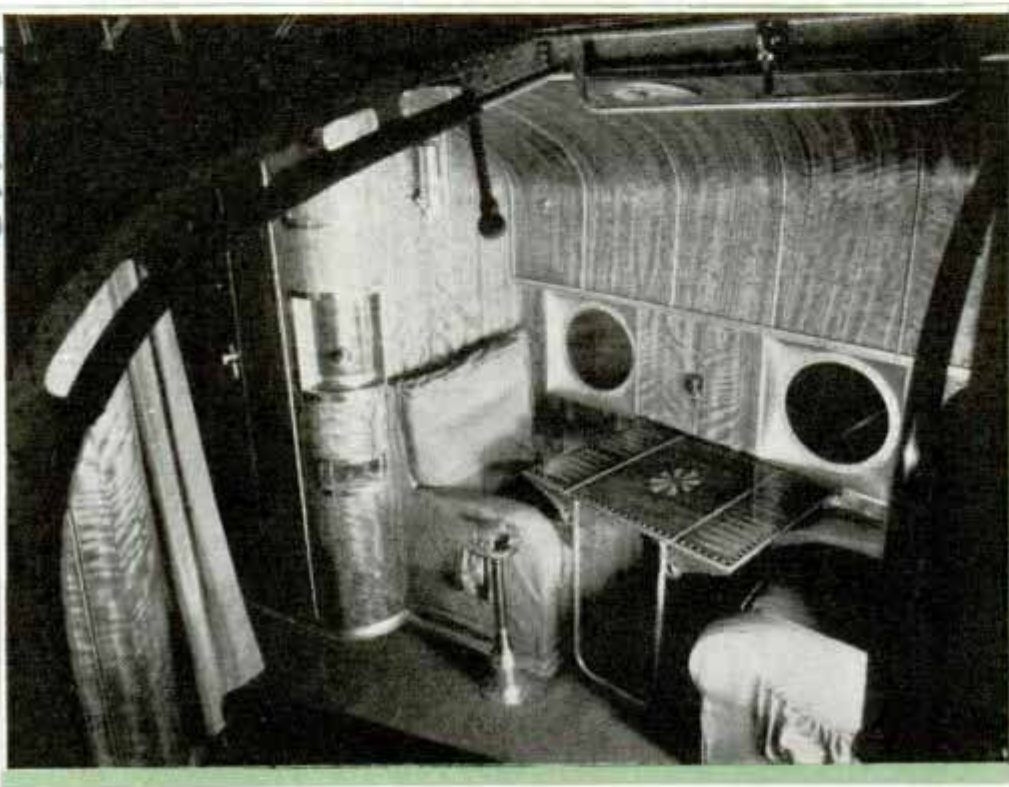

Two Views of the Interior of the Brazilian Clipper; Note the Spacious Cabin Space per Passenger as Compared with the Ordinary Plane

THE building of clipper ships for the American merchant air marine is rapidly spreading the fame of Yankee prowess and craftsmanship over the seven seas. The new multi-motored clippers, like their forerunners, the sailing clippers, are built and launched from the granite shores of New England.

The last flying boat launched, the great Brazilian Clipper, smashed ten world records before going into active service. Subsequently, she flew the round-trip between Buenos Aires and territorial United States, returning in five days, including overnight stops! That is a record to conjure with. With one stroke, this feat has made America mistress of the ocean airways as England is mistress of the high seas.

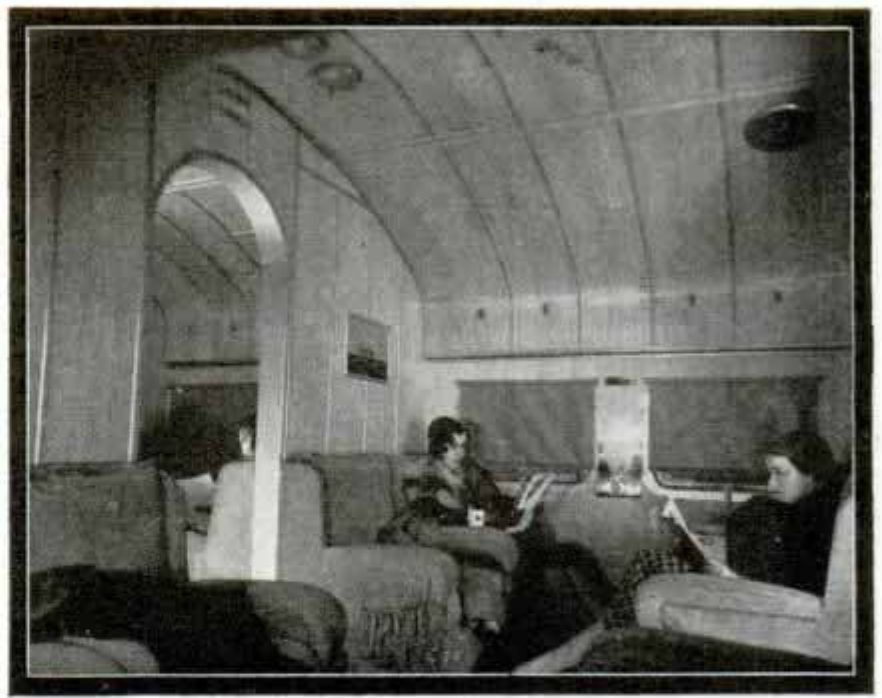

smashing records and receiving the acclaim of two continents, the proudest man alive was her designer, I. I. Sikorsky. In an exclusive interview with Popular Me-

While the Brazilian Clipper was out

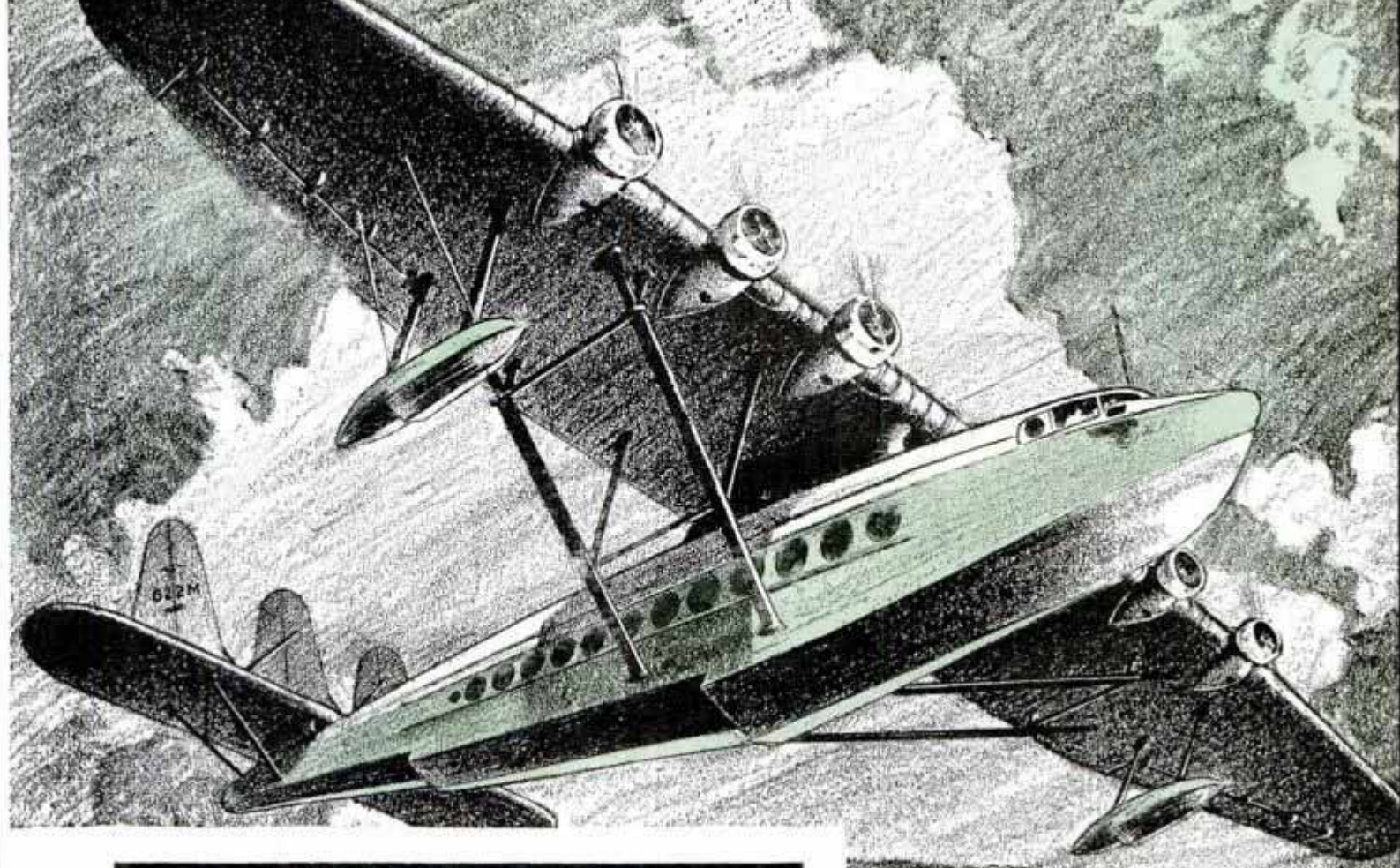

Drawing of the Proposed 100-Passenger Atlantic Clipper and Col. Charles A. Lindbergh at the Controls of the Brazilian Clipper

D1298

chanics, Mr. Sikorsky discussed plans for a new 100-passenger clipper ship which is occupying him and his associates.

"Present-day practice among air lines operating over land has resulted in the creation of fast planes carrying ten to fourteen passengers," he said, "but the experience of air lines operating transports over ocean stretches seems to dictate another solution, the use of multi-motored flying boats with large passenger-carrying capacity.

"Three years ago, the American Clipper "S-40" went into the air express service between North and South America. She

has proved herself an outstanding success, maintaining an almost perfect on-time record of 99.8 per cent. She has successfully flown the longest over-water scheduled route in the world, between Jamaica and Barranquilla, South America.

"The Brazilian Clipper is another step in the evolution of ocean transport toward a new type of clipper that will meet every safety requirement and save days of time in flying the Atlantic ocean.

"The 'S-42,' or Brazilian Clipper, may really be considered the forerunner of trans-oceanic designs. The main characteristics of the 'S-42' are the combination

127
46

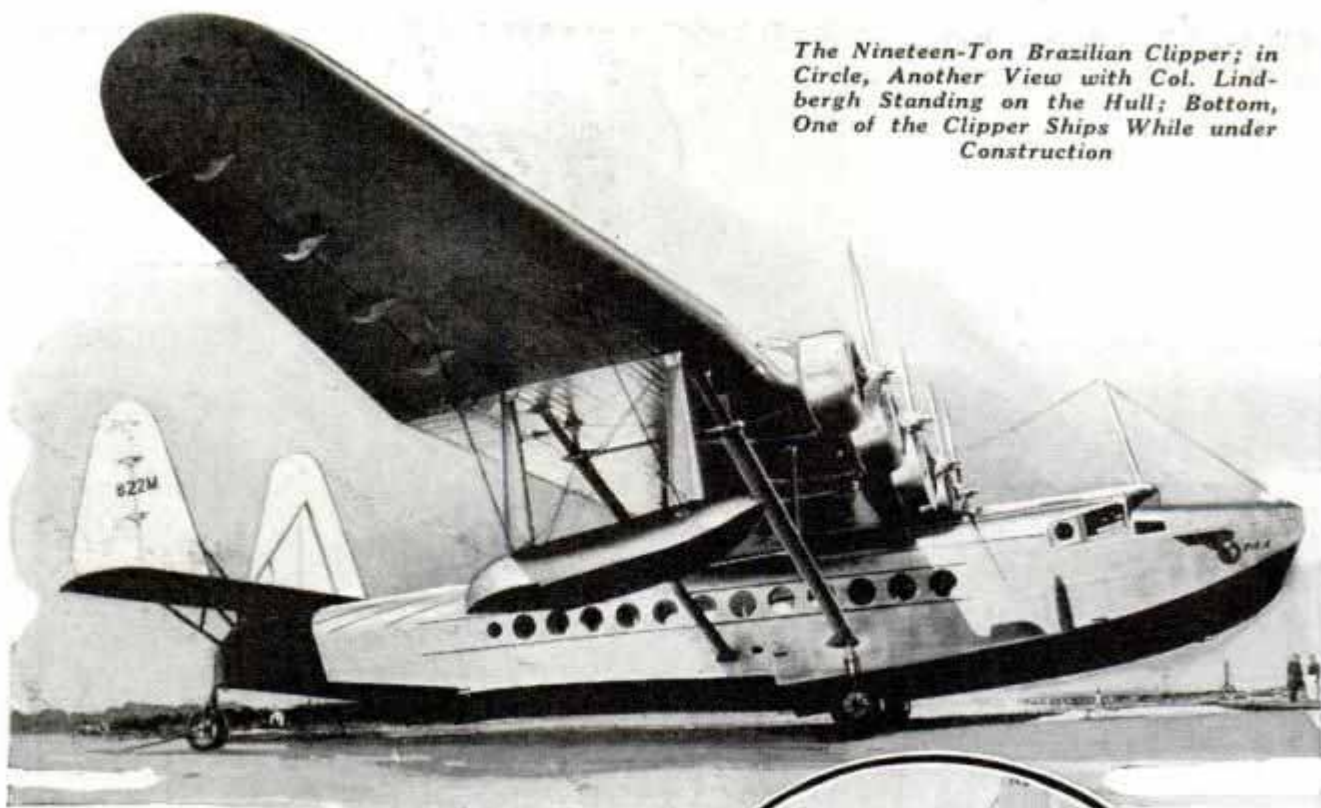

The Nineteen-Ton Brazilian Clipper; in Circle, Another View with Col. Lindbergh Standing on the Hull; Bottom, One of the Clipper Ships While under Construction

of long-range flying with high-lifting capacity and high cruising speed, a combination surpassing any other ship now in service. Carrying 4,500 pounds, the 'S-42' covered 2,000 kilometers at an average speed of 157.5 miles per hour. And as for altitude, she hauled 11,000 pounds up to 20,400 feet! And in still another flight she reached 15,000 feet with a load of 16,500 pounds. These feats of the 'S-42' are world records."

Concerning equipment for trans-Atlantic flying, Mr. Sikorsky said:

"While the 'S-42' is entirely suitable to start a trans-Atlantic passenger service by way of the Azores and Bermuda, yet we believe that in the future passenger traffic will justify substantially larger flying boats. Therefore, we are working on a still larger clipper, with a gross weight of fifty tons and six motors developing 6,000 horsepower together.

"By present standards, of course, such a ship is fairly huge, but I believe it is the



most economical type of craft for trans-oceanic passenger service. We will provide passengers with roomy, comfortable staterooms, dining salons, promenades,

(Continued to page 134A)

D 1225

*Maximilian Skupen,
over airport at Staaken*

Parachute Jumper Talks by Radio as He Falls

How does it feel to make a parachute jump from an airplane? A German jumper decided the only way to describe his sensations was to relate them as they occurred during the descent. Accordingly he equipped himself with a microphone and radio-sending apparatus which he carried over the side when he leaped and broadcast his sensations as he fell, describing not only his feelings but what he was able to see and hear from the time he jumped until he landed. Those who watched the jump heard his voice through loud speakers.

D 1226

HIGH-SPEED CAMERA TAKES PICTURE OF BIRD IN FLIGHT

By making a photograph in one fifty-thousandth of a second, an action picture of a dove in flight was obtained recently at the Massachusetts Institute of Technology. The photograph, made just as the bird launched itself in the air, reveals in detail the posi-

Cambridge Mass

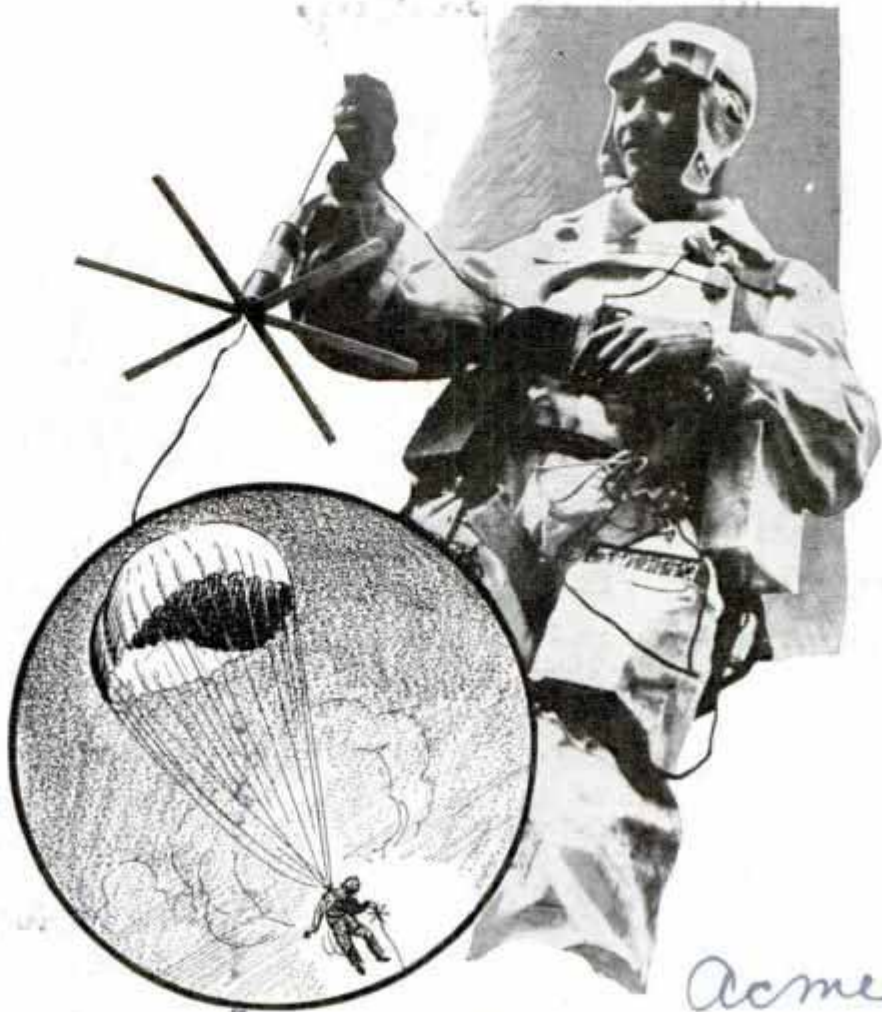

Parachute Jumper Carrying Radio-Sending Apparatus Which He Used to Convey His Sensations to Listeners as He Descended

Acme

tion of the primary and secondary feathers of the wings in a fast downward stroke as the dove sought to gain altitude. It can be seen that the feathers, except at the wing tips, overlap to prevent the passage of air through the wings. On an upstroke, the primary and secondary feathers are rotated slightly to allow air to pass through and thus reduce air resistance. The picture was made with the aid of a unique electrical circuit which produces an instantaneous flash of great brilliancy.



Picture Made with High-Speed Camera Just as Dove Launched Itself in Flight; the Photo Was Taken in One Fifty-Thousandth of a Second

*Photo by Prof. Harold G. Edgerton
and Kenneth
Sesemich
Electrical Engineering
Laboratory*

Pres memo 10/2/34

Berlin Commerce

*Reported by Vice
Consul C. J. Zawodski*

Acme

BRONZE PIPE WITHOUT THREAD IS SEALED AT FITTINGS



Fittings with Special Alloy Permit the Making of Joints with Threadless Pipe

Threadless fittings for bronze and copper pipe are made with a brazing alloy that provides a vibration-proof, corrosion-resisting seal when an oxyacetylene flame is applied. The alloy is incorporated as a ring in each opening of the fittings. The pipe is easily assembled by slipping the end into the fitting, heating the pipe so that the alloy melts, and then applying the flame to the fitting until the alloy seal appears as a white ring around the pipe.

SELF-MEASURING BOTTLE CAP FOR MEDICINE CONTAINER

An accurately measured dose of medicine can be poured without the inconvenience and uncertainty occasioned in using a spoon, measuring glass or dropper if



your medicine bottle is equipped with a special self-measuring cap. The capacity of the cap depends on the amount of the dose prescribed. Within the cap is a hollow cone tapering upward and with a small opening at its apex. To obtain a dose the bottle is shaken, the contents being forced upward

into the cone, a part escaping through the apex to become trapped between the outer wall of the cone and the inner wall of the cap. When the liquid in the cap reaches the level of the hole in the cone, which can be seen through the transparent wall of the cap, the dose is complete and the cap will hold no more. The cap can then be unscrewed and the dose taken directly from it. In pouring out the dose, no additional contents of the bottle escape since a vacuum is created which prevents flow through the small hole in the cone. However, if a dose is prescribed in drops, it can be measured by holding the bottle upside down and tapping the bottom, one tap for each drop.

OVERCOATS FOR GRAIN TANKS KEEP OUT THE MOISTURE

Concrete grain elevator tanks in the mid-west are being treated to winter overcoats to keep out moisture. First an asphaltic mixture is applied pneumatically to the outside to seal the cracks and provide an elastic weather and moisture-proof coating. Over this is placed a coat of metallic

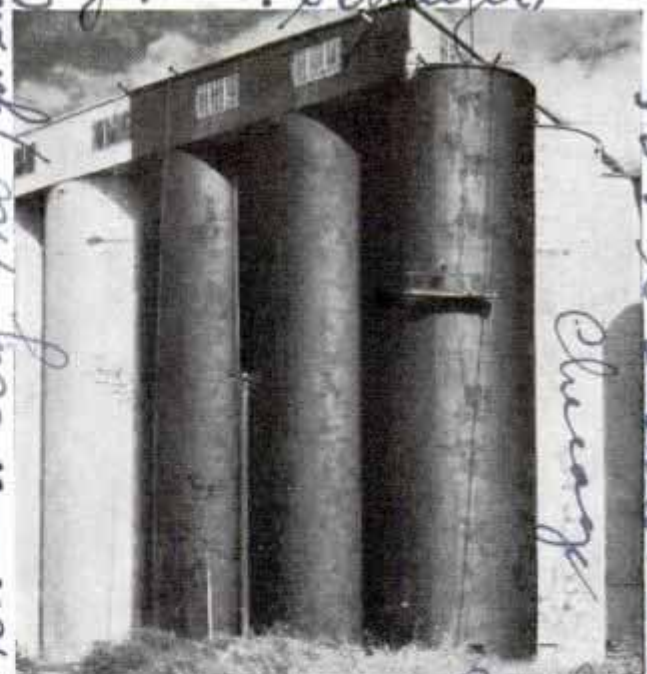

Concrete Grain Elevator Tanks Covered with Asphalt, Then with Aluminum to Keep Out Moisture

aluminum which lowers the temperature inside the bins in hot weather, it is claimed.

A flashlight having a range of about one mile has been put on the market.

Walworth Co. chm. 60 E 42nd

D1258

D1295

no for safe work at Kansas City

John V. Schaefer
Chicopee
84-75
Board Electric Corp
257 Cornhill Ave

D1292

Northwestern School of Taxidermy, 3378 Elwood Bldg. Omaha, Neb

POPULAR MECHANICS

49

Beauty of Wild Life Is Preserved by New Art

Taxidermy, the art of mounting the trophies of rod and gun, is the latest addition to home craft work. It can be learned satisfactorily by those who have the desire to know it. Once learned, it becomes a source of intensive interest and can be turned into a source of additional income. Birds and beasts can be prepared so skillfully that their beauty in the natural state can be preserved permanently. The use of

ad on back cover



Two Examples of How Taxidermy May Be Used to Produce Artistic Things for the Home or Office



mounted birds and animals, even domestic ones, in the office and the home is growing steadily. Decorative and useful articles can be created for the home by the home craftsman who has added taxidermy to his work. The field offers opportunities for producing novel effects, such as a humorous grouping of small animals or birds.

sheet without "pin-cushioning" the surface. In using the instrument with an adapter for making spirals an attachment on the slide rod with a tube threaded inside is employed. The drawing lead is moved along a screw carrier as a cog wheel mounted on the tube is turned. Adjustments can be made to draw spirals one thirty-second of an inch to three inches between curves.

DRAWING INSTRUMENT OFFERS MANY TOOLS IN ONE

D1259

Five tools are combined in a drawing instrument for mechanical work which performs the functions of a compass, ellipsograph, protractor, spiralgraph and scroll. The framework is an eight-inch metal bar with legs on each end. On a vertical shaft through the center is a slotted bar, enough shorter than the suspension framework to make a complete turn within the legs. Since the inscribing apparatus is all suspended, it is unnecessary to make holes in paper when drawing circles and any amount of tracing can be done on a single

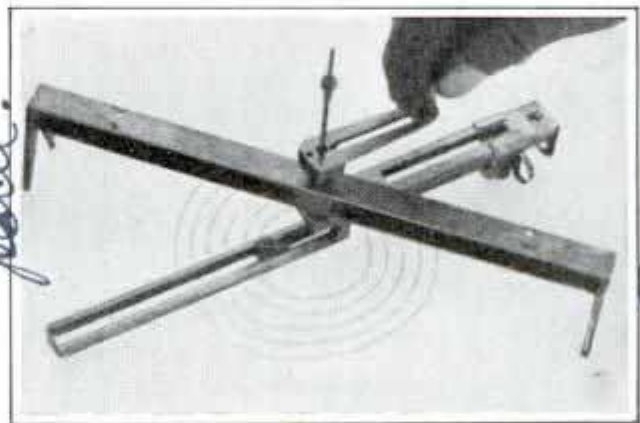

This Drawing Instrument Serves as a Compass, Ellipsograph, Protractor, Spiralgraph and Scroll

101 Bonita Ave. not yet on market

Wm. C. J. Seyer, 818 Alamo St. San Francisco, Cal.

Robot Sentinels Guard Ship from Fire Hazard

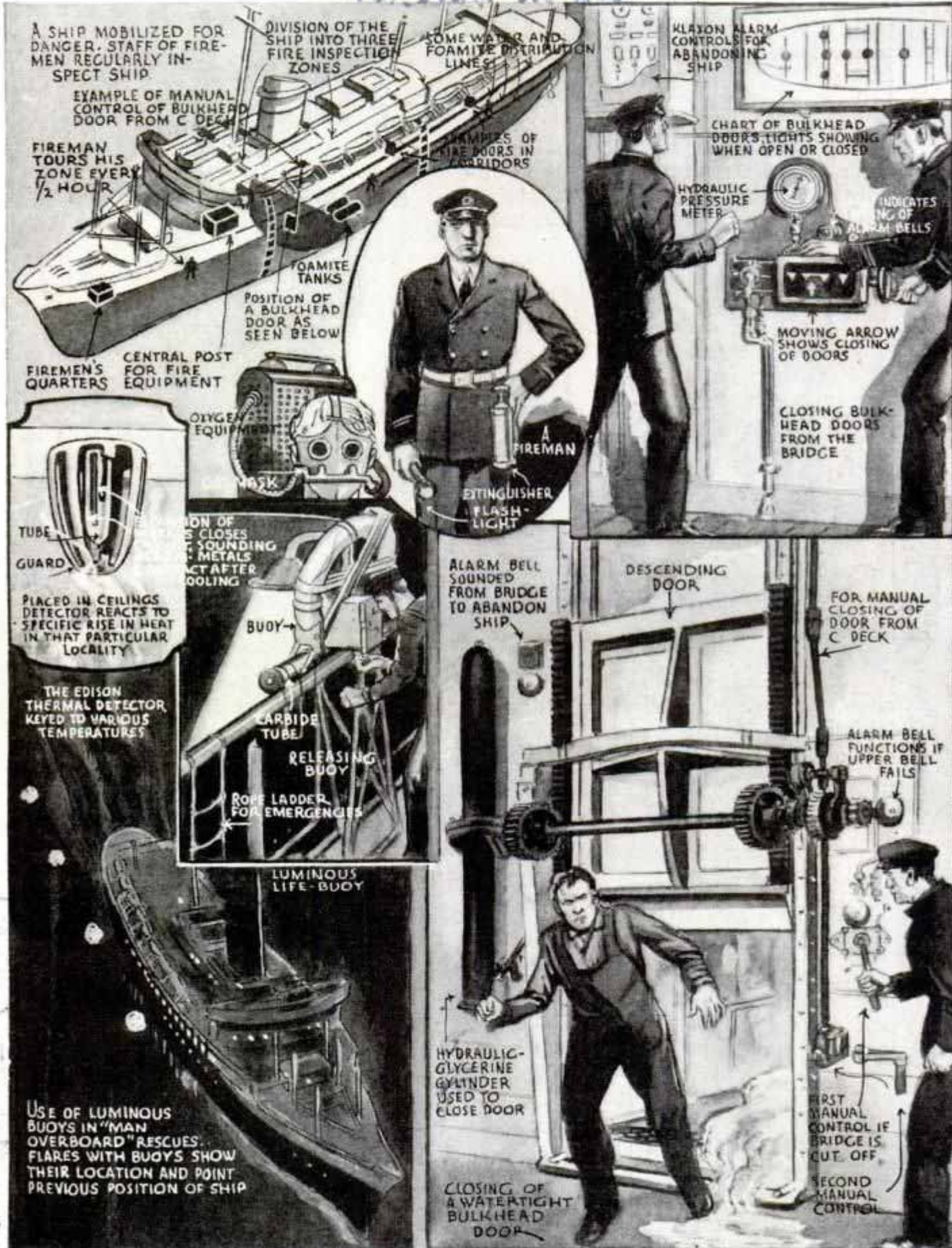

Fire—One of the Gravest Dangers Facing a Ship—Is Being Prevented and Fought Today with the Aid of Elaborate Protective Devices, Incorporated in the Cabin Liner "Champlain"

System Detects and Smothers Blaze at Start

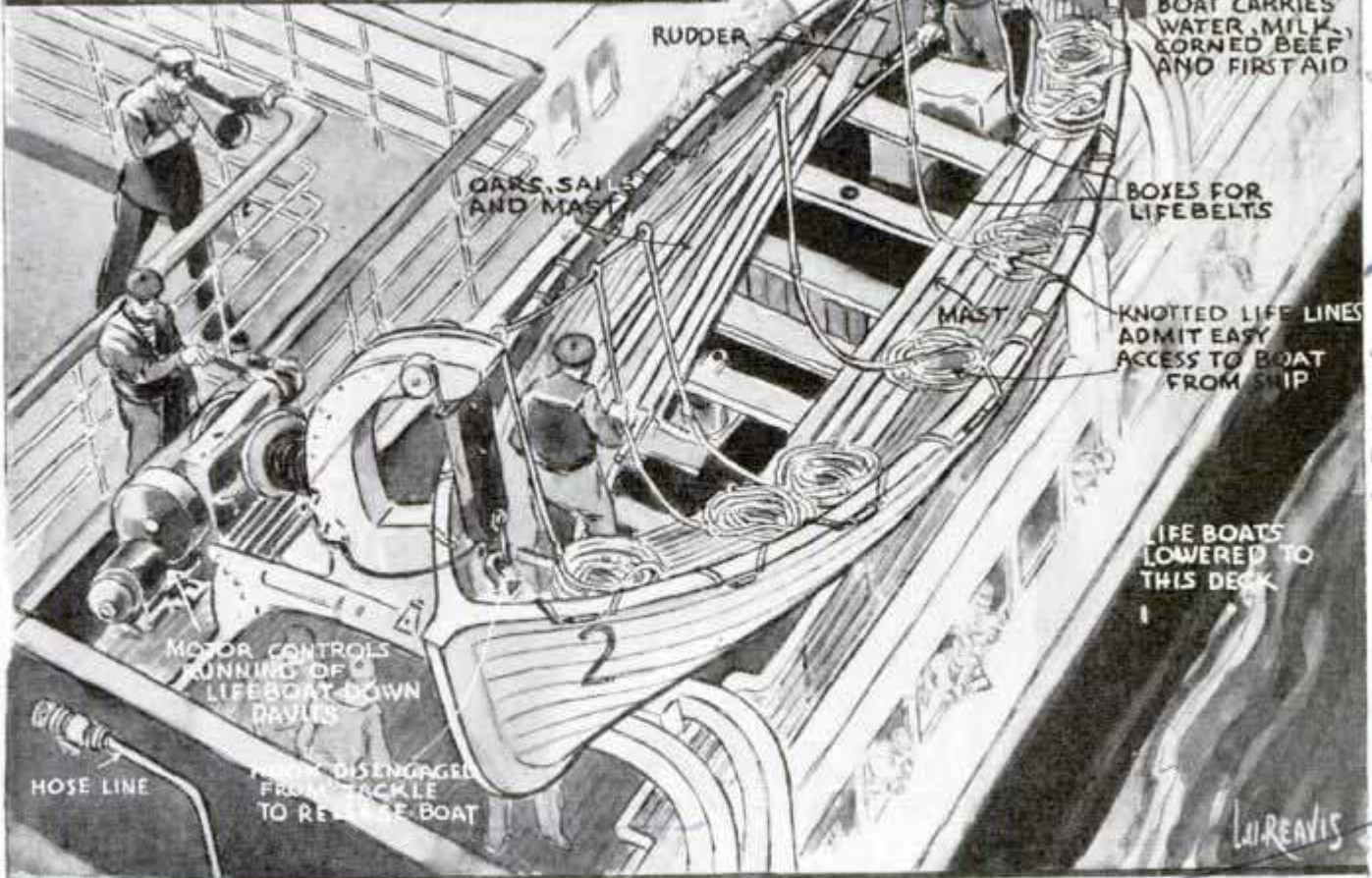
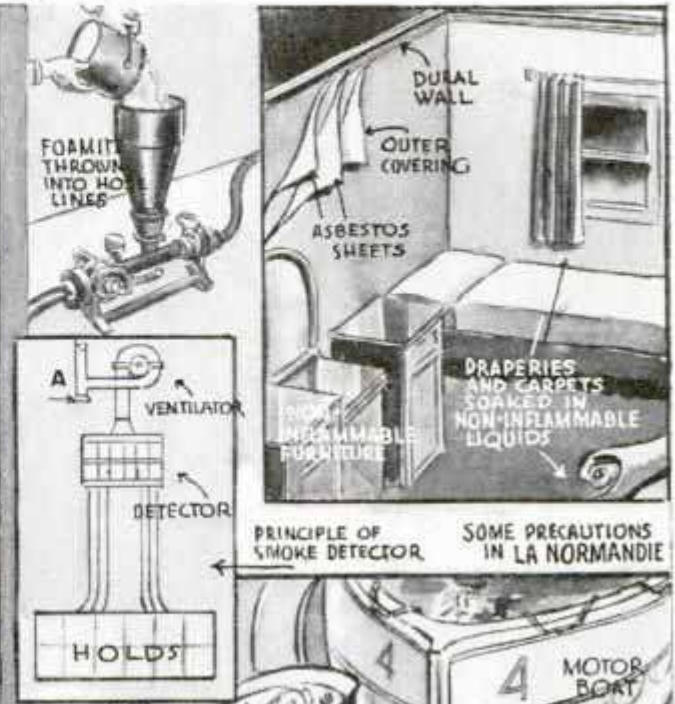
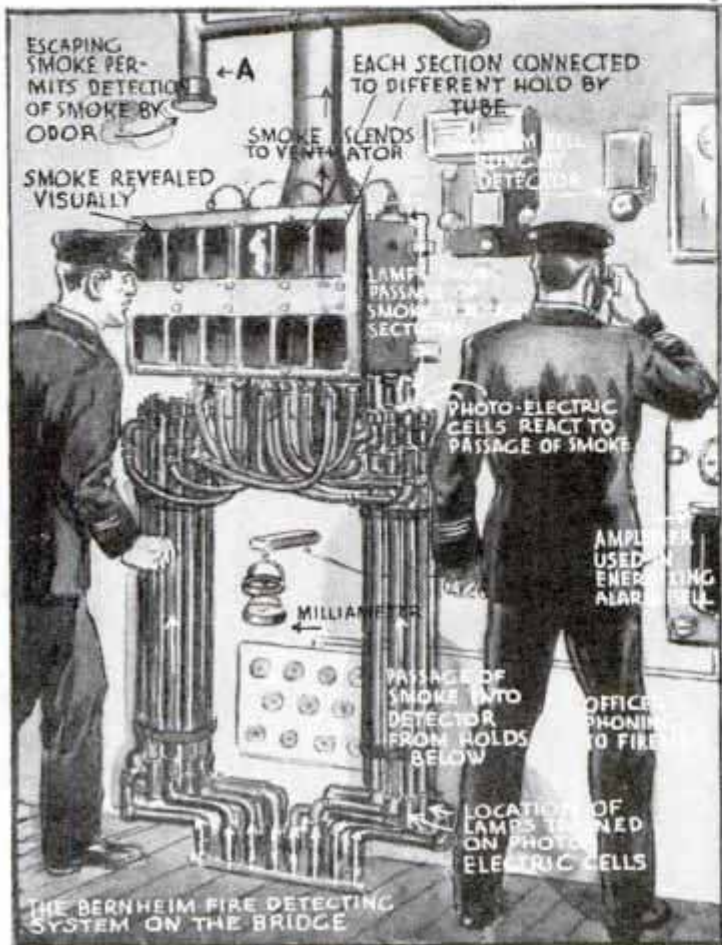

145 W. 45th St., New York

Detection Is the Keynote in the Protective System and Robots Stand Guard to Flash a Warning and Enable Trained Fire Fighters to Reach a Blaze Before It Has Gained Headway

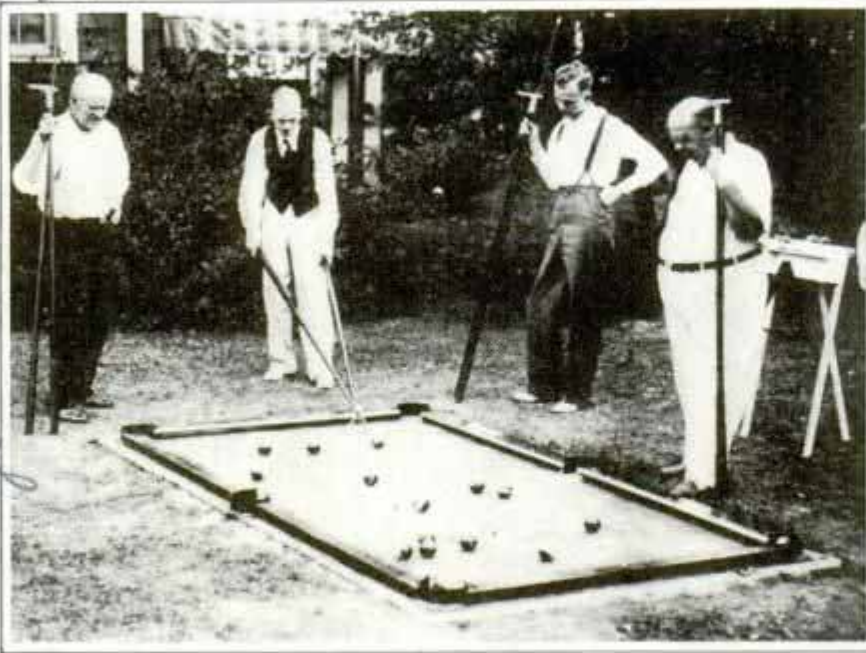

This Billiard Table for Outdoor Play Is Made of Concrete and Covered with Rubber; Note the Rake Used with Cue in Making Shots

BILLIARD TABLE OF CONCRETE FOR OUTDOOR PLAY

For the billiard enthusiast who likes to play at home but has no room for a table in the house, an Ohio man has developed an outdoor billiard table. Built on a concrete base, it has rubber cushions and resembles a regulation pocket billiard table except that it rests directly on the ground. Balls a trifle larger than billiard balls are used and a heavy cue is employed with a rake for all shots, the rake operating on a swivel. The most popular game for this table is a cross between pool and billiards. A ball into a pocket counts one, a billiard three and a three-ball billiard six. Balls going into pockets on one of these shots are added to the score.

ZIPPER ACTION FOR LAMP CORD UNSHEATHS CONDUCTORS

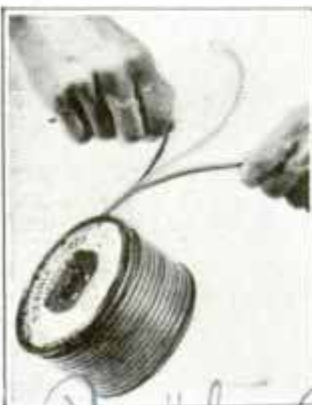

Lamp-cord insulation with zipper action for opening permits easy, quick and safe unsheathing and separation of the conductors. The rubber-jacketed conductors are parallel and when pulled apart

the jacket divides easily and evenly, leaving a complete rubber insulation on each conductor. The cord can be stripped down without impairing the properties of the individual conductors and is said to be long wearing, flexible and fray-proof.

D1370 GREASE CARTRIDGE FOR AUTO GUN

Grease packed in cartridges and a new type "gun" to "shoot" the lubricating materials to all parts of the automobile have been introduced. To fill the grease gun, the operator merely slips in a factory-loaded cartridge of the lubricant desired. After using the required amount, he removes the cartridge and substitutes another. Each cartridge can be used again, and repeatedly, until empty. In this way, a single gun serves for a full greasing operation involving the use of several different lubricants. Units consisting of the gun



Top, Inserting Grease Cartridge; Bottom, Cutaway Showing Parts of Grease Gun

and six cartridges of different lubricants are being marketed by the Standard Oil company of Indiana. The cartridges are the non-refillable type. The new greasing system makes possible more efficient home lubrication of the automobile.

*clm. C. K. Bricker
Besley, Ohio*

D1254

*U.S. Rubber Co
1790 Massachusetts Ave
Chicago
910 S. Michigan Ave
Chicago*

Plumber-Artist Achieves Fame with Hobby

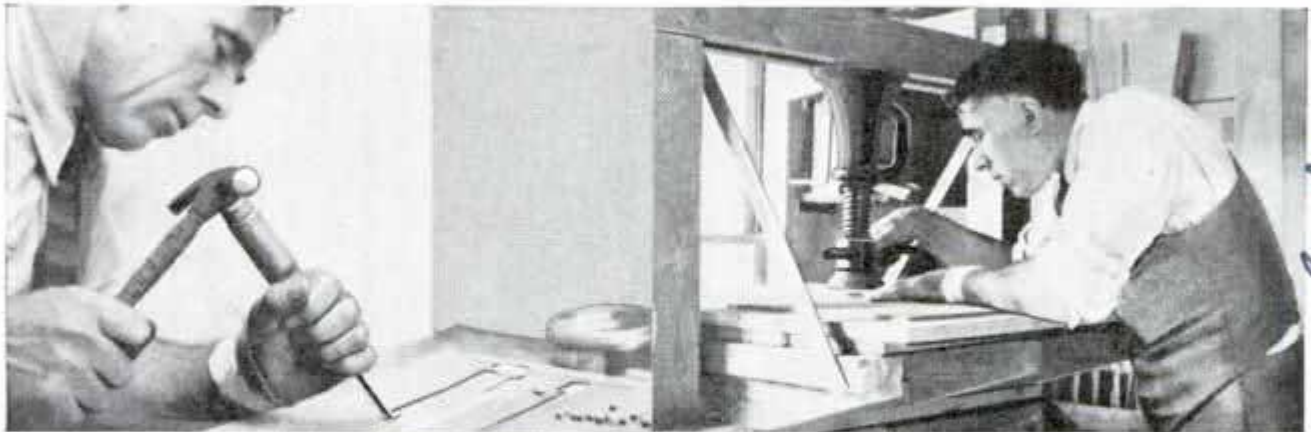

Top, Left, Chiseling Recess for Inlay; Right, Press Makes Strong Bond; Bottom, the Finished Work



Developed as a hobby in the rear of his plumbing shop, an original method of making pictures and mosaics of hardwood inlays is bringing widespread fame to F. F. Burfitt of Portland, Ore.

His latest portrait, that of President Roosevelt, has been obtained by the postmaster general to be hung in the post-office building in Washington. At exhibitions of his work, one at A Century of Progress, Chicago, and another in Paris, France, his skill and originality in producing unusual effects with wood and glue have been acclaimed. The method differs from ordinary inlays in that it is perma-

nent and almost perfect from a mechanical standpoint. Instead of thin veneers, the pieces of wood used to produce his figures, in various colors, are one-quarter of an inch thick. Each piece is inserted in a recess chiseled out in the base board and glued

in under pressure of a hand press. A waterproof glue, which is not affected even by boiling water, makes the bond permanent. The artist has produced mosaics containing as many as 10,000 pieces. In the Roosevelt portrait, some of the pieces were only $\frac{129}{10000}$ ths of an inch thick. The work starts with a pencil sketch from which the artist works to dimensions, measuring each feature and transferring it to the board.

One-Lamp Stop-and-Go Signal Has Small Timer Lights

Greater simplicity of design is found in the latest traffic signal lights recently demonstrated in London. There is only one large signal face for red, green and amber. The light also has pilot duration lamps to indicate the unexpired period of the main signal, showing the motorist whether he has time to reach and cross the intersection before the light changes. The duration lights are much smaller than the main signal.

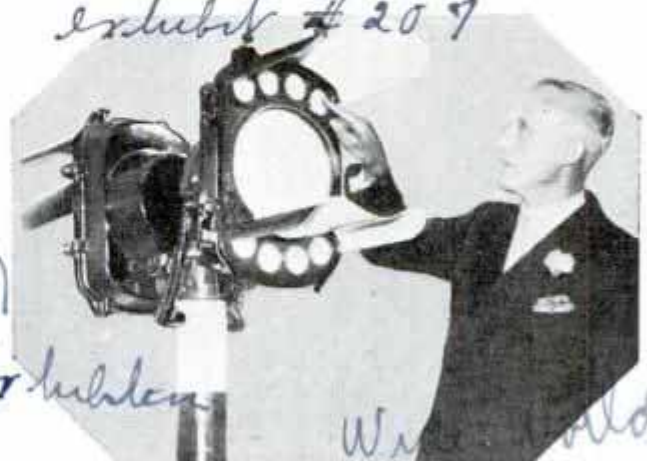

Latest Traffic Signal, with One Large Lamp and Several Small Time-Interval Lights

An electric-eye counter on a toll bridge not only counts all cars crossing but also records the direction of travel.

General Electric Review

Salisbury, N.C.

D1355
2636 S. Market St
Portland Oregon
7134 N. E. Sandy Blvd.

History of improvement was
gradually developed

THE STORY OF HOME BUILDING



In Earliest Times Our Ancestors, as They Roamed in Search of Food, Acquired the Habit of Seeking Shelter in Natural Caves

When the Ice Descended from the Arctic, Driving People Southward Where There Were No Caves, Primitive Man Built Crude Mud Huts



As Man Progressed, He Acquired Cattle and Roamed About Seeking Pasture; Then He Built a Cave of Skins



As He Found How to Make Better Tools, Primitive Man Began to Cut Blocks of Stone and to Make Bricks of Clay to Build a More Permanent Form of Shelter



When He Learned How to Fashion Crude Bronze Tools He Began Cutting Down Trees and Building Log Caves



Man's Earlier Habitations Were Heated by a Fire on the Floor; from a Hole Cut in the Roof the Chimney Gradually Evolved

Lights Emphasize Beauty of Milan Cathedral

Milan cathedral, one of the architectural wonders of the world, is rendered even more beautiful when its spires are accentuated by night illumination. The cathedral was lighted in honor of a recent visit of Premier Mussolini and the lights emphasized the lacy filigree work adorning the outside of the structure, as shown by the night photograph.

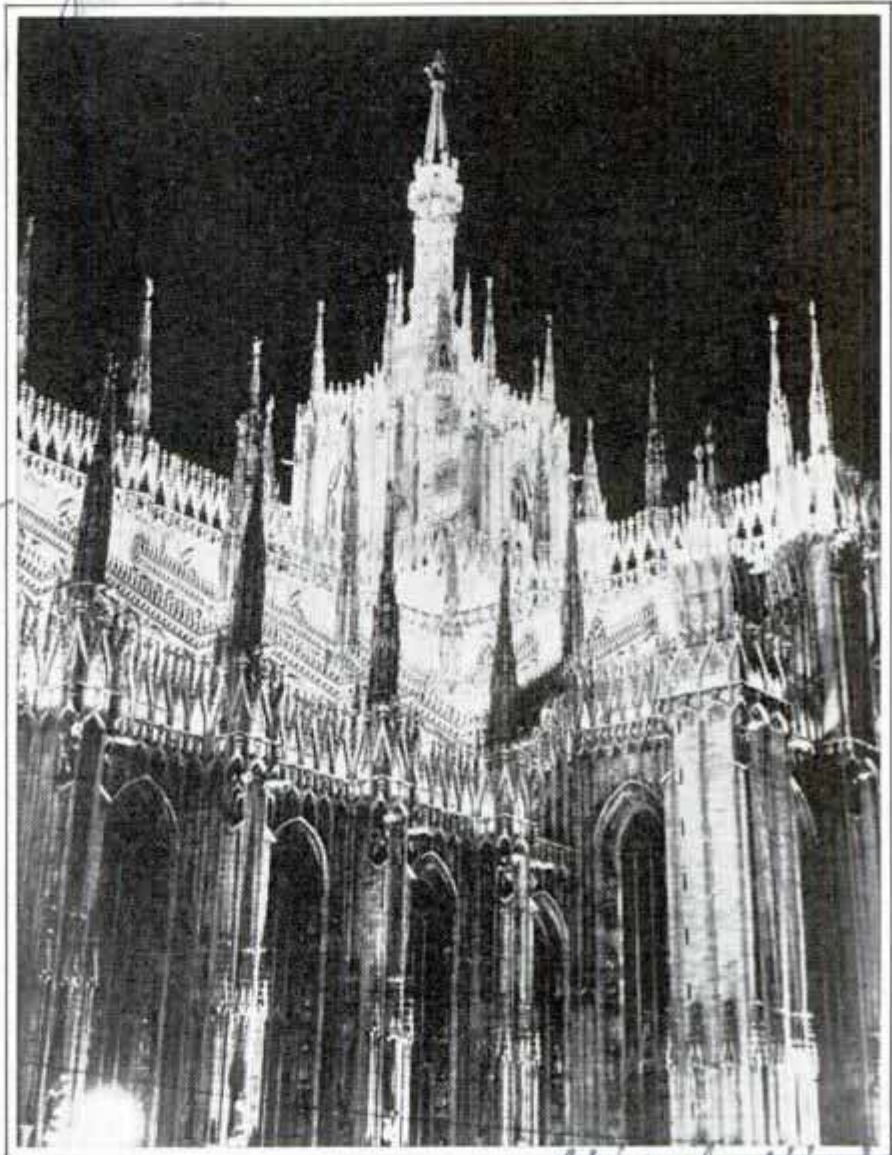

Beautiful Milan Cathedral as It Appeared When Illuminated at Night; Note How the Lights Emphasize the Graceful Outlines

REFUSE COLLECTED IN ROTATING TANK ON TRUCK BODY

Garbage disposal is simplified by a refuse collector consisting of a large steel tank mounted on a truck body. The tank is set on a cradle in such a way that it is pitched forward at an angle, and the receptacle can be rotated in either direction. The machine is filled from the rear and doors can be opened in three ways to permit various sizes of materials to be loaded. In operation the tank turns at an idling speed of from six to twelve revolutions per minute. This motion, due

to the angle at which the tank rests and to low steel vanes inside the tank, pushes material forward automatically. In dumping, a hydraulic hoist elevates the tank to the proper angle after which a tail gate is automatically opened and the body is rotated in reverse direction to break up the load and force it out. One man can operate the entire unit from the driver's seat and the tank does not permit odors, dust or liquids to escape. The collector has also been found well adapted to snow removal.



Refuse Collection Truck Equipped with Rotating Tank Which Aids in Loading and Dumping

Names and addresses of manufacturers and dealers in articles described, and any other details in our possession, will be furnished by our Bureau of Information upon request, accompanied by postage.

American La France Bldg Broadway
and Joseph P. Fish Bldg Broadway

D1269

TELLING *the* WORLD

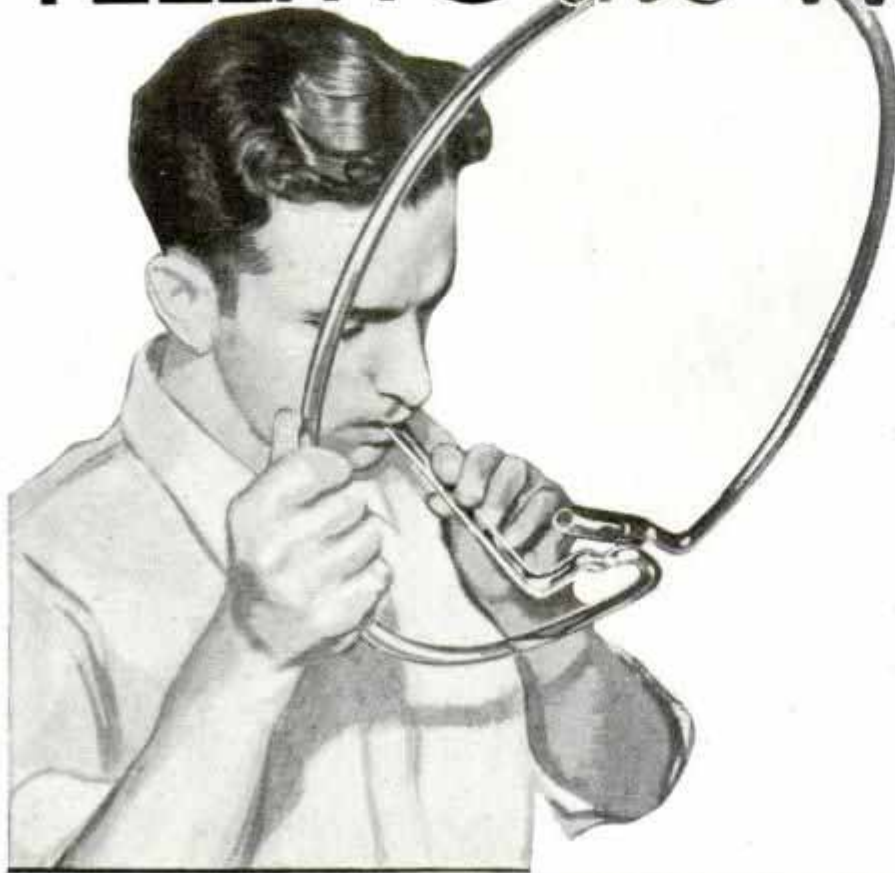

Behind the glamour of this extravaganza of illumination lies the hard fact that the cost of maintaining the nightly "show" runs into millions of dollars annually, a huge expenditure whose beneficiaries are the artists and construction men who design, build and install the signs, the real estate men who collect high rentals for sign space on the street, the company providing the electric current, and many others.

The job of keeping in nightly scintillation the bright spots of the world's principal thoroughfares involves the close cooperation of more than thirty differ-

SPEAKING a language all can understand, the intermittent flash of bulbs and tubing packs a story in a word—and the word sticks. The punch it deals to the public consciousness is as great as its illuminating power plus a cleverly executed idea.

Following this principle the vast industry which deals in electric signs has converted the world's centers from darkness to brilliance, added to the gayety of nations, turned night into day and given employment to thousands of persons skilled in the varied crafts of sign building, in its electrical phase one of the most astonishing products of the twentieth century.

What else but its electric signs is responsible for Broadway's fame throughout the universe as the "Great White Way," whose nightly brilliance has won it a reputation as "the brightest spot on earth?"

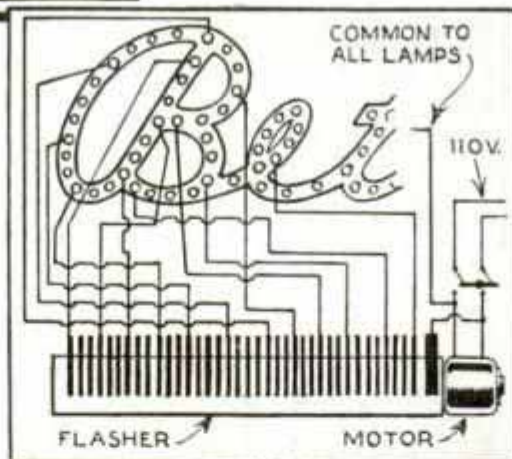

Above, Blowing into Tubing after Heating to Keep Passage Clear; Left, Diagram of Circuit for Script-Writing Flasher; Below, Sign Building Involves Many Crafts

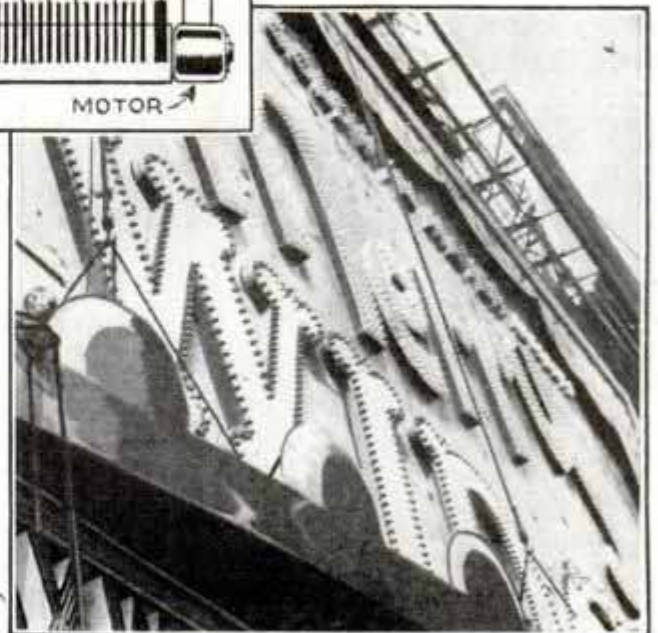

D1269

in LIGHT

Testing Current Source for Tube Sign and, Below, Flasher Control Unit Which Governs Four Different Sets of Lights on Large Sign

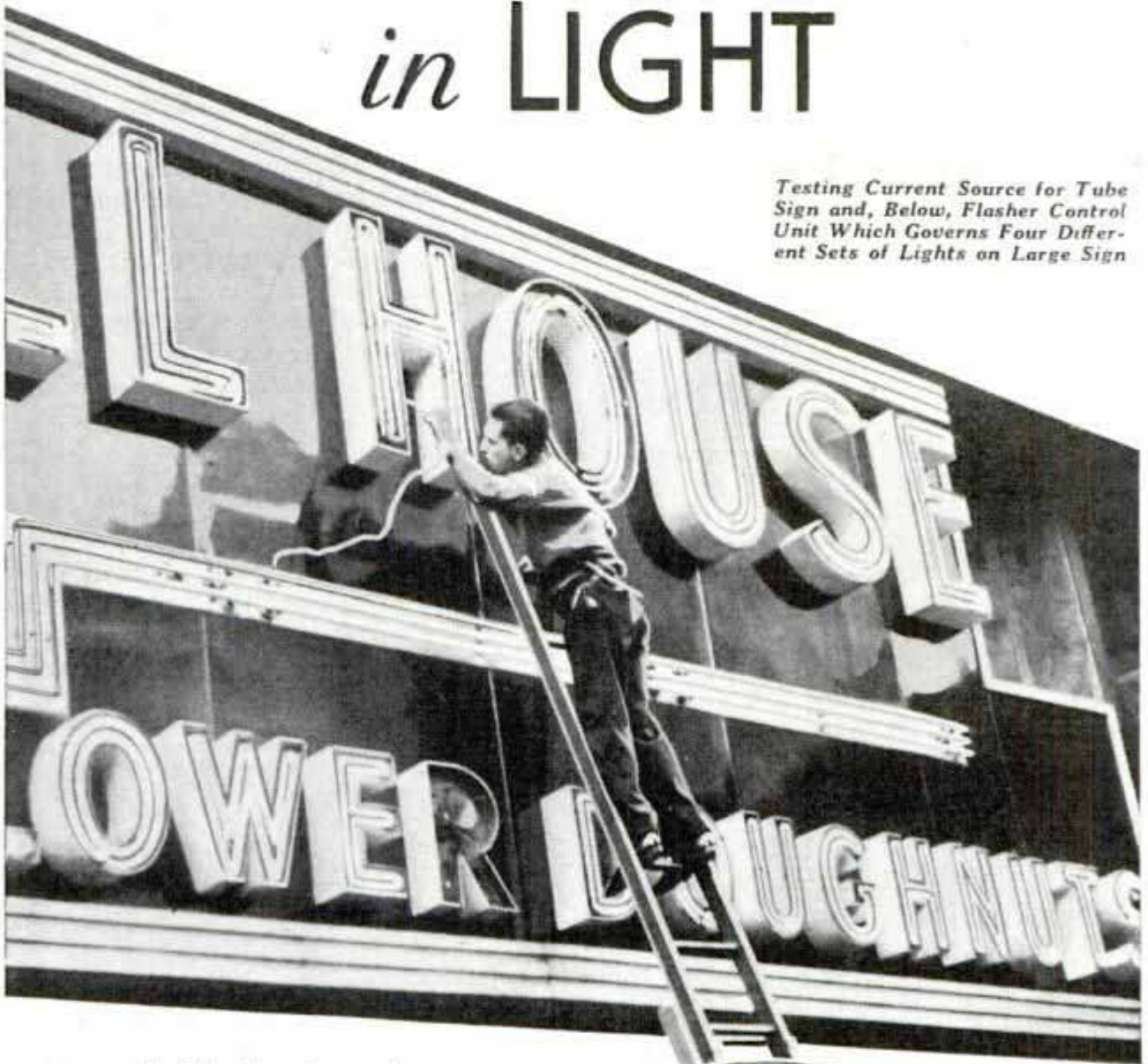

ent types of skilled artisans, sign writers, scenic artists, electricians, mechanical engineers, metal plate workers, and blacksmiths, in addition to every type of worker employed in the building trade.

Getting down to specific figures, the electric signs in Times Square, the heart of Broadway, burn a total of 500,000 watts per hour from sundown until 1:00 a.m. The larger signs, referred to in the trade as "electric spectacles," range in cost from \$40,000 to \$100,000 a year complete from designing to servicing. Smaller signs run as low as \$5,000 a year.

The most prominent spot on Broadway and, indeed, as A. D. Donnaud, of the General Outdoor Advertising company, which builds and services practically all of the big signs in Times



Square, says, "the world's greatest spectacular space at the world's greatest point of circulation," is occupied by Squibb's

Quality neon sign
 Coy 230- I have
 new york



yellow sun rising from a sea of blue. Someone has estimated that it costs the advertiser \$275 a night to tell the world in light.

This sign, with its 10,000 white and colored bulbs, burns 196 kilowatts an hour, or enough to light 30,000 average homes. Fifty-five feet high and twenty-nine feet wide, its individual letters ranging in height from four feet to nine feet, it is equipped with a special electric switch with an astronomic dial which automatically turns on the lights at sundown. Construction of the sign included 94,500 feet of wire and five tons of iron and sheet metal.

One peculiarity of the sign-building business is that the builder's work does not cease with the delivery of the sign. Two men walk about Times Square all night watching the lights to make sure all the bulbs are working and jot down those which have gone dead. They record an average of 1,000 bulb "fatalities" nightly, the causes being wind, rain and sudden changes in temperature. A crew of four men pick up these reports in the morning and replace the useless bulbs, lowering themselves in bosun's chairs from the tops of the signs.

The electric bulb in many quarters is giving way to the "canned lightning" of gaseous tubes. Remarkably attractive "paintings in light" have been produced through the use of the variety of colors available to the designer of tubing signs, including red, blue, green, gold and variations of these hues.



Above, Transferring Diagram to Asbestos Pattern and, Below, Glass Bender Shaping Tubing to Conform with Pattern

The invention of Georges Claude, French scientist, the tube process is based on the action which takes place when electrical current passes through certain gases. Originally known as "neon" lighting because this was the gas used producing red light, the method is still popularly and erroneously referred to under this name although a variety of gases producing a variety of colors have since been introduced, including argon, krypton, xenon and helium, as well as mercury.

Neon gas used alone will give red, a slight amount of neon mixed with a large amount of argon gas will give a blue-green color. Argon gas alone in clear glass

tubing gives blue, while the same gas if flowing through a canary-colored tubing produces green, mercury being used as a catalyzing agent. Helium gas used alone gives a white glow in clear glass tubing, while the same gas when passed through canary tubing produces a gold light. By means of splicing clear glass tubing onto canary tubing, it is possible to have a combination of colors by using a single gas; thus, argon flowing through clear and then through canary tubing will show blue in the clear section and green in the

New York City D1313

other. The making of gaseous tube signs is a major craft today, calling for a certain facility in the bending of the glass tubes that many attempt but comparatively few succeed in doing. It takes from six months to two years to train a man in this craft and even then some are unable to "get the knack" of the thing.

The basis of a tube sign is a full-size drawing of the letters or design. This is transferred onto asbestos, which then becomes the pattern for the glass blower, or bender, and is kept on file for future repairs. With the pattern before him, the bender heats a length of glass tubing over a gas burner, blows into it to keep the walls of the tube from contracting and immediately bends the tubing to the indicated design, using the pattern as a guide by bending directly on the pattern. Closing up of the ends to permit eventual "pumping" out of air from the tubing follows, after which the glass-enclosed electrodes are spliced on at each end of the sign unit.

Complicated though the tricks of lights in continual motion may appear, there is a basic principle back of every one of the ceaselessly flashing and blinking signs, no matter how large or small, and this is embodied in what is technically known as the "flasher." Housed in a so-called "hut" on the roof or under it, it may be compared to a series of revolving wheels or drums in close "barrel" formation and having flat treads broken at intervals by spaces. The flasher, driven by a motor connected through a belt and pulley to a worm gear, actuates the lights at stated intervals. The lights go on when contact is made, they remain dark when there is no contact.

Always the demand is for bigger and brighter signs and more "action."

see April 1934 — D1334
NO AUTO LIGHTS USED ON ROAD WITH SODIUM LAMPS

Motorists traveling the Rome-Ostia auto highway are required to turn off their car lights at night since the highway has been equipped with sodium lamps for illuminating the road. These lamps provide plenty of light without shadows or glare, and it has been found that turning out car lights reduces the glare still further without reducing visibility.



Electric Router That Runs at High Speed May Serve Many Purposes of the Craftsman

HIGH-SPEED ELECTRIC ROUTER AID TO HOME CRAFTSMAN

Weighing only four pounds, but capable of producing excellent results at high speed, a new electric router has many uses in home craftsmanship. The machine, embodying a number of advanced features, will rout, groove, rabbet or do template routing, inlaying, molding cuts, shaping, dovetailing, carving and sanding—all without expensive attachments. Depth of the cut is regulated by a thumbscrew.

D1283

PIPE RINGS STOP TREE ROOTS FROM CLOGGING SEWER

Chemically treated rings, inserted in the bell of each joint of pipe, are designed to prevent tree roots from clogging sewer mains. The chemical action of the ring kills the tiny feeder roots attempting to penetrate small openings around the joints, but does not harm the tree or plant. The rings are inserted when the pipes are laid.



Stop-Root

Cow's horns are used instead of metal plates to repair broken bones, their flexibility and strength being almost ideal for grafting purposes.

Experiments by Dr. ...

Chicago, which is being to Chicago, 110 W. 110th, Chicago, Ill. A.P.C. Mfg. Co. Quincy, Ill. Watkinson, Ill.

same service 10/15/34

Richard ...



Blowing Rice-Hull Ashes into the Attic of a Building to Form Layer of Fireproof Insulation

RICE-HULL ASH INSULATION BLOWN INTO BUILDING

Rice-hull ashes are blown into the attics of homes and office buildings to serve as insulation by a recent process which makes it possible to put a four-inch layer of this fireproof material in place quickly. A thin layer of the ash powder is laid first, then the fluffy portion of the ash, and over this another layer of powder is spread. This keeps the ash from packing and enables it to retain its millions of air cells necessary for insulation purposes. The ash does not pass through the blades of the blower but enters the discharge pipe through a hopper. A flexible pipe in the attic assures an even distribution.

SIGHT IS RESTORED TO BLIND BY GRAFTING CORNEA

By grafting new corneas on both eyes, sight has been restored to Miss Daphne Muir, English novelist, who became blind when both corneas were injured in an ac-

cident several years ago. The cornea is not the eye lens, but a transparent tissue in front of the lens. Numerous cases have been reported of a successful graft of a cornea onto one eye, but there are said to be no other cases of a double cornea transplant. The grafted corneas were taken from eyes which had to be removed from patients suffering from other conditions, and instead of being stitched to underlying tissues, they were held in place by strands of surgical silk applied something like a cross-stitch in embroidery, pressure holding the new tissues in place until they grew fast. Miss Muir's vision is not perfect, but she can see to go about the streets and can read newspaper headlines and her own correspondence.

SERPENTINE COILS OF METAL VULCANIZE INNER TUBES

Mass production of automobile inner tubes is made possible with the aid of huge metal coils which resemble a giant serpent when viewed as a unit. The snake-like coils are called mandrilles and are used for vulcanizing the rubber tubes.



These Snake-like Coils Are Called Mandrilles and Are Used to Vulcanize Automobile Inner Tubes

There are over 17,000,000 radio-equipped homes in the United States, but only about 11,000,000 with telephones.

emb. J. Leland Elam
Elk Grove, Calif.

D.W. Larry Janssen,
Elk Grove, Calif.

Operation Dr. Super
Thomas, of Cardiff
and London.

D1252

D1345

in Scotland

Science Service 10/16/34

Co. - Chemite Mfg Co
1312 2nd St
Albany, N.Y.

Insects Captured in Nets Attached to Kites

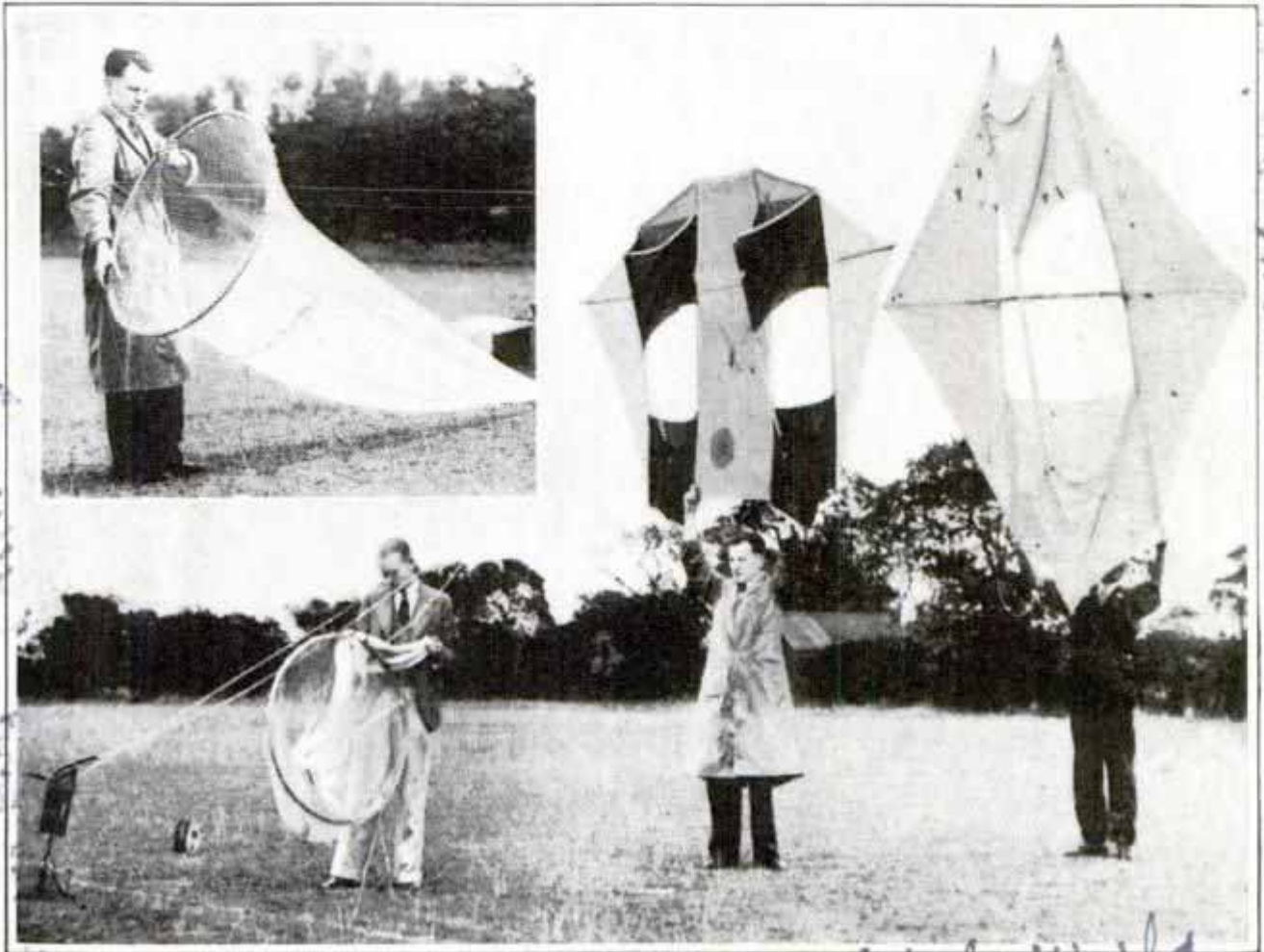

The nets are made of fine mesh and are attached to the kites by means of a special device which allows them to be opened and closed from the ground.

These Nets, Attached to the Big Kites, Are Sent Aloft to Collect Insect Specimens; by Means of Chemical Fuses, the Nets Can Be Opened and Closed from the Ground

Wide World

at Hull University Hull

Big nets attached to huge kites are being used in England in an effort to determine the species of insects being carried into that country by the winds from the continent. The nets and kites also determine at what heights the insects are found. By means of chemical fuses it is possible to open and close the nets at will from the ground.

low intricate contours with the machine. With a radius rod in place, it will automatically cut arcs or complete circles. The torch can travel up an incline of ten degrees on steel plate without slipping. Once

MOTOR TORCH SHAPES STEEL TWO INCHES THICK

D/322

Adjustable to travel at various speeds, a new motor-propelled cutting machine is available for cutting steel plates and slabs into shapes having straight, circular or irregular outlines. The motorized torch, which uses acetylene gas, is guided by hand along the contour laid out and scribed directly on the plate or slab. It is possible to turn sharp corners and to fol-

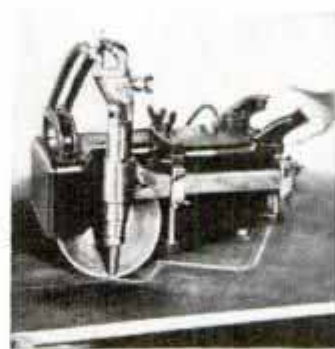

the operator has set the travel speed, lit the torch and pressed the starting switch, he can confine his attention to guiding the machine. It is only sixteen inches long, uses

110-volt alternating or direct current and weighs only forty-eight pounds.

Our Bureau of Information will answer questions regarding articles in this magazine, if accompanied by return postage.

Air Reduction Sales Co. 1100 1st St. N.W. Wash. D.C.

D1270

Mr. Jacob Meschen
A. 2240, 500. 5th Ave
New York City

The AMAZING

New Separator Mfg. Co
and Bristol, Conn



Ullta
man... and
Cullen Co

TAKING its cues from the automobile and the airplane, the bicycle of today has staged an amazing come-back in the past two years. With 3,000,000 cyclists already riding the highways and byways, the springing up of bicycle clubs all over the country and the revival of the famous American Wheelmen of America, the national cycling organization, plans are being made for the building of bicycle paths alongside the highways.

Sales of bicycles totaled 408,697 in 1933 as against 249,500 in 1932, an increase of sixty-three per cent, and the figures for 1934 show a continuing rise in sales.

Cycling as a sport and as a means of getting about is now being used at schools and colleges, at vacation resorts, in city parks, in the smaller towns and the less populated parts of cities. The renting of bicycles for a ride of an hour or so in a park or along a quiet street has become an important phase of the revived in-



Above, Playing Bicycle Basketball; Center, Combination Horn and Light, One of the Latest Accessories; Below, Taking Brake Temperature during Test

D1270

RETURN of the "BIKES"



terest in cycling and many have found this a way of making some extra money or of creating an established business earning a man-size living. A student at the University of Michigan, finding himself low in cash, managed to get together enough to buy twenty new bicycles and with this equipment started a renting business which brought him a fair income.

Boys obliged to add to the family income have found the bicycle a good way to do it. Starting up a "business" of light delivery service, boys have made money delivering monthly bills for public utility companies, collecting for installment houses and real estate owners, taking orders for groceries and then delivering the goods, delivering lodge, party and club notes, delivering special delivery letters for the post office, delivering for cleaning and pressing establishments, for florists and for ice-cream dealers. One city library has built up a telephone trade through the use of boy



A Pioneer Cyclist and a Cycle Parking Lot on Bicycle Day at the 1934 World's Fair Indicating the Popularity of Bicycles Today

Col. Albert A. Pope 63

D
1290
64

New Departure
Bristol, Conn
POPULAR MECHANICS

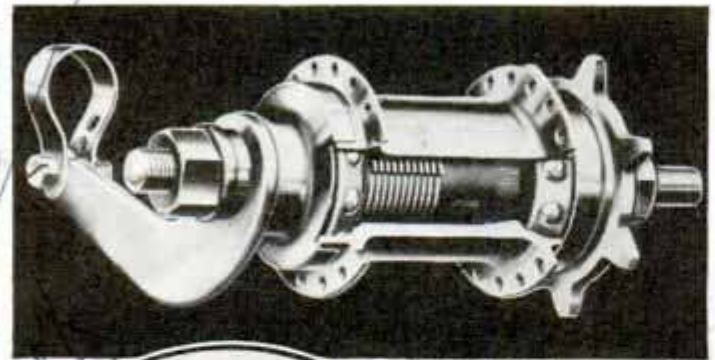

the most grueling punishment. At the end of each ride engineers examined the metal, they took its temperature, disassembled it and examined minutely the effects of the terrible strain.

Then, with their data assembled and with the knowledge gained from the design and manufacture of heavy-duty ball bearings for automobiles and machinery, a brake was designed and built which included twenty-two brake disks and twenty-one braking surfaces, and a leverage was set up which makes it possible for a 200-pound man to exert 2,350 pounds of pressure

Above, Brake Which Will Stand Pressure of 2,350 Pounds per Square Inch, and Eighty-Pound Motor Bikes Capable of Fifty Miles an Hour; Right, Pedal Lights to Warn Motorists, and Bicycle with Two-Speed Drive

cyclists who collect books on the day they are due and deliver new books where wanted. Bicycles made in American factories today stress streamlining, lightness and speed, and make use of chrome-plating to improve the appearance of the vehicles. A bicycle which emphasizes its lightness weighs slightly over thirty pounds and is equipped with a hand brake operated from the handle bars. A streamlined bicycle is equipped with rubber mountings to decrease rattles. Particular importance is seen in the placing of these rubber mountings at the front and rear axles.

Inventors are constantly at work developing new conveniences for the bicycle rider. To illustrate the thoroughness with which experiments are carried on preliminary to manufacture, consider the methods used by a prominent maker of coaster brakes for bicycles.

For weeks husky testers maintained a camp in the vicinity of a New England mountain. Day after day they coasted down the precipitous mountain roads. Many types of brakes were subjected to

per square inch on the 12.20 square inches of available, usable braking surface. The principal parts of the brake are made of the toughest steels—nickel with relatively high chrome content.

A two-speed drive device being offered by one company prevents laborious walking up hill or trudging through mud or snow. The rider, operating a conveniently located lever, which shifts the gears easily, goes into low speed as soon as a hill is encountered or the going becomes difficult and resumes high speed when smooth roads are reached. The low speed is two-

(Continued to page 130A)

U.S. Patent Co.
209 W. Jackson St.
Chicago, Ill.

Suber
Hass

Dist.

Collegi Co.
Cyrus, Ohio

D 1101. The National Standard
 Pipes, Inc. Worcester
 65 Mass
 Branches Akron Ohio Los Angeles
 Sturport, Ind.

POPULAR MECHANICS

Home Furnishings Made of Braided Wire

Flat braided wire, originally developed for reinforcing the edge of automobile tires, has been found adaptable to the making of a large variety of home furnishings and other articles. It is not only strong and flexible, but can be made in many patterns and designs and hence has been found ideal in combining decoration with durability. It is manufactured of various metals and has been found suited to such a variety of uses as automobile tire covers, lamp bases and shades, floral baskets, urns and vases, beverage sets, casserole and fruit-bowl holders, novelty jewelry, waste baskets, magazine holders, candle sticks and screens. It is also used in reinforcing furniture, and chairs and buffet tables have been made of it while it lends itself readily as a reinforcing material and protective covering for rubber hose.



This Tire Cover and the Flower Basket, the Table and the Lamp and Shade All Are Made of Flat Braided Wire

Grooved Brick with Tie Rod Makes Buildings Stronger



Rods Tie Bricks Together in Wall

Increased safety may be built into the home, factory or office building by using a new grooved brick into which is imbedded a steel tie rod. A layer of horizontal rods at every fourth course of height is tied together with steel clamps connected to the vertical rods, thus tying the entire wall into a solid mass. The vertical tie rods can be made in any length desired, so that the brick mason is unhampered in laying the brick. Special attention is given construction at corners of the wall to give even greater safety. Buildings with walls of this type are said to be practically storm and earthquake proof. The walls can be of any thickness desired.

D 1245
 Otto G. Nevez, S.O. S. Buck

D1100

Is Your DRIVING "Touch"

Carl Frederick C. Russell
116 Walbuds Road
Hartford, Conn

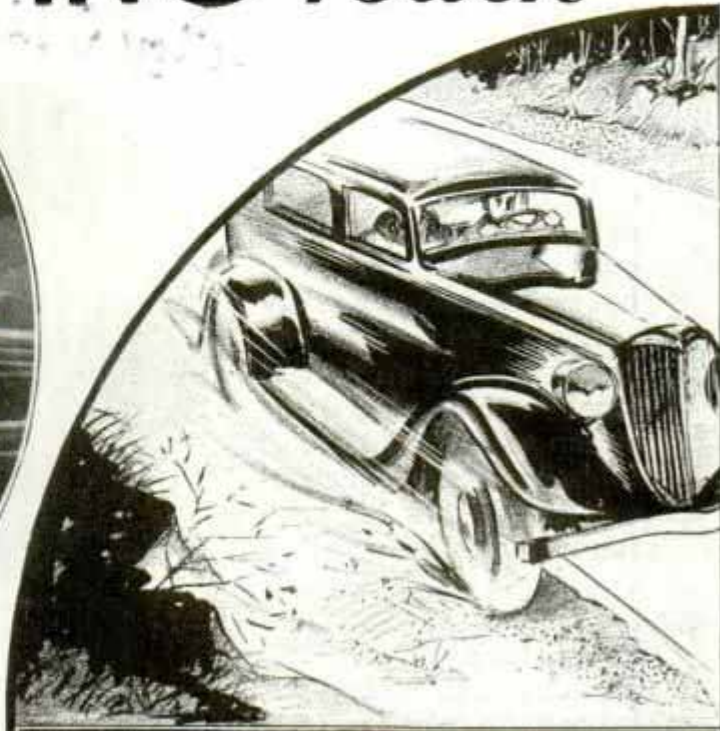
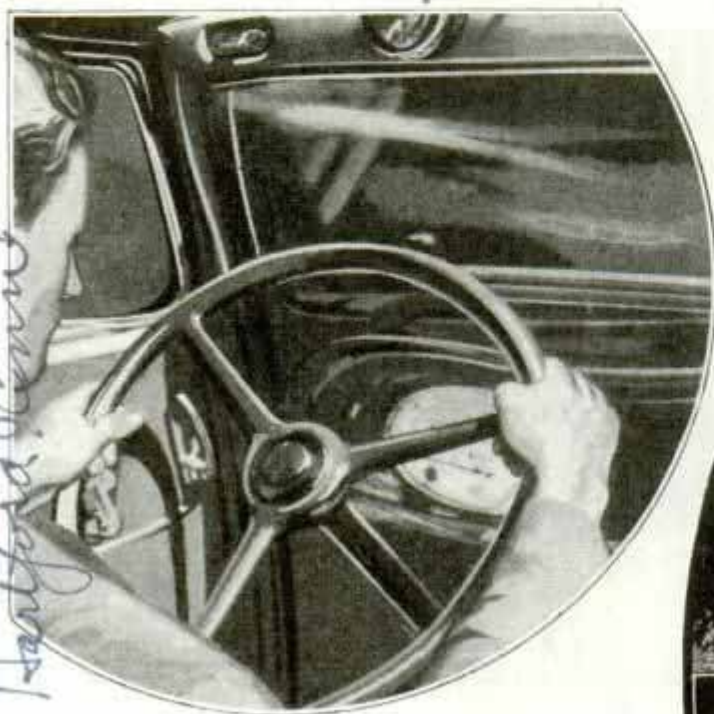

YOU may have to learn to drive all over again to get the best out of your new car. Improvements have made many habits and pet ideas of veteran drivers obsolete.

Many owners who condemned free wheeling were simply covering up their own inability to operate the free-wheel control skillfully. Others do not shift into second gear on steep down grades because they cannot make up their minds to go straight through to second from high.

"Double clutching" has no place in modern transmissions, except in those cars where the gears actually are not of synchronized design. The purpose of this process is to bring the gears into suitable speeds for meshing. To shift into second when going down hill the old-fashioned driver declutches and shifts to neutral. Then he engages the clutch and races the motor to bring up the speed of the gear on the transmission countershaft with which the second-speed gear of the main transmission shaft will mesh. Finally he completes the shift by declutching and pushing the shift lever through to the second-speed position. All this is unnecessary—often disturbing—to a synchro-mesh transmission.

The importance of "touch" in bringing out the best in the new cars is best illus-

Always Be Prepared for a Blowout by Gripping the Wheel Firmly with a Thumb around a Spoke to Prevent Wheel from Slipping; Never Try to Pull Out of Soft Shoulders Suddenly—Allow the Car to Lose Speed First; Don't "Out-Drive" Your Headlights—Be Sure You Can Stop in the Distance You Can See Ahead



D1100

MODERN?

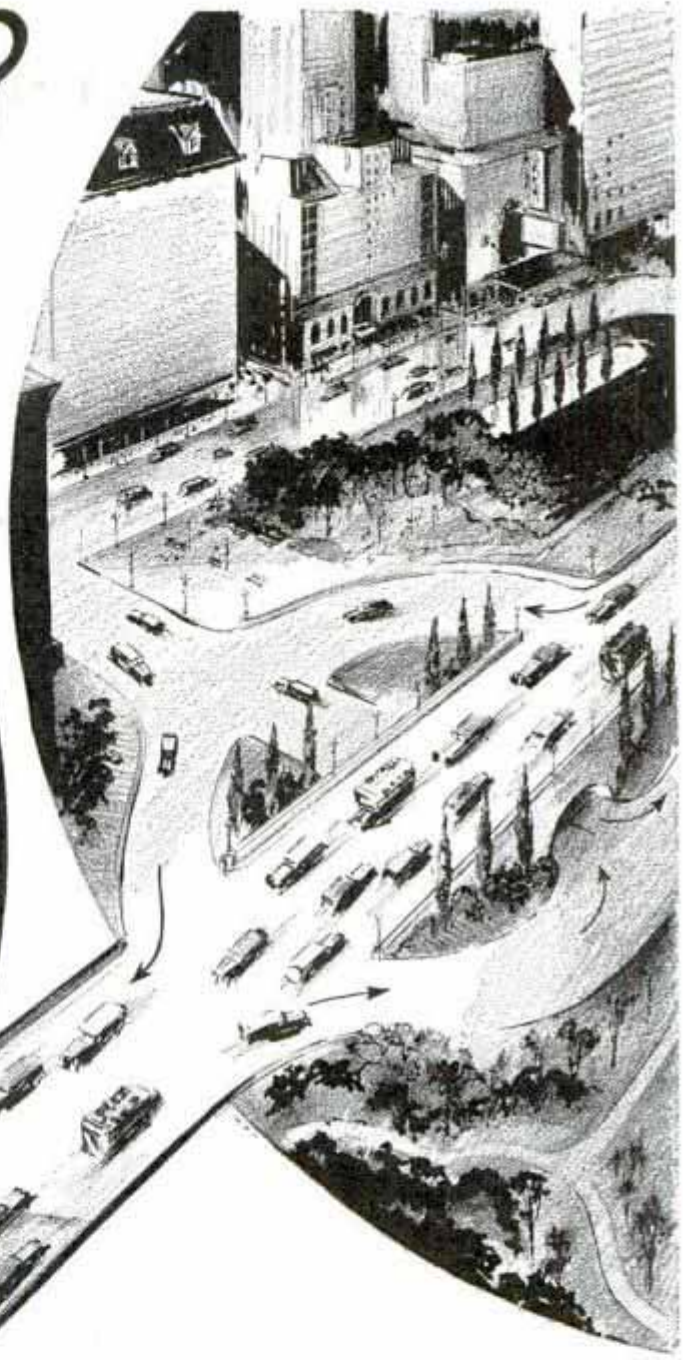
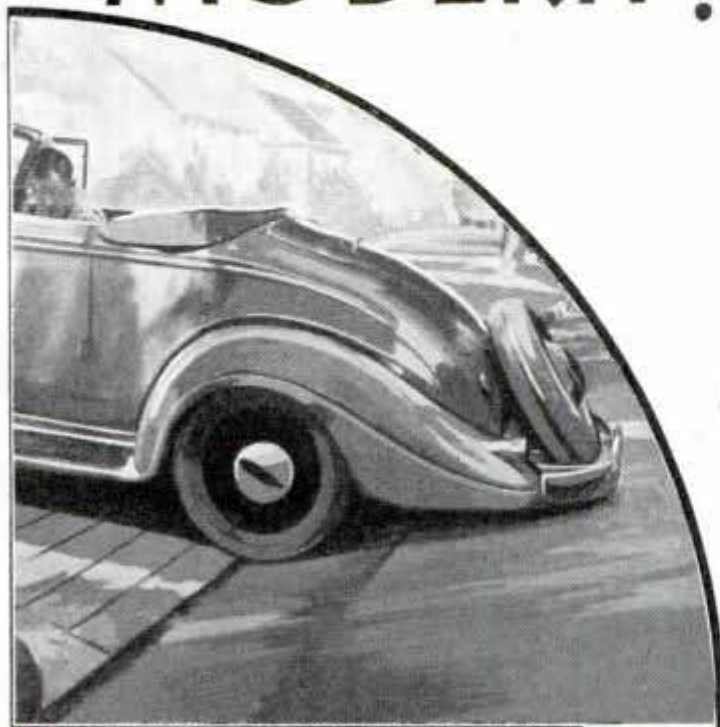

High-Speed Roads Call for Extra Driving Skill; Be Sure of Your Brakes and Use Special Care in Backing

trated in braking. To stop any car equipped with a vacuum assister, the driver has but to press his foot lightly against the brake pedal. If he bears down on the pedal, the car will stop too abruptly, not only in-

creasing the possibility of a skid but making it more difficult for the driver behind to avoid a rear-end collision. Any driver who is accustomed to "jumping" on the brakes in order to bring his old car to a stop must turn over a new leaf the moment he takes the wheel of a new model.

Special care must be exercised in using the modern hand brake, especially where this is simply another way of operating the four sets of service brake shoes. If the hand brake is on the propeller shaft it never should be used while the car is in motion. If it operates through the service brakes it should be used sparingly, even for parking. One of the new rules with this latter type of hand brake is to avoid



Above, Testing a Streamlined Model; Right, Gear Shifting Is Smoother if Clutch Pedal Is Not Pushed Too Far

means that as soon as the accelerator is allowed to come up to the idling throttle position the engine itself will furnish an immediate and noticeable check on speed. This braking force should be allowed to take effect before the braking system is brought into action,

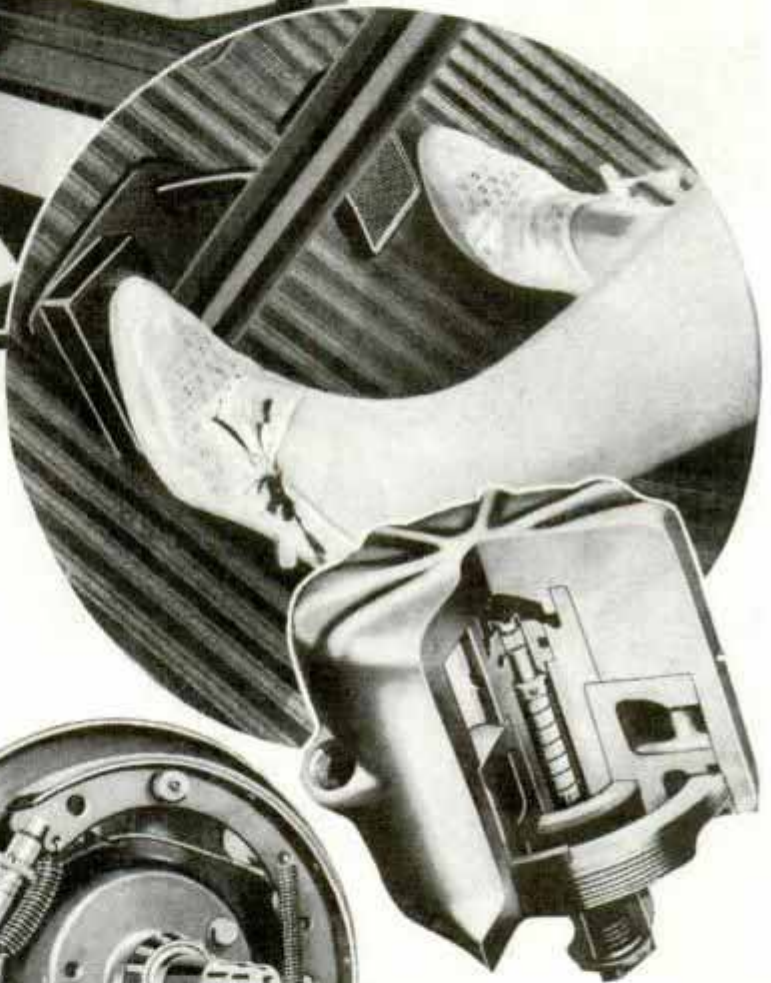

using the service brakes too freely before parking. Service men say most of the trouble with today's brakes is caused by warped drums, ninety per cent of the warpage resulting from setting the brakes for parking when the drums are hot.

A hand brake that forces the brake shoes to bear against hot drums produces a distortion that makes it impossible to obtain equalization. This, in turn, results in uneven wear on the drums and shoes. Eventually the owner is forced to have the drums trued by scraping off the high spots. That thins the stock and makes the drums that much easier to warp again, because invariably the owner fails to realize that his old-fashioned driving was at the seat of the trouble. Try not to use the brakes more than absolutely necessary.

Because all the new cars travel so much faster, the matter of touch in braking is all the more important. High compression



Above, Give Your Thermostatically Controlled Shock Absorbers Time to Adjust Themselves to New Kind of Road; Left, the Internal Expanding Brake Does Not Burn and Seize When Over-Used on Long Grade; It Simply "Fades" and Fails to Stop Car Efficiently

otherwise there may be too much deceleration for the good of the car's stability.

Straight-line steering is essential when the brakes are applied, but the old-fashioned driver is likely to think he must tug at the wheel to keep the car on a straight

(Continued to page 120A)

D 1100



DON'T USE BRAKES ON A CURVE. BRAKE BEFORE YOU REACH IT AND THEN STEP ON THE ACCELERATOR

FALLACIES of DRIVING

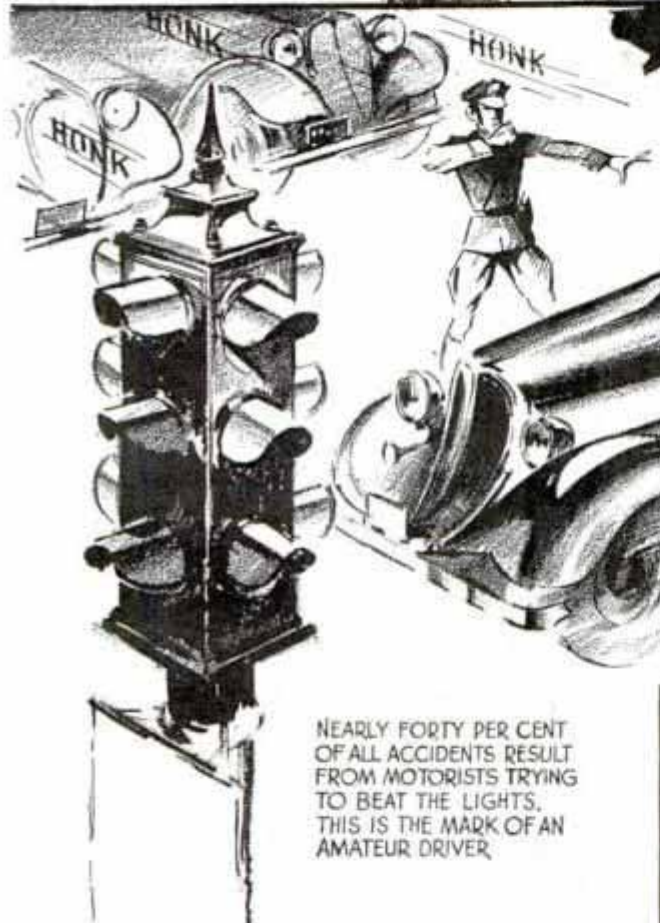

NEARLY FORTY PER CENT OF ALL ACCIDENTS RESULT FROM MOTORISTS TRYING TO BEAT THE LIGHTS. THIS IS THE MARK OF AN AMATEUR DRIVER



DON'T DOUBLE CLUTCH ON A HILL. PULL THE LEVER BACK FAST



IT'S A WASTE OF BULBS AND DOES NOT SAVE THE BATTERY TO BURN LIGHTS IN THE DAY WHILE TOURING

D 1198

Prof. Allen Ray Carpenter
Pasadena Calif
POPULAR MECHANICS

How Singers for Radio Are Made in Studio

Conch John A. Maloy, Box 292, Hollywood, Calif

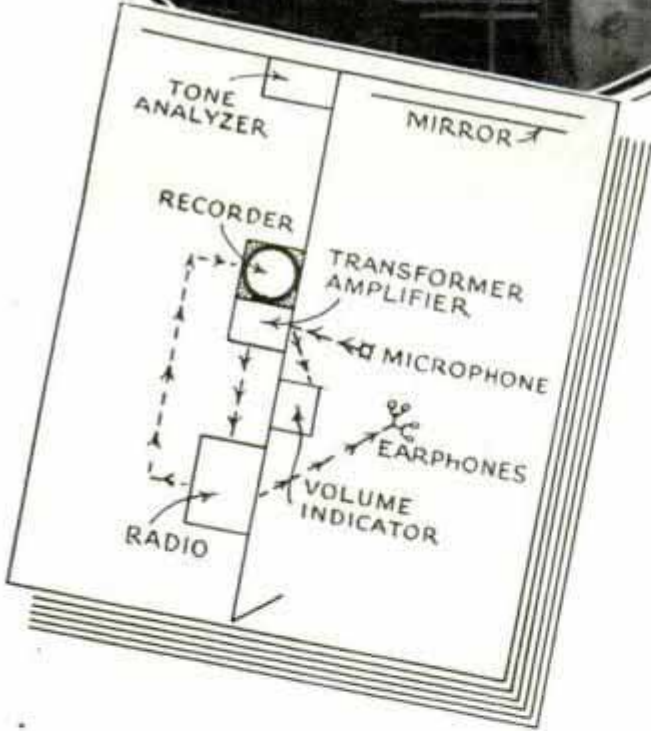
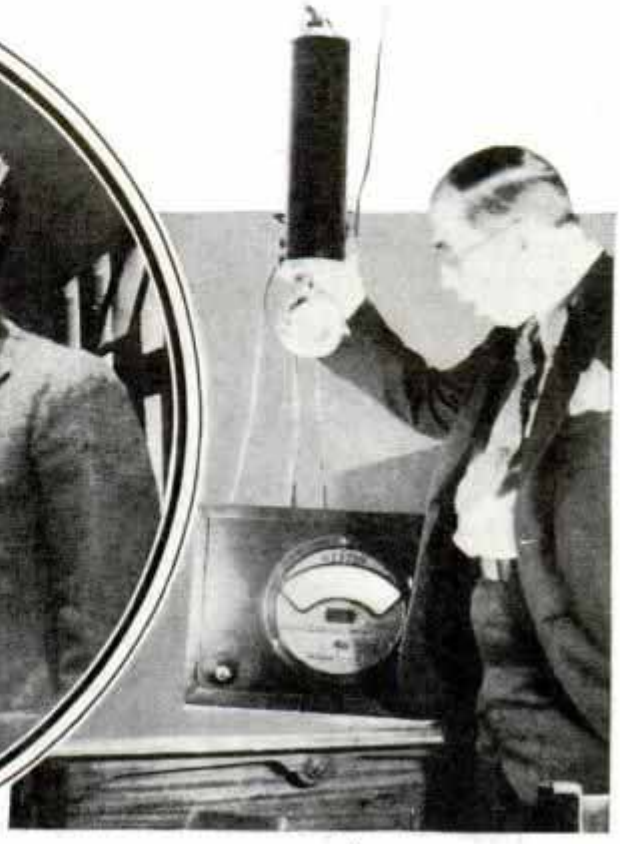

Teacher and Student at Microphone Listening In on Headphones, and Volume Indicator Showing Power of Voice; Left, Plan of Training Studio

Singing over the radio is unlike any other singing and many artists have been forced to change their technique entirely when they appear before the microphone. The best voice for broadcasting purposes is one that is soft and yet clear, for volume can be produced in the amplifier, but reduction of volume cannot always be obtained satisfactorily. One voice teacher who trains radio singers has developed a complex set of mechanical devices to aid

the artists. One set-up is so arranged that it duplicates broadcasting conditions and, in addition, brings the singer's voice back to him through headphones so he can hear exactly how it is coming from the loud speaker. In the studio the student sings into a microphone and observes the needle of a volume indicator. His problem is to develop smoothness and evenness, and when the needle remains fairly steady, he knows he is doing this. A mirror in the studio also enables him to watch his posture. The microphone carries the voice to a transformer-amplifier in another room. Here also is a radio receiver which, in addition to its loud speaker, is equipped with earphones. Leads carry the earphones back to the studio so both instructor and pupil can listen in. There is also a phonograph recorder on which a record of the student's performance can be taken. This record together with a corrected version made by the instructor is taken away by the student to use as a guide in practice. The recorder can also pick up a voice com-

D1227

ing over the loud speaker and sometimes students living at a distance and doing radio work ask that a recording be made of their singing by the instructor who sends them the records together with another set containing the corrections. Radio tubes which control a revolving dial enable the student to maintain correct pitch. The student watches the dial. When his tone drops in pitch, the dial moves in one direction, when it rises, it moves in the opposite direction and when he is on pitch it remains stationary. A tremolo causes it to vibrate.

WEATHER FORECASTER SHOWS CHANGES ON DIAL D1199

Coming changes in the weather are shown by a mechanical forecaster. On the dial of the instrument are chemical strips indicating the degree of moisture in the air by their color. The user notes the prevailing color and turns the dial until the indicator points to a similar color on the dial card. The dial is then moved until the direction of the wind appears in an upper opening and a built-in barometer is con-

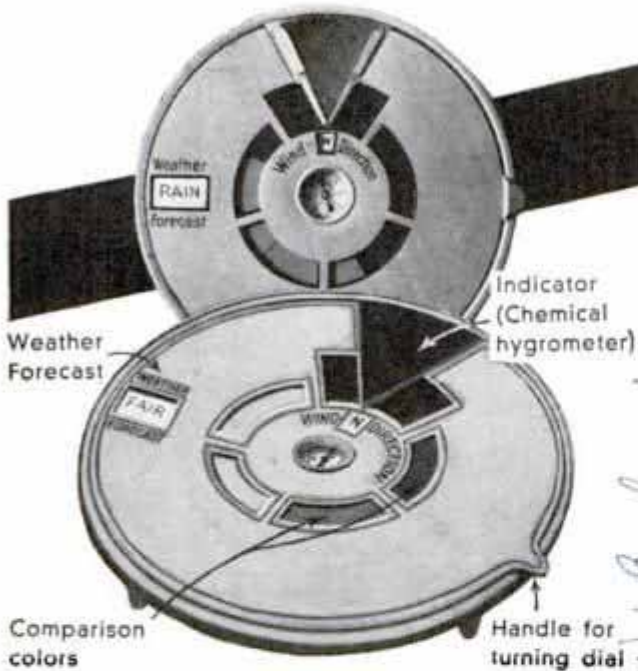

Dial of Weather Forecaster Which, When Properly Adjusted, Indicates Changes in Advance

sulted to determine if the pressure is rising or falling. A compass in the center of the dial aids in finding wind direction. When all adjustments have been made on the dial, the weather forecast is read in a window on the left of the instrument.



Even the Smallest Member of the Hiking Family Can Go Along, Riding in This Fashion

HIKING HARNESS HOLDS CHILD ON WEARER'S BACK

When the family club goes hiking in England, the youngest member may ride on the father's back, sitting comfortably in a saddle supported by harness and holding on to the straps. Offered by a Manchester company, the outfit calls to mind the method used by the American Indian squaw in carrying the youngest member of the family on her back.

HANDY OILER HAS FORCED FEED AND FLEXIBLE SPOUT D/2/2

Equipped with a flexible spout for reaching cups or bearings at any angle, a new forced-feed oiler is handy for the serviceman. It is designed for lubricating bearings inside of automobiles, electric refrigerators, cash registers, oil burners, computing machines, elevators, motor boats and other machines. A vent cap prevents leakage while carried in tool kit.

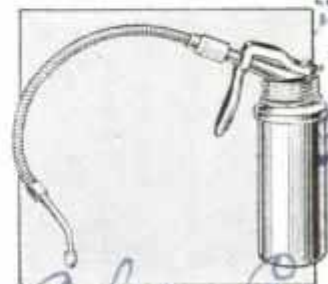

Edward R. Buck & Sons Ltd. Eng.
Linden Road, Manchester.

W. Inland
London, W. Inland

Capt. O. M. Watts Ltd.
20, 22 Maddox St.

258
Sexton Oldy

minneapolis
men

*Judd Mygale
25 and Hunting
Park Ave. Phila*

D1237

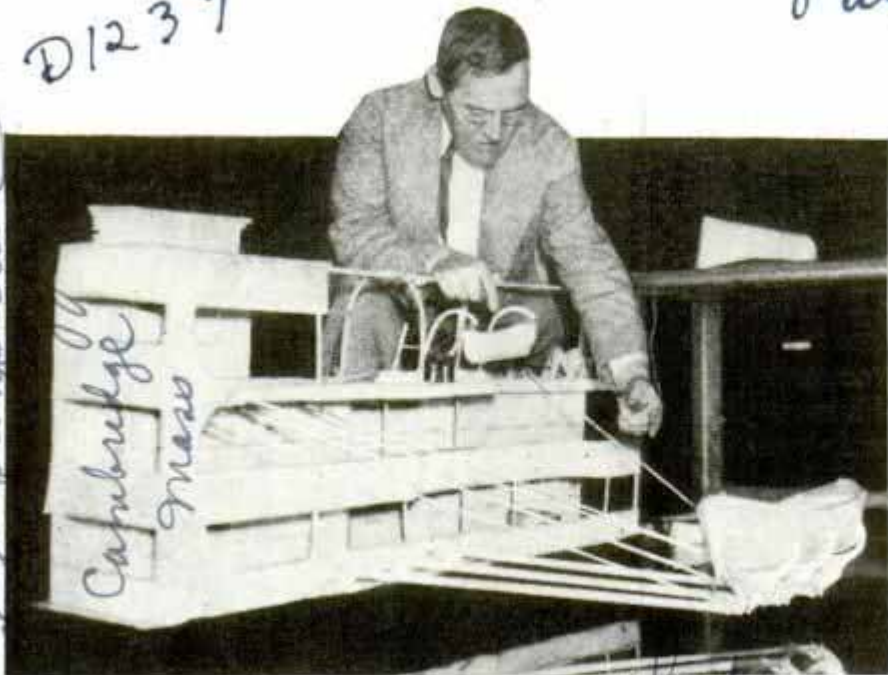

but
Model of Apparatus for Launching Lifeboats; Three Iron Claws Grasp the Boat and Lower It Gently into the Water

IRON FINGERS LOWER LIFEBOAT AND MAKE LAUNCHING SAFER

In many sea disasters rescue work has been hampered greatly through inability to launch lifeboats properly. One inventor claims to have solved the problem of launching boats by using three iron claws or fingers which reach up and cradle a boat, lowering it gently into the water regardless of the angle at which a ship lists. The lowering apparatus is controlled by one steel cable and has been successfully demonstrated in model form.

RUBBER-PAVED TENNIS COURTS REQUIRE NO UPKEEP

Tennis courts made of rubber tiling set in a concrete base and with rubber marking lines embodied in the construction require no upkeep

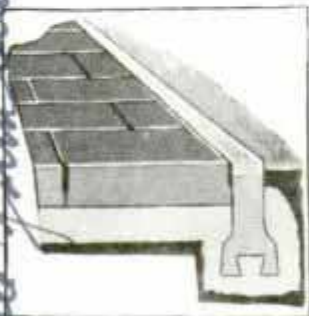

and a machine-surfaced rubber paving for this purpose is neither glossy nor slippery and can be used in winter as well as in summer. After a rain such a court requires only a squeegee rubber to remove the water and final drying with a mop for the surface to be in good condition. The blocks are se-

cured in the concrete by a dovetailed underbody and each block is so constructed that a watertight sealing joint can be made to be used for the pavement. The rubber blocks can also be laid on wood, if desired, or even on the surface of a clay court.

D1216

STAINLESS STEEL PLANE WELDED IN ONE PIECE

Made of stainless steel and welded into what amounts to one piece of metal, a streamlined airplane with 100,000 miles in the air has been retired to a place on the lawn of

the Franklin Institute in Philadelphia. Stainless steel and streamlining effects similar to that used in building the "Zephyr," one of the latest streamlined trains, were employed in constructing the plane. The metal is spot welded throughout.

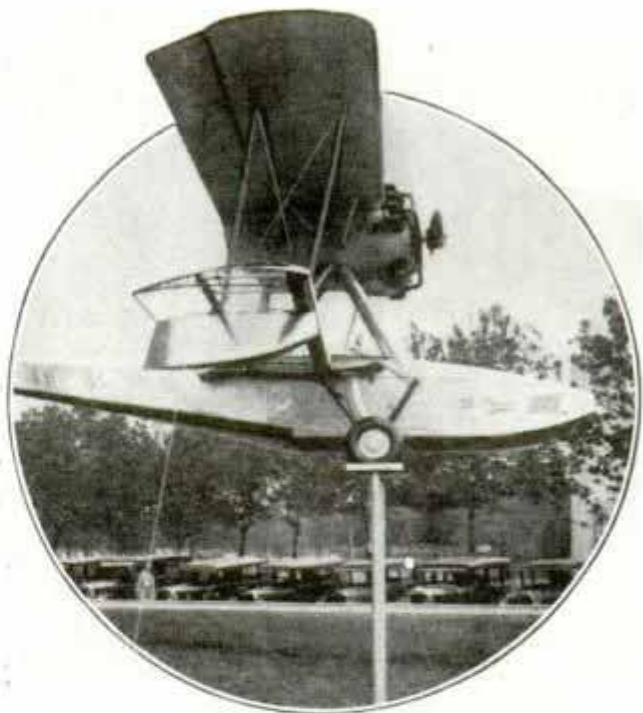

Stainless Steel Frame with Fabric Removed from Wings to Show Its Metal Construction

Names and addresses of manufacturers and dealers in articles described in this magazine will be furnished by our Bureau of Information upon receipt of a stamped, self-addressed envelope.

*Clayton A. Winter, World
10/1/34
see form letter
D1213*

D 1238

International News Photos
 Div. 5715 Hearst Bldg

new menace in NIGHT DRIVING



Above, Glare Resulting from Poor Bulbs; Right, Checking Headlights in a "Safety Lane" with Device Which Measures Intensity of Beams

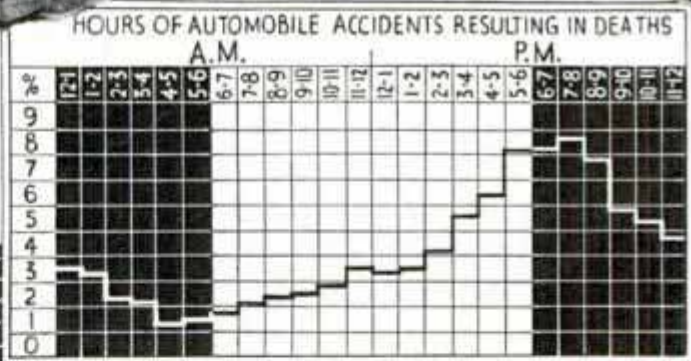
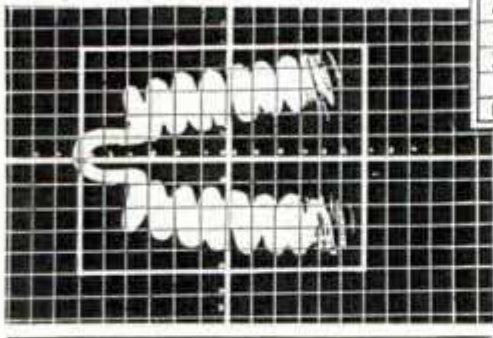
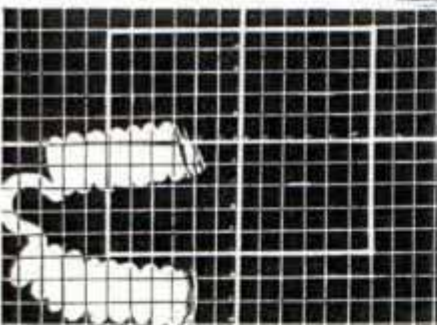

Above, Note Peak Hours for Accidents; Left, Filament Images of Bulbs; the One Above Is Inaccurate, the One Below Is Correct

DON'T buy "bargain" bulbs. This is the advice of Prof. F. C. Caldwell of the Ohio motor vehicle bureau who says the new pre-focused headlamps with which many current model cars are equipped have brought a new menace to night driving. The pre-focused lamps insure better lighting—provided the bulbs used in them are made to the close specifications neces-

sary for good results. An essential characteristic of the pre-focused equipment is precision and if the bulb used does not fit precisely and does not have filaments positioned correctly, there is impairment of the headlight beam and excessive glare. The only safe procedure is to buy bulbs made by reputable manufacturers. Unless the public refuses to use the lamps of doubtful merit, Prof. Caldwell declares lighting conditions on the highways may be worse than for many years.

D 1256

Civil John Marcy
Box 292

Hollywood Calif

Huge Tube Built to Film "Sand Hog" on Job

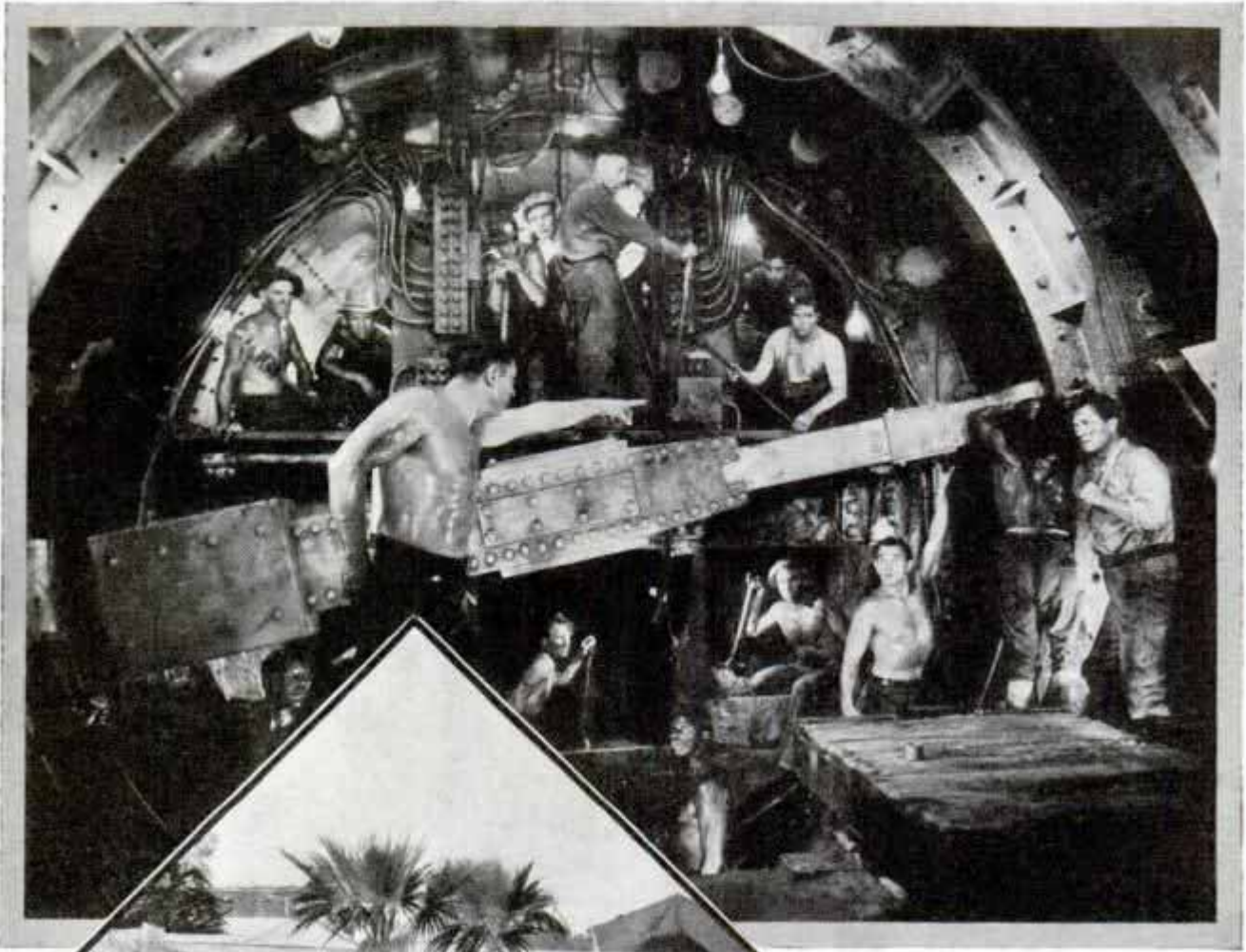

Top, Scene in Giant Tube Constructed to Film Perils of "Sand Hog"; Bottom, Tube as It Appeared on Movie Lot

of the East river tunnel in New York, exact to every bolt and nut. Wherever possible, wood takes the place of metal to save expenses, the wood being coated with metallic paint. The gantry, the superstructure housing hoisting engines and equipment, is forty-four feet high. An excavation

Perils of the "sand hog," who helps to drive vehicular tunnels through mud and silt sixty to seventy feet below the surface of a river, are made more realistic in a motion picture by using a giant tube to show actual working conditions. Extending 425 feet across the Fox studio lot, the tube is more than seventeen feet in diameter. Its interior is a detailed reproduction

of 550 cubic yards of earth was made for the hoist shaft. For the final touch of realism, eight mine cars and an electric locomotive were used on the set. Borden Chase, who spent ten years as a sand hog before turning to writing, estimates that mortality in such tunnel work averaged around twenty-five per cent until 1900 when compressed air began to be used.

East River

Madison, Wis

D 7184

SALT BATH SEASONS TIMBER WITHOUT KILN DRYING

Rapid seasoning of certain species of wood without kiln drying is being accomplished at the United States forest products laboratory in Wisconsin. The treatment consists of soaking or boiling wood in a solution of common salt or some other chemical. The salt bath accomplishes in a week or two what usually takes months to do. Kiln drying, following the soaking process, may be dispensed with. The treatment is said to eliminate splitting of the wood while it is being seasoned. Experts are investigating the possibility that the treatment may be used for fireproofing and preserving wood.

D 135

ELECTRIC PENCIL FOR ETCHING OR SOLDERING STEEL

Etching, spot-annealing or hard-soldering can be done on steel or iron with an electric pencil that may be plugged into any 110-volt alternating-current socket. The device consists of the metal pencil and an aluminum case containing a switch and necessary circuits. The etcher has copper stylus tips which are inserted like leads in a mechanical pencil. Steel or metal objects on which names, marks, lettering or numbers are to be etched are brightened to form a good electrical contact and are then placed on the contact plate forming the top of the case. The marking is done slowly and with moderate pressure. Two ranges of current are available.

1505 E Michigan, 1605 E Michigan, R. B. Quinn Co.

Aluminum alloy



COATING ON ALUMINUM PISTON GIVES LONGER LIFE

Aluminum pistons for automobiles are being made more resistant to wear by a new electro-coating process developed by the Chrysler engineering division. The process gives the piston a coating said to be almost as hard as a diamond. Immersed in a solution of sulphuric acid maintained at seventy degrees, the piston is the anode.

Metallurgical div.

D 1321, Chrysler Corp 347



One Step in Coating of Aluminum Pistons to Give Them Extra Hard Wearing Surface

for the coating operation. It emerges from the solution with an extremely thin aluminum oxide surface. Aluminum oxide is so hard that few tools can cut it, so all work must be completed before the piston is treated. In tests, the coated pistons have run 100,000 miles without scoring.

PULL WIND CLOCK FOR DESK NEEDS LITTLE ATTENTION

Little attention is necessary to keep an attractive pull wind desk clock running properly. This clock has in its base a rubber button to which is attached a metal cable. Pulling the cable winds the clock. The wood case is finished in ivory with a black base.

\$ 3.35 higher

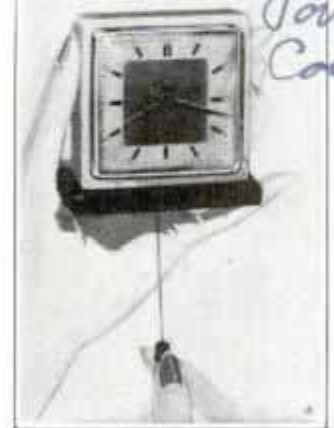

you need

New Haven Clock Co, New Haven Conn

D1244

Conk Don Classroom
4 W. 10 3rd St
New York

BRITAIN BIDS for

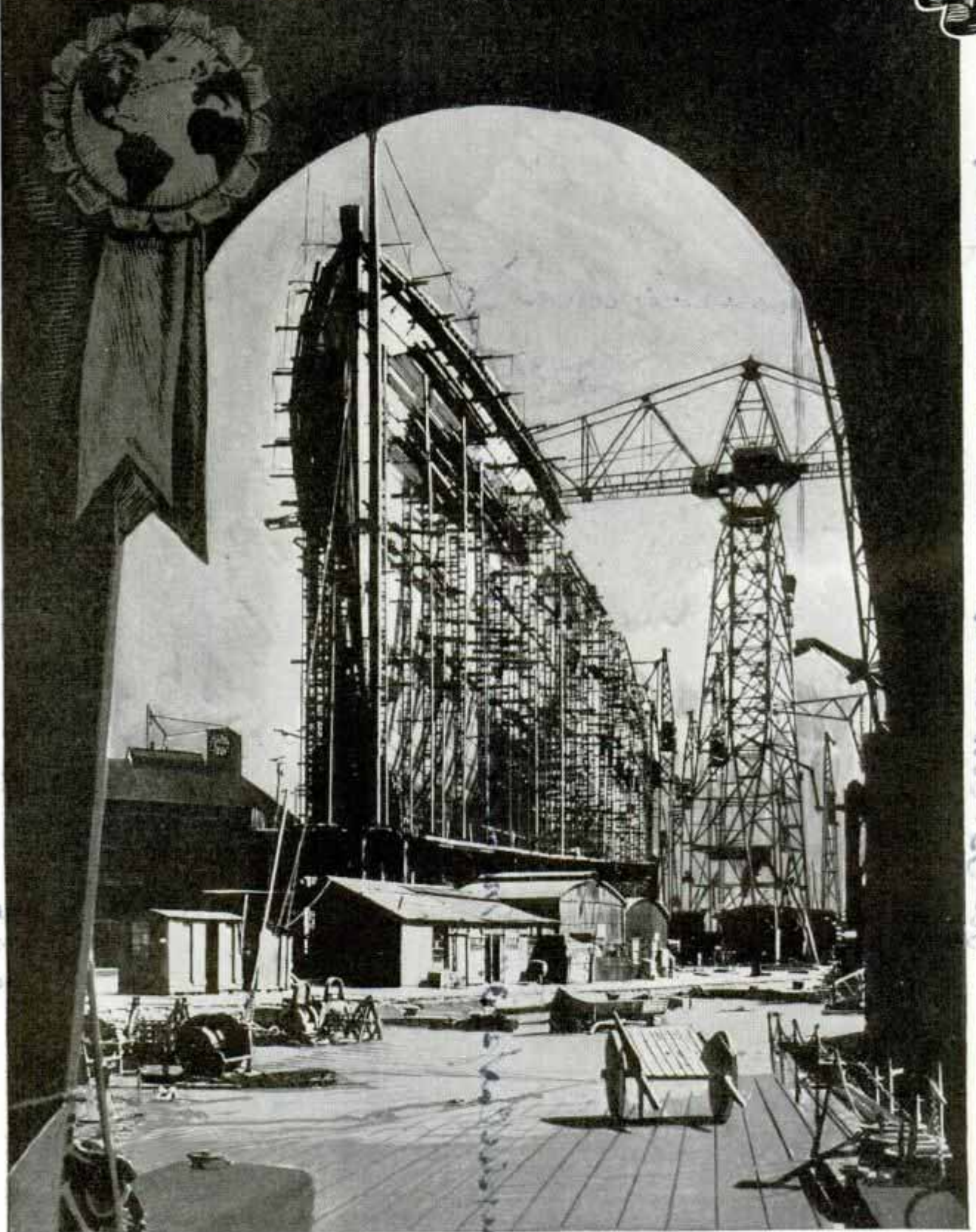

Handwritten notes on the right margin, including the number '12021' and other illegible scribbles.

Building the "Queen Mary" in Scotland; the Vessel Is More Than 1,000 Feet Long and Carries a Power Plant Big Enough to Serve the Needs of a Large City

ATLANTIC Blue Ribbon

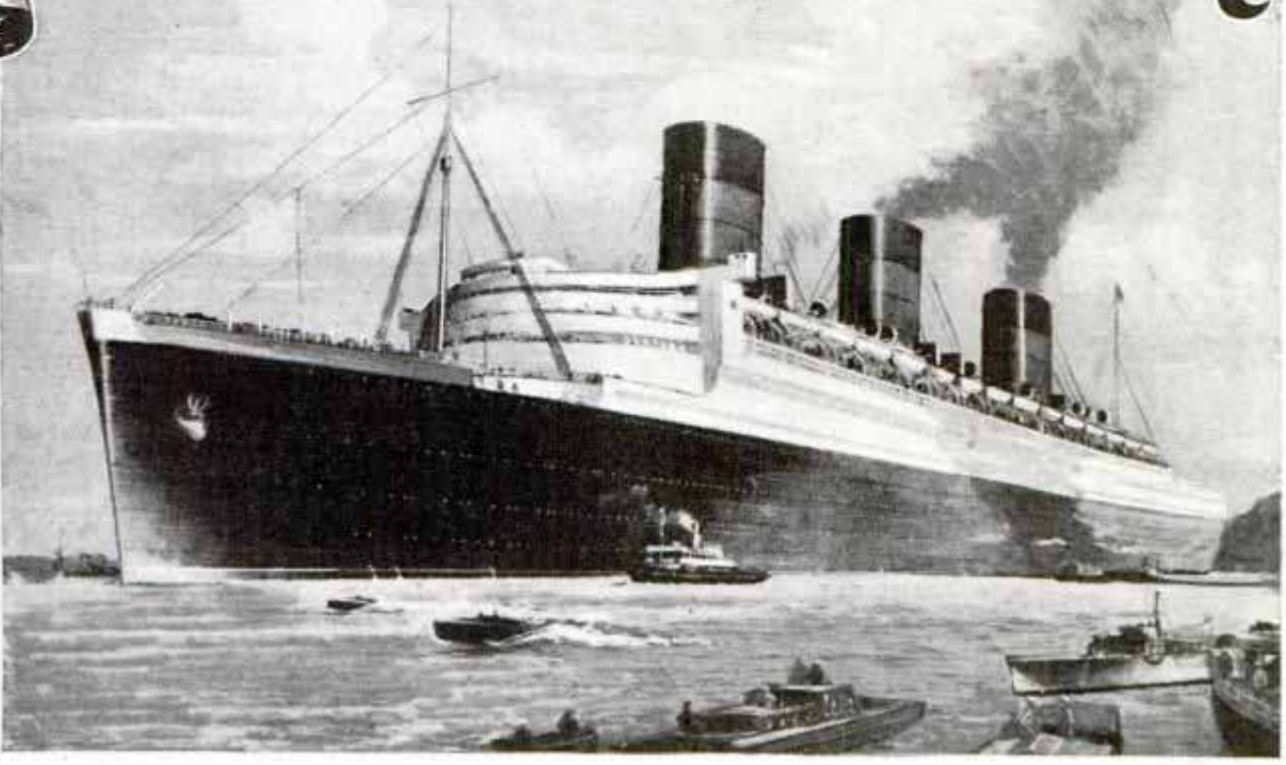

The "Queen Mary" as She Will Appear in Service; on This "Floating Continent" Great Britain Is Pinning Her Hopes of Regaining Transatlantic Speed Honors

THAT'S not a ship," said an engineer who witnessed the launching of the gigantic Number 534 at Clydebank, "that's a floating continent"! And so it appeared to the 250,000 people who saw the Queen of England send the white sea bird, now called "Queen Mary," down the ways.

She now floats at her dock in John Brown's famous shipyard, while machinists, decorators, electricians, carpenters and painters groom her for the great transatlantic race which all England hopes will bring back the bonnie blue "riband," long held by the Cunarder "Mauretania." A friendly rivalry between the British and French has created much suspense among maritime nations. The upshot of the race will, of course, not be known until the "Queen Mary" makes her first passage to America, tentatively scheduled for 1935. The new French liner, "Normandie," will precede her by several months.

Competition or no, the "Queen Mary" is a vessel worthy of carrying on the tradi-

tion that England rules the waves. The "Normandie," so far, is 1,029 feet long, a mere eleven feet longer than the "Queen Mary." At the last minute, however, the British may add a bit to the Cunarder's bow and, at least, equal the over-all length of the French liner.

The English claim that the "Queen Mary" will embody the latest improvements can scarcely be disputed. Inside the rakish hull is enough energy to meet the power requirements of a city like Albany, N. Y. According to British engineers, she is the largest power unit ever launched. The electrical transmission system requires 4,000 miles of wire. Lights will flash, wheels will turn, doors will swing, music will play, bells will ring under the impulse of electric current coursing through the walls, ceilings and floors of the ship.

Seven turbo generators, capable of delivering 10,000 kilowatts per hour, will heat, light, ventilate and drive this floating metropolis. Twenty-one elevators, suffi-

D 1244

Here Are Two of the Factors Which Are Expected to Add Speed to the "Queen Mary"; Above Is the Razor-Like Bow of the Vessel and Below, a View of the Streamlined Contour of Three of the Decks

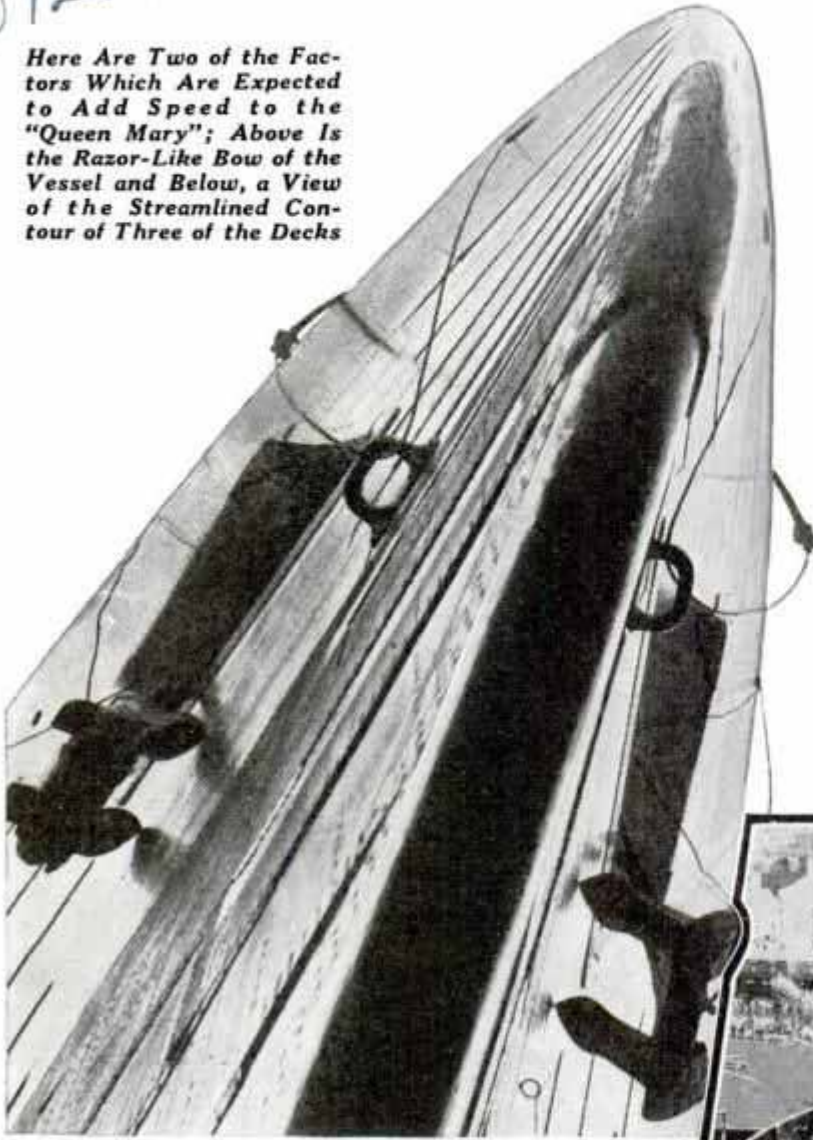

boilers, with single reduction geared turbines.

The propellers are worthy of such a ship. Each costs \$35,000, weighs thirty-five tons, and consists of four streamlined blades. They are composed of resistant manganese bronze and have a diameter of twenty feet. Six fueling stations distributed around the vessel make it possible to fill fifty bunkers with oil in eight hours. The "Queen Mary" will be able to embark and disembark passengers, refuel, take on provisions and start back on her tracks within twelve hours after docking.

As she is, the ship's over-all length is 1,018 feet, her beam is 118 feet, her depth from keel to

cient for a fifty-story skyscraper, will carry the crew, passengers and freight between the twelve spacious decks. To supply staterooms, baths, swimming pools, kitchens and fire plugs with water connections requires about fifty miles of pipe.

Four sets of engines will turn the four propellers and send the 73,000-ton colossus forward at a speed of about thirty-five miles per hour. The space used by turbines, boilers and auxiliary machinery equals the full length of many so-called giant ships. Specialized mechanics must fit the 257,000 turbine blades, and gear wheels are lined up to a thousandth of an inch. The builders claim that the power and efficiency of the engines will surpass any afloat, which means that they must exceed 200,000 horsepower. The foremost marine experts of England devised the propulsion system in a series of secret conferences. They adopted high-pressure, high-temperature steam and water tube

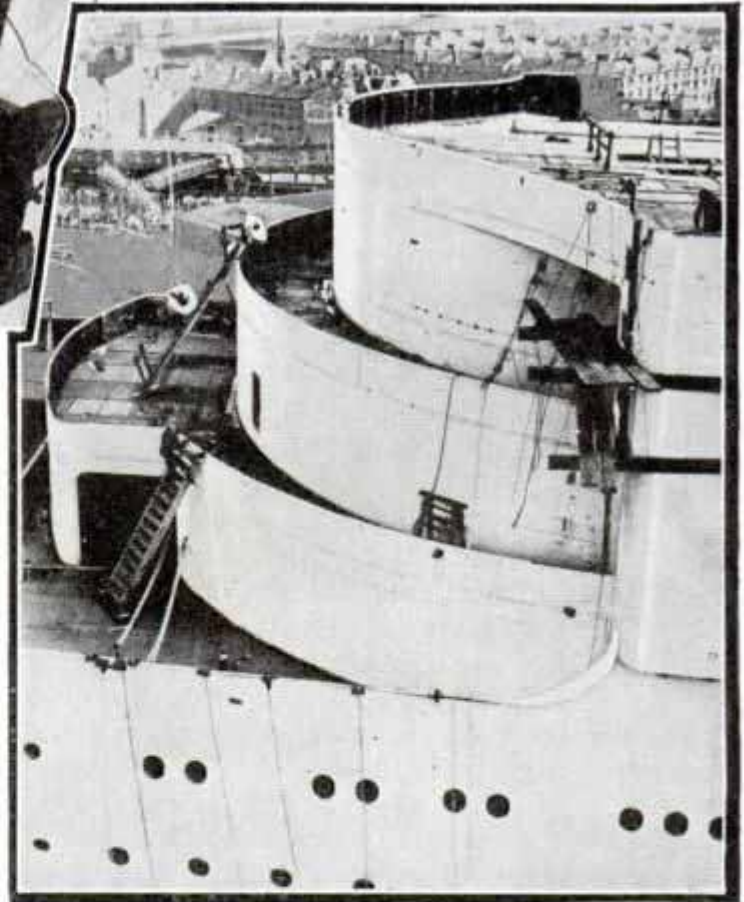

the highest point of the superstructure is 135 feet. With sloping stem and cruiser stern, and three funnels graduated to assist in the discharge of gases, you have the ship's general form. The double hull contains the fuel and water supplies. In all,

there are 160 water-tight compartments below the bulkhead deck, giving her unusual structural strength and a high safety factor.

Baths, showers, wash basins, telephones, thermostats and ventilators are standard stateroom equipment. Four separate water-supply systems will lead into the first-class cabins, giving the passenger a choice of hot and cold, in both salt and fresh water. The public rooms, lounges, verandas, play decks, swimming pools, reception halls, Turkish baths, gymnasiums, tennis courts, and ball rooms will give passengers every opportunity for recreation and exercise, while the third-class accommodations will be superior to the first class of ships fifty years ago. Unusually

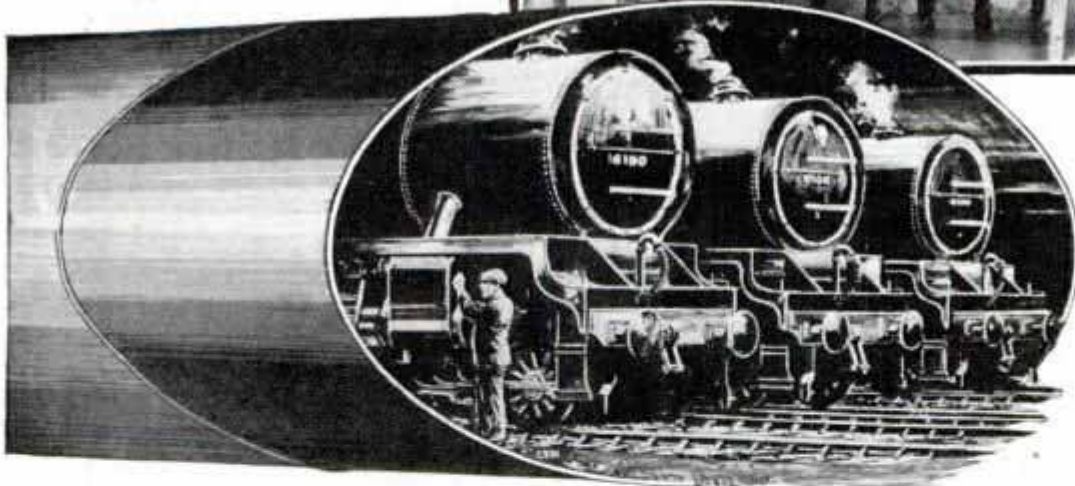
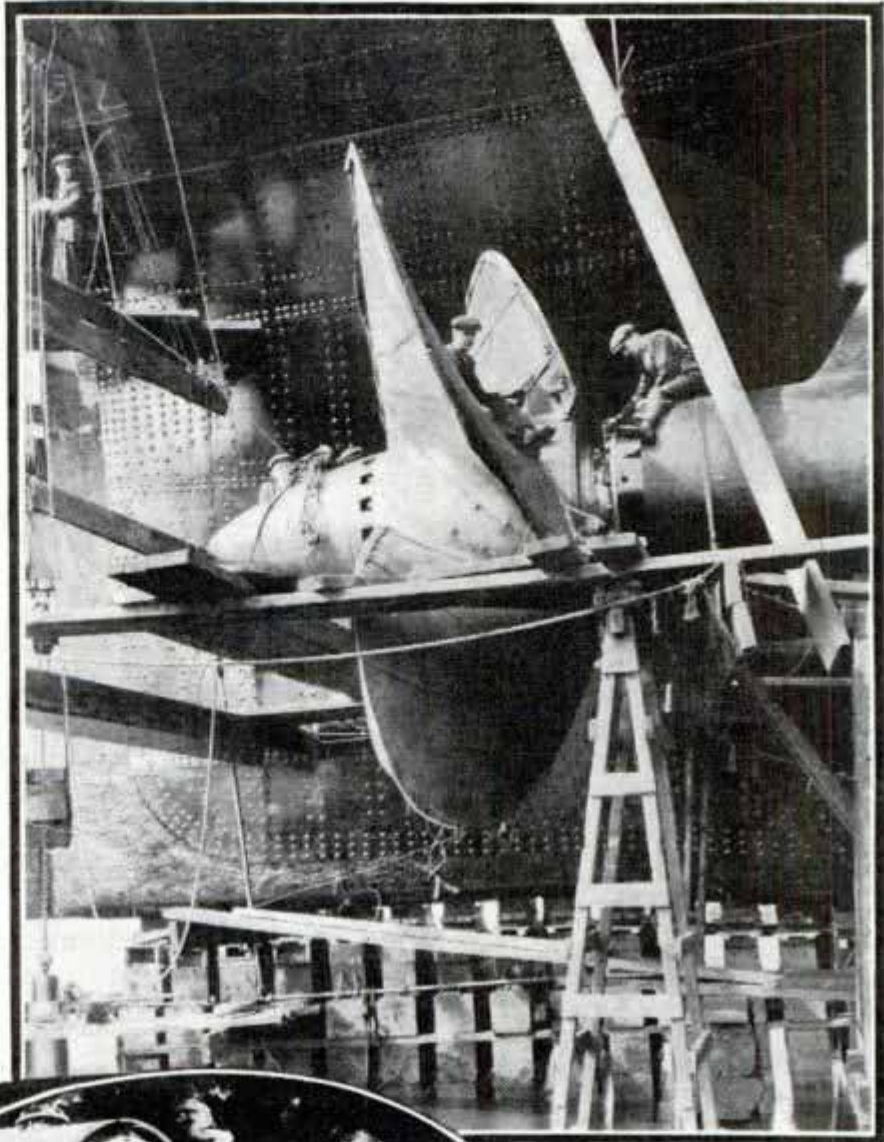

Above, Installing One of the Huge Propellers, Weighing Thirty-Five Tons; Left, Three Locomotives Could Be Placed Side by Side in One of the Funnels of the "Queen Mary"

large lifeboats with powerful engines, radio transmitters and water tanks, will hang from newly invented gravity davits. Each lifeboat can be lowered, fully loaded, to the water level within a few seconds, under the control of one man. Electric capstans with a combined pull of 400 tons will halve the time now required to draw a great ship safely to her berth.

When the master of the "Queen Mary" sets her course, she will be kept true to

the compass by a powerful electric hydraulic four-ram steering gear. Officers on the bridge will have many ingenious devices to ease their work and to enable them to see not only fore and aft, port and starboard, but also below and above. The configuration of the ocean bottom will be revealed automatically by a depth-sounding device. Submarine signaling, wireless telegraphy and telephony comprise the

(Continued to page 122A)

Conv. Sec. Lem Benn
Avena Jr. 1012
Washington
Dayton, Ohio

D 1230

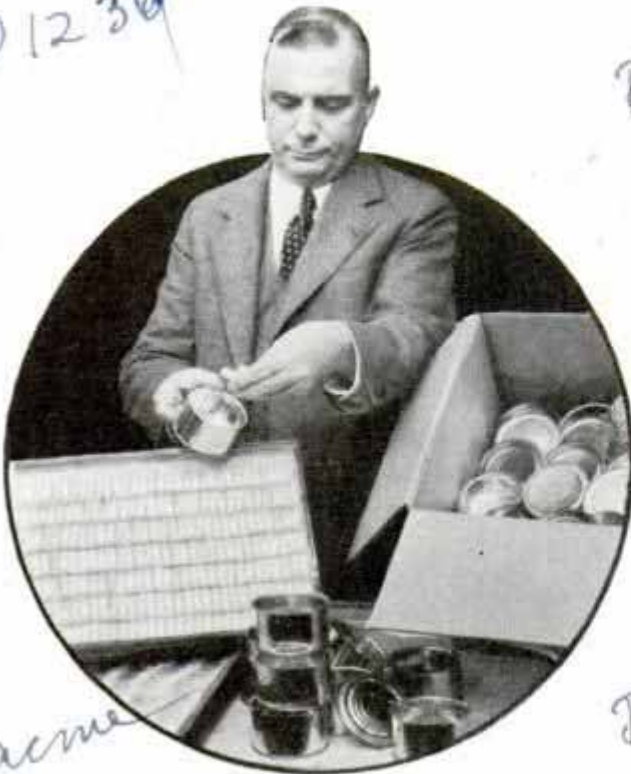

Containers in Which Parasite Flies Are Shipped to Wage Battle against Earwigs

CITY SELLS PARASITE FLIES TO FIGHT EARWIGS

One city adds to its revenues by selling flies, and this year has made about \$2,300 profit from the venture. Years ago, Portland, Ore., became infested with an influx of earwigs. French entomologists discovered an earwig parasite fly and the parasites were imported to eradicate the pests. Now Portland itself is engaged in shipping these flies to other parts of the country where earwigs abound. The flies are shipped in tin cans and are unharmed by long railroad rides.

OVAL NAIL WITH CHISEL POINT IS EASIER TO DRIVE

Oval-shaped nails with chisel points are said to be easier to drive, harder to pull, less liable to split the wood and harder to bend than the ordinary round nail.



The sharp chisel point cuts cleanly across the wood grain, allowing the oval shank to enter the wood with the grain, free from fiber distortion.

D 1235

Northwestern
Day Wire Co

FORTUNE IN POUND OF PIG IRON WHEN MADE INTO SPRINGS

One pound of pig iron costs the manufacturer less than ten cents, but the same pound, when converted into steel and made into little spiral springs which move the balance wheels of watches, is worth a fortune. These springs, weighing less than one-tenth of a grain each, sell for as much as six dollars apiece. It is estimated that 80,000 such springs, valued at \$320,000, can be made from one pound of iron. In like manner, one pound of cotton, worth only a few cents, can be converted into material valued at from \$15 to \$20. It can be spun into 25,000 miles of thread.

D 1299

SHREDDER MAKES EXCELSIOR OF OLD NEWSPAPERS

Old newspapers and magazines are converted into excelsior for use in packing articles for shipping by running the paper through a shredder consisting of a motor-operated disk of large size carrying three knives which cut against a stationary knife in the frame. As the disk revolves at high speed the knives shear against the stationary blade and cut the paper on the principle of the ordinary scissors. Newspapers, in stacks up to one-half inch thick,

D 1236



Shredding Machine Which Converts Old Newspapers and Magazines into Excelsior

are fed into the shredder on rollers and the shredded paper passes into a discharge spout at the base of the machine. The capacity of the shredder is about 1,200 pounds per hour.

Mitty S. Merrill
Saginaw, Mich

Invent. by George Trier
125 In. Chester Ave.
D/1298

DUMMY BELL BOYS HOLD CARDS ANNOUNCING SPEAKERS

At a recent session of the National Safety Congress twenty-six dummy bell boys served as guides for those in attendance. In previous years it was necessary to have an attendant for each meeting room as there were more than 100 sectional meetings and nearly 400 speakers during the five-day session. This year dummies were cut from plywood and painted to represent bell boys, one being placed at the door of each meeting room. Clips at the top of the board held by each dummy were used to clamp into place signs denoting the session in progress. Holders made of wire contained the name of each speaker as he appeared on the platform, the signs being changed as the speakers changed, so that visitors could tell at a glance the session which was in progress and the person who was being heard at the moment.

D/1298



Pat. Pending
Park

Miniature House, Resembling a Log Cabin, Is Made of Empty Rifle Cartridges

MODEL HOUSE OF CARTRIDGES MADE BY SOLDERING

Empty twenty-two caliber cartridges, about 1,500 of them, are used in a miniature one-room house produced by George Trier of Illinois. The house is complete, even to the chimney made of the shells. Two and one-half pounds of solder were used in the small structure, which closely resembles a log cabin. Only the windows and door are not made of the cartridges. Approximately eighteen hours of spare time work were occupied with the task.

AUTOMOBILE KEY EJECTS ITSELF WHEN DOOR IS LOCKED

For the forgetful motorist who parks his car and walks away leaving the key in the ignition lock or door, one inventor has made a self-ejecting key which springs back into the hand as the key is turned to the locked position. A strong spring is installed in a slot in the key shank. Studs coil the spring as the key is inserted in the lock, and release it on withdrawal.

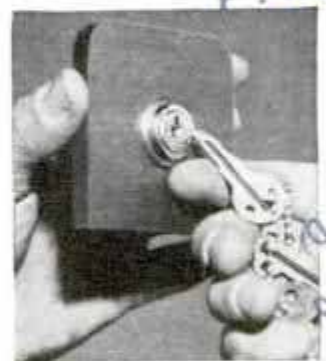

D/268
Invent. by
Ivan, B. & Wm. B. Swanwick
25 Pleasant Ridge Ave., Columbus, Ohio

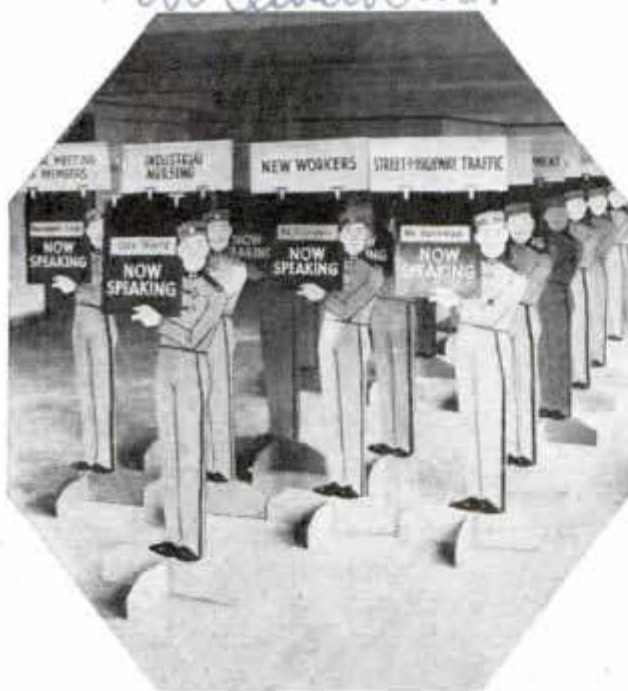

These Dummy Bell Boys Served as Guides for Various Sectional Meetings of a Recent Convention

NON-SPARKING TOOL METAL REDUCES HAZARDS

D/224

Sparks flying from steel tools have caused many fires and accidents. Now a non-sparking metal for tools has been produced to reduce these hazards. The metal is an alloy of copper and beryllium. Heat treating of the alloy results in a tough, hard material of high tensile strength.

Stanley Tool Works
New Britain Conn

and Harry Barrington, 205 Washington Blvd. and Club Park Bldg.

D7256

Col. John L. Cooney,
3107 - 19th St. N.W.
Washington D.C.

The RACE HORSE



CAN the doping of race horses be stopped? Uncle Sam is taking steps to do so.

Last year federal agents working under cover during the racing season made the startling disclosure that over 300 horses in as many races at leading tracks were doped. The doping of horses consists of some of the most inhuman practices conceivable. Tongues are pulled forward and their "swallows" rubbed dry. Then on the base of the tongue powdered heroin is spread. This "hop" makes a horse run wild until he literally drops dead in his tracks. Or, thirty minutes before a race, the horse is drenched through the mouth with a liquid caffeine mixture containing heroin, strychnine, digitalis and other stimulants. Or a hypodermic needle is thrust into the neck and heroin is injected directly into the bloodstream.

*Why Dope Horses Which Naturally Run Like This?
Below, a Small Tin of Oriental Dope*

DOPE *Racket*

To wipe out this racing evil veterinarians and chemists from every racing state met recently with Commissioner H. J. Anslinger, chief of the federal narcotics bureau at Washington. The result was a resolution* to form a central bureau in the treasury department for the purpose of research and study necessary to unify the procedure to be followed by each state racing commission in de-



Above, Making Saliva Test of Race Horse; Below, These Hypodermic Syringes Were Confiscated at a Nationally Known Race Track

tecting and preventing doping. Also steps were taken to bring into line those states which do not fully enforce their anti-doping laws.

During the meeting a demonstration was given of the saliva test, widely used in Europe to prevent doping. This consists of inserting into the horse's mouth a gauze pad saturated with distilled water which, as he masticates, produces a flow of saliva. This saliva is captured in a basin and with it other saliva taken from the mouth by

drying it with a pad of dry gauze. Examination of the saliva by a chemist shows the presence of strychnine, heroin, digitalis or other drug, in which case the horse is not permitted to race.

Nearly all the states now permitting racing have adopted the dope-box saliva test. This means that before horses are permitted to race in these states they will be examined for the detection of dope. In addition, California requires that racers be in a receiving barn or paddock an hour before a race starts. "If we had such a regulation as this applying to the country as a whole," says Mr. Anslinger, the racing dope evil would be greatly curtailed. The effects of a drug would wear off before a race, or at least permit us to know whether a horse had been doped or not."

The purpose in doping horses is to make them "race up." A hypodermic of cocaine or heroin has the same stimulating effect on horseflesh that a stiff drink of liquor has on a man. He feels cheerful, full of pep and ambitious to run. Physically, however, dope has a depressing effect on a horse. For this reason strychnine is given along with heroin. Strychnine is a powerful heart and muscle stimulant. Cocaine

(Continued to page 122A)

*The White Motor Co
842 E 79th
Cleveland, Ohio*

D/1246

"Pancake" Motor Drives Streamlined Truck

*Emb. James Scotland
77 Coramond Road
Cleveland Heights Ohio
399*

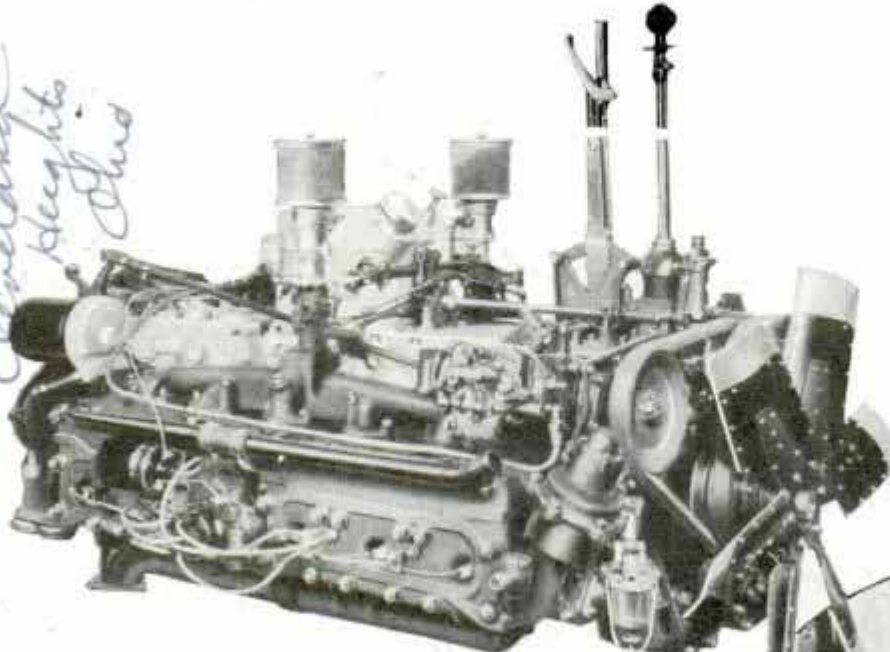

Top, Horizontal or "Pancake" Motor Used in New Truck; Right, Short Front of Truck Designed to Decrease Wind Resistance; Note Driver's Position

cylinder sleeves that may be replaced when necessary, eliminating cylinder re-boring. Exhaust valve seats are made of stellite, a heat-resistant alloy. The crankcase and four cylinder blocks, each containing a bank of three cylinders, are cast in one piece. The transmission has five speeds forward and one reverse. It is claimed that gasoline con-



Powered by a twelve-cylinder, 130-horsepower engine of horizontally opposed or "pancake" design, a new streamlined truck embodies some unusual features. To aid streamlining, the engine house at the front has been removed entirely, the pancake engine being mounted under the truck just over the front axle. So placed, it has been possible to incorporate the engine controls in one assembly. Thus, the radiator, instrument panel and emergency brake together with the motor, clutch and transmission are mounted on a sub-frame and can be removed from the truck as a unit. The pancake engine has removable

sumption is less than that of a six-cylinder engine of smaller displacement.

*Emb. Alfred U. Child
Beach Haven,
Jamaica*

D/1228

Kamukura, Japan

Motorcycle Sidecar with Top Has Spare Wheel Space

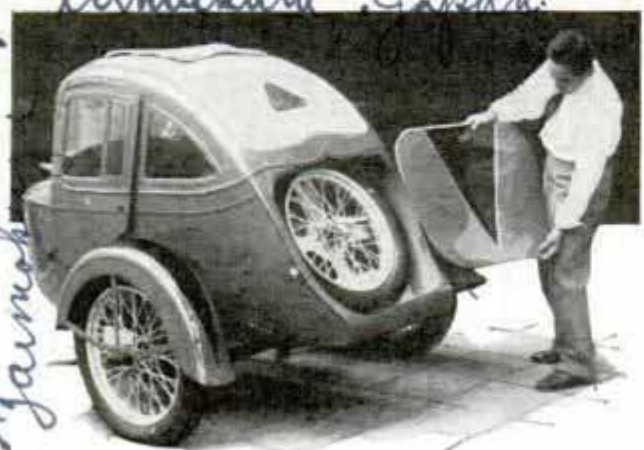

Special Sidecar for Motorcycle, with Cover of Spare-Wheel Compartment Opened

Fitted with a top to protect the occupant from the weather, a new sidecar for the motorcycle has space for a spare wheel and tire. The spare wheel fits into a compartment at the back of the sidecar, a cover giving easy access to the wheel in case of trouble. The sidecar was designed by Japanese engineers.

Names and addresses of manufacturers and dealers in articles described in this magazine will be furnished by our Bureau of Information upon receipt of a stamped, self-addressed envelope.

no further data

GLASS ABSORBS HEAT OF SUN BUT ADMITS LIGHT

Window glass has been developed which takes the heat out of sunlight but permits the light to pass. The heat-absorbing glass contains iron, and objects viewed through it have a greenish-blue color because some of the red rays of sunlight have been removed. Small amounts of iron in glass absorb ultraviolet and infra-red, the heat rays of sunlight. The visible part of sunlight contains only one-third of the heat in the sun's rays and the new glass cuts out the invisible rays but permits most of the visible rays to pass. While the heated glass might be expected to raise the temperature of a room as a whole, the effect on a person in the direct sunlight is much less than for ordinary glass. The glass is particularly suited to offices and factories.

ALL-METAL WINDOW AWNING IS ADJUSTED BY LEVER

Controlled by a single lever that is operated from the inside of the house, all-metal window awnings now on the market are fire and weather proof. The awnings do not have to be taken down in the fall and put up in the spring. To have the awning as a shade,

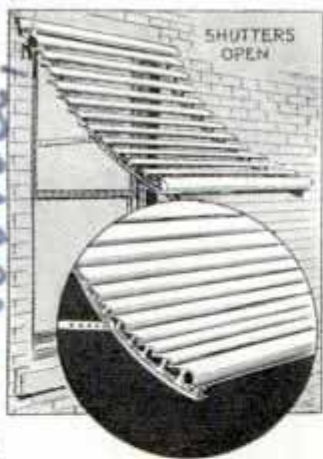

it is only necessary to raise the adjusting lever. This causes the shutters to close and to shed the light, rain or snow. The lever also opens the shutters to let the breezes and sunlight pass. Easy installation is another feature.

RECORD OF MILES PER HOUR KEPT BY SPEEDOMETER

One speedometer now offered not only tells the miles per hour, total mileage and trip mileage, but also keeps an exact record of the miles per hour traveled at all times during a trip. While a disk revolves in the speedometer head, a moving pencil-needle, actuated by the same mechanism that controls the mile-per-hour indicator,



© Paramount Productions, Inc. This Speedometer Keeps a Chart Record of the Miles per Hour Traveled during a Trip

marks a chart affixed to the disk. At the end of a trip, the chart can be removed to preserve as a record, and a fresh one inserted. The record enables the car owner to learn the most economical running speed and to keep a close check on fuel and oil consumption. It is also a verification of speed in case of accident.

RAZOR RACK AND BLADE HOLDER CLIPS TO CABINET SHELF

Safety razor and ten new blades may be stored neatly in the medicine cabinet by slipping them into a combination rack and holder that clamps to the shelf. The razor hangs handle down, while a small drawer just above holds the blades. An automatic stop prevents the drawer from falling out and spilling the blades. The device is attached to the edge of the shelf, utilizing the underside. It is offered in several colors.

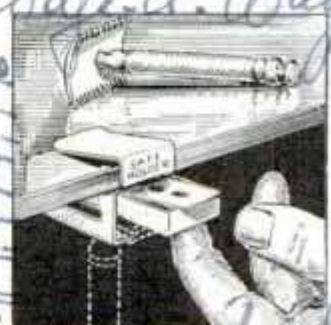

S. S. Bond 206 W. 8th St. Emporium, Wichita, Kans.

10/4/34

Chimer Register Co. 834 S. Figueroa Los Angeles

D1233

D1249

D1251

D1220

Boamberg Products Co. 105 S. Jefferson

RADIO COMPASS LEADS FLYER TO BROADCAST STATION

Pilots flying over oceans or unknown routes are enabled to find their way directly to any broadcast station by using a long-range automatic radio compass consisting of an indicating dial mounted in the cockpit, an aircraft radio receiver and compass converter unit, a dynamotor and a loop antenna mounted in the fuselage, the complete assembly weighing less than forty-five pounds. When within range a pilot may tune in on a station by using earphones. If the ship is headed directly toward the station the indicator dial needle points to zero. If it is off course, the needle points to left or right as the case may be. The instrument also enables a pilot to locate his position over land or sea. To do this, he tunes in several stations, determines their direction, and by a system of triangulation fixes his own position.



Throwing Stick Used Instead of Bow to Shoot Arrows; It Was First Employed by Mayan Hunters

ARROWS THROWN WITH STICK INSTEAD OF BOW

Ancient Mayan hunters used a "hulche," or throwing stick, instead of a bow to shoot their arrows great distances with deadly accuracy, and the weapon is being revived in modern sport on the Pacific coast. Archæologists found specimens of the throwing sticks in Yucatan. These were brought back and have served as models for sticks being used by archers today.

REVOLVING TOP FOR CHIMNEYS CREATES BETTER DRAFT

Combination smoke cowl and ventilator, a revolving top for chimneys, is available



for the purpose of creating a better draft for the furnace. The top part of the device turns and is so arranged that the wind keeps the mouth or open end away from the direction in which the wind is blowing. This creates a vacuum, setting up a draft from the flue through the cone

and out. The top also can be used as a ventilator.

TAG BOARD SHOWS LOCATION OF CABLE REELS IN YARD

To indicate the exact positions of heavy cable reels in storage yards, an employe of a telephone supply company devised a tag board indicator. Each reel is assigned

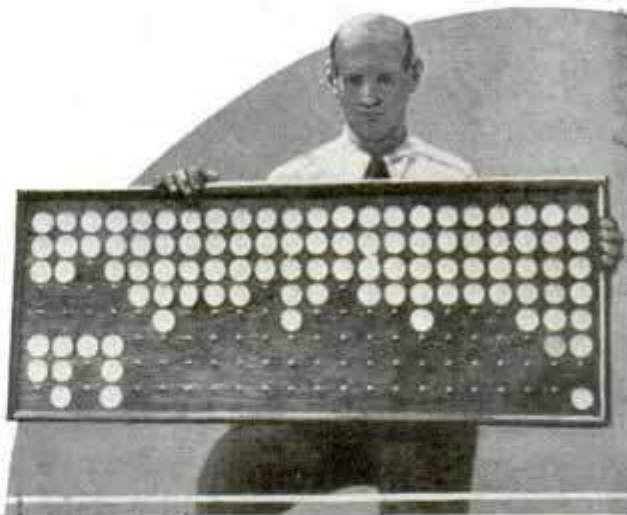

Tag Board Used to Indicate the Exact Location of Heavy Cable Reels in a Storage Yard

a given position in the yard and its exact location is indicated on the board which is equipped with pegs from which circular tags are hung. Each tag contains information as to the size and quantity of cable on the reel it represents and is hung in a position corresponding to the location of the cable in the yard.

Western Electric Co
Branch at Syracuse, N.Y.

Handwritten notes:
D. 1241
2100 N.
Beachwood Drive Hollywood Calif.
D 1158
Islandale, Calif.
D 1223
D 1136
Peter A. Segnan, 320 Island Blvd, Newark, N.J.
by Earl B. Powell, July 1937
Cmt. quantity 1000000 2000000 3000000 4000000 5000000 6000000 7000000 8000000 9000000 10000000
Cmt. 1000000 2000000 3000000 4000000 5000000 6000000 7000000 8000000 9000000 10000000

D 1301

55% OF ALL MACHINERY IN THE COUNTRY IS MORE THAN 10 YEARS OLD

MEN WANTED

AMERICA NEEDS
400,000 NEW
HOMES EVERY
YEAR

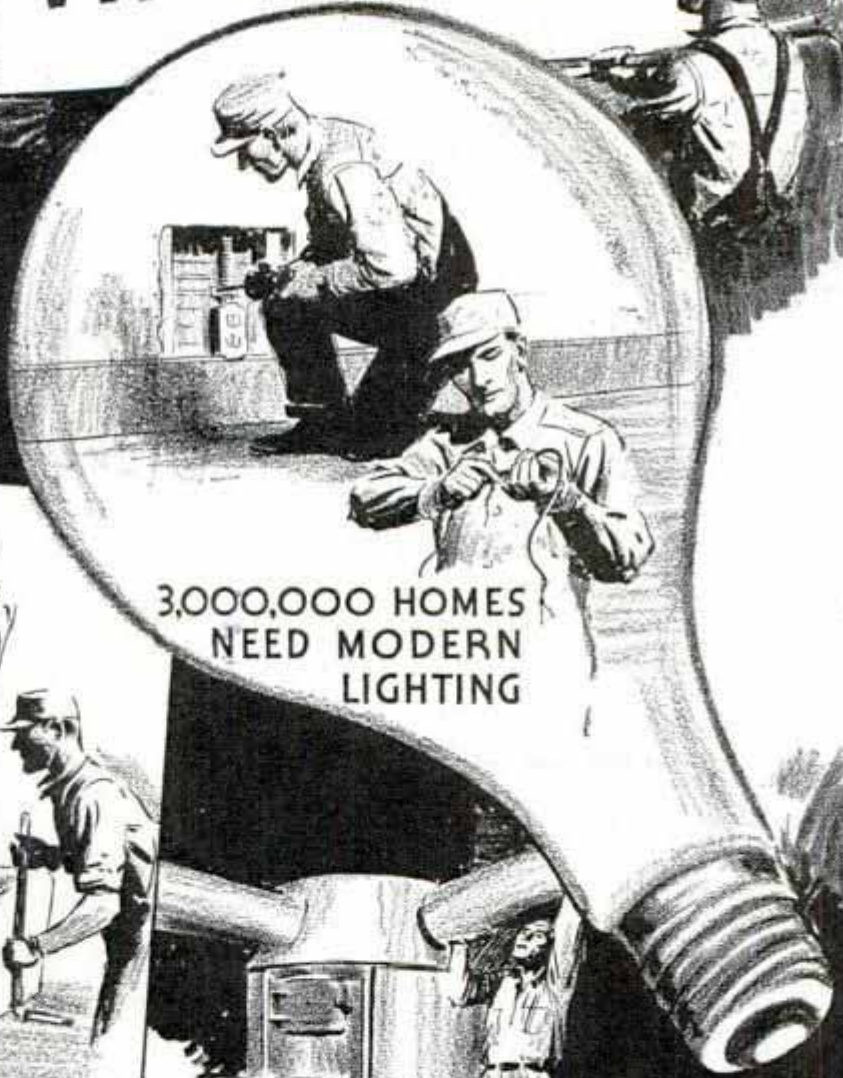

3,000,000 HOMES
NEED MODERN
LIGHTING



MORE THAN 10,000,000
HOMES NEED A TUB
OR SHOWER

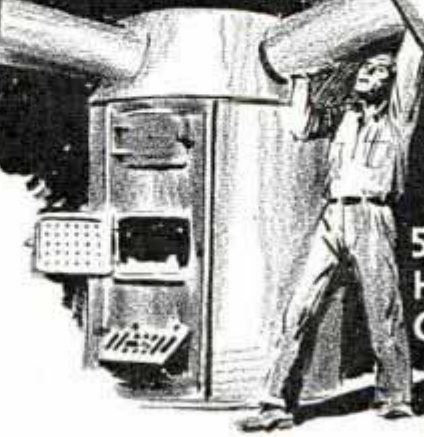

56% OF CITY
HOMES HAVE NO
CENTRAL HEATING

Under Government Auspices, Investigators of the Real Property Inventory Are Making a Survey of American Homes; These Figures Represent Findings from the First Million Homes Canvassed

Washington, D.C. 87

Wm. Young Cincinnati Ohio

D1295

James Lewey Sierra Madre Calif

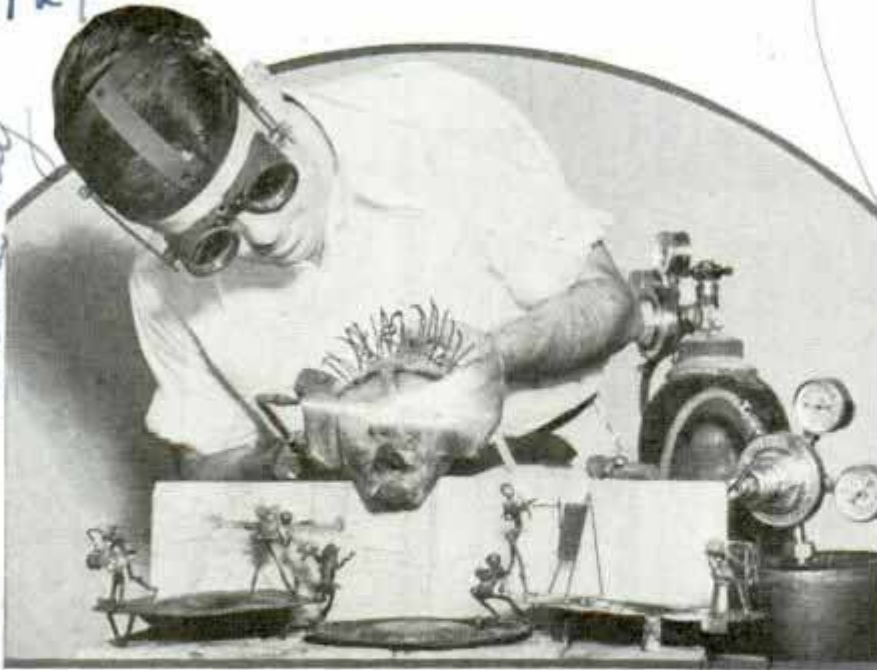

pat
Making Grotesque Figures of Wrought Iron with the Aid of a Blowtorch, a Welding Rod and a Pair of Pliers

SCULPTOR USES BLOWTORCH INSTEAD OF CHISEL

One California sculptor works with metal instead of marble or clay and uses a blowtorch instead of a chisel. He builds up grotesque figures of wrought iron, modeling the hot metal with the aid of an acetylene torch, a welding rod and a pair of pliers.

SIMPLIFIED GAS COMPRESSOR FOR QUIET REFRIGERATION

Refrigerating machinery can be made to operate almost silently by use of a new, lightweight gas compressor. Piston rings, piston pins, crankshafts, connecting rods, gears, cams and valves are omitted from the compressor. Its cylinders are bored in cylindrical blocks, each of which resembles the cartridge chamber of a revolver. When pistons are inserted in the cylinders, the rotation of a cylindrical block causes the pistons of both blocks to work back and forth, compressing the gas in them.

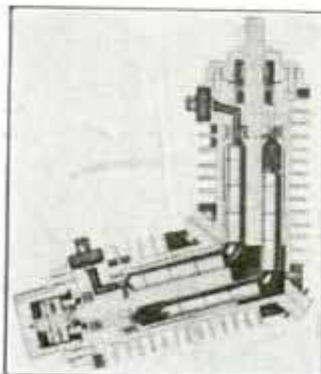

The new design reduces the weight of the compressor by forty-five per cent. Vibra-

BACKING LIGHT WARNS DRIVER OF THE CAR BEHIND

Drivers at the rear can be warned of an intention to back up if the automobile is



Reversing Signal Which Lights and Sounds Horn When Gears Are Shifted

Exhibit #208 Inventor of Patents

equipped with a reversing signal devised by an English inventor. When the car is shifted into reverse, this device automatically sounds a horn and a light at the rear illuminates a glass disk with the word "Reversing" on it.

Thermal Trucks Mfg Co. 112 and 114 Pacific Road

Chicago Trib 10/23/24

Dr. Charles S. Abbot,
Dir. of observatory
at Mt. Wilson
D129

**BLUE STAR LIGHT IS DEATH RAY
BUT AIR PROTECTS EARTH**

If it were not for the atmosphere above the earth, all life would be wiped out by the rays from huge "stars of death." The Smithsonian Institution has found that virtually all of the blue stars emit death rays which, however, are screened out by a layer of ozone high in the earth's atmosphere. These stars have a surface heat of 36,000 degrees Fahrenheit, three times as hot as the sun, but they were found to give off few of the sun's beneficial type of ultraviolet or heat rays.

**LOUVERS UNDER FRONT FENDER
VENTILATE ENGINE**

Engine heat is kept out of the passenger compartment of one make of motor car by louvers located under the front fenders. Heat from the motor passes out through these louvers and, traveling down along the under side of the fenders, is carried away beneath the car. With such an arrangement, ventilating openings in the hood can be made smaller and given an ornamental treatment heretofore impossible. The plan also prevents engine heat from entering through the open windows.

Packard Motor Car

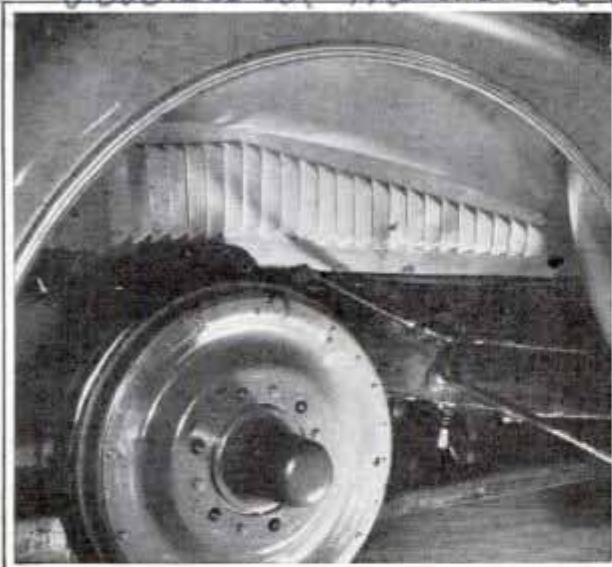

Louvers under Fenders Dissipate Engine Heat and Keep Passenger Compartment More Comfortable

Inquiries as to makers of articles described in Popular Mechanics, will be answered by our Bureau of Information upon receipt of return postage.



As Pianist Touches the Keys, Colors Corresponding to Notes Appear on White Disk

**PIANO PLAYS MUSIC IN COLOR
ON WHITE DISK**

Different notes in a composition are reproduced in color on a white disk by a piano exhibited recently in London. The colors appear on the disk as the music is heard. Each note has its own color.

**PEN REST FOR EASY WRITING
GUIDES THE POINT**

Writing without the usual fatigue is made possible by using an attachment for a pen. The device projects from the pen staff just above the point, serving as a rest and helping to steady the hand. The user is enabled to hold the pen point at the proper angle to write a certain style, making the device an aid in learning penmanship. In addition, the attachment contains a point that holds sufficient ink for writing two pages before being dipped into the writing fluid again. The point is stainless steel.



Miss Mary K. Yude.
303 W. 89th St.
New York

Exhibit # 46

1580
D1279
D1248

Westinghouse X-Ray Co. 21-16-43rd
Brooklyn, N.Y. 1308

Taken by Harold
O. Peterson
Westinghouse X-Ray Co.
Brooklyn, New York
Museum

X-RAY

The MASTER

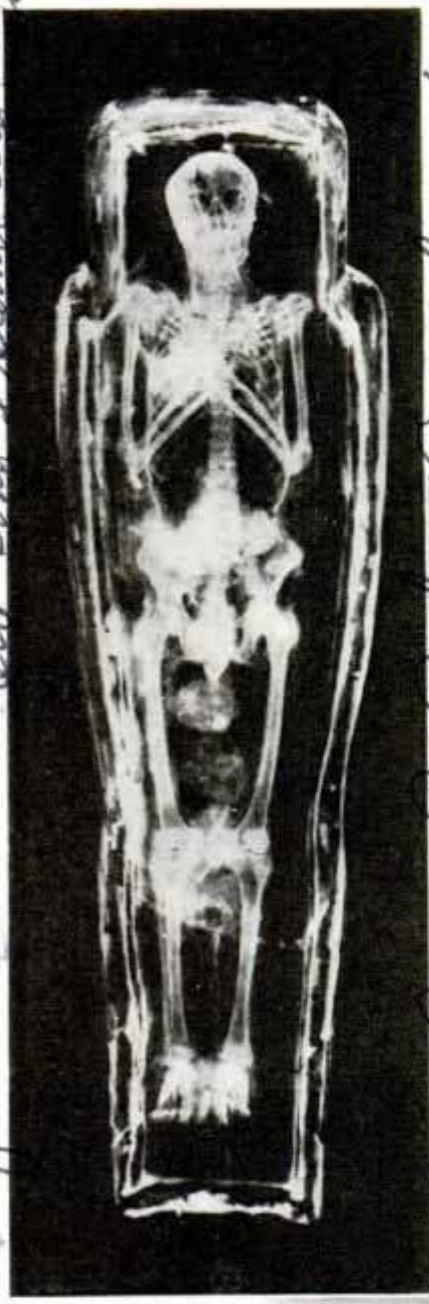

Miss Anna B. Bollen
Field Museum

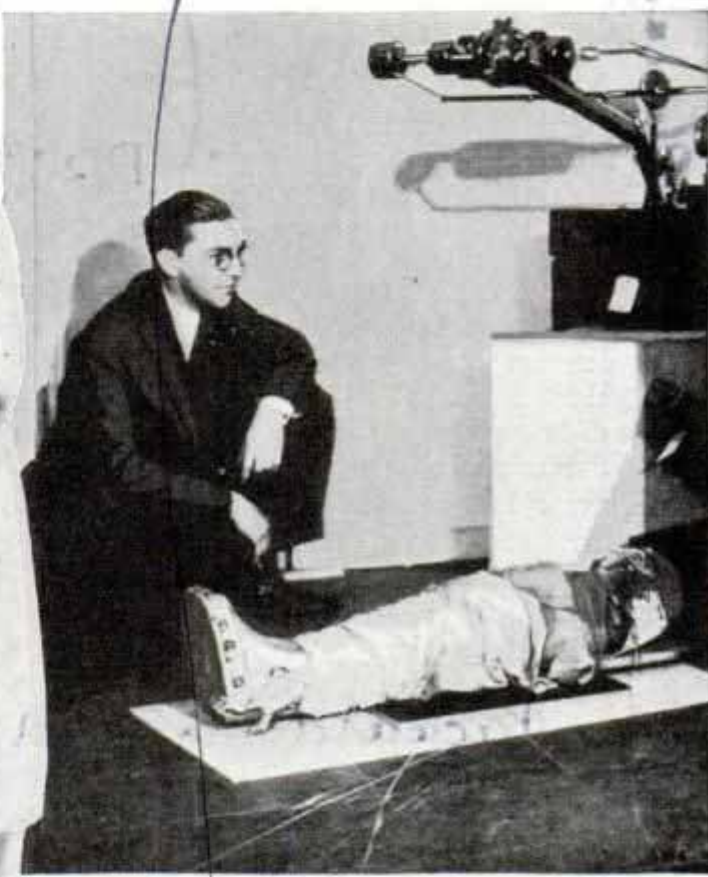

Taking X-Ray Picture of Mummy of Child
and, Left, X-Ray of Mummy on Film Seven
Feet Long and Two Feet Wide

By KENNETH CRIST
1158 W. Vermont Ave

THERE is in this world a "Sherlock Holmes" far greater than Conan Doyle's fantastic wizard; not a man, not a genie, not even a ghost. It is the strange, invisible cyclops of science that sees all, reveals all, and possesses the power to bombard your body with billions of tiny projectiles. It is the mightiest of all detectives and, because it mystified experts, you learned to call it X-ray.

With this magic eye you can look through five inches of solid steel. You can check metals for tensile strength, examine

boxed candy for foreign particles, or explore a child's stomach for a swallowed button. You can spot defects in castings, in welds, and in rubber. You can find out what is wrong in hidden assemblies, tell frosted oranges from fruit that is good, remove hair, sterilize criminals, or expose broken bones in the human frame.

Without it your shoes might fail to fit your feet, the police would lose a snare for forgers, "doctored" pictures could be passed off as masterpieces, and electricity would splutter to naught as a treatment for cancer. Yet, if it had not been for a common latch key tossed carelessly to a

Dr. Jesse W. M. Hummer, D 1308
~~Research Institute, Phillips~~
~~California~~

Right, Using "Cross-Eyed" X-Ray,
a Three-Dimensional Machine Which
Makes It Possible to Measure Internal
Body Cavities

1201 California St
Pasadena

of MAGIC

Calif. Institute of
Technology

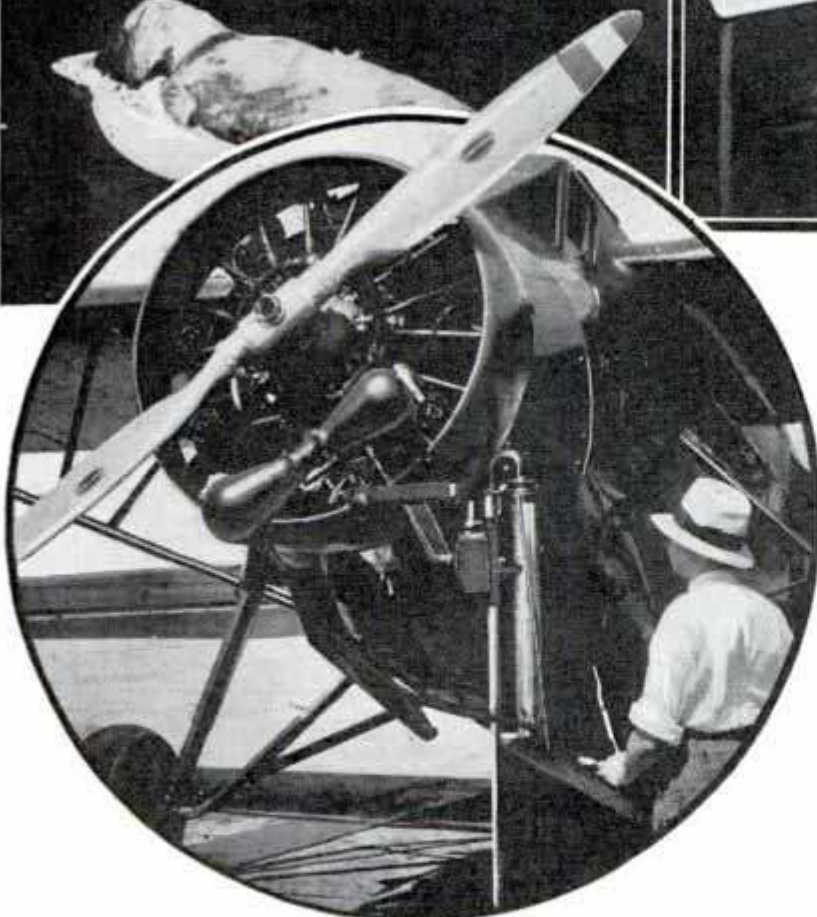
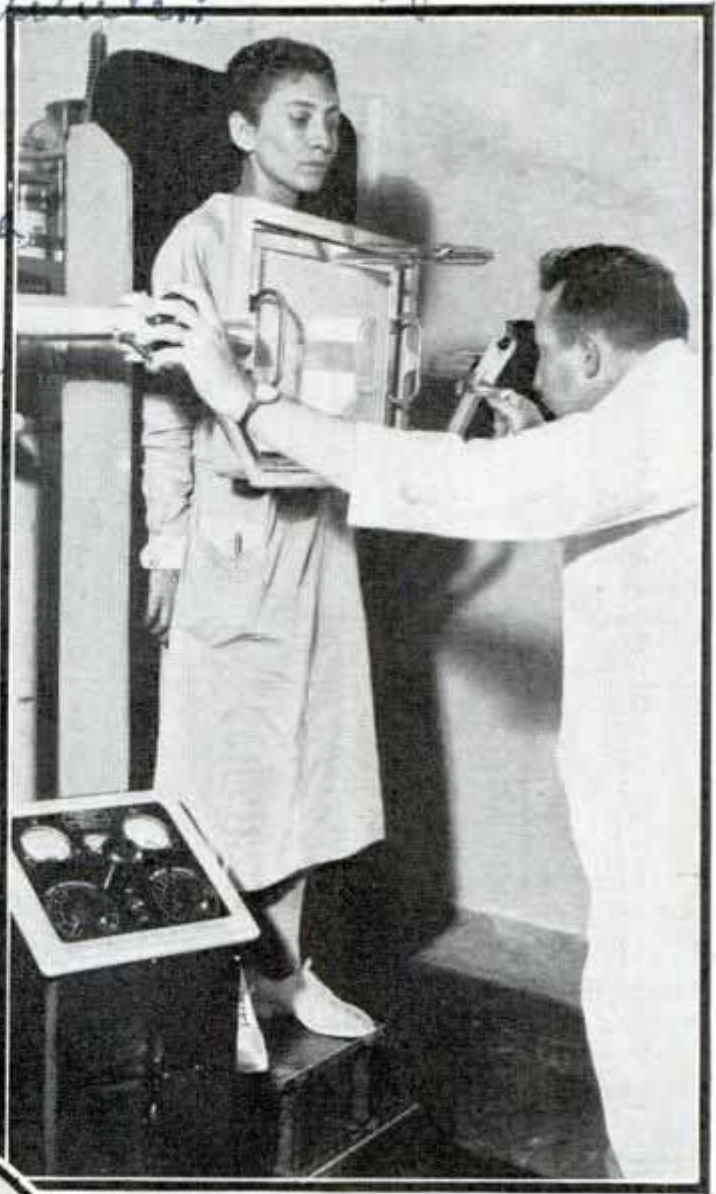

This Small Portable X-Ray Unit Is Being Used to Inspect
Airplane Parts and for Work on Construction Jobs Outside
the Laboratory

desk in Bavaria you might never have had the X-ray! Dr. William Konrad Roentgen entered his laboratory at the University of Wurtzburg and thoughtlessly flipped his key at a desk in which there was photographic film. There were experiments to do with a vacuum tube and the known Lenard rays.

When darkness came Dr. Roentgen saw a strange and eerie illumination appear in the tube's vicinity. It was a glow that science did not know and he got out his film for a picture. When he developed his negatives he was amazed to find a photograph of his key. There was just one way to explain it—the glow had passed through his desk!

He announced X-ray in December, 1895. Within a year machines

D1308
92

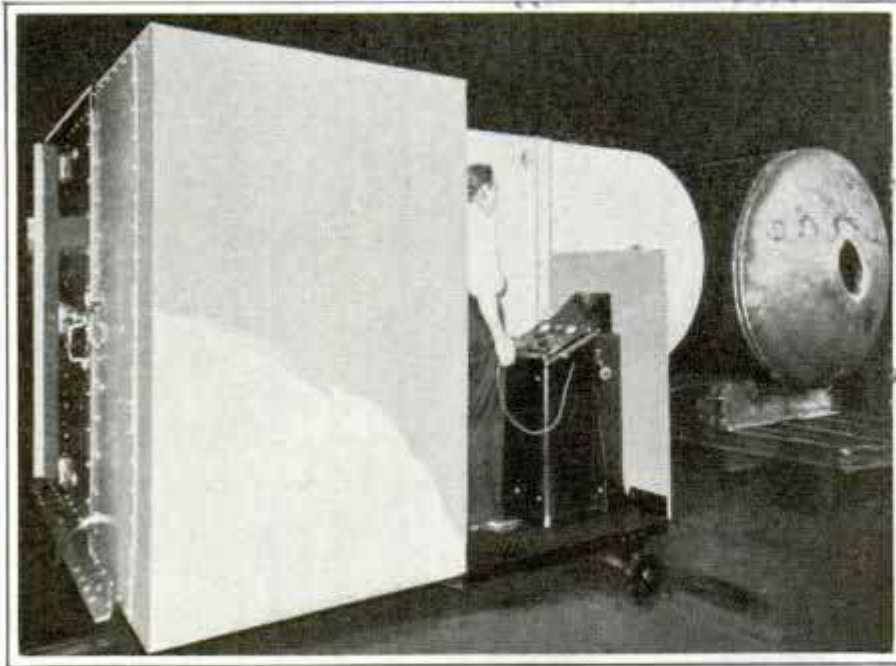

far shorter than that. You have to forsake the "mu" and adopt the Angstrom unit with its symbol, "A," denoting .0000000001 meter, to continue through the spectrum sequence.

You can see red light at 7,000-A, a part of the visible spectrum. Between red light and ultraviolet fall all other spectral colors. In the ultraviolet "band" below 1,800-A you have to work with a vacuum tube or else the air will absorb the radiation. When you get below 500-A you leave the ultra-

violet and come within the scope of what are called "soft" X-rays. As you shorten the X-ray wave length you increase its power. You can get X-rays so short by using a 600,000 to 800,000-volt transformer that they actually bridge the gap between light and radium radiation!

Because this is true, your



were functioning in the major centers of the earth. Always, however, there remained the "X"—that mute, algebraic symbol of mystery. It took modern science to expose to you these truths:

In the spectrum sequence there come radio waves, heat waves, visible light, ultraviolet, and then X-rays. All of these phases pass through ether in a wave-like path at 186,000 miles a second. They are not all the same for the reason that each has a different wave length.

If you measured the longest radio wave you would find it about 10,000 meters from crest to crest, a distance approaching five miles. It is possible, however, for a radio wave to be as short as one-half an inch. You figure a meter at 39.37 inches and then take a millionth of that, called a "mu," to measure the shortest heat wave. Yet, there are waves

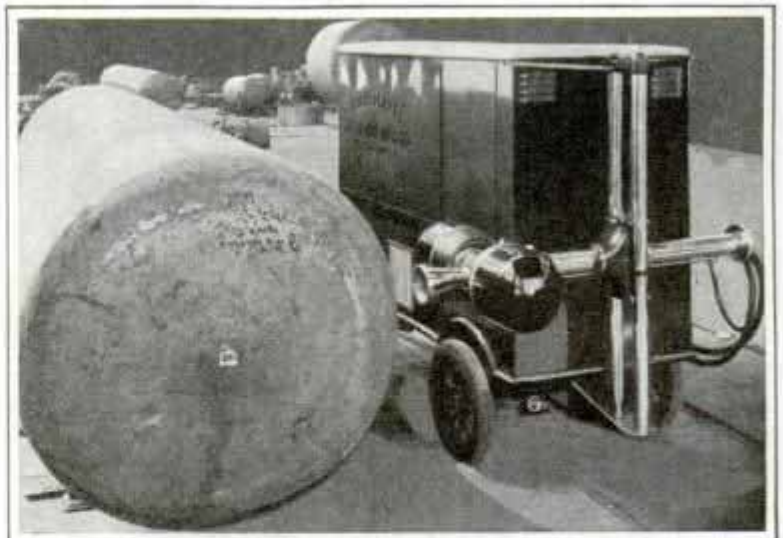

Top, High-Voltage X-Ray Plant for Examining Steel; Center, the Orange at the Left Was Frozen; That at the Right Was Good; Bottom, Weatherproof Portable X-Ray Unit

physician has a range in the X-ray wave length he selects in treating his patients. If he is handling a cancer case he may use a radiation a thousand times as strong as the one he would need to examine your broken rib. There was a time when the

D1308

Owner - Mrs. Barber
Scraper, W. Va. 93

medical profession controlled the X-ray field. That day is gone, for industry has adopted the magic eye and turns it on its products. All of the seventy-five miles of steel welds in the Boulder dam penstocks are being checked with X-ray. That one job involves 24,000,000 square inches of film and 159,000 separate X-ray exposures!

Airplane manufacturers, motor car plants, and engineers installing high-pressure steam lines frequently X-ray their castings. They know that the pictures they get will show up all shrinkable areas, gas voids, cracks, or "worm holes" caused by using a sand that is too wet. Because metals are made up of crystals an X-ray will tell you exactly what to expect in tensile strength. When you roll silver, copper or iron into sheets or draw it into wire you deform its natural crystal structure. Then you heat-treat to produce the desired mechanical properties. If you want to know exactly what happened you turn to X-ray analysis. It will tell you how the little cubes that build up the crystals are oriented in respect to the geometry of the whole. Upon this orientation depend the metal's elastic properties.

It has made its debut in the tire business and reveals fiber formation in rubber. If you go in for buying paintings you had better check up with X-ray. That way you can keep from being fooled with spurious "old masterpieces."

X-ray in the hands of police will reveal the forger's pen. It will spot re-tracings on questioned documents and befuddle the smoothest defendant. It closes the door to chicanery and fake and gives you scientific protection.

Modern X-ray safeguards your life, saves your money, serves your business, defends your health, prevents accidents, treats your ills, and helps to keep you from being swindled. What more can you ask—even of Sherlock Holmes?

MIDGET COW ONE YARD LONG IS A FAMILY PET

D1353

Two years old and three feet long, "Mabel," a perfectly formed Aberdeen Angus heifer, is the pet of a West Virginia family. The cow's parents are of normal size but Mabel is only twenty-nine inches high, one yard long and weighs only 140 pounds.



and
This Midget Cow Is Two Years Old but Weighs only 140 Pounds and Is Less Than Thirty Inches High

A sub-normal gland is believed to have been responsible for her midget proportions. The animal follows children of the family around like a dog.

D1325

DOUBLE-LIGHT HAND LANTERN WORKS ON DRY BATTERIES

Equipped with a double light, one a spot beam in front and the other a floodlight at the bottom, a new hand lantern operates on dry batteries. Either light may be brought into instant use by flipping a double-action switch. The lantern is compact,



standing only four and one-half inches high. The metal handle has a key slot for hanging on a nail or rope. Provision is made for hinging so the lantern can be placed upside down with the floodlight at the top. Made by Delta

Electric company, the lantern has a circuit that permits operation on either two or four standard one and one-quarter inch flashlight batteries.

Wild Cat.
Delta Electric Co.
Marion Ind

Diving Lamps Aid Hunt for Sunken Gold



Top, Examining Diving Apparatus and Lamps; Right, How Outfit Appears Moving along River Bottom

under working conditions. The sunken ship, the "Hussar," is believed to contain \$4,000,000 sent across to pay British soldiers and sailors during the Revolutionary war.

D1257

RAILROADS TO SAVE MILLIONS BY WELDING RAIL GAPS

If the small gaps between rails were not there, it is estimated that five years would be added to the life of railroad rails with a saving to the industry of \$180,000,000 a year in decreased depreciation. And the railroads believe they have found the key to the problem in welded joints between the rails, making the track two continuous pieces of metal. Gaps between rails have been thought necessary because of the expansion and contraction of metal in hot and cold weather but engineers have found there

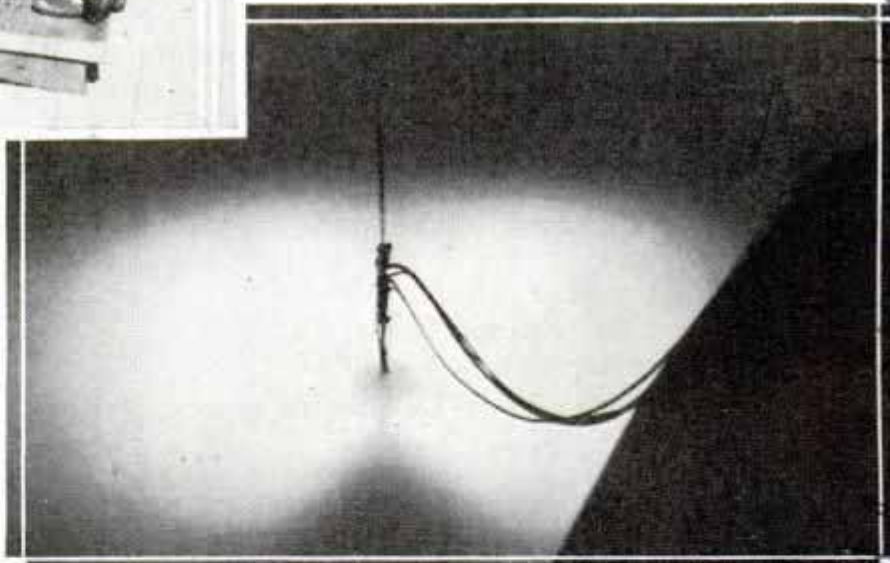

is a wide difference between the theoretical expansion and the actual expansion. In America the change is only one-third that calculated and experimental sections of track have been welded without any trouble resulting. The plan is to weld the rails in summer when expansion is greatest. In winter the rails try to shorten and stress on a given cross-section may rise as high as 247,000 pounds to the square inch, but this is well within the elastic limits of the steel and of the weld.

Science Service

10/18/34

Westinghouse Lamp Co
150 Broadway New York

Empire Marine + Salvage Co, 154 Nassau Street

Dr. Max Trumpler
Clinical Laboratories
Medical Arts Bldg
Medical D/1306 Park

**GAS AS FIRE ALARM FOR SHIPS
WAKES PASSENGERS**

Some new means of arousing passengers when fire breaks out aboard ship is being sought as a result of the "Morro Castle" disaster, in which there was heavy loss of life. A clinical laboratory has devised a method that dispenses with bells and sirens, using instead a gas. Introduced into the ship's ventilating system, sulphur dioxide would be carried to every part of the ship, quickly becoming so irritating that all passengers would awaken. Sleep with this gas present in the room is said to be impossible, making such a system a positive alarm in case of fire. The gas is not released in quantities sufficient to result in injury, its flow being carefully regulated by sensitive control valves.

Echbart

**GAUGE TESTS GASOLINE PUMP
AS AUTO ENGINE RUNS**

Testing the gasoline pump on the automobile is made easy by a gauge that works while the engine runs. The gauge checks up on the suction and pressure pull of the

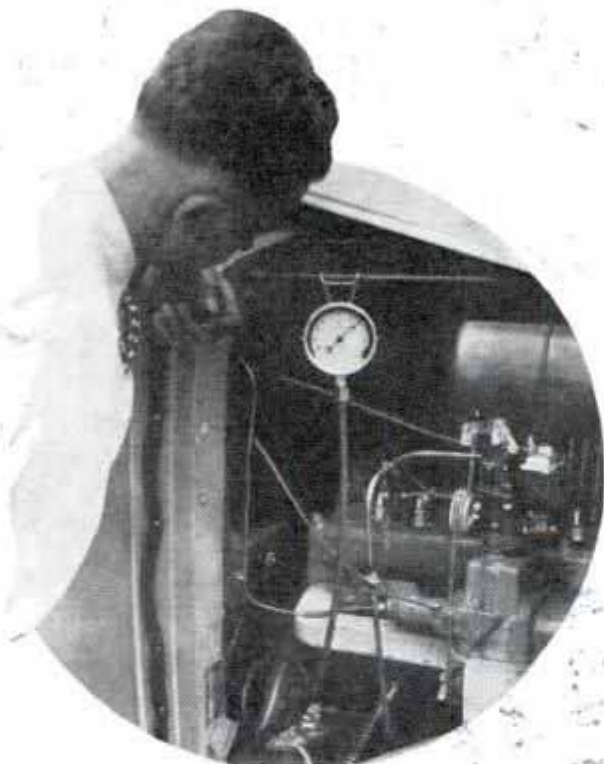

Efficiency of Fuel Pump Is Tested Easily by Gauge That May Be Attached While Engine Runs.

pump and the fuel delivery system. Leaking valves and fuel lines, as well as defective diaphragms may be detected quickly with the device.

Crosley Instrument
144 S. River St. All

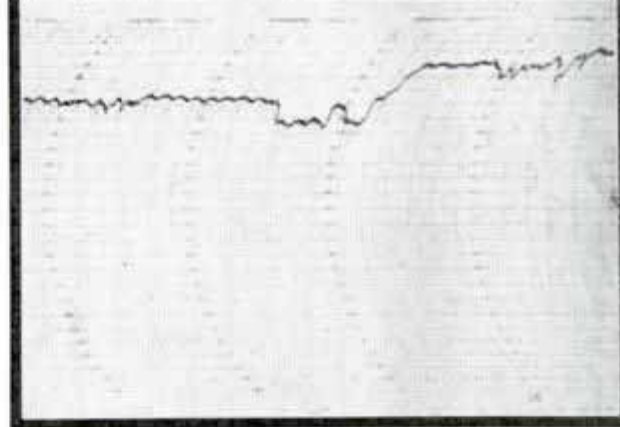

This Instrument Keeps a Continuous Record of the Depth of the Sea Bed

**DEPTH OF SEA BOTTOM SHOWN
ON CHART BY RED LIGHT**

One of the safety features of the mammoth new British liner, "Queen Mary," is a depth finder which operates a pencil and shows by a graph the depth of the sea bed at any time. The graph is horizontal so the record is seen in its true perspective. At night a red light flashes every three seconds on the dial, giving a visual indication of the depth. Changing charts is easy and current to run the fathometer is supplied by the vessel's own generating plant.

The Chinese were the first to use fingerprinting, applying thumb prints as seals on legal documents.

Carl L. Stone
Bennett

Submarine Signal Corp.
London, U.S.I., England
New York
145 Hudson St.

D1248
96

W. W. Kaplan, Esq.
Watkins, Lifeguard
Corps
Santa Monica
Calif.
Wm. H. Heston
Benjamin Stevens Jr.
1612 Washington St.



Using a Paddleboard Equipped with a Water Glass and Eye-Piece in Searching for Articles Lost by Bathers

WATER GLASS IN PADDLEBOARD HELPS FIND LOST ARTICLES

Life guards at Santa Monica, Calif., use a paddleboard equipped with a water glass in searching for lost articles which have been dropped into the water. The plate glass is fitted into the bottom of a hollow paddleboard and an eye-piece is attached to the top, so the craft is operated like a miniature glass-bottom boat. It has been used for locating lost anchors and cables in the yacht harbor and for quick search of the ocean bottom at depths of from thirty to forty feet.

FURNACE FIRE STARTER IN BAG ELIMINATES KINDLING

Coal furnace fires can be started quickly and without the work or muss of preparing kindling by using fire starters contained in small Cellophane bags. The package is lighted and tossed into the fire box and coal placed around it. Then the door is closed and the draft opened until the coal is burning. The bag contains a shredded material which is



a by-product from the manufacture of shoe soles and heels. This material is a combination of cotton, zinc, sulphur and rubber and a small amount of it becomes hot enough to ignite coal. The zinc assists in removing soot, the sulphur causes flaming and the cotton and rubber prolong the heat until the coal is burning.

THOUSANDS OF TINTS USED BY MOSAIC WORKERS

About 15,000 varieties of colors are employed by mosaic workers in Rome, and there are about fifty shades of each of these colors, thus offering 750,000 tints which the trained artisan can distinguish easily. With three-quarters of a million tints from which to choose, it might be thought that the most varied and beautiful paintings could be faithfully copied, but the mosaic workers complain that they need still more varieties from which to select.

"T.R.'S" FACE CARVED ON CLIFF MARKS ROOSEVELT ROAD

Appropriately marking the Roosevelt highway in California, a sculptor has



Covered with Cement, This Head of Theodore Roosevelt Overlooks Highway in West

carved a likeness of the face of Theodore Roosevelt on a cliff by the road. The face is coated with cement to make it more permanent. The sculptor caught much of the dynamic "T.R.'s" personality in his art.

Living Card Sole + Ideal Co.
Santa Monica, Calif.

Don't let this happen to you!

D1261

1261

5 cents
Covered with Cement
This Head of Theodore Roosevelt
Overlooks Highway in West

POPULAR MECHANICS

RECORDER SHOWS VIBRATIONS IN THREE DIMENSIONS

Vibrations in three dimensions, two horizontal and one vertical, can be measured by an apparatus which is an adaptation of the seismograph. The instrument is useful in studying vibrations produced by machinery, power plants, aircraft engines and in showing the effect of traffic vibrations on buildings and foundations. The three-dimension record makes it possible to ascertain in which path the shaking is worst, the story being told on a strip of motion-picture film. For the airplane, the instrument makes it possible for the pilot to tell at a glance whether his motor is in trouble and to differentiate between engine vibration and that caused by rough air. The instrument consists of a weight suspended in a frame by means of springs and a means for recording relative motion between the mass and the frame. Relative motions between weight and frame result in the rotation of three spindles which carry mirrors reflecting images of a lamp filament upon a photographic film.



Using an Apparatus Like a Seismograph Which Records Engine Vibrations in Three Dimensions

RIMLESS GLASSES HELD AT TOP REDUCE BREAKAGE

Some of the features of nose glasses and spectacles are combined in spectacle mountings which hold the lenses in place



Spectacle Mounting Attached at Top of Each Lens; Note the Strain Such a Mounting Stands

with only one attachment, and that at the top of the lens, instead of the side. The elimination of inside and outside attachments, and the making of the mounting in one piece greatly reduce the breakage of lenses. The top attachments give a wider field of vision by eliminating the "blind spots" common to many types of glasses. The long leverage of a top spring acts as a check and prevents the lenses from moving up or down while a horizontal cleat under the upper corners prevents wobbling or sidewise movement.

ALL-ANGLE LEVEL CAN BE USED IN VARIOUS POSITIONS

Capable of giving a reading in any position from horizontal to vertical, an all-angle level is used for obtaining angle recordings on overhead work or on that at an incline as well as for horizontal work. To use, it is only necessary to turn the graduated dial to the angle desired and apply the level to the work which is to be adjusted.

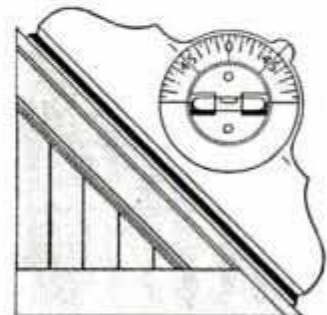

Universal Metal Co
77 W. 42nd St. New York

Dr. James E. Schrader, Prof. of Physics, Drexel Institute, Philadelphia

Chicago, Ill. Chicago, Ill. 105th St. Wabash

D/201 B neygravity 97 neygravity 520. 5th Ave neygal

The J. & J. Optical Co., 301 W. 4th St., Providence, R.I.

NEW for YOUR

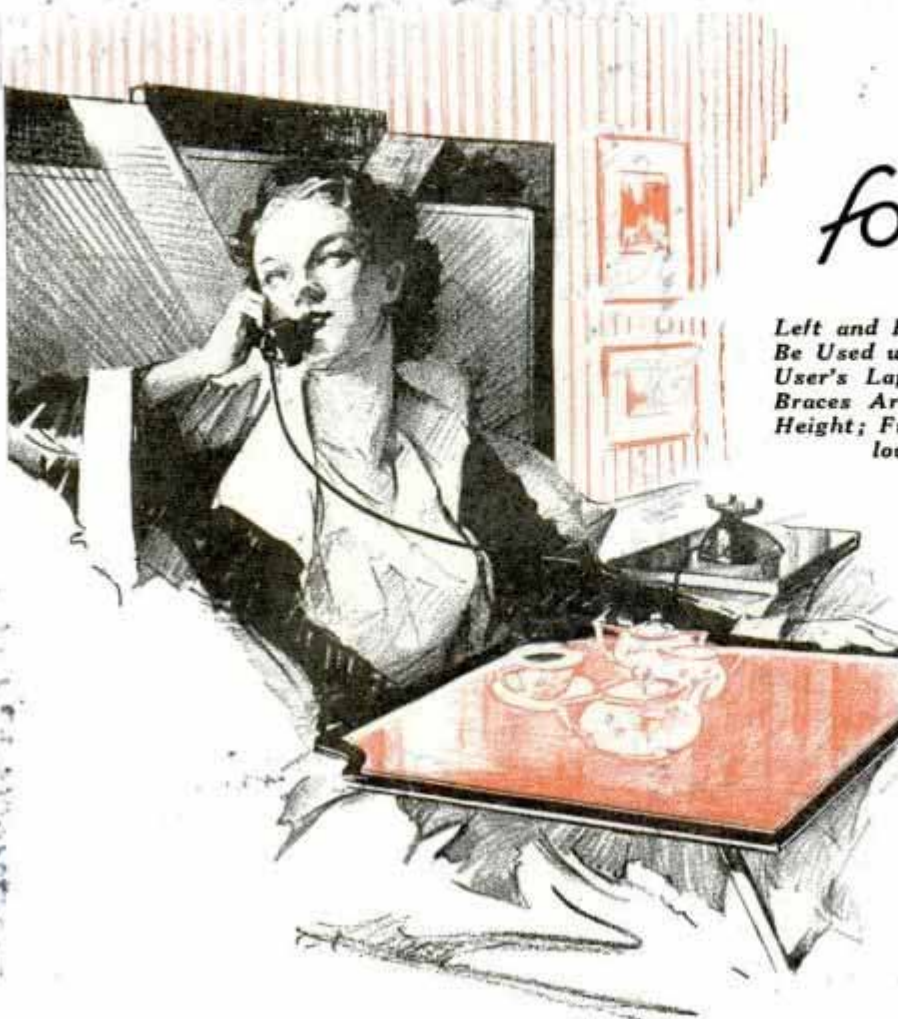

Left and Below, Two-Leg Table That May Be Used with Chair or in the Automobile; User's Lap Supports One Side; Legs and Braces Are Steel and Are Adjustable for Height; Front Corners Are Cut Out to Allow for Arms of the Chair



Center, Right, Latest Electric Iron Has Its Own Stand That Permits Housewife to Leave Iron at Any Spot on the Board; Pushing a Button Swings Two Metal Rests under Iron to Make the Stand; No Heat Is Transmitted to the Rests; Another Touch of the Button Causes Rests to Spring Back into Place; Below, Left, Combination Ironing Board and Step Ladder with Basket Holder and Sleeve Board Attachments; the Device Is Collapsible for Easy Storage When Not in Use; It Is Capable of Supporting Unusual Weight



Bottom, Right, Lingerie and Clothes Drier May Be Hung from Top of Door, on Window Ledge, on Door Knob, on Chair Back and Other Handy Places

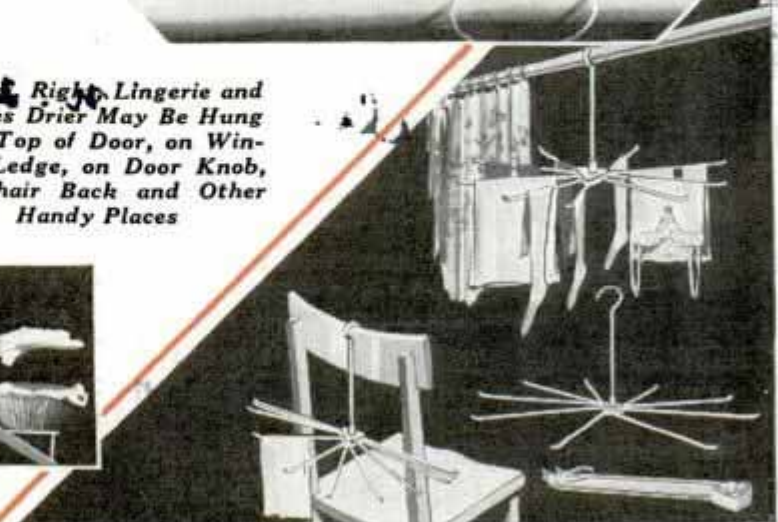

CONVENIENCES HOME



Above, Steam Cooker Steams Three Vegetables at the Same Time without Mixing the Flavors; It Cooks at Half the Gas Pressure Used in Boiling; Circle, Right, Rubber Grip for the Bathtub Is Held in Place by Suction Cups That Do Not Mar Tub Finish; Metal Plate Molded into the Grip Makes It Possible to Shape It to Contours of Tub Rim;

Below, Handy Beverage Wagon May Be Folded After Using and Placed in Closet or behind Door; the Two Trays Can Be Removed and Used Separately; the Wagon Is Heat and Alcohol Resistant



Below, Wooden Laundry Tongs Save the Hands on Wash Day; Insulated against Heat, They Are Used to Lift Clothes from Boiler or Rinse Water and to Feed Them into Wringer

Suggest pocket size reflex receiver

International Radio Corp

Ann Arbor

D1209

Mr. Sol. J. Long, address unknown, 1334 Main at Memphis, Radio and Electrical Engineer



Radio Set for the Man on Foot; the Receiver and Batteries Are Attached to the Belt

RADIO SET FOR PEDESTRIANS IS ATTACHED TO BELT

Pedestrians can now enjoy radio programs as they walk by using a small radio receiver which weighs only three and one-half pounds and which can be worn under the clothing. The loud speaker rests in a breast pocket and is fed by wires leading from the receiving set attached to the belt. Power is supplied by batteries strung along the belt. The set is suitable for motorcycle or mounted officers and for the policeman walking a beat.

VACUUM TURBINE TO MAKE ICE BY USING WARM SEA WATER

Differences between the temperatures of surface water and water from the depths of tropical seas will be utilized in a vacuum turbine designed to produce ice. In the laboratory, a small model of the turbine works perfectly. Water fills half of the system and a small reservoir or boiler. Air in the upper part is exhausted to as great a vacuum as practical. The upper coils are cooled by a wrapping of wicks

that dip into water, the evaporation acting as a cooling system. Holding the hand on the reservoir starts the system, the water beginning to "boil" quickly on account of the vacuum. This "steam" passes through a nozzle, actuates a small turbine, and exhausts into the cooler tubes where it is condensed to fall back into the system, ready for the process to be repeated. The condensation maintains the vacuum. The entire system is inclosed. A similar plant, many times larger, has been mounted on a ship for operation in tropical seas, where surface water frequently is thirty degrees warmer than that from the depths. By making use of this difference in temperature, Georges Claude, the inventor, hopes to make ice in his vacuum turbine. The surface water will be made to boil in a partial vacuum, with cold water from the depths acting as a condensing agent.

see page 12

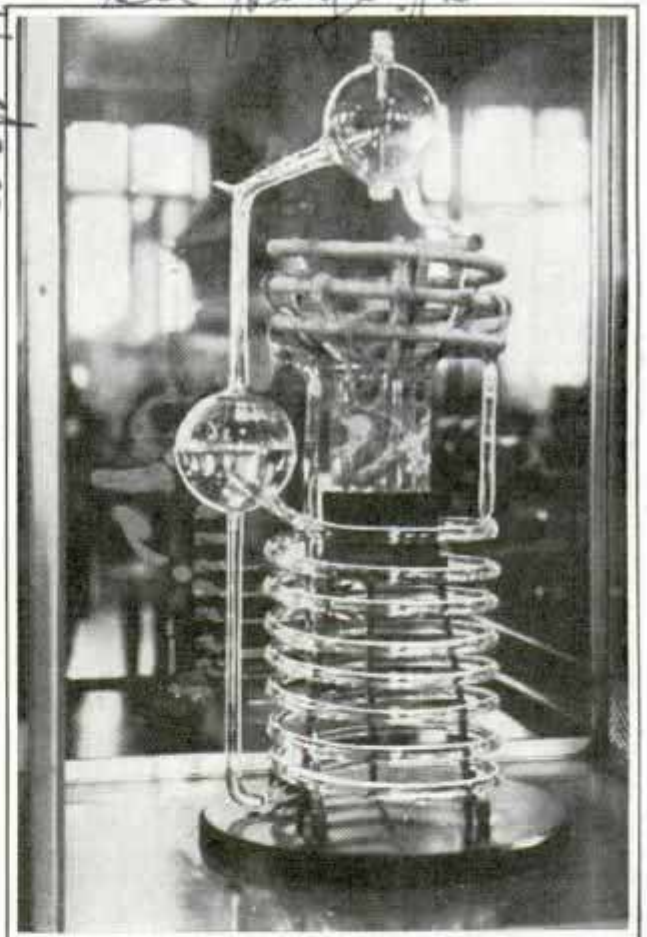

Temperature Turbine of Glass Is Entirely Inclosed; Heat of Hand Starts It Operating

Whenever you find that you wish to know more about any article in this magazine, write our Bureau of Information, inclosing return postage.

in Franklin Museum Philadelphia

Mr. American Carrier, 117 West 11th Street, New York



D 4643

COMPLETE TRANSMITTER... *for Beginning Amateurs*

THE newcomer joining the rapidly increasing ranks of amateur radio operators is no longer handicapped by a lack of efficient and inexpensive apparatus. This compact c.w. or "key" transmitter enables the amateur to start out with a minimum investment and yet have an instrument that will deliver a high quality c.w. signal which meets all government requirements. It will also serve as a stand-by transmitter in a higher-powered amateur station to be used when full power is not required. Starting with this well-designed unit, the beginner can build or purchase additional

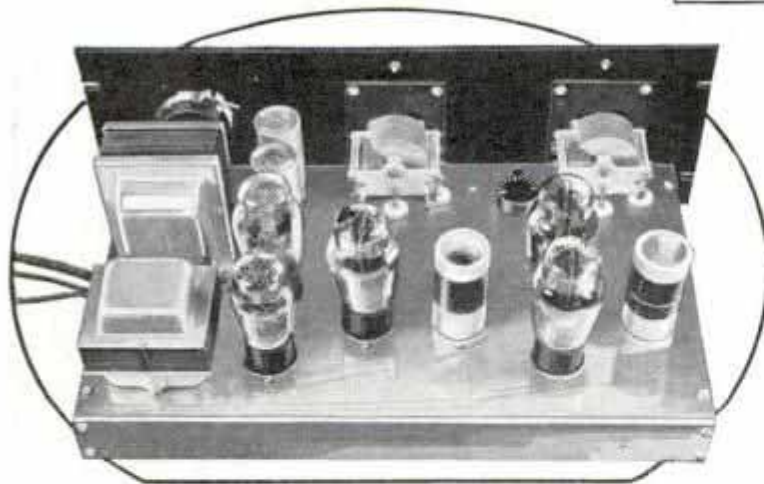

A separate power supply is used for the oscillator to reduce frequency "chirp" and a meter is provided with a switching arrangement to read plate and grid currents. Complete instructions and tuning charts are supplied. The instrument is self-contained, as shown in the photos, and plugs directly into a 110-volt, 60-cycle outlet. A telegraph key is connected to two insulated leads, brought out from the chassis, and the usual single-wire Hertz, or a Zeppelin-type, antenna may be employed.

(Continued to page 118A)

equipment as desired. The measured output of the transmitter is 28 watts on 3,500 and 1,700 kilocycles, 25 watts on 7,000 kilocycles, 13.2 watts on 14,000 kilocycles. It is crystal controlled, employing a type-47 tube for the oscillator and parallel 46's in the power amplifier. Interchangeable coils are provided for the various bands and the power amplifier is operated on the crystal frequency in each case.

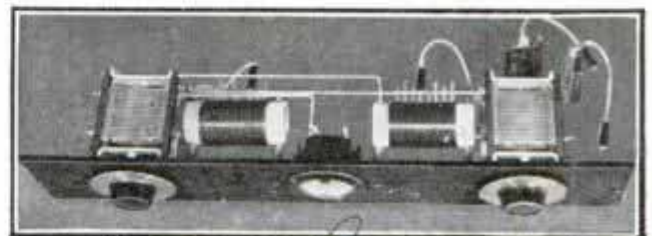

*Collins Radio Co.
Radio Products Division*



LITTLE GIANT FOR A.C.

ALTHOUGH a midget in size, this little set has most of the important features usually found in large modern receivers. It is a full superheterodyne, with automatic volume control, latest tubes and a real dynamic speaker. The distance range is exceptionally good, and strong local stations were separated easily when this little receiver was thoroughly tested in Popular Mechanics radio laboratory. It is very compact, easy to build and the parts have been carefully selected.

It would be difficult to imagine a more flexible individual receiver of portable type. The chassis is 9 in. long and 5 in. wide; when completed the height is only 6¼ in. with tubes in position.

Because of its compact size and light weight, it may be installed in cabinets of unusual design, two of which appear in the photos. An inexpensive type is shown at upper left; the inside dimensions are 5 by 6¾ by 9¼ in. A more elaborate va-

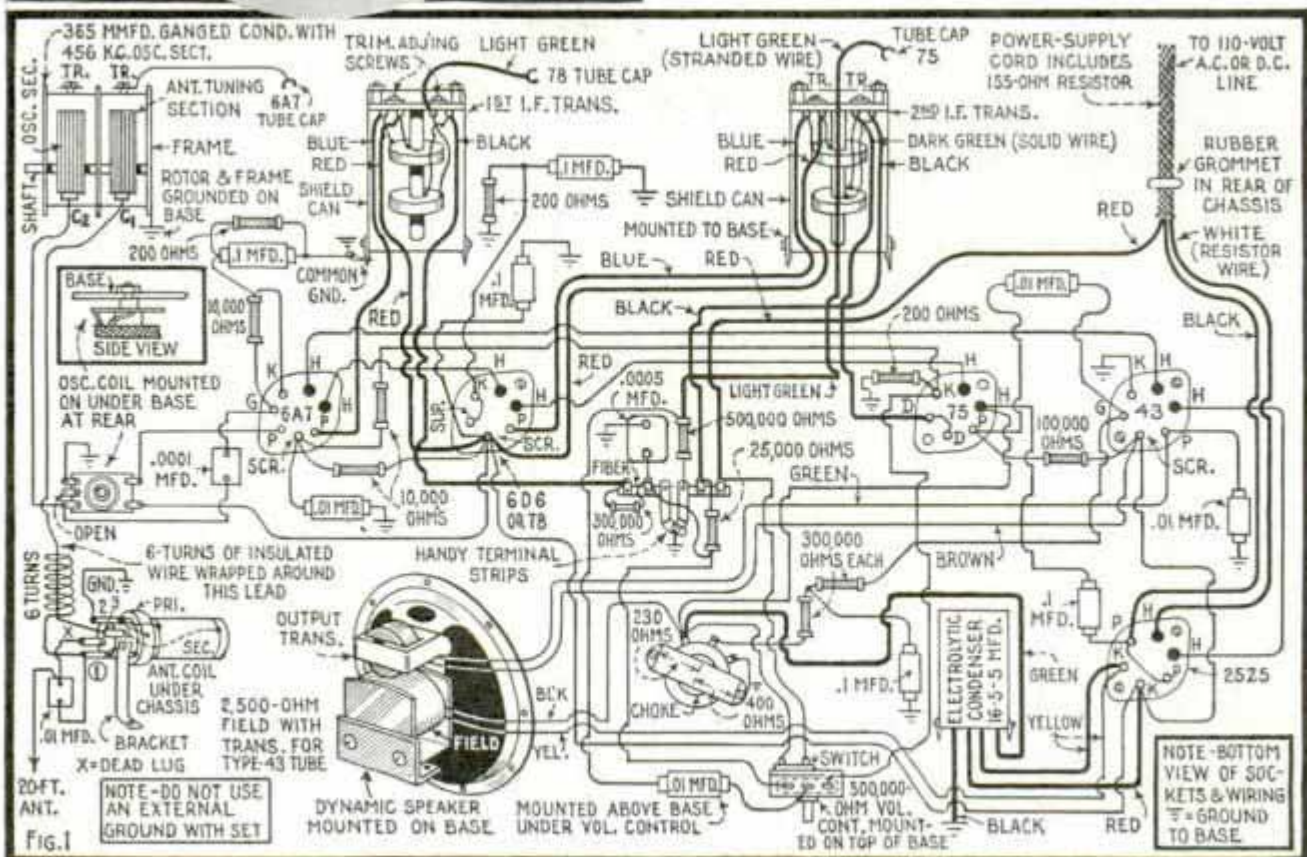

FIVE-TUBE SUPER OR D.C.

riety at upper right represents a group of seven books; the case is made of wood covered with morocco leather, hand tooled in gold leaf. A 25-ft. spool of flexible insulated antenna wire is permanently fastened to the set.

All of the actual wiring is clearly shown in Fig. 1, as viewed from the underside of the base. The various parts are in their approximate positions; however, they are spread out to simplify the wiring diagram. Sectional diagrams of the intermediate-frequency transformers and ganged-condenser unit, mounted on top of the base, are also included in detail. The base is formed from a single metal sheet and the dimensions are given in Fig. 2. A cut-out section is required for the speaker, which is mounted directly on the base. A completely formed and drilled base is available if desired. The bracket de-

(Continued to page 118A)

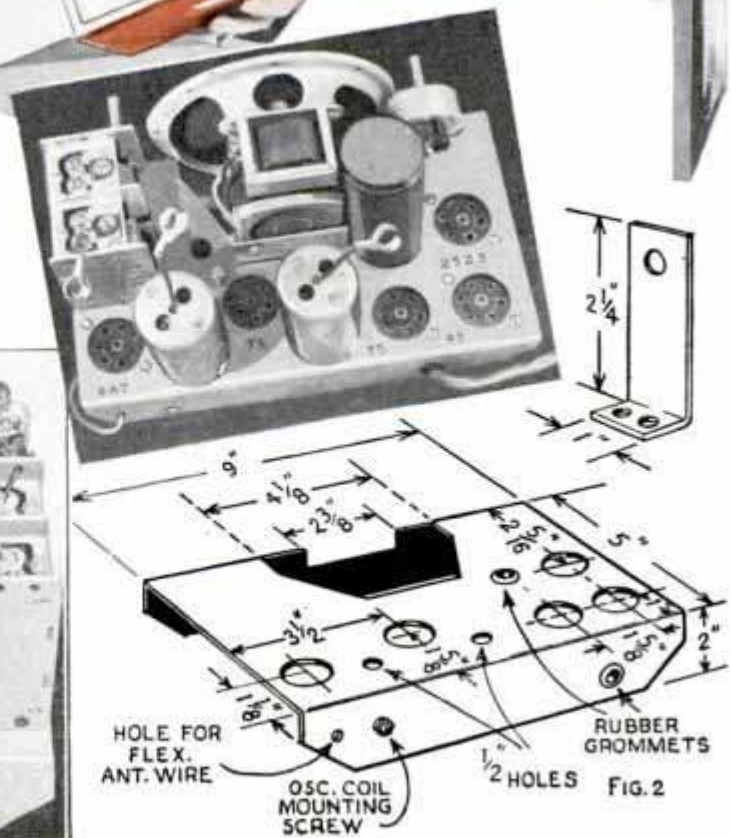
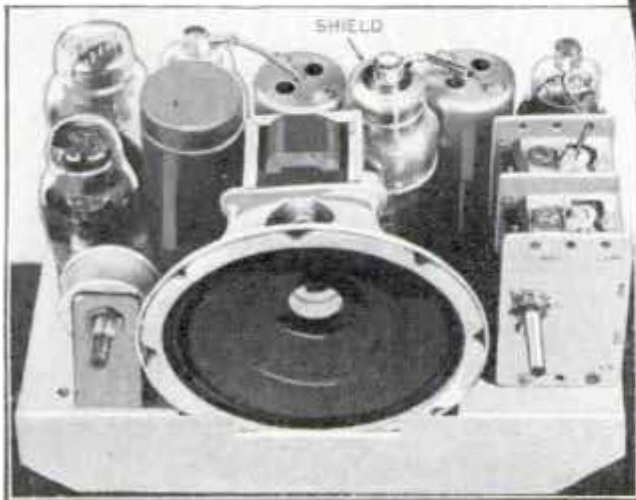

Homemade Trouble Locator for Power Units

By S. H. BURNS



RADIO service men and experimenters will find this simple low-cost device a valuable addition to their testing equipment. The regular set tester shows just what is taking place in each tube circuit, with the exception of the rectifier. If a bad condenser or an open choke in the power-supply circuit is suspected, it has been necessary to remove the chassis and break the connection between the rectifier filament and the choke-condenser system before checking.

This device, in conjunction with the set tester or a single meter, enables the service man to locate the trouble immediately. It consists of a homemade filament transformer wired to a 4-prong adapter, which is assembled from a 4-prong tube base and a Na-ald adapter-socket section. The adapter assembly is shown in Fig. 1. All connections between the base and adapter-socket sections are clearly shown in Fig. 7. The filament terminals of the socket section are connected to the cable leads that go through the bakelite strip to the secondary of the filament transformer. The

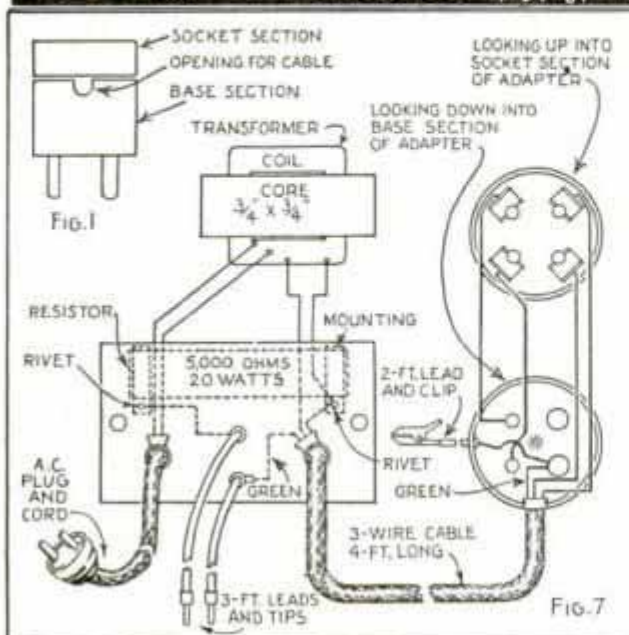
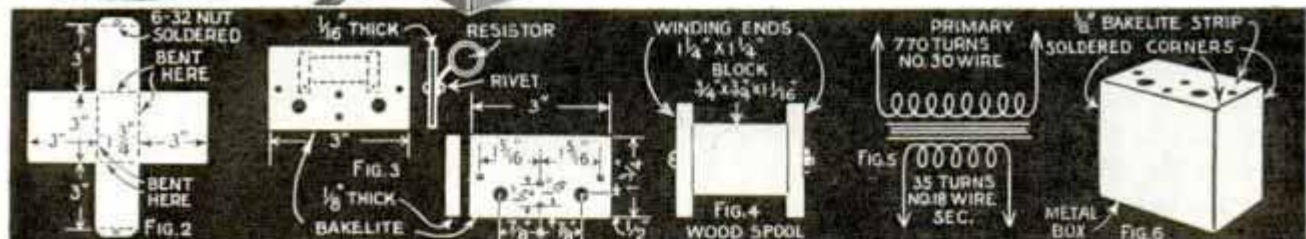

transformer construction details are fully covered in Figs. 4 and 5; the bakelite terminal strips in Fig. 3 and the metal container in Figs. 2 and 6. The 5,000-ohm resistor protects both the meter and power unit. The core of a discarded choke or output transformer with a center leg may be used, the over-all dimensions being $3\frac{1}{4}$ by $3\frac{1}{4}$ in. Both enameled-copper wire coils are wound on the spool form detailed in Fig. 4. The primary requires 300 ft. of enameled wire, and the secondary 15 ft., of the sizes given. A standard 5-volt, 3-amp. unmounted filament transformer may be used if you do not wish to make your own.

(Continued to page 118A)



VACUUM CLEANERS



FOR CAMPERS



PUBLIC ADDRESS



FARM RADIO



SOUND TRUCK

110 VOLTS, A.C. FROM AUTOMOBILE BATTERY— 32-V. FARM PLANT OR 110-VOLT D.C. LINE

type-25Z5 rectifying tube and is provided with a rugged base and baffle. The cone is 10 in. in diameter and the voice-coil impedance is 10 ohms at 400 cycles. A standard voice-coil transformer of 4,000 ohms, or any special transformer, is supplied at no additional cost. This speaker operates on 110-volts, 50-60 cycle a.c. current; however, other voltages are available.

D4645

Tube Resembles Acorn in Size and Shape

Amateurs and experimenters in ultra-high frequency reception and transmission, in the 2 1/2-meter and lower wavelength bands, no longer lack the proper type of tube for these microwaves. The Amateur Radio Division of the RCA

Low-Cost Unit Supplies 110-Volts A.C. Anywhere

Available in three types, this compact, inexpensive unit produces regular 110-volt alternating current from 6-volt storage batteries, 32-volt farm plants and 110-volt d.c. systems. There are no rotating parts and the only element that moves is a vibrator which plugs in just like a radio tube. It will operate standard a.c. receivers in the home, midget sets in autos, vacuum cleaners and other a.c. appliances wherever a 110-volt a.c. supply is lacking.

Speaker Is Designed for Efficient Short-Wave Reception

Low hum level, and unusual sensitivity to voice frequencies, are features of this self-powered dynamic speaker specially designed for short-wave work. It employs a



Radiotron company have made these tubes available; they offer an attractive field for experimenters who wish to explore the possibilities of these extremely short waves. Because of its minute size, the

Camden, N.J.

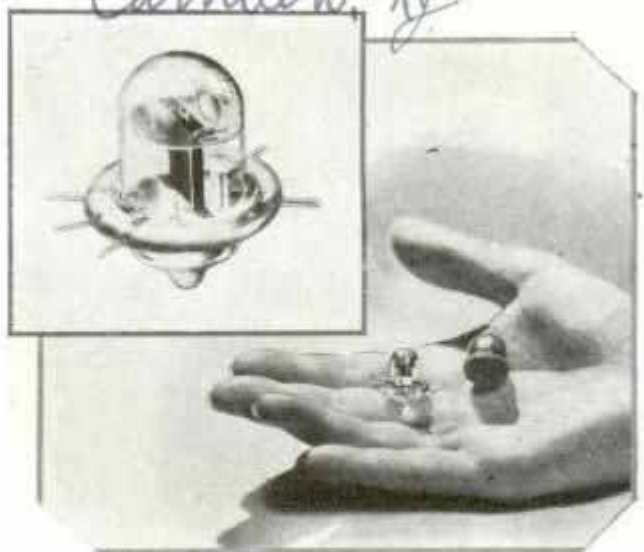

Above, Miniature Tube Showing Clip Leads through Glass Envelope; Below, Compared with an Acorn

acorn-type tube is especially suited for use in portable radio equipment where conservation of space is important.

Wright - De Coster, Inc. 2251 University Ave. St. Paul, Minn. D4640

128 E 10th St St. Paul, Minn

Pineville Aquarium Co. Racine Wis } *Chicago Aquarium Supply Co. 2206 W. Madison Chgo*

AMATEUR MECHANICS

A Lighted WALL AQUARIUM..

By FLOYD M. MIX

HANGING on the wall like a picture, this aquarium is indirectly illuminated by a built-in light, which also serves as a heater for tropical fish. All sides are pieces of double-strength window glass cemented in an angle-brass frame and a colorful submarine picture on the back, which can be viewed from the front, through the aquarium, lends additional interest.

You will need about 15 ft. of $\frac{1}{2}$ by $\frac{1}{2}$ by $\frac{1}{16}$ -in. angle brass and some No. 16-gauge sheet brass. Begin by cutting the angle brass to the various lengths shown in the drawings. Note the angles at the corners where the pieces are to fit together and saw them off so that they will fit flush. Accuracy of the corner angles can be tested with a bevel square as shown in one of the photos. Next, take the four vertical pieces of the frame and alter the angle of these pieces by squeezing them in a vise. The angles should be approximately 70° for the rear corners and 110° at the front corners.

In assembling, start by soldering the sheet-brass bottom to the bottom frame. C-clamps will hold the pieces of angle brass together while soldering. Solder the rear



H. Leutsch, 2954 Sheffield Ave Chicago
not in file 10/22/33

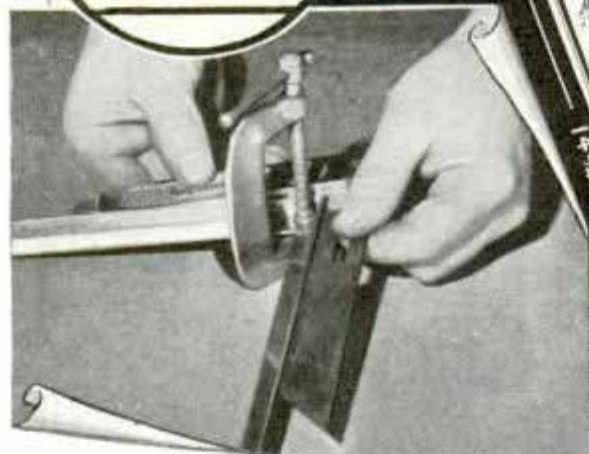

vertical frame members to the bottom frame; then a crosspiece, which will serve as the rear top piece of the light compartment. A strip of flat brass, bent as shown, forms three sides of this compartment. A narrow lip at the lower edge will facilitate soldering it to the bottom of the aquarium. The top part of the compartment is reinforced with pieces of angle brass, soldered in as shown, which also provides a ledge for a small piece of glass, to be cemented in later. The two front vertical pieces are soldered to the bottom frame, after which the top frame is added. All joints except one rear top corner, are soldered. Some of the top and bottom frame pieces must be spread apart their

entire length to get a snug fit at the corner joints. A small angle bracket is bolted to the bottom of the light compartment to hold a socket. The rear bottom frame member is cut away to insert the socket.

You are now ready to insert the glass. To determine the exact shape and size of the pieces, cut cardboard patterns that will project $\frac{1}{4}$ in. over the inside edge of the frame members. Then cut the glass accordingly and fasten it in place with aquarium cement. As one top corner of the frame was not soldered, the insertion of the rear glass is easy, but would be im-

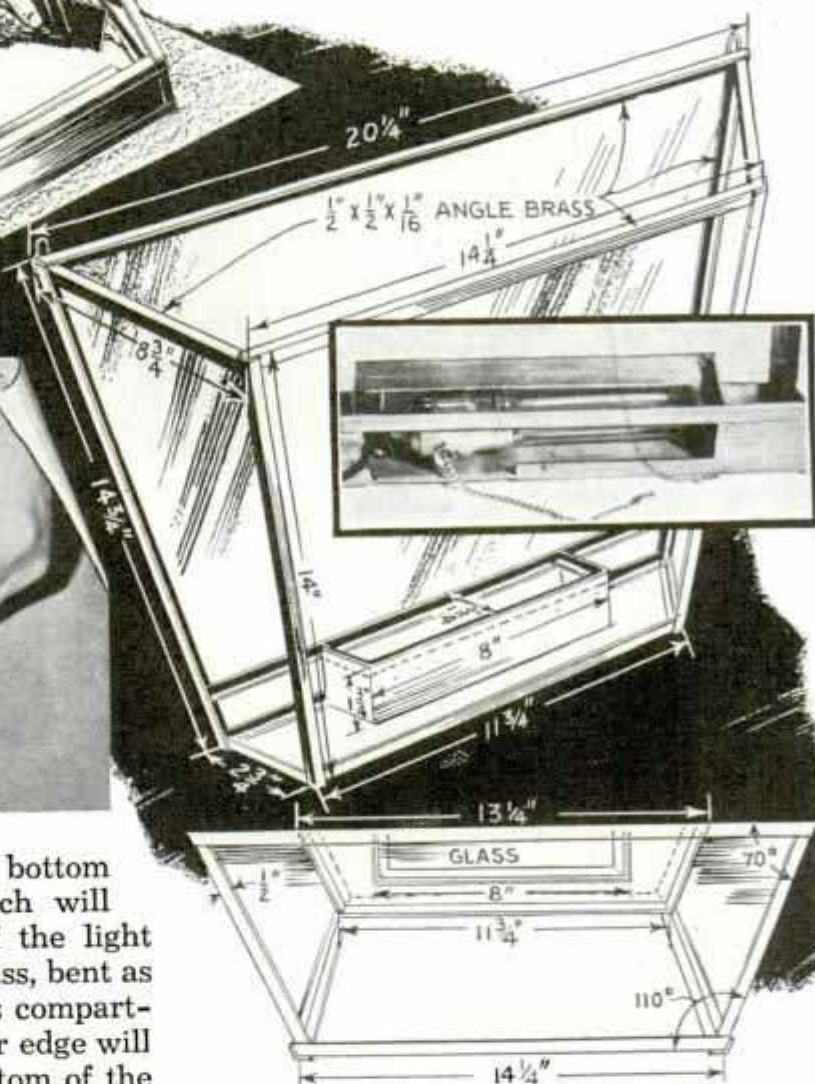

possible, however, if this joint had been soldered. Therefore it must be done after the glass has been inserted. In doing so, avoid getting the glass too hot, or it may crack. A green bronze on the brass portions has been found effective. Two wire hooks soldered to the rear top frame hold the aquarium on the wall and a 25-watt show-case bulb is inserted in the socket.

Novelty Windmill Serves as Twine Holder



Conveniently hung on the wall, this ornamental Dutch windmill serves as a twine holder and also carries a memo pad. The twine is wrapped around a pulley on the shaft a couple of times and is then threaded through a hole in the side, so that pulling the twine out will cause the sails to turn. To make one, get a cigar box, strengthen the corners with brads and then attach a wood block, which holds a small memo pad, to the lower corner of the lid as indicated in the upper left-hand detail. There is room in the box for small balls of twine, while larger ones are accommodated by cutting a hole in the lid and recessing the back of the block. The body of the mill is shaped from a $\frac{3}{4}$ -in. white-pine block, the sides being sloped and the dome rounded. The platform is a wood strip nailed on separately. After the block has been carved to shape, it is attached to the cigar-box lid and then the entire surface is given a coat of gesso or plastic paint. While this is still soft, the details such as clouds and grass of the background, and the window and the railing effects of the

mill may be worked in. When dry, the surface is painted to suit. Thin brass or tin sails are soldered to a cross, which is in turn soldered to a shaft. This may be a nail. The pulley, shown in the lower right-hand detail, also serves to keep the shaft in place.

☐ The first time a can of glue is opened, wash the glue from the cap and top of the can and apply a little vaseline to them to prevent the cap from sticking the next time the can is opened.

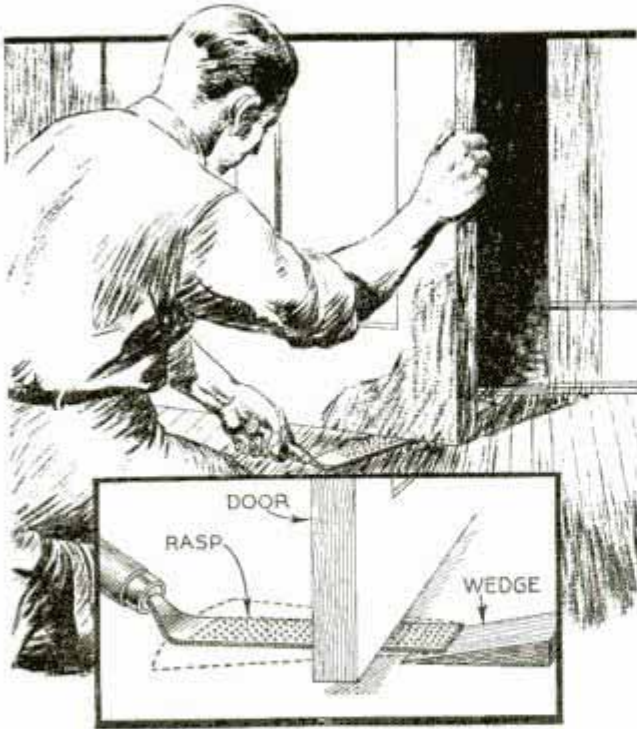

Rasp Used with Wedge for Planing Off Portion of Door to Prevent Binding

Rasp and Wedge Repair Sticking Door

Often, when a door sticks at the bottom, the trouble is confined to a small space that can be planed down with a wood rasp without removing the door. First heat the rasp tang and bend it upward as shown, after which the rasp is inserted under the door and a wooden wedge is slipped under one end to hold it parallel with the surface to be planed. Then by moving the rasp back and forth as indicated by the dotted lines, enough wood can be removed to cure the trouble.

Improving Your Coal Hod

When a coal hod is used for carrying hot ashes, a sheet-metal shield slipped over the bail will deflect the heat away from the hand. Small tabs cut in the metal as shown in the left-hand drawing, are



Hose Prevents Coal Hod Marring Floors, and Shield on Bail Protects Hand from Hot Ashes

bent around the bail to hold the shield in place. The right-hand detail shows a length of old garden hose around the bottom of a hod to prevent it from marring the floor. The hose is slit along one side and then slipped over the edge of the base where it will stay without fastening.

Rubber Insulation Removed from Wire with Lacquer Thinner

To quickly remove rubber insulation from wire roll up the latter and put it in a shallow pan containing some lacquer thinner. After soaking the insulation from a few minutes to an hour, as necessary, you will find that it can be pulled off the wire with ease, as the lacquer thinner causes the rubber to swell. If the insulation is put away to dry, it will serve nicely as rubber tubing of small diameter.



Asbestos Insulation Prevents Vapor from Freezing in Vent Pipe

To prevent vapor from freezing and clogging the end of a vent pipe in winter, the portion of the pipe projecting above the roof may be insulated. This can be done by slipping a large galvanized pipe over the vent and then filling the space between the two pipes with asbestos wool. For best results, the galvanized pipe should be large enough in diameter to provide a 2-in. space between

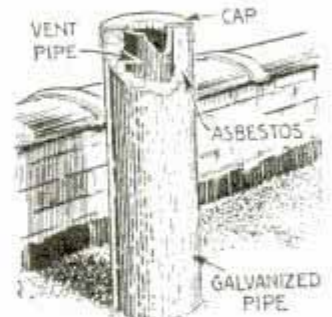

it and the vent pipe. A galvanized cap having flanged edges and a hole in the center of the same diameter as the inside diameter of the vent pipe, should be placed over the top of the assembly to protect the asbestos against rain.—George H. Valiquette, Ottawa, Ont., Can.

SHUFFLEBOARD COURT

for the Basement Game Room



L AID out on the floor of your basement, a shuffleboard court provides a competitive game that requires skill. The width of the court should be 4 ft., while the length can be varied according to the floor space available, at least 25 ft. being preferable. First mark off the court, clean the concrete and apply two coats of dark, gray paint. Then mark out the end zones and paint the scoring divisions. Two coats of spar varnish followed by a thorough polishing with powdered wax will give the court a smooth, polished surface. The equipment for the game consists of eight hardwood pucks and two pushers, made as shown in the circular detail. For a scoreboard, purchase a child's counting frame in a dime store, remove the wire and beads and assemble them on a board as shown in the lower detail. To play the game, all the pucks are pushed from one end of the court to the other in an effort to get them wholly within one of the scoring divisions. A puck may be touching one of the dividing lines provided its edge does not extend over the center of the line. Fifty points make a game. Besides the scoring divisions, there is a division of minus 10, which is a penalty. For two players, each one pushes the pucks first from one end and then the other, the players alternately shooting one puck at a time. When four play, partners remain at opposite ends of the court, the opponents alternately shooting one puck at a time.

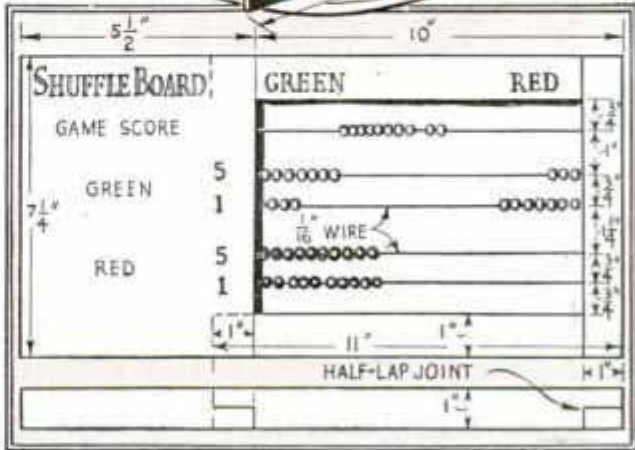
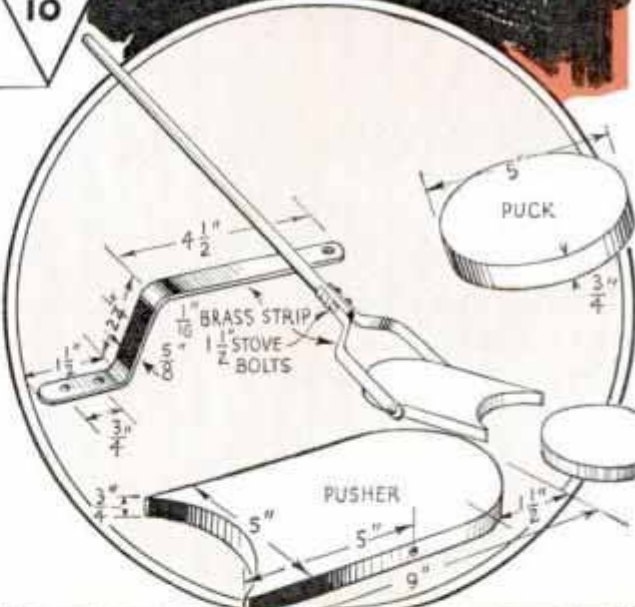
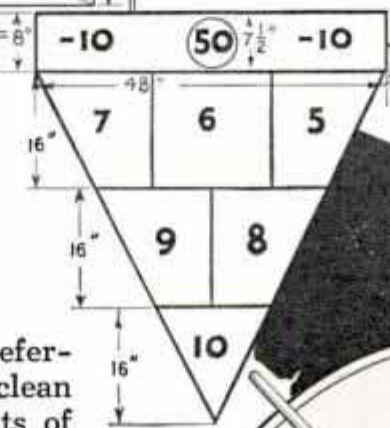

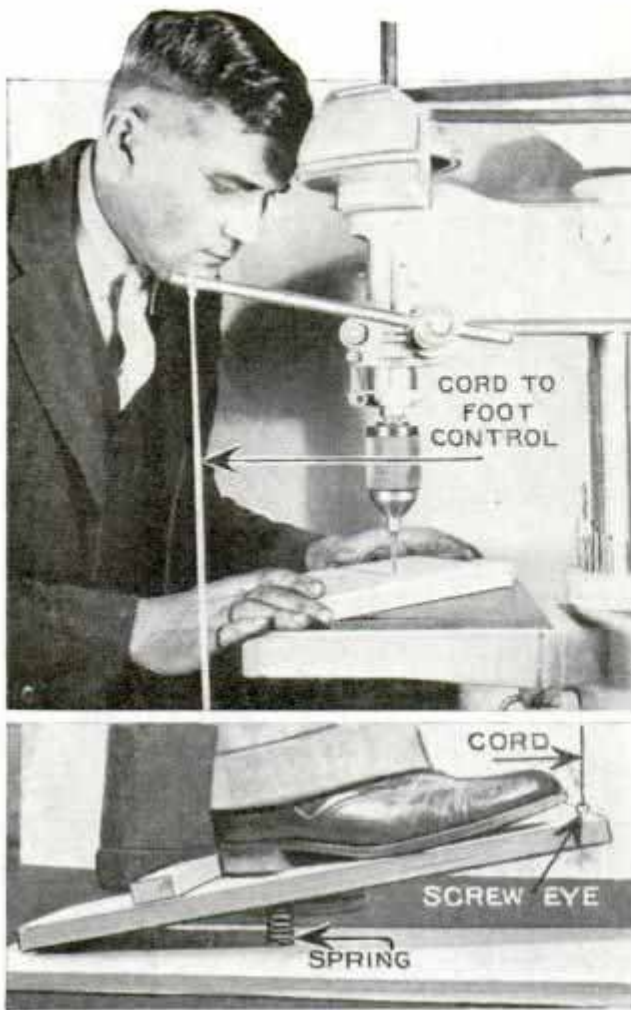

Controlling Drill-Press Spindle by Foot When Routing Leaves Both Hands Free to Guide the Work

Foot Control for Routing with Drill Press

Leaving both hands free to guide the work when routing with a drill press, this foot-operated attachment makes it possible to do the job more accurately than when one hand is used to operate the drill-press spindle. As shown in the photos, the attachment consists of two wood blocks hinged together at one end with a compression spring between them. To a screw eye in the upper block is attached a strong cord or wire, which in turn is fastened to one end of the drill-press arm. For drill presses that have no spring to raise the spindle when it is released, a small coil spring or a strip of rubber can be attached to the free end of the arm and to the frame to raise the spindle.

¶Two or three drops of 10-per-cent aluminum-sulphate solution added to a small bottle of mucilage will increase its adhesive qualities.

Solution to Prevent Photographs from Curling in Cold Weather

To prevent photographic prints from curling in cold, dry weather, brush over the back of the paper a solution consisting of table gelatine 1 oz., and water, 10 oz. After the prints have been brushed with the solution, place them under some heavy books or other weights to flatten out.

Shoes Cleaned with Cuticle Remover

Ordinary cuticle remover has been found an effective cleaner for removing spots on white kid shoes. Just moisten a clean cloth with cuticle remover, rub the moistened part over the soiled spot, and see how quickly it will disappear. This is especially handy if your shoes get spotted when away from home where a cleaning fluid is not at hand.



Hose on Teakettle Aids in Watering Caged Pets

Difficulty often experienced in filling water containers inside of cages or pens is overcome readily by slipping a length of garden hose over the spout of an old teakettle and using it as shown. The hose can be slipped through the wire mesh of the cage and the water poured into a container without spilling.

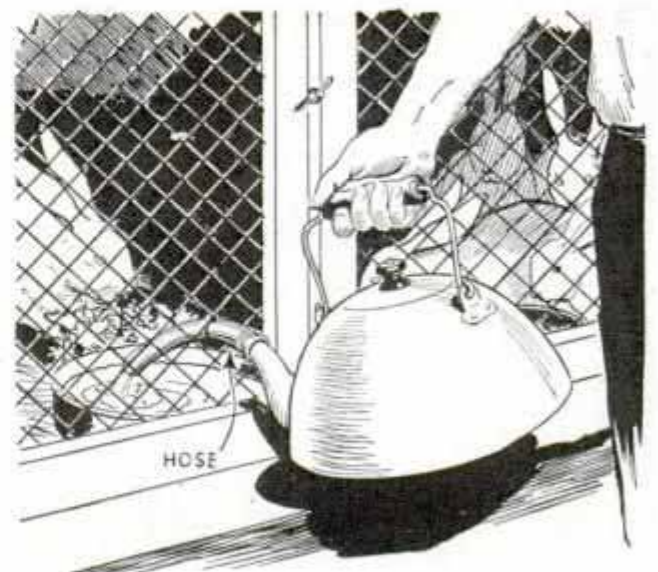

Length of Garden Hose on an Old Teakettle Spout Provides Handy Container for Watering Pets

Combining Book Racks with Table Lamps

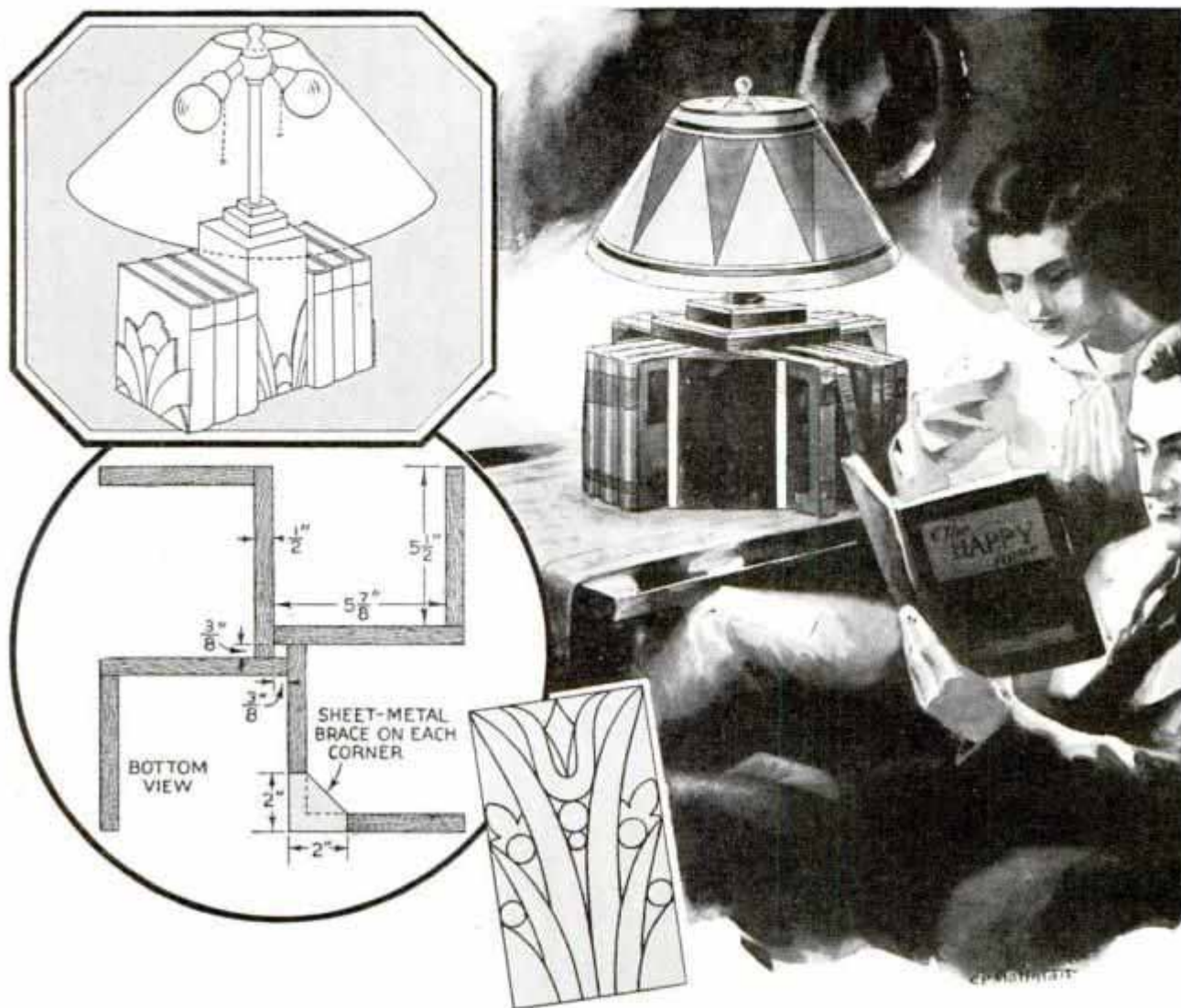

A combined table lamp and book rack is an attractive piece of furniture that readily lends itself to many variations of designs. The one on the table consists of a solid or hollow block 5 in. square with triangular book ends at the corners. The book ends are glued up of contrasting woods, and, for decorative effects, the exposed faces may be carved, scroll-sawed, painted or left plain. After squaring the ends of the block, cap the upper end with a square piece large enough to overlap the tops of the book ends, to which it is nailed or screwed. For appearance, a smaller block is nailed to the cap, after which both are drilled to take the lamp standard. To hold the assembly together, a square piece of aluminum or brass is screwed to the bottoms of the center block and the book ends. The underside of this is covered with felt to prevent scratching the table

top. The lamp shown in the upper left-hand detail has a square center block, similar to the one just described, and the block is mounted on a base to which the book ends are also screwed. In making the lamp shown in the lower detail, use well-seasoned stock and glue and screw the parts together, bracing the joints on the bottom with sheet metal. In assembling the parts, leave a hole in the center for the lamp standard as indicated.

Giving Copper Articles a Black Color

Copper articles may be colored a deep black by first cleaning them and then applying a saturated solution of copper nitrate, after which they are heated to bring out the color. A sodium-sulphide solution will produce a rich, mulberry color, which will blacken with repeated applications.



When Duplicate Forms Are Needed, Cardboard Spacing Strips Help to Do the Ruling Quickly

Cardboard Strips Aid in Ruling Special Forms

To save time in ruling a number of duplicate forms, several cardboard strips were spaced on a drawing board to get the desired vertical lines and then fastened at the ends with thumb tacks so that sheets of paper could be slipped under them from one side. Spacing marks for the horizontal lines were made next on each strip, after which the ruling was done with speed.

Sealing Ash-Pit Door to Use Blower on Furnace

If you have a blower on your furnace to aid in burning buckwheat coal and find

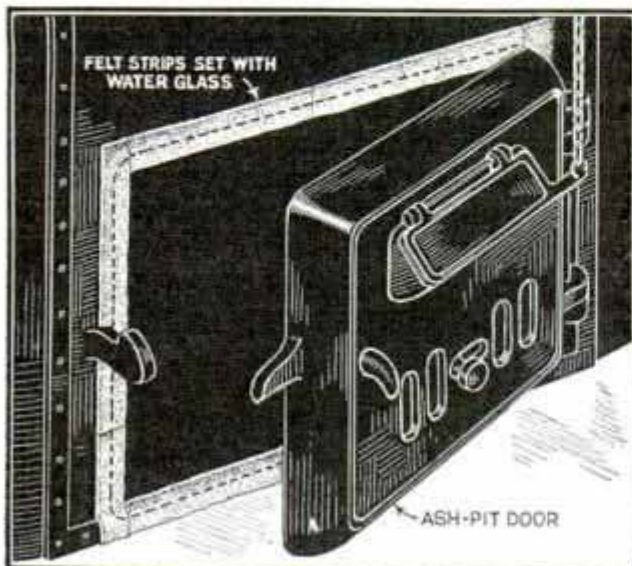

Felt Applied to Edge of Ash-Pit Door Prevents Loss of Draft When Using Blower on Furnace

that there is a loss of draft by air leaking around the ash-pit door, the application of felt strips around the opening as indicated will end the trouble. Water glass provides a good adhesive for sticking the felt strips to the metal around the door opening.

Corrugated Fasteners Keep Bolts from Turning in Wood

When carriage bolts are used in wood, it often decays around the hole and the bolt turns so that the nut cannot be loosened. To prevent this, drive a couple of corrugated fasteners into the wood on opposite sides of the hole before putting the bolt in place. It is best to drive the fasteners into the wood across the grain to avoid splitting the work.

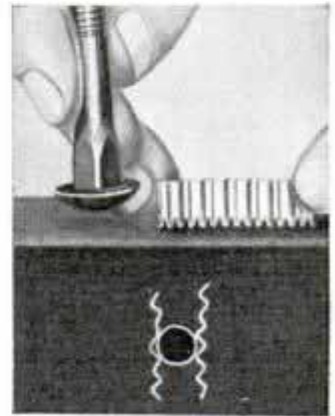

Celluloid Plate Centers Work for Wood Lathe

To center work for his woodturning lathe, one man uses the gauge shown. A square sheet of celluloid is drilled through the center and circles are scribed around this point with a scratch compass, after which diagonal lines are scratched from corner to corner. When placed on the work, it is easy to adjust the position of the circles for cylindrical work or the diagonal lines on square stock to indicate the center, which is then marked with a pencil. — G. E. Hendrickson, Argyle, Wis.

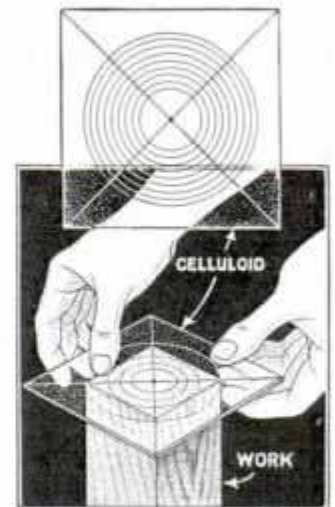

Unpainted garden or porch furniture made of oak or teak should be treated with linseed oil at intervals to preserve its color and prevent the wood from cracking.

no 03 8

Hand-Carved *Mahogany* **BUFFET**

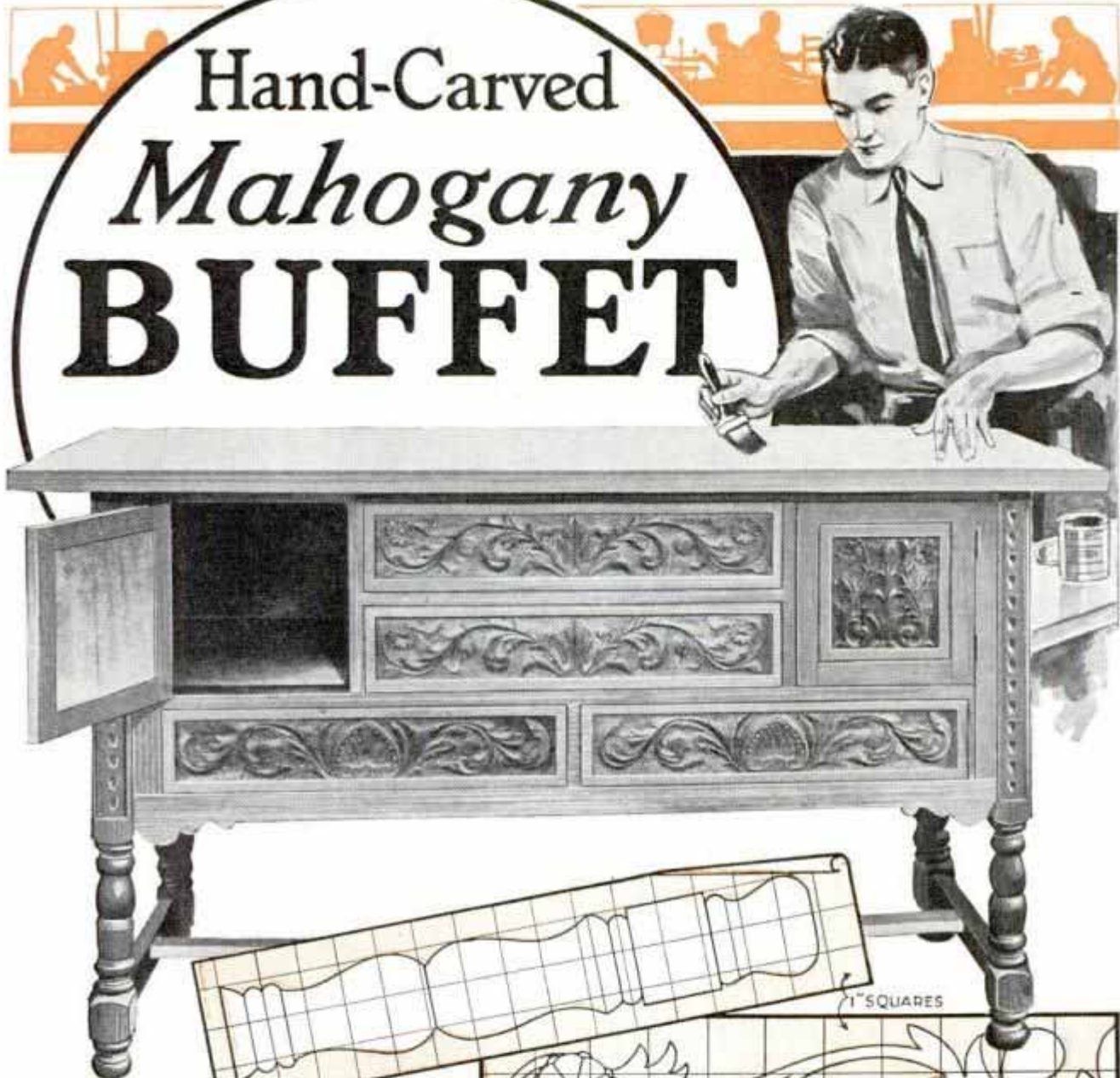

① LEG, 4 REQUIRED

② CARVING FOR CENTER DRAWERS

THIS handsome example of a carved mahogany buffet comes within the scope of the average craftsman. The original, shown here, is one of several built by students of the John Muir Technical High School, Pasadena, Calif., and the young man who finished this particular job had no previous experience in wood carving.

Over-all dimensions are given in the front and end views, Fig. 7. The solid top is built up of mahogany planks doweled and glued together. Legs, Fig. 1, are turned from 2½-in. stock, and joined in pairs with a ¾-in. panel at the top and a 1¼-in. cross piece at the bottom. The two

pairs of legs are then joined by framing as in Fig. 8. The front of this framing, which serves as divisions between doors and drawers, is ¾ by 2 in., with the exception of the top member, which is 1 in. thick. For the hidden part of the framing, pine is used. The partitions are mortised into top and bottom frame members. The bottom drawers slide on guides, while the central drawers are supported on rails forming part of the framing. Drawer

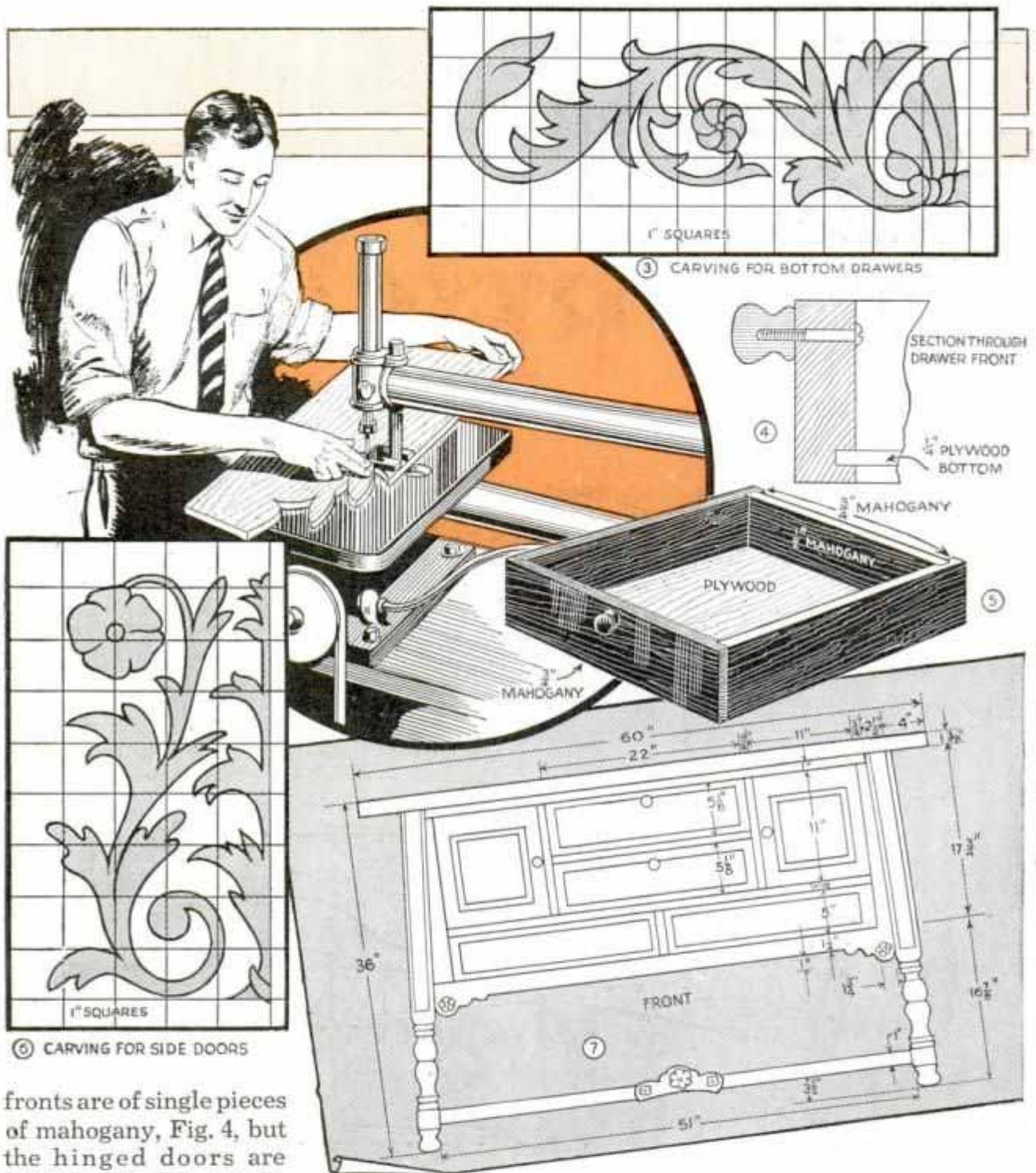

fronts are of single pieces of mahogany, Fig. 4, but the hinged doors are built up of a panel mortised into a frame as in Fig. 9. The perspective of the drawer, Fig. 5, shows the method of assembly. The solid top is held securely on the frame by driving screws up through the latter, all screw heads being well countersunk.

Figs. 2, 3, and 6 show carving designs for the drawers and doors. All pieces should be carved before assembly, so that they can be held in a vise or clamp. Sketch the patterns on heavy paper and transfer directly to the wood by tracing the design over carbon paper. Then outline the pat-

tern as shown in the first operation, Fig. 10, using the skew chisel on all straight cuts and gouges of suitable sweep for the curved parts of the pattern. Relieve the pattern with a straight chisel to chip out the waste to a uniform depth. The ground is worked over with a carver's grounding tool moved irregularly over the surface and tapped lightly with a wooden mallet. In case you wish to avoid the work of carving, it may be imitated with scroll-sawed overlays of 1/4-in. matching plywood, fastened with glue and brads.

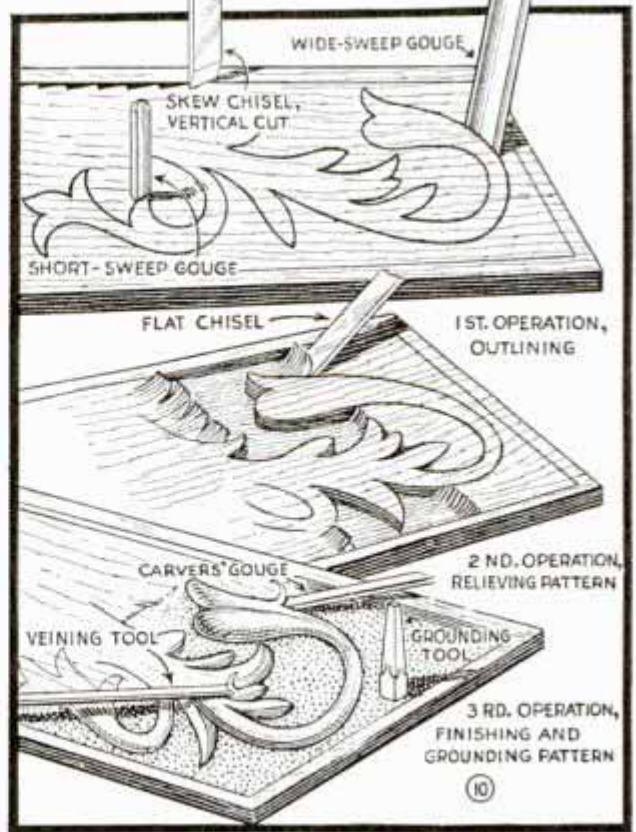
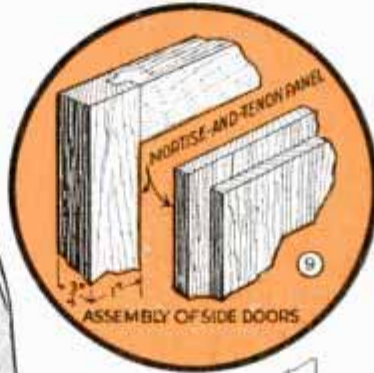
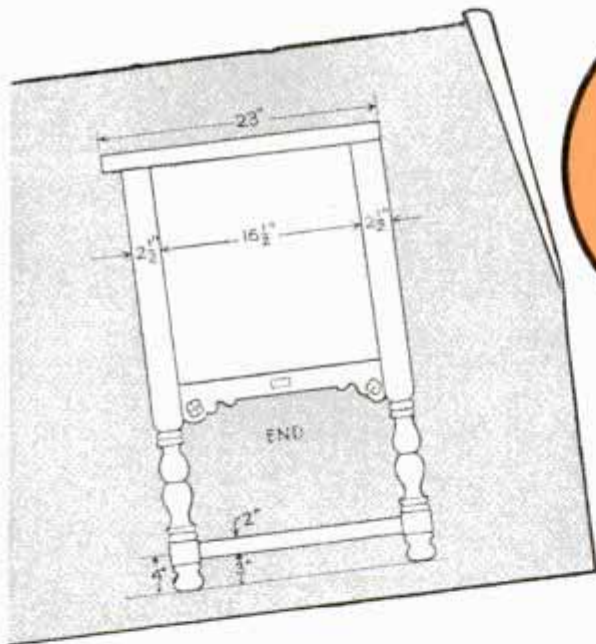
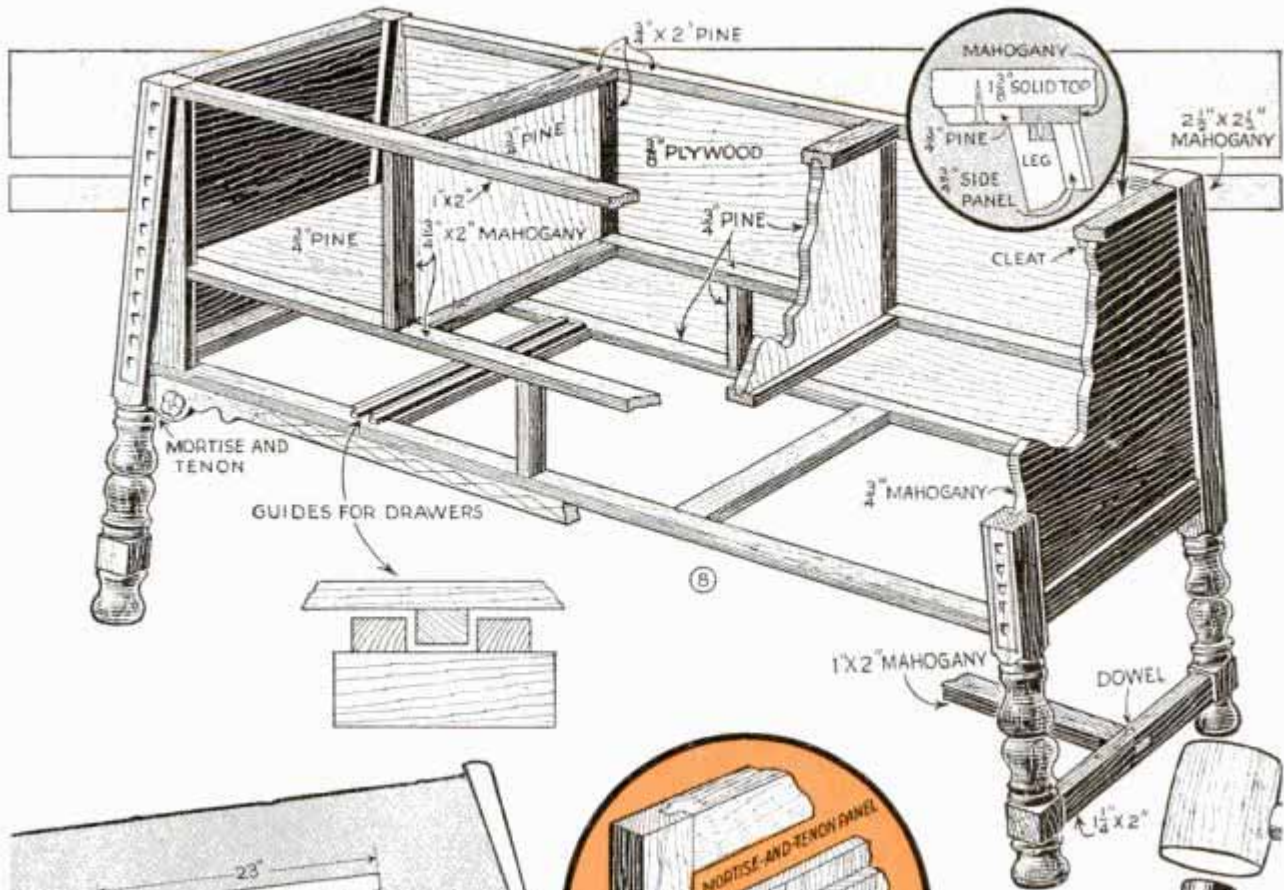

When assembly is completed, the surface of the mahogany is moistened with a wet cloth to raise the grain, and thoroughly sanded, the process being repeated until the grain does not rise any more. It is then treated with water stain in walnut or mahogany, as individual taste dictates. Next, sandpaper with a fine grade, following with an application of oil stain, and then sandpapering again. After this, three successive coats of clear lacquer or shellac, smoothing with pumice stone after each except the last. To produce a soft satin finish rub down the surface with powdered rottenstone and oil.

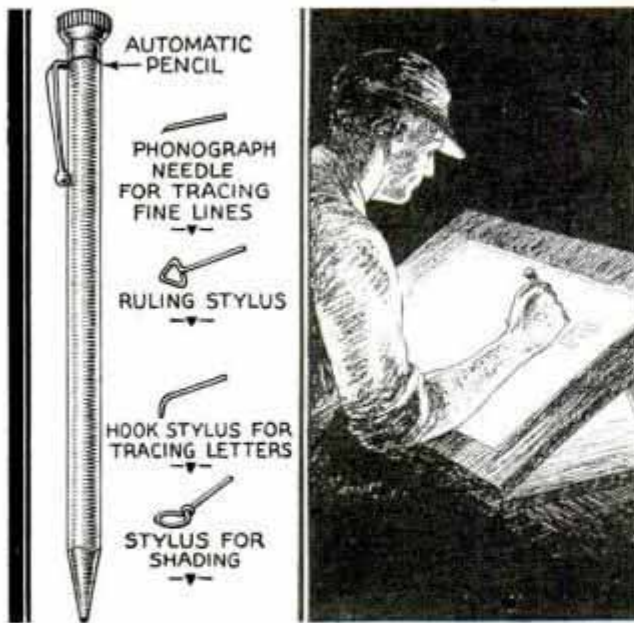

Stylus Points for Mimeograph Stencil Work Made from Hairpins and Phonograph Needles

Homemade Stylus Points Fit Automatic Pencil

Stylus points for lettering or cutting designs on mimeograph stencils are made easily from phonograph needles and pieces of hairpins, and are conveniently held in an automatic pencil. The stylus shown at the top of the drawing is a phonograph needle and is used for tracing fine lines, a blunt needle being used for heavier work. The ruling stylus is made from a piece of hairpin and will not cut through the stencil, while the hook stylus is for tracing letters through a celluloid lettering guide. The stylus shown at the bottom is also made from a hairpin and is used in connection with a screen for shading.

Rollers on Clothes Wringer Renewed with Radiator Hose



When the rubber covering on your wringer rollers becomes pitted or worn, do not throw them away. Instead, smooth up the rubber with a sharp knife and then cover the rollers with lengths of radiator hose. Coat the rollers and the inside of the hose with rubber cement and slip the

hose over the rollers before the cement starts to dry. There are several types of radiator hose, and, in selecting it, get the kind that has fairly thick walls of live rubber. Avoid the type that is reinforced with steel wires as the latter make the hose stiff.—N. J. Denman, Flint, Mich.

Holder for Small Paint Cans

To prevent paint that runs down the sides of the can from soiling the hands or dropping onto the work or floor, use this holder. It is made by cutting away the upper part of a tin can as indicated by the dotted lines, to leave a projection, which is then bent over to provide a handle.

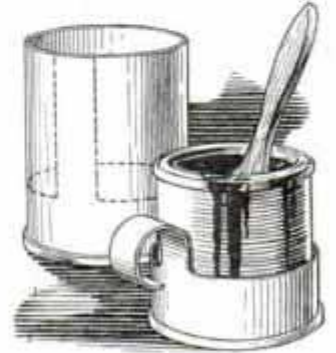

Large Funnel Helps When Baking Angel-Food Cake

In order to get a uniform temperature on all sides of a pan in which an angel-food cake is baked, and to help absorb shocks that might cause the cake to "fall," one woman recommends the use of a large tin funnel. The latter is placed in the cen-



Pan Set on Funnel in Oven to Get Uniform Temperature When Baking Angel-Food Cake

ter of the oven with the spout upward, after which the pan containing the cake batter is set over it as shown.—G. E. Hendrickson, Argyle, Wis.

Model-Ship Grating Bars Alined Accurately

Accurate alinement of grating bars on ship-model hatches is one of the details that give your model the touch of fine workmanship. Such correctness of detail can be done with little added effort, although it will require care, patience and time. In the example illustrated, the overall size of the hatch was $1\frac{1}{2}$ by $1\frac{1}{4}$ in., and the trim was $\frac{1}{8}$ in. The assembly is first made up of $\frac{1}{4}$ -in. white pine, the parts being glued together. The circular insert shows how the ends are cut down at an angle to the center line. The height should be $\frac{1}{32}$ in. less than the finished height to allow gluing a piece of this thickness over the top, after the grating notches are cut. The whole assembly is trimmed to $\frac{1}{8}$ in. Next, the location of the bars is carefully marked and the notches cut with a model-makers' hack saw. The rods are cut from small wire paper clips and pressed into the notches. Then the top piece is laid on and a small clamp is applied as in the lower right-hand detail. This squeezing process imbeds the rods in the soft wood, making it unnecessary to cut slots in the top piece. Then the clamp is removed and glue is applied, after which the clamp is replaced, tightened and the assembly set away to dry. A small portion of the $\frac{1}{32}$ -in. piece is allowed to hang over the edge. This is cut down with a sharp knife to simulate a hinged joint at the peak. A larger paper clip than those used for the grating bars, is straightened out and glued into place as shown in the lower left-hand detail. After sanding and scraping off excess glue, a coat of white paint is applied. A real trim job can be had by applying a coat of black paint to the cross bars and the hinge rod.

A second method of fitting grating bars is to use strips of $\frac{1}{16}$ -in. sheet fiber. These are clamped together between two strips of wood, and holes to receive the grating bars are drilled. The bars are put through the strips while the latter are still together. Then the assembly is placed in the hatch opening and the fiber pieces pushed out to the sides. A touch of glue applied to the fiber strips will hold them securely to the edge of the opening and the grating bars will be in perfect alinement.—Kenneth Cloud, Chicago.

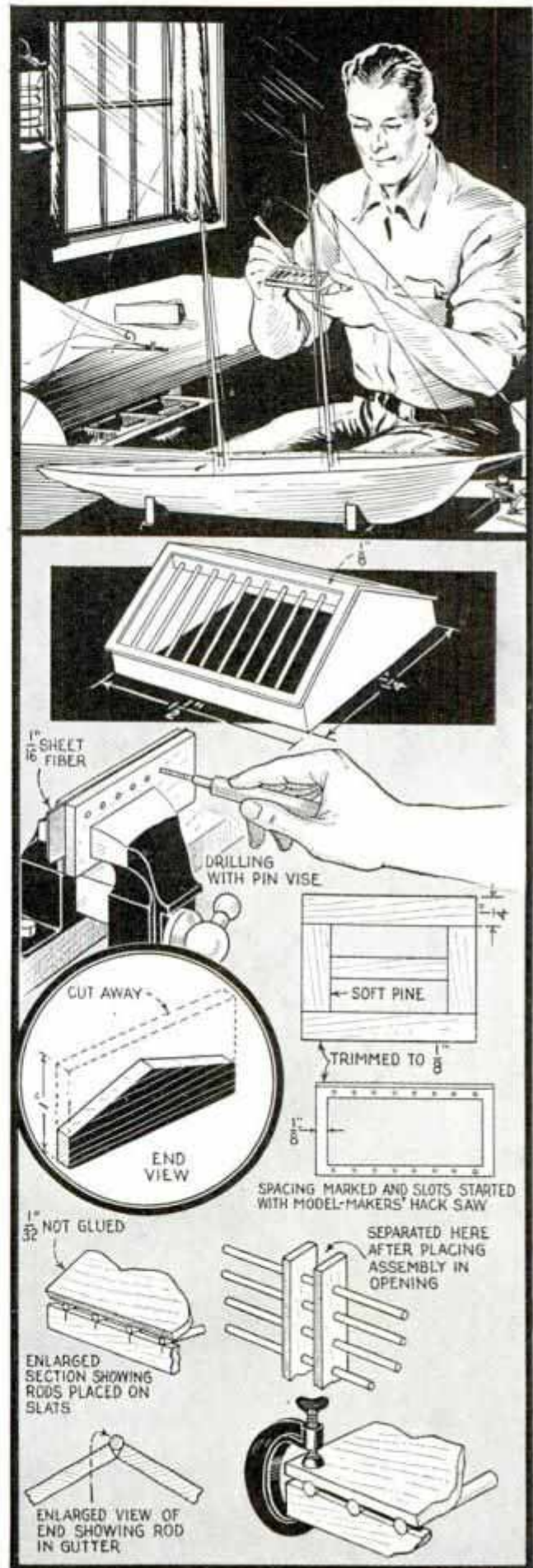

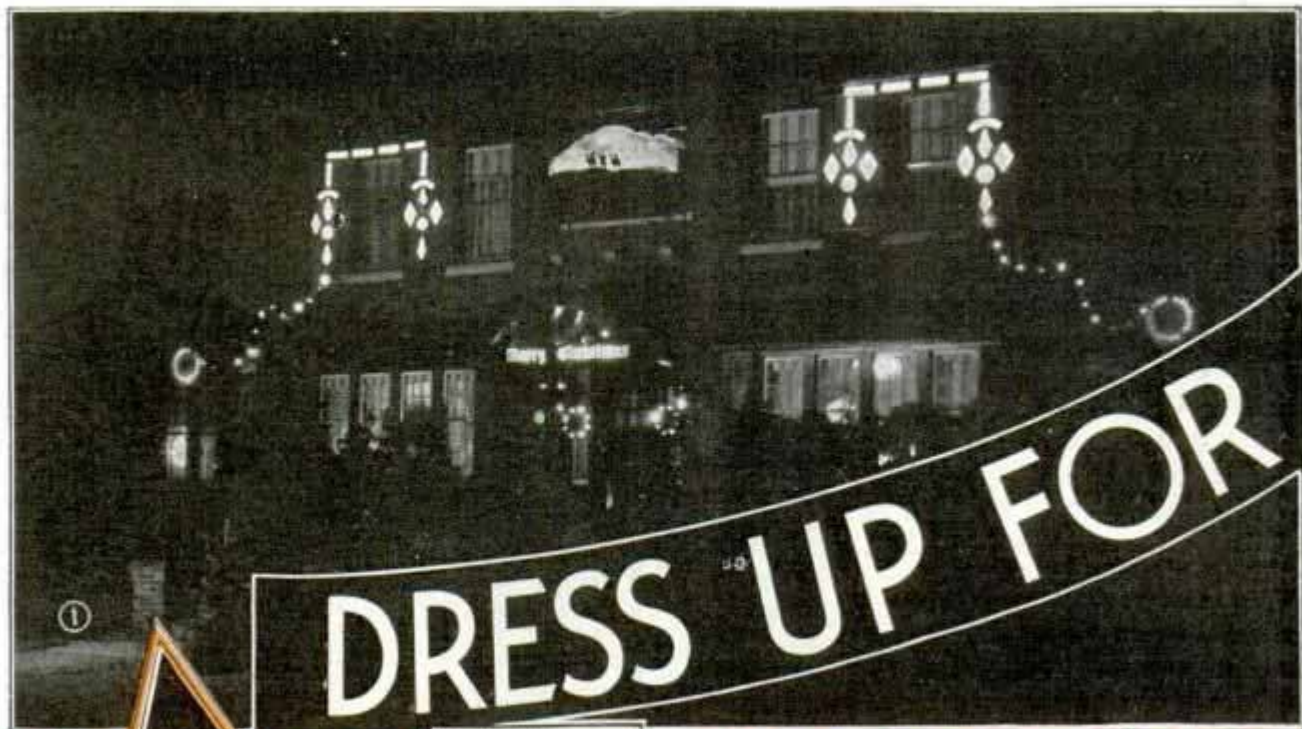

DRESS UP FOR

Outdoor Christmas lighting can be applied effectively to any home, using simple arrangements of colored lights in festoons, stars and wreaths

WITH the infinite variety of materials which can be purchased and made, Christmas decorating in light and color becomes a pleasurable task. Several fine examples of exterior lighting are shown in Figs. 1 to 4. In planning such a decorative treatment, it is best to work from a snapshot, dotting in the lights with colored ink. Work for a balanced and orderly effect; a few lights carefully placed are better than a multitude of lights strung in a haphazard manner. Notice the effective use of cut-out figures as detailed in Fig. 5. Window treatment is important—one or two windows carefully done will brighten

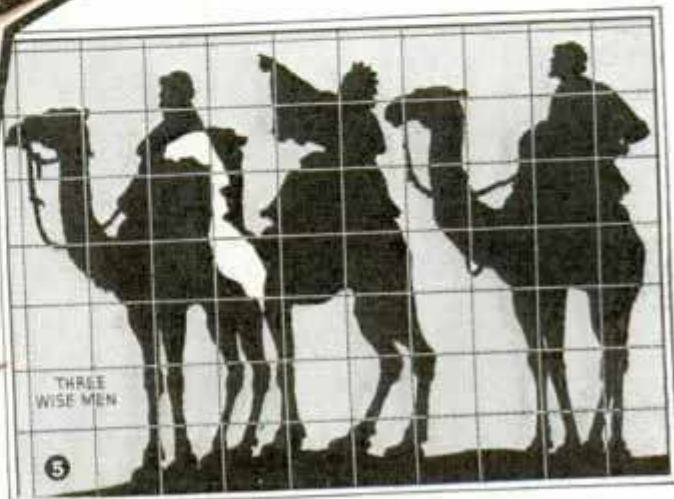

Photos Courtesy General Electric Co.

Christmas



This seasonal cut-out has a wide variety of uses in Christmas decoration.

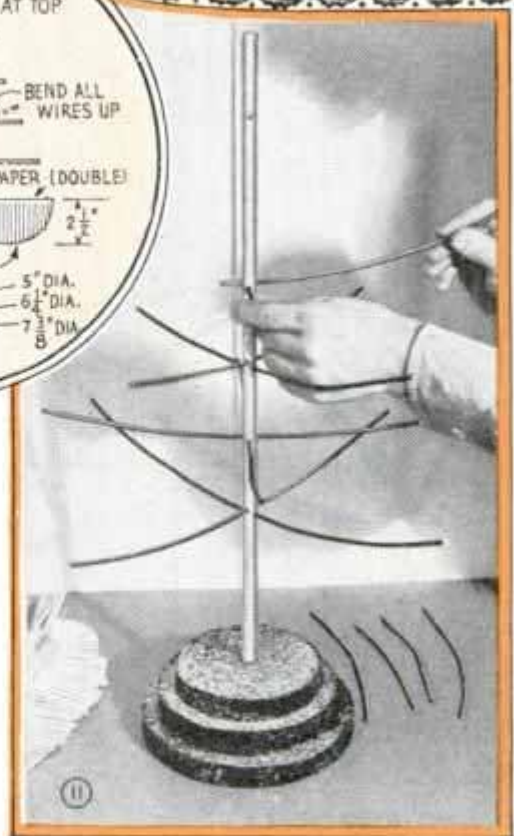
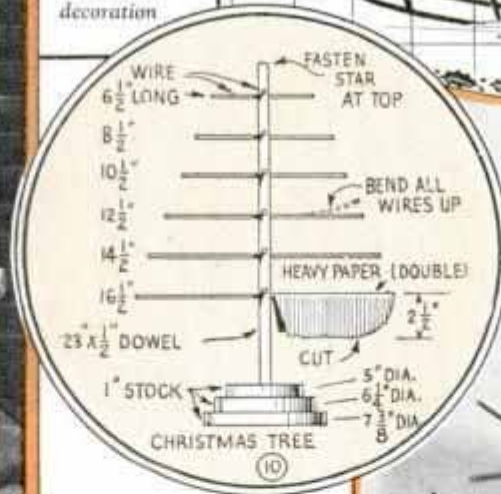

up the whole house. Fig. 6 shows a shallow frame which fits the window opening. The frame is slotted down the center to take a pane of glass on which has been painted a suitable silhouette such as one detailed in Fig. 8. The back of the frame is covered with cardboard, and carries a field of cut-out stars backed with small squares of Cellophane. Any suitable scene can be used for the foreground, pasting it directly to the window. When lighted, the interior bulbs throw the silhouette



Above, Three Window Cut-Outs; the Silhouette Is Black Paper, While the Colored Portions Are Semi-Transparent Paper; a Small Lamp Illuminates the Moon and Stars

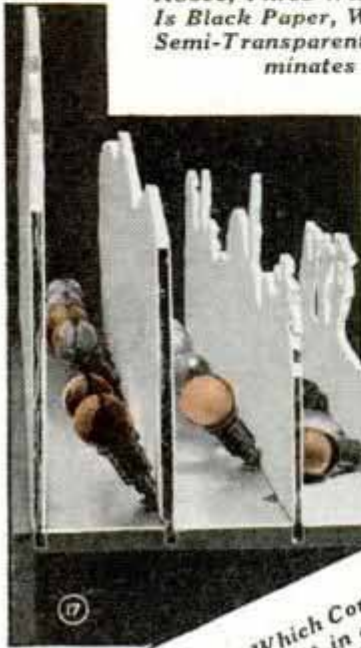

A Plane Picture Which Consists of Vertical Pieces Set in a Base and Illuminated with Colored Lights; Right, Ice Piles with Flashing Colored Lights; Lamps in Wire Guards Do Not Melt the Ice



1/4" PLYWOOD COVERED WITH SILVER PAPER

Small Plywood Christmas Trees Make Good Table Ornaments or, Indirectly Lighted, Outdoor Decoration; the Trees Should Be Decorated with Tinsel and Balls



This tree fairly sparkles with colorful Cellophane stars

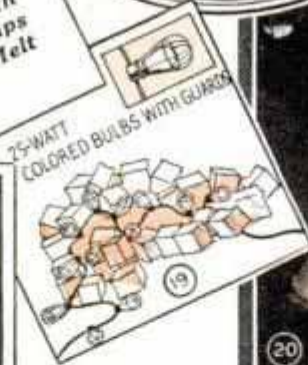

into strong relief and color the foreground, while a separate light outside and behind the frame illuminates the moon and stars, Fig. 7. Three other forms of simple window treatment are shown in Figs. 12 to 14. Christmas trees for the table are shown in Figs. 9, 10, 11, 15, 16 and 21. A combination lamp and tree, with its Cellophane stars, Fig. 21, is especially attrac-

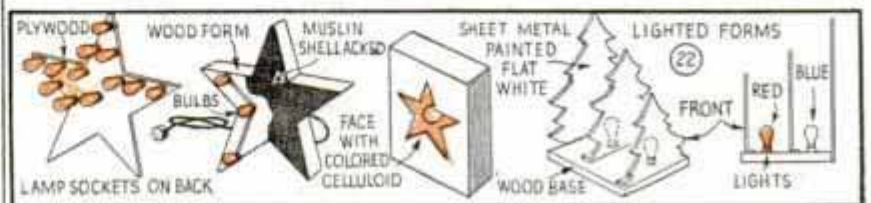

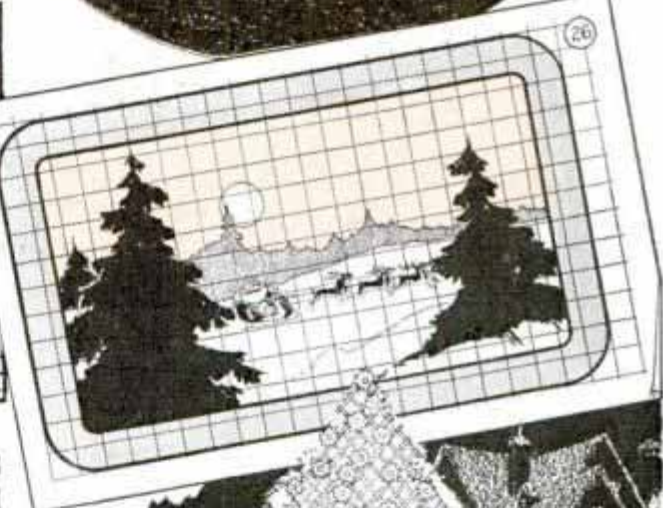
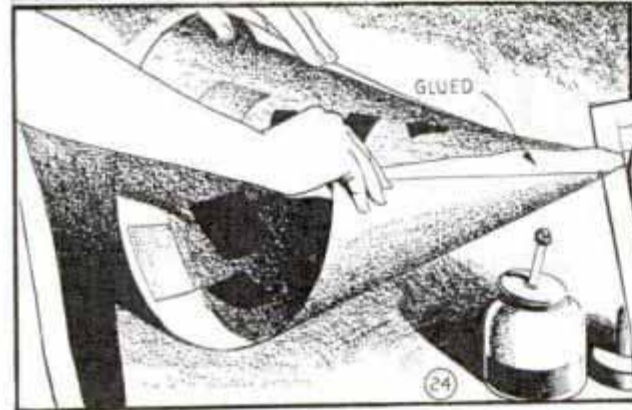
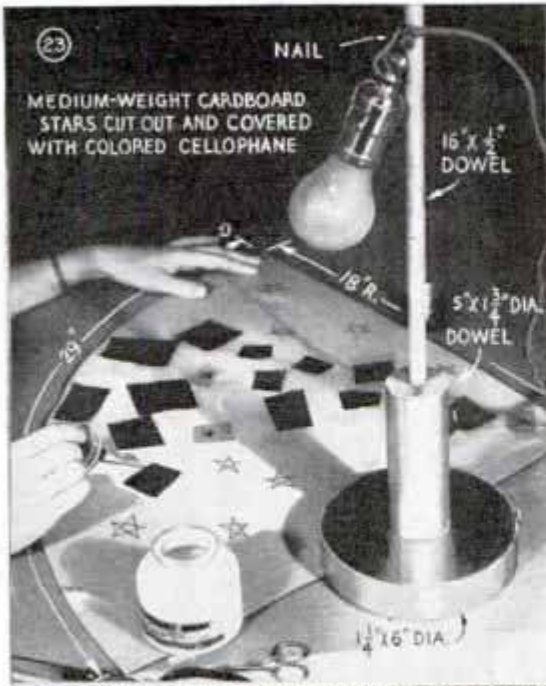

tive. Its construction is shown in Figs. 23 and 24. A number of smaller window and table ornaments, using lamps to make them effective, are shown in Fig. 22. Plane pictures, consisting of several vertical pieces, each above the level of the one just ahead of it, with colored lights between, as shown in Fig. 17, make excellent displays. An artificial outdoor tree is shown in Fig. 18, while illuminated outdoor ice piles are illustrated in Figs. 19 and 20.

There are many other simple ideas that can be applied to Christmas decoration. Colored Cellophane pictures for the fireplace, Figs. 25 and 26, may be illuminated from the rear. First a wood frame is covered with clear Cellophane, after which parts of the picture, such as the sky, trees, moon and landscape, are cut out of suitable colored Cellophane and glued to the clear piece. Where it is rather difficult or impractical to use strings of lights out-



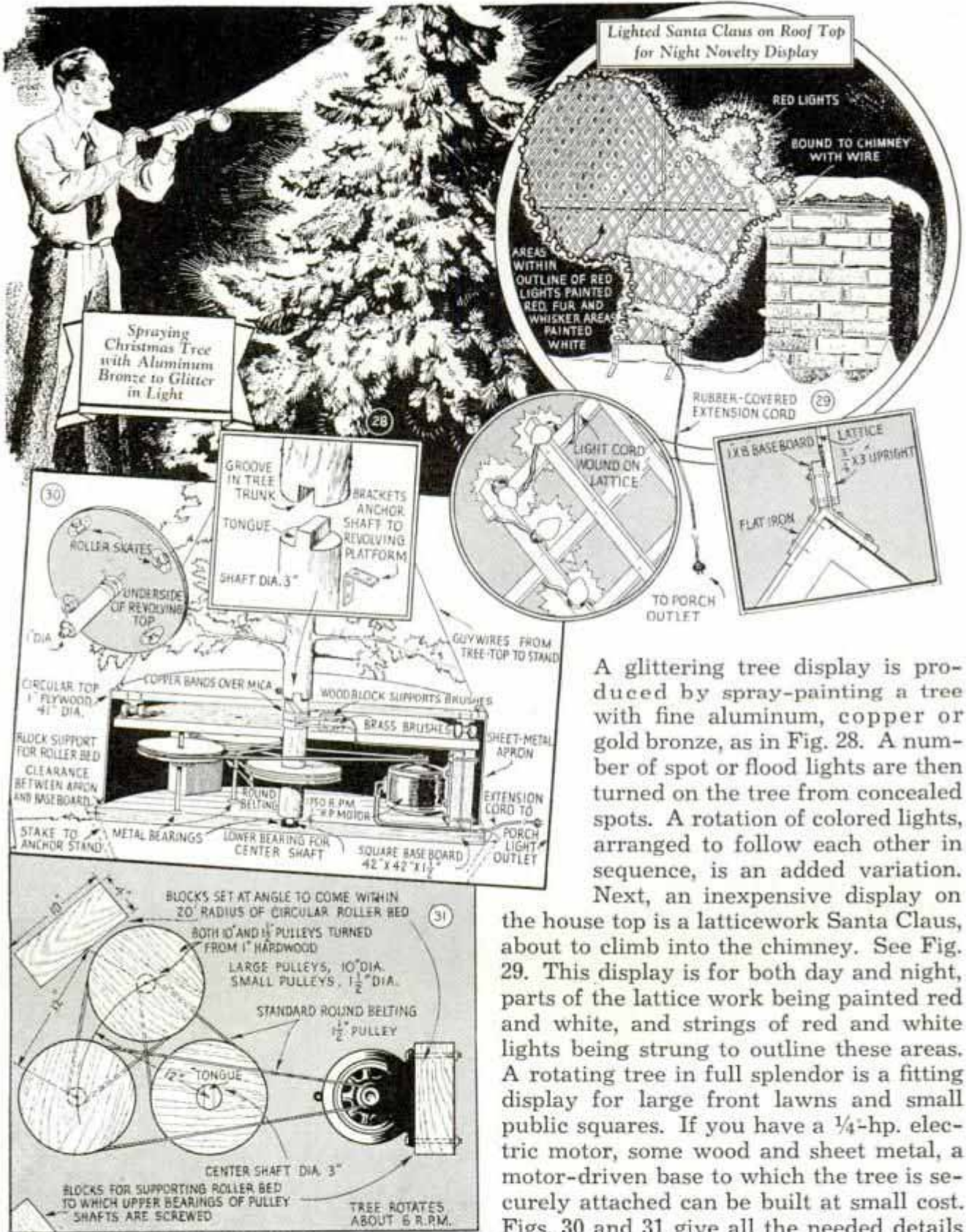

Spraying Christmas Tree with Aluminum Bronze to Glitter in Light

Lighted Santa Claus on Roof Top for Night Novelty Display

ROLLER SKATES
UNDER-SIDE OF REVOLVING TOP
COPPER BANDS OVER MICA
WOODBLOCK SUPPORTS BRUSHES
BRASS BRUSHES
SHEET-METAL APRON
EXTENSION CORD TO PORCH LIGHT OUTLET
MOTOR 1/2 HP
6 R.P.M.
SQUARE BASE BOARD 42" X 42" X 1 1/2"
LOWER BEARING FOR CENTER SHAFT
METAL BEARINGS
STAKE TO ANCHOR STAND
GUY WIRES FROM TREE-TOP TO STAND

BLOCKS SET AT ANGLE TO COME WITHIN 20' RADIUS OF CIRCULAR ROLLER BED
BOTH 10" AND 1 1/2" PULLEYS TURNED FROM 1" HARDWOOD
LARGE PULLEYS, 10" DIA.
SMALL PULLEYS, 1 1/2" DIA.
STANDARD ROUND BELTING 1/2"
PULLEY
CENTER SHAFT DIA. 3"
BLOCKS FOR SUPPORTING ROLLER BED TO WHICH UPPER BEARINGS OF PULLEY SHAFTS ARE SCREWED
TREE ROTATES ABOUT 6 R.P.M.

A glittering tree display is produced by spray-painting a tree with fine aluminum, copper or gold bronze, as in Fig. 28. A number of spot or flood lights are then turned on the tree from concealed spots. A rotation of colored lights, arranged to follow each other in sequence, is an added variation.

Next, an inexpensive display on the house top is a latticework Santa Claus, about to climb into the chimney. See Fig. 29. This display is for both day and night, parts of the lattice work being painted red and white, and strings of red and white lights being strung to outline these areas. A rotating tree in full splendor is a fitting display for large front lawns and small public squares. If you have a 1/4-hp. electric motor, some wood and sheet metal, a motor-driven base to which the tree is securely attached can be built at small cost. Figs. 30 and 31 give all the needed details of construction and assembly. Be sure to follow the pulley sizes so that you will get the speed reduction needed, which should be about six r.p.m. for the tree. The sheet-metal apron, which keeps drifting snow from getting inside, is screwed on last after all necessary adjustments have been made to the driving and lighting mechanism.

doors, colored-glass reflectors may be attached to a lattice framework, cut to the general shape of a Christmas tree as in Fig. 27. This is set where the light from passing autos will cause the imitation tree to reflect in many red and green spots, producing the effect of a light-strung tree.

Rotating Tie Holder Occupies Small Space

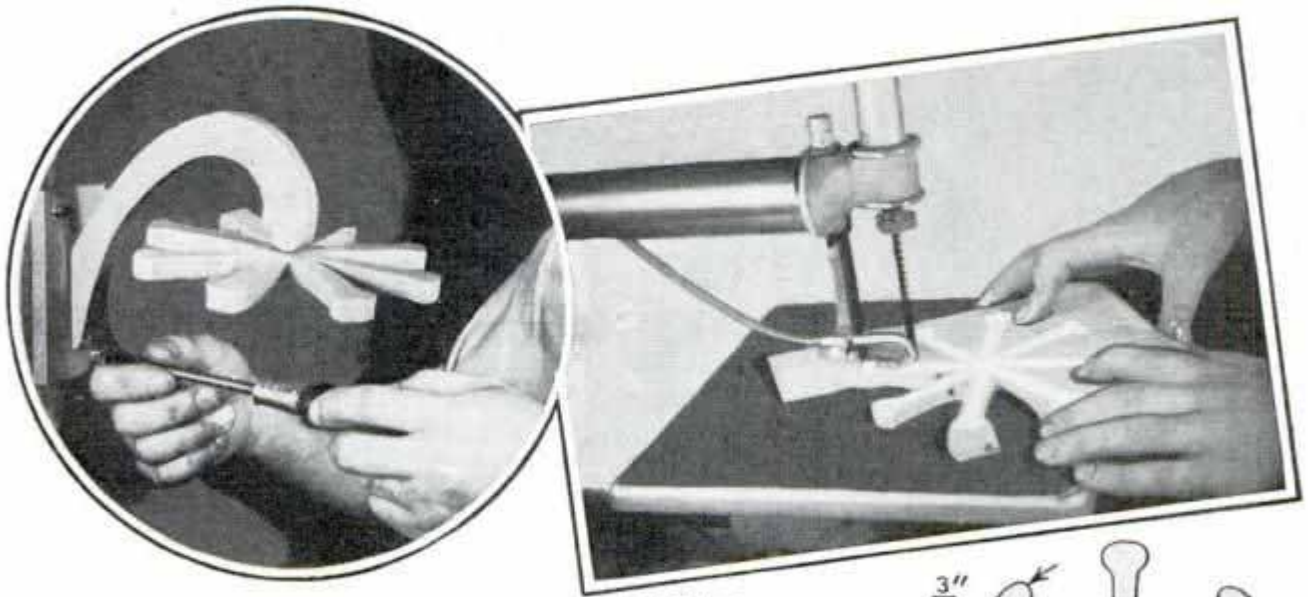

Occupying little space, this rotating tie rack enables you to make a selection quickly as a light touch of the hand to turn it gives full view of the ties which can be neatly arranged on its eight arms. The rotating part may be scroll-sawed from a $\frac{1}{4}$ -in. plywood disk, or it may consist of a small wood spool drilled for several short dowels, glued in place. A single wood screw holds the rotating piece loosely to a curved plywood bracket. This is fastened to a small piece of flat

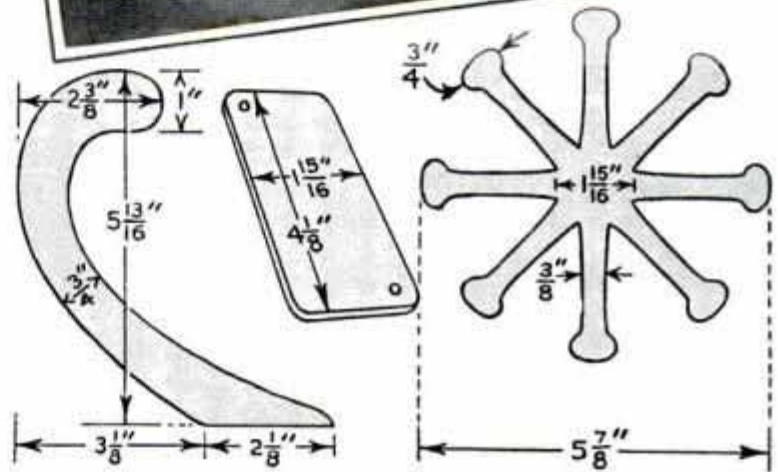

stock which is in turn screwed to the wall. Sand the parts smooth and enamel.

To Keep Utensils within Easy Reach on Swinging Shelves

Where kitchen storage space is provided under shelving or cupboards, you will find it highly convenient to have small shelves on the inside of the doors as shown in the photo. The utensils most frequently used are kept on these shelves because they are so readily accessible when the door is swung open. The shelves may be built of either wood or sheet metal. In both cases it is best to provide a ledge along the edge to keep the pots and pans from slipping off. If the shelf is made of sheet metal, the ledge may be part of the shelf itself, formed by bending the edge up at right angles, which will also serve to increase the rigidity.



☛ Dried coffee grounds make good filling for pincushions as they will not rust the needles or pack solidly inside the cushion.

Novel Division Lines Improve Rule



Lines Scratched in Surface of Rule to Indicate Division Marks, Aid in Making Line Drawings

As an aid in quickly determining the fractional divisions on a rule when making drawings, one man marked off the $\frac{1}{4}$ -in. divisions with lines as shown. These lines, which are scratched in the rule and filled with black paint, serve to carry the eye immediately to the division line, and will be found especially handy where the rule divisions are $\frac{1}{16}$ or $\frac{1}{32}$ in. apart.

Protecting Photos against Insects

To prevent insects from destroying the gelatine coating on the surface of framed photos apply a thin coat of shellac or good varnish around the rabbet of the frame before putting the glass front in place. This will keep them from entering the



front of the frame, while a strip of heavy paper pasted over the joint between the backing and the frame with a mixture of library paste, 2 parts, and arsenic, 1 part, will keep them from entering at the back of the frame. For unframed photos, there are several preparations on the market that

can be applied to the gelatine surface to protect it. It has also been found that prints that have been soaked in 10 per cent formaldehyde will not be attacked by insects. If the photo is mounted so that it will not be bent, a thin coat of white shellac will protect the surface.

Repairing Worn Suitcase Latches with Pocket Nail File

Have you ever been in a hurry to catch a train and found that the small lugs on the latches of your bag or suitcase were worn so that the catches would not hold? If so, a temporary repair can be made in a couple of minutes by squaring up the lugs with a nail file so that the catches will hold until a permanent repair can be made.—Frank W. Bentley, Jr., Missouri Valley, Iowa.



Wire Tool Removes Ice and Sleet from Clothesline

Sleet and rain frozen on a clothesline are easily removed with the tool shown. It is merely a length of heavy wire with one end coiled around the line and the

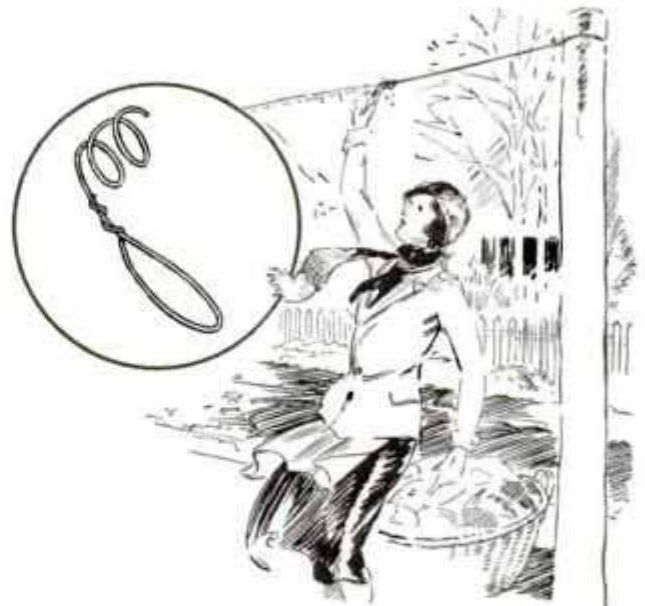

Wire Coiled around Clothesline Provides Tool for Removing Ice and Sleet from Clothesline

other bent to serve as a handle. When not in use, the tool may be moved to one end of the line where it will be out of the way.

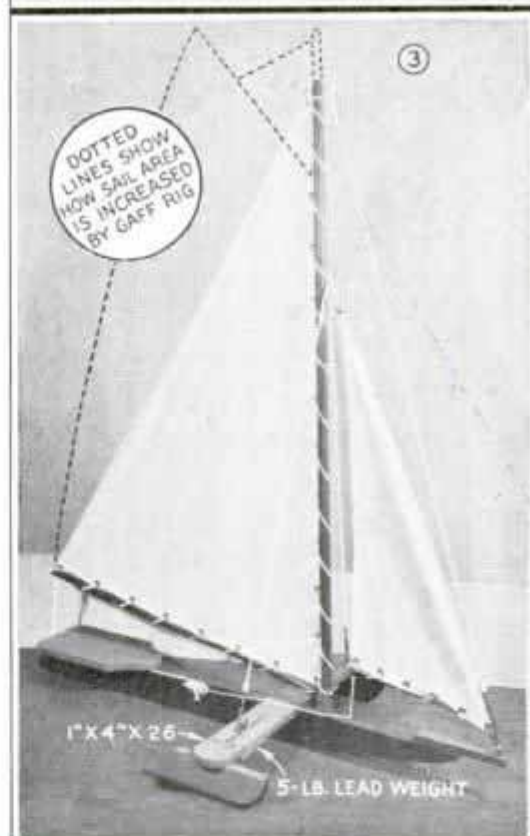
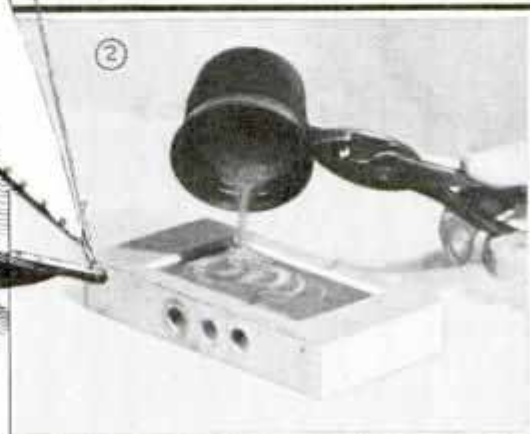
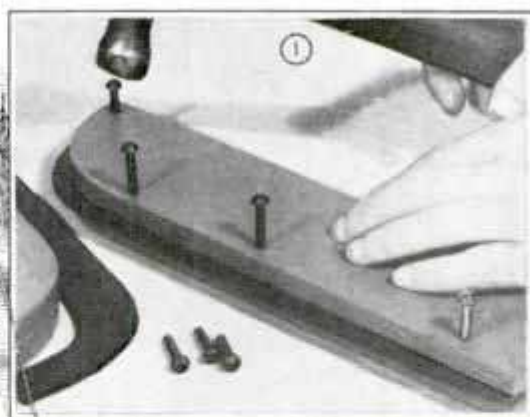

SAIL it as a model—let it tow you on skates—ride it like a big 'un—that's the three-purpose model ice boat. First make the main runner, then the two smaller runners. The bottom of the big runner can be capped with a length of flat or round metal, but the small runners need a sharp edge in order to prevent side drift. For this purpose you can use $\frac{1}{8}$ -in. sheet-metal shoes riveted into a slot cut in the underside of the runner, as shown in Fig. 1. Make the cross arm about 26 in. long, and slot it near each end to provide an adjustment for the 5-lb. lead weights used as ballast. These are not necessary when you ride the sled, but they are needed when the boat sails alone to prevent "hiking." The weights can be made easily by cutting a section out of a block of wood and using this as a mold, as shown in Fig. 2. The actual size of the boat can be varied up or down to suit. Do not try to crowd on too much sail; 10 or 12 sq. ft. is sufficient. If you want more canvas, use the gaff rig. This will add 4 or 5 ft. to the area without raising the center of effort.

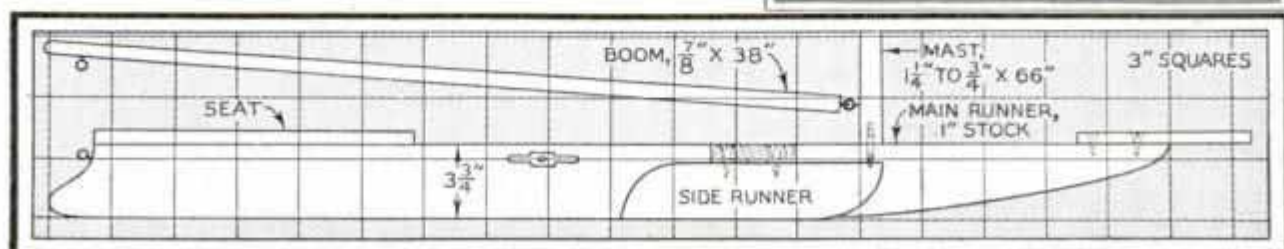



Pulling Newly Filed Saw over Edge of a Scrap Board to Remove Burrs from Teeth

Removing Small Burrs from Teeth of Filed Saw

After filing a hand saw, pull it from heel to point across the edge of a scrap board. This will remove from the teeth the small burrs made by the file. Unless this is done, the burrs break off in the first saw cut made after filing and dull the teeth.—Wayne C. Leckey, Aurora, Ill.

Using Razor Blade to Determine Emulsion Side of Photos

Amateur photographers who experience difficulty in finding the emulsion side of panchromatic plates when loading plate holders in the dark, can eliminate this trouble by using a safety-razor blade. Lay the plate on a flat surface, and with the sharp edge of the blade rub the surface of the plate at one corner, at the same time applying light pressure. The blade will drag slightly on the emulsion side of the plate and

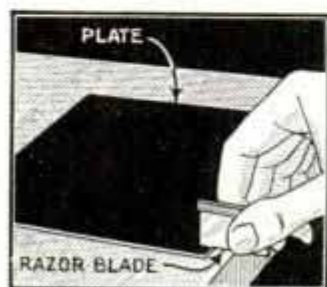

will slide easily on the glass side.—Benjamin Heller, New York City.

Concealed Braces Help to Prevent Doors from Sagging

Sagging doors can be braced by making a saw cut in each corner as shown and then inserting triangular pieces of heavy sheet metal into the cuts. Soft-iron rivets driven into holes drilled through the wood and metal hold the braces in place. It is a good idea to use rivets short enough to permit filling the ends of the holes with plastic wood, which, when dry, can be sanded down and stained to match the door.

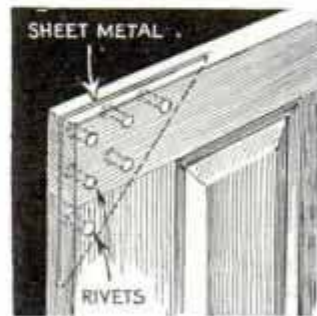

Toothbrush Clamps on Drawing Board for Pen Cleaner

An effective wiper and cleaner for lettering brushes and ruling pens may be made by bending the celluloid handle of a toothbrush so that it will clamp over the edge of a drawing board. Before trying to



Old Toothbrush Bent to Clamp over Drawing Board Serves as Pen Cleaner

bend the handle, soften it slightly by steaming it over a teakettle spout.

☐ If all the washed clothes to be ironed are hung on one line, they can be sprinkled evenly with a fine spray from a hose and rolled up as they are removed from the line, thus saving time of sprinkling.

Gay-Colored Pony Desk Has Kiddy-Car Seat

When using this novel pony desk, which delights tots of kindergarten age, the child sits astride a seat that is similar to one on a kiddy car, but instead of handle bars, there is a writing desk with a slanting top. This is arranged to slide up or is hinged at the upper edge so that the child can open it easily in order to store paper, pencils, etc., inside. A ledge along the bottom of of

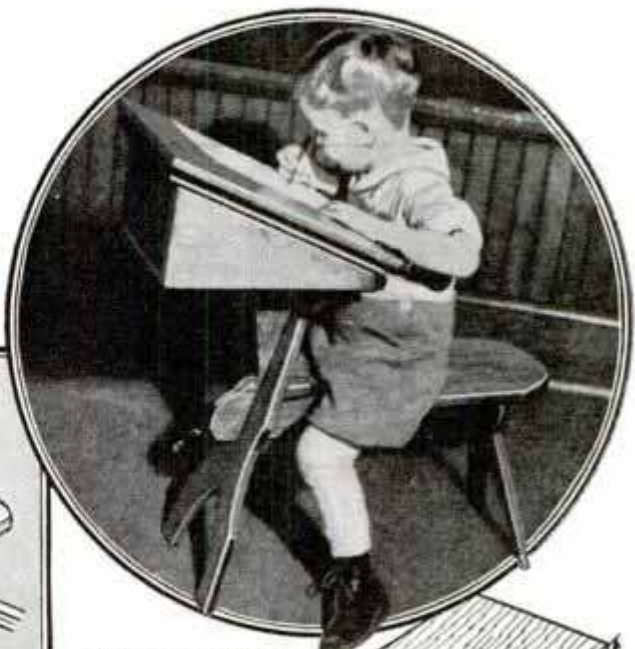
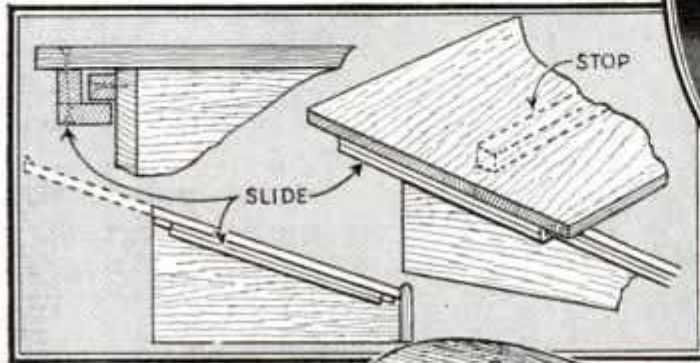

TOP MAY BE HINGED OR ARRANGED TO SLIDE

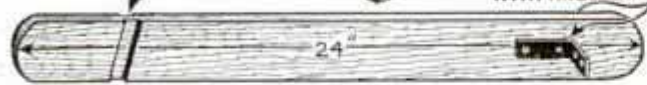
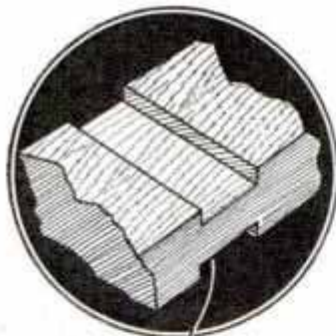

BRACED TO FRONT LEG WITH ANGLE BRACKETS

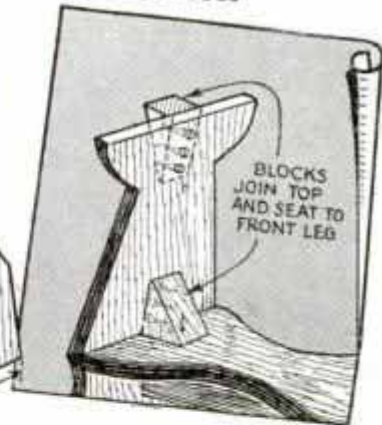
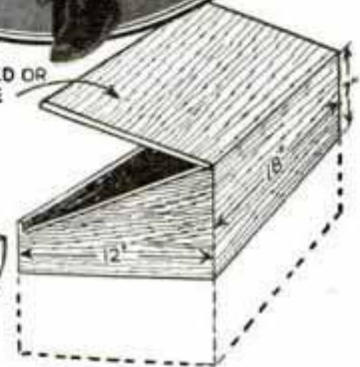
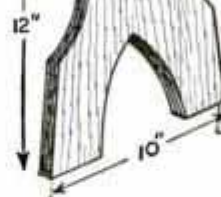

the top holds pencils and crayons at hand. The sturdy legs are attached to a rail on which the seat is also mounted, and the whole thing rests solidly on the floor. Although a suggested method of assembly is shown in the details, this may be altered at your discretion as necessary with the stock at hand. Painted or lacquered in bright colors, which, when dry, may be covered with a coat of clear varnish, this desk will be found highly successful in keeping the little one busy.

☐ A piece of fine wire mesh fastened to a small wood frame and hung on the wall makes a good match scratcher.

How to Antique Masts and Yards

A realistic weathered finish on masts and yards of ship models can be produced by brushing on a coat of dark, walnut oil stain and then immediately wiping it off with a soft cloth, after which the wood is allowed to dry for about 5 min. The work is next rubbed down with a cloth dipped in varnish remover to "gray out" the initial stain. After drying overnight, the surface is rubbed down with fine, steel wool to its finished smoothness.

Ashes Removed from Heating Stove without Raising Dust



Closed Pail Fitted with Chute Receives Ashes Raked from Stove and Prevents Dust in the House

To avoid getting dust in the house or ashes on the floor when cleaning your heating stove, use an ash hoe and a pail similar to the one shown. An opening in one side of the pail is fitted with a sheet-metal chute or trough, which slides under the opening in the ash pit to receive the ashes as they are raked out. The hoe handle is manipulated through a small hole in the side of the can opposite the chute.—A. H. Waychoff, Riverside, Calif.

Drying Freshly Painted Articles in Your Oven

If it is desired to speed the drying of small wood and metal articles that have been freshly painted, slip them in the oven of your stove. While different finishes have different drying speeds, it will be found that a temperature of 125° Fahr. will dry an object in about half the time required at average room temperature. Do not exceed this temperature for wood articles as higher

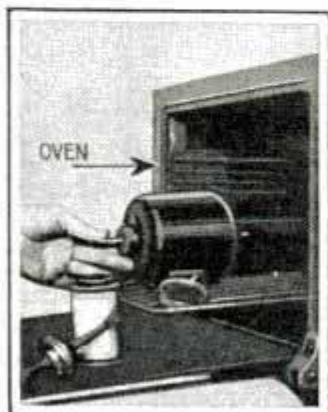

temperatures are likely to drive moisture from the wood and spoil the finish. On metal articles, however, temperatures up to 160° may be used. If you are using regular baking enamel, it is best to follow the temperature directions printed on the can.—C. E. Packer, Chicago.

Magnets Move Actors on This Miniature Stage

Young children may be kept happily entertained with a toy stage, made of cardboard, across which cut-outs of comic characters from the newspapers, or snapshots of the children themselves, are made to slide with a moving magnet held under the stage floor. A paper clip on the folded base of each cut-out adds the necessary iron which is attracted by the magnet. The sections of the stage are cut from two 22 by 28-in. sheets of poster board, or any medium-weight cardboard, and folded according to the patterns shown. Two side stretchers complete the framework which is then assembled with ½-in. paper fasteners. A sharp ice pick will be found convenient for making the holes for the fasteners. Interchangeable backdrops, consisting of sheets of colored paper on which appropriate scenes may be painted, are suspended from 1-in. strips of cardboard which rest in notches cut in the top edge of the side stretchers. The proscenium opening is finished off by simulating the folds and creases of the drapes with paint or crayon. A curtain consists of a piece of cardboard that may be slipped readily down behind the proscenium at the close of the performance and removed at the opening of the act. If it is desired to illuminate the stage, a flashlight bulb and battery may be connected, as shown, and suspended over the stage from a cardboard support fastened to the side stretchers. Oiled, colored tissue paper may be used over the light bulb to produce special lighting effects. Additional action may be had by mounting cut-outs of boats, trains, giants, dinosaurs and other large figures on sticks and manipulating them from the wings.

☞ If a scrubbing brush is dipped in strong salt water after using and then hung up to dry, it will be clean and will last longer.

MAGNETIC THEATER

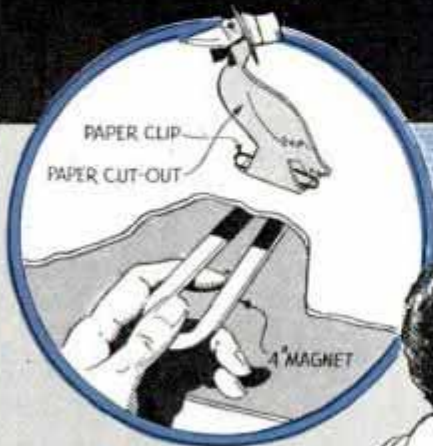
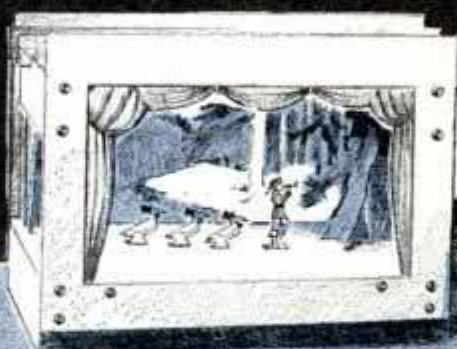

Cut-Out Figures on Paper Clips or Small Pieces of Sheet Iron, Are Moved Across the Stage with a Magnet Held under the Stage Floor

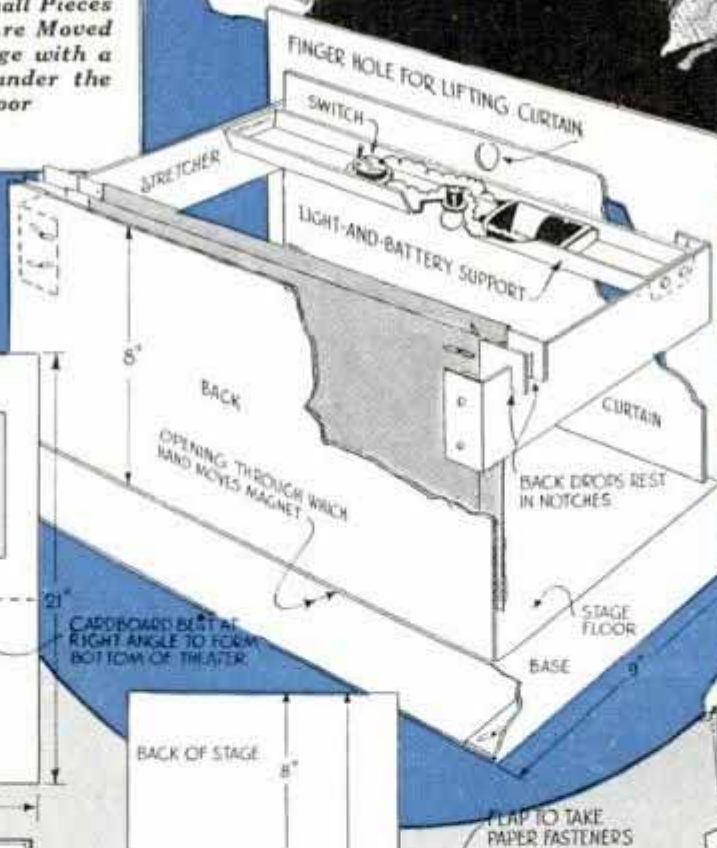

STANDARD $\frac{1}{8}$ " PAPER FASTENERS ARE USED IN ASSEMBLING

OPENING CUT TO SIMULATE DROPPES

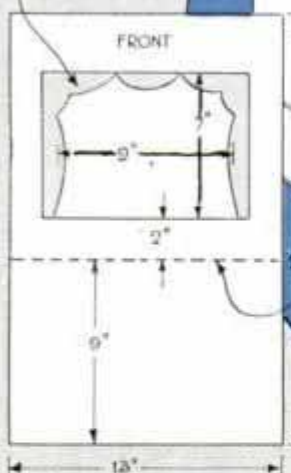

The Stage Is Lighted with a Small Flashlight Battery and Bulb

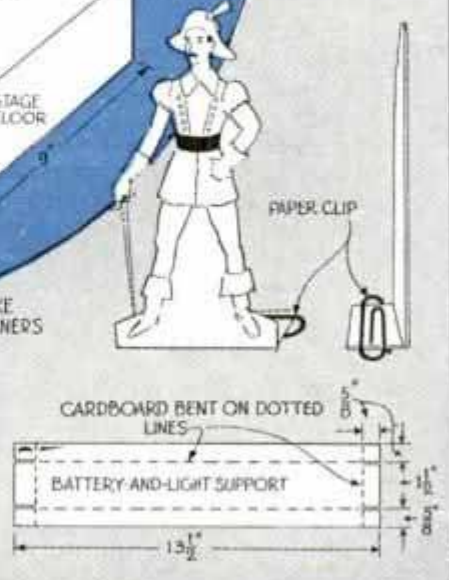
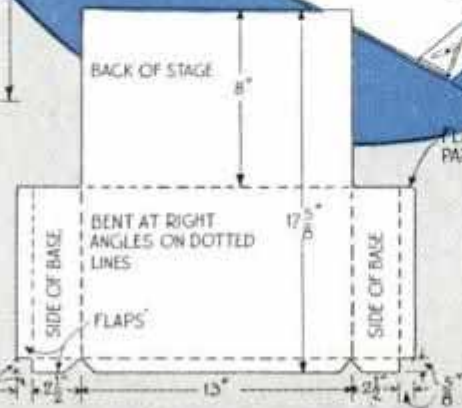

Paste in Collapsible Tubes Applied Neatly with Soda Straw

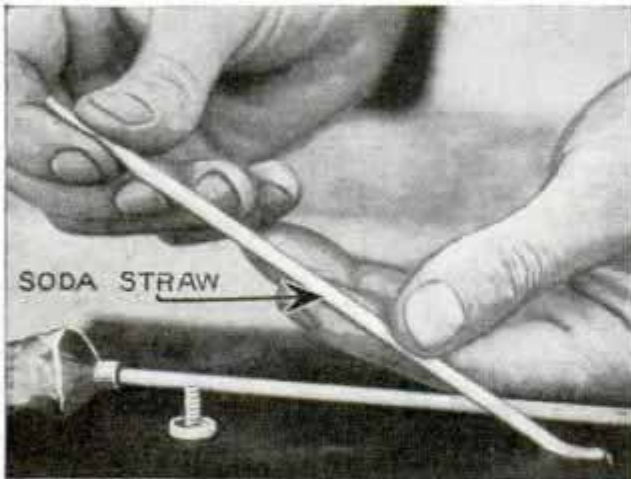

Using a Soda Straw to Apply Paste Contained in Collapsible Tubes Assures Neat Job

By using an ordinary soda straw, paste or cement, that comes in collapsible tubes, can be applied in small drops or in a neat

ribbon, without smearing. The straw also saves time in replacing the cap every time the tube is laid down. To fill the straw, insert one end into the tube, squeeze the paste into it and then fold over the outer end to seal it. After removing the straw, flatten the other end and apply the paste by squeezing the folded end.—Frank W. Bentley, Jr., Missouri Valley, Ia.

Homemade Solution for Cleaning Walls

For cleaning painted walls and woodwork, an effective cleaning fluid is made cheaply by mixing equal parts of kerosene, vinegar and soft water. Rain water caught in an earthen vessel will do. To clean a wall, dip a clean, soft cloth in the liquid and sponge it, after which the loosened dirt is removed by sponging the wall with a cloth dipped in clear water. The vinegar eliminates the offensive odor of kerosene.

BUILD YOUR BOAT THIS WINTER



"Roamer," 16-Ft.
Outboard Cabin Cruiser

during those numerous spare hours, so that it will be ready to launch when the boating season opens. Popular Mechanics blueprints cover boats of all kinds, and among them you may find one that is suited to your needs.

"Roamer"—16-ft. outboard cabin cruiser; two berths. 6 prints, (765 to 770)—\$1.00.

"Hi-Ho"—14-ft. outboard or inboard family runabout. 6 prints, (840 to 845)—\$1.00.

"Pop's"—Speedy 12-ft. Class-A racer with step bottom. 2 prints, (813 and 814)—50c.

16-Ft. Canoe—Cedar planking covered with canvas. 2 prints, (811 and 812)—50c.

14-Ft. Outboard Motor Boat—Round bottom with step. 2 prints, (645 and 646)—50c.

15-Ft. Rowboat—Flat bottom; heavy transom for outboard. 1 print, (644)—25c.

12-Ft. Sailing Skiff—Flat bottom with centerboard well. 2 prints, (524 and 525)—50c.

Double End Duck Boat—Wooden frame covered with canvas. 10 ft. long. 1 print, (703)—25c.

12-Ft. Rowboat—Sturdy flat bottom; fine for rental purposes. 1 print, (707)—25c.

POPULAR MECHANICS 400 Blueprints also include plans on woodworking, metal work, homemade shop machinery, toys for the children, novelties and craft work, besides a wide range of model-making projects. A complete list will be sent for 3c to cover mailing costs. Address Popular Mechanics Blueprint Department, 200 E. Ontario Street, Chicago.

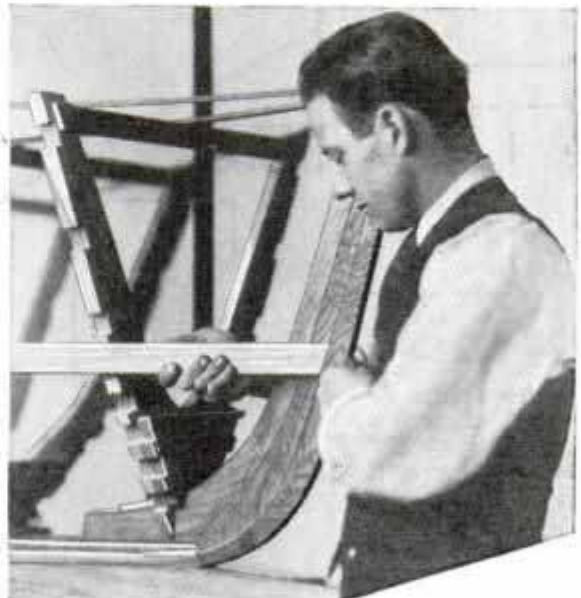

Titles Washed into Scenes of Marine Movies



Underwater Scenes for Home Movies Simulated by Photographing Goldfish in Aquarium Containing Marine Plants

Appearing on a screen as though they were washed in by a wave, appropriate titles for home movies of marine scenes are made as shown in the left-hand detail. The title is first lettered in the surface of wet sand, and then photographed upside down. Allow sufficient time for exposure of the title and then have someone standing outside of the lens range throw a bucket of water over the sand with a sweeping motion. In order to get the title

to appear correctly on the screen, the portion of the finished film containing the title is cut out, the ends reversed and then cemented in place.

The right-hand drawing shows a simple method of getting underwater scenes of fish and plants. The camera is merely held against an aquarium as the scene is taken. Use only a rectangular aquarium with sides of clear glass, otherwise the image will be distorted on the film.

Heavy Cardboard Folded over Clothesline Spaces Garments

When coat hangers are used to hang garments on a clothesline to dry or air out, it is a good idea to fold a piece of heavy cardboard over the line and suspend the hangers from it as shown. This prevents the garments from sliding together if the line sags and keeps them spaced so that air can circulate freely around them. The cardboard is perforated near the lower edge to receive the hangers.

Use a Fine-Tooth Saw for Cutting Thin Metal

When sawing thin metal, use a fine-tooth blade so that at least two of the teeth are in contact with the metal all the time as the saw is pulled across it. With a coarse blade the edge of the metal gets between the teeth and may break them.



Chicago

3017 Carroll Ave

Chicago
Tel. Nevada 6373

Building MODEL

by...
**W. CLYDE
LAMMEY**

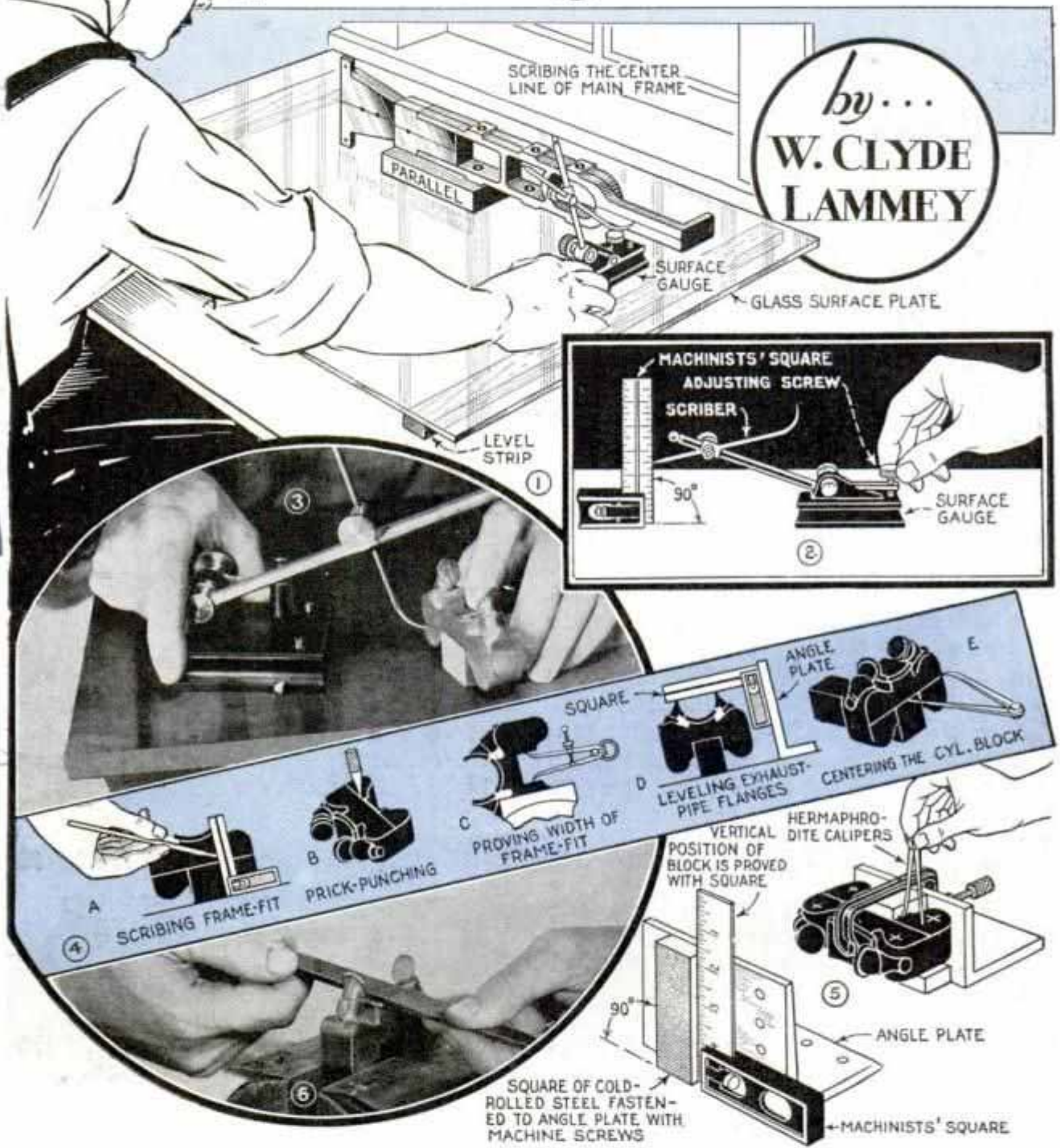

PART I, THE CHASSIS

AS a rule, the main frame in a set of small-scale castings comes drilled for drive-wheel axles, and the main section of the frame is milled accurately to size. Set up the main frame as in Fig. 1 and scribe a center line with a surface gauge. In this operation, set the surface gauge as in Fig. 2. A piece of heavy plate glass will serve for a surface plate. Next, fit the cyl-

inder block to the frame and scribe the exact location of all holes for the dummy cylinder heads as in Figs. 3, 4 and 5. In this work you will need an angle plate and several squares of cold-rolled steel for use as parallels and locating blocks as indicated in the details A to E of Fig. 4. To make an angle plate, cut a short length from a piece of heavy angle iron and have the

Supplies from 'S. H. Daniels, Inc. (Chicago) Model Engineers

*Scale models done
15/16 S. Wabash
Chicago*

LOCOMOTIVES

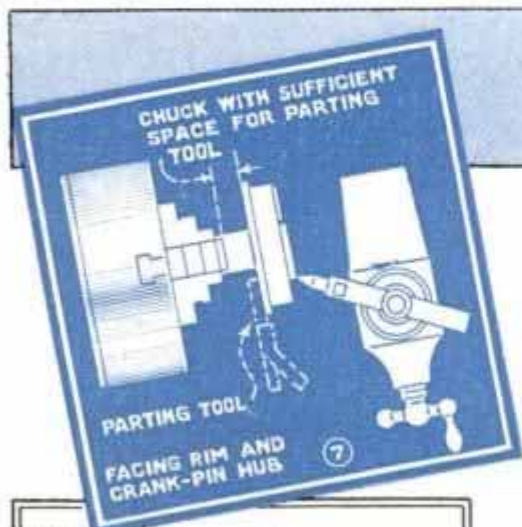

Complete kits of parts, furnished by manufacturers, make the hobby of building scale-model locomotives increasingly popular. The castings in the kits are either rough so you can finish them yourself, or are finished so you need only assemble them.

two outer faces milled true in a machine shop. Drill a number of holes through the halves of the angle, so that you can fasten steel squares to the plate as in the lower detail of Fig. 5. Before drilling, carefully check all your measurements with the blueprints. Prick-punch the centers and scribe two or more concentric circles as in Fig. 8. Then set up the cylinder block for spotting and drilling as in the upper detail of Fig. 5. First spot the holes with a drill smaller than the diameter of the finished hole as in Fig. 8. Start this drill with very light pressure to prevent creeping. Re-check before final drilling. Any holes spotted slightly off-center may be re-centered with a new prick-punch mark. After the

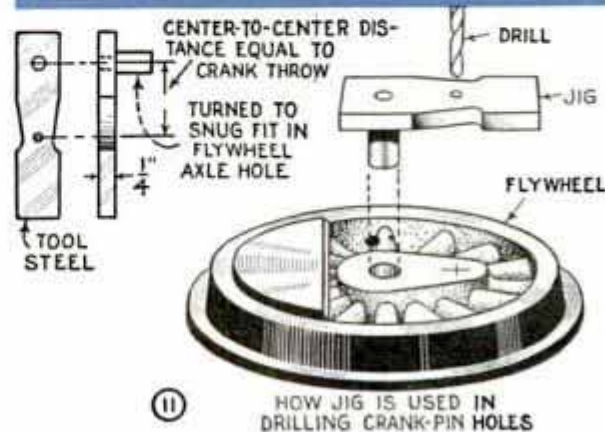
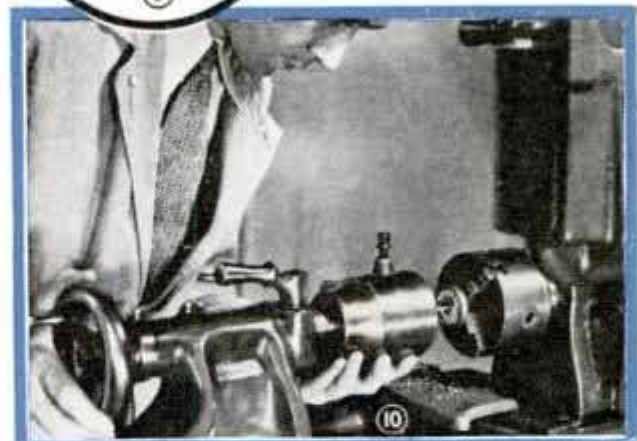

Metal turning by S. Smith Bend Lathes Co. South Bend, Ind.



drilling is done, true the cylinder-block faces with a file, Fig. 6, check for length and width, true up the boiler saddle and steam pipes to the required radius and drill and tap the necessary holes for attaching the block to the frame. The dummy cylinder and valve-chest heads and the crosshead guides can be left until later in the assembly.

Small-scale drive-wheel castings usually come with a chucking lug or boss cast on the back face. True the chucking lug first with a light cut, reverse the wheel and re-chuck as in Fig. 7, allowing space for the parting tool between the chuck jaws

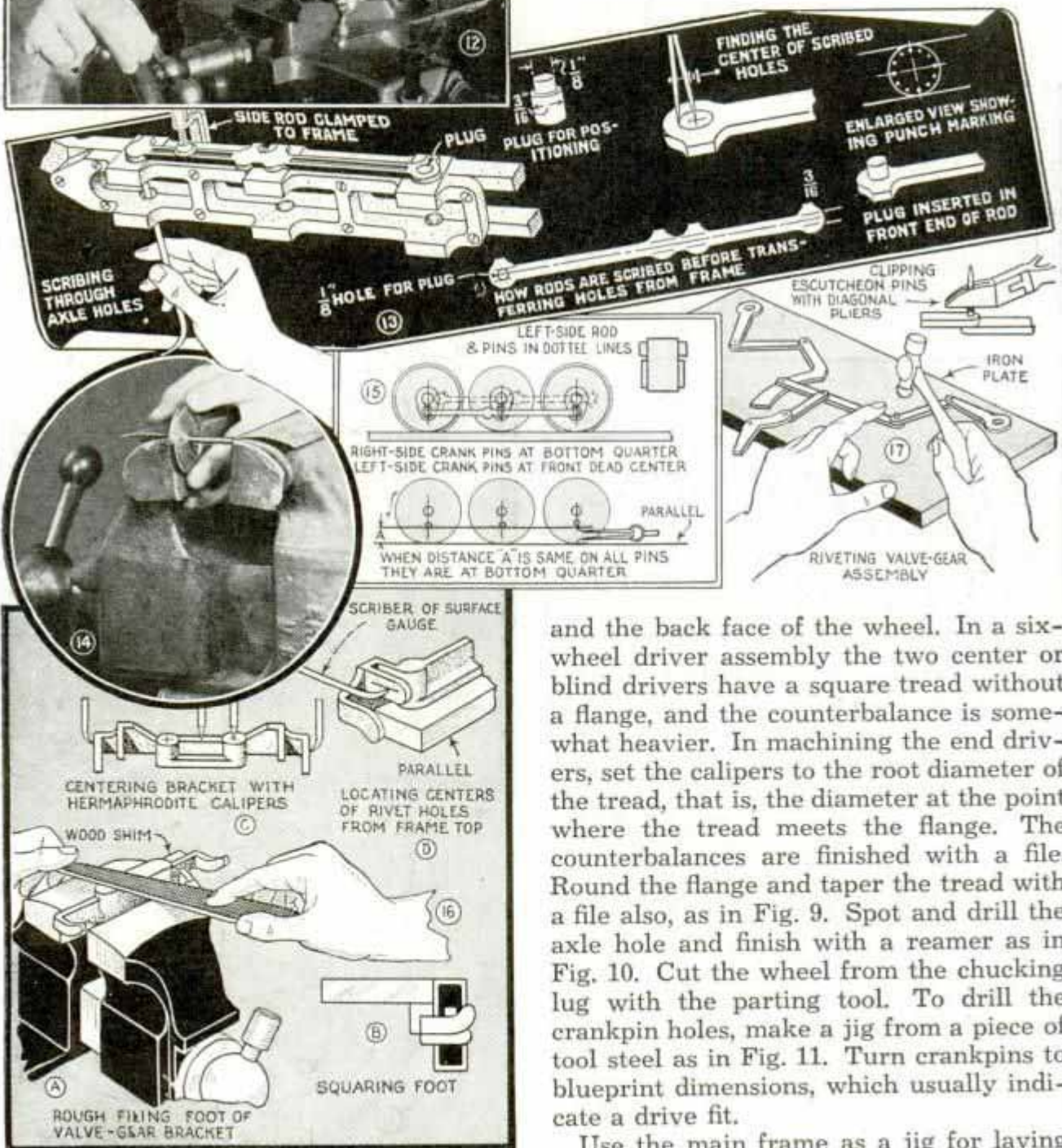

and the back face of the wheel. In a six-wheel driver assembly the two center or blind drivers have a square tread without a flange, and the counterbalance is somewhat heavier. In machining the end drivers, set the calipers to the root diameter of the tread, that is, the diameter at the point where the tread meets the flange. The counterbalances are finished with a file. Round the flange and taper the tread with a file also, as in Fig. 9. Spot and drill the axle hole and finish with a reamer as in Fig. 10. Cut the wheel from the chucking lug with the parting tool. To drill the crankpin holes, make a jig from a piece of tool steel as in Fig. 11. Turn crankpins to blueprint dimensions, which usually indicate a drive fit.

Use the main frame as a jig for laying

out and drilling the holes in the siderods as in Fig. 13. Cut the drive-wheel axles to length from the material supplied with the castings. Press an axle into each of the two end drivers and the one center driver, using an arbor press or a vise with copper-lined jaws as in Fig. 14. At this stage fit the composition drive gear. On the Pacific-type locomotive this gear is mounted on the rear drive-wheel axle while on the Hudson type it is mounted on the center drive-wheel axle. On others the location

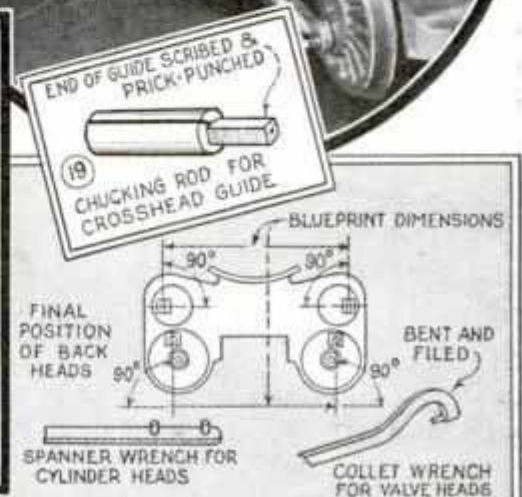
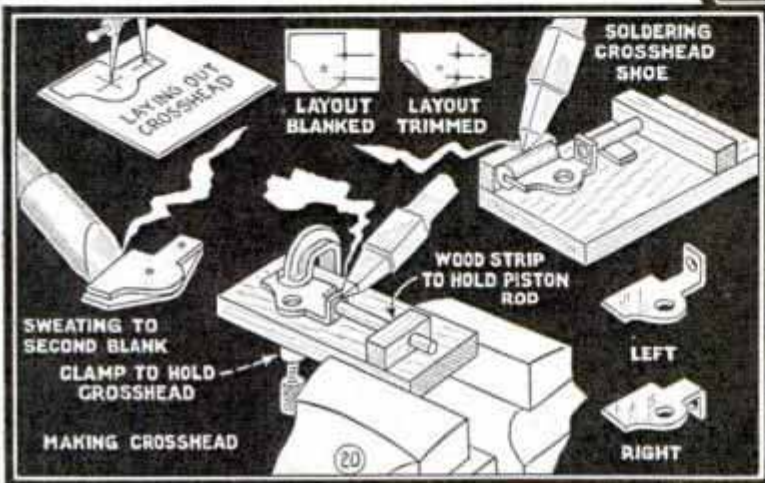

of the driving gear is governed by the design of the model. Assemble this gear on the axle according to your blueprints. Place the axles in the main frame with the three wheels on one side, and start the remaining three wheels on the axles, using hand pressure only. Usually a thin washer goes between the wheel hub and the frame. Slip a siderod on the pins of the drivers that are fully seated on the axles and set the assembly on a surface plate. With an outside caliper, set the rod on the bottom quarter as in Figs. 15 and 18. Turn the wheels on the opposite side until the siderod will slip on. Then set these wheels on the forward quarter, turning them by hand and making sure that the first three do not move from their original position. Roll the chassis on the surface plate. If the rod binds as it crosses the dead centers, turn the loose wheels slightly until the assembly revolves freely. Then remove the rod and force the wheels on the axles. This simple method is sufficiently accurate for the purpose and saves the time necessary to make up a special jig. At this stage the chassis is ready for the motion work consisting of the valve gear, generally of the

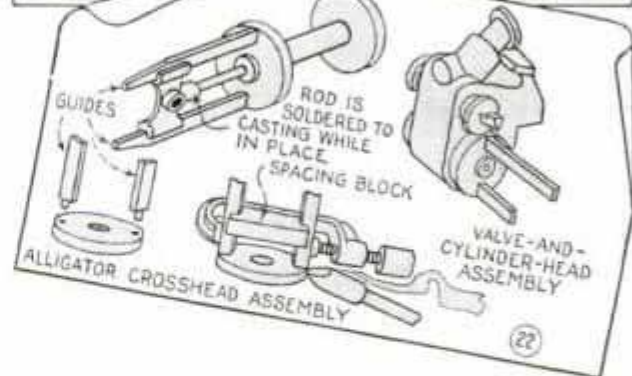
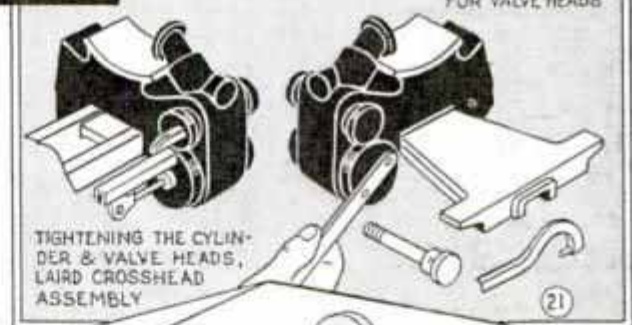

Walchaert type, the crossheads and valve-guide assemblies and the cylinder and valve heads. First prepare the valve-gear bracket casting as in Fig. 16, in the order indicated by letters. Then make up the valve gear, which in small-scale models is usually made from German silver and riveted together with escutcheon pins as in

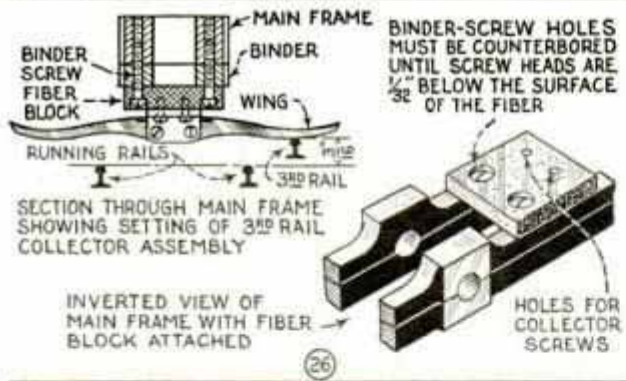
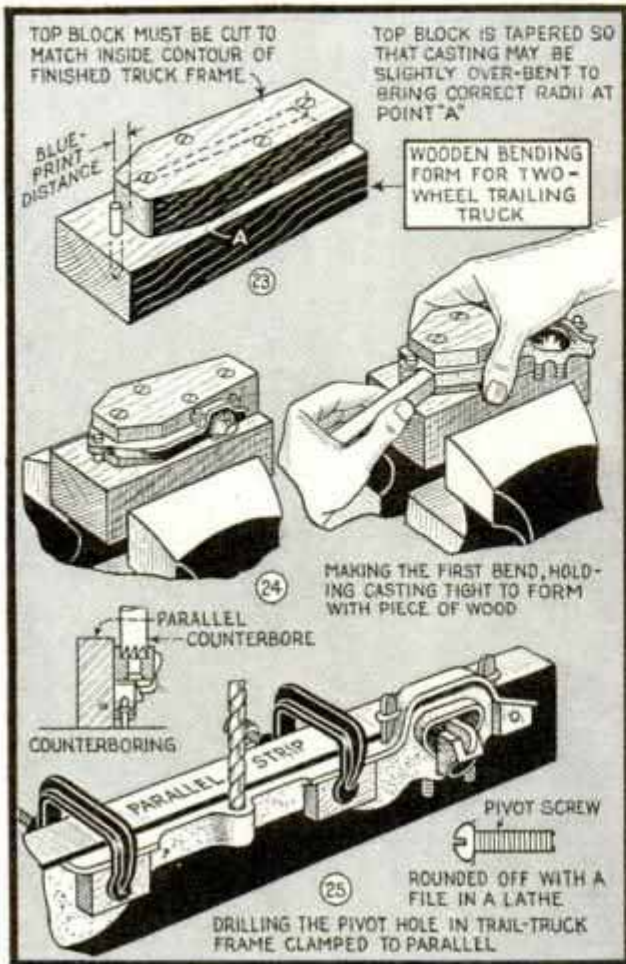
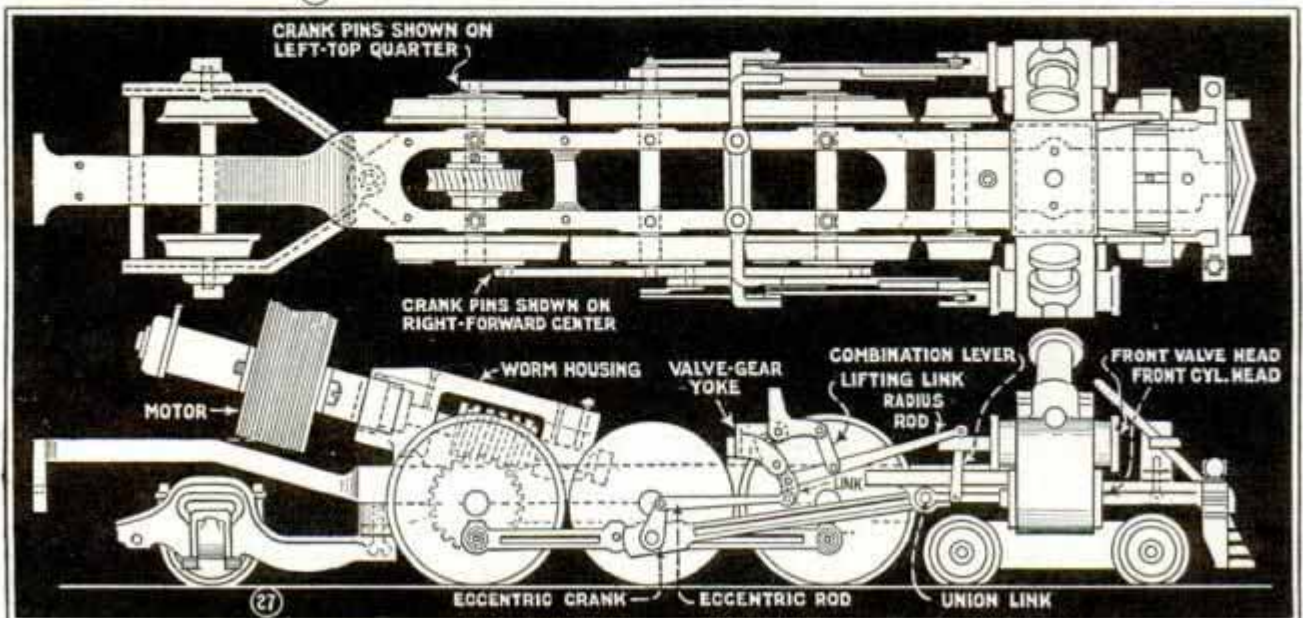
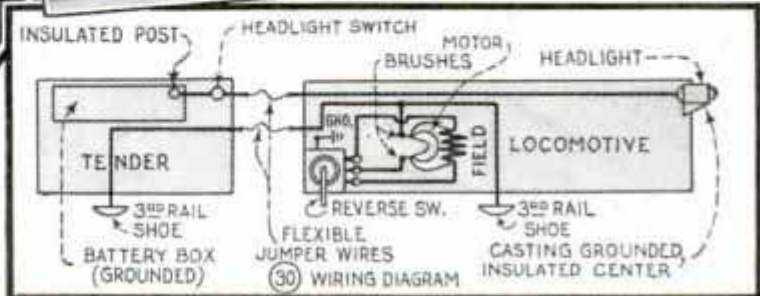
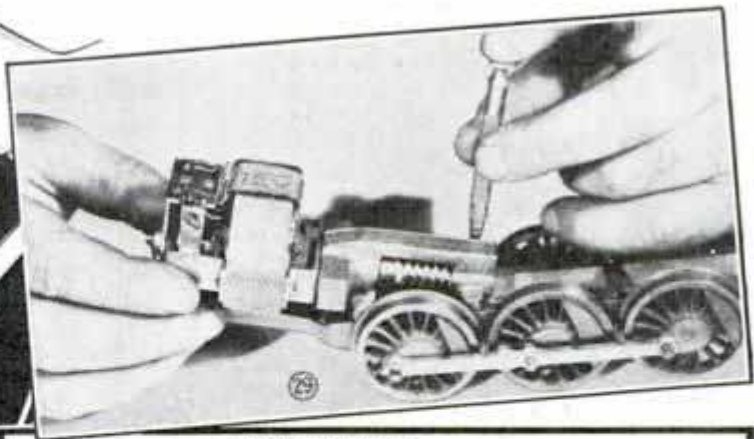
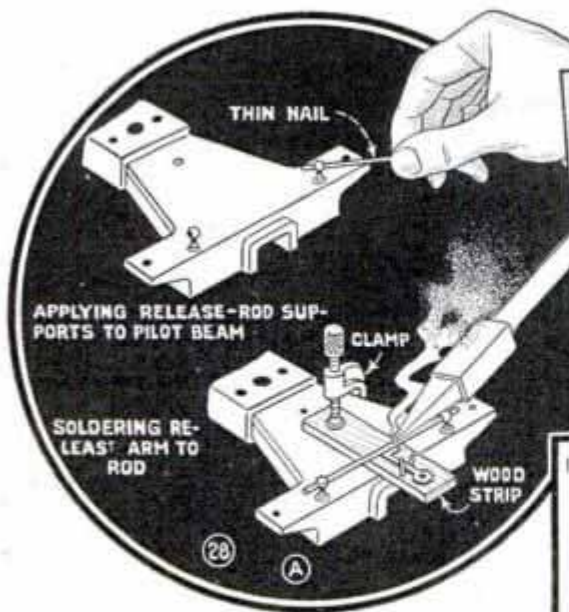

Fig. 17. Fit the valve-gear bracket on the main frame, then turn out the cylinder and valve heads to blueprint dimensions. The crosshead used in small working models is generally of the Laird type, made from German silver. Fig. 20 shows the various steps in making up this type of crosshead. A useful kink for holding the square stock in a three-jaw chuck is shown in Fig. 19. The small rolled-steel square from which the Laird-type crosshead guide is made, is pressed into the end of a short length of thick-walled brass or steel tubing slotted along the length as shown. The necessary round projection is turned on the end of the square, which is drilled lengthwise to take the round crosshead shoe. The rounded end fits in a hole drilled in the back cylinder head where it is soldered. The complete assembly of the cylinder heads fitted with the Laird-type crosshead is shown in Fig. 21. With this done, hook up the valve gear and the main rods to complete the assembly. The alligator-type crosshead assembly, as shown in Fig. 22, is more commonly used on large-scale models.

Wheels for the lead and trailer trucks of the locomotive and also the tender truck wheels are a straight duplicate turning job on cold-rolled steel as in Fig. 12. When turned to finish size the wheels are chucked individually and center-drilled for the axles. The latter are usually shouldered on the tender and trailer trucks but are straight on the locomotive lead truck due to the design of the frame. Where the truck is of the outside frame type, such as





tender and locomotive trailer trucks either two or four-wheeled, the axles project beyond the wheel hub and enter holes drilled in the side frames on which are cast the dummy axle boxes. The frame for the locomotive lead truck and also the frames for the tender trucks require practically no finishing as they come in complete units. It is only necessary to locate and drill the holes for the axles and the screws which attach the complete truck to the frame. On some models the truck frames are in three parts, a center crosspiece and two side members which must be joined with screws to form the complete unit. Figs. 23, 24 and 25 show how the two-wheeled locomotive trailer truck frame is formed. This is furnished as a soft casting and must be bent to the proper shape over a wooden form as in Fig. 24. This truck is used on the Pacific-type locomotive.

The drive unit of the electrically driven locomotive consists of the motor, worm, and a cast housing which is fastened to the main frame with screws and supports both the motor and driving worm. The housing is drilled and reamed to form bearings for the projection of the motor shaft which carries the worm gear. The latter is keyed to the shaft with a transverse pin and provision is made to take up the end thrust. The drive unit is then mounted on the main frame as in Figs. 27 and 29. The worm housing is somewhat oversize in the rough casting and it will likely be necessary to file down the mounting lugs or feet so that the worm meshes properly with the

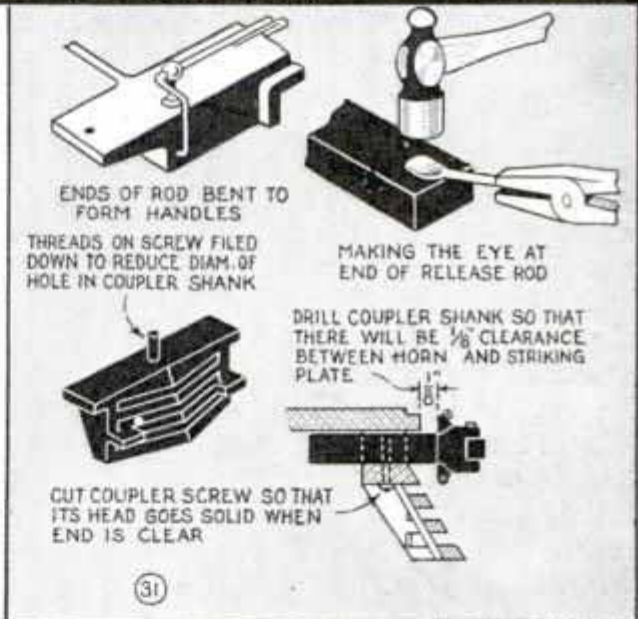

fiber gear. This part must be fitted with care to insure a free-running drive. Fig. 27 shows the assembly of a Pacific-type chassis, the construction of which is typical of small-scale, electric models.

The usual manner of mounting the third-rail collector shoes is shown in Fig. 26. The shoes are generally furnished complete. Fig. 30 shows a typical wiring diagram for third-rail operation. Before wiring up completely, connect the motor leads to a transformer and run the chassis under power for a time to break it in. To finish, fit and attach the pilot, the pilot and tender couplings and the release rods as in Figs. 28 and 31.

(To be continued)

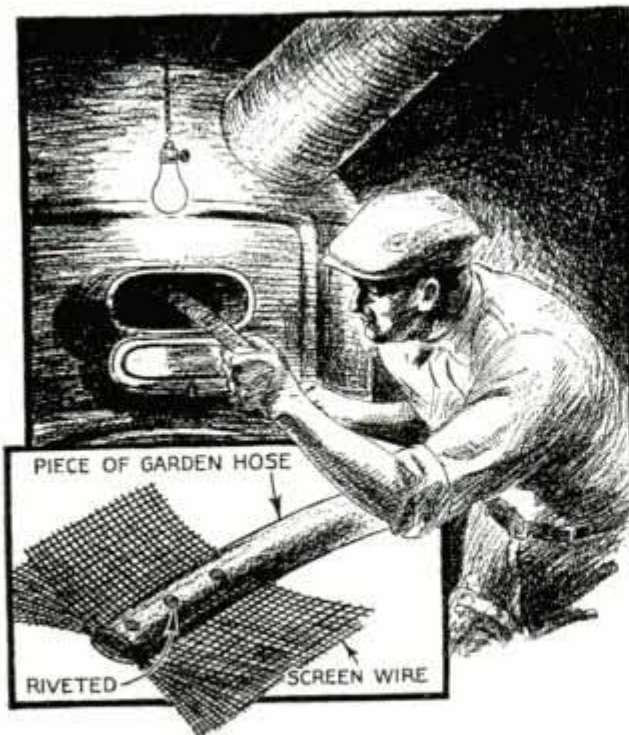

Flexible Cleaning Brush for Removing Soot from Radiating Drum in Hot-Air Furnace

Furnace-Cleaning Brush Has Flexible Handle

After many discouraging attempts to remove soot from the radiating drum in a hot-air furnace, I made a brush from a length of old garden hose and pieces of screen wire. The hose was split at one end and several squares of the screen wire inserted and riveted in place as indicated. When forced into the flues, the rubber handle of this cleaner allows the brush to follow the curves, and a twisting motion scrapes the soot from the entire surface.—G. E. Hendrickson, Argyle, Wis.

Coat Hangers That Fold Flat

Coat hangers made as shown will fold compactly and will take very little space in your bag or suitcase. Get three strips of hardwood, one 16½ in. long and two about 9½ in. long. Cut a slot in one of the short strips and then assemble them as indicated with small machine screws, using a spacing washer at one end of the longer strip so that the hanger will fold

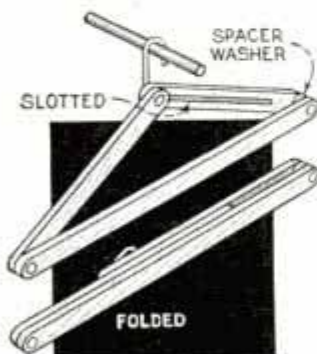

flat. After driving the nuts down on the screws so that the strips pivot easily, cut off the ends and rivet them over the nuts, smoothing the ends with a file to prevent tearing the clothing.—Chas. Tyler, Chicago.

Making Strong Ship-Model Railings

As most ship-model hulls are carved from soft wood, the posts supporting the rails loosen and get out of line, which results in frequent repairs. To eliminate this, a small rabbet is cut into the top edge of the hull where the rail is to be fitted, after which a piece of hardwood of the same size as the rabbet is drilled to receive the rail posts at the specified intervals. The rail is then built up with the hardwood stick as a base. When completed, this assembly is glued into the rabbet, and irregularities are sanded off flush with the hull.

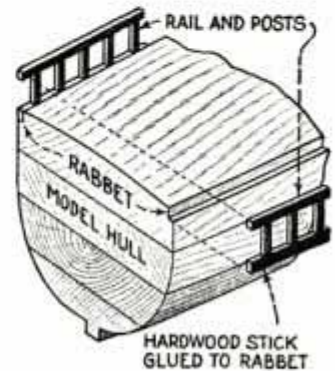

Guide for Drilling Dowel Holes

An accurate guide for drilling dowel holes is made easily from a hardwood block by drilling two holes through it as shown. In use, the guide is placed over

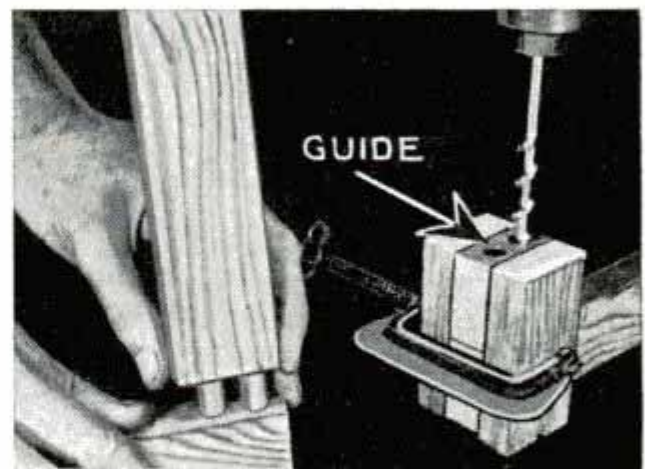

Hardwood Block with Holes, Clamped to Work, Is Useful Guide for Drilling Dowel Holes

the work where the dowel holes are to be drilled and held in this position securely by means of two blocks clamped to the work as shown in the right-hand detail.



BELT SANDER

run by

DRILL PRESS

MADE from a few pieces of scrap wood and four ball or roller-bearing skate wheels, this simple sanding attachment can be used on any drill press and will greatly increase its scope of usefulness. While the attachment was designed for sanding small and medium-sized wood parts, the dimensions can be altered to give it larger capacity with equally good results.

The first step is to make the rollers. Drill holes lengthwise in the ends of two 8-in. lengths of 1½-in. hardwood for the spindles. The holes must be centered and must be in perfect alignment, and just large enough so that ¼ by 2-in. bolts can be driven in to a tight fit. Three bolts are used and a 3-in. length of ¼-in. steel rod, which is to project beyond one of the wheels to serve as a drive shaft as in Fig. 1. Cement or waterproof casein glue may be used to help hold the bolts tightly. After driving them home, cut off the heads and set up in a lathe so that the blocks can be turned down to 1⅜

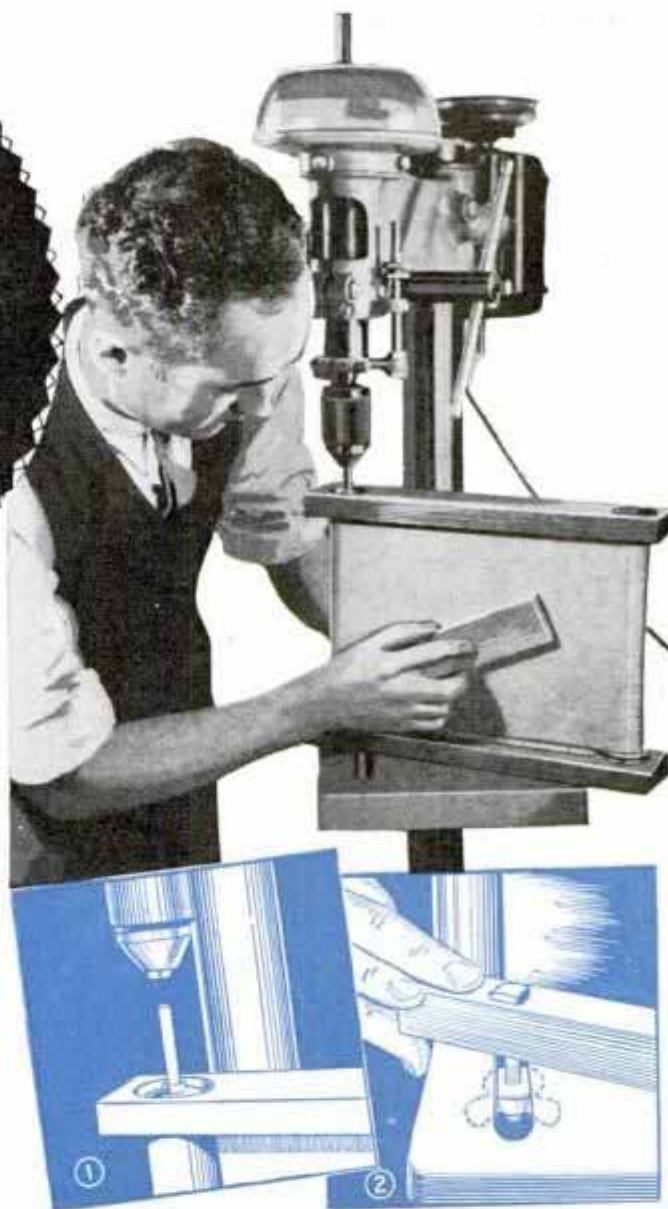

in. diameter. This method will assure getting the bolts concentric with the rollers.

The frame is then assembled. It consists of two lengths of hardwood, 3 by 14 by ⅝-in. At one end of each a hole is drilled to receive a skate wheel which should fit snugly. Also, be sure that the holes are centered the same distance from the ends. The bearing holes at the other end of these

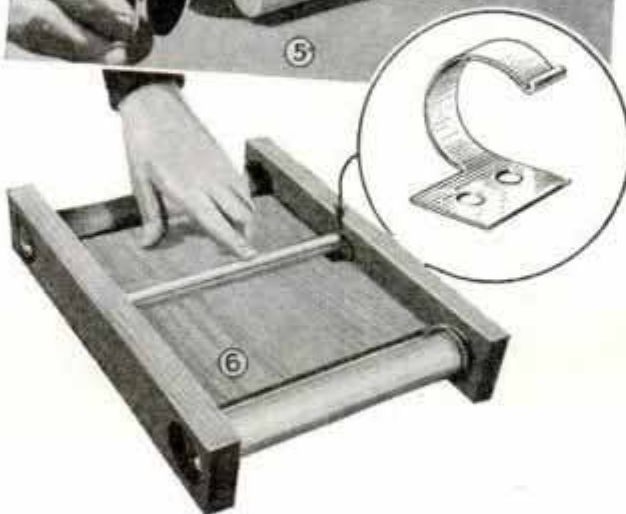
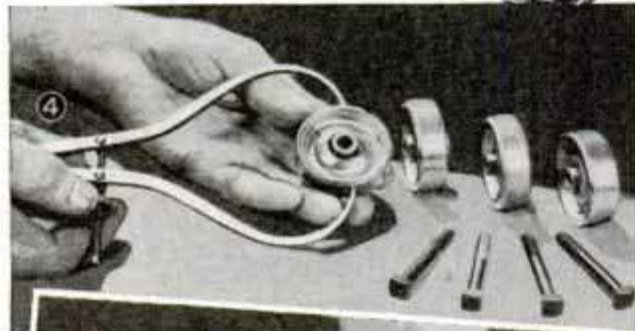
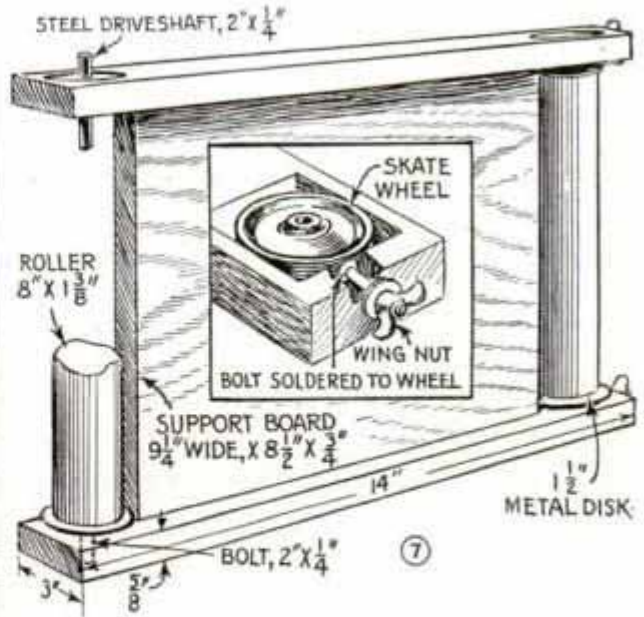

end adjustable for tightening the sanding belt. The adjustment is pictured in the detail of Fig. 7. The frame members that hold the bearings are then fastened to a support board with glue and screws, as in Fig. 3, taking care to get the holes in alignment. One side of the board should be flush with the surface of the rollers when they are fitted in place. When fitting the rollers, use washers between them and the bearings as shown in Fig. 5.

Fig. 6 pictures an alternate method of keeping the belt tight. This tension take-up consists of an 8-in. dowel supported at each end by small steel springs. A detail of the spring is shown in the circular insert. Two holes are drilled through the lower frame member for small bolts that hold the sanding attachment securely to the drill-press table as in Fig. 2. Give the support board one coat of shellac and then sand and polish it down smooth, rounding the edges next to the rollers. It is also advisable to give the drive roller several coats of rubber cement to increase its gripping power. Allow the cement to dry well so that it is not tacky.

In attaching the sanding belt, it is wrapped around the rollers and jointed with glue over the support board in front. If it is necessary to have sanding belts already cemented up, larger rollers must be used so that the "sleeves" can be slipped in place over the top. With as small a sander as this one, the former method is preferable as large rollers increase the tendency toward vibration, while with the size specified, it is entirely absent.

frame pieces are rectangular, the width being such that the wheel can be moved back and forth. making the roller at this

A Combination Lens Hood and Filter Holder

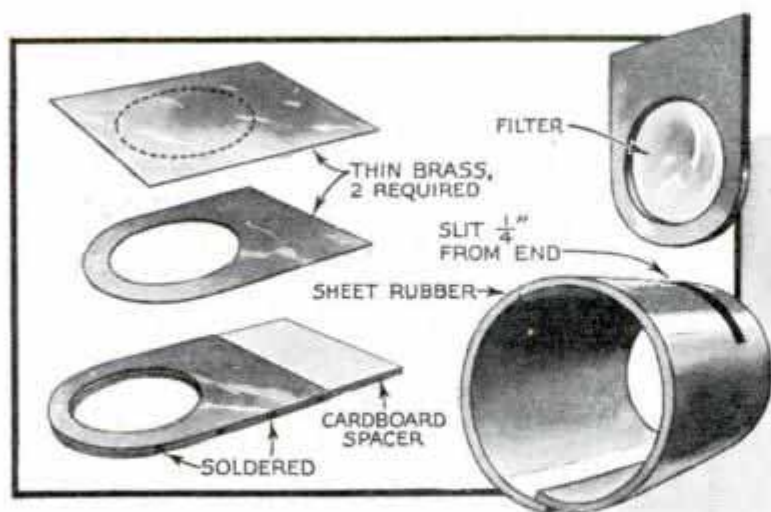

Fitting snugly over a camera lens, this hood, which also serves as a holder for inexpensive gelatine filters, is made easily from a piece of inner-tube rubber. The pattern is shown in the lower detail. After cutting the rubber, cement the ends together with rubber cement. Apply a thin film of cement to each edge, allow the cement to dry and then press the rubber together firmly, holding it between two blocks and a C-clamp. A narrow slit is then cut about $\frac{1}{4}$ in. from the small end to take the filters, which are slipped into small brass frames. These are made from two pieces of thin sheet brass slightly larger than the lens of the camera. Clamp

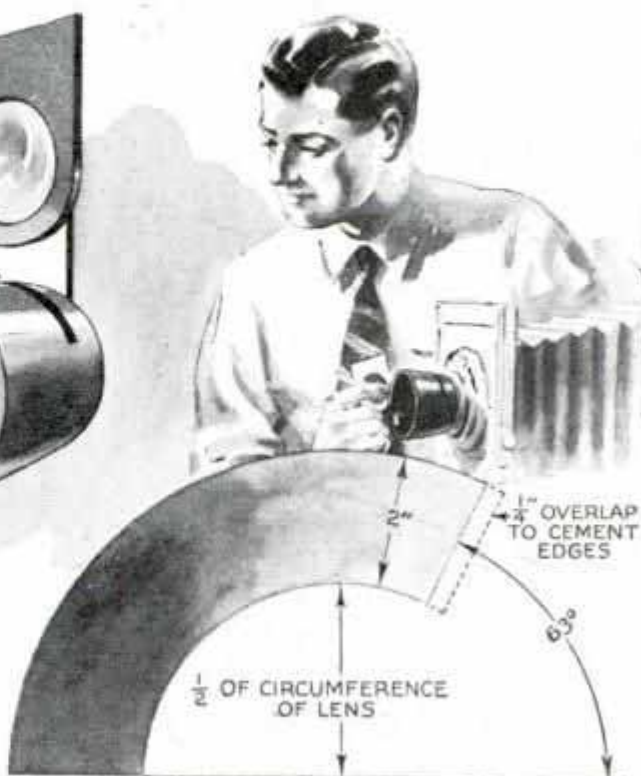

the pieces together and drill a series of small holes as indicated by the dotted lines. Then cut out the center portion, smooth the edges with a file and round the lower edge as shown. After slipping a cardboard spacer between the pieces, the sides and rounded end are soldered together at the edges.

Cardboard Disks Cut Quickly with a Safety-Razor Blade

To cut true disks of any diameter from cardboard, paper, etc., without a special compass cutter, place the work on top of a pine board, bench or table top, press a thumb tack through the center and press the corner of a safety-razor blade through the cardboard and into the bench at the determined radial point. The blade should be imbedded firmly in the wood and the cutting edge in line with the circumference of the disk. Then by pulling the cardboard against the razor slowly you will have no trouble in cutting out the disk.

While paraffin is often used on stored lumber to prevent checking and warping, an application of kerosene will produce better results; lumber coated with kerosene may be exposed to excessive heat without warping or checking.



Cardboard Disks of Any Diameter Are Cut Easily with Aid of Thumb Tack and Razor Blade

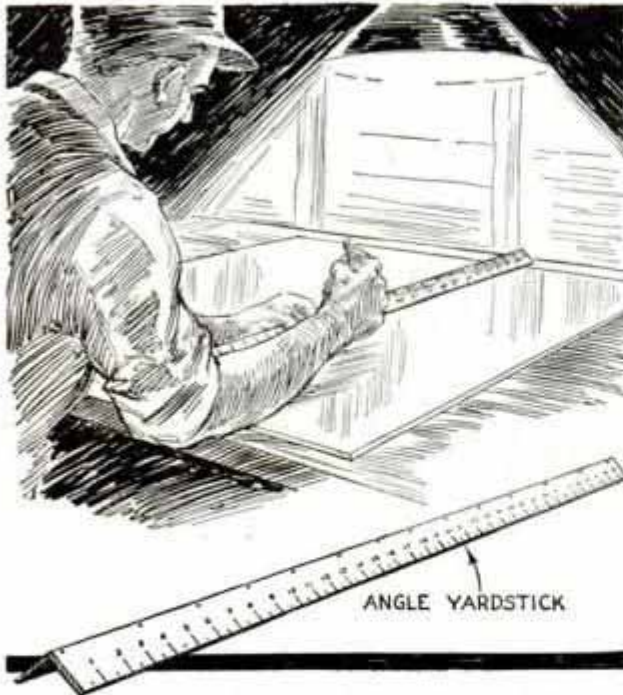

For Cutting Glass, Two Yardsticks Screwed Together Provide an Angle Straightedge That Lies Flat

Angle Yardstick for Cutting Glass

Screwed together at an angle as shown, two hardwood yardsticks provide a straightedge, that will not warp, for cutting glass. Besides lying flat on the glass, the edges provide firm anchorage, making it easy to hold the straightedge in place, with less tendency to slip.

Efficient Safety Valve for Boilers and Compressed-Air Tanks

An adjustable safety valve that can be set to open at almost any pressure can be made from a coil spring, two pipe nipples, a coupling, cap and a set screw. The inside edge of the lower nipple is beveled to fit a corresponding bevel on the valve,

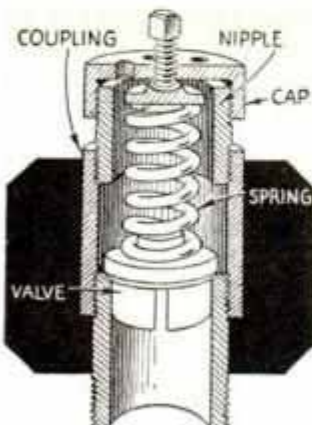

which can be turned from a pipe plug or a short piece of round brass. The upper end of the valve is turned down to fit inside the spring, which may be an auto valve spring. After drilling and tapping the cap for a set screw to adjust the spring

pressure, turn a metal disk with a boss on the lower side and place it under the

set screw with the boss extending into the end of the spring. Drilling holes in the cap for steam or air to escape completes the job.—G. H. Meyer, Blackduck, Minn.

Hoods on Signal Lamps Prevent Rain Extinguishing Flame

To prevent rain from extinguishing the flame on bomb-type signals used on a road-construction job, a contractor fitted them with hoods. These were made of sheet iron and supported by brackets of the same material riveted on and bent, as shown by dotted lines, so they could be clamped around the necks of the signals, permitting quick detachment.



Concrete Smoothed with Finisher Made from Old Belting

In finishing concrete roads, one contractor found that a smooth job could be done quickly with the finisher shown in

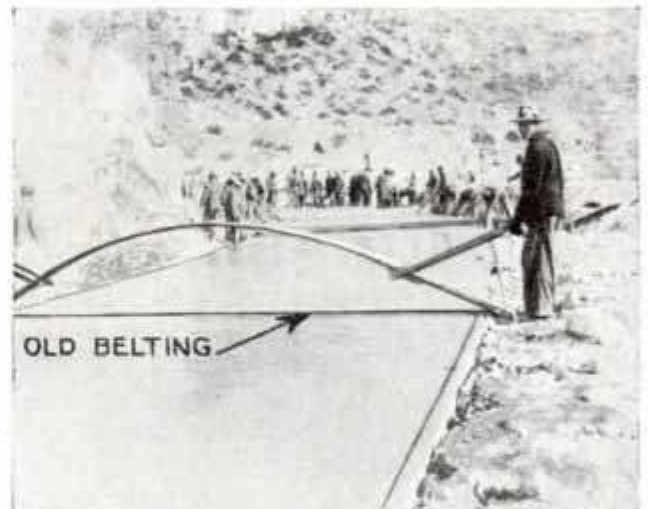

Length of Old Belting Stretched over Ends of Bowed Board Smooths Freshly Poured Concrete

the photo. It is made by nailing a strip of old belting over the ends of a bowed board. Handles of discarded plows, bolted to the board, permit two men to move the finisher without stooping.

Serviceable Windmill Built from Junk Parts

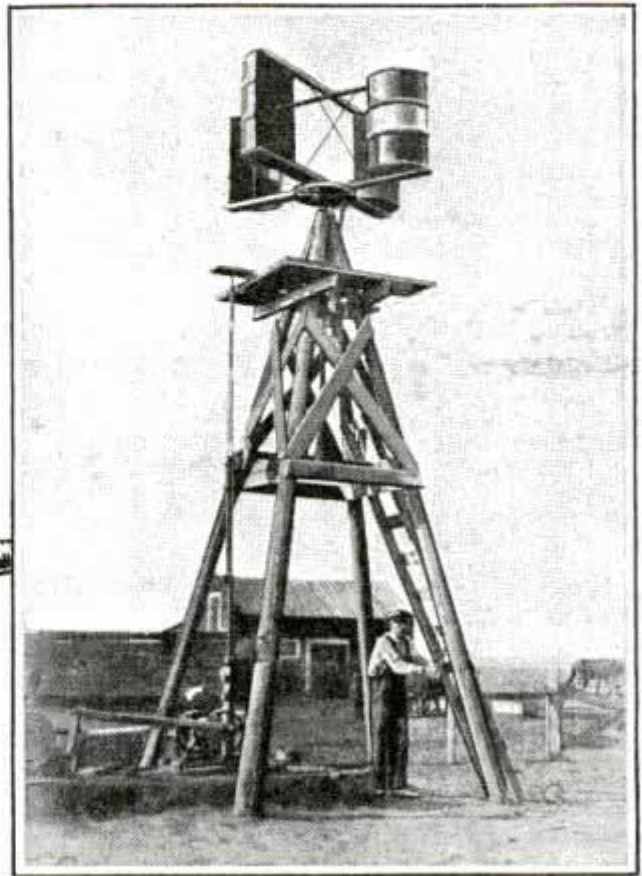
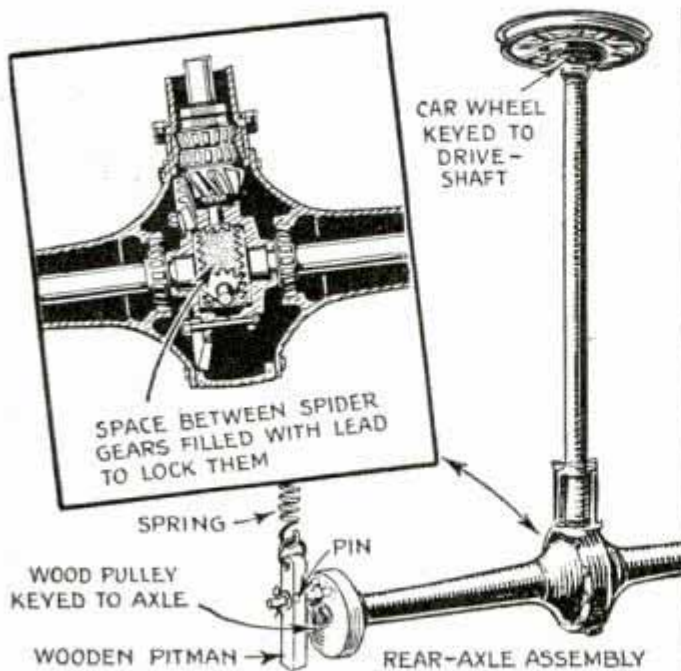

This windmill cost the owner nothing as he had the junk parts from which it was built. Two oil drums are cut in half vertically to provide the vanes, which were mounted on a wooden frame to rotate on a horizontal plane. The frame was centered and securely fastened to an auto wheel by means of U-bolts, and the wheel was then keyed to the end of a driveshaft on a rear-axle assembly, which was rigidly fastened on a tower made of poles and old lumber. With this arrangement, it was necessary to make both axes of the rear

end work as one, and therefore the space between the spider gears was filled with lead to lock them. On the end of one axle, a wood pulley was keyed, this being provided with an eccentric pin to drive a wooden pitman, the lower end of which was connected to the pump.

Checking Clerk's Writing Pad Held Conveniently on Arm

A checking clerk who was often required to give the men a hand in moving heavy boxes on a shipping platform, used a writing pad, which he strapped to his arm as shown in the drawing. This permitted him to keep loose sheets handy for checking the shipments as they were being loaded, yet help the men whenever necessary. The pad is merely a piece of light plywood fitted with straps and buckles so that it can be fastened to the forearm as shown. A heavy rubber band around the pad near each end holds loose sheets in place.

☐ If the teaspoon used for serving jelly is first dipped in clean water, the jelly will not stick to it.



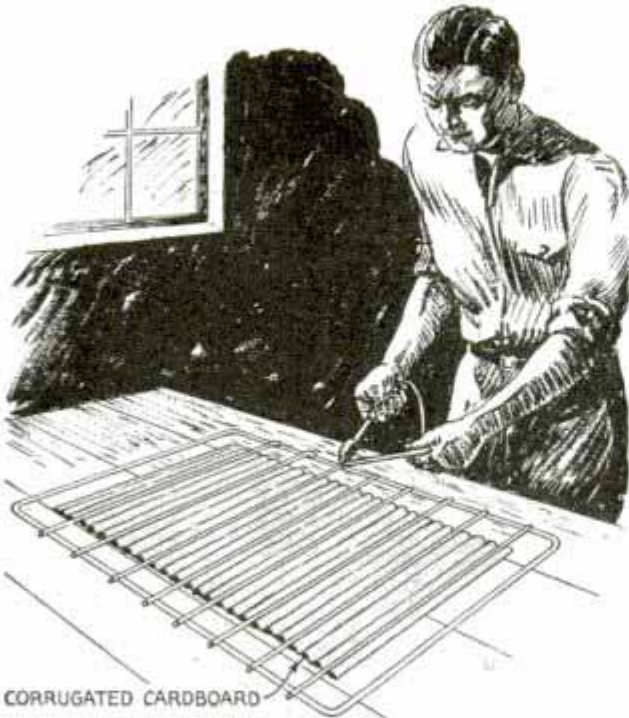

CORRUGATED CARDBOARD

Corrugated Cardboard Holds Cross Wires Evenly Spaced for Soldering When Making Gratings

Corrugated Cardboard Spaces Wires for Soldering

When making up a number of small wire gratings, a tinsmith found that a piece of corrugated cardboard was convenient to hold the cross wires while soldering them to the frame. This method made it easy to keep the cross wires parallel and equally spaced, and, instead of marking off the spacing on the frame, only the corrugations need be counted. Where a number of duplicate pieces are made, the grooves in which the wires are laid should be marked for identification at a glance.

Flashlight Used to Test Fuses

An ordinary flashlight with a clip attached to the case makes a handy fuse tester. The clip is attached near the bulb end with a small machine screw, which is insulated from the case with a fiber bushing and two fiber washers as shown. The method of wiring the clip into the flashlight circuit will depend on the type of flashlight used, the idea being to complete

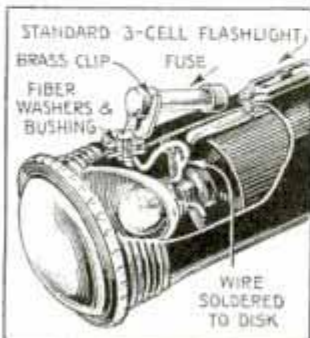

the circuit by touching the fuse to the clip and to the case, which will light the bulb if the fuse is good. In the flashlight illustrated, the bared ends of a short insulated wire were soldered to the machine screw and to a metal disk, which was soldered to the bulb socket. This alteration does not interfere with the regular use of the flashlight.—R. B. Davidson, Florence, Ala.

Pin-Cutter Attachment for Lathes

When a number of short pins or rivets of equal length are needed, they can be cut quickly in a lathe from small rods with this cutter. It is made from a flat bar of tool steel and the ends are turned down to form two projections, or shafts to carry the cutter and stop collar. The latter governs the length of the pins and is turned down from tool steel to a diameter equal to the width of the cutter. It is bored to fit the cutter shaft, where it is held with a set screw. An angle plate is center drilled on one face to take the short end of the cutter shaft and form an outboard bearing. Offset from the center on the same radius as the cutter, a second hole is drilled in the

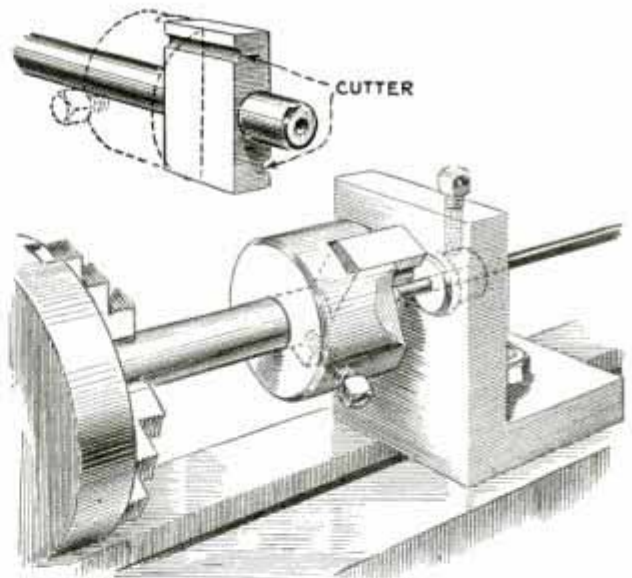

Pins Can Be Cut Easily in a Lathe from Small Rods with This Attachment

angle plate to take a bushing, which holds the material to be cut. The bushing is held in place with a set screw.

Water poured over the surface of printers' ink, after part of it has been taken from the container, will prevent the ink left in the container from drying.



How to Use WOOD-TURNING TOOLS

WOOD-TURNING tools are in many respects similar to hand chisels, especially the way they are handled, the cutting action being essentially the same. One of the most common faults is due to holding the tool so that its action is that of a scraper. Scraping cuts have their place in good practice on faceplate work but the tendency is to duplicate this action of the tool on work between centers by holding the handle on a line with the horizontal axis of the revolving work. Fig. 1 shows the correct tool position for cutting. The tool rest should be from $\frac{1}{8}$ to $\frac{1}{4}$ in. above the horizontal centerline of the work, and most important of all, the level of the tool should be held nearly tangent to the curved surface of the stock being turned. This position of the tool brings the cutting edge into action so that the chip is lifted off clean without any tendency to drag and tear the grain. However, when held at this angle, the tool is somewhat more difficult to control in close work, yet a little practice will enable you

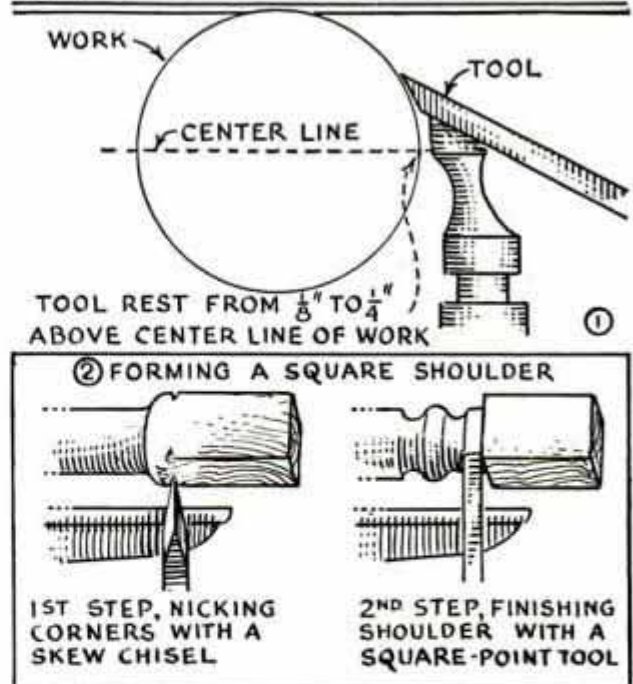

to acquire the knack in a fair degree. In turning work between centers the first operation is that of roughing the square stock into round. The gouge is always used for this as it does not tend to split

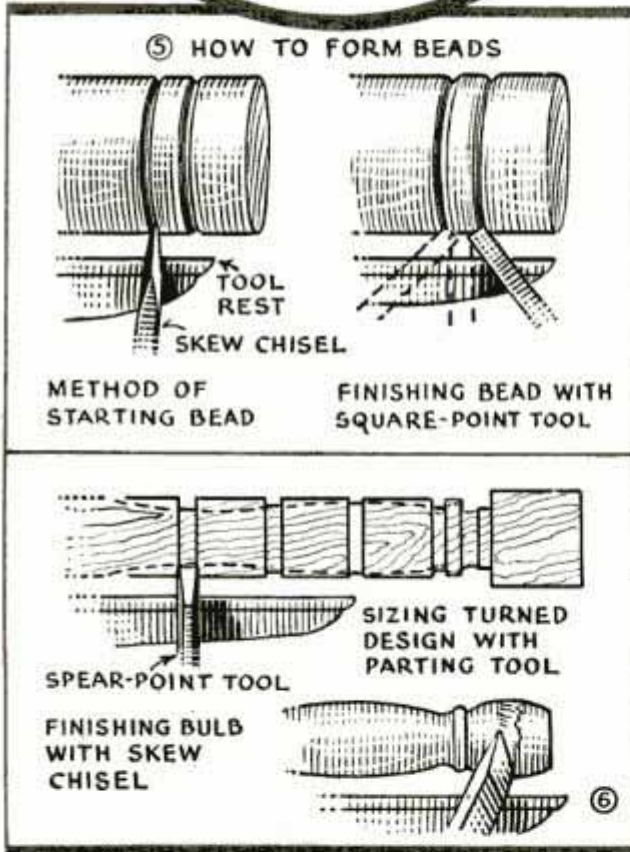
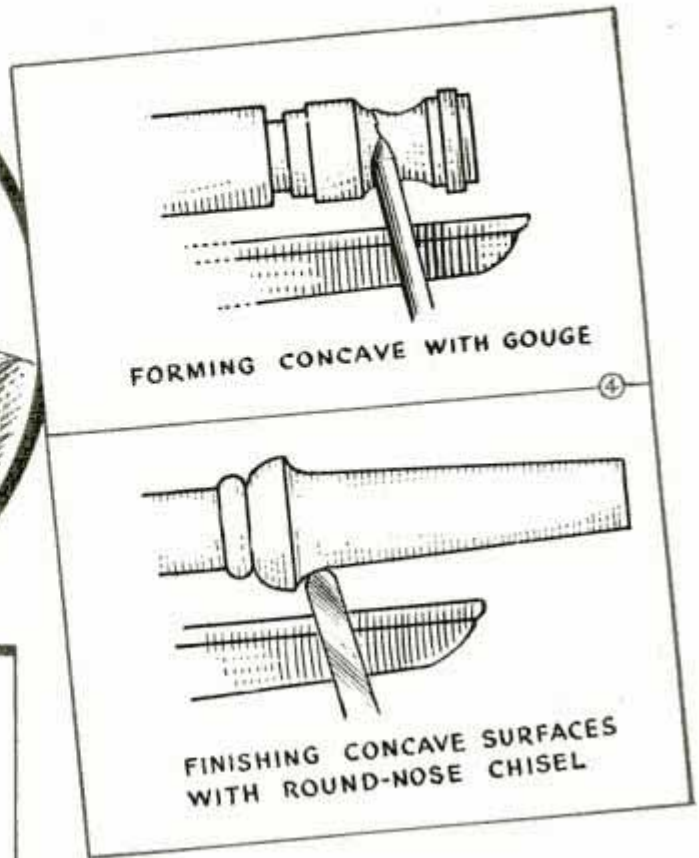

off the square corners at the start. The tool is held as shown in the circular photo, the palm of the left hand resting on the tool support and the fingers grasping the body of the tool near the point. The cut is started near the center of the work and progresses toward the right. When cutting, the blade of the tool is tilted slightly so that the chips are thrown to the side away from the worker. When the gouge is used for roughing out the work, avoid bringing the cut up to a high place for the tool is then likely to dig in and splinter

the stock. After a few cuts have been taken from the center toward the right, the worker changes his position and cuts to the left toward the headstock, alternating in this way until the work is brought to a cylindrical form. This method avoids forming a high shoulder at the center of the work. In turning table legs it is often necessary to leave a square section at one end. This may be formed by turning the gouge over and starting the cut on the corners with the tool in this position, and as it enters the wood it is slowly rolled back to bring the concave side up. This forms a rounding shoulder as a starting point for the roughing cuts on the portion that is to be turned down.

A good method of forming a square shoulder is shown in Fig. 2. The first cut is made with the skew chisel placed edge-wise on the rest with the acute angle of the bevel down. In this position the tool is run straight in to check or nick the corners of the work. Then the square-point tool is placed on the rest with one side flush with the checked corners and run straight in to remove the waste. Either the gouge or the round-point tool may be used in forming a concave as in Fig. 4. The round-point tool may be run straight in, provided the width of the groove is

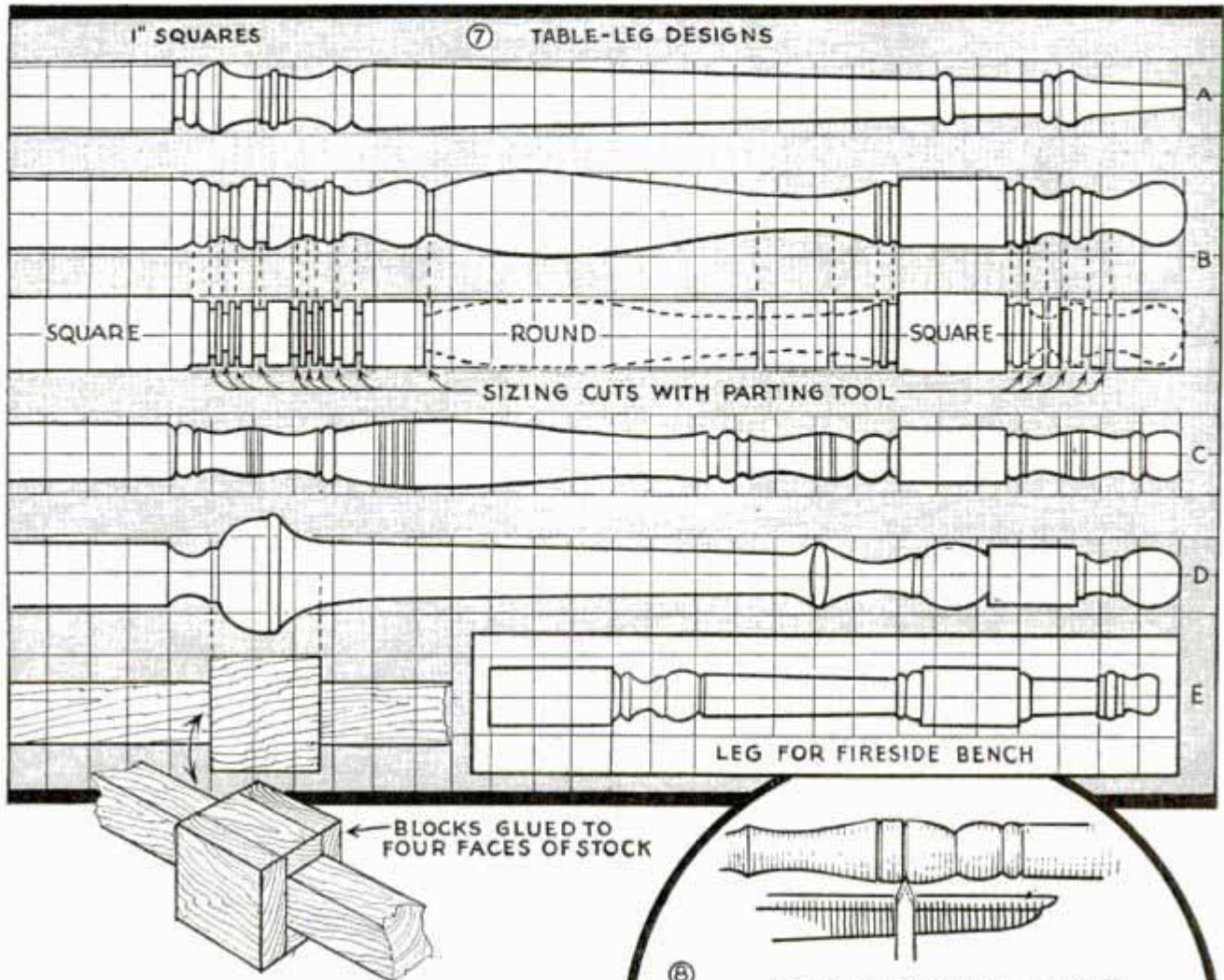

greater than the width of the blade, to prevent binding. If a gouge is used to cut a concave, the blade is rolled over on the tool rest and the handle is swung slightly to the right for the first cut, which is only started sufficiently to lift the chip. In making the second cut for size, the position of the tool is reversed and as the cut progresses the blade is rolled back to the normal position. The method is used because it produces a glass-smooth surface.

Beads are formed by making two light V-cuts with the skew chisel held on the rest as in Fig. 5, after which the bead is rounded over with the square-point tool. Wide beads and bulbs are first roughed out with the round and spear-point tools and finished with the skew chisel as in Fig. 6. When making paring cuts the skew chisel is held in the same manner as the gouge. Care must be taken when using the skew chisel on paring cuts that the point of the blade does not catch in the wood, for should this happen the tool is likely to be thrown from the hands with dangerous force. It should be noted also

that the paring cut is always started from the highest point on the work and runs downward with the grain of the wood.

To duplicate the design of a single turning it is best to lay out and size the work with the parting tool as in Fig. 3. The diameters at the grooves are calipered from the original turning, which is to be duplicated, the locations of the sizing grooves are marked on the work and the grooves are run in with the parting tool, the cut calipered as it is made. Ornamental V-cuts and tapered sections may be finished as in Fig. 8. A number of designs for turned table legs are shown in Fig. 7.

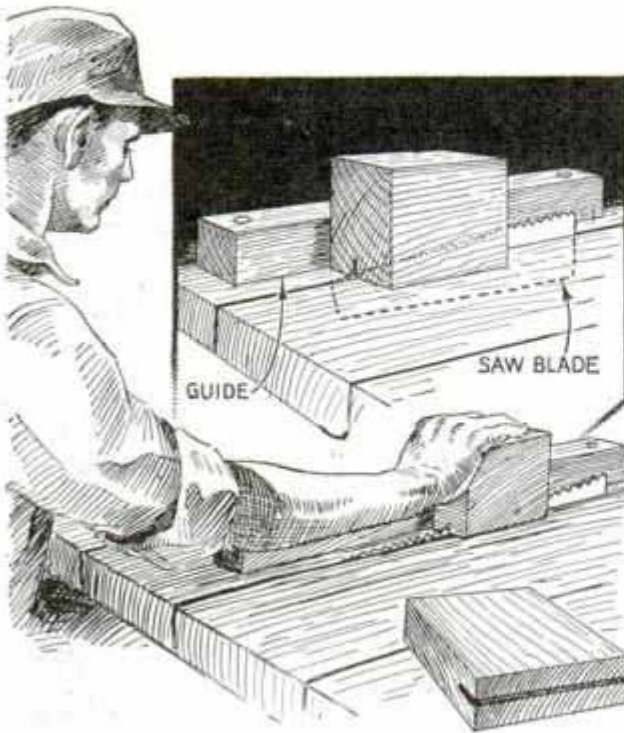

Small Wood Blocks Slotted by Pushing Them over Teeth of Saw Blade Set in Bench Top

Saw Blade Wedged in Bench Top for Slotting Small Blocks

On a job requiring a quantity of small wood blocks in which slots were to be sawed to a uniform depth, and no circular saw being at hand, the job was done as shown. A piece of fine-tooth saw blade was wedged in a crack in a workbench top with the teeth upward, setting the blade at a slant to expose one end to the depth of the cut required. A guide strip was then nailed onto the bench at the side of the blade. By holding a block against the guide and pushing it with short strokes against the saw teeth, the slot was cut quickly.

Substitute for Drilling Dowel Holes in End of Small Round Work



Instead of trying to drill an accurately centered hole in the end of small round work to take a dowel, it is easier to turn

down the end of the work to serve as the dowel. If a lathe is not available, this can be done on a circular saw. Place the end of the work on the saw table against the miter gauge as shown. Then, while hold-

ing the gauge steady, gently rotate the work against the saw blade, at the same time slowly moving it back and forth from the end to a mark previously made to indicate the desired length of the dowel.—Frank W. Bentley, Jr., Missouri Valley, Ia.

Fuller Ball Provides Finger Rest on a Nail Set

If a fuller ball is forced over the tapered end of a nail set at a position where the third finger ordinarily rests, it will be found that the tool can be held more comfortably without tiring the muscles of the finger, especially when using the set for long periods.

Slight depressions may be made in the rubber to take the finger tip.



Pipe-Cleaning Tool Made from Stick and Bottle Caps

For removing rust, soot or corrosion from the inside of a pipe, an efficient tool can be had by nailing bottle caps to a stick as shown. The crimped edges of the

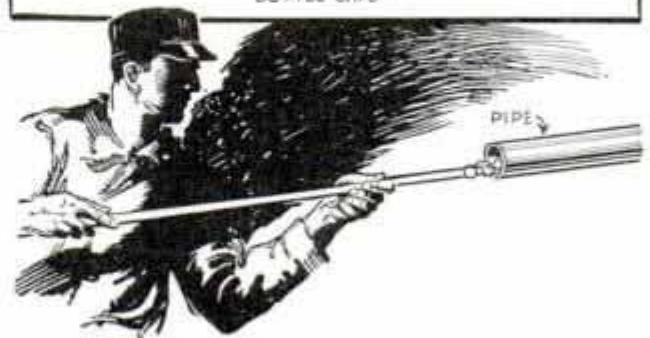
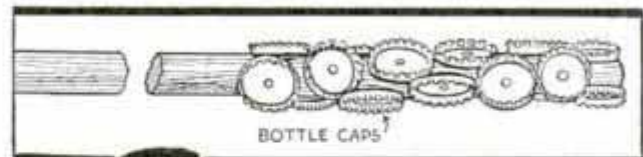

Corrosion in Pipe Removed with Tool Made by Nailing Bottle Caps to a Stick

caps provide a scraping edge that will clean a pipe quickly when the tool is pulled back and forth through it with a twisting motion.

Two Useful Suggestions for Store Keepers



Where fruit is pyramided in a window, a covering of Cellophane will help to protect it against flies during summer and frost during winter. A sheet of Cellophane rolled into a cone shape and glued to barrel hoops, as shown, will cover the fruit without detracting from its appearance. A



loop of tape at the apex of the cone permits it to be lifted.

At the right is shown how a large fishhook is wired to a bamboo pole for lifting packages off high shelves. By pulling on the pole so that the hook punctures the package, the barb will catch in the cover.

This Self-Heating Soldering Iron Is Handy for Light Work

Using alcohol as fuel, this self-heating soldering iron will be found efficient for light work such as radio repairing. A 5-in. length of copper tubing, bent at right angles near one end and then notched as shown in the circular insert, serves as the soldering copper. After closing the notched end with a pair of pliers and threading strands of cotton wicking through the tube so that they project through a hole directly under the bent end, the tube is soldered over a hole drilled through the top surface of a small screw-top can. When the wick is lighted, the flame heats the end of the copper tube quickly.

☐ Charcoal packed around fence posts will prevent them from rotting for many years; another good treatment is to apply a paste made of linseed oil and ashes to the posts before setting them in the ground.

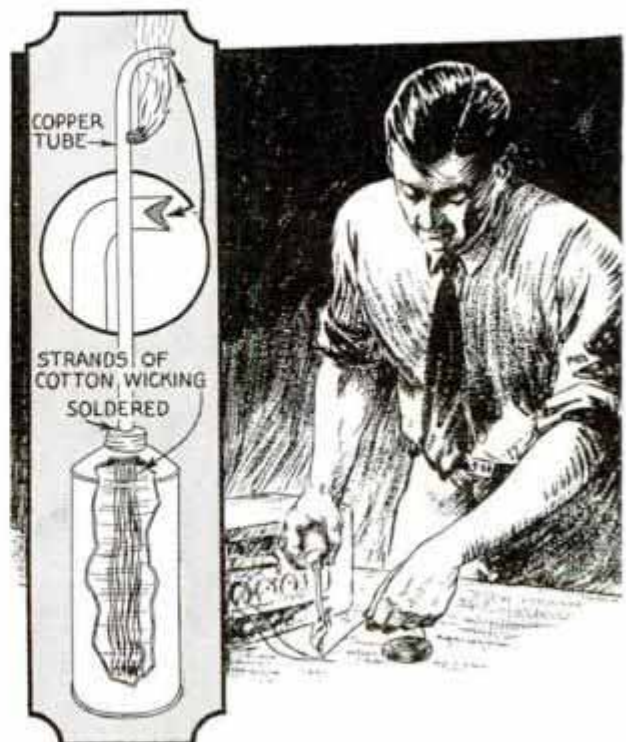

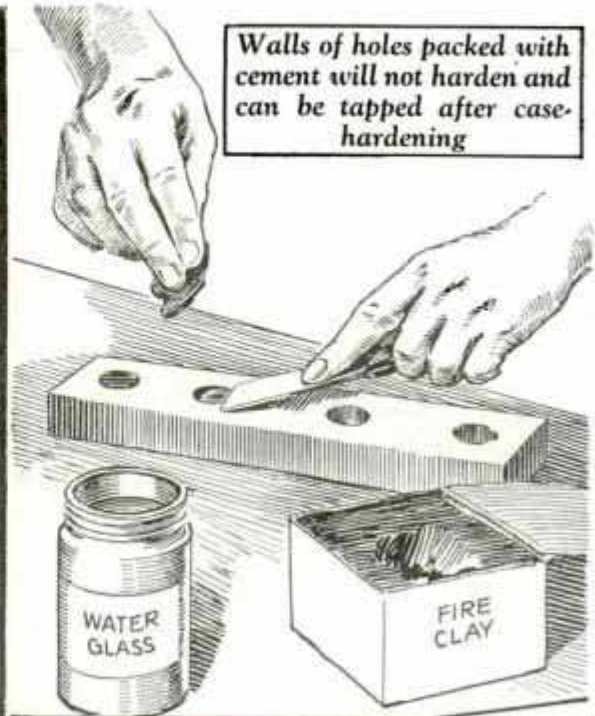
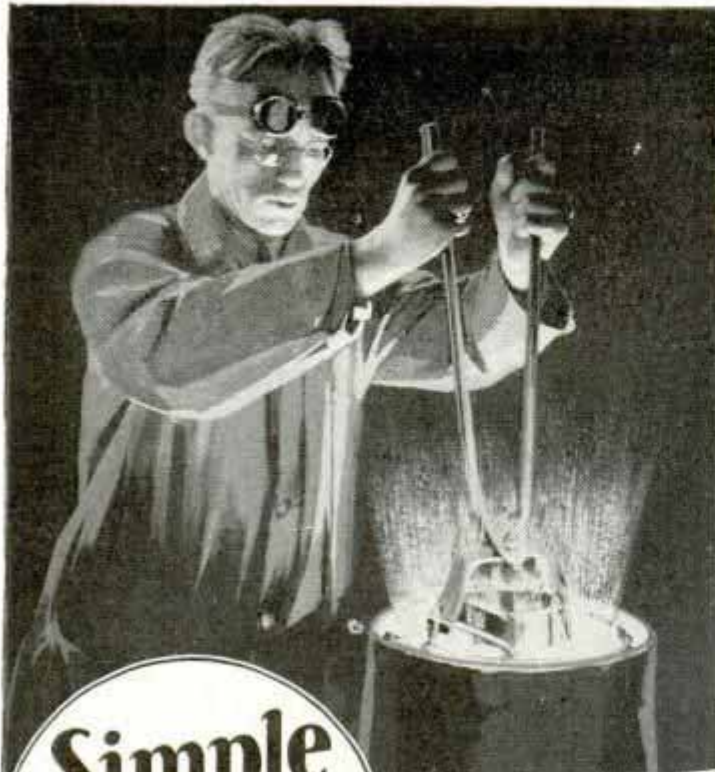

Simple Methods to

CASEHARDEN

By C. A. CROWLEY

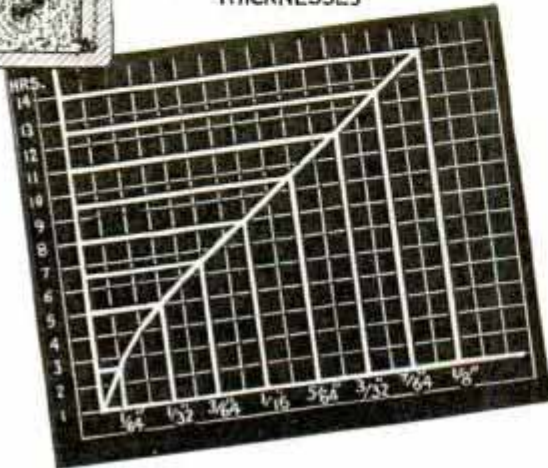
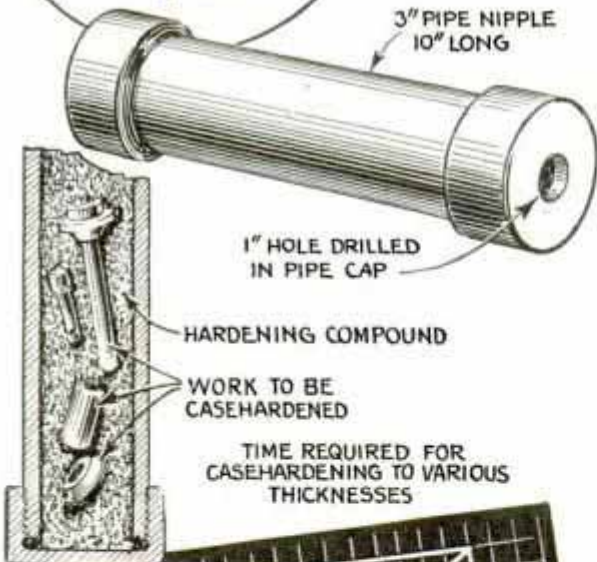

CASEHARDENING, or the process of making soft steel and iron hard on the surface, may be done by anyone. This valuable process enables the worker to make tools from as tough a grade of mild steel as he may choose and at the same time produce hardness where it is wanted without making the metal brittle. As an illustration, suppose you are making an axle shaft for a sanding machine which will have to stand severe use and accordingly must be able to resist bending and mechanical shocks and at the same time must be so hard that it will wear a long time in its bearings. For a problem like this the best thing to do would be to select a tough grade of low carbon steel and caseharden the surface to produce wearing properties. By using this process it is possible also to fashion cutting tools from soft steel, which can not be hardened by ordinary methods, and then caseharden the parts which are to be ground to a cutting edge. Where great strength is required this process offers the ideal solution as it makes possible the combination of great strength and extreme hardness in

Anti-Borax Co

7101 W. Wayne, Chgo

Bell & Loosett

Co. 3000 Wallace

Chicago



IRON and STEEL

the same piece of metal. In casehardening, the surface of the metal is first made to absorb carbon, the element which gives steel its hardness. This is called carburization. By carburization the surface of the iron is changed into steel which may be hardened and tempered in the same manner as tool steel.

The piece to be casehardened is packed in an iron pot, completely surrounded with a carburizing compound. The compound may be purchased ready mixed from a supply house, or, if preferred, a good one may be made by mixing hardwood charcoal, 13 parts, barium carbonate, 3 parts, precipitated chalk or whiting, 1 part, and sodium carbonate or soda ash, 2 parts, all by weight. The pot may be made from a short length of gas pipe and a pair of pipe caps to fit. The dimensions shown in the drawing were selected as being convenient and may be varied to suit the work at hand. One of the caps should be put on loosely so that it may be removed easily. This cap should also be the one through the center of which a hole is drilled to serve as a vent and to permit the introduction of a thermocouple pyrometer such as was described in the November, 1934, issue of Popular Mechanics. Although a thermocouple is not absolutely



necessary for this work, it is highly convenient. In its absence temperature can be judged by color. After thoroughly cleaning the work, it is placed in the pot, care being taken to completely surround it with the compound. The work should not touch the sides of the pot.

The heating is done best in a furnace. A gas-fired furnace, which is ideally suited to this purpose was described in the November, 1932, issue of Popular Mechanics. If a forge is at hand it may be used for the heating. In this case the pot with its charge is packed into the hot coals which should completely surround the pot. In

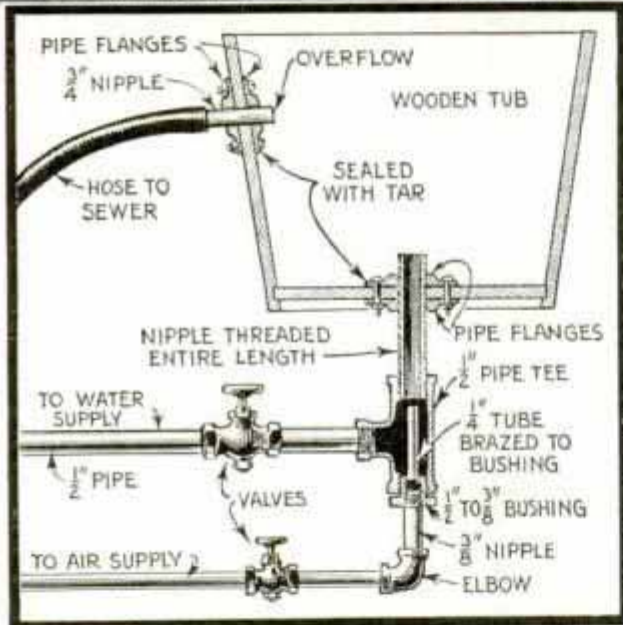

Quenching Tub in Which a Blast of Air Assures Rapid and Uniform Cooling of Heated Work

either method the work is slowly brought to a bright orange temperature, or if a pyrometer is used, to a temperature of between 1,600° and 1,750° Fahr. The lower temperature should be used for small articles. When this temperature is reached the fire is adjusted carefully to hold the temperature as uniformly as possible. The accompanying chart gives the approximate time, after the work has been brought to temperature required, to produce various depths of hardening. If you are uncertain as to how thick a case you wish to produce, small pieces of metal of the same kind as the work should be inserted into the pot with the charge at the start. Re-

move one of them from time to time and quickly plunge it into cold water. These test pieces are removed easily without disturbing the charge if attached to short lengths of wire which extend through the vent hole. The hardness of the case may be tested by applying a file, and the thickness of the case checked by grinding through the case until the soft metal is reached. After heating the work the required period of time, the pot should be taken from the fire and its cap removed. The contents are then dumped quickly into a tub of cold water to harden the work. A good quenching tub, which uses a blast of air to assure rapid and uniform cooling is shown in one of the drawings. The air supply may be had from a small compressor. If air is not available, running water may be used alone provided the work is not all dumped into one spot too quickly. This method of hardening is usually satisfactory for small articles; however, for large work it is a good plan to allow the carburized work to cool in the pot without quenching in water and later to reheat to the hardening temperature and dump into the cold water as just explained.

Sometimes you may wish to harden only a portion of the surface of a job. There are several ways of accomplishing this and the method selected will depend upon the nature of the work at hand. The simplest method consists in copper-plating the parts which are not to be hardened before placing them in the pot. This is done most readily by immersing the well-cleaned work for two seconds in a dip-plating solution made by dissolving copper sulphate, 10 oz., in water, 1/2 gal. To this solution is added slowly with caution, concentrated sulphuric acid, 1 oz. This solution should be kept in a stone jar. Cleaning is accomplished by scrubbing with strong soap and washing thoroughly in clean water. The parts to be hardened should be painted with orange shellac or melted paraffin before dipping them into the plating solution. The paraffin or shellac will burn off when the work is heated and in no way interfere with the casehardening, although the copper-plated portions will not be hardened at all. The copper-plating solution also may be applied with a brush to the parts that are to remain soft. Another system in common use for preventing parts from be-

coming hardened consists in leaving spare metal, which can later be removed either by grinding or by a finish cut in the lathe. The inside of holes to be tapped after hardening may be protected from hardening by packing them full of a special cement before placing the work in the furnace. The cement is made by thoroughly mixing fire clay, 2 parts, water glass, 1 part, fine sand, 1 part, and enough water to make a sticky, dough-like cement.

Old Auto Tires Help When Rolling Heavy Barrels

In a warehouse where heavy barrels, weighing from 300 to 500 lbs., were stored on end, but had to be tipped over so that they could be rolled to the loading platform, breakage of staves often resulted. This was avoided by slipping old auto tires over the barrels before tipping them. It was also found that when a barrel had to be rolled some distance, use of two tires lessened the risk of damaging the barrel by hitting rough places or obstacles.



Old Auto Tires Useful in Avoiding Breakage When Handling Heavy Barrels in the Warehouse

Extension Shelf on Ladder Keeps Tools at Hand

Short stepladders, provided with an extension shelf, will often serve the purpose of larger ones. A plywood shelf is fastened



Supported on Screw Eyes, This Extension Shelf for Small Stepladders Keeps Tools within Reach

to a length of $\frac{1}{4}$ -in. iron rod, bent to a U-shape so that the ends can be slipped into screw eyes driven into the front edge of the ladder rails. A slight offset bent in the rod, a couple of inches from each end, rests against the center screw eye on each side when the shelf is extended. When not in use, the rod is removed from the center screw eyes and is slipped into the lower ones in order to bring the shelf flat on the ladder top.

Powder Puff on Show-Card Writer's Hand Prevents Soiling Work

Sewed to an elastic band, which is slipped over the wrist as shown, a powder puff will be found handy by show-card writers to prevent perspiration on the hand from soiling the work. The ball of the hand rests comfortably on the powder puff, which slides along on the work as the lettering progresses. A dusting with talcum powder at intervals will make the puff slide easily on the paper.—G. E. Hendrickson, Argyle, Wis.

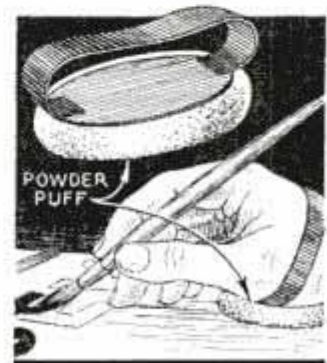



Short Pieces of Hose on Motor Section Car Sweep Small Rocks Off Rails

Sweeps on Section Car Brush Small Objects Off Rails

To prevent his motor car from being derailed by stones thoughtlessly placed on the rails by children, a railroad track foreman made a pair of sweeps from lengths of old garden hose and attached them to the front of the car. Each sweep is held vertically just above the rails with a metal band, which is attached to a piece of angle iron bolted to the end of the car.

Vest-Pocket Flashlight Sets Off Photoflash Bulbs

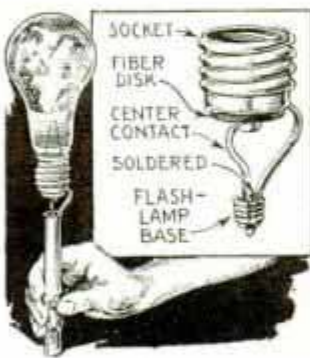

or fiber disk in the bottom to hold the center contact and the base of a burned-out flashlight bulb with the glass removed. The socket and lamp base are fastened together as shown in the detail by means of a stiff, brass strip, which is soldered to

With the attachment shown, an ordinary vest-pocket flashlight can be used to set off photoflash bulbs. The attachment consists of the threaded part of a standard lamp socket with a wood

them, the two center contacts being connected with a short, insulated wire. In use, the photoflash bulb is screwed into the socket, after which the attachment is substituted for the bulb in the flashlight.—W. E. Steward, Sewaren, New Jersey.

Substitute for Sand Blasting

Sand-blasted finish can be simulated on the surface of metal by using emery cloth in the following manner: The abrasive side of the cloth is placed in contact with the surface to be treated, after which the back of the cloth is struck with a hammer. The intensity of the blows and the number required are dependent upon the surface effect desired. A medium grade of emery cloth is recommended. The method is especially effective on soft metal, and for producing the appearance of a cast surface on portions of a casting that have been marred or from which fins have been removed.

Clips Hold Chemical Graduates to Underside of Shelf

By fastening flanged-bottom graduates to the underside of a shelf, preferably above a sink, considerable space is saved and the chances of knocking them to the floor are lessened. Clips, screwed to the shelf to hold the graduates,



consist of squares of copper, monel metal or other non-rusting material. The two opposite edges of the square are bent so that they will catch the flanged bottom. At the rear, the edge is turned down to form a stop.—Walter Burton, Akron, O.

☐ The copper sides of old cylinder-head gaskets make good shims.

IGNITION TESTER *for the Garage*

MADE at practically no cost as the parts are available in most garages, this ignition tester will check accurately coils, condensers, distributors, and can be used for synchronizing dual sets of points in distributors. It consists of a small electric motor, such as a fan motor, to drive a distributor, which is used in making all tests, a salt-water or wire-wound rheostat to control the speed of the motor, a double-pole, double-throw switch used to run the current directly to the motor or through the rheostat, a large wooden ring and a wood support to hold the distributor, all parts being assembled on a board, which is screwed vertically to a base as shown in Fig. 1.

The motor is mounted with the long end of the shaft upward and is connected to the shaft of the distributor with a piece of rubber tubing. The jaws of the distributor support are grooved vertically to take the distributor-shaft housing and are clamped to the latter by means of wood screws. Between the distributor and the motor is the wooden ring which is divided into degrees. This may be turned on a lathe, and a brass spark ring mounted inside of it. In service work, it will be found convenient to have the degree markings for the spark ring on a separate ring of cardboard, which rests on top of the wood ring as shown in Fig. 1, so that the markings can be shifted to agree with the spark produced. The spark jumps from the brass ring to a rotating wire arm, which is soldered to the shaft of the motor and rotates just above the upper edge of the ring.

With the tester, trouble in the ignition system is checked by comparing the action of the suspected part with a new part of

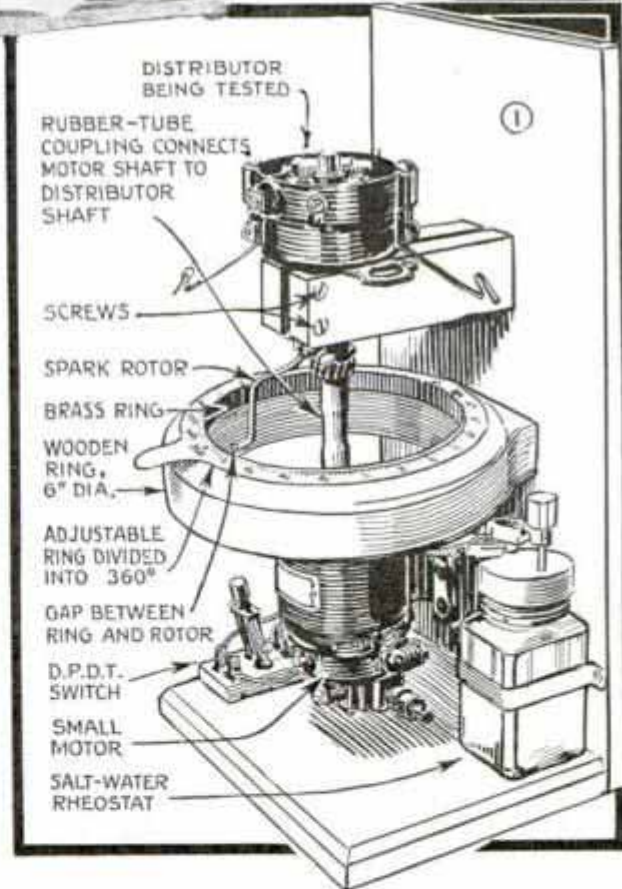

the same type that is known to be in good condition. A coil to be tested is wired to a 6-volt storage battery and to a distributor mounted in the tester as shown in Fig. 2. The high-tension terminal of the

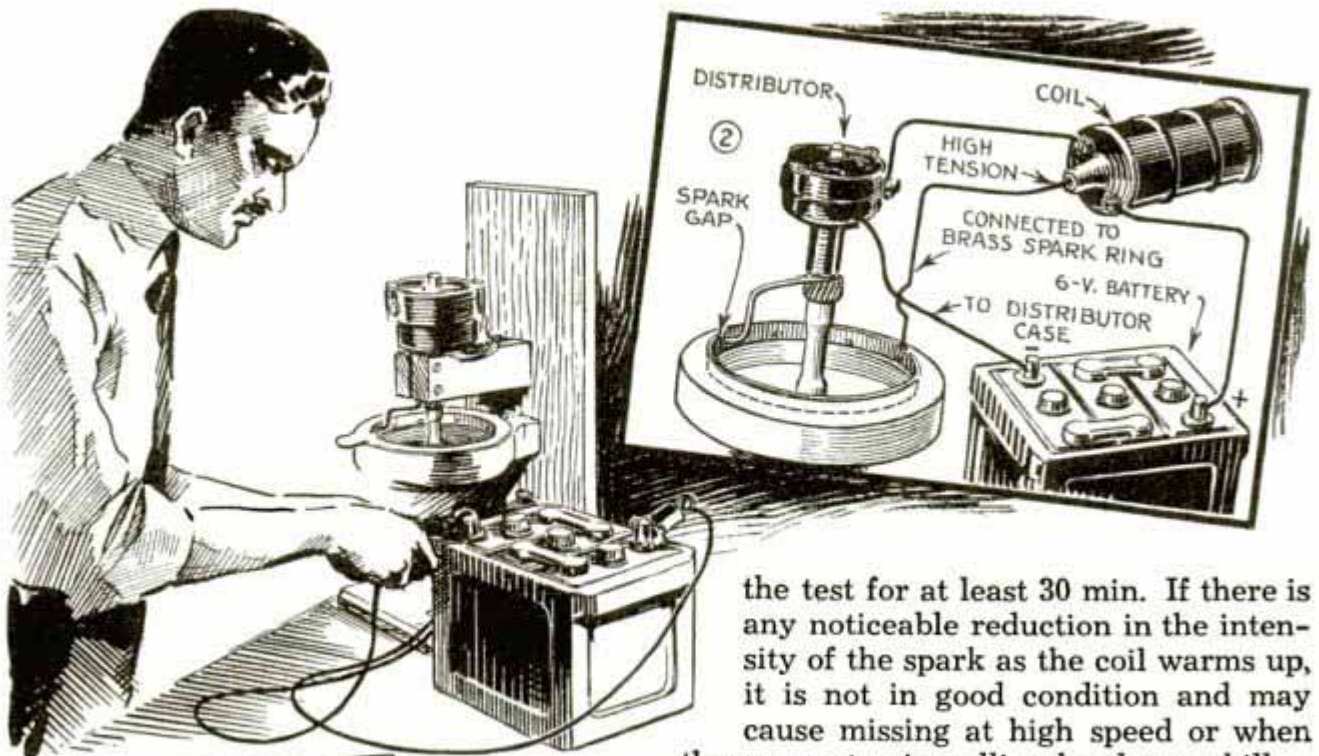

the test for at least 30 min. If there is any noticeable reduction in the intensity of the spark as the coil warms up, it is not in good condition and may cause missing at high speed or when the car motor is pulling hard on a hill.

Using well insulated test points and a coil that is in good condition, distributor caps and rotors can be checked for cracks or leaks by applying the high-tension current to opposite sides of the piece or from terminal to terminal as in Fig. 3. If there is considerable sparking at the breaker points and the secondary spark is weak, the fault is probably in the condenser, Fig. 4. With the tester wired for testing a coil, first check the regular condenser; then a new one, and note any change that takes place. This is a sure way of finding the best condenser for use with any particular coil.

Distributor testing is handled by wiring it up with a good coil, Fig. 5. Of course, the points should be clean and separated about .018 in. With the tester running at moderate speed, note the action of the spark. A double spark indicates weak springs on the point arms, which result in "point bounce." Sparks occurring at irregular intervals indicate a worn distributor shaft and bushing or a worn cam. If the sparks do not occur the right number of degrees apart for the distributor being tested, this fact will be shown by the degree markings on the brass ring. By shifting one set of points in a distributor that has two sets, they may be synchronized while the tester is running. The operation of an automatic spark control can also be checked with the tester.

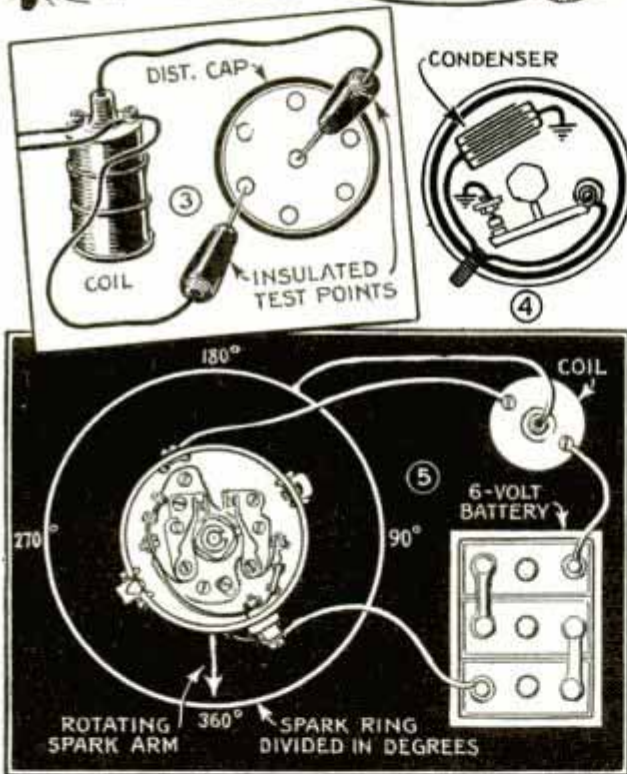

coil is then connected to the brass spark ring, after which the spark gap between the rotating arm and the ring is adjusted to about $\frac{1}{4}$ in. With this done, start the tester and note the heat and regularity of the spark. Then speed up the tester until the spark weakens and disappears. Repeat this test with a coil that is known to be in good condition and you will have a comparative check on your suspected coil. The final check to determine its suitability for continued running is to leave the coil on

Heat Control Affects Carburetor

Thermostatic heat controls used on many automobiles to regulate the temperature of the mixture before it enters the cylinders are sometimes rather critical in their adjustment. What seemed to be too lean a mixture for good running on one car was traced to a faulty thermostat, which kept the gasoline-and-air mixture too cool.

Mounting Super-Balloon Tires

If you have had trouble in getting a valve stem of a super-balloon tire through the hole in the rim, this kink will be of



assistance. A short length of small size chain is soldered to the end of an old valve cap, which is screwed on the end of the valve stem. It is then an easy matter to pull the stem through the hole in the rim.

Hand-Operated Wiper Cleans Inside Surface of Windshield

By mounting a hand-operated windshield wiper so that the squeegee rubs against the inside surface of the glass, an effective means is provided for removing condensed moisture from windshields of closed cars. The wiper arm will provide a handle so that no change in the construction of a standard wiper is necessary. In



Condensed Moisture on Inside Surface of Windshield Cleaned Off with Hand-Operated Wiper

some cases where the construction will permit, a dual wiper arm can be fitted to the power wiper so that one blade will clean the inside of the glass.



TACKS DROP IN TROUGHS

Corrugated Iron on Floor of Shop Prevents Tacks Dropped on Floor from Puncturing Tires

Floor of Corrugated Iron Prevents Punctures in Repair Shop

In an auto-upholstering shop where tacks were often dropped on the floor and punctured tires if a car was driven over them before they were swept up, the shop owner laid corrugated sheet iron over the portion of the floor where the repair work was done, after which the car to be repaired was driven onto it. In this way, if any tacks were dropped, they fell into the corrugations where they did not come in contact with the tires.—G. E. Hendrickson, Argyle, Wis.

Oil Grooves Cut with Old Valve

When a regular tool is not at hand for cutting oil grooves in re-babbitted bearings, one can be quickly improvised by filing teeth around the head of an old motor valve. When held in an electric drill, the valve works like a rotary saw and quickly grooves the babbitt lining of the bearing as shown.—W. F. Lowder, Humboldt, Ia.

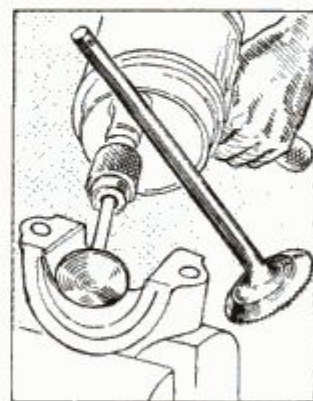

Electric Drill Helps in Cleaning Boiler Flues Quickly

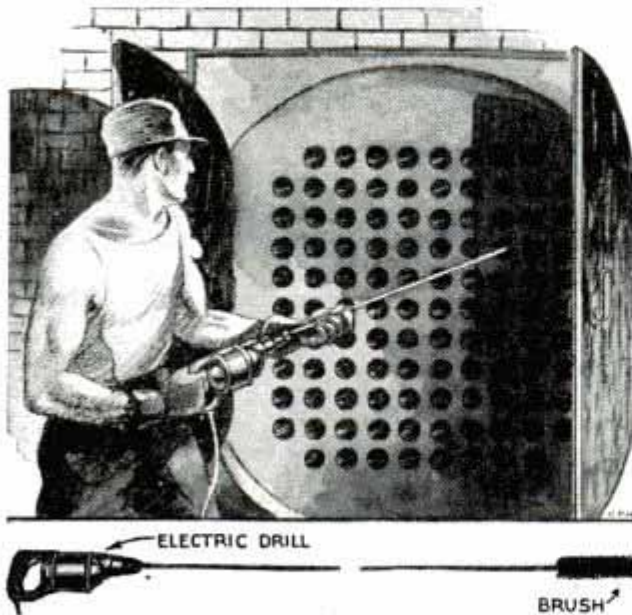

*The Job of Cleaning Boiler Flues Is Made Easy by
Using an Electric Drill*

Firemen and janitors who often have the tedious job of cleaning boiler flues, will find that much time and effort can be saved by using an electric drill to rotate the brush. The hand grip of the brush is cut off and the shank is chucked in the drill as shown. If you find that the shank is too large to fit the drill chuck, the end should be turned down to fit, which is preferable to filing.

Waste Prevents Chatter Marks When Countersinking Holes

To prevent chatter marks in metal when countersinking holes for screw heads, place a small piece of waste rolled into a compact ball over the hole. Then bring the countersink down on the waste and start the machine. The waste packs in the flutes of the countersink and prevents chattering.—Floyd F. Holly, Stamford, Conn.

The Next Issue

WINDSOR CHAIRS BUILT IN YOUR WORKSHOP

Two outstanding examples of Windsor chairs shown in every detail. This article shows you each step in making the parts and the method of assembling, gluing and finishing this well-constructed furniture.

AIR COMPRESSOR RUN BY SCROLL SAW

Simple, efficient air compressor, made mostly from wood parts, fits on the scroll-saw table and can be used for jobs such as spray-painting.

SHIP PLAQUES IN CARVED RELIEF

Recessed background, which you can cut away with hand tools, gives realistic effect of bellied sails and rounded hull standing out in bold relief.

NOVEL WORLD-GLOBE MOUNTINGS

Several methods of mounting your world globe; one method shows how an electric clock motor is used to make the globe rotate and tell time.

MAKING MONEY ON THE ICE

Arctic tenpins, snowbird sails and other popular items that find ready rental on the ice and will bring profit to the enterprising builder.

USING HAND PLANES

Expert tells what can be done with hand planes and the right way to use them in various woodworking jobs that demand care and accuracy.

New Drill Press

New "DELTA" Models Now Complete Full Line of Modern Drill Presses

Two new "Slo-Speed" Drill Presses together with other models now makes available Delta Drills for every purpose—in home workshop and factory alike. A Delta Drill Press is almost a complete workshop in one tool. It can be used for mortising, routing, drilling, carving, sanding, shaping and surface grinding. Delta Drill Presses embody Delta "quality" throughout—and yet are priced at unusual low price levels. Send for catalog. See coupon below.

NEW TOOLS—NEW FEATURES IN 1935 "DELTA" LINE!



NEW 6-INCH JOINTER

Has new Patented Fence and many unusual improvements.



NEW SCROLL SAW

Cuts with finest jeweler's blades at full motor speed. Many other features

The new "Delta" Drill Presses are but two of the many new improvements and tools announced this year by Delta engineers. This year the Delta line of motor-driven woodworking tools is more complete than ever before. Delta standards of efficiency, quality and convenience have been strictly maintained—and Delta prices still kept at their low levels. Good compact motor-driven tools are within the reach of all. Every woodworker will find the new 1935 Delta line of unusual interest.

The "Delta" line includes: Jointers, Circular Saws, Band Saws, Scroll Saws, Drill Presses, Woodturning Lathes, Boring, Routing, Sanding, and Mortising Attachments—and a complete line of accessories.

WRITE FOR CATALOG

The 1935 catalog of Delta quality motor-driven tools is now off the press. It is crowded with photographs and information about the new line of 1935 Delta tools. It shows how Delta tools are built to stand the grind of production work, and yet are so low priced as to be within the reach of all.

Send coupon so your name will be placed on the mailing list to receive the 1935 Delta catalog without delay. Enclose only 10c at same time for Book of Practical Delta Projects. 32 pages of new and novel things to make, with many blue prints, working drawings, photographs and illustrations—and complete directions.

DELTA MANUFACTURING COMPANY. Dept. A 135
3775 N. Holton Street Milwaukee, Wisconsin

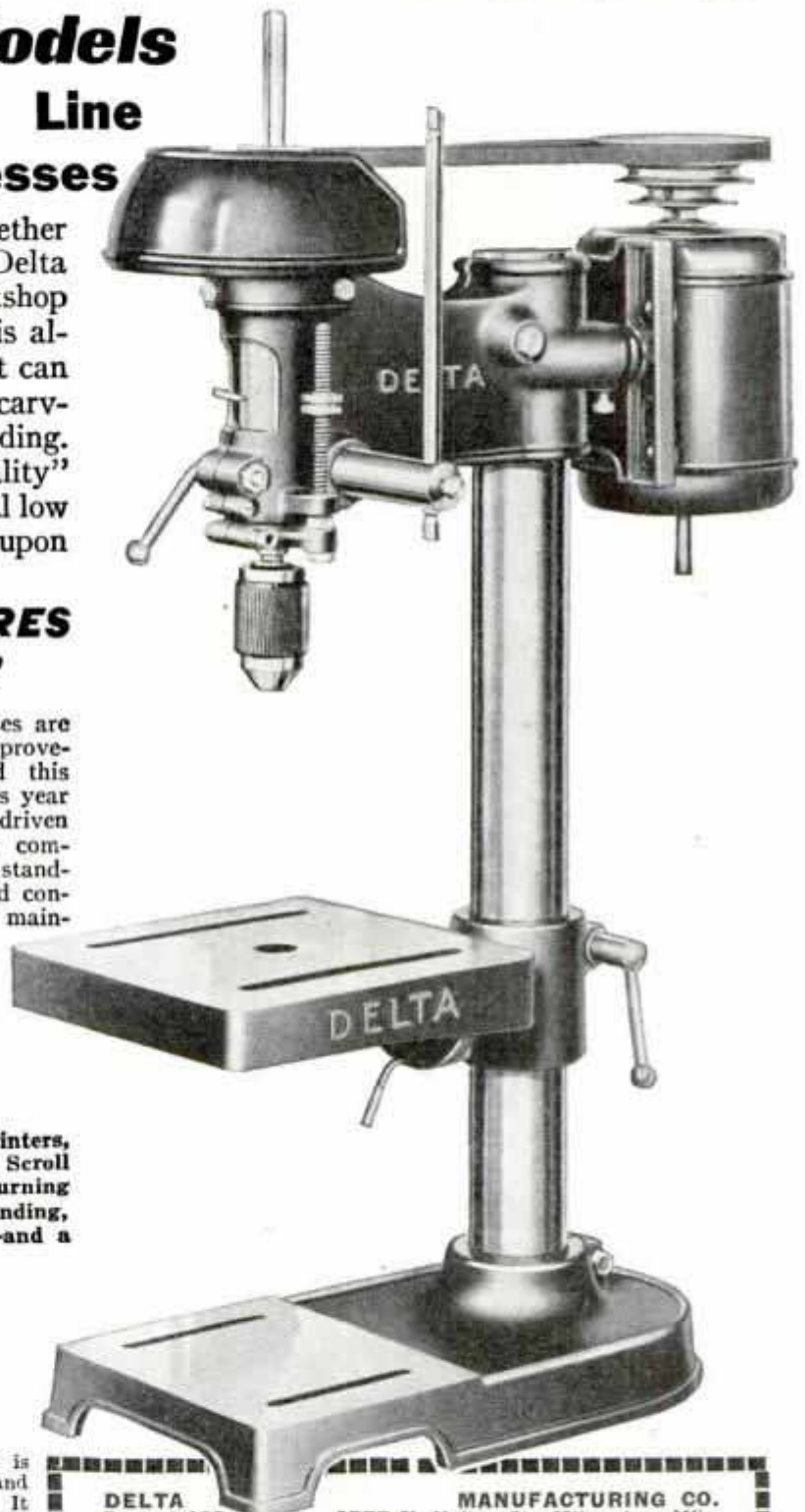

DELTA MANUFACTURING CO.
Dept. A 135 3775 N. Holton St., Milwaukee, Wis.
I enclose 10c (stamps or coin), for which please send me one copy of "Practical Delta Projects". Also place me on your mailing list to receive 1935 Delta catalog of quality motor-driven woodworking tools.

Name.....Age?.....

Address.....

City.....State.....

Check here if you are a Delta user now.

TIRED OUT?...



ACROSS HIS DESK flows the news of the world: Ray Baker of International News Service. 70,000 miles of telegraph wires and direct cable loops with foreign countries flash 100,000 words a day to Baker...to be quickly judged and edited. He says: "The man on the INS news desk has a high-pressure job. The most enjoyable way of easing the strain that I know is smoking Camels."



HOCKEY STAR. "Bill" Cook says: "I smoke only Camels. Their taste sure hits the spot! I smoke a lot. Camels never get on my nerves or tire my taste."



BUSINESS GIRL. Eve L. Miller: "I smoke Camels because I appreciate delicacy of flavor—and Camels give me a 'lift' when my energy is low."

CAMEL'S COSTLIER TOBACCOS

When writing to advertisers please mention Popular Mechanics

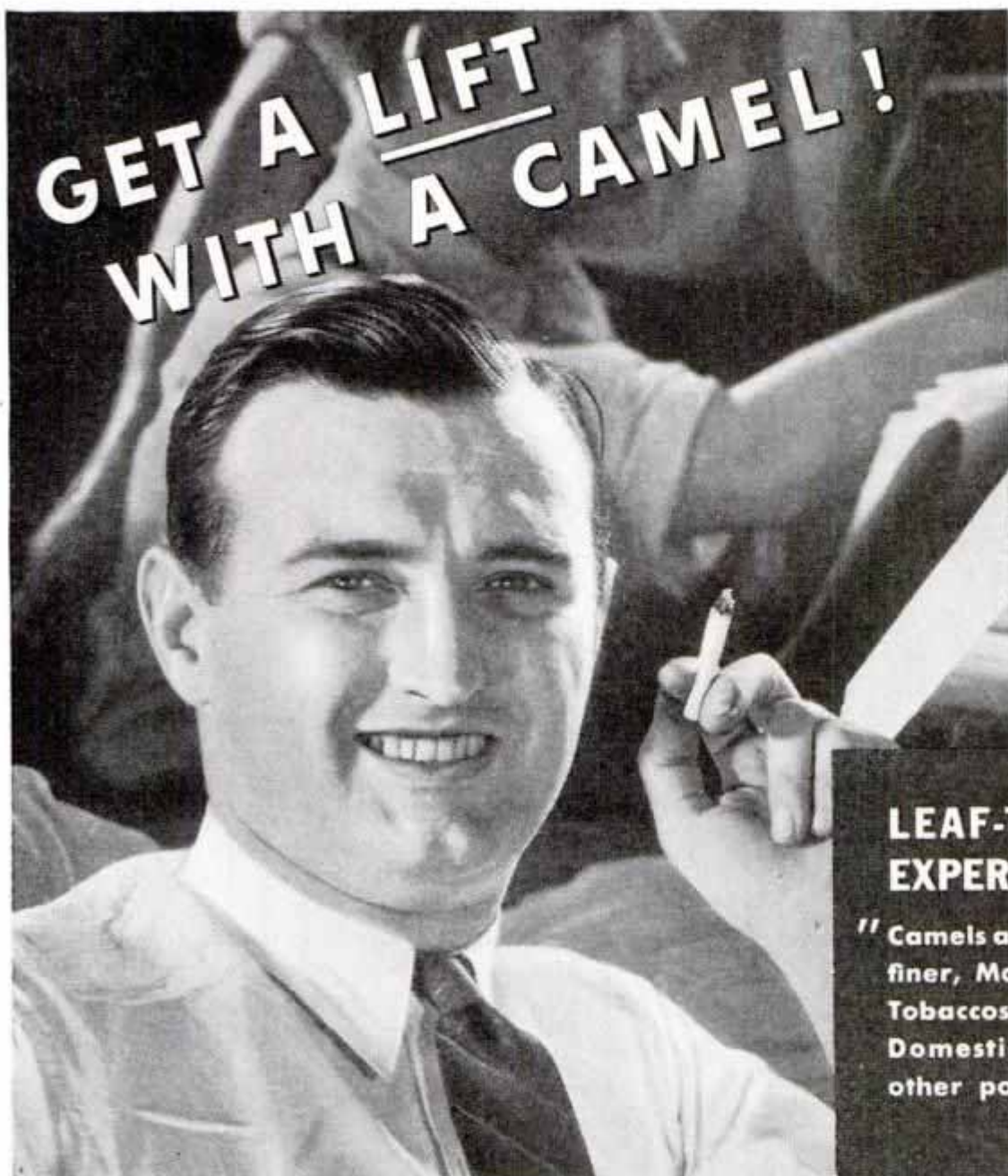

**GET A LIFT
WITH A CAMEL!**

**LEAF-TOBACCO
EXPERTS AGREE:**

**"Camels are made from
finer, More Expensive
Tobaccos—Turkish and
Domestic—than any
other popular brand."**

**PERSONAL EXPERIENCES THAT POINT THE
WAY TO INCREASED ENERGY!**

Newspaper man—hockey star—business woman—wherever smokers are placed in life, they notice a positive energy-refreshing effect from smoking Camels when they are tired or "out of sorts." Ray Baker says: "My experience has been that whenever I feel 'all in' Camels bring back my pep, and I can tackle the next big story with renewed energy! For over ten years I've preferred Camels. They have a rich, distinctive flavor that just suits me. And I can smoke Camels continually without jangled nerves."

Science confirms the experience of smokers regarding Camel's "energizing effect." You can smoke them freely since Camel's matchless blend of costlier tobaccos never upsets the nerves!



NEVER GET ON YOUR NERVES!

Copyright, 1934,
E. J. Reynolds
Tobacco Company

When writing to advertisers please mention Popular Mechanics

Make your own Christmas card with G-E MAZDA PHOTO LAMPS



How this card was made! The tree was cut out of composition board, because a regular tree does not produce a simple silhouette. It was placed before a light colored wall with a G-E MAZDA Photoflash lamp behind it, directed at the wall. When the pose suited, the lamp was flashed. Another method is to put a sheet over a doorway behind the subjects and to flash the lamp in back of the sheet.



G-E MAZDA
Photoflash lamp



G-E MAZDA
Photoflood lamp

Christmas cards are easy to make . . . and loads of fun . . . thanks to G-E MAZDA Photo lamps. These magic lamps open scores of possibilities for creating "different" cards . . . as well as for capturing happy moments the year 'round . . . through INDOOR PICTURES.

G-E MAZDA Photoflood lamps, used with super-sensitive film, enable you to take dozens of pictures at night . . . SNAPSHOTS, if you use a camera with a fast F/6.3 (or faster) lens; TIME EXPOSURES of one or two seconds, with box or slow lens folding cameras. Excellent for taking home movies.

FOR BABIES, PETS and action scenes, you need G-E MAZDA Photoflash lamps. They make such pictures as easy as snapshots in sunlight. Use them anywhere (operate on batteries or house current) with any camera which can be set for "time." Each lamp gets one picture. 15 cents list.

Your druggist or camera dealer can supply you with lamps and film. General Electric Company, Nela Park, Cleveland, Ohio.

**GENERAL  ELECTRIC
MAZDA PHOTO LAMPS**

COMET ON RAILS BRINGS AIR SPEED TO EARTH

(Continued from page 10)

wagon trains were organized to carry supplies into the new settlements. Freight cost ten dollars a hundred pounds to Santa Fe and twenty-five dollars per hundred to Los Angeles.

In the stage lines of 1858, a passenger with an iron constitution could undertake a trip lasting twenty-four days, and twenty-four hours each day, between St. Louis and San Francisco, for a fare ranging from \$100 to \$600. Horses and drivers were changed all along the route.

The pony express first ran in 1858 on an experimental basis. In the next year, its organization numbered 500 horses, 190 relay stations, 200 hostlers, and eighty first-class riders, including Buffalo Bill.

The fastest riders covered the 1,900 miles between St. Joe, Mo., and Sacramento in eight days, but usually the journey required ten days. What won great fame for the riders was their expertness, endurance, and reliability. Out of 650,000 miles covered, they lost only one mail. Buffalo Bill made a record of 384 miles in a single ride.

The pony express didn't last long because a new form of rapid word transit, the telegraph, came into vogue and in the midst of the Civil war, congress got the first transcontinental railroad under way, in 1863. The Union Pacific worked west from Missouri, while the Central Pacific worked east from California.

In May, 1869, the tracks were joined, a golden spike was driven into the polished tie of California laurel, and as the blows of the hammer were "broadcast" over telegraph wires attached to the rails, all the country knew that at last the Atlantic and Pacific coasts were tied by threads of steel.

Eighteen hundred miles of track had been laid through the wilderness between California and the Mississippi, ranking, after the Panama canal, as the greatest feat of American engineering. Its cost to the nation was \$830,000,000.

Barely sixty-five years have elapsed. The same distance was recently covered by Colonel Roscoe Turner in slightly more than ten hours! Of course, Colonel Turner's flight did not happen without previous preparation and experience. As recently as 1920, one of the great goals of

(Continued to page 138A)



● **KODAK SIX-16 (f.4.5)**

—the camera for those who know. Snaps open at the touch of a button. The Kodak Anastigmat *f.4.5* lens gives greater snapshot scope . . . and the Compur shutter's 1/250 second speed "stops" most action. Has both eye-level and reflecting finders. A self timer lets you get in the picture yourself. . . For 2½ x 4¼ inch pictures—\$40.



● **KODAK RECOMAR "18" (f.4.5)**—most versatile of Kodaks. With *f.4.5* Kodak Anastigmat lens . . . 1/250 second Compur shutter. Double-extension bellows for close-ups . . . long-focus and wide-angle lenses may be used. Ground-glass focusing. Uses cut film, film packs or plates. For 2¼ x 3¼ inch pictures—\$46.



● **KODAK DUO SIX-20 (f.3.5)**—a true miniature camera—yet it makes a larger, album-size picture . . . takes sixteen 1½ x 2¼ inch pictures on a roll of 620 film . . . *f.3.5* Kodak Anastigmat lens . . . 1/300 second Compur shutter . . . \$52.50.

● **KODAK VOLLENDIA (f.3.5)**—a fine miniature camera. Takes sixteen 1 3/16 x 1 9/16 inch pictures on a roll of "vest pocket" film. Eight-speed Compur shutter . . . *f.3.5* lens . . . eye-level finder. Price—\$33.50.

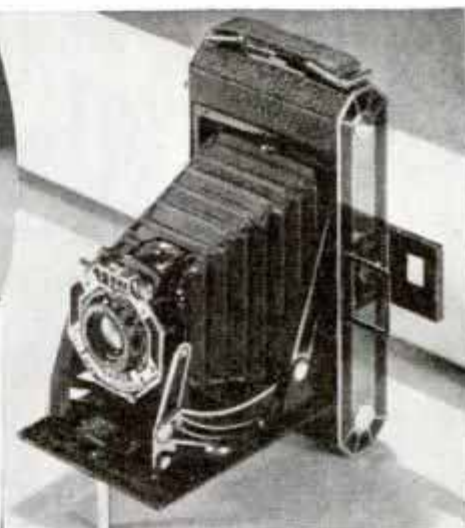

● **KODAK SIX-20 (f.6.3)**—styled for 1935. The *f.6.3* Kodak Anastigmat lens gives clear snapshots. It opens at the touch of a button. Has 1/100 second shutter. Eye-level and reflecting finders. For 2¼ x 3¼ inch pictures—\$17.50. Other models from \$14.

Gifts

YOU'LL WANT TO GIVE — AND GET

● IT'S CHRISTMAS . . . Kodaks are on parade. Precision Kodaks with fine, fast lenses . . . inexpensive Kodaks for beginners . . . tiny Kodaks for miniature snapshots. Brownies as low as \$1; Kodaks, \$5 up. See them at your dealer's. Give a Kodak. **ONLY EASTMAN MAKES THE KODAK**

GIFTS GALORE

Send today for catalog showing all latest Kodaks. Mail this coupon to Eastman Kodak Co., Rochester, N. Y.

Name _____

Street _____

City _____

State _____

718-1-30

When writing to advertisers please mention Popular Mechanics

COMPLETE TRANSMITTER FOR BEGINNING AMATEURS

(Continued from page 101)

The lower photo shows the Collins antenna-coupling unit, for use with this transmitter, which insures maximum efficiency with practically any type of sky wire. Schematic diagrams of each unit are given in Figs. 1 and 2. Thoroughly tested in Popular Mechanics radio laboratory,

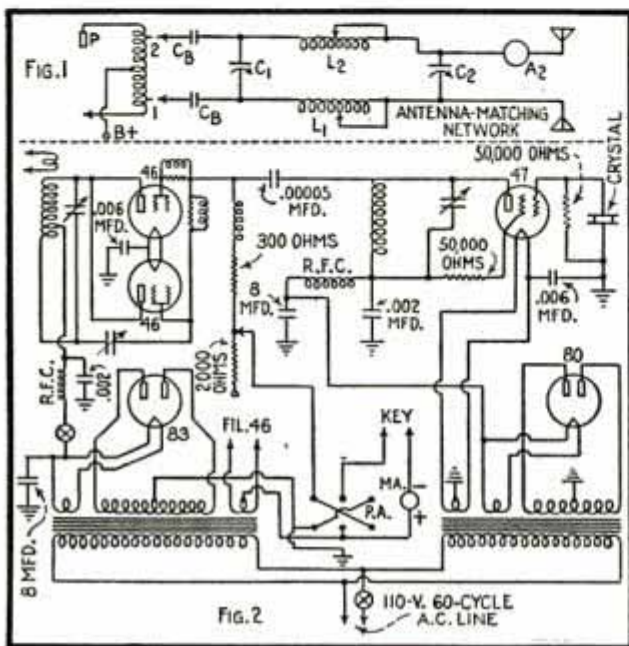

the results were highly satisfactory. Several users have reported working Mexico City, Hawaii and New Zealand.

HOMEMADE TROUBLE LOCATOR FOR POWER UNITS

(Continued from page 104)

To use the device, remove the rectifier tube from the receiver and insert the adapter, placing the tube in the top section. Plug in the a.c. cord and the tube will light. The test leads are connected to an external 100 m.a. meter, the ground lead clipped to the chassis, and the receiver is then turned on. A reading of between 50 and 80 mils will be noted. Now shut off the set and remove the clip from the chassis; again turn the set on and note the meter reading. If it reads the same as before, it means that the filter condenser connected nearest the rectifier is shorted. If this reading is somewhat less, one of the other condensers is at fault. If, with the ground clip on the chassis, the reading is about 70 and when the clip is removed the reading is zero, the choke is defective.

LITTLE GIANT FIVE-TUBE SUPER FOR A.C. OR D.C.

(Continued from page 103)

tailed in Fig. 2 is for mounting the combination volume control and switch.

To avoid confusion in wiring the tube sockets, they should be mounted on the base so that the large holes for the heater terminals are in the same positions, viewed from below, as shown in Fig. 1. A complete list of materials, with additional wiring and balancing data, may be obtained upon application without charge. A schematic circuit diagram is shown in Fig.

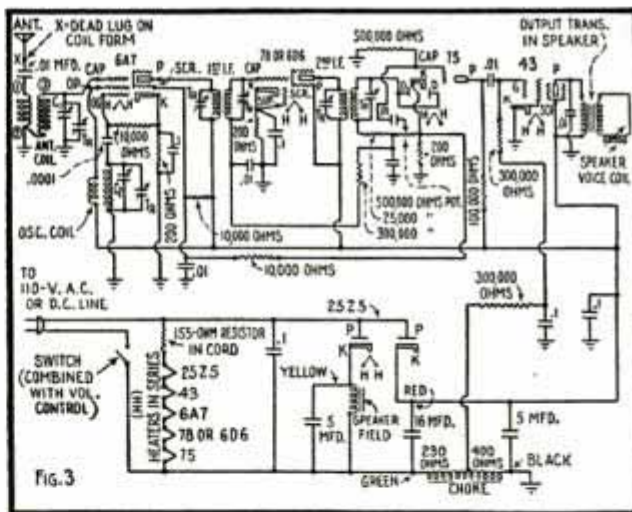
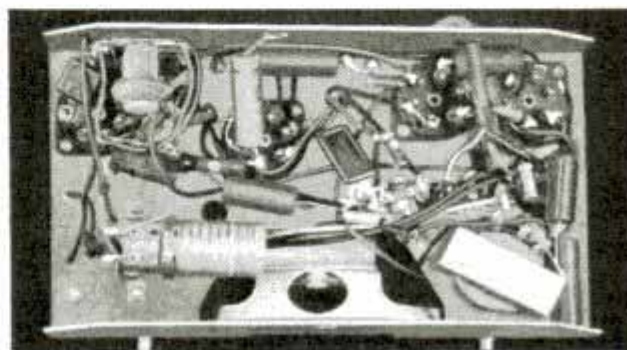

3. An enlarged blueprint of all diagrams is available; those who wish it should specify blueprint R-205.

To balance the set, tune in a weak signal and adjust the TR. condensers, in the top of the I.F. transformers, with a small screwdriver for loudest signal. Do not turn the screws more than one complete turn in either direction. The next step is to adjust the ganged-condenser unit in the usual manner so that it will track evenly across the entire dial.

With condenser plates all out, adjust front section TR. until police calls are heard. Then rear TR. for loudest signal on any low-wave broadcast station.

"Friction Fighters" Find New Way To Refine Oil

that will make Millions of Cars Start Easier this Winter

Why Mobiloil Arctic...
made by the Socony-
Vacuum Clearosol
Process... makes starting
easier... lasts longer
... keeps cars better
protected against Winter

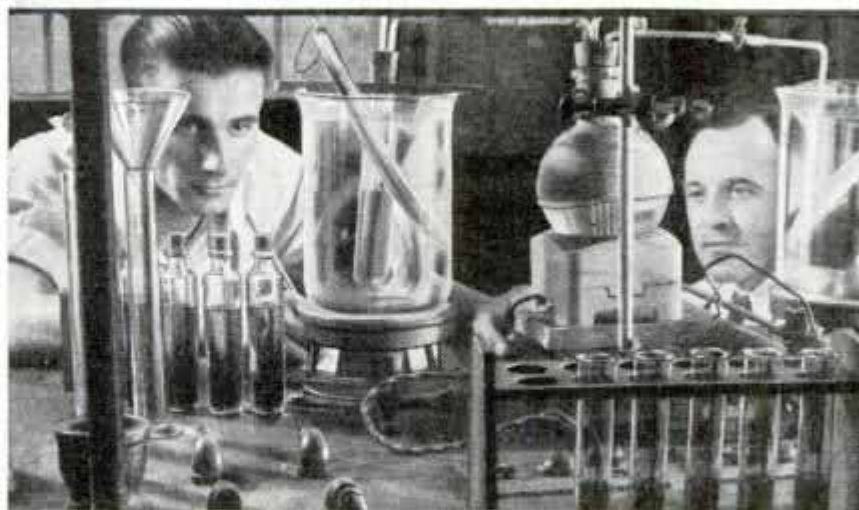

SCIENTISTS WORKED *ceaselessly* to perfect the new Clearosol Process



THESE HUGE tanks hold materials that wash impurities from oil

MILLIONS OF CAREFUL motorists right now are getting their cars ready for the hard Winter driving that's ahead.

Before you change oil—read the whole story of this remarkable new development in oil refining.

Instead of relying on filter and acid baths, as is customary, the new Socony-Vacuum Clearosol Process actually *dissolves out* the impurities in crude oil.

What happens to the oil is amazing. It is practically 100% pure lubricant. When you put it in your engine, you discover these things:

FIRST—Mobiloil Arctic made by this new process makes starting much easier in cold weather.

SECOND—Mobiloil Arctic made this way lasts as much as 25% longer.

THIRD—Engines stay cleaner—you'll have no gummed rings or stuck valves as a result of using this oil.

Now is the time to get your car in shape for hard Winter driving. Go to the nearest Mobiloil dealer—you'll know him by the Mobiloil sign with the red Gargoyle or the sign of the Flying Red Horse . . . and refill with clean Mobiloil Arctic. Act now. Socony-Vacuum Oil Company, Inc.



Below — The same engine, used in two tests, was first run with ordinary oil (upper picture). The lower picture shows how much cleaner engines stay when you use this new type Mobiloil Arctic.

FOURTH—Mobiloil Arctic holds its body at high temperatures, and guards your engine against wear, no matter how hot it gets.

With these many advantages, you might well expect this marvelous new Mobiloil Arctic to cost more. But it doesn't. The price per quart has not been advanced one single cent.

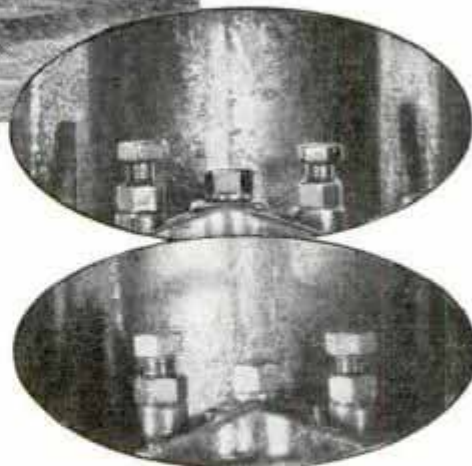

Mobiloil Arctic

MADE BY THE NEW SOCONY-VACUUM CLEAROSOL PROCESS



IS YOUR DRIVING 'TOUCH' MODERN?

(Continued from page 68)

course. Much of the trouble experienced with the new cars is due to motorists trying to "drive" them. That's wrong. The new cars require "guiding." They operate more effectively with restraint on the part of the driver.

Maximum braking force should be applied after the car's speed has been brought down to safer limits. If the car is brought to a stop within 160 feet from a speed of sixty miles per hour, and weighs 3,500 pounds including load, it develops 280 horsepower. This power would be sufficient to throw the car 120 feet into the air. If, however, the driver slows down moderately until the car drops to a speed of thirty miles per hour, and then makes an efficient stop within forty feet, the horsepower developed is reduced to 140 and the car could be thrown into the air only thirty feet by reason of this power.

Handling "knee-action" cars calls for special ability not acquired by experience with yesterday's automobiles. Since there are several designs of independent front springing in service, methods of handling differ. Also there is no general agreement among drivers as to what methods are best for the handling of any one type of knee action, with the possible exception that cars with this feature take curves better when "nosed" around the turns. Skillful drivers are able to "gun" knee-action cars around curves, stepping on the gas at exactly the right moment to produce a safe and effective swing of the tail, but the average driver will fare better if he takes curves at his usual gait and watches his steering. Special care must be taken to see that the steering wheel does not spin to the straight-ahead position too suddenly. Modern drivers "brake" the steering wheel by applying finger pressure against the rim as they are going out of a turn.

These large tires do not, as many drivers suppose, give greater security in case the car goes off into the soft shoulder. They produce a terrific drag when leaving the hard surface. For that reason it is highly dangerous to try to return to the hard-surfaced portion of the road immediately. Cling to the wheel and let the car lose speed. Continue in the rough until you are sure you can cut back to the road without a bad skid.

Many of the new cars have clutches that do not engage until the pedal is well up. Because of this arrangement the driver should not rest his foot on the pedal when the clutch is engaged. He should avoid nervous tension against the pedal, especially when accelerating in the lower gears. Recently there have been quite a few cases of drivers having difficulty backing up hill. It was found they did not let the clutch pedal come up far enough for the clutch plates to take hold.

Complaints of clutch chattering have been traced to tardiness in engaging the clutch and in accelerating the motor. To engage a modern clutch too slowly, while at the same time not feeding enough gas to start the car with deliberation, simply forces the clutch plates to chatter. Modern cars are actually "cushioned" for a more abrupt start.

Never before has it been more important to handle the accelerator pedal carefully. Excessive wear on the gears, universals, rear end and tires is the penalty for ignoring this point. Sudden throttle closing causes high vacuum in the cylinders, wastes oil and makes carbon. At the same time the fuel pump overfeeds the carburetor.

Motorists who have not broken in a new car in several years will find it well to scrap the idea of holding to a steady gait of around twenty-five miles per hour during the first 500 to 1,000 miles. The ideal plan is to drive twenty-five miles per hour for a few minutes, then switch to thirty-five or forty for a short spurt. If not overdone, some reasonably fast city traffic is not a bad environment for the new car.

Be prepared for a front tire blowout by having a firm grasp on the wheel. Twist the thumb of at least one hand over a wheel spoke so there will be less chance of the rim slipping through your hands. There is a big drop when a balloon tire goes flat and a terrific drag to be overcome. Watch speed in the lower and now silent gears. Consider the high rate of compression deceleration when the throttle is closed after reaching a high speed in low or second. There is also a good possibility of backing up too swiftly with a car that is also quiet in reverse.

If the new car is to be a complete success it must be treated to new-era driving free from old-car complexes.



FOR CHRISTMAS

GIVE YOURSELF THIS NEW GENERAL ELECTRIC COMPLETE WORKSHOP

No belts • No pulleys • Six machines in one, instantly interchangeable • Nothing else to buy

Never before have so many practical working features been included in a motorized workshop. Every attachment is driven *directly* from the G-E motor. No frictional power losses or vibration to interfere with accurate work. Compact but sturdy, reinforced steel cabinet gives firm support.

SIX MACHINES IN ONE

(1) Circular saw with all adjustments, (2) Jig saw, (3) Sabre saw for wood and metal work, (4) Nine-inch lathe and two wood-working tools, (5) Eight-inch sander and sanding table, (6) Drill chuck with set of nine drills, General Electric quality throughout.

See It At
Your G-E
Refrigerator
Dealer's

COMPLETE . . . ECONOMICAL . . . ACCURATE

YOU are through buying when you get this complete outfit. Motor, bench, and all tools come with it. Made for the professional or amateur woodworker, the small shop or the home craftsman. Equally efficient for all, because the vast resources of General Electric Company contributed to its painstaking development. Look at that motor. Though compact, it is a high-efficiency ball-bearing motor with $\frac{3}{4}$ " shaft reduced to $\frac{5}{8}$ " at the bearings. Ample power at the cutting edge is assured by the powerful torque of the motor and the inertia of its armature.

Imagine—a complete power workshop which takes a floor space of only 18 by 38 inches! When you see it demonstrated—at your nearest G-E refrigerator dealer's—you will marvel at its completeness, its all-round efficiency, its practical working features, its ruggedness—and, with all these things, its amazingly low price.

Surprisingly low current consumption cuts down operating cost to a level never before achieved.

FREE!

MAIL COUPON BELOW

for illustrated book with full story of G-E WORKSHOP



COMPLETE G-E WORKSHOP

Motor Bench Tools **\$10⁰⁰** DOWN
Balance in Easy Payments

General Electric Company
Nela Park, Dept. PM 1
Cleveland, Ohio

Please send me FREE your book describing complete G-E WORKSHOP.

Name _____
Address _____
City _____ State _____



COMBINATION SABRE AND JIG SAW, for wood or metal. Table tilts 45°. Self-aligning overhead arm quickly secured by single bolt. Saw chuck holds machine files with round shanks up to $\frac{1}{4}$ -inch diameter, greatly increasing wide scope of machine. Sabre saw can be attached in 6 seconds.



CIRCULAR SAW 8" diameter, direct motor driven; tilting table, $10" \times 14\frac{1}{2}"$, easily set for depth of cut and for any bevel up to 45°; adjustable protractor and mitre gauge; self-squaring rip guide with table calibrated in inches, front and rear; self-setting safety-guard.



LATHE swings work up to 9" diameter, turning lengths, with extension, up to 30". The face plate, fitted with removable cone and spur centers, screws directly on motor shaft, or is carried on special mandrel held in chuck.



SANDER TABLE is grooved for the mitre gauge and rip guide of the saw and is slotted for metal cutting saws or milling cutters. The 8-inch sanding disc screws directly on motor shaft or is carried by the arbor held in chuck.



QUICK CHANGE ATTACHMENT CLAMP makes the attachment of the sanding table, sabre or jig saw and tool post a matter of a few seconds. Construction is rigid and easily adjustable.

GENERAL ELECTRIC

When writing to advertisers please mention Popular Mechanics

RELIEVE ACID INDIGESTION WITHOUT HARSH, RAW ALKALIES!

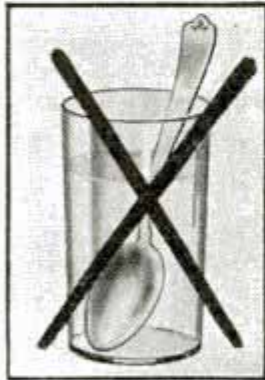

Millions Have Found Faster, Surer Relief In New-Type Mint

HEARTBURN is distressing. But there's no longer any need to resort to harsh alkalies in order to relieve a sour stomach, gas, or after-eating distress.

Strong, water-soluble alkalies taken in excess may change the stomach juices *completely*—slowing up digestion instead of helping

it. The new, advanced, most effective and *safe* relief for acid stomach is TUMS. TUMS contain no soda or any other water-soluble alkali—instead this candy-like mint contains an unusual antacid soluble only in the presence of acid. When the excess acid in the stomach is neutralized, the remainder passes on undissolved and inert. No danger of alkalosis or kidney poisoning from TUMS.

Try TUMS—3 or 4 after meals, when distressed. Eat them just like candy. You'll be grateful for the wonderful relief. 10c a roll at all drug stores. 3-roll carrier package, only 25c.

Free

1935 Calendar - Thermometer, beautifully designed in colors and gold. Also samples TUMS and NR. Send stamp for postage and packing to A. H. LEWIS CO., Dept. 21-AKK, St. Louis, Mo.

TUMS

FOR THE TUMMY

TUMS ARE ANTACID . . . NOT A LAXATIVE

10c

HANDY TO CARRY

For a laxative, use the safe, dependable Vegetable Laxative NR (Nature's Remedy). Only 25 cents. **NR**

Home Automatic Cigarette Machine

Put tobacco and block of papers on machine. **TURN THE CRANK**—PRESTO—CIGARETTES. Easy—simple. All metal construction. Guaranteed. No cloth ribbons; no special tube or gummed papers required. ASK FOR FREE ILLUSTRATED FOLDER. AUTOMATIC CIGARETTE MACHINE WKS., PM-1, 1055-57 Sheridan Rd., Chicago, Ill.

COMPLETE Movie Outfit

No knowledge of photography required. You can take and show movies equal to those produced by most expensive outfits. **BIG VALUE.**

\$9⁰⁰

CAMERA—takes clear, brilliant pictures. Uses 16mm. film, 50 ft. roll.
PROJECTOR—shows pictures, big, clear and life-like. Uses 16mm. film. Operates from any light socket.

DON'T MISS THIS BARGAIN
 We also have a complete list of film subjects for any projector. Write NOW for big, FREE Catalogue of Movie supplies.
PARAMOUNT MFG. CO.
 Dept. G-76 Boston, Mass.

BRITAIN BIDS FOR ATLANTIC BLUE RIBBON

(Continued from page 79)

communications system. The "Queen Mary" has a siren voice that will carry from ten to fifty miles. The tone will be two octaves lower than middle "A," and will have a soft mellowness that will not shock passengers or prove unmusical to the ear. The 140-ton rudder can be entered through either of two doors. Inside is enough room for several men to move around.

An investment of \$100,000,000 makes it possible for this colossus to leap across the ocean. About 250,000 people contributed to her design and construction. Thirty-five thousand tons of steel entered into the construction. Ten miles of carpets cover her floors.

The ship's running costs will mount into millions every year. Can enough passengers be lured to fill all the available accommodations? Many factors will decide that ultimately.

THE RACE HORSE DOPE RACKET

(Continued from page 83)

and morphine are not greatly favored by the dopesters. Their tendency is to make a horse more or less unruly. Heroin is milder and produces those illusions of grandeur so necessary to big running. Where a horse is sulky, only heroin alone is used. He has enough heart and strength to carry himself through the race without the artificial stimulus.

After horses have been doped for a considerable period they, like humans, become dope addicts. They cannot perform unless they have been given a "shot" before they enter a race. "Hopheads" they are called and every now and then one drops dead in the midst of a race. Horses are also given dope to make them lose races. Chloral hydrate, given in a milk solution to prevent the burning of the animal's throat, makes the animal groggy. The most fiendish method of obtaining this end, however, is the insertion into the nostrils of a racer of a sponge. Aside from its cruelty, doping inflicts injury on the racing stock of the country. Mares and sires that have been doped cannot produce healthy offspring.

WITTE DIESEL ENGINES



**A DIESEL
YOU CAN
AFFORD
TO OWN**

Sizes
5 and 10 H-P.

Horizontal... Hopper Cooled... Solid
Injection... Four Cycle... Easily
Started... Entirely Self-Contained
**Enclosed, Self-Oiling,
Timken Roller Bearing**

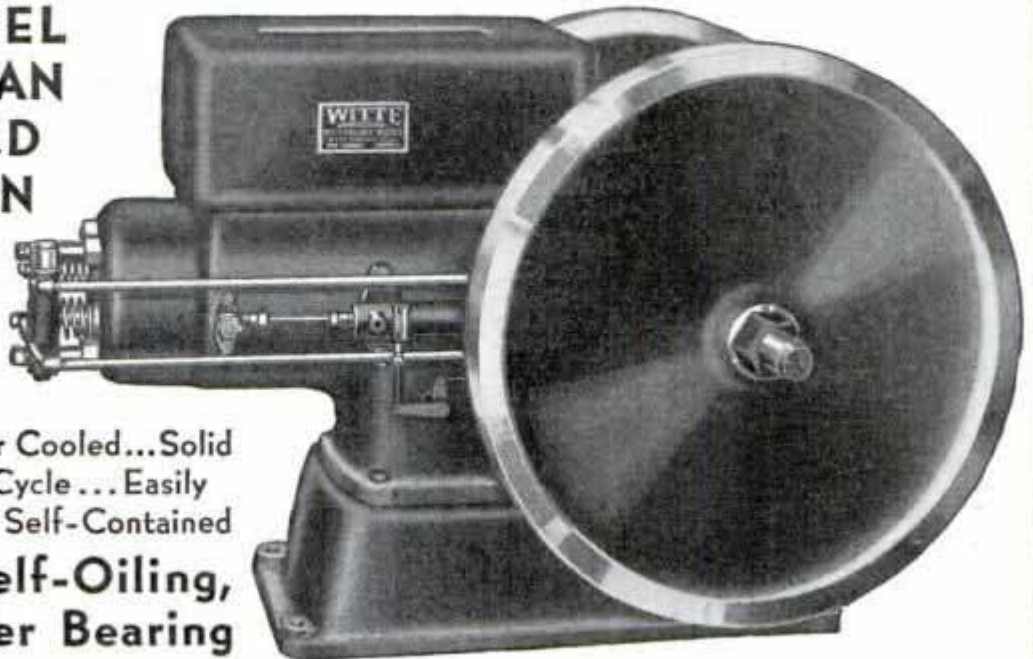

The Engine That Pays for Itself

THE economy of large diesel engines is well known, yet the WITTE Diesel will operate just as economically, or at about one-eighth the cost of gasoline. Where an engine is used several hours each day the savings in fuel over the ordinary gasoline engine will actually pay for the diesel engine and earn a big profit thereafter. The simplicity of the WITTE Diesel is an important advantage which is reflected in its amazing economy of operation. It's the last word in dependable economical power.

Sold Direct - Factory to YOU

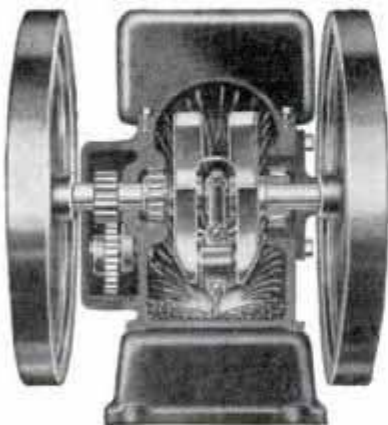

Showing Oiling System and
Counter-Balanced Crankshaft

Over 65 years of experience as exclusive engine builders is incorporated in our products, assuring you of the utmost perfection, economy, efficiency, dependability and satisfaction. WITTE Engines are all of one standard design, simple in construction, easy to understand and operate, with all parts accessible for adjustment. These engines are made so simple and have so few moving parts that it requires no unusual skill or tools to operate or adjust them. Until recently, the economy of low grade fuels was only available to power users on a large scale. This low cost power is now available to everyone through the WITTE Diesel. Write for Bulletin 25.

**We also make a complete line of
Gasoline... Kerosene and Natural Gas
Engines... Catalog FREE.**

210-A Carson St.
PITTSBURGH, PA.

WITTE ENGINE WORKS

1741 Oakland Ave.
KANSAS CITY, MO.

Easy to Play



What a thrill when you play your first tune, on a P-A Sax. Then popularity... admiring friends, good times, a glorious future. Try a new model P-A Sax, Trumpet, Trombone, Clarinet at your local music store, or write for beautiful literature. No obligation. Easy terms. Write today. • 1144 **PAN-AMERICAN** 103 P-A Bldg., ELKHART, IND.

Moderate Price

SENSATIONAL NEW DRILL PRESS AT AMAZING LOW COST

Three tools in one. Three speeds. Full floating pulley with oilite bronze bearings. Drills to the center of 14-inch circle. Highest quality, precision built. Amazingly accurate, fast, safe, and dependable. Write for Free Folder and sensational Direct-To-You Prices. Also get lowest prices on Blue Star fast, accurate, full-sized BAND SAW and Sturdy, Big, three-speed WOOD LATHE companion tools of the New DRILL PRESS. Do it now!



BLUESTAR PRODUCTS
994 Main St., Fairfield, Iowa

FREE Send for special Factory-To-You Bargain Prices and FREE folders on Blue Star Products.

BURN YOUR NAME ON TOOLS

WITH THE ARKOGRAF

PROTECT YOUR TOOLS FROM THEFT
Write with electricity any name or design on the hardest and finest tools and instruments, or any metal, like writing on paper with pen or pencil. **Complete Outfit \$3.50** — Prepaid Anywhere. Interesting illustrated circular free. Write today. Agents wanted. **ARKOGRAF PEN CO., 3927 S.E. Stark St., Portland, Ore.**



MAKE 1935 HAPPIER!
Your Tools in a GERSTNER Chest will help
Free Catalog
GERSTNER TOOL CHESTS
437 Columbia St. Dayton, Ohio

Catch Fish!

Eels, Mink, Muskrats with our new folding galvanized **STEEL WIRE TRAP**. Write for our **FREE TRAP OFFER** and Bargain Catalog. \$1 Box of our famous Fish Bait **FREE** to introduce our traps. **WALTON SUPPLY CO., 3509 JUNIATA AVE., ST. LOUIS, MO.**

DO YOU

WANT a new business profession of your own, with all the trade you can attend to? Then become a foot correctionist, and in a few weeks earn big income in service fees,—not medical nor chiropody—easy terms for home training, no further capital needed, no goods to buy, no agency. Established 1894. Address **Stephenson Laboratory, 1 Back Bay, Boston, Mass.**

WILL YOU WEAR THIS SUIT and Make up to \$12 in a Day!

Let me send you this fine all-wool tailored suit **FREE OF COST**. Just follow my easy plan and show the suit to your friends. Make up to \$12 in a day easily. **No experience—no canvassing necessary.**
Send for Samples—**FREE OF COST**
Write today for **FREE** details, **ACTUAL SAMPLES** and "sure-fire" money getting plans. Send no money.
H. J. Collins, Progress Tailoring Co., Dept. N-216, 500 S. Throop St., Chicago, Ill.

FASTENING SHELVES to MASONRY WALLS

Cut holes into the masonry with a cold chisel, insert bolts with heads in to form studs, and tamp remaining open spaces full of Smooth-On No. 1. Let the Smooth-On harden, then slip the brackets, cleats or uprights over the studs and fasten with nuts and washers. Use this method to anchor cellar shelves, partitions, wall cabinets, etc. Makes a strong, permanently tight connection that meets every need.

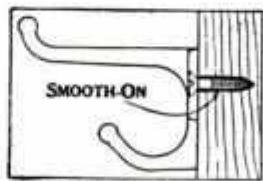

Tightening loose wood screws

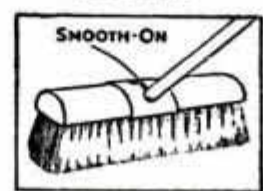

Tightening loose handles

SMOOTH-ON No. 1 stops leaks of water, steam, oil, gas and smoke. Makes a pressure-tight seal at joints, cracks and breaks in pipes, boilers, radiators, tanks, ovens, hot-air and smoke ducts, pails, etc. Tightens loose handles on tools, cutlery, push brooms, umbrellas. Makes stripped nuts, bolts and screws hold. Tightens loose locks, hinges, casters, hooks, stems, chair arms and legs, posts set in metal or concrete, etc. Stops leaks in automobile radiators, hose connections, cracked water jackets and gear cases, oil and gasoline lines, keeps nuts, lubricator connections, hub caps and wood screws from coming loose, makes headlight and dash supports tight and proof against rattle. Applied cold and holds in any metal, concrete, masonry, tile or wood.

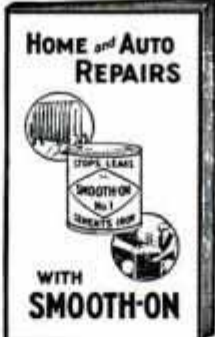

Write for **FREE BOOK**



Home and car owners find uses for Smooth-On every month in the year and save from 50 cents to many dollars on each application. Making these emergency and routine repairs yourself avoids expense and delays for professional fixers and is easy if you follow instructions in the Smooth-On Repair Book which will be mailed on request. Be ready the instant trouble shows up by keeping a can of Smooth-On in your repair kit and the booklet handy for quick reference.

Get the booklet from us and Smooth-On No. 1 in 7-oz., 1-lb. or 5-lb. tins from any hardware store.

Do it with SMOOTH-ON

SMOOTH-ON MFG. CO., Dept. 37
574 Communipaw Ave., Jersey City, N. J.

Please send the free Smooth-On Repair Book.

Name.....
Address.....
1-35.....

When writing please mention Popular Mechanics

HE'LL USE LEPAGE'S



"I MADE IT MYSELF"

● As he points with pride to his doghouse, his first effort in craftsmanship, he probably didn't use glue.

But he'll try other projects where he'll want snug joints, reinforce nails and screws, fill small cracks and nail holes. Then he'll discover that glue actually helps to make a workmanlike job.

Will he bother with a glue pot, when LePage's is so easy to use right from the can? Would you, when the difference in cost is hardly worth mentioning? You can get it from your hardware dealer.

RUSSIA CEMENT COMPANY

Laboratories and Factory • Gloucester, Mass.



WHEN IT'S NEEDED IN A HURRY!

Servicemen—Amateurs—Experimenters depend on
BURSTEIN-APPLEBEE CO.

America's Largest Radio House in America's Handiest Shipping Point. 1012-A McGee Street, Dept. 191, Kansas City, Mo.

1935 CATALOG
148 Pages
Write for a copy.

S AGENTS 500% PROFIT
GUARANTEED GOLD LEAF LETTERS
For Store fronts and office windows. Anyone can put them on. Free samples. Liberal offer to general agents.
METALLIC LETTER CO. 438 N. Clark St. Chicago

HAND-EE GRINDER

QUICKER BETTER JOBS

Weights 1 pound. Plug in any light socket and do 1001 jobs. Do away with slow hand work. Grinds, routs, drills, carves, sharpens, cuts, engraves. For shop, home or tool kit. (Model A), A. C. or D. C. operation, 110v., 13,000 r.p.m. Order on 5 day trial satisfaction guaranteed.

Ask for **FREE Booklet**

\$10.00
and up
Postpaid
U. S. A.
With 3 wheel shapes Free. Order today.

New MASTER CRAFTSMAN'S SET
17 useful accessories to grind, drill, polish, sand, cut, carve, engrave, etc. Prepaid \$5.00

CHICAGO WHEEL & MFG. COMPANY
108 S. Aberdeen St. Chicago, Ill.

MOVIE MAGIC IN THE MAKING

(Continued from Roto Section)

inside and outside the studios are trying to impart a three-dimensional quality to the screen and now they think that success is not far off.

About 275 professions, arts and crafts are represented among the 30,000 employes who work behind the scenes in Hollywood. The jobs range from gardeners and members of "swing gangs," who do general roustabout work, up to the directors and stars themselves. The studios have work for school teachers who coach juveniles between scenes, for hospital attendants in the emergency hospitals on each lot, for writers in the scenario and publicity departments, and for architects and draftsmen in the set designing departments.

Each studio employs fashion designers and costume makers, location men whose work it is to spot likely places for location trips, model makers, blacksmiths, carpenters, painters, and plaster casters who manufacture the lifelike sets, librarians and research workers who authenticate costumes and furnishings for period plays, musicians for the studio bands and orchestras, hair dressers, truck drivers, stenographers, and scores of others.

In the technical trades there are film laboratory workers who develop and print the films in automatic machines, chemists and engineers who produce rainstorms, fogs, and other effects on demand, electricians for construction and operation, film projectionists, and the sound engineers and their crews. At the top of the heap are the head cameramen, the make-up artists, and the directors. Salaries of several thousand dollars a month are not uncommon here.

How does one obtain a "behind the scenes" job in films? One of the best ways is to gain experience in a particular trade and then await an opening. Once on the studio payroll there may be an opportunity for advancement or a chance to switch to another department. Property boys who move furniture around the sets sometimes graduate to set dressers and film cutters and editors may become directors or assistant directors. Another way is first to obtain a lower paid job with one of the small companies. The big drawback is that there are four or five people in Hollywood for every available job.

CHEAP OIL BURNER INVENTED SWEEPING THE COUNTRY

Beats Coal or Wood

AGENTS,
SALESMEN
BIG MONEY

Slips Into Any Old Stove, Range or Furnace. No Dirt, Ashes—Twice the Heat, Half Cost

COOKS A MEAL for 1c

Beats any oil burner ever gotten out for low cost, perfect performance. Slips into any old stove, range or furnace; burns cheap oil a new way, without generating or clogging up. Intense heat instantly BY SIMPLE TURN OF VALVE.



Here's a REAL one. Clark of Ind. sold 93 in 30 days. O'Toole of Mass. sold 164 in July. Get YOUR OWN oil burner FREE and Make REAL Money. Write quick.

TRY AT OUR RISK — 30 DAY TRIAL — prove it ends drudgery and dirt of coal or wood; cuts fuel bills in half, pays for itself quickly by what IT SAVES.

FREE SAMPLE TO AGENTS offered to one energetic man or woman in each locality who will demonstrate and take orders. Write quick, be first to learn how to make REAL MONEY right now, spare or full time—mail 1c postcard today. UNITED FACTORIES, A-751 Exchange Bldg., Kansas City, Mo.

IDEAL SUPER-DETAIL FLYING PLANES MOVABLE CONTROLS OPERATED FROM COCKPIT DESIGNED FOR YOU BY FLYING MEN

You'd like an experienced flyer to help you lay out a plane with controls that work elevator, rudder and ailerons from the cockpit. That's what IDEAL does! Experienced flyers who have spent their lives designing and flying planes have laid out these big, beautiful flying models. That's why you learn aviation principles building planes the IDEAL way. That's why IDEAL planes are absolutely accurate 100 percent scale models—perfect, complete in every detail. Also includes bright, high lustre finish and many other exclusive Super-Detail fittings.



Boeing P-26A Wingspan 21 1/4" exact 3/4" scale kit complete \$1.75.

Send check or money order today for the plane pictured. Also send 3c for folder showing latest model planes. 26 West 19th Street, New York City, N. Y.

IDEAL AEROPLANE & SUPPLY CO., INC.

New "Cyclone" Motor Sled READY!

For Home Builders

Now you can easily build Mead's new, streamlined MOTOR SLED at home from drawings, parts or complete Construction Kit. Use OUTBOARD or other engine! Amazing speed. Low cost. PAY AS YOU BUILD! Rush 10c for Catalog No. 3. ICE-BOATS, Ki-Yaks, Sud-bontal



MEAD GLIDERS, 12 S. MARKET, Dept. 1-B, CHICAGO

VOICE

100% Improvement Guaranteed

We build, strengthen the vocal organs—not with singing lessons—but by fundamentally sound and scientifically correct silent exercises...and absolutely guarantee to improve any singing or speaking voice at least 100%... Write for wonderful voice book—sent free, but enclose 3c for part postage. Learn WHY you can now have the voice you want. No literature sent to anyone under 17 years unless signed by parent.

**PERFECT VOICE INSTITUTE, Studio 13-51
308 No. Michigan Ave., Chicago**

Print Your Own

Cards, stationery, circulars, tags, labels, advertising, etc. Save money. Print for Others; Big Profits; easy rules sent. Will do popular Raised Printing like Engraving. Junior press \$5.90, job presses \$11 up. Send for free catalog and all details. THE KELSEY COMPANY, A-37 MERIDEN, CONN.

ARMY AND NAVY SUPPLY CO.

Bargains—Army, Sport Goods, Firearms, Clothes, Shoes, etc. Send 10c for new catalog, to be redeemed on first order

Army & Navy Supply Co. 4772 Lester St. Richmond, Va.

Build the 4-mast Barque, California

Accurate, detailed blue prints of this handsome steel barque. Complete fittings and construction sets for steam trawler and other popular models, including Sovereign of the Seas. Send 15c for illustrated catalog.

A. J. Fisher, 1002-1 Etowah Ave., Royal Oak, Mich.

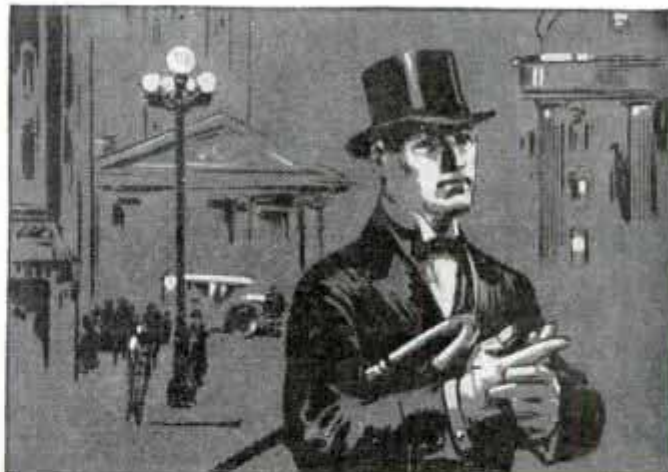

Follow this Man

Secret Service Operator 38 is on the job

FOLLOW him through all the excitement of his chase of the counterfeit gang. See how a crafty operator works. Telltale finger prints on the lamp stand in the murdered girl's room! The detective's cigarette case is handled by the unsuspecting gangster, and a great mystery is solved. Better than fiction. It's true, every word of it. No obligation. Just send the coupon and get—

FREE!

The Confidential Reports No. 38 Made to His Chief

And the best part of it all is this—it may open your eyes to the great opportunity for YOU as a well paid Finger Print Expert. This is a young, fast-growing profession. This school has taken men and trained them for high official positions. This is the kind of work you would like. Days full of excitement. A regular monthly salary. Rewards.

Can you meet this test?

Are you of average intelligence? Are you ambitious? Would you give 30 minutes a day of your spare time preparing yourself for this profession? Answer "yes" and I'll show you how it is possible for you to attain all this. Send the coupon and I'll also send the Free Reports.

INSTITUTE OF APPLIED SCIENCE
1920 Sunnyside Ave., Dept. 93-51 Chicago, Illinois

Institute of Applied Science
 1920 Sunnyside Ave., Dept. 93-51 Chicago, Illinois
 Gentlemen:—Without any obligation whatever, send me the Reports of Operator No. 38, also your illustrated Free Book on Finger Prints and your low prices and Easy Terms Offer. Literature will NOT be sent to boys under 17 years of age.

Name

Address

Age

When writing please mention Popular Mechanics



For those all-important FINISHING TOUCHES

Not for a minute would we belittle the skill and effort it takes to turn out a stool like the one at the left. But it is still a plain, unfinished piece of furniture — you wouldn't feel very proud of it.

On the other hand this same stool can be beautifully inlaid, an attractive corner bead put on the edges, and the aprons rounded over—all with a Stanley Electric Router-Shaper.

Corner beading, dovetails, inlaying, dado, rabbet and molding cuts — these are typical of the hundreds of woodworking operations that can be handled easily with this inexpensive home workshop outfit.

Don't be satisfied with plain, unfinished work. Write for catalog which describes the Router-Shaper and shows what it will do.

THE STANLEY ELECTRIC TOOL COMPANY
105 Elm St. - New Britain, Conn.

STANLEY ELECTRIC ROUTER-SHAPER

Made by the Makers
of the World Famous STANLEY TOOLS

At Last!

An Electric Router and Shaper
Designed for the Home Workshop



A NEW "DE LUXE" SPEED LATHE
with COMPOUND SLIDE REST
"The ideal lathe for the home workshop."
Write for new FREE booklet—just post.
We also manufacture Compound Slide Rests for all makes of lathes.
CLAUSING MFG. CO. Dept. 515 OTTUMWA, IOWA

Heating Plant Trouble?

Undersized Boilers and Sluggish Circulation CURED on existing and new Hot Water Heating Plants by same method used for years on large systems, now available for your home. Quick to install. Saves fuel. For coal, oil or gas. Not a "gadget." Write today for details.

U. S. FOUNDRY & MACHINE CORP.
P. O. BOX 123 JERSEY CITY, N. J.



Forms to cast Lead Soldiers, Indians, Trappers, Hunters, Wild and Farm Animals. 239 different forms to select from. Every form guaranteed to cast perfect figures. Send 5c stamp for illustrated catalogue.

HENRY C. SCHIERCKE Spencer Rd, GHENT, N. Y.

BABY CALCULATOR
CHICAGO & S. A.
PATENT APPLIED FOR

VEST POCKET ADDING MACHINE
Adds, Subtracts, Multiplies, Divides. Does work of costly machine. Net a toy. Million dollar capacity. Simple and accurate. Guaranteed 5 years.

FREE TRIAL
—SEND NO MONEY—

\$2.50
Total Cost

Just name and address. We will ship Calculator immediately. On delivery pay postman \$2.50 (plus few cents postage). (If outside U. S. send sub.) 30c additional in Leatherette Case. If not satisfied after 10 days' trial you get your money back. **THOUSANDS OF SATISFIED USERS.** Write for Agents' Proposition. **CALCULATOR MACHINE CO. (Mfrs.)**
P. O. Box 1118, Dept. 31, CHICAGO, ILLINOIS

THE LURE OF PUZZLE INVENTING

D1229 (Continued from page 23)

Puzzle solving, like puzzle inventing, involves a certain approach, without which the puzzler wanders aimlessly about, growing more irritable by the minute.

"Concentrate and speculate but, above all, calculate," was Sam Loyd's advice. "Aimless trials befoe the issue."

Alertness and clear thinking are essential to the puzzle solver who is expert at the game. These are the reasons why puzzles are regularly used in intelligence tests. Called the most universal of all pastimes, puzzle solving was termed by Sam Loyd as "a gymnasium for the exercise of wits."

Children are the greatest puzzle fans in the world, because their natural curiosity draws them to problems of all sorts. Since, as Sam Loyd said, "native cleverness will often outstrip academic training in puzzle solving," bright children are a fair match for adult puzzlers, especially since the best specimens are not always those which involve complex mathematical gyrations, but rather elementary principles.

A psychologist has analyzed both puzzle inventor and puzzle solver in this manner: "There is probably in the proponent of the puzzle the unconscious or sub-conscious desire to perplex his friends and by confounding them, perhaps to establish his own superiority. And the solver on his part is not willing to admit that he is beaten and likes to feel that he is as cunning as his neighbor."

The history of puzzles has been traced back to the Egyptians, the Chinese and other sources of great antiquity, but it was not until the early seventeenth century that there appeared a puzzle maker as we understand one today. His name was Niccola Fontana, of Italy, commonly known as "The Stammerer," and some of the puzzles contained in the book he published in 1606 are still favorites in our own day.

Jig-saw puzzles date back to the ancient Egyptians, but that did not prevent them from becoming the rage a while ago when fans in the United States absorbed a total of more than 100,000,000 of these puzzles during a seven-month period. The movement was started by the Einson-Freeman company, of Long Island City, when a business house asked for an idea to further its sales. The jig-saw puzzles

(Continued to page 130A)

Finest Christmas Gifts for Your Skiing Friends

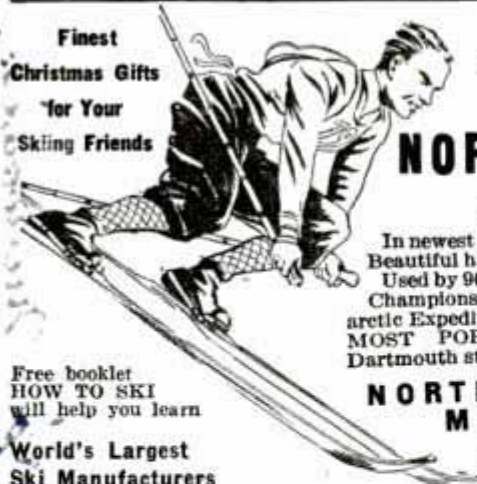

Jumping, racing, downhill, slalom and touring models of

NORTHLAND SKIS

In newest and smartest designs. Beautiful handrubbed finish. Used by 90% of the experts and Champions, by the Byrd Antarctic Expedition and voted THE MOST POPULAR SKIS by Dartmouth students.

NORTHLAND SKI MFG. CO.

95 Merriam Park, St. Paul, Minn.

Free booklet HOW TO SKI will help you learn

World's Largest Ski Manufacturers

For Economy BUY—For Income SELL

The FIFEL-GEARED PIERRENCH KIT

NEW 7" and 8 1/2" Sizes—Each with 3 instantly changeable Jaws A \$50 Service at the Cost of One Tool! Mail this Ad Today with your address Get FREE—7-Edge End-&-Angle Screwdriver, 101 Picture Manual of Mechanics, with

User Offer, or Distributor Territory and Free Kit Offer. Be a Plierench Man, They're making \$35 to \$125 Weekly!

AMERICAN PIERRENCH CORP'N APM-4809 N. Ashland Ave., CHICAGO, ILL.



MEN—MAKE MONEY

Get into something for yourself, where your income is practically unlimited—The American Electric method of floor surfacing gives you that opportunity. Large profits—Work easy to get—Small amount starts you—Write quick—No obligation.

THE AMERICAN FLOOR SURFACING MACHINE CO. 523 So. St. Clair St. Toledo, Ohio



Reconditioned MOTORS & PARTS

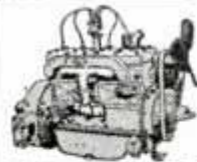

Write us for prices on guaranteed reconditioned motors, transmissions, rear ends, gears, parts, etc., for all makes of passenger cars and trucks, regardless of age. Million dollar stock. You save up to 75%.

The ORIGINAL **WARSHAWSKY & CO.** 1915-35 So. State St. Chicago, Ill., U.S.A.

Write Dept. PM 3

WOOD WORKING MACHINES FROM OLD AUTO PARTS!

Save! Build your own from auto parts using our plans and special parts. Band saw; circular saw; drill press; shaper; lathe. Send dime for illustrated catalog containing details, several free plans, and treatise on wood finishing. A big dime's worth! (Refunded on first order.)

BUILDERS SERVICE CO. 21 N. Commonwealth Ave. Dept. G Elgin, Ill.



HAVE A LAUGH!

Amaze, amuse, mystify and entertain your friends. Be the life of every party. Write for our free, illustrated "Laff Bulletin" featuring scores of newest and funniest jokes, tricks and novelties. Enclose 25c and we'll include THREE of our latest laugh riots.

HAV-A-LAF COMPANY Box 1204-P ST. LOUIS, MO

WOOD IN CANS-TUBES

has 1001 USES IN the Home.. Workshop and Factory ...



Plastic Wood handles like putty—dries to hard, Permanent Wood—will hold nails, screws; can be planed, sawed; will not chip, crack. Takes paint perfectly.

Plastic Wood will adhere to any clean, dry surface—wood, metal, stone, glass, porcelain. It is waterproof, grease-proof and weather-proof.

Plastic Wood comes in nine colors—natural, white, oak, walnut, light and dark mahogany, cedar, gum wood, ebony. Sold at all Paint, Hardware, Department Stores.

FREE Write the A. S. Boyle Co., Inc. 1934 Dana Ave. Cin., Ohio,

Dept. PM 1 for booklet "200 Things to do with Plastic Wood."

Name _____ Address _____

PLASTIC WOOD

AERO SOCKET LIMBS

Are made to be comfortable. Chafing, sore spots, blisters are unknown to wearers of Aero Socket limbs.

Write for circular today. Aero Socket Artificial Limb Co. La Crosse Wis.



IF YOU'RE INTERESTED IN ARC WELDING PROFITS



This new Hobart "Simplified" Welder lets you start big paying business of your own—lets you make hundreds of dollars extra profit each month. Unusually low prices lets you easily pay for it out of increased profits it brings.

get this NEW Arc Welding Book FREE
30 DAYS TRIAL AT OUR RISK \$30 MONTHLY!

Thousands of shops are earning big money with Hobart—cash in on the profitable jobs and construction work it lets you handle. Comes in 125, 200, 300 and 400 ampere sizes, Electric, Belted or Gas Engine Drive. Write us today for new low prices and FREE ARC WELDER MANUAL.

HOBART BROS. Box M-151 Troy, Ohio



HOME CHARGE

Your Battery

for a NICKEL

with the New Hi-Rate
10 to 6 Ampere AUTOMATIC

HOMCHARGER

P LUGS in any lamp socket. Charges any auto-type battery overnight. Creates no radio interference. Uses no expensive bulbs, "dry units" or messy liquids. Has only **One** moving part, replaceable for \$1.00, after thousands of hours' use.

The **Fastest**, most **Efficient** and **Longest-Lived** home charger made. Ideal for Battery Station, Garage, Trucks, etc. Money-back guarantee. Nearly one million sold since 1920 at \$19.50 list. Now, only \$16.95 *postpaid* (or at your dealer), complete with ammeter, 10-foot cables, dash plug, etc.

Write for introductory proposition and **FREE** booklet.
(Commission Salesmen Wanted)

THE AUTOMATIC ELECTRICAL DEVICES CO.
Dept. 3 324 East Fourth Street
CINCINNATI, OHIO



THE LURE OF PUZZLE INVENTING

(Continued from page 128A)

suggested boosted the client's business 400 per cent and started the fad which took the jig-saw puzzle out of the "give-away" class into the commodity category.

The cross-word puzzle seems to be with us to stay. It has survived through many seasons and has become so popular that entire books full of them are sold, a total of more than a million copies of these having been sold in this country since they were introduced in 1924. The effect on the sale of dictionaries has been very marked, and newspapers which have added the cross-word puzzles to their regular features account it one of their most popular.

The puzzle inventing field is as much the province of the amateur as any other hobby, with the added advantage that he may strike something that will put him in clover for life. National advertisers are continually searching for new puzzles and games to use for premiums and it is to the amateur that they look for that sensational new idea that will sweep the country.

THE RETURN OF THE "BIKES"

(Continued from page 64)

thirds the normal gear ratio. Another company offers a single cylinder, air-cooled motor which fits back of the saddle on any make of bicycle and permits the rider to attain rates of speed ranging from a crawl to twenty-eight miles per hour. It is estimated that one can travel on a bicycle so equipped for a distance of 500 miles without paying more than a dollar for fuel. Other "gadgets" are a speedometer which shows both the speed at which the bicycle is traveling and the total mileage covered, a streamlined saddle, balloon tires, rims of chrome-plated steel in place of wood, a combination headlamp and horn unit, the lamp equipped with an automotive type lens, and a "pencil-type" tire gauge.

With increased interest in bicycling has come renewal of cycling tours. In three transcontinental bicycle tours recently completed six days were cut from the time made in 1896, but credit for this accomplishment is given to better roads and improvements in equipment rather than increased speed.

Photographs for this article were supplied by courtesy of the New Departure Manufacturing Co.; Delta Electric Co.; Westfield Manufacturing Co.; the Colson Co., and V. Herrick and Co.)

W. J. Melwankar
Outboard Motors Corp
1879
1943

HIGH POWERED TELESCOPE

GENUINE BROWNSCOPE AT AMAZING PRICES

Most powerful in America for the money! 15 power long range telescope. Can see moon's craters or time on pocket watch a block away. 5 sections. Approx. 3 ft. long. Fine lenses. Brass bound. Can be used as powerful microscope.

Vol. magn. 612X. Only \$1.69 postpaid. C. O. D. 24c extra.

\$1.69 Special Super-Power 30X Telescope. Similar to above but more powerful. Guaranteed to see 900 times larger in surface and 30 times closer. 31 mm. objective 4 powerful lenses. Large field. Includes powerful microscope feature. Only \$1.98 postpaid.

BROWNSCOPE CO., Dept. 41 234 Fifth Ave., New York, N.Y.

PENNY EACH!! Beautiful Window Sign Letters, Lowest Price in America, Finest Quality, 5 Year Guaranteed. New Styles. Tremendous Demand. Big Profits. Easily Applied. Record Breaking Offer. **FREE** Samples and Working Equipment. **Hurry!** ATLAS SIGN WORKS, 7843 Halsted, Chicago, Ill.



200 RIDER AGENTS WANTED!

Ride and exhibit sample of our new Balloon-Tire Mead RANGER, and make money. Write quick for **FREE** color Catalog, marvelous new prices, special offers. Chance of lifetime!

\$19.95

SEND NO MONEY

Mead's Sentinel bike, \$19.95—Rangers a few dollars more. Get our astonishing new prices, terms. You **SAVE** 1-3 buying direct from Mead!

30 Days' Trial

Ride a genuine Mead bike 30 days without "buying for keeps." If not satisfied, return at our expense. Write for Catalog now—Special Offer—if you hurry!

Tires Save One-Half on lamps, wheels, tires, equipment. Write . . . a postal will do.

Mead CYCLE COMPANY
DEPT O-114 CHICAGO

Catalog Free



Edward Warner Corp 1879
Outboard Motors Corp
1943

INVENTORS

act
now to

**PROTECT YOUR IDEAS
WITH A U. S. PATENT**

**MAIL COUPON FOR MY FREE
BIG 44 PAGE BOOK
AND FREE FORM FOR RECORDING
YOUR INVENTION**



CLARENCE A. O'BRIEN
Registered Patent Attorney

MY BIG BOOK TELLS YOU

The Importance of Quick Action

If you have a new idea that is patentable—and want to secure for yourself your inventor's sole right to profit from the idea—you can't afford to lose time in securing the protection of a U. S. Patent. Other inventors may be working on the same idea right now. Should they develop this idea and file patent application before you do—the burden of establishing

priority will be upon you. My Big Book—"How to Obtain a Patent"—will tell you the quickest possible way to secure Patent Protection for your idea. **SEND FOR IT TODAY!**

The First Important Step in Securing a Patent—is to obtain the services of a Registered Patent Attorney. The U. S. Patent Office advises that you secure the aid of an experienced, **Registered Patent Attorney** to prepare your statements. Establish the date of your invention as explained in My Book and disclose your idea to him in correct form. He then makes a **SEARCH** of the Patent Office Records and reports to you on existing U. S. Patents which might bear on your invention, giving his opinion on the advisability of proceeding and filing formal application.

SMALL IDEAS MAY HAVE LARGE COMMERCIAL POSSIBILITIES. Ideas do not have to be complicated to be profitable when patented. The 5c and 10c stores flourish on simple patented products which are commercially successful. The zipper, safety pin, thumb tack, paper clip, collar button—all are simple yet familiar inventions—brought their inventors rich rewards.

Reasonable Fees—Convenient Terms

Don't worry about finances. My fees are very reasonable—I can arrange convenient terms of payment. It is my custom to permit clients to pay for my services in installments as the application progresses in my office. See My Big Book for fees in obtaining Patent. It explains my arrangements clearly. **Send for it NOW.**

Request My Book—NOW!

Know exactly what you should do to secure a Patent—what must be done every step of the way—how the Patent Law protects you—what I, as a Registered Patent Attorney, can do for you. **Mail the coupon NOW.**

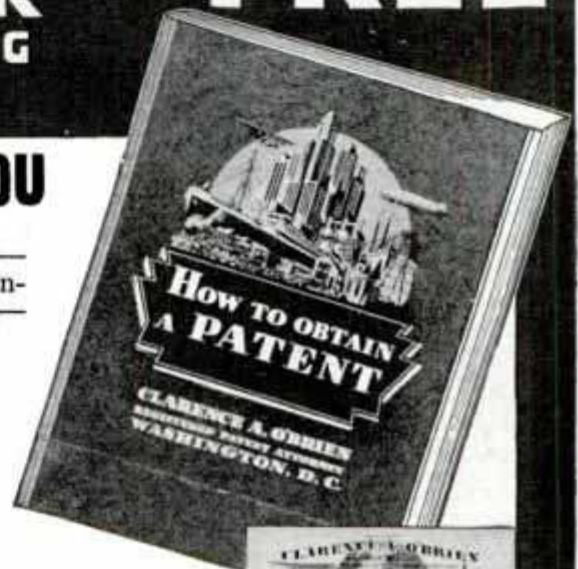

FREE Record of Invention Form

Use my FREE "Record of Invention" form to assist you in recording the descriptive outline of your idea and to establish the date of your invention. With it you can make a rough sketch of your idea and have it witnessed in a manner of value to you as evidence should occasion arise.



CLARENCE A. O'BRIEN
REGISTERED PATENT ATTORNEY

702 Adams Building

WASHINGTON, D. C.

Please send me at once your Big Free 44-page Book, "How to Obtain a Patent," and your Specially Prepared "Record of Invention" form. This request does not obligate me.

Name

Address

(Please write or print plainly)

When writing to advertisers please mention Popular Mechanics

PATENTS

Booklet Free Highest References
Promptness Assured Best Results

Send drawing or model.

ALL BUSINESS GIVEN PROMPT AND PROPER ATTENTION

Listed Patent Lawyer in the latest editions of the Rand-McNally Directory of Bankers and Bank-Recommended Attorneys, published by Rand-McNally & Co., Chicago, Ill.; The Baggott & Ryall Directory of Guaranteed Attorneys, published by Legal Directory Corporation, Boston, Mass.; Flugel's Law List, published by Legal Directory Publishing Co., St. Louis, Mo.; American Lawyers Annual, Cleveland, Ohio; Bankers Service Legal Directory, Bankers Service Co., Boston, Mass.; Eyre's Law List, 9 Park Place, New York City, and the Central Guarantee Co., Bankers and Lawyers Directories, Empire State Bldg., New York City.

WATSON E. COLEMAN,
REGISTERED PATENT LAWYER

Victor Building, 724 Ninth Street, N. W.
WASHINGTON, D. C.

INVENTORS PATENT YOUR IDEAS

SEND FOR FREE BOOK



HOW TO OBTAIN A PATENT, written by a Former Member of the Examining Corps (1922-24) of the U. S. Patent Office. If you want to profit by your idea, you should take steps to apply for a U. S. Patent at once. Your first step is to get this Free Book. This interesting illustrated book contains valuable information you should have. It tells you fully how to obtain a patent on your idea in the quickest way. With this Free Book you will also receive a "Record of Invention" form on which you can easily record your idea. Personal and Confidential Service: Your case will be personally handled only by a Registered Patent Attorney who is also a Former Member of the Examining Corps of the U. S. Patent Office. All communications will be strictly confidential.

MAIL COUPON TODAY for FREE PATENT BOOK and RECORD OF INVENTION Form.

MILLER & MILLER

REGISTERED PATENT ATTORNEYS
FORMERLY IN EXAMINING CORPS U. S. PATENT OFFICE

1638 Woolworth Bldg., Dept. 15A, New York City
MILLER BUILDING, Dept. 15A, WASHINGTON, D. C.

Please send me your Free Book, "How to Obtain a Patent," and your "Record of Invention" form.

NAME.....

ADDRESS.....

PATENTS Free Booklet

Instructive and understandable. Limited Edition
Write at once for your copy

G. JAMES COTTRELL, Patent Lawyer
Former Examiner U. S. Patent Office
527 Fifth Avenue New York City
Suite 510 Dept. A-1

INVENTORS

A patent is a Deed to intellectual property. Property has a value. To obtain patents, trade marks, Write to

ASSOCIATED SERVICE 18 East 41st St.
New York City
Our 50 years practice is your guarantee
We perform as we promise

Inventors! WE GIVE RESULTS!

SEND FOR
FREE
BOOK
"PATENT SENSE"

PATENTS

Protect yourself by retaining a legal firm that has been in good standing before the Patent Office over sixty years. . . . Preliminary advice FREE . . . estimate of costs submitted. Write full particulars to Dept. 5-635 F St. N. W. Washington, D. C.

ESTABLISHED 1869

Lacey and Lacey

PATENTS—TRADE MARKS

All inventions submitted held confidential and given personal attention by members of the firm.

Form, "Evidence of Conception" and instructions, "How to Establish Your Rights"—FREE!

LANCASTER, ALLWINE & ROMMEL
Patent Law Offices

412 Bowen Bldg.

Washington, D. C.



GEARS

In Stock — Immediate Delivery

Gears, speed reducers; sprockets, thrust bearings, flexible couplings, pulleys, etc. A complete line is carried in our Chicago stock. Can also quote on special gears of any kind. Send us your blue prints and inquiries.

Write for Catalog No. 10
CHICAGO GEAR WORKS
769-773 W. Jackson Blvd., CHICAGO, ILL.

Free to Men Past 40

What is prostate gland disorder? Why does it come to so many men past middle age? Why does it cause loss of health, sciatica, aching feet, back and legs? Amazing book, written in a way you can understand it, answers these questions and tells how thousands of men have found relief without drugs or surgery. Simply send name and address for copy. No obligation. Address W. J. Kirk, Pres. The ELECTRO THERMAL CO., 2185 Morris Ave., Steubenville, Ohio.

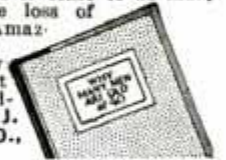

Electroplating with Gold & Silver

and other plating information in Shop Notes for 1933. Illustrated. 50 cents, postpaid.
Popular Mechanics Press, 200 E. Ontario Street, Chicago

To PROTECT YOUR INVENTION - Use this coupon, NOW

Delays are dangerous and may be very costly. My personal service assures prompt action, strict confidence, and a minimum of expense. I suggest that you send me a model or drawing, or sketch and description of your invention, and \$5.00. I will make a search and report

promptly as to its patentability and send you a copy of my 72-page booklet. Or, if you prefer to read my booklet first, mail the attached coupon at once. I will also send my "Record of Invention" form. (Over 37 years experience as a Registered Patent Attorney.)

L. F. Randolph, 302-D Victor Bldg.
Washington, D. C.,

Please send me at once, free of charge, your 72-page booklet and "Record of Invention" form.

Name.....

Address.....

A PERSONAL CONFIDENTIAL PATENT SERVICE

CLEANS AUTOS NEW WAY!

**STRANGE
CHEMICAL
SPONGE**



Revolutionary invention cleans autos like magic! Banishes dust, dirt, grease, traffic film—thanks to secret chemical and sensational, self-sudsing feature. Also cleans linoleum, woodwork and windows without work! Auto owners and housewives wild about this strange chemical sponge!

**AGENTS!
MAKE BIG MONEY!**
New, easy plan. Simply show and take orders. No experience needed. No risk. **FREE OUTFIT!** Write today for all details.

KRISTEE MFG. CO., 1351 Bar Street, Akron, Ohio

NOW YOU CAN DO IT!

Build most anything—a Swayne-Robinson Series 200 Lathe is a precision tool, husky and dependable. It is a workshop in itself at a very low cost. Write!

SERIES 200 LATHE is completely equipped as illustrated: Timken Bearings, hollow spindle, 4 speeds, 8 in. swing, 18 in. between centers, only \$39.50. 24 in. between centers, \$41.50. Extension for woodworking, only \$5.00 extra.



**ONLY
\$39.50**

SWAYNE ROBINSON & CO.
• 250 MAIN STREET • RICHMOND, INDIANA •

BUILD Your own HUMIDITY system

Controlled humidity is the most important factor in air conditioning. Most rooms are drier than the Sahara Desert. It causes sore throats, colds, pneumonia, etc. It destroys your furniture and furnishings.

Now you can install in two hours an automatic humidity system, using waste heat. The Moore System, (fully patented) maintains a proper humidity, automatically, and reduces fuel cost up to 25%.

Send for blue print and data describing how to build your own system. State your type of heating.

MOORE MANUFACTURING COMPANY
607-B-Washington Blvd., Chicago, Ill.

Write Today—
for Blueprint
and Data Book



GREATEST MICROSCOPE VALUE EVER OFFERED

Student Type . . . \$1.00

Magnifies 50x or 2500 times in square areas. Durable construction. Compound ocular lenses. Nickered tubes. Tilting stand. Adjustable mirror. Complete with prepared and plain slides. Never before sold for less than several times its present cost. \$1.00 postpaid.

ALBERT VURE, 307 Throop Avenue, Brooklyn, N. Y.



Ideal Xmas Gift for Man or Boy!

Instructive! Entertaining! Educational!

NEW WORLD WIDE SHORT WAVE RECEIVER

POWERFUL — SENSITIVE — ALL ELECTRIC

Here is a modern Short Wave receiver that gets foreign broadcasts, police calls, amateurs, airplanes, etc. **DIRECT**, with a volume and circuit that will **amaze you!** (12,500 mile reception record!) This set is entirely self-contained and plugs in directly to any 105 to 125 volt AC or DC house current outlet. No batteries or separate power supply needed! Works on any aerial. Tunes from 15 to 200 meters. **COMPLETE KIT** of all necessary parts (including neat metal chassis with all holes drilled) and clear, detailed picture instructions to build this remarkable Three Tube receiver. **\$5.95**

TWO TUBE Dry Cell Model (Illustrated) or **AC Model**. Complete Kit. \$4.75. 200 to 625 meter Broadcast band coils. \$1.25 Kits wired and tested. \$1.25 Tubes. 55c ea.

ORDER NOW! GUARANTEED RESULTS !!

Send \$1.00, balance C. O. D. Free literature on request.
HARRISON RADIO CO., Dept. P-1, 142 Liberty St., N.Y.C.



SPECIAL OFFER! GUARANTEED UNDERWOOD

Yours for
10¢ a Day

**No Money
Down**

Sent on
10 DAY FREE TRIAL

\$100.00 MODEL ONLY \$39.90



Positively the greatest bargain ever offered. A genuine full-sized office model Underwood No. 5 for only \$39.90 (cash) or on easy terms. Has up-to-date improvements including standard 4-row keyboard, backspace, automatic ribbon reverse, shift/lock key, 2-color ribbon, etc. The perfect all purpose typewriter. Completely rebuilt and **FULLY GUARANTEED**. Lowest Terms—10c a Day.

Learn Touch Typewriting
Complete (Home Study) Course of the Famous Van Sant Speed Typewriting System—fully illustrated, easily learned, given during this offer.

Money-Back Guarantee

Send coupon for 10-day Trial—if you decide to keep it pay only \$3.00 a month until \$44.90 (term price) is paid. Limited offer—act at once.

INTERNATIONAL TYPEWRITER EXCHANGE.

231 West Monroe St., Chicago, Ill., Dept. 101

Send Underwood No. 5 (F. O. B., Chicago) at once for 10-day trial. If I am not perfectly satisfied I can return it express collect. If I keep it I will pay \$3.00 a month until I have paid \$44.90 (term price) in full.

Name..... Age.....
Address.....
Town..... State.....



BOYS—Here's something you have needed and dreamed of owning. A real lifting Miniature Screw Jack like the Big Simplex Jacks that are used by railroads, bridge builders, motor trucks, house movers, etc. (Compare it with the Big Simplex Jacks at your hardware store.) You need Jacks in Manual Training and at your Work Bench. **DAD** can find innumerable uses for the Simplex Miniature Jack or a set of them around the house . . . for lifting, straightening and supporting Sagging Windows and Door Frames, Boilers, Radiators, Pipes, Ice Boxes, etc., and for clamping glued work, stretching shoes, etc.

Why not buy on a "Father and Son partnership Deal"?

Simplex Miniature is a real Jack, not a toy, lifts 500 lbs. easily, yet is only 3 inches high (closed), ball bearing, finished in Red, Blue, Green or Orange Enamel. Chromium plated lever bar.



3 Inches High
When Closed
Capacity
500 lbs.

PRICE 25c POST PAID

TEMPLETON, KENLY & Co. (Est. 1899)
1020 South Central Ave., Chicago, Ill.

I enclose..... for (specify color.....)

Simplex Screw Jacks at 25c each. Money to be refunded if not more than satisfactory.

Name.....

Address.....

When writing please mention Popular Mechanics

The Old Reliable Credit Jewelers

LOFTIS

JEWELRY COMPANY EST. 1858

Dept. H894
30 No. State St.
Chicago, Ill.

Send for FREE Catalog Use your Credit!

QUALITY CHRISTMAS GIFTS
GENUINE **Diamonds** GUARANTEED

Rings are Solid White Gold, artistically engraved

No. 43

Man's Elgin Strap Watch. Very special bargain. Excellent timekeeper. \$16.95 \$1.69 Down--50c a Week

No. 43

"Joan" Bulova Baguette Watch. Very exquisite, white gold finish case. \$29.75... \$2.97 Down--\$1 a Week

No. 28

Blue-White Diamonds! A Buy!
No. 28 \$100 \$2.50 a Week

No. 38

No. 38 \$60 \$1.25 a Week

No. 29-- Solid White Gold Wedding Ring; 5 Diamonds. \$16.50. 50c a Week

Credit Terms: Pay one-tenth down; balance weekly, semi-monthly, or monthly at your convenience.

BUY NOW!

Our References: Any Bank or Banker in the U. S. A.

AN IDEAL XMAS GIFT

A genuinely scientific outfit, equipped with the well known 100-power Wollensak microscope, including all accessories and book of directions for slide making, in a handsome polished-wood gift case. **\$8.50**

More elaborate sets, with 150-power Wollensak microscope, \$17.50; and with 425-power Wollensak microscope, \$27.50.

Send 10c for new 32-page illustrated catalog listing more than 1500 chemical and biological items at our school prices.

Sources of Scientific Supplies for Schools and Colleges

NEW YORK BIOLOGICAL SUPPLY CO.
Box 15, 34 Union Sq., N. Y. C.



Sensational Radios

New Farm Radios—3-Tube, and 6-Tube B-Less Models.

Auto and All-Wave Electric Radios. World's cheapest. No-cost sample.

J-20th Century Company . . Kansas City, Mo.

150 JIG SAW

Postpaid (C.O.D. or outside U.S. \$1.75)

FREE Adapters, 12 assorted Blades and Booklet, "Make Your Own Jig Saw Puzzles". All metal construction. 15" long, 8" high, 6 1/2" table.

Order now or send 3c stamp for NEW 1935 24 page Catalog fully describing all our equally low-priced power tools and accessories including Shaper, Lathes, Drill Press, Sander, Line Shaft, etc., etc.

J&H METAL PRODUCTS CO 486 St. Paul St., Rochester, N. Y.



BUILD DUTCH WINDMILLS LIGHOUSES, DOLLHOUSES, ETC.

BIG PROFITS SELLING TO OTHERS
BEAUTIFY YOUR GARDEN

Easy to build from our BLUE PRINTS. Model B30 as pictured 24" high x 20" long, with wings operating farmer at buck saw. Plans and full instructions, only 65c.

XMAS SPECIAL

Model B30 KNOCK DOWN KIT ready to assemble ONLY \$5.75

Model B10 Mill (Hexagon Style 30" high) \$.75
Model H10 Lighthouse (Octagon Style 40" high) 1.00
Model A1 Dollhouse (Two Story 24 x 36)75
Lawn Figure cutout patterns—Sun Bonnet Girl, Holland Pair, Dutch School Boy and Tulip Girl, 35c Each, all 4 only \$1.00.

Send only 10c for catalogue containing over 25 illus. and Miniature Dutch Boy pattern. FREE with order.

CRAFTSMAN'S MODEL CO.
Dept. P-1, 2030 N. 41 St. Milwaukee, Wis.



SIKORSKY SEES DAWN-TO-DUSK TRANS-ATLANTIC FLIGHTS

(Continued from page 46)

smoking lounge, recreation rooms, tubs and showers, library, movies, and practically every comfort found on small de luxe steamers.

"The 'Atlantic Clipper,' as we have named the new flying boat, will have a cruising range of 4,000 to 4,500 miles. Of course, if fueling stops can be arranged every 2,000 miles or so, it will allow the vessel to increase her pay load considerably. On the oceanic route between the United States and South America, for instance, the new clipper will have accommodations for 100 passengers."

The American preference for monoplanes and their wonderful record for airworthiness has prompted Sikorsky to specify a single wing for his newest undertaking. The wing will be four to five feet thick and the span will be about 175 feet. Inside there will be ample storage space not only for fuel, but for passenger baggage, mail, express and a large number of auxiliary mechanisms. The passengers and crew will have quarters in the giant boat hull, which will measure eighteen feet from port to starboard and more than 100 feet from stem to stern.

"Notwithstanding these unusual dimensions," said the designer, "the exterior of the 'Atlantic Clipper' will resemble the present Brazilian Clipper. We are making important engineering improvements in the power plants and in details of navigation and interior equipment, but in general outline she will resemble the 'S-42'."

The engineering specifications of the "Atlantic Clipper" call for electrically and hydraulically controlled high-lifting wing flaps, variable-pitch propellers and superchargers. The 1,000-horsepower engines will also establish a record for transports. The present Pratt and Whitney Twin Wasp rates 900 horsepower, but improvements now under way will bring the rating up to 1,000 horsepower.

What of the practicability of navigating huge transports in the stratosphere?

"I believe," said Sikorsky, "that 20,000 feet is an all-around efficient altitude for long-distance passenger vessels. At 20,000 feet, we do not have to seal the apertures and the ship can have large windows and

(Continued to page 136A)

BATTERY DOWN?

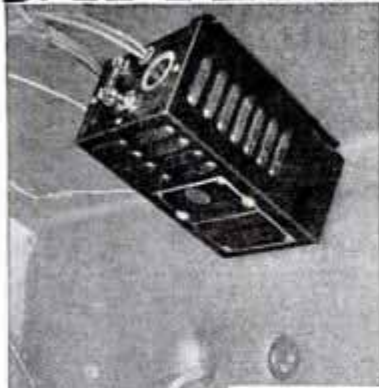

Install this simple



AUTO-CHARGER

No more "dead" batteries . . . use all the "juice" you want for car radio, heater, defroster and other accessories. Install the new K R W Auto-Charger

and insure positive zero-weather starting. Plugs into any light socket and charges while your car is idle. Fits ALL cars; installs neatly beneath dash with one drill hole. May also be installed in garage for charging battery without removal from car. K R W Charger has many exclusive features: operates on both 25 and 60 cycles; 50% larger transformer yet uses only 50 watts; patented Thermal Relay prevents current flow-back if power fails; two charging rates, 2 and 5 amps., with automatic safeguard against overcharge. No liquids, bulbs or moving parts—simple, compact, complete . . . and unconditionally guaranteed for one year. Order today or write for circular.

\$6.75
To Buffalo



AGENTS WANTED everywhere.

K. R. WILSON 11 Lock Street **BUFFALO, N.Y.**
EXCLUSIVE BUILDER OF APPROVED FORD SHOP EQUIPMENT SINCE 1916

ONLY \$6.95 Metal Cutting Lathe
A PRECISION TOOL
Less Chuck . . . \$3.00 extra for Chuck



\$6.95 without Chuck . . . \$9.95 with Chuck. Send \$2.00 deposit, balance C. O. D. Money back guaranteed.

Most amazing bargain ever offered on a metal cutting lathe. Be wise. Send at once.
National Electric Tool Co., 560 Wash. Blvd., Dept. 341, Chicago

Make up to \$150 Weekly GIVING AWAY FREE RADIOS



RCA Licensed Automobile and Home Radio Sets for American, European and South American Reception. Beautiful World Master floor model radios. Guaranteed foreign reception. Custom made with exquisite all matched walnut cabinet, arcoplano dial, twin illumination, dynamic speaker and automatic volume control. Given away absolutely FREE with our new sensational unique PUNCH SALES CARD PLAN. This is the opportunity of the year—makes up to \$150 cash each week for yourself. Every home, car owner, store, office, factory, lodge, club or individual wants these marvelous new FREE RCA LICENSED RADIOS.

WRITE TODAY For OUR 3 NEW STARTING OFFERS
Start at once making money with our unique sales plan. Write for full information how you can secure any or all of these plans.
DELUXE MFG. CO., Dept. 155, 173 W. Madison St., Chicago, Ill.

When writing please mention Popular Mechanics.

1935 MODEL ATLAS "UNIT-PLAN" Metal-working Lathe . . . designed so units may be added

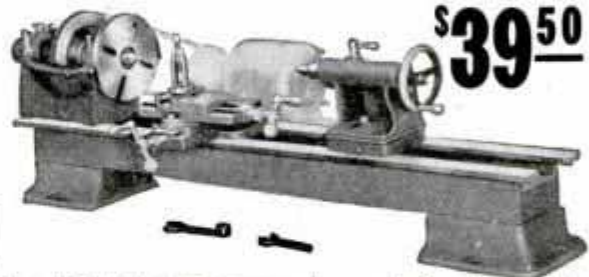

\$39.50

1

Here's a lathe that meets every need economically. As your shop grows, you can add to it UNIT by UNIT until you have a fully equipped, back-gear screw-cutting lathe, capable of every kind of lathe work—as fine a tool as a man could wish for.

This first step has a precision-ground bed of heavy ribbed cast iron; hollow headstock spindle; tailstock; compound rest; driving belts and pulleys, etc. Takes 24 in. work between centers and has 10 in. swing.



\$49.25

2

By adding countershaft assembly you get greatly increased power and wider speed selection. Ideal for all small metal jobs and work on radio, armatures, valves, pistons, etc.



\$87.50

3

Built up, UNIT by UNIT, to this complete back-gear, screw-cutting lathe which will do well any job within its size capacity with the highest degree of accuracy and with an abundance of power. Cuts 4 to 72 threads per inch. Automatic, reversible feeds. Sixteen speeds, from 28 to 2,072 R.P.M.

All lathes sold on 2 weeks' trial, money back guarantee. Full line of attachments at reduced prices.

ATLAS PRESS COMPANY
1843 N. Pitcher St., Kalamazoo, Michigan

ATLAS DRILL PRESSES
\$13.95 to \$33.45



FREE CATALOG

Please send me your new FREE catalog of ATLAS metal lathes, wood lathes, drill presses and attachments, also arbor presses.

NAME.....

ADDRESS.....

CITY.....STATE.....

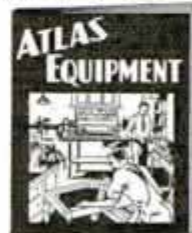

BUILD

YOUR OWN

It's easy to build your own Broadcast or Short Wave Receiver, tube tester, transceiver, etc. Parts for practically all radio kits described in Popular Mechanics and other magazines can be purchased here. For example: the ALL STAR All-Wave Superhet, the BAND SPREAD PORTABLE (both described in December Popular Mechanics) and many others. Tell us your requirements or send Parts List. **SAVE MONEY** by buying from us at **LOWEST WHOLESALE PRICES!**

FREE Catalog

Our newest FREE 1935 Radio Catalog is the greatest ever published! 192 pages packed from cover to cover with over 50,000 items. Big Sections on Broadcast and All Wave Sets, Refrigerator Parts, Public Address, Tubes, etc. Also the World's Greatest array of Short Wave Sets, Kits and Parts, Preselectors, Transmitters, Transceivers, etc. All nationally advertised lines—all at **LOWEST WHOLESALE Prices!**



RADIO

WHOLESALE RADIO SERVICE CO.
 NEW YORK 100 Sixth Avenue
 ATLANTA 430 W. Peachtree St. S.W.

Department PM-15.

Send me your FREE 1935 Catalog of 192 pages. Quote me on kit of parts as described in attached letter.

Name.....
 Address.....
 City..... State.....

OIL BURNER COMPLETE! \$10

Easy to install, operate—fits any stove. Nothing to get out of order. Heats 6 rooms economically—burns any grade oil. Furnace Burner \$15 complete. Offer is limited at these prices. Order today! **Red-X Co., 3948 So. Western Ave., Chicago, Ill.**

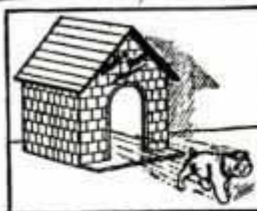

RADIO REX An amazing scientific sound operated toy. A sensational little bulldog leaps out of his kennel **WHEN YOU CALL HIM.** It will delight you and your friends as its mystery has an irresistible appeal to everybody. Nothing else like it. Makes an ideal Xmas gift. Send for one or more to-day. \$1.10 **POSTPAID.** Cash with order. Rex comes in a sturdy, attractive kennel. Guaranteed as represented, no strings or tricks.

DIXIE DISTRIBUTORS, 139 S. 2nd St., Memphis, Tenn.

A HAND, BAND, AND CIRCULAR SAW FOR LESS THAN 5 CENTS EACH

Why not file these saws yourself, save filing expense and get a better saw? Or file them for others and make money. Fine cutting saws are in big demand. Send for booklet **THE ART OF SAW FILING** by an expert filer of 40 years' experience and you will be surprised how easy it is to do this work. Original. New method. Scientific and practical. Thorough. Complete. With a model constantly before you, you cannot fail. Useful information for every saw owner. Limited Introductory Price 25 cents. **A. P. SHEBEL, 730 So. 2nd St., Milwaukee, Wis.**

AN IDEAL XMAS GIFT

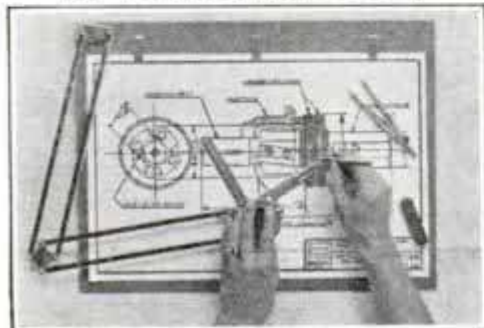

DRAFTO

Portable Drafting Machines for Shop, Home and School

Complete machines with accurate parallel mechanism, protractor scales, board, and paper clamps. **9x12 in.**

Sheets \$4.25
12x18 in.

Sheets \$6.50

Prepaid delivery if cash with order. \$1 must accompany C. O. D. order.

DRAFTO CO.
Meadville, Pa.

SIKORSKY SEES DAWN-TO-DUSK TRANS-ATLANTIC FLIGHTS

(Continued from page 134A)

roomy cabins. Above 20,000 feet it is really uncomfortable without air-conditioning equipment, and that takes up a lot of valuable space and diminishes passenger comfort. The 'Atlantic Clipper' will have a cruising speed of 150 to 200 miles an hour, which is fast enough to attract trans-oceanic customers.

"Looking at the present situation of aviation," he continued, "I see no technical barriers in the way of a regular trans-Atlantic service. We have enough experience, equipment and trained mechanics to keep the line running on time all year round."

Turning to the possibilities of stratosphere flying, the designer said he could not foresee a great commercial development of aviation at that altitude. He believes that the stratosphere has military advantages which could be developed and that the stratosphere might be useful in transporting very urgent mail over long distances, but for passenger travel, the high cost and discomfort would make the stratosphere impractical.

"After all," he said, "the earth is pretty small when you calculate its size in terms of an airplane. At 200 miles per hour, one can cross the Atlantic ocean in about fifteen hours—from dawn to sunset. Cruising speeds in excess of 200 miles per hour are, therefore, not advisable for ocean transports, in my opinion."

He holds that aluminum magnesium alloys will remain the standard materials for plane construction. And as things are now, the internal combustion engine is here to stay for a while, "Although I believe," he continued, "that some sort of cheap safety fuel will be worked out and engines adapted for its use."

COAL DUST SPREAD ON FIELD SPEEDS PLANT GROWTH

By spreading coal dust on their fields, Russian farmers are speeding up the growth of cotton plants by a month or more. The darkened surface of the dusted land absorbs heat readily during the day and re-radiates it as warmth at night, thus warming the cotton plants and causing them to mature earlier.

Handwritten notes:
 D1329
 See later more news
 Karshatov 4/2/35

NEW "BOICE-CRANE" 1935 Catalog



Our 25th Year

Send now..Get full details..New Silver Anniversary Designs..Ahead of field...Features never seen that you will want..High quality..Accurate...Low prices...Write today.

New TILT-ARBOR Saw
Silver Anniversary Value throughout! 21 Inch capacity extension bars at no extra cost! "Micro-set" fence. "Auto-set" Miter Gauge! Mammoth table with 12 inch cut off capacity! Takes a 10 inch blade! Other features of high merit. Investigate this ultra-modern Boice-Crane Saw and new 6 Inch Jointer.

NEW GAP-BED LATHES
Afford 45% extra capacity. No extra cost.
Dept. PM-1-L
W.B.&J.E. BOICE Toledo, Ohio

24" JIG SAW

10 Day Trial

"How to Spin Metal on Lathe" Booklet 25c

600 POWER MICROSCOPE \$8.50

Triple Objective Brownscope "Professional"



THE NEW SUPER-POWER 100X TO 600X BROWNSCOPE. The QUALITY microscope satisfying the demand for ultra-high power at low cost. Substantially and precisely made. Nickel-plated tube and machined brass parts. Compound lenses. Large concave mirror. Heavy tilting base with lever for locking it at any angle. Fine rack and pinion focusing with TWO adjusting wheels. Power 100X to 600X in six steps. Power is varied by rotating the dust-proof 3 objective nosepieces, or by adjustment of the eyepiece. Comes complete with fine wood carrying case, prepared and plain slides, instruction book, and elaborate 6 piece set of dissecting instruments mounted in carrying case. Only \$8.50 postpaid.

Optical Catalog Free

BROWNSCOPE CO. Dept. 41, 234 Fifth Ave. NEW YORK, N. Y.

COMPLETE ELECTRIC PLANTS



ONAN A.C. PLANTS furnish the same current as city service. Operate Radio, Water System, Refrigerator, all Appliances.

SIZES 300 WATTS UP

Have A.C. Current anywhere. Models \$100 and up. Easy to install. Available from stock. Ideal for farms, camps, lake homes and commercial purposes.

D. W. ONAN & SONS
940 Royalston Ave., Minneapolis, Minn.

MAKE MONEY MAKING DO-NUTS

Steady income in spare or full time making the new, greaseless do-nuts, baked by electricity. Delicious! Healthful! Start in your own kitchen. No canvassing. Stores, lunch rooms, buy all you make. Cash daily. Big profits. Start with \$25. Total investment less than \$60. Write today for FREE PLAN. No obligation, no salesmen.

RINGER DO-NUT COMPANY
144 Main St. N. E., Minneapolis, Minn.



BUY OR BUILD! WE'LL HELP!

We manufacture the popular streamlined Banner Trailer with independent wheel suspension; also campers, chassis. We supply parts, blueprints and book of designs. Write today for free literature. Dept. D-4, Trotwood Trailers, Inc., Trotwood, Ohio.



COPY-STAMP THE STAMP OF A THOUSAND USES



Prints postcards, letters, menus, school-work, notices, drawings, tags, etc. Used by hundreds of business concerns, schools, clubs, churches, and others. Quick, clean, automatic, instantly changeable. FIVE SIZES: \$5.00 and up

THE STENCIL-STAMP CO. INC.
53 Park Row New York, N. Y.

When writing please mention Popular Mechanics

Cutting DIFFICULT Corners WITH



Genuine MASONITE PRESWOOD

EVERY craftsman has certain difficulties he dreads to encounter . . . cross-grain cutting, warping, chipping, splitting, tools being dulled, and many others. Most of them can be avoided with Genuine Masonite PRESWOOD.

This all-wood material is absolutely grainless. It comes in boards 1/8", 3/16" and 1/4" thick, 4' wide, 12' long. Will not chip or split. Moisture-resisting, it will not warp. Contains no glue or binder. Natural warm brown surface can be used without further treatment. Or it can be varnished, lacquered or enameled with any standard finish.

People everywhere are modernizing their homes. Home-craftsmen are finding they can make alterations themselves . . . with PRESWOOD. Ideal for shelves, cabinets, closets, stairs, walls, partitions and ceilings. Try it yourself! Send the coupon for booklet of plans and specifications for many useful articles.

PM-1-35

MASONITE CORPORATION
111 West Washington Street, Chicago, Ill.

Please send me the free booklet, "You Can Make These Useful Things," and a sample of PRESWOOD. From what nearby lumber dealer can I buy PRESWOOD?

Name _____

Address _____

City _____ State _____

OWN A Potato Chip Factory

COMPLETE

NEW "HOME FACTORY" MAKES PERFECT POTATO CHIPS—DONUTS—SALTED NUTS

Stop looking for something difficult. Turn potatoes into cash. I show you just how with my newly perfected outfit. Start anywhere. Very little cash needed. Exclusive location. Profits pour in. No experience needed. I furnish the plans. Begin anywhere—village, small town, city or suburb. A big opportunity is waiting. Business permanent.

MAKE UP TO 500% PROFIT ON RAW MATERIALS

Raw materials are plentiful and cheap. Highly perfected outfit and confidential plans make operation simple, with startling profits certain.

WE HELP FINANCE YOU

and locate you. Send no money, just name, for book of facts and free opportunity.

Newly perfected, rapid, direct-to-lat slider with outfit at no extra charge.

LONG-EAKINS COMPANY

128-S. High St.

Springfield, Ohio

EARN CASH *Have FUN* Casting Toys With NEW HOME FOUNDRY



Learn a trade, earn money casting metal toys with amazing new HOME FOUNDRY SET! Chance for BIG PROFITS... fun, too! Ideal for Xmas gift. (Show this to your folks.) Complete "A-figure" Soldier Casting Set "A" only \$1.25 postpaid in U.S.A. At your Dealer, or order direct. *Hurry.*

Only \$1.25 **PREPAID**

295 NEW ELECTRIC SETS

Wonderful new electric sets only \$2.95 postpaid, contain paints, molds, electric ladle, metal, etc. Order **YOURS** now! No. D-21 (Machine Gunner), No. D-22 (Cavalry & Infantry), No. D-23 (Airplane & Crew) No. D-24 (Racing Car Group). Catalog FREE with order, or rush to stamp. *Orders shipped same day received!*

FREE CATALOG With Order Or Send 3c Stamp

Earn Money with this WONDERFUL NEW INVENTION!

Real Money Maker for Part or Full Time AGENTS!

Make quick PROFITS with new, patented invention—sells on "flash" demonstration. Main or side-line. Big, new market.

Soldering Iron and Blow Torch IN ONE! Light, portable. Eliminates pump, pressure system, stove, charcoal—ALL!

PROOF IT SELLS!—Agent Rowland earned \$300 a month. —Ware sold 60 irons while stopping in hotel! "Going like hot cakes," says Bailey.

WRITE quick—get established for EXCLUSIVE territory. A postal will do!

JUSTRITE MFG. CO., 2061 Southport, Dept. 1351, Chicago

COMET ON RAILS BRINGS AIR SPEED TO EARTH

(Continued from page 116A)

aviation was a non-stop coast-to-coast crossing. It was finally made, on May 31, 1923, by two army flyers, Lieutenants Macready and Kelly, who covered the 2,700 miles in twenty-seven hours and fifty minutes. The United Air Lines now carries travelers from coast to coast between noon and breakfast the next morning. TWA planes depart from New York at 4:00 p.m. and arrive at Los Angeles at 7:00 a.m., the following morning.

The Union Pacific streamliner, with a single trip, lopped nineteen hours and forty-five minutes from the regular train time between Los Angeles and Chicago.

Oddly enough, the coast-to-coast steam train record is of long standing, having been made in 1906 by the late E. H. Harriman, then chairman of the board of the Union Pacific, who sped across the country in seventy-one hours and twenty-seven minutes.

The end of bringing east even nearer to the west is not yet in sight, however. The present world speed record, 440 miles per hour, is held by Lieutenant Francesco Agello, of the Italian Speed School. With an engine rated at 3,500 horsepower, he piloted his seaplane at a speed of more than seven miles per minute. But even this is not considered final, since he is working for a speed of 600 miles per hour.

The Burlington's and Union Pacific's streamliners have smashed all the long-standing records of steam railroads. Already the Union Pacific has projected a nine-car train. The present six-car train has attained a trial speed of 120 miles an hour, while the trains to come may do even better. In less time than we anticipate, the new featherweight streamliners will open up sections of this country which have remained relatively remote.

The amazing fact about the streamliners is that the cruising range is about ten times that of a steam train. The latter must stop for fuel and water every 100 miles, but the streamliner can keep going for 1,000 miles without a stop!

Easy mount

Any spring-operated clock can be converted into an electric timepiece by installing a small motor and clock movement behind the dial.

Kuempe Co.

Stoves AT FACTORY PRICES!



Sale Catalog—FREE
 Over 200 Styles and Sizes of Stoves, Ranges, Furnaces at Factory Prices and Easy Terms—as little as 18c a day. More Bargains than in 20 Big Stores. New styles, new features, new colors. Year to Pay—30 days free trial—360 days approval test—24-hour shipments. Over 900,000 Satisfied Users. 35 Years in Business. Write for FREE Catalog.

Kalamazoo Stove Co., Mfrs.
 391 Rochester Avenue
 Kalamazoo, Michigan

"A Kalamazoo Direct to You"

METAL-WORKING LATHE..



Complete with compound slide-rest, chucking device; 6" swing, 24" length overall, weight 22 lbs. Extra bed-length, 50c foot; attachments for wood-turning, milling, grinding, sawing, drilling, etc., at low prices. Send \$1, shipped C.O.D. in U. S., balance plus express charges. **FREE, 96-page "American Homecrafters' Manual" with each machine.** Send 10c stamp or coin for sample copy "AMERICAN HOMECRAFTER" our how-to-make-it publication, and complete catalog of all machines, including the "American Junior" complete line of power tools at \$2.50 each (drill press, wood lathe, bench saw, shaper, sabre scroll saw, disc sander)—you can have a COMPLETE SHOP for only a few dollars.
AMERICAN MACHINE & TOOL CO., Dept. P. 3, 200 Broadway, New York

\$8.75 COMPLETE

RIDE AND SAVE!



The Greatest Sport on Wheels—that's Motorcycling—and it costs so little. Send for catalog on latest models. New super-power motor—greater performance—brilliant color-options at no extra charge. Write today.
HARLEY-DAVIDSON MOTOR CO.
 Dept. P Milwaukee, Wis.
HARLEY-DAVIDSON Motorcycles

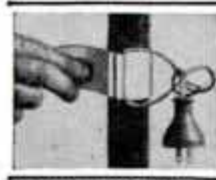

Electric Hot Collar Prevents Freezing
 Automobiles—Simply attach to wall plug in garage and freezing and STARTLING worries are over. Thaws out pipes, drains, melts grease, heats water. Applied instantly. No tools. Sent post-paid \$1.50.
CHAMPION PIPE HEATER CO.
 252 West 55th Street New York City

KINKADE GARDEN TRACTOR

and Power Lawnmowing Attachments
 A Practical, Proven Power Cultivator and Plow for Gardeners, Suburbanites, Truckers, Florists, Nurserymen, Fruit Growers and Poultrymen. Low Prices—Easy Terms.
AMERICAN FARM MACHINE COMPANY
 1058 33rd Ave. SE. Minneapolis, Minn.



Catalog No. 34-A Illustrating Electrical, Mechanical and Model Makers' Supplies, Small Steam & Gasoline Engines, Motors, Generators, Lathes, Drill Presses, Bench and Band Saws, etc.—16 & 22 Dywida-Motors, School Projects, Engine Castings, Motor Parts, etc.—Books, Blue Prints, Brass and Steel Tubing, Gears, Pulleys, Hangers, Experimental Material.
 Big Copy. Mailed anywhere for 20 cents. 25 cents Canada, refunded first order.
LOOMIS ELECTRIC COMPANY
 2822 N. California Ave. Chicago, Ill.



Earn Cash at Home!
 Grow fancy giant mushrooms in cellar, attic, barn. Easy, odorless method. We show you how, furnish guaranteed materials and buy crops. Valuable big book, pictures free if you write quickly. (Est. 1908.)
UNITED CO. 3848 Lincoln Ave. Dept. PM-1, CHICAGO

RAISE GIANT FROGS

BIG PROFITS IN "NUFOND GIANTS"
 Breeder lays 10,000 eggs each year. Bullfrogs sell \$1.00-\$3.00 dozen. No experience necessary. Backyard pond starts you. Raised in any climate. Our FREE book "A Fortune in Frogs" explains everything. Write **AMERICAN FROG CANNING COMPANY** (Originators of Canned Frog Legs and Frog a la Queen)
 Dept. 133-A New Orleans, La.

When writing please mention Popular Mechanics

Turn Music into Bank Notes with COIN OPERATED PHONOGRAPHS



THESE marvelous instruments are placed on a commission basis in cafes, restaurants, taverns, confectioneries, and drug stores. Average earnings per instrument are from \$70 to \$110 a month. You, the owner and operator, get 75% to 80% of this. Your receipts are all cash. The returns are steady, permanent, changing hardly at all with the seasons. To start you need only a little capital and no previous experience. A spectacular return on your investment and a handsome salary your immediate reward. Several choice territories now open for live wires who are seeking an unusual profit opportunity. Mills Novelty Company is a \$10,000,000 business, established 1889, world's largest manufacturers of coin operated machines. Send for "MAKING MONEY TODAY." Free!

Mills Novelty Co., 4100 Fullerton Ave., Chicago, Ill.

FREE "Making Money Today" tells simple means of getting started in coin-controlled phonograph operating. Sign below and mail to Mills Novelty Co., 4100 Fullerton Ave., Chicago. No obligation.

YOUR NAME.....
 ADDRESS.....
 TOWN..... STATE.....

HAND ROUTER—INDISPENSABLE AID TO EVERY CRAFTSMAN



Duplicates work of high-priced power machines. For routing, fluting, inlaying. Simple to operate. Works in wood, leather, and linoleum. Nothing like it elsewhere. Price \$2.50, postpaid, 3 blades and compass free. Money refunded after 10-day trial if not satisfied. Ideal Xmas gift. Write for circular.



KRAUT & DOHNAL, Dept. PM2
 325 S. Clark St., Chicago, Ill.

500 POWER MICROSCOPE with Complete Biological WINNERSET



Substantial, rugged and precise, this fine American Made Winn Microscope provides you with any magnification desired between 75X and 500X, so that you actually have innumerable microscopes in just one instrument. Every refinement essential for accurate work is included, such as compound lens system, clear definition, excellent resolving power, rack and pinion focusing, adjustable and removable mirror, additional mirror mounting on movable stage, slide clips, substage color filters, clips, etc.

WINNERSET NO. 8 includes, in addition to this marvelous microscope, a complete biological outfit consisting of:
 10 plain slides . 1 prepared slide . 1 cavity slide
 6 vials containing selected specimens . 2 culture tubes . lens cleaning tissue . 12 slide labels . 12 cover glasses . specimen collection jar . powerful magnifying and dissecting stage . dissecting blade . dissecting forceps . dissecting needles . scissors . sanitary dropper . vial of xylol . 3 vials of stains . brush for stains . sealing liquid . graduated dropper . 3 color filter . complete instruction book. Microscope and set delivered complete for **\$6.75** only.....
 With electric substage lamp, \$8.75.

OUR POLICY—GUARANTEED SATISFACTION
 All C. O. D. orders require a \$2.00 Deposit
J. H. WINN MFG. CO.
 Dept. 123, 124 West 24th St., New York

\$200 First Week In OWN Business

We want a reputable, honest man in each county. This man does not need to have any special experience or more than ordinary ability, but he must be honest and courteous.

Such a man we will start in business for himself. You can make far above average profits in the rug-cleaning business—a high-grade business all your own. Many earn \$125 to \$200 per week—some considerably more. L. A. Eagles took in \$200 his first week in Madison, Wis. No shop necessary. The H-B rug-washer finishes rugs like new on the customer's floor. There are hundreds of customers—in your vicinity and nearby towns.

The H-B rug-washer is very simple. Anyone can run it. Electricity does the work. Simply clean a few rugs. These customers tell others and also give you their future work. Soon you will have a prosperous year-around business. Send coupon for booklet explaining everything.

"Monthly Profits \$400"

C. R. Bergsath writes, "My profits run about \$400 every month." M. O. Malmin earned 3 times the cost of his machine the first two months.

"Never a Complaint"

C. J. White says: "\$100 business in six days—never a complaint." That is the nicest part of this business—every customer is more than satisfied. Stains and blotches disappear and vivid colorings and freshness in faded floor coverings come back.

"Profits Pay for Home"

Harry Hill built and paid for a home from rug-washer profits. His first day's business was \$86. You, too, can enjoy a large income. H. Riley says: "One job, about 13 hours work, brought in \$75."

Backed by \$58,000,000 Company

Every H-B rug-washer is guaranteed by a 127-year-old \$58,000,000 company. You take no risk. This method has been successful 12 years. H-B rug-washers are used by United States government and by Statler and other leading hotels. They are GUARANTEED.

Easy Terms

The complete equipment is inexpensive. A reasonable down payment brings every thing to you and the balance is paid monthly. From the start, you have your own business—one that is profitable and of which you can be proud.



Free Book—Mail Coupon NOW!

H-B Co., 6091 H-B Bldg.,
Racine, Wisconsin.

Gentlemen:—Send at once (no obligation) your free booklet illustrating rug-washer and telling how I can own my own business; how I can earn large profits at prices below other methods; how I can enjoy a permanent year-around business; how I can become financially independent in a very short time; and how I can pay on easy terms.

Name.....
Address.....
City..... State.....

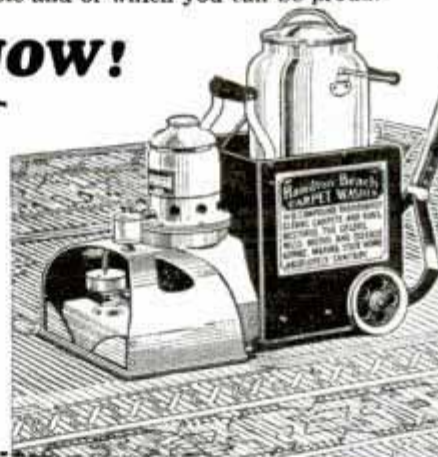

**AMAZING NEW 1935
ALL ELECTRIC
ALL WAVE
RADIO!**

**NEW SENSATION STARTLES
RADIO WORLD!**

A complete ALL ELECTRIC—ALL WAVE radio for only \$6.95. Not a toy—a real receiving set that brings in standard broadcasts, police calls, amateur broadcasts, and airplane calls just like the most expensive radios. Beautiful metal cabinet. Amazing selectivity—full vision dial—single knob volume control—wave band lever.

SEND ONLY \$1.00 pay the balance \$5.95, plus a few cents postage, when your radio is delivered. Write for FREE details.

STEINBERGS, Inc. Dept. PM-1 Cincinnati, O.

**MONEY-BACK
GUARANTEE**

\$6.95

**COMPLETE
With Earphones**

BUILD IT YOURSELF

JIM DANDY CABIN TRAILER

Classy! Roomy! Easy to build at low cost! Plans and instructions only \$1.00—include all Diagrams, Sketches, Photos, Material List, etc. Big Value! Mail-Dollar Bill to Jim Dandy, Box 125-A, Wausau, Wis.

CHEMISTS NEW CATALOGS

Catalog listing 10,000 chemicals, drugs, flavors, etc., and 1,700 Scientific Books, sent for 25c. Catalog with 3,000 illustrations of laboratory apparatus, 50c. Glass Still as illustrated, Cap. 1 Qt., \$9.00.

LABORATORY MATERIALS CO., 639 E. 71st St., CHICAGO, ILL.

FREE BARGAIN BOOK

listing everything photographic and a complete line of microscopes, telescopes, binoculars and weather instruments at lowest prices. Excellent gift items. Write now for free copy to:

CENTRAL CAMERA CO., Dept. PM-1J
230 S. Wabash Ave. Chicago, Illinois

Every Wood Craftsman Should Have
This 100 Page Book No. 8

material such as foreign woods—lovely crotch, butt, burl, fiddle back, etc. Veneers, Panels and Solid Woods. Lists and illustrates 76 Blue Print Designs for Scroll Patterns, Inlay Table Tops, etc.

New Process of Inlaying—22 Boxes, Bookends—Trays, Plaques, etc., Kits for which come complete—anyone can make these wonderful articles at a fraction of store cost. They make exquisite Christmas Presents. Write today.

only
10¢

CRAFTSMAN WOOD SERVICE CO.

We Ship All Over The World
2728 MARY STREET CHICAGO

DRIVER WORKSHOP

Price
\$49⁹⁵
complete
as shown

In starting to equip a home workshop there is no need of a heavy investment in power tools. DRIVER has proved this to the satisfaction of thousands of owners. Sterling quality can be built into lighter tools, — by DRIVER.

Start with the group shown above, — or with a single machine if you prefer. Then add others at your convenience.

The above group comprises:

- | | |
|--------------------|------------------------|
| 1—L500 Lathe | 1—D110 1/2 H. P. Motor |
| 1—J505 Jig Saw | 2—V342 Belts |
| 1—D521 Drill Press | 3—Instruction Books |
| 1—PV175 Pulley | |

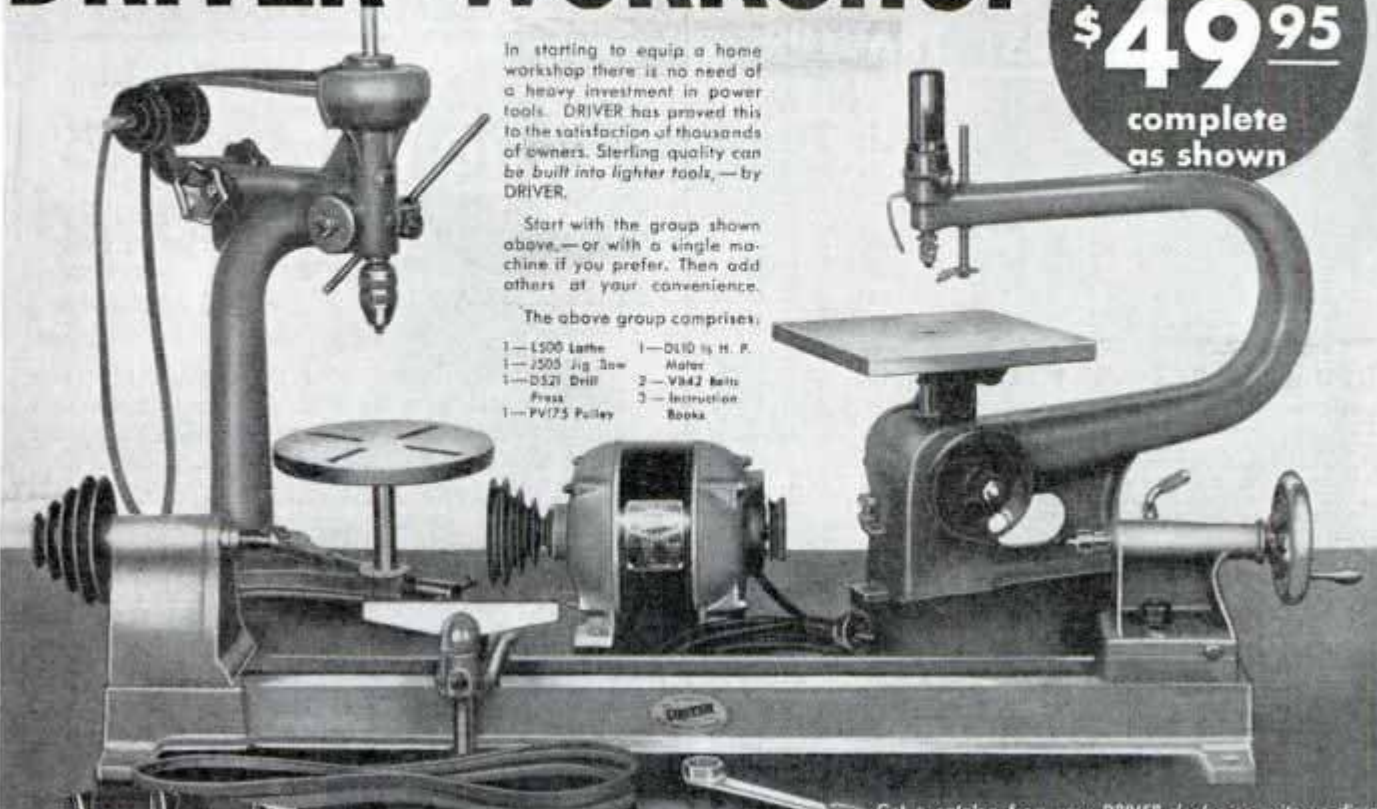

Get a catalog from your DRIVER dealer or write us direct

WALKER-TURNER CO., INC.

115 BERCHMAN STREET

PLAINFIELD, N. J.

Fine Furniture Factories and Cabinet-makers insist on

TRADE MARK
"Jorgensen"
REG. U. S. PAT. OFF.

CLAMPS

for firm joints, greater strength, handiness and long life. For home craftsmen Jorgensen has Pony Fittings that go on ordinary 3/4" pipe to make clamps of any length. (Fittings for 2 Pony 500 Clamps \$3.00 plus postage, 6 lbs.). Jorgensen Handscrews grip straight or at angles. Will not split, spring or loosen. (2 No. 1 Handscrews: 10-inch jaws, open 6 inches, \$2.50 plus postage, 6 lbs.).

Catalog FREE ADJUSTABLE CLAMP COMPANY
"The Clamp Folks"
421 N. Ashland Ave., CHICAGO, U. S. A. PONY 500



NEW DUAL RAY HEALTH LAMP UNIT

Ultra Violet and Infra Red Ray in One Lamp
Health giving. Prevents Rickets and Skin disorders. Gives Sun-tan—Vitamin "D". Automatic safety control. 110 Volt AC or DC. Free Details.

COMPLETE with Goggles only
\$3.50
postpd.

BEYER MFG. CO., 4655 Lincoln Ave., Dept. A-1 Chicago, Ill.

Red Bakelite
Leak-Proof Cap
4 Fluid oz.

KILLS CORROSION!

Esso Handy Oil kills corrosion. And, unlike virtually all other household oils, it contains no acid-forming element to actually cause corrosion! It's a superior lubricant for fine mechanisms in the home, office, and car.

CRYSTAL-CLEAR • 100% LUBRICATING PREVENTS RUST



DO YOUR OWN PRINTING

circulars, envelopes, menus, notices, cards, etc., with a handy and serviceable home made press which anyone can easily build in an hour or so. Costs less than one dollar to make. Does good work, saves printing costs. Send only 10 cents, cash or stamps for illustrated circular. CARL EDQUIST Dept. P., Odessa, Minnesota



SNAPPY XMAS TIES

GENUINE LEATHER CAN'T BE TOLD FROM SILK
STRONG APPEAL TO MEN AND BOYS.
Fancy patterns; durable, won't wrinkle. SELL ON SIGHT; big profits, repeat orders. Be independent, have your own business. \$5 TO \$10 A DAY EASILY. Extra bonus for live wires. Send 50c or stamps for sample and kit. Information free.
CENTURY TIE CO., Dept. 2, 2333 W. Grand Blvd. DETROIT, MICH.

BE INDEPENDENT—Sell METLMACHES The Modern Mach

THE 20th CENTURY INVENTION THAT REVOLUTIONIZED THE MACH. INDUSTRY. A REAL WATER, CHILD AND RAT PROOF SAFETY MACH MADE OF METAL. LIGHTS 1000 TIMES OR MORE.

SEND \$1 FOR 15 METLMACHES. SELL THEM FOR 11c EACH. MAKE 30% PROFIT. \$1 INVESTED TODAY MAY MEAN YOUR FUTURE INDEPENDENCE. COMPETENT MEN WANTED.

EVERY DEALER A PROSPECTIVE CUSTOMER. SAMPLE AND SALESMAN'S TERMS 15 CENTS. METALMATCH CORPORATION, DEPT. 115 WARSAW, ILLINOIS

DEPENDABLE POWER WITH THIS LOW-COST TRACTOR



New Air Tires!

New models equipped with popular low pressure balloon tires for greater speed and economy or standard steel wheels with pyramid lugs, if you prefer.

Models for every need, 1 to 5 H.P., walking and riding types; air cooled engine; gear shift with 3 speeds forward and reverse; attachments for every kind of farm work. Write for FREE CATALOG picturing all models and giving LOW FACTORY PRICES.

Save at Factory Price!

Buy direct from factory and save! Famous SHAW DU-ALL TRACTOR saves time, labor and money. Dependable. Guaranteed. Just the thing for farms, truck gardens, orchards, nurseries, poultry farms, ranches, estates, golf courses, etc. Plows, harrows, discs, furrows, seeds, cultivates, harvests, mows, rakes, and hauls hay, mows lawns, cuts tall weeds, operates washing machines, concrete mixers, wood saws and other belt machinery. Easily operated by woman or boy. Handles adjustable.

10 Days' TRIAL

Use it 10 days at our risk. Write for generous offer. Address nearest office.

SHAW MFG. CO., Desk 4501

GALESBURG, KANSAS
COLUMBUS, OHIO
812 Magnolia, Chicago, Ill.



AGENTS!

Write nearest office for Generous Offer to Agents. Make big money demonstrating S H A W D U - A L L Tractors to your neighbors.

HEAR the Full Beauty OF FOREIGN BROADCASTS

\$6.00

PLUS INSTALLATION

WITH THE RCA
Noise reducing
Antenna

You'll never know how good your all-wave set is until you hear it with this scientific antenna. Ask your dealer or service engineer for a *Certified Installation*.

RCA PARTS DIVISION, Camden, N. J.



WORLD WIDE ANTENNA SYSTEM

SEND FOR THE FREE BOOKLET "ANTENNA FACTS"

WORLD WIDE ALL WAVE RADIO \$19.95



Get stations all over the world with this POWERFUL radio receiver! All Wave—15 to 600 meters! Works on two inexpensive batteries! NOT a toy or attachment! **Results Guaranteed!** Am kits include all parts mounted on attractive metal chassis and panel. Clear picture instructions. Wire it yourself! It's easy!
ONE TUBE KIT—\$1.95 • **TWO TUBE KIT—\$2.95**
ALL ELECTRIC 105-125 volt AC-DC two tube house current set. No batteries needed! Complete Kit \$3.95
 Kits wired 75c extra. Tubes 85c ea. Double Phones \$1.25
ORDER NOW! Send \$1. balance COD, or postpaid if full remittance. **Postcard brings free literature.**

Free!! Large three color Map of the WORLD, valuable Now!
 Short Wave data, etc.!! Send 10c for handling.
Ace Radio Laboratories Dept. P-1, New York City

WORLD'S Fastest TRAIN

NOW—model of famous C. B. & Q. "Zephyr." The finest, most modern electric train ever offered. Cast aluminum cars, perfectly streamlined. Individual shatter-proof windows. Positive couplings. New brushless motor (no radio interference). Steel wheels, bronze bearings. Solid T rails, real spikes and wood ties. Runs 120 (miniature) m.p.h., smoothly, quietly. At your dealers or write—WESTERN COIL & ELEC. CO., Dept. PM-1****

Send today for information, sample rail, tie and spikes—**FREE**
RACINE, WISC.



ELECTRIC FUN!

Make things spin, buzz, shoot, flash, mystify, with electricity! Book of 200 stunts with 110 volts. Postpaid \$1.

CUTTING & SONS, 15 M Street, CAMPBELL, CALIF.

LATEST TYPE SHORT WAVE RADIO

\$23.90
COMPLETE

Enjoy programs from London, Paris and Berlin or—money refunded. Marvellous tone and volume. Buy direct from factory—14 years' experience. Full line \$16.95 and up. Also \$18.95 battery and \$19.95 auto radios. Write quick for territory and terms.
D. C. WILCOX, 308 W. Randolph Street, Chicago

AGENTS WANTED

MAKE MONEY PRINTING

letter and billheads, circulars, cards, for friends, spare time. Easy to learn, easy to get jobs. Printing Presses \$12; new type faces, complete supplies, lowest prices. Send stamp for catalog.
PEIFFER CO., 21-A; 6 Columbia St., Newark, N.J.



MAKE MONEY!

DEVELOP and PRINT SNAPSHOTS AT HOME

Make Money—Save Money—Make Better Pictures by Developing and Printing snapshots yourself. Make more prints from your old negatives. Winner Photo-Set is not a toy but a scientifically designed kit containing enamel trays, glass graduate, stirring rod, developer powders, ONLY **\$2.25** delivered U. S. A. DELUXE SET with professional type equipment for the more advanced worker... **\$3.95**
\$1.00 deposit on C. O. D. orders.
J. H. WINN MFG. CO., Dept. 124, 124 West 23 St., New York

Winner
PHOTO-SET

MAKE MONEY!

INSTALL YOUR OWN BURNER

At last! A quality burner in the low priced field. Our burners bought by U. S. Govt.! Now you can buy direct at one low price complete with full set of electric controls, wire, etc., plus complete instructions for making your own installation. Write for amazing low price and free literature today!

CHALMERS OIL BURNER CO.
1238 Central Ave., Minneapolis, Minn.



FREE LITERATURE SEND TODAY!

COMPRESSORS - CAR WASHERS - ARC WELDERS - BATTERY CHARGERS



INCREASE PROFITS without INVESTMENT

This money-making equipment will bring you \$150 to \$300 profit monthly. Requires no experience to operate . . . comes on 30 Days' Trial. Shouldn't cost a cent . . . will pay for itself on EASY MONTHLY PAYMENTS as low as \$10. Used by U. S. Govt. Write for details, no obligation, to

HOBART BROTHERS CO. Box M-15 Troy, Ohio

30 DAYS TRIAL

BOYS! THROW YOUR VOICE



Into a trunk, under the bed or anywhere. Lots of fun fooling teacher, policeman or friends.

THE VENTRILO

a little instrument, fits in the mouth out of sight, used with above for Bird Calls etc. Anyone can use it. Never fails. A 64-page Book on Ventriloquism and the Ventrilo. All for 10c Postpaid.



LEARN TO DANCE — AT HOME WITHOUT MUSIC OR A PARTNER

This book will teach you in a few hours—at home—in private—how to learn old as well as modern dances—the Fox Trot Steps, the Tango, the C-Begate Dances, the Waltz, the One-Step, the Two-Step, etc., etc.

This book will train you to be an easy, confident dancer by a system so clear, so simple, so complete that you will soon start dancing gracefully—even though you've never danced before.

You cannot possibly go wrong. The directions are so easy to follow, you'll be dancing before you know it. The Primary Positions of the feet are carefully illustrated and explained, which is so essential to learn correctly. Here are some of the dances described: SQUARE DANCES—The March, Quadrilles, Movements, The Plain Quadrille, Fancy Quadrilles, The Jig, Gavotte, Minuet, The Scabille, The Star, The Basket, The Surprise Quadrille, The Lancers, The Royal Lancers, The Caledonians, The Prince Imperial, Waltz Quadrilles, The Glide Lancers, The Virginia Reel, Pop Goes the Weasel, The Glide Caledonians, ROUND DANCES, Old and Modern Waltzes, The New Swoony Waltz, The Redowa, "The Ragout" or "Kni-kerbocker," The Polka, Polka Mazurka, Polka Krakowa, Bohemian Polka, The Schottische, The Gigue, The German, The Mazur, Two Step, Three Step, MODERN DANCES, Tango, Fox-Trot, etc. It gives the figures of the GERMAN, The Mazur, The Cheated Gentleman, The Mysterious Hands, The Auction, The Rump, Blind Man's Buff, The Handkerchief Chase, The Apples, The Two Lines, Pass in the Corner, Knot, Serpent, Baskets' Grand Chain, Jerusalem, etc. 25c postpaid.



PEA-MATIC REPEATER-12 SHOT



Here it is, boys. You can have an immense amount of fun with this new pistol. It shoots 12 to 15 ordinary peas without reloading. All you need do is to load the gun with peas, pull the trigger and keep on firing until the barrel is empty. Then reload and fire again. It is absolutely harmless and safe. Nothing to explode. These pistols sell like hot cakes, so get yours AT ONCE. Be the first boy in your town to own one of these automatic repeating pistols and be the envy of all the other kids in the neighborhood. PRICE ONLY 25 CENTS. Holster for Pea-matic 25c.

25c Post-paid.

Auto Scare Bomb

The Auto Bomb is attached to the motor of your car, fastening one wire to the spark plug terminal and the other wire to any part of the motor to serve as a ground. The instant your "victim" steps on the starter, there is a shrill whistle, followed by a loud bang. The driver thinks his car has exploded. Can be attached in a few seconds. Does not harm the car. Gives you more protection than an insurance policy—catches the thief in the act. PRICE 15c Each, 3 for 40c. Shipped by Express, not prepaid.

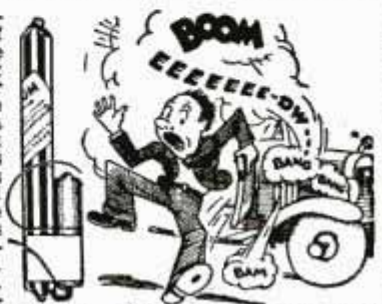

MAKE YOUR OWN RADIO

Enjoy the thrill of base ball games, market reports, latest news, etc. This copyrighted book tells you how to make a RADIO SETS" shows how to make and operate inexpensive Radio Sets, the materials for which can be purchased for a mere trifle. Also tells how to build a short-wave Receiver for bringing in foreign stations, police calls, ships at sea, etc. ONLY 15c p.pd.

Daisy Water Pistol

6-Shot Repeating Water Pistol—very latest design—looks just like a Police revolver. Blue steel finish. Squirts 25 feet. When diluted ammonia is used is very effective against vicious dogs, tramps, animals. 7 inches long. PRICE 25c POSTPAID.



WONDERFUL X-RAY TUBE

A wonderful little instrument producing optical illusions both surprising and startling. With it you can see what is apparently the bones of your fingers, the lead in a lead pencil, the intricate opening in a pipe stem, and many other similar illusions. Price, 10c, 3 for 25c, p.pd.



Very striking, quaint and uncommon. Silver finish; skull and crossbones design, two brilliant, flashing gems sparkle out of the eyes. Said to bring good luck. Only 25c p.pd.

250 Magic Tricks

An excellent little book containing nearly 300 tricks for parlor or stage that anyone can do. Tricks with cards, coins, handkerchiefs, eggs, bottles, string, etc. Also Second Sight, Shadowgraphy, etc. Profusely illustrated. 10c postpaid.

125 CARD TRICKS and sleight of hand. Contains all the latest and best card tricks as performed by celebrated magicians, with exposure of card tricks used by professional gamblers. Price 25c postpaid.

SNAPPY JOKES. A splendid collection of rich and rare jokes, compiled by a jolly bartender for stag parties, smokers, etc. 10c.

FORTUNE TELLING BY CARDS, dice, dominoes, crystal, etc. Gives meaning of every card, how to deal and lay them out, etc. Price 10c postpaid.

LEARN TO HYPNOTIZE. Book tells how to hypnotize, how to produce sleep, how to awaken a subject, medical hypnotism, hypnotism in diseases, how to hypnotize animals, etc. Price 10c postpaid.

STAR TOY MAKER

Greatest boys' book written. Tells how to make a Pinhole Camera, a Game, model Railroad, a Telephone, Boomerang, Telegraph Instrument, Box Kite, Talking Machine, Microscope, Electric Motor, Electric Door Bell, Water Wheel, Paddle Raft, pair of Skis, a Dog Sled, Bird House, Rabbit Yard, etc. 64 pages, 150 illustrations. PRICE 10c.

MIDGET BIBLE. Size of a postage stamp. Over 200 pages. Remarkable curiosity. Said to bring good luck. Price 15c postpaid.

DREAM BOOK and FORTUNE TELLER. Tell your own fortune. With dictionary of dreams and interpretations, lucky numbers, oracles, divinations, palmistry, etc. 10c.

HOW TO TIE KNOTS. 32 page book tells how to make different knots, hitches, splices, etc. 100 illustrations. Price 10c postpaid.

5-MINUTE HARMONICA COURSE. A new, easy-teaching method. Teaches how to play, to use the tongue, tremolo, fully illustrated. Price 15c postpaid.

BOY ELECTRICIAN

Book tells all about electricity in simple language. How to make batteries, dynamos, motors, telephones, bells, coils, engines, lights, telegraph apparatus, alarms, radios, etc. 64 pages. Fully illustrated. PRICE 10c postpaid.

JOHNSON SMITH & CO. RACINE, WIS.

Dept. 845
A copy of our NEW CATALOG mailed on receipt of 10c., or the De Luxe Edition with cloth binding 25c. Bigger and better than ever. Only book of its kind in existence. Contains all the latest tricks in magic, the newest novelties, puzzles, games, sporting goods, rubber stamps, unusual and interesting books, curiosities in seeds and plants, etc., unobtainable elsewhere. Remit by Coin, Money Order, Check or unused U. S. Postage Stamps, for all articles listed above. Canadian money, stamps, Postal Notes and British P. O. Orders accepted.



CHAMELEONS — 25c

LIVE, SAFE DELIVERY GUARANTEED



Watch it change its color!
Get one of these most wonderful of all creatures. Watch it change its color. Study its habits. Wear one on the lapel of your coat as a curiosity. Watch it shoot out its tongue as it catches flies and insects for food. No trouble to keep. Can go for months without food. Measures about 4 inches in length. Shipped to any address in U. S. A. by mail. We guarantee safe arrival and live delivery. PRICE 25 CENTS POSTPAID. Specially prepared Chameleon food 15c.

BIG ENTERTAINER

326 Jokes and Riddles, 25 Magic Tricks, 10 Parlor Games, 73 Toasts, 13 Fairy Tales, 105 Money-making Secrets, 22 Monologues, 21 Puzzles and Problems, 5 Comic Recitations, 10 Funny Readings, 11 Parlor Pastimes, 13 Flirtations, 110 Girls' and Boys' Names and their Meanings, 10 Picture Puzzles, 60 Amusing Rhymes, 37 Amusing Experiments, Deaf and Dumb Alphabet, Shadowgraphy, Gypsy Fortune Teller, How to Tell Fortunes with Cards, Dice, Dominoes, Crystal, Coffee Cup, etc. Hypnotism, Ventriloquism, Cut-outs for Checkers and Chess, Dominoes, Fox and Geese, 9 Men Morris, Spanish Prison Puzzle, Game of Anagrams, 25 Card Tricks, Crystal Gazing, etc. ALL FOR 15 CENTS POSTPAID. Big novelty catalog 10c.

BLANK CARTRIDGE PISTOL

REVOLVER STYLE

Three new models now out 25c, 50c and \$1.00. Well made and effective. Modelled on pattern of latest type of Revolver. Appearance alone enough to scare a burglar. Takes 22 Cal. Blank Cartridges obtainable everywhere. Great protection against burglars, tramps, dogs. Have it lying around without the danger attached to other revolvers. Fine or 4th July, New Year's, for stage work, starting pistol, etc. SMALL SIZE 4 in. long 25c. MEDIUM SIZE 5 in. long 50c. LARGE SIZE 6 in. long \$1.00. BLANK CARTRIDGES 50c per 100. HOLSTER (Cowboy type) 50c. Shipped by Express only not prepaid. Big novelty catalog 10c. JOHNSON SMITH & CO., Dept. 845, Racine, W



\$75 for the 9-in. x 3-ft.
Back-Gear, Screw-Cutting
"Workshop"
Bench Lathe
less motor drive

on Easy Payment Terms

You can buy this South Bend Lathe Direct from the factory for only **\$19 Down**
\$6.50 a month

THE new 9 1/2" swing by 3' bed Workshop Bench Lathe turns, faces, bores, cuts threads and performs all kinds of machining operations on cast iron, steel, all soft metals, wood, compositions and other materials. Has the power to reduce the diameter of a steel shaft 1/4" in one cut. Takes 18" between centers; weighs 300 lbs. Constructed entirely of cast iron and steel. It is a rigid, powerful, accurate, modern lathe.

Weight
300 lbs.

FEATURES include back-gear, headstock with six spindle speeds; cuts threads 4 to 40 per inch; has automatic longitudinal feed to carriage as fine as 350 per inch; graduated compound rest; 3/4-in. hole through spindle; three V-ways, one flat way on bed; all gears machine cut of steel and cast iron. It is a genuine South Bend Lathe, accurately built and recommended for the most accurate work.

PRICE of \$75 includes bench lathe complete, as illustrated, but does not include motor drive. Price with motor drive, including 1/2 H.P. reversing motor and drum reversing switch as shown \$94. Other bed lengths 3 1/2', 4' and 4 1/2' in Bench type and Floor leg type, countershaft and motor drive at similar low prices, on Easy Terms.



Operates from Lamp Socket for 2c per hour

9 1/2" swing x 3' bed Workshop Bench Lathe with Horizontal Motor Drive complete with reversing motor and reversing switch as shown... **\$94.00**
\$24.00 Down, Balance \$7.00 a Month.

THE 9" Workshop Lathe is used by manufacturing plants, machine shops, government laboratories, schools and home shops. Automotive service shops use it for armature work, valve refacing, machining pistons, making bushings, etc. Send in your order now with down payment for 30-day trial in your own shop. Small monthly payments will take care of the balance. Immediate shipment in time for Christmas, if you wish.

96 Other Sizes and Types on Easy Payments Direct From The Factory

Any size or bed length South Bend Lathe from 9" swing to 18" swing priced from \$75 to \$1500 may be purchased on the Easy Payment Plan. One small down payment puts the lathe to work in your own shop so you can meet the monthly payments with the earnings. If you are interested in any size or type of lathe, write to us and we will send you an itemized quotation showing the cash price, the down payment, the monthly payment and the number of months to pay. This will put you under no obligation to us whatever. You can then decide whether or not you wish to purchase.

Why look for a second-hand lathe when you can buy any size or type new guaranteed South Bend Lathe on the Easy Payment Plan, by making a small down pay-

ment with the order and paying the balance monthly. Listed below are a few popular sizes:

| Size of Lathe | Weight Lbs. | Price Crated C'shaft Drive | Down Payment | Monthly Payment |
|-------------------------|-------------|----------------------------|--------------|-----------------|
| 9" x 3' "Toolmaker" | 325 | \$140.00 | \$ 31.00 | \$ 9.00 |
| 9" x 3' Junior | 375 | 170.00 | 35.00 | 11.50 |
| 9" x 3' Std. Chge Gear | 420 | 225.00 | 45.00 | 15.50 |
| 11" x 4' Std. Chge Gear | 710 | 300.00 | 60.00 | 19.50 |
| 13" x 5' Std. Chge Gear | 1090 | 352.00 | 75.00 | 25.00 |
| 16" x 6' Std. Chge Gear | 1840 | 480.00 | 100.00 | 29.00 |
| 16" x 8' Std. Chge Gear | 2000 | 520.00 | 107.50 | 30.50 |
| 18" x 8' Std. Chge Gear | 2600 | 635.00 | 125.00 | 34.00 |

SOUTH BEND LATHE WORKS
601 E. Madison St., South Bend, Ind., U.S.A.

Please send me quotation and illustration on the following lathe:

Swing..... Length of bed.....
Countershaft Drive..... Motor Drive.....
My work is.....
Name.....
Address.....
City..... State.....

Write for Free Bulletin 5-B

Get a copy of this valuable and instructive 32-page catalog illustrating, describing and pricing the 9" Workshop Lathe and all its accessories and attachments. If interested in a larger lathe, also ask for General Catalog No. 94. Mailed free postpaid, to any address.

SOUTH BEND LATHE WORKS
601 East Madison St., South Bend, Ind., U. S. A.

ANNOUNCING AMAZING TYPEWRITER BARGAIN

BRAND NEW MODEL No. 5
REMINGTON
PORTABLE
10¢ A DAY
MONEY BACK GUARANTEE



10 DAY
FREE TRIAL
OFFER

BIG PRICE REDUCTION

● Positively the greatest portable typewriter bargain ever offered! Now for the first time Remington, world-famous manufacturer, offers a NEW purchase plan... only 10¢ a day buys this latest model machine! Not a used or rebuilt typewriter. Not an incomplete machine. A beautiful brand new regulation Remington Portable. Standard 4-row keyboard; Standard width carriage; margin release on keyboard; back spacer; automatic ribbon reverse; every essential feature found in standard typewriters!

Money making opportunities always open

Hundreds of jobs are waiting for people who can type. A typewriter helps put your ideas on paper in logical, impressive form... helps you write clear, understandable sales reports, letters, articles, or stories. A Remington Portable has started many a young man and woman on the road to success.



A Gift for Every Member of the Family

If you want a gift for birthday, Christmas, or graduation... one that Father, Mother, Sister or Brother will use and appreciate for years to come... give a Remington Portable. It's the one gift that can be used with both pleasure and profit by every member of the family.

ACT... WHILE LOW PRICE HOLDS GOOD!

New wage scales in our own factories, and in the factories of the companies which make our materials, point definitely to higher prices. Stocks of machines on hand make possible the present unbelievably low cash price on this machine. Everything points to higher prices. We don't believe that we can maintain the present big price reduction in the face of constantly rising costs in every one of our departments. So we say "Act fast!"

10 DAY FREE TRIAL OFFER

You can try this machine for 10 days without risking one penny of your money. Not even shipping charges. Send for complete details on this most liberal offer. Get attractive new catalogue illustrating and describing the many Remington models available on unusually low terms. Clip coupon today!

EVERY ESSENTIAL FEATURE found in Standard Machines

Buying a typewriter isn't like buying a suit of clothes. Many Remington portables, seeing 10 years of hard service are still in active use. When you buy... buy a machine with every standard feature. The Remington No. 5 is the most compact and durable portable ever built... includes all essential standard typewriter features. This beautiful machine

represents the height of economy... unequalled economy in first cost... unequalled economy in service.

It is today the best value ever offered in typewriter history... and that statement comes from the company that has constantly made typewriter history. Buy now. It is a real bargain offer.

Specifications...

The Model 5 includes every essential feature found in standard typewriters. It has standard 4-row keyboard, complete visibility, standard width carriage for long envelopes. Carriage return lever of exceptional design for easy and rapid operation.

Margin release on the keyboard. Automatic ribbon reverse. Back spacer. Two color ribbon shift. Variable line spacer. Adjustable margin stops. Auto set Paragraph Key (one of the most useful features found on any typewriter). Weight 11 lbs. 13 oz. Furnished with Pica or Elite type.

TYPING COURSE

FREE

When you get your new Remington No. 5, you will get with it... ABSOLUTELY FREE... a 18-page course in typing. It teaches the Touch System, speeds up work. It is simply written and well illustrated. Instructions are easy as A.B.C. Even a child can understand this method. A little study and the average person, child or grown-up, becomes fascinated. Follow this course during the 10-DAY FREE TRIAL OFFER that we give you on your typewriter. At the end of that time, you should be able to dash off letters faster than with pen and ink.



CARRYING CASE

FREE

With every Remington No. 5, a FREE carrying case sturdily built of 3-ply wood. Covered with heavy DuPont fabric. Top is removed in one motion, leaving machine firmly attached to base. Can be used anywhere... on knees, in chairs, on trains.



Remington Rand Inc., Dept. 152-1, Buffalo, N. Y.
Please tell me how I can buy a new Remington Portable typewriter for only 10¢ a day. Also enclose your new catalog.

Name _____
Address _____
City _____ State _____

CLIP COUPON NOW

REMINGTON RAND INC., DEPT. 152-1 BUFFALO, N. Y.

LEARN
AT
HOME

TO

MOUNT

AND
ANIMALS

SAY, JIM, THAT DUCK
ACTUALLY SEEMS ALIVE!
MOUNTING BIRDS AND
ANIMALS LOOKS LIKE
A MIGHTY
FASCINATING
HOBBY.



IT IS, ED, AND A MONEY-MAKER, TOO. — IN FACT MY
WORKBENCH NOW PAYS ME A FINE PROFIT. I MOUNTED THIS
FROG GROUP AS A WINDOW DISPLAY FOR A MERCHANT —
THAT BRINGS MY SPARE TIME
EARNINGS UP TO \$57 THIS MONTH.



BUT
WASN'T
IT HARD
TO
LEARN,
JIM?



IT'S EASY, ONCE YOU GET THE HANG OF IT. I
LEARNED RIGHT HERE AT HOME IN MY SPARE
TIME FROM THE N.W. SCHOOL OF TAXIDERMISTRY. NOW
I GET TWICE AS MUCH FUN FROM MY HUNTING
AND FISHING AS I DID BEFORE I KNEW TAXIDERMISTRY.
USEFUL ARTICLES, LIKE THAT QUAIL LAMP AND
OWL AND SQUIRREL BOOK-ENDS, ARE GREAT FOR
SPORTSMEN'S DENS—I'VE SOLD A BUNCH OF THEM.
FOR THE MAN WITH A WORKBENCH, TAXIDERMISTRY
IS THE GRANDEST HOBBY IN THE WORLD!
WHY DON'T YOU TAKE IT UP, ED?

JIM, YOUR DEN IS
WONDERFUL! I AM GOING
TO LEARN TAXIDERMISTRY. WHAT
IS THAT ADDRESS? — I'LL
WRITE TONIGHT!

FUN! FASCINATION! PROFIT!

Men, Boys:— **LEARN** the Beautiful **ART OF TAXIDERMISTRY**

Our School (Est. 1902) Teaches You **BY MAIL**, Easily and Quickly

SEND COUPON FOR
FREE BOOK



Mount Your Game Trophies

Decorate your home and den. Have your own museum. Mount expertly **Game-Birds, Animals, Fish, Game-Heads, Tan Hides, Make Robes and Rugs.** Mount and keep your **Trophies.** They are valuable. The most fascinating and profitable hobby in the world. A marvelous art! Investigate; you will be delighted. Send the **Coupon Now** for the beautiful **Free Book.**

Old Reliable School

Thirty years in business; 250,000 delighted graduates, endorsed by sportsmen, craftsmen, schools, museums. We **guarantee** to teach you successfully. Thousands of **Popular Mechanics** readers are our graduates; and highly enthused. **You** will be also. May we send the free illustrated Book?

No Wild-Game Needed

Mount **Common**, even **Domestic**, specimens. Use rabbits, squirrels, pigeons, pets, chicks, even frogs. Create humorous groups and book-ends and frogs shown above. Lots of fun and fascination. **Profitable, Too.** Big profits in spare time, selling Craft-work.

BIG PROFITS

Mount wild-game for sportsmen. Sell your own specimens. Create **Craft and Novelty** groups—big demand at liberal prices. Combine mounted specimens with lamps, book-ends, hat-racks, door-stops, ash-trays, in fact endless alluring articles of your own creation. Many students earn **\$50 to \$80 a month** from spare time alone. Others earn **\$1000 to \$2000 a year.** Pleasure and Profit!

Also Learn Tanning

New wonderful method—makes real leather—harness, belt, lace buckskin. A real business, easily learned, **Very Profitable**—At last you can learn real genuine **chrome-tanning!**—Investigate now.

FREE BOOK COUPON

The Northwestern School of Taxidermy
3371 Elwood Bldg., Omaha, Nebr.

Please send at once the beautiful **TAXIDERMISTRY BOOK**, explaining how I can learn to mount **BIRDS AND ANIMALS**, also how I can learn **CRAFT TAXIDERMISTRY AND CHROME TANNING.** No obligation on my part.

Name..... Age.....

Mail the Coupon

Or a post-card will do. The 48-page unique book tells all about Taxidermy. Hundreds of beautiful pictures of wild-game and craft-work. Send for your free copy **now.** You will always be glad that you did. Please state your **age.**

The Northwestern School of Taxidermy
3371 Elwood Bldg., Omaha, Nebr.



Your
FREE BOOK
Await
Your
Request