

RADIO TO TRANSMIT POWER

POPULAR MECHANICS

MAGAZINE

WRITTEN SO YOU CAN UNDERSTAND IT



NOV.
25 CENTS
30c IN CANADA

SEE PAGE 646



P.S.

ANNOUNCING AMAZING TYPEWRITER BARGAIN

BRAND NEW MODEL No. 5
**REMINGTON
 PORTABLE**
10¢ A DAY
 MONEY BACK GUARANTEE



**10 DAY
 FREE TRIAL
 OFFER**

25% PRICE REDUCTION

● Positively the greatest portable typewriter bargain ever offered! Now for the first time Remington, world-famous manufacturer, offers a NEW purchase plan... only 10¢ a day buys this latest model machine! Not a used or rebuilt typewriter. Not an incomplete machine. A beautiful brand new regulation Remington Portable. Standard 4-row keyboard; standard width carriage; margin release on keyboard; back spacer; automatic ribbon reverse; every essential feature found in standard typewriters!



A Gift that Points the Way to Success

For birthday, Christmas, wedding, anniversary or graduation... give a Remington Portable. This one gift every member of the family will welcome. When Dad brings home work from the office, when Brother has reports to get out, when Sister and Mother answer correspondence... a typewriter will do every task faster, neater.

Make Leisure Hours More Fun

A Remington Portable can be carried anywhere and used anywhere. Catch up on correspondence. Write a diary of many experiences. Only a diary will give you a good permanent record of what you have done and what you have seen. You will want a typewriter some day. Get it now!



ACT... WHILE LOW PRICE HOLDS GOOD!

New wage scales in our own factories, and in the factories of the companies which make our materials, point definitely to higher prices. Stocks of machines on hand make possible the present unbelievably low cash price on this machine. Everything points to higher prices. We don't believe that we can maintain the present 25% price reduction in the face of constantly rising costs in every one of our departments. So we say... "Act fast!"

10 DAY FREE TRIAL OFFER

You can try this machine for 10 days without risking one penny of your money. *Not even shipping charges.* Send for complete details on this most liberal offer. Get attractive new catalogue illustrating and describing the many Remington models available on unusually low terms. Clip coupon today!

EVERY ESSENTIAL FEATURE found in Standard Machines

Buying a typewriter isn't like buying a suit of clothes. Many Remington portables, seeing 10 years of hard service are still in active use. When you buy... buy a machine with every standard feature. The Remington No. 5 is the most compact and durable portable ever built... includes all essential standard typewriter features. This beautiful machine

represents the height of economy... unequalled economy in first cost... unequalled economy in service.

It is today the best value ever offered in typewriter history... and that statement comes from the company that has constantly made typewriter history. Buy now. It is a real bargain offer.

Specifications...

The Model 5 includes every essential feature found in standard typewriters. It has standard 4-row keyboard, complete visibility, standard width carriage for long envelopes. Carriage return lever of exceptional design for easy and rapid opera-

tion. Margin release on the keyboard. Automatic ribbon reverse. Back spacer. Two color ribbon shift. Variable line spacer. Adjustable margin stops. Auto set Paragraph Key (one of the most useful features found on any typewriter). Weight 11 lbs., 13 oz. Furnished with Plea or Elite type.

TYPING COURSE

When you get your new Remington No. 5, you will get with it... **ABSOLUTELY FREE**... a 19-page course in typing. It teaches the Touch System, speeds up work. It is simply written and well illustrated. Instructions are easy as A.B.C. Even a child can understand this method. A little study and the average person, child or grown-up, becomes fascinated. Follow this course during the 10-DAY FREE TRIAL OFFER that we give you on your typewriter. At the end of that time, you should be able to dash off letters faster than with pen and ink.

FREE



CARRYING CASE

With every Remington No. 5, a **FREE** carrying case sturdily built of 3-ply wood. Covered with heavy DuPont fabric. Top is removed in one motion, leaving machine firmly attached to base. Can be used anywhere... on knees, in chairs, on trains.

FREE



Remington Rand Inc., Dept. 152-11 Buffalo, N. Y.

Please tell me how I can buy a new Remington Portable typewriter for only 10¢ a day. Also enclose your new catalog.

Name _____

Address _____

City _____

State _____

CLIP COUPON NOW

CHARGE YOUR RUN DOWN BATTERY IN YOUR OWN GARAGE

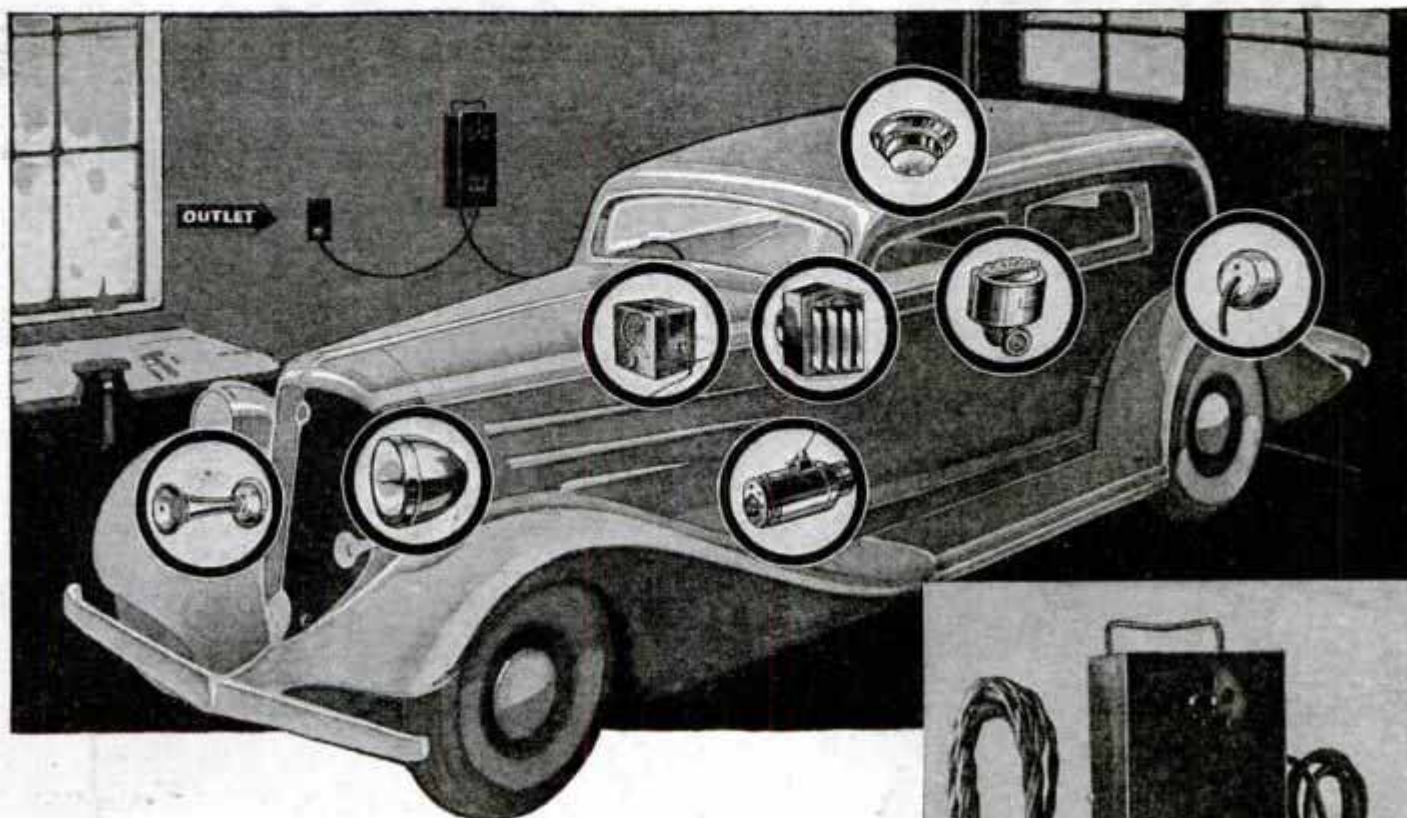

\$12.95 BUYS THIS COMPLETE HOME BATTERY CHARGER

(Prices slightly higher West of Rockies)

Look at all the electrical accessories on your car . . . headlights, horns, heater, radio, dome and dash lights, cigar lighter, tail-lights, etc. All of them contribute to your safety and pleasure while driving. Yet they all are made possible by the storage battery which furnishes the necessary power. Don't sacrifice these comforts merely because they discharge your battery.

The New Tungar Home Charger guarantees a fully charged battery at all times. It delivers a full 5-ampere charge. Like any appliance, you simply plug it into any A-c. electric outlet. No messy floorboards to handle. Wiring accessories furnished permit easy connection of Charger to battery through special outlet on steering post. For a few cents, the 5-amp. Tungar operates safely all night. Batteries are protected from over-charging and power failure. The 5-amp. Tungar prevents run-down battery troubles before they start. It assures proper operation of all the electrical accessories on your car. See your dealer or mail the coupon today for complete information.



Section A-8211, Merchandise Dept.,
General Electric Company,
Bridgeport, Conn.

Please send me complete information
on the 5-amp. Mercury Tungar Battery
Charger.

Name.....
Address.....
City.....

GENERAL ELECTRIC

AUTOMOTIVE PRODUCTS

MERCHANDISE DEPARTMENT, GENERAL ELECTRIC COMPANY, BRIDGEPORT, CONN.

"MAKE SURE THE RADIO TUBES
YOU BUY ARE REALLY NEW"

*radio's big stars
urge you ...*



"REMEMBER, FRIENDS, EVEN AN ENGINEER CAN'T TELL A NEW TUBE FROM A USED TUBE. THESE SEALED CARTONS PROTECT YOU AGAINST OLD RADIO TUBES SOLD AS NEW... AND THAT'S ONLY THE BEE-GINNIN'. IT MEANS THAT YOU FOLKS WILL HEAR OUR PROGRAMS JUST AS IF YOU WERE ABOARD THE SHOWBOAT WITH US."

Charley Winger as CAPTAIN HENRY

INSIST ON THIS SEALED CARTON

and you are sure of getting genuine
Micro-Sensitive RCA Radio Tubes

LOOK FOR THIS SIGN
in your neighborhood. It
identifies a dealer selected by
RCA to serve your radio
tube needs.



TUNE IN on Radio
City Studio Party 9 to
9:30, E.S.T., every Satur-
day night over N. B. C.
Blue network... Stars
of favorite programs.

DON'T be fooled by old worn-out radio tubes palmed off on the public as new. Ask for genuine RCA Radio Tubes that come to you in a sealed, non-refillable carton. They can be tested without removing the carton... but the carton *must be destroyed* before tube can be used.

To increase your radio pleasure, ask your nearest authorized RCA Radio Tube Agent for the new Micro-Sensitive RCA Radio Tubes.

These are the tubes guaranteed by the RCA Radiotron Company to give you these five big improvements: (1) *Quicker Start.* (2) *Quieter Operation.* (3) *Uniform Volume.* (4) *Uniform Performance.* (5) *Sealed Carton Protection.*



BE CAREFUL

Hundreds of thousands of used radio tubes are being sold as new by dishonest dealers — slipped into new open-flap cartons — so you can't tell the difference.



Cunningham
Radiotron



Popular Mechanics Magazine

H. H. WINDSOR, Founder

H. H. WINDSOR, Jr., Editor and Publisher

November, 1934

Vol. 62, No. 5

Special Features

| | |
|--|-----|
| <u>The Latest in Television</u> | 643 |
| <u>Armor for Gridiron Players</u> | 650 |
| <u>Wings over the Spanish Main</u> | 657 |
| <u>The World's Largest Eye</u> | 676 |
| <u>From Thick to Thin in Building</u> | 682 |
| <u>Cooling by Steam</u> | 690 |
| <u>Power by Radio</u> | 696 |
| <u>New Tricks of Weather Forecasting</u> | 706 |
| <u>Queer Fish of the Gulf of Mexico</u> | 714 |
| <u>The Wonders of Glass</u> | 722 |
| <u>Servicing the New Cars</u> | 728 |

(Continued on next page)

In the Land of Make Believe

NOTHING is impossible in the movies. Hollywood can turn out a picture showing actors strolling the Paris boulevards although these people may never have set foot in France. Hollywood can produce a scene depicting a hungry lion chasing a frightened monkey although the animals may never have seen each other in the flesh. Clever and ingenious tricks which defy deception have been developed by the movie industry in making the "impossible" shots you see almost daily on the screen. In the December issue are eight pages in color depicting unusual movie scenes and an article describing how they are made.

Next Month

MECHANICAL brains are coming to the aid of medical science in its ceaseless war on disease. Chattering tabulating machines have revealed the types of children most susceptible to infantile paralysis and mathematics has shown that people pass through a cycle during which they are alternately more and less susceptible to common colds. Read next month how epidemics and plagues are being fought today.

The Super-Power Age

A LITTLE more than fifty years ago, Thomas A. Edison began selling electric current to fifty-nine customers. Today, through the miracle wrought by the transformer and alternating current, we have vast power units like Niagara Falls and Boulder Dam. In the next issue is an article telling how high-voltage electrical transmission has created new wealth and new industries with even larger projects contemplated.

Want a Home?

IF you want to build a home or repair one you already own, Uncle Sam is willing to aid you. He is now helping to finance home owners in modernizing their property and soon will be ready to aid the man who wants to build. Read in the December issue how the government will help you build your own home.

Original - 695

A.S. DUESENBERG

GENIUS OF AUTO ENGINEERING

Depends on

PYROIL

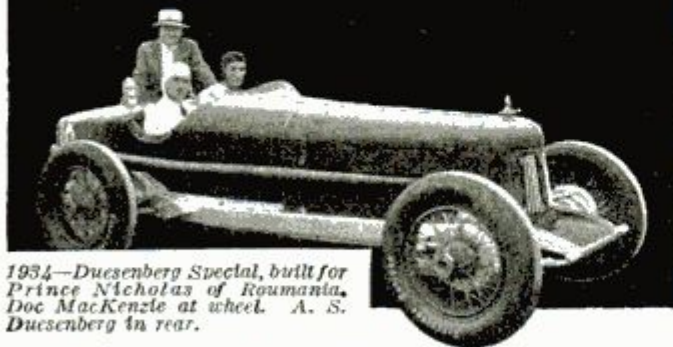

1934—Duesenberg Special, built for Prince Nicholas of Roumania. Doc MacKenzie at wheel. A. S. Duesenberg in rear.

To the automobile engineering world, the name of Duesenberg stands for genius and authority. Recently, Mr. A. S. Duesenberg built his latest and finest race car, shown above, on special order for Prince Nicholas of Roumania. Here's what Mr. Duesenberg has to say:

"For the past two years I have used Pyroil to lubricate and to assure me of bearing and motor efficiency in my race cars. Because of its performance for me, I am recommending it to Prince Nicholas in addition to sending him enough Pyroil for the racing he will do this year with the car I am shipping to him in Paris."

(Signed) A. S. DUESENBERG

Pyroil is not a substitute for regular lubricants. You simply add Pyroil by the ounce to each filling of gasoline, oil and grease. Frees valves, seals rings, banishes hard carbon. Increases power—gives you a new driving thrill! Safeguards every part of engine head, base and gears. Saves far more than its cost.

Use Pyroil regularly. Ask at your service station or garage. Or, mail coupon below. Manufactured and Guaranteed by Pyroil Company, W. V. Kidder, Pres., 511 Pyroil Bldg., LaCrosse, Wis., U. S. A.

Pyroil has been tested and proved in Popular Mechanics Laboratory and is used on printing and binding equipment in Popular Mechanics' huge Chicago publishing plant.

DISTRIBUTORS

Check square in coupon and mail for full facts of extremely desirable money-making openings available. Tremendous growing demand everywhere. (See Saturday Evening Post, Oct. 20; Country Gentleman, Nov.; Time, Oct. 22.) Don't delay.



Genuine Pyroil is protected by U. S., Canadian and foreign patents issued to W. V. Kidder, its inventor. Identified by lithographed, factory-sealed cans, bearing signature below. Not sold under any other name.

W. V. Kidder



PYROIL COMPANY,
 511 Pyroil Bldg., LaCrosse, Wis., U. S. A.
 Please send me important facts of Pyroil's economy and efficiency when used in my motor. Also, send Trial Test Offer.
 Please send Distributorship Opportunity facts.
 Name.....
 Address.....
 City..... County..... State.....

Genuine

PYROIL

LUBRICATION PROCESS

(Contents—Continued)

more on page 686

- Advertising—cardboard heads of actors, in parade...726
- Airplanes
 - "air brake," to slow down glider686
 - motor test stand on wheels710
- Architecture—models show wind resistance of skyscrapers732
- Automobiles, Accessories
 - brake and clutch lock prevents removal700
 - clothes bag on roof of car703
 - luggage rack held on top by suction719
- Automobiles, Design
 - car made from junk parts is chain-driven....710
 - steering wheel has spring post726
- Automobiles, Driving—reflectors for pedestrians warn night motorists721
- Automobiles, Manufacturing—cylinder walls measured by thickness gauge712
- Automobiles, Repairing—door hinge pin expands...705
- Automobiles, Tires—inner-tube leaks revealed by red vapor gun737
- Automobiles, Truck
 - fan inside wheel cools tire and brake drum....675
 - long, paints road stripes736
- Aviation
 - fireproof gloves added to equipment.....719
 - planes lose bearings over iron deposits679
- Bicycles—"fingerprinting" guards against theft...685
- Bicycle, Racing—camera on motorcycle films race..703
- Boats—kit adapts Model A engine for695
- Boulder Dam—rises ahead of schedule731
- Camera—movie snaps, source of income686
- Chisel—with motor, removes putty681
- Construction—factory-built house hauled by truck.679
- Crusher—giant, used for rock and ore688
- Dogs
 - catering to, becomes a business709
 - yoke for runaway705
- Electrical Apparatus
 - fuse renews itself when shaken sharply.....675
 - switch keeps heat at exact temperature737
- Etching—monograms and numbers on glass by easy method733
- Fire Fighting Devices—asbestos suit and umbrella.695
- Flies—catching contest in Tokyo705
- Flowers
 - arrangement for watering second-story window box681
 - frozen in ice molds for shipping721
- Fruit—stamper "walks" over fruit without bruising.717
- Furniture—cedar chest in foot of bed712
- Garbage—odorless truck is more sanitary731
- Gold Mining—giant dredge digs deep for ore713
- Hammer—silencer screws on733
- Hat—stamped from one piece of cloth700
- Household Devices738, 739
- Insects—fire and oil barriers used to fight674
- Insulation—made of fine sand705
- Lamp
 - fifty-pound bulb is five feet high712
 - non-glare cap for bulb713
- Lamp Shade—snowflakes used as models for720
- Lawn Roller—with spikes, improves grass733
- Lightning—thunderbolt due to breaking of raindrops688
- Lock Nut—automatic has pin to prevent loosening.737
- Metals—products of powder694
- Model Making
 - gearless transmissions for airplanes673
 - liner "Rex" modeled from postcard pictures...710
 - locomotives, wooden, built to scale673
- Monument—to army mascot erected in France ...674
- Motion Pictures
 - midget, eight-inch actors in704
 - "natural vision" latest invention701
 - traveling theater housed in trailer680
- Music—adjustable chart speeds teaching694
- Organ—photo-cell, homemade675
- Paint—glows in "black light" of ultra-violet lamp..721

Follow the Direct Road to Success

Do you want a better position and a larger pay envelope? There is just one way to win success—be head and shoulders above your fellows by gaining a broader basic education.

Mathematics is the basis of all education. Not a day passes in which you do not have to use mathematics in your work. Do you make your own calculations, or are you handicapped by your inability to do this work yourself? Here is the whole secret of success: This is why mathematics is taught in every school and college. A thorough knowledge of it makes clear so many things which are puzzling you today. Do not let another day pass without doing something to improve your knowledge of mathematics. But how can you obtain this knowledge? By going back to school or college, or taking an expensive correspondence course? You need do neither!

At Last! Mathematics Self-Taught This Simple, Easy Way!

Now you can take advantage of this easy method which has been worked out by an expert for those who do not wish to give the time and money required by other methods of mathematical study. A very simple and extremely interesting group of books has been prepared for you by a man who has devoted his life to teaching practical men the fundamentals of this important subject.

MATHEMATICS FOR SELF-STUDY

By J.E. Thompson, B.S. in E.E., A.M.
Dept. of Mathematics, Pratt Institute, Brooklyn

These books start right from the beginning with a review of arithmetic that gives you all special short-cuts and trick problems that save countless hours of your time and make you more valuable to yourself and your job. Then they go right into higher mathematics and show you how simple it is when an expert explains it for you. Don't

let appearances fool you, mathematics is *easy*. You can get these books on approval and see for yourself how much enjoyment you can have while getting this valuable training and solving interesting practical problems that puzzle your friends and fellow-workers. In no time at all you will be tackling with ease the most difficult question on this subject.

A Complete Reference Work on Mathematics in These Four Inexpensive Books

Starting from the first simple principles, these interesting books take you, by easy stages, into the detailed applications of higher mathematics. Each step is clearly explained and is followed directly by sample problems.

Arithmetic for the Practical Man
Algebra for the Practical Man
Trigonometry for the Practical Man
Calculus for the Practical Man
4 Volumes—1240 Pages—Illustrated

An Expert Gives You These Simplified Methods

Mr. Thompson, the author of these books, is not an ordinary teacher of mathematics. He has had many years' experience in giving students the kind of mathematical training they need in practical work. He presents each practical method and problem in the clearest and simplest way. He gets right down to the kind of information that you need in your daily work. Look up any mathematical problem that puzzles you in these books and see how quickly you get the solution.

SEND NO MONEY EXAMINE THESE BOOKS FOR 10 DAYS FREE



The coupon brings you the four books for 10 days' free trial and "RECREATIONS IN MATHEMATICS" free. After 10 days, return the books to us without obligation or send us the small down payment of \$1.65—balance in three monthly payments of \$2.00 each (5% discount for cash).

Free

"RECREATIONS IN MATHEMATICS"

Regular \$1.50 Book

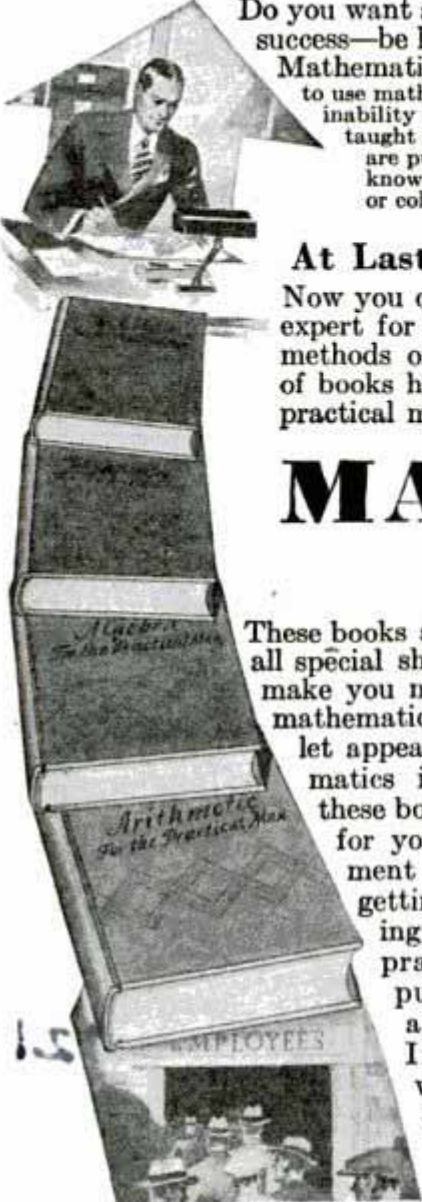
Have fun with mathematics! Whether amateur or expert, your ingenuity will be stimulated, your curiosity teased, by any of the entertaining mathematical puzzles or riddles in this book. Learn how to find the age of another person, solve the famous "Problem of the Magic Square," Kirkman's School Girl Problem, and many others. Instructive too. This \$1.50 cloth bound book given absolutely free with MATHEMATICS for SELF-STUDY.

MAIL THIS COUPON

D. Van Nostrand and Co., Inc.
250 Fourth Ave., New York

Send me on approval MATHEMATICS FOR SELF-STUDY in 4 volumes and "RECREATIONS IN MATHEMATICS" free. Within 10 days I will either return the books or send you \$1.65 as first payment and \$2.00 per month for 3 months—total \$7.65. (5% discount for cash.)
(Pop. Mech. 11-34)

Name

This One



JB2X-TKX-EU9L

Reference.....

BUILD RADIO

NEW-INEXPENSIVE TWO-WAY 5 METER PHONE for BEGINNERS

5 Meter Phone Communication opens a thrilling new Amateur radio field. Thousands are interested. Newcomers and experimenters particularly will find the 5 Meter Phone Band full of fascination. You can build your own Amateur 5 Meter Two-Way Phone at an amazingly low cost. Designed by Jones and Marsh. Kit of essential parts sells at only \$3.84. Kit complete with accessories including hand microphone, type '19 tube, and batteries, is only \$9.69. Simple to build. With complete blueprint. Equally successful as transmitter and receiver.

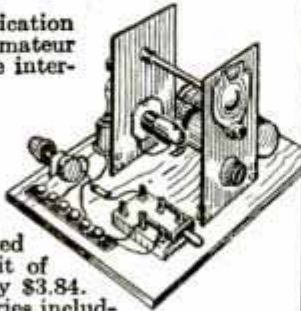

FREE 1935 RADIO CATALOG

The most complete Catalog in Radio is ready for you. Write for your FREE copy at once. Packed with the latest All-Wave and European-range Radio Receivers—Battery, 32 Volt and Electric Models—Short Wave Transmitting and Receiving Equipment—an amazing Public Address listing—Test Instruments—thousands of replacement parts and accessories—over 100 pages!

NEW SET-BUILDING KITS

Build your own Radio! The new ALLIED Catalog is packed with the latest Short Wave, Long Wave, and All-Wave Set-building Kits. We can supply you with matched Kits for building any radio circuit described in Popular Mechanics or in any other magazine or handbook. Order your kit today or send for FREE Parts Lists.

WRITE FOR YOUR CATALOG TODAY

ALLIED RADIO CORPORATION

833 W. JACKSON BLVD., CHICAGO, ILL.
Dept. K.

Send me at once:

FREE 1935 RADIO CATALOG.

Enclosed you will find \$.....for the following:

5 Meter Essential Parts. Complete Kit.

Name

Address

CityState.....

(Contents—Continued)

| | |
|--|-----|
| Paint Can—has wire mixer | 725 |
| Poster Stamps—collecting, latest fad | 725 |
| Pottery—electric kiln for home use | 680 |
| Quail—farm raises bobwhites like chickens | 718 |
| Radio—practical suggestions | 745 |
| Radio, Apparatus | |
| antenna eliminator also a wave trap | 746 |
| how to build an amplifier rack | 741 |
| low-cost power unit for cathode-ray tube..... | 744 |
| portable meter has hinged mounting | 746 |
| remote control, inexpensive easily installed..... | 746 |
| two-way five meter phone for beginners | 742 |
| Radio, Application—metal detector weighs less than ten pounds | 746 |
| Radium—aids plant growth | 685 |
| Railroads | |
| detector car finds rail flaws | 687 |
| fireless geared locomotives charged with steam..... | 740 |
| Saw—air-driven, cuts piling beneath water | 726 |
| Screwdriver—holds screw by its slotted head..... | 689 |
| Seismograph—tells weather by pulsations | 720 |
| Sewer—valve stops water from entering basement..... | 736 |
| Ships | |
| “blind” steered with radio beacons | 720 |
| stops propeller “shake” with jumping weights..... | 721 |
| two rudders enable boat to turn quickly | 711 |
| Show Card—lettering guide makes printing easy... .. | 740 |
| Steamship—giant British dwarfs large buildings... .. | 727 |
| Stool—fireside, made from old tires | 740 |
| Telephone—users see each other by television | 689 |
| Tennis Racket—stringer easy to operate | 719 |
| Tool—boring bar made adjustable | 717 |
| Traffic Signal—time beam warns of light changes .. | 732 |
| Treasure Finders—gold hunters use latest scientific aids | 688 |
| Ventilator—portable, removes fumes | 681 |
| Violins—“aged” artificially with silk linings | 702 |
| Warfare—“invisible dust” curtain to halt planes... .. | 693 |
| Washing Machines—“mark time” switch protects clothes | 685 |
| Window—automatic closer works when it rains..... | 694 |
| Yacht, Racing—British challenger has all-steel hull..... | 734 |

Reflector

AMATEUR MECHANICS

| | |
|--|-----|
| Automobiles, Repairing—checking spring tension on breaker arm of distributor points | 753 |
| Bed Springs—sprayed with oil eliminates squeaks .. | 750 |
| Bleacher Seats—back rest for | 764 |
| Calling Cards—photographic | 749 |
| Clothespins—spring-type every day uses for | 774 |
| Clothes Stick—rubber cup prevents scalded hands..... | 780 |
| Drill Press—iron rods pointed with | 770 |
| Eggs—testing for freshness | 773 |
| Electrical Apparatus—protection against shocks from motor-driven machines | 765 |
| Faucet—altering handles, makes easy to operate... .. | 759 |
| Fishing—line dried on rod | 780 |
| Flatiron—how to retain heat | 778 |
| Furnace | |
| ash can under floor prevents dust..... | 775 |
| old tire keeps baby from hot-air register..... | 752 |
| Furniture | |
| novel English chair | 751 |
| sea-go-in’ desk set, a | 772 |
| Glove Holder—mouse trap used as a | 759 |
| Grease Gun—improvised, small | 779 |
| Hose—hydrometer nozzle for small powerful stream..... | 780 |
| Hunting—sunken duck blind permits quick action... .. | 771 |
| Jig Saw—C-clamp holds tension rod while chang- ing blades | 775 |
| Juice Extractor—made from aluminum tube | 764 |
| Kettle—holes in side aid in draining cooked food... .. | 758 |
| Knife—fuller ball protects fingers from blade | 750 |
| Laundry—container on side of tub | 770 |
| Lighting Fixtures—wall and ceiling in modern style..... | 753 |
| Linoleum Blocks—gouges for carving from pen points | 780 |

(Continued to page 8A)

MONEY—\$\$\$—what will YOU do for it?

Have you—like most men—said to yourself at one time or another—

“I’d do almost anything for money”?
And did you really mean what you said—
—are you ready to back word with action?

If so—read on. If not—turn the page.

IF you want something out of life, you’ve got to pay for it—in one way or another.

Money—business success—prestige—position—these things don’t come for a wish—you have to pay for them.

To earn more—you must learn more—know more—be able to do more.

Your spare time—spent in training—under the LaSalle Problem Method—is a short cut to this larger ability.

But even this short cut requires its price—calls for initiative, ambition, extra effort. Consequently, the many pass it by—continue vainly to hope for luck or pull or “something” to bring their desired success.

But the few who are really in earnest—and there have been more than three-quarters of a million of them in the twenty-four years of LaSalle’s history—find in LaSalle training their pathway to promotion, to a business of their own, to prestige, to money.

Take, just for example, these four cases:

IN 1924, a Bookkeeper— IN 1927, Vice-President

Mr. A—— of Indiana was marking time in a bookkeeper’s job back in 1924—after a fine war service and various attempts to find himself in farming, in managing a truck line, and in other jobs. With his enrollment in LaSalle came the change upward.

First he became office manager of a cannery firm, then entered the automobile field, and in 1927 became vice-president of one of the large automobile sales agencies of the Middle West. He says, “Spare time invested in study with LaSalle pays compound interest.”

GETS the Last Laugh!

“Mr. C. P. A.”—that’s what the boys at the bank jokingly called Fred Williams when he enrolled with LaSalle. The idea of a 21-year-old trying to learn—*by home study*—a branch of business as specialized and highly paid as Higher Accounting!

But Williams got the last laugh. Not only did he pass the C. P. A. examination—but today, just nine years later—he is head of his own Chattanooga firm, and clearing—on the average—\$9,000 a year. The men who once laughed at his ambition are coming to him for jobs.

Mr. Williams writes: “Your representative told me when I enrolled that I would receive \$50 for each hour of study, but I have far exceeded that figure a number of times.”

CLIMBS Out of 20-Year Rut—

The future looked bright when Arthur Griffin—“just a kid”

—went to work as a railroad clerk twenty years ago. A year passed—then another—and another—and, to his horror—he gradually realized that he was caught in a rut, with his best years almost gone. Perhaps you know how helpless he felt.

Courageously, this Washington, D. C. man looked the facts in the face—saw that while faithful service often goes unrewarded, the man who *makes* himself more valuable always gets higher pay and promotion. He invested his spare time in Traffic Management training.

Today he writes, “My recent appointment as a tariff examiner with the Interstate Commerce Commission is due to LaSalle . . . My progress started as I studied with you, and now I am not only in a position that pays a much greater salary (100% greater) than I was getting, but my future looks bright.”

FROM \$12.00 a Week to \$6,000 a Year!

Bachman wanted to get into Law but his chances looked mighty slim. Nothing better than an average education behind him—a family to support on \$12 a week—no money, no time and no law school within hundreds of miles of his home!

It looked impossible—yet today E. A. Bachman is a successful lawyer in Chattanooga, Tennessee, and his income tax reports show earnings as high as \$6,000 a year.

No wonder that today he writes, “It is due to LaSalle training that I hold my present position. I certainly can recommend your law training to anyone. It is as thorough as any resident course.”

TWO FREE BOOKS

Tell You How to Get Money

We could go on and on—through hundreds of similar cases of LaSalle members who wanted success, and got it.

But you have had enough proof. What is needed now is—*action*.

Two books will give you all the facts you need to start—one, a 64-page book outlining the requirements and opportunities in the business field that most appeals to you; the other, “Ten Years’ Promotion in One.” LaSalle will send them both to you free.

If you really mean what you say when you tell yourself that you want more money—fill in, clip and mail the coupon NOW.

LaSalle Extension University

THE WORLD’S LARGEST BUSINESS TRAINING INSTITUTION

----- Find Yourself Through LaSalle! -----

LA SALLE EXTENSION UNIVERSITY, Dept. 1164-R, CHICAGO

I would welcome your booklet on the business field I have checked, together with a copy of “Ten Years’ Promotion in One,” all without obligation.

- | | | |
|---|--|---|
| <input type="checkbox"/> Business Management | <input type="checkbox"/> Chain Food Store Management | <input type="checkbox"/> Credit and Collection Correspondence |
| <input type="checkbox"/> Higher Accountancy | <input type="checkbox"/> Paper Salesman’s Training | <input type="checkbox"/> Business English |
| <input type="checkbox"/> Expert Bookkeeping | <input type="checkbox"/> Law: LL. B. Degree | <input type="checkbox"/> Commercial Law |
| <input type="checkbox"/> C. P. A. Coaching | <input type="checkbox"/> Industrial Management | <input type="checkbox"/> Effective Speaking |
| <input type="checkbox"/> Modern Salesmanship | <input type="checkbox"/> Modern Foremanship | <input type="checkbox"/> Commercial Spanish |
| <input type="checkbox"/> Traffic Management | <input type="checkbox"/> Personnel Management | <input type="checkbox"/> Telegraphy—Railway and Commercial |
| <input type="checkbox"/> Railway Station Management | <input type="checkbox"/> Banking and Finance | |
| <input type="checkbox"/> Modern Business Correspondence | <input type="checkbox"/> Railway Accounting | |

Name

Address..... Present Position.....



(Contents—Continued)

Thousands are Amazed
OVER *Marvelous Results*
 with **LOW PRICED AIR CONDITIONER**

SAVES
25% of COAL BILLS
 BY ADDING MOISTURE
 TO THE AIR

CAPLAIR
 2 Gal. Capacity



**10 DAYS
 FREE
 TRIAL**

Wonderful Invention

NEW PATENTED PRINCIPLE

Perhaps no invention in years has accomplished so much as CAPLAIR. Efficiency and Low Price makes it practical for quick sale and in line with a necessity for any home. The public are air condition minded. They know what it means to their health. But the startling advantage that wins public favor is it actually saves coal bills.

Needed in Every Home

Easily fits any radiator and once in the home every member of the family enjoys better health. Freedom from colds. Hot Dry Air cuts down our resistance. CAPLAIR gives nature a chance to safeguard the nose and throat and ward off respiratory diseases. The scientific features of CAPLAIR are covered by patents and are not found in any other device of its kind. CAPLAIR is Automatic, it evaporates the proper amount of moisture according to the heat in the radiator. Simply add water.

WATER EVAPORATION IS ESSENTIAL

Better Health — Freedom from Colds

The winter months are long months and you need heat but you need humidity with the heat or you suffer the consequences because hot dry air seeks moisture and gets it and each living object in the room is a victim. Water evaporation is necessary. Your health demands it! Beneficial to the system! Nature provides a body temperature of 98.6° F. When the body temperature rises it arouses the nervous system. Maintain uniform body and room temperature with humidified air.

BIG FIELD! BIG DEMAND!

No matter what you have ever sold or if you never sold anything before. This is your big chance. Even beginners can make Big Money. There is no secret about the profits you make, even spare time pays big. The only way you can limit your profit is to limit your calls each day. CAPLAIR will sell itself if you give it the opportunity. Territory is going fast but the field is big! Every home is interested in health protection and sales come easy, the demand is enormous. If you are interested in making real money don't delay. ACT TODAY!

The CAPLAIR Maintains Humidity At Proper Health and Comfort Levels

It is easy to understand why CAPLAIR is so effective to GOOD HEALTH in the home. It adds proper moisture to the air you breathe according to the heat in the room. Thus you can avoid the opening and closing of doors and wasting of heat. Respiratory diseases are common during the heating months. No one is immune! Protect the health of the family. Let CAPLAIR add the proper humidity.

BE THE FIRST IN YOUR LOCALITY

MONEY BACK GUARANTEE

MAIL THIS COUPON TODAY
for AMAZING 10 DAY TRIAL OFFER

LONDON & WARNER, Dept. K24
 360 N. Michigan Ave., Chicago, Ill.

Cheek Radiator Thickness
 6 7 8 9 10 11 inches

Gentlemen:

Send me one CAPLAIR Air Conditioner, postage PREPAID. I will try it for 10 days under terms of my Money-Back if not satisfied.

\$4.65 enclosed.

Send C. O. D. \$4.65.

Name.....

Street.....

City.....

State.....

P. S.—You save money by ordering 2 CAPLAIRS for \$9.00.

| | |
|--|-----|
| Liquids—spout helps to pour | 752 |
| Locks—eccentric, for your garage doors | 765 |
| Masquerades—something new in halloween costumes | 766 |
| Microscope—exploring with a | 761 |
| Model Making | |
| building a model of "Roamer" | 754 |
| ideas for model-railroad fan | 776 |
| Motion Pictures | |
| reel for developing film | 750 |
| screen folds into wood case | 779 |
| Painting—aid in drying small articles | 774 |
| Pastry | |
| rubber bands gauge thickness of pie crusts | 764 |
| rubber on corners of board prevents it from slipping | 764 |
| Photography | |
| how to prepare ground glass for fine focusing | 750 |
| rubber band holds tripod steady | 760 |
| Picture Frame—brads driven in with pliers | 752 |
| Rifle—cleaning barrel | 759 |
| Scales—balance, made from scrap parts | 759 |
| Sifter—rolling, for ashes on icy sidewalk | 779 |
| Sign—illuminated by light from cars | 770 |
| Soldering—lead pencil aids in | 760 |
| Soldering Iron—using electric-heater element to heat a | 752 |
| Spindles, Wood—lathe set-up for turning small | 780 |
| Thermos Bottle—cool grip on hot cup | 748 |
| Tinfoil—locks common pin in place | 770 |
| Toys—kicking hobby horse, a | 747 |
| Upholstery—re-webbing chairs | 775 |
| Vise—bench, improvised from woodworkers' clamps | 769 |
| Window Sash—shade tassel hides wedge used to quiet | 769 |

SHOP NOTES

| | |
|--|-----|
| Automobiles, Repairing—installing crankcase gaskets | 800 |
| Aviation—hinged pipe mast for wind sock | 786 |
| Barrel—feed, sections of tire hold lid | 786 |
| Creeper—padded, on casters protects knees | 786 |
| Drafting—finger holes make rule easy to manipulate | 799 |
| Heat Treating—brass, copper and aluminum | 781 |
| Ink—how to dry quickly | 798 |
| Lathe, Wood—adapted to turning work of small diameter | 799 |
| Live Stock—fly repellents for | 793 |
| Lock Washer—helps hold set screws | 792 |
| Milling Machine—vise setup holds work rigidly in | 792 |
| Motorcycle—shield protects rocker-arm bearings on | 799 |
| Motors, Electric—rewinding | 794 |
| Oilstones—both sides exposed in box | 790 |
| Oxyacetylene Torch—making smooth cut in metal | 799 |
| Photography—print straightener from old wringer | 785 |
| Plaster—loose, anchored without nails or screws | 793 |
| Poultry | |
| arm band on bucket aids feeding chickens | 792 |
| humane method of transporting | 793 |
| Printing—keeping press ink warm in winter | 800 |
| Punch Press—straightening short shafts in | 798 |
| Rafters—erecting single-handed | 784 |
| Rope—whipping ends to prevent unraveling | 785 |
| Saw—stationary guide for cutting angles | 791 |
| Show Card—thumb tack on lettering brush helps preserve chisel edge | 784 |
| Sign—swinging, danger, warns motorists | 784 |
| Tank, Water—fermenting straw keeps water from freezing | 791 |
| Tools | |
| doing it safely | 787 |
| how to test edge of | 784 |
| polisher made from spool | 786 |
| Trees—birch, serve as danger signs at intersections | 799 |
| Water Trap—for steam or air lines | 792 |
| Whiting—sifted, makes good powder for polishing | 790 |
| Woodworkers'—bar clamp, made from scrap parts | 793 |
| Yardstick—handle helps when wearing gloves | 784 |



You hear it on all sides, this eternal demand for money. The butcher, the baker, the candlestick maker—*money, money, money!*

When the bills pour in and you stack them alongside your pay envelope—honestly, don't you have a sense of futility? Don't you wish you had a job that paid more money?

Well, the only way to get *that* job is to fit

yourself for it—to acquire *training* that you can convert into cash.

And you can do it! Thousands have done it. They have found the answer to their problems in spare-time study of International Correspondence Schools Courses. Perhaps modern training is the thing you need most. This coupon will bring you complete information—free.

INTERNATIONAL CORRESPONDENCE SCHOOLS

"The Universal University"

BOX 5532-H, SCRANTON, PENNA.



Without cost or obligation, please send me a copy of your booklet, "Who Wins and Why," and full particulars about the subject *before* which I have marked X:



TECHNICAL AND INDUSTRIAL COURSES

- | | | | | | |
|--|--|--|--|--|---|
| <input type="checkbox"/> Architect | <input type="checkbox"/> Telegraph Engineer | <input type="checkbox"/> Plumbing | <input type="checkbox"/> Steam Fitting | <input type="checkbox"/> Air Brakes | <input type="checkbox"/> R. R. Signalman |
| <input type="checkbox"/> Architectural Draftsman | <input type="checkbox"/> Telephone Work | <input type="checkbox"/> Heating | <input type="checkbox"/> Ventilation | <input type="checkbox"/> Highway Engineering | <input type="checkbox"/> Chemistry |
| <input type="checkbox"/> Building Estimating | <input type="checkbox"/> Mechanical Engineer | <input type="checkbox"/> Sheet Metal Worker | <input type="checkbox"/> Steam Engineer | <input type="checkbox"/> Coal Mining Engineer | <input type="checkbox"/> Navigation |
| <input type="checkbox"/> Wood Millworking | <input type="checkbox"/> Mechanical Draftsman | <input type="checkbox"/> Steam Electric Engineer | <input type="checkbox"/> Civil Engineer | <input type="checkbox"/> Air Conditioning | <input type="checkbox"/> Boilermaker |
| <input type="checkbox"/> Contractor and Builder | <input type="checkbox"/> Machinist | <input type="checkbox"/> Surveying and Mapping | <input type="checkbox"/> Refrigeration | <input type="checkbox"/> Textile Overseer or Supt. | <input type="checkbox"/> Cotton Manufacturing |
| <input type="checkbox"/> Structural Draftsman | <input type="checkbox"/> Pattermaker | <input type="checkbox"/> R. R. Locomotives | <input type="checkbox"/> R. R. Section Foreman | <input type="checkbox"/> Woolen Manufacturing | <input type="checkbox"/> Agriculture |
| <input type="checkbox"/> Structural Engineer | <input type="checkbox"/> Heat Treatment of Metals | <input type="checkbox"/> R. R. Bridge and Building Foreman | <input type="checkbox"/> R. R. Bridge and Building Foreman | <input type="checkbox"/> Fruit Growing | <input type="checkbox"/> Poultry Farming |
| <input type="checkbox"/> Inventing and Patenting | <input type="checkbox"/> Bridge Engineer | | | <input type="checkbox"/> Radio | <input type="checkbox"/> Marine Engineer |
| <input type="checkbox"/> Electrical Engineer | <input type="checkbox"/> Bridge and Building Foreman | | | | |
| <input type="checkbox"/> Electric Lighting | <input type="checkbox"/> Gas Engines | | | | |
| <input type="checkbox"/> Welding, Electric and Gas | <input type="checkbox"/> Diesel Engines | | | | |
| <input type="checkbox"/> Reading Shop Blueprints | <input type="checkbox"/> Aviation Engines | | | | |
| | <input type="checkbox"/> Automobile Mechanic | | | | |

BUSINESS TRAINING COURSES

- | | | | |
|--|---|---|--|
| <input type="checkbox"/> Business Management | <input type="checkbox"/> C. P. Accountant | <input type="checkbox"/> Service Station Salesmanship | <input type="checkbox"/> Railway Mail Clerk |
| <input type="checkbox"/> Office Management | <input type="checkbox"/> Bookkeeping | <input type="checkbox"/> First Year College | <input type="checkbox"/> Grade School Subjects |
| <input type="checkbox"/> Industrial Management | <input type="checkbox"/> Secretarial Work | <input type="checkbox"/> Business Correspondence | <input type="checkbox"/> High School Subjects |
| <input type="checkbox"/> Traffic Management | <input type="checkbox"/> Spanish | <input type="checkbox"/> Lettering Show Cards | <input type="checkbox"/> College Preparatory |
| <input type="checkbox"/> Accountancy | <input type="checkbox"/> French | <input type="checkbox"/> Stenography and Typing | <input type="checkbox"/> Illustrating |
| <input type="checkbox"/> Cost Accountant | <input type="checkbox"/> Salesmanship | <input type="checkbox"/> Civil Service | <input type="checkbox"/> Cartooning |
| | <input type="checkbox"/> Advertising | <input type="checkbox"/> Mail Carrier | |

Name.....Age.....Address.....

City.....State.....Occupation.....

If you reside in Canada, send this coupon to the International Correspondence Schools Canadian, Limited, Montreal, Canada



I WISH I WAS A
STAR SALESMAN
LIKE YOU - BUT I
HAVEN'T THE COURAGE
TO TRY IT!

NONSENSE!
I MADE GOOD
FROM THE START
SO CAN YOU..
LISTEN....

"I USED TO THINK SELLING WAS HARD Until N.S.T.A. Showed Me How!"

"THREE years ago Jim, I was just like you. No future in the job I had. Like you, I knew that the big money is made by salesmen. But I didn't dream I could ever become one until I learned about the National Salesmen's Training Association. Now you see what this training has done for me. They took me absolutely "green" as far as selling was concerned, and gave me my start. They made me one of the best salesmen the firm has. Training is all you need. With it, you won't find selling hard. It's really easy and you'll make the kind of money you want."

Remarkable Book Now FREE

Thousands of men are thanking their lucky stars that they had National Salesmen's training to help them through the last few difficult years. They came through with flying colors; many report the biggest incomes of their lives now.

If your future looks gloomy—if you're tired of waiting for things to come back in your old line—find out what N. S. T. A. can do for you. Don't turn your back on selling opportunities because you've heard others talk about "born salesmen." A postal or your name and address on the margin of this page will bring you full particulars of N. S. T. A. training and free employment service; also a Free copy of "The Key to Master Salesmanship." Write today!

National Salesmen's Training Association
Dept. 5-107, 21 W. Elm St., Chicago, Ill.

Play the Hawaiian Guitar like the Hawaiians!

FAMOUS NATIVE HAWAIIAN INSTRUCTORS teach you to play this fascinating instrument. ONLY 4 MOTIONS—No previous musical knowledge needed. OUR 52 EASY LESSONS teach you the enchanting music you hear over the radio.

GIVEN—when you enroll
—a sweet toned
HAWAIIAN GUITAR, complete
playing outfit
and carrying
case.

WRITE AT ONCE for attractive offer and easy terms.



FIRST HAWAIIAN CONSERVATORY OF MUSIC, Inc.
8th Floor, Woolworth Bldg. Dept. 250 New York, N. Y.
Approved by New York State Board of Regents

When writing please mention Popular Mechanics

BE SENSIBLE

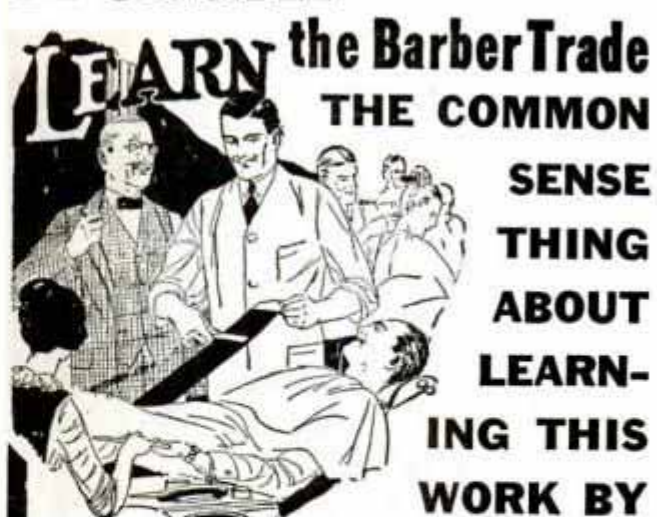

LEARN the Barber Trade
THE COMMON
SENSE
THING
ABOUT
LEARN-
ING THIS
WORK BY

Moler's New Plan Is The Absolute Assurance of Success

The Barber Code has made a wonderful business of this industry.

Guaranteed salaries and shorter hours. Can earn living while learning. Booklet B, proposition.

Write the Branch nearest for Booklet B, explaining the MOLER SPECIAL HALF RATE THIS MONTH.

NEW YORK, N. Y.
ST. LOUIS, MO.
ATLANTA, GA.
MEMPHIS, TENN.

CHICAGO, ILL.
CLEVELAND, OHIO
CINCINNATI, OHIO
MILWAUKEE, WIS.

MOLER SYSTEM OF COLLEGES
A National Institution

Electrical Refrigeration



Big new field — one of few that prospered during depression — offers well-paid jobs with a future to men trained in selling, installing, and servicing. Thousands of new units being sold and installed in homes, stores, offices, plants, etc. Home study will fit you for good job in 6 to 12 months. Employment service included. Send TODAY for Free Bulletin. No obligation.

American School, Dept. ER845, Drexel at 58th, Chicago

RADIO ENGINEERING

RCA Institutes offers a combined course of high standard embracing all phases of Radio. Practical training with modern equipment at New York and Chicago schools. Also specialized courses and Home Study Courses under new "No obligation" plan.

Illustrated Catalog on request.

RCA INSTITUTES, INC. Dept. PC-34
75 Varick St., New York 1154 Merchandise Mart, Chicago
Recognized Standard in Radio Instruction Since 1909



Learn to Write

Begin Today. Write for my Free Book, "How to Become a Good Penman." It contains specimens and tells how others learned to write in spare time. Your name elegantly written on a card if you enclose stamp for postage. Write today. F. W. TAMBLYN, 418 Ridge Bldg., Kansas City, Mo.

LEARN WATCH REPAIRING



AT HOME You can learn by our modern and original system of instruction every part of the Watch Repairing Trade at home as good or better than at a shop. You can earn money while earning and secure a well paying position or start in business after completing our course of instruction. Good watch repairers are always in demand and earn very good salaries. For particulars apply to the Wisconsin School of Watch Repairing 524 E. Mason St., MILWAUKEE, WIS.

Train In Only 12 Weeks for ELECTRICITY in the Big Chicago Coyne Shops

Do actual work on Electrical equipment worth many thousands of dollars to qualify yourself for a big pay job. Learn to wind armatures, be an illumination expert, do signal engineering, be a power plant or substation operator, or prepare for other big-pay electrical jobs. All under individual instruction and on the sort of work you will meet out in the field on a real job.

All Actual Shop Work

The remarkable "Learn By Doing" method used in the great Coyne Shops train you to master Electricity and its many branches in 12 weeks. Actual shop work—not a correspondence course—you don't have to recite. Instead you are trained by actual work in wonderful, modern daylight shops on the finest kind of Electrical equipment, under personal supervision of expert instructors. That's why Coyne Training prepares you as a real Electrical Expert in such a short time.

You Need No Previous Experience or Higher Education to Succeed

If you understand simple English you can be trained the Coyne way—by actual experience on a wide variety of up-to-date generators, motors, dynamos, batteries, automotive and aviation engines, electric signs, etc. Do the actual jobs you will be called on to do out in the field. When you finish Coyne Training you can confidently tackle any job, for you will have actually had similar work during your training.

On Jobs Like These—No Correspondence
Real Work on Modern Electrical Equipment

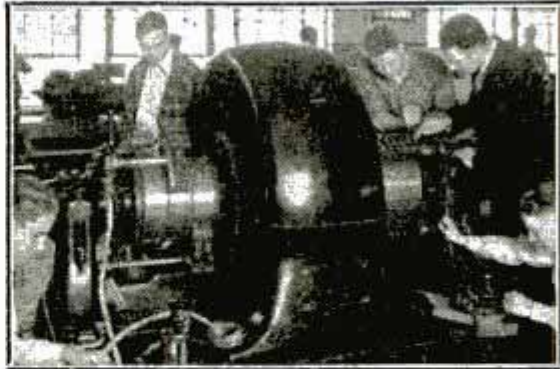

Working on Real Electrical Equipment at Coyne

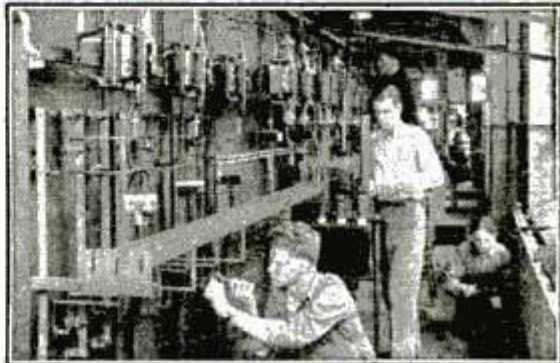

A Real Switchboard in the Coyne Shops

ASTOUNDING Offer! PAY COST OF TRAINING AFTER YOU GRADUATE Over a Year to Pay in Small Monthly Payments

NO RED TAPE—NO STRINGS TO MY OFFER—YOU RUN NO RISK! I'LL TRAIN YOU IN MY SHOPS FOR 90 DAYS—YOU GET OVER ONE YEAR TO PAY TUITION AFTER GRADUATION! Make your first payment 60 days after your 12 weeks Training period and then take over a year to pay the balance in small monthly payments.

Your earnings on the job as a Coyne Trained Graduate should make it easy. I'm willing to back you in this way because hundreds of my successful graduates have proved to me that the fellow who wants to improve himself and his conditions is the finest credit risk in the world.

Earn Living Expenses While You're Training!

Many of my students work part time to help pay their living expenses while they are training. My Employment Department will also assist you to find a spare time job to cover a good part of your room and board expenses.

Employment Help For You After Graduation

My Graduate Employment Service will give you real employment help. As one of my graduates you will get assistance quickly, and every help we can give you to locate a job for which you have been trained.

ELECTRIC REFRIGERATION AIR CONDITIONING

Included without Extra Cost

The fastest growing industries in America today. Manufacturers and Distributors of Refrigeration and Air Conditioning equipment need Trained men who have Specialized in these rapidly expanding fields.



Here at Coyne you will prepare to fill a job as Installation and Service man, Shop Mechanic, Tester, Assembler, Inspector, etc. You will learn about various types of compressors, condensers, temperature control devices, thermostatic and expansion valves—you will do actual work on latest types of Refrigerating and Air Conditioning machines. And, it won't cost you one extra cent to get this remarkable training. I include it absolutely Free with your regular Electrical Training.

Get This FREE BOOK

Get the new "Coyne Opportunity Book," giving all facts about Coyne Training. Photographs of Shops showing students at work on modern electric equipment under the personal supervision of Coyne Expert Instructors. Also details of my Spare Time Employment Offer, Pay After Graduation Plan and Graduate Employment Service. Yours without cost. Simply Mail the coupon.



MAIL Coupon NOW!

H. C. Lewis, President
Coyne Electrical School, Dept. 84-72
500 S. Paulina St., Chicago, Ill.

Send me your big FREE Book about Coyne Training and give me all details regarding your "Spare Time Employment Offer" and "Pay After Graduation Plan" of easy, monthly payments.

NAME.....
ADDRESS.....
CITY.....STATE.....

H. C. LEWIS, Pres. Founded 1899
COYNE ELECTRICAL SCHOOL
500 S. Paulina St., Dept. 84-72, Chicago, Ill.

BE A

MANY

I'll train you

If you are dissatisfied with your present job—if you are struggling along in a rut with little or no prospect of anything better than a skinny pay envelope—**Clip and Mail the Coupon NOW!** Get my big 64-page **FREE BOOK** on the opportunities in Radio. Read how quickly you can learn at home in your spare time to be a Radio Expert—what good jobs my graduates have been getting—real jobs with real futures.

Real Opportunities Ahead in Radio for Trained Men

It's hard to find a field with more opportunities awaiting the trained man. Why in 1933—one of the worst depression years—the Radio industry sold \$213,000,000 worth of sets and parts! Radio set sales **INCREASED 45%**—tube sales **INCREASED 25%**! Over 300,000 people worked in the industry! It's a gigantic business, even in the worst business years. And look what's ahead! Millions of sets are going out of date annually. 18,000,000 sets are now in operation on which over \$200,000,000 are spent **EACH YEAR** for repairs, servicing, new tubes, etc. Broadcasting stations pay their employees (exclusive of artists) approximately \$23,000,000 a year. Advertisers pay 600 great Broadcasting Stations over \$75,000,000 a year for Radio time and talent. A few hundred jobs that paid \$40, \$60, \$75 a week 20 years ago have grown to thousands. These figures are so big that they're hard to grasp. Yet they're all **TRUE!** Here's a new industry that has grown to be a commercial giant! No wonder great business leaders predict a brilliant future for the great and growing Radio industry.



J. E. SMITH
President National Radio Institute
The man who has directed the Home Study Training of more men for the Radio industry than any other man in America.

Broadcasting Stations

Employ managers, engineers, operators, installation and maintenance men for jobs paying up to \$5,000 a year.

Loud Speaker Apparatus

Installation and service work is another growing, money-making field for trained Radio men.

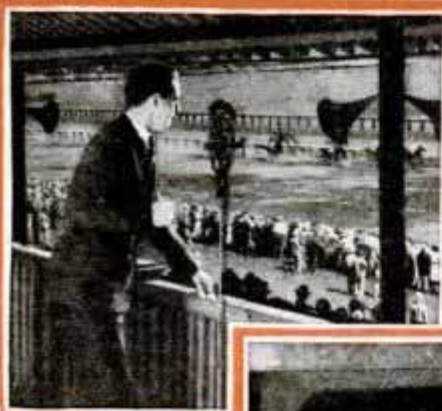

Set Servicing

Spare time set servicing pays many N. E. L. men \$5, \$10, \$15 a week extra. Full time men make as much as \$40, \$60, \$75 a week.



Sample Lesson FREE

Take advantage of this offer. Mail the coupon *Right Now*, and I'll send you **FREE** a Sample Lesson that only my students have received in the past. This fascinating book, "A Bird's-Eye View of Radio," is just packed and jammed with information about this growing industry. The reason I am willing to send it to you is to **PROVE** that my Course is simple, easy to understand, and enjoyable to study. I want to **SHOW YOU** that I can train you, just as I have **ALREADY** trained thousands of men. Many of them with not even a grammar school education, and no Radio or technical experience, have become Radio experts, and now earn two or three times their former pay. Mail the coupon **NOW**.



Some Other Jobs N.R.I. Trains Men For

- Radio Service Business of my own
- Spare-time Radio Service work
- Retail Sales of Radio Sets and Equipment
- Service Expert for Retail Stores
- Broadcasting Station Operator
- Aircraft Radio Operator
- Ship Radio Operator
- Loud Speaker Systems, Installation and Service
- Auto-Radio Installation and Service
- Television Station Operator
- Commercial Radio Station Operator

You Get PRACTICAL EXPERIENCE with RADIO EQUIPMENT I GIVE YOU



I'll show you how to use my special Radio Equipment for conducting experiments and building circuits used in such well-known sets as Westinghouse, General Electric, Philco, R. C. A.-Victor, Majestic and others. You work out with your own hands many of the things you read in our lesson books. This 50-

method of training makes learning at home easy, interesting, fascinating, intensely practical. You learn how sets work, why they work and how to make them work.

RADIO EXPERT

MAKE \$40 \$60 \$75 A WEEK

at home • Mail coupon for **FREE PROOF**

Get Into This Field With a Future

There's opportunity for you in Radio. Its future is certain. Television, short wave, police Radio, automobile Radio, loud speaker systems, aviation Radio, marine Radio—in every branch developments and improvements are taking place. Here is a real future for additional thousands of trained men who really know Radio. Get the Training that opens the road to good pay and success! Send me the Coupon NOW—and get full particulars on how easy and interesting I make learning at home. Read the letters from graduates who are today earning real money in this fascinating industry.

Learn At Home In Your Spare Time To Be a Radio Expert

Hold your job. There is no need for you to leave home. I will train you quickly and inexpensively in your spare time. You don't have to be a high school or college graduate. My Course is written in a clear, interesting style that most anyone can grasp. I give you practical experience under my 50-50 method of Training—one half from Lesson Books and one half from practical experience with equipment I give you. This unique and unequalled method has been called one of the greatest developments in home study Radio training.

Many Make \$5, \$10, \$15 a Week Extra in Spare Time While Learning

My big 64-page book gives proof that many make \$5, \$10, \$15 a week extra servicing sets in their spare time soon after enrolling. I give you plans and ideas that have made good spare time money—\$200 to \$1,000 a



year—for hundreds of fellows. My Course is famous as "the one that pays for itself."

Money Back If Not Satisfied

I am so sure that N. R. I. can train you at home satisfactorily that I will agree in writing to refund every penny of your tuition if you are not satisfied with my Lesson and Instruction Service upon completing your Course. You'll get a copy of this agreement with my Book.

64-Page Book of Information Free

Get your copy TODAY. It's free to any ambitious fellow over 15 years old. It tells you about Radio's spare time and full time job opportunities; it tells you about my Course; what others who have taken it are doing and making. Find out what Radio OFFERS YOU—without the slightest obligation. MAIL THE COUPON in an envelope, or paste it on a penny postcard NOW.

**J. E. SMITH, President
NATIONAL RADIO INSTITUTE
Dept. 4MP, Washington, D. C.**



Clears \$4,500 In 18 Months

"Before taking your Radio Course I was making \$18 a week. I came here three years ago. In about 18 months I made about \$4,500 in Radio. I cannot say too much for the wonderful help I have received from N. R. I."—NOEL W. RAY, 619 Broad St., Gadsden, Alabama.



Spare Time Work Pays \$18 A Week

"I do only spare time Radio work and average \$18 a week. People who in good times would buy a new Radio, now have the old one fixed."—STEPHEN J. DRAPCHATY, 407 Wunderlich Avenue, Barberton, Ohio.



Now Owns Own Business

"If I had not taken your Course I would be digging ditches instead of running my own business. One week I made \$75 on repairing alone, and this doesn't count sales. If a fellow wants to get into Radio, N. R. I. is the starting point."—R. S. LEWIS, Modern Radio Service, Pittsfield, Ohio.



Mail Now for FREE 64 Page Book

**J. E. SMITH, President
National Radio Institute, Dept. 4MP
Washington, D. C.**

Dear Mr. Smith: Without obligation send me the Sample Lesson and your free book about spare time and full time Radio opportunities, and how I can train for them at home in spare time.

(Please print plainly)

R

NAME.....AGE.....

ADDRESS.....

CITY.....STATE.....

For MORE PAY Learn DRAFTING FROM AN ENGINEER

Learn by mail at home

Prosperity is coming. Be prepared for a bigger, better job. Get the training now.



These TOOLS and Other EQUIPMENT Given When You Start



"I will train you by mail,"
Engineer Dobe

WRITE for valuable book, "Success in Draftsmanship"—free. See coupon below.

I'LL TRAIN a number of selected students as practical Draftsmen. Yes, I furnish you all tools and a drawing table. And I'll teach you in a surprisingly short time by mail in your spare time until you actually have a desirable draftsman's job so that you are fully satisfied.

Trained men needed now; jobs pay \$50 a week or more; be prepared!

Keep the job you have now while training. I'll tell you how to start earning extra money a few weeks after beginning my training. Get started now. Send coupon.

Jobs Open NOW!

After training you I help you to a job without charging you a cent for this service. For 30 years employers of Draftsmen have been writing me when they want help.

- Aviation
- Electricity
- Machinery
- Auto Work
- Building Work

All these industries and others, too, must have draftsmen in their offices. These industries are now growing fast; be prepared. You do not need a high school education to learn by the Dobe method. No previous experience necessary.

But you must have willingness and a record of honesty.

Money Back if Not Satisfied

You must be entirely satisfied with my personal training UNTIL COMPETENT and UNTIL assisted to a position OR (notice this!) you get ALL YOUR MONEY BACK.

START NOW and get the training. Then YOU will be the one who is ready for that bigger, better job. So, send the coupon NOW.

FREE BOOK

ENGINEER DOBE, Div. 33-78, Libertyville, Ill.

Send me your free book "Successful Draftsmanship" and please explain how you will assist me to a good position as a draftsman.

Name..... Age.....

Address.....

BE A Traffic Manager Big Pay—Big Opportunity

Big business needs trained traffic men and pays them well. Train in your spare time for this highly profitable, growing profession. Low cost; easy terms.

Write now for valuable, interesting 64-page book—FREE.

LASALLE EXTENSION UNIVERSITY
Dept. 1164-T, Chicago



FREE

Write for illustrated booklet describing money making opportunities in PHOTOGRAPHY. Pleasant and profitable occupation. Steady employment, permanent independence. Famous N. Y. I. personal attendance or Home Study courses will enable you to earn good income as professional photographer—Commercial, News, Portrait, or Motion Picture Photography.

New York Institute of Photography

Founded 1910

PHOTOGRAPHY 10 West 33 Street (Dept. 49) New York City

ARMOUR INSTITUTE OF TECHNOLOGY

A COLLEGE OF ENGINEERING AND ARCHITECTURE

41st Year. Fully accredited by North Central Assn. 4 yr. courses in mechanical, electrical, civil, chemical, fire protection engineering, science and architecture, leading to B.S. Degree. All student activities—athletics, good living accommodations. Day and evening classes. Bulletin sent on request.

ARMOUR INSTITUTE OF TECHNOLOGY

3306 FEDERAL STREET CHICAGO, ILLINOIS

FREE CATALOG OF PRACTICAL BOOKS...

Complete description of Drake books, covering RADIO, AVIATION, ENGINEERING, AUTOMOBILE WORK, BATTERY WORK, ELECTRICITY, BUILDING, SHEET METAL WORK, PAINTING, SIGN MAKING, LETTERING, COMMERCIAL ART, will be sent to you on request.

Frederick J. Drake & Co.
181 N. Michigan Blvd. Chicago

ELECTRICAL ENGINEERING

A BROAD, basic, intensive course for men of limited time, complete in one school year. Approved by educators, endorsed by industry. Modern buildings, 4 1/2 years' successful experience. Catalog on request.



BLISS ELECTRICAL SCHOOL

121 Takoma Ave., Washington, D. C.

LEARN WATCHMAKING AND ENGRAVING

BY OUR PROFIT-SHARING PLAN OUR GRADUATES SUCCEED

One of our Iowa students started in a very small way—now doing over \$30,000 a year. Another in Wisconsin, over \$10,000 the first year. Day or night classes. Call or write for FREE BOOK. Chicago School of Watchmaking, Dept. 2101, 155 N. Clark St., CHICAGO.

Why VOICE Students Fail

SENT FREE No Obligation to Buy

If you act quick!—we will send postpaid—for 30 days' free reading—new Voice Book disclosing startling VOICE FACTS that may save hundreds of dollars to every man or woman seeking a strong, rich voice for either singing or speaking. 30 days' free reading—then send \$1.00. Otherwise, return it—that's all! PROF. E. FEUCHTINGER Studio 13-58 308 North Michigan Avenue Chicago



Learn to
MAKE MORE MONEY

MANY R.T.I. TRAINED MEN

Earn \$35 to \$75 a week

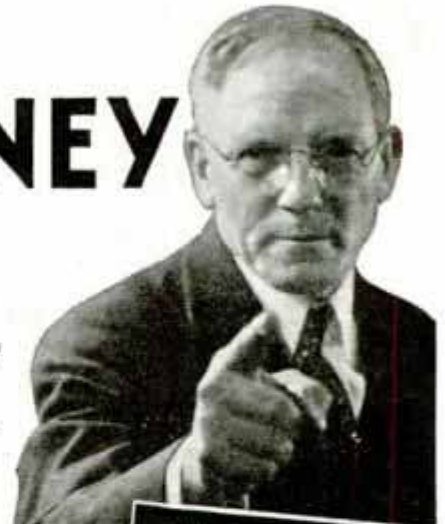

My Training is
ENDORSED and
RECOMMENDED
to you by more
than 40 leading
Manufacturers
in **RADIO**

I'll train you **AT HOME**
FOR FULL TIME OR SPARE TIME —
Good Pay RADIO JOBS



Why stick on a small-pay, no future job? Find out what Radio offers YOU. Clip the coupon NOW. Get my big FREE book on Radio and its opportunities. Read how quickly you can learn at home in your spare time to be a Radio Expert.

Radio Is Full of Real Opportunities For Trained Men

My book has shown hundreds of fellows how to make more money and win success. It tells you about the famous Advisory Board of top-notch Radio engineers who take time from their jobs with big Radio Companies to direct and supervise your R-T-I Training . . . about the 45 leading Radio Manufacturers who endorse my training and recommend it to you . . . about hundreds of students and graduates who have doubled and tripled their earnings as a result of R-T-I Training . . . about the wonderful future ahead for trained men in Radio.

Many Make \$5 to \$20 a Week In Spare Time . . . While Learning

That's what many of my students do soon after enrolling. Hold your job. Give me only part of your spare time. When you enroll for R-T-I Training, I'll send you clear, simple instructions for cashing in on part of your spare time by doing neighborhood service jobs. L. M. Christensen, Deweyville, Utah, wrote: "Have already made \$250 doing spare time Radio work. Did my first job two weeks after enrolling."

Over \$300 A Month

"I knew absolutely nothing about Radio before enrolling with R-T-I. Last month I made over \$300, all because of my R-T-I Training, and I am looked upon as being the best serviceman in this part of the country." — HERBERT B. THOMPSON, P. O. Box 279, Gorman, Texas.



Spare Time Work Pays \$500 First Ten Months

"In the ten months since I enrolled for your training I've made over \$500 doing spare time work. Today am averaging \$20 a week from this source. Got my first job after finishing my fourth lesson." — DELMAR GROTE, Route 5, Greenville, Ohio.

My Money-Back Agreement Protects You

Radio service work is just the starting point in R-T-I Training. I give you FIVE Advanced Courses, without a penny extra cost, that takes you up through the very latest developments in Radio and into the new and larger field of Electronics—Television, Sound Pictures, Photo Cells and Public Address Systems. I give you Radio Equipment for conducting experiments and making tests that make R-T-I Training practical "Shop Training" for the home.

Mail Coupon NOW

INVESTIGATE! Learn why 45 big Radio manufacturers endorse and recommend R-T-I Training . . . how the famous R-T-I Advisory Board works for you and with you . . . what my Employment Department does to help you get into your favorite branch of Radio after graduation . . . about my Money-Back Agreement and the many other outstanding R-T-I features. Clip and mail the Coupon NOW.

RAY D. SMITH, President
RADIO & TELEVISION INSTITUTE, Chicago

"SHOP TRAINING FOR THE HOME"



Directed and Supervised By Real Radio Engineers

Dr. C. M. Blackburn
Chief Radio Engineer
Stewart-Warner Corporation

Kendall Clough
Chief Engineer
Clough-Brengle Co.
(Radio Engineers and Manufacturers)

Karl Hassel
Chief Engineer
Zenith Radio Corporation

Homer Hogan
General Manager
Radio Station KYW,
Chicago

E. E. Gramer
Chief Engineer
Standard Transformer Corp.

F. D. Whitten
Service Mgr., Chicago
Plant Philco Radio
and Television Corporation

Mail This FOR FREE BOOK

RAY D. SMITH, President
Radio & Television Institute (R-T-I)
2130 Lawrence Ave., Dept. 18
Chicago, Ill.

Dear Mr. Smith: Without obligating me, send FREE BOOK about spare-time and full-time Radio opportunities and how I can train for them at home.

Name.....
Address.....Age.....
City.....State.....

R-T-I'S Famous Advisory Board of Nationally Known Radio Engineers and Executives

CHEMISTRY



Complete, practical home-study courses prepared by some of the best-known chemists in this country, including ALLEN ROGERS, B.S., M.S., Ph.D.—Head of Department of Industrial Chemistry, Pratt Institute; L. M. TOLMAN, Ph.D.—Formerly Chief Chemist, Wilson & Co. Now Vice-president, United Chemical and Organic Products Co.; BRADLEY STOUGHTON, B.S.—Head of the Department of Metallurgy, Lehigh University, and OWEN L. SHINN, Ph.D.—Professor of Applied Chemistry, University of Pennsylvania.

Mail Coupon for Free Booklet

INTERNATIONAL SCHOOL OF CHEMISTRY

Associated with the International Correspondence Schools Box 5537-H Scranton, Penna.

Without cost or obligation, please send me full details of your home-study course in

- Analytical Chemistry
- Industrial Chemistry
- Chemical Engineering
- Short Chemistry Course
- Pharmacy

Name.....

Address.....

Be an ARTIST



MAKE \$50 TO \$100 A WEEK!

Many of our successful students are now making big money. Our simple methods make it easy to learn Commercial Art, Cartooning and Designing at home, in spare time. New low tuition rate. Write for big free book "ART for Pleasure and Profit," today. State age. Address:

STUDIO 1211, WASHINGTON SCHOOL OF ART
1115—15TH ST., WASHINGTON, D. C.



U.S. GOVERNMENT JOBS



START \$1260 to \$2100 YEAR

MEN—WOMEN—18 to 50

STEADY WORK

Many Fall and Winter Examinations Expected

Common Education Usually Sufficient

Mail Coupon

Today—

SURE

Name.....

Address.....

Franklin Institute
Dept. J174
ROCHESTER, N. Y.

Gentlemen: Rush to me, FREE of charge, list of U. S. Government big pay jobs. Send me FREE 32-page book describing salaries, vacations, hours, work, and full particulars on how to get one of these jobs.

Amazing Sensational Discovery REFINISHES AUTOS Like NEW!



PAYS UP TO \$7.00 IN AN HOUR

Kar-Nu is a new, miracle discovery—a transparent, magic-like fluid with which anyone can refinish any color automobile easily, quickly and economically without polishing, waxing, rubbing or painting. Just wipe it on with a cloth immediately dullness, discoloration, shabbiness, sun fade disappear, instantly, as if by magic, the old finish is rejuvenated and restored to the lustre, life glow and beauty of the original factory finish. As KAR-NU dries it seals the pigment and protects the finish from further wear. Lasts 8 to 12 months. GUARANTEED. Equal in beauty to a repaint or refinishing job which costs \$25.00 to \$75.00.

Not A Wax Polish or Paint
Lasts 8 to 12 Months
GUARANTEED

FREE SAMPLE

Enormous demand! Millions want it! W. L. Morgan of Mass. earned \$10.61 in a single hour. Sell KAR-NU to individuals, fleet owners, garages, auto accessory stores, used car dealers, etc. No experience necessary. Write for FREE sample to prove our claims and territory offer.

KAR-NU CO., Dept. C-30, Oakley Station, Cincinnati, Ohio



Be a DENTICIAN

Learn at home to make Crowns, Plates, Bridgework, etc., for Dentists. Easy practical way to learn mechanical dentistry at home in spare time. Full equipment of tools and materials included with course FREE. Low tuition. Easy terms. Write for FREE BOOK about this money-making profession that is not affected by "machine age."

McCarrie School of Mechanical Dentistry
207 N. Broad St. Dept. 604 Philadelphia, Pa.

Learn Photography at HOME

Make money taking pictures. Prepare quickly during spare time. Also earn while you learn. No experience necessary. New easy method. Nothing else like it. Send at once for free book. OPPORTUNITIES IN MODERN PHOTOGRAPHY, and full particulars.

AMERICAN SCHOOL OF PHOTOGRAPHY
Dept. 1358, 3601 Michigan Avenue Chicago, U. S. A.

Learn to Dance

You can learn all the modern dances—the latest Tango steps, the new Fox Trots, dreamy Waltzes, smart Collegiate Steps, and popular Society Steps at home, easily and quickly. New chart method makes dancing as simple as A-B-C. No music or partner required. Don't be a wallflower. Learn to dance. Complete course—285 pages, 64 illustrations, sent on 5 Days' Free Trial. Equals \$20.00 course. Send no money. Pay postman only \$1.98, plus postage upon arrival. Money back if not delighted. Catalog Free.



Franklin Pub. Co., 800 No. Clark St., Dept. 9466, Chicago

ENGINEERING and ARCHITECTURE

INTENSIVE PRACTICAL TECHNICAL COURSES in Electrical, Mechanical, Structural, Architectural Engineering. Degree in 2 yrs. Diploma in 1 yr. Short courses in Electricity, Power Plants, Electric Refrigeration, Radio, Television, Drafting. Nonelectives eliminated. TIME AND MONEY SAVED. Low tuition. Extensive modern equipment. Part-time work during training. 34 yrs.' experience producing successful men. Write for catalog.



FINLAY ENGINEERING COLLEGE
1001 Indiana Ave. Kansas City, Mo.

CRIME DETECTION SECRET SERVICE AND FINGER PRINTS

SECRET SERVICE BOOK FREE

For 30 Days Reading
No Money Down—Actual Crime Cases—
If You Act Quick!—We will send you this stirring book on Crime Detection, Secret Service and Identification Work for 30 days free reading. Send no money. If you decide to keep it, then send only \$1.00. If not, return it. WRITE TODAY. Not sent to boys under 17 years of age.

T. G. Cooke, Book Dept. 13-58 1920 Sunnyside Ave., Chicago

When writing please mention Popular Mechanics

Say Fred, be sure to get this Taxidermy book. It's now sent free. You will surely be interested.

LEARN TO MOUNT BIRDS & ANIMALS—BE A TAXIDERMIST

THAT WAS A GREAT HUNTING TRIP, BILL, ALL THE DUCKS WE WANT. BUT IT SEEMS A SHAME TO THROW AWAY THIS BEAUTIFUL PLUMAGE.

THAT'S JUST WHAT I'VE BEEN THINKING—JIM, I'M GOING TO WRITE TO THE NORTHWESTERN SCHOOL OF TAXIDERMISTRY AND SEE IF I CAN'T LEARN TO MOUNT MY BEST TROPHIES.

WELL, I SEE YOU REALLY ARE TAKING UP TAXIDERMISTRY IN EARNEST, BILL.

THAT'S RIGHT, JIM—AND I'VE NEVER HAD SO MUCH FUN IN MY LIFE. I'VE ACTUALLY DOUBLED THE PLEASURE I GET FROM MY HUNTING AND REALLY HAVE SOMETHING TO SHOW FOR IT. COME IN THE HOUSE AND I'LL SHOW YOU SOME OF MY WORK.

LATER

I'VE SOLD MANY BOOK-ENDS, LAMPS, ASH-TRAYS, PIPE RACKS, AND SO ON TO SPORTSMEN FOR THEIR DENS — I'VE LEARNED TO TAN FURS FOR CAPS, SCARFS AND RUGS, AND — BEST OF ALL— INSTEAD OF THROWING AWAY THOSE COW-HIDES, I TAN THEM INTO LEATHER FOR BELTS, HARNESS AND STRAPS.

BUT WASN'T TAXIDERMISTRY HARD TO LEARN, BILL?

HARD? NOT A BIT, AFTER YOU GET THE HANG OF IT. WHY JIM, TO ME TAXIDERMISTRY IS THE GRAND-EST HOBBY IN THE WORLD. I'VE MADE AS HIGH AS \$75 PER MONTH IN MY SPARE TIME, MOUNTING TROPHIES FOR HUNTERS. WHY DON'T YOU TAKE IT UP?

I'M SURE GOING TO — WHAT'S THAT ADDRESS? I HAD NO IDEA WHAT I'VE BEEN MISSING.

Amazing Pleasure and Profits in This Art

YOU LEARN IT EASILY, QUICKLY, BY MAIL IN SPARE TIME

Men, boys, women,—Study Taxidermy. Taught by Experts. ALL SECRETS revealed. It will amaze and delight you.



Hunters — Fisherman

Save your game trophies. They are **Valuable**. Mount them for home and den. Have a **Museum**. Win fame as a Taxidermist. Make undreamed-of money in spare time. . . You learn to mount (stuff) *expertly*, **Birds, Animals, Fish, Game-Heads**, just like life. That is Taxidermy. You can be a Taxidermist. Will you? Surely you are interested. Mail **Coupon** right now for the astonishing **Free Book**.

Wild Game Not Needed

You can use common animals and birds; squirrels, rabbits, little chicks, puppies, kittens, pigeons, even frogs. Mount them in human and humorous groups. Real **Fun**; and profitable, too. This is known as **Craft and Novelty taxidermy**; it's included in our unique lessons. It's **Marvelous**. Write the school this minute!

Success Guaranteed

This old reliable school in 30 years has graduated 200,000 students; all in Taxidermy **Only**. Ask our 200,000 graduates! They **Know** we can teach you successfully. Our great success permits this **Guarantee**. Grasp this **Opportunity**—send coupon right now, **TODAY**, for the **Free Book**.

Big Profits in Spare Time

Many students earn from \$40 to \$75 monthly in spare time. Some earn thousands of dollars each year. Sportsmen bring their trophies to be mounted. Besides you can sell your own **Novelty** groups for homes, dens and for merchants' window display.

Learn Tanning

Tan fine harness, sole and chrome leathers; also furs with the hair on. **Expert Methods**, easily learned. **Save Money** making your own leathers; **Make Money** tanning for others. **Quick Sure Profits**. The **Free Book** tells about it. Send coupon.

Mail Coupon

Or a postcard will do. No obligation on your part. The beautiful **Book**, with hundreds of entrancing **Pictures** is **Free**. Do not miss this wonderful **opportunity** to obtain the marvelous and valuable book, **FREE** and **POST-PAID**. Write today. State your **Age**.

FREE BOOK

Northwestern School of Taxidermy, 3378 Elwood Bldg., Omaha, Neb. Send me your free illustrated book, "How to Mount Game". Also tell me how I may learn this fascinating art easily and quickly by mail. No obligation.

Name _____ Age _____
Address _____



NORTHWESTERN SCHOOL OF TAXIDERMISTRY
3378 Elwood Bldg., Omaha, Neb.

SEND COUPON TODAY FOR WONDERFUL FREE BOOK

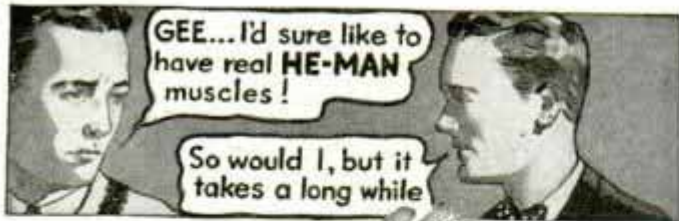

—says Charles Atlas
Holder of title, "World's Most Perfectly Developed Man" won in national and international contests.

"Bunk!"

I'll Prove in the first 7 days YOU can have a Body like Mine!"

DON'T get the idea that it takes a lot of time and hard work for you to get smashing strength and powerful muscles! Don't think you need dumbbells, springs or any other contraptions!

Both these ideas are all bunk—and I have PROVED it. All I need is 7 days to prove what I can do for you! And I don't need any apparatus either. In fact, I don't believe in artificial methods that may strain your vital organs for life!

NATURAL Methods Are All I Need

Above you see an actual photo of how I look today. No muscles have been "painted on." This is the camera's honest proof of what I did for MY body. Now I'm ready to prove what my secret of Dynamic Tension can do for YOURS!

A few years ago I was a physical wreck, a 97-pound weakling—flat chested, arms and legs like pipestems. I was worried. I studied myself. Then I found a new way to build myself up. A way that was simple, natural, quick, and sure! "Dynamic Tension" is what I called it. In a short time I had the body that has twice won the title of "The World's Most Perfectly Developed Man."

Get My FREE Book

Thousands of others now know from their own personal experience what Dynamic Tension has done for them. My interesting booklet, filled with pictures tells my story—and theirs.

This little coupon brings you my free book, which tells all about it. No cost or obligation.
I just want to give you proof that I can do for you what I have done for so many others; give you broad, powerful shoulders, biceps that bulge with smashing strength, a chest which stands out solid and muscular, and an evenly developed body that will make others look like dwarfs next to you. Mail this coupon TODAY! CHARLES ATLAS, Dept. 8-L, 115 East 23rd St., N. Y. C.

CHARLES ATLAS, Dept. 8-L
115 East 23rd Street, New York, N. Y.

I want the proof that your system of Dynamic Tension will make a New Man of me—give me a healthy, husky body and big muscle development. Send me your free book, "Everlasting Health and Strength."

Name.....
 (Please print or write plainly)
 Address.....
 City..... State.....

Air Conditioning



Why don't you get into this profitable new line—replacing old-fashioned heating and ventilating systems in factories, offices, homes, etc., with modern air conditioning equipment?—and planning new buildings for air conditioning? Architects and Builders— heating and ventilating experts— steamfitters and plumbers— must meet this increasing demand for ways of

Controlling Winter and Summer

Made-to-order weather adds much to the comfort, health, and happiness of humanity. Air-conditioned working quarters materially reduce lost time due to illness, and increase employe efficiency— air-conditioned homes insure comfortable inside temperatures regardless of the weather and cut down doctors' bills—air-conditioned apartments bring increased rentals that soon pay for the installation.

Air Conditioning offers you a real chance to get into a new and growing line where good-paying jobs are constantly opening up. Like the auto and radio, this new development is sweeping the country and revolutionizing industry.

What is the "Trade-In" Value of Your Present Job?

When changing conditions threaten to wipe out your present job, it's up to you to fit yourself for something else that will continue to provide well-paid employment during your working life. Usually a little additional information will adapt your experience to one of the new jobs— often offering more money and brighter prospects. Don't wait until your job is kicked out from under you— meet the changes as they come and ride the wave of progress to better times.



Our Air Conditioning Course will give you by home study, in a short time, thorough and up-to-date training in this profitable new line. All texts furnished—small monthly payments. Send TODAY for Free Bulletin. No obligation.

American School

Dept. AC845, Drexel Ave. at 58th St., Chicago



Become a Radio Expert

GOOD JOBS



Learn RADIO-TELEVISION ELECTRICITY-TALKING PICTURES

Times are getting better. Trained men are getting jobs. National will quickly train you to qualify in all branches of radio, television, talking pictures, broadcasting, operating and general electricity. Thorough, practical training. Over \$100,000 in modern equipment. National graduates in demand. Regardless of age or education you can learn profitable trades in a few months.

QUALIFY AS A

- Radio Repair Man
- Television Expert
- Control Operator
- Station Technician
- Sound Expert
- Ship Operator
- Broadcaster
- Electrician
- and many other jobs

EARN ROOM AND BOARD WHILE LEARNING

75% of our students earn living expenses while receiving training. We help you get a job. For limited time will allow your coach railroad fare to Los Angeles.

TRAIN IN LOS ANGELES

This is the Ideal City. Center of Greatest Activity in Radio, Talking Picture and Electricity. 30,000 successful graduates. School established 29 years. Send for free descriptive book and enrollment details.

NATIONAL RADIO & ELECTRICAL SCHOOL - Los Angeles

Dept. PMR-11, 4006 Figueroa St.
Send Book and full details of Courses.

NAME.....
 ADDRESS.....
 CITY..... STATE.....





A **SKINNY** MAN
HASN'T A CHANCE. I WISH I
COULD GAIN FLESH

NEW EASY WAY ADDS 5 to 15 LBS.—QUICK!

DOCTORS for years have prescribed yeast to build up health. But now with this new discovery you can get far greater tonic results than with ordinary yeast—regain health, and also put on pounds of firm flesh—and in a far shorter time.

Not only are thousands quickly gaining solid, good-looking pounds, but also clear skin, freedom from indigestion and constipation, new abounding pep.

This amazing new product, Ironized Yeast, is made from special *brewers' ale yeast* imported from Europe, the richest yeast known, which by a new process is concentrated 7 times—made 7 times more powerful. But that is not all! This marvelous, health-building yeast is *ironized* with 3 kinds of strengthening iron.

Day after day, as you take Ironized Yeast, watch flat chest develop, skinny limbs round out attractively. Skin clears, new health comes—you're a new person.

Results guaranteed

No matter how skinny and weak you may be, this marvelous new Ironized Yeast should build you up in a few short weeks as it has thousands. If you are not delighted with the results of the very first package, your money back instantly.

Special FREE offer!

Purchase a package of Ironized Yeast at once, cut out the seal on box and mail to us with a clipping of this paragraph. We will send you *free* a fascinating new book on health, "New Facts About Your Body". Remember, results are guaranteed with the very first package—or money refunded. At all druggists. Ironized Yeast Co., Inc., Dept. 5311, Atlanta, Ga.

"I'LL TELL YOU
HOW TO
GAIN POUNDS
QUICK!"



35 - but out of date!

● He's young; a few years ago his friends and associates predicted a great future for him. But something happened. The world got ahead of him. He didn't realize it until the business procession was almost out of sight. He is not alone in his predicament.

THINGS are happening today, men. Faster than they ever happened before. Old standards are passing. Success has a new order of requirements.

Yesterday a man was merely required to do his job well. Today he must do that same job well—but he must also know the fundamentals of all other jobs associated with his work. *Specialization relates to business—not to the jobs in that business.*

What does this mean to you? Just this: The men who succeed hereafter are going to be exclusively those who combine study with their labors. They must capitalize their spare time. Not only study of a particular job but other subjects directly or indirectly related to that job and the promotions which should grow from it.

Realization of this fact is causing thousands of successful men, in many lines of endeavor, to enroll with the International Correspondence Schools at Scranton for home-study courses. The value of these courses is established. The individual who applies himself can get inestimable benefit from them. He can head himself toward promotion and more money—that's a great benefit these days! *And arrangements can be made for him to pay as he studies. Mail the coupon today!*

INTERNATIONAL CORRESPONDENCE SCHOOLS

"The Universal University" Box 5534-H, Scranton, Penna.
Without cost or obligation, please send me a copy of your booklet, **"Who Wins and Why,"** and full particulars about the subject before which I have marked X:

- TECHNICAL AND INDUSTRIAL COURSES**
- Architect
 - Architectural Draftsman
 - Building Estimating
 - Wood Millworking
 - Contractor and Builder
 - Structural Draftsman
 - Structural Engineer
 - Electrical Engineer
 - Electric Lighting
 - Welding, Electric and Gas
 - Reading Shop Blueprints
 - Telegraph Engineer
 - Telephone Work
 - Mechanical Engineer
 - Mechanical Draftsman
 - Machinist Toolmaker
 - Inventing and Patenting
 - Patternmaker
 - Heat Treatment of Metals
 - Bridge Engineer
 - Bridge and Building Foreman
 - Gas Engines Diesel Engines
 - Aviation Engines
 - Automobile Mechanic
 - Plumbing Heating
 - Air Conditioning
 - Sheet Metal Worker
 - Steam Engineer
 - Steam Electric Engineer
 - Civil Engineer
 - Surveying and Mapping
 - Refrigeration
 - R. R. Locomotives Air Brakes
 - R. R. Section Foreman
 - R. R. Bridge and Building Foreman
 - R. R. Signalman
 - Highway Engineering
 - Chemistry Pharmacy
 - Coal Mining Engineer
 - Navigation Boilermaker
 - Textile Overseer or Supt.
 - Cotton Manufacturing
 - Woolen Manufacturing
 - Agriculture Fruit Growing
 - Poultry Farming Radio
 - Marine Engineer

- BUSINESS TRAINING COURSES**
- Business Management
 - Office Management
 - Industrial Management
 - Traffic Management
 - Accountancy and C.P.A. Coaching
 - Bookkeeping
 - Secretarial Work
 - Cost Accountant
 - Salesmanship Advertising
 - Service Station Salesmanship
 - Wallpaper Decorating
 - Salesmanship
 - Business Correspondence
 - Lettering Show Cards Signs
 - Stenography and Typing
 - Civil Service
 - Mail Carrier
 - Railway Mail Clerk
 - Grade School Subjects
 - High School Subjects
 - College Preparatory
 - First Year College
 - Illustrating Spanish
 - Cartooning French
 - Lumber Dealer

Name.....Age.....
 Address.....
 City.....State.....
 Occupation.....
 If you reside in Canada, send this coupon to the International Correspondence Schools Canadian, Limited, Montreal, Canada
 When writing please mention Popular Mechanics

BIG MONEY!

THIS QUICK SELLING HEATER
 You'll find big profits falling in your lap—letting your friends see this marvelous **SUNSHINE RADIANT HEATER.** Every home a hot prospect. Gives clean, live gas heat no matter where you live for 1½ an hour. No servicing; no installation—no investment nor stock. You collect profits in advance. Thousands in use!

FREE Most startling offer ever made! Try one in your own home 15 days. Write quick for full details and make territory reservations.

SUNSHINE PRODUCTS CO.
 Dept. 5012 5127 W. 65 St., Chicago, Ill.

Makes and burns its own gas. No smoke, dirt or ashes.

Showcarder

The Complete Sign Department

Clever patented device makes you a professional sign writer. No experience necessary. With SHOWCARDER any retail merchant can have all the artistic signs he needs for just the cost of the card stock.

FREE! Complete Catalog of latest models and sample sign sent on request.

SHOWCARDER, INC., 2302 University Ave., St. Paul, Minn.

Learn Public Speaking

At home—in spare time—20 minutes a day. Overcome "stage-fright" gain self-confidence, increase your salary, through ability to sway others by effective speech. Write now for free booklet, *How to Work Wonders With Words.*

NORTH AMERICAN INSTITUTE, Dept. 1358
 3601 Michigan Avenue, Chicago, Illinois

VOICE

100% Improvement Guaranteed

We build, strengthen the vocal organs—not with singing lessons—but by fundamentally sound and scientifically correct silent exercises... and absolutely guarantee to improve any singing or speaking voice at least 700%... Write for wonderful voice book—sent free. Learn WHY you can now have the voice you want. No literature sent to anyone under 17 years unless signed by parent.

PERFECT VOICE INSTITUTE, Studio 13-58
 308 No. Michigan Ave., Chicago

SONGS WANTED FOR RADIO BROADCAST

NEW WRITERS INVITED

Cash Payments Advanced. Writers of Songs Used and publication secured. Send us any likely material (Words or Music) for consideration today. Radio Music Guild, 1650 Broadway, New York.

"BECOME A LIGHTNING TRICK CARTOONIST"

Send \$1.00 for Laugh Producing Program of 23 Trick Drawings with Instructions. Catalog of Chalk Talk Supplies Free.

BALDA ART SERVICE, Dept. 1, Oshkosh, Wis.

How To Secure A Government Position

Why worry about strikes, layoffs, hard times? Train now for a Government job. Many examinations expected! Increased salaries, steady work, travel, good pay. Let me help you become a Railway Postal Clerk, Post Office Clerk, City Mail Carrier, Rural Carrier—or help you get into any other Government job you want. I was a Secretary Examiner of Civil Service Commission for 8 years. Have helped thousands.

Now FREE My 32-page book tells about the jobs open—and how I help to qualify you to get one. Send the coupon for your copy TODAY.

A. R. Patterson, Civil Service Expert
PATTERSON SCHOOL, 811 Wisner Bldg., Rochester, N. Y.
 Please send me, without obligation, your free book "How to Secure a Government Position."

Name.....
 Address.....

Get BIG MUSCLES Quick this Amazing New Way!

Sensational New Home Outfit Puts Layers of SOLID MUSCLE on Every Inch of Your Body!

Watch he-man muscles grow like magic with this new kind of Home Gymnasium! Quickly builds smashing strength and remarkable

all-around bodily development. Gets RESULTS in only HALF the time! You can begin to FEEL tough, steel-strong ridges of handsome muscle pushing their way up to the surface of your arms, shoulders, chest, back, thighs, calves! You can quickly develop a vise-like grip, superman STRENGTH. With deeper chest, bigger lungs, stronger stomach muscles, your "wind," power and endurance can easily be DOUBLED!

Read the 23 Big Features you get—never before such a COMPLETE Home Gym, PLUS special courses and valuable information, for so low a price! Then read our no-risk offer below and act at once!

HOME TRAINING CAMP
23 BIG FEATURES
for ONLY **\$3.95**

- 1—Complete Wall Exerciser—for general body development.
- 2—Adjustable Headgear—for building sturdy, powerful neck muscles.
- 3—Foot Gear—for ankles and calves.
- 4—New Type Hand Grips—strengthen fingers, put new force into wrists, forearms.
- 5—Patented Stirrup—will not slip. Puts new power into legs, muscles of stomach and thighs.
- 6—Rowing Machine Attachment—gives you the back-building advantage of this great sport.
- 7—Chest Expander—Ten Cables, 200 lbs. resistance. A quick way to build the kind of chest you have always longed to have.
- 8—Muscle Clock—Measures your muscle power. Shows what your muscle power is in pounds.
- 9—Foot-Gear and Ankle Strengtheners—to put new endurance into your ankles and to lift and strengthen your arches.
- 10—Special Skip Rope—for increasing speed and developing your wind.
- 11—20 Famous Wrestling Holds—clearly pictured and described.
- 12—15 Secrets of Jiu Jitsu—making you the master of any man, regardless of his size.
- 13—17 Right and Wrong Boxing Positions—clearly shown in pictures.
- 14—10 Feats of Strength—tricks you can easily do which will amaze everyone.
- 15—17 Tricks of Hand Balancing—some of the stunts which have astounded you on the stage.
- 16—35 Food Facts—scientific information told in a simple way. What to eat to create new power and vitality.
- 17—Special Ways to Get Bulging Biceps—clear instructions for using this apparatus to rebuild that specific part.
- 18—Secrets of Chest Expansion.
- 19—The Stomach Muscles and How to Strengthen Them—special advice on this important zone of the body.
- 20—Ways to Put New Power Into Your Legs and Thighs—many otherwise strong men are weak here.
- 21—Hints on Increasing the Strength of Your Back—for greater lifting ability.
- 22—PRIVATE Letter to Men—pointing dangers and safeguards you should know for your own protection.
- 23—Complete 150-Page Health Book—simply and clearly written (and illustrated) by great doctor. Straight answers to questions that have puzzled you.

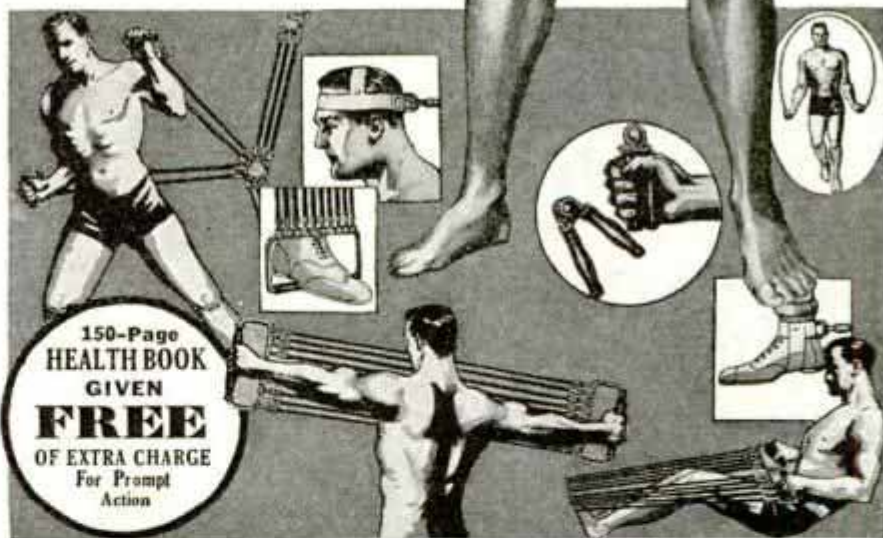
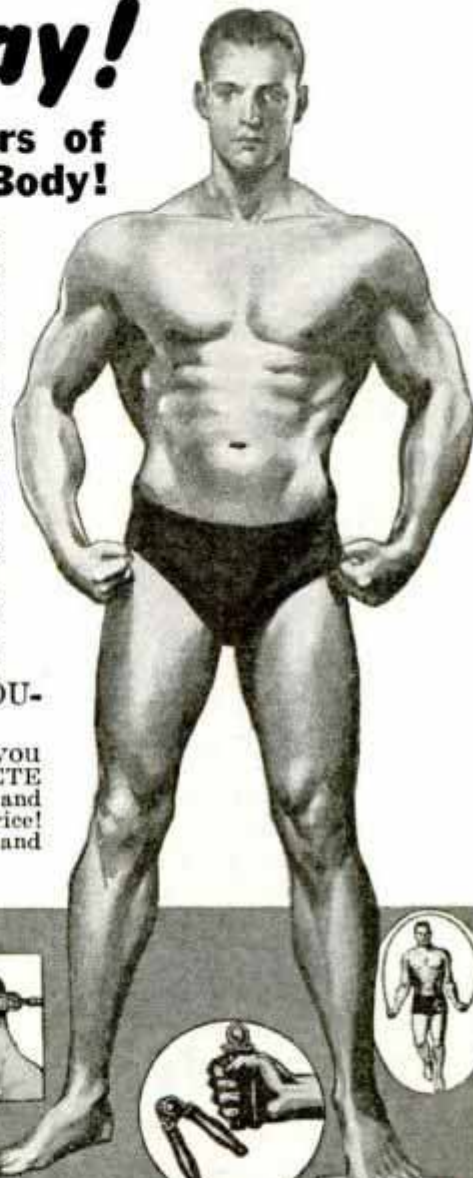

150-Page
HEALTH BOOK
GIVEN
FREE
OF EXTRA CHARGE
For Prompt
Action

SEND NO MONEY

Don't send a penny with this coupon. When this big outfit—in Plain Package—is delivered, merely deposit special price of only \$3.95 plus actual delivery charges. (This special price pays for ALL 23 features—nothing more to pay at any time.)

If, after 5 days' examination, you are not convinced this great home gymnasium will give you the kind of body you have always wanted—with glowing health, never-failing strength and manly power—then send back all material and your \$3.95 will be refunded at once.

Now you can HAVE the kind of body you have always wanted! Mail coupon—without money—at once. GYM HOME TRAINING CO., Inc., Dept. 111, 115 East 23rd St., New York City.

GYM HOME TRAINING CO., Inc.,
Dept. 111, 115 East 23rd St., New York City

Send me at once—in a plain, unmarked container—complete home gymnasium, including all features listed on this page. When package is delivered I will deposit \$3.95, plus actual delivery charges.

Canadian orders \$3.95 cash with order. Foreign orders \$4.95 cash with order.

If, after 5 days' examination, I am not delighted with this complete outfit, I may return it and you will at once refund my \$3.95 (Foreign \$4.95) in full.

SPECIAL: Act at once and get this 150-page Health book ABSOLUTELY FREE!

Name.....

Address.....

City..... State.....

Check here if you are enclosing \$3.95 right WITH this coupon. In that case, we will pay the delivery charge and you will make this saving.

Train for

**RADIO TELEVISION
TALKING PICTURES
IT TAKES ONLY 10 WEEKS!**

**All
Practical
Training
on Real
Equipment**



PAY AFTER YOU GRADUATE

**AMAZING
LOAN
PLAN**

**Over a Year to Complete
Small Monthly Payments**

I mean exactly what I say. There is no red tape—no strings to my offer—You run no risk. I'm ready to take you into my big shops, give you 10 weeks of Coyne Training and you won't have to pay me until after you graduate. You don't make your first payment until 60 days after your 10 weeks' training period is over, and then you have over a year to make the small, monthly payments. I'm willing to back you because so many of my successful graduates have proved that their increased earnings with Coyne Training make it possible to repay the loan easily.

NO BOOKS — NO CORRESPONDENCE

**You Don't Need Advanced
Education or Previous Experience**

**ALL
PRACTICAL
WORK**

The remarkable "Learn-by-Doing" methods used in the great Coyne Shops will train you to easily master Radio without advanced education or previous experience. Your Shop work is all practical — You get individual instruction and do the sort of work you meet out in the field on a real job. Do radio wiring, repairing and servicing; work on A.C. Superheterodyne sets, analyzers and test instruments. Learn how to operate television receiving and transmitting equipment, also how to test and service sound picture equipment.

SPARE TIME WORK WHILE TRAINING

**JOB
HELP**

**To Help Meet Living Expenses
Employment Help After Graduation**

Special low room and board rates for Coyne Students. My Employment Department helps you to get a spare time job to cover living expenses. You get employment help after you graduate to assist you find a good paying job for which you have been trained.

**ELECTRIC REFRIGERATION
Air Conditioning—**

**Big new course on latest type Freon
Equipment included without extra cost**

**NO
EXTRA
COST**

Send Coupon for Details

Get the Free "Coyne Opportunity Book" containing pictures of my Shops and full details of my amazing Tuition Loan Offer.

**Coyne Electrical & Radio School
500 S. Paulina St., Dept. 84-3H, Chicago, Ill.**

H. C. Lewis, Pres., Coyne Electrical and Radio School,
Dept. 84-3H, 500 S. Paulina St., Chicago, Ill.

Send me your Big Free Book about Coyne Training and give me all details regarding your Spare Time Employment Offer and Pay After Graduation Plan of easy, monthly payments.

Name.....
Address.....
City..... State.....

When writing please mention Popular Mechanics

Law!

LEARN AT HOME

Are you adult, alert, ambitious, willing to study? Investigate LAW! We guide you step by step—furnish all texts, including 14-volume Law Library. Training prepared by leading law professors and given by members of bar. Degree of LL. B. conferred. Low cost, easy terms. Send NOW for Free, 64-page "Law Training for Leadership."

LaSalle Extension University, Dept. 1164-L, Chicago

**BE A RAILWAY
TRAFFIC INSPECTOR**



**You Can Qualify Quickly for a Good Job
TRAINED MEN—19 to 50—wanted in the Railway and Bus Passenger Field. Good pay—interesting work—rapid advancement. Travel or stay near home. On completion of a few weeks' home-study course, we help place you in a position paying up to \$140 per month, plus expenses, to start, or refund tuition. Increased demand now for trained inspectors. Terms, Free Booklet. STANDARD BUSINESS TRAINING INSTITUTE, Div. 211, Buffalo, N. Y.**

**CARTOON YOUR WAY
TO SUCCESS!**



DON'T COPY — LEARN TO ORIGINATE!

RAYE BURNS will teach you HOW TO CREATE ORIGINAL CARTOONS at home that you can SELL! Course contains 26 lessons and over 600 illustrations. All for Only.. **\$ 2.85**

Send name and address for free details.
RAYE BURNS SCHOOL, Dept. M-X, BOX 2194, Cleveland, Ohio

**Learn
ADVERTISING
at Home**

Greater opportunities now in advertising. Learn easily and quickly in spare time. Practical work. No text books. Old established school. Low tuition—Easy terms. Send for free booklet of interesting information.
**Page-Davis School of Advertising
Dept. 1358, 3601 Mich. Ave., Chicago**

350 LITTLE BLUE BOOKS 5¢ EACH

Send post card for our free catalogue. Thousands of bargains. Address: **LITTLE BLUE BOOK CO., Catalogue Dept., Desk 317, Girard, Kansas.**

**New Ideas now Salable
Before Patenting**

Safe, practical plan for marketing inventions of merit before patenting. For information, write **Chartered Institute of American Inventors**
592 Barrister Building Washington, D. C.
"World's Largest Organization of Inventors"

GOV'T. JOBS

- | | | |
|--|--|---|
| SALARY TO START \$105 to \$175 MONTHLY MEN.. WOMEN Age Range 18 to 50 | <input type="checkbox"/> Ry. Mail Clerk | <input type="checkbox"/> POSTMASTER |
| | <input type="checkbox"/> P. O. Laborer | <input type="checkbox"/> Seamstress |
| | <input type="checkbox"/> R. F. D. Carrier | <input type="checkbox"/> Auditor |
| | <input type="checkbox"/> Special Agent | <input type="checkbox"/> Stenographer |
| | <input type="checkbox"/> Customs Inspector | <input type="checkbox"/> U.S. Border Patrol |
| | <input type="checkbox"/> City Mail Carrier | <input type="checkbox"/> Telephone Opr. |
| | <input type="checkbox"/> P. O. Clerk | <input type="checkbox"/> Watchman |
| | <input type="checkbox"/> Matron | <input type="checkbox"/> Skilled Laborer |
| | <input type="checkbox"/> Immig't Inspector | <input type="checkbox"/> Statistical Clerk |
| | <input type="checkbox"/> Typist | <input type="checkbox"/> File Clerk |

GOVERNMENT INSTRUCTION BUREAU, Dept. 111, St. Louis, Mo.
Send me FREE particulars "How to Qualify for Government Positions" marked "X". Salaries, locations, opportunities, etc. ALL SENT FREE.

Name.....
Address.....

Burlington's Diesel-powered "Zephyr" used only \$10.72 worth of fuel oil in its 1,015-mile non-stop run from Denver to Chicago

Photo courtesy Burlington R. R.



Diesel Engineering

The Diesel is fast replacing old-type engines in locomotives — ships — industrial and commercial power plants — motor cars and trucks — aircraft — tractors. As a result, many old jobs have been greatly changed or actually wiped out.

New Jobs For Old

Every industrial change throws many good jobs into the discard — but it creates more and better jobs. The automobile ruined scores of industries based on providing horse transportation — but the motor industry employs even greater armies of workers. Radios supplanted talking machines — electric refrigerators wrecked the iceman — air conditioning is driving out old-fashioned heating and ventilating systems.

Diesel Engineering is the great opportunity of today. The field is developing with amazing rapidity — on land and water and in the air. This is your opportunity to get in on the ground floor of a new and prosperous industry that will provide plenty of good jobs during your lifetime.

Is Your Job Safe?

There is a growing scarcity of men trained to install, operate, and service Diesel engines. New Diesel Engineering Course — just released for home study by one of America's leading educational institutions — will give you, in a short time, thorough training in modern Diesel engine practice. All texts furnished. Send TODAY for Free Bulletin. No obligation.

American School

Dept. D845, Drexel Avenue at 58th Street, Chicago, Ill.

Improves Handwriting In 3 Hours

Marvelous invention. Corrects poor writing in few days. Amazing results guaranteed. No failures. Positive proof and complete outline mailed FREE. Write quickly.

OZMENT INSTRUCTION BUREAU, Dept. 34, St. Louis, Mo.



TRI-STATE COLLEGE

B. S. Degree in 2 years. World famous for technical 2-year courses in Civil, Electrical, Mechanical, Chemical, Radio, Aeronautical Engineering; Business Administration and Accounting. Equivalent in technical hours to 4-year course. Those who lack high school may make up work. Low tuition. Low living costs. Located in picturesque hill and lake region. Students from every state and many foreign countries. 51st year. Enter Sept., Jan., March and June. Write for catalog.

4114 COLLEGE AVE., ANGOLA, IND.

STOP Your Rupture Worries!

Why worry, suffer with that rupture? Learn about my perfected invention. It has automatic Air Cushions which bind and draw the broken parts together as you would a broken limb. No obnoxious springs or pads. No salves or plasters. Sent on trial to prove it. Beware of imitations. Never sold in stores. Write today for full information sent free in plain, sealed envelope.

H. C. BROOKS, 111-A State Street Marshall, Michigan

No JOKE TO BE DEAF

—Every deaf person knows that—

Mr. Way made himself hear his watch tick after being deaf for twenty-five years, with his Artificial Ear Drums. He wore them day and night. They stopped his head noises. They are invisible and comfortable, no wires or batteries. Write for TRUE STORY. Also booklet on Deafness.



THE WAY COMPANY
729 Hofmann Bldg. Detroit, Michigan

Get on AVIATION'S PAYROLL!

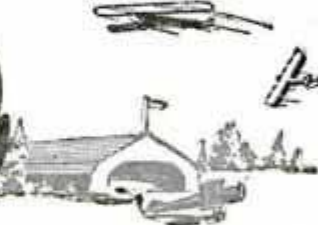

WALTER HINTON: trail blazer, pioneer, explorer, author, instructor, AVIATOR. The first man to pilot a plane across the Atlantic, the famous NC-4, and the first to fly from North to South America. The man who was a crack flying instructor for the Navy during the War; who today is training far-sighted men for Aviation. Hinton is ready to train you at home in your spare time. Get his book. Listen to what he has to say. He brings you real opportunity to get into Aviation and cash in on its big future.

PREPARE QUICKLY AT HOME In Spare Time

for a GOOD PAY Aviation Job

You don't need to give up your present job—don't need to leave home to get your training in Aviation. I've made it downright easy for you, I've put my own fifteen years' of experience—backed by over 400,000 miles of flying—five years of instructing in the Navy—all into my quick, simple, thorough, home-study course. My up-to-date course gives you the ground work you need to get and keep a real job in this fascinating, fast-growing industry.

No Experience Needed

You don't even need a high school education — don't have to know anything about planes or engines to learn the ground work of Aviation with my practical course. Everything is clearly explained—illustrated by countless pictures, drawings and charts. Many of my graduates, who didn't know a thing about Aviation when they enrolled for my training, are holding down fine jobs right now—in the air and on the ground. **Over forty different kinds of jobs to choose from now—and Aviation is growing fast.** Get the facts about my practical Course, free Employment Service, and Money-Back Agreement NOW!



\$75 a Week as Instructor

Robt. N. Dobbins, a Hinton graduate, writes: "I cannot thank you enough for the assistance you gave me in getting my present position. Last week they promoted me to Chief Instructor, at a big salary increase."

There's No Time to Lose — Get My FREE Book NOW!

Don't wait and let the other fellows get ahead of you. Think about your own future. Let me prepare you for a good job paying \$30.00 a week or more.



Get the FACTS. Mail the handy coupon below today—right now. I'll send you my big new FREE Book — packed with interesting facts about your opportunities in Aviation. Act NOW.



Passenger Agent

"My success with your course is attested by the fact that I had hardly completed my studies when I accepted a position with the Transcontinental Air Transport, Inc." C. E. McCollum, Passenger Agent.

Rush to Washington!

WALTER HINTON, Pres. Aviation Institute of U. S. A., Inc.
1115 Connecticut Avenue, N. W.
Washington, D. C.

801-Y

Send me without obligation a FREE copy of your book, "Wings of Opportunity." I want to know about the opportunities for me in Commercial Aviation and your method of training men at home in spare time.

Name.....
Address.....
City..... State.....

When writing please mention Popular Mechanics



Follow this Man

Secret Service Operator 38 is on the job

FOLLOW him through all the excitement of his chase of the counterfeit gang. See how a crafty operator works. Telltale finger prints on the lamp stand in the murdered girl's room! The detective's cigarette case is handled by the unsuspecting gangster, and a great mystery is solved. Better than fiction. It's true, every word of it. No obligation. Just send the coupon and get—

FREE!

The Confidential Reports No. 38 Made to His Chief

And the best part of it all is this. It may open your eyes to the great future for YOU as a highly paid Finger Print Expert. More men are needed right now. This school has taken men just like you and trained them for high official positions. This is the kind of work you would like. Days full of excitement. Big salaries. Rewards.

Can you meet this test?

Can you read and write? Are you ambitious? Would you give 30 minutes a day of your spare time preparing yourself for this profession? Answer "yes" and I'll show you how to attain all this. Send the coupon and I'll also send the Free Reports.

INSTITUTE OF APPLIED SCIENCE
1920 Sunnyside Ave., Dept. 13-58 Chicago, Illinois

Institute of Applied Science
1920 Sunnyside Ave., Dept. 13-58 Chicago, Illinois

Gentlemen:—Without any obligation whatever, send me the Reports of Operator No. 38, also your illustrated Free Book on Finger Prints and your low prices and Easy Terms Offer. Literature will NOT be sent to boys under 17 years of age.

Name

Address

Age

When writing please mention Popular Mechanics

Increase Your Earning Power

Apply time and labor-saving kinks to your work. Your efficiency will soon be recognized and you will be in line for advancement.

If you do machine shop work of any kind, sheet-metal work, painting, carpentry, auto repairing, farming, concrete work, plumbing, electrical work, welding, building-glass work, general repairing, tool-making, poultry raising, masonry or home repair work, get this

LIBRARY OF 3600 TIME AND LABOR SAVING IDEAS FOR SHOPMEN AND HANDYMEN

RECENTLY PUBLISHED

SHOP NOTES for 1934

480 Articles
580 Illustrations
224 Pages
Price 50c
See partial list of contents below

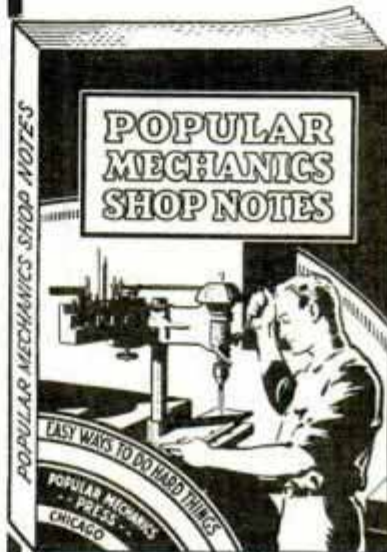

Including the new 1934 issue illustrated above, there are eight volumes in the Shop Notes Library of 3600 easily understood short cuts to every-day jobs. Here are just a few of the subjects taken from the latest issue.

- | | | |
|--|---|--|
| Auto Generators Converted into Motors | Handles, Personal, for Better Hammering | Sanding Machines, Motor Driven, for Small Shop |
| Air Compressor, Small | Hedge Trimmer, Electric | Sawhorse for all Purposes |
| Bandaw Blades, Tricks of Coiling | Jigsaw, Profits from Knives and Other Straight Edge Tools, Tricks of Sharpening | Serving Cabinet, Martha Washington |
| Bandaw, Homemade, for Workshop | Lathe Tools, Sharpening | Steel Ball Uses in Machine Shop |
| Car Transmission as Clutch on Power Unit | Metal Turning on Wood-working Lathe | Surface Grinder for Finishing Metal |
| Coffee Table, Dutch-Foot | Nails, Mechanics of Using | Smoking Stand, English Steadyrest, Ball-Bearing Scrollaw, Heavy Duty |
| Drillpress, What You Can Do With | Painting Your Home, Tricks of | Saw-Filing Table, Modernized |
| Electroplating with Lead, Zinc and Cadmium | Punch, Accurate Hole Rafter Framing Table | Screw-Top Table, Chairside, for Living Room |
| Farm, Practical Suggestions for | Routing, Jigs and Fixtures for | Vise, Quick Acting |
| Flower Stands, Bent Iron | Spray-Painting Booth with Forced Draft | Welding, Hand |
| Furnace Draft Control, Electric | Saws, Tricks of Driving | Welder, Electric Arc, for Small Shop |
| Garden Tractor, Simple | Sandblasting Light Work, Simple Gun for | |

Each volume contains approximately 450 articles and 500 illustrations and has 192 or more pages. This unrivaled library of shop helps may be secured for a limited time only. After the present supply of books is exhausted the offer must be withdrawn.

* Send No Money *

POPULAR MECHANICS PRESS,
200 E. Ontario St., Room 1134, Chicago, Ill.

Send me, as per your offer, the following books. I will pay postman price and small amount of postage. My money will be refunded if I am not satisfied. (Check what you want.)

- 1934 Shop Notes and Lathe Handbook, both for 98c.
 Shop Notes Library (8 vols.) \$3.50.

Name

Street and No.....

City.....State.....

* C. O. D. applies to U. S. and possessions only. If you reside elsewhere, remittance must accompany order.

To those who think Learning Music is hard-

PERHAPS you think that taking music lessons is like taking a dose of medicine. It isn't any longer!

As far as you're concerned, the old days of long practice hours with their hard-work exercises, and expensive personal teacher fees are over with.

You have no alibis whatsoever for not making your start toward musical good times now!

For, through a method that removes the boredom and extravagance from music lessons, you can now learn to play your favorite instrument entirely at home—without a private teacher—in half the usual time—at a fraction of the usual cost.

Easy As Can Be

The lessons come to you by mail from the famous U. S. School of Music. They consist of complete printed instructions, diagrams, and all the music you need. You're never in hot water. First you are told how a thing is done. Then a picture shows you how, then you do it yourself and hear it. No private teacher could make it clearer or easier.

Over 700,000 people learned to play this modern way—and found it easy as A-B-C. Forget that old-fashioned idea that you need special "talent." Just read the list of instruments in the panel, decide which one you want to play, and the U. S. School will do the rest. No matter which instrument you choose, the cost in each case will average the same — just a few cents a day.

LEARN TO PLAY BY NOTE

- Piano
- Guitar
- Organ
- Violin
- Saxophone
- Ukulele
- Tenor Banjo
- Hawaiian Guitar
- Piano Accordion
- Or Any Other Instrument



Send for Our Free Book and Demonstration Lesson

If you really do want to play your favorite instrument, fill out and mail the coupon asking for our Free Booklet and Free Demonstration Lesson. These explain our wonderful method fully and show you how easily and quickly you can learn to play at little expense. U. S. School of Music, 711 Brunswick Bldg., New York City.

U. S. SCHOOL OF MUSIC, 711 Brunswick Bldg., New York City.

Send me your amazing free book, "How You Can Master Music in Your Own Home," with inspiring message by Dr. Frank Crane; also Free Demonstration Lesson. This does not put me under any obligation.

Name.....
 Address.....
 Instrument..... Have you this Inst.?



High School Course in 2 Years

Your 2nd Chance

You can complete our simplified High School Course at home in 2 years. Meets all requirements for college entrance, business and the professions. Standard High School texts supplied. Diploma awarded. Separate subjects if desired.

20 Other Courses Over 200 noted Engineers, Business Men, and Educators helped prepare the special instruction which you need for the well-paid positions in—Business—Architecture—Automotive—Drafting—Electrical—Mechanical—Steam—Civil—Law. Check X before course that interests you; mail TODAY for Free Bulletin. No obligation.

American School, Dept. H845, Drexel at 58th, Chicago

RADIO ENGINEERING, broadcasting, aviation and police radio, servicing, marine and Morse telegraphy taught thoroughly. Nine months' engineering course equivalent to three years' college radio work. School established 1874. All expenses low. Catalog free. Dodge's Institute, Ada St., Valparaiso, Ind.

STOP WORRYING About Your Family



Protect them NOW with this GUARANTEED

LIFE INSURANCE

Suppose your family suddenly had to face the future alone. Would you leave them Protection—or Poverty? Learn how only \$1.00 can safeguard them RIGHT NOW with standard "old line" LEGAL RESERVE LIFE INSURANCE. Special "Modified Life" policy, only \$1 a month for first five years, is guaranteed by over \$18,000,000 assets, 29 years' safety. Includes regular cash loan, paid-up and extended insurance values.

\$1.00 a month

SEND NOW FOR FACTS Same premium for all ages. 18 to 50

We Have No Agents Learn how Postal Life—having no salesmen—SAVES you usual agents' commissions. Over \$40,000,000 already paid to policy holders. Write for free information about this dollar-a-month policy. State exact date of birth, occupation. No obligation.

POSTAL LIFE INSURANCE CO. 155 Postal Life Building New York City

ROOSEVELT AVIATION SCHOOL

Located at Famous Roosevelt Field Complete Facilities for all Aviation Training Write Registrar, Drawer F, Mineola, N. Y.

INDIANA TECH DEGREE IN TWO YEARS

B. S. Degree in Electrical, Civil, Chemical, Radio, Mechanical or Aeronautical Engineering in two years. Located in Electrical Hub of West. Earn Board. Low tuition. Enter Dec., Mar., June. Catalog. INDIANA TECHNICAL COLLEGE, 229 E. Washington St., Fort Wayne, Indiana

INFERIORITY COMPLEX

is a "disturbance centre" in subconsciousness, generating powerful negative impulses, causing self-consciousness, lack of charm, nervousness, worry, weak will, etc. To struggle against these personality-weakening forces is in vain—REMOVE THEM ALTOGETHER by reconstructing within yourself a powerful positive subconscious mind—vibrant, confident, resourceful! Write for FREE BOOK.

British Institute of Practical Psychology, Inc. Dept. PM-11, Stamford, Conn.



Recently we have received many letters outlining problems similar to the one you now face.

You had planned on stepping from high school into college. And your parents had planned on it too. But the economic upheaval of the past few years has played havoc with countless well-laid plans—and family budgets.

It's tragic in a way, but life is an experience of constant changes. In the final analysis we are responsible for our own defeats—and our own victories. *No man is ever licked who is still willing to fight.* And with hope of a college career gone, you are still eager to fight for realization of your life's dream. You have a spirit not to be denied!

You want to be an electrical engineer. You had planned on studying this subject at college. All right, you CAN be an electrical engineer.

Directed home study is the answer to your problem. Maybe you are fortunate and have a job. The answer to your dream lies in the utilization of your spare time. Many of the world's electrical engineers got their starts by studying International Correspondence Schools Courses in their spare time. This is also true of leaders in a wide range of professions.

Our Electrical Engineering Course, as is true of the other 300 courses taught by these Schools successfully for over forty years, was prepared by outstanding authorities on that subject—and is under constant revision.

You are standing on the threshold of a new era in this nation's economic and social life. Today, more than ever before, training is an essential to success. If you make the most of your talents and your opportunities, great things are in store for you. In your present situation, I.C.S. training is a real opportunity for you. Talk the matter over with your father and mother. The cost of an I.C.S. Course is remarkably low, with the privilege of small monthly payments.

INTERNATIONAL CORRESPONDENCE SCHOOLS

Box 5533-H, Scranton, Penna.

Explain fully about your course in the subject marked X:

- | | |
|---|---|
| <input type="checkbox"/> Chemistry | <input type="checkbox"/> Accountancy |
| <input type="checkbox"/> Radio | <input type="checkbox"/> Advertising |
| <input type="checkbox"/> Aviation | <input type="checkbox"/> Electrical Engineering |
| <input type="checkbox"/> Refrigeration | <input type="checkbox"/> Drafting |
| <input type="checkbox"/> Air Conditioning | <input type="checkbox"/> Show Card Lettering |
| <input type="checkbox"/> Architecture | <input type="checkbox"/> Good English |

Name.....Age.....

Address.....

When writing please mention Popular Mechanics

Books on Many Practical Subjects

Popular Mechanics Press specializes in supplying the outstanding best books on many subjects. As new books of merit appear, we will revise the list accordingly.

- AIR CONDITIONING**
Complete, authoritative. \$4.00
- ARITHMETIC**
New, time, space saving methods of figuring. \$1.50
- ARMATURE WINDING and Motor Repair**..... \$3.00
- AUTO ENCYCLOPEDIA**
Dyke's. Latest Edition Covers Recent Improvements..... \$6.00
- AUTO GENERATORS CHANGING TO 110V.**
A. C. Generators..... \$1.00
- AUTO KINKS**
for Owners, Tourists (2 vols.)..... \$1.00
- AUTO TRAILER**
Building..... \$1.00
- BIRD HOUSES**
How to Make..... \$1.00
- BLUE PRINT READING**
For Machine Trades... \$1.50
- BOAT BUILDING**
New Edition of Popular Mechanics book..... \$3.00
- BOOKKEEPING**
Complete Course, Single and Double Entry... \$3.50
- BOY MECHANIC**
Famous 4 Vol. Library, 4000 Things to Make. \$7.00
- BUILT-IN FURNITURE**
Complete Instructions. \$2.50
- CALCULATOR**
Ropp's Mathematical.. \$1.00
- CARPENTRY**
Hand book of 336 Kinks. \$1.50
- CHEMICAL MAGIC**
Fun and Education... \$1.00
- CHEVROLET SIX**
Complete Book Covers 1932 Models. \$2.00
- CONCRETE**
173 Ways of Using... \$1.00
- DANCING**
Modern Ballroom..... \$2.00
- DOG TRAINING**
For Home, Stage and Moving Pictures.... \$1.50
- FARMER'S BOOK**
of 861 Kinks and Book for Farmers' Wives.. \$1.00
- FORD MODELS VS. B and A**
Excellent new book... \$2.50
- FORMULAS**
10,000 Money Making.. \$4.00
- FROG INDUSTRY**
New book on profit making in..... \$2.00
- FURNITURE MAKING**
42 Popular Pieces.... \$2.50
- GARDEN GUIDE**
New edition..... \$2.50
- GLASS**
Working..... \$1.75
- LATHE WORK (METAL)**
and Drilling and Thread Cutting..... \$1.00
- LOCOMOTIVE**
Modern Passenger Lithographic Model Shows Every Part..... \$1.00
- LOG CABINS**
How to Build..... \$2.50
- MAKE IT YOURSELF**
900 Different Articles.. \$3.00

- MATHEMATICS**
Made Easy for the Practical Man..... \$1.50
- MECHANICAL DRAWING**
Practical Course In... \$1.00
- MONEY MAKING IDEAS**
1000 Spare Time..... \$1.00
- OCEAN LINER**
Europa, Lithographic Model, Shows Every Part... \$1.00
- OUTDOOR OPPORTUNITIES**
for Making a Living... \$2.00
- OUTDOOR SPORTS**
for All Year 'Round New Edition..... \$2.00
- PAINTING**
House (Best Methods).. \$2.00
- PAPER MAGIC**
by Houdini..... \$2.00
- PLUMBING**
500 Plain Facts for Every Homeowner... \$1.50
- POULTRY**
Breeding and Management..... \$2.00
- PROSPECTOR'S HANDBOOK**
Practical Methods.... \$3.00
- RADIO**
Amateur's Handbook... \$1.00
- RADIO SERVICING**
How to make money at it..... \$1.75
- REFRIGERATION**
Modern Electric and Gas (Just Out)..... \$4.00
- REWINDING SMALL MOTORS**
Fractional H. P..... \$2.50
- ROCK GARDENS**
How and Where to Build..... \$1.00
- SHIP MODEL MAKING**
Sovereign of the Seas... \$1.00
- SHOP NOTES**
8 Vols. of 3600 Valuable Kinks..... \$3.50
- SLIDE RULE**
How to use..... \$1.75
- STEEL SQUARE**
Pocket Book, Practical \$1.00
- STORAGE BATTERIES**
(New work) Building and Repairing..... \$2.50
- TELESCOPE MAKING**
Amateur..... \$3.00
- TOYS**
Easy to Make..... \$1.44
- UPHOLSTERY**
Easily Followed Instructions..... \$1.60
- WALL DECORATION**
(Interior) Newest Methods..... \$3.00
- WELDING ENCYCLOPEDIA**
All Methods..... \$5.00
- WHITTLING**
Only Book on Subject.. \$1.35
- WIRING**
House (New Book)... \$2.50
- WOOD TURNING**
Course in Practical... \$1.50
- WOODWORKING SHOP**
Motor-Driven (3 vols.) \$3.00
- WRIGHT WHIRLWIND ENGINE**
Lithographic Model Shows Every Part... \$1.00

Books sent C. O. D. anywhere in U.S.

Just check the books you want, write your name and address below, and mail the advertisement. It is your order blank. When post-man hands you books, pay him the price and few cents postage. If outside the U. S. remit when ordering and include 10 cents per book extra for postage. We have many other books on these and 2,000 other subjects. Catalog free.

Name.....

City.....State.....

Address.....

Mail to Popular Mechanics Press, Room N 4—200 East Ontario St., Chicago, Ill.

World's **LOWEST PRICED** Automatic Oil Burner

SAVES 25% in Fuel Costs

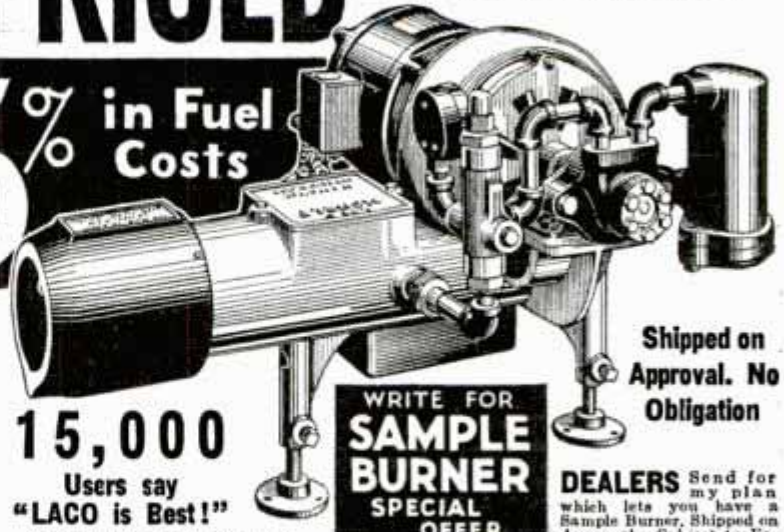

"Beats High Priced Burners," say thousands!

Why slave another winter with coal and ashes? . . . why risk ill-health with uneven heat? . . . when you can now own this sensational new LACO—Ford of oilburners—at the **WORLD'S LOWEST PRICE!** \$50 to \$60 less than any other!

Built and guaranteed by the largest exclusive oil burner Mfr. Fully approved by the Underwriter's Lab. Full size—full capacity—gives abundant heat. Highly improved in design. None more durable. Requires less servicing.

COSTS LESS FOR FUEL! Burns "heavy" oil which not only costs less, but delivers more heat. New way of burning oil—*Quiet-sized Flame*—uses 96% AIR, only 4% OIL. Every particle of heat is extracted from every drop of oil. Patented "High Pressure Carburetor" mixes oil and air thoroughly. . . . creates a slow spiral floating flame in perfect suspension. More efficient and quiet than flame which shoots through furnace with a roar, wasting fuel up the chimney!

MANY NEW FEATURES! Fully automatic. Complete with thermostat and tank switch. Operates without attention. Maintains uniform warmth. Safest known. New-type packing-less pump—radio-proof coil—indestructible all-brass tubing—new steel long-life electrodes. Only 1 moving part. Easy to install in any heating plant.

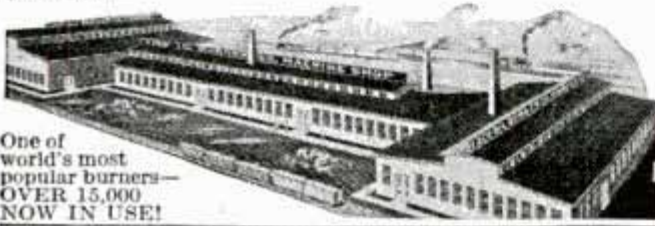

One of world's most popular burners—**OVER 15,000 NOW IN USE!**

15,000

Users say
"LACO is Best!"

"I have had one of your Lacos 5 yrs. My father has had one 4 yrs. They work fine. No service calls in the last 2 years."
S. W. HOYT, (Conn.)
"My Laco in an 8-room house used only \$64 worth of oil last winter, the worst here in 25 years."
R. R. McCONCHIE (Wash. D.C.)
"After 11 yrs. experience with oil equipment, I find LACOB better than any other."
C. QUACKENBUSH (Md.)

LACO OIL BURNER CO.
1114 Union St.
GRISWOLD, IOWA

World's Largest Exclusive Builders of Oil Burners

WRITE FOR SAMPLE BURNER SPECIAL OFFER

Shipped on Approval. No Obligation

DEALERS Send for my plan which lets you have a Sample Burner, Shipped on Approval. Subject to Examination. Without Obligation.

Add to your regular line. Low price and special features make LACO a wonderful seller.

HOME OWNERS: Have your local LACO dealer quote you the very low price. If there is no LACO dealer near you, mail the coupon. **SEND NOW!** Get Low Price, full details **AT ONCE!**

LACO OIL BURNER CO.,
1114 Union St., Griswold, Iowa.
Please mail prices, booklets and details of the Shipped-on-Approval Plan.
NAME.....
TOWN.....
STATE.....

BECOME AN EXPERT ACCOUNTANT

Executive Accountants and C. P. A.'s earn \$3,000 to \$15,000 a year. Thousands of firms need them. Only 12,000 Certified Public Accountants in the U.S. We train you thoroughly at home in spare time for C.P.A. examinations or executive accounting positions. Previous experience unnecessary. Personal training under supervision of staff of C.P.A.'s, including members of the American Institute of Accountants. Write for free book, "Accountancy, the Profession that Pays."

LaSalle Extension University, Dept. 1164-H, Chicago
The School That Has Trained Over 1,200 C. P. A.'s

LEARN WATCH REPAIRING

Be a watchmaker—you can learn this profitable trade at our resident school or by correspondence in a few months in your own home. After you complete the course, you will know how to repair watches and be ready to fill a position or go in business for yourself. Ask for Our Free Book. It explains our system and terms.

THE DESELMS WATCH SCHOOL
37 S. Wabash Ave. CHICAGO, ILLINOIS



5,000 to 10,000 Additional **SAFE** Miles from Smooth Tires *Cuts* new pattern back. Used world's largest tire factories, U. S. Govt. New non-skid.

KWICK-KUT MFG. CO., 3830 Arsenal St., St. Louis, Mo.

Start a New Business for only **\$6.50** Nothing else to buy!!

Owners pay \$1.00 per tire. Less than half hour's work. Many operators do fifteen and more daily. Nothing to sell but service. Full easy instructions sent. Send money order. Get started. Pleasant new business of your own.

FREE!

Sample copy of "SCIENCECRAFT" magazine. Packed full of the latest and most fascinating experiments in ALL branches of SCIENCE! No other magazine like it. Send 3c stamp for copy, details how to obtain free valuable scientific literature, and all scientific apparatus at large discounts. Do not omit stamp.
SCIENCECRAFT MAGAZINE P-5049 N. Bernard St., CHICAGO, ILL.



DRAFTING

BOOKS SENT FREE! ON APPROVAL
5 VOLUMES BRAND NEW EDITION

For Beginners

Written so you can understand every word, by 22 famous engineers and architects. DeLuxe flexible binding, nearly 2,000 pages, 1546 blue-prints, charts and diagrams; prepares you for a good drafting job in mechanical or architectural lines. Sent for 10 days' free use if you mail coupon immediately.



Only 15 minutes a day with these **WONDER BOOKS** will prepare you for a good drafting job in less than a year. Mechanical and architectural drafting from simple straight lines to important complex plans. *A step at a time!* Built especially for beginners, for men with only grammar schooling. Drafting room practice, **PLUS ENGINEERING**, made easy and clear. **Includes complete course in blue-print reading.**

Big Field Big Demand Big Pay

Competent draftsmen are urgently needed right now in all building and manufacturing lines at \$30.00 to \$75.00 a week. That's just the beginning—**FOR DRAFTSMEN HAVE THE BEST CHANCES FOR ADVANCEMENT.** Pleasant, fascinating work, easy to learn and do. Learn quickly with these books—send coupon for a set **FREE** and see for yourself.

A year's consulting membership in the American Technical Society now given free to all readers of this famous cyclopedia of drafting. Many say that it is worth more than the cost of the books.

Complete set of drawing instruments if you send for these drafting books **NOW.** These instruments are made of the finest of German silver, are absolutely accurate and are packed in velvet lined leatherette pocket case. Real \$10 value, but free to you with these books.

AMERICAN TECHNICAL SOCIETY
Dept. D-819, Drexel at 58th St., Chicago, Ill.

American Technical Society, Dept. D-819, Drexel at 58th St., Chicago, Ill.
Send for 10 days' free use New 5 volume set of drafting. I will pay the few cents delivery charges. If I wish, I may return books in 10 days and owe you nothing but if I decide to keep them, I will send \$2.00 after 10 days, then only \$3.00 a month until \$24.80, the special introductory price, is paid. Send latest edition and include drawing instruments.

Name.....

Address.....

Attach letter stating age, occupation, employer's name and address and that of at least one business man as a reference.

Classified Advertisements

WORLD'S BEST WANT AD MEDIUM

Advertisements in this section, 35 cents per word, each insertion, minimum 10 words, payable in advance
To be inserted under proper classification in December issue, copy should be in our office October 16th

ADVERTISING AGENCIES

ADVERTISE Profitably: \$15 reaches 6,000,000 Sunday newspaper readers with 24 word ad. Newspaper, magazine rate-guide, free. Chicago Union Agency, 20 West Jackson, Chicago.

ADVERTISE In country weeklies. Lists free. Meyer Agency, 4112 Hartford St., St. Louis, Mo.

LEARN Advertising quickly at home. New easy practical plan. No text books. Interesting booklet free. Page-Davis School of Advertising, 3601 Michigan, Dept. 343-C, Chicago.

FREE—New Advertisers Rate Guide, 44 pages. Includes everything. Lowest rates. E. H. Brown Advertising Agency, 140 S. Dearborn, Chicago.

8. **WHAT** is a "Record of Invention" form? See page 43A.

FOR ADVERTISERS

FUN—Magic—Mystery. Copy 5c. Goodall Adv. Co., Box 1592, San Francisco.

30 **WORDS** Printed 10,000 advertising circulars and mailed to prospects \$1.00. Lee Agency, Sheridan, Ark.

ADVERTISE: 24 Words in 250 newspapers \$10. Lists free. Advertising Service Bureau, 4650 Drexel, Chicago.

BUSINESS SERVICE

ENGINEER Will attend your Detroit business, purchase, promote. Confidential, \$1.00. Layrow, 4368-W, Warren, Detroit.

USE Our 5th Ave. address on your stationery and secure prestige (great asset). We receive mail, telegrams, and telephone messages and remain same to you daily. \$2.00 monthly. New York Mail Service, 15 Park Row. Also 210 - 5th Ave., New York. (Est. 1919.)

USE Our office—Mail, phone calls, telegrams, answered, forwarded. Merchandise received. Consignments handled. Contacts made. \$3 month. Mr. White, 415 Chamber Commerce, Indianapolis, Ind.

MAGICAL Messages composed for post cards, \$2 each. Send data with remittance. Jed Scarborough, Maplewood, N. J.

DELAWARE Charters; fees small; free forms. Chas. G. Guyer, 901 Market St., Wilmington, Del.

INFORMATION

"**PROFITS** In Stamps" reveals amazing opportunities for profit in stamps of philatelic value available at local post-offices. Nine comprehensive chapters. Detailed descriptions and values over 400 recent stamps. Money-back guarantee. Only 50c postpaid. Publisher, 342 Brook, Passaic, N. J.

MONEY From waste cloth. Particulars for stamps. Smitty, Box 248, Oklahoma City, Oklahoma.

WRITERS SERVICE

WRITERS! Manuscripts professionally typewritten. Free criticism, markets. Miller, 216 Maple, Irvington, New Jersey.

AUTOMOBILE SERVICE EQUIPMENT

DEMONSTRATORS, Compressor, test bench, 8-hour battery charger—are welder. Guaranteed. Trial and terms. Ken's Equipment Exchange, Box M-1142, Troy, Ohio.

AUTOMOBILE SUPPLIES

AUTOMOBILE Supplies! Radios! Bankrupt stocks! World's lowest prices! Reconditioned AC spark plugs 29c! Hot water auto heaters \$3.98! House radios \$12.85! Paint 9c gallon! Seat covers 98c! 1000 bargains! Free bulletin! Standard Liquidators, 1363-A Gratiot, Detroit.

GENERATORS, Starters, distributors, magnetos or electrical parts for any auto, truck or bus. New, used and rebuilt. Save up to 75%. Write for prices. State Ignition Service, 2002 South State Street, Chicago, Illinois.

PARTS: Passenger cars, trucks, tractors. Over ten thousand dismantled. Complete motors, transmissions, rear ends, clutches, or any part. No catalog. Write for prices. Unit Parts Rochester Corp., 1187 East Main Street, Rochester, N. Y.

NICKEL Plating outfits, connect to your battery. No tanks used, thousands in use. \$3.00 prepaid. Gunmetal Co., Ave. J, Decatur, Ill.

A.C. AUTO GENERATORS

TEN Practical and inexpensive changes converting Dodge 12-V, Ford T. A., Chevrolet Delco 6-V generators into 100-500 watt capacity a.c. generators, or into 32-110-V d.c. motor or generator. Dodge is 500-W self-excited. All in one book illustrated with complete simplified instructions and drawings for only \$1. Autopower, 408-B, S. Hoyne Ave., Chicago.

FOR FORD OWNERS

FORD Repair book for V-8 and Model A. Includes data taught in Ford training schools. Answers 600 mechanical and electrical questions in non-technical language. Used in hundreds of Ford garages. 144 pages, many charts and diagrams. Sold on money-back guarantee. Price \$1.00, postage prepaid. Trade Press Publishing Co., 403 E. Michigan St., Milwaukee, Wis.

MOTORCYCLES, BICYCLES AND SUPPLIES

USED Motorcycle parts. Trade. Tower Cycle Co., 4106 Lee, St. Louis, Mo.

MOTORCYCLES—Direct to you at rock-bottom wholesale prices. Rebuilt, roadtested and guaranteed Indians, Harleys, etc. Send 10c today for "Bargain Bulletin 43." Crandall Hicks Co., 780 Commonwealth Avenue, Boston, Mass.

HENDERSON, Excelsior, Harley, Indian, used parts, alloy pistons, catalogue and wings pin 10c. Ballak, 100 N. 12th, St. Louis, Mo.

MOTORCYCLE Bargains, lowest prices, bargain sheet for stamp, motorcycle accessories, largest line in America, lowest prices. Largest motorcycle mail order house in the United States. Rochester Harley Davidson Corporation, 129 West Main St., Rochester, N. Y.

SEND 15c For illustrated used Motorcycle catalog. Large stock. Bargains. Indian parts. Accessories. Indian Motorcycle Sales, Kansas City, Mo.

BATTERIES

EDISON Storage batteries for power and lighting systems, non-acid, non-corrosive. Five year unconditional notarized guarantee. 15 year life. Free illustrated literature. Plants, generators, etc. See Jay Battery Company, 82 Sterling Avenue, Yonkers, New York.

EDISON Storage batteries for all types of lighting systems. Uses no acid. Odorless. Long life. Guaranteed. Generating plants, motor bargains. Free interesting literature. Hawley Smith Company, 22 Washington Ave., Danbury, Conn.

DIRECT Drive wind driven battery charger and light plant. Complete plans 35c. Paul Dickson, Beaconsfield, Iowa.

AVIATION

100 **AIRPLANES.** Repairable crackups \$30 up. Send 20c for Used Aircraft Directory, Athens, Ohio.

5. **HOW** Many years does a mechanical patent remain in force? See page 43A.

GET Into aviation. Air transport pilots get up to \$7,000 per year; mechanics, \$2,500. Learn at this government approved school. Write for complete information. State age. Lincoln Flying School, 2004 Aircraft Building, Lincoln, Nebr.

MODEL AIRPLANES

BIG Package of model airplane samples. Send dime for packing and postage. Aero Shop, 3050 Huribut Ave., Detroit, Mich.

6. **HOW** Does the issuance of a patent protect the inventor? See page 43A.

BOATS, OUTBOARD MOTORS, ETC.

CANOE—Canvas covered, 16 foot, complete plans in October Rudder, 35c. Free boat-building catalog. Rudder Publishing Company, 15 Murray Street, New York City.

CARTOONING

CARTOONISTS—20c Brings list cartoon markets, syndicates, etc. Smiths Service, PC, Wenatchee, Wash.

LEARN Cartooning:—30 lessons, 500 illustrations, with drawing pens and pencils. Postpaid complete \$1.00. Scovell Studios, Box 610, Hollywood, Calif.

AMATEUR Cartoonists! Make big money. Send 50c for latest book. Rohssler, 36 Norfolk, New York City.

SKETCH, Copy, make money at home. Particulars free. Paisley, 102 N. Broadway, St. Louis, Mo.

SEND \$1.00 For 10 lessons in theatrical showcard and poster lettering. Phil Grant, 225 Bennett Avenue, New York City.

BOOKS AND PERIODICALS

BOOKS That tell how to make money—start a new business—learn a new trade. List free. Book Service, Hutchinson, Kans.

FOR BOYS AND GIRLS

EARN Christmas money—Order 50 sets Christmas seals. Sell 10c each. When sold return \$3.00, keeping \$2.00. StNicholas Seal Co., Dept. 43PMN, Brooklyn, New York.

HARMONICA Instructor, 25c. Play in one hour. G. Eisea, Bowling Green, Ohio.

GAMES

PLAYS, Operettas, musical comedies, complete minstrel first-parts with song programs, blackface skits, vaudeville acts, monologs, dialogues, recitations, juvenile plays and songs, musical readings, entertainments, make-up goods. Catalog free. T. S. Denison & Co., 623 So. Wabash, Dept. 11, Chicago.

MAGIC TRICKS, BOOKS AND JOKER NOVELTIES

158 **PAGE** Book exposes famous illusions—shows how to build equipment—50c. Educational Supply, 10-L, Racine, Wis.

MAGIC, Tricks, books; catalogue 10c. Floyds, Dept. 11, East Orange, N. J.

PUZZLE—World's greatest; solving time eight hours. Sample 10c. Herald, 1717 Lake Bluff, Milwaukee, Wis.

MAGIC Magazine revealing hundred tricks. Sample 15c. Brownlee, 218 Henry, New York.

35 **CARD** Tricks including magic catalog 25c. Lonergan, 159 N. State, Chicago.

FIVE Professional tricks and latest catalogue, 25c. Frank Lane, 80 Boylston, Boston, Mass.

125 **CARD** Tricks 25c. Speizer Service, 1449 Van Cortlandt, Schenectady, N. Y.

FUN! "13 Funny Love Letters," 10c. Stukes, 2112 Venus, Jacksonville, Fla.

MAGIC Catalogue 20c. Lynn, 105 Beach, Dept. 3, Jersey City, N. J.

LARGE Professional magic catalogue, 25c. Holden, 220 W. 42nd St., New York.

CHALK TALKS

LAUGH Producing program, \$1.00. Catalog free. Balda, The Cartoonist, Oshkosh, Wisconsin.

RADIO SETS AND SUPPLIES

MAKE Simple long distance crystal radio. Super crystal with instructions, 25c. Music Sales, Independence, Mo.

BLUEPRINT, Data, 18 crystal sets—tubeless; 1850 mile; selective; speaker. 25c coin. Modern Radiolabs, 151-C Liberty, San Francisco.

RADIOS, Buy direct. Murray Barron, 1217 R.C.A. Building, New York.

EXPERIMENTERS Quarter pound hardware assortment, 25c postpaid. Satisfaction guaranteed. Music Sales, Independence, Mo.

PHILCO Three tube short-wave converter, \$10.00. H. Zettler, Luxemburg, Wis.

WE Build short-wave receiver described page 261 August issue Popular Mechanics. Hallcrafters, 3901 Southport, Chicago.

SHORT Wave sets, kits, supplies. Wholesale catalog, 5c. Federal Telegraph, Box 344B, Indianapolis, Ind.

RADIOS—World's cheapest. Sensation. No-cost sample. J-20th Century Co., Kansas City, Mo.

MICROPHONE 24K Gold buttons, complete with stand, \$3. Faas Research Laboratory, South Orange, N. J.

"**POCKET** Radio," \$2.15 C.O.D. Order immediately. Particulars free. Neil Tasker, Shamokin, Penna.

RADIO INSTRUCTION

THE First school to offer instruction in practical radio engineering. A thorough home-study (or residence) course for men serious about radio. Write today for details and free 40-page illustrated catalog. Capitol Radio Engineering Institute, Dept. P 11, 14th and Park Road, Washington, D. C.

RADIO Engineering, broadcasting, aviation and police radio, servicing, marine and Morse telegraphy taught thoroughly. All expenses low. Catalog free. Dodge's Institute, Ames St., Valparaiso, Ind.

TRADE AND TECHNICAL SCHOOLS

LEARN Advertising—Men and women. A national advertising agency established 32 years will teach this most interesting and profitable profession by mail to limited number students. Permanent connection with organization for those who make satisfactory progress. Advertising Institute, 130 So. Broadway, Los Angeles.

NOVELTIES AND CURIOS

STROBOSCOPE Complete with electric motor and neon lamp \$1. Powerful spectroscopy shows sun's double sodium line, brilliant spectra of elements. New invention, \$2.50. Kutting Sons, Campbell, Calif.

STAMP COLLECTING

SCARCE Airmail and triangle. Beautiful Uruguay "flying horse" airmail and scarce Guatemala triangle (smallest in the world) are included in our big packet of 60 different stamps from Alouites, Grand Liban, Venezuela, British and French Colonies, etc. All for 5c to approval applicants. Big illustrated lists free with each order. Write today! Mystic Stamp Co., (Dept. 80), Camden, New York.

FREE! U. S. 30c, 50c, \$1.00 postage dues (cataloging 45c), and 40 other beauties, for 3c postage! New Byrd stamp, for mail going to South Pole, 3c. Block four, 15c. Watermark detector, 2c. 15 different Confederate prints, 10c! United States price-list, free! Approvals with each order. Tatham Stampeo, (D125), West Springfield, Mass.

THE Queerest stamps. Our special packet includes world's largest airmail stamp; smallest stamp ever issued; scarce triangle from Bolivia; Japanese "earthquake" stamp; Newfoundland map; weird Afghanistan, Manchukuo—and many others. (No Europe.) Price only 10 cents to approval applicants. R. M. Stamp Co., Box 112, Port Chester, New York.

CAICOS Islands—Also early United States, Uganda, Niger Coast, Congo, Nicaragua, Monte Carlo, Newfoundland, Canada, Ubangi—"countries collectors haven't got"—free for 5c postage. Hurry! For yours. Empire Stamp Company, Dept. PM, Toronto, Can.

THE First balloon flight stamps in the world are the commemoratives of Professor Picard's famous flight into the stratosphere; few collectors have one; we will send it together with complete set (6 values) of Denmark's beautiful Viking ships and 12 Newfoundland and Canada, all for 10c to approval applicants. Globus Stamp Co., 268 - 4th Ave., Dept. 50, New York, N. Y.

45 DIFFERENT U. S. 10c with approvals. Boesch, 1956 - 84 Street, Brooklyn, N. Y.

NORSE-AMERICAN Set, free!! Particulars. 5c. Falbaum, Cameron, Mont.

TRIANGLE From Costa Rica, Venezuela airmail, many scarce stamps, blank album, perforation gauge, hinges, watermark detector, millimetrescale. Price 5c with approvals. Mohawk Stampeo, Box 932, Mar Vista, California.

1000 UNITED States and foreign, mixed 25c. Johnel, 1748 Carmen Ave., Chicago, Ill.

100 EGYPT, Palestine, Syria, etc., 15c. Donald Cassel, Northwales, Penna.

GERMAN Mint sheets, inflation period 1919-1923; 100 varieties, perfect condition, reasonable. Helios Co., 799 Broadway, New York City.

ONLY Junior's and beginner's stamp magazine in America! Sample 5c. Editor, 3033 Grand Avenue, Detroit, Mich.

FREE!!! Russia ethnographic set or three Spain airmails. Postage 3c. Roberts, 901F Fourth, Baycity, Mich.

MALDIVE Islands, Brunei, Charkhari, Turks Caicos Islands, \$5 U. S., genuine Baden, and Imperforate Byrd. Absolutely free to approval applicants enclosing 3c postage! Viking Stamp Co., 1 Hanson Place, Brooklyn, N. Y.

FREE Stamp outfit! Includes fine triangle, packet handsome ship stamps, complete set airmails, watermark detector, bargain lists and coupons! Postage 3c. Dandy approvals included. Midwood Stampeo, Midwood Station, Brooklyn, N. Y.

SPECIAL!!! Dollar catalog packet 3c with approvals. Jorgensen, 2433, 57th, Cicero, Ill.

U. S. Revenues: 250 mixed, 25c! Pound, 75c! Vanvoorhis, Hyndman, Penna.

ALL A's: Abyssinia, Afghanistan, Alaouites, Andorra, Algeria, Armenia, Azerbaijan, Argentina, Australia, Austria, Azores, Albania, Angola, Aguera, only 10c with approvals. Gem, 1830 Unionport Road, New York.

LUXEMBURG: 25 Different stamps of this little principality, big bargain at 15 cents to approval applicants. Ancher Stampeo, Rutherford, N. J.

1,000 U. S. Mixed including commemorative 30c to applicants foreign approvals. Dolincos, 31 Park Row, New York.

WHOLESALE Catalog for dealers. Illustrated. Postage 5c. Frank Company, 4900 Chalgrove, Baltimore, Md.

FREE \$1.00 U. S. stamp with request for 48 page illustrated price-list of U. S. and foreign stamps. Also fine stamps on approval. Reference necessary. New Hussman Stamp Co., 1122 Pine Str., St. Louis, Mo.

SURPRISE Packet, Shanghai, North Borneo, etc., 10c to approval applicants. Western Stampeo, 121 W. 2nd, Los Angeles, California.

FREE—Complete charity and superb commemorative set to serious approval applicants for 5c postage. Reference. Royal Stamp Co., Dept. P, 6806 - 17 Avenue, Brooklyn, N. Y.

CANADIAN—High quality. 50 variety 50c; 75 variety \$1. Cash with order. Porter & Buckland, Box 1703, Winnipeg, Canada.

EXCELLENT Penny approvals. Westminster Stamp Co., Box 392-B, Evanston, Ill.

CHOOSE Your premiums! Jungle stamps! Animal! Bird! Airmail! Triangle and Map stamps! Pick any ten from our big approval selections. Enclose 5c postage. Stamp Importers, Akron, Ohio.

FREE Set five Russian Ethnographics for 3c postage to approval applicants. Integrity Stamp Co., Fort Washington, Pa.

100 UNUSED Stamps 10c. Approvals. Budniek, 1107 Admiral, Elmira, N. Y.

WONDERFUL Packet free! To applicants requesting our approvals. Stampeo, 8429 Island Drive, Seattle, Wash.

ONE Pound fine mixed stamps! 50c. Rettig, 105 East 102nd St., New York.

PENNY Approvals with souvenir. References. "Brook," 305 Brook Ave., Bronx, New York.

FREE. 25 Different Italian to approval applicants. Enclose stamp. Rogers, Box 935, Houston, Texas.

MAGNIFIER, Stock book, stamp album, hinges, watermark detector, perforation gauge, millimetrescale, packet scarce stamps. Price 5c with approvals. Atlas Stampeo, Box 4025, Culver City, California.

MONGOLIAN Set free to approval applicants. Edward Hammond, Auburndale, Mass.

INTERESTING Free packet to approval applicants. Write. Neely, Greenfield, Ohio.

MAGNIFICENT Lot—Air mail, British, French Colonies, Ruanda, Mongolia, Touva and others, only 10c with superior approvals. Lucas Stamp Service, Box 293, Los Angeles, California.

RUSSIA Commissar murder set free to approval applicants. 3c postage. Auer, 47-17 39th Street, Long Island City, N. Y.

500 MIXED Containing 55 different American, 10c! Approvals. Paul Baringer, Defiance, Ohio.

10c EACH, 4 Antigua, 7 Barbados, 30 Canada, 3 Dominica, 5 Grenada, 13 Jamaica, 5 Leewards, 10 Kenya, 4 Montserrat, 15 Newfoundland, 10 Trinidad, 15 Egypt. All 12 \$1.00. Westminster Stampeo, 5060, London, Canada.

105 DIFFERENT Congo, Hyderabad, Guinea, etc., 3c to approval applicants. Extra—Airmail set included free with above. H. Hunziker, Box 225, Minneapolis, Minn.

BASUTOLAND No. 1. New stamp. New country. Free to new friends. We want to tell you about our three kinds of approvals. (250 10c items listed.) Amity Stamp Service, Amityville, N. Y.

FREE! Gorgeous packet including Spanish airmail, map, ships and animal stamps, to approval applicants only, enclosing 3c postage. Imperial Stampeo, Fontana, Calif.

PRICED-RIGHT Approvals. Better grades. Want lists. Tonka Specialty Co., 3336 Ainslee, Chicago.

1000 WORLDWIDE Mission mixture 25c. Monjar, 1553 Knox, Cincinnati, Ohio.

SCARCE Panama triangle, octagon stamp, Confederate essay, and 50 others to approval applicants sending 5c postage. Philips Stampeo, D7, W. Springfield, Mass.

1000 DIFFERENT 95c—500, 45c; also packets, sets and singles. Price lists free. John Graf, 1874 Loring Place, New York.

FREE Set to approval applicants. Bill Stadler, Vineland, N. J.

WHOLESALE Catalog for dealers. Illustrated. Postage 5c. Frank Company, 4900 Chalgrove, Baltimore, Md.

ILLUSTRATED 120 Page album with 100 different United States-Canada 30c. Van Wie, 14 Van Zandt St., Schenectady, N. Y.

SET Stamps from Martinique 3 cents to new approval applicants. Herbert Knowles, Madison, Conn.

ABYSSINIA Free. Twenty-five beautiful picture stamps from Abyssinia including scarce airmails to all becoming steady approval customers. Send 10c for gigantic collection and special offers. Walker, 569 South Fremont, Los Angeles, Calif.

SCARCE Morocco airmail, Eritrea camel stamp, maps of stamp countries, watermark detector, hinges, perforation gauge, stamp album, many scarce stamps, 5c with approvals. Superior Stampeo, Box 8276, Palms-Station, Los Angeles, California.

1000 HINGES Free to approval applicants. Stamp Mart, Bushnell, Ill.

MAMMOTH Mystery packet of rare stamps for only 10c to serious approval applicants, also valuable free premiums with every selection afterward. Our stamps are better and our service is different. Fair-play Stamp Service, 1215 Browning Blvd., Los Angeles, California.

20 DIFFERENT Airmails 10c. Berry's, 219 Barrett, Syracuse, N. Y.

555 U. S. 15c. 500 foreign 15c. Premiums. Dancer, Mansfield, Ohio.

25 CANADA Including 20 different 15c to approval applicants. C. A. Leeson, 674 Yonge St., Toronto, Canada.

40 VENEZUELA, Chile, etc., 5c. Approvals. Maxwellton Stampeo, Piedmont, Calif.

1000 HINGES 5c With penny approvals. Ephriam Stampeo, River Forest, Ill.

BREAKING Valuable collection for estate. Important buyers, dealers, write. Countries? Perfect zeppelin set, \$12. Smith Novelty Jobber, Miami-Beach, Fla.

10 LB. U. S. Mixture, \$2.50, postpaid. Continental Stampeo, LaGrange, Ill.

COMMEMORATIVES 10 Different free with approvals. Wollaston Stampeo, Wollaston, Mass.

BEST One cent approvals in America. F. Hand, 1117 So. 60th St., Philadelphia.

SCARCE Indio-China and Paraguay airmails; pocket album, hinges, watermark detector, and big packet stamps, only 5c to approval applicants. Penny Stampeo, 633P Maryland, Glendale, Calif.

ALBUM Free—Spaces for 400 stamps, 2000 Illustrations. Free to buyers of my approvals. F. Stern, 24-54 Chauncey St., L. I. City, N. Y.

SCARCE Iceland airmail triangle and fine packet of 65 different stamps including Jamaica, Inini, French Colonies, savages, boats, airplanes, and animal stamps. Big illustrated pricelist. Only 5c to approval applicants. Potomac Stamp Co., 3708 - 13th Street, Dept. P., Washington, D. C.

MAGNACROCIOUS Galaxy—Ten scarce stamps 10c with foreign approvals. Swalley Stamp Company, 1119 Trenton, Los Angeles, California.

WEIRD Flying Garuda with 100 different 5c. Approvals. Burke, Marshfield, Vt.

MONGOLIA, Georgia, stamps from 50 other countries 6c with approval request. Ransom, 1333 Pontiac, Ann Arbor, Mich.

FREE Triangle with 55 different, including Abyssinia, Guiana, Hyderabad, Madagascar, etc., with approvals 5c. Cresta Stampeo, Box 2062M, Fresno, Calif.

EARN Cash, stamps. Sell my approval books. Ellison, 2841 West 37th Street, Brooklyn, N. Y.

SCARCE Paraguay, Graf Zeppelin airmail triangle, pocket album, watermark detector, packet stamps from Africa, Asia, Canada, South America, etc., 6c to approval applicants. Glendale Stamp Company, 1342P Linden, Glendale, Calif.

INVERTED Postcard 25c. Hughes, 2563 Flower, Walnut Park, Calif.

50 OLD Stamps 1c. Album 3c. Bulliard, 446 Tremont, Boston.

SENSATION Packet: Corea, Liberia, triangles, British Colonials 10c. Steele, Springdale, Pa.

ILLUSTRATED Album holding 4000 stamps to approval applicants 20c. Swan Stamps, 605 Swan, Dunkirk, New York.

STAMPS Wanted; for sale; to exchange. Write. C. Ritchie, Watertown, South Dakota, U. S. A.

200 DIFFERENT 10c. Big 60% approvals. Covert Stamp, 39 State, Rochester, N. Y.

UNITED States stamps—40 different with pricelist 10c. Seidenberg, Baroda, Mich.

UNITED States mission 50c pound; 5 for \$2.00. Canada 75c, 3 for \$2.00. Mission Company, 4512 No. Racine, Chicago.

FREE! 30 Different Angola, Cape Verde, Guinea, Portugal, Mozambique, St. Thomas. Send return postage. Depraw, Ocean Park, California.

YOU'VE Tried the rest, now get the best! We have answered all advertisements, compared premiums, approvals, etc., and absolutely proven that ours are superior. Send 10c for "Challenge Offer" with approvals. Bargain Stamp Service, 1332 South Hope, Los Angeles, Calif.

UNITED States! World's lowest prices guaranteed! Box 114, Minneapolis, Minn.

AMAZING Value—35 different U. S.: 1861, commemoratives, air-mail, etc., 10c to approval applicants. Stamp Shop, 809 Holland Bldg., St. Louis, Mo.

CARIB Archer, (Inini), map stamp, 1892 South American envelope included in quality packet, hinges, stamp wallet, 10c to collectors desiring approvals. United Pacific Philatelists, Box 25M, Ventura, Calif.

AIRMAILS—From Brazil, Chile, Colombia, Ecuador, Mexico—all for 10c, with double premium penny approvals. Progress Stamp Service, Franklin Park, Ill.

FREE Dollar packet to one cent approval applicants. Harlan, 5307 S. Marshfield Ave., Chicago, Illinois.

THIS Ad worth 25c. If you send for our approvals and buy 50c worth or more—large selection of U. S. and foreign—reasonable prices. Morton Stamp Co., 1121 Olive, St. Louis, Mo.

LIBERIA—Eight big bi-colored beauties showing water buffalo, hippopotamus, negro president, etc., only 6c with approvals. Garcelon Stampeo, Box 835, Calais, Maine.

COMMEMORATIVES—10 Different and 30 other Canadian only 15c. World special—500 different 30c; 1000 diff. 85c; 2000 diff. \$2.50. Approvals with each order. Victoria Stamp Company, London 4, Canada.

FREE—To approval applicants. Five beautiful airmails from five different countries. Green & Co., Norwood, Ohio.

STAMPS, 200 Different, catalogue over \$4.00, and catalogue, 10c. Norman Shultz, Salt Lake, Utah.

SCARCE Zeppelin and triangle. Famous Russia Zeppelin stamp and beautiful Lithuania airmail triangle; also big packet of 53 different stamps including Azerbaijan, Epirus, new Martinique, etc., and illustrated lists—all for 5c to approval applicants! World-Wide Stamp Co., Box 600, Camden, New York.

STAMPS Sent on approval. 50% discount. Fred Herzberg, 197 Grantley Ave., Elmhurst, Illinois.

200 DIFFERENT Stamps, triangle, airmail, etc., 10c. R. H. Carlton, 209 W. Fourth, Los Angeles, Calif.

BYRD Commemorative and 34 different U. S. including early issues, high values, commemoratives, airmail, envelopes, special delivery, postage due and revenues cataloging over 85c. All for 7c to approval applicants. Illustrated pricelist free. Curban Stamp Co., Dent, P. Gloucester, Mass.

30 DIFFERENT Japan 10c. Fred Onken, 630 79th Street, Brooklyn.

NEWFOUNDLAND, 15 Different 5c with approvals. Hudson Co., Plainfield, N. J.

U. S. \$2 Wine 8c with approvals. Arrow Stamps, Plainfield, N. J.

ILLUSTRATED U. S. list, price 50c, large complete U. S. price list free. Stanley Gibbons, 38P Park Row, N. Y.

RARE COINS

FREE!—Foreign coin, banknote, and large illustrated coin catalogue,—4c postage. Souvenir California gold quarter size 26c; 3/4 size 53c; both 65c! Round or octagon, set of each \$1.30! Approvals with each order. Tatham Coinco, West Springfield, Mass.

UP To \$15.00 each for certain Indianhead pennies; send dime for list of these wanted. Coin-Shop, "D," Springfield, Mo.

3 FOREIGN Coins and price list 10 cents. Stephens, 1702 Main St., Elkhart, Ind.

OLD Money wanted. Do you know coin collectors pay up to \$100.00 for certain U. S. cents? High premiums for all rare coins? I buy all kinds. Send 4c for large coin folder. May mean much profit to you. B. Max Mehl, H Mehl Bldg., Fort Worth, Texas.

HIGHEST Prices paid for old U. S. coins. Ed. O. Webb, Box 592, San Jose, Calif.

\$35.00 IN Genuine Confederate bills, 25c. Paul Summers, Sagerton, Texas.

20 NICELY Assorted coins 25c. Otto Oddehon, 800 1/2 Grand, Kansas City, Mo.

COIN Book, over 800 illustrations, 100 pages. Biggest and best book for price, \$1. Money refunded if unsatisfactory. 100 foreign copper and nickel coins \$1. Dealers write for prices on rare coin book. Gutttag Bros., 42 Stone Street, New York.

HIGHEST Prices paid for Indian head pennies. Send dime for list of those wanted. Coin Shoppe, Box 407-PM, Ottawa, Ill.

WHOLESALE Prices on American and foreign coin. Price list 3c stamp. Geo. Best, Cedar Rapids, Iowa.

HIGHEST Prices paid for Indian head cents. Send dime for list of those wanted. Coin Shoppe, Box 407-PM, Ottawa, Ill.

CALIFORNIA Gold quarter size 27c; 3/4 size, 53c; 3c piece and catalogue, 10c. Norman Shultz, Salt Lake, Utah.

UNITED States white cent and bargain selling price list 10c. Arcy, Box 483, Muskogee, Okla.

WE Buy 1907 Indian head cents. Full information one dime (coin). New Miss Mattick Co., Box 3450, Altoona, Pa.

11 DIFFERENT Coins, 3 bills and catalogue, 25c. Creamer's, 1112 Somerset, Baltimore, Md.

UNITED States, Large cent, two-cent bronze, three-cent nickel and bargain list, 25c. Thirteen dates large cents, \$1.00. George P. Coffin, Augusta, Maine.

CAMERAS AND PHOTO FINISHING

FREE! Bargain catalog—Greatest inventory clearance sale in our 35 years. Send for your free copy listing thousands of cameras, lenses, accessories and photographic supplies. Central Camera Co., Dept. PM11H, 230 S. Wabash Ave., Chicago, U.S.A.

TRIAL Offer. Roll developed and 8 prints 25c. Prints 3c each. Beautiful 10-inch enlargement 25c. Photo Christmas cards or photo calendars 10c each, 14 for \$1.00. Young Photo Service, 405 Bertha St., Albany, N. Y.

25 BEAUTIFUL Embossed Christmas cards from your favorite kodak negative. With envelopes to match only \$1. Films developed 16 prints finished 25c. Summers' Studio, Unionville, Mo.

4x6 ENLARGEMENTS 5 For 25c; 100—\$4.00. Enlargers, 4118-8 Overhill, Chicago.

ROLL Developed, 8 prints, oil painted enlargement, 25c. Prompt service. Work guaranteed. Individual attention to each picture. Janesville Film Service, C15, Janesville, Wis.

DEVELOP Pictures yourself. Camera, films, developing chemicals, printing materials, directions. Complete photographic outfit \$1.00. Photocraft, 100 Forsyth, New York.

ROLL Developed, 8 prints, oil painted enlargement, 25c. Prompt service. Work guaranteed. Individual attention to each picture. Janesville Film Service, C15, Janesville, Wis.

ROLL Developed—Eight guaranteed Nu-border prints. Two Nu-border enlargements, 35c coin. Giant Snapshots, Inc., Dept. A, Green Bay, Wis.

NEW! Beautiful art panel prints 6c. Sample with "trial order." Roll developed and eight prints 25c; reprints 3c. Ideal Photo Service, Box 2255, Paterson, N. J.

ANY Photo, snapshot or negative enlarged 8x10 39c. Texas Studios, MI, Sweetwater, Texas.

ROLL Developed and two sets prints 25c. 20 reprints 25c. Photoshop, Sweetwater, Tex.

SUNLIGHT (Washproof) prints from negative on paper, linen, wood, etcetra. 2 minute Transfoto. Results guaranteed. Bottle sufficient 100 4x6 prints 75c. (COD. \$1.) Cdor, 50 E. Fordham Road, New York City.

20 FADELESS Reprints 25c. Roll developed, printed 15c. Satisfaction guaranteed. Silas Henke, Armstrong, Iowa.

DEVELOP And print snapshots yourself. Learn fascinating photo-developing with Winner Photo-Set. Contains dark-room lamp, genuine enamel trays, glass graduate, stirring rod, developer and fixing powders, printing frame, Agfa printing papers, complete directions, only \$2.25 postpaid. Winn Co., 124 West 23rd Street, New York.

SELL Your snapshots. Booklet listing 100 markets 20c. Box 402, Hutchinson, Kans.

HAND Colored enlargement with each roll 25c. 40 reprints 50c. Colorgraph—8, Dunning Station, Chicago.

COLORED Enlargement with each film developed—a professional enlargement painted in oils and eight Gloss-tone prints, deluxe finish, guaranteed not to fade, 25c. Super quality—Speedy service—Satisfaction or money refunded. LaCrosse Film Company, Dept. 19, LaCrosse, Wis.

MAKE Money in photography. Learn quickly at home. Spare or full time. New plan. Nothing like it. Experience unnecessary. American School of Photography, Dept. 3436, 3601 Michigan Avenue, Chicago.

ROLLS Developed. Two beautiful double-weight professional enlargements and 8 guaranteed Never Fade Perfect Tone prints. 25c coin. Rays Photo Service, LaCrosse, Wisconsin.

6 CHRISTMAS Cards, envelopes to match with every film developed and printed 25c. Newton, 4118-8 Overhill, Chicago.

16 BEAUTIFUL Gloss prints and two enlargement coupons only 25c. Imperial Film Service, Unionville, Mo.

KODAK Pictures enlarged, 5x7 10c, 3 for 25c. Send negative film. Stanley Studio, Des Moines, Iowa.

20 REPRINTS 25c. Films developed, two prints each negative, 25c. Skrudland, 4118-Overhill, Chicago.

FILMS Developed 5c per roll; prints 3c each. Ask for special bargain list. Roanoke Photo Finishing Company, 161 Bell Ave., Roanoke, Va.

YOUR Favorite kodak pictures enlarged size 5x7. 10c. Three for quarter, coin. Send best negatives (film) today. Address: Darmer Photo Lab., Enlarging Dept. 9, Des Moines, Iowa.

INCOME From your camera instead of expense. Low cost home course teaches you to make photographs for magazines, newspapers, advertisers. Tremendous demand. Earn good money wherever you live. Free book. Universal Photographers, Dept. 104, 10 West 33rd St., New York.

ROLLS, Developed, printed, 25c. Make your films to the biggest and best. Roll developed and 8 good prints guaranteed plus 8x10 inch enlargement coupon only 25c. Reprints any size 3c each. Geppert Studios, Dept. 130, Des Moines, Iowa.

TWO Crystal stiple enlargements with each roll 25c. Photoshop, 4112-8 Oriole, Chicago.

HAVE You a camera? Send ten cents for recent number of our big magazine, showing how to make better pictures and earn money. American Photography, 116 Camera House, Boston, 17, Mass.

MOTION PICTURES AND SOUND EQUIPMENT

SILENT, Soundisc, S.O.F. film for sale or rent anywhere. Cheapest rates. Agent for all makes 8, 9 1/2, 16, 35mm equipment. Trades accepted. DeVry 35mm still camera \$5.44, projector \$9.84, 100 ft. 16mm film with processing \$2.50. Victor Turret No. camera \$70.00 DeVry 16mm automatic 10 ft. camera \$11.75. Bell & Howell projector \$74.50. Film library membership free, catalog. Eastman 400 ft. reels 38c. Humidec cans 45c. Cement 20c. Splice 8c. Film cleaner 25c. Preservatives 25c. Beads screen \$1.00. Mogull Bros., 1944-J Boston Road, New York City.

WANTED—35mm and 16mm films and negatives of circus parades, performances, etc., old and new prints, must be perfect. E. Sullivan, 3939 Flad Ave., St. Louis, Mo.

LEARN The motion picture theatre business. Big opportunities for trained men. Catalog T free. Theatre Institute, Elmira, New York.

CLOSE-OUTS—16mm Projectors, film, listings stamp. Box 2133, Paterson, N. J.

16MM FEATURES Rented anywhere \$5.00. Shorts dollar reel. Lists. Thousand feet 35mm \$1.00. Remington Pictures, Cincinnati.

DEVELOP And print your own movies. Instructions \$1.00. Milio, 620 Myrtle Ave., Brooklyn, N. Y.

100 FEET 35mm 27c; odd reels 80c plus postage. 6 reel features \$6.00. Bargain list 3c. Hoffman Film Service, 57 Broad, Albany, New York.

BARGAINS, Used theatre projectors, parts, soundheads, turntables, amplifiers, horns. Catalog mailed. S.O.S. Corp., 160 Broadway, New York.

FREE New 16mm, 8mm bargain lists. Mickey Mouse projector outfits \$4.95. Film 35c up. Art sample 25c. Home Movies, Box 32, Easton, Penna.

WESTERNS: 500 Ft. 85c. Jersey Films, 2075 Richland, Lakewood, Ohio.

AMERICA'S Greatest 16mm values. Film sold, rented, exchanged. Projector bargains. Dime brings illustrated catalogue, two "end" titles. Eastin Films, Dept. 23, Galesburg, Illinois.

BASS Offers for a limited time brand new 100 ft. Stewart-Warner 16mm Cine camera, complete with case, F:3.5 lens, worth \$50.00, at \$18.50 each. Hundreds of other bargains in Bass Bargaingram No. 21, mailed on request. Write to Value Headquarters. Bass Camera Company, 179 W. Madison St., Chicago, Ill.

BUSINESS OPPORTUNITIES

SCREW-HOLDING Screw drivers! No magnetic! Remove, hold, insert screws in accessible places. Factories, garages, electricians, mechanics, radio, autoists; no competition! Quick sales, big profits. Exclusive territories; also foreign. Toolco, 5061 Winthrop Bldg., Boston, Mass.

PLASTEX Industries offers industrious men an opportunity to start a business of their own, manufacturing art goods, novelties, souvenirs, etc., in Plastex and marble imitation. 5c material makes \$1 articles. Rubber moulds furnished for speed production. Small investment brings big returns. You are just in time for big Christmas business now starting. Write for interesting booklet mailed free. Plastex Industries, Dept. A, 1085 Washington Ave., New York.

ESTABLISH Permanent repeat business installing brand new, much needed service in garages, ignition shops, etc. Norman, 4638 Washington, Chicago.

MAIL Order drug store. Let us supply your drug store wants. Information given; stamp appreciated. Mequon Drug Store, Thiensville, Wis.

SELF-STARTER For mail order beginners; set of ten practical outlines meeting new conditions. Details free. Geo. E. Cassidy, 509 Fifth Avenue, New York.

OPERATE Profitable sparetime mail order business. Dime brings particulars. Service, Box 5524-PM, Cleveland, Ohio.

BARGAINS—Paint spray outfit, gasoline engine drive. Terms—trial. Helmick Paint Spray Exchange, M-1143, Troy, Ohio.

"SCHEMER Magazine," Alliance, Ohio, prints schemes, ideas, business starters, formulas; winners—\$10,000 to \$50,000 reported. 36th year. \$1. Subscribe now. Six months special, only 30c.

RECLAIM Used motor oil easily, cheaply. No filtering process. Particulars 10c. Ralph Brooks, Arkansas, Wis.

WE Make synthetic rubber composition molds. Send model or description for estimate. Duplicate perfectly. Low prices, less than fourth cost of rubber molds. Equally good and lasting. If desired, make your own S.R.C. molds. We teach marblizing and mold making in all branches. Send dime for rubber mold and marblized samples. Cowell Institute, Grayling, Mich.

OLD Spark plugs worth 3c each. Thousands being rebuilt. Start profitable route. Collecting, selling, shipping, instructions 25c. Hammond Sales, Paulding, Ohio.

BUILD Up for yourself—profitable, lifetime business right in your own home, working for us. No canvassing. Send dime for particulars. S. R. Merritt, 2719 Second, Baker, Oregon.

PROFIT With new products. Make, sell, repeat. Guaranteed formulas. Special prices, leads. Biggest catalog free. Gibson, Chemist, BD-4702 North Racine, Chicago.

AMAZING New deal in formulas, manufacturing processes, all lines. Write, H. Newman, Box 58, Chicago.

ARTIFICIAL Marble plans, formulas, instructions. Details free. Marble Institute, 4612 North Hermitage, Chicago.

DIME Brings 500 money makers. Bruce, 1315 E. 63, Chicago.

SCREW-HOLDING Screw drivers! Not magnetic! Remove, hold, insert screws in accessible places. Factories, garages, electricians, mechanics, radio, autoists buy; no competition! Quick sales, big profits. Exclusive territories; also foreign. Toolco, 5059 Winthrop Bldg., Boston, Mass.

SELL Common lb. Complete (coin). 10c.

LEARN Pas-sueding. New and different. Enormous profits. Get started before Christmas. \$1.00 brings sample and full particulars. Write L. C. Bedwin, 21 Baker St., Foxboro, Mass.

HOME Manufacture—"Formula-ist," year, 10c. Surprise gift included. Beyler, Tipton, Indiana.

WIN Thousands cash! Send 10c. list, legitimate contests. World Contests Magazine, 6823C - 17th N. E., Seattle.

MAKE Your own products. Employ agents yourself. Toilet articles, soap, extracts. We furnish everything. Valuable book free. National Scientific Laboratories, 1950W Broad, Richmond, Va.

NEED Cash? 500 spare and full time money making suggestions. Guaranteed practical. Act promptly; enclose only 50c. L'Atelier, Box 681, Detroit, Mich.

HOW To increase your income. 48-page bound volume—35c. Educational Supply, Dept. 10-L, Racine, Wis.

100% PROFIT. Sell Hom-sharpener. Every skater, butcher, baker, cabinetmaker and shoemaker a prospect. 50c for sample and salesplan will start you right away. Act quick. Write at once for further information. L. Schultheiss, 2818 W. Highland Blvd., Milwaukee, Wis.

NON-ALCOHOLIC Vanilla flavor liquid. Guaranteed tested formula 35c coin. F. L. Peters Co., Salem, Mass.

START A mail order business, and receive a steady stream of money daily. Complete plan 50c. Abatta, 548 - 17th Str., West New York, N. J.

HOMEWORKERS, 87 Ways to make money without peddling. Free particulars. Victoria Co., Box 666, Albuquerque, New Mex.

"KEY To Business Opportunities," 10c. Martinez, 1340, San Bernardino, Calif.

500% PROFIT Manufacturing products yourself, write Thomson, 7309 Pingree, Chicago.

MAILING Secretaries wanted. Experience unnecessary. Pay weekly—part in advance. Contract—details, 3c stamp. Nagel Enterprises, 1329 Olive, Indianapolis, Ind.

9. WHY Does the patent office advise applicants to employ registered patent attorneys? See page 43A.

THERE'S Money in the collection business. Write Cole Associates, Tower, Syracuse, N. Y.

RAISE Pheasants for profit. 24-page booklet tells how—10c. Pheasantry, Dept. 3, Racine, Wis.

HAVE \$35,000 To invest, in patented or unpatented idea, either in manufacture or promotion. Would like to give my services either as partner, or otherwise. Harold Hilton, 1749 Grand Concourse, New York City.

1000 WAYS Making money, details dime. Moyer Supply, Milton, Pa.

MAKE Fast-selling products. Any formula 30c or money back. Ogg Laboratories, Tampa, Florida.

DISTRIBUTORS—Supply revolutionary corn remedy to stores. New sales plan results in landslide of orders—Up to 150% profit. Write for exclusive franchise. Reliable Specialty Corp., Buffalo, N. Y.

DISTRIBUTORS Wanted for Sealtek—New compound which eliminates puncture leaks and lengthens tire life. Biggest hit in automotive history. Chance to make a fortune. For exclusive territory and sample proposition, write Seiberling, 1614a Estes, Chicago.

ARTIFICIAL Marble formulas, three for 25c. Johnson, 4520A Christiana, Chicago.

SIGNS Easily painted with letter patterns. No lessons or experience required. Booklet samples and index hand, mailed 10c. Refund on first order. John Rahm, A2120 Neva, Chicago.

EARN Quick cash raising mushrooms in cellar, shed, attic. We buy crops. Guaranteed materials furnished. Easy. Odorless method. Book free. United, 3848-BO Lincoln Ave., Chicago.

SEE Our display advertisement on page 126A this issue. Rapaport Bros., 703 West Ohio, Chicago.

\$5 To \$50 Weekly. Grow fancy "White Queen" mushrooms in cellar or shed. Free mushroom book tells how. American Mushroom Industries, Ltd., Dept. 835, Toronto, Ontario.

NEW York office, valuable business asset. Dependable desk mail and 'phone service \$5 monthly. Mail and 'phone \$2. Invaluable money-saving information such as buying, selling or any other reasonable information \$1 yearly. Co-operative Inventors, 126 Lexington Avenue, New York.

REAL Depression buster plan, complete—10c! Merriam Service, 4649-V Woodlawn, Chicago.

HUSTLERS! New money getter. Magazine; latest songs, jokes, opportunities, etc. 10c. (None free.) Ads. 3c word. Review, 296 So. Euclid, Pasadena, Calif. (Writers wanted.)

PROFITABLE Mail order ideas originated. Write, H. Celestine, Blissfield, Mich.

FREE Books, mail order business. Stamp appreciated. Dolsen Herald, 36 Liberty Street, Brooklyn, New York.

MAKE Money at home. Hundreds of plans, schemes, ideas. Magazine, 6x9, 32 pages, three months 10c. Home Industries, Irvington, Nehr.

HANDY Men—Establish vacuum cleaner repair service. Big profits. Write Myers Sales, Codorus, Pa.

NEW Money-Making plan for stamp. Hurry. George Talbot, Norwood, Mass.

TWELVE New successful money-makers. J. Home, 3949 Metropolitan, Chicago.

LIQUID Marble—Anyone can make! Colorful, glazed! Molded, brushed, sprayed. Rubberlastic molds. Composition flooring. Big money making these! Particulars free. Marbleizing Service, Edwardsville, Ill.

FREE Circulars describing how you can make real, big money in mail order business at your home. Write today, Dept. 8, Mail Order Institute, 669 Marcy Avenue, Brooklyn, N. Y.

100 PROFITABLE Mail order and local business plans. A. Pruitt, Elburn, Ill.

WIN Thousands cash! Send 10c. list, legitimate contests. World Contests Magazine, 6823A - 17th N. E., Seattle.

SUCCEED With your products. Learn how. Formulas, Processes. Analytical service. Catalog free. B. Thaxly Co., Washington, D. C.

HANDY Men—Establish vacuum cleaner repair service. Big profits. Write National Distributing Co., Box 32, Washington, D. C.

CHEMICAL Expert will furnish formulas and trade secrets. All lines. Lists free. W. L. Cummings, Ph. D., 228 Gordon Ave., Syracuse, N. Y.

START Little business anywhere. Everything furnished. No canvassing. Maywood, PM 923 Broadway, New York.

MAKE Big money molding novelties. Sample mold 25c. Write for details on free course in mold making. Stewart's Studio, B2102 West 19th, Chicago.

MANUFACTURING And retail business. Suited for a man and woman or two women. Excellent profits, big sales. No chain competition. Easy to learn. Hardly any capital. Free literature. Success Associates, Box 852, Syracuse, N. Y.

START Your mail order business right. There are certain essentials—Promotion methods indispensable in selling successfully by mail. Without them you can't make a profit. Using them means establishing and maintaining a paying business. Send only one dollar or free literature for purple stamp. Techman, 2861 W. Grand Blvd., Detroit, Michigan.

SELL By mail. Books, novelties. Bargains! Big profits. Particulars free. B. Elfcio, 525 S. Dearborn, Chicago.

CASH Income daily resilvering mirrors at home. Replating autoparts, tableware, etc. Outfit furnished. Write Sprinkle, Plater, 127, Marion, Ind.

BIG Money at home plating auto parts, reflectors, mirrors, chandeliers; by new method; experience unnecessary. Outfits furnished. Gunmetal Co., Ave. N, Deatur, Ill.

FREE Booklet describes 87 plans for making \$20-\$100 weekly, in home or office, business of your own. Elite Co., 214 Grand St., New York.

ARTIFICIAL Marble sanitary flooring, instructions covering wood or cement flooring 1/2 inch thick, fireproof, all colors, low cost. Ornamental casting, concrete plaster papier-mache decorations, garden furniture, statuary, flexible molds, particulars and illustrations free. Chris. Mahler, Elmont, N. Y.

MAKE Products yourself. Tested formulas—catalog free. Grinstead Laboratory, Edwardsville, Ill.

MAIL Order business is your opportunity. Many began small, now earn thousands yearly. No personal contact. Boundless opportunities. Have had over 30 years experience; will help you succeed. Send 25c for valuable booklets, none free. B. Breniser, 257 South 21st, Philadelphia.

FORMULAS AND TRADE SECRETS

MULTIGRAPH Ribbon rejuvenator, formula \$1.00. Many other guaranteed formulas. Profits tremendous. List free. Thermo, Peoria, Ill.

MODERN Beauty products, 10 formulas 50c. Clenco, Postal Box 17, Verdun, Que., Canada.

5 GASOLINE Intensifying and decarbonizing formulas—\$3.00! Manufacturing formulas supplied! T-S-G Co., P. Box Ten, Wilkinsburg, Pa.

500 FORMULAS 25c; Moneymaking literature free. "Ideal," 178P, Parkridge, Ill.

FORMULAS—32 Different solders 50c. G. Pennington, R1, Robbinsdale, Minn.

SPECIAL Formulas not listed elsewhere from Chemist, 830 South 41st Street, Omaha, Nebraska.

FORMULAE And processes developed for making automobile anti-freeze, stopleaks, synthetic resin polishes, etc. Chemical Research Laboratories, Ossining, N. Y.

ANY Formula 50c guaranteed. McAlea, 1619 Mediterranean, Atlantic City, N. J.

ANY Formula you desire 25c (coin). Westcott, Clyde, N. Y.

CHEMICAL Coal saver; latest economical formula, 25c. Duffy, Covington, Ky.

10. WHEN Can an article be marked "Patent Applied For"? See page 43A.

25 LATEST Beauty, polish, soap formulas, source of supply, only \$1.00. Big profits. Olender Co., 1228 Park Row Bldg., New York.

3,000 FORMULAS, Facts, processes, trade secrets in Dr. Brown's Book of Formulas—380 pages. Price, postpaid \$1.00. Ogilvie Publishing Co., 57 Rose Street, Dept. 25, New York.

FORMULAS, Plans, ideas. Literature free. Belfort, 4042 N. Keeler, Chicago.

MANUFACTURERS' Service. Box 628, Central Station, St. Louis, Missouri, furnishes formulas successful manufacturers use. Particulars free.

500 MONEY Making formulas 25c. Descriptive circulars free. Harvey Teeple, Decatur, Ind.

NEWEST Guaranteed formulas. Catalogue free. Special prices, leads. Gibson, Chemist, B D 4702 N. Racine, Chicago.

GUARANTEED Formulas, best science can produce for making popular, biggest-selling specialties all lines. Don't buy formulas till you've received valuable eye-opening literature. Miller, Chemist, 706-F Jetton, Tampa, Fla.

SUCCEED With your product. Learn how. Formulas. Processes. Analytical Service. Catalog free. B. Thaxly Co., Washington, D. C.

FORMULAS, All kinds. Guaranteed. Catalog free. Kemico, 31, Parkridge, Ill.

TESTED Formulas—Newest, guaranteed! Catalog free. Grinstead Laboratory, Edwardsville, Ill.

ART NOVELTIES

MAKE Big money molding novelties. Details free. Sample mold 25c. Write today. Stewart's Studio, P2102 W. 19th, Chicago.

CHEMISTRY

HANDBOOK For chemical experimenters (revised 1934) illustrated, 50c. Experiment booklet 15c. Catalogue 10c. Reading Scientific Co., Reading, Penna.

ANYTHING Analyzed. Practical formulas. Write, Associated Chemists, Indianapolis, Ind.

AMATEUR Chemist magazine—3 months 25c. 1017 High, Petersburg, Va.

CHEMICALS, Laboratory glassware and apparatus. Catalog CP. Biological Supply Co., 1176 Mt. Hope Ave., Rochester, N. Y.

CHEMISTRY Magazine. Hundred experiments. Sample 15c. Brownlee, 218 Henry, New York.

CHEMISTS' Slide rule, editorial Jan. issue, saves time solving equations, gives molecular weights, shows formulas, 391 compounds. Durable precision instrument. Postpaid, complete instructions, two dollars. MWC Company, 508 Andrus Bldg., Minneapolis, Minn.

FREE! "Sciencecraft" Magazine and other scientific literature. See page 27A.

SEND 10c For new catalog listing chemical, microscope and photographic kits and supplies. Special 30 day offer to those who send immediately. Winn Company, 124C West 23 Street, New York.

SCIENCE

TRUE Scientific solution of the bewildering problem of: "What would be the result if an irresistible force collided with an immovable body?" Enclose one dollar bill for your copy of this esoteric analysis. Carroll Spencer, 7214 Quick, River Forest, Ill.

AGENTS WANTED

AGENTS—Specialty salesmen—Demonstrators—with automobiles preferred. America's latest patent development for auto owners. Subtype eliminates flat tire worries forever. No jacking of car necessary. Device which thousands of autoists buy on demonstration. Your profit \$5 on every sale. Send now for exclusive territories and full descriptive details. Wolf Specialty Co., Dept. P, 85 E. Hawthorne Ave., Valley Stream, L. I., N. Y.

MEXICAN Feather pictures Christmas novelty. Send 25c (stamps) for \$1.00 worth sample and details. Mexican Art, Apartado 1593, Mexico, City.

PROFIT With new products. Make, sell, repeat. Guaranteed formulas. Special prices, leads. Biggest catalog free. Gibson, Chemist, BD-4702 North Racine, Chicago.

SEND Hose size for samples and opportunity for \$20 week job. Just show sensational guaranteed hosiery to friends. Dignified pleasant easy work. Everything supplied Wilknit Hosiery, Desk 3711, Greenfield, O.

LARGE, Steady profits. Make-sell amazing anti-freeze solution for autos. Will not freeze at 22 below. Made in few minutes. Send only 25c today for formula. Allied Research, 2217 N. Kilbourn, Chicago.

FREE Plan shows how to make money at home, spare time, no peddling or canvassing. Special introductory offer. Enclose dime to cover handling expenses. Dept. 9, Cocheo Libraries, Dover, N. H.

HOUSE To house—20th century medical remedy. 100% profit to workers. Exclusive territory to producers. Write Box 254, Trinidad, Colo.

SELLS Like hot cakes. Big profits. New laundry soapflakes. Perfumes clothes lastingly when washing. Territory given. Sunset Laboratories, Lynbrook, N. Y.

AGENTS Wanted. Men, women. Fastest selling article on market. Absolutely new; demand already created. Every home a prospect. Big profits. S. C. L. Sales Agency, Montgomery, W. Va.

\$6.00 HOURLY. Amazing Karnu refinishes autos like new without rubbing, polishing, waxing or painting. Wipes on with cloth. Lasts 8 to 12 months. Free sample. Karnu, Dept. C-108, Cincinnati, Ohio.

GENUINE Gold letters for store windows. Easily applied. Free samples. Liberal offer to general agents. Metallic Letter Co., 438-B North Clark, Chicago.

100% PROFIT In the mystery cigar lighter. No flint or friction. What makes it light? No wind can blow it out. Retail 25c. Sample and sales plan 25c. New Method Company, Desk PM-23, New Method Bldg., Bradford, Pa.

STRANGE Ironing cord. Prevents scorching. Saves electricity. Abolishes kinks, snarls. Approved by Good Housekeeping. For telephones also. 140% profit. Samples furnished. Neverknot, Dept. 11-A, 4503 Ravenswood, Chicago.

AGENTS—New auto drain plug going wild! Button control on dash drains oil; no getting under car. Saves half oil bill. Priced so low everybody buys. Free sample offer! Write Toman Sales Company, Dept. R-210, 2621 W. 21st St., Chicago, Ill.

MAKE Big money! Commissions advanced. Sell raincoats and zipper jackets. Latest style and quality. Lowest prices. Experience unnecessary. Outfit free. Goodyear, H-712 Roosevelt, Chicago.

300% PROFIT Selling new "20-in-1" kitchen utensil. Retail 25c. Costs you \$1.00 a dozen. Sample 10c. New Method Co., PMM-23, Bradford, Pa.

NEW Silver tinselled Christmas signs, 9"x12", cost 3 1/2c, retails 25c, sample free, clean up this Christmas! Lowy, 8 West Broadway, New York.

GOLD Embossing ink. Engrave Christmas cards. Farrand Chemical Company, Tyrone, Pa.

DISTRIBUTORS: New door knocker and keyhole illuminator. Territory open. Klocker-Lite Company, 3292 West 125th Street, Cleveland, Ohio.

WALL Papers, paints, wholesale. Large savings. Advice given. Samples. Paint Shop, 218 Division, Grand Rapids, Mich.

MARRIED Man with spare time to distribute free samples coffee, flavoring, food products and make customers. Must devote at least two hours daily and be satisfied with up to \$3 in an hour. Permanent, Blair, Dept. DFS 17, Lynchburg, Va.

IF You want to get your groceries and household supplies at wholesale, and a wonderful chance to make \$15 a day besides, send me your name immediately. No experience necessary. Albert Mills, 4672 Monmouth, Cincinnati, O.

SENSATIONAL New 15c scissor sharpener proves amazing seller. Make 200%. Sample, details 10c. Dandee Company, 14 North Sixth Street, Minneapolis, Minn.

DOUBLE-EYED Self threading needle packages, size 3/9. Blind people thread them, invaluable for failing sight, necessary for good sight. Sample, particulars 10c. Agents wanted. Wm. Oglesby, Vandalia, Ill.

SALES Kit free. Write for our free offer and catalog of household deals, cosmetics, extracts, etc. Make big money selling your friends and neighbors. Clyde Collins Chemical Co., Dept. PM-10, Memphis, Tenn.

AGENTS! Sell burglar-proof window locks! Every home needs 10 or more. Sample free! C. Franck, 10100 Harper, Detroit, Michigan.

OUTSTANDING Seller, Sobrite metal polishing cloth. Steady repeater. Sample free. Peer, 32P Union Square, New York.

AGENTS: Smash go prices! Santos coffee 12c lb. 4-oz. vanilla 8 1/2c. \$1.00 size tonic 14c. Razor blades, 10 for 8 1/2c. 100 sticks chewing gum 12c. Christmas cards, 21 in box, 14c. 150 other bargains. Experience unnecessary. Write Carnation Co., PO, St. Louis, Missouri.

SELL "Lucky Seven" Christmas packages! 25c seller—20c profit! Big flash! Particulars free. Three packages 25c. Elfko, 523 South Dearborn, Chicago.

SELL By mail: 36 paged prospectus and catalog, 3c. Smith Novelty Jobber, Miami-Beach, Fla.

500% PROFIT Strong vanilla flavoring \$.01 1/4 ounce. Mann, Box 1819, Milwaukee, Wisconsin.

\$2.00 HOURLY With new, scientific cream that mends all cloth easily, quickly, invisibly, without needle and thread. Stands laundering. Free sample. Sew-No-More Co., Dept. C-744, Cincinnati, O.

MAKE Products yourself. Formula catalogue free. Kemico, 45, Parkridge, Ill.

BEAUTIFUL Foil window sign letters. Penny each. Popular sizes. Easily applied. Samples, complete working equipment free. Atlas Sign Work, 7941 Halsted, Chicago.

REGULAR Income; home, office, no canvassing. McArthur Co., Desk 5, Butte, Mont.

\$50.00 WEEKLY. Sell 5 glasses California orange jelly, 25c. 200% profit. 5 glass sample 25c. Cutter-Clarke, 5515M Ruthelen, Los Angeles, Calif.

1000 BEST Sellers, blades 65c hundred, needle books 25c dozen. Free wholesale catalogue. Paty Company, 5P Elston, Somerville, Mass.

AGENTS Wanted. Men and women can make good profits selling new attractive office specialty. Pleasant work with splendid possibilities. Torit Mfg. Co., St. Paul, Minn.

CHRISTMAS Cards—21 card assortment sells fast at 60c! Send 30c for sample box, or particulars free. New England Art, North Abington, 86, Mass.

MAKE More money selling shirts, ties, underwear, dresses, hosiery, raincoats, sweaters, coveralls, pants, uniforms. Outfit free! Nimrod Company, Department 8, 4922-28 Lincoln Avenue, Chicago.

NEW \$30.00 Value radio given in "free deal." Earn up to \$100.00 weekly. New sales plan. Also auto radios. Meritone Mfg. Co., 3857 North Hamilton, Chicago.

FREE Literature describing many money making plans. Belfort, 4042 N. Keeler, Chicago.

SUCCEED With your products. Learn how. Formulas. Processes. Analytical service. Catalog free. B. Thaxly Co., Washington, D. C.

CASH Income daily resilvering mirrors at home. Replating autoparts, tableware, etc., outfit furnished. Write Sprinkle, Plater, 128, Marion, Ind.

OPERATE Home mail order business, selling our products. Everything furnished. Superior Specialties, Springfield, Ill.

150% PROFITS In stationery monogram sets. Box 150, Wausau, Wis.

TEN To thirty dollars a day easily made with Quixne, the entirely new and sensational automobile and furniture permanent beauty treatment. No rubbing or polishing. Get free sample and details. General Paint & Chemical Co., Cincinnati, O.

AGENTS—Engraved name plates, number plates, signs, etc., easily sold, profits large. Brett Bros., Winthrop, Mass.

PORTRAIT Agents throughout the world, get my free catalog, portraits, frames. Lowest prices. Picture Man Friedman, Dept. 9, 528 Cornelia, Chicago, Ill.

BIG Money applying gold initials on automobiles. Easiest thing today. No experience needed. Free samples. "Ralco," 1084 Washington, Boston, Mass.

MAN In each town to plate auto parts, reflectors, bathroom fixtures, refinish beds, mirrors, chandeliers; by new method. No capital or experience required. Simple plan of manufacturing at home starts you in big money-making business. Outfit furnished. Free particulars and proofs. Gun Metal Co., Ave. H, Decatur, Ill.

BIG Money and fast sales. Every owner buys gold initials for his auto. You charge \$1.50; make \$1.45. Ten orders daily easy. Write for particulars and free sample. American Monogram Company, Dept. 40, East Orange, N. J.

AGENTS—Opportunity to make money; book containing 87 successful business plans; home or office; send for free introductory booklet. Elite Co., 214 Grand St., New York.

AGENTS: Stamping names on pocket-key protectors. Sample check with your name, address, 25c. Stamping outfits. Emblem checks, check-fobs, name plates. Hart Mfg. Co., 303 Degraw St., Brooklyn, N. Y.

AMAZING Cleaner. Cleans everything. Sample free. Besterer, 5007P Irving Park, Chicago.

A BUSINESS Of your own making sparkling glass name plates, numbers, checkerboards, medallions, signs. Booklet and sample mailed free. E. Palmer, 512, Wooster, Ohio.

PROFITABLE Home business. Legitimate. No canvassing. Maywood Publishers, P-923 Broadway, New York.

OUTSTANDING Easy selling products. No competition. Sample 10c. Mint Co., Baroda, Mich.

SELL Made to measure raincoats. Outfit free. Goodyear Rainwear, 13 West 22nd, New York.

EARN Money at home. Easy dignified proposition. No canvassing. Hetzel, 802 Garden, Hartford, Conn.

BE Independent. Own your business: experience unnecessary, selling \$10,000 accidental death, \$50 accident; \$25 sick weekly benefits—\$10.00 yearly. Other amounts proportionate. Guaranteed steady renewal income. \$250,000 deposited insurance department. Universal Policy, 716-A Lefcourt Bldg., Newark, N. J.

INITIALING Automobiles biggest money maker today. New type requiring no varnish to apply. Write for samples. International Monogram & Transfer Co., Box 6365, Philadelphia, Pa.

MAKE Products yourself—Tested formulas. Catalog free. Grinstead Laboratory, Edwardsville, Ill.

HIGH-GRADE SALESMEN WANTED

YEAR'S Income in 3 months! New federal, state and code laws create immense demand for simplified record system every businessman must have to protect himself against fines and penalties. Millions users must buy again now. Our men selling 5 to 25 daily our officially approved, copyrighted Liberty Tax Record. \$3.50 cash profit every sale. Repeat commissions without callbacks. Live leads furnished. Big season now. Choice territories going fast. Commonwealth Publishing Company, 508 So. Dearborn, Chicago.

MEN Wanted by world-wide industry—Apply by letter only giving age, experience, references. Industry and reliability main qualifications. Man selected will become authorized Rawleigh dealer on our capital and taught how to establish a profitable business in over 250 farm and home necessities. Man with auto preferred to introduce products and travel steadily. Write immediately. Rawleigh, Dept. K-N-PPM, Freeport, Ill.

CALL On gas stations, garages, stores. New chemical sponge, whirlwind seller. Cleans automobiles without work. Phenomenal profits. Outfit free. Kristee, Box 1441, Akron, O.

AUTO Accessory salesmen: Complete line fastest sellers. Prices dealers want to pay. Big commission daily. Exclusive territory. National, 1910-BG Wentworth, Chicago.

EVERYBODY Buys business stationery. New items. Highest quality. Lowest prices. Free cuts. Quickest delivery. Big comm. daily. Experience unnecessary. Self selling outfit free. David Lionel Press, 312 South Hamilton, Dept. F, Chicago.

LIBERAL Cash earnings daily plus extra cash bonuses representing leading manufacturer men's fine shirts, ties, hose, underwear, pajamas, raincoats, ladies hose. Sensational free outfit makes easy sales. Write Dept. L10, Sterling, North Bergen, N. J.

SALESMEN: Acquainted with garages, filling stations, to handle local business. Write Colgra, 2624 N. Third St., Milwaukee, Wisconsin.

TAILORING Sensation! Sell men's suits! \$6.95 and commission \$3.00. Bonus. Suit furnished. Free outfit. Also lowest priced rainwear line. Service, DA-1617 N. Damen, Chicago.

MAN—Handle regular store route. Place nationally advertised 5c-10c counter card mdse. New aspirin deal. 16 tablets 10c. 85 more fast sellers. 100% profit. No investment. Catalog free. World's Products Co., Dept. 11810, Spencer, Ind.

SALESMEN Calling on hardware, oil burner, plumbing trade. Write SSS, 138 Holden, Minneapolis, Minnesota, for details.

MARVELOUS New specialty, lace transparent stenocuffs. 180,000 pairs sold last winter. Season is on! You should earn \$20 daily. Write for details. Sameco Stenocuff Corp., Brockton, Mass.

GO Into wholesale business without investment. Call on stores with biggest line self-selling counter displays: Aspirin, razor blades, handkerchiefs, breathlets, household cement, 79 different items. Up to 125% profit for you. Experience unnecessary. Write for catalog and plans. Procopax, Dept. 36-CD, 1956 S. Troy, Chicago.

AMAZING Money maker! Ladies' genuine steerhide leather handbag at almost half regular price. Big commissions. Lifetime quality. New, exclusive features. Two zipper compartments. 22 karat gold engraved name and initials. Free coin purse, mirror, key case. Holiday sensation. Sells on sight. Free sample offer. Halvorsen, Dept. A-6, Chicago.

SALESMEN Calling on all classes retail stores to sell the new Economy—low priced—efficient show window lighting units. Protected territories, good profits. Act at once, winter season just starting. Carlon Products Company, 1210 East 113 St., Cleveland, O.

EVEN Temperature hot-air circulator. Sells \$1.50 to every household, big profits. Schilling, 1437 Tulsa, Okla.

MAKE Big money steady. High grade coveralls, shopcoats, pants, shirts, summer suits. Advertising on back. Fast sellers. Free outfit. Strong Mfg. Co., 901 West Jackson, Dept. N-9, Chicago.

SALES Books and labels. Sell sales books in small quantities at attractive prices, also "Allpurpose" pocket label that sells at every stop; good commissions. Technocrat, 81 Kingston, Boston.

\$5 SPOT Cash on every \$6 sale! Connect with a winner. Earn up to \$20 daily. New plan of protection at cost. Everyone a prospect. Free outfit explains fully. Provident Aid Society, Dept. M-527, South Bend, Ind.

NEWEST. Most amazing deal for stores, shops. Inexpensive. Big business increase or money back. Gold mine for salesmen. Outfit free. Stimulators, 343 Madison, Chicago.

PERFUMED Business cards illustrated in several colors. For many lines of business. Sell fast to merchants dealing with feminine trade. Robert, 1458 E. 17th, Cleveland.

BIG Money in tire patches. Sell new auto tire patch to service stations, garages, etc. Tiger-Grip patches guaranteed 10,000 miles. \$75 weekly for salesmen or distributors. Protected territory. Write Economy Rubber Co., 721 Burkhardt, Dayton, Ohio.

AMAZING Zipper pinless clothes line. Lightning demonstration, sure sale every home. Free guarantee sales plan. Dunn Bros. Hempstead, N. Y.

WONDERFUL Opportunity. \$20.00 a day can be earned. No experience necessary. You can start at once. Showing the latest thing out. Self protection and home protection at cost. Ages 1 to 80. Not insurance but provides benefits up to \$1000.00 natural or accidental death. \$20.00 per week if sick or injured. Address National Aid Society, Dept. B, Springfield, Ill.

BRAND New grab-bag deal. Going big everywhere—big profits—swift sales—fast repeats. No restrictions. All dealers buy. Act! K&S, 4373 Ravenswood, Chicago.

PENNY Each, popular sizes. Non-tarnishable window sign letters. Enormous profits. Free working equipment, samples. Record breaking offer. Atlas Sign Works, 7941 Halsted, Chicago.

MAKE More money selling shirts, ties, underwear, dresses, hosiery, raincoats, sweaters, coveralls, pants, uniforms. Outfit free! Nimrod Company, Department 65, 4923-28 Lincoln Avenue, Chicago.

SOMETHING New in fire extinguishers. Red Comet automatics. Proved in west five years. Exclusive territory. Low price opens pocketbooks. Write Red Comet, 404 Comet Building, Littleton, Colo.

SALESMEN—Sell collection systems. 400% commission. Sayers Systems, 2801-123 Sheffield, Chicago.

STICK-ON Window sign letters. 500% profit. Free samples. Metallic Co., 438-A N. Clark, Chicago.

NEW Specialty—Sells every business and professional man. Four \$15 sales daily pay \$280 weekly. Foyer cleared \$4920 in three months. Write, F. E. Armstrong, President, Dept. PM, Mobile, Ala.

SELL Stores or homes—Scissors sharpeners, gas lighters, razor blades, aspirin, breath gum, chewing laxative, adhesive tape, polish, handkerchiefs, polishing cloths, shoe laces, many others. Attractive displays. Catalog free. Superba Co., S-303, Baltimore, Md.

HELP WANTED

BE An independent local merchant earning up to \$60 a week. I'll start you in grocery supply business paying immediate income. No experience needed. No risk. Details mailed free. Albert Mills, 4671 Monmouth, Cincinnati, O.

EARN Quick cash raising mushrooms in cellar, shed, attic. We buy crops. Guaranteed materials furnished. Easy. Odorless method. Book free. United, 3848-AU Lincoln Ave., Chicago.

GROW Mushrooms. We show how. Use cellar, shed, etc. Plant now. Overnight crops. Splendid income. Data free. Interstate, NX-7357 Cottage Grove, Chicago.

BIG Money growing mushrooms. Cellar, idle places. Supplies furnished. Free book. Mushroom Growers, AJ-433 N. Clark, Chicago.

WE Purchase all Indianhead pennies. Price list 10c. Photopennies, 100 Forsyth, New York.

AGENTS—Mosco corn and callous remover will build you a steady repeat business. Send today for pocket-size trial outfit. The Moss Company, 44 Seale Bldg., Rochester, N. Y.

EDUCATIONAL AND INSTRUCTION

LEARN Saxophone repairing at home. We teach you how. Send for prospectus. American School of Saxophone Repairing, Box 733, Evansville, Ind.

MEN—Women, 18—50. Government jobs. \$105-\$175 month. Many fall examinations expected. List positions—particulars free. Write today. Franklin Institute, Dept. J3, Rochester, N. Y.

DOCTOR of theotherapy home-study. Bulletin 10c. Abbey, South Whitley, Ind.

BECOME An investigator. Write former agent United States secret service Joseph Kavanagh, PM-114, Hoboken, N. J.

LEARN Drafting. Big pay. Complete course \$2.85. Neff School of Drafting, Box 685, Dayton, Ohio.

MEN Wanted—To learn Machinist trade Tool and Die making, Automatic screw machine. Get experience on actual work. Employment help. Start now. Days—evenings. Write for free book. Allied Screw Machine Co., 601 Lake St., Chicago.

LEARN Movie recording, projection, camera, television, etc. At home or our studio. Big pay opportunities everywhere. Motion Picture Engineering Institute, 6605 Hollywood Blvd., Hollywood, Calif.

BE An inspector. Write former railway superintendent special agents, Superior Schools, Crozier Building, Chester, Pa.

AMATEUR Artists learn by doing real commercial art jobs. Successful advertising art director offers unique personal instruction plan by mail. Send 10c coin or stamps for test lesson and full information. Jess Ingraham, 6735-A Radford Avenue, North Hollywood, Calif.

LATEST Developments in arithmetic easily learned. Frederick A. Smith, 2410 Smalley Court, Chicago.

GET U. S. government job—Start \$105-\$175 month. Men-women, age 18-53. Are you eligible for eligibility test? Get our free questionnaire—find out. No obligation whatever. Instruction Bureau, 101, St. Louis, Missouri.

BOOKBINDING Taught by mail. For information write Hartley, 156 Malone Ave., Belleville, N. J.

HOME Study courses leading to degrees: Writing; arts and sciences; education; psychology; chemistry; law; theology; home economics; engineering; business; agriculture. Many others. McKinley-Roosevelt University, Chicago.

BECOME A landscape architect. Easy to learn by mail. Wonderful opportunity for money-making. Earn while you learn. Write for free opportunity booklet and details. American Landscape School, 805 Plymouth Bldg., Des Moines, Iowa.

LEARN Chiroprody. Complete course by correspondence. Evans Foot Inst., Montgomery, Ala.

U. S. GOVERNMENT Positions. \$1700-\$1900 and up a year. Let our expert (former government examiner) prepare you for a position in the railway mail service, rural carrier, post office, customs and other branches. Write today for free booklet. Dept. 8, Patterson School, Rochester, N. Y.

SHORT STORIES

SHORT Stories revised, typewritten, marketed. Write for details. Hursh Service, Box P-1013, Harrisburg, Penna.

PRINTING, MULTIGRAPHING AND MIMEOGRAPHING

1000 **BUSINESS** Cards \$1.00. Other printing reasonable. United, Pottstown, Penna.

250 **LETTERHEADS**. Bond paper 8½x11, \$1.25. 250 envelopes, 6¢. \$1.00. Postpaid. Schaffer Press, 687 Seneca Ave., Brooklyn, New York.

EXTRA Money: Our practical plans for winners. Write today. Hunt Products Co., Box 202, Trenton, N. J.

1000 **CARDS** \$1.40. Illustrations. Anything printed. Bradshaw, 3214 Huron, Chicago.

STATIONERY. Circulars, checks, loose-leaf, ruling, binding. Commercial Press, Batavia, Ohio.

BETTER Grade printing, reasonable priced. Free samples. Economic Press, Leonia, N. J.

1000 **BUSINESS** Cards, card case, \$1.50. Miller, Printer, Ambler, Pa.

1000 **LETTERHEADS**. Envelopes, circulars \$2.95. Low prices leaflets, folders, catalogs. Mimeographing. Multigraphing. Samples. Frazer Press, Box 45-D, North Topeka, Kan.

PRINTING OUTFITS AND SUPPLIES

LITHOGRAPHING. Printing presses, \$4.00 up. "Bargainists," 1354 Hayden, Cleveland (Stam.)

HAND Press, type and complete printers' supplies. Advise equipment you need and we quote prices; or send stamp for catalog. P. Peiffer, 15-A, 6 Columbia St., Newark, New Jersey.

USED Press bargains. What size do you want? Send stamp for reply. Exchange D-1, 480 E. Main, Meriden, Conn.

PRINT Your own cards, stationery, circulars, advertising, etc. Save money. Easy rules furnished. Print for others, big profits. Junior press, \$5.90; job presses, \$11; power, \$149. Write for free catalog and full information. Kelsey Co., T-11, Meriden, Connecticut.

BUILD Your own press. Material costing less than \$1.00. Detailed instructions 20c. Earle Nason, 19 High, Somerville, Mass.

PRINTING Presses and supplies. Lists 3c. Popular Bargains, Richland, Pa.

PRINTING Presses, type, supplies. Lawrence, 1426 South St. Francis, Wichita, Kans.

BARGAINS Used presses, type. Send stamp. Box 15, Cambridge, Mass.

PRINTING Outfits—Presses, type supplies, type novelties. Send stamp for catalog. Model Press, York, Penna.

TYPEWRITERS AND SUPPLIES

TYPEWRITERS, \$5.99-\$17.99. Ribbons 35c. Mimeographs, registers, adders, watches. Knights, 1517 Olive, St. Louis, Mo.

GUMMED LABELS

PRINTED—Your copy. That catch the eye! P-Wetzel, Valhalla, N. Y.

1,000 PRINTED: Name, business, address 50c. JBS Company, Box 93, Holyoke, Mass.

DUPLICATORS AND DEVICES

INCREASE Business. "Excellograph" rotary stencil, clay and film duplicators \$3.85 to \$37.50. Prints anything. Typewritten, penned, drawn, traced. Colors. Folder free. Pittsburgh Typewriter Supply, Suite 518, Pittsburgh, Pa.

RUBBER STAMPS

REGULATION Size stamps—2½ inch lines 25c line. Northlake, Peoria, Ill.

RED-RUBBER, 2 Lines 25c; 3 lines 35c. Fehlberg, 921 Farnam, LaCrosse, Wis.

NAME, Address, 2 lines 25c; 3 lines 35c. Stamp Works, Auburn, Nebr.

TOBACCO

BOX Cigars free with 12 lbs. mild smoking \$1.25 or 10 lbs. bulk-sweetened chewing \$1.30. Tobacco Union, B126, Bandana, Ky.

SUBAC—The wonder smoking tobacco, blending Virginia grown Gold Leaf, Burley and Turkish tobaccos, 3 lbs. \$1.10 postpaid. Belmont Farms, Box 44, Chatham, Va.

QUALITY Leaf tobacco. Try our package containing 6 marked kinds, \$1.00 prepaid. Price list on request. Farmers Exchange, Edgerton, Wisc.

RAZORS AND BLADES

SHARPEN Razor blades. Opportunities everywhere. Easy, light work. Excellent machines \$75.00 to \$150.00. Velvet Edger, 725 West 59th Place, Los Angeles, Calif.

LEATHER

LEATHERCRAFTSMEN—Write for free instructions and price list of leather, tools, etc. Send 5c for sample cards. Address Wilder & Company, Dept. M, 1038 Crosby St., Chicago, Ill.

FIELD GLASSES, MICROSCOPES AND TELESCOPES

TELESCOPE Tripod stand. Fits all telescopes and binoculars. Completely adjustable. Scope can be pointed any direction. Jaws cork-lined to prevent injury to scope. Heavy, sturdy construction. Weight four pounds. Height twenty inches. Only \$2.95 postpaid. Brownscope Co., 234 Fifth Ave., New York.

500X MICROSCOPE \$3.95. 30X telescope \$1.98. America's lowest prices. Optical catalogue free. Brownscope Co., 234 Fifth Ave., New York.

GREATEST Microscope value ever offered. 50X magnification. Sturdy. Compound ocular lenses. Nickel tubes. Tilting stand. Adjustable mirror. With complete equipment. Never before sold for less than several times its present cost. \$1.00 postpaid. Vure, 307 Throop Ave., Brooklyn, N. Y.

DIAMONDS, WATCHES, ETC.

WATCHES 7 To 21 jewel movements. New non-tarnish cases \$3.00 up. Postcard brings descriptive list. Anderson, Box 3177, Miami, Florida.

MEXICAN OPALS

GENUINE Mexican opals. Perfectly cut. Edomao, Apartado 762, Mexico City.

GUNS, FISHING TACKLE AND SPORTING GOODS

NATIONALLY Advertised new guns, delivered at bargain prices. Catalogue free. Hoyt's, Sac City, Iowa.

FISHERMEN—Make your own sinkers with our molds. Several styles, many sizes. Free folder. Reading Instrument Co., Box 78, Reading, Pa.

ANTIQUES, WAR RELICS AND INDIAN GOODS

INDIAN Relics, flint, arrows. Buy or sell. J. Townsend, Export, Penna.

WAR Relics for clubhouse or den. Vickers aircraft machine guns; cost government \$700; rendered unserviceable without marring. Only \$7.75 each. Sent COD on payment of \$1.00. Weight 33 lbs. Fiala Outfits, 47 Warren Street, New York.

INDIAN Relics. Beadwork. Coins. Curios. Catalogue and arrow, 6c. Vernon Lemley, Northbranch, Kans.

MUSIC AND MUSICAL INSTRUMENTS

HAWAIIAN Guitar given students taking course of home instructions. Guaranteed. Paramount Conservatory of Music, 246 East 18th, Vancouver, Canada.

PLAY Hot saxophone. Complete course—Modern saxophone, twenty-five lessons by Thompson, the master teacher. Thousands have been sold. For teacher or pupil, \$2.00 postpaid—Order today. Caton Publishing Company, 811 South Hill, Los Angeles, Calif.

MINSTREL Show—Complete \$1.00. Circular free. Rialto Publishers, 1658M Broadway, New York.

POEMS Set to music. Published. Send poems. McNeid, 1582 W. 27th St., Los Angeles, Calif.

MUSIC Composed to words. Wonderful proposition. Bauer Bros., Oshkosh, Wis.

SONGS Composed, published, royalty basis. Stevens, 2407 East Admiral, Tulsa, Oklahoma.

DUO-FLEX Reeds for clarinets, and saxophones eliminate your reed troubles. Write for circular. Duo-Flex Reeds, 1204 1st Ave., Evansville, Ind.

SONG Writers. Send for our "Publishing Agreement." McKinley Music Printers, 1501 E. 53th St., Chicago.

NEW Deal. Write Sequoia Songwriters Service, Sherman Branch, Los Angeles, California.

WANTED: Original poems, songs. MMM Publishers. Studio Building, Portland, Ore.

\$\$\$SONGWRITING\$\$\$. Good money being made from songs through talking pictures, radio, phonograph, music publishers. "Hit" writers revise, arrange, compose music to your lyrics, lyrics to your music. We submit to studios and other markets. Free reading. Send for booklet. Universal Song Service, 671 Meyer Bldg., Hollywood, Calif.

PATENT ATTORNEYS

PATENTS—Before too heavy an outlay of time or money is made on an invention, a search of the Patent Office records should be made to determine as nearly as possible whether or not the same idea has been patented before. The cost of this search is small, while the value of the facts it uncovers is often considerable. We offer inventors and manufacturers a thorough, prompt, confidential search service—plus experienced counsel and assistance in every phase of Patent and Trademark practice. Write for my free book containing valuable information relating to patent procedure. Clarence A. O'Brien, Registered Patent Attorney, 58-L Adams Building, Washington, D. C.

1. **WHAT** Is the only effective way to protect an invention? See page 43A.

INVENTORS: Send immediately for your copy of our big, new free book, "Patent Protection." Forty-eight pages of interesting facts. Tells how patent laws protect you; kind of sketch or model needed; simple steps to take without cost; how successful inventors have secured financial assistance; shows interesting inventions; illustrates important mechanical movements. Other men have read and profited by this book. With book we also send free Evidence of Invention form, that you can use to establish date of disclosure. Prompt service, reasonable fees, special deferred payment plan. Strictest secrecy. Thirty-six years' experience. Highest references. Write us today. The facts in our book are worth money to the man with a good invention. Address: Victor J. Evans & Co., Registered Patent Attorneys, 400-M Victor Building, Washington, D. C.

PATENTS—Proper service for manufacturers and individual inventors. Established 1895. Reasonable charges. Consult Chandlee & Chandlee, Patent Attorneys, 902 F. Street, Washington, D. C.

SPECIALIST, Electro, mechanical patents. Parish, Engineer, 369 Fulton, Brooklyn, New York.

UNPATENTED Ideas can be sold. I tell you how and help you make the sale. Free particulars. (Copyrighted.) Write W. T. Greene, 907 Barrister Building, Washington, D. C.

A NEW Deal for inventors: Combined patent attorney and development engineer service. Simple case attorney's charge \$50.00. Search \$5.00; trade-marks complete \$35.00; copyrights \$8.00. J. J. O'Brien, Patent Attorney-Engineer, Reg. 1909, 108 West 42nd St., New York City.

INVENTORS—Send for free booklet "Patent-Sense." Information based on 64 years experience. Lacey & Lacey, Dept. 5A, 635 F St., Washington, D. C.

INVENTORS May now market practical new ideas before patenting. For information, write Chartered Institute, 554 Barrister Building, Washington, D. C.

ESTABLISHED 1864. Milo B. Stevens Company. Free booklet. Patents. Trade marks. Copyrights. Offices: Monadnock Block, Chicago; American Security Building, Washington, D. C.

PATENTS. Instructions "How to Establish Your Rights" and form, "Evidence of Conception"—sent free! Lancaster, Allwine & Rommel, 411 Bowen Building, Washington, D. C.

PATENTS Procured; trade marks registered—preliminary advice furnished without charge. Booklet and form for disclosing idea free. Irving L. McCathran, 700A International Bldg., Washington, D. C.

\$40.00—**FORMER** Examiner. Registered. Samuel Goldstein, 275 E. Gunhill, New York.

PATENTS. Booklet free. Highest references. Best results. Promptness assured. Watson E. Coleman, Patent Lawyer, 724 Ninth St., Washington, D. C.

"**INVENTOR'S** Guide," valuable information free. Frank Ledermann, Registered Attorney-Engineer, 220 Broadway, New York.

L. F. RANDOLPH, 302-B Victor Building, Washington, D. C. Low cost. Book and information free.

INVENTIONS WANTED

SMALL Inventions wanted. Stanley Hull, 7829 Euclid Avenue, Cleveland, Ohio.

2. **WHAT** Is the first step in making application for patent? See page 43A.

INVENTIONS Wanted, patented, unpatented, any size, any material, for any legitimate purpose. Bosley Mfg. Co., 79 High St., Torrington, Conn.

INVENTIONS Wanted—Patented, unpatented. If you have an idea for sale write Hartley's, Inc., Box 928-E, Bangor, Maine.

FOR INVENTORS

INVENTORS: Send immediately for your copy of our big, new free book, "Patent Protection." Forty-eight pages of interesting facts. Tells how patent laws protect you; kind of sketch or model needed; simple steps to take without cost; how successful inventors have secured financial assistance; shows interesting inventions; illustrates important mechanical movements. Other men have read and profited by this book. With book we also send free Evidence of Invention form, that you can use to establish date of disclosure. Prompt service, reasonable fees, special deferred payment plan. Strictest secrecy. Thirty-six years' experience. Highest references. Write us today. The facts in our book are worth money to the man with a good invention. Address: Victor J. Evans & Co., Registered Patent Attorneys, 401-M Victor Building, Washington, D. C.

4. **TO** What president was issued patent for expanding air-chambers to lift river boats over sand bars? See page 43A.

INVENTORS, Attorneys: patent drawings from your sketch or specification. Fees reasonable, work confidential. 14 years experience. M. Walton, 869 Gephart, Cumberland, Maryland.

PATENTABLE Ideas protected. Free certificate of conception for preferential patent protection. Guaranteed Patent Protection Co., Grand Central Palace, New York City.

PATENTS—Small ideas may have large commercial possibilities. Write immediately for information on how to proceed and "Record of Invention" form. Delays are dangerous in patent matters. Clarence A. O'Brien, 58-K Adams Building, Washington, D. C.

INVENTORS, Practical and sound ideas, no junk. New list monthly. 25c coin. Clair, Box 161, Granite City, Ill.

TO Inventors: We are in the market to purchase a good patent, preferably a five and ten cent store item. Will purchase outright or royalty. Purchasing Agent, 241 Front St., New York, N. Y.

PATENT Research bureau specializes in patent searches. Moderate fees. Free book. Box 61, Washington, D. C.

GET Your own patent; legal blanks, full instructions \$1. A. Barton, 326 Stanley Terr., Chicago.

MANUFACTURERS Everywhere seek new inventions to improve their product. List of wanted inventions sent free on request. Use our legal form for recording proof of invention. Write W. T. Greene, 944 Barrister Building, Washington, D. C.

INVENTORS Wanting to realize on new ideas before patenting, write Chartered Institute, 558 Barrister Building, Washington, D. C.

INVENTORS—Ideas developed into practical inventions and working models built. Electrical problems solved. Lowest prices and confidential service. Reo-Paul Engineering Co., 1208 E. Monument St., Baltimore, Maryland.

INVENTOR'S Universal Educator: contains 900 mechanical movements; 50 perpetual motions; instruction on procuring and selling patents and selecting an attorney, etc. Suggests new ideas. Price \$1.00 postpaid in U. S. A. Address Albert E. Dietrich, 602B Ouray Bldg., Washington, D. C.

INVENTORS: "Making Inventions Pay," our 32-page illustrated book, mailed upon receipt of 3c postage. Crescent Tool Company, Dept. Z, Cincinnati, Ohio.

PATENTS FOR SALE

BEAUTIFUL And attractive automobile smoking set, this article has large possibilities, sell outright or royalty. Adolph Binder, 329 N. Erie, Spokane, Wash.

NAIL Straightener; 10c staple for chain stores. Guillemet, 3529 Mission, San Francisco.

3. HOW Many patents were issued to Thomas A. Edison? See page 43A.

A CURTAIN Rod that carries window blind, lace curtains, drapes and names of firms in gold letters on plush at upper sash and dwellings especially. Inventor C. O. Wallace, 714 Central, Cheyenne, Wyo.

FOLDING Seat. Can carry in pocket. Strong, light. Sales possibly millions. Long, 503 Warren St., Flint, Mich.

PATENTED Automatic oyster opening machine for sale or partner, ideal raw-bar, etc. B. Abbate, 451 East 22nd Street, Baltimore, Maryland.

640 PROMISING inventions to manufacture. List free to manufacturers; others 6c. Chartered Institute, 555 Barrister Building, Washington, D. C.

BRONZE TABLETS

BRONZE Tablets, hardware, desk plates, wall plates, memorials, grave markers. Bronze, brass and aluminum casting. Wand-key Pattern & Foundry Co., Anderson, Ind.

MODELS AND MODEL SUPPLIES

MODEL Railroad equipment—00 gauge. List one dime. Nason Railways, New Rochelle, N. Y.

7. IS it compulsory to prepare a working model before making application for a patent? See page 43A.

50 CAMEL Hair brushes for painting models \$1.00 postpaid. Bilvian, 146 Front, New York City.

MODEL Railroad Magazine will help you enjoy model railroading. Send dime now for sample. 535 S. 84th St., Milwaukee, Wis.

SHIP Model fittings—send stamp for new price list. The Wilson Co., Bristol, Conn.

MODEL Maker's supplies, new catalog 17A, 15c. Howardco, 2417 N. Ashland, Chicago.

EVRAV'S Engine catalog (No. 34) or supply catalog (No. 35), either postpaid 20c. Circular free. Evraymesco, Box "C," 28 No. Clinton, Chicago.

THE Modelmaker. The magazine for those interested in building model railroads, boats, engines. Send 15 cents for copy. Modelmaker Corp., 330P West 34 Street, New York, N. Y.

SHIP Models—Build 18" Flying Cloud, Constitution or Galleon. All materials including full-sized plans only \$1.50 from Hancock, 323 Douglass Ave., Portsmouth, Virginia.

MODEL Ship fittings. Dime brings list. Anderson's, 301 Parliament St., Toronto, Ontario.

BRASS Gears and model supplies. Send for catalog. The Pierce Model Works, Tinley Park, Ill.

MODELS—Your ideas developed into practical working models. 30 years' successful experience; thousands of satisfied customers. Confidential service guaranteed. Bank references. Send 3c postage for 32-page book—"Making Inventions Pay." Crescent Tool Company, Dept. Y, Cincinnati, Ohio.

PATENTS. Low cost. Book and information free. L. F. Randolph, 302-C Victor Building, Washington, D. C.

BUEPRINTS

MAKE At home. Guaranteed instructions \$1.00. Rupert Allen, Perryton, Texas.

SURVEYING INSTRUMENTS

WARREN-KNIGHT Factory rebuilt transits and levels are profitable investments. Largest selection in United States. Sale or rent. Terms if desired. Economical repairs made to any make instrument or liberal allowance for your old instrument in trade. Write for list M-811, Warren-Knight Company, 136 N. 12th St., Philadelphia, Pa.

WELDING AND SOLDERING

WELDING And brazing oxy-acetylene equipment, new and rebuilt. Superior Oxy-Acetylene Company, Hamilton, Ohio.

SPECIAL Bargains in generators suitable for welding. Also other generators and motors. Electrical Surplus Company, 1835 Milwaukee Ave., Chicago.

DEMONSTRATORS. Electric arc welders. Money-saving prices. Used by the government. Trial and terms guaranteed. Hobart Welders, M-1144, Troy, Ohio.

WELDING Outfits, new and rebuilt \$15.00 up. Instruction book, prepaid, upon receipt of \$.75. Welders Supply & Mfg. Co., Cincinnati, Ohio.

ARC-WELDING Outfit \$1.25. Weld fenders, braze, solder. Lavrow, 4368-W. Warren, Detroit. Stamp appreciated.

HEATING AND VENTILATION

REDUCE Heating losses 60%. Six practical plans 50c. Fuel-Saver Devices, 900 Manhattan, Dayton, Ohio.

MACHINERY, TOOLS AND SUPPLIES

HARD To get materials plus money-making ideas for inventors, craftsmen and manufacturers. A book every thinker should have—only 10c. The most varied line available of electrical, hardware specialties, metals, bakelites, woods, chemicals, insulations, minerals, compounds and rare materials. Unusual listing of motors, belts, gears, pulleys, bearings, wheels, switches, drives, machinery, tools, flexible shafts, compressors, sprayers, blowers, fans, drills, instruments, welding material, adhesives. Get yours now. 1/20 h.p. variable speed 2 shaft ac-dc motor \$4.95 postpaid. E.M.A. Corp., 3539-47 Fifth Ave., Chicago, Ill.

10"x5" QUICK Change Champion lathe \$125.00; 12" Hendey shaper \$75.00; No. 60 Heald cylinder grinder \$175.00; all sizes and types of machine tools. Send for catalogue listing other bargains. Terms to suit. Cincinnati Machinery & Supply Co., 27 W. 2nd St., Cincinnati, Ohio.

BARGAINS: Used service station, garage equipment. Fesco, 3117 Roosevelt, Chicago, Illinois.

FOR Sale—Hot dip and electro tinning equipment for manufactured articles, copper, milk cans, etc. Expert advice. Retinning Mfg. Co., 3021 Greenview, Chicago.

BARGAINS, Demonstrators, electric arc welders, guaranteed, 30 days trial and terms. Write Ken's Equipment, Box M-1145, Troy, Ohio.

HARD To get supplies; specialties; tools; metals; motors; pumps; gears. Catalog 10c. Kostka, 2350-H South Crawford, Chicago.

ELECTRICAL EXPERIMENTS

BANKRUPT Stock—Electrical experimental kits. Kit makes motors, detectophones, arc furnace, telephones, etc. Salvage price \$1.99. Other outstanding electrical values. Catalog—stamp. Electrical Salvage Co., Box 524-N, Lincoln, Neb.

ELECTRICAL SUPPLIES

INSULATION, Wire, varnishes, supplies, etc. Send 3c stamp for bulletin. Autopower, 408-B Hoyne Ave., Chicago.

MANUFACTURING

MANUFACTURING, Models, dies, stampings, brasswork, moulds for castings, vulcanizing. Circular free. Baums Metal Specialties, Kansas City, Mo.

INVENTIONS Manufactured in any quantity at low cost. Stampings, dies, models, etc. Estimates and free catalog. Crescent Tool Co., Dept. X, Cincinnati, Ohio.

METAL Articles developed and manufactured. Model making. Reasonable price and first class workmanship. W. F. Meyer Company, Bedford, Indiana.

ENGINES, MOTORS AND DYNAMOS

1500 WATT Auto-transformers 220/110 volts \$5.00. Motors, generators, converters. Queen City Electric, 1736 Grand Avenue, Chicago.

C & N Safety Load Clutch allows full motor speed before taking load. No dimmed lights when starting. For pumps, washing machines, lathes, compressors, saws, any unit starting under load. Replaces regular motor pulley on standard 1/4 and 1/2 h.p. motors. Furnished for V or flat belt to fit 1/2 or 3/4 motor shaft. \$5.50 cash with order. Agents wanted. Contractors Service Company, P. O. Box 552, Attleboro, Mass.

MIDGET-AUTO Engines. Castings or finished. Bargain lists 10c. Columbia, 4020 West Lake, Chicago.

WINDING Data, 100 AC motors, various horsepower and voltage, \$1.00. Motor Data Co., 3002 Monroe, Kansas City, Mo.

1/2 HORSE Alternating motors \$12.90. 1/12 horse Universal motors \$2.75. Refrigerator air compressors \$4.50. Electrical Surplus Company, 1835 Milwaukee Ave., Chicago.

GOVERNORS Control auto engines—stationary or portable uses. New big discount. No cash down. Candee-Smith Governor Co., 215 North Los Angeles St., Los Angeles.

TAXIDERMISTRY

TAXIDERMISTRY Supplies—Quality artificial eyes, teeth, genuine Jonas head forms. Tools, materials, etc. Everything for the progressive taxidermist. Send for big illustrated catalogue—Free. Jonas Bros., 1049 Broadway, Denver, Colo.

LEARN Taxidermy. Five courses. Blue Beaver Taxidermy School, Lemont, Ill.

TATTOOING OUTFITS AND SUPPLIES

AMATEURS Electric tattooing outfits \$5.85. Battery outfits \$4.00—Manual included. Illustrated list free. Chicago Tattoo Supply House, 651A South State, Chicago.

TATTOOING Outfits, supplies, illustrated list free. "Waters," 965 Put-nam, Detroit.

BARTER AND EXCHANGE

SWAP Anything. Send your list and stamp. Stewart Marshall, Rome, Ga.

FOR SALE—MISCELLANEOUS

PROSPECTORS—Get the gold with portable sluice and gold saver. Harvey, Box 266, Clinton, Okla.

BURIED TREASURE

TREASURE Seekers—Learn scientific methods. Wyss, 104 1/2 Frances, St. Joseph, Missouri.

BURIED Treasure, send for free literature, photographs. Fisher, Palmer Building, Hollywood.

DOGS AND PETS

LIKE Them fat and woolly? "Baby" dogs offered for new homes! Pedigreed Newfoundland, reasonable. Royal Kennels, Napierville, Que.

HIGH Class cooners, long trial. Money back guarantee. D. Scott, Martin, Tenn.

CHOW Puppies; dark red. Champion pedigree. Gerald Reimers, Manning, Iowa.

200 HUNTING Dogs. All kinds \$10 up. Dog supplies. Catalog. Kaaskaskia Kennels, KS, Herrick, Ill.

REGISTERED Hound puppies, Redbones, English Blueticks, long eared Black and Tans. Cheap. Henry Hainline, Creston, Ia.

BEAUTIFUL Pure white police dogs. Ansonia Kennels, Mose, N. Dak.

FARMS AND FARM LANDS

INDEPENDENCE, Security assured, North Dakota, Minnesota, Montana, Idaho, Washington, Oregon farms. Bargain prices, easy terms. Descriptive literature, impartial advice. Mention state. J. W. Haw, 119 Northern Pacific Railway, St. Paul, Minn.

50 ACRES, Good living assured; cow, heifers, poultry, implements, hay, corn, beans, potatoes, vegetables, some furniture included; 6-room home, 36x40 barn, 80 fruit trees, electricity available; borders fine stream flowing into lake. Only \$1400, part cash; details in free fall bargain bulletin. Strout Agency, 255-P 4th Ave., New York City.

THE "New Deal"—Good farms are cheaper and renter lower in Minnesota, North Dakota, Montana, Idaho, Washington and Oregon. A small investment at unprecedented low prices today will increase as normal conditions return. Write for free book and low homeseekers' rates. E. C. Leedy, Dept. 457, Great Northern Railway, St. Paul, Minn.

\$5 DOWN, \$5 Monthly, 20 acres in Missouri Ozarks, \$100. Fishing, hunting, trapping. Hubbard, 216 Grossman Bldg., Kansas City, Kansas.

POULTRY

POULTRY Tribune—Leading poultry magazine. Five years \$1.00; six months trial 10c in U. S. Poultry Tribune, Dept. C-93, Mount Morris, Ill.

FROG RAISING

BIG Profits raising jumbo bullfrogs. New industry. Easy. Interesting. Send 10c for literature. American Frog Industries, Box 336, Rayne, La.

ROOTS AND HERBS

JUST Out! World's Greatest "Herbalist Almanac." Beautifully illustrated in natural colors. Contains over 500 old-fashioned herb medicine recipes and Indian secrets for home use. 10c (coin) postpaid. Worth dollars! Botanica, 145 W. 112th St., Chicago.

FREE—Root and herb medicine book. Remedies for many ailments, write. Choctaw Medicine Co., Centreville, Mich.

OLD GOLD WANTED

CASH For gold teeth, jewelry, watches. 100% full gold value paid day shipment received. Satisfaction absolutely guaranteed or articles cheerfully returned. Licensed by United States government. Information free. Chicago Gold Smelting & Refining Co., 357 Champlain Bldg., Chicago.

AQUARIUMS

EASY To make. Breed fish. Instructions 10c. Aquarium, Fullerton, Pa.

TREASURE FINDERS

PROF. Magnetic mineral rods with complete placer book, \$4 value for \$1.75. Many successes. Golden B. Ray Co., 501 7 Street, San Francisco.

BUILD Your own inexpensive radio-active detector. Complete drawings and instruction \$1. John Segee, Dorer, N. H.

PENMANSHIP

POOR Handwriting quickly changed to good. Particulars free. Enclose quarter for your signature. 12 beautiful styles. Expert Penman, Box 194, Pasadena, Calif.

RABBITS

RAISE Rabbits for us. We supply stock and buy what you raise, paying you highest prices. Established 20 years. Rabbit book, catalog and monthly market bulletin showing prices we pay our breeders, 10c. Address Outdoor Enterprise Co., Inc., Box 51, Holmes Park, Mo.

PERSONAL

HYPNOTIZE Instantaneously! New dollar book 25c. Lonk Institute Hypnotism, D-1613, Palatine, Ill.

STOP Being timid or cowardly. Formula (25c) coin. Wolfe, Box 174, Easthampton, Massachusetts.

STAMMERERS Learn perfect speech at home. Low cost. Write Fetherston Institute, Lake Mills, Wis.

MISCELLANEOUS

MAKES Old guns like new. New Method Gun Bluer. No heating necessary. Easily applied with brush. Enough to blue 5 guns \$1.00. Send for circular, "What Gunsmiths Say." New Method Gun Bluing Co., Desk PCB-23, Bradford, Pa.

DEVELOP Pictures yourself. Camera, films, developing chemicals, printing materials, directions. Complete photographic outfit \$1.00. Photocraft, 100 Forsyth, New York.

GRAIN Buster mills, hammer type, \$37.50 up. Link Company, Fargo, N. D.

CUTS Anybody can make. Zinc etching process. Specimens, particulars, testimonials, for stamp. J. C. Day, Windfall, Ind.

SWAPPER'S Friend, R4, Saline, Michigan. Interests swappers, collectors, sportsmen. 50c year, sample 10c.

YOU Are wanted to resilver mirrors at home. Profitable business plating autoparts, tableware, etc. Write Sprinkle, Plater, 288, Marion, Ind.

AMATEUR Cartoonists—Earn \$25.00 week, spare time, copying cartoons for advertisers. 3-M Syndicate, Argyle, Wis.

TRAIN Your dog:—Vaudeville or home amusement. 80 interesting tricks with complete instructions \$1.50. Collier Trainers, Box 610-P, Hollywood, Calif.

NEON Tube \$1. Light with old Ford spark coil. Many interesting experiments. Neon Laboratories, Beggs, Okla.

UP To \$50.00 paid for Indian head cents, half cents \$250.00; large cents \$2,000.00, etc. Send dime for list. Romanocoinshop, Dept. 299, Springfield, Mass.

CASH For used drawing sets, slide rules, microscopes, engineering instruments. Highest prices paid day shipment received. Satisfaction guaranteed or shipment cheerfully returned. Elman's, 2302B VanBuren, Chicago.

WRITING Inks. 25c quart, all colors. Century Inks, 6920—17th Ave., Brooklyn, New York.

HIGH SCHOOL Education at Home

Here in 15 wonderful texts is the equivalent of a High School Education. Each subject taught by fascinating "Question and Answer" method. Now used in 12,000 high schools. Certificate awarded It's fun to learn this easy inexpensive spare-time way. Greatest bargain in brain power.



Write for FREE Book

Send for Free Book Find out how YOU can quickly prepare for bigger pay and social culture. Send this ad with name and address for FREE booklet, "What a High School Education Can Do for Me." High School Home Study Bureau, 45 E. 17th St., Dept. 3378 New York, N.Y.

You Can Now Make More Money

Let us show you how easy it is to make special, individually fitted foot supports. New System. Supports bring ten to twenty times their small cost. No capital or store needed. No house-to-house selling. Highly profitable, respected occupation, full or part time. You can learn quickly in your own home. Send your name for full information free. Address,

B. A. Metzdorf, American College, 50 W. Illinois St., Chicago

CHEAP OIL BURNER Invented

COOKS A MEAL FOR 1c



AGENTS Big Money—It's Sweeping the Country Clark sold 93 in 30 days. O'Toole sold 164 in a month. Write quick for REAL money making offer.

Slips into Any Old Stove, Range or Furnace; Beats Coa or Wood; No Dirt or Ashes; HALF THE COST.

United Factories, 134 Exchange Bldg., Kansas City, Mo., have brought out an amazing oil burner which experts and 15,000 users say beats any ever gotten out. Burns cheap oil a new way, without generating or clogging up; gives intense heat at HALF COST by turn of valve. One free to one person in each locality who will demonstrate and act as agent. Write quick, be first to learn how to end drudgery of coal and wood and make big money, spare or full time—mail 1c postcard today.

LEARN ACCOUNTING at home at a fraction of the usual cost

NEW developments in business spell attractive and tremendously broadened opportunities over next few years for men who know accounting. Responsible work; better than average pay; direct road to executive positions or own practice.

Train yourself now in spare time, with identical lecture notes, practice sets, problems and solutions developed at Northwestern University and used in over a hundred other colleges. Organized, graded lessons for systematic home study, from elementary to advanced accounting, including costs, audits. Thousands have learned this practical, low cost way; splendid C. P. A. preparation.

Send for This FREE BOOKLET

Fill in and mail the coupon below for free booklet, "How to Train for New Opportunities in Accounting," with full details of unique advantages offered and easy terms of payment. No salesman will call. Write now.



Mail This Form

The Ronald Press Company, Dept. M-807
15 East 26th St., New York, N. Y.

Send me free booklet giving full information about use for Home Study of the Complete Accounting Course material developed at Northwestern University.

Name.....
Address.....
City..... State.....

LEARN CARTOONING

by the method that has developed hundreds successfully. Send name, address and age for free chart to test your ability.

The Landon School, 1738 National Bldg., Cleveland, Ohio

Wrestling Book Learn at Home FREE



Be an expert wrestler. Learn at home by mail. The greatest wrestlers of all, Frank Gotch and Farmer Burns, both world's champions have prepared the most wonderful course of lessons ever written on Physical Culture and Expert Wrestling. Be strong and healthy! Handle big men with ease. This great free book tells you how. Don't delay. Write now. State your age. Farmer Burns School, 3378 Elwood Bldg., Omaha, Neb.

DIESEL

THE NEW OPEN DOOR TO SUCCESS

Learn Diesel Engines NOW!
Don't Wait! Diesel Power is the big, new field for greater opportunities and bigger pay. GET OUT OF THE RUT! BE AN EXPERT DIESEL ENGINEER and advance with this great new industry that is sweeping the world. LEARN DIESELS in our big, nationally recommended DIESEL Schools and Shops. The original, exclusive DIESEL Schools of



New streamlined trains are DIESEL POWERED.

the United States and Canada . . . established many years and always ahead in training and equipment. More engines . . . more successful graduates . . . more Big Pay Jobs.

Send for your FREE copy of "Diesel News," containing up-to-the-minute information about the amazing opportunities everywhere for trained DIESEL men.



Book K Explains All Practical School Courses—Day and Night. Book H Explains Home-Study Combination Course.

HEMPHILL DIESEL ENGINEERING SCHOOLS, INC.

2127 San Fernando Road, Los Angeles, Calif.
 P. O. Box 101, Chicago, Ill. P. O. Box 892, Oklahoma City, Okla.
 502 Westlake N., Seattle, Wash. - 1043 Pender St., Vancouver, B. C.

Nation-wide Employment Service is Free to all Hemphill Graduates

AMERICA'S ORIGINAL EXCLUSIVE DIESEL TRAINING SCHOOLS

PLAY PIANO WITHOUT AID OF NOTES OR TEACHER

Our amazing new method enables anyone to play piano chords and accompaniments in a few hours of home study. Gives you quick mastery of

HOT RHYTHMS, JAZZ BREAKS, TRICK ENDINGS

Dirt Effects, Sock, Stomp, etc. No tedious lessons or exercises. Simple, direct and complete. Satisfaction guaranteed. Introductory price only \$1.00. Postman \$1.20 plus C.O.D. charge.

WILLIAMS INSTITUTE, Dept. C, 112 Ridge Ave., DAYTON, OHIO

Anyone CAN LEARN

No talent or experience necessary. Fascinating work. Pays Big Money. Complete instruction book tells about: Alphabets, Colors, How to Mix Paints, Show Cards, Window Board and Wall Signs, Ready made letters, Eddings, Tricks of the Trade, also gives 100 Alphabets and Designs. Book bound in flexible imitation leather—gold edges, and four hole binding Show Card Pens. Sent postpaid \$3.00 (C. O. D.) 10c extra.

Ogilvie Pub. Co., 57 Ross St., Dept. 20, N. Y. City

EARN MONEY IMMEDIATELY—
WE FURNISH EQUIPMENT TO START!!

MAIL FOR FREE INFORMATION

BEDFORD YMCA TRADE SCHOOL

1115 Bedford Ave., Dept. PM-18
 Brooklyn, New York City, N. Y.

Auto Mechanic Talking Pictures
 Aviation Mechanic Welding
 Aeronautical Engineering
 Refrigeration Machine Shop
 Oil Burner Commercial Art
 Air Conditioning Sign Painting
 Electrical Window Display
 Radio and Television Mechanic
 Architectural-Mechanical/Drafting

Name

Address



Supports Self By Writing

"When I reached this town I was a real child of the depression. I had no job, and no chance of getting one. I saw your ad, borrowed the money to pay for the course, and finally finished it. But before finishing I had become self-supporting as a correspondent for the state papers. I believe that if those who want to be writers will apply themselves to your course they will soon know whether their living is coming out of the writing market."

EDWARD G. FOSTER
Talihina, Okla.

How do you know you can't WRITE?

Have you ever tried? Have you ever attempted even the least bit of training, under competent guidance?

Or have you been sitting back, as it is so easy to do, waiting for the day to come some time when you will awaken, all of a sudden, to the discovery, "I am a writer."

If the latter course is the one of your choosing, you probably never will write. Lawyers must be law clerks. Doctors must be internes. Engineers must be draftsmen. We all know that, in our times, the egg does come before the chicken.

It is seldom that any one becomes a writer until he (or she) has been writing for some time. That is why so many authors and writers spring up out of the newspaper business. The day-to-day necessity of writing—of gathering material about which to write—develops their talent, their background and their confidence as nothing else could.

That is why the Newspaper Institute of America bases its writing instruction on journalism—continuous writing—the training that has produced so many successful authors.

Learn to write by writing

NEWSPAPER Institute training is based on the New York Copy-Desk Method. It starts and keeps you writing in your own home, on your own time. Week by week you receive actual assignments, just as if you were right at work on a great metropolitan daily. Your writing is individually corrected and constructively criticized. A group of men, whose combined newspaper experience totals more than 200 years, are responsible for this instruction. Under such sympathetic guidance, you will find that (instead of vainly trying to copy some one else's writing tricks) you are rapidly developing your own distinctive, self-flavored style—undergoing an experience that has a thrill to it and which at the same time develops in you the power to make your feelings articulate.

Many people who should be writing become awe-struck by fabulous stories about millionaire authors and, therefore, give little thought to the \$25, \$50 and \$100 or more that can often be earned for material that takes little time to write—stories, articles on business, fads, travels, sports, recipes, etc.—things that can easily be turned out in leisure hours, and often on the impulse of the moment.

A Chance to Test Yourself

We have prepared a unique Writing Aptitude Test. This tells you whether you possess the fundamental qualities necessary to successful writing—acute observation, dramatic instinct, creative imagination, etc. You'll enjoy taking this test. The coupon will bring it, without obligation. Newspaper Institute of America, 1776 Broadway, New York.

Newspaper Institute of America
 1776 Broadway, New York

Send me, without cost or obligation, your Writing Aptitude Test and further information about writing for profit, as promised in Popular Mechanics, November.

Mr. }
 Mrs. }
 Miss }
 Address

(All correspondence confidential. No salesmen will call on you.) 62K364

Why don't you write?

The MACHINISTS' Home-Study Course helps men get ahead

A man can go just so far in machine shop work with only his every-day experience to aid him. The men who get ahead are those who equip themselves with knowledge—who prepare to take advantage of the breaks. Many have done so with these practical books; you can too.

AMERICAN MACHINISTS' LIBRARY

6 volumes—2,000 pages—2,500 illustrations

(A combined home-study course and reference library)

This library of machine shop practice was written for practical men. It gives you the best methods for every kind of machine shop work. It explains machine tools and their operation, tool work, gears and grinding, jigs and fixtures, automatic screw machines, their tools, punches, dies, etc. Plainly written—completely illustrated—the best kind of help to the machine-shop man who wants to advance himself.

Free
T
R
I
A
L

No money down—
only 7c
a day



FREE EXAMINATION COUPON

McGRAW-HILL BOOK CO., Inc., 330 W. 42nd St., NEW YORK

Send me for 10 days' free examination the AMERICAN MACHINISTS' LIBRARY. If satisfactory, I will send \$1.50 in 10 days and \$2 monthly until the special price of \$17.50 is paid. If not wanted, I will return the books postpaid.

Name.....
Address.....
City and State.....
Position.....
Company..... P.M.11-34

STEP INTO THE Spotlight



Banish Boredom... Earn Extra Money START TO PLAY VERY FIRST DAY

Picture the joy of playing a snappy foxtrot, dreamy waltz or mellow old favorite on the Xylorimba. No reason why you shouldn't! Xylorimba is easiest of instruments to play and yet the most spectacular. In constant demand by orchestras, radio stations, at lodge meetings and parties. Marvelous opportunity to increase popularity, make big spare-time money. No bothersome practice or exercises. With Free easy lessons you actually Start to Play Very First Day.

BIG FREE BOOK tells all about Deagan line, liberal trial offer and easy payments. Send coupon today for your free copy.

J. C. Deagan, Inc., Dept. 7458, 1770 Berneau Ave., Chicago
Send me, without obligation, full details of Free Trial offer and easy-payment plan on the Deagan Xylorimba.

Name.....
Address.....

at last **CARTOONING** MADE EASY

NEW, ORIGINAL, COMPLETE COURSE, especially prepared by one of today's cleverest newspaper and magazine cartoonists. Full of punch and interest. 50 fascinating lessons. Hundreds of step-by-step Cartoons. EXTREMELY EASY. Learn quickly right from the start, either for fun and spare money or to become a professional cartoonist! Money Back Guarantee. Or, send for Free details. Don't delay.

Complete COURSE only \$2.75

AMERICAN SCHOOL OF CARTOONING
Dept. 111 614 West Austin Ave. Chicago, Ill.

BE AN EXPERT MECHANIC

Lots of good jobs, right now, for trained auto mechanics. We train you for jobs paying \$50 to \$60 a week in mechanics, welding and metal finishing. Practical, personal instruction and actual shop practice. You learn by doing! Low tuition. Weekly payments. Life scholarship. School licensed by State. FREE course in aviation mechanics for those who enroll promptly in Auto Mechanics course. Learn your trade in Detroit, the heart of the automobile industry. Write today for full information.

Michigan Trade School, Inc., 3782 Woodward, Detroit, Mich.

Write for FREE CIRCULAR

BE A POULTRY EXPERT
Make \$40, \$50, \$60 a Week

Free book shows how to get started quickly. You'll be surprised at the amazing profit opportunities in the poultry business. Wherever you live—whatever you do—it is easy to start on a spare or full time basis. Free book tells all. Send for "How to Raise Poultry for Profit." You learn right at home in spare time by methods endorsed by colleges and leading poultrymen. Know how to get the maximum profits from interesting, healthy work. Iron-clad agreement protects you. We have prepared hundreds for good jobs and businesses of their own. Write now for free book. No obligation. National Poultry Institute, Inc., Dept. 311, 2005 15th St., N.W., Washington, D. C.

AT HOME—in your spare time learn Free DRAFTING

Send NOW for Free Trial Lesson in Drafting. See how easy it is by the famous C.T.C. Method. All tools furnished. In no time at all you will be ready to make money in drafting. Write today!

CHICAGO TECH COLLEGE
P 145 Tech Bldg., 118 E. 26th St., Chicago, Ill.

Astounding—Bewildering Card Tricks
for Parlor entertainment that defy solution. Not sleight of hand. Something new. First publication of famous WORD trick unsolved in thirty years. Book 50 cents.

P. J. FOSTER, P. O. Box 134, Swarthmore, Pa.

\$2.30 Investment Brings \$16.00 Cash
\$61.60 daily profits making potato chips the Vita-Seald Way. \$16.00 worth (\$13.70 profit). Turned out in only an hour. Novel plan makes stores, grocers, restaurants, etc., your regular customers. Equipment requires only 52 x 20 inches. Write for easy term offer.

Vita-Seald Potato Chip Co., Dept. 511, 500 N. Dearborn, Chicago

Men & Women Earn Cash at Home!

Grow fancy giant mushrooms in cellar, attic, barn. Easy, odorless method. We show you how, furnish guaranteed materials. Market facilities furnished. Valuable big book, pictures free if you write quickly. (Est. 1908.)

UNITED CO. 3848 Lincoln Ave. Dept. P-11 CHICAGO

AIR CONDITIONING

Its opportunities are as big in winter as in summer. Plumbing and heating engineers must know Air Conditioning. Mail the coupon for information — FREE.

INTERNATIONAL CORRESPONDENCE SCHOOLS

BOX 5538-H, SCRANTON, PENNA.
Send information on subject checked:
 AIR CONDITIONING
 REFRIGERATION CHEMISTRY

Name.....
Address.....

Play A Tune In 10 Minutes

On your Spanish Guitar, Uke, Tenor Banjo, Mandolin or Banjo Mandolin. No knowledge of music necessary. No practice. Play first by number, then by note. Simply attach E-Z Player to your favorite instrument — press numbered keys and play.



FREE

instruction book with numbered tunes and chords comes with every E-Z Player. Start playing popular tunes by number right off the reel. Put the life of the party—the center of attraction—a radio star. Don't wait. Write today for 3-Day Free Trial Offer and Special Guitar Values. A postcard will do.

FERRY SPECIALTIES, INC.
Dept. 4311 Evanston, Ill.

900 WORKSHOP IDEAS

Why "putter" when you can make hundreds of articles for beauty, utility and dollar and cent profits?

"Make It Yourself"

Newest edition: 480 pages, 823 pictures. Size: 7x10x1½ inches. Sent postpaid anywhere upon receipt of price or C.O.D. in U.S.A. paying postman price and postage. **\$3**

Send for it!

POPULAR MECHANICS PRESS
Room 1134

200 E. Ontario St. Chicago

INCLUDING:
Toys, Models
Furniture
Garden Equipment
Home Repairs
Sports Equipment
Auto Kinks
Radio Equipment
Workshop Tools and Machinery
Articles on Working:
Wood, Metal, Leather, Glass, Etc. Etc. Etc.

Profit from Books

Popular Mechanics Press specializes in supplying books on any subject. Look over this list. Check the books you want, and mail this advertisement as your order blank. Catalog with lists on 2,000 subjects free.

- AUTO RACING**
How to Build Dirt Track Racers \$1.00
- AUTO REFINISHING**
Latest Methods \$1.50
- BRICKLAYING**
Plain and Fancy \$1.50
- CAMPS AND LOG CABINS** (Building).... \$2.00
- CARBURETORS (All Makes)**
New, Revised Edition... \$2.50
- CARPENTRY**
All Forms \$2.00
- CHEMICAL FORMULARY**
5000 New Formulas... \$6.00
- DIESEL HANDBOOK**
New, Latest Information \$5.00
- DRAWING**
Freehand and Perspective \$1.50
- DRY CLEANING (Practical)**
and Dyer \$3.00
- ELECTRICAL DICTIONARY**
Practical 50c
- ENGINEERS' VEST POCKET**
Reference Book \$1.50
- FURNITURE REPAIRING**
Finishing and Decoration \$3.00
- HANDY MAN'S HANDBOOK**
Repair Work \$3.00
- HYPNOTISM**
Science of \$2.00
- INVENTIONS**
How to Make Pay \$2.50

- LANDSCAPE GARDENING**
Practical \$2.50
- LEATHER WORK**
Artistic \$1.50
- LOCKSMITHING**
Revised Edition \$2.00
- MODEL MAKING**
Many Kinds \$3.00
- MUSHROOMS**
Raise for Market \$1.75
- PATTERN MAKING**
Excellent New Book... \$1.50
- PHOTOCELLS**
What They Are and How Used \$2.50
- PLASTERING**
Best Instruction Manual \$1.25
- RADIO PHYSICS COURSE**
Most Complete \$3.75
- REFRIGERATION SERVICE**
Manual (All Makes) ... \$5.00
- RUBBER ARTICLES**
How to Make \$2.00
- SHEET METAL**
Construction Work... \$2.00
- Steam Engineer's License**
How to Obtain \$2.00
- WELDING ENCYCLOPEDIA**
All Methods \$5.00
- WOOD, COLORING**
Finishing and Painting. \$3.50
- WROUGHT IRON WORK**
Practical \$1.35

SEND NO MONEY

Just check the books you want, and mail the whole advertisement. It is your order blank. When postman hands you books, pay him the price and few cents postage. If outside the U. S. remit when ordering and include 10 cents per book extra for postage.

POPULAR MECHANICS PRESS, Room P-11, 200 East Ontario St., Chicago, Ill.

LEARN AUTO MECHANICS in 8 weeks!

Earn \$35 to \$75 a week as an Auto Mechanic. Never in the history of the automotive business has there been such a demand for TRAINED men. 8 weeks training fits you for a job that's waiting for you or to open your own repair shop. Read what two McSweeney trained men have done. Hundreds of others can tell you facts equally interesting. Don't look for a job! TRAIN for it!

Farrell, Pa.
Dear Mac: Please forward me your catalog. I want it to add to my traveling souvenirs. I am working in a modern garage although I have been out of school only four weeks, thanks to McSweeney Training. My best regards to all. M. Klushauk

Rector, Ark.
Dear Mac: Just a few lines which might interest you. I left your school two years ago last May. Since I left I have not seen a day I could call "hard times." I have been working ever since I left and have averaged in my earnings \$173.00 a month, in spite of the hard times. Many thanks. Thos. J. Sharp

EIGHT WEEKS of Actual Shop Training

No books or lessons the McSweeney way. First you learn the "why" of everything you do; then under competent instructors, you DO the job. You work on real equipment and machines, with the real tools of the auto expert. In eight short weeks you are TRAINED to hold down a permanent BIG PAY job. Any man 16 to 50 can learn. Write today for New Low Tuition Offer.

AVIATION GROUND COURSE

Aviation is coming and coming fast! Prepare now for the wonderful opportunities of the future. Each plane needs many mechanics on the ground.

MONEY BACK GUARANTEE!

In eight weeks of intensive training; actual shop work with real tools on real equipment; you will be qualified to accept a Big Pay Job as an Auto Mechanic. If you are not satisfied with your qualifications, your tuition will be refunded.

FREE Write today for Big Free Book on AUTOS. Get the facts about jobs; and Low Tuition Offers. Mailing the coupon does NOT obligate you. It obligates ME to tell YOU how you can train for Big Money in eight short weeks. Address Dept. 10-11

McSWEENEY SCHOOLS AUTOMOBILE - AVIATION CLEVELAND, OHIO or KANSAS CITY, MO.

Write Our School Nearest You

McSweeney Auto and Aviation School,
Dept. 10-11, Cleveland, Ohio or Kansas City, Mo.

Without cost or obligation, send me your Big FREE Book on Autos; also full information about your low tuition offer.

Name.....

Street.....

Town..... State..... Age.....

ELECTRICAL BOOKS

shipped FREE

10 BIG BOOKS

A·C·RADIO TELEVISION
EVERY ELECTRICAL SUBJECT COVERED

Here's great news for anybody interested in Electricity. BRAND NEW edition of Applied Electricity brought right down to date with every NEW Electrical subject fully covered. 10 big Volumes and all shipped FREE for examination.

For Beginners and Experts



Over 3000 pages — hundreds of illustrations — the most complete work of its kind ever published. Dynamos, motors, power stations, radios, television, everything electrical explained clearly so anyone can understand them.

BIG FIELD! Big Demand! Big Pay!

Men who understand electricity are urgently needed right now in thousands of industries. Autos, airplanes, machine shops—practically every industry depends on electricity and men who know this subject make big money. Pleasant, fascinating work, easy to learn and do; learn quickly with these books. Send coupon for a set for FREE examination and see for yourself.

FREE [A year's consulting membership in the American Technical Society now given free to all readers of this famous Cyclopedia of Electricity. Many say, "That's worth more than cost of books."]

AMERICAN TECHNICAL SOCIETY
Dept. E819, Drexel at 58th St., Chicago

American Technical Society, Dept. E819, Drexel at 58th St., Chicago
Send for 10 days' free use, BRAND NEW 10 volume set of Electrical Engineering. In return for making this coupon promptly, send free, certificate of membership in the American Technical Society entitling me to full consulting privilege for one year. I will pay the few cents delivery charges on the books. If I wish I may return them in 10 days and owe you nothing, but if I keep them I will send \$2.00 after 10 days then \$3.00 a month until the special price of only \$29.80 is paid.

Name.....
Address.....
City..... State.....
Attach letter stating age, occupation and name and address of employer and at least two business men as reference.



GET A Government JOB

\$1260 to \$2100 Year to start

Men—Women
18 to 50
STEADY WORK
Many Fall and Winter examinations expected
Common education usually sufficient

Franklin Institute
Dept. J180, Rochester, N.Y.

Rush FREE, list of U. S. Government big pay LIFE JOBS, 32-page book describing salaries, hours, work and telling how to get a position.

COUPON
Name.....
Address.....

Mail coupon Today—SURE

When writing please mention Popular Mechanics

for Success in AVIATION

You Need LINCOLN Training

LINCOLN is ready to train you for a big pay job and a fascinating career as pilot or master mechanic... to give you the proper training with unexcelled equipment and Government Licensed instructors.

Government Approved School. Primary and advanced flying. Training includes night flying, blind flying, acrobatics, cross country flying, etc. Master Airplane and Engine Mechanics course prepares you for mechanic's position.

\$500 a Month—That's the kind of pay airline pilots earn. Airplane and Engine Mechanics also earn good pay. Let Lincoln's unexcelled training equip you for these better aviation jobs. Government spending millions promoting aviation means thousands of new jobs. Backed by 14 years experience teaching aviation. 24 years successful mechanics trade school. Write. Please state your age.

LINCOLN AIRPLANE & FLYING SCHOOL
208-D Aircraft Bldg. Lincoln, Nebraska

LEARN MECHANICAL DENTISTRY

Special Tool Offer — NOW

Don't waste the best years of your life. Learn this money-making business in a few months in Day or Evening sessions and become independent. Big demand. School is highly endorsed. Estab. 1920. Practical training. Individual instruction. Easy terms. Write TODAY for FREE Catalog P.

NEW YORK SCHOOL OF MECHANICAL DENTISTRY, 125 W. 31 St., NEW YORK

HEALTH STRENGTH

and 10 to 25 inches solid rippling super-muscle in 30 days—or your MONEY BACK!

My world-famous Stebbing 4 in 1 Course guarantees Dynamic Energy, Doubled Stamina, Virile Manhood, Robust Health, Normal Weight, 2-5 inches on Chest & Arms, Iron Will, 100% Nerve Force, Rigid Self Control, Personal Magnetism—or no cost. Complete Course only \$2.00 or particulars FREE.

LIONEL STEBBING, Dept. P.M.10
Forest Hills New York

Homestudy Courses RADIO, PUBLIC ADDRESS, in-ELECTRICITY ELECTRONIC WORK

Homestudy Course No. 112 teaches theory and practice of electricity—very complete and understandable. Course No. 113 covers radio, public address, photo electric, electronic work. Unusually clear and up-to-date. Lowest cost—best value homestudy courses in America. Payment plan (\$1.00 per month). Write for Catalog.

LINCOLN ENGINEERING SCHOOL, 855-A S. 37th St., Lincoln, Neb.

SHIP MODELS

Get this dandy catalog of true-scale models of Flying Cloud, Viking, Blue Nose, Golden Hind, deluxe fittings. Send 15c (in coin) for your copy.

ROY HANCOCK, 323 Douglas Ave., Portsmouth, Virginia

SHOW CARD LETTERING

HERE is the very course you need if you seek a position as a Show Card Letterer or Sign Letterer, or want to have a business of your own. Complete and practical and especially arranged to meet the needs of the student who studies at home. Written by E. L. Koller, Principal of the International School of Art, member of the American Federation of Arts, and The National Society of Craftsmen. Mail coupon for Free Booklet.

INTERNATIONAL SCHOOL OF ART
Division of the International Correspondence Schools
Box 5536-H, Scranton, Penna.

Without cost or obligation, please send me full details of your home-study course in

Illustrating Show Card Lettering Cartooning

Name.....
Address.....

LEARN TO PLAY THE HAWAIIAN GUITAR

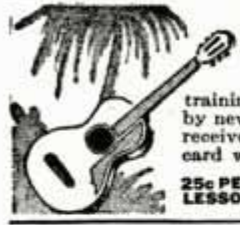

the Hawaiian way. Surprise and entertain your friends. Amazing new simple method makes learning to play from REGULAR PIANO MUSIC as fascinating as a game. Shows you in pictures how to do it. Previous musical training and talent unnecessary. Earn while learning by new plan. You pay for the lessons just as they are received. Write today for free information. A post-card will do. (Fine guitars supplied \$5 up.)

25c PER LESSON ACADEMY OF HAWAIIAN MUSIC
6th Floor Lyon & Healy Bldg., Dept. 67, Chicago

EASY WAY TO MAKE MONEY IN RADIO

Up to \$3 an hour easy in a short time. New training method and service equipment offer starts you earning quickly. Details of no-cost plan sent FREE. Write

Radio Training Association of America
Dept. PM-411, 4513 Ravenswood Ave., Chicago, Ill.

ARTISTS MAKE MONEY

Find out your ability. Send name, age, occupation and address for Free Vocational Art Test.

Federal Schools, Inc., 11134 Federal Schools Bldg., Minneapolis, Minn.

When You Build the "SOVEREIGN" You Can Build Them All

Complete book on building Popular Mechanics Famous Museum Ship Model "Sovereign of the Seas." Price \$1.00 postpaid.
Popular Mechanics Press 200 E. Ontario St., Chicago

\$ MONEY-MAKING \$ OPPORTUNITIES

For those who need larger incomes or must seek new occupations. The following workable, tested plans are adaptable both to the needs of the country or city dweller either for part time development or principal income source.

- Every idea set forth in these books has been used by others for profit. They are well worth your consideration.
 - Plan No. 1**—\$50 a Week with Car and Camera. Paul G. Holt tells you how he made a daily average of \$11.30 profit. Price \$1.50.
 - Plan No. 2**—Radio Servicing. Let an expert teach you how to engage in this money making business. Price \$1.75.
 - Plan No. 3**—Refrigeration Service. Official manual covers all makes. Good service men are needed. Price \$5.00.
 - Plan No. 4**—Automobile Refinishing. Start a lucrative business of your own. Fine possibilities here. Excellent new instruction book. Price \$1.50.
 - Plan No. 5**—Outdoor Opportunities. The raising of small animals, birds and plants for profit. Price \$2.00.
 - Plan No. 6**—10,000 Money-Making Formulas. Complete instructions for the making of commodities at small cost that may be sold at a handsome profit. Price \$4.00.
 - Plan No. 7**—How to Make Money at Home. 100 successful ways for women to make money. Price \$2.00.
 - Plan No. 8**—100 Civil Service Examinations. Covering steady Government jobs. All types of positions. Better business means thousands of new jobs. Prepare now by studying this new book. Price \$3.50.
 - Plan No. 9**—Making Poultry Pay. The proper breeding and management of fowls for higher egg production. Price \$2.00.
 - Plan No. 10**—Fur Farming for Profit. Complete instructions that enable the beginner to succeed from the start. Price \$4.00.
 - Plan No. 11**—Rabbits for Food and Fur. A complete guide to the successful rearing and breeding of rabbits. Price \$2.00.
 - Plan No. 12**—The Frog Industry. Should be considered more as a side line than as a major means of income. Price \$2.00.
 - Plan No. 13**—How to Live on a Subsistence Homestead. Facts and figures on how one family fled from the city and found security and independence. Price \$2.50.
 - Plan No. 14**—New Ways to Make Money. Roger Babson points out to young men and women the profit possibilities in 50 fundamental industries. Price \$2.50.
- Any of the above mailed postpaid upon receipt of price or sent C.O.D. anywhere in U. S. Pay postman price and few cents postage.

POPULAR MECHANICS PRESS
Room 1134 200 E. Ontario St. Chicago, Illinois

When writing please mention Popular Mechanics



Turns Spare Hours Into Cash!

UP to \$40 Weekly In Your Own Home



No soliciting! No canvassing! We show you how to make big money decorating fast-selling Giftwares. We start you with the big \$10 Artist's Outfit shown above. We supply you with \$150 worth of Giftwares free of extra charge and show you how to dispose of them without leaving your home. We give you 29 Tested Plans for making money. One Fireside Member says: "I made \$100 on furniture in one week." Another writes, "My sales were \$500 for 5 weeks. This is my first year." R. M. P., of Ill., says: "I did \$3,500 worth of business last year and over \$12,000 this year." D. W., New Mexico, reports: "I would not take \$1000 for my Course."

No Experience Needed
You too may have a guaranteed income opportunity with Fireside. No tiresome study. You learn by doing. No artistic ability necessary. Our easy 3-Step Method makes the work easy to learn and easy to do and fits you to make good money practically from the start.

Quick Sales in Your Home
No need to leave the house to dispose of everything you make. Our new automatic salesman does all the selling for you. Designed to quickly find cash buyers for all the Giftwares you can turn out.

No Cost Plan
Send coupon for details of new plan that pays for your Fireside Course besides putting big cash profits in your pocket. Mail coupon now while openings for new members are still being offered.

FIRESIDE INDUSTRIES
Dept 66-S, Adrian, Mich.

Fireside Industries,
Dept. 66-S, Adrian, Mich.

Send me FREE Book on Home Decorating for a big steady income. Also details of plan that will pay for my Course and give me big profits besides.

FREE!
Book on decorating at home for big money. Tells how to get big assortment beautiful Giftwares free of extra charge.

NAME.....
ADDRESS.....
CITY..... STATE.....



Know Electricity as Experts Know It—and Get an Expert's Pay!

Recovery has begun! The months ahead are charged with significance and expectation. What will you do to get the jump on the other fellow?
Thousands of men have used

The Croft Library of Practical Electricity

The Croft Library is a complete electrical educator. It is founded on practice—on 20 years of shirt-sleeve experience—on work as it is actually done. It is jammed from cover to cover with the kind of hard-headed facts you want. Written so that the beginner can easily understand it, yet so sound, so thorough, that it is the daily guide of 59,000 highly paid electrical workers and engineers. Croft tells you the things you need to know about motors, generators, armatures, commutators, transformers, circuits, switchboards, distribution systems—electrical machinery of every type—wiring for light and power—wiring of finished buildings—underwriters' and municipal requirements—illumination in its every phase—the most improved methods of lighting—lamps and lamp effects, etc.—how to do a complete job, from estimating it, to completion.

No money down—easy payments
Fill in and mail the coupon attached and we will send you the entire set of seven volumes for ten days' Free Examination. We take all the risk—you assume no obligation. If you decide to keep the books, send \$1.50 in ten days and the balance at the rate of \$2.00 a month. Send the coupon NOW and see the books for yourself.

FREE EXAMINATION COUPON

McGRAW-HILL BOOK CO., 330 W. 42nd St., New York

Send me for ten days' free examination the Croft Library of Practical Electricity. If satisfactory I will send you \$1.50 in 10 days and \$2.00 monthly until the price of \$19.50 is paid. If not wanted, I will return the books postpaid. (To insure prompt shipment write plainly and fill in all lines.)

Name.....
Home Address.....
City and State.....
Position.....
Name of Company..... PM-11-34



on approval. Just mail the coupon and we'll send you a set of these remarkable auto books, just off the press. Whether you are a mechanic or helper, expert or apprentice, auto owner or driver, if you're interested in knowing all about automobile mechanics, then take advantage of this FREE OFFER.

DON'T SEND A PENNY!

A better job—in the gigantic auto industry, BIGGER PAY—a chance to go into business for yourself and get a share of the huge profits that are waiting for any man who even half tries to improve himself. Learn Auto Engineering with these wonder books a new way—without studying or memorizing. Simply use the JIFFY INDEX to look up the answer to any auto problem. Built by eleven of America's greatest automobile engineers, and written in simple language so you can understand it.

FREE! Privilege of consulting Automobile Engineers of American Technical Society for one year without cost if you mail coupon immediately.

If you send NOW we will include an extra volume No. 7 which covers all 1934 car improvements—knee action wheels, streamlining, booster brakes, etc.

CAN YOU FIX IT?

These wonder books tell step by step HOW to take out "play" in differential—to kill the shimmy in steering—to set TIMING—how to put your finger instantly on engine trouble and then the quick expert way to FIX it. Newest improvements fully covered. Equal to a complete trade course at less than a fourth the cost.

6 Big Volumes Latest Edition

2500 pages, 2000 illustrations, wiring diagrams, etc., including Aviation Motors. De Luxe edition, gold-stamped flexible binding.

AMERICAN TECHNICAL SOCIETY, Dept. A819, Drexel Ave. & 58th St., Chicago, Ill.

I would like to see the new 6-volume edition of your AUTO BOOKS. I will pay the few cents delivery charges only, but if I choose to, I may return them express collect. If after 10 days use I prefer to keep them, I will send you \$2 and pay the balance at the rate of only \$3 a month, until \$24.80 is paid. Please include free consulting membership and extra Vol. 7 as per your offer above.

Name.....
Address.....
Attach letter stating age, occupation and name and address of employer and at least one business man as reference.

When writing to advertisers please mention Popular Mechanics

PLAY GUITAR!



FREE Gibson BOOK

Win popularity and bigger income with a Gibson Guitar, Banjo or Mandolin. Trial and easy payments. Free book gives valuable facts. You learn easily. Write today.
GIBSON, Inc. 1150 Parsons St., Kalamazoo, Mich.

62 ART LESSONS

Only \$1.95 POST PAID COURSE COMPLETE

Become a Talented Artist with Big Income
Course also teaches commercial art, cartooning and lettering. By Alexander Murray, famous art instructor. 815 illustrations. Clear instructions. 125 sheets of drawing paper FREE. Money back if not delighted after inspecting. Complete course only \$1.95 POSTPAID or send no money and pay postman plus postage. Pay no more. Get started at once.

EDUCATIONAL SUPPLY CO., Dept. 100-L, RACINE, WIS.

LEARN WATCHMAKING

and become independent. We help you secure a position. Easy to learn. Send for FREE CATALOG.
ST. LOUIS WATCHMAKING SCHOOL DEPT. 5 ST. LOUIS, MO.



ATTENTION INVENTORS!

Want to know more about How to Invent? What to Invent? How to make your patented invention pay? Then read my new book—VALUABLE HINTS TO INVENTORS—It is the accumulated results of years of practical experience. Recommended by U. S. patent officials. Not an advertising pamphlet, it's an honest-to-goodness book, that all inventors should read. \$1 postpd. Address, A. F. Gillet, 4747 Cap. Ave., Omaha, Neb.

SUPPRESSED KNOWLEDGE OF THE AGES

What strange powers did the ancients possess? Where was the source of knowledge that made it possible for them to perform miracles? Were these profound secrets burned with ancient libraries, or are they buried beneath crumbling Temple walls?
These wise men of the past knew the mysteries of life, and personal power. This wisdom is not lost,—it is withheld from the mass. It is offered freely TO YOU if with an open mind, you wish to step out of the rut of monotonous existence and MASTER YOUR LIFE.

THIS FREE BOOK

Man's intolerance has at times swept his achievements from the face of the earth, yet secret brotherhoods have preserved this sacred wisdom of the ages. The Rosicrucians, one of these ancient brotherhoods, INVITE YOU to write and secure a free copy of the "Wisdom of the Ages." It will point out how you may receive age-old truths. You can learn to MAKE YOUR LIFE ANEW—the fulfillment of your ideals awaits you. Address:

SCRIBE L.B.R.
ROSIKRUCIAN BROTHERHOOD
SAN JOSE (AMORC) CALIFORNIA

HOW TO OBTAIN A PATENT

My Big Book Tells You

The Importance of Quick Action

If you have a new idea that is Patentable—and want to secure for yourself your inventor's sole right to profit from the idea—you can't afford to lose time in securing the protection of a U. S. Patent. Other inventors may be working on the same idea right now. Should they develop this idea and file patent application before you do—the burden of establishing priority will be upon you. My Big Book—"How to Obtain a Patent"—will tell you the quickest possible way to secure Patent Protection for your idea. Send for it TODAY.

THE FIRST IMPORTANT STEP IN SECURING A PATENT

is to obtain the services of a Registered Patent Attorney. Establish the date of your invention as explained in My Book and disclose your idea to him in correct form. He then makes a SEARCH of the Patent Office Records and reports to you on existing U. S. Patents which might bear on your invention, giving his opinion on the advisability of proceeding and filing formal application. How this inexpensive step can save you money, time and delay when Patenting your idea—how it tells you whether or not it is worth your while to

file formal Application—all is explained in My Big Book.— Send for it TODAY. If you have developed some improvement, something which adds to the usefulness of any product—whether this product is Patented or not—you should protect your improvement with a Patent at once. Send for My Big Book which tells you how.

Send For
This FREE
BOOK

REQUEST MY BOOK—NOW

Know exactly what you should do to secure a Patent—what must be done every step of the way—how the Patent Law protects you—what I, as a Registered Patent Attorney, can do for you. Mail the coupon NOW.

ALSO FREE RECORD OF INVENTION BLANK

This FREE Record of Invention Form enables you to make in convenient form a sketch of your idea and have it witnessed in a manner of value to you should the occasion for evidence arise. MAIL THIS COUPON TODAY and obtain my FREE BOOK and record of Invention Form.



INVENTORS

And Mechanical Minded Men!

ANSWERS TO QUESTIONS

Asked on Pages 28A to 35A Classified Section

1. By patenting the invention. (See question page 34a classification "Patent Attorneys.")
2. Send sketch or model and description with search fee to a registered patent attorney. (See question page 34a classification "Inventions Wanted.")
3. 1101 U. S.—1279 Foreign. (See question page 35a classification "Patents for Sale.")
4. Abraham Lincoln. (See question page 34a classification "For Inventors.")
5. 17 years. (See question page 28a classification "Avtation.")
6. It confers on patentee the exclusive right to make, sell and use the invention covered by the patent. (See question page 28a classification "Model Airplanes.")
7. No. Pencil sketch and description will usually suffice. (See question page 35a classification "Models and Model Supplies.")
8. A form on which an inventor may execute his sketch and description. When properly filled out it is documentary evidence of your conception of the invention. (See question page 28a classification "Advertising Agencies.")
9. Because a layman or a lawyer in general practice is not learned in patent office practice. (See question page 31a classification "Business Opportunities.")
10. As soon as patent application covering the invention is filed in United States Patent Office and official receipt received. (See question page 31a classification "Formulas and Trade Secrets.")

CLARENCE A. O'BRIEN

REGISTERED PATENT ATTORNEY

70-Z Adams Building

WASHINGTON, D. C.

Please send me your FREE BOOK, "How to Obtain a Patent," and your "Record of Invention" Form, without any cost or obligation on my part.

NAME.....

ADDRESS.....

(Important: Write or print name plainly)

INVENTORS - PATENT YOUR IDEAS

SEND FOR FREE BOOK

Your Patent Application Must be filed for Examination by the Examining Corps in the U. S. Patent Office. Choosing your Patent Attorney is an important matter. Why not select a Registered Patent Attorney having had personal experience in the Examining Corps of the U. S. Patent Office?



MAIL COUPON TODAY for FREE PATENT BOOK and RECORD of INVENTION Form.

MILLER & MILLER REGISTERED PATENT ATTORNEYS FORMERLY IN EXAMINING CORPS U. S. PATENT OFFICE

1638 Woolworth Bldg., Dept. 114A, New York City
MILLER BUILDING, Dept. 114A, WASHINGTON, D. C.

Please send me your Free Book, "How to Obtain a Patent," and your "Record of Invention" form.

NAME.....

ADDRESS.....

Inventors! WE GIVE RESULTS!

SEND FOR FREE BOOK PATENTS

Protect yourself by retaining a legal firm that has been in good standing before the Patent Office over sixty years. . . . Preliminary advice FREE . . . estimate of costs submitted. Write full particulars to Dept. 5-635 F St. N. W. Washington, D. C.

ESTABLISHED 1869

Lacey and Lacey



BUCHSTEIN'S FIBRE LIMB

is soothing to your stump—strong, cool, neat, light. Easy payments. Brace for all deformities.

D. BUCHSTEIN CO. 610 3rd Ave., So., MINNEAPOLIS, MINN.

Send for Catalog Today

Handbook for Farmers

861 discoveries by practical farmers, telling how to make, repair or improve the various devices and machines used about a farm or garden. 683 illustrations. "The Most Remarkable Book Ever Published for Farmers," says one authority. *Send No Money.* When the postman delivers the book to you, hand him \$1 plus the few cents postage.

POPULAR MECHANICS PRESS
Popular Mechanics Building, Room 711, Chicago, Ill.

New Gland Health

Would you like to again enjoy life—with renewed strength and health? Do you suffer night risings, pains in back, legs, feet—constipation, etc.? Science has made an amazing discovery for you—a new drugless home prostate gland treatment. Endorsed and used by many doctors. Over 100,000 users. Sent on trial. If you don't feel 10 years younger in 7 days, pay nothing. Write for offer and daring free book of facts for men past 40. **W. J. KIRK, Pres., 2183 Morris Ave., Steubenville, Ohio.**

for Men Past 40!

DO YOU INVENT - for fun, or for profit?

L. F. Randolph, 302-D Victor Bldg., Washington, D. C.

Please send me at once, free of charge, your 72-page booklet and "Record of Invention" form.

Name.....

Address.....

Even simple inventions may have large commercial possibilities. If you are inventing to make money, and not just as a hobby, you should take extreme care to properly protect your ideas. Write today for my 72-page free book and full information about my personal, confidential

patent service. Or send model and description of your invention and \$5.00 for an immediate search and report as to its patentability. Book and information free, anyway. (Registered Patent Attorney—over 37 years experience.)

DONT DELAY, USE THE COUPON, NOW



GEARS

In Stock — Immediate Delivery

Gears, speed reducers; sprockets, thrust bearings, flexible couplings, pulleys, etc. A complete line is carried in our Chicago stock. Can also quote on special gears of any kind. Send us your blue prints and inquiries.

Write for Catalog No. 10
CHICAGO GEAR WORKS
769-773 W. Jackson Blvd., CHICAGO, ILL.

PATENTS—TRADE MARKS

All inventions submitted held confidential and given personal attention by members of the firm.

Form, "Evidence of Conception" and instructions, "How to Establish Your Rights"—FREE!

LANCASTER, ALLWINE & ROMMEL
Patent Law Offices

412 Bowen Bldg.

Washington, D. C.

PATENTS

Booklet Free Highest References
Promptness Assured Best Results

Send drawing or model.

ALL BUSINESS GIVEN PROMPT AND PROPER ATTENTION

Listed Patent Lawyer in the latest editions of the Rand-McNally Directory of Bankers and Bank-Recommended Attorneys, published by Rand-McNally & Co., Chicago, Ill.; The Baggott & Ryall Directory of Guaranteed Attorneys, published by Legal Directory Corporation, Boston, Mass.; Flugel's Law List, published by Legal Directory Publishing Co., St. Louis, Mo.; American Lawyers Annual, published in Cleveland, Ohio; Bankers Service Legal Directory, published by Bankers Service Co., Boston, Mass.; Eyre's Law List, 9 Park Place, New York City; Walters Legal Directory, Omaha, Nebraska, and the National Directory of Attorneys, Baltimore, Maryland.

WATSON E. COLEMAN,
REGISTERED PATENT LAWYER

Victor Building, 724 Ninth Street, N. W.
WASHINGTON, D. C.

INVENTORS

48 PAGES OF FACTS FOR

HAVE you an invention—or an idea for one—that will save time, save labor, make money or give pleasure? If you have, then this interesting, new **FREE BOOK**, was meant for you. It's crammed full of practical, useful information that the man with an invention needs to know. Tells you facts like these: How the Patent Laws protect you and why, if you have an invention, you need a Patent at all; what a competent Patent Attorney can do for you; what kind of a sketch or model is needed; how to make a disclosure of your idea right away, to help establish your claims; how some successful inventors have secured

financial assistance; tells about interesting inventions that have proved successful and shows you 115 different mechanical principles that inventors have used in working out ideas; also gives much other information that every man who has an invention—large or small—can use to his advantage and profit. Read what the inventors below say about this book. Then, if you have an invention yourself—even though it is still in the rough or crude stages—write us for a copy. Our business is to help you if we possibly can. You'll welcome a book of facts like this.

The Big Age of Invention Is Still Ahead

Below is one of our newest trains. It's the crack, streamlined express of the Union Pacific. Does 110 miles an hour. This is only a glimpse of what's ahead. Experts say that within the next ten years the railroads will have to be revolutionized. Henry Ford says that we're still living in the stage coach age. C. F. Kettering, Vice President of General Motors, says: "We're only entering the great period of inventive

advancement." Men who are poor today will be big financial successes a few years from now, because of inventions. And remember that many of the largest fortunes have been made—and will be made—from simple ideas. An inventor's first step is to get the important facts about **PROTECTION**. We gladly supply them to serious, interested men.



What Inventors Say:

One inventor writes: "I want to compliment you on the publication of a book so replete with information naturally of great interest to inventors."
 Another writes: "Your book sure is a wonderful guide for an inventor. I shall keep together the book and all references to have same on hand."
 Still another man says: "I have read your book Patent Protection thoroughly and I feel sure that whenever the need of information arises I will know how to proceed in order to patent any device that I may happen to think of."

Who Are Inventors?

Some of the most successful inventions have come from men who didn't consider themselves inventors at all. A dentist invented the stock ticker; a bank clerk the hand camera; a school teacher the telephone; and a farmer invented the typewriter. No matter who you are or what you do, if you have an idea for an invention that will serve a useful purpose, you are entitled to your just reward and the Patent Laws are designed to protect the poor man and the rich man alike. But you must know how to take advantage of them. Our book will tell you how.

Your Copy is FREE

Many illustrations and examples taken from inventive history make this a real guide book for inventors. If you have an invention, even a sketch or a model, send it to us. We'll gladly send you a copy with our compliments.

WRITE to **VICTOR J. EVANS & CO.**

Registered Patent Attorneys,
Main Office, 500-M, Victor Building, Washington, D. C.
 Branch Offices: 1640-N Conway Building, Chicago; 1007-N Woolworth Building, New York; 514-N Empire Building, Pittsburgh; 736-N Security Building, Los Angeles; 1010-N Hobart Building, San Francisco.

Kindly send me a **FREE** copy of your book, "Patent Protection," and other facts of interest to an inventor.

Name.....
 Street and No.....
 City or Town.....State.....

RADIO

● holds great rewards
for trained men



Almost in a decade radio has become a giant industry. The opportunities created will be enjoyed by trained men. The International Correspondence Schools Radio Course, prepared by leading authorities and constantly revised, will help make you a trained man! A fascinating book—FREE.

ELECTRICAL ENGINEERING

—A Great Industry with a Great Future

The new course in Electrical Engineering covers this fascinating field thoroughly. If you are just starting or are partly on the way to a real paying position in this industry, this new course brings the broader knowledge necessary for advancement. The coupon brings complete information.



MECHANICAL ENGINEERING

—A Field with a Future

This course has meant advancement to hundreds of ambitious men, mechanics, draftsmen, blacksmiths, foundrymen, patternmakers, apprentices, and mechanical engineers—men who wanted to get ahead and to earn more money. You will find, as they have found, that enrolling for an I. C. S. Course is an investment in a Bigger Future. Use the coupon!



AUTOMOBILE EXPERTS

are always in demand

The rapid progress in manufacture and service of the modern automobile brings new opportunities to thousands of ambitious and forward-looking men. There's always a demand for trained men. The new I. C. S. Automobile Course will make you a trained man! The time to act is now. Use the coupon.



INTERNATIONAL CORRESPONDENCE SCHOOLS

BOX 5535-H, SCRANTON, PENNA.

Without obligation, send me full information on subject checked below:

RADIO AUTOMOBILE COURSE
 ELECTRICAL ENGINEERING
 MECHANICAL ENGINEERING

| | | |
|--|--|-------------------------------------|
| <input type="checkbox"/> Architecture | <input type="checkbox"/> Drafting | <input type="checkbox"/> Accounting |
| <input type="checkbox"/> Concrete Construction | <input type="checkbox"/> Good English | |
| <input type="checkbox"/> Reading Shop Blueprints | <input type="checkbox"/> Salesmanship | |
| <input type="checkbox"/> Civil Engineering | <input type="checkbox"/> Advertising | |
| <input type="checkbox"/> Diesel Engines | <input type="checkbox"/> Show Card Lettering | |
| <input type="checkbox"/> Gas Engine Operating | <input type="checkbox"/> Civil Service | |
| <input type="checkbox"/> Refrigeration | <input type="checkbox"/> High School Subjects | |
| <input type="checkbox"/> Chemistry | <input type="checkbox"/> Air Conditioning | |
| <input type="checkbox"/> Highway Engineering | <input type="checkbox"/> Inventing and Patenting | |
| <input type="checkbox"/> Poultry Farming | <input type="checkbox"/> Aviation Engines | |

Name _____

Address _____

Fortune in Frogs

RAISE TWO-POUND BULLFROGS!

SPECIAL BREED "NUFOND GIANTS." Breeder lays 10,000 eggs each year. Bullfrogs sell \$3.00 dozen. No experience necessary. Backyard pond starts you. Raised in any climate. Get started now! FREE, illustrated book "A FORTUNE IN FROGS" tells how. Write today. AMERICAN FROG CANNING CO., Dept. 133-W, New Orleans, La. Originators of CANNED Frog Legs and Frog a la Queen.

MAKE MONEY AT HOME!

Learn easy Koehne Method of coloring photos and miniatures in oil. New! No art talent needed. Big demand. Send for free booklet, *Make Money At Home*. NATIONAL ART SCHOOL 3601 Michigan Ave., Dept. 1358, Chicago

The Mystic Language of Zend

Ordinary Conversation learned in a week. Foreign Sounding—Short as English. Invaluable for private Notes and Correspondence. "Ru nu dery su vo"? Text Book, 2 Dimes.

ZENDU Dept. N. BURBANK, CALIF.

BUILD DUTCH WINDMILLS

Beautifully Your Garden—Make Money Selling to Others

Easy to build from BLUE PRINTS. Model B10 (Hexagon style 30" high) 75c. Model B25 attractive Dutch Windmill operating DUTCH GIRL CHURNING BUTTER 50c. Knock Down Kit for Model B25 only \$4.00. Lawn cut out patterns: sunbonnet girl, Dutch boy, Tulip Girl and Holland pair. 35c each. 4 for \$1.00. For Catalog send 10 cents. Free with order.

Craftsman's Model Co., Dpt. P13, 2030 N. 41st St., Milwaukee, Wis.

RAISE GUINEA PIGS

For us. Large Profits. No experience necessary. We supply breeders and buy the young, paying up to \$2.00 a pair. Write—FREE book.

Research Supply Corporation, Dept. R-2, 2436 W. York St., Phila., Pa.

RAISE RABBITS FOR US

WE SUPPLY STOCK AND BUY WHAT YOU RAISE

PAYING YOU HIGHEST PRICES—Established 20 Yrs. Rabbit book catalog and monthly market bulletin showing prices we pay our breeders. 10c. Address OUTDOOR ENTERPRISE CO., Inc., Box 400, NEW CITY, N. Y.

POULTRY PAPER 12 BIG ISSUES 25c

OLDEST BEST

Paste or pin this ad on a letter with your name and address and mail it to us with 25c. (stamps or coin) for the next 12 issues. American Poultry Journal 532 So. Clark Street Chicago, Illinois

\$25 A WEEK FOR YOU

and work 12 hours a week. Great plan (illustrated) to breed PR Royal squabs. Ask for new free Library 4, send 3-ct. stamp for mailing. Get details, learn what, why, how, where, latest facts. Our 34th year. Reference any bank. PLYMOUTH ROCK SQUAB CO., 634 H. St., Melrose, Mass.

Save \$50 Automatic Oil Burner!

On LACO'S
New 1935

WRITE
for my special
**Shipped-On-Approval
Plan!**

L. A. COCKLIN, Pres.

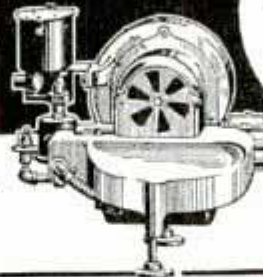

Lowest Priced Quality Burner
BURNS OIL NEW WAY
—Cuts Fuel Bills Almost in Half!

Now you can easily afford OIL HEAT—at its best! At less cost than ever before, your home can now be heated just right, always—no work, no dirt, no ashes, no coal bin—tull, clean basement.

For the new 1935 Laco is the **WORLD'S LOWEST PRICED Automatic Oil Burner**. And it actually **SAVES YOU 25% IN FUEL COSTS!** It is 10 times **SAFER!** Easier to install. Less servicing required. Thousands of delighted owners say, "Buy a Laco for real satisfaction!"

Hotter Flame With Less Oil!

Positively the cheapest to own. Burns oil only when motor is running. Oil rises up through redhot porous Mineral Wick—turns to hydro-carbon gas, ignites electrically. Burns 96% air—only 4% oil—gives intensely hot flame—clean, smokeless. Practically noiseless. Almost no electricity cost—1/250th b. p. motor runs only when fire burns.

Fully Automatic Just set the thermostat at the degree of warmth you want—and forget you have a heating plant! New **DOUBLE** safety devices prevent all possibility of trouble. Controls operate automatically—and **POSITIVELY** safe burner built!

Heats 2 to 10-room home. Beautifully finished in polished aluminum and nickel-plating. Comes complete with thermostat and automatic controls.
SEE it—EXAMINE it—without obligation. Mail the coupon

LACO OIL BURNER CO., Dept. 1134, Griswold, Iowa

Saved Me \$50 in Fuel

"I saved \$50.52 in fuel cost the first winter after putting in a Laco Oil Burner. It heats my house much better all winter and is satisfactory in every particular."
ALICE GOODRICH, Maine.

Less Than Coal

"I am very keen about my Laco Burner. It gives me more heat at less cost than coal and sure saves lots of work and dirt."
L. E. SAWYER, Wisconsin.

SAVE By Ordering Immediately!

Now is the time to buy! Prices can never be lower. Sure to advance soon. We are still using steel bought months ago. But steel and labor costs are going up. Soon our prices must follow. NOW, however, you can save as never again. If you are going to buy an oil burner in the next few years, **NOW IS THE TIME TO DO IT!**

Laco is built and guaranteed by the world's largest exclusive oil burner mfr.

Amazing Opportunity for DEALERS! With the nation turning overwhelmingly to Oil Heat—with Laco's Low Priced burner going like wild-fire—I am offering dealers a most unusual opportunity to **MAKE BIG MONEY!** Get my unique plan that has started hundreds of dealers. This plan lets you have a Sample Burner, subject to examination, without obligation.

If you are a home-owner, have your local Laco dealer quote you the very low price. If there is no Laco dealer near you, mail me the coupon and I'll give you full details! **SEND NOW! Get Low Prices AT ONCE!**

Mail Coupon for SAMPLE BURNER Plan

LACO OIL BURNER CO., Dept. 1134, Griswold, Iowa.

Please mail me your Shipped-on-Approval plan, low prices, free booklets, etc.

NAME.....

TOWN.....STATE.....

I am a dealer.....Home Owner.....

Better Pay—Better Opportunities

STUDY LAW ONE YEAR A new clear-cut, easy, proven method. Only *Same Law Attorneys Get*

Win back those pay cuts! Law made easier than you have dreamed. Big opportunities, professionally and in business, await law-trained men and women. Successful graduates many states. No entrance requirements. Personal instruction. Moderate cost. Easy payments. Write for Catalog PM giving Bar requirements in all states, and other valuable information.

WEBSTER LAW SCHOOL, 420 Lexington Ave., New York, N. Y.

BE AN ARTIST

WE CAN TEACH YOU DRAWING in your own home during your spare time. Thirty-five years of successful teaching proves our ability. Artists receive large salaries.

Write today for Art Year Book **SCHOOL OF APPLIED ART** Dept. 184, 10 E. Huron St., Chicago, Ill.

CIVIL SERVICE

VALUABLE INFORMATION FREE
COLUMBIAN CORRESPONDENCE COLLEGE
WASHINGTON, D. C.

PHOTO-ENGRAVING LEARN IT AT HOME

We Furnish all equipment and materials including large photo-engraving camera complete with lamps, lens and screen. When you have finished the course you can establish a good paying independent business with the equipment furnished or work for others at a big salary. Photo-Engraving offers greater opportunities today than any other industry. Every picture in this issue of Popular Mechanics was engraved by the process we teach you. Earn good money while learning. Write today for our new illustrated catalog which was engraved on equipment such as we furnish. You will not be obligated in any way by writing.

Aurora School of Photo-Engraving, Dept. 1114, Aurora, Mo.

A copper plate to print above picture size 8 by 10 inches sells for \$15.37.

LEARN in Los Angeles

AUTOS-DIESELS

You can qualify FOR THESE GOOD JOBS

Auto Auto Mechanic
Auto Electrician
Battery Expert
Carburetor Expert
Diesel Diesel Mechanic
Fuel Injection Expert
Diesel Service Man
Mechanic

High speed Diesels being rapidly developed for service in trucks, boats, airplanes, streamline trains, power shovels, etc. Trained men needed. Opportunities increasing for good jobs. The trained man must be master of all branches of auto repairing preparatory to entering the Diesel field.

Good Jobs for Trained Men

National Automotive School trains you in both trades—auto and high speed Diesels. Practical shop methods. Expert instructors. A million dollar school to train you by proven methods. Established 29 years.

Spend Winter in California

Learn auto and Diesel trades under ideal conditions in Los Angeles. Student body arranges delightful pleasure trips while you are training.

Railroad Fare Allowed

No matter how far you reside from Los Angeles, cost of enrollment is as low as if you lived in Calif. For a limited time National will continue to allow coach railroad fare from any part of United States to Los Angeles. This cost continued despite the fact that the new and enlarged high speed Diesel Engine course is offered including complete auto training at no extra cost.

Earn Room and Board while Learning

Majority of our students earn room and board while taking course. We assist students to obtain part time jobs. Men of all ages can enroll. You can take as long as desired to complete the course.

Free Employment Help

We assist students to make contacts for good pay jobs in automotive and Diesel fields.

Send Coupon for Free Auto Diesel Book

Gives full details about National courses. Explains what you will learn, how you will learn, and method for obtaining good pay job. Send coupon immediately.

NATIONAL AUTOMOTIVE SCHOOL Los Angeles

Dept. PMA-11, 4006 South Figueroa St., Send Free Auto Book and Special offer.

Name.....

Address.....

City.....State.....



How does **YOUR** eye stack up with **DAD'S**?

Can you outshoot your Dad—can you put thirty shots closer to the bullseye than Dad can—and can the two of you, as a father and son team, outscore thousands of other father and son teams throughout the country? Well . . . here's a real chance to find out—and a chance to win yourself one of twenty-four beautiful silver cups, a bronze medal, or an expert marksman button—and your chance to help your Dad win an auto or home radio, field glasses, or a fine razor. All you have to do to try for these fine prizes is write to: *Frank W. Farnsworth, Executive Secretary, Dept. S—International Air Rifle League, Room 1002—1790 Broadway, New York City.* You'll get full information and targets by return mail. Then take Dad to your nearest **DAISY DEALER**—pick out the **DAISY** that feels "right" to both of you—buy it—practice together every spare minute, the rest will be easy. Hop to it—send for your official targets today. Win with a **DAISY!**

DAISY MANUFACTURING CO.
270 Union St. Plymouth, Michigan



DAISY AIR RIFLES

When writing to advertisers please mention *Popular Mechanics*

"FOR HOURS, DOC,
SHE'S ONLY SAID
'PHEW!'"



HER husband feared it was an attack of her old asthma, but the eminent M. D. correctly diagnosed the trouble as "Gas-ma"—overpowering smoke-clouds from a long-neglected pipe and grouchy tobacco. The best tobacco in the world is unhappy in an unclean pipe, and hubby's was far from the best.

Clean out the old pipe, friend. Pack it with Sir Walter Raleigh Smoking Tobacco. Then puff away and watch your Sweet Mama smile again. Sir Walter Raleigh has a mildness that wins you, and a delicate fragrance that wins others. Sales of this choice Kentucky Burley blend have boomed because it really *has* the mildness mankind is searching for. Try a tin . . . will ya, man?

Brown & Williamson Tobacco Corporation
Louisville, Kentucky. Dept. P-411



Send for this
FREE
BOOKLET

It's 15¢
—AND IT'S
MILDER

D1143

Too Much of Everything?

IN recent teachings, people have advanced the theory that you can make almost too much of everything and that we must restrict the output of effort and, with that, brains. These are false premises. There will always be work for brains and skill combined.

I believe that these theories, or the popularity of them, is decreasing, and that they will continue to decrease, so that in a short time we will return to the desire of improving living standards which have contributed so much to this world's progress.

WILLIAM S. KNUDSEN,
Executive Vice-President,
General Motors Corporation.

*General Motors Building
Detroit, Mich.*

The GREATEST MOVING THING

Cont. Don Blasseman, 55 W. 86th, New York
 Dec. 1932 SP



NORMANDIE'S FORWARD FUNNEL (INTERIOR) IN PLACE



NORMANDIE WOULD TOWER OVER FAMOUS SKYSCRAPERS



WEIGHT OF NORMANDIE WORLD'S LARGEST SHIP $7\frac{1}{2}$ TIMES THAT OF EIFFEL TOWER

NORMANDIE'S FUNNEL WOULD HOLD BOTH TUBES OF HOLLAND VEHICULAR TUNNEL

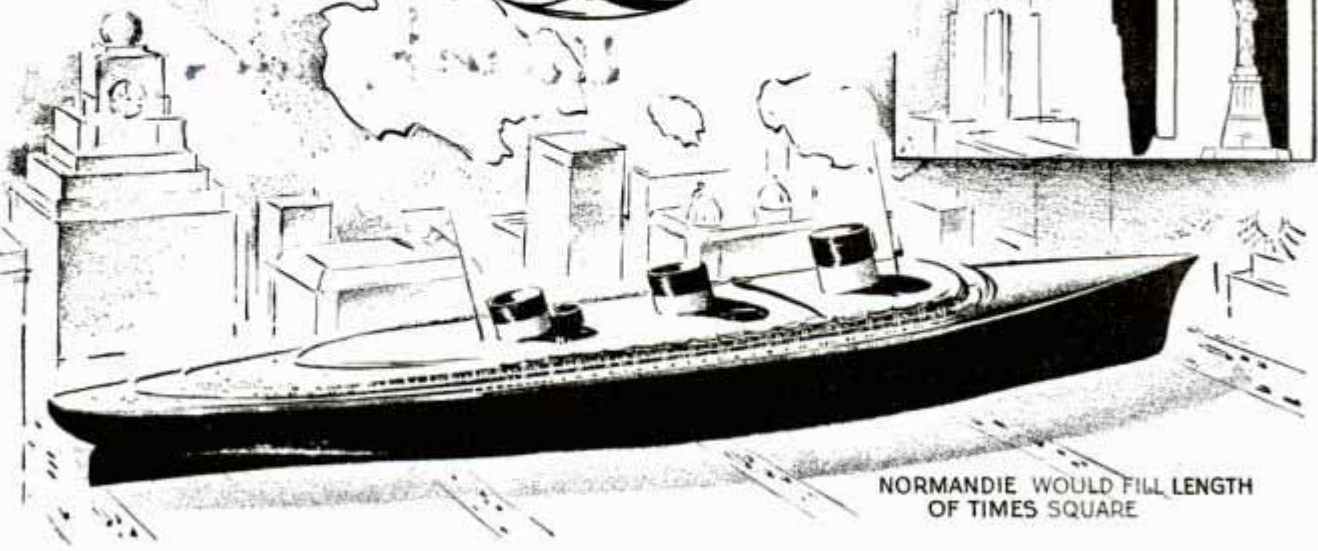
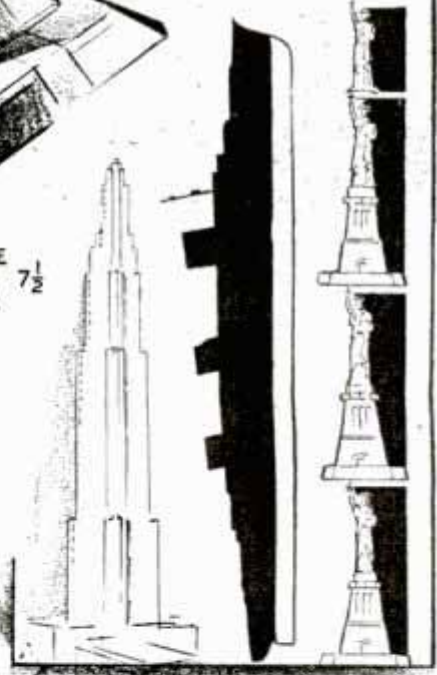
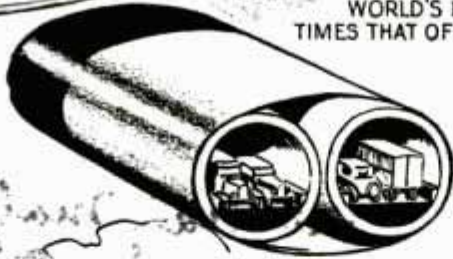

NORMANDIE WOULD FILL LENGTH OF TIMES SQUARE

The French Liner "Normandie" Will Make Most Present-Day Ships Look Like Pygmies; It Is 1,027 Feet Long, 119½ Feet Wide, 128 Feet High and Is of 75,000 Gross Tons

Braunische Röhre tube. cl no. Her. Baren
Markt mit Ardenne. für no. 1000000

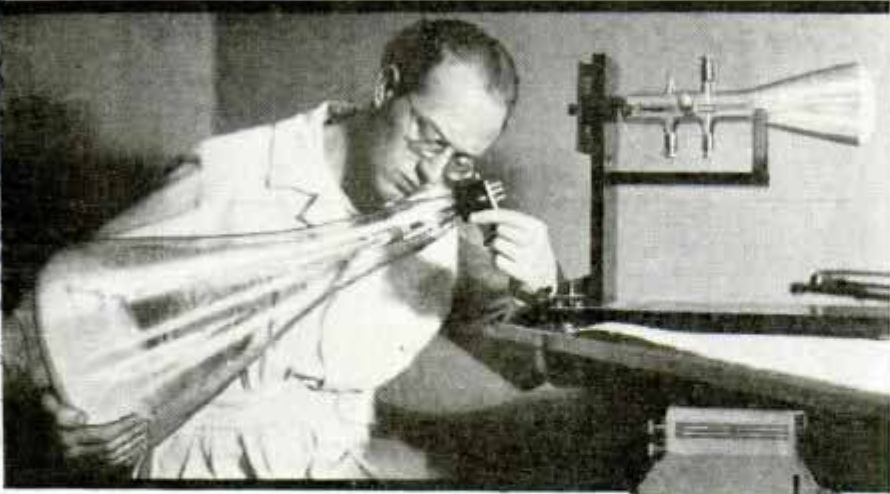

Above, Large Cathode-Ray Tube Used for Receiving Television Images

only a few minutes after the action has occurred.

Sound and vision programs are transmitted on neighboring wave lengths but on the receiver these two carriers are picked up by a common aerial circuit, amplified by the common high-frequency stage and then detected and filtered separately. Thus only one tuning control is necessary to get the sound and vision program simultaneously and there is no chance of receiving a picture with the wrong sound accompaniment. By turning the tuning control a little to one side, sound can be received without the picture, and by turning to the other side a silent picture can be received.

A German radio engineer has developed an exceptionally large cathode-ray tube which receives images about seven by nine and one-half inches. The system for synchronizing sound and action is operated entirely by wireless with the aid of special impulses which are transmitted by the Berlin broadcasting system. The tube in which the images are viewed and the loud speaker bringing in the sound are contained in a cabinet no larger than an ordinary radio receiver and such sets are being made to retail for about



Above, Scanner and Television Apparatus Which Utilizes Movie Film in Transmission; Left, German Television Receiver

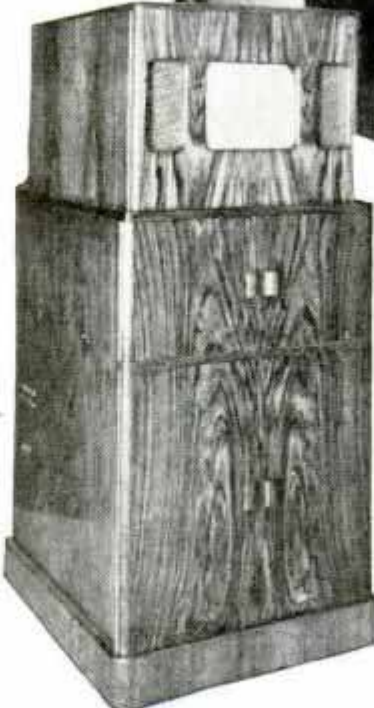

\$200. Due to the fact that the cathode-ray tube which shows the image also acts as a rectifier, the loss of energy is not as high as usual with this form of apparatus and pictures are much clearer as a result.

The television trucks broadcast on a seven-meter wave and have a working radius of forty

miles although broadcasts often are received within a radius of 120 miles. It is believed that this radius can be greatly increased or that relay stations can be set up to enable distant points to pick up such broadcasts.

In using cathode-ray tubes as receivers, it is claimed extra tubes can be fitted by extension leads to the main set, just as extension loud speakers are added to the radio.

at no. 03 army connect. Chicago

7950 Loomis St.

Midget Submarine Runs Six Miles an Hour



same
Jackson Park.
ing,
Resembling a large fish, this one-man submarine has been tested successfully in lake waters; its inventor is shown after making another test run

Resembling a large metal fish, a ten-foot submarine has been undergoing tests in the vicinity of Chicago. Weighing 1,000 pounds, the midget craft has a cruising speed of six miles per hour and submerges to a depth of seventeen feet. It has space for the inventor-operator to shift his controls easily.

ing, contour plowing, rotation of crops and putting hillsides back into trees or grass.

BUILDING CAMOUFLAGED BY NET TO FOIL AIR ATTACK

D1020.

Hiding large buildings from the eyes of airplane observers is accomplished in Japan by shrouding the structure with large nets. The net has an effect similar to that produced on ships and airplanes by camouflage paint applied in odd streaks. The net was used to demonstrate methods of foiling an attack from the air.

MANY MILLION ACRES RUINED BY EROSION OF SOIL

2046

Unrestrained soil erosion is building in America a new public domain of worn-out and severely impoverished land, says H. H. Bennett, director of soil-erosion service of the department of agriculture. He said seventy-five per cent of the land in this country is subject to some degree of washing when used for cleaning tilled crops or severely over-grazed and estimated 35,000,000 acres of land have been made essentially worthless by rain-wash, and the loss to this country occasioned by erosion is equivalent to 140,000 farms of 250 acres each. Simple methods of checking erosion are known, and, in the main, consist of changes in the farm set-up, terracing, strip farm-

Washington D.C.



Osaka

Wash. D.C.
Net is shown drawn over upper portion of building in Japanese city as latest means of camouflage during war games

Dep. of Interior

D 10 75

Navy's Latest Plane Carrier Is Fast in Trials

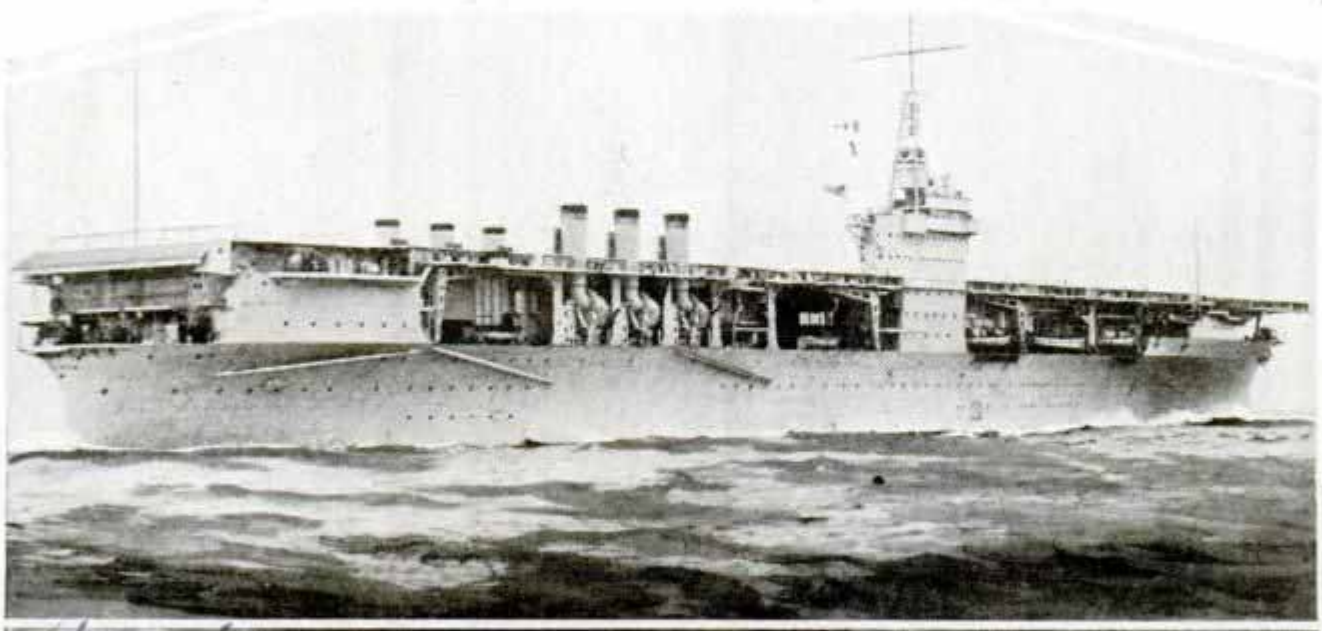

Here Is the Navy's New Plane-Carrying Vessel, the First Built Especially for That Purpose; Folding Funnel Is One Feature of the Ship, Named "Ranger"

Stretching her sea legs for the first time off the Maine coast, the U. S. Navy's new plane-carrying ship developed high speed, turning up to twenty-eight knots. The craft is the first American vessel planned specifically for carrying airplanes. The others, "Saratoga," "Lexington" and "Langley," were converted from other types of ships. The latest carrier, "Ranger," is 765 feet long with broad decks to facilitate landing of planes. Space for 126 planes is provided on the "Ranger," which is manned by 1,100 officers and men. A feature is a collapsible funnel that can be shifted to horizontal position when planes are alighting.

of two pontoons supporting a platform on which are mounted two bicycle frames ridden tandem fashion. The pedals turn a paddle wheel mounted at the rear.

PEDAL-DRIVEN BOAT ON PONTOONS

Propelled like a bicycle, a pontoon boat for two passengers is proving popular on St. Louis lagoons. The craft consists



Pontoon Boat Operated by Pedals Which Turn Paddle Wheel at the Rear

d. m. & m. Blank, 3615 Hartford

D 90 9

ELECTRIC DRILL EASY TO BUILD OF OLD GENERATOR AND KIT

By using an old model-T Ford generator and a special kit, almost anyone can build an electric drill at home. The generator is used as the motor, no change being made in the field coils. Complete instructions are furnished for conversion to motor purposes. Drill, gears, chuck and other parts are supplied with instructions for assembling. The drill shaft operates at 370 revolutions per minute in two renewable phosphor bronze bearings of large size. The drill operates at a speed found suitable for drilling a wide variety of metals. It runs on 110 volts, either alternating or direct current, and thirty-volt operation can be obtained if specified.

17.85

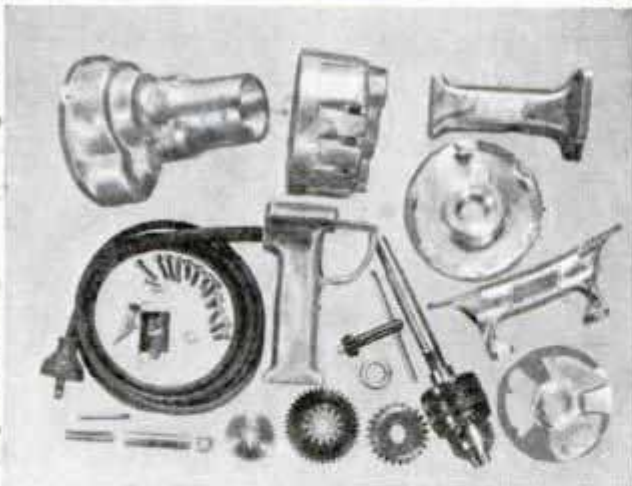
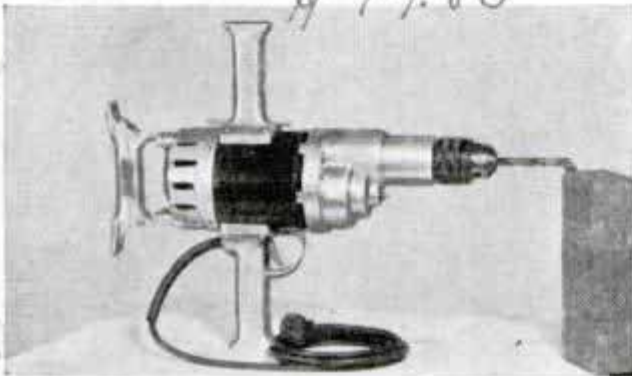

Top, Electric Drill with Generator in Center; Bottom, Parts Used in Assembling Drill

LIFE-SIZE ANIMALS ARE BUILT FROM SMALL MODELS

Small models of animals found in Africa are serving to guide workmen engaged in constructing full-size mountings of animals in the African hall of the Academy of Science building in San Francisco. Frank Tose, director of exhibits, spent fourteen months in Africa gathering plant life.

Golden Gate Park



International.
Model of Giraffe Which Was Used in Constructing Life-Size Animal for Museum

making paintings and plaster models from which the animals could be mounted in life-like surroundings. One life-size giraffe in the exhibit is a remarkable feat of taxidermy, mounted with the aid of a small model prepared by the director of exhibits.

AUTO MIRROR IN RUBBER FRAME UNDAUNED BY VIBRATION

Heavy rubber is used for the frame and post for a rear-vision mirror which fastens to the fender or side of a truck or car. Since the mounting and support are flexible, the mirror is not likely to be broken from vibration caused by fast driving over rough roads, and if it is struck by any object, the post bends with the blow and the glass is unlikely to break.



Those wishing further information on anything described in our editorial pages can obtain it by addressing Bureau of Information; please inclose return postage.

Handwritten notes on the right margin:
D1088
Auto Embroidery Co.
149-151 E. 4th St. New York



Wide World

How Field Radio Equipment Is Transported by the Italian Cavalry During War Games; Note Position of Aerial on the Horse's Back

CAVALRY CARRIES RADIO SET ON HORSE'S BACK

During peace-time maneuvers of the Italian army, radio equipment sometimes is transported by the cavalry by mounting it on horseback. The equipment, including a radio set and aerial, is carried to communications headquarters such as might be set up in the field for use in time of war.

ERRORS BRING HIGH PRICES TO STAMP COLLECTORS

Errors usually cost money in industry but mistakes mean more money for stamp collectors. When someone in the bureau of engraving and printing in Washington makes a mistake and stamps are printed before the error is corrected, there is a rush by collectors to obtain the few "queer" stamps. Several years ago an air-mail stamp was printed showing a plane in flight for the center design. A few were turned out with the plane upside down and collectors rushed to snap them up. Another time a five-cent stamp was turned out in red instead of blue until the mistake was caught,

and again collectors profited. Sometimes perforating machines do not work right and the errors bring high prices. Contrary to general opinion, it is not necessarily the age of the stamp which lends it value, but its rarity. As a result some of the error issues today are more valuable than some stamps printed before the Civil war, for stamp collectors are always looking for the unusual.

D1055

BELT ROD HOLDS CAMERA FOR QUICK "SHOTS"

Taking amateur motion pictures is speeded up by a camera-supporting rod that hooks over the user's

belt. The single leg of the device is so short that it does not wobble. Since the rod, with the camera attached, moves as fast as the operator, it eliminates the slow process of making movies with a tripod which requires several minutes to set up and take down when scenes change.

\$7.50 Belt Rod

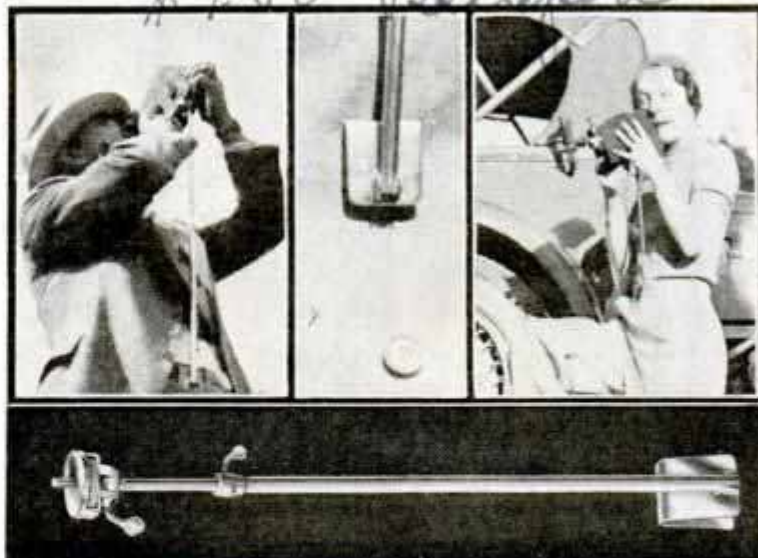

Showing Some Uses of One-Leg Supporting Rod for Camera; Bottom, the Rod That Hooks over Camera Operator's Belt

Inquiries as to makers of articles described in Popular Mechanics, will be answered by our Bureau of Information upon receipt of return postage.

*Cont. William Allen Ward, Dallas, Texas
Box 4282, Station D319*

Wm. J. Isaac, 312 W. Page, Dallas, Texas

Railway Crosses Open Sea on Top of Dam



Passenger Train Speeds Along on Top of Dam While Waves from German North Sea Dash High; This Railroad Links Island to the Mainland

Faster schedules from Berlin and Hamburg to Sylt, a resort town, have been inaugurated as the result of completion of a railroad dam connecting an island to the mainland in the German North sea. Trains operate on top of the dam, running through spray from the waves when the sea is rough. A special wall at the south base of the dam protects the railroad in stormy weather. The dam was constructed to prevent interruption of steamer-train service by shallow water and ice.

working parts are enclosed and the cylindrical welded tank contains a conical brass strainer to catch the dirt.

RADIATOR AND BLOCK CLEANER IS EASY TO OPERATE

Automobile radiators and blocks can be cleaned quickly and efficiently by using a unit consisting of a pump driven by an electric motor, supplying a solution to the radiator in excess of the combined capacity of radiator and block, thus cleaning out the clogged openings. The one and one-quarter inch rotor-type bronze pump is driven by a one-horsepower electric motor and delivers as much as sixty gallons of solution per minute. The apparatus is mounted on casters and hence is portable.



Pump Driven by Electric Motor Which Cleans Auto Radiator and Block Quickly and Efficiently

Stowe Mfg. Co., Upper Sandusky

D 10 79

*Mr. Harold J. Wilkins
Columbie, 29 Bean Road
Dexley Heath, nr. London, Eng*

Hindenburg

Wattenmeer Sea!

Vertical text on the right margin, possibly a page number or reference.

ARMOR SAVES

Emb. John Cornell, 1509. 5th Ave
Los Angeles, Calif



SLIPSHOD playing and unnecessary injuries are caused by the average football player's careless attitude about his uniform and protective gear. Here's what Erny Pinckert, all-American half-back on recent champion University of Southern California football teams and now a first-rate professional player, has to say about it:

"Famous football stars are particular about the preparation and care of their playing equipment."

Pinckert is applying his knowledge of the game and its problems to the manufacturing of football equipment. He designs gear which allows full use of the body while protecting the danger spots.

Every good player is finicky about the fit of his shoes and his pants. The importance of being particular about shoes is obvious. All players insist on a perfect fit.

Top, Shoulder Harness; Center, Free Movement; Bottom, Nose Protector

W. H. Jackson & Sons.
Trojan Shoe Shop.
814 W. Jefferson Blvd.
D 102750

GRIDIRON STARS

Los Angeles, Calif.

Important stars are allowed to have special shoes which may cost as much as twenty or twenty-five dollars a pair. They may even have shoes made especially for their needs. Such needs may be a matter of size as in the case of Ernie Smith, U.S.C.'s 1932 all-American tackle, who took a special 12½ E size, or they may have to do with a star backfield man's desire for a lightweight speed shoe.

Backfield stars on big teams also have a pair of "game" shoes—special shoes which are worn only during actual games. These are made of light materials such as kangaroo leather. Different kinds of cleats can be attached to most of the best



also helmet.
newish & similar
Chicago
A. S. Spalding 105 Nassau
211 S State

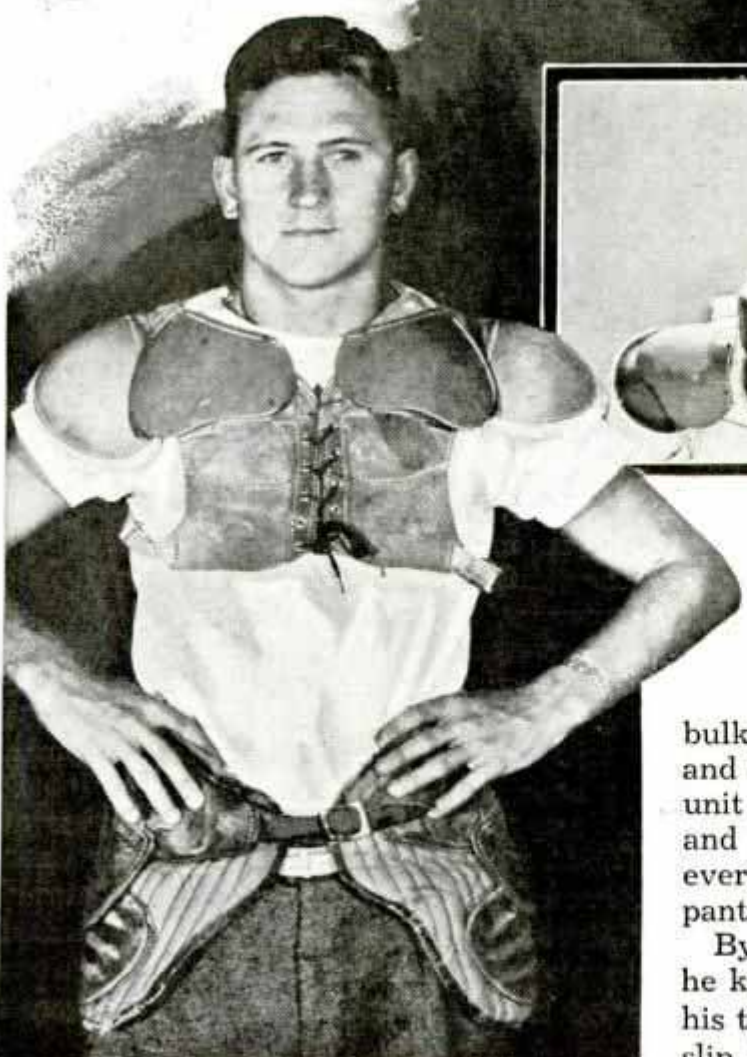

Top, Special Helmet with Thick Lenses; Center, Testing Shoulder Pads; Bottom, Player Demonstrates Latest "Armor"

shoes now. Football pants are no longer heavy canvas affairs stiff with rattan thigh protectors and bulky with pads. The padding for the hips and kidneys is now applied as a separate unit in most outfits. The pants are light and can be made to fit. Whether in his everyday twill pants or his silk "game" pants, the star demands a perfect fit.

By the time a player has become a star he knows how much padding he needs on his thighs and knees. Pads for these spots slip into inside pockets in the pants. A

see. Dec. 1933-888, 9

Navy's First Iron Ship Is Ninety Years Old

Built at Erie, Pa., in 1844, the U.S.S. "Wolverine" has the name of being the first iron ship built for the United States Navy. Ninety years later, the famous vessel, now out of commission, is moored on the shore of Misery bay near Erie. While her superstructure reveals the ravages of time, her hull and machinery are in a remarkable state of preservation. The "Wolverine" is 168 feet long, twenty-seven-foot beam, ten-foot draft, with a tonnage of 680. Its paddle wheels are twenty feet in diameter, with sixteen paddles on each wheel. The vessel had a speed of about ten knots. While in commission, it carried six six-pound guns, two two-pound guns and a small howitzer used for signaling.

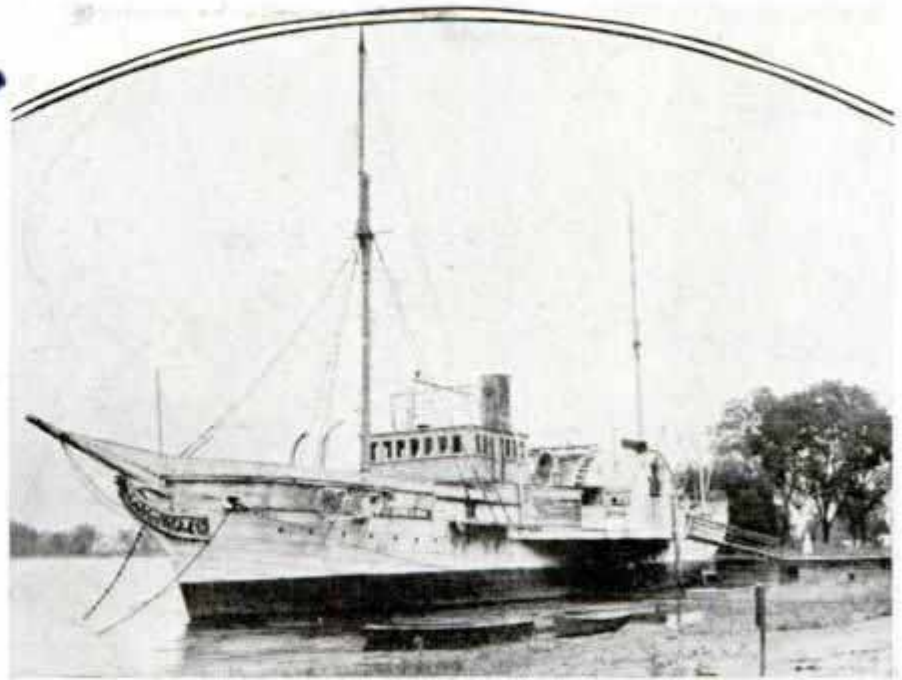

First of the Navy's Steel Vessels, This Craft Is Shown Moored Near Erie, Pa., with Its Superstructure Showing the Ravages of Time

ticularly those who play football and baseball. To persons engaged in occupations where there is danger of eyeglasses being broken, the new glasses will be offered as a means of protection. In tests, the glasses crack but do not shatter.

**SHATTER-PROOF EYEGASSES
USEFUL FOR ATHLETES**



These Eyeglasses Cracked But Did Not Shatter When Pounded with Small Hammer in Severe Test

**PLATING ON POLISHED METALS
GIVES BETTER PROTECTION**

Better protection of metals against corrosion is claimed for a new method of plating discovered in England. A scientist was watching the arrival on the surface of polished copper of a minute film of zinc crystals which had boiled over to their new location, owing to rapid heating of an electric wire in a vacuum. As a beam of electrons fell on the surface, the scientist saw about twenty bright circles weaken and vanish. He repeated until the twelfth film of zinc crystals stood fast, indicating the liquid layer of polished copper had absorbed all the crystals possible. When the scientist bombarded polished iron with the crystals, the zinc layer stood fast at the second trial. The effect of the discovery is that whereas films on unpolished metals will stand fast at the first attempt and are soon rubbed off, the films on polished metal can never be totally removed and, in some cases, will efficiently guard against rust and corrosion.

U. S. Oetichson & Co
 48 3-5th
 New York
 July 1934-35
 Dub.
 maker unknown.

D/093

D 13

cmb. Williams

of Science and Technology
 H. W. ...
 Prof. L. J. French

D/069
 Mrs. J. Red Jacob
 318 Cleveland Club
 Cleveland, Ohio

Radio 'Pilot' Guides Ship into Harbor in Fog

Illustrated London News 8/18/34 P. 257

Marconi
marine communication Co.
Marconi House Strand, London
W.C. 2 London, England

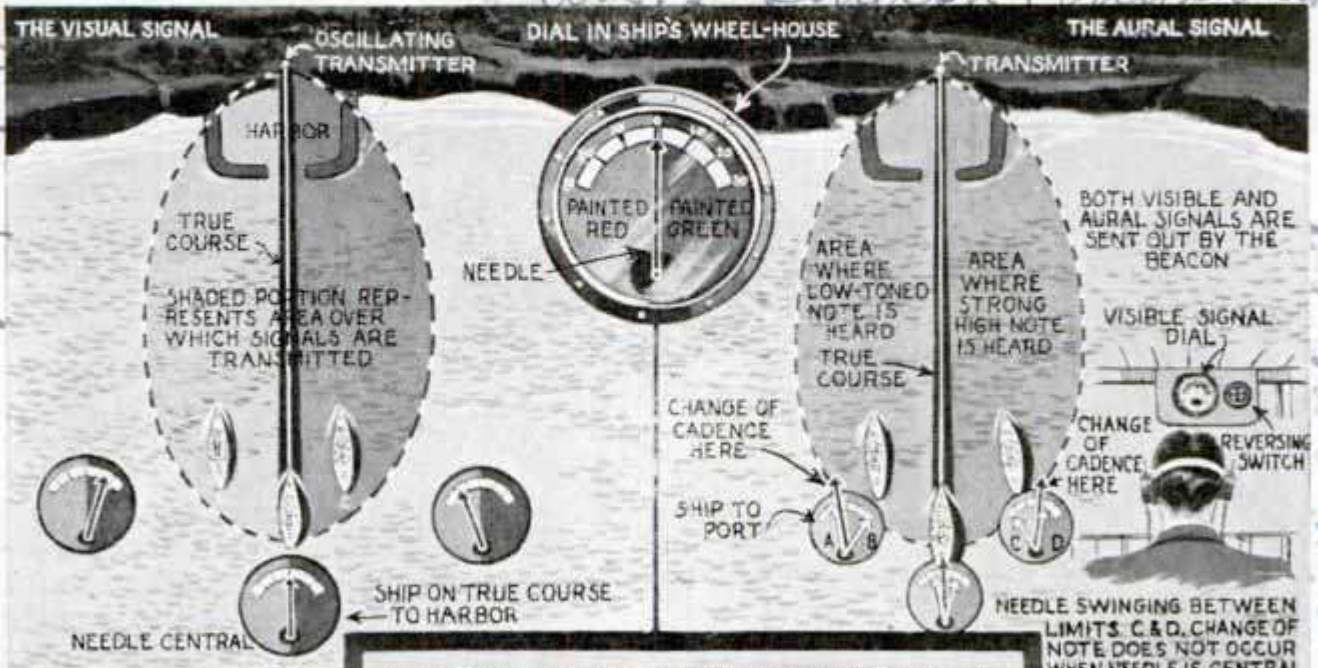

WITH THIS METHOD OF SIGNALING IT IS POSSIBLE TO NAVIGATE A SHIP IN THE THICKEST SEA FOG.

TRANSMITTING REFLECTOR AERIAL SYSTEMS SWING RIGHT & LEFT OVER A TOTAL ARC OF 6 DEGREES

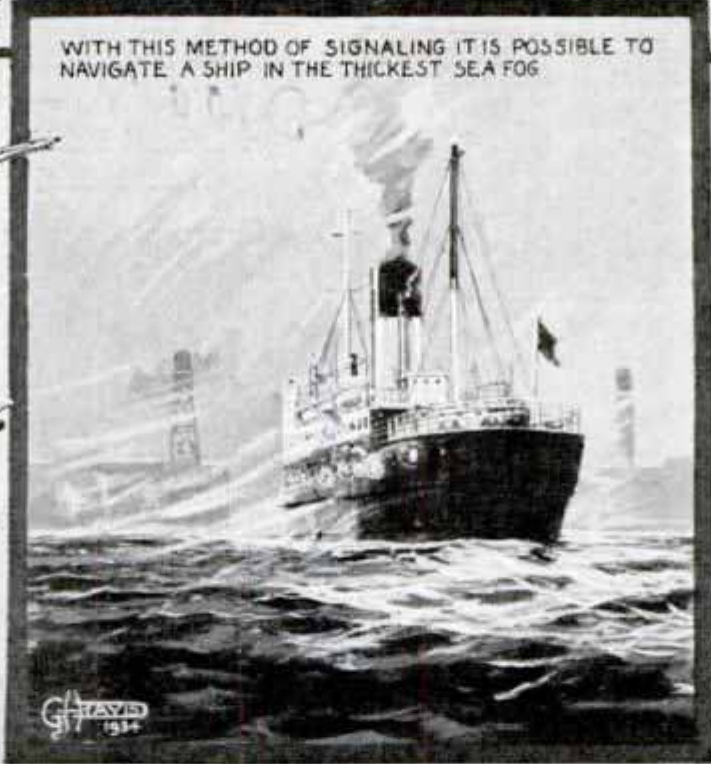
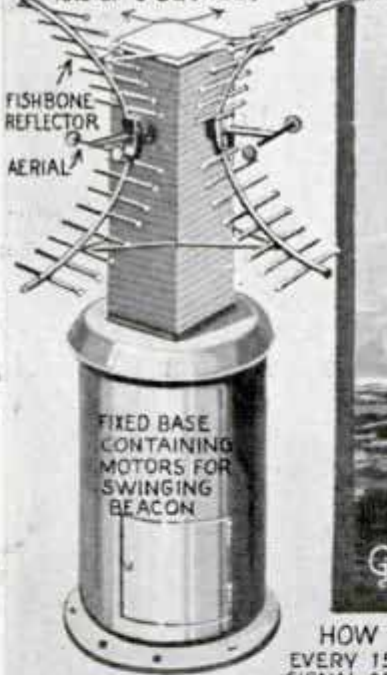

RECEIVER

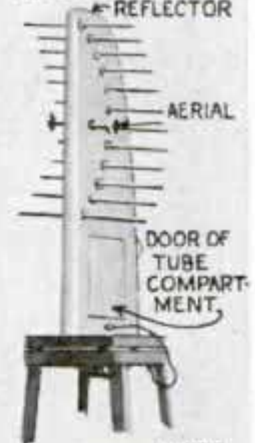

HOW THE DISTANCE IS DETERMINED

EVERY 15 SECONDS A SOUND SIGNAL AND A WIRELESS SIGNAL ARE TRANSMITTED FROM THE BEACON. THE WIRELESS SIGNAL IS HEARD INSTANTANEOUSLY AND A STOP-WATCH IS STARTED AND WHEN THE SOUND SIGNAL ARRIVES THE CALIBRATED STOP-WATCH GIVES THE DISTANCE



Essentials of Marchese Marconi's System for Guiding Ships into Harbor in Foggy Weather; Transmitted on a Wavelength of About Sixty Centimeters, Radio Signals and Sound Signals Are Sent Every Fifteen Seconds to Vessels Preparing to Make Port; Visual Signals Are Picked Up by Ship's Receiver and Ship's Course Is Indicated on Dial, as Shown at Top, Left, While a Microphone Picks Up Sound Signals to Be Carried to the Navigator by Headphones or Loud Speaker, as Illustrated at Top, Right; Stopwatch with Special Calibrations Shows Distance from Transmitting Beacon by Timing the Speed at Which the Signals Travel, the Speed of Radio Waves and That of Sound Being Known

Stamped Postcards Collected as Latest Hobby



Examples of Latest Hobby, Collection of Cards Bearing Pictures and Stamps of Certain Countries

Picture postcards, bearing the stamp on the picture side, are being collected as a hobby in European countries. Thus, the card shows a view of the country, as well as the stamp, giving the stamp collector a new method of increasing his collection and adding interest to the work.

WIND IS ROBBING RANGE LANDS DUST CLOUDS PROVE

Dust clouds which swept over nearly half the United States this year originated largely on over-grazed, semi-arid lands

plowed for wheat near the eastern side of the Rocky mountains, according to the forest service. Permanent damage to land as well as to current crops results from such dust clouds which are becoming increasingly common. Wind erosion on the plains is like water erosion in states farther east. Unless more conservative grazing is practiced and greater care is exercised in plowing extensive areas for wheat in areas subject to drought,

desert conditions will begin, and once started, such lands cannot be reclaimed.

MOTOR EXHAUST GAS TESTER REVEALS POWER WASTE

Sources of power waste by the automobile engine are revealed quickly by a fuel combustion tester that analyzes the exhaust gas. Used after repairs have been made, it shows the owner the new efficiency with which carburetor, ignition system and other parts of the motor operate. Used before repairs are made, it shows the mechanic the source of trouble,

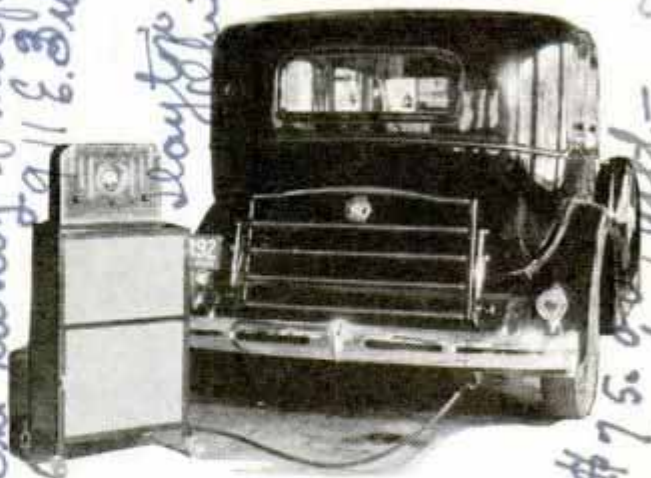

Test Equipment Takes Sample of Exhaust Gas and Analyzes Motor Troubles

saving time ordinarily spent in the trial-and-error method of locating the point of power waste. The tester is supplied with and without a portable cabinet stand.

Emb. Aug. Rudolf Trimmel Laxenburger, 26 Wien X Austria

D 692

U.S. Dept. of Agriculture, 5/15/34 Press Service Washington D.C.

The Lantry-Phelps Corp. 11 E. 3rd

stay to this

#75.00 cabinet \$95.00

and in price

Dyna... New York



WINGS
over the
SPANISH
MAIN

H. FOSTER

D965



SPANISH Galleon (left) being overtaken by Pirate ship (right) in the Caribbean; typical of the olden days, this picture is reproduced from a painting.



D965

TOP, bridge of clipper plane, showing pilot, co-pilot, radio operator and mechanic. Bottom, native of Nassau uses bow and arrow instead of rod and reel.

D965



MAYAN pottery carrier on his way to market is frequently seen by air travelers in the Caribbean.

ONLY yesterday, it seems, an iron ring of wooden ships scoured the seas and chased gilded galleons for pieces of eight. Blackbeard, Captain Kidd, and Sir Henry Morgan, spread terror over that stretch of land and water known as the Spanish Main.

Today silver wings fly over the Spanish Main, where white sails once beat against the wind. Trading clippers charge across the skies like meteors, and alight on harbors where pirates once hid, awaiting their prey. Under the mouths of cannon, up to the walls of forts, and into the dens

of pirates, the broad-winged ships of the Pan American fleet carry passengers, mail and cargoes of commerce.

Peace reigns over the Spanish Main. High-pooped frigates have given way to winged amphibians and swashbuckling buccaneers to sea-roving pilots. Lone travelers go where armed men once feared to tread.

That is the change which has come over the Spanish Main. The giant seaplanes and flying boats, the multi-motored amphibians have quickened the pulse of life in the Antilles. They bring letters one-



CHRISTOPHE'S Citadel overlooking hills of the island of Haiti, grim reminder of the olden days to passengers of the great clipper ship flashing by at high speed.



D965
WATERFRONT at Nassau, Capital of the Bahamas, off the Florida coast, with sponge wharf and fishing boats in the foreground.

day old from cities that formerly were separated by a week or two of travel.

Everywhere the traveler cruising over the Spanish Main sees reminders of the buccaneers. Everywhere one is directed to secret burials of pirate gold. Hardly a league of land can be found between Barranquilla and the Ten Thousand Islands where tradition does not have it that Captain Kidd buried his treasure. Strange enough, the only place where Captain Kidd's treasure has been found is not in the Spanish Main but on Gardiner's Island, in Long Island Sound. Port Royal, Porto Bello, Maracaibo, Puerto Principe, Tortuga—great names in a pirate's geography—are now reached by fleet-winged aircraft flying over the

air bridge from the States.

What would Sir Henry Morgan and his freebooters think of those streamlined greyhounds of the sky? Seventeen-ton clipper ships roaring down the Main at two and one-half miles per minute! And behind them an armada of 100 ships criss-crossing the Caribbean and spinning an airway web over 10,000 miles of open water!

In the olden days, it took weeks to cross the Main; today it is a matter of hours. Passengers recline in soft velvet, sip cold drinks, and look down upon the turquoise sea and palm-fringed islands.

But never for a minute are they out of touch with civilization. The radio man sits at his post relaying orders to pilots



ABOVE, Mexican
senorita with beautiful
native-woven rug
in the background.

BELOW, native women carrying huge
baskets of coal to refuel ship in the
West Indies.





8965
TOP, giant silver-winged clipper ship taking on passengers and mail at one of the ports of call where pirate ships once flaunted the "Jolly Roger." Left, native woman and child of the type frequently glimpsed by the clipper's passengers as they visit sections of Caribbean towns.



2965



RIGHT, fiesta time in Old Mexico brings the brave caballero to woo his senorita beneath a soft southern moon; a scene beside the waters of the Caribbean.



D965

who guide their ships with a precision that would make a pirate blush with envy.

In days of yore, the pirates swore allegiance to their leaders in oaths signed with blood. Their code was, "No prey, no pay!" And just as the lives of modern employes are insured, the pirate chiefs insured the lives and limbs of their men. Six hundred pieces of eight (a piece of eight was worth one American dollar), for loss of a right arm; five hundred pieces of eight for a left arm; one hundred pieces of eight for an eye, and one thousand for total disability or death. \$1000 in those days was equal to more than \$20,000 today.

Life and limb are safer on the Spanish Main than they have ever been. Millions of passengers have been carried and hundreds of millions of miles have been flown, but not one passenger on the Pan American lines has met with a major disaster. This

Airways, 13584, 2nd



TOP, interior of clipper plane, showing passengers playing bridge, while girl traveler reads; through the doorway, the co-pilot chats with passengers. Bottom, water boy of Managua stops to be photographed as he plies his trade, a common sight in many Caribbean countries.

D965



TOP, sailing majestically through silver-tinted clouds, the great clipper roars southward above a land made more romantic by countless legends of bold pirates. **BOTTOM**, fisherman offers his wares in seaport town in Cuba.

D965



record is maintained under the strictest discipline any non-military organization has ever set up.

Pilots are trained not only in mechanics and aerodynamics, but in the more delicate matter of responsibility.

Pan American has developed 147 airports and 72 ground radio stations, while as many private weather stations maintain contact with the airliners. While covering jungles, mountains, deserts, and the longest over-water stretches on any airway, Pan American ships have maintained an accuracy of 99.68 per cent in their schedules. From being one of the most inaccessible regions in the Western Hemisphere, the scattered islands on the Main have become among the most accessible. And while in former days a

LEFT, Guatemalan woman carries child in arms while balancing heavy basket. Below, famous Moro Castle at Havana, Cuba.

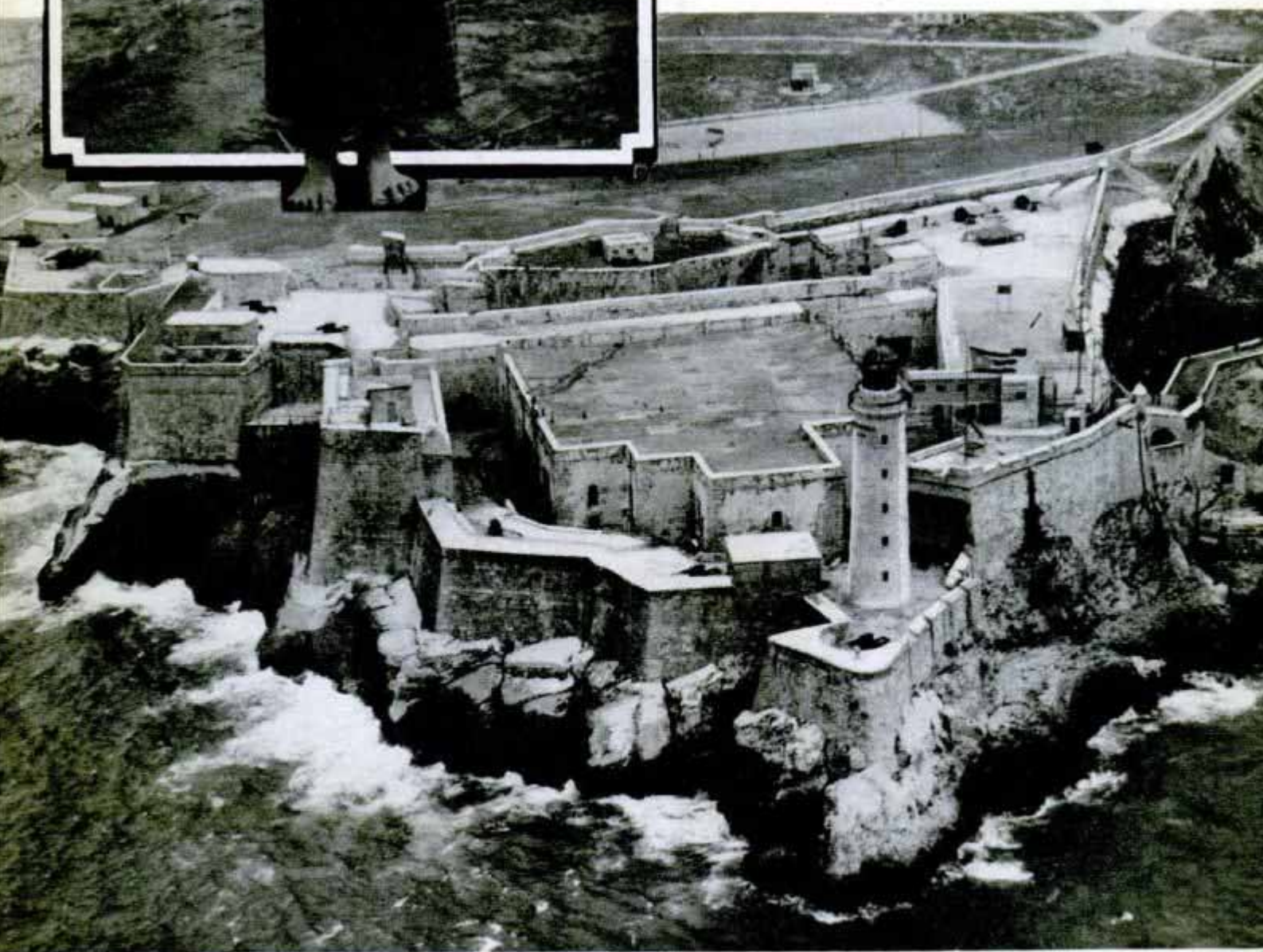



WATER carriers of Bar-
ranquilla, Colombia, in
South America, gather to
fill their casks and to gos-
sip before starting their
rounds of the town.



CLIPPER ships, one of which is shown at lower left, rise from this airport, one of the finest in the world, at Miami, Fla.

cruise through the West Indies was fraught with danger from that bloody fraternity known as the "Brethren of the Main," today it is among the safest places to visit.

On Seven League Air Boots, you can now cover by air the routes used by the Spanish galleons and their naval convoys in carrying treasure from Cartagena in the New World to Cadiz, Spain. Scarcely a ship ever left port that she was not attacked by the "Brethren of the Main," who ruled the Caribbean for more than a century.

At Port Royal, Jamaica, where today the wings of clipper ships are a common sight, you can still see the moats and drawbridges of Old Fort Charles, the pirate stronghold. Port Royal, in the heyday of pirateering, was the wickedest

place under the sun. Part of the town now lies under the sea, submerged by a terrible earthquake. Many a bold plot was hatched inside the walls of Port Royal. Here Sir Henry Morgan ruled with an iron fist. On the ramparts of Fort Charles, Admiral Horatio Nelson paced up and down, awaiting an attack from the French fleet, which never came. The once-busy waterfront is almost deserted, while Kingston, across the harbor, prospers.

Shot-riddled vessels carrying the Jolly Roger are gone; the proud figureheads of bristling frigates are no more. But on any morning or evening, with the rising and setting sun, you can see a great silver-winged bird dip into the blue waters as it skims past the abandoned nest of saber-slashing pirates.

096

SCENE in Haiti showing natives' means of transportation. Below, wash day along Magdalena River in Colombia, South America.

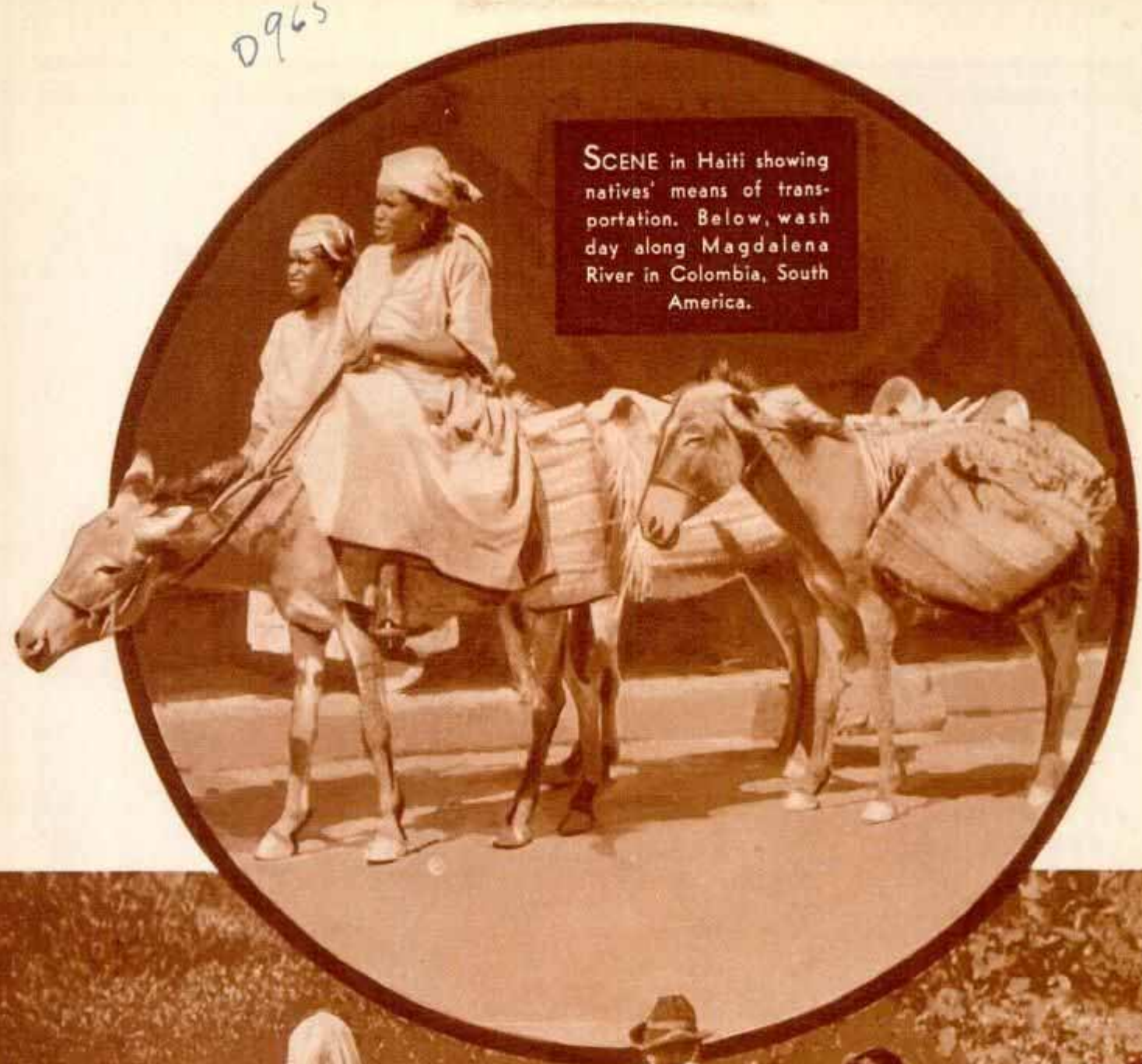

D965



HUMAN "Beasts of Burden" are common in countries visited by the clipper ships; here is a water vender, typical of Mexico's mountain cities, plodding along with his huge water container at Guanajuato.

D 10 4 3
Oliver and Edward
Mayer, 319 S. Esplanade
Elser's, Los Angeles, Calif.
Tiny Locomotives of Wood Are Built to Scale

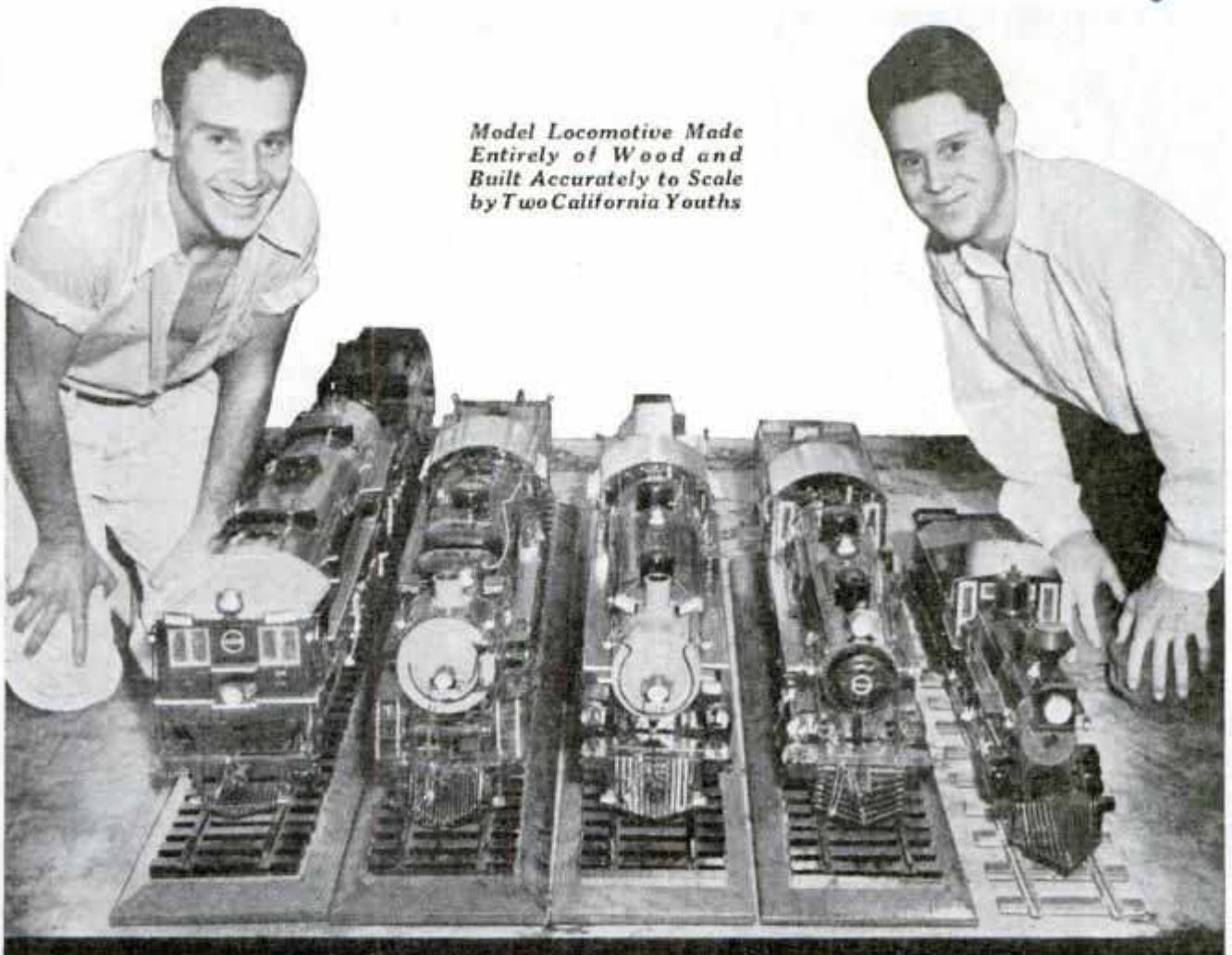

Model Locomotive Made Entirely of Wood and Built Accurately to Scale by Two California Youths

Acme
 Constructed entirely of wood, scale model locomotives are being built by two Los Angeles boys, sons of a retired railroad engineer. Several months are spent in completing each model, since all machinery is fashioned in wood according to scale. The work is done in a small shop in their father's garage.

no motor stick is used. The midget model transmission weighs one-fiftieth of an ounce, while a larger transmission designed to propel models of multi-motored airplanes weighs one-quarter ounce. This transmission is used in models with twenty-four-inch wing spread.

MODEL PLANE TRANSMISSION GIVES MORE POWER

D 10 4 6
 Gearless transmissions are being offered as a means of improving the performance of model aircraft. The transmissions are multiple band motors, using two or more thin strands of rubber instead of one thick strand. The result is more power with twice the endurance of a direct drive. The prime mover is made of duralumin and music wire, with two or more separate strands of rubber on the two or more separate crankshafts. It is easily glued to the motor stick or to the built-up fuselage if

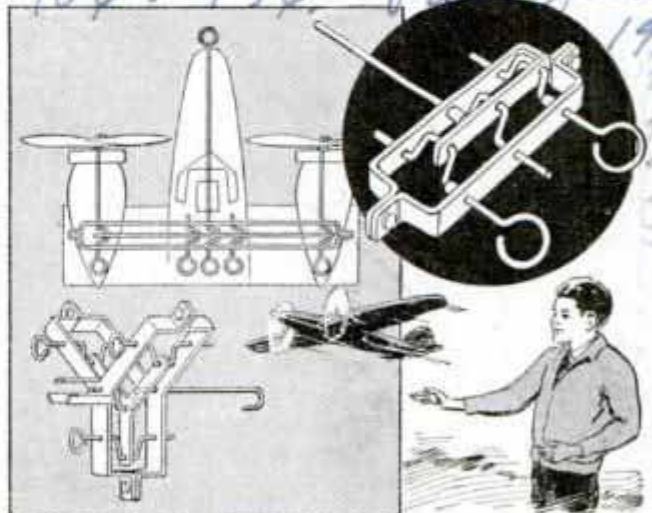

Circle, Transmission for Model Planes; Left, How Transmission Is Installed in Multi-Motored Craft

Model Airplane Motors 2322

D 1041



This Monument Was Erected to the Memory of a Dog Mascot of a Division of the French Army

MONUMENT TO ARMY MASCOT IS ERRECTED IN FRANCE

In memory of the mascot of one division of the French army during the World War, a monument has been erected near Paris. The monument contains the figure of the mascot and of a French soldier. It was erected through public subscription.

FIRE AND OIL BARRIERS USED TO FIGHT CHINCH BUGS

Last summer thousands of men dug millions of rods of furrows, poured millions of gallons of oil in thousands of miles of barriers and even fired grain fields in a desperate fight against chinch bugs. The United States* department of agriculture appropriated \$1,000,000 and distributed 6,000,000 gallons of material for this purpose—amounts multiplied many fold by states, communities and individuals. Despite these efforts, as much as eighty per cent of certain crops fell before these insect ravagers and the drought which enabled them to breed. So minute that it takes 8,500,000 to make a bushel, the adult bugs flew and the young bugs crawled from small grain to corn fields. Yet, according to government entomologists, sev-

enty-five per cent of this damage from chinch bugs could have been avoided by the adoption of simple expedients. Most effective is the cultivation of crops immune to these insects, including alfalfa; red, sweet and alsike clover; cowpeas, soy beans, sunflower, flax, sugar beets, artichokes, potatoes and rape. Rotating crops also is effective, with this plan recommended: 1. Wheat; cowpeas or soy beans; wheat with some oats or rye; red or sweet clover. 2. Corn; wheat or oats; red or sweet clover or alfalfa. More spectacular but less effective is the burning of fields—a method said to have been practiced by the Indians. To be effective, burning must be done between December and mid-April. After the adult bugs have flown from their hiding places in spring and begun breeding, most important defense is the erec-



Digging Furrows to Protect Field from Chinch Bugs, and Fighting the Insects with Fire

tion of a ridge around the field to be protected by plow, disk cultivator or road-grader, with postholes, eighteen to twenty inches deep sunk into the bottom of the furrow at one to four-rod intervals. On the brow of the ridge a line of creosote is

Emb. Victor Rubin, 1512 Sherwyn Ave., D 1025

*Dr. James ...
Frederick Sammes ...
Los Angeles Calif.*

laid. The holes should be flared to this line and kept dusted. Avoiding the odor of creosote—~~which~~ must be renewed daily the first week, then every two or three days—the invading bugs tumble into the posthole traps and are destroyed.

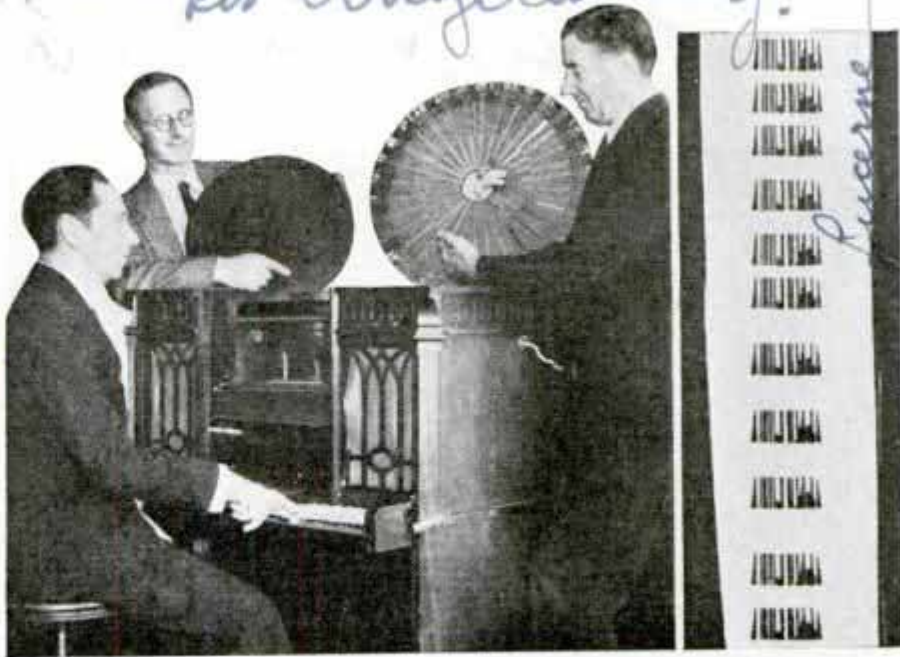

Homemade Electric-Eye Organ and the Revolving Disks and the Film Sound Track of Tones Used in Playing It

FAN INSIDE WHEEL COOLS TRUCK TIRE AND BRAKE DRUM

Successful tests of a method of lowering brake drum and rim temperatures for trucks and buses have been conducted by the B. F. Goodrich company. Invented by the Rogers Brothers corporation, the method consists of a fan built inside the wheel to dissipate heat on dual-tired vehicles. In tests, the fan lowered temperatures about fifty per cent, indicating that its use in normal service would prolong tire and brake life.

Rogers Brothers Corp. Albion, Pa.

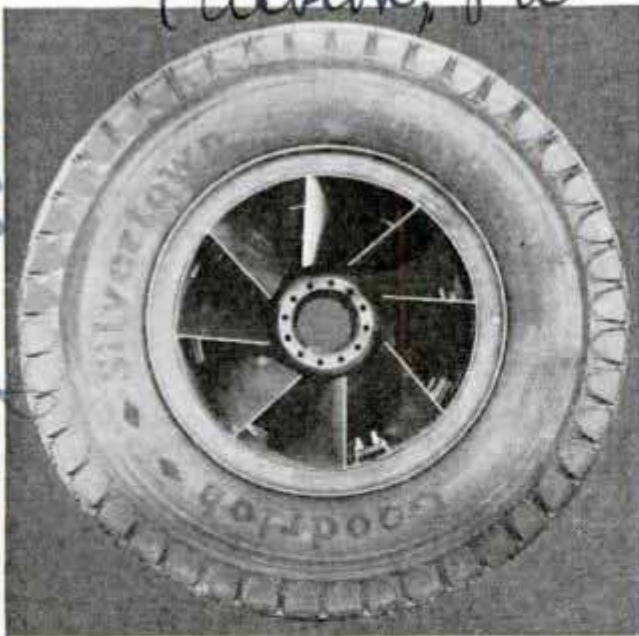

Fan Built Inside Auto Wheel to Lower Tire and Brake Drum Temperatures of Trucks and Buses

HOMEMADE PHOTO-CELL ORGAN HAS FINEST TONES

Music with the tonal quality of that produced by famous musicians can be played by any pianist on a homemade organ con-

structed from a dishwasher motor, an old keyboard, tin cans, a loud speaker and other "gadgets." The organ contains a photo-electric cell on which a beam of light shines through revolving disks. A film sound track of tones rephotographed on the disks is converted into sound when the beam reaches the photo-cell, reproducing the original tone of the virtuoso.

D/052

LATEST FUSE RENEWS ITSELF WHEN SHAKEN SHARPLY

Self-renewing mercury circuit breakers in the form of fuses are being offered to eliminate the nuisance of blown fuses. To recondition the mercury type, the householder removes the fuse from its socket, grasps it by the head and, with contact point down, gives it a sharp snap in the manner of resetting a clinical thermometer. Under overloads or dead shorts, the mercury used as the fusible element volatilizes and expels itself into an expansion chamber. Snapping it causes the mercury to return to contact position. One fuse, blown 1,000 times in test, is still in operation.



*Lucerne
40.3 H. Lucerne
Blod.*

*Ever. hu
... ..*

W.C. Cummings Co.

D1005

John A. Corning
3107-19 H. N. H. U.
Washington D.C.

The WORLD'S



new instrument? What new astronomical fields do they expect to explore with this giant reflector, twice the diameter of any in existence?

The first purpose of a telescope is to collect light. One hundred inches greater in diameter than the existing telescope at Mount Wilson, the new telescope will have four times the surface area of it. This means that it will have four times the light-gathering power of the present telescope and will be capable of revealing stars four times as faint as those now revealed.

Scientists estimate the number of stars that will be brought into our ken by the new telescope at

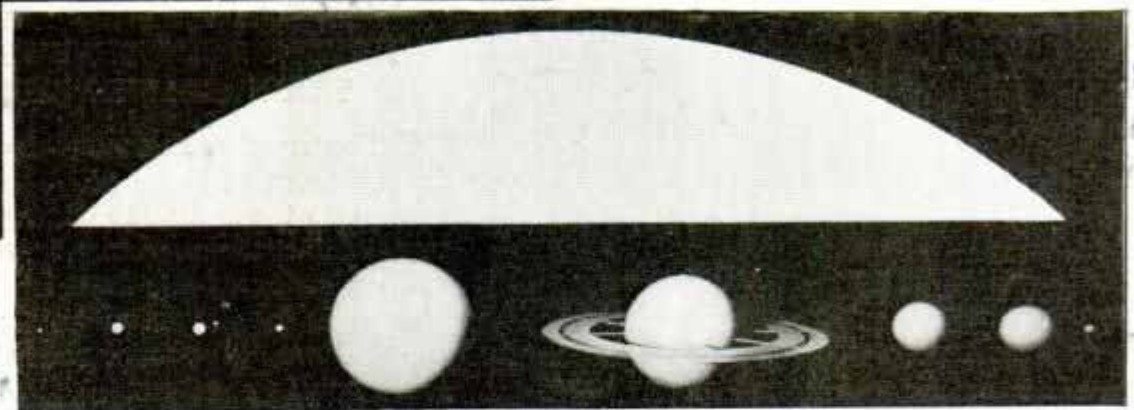

Above, Our Universe as It Might Appear from Distant Star; Below, Model of Segment of Sun in Scale with Planets; Earth Is Third from Left, the Dot Beside It Indicating the Moon

RECENTLY science took a peek at its most famous baby. It lifted the cover, so to speak, and looked in on the 200-inch telescopic "eye" cast last March at Corning, N. Y. The baby was doing well. Now it remains only for this marvelous scientific achievement to finish cooling before it is mounted at Mount Wilson observatory, California, to become the world's largest reflecting telescope.

What do scientists expect to see with this

1,500,000,000—about as many as there are people on the earth. Even this number may be exceeded for the estimate takes no account of the "cumulative effect of the photographic plate"—its ability to record more stars than can be seen with the telescope. Only about 6,000 stars can be seen with the naked eye.

Magnification of heavenly bodies is something apart from picking up light thrown off by them. In the field the new

Corning Glass Works.

Andromeda Galaxy

Paradise

D1005 0310

Largest EYE

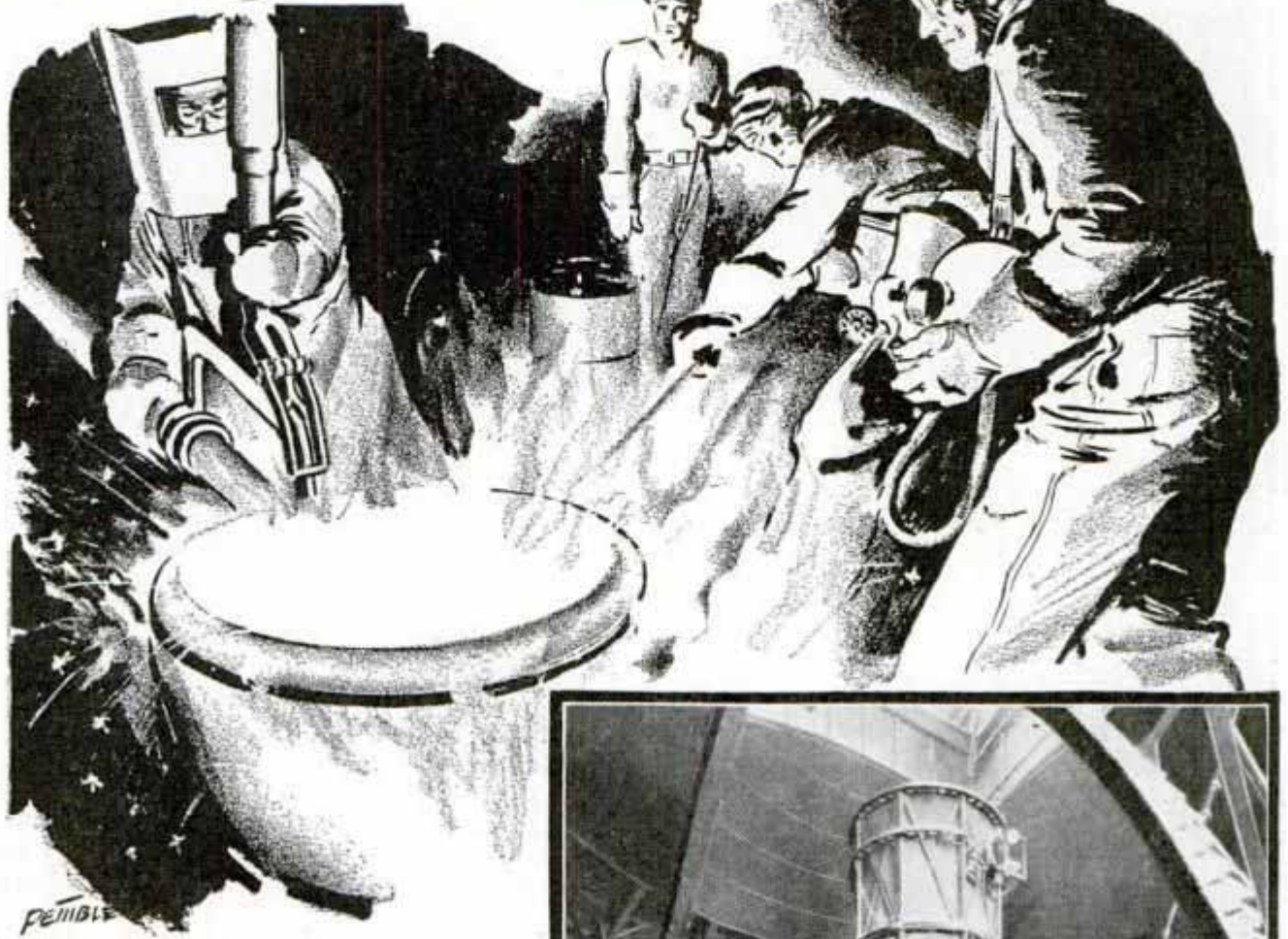

telescope will have its function also. Though not so important as gathering faint starlight, the bringing of the moon and other celestial spheres closer to the earth will be of incalculable value to science. In the case of the moon, that body will be brought within twenty-four miles of the earth. This is startlingly close. Tall buildings, if such existed on that body, would be easily discernible and objects separated by no more than thirty feet would be distinguishable.

Mountains are known to exist on the moon. Great craters or pits may be seen, and have been photographed. Even the shadows cast by the moon mountains stand revealed on photographic plates already made. Through previous studies scientists know that the moon is not inhabited—that it is a dead or burned-out planet. It pos-

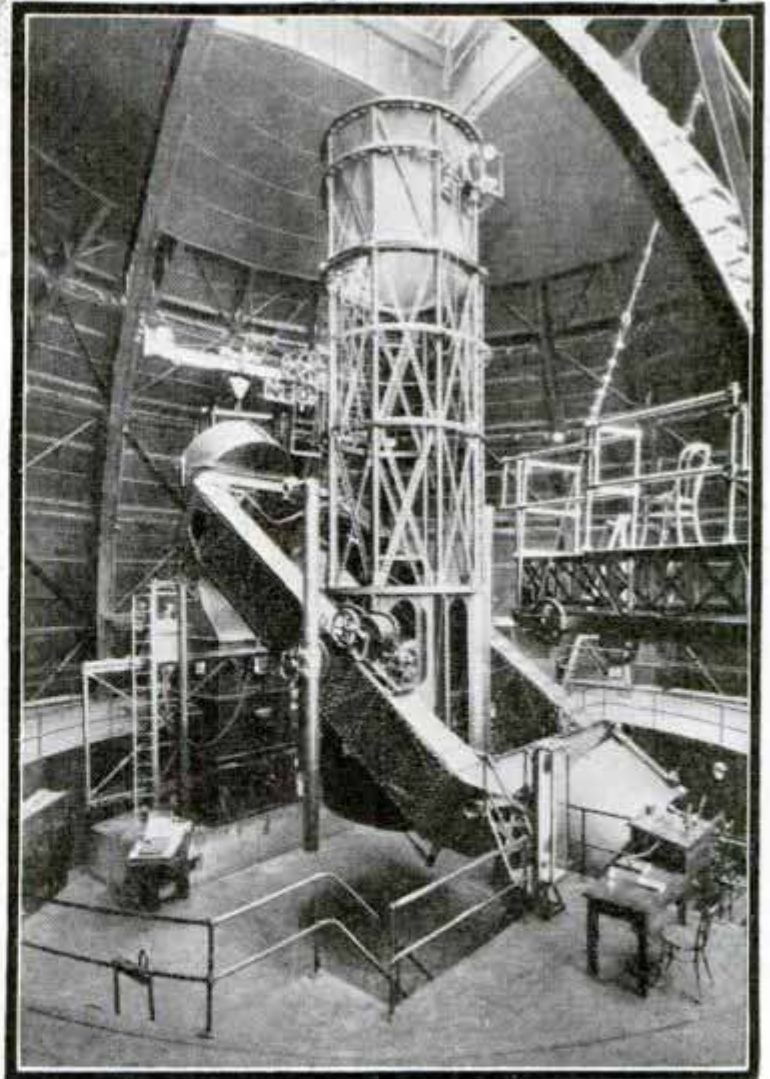

Above, Bowl of Molten Glass Ready for Pouring into Mold for "Eye"; Below, 100-Inch Telescope at Mt. Wilson

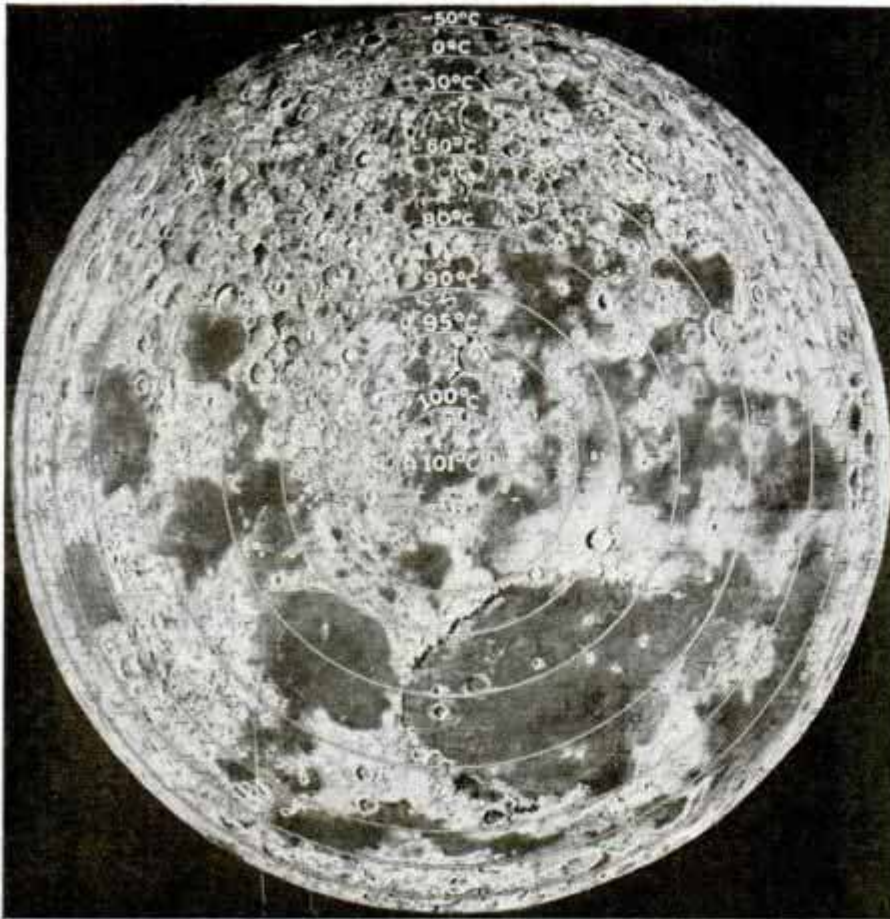

Composite Photograph of Moon Showing Its Craters; Circles Show Temperatures as It Faces Sun; Temperatures Are Lower at Edges

esses no atmosphere, no water, no vegetation or life—at least as we know it. But scientists would like to know more about the moon's craters, its mountains and, particularly, its "soil." More knowledge about the moon might help solve the question, "Where did the moon come from?" That the new telescope will bring this body, 240,000 miles away, within twenty-four miles of us is a marvelous achievement.

The new telescope also may help solve the question as to whether our universe is "expanding" or not. Are the nebulae—the vast star worlds of space—receding from the earth at tremendous speeds? Science's method of checking up on these nebulae is by photography, but hitherto they have moved too fast for their reddened light to be accurately photographed. But the 200-inch telescope with its red sensitive photoelectric cell will "spot" them on camera plates regardless of their speed.

The study of our solar system will be greatly enhanced by the new telescope. It will be possible with the new instrument to photograph the faint satellites of some of the planets whirling along with us

around the sun. Mars, the most intriguing of all the planets as regards life, will be brought so close that a great city, if one exists there, could be dimly outlined.

In the case of comets, which cut through the heavens sometimes very close to us, it will be possible to follow them further into space than heretofore. More knowledge thus should be gained of their behavior in the vast reaches of the void where they speed eternally. Pluto, at the outpost of our sun world, latest discovered member of our family, will be brought within 370,000 miles of the earth. Physically it is distant 3,700,000,000 miles.

In the field of photography the new telescopic camera will take photographs ten times faster than existing telescopes. This is because of the focal length of the "camera" to the lens—fifty-five feet by 200 inches. In existing telescopes the ratio is not less than one to five or one to six. The secret of this photographic speed is more light. The 200-inch lens will permit almost instantaneous exposures. The faster the camera photographs, the less blurring, twinkling and shimmering of the atmosphere on the photographic plate. This means clearer photographs of the stars and nebulae.

Planets of other star-suns, like ours, will not be visible. All that can be gleaned of them will be the knowledge gathered from the light coming to us from them and their central sun. The nearest of these sun-stars, outside our own solar system, is four and one-half light years away—27,000,000,000,000 miles.

Does the new telescope mark the limit of man's ability to penetrate the void in his search for starry knowledge? From the standpoint of size this is largely believed to be true. There was grave doubt as to whether this mirror would come

(Continued to page 130A)

D100

Honeycomb Cottages Inc.
Hollywood Blvd. and
Western Ave., Hollywood, Calif.

POPULAR MECHANICS

679

Factory-Built Home Hauled to Site by Truck

Factory-built homes, ready to live in when they leave the builder, are being constructed in Los Angeles. They are moved by truck to any desired location and set in place in a few hours. These houses are built in sections and a small cottage may be ordered and additional rooms can be added later, the planning and construction being such that the extra room or rooms, already built, can be sent to the house by truck and quickly attached. The homes are said to be termite-proof, storm-proof and resistant to earthquakes. Walls are six inches thick throughout, air-dried redwood



Hauling a Factory-Built Cottage to Its Future Site, and Views of Kitchen and Living Room

many designs and combinations from which to choose, ranging all the way from a cottage with one bedroom to a house with five sleeping rooms. Interior walls are of redwood with the exception of the living room which is paneled in knotty pine. The roof can be finished with tile, shingles or a form of planking. Quality paint and standard hardware and plumbing fixtures are used and factory production reduces the cost of such homes as compared with similar houses constructed in the usual way.



is used for exterior walls and the chimney is reinforced with steel. There are

PLANES LOSE THEIR BEARINGS OVER BIG IRON DEPOSITS

D1051

Airplanes flying over Minas Geraes, Brazil, frequently are thrown off their course on account of large iron deposits in that area. Compasses cannot be relied upon. Brazilian planes in recent practice maneuvers were unable to proceed when the pilots lost their bearings.

emb. Hector Ribeiro

Honeycomb Cottages, Inc.

Architect - Wallace

Traveling Movie Theater Is Housed in Trailer

1837
Pittsburgh, Pa.

Body

McCall Co 230 Park Ave New York

Harrop Ceramic

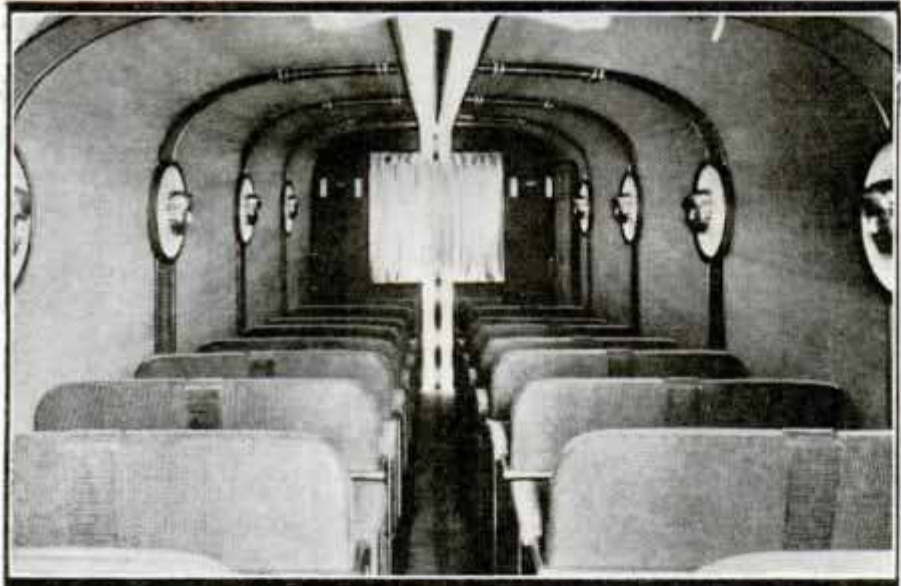
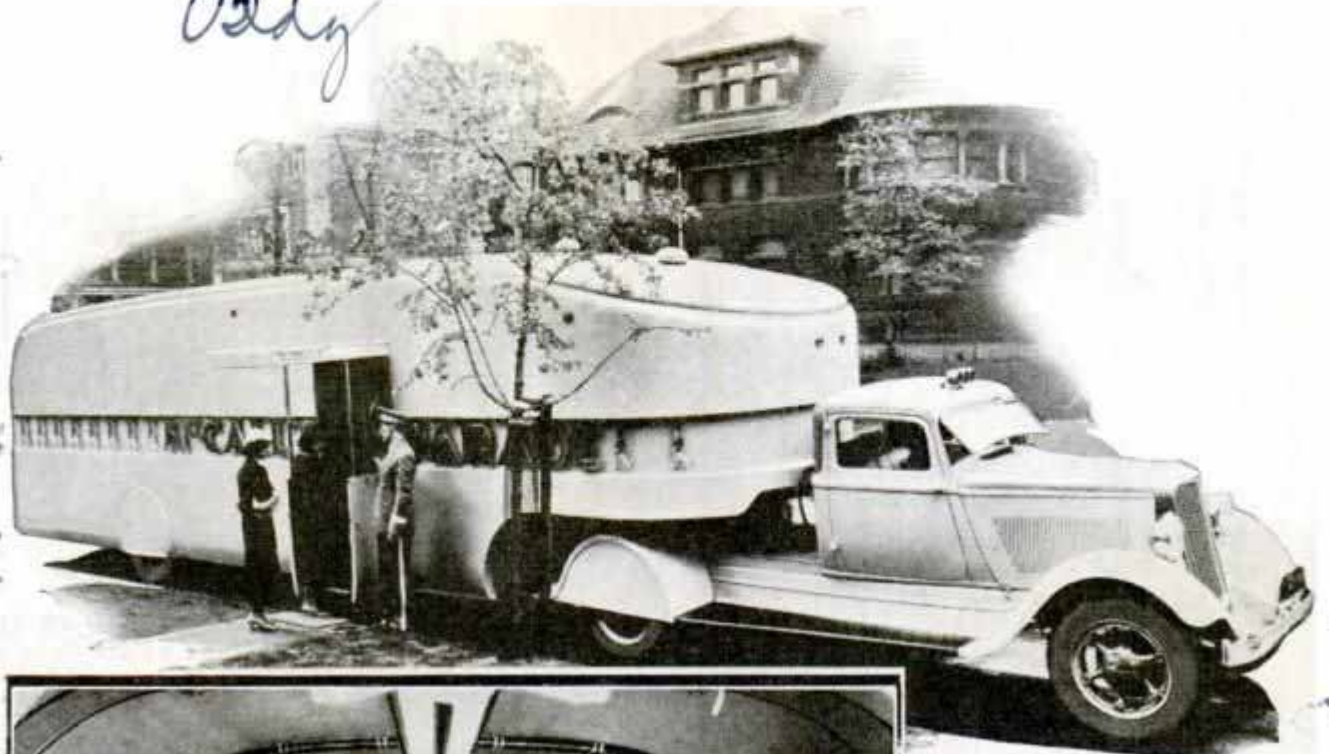

Exterior and Interior of Movie Theater on Wheels; It Is Fully Equipped and Seats Thirty-Two Persons

ing machine, a generator and a switchboard from which the lights are controlled.

HOME ELECTRIC KILN MAKES POTTERY AT LOW COST

Pottery making in the home or small shop is made practical through the use of a small electric kiln that operates at low cost. Plugged into a standard light socket, it fires up to 2,000 degrees Fahrenheit. The cost for one and one-half hours of baking is about four cents. The firing chamber is three and one-half inches by three and one-half by four. Before this small kiln was

Housed in a semi-trailer and pulled by a two-ton truck, a traveling movie theater is operated by one company to advertise women's fashions. Entrance to the talking picture theater on wheels is at the front where a door folds upward to become a canopy. Double doors at the rear are operated synchronously with steps. Aluminum panels are used in the streamlined body. There are sixteen double seats, each pair being somewhat higher than the ones in front. The interior lighting consists of tubular lamps running lengthwise overhead and illuminated masques along the walls. The control room occupies the space between the stage and the nose of the body and in it are the projector and talk-

made practical through the use of a small electric kiln that operates at low cost. Plugged into a standard light socket, it fires up to 2,000 degrees Fahrenheit. The cost for one and one-half hours of baking is about four cents. The firing chamber is three and one-half inches by three and one-half by four. Before this small kiln was devised, the student had to take his pottery to a commercial kiln for baking.



\$ 15.00

Harrop Ceramic

S. 54th Ave and Rogers St.
**CHISEL WITH ELECTRIC MOTOR
REMOVES HARD PUTTY**

Hard putty on steel window frames can be removed easily and quickly by using a new motor-driven chisel. The electric motor, at one end of a flexible three-foot shaft, is strapped to the side of the operator to relieve his hands of unnecessary weight. At the other end of the shaft is a hammer cylinder into which the chisel is inserted. The machine also may be used as an electric hand polishing device, for chiseling hard materials and for special cleaning operations.

D1048

**PORTABLE VENTILATOR UNIT
REMOVES FUMES QUICKLY**

Welding fumes and foul air can be removed quickly from enclosed spaces with a portable ventilator developed recently. The unit is compact and can be lowered through an opening with a fourteen-inch diameter. The weight, including electric motor, is only eighty pounds, so that it



This Unit, with Arrow Pointing to Location of Fan, Removes Fumes at Rapid Rate

may be set up and operated by one man. Fumes and foul air are removed at the rate of 1,500 cubic feet per minute.

Coburn Engineering Corp



Simple Hose Attachment for Watering a Second-Floor Window Box from the Ground

**TOOL FOR "AERIAL GARDENING"
WATERS SECOND FLOOR BOX**

Caring for a window garden on the second floor in the absence of the owners was the problem solved by their neighbor. By rigging up a device to hold the hose at the correct height, the substitute gardener was able to water the plants in the box several feet above his head. This eliminated the necessity of entering the home to reach the box.

Names and addresses of manufacturers and dealers in articles described, and any other details in our possession, will be furnished by our Bureau of Information upon request, accompanied by postage.

Greenwich Village New York

D1016

From THICK to THIN in

materials are pre-tested carefully. The result is that there are rigid airplane wings built of materials scarcely thicker than egg shells, streamlined trains built of thin metal sheets, skyscrapers standing on steel matchsticks, building fronts of transparent glass and very thin partitions between rooms.

The plywood industry is the father of the fashion of going from thick to thin. Two recent discoveries in the fabrication of ply materials promise to cause many

Left, "Armored" Wood, Showing How a Thin Sheet of Aluminum Covers Piece of Plywood

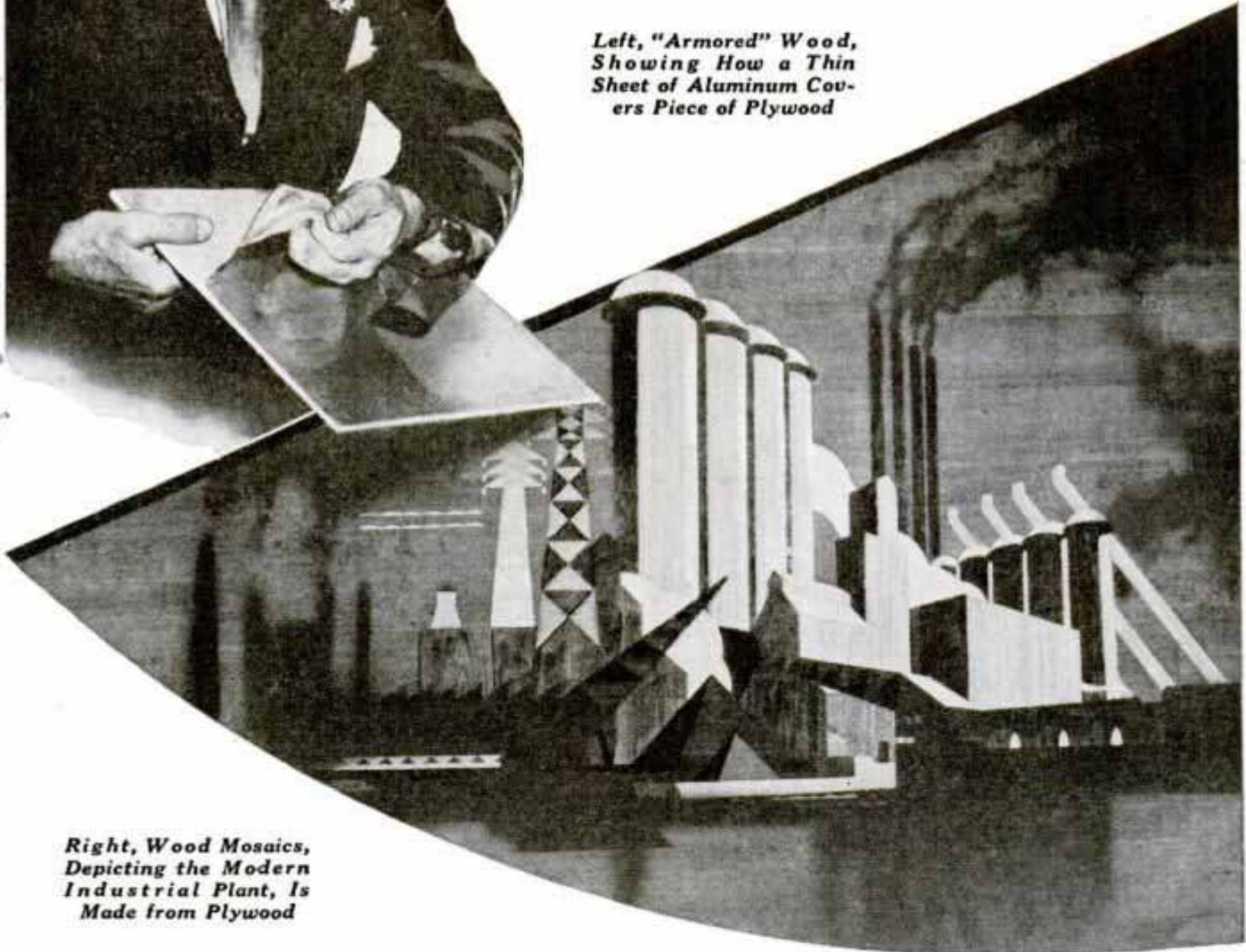

Right, Wood Mosaics, Depicting the Modern Industrial Plant, Is Made from Plywood

EVERYTHING is going from thick to thin. The difference between old and new construction, whether it be furniture or bridges, is mainly in the amount of waste. Under old methods materials were wasted because so little was known about their nature and characteristics. Today,

things to go from a traditional thickness to an uncommon thinness.

The most important development is the process for manufacturing plywood with phenolic resins as a binder instead of glue. The custom of gluing thin sheets of wood veneer into a panel prevented the use of

United States Plywood Co.

make all 103 Park Avenue New York D 1010

BUILDING

articles mentioned

plywood in damp or exposed places. Phenolic resin is one of the chemical plastic products and until recently its ability to

Below, Room in This Modern Home Is Papered with Wooden Wallpaper, a Boon to Builders



Above, the Young Lady's Hat, Belt, Purse and Gloves Are Made of Wood; Special Processes Convert Wood into Materials That May Be Used for Many Unusual Purposes

Chicago - 145 W. Wacker Drive

weld wood veneer was not suspected. Since no water is involved, the phenolic resin can scarcely be called a glue. But it does have the capacity, when sandwiched between two sheets of veneer and subjected to heat and pressure, to weld the plies into waterproof, germ-proof, weather-proof

panels. While under pressure, the resin penetrates the wood fibers to a depth of one-sixteenth of an inch on both sides, forming a bond of great strength.

As the first weather-proof panel ever made, the new welded plywood finds extensive use in modern construction work. You can now build a house with a plywood exterior that will be as weather-resisting as any other type of wood construction. You can use plywood on garages, barns and damp cellars, without the fear that it will check or warp. Welded plywood has been seized by small boat builders as a surface material which combines unusual strength with thinness.

In order to add even greater strength

U.S. Plywood

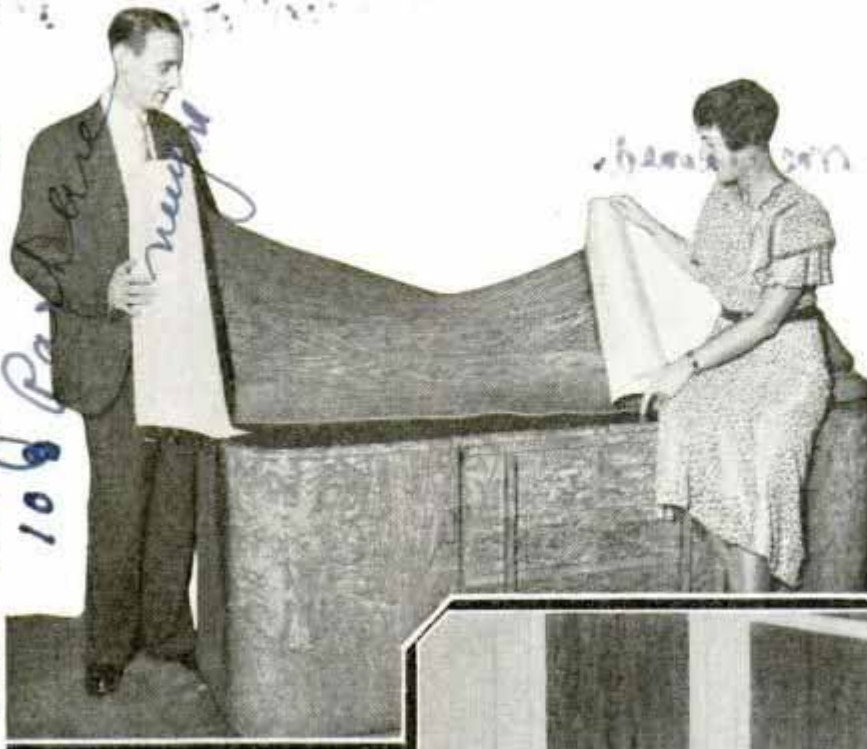

Top, Wooden Wallpaper with Cloth Backing; Center, Applying Wooden Wallpaper; Bottom, Foreign and Domestic Woods Used in Wooden Wallpaper and Plywood

and durability to welded wood, manufacturers recently conceived the idea of covering it with thin sheets of metal. In this wise they have created what might be described as "armored" plywood, with the strength of metal and the flexibility of wood. The idea was of such importance that builders of Burlington's streamlined "Zephyr" adopted it for all cars of the train. In this instance the welded wood is covered with stainless steel and gives the appearance of unusual strength. The unexposed side of the "armor" is covered with a sheet of electrolytic copper, which is welded to the stainless steel. Thus the core of the "Zephyr's" armor, three-ply basswood, is forever sealed

against the air. It is now possible to glue metal to wood in such a way that the differences in expansion and contraction of the metal do not affect the strength of the bond. A special elastic glue has made possible the use of plywood as wing material for airplanes. A thin duralumin sheet covers the plywood and renders the wing impervious to the weather. In addition to this many common metals can be made to cover plywood panels, including copper, lead, silver, duralumin, steel, iron, chromium, and many alloys rolled into thin sheets.

Another recent advance is the use of phenol resin to give a high polish to fine woods. This polish gives depth to the grain and gives the wood surface a rich and iridescent luster



which is hard and never dulls. When surfaced with such a polish, a thin ply of expensive wood like mahogany can be

D1010
 101
 Plywood
 101
 Plywood
 101
 Plywood

Tel. Brookfield 3964 685

welded to cheaper board and used for table tops and other articles in the home.

Designs on cloth or heavy paper can also be covered with the phenol polish, which makes them resistant to wear.

In the building industry plywood is now displacing thick boards in the construction of concrete forms. Because it is highly water-resistant, one piece can be used from seven to ten times, besides saving from forty to seventy-five per cent of carpentry labor.

The possible uses of plywood in home building are numerous. Outside and inside walls, floor bases and coverings, ceilings, panels, cabinets, doors, and dozens of other articles are now available to home builders. Manufacturers estimate that the average home has from 6,000 to 8,000 square feet of space where plywood might be used advantageously.

D1067

"FINGERPRINTING" OF BICYCLES GUARDS AGAINST THEFT

Bicycle owners of Evanston, Ill., are being offered protection against theft by a "fingerprinting" system. Bicycles carried to the police station are registered, the frame number being recorded. If the bicycle has no frame number, a registration number is stamped upon the frame by the police department. Then the owner is fin-

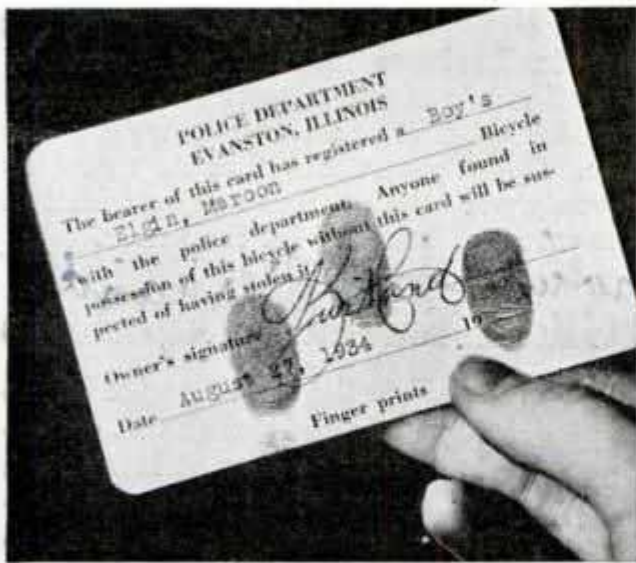

Registration Card Bearing Owner's Fingerprints Helps to Reduce Bicycle Thefts

gerprinted and issued a license card bearing the name, address and physical description, as well as details of the bicycle's construction.

Carl Max Karant



Radium Dust Speeds Up Growth of Plant (Left) Compared to Normal Growth, Shown at Right

RADIUM AIDS PLANT GROWTH BY NOURISHING ROOTS

Radium dust, added to the soil, will speed up growth of plants. Dr. Luther Gable has found that this method may be used in growing expensive greenhouse flowers. Unusual growth resulted from a three-weeks' experiment in which radium dust caused intense root formation.

D1065

"MARK TIME" WASHER SWITCH PROTECTS CLOTHES

Washing machines may be equipped with a "mark time" switch that permits the washer to operate any predetermined number of minutes. The switch protects clothes by cutting off the machine when the washing period is finished. A pointer can be set for correct washing of popular fabrics.



Means Feb 1935 260. York City

M. H. Rhodes, chie.

Box 53, Brookfield Ill. Residence - 3849 Woodridge Road.

Making Movie Snaps Becomes Real Business

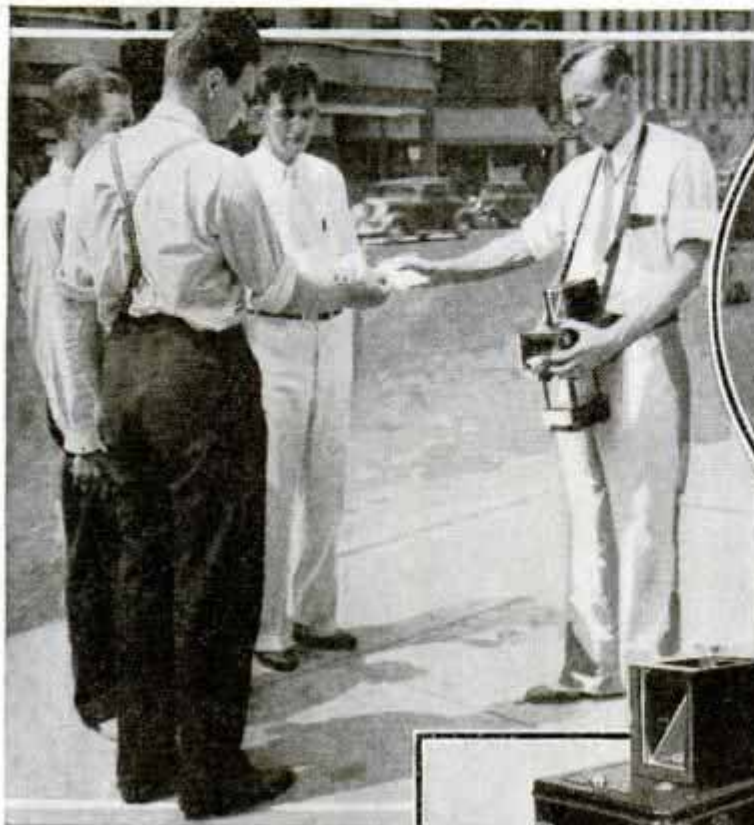

Making Unposed Snapshots with This Standard Newsreel Camera Earns a Living for This Photographer

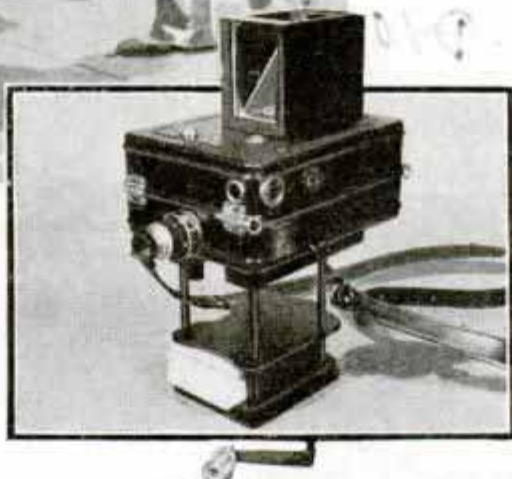

Unposed snapshots, made with a standard newsreel camera, are the basis of a new business that may be carried on wherever crowds gather. As a person walks along, the movie camera man snaps three views quickly, then hands his subject a card. On the card is a place for inserting a coin. A number identifies the snapshots for the photographer. Mailed to the photographer with the coin, the card brings in reply the three views to the

subject. Some of these movie snapshot operators use a DeVry newsreel camera using thirty-five-millimeter film, with an attachment for taking three frames of the subject. A shoulder strap holds the camera steady for shooting. The film is sufficiently large for making clear enlarged prints of the regular two and one-quarter by three and one-quarter photo size. Operators report that as many as seventy per cent of their subjects mail in the cards with money for the prints.

Mr. William Hawley Bowles San Fernando Calif
"Air Brake" to Slow Down Glider for Safer Landings

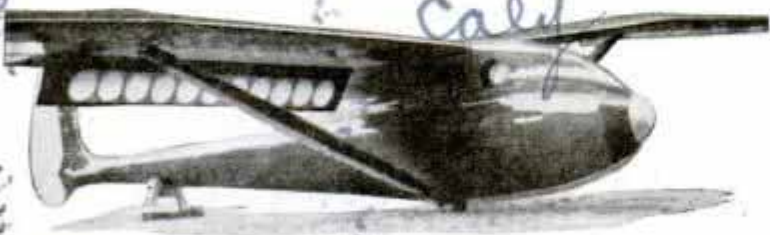

D10
Glider Equipped with "Air Brake" on Trailing Edge of Wing to Slow Down Craft for Safer Landing

Sailplanes and other craft of the motorless or glider type can be landed more safely by attachment of a flap or "air

brake" to the trailing edge of the wing. One glider with this equipment lands easily at low speed, the flap retarding the speed considerably to bring the craft to earth more quickly and at the landing field selected.

☐ American-operated air lines flew 796,950 miles per accident in the first six months of 1934 according to figures of the department of commerce.

D/10/30 Sperry Corp 40 Flatbush Ave. Brooklyn, N.Y.

Detector Car Finds Flaws in Rail as It Rolls

Into railroading has come special equipment which speeds up the tedious task of locating and repairing defective rails. In effect, the equipment is a scientific track-walker with an eye that penetrates to the interior of the rail to detect flaws that would be hidden from the human eye. This equipment is the Sperry detector car, which is fitted with apparatus that picks up electrical impulses indicating defects as the car rolls along at six miles per hour. One instrument marks the location of the defect on the rail so that maintenance crews may make repairs quickly, while another instrument records on tape the location of the faulty rail in relation to the whole line. This information enables the maintenance department to distribute re-

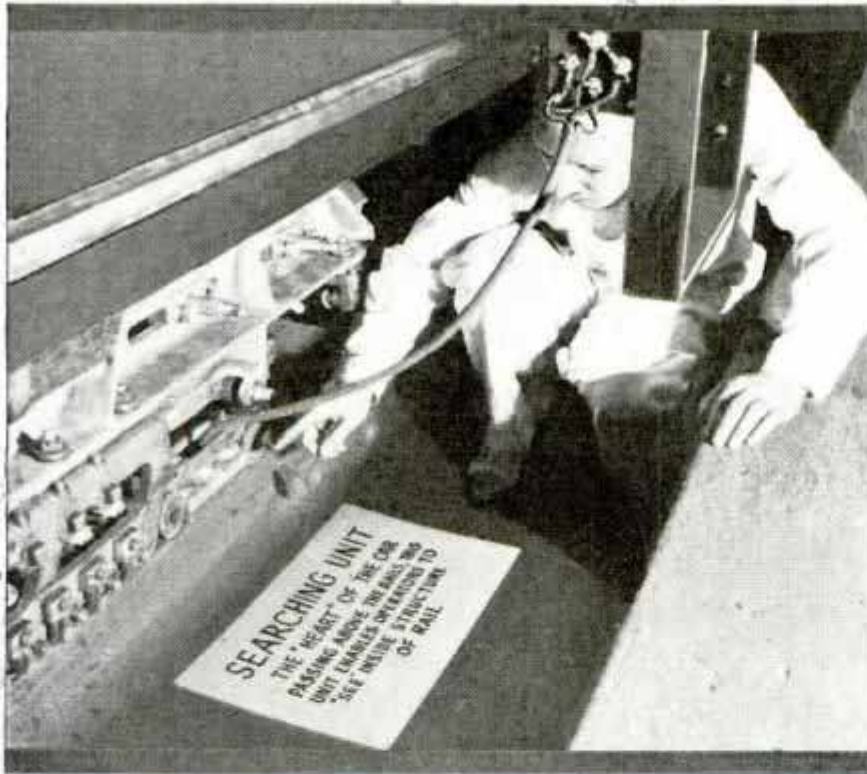

Top, Operator at Record Table in Detector Car Watches Tape for Flaws in Rail; Bottom, Operator Pointing to "Heart" of Detector

century before automobiles were dreamed of, Hugo de Vries, a Dutch botanist, discovered why flowers swell when supplied with water. Although he never suspected it, the facts he learned were used many years later in developing the hard-working storage battery. De Vries found plants supplied with water tended to swell because the water passed through the "one-way valve" or membrane of the plant cell into the interior without allow-

pairmen properly and also serves as a warning to dispatchers routing trains along that particular stretch of track.

STUDY OF FLOWERS PRODUCED MODERN STORAGE BATTERY

If cut flowers remained wilted even when placed in fresh water, we might still have to crank automobiles by hand. Nearly a

ing the salts within to escape. He finally discovered that gases formed when the cell salts were diluted with water caused the swelling. The general process is called osmosis. Later chemists learned to isolate hydrogen molecules which retain and carry electrical charges. Today we call them ions, meaning goers, because they move about in the solution of a storage battery, absorbing or giving off electrical energy.

Ans. Harold J. Bodkin 1426 Bridge

LATEST PIRATE GOLD HUNTERS ENLIST SCIENTIFIC AID

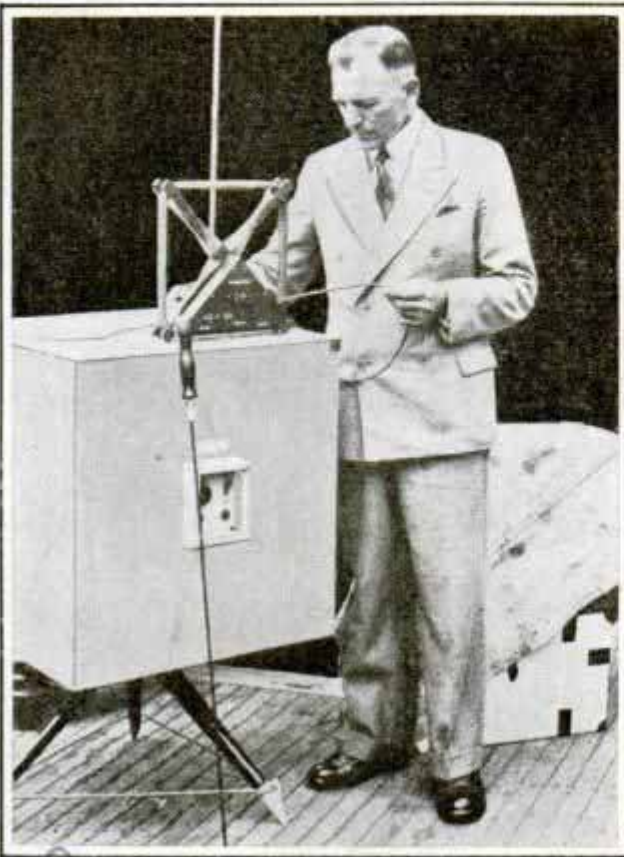

Examining Latest Scientific Equipment Designed for Hunting Buried Loot of Pirates

Equipment for locating fabulous treasure believed to have been buried on Cocos island in the Pacific will be used by an English syndicate. The treasure, according to legend, was hidden by pirates on the island many years ago. All the latest apparatus designed to help locate buried treasure will have a part in the search. The syndicate has heavy financial backing.

THUNDERBOLT DUE TO BREAKING OF RAINDROPS

Why flaming bolts of lightning occur during rainstorms has been explained by means of a homemade glass apparatus about the size of a restaurant coffee percolator. Physicists in the

Sloane laboratory at Yale University caused a small stream of water drops to fall crosswise through an air jet in the percolator. Electrical instruments caught the water particles as they were tossed about and showed that they were charged with electricity. The droplets acquired the charge, the physicists explained, through being torn apart, a process called ionization. That is, in breaking up, some of the water molecules were split and each broken molecule showed an electrical charge. The amount of charge was found to increase as the velocity of the air jet was increased. At 145 degrees Fahrenheit, the charge was eleven times as strong as it had been at just above freezing. The experiments apparently confirmed the theory that thunderbolts are caused by the building up of electrical charges through disruption of the raindrops.

GIANT "JAW" CRUSHES ROCK WEIGHING TEN TONS

Masses of stone and ore weighing as much as ten tons can be crushed into small pieces by a giant "jaw" machine in Germany. The crusher handles the contents of a twenty-ton truck in one and one-half to two minutes and has a capacity of 500 to 800 tons per hour. The purpose of the machine is the crushing of the largest blocks found and in the mining of ore.

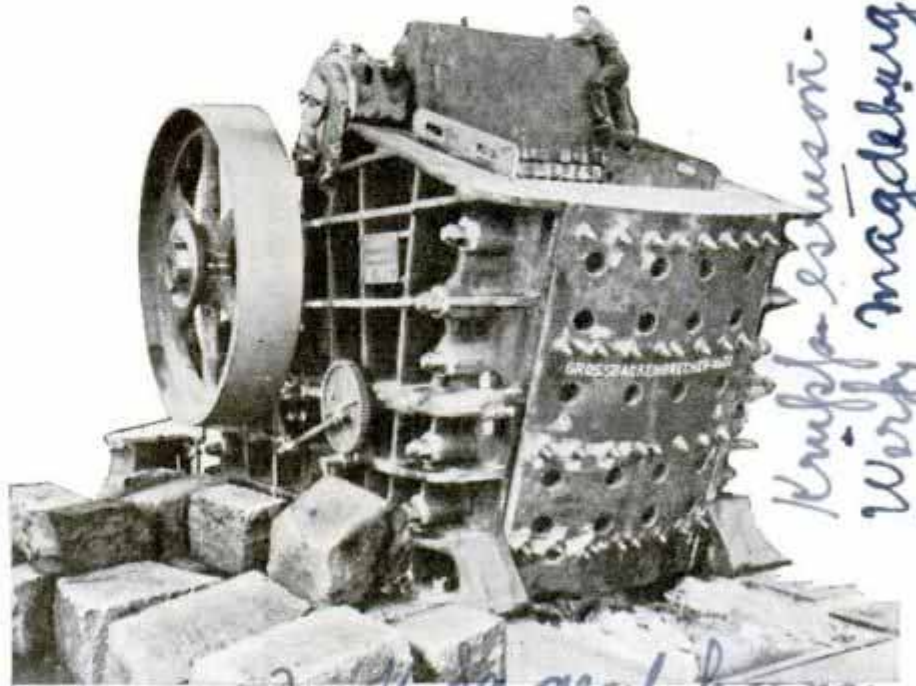

Huge Rock Crusher at Work; an Idea of Its Size Is Gained by Comparing It with the Figure of Workman Shown on Top

D1047
D1015
Photo. - Maguer. 11/1/34
D46
number to - "Seismometer" written in H. Baer's
maker unknown.
D1047
D1015
Sloane laboratory at Yale University
new stream
Krupp - Essen
Werk Magdeburg
Duchow Germany
No. 11 Bogenstrasse
new stream

Phone Users See Each Other by Television

*D992 Television Exhibits Corp
Electrical Bldg
Northbrook Island, Fair
do not answer request for better address*

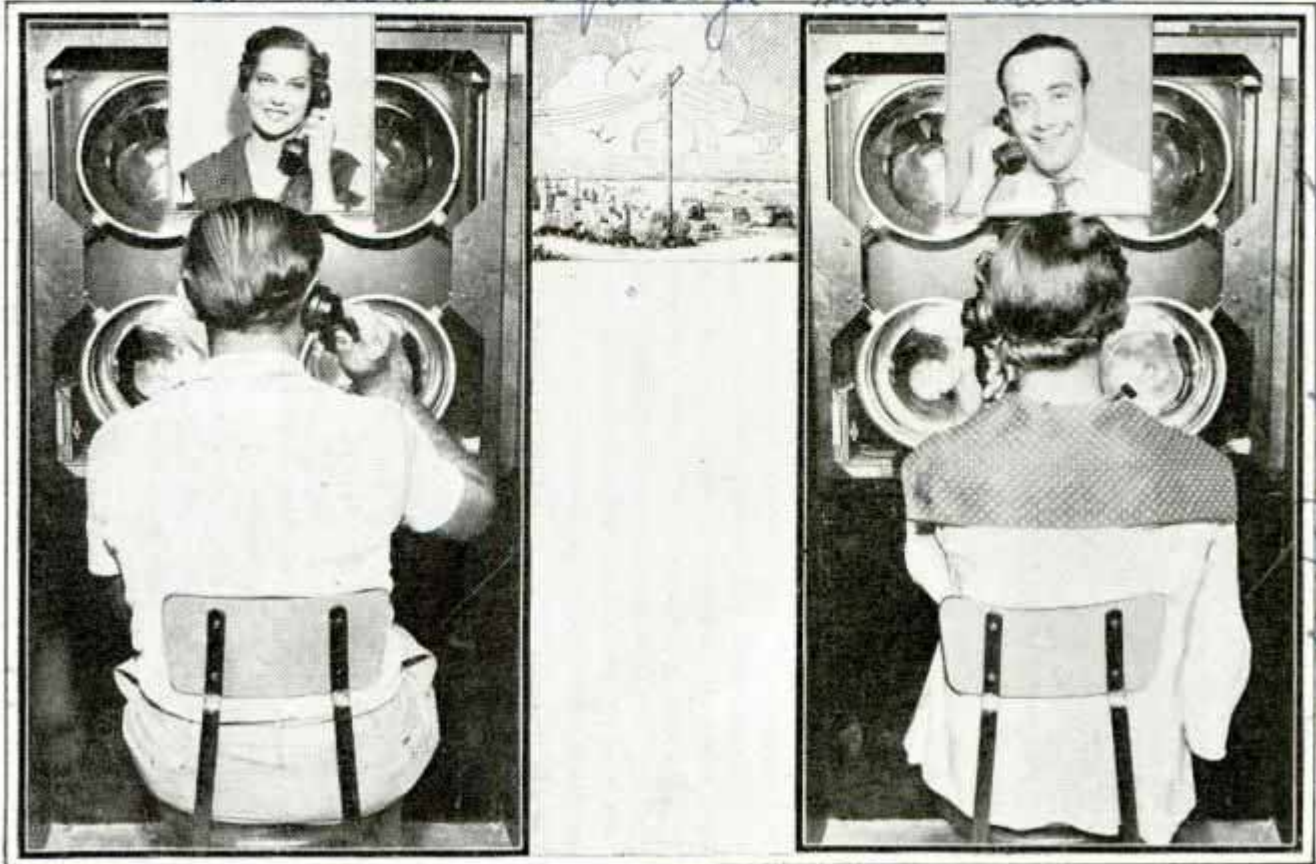

Two Telephone Users Sitting Before Instruments Equipped with Television Transmitters and Receivers; Small Photos above Head of Each Illustrate How They See Each Other through Medium of Telephone

Two-way television, making it possible for users of the telephone to see each other, is accomplished in a demonstration system, devised and constructed by pioneering engineers in the television field. The system incorporates a glow lamp of an advanced type that assures long service and improved pickup of images, as well as perfected synchronization between the sending and receiving scanning disks. The glow lamp is a delicately constructed tube containing a highly specialized filament. It is in the experimental stage. The scanning disks are used for transmission and reception of the image, a device that presents the lines of the face or figure through the use of rapid motion set up by electrical impulse. In the demonstration system, only one scanning aperture is used for both sending and receiving, while radio television uses two apertures. Through the one aperture in the telephone setup, the image of the telephone user is picked up and transmitted to the listener at the same time the listener's image is picked up and flashed to a screen in the talker's

booth. Engineers of the Television Exhibits corporation, which operates the system, predict the day when such equipment may be made standard for every telephone at reasonable cost.

D958
SCREWDRIVER HOLDS SCREW BY ITS SLOTTED HEAD



Easy insertion of screws in close places is accomplished by a screwdriver that grips the slot in screw heads. The tool is equipped with a knurled slide that is pushed downward to cause the blade to grip the slot of the screw. Pushing the slide

upward releases the screw. Corrugations on the blade and the gripping lever insure positive hold on the screw head.

*Referring to Western Television Co
North Chicago, Ill*

Mullen Mfg. Co.

Cont. Don Isassman
 05 W-86th St
 NYC
 D975

from STEAM . . .

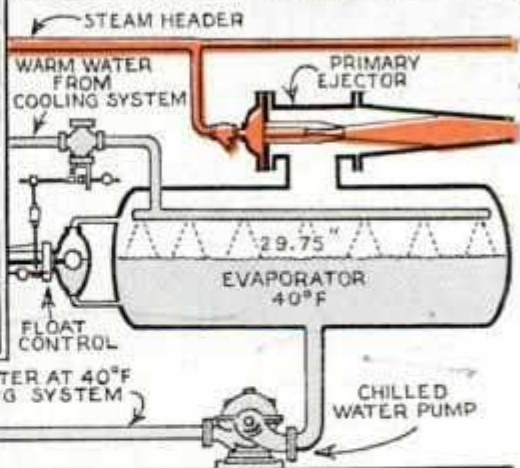
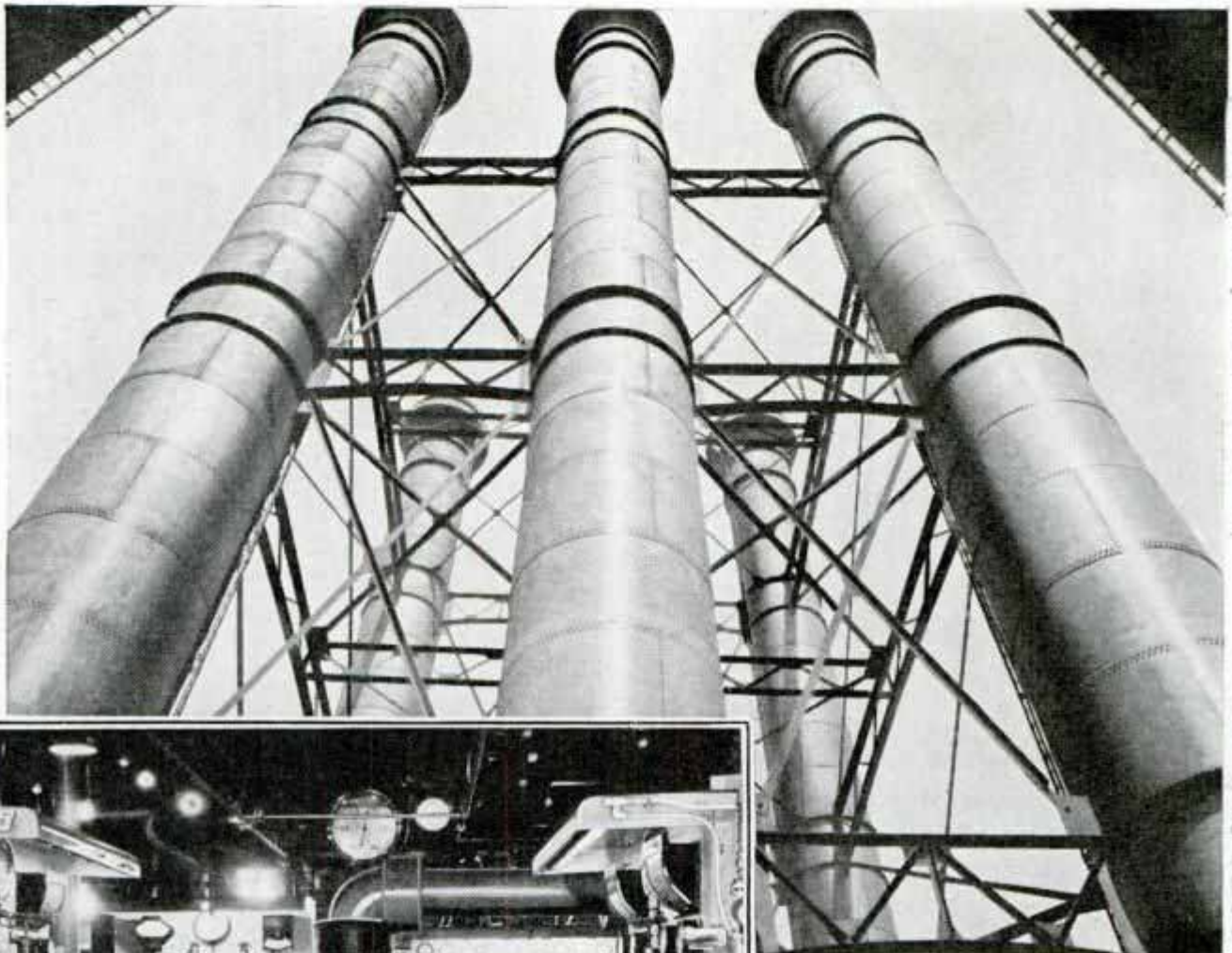

Top, Battery of Chimneys at Steam-Generating Plant; Bottom, Left, Boiler Operating Room; Bottom, Right, Equipment for Chilling Water

at a temperature of 350 degrees Fahrenheit, and get cold water at a temperature of forty degrees Fahrenheit, which is only eight degrees above freezing. The difference at two ends of the apparatus is 310 degrees.

The way steam chills air can be explained by a comparison with the feat of boiling potatoes on the top of Pikes Peak.

At this high altitude the water boils at a lower temperature than at sea level. If you go a step further and create a vacuum in a water tank, you can get water to boil at forty degrees Fahrenheit, which is pretty cold. The evaporation of boiling water cools the remaining water correspondingly. The chilled water can then be passed through the pipes of a cooling system, or

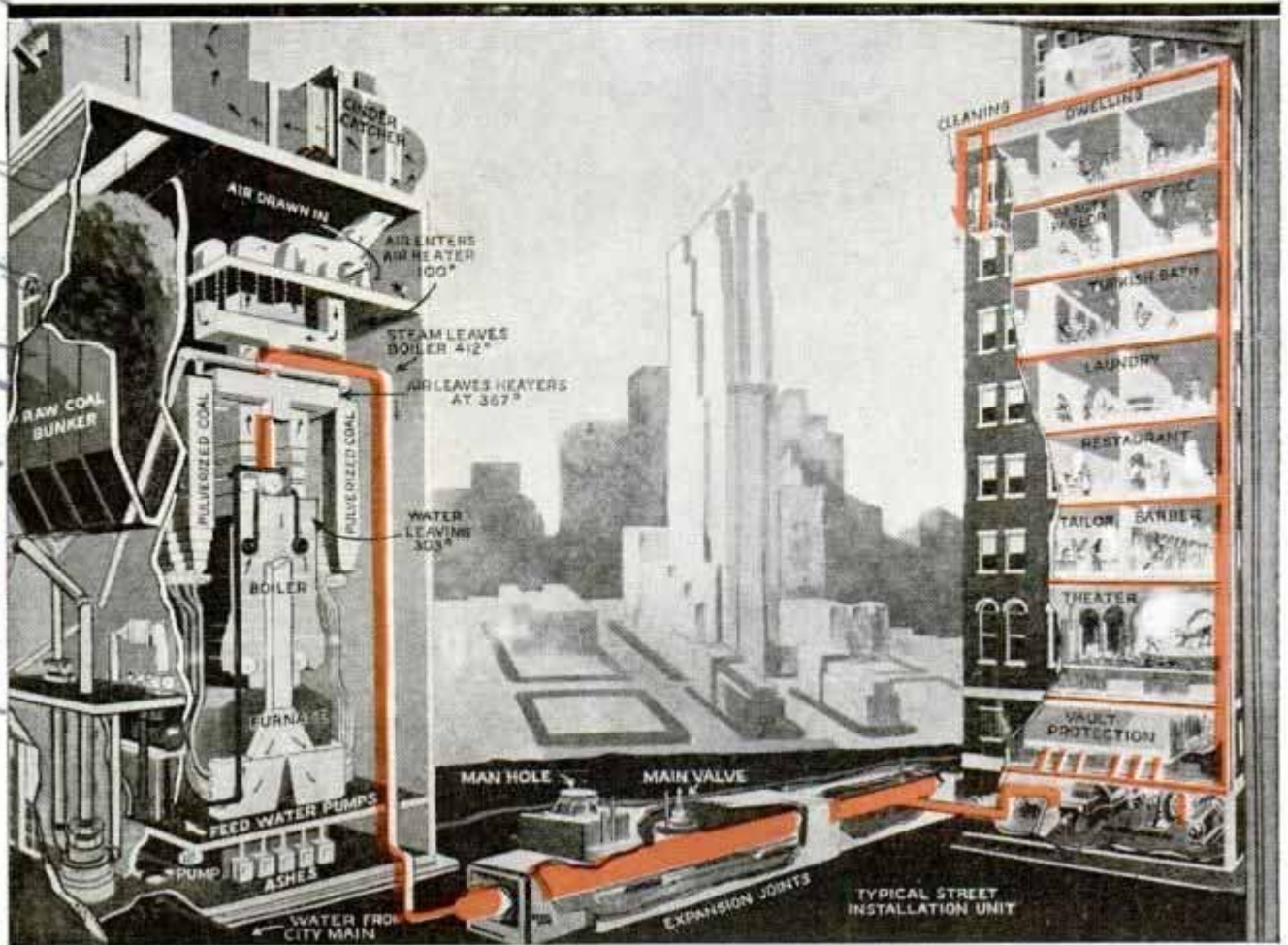

How Central Power Station (Left) Generates and Delivers Steam to Building, Shown at Right, for Heating, Cooking, Power and Industrial Services

it can be used as a spray to wash and cool air before being transmitted through ducts to various parts of a building.

For practical purposes, it is seldom necessary to chill water below forty degrees Fahrenheit, but if brine water is introduced in the system, it is possible to chill it below the temperature of ice.

Steam chilling is extremely practical where central power stations produce and convey steam to customers via underground pipes. The New York Steam corporation sells 1,250,000,000 pounds of steam to the New York Central railroad in one year, and billions of other pounds to buildings which have no heating facilities of their own. Now the company is using its regular steam pipes for delivering steam to chill buildings.

The most recent installation of chilled steam equipment is in the new British Empire building, in Radio City. The system distributes 240,000,000 cubic feet of conditioned air every hour, and circulates 2,600,000 gallons of refrigerated water. The air conditioning is noiseless.

Between steam cooling and electrical cooling, the costs are about equal if you can buy steam at the rate of sixty cents per 1,000 pounds and electricity at one and three-fourths cents per kilowatt hour. It costs, roughly, about two-thirds as much to steam-chill a building in summer as it costs to steam-heat it in winter. According to the current rate, it costs \$2 per 1,000 cubic feet to heat a large building for one heating season. To cool the same volume of space would cost between \$1.25 and \$1.50 for the cooling season.

The equalization of load on the underground pipes of a public utility company selling steam is one factor greatly in the favor of steam chilling. It is estimated that many customers now buying steam-heating service only could also buy steam chilling for a fractional additional cost.

The application of steam jet cooling to the home has not been carried on extensively, although it is practicable. Heating and cooling units are now made which use the same boiler for both summer and winter air conditioning.

do not give 280 Madison Ave. New York. underground steam supply system

D9 707 90

"Invisible Dust" Curtain to Halt War Planes

"Invisible dust" which can halt airplane engines in midair and can be hung as a vast curtain or protective wall about a nation's borders to guard against sky invaders is the object of experimentation in Europe. Nikola Tesla, famous inventor, claims he has discovered force rays which can be projected like long curtains and through which planes cannot penetrate. These rays, he said, would be made of particles, possibly dust of some sort, microscopically fine, driven electrically and projected into walls miles high and 100 miles each in length. The particles would travel with the unheard of velocities of 50,000,000 volts. Ten thousand planes flying into one of these curtains would all be destroyed, the inventor

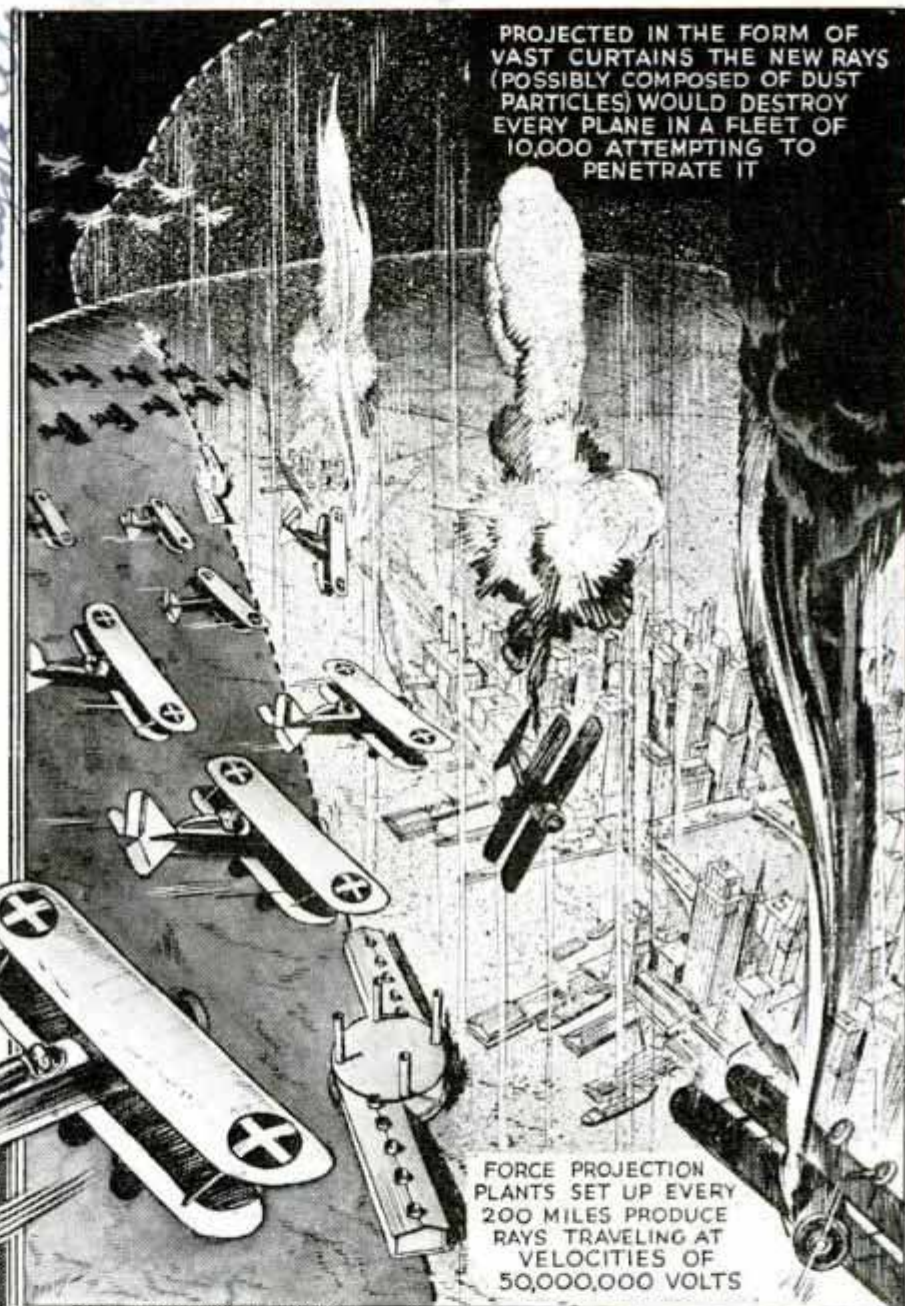

PROJECTED IN THE FORM OF VAST CURTAINS THE NEW RAYS (POSSIBLY COMPOSED OF DUST PARTICLES) WOULD DESTROY EVERY PLANE IN A FLEET OF 10,000 ATTEMPTING TO PENETRATE IT

FORCE PROJECTION PLANTS SET UP EVERY 200 MILES PRODUCE RAYS TRAVELING AT VELOCITIES OF 50,000,000 VOLTS

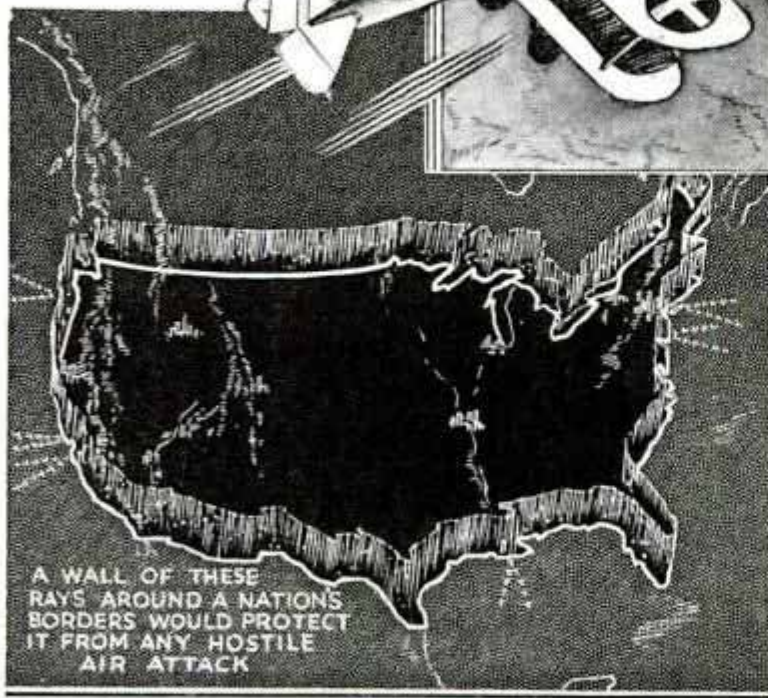

A WALL OF THESE RAYS AROUND A NATION'S BORDERS WOULD PROTECT IT FROM ANY HOSTILE AIR ATTACK

Diagram Showing How Country Would Be Protected from Plane Attack by Impenetrable Curtain of Force Rays

averred, and visioned force projecting plants set up every 200 miles along a nation's borders, each shooting rays 100 miles on either side. Tests of this form of defense are said to have proved successful when several planes flying into such a curtain were forced to land through engine failure. The dust beams would shoot in straight lines and it is said complete and permanent engine failure results when the particles are "breathed" by the motors of a plane. Anti-aircraft guns could project the dust curtains.

Blue. 4.15 Lexington New York

Rainout

*Automatic Equipment Co
49 Summit St. Boston Mass
09.70*



Automatic Device, Inset, Closes Window When It Rains; Above, Device in Open Window

AUTOMATIC WINDOW CLOSER WORKS WHEN IT RAINS

Windows in the home may be lowered when it rains in the owner's absence by means of an automatic closing device now on the market. When the device is set with the window raised, a piece of soft lump sugar is inserted as the cartridge. Drops of rain quickly disintegrate the sugar cartridge, causing a catch to release the window, which closes by gravity. Special arrangement of the window ropes keeps the window from banging shut and perhaps breaking the glass. The device is easily attached, requiring no change in window or window weights.

PRODUCTS OF METAL POWDER

Metals in the form of powder are being molded into various products by the application of pressure. After being molded, the products are heated to a definite degree to coalesce them, resulting in firm metal objects, usually free from defects. The process replaces certain methods of

casting. Eighteen elements or metals, including aluminum, arsenic, antimony, boron, cadmium, cobalt, copper, chromium, iron, lead, magnesium, molybdenum, nickel, silicon, silver, tin, tungsten and zinc, are obtainable in powder form. One automobile company uses powdered sponge iron, subjected to high pressure and heat, to produce certain parts for cars.

ADJUSTABLE MUSIC CHART SPEEDS UP TEACHING

With the aid of an adjustable music chart, classroom instruction of groups of pupils is speeded up since the teacher can present groups of three or four notes in various combinations and in an endless number of settings so accurately and rapidly that the pupil learns to recognize them much more quickly. This chart can be operated more rapidly than the flash card system and no time is lost in changing from one key to another. It is also possible to give the pupil a clear grasp of key signatures, letter names, transposition and elementary scale and chord recognition in all keys. The chart consists of a ruled cardboard attached to a frame with grooves at top and bottom in which the key signature charts slide. By exposing as many sharps or flats as wanted, it is thus possible to display any key signature from

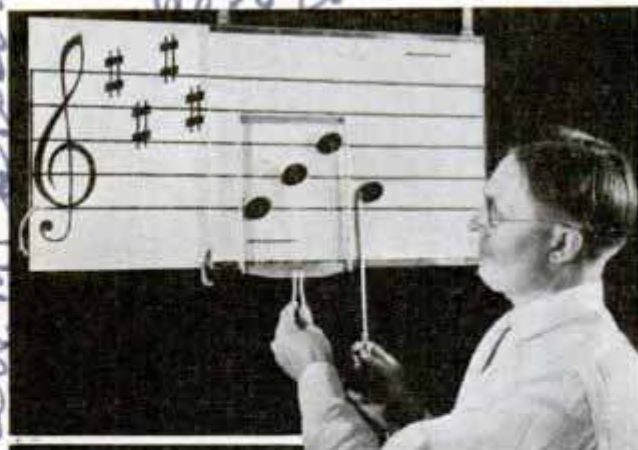

Teaching the Meaning and Position of Musical Symbols Is Made Easy by Adjustable Chart

one to five sharps or flats. There are two note holders, one consisting of a metal frame on which three notes slide up and down on piano wires while the other is a single note on a handle. Using the two together makes possible an almost endless combination of tone groups.

*Carlson Musicgraph
P. Platt*

Cont. E. F. Cone, No. 401,

See Dec. 1932. 935

098

and back in Carlson

D955. *Wells Asbestos & Engineering Supplies*
POPULAR MECHANICS

Std. Bestable Works
Slough, Bucks. Engla

Asbestos Suit and Umbrella Protect Fireman



Fire Fighter in Asbestos Costume and Carrying Asbestos Umbrella Pushes His Way into the Flames with Hose, Attacking Fire at Its Source; Inset, Fireman in Protective, but Strange-Looking Suit

London fire fighters now carry umbrellas when fighting flames at close quarters, but the umbrellas are made of asbestos instead of silk and protect the firemen from the flames. The fire brigades are also

equipped with asbestos suits, complete even to gloves and masks. With such an outfit a fireman can virtually wade through flames and come out unscathed. It enables hose crews to fight fires at closer quarters.

^{D980} Conversion Kit Adapts Model A Engine to Operate Boat

Ford Model A engines can be converted for use in boats by using a kit and special equipment now on the market. The kit comes complete with all necessary bolts, fittings, washers and adapters. An oil cooler, three-in-one manifold and a reverse gear in a special housing also may be obtained, if the owner desires to put his boat and engine in condition for hard service. The Model A motor with standard head, pistons, carburetion and ignition is rated at forty-brake horsepower at 2,200 revolutions per minute.



Model A Engine as It Appears Mounted for Use in Boat; Special Kit Facilitates Conversion of Motor to Marine Purposes

Cesar Smith & Sons Co

*to Daily News-Chicago
 Ed. Englewood Hotel, 740
 Englewood Ave.
 Chicago, Ill. 786.*

POWER to come

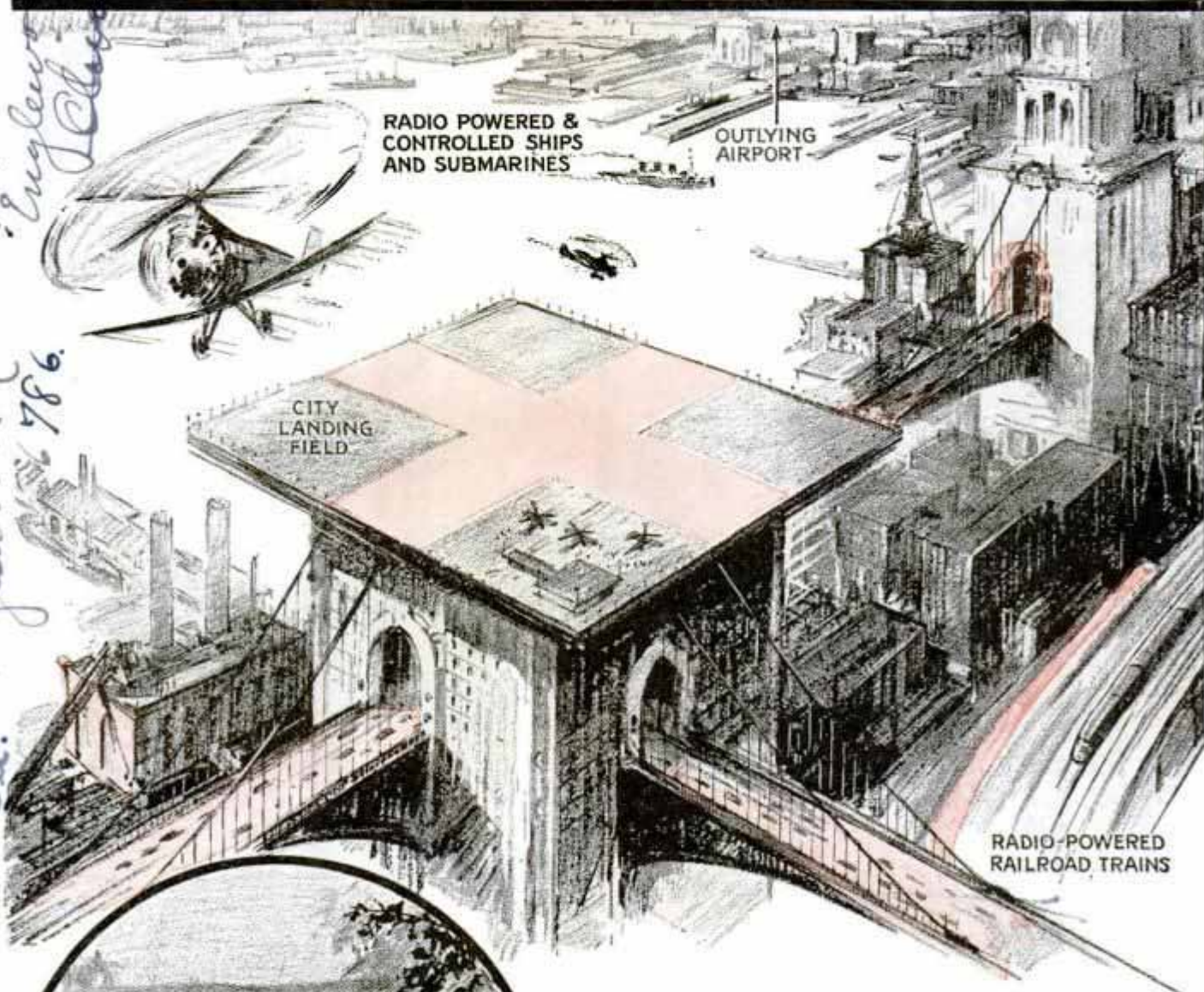

By **EARL C. HANSON**

Famous Radio Inventor
 As told to Chas. J. Gilchrist

DEVELOPMENTS in radio have come with such startling rapidity that it is hardly possible to say definitely there is anything radio will not be able to do. Already airplanes can be guided through storm and fog by radio and be kept exactly on their courses.

Aboard a ship coming into harbor the captain need have no eyes at all as long as



Carl C. Hanson,
 Howard Hotel,
 740 Englewood
 Chicago. D972

by RADIO

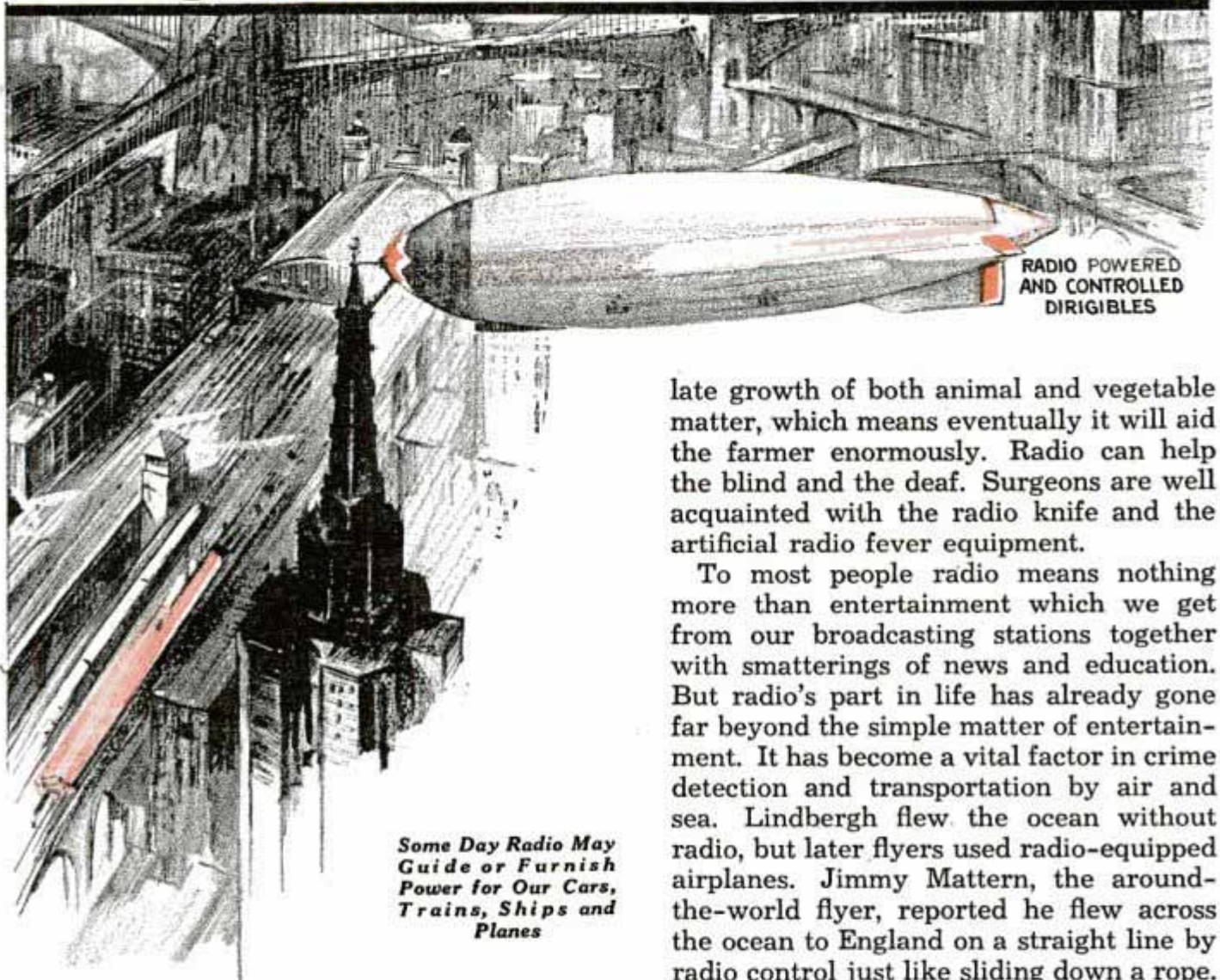

RADIO POWERED AND CONTROLLED DIRIGIBLES

Some Day Radio May Guide or Furnish Power for Our Cars, Trains, Ships and Planes

his ears can follow the tones produced by his special radio receiver. A cable laid along the harbor bottom in the middle of the channel carries the electrical impulses. His ears tell him if his ship has strayed too far from the line of the cable.

Motive power in the future will in all probability be furnished by radio for operating trains, automobiles, trucks, and street cars. Not only can the radio energy furnish the motive power, but also it can provide heat and light. In some not far distant time radio will be used to stimu-

late growth of both animal and vegetable matter, which means eventually it will aid the farmer enormously. Radio can help the blind and the deaf. Surgeons are well acquainted with the radio knife and the artificial radio fever equipment.

To most people radio means nothing more than entertainment which we get from our broadcasting stations together with smatterings of news and education. But radio's part in life has already gone far beyond the simple matter of entertainment. It has become a vital factor in crime detection and transportation by air and sea. Lindbergh flew the ocean without radio, but later flyers used radio-equipped airplanes. Jimmy Mattern, the around-the-world flyer, reported he flew across the ocean to England on a straight line by radio control just like sliding down a rope. It was that accurate.

The United States navy department took up the idea of guiding ships into harbors by radio many years ago. New York harbor was equipped and experimental installations made on the Atlantic and Pacific coasts. Research engineers of the war and navy departments have done remarkable work along the line of guiding craft with no one aboard.

Radio's most fundamental virtue to the flyer is the fact its signals are not stopped by night or fog. Blind conditions have long been the most dangerous hazard in



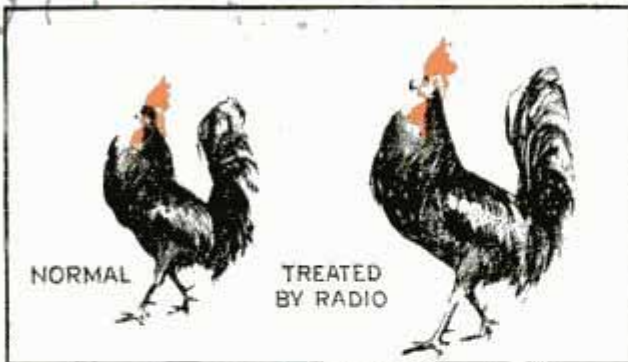

over the airplane course from New York to Chicago. It will weave through the mountain passes, over the plains, and under the streams. A vacuum tube oscillator will motivate the wires and create the signals they radiate. On one side of the wires will be the course for flyers headed east. On the other the west-bound course. All the pilot has to do is to keep the signal

from the wire constant in his receiver. One signal will take him to New York and another to Chicago just as surely as if he was riding on iron rails. Neither fog nor storm interfere

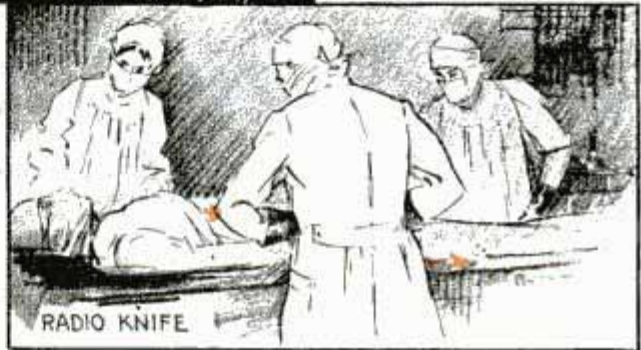

Radio Already Is Used in Medicine and in Guiding Ships; Its Possibilities in Industry and Agriculture Are Almost Limitless



flying. Fog is the pilot's greatest bugaboo. Sunshine can't get through it and it is hard to believe artificial light of any sort can do what the sun cannot. But radio can.

A long line of wire is being contemplated

with his radio guide. The signal is maintained constantly except when the landing field desires to send out a message, weather information, dispatching or traffic orders. This idea has been tried out successfully on commercial-type planes. Now it becomes practical for the private flyer and is the latest incentive for the increase of privately owned planes, for which it cuts insurance rates. For private planes the installation costs no more than \$100, which is very inexpensive for an infallible guide even in the blindest of flying weather.

The next step in the aviation control guiding system by radio, concerns landing and taking off from the field. Blind flying tests have proved this system safe even when the pilot can't see a thing. Let us say, for example, the flyer is approaching the field and planning to land. At 4,000 feet from the field a radio signal warns him he is just that far away. His altimeter



BURIED
HIGH-FREQUENCY
CABLE

*The Same Radio Energy Which Can Guide Planes
May also Furnish Heat and Light for the Home*

gives him his altitude. Then the radio station at the landing field contacts him, giving him wind direction and velocity so he can plan his landing accurately. When the field is clear and it is safe for him to land, the ground operator radios him and he can circle the field and come in. This is what I call the radio elevator.

The autogyro is gradually coming into its own in commercial aviation. Its main

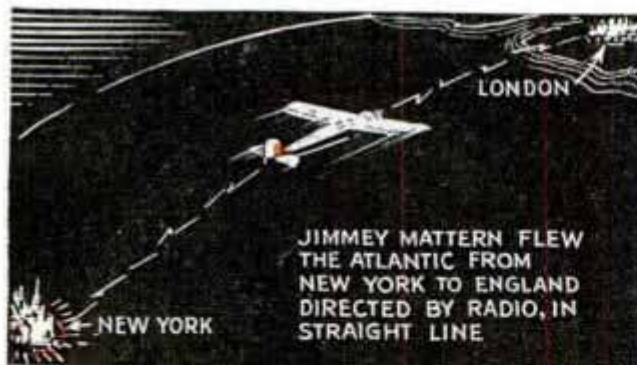

JIMMEY MATTERN FLEW
THE ATLANTIC FROM
NEW YORK TO ENGLAND
DIRECTED BY RADIO, IN
STRAIGHT LINE

virtues are the little space necessary for landing or taking off and the ability to fly at slow speeds. For a long time the principal trouble with passenger flying has been the time lost by the passenger in getting to the flying field for the take-off and getting from the flying field on landing at the other end, to his destination in that city. Our flying fields are always so many miles away from the center of business that the busy executive must lose an hour or so at each end of the flight. Just as radio can control airplane flights, it can control autogyro flying and aid materially in making the autogyro the short-haul



ship, for it can land in parks, or on top of big buildings. From such headquarters in congested sections it can fly passengers to and from the airport. Autogyros, will, I firmly believe, play a very important role in cooperation with the radio elevator. Passengers can be carried quickly from the business sections to outlying airports.

The cable system for guiding ships into harbor can be applied to ocean flying and to guiding blind persons. Wave lengths of 30,000 to 600,000 meters have been proved to be practical. These frequencies will travel through fog or water with no loss. Radio also can be used in communicating with people in underground mines. The trouble has always been that the minerals in the ground have killed radio signals just as a steel viaduct or bridge hampers the radio in cars. But by using this same cable system such a method of talking to the surface has been devised.

(Continued to page 120A)

245 7th Ave
New York City

sell 700

936.

make - hand / see letter
Dreeman - is on
Hobby chains lose
231 W. Jackson

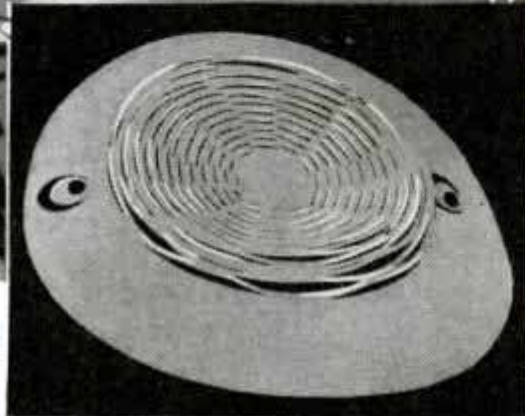

One-Piece Fabric Hat, Inset, Shown as It Appears on Wearer's Head; the Crown Stretches

HAT STAMPED FROM ONE PIECE OF CLOTH SELLS FOR DIME

Cool and shady hats in a variety of colors are being produced to sell for ten cents each. The hats are die stamped from a single piece of buckram in such a manner that the crown of the hat stretches over the head when the brim is pulled down.

AUTO BRAKE AND CLUTCH LOCK PREVENTS REMOVAL OF CAR

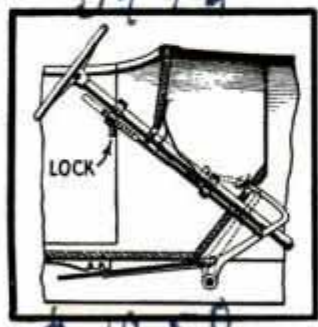

Removal of the automobile from its parking place can be prevented by a device that locks the brake and clutch. It cannot be filed, sawed, chiseled or cut with any tool other

than a cutting torch and cannot be opened with master keys. The device is case-hardened. It can be attached to the steering post in thirty minutes and, unlike

10.50

wheel locks of certain types, does not weaken the steering apparatus. The locking post also can be used in adjusting brakes, changing tires on inclines and locking the car safely while the motor runs to build up the battery or to warm up in cold weather.

RAND GOLD MINES ARE SALTED TO KILL HOOKWORMS

Gold mines on the Rand, in South Africa, are being salted to prevent the hatching of hookworm eggs and to kill the larvæ. After some 200,000 blacks and 20,000 white miners became afflicted with hookworm, a salt solution above twenty per cent was used to scour corridors, buckets, cages and banisters and all exposed earth and waste was covered with a layer of salt an inch thick. Now the disease is no longer a physical handicap to the workers.

MAN-SIZED ROLLER BEARING CARRIES GREAT LOAD

So large that a man can walk through it, a giant bearing designed for use in a cement mill can carry a load of more than 1,000,000 pounds. The bearing, containing seventy-eight tapered rollers mounted in two rows, weighs two and three-quarter



So Large That a Man Steps through It, This Bearing Carries Huge Loads

tons. Bearings of still greater capacity are made by the Timken Roller Bearing company for use in large plants.

A.B.C. Locking Device The Timken Roller Bearing Co. Cincinnati, O.

D 933. *draw. W. P. Oeder*
1183 E. Manfosa
 POPULAR MECHANICS 701
Altadena, Calif

"Natural Vision" Is Latest Movie Invention

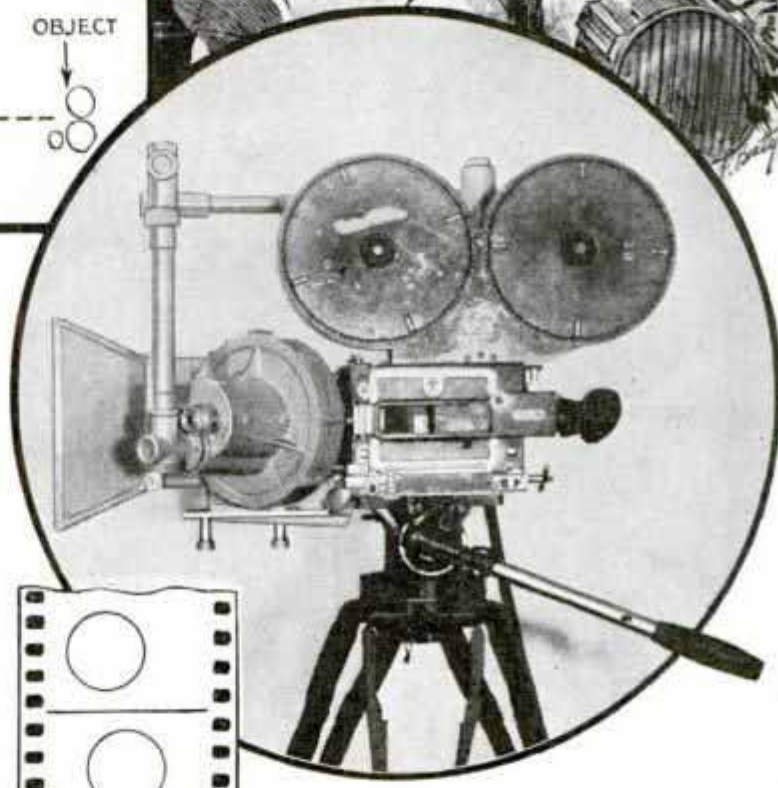
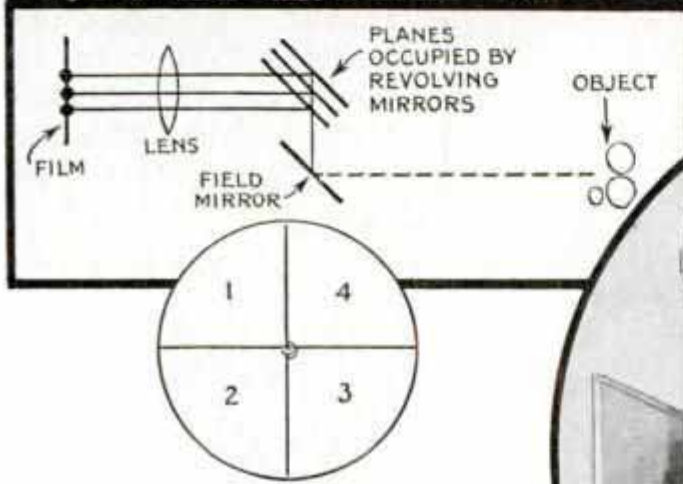

Circle, Three-Dimension Movie Camera; Bottom, Left, Illustrating Revolving Mirror Principle; Below, Strip Showing How Four Frames Snapped at Different Angles Take on Three-Dimensional Properties When Run through Projector

"Natural vision" or third-dimension motion pictures can be produced with an attachment that fits any standard movie camera. The attachment, weighing about fourteen pounds, is connected to the camera on a special arm that does not interfere with camera operation. Through the use of mirrors revolving in different planes, which present slightly different views of the subject to the camera as successive frames of film are exposed, optical displacement sufficient to give third-dimension effect is achieved. The work is all accomplished within the camera, eliminating attachments for the projector in which the film is used and special devices for the eyes of the spectator. Distortion of the picture when viewed closely from the side of the screen is virtually eliminated.

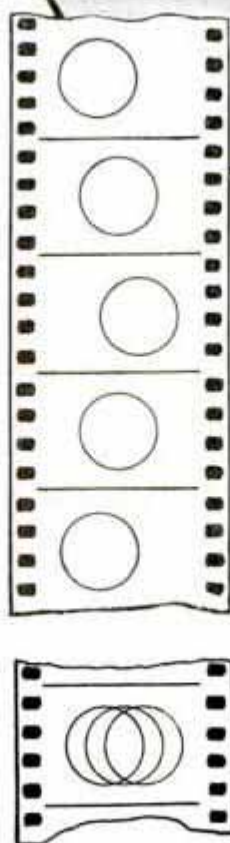

Grain of the photographic emulsion also is eliminated by this process. Pictures made with the attachment have a softness, yet also retain sharpness of outline. The same motor which drives the attachment also drives the camera, thus making possible perfect synchronization. The effect is to give the eye first a head-on view of the subject, then a view slightly to the right, then a view head-on and finally a view slightly to the left. As the film is run through the projector, the eye is not conscious of the four separate views. Instead, the subject appears to have depth, a result long sought.

see July 1935 - 92

Camera on Motorcycle Films a Bicycle Race

Spectacular effects were obtained in making a motion picture of a bicycle race by mounting the movie camera on the rear of a motorcycle. The motorcycle traveled around the track in one direction while the racers pedaled in the opposite direction, the cameraman grinding away as his mount bore down on the riders who separated to form a lane for the mounted camera as they came abreast of it. The arrangement resulted in several bad spills in one of which several riders and the cameraman and motorcycle driver were injured when the wheel of a bicycle collapsed as it neared the motorcycle and the cyclists piled up with the motorcycle.



How Camera Is Set Up to Make Movies of Fast Moving Bicycle Riders

© International News Photos

CLOTHES BAG ON CAR ROOF SOLVES PROBLEM

D 985

Clothes are kept unwrinkled and in press in a roomy bag with large compartments which fits into a waterproof and dustproof canvas case which in turn is securely attached to the roof of the car. The bag solves the luggage problem when motoring as it is out of the way and holds as much as several suitcases. The canvas case is attached to the rear bumper with a

pair of metal springs and with rope fasteners in front. The springs hold the case taut but do not touch the car. The clothes bag is pulled into place in the case by hooking it to a pull cord with which the inside of the case is equipped. The bag is equipped with handles and one pull on the

bottom handle brings the bag out where it hangs down the back of the car. When detached from the pull cord hook it can then be folded in the middle and carried by the two end handles like a suitcase. If an article is wanted on the road, the bag can be pulled out and opened without removing it from the case.

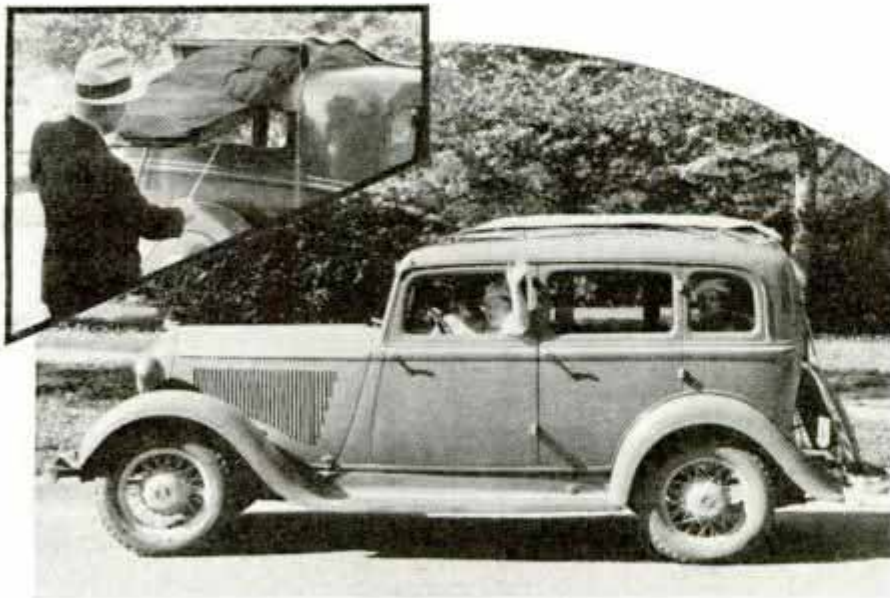

Bag Attached to Roof of Car Keeps Clothes Unwrinkled; Inset, Inserting Bag in Waterproof Case

Karry & Hal Wardrobe Co

Our Bureau of Information will answer questions regarding articles in this magazine, if accompanied by a stamped, self-addressed envelope.

D923.

5018 Esplanade
Los Angeles, Calif

Eight-Inch Actors Appear in Midget Movies

Hamilton Steele Productions
2808 Hymans
Hollywood
Calif



One Hollywood producer is making a series of motion pictures in which the actors are eight-inch figures that perform like real troupers. Their lifelike movements are attained by shooting the scenes with what is known as "stop motion." Each progressive pose of a figure in motion is taken separately, then the figure is moved and another shot is taken. Such shots, when thrown on the screen in rapid succession, present smooth realistic motion. The figures are of plastic material with enough resilience to prevent cracking. Infinite care and skill are required in working the individual figures as each successive pose varies in progression but a fraction of an inch from the preceding one. For instance, 130 distinct poses were necessary in order to show one of these figures entering a room and sitting in a chair. To film a one-reel picture of 1,000 feet requires five weeks of steady work with these little figures, for putting them through their roles is a tedious process. Once the entire action is on the film, the pictures are cut and edited the same as any other motion picture. After the cutting and editing, they are synchronized with sound effects, voices and music.

Top, Small Movie Set on Which Eight-Inch Actors Perform; Below, Several Scenes in Which the Small Plastic Figures Were Used in Midget Movies

Com. H. S. ... 617 Ikehukord, Tokyo, Japan D1012

POPULAR MECHANICS *Waterolier Co. Albany, N.Y. D986*

FLY CATCHING CONTEST

Tokyo recently concluded a city-wide fly catching contest to help rid the city of the pests. It was won by a man who claimed he had bagged 198,000 insects and received a prize from the mayor for the feat. Second honors went to a fly catcher with 190,000 to his credit. The contest resulted in an inquiry from a foreign country on price quotations for 5,000,000 flies to be used for goldfish food, but it was necessary to disappoint the prospective buyer because the contestants had not saved their flies.

YOKE STOPS RUNAWAY DOGS BY BUMPING LEGS *D994*

Yokes similar to those farmers use to prevent cows from jumping fences are now being attached to dogs to keep them from running away. The yoke is fastened about the neck and can be adjusted so it does not interfere with the animal when he walks or trots, but begins bumping his legs when he starts to run. It is useful in training dogs to obey commands, and the animal soon learns to stop when ordered after which the yoke can be discarded.



Yoke Bumps Dog's Legs When He Runs; It Is Used for Training Purposes

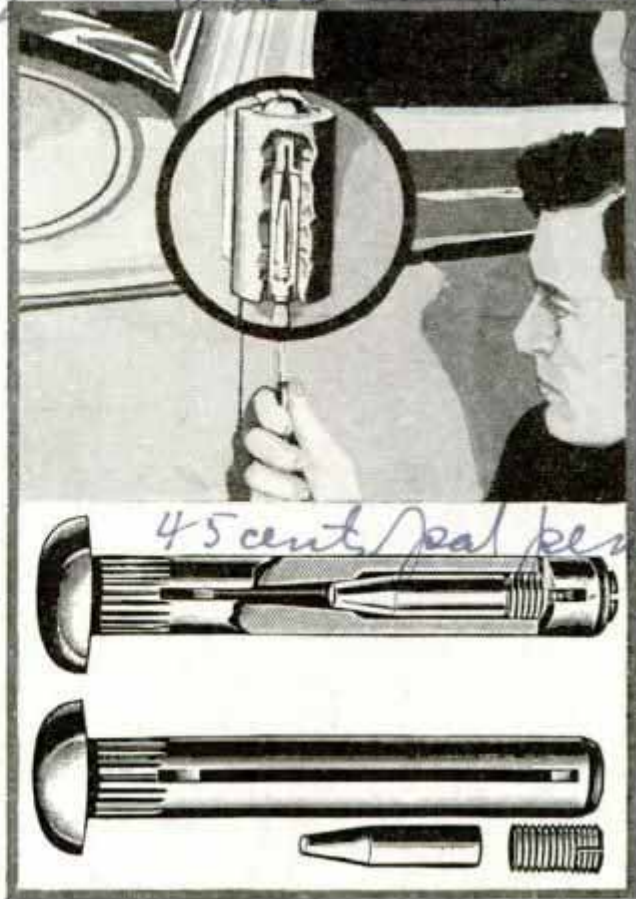

Cross-Section of Hinge Pin; Circle, Installation in Door of Automobile

CAR DOOR HINGE PIN EXPANDS TO TAKE UP WEAR

Expansion lubricated hinge pins for automobile doors are being offered as replacements for worn and rusty pins. The new pin is made of three parts, the pin, the expanding plug and the adjusting screw. The hollow center is packed with heavy grease before installation to keep the hinge and pin lubricated indefinitely. The adjusting screw, tightened with a screwdriver, causes the plug to expand until the door is held securely, eliminating rattles.

INSULATION MADE OF FINE SAND

Heat-insulating material, described as an impalpably fine network of purest sand, interlocked with air and extremely light in weight," has been introduced recently. The most powerful microscope fails to reveal its texture. The insulating power is estimated at ten per cent more than that of still air and almost double that of many commercial heat insulators. The material withstands a temperature of 1,500 degrees Fahrenheit. It is intended for use in refrigerators, electric ovens and furnaces.

Automobiles registered on January 1, 1934, numbered 33,562,059, a decrease as compared with the beginning of 1933.

Dept. of Commerce

Univ. of Chicago Urbana Ill. Dr. J. S. Kestler

d. w. C. & Huber, Travelers Insurance Co.

0859 **NEW TRICKS of**



IF you could do something about the weather, the whole world would hail you, for millions of dollars and many lives would be saved every year. Next to a means of weather control, mankind needs some infallible way of predicting tomorrow's weather today, although meteorologists are not certain that this will ever become an exact science.

Striving for greater accuracy in its forecasts, the weather bureau is increasing the data used in its calculations, is preparing to decentralize its service, and is trying out the new air mass analysis system to supplement present methods of forecasting. Air mass analysis, used in this country for the benefit of aviation, includes gathering daily data from the upper air.

"On the average, the weather bureau at present is right about eighty-five per cent of the time," Dr. Willis Ray Gregg, chief of the weather service, says. "With the



Following Ascent of Pilot Balloon with Theodolite to Determine the Direction of Air Currents and Launching a Weather Balloon

Handwritten notes on the left margin.

Handwritten notes on the right margin.

Handwritten notes at the bottom right.

Cont. Thomas G. Thomson, Jr.
10555 Holman Ave.
Los Angeles, Calif.

DP 59

Weather Forecasting

changes now being made we hope to increase the accuracy of forecasts for the twenty-four-hour period and in addition make reasonably accurate predictions for as far as two days or more in the future. Also, we hope for exceptional accuracy in short forecasts, such as definitely foretelling the weather for the next eight hours.

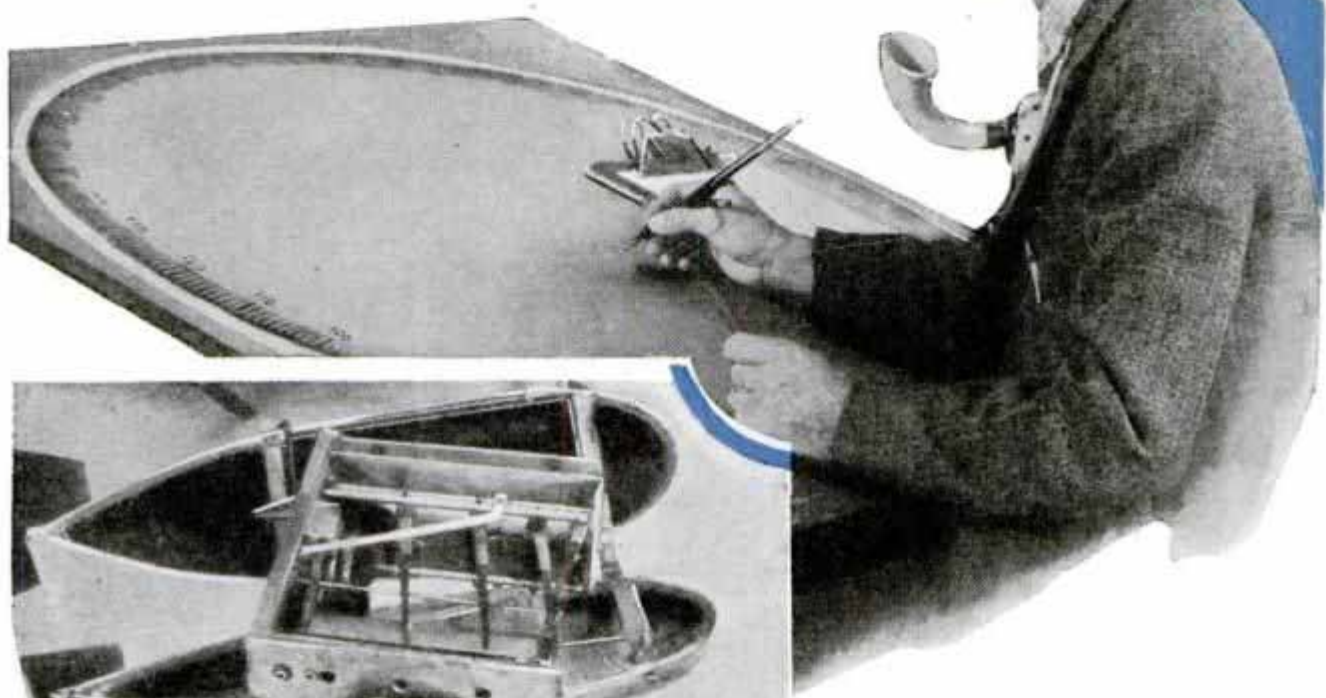

Plotting Wind Forces and Directions at Different Altitudes from Information Telephoned by Observer Watching Free Balloon; Below, Instrument on Plane Which Records Air Conditions

range forecasts, like predicting the weather a season or a year in advance. From studying weather cycles of the past several centuries, forecasters believe that the years of deficient rainfall in the United States are about over, but to date the study of weather cycles, sun spots, ocean currents, and other phenomena have been productive only in a general way and no truly accurate predictions can be based on them. One exception is a relation that has been found between Australian weather and the monsoon season of India.

This is vital for the safety of aviation." Not only do meteorological officials expect to extend the time of their predictions, but they hope that shortly steps can be taken that will lead to accurate long-

This allows forecasters to make quite accurate predictions ahead of time as to the dates and extent of the Indian storms. "There is reason to hope that long-range forecasting will be aided by a study of the

July 1, daily airplane flights started at twenty stations in the United States, carrying instruments to 17,000 feet altitude, and giving the weather bureau three-dimensional conditions, including upper barometric readings and temperatures that cannot be obtained with the small balloons now used for studying wind currents. The theory behind the study is that weather changes occur when warm moist blocks

(Continued to page 116A)

Left, Battery and Parachute Used for Night Balloon Observations and Anemometer Which Registers Force of the Wind

temperatures and air currents in the stratosphere," Dr. Gregg says. "Man knows very little about conditions in the belt from ten to fifty miles above the earth and it may be that radio-controlled balloons carrying meteorological instruments can bring down data from which fairly long-range predictions can be made."

Stratosphere flights so far have revealed little except that the "drift" in the rarefied air is toward the southeast, the direction that is taken by many of the lower air currents that sweep across the United States. If the stratosphere has any secrets to reveal many flights must be made before enough data can be assembled on which to make forecasts. Meteorologists may even have to invent new instruments to record some of the things they will want to know.

The study of air masses is the first step in observing the upper air. Beginning



Inspecting Weather Information on a Teletype Machine and, Above, Weather Bureau Official Studying Sunshine Recorder



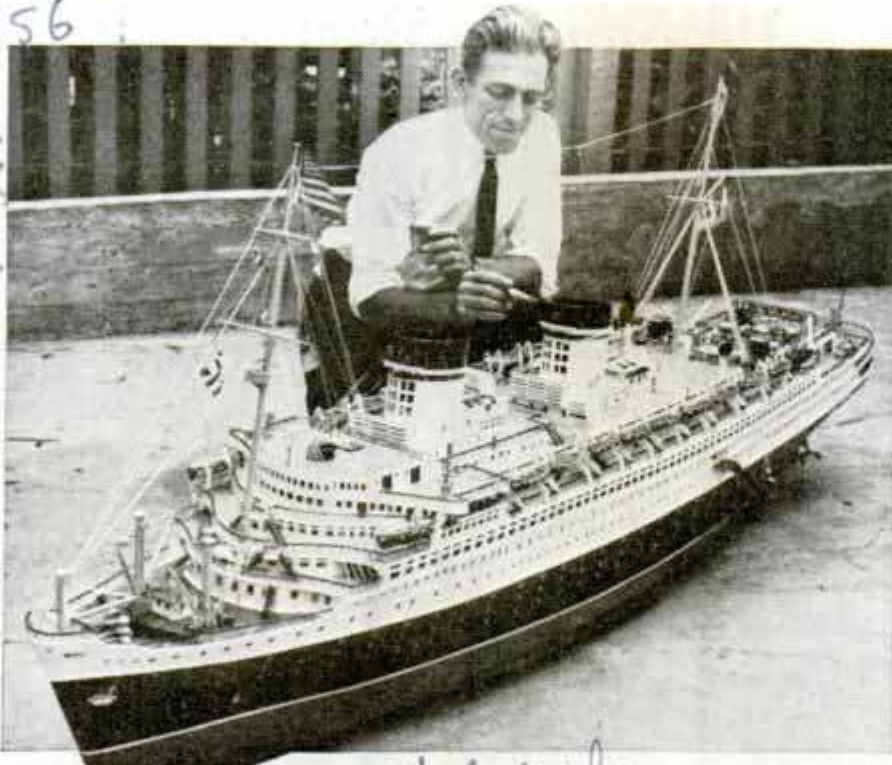

Liner "Rex" in Miniature, as Fashioned by Home Craftsman Who Had No Working Plans Except Picture Postcards of the Ship

ITALIAN LINER "REX" MODELED FROM PICTURE POSTCARDS

Modeled entirely from picture postcards, a small-scale ship closely resembling the Italian liner "Rex" has been constructed by a craftsman in Brooklyn, N. Y. The builder never saw the liner before assembling his eight-foot model. The small craft is complete in all details. All of the equipment was fashioned by hand.

MOTOR TEST STAND ON WHEELS TRAVELS AT HIGH SPEED

There is at least one building that can do seventy miles per hour. It is a small shop, part of a testing plant for airplane

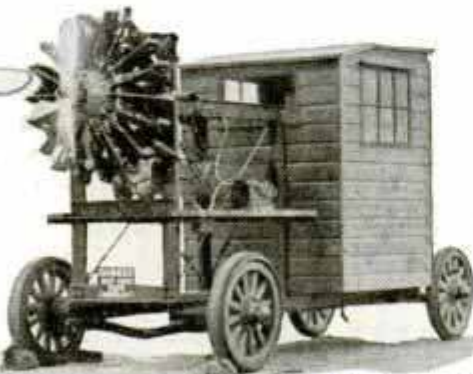

Wheeled Testing Block for Aircraft Motors Also Carries Small Mechanical Repair Shop

engines in use at the Roosevelt flying field on Long Island. The engine test stand and the building are mounted on wheels and the vehicle, with an airplane motor in place, can be propelled at a speed of seventy miles per hour.

JUNK PARTS AUTO IS CHAIN-DRIVEN

Two San Francisco school boys wanted an automobile but had only \$9.65 after pooling their money—not enough to buy a car. So they decided to make one. They made a technical survey of every junk yard and motor wrecking estab-

lishment in town, spent \$9.50 and two weeks of work, blew the remaining fifteen cents for oil, borrowed some fuel from the family car and were ready to go. Their vehicle has a streamline body, a motorcycle engine, a one-wheel brake and the "connecting rod" is a bicycle sprocket.



Chain-Driven Auto Made from Junkyard Parts Has a One-Wheel Brake

chain. They claim their chain-drive car will make forty-two miles per hour.

Popular Mechanics Magazine does not publish the name of the maker of, or dealer in, any device described in its pages, but this information will be furnished by our Bureau of Information upon request, accompanied by stamped envelope.

Antonio Braccio
Bull by Larry Hunt and Walter Burfoot.
956

W.D. Wale
1388
8961

Paul D.
1420

Steven Arata and Ernest Bryner

Acme

D 932

Two Rudders Enable Boat to Turn Quickly

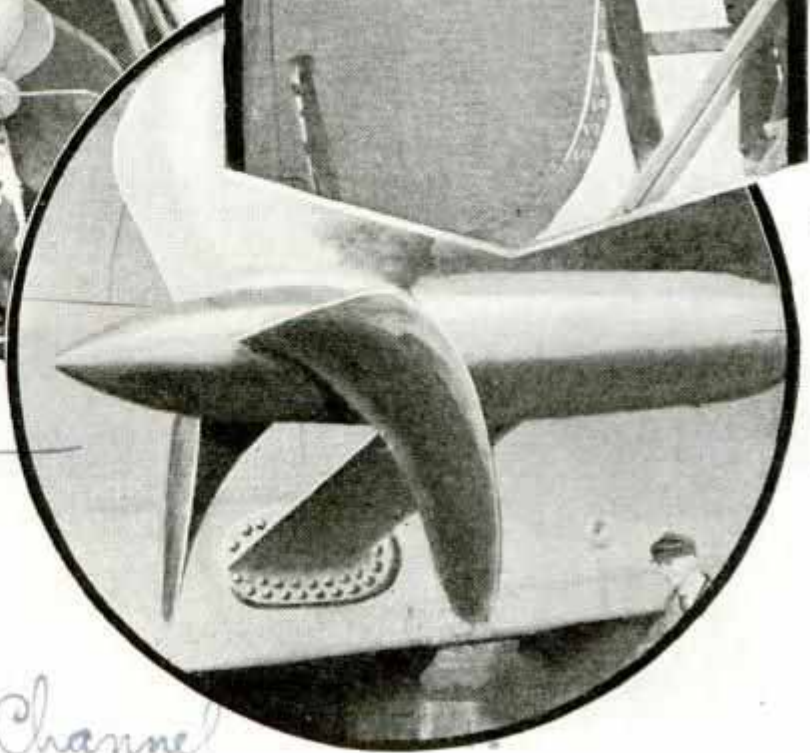
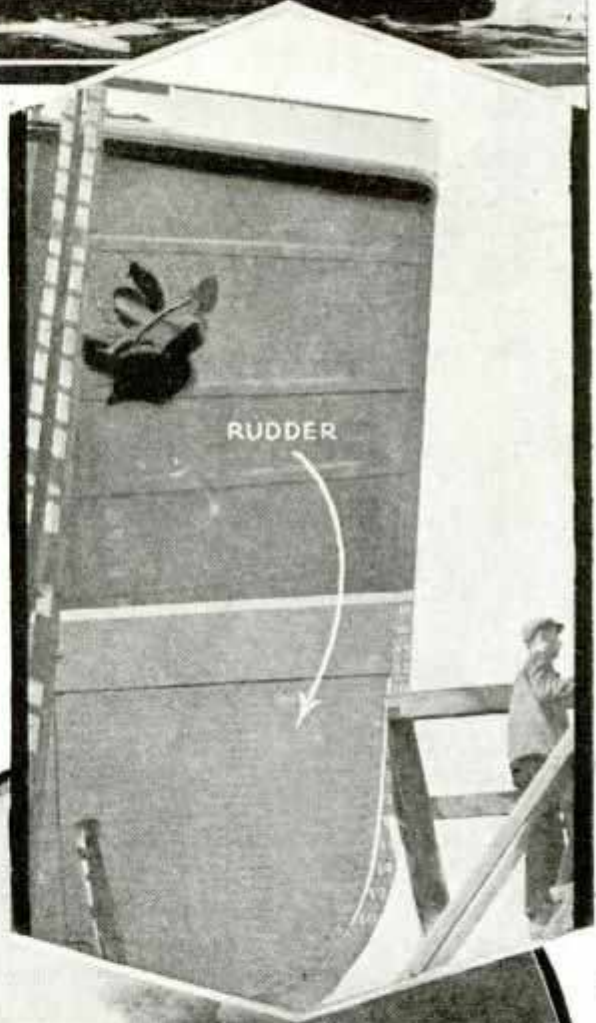
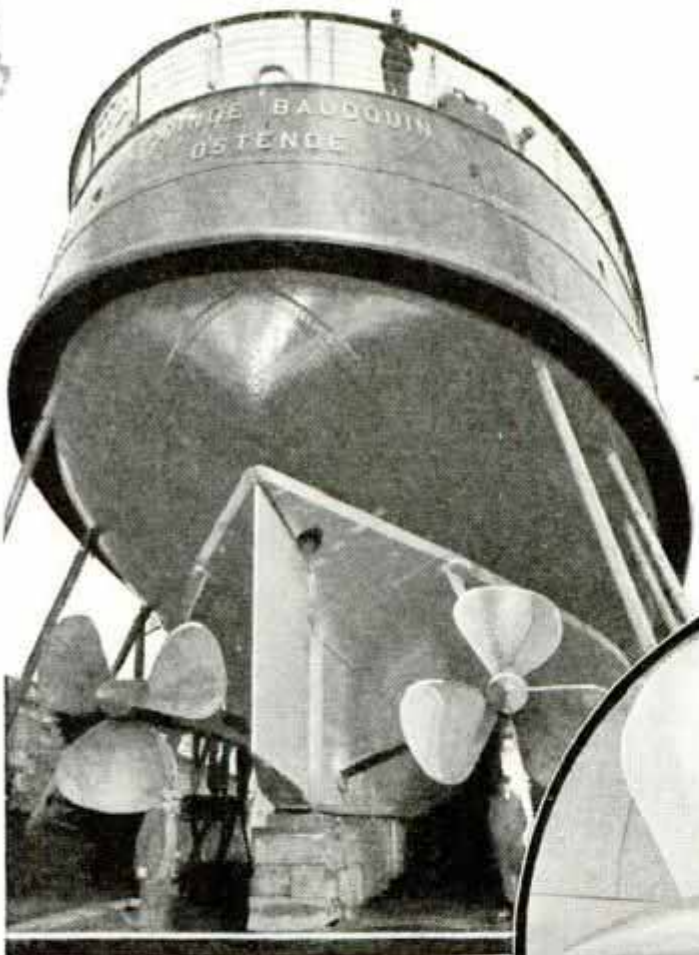
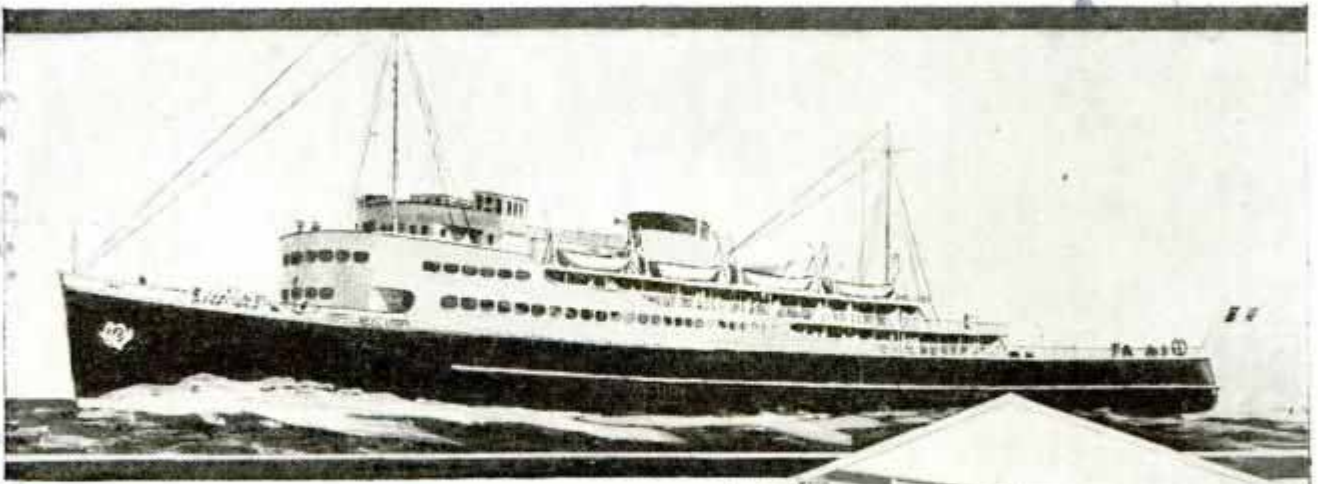

Streamlined Motorship, "Prince Baudouin," Which Carries Mail and Passengers between Dover and Ostend at Speed of Twenty-Seven Land Miles per Hour; Note Pointed, Trailing Stern and Two Rudders, One at Each End, Which Enable Craft to Make Complete Turn in Twice Her Length, or 720 Feet; Each of Her Streamlined Propellers Is Driven by a Twelve-Cylinder Diesel Engine of 8,500 Horsepower

English Channel

D 932

Alameda Calif

D907
712

Decorative
Furniture

New Albany
Ind.



Cedar Chest Drawers in the Foot of This Bed and Shelves at the Head Utilize Space Usually Wasted

CEDAR CHEST IN FOOT OF BED GIVES STORAGE SPACE

Extra storage space for blankets is provided by cedar chest drawers built into the foot of a bed which also contains built-in shelves at the top large enough to hold several books, a radio and a clock. This bed offers the utility of three separate pieces of furniture.

CYLINDER WALLS MEASURED BY THICKNESS GAUGE

Thickness of the cylinder walls in a motor are measured accurately at one automobile plant with a gauge which employs magnetic force. This gauge is lowered into each bore and instantly determines whether the walls are of the required thickness. It is an electric magnet with a meter which measures the current needed to energize the magnet. As the volume of steel or iron presented to the two poles of a magnet is increased, more magnetic force will be required to hold the metal to the magnet.



Use by Packard Motor
Carls. 1580 Leonard Blvd

Electric magnet

D942

FIFTY-POUND LAMP BULB IS FIVE FEET HIGH

Fifty-six inches high and weighing about fifty pounds, a huge glass bulb is used in a laboratory model of a 100,000-watt, 115-volt incandescent lamp bulb made by the Westinghouse Lamp company. Because of its great size, this bulb, when exhausted and having a partial vacuum within, must be strong enough to withstand a crushing strain of 40,000 pounds. Glass walls one-fourth of an inch thick resist the crushing and withstand the tremendous temperature generated by incandescent tungsten wire thicker than a fountain pen. The filament of such a lamp would operate at about half the temperature of the sun's atmosphere, equivalent to an energy of

135 horsepower, and properly conserving this heat requires filling the bulb with 200 quarts of argon gas. The average American family pays about \$2.50 per month for



Girl Inside Glass Globe of Giant Light Bulb Demonstrates Its Huge Size

electric light, but if this lamp were burned, it would cost about five dollars an hour. If its light could be piped around a town like gas, one such lamp would illuminate about 200 homes.

roadway
newspaper

Giant Dredge Digs Deep for Gold-Laden Ore

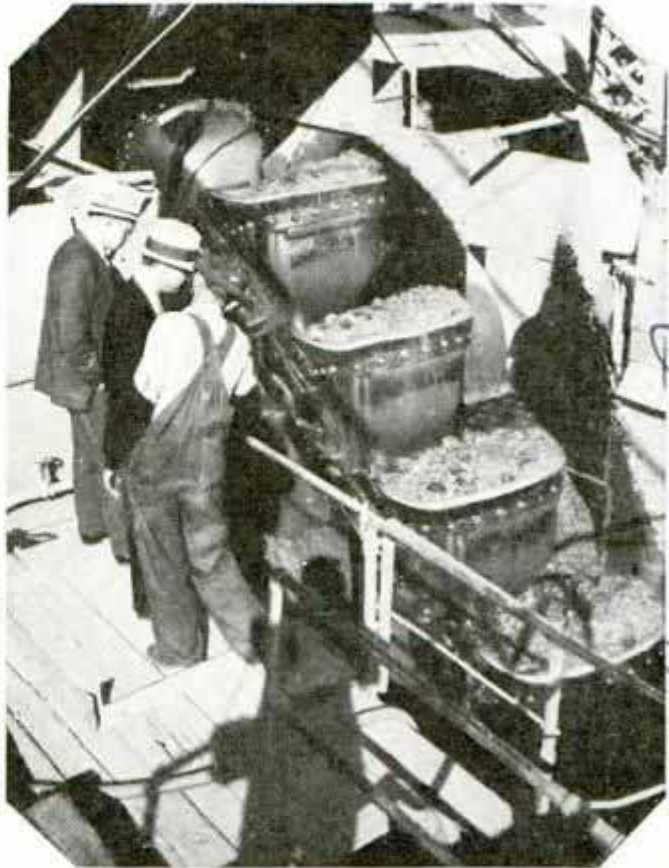
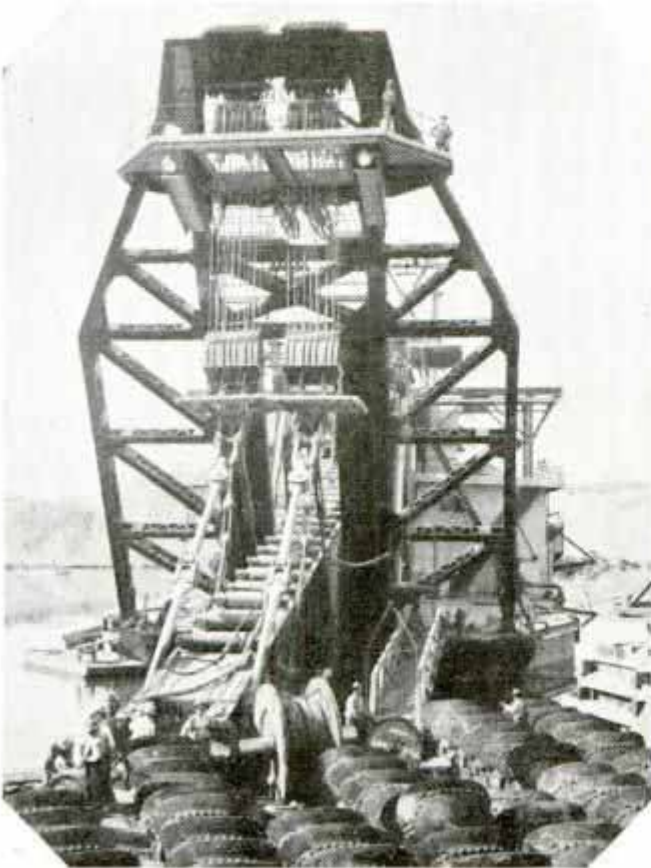

Left, Digging End of Dredge Before Buckets Were Attached; Fully Equipped, Dredge Weighs 3,500 Tons; Right, Endless Conveyor with Gold-Bearing Gravel Scooped from the Depths

Digging, washing and stacking nearly 400,000 cubic yards of gravel a month, a giant gold-mining dredge is being operated in the Hammondton area of northern California, known as the most extensive gold fields in North America. Having a total length exceeding that of a small ocean-going steamer, and weighing 7,000,000 pounds, the monster nudges its huge nose into the gravel banks, bringing up, in giant steel buckets mounted on an endless conveyor line, some 15,000 cubic yards of gold-bearing material every twenty-four hours. A huge steel crane raises and lowers the bucket line to the desired position, enabling the dredge to work to a record unheard of depth of 110 feet below water-level as well as 30 feet above, or a total perpendicular range of 140 feet. As it comes aboard, the gravel is distributed over rows of riffles, where quicksilver picks up the fine gold particles as the gravel-laden stream of water passes down the incline. Washed material is fed to a four-foot rubber conveyor belt running on the stacker or "ladder" that reaches out 250 feet behind the dredge. The machine

is a complete placer-mining plant—all self-contained and so efficient as to recover with profit the values from gravel carrying as little as six to seven cents a yard. Operated by electricity, the new dredge consumes enough current to supply the domestic needs of a city of 70,000 persons.

NON-GLARE CAP FOR LAMP BULB PROTECTS THE EYES

More efficient, non-glare light may be obtained from an electric lamp by equipping the bulb with a cobalt blue-glass cap. The cap fits the large end of twenty-five, forty, fifty, sixty and seventy-five-watt bulbs. Eyesight injury from the strain of sharp light is prevented by the soft glow from a capped bulb.

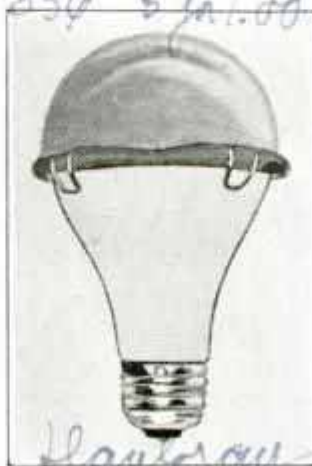

Raytheon
Barton Mfg. Co.

see Jan. 1928 - 75

Yuba
probably
Mfg. Co. 351
California
San Francisco, Calif.

D960. Crk. Tom White, 05 or 99
Alameda - Calif

D884

Handwritten notes on the left margin, including "Box 496 Biloxi Miss" and other illegible scribbles.

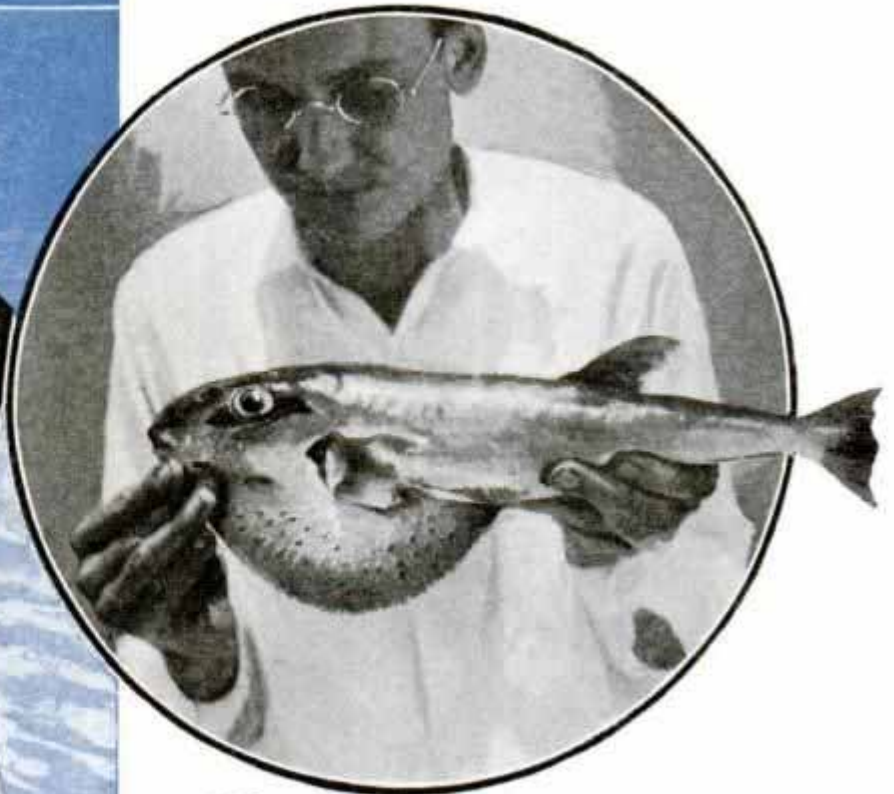

QUEER

By ANTHONY V. RAGUSIN

Box 496 Biloxi Miss
EXPLORERS have covered almost every foot of land on the globe, but the sea, with its many strange inhabitants, still holds a challenge to the man looking for new thrills and adventures. The Gulf of Mexico is especially fascinating for its marine life. Deep-sea fishing among the islands off Biloxi, on the Mississippi coast, will generally reward the fisherman with plenty of sport and some almost unbelievable residents of the sea.

The sharksucker or remora, one of the oddities of the sea, is the original hitchhiker. With its waterboard or adherent pad on the top of its head, furnishing a suction-like arrangement, this fish attaches itself to the side of some big fish and rides for miles. Early mariners called the remora the "ship-stayer" because it often hitched itself to boats.

Flashing like a Toledo blade, the cutlass fish, sometimes called the silver eel, is practically the shining sword of the Gulf. It is thin and shaped like a cutlass and has a small mouth with sharp needle-like teeth. Due to remarkable flexibility, it

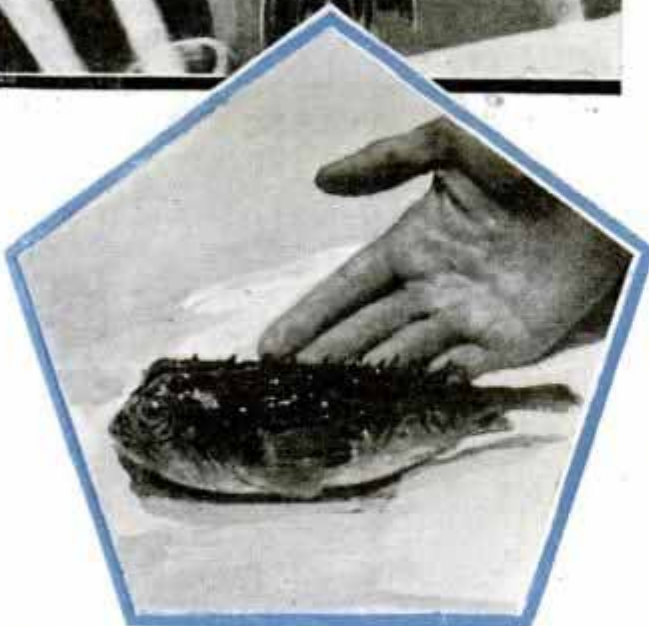

Top, Left, Drum Fish with Powerful Teeth Capable of Crushing Oyster Shells, Caught by Maj. A. B. Lambert; Top, Right, "Blow Fish" Which Puffs Up to Frighten Enemies; Bottom, Porcupine Fish with Its Coat of Armor

Handwritten notes at the bottom right, including "Box 496 Biloxi Miss" and other illegible scribbles.

D 8 8 4 3 5 2

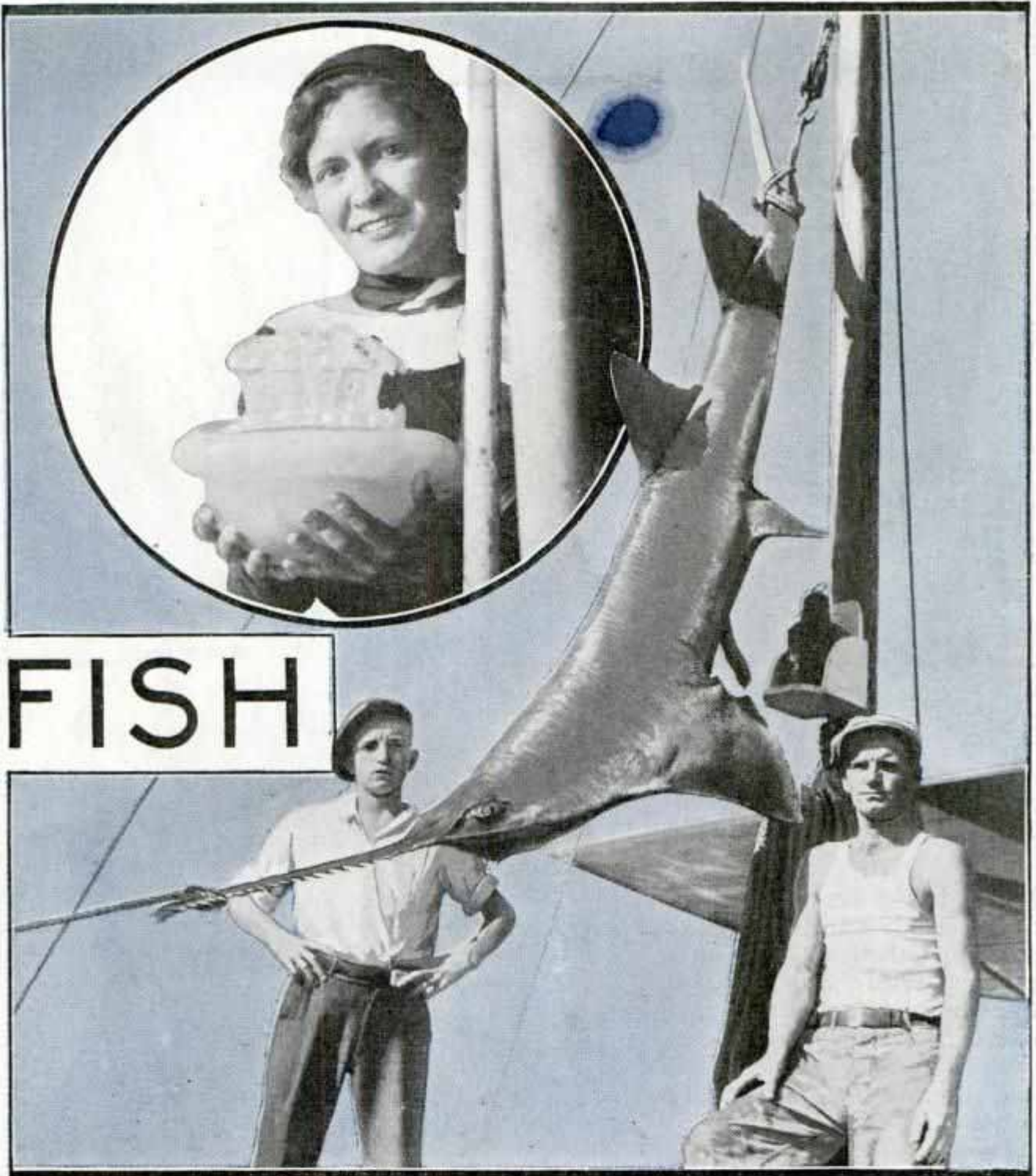

FISH

Circle, Huge Cup Fish, Shown in Young Woman's Hands, Is One of the Many Species of Jellyfish Found in the Gulf; Below, Large Sawfish Caught in Shrimp Trawl Net by Fishermen in the Gulf of Mexico

furnishes a real fight when hooked on rod and reel.

Frequently the waters among the islands off Biloxi are suddenly disturbed by the leap of the leopard ray, known to scientists as spotted ray. It reaches a size of ten feet. Flat and shaped somewhat like a kite, it has a powerful arrangement of teeth in crushing-mill fashion. Then there is the great ray, truly one of the queer fishes. Called the manta, giant ray, sea

devil, sea bat and other names, they have been known to attain a weight of 8,000 pounds. One day, while en route from Main Pass to Breton island, the lookout on a yacht sighted more than twenty of these strange creatures lolling atop the water. From head to tail, they measured eighteen feet, while across they were about twenty feet.

In Central America the Spanish name of "manta" was given them, meaning blanket.

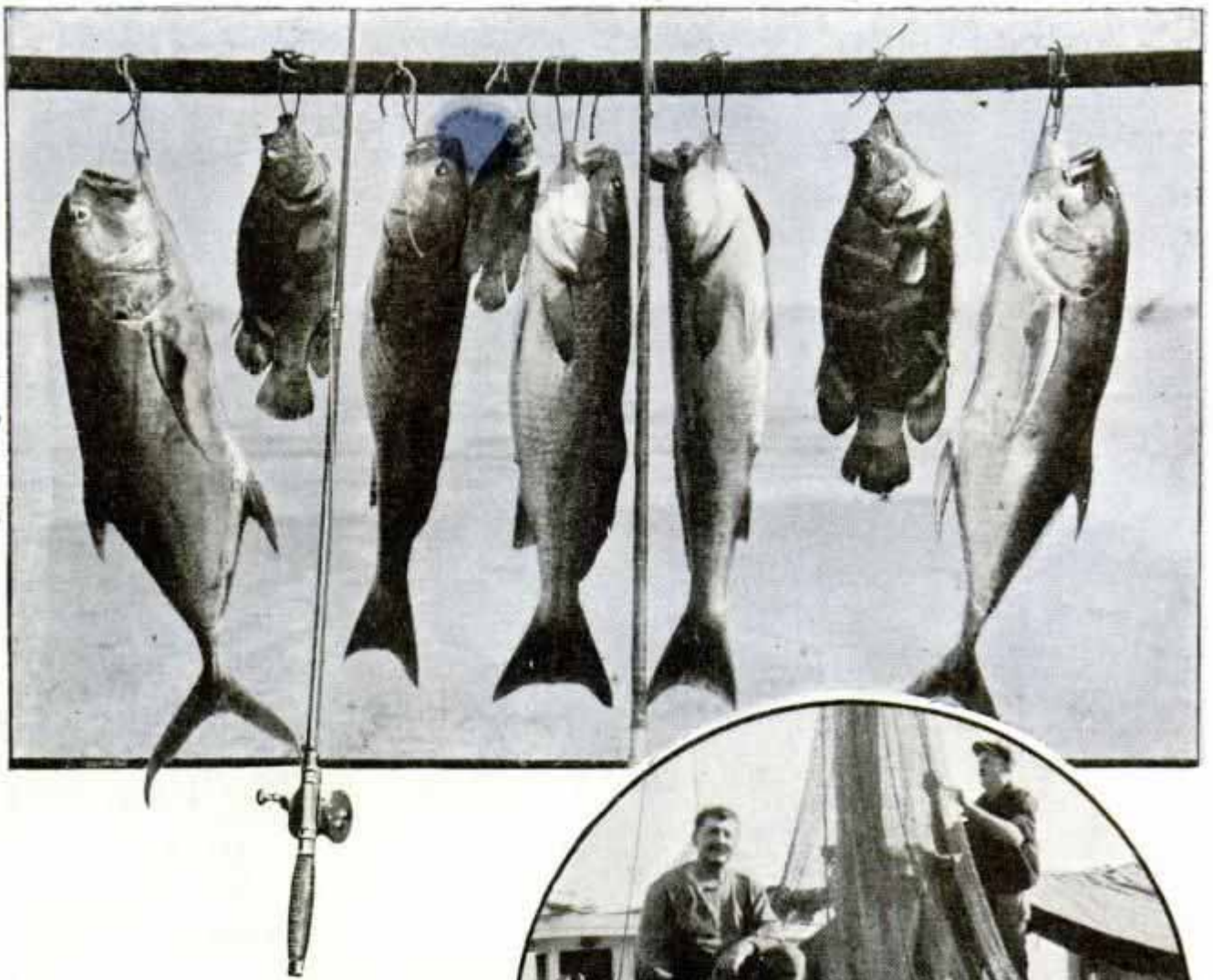

Divers in the tropics avoid the manta, holding to the traditional story that the giant ray will engulf a man and slowly devour him. Such, however, seems to be mythology. The manta is dangerous when wounded and can be taken only by harpoon after a hard battle of several hours.

The cow fish has a coat of armor consisting of hardened scales which form a bony box from which the jaws, fins and tail can be moved freely. The name is applied because of small horns in front of its eyes. The porcupine fish is one of the most grotesque members of the finny tribe, being of olive color and spotted with black dots. Armed with sharp-pointed spines, it is difficult to handle without being injured. Like blow fish, which also are found in the Gulf, porcupine fish are capable of inhaling air or water to form a balloon-like appearance to frighten enemies.



Top, Gulf Game Fish, Including Jackfish at Each End, Three Large Redfish or Channel Bass in the Center and Three Smaller Blackfish; Bottom, Fishermen Repair Nets Torn by Sawfish

Although a small fish, generally running about six or seven inches in size, the bat fish looks the least of any like a fish. It appears to be a toad, but has spine-like scales and a spinous dorsal fin.

While the drum fish is not exactly a queer specimen, its powerful jaws hold a set of mill-like teeth with remarkable crushing force. Schools of drums, from

(Continued to page 120A)

D921. chm. Mr. Haymaker, 4805 Everett St. Los Angeles, Calif.

Stamper "Walks" over Fruit without Bruising

Trade names in indelible ink are placed on such perishable fruits as avocados, pears and apples without bruising the fruit by using a stamper which handles 125 pieces per minute. Heretofore fruits easily bruised have been stamped by hand, a slow and tedious process. An automatic spring adjustment makes it possible for the stamper to ink fruits of various sizes. There are two revolving disk sets serving two rows of fruit simultaneously. Each disk contains eight

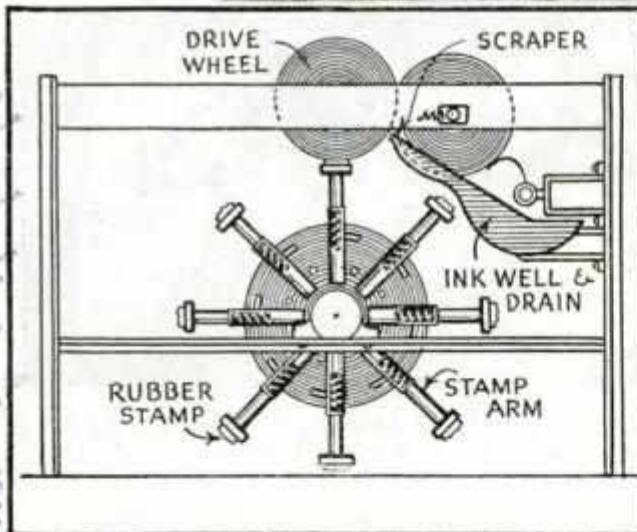
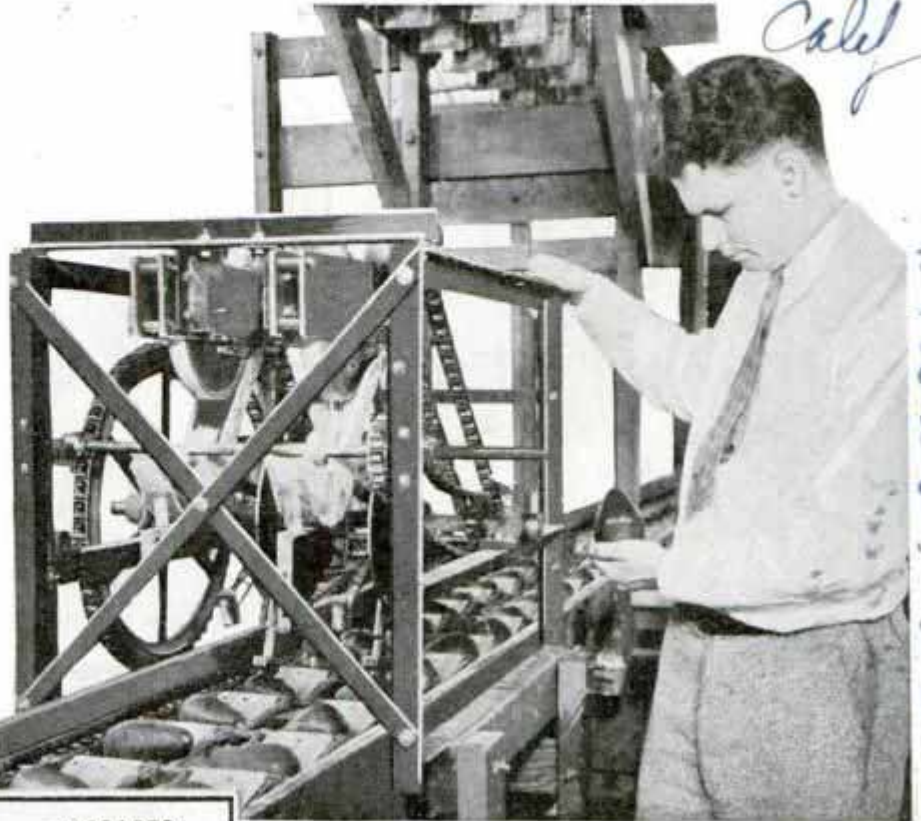

Stamping Machine Which "Walks" over Fruit and Diagram Showing the Method of Operation

canvas baskets. The arms are spaced to meet every piece of fruit in the center of its basket, the stamper printing the name as it "walks" over the fruit. There is pressure enough to leave a clear impression.

D944

BORING BAR MADE ADJUSTABLE TO INCREASE ACCURACY

Greater accuracy is obtained for a boring bar by designing it with an adjustable head. A shank permits attachment to the machine on which the tool is to be used. A micrometer screw and the graduated head give accuracy of settings. The tool can be adjusted quickly and locked rigidly when boring. It is offered as a time saver in machine shops.

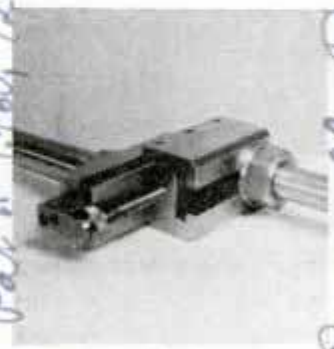

arms, each being set into a tube against a spring which holds the arm at full length. A telescoping plunger takes care of the large fruit by shortening the radius of the stamp arm as it passes over the fruit. A rubber stamp is attached to each arm, ink is placed in a sheet-metal well and a light spring steel paddle carries the ink from the well to the face of the inking wheels as the latter revolve on a spring tension bearing. A light spring scraper removes surplus ink and the rubber stamp arms on the assembly wheels in rotation press against the inking wheel and then pass over the fruit as it travels along below in

Ⓢ Cellophane is being used for coin wrappers, enabling bank tellers to count the money without unwrapping the rolls.

Cont. J. W. Knapp and

Russell Boring Bar Co. Middletown

C. Salgado & Sons. Inc.
25 Madison Ave.
Chelsea Mass

if one fails the second is switched on automatically. Gas flame torches instead of chemical washes and dustings are used to sterilize hatchery equipment and all feeding trays are sterilized daily. Hollow tile was found best suited for brooder houses, each of which is equipped with an electric mothering unit with thermostat control to protect the baby birds from drafts. Later the birds are placed in exercising pens of wire netting where they are kept until transferred to the wilds, where landowners agree no shooting will be permitted through the next two seasons to allow them time to mature.

Aerol Burner Co

STRINGER FOR TENNIS RACKET IS EASY TO OPERATE

So simple in operation that anyone can operate it, a new machine for stringing tennis rackets is being offered as a substitute for hand work. The stringing device



Simple Apparatus for Stringing Tennis Rackets Does the Job with Precision

substitutes precision methods for human judgment on tension of the strings, doing the job exactly the same each time. The average player, with the aid of the machine, can take care of his own racket, and possibly those of his friends, turning out work similar to that of professionals.

FIREPROOF GLOVES ARE ADDED TO FLYER'S EQUIPMENT

Fireproof gloves have been added to the equipment of the British Royal Air forces for use in fighting the flames when a ship catches afire. The gloves adopted were found in tests to withstand terrific heat

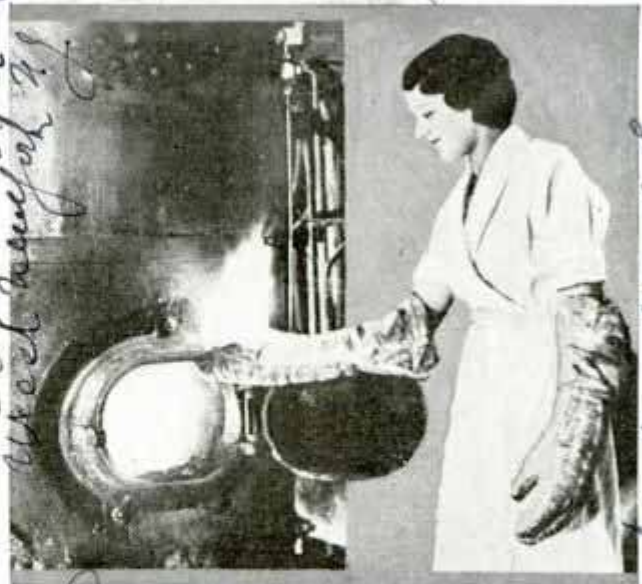

Testing Fireproof Gloves by Picking a Live Coal from the Inside of a Blazing Furnace

without scorching. The tests included picking blazing coal from a furnace with the gloves, grasping a red-hot steel bar, holding the gloved hand in the heat of a forge fire for thirty seconds and bending a red-hot steel bar placed in a vise.

LUGGAGE RACK ON AUTO TOP HELD IN PLACE BY SUCTION

Suitcases, camping equipment and other bulky articles can be stowed on top of the car if the auto is equipped with a luggage carrier which attaches to the top with suction-cup grips. It consists of a tubular steel vacuum storage-tank frame with large rubber suction cups at each corner. These cups hold the carrier in place by vacuum from the motor supplied through a section of tubing connected to the windshield wiper. When the motor is shut off check valves in the rubber cups and frames maintain suction to hold the carrier in place. The carrier will hold several suitcases. It can be converted into a table by attaching legs at the four corners.

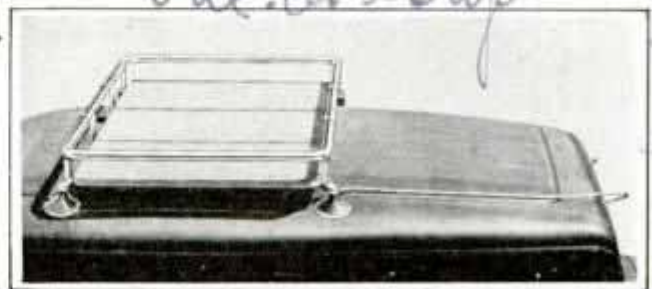

Suction Cups at Each Corner Hold Luggage Rack; Motor Supplies Vacuum for the Cups

Belg's Asbestos and Engineering
Subsidiaries Ltd. 159, D'Almeida
London, W. 1

Toledo Engineering Co

Seismograph Tells Weather by "Pulsations"

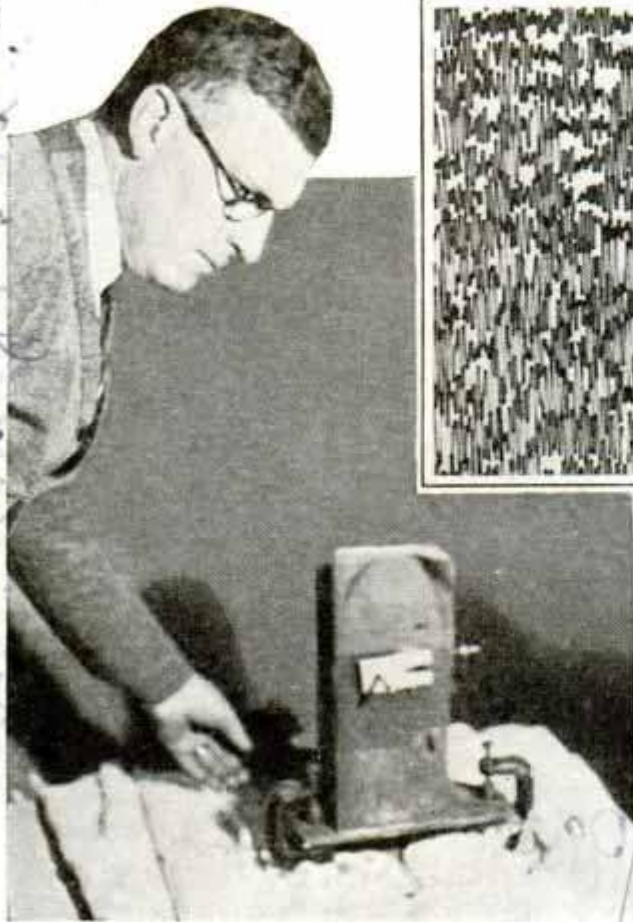

Seismograph Recorder and Lines Made by It from Which Weather Forecasts Can Be Made

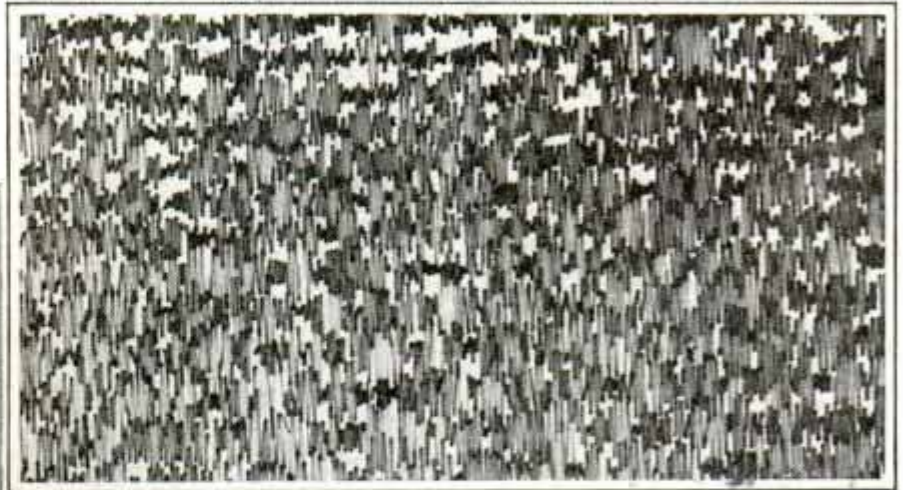

Seismographs, long used to record earthquake tremors, have also been found to forecast the weather. Dr. Albert J. Newlin,

director of the Santa Clara university observatory, says these instruments make accurate weather forecasts from one to two days in advance of changes indicated by barometers. Seismographs constantly make zigzag lines and these were formerly thought to be the result of waves pounding on the seashore or of very remote earth tremors. Now they are believed to be from some other source and are recorded simply as "pulsations." When the pulsation line becomes intense both in frequency and amplitude, it has been noticed that a high barometer and clear weather follow. When the line decreases both as to frequency and amplitude, foul weather follows.

Snowflakes Are Used as Models for Glass Lamp Shade

Enlarged microphotographs of snowflakes provide the geometric designs for a glass ceiling lamp consisting of three plates of glass joined by metal strips to form the sides and a smaller triangular piece, also with a snowflake design, for the bottom. Snowflakes are intricate aggregations of ice crystals which always build up into a geometric pattern. For the snowflake light, four typical designs were selected and stencils were carved from them on glue-coated paper. These stencils then were glued to the glass plates which were cut to hexagonal or triangular patterns. Clear glass with a flashed opal surface was used. With a sand blast, the design of the flake was cut through each opal layer to the clear glass, resulting in an opal-white flake in relief upon a ground-glass background.



Lamp Shade with Designs Copied from Snowflakes

Emb. John L. Comity, 3707 19th St. N.W., Washington, D.C.

Made by Miss Mary Allerton Reed

Santa Clara, Calif

19th Army Parkway, 10th St. La

Hung in Mineral Hall, National Historical Museum

SHIP STOPS PROPELLER "SHAKE" WITH JUMPING WEIGHTS

When the propeller of a ship turns at high speed and slaps the water, it makes something shake and there is no way of deadening the shock with springs. Ship-builders, however, are counteracting propeller vibration by creating a new vibration of about the same force to offset it. A weight about equal to that of a trolley car is suspended on a beam in the center of the ship, and is made to vibrate up and down by machinery which can be controlled to conform to the speed of the propeller. When this weight attains a certain speed of vibration it crosses out the propeller "shake," and the two exactly counteract each other.

REFLECTORS FOR PEDESTRIANS WARN MOTORISTS AT NIGHT

Pedestrians walking along highways at night can warn motorists of their presence by carrying small reflectors of metal



Child Is Shown Carrying Reflector to Warn Approaching Autos; Inset, the Reflector

and glass. It consists of a rectangular metal frame with a reflector between two pieces of glass and a handle for carrying. The reflector picks up and throws back the light from car headlamps long before the driver can see the person who is carrying the safety device.

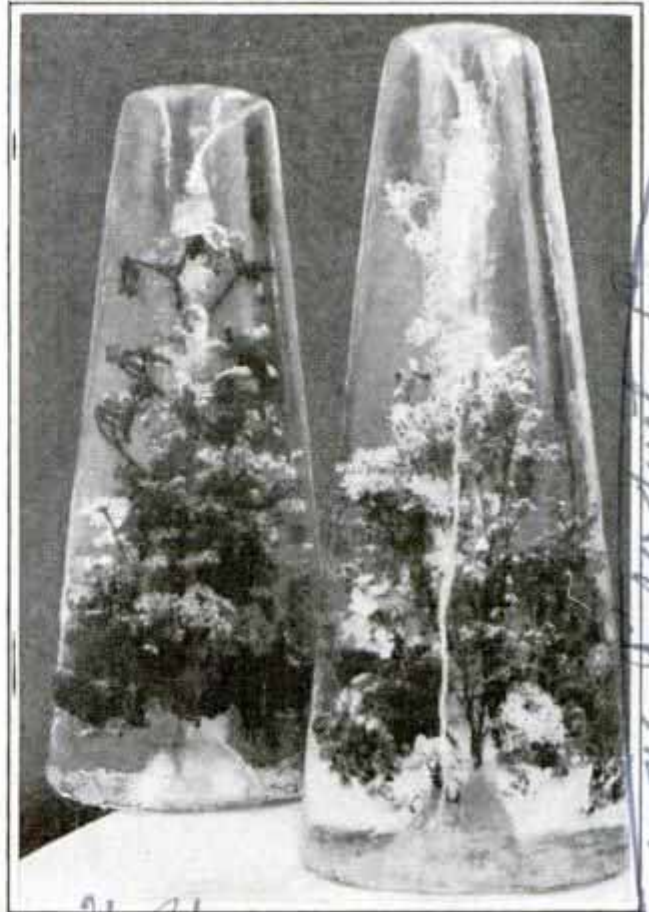

Native Plants Make the Trip from Australia to London Encased in Molds of Ice

FLOWERS FROZEN IN ICE MOLDS KEEP FRESH WHEN SHIPPED

Shipped in frozen molds, native flowers retain all their original fragrance on the long trip from Australia to London, keeping fresh for weeks. Before being placed aboard ship, the flowers are packed in molds, which then are frozen.

PAINT GLOWS IN "BLACK LIGHT" OF ULTRA-VIOLET LAMP

Fluorescent paint that glows in the invisible light of an ultra-violet lamp is now on the market. Under ordinary illumination, the paint resembles other paint, but under the ultra-violet ray, it emits brilliant light of any desired color. Objects not coated with the paint disappear in the background. The product lends itself to decoration of objects, walls or windows in the home, to creation of luminous spectacles on the stage, to production of unusual effects on paintings, sketches and murals, and to many other purposes. A special cold cathode tube is recommended to get best results with the paint.

Science device 5/1/34

Experiments on Italy

D638

D910

D943

See page 1936-1359

Chas. Best, Jr. Wood

Wood, Glass, Co.

Vertical handwritten notes on the right margin, including "Northern Life" and "I write for Bros. Laboratories".

D966

1811 E. Wood Place
Milwaukee Wis

The WONDERS

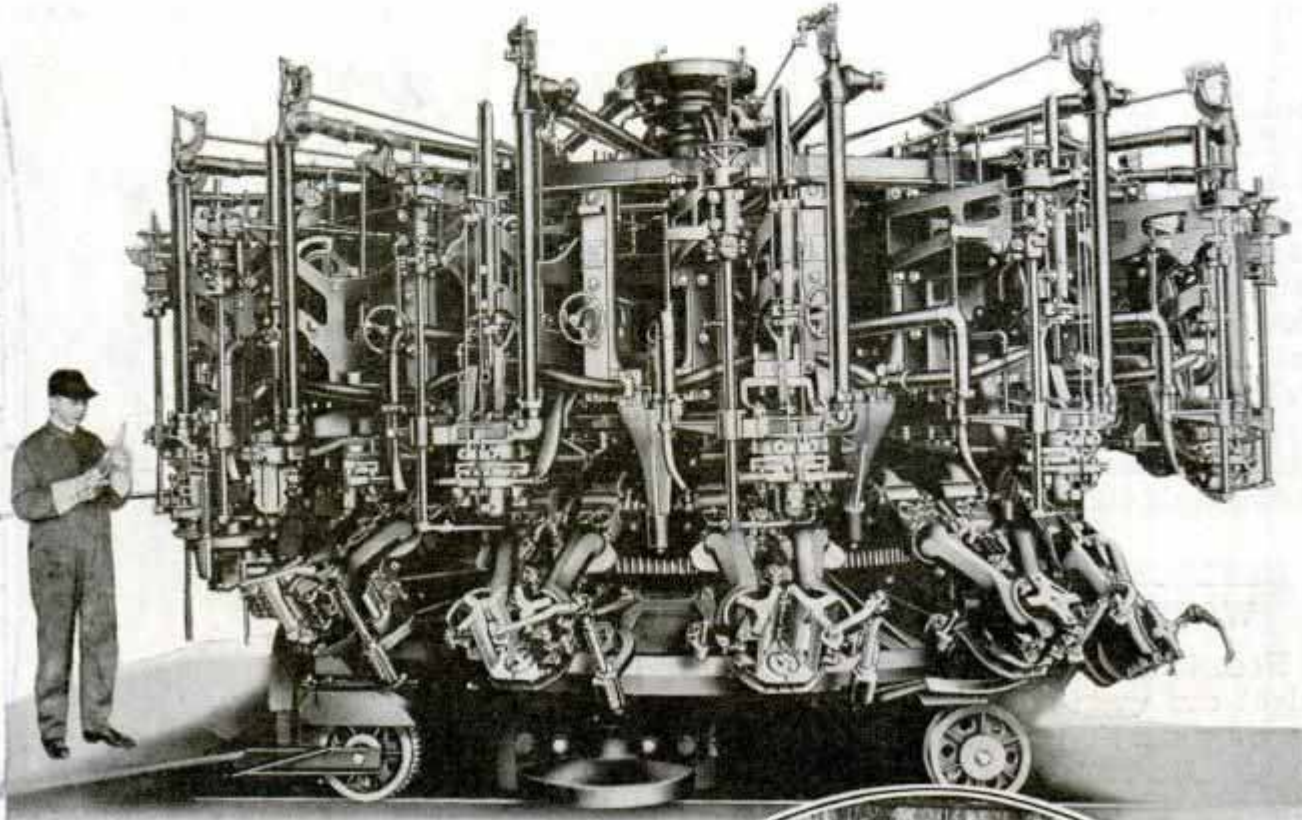

Courtesy Owens-Illinois Glass Co.

GLASS as heavy as iron and spun as fine as silk, glass that stops X-rays like lead, glass as strong as wrought iron, glass that can be heated red hot and plunged into ice water without breaking, glass that is used like pipes to conduct fluids, glass that looks like diamonds—these are some of the triumphs of modern industry.

Although glass has been known a long time and is even found in nature as obsidian, a black opaque glass, it has remained for the scientist to show us what man can do. "As brittle as glass" is an old saying which cannot be said to be truthful any more. In fact, glass will maintain its shape under pressure which will make metals bend like putty.

This is hard to believe but tests at the Corning glass factory, where every kind of glass from bottle glass to that used in the new two-hundred-inch mirror of the world's largest telescope is made, show



Courtesy Pittsburgh Plate Glass Co.

Top, Scene in Glass Factory; Bottom, Bullet Pierces Boiler Plate (Left) but Not the Glass

that this is true. The resistance of glass to crushing is extremely great. It would take about eight loaded freight cars weighing about 350 tons, or 700,000 pounds, to crush a two-inch cube of hard glass. Even

of GLASS

D966
Pyrex
Corning
Islands Works
Corning, N.Y.

Right, Large Flask for Use in Laboratory Is Made of Glass Which Resists Sudden Heating or Cooling; Such Glass Is a Boon to the Chemist Because It Permits Him to Complete Many Experiments That Might Fail If Test Tubes Should Break

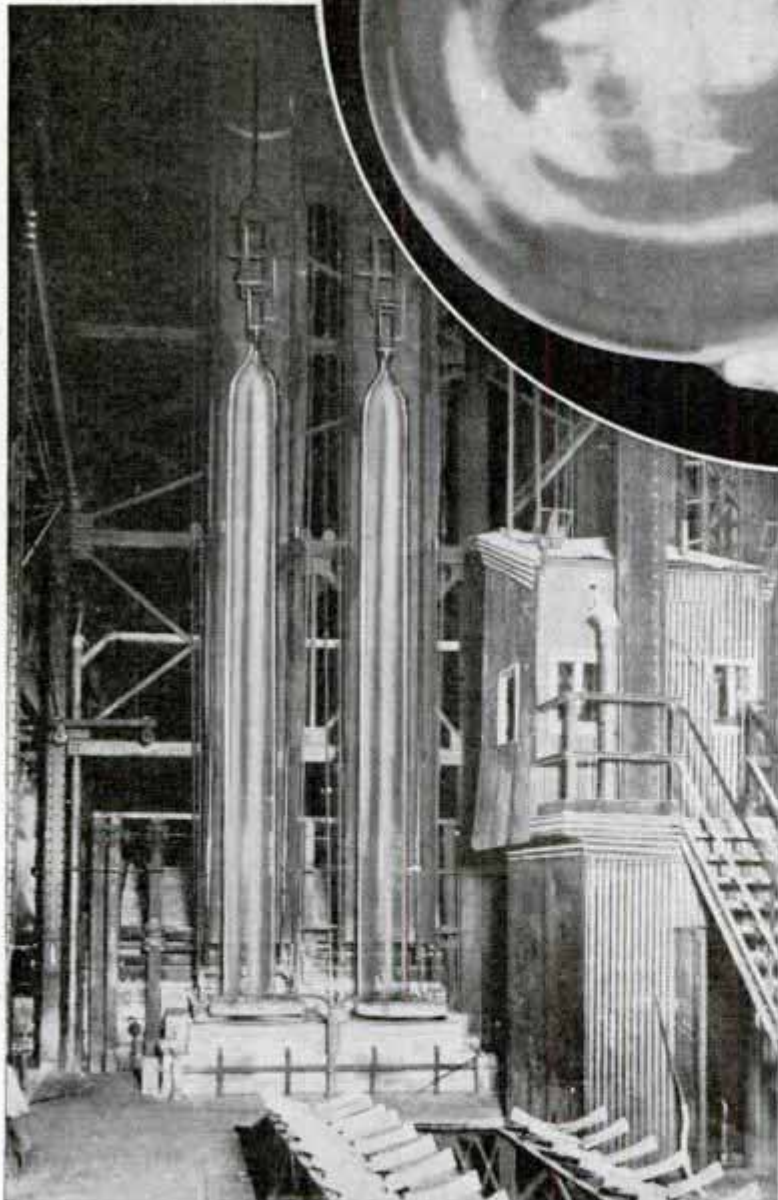

Large Cylinders of Glass Are Drawn and Split in the Manufacture of Huge Panes

Pittsburgh Plate

cast iron will yield before this hard glass.

There are three main kinds of glass. There is the soda-lime variety which goes to make up bottles and window panes. Sand, lime and carbonate of soda, the ordinary washing soda, go into such uses. Lead glass contains lead salts instead of lime. The cut glass, so popular twenty years ago, was lead glass which has great brilliance and can be given a high polish. Glass can be made with so much lead in it that its weight will be equal to that of grey cast iron. Such glass can be used to protect X-ray technicians against the dangerous effects of these rays.

All transparent objects bend light in greater degree and this

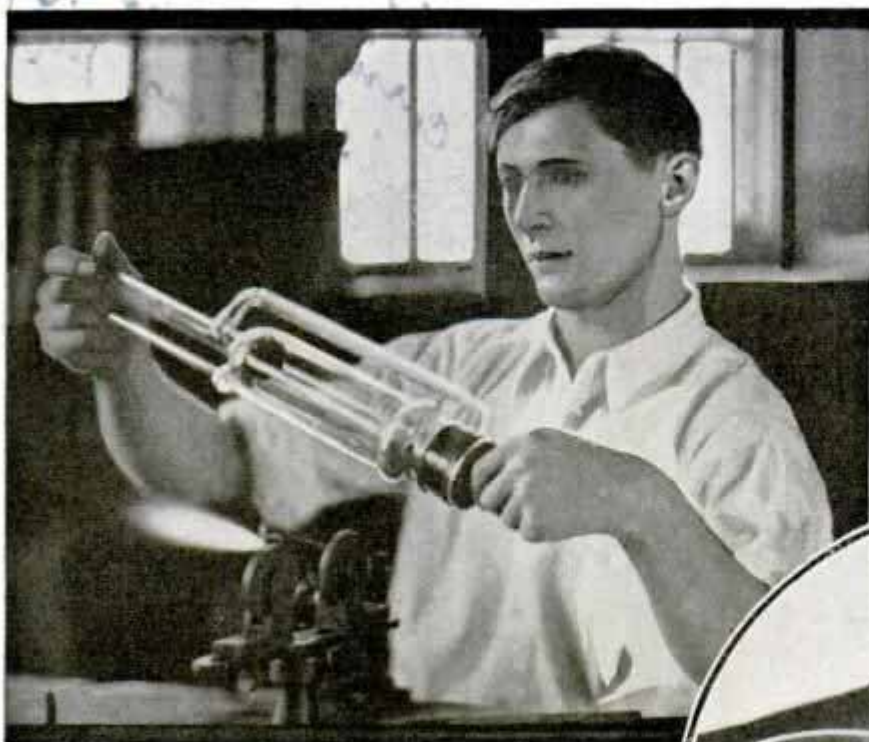

pies and custards in some glass dishes without fear of breakage.

Baking can be done more economically in glass than in metal because glass has low heat reflecting power. If you will place a glass plate under an aluminum baking dish, the baking will go faster.

Glasses of all kinds are made today, including

amount of bending is called the refractive index. The more light is bent, the greater the sparkle. The index of a diamond is 2.42, quite high, while the best lead glass has an index of 2.00. So, even today, we cannot manufacture the diamond although we imitate it closely.

Why does a hot bottle placed in ice cold water break? Think of a mud puddle. The sun dries the top layer. It dries and shrinks and breaks away from the cooler bottom layer of water which hasn't changed its shape. The same thing happens to a glass dish or bottle which is placed hot into cold water. As the surface layer of glass cools and tries to shrink to its normal shape, it breaks away from the bottom layers and the glass cracks. Some glass made from certain forms of silica can be heated white hot, plunged into cold water and remain unbroken. Why? This brings us to the third form of glass.

Borax or boric acid when mixed into glass gives it the property of expanding very little when hot and consequently contracting little when cooled. This means little shrinkage. Glass made of such a composition is therefore not subject to the stresses that break ordinary glass when cooled or heated suddenly. That is why you can bake



Courtesy Pittsburgh Plate Glass Co.

Top, Glass-Blowing; Center, Hot Quartz Tube Does Not Crack in Cold Water; Bottom, Silvering Mirrors

those that will transmit only the invisible ultra-violet light for taking pictures in a dark room; those that will stop bullets, and glasses so thin that they will be broken by the breath.

Collection of Poster Stamps Is the Latest Fad



Some Examples of Poster Stamps Collected as Hobby; Right, Stamps Are Kept in Book Like Those Used for Postage Stamps

Poster-stamp collection is the latest fad to make its appeal to the thousands of men, women and children who make a hobby of collecting and classifying everything from postage stamps to match books and picture post cards. Poster stamps are the stickers and labels used to commemorate some event or to advertise or attract attention to some commercial product. The hobby costs virtually nothing since the source of such labels is almost endless. Hotel baggage labels, stamps advertising conventions, fairs and expositions, safety-first stickers, and the hundreds of varieties of labels used on manufactured products are only a few of the possibilities. The hobby has a definite educational value if stamps calling attention to historic events are collected. The collection is preserved in stamp books like those used for postage stamps and many collectors obtain foreign stickers by trading with collectors in other countries. Usually related subjects are segregated in each collection and finally a collector becomes interested in one par-

ticular form of poster stamp and concentrates on obtaining a complete file of such stickers.

1024

PAINT CAN HAS WIRE MIXER FOR USE BEFORE OPENING

Paint can be mixed inside a new-type can equipped with a mixing paddle and handle that folds flat against the can when not in use.



Before the can is opened, the wire handle is operated to stir the paint, eliminating the possibility of losing part of the contents over the sides of the can while mixing in the ordinary manner. The metal handle also aids in opening the can.

Vertical handwritten notes on the right margin, including 'Chicago' and other illegible scribbles.

Valentine & Co

D937

Wheeler and Woolsey

677 Cambridge Road, Prentice, Wis. 53091



Theater Employes Wearing Cardboard Heads of Motion-Picture Actors as a Means of Advertising; Note Close Resemblance to the Actors

CARDBOARD HEADS OF ACTORS WORN TO ADVERTISE FILM

Giant cardboard heads of motion-picture actors were worn in a parade recently to advertise a San Francisco theater. The heads were naturally colored and made to resemble closely the actors. Transparent colored gauze in the necks enabled the wearers to see where they were going.

AIR-DRIVEN SAW CUTS PILING BENEATH THE WATER

Operation of machinery under water has always been difficult because powering such a machine offered a problem. A chain-type sawing tool is being used, however, in cutting piling off under water and doing similar work, compressed air furnishing the power. This tool, operated by two men, is made up of a supporting member composed of saw steel in laminated form, a slot being left around the outer edge of the oval support for the links of the endless-chain saw to travel. Such a tool has operated seventy feet under water, but it is not limited to such work for it is also built with an electric drive and then can be used for cutting heavy timber in shipbuilding operations and in felling

big trees. It eliminates the ax in felling trees, for the wedge-shaped portion usually chipped out with the ax is sawed out with two cuts of this saw after which the felling cut is made on the opposite side of the tree.

D99

STEERING WHEEL HAS SPRING POST

New safety for the automobile driver is the purpose for which a spring-equipped steering post has been designed. In case of an accident, the spring permits the post to shorten, providing a space of several inches for part of the shock to be absorbed before the driver's body is forced against the steering wheel. In addition,

the level of the wheel is lowered as the spring gives, reducing the hazard of the driver's head striking the wheel. Under ordinary driving conditions, the spring-equipped wheel turns the wheels easily. The slight springiness in the post is be-

Pat Feb 3/1931 # 1,791,001



Driver Holding Collapsible Steering Wheel; Dotted Lines Show How Far Post Lowers

lieved to eliminate some of the fatigue of long trips, since much shock transmitted from the wheels would be absorbed.

Wm. Anders Gilberg

Giant British Liner Dwarfs Large Buildings

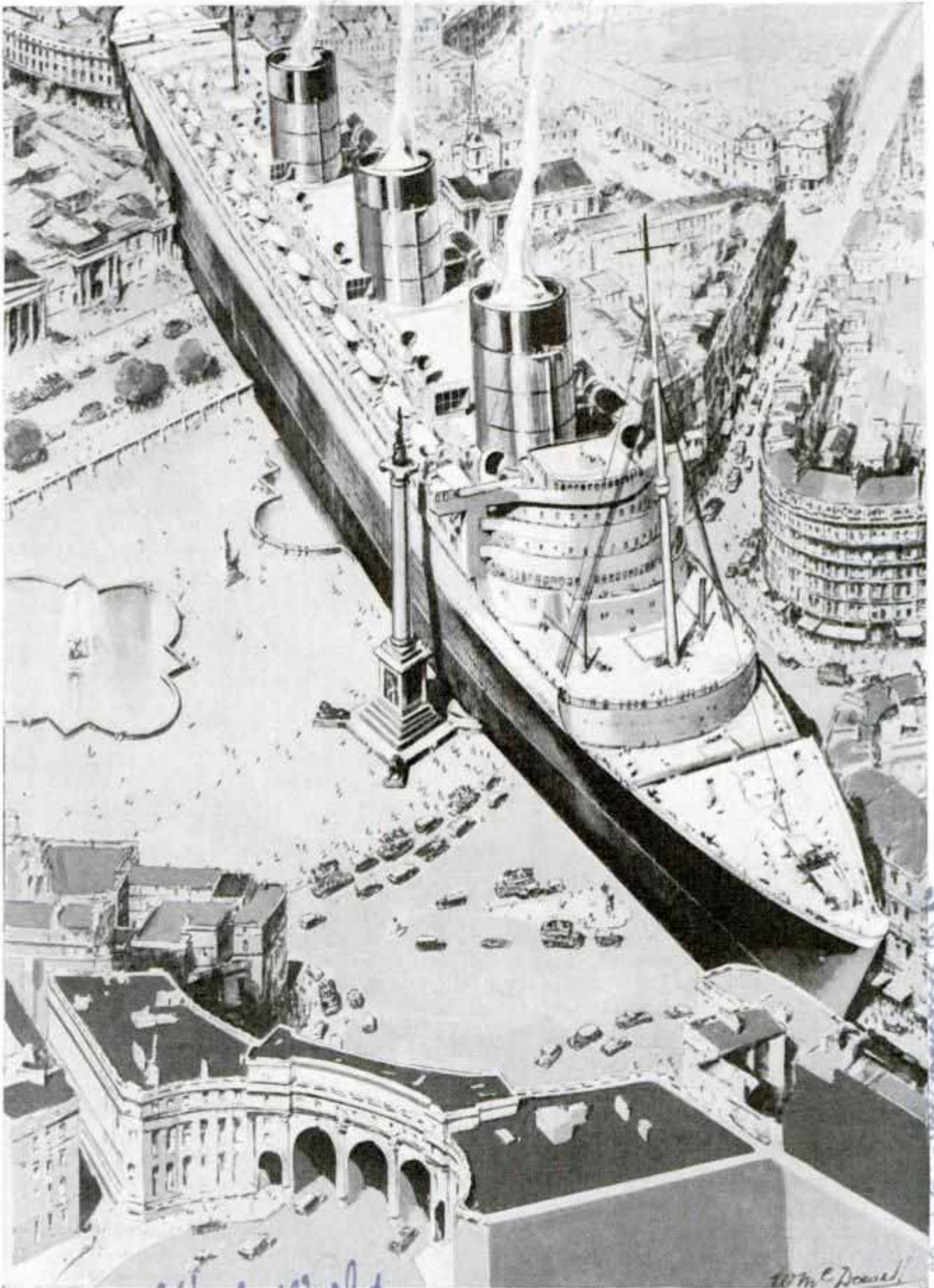

Wide World
Drawing Shows How Cunard White Star Steamship "No. 534" Would Appear if Placed in Trafalgar Square, London, with Bow Cutting into Whitehall and Stern at Garrick Theater, 1,020 Feet Distant

D918

Mr. Frederick C. Russell
115 W albridge Road

SERVICING

Hartford, Conn.

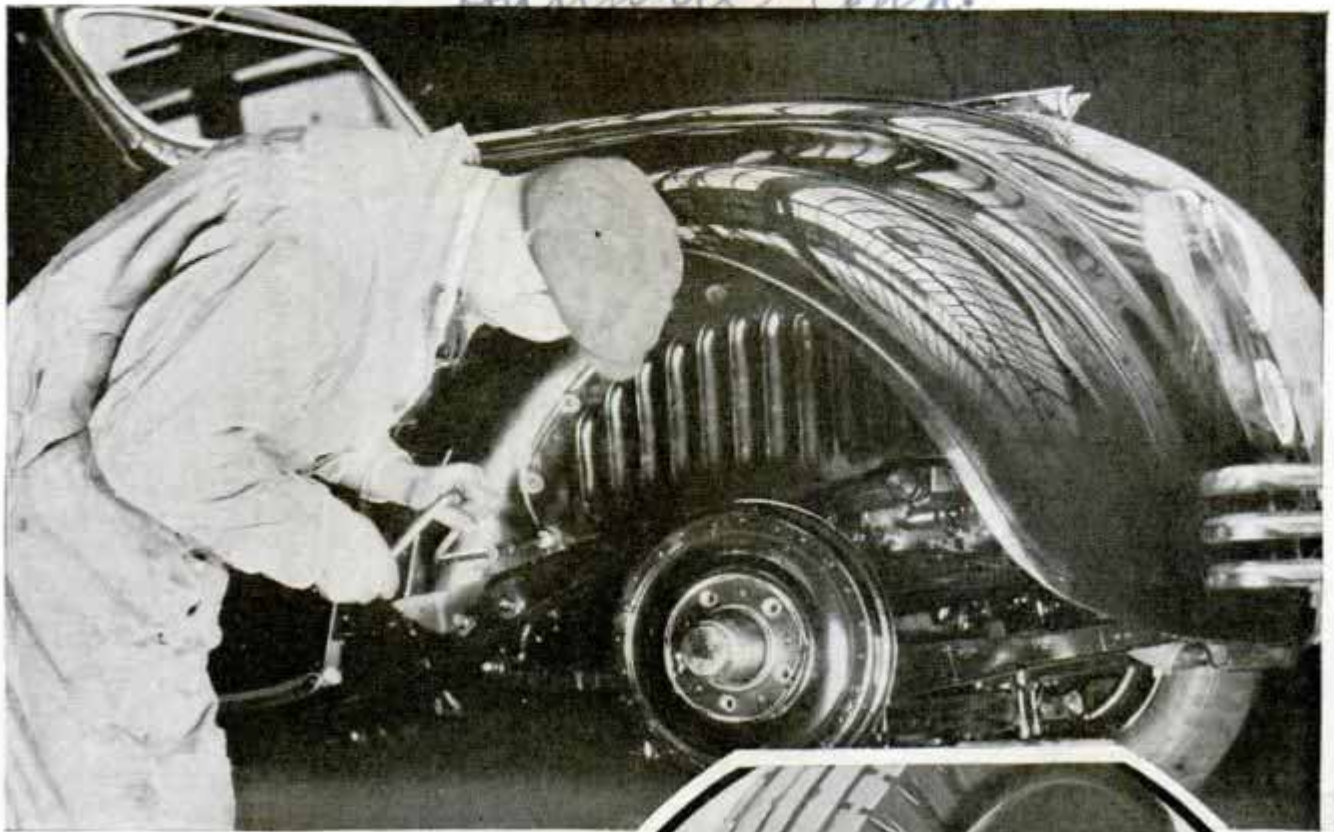

Top, Reaching Valves by Removing Plate under Fender;
Bottom, Adding Fluid to Knee-Action Unit

TODAY'S automobile service man has put away his monkey wrench and "hunches." He has an utterly new type of automobile to keep in tune and he is learning how to use a wide assortment of ingenious devices to keep the new products new.

Taking the guesswork out of service has been brought to a head by the offering of new design which cannot be handled along conventional lines. The result is such novel developments as the free-wheel lift, the turning radius gauge, the friction meter for direct testing of brake lining, all the new equipment for handling cars with knee action and even such timely devices as a special curb jack for cars with low splash pans, overhanging bumpers and independently sprung front wheels.

Not only are engines being tested for accuracy of spark timing while they are in operation but a highly advanced system utilizes a neon light for checking ignition. Each time the spark plug of a cylinder of

an engine so tested fires, a small neon lamp, flashing in time, illuminates a polished steel ball set in the rim of the flywheel. The effect is to make the ball appear to stand still. While this is in process the mechanic merely rotates the distributor until the ball appears directly in line with the pointer. Timing, by this method,

Blackhawk Mfg Co
Dept. W-70
Chicago, Ill.

Designed for Cities Service Co

0918

the NEW CARS

Above, Neon Light Flashing in Time with Small Steel Ball Set in Flywheel Makes Spark Timing Simple; Inset, Location of Ball on the Flywheel

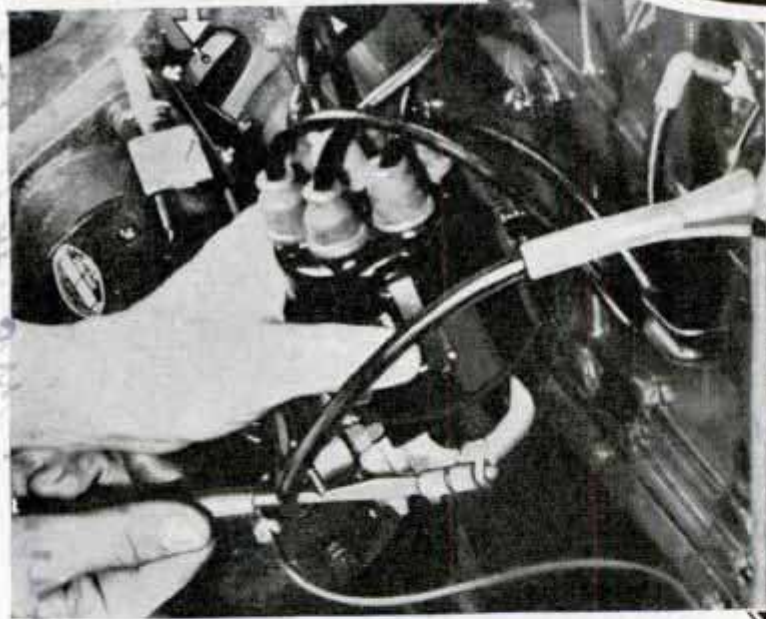
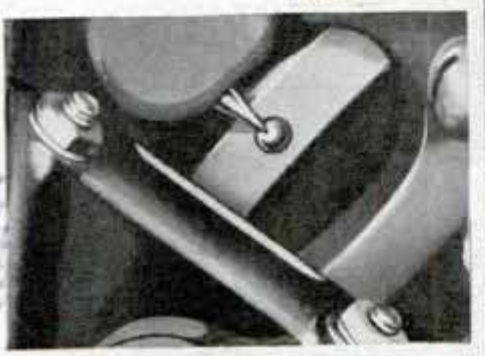
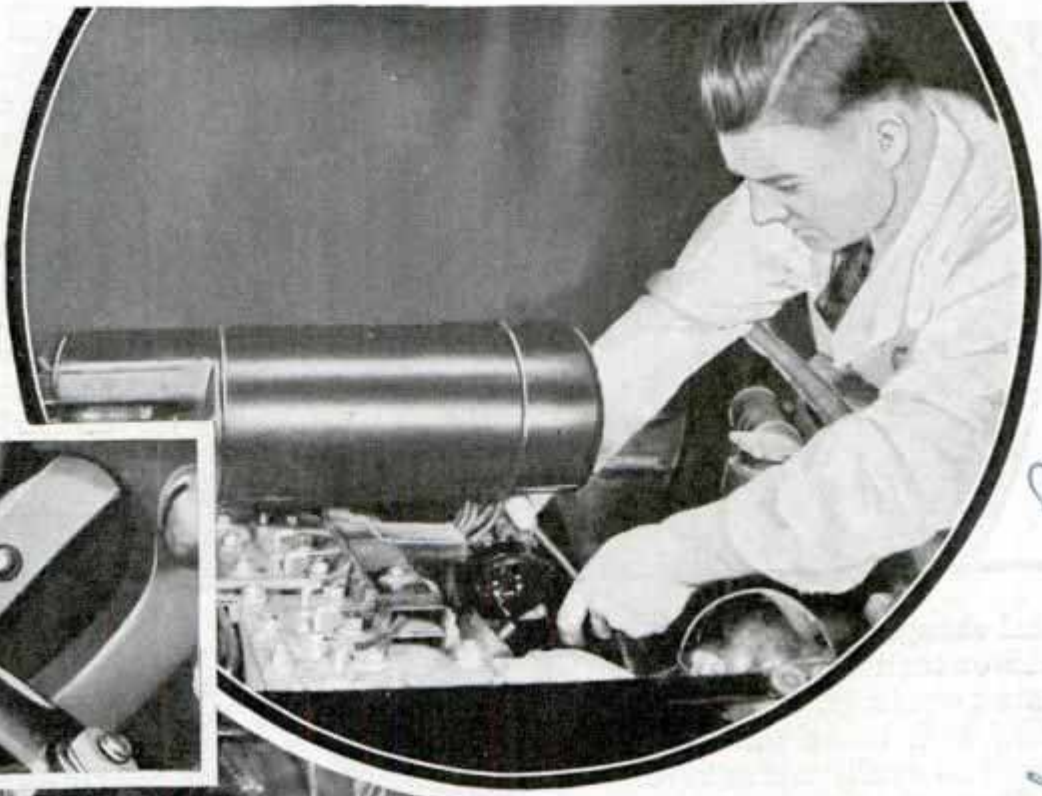

Above, Hood Lifts as Complete Unit to Give Easy Access to Modern Motor



Compression Gauge, Shown in Place, Replaces Method of "Feeling" Resistance to Hand Cranking

can be set to an accuracy of one-half of one degree.

With such ignition-checking equipment a spark timing adjustment can be made in less than five minutes, thus assuring the owner better results from his motor and encouraging car designers to continue with their efforts to fashion cars critical in their adjustments. This process is similar to the stroboscopic effect obtained with a bank of electric lights set to flash in time with any moving part of the car. Where such

equipment is used it is possible to see exactly how the engine's valves behave when operating at high speed. Any tendency toward stickage is quickly detected. Weak valve springs immediately show up.

Revolutionary methods of servicing the newer cars are due, not merely to mechan-

Designed for Citizens Service & designed by 60 Wall St. New York

Designed by SPB

May 6, 30 - 1930

D918

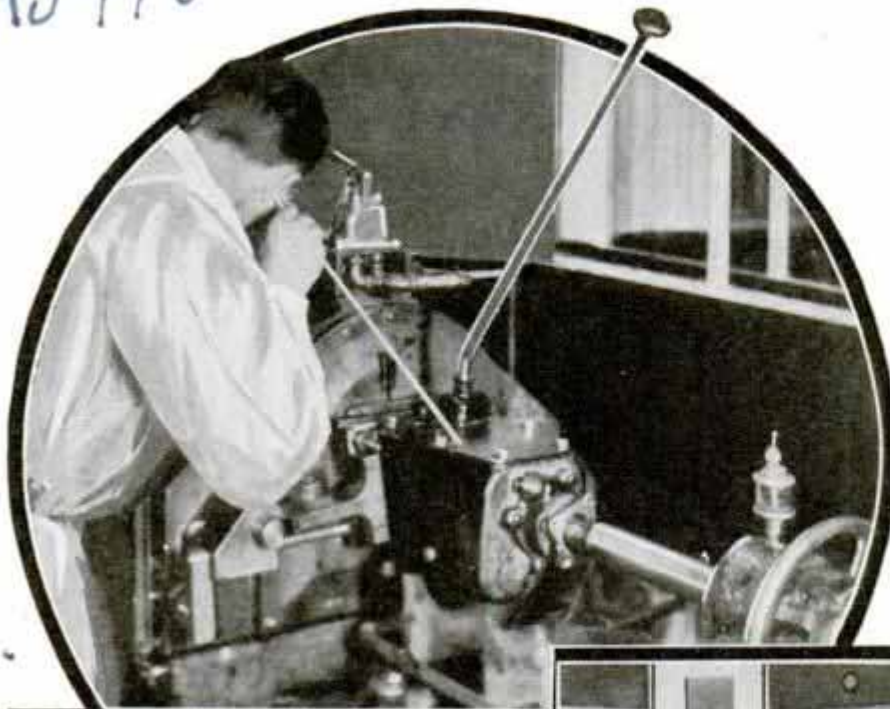

charge being ignited too soon or too late, causing a marked loss of efficiency even though the engine may be in perfect condition otherwise. A weak coil or interrupter points that are burned, incorrectly spaced or out of synchronization will result in incomplete combustion. The gas analyzer reads in terms of the ability of valves, ignition, timing and carburetion to do the job properly. Carburetion is considered

ical changes, but to alterations in the external appearance of the latest creations. Two of the latest cars with lower wind resistance have unusually accessible engines because the hood raises as one piece and lifts well out of the way of the mechanic working on the motor. With these cars it no longer is necessary to drop one side of the hood to lift the other. Especially interesting is the method of getting at the valve compartment, which is reached by removing a cover plate under the right front fender.

Carburetor adjustments are now being amplified by checking the quality of exhaust gases. With the engine running, the analyzer is attached to the tail pipe and the indicator is watched carefully. Contrary to popular belief an over-rich mixture is not viewed immediately as due to the carburetor. Spark plugs with deteriorated points that greatly increase the gap, for instance, cannot burn the standard charge of fuel as introduced by a correctly adjusted carburetor. If gum formations prevent valves from seating properly, fuel cannot be compressed to the desired explosive limit and the exhaust will show too much unburned fuel. Incorrect timing results in the gas

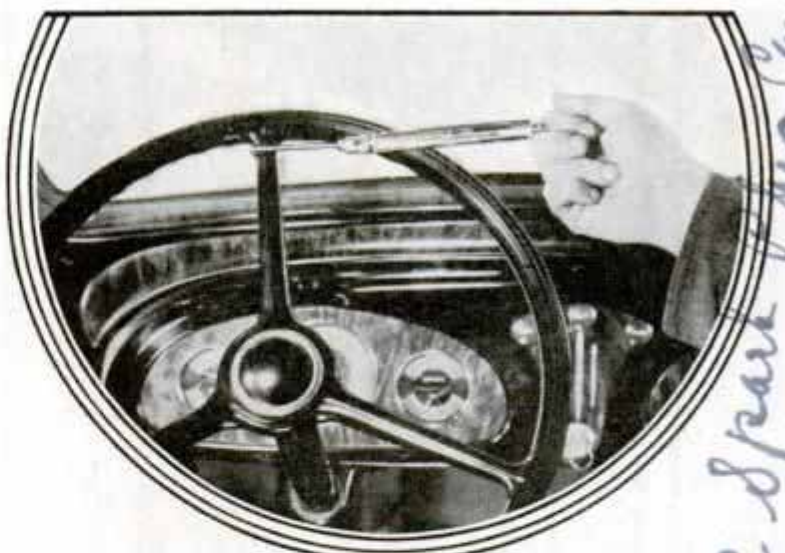
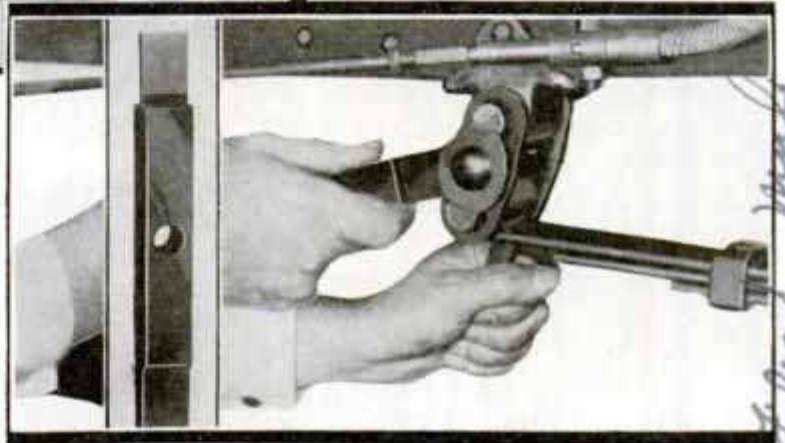

Top, Stethoscope Used to Detect Transmission Noises; Center, Gauge for Self-Adjusting Shackles; Bottom, Gauge Tests Effort Required to Turn Steering Wheel

last because it is usually least to blame. Because the modern fuel pump is such an important feature of any motor's efficiency many service men are now using a special pump analyzer with a gauge giving precision reading at as low pressures

Charles Englehart, Newark, N.J.

AC Spark Plug Co. Dept., Newark, N.J.

test - ac spark

signature

Moto. Sewing Corp
769 Albany Ave
Brooklyn, NY
D 947

as one to five pounds per square inch. All tests are made under actual operating conditions.

Testing the efficiency of spark plugs while they are in operation on the engine is another of the modern steps in service. Unique among the new devices is one that sways the car from side to side while it is being lubricated. Since this imitates actual driving conditions over a rough road it is a short cut to the cause of squeaks.

An amazing amount of new equipment has come on the market to provide ways of keeping cars in alinement. Axle presses, frame straighteners, wheel balancers, wheel aliners and tracking gauges are among the assortment of devices to keep

(Continued to page 128A)

BOULDER DAM RISES RAPIDLY FAR AHEAD OF SCHEDULE

Two years ahead of its scheduled progress, Boulder Dam is rising rapidly. More



© International News Photo
Dotted Line Shows Work Yet to Be Done on Boulder Dam, While Below Is the Completed Section

than 460 feet of concrete have been poured above the foundation, with the completed dam to be 267 feet higher.



Emptying Garbage Can into Loading Receptacle; the Larger Garbage Container Is Water and Air Tight, Preventing Escape of Odors

ODORLESS GARBAGE TRUCK IS MORE SANITARY

Garbage collection trucks which do not advertise their presence by their odor are being operated in Indianapolis. The truck itself drives through all four wheels, has a rated capacity of one and one-half to two tons and is equipped with both standard and auxiliary transmissions, giving it a total of eight forward speeds and two reverse. The body is operated hydraulically by the truck engine. On the rear is a loading receptacle holding three-fourths of a cubic yard. When it is filled, it is automatically raised to the top of the body and dumped in the main compartment which has a capacity of six cubic yards. The entire body is both water and air tight. When closed, there is no odor. The entire body is raised by a slant type hydraulic hoist for emptying the main compartment.

Popular Mechanics Magazine does not publish the name of the maker of, or dealer in, any device described in its pages, but this information will be furnished by our Bureau of Information upon request, accompanied by stamped, self-addressed envelope.

Maber } marmion-depington
Co. 1001 York
Indianapolis, Ind.

D993
732

Models Show Wind Resistance of Skyscrapers

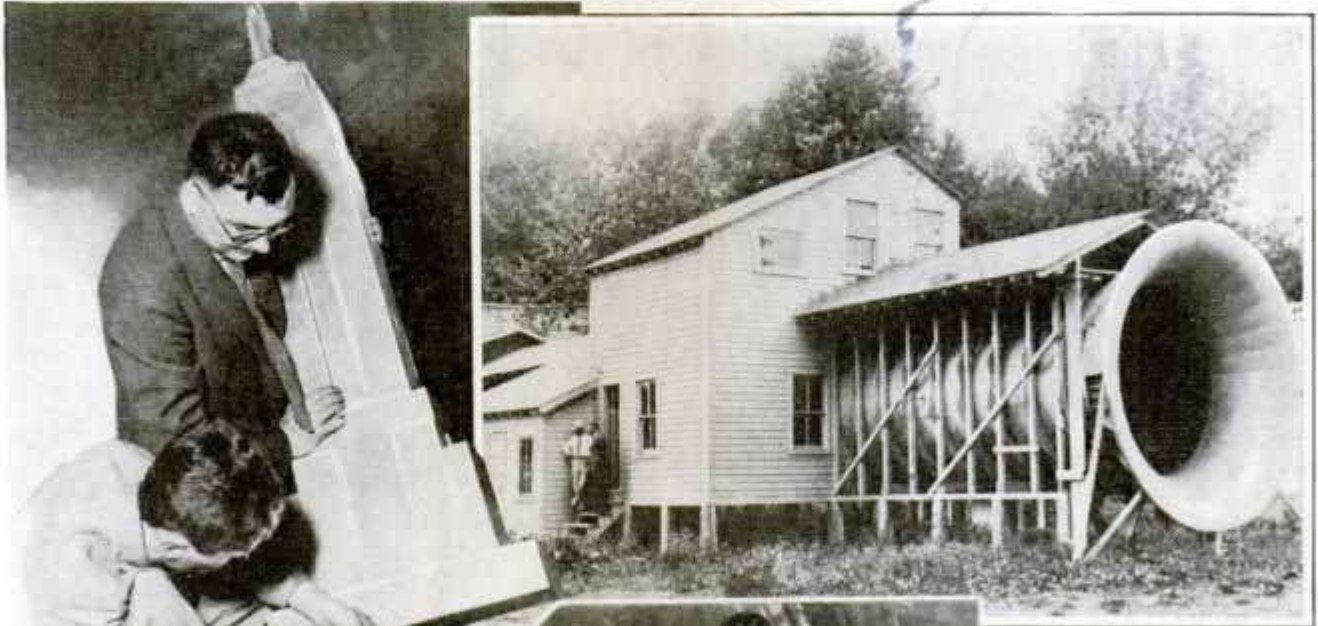

Top, Left, Model of Skyscraper; Right, Wind Tunnel for Tests; Bottom, Model Undergoing Tests in Tunnel



Wide World

An important factor which must be taken into consideration before construction of a skyscraper is started is wind resistance. To determine this accurately, models of skyscrapers are made and tested in a big wind tunnel at the bureau of standards in Washington. The resistance to the air as it blows against the upper part of the building is then measured by means of small rubber pipes leading from the model to registering apparatus. In this manner the swaying or rocking of any building can be determined before it is built and changes made in plans.

changes from red to green, or back again, the white-beam indicator moves around the edge of the red or green signal face in the manner of a clock's hand. When it completes the circuit, returning to the same position that "twelve o'clock" has on the clock, the signal changes to the opposite color.

By watching the moving white beam, automobile drivers and pedestrians time the period remaining before the signal will change. The signal lamp has only four

faces, one in each direction, instead of the twelve used in some types of signals. The familiar amber signal is eliminated. Thus, with the red signal showing against north and south traffic, the green light permits traffic east and west. One bulb lights the signal lamp.

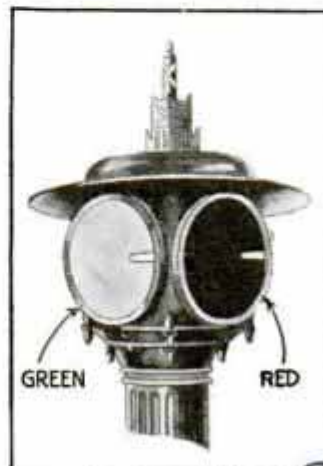

TIME BEAM IN TRAFFIC SIGNAL WARNS OF LIGHT CHANGES

Accurate timing of stop and go periods at street intersections is accomplished in an economical traffic signal equipped with a white timing beam. As the traffic light

D977

Robert J. Puths, 3204 Parkside

Vertical handwritten notes on the left margin, including "D993" and "732".

LAWN ROLLER WITH SPIKES IMPROVES THE GRASS

Lawns and golf courses can be kept in condition with the aid of a hollow spike roller which can be operated by hand or by power. It is equipped with hollow spikes two inches long and three-fourths of an inch in circumference at one end, tapering to one-half inch. As the roller moves over the turf, the spikes cut a plug of soil which is deposited inside the roller as it revolves. A clean-cut depression is left in the ground and the soil is removed in such a manner that none is spilled over the grass. When the container is filled, it is emptied by removing side plates. Following the use of the roller, top dressing and fertilizer are applied, these reaching the roots, where they will do the most good, through the spike holes. It is also claimed the roller tends to make the turf springy and the depressions enable water to penetrate more easily.



Roller with Spikes Cuts Small Holes in Lawn to Make Cultivation of Grass Easy

MONOGRAMS ETCHED ON GLASS BY EASY METHOD

Letters and numbers can be etched on beverage sets and other glassware by an easy method devised for use in the home. It consists of cementing prepared letters

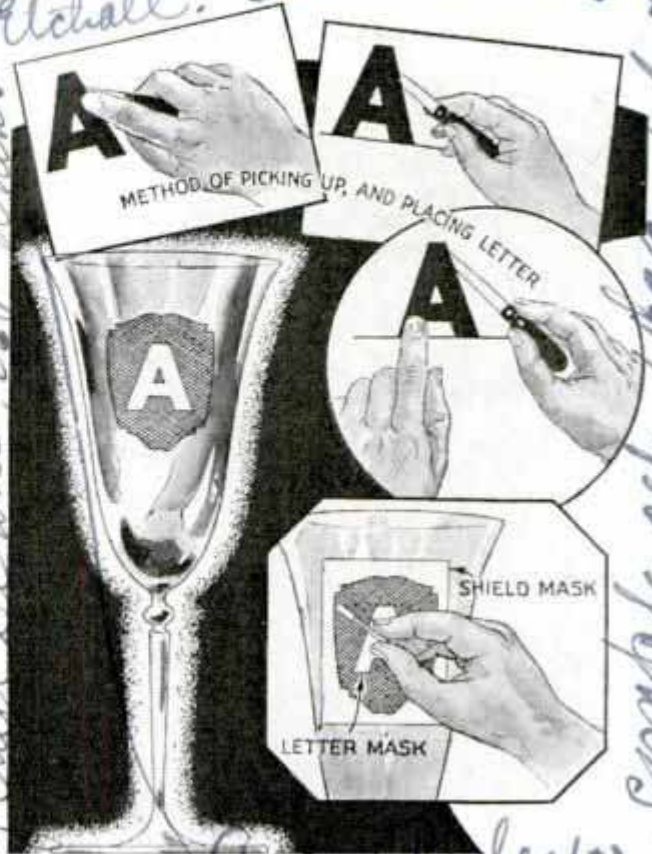

Four Steps in Etching Monogram on Glass; Left, Beverage Glass with the Monogram in Place

and numbers on the glass, followed by the application of a special etching cream. The process requires only about five minutes for the etching cream to take effect, after which both cream and paper letters and numbers are removed from the glass. Monograms may be applied on auto windows or windshield by the same method.

SILENCER SCREWS ON HAMMER TO REDUCE NOISE

Equipped with a screw-on silencing device, an improved hammer makes little noise when in use. The silencer consists of a steel-capped rubber disk that screws on the threaded head of the hammer. The tool can be used with or without the silencer.

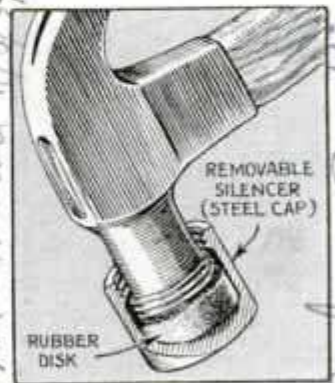

A new method of reading fingerprints enables the expert to tell something of the race of the person who made them.

Long acres Country Club Trenton, N.J. resident manager 1995

one consolidated corp 70 Pine St. New York N.Y. cat. 10cents
complete set. large set Elchall. 2 doz monogram 1.00
John B. New-lab. Jr 29 Virginia Ave.
not on market 11/5/34
Sold by Elchall to Elchall

British Cup Challenger Has All-Steel Hull

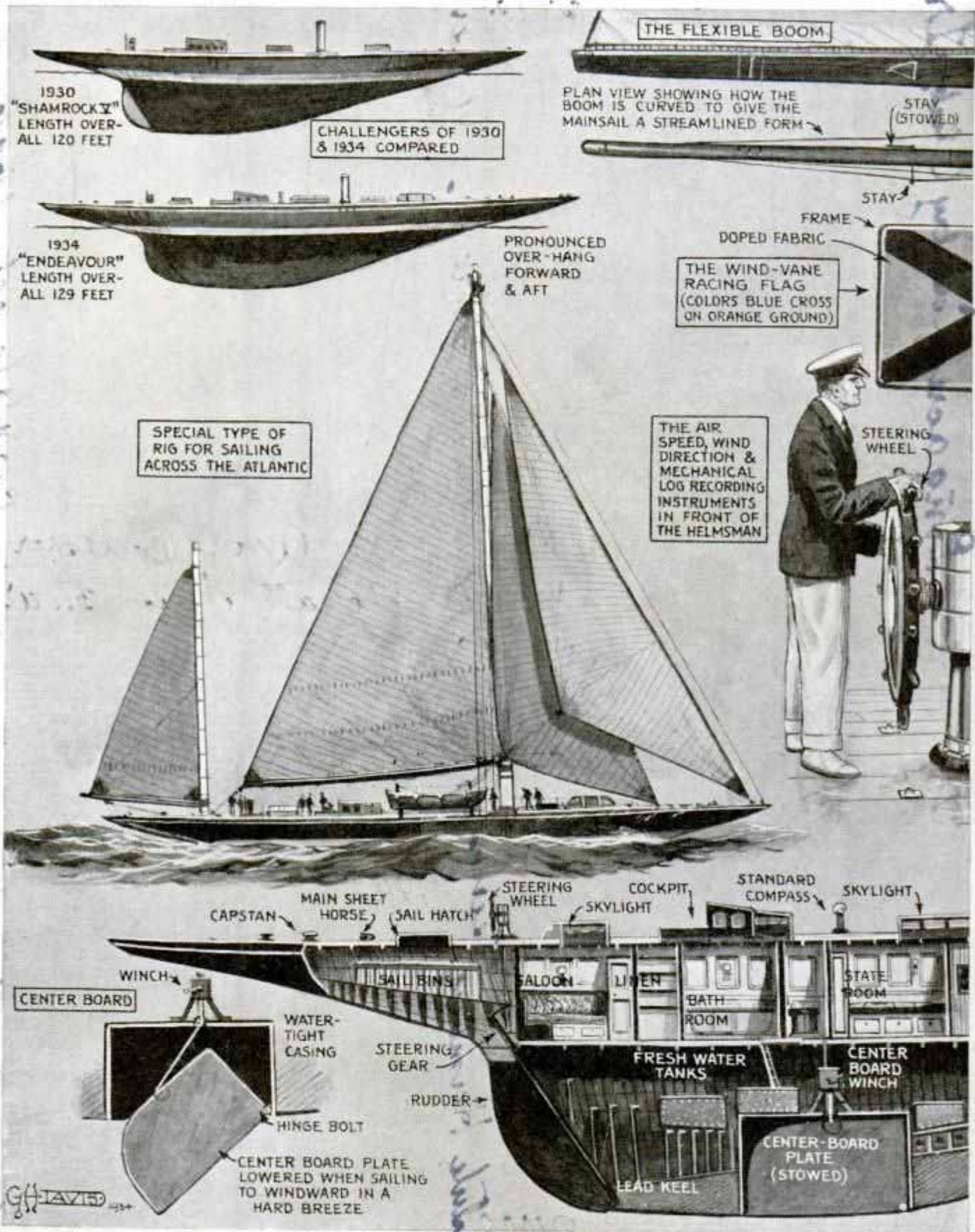

During More Than Eighty Years British Yachtsmen Have Made Fourteen Unsuccessful Attempts to Wrest the World's Premier Yachting Trophy from This Country; Diagrams Show Details of Construction of the "Endeavour," England's 1934 Challenger; Note the Pronounced Overhang Forward of the All-Steel Hull and the Flexible Boom Which Bends with the Curve of the Mainsail and Sets This Sail into a Streamline Form to Lessen Head Resistance; This Is the First British Challenger to Have an All-Metal Hull and the Construction Cost Was About \$150,000

Rep. Lintner's Hillside Road, Ewell

J. W. M. D. Parker

D952
735

Flexible Boom Sets Sail in Streamline Form

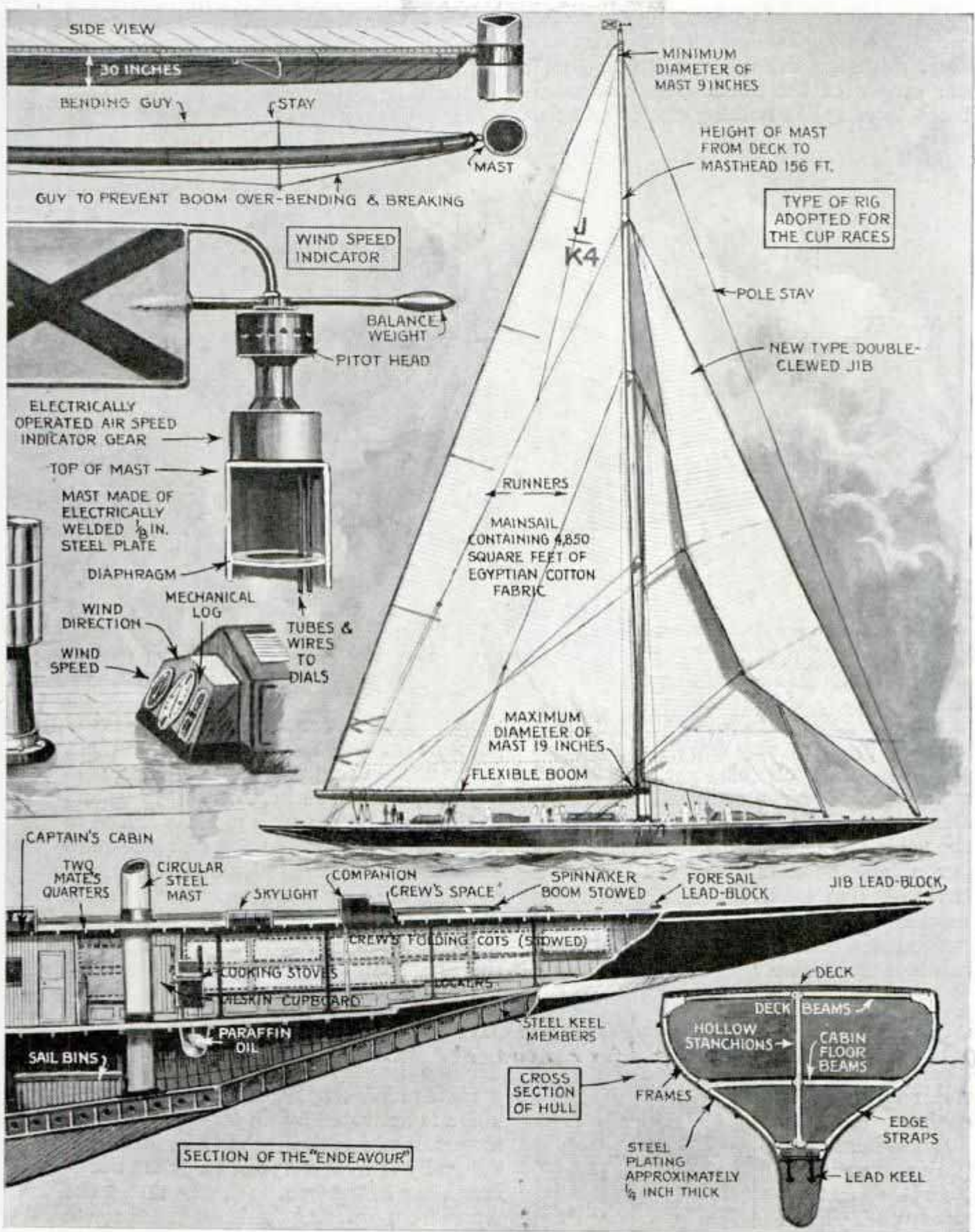

The "Endeavour's" Circular Mast, Weighing More Than 5,500 Pounds, Is Built Up of High-Tensile Steel Plating, One-Eighth Inch Thick and Electrically Welded; the Cutter Has a Racing Flag of Doped Canvas on a Tubular Frame and This Is Mounted on the Masthead on Ball Bearings and Connected with Recording Instruments Giving Wind Direction on a Dial Placed Before the Helmsman; There Is Also a Mechanical Log and a Wind-Speed Indicator Which Operates on Lines Similar to the Air-Speed Indicators with Which Aircraft Are Equipped

Long Wheelbase Truck Paints Road Stripes

When you overtake a lean, long, narrow car with a wheelbase of twenty-four feet, don't misjudge the driver for "hogging" the center of the road. The elongated truck, looking like nothing else on wheels,

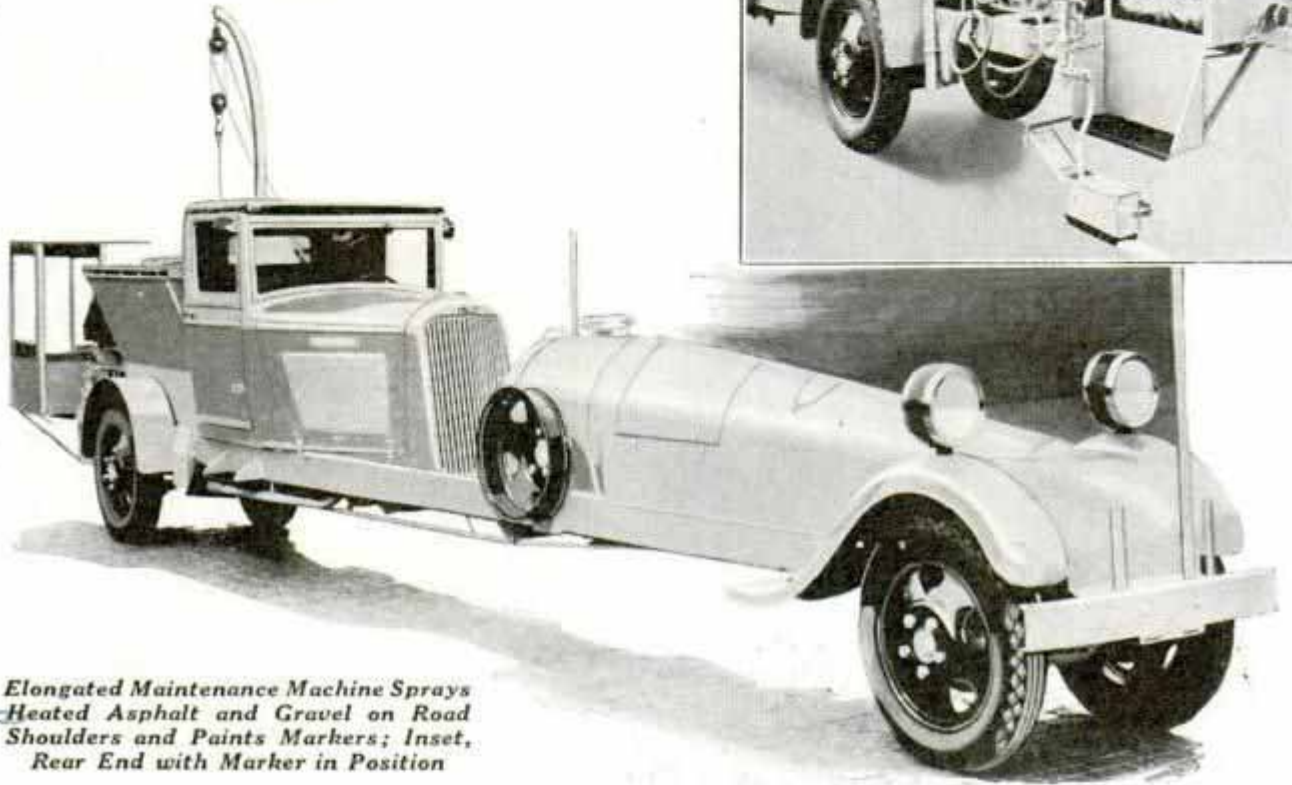
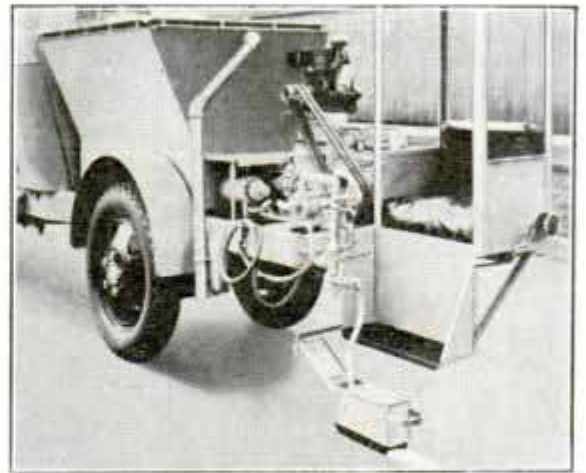

Elongated Maintenance Machine Sprays Heated Asphalt and Gravel on Road Shoulders and Paints Markers; Inset, Rear End with Marker in Position

is used in Indiana to paint the white or yellow stripes running down the center of the road and it can also sprinkle heated asphalt and gravel on road shoulders. Despite the long wheelbase, the tread of the vehicle is only thirty-six inches. Under a long hood in front are housed a twenty-gallon kerosene tank, a standard gasoline tank, a tool box and a seventy-five gallon asphalt tank. Back of the truck cab is a 165-gallon fuel tank for heating

asphalt. In the rear of the frame is a small gasoline engine for driving an asphalt pump as well as a compressor for supplying air pressure to kerosene burners and to the tank from which paint is forced to the paint spray box at the extreme rear. There are two masts to aid the driver in steering a straight course. The vehicles are said to steer easily despite their great length. Road marking is speeded up through use of the odd-looking trucks.

Sewer Valve Stops Water from Backing into Basement

Sewage and flood water are prevented from backing into the basement of the home if the residence is equipped with a sewer valve which is operated by the back-flow. It is contained in a non-corrosive cast-iron box which is attached to the sewer lateral un-



der the basement floor, and all moving parts are of copper or aluminum. The valve is activated by an air-tight float by means of which the gate is brought automatically to a closed position as the back-flow rises in the box, thus preventing the water from entering the basement through the floor drain. The valve also is made in larger sizes for street sewers and sluice, river and tide outlets, as well as between settling basins in disposal plants.

Conway Engineering Co. 1338 Second

Dodge Brothers Corp. Div. of Chrysler Motors, Detroit, Mich.

Conway

2998

Little Isairit Backwater Sewer Valve

Penn Electric Switch Co
Les Moines Iowa 1933 Thomas
D949

SENSITIVE SWITCH KEEPS HEAT AT EXACT TEMPERATURE

Uniform temperatures, within one-quarter degree of that desired, can be maintained in the home by an unusually sensitive thermostatic switch now on the market. Instead of reacting to temperature changes in the room, the unit is affected by the normal current flow through the instrument. The heat of electricity passing through the switch causes contacts to operate the heating plant. As temperatures drop, the contacts close and start the furnace. At the same time, electricity heats the thermostatic element. When the element has been raised in temperature to the point set on the instrument, the contacts open and stop the furnace. While the element heats faster than the heating plant supplies warmth to the home, it also cools faster, resulting in more frequent operation of the heating plant, but for shorter periods. This causes a steady heat to be produced, holding temperatures at exactly the degree desired and eliminating those



Switch Installed Just above Baseboard; Inset at Top, Closeup of Thermostatic Switch

periods of under and overheating when the plant lags far behind the control system. Mounted near the baseboard, the unit catches the downward drift of room temperature sooner than the occupant.

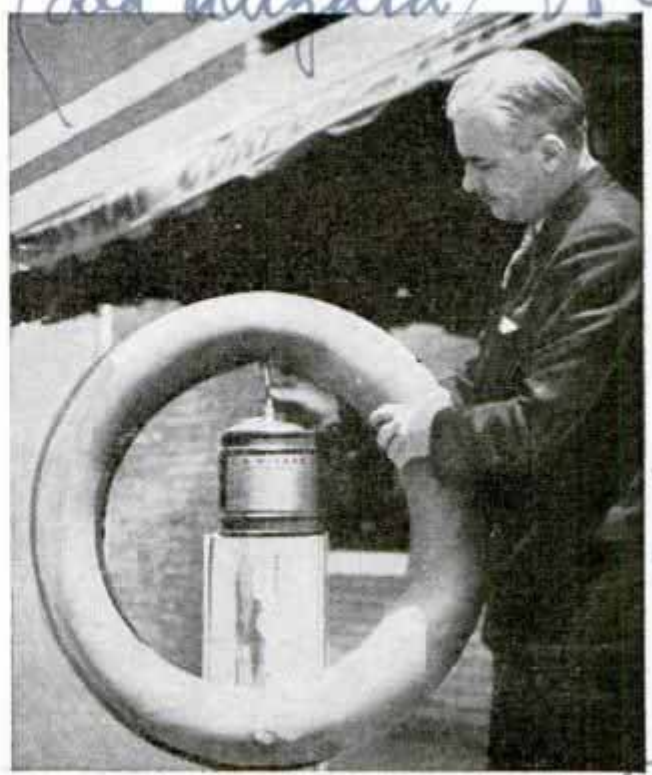

Equipment for Inflating Inner Tube with Reddish Vapor to Reveal Punctures

INNER TUBE LEAKS REVEALED BY RED VAPOR "GUN"

Leaks in inner tubes may be detected easily with a device that sprays a fine vapor into the tube, coating the inner surface. Wherever there is a leak, a moist red spot appears on the outer surface. The device is especially effective on tubes with high-pressure leaks and on porous tubes. It is attached to the regular air line of the service station. Its capacity is one gallon of special fluid.

AUTOMATIC LOCK NUT HAS PIN TO PREVENT LOOSENING

Designed to fit any standard thread, an automatic lock nut has a pin that prevents vibration and shock from loosening the nut. The pin is engaged by the thread of the bolt, following the thread at an angle. The nut can be put on and taken off like an ordinary nut without impairing the thread on the bolt. Nut and pin are manufactured in a single unit.



Automatic Nut Co

Pilot Day Corp
3210
Los Angeles

DP-68

LATEST HOME



Love Seat with Permanent Back and Arm Which Unfolds to Become a Standard Size Bed with a Full Inner-Spring Mattress; Note How Seat Section Is Pulled Out



Above, Screw-Shaped Prong Like a Cork Puller for Lifting Pickles and Olives from Bottles with Narrow Necks; Below, Metal Handle with a Suction Cup on the End Which Makes a Sandwich Tray out of an Ordinary Plate; It Can Be Attached or Removed in an Instant



Small Electric Refrigerator Which Opens at Top Like a Chest; It Contains More Than Four Square Feet of Storage Space and the Racks in the Recessed Door Are Handy for Storing Small Food Articles



ACCESSORIES



Left, Sewing Bag with Folding "Legs" Which Hold It Open on the Table; Right, Transparent Tissue Disks Which Seal Jars of Jams or Jellies without Use of Paraffin or Metal Tops; the Seals Are Attached with Rubber Bands



Above, Auto Seat for the Baby Which Is Held in Place with a Safety Strap and Has Comfortable Foot Rest and Arm Supports

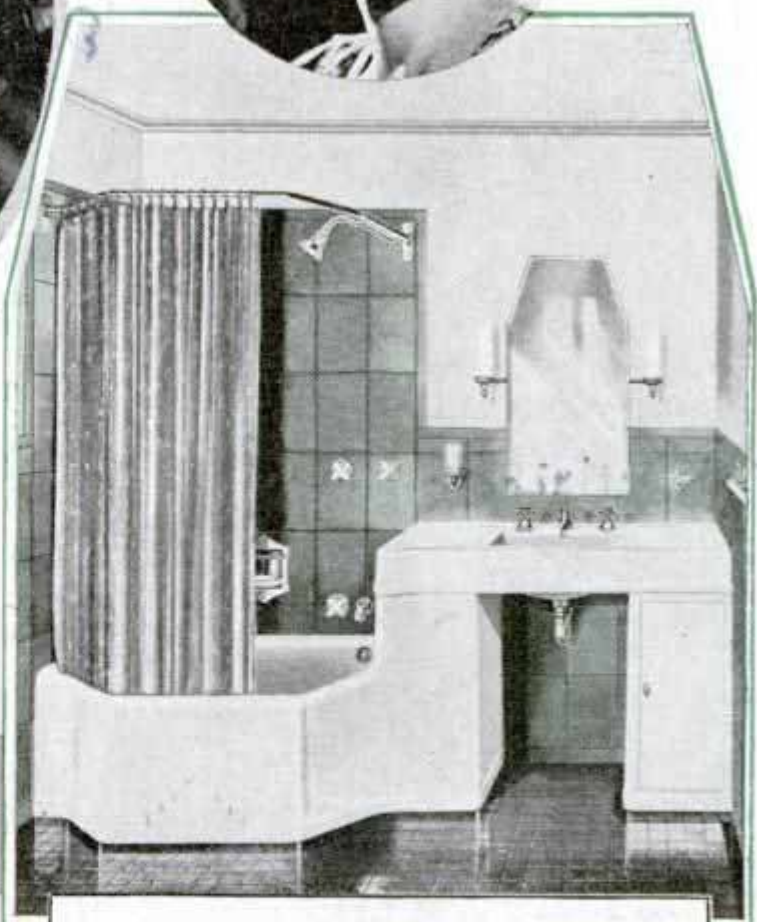

Left, Dial Instrument Which Shows Both Temperature and Humidity of Air in Room; Above, Washstand and Bathtub in One Unit; Note Cabinet in Stand and Small Space Occupied



49th and Harrison
Pittsburgh, Pa

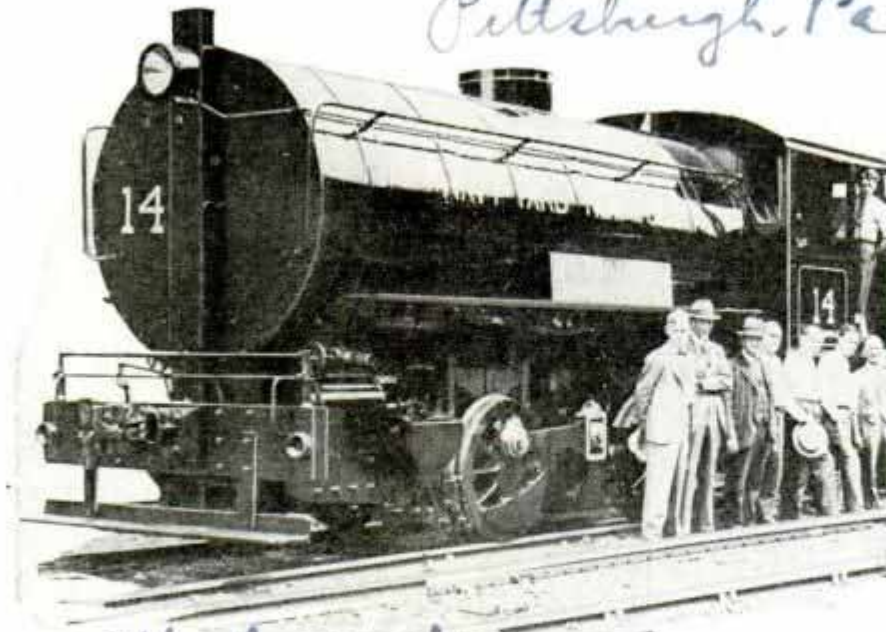

Wide World

Fireless Geared Locomotive Whose Tank Is Charged with Enough Water and Steam from a Stationary Boiler to Operate for Several Hours

FIRELESS GEARED LOCOMOTIVE IS CHARGED WITH STEAM

Switching in the Brooklyn navy yard is now being done with a big fireless geared locomotive whose tank is charged with water and steam from a stationary boiler. The engine runs for several hours on a single charge, and with an initial steam pressure of 200 pounds, it can be operated without loss of pulling power until the pressure is below fifty pounds. Charging takes about twenty minutes, less time than is required for taking coal and water on an ordinary steam locomotive.

SHOW CARD LETTERING GUIDE MAKES PRINTING EASY

D940

Mexico: \$8.50



Lettering Guide Outfit Helps Novice Print Attractive Display Cards

Attractive window cards, counter cards and price tickets can be turned out by the novice with the aid of a lettering guide

Warren. Knight Co

which requires neither skill nor experience to operate. The outfit consists of a metal lettering board with a clip at the top to hold the cards in place, a stencil containing the alphabet in letters three-quarters of an inch tall and another stencil to make numerals one inch tall, jars of paint in five colors, a special brush pen for printing, a water jar, stirring rod and an assortment of cards with art borders. The set can also be used for bulletin board work and for all kinds of display signs and notices. The brush pen is used by pushing down the top and dipping the extended portion into the paint. When the pressure is released, the pen goes back into position and the paint is held in a reservoir and fed automatically.

D935

SPRING SEAT FIRESIDE STOOL MADE FROM OLD TIRES

Comfortable fireside stools large enough to seat two or three people are being made from old automobile tires and coiled springs taken from old seat cushions. Three old casings of the same size are bolted together with short bolts at several points on the sides of the tires. Boards are cut to fit the top and bottom and bolted to the casings after the center is filled with the springs. The top board is then padded and covered with tapestry or other bright cloth which is draped over the sides to conceal the tires.



Popular Mechanics Magazine does not publish the name of the maker of, or dealer in, any device described in its pages, but this information is kept on file and will be furnished by our Bureau of Information upon request, accompanied by postage.

Made by Howard Cole
Knox 3746 Filson



How to Build an AMPLIFIER RACK

By FRANK L. BRITTIN

THIS general-purpose rack can be built with few tools and the dimensions may be altered easily to suit individual needs. Construction details are quite simple and the cost is within the reach of average experimenters. The rack shown in the photo may be used to house a complete public-address amplifier including a phonograph turntable. It is also suitable for an amateur transmitter or a speech amplifier of the 3-unit type, described in the October issue, with ample room below for a modulator unit. Smaller table-type racks

(Continued to page 120A)

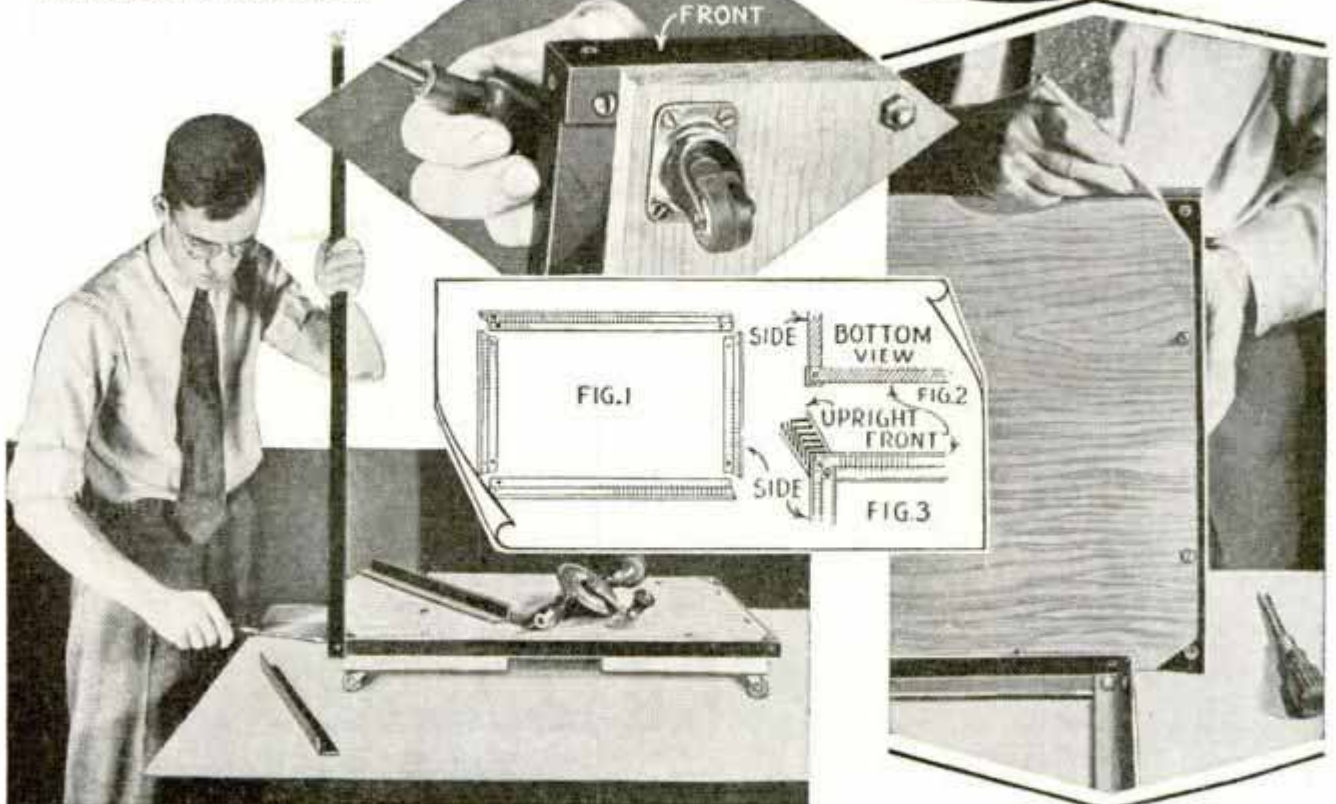



TWO-WAY

By F. C. JONES and W. F. MARSH

SIMPLICITY is the keynote of this inexpensive one-tube combination phone transmitter and receiver designed for the 5-meter amateur phone band. Although the 5-meter signals, sent and received with this transceiver, are useful over only a few miles, the band is not crowded and there is a thrill in using radio phone even though the other station is only a few houses away.

The type-19 tube employed operates on two ordinary No. 6 dry cells and a bank of either three or four small 45-volt B-batteries.

The plywood base is $\frac{3}{8}$ by 12 by 17 in. Two bakelite panels, Figs. 2 and 3, are mounted 6 in. apart, by means of small angle brackets. The schematic diagram is given in Fig. 1 and the simplified wiring diagram is shown in Fig. 4. If the builder desires to make the rig more compact, the baseboard may be smaller and two fahnestock clips, for the dry cells, mounted at any convenient point so that all batteries can be housed in a separate box. This arrangement is shown in a photo on another page.

A hole, 1 in. in diameter, is cut in the rear panel for the tube-socket leads and the 6-prong socket is mounted directly over this hole. The plate coil

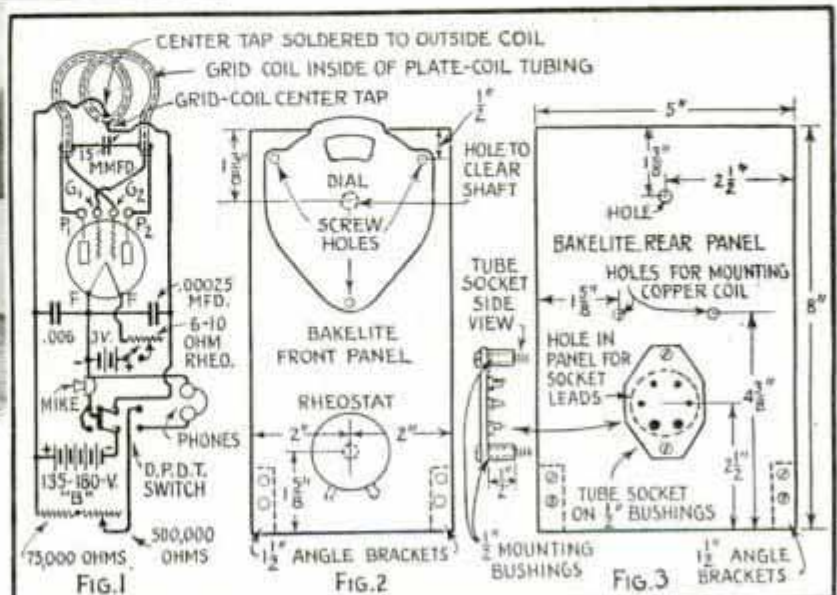
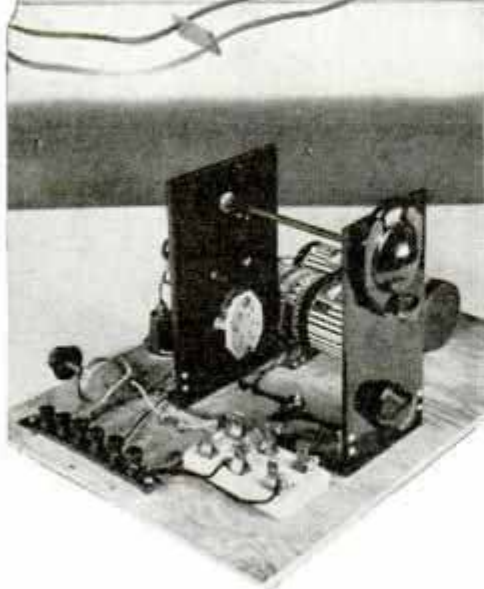
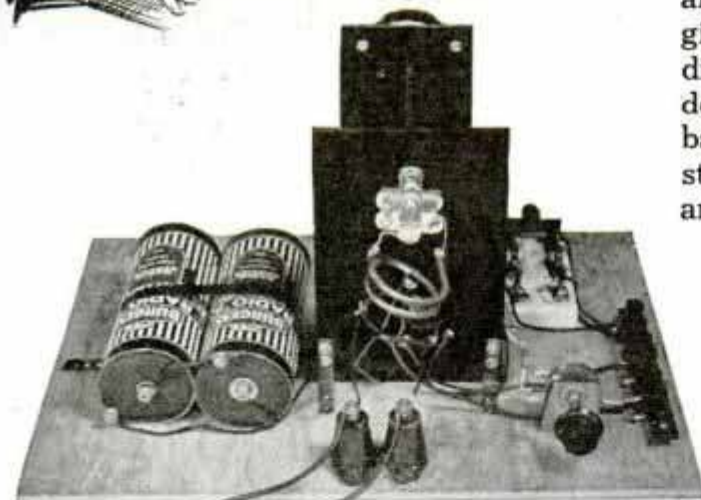

FIVE-METER PHONE for Beginners



consists of two turns of $\frac{3}{16}$ -in. copper tubing that is easily wound on a form $1\frac{5}{8}$ in. in diameter. A hole is cut in the exact center of this copper coil with a file, so that the flexible insulated wire for the grid coil, inserted inside, may be brought out for its center tap. Tape the soldered center-tap grid-coil connection carefully so that it will not short on the copper coil. The ends of the copper coil fit tightly in the holes drilled in the rear panel and extend through the panel. The variable condenser



(Continued to page 124A)

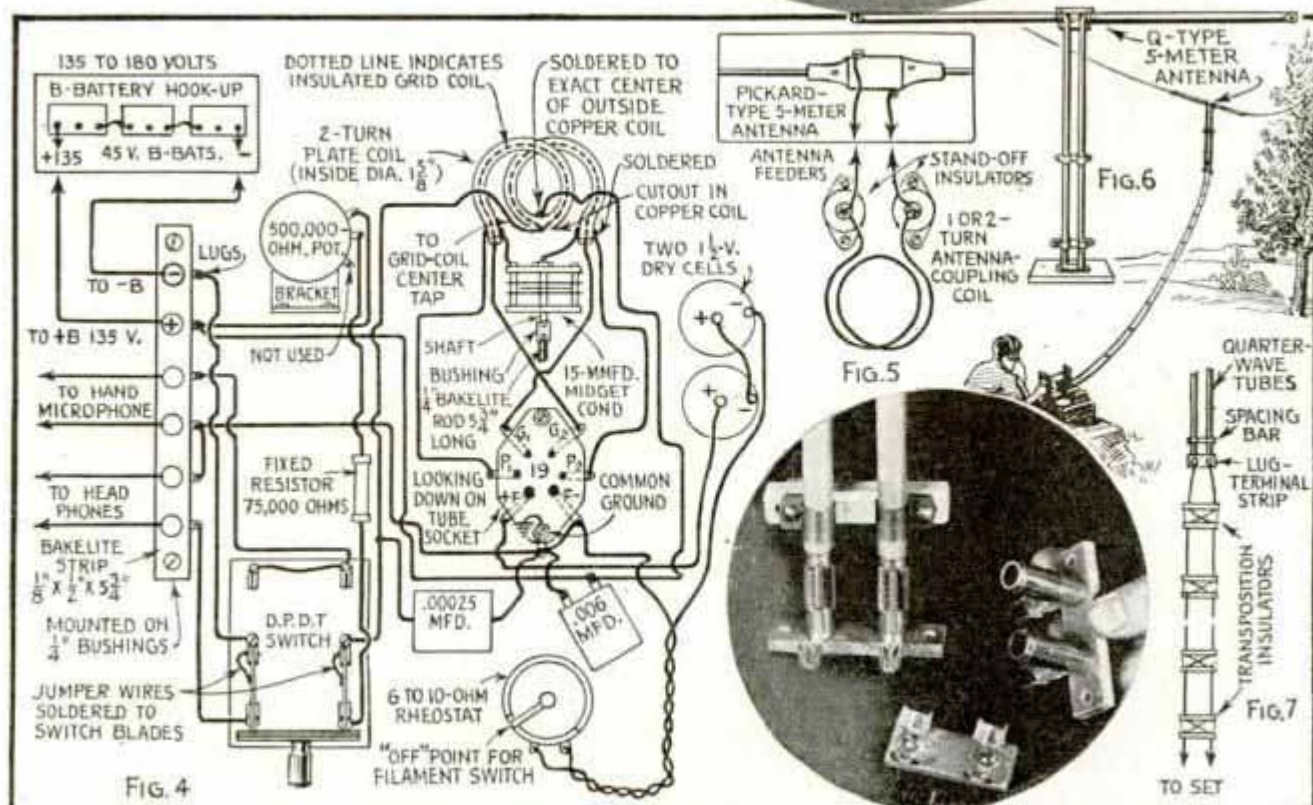

Low-Cost Power Unit for Cathode-Ray Tube

By EDWIN EWING

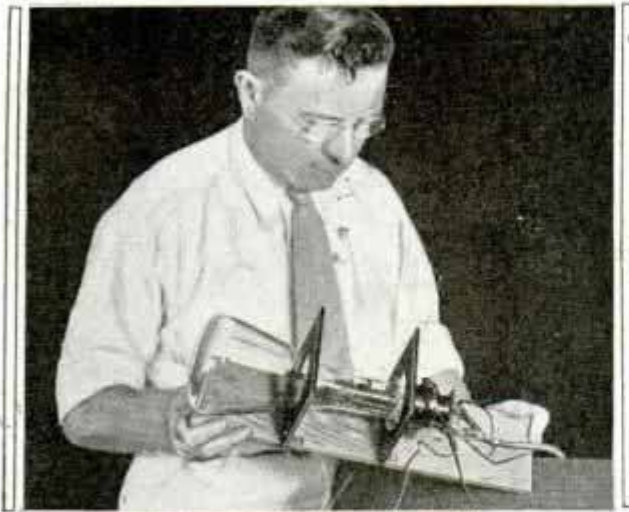

NOW that reasonably priced cathode-ray tubes are available, an entirely new field has been opened for the amateur experimenter. Service men also are provided with the means for constructing a useful oscilloscope previously found only in large laboratories. The purpose of this article is to describe an inexpensive power unit suitable for most of these tubes.

A voltage-doubling system of rectification is employed, which permits the use of low-voltage filter condensers and rectifier tubes. The transformers are ordinary broadcast types and all parts, with a few exceptions, can be salvaged from old receivers. The wiring diagram is given in Fig. 1. The cable, tube and vertical-amplitude transformer are shown in Fig. 2. As the tube-socket connections given are for an experimental cathode-ray tube, they will vary slightly for the RCA type-906, and Dumont tubes, which do not have external-clip connections on the base.

(Continued to page 122A)

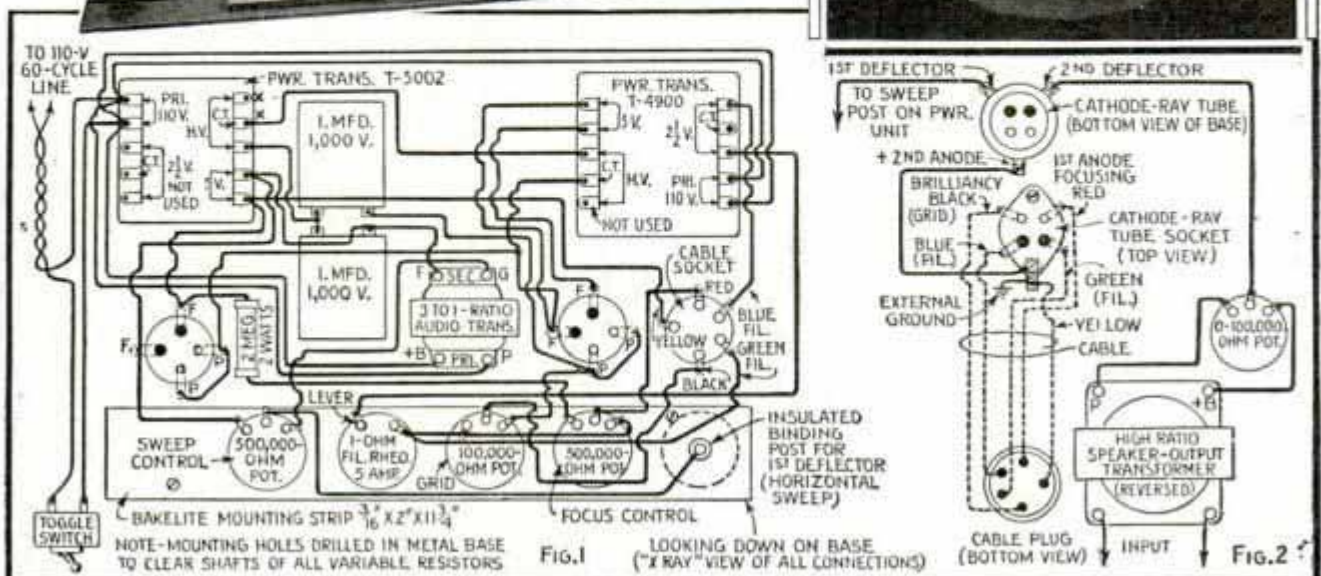
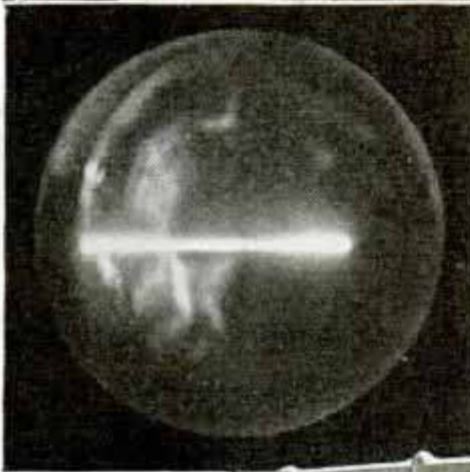

Practical RADIO SUGGESTIONS

BLADE CLAMPED BETWEEN BLOCKS OF WOOD

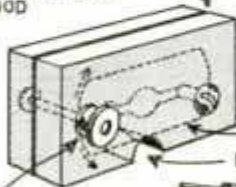

THUMBNOT FOR ADJUSTING DEPTH OF CUT

Insulation Trimmer, Made from Old Razor Blade, Adjustable for Depth of Cut

RAZOR BLADE

NOTCH CUT IN BLOCK TO FIT DIAMETER OF INSULATION ON WIRE



Right, Fly Cutter for Use in an Ordinary Bit Brace

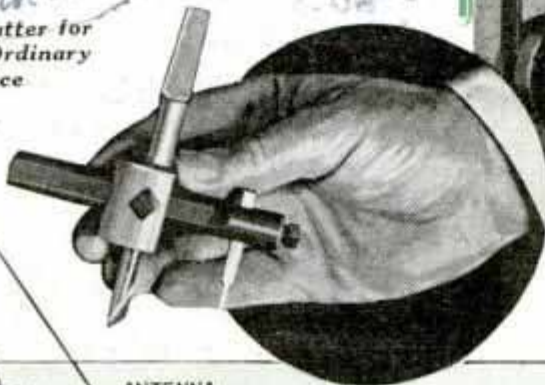

Above, Cutting Large Holes for Mounting Tube Sockets and Other Parts on Metal Bases; Adjustable Fly Cutter Has Round Shank That Fits Hand or Power Drills

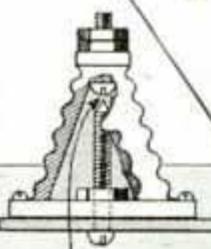

ANTENNA LEAD-IN

SAFETY GAP FORMED BY POINTED END OF MACHINE SCREW WHICH IS GROUNDED ON METAL STRIP

BRASS STRIP

TO RECEIVER

PORCELAIN STAND-OFF INSULATOR

TUBULAR INSULATOR

GROUND ROD

Right, Duplex Receptacle, with Bakelite Cover, Is Easily Mounted on Workbench, Receiver Cabinet or Amateur Apparatus for Convenient Power-Line Outlets

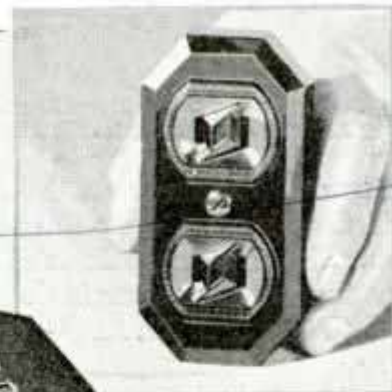

HANDLE MADE FROM STRAP METAL

TOGGLE SWITCH GUARD

WIRES ENTER BOX

PORTABLE RECEIVER OR TEST SET

Combination Ground-Rod and Lightning Arrester Keeps Lead-In Taut; Below, Jack Terminals for Several Receivers on Single Antenna; for Different Antenna Combinations Use Bakelite Strip

TO SET

TO ANTENNA LEAD-IN

METAL STRIP

ADDITIONAL PIN-JACK

PIN-PLUG

PIN-JACK

SMALL TYPE STAND-OFF INSULATOR



Above, External Switch for Portable Apparatus; Left, Handy Continuity Tester Has Flash Lamp Mounted on Test Prod; Small Battery Fits in the Pocket

*Radio City Products
Middle States Electric Co
560 W. Monroe, Chicago*

Radio City Products

Metal Detector Weighs Less Than Ten Pounds



This compact metal locator consists of an exploring coil connected to a battery-operated unit with a length of cable. The coil and flexible cable enable the operator to explore the face of a cliff, or old mine shafts, without leaving the top level. The meter



Above, Portable Metal Locator Showing Coil and Indicating Meter; Below, Exploring the Face of a Cliff

is adjusted to a mark on the dial and the coil is then moved over the suspected location. The presence of metal is indicated when the meter pointer is deflected to the left. The coil is 28 in. in diameter

Antenna Eliminator Also Serves as Wave Trap



Equipped with tunable coils and condenser, this antenna eliminator is claimed to improve selectivity and enable the owner to use any receiver without the usual antenna. It may also be employed as an ad-

juster to regulate a standard outside antenna for all-wave receivers, or as a wave

trap, to tune out interfering stations. The connections to the receiver are quite simple and can be made by any set owner.

Portable Meter Has Hinged Mounting



A sturdy hinging arrangement is used to raise or lower this meter until the desired reading angle is secured. This enables the experimenter, or service man, to keep the scale within the line of vision without moving from his working position.

Inexpensive Remote Control Is Easily Installed

No complicated mechanical connections or electrical contacting devices are required for this remote-control unit that may be attached to practically any type of receiver. The control head may be placed 15 feet from the set, which can be tuned either directly or at the remote point.

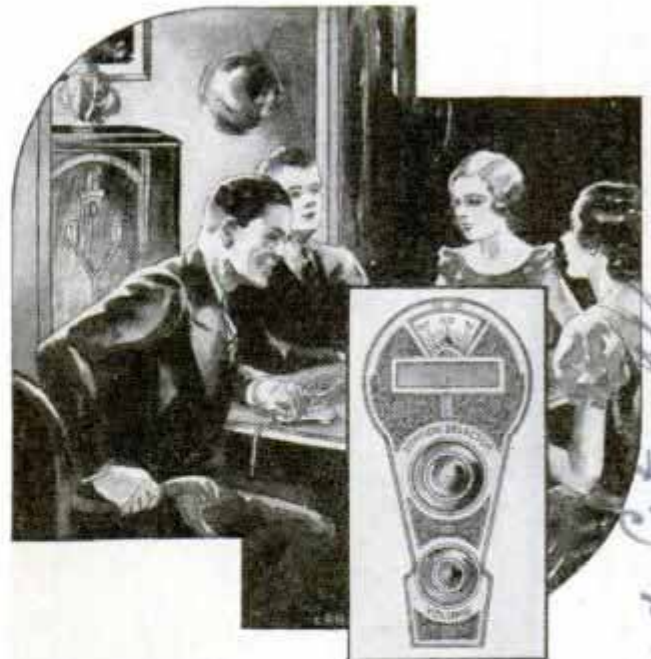

Station Selector and Volume Control Showing Cable Connected to Corresponding Controls on Receiver

Blueprints covering radio construction articles in past issues can be obtained for 25 cents each; when material lists are not included in the articles, these are available without charge on receipt of postage.

Submarine in Mexico

460 3

D4553

D4605

Palmer Electrical D4568
Co 23 d. h. f. Co
Clair Toledo Co.

Direct Electrical
Instrument Co. 10 Suffolk, Calif.
Long Island City, N.Y.

Hada Radio +

AMATEUR MECHANICS

KICKING HOBBY HORSE

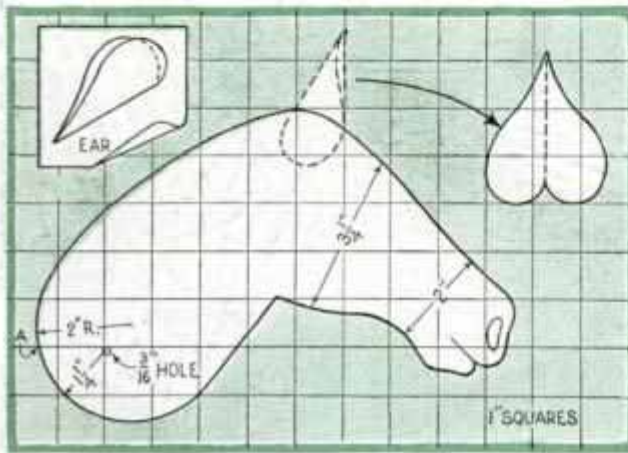

By A. A. STEVENS

WHEN this hobby horse is pushed along, two rods, working on a crank in the rear axle, cause the head to be moved down and the hind legs upward, giving the effect of a horse kicking. It may be built from a few pieces of $\frac{3}{4}$ and $\frac{1}{4}$ -in. lumber, and the rods and tin disks taken from several rolls of roofing paper. A hole is drilled in the neck for a pivot pin and the ears, cut from leather, are tacked on. In assembling the head between the front legs, a $4\frac{1}{2}$ -in. coil spring is attached to keep the head erect. The front legs are separated by blocks a trifle thicker than the head, allowing it freedom of movement. The upper block projects above the top of the legs and is fitted with a piece of dowel rod to form handle bars. A flat-iron hinge, parts of which are joined by a pin, connects the front leg and head assembly to the body, permitting the horse to be turned in either direction. The rear legs are pivoted to the body, one on each side, using a suitable bolt with washers between legs and body. Iron rods, $\frac{1}{4}$ in. in diameter, are used for the axle, bracing

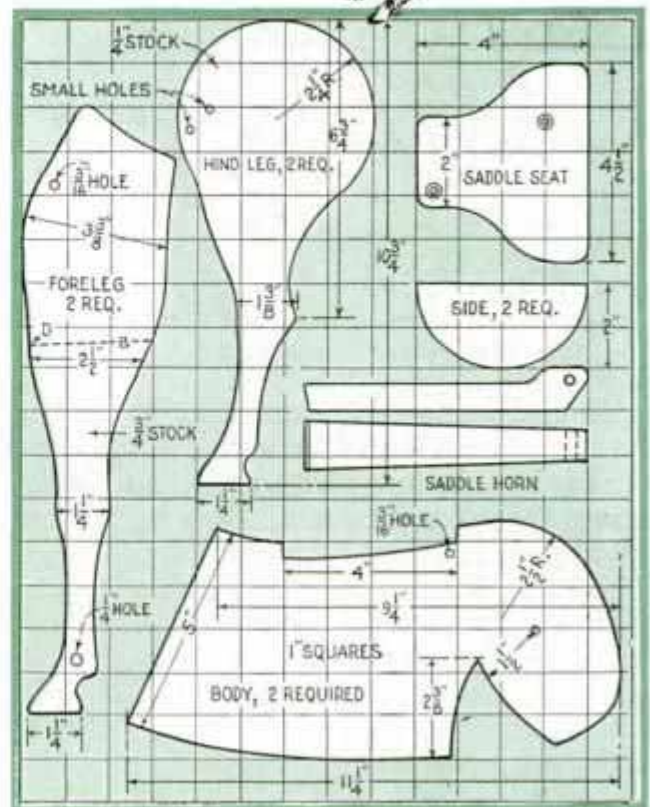

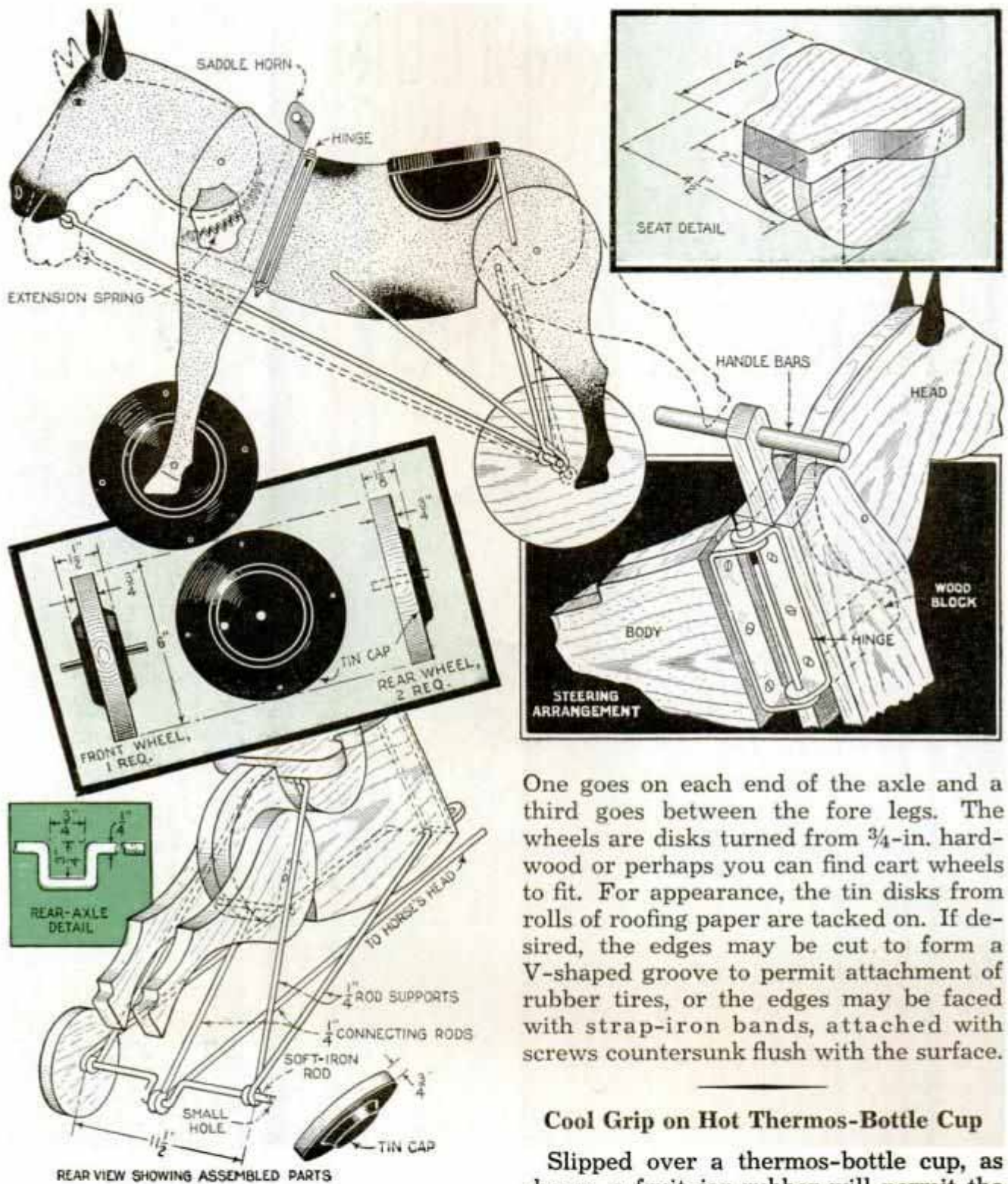

rods and connecting rods that move the head and hind legs. The crank at the center of the axle takes both connecting rods; one attaches to the head, just under the mouth, and the other goes to the hind legs. The latter has a crosspiece welded on, to fit holes in the legs. Four brace rods extending from the body hold the axle in position. Two of these hook into the body just behind the seat and another pair are attached to the forepart of the body, near the lower edge. Wheels are then fitted.

One goes on each end of the axle and a third goes between the fore legs. The wheels are disks turned from $\frac{3}{4}$ -in. hardwood or perhaps you can find cart wheels to fit. For appearance, the tin disks from rolls of roofing paper are tacked on. If desired, the edges may be cut to form a V-shaped groove to permit attachment of rubber tires, or the edges may be faced with strap-iron bands, attached with screws countersunk flush with the surface.

Cool Grip on Hot Thermos-Bottle Cup

Slipped over a thermos-bottle cup, as shown, a fruit-jar rubber will permit the



handling of hot coffee with less danger of burning your fingers. The ears of the rubber form contacts for the finger ends, keeping them from direct contact with the hot cup. The rubber is easily kept clean.

Photographic CALLING CARDS ..

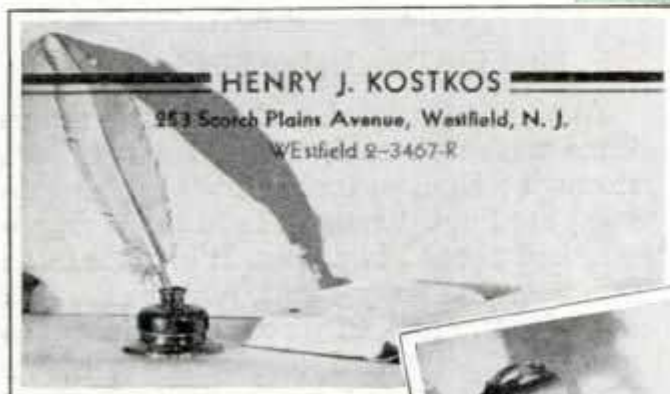
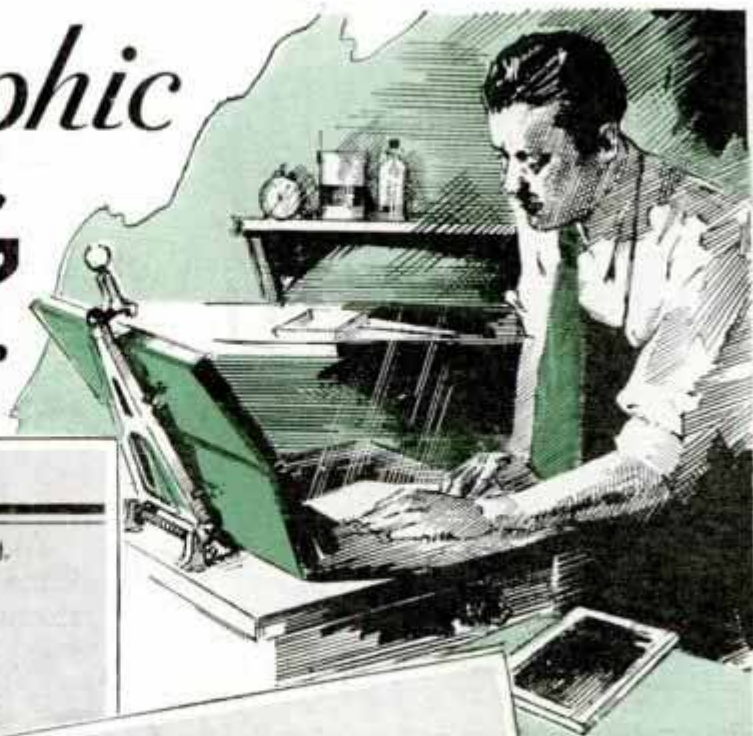

FOR personal or business use, photographic calling cards can be made unusual and memorable as well as inexpensive. The idea is to combine the name and address of the user with an appropriate photo which emphasizes his business, profession or hobby. If you are an artist this might be a photo of you at your easel, or if you build ship models, it may be a picture of your best model. As a mechanic you could use a photo of a lathe or set of tools, while a radio man could use a view of his testing bench and instruments.

First select the picture and make, or have made, an enlargement, which is suitably arranged and pasted to a piece of white cardboard, 4 by 6½ in. in size. The lettering of your name, address, etc., can be done by hand with black India ink. In some cases this matter can be set up by a printer and the proof pasted on the card. Be sure to have the lettering twice the size that it is to be on the calling card. After the enlarged card has been completed, it is photographed. On a camera that has a ground glass, mark a 2 by 3¼ in. rectangle on it with a pencil. Adjust the focus and distance from the card until



its image just fills the rectangle, and the details show up sharply. This method can also be used on a roll-film camera, by fitting a sheet of tracing paper across the film guides. This will then serve the purpose of a ground glass. Then make the exposure in the usual way. The resulting negative can be used indefinitely and a fine linen-finished paper is appropriate.



Mixture of Oil and Kerosene Sprayed on Bed Springs Eliminates Squeaks During Dry Weather

Bed Springs Sprayed with Oil to Eliminate Squeaks

During continued dry periods the best of bed springs often squeak at the slightest move of the sleeper. One of the easiest ways to eliminate the squeaks is to spray the springs with a mixture of kerosene and auto cylinder oil. This can be done with an insect spray gun, first covering the bedstead with old newspapers to avoid getting oil on the finished parts. Or, the springs can be removed and the job done outside. Then a permanent cover should be placed over the springs to prevent oil from soiling the bed clothing.

Fuller Ball Protects Fingers from Knife Blade

A fuller ball split to the center hole on one side and slipped over a knife blade will protect the index finger in many close jobs of cutting and trimming. Use a $\frac{1}{2}$ or $\frac{3}{8}$ -in. ball and place it in the position shown in the photo. The ball fits snugly and will make a great deal of difference in the ease with which the knife can be manipulated.

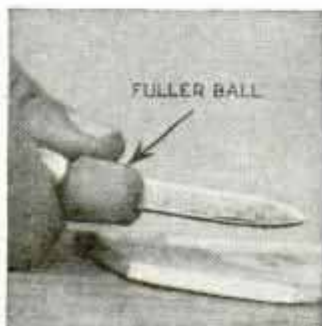

How to Prepare Ground Glass for Fine Focusing

When it is necessary to make extremely sharp pictures with a camera, make a spot about the size of a quarter of a dollar on the matte side of the ground glass with glycerine. Focusing is done at this spot, preferably with a magnifying glass. This method is especially desirable when focusing near-by objects and the depth of focus is small.

Reel for Developing Movie Film

Anyone can develop their home movie films with this reel, which rotates them through a shallow tank containing the developing fluid. The reel is 15 in. in diameter and about 24 in. long. It is made from two $11\frac{1}{2}$ -in. tin pot lids, which serve as hubs for the reel, 21 pieces of $\frac{1}{8}$ -in. brass rod, 25 in. long, and a broomstick, which

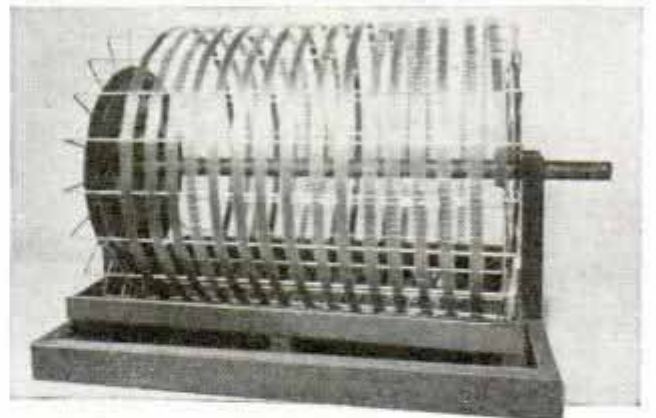
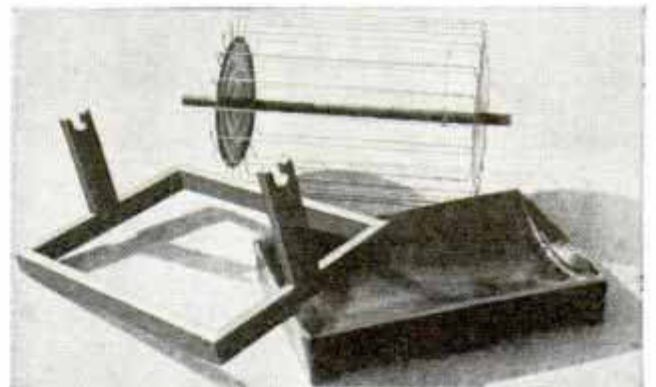

Reel Made of Tin Lids and Brass Rods Rotates Movie Film in Developing Fluid

serves as an axle. The rods are bent at right angles 2 in. from each end and are soldered to the lids as indicated. A developing tank to fit the reel is made of sheet tin nailed to three wood blocks and a frame supports the reel which will accommodate 100 ft. of film if spacers are used.

Novel ENGLISH CHAIR

combines table and bookshelf

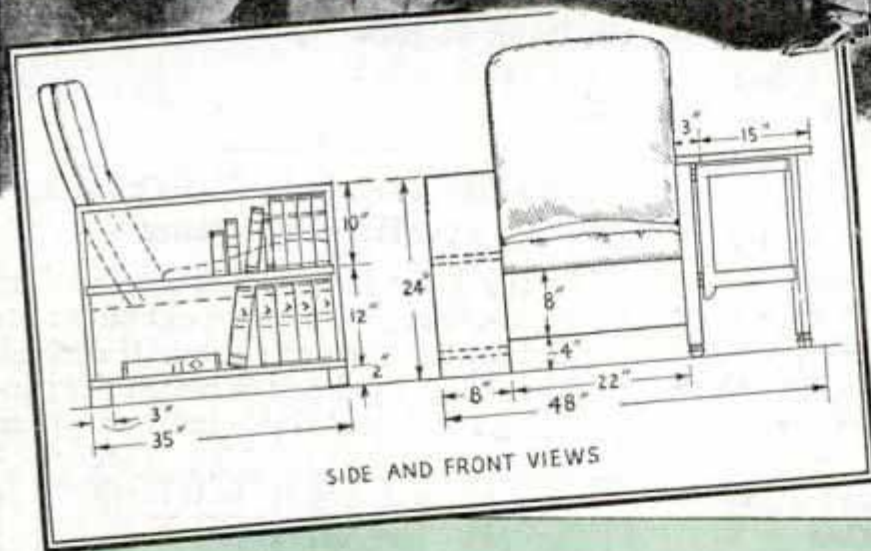
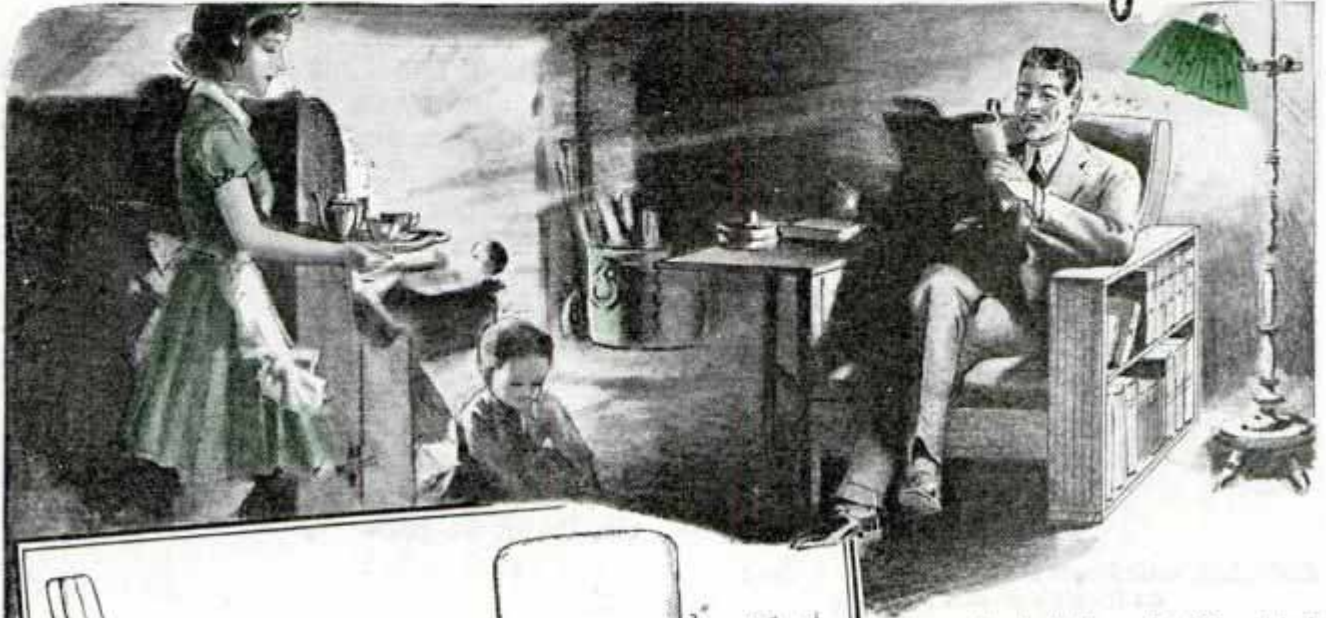

Bookshelf and table added to this easy chair make it ideal for home comfort. A gate leg, hinged to the front leg, swings back against the chair arm when the table leaf is dropped. The curved chair is pivoted near the top of the rear legs and a bolt in a slot, at the other end, permits adjustment

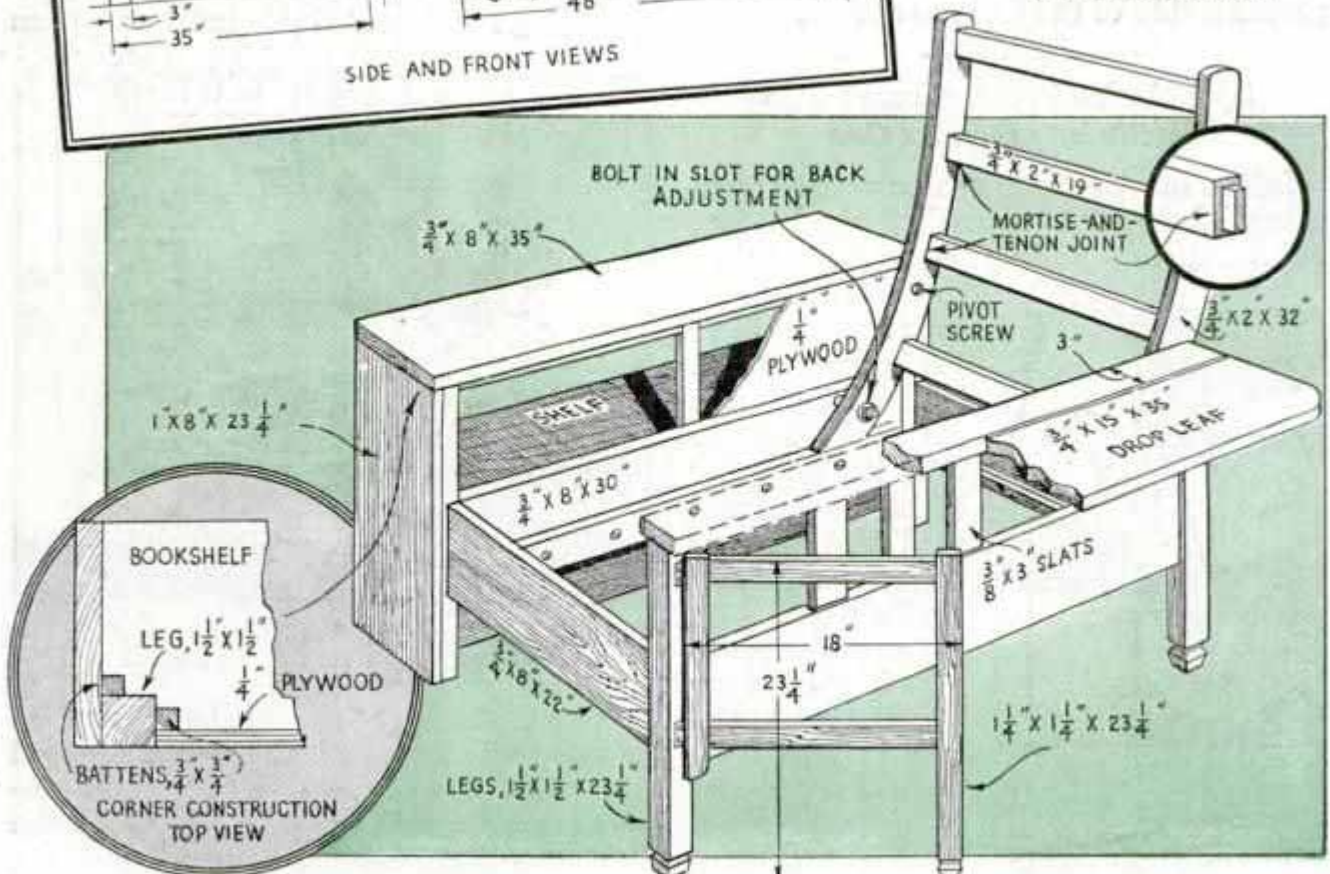

Utilizing Electric-Heater Element to Heat Soldering Iron



Radio Mechanic Heats His Small Soldering Iron with an Electric-Heater Element

Not having an electric soldering iron, a radio mechanic used an electric-heater element of the type wound over a cup-shaped form, to heat his iron. The element was screwed into a socket located conveniently on his workbench. It only took a few moments to heat the iron, which was placed inside of the form as shown.

Spout Helps Pouring from Large Bottle into Smaller One

Ink or other liquids can be poured from a large bottle into a smaller one by improvising a spout from a cardboard disk and a pen, to fit over the mouth of the larger bottle.



The disk is cut slightly larger than the diameter of the bottle mouth and the pen is forced into a small hole near one edge, while a V-notch for an air vent is cut in the opposite edge. The cardboard disk is held firmly against the mouth

of the larger bottle while the fluid is being poured. This method proved more efficient than using a paper cone when a funnel was not at hand.

Brads Driven in Picture Frame with a Pair of Pliers

Mounting small pictures in frames can be simplified by driving the brads to hold the picture backing in place with a pair of pliers as shown, instead of using a hammer. Any pair of slip-joint pliers are suitable for this purpose. A wide rubber band should be slipped over the jaw of the pliers that contacts the frame to prevent marring the finished surface.



Auto Tire Keeps Baby from Crawling over Hot-Air Register

If your baby burns itself by crawling over hot-air registers, place old auto tires around the registers as shown. If desired, the tires can be painted to match the surrounding furniture. If you have a pipeless



Painted and Placed over Hot-Air Register, Auto Tire Keeps Baby from Getting Burned

furnace, the tire should be nailed to wooden blocks so that it will be raised above the floor a few inches to avoid obstructing the cold-air passage around the register.—J. W. Sweeney, Shenandoah, Pa.

Wall and Ceiling Fixtures in Modern Style

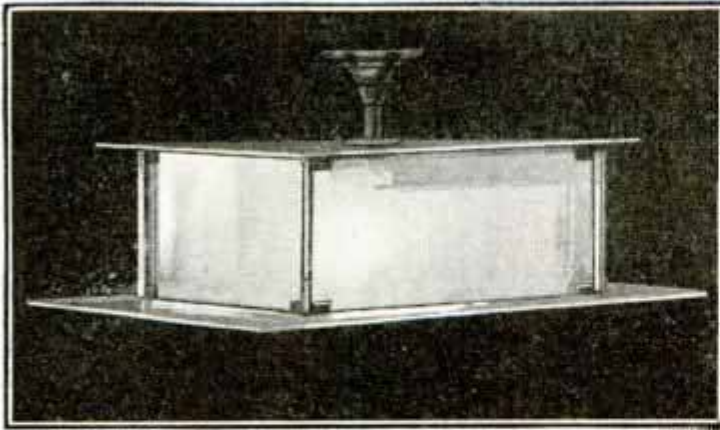

Simplicity of design and assembly, using sheet metal and frosted glass, make these lighting fixtures unusually attractive. For the ceiling fixture, two rectangular pieces of sheet aluminum are used. Corner brackets, shown in the details, are formed to hold the frosted-glass sides. Copper or aluminum posts are drilled and tapped at each end, so that when screws are driven through the top and bottom pieces, into the ends of the posts, after they have been set on the corner brackets, the whole assembly is held together securely. Crosspieces under the top are drilled to take a pipe nipple which is screwed into a double socket and a "crowfoot." Thread the pipe on the outside so that two locking nuts can be used to hold it securely on the crosspieces. A length of aluminum tubing and a canopy to match are then slipped on, the crowfoot being removed temporarily and screwed to the ceiling. After wiring, the fixture is attached to the crowfoot and the canopy slipped up to hide it. The lower details give suggestions for wall fixtures which will go well with the ceiling unit.—C. J. Colwell, Chicago.

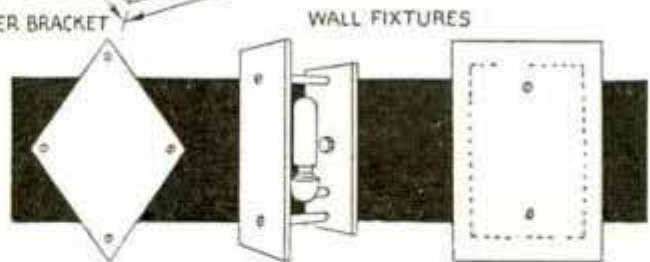
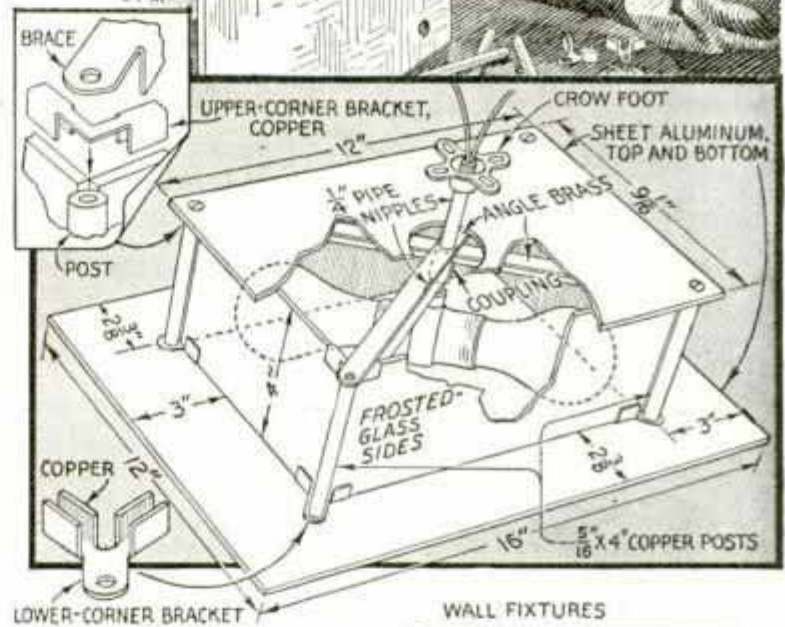

Checking Spring Tension on Breaker Arm of Distributor Points

Unsatisfactory operation of an auto motor is sometimes caused by incorrect tension of the spring on the breaker arm of the points in the distributor. This spring should be strong enough to cause good

contact between the points at all motor speeds. The tension ranges between 18 and 22 oz. as measured by a spring scale. An ordinary spring balance in a horizontal position may be used for checking the tension while the timer is in place on the car. If greater accuracy is necessary, it is best to remove the distributor and hold it in the hand so that the spring balance will work in a vertical position, thus making the correct allowance for the weight of the scale hook. Too much tension will shorten the life of the points.

This drawing is a reproduction of the original drawing in the magazine. The original drawing is in black and white. The drawing is a technical drawing of a lighting fixture. The drawing shows a perspective view of the fixture and a top-down view of the fixture. The perspective view shows the fixture is a rectangular box with frosted glass sides and a metal frame. The top-down view shows the fixture is a rectangular box with a diamond-shaped top and a rectangular bottom. The drawing is labeled with various components and dimensions. The drawing is a technical drawing of a lighting fixture.

Building a Model



up of two pieces of $\frac{3}{16}$ -in. birch plywood cut roughly to form and glued together with casein glue. When dry, the part is sawed and sanded to the finish size and rabbeted as shown in the sectional view. Next, the white-pine keel and the hardwood keel form are made as shown in Fig. 2. One end of the keel is beveled to fit the notch in the stem. It is also rabbeted the entire length as shown in the cross section. The keel form is hollowed on the top edge to a depth of $\frac{1}{4}$ in. at the center of the curved portion, the dimen-

sions indicating the approximate length of the curved section. The stem is fastened to the keel with screws and glue, the keel form is fitted with an upright and cross-piece as shown in Fig. 2, and the keel and stem are fastened to the form with screws. This arrangement holds the parts securely in place while assembling the hull.

The next step is to saw out the eight frames detailed in Fig. 3. Sketch each half frame from a center line on heavy wrapping paper, then fold the paper along the center line with the pattern on the outside after which you can cut along the line with a pair of scissors, making both sides symmetrical. The pattern is then pasted lightly on $\frac{3}{8}$ -in. white-pine plywood, as a

PROBABLY you have often wanted a model of a trim power boat for the den or mantel—a model typically modern and one that you have built yourself. Very few designs lend themselves so admirably to this purpose as that of "Roamer," and a miniature of this 16-ft. outboard cabin cruiser will catch the eye of any boat enthusiast. A scale of 2 in. per foot was found advisable, which gives the model an over-all length of 32 in. and a beam amidships of 11 in. This size enables you to make use of ready-made fittings offered by dealers in model supplies, although, if you wish, you can make them yourself.

Construction of the model begins with the stem detailed in Fig. 1. This is built

Plywood. Craftman's Wood Service
2727 Mary Ave Chicago

of "ROAMER"

A 32-in. model of "Roamer", a 16-ft. outboard cabin cruiser. Its graceful sheer lines, the generous flare to the freeboard and its trim cabin lines can be faithfully reproduced without tricky hand work and tedious assembly of fine details



guide for cutting to size with the scroll saw. The notches for the deck beams are indicated by dotted lines; they must be cut as shown so that the lower edge of the beam will overhang on the forward frames and the upper edge on the after frames. Note from Fig. 2 that the frames are spaced 4 in. apart on the keel and that the transom, which is frame No. 8, is set at an angle of approximately 7° with the keel. In fitting frame No. 1 it will be necessary to taper the end of the keel on both sides where it joins the stem so that the frame will fit down over the end of the keel. Join the seven frames to the keel with glue and No. 4 flat-head brass screws, $\frac{5}{8}$ in. long, leaving the transom loose until the chines and deck beams are screwed and glued in place.

Both chines and deck beams are ripped $\frac{3}{8}$ in. square from clear white pine, 36 in. long. Bending is

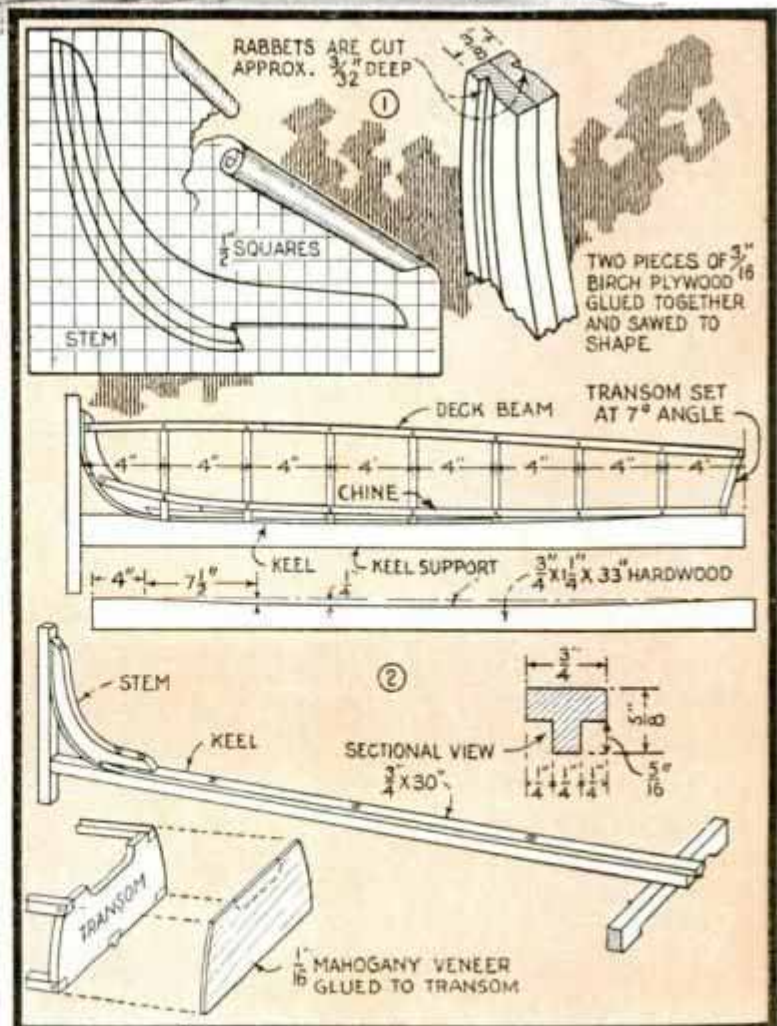

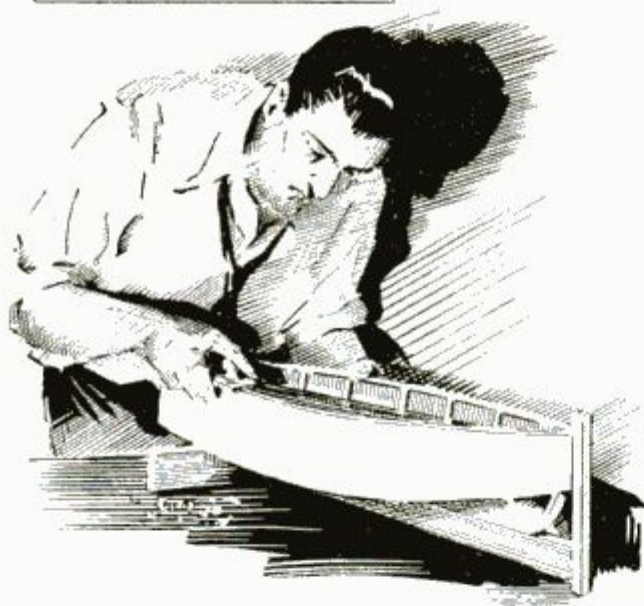
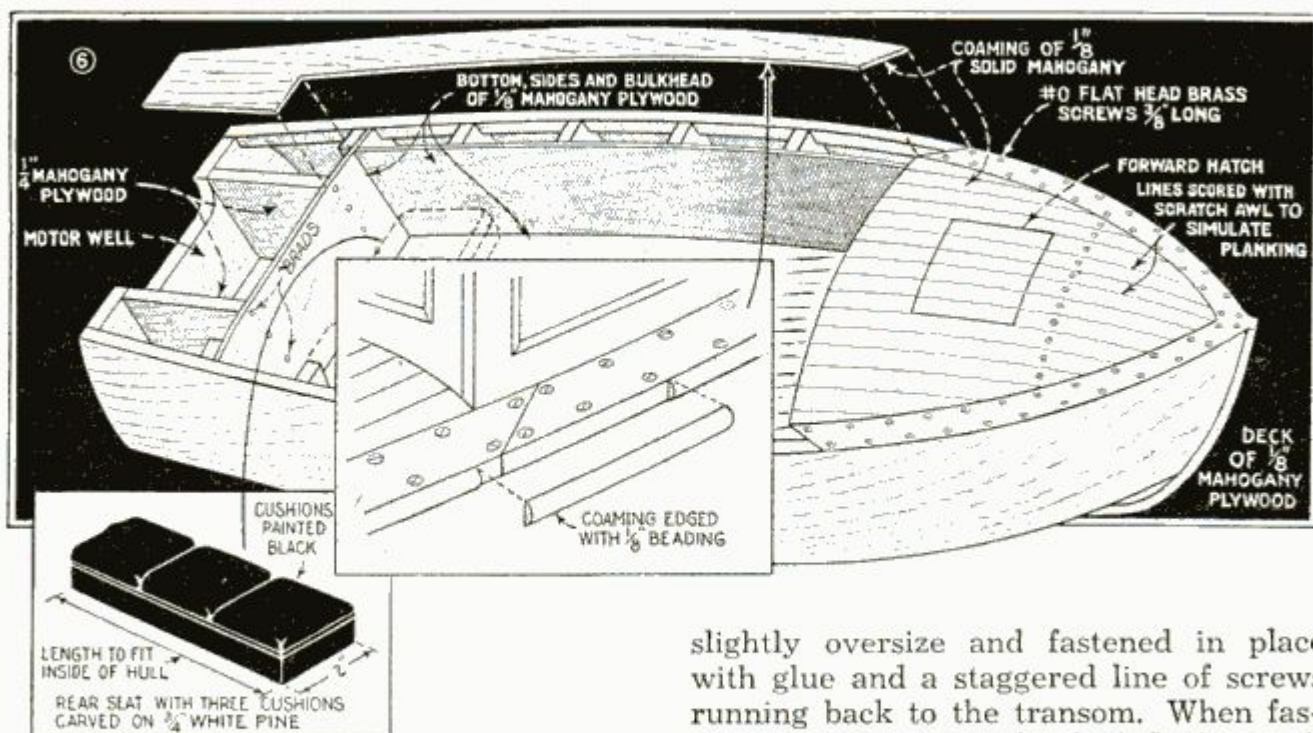

of screws spaced $\frac{3}{4}$ in. apart into each frame, working from stem to stern, then drive a line of screws into the chine, beginning at the forward end and working aft, spacing not more than $\frac{3}{4}$ in. apart. Finish the edges flush with the sides and drive a single screw through the keel into the transom, countersinking the screw hole and filling with a cold-water putty.

The bottom, sides, and the bulkhead that forms the forward end of the motor well are cut to size from $\frac{1}{8}$ -in. mahogany plywood. The bottom piece extends from the second frame back to the transom and should be a fairly close fit against the frame uprights. With all parts in place as shown in Fig. 6, the hull is completed with the coaming strip. The coaming strip is cut

slightly oversize and fastened in place with glue and a staggered line of screws running back to the transom. When fastened in place it is finished flush on all edges with a fine rasp. After both strips have been applied, set a marking gauge to the width of the strips at the point where they join the deck and score a line on the edge of the deck to the bow, taking care that the lines do not extend beyond the point where they meet. Score heavy lines about $\frac{5}{16}$ in. apart each way from a center line on the deck to represent planking, and also a square to simulate the forward hatch. The edge of the coaming from bow to stern is finished with a $\frac{1}{8}$ -in. beading fastened with glue and lill pins as in the enlarged detail of Fig. 6. The rear seat is a block of the dimensions and form shown which effectively imitates the cushions.

(To be continued)

Holes in Side of Kettle Aid When Draining Cooked Food

To prevent escaping steam from burning the hands and arms when draining a



kettle of cooked food, drill several small holes in one side of the vessel just below the rim. The holes permit water to be drained off without sliding back the lid.—A. H. Waychoff, Tempe, Arizona.

Mousetrap Used as Glove Holder

Conveniently screwed to the basement wall, a mousetrap provides a good holder for a pair of gloves that are worn while tending the furnace. The wrists of the gloves are slipped under the jaw of the trap, which holds them closed so that dust cannot get inside. The same idea can be used in a home garage where a pair of gloves are often kept on hand to wear while making minor adjustments on the motor or working on other greasy parts of the car.

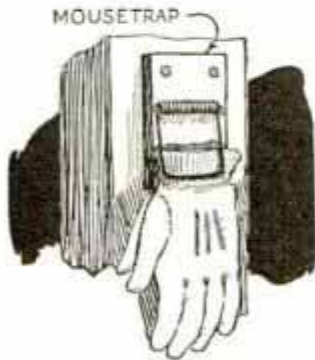

Cleaning a Rifle Barrel

To do a thorough job of cleaning a rifle, it is necessary to rotate the cleaning rod inside of the barrel. This is best done by bending the end of the rod at right angles as shown and providing it with a loosely fitted hardwood grip. With this simple alteration, the rod can be rotated with ease.



Sensitive Balance Scales Made from Scrap Parts

Amateur chemists and photographers will find these scales, which are made from scrap pieces of 2 by 4-in. stock, fairly accurate. Two end pieces are supported vertically by headless spikes, which rest in slots cut in the heads of stove bolts that have been countersunk in a wooden arm. The latter is similarly pivoted in the center to a base, which carries two fixed vertical supports. A couple of lengths of flat iron are pivoted loosely to the end pieces and are swung on pins set in the supports. After the scales have been balanced with shot or scrap pieces of metal placed in shallow holes drilled in the ends of the vertical pieces, tin pans are fastened in

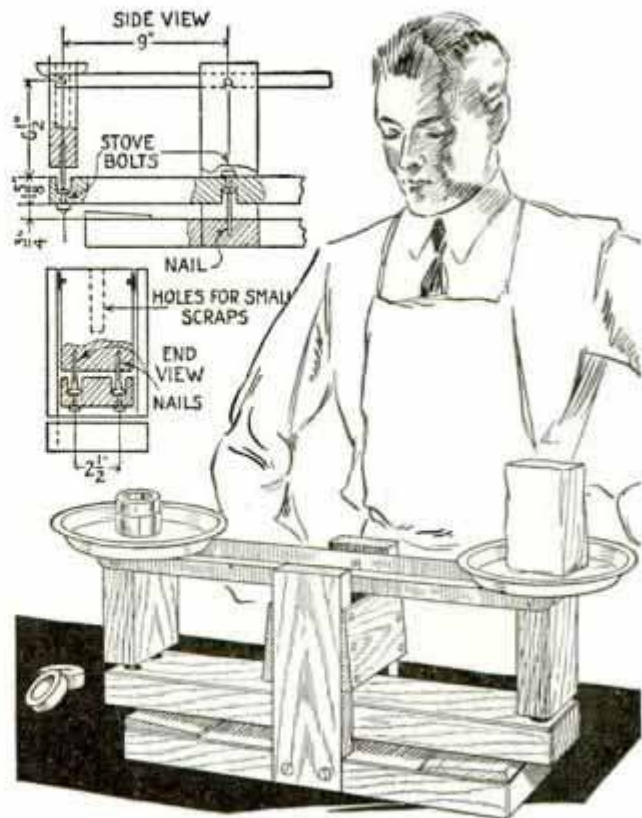

These Balance Scales Weigh Quite Accurately with Weights Made of Lead-Filled Pipe Nipples

place for trays. Short pipe nipples filled with lead are used as weights. These are made the correct weight by drilling out some of the lead so that they correspond to standard weights or with a known quantity of some substance such as sugar. —Thurman A. Phillips, Chicago.

Altering Faucet Handles to Make Them Easier to Operate

To provide easy manipulation of his water-faucet handles, one home owner altered them so that they operated with a crank action. One end of handles having only one cross bar was cut off near the center and then soldered vertically to the tip of the other end of the handle to form a crank. On handles that had two cross bars, one of them was sawed off and one of the pieces soldered vertically to one end of the remaining bar as shown. —Andrew Vena, New York.





Anchor for Steadying Camera Tripod in Wind Made from Rubber Band, Cords and Wire Stake

Rubber Band Holds Camera Steady on Windy Days

For holding a camera tripod steady in a wind, take a heavy rubber band and fasten two lengths of cord or light rope to it as shown. Tie one cord to the camera screw and the other to a wire stake. After setting the tripod, push the stake into the ground at an angle. The tension of the band will then hold the camera steady.

Lead Pencil Aids in Soldering

To give your soldering jobs a neat appearance without grinding or filing to remove excess solder, rub the surfaces where solder is not wanted with a lead pencil. Graphite in the pencil forms a coating which prevents the solder from sticking.

What Do You Want to Make?



Governor Winthrop Desk

400 POPULAR MECHANICS BLUEPRINTS,

clear, accurate and easy to understand, show how to make any number of useful and practical things that will save you time and money. This extensive service fits in with your hobby interests, provides ideas for improving your home and furnishes suggestions for making money in your spare time. Free list of blueprints sent for 3 cents postage.

Outdoor Sports

Air-Propelled Ice Boat—Simple streamlined design using a motorcycle engine. The body is covered with heavy canvas. 785—25c.

Homemade Snowshoes—Method of steaming and bending frames which are strung with rawhide cord. 2 prints, 796 and 797—50c.

8-Ft. Bobsled—Has auto-type steering gear and carries big load. Supports made from pipe fittings. 632—25c.

Worth-while Furniture

(Choice of 73 projects)

Governor Winthrop Desk—Exact copy of famous historic masterpiece; a highly prized antique. 3 prints, 846 to 848—75c.

Thomas Jefferson Music Stand—Exquisite piece of work that can also serve as magazine rack. 2 prints, 871 and 872—50c.

Small Drum Table—Has 18½ in. top and a turned central pedestal. 536—25c.

Smoking Stand—Four turned legs and concealed ash receiver. 521—25c.

Price of blueprints is 25 cents each or six for \$1.00. Address Blueprint Department, Popular Mechanics Magazine, 200 East Ontario St., Chicago.



Air-Propelled Ice Boat

Exploring with a



MICROSCOPE

MICRO-ORGANISMS, as minute living bodies are called, are not only found in water, but they live in great numbers in the air we breathe, in the coal we burn and in the soil. An inexpensive compound microscope and a few homemade accessories are all that you need to make visible this vast unseen population. These tiny living things are not all there is for you to look at, for your microscope will also show you that even the finest particle of common salt or baking soda has been formed by nature into a more perfect and more beautiful crystal than the lapidary can ever hope to hew from the crude diamond or sapphire.

Regardless of the type of microscope you select, you will need a good microscope lamp. The homemade one shown was constructed from a square coffee can, a few scraps of tin from another can and an extension cord with its socket fastened to the can top so that the spherical part of the 25-watt frosted bulb is directly back of the 2½-in. hole. The ears which are shown soldered above and below the hole are to hold colored glass or celluloid filters so that the specimens may be viewed with whatever color of light is the most effective. An ordinary reading glass may also



*Common
Dog Flea*

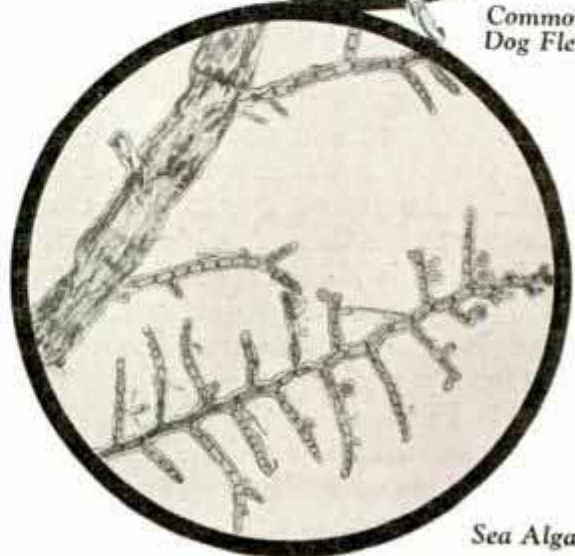

Sea Algae

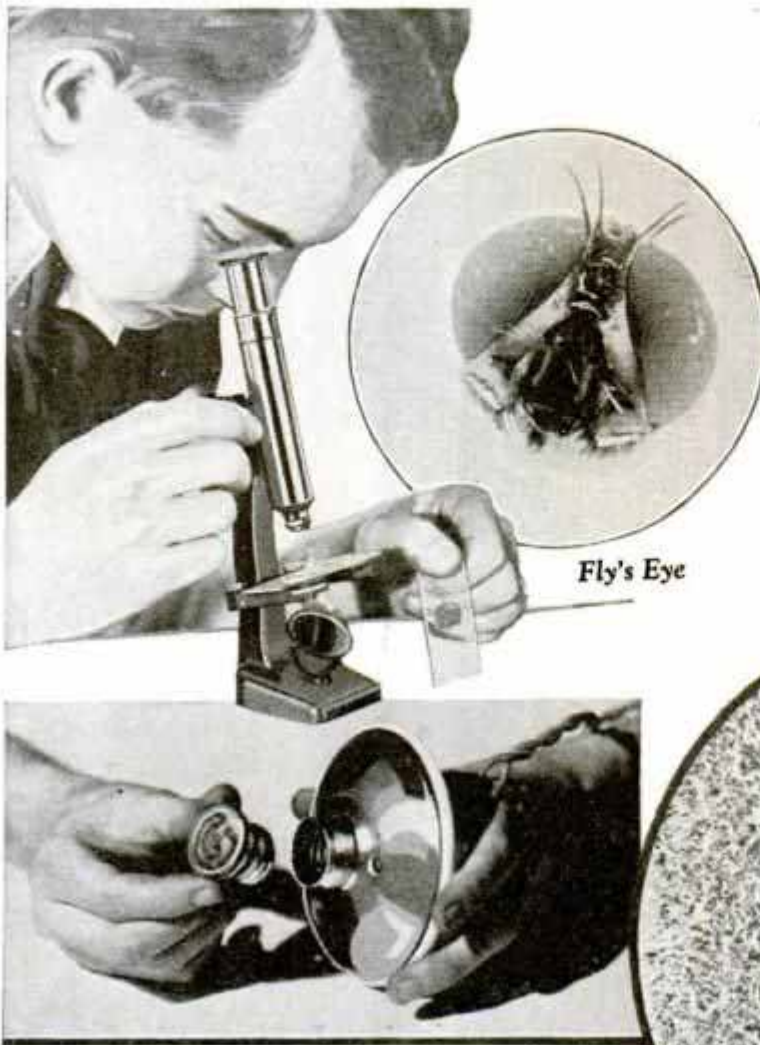

Specimen Heater Can Be Made from Cigar Lighter Screwed into Lamp Receptacle; Right, Cross Section of Pieces of Leather Seen through Microscope

be used to concentrate light on the mirror.

Set the lamp in front of the microscope and about 9 in. away, facing the adjustable mirror. While looking through the tube you can now easily adjust the mirror so that it picks up the beam of light from the lamp and reflects it through the tube. In looking into the microscope both eyes should be kept open. After a little practice you will experience no difficulty in doing this and you can use first one eye and then the other. This will avoid eye strain and make your experimental work much more comfortable. A slide upon the center of which is placed a drop of water taken from a stagnant pool may now be placed under the clips so that the water drop is directly under the objective. The objective is the lens at the bottom. The top lens is known as the eyepiece. With the slide in place carefully turn the coarse adjusting screw so that the objective is as close as possible to the water drop with-

out touching it. Next look through the tube and turn the coarse adjusting screw slowly in the other direction, thus lifting the objective slowly until the living matter in the water drop comes into view. Focusing, as this operation is called, may now be finished by turning the fine or micrometer adjustment whichever way produces the best image. If focusing is started with the objective high above the slide there is danger of passing through the focusing point and jamming the lens against the slide which would very likely re-

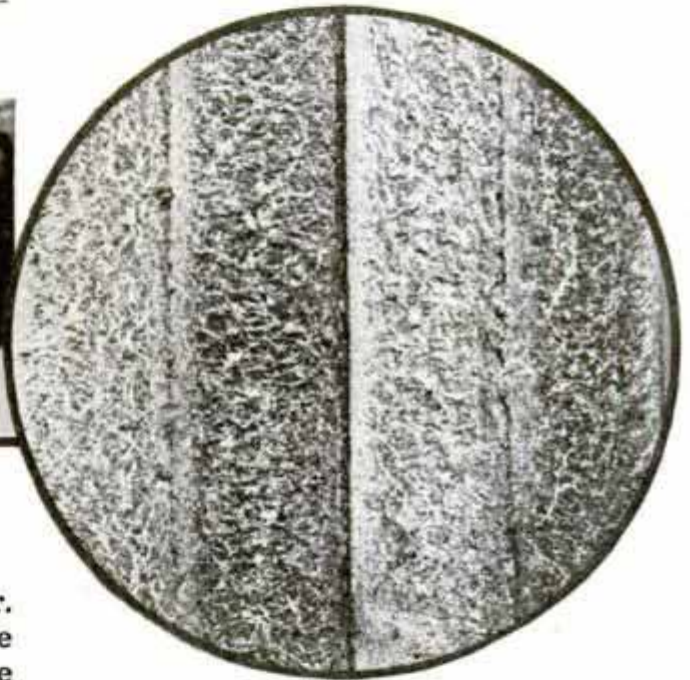

sult in serious damage to the lens, which is the most valuable part of the instrument.

If your microscope is equipped with additional objectives try both the high and low power on the slide. With the microscope focused on the object try placing various colored filters in the lamp and note which produces the greatest contrast. By using the filters it is possible to bring into view objects which were entirely invisible or at best only vague with ordinary light. Beautiful crystals which appear as sparkling gems under the microscope may be made by crystallizing table salt upon a clean slide. To do this dissolve as much salt in a spoon or a small dish of hot water as possible. A handy heater for microscope work is made by screwing an electric cigar lighter such as is sold at almost all elec-

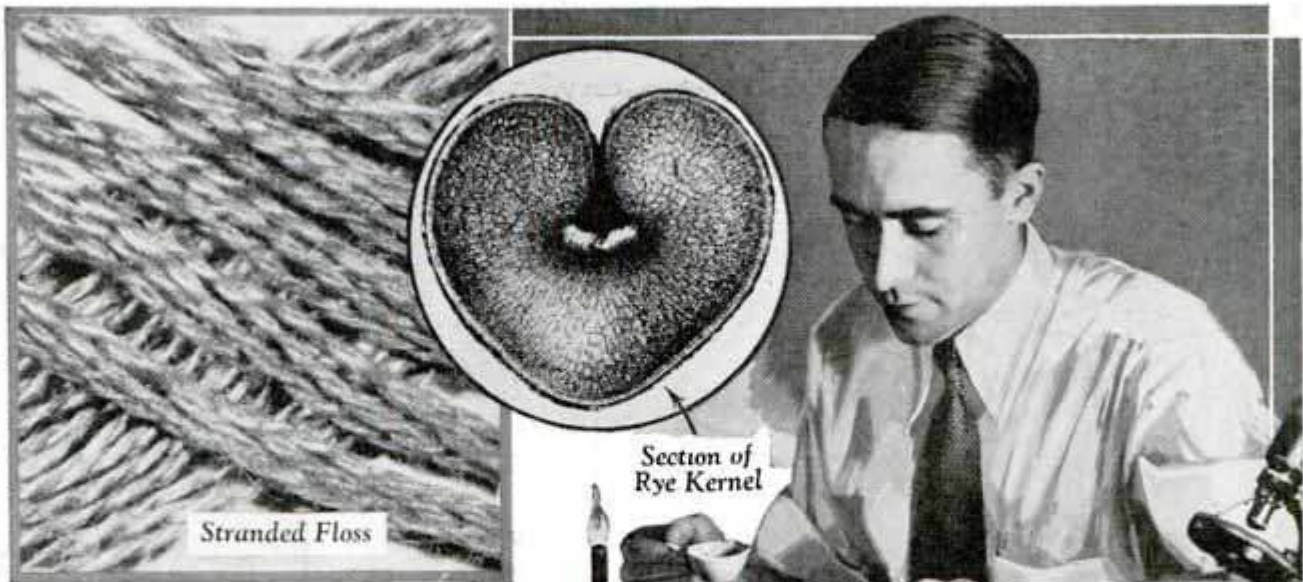

tric shops into a lamp receptacle. When the water has dissolved as much salt as it will, transfer a small drop of the solution to the center of a slide as shown at right, and let it stand for a few minutes to crystallize. The slide may then be placed on the stage of the microscope and the instrument focused. The beauty and detail of the crystal can be enhanced greatly by using a colored filter over the lamp. Other substances, such as baking soda, epsom salts, tartaric acid, quinine, or any other chemical may be treated in the same manner but in each case the shape of the crystals will vary. Substances which form crystals when treated in this manner are said to be crystalline, and those which will not, such as egg albumen or gelatine, are said to be amorphous. Some substances exist in both forms, thus opening up possibilities for vast numbers of interesting experiments. There are many very interesting books devoted to this subject alone.

So far we have only looked at things which are transparent, but there are just as many interesting opaque things to look at. A piece of coal or mineral, the wing of a bug, a piece of paper, a green leaf or a metal specimen and many other things of great interest and beauty under a microscope can only be examined if the light is directed on them from above. The lens should be adjusted so that an intense concentrated beam of light is focused on the part of the object to be examined just under the objective, which may be done with a reading glass. If you wish to experiment with colored light, a filter may be clipped



Below, Bacteria in Milk

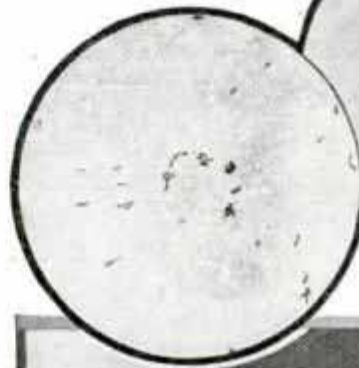

Above, Strands of Mercerized Cotton

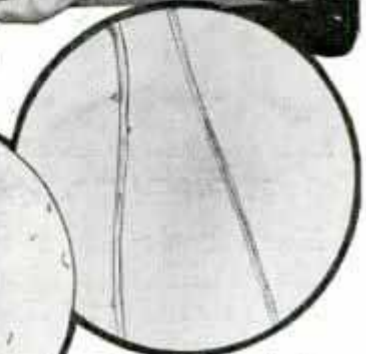

over the lens, and another of a different color over the lamp for unusual effects.

Back Rest for Bleacher Seats



Made from Iron Rods and Canvas, This Portable Back Rest Folds into Compact Bundle

Much back strain can be eliminated while watching athletic sports from bleacher seats by using this back rest. It is made from canvas and two $\frac{1}{4}$ -in. iron rods. One 4-ft. length of rod, which is bent to a U-shape 14 in. wide to form the back, has eyes bent on the ends to take the other rod. This one is $4\frac{1}{2}$ ft. long and is bent to a U-shape to form the seat, which has hooks at the ends to slip over the edge of the bleacher seat. Half loops, bent in the side rods, take short chains to hold the back vertically when in use. Sewing a strip of canvas to the top of the back and to the sides of the seat completes the job.

Rubber on Corners of Pastry Board Prevents It from Slipping

RUBBER CUT FROM INNER TUBE.



When using a pastry board on which to roll pie and biscuit dough, triangular shaped pieces of rubber tacked or glued to the underside of the board at the corners will keep it from sliding on the surface of the table. If tacks are used, they should be driven

well into the rubber so that they will not scratch the table.—A. J. Calandra, Gloversville, N. Y.

well into the rubber so that they will not scratch the table.—A. J. Calandra, Gloversville, N. Y.

Efficient Lemon Juicer Made from Aluminum Tube

Pushed through the center of a lemon, a small aluminum tube serves as an effective juice extractor. The central portion of the tube is perforated to permit the juice to flow out of the tube when the lemon is squeezed. For easy insertion of the tube into the lemon, sharpen one edge of the tube or drive a pointed aluminum plug into the end.



Rubber Bands Gauge Thickness of Pie Crusts

To assure uniform thickness of pie crusts, one housewife suggests the use of two heavy rubber bands, which are slipped over the ends of the rolling pin. If single bands do not raise the rolling pin enough, two or three can be used at each end, placing them one over the other.



Narrow Rubber Bands Slipped over Ends of Rolling Pin Assure Uniform Thickness of Pie Crusts

Eccentric Locks to Hold Your Garage Doors

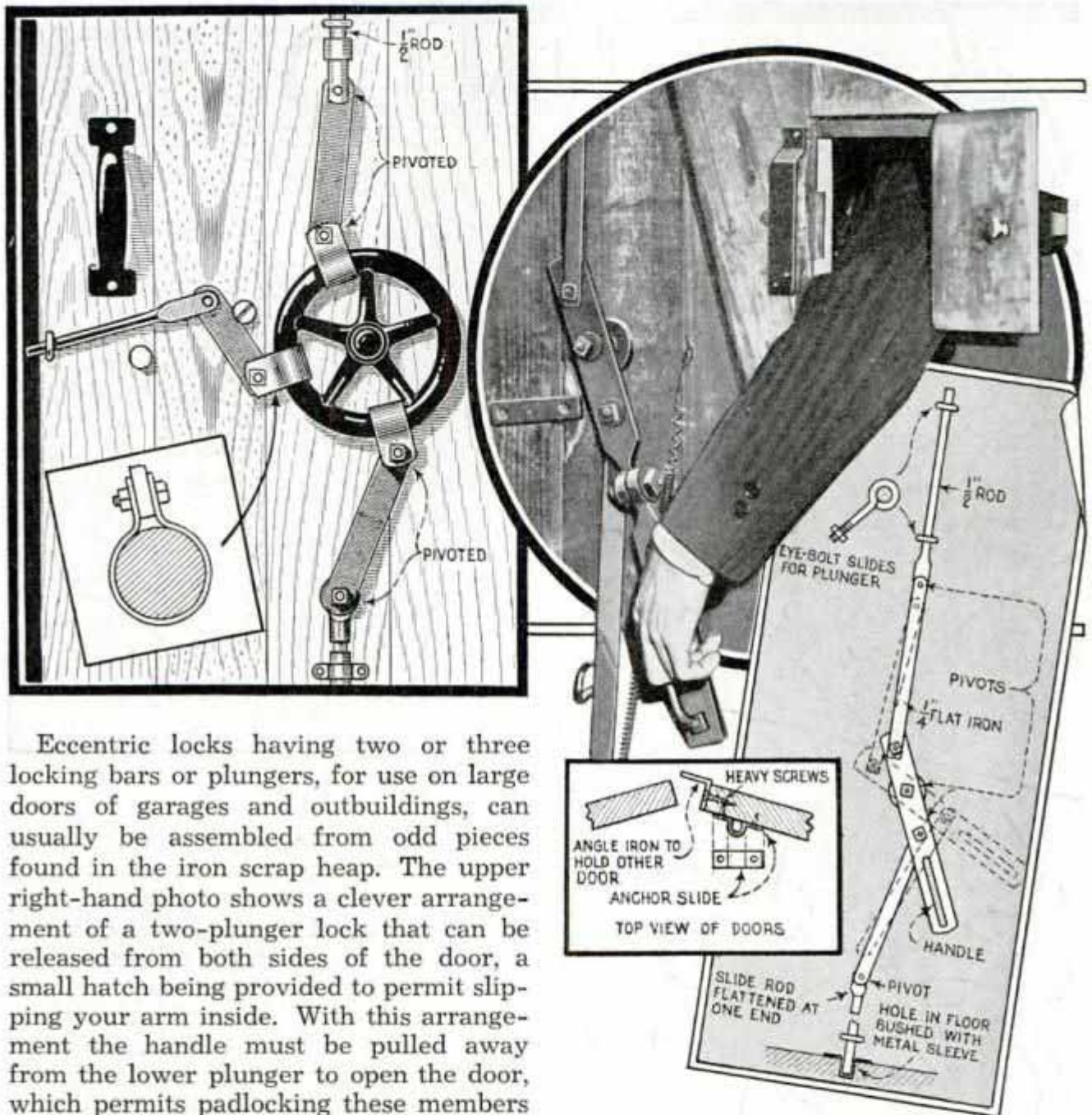

Eccentric locks having two or three locking bars or plungers, for use on large doors of garages and outbuildings, can usually be assembled from odd pieces found in the iron scrap heap. The upper right-hand photo shows a clever arrangement of a two-plunger lock that can be released from both sides of the door, a small hatch being provided to permit slipping your arm inside. With this arrangement the handle must be pulled away from the lower plunger to open the door, which permits padlocking these members together, suitable loops being welded onto them to take the padlock. At the left is shown a three-plunger arrangement, operated by means of a small wheel.—V. P. McMahon, Chicago.

Protection against Electric Shocks from Motor-Driven Machines

Electric shocks from motor-driven equipment, such as washing machines, can be prevented by grounding the motor housing to a cold-water pipe. This is done best by soldering the bared ends of an insulated wire to the housing and to the pipe, first thoroughly cleaning the metal

where the solder is to be applied, so that no paint will insulate the wire. Another way of making the connection, is to loosen a screw in the housing, twist the end of the wire under the head and then tighten the screw against it. A large battery clamp can be used to connect the other end of the wire to the water pipe. Electric current usually reaches the metal work of the machine in two ways: An insulated wire inside the motor may become bared through overheating or mechanical wear and touch the housing, or moisture in the motor may cause small currents to leak through to the housing.

Something New in

HALLOWEEN

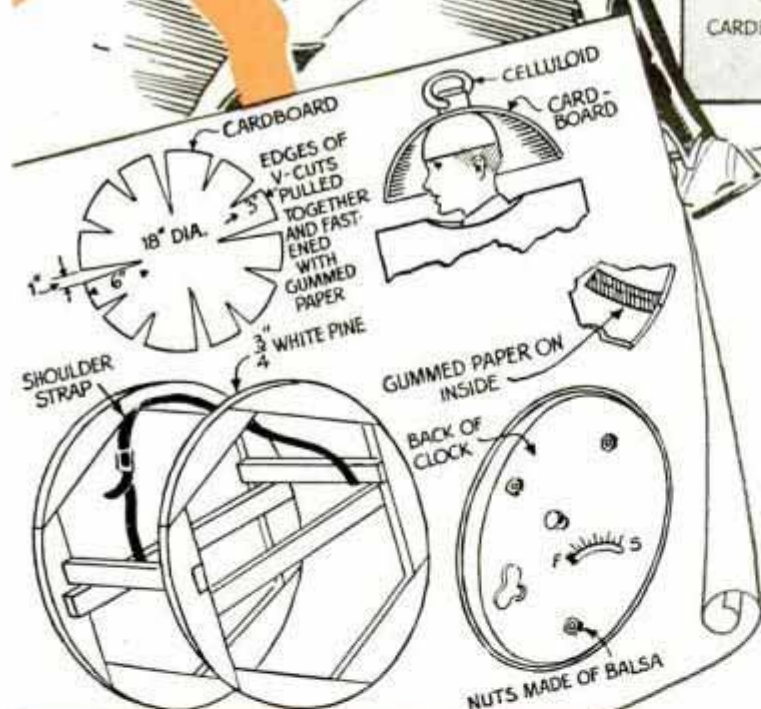
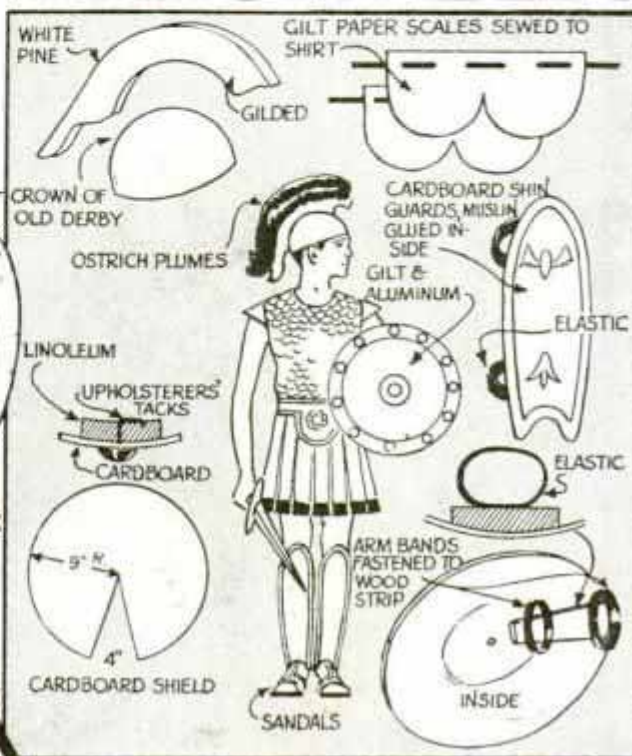

HERE is an opportunity to get away from the conventional in masquerade costumes. Making the robot requires a lot of work, but it is worth the effort to create a real sensation at a party, and assuredly this mechanical man will be the talk of the community.

The simplest costume is that of the infant, and at the same time it is extremely effective, because it will completely disguise the age and sex of anyone. The flesh-tinted cheesecloth covering for the face rounds the mature contours into those of a child, and while the

wearer can easily see and breathe through the cloth, the other guests cannot penetrate the disguise. Use white cheesecloth and give it the lightest flesh tint with commercial dye. When dry, stretch over the features and knot at the back, as shown. Then paint in eyes, eyebrows, nostrils and mouth with water colors, giving a touch of rouge on the cheeks. Brush the natural hair back to permit a high forehead, attach

COSTUMES

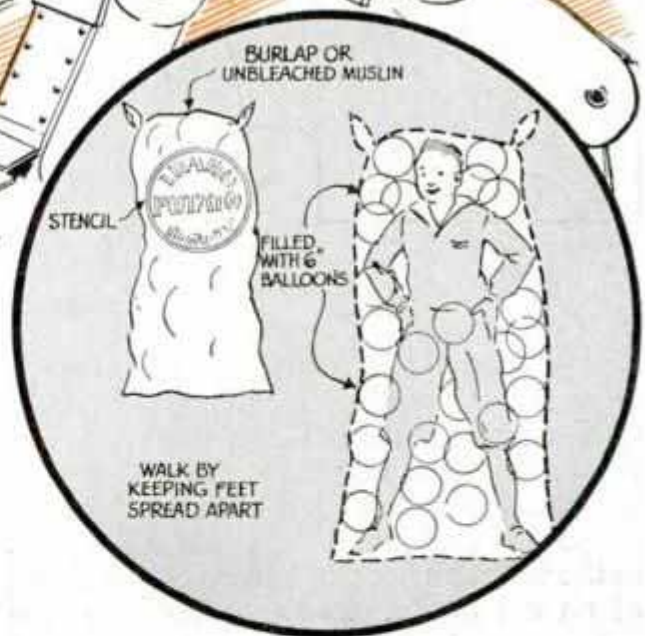
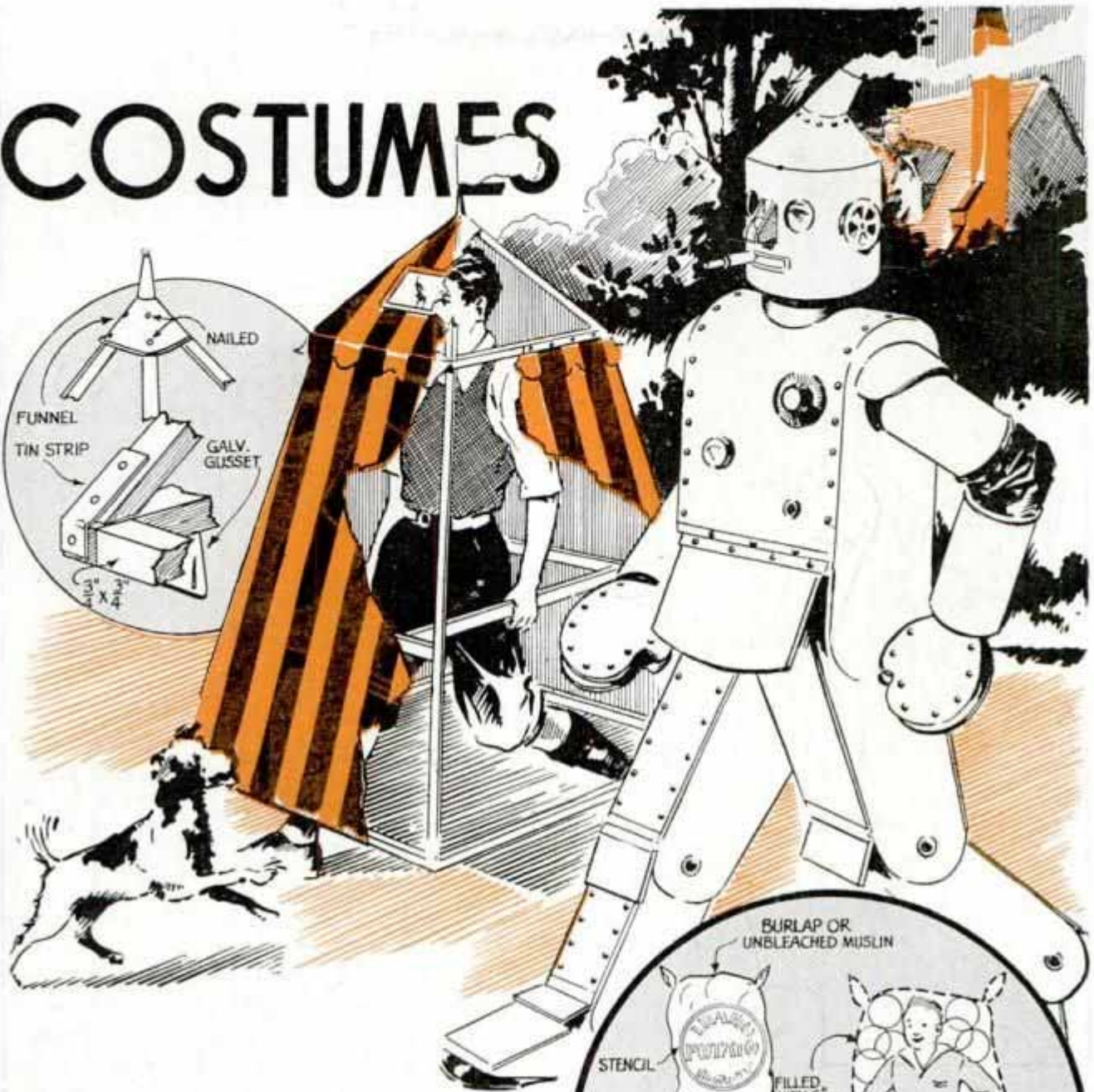
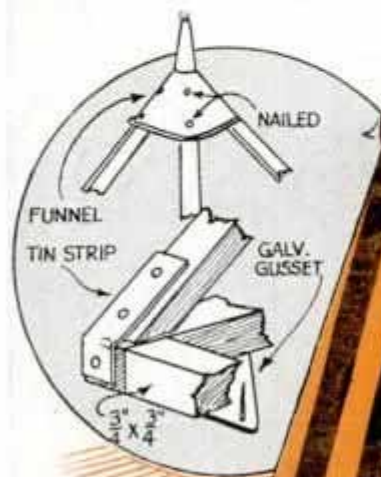

a blond curl of false hair and cover the head with a frilly cap tied under the chin.

The Roman gladiator costume is also effective. The helmet is the crown of an old derby hat surmounted with a curved wooden crest and ostrich plumes. The crest is scroll-sawed from $\frac{3}{4}$ -in. white pine and tacked from the inside. Drive in large-headed tacks through a strip of reinforcing cardboard. A convincing coat of mail is made by sewing scales of gilt paper on an undershirt, the scales overlapping each other. Sew on paper or leather epaulettes, and make a belt of red and black oilcloth. The skirt should be an accordion-pleated white one with a red hem.

Two novel disguises, both easy to make, are the alarm clock and the tent. For the alarm-clock framing, use $\frac{3}{4}$ or $\frac{1}{2}$ -in. white

pine, and cover with heavy cardboard, cutting an opening at the top for the head, and another at the bottom which is large enough to pass over the entire body. The frame is provided with shoulder straps for comfort. Give the clock a coat of ivory brushing lacquer and paint the numerals in black. Hands are cut from plywood and

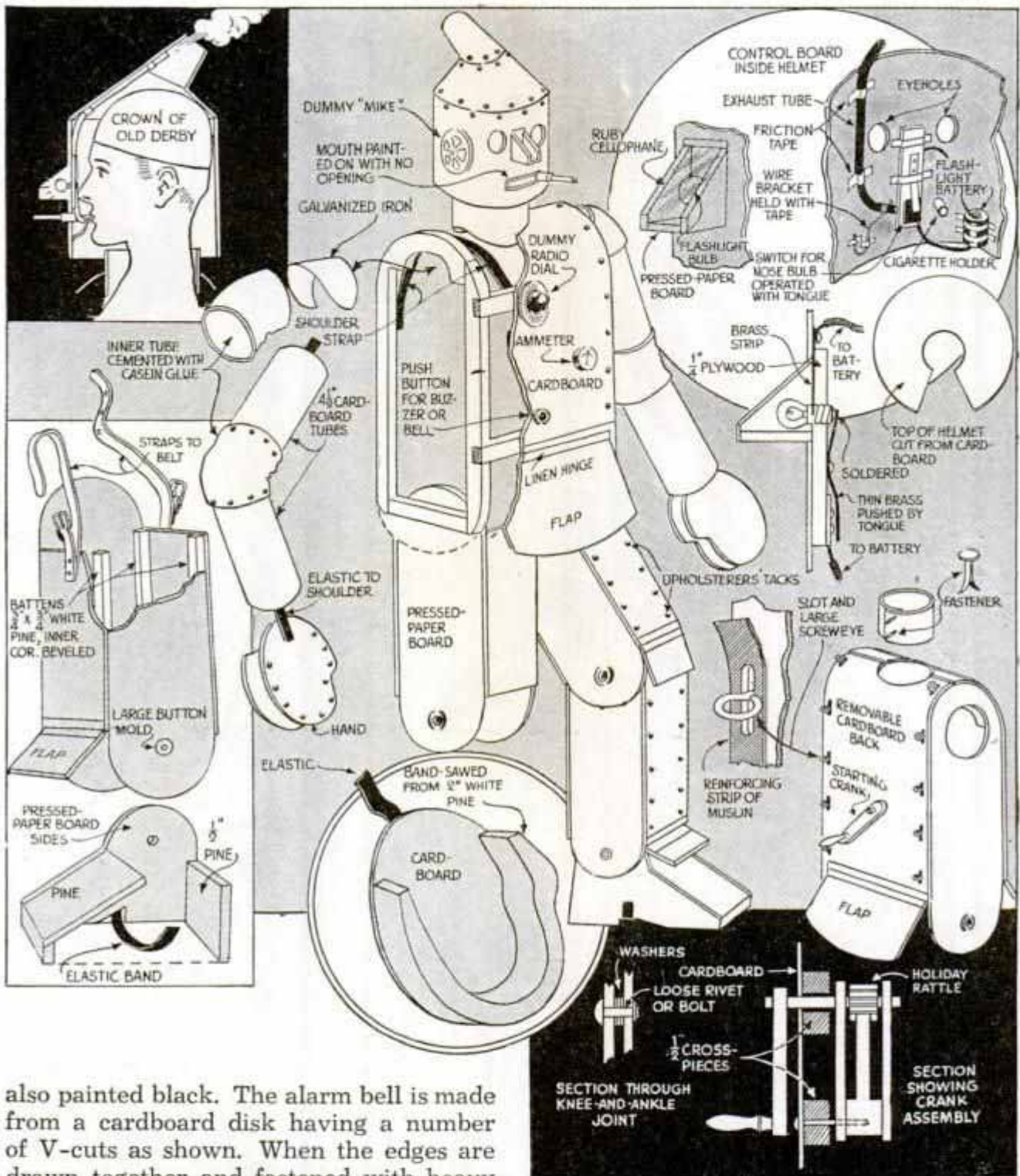

also painted black. The alarm bell is made from a cardboard disk having a number of V-cuts as shown. When the edges are drawn together and fastened with heavy gummed paper on the inside, the correct shape will be formed. The bell is fastened to the wearer's head by means of the crown of an old derby. The tent costume is a frame worn in the same way, and covered with unbleached muslin. It is light, roomy and well ventilated. When not moving about, the entire weight rests on the floor. Insert a panel of mosquito netting as indicated to permit sufficient visibility.

The animated sack of potatoes is sure to get a big hand. Sew up a large bag of muslin and stencil on a design. The wearer

gets in and stands with feet apart while assistants pack rubber balloons, partly inflated, around him, in order to make the sack lumpy. Stitch the top with cord, arranged so that the user can open it instantly with a jerk if necessary.

You will have plenty of fun with the smoke-belching robot, which may be equipped with as many fun-making gadgets as you can devise. In making the robot, the frame must, of course, be fitted to the wearer, and should be made as large as

possible to permit freedom of movement. The helmet, collar, coat with sleeves, and the legs are separate units for ease in putting on and taking off. The sleeves are made up of cardboard tubes with rubber joints. They are supported at the shoulder on a curved piece of sheet iron as shown. The wearer draws on the legs with shoes attached and adjusts them to his belt. Next he gets into the coat through the open back, which is attached by means of screw eyes in slots, a quarter turn locking each. An amusing feature will be a crank at the back, operating a holiday rattle on the inside. On the front of the coat other devices can be installed, such as radio dials, ammeters, push buttons, etc. The last could be made to sound a real buzzer, with a flashlight battery fastened to the frame of the coat, inside.

To make your halloween costume spooky, mount small colored flashlight bulbs on a wire frame shaped similar to a pair of glasses and wear it under your mask. Wire the bulbs to a flashlight battery concealed in a pocket of the costume and provide a push button to control the

Colored Flashlight Bulbs on Halloween Costume Flashed by Hand to Produce Weird Effects

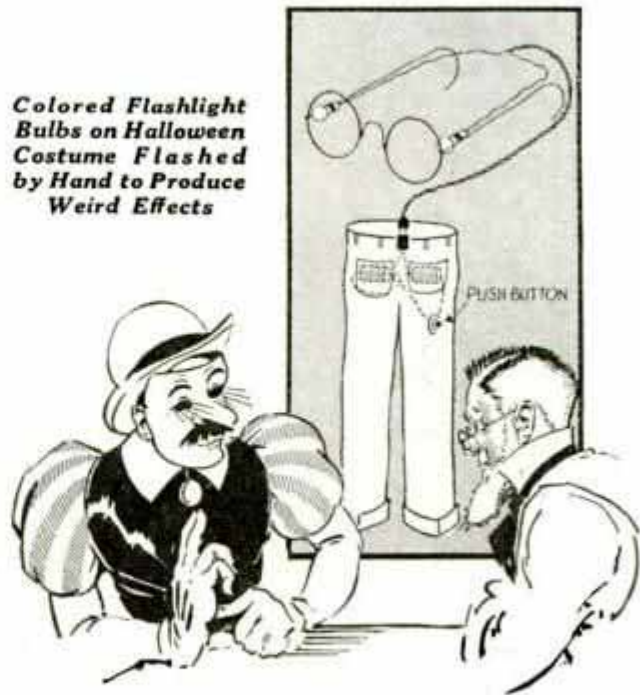

lights. A still more novel effect can be had by using two push buttons so that the lights can be controlled individually. Besides the method illustrated, the lamps may be used to simulate flashing stickpins, red stoplights on your coat tail, brilliant cuff buttons and many other variations.

Bench Vise Quickly Improvised from Woodworkers' Clamps

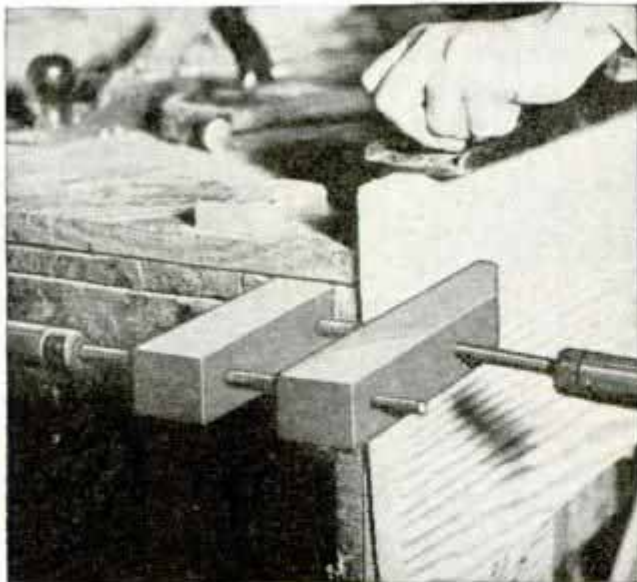

Woodworkers' Clamps Fastened to End of Workbench Serve as Emergency Vise for Large Panels

In the absence of a woodworkers' vise in the home workshop, one can be quickly improvised from a pair of wood clamps as indicated. Merely cut a square hole in the side of the workbench, near the end, to take one of the clamp jaws. In this way,

the bench serves as the stationary vise jaw. A vise of this kind is especially handy for holding large plywood panels.

Window-Shade Tassel Hides Wedge Used to Quiet Sashes

To assure that a small wooden wedge used to prevent window sashes from rattling would be at hand when needed, one home owner fixed the tassel on the window shade to hold the wedge as shown. A small screw hook was driven into the body of the tassel to take a screw eye in the wedge. When hung on the hook, the wedge is completely covered by the tassel and is quickly removed for use.—L. H. Georger, Buffalo, N. Y.

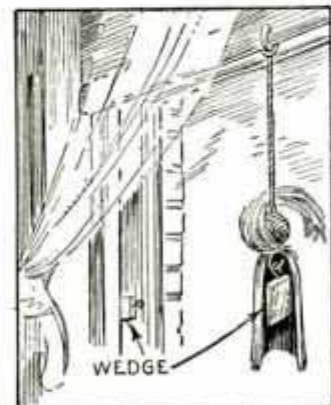



This Double-Purpose Container Cut from a Tin Can Will Prove Helpful on Wash Day

Container Holds Laundry Articles on Side of Washtub

Many steps can be saved on wash day by placing various laundry accessories in a container cut from a square tin can and hung on the rim of the tub as indicated. A container of this kind may also be used to hold clothespins as it can be hooked over the line and pushed along.

Tinfoil Locks Common Pin in Place

Wrapped around the ends of a pin, a piece of tinfoil from a cigarette or tobacco package will help to prevent the pin from

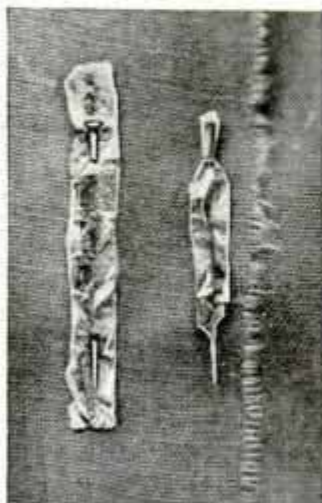

working out of light or loosely woven cloth. Cut a piece of foil $\frac{1}{2}$ in. wide, and $\frac{1}{2}$ in. longer than the pin. Fold it together until it is approximately $\frac{1}{8}$ in. wide, and run the pin through it as shown at the left. Then press both ends of the foil tightly around the pin as in the right detail. A pin locked in this way will hold despite strong pulls and jerks.—F. W. Bentley, Jr., Missouri Valley, Ia.

Sign Illuminated by Light from Cars

When mounted on a post along the roadside, light reflected from car headlamps illuminates this sign. A stencil of the desired lettering is cut from cardboard or sheet metal, preferably the latter, after which it is backed with clear Cellophane. If desired, small pieces of colored Cellophane can be glued to the stencil behind the letters. Next, tinfoil is placed behind the Cellophane to serve as a reflector, after which the whole assembly is put in a wood frame and backed with plywood. If a dull black finish is applied to the stencil it will make the letters stand out conspicuously.



Iron Rods Pointed with Drill Press

For pointing iron rods quickly with a drill press, an Arizona blacksmith uses a hardwood block, grooved to hold a file. One side of the groove is vertical while the other is cut at an angle. The file is laid against the slanting side, and the rod, held in the drill-press chuck, is fed down against it, the vertical side serving the

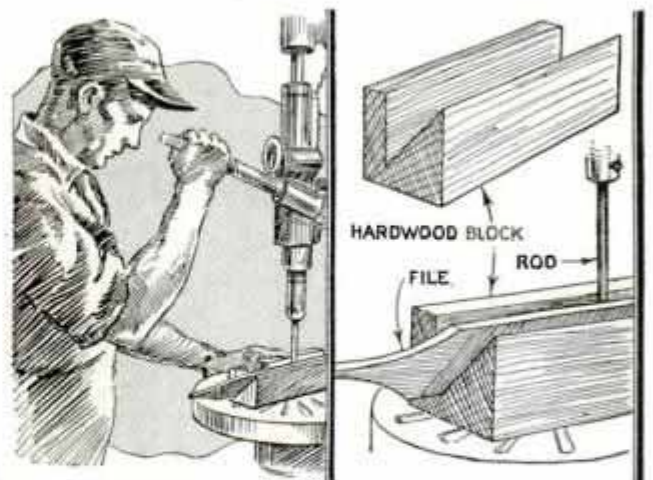

File Held at Angle in Hardwood Block Enables Use of Drill Press to Point Iron Rods

purpose of a steadyrest for the rod. Obviously, the angle of the point depends on the angle of the file and can be varied by changing the groove to suit.—A. H. Waychoff, Tempe, Ariz.

SUNKEN DUCK BLIND

permits quick action

This dry and comfortable, sunken blind for duck hunters consists of a sheet-metal drum and two counterweighted cover pieces that slide apart quickly at the instant a foot-releasing trip is touched. The cover pieces are fitted with rollers that run on a steel track, and all unnecessary noise is prevented by rubber bumpers. To provide an adequate lookout and vent, part of each cover is cut away and a hood is mounted over the opening thus formed. Inside the drum, a swinging seat and a cartridge shelf are conveniently arranged

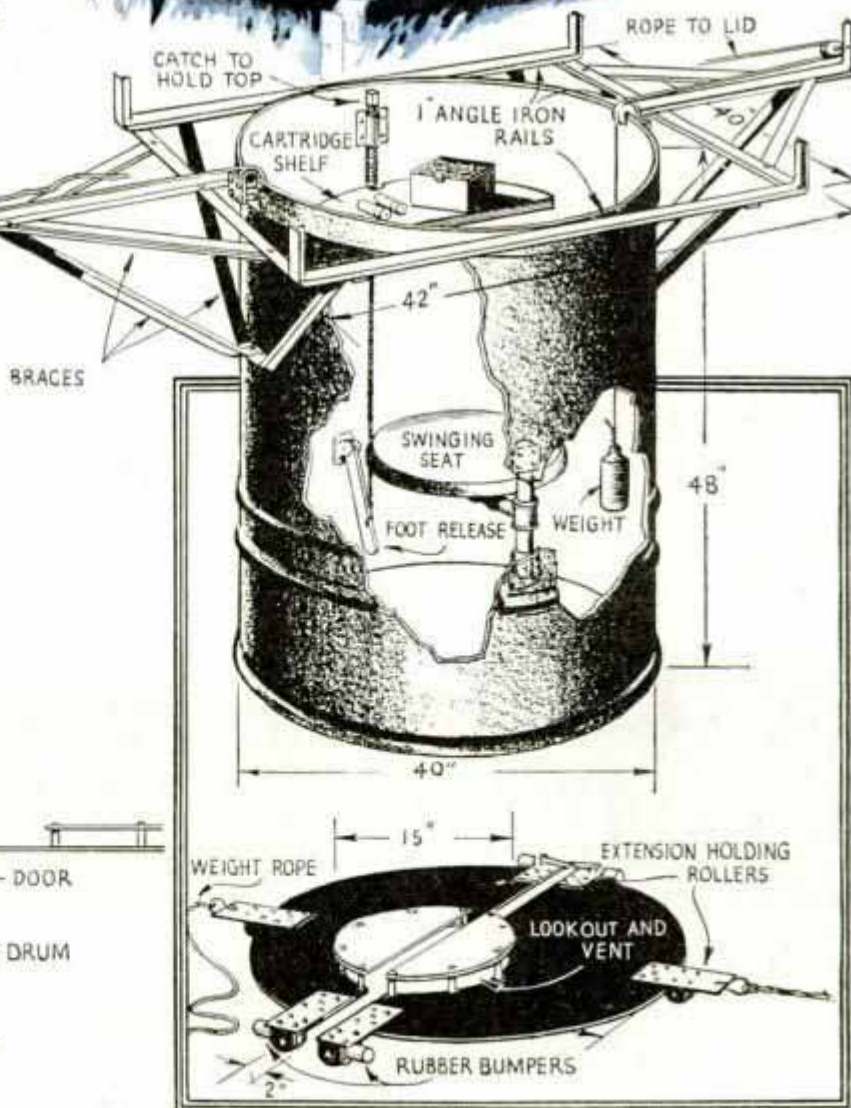
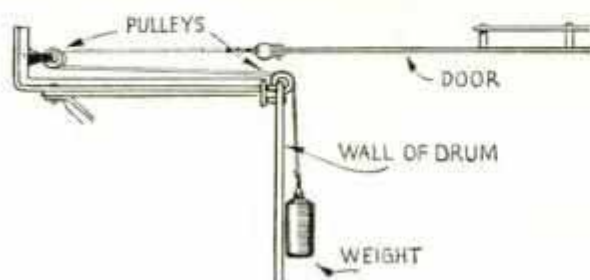
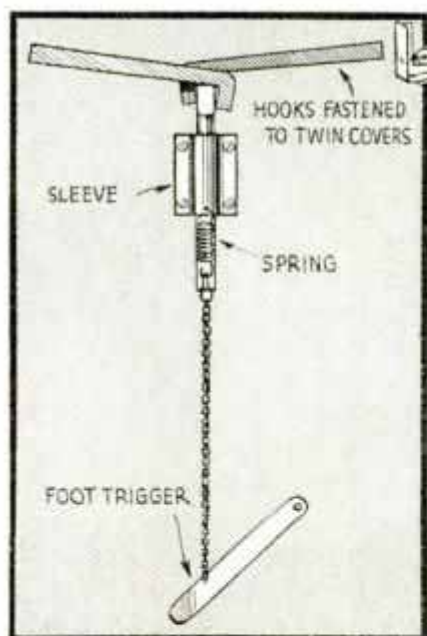



THE TOP SPOKE WINDS THE WATCH

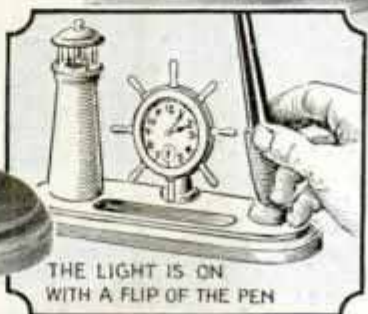

THE LIGHT IS ON WITH A FLIP OF THE PEN

This Novel Desk Set Features a Lighthouse Whose Beacon Is Turned On by Flipping the Penholder Forward; the Unit Is Quite Attractive in Brass and Walnut

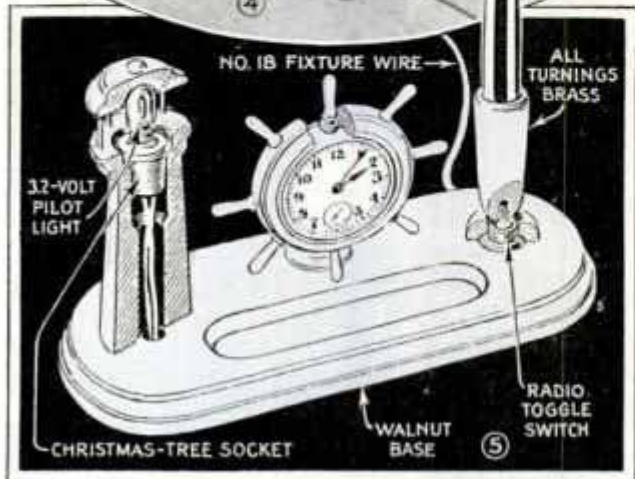
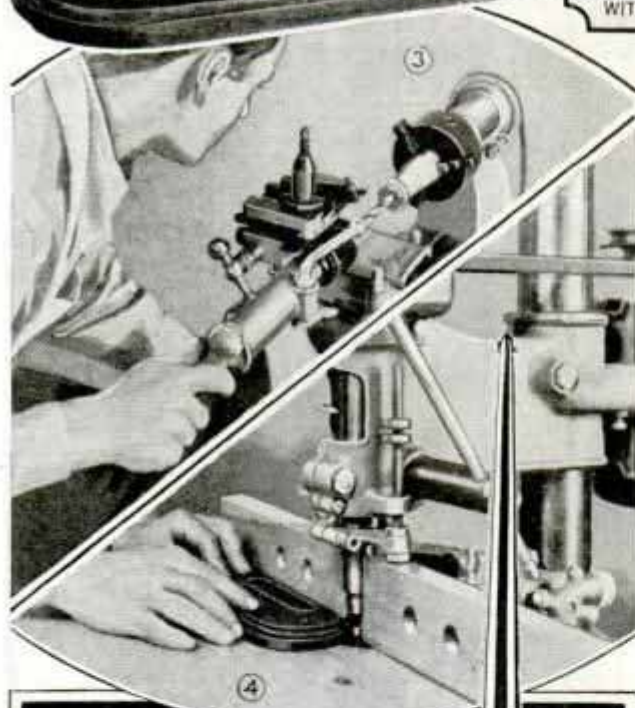

NAUTICALLY minded craftsmen will appreciate this novel desk set, and even the landlubber must concede its charm and practicability. There's a pen handy to your touch, a watch encased in a ship's wheel, and a lighthouse which throws out a cheerful glow when the pen is pulled forward. The completed set is shown in Fig. 2.

With the exception of the walnut base, all of the parts are made of brass. Construction can start at any point, and needs little elaboration beyond what is shown in the sketches and photos. The lighthouse is best turned in a chuck, as shown in Fig. 1, so that the tailstock can be pushed aside later and the holes drilled as in Fig. 3, to accommodate the light socket and the wiring. The dividing head on the lathe can be used to good advantage in locating the holes for the pins which make the light cage. A section from a test tube can be used for a glass frame if you desire this extra touch. Fig. 4 shows the base being shaped on the drill press. The over-all dimensions are 9 by 3 1/4 in., with a finished thickness of 5/8 in. The edge can be simply rounded over if you wish an easier form of construction. Use the drill press, too, to rout the recess in the face of the base and the recesses necessary to accommo-

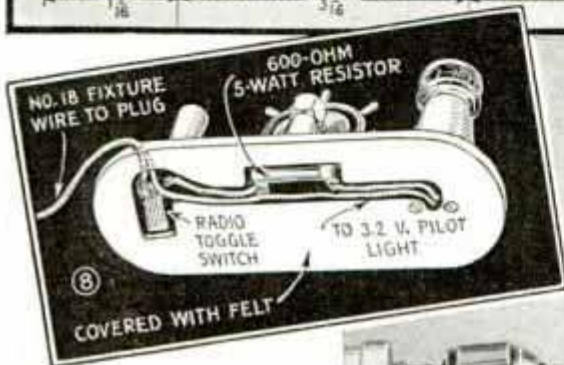
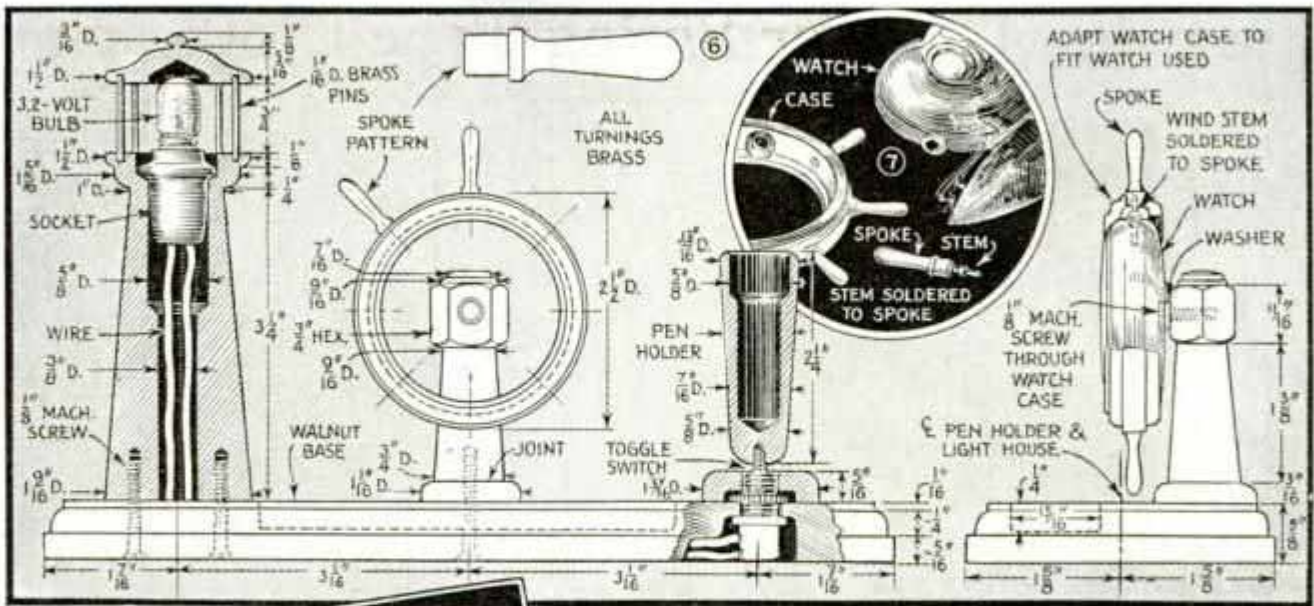

date the wiring and electrical fittings.

As can be seen in Figs. 5 and 6, the original case around the winding stem of the watch is cut away, and the top spoke of the wheel is soldered to the stem as in Fig. 7. The hole for this spoke through the watch case should be a loose fit so that the stem can be pulled out slightly for setting the watch. All of the other spokes are a tight fit in their respective holes. No exact dimensions can be given for the watch case, as this is dependent on the watch which you will use. The manner of mounting is by means of a $\frac{1}{8}$ -in. machine screw, which is inserted through the back plate of the watch, after first grinding the head down very thin. The light control is very simple—merely a radio toggle switch which also serves as a mounting for the penholder. The switch lever should be cut down and threaded to fit a corresponding tapped hole in the small end of the penholder turning. Bore the inside of the holder out to take a



standard desk fountain pen, and, if you buy one of these especially for the job, get one with vertical stripes to carry out the nautical motif. A spar buoy, you know!

Fig. 8 shows the wiring. The resistor takes care of the usual 110-volt power line when used in connection with a 3.2-volt pilot light of the kind used on radios, and gives good illumination

although it is in no sense a desk lamp all in itself. Fig. 9 pictures another operation in the turning—forming the wheel spokes. These are easily made by using $\frac{3}{16}$ -in. brass rod held in a drill chuck. Before assembly, buff the work to a brilliant polish with tripoli or rottenstone, and then spray with clear lacquer to hold the finish.

Testing Eggs for Freshness

An egg can be tested for freshness by dropping it in a cupful of water in which salt, 2 tablespoonfuls, has been dissolved. If the egg settles to the bottom, it is fresh, but if it remains suspended between the top and bottom of the solution, it is four or five days old. If it floats, it probably has been in storage.

Everyday Uses for Spring-Type Clothespins

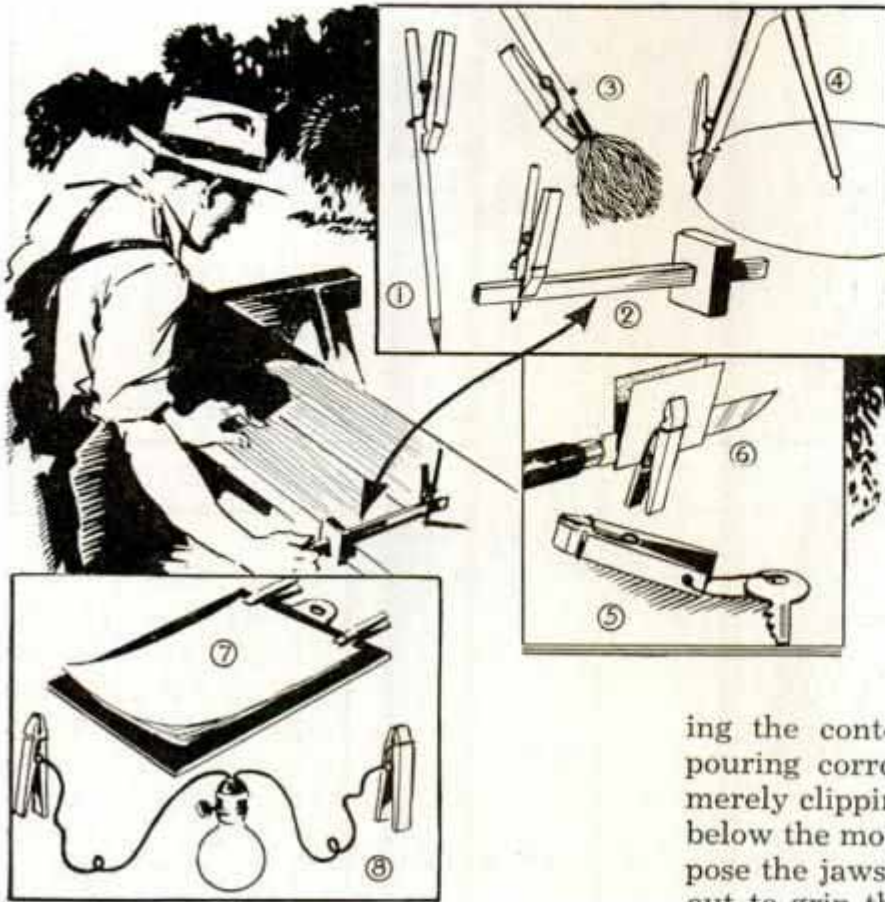

With a few slight alterations ordinary spring-type clothespins can be put to numerous uses. Fig. 1 shows how half of a clothespin can be clipped to a pencil to serve as a pencil clip, while in Fig. 2 the same idea is used in connection with a marking gauge. In the latter case the clothespin is pushed toward the point of the pencil. The gauge is then set and lines can be marked parallel to the edge against which the gauge block rides, as shown in the illustration. A 10 or 12-in. handle fitted with half of a clothespin to hold a wad of cloth firmly, as shown in Fig. 3, makes a practical milk-bottle washer. One leg of a large, wooden compass may be fitted similarly to hold a chalk crayon, as in Fig. 4, which is handy for scribing circles on blackboards. Keys to outbuildings often are misplaced or lost, and to avoid this you can tie the key to a clothespin, Fig. 5, which may then be snapped to some convenient support. Fig. 6 shows how a knife sharpener is improvised by folding a strip of sandpaper with the sanded surfaces together over the knife blade. Then clip a clothespin over the paper, as

shown, and draw the knife back and forth between the paper. Screwed or tacked to the edge of a piece of plywood, as in Fig. 7, two clothespins will hold shipping bills and other memoranda from blowing away in the wind. Electrical workers who need "jumpers" for testing, etc., will find clothespins, having the jaws lined with thin sheet brass or copper, soldered to the testing leads as in Fig. 8, a quick method of making connections. Also, a test tube may be held conveniently when heat-

ing the contents over a flame or when pouring corrosive or poisonous acids, by merely clipping a clothespin around it just below the mouth. When used for this purpose the jaws of the clothespin may be cut out to grip the tube securely.—J. G. Van Hook, Somerset, Ky.

Thumb Tacks Aid in Drying Small Painted Articles

Small articles that require painting on both sides can be dried without smearing the painted surfaces by placing them on the pointed ends of thumb tacks arranged on a flat surface. A pin pushed in the edge of each article aids in handling them.

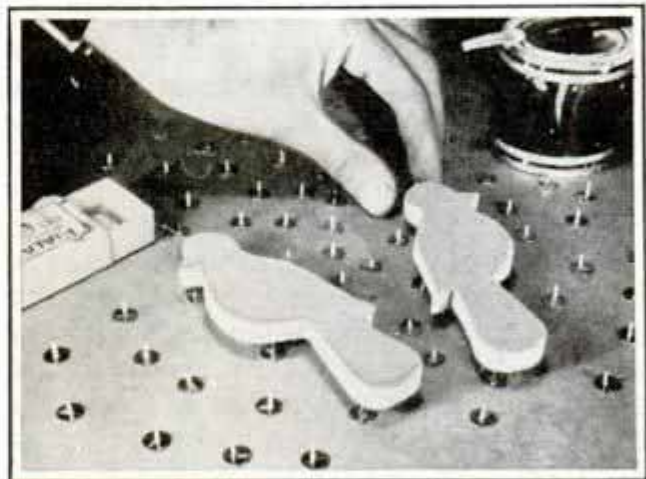

Thumb Tacks Support Small Painted Articles to Dry without Smearing the Wet Surfaces

Re-webbing Upholstered Chairs

Undue weight or strain on the seat of an upholstered chair often loosens the tacks that hold the webbing across the bottom and allows the seat to sag. This can be prevented by re-webbing the chair and anchoring the end of the webbing to pieces of flat iron screwed to the lower edges of the seat frame. To do this, cut the webbing in strips of proper length, allowing a few inches at the end for a hem. Then hem one end of each strip, slip the iron through the hem and screw it in place, first spacing the strip to come directly underneath the rows of springs in the seat. Next screw an iron in place on the opposite side, leaving it loose enough to slip the end of the strip underneath it. Then, with the stretcher shown in the lower detail, tighten the strips and sew the hem to hold them. The stretcher consists of two turn-buckles, two lengths of clothesline cable, which has hooks on two of the ends, and a

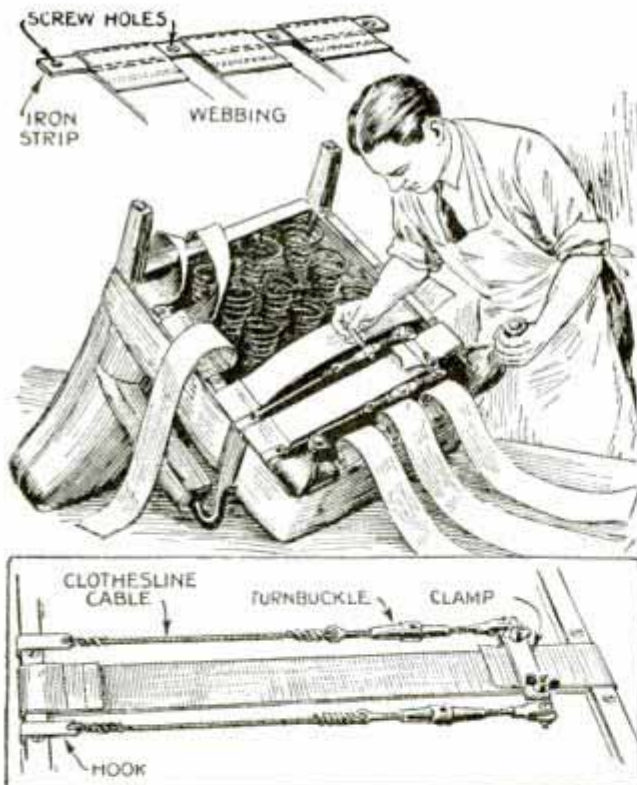

Iron Strips Hold Tightly Stretched Webbing on Frame of Upholstered Chair Seat

flat iron clamp for gripping the end of the webbing. After the strips have been stretched, tighten the iron that was left loose. This same procedure is then applied to the other side of the seat frame, weaving the strips between those that have already been tightened.

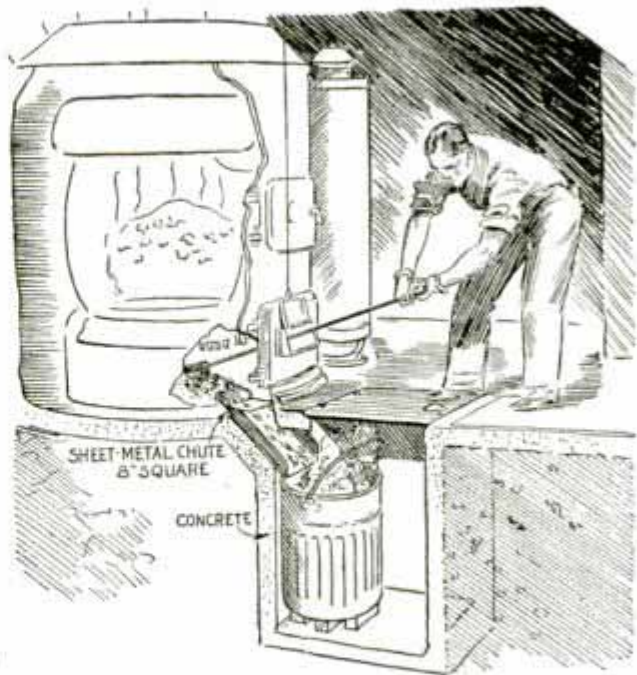

Ash Can under Basement Floor Permits Transfer of Ashes from Furnace without Dust

Pit in Front of Furnace Helps Prevent Dust in Basement

Dug under the basement floor in front of your furnace and lined with concrete, a pit large enough to accommodate an ash can will enable you to remove ashes from the furnace without raising dust in the basement. A sheet-metal chute leads from a hole in the furnace ash pit to the can as shown. The top of the pit can be covered with a hinged lid.—R. K. Beal, Marion, O.

C-Clamp Holds Jig-Saw Tension Rod while Changing Blades

To relieve the inconvenience of changing blades on the jig saw with one hand while the other is holding down the tension rod, a C-clamp may be tightened over the top of the rod case, so that both hands will be free to aline and fasten the blade.

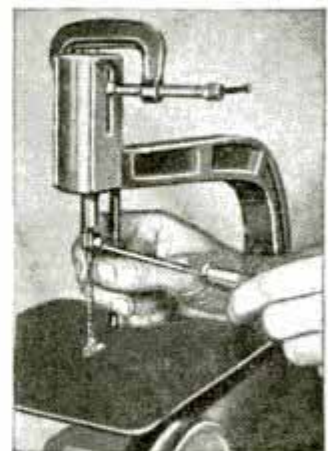

On jig saws having a tubular case around the tension-spring assembly, a small C-clamp may be fastened onto the lower end of the tension rod just above the blade chuck.—Ray J. Marran, Kansas City, Mo.

IDEAS for the

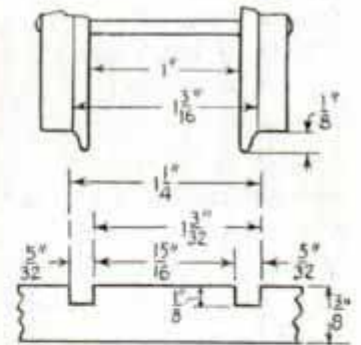
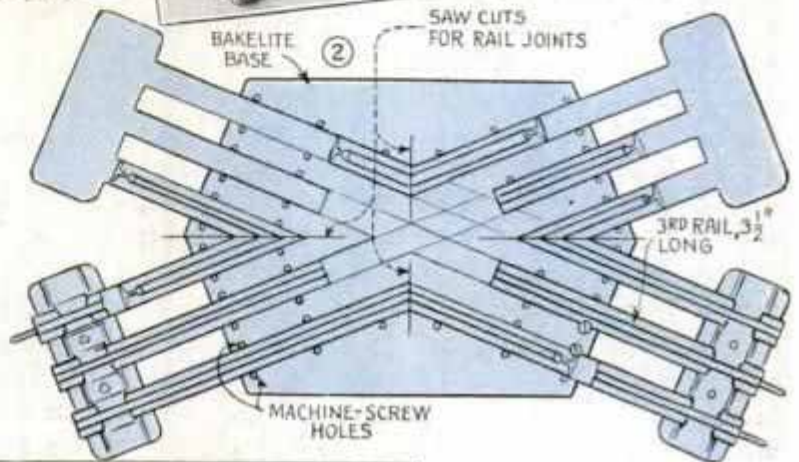
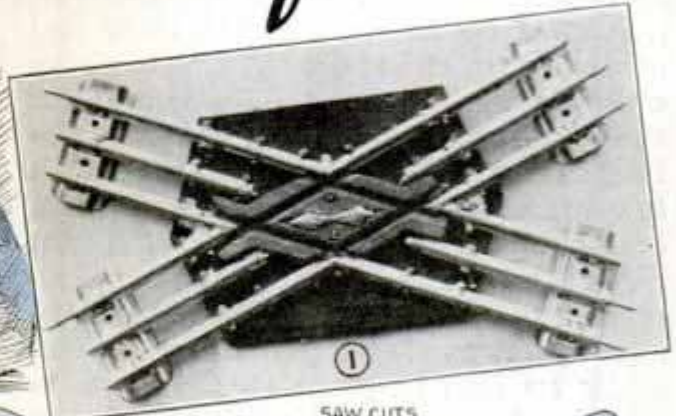
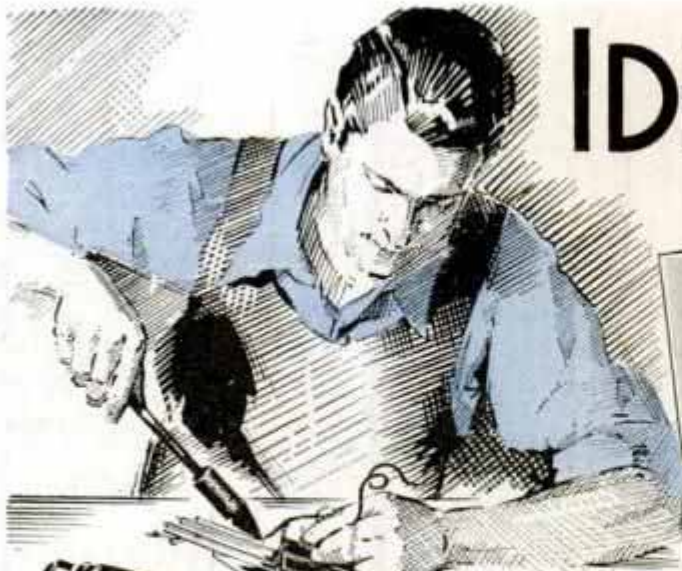

⑤ CROSS-SECTION OF FLANGE GROOVE IN CROSSING BLOCK

by
J.D. Brubaker

YOU can make your own switches and crossings from ordinary track and pieces of old radio panel or plywood. Bakelite or similar material is better than plywood as the latter may warp. To make a crossing from two pieces of straight track, remove the center tie of each piece with a screwdriver as in Fig. 3. Then lay one section of track on the base and mark along both sides of each rail with a sharp pencil. If bakelite is used, the surface should be sanded to show pencil marks. Place it at an angle of 45 or 90°, depend-

ing upon what type of crossing is wanted, and mark again. Mark where the outer rails will butt together and make long lines in the direction of the saw cuts to be made, as shown in Fig. 2. Lay each section of track on the base and mark and cut it with a fine coping saw, Fig. 4. Holes are drilled and tapped for short No. 4-36 machine screws to hold the rails to the base. The four parts of track are mounted in place and the heads of the machine screws are soldered to the rails. The butt joints at the frog points should be soldered, fill-

MODEL-RAILROAD FAN

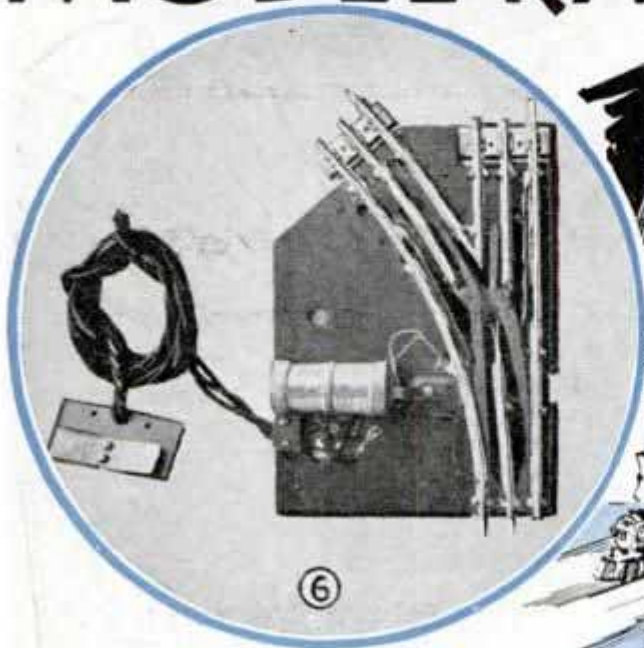

ing in the corner with solder to reinforce it. A block of hardwood is cut to a thickness equal to the height of the rail, which is usually $\frac{3}{8}$ in. This block is cut and fitted into place and fastened with countersunk machine screws before cutting the channels for the flanges. These channels are marked with the block in place. Then remove it and cut them out with a coping saw, cutting the whole length of the groove at one time. The dimensions for these grooves are in Fig. 5. Check your engine to see if the gauge of the wheels and depth of flange agree with the drawing. If not, you will have to allow for any difference there may be. The most important thing is to make the depth exact so that the wheel will rest wholly on the flange as it crosses the gap in the rail. The four pieces of third rail are connected together by means of No. 18 or 20 bare copper wire. The wires are run in small holes starting in the ends of the diamond center, going down at a sharp angle to clear the flange groove, coming out in the bottom of the block. Short notches are cut, through which the wires are led out and soldered into the ends of the third rails. The contact piece in the center is made by spreading the wires apart in a diamond shape, filling in with solder to form a raised surface. The ends of the third rails must come very close to the wood block to keep

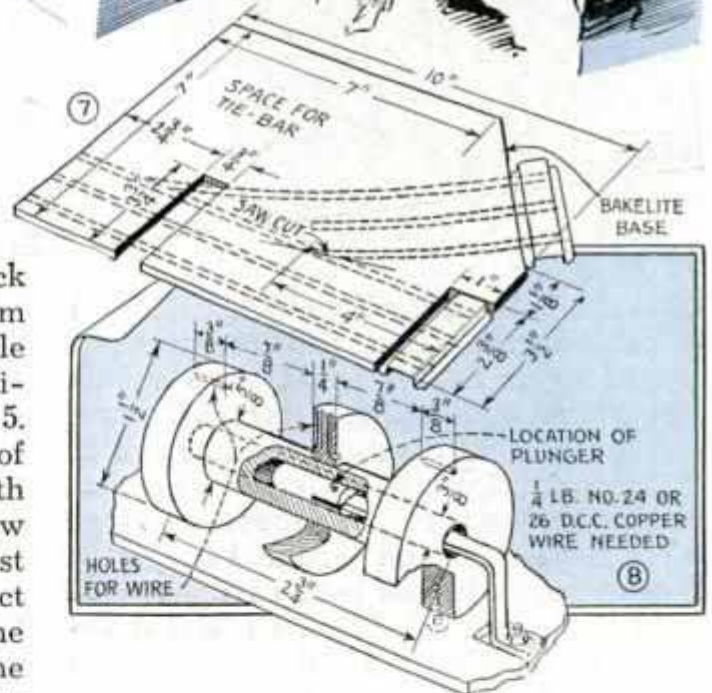

the collector shoe of the engine from catching in the gap. The completed crossing is shown in Fig. 1.

A good switch, as shown in Figs. 6 and 9, can be made in the same general manner. Remove two ties from each piece of track, one of which is a curved section. Before putting the rails on the base, cut a slot in the side of base, Fig. 7, for the tie bar. The third rail between the wooden switch points is set over at the inner end to clear the flanges of engine and cars. The frog block is held with machine screws

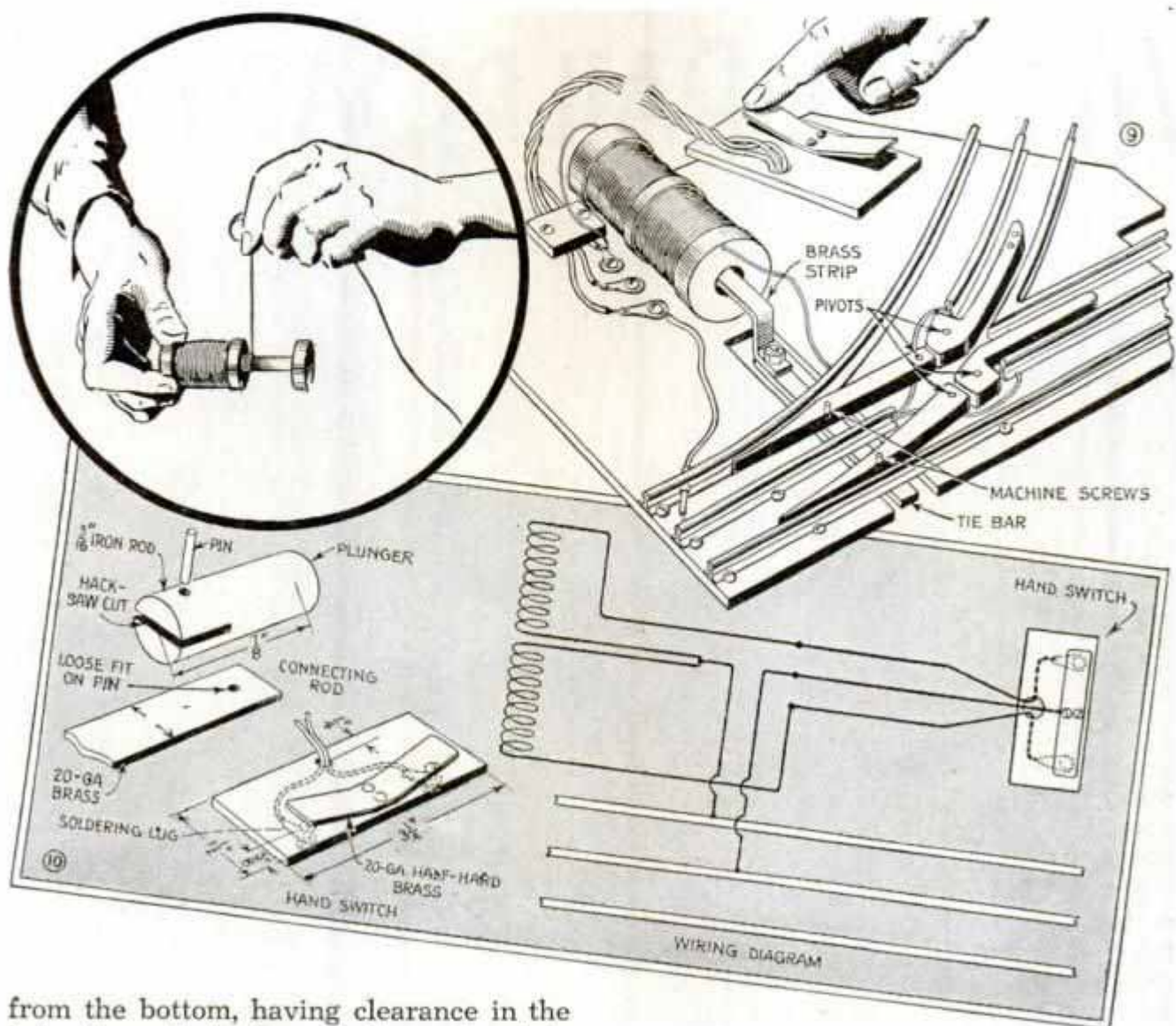

from the bottom, having clearance in the holes through the base, and screwing into tapped holes in the wood. The switch points pivot on machine screws at the frog end, installed in the same manner except that the wood is tapped only part way. The machine screw is run into the hole so that it is tight, leaving the head and body of it free to rotate in the base as the switch point is moved. The points are tied together by a $\frac{1}{2}$ -in. strip of bakelite, thinner than the base to avoid rubbing on the floor. The pivot screws in this strip are countersunk into it and are inserted from the bottom as before with a tight fit in the wood switch point. For hand operation a small knob can be bolted through the end of the tie bar but for electrical remote control, a solenoid coil is made to operate an iron plunger connected to the tie bar by a narrow brass strip. Fig. 8 shows how the solenoid form is made. Both parts should be wound full of No. 24 or 26 double cotton-covered wire with the ends leading out through the small holes drilled

as indicated. About $\frac{1}{4}$ lb. of wire is required. A small hole is drilled to take a nail used as a rivet which connects the plunger and connecting rod. The wiring diagram is shown in Fig. 10. Connection to the third rail is made through a hole drilled in the side rail, using insulated bell wire. The guard rails opposite the frog are made of heavy wire and soldered to the outside rails. Wire is better than wood as it is easily adjusted and does not let the sharp flanges of the engine cut into and climb over it. The constructional details of this switch as shown are for 0-gauge track, and the same method is used for standard-gauge systems, but for standard-gauge use, the solenoid-coil form should be about 2 in. outside diameter to allow for more wire due to the higher voltage used on those systems.

☐ A flatiron will retain heat longer if a brick is used as an iron stand.

Home-Movie Screen Folds into Wood Case

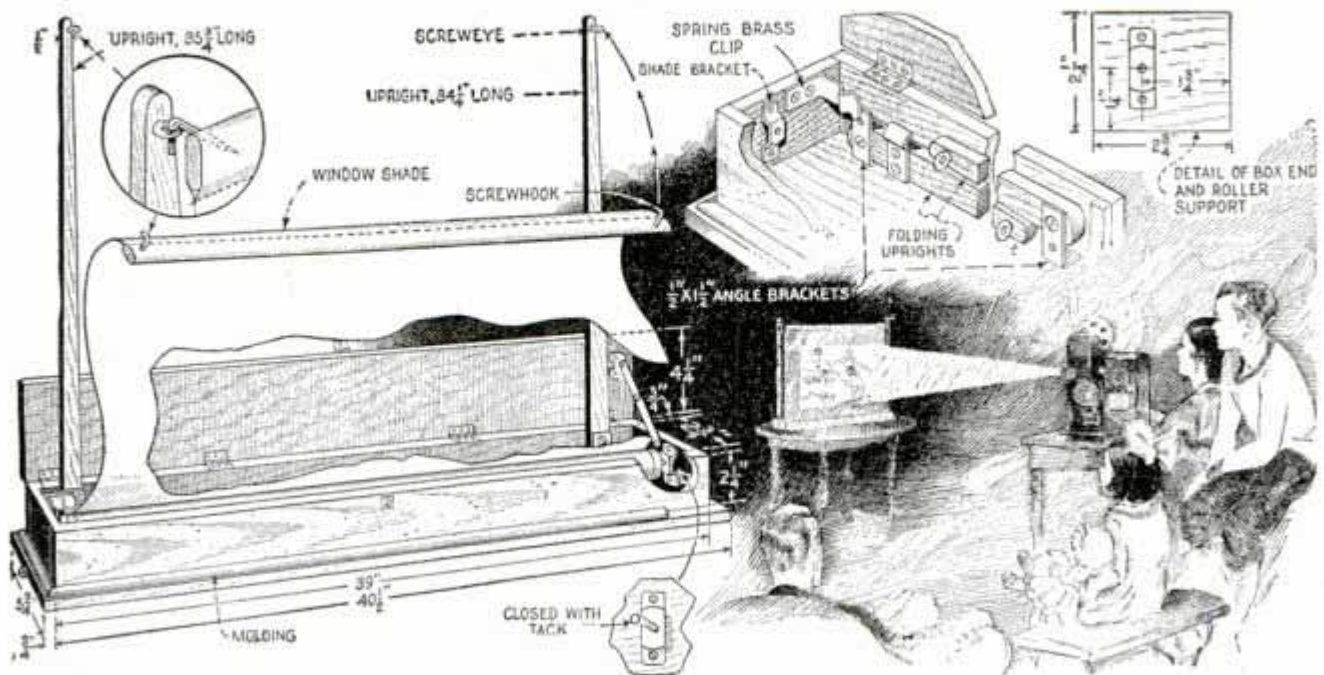

Folding into a neat wood case, fitted with a hinged cover, this portable home-movie screen can be set up quickly on any chair or table. The screen is a 36-in. white window shade set in brackets screwed to the ends of the case. To prevent the end of the roller held by the slotted bracket, from slipping out of place, the slot is closed with a tack. Pivoted uprights that fold into the box support the screen,

screw hooks in the shade fitting into screw eyes on the uprights. Note that the uprights are pivoted at their lower ends to angle brackets, and that the pivot point of one is higher than that of the other to permit them to lay horizontally, one on the other. To keep them up vertically, spring-brass clips, made as shown, are effective, one part being screwed to the case and the other to the upright.

Rolling Sifter Applies Even Coat of Ashes to Icy Sidewalk

For spreading salt or ashes to prevent accidents caused by slipping on icy sidewalks, this sifter applies an even coating. It is made from a square tin can perforated on all four sides, and fitted with heavy metal bands at the ends so that it can be rolled over the walk. A handle for pushing the sifter is made by doubling and twisting heavy wire, a square loop for a hand grip being provided and the ends bent to fit holes in the ends of the can.

Small Grease Gun Improvised from Tooth-Paste Tube

When refilling small grease cups that are hard to reach, get an old tooth-paste tube, remove the crimped strip on the lower end, and fill the tube with cup grease. After replacing the strip, you can fill the cups by squeezing the tube.

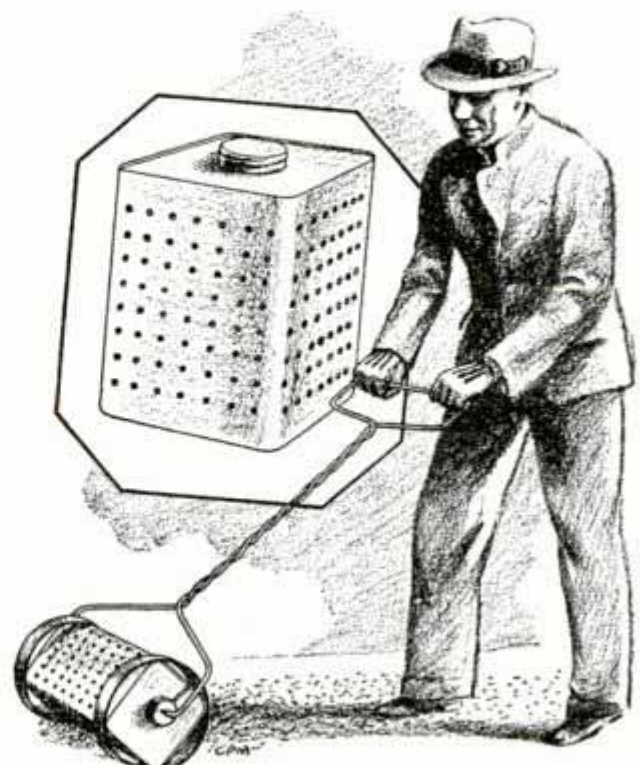

Lathe Set-Up for Turning Small Wood Spindles

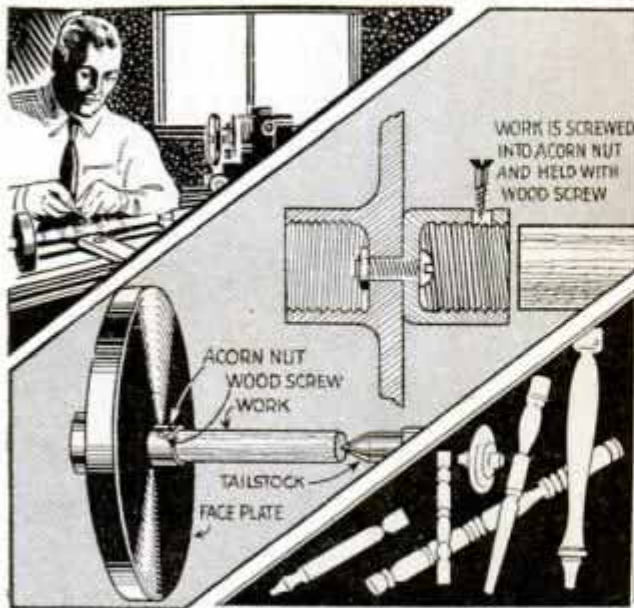

Acorn Nut Bolted to Lathe Faceplate Holds Small Stock When Turning Tiny Model Parts

To turn small wood spindles for models, an acorn nut can be attached to the faceplate with a stove bolt as shown. The nut is drilled in the side for a wood screw, which holds the work. By using different sizes of nuts, it is possible to turn spindles as small as a match provided the turning tools are handled carefully.

Hydrometer Nozzle Directs Small Powerful Stream of Water

Slipped over the brass connection on a garden hose, a rubber nozzle taken from a hydrometer will produce a small stream of water that is useful for many cleaning purposes around the home. With the nozzle, water is readily directed into places inaccessible by other means. It is also handy when washing a car with a garden hose, as it gives the stream more force with less water consumption.



Gouges for Carving Linoleum Blocks from Pen Points

Steel pen points, when sharpened and reversed end for end in the holder, make good gouges for carving linoleum blocks.

If a point of relatively soft steel is used, it is possible to reshape the curve to make U and V-shaped gouges. Except for the necessity of resharpening them frequently, they compare favorably with those made from tool steel.—Cecil Gabler, Marion, O.

Fishing Line Dried on Rod

Instead of removing the line from your fishing rod to dry, clip a couple of spring-type clothespins to the rod and wind the line on them as it is unreeled. A small nail driven into each pin near the outer end will keep the line from slipping off. The clothespins are easier to carry on a fishing trip than a drying reel, and save time.

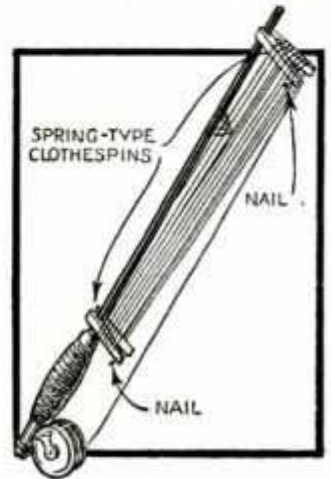

Rubber Cup on Clothes Stick Prevents Scalded Hands

Women who have suffered scalded hands when lifting clothes from a tub of boiling water with a clothes stick, will find that a rubber suction cup, such as used by plumbers, will prevent these accidents. Hot water running down the stick is caught by the cup and deflected into the tub. This arrangement may also be used when washing windows to prevent water from running down the brush handle.



Plumbers' Rubber Suction Cup Slipped over Clothes Stick Prevents Boiling Water from Scalding Hands



SHOP NOTES

HEAT TREATING

Brass, Copper and Aluminum



Brass, copper and aluminum made hard and brittle by hammering, bending and other shop operations, are restored to their former softness by annealing.



water; however, there are a few tricks which make this work a lot simpler and more effective. With some metals like aluminum and aluminum alloys, annealing by simply heating in an open flame is not satisfactory because of the action of the fuel on the metal and also because of the danger of overheating and spoiling the job

METALS such as brass, copper and aluminum frequently become hard and brittle, either due to hammering or other severe shop operations, and unless they are properly annealed or softened, they will break or tear and spoil a good job. All of these metals and most of the common alloys except aluminum and its alloys can be softened to some extent by simply heating them and either allowing them to cool in the air or plunging them into cold

entirely. Where tarnish formed during the heating will cause no trouble, copper and brass may be softened sufficiently for most purposes by heating them to a dull red heat and either cooling in air or plunging into cold water. The metal should be heated in a furnace or on a hot plate so that all parts are equally heated. A better plan, if convenient, is to heat the work in a simple furnace. An outfit of this type is quickly assembled by building a shield of brick

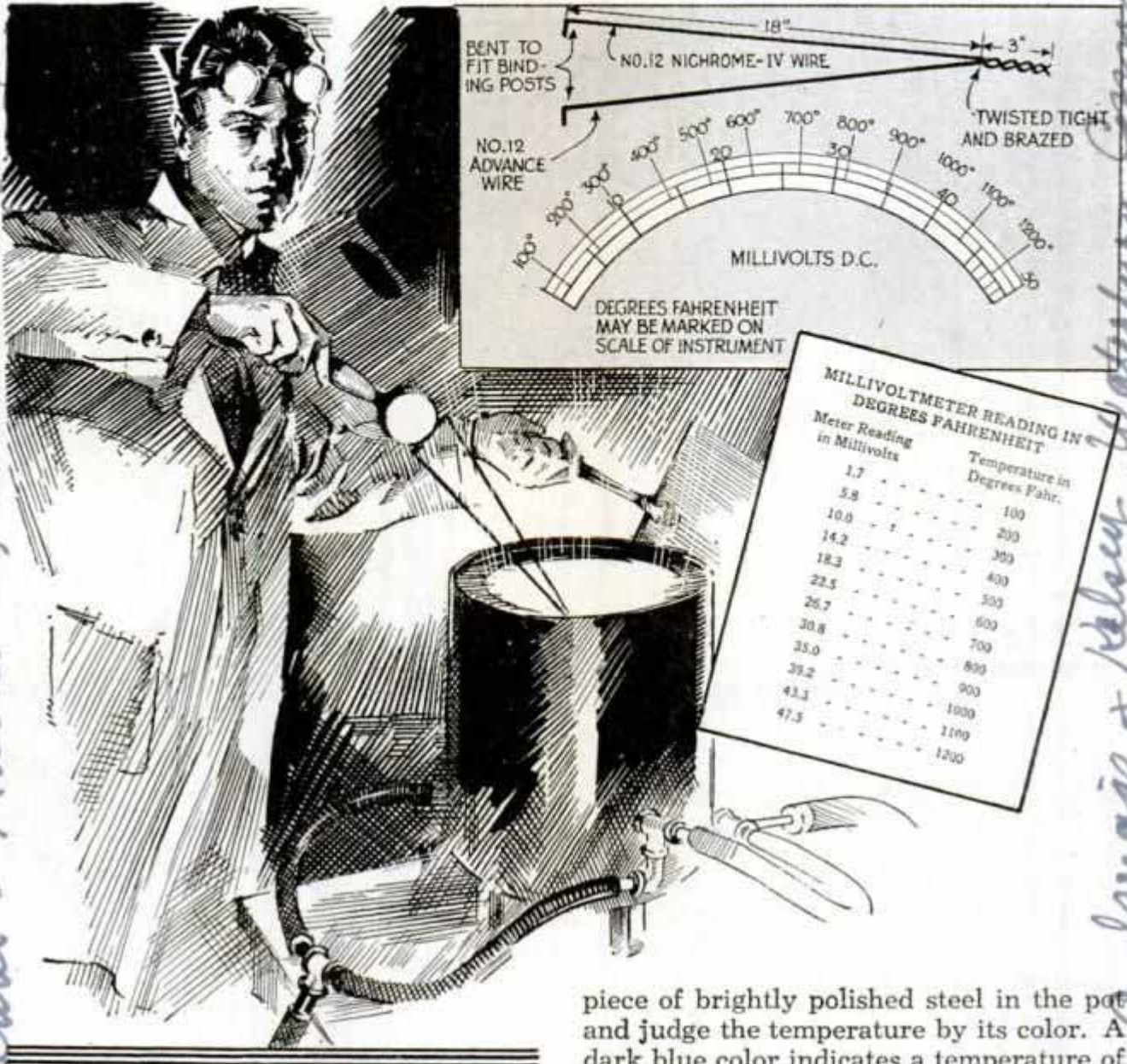

| Meter Reading in Millivolts | Temperature in Degrees Fahr. |
|-----------------------------|------------------------------|
| 1.7 | 100 |
| 5.8 | 200 |
| 10.0 | 300 |
| 14.2 | 400 |
| 18.3 | 500 |
| 22.5 | 600 |
| 26.7 | 700 |
| 30.8 | 800 |
| 35.0 | 900 |
| 39.2 | 1000 |
| 43.3 | 1100 |
| 47.5 | 1200 |

or asbestos board around a gas hot plate. A sheet of steel placed over the burner prevents the flame from coming in direct contact with the work. Although the simple procedure just described is adequate for ordinary purposes, it is better practice to heat brass and copper as well as aluminum in a furnace as free as possible from gases. It is also equally important that the temperature to which these metals are heated be rather accurately controlled. The easiest method of heating to get these results is by placing the work in a closed metal container such as a thick-walled iron pot fitted with a lid and to place this in a furnace such as described in the November, 1932, issue of Popular Mechanics. To prevent overheating, some method of measuring the temperature inside the iron pot is essential. The easiest plan is to place a

piece of brightly polished steel in the pot and judge the temperature by its color. A dark blue color indicates a temperature of about 570° F. Red indicates 725° F. and a bright red which is almost white indicates a temperature of 1200° F. or more.

At a cost of only a few dollars anyone can make a simple thermocouple pyrometer which will take the guesswork out of heat treating. All that is needed is an inexpensive d.c. millivoltmeter (0 to 50 millivolts), 21 in. each of Nichrome IV and Advance resistance wire and two binding posts. Dimensions for the handle will depend upon the size of the meter. The binding posts are connected to the meter posts inside the case. Heavy wires should be used for this and they should be well soldered. The bent ends are inserted in the binding posts and tightened and the instrument is ready to use. It may be tested by placing the joined ends of the wire in the flame of a burner for a few minutes. If the meter needle moves in the wrong

Nichrome wire - nichrome form
 Advance wire - Harris Co, Harrison N.J.

Langley & Kellogg, Watertown, Conn.
 Newark, N.J. or Bristol

Weston Electrical Instruments!
 Corp. 119 1/2

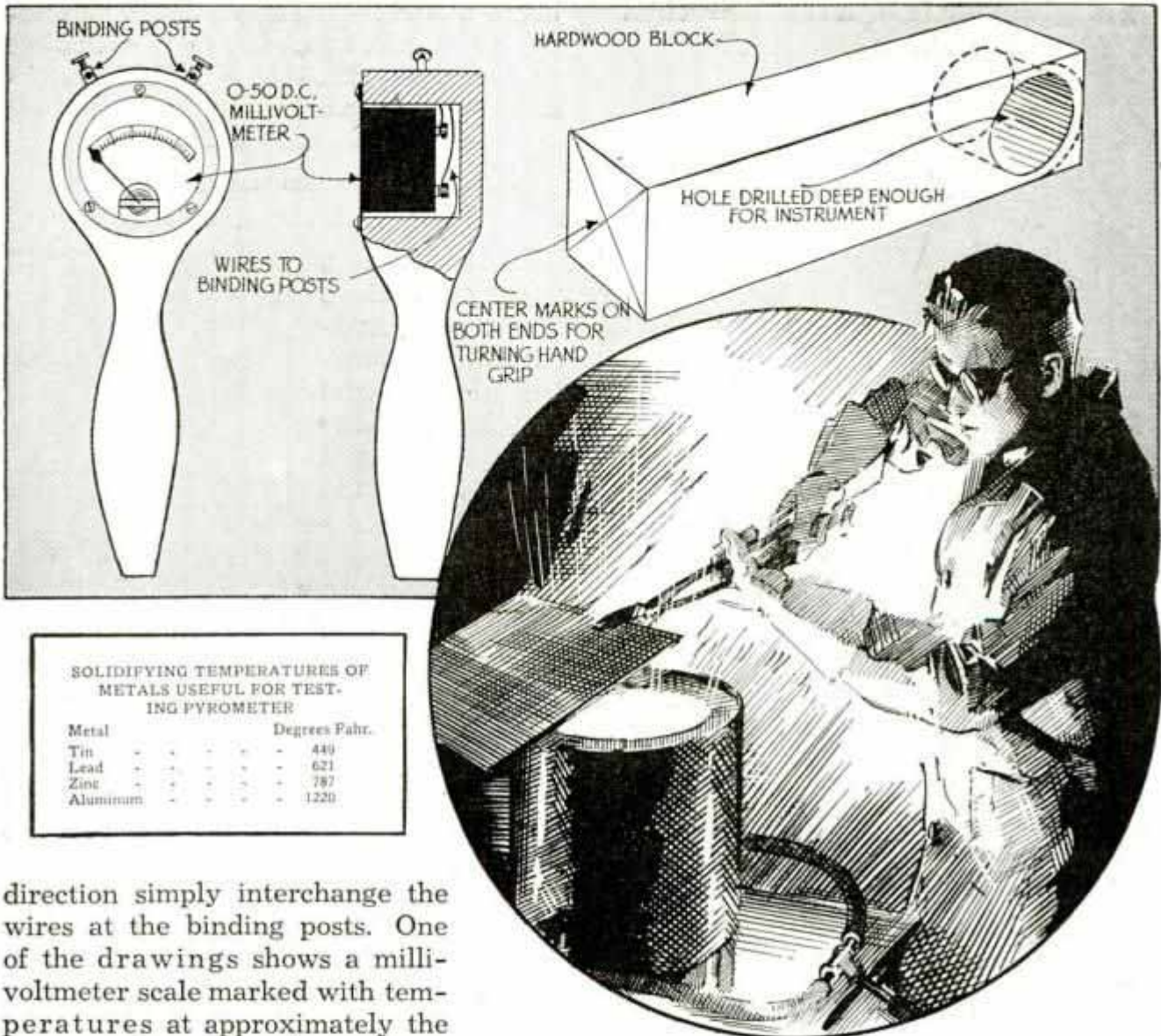

SOLIDIFYING TEMPERATURES OF METALS USEFUL FOR TESTING PYROMETER

| Metal | Degrees Fahr. |
|----------|---------------|
| Tin | 449 |
| Lead | 621 |
| Zinc | 787 |
| Aluminum | 1220 |

direction simply interchange the wires at the binding posts. One of the drawings shows a millivoltmeter scale marked with temperatures at approximately the proper points. The glass cover may be removed and the values marked on the scale, or millivolt readings may be taken and converted into temperature by glancing at the table. The figures given are average values and will be found close enough for many purposes. However, if more accuracy is desired the instrument should be calibrated by placing the couple in molten tin and allowing the metal to cool slowly. As cooling progresses the meter reading will slowly drop until the metal starts to solidify. At this point the needle will remain stationary until all of the tin has solidified, after which it will again continue to move toward zero. The point at which the needle remained stationary during the solidification of the metal should be recorded as it indicates a temperature of 449° F. Other accurate temperatures may be located on the pyrometer by performing a similar test with other metals, solidifying temperatures of

which are given in a table. These points may be marked on the instrument scale and intermediate temperatures found by dividing up the space between them.

Aluminum is annealed by heating it in a closed container placed in a furnace or oven to a temperature of 650° F. The work is slowly heated until all parts have had time to get to this temperature. The thermocouple may be inserted into the heating pot from time to time and as soon as the temperature reaches 650° F., the burners should be cut down to hold this value until all parts are heated. Some care is required in controlling the furnace to prevent overheating. The common aluminum alloys are treated in the same manner. For the best results with brass, follow the same methods as described for aluminum except that the temperature should not exceed 1112° F. for ordinary grades. Copper may be similarly annealed at 1202° F.

Swinging Danger Sign at Construction Job Warns Motorists



Swinging Sign at Street-Repair Job Attracts Motorists' Attention Quicker Than Stationary One

After having considerable trouble with motorists not noticing a warning sign set up in a street while repairing it, the contractor rigged up a swinging sign, which attracted attention quicker than a stationary one. The sign was pivoted to the top of a post by means of a bicycle pedal as shown. A concrete weight on the lower end of the sign kept it moving for several minutes once it was started. Workmen passing near the sign gave it a swing to keep it in motion and the warning was kept moving practically all day.

Thumb Tack on Lettering Brush Helps Preserve Chisel Edge



To assure that his chisel-edged brush would be held correctly, one show-card writer put a thumb tack in the handle at the point where the tip of his index finger ordinarily rested. This served as a guide to hold the

brush at the right angle without the necessity of looking at the edge each time the brush was picked up.—G. E. Hendrickson, Argyle, Wis.

Handle Simplifies Use of Yardstick When Wearing Gloves

Bricklayers, masons and others who use a yardstick when wearing gloves, will find that a screen-door pull screwed to one side of the stick near the center makes it much easier to handle. This permits the stick to be picked up readily without removing the gloves.



Erecting Rafters Single-Handed with These Supports

Often the work of erecting rafters on small buildings can be done single-handed if you use a pair of supports on which the rafters may be rested while nailing the lower ends to the plate. Each support is merely a suitable length of 2 by 6-in.

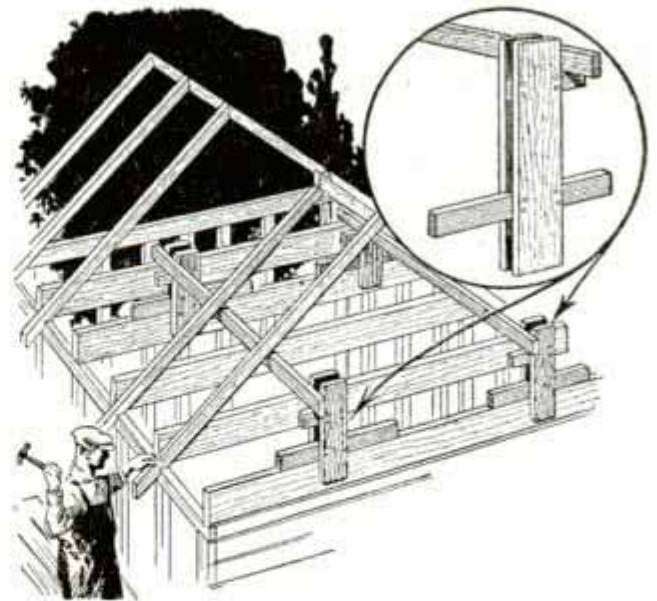

One Man Can Erect Rafters When Aided by These Wooden Supports

stock held at each end by a double leg which is slipped over the joist as shown.

☐ To test the edge of tools, keep a piece of hardwood dowel rod handy in your kit.

Photo-Print Straightener from Old Wringer

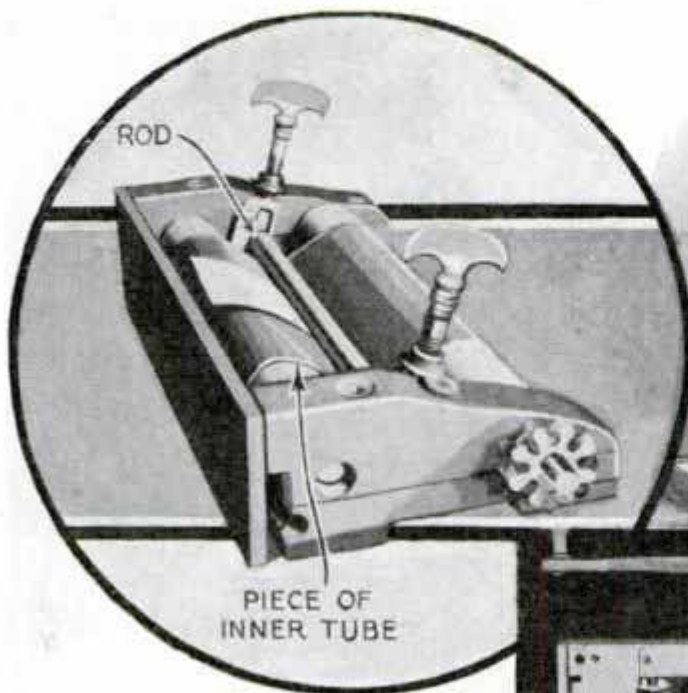

Photographers who are without a print straightener, can readily improvise one from a discarded hand clothes wringer. Cut off the gears from the roller shafts with a hack saw, allowing enough of the shaft to extend beyond the rollers to be slipped into a hardwood frame. Then cut a section of inner tube, slip it over the rollers and hold them apart until the tube is just taut. In this position, measure the distance between the centers of the shafts and add $\frac{1}{4}$ in., which gives you the correct spacing for the bearing holes to be drilled in the frame. A $\frac{1}{2}$ -in. brass rod, just as long as the rollers, is

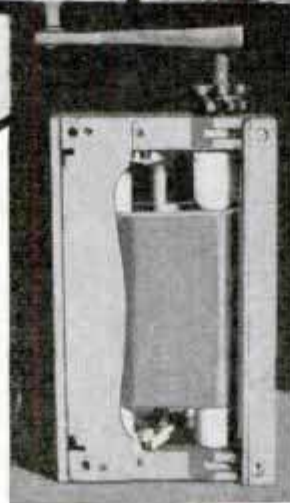

pushed inside of a piece of smooth-surface rubber hose or tubing a trifle shorter than the rod. The latter is fitted into the adjustable thumbscrew bearing assemblies taken from the wringer, which are screwed to the center of the frame. The small roller depresses the inner tube and the prints are passed between the two, adjustment for pressure being obtained by

the thumbscrews. If desired, it may be driven by a small electric motor, but in this case, it will be necessary to leave a gear on one of the rollers to be used as a pulley to take a belt. Space between the teeth should be filled with solder and the surface turned down so that the pulley will be perfectly round.

Whipping Rope Ends to Prevent Them from Unraveling

Every person handling rope should know this simple method of whipping the ends with cord to prevent unraveling. Start in the position shown in Fig. 1, with the ends A and B hanging free. Grip the cord at C and wrap it around the end of the rope, wrapping toward the left hand. After the wrapping has been completed, run the end B through the loop D, Fig. 2, and pull both the end and loop underneath the wrapping tightly. Now cut off the loose ends and you will have a neat job as shown in Fig. 3.—I. W. Dickerson, Charles City, Ia.

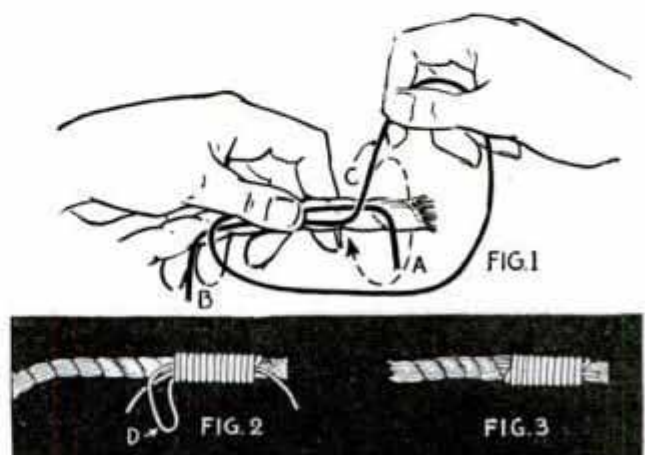

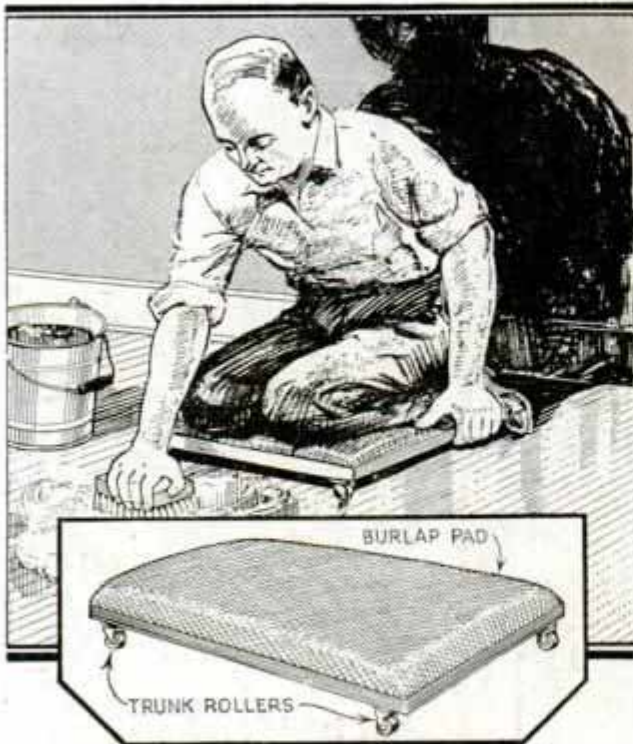

Padded Creeper Makes Work of Scrubbing Floors with Hand Brush Less Tiresome

Padded Creeper on Casters Protects Knees When Scrubbing

One janitor who has several floors to scrub each day makes his job less tiresome by using this creeper on which to rest his knees while working. It consists of a 1-in. wood block to which are fastened four trunk rollers and a burlap-covered pad as indicated. Trunk rollers or casters permit the creeper to be pushed in any direction.—Laurence M. Phillips, Pontiac, Mich.

Sections of Auto Tire Hold Lid on Feed Barrel



When feed is kept in a barrel in a stock pen, four narrow sections of auto casing nailed to the sides of the barrel as shown will serve as clamps to keep the lid in place. These clamps are strong enough to prevent

cattle from pushing the lid off, yet they are flexible enough for a man to remove it easily.

Tool Polisher Made from Spool

To remove rust and stains from his tools, and, at the same time keep them oiled, a carpenter made a handy polisher from a spool. A felt disk with a small hole in the center was held on one end of the spool with a piece of cloth, after which the hole in the spool was filled with fine abrasive powder. In use, a few drops of oil added to the powder keeps it feeding slowly through the cloth.



Hinged Pipe Mast for Wind Sock

With this hinged support, which can be lowered, it is unnecessary to climb a pole in order to adjust a wind sock at an airport. The support is made of large pipe and is bolted to a sleeve, which is welded to a hinged base. Legs of smaller pipe brace the support and are flattened at the lower ends so they can be screwed to a

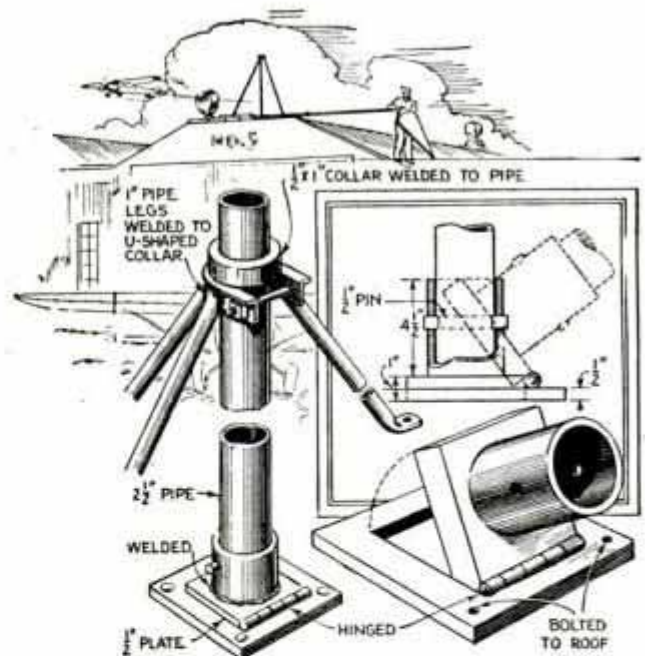

Wind-Sock Mast Attached to Hinged Base Is Lowered Easily for Adjusting the Sock

hangar roof. The upper ends of the braces are welded to a U-shaped piece of angle iron, which straddles the pipe. A bolt through the ends of the angle iron is used to hold the mast upright.



Doing it Safely!

By
W. Clyde Lammey

YOU can easily acquire the habit of handling tools carefully, not only for the good of the tool itself but for your own safety as well. This applies equally to both hand tools and power equipment. A chisel or an ordinary pocketknife might be the cause of an accident if it is allowed to slip or otherwise get out of control, due to carelessness or a moment of inattention. Manufacturers of power-driven equipment for the home workshop have provided various safety devices and to get the maximum protection from these accessories one must keep the machine in the proper condition and use it with due care.

The circular saw is now used in practically all home workshops, and if the operator will observe consistently a few simple precautions it is fully as safe to use as a hand saw. As it is now made, the machine has been so perfected that it is



Upper Left, Upper Guide of Band Saw Is Adjusted to Just Clear the Work; Upper Right, Using a Push Stick When Ripping Off Narrow Strips

practically foolproof mechanically. It is only necessary to see that the blade is properly set and sharpened at all times. This means that the teeth of the blade must have a uniform degree of set and must be kept sharp if the saw is to do its best work. Joint the blade each time you file and set it, to insure correct balance. If the blade is out of balance it is unsafe. When setting up or moving the saw be careful to place the machine in such a position in the shop that you have adequate light directly on the table, and remove anything above or near the machine that



Above, It Pays to Protect Your Eyes from Small Flying Bits of Metal When Using a Lathe or Grinder; Right, Keep the Circular-Saw Table Clear and Hold the Work on Each Side of the Blade

might possibly be dislodged and fall on the blade while the machine is running. Lack of caution in this one respect has been the direct cause of serious accidents.

The careful operator of a circular saw acquires by practice the habit of knowing instinctively at all times just where his hands are and what they are doing. He keeps his attention concentrated on the machine all the time it is running and he allows nothing to distract this attention even for a moment. He is also very particular about a dangling shirt sleeve or necktie which might get caught in the blade. When ripping long narrow stock he first makes sure that the fence is securely fastened with the means provided, and if the stock is too long to handle

easily, he runs the cut half way through, stops the machine, turns the material end for end and finishes the cut. When ripping certain kinds of stock, the careful operator is always on the alert for splinters that may possibly be broken off by the passage of the blade through the wood. Should these loose splinters be caught by the teeth they might be thrown with dangerous force. It is also wise to keep all small pieces of waste cleared away from in front of the machine as these may be the cause of a misstep while bending over the saw. When squaring the ends of a number of small pieces, measure the length required so that you can cut off at least $\frac{1}{2}$ in. of waste at the ends. Then there is no danger of the waste material breaking up

in small pieces as it is being cut off. Do not allow these small blocks to accumulate on the table at the rear of the blade. Stop the machine and clear them away.

Another and very important precaution is the use of a push stick when ripping narrow stock on the saw table or handling thin narrow stock over the jointer. A suitable push stick is simple to make and reduces the hazard to a



minimum. Use the push stick when jointing thin stock or short pieces on the jointer. The dado head should always run under a suitable table insert, which is usually provided with the saw. In this way only that portion of the head which does the cutting is exposed. And, never under any circumstances attempt to cut a groove with the dado head "freehand," that is, without the guides. This can be done with

the saw blade with a reasonable degree of safety, provided you use a blade with a wide set, but it is never advisable and the larger the piece of stock the greater the accident hazard. There are a number of other special operations with the circular saw and its accessories, such as the molding-cutter attachment, which may be done with the same degree of safety as the operations that are more common.

As made at the present time, band saws and the power scroll saws are in many ways more safe to use than hand tools because of the higher cutting speeds and smoothness of operation. Band saws in particular are so made that the blade is guarded at every point where it is likely to cause injury, and the mechanical con-

Always Have Plenty of Light on Your Work and Don't Let Anything Distract Your Attention; Rushing a Job Carelessly Results in Poor Workmanship and Involves an Unnecessary Hazard



When Dressing Emery Wheels, Stand to One Side and Not Directly in Front of the Wheel

struction of present-day power jig saws is such that it is practically impossible for the blade to cause any serious injury. However, it should be remembered that no matter how well a machine may be built, or how completely it may be guarded, carelessness on the part of the operator always creates an accident hazard. There are only two principal causes of trouble with the band saw; the first is running the machine with the guides and wheels improperly aligned and the second is the failure to make sure that the stock has a firm bearing on the table. Make sure that the table is clear of all small blocks of waste from previous work, see that the

stock to be cut rests securely on the table at the beginning of the cut and be careful where your fingers are at the moment the blade cuts through the work at the finish. Keep the upper guide as low as possible, adjust it so that the lower side just clears the work. Be sure that the table clamps on the trunnions are tight, to prevent the table from tipping unexpectedly and throwing the

work out of line with the blade. If you must remove small pieces of waste from under the guides by hand either stop the machine or use a short stick. What applies to the band saw by way of precaution also is true of the power scroll saw, as the cutting action is essentially the same.

When you use your metal-turning lathe on straight work where the tool is taking off a fairly heavy cut, keep your hands away from the curling chip. The edges are often razor-sharp and unless one is very careful, these chips may cause painful injury. If you do not wear glasses it is advisable to wear a pair of industrial goggles when you are working with either a wood

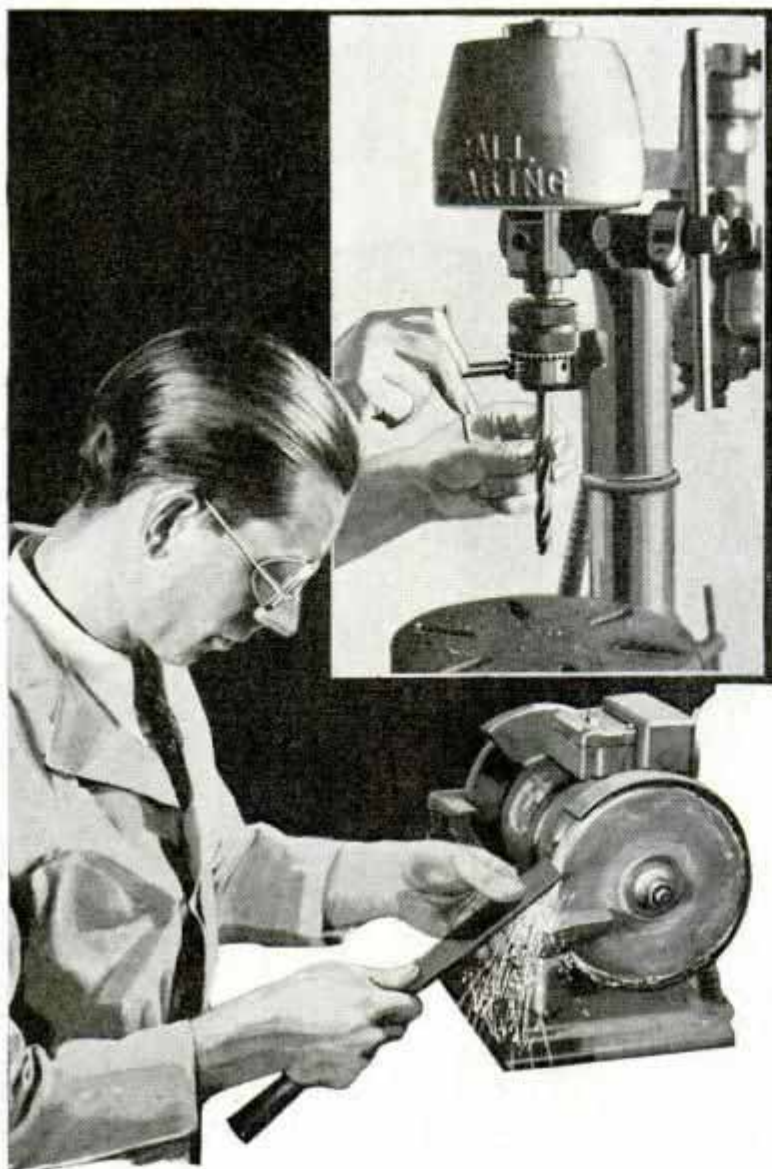

Above, Be sure to Remove the Wrench from the Drill Chuck before Starting the Machine; Below, When Grinding Edge Tools See That the Blade Bears Firmly against the Tool Rest

or metal-turning lathe and also when grinding tools or other work on an electric grinder. It is well to be careful about unbuttoned sleeves and to fasten securely any loose part of the clothing so that it cannot possibly catch in the revolving work or any moving part of either the metal or wood-turning lathe.

When two or more persons are operating the machines in the shop there should be some understanding between them so that one does not distract the attention of the other. This is a most frequent source of accidents. Obviously the machinery cannot be at fault. Many operators acquire the faculty of anticipating any possible trouble they may be likely to have with a special piece of work. Suppose for example you wish to drill a hole of medium size through an irregularly shaped piece of

work on the drill press. Without thinking, many will grasp a small piece of work of this kind in one hand and attempt to hold it securely while the drill passes through. If the drill bit should bite suddenly the work is almost certain to revolve with the bit, and the sudden movement would be equally as certain to injure the hand, especially if there were any sharp projections. Small metal parts to be drilled on the power press should always be held in a vise, or lacking this, a suitable C-clamp.

One can easily learn how to use the various home workshop machines in the proper way, but one must be ever on guard against a moment of inattention, a lack of precaution.

Both Sides of Oilstones Exposed in This Box

By mounting an oilstone in a wooden frame with a hinged lid on each side, you will not get the stone dirty when reversing it to use the opposite side. The two end pieces of the frame are cut slightly shorter than the width of the stone so that when screws are driven into them through the side pieces, the stone is held rigidly.

Pieces of felt glued to the inside of the lids absorb the oil and keep the stone moist.

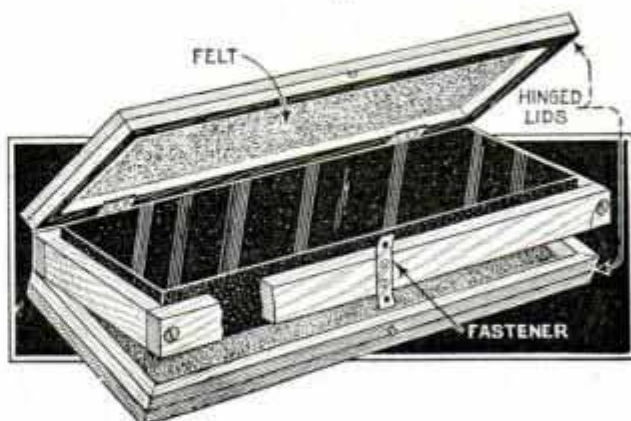

Frame with Two Hinged Lids Keeps Your Oilstone Clean and Handy to Use

☞ Sifted whiting dusted over cloth buffing wheels makes an excellent powder for polishing metal.

Guide for Cutting Angles on Stationary Saw

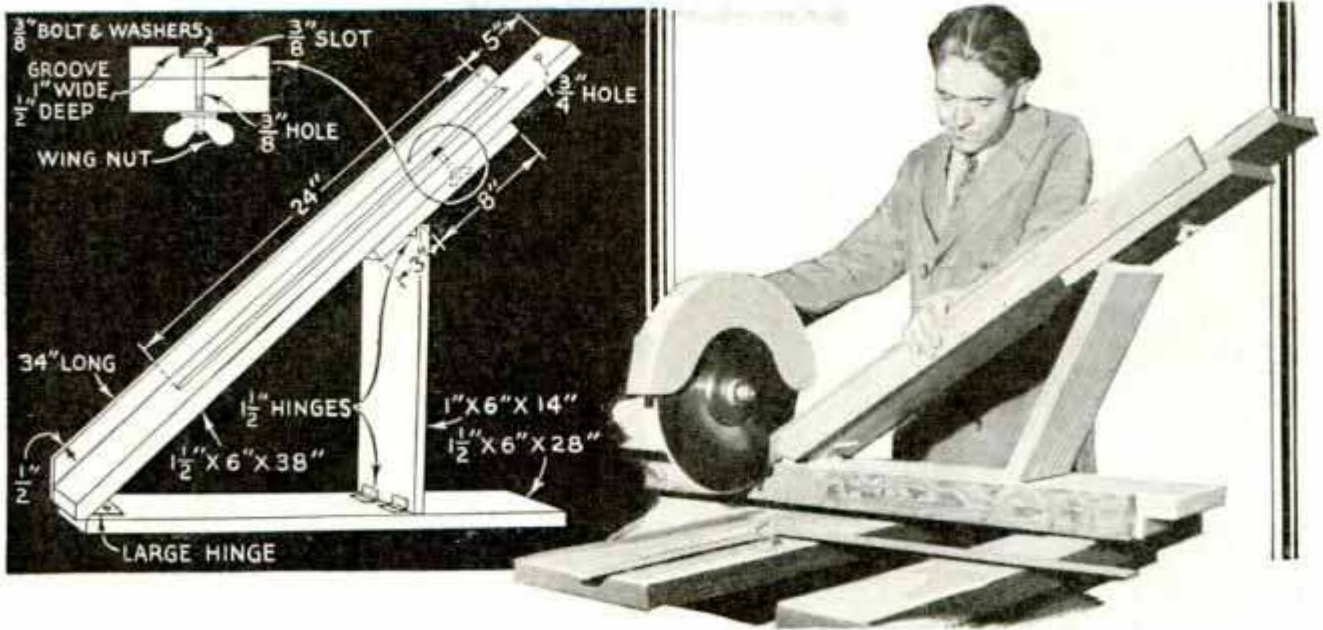

If you have a circular saw not equipped with a tilting table, angle cuts from 25 to 65° can be made by using this adjustable guide, which is a hinged assembly consisting of a base, work rest and a support for the latter. Notice the bolt and wing nut under the work rest to hold it at any desired angle, adjustment of the angle being obtained by moving the bolt up or down in a 24-in. slot in the rest. The support is

hinged to the base and to a block, which carries the bolt as indicated. When a number of pieces are to be cut, a stop may be clamped to the work rest after the pieces have been cut off at one end. By doing this, the pieces are cut uniformly without measuring them. Material up to 6 or 8 ft. long can be cut on the guide conveniently by one man, but for longer stock, it is best to have a helper.

Fermenting Straw Keeps Water in Tank from Freezing

Used successfully on a live stock farm in Minnesota, this self-operating water-tank heater utilizes heat produced by fermentation of a mixture of straw and horse manure. A 17 or 18-ft. length of 1½-in. pipe is bent to a U-shape about 1 ft. wide, depending on the height of the water level maintained in the tank, and is installed in one side of the tank as indicated by dotted lines in the drawing. For efficient operation, it is necessary that the water level in the tank be kept above the upper end of the pipe at all times. After installing the pipe, cover it 2 or 3 ft. deep with the straw-and-manure mixture, extending the latter around the sides of the tank as indicated. Also put a wood cover over the tank and cover it with the mixture, leaving a drinking hole

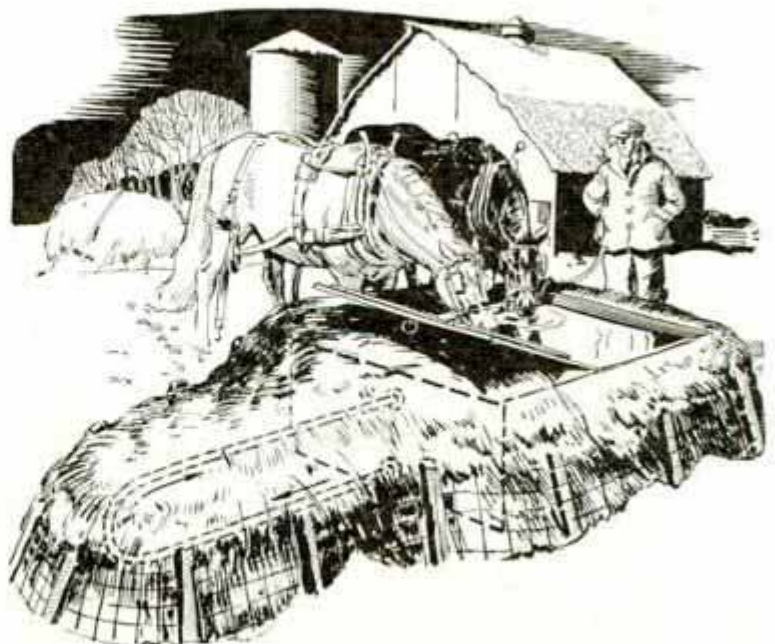

at one end. A hinged lid, preferably one that is insulated to keep out cold air, should be put over the hole.



Band around Feed Bucket, with Loop for Arm, Holds Latter Conveniently for Scattering Contents

Arm Band on Bucket Aids When Feeding Chickens

When a bucket is carried in one hand while feeding chickens or sowing seed, an iron band around the bucket, under the rim, as shown, will make it less tiresome to carry. The band has a loop formed on one side to take the arm. In use, the arm is pushed through the loop with the hand supporting the bottom of the bucket.

Water Trap for Steam or Air Lines

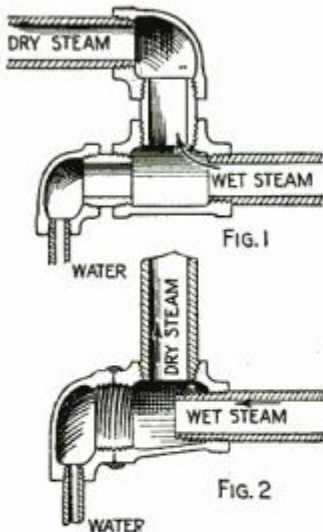

Here are two effective methods of freeing steam pipes of water. The arrangement in Fig. 1 consists of a tee and an elbow connected to the steam line by means of a nipple. The steam entering the tee makes a sudden right-angle turn upward, while the water, carried by its own momentum, continues straight through into the elbow and is led down to a return line, steam trap or even a collecting chamber, which may be blown off occasionally. Fig. 2 shows a neater and more effective assembly using a reducing tee and having the outlet, oppo-

site the end of the steam pipe, a size or two larger. To this is welded a reducing elbow. The steam pipe is screwed into the tee so that its end comes opposite the center of the side outlet. The efficiency of the latter arrangement is greater owing to the fact that there is nothing to obstruct the water before it strikes the back wall and is deflected downward to the drain, or through a return pipe.

site the end of the steam pipe, a size or two larger. To this is welded a reducing elbow. The steam pipe is screwed into the tee so that its end comes opposite the center of the side outlet. The efficiency of the latter arrangement is greater owing to the fact that there is nothing to obstruct the water before it strikes the back wall and is deflected downward to the drain, or through a return pipe.

Lock Washer Helps Hold Set Screws

Hollow set screws used in various machines are often placed together to prevent loosening. One mechanic has found that the screws will hold better if a lock washer is inserted between them as indicated in the drawing.—Thomas Trail, Baltimore, Md.

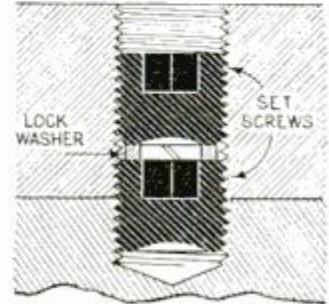

Vise Setup Holds Work Rigidly in Milling Machine

Here is a vise setup for shaping or milling duplicate round work that has many advantages over the usual method of re-seating the work with a hammer. Two steel blocks are placed between the vise jaws as shown and the work is laid on the larger one, B, after which a third block, A, is used as shown. When the vise is tightened, block A forces the work against

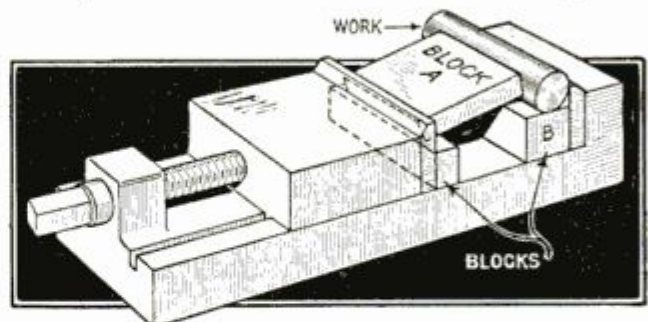

This Setup in a Milling Machine Eliminates Seating Work After Tightening It in a Vise

block B and prevents it from rising, which it has a tendency to do when the jaws are tightened with the ordinary setup.

☞ Oxalic acid dissolved in water is excellent for cleaning tarnished brass.

Fly Repellents for Live Stock

Experts at the Nebraska college of agriculture suggest the following mixtures to keep flies away from live stock. A solution of used crankcase oil, 1 gal., and oil of tar or cold-tar stock dip, 1 pt., sprayed on the animals has been found effective. Another good solution for the purpose consists of fish oil, 1 gal., oil of tar, $\frac{1}{2}$ gal., and crude carbolic acid, 1 oz. A third solution consists of laundry soap, 3 bars, dissolved in cold-tar dip, $4\frac{1}{2}$ qts., fish oil, $4\frac{1}{2}$ qts., kerosene, 3 qts., whale oil, 2 qts., and oil of tar, $1\frac{1}{2}$ qts. If applied lightly, these repellents will not injure the animals or discolor their hair.

Woodworkers' Bar Clamps Made from Scrap Parts

By using a screw from a broken C-clamp or one taken from an old washing-machine wringer, a bar clamp can be made at small cost. A hardwood bar has several oblique slots cut in the lower edge and a block, which carries the screw, is bolted to the front end. This block is slotted to straddle the bar as shown. Near the upper end, the

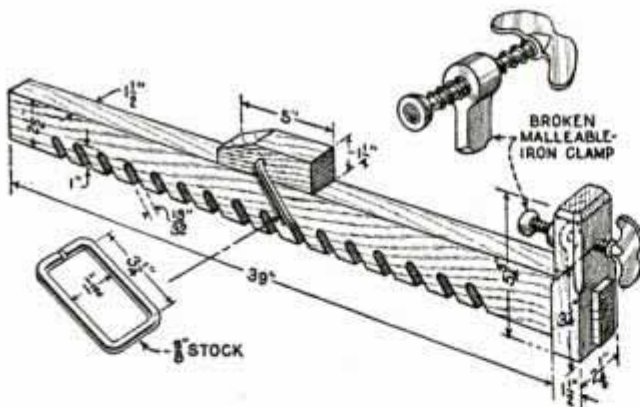

Woodworkers' Bar Clamp Made from Hardwood and Screw from Broken C-Clamp

block is drilled to take the screw and is mortised on the inside surface for the broken segment of the clamp, which should fit the mortise snugly. A sliding stop carries an iron-rod loop or ring, which works in the slots.

Loose Plaster Anchored without Nails or Screws

To securely anchor plaster that has loosened on a wall, one paperhanger uses plaster of paris, which he forces into place



Loose Plaster on Wall Securely Anchored to Lath with Plaster of Paris

with a paper funnel. First, he cuts the wallpaper, folds it back, and drills a hole through the lath and plaster. Then, holding the loose plaster firmly against the lath, he squeezes the plaster of paris into the hole, taking care to get plenty of it behind the lath to form a good anchor. As the funnel is withdrawn, the hole is filled flush with the wall. If the loose plaster is held against the wall until the plaster of paris sets, which only takes a few minutes, a neat job will result.

Humane Method of Transporting Fowls

When several live fowls are taken to market in a car it is common practice to tie their legs together and then lock their wings. A more humane method is to put each bird in a paper bag from which one corner of the bottom has been torn away to provide an opening for the head of the fowl. The top of the bag is tied about its legs as shown preventing the birds from flopping about.



REWINDING



Above, sawing out wire slots in commutator bars. Below, commutator bar marked with center punch



Loosening and driving out the coil wedges

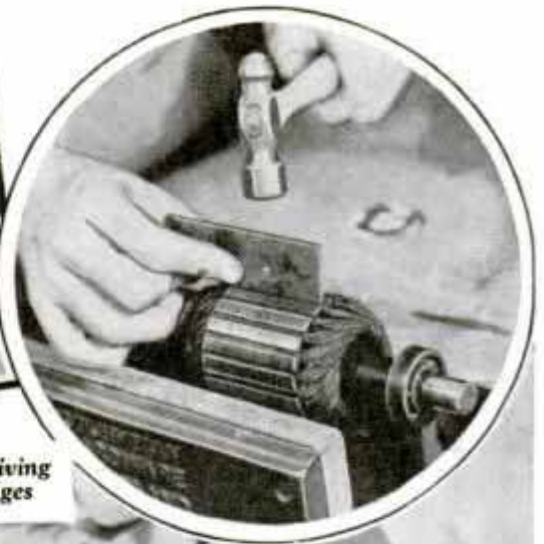

By C. A. CROWLEY

ELECTRIC motors, either a.c. or d.c., whose windings have been burned out or damaged may be repaired or completely rewound by anyone with only such simple tools as are available in any shop. Before taking the motor apart the frame parts should be marked with a file to simplify reassembly. End plates of some motors will fit together in several positions but the armature may not turn freely unless the parts are replaced in their original positions. If the armature has already been stripped of its old winding, it is not possible for the amateur to work out the windings required, unless the necessary information as to the wire size, turns and connections can be procured from the manufacturer of the motor. Most motor



MOTORS

If care is taken the wedges can be saved for replacement. If they are damaged new ones will need to be cut to the same size from wood or sheet fiber.

As the old wire is removed, a simple system of marking and recording should be used so that the new windings may be made exactly like the old ones. The first step in recording the old windings is to find the last coil which was wound onto the armature. This will be the one which can be unwound without disturbing other coils. The two ends of this coil are soldered to two of the copper commutator bars. One of the ends

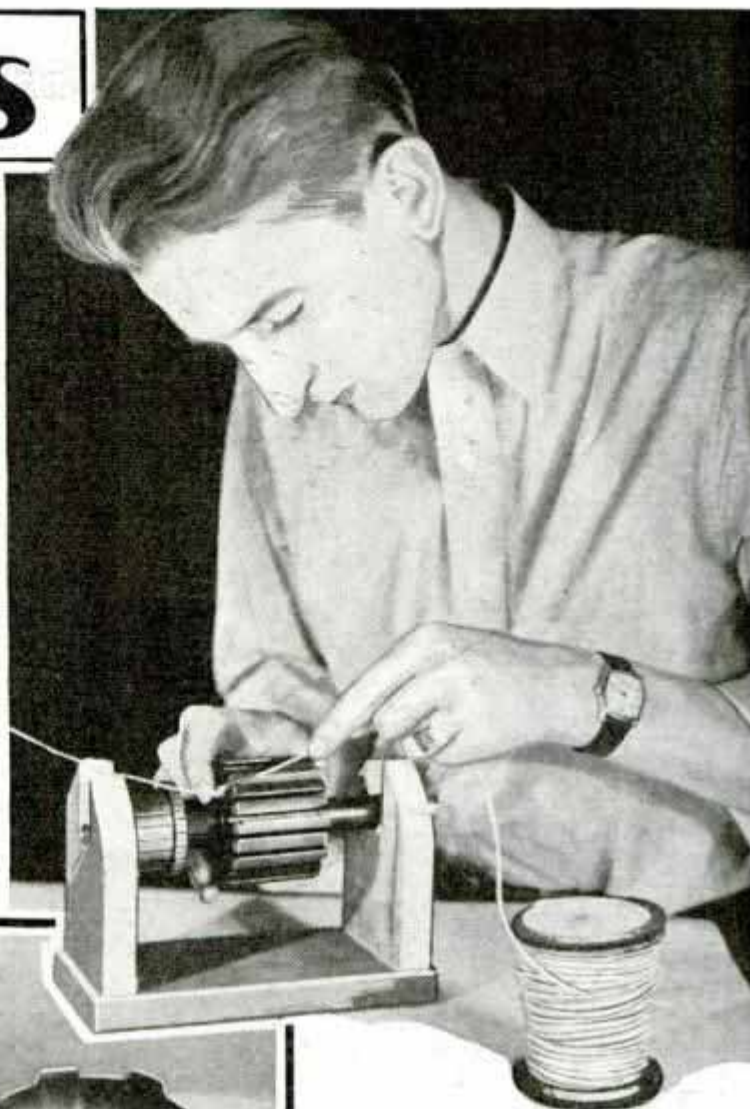

Stand for holding the armature makes rewinding easier



The motor is carefully dismantled

is located and the bar to which it is connected is marked with a center punch to indicate that it is segment No. 1. This same coil end is then cut from the segment and lifted from the first slot through which it passes. The metal on each side of this slot is then marked with an X to indicate that the slot between the marks is No. 1 slot. To make identification of the other slots and segments easy, the armature is held in front of you with the commutator closest. The marked bar is No. 1 and the next bar to it when your eye follows around in the same direction as the hands of a clock is bar No. 2, etc. The slots in the armature

are given numbers in this same direction. The winding may be recorded as removed by drawing a diagram like the one shown as the work progresses. Although this gives adequate information

after only one coil has been removed in the hands of an experienced winder, the table method of recording will be found simpler to follow by the beginner. An example of such a table is shown. To illustrate the use of the table method of recording we will go through the process of taking data on an armature which has 16 slots and 16 segments in the armature. After locating the last coil placed on the armature, we mark one of the commutator bars to which it is connected and cut the end of the coil from this bar and lift it from the slot. This slot is marked No. 1 as explained above. This information is re-



Armature slot is marked with a file

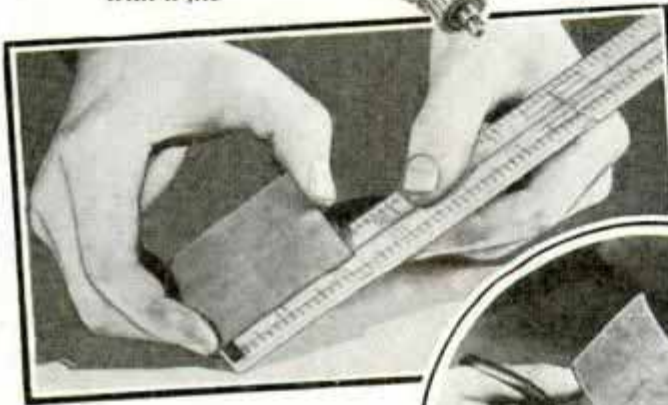

Above, measuring old slot insulation to get pattern for new insulation which is cut from wood or sheet fiber

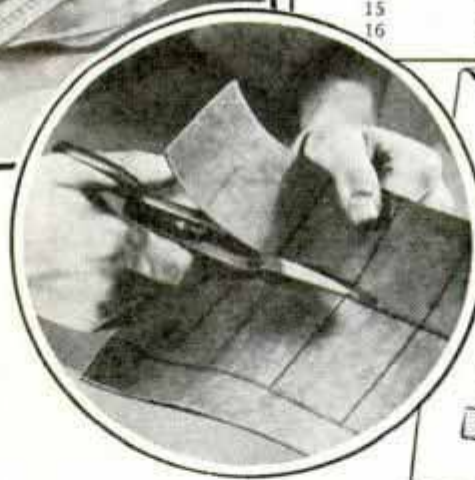

corded in the first line of the table. We next unwind this same wire from the next slot through which it passes. We find this to be No. 9 slot and record it as shown. We can now proceed to unwind the coil completely while counting the turns. In this case there were ten turns in the coil as indicated in the table. Pulling the wire free, we find that the other end of the coil is connected to bar No. 2. We can now remove the wire completely; however, it should be placed in a box so that all of the wire removed from the armature may be weighed in order to determine how much wire will be required for rewinding. The next coil removed and recorded by the same method should be the one which is left free for removal without disturbing the remaining coils. In

our illustration this coil has one of its ends connected to bar No. 2. After noting this in the table we cut it loose and remove the coil exactly as before, recording all of the data in the table. The remaining coils are removed and recorded in exactly the same manner. When all of the coils have been removed we weigh the wire and add about 10 per cent to find the weight of the wire needed to do the job. The size of the wire is next determined with a wire gauge.

| Recording an Armature Winding | | | | |
|--|---------|---------|--------|-------|
| Size of Wire Used—No. 18. Weight of Wire—2¼ Lbs. | | | | |
| From Bar | To Slot | To Slot | To Bar | Turns |
| 1 | 1 | 9 | 2 | 10 |
| 2 | 2 | 10 | 3 | 10 |
| 3 | 3 | 11 | 4 | 10 |
| 4 | 4 | 12 | 5 | 10 |
| 5 | 5 | 13 | 6 | 10 |
| 6 | 6 | 14 | 7 | 10 |
| 7 | 7 | 15 | 8 | 10 |
| 8 | 8 | 16 | 9 | 10 |
| 9 | 9 | 1 | 10 | 10 |
| 10 | 10 | 2 | 11 | 10 |
| 11 | 11 | 3 | 12 | 10 |
| 12 | 12 | 4 | 13 | 10 |
| 13 | 13 | 5 | 14 | 10 |
| 14 | 14 | 6 | 15 | 10 |
| 15 | 15 | 7 | 16 | 10 |
| 16 | 16 | 8 | 1 | 10 |

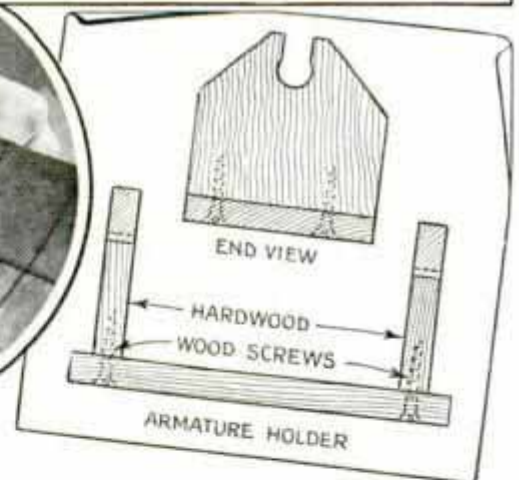

Armatures are wound and connected by so many methods that it is impossible to make a general rule for winding and connecting the coils; therefore the exact connections as found on the armature, regardless of the number of slots and segments, should be followed carefully when removing the old winding and placing the new one on the core. In some armatures you will find that there are dead coils that are not connected to commutator bars. When this condition is found it should be duplicated in the rewinding. Also, you may find that some of the commutator bars are not connected to coils but simply connected to

other bars. When this condition is found it should be noted so that the same connections can be made when rewinding. If the commutator is removed it must be replaced so that bar No. 1 is over the same point on the shaft as it was originally. Some rotors, as the rotating member of an induction motor is called, are wound with only two coils of wire. The ends of these coils are connected to brass or bronze disks upon which brushes rub when the motor is in operation. When taking data for rewinding this type of motor, the slots should be numbered starting at any convenient point and the wire removed carefully, noting not only the slot from which it was removed and the number of turns but also the direction in which the coil was wound so that new wires can be wound on in exactly the same manner.

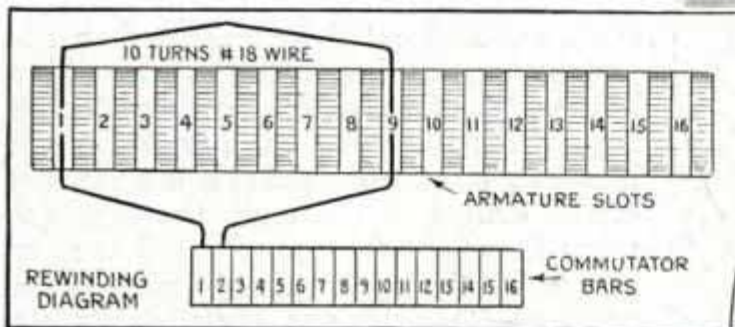
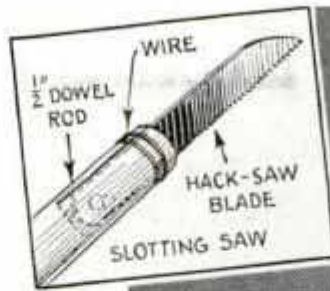

Above, old wire weighed to find amount required. Below, wrapping tape between commutator and iron core



When working on a motor of this type it would be well to work out a simple table to meet your special requirements before removing any of the wire. The size of the wire for the two coils will be different so it will be necessary to use two sizes of wire for rewinding.

With the old wire removed, the insulation from the slots should be removed and one piece of it measured, so that new insulation can be cut to slightly larger dimensions from fiber with a photo trimmer. The old wires and solder are next sawed out of the wire slots in the commutator bars. A convenient tool for this job is made by mounting a length of hack-saw blade in a piece of dowel rod. The space between the commutator and the iron core is then partly filled with plain cotton tape, which will serve to prevent the ends of the coils from being pressed against the metal shaft. Shellac may be used to hold the cotton tape in place. A winding frame of suitable dimensions to hold the armature

is then built from wood. With the armature mounted in the rack, the winding is started by winding on the last coil that was removed, or the coil recorded at the bottom of the record table. The ends of the coil should be left long and marked for the bar to which they are to be connected so that all of them may be soldered to the proper bars after the entire rewinding job has been completed. Any convenient plan of marking the leads may be used. While winding, the coils should be neatly formed and the wires pressed tightly into the slots, always being careful to avoid damaging the insulation. The ends of the coils should be neatly formed so that there will be



plenty of room for the entire winding. The wire used should have the same kind of insulation as was originally used on the machine to insure plenty of room. When the winding has been completed, the leads are pressed into the bar slots and soldered securely, after which the surplus solder may be removed with a file. The windings are then bound down tightly as they were before and given a coat of varnish. If a can of varnish large enough for the job is available the best plan is to dip the armature and allow it to soak up as much varnish as it will. After a thorough drying, the armature is ready for installation in the motor.

Induction motors frequently have a rotor without windings but have two windings on the frame or stator. These machines are very easy to rewind by simply removing the old winding and recording the slots, turns, wire sizes, direction of windings and connections. A suitable ta-

ble for recording these values may be made by anyone. If an induction motor hums when connected to the line but will not start until given a brisk spin you will know that the starting winding, or the winding of small wire only, has burned out. In this case only this winding has to be replaced.

Straightening Short Shafts in a Punch Press

A method of rapidly straightening small, short shafts in a punch press is shown in the illustration. A holder is put in the ram of the press and is threaded to fit the adjustable hammer. Two V-blocks, with keys fitted to the bottom, slide in a keyway in the bolster plate and support the shaft to be straightened. The shaft is turned by hand so that high spots can be located by means of an adjustable pointer bolted to the edge of the bolster. The force of the hammer blows is regulated by turning the handles of the hammer. For straightening shafts that are center drilled in the ends, the arrangement shown in the upper detail is often screwed to the bolster plate in place of the pointer.

—Chas. Kugler, Philadelphia, Pa.

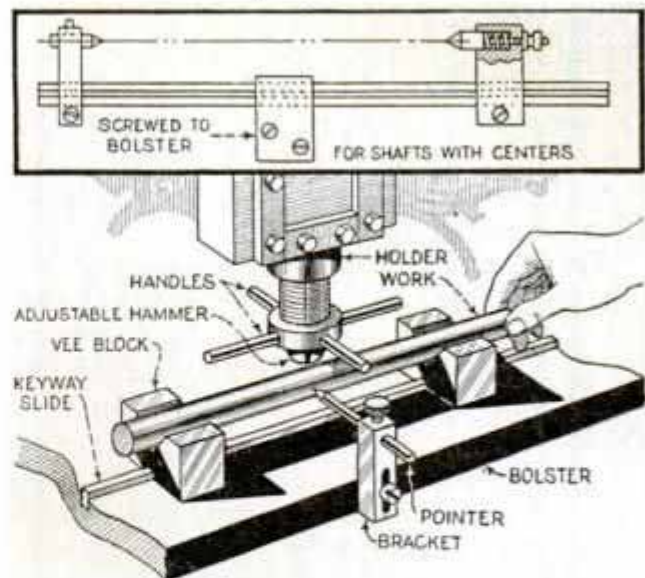

Simple Set-Up for Straightening Short Rods and Shafts in a Punch Press

Ⓛ Denatured alcohol added to India ink in the proportion of ink, 1 fluid oz., to alcohol, 10 drops, will cause the ink to dry rapidly and add brilliancy to the work.

Making a Smooth Cut in Metal with Oxyacetylene Torch

When metal is cut with an oxyacetylene torch, the edges are generally left rough. To make a smooth cut, proceed as follows: Heat the part to be cut with a rich flame until the metal begins to burn. Then, while still applying the torch, turn off the acetylene gas and use straight oxygen, which will make a clean cut as long as the preheated metal retains enough heat. When the metal starts to cool, repeat the procedure.—C. E. Walton, Lewisburg, Pa.

Shield Protects Rocker-Arm Bearings on Motorcycle

To keep dirt out of the rocker-arm assembly of motorcycles, some racing drivers use a shield like the one shown. A framework of light metal is constructed to fit over the cylinder head and is covered with fine copper mesh. The shield is applicable to any motorcycle using overhead valves and will greatly increase the life of the rocker-arm bearings.—James Hennessey, Alameda, Calif.

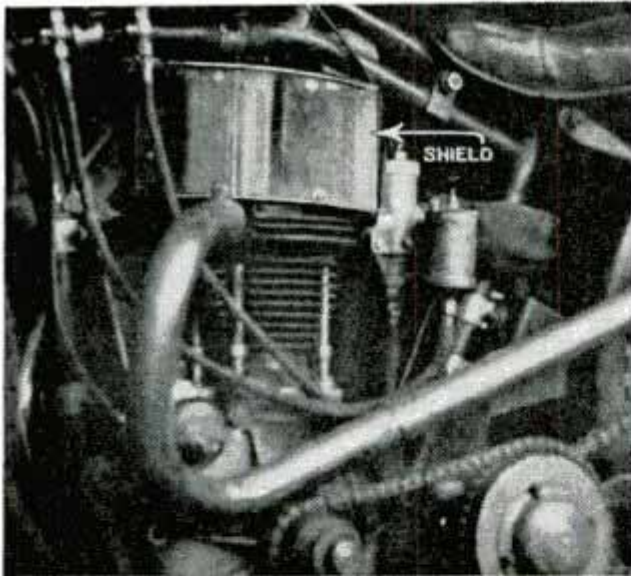

Fine Wire-Mesh Shield Keeps Dirt Out of Rocker-Arm Assembly on Motorcycle

Birch Trees Serve as Danger Signs at Road Intersection

Silver birch trees are being planted at the corners of crossroads near Oxford, England, so that their white trunks will reflect light from car headlamps and thus serve as a warning to the motorist that he is approaching a crossroad.



Chuck and Tailstock Center for Turning Small Work in Wood-Turning Lathe

Wood Lathe Adapted to Turning Work of Small Diameters

With the homemade chuck and tailstock center shown, you can easily turn work of small diameter. The chuck is a small disk of hardwood, screwed to the faceplate, with a tapered hole bored in it as shown. A 1-in. length of drill rod is then drilled at one end to a depth of $\frac{1}{16}$ in. with a drill bit $\frac{1}{16}$ in. smaller than the diameter of the rod. Then the projecting lip is reamed with a bit larger than the diameter of the rod. This leaves a sharp edge, which engages the work while the friction grip of the headstock chuck drives it.

Finger Holes Make Draftsmen's Rule Easy to Manipulate

Draftsmen will find that they can move their rules about easily on drawings if a couple of holes are drilled part way through one side of each, at the center as shown. The holes should be about 2 in. apart and just large enough to take the tips of the first and third fingers.

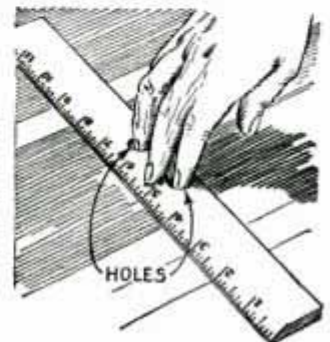



Electric Heater Warms Ink in Printing Press and Prevents Paper Sticking to Type

Keeping Press Ink Warm in Winter

Owners of small newspaper offices and job-printing shops equipped with flat-bed presses who use the same grade of ink the year around, will find that trouble experienced in cold weather by having the paper stick to the type can be eliminated by keeping the ink warm. Fasten an electric heater to the frame of the press just above the ink fountain and direct its heat rays toward the center of the fountain.

Installing Crankcase Gaskets

When replacing the crankcase on a car, first soak the gasket, if cork, in water. Then put it in place and tie it fast on each side with a fine cord. This will hold the gasket until the crankcase can be bolted in place. The cords need not be removed as they will not bother.

The Next Issue

SAFE, FRONT-STEERING ICE BOAT DOES NOT SPILL

Small, easily handled ice boat that anyone can make. Skids or buffers on the outside end of the cross beam that carries the two rear runners, prevent spilling. A tiller at the rear controls the single steering runner at the front.

HOW YOU CAN MAKE VENETIAN BLINDS

More popular today than ever! This article goes into details of construction and shows how you can make these attractive window blinds at little cost.

TRICKS OF USING WOOD CHISELS

You can soon become adept at handling wood chisels and gouges by carefully reading information by an expert who describes the technique of using them.

METAL SPINNING ON THE LATHE

Artistic bowls, trays and other objects spun from pewter, copper or aluminum mounted on wood forms held by the faceplate of your woodworking lathe.

REMOVING FURNITURE SCARS

Scratches, dents and scars that mar the appearance of your valuable pieces of furniture can be removed, filled and made less conspicuous by simple methods.

WATCH-DRIVEN TOYS

Old watches with the escapement removed are fitted with a small crank to impart reciprocating movement to animate several toys made of balsa wood.



MORE "punch" than a motorcycle motor has ever had before—that's what is shooting Harley-Davidsons ahead to victory on track and hill the world over.

Wait till you *feel* the thrill of that surging power under you as you zoom up grades and flash down straight-aways! There's no ride like a Harley-Davidson ride—and never before has there been a Harley-Davidson to equal the 1934 models with their marvelous TNT motors.

Your nearby Harley-Davidson dealer will be glad to show you how quickly you can learn to ride a Twin or Single — and how easy they are to buy on his time-payment plans. See him soon — and mail the coupon.

Ride a

HARLEY-DAVIDSON

Mail this Coupon

Harley-Davidson Motor Co., Dept. P., Milwaukee, Wis.
Interested in Motorcycling. Send illustrated literature.
Postage Stamp is enclosed to cover cost of mailing.

Name _____

Address _____

My age is 16-19 years, 20-30 years, 31 years and up, under 16 years. Check your age group.

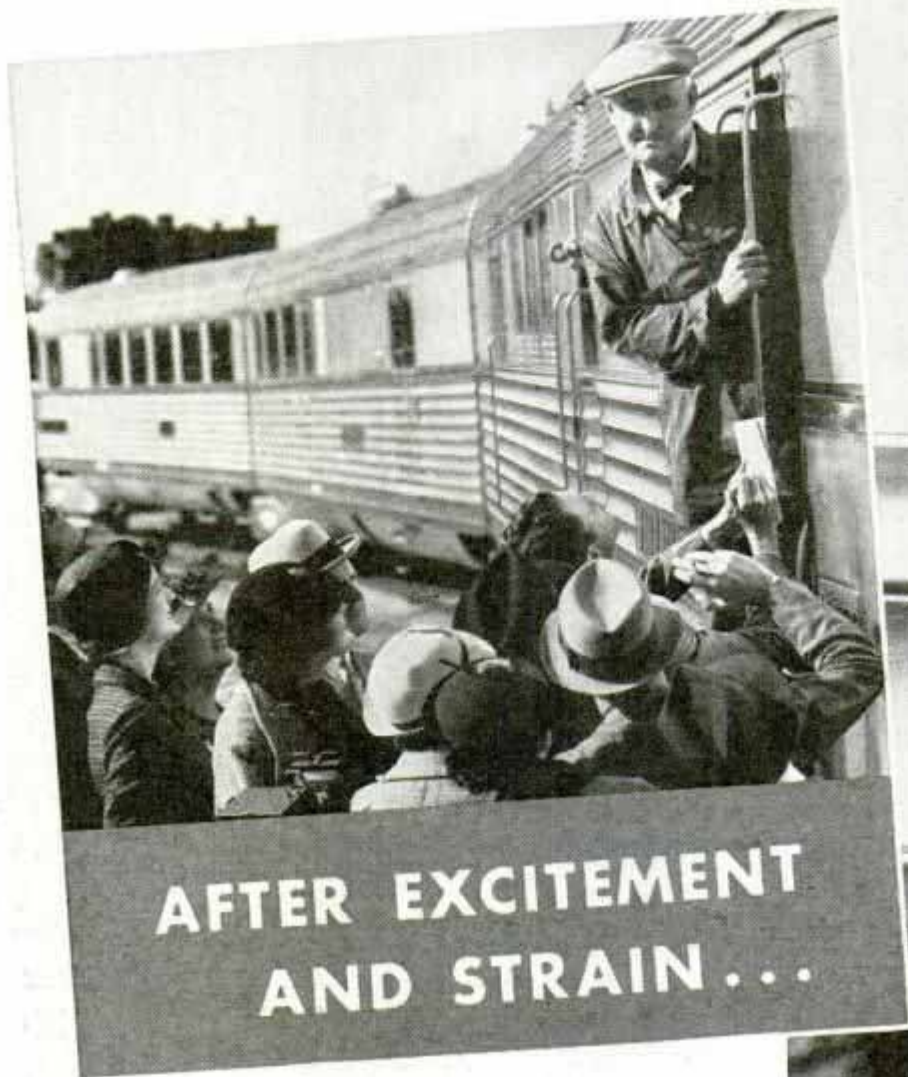

**AFTER EXCITEMENT
AND STRAIN...**

RAILROAD HISTORY entered a new phase as the Burlington's "Zephyr" flashed across the Great Plains from Denver to Chicago—1015 miles in 785 minutes—to set a flock of new records! Jack Ford was at the throttle.

Copyright, 1934, R. J. Reynolds Tobacco Company

A PLEASURE away fatigue and

Jack Ford, crack Burlington engineer, says: "When the 'Zephyr' rolled to a stop at Chicago, I'd been through a lot of excitement and strain and felt pretty much used up. But a Camel quickly gave me a 'lift' and I felt O. K.

"Most railroad engineers prefer Camels. And Camels help to increase

Camel's Costlier

LEAF- TOBACCO EXPERTS AGREE:

"Camels are made from finer, More Expensive Tobaccos—Turkish and Domestic—than any other popular brand."



When writing to advertisers please mention Popular Mechanics

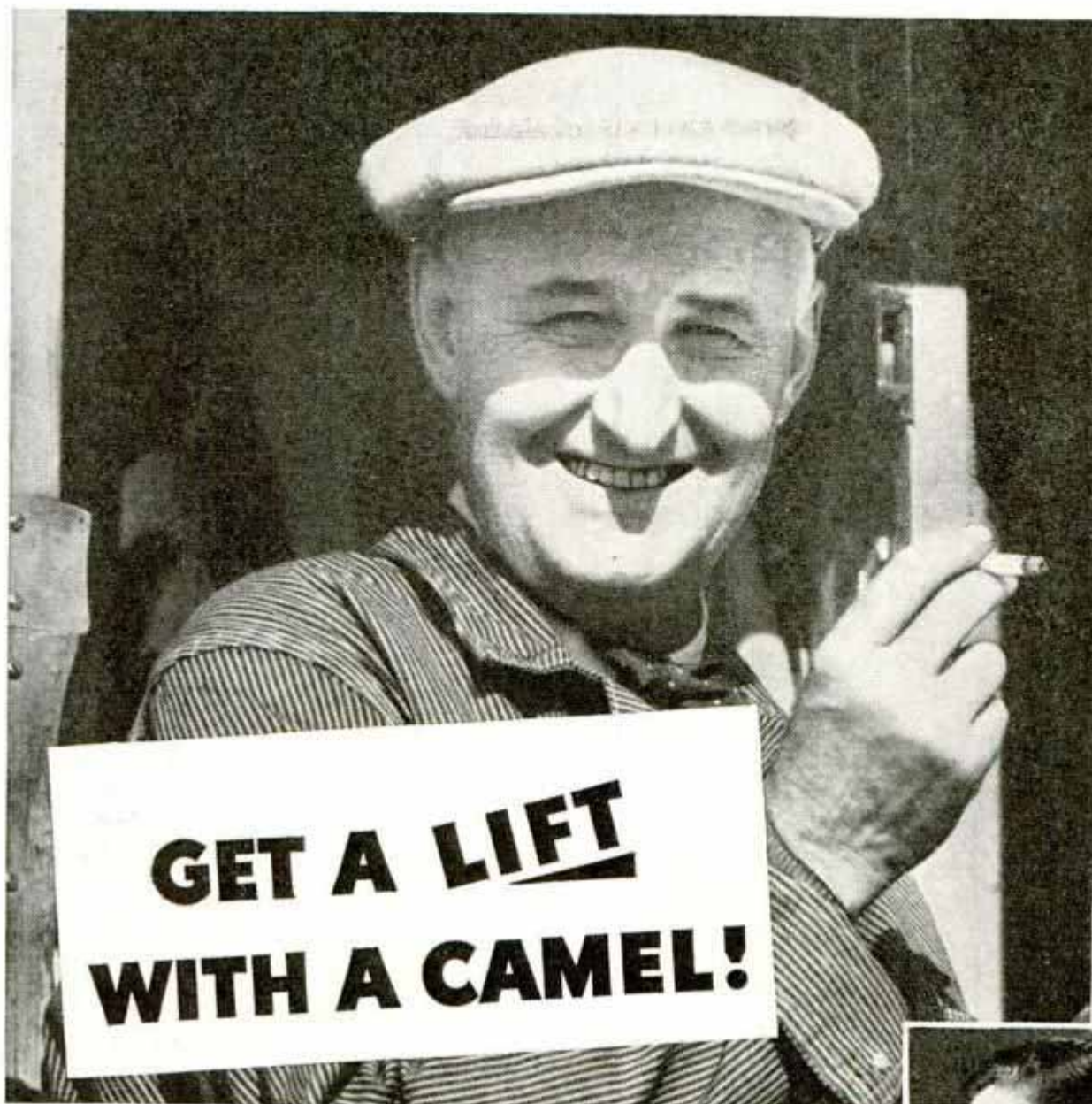

**GET A LIFT
WITH A CAMEL!**

that drives
listlessness!

their energy when they feel worn out. I've smoked a lot of Camels in my time, and that goes for me—all the way."

The findings of a famous scientific laboratory have confirmed Camel's "energizing effect." So begin today to enjoy Camels *often!* The costlier tobaccos in Camels never affect the nerves.

SECRETARY. Says Elizabeth Harben: "I smoke a great deal, but I am careful in my choice of cigarettes. I prefer Camels. They don't make my nerves jumpy."



SPORTSWOMAN PILOT. Mrs. Cecil Kenyon says: "Camels are the mildest cigarette I know. Morning, noon, and night I can smoke them steadily—without a touch of upset nerves."

Tobaccos never get on your Nerves!

TAKE *Dozens* OF SNAPSHOTS AT NIGHT



IT'S EASY. Snapshots at night are now as easy to take as snapshots in the sunlight . . . thanks to super speed film and G-E MAZDA Photoflood lamps. And they're inexpensive, too . . . for G-E MAZDA Photoflood lamps are good for two hours of picture-taking . . . good for dozens of pictures.

All you need is a camera with a fast F/6.3 lens* (use wide open), some super speed film, and a few G-E MAZDA Photoflood lamps in your light sockets. Then you are ready to snap pictures of your family, friends, parties or workshop products . . . indoors AT NIGHT!

Your druggist or camera dealer can supply you with film and lamps. General Electric Company, Nela Park, Cleveland, Ohio.

* Box cameras and folding cameras with slow lenses can get good pictures with time exposures of one or two seconds.

FOR ACTION PICTURES

and shots of babies and pets, use G-E MAZDA Photoflash lamps. They operate simply, in light socket or from flashlight batteries. Enable even box cameras to get lively night shots. Each lamp gets one picture. Retail for 15c.



GENERAL ELECTRIC
MAZDA PHOTO LAMPS

NEW TRICKS OF WEATHER FORECASTING

(Continued from page 708)

of air from the tropics and cold dry blocks from the frigid zones meet in the temperate latitudes and are then boosted eastward by the earth's rotation. Instead of equalizing each other the air masses tend to preserve their original characteristics, and where two of the masses join the differences in temperature and moisture content create unstable weather. It has been found that the warm masses from the tropics tend to rise above and flow over the denser cold masses, the result being cloudiness, squally weather and rain.

Eventually, when sufficient data have been compiled, a new technique in forecasting may result because weather experts know that some of the weather on the surface is first manufactured in the upper portions of the air masses. Another problem the forecasters would like to solve is why the air masses move toward each other apparently without rhyme or reason. If the causes of this could be found it might mark a great step toward predicting general weather conditions a week or so in advance.

However, weather officials know that no matter how accurate a general prediction covering a wide area may be, the weather at any particular point is influenced by local topography. That is the reason why the forecasting system is being decentralized. Local forecasts that take local conditions into account will be more accurate than predictions of general weather trends.

As an example, this "local knowledge" has increased the safety of air transportation at a western airport where pilots could never be sure when a dense fog might blanket the field. Recently the local weather bureau discovered that when the wind shifts to a certain quarter at one of its mountain observation stations, fog always settles in the vicinity of the airport a few hours later. Now the weather bureau can warn the airport dispatcher several hours ahead of time when a fog is due. Local studies like the above, it is hoped, will enable forecasters to anticipate fogs in other districts.

The use of an international code provides ten times more data on weather than were previously reported. Weather offi-

(Continued to page 134A)

Take snapshots like this—

AT NIGHT!



IT'S EASY TO MAKE THIS PICTURE

Use Kodak "SS" Film. Set your camera for 1/25 second—open lens diaphragm to *f.6.3*. Put 1 Mazda Photoflood bulb in lamp A—2 in lamp B. Distances as indicated.

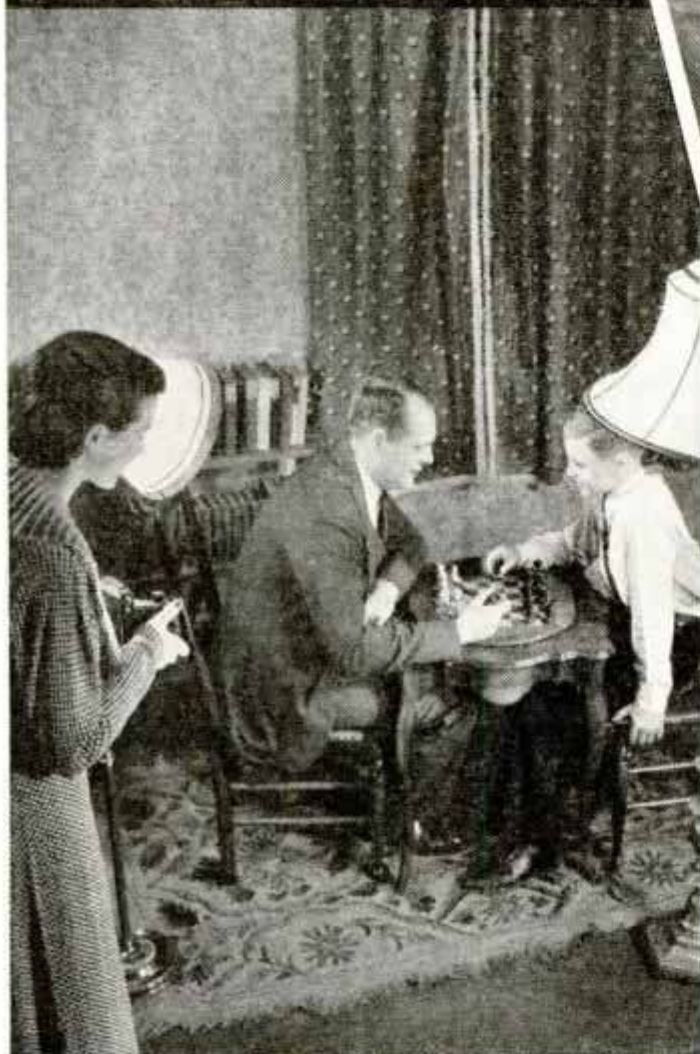

Sight the subject, click the shutter—and you've made the picture. Photoflood bulbs cost 25¢ each—last for many pictures.

... with Eastman's new high-speed "SS" Film

CAMERAS HAVE BEEN GIVEN new vision. You can take snapshots indoors . . . *at night!* What a wealth of new picture opportunities. The fireside scenes—the parties—the children at their indoor games.

Use a camera with an *f.6.3* (or faster) lens, loaded with Kodak Super Sensitive Panchromatic Film. This high-speed (extra sensitive) "SS" Film does the trick—it's three times as fast as ordinary film under artificial light.

For light, use two or three Mazda Photoflood bulbs. Just hold the camera in your hands, set for 1/25 second, lens at *f.6.3* opening, and click the shutter.

For indoor pictures at night with slower lens cameras (including box models) use Verichrome (or "SS") and a Photoflash bulb—see free folder—with camera set for "time" exposures.

FREE FOLDER . . . Complete instructions on indoor night photography. Photoflood snapshots . . . Photoflash pictures . . . all are covered in this free folder. At your Kodak dealer's—or write for your copy today. Eastman Kodak Co., Rochester, N. Y.



KODAFLECTOR—Inexpensive, efficient, sturdy, easy to use . . . makes 2 Photoflood bulbs do the work of 9. Complete, with folding stand, reflectors and cord, \$5.

Kodak "SS"—the lightning-fast film with the green lightning flashes on the familiar yellow box—the film that, indoors or out, in any light, improves picture quality.

Kodak Six-20 with Kodak Anastigmat lens *f.6.3* is ideal for night snapshots. Pictures $2\frac{1}{4} \times 3\frac{1}{4}$ inches, price \$17.50. Kodak Six-16, with *f.6.3* lens, pictures $2\frac{1}{4} \times 4\frac{1}{4}$ inches, \$20.

IF IT ISN'T AN EASTMAN, IT ISN'T A KODAK

When writing to advertisers please mention Popular Mechanics



This 48-Page Book and a Generous Sample

BOTH FREE!!

Every handyman, home-craftsman and manual-training student should have this interesting and helpful Gluing Guide. It contains dozens of money-making and money-saving ideas on building, repairing and mending things easily and *permanently*. It tells how you can glue everything to stay glued . . . in spite of moisture, heat, rough usage or plain neglect.

FREE SAMPLE CASCO Waterproof GLUE

AT NO COST, you will also receive enough CASCO to do several gluing jobs. This is the same super-strength, wonder-working adhesive used in big woodworking and furniture factories. You will be amazed and intrigued to find that CASCO—a clean, non-odorous powder—mixes so quickly in cold water, forming a creamy, easy-spreading glue that makes all jobs *permanent, heat-proof and moisture-proof*.

The Big Secret of CASCO'S Great Strength

Unlike ordinary glues and pastes, which harden merely by evaporation, *CASCO sets chemically like concrete*. You only have to glue it once with CASCO.

• Your Hardware Dealer carries CASCO in 10c, 25c, 40c and 65c cans. Also 5-lb. and 10-lb. sizes. •

TEAR THIS OUT MAIL TODAY (Save 2c—stick it on a penny post card)

THE CASEIN MFG. CO. OF AMERICA, INC.
 350 Madison Ave., New York, N. Y.

Please send me my copy of the CASCO Gluing Guide together with your free trial sample.

Name

Street

City..... State.....

P. M. 11-34

A Few Hints on Gluing

When gluing doweled or mortise-and-tenon joints, it is better to apply the glue inside of the mortises and dowel holes than to apply it to the dowels and tenons where it may be scraped off in assembling the work. A toothbrush is often handy for applying the glue. For small mortises, the bristles of the brush may be cut short, or the brush may be whittled down in width, to get into tight places. An ordinary comb is handy for applying glue to narrow grooves. In assembling panel work, be sure that there is plenty of space to permit the panels to shrink or swell a reasonable amount without striking the bottom of the grooves in which they fit. This precaution is unnecessary when plywood panels are used. The usual tedious job of applying glue to inlay grooves can be done easily by thinning it enough to be applied with an oil can, the spout of which has been cut off so that the opening is relatively large. Another job that often puzzles the layman is getting just the right amount of glue on an overlay. This can be done easily by covering a surfaced board with glue, pressing the overlay firmly into the tacky surface and then immediately removing it and placing it in position on the work. Just the right amount of glue will adhere to the underside of the overlay to make it stick in place properly without letting the glue squeeze out from under the edges when the panel is pressed into position.

Model-Makers' Screw Clamps Made from Discarded Skates

Toe clamps taken from discarded roller or ice skates are handy for holding small model parts to glue them. The slightly curved ends of the clamp jaws are straightened as indicated. For a wider span, the clamp jaws may be screwed on a piece of drill rod, which has been threaded to the center from each end and filed to take the skate key.

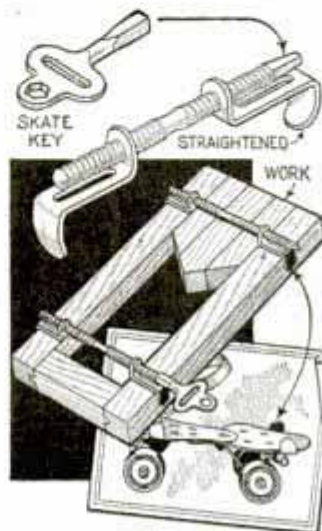

new**6-INCH
JOINTER****by "Delta"****SPECIAL
FEATURES****of New "Delta" 6-in. Jointer**

1. New Patented Delta fence with 3 Automatic Stop Positions;
2. Full 6-inch Capacity;
3. New Free Swing Dual Control Handle;
4. Cuts up to 1/2-inch deep rabbet;
5. Long Hollow-cast Tables;
6. Special Dove-Tailed Ways on which Tables ride.

And many other unusual features and improvements.

**NEW TOOLS—NEW IMPROVEMENTS
IN 1935 "DELTA" LINE**

The new 6-inch Delta Jointer is but one of the many new improvements and tools announced this year by Delta engineers. This year the Delta line of motor-driven woodworking tools is more complete than ever before. Delta standards of efficiency, quality, and convenience have been strictly maintained—and Delta prices still kept at their low levels. Good compact motor-driven tools are within the reach of all. Every woodworker will find the new 1935 Delta line of unusual interest.

**MAIL COUPON FOR
1935 "DELTA" Catalog**

It is crowded with photographs and information about the new line of 1935 Delta tools. It shows how Delta tools are built to stand the grind of production work, and yet are so low priced as to be within the reach of all. So your name will be placed on the mailing list to receive the 1935 Delta catalog without delay. Enclose only 10 cents at same time for Book of Practical Delta Projects, 32 pages of new and novel things to make with over 100 blue prints, working drawings, photographs and illustrations—and complete directions.

NEW BOOK for WOODWORKERS

32 page book "Practical Delta Projects"—crowded with new and "out of the ordinary" things to make—with over 100 photographs, working drawings, and easy-to-understand illustrations. Simple, complete instructions make every project easy to follow. Every woodworker should have this book. Send 10c with coupon. 1935 Delta catalog mailed postpaid.

DELTA MANUFACTURING COMPANY
3775 N. Holton St., Milwaukee, Wis. Dept. A1134

DELTA MANUFACTURING CO., Dept. A1134
3775 N. Holton St., MILWAUKEE, WISCONSIN

I enclose 10c (stamps or coin), for which please send me one copy of "Practical Delta Projects." Also place me on your mailing list to receive 1935 Delta catalog of quality motor-driven woodworking tools.

Check here if you own Delta tools now.

Name..... Age?.....

Address.....

City..... State.....

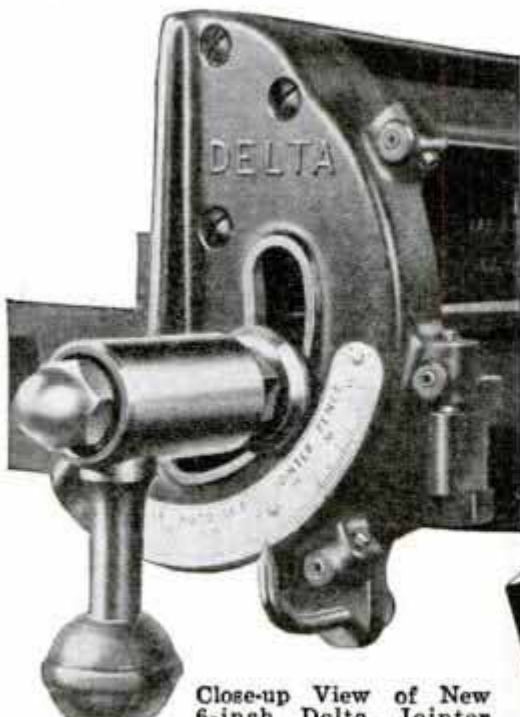

Close-up View of New 6-inch Delta Jointer showing New Free Swing Dual Control Handle—but one of the many special features of this unusual Tool. Note 3 Automatic Stops for setting fence quickly in most-used positions.



When writing to advertisers please mention Popular Mechanics

D972 POWER TO COME BY RADIO

(Continued from page 699)

No transmitter of the type ordinarily used in radio is necessary. The station on the surface would need only a power amplifier impressing voice energy upon a loop placed directly above the mine. To receive the signals below the surface of the ground the miners would need an amplifier to which a loop is connected at the input and a set of headphones at the output. Using audible frequencies, the signals penetrate the upper strata of the earth's surface with the metal in the ground actually helping conduct them instead of absorbing them.

Electric generators could be used in the mine for communicating back to the surface, but if the generators were electrically powered, there is a possibility the power supply would stop if an explosion or cave-in broke the wires. So I suggest the use of hand-driven generators for the purpose.

All this cable development opens up an amazing new field of radio-electrical technique which will enter into our homes to make our future lives more carefree. It is my belief that the application of the vacuum-tube oscillator to super-power transmission cables may change our whole understanding of the uses of such radiant energy for purposes involving the use of heat, light and power.

Cables can be laid along or under highways. These can furnish power to automobiles, trucks and street cars. They can also furnish heat and light to mobile units passing along the highways. And units powered in such a way would need no gears to be shifted. Variable condensers and inductors would time the motor units.

In our homes we can carry the same idea further. A coil underneath the ironing board powered by the cables along the highway in front of your house can heat your iron. From the same source you could heat your house, do your cooking and operate other appliances. These same cables running along the street also may bring you entertainment and news in the future by carrier current telephony.

And it is quite possible your future gardens will be grown by radio, that the arid deserts can be made fertile by radio, that the growth of animals can be stimulated tremendously by radio. A solar generator

(Continued to page 136A)

D884 QUEER FISH

(Continued from page 716)

three to four feet in length, and weighing from forty to sixty pounds each, can make short work of a small oyster reef. When young, they are striped like a zebra. Later they become a dusty color. A large female will lay 6,000,000 eggs.

One of the most interesting fishes of the Gulf is the sawfish which possesses a strong flat blade protruding from its head. Sharp, pointed teeth are embedded on both sides of the blade. It is a common custom for fishermen to cut off the saw-like blade for a souvenir.

Among the strange members of the shark family is the hammerhead, which has its eyes on the side of its T-shaped head. This head is really a curious flattened expansion from its body. The thrasher shark is another odd fish. With the upper lobe of its tail as long as the rest of its body, it swims swiftly into a school of small fish, slashing and whipping its tail violently. Within a few minutes scores of fish become dazed. Then the thrasher wheels about, opens its mouth and swallows its prey.

HOW TO BUILD AN AMPLIFIER RACK

(Continued from page 741)

of this description can be used for housing homemade receivers.

Ordinary angle iron, $\frac{1}{8}$ by 1 by 1 in., is employed. For the large floor rack illustrated, four 5-ft. lengths are required for the uprights. The top and bottom angle-iron frames are built exactly alike. The construction is shown clearly in the photos and Figs. 1, 2 and 3. Four 26-in. lengths and four pieces $14\frac{3}{4}$ in. long are used for the frames. These pieces are drilled for $\frac{1}{4}$ by $\frac{3}{4}$ -in. stove bolts, as indicated. Both frames are now assembled, with a single bolt at each corner, as shown in the photo at lower right. The wood baseboard and bottom strips are bolted to the lower frame with long stove bolts.

Sheet steel, in a perforated cane pattern, is fastened to the sides and top with machine screws. The shelves may be made of sheet iron or plywood 15 in. wide and $25\frac{3}{4}$ in. long. The front panel construction is optional; for this rack, two $26\frac{1}{2}$ by 30-in. heavy-gauge sheets of satin-finished eraydo were used.



“NO DEAR, YOU CAN’T GET BY WITHOUT SHAVING”

“You can’t get by without shaving.” Your wife—your girl—your associates may not tell you this. But that’s what they probably *think* when your face is marred by stubble. For bristles are repulsive to everyone, men and women alike. So how can any man afford to risk the good opinion of others by failing to shave often and well!

Today shaving is not a task. The Gillette “Blue Blade” positively guarantees ease and comfort—even if your skin is tender. In fact—this blade is especially made for men with tender faces—and permits twice-daily shaving, when necessary, without irritation.

The Gillette “Blue Blade” is sharp—amazingly sharp—the smoothest-shaving blade that can be produced. See how its perfectly finished edges—automatically ground, honed and stropped—skim through your beard. Enjoy the benefit of blade-making equipment not equaled anywhere—and inspection methods that eliminate any blade with the slightest flaw.

And when you unwrap your first Gillette “Blue Blade” notice how it is “anchored” in the envelope so the edges reach you undamaged—just as they left the factory. Try this blade on our money-back guarantee of satisfaction. Ask your dealer for Gillette “Blue Blades.”

GILLETTE BLUE BLADES
NOW 5 for 25¢ • 10 for 49¢



BOYS! Learn to Play Billiards AT HOME!

A Genuine Brunswick Completely Equipped Pocket Table 42½" x 22½" **\$5.50**

Cushion Covered Gully Table \$7.95
Slightly higher in West and Southwest

Boy! What fun you'll have with the gang all there, playing on this genuine Brunswick Pocket Billiard Table! And your Dad—he'll want to get into the game, too. For this Brunswick Junior Playmate is a scientifically scaled replica of Brunswick's famous regulation tables—the kind your Dad plays on in YMCA's and commercial billiard rooms. It teaches you to have the same keen eye and cool, steady nerve that the big tables develop. Junior Playmates come fully equipped in sizes for all ages at very modest prices. See them on display at your favorite store!

FREE! Send for Big 56-Page Book of FREE LESSONS by World's Best Billiard Players

THE BRUNSWICK-BALKE-COLLENDER CO.
623 S. Wabash Ave., Chicago, Illinois, Dept. B71

Name.....
Street.....
City..... State.....

Ideal TRAILER HITCH BALL JOINT

Also the **BULLDOG** MOST PRACTICAL HITCHES MADE!



ONLY \$3

Combi-Chasi and Ideal Axles; Tongues and Tongue Ends; Inner-Spring Beds; Flush Electric Lights; Stoves; Sinks; Windows; Full Size Blueprints FREE with Parts. Guide to Trailer Building, 25c. Two models on exhibit at World's Fair.

HAMMER BLOW TOOL CO., 606 Third St., Wausau, Wis.

LOOK, MEN and BOYS!

Have You Seen Them?

GENUINE LEATHER TIES; can't be told from silk. Fancy patterns; durable, won't wrinkle. **SELL ON SIGHT;** big profits, repeat orders. Be independent, have your own business. **\$5 TO \$10 A DAY EASILY.** Extra bonus for live wires. Send 50c or stamps for sample and kit. Information free.

CENTURY TIE CO., Dept. P, 2333 W. Grand Blvd. DETROIT, MICH.

Has a **RIFLED** barrel



Crosman SILENT .22 Rifle

NO CLEANING
LOW COST AMMUNITION
ADJUSTABLE POWER
PEEP SIGHTS

Grooves inside barrel make the Crosman a real rifle with all the hair-splitting accuracy this term implies. Shoots bullet same size as .22 powder rifle, but silently, powerfully, with no recoil, using the terrific force of compressed air—same force U. S. Navy uses to drive 2000 lb. torpedoes. Marvelous for target, small game. Single and 20 shot repeater models. No license required.

FREE booklet containing important target and game shooting facts. Also free Crosman Catalog—or ask your dealer.

Crosman Arms Co., 413 St. Paul St., Rochester, N. Y.

LOW-COST POWER UNIT FOR CATHODE-RAY TUBE

(Continued from page 744)

The metal chassis is 8½ by 12 by 2¾ in. high; all variable controls must be well insulated and the operator should avoid touching the metal chassis when the power supply is on. Note in Fig. 3 that the power-transformer secondaries are connected in series. If necessary to increase the output voltage, shift the lower X connection to upper X. With all connections made, except to input, turn the variable controls half way on before switching on the line supply. If your cathode-ray tube requires 2½ volts, turn the filament rheostat full on; if lower filament voltage is specified, check at tube socket with a voltmeter.

A clear spot on the tube should be obtained by adjusting the focusing control, if not, reverse the primary connections on one of the power transformers. Now adjust the sweep control so that the beam traces a horizontal line about 2 in. long, as shown in the insert photo at upper left.

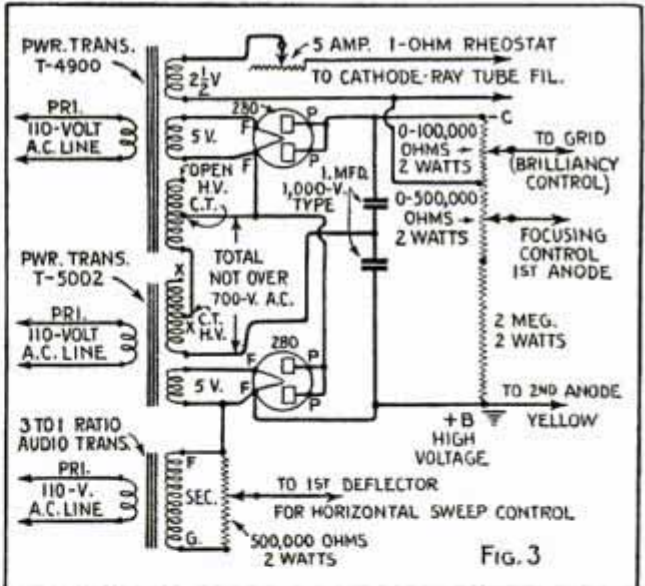

The fuzziness noted at the ends of this line are due to a defective a.c. supply obtained from a d.c. to a.c. converter; your line should be clean cut. Brilliance is controlled by the grid potentiometer. The photo at lower right shows some of the varying lines traced by organ music obtained by clipping the input leads across the voice coil of a receiver. In addition to checking distortion in amplifiers, the oscilloscope may be used to check amateur transmitters, vacuum tubes, condensers and inductances.

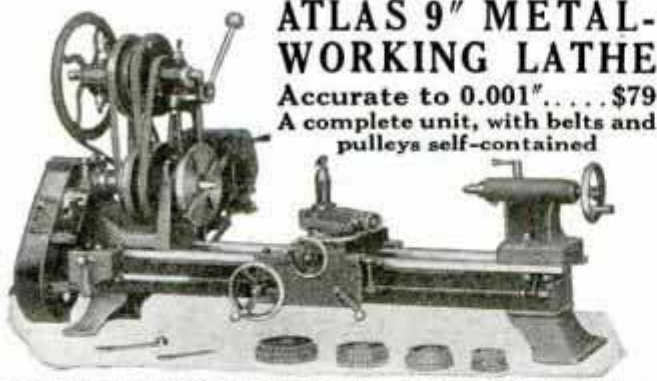

ATLAS 9" METAL-WORKING LATHE
 Accurate to 0.001" . . . \$79
 A complete unit, with belts and pulleys self-contained

It's ready to run, this 9" Atlas Lathe. Self-contained counter-shaft, all belts included in the price. Set a motor on the bracket, plug into a light socket and it's ready to go. No outside shafting to place. No extras to buy. A real lathe, running-tested to .001" accuracy before it's shipped. Six speeds with compound device that cuts out complicated back gears. Efficient V-belt drive. Automatic reversible feed; hollow headstock spindle; graduated compound rest. Cuts 4 to 72 threads.

18" bed (also larger sizes up to 36") of heavily ribbed cast iron machined and ground on precision equipment. IMMEDIATE SHIPMENT for 2 weeks' trial with guarantee of money back if not satisfied. Write for Easy Terms and free illustrated catalog of the ATLAS FULLY EQUIPPED LATHE. Real metal-working Lathes as low as \$40. Write for information.



ATLAS DRILL PRESSES
 \$13.95 to \$33.45

Small, medium and big—for bench or floor. Quality-built tools with more and bigger bearings at prices below what you've had to pay up to now. Special construction prevents side-play in quill.

ATLAS PRESS CO.
 1843 N. Pitcher St.
 Kalamazoo, Mich., U. S. A.



BURN YOUR NAME ON TOOLS WITH THE ARKOGRAF

PROTECT YOUR TOOLS FROM THEFT
 Write with electricity any name or design on the hardest and finest tools and instruments, or any metal, like writing on paper with pen or pencil.
Complete Outfit \$3.50 — Prepaid Anywhere
 Interesting illustrated circular free. Write today. Agents wanted.
 ARKOGRAF PEN CO., 3927 S.E. Stark St., Portland, Ore.

SHAW DU-ALL TRACTOR

Hurry! Low prices still in effect but can't be guaranteed! Amazing money-maker for farms, truck gardens, nurseries, etc. — Flows, discs, weeds, cultivators, mows, rakes, hauls; runs belt driven machines. Gear shift models, 1 to 5 H. P. Costs 3c per hour to run. Write for **FREE CATALOG** and **10 DAY TRIAL OFFER**. Also **SPECIAL OFFER** to AGENTS. Address nearest office.
SHAW MFG. CO., Dept. 4511
 Galesburg, Kansas Columbus, O.

Your tools last longer—Your work becomes easier—When you use a **GERSTNER Tool Chest**. **MACHINISTS, TOOLMAKERS, Get FREE CATALOG.**
GERSTNER TOOL CHESTS
 435 Columbia St. Dayton, Ohio

LOG SAWS

MAKE MONEY—BE YOUR OWN BOSS
 Turn Your Trees Into Cash
 Be independent, start a wood sawing business, have money coming in all the time. Use the portable engine year 'round. Pays for itself. Low factory prices. Big **FREE** Catalog.
WITTE ENGINE WORKS
 6748 OAKLAND AVE. KANSAS CITY, MO.

NEW HEAT-DIRECTOR
gives greater comfort **BURNS OIL**

Directs radiant heat where you want it

Here's clean stove-heating! If you are tired tending ashes, investigate the new Superfex oil-burning heating stoves. The Superfex Heat-Director has patented shutter-like heat projectors which may be opened to direct radiant heat at any desired angle.

The Heat-Director is set up and connected with a flue like any stove. Draft regulation is automatic. The vaporizing burner is easy to regulate. The removable fuel tank holds oil for as many as forty-six hours.

There are seven Superfex models—three Heat-Directors and four Radiating heating stoves. See your dealer.

For one-room chilly spots, get a portable Perfection oil burning room heater

SUPERFEX
Oil Burning The Mark of Quality
HEATING STOVES

PERFECTION STOVE CO., 7710-B Platt Ave., Cleveland, O.
 Please send booklet on clean oil heat without a furnace.

Name _____
 St. or R. F. D. _____
 Post Office _____ State _____

FREE BOOKLET FOR YOU

Build your Own RADIO
BROADCAST-SHORT WAVE

NEWEST IDEAS
as sponsored by
POPULAR MECHANICS
and leading
Technical & Radio Magazines

Free CATALOGUE

OVER 50,000 ITEMS



It's easy to build your own broadcast or short wave set, tube tester, transceiver, etc. We can supply approved radio parts for practically any radio kit described by **Popular Mechanics**, and other magazines. Be up-to-date with the latest radio innovations! Save money by buying at **LOWEST WHOLESALE PRICES!**

Our newest **FREE 1935 Radio Catalog** is the greatest ever published! 192 pages crammed from cover to cover with over 50,000 items! Contains Specialized Departments on Broadcast and All-Wave Sets, Refrigerator Parts, Public Address and Electrical Appliances. Also world's greatest array of Short Wave Sets, kits and parts! Hundreds of nationally advertised lines. Thousands of Bargains!

Wholesale Radio Service Co.,
100 Sixth Avenue, Dept. PM-114,
New York City.

() Send me your new **FREE 1935 Catalog** of 192 pages.

Name.....

Address.....

City.....

State.....

600 POWER MICROSCOPE \$8⁵⁰
Triple Objective Brownscope "Professional"



THE NEW SUPER-POWER 100X TO 600X BROWNSCOPE. The **QUALITY** microscope satisfying the demand for ultra-high power at low cost. Substantially and precisely made. Nickel-plated tube and machined brass parts. Compound lenses. Large concave mirror. Heavy tilting base with lever for locking it at any angle. Fine rack and pinion focusing with **TWO** adjusting wheels. Power 100X to 600X in six steps. Power is varied by rotating the dust-proof 3 objective nosepiece, or by adjustment of the eyepiece. Comes complete with fine wood carrying case, prepared and plain slides, instruction book, and elaborate 6 piece set of dissecting instruments mounted in carrying case. Only \$8.50 postpaid.

Optical Catalog Free
BROWNSCOPE CO. Dept. 52, 234 Fifth Ave.
NEW YORK, N. Y.

BUILD YOUR OWN PRINTING PRESS

For only a few cents and with an hour's spare time, you can actually build a genuine, fool proof, printing press which produces work equal to regular printing. Anyone can make it. Ideal for circulars, cards, notices, menus, etc. Saves money. Full instructions—plans and illustrations—**CARLE EDQUIST, DEPT. P. M. ODESSA, MINNESOTA** postpaid for only 10c cash. Send at once.

Get PAID HOURLY

MAKE BIG MONEY!

Showing my sensational, new, personalized Hat and Cap Sample Line—fits in pocket—displays values men grab for—rich felts—exclusive styles—superior qualities. Priced as low as \$1.95. Nothing to deliver. Just write orders and pocket your profits. Fit and Satisfaction Guaranteed.

COMPLETE OUTFIT SENT FREE!

You don't invest a penny to get this money-making opportunity. I even give hats and caps to sincere salesmen. Send me your head size and name—get the facts. You can start pocketing cash in five minutes with my plans. Rush name.

TAYLOR HAT & CAP MFRS., Dept. 12-L
15-17 W. 6th St. Cincinnati, Ohio

MADE TO MEASURE

Exclusive maker of nationally famous Taylor Rain-proof Caps, the classy headwear. Smart new patterns—lower prices—no experience needed to make big cash profits hourly—**Elliot, Utah**, took five orders the first 15 minutes.

TWO-WAY FIVE-METER PHONE FOR BEGINNERS

(Continued from page 743)

leads are soldered directly on the ends of the copper coil. The tube-plate leads P₁ and P₂ are soldered at the same point; it will be noted that the grid-coil leads continue on out to the grid socket terminals G₁ and G₂. The common ground connec-

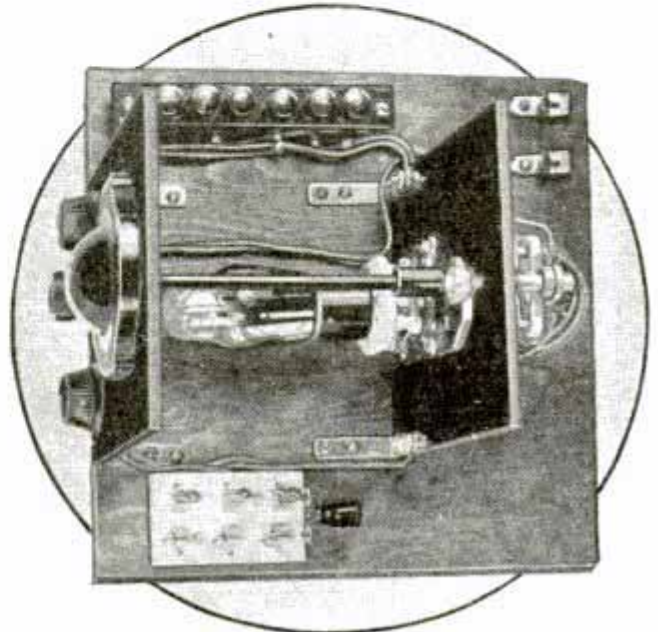

tion is made on a soldering lug placed under the socket-mounting bushing at the rear of the panel.

Two porcelain stand-off insulators, for the antenna feeders and coupling coil, Fig. 5, are mounted as shown. The coupling coil is the same diameter as the other coils and may be made of ordinary insulated hook-up wire sufficiently stiff to be self-supporting. This coil is placed about 1/4 in. from the copper coil. The change-over switch and all other connections are clearly shown in Fig. 4 and the various photos.

The parts cost, including tube, batteries, hand microphone and head phones, about \$13.00. A complete material list may be obtained upon application without charge. The 5-meter antenna used is optional; the Pickard variety described in the May issue, or the Johnson "Q" type, illustrated in Figs. 6 and 7, are both suitable low-cost ready-made units. An enlarged blueprint of the layout and wiring diagrams is available, those who wish it should specify blueprint No. 203. The antenna is suspended as high as possible and the feeders may be separated with 2-in. strips of bakelite or transposed as shown in Fig. 7.

World's FINEST ENGINES

AT OUR LOW PRICE IT WILL PAY TO BUY NOW!

WHY are over 95% of auto sales in the "under \$1,000" class? I'll tell you—folks want Real Quality for a LOW PRICE.

It's the same with engines—folks want dollar for dollar value for their hard earned cash. That's why WITTE builds and sells more engines direct than all other manufacturers combined, 27 different engines and combinations. A size and style for every purpose, 1 1/2 to 30 H. P.—\$45 up, according to size and style. Sold direct from factory to you—cash or easy terms. Buy NOW and SAVE.

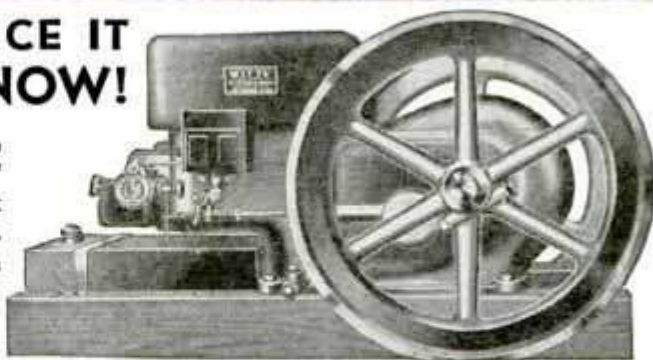

A SELF-CONTAINED POWER PLANT

Furnished in two styles: open style with Removable Die-Cast Bearings and oil and grease cup lubricators; or Enclosed, Self-Oiling, Timken Roller Bearing model. Either style on wood skids or iron base. Economical to operate on cheap fuels or natural gas, no experience necessary. Tell us what you want to use your engine for and we will, without obligation, recommend the best engine for the job.

SHIPPED FROM KANSAS CITY OR PITTSBURGH
 1748 Oakland Avenue || 1748 Central Warehouse
 KANSAS CITY, MO. || PITTSBURGH, PA.

WITTE ENGINE WORKS



Write today for Catalog and prices.

Ed. H. Witte, Pres.

World's Largest Exclusive Engine Factory—350,000 IN USE



AMAZING AUTO COMPASS

Don't lose time and money by taking the wrong road and going many miles out of your way. This new AIRPLANE TYPE COMPASS constantly tells your direction of travel. Sticks to windshield. Base 1 1/2" diameter. ONLY \$1.95 POSTPAID, including Compensator. SATISFACTION GUARANTEED or your money refunded if returned within ten days.

AGENTS WANTED!

HULL MFG. CO., Box 246-D11, WARREN, OHIO



Send No Money GUARANTEED UNDERWOOD

Regular Model ~~\$100~~
 Only \$39.90
 Cash

or On Easy Terms
 10 Day Trial
 No Money Down



Famous No. 5 Refinished

Positively the greatest bargain ever offered. A genuine late model Underwood No. 5 for only \$39.90 (cash) or on easy terms. Has up-to-date improvements including standard 4-row keyboard, backspacer, automatic ribbon reverse, shift-lock key, 2-color ribbon, etc. The perfect all purpose typewriter. Completely refinished and FULLY GUARANTEED.

Money-Back Guarantee

Send coupon for 10-day Trial—if you decide to keep it pay only \$3.00 a month until \$44.90 (term price) is paid. Limited offer—act at once.

Learn Touch Typewriting
 Complete (Home Study) Course of the Famous Van Sant Speed Typewriting System—fully illustrated, easily learned, given during this offer.

INTERNATIONAL TYPEWRITER EXCHANGE,
 231 West Monroe St., Chicago, Ill., Dept. 1101

Send Underwood No. 5 (F. O. B., Chicago) at once for 10-days' trial. If I am not perfectly satisfied I can return it express collect. If I keep it I will pay \$3.00 a month until I have paid \$44.90 (term price) in full.

Name..... Age.....
 Address.....
 Town..... State.....

Pins 35¢ Rings 1.65
BIG CATALOG FREE Get Yours Today
CLASS PINS—any letters, any year any colors. Silver plated, 1 to 11, 40¢ ea; gold plated, 50¢ ea; sterling, 60¢ ea. Silver plated, 12 or more 35¢ ea; gold plated, 45¢ ea; sterling, 55¢ ea. Sterling silver rings as shown, 1 to 11, \$1.99 ea; 12 or more \$1.65 ea.
 Metal Arts Co., Inc., Factory 44, Rochester, N. Y.

Easy WITH A... PA

You can't imagine the joy you will get out of playing a P-A Sax! It's so simplified you'll master it easily and quickly. From the very start you'll attract that warm admiration you so much desire, and with your rapid progress will come a fine, easy job; big pay; social position; the primrose life. Send today for free booklet, beautifully illustrated, of P-A instruments. Moderate price and easy terms. Write today.

PAN-AMERICAN, 1103 P-A Bldg., Elkhart, Ind.

Moderate Price



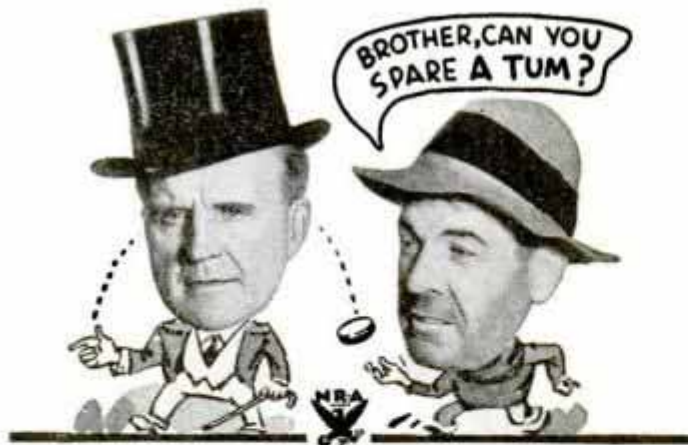

Everybody Knows TUMS Relieve Acid- Indigestion!

PEOPLE of all ages, from all walks of life, depend on TUMS regularly. For millions already know that these delightful candy-like antacid mints quickly dispel gas and counteract excess acid. Wonderful to relieve and prevent acid indigestion, sour stomach, heartburn, belching and nausea. They contain no soda nor any water soluble alkali. When TUMS correct the acid condition, any excess passes off inert and unabsorbed. Try TUMS yourself—whenever foods or gassy drinks bring on stomach distress. Handy—effective. Get a roll today at any drug store—only 10c.

Free

1935 Calendar-Thermometer combined, in beautiful 3-color design, also sample TUMS and NR. Send name, address and stamp to A. H. LEWIS COMPANY, Dept. 21-SW, St. Louis, Mo.



TUMS ARE
ANTACID . . .
NOT A LAXATIVE

FOR THE TUMMY

HANDY TO CARRY

For a laxative, use the safe, dependable Vegetable Laxative NR (Nature's Remedy). Only 25 cents.



ELECTRIC FUN!

Make things spin, buzz, shoot, flash, mystify, with electricity! Book of 200 stunts with 110 volts. Postpaid \$1.

CUTTING & SONS, 114 M St., CAMPBELL, CALIF.

Be a McNess Man

**No Time Like
Now to Get in—
Make \$35 to \$75 a week**

It's no trick to make up to \$12 a day when you use your car as a McNess "Store on Wheels." Farmers are buying everything they can from McNess men. Attractive business-getting prizes, also money-saving deals to customers make selling McNess daily necessities a snap. This business is depression-proof.

We Supply Capital—Start Now!

There's no better work anywhere—pays well, permanent, need no experience to start and we supply capital to help you get started quick. You start making money first day. Write at once for McNess Dealer Book—tells all—no obligation. (92)

FURST & THOMAS, 123 Adams St., Freeport, Ill.

**Use Your
CAR
to Raise
Your
PAY**



A PRECISION TOOL \$39.50

Completely equipped as illustrated. Timken Bearings, 4 speeds, hollow spindle, 8" swing, 18" between centers. Extension for woodworking only \$5.00 additional. Adds 36" between centers. Est. since 1842

The Series 200 Lathe is a husky, accurate, dependable tool for general work in garage and shop. A remarkable value—a complete home work shop in itself. Write for descriptive folder.

SWAYNE ROBINSON & CO.
• 250 MAIN STREET • RICHMOND, INDIANA •

Stoves AT FACTORY PRICES!



Send for **FREE** Catalog
Over 200 Styles and Sizes of Stoves, Ranges, Furnaces—174 ranges, 12 heating stoves, 22 furnaces. More Bargains than in 20 Big Stores. New styles, new features, new colors. Cash or easy terms. Year to Pay—30 days free trial—360 days approval test—\$100,000 Bank Bond Guarantee—24-hour shipments. Over 850,000 Satisfied Users 34 Years in Business

Write for **FREE** Catalog
The Kalamazoo Stove Co., Mfrs., 391 Rochester Ave., Kalamazoo, Mich.

"A Kalamazoo Direct to You"

MAKE MONEY CASTING LEAD TOYS



Get this complete outfit. Full equipment for casting. Molds for three different figures. Paints for coloring. Make all the toys you want. Earn handsome profits selling them. Ask dealer for JUNIOR CASTER, or send \$2.50 money order and outfit will be shipped (postpaid in U. S.). State choice of U. S. Soldiers, Wild West Cowboys, U. S. Machine Gunners. Large illustrated Casting Book sent FREE on request.

Rapaport Bros., 703 W. Ohio St., Chicago
FREE — 24 PAGE BOOK

EARN UP TO \$10.00 a day **NEW LOW PRICED "PINLESS" CURTAIN STRETCHER!** **NO INVESTMENT REQUIRED!**

Just what every housewife is looking for—no pins that tear costly curtains—no heavy wooden frames—just two triple cadmium rods and a hanger. Sell at a profit. Write for FREE money making details.

THE EVANS MANUFACTURING CO., Dept. PM-114, Cincinnati, Ohio

HOUSEHOLD REFRIGERATION

This booklet explains mechanical refrigeration in plain language, points that interest the buyer and user. Postpaid 25 cents.

THOMAS P. KENNY Grafton, W. Va.

ARMY AND NAVY SUPPLY CO.
Bargains—Army, Sport Goods, Firearms, Clothes, Shoes, etc. Send 10c for new catalog, to be redeemed on first order
Army & Navy Supply Co. 4772 Lester St. Richmond, Va.

AT LAST! A REAL POCKET RADIO



Can actually be carried in pocket or purse! No tubes—batteries—nothing to wear out. Simply clip to ANYTHING made of metal for clear toned reception! One control—gets all stations from 50 up to 100 miles under favorable conditions. Short Wave and Police Calls also! No aerial or complicated wires needed! Foolproof—and practical—great novelty. Can be used ANYWHERE—while walking, riding, etc.! Complete with tiny phone.

Nothing else to buy. Send only \$1.00 and pay postman \$1.95 plus postage or send \$2.99 (M.O., Currency, Check). Promptly sent p.p.d. Complete Ina. Included. Guaranteed. Order now! (Foreign orders 50c extra.)
TINYTONE RADIO CO. Dept. P Kearney, Nebr.

OWN A Potato Chip Factory

NEW "HOME FACTORY" MAKES PERFECT POTATO CHIPS—DONUTS—SALTED NUTS

Stop looking for something difficult. Turn potatoes into cash. I show you just how with my newly perfected outfit. Start anywhere. Very little cash needed. Exclusive location. Profits pour in. No experience needed. I furnish the plans. Begin anywhere—village, small town, city or suburb. A big opportunity is waiting. Business permanent.

MAKE UP TO 500% PROFIT ON RAW MATERIALS

Raw materials are plentiful and cheap. Highly perfected outfit and confidential plans make operation simple, with startling profits certain.

WE HELP FINANCE YOU

and locate you. Send no money, just name, for book of facts and free opportunity.

LONG-EAKINS COMPANY

1128-S. High St.

Springfield, Ohio



Newly perfected, rapid, direct-to-plate slicer with outfit at no extra charge.

DEAFNESS IS MISERY



Many people with defective hearing and Head Noises enjoy conversation, go to Theatre and Church because they use Leonard Invisible Ear Drums which resemble Tiny Megaphones fitting in the Ear entirely out of sight. No wires, batteries or head piece. They are inexpensive. Write for booklet and sworn statement of the inventor who was himself deaf.



A. O. LEONARD, Inc., Suite 699, 70 5th Ave., New York

FREE

The NEW BENJAMIN 25 SHOT REPEATER with BOLT ACTION—HAMMER FIRE—HAIR TRIGGER—PRICE \$7.50 is the most sensational improvement in air gun history. Send name—address—age—kind of gun you now have—if any—for your copy of BB MAGIC—FREE—A real gun manual based on U. S. Army regulations, etc. Also ask for details of 1934 BENJAMIN SUPER SINGLE SHOT—PRICE \$5.50 and our SPECIAL INSTRUCTION COURSE. Write Now.

BENJAMIN AIR RIFLE CO., 695 N. Broadway, St. Louis, Mo., U. S. A.

Print Your Own
Cards, stationery, circulars, tags, labels, advertising, etc. Save money. **Print for Others; Big Profits;** easy rules sent. Will do popular Raised Printing like Engraving. Junior press \$3.90, job press \$11.00. Send for free catalog and all details.

THE KELSEY COMPANY, A-37 MERIDEN, CONN.

Build the 4-mast Barque, California
Accurate, detailed blue prints of this handsome steel barque. List free. Complete fittings and construction sets for steam trawler and other popular models, including Sovereign of the Seas. Send 15c for illustrated catalog.

A. J. Fisher, 1002-1 Etowah Ave., Royal Oak, Mich.

JOIN THE GOLD RUSH

Gold is now selling at highest price in history and millions of dollars are being made. We need agents of good character (young college men preferred) to buy old gold. Make \$40 to \$75 weekly. **NO RISK.** No experience necessary. No Triflers. Booklet and Information sent on request. Address **HAMMOND & COMPANY (Dept. 10), Licensed Gold Refiners, 1841 Broadway, New York.**

To STOP LEAKS of water, steam, gas or oil from PIPES, BOILERS, TANKS

Smooth-On No. 1 judiciously applied at cracks, leaky seams, pipe threads and flanges, seals steam, water, gas, oil, or smoke leaks quickly and permanently.

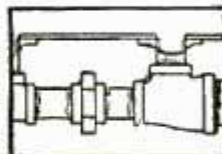

Pipe Leaks

Householders find hundreds of uses, such as making stripped screw bolt and nut threads hold, tightening loose hooks, locks, hinges, bath room fixtures, handles, casters, mending leaky pots, pans, stove ovens, etc. Excellent for stopping leaks in auto radiators, cracked water jackets, leaky seams in gas tanks, tightening loose hub caps, exhaust pipe and heater connections, lamp and tire braces, etc. A Smooth-On repair holds on any metal and is proof against pressure, heat and vibration.



Boiler Leaks

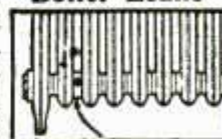

Radiator Leaks



Fire Pot Leaks

Keep Smooth-On handy and follow the directions in our free book. Expansion of the Smooth-On in hardening will do the rest. The



Smoke Leaks

HOME and AUTO REPAIRS

WITH **SMOOTH-ON**

Smooth-On Booklet shows repairs that any home owner can make with big savings, and with perfect results.

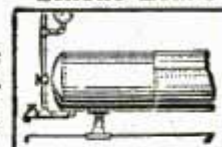

Tank Leaks

Write for **FREE BOOK**



Return the coupon for this booklet, and get Smooth-On No. 1 in 7-oz., 1-lb. or 5-lb. can from any hardware store.



Furnace Gas Leaks

Do it with SMOOTH-ON

SMOOTH-ON MFG. CO., Dept. 37, 574 Communipaw Ave., Jersey City, N. J.
Please send the free Smooth-On Repair Book.

Name.....
Address.....
11-34.....

"REMEMBER LAST WINTER!"



He counted 19 stalled cars in 9 miles of driving

Mr. J. Edward Lynch, 1195 Union St., Brooklyn, N. Y., drives 9 miles to his office each morning. And on Nov. 15th last Winter he counted 19 cars stalled along the road with "freeze-up" troubles.

But Mr. Lynch's garage service-man had shown him how inexpensively his car could be protected *all Winter long* with only one shot of concentrated anti-freeze. (Yours can show you the same protection-chart, too.) The only anti-freeze that is guaranteed to do this is Eveready Prestone. It will not boil off.

Make the Nose Test: Eveready Prestone, truly non-evaporating, is odorless. But "boil-away" anti-freezes can always be identified by the odor. Regardless of special "treatments," they will evaporate when the engine runs at high speeds.

Mr. Lynch rode all last Winter safely protected by Eveready Prestone. He's using it this year, too... And saving himself a lot of worry and expense.



SAME LOW PRICE!

\$2.95 Per Gallon

**EVEREADY
PRESTONE**

TRADE MARK

IT'S ALL ANTI-FREEZE... no water

SERVICING THE NEW CARS

(Continued from page 731)

cars running true. All this has been complicated by the introduction of independently sprung front wheels. Camber is adjusted on knee-action wheels by removing shims while the caster angle usually is adjusted through loosening the nuts that hold the control arms to the upper and lower knuckle support yokes and by then turning the upper support bolt. It is work calling for accuracy, and in knee-action jobs this accuracy must be combined with other considerations, such as seeing that there are no passengers aboard during the test, that (if coil springs are used) the two front springs are expanded to within one-sixty-fourth inch and that the front tires are properly inflated and equal in wear. To check the accuracy of such changes the latest equipment obviously is desirable. One tool used for this purpose is combined with a turning plate to check king pin inclination as well.

Have you ever considered having tire resiliency checked? This is done by means of a bulge gauge. Tires must have the same resiliency if the car is to ride comfortably and safely. Accuracy in tire pressures will not control resiliency, and any effort to do so may result in having one tire softer than another. Checking with a bulge gauge often results in discovering the cause of unbalanced conditions with the shimmy, wheel tramp and other difficulties which they create.

The mechanic who used to spin the hand crank to test compression now uses a pair of gauges which reveal the amount of compressed air admitted to a cylinder being tested and the ability of the cylinder to hold it. The point of leakage at valves or pistons is definitely located under the newer method by using a stethoscope.

If the new car doesn't run properly there is some efficient device somewhere to prove what is wrong with it; and if it seems to be giving satisfaction the wise motorist will avail himself of the opportunity to make sure he is really getting his money's worth. Detroit aimed merely to provide a new era in cars but succeeded in starting the ball rolling toward a new era in service.

Guesswork is being taken out of service. That means putting dollars back into the car owner's pocket.

Designed for Salesmen
Dear Mr. C. Road Talmadge

LOFTIS BROS. & CO. LASTING - WORTH-WHILE -

GIFTS OF JEWELRY

Let us send you one of our new style, exquisite Diamond rings for "her" gift. If you do not think it one of the handsomest Diamond rings ever shown and a tremendous bargain. RETURN AT OUR EXPENSE. Our 70-year old reputation is YOUR GUARANTEE OF SATISFACTION.

BUY NOW BEFORE OUR PRICES GO UP

No. 11 - Exquisite Ring of Solid 18-K White Gold; Blue White Diamond \$25. \$1.00 a Week

No. 39 - Solid White Gold Wedding Ring; 6 Diamonds \$16.50 50c a Week

No. 13 - Man's Elgin Wrist Watch. Excellent timekeeper, good-looking No. wrist watch . . \$16.50 13 50 Cents a Week

No. 40 - Beautiful baguette wrist watch, natural yellow gold, with silk cord bracelet, excellent timekeeper . . . \$19.95 50 Cents a Week

SEND FOR NEW CATALOG

TERMS: One-tenth down; balance weekly, semi-monthly or monthly by your convenience

LOFTIS JEWELRY CO. CATALOGUE EXPLAINS EVERYTHING. Full Particulars of Little Easy Credit Plan. Write today.

30 N. STATE ST., CHICAGO, ILL., DEPT. F 894
YOUR MONEY BACK IF NOT SATISFIED

A BIG NEW WOOD LATHE AT A SENSATIONAL LOW PRICE

Turns 8" Diameter 36" Between Centers **SPECIAL OFFER**



Extra heavy wood lathe, all steel bed, 48" long, now at lowest prices ever quoted! Heavy duty headstock with 3-step cone pulley for V-belt. Extra long reservoir oiler bearings. 8" long tool rest and many other special features. Accessories include 3-step cone motor pulley, V-belt, and set of 4 turning chisels. Write for FREE Catalog, lowest prices, Special Offer, and details on New Band Saw and Drill Press. Heavy Duty, Precision Made Machines at Blue Star's Sensational Direct-to-you Low Prices. No agents or chain stores.

BLUE STAR LATHE, 357 Main Street, FAIRFIELD, IOWA

COMPLETE ELECTRIC PLANTS

\$99 ONAN A. C. PLANTS furnish the same current as city service. Operates Radio, Water System, Refrigerator, all Household Appliances.

SIZES 300 WATTS UP

Direct Current Models as low as \$99. No battery used to start the engine. Easy to install. Available from stock. Ideal for farms, camps, lake homes, and commercial purposes.

D. W. ONAN & SONS, 938 Royalston Ave., Minneapolis, Minn.

MAKE MONEY PRINTING

letter and billheads, circulars, cards, for friends, spare time. Easy to learn, easy to get jobs. Printing Presses \$12; new type faces, complete supplies, lowest prices. Send stamp for catalog.

PEIFFER CO., 5-A; 6 Columbia St., Newark, N. J.



Don't Burn Coal HEAT WITH HOME-MADE GAS

ONLY 1 1/2c PER HOUR

AN amazing new way has been found to turn liquid fuel into instant heat. Now only a few pints of liquid will heat your home for hours except in sub-zero weather. This revolutionary invention has proved so satisfactory in several thousand homes that it will now be sent on 30-day TRIAL to responsible people. Learn, right in your home, how this new type "radiant" heater burns 98% air. No piping. No installation. Hotter than city gas or electric heaters at one-tenth the cost. No soot or ashes. Portable—carry it anywhere. Test it 30 days, without obligation, get it FREE if you will help introduce to friends and neighbors. Positively no selling required. Rush your name and address at once for Free Offer.

AGENTS!

Send for new plan. Everything furnished. Full-time or spare-time. Write quick.

THE AKRON LAMP CO.
1201 High Street, AKRON, OHIO



This OIL does 2 EXTRA JOBS

CLEANS AND PREVENTS RUST while it lubricates



Three fine oils are blended in 3-in-One to make it provide far more protection than ordinary light lubricants. Every drop of 3-in-One acts three ways to prevent friction and wear. Try it; 3-in-One will save you money. Sold by stores everywhere. Handy cans and bottles.

3-IN-ONE OIL
A SCIENTIFIC BLEND OF MINERAL, MINERAL AND VEGETABLE OILS

**LUBRICATES
CLEANS AND
POLISHES
PREVENTS
RUST AND
TARNISH**

MANUFACTURED BY THE
THREE IN ONE OIL CO.
NEW YORK, U.S.A.

A HIGHLY PENETRATING OIL FOR ALL
BICYCLES, SEWING MACHINES, SLIGHT
LAWN MOWERS, FIREARMS, PUMPS,
AUTOMOBILE PARTS, TOOLS, ETC.

BOYS! Discover Amazing Chemical Secrets

Perform dazzling, breath-taking experiments and mystify your friends with a Gilbert Chemistry Outfit. Make invisible ink such as used by Great War secret service agents. Change water into wine. Change wine into milk. Make a lump of sugar float in water. Dye cloth. Make a chemical barometer that forecasts the weather. A Gilbert Chemistry outfit makes you master of dozens of uncanny scientific feats.



FREE — Exciting Magazine and Booklet "How to Become a Chemist"

Clip the coupon below and mail it today for free copy of Mr. Gilbert's booklet, "How to Become a Chemist" illustrating and describing each Gilbert Chemistry outfit. Also copy of the thrilling new magazine "Home Chemistry." But hurry! The supply of magazines is limited.

THE A. C. GILBERT COMPANY
407 Erector Square, New Haven, Conn.

Please send illustrated booklet "How to Become a Chemist" and magazine "Home Chemistry"—both free.

Name.....

Street.....

City.....State.....

When writing please mention Popular Mechanics



Clean PLUGS save gas!

MAKE EASY STARTING, TOO . . . INCREASE POWER AND PEP. HAVE YOUR SPARK PLUGS CLEANED BY

THE AC METHOD **5c a plug**



Oxide coating forms on all spark plugs—wastes gas, causes hard starting and loss of power. The AC Spark Plug Cleaner thoroughly removes this coating. Badly worn plugs should, of course, be replaced with new ACs.

AC SPARK PLUG COMPANY

Look for the "Plug-in-the-Tub" Flint, Michigan St. Catharines, Ontario
Plugs for Canadian market made at St. Catharines, Ontario

Laboratory Supplies at School Prices!

You can buy from us the same high quality laboratory supplies we furnish schools and colleges—AT OUR SCHOOL PRICES.

Send 10c for new 32-page catalog listing more than 1,500 items of chemicals, apparatus, glassware, microscopes, books and accessories. Deduct price of catalog from payment for first order. Source of Scientific Supplies for schools and colleges.

New York Biological Supply Co., Dept. 15, 34 Union Sq., N. Y.



Catalog No. 34-A Illustrating Electrical, Mechanical and Model Makers' Supplies, Small Steam & Gasoline Engines, Motors, Generators, Lathes, Drill Presses, Bench and Band Saws, etc., 16 & 32 Dyna-Motors, School Projects, Engine Castings, Motor Parts, etc., Books, Blue Prints, Brass and Steel Tubing, Gears, Pulleys, Hangers, Experimental Material.

Big Copy. Mailed anywhere for 20 cents. 25 cents Canada, refunded first order.

LOOMIS ELECTRIC COMPANY
2822 N. California Ave. Chicago, Ill.



COMPLETE Movie Outfit

Get this complete outfit to take and show home movies. Only \$7.50 Postpaid. Regular \$20.00 value. Gives pleasure to the whole family

\$7.50
Postpaid

CAMERA—takes clear, brilliant pictures. Uses 16mm. film, 50 ft. roll.
PROJECTOR—shows pictures, big, clear and life-like. Uses 16mm. film. Operates from any light socket.



DON'T MISS THIS BARGAIN

We also have a complete list of film subjects for any projector. Write NOW for big, FREE Catalogue of Movie supplies.

PARAMOUNT MFG. CO.
Dept. G-74 Boston, Mass.

THE WORLD'S LARGEST EYE

(Continued from page 678)

through perfect. The chief fear was that the great saucer would crack while fusing; also of "bubbles" forming in the glass. The giant reflector has yet to finish cooling; then to be ground and polished. Cooling is taking place gradually. When it comes to grinding and polishing the great mirror, expert workmen must proceed with extreme caution for even the heat of a human body as it bends over the glass can cause a heat reaction which will be reflected in the grinding. So mathematically exact must the "finishing" be that labor on the mirror will be interrupted every fifteen minutes to give it time to "cool down."

The difficulties of constructing a larger mirror are realized more fully when the dimensions of the 200-inch mirror are presented. Its weight, when finished, will be about eighteen tons, its focal length is fifty-five feet and its radius of curvature is 111 feet. The diameter of the hole in the center is forty inches and the ribs are from three and one-half to four and one-half inches thick.

Mounting also is another factor which may preclude a larger telescope. For this telescope a monumental base must be built and machinery surpassing any ever constructed must be built for revolving it with the stars. The skeletonized framework which supports the fifty-five-foot barrel as it projects heavenward weighs several tons. An elevator will be used to gain the top of this barrel. Across it the distance will be twenty-four feet. Cost also is another deterrent factor in the construction of a larger telescope. The cost of this one, including equipment, will run in the neighborhood of \$6,000,000.

To take the place of such equipment it has been suggested that "electronic telescopes" be built. These telescopes would step up faint starlight, not by mirrors, but by an electric apparatus. Photo-electric cells would pick up the faint starlight from a silver-coated plate and convert it into electric energy. After being amplified in electronic tubes this starlight would be reconverted into light. Passing through the electric tube would be equivalent to stepping up the starlight as much as could be effected with a 2,000-inch mirror. Scientists predict that some day such a telescope will be built.

Dr. J. J. Moore forms this or instead of 12
new when from laboratory



**NEW GEM
NOW \$14⁵⁰**

20,000-Word Book Included

You need not be a scientist to use the simply operated New Gem, yet it is a scientific microscope. Only at much higher prices can you equal its illumination and sharp resolution. Made by America's largest optical institution that supplies hospitals, doctors and colleges. Magnifies 75 to 172 diameters. Yields remarkable photomicrographs. Walnut case and 20,000-word illustrated book included. Extra objective magnifies to 300 diameters, \$2.50 (book II, 20,000 words, included). Ask your dealer.

Write For Free Literature

Bausch & Lomb Optical Co., 761 St. Paul St., Rochester, N. Y.

BAUSCH & LOMB



PROMOTED!

... because he made his ideas COUNT!

PERHAPS Jim was no brighter than other young fellows about the office. But he had one good practice. When he had an idea for improving office routine or increasing sales, he typed it out neatly on his Remington Portable and sent it into the head office. Those neat memos of Jim's were read, they attracted the boss's attention. When a vacancy occurred, it was natural to give Jim the promotion.

Every boss is looking for good ideas. A Remington Portable will help you put your thoughts on paper in clear, easy-to-read style. Executives have no time to struggle with handwriting. Big magazines won't even consider stories and articles that aren't typed. Typewriting has helped many young men and women to bigger earnings and lasting success.

AMAZING TYPEWRITER BARGAIN!
New Remington Portable only 10¢ a day!

Now buy this beautiful brand new regulation Remington Portable, direct from factory for only 10¢ a day. Standard 4-row keyboard; standard width carriage; margin release on keyboard; back spacer; automatic ribbon reverse; every essential feature found in standard typewriters. Carrying case free. Now reduced 25%...



10 Days Free Trial Offer

absolutely the biggest typewriter value ever offered! Try it in your home or office 10 days free. If you do not agree that it is the finest portable at any price, return it at our expense. Don't delay. **FREE TYPEWRITER COURSE.** Mail coupon now.

Remington Rand Inc., Dept. 152A11, Buffalo, N.Y. Please tell me how I can buy a new Remington Portable typewriter for only 10¢ a day. Also enclose your new catalog.

Name _____
Address _____
City _____ State _____
When writing please mention Popular Mechanics

MOST COMPLETE MANUAL OF WHITTLING EVER PUBLISHED

yours for 3c



OVER 40 fascinating pages of things to make with a pocket knife! Make match-men, scissors that open and close, ships in bottles, and dozens of other things. Send 3c in stamps today... and be sure you have on hand a Remington high-carbon steel pocket knife. Remingtons are the choice of men who know knives... they hold a razor-sharp edge—they've got backbone—they're dependable!



"THE KING WHITTLES KNIFE" R-100 A



SEND 3c STAMP WITH THIS COUPON

REMINGTON ARMS CO., Inc.
Dept. E3, Cutlery Division,
Bridgeport, Conn.

[I enclose 3c stamp.
Please send "Things to Do With a Pocket Knife."]

Name _____
Street _____
City _____ State _____

I'LL MAKE THIS POST WATERTIGHT WITH WOOD IN CANS



Dries to Hard, Permanent Wood Handles Like Putty - 1001 Uses Waterproof - Weatherproof

Prevent deterioration and decay—check those vital spots—porch pillars, leaky window-sills, under window-sills, door frames, cracks in stucco, cement, bricks—use *Plastic Wood* and be assured of a permanent repair—will withstand the ravages of bad weather.

Plastic Wood offers the means of saving many dollars where repairs are needed—this marvelous discovery—a wood in putty form hardens into lasting wood—can be sawed, planed; holds nails and screws firmly without splitting or crumbling; can be sanded, painted or varnished; will adhere permanently to any clean and dry surface—wood, metal, stone, tile and glass.

Never be without Plastic Wood. Get a 25c tube or 35c can at any paint, hardware or department store.



PLASTIC WOOD

Make your own Rubber Stamps THE DUPLISTAMP WAY.
 TYPEWRITSERS... or DRAW on a stencil... attach to DUPLISTAMP & print. One stencil prints 5000 impressions. Send \$1.25 for complete 3"x1" sample. Post Card also \$1.50.
 EASY DUPLISTAMP CO., 132 W. 46 St., N. Y. C. AGENTS WANTED



The most amazing "ALL-PURPOSE-KITCHEN-TOOL" ever invented. Slices, cuts, grates, cubes, shreds vegetables of all kinds, cheese, sausage, etc. Nothing like it anywhere. Patented on 12 exclusive points. Every housewife, restaurant, hotel, etc., buys on 2-minute demonstration. Sells for \$1.50. Up to 150% profit. Agents, Distributors, Crew Managers, Window Demonstrators, etc., can make fortunes. Send \$1.00 for sample or write quick for free information and territory reservation.
STARRETT MFG. CO., 442 N. Oakley Blvd., CHICAGO

Saw Filing PAYS!

Steady growing business, all cash, no canvassing. Start in spare time. No experience needed. No eyestrain. With a **FOLEY Automatic Saw Filer** you can file hand, band and circular saws, easily, quickly, accurately! Small investment. Send postcard for **FREE PLAN and Special Offer**. No obligation.
FOLEY MFG. CO., 1116-4 Foley Bldg., 11 Main St. N. E., Minneapolis, Minn.
 See Foley exhibit New York Power Show, Dec. 3-8.



PANTS MATCHED TO ANY SUIT

DON'T DISCARD Your OLD SUIT
 Wear the coat and vest another year by getting new trousers to match, Tailored to your measure. With over 100,000 patterns to select from we can match almost any pattern. Send you a sample of cloth today, and we will submit **FREE Sample** of best match obtainable.
MATCH PANTS CO., 20 W. Jackson Blvd., Room 1143, CHICAGO



NEW! SENSATIONAL SELLER AGENTS WANTED to introduce
 No. 473 deal consisting of 10 blue steel safety razor blades, 1 tube of shaving cream, 1 styptic pencil and 1 Goodrich hone, all quality merchandise. It's the outstanding seller of the day. At 49c it's a sell out. **FREE** wholesale catalog.
SAMPLE DEAL 25c Doz. 21c ea. deal, Gr. 19c ea. deal
Spors Co., 934 Main St., Le Center, Minn.

New Hi-Speed Power Mixer AMAZES HOUSEWIVES!
MAKE BIG MONEY REPRESENTING WORLD BEATER! Works like \$18.00 Mixer, yet less than \$2.00. Powerful hydromotor mixes food drinks, Ovaltine, Malted Milks, etc., whips cream, beats cake batter. Attaches to all vacuets. **COMMISSIONS PAYABLE ADVANCE.** Write for exclusive territory selling plan TODAY!
World Beater Products Company, 3954 Drexel Blvd., Dept. 100, Chicago, Ill.

Home Automatic Cigarette Machine
 Put tobacco and block of papers on machine. **TURN THE CRANK—PRESTO—CIGARETTES.** Easy—simple. All metal construction. Guaranteed. No cloth ribbons; no special tube or gummed papers required. **ASK FOR FREE ILLUSTRATED FOLDER, AUTOMATIC CIGARETTE MACHINE WKS., PM-11, 1935-57 Sheridan Rd., Chicago, Ill.**

BUILD A DESTROYER MODEL
 For only \$6.00 (and P. P. charges) we supply a completely finished, shaped and sanded smooth hull 22 in. long, and all fittings ready to assemble, together with full size drawings and clear instructions. **Other models from \$1.50 up:** Santa Maria, Mayflower, Flying Cloud, Coach or Covered Wagon.
 Send \$3 stamp for catalog
MINIATURE SHIP MODELS Dept. RT., Parkside, Pa. 520 Runnyside Rd., Toronto, Ont.

PROFITS \$160 to \$300 Monthly—WITHOUT INVESTMENT

| | | | | |
|--|--|--|--|--|
| <p>AUTOMATIC AIR SERVICE Brings bigger business to you without investment. Believes, space saving, always ready. \$12 Monthly.</p> | <p>ARC WELDER Profits \$300 to \$400 monthly with new "SIMPLIFIED" Welder. Electric, belted, gas engine drive.</p> | <p>8-HOUR BATTERY CHARGING Put your shop above competition. Halves electric bills. Doubles profits. Only \$10 Monthly.</p> | <p>20 MINUTE Car Washer Big profits washing cars—saves 2-3 time, does better job. Savings pay for it. Only \$17 Monthly.</p> | <p>Tear out and mail this ad. Check items of interest—no obligation. HOBART BROTHERS Box M-1141, Troy, O.</p> |
|--|--|--|--|--|

WRITE TODAY » Only \$16 Monthly—30 Days Trial to Prove it « OBLIGATION

KEYSTONE



HOME WORKSHOP SAWS

Made by DISSTON in U. S. A.

ALL AT LOWERED PRICES

For home-crafters and others who have small bench saw machines, here is bigger-than-ever value! Circular saws made by Disston, all at new lowered prices, at hardware dealers. Ask for Disston-made Keystone Circular Saws. If dealer does not have them, write us. We will see that you are supplied at these prices.

| | |
|--|---------------------------|
| Cross-cut or Rip or Combination type | |
| 6" 1/2" hole \$1.00 | 8" 1/2", 5/8" hole \$1.40 |
| 7" 1/2" hole 1.25 | 10" 5/8", 3/4" hole 1.80 |
| New... Smooth-cutting, Hollow Ground Combination | |
| 6" 1/2" hole \$2.50 | 8" 1/2", 5/8" hole \$3.60 |
| 7" 1/2" hole 3.00 | 10" 5/8", 3/4" hole 4.50 |

Made only in above sizes and holes
Prices slightly higher in Canada

Write for "Valuable Hints on the use and care of Motorized Home Workshop Saws and Tools."

HENRY DISSTON & SONS, INC.
1111 Tacony, Philadelphia, U. S. A.
Canadian Factory: Toronto

MAN! WHAT A HIT!
NEVER MADE SO MUCH
MONEY BEFORE IN MY
LIFE!

New
Toy Sensation
WORKS LIKE
MAGIC!



TAILSPIN TABBY—the new sensation—wags its head, wags its tail—does hundreds of other funny capers APPARENTLY WITHOUT THE AID OF HUMAN HANDS! Looks like \$1.00 seller, yet retails for 25c. Demonstrators earn up to \$10.00 a day. Write for free facts—enclose 25c for working sample.

TOY FOLKS, Dept. PM-114, East Aurora, N.Y.

\$19.95 Now buys a genuine
MEAD Bicycle

RANGERS cost a few dollars more. Do not buy until you get our astonishing new prices and terms.
30 Days' Trial We ship on approval. If not satisfied after trial return the bicycle at our expense.
Tires lamps, wheels, equipment at half usual prices. Write for marvelous new prices and terms.



Mead CYCLE COMPANY Write us today for free catalog
DEPT. L-114 CHICAGO

CHEMISTS NEW CATALOGS

Catalog listing 10,000 chemicals, drugs, flavors, etc., and 1,700 Scientific Books, sent for 25c. Catalog with 3,000 illustrations of laboratory apparatus, 50c. Glass Still as illustrated, Cap. 1 Qt., \$9.00.
LABORATORY MATERIALS CO., 635 E. 71st St., CHICAGO, ILL.

BUILD IT YOURSELF

JIM DANDY CABIN TRAILER
Cinsey! Roomy! Easy to build at low cost! Plans and instructions only \$1.00—include all Diagrams, Sketches, Photos, Material List, etc. Big Value! Mail Dollar Bill to Jim Dandy, Box 125-A, Wausau, Wis.



N O W !

THE

Chance OF A Lifetime TO FIX UP YOUR HOME

THE National Housing Act is now in operation. YOU can obtain funds to modernize your home . . . make use of waste space . . . brighten up dingy nooks and corners. Turn the attic into a spare room . . . the basement into a game room. In short, make those changes you've always wanted.

And when you do, you'll find genuine Masonite Products do a big job for the money. PRESWOOD and QUARTRBOARD Masonite Insulation, for partitions, walls and ceilings. TEMPRTILE for realistic tile effects. CUSHIONED FLOORING to give the appearance of expensive inlaid floors.

Masonite Products are *all-wood* and grainless. Noted for easy workability, even by amateurs.

Find out how YOU can take advantage of the National Housing Act. The lumber dealer in your neighborhood will be glad to tell you all about it.

● GENUINE
Masonite
PRESWOOD

Masonite Quatrboard • Masonite Cushioned Flooring
Masonite Temprtle • Masonite Structural Insulation
Masonite Insulating Lath

MASONITE CORPORATION PM-11-34
111 W. Washington St., Chicago, Ill.

Please send me your free booklet entitled "You Can Make These Useful Things." Where in my neighborhood can I see samples of Masonite Products?

Name _____

Address _____

City _____ State _____

When writing please mention Popular Mechanics

Easy to See Why Millions Have Switched to LEE JELT DENIM OVERALLS!

AND HERE'S WHY LEE'S WEAR MONTHS LONGER

SUSPENDERS WON'T SLIP

BIB CAN'T GAP

LONGER WEARING POCKETS

U-SHAPED CROTCH

SHRINK FAR LESS

1716 EXTRA FEET OF YARN IN EVERY PAIR

...Plus 22 More Exclusive Features

WITH all these valuable features and 22 more besides, no wonder millions have switched to Lee Overalls. Remember, too, they're the only overalls made of genuine JELT DENIM with the tighter weave that means greater freedom from snags, rips and tears—record low shrinkage—MONTHS LONGER WEAR. So buy Lees next time and see how much they save.

THE H. D. LEE
MERC. CO.
Dept. R-171
Minneapolis, Minn.
Trenton, N. J.
San Francisco, Cal.
South Bend, Ind.
Salina, Kansas
Kansas City, Mo.

UNION-MADE

Lee OVERALLS

FREE: Write for FREE SAMPLE of Jelt Denim and name of nearest Lee dealer.

NEW TRICKS OF WEATHER FORECASTING

(Continued from page 116A)

cialists who look toward the west for general weather trends are receiving a wealth of information from ships on the Pacific that enables them to visualize conditions much more accurately than in the past. The movement of cold air masses in the north Pacific plays such an important part in making continental weather that the meteorologists think that ultimately research on the coasts of the Orient will be used to supplement the ship reports.

Another way that weather is anticipated is by "backtracking" each change to its source. When a storm occurs the weather officials study the day-by-day weather maps of the previous week. This type of research recently resulted in the discovery that the heavy summer rains that occur in Arizona really originate in the Gulf of Mexico, instead of in Sonora as had been supposed. Now, when a storm moves westward across the Gulf and inland over Mexico the weather bureau can anticipate rain in Arizona nearly a week before the storm reaches that state.

Aside from its general forecasts, the weather bureau expects that its special services will also be made more accurate by the present campaign. These services include warnings of storms to marine shipping, flood warnings, and warnings to pilots of conditions likely to form ice on airplanes. A recently added service is that of foretelling "forest-fire weather," based on a study of winds, humidity, combustion temperature, and the inflammability of materials. At the same time that meteorologists are making forecasts two days in the future they are working toward reliable predictions for as far as four or five days ahead. They foresee such a need when dirigibles will be making long over-water flights on regular schedules.

Comparatively little is known yet about clouds, although clouds have been used in forecasting for centuries. Since clouds result from conditions in the air quite accurate forecasting is possible by observing them, but the trouble is that they are often misinterpreted. When the study of clouds is complete, weather officials say, there will be many more classifications than at present and more accurate "snapshot" forecasting will be possible.

WEAVING MATERIALS BAMBOO RATTAN
Reed, Colored Raffia, China Grass, Chair Caning, Chair Frames and Stools, Basketry and Furniture Weaving. Send 10c for Catalog. Instructions Free. **AMERICAN REEDCRAFT CORPORATION**
Dept. P 130 Beekman Street New York, N. Y.

Red Bakelite
Leak-Proof Cap
4 Fluid ozs.

FOR LEATHER DRESSING ESSEO TOO

Esso Handy Oil is more than a squeak-eliminator... more than a lubricant... more than a rust preventive for tools and hardware. It is also excellent for softening and waterproofing boots, saddles and golf bags.

ESSO INC., 26 BROADWAY, NEW YORK CITY

CRYSTAL-CLEAR • 100% LUBRICATING PREVENTS RUST

FREE big book telling about the fun and thrills you can have with Chemistry!

Think of the fun you could have with one of these new, 1934 CHEMCRAFT Chemistry Outfits . . . the latest, most advanced sets. Hundreds of exciting experiments and magical chemical tricks. You'll be thrilled when you read all about the things you can do . . . so send a postal card or letter asking for our Big, Free Magazine. It's packed full of useful information for Junior Scientists, tells all about many science outfits and also contains a dandy story you'll sit up nights to read. Do it now . . . a postal card will bring you this magazine free.

**The PORTER
CHEMICAL CO.**
3411 Prospect Avenue
Hagerstown, Maryland



Glazed Pottery Made Without Molds

Make beautiful, colored, glazed concrete pottery. Washable, everlasting. No experience needed. Complete pottery plants using no molds, power or costly tools, making 2,500 different designs bird baths, vases, jars, etc., cost less than one mold by old methods. Use only sand and cement. Money making business. Book, color plate, etc., 10c.

NATIONAL POTTERIES COMPANY
1115 Hawthorne, Room 1, Minneapolis, Minn.



AGENTS Make \$380 Monthly

Selling 10 CARTER WINDOW WASHERS daily. Cleans, dries, polishes. No mess. Good Housekeeping approval. Restricted territory. Write today.
Carter Products Corp., 998 Front Ave., Cleveland, Ohio

MULTIPLY and DIVIDE

EASILY - QUICKLY - ACCURATELY



Something NEW! A Dictionary of numbers! The Math Pony has multiplied 90,000 products for you. Accurate answer! Saves time, mental effort, and errors. Very easy to use. For School, Business, and Home. 212 pages. HEAVY PAPER COVER \$1.00. ART FABRIKOID COVER was GOLD. \$2.00. Circular free. The Math Pony Pub. Co., Box 1810, M1, Milwaukee, Wis.

CLEANS AUTOS NEW WAY!

STRANGE CHEMICAL SPONGE



Revolutionary invention cleans autos like magic! Banishes dust, dirt, grease, traffic film—thanks to secret chemical and sensational, self-sudsing feature. Also cleans linoleum, woodwork and windows without work! Auto owners and housewives wild about this strange chemical sponge! **SAMPLE OFFER!** Samples sent at our risk to first person in each locality who writes. No obligation. Be first—send your name today!



**AGENTS!
MAKE BIG MONEY!**
New, easy plan. Simply show and take orders. No experience needed. No risk. **FREE OUTFIT!** Write today for all details.

KRISTEE MFG. CO., 1361 Bar Street, Akron, Ohio

A GREAT XMAS PRESENT for the Boy!

COMPARE the outstanding features of this Remington Bolt Action Rifle, Model 33, with any other .22 rifle on the market today. Then if you agree with the hosts of present owners that it's the greatest gun value ever offered, it's yours for

ONLY \$5.50



White metal bead front sight.

Long barrel, 24 inches, selected steel, specially bored and rifled to give extreme accuracy.

Right weight—4½ lbs. Light enough to carry all day; heavy enough to hold steady.

Beautifully balanced for shooting in any position.

Finger grooves allow firm grip, steady, accurate aim.

Handles all types of rim fire .22's . . . shorts, longs, long rifle; regular and Hi-Speed.

Adjustable rear sight.

Easy take down...no tools needed.

Bolt head shrouded for extra safety.

Automatic ejector—strong, positive!

Double locking lugs on bolt insure greatest accuracy and safety.

Bolt handle and lugs one solid piece, permanently locked into bolt.

Bolt, bolt handle and trigger chromium plated. **NO RUSTING!** Smooth operation.

Bolt safety permits removing cartridge from chamber while safety is on.

One-piece American walnut stock and fore-end.

Shotgun type steel butt plate.

See this wonderful rifle at your dealer's and be all set for Xmas or write today for descriptive folder. Remington Arms Co., Inc., 1734 Seaview Avenue, Bridgeport, Conn.

Remington



When writing please mention Popular Mechanics

D1027

ARMOR SAVES GRIDIRON STARS

(Continued from page 652)

in order to make sure that it did not impair his vision too much.

Ordinary equipment protects six danger spots. The adjustable pads in the pants cover the knees and thighs. The hip pads take care of both hips and kidneys. The shoulder pads protect all of the shoulders including the collar bones. The headgear protects the upper part of the head.

The biggest stars, who usually are unbothered by frequent injuries, prepare their equipment chiefly in the matter of fit and efficiency. They may add a bit of padding here or trim some from there; they may insert an elastic strip in one place or cut a slit elsewhere. Eventually many of these little details become a part of standard equipment.

A football star can't afford to take unnecessary chances.

POWER TO COME BY RADIO

(Continued from page 120A)

could furnish power for a vacuum-tube oscillator. High in the air a metal-covered balloon could be held by a copper-plated steel wire. The sun could furnish the power which would be turned into radio power, shot up to the balloon which would, I believe, in turn precipitate rain. That could for all time end such things as droughts and it could also eliminate the great waste areas now covered with blistering sun and sand.

Enormously high-frequency radio power could be used to dehydrate fruit and vegetables. And the power, in addition to extracting all moisture so fruit and vegetables could be kept almost forever without losing their health-giving qualities, would also kill disease germs in the fruit or vegetables. Great hydroelectric projects could transmit radio frequency for reclamation projects.

These possibilities are, of course, in the future. Already we have train and airplane communication by radio, the guiding of ships in harbors, aids to the deaf, the blind, the miner, the surgeon. Only the future years of laboratory development and commercial adaptation of these developments can prove to the world just how powerful and far reaching are their uses to humanity.

Wear this New Model



ELGIN
30 DAYS FREE

You've always wanted a good watch. Here is your opportunity to own the famous Elgin at the lowest rock-bottom factory price. All the newest models in pocket and wrist watches for ladies and gentlemen factory cased and guaranteed.

No Money Down — No C.O.D. To Pay! We will send you your choice of watches to wear, examine and admire for 30 days—then pay only a small amount monthly. No interest. No red tape. Thousands of satisfied customers.

Genuine DIAMONDS

Thousands are proud owners of Certified Perfect Diamonds. We actually send you your choice of a perfect blue white diamond for 30 days inspection in your own home. Newest style mountings for ladies and gentlemen.

TAKE A YEAR TO PAY—Your credit is good. Easy monthly payments.

Write Today for special Bargain bulletin and free trial offer. A postal card will do.

HELZBERG'S DIAMOND SHOP
Dept. 302, KANSAS CITY, MO.



HAND-EE GRINDER

QUICKER BETTER JOBS



Weights one pound. Plug in any light socket and do 1001 jobs. Do away with slow hand work. Remove burrs, take out nicks, sharpen tools, etc. Grind where files won't reach. For shop, home or tool kit. (Model A.) A. C. or D. C. operation, 110v., 13,000 r. p. m. Order on 5 day trial, satisfaction guaranteed.

Ask for **FREE Booklet**

LARGER SIZE, Hi-Power (Model B) weighs 3 lbs., 17,000 r.p.m., \$35. F.O.B. Chicago

100 SHAPES AVAILABLE

CHICAGO WHEEL & MFG. CO.
108 S. Aberdeen St., Chicago, Ill.

(Model A) **\$11.50**
Postpaid U. S. A.
With 3 wheel shapes **Free Order today**

DO YOU WANT a new business profession of your own, with all the trade you can attend to? Then become a foot correctionist, and in a few weeks earn big income in service fees,—not medical nor chiropody—easy terms for home training, no further capital needed, no goods to buy, no agency. Established 1894. Address **Stephenson Laboratory, 1 Back Bay, Boston, Mass.**

BABY CALCULATOR
CHICAGO U.S. PATENT OFFICE

VEST POCKET ADDING MACHINE
Adds, Subtracts, Multiplies, Divides. Does work of 3000 machines. Not a toy. Million dollar capacity. Simple and accurate. Guaranteed 5 years.

FREE TRIAL **\$2.50**
—SEND NO MONEY— **Total Cost**

Just name and address. We will ship Calculator immediately. On delivery pay postman \$2.50 (plus few cents postage). (If outside U. S. send cash.) 10c additional in Lanthanite Case. If not satisfied after 10 days' trial you get your money back. **THOUSANDS OF SATISFIED USERS.** Write for Agents' Proposition. **BABY CALCULATOR MACHINE CO.** (Mfrs.) P. O. Box 1118, Dept. 31, CHICAGO, ILLINOIS

"AMERICAN JUNIOR" POWER TOOLS

\$2.50 EACH



A sensational New Deal in Power Tools—Now EVERYONE Can Have a Completely Equipped Shop for a few dollars. Mass production, big sales-volume and improved designs permit this amazing value. Not toys, but

MASSIVE GREY IRON CASTINGS AND STEEL—workable, sturdy, unconditionally **GUARANTEED** to do the work intended.

LATHE 6 in. swing, 12 in. c. to c., extra lengths 50c per ft.; centers 35c extra; other accessories include, chucks, saw-table, face-plates, etc., a complete shop in itself.

DRILL PRESS 10 1/2 in. high, 6 1/2 in. swing, distance chuck to base 7 in., takes 9-32 in. drills; chucks 20c, swiveling table 35c.

BENCH SAW adjustable for depth cut, takes 5 in. blades; rip-gauge furnished, 4 in. blade 50c, 5 in., 75c.

SABRE SAW does all scroll and band saw work better and faster, blades 15c.

DISC SANDER with table tilting 45 degrees up or down, used for finishing, jointing, grinding, buffing, etc., most useful all round finishing machine.

SPINDLE SHAPER takes 1 in. x 4-16 in. cutters, does all molding.

EACH MACHINE \$2.50 COMPLETE

FREE "American Homecrafters Manual," 96-page instruction book (\$1) free with every purchase.

Customers also receive FREE the "AMERICAN HOME-CRAFTER," our how-to-make-it periodical, a digest of the best construction stories and home workshop ideas in all the monthly magazines. Send 10c stamps for catalog of our full line, including 6 in. Metal Working Lathe \$5.75 and other tools, and sample copy "American Homecrafter."

Send \$1 deposit on any machines, balance plus express C.O.D. in U. S., plus 25c packing charge orders under \$3.

AMERICAN MACHINE & TOOL CO.

Dept. 2P 200 Broadway, New York, N. Y.

Men & Women Earn Cash at Home!

Grow fancy giant mushrooms in cellar, attic, barn. Easy, odorless method. We show you how, furnish guaranteed materials. Market facilities furnished. Valuable big book, pictures free if you write quickly. (Est. 1908.)

UNITED CO. 3645 Lincoln Ave. Dept. P.M. CHICAGO

EUROPEAN RECEPTION GUARANTEED

or money refunded; enjoy programs—London, Berlin & Madrid, also U. S. Amazing reception, volume and tone.

AGENTS WANTED—MAKE BIG MONEY Spare time, quick sales. Write today for illustrated literature, territory & terms. Buy direct from factory.

M. M. WILCOX 308 W. RANDOLPH ST. CHICAGO, ILL.

How to MAKE YOUR BASEMENT a place of BEAUTY

The most unusual book of the year, "Your Basement—What To Do With It—How To Do It," provides you with all necessary plans, drawings, layouts, directions and beautiful illustrations (some in color) for transforming your cellar or basement into a liveable, enjoyable den, tap room, card room, yacht deck, playroom or any of many other marvelous transformations. Written and illustrated so anyone can understand and proceed. Complete, only 25 cents, postpaid. Easily worth \$2.00. Send 25c in cash or stamps at once.



SWANSON BROS.
732 Sherman St., Chicago, Ill.

Make up to \$150 Weekly GIVING AWAY FREE RADIOS



AND 10 STAR "SPECIALS"

RCA Licensed Home Radio Sets for American, European and South American Reception and our 10 STAR items including Chest of Silver, Man's Wrist Watch, Electric China Coffee Set, Bridge Table and Chairs, Lady's Wrist Watch and other valuable gifts all given away absolutely FREE with our new sensational unique PUNCH SALES CARD PLAN. This is the opportunity of the year—make up to \$150 cash each week for yourself. Every home, car owner, store, office, factory, lodge, club or individual wants these marvelous new FREE RCA LICENSED RADIOS or any of the valuable 10 STAR items.

WRITE TODAY FOR OUR 3 NEW STARTING OFFERS Start at once making money with our unique sales plan. Write for full information how you can secure any or all of these plans.

Deluxe Mfg. Co., Dept. 124, 173 W. Madison St., Chicago, Ill.

Cash Daily Making Do-Nuts!



Big Profits in Your Own Business at Home

Greaseless!

HERE'S a steady, fine-paying business that earns big profits—you get two to three times your production cost. You get cash every day. Start right in your own home, in spare time, or have a shop of your own. Men and women in many parts of the country earning good steady incomes—making a product that everybody likes, that sells on sight—delicious, greaseless do-nuts, baked by electricity with the Ringer Electric Do-Nut Baker.

"Your machine has made a 'New Deal' for us," reports H. E. Burns, West Va. "I am getting on my feet again, thanks to your Do-Nuts. They sell themselves. Am working my machine 8 to 10 hours a day so you see business is good."

Year 'Round Business

—Steady demand from stores, cafes, homes—and a fast seller at Fairs, Parks, Beaches, Highway Stands, Rinks, etc.

S. W. Pitts, Kentucky, writes, "Have tried out several different kinds of do-nuts. Am well pleased. They take like hot cakes. Have a chance to get contracts beyond our capacity with one baker alone, and am contemplating purchasing another soon."

D. D. Shanklin, Mo., reports, "My business is automatically increasing itself all the while. Looks as though I will have to soon devote my full time to it." F. A. Manguso, Colo., writes, "I have 25 stores selling Do-Nuts for me."

No Canvassing These delicious Do-Nuts speak for themselves. Grocers, restaurants, drug stores, lunch counters buy all you can make. Or, as others are doing, you can sell your entire output profitably by men, women or boys on commission basis. Ringer Do-Nut Baker operators who started in spare time at home now have attractive, profitable shops of their own.

Start Now! It takes only \$25 to start you . . . total investment less than \$60. Get into the business that brings freedom from financial worries—that will make you independent, happy and prosperous. NOW is the time to start!

WRITE FOR FREE PLANS

—they show you how easy it is to start making money at once. Send coupon or a penny post card for full information. No obligation. No salesman will call. Write today. Ringer Do-Nut Co., 143 Main St. N. E., Minneapolis, Minn.



Mail Coupon for FREE PLAN

RINGER DO-NUT COMPANY
143 Main St. N. E., Minneapolis, Minn.

Please send me Free Plans and full information about the Ringer Do-Nut Baker.

Name.....

Address.....

City..... State.....

When writing please mention Popular Mechanics

MEN WANTED

UNUSUAL OPPORTUNITY TO STEP INTO BIG PAY WITHOUT EXPERIENCE, CAPITAL OR INVESTMENT

for
STEADY JOBS



Show merchants, business and professional men sensational new way to save \$50 to \$100 a year in the regular operation of their business. An extraordinary new plan for untrained and unskilled men to make big money in a clean, legitimate, dignified business. By even devoting only a few hours each week to this business it nets you a big weekly income.

NO HIGH PRESSURE SELLING REQUIRED

With my plans you deal in staple necessities used daily in every business institution, office or plant. This is not stocks, bonds, insurance or a credit system, but a complete service as necessary as heat and light to daily operation. With these plans you show business men positive and immediate cash savings that startle them into action. I give you full credit for all repeat orders. You get your pay daily or by the week, as you prefer.

POSITIVELY NO INVESTMENT

I do not want a cent of your money nor or ever. I have nothing to sell you. There are no deliveries to make—no house to house canvassing to do—no collections—nothing for you to buy. To sincere men I send, absolutely free, complete plans and outfit costing me over \$15,000 to produce. This is a unique, compact encyclopedia—a marvelous, efficient, self-demonstrating unit that brings cash into your pocket the first hour. Complete details sent free and without obligation. Better write me now—this offer might not appear again. Send name.

E. A. KAESER, President

Dept. 531 4142 Davis Lane Cincinnati, Ohio

Established 1894

HAND ROUTER Indispensable Aid to Every Craftsman



Duplicates work of high-priced power machines. For routing, fluting, inlaying, etc. Simple to operate. Works in wood, leather, and linoleum. Nothing like it elsewhere. Price \$2.50, post-paid, 3 blades and compass free. Money refunded after 5-day trial if not satisfied. Write for circular.



KRAUT & DOHNAL, Dept. PM,
325 S. Clark St. Chicago, Ill.

MAKE YOUR OWN ELECTRIC DRILL



From Model T Ford Generator, 0 to 1/2 in. \$1785 Capacity. We furnish all other parts for

Compares with any \$45.00 Drill. Moderate speed permits more uses than ordinary Drills. Operates on 110 volts AC or DC or 32 Volts. Same as used in our workshop, and guaranteed satisfactory. Write for picture & complete description.
Rand Co., Dept. 200, 2004 Grand Ave., Kansas City, Mo.

MAKE MONEY AT HOME

Home Industries Magazine will show you how. Hundreds of plans, schemes, ideas and suggestions for a business of your own. Magazine, 32 pages, three months' trial, 10 cents.

HOME INDUSTRIES, Box 84, Irvington, Nebr.

PONY 500 TRADE MARK
Jorgensen
REG. U.S. PAT. OFF.

Chosen for the HOME WORK SHOP
Century of Progress, Chicago

Your joints can be no better than your clamps. Buy the best. "Jorgensen"—clamps of all types. Chosen for the Home Work Shop, at "Century of Progress," Chicago. Pony Fittings go on 1/4 in. pipe (bought anywhere), make clamps of any length—handle large or small work. Fittings for 2 Pony Clamps \$3.00 plus postage, 6 lb. Jorgensen Handcraws, standard the world over, grip straight or on angles. Will not split, spring or loosen. Two No. 1 Handcraws (10 in. jaw open 6 in.) \$2.50 plus postage, 6 lb.

Send \$1 Adjustable Clamp Co. Catalog
pay postman balance **421 N. Ashland Ave., CHICAGO** **FREE**

SPECTACULAR INVENTION CUTS GASOLINE BILLS up to 35%—EMBODIES ENTIRELY NEW PRINCIPLE

Introducing — Leen-A-Mix — Sensational New Thermostatic Air Control Valve. NOW comes a new discovery which has been long awaited by automobile owners—**A Real Gas Saver!** Based on scientific principles, endorsed by motor experts. Leen-A-Mix gives cars more speed—extra power and pep—yet slashes gas costs. Ford driver reports mileage boosted 50%—from 15 to 23 miles per gallon. Amazing results have been obtained on all makes.

MAKE UP TO \$40.00 DAILY!
Every car owner is potential market for Leen-A-Mix. No wonder Kellar, Illinois, made over \$50.00 in one day. You can do as well—maybe better. Write for money making sales plan and liberal free test offer.

METAL SPECIALTIES MFG. COMPANY
Dept. 11-P 3200 Carroll Avenue Chicago, Illinois

STUCCO SPRAYING MACHINE

FUSES A PLASTIC MIXTURE ON TO ANY MASONRY SURFACE. It waterproofs and fills all cracks. It can be applied in any thickness desired and 50 colors. For over six years in use under all conditions and in practically every climate.

OFFERS BIG EARNINGS Operators report costs of 8c to 10c per sq. yd. Sell for 20c to 35c. The profit offered in your territory by increasing demand for color and big government renovating campaign. Machine furnished on free trial and easy payments. Territory protected. Write today for complete details.

Colorcrete Industries, Inc.
570 Ottawa Ave. Holland, Mich.

MONEY in METLMACHS
THE MODERN MACH

The 20th Century Invention that revolutionized the mach industry. A real water, child and rat proof safety mach, made of metal. Lights 1000 times or more. Send \$1 for 15 METLMACHES, sell them for 10c each, make 50c profit. \$1 invested today may mean your future independence. Every dealer a prospective customer. Sample and salesman's terms 15c. Competent men wanted.

Metalmach Corporation, 115 Water St., Warsaw, Ill.

NEW MILEAGE RECORDS WITH VACU-MATIC—The Carburetor That Breathes

AGENTS: Write now for free sample offer regarding Vacu-matic motor device. Automatic control. Wonderful demonstrator. Just what car owners are looking for. Saves up to 30% on gasoline. More power, smoother running, quicker starting. Write today to **VACU-MATIC CO., 7617-63 W. State St., Wauwatosa, Wis.**

GROW MUSHROOMS We show you how; use cellar, idle space; plant all seasons; overnight crops. 540% profit; our service free. Act quick.

INTERSTATE MUSHROOM INDUSTRIES
NH-7357 Cottage Grove Ave. Chicago, Ill.

GIVEN

Simply send name and address

BOTH GIVEN

Boys' and Men's six-jewel lever movement Wrist Strap Watch with metal link bracelet or 22 cal. Hamilton Repeater Rifle with magazine holding from 12 to 15 cartridges. Merely give away FREE beautifully colored art pictures with our Famous WHITE CLOVERINE SALVE which you sell at 25c per box (giving picture free) and remit as per plan in catalog. Liberal Cash Commissions. Our 39th year. Be first. Offer limited. Write quick for order of salve. **Wilson Chem. Co., Dept. 49-K** Tyrona, Pa.

SEND NO MONEY WRITE NOW

END Battery Worries

with **KRW**
AUTO-CHARGER



"It works while your car is idle"

No excuse now to have a dead battery. . . latest KRW Auto-Charger for ALL CARS keeps battery up in any kind of weather. Gives all the "juice" needed for positive starting, operating auto radio, hot water heater, defroster and other electrical devices. Light weight, 7 lbs. Only 7" x 4 1/4" x 3". Easy to install, drill one hole in underdash. The KRW Auto-Charger goes where you go, works while your car is idle. . . simply plug into nearest light socket. Operates on 25 to 60 cycles, using only 50 watts. Can't overcharge because charging rate tapers automatically when battery reaches full capacity. No liquids, bulbs or moving parts. Has two charging rates—2 and 5 amps. Fuse guards against current flow-back if power circuit fails. **\$6.75** Unconditionally guaranteed for one year. Ask any Ford Dealer who we are (Est. 1916). Circular on request. AGENTS WANTED everywhere.

K. R. WILSON • 11 Lock Street • Buffalo, N. Y.

New "Cyclone" Motor Sled

READY!

For Home Builders

Now you can easily build Mead's new, streamlined MOTOR SLED at home from drawings, parts or complete Construction Kit! Low cost. Amazing speed. Seats 2. Back 10¢ for Catalog No. 3. MEAD GLIDERS, 128 S. Market, Dept. 111-B, CHICAGO.



ELECTRIC PEN

for Burnt Wood Etching

Loads of fun—profitable tool! Simple—safe—durable—burns on wood, leather, velvet. Specially designed heating element keeps point at uniform temperature.



Read article in March, 1934, Popular Mechanics, page 456
Electric Pen Complete \$1.50. **ORDER TODAY**
Panel (Illustrated), 8 in. 25¢. Write for catalog 69 M
THAYER & CHANDLER, 910 W. Van Buren St., Chicago

The "AVIATOR" Identification Ring and Bracelet—Name and address engraved—FREE. Made of beautiful white metal. Non-tarnishable.

Sent Postpaid for money order or well wrapped coin and give size or send string for measurement.

P. A. R. COMPANY, BOX 306-P GALVESTON, TEX.

The Midget "Five-in-One," Slide Rule

is a combination Mannheim, Polymeric Log-Log, Binary, Add and Subtract Slide Rule. It will instantly add, subtract, multiply and divide any combination of whole numbers, fractions, mixed numbers and decimals. Gives every root and power, also Logs, Sines and Tangents. Made of aluminum with scales on white celluloid enamel. Size 4 in. Approved and adopted by colleges. Price with instructions and Fabricoid Case \$2.00. With leather case \$2.50. Sent C.O.D. if desired. Catalogue Free.

L. TAVELLA SALES CO. 21 West Broadway NEW YORK

New DRIVER

1935 POWER TOOLS!

FREE A 72 PAGE BOOK OF INSTRUCTION WITH EACH TOOL ILLUSTRATED BELOW.



Books are available at 50¢ each, \$1.50 for 4 postpaid.



J 505
14" Jig Saw



B 735
8" Bench Saw

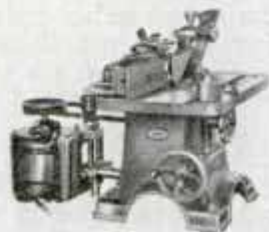

S 775
Shaper



BN 725
12" Band Saw



D 920
Drill Press

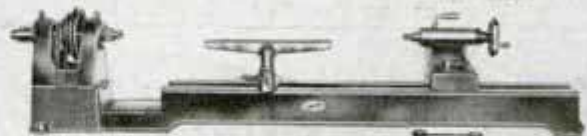

L 751
Gap Bed Lathe

The new DRIVER line is ready. Lathes, Bench Saws, Drill Presses, Band Saws, Jointers, Shapers and Jig Saws—three different lines in three price ranges. See your local dealer today for these new models or use the coupon below for descriptive circular.

WALKER-TURNER CO., INC.

1114 Berckman St. Plainfield, N. J.

Please send me your free folder covering new tools

Name _____
Address _____
City and State _____

When writing please mention Popular Mechanics



In the strict sense of the word, a can of LePage's Glue is not a tool; but when a craftsman writes: "It's the handiest tool in my workshop," it must be part of the tool kit.

Yes, it must be important because the craftsman or hobbyist who has spent money for lumber in making a project isn't taking any chances on a questionable glue. He wants strength and usually a slow setting glue to adjust joints. He likes to complete his work without unnecessary stops such as "messaging" around with glue pots. That's why the amateur as well as the top-notch prefers the ready-to-use LePage's.

Keep it in mind next time you visit your hardware store.

RUSSIA CEMENT CO.

Laboratory and Factory • Gloucester, Mass.



Information on any book free. Write Popular Mechanics Press, Chicago, Ill.

INSTALL FROSTOFF and automatically defrost your refrigerator!

10 DAY TRIAL OFFER!

Bring your refrigerator up-to-date! Don't permit those ice-coated coils to run up big electric bills—spoil food—lock in ice-trays! FROST-OFF solves these problems. Works automatically, without trouble or attention. Its low price is quickly repaid in SAVING ON ELECTRICITY. Write us for proof. Also details of Liberal 10 Day Trial Offer. Get all facts now—don't go on paying big electric bills!

THE FROSTOFF CO. INC.
250 East 43rd St. Dept. A-1 New York

RADIO BUILDERS!!

Do you intend to build any radio apparatus described in Popular Mechanics Magazines or Blueprints? If so, we urge you to send for our **FREE** special tabulated list of approved parts for that set.

Our more than eight years' experience as the leading amateur and experimenter's supply house is your assurance of intelligent, dependable SERVICE, and our low wholesale prices will please you. Whether you buy one part or an entire kit from HARRISON—

YOU WILL SAVE !!

(Our laboratory assemblies and wires kits at reasonable rates)

NEW WORLD WIDE SHORT WAVE RECEIVER POWERFUL, SENSITIVE, ALL-ELECTRIC



Here is a modern Short Wave receiver that gets foreign broadcasts, police calls, amateurs, airplanes, etc. DIRECT, with a volume and clearness that will amaze you! **12,500-mile** receiving record! This set is entirely self-contained and plugs in directly to any 105 to 125-volt A.C. or D.C. house current outlet. No batteries or separate power supply needed! Works on any aerial. Tunes from 15 to 200 meters.

\$6⁷⁵

COMPLETE KIT of all necessary parts (including neat metal chassis with all holes drilled) and clear, detailed picture instructions to build this remarkable Three Tube receiver—

TWO-TUBE Dry Cell Model (Illustrated) or \$4⁷⁵
AC Model. Complete Kit.....

200 to 625 meter Broadcast band coils—\$1.25

ORDER NOW! Guaranteed Results!!

Send \$1, balance C.O.D. **FREE literature on request.**

HARRISON RADIO CO. 142 Liberty Street Dept. P-11, New York City

LOOK MEN
MAGIC CASE HANDS YOU LIGHTED CIGARETTE

Take a beautiful enameled Case from your vest pocket. Press a magic button! Automatically there is a spark, a flame. A LIGHTED Cigarette is delivered to your lips. You PUFF and SMOKE. A revolutionary invention, perfected, guaranteed, unusually low priced. Get a Magic Case for 15 Days' Trial at our risk.

AGENTS!
Big Profits—Easy—Quick! New "No-Selling" Plan starts you. Get trial offer.

MAGIC CASE MFRS., Dept. S-379
4234 Cozans Avenue St. Louis, Mo.

MOULDS FOR METAL CASTINGS MADE TO ORDER

Metal Toys, Novelties, Ashtrays, Bookends, Model Ship, Aeroplane and Railroad parts, in fact anything of cast metal can be easily and quickly produced in unlimited quantities with Bronze moulds. No experience required. Send sketch or description of article you want to cast for price on Mould and full information. New ideas developed and models made. Write for free Interesting Booklet "M" on Casting Metal.

METAL CAST PRODUCTS CO.
1694 Boston Road Dept. 24 NEW YORK CITY

NEW DUAL RAY HEALTH LAMP UNIT
Ultra Violet and Infra Red Ray in One Lamp Health giving. Prevents Rickets and Skin disorders. Gives Sun-tan—Vitamin "D". Automatic safety control. 110 Volt AC or DC. Free Details.

COMPLETE with Goggles only \$3⁵⁰ postpd.
BEYER MFG. CO. 4655 Lincoln Ave. Dept. A-11 Chicago, Ill.

EARN UP TO \$25 A WEEK, OR MORE

Grow our famous Fancy White Queen Mushrooms. Exclusive new process. Bigger, better, quicker crops. More money for you! Enormous new demand. Illustrated book free. Write today!

AMERICAN MUSHROOM INDUSTRIES, Ltd.
Dept. 842 Toronto, Ont

THIS BOOK FREE
GROW MUSHROOMS THEY PAY

\$400 PROFIT MONTHLY RIGHT NOW IN YOUR SHOP WITH THIS NEW SIMPLIFIED ARC WELDER



Start big paying business of your own. Unusually low prices lets you start in this profit making work at less cost than you imagine. Profits will easily pay for it. Now is the time to buy before inflation comes.

30 DAYS TRIAL AT-OUR-RISK \$30 MONTHLY

Thousands of shops are earning big money with Hobart cashing in on the many profitable jobs and construction work it lets you handle. Check the size you're interested in, tear out ad and mail today to

HOBART BROS., Box M-114, Troy, O.

- Gas
- Electric
- Belted
- 125 Amp.
- 200 Amp.
- 300 Amp.
- 400 Amp.

Cheaper HEAT Without COAL



**Agents
Wanted**

EARN \$60 A WEEK!

Write for FREE Burner offer and protected territory

Men and women wanted to demonstrate and take orders for this wonderful invention. This year's sales are tremendous. Make big money. Experience unnecessary.

New Invention Fits Any Stove or Furnace

Remarkable invention burns 96% air, 4% of a cheap variety of oil obtainable everywhere. Does away with coal, wood, ashes, dirt and drudgery. Quick, clean, silent heat. 3 times hotter than coal, and cheaper. Temperature control gives any amount of heat desired—no more getting up on bitter cold, wintry mornings. Many automatic features. No gas or electricity needed. Safe as ordinary kitchen range. Easy to install—no damage to stove—simply sits in firebox of any stove range, or furnace. Costs just a few cents a day to operate.

TRY 30 DAYS AT OUR RISK

Low introductory price and 30 day trial. Write for free catalog. AGENTS and spare time workers: Oil heat saves money this year; people buy to save! Write immediately for free burner offer that starts you in business for yourself. Act NOW!

BRIGHAM OIL BURNER CO.

2927M Clark Ave.

St. Louis, Mo.

\$1.50 JIG SAW Post Paid

(C. O. D. or outside U. S. A., \$1.75 plus ADAPTERS, 12 ASSORTED SAW BLADES, and BOOKLET, "How to Make Jig Saw Puzzles."

New Feature Hardened steel grooved roller saw guide, formerly found only on most expensive machines. Your fractional H.P. motor runs saw. All metal construction. 15" long 8" high, 6 1/4" table.

Send 2c stamp for catalog fully describing all our low priced tools.

J&H METAL PRODUCTS CO. 486 St. Paul St., Rochester, N. Y.



"The Puzzlemaker"

Cuts Wood 2" Thick

EARN BIG MONEY AT HOME!

Experience unnecessary. Grow year 'round, in basement, cellar, garage, idle places. **FREE BOOK.**

MUSHROOM GROWERS, AD-433 N. Clark St., Chicago

TOUGH FILM PENNZOIL

MAKES CARS GO FASTER... SAVES ON GASOLINE



Catch Fish!

Eels, Mink, Muskrats with our new folding galvanize!

STEEL WIRE TRAP Write for our **FREE TRAP OFFER** and Bargain Catalog. **WALTON SUPPLY CO., Dept. 1, ST. LOUIS, MO.**

S AGENTS 500% PROFIT GUARANTEED GOLD LEAF LETTERS For Store fronts and office windows. Anyone can put them on. Free samples. Liberal offer to general agents. **METALLIC LETTER CO., 438 N. Clark St., Chicago**

Forms to cast Lead Soldiers, Indians, Trappers, Hunters, Wild and Farm Animals. 239 different forms to select from. Every form guaranteed to cast perfect figures. Send 5c stamp for illustrated catalogue.

HENRY C. SCHIERCKE Spencer Rd. GHENT, N. Y.

MAN IN EACH TOWN To Plate auto parts

reflectors, mirrors, etc., by new method; no capital or experience required. Outfits furnished. Free particulars. Write Today!

GUNMETAL CO., Ave. M, Decatur, Ill.

Big 3 1/2 ft. Telescope Five sections. Brass bound. Powerful 8-X Lenses. 10-Mile range. Special Eye Piece for looking at the Sun, included FREE. Can be used as a Microscope. Guaranteed big value. Postpaid, \$1.75. C. O. D. 15c extra. **Benner & Company, Box 1-48, Trenton, N. J.**



The First Thanksgiving

NO! They did not have Norton Pike Oilstones that far back. Our first forefathers had to worry along with most anything to sharpen their axes, knives and other tools.

Grandfathers living today were taught by their grand-dads how easy it is to put keen edges on tools with Pike whetstones and oilstones (now called Norton Pike). And apprentices before the Civil War learned from their fathers and grandfathers. During our 111 years, millions of men who love tools must have been made cheerful with millions of the world's best sharpening stones.

Now there is a simple and reliable sharpening guide to be thankful for. "How To Sharpen" is a booklet packed full of information gathered from experts in all trades—where to use the famous India Oilstone, the Hard Arkansas, the Washita.

It describes the best axe stone; the handiest carving knife sharpener for that turkey, and all the smart ideas to save time and sweeten tempers. Send for your copy today. It's free!

NORTON  *Established 1823*
Use what Experts use **PIKE Products**

BEHR-MANNING CORP., U. S. Sales Representatives
Dept. A, Troy, N. Y.

Send me free, Norton Pike Book, "How to Sharpen."

Name.....

Address.....

When writing please mention Popular Mechanics



BUY NOW and SAVE!

Watches and Diamonds
At All-Time Low Prices

ACT QUICKLY!

When Present Supply Is
Gone Prices Must Go Up

BUY NOW—PAY LATER

We plan for the future, so sometime ago we contracted for enormous quantities of Watches and Diamonds at lowest depression prices. Heavy taxation, difference in foreign exchange costs, big advances in labor costs, and higher commodity prices have already forced prices up—and they must go higher. BUT WE BOUGHT BEFORE PRICES ADVANCED, and we pass this saving on to you—but you must act promptly before these watches and diamonds are gone.

We Sell Nationally Advertised Watches, Diamonds and Silverware Direct-To-You on Easy Payments

Think of it—even with these low prices you can still use our easy payment plan to buy a watch or diamond. There is no reason now why you cannot own jewelry which you know is the best, and which you can be proud to own through the years to come.

\$3.50 a Month
Makes It
Easy For
You To Own a Valuable Watch or Diamond

We trust the people who buy here and as a result you can enjoy the pride of owning a really fine watch, diamond, or silverware while you pay by our special easy "Santa Fe Way." We have removed every obstacle. Send now for our FREE catalog while our stocks last at these prices.

Write for **FREE Catalog and FREE beautiful circular illustrating Fine Watches, Diamonds, and Silverware.**

SANTA FE WATCH COMPANY

Dept. B-6, Thomas Bldg., Topeka, Kansas.

SANTA FE WATCH CO.,

Dept. B-6, Thomas Bldg., Topeka, Kansas.

- Please send me the catalog I have checked.
- Railroad and Dress Pocket Watches.....
 - Ladies' and Men's Wrist Watches.....
 - Ladies' and Men's Diamond Rings.....

NAME

ADDRESS



EASY

You'll advance faster with an easy playing Conn. Choice of the world's greatest artists. Many exclusive features yet they cost no more. Home trial. Easy payments. See your dealer or write for free book. Mention instrument.

C. G. CONN, Ltd.
1131 Conn Bldg., Elkhart, Ind.

CONN
World's Largest
Manufacturers of
BAND INSTRUMENTS



BIG 12 in. and 15 in. Flying SCALE MODELS

Any 2 for Guaranteed to fly. Complete kit—everything included. Easy to build.

50c Curtiss Hell Diver, Spad Biplane, Puss Moth, Monocoupe, Sparrow Hawk, Polish Fighter, Fokker D-8, Fokker Triplane, Boeing Fighter, Sopwith Camel, Heath Parasol, British S.E.5.

26-28 West 19th Street, New York City, N. Y.

IDEAL AEROPLANE & SUPPLY CO., INC.

500 Power American Made MICROSCOPE & SET



Substantial, rugged, precise, this fine Winn Microscope provides you with any magnification desired between 75X and 500X. Includes every refinement essential for accurate work: Compound lens system, clear definition, rack and pinion focusing, adjustable removable mirror, additional mirror mounting on movable stage, slide clips, substage color filters, clips, etc. In addition to microscope, Winnset No. 8 includes complete Biological outfit, consisting of slides, Dissecting Tools, Stains, Color Filters, etc. Complete price of Microscope and Set, only \$6.75 delivered. With substage lamp, \$2.00 extra.

Free Folder on Uses of Microscope
J. H. WINN MFG. CO., Dept. 72, 124 W. 23 Street, NEW YORK

G. E. MOTORS

made by General Electric Co., originally intended for large manufacturer. Specifications: 1-30 H. P.—4800 R. P. M. Universal A. C. and D. C. 110 volts instant reverse. Slat Diameter 3 inch, length 5 inch. Shipping wt. 3 lbs. Add 25c for packing and mailing. Original price \$12.00. Bargain price, while they last. Send for Catalog of Paint Spray Equipment and General Electric Motors 3412.

\$2.45
Each



NATIONAL ELECTRIC TOOL CO.

560 W. Washington

Dept. 3211

Chicago, Ill.

New BIG WOODWORKING EQUIPMENT CATALOG Free!



New and Improved Machines
Your copy is ready! The New H & A woodworking equipment catalog. Highest quality, precision built, ball bearing machines for home or commercial shop. Many new features and latest improvements in Band Saws, Jointers, Lathes, Saw Tables, Shapers, etc. A complete line priced reasonably low! Write for your FREE catalog. SPECIAL OFFER.

HESTON & ANDERSON, 611 Grant Ave., FAIRFIELD, IOWA

Reconditioned MOTORS & PARTS



Write us for prices on guaranteed reconditioned motors, transmissions, rear ends, gears, parts, etc., for all makes of passenger cars and trucks, regardless of age. Million dollar stock. You save up to 75%.

**THE ORIGINAL
WARSHAWSKY & CO.**
1916 S. State St. Dept. PM. 1 CHICAGO, ILL., U. S. A.

BOYS! THROW YOUR VOICE

Into a trunk, under the bed or anywhere. Lots of fun fooling teacher, policeman or friends.



THE VENTRILO

a little instrument, fits in the mouth out of sight, used with above for Bird Calls etc. Anyone can use it. Never fails. A 16-page course on Ventriloquism and the Ventrilo. All for 10c Postpaid.



JOHNSON SMITH & CO. Dept. 843 RACINE, WIS.

BOY AMATEUR ELECTRICIAN 10c



The HOW and WHY of electricity fully told in simple language that any boy can understand. Scores of plans and instructions for making—dry batteries, dynamos, electric motors, telegraph apparatus, telephones, electric lights, electric door bells, alarms, electric engine, rheostat, mail box alarm, electro-magnets, automatic incandescent flash, electric shocking machine, wireless telegraph apparatus, induction coil, etc. Tells all about electric wiring, static electricity, magnets and magnetism, conductors and insulators, electrostatic induction, electrocution, electrophorus, condensers, Leyden jar, dynamic electricity, the voltaic cell, electro-magnets, electrolysis, electro-plating, electro-typing, how to build a radio for a few cents, etc. 64 pages, 100 illustrations. 10c. postpaid. JOHNSON SMITH & CO., Dept. 843, RACINE, WIS.

MAKE YOUR OWN RADIO



Enjoy the concerts, the sports, the games, market reports, latest news, etc. This copyrighted book "EFFICIENT RADIO SETS" shows how to make and operate inexpensive Radio Sets, the materials for which can be purchased for a mere trifle. Also tells how to build a short-wave Receiver for bringing in foreign stations, police calls, ships at sea, etc. ONLY 15c p.pd.

Daisy Water Pistol



6-Shot Repeating Water Pistol—very latest design; looks just like a Police revolver. Blue steel finish. Squirts 25 feet. When diluted ammonia is used is very effective against vicious dogs, tramps, animals. 7 inches long. Very simple to load and discharge. PRICE 25c POSTPAID.

STAGE MONEY



With a bunch of these bills, it is easy for each person of limited means to appear prosperous by flashing a roll of these bills at the proper time and peeling off a genuine bill or two from the outside of the roll, the effect created will be found to be all that can be desired. Prices: 15 Bills 10c, 40 Bills 20c, 120 for 50c or \$3.50 per thousand postpaid.



Good Luck Ring 25c

Very striking, quaint and uncommon. Silver quality skull and crossbones design, two brilliant, flashing gems sparkle out of the eyes. Said to bring good luck. Only 25c p.pd.



JOHNSON SMITH & CO. RACINE, WIS.

Dept. 843
A copy of our NEW CATALOG mailed on receipt of 10c., or the De Luxe Edition with cloth binding 25c. Bigger and better than ever. Only book of its kind in existence. Contains all the latest tricks in magic, the newest novelties, puzzles, games, sporting goods, rubber stamps, unusual and interesting books, curiosities in seeds and plants, etc., unobtainable elsewhere. Remit by Coin, Money Order, Check or unused U. S. Postage Stamps, for all articles listed above, Canadian money, stamps and Postal Notes accepted.

BLANK CARTRIDGE PISTOL REVOLVER STYLE

Three new models now out. 25c, 50c and \$1.00. Well made and effective. Modeled on pattern of latest type of Revolver. Appearance slick enough to scare a burglar. Takes 22 Cal. Blank Cartridges obtainable everywhere. Great protection against burglars, tramps, dogs. Have it lying around without the danger attached to other revolvers. Fine or 4th July, New Year's, for stage work, starting pistol, etc.



25c
50c
\$1.00

SMALL SIZE 4 in. long 25c. MEDIUM SIZE 5 in. long 50c. LARGE SIZE 6 in. long \$1.00. BLANK CARTRIDGES 50c per 100. HOLSTER (Cowboy type) 50c. Shipped by Express only not prepaid.

CRYSTAL RADIO SET \$1.00

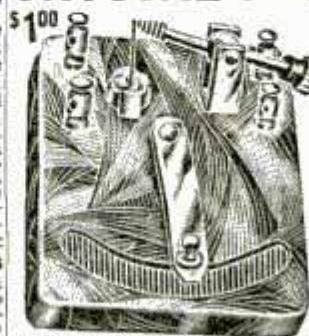

Say what you will about Electrical and Battery Sets, a CRYSTAL set has them all beat for simplicity and clearness of tone. There is absolutely no noise and no distortion—no batteries to buy—no tubes to wear out—no maintenance expense whatsoever. Cost nothing to operate and will last indefinitely. Reception is loud and clear. This Receiver is guaranteed to work equal to the most expensive Crystal Set you can buy. Has a receiving radius of over 25 miles, or under favorable conditions up to 100 miles. Constructed of the finest materials throughout, including super-sensitive crystal, securing quick results. PRICE of Receiver only \$1.00 postpaid. Or complete with Ear Phone and Aerial Kit—everything all complete—nothing more to buy. \$2.95 postpaid. JOHNSON SMITH & CO., Dept. 843, RACINE, WIS.

250 Magic Tricks

An excellent little book containing nearly 300 tricks for parlor or stage that anyone can do. Tricks with cards, coins, handkerchiefs, eggs, bottles, strings, etc. Also Second Sight, Shadowgraphy, etc. Profusely illustrated. 10c postpaid.

125 CARD TRICKS and sleight of hand. Contains all the latest and best card tricks as performed by celebrated magicians, with exposure of card tricks used by professional gamblers. Price 25c postpaid.

SNAPPY JOKES. A splendid collection of rich and rare jokes, compiled by a jolly bartender for stag parties, smokers, etc. 64 pages. PRICE 10c postpaid.

FORTUNE TELLING BY CARDS, dice, dominoes, crystal, etc. Gives meaning of every card, how to deal and lay them out, etc. Everything explained in simple language. Price 10c postpaid.

LEARN TO HYPNOTIZE. Book tells how to hypnotize, how to produce sleep, how to awaken a subject, medical hypnotism, hypnotism in disease, how to hypnotize animals, etc. Price 10c postpaid.

STAR TOY MAKER

Greatest boys' book written. Tells how to make a Pinhole Camera, a Cannon, model Railroad, a Telephone, Bombs, etc. Includes: Talking Machine, Microscope, Electric Motor, Electric Door Bell, Water Wheel, Paddle Raft, a pair of Skis, a Dog Sled, Bird House, Rabbit Yard, etc. 64 pages. 150 illustrations. PRICE 10c.

MIDGET BIBLE. Size of a postage stamp (yet 200 pages). Remarkable curiosity. Said to bring good luck. Price 15c postpaid.

DREAM BOOK AND FORTUNE TELLER. Tell your own fortune. With dictionary of dreams and interpretations, lucky numbers, oracles, divinations, palmistry, etc. Price 10c postpaid.

HOW TO TIE KNOTS. 32 page book tells how to make different knots, hitches, etc. 100 illustrations. Price 10c postpaid.

5-MINUTE HARMONICA COURSE. A new easy self-teaching method. Teaches how to play, to use the tongue, tremolo, fully illustrated. Price 15c postpaid.

WONDERFUL X-RAY TUBE

A wonderful little instrument producing optical illusions both surprising and startling. With it you can see what is apparently the bones of your fingers, the lead in a lead pencil, the interior opening in a pipe stem, and many other similar illusions. Price. 10c, 3 for 25c, p.pd.

CHAMELEONS — 25c

LIVE, SAFE DELIVERY GUARANTEED



Watch it change its color! Get one of these most wonderful of all creatures. Watch it change its color. Study its habits. Wear one on the lapel of your coat as a curiosity. Watch it shoot out its tongue as it catches flies and insects for food. No trouble to keep. Can go for months without food. Measures about 4 inches in length. Shipped to any address in U. S. A. by mail. We guarantee safe arrival and live delivery. PRICE 25 CENTS POSTPAID.

BIG ENTERTAINER



326 Jokes and Riddles, 25 Magic Tricks, 10 Parlor Games, 73 Toasts, 13 Fairy Tales, 105 Money-making Secrets, 22 Monologues, 21 Puzzles and Problems, 5 Comic Recitations, 10 Funny Readings, 11 Parlor Pastimes, 13 Flirtations, 110 Girl's and Boys' Names and their Meanings, 10 Picture Puzzles, 69 Amusing Rhymes, 27 Amusing Experiments, Dumb and Dumb Alphabet, Shadowgraphy, Gypsy Fortune Teller, How to Tell Fortunes with Cards, Dice, Dominoes, Crystal, Coffee Cup, etc. Hypnotism, Ventriloquism, Cat-in-the-Hat, Checkers and Chess, Dominoes, Fox and Geese, 9 Men Morris, Spanish Prison Puzzle, Game of Anagrams, 25 Card Tricks, Crystal Gazing, etc. ALL FOR 12c.

6-Shot Repeating Pistol



SHOOTS RUBBER BANDS 25c

BREAK OPEN TYPE Just Like Real Revolver

For a toy revolver, this is a splendid imitation of the real thing. At first glance it might easily be taken for a regular revolver. It is a FULL SIZE WEAPON, well made, with blue steel baked enamel finish. It fires from 6 to 8 rubber bands in rapid succession, as fast as you can pull the trigger. It breaks open in the middle just like an expensive revolver. Measures 8 inches long, with 3-inch barrel. Strongly made of 20 gauge steel. Looks exactly like a real gun and clicks like one when fired. A supply of rubber bands given with each gun. Packed in individual carton complete with directions. PRICE 25 CENTS BY MAIL POSTPAID. JOHNSON SMITH & CO., Dept. 843, Racine, Wis.

\$7⁰⁰ A Month

for the new
9" x 3' SOUTH BEND
 Back Geared, Screw Cutting
"Workshop" Lathe

Total Price \$94
 Down Payment \$24
 11 Months to Pay

Operates
 from
 Lamp
 Socket
 for 2c
 per hour

Wt.
 300
 lbs.

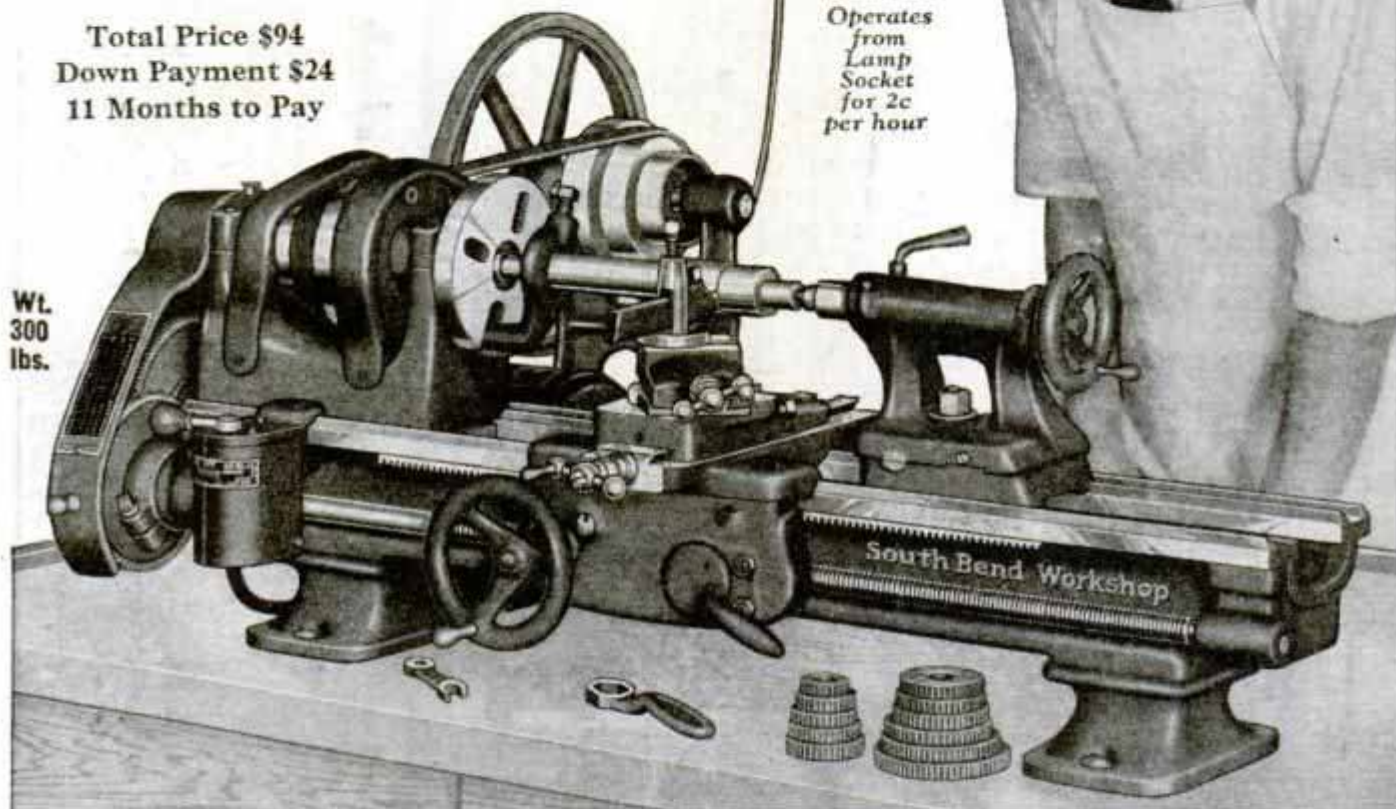

9 $\frac{1}{2}$ " swing x 3' bed South Bend "Workshop" Bench Lathe, Complete with \$94
 Reversing Motor, Reversing Switch and Motor Drive, Wt. crated, 300 lbs.

Over 35 Modern Features

The 9-inch "Workshop" is a Metal Working Lathe. Handles all general machining operations. Also used for wood turning and machining compositions. Cuts screw threads 4 to 40 per inch. Hundreds now in use in manufacturing, machine shops, auto service shops, electrical shops, laboratories and home workshops. Features include: Back-Geared headstock; 6 spindle speeds; power feed to carriage as fine as 350 per inch; reverse for threads and feeds; graduated compound rest. Price without motor drive, \$75. Bed lengths 3', 3 $\frac{1}{2}$ ' and 4'. Easy Terms, 30 day trial. Lathe is shipped immediately on receipt of down payment. (An Ideal Christmas Gift.)

Use Coupon or Write

SOUTH BEND LATHE WORKS
 641 E. Madison St., South Bend, Ind., U.S.A.

Please send me the booklets checked below.

- "Workshop" Bulletin No. 5-W (Free)
 31st Edition of "How to Run a Lathe" (25c)

Size of Lathe interested in.....
 Class of Work.....
 Name.....
 Address.....
 City..... State.....

Write for Free Bulletin 5-W

describing the "Workshop" Lathe and the work it does. Also describes and prices attachments, chucks and tools which can be shipped with lathe, or later when needed. Mailed free, postpaid, on request, to any address.

Other Sizes and Types of Lathes

South Bend Back-Geared, Screw Cutting Precision Lathes are built in 96 other sizes and types from 9" to 36" swing, with countershaft drive and with individual motor drive, bench and floor leg models, including Tool Room Lathes, Gap Bed Lathes, and Brake Drum Lathes, price range \$108 to \$1500. If larger lathe than the 9-inch swing "Workshop" Lathe is wanted, mark coupon or write.

⌈ New revised 31st Edition of "How to Run a Lathe", 160 pages, is just off the press, ready for mailing. Price per copy, 25c postpaid. Coin or stamps of any country accepted. ⌋



SOUTH BEND LATHE WORKS

641 E. Madison St. South Bend, Ind.

Established 1906-Users in 97 Countries

MOVIE STARS *Enthuse* OVER THE *New* 1935 MIDWEST-16



World-Wide Entertainment
Hollywood, Calif. "Until I received my new Midwest radio, I had never thought it possible to bring in entertainment from half way around the world so clearly."
Jean Harlow
 (Metro-Goldwyn-Mayer Star)



Amazing All-Wave Performance
Hollywood, Calif. "My Midwest is the best set I have ever tried. It gives me super foreign reception and new radio adventure. Its performance on all five wave bands amazes me!"
RICHARD ARLEN
 (Paramount Featured Player)



Thrilling Foreign Reception
Hollywood, Calif. "Not until I tried out my Midwest 16 did I really appreciate what radio reception was. It thrills me to bring in distant foreign stations as clearly as local programs!"
 (Paramount Star) *Claudette Colbert*



Better Foreign Reception
Hollywood, Calif. "I am quite enthused with my Midwest. Many friends who have heard it are delighted with its performance. It brings in, without a doubt, the finest all-wave reception I have ever heard!"
Neil Hamilton

Thrill to Unequaled World-Wide Performance with this.

Amazing NEW 1935 SUPER Deluxe 16-Tube ALL-WAVE Radio

9 TO 2,400 METERS (12,000 MILE TUNING RANGE)

30 DAYS FREE TRIAL



Guaranteed WORLD-WIDE RECEPTION!

BEFORE you buy any radio, write for FREE copy of the new 1935 Midwest "Fifteenth Anniversary" catalog. See for yourself the many reasons why over 110,000 satisfied customers have bought their radios direct from Midwest Laboratories . . . and saved from 1/3 to 1/2. Learn why Midwest radios out-perform sets costing up to \$200 and more. You, too, can make a positive saving of from 30% to 50% by buying this more economical way. Why be content with ordinary so-called "All-Wave", "Dual Wave", "Skip Wave" or "Tri-Wave" receivers when Midwest gives you more wave lengths in today's most perfectly developed 16-tube Super deluxe ALL-WAVE radio that are proven by four years of success . . . that carry an iron-clad guarantee of foreign reception! These bigger, better, more powerful, clearer-toned, super selective radios have FIVE distinct wave bands; ultra short, short, medium, broadcast, and long. Their greater all-wave tuning of 9 to 2400 meters (33 megacycles to 125 KC) enables you to tune in stations 12,000 miles away with clear loud speaker reception. Write TODAY for new FREE catalog!

Now, you can enjoy super American, Canadian, police, amateur, commercial, airplane and ship broadcasts . . . and derive new delight and new excitement from unequalled world-wide performance. Now, you can enjoy the DX-ing hobby and secure verifications from more of

the world's most distant stations. Thrill to the chimes of Big Ben from G8B, London, England . . . tune in on the "Marseillaise" from FVA, Poitouise, France . . . hear sparkling music from EAO, Madrid, Spain . . . delight in lively tangos from YVIB, Caracas, Venezuela . . . listen to the call of the Kookaburra bird, from VK2MB, Sydney, Australia, etc. Send today for money-saving facts.

TERMS AS LOW AS \$5.00 DOWN

WORLD'S GREATEST RADIO VALUE
\$57.50 with New **Deluxe Auditorium-Type SPEAKER**
 . . . LESS TUBES . . .



NEW STYLE CONSOLES
 The new, big, Midwest 26-page 1935 catalog pictures a complete line of beautiful, artistic de luxe consoles and chassis . . . in four colors . . . a model for every purse. Hand made by master craftsmen, they harmonize beautifully with any furniture arrangement. Write for new FREE catalog today!

50 ADVANCED 1935 FEATURES
 Here are a few of Midwest's superior features. Controllable Expansion of Volume-Selectivity-Sensitivity (Micro-Tenuator) . . . Fidel-A-Trol . . . Triple Calibration Plus . . . Pure Silver Wire . . . Ceramic Coil Forms . . . Separate Audio Generator . . . Simplified Tuning Guide Lights . . . Compact Synchronized Band Switch . . . Amplified Automatic Volume Control . . . 7 KC Selectivity . . . Power Driver Stage . . . 16 Latest Type Tubes . . . etc. Read about these and 38 other features in the new FREE Midwest catalog. Never before so much radio for so little money. Write for FREE catalog.

DEAL DIRECT WITH LABORATORIES

Increasing costs are sure to result in higher radio prices soon. Buy before the big advance . . . NOW! . . . while you can take advantage of Midwest's sensational values . . . No middlemen's profits to pay. You can order your radio from the new Midwest catalog with as much certainty of satisfaction as if you were to select it in our great radio laboratories. You save 30% to 50% when you buy direct this popular way . . . you get 30 days FREE trial . . . as little as \$5.00 down puts a Midwest radio in your home. Satisfaction guaranteed or money back. Write for FREE catalog.

SAVE UP TO 50%

Sign and mail coupon . . . or, send name and address on postal card . . . NOW!

Jean Harlow, Richard Arlen, Claudette Colbert, Neil Hamilton, Maureen O'Sullivan, Gloria Stuart and Ginger Rogers are some of the movie stars who prefer the Midwest radio because it gives them the super all-wave reception that they desire. Try the Midwest for thirty days before you decide. Midwest gives you triple protection with: A one-year guarantee, foreign reception guarantee, money-back guarantee.

MAIL COUPON TODAY! FOR AMAZING 30-DAY FREE TRIAL OFFER AND NEW 1935 CATALOG

MIDWEST RADIO CORP., Dept. 719 Cincinnati, Ohio. Without obligation on my part send me your new FREE 1935 catalog, and complete details of your liberal 30-day FREE trial offer. This is NOT an order.

User-Agents Make Easy Extra Money Check Here for Details

Name
 Address
 Town State

MIDWEST RADIO CORP.
 DEPT. 719 - CINCINNATI, OHIO, U. S. A.
 Established 1920 Cable Address Miraco. . . . All Codes

I'm no dirt farmer
but I was brought up on a
tobacco farm and I know
mild ripe tobacco...

have a Chesterfield

*Down where tobacco
is grown folks say . . .*

"It's no wonder that so many people
smoke Chesterfield cigarettes.

"To begin with they buy mild ripe
tobacco . . . and then they age it.

"It costs a lot of money . . . but
it's the one way to make a milder, bet-
ter-tasting cigarette."

