

MIDGET AUTO RACING CARS

POPULAR MECHANICS

MAGAZINE

WRITTEN SO YOU CAN UNDERSTAND

REG. TRADE MARK, GREAT BRITAIN, NO. 40428

OCTOBER
25 CENTS
30c IN CANADA

SEE PAGE 536





MARFAK STAYS PUT

Grease type universal joints require a lubricant that is both cohesive and ductile. Texaco Marfak combines both these qualities. Notice how Marfak holds together while following and freely lubricating the moving parts.

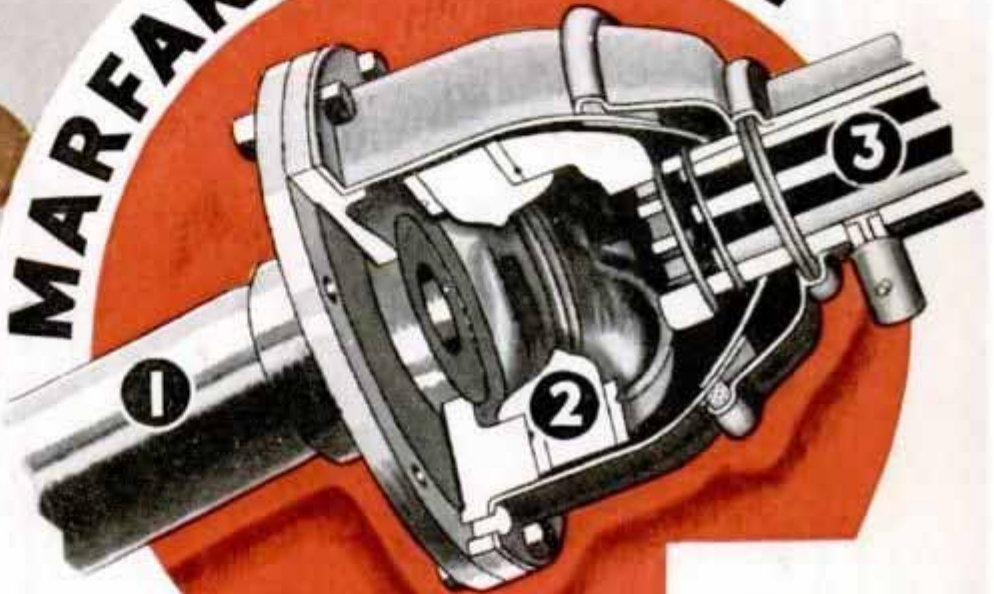

1. DRIVING UNIT
2. CROSS MEMBER
3. DRIVEN UNIT

THE UNIVERSALS OF YOUR CAR work at upward of 3,000 r.p.m. under the heaviest loads. It takes an exceptional lubricant to stand up here. Marfak refuses to "throw-off" no matter how great the speed. It saves the wear and brings quieter, safer operation under every load condition.

Most grease-lubricated universals in automotive equipment contain Marfak when they leave the factory. Marfak protects—and retains its lubricating qualities longer than any other grease lubricant.

Ask for Texaco Certified Lubrication with Marfak. There is nothing like it for grease-type universals, wheel-bearings, and many other chassis parts. Try it. Enjoy your car's quieter action, the added security and economy it brings. Stop at any Texaco Certified Station.



THE TEXAS COMPANY
Texaco Petroleum Products



Copyright, 1934, THE TEXAS COMPANY

TEXACO *Certified* **LUBRICATION**

The Texas Company is the only company that makes Marfak

New INVENTION

**7 MILES MORE PER
GALLON on PLYMOUTH**

**MOTORIST SAVES
\$180.00 a YEAR.**



Saves up to Thirty Per Cent On Gas.
Provides Faster Pick-Up—More Power—
Greater Mileage and Smoother Running.

GET FREE INFORMATION

VACU-MATIC

the Carburetor Control
that "Breathes"

AT LAST! Automotive engineers have smashed down the barriers to perfected combustion! The new VACU-MATIC solves the secret of greater power! With almost magical action, this amazing invention instantly puts new life and pep in any motor. It adds mileage to every gallon of gasoline . . . produces split-second pick-up, sensitive accelerator response, greater speed and smoother running . . . unfolding a new driving thrill for you!

Entirely New — Nothing Like It!

The self-starter—four wheel brakes—knee action—streamlining . . . and now VACU-MATIC! The greatest motor improvement of recent years! With it, engineers have achieved a practical means of AUTOMATICALLY balancing air and gasoline in correct proportions for ALL speeds! Functioning directly with the manifold vacuum, VACU-MATIC actually "breathes" when needed, giving your motor correct combustion. Sharply cuts fuel wastes, saves dollars in gas costs, reduces carbon and gives your engine new pep, greater power and longer life.

Agents and Salesmen

If you are interested in earning up to \$15 daily, check coupon. Exclusive territories now being granted.

Fits All Cars

VACU-MATIC is constructed of six parts, electrically welded into one unit, correctly adjusted and sealed at the factory. Nothing to regulate. Any motorist can attach VACU-MATIC in ten minutes. Once in, its only reminder is the surge of instant power and speed it gives to the motor and the savings it affords your pocketbook.

The VACU-MATIC Co., Wauwatosa, Wis.

SAVES GAS!

F. S. Peck Insurance Agency
212 CAPITAL BANK BUILDING

General Agents

March 15, 1934.

Telephone Main 287

Vacu-matic Carburetor Co.
7617 W. State St.
Wauwatosa, Wisconsin.

Gentlemen:

I thought it might be interesting for you to know that I had an automatic gas consumption tester attached to my Plymouth Six and obtained an average of 15 miles to the gallon. I then installed your Vacu-matic to satisfy myself as to its merits and under the same conditions and the same course of travel I obtained an average of 22 miles per gallon, which you see is an increase of 7 miles per gallon. At our present price of gasoline and traveling approximately 1500 miles a month, this means a saving to me of \$15.00 a month or \$180.00 a year.

I am writing this letter unsolicited on account of the satisfaction I have had since this installation.

you see fit.

You may use this letter as

Yours very truly,

F. S. PECK INSURANCE AGENCY,
By *[Signature]*

FSP/H

* The above letter from California is unsolicited, and is just one of the many letters received from enthusiastic users.

Guaranteed Gas Savings

The VACU-MATIC proves itself on every car. It is guaranteed to give worth-while gas savings, quicker pick-up, and more power or it costs you nothing. "On a test I gained an average of 4 miles on a gallon," writes Alex Wertz. "Vacu-matic is the best I have ever tried." Clarence Rutzin—"I have tried the Vacu-matic on several tests and find that I get between 5 and 6 miles per gallon increase, have more mileage, have greater pickup."

Free Details

Learn about this remarkable device that so greatly affects the entire performance of your motor. Learn why your car is costing you extra money to operate without VACU-MATIC. See why your VACU-MATIC equipped car will leap away from traffic without sputter or hesitation. Discover a new driving thrill and enjoy the savings that more than offsets VACU-MATIC's slight cost. Get the facts! Write today!

— — — — •FREE OFFER COUPON• — — — —

THE VACU-MATIC COMPANY
7617-60 W. State St., Wauwatosa, Wis.
Gentlemen: Please send me full particulars concerning the Vacu-matic and details of your Free Offer. This of course does not obligate me in any way.

Name

This One

Address

City

State



SBEE-H7C-3PSH



Telephone Transmitter and Receiver used at the Philadelphia Centennial

From one telephone to thirteen million



Fifty-eight years ago a telephone was demonstrated at the Philadelphia Centennial. Today, there are more than thirteen million Bell telephones in the United States. Three-quarters of a million people own the Bell System. They and their families would make a city larger than Philadelphia.

It took long years of pioneering, forward-looking planning and honest management to build the Bell System as it is today, a national institution fulfilling a national need.

It is a big system, for it serves a big country. It has grown in size and usefulness because it has been built upon the solid foundation of service to the public. Its constant purpose has been to give you the best possible telephone service, and the most, at the lowest cost consistent with financial safety.

The test of trying times has shown the soundness of its structure and the rightness of its one policy, one system and universal service.

Bell Telephone System



When writing to advertisers please mention Popular Mechanics

Popular Mechanics Magazine

H. H. WINDSOR, Founder

H. H. WINDSOR, Jr., Editor and Publisher

October, 1934

Vol. 62, No. 4

Special Features

Flying the Stratosphere <i>(W. J. P. Pat.)</i>	492
The Miracle of Light <i>(World's Fair)</i>	497
The Electrified Home <i>(Friedman)</i>	514
Fog Still Challenges Inventors	520
Proving Ships in Tanks	526
Thrills in Homemade Movies	530
The Gadget King of America <i>(W. and)</i>	536
Things Lightning Does and Doesn't	546
A Million Dollar Hobby <i>(Stamps)</i>	552
Magic for Everybody	569
Mechanics of Teaching Your Dog	574

(Continued on next page)

Flying the Spanish Main

SEVENTEEN-TON clipper ships today roar above the Spanish Main where yesterday pirate ships chased gilded galleons for gold. Nowhere else in the world do scheduled aircraft fly so fast, so far and so safely. In the olden days of terror, weeks were required to cross the Main. Now, on seven-league air boots, you can do it in a matter of hours. Sixteen pages of pictures in color in the November issue show you how aviation has conquered the Main and an article contrasts travel in the days of the freebooters with a journey in a clipper ship at two and one-half miles per minute.

Next Month

TODAY'S up-to-date service man does not depend on a monkey wrench and a "hunch" when he starts tinkering with your car. He uses such aids as neon lights to check ignition, an exhaust gas analyzer, frame straighteners, axle presses, wheel balancers and aliners and tracking gauges. An article in November describes the modern equipment for servicing your car.

Cooling with Steam

THE same steam plant which keeps your home warm in winter can keep you cool in summer. This "steam vacuum" system of refrigeration is cooling many New York skyscrapers and its simplicity, lack of moving parts, safety and economy make it practicable for the home. Read about the possibilities of this type of air conditioning in the next issue.

Some Queer Fish

THE Gulf of Mexico is filled with grotesque and mysterious creatures. For instance, there is the blow fish which inflates itself like a balloon to frighten its enemies, the cow fish with horns in front of its eyes and the porcupine fish with a protective coating of spines. In the November issue a writer who has caught many of these denizens of the deep tells you of the queer fish of the Gulf and their habits.



If you have used Pyroil, you know its supreme qualities of lubrication. You have been able to measure visibly, the added power, added mileage and generally increased efficiency Pyroil has effected. Yet, in addition to this, is the matchless element of safety and protection with which Pyroil constantly guards all frictional parts of your motor against wear and damage. Here is a quality to be appreciated when you see how Pyroil reduces repair expense; when you see how much longer valves and rings function properly and how carbon formations fail to accumulate.

Figured in the actual power cost and repair savings it effects, Pyroil costs you nothing to use! It is a paying investment. And, it adds immeasurably to your pleasure in motoring.

Pyroil is sold the world over. It is used and depended on by engineering authorities . . . Barney Oldfield, A. S. Duesenberg, Bill Cummings, Louis Meyer and many others. If you haven't tried Pyroil look for the Pyroil sign or banner, and drive in. The service station or garage attendant will hand you an interesting pamphlet which tells you the important story of this supreme lubrication accomplishment. Or, mail the coupon below, at once. It will bring you valuable information and our Trial Test Offer, at no obligation. Manufactured and Guaranteed by Pyroil Company, W. V. Kidder, Pres., 510 Pyroil Bldg., LaCrosse, Wis., U.S.A.

Pyroil has been tested and proved in Popular Mechanics Laboratory and is used on printing and binding equipment in Popular Mechanics' huge Chicago publishing plant.



Simply add TO GAS OIL & GREASE



SEE THE PYROIL EXHIBIT AT THE 1934 WORLD'S FAIR (General Exhibits Bldg.)

Genuine Pyroil is protected by U. S., Canadian and foreign patents issued to W. V. Kidder, its inventor. Identified by lithographed, factory-sealed cans, bearing signature below. Not sold under any other name.

W. V. Kidder

PYROIL COMPANY
510 Pyroil Bldg., LaCrosse, Wis., U. S. A.
Please send me important facts of Pyroil's economy and efficiency when used in my motor. Also, send Trial Test Offer
 Please send Distributorship Opportunity facts.

Name.....
Address.....
City..... County..... State.....

Supreme lubrication

DISTRIBUTORS

Check square in coupon below and mail at once for full facts of extremely desirable money-making openings available. Tremendous growing demand everywhere makes Pyroil your greatest opportunity. (See Saturday Evening Post, Sept. 15; Country Gentleman, Oct.; Time, Sept. 17.) Don't delay.

(Contents—Continued)

Home Ingredare - 5:40 all day

- Agriculture—light wakes sleeping seeds and speeds growth 551
- Air Conditioning—mines in South Africa, proposed. 535
- Airplane
 - reversible pitch propeller acts as brake 561
 - thrills of flying the mail 562
- Amusement Devices—aerial swing loops the loop forty feet above ground 568
- Astronomy—invisible light from stars shown by photographs 517
- Automobiles, Accessories
 - carrier for oil clamps under hood 568
 - exhaust gas made safe by fuel vaporizer..... 540
 - protector for gas tank prevents theft of fuel. 567
 - radiator freed of scale by tablets in water..... 551
 - water loss from radiator ended by sealed cooling 542
- Automobiles, Buses—articulated coach train climbs Alps 542
- Automobiles, Design
 - one-horsepower, one passenger car 518
 - streamlined car has motorcycle engine..... 541
- Automobiles, Manufacturing—induction oven cool to man, bakes paint on metal 572
- Automobiles, Racing—midgets of the roaring road. 558
- Automobiles, Repairing
 - brake-shoe stretcher aids on relining 551
 - cylinder gauge saves time in refitting pistons. 557
- Automobiles, Trucks—sleeping berth in cab 523
- Aviation—floating seaplane hangar rests on pontoons 519
- Boat—pontoon, without hull is safer 580
- Bolt—connects two wires without soldering 580
- Book Ends—with zipper base 529
- Camera—combined with microscope in one outfit... 572
- Canaries—nail file for 577
- Cancer—use of cold light in diagnosing..... 534
- Disinfectant—silver used as 573
- Door—bronze, ten-ton, thirty-five feet high 519
- Electrical Apparatus—stamp sears paper and prevents forgery 543
- Electric Eye—counts autos, ignores others 534
- Fan—electric, atomizer keeps insects away 518
- Fishing
 - aluminum holder for bait fastens to fishing rod. 545
 - fertilizer for plants aids growth of fish 545
- Flies
 - avoid blue boxes 571
 - used in study of man's heredity 524
- Forestry—use of fire in destroying insects 567
- Fountain—memorial to Sousa 517
- Funnel—with air groove 533
- Furniture—sideboard, curved, utilizes corner space. 525
- Gasoline—knock measured by test engine 566
- Gas Pipe—detector finds leaks quickly 543
- Glass—vacuum disks grip for carrying 551
- Gold
 - placer mine thawed out by diverting river..... 580
 - sluicing wheel lifts water to wash pay dirt... 544
- Golf—non-slip club tape gives positive grip 572
- Horse Racing—periscope used to see over crowd... 561
- Household Devices 578, 579
- House Numbers—holder for 535
- Insects
 - fighting the honey bug 549
 - magic poisons not harmful to man..... 513
- Lamp—pocket, with headband leaves hands free... 533
- Lamp, Electric—socket locks 565
- Lathe—huge, turns out giant masts 543
- Light—garden, shaped like mushroom 556
- Lighting—Germany's Black Forest village uses unusual method of 550
- Lightning—speed of 544
- Match Holder—pocket, contains compass 525
- Metal—tested with varnish to show weak spots... 557
- Microscope—combined with camera in one outfit... 572
- Moistener—water visible with glass reservoir..... 561
- Museum—clipper ship converted into 556

Genuine **PYROIL** LUBRICATION PROCESS

Every Needed Fact, Figure, Formula—
Every Shortcut and Special Method

in the

WHOLE FIELD OF MATHEMATICS

Now in ONE Handy Volume



For the first time you can have this wealth of practical mathematical information, covering every trade and business, condensed into one handy book for quick reference. This volume puts right at your fingertips instant facts and formulas for making every kind of mathematical calculation. From hundreds of different sources, this priceless information has been gathered together, boiled down into brief, simple language, and applied to actual problems. Every man in business, every man in the mechanical trades, every man who ever uses a tool or has to make calculations or estimates in office, shop, or home, will find here a treasury of money-making, money-saving ideas.

THE HANDBOOK OF APPLIED MATHEMATICS

No previous knowledge of mathematics is needed. No study is required. The specific information you want is easy to find, by looking it up in the index. The book takes up every trade and gives you practical methods, easily worked formulas for solving every problem. Thousands of specific examples show you just how to make your calculations. If your work involves mathematics in any way this complete reference handbook is an indispensable part of your equipment. It is an amazing time-saver for any one concerned with engineering, architecture, electricity, mechanics, construction, automobiles, machinery, printing, or any other industrial work; or with accounting, auditing, manufacturing costs, taxes, or any other business mathematics. No practical man, no house-owner who makes an occasional repair, no one who has a home workshop can afford to be without the valuable information quickly found in this book.

Save Time—Be Sure of Your Facts

One quick turn to the index in this complete reference volume and you find at once all the facts about your subject—the best methods of doing the work, the easiest formula for making the calculations, completely worked out sample problems that show you just what to do. You avoid the expensive errors that handicap the man who merely guesses. Think what an advantage it is to have all this information gathered into one handy book that you can carry in your pocket. Act today and take advantage of your opportunity to examine this book for five days free.

Simplified, Dependable Methods by an Expert

The author of this book, Mr. Martin E. Jansson, has had the widest experience in practical work. Trained as a civil engineer, he has built tunnels and dams, roads and houses; he has had years of experience in railway and industrial construction work. He has instructed adult classes at New York University. He gives you the benefit of his wide experience in this book.

See How Thoroughly It Covers the Needs of YOUR Work

Arithmetic (including Slide Rule)	Concrete Brickwork	Machine Shop
Algebra	Carpentry and Building	Automotive Shop
Geometry	Lathing and Plastering	Sheet Metal Work
Trigonometry	Painting	Electricity (D.C. and A.C.)
Weights and Measures	Plumbing	Print Shop
Mechanics	Heating	Business Mathematics
Excavations and Foundations		Accounting

Free This Valuable Cloth Bound Book RAPID ARITHMETIC

This book gives you quick methods of addition, subtraction, multiplication, division, fractions, interest and discount, percentage, calculating powers and roots, and every arithmetical problem. Also many interesting and curious puzzles of numbers, both amusing and instructive. Regular price \$1.50. Given absolutely free with THE HANDBOOK OF APPLIED MATHEMATICS.

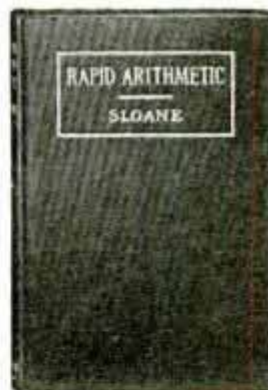

5 DAYS' FREE EXAMINATION SEND NO MONEY—MAIL THIS COUPON

D. VAN NOSTRAND CO.,
250 Fourth Ave., New York

Send me on approval *The Handbook of Applied Mathematics* and *Rapid Arithmetic* free. Within 5 days after I receive the books, I can return them and owe nothing. If I keep them I will send you \$2.00 as first payment and I will pay \$2.00 monthly thereafter for 2 months—\$6.00 in all. (5% discount for cash. Same return privilege.) (P.M. 10-34)

Name

Address

City..... State.....

Reference

Address

BUILD these RADIOS AND RADIO DEVICES described in POPULAR MECHANICS MAGAZINE

Thousands are building the successful Radio Sets and Radio Devices described each month in POPULAR MECHANICS MAGAZINE, bearing the stamp of approval of the POPULAR MECHANICS Radio Laboratory. When you build your POPULAR MECHANICS set, for assured results—use only approved parts, carefully selected in kit form exclusively for you, at prices which will save you money. Easy to understand, accurate, and completely detailed blue prints are available with each kit. The five Radio Devices which are described below are only a few of the popular kits which are available. Order your kit today from ALLIED—Radio Parts Headquarters, or send for FREE Parts Lists for building any Radio Circuit which has appeared in POPULAR MECHANICS or any other magazine or handbook.



LITTLE GIANT AC-DC PORTABLE. Described in Popular Mechanics for March, 1934. A four tube midget with amazing power. Kit of selected parts with speaker, less tubes. **\$1061**

PENTAGRID MAGIC WAVE CONVERTER. Described in Popular Mechanics for successful S. W. converter without plug-in coils. Kit of parts, less tube.

BOX SHORT Described in April, 1934. A **\$1191**

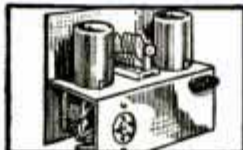

POPULAR MECHANICS 2A3 P. A. AMPLIFIER. Described in February, 1934, Popular Mechanics. An all-purpose powerful amplifier, for practical low-cost operation. Kit of parts. **\$3629**

BEGINNER'S 2 TUBE ALL-WAVE SET. Described in Popular Mechanics for January, 1934. Anybody can build this flexible little set, either for battery or A. C. use. Kit of parts, less accessories. **\$1357**

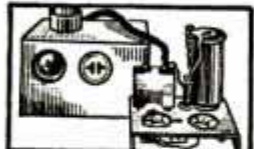
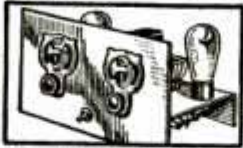

TUBE RELAY FOR ELECTRIC EYE. In Popular Mechanics for July, 1934. A low-cost tube operated photo-cell relay for hundreds of applications on 110 Volt, A. C. or D. C. Kit of parts with tube and photo-cell **\$2025**

ALLIED RADIO Corporation

833 W. JACKSON BLVD., CHICAGO, ILL. DEPT. K.

Enclosed you will find \$ for which you will send me the Popular Mechanics Radio Kit or Kits I have checked below:

- Little Giant AC-DC Portable.
- Pentagrid Magic Box S. W. Converter.
- Pop. Mech. 2A3 P. A. Amplifier.
- Beginner's 2 Tube All-Wave Set.
- Tube Relay for Electric Eye.

Send me your FREE 100 Page Catalog.

Name

Address

FREE
1935
RADIO
CATALOG



(Contents—Continued)

Navy, British—"Nelson" helped to float by "sallying ship" 524

Parachute—gliding lowers balloon gondola 535

Paving—portable concrete slabs cut expense 560

Pearls—found in America shipped to Orient 543

Photography—paper or fabric sensitizer speeds enlarging 557

Police—one man bulletproof shield used in war on crime 534

Postal System, U. S.—few things delay mail delivery 525

Poultry
egg counter on wing keeps record 542
new use for chicken feathers 557

Radio—easy solutions for common problems 585

Radio, Apparatus
amplifier, general-purpose, uses receiving tubes. 584
cathode ray oscilloscope for amateurs 586
code sender is semi-automatic. 586
installed on cultivator 555
mirror-drum television in kit form 586

Radio, Automobile—set above windshield 581

Radio, Broadcasting—big wren that personifies the name of WREN 544

Radio, Receiver
beginners' two-tube for short waves 582
eight-tube, covers five bands 586

Railroads
locomotive has six engines but will run on any five 566
steam-driven motor train burns coal-tar oil. 524
streamlined engine, driver's cab at front. 560

Refrigerator—kerosene, milk for quintuplets cooled in 540

Restaurant—rolling, made of aluminum 534

Salt—well taps ocean of brine 541

Sandpaper—block holds abrasive in place 517

Ships
arc-welded steel freighter has no rivets 529
compressed-air stabilizer stops roll of 573
"four-leaf clover" propeller to drive "534" 528
proving ships in tanks 526
steamer "boiled" in water to free congealed oil. 568

Sled, Motor—giant screw propels 549

Soldering Iron—uses electric plug as handle 540

Spray Gun—applies plaster in uniform coatings. 540

Sprinkler—on wheels operated by water turn-motor. 550

Stitcher—portable for bags and cartons 580

Track—sprint blocks permit faster start 523

Tractor—"trains" move freight in far north 555

Traffic—glare meter tests auto headlamps 518

Tunnel—train operates door when it approaches. 567

Walnuts—ethylene gas, hulls 556

Watch Repairing—quick timer speeds up 565

Water—filter removes disease germs 541

Water Sports—floating ball with paddle propels swimmer 545

X-Ray—on wheels, tests heavy steel 577

AMATEUR MECHANICS

Automobiles, Driving—window cushioned, prevents injury to dog 592

Baby Carriage—canvas pouch on, holds packages. 593

Baby Crib—clothes and linen at hand, under 601

Bacon—simple method for removing rind 590

Burglar Alarm—operated by door switches 598

Camp Trailer—water system for 609

Chemical Apparatus
sanded space on glass graduate prevents error. 592
suction pump helps filter solutions 613

Chinaware—how to remove stains 598

Clock, Electric—on lampshade 600

Coil Spring—sections anchor tubing or cord to wall. 608

Dog House—has adjustable ventilator 609

Duplicator—stencil paper used on homemade. 593

Dustpan—aids in fighting fire 608

Eaves—self-cleaning strainer prevents leaves. 600

Are You STILL in the DEPRESSION??

TIMES are better. Business is out of the rut—well ahead of a year ago. Millions of men have gone back to work. There's more money in lots of pay envelopes. But what good is that to you, if *your* pay check is still written in depression figures?

You weren't so discontented a year ago. In fact, you considered yourself lucky to have a job. But now—you have begun to wonder and worry why the oncoming tide of prosperity hasn't reached you yet. The situation is getting desperate. Bills continue to pile up. You can't get along forever on a "shoe string" budget. You *must* win back those pay cuts. Other men are doing it—how can you?

Certainly, you can't work any harder than you have been. And it isn't a question of your intelligence, honesty or ambition. Those virtues do not solve today's problem—they are often insufficient to hold down a job, as millions unemployed sadly testify.

But there *is* a way to get back to the prosperity pay check. A way that's probably far easier than you have dreamed. A *plan* that has been "depression-tested."

During the worst period of the depression, this plan was helping thousands of men and women forge ahead. Today, during recovery, these same men and women—their ranks swelled by thousands more—are being picked for top positions. They are escaping years of monotonous, routine service—achieving their dreams while they are young enough to enjoy success in its fullest measure.

Since this plan brings results in bad times as well as



good, it obviously works independently of business conditions. As unbelievable as that may sound, remember that success is largely up to the individual. Most men struggle through a depression all their lives. The few who forge ahead ride to success the same business tides that sweep the majority to failure.

The LaSalle Success-Building Plan is made for men like you—men with courage, ambition, persistence, who need expert guidance to make the most of their efforts. But LaSalle supplies even *more* than that. Not only individualized training and coaching to help you meet today's crying needs . . . but also the very steps you need to take to fill the job ahead, and force that pay raise *quickly*. Any

synopsis of this plan, which we might include here, could give you only a vague idea of this service. We suggest you mail the coupon for complete details on your own line of work.

Today's Danger

There's a real danger to accepting "depression pay" these days. A danger that lower wages will continue to dog you—for no employer will pay more until he is convinced you are worth more. Some day, some way, you've got to convince him. There's no time to lose. The sooner you begin, the better.

If the LaSalle Plan has fulfilled this aim for thousands, isn't it logical to expect it can do as much for you? This coupon can easily become your passport to better times. Mail it today.

LaSalle Extension University, Dept. 1064-R, Chicago

I would like to know about your Success-Building Plan and service in the business field I have checked.

- | | |
|--|--|
| <input type="checkbox"/> Business Management | <input type="checkbox"/> Industrial Management |
| <input type="checkbox"/> Higher Accountancy | <input type="checkbox"/> Modern Foremanship |
| <input type="checkbox"/> Traffic Management | <input type="checkbox"/> Personnel Management |
| <input type="checkbox"/> Modern Salesmanship | <input type="checkbox"/> Business Correspondence |
| <input type="checkbox"/> Commercial Law | <input type="checkbox"/> Business English |
| <input type="checkbox"/> Law: Degree of LL. B. | <input type="checkbox"/> Effective Speaking |
| <input type="checkbox"/> Expert Bookkeeping | <input type="checkbox"/> Office Management |
| <input type="checkbox"/> C. P. A. Coaching | <input type="checkbox"/> Stenotypy |



Name.....Age.....

Address.....

**LaSalle
Extension University**

When writing to advertisers please mention Popular Mechanics

"I Saved Six Orders And Made 2 Weeks' Pay in One Day"



Thanks To This Pocket Volume!

IN my first five years as a salesman, I never made more than \$45 a week. I knew I ought to make more. But I was ignorant—untrained—didn't really know how to sell. I was commencing to despair of ever learning by experience.

It wasn't until one day, when I was reading a certain magazine, that I ever knew there was any other way to learn.

What I read gripped my imagination. I wrote to find out more about the sensational training mentioned, and the amazing new Free book, "The Key to Master Salesmanship," which was promised. When the book arrived, however, it had a companion—a tiny pocket volume called "Mistakes Commonly Made in Selling."

Do you know, that little book was alive with ideas for me! Just one page tipped me off to a bad mistake I was making. Moreover, it showed me how to save at least six recent prospects—turn them into sales, although I thought my chances were gone. In one day, just calling on those six old, supposedly hopeless prospects, I got every one of them—and made \$90—two ordinary weeks' pay!

You bet I enrolled for the full course of training after that! Today I am making \$4200 a year more than I did then. I've lost my envy of the "born" salesman; this training made a successful salesman out of me, as it can out of anyone with ordinary brains and education.

Two Books FREE!

Whether you are plugging along unsuccessfully as a salesman, or are down in the rut in a routine job, send in the coupon today for your Free copies of these two wonderful books. See why so many men, who read these books, have since mounted into the big-pay ranks of successful salesmen, through this easy form of training. No cost; no obligation. Act now!

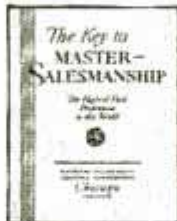

NATIONAL SALESMEN'S TRAINING ASSOCIATION
Dept. R-107, 21 W. Elm St., CHICAGO, ILL.

National Salesmen's Training Association
Dept. R-107, 21 W. Elm St., Chicago, Ill.

Without obligation to me, please send me "Mistakes Commonly Made in Selling," as well as "The Key to Master Salesmanship," and full details of your various service features, including your FREE Employment Service.

Name.....
Address.....
City..... State.....
Age..... Occupation.....

(Contents—Continued)

- Envelope—large, made from two small ones 590
- File—making tangs safe 619
- Flowers—artificial, made from tin cans 607
- Furnace—retriever for articles lost under grating 608
- Furniture—writing desk in Colonial design 610
- Home—improvements in the 602
- Iceboxes—repairing leaky 592
- Ice Pick—improving handle 600
- Jewelry Boxes—cork feet for 614
- Jig Saw
 - rack holds tools on arm of 620
 - ripping fence, for 600
- Ladder
 - folding, fastens to wall 620
 - pad for carrying, made from inner tube 598
- Lamp—emergency shade made from corks and paper 620
- Lily Ponds—how to remove scum 601
- Mandolins—clamps for repairing, bowl shaped 614
- Marionettes—secrets of making 615
- Milk-Door—opening, how to make burglarproof 607
- Motorcycle—shields protect legs 608
- Pipe—hole dug by water pressure 612
- Razor Blade—pocket knife holds while stropping 592
- Rose Bushes—how to propagate 608
- Rubbers—drip pan holds wet 592
- Seat—canvas, child's, for use at movie 590
- Ship Model
 - dummy helpful for dimensioned details 589
 - how to simulate antique wear 620
 - Viking, for beginners 587
- Smokers' Accessories
 - button improves pipe 598
 - novel cigarette holder 591
- Star—five-point, how to draw 598
- Stove—soot removed without soiling floor 590
- Tennis—regulation size table 599
- Vacuum Cleaner—motors, old, useful in workshop 601
- Ventilation—for room without draft 620
- Wall Safe—electrical hookup opens 613
- Wax Crayons—what you can do with 594

SHOP NOTES

- Automobiles, Repairing
 - how to service knee-action wheels 636
 - lock washers prevent sticky valves 639
 - tool box on two wheeled cart 639
 - trouble light connected to live side of generator 639
 - wire used as clamps for radiator hose 635
- Automobiles, Trucks—warning flags aid drivers to steer through gateway 639
- Belts—leather, splicing 634
- Blowtorch—heating water with a 624
- Boats—protection against winter 626
- Bushings—babbitt, casting of odd sizes 630
- Dry Cleaning—cord-pulley arrangement for putting covers over garments 629
- Elevator—automatic guard for open shaft 624
- Filling Station—method of illuminating free-air stand 638
- Gate—wire, auto-spring leaf keeps taut when closed 634
- Hack Saw—using your 631
- Jig—to hold work in lathe for milling cuts 635
- Ladle—screen-wire shield protects hands when carrying 630
- Links—labor-saving uses for parallel, pivoted 625
- Lubricant—weather-resisting, a 623
- Magnifying Glass—fastened on flashlight 624
- Motorboats, Racing—grooved pistons for 640
- Nuts—holder for re-tapping in a lathe 624
- Paper—makes stacks of cans and packages rigid 630
- Sheet Metal—an adjustable spacing centerpunch 640
- Shovel—holes in, aid in handling wet mixtures 628
- Soldering—with an electric arc 621
- Suitcase—serves as portable desk 630
- Tanks, Storage—lowered into hole with aid of water 634
- Threads—cut with dies on lathe 629
- Vise—drill press, feet improve 629

Make Money
as a
PRINTER

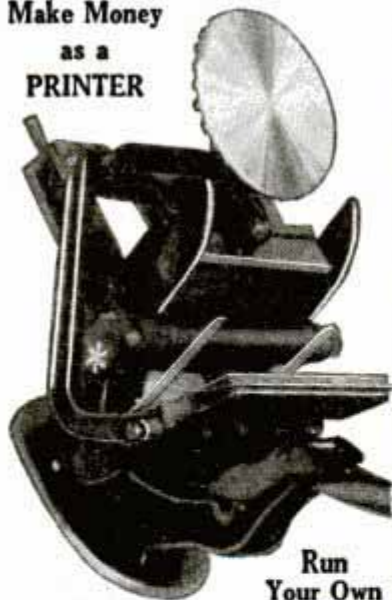

Run
Your Own
MOVIE



300 PRIZES GIVEN

Here's a Job Waiting For You!

BOYS! Win this 1934 deluxe motorbike and shoot down the street like an arrow. Bike fully equipped as shown. Get a printing press, open a shop of your own. Run a movie; make money. You can get these prizes, and 300 more, *without cost!* Besides, you can earn CASH and gain valuable business training that will better enable you to step into a good job later on.

Just deliver our fine magazines to customers in your neighborhood. It's easy. Will not interfere with school or play. Mail the coupon NOW and we'll start you on the happy road to MONEY and PRIZES!



WIN
THIS
BIKE

Mail This Coupon At Once!

Mr. Jim Thayer, Dept. 416
The Crowell Publishing Co.
Springfield, Ohio

Dear Jim: I want to start earning MONEY and PRIZES and take advantage of your business training.

Name _____ Address _____

City _____ State _____ Age _____

Be an ARTIST

MAKE \$50 TO \$100 A WEEK!

Many of our successful students are now making big money. Our simple methods make it easy to learn Commercial Art, Cartooning and Designing at home, in spare time. New low tuition, rate. Write for big free book "ART for Pleasure and Profit," today. State age. Address: STUDIO 1210, WASHINGTON SCHOOL OF ART 1115-15TH ST., WASHINGTON, D. C.



Learn
PHOTOGRAPHY
at Home

Make money taking pictures. Photographs in big demand. Commercial Photography also pays big money. Learn quickly at home in spare time. No experience necessary. Write today for new free book, *Opportunities in Modern Photography*. American School of Photography, Dept. 1357, 3601 Michigan Ave., Chicago.

RAISE CHICKENS in CAGES The ARNDT Way

There is money in raising chickens by this new and revolutionary method, developed by Milton H. Arndt, world-known hatchery specialist. Mr. Arndt keeps over 9,000 birds on his one-acre demonstration farm. He cordially invites you to visit his farm and see for yourself how healthy, contented and productive chickens can be when kept in cages.

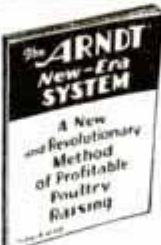

He has also explained every step in raising poultry the ARNDT way, from chicks to layers, in a 160-page book, entitled "The ARNDT New-Era System." A real practical text-book with 100 illustrations. By this System, you can start with 100 chicks or a dozen hens and expand until you have a fine, paying business. Thousands already using this modern system.

10c Invested NOW May Change Your Future

Send 10c today, coin or stamps; we will mail postpaid. "The ARNDT New-Era System." This Book may change the entire future of your life, by showing the way to a bigger and surer income from poultry.

M. H. ARNDT
Dept. 45 Trenton, New Jersey



Licensed Airmen

Pilots and Mechanics wanted for transport and commercial work. You can't fly or service aircraft without U. S. license. Our new Commercial Aeronautics Course prepares you, in short time, to pass pilots' or mechanics' written license examinations. Send TODAY for Free Bulletin. No obligation.

American School, Dept. A745, Drexel at 58th, Chicago

ELECTRICAL ENGINEERING

A BROAD, basic, intensive course for men of limited time, complete in one school year. Approved by educators, endorsed by industry. Modern buildings, 41 years' successful experience. Catalog on request.



BLISS ELECTRICAL
SCHOOL
120 Takoma Ave., Washington, D. C.

Improves Handwriting In 3 Hours

Marvelous invention. Corrects poor writing in few days. Amazing results guaranteed. No failures. Positive proof and complete outline mailed FREE. Write quickly.

OZMENT INSTRUCTION BUREAU, Dept. 34, St. Louis, Mo.

Why VOICE Students Fail

SENT FREE No Obligation to Buy

If you act quick!—we will send postpaid—for 30 days' free reading—new Voice Book disclosing startling VOICE FACTS that may save hundreds of dollars to every man or woman seeking a strong, rich voice for either singing or speaking. 30 days' free reading—then send \$1.00. Otherwise, return it—that's all! PROF. E. FEUCHTINGER Studio 13-57 308 North Michigan Avenue - Chicago

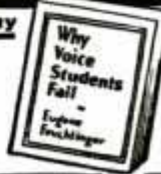

Train for

RADIO TELEVISION AND TALKING PICTURES

IT TAKES ONLY 10 WEEKS IN THE BIG CHICAGO COYNE SHOPS!

YOU DON'T NEED ADVANCED EDUCATION OR PREVIOUS EXPERIENCE TO MASTER COYNE TRAINING!

The remarkable "Learn by Doing" methods used in the great Coyne Shops in Chicago, will Train you to easily master my course in Radio and its many branches. Coyne doesn't teach you by correspondence—You don't study from books—You don't get lessons in a classroom—You don't have to recite—Instead, you are trained right in wonderful, modern, daylight shops on the finest kind of Radio, Sound and Television equipment under the personal supervision of expert instructors. You get individual instruction and only do the sort of work you will meet out in the field on a real job.

ACTUAL SHOP WORK ON RADIO, CODE, TELEVISION AND SOUND EQUIPMENT

Spend only 10 weeks doing actual work on Radio equipment worth many thousands of dollars and you should be ready to qualify for a big pay job. Get valuable practical experience by working on a wide variety of modern, up-to-date A.C. Superheterodyne sets, oscillators, analyzers and test instruments. Learn how to operate television receiving and transmitting equipment, also how to test and service sound picture equipment. Coyne Training further prepares you for Amateur Radio Telephone or 2nd Class Operators License and all code and Department of Commerce rules for a government License Examination.

DO JOBS LIKE THESE—NO CORRESPONDENCE—REAL WORK ON RADIO & TELEVISION EQUIPMENT



Students operating our modern Transmitter

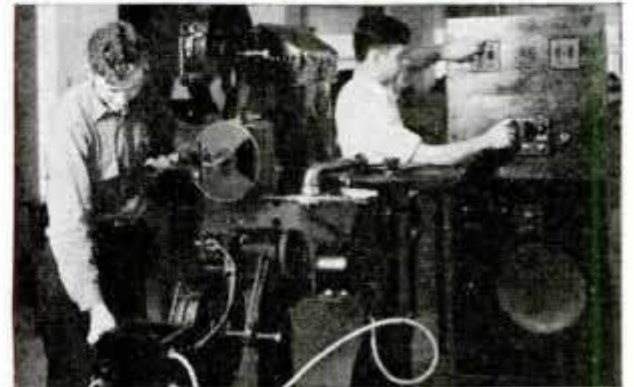

Instructor explaining our Television Camera and Scanning Unit

Astounding Offer! PAY YOUR TRAINING EXPENSE AFTER YOU GRADUATE *in Small* MONTHLY PAYMENTS

NO RED TAPE—NO STRINGS TO MY OFFER—YOU RUN NO RISK! I'LL TRAIN YOU IN MY SHOPS FOR 90 DAYS—YOU GET OVER ONE YEAR TO PAY TUITION AFTER GRADUATION!

I mean exactly what I say. I'm ready to take you into my big Shops, give you Coyne Training and you won't have to pay me until after you graduate. Even then, you don't make your first payment for 60 days after you have finished your Training and you have over a year to make the small, monthly payments. I'm willing to back you in this way because hundreds of my successful graduates have proved to me that the fellow who wants to improve himself and his conditions is the finest credit risk in the world.

EARN LIVING EXPENSES WHILE YOU'RE TRAINING!

Don't let shortage of cash hold you back. Many of my students work part time to help pay their living expenses while they are training in the great Coyne Shops. My Employment Department will also assist you to find a spare time job to cover a good part of your room and board expenses.

YOU GET EMPLOYMENT HELP AFTER YOU GRADUATE

I don't forget about you after you complete your Training. My Graduate Employment Service will give you real employment help. I have spent many years in bringing good jobs and Coyne Graduates together. As one of my boys you will get assistance quickly. You have the assurance of this great Training School that every employment assistance will be extended to locate you in a job for which you have been trained.



Founded 1899



Electric Refrigeration and Air Conditioning Course included without extra cost

Here at last! The fastest growing industries in America to-day. Manufacturers and Distributors of Refrigeration and Air Conditioning equipment need Trained men who have Specialized in these rapidly expanding fields. Here at Coyne you will prepare to fill a job as Installation and Service man, Shop Mechanic, Tester, Assembler, Inspector, etc. You will do actual work on latest types of Refrigerating and Air Conditioning machines. And, it won't cost you one extra cent to get this remarkable training. I include it absolutely Free with your regular Radio Training.

Here's where you Learn-By-Doing

MAIL THE COUPON!

and I'll send you the new "Coyne Opportunity Book," giving you all the facts about Coyne Training and showing hundreds of my students at work on modern, electrical equipment under the personal supervision of Coyne Expert Instructors. You will also get the details of my Spare Time Employment Offer, my Pay After Graduation Plan and Graduate Employment Service. Simply Mail the coupon and I'll rush all details to you.

Get This FREE BOOK



**H. C. Lewis, President
Coyne Electrical School, Dept. 74-3H
500 S. Paulina St., Chicago, Ill.**

Send me your Big FREE Book about Coyne Training and give me all details regarding your "Spare Time Employment Offer" and "Pay After Graduation Plan" of easy, monthly payments.

Name.....
Address.....
City..... State.....

COYNE H. C. LEWIS, PRESIDENT **ELECTRICAL SCHOOL** FOUNDED 1899
500 S. Paulina St., Dept. 74-3H, Chicago

The 97-lb. Weakling

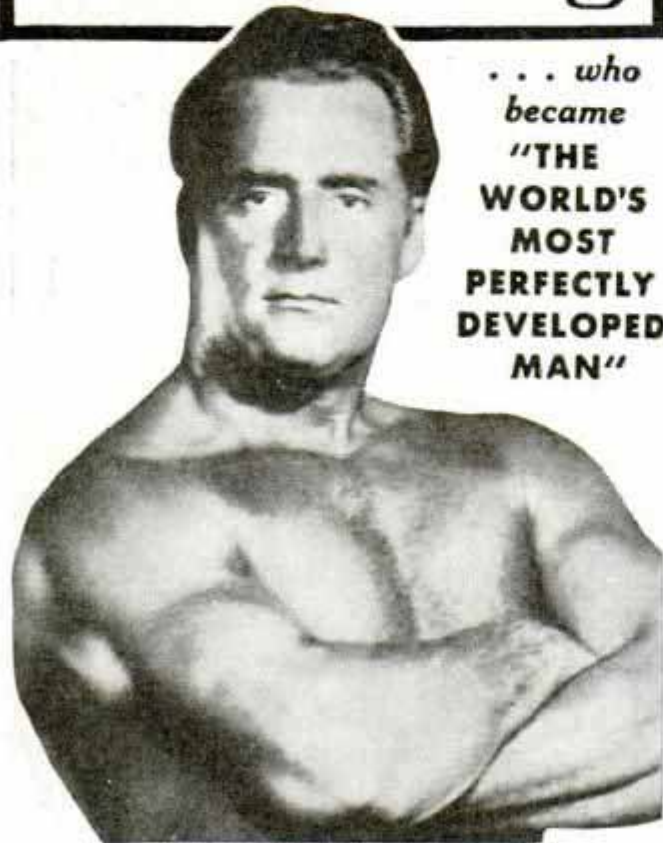

... who became
"THE
WORLD'S
MOST
PERFECTLY
DEVELOPED
MAN"

By CHARLES ATLAS

THEY used to think there wasn't much hope for me. I weighed only 97 pounds. I was a sickly scare-crow. Then I discovered *Dynamic-Tension*. It gave me the body that twice won the title, "The World's Most Perfectly Developed Man." Now I make you this amazing offer: *At my own risk I'll give you PROOF in just 7 days that my same method can make you over into a NEW MAN of giant power and energy!*

No "if's"—"and's"—or "maybe's." Just tell me where you want handsome, steel-like muscles. Are you fat and flabby? Or skinny and gawky? Are you short-winded, pepless? Do you hold back and let others walk off with the prettiest girls, the best jobs? *Give me just 7 days!* I can PROVE that *Dynamic-Tension*—without any pills, or unnatural dieting or apparatus that may strain your heart and other vital organs—can make you a healthy, confident, powerful **HE-MAN!** In just a few minutes a day!

Free Book!

Mail coupon NOW for my illustrated book, "Everlasting Health and Strength." Tells all about *Dynamic-Tension*. Shows actual photos. It's a valuable book! And it's FREE. Send for your copy today. Address me personally: Charles Atlas, Dept. 8-K, 133 East 23rd Street, New York, N. Y.

CHARLES ATLAS, Dept. 8-K,
133 East 23rd Street, New York, N. Y.

I want the proof that your system of *Dynamic-Tension* will make a New Man of me—give me a healthy, husky body and big muscle development. Send me your free book, "Everlasting Health and Strength."

Name
(Please print or write plainly)

Address

City..... State.....

© 1934, C. A. Ltd.

When writing please mention *Popular Mechanics*

Prepare Quickly at Home for the BIG PAY JOBS IN AVIATION

Don't envy men who are enjoying a romantic, thrilling aviation career with big pay. You can learn aviation right at home.



LINCOLN Trains You in Your Spare Time

No need to give up your present job, no need to leave home. Lincoln's 14 years' experience teaching aviation and 24 years' success as a mechanics' trade school put into this quickly mastered home-study course. All courses backed by this world's best known resident aviation school which is Government Approved.

Gives you the necessary foundation required for good pay aviation jobs. Complete, fascinating, easy-to-learn course taught by experienced resident school instructors. Students in every state and 25 foreign countries enrolled in this Home Study Extension department. Taught in either English or Spanish. Don't wait. Write now for full details.

LINCOLN AIRPLANE & FLYING SCHOOL
2051 Aircraft Bldg. Lincoln, Nebr.

Electrical Refrigeration



Big new field — one of few that prospered during depression — offers well-paid jobs with a future to men trained in selling, installing, and servicing. Thousands of new units being sold and installed in homes, stores, offices, plants, etc. Home study will fit you for good job in 6 to 12 months. Employment service included. Send TODAY for Free Bulletin. No obligation.

American School, Dept. ER745, Drexel at 58th, Chicago



Learn to Write

Begin Today. Write for my Free Book "How to Become a Good Penman." It contains specimens and tells how others learned to write in spare time. Your name elegantly written on a card if you enclose stamp for postage. Write today. F. W. TAMBLYN, 416 Ridge Bldg., Kansas City, U. S. A.



START \$1260 to \$2100 YEAR

MEN—WOMEN—18 to 50

STEADY WORK
Many Fall Examinations
Expected

Common Education
Usually Sufficient

Mail Coupon
Today—
SURE

Franklin Institute
Dept. H180
ROCHESTER, N. Y.

Gentlemen: Rush to me, FREE of charge, list of U. S. Government big pay jobs. Send me FREE 32-page book describing salaries, vacations, hours, work, and full particulars on how to get one of these jobs.

Name

Address

Learn at Home to Make More Money



Broadcasting Stations employ managers, engineers, operators, installation and maintenance men for jobs paying up to \$5,000 a year.



Set servicing pays many N. R. I. men \$200 to \$1,000 a year for their spare time. Full time men make as much as \$40, \$60, \$75 a week.



Installing and servicing loud speaker apparatus is another growing, money-making field for Radio trained men.

Some Other Jobs N.R.I. Trains Men For

- Broadcast Engineer.
- Operator in Broadcast Station.
- Aircraft Radio Operator.
- Operator of Airway Beacons.
- Government Radio Operator.
- Ship Operator.
- Service man on Loud Speaker Systems.
- Installation Engineer on Loud Speaker Systems.
- Sales Manager for Retail Stores.
- Service Manager for Retail Stores.
- Auto Radio Installation and Service man.
- Television Broadcast Operator.
- Television Engineer.
- Set Servicing Expert.

I'll train You Quickly for Radio's GOOD spare time and full time Jobs . . .

**Mail Coupon
for FREE
Information**

Why slave your life away in a no-future job? Why skimp, why scrape, trying to pay your bills? I'll train you quickly for the live-wire field—the field with a future—**RADIO**. \$40, \$60, \$75 a week—that's what many Radio Experts make. \$5, \$10, \$15 a week extra money—that's what many of my students make in their spare time shortly after enrolling. My free book tells you about Radio's spare time and full time opportunities—about my tested training—about my students and graduates—what they are doing and making. Get this book. Be a Radio Expert. The Radio field is big enough to absorb many more properly trained men.

Many Radio Experts Make \$40, \$60, \$75 a Week
Spare time and full time Radio Service, Installing, Operating, Maintaining Broadcast, Aviation Radio, Commercial, Ship and Television stations, a Radio service business of your own—I'll train you for these and other good jobs in the manufacture, sale and service of Radio and Television apparatus. My FREE book tells you about the many money-making opportunities in Radio. Get a copy. Mail Coupon today.

Save—Learn at Home in Your Spare Time
You don't have to leave home and spend \$500 to \$1,000 to study Radio. I'll train you quickly and inexpensively right in your own home and in your spare time for a good Radio job. You don't need a high school or college education. Many of my successful graduates didn't even finish grade school. My practical 50-50 method of training—half with lessons, half with Radio equipment—gives you broad practical experience—makes learning at home easy, fascinating, practical and rapid.

Many Make \$5, \$10, \$15 a Week Extra in Spare Time While Learning
My book shows how my special training, instruction material, plans, ideas, and my twenty years' experience training men for Radio careers has helped many students make \$200 to \$1,000 a year quickly in their spare time. My Course is famous as "the one that pays for itself."

Your Money Back if Not Satisfied
I'm so sure you will be satisfied with my training that I agree in writing to refund every penny of your money if you are not entirely satisfied with my Lesson and Instruction Service when you finish.

Find Out What Radio Offers You
Act today. Mail the coupon. My 64-page book will be sent free to any ambitious fellow over 15 years of age. It tells about Radio's opportunities—explains the eighteen star features of my Course—shows letters of what others are doing and making. There is no obligation. Mail the coupon in an envelope or paste on 1 cent post card. **J. E. SMITH, President**
National Radio Institute, Department 4KP
Washington, D. C.

Sample Lesson FREE

Take advantage of this offer. Mail the coupon **Right Now**, and I'll send you **FREE** a Sample Lesson that only my students have received in the past. This fascinating book, "A Bird's-Eye View of Radio," is just packed and jammed with information about this growing industry. The reason I am willing to send it to you is to **PROVE** that my Course is simple, easy to understand, and enjoyable to study. I want to **SHOW YOU** that I can train you just as I have **ALREADY** trained thousands of men. Many of them with not even a grammar school education, and no Radio or technical experience, have become Radio experts, and now earn two or three times their former pay. Mail the coupon **NOW**.



Here's Proof

"Made \$6,000 in 2 Years"

"Soon after the depression started, I found myself without a job, but I was well protected with N. R. I. training. I swung right to full time Radio servicing and I have made over \$6,000 in a little over two years."
—WM. SPARTIVENT.
Sparty Radio Service, 93 Broadway, Newark, N. J.

"\$500 a Year in Spare Time"

"Although doing spare time Radio work only, I have averaged about \$500 a year extra in addition to my regular income. Full time Radio work would net me many times that amount."
—EDW. H. FAWCETT, Slough Rd., Ladner, B. C., Canada.

"Good Position, Good Pay"

"I am Chief Operator at Radio Station WSMK. This is a good position with good pay. I have advanced in Radio right along. I recommend N. R. I. to anyone who wants to be successful in Radio."
—JOHN HAJDUK, JR., 21 Gerard Ave., Southern Hills, Dayton, Ohio.



MAIL THIS NOW
for FREE 64 page book

J. E. SMITH, President
National Radio Institute, Department 4KP
Washington, D. C.

Dear Mr. Smith: Without obligation send me the Sample Lesson and your free book about spare time and full time Radio opportunities, and how I can train for them at home in my spare time. (Please Print Plainly)

NAME.....
ADDRESS.....
CITY.....
STATE..... R

BUY NO INSURANCE until you learn about \$100 A MONTH POSTAL LIFE'S POLICY

Only POSTAL LIFE of NEW YORK gives you an insurance value like this, for Postal sells direct and has NO AGENTS. That is why Postal's low premium of only \$1 a month buys \$1,221 of insurance at age 20; \$1,088 at age 25; \$948 at age 30; \$813 at age 35, etc.; all ages, 18 to 50, men and women. Send coupon to find out amount at your age.

Real "Old Line" LEGAL RESERVE life insurance that offers you lifetime protection with cash-loan values and standard provisions and benefits printed in the policy and guaranteed. This 29-year-old safe company, operating under the rigid New York State insurance laws, has paid out over \$40,000,000 to policy holders and their families. Mail coupon today. No obligation.

POSTAL LIFE INSURANCE CO.—ARTHUR JORDAN, Pres.
Dept. 671, 511 Fifth Avenue, New York, N. Y.

Please mail details of your \$1.00 policy.

Exact date and year of birth.....

Occupation.....

Name.....

Full address

BUY DIRECT AND SAVE

M O L E R

Learn Beauty Culture or Barbering
Earn while learning, day, night classes. Write for free Booklet "B". Moler College, 139 East 23rd St., New York

Burlington's Diesel-powered "Zephyr" used only \$16.72 worth of fuel oil in its 1,015-mile non-stop run from Denver to Chicago

Photo courtesy
Burlington
R. R.



Diesel Engineering
The Diesel is fast replacing old-type engines in locomotives—ships—industrial and commercial power plants—motor cars and trucks—aircraft—tractors. As a result, many old jobs have been greatly changed or actually wiped out.

New Jobs For Old

Every industrial change throws many good jobs into the discard—but it creates in more and better jobs. The automobile ruined scores of industries based on providing horse transportation—but the motor industry employs even greater armies of workers. Radios supplanted talking machines—electric refrigerators wrecked the iceman—air conditioning is driving out old-fashioned heating and ventilating systems.

Diesel Engineering is the great opportunity of today. The field is developing with amazing rapidity—on land and water and in the air. This is your opportunity to get in on the ground floor of a new and prosperous industry that will provide plenty of good jobs during your lifetime.

Is Your Job Safe?

There is a growing scarcity of men trained to install, operate, and service Diesel engines. New Diesel Engineering Course—just released for home study by one of America's leading educational institutions—will give you, in a short time, thorough training in modern Diesel engine practice. All texts furnished. Send TODAY for Free Bulletin. No obligation.

American School

Dept. D745, Drexel Avenue at 58th Street, Chicago, Ill.

When writing please mention Popular Mechanics

BE A Traffic Manager Big Pay—Big Opportunity

Big business needs trained traffic men and pays them well. Train in your spare time for this highly profitable, growing profession. Low cost; easy terms.

Write now for valuable, interesting 64-page book—FREE.

LASALLE EXTENSION UNIVERSITY
Dept. 1064-T, Chicago



Be a DENTICIAN

Learn at home to make Crowns, Plates, Bridgework, etc., for Dentists. Easy practical way to learn mechanical dentistry at home in spare time. Full equipment of tools and materials included with course FREE. Low tuition. Easy terms. Write for FREE BOOK about this money-making profession that is not affected by "machine age."

McCarrie School of Mechanical Dentistry

207 N. Broad St.

Dept. 603

Philadelphia, Pa.



TRI-STATE COLLEGE

B. S. Degree in 2 years. World famous for technical 2-year courses in Civil, Electrical, Mechanical, Chemical, Radio, Aeronautical Engineering; Business Administration and Accounting. Equivalent in technical hours to 4-year course. Those who lack high school may make up work. Low tuition. Low living costs. Located in picturesque hill and lake region. Students from every state and many foreign countries. 51st year. Enter Sept., Jan., March and June. Write for catalog.

4104 COLLEGE AVE.,

ANGOLA, IND.

BE A PASSENGER TRAFFIC INSPECTOR



Better Business Has Opened New Opportunities ACTIVE MEN—19 to 50—wanted in the Railway and Bus Field. Good Pay—interesting work—rapid advancement. You can quickly qualify by our short, home-study course and on completion we will help place you in a position at up to \$140 per month, plus expenses. For 10 yrs. we have located positions for our graduates or refunded tuition. Costs little; terms. Free Booklet. STANDARD BUSINESS TRAINING INSTITUTE, Div. 210, Buffalo, N. Y.

MODERN BOOKKEEPING in 12 Easy Lessons

by an expert. Learn easily by mail, to open, keep and close books. \$16 pays for entire course. Small easy payments. THE FRAZEE METHOD, 44A Wayne Place, NUTLEY, N. J.

\$\$\$ SONG WRITING \$\$\$ BIG ROYALTIES

paid by Music Publishers and Talking Picture Producers. Free booklet describes most complete song service ever offered. Hit writers will revise, arrange, compose music to your lyrics or lyrics to your music, secure U.S. copyright, broadcast your song over the radio. Our Sales Department submits to Music Publishers and Hollywood Picture Studios. WRITE TODAY for FREE BOOKLET.

UNIVERSAL SONG SERVICE, 627 Meyers Bldg., Western Avenue and Sierra Vista, Hollywood, California

Inventions Wanted Patented or Unpatented

If you have a practical, useful invention for sale, patented or unpatented, write

Chartered Institute of American Inventors
523 Barrister Building Washington, D. C.

"World's Largest Organization of Inventors"



Copy this girl and send us your drawing—perhaps you'll win a COMPLETE FEDERAL COURSE FREE! This contest is for amateurs, so if you like to draw do not hesitate to enter.

Prizes for Five Best Drawings—FIVE COMPLETE ART COURSES FREE, including drawing outfit. (Value of each course, \$190.00.)

FREE! Each contestant whose drawing shows sufficient merit will receive a grading and advice as to whether he or she has, in our estimation, artistic talent worth developing.

Nowadays design and color play an important part in the sale of almost everything. Therefore the artist, who designs merchandise or illustrates advertising has become a real factor in modern industry. Machines can never displace him. Many Federal students, both men and girls who are now commercial designers or illustrators capable of earning from \$1000 to \$5000 yearly have been trained by the Federal Course. Here's a splendid opportunity to test your talent. Read the rules and send your drawing to the address below.

RULES FOR CONTESTANTS

This contest open only to amateurs, 16 years old or more. Professional commercial artists and Federal students are not eligible.

1. Make drawing of girl 4½ inches high, on paper 8 inches wide by 7 inches high. Draw only the girl, not the lettering.

2. Use only pencil or pen.

3. No drawings will be returned.

4. Write your name, address, age and occupation on back of drawing.

5. All drawings must be received in Minneapolis by Sept. 25th, 1934. Prizes will be awarded for drawings best in proportion and neatness by Federal Schools Faculty.

◀ FEDERAL SCHOOLS ▶ INC ▶

Dept. 10134 Federal Schools Bldg., Minneapolis, Minn.

When writing to advertisers please mention Popular Mechanics



Attention

MEN WHO WANT TO GET MARRIED!

Most likely your income has been reduced. And yet—

You and that girl of your dreams have the precious hope of facing life together!

The obstacle is money—more money.

Listen: Thousands of men, even in these times—men who faced the same problem that now troubles you—have learned the secret. They're making themselves more valuable on their present jobs, preparing themselves for the bigger opportunities ahead!

They're doing it by devoting a portion of their spare time to study—by mastering International Correspondence Schools Courses that are modern and practical in their training. Many of today's business leaders started this very way.

You can do the same thing—and realize that hope you hold so dear. It takes work and sacrifice—what worth-while thing doesn't? The coupon will bring you good news—mail it today!

INTERNATIONAL CORRESPONDENCE SCHOOLS

"The Universal University" Box 5529-H, Scranton, Penna.

Without cost or obligation, please send me a copy of your booklet, "Who Wins and Why," and full particulars about the subject before which I have marked X:

TECHNICAL AND INDUSTRIAL COURSES

- | | |
|--|--|
| <input type="checkbox"/> Architect | <input type="checkbox"/> Automobile Mechanic |
| <input type="checkbox"/> Architectural Draftsman | <input type="checkbox"/> Plumbing <input type="checkbox"/> Heating |
| <input type="checkbox"/> Building Estimating | <input type="checkbox"/> Air Conditioning |
| <input type="checkbox"/> Wood Millworking | <input type="checkbox"/> Sheet Metal Worker |
| <input type="checkbox"/> Contractor and Builder | <input type="checkbox"/> Steam Engineer |
| <input type="checkbox"/> Structural Draftsman | <input type="checkbox"/> Steam Electric Engineer |
| <input type="checkbox"/> Structural Engineer | <input type="checkbox"/> Civil Engineer |
| <input type="checkbox"/> Electrical Engineer | <input type="checkbox"/> Surveying and Mapping |
| <input type="checkbox"/> Electric Lighting | <input type="checkbox"/> Refrigeration |
| <input type="checkbox"/> Welding, Electric and Gas | <input type="checkbox"/> R. R. Locomotives <input type="checkbox"/> Air Brakes |
| <input type="checkbox"/> Reading Shop Blueprints | <input type="checkbox"/> R. R. Section Foreman |
| <input type="checkbox"/> Telegraph Engineer | <input type="checkbox"/> R. R. Bridge and Building Foreman |
| <input type="checkbox"/> Telephone Work | <input type="checkbox"/> R. R. Signaller |
| <input type="checkbox"/> Mechanical Engineer | <input type="checkbox"/> Highway Engineering |
| <input type="checkbox"/> Mechanical Draftsman | <input type="checkbox"/> Chemistry <input type="checkbox"/> Pharmacy |
| <input type="checkbox"/> Machinist <input type="checkbox"/> Toolmaker | <input type="checkbox"/> Coal Mining Engineer |
| <input type="checkbox"/> Inventing and Patenting | <input type="checkbox"/> Navigation <input type="checkbox"/> Boilermaker |
| <input type="checkbox"/> Patternmaker | <input type="checkbox"/> Textile Overseer or Supt. |
| <input type="checkbox"/> Heat Treatment of Metals | <input type="checkbox"/> Cotton Manufacturing |
| <input type="checkbox"/> Bridge Engineer | <input type="checkbox"/> Woolen Manufacturing |
| <input type="checkbox"/> Bridge and Building Foreman | <input type="checkbox"/> Agriculture <input type="checkbox"/> Fruit Growing |
| <input type="checkbox"/> Gas Engines <input type="checkbox"/> Diesel Engines | <input type="checkbox"/> Poultry Farming <input type="checkbox"/> Radio |
| <input type="checkbox"/> Aviation Engines | <input type="checkbox"/> Marine Engineer |

BUSINESS TRAINING COURSES

- | | | |
|--|--|--------------------------------|
| <input type="checkbox"/> Business Management | <input type="checkbox"/> Business Correspondence | <input type="checkbox"/> Signs |
| <input type="checkbox"/> Office Management | <input type="checkbox"/> Lettering Show Cards | |
| <input type="checkbox"/> Industrial Management | <input type="checkbox"/> Stenography and Typing | |
| <input type="checkbox"/> Traffic Management | <input type="checkbox"/> Civil Service | |
| <input type="checkbox"/> Accountancy and C.P.A. Coaching | <input type="checkbox"/> Mail Carrier | |
| <input type="checkbox"/> Bookkeeping | <input type="checkbox"/> Railway Mail Clerk | |
| <input type="checkbox"/> Secretarial Work | <input type="checkbox"/> Grade School Subjects | |
| <input type="checkbox"/> Cost Accountant | <input type="checkbox"/> High School Subjects | |
| <input type="checkbox"/> Salesmanship <input type="checkbox"/> Advertising | <input type="checkbox"/> College Preparatory | |
| <input type="checkbox"/> Service Station Salesmanship | <input type="checkbox"/> First Year College | |
| <input type="checkbox"/> Wallpaper Decorating | <input type="checkbox"/> Illustrating <input type="checkbox"/> Spanish | |
| <input type="checkbox"/> Salesmanship | <input type="checkbox"/> Cartooning <input type="checkbox"/> French | |
| | <input type="checkbox"/> Lumber Dealer | |

Name.....Age.....

Address.....

City.....State.....

Occupation.....

If you reside in Canada, send this coupon to the International Correspondence Schools Canadian, Limited, Montreal, Canada

When writing please mention Popular Mechanics

Learn to Play

Sample Lesson in Piano, Organ, Violin FREE



To prove how quick and easy our modern method of teaching is we will send a typical lesson absolutely free to any child or grown-up who would like to become a musician. Our home study course is complete, the most successful that we know of in America. Lessons are conducted with individual instructions and recitations at the mere price of service, supplies and mailing. We have thousands of accomplished graduates and students. You will not be disappointed. Send for the free lesson today. Address American College of Music, 1370 Main St., Kansas City, Mo.

ARMOUR INSTITUTE OF TECHNOLOGY

A COLLEGE OF ENGINEERING AND ARCHITECTURE

41st Year. Fully accredited by North Central Assn. 4 yr. courses in mechanical, electrical, civil, chemical, fire protection engineering, science and architecture, leading to B.S. Degree. All student activities—athletics, good living accommodations. Day and evening classes. Bulletin sent on request.

ARMOUR INSTITUTE OF TECHNOLOGY
3306 FEDERAL STREET CHICAGO, ILLINOIS

LEARN WATCH REPAIRING



AT HOME You can learn by our modern and original system of instruction every part of the Watch Repairing Trade at home as good or better than at a shop. You can earn money while learning and secure a well paying position or start in business after completing our course of instruction. Good watch repairers are always in demand and earn very good salaries. For particulars apply to the Wisconsin School of Watch Repairing 524 E. Mason St., MILWAUKEE, WIS.

Learn to Dance

You can learn all the modern dances—the latest Tango steps, the new Fox Trots, dreamy Waltzes, smart Collegiate Steps and popular Society Steps at home, easily and quickly. New chart method makes dancing as simple as A-B-C. No music or partner required. Don't be a wallflower. Learn to dance. Complete course—285 pages, 54 illustrations, sent on 5 Days' Free Trial. Equal \$20.00 course. Send no money. Pay postman only \$1.98, plus postage upon arrival. Money back if not delighted. Catalog Free.



Franklin Pub. Co., 800 No. Clark St., Dept. 9465, Chicago

MAKE YOUR OWN MOTORS



Model T Ford Generator makes 1/4 H. P. Motor, reversible and variable speed up to 7000 R. P. M. Dodge 12 V Generator makes 1/2 H. P. Motor. Other Generators can be used. All operate on regular or 32 volt current. Complete, illustrated and tested plans so simple a boy can use. Regular price \$3, now \$1 for a limited time only. Be sure to mention kind of Generator and current. You can sell these motors at a nice profit. Money back if plans don't work. Dept. 100, 2004 RAND CO., Grand Ave., Kansas City, Mo.



"BECOME A LIGHTNING TRICK CARTOONIST"

Send \$1.00 for Laugh Producing Program of 23 Trick Drawings with instructions. Catalog of Chalk Talk Supplies Free. BALDA ART SERVICE, Dept. 1, Oshkosh, Wis.

Learn ADVERTISING at Home

Greater opportunities now in advertising. Learn easily and quickly in spare time. Practical work. No text books. Old established school. Low tuition—Easy terms. Send for free booklet of interesting information.

Page-Davis School of Advertising
Dept. 1357, 3601 Mich. Ave., Chicago

RADIO ENGINEERING

RCA Institutes offers a combined course of high standard embracing all phases of Radio. Practical training with modern equipment at New York and Chicago schools. Also specialized courses and Home Study Courses under new "No obligation" plan. Illustrated Catalog on request.



RCA INSTITUTES, INC. Dept. PC-34
75 Varick St., New York 1154 Merchandise Mart, Chicago
Recognized Standard in Radio Instruction Since 1909

Say Fred, be sure to get this Taxidermy book. You will surely be interested. It's now sent free.

LEARN TO MOUNT BIRDS & ANIMALS - BE A TAXIDERMIST

1 THAT WAS A GREAT HUNTING TRIP, BILL, ALL THE DUCKS WE WANT. BUT IT SEEMS A SHAME TO THROW AWAY THIS BEAUTIFUL PLUMAGE.

2 THAT'S JUST WHAT I'VE BEEN THINKING - JIM, I'M GOING TO WRITE TO THE NORTHWESTERN SCHOOL OF TAXIDERMISTRY AND SEE IF I CAN'T LEARN TO MOUNT MY BEST TROPHIES.

3 WELL, I SEE YOU REALLY ARE TAKING UP TAXIDERMISTRY IN EARNEST, BILL.

4 THAT'S RIGHT, JIM - AND I'VE NEVER HAD SO MUCH FUN IN MY LIFE. I'VE ACTUALLY DOUBLED THE PLEASURE I GET FROM MY HUNTING AND REALLY HAVE SOMETHING TO SHOW FOR IT. COME IN THE HOUSE AND I'LL SHOW YOU SOME OF MY WORK.

5 I'VE SOLD MANY BOOK-ENDS, LAMPS, ASH-TRAYS, PIPE RACKS, AND SO ON TO SPORTSMEN FOR THEIR DENS - I'VE LEARNED TO TAN FURS FOR CAPS, SCARFS AND RUGS, AND - BEST OF ALL - INSTEAD OF THROWING AWAY THOSE COW-HIDES, I TAN THEM INTO LEATHER FOR BELTS, HARNESS AND STRAPS.

6 BUT WASN'T TAXIDERMISTRY HARD TO LEARN, BILL?

7 HARD? NOT A BIT, AFTER YOU GET THE HANG OF IT. WHY JIM, TO ME TAXIDERMISTRY IS THE GRAND-EST HOBBY IN THE WORLD. I'VE MADE AS HIGH AS \$75 PER MONTH IN MY SPARE TIME, MOUNTING TROPHIES FOR HUNTERS. WHY DON'T YOU TAKE IT UP?

8 I'M SURE GOING TO - WHAT'S THAT ADDRESS? I HAD NO IDEA WHAT I'VE BEEN MISSING.

Amazing Pleasure and Profits in This Art

YOU LEARN IT EASILY, QUICKLY, BY MAIL IN SPARE TIME

Men, boys, women, - Study Taxidermy. Taught by Experts. ALL SECRETS revealed. It will amaze and delight you.



Hunters - Fisherman

Save your game trophies. They are **Valuable**. Mount them for home and den. Have a **Museum**. Win fame as a Taxidermist. Make undreamed-of money in spare time . . . You learn to mount (stuff) **expertly, Birds, Animals, Fish, Game-Heads**, just like life. That is Taxidermy. You can be a Taxidermist. Will you? Surely you are interested. Mail **Coupon** right now for the astonishing **Free Book**.

Success Guaranteed

This old reliable school in 30 years has graduated 200,000 students; all in Taxidermy **Only**. Ask our 200,000 graduates! They **Know** we can teach you successfully. Our great success permits this **Guarantee**. Grasp this **Opportunity** - send coupon right now, **TODAY**, for the **Free Book**.

Mail Coupon

Or a postcard will do. No obligation on your part. The beautiful **Book**, with hundreds of entrancing **Pictures** is **Free**. Do not miss this wonderful opportunity to obtain the marvelous and valuable book, **FREE** and **POSTPAID**. Write today. State your **Age**.

Wild Game Not Needed

You can use common animals and birds; squirrels, rabbits, little chicks, puppies, kittens, pigeons, even frogs. Mount them in human and humorous groups. **Real Fun**; and profitable, too. This is known as **Craft and Novelty taxidermy**; it's included in our unique lessons. It's **Marvelous**. Write the school this minute!

Big Profits in Spare Time

Many students earn from \$40 to \$75 monthly in spare time. Some earn thousands of dollars each year. Sportsmen bring their trophies to be mounted. Besides you can sell your own **Novelty groups** for homes, dens and for merchants' window display.

Learn Tanning

Tan fine harness, sole and chrome leathers; also furs with the hair on. **Expert Methods**, easily learned. **Save Money** making your own leathers; **Make Money** tanning for others. **Quick Sure Profits**. The **Free Book** tells about it. Send coupon.

FREE BOOK

Northwestern School of Taxidermy, 3377 Elwood Bldg., Omaha, Neb. Send me your free illustrated book, "How to Mount Game". Also tell me how I may learn this fascinating art easily and quickly by mail. No obligation.

Name _____ Age _____
 Address _____



NORTHWESTERN SCHOOL OF TAXIDERMISTRY
 3377 Elwood Bldg., Omaha, Neb.

SEND COUPON TODAY FOR WONDERFUL FREE BOOK

BE A RADIO EXPERT



MANY R-T-I TRAINED MEN MAKE \$35 TO \$75 A WEEK

- Dr. C. M. Blackburn
Chief Radio Engineer
Stewart-Warner Corporation
- Kendall Clough
Chief Engineer
Clough-Bremble Co.
(Radio Engineers and Manufacturers)
- Karl Hassel
Chief Engineer
Zenith Radio Corporation
- Homer Hagan
General Manager
Radio Station KYW, Chicago
- E. E. Gramer
Chief Engineer
Standard Transformer Corp.
- F. D. Whitten
Service Mgr., Chicago Plant
Philco Radio and Television Corporation

Let these engineers right from the heart of the big Radio Industry train you at home for good pay Radio Work.

Get out of the rut. Train now, as big radio manufacturers want you trained. Fit yourself for good-pay work in Radio—the field with a future. My FREE book tells how R-T-I trains you quickly and inexpensively right in your own home and in your spare time.

Turn Your Spare Time Into Money
Many R-T-I students make \$5, \$10, \$15, and more, a week in spare time work soon after enrolling. I send you instructions which you should master quickly for doing Radio jobs common in most communities—plans and ideas which have helped hundreds of my "boys" pay for their R-T-I Training with spare-time earnings.

Mail Coupon for FREE Information
My free Book tells you about Radio's spare-time and full-time opportunities—about my manufacturer-endorsed Training—about the famous Advisory Board of top-notch engineers who direct and supervise R-T-I Training—about hundreds of R-T-I students and graduates who are making \$35 to \$75 a week, and more, in Radio.

R-T-I TRAINING IS ENDORSED BY MORE THAN 40 LEADING RADIO MANUFACTURERS

Get the facts about Radio's opportunities for TRAINED MEN—about the exclusive features that make R-T-I Training so outstandingly successful—about R-T-I Working Outfits and 5 Advanced Courses furnished without extra cost. Act today. Get out of the rut. Mail the coupon NOW for my FREE Book. There is no obligation.

RAY D. SMITH, President
Radio & Television Institute (R-T-I)
2130 Lawrence Ave., Dept. 17
Chicago, Ill.

THESE TOP-NOTCH ENGINEERS

Working right in the heart of the

RADIO INDUSTRY

Will Direct and Supervise

YOUR R-T-I TRAINING

MAIL COUPON FOR FREE BOOK

RAY D. SMITH, President
Radio & Television Institute (R-T-I)
2130 Lawrence Ave., Dept. 17
Chicago, Ill.

Dear Mr. Smith: Without obligating me, send FREE BOOK about spare-time and full-time Radio opportunities and how I can train for them at home.

Name.....
Address.....Age.....
City.....State.....



When writing please mention Popular Mechanics



High School Course in 2 Years

Your 2nd Chance

You can complete our simplified High School Course at home in 2 years. Meets all requirements for college entrance, business and the professions. Standard High School texts supplied. Diploma awarded. Separate subjects if desired.

20 Other Courses Over 200 noted Engineers, Business Men, and Educators helped prepare the special instruction which you need for the well-paid positions in —Business —Architecture —Automotive —Drafting —Electrical —Mechanical —Steam —Civil —Law —Cook & before course that interests you; mail TODAY for Free Bulletin. No obligation.
American School, Dept. H745, Drexel at 58th, Chicago

LEARN MECHANICAL DENTISTRY SEND FOR FREE BOOK

Special Tool Offer — NOW

Don't waste the best years of your life. Learn this money-making business in a few months in Day or Evening sessions and become independent. Big demand. School is highly endorsed. Estab. 1920. Practical training. Individual instruction. Easy terms. Write TODAY for FREE Catalog P.

NEW YORK SCHOOL OF MECHANICAL DENTISTRY, 125 W. 31st St., NEW YORK

ENGINEERING and ARCHITECTURE

INTENSIVE PRACTICAL TECHNICAL COURSES in Electrical, Mechanical, Structural, Architectural Engineering. Degree in 2 yrs. Diploma in 1 yr. Short courses in Electricity, Power Plant, Electric Refrigeration, Radio, Television, Drafting. Nonessentials eliminated. TIME AND MONEY SAVED. Low tuition. Extensive modern equipment. Part-time work during training. 34 yrs.' experience producing successful men. Write for catalog.

FINLAY ENGINEERING COLLEGE
1001 Indiana Ave. Kansas City, Mo.

LEARN WATCHMAKING AND ENGRAVING

BY OUR PROFIT-SHARING PLAN OUR GRADUATES SUCCEED

One of our Iowa students started in a very small way—now doing over \$30,000 a year. Another in Wisconsin, over \$10,000 the first year. Day or night classes. Call or write for FREE BOOK.

Chicago School of Watchmaking, Dept. 2001, 155 N. Clark St., CHICAGO.

SUPPRESSED KNOWLEDGE OF THE AGES

What strange powers did the ancients possess? Where was the source of knowledge that made it possible for them to perform miracles? Were these profound secrets burned with ancient libraries, or are they buried beneath crumbling Temple walls?

These wise men of the past knew the mysteries of life, and personal power. This wisdom is not lost,—it is withheld from the mass. It is offered freely TO YOU if with an open mind, you wish to step out of the rut of monotonous existence and MASTER YOUR LIFE.

THIS FREE BOOK

Man's intolerance has at times swept his achievements from the face of the earth, yet secret brotherhoods have preserved this sacred wisdom of the ages. The Rosicrucians, one of these ancient brotherhoods, INVITE YOU to write and secure a free copy of the "Wisdom of the Sages." It will point out how you may receive age-old truths. You can learn to MAKE YOUR LIFE ANEW—the fulfillment of your ideals awaits you. Address:

SCRIBE L.R.G., ROSICRUCIAN BROTHERHOOD SAN JOSE (AMORC) CALIFORNIA

YOU'RE NEXT

Do you want a handsome, powerfully built body? INCHES of solid muscle added to your arms, legs, shoulders, chest? Just give me ONE WEEK to prove I can "make you over." Send today for my sensational new way to grow strong.

"MIRACLE EXPANSION"—the New Short-Cut to Health, Strength, Muscles

YES sir, here's where I prove I can cover your body with bulging bands of muscle—broaden your shoulders, deepen your chest, give you a mighty pair of biceps—all in less time and with less effort than you ever thought possible. I'll strengthen your internal organs, too, fill you chock full of health and energy. You'll be astonished the way your whole body responds to this new, wonder method. Try "MIRACLE EXPANSION" for yourself. You don't risk a cent.



Now See Your Muscles Grow

Here's my sensational offer to you: Send me your name, address and ONE DOLLAR and I'll start you on "MIRACLE EXPANSION" by return mail. Follow my easy, fascinating instructions for a week. They require just a few minutes a day. If you're not delighted with results, back comes your dollar. I'll give you a NEW BODY or no cost. Send \$1.00 TODAY. Address

Harry Titus **TITUS** Physical Culture Director School
39 Union Square West, Dept. M-10, New York, N. Y.

Wrestling Book FREE

Learn at Home



Be an expert wrestler. Learn at home by mail. The greatest wrestlers of all, Frank Gotch and Farmer Burns, both world's champions have prepared the most wonderful course of lessons ever written on Physical Culture and Expert Wrestling. Be strong and healthy! Handle big men with ease. This great free book tells you how. Don't delay. Write now. State your age.
Farmer Burns School, 3377 Elwood Bldg., Omaha, Neb.

GET IN THE MONEY!



Plenty of good jobs, right now, for our graduates. We train you for steady jobs paying from \$50 to \$60 a week. Practical, personal instruction and shop practice. School is fully equipped. Licensed by State of Michigan. Tuition is low. Complete courses in Auto and Aviation Mechanics; Art and Acetylene Welding; Metal Finishing. Write for full information, stating which courses interest you most.

MICHIGAN TRADE SCHOOL, Inc.
3762 Woodward, Detroit, Mich.

Write for FREE CIRCULAR

FREE TRIAL LESSON in Drafting

If over 17 years of age send for this Free Trial Lesson in Drafting. Interesting and instructive. Shows how easy to learn at home by C.T.C. Method. We furnish all tools. Get ready now for money-making opportunities opening for trained Draftsmen. Write today.
CHICAGO TECH COLLEGE
M 145 Tech Bldg., 118 E. 26th St., Chicago, Ill.



"YES, I NOW HAVE A SWELL DRAFTING JOB. I PREPARED MYSELF IN TIME. ENGINEER DOBE TAUGHT ME DRAFTING BY MAIL"

"I'LL PREPARE NOW. I'M STILL IN TIME. I'LL SEND THE COUPON BELOW TODAY FOR ENGINEER DOBE'S FREE BOOK ON DRAFTING"

For MORE PAY Learn DRAFTING FROM AN ENGINEER



Learn by mail at home!



For 34 years (since 1900) I have trained thousands and thousands of successful graduates.

These TOOLS and Other EQUIPMENT Given When You Start

NOW is the time to prepare. It's high time. You don't know how soon business will boom in lines that need draftsmen. When those jobs are open, the big companies will take the men who have prepared. So, prepare NOW! Be trained now for that better job!

Jobs Now

in aviation, electricity, machinery, auto work and certain building lines. Even now all these industries and others, too, are employing draftsmen. How long before business will roll up big, immensely, with jobs plentiful? BE PREPARED. Jobs pay \$50 a week or more. I'll train you until competent and until assisted to a position OR all your money back. With the Dobe method, no previous experience is necessary.

FREE BOOK

ENGINEER DOBE, Div. 33-77, Libertyville, Ill.

Send me your free book "Successful Draftsmanship" and please explain how you will assist me to a good position as a draftsman.

Name..... Age.....

Address.....

In These
Famous
Chicago
Training
Shops

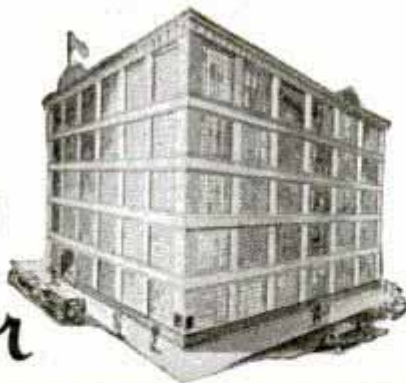

Train for

ELECTRICITY IN 12 WEEKS AT COYNE

Prepare yourself in my wonderful Daylight training shops, for a job you like . . . a job that brings good pay—in the one industry that is constantly going ahead, even through the hardest times. After my practical shop training in this world-famous Chicago school you are ready to hold down a good job at good pay as a trained Electrical man and you have the skill and knowledge that will help you rise to one of the bigger, better paid jobs of the trained executive.

All Practical Training on Real Equipment You Don't Need Advanced Education or Previous Experience

You get triple training at Coyne—through your eyes, your ears, and your hands. And it is all practical down-to-earth training on real, modern electrical machinery and equipment. Real line generators, motors, dynamos, etc.—all right here in big daylight shops for you to work on and gain practical knowledge from actual operation. No dull books—no correspondence. You don't even need advanced education or previous electrical experience to master my easy shop training methods.

Amazing Student Scholarship Loan Plan PAY FOR TRAINING AFTER YOU GRADUATE In Small Monthly Payments

Lack of ready cash need not stop you from getting Coyne training. If you are ambitious and determined to improve yourself—if you are anxious to get ahead in the great field of electricity—I will let you take your training now . . . and you can pay me back after you graduate, in easy monthly payments. You deal with me direct when you make a tuition loan, no red tape, no financing to do—and I don't ask you to pay me one cent of this loan until 60 days after you graduate, and even then I give you over a year to complete your payments. Your increased earnings should much more than pay your loan. I am willing to make you this remarkable offer only because I know from experience that once a fellow gets my training he should find it easy to pay me back.

Spare Time Work While Training Employment Help After Graduation

I help you to find spare time work to help pay your living expenses while training. Then after graduation you are given the help of my employment department to assist you in a job for which you have been trained for.

Electric Refrigeration—Air Conditioning

So that your training will be complete and to increase your earning capacity I will include for a short time my big new course in Electric Refrigeration and Air Conditioning.

Send Coupon for Details

Mail the coupon at once for my big, illustrated Free Book that tells all about Coyne training, the amazing opportunities in the electrical field, and complete details of my spare time employment service and my Pay After Graduation Plan.

COYNE ELECTRICAL SCHOOL

H. C. Lewis, Coyne Electrical School,
500 South Paulina St., Dept. 74-72, Chicago, Ill.

Dear Mr. Lewis:—Send me your big Free Book about Coyne training, and give me all details regarding your spare time employment service and Pay After Graduation Plan of Easy Monthly Payments.

Name

Address

City State

When writing please mention Popular Mechanics

Law!

LEARN AT HOME

Are you adult, alert, ambitious, willing to study? Investigate LAW! We guide you step by step—furnish all texts, including 14-volume Law Library. Training prepared by leading law professors and given by members of bar. Degree of LL. B. conferred. Low cost, easy terms. Send NOW for Free, 64-page "Law Training for Leadership."

LaSalle Extension University, Dept. 1064-L, Chicago

AVIATION PAYS!



Plenty of Jobs and Big Salaries for Well Trained Men

Prepare for this fast growing industry now! Get started right by training at famous Roosevelt Aviation School located on Roosevelt Field—world's busiest civilian airport. You learn more here because there's more to learn about. Finest training facilities for mechanical and Sport or Professional flight instruction. Courses offered include Regular Mechanic, Master Mechanic, Amateur, Private, Limited Commercial and Transport Pilot. Write for booklet (P.M.). State age and preference of course.

ROOSEVELT AVIATION SCHOOL

Roosevelt Field, Mineola, New York

AUTO REPAIRS MADE EASY

-by MAIL

Make money. New, practical course by Chas. H. Spath. Learn how to get into this money-making field.

Send for FREE BOOK

AUTOMOTIVE INSTITUTE
517N Castle Bldg., Kansas City, Mo.

CRIME DETECTION SECRET SERVICE AND FINGER PRINTS

SECRET SERVICE BOOK FREE

For 30 Days Reading
No Money Down—Actual Crime Cases—
If You Act Quick!—We will send you this stirring book on Crime Detection, Secret Service and Identification Work for 30 days free reading. Send no money. If you decide to keep it then send only \$1.00. If not, return it. WRITE TODAY. Not sent to boys under 17 years of age.

I. G. Cooke, Book Dept. 13-57 1920 Sunnyside Ave., Chicago

350 LITTLE BLUE BOOKS 5¢ EACH

Send post card for our free catalogue. Thousands of bargains. Address: LITTLE BLUE BOOK CO., Catalogue Dept., Desk 316, Girard, Kansas.

GOV'T. JOBS

SALARY TO START \$105 to \$175 MONTHLY MEN WOMEN
Age Range 18 to 50

() Ry. Mail Clerk
() P. O. Laborer
() R. F. D. Carrier
() Special Agent
() Customs Inspector
() City Mail Carrier
() P. O. Clerk
() Matron
() Immig't Inspector
() Typist

() POSTMASTER
() Seamstress
() Auditor
() Stenographer
() U.S. Border Patrol
() Telephone Opr.
() Watchman
() Skilled Laborer
() Statistical Clerk
() File Clerk

OZMENT INSTRUCTION BUREAU, Dept. 111, St. Louis, Mo.
Send me FREE particulars "How to Qualify for Government Positions" marked "X". Salaries, locations, opportunities, etc. ALL SENT FREE.

Name

Address

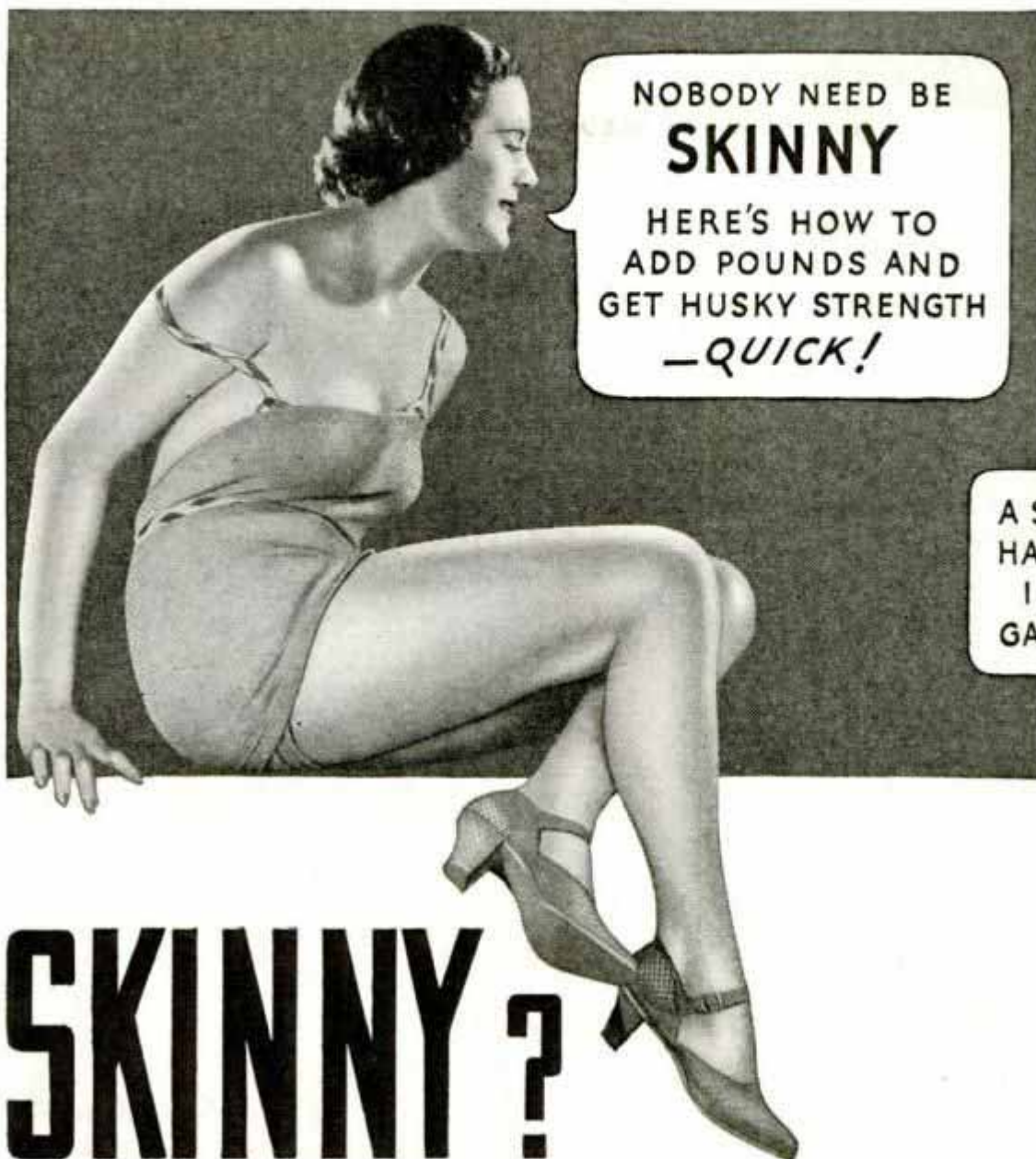

NOBODY NEED BE
SKINNY
HERE'S HOW TO
ADD POUNDS AND
GET HUSKY STRENGTH
—*QUICK!*

A SKINNY FELLOW
HASN'T A CHANCE
I WISH I COULD
GAIN SOME FLESH



SKINNY?

NEW DISCOVERY ADDS SOLID POUNDS

—*double quick!*

5 to 15 lbs. gained in a few weeks with new double tonic. Richest imported brewers' ale yeast concentrated 7 times and combined with iron.

NO NEED to be "skinny" when this new easy treatment is giving thousands solid flesh and new good looks—in just a few weeks!

Everybody knows doctors for years have prescribed yeast to build up health. But now with this new discovery you can get far greater tonic results than with ordinary yeast—regain health, and also put on pounds of husky flesh—and in a far shorter time!

Not only are thousands quickly gaining solid, good-looking pounds, but also clear skin, freedom from indigestion and constipation, new pep.

Concentrated 7 times

This amazing new product, Ironized Yeast, is made from special brewers' ale yeast imported from Eu-

rope, richest yeast known, which by a new process is concentrated 7 times—made 7 times more powerful.

But that is not all! This marvelous, health-building yeast is ironized with 3 kinds of iron.

Day after day, as you take Ironized Yeast, watch flat chest develop, skinny limbs round out attractively, new health come—you're a new person.

Results guaranteed

No matter how skinny and weak you may be, this marvelous new Ironized Yeast should build you up in a few short weeks as it has thousands. If you are not delighted with the results of the very first package, your money will be instantly refunded.

Special FREE offer

To start you building up your health *right away*, we make this absolutely FREE offer. Purchase a package of Ironized Yeast at once, cut out the seal on the box and mail it to us with a clipping of this paragraph. We will send you a fascinating new book on health, "New Facts About Your Body", by a well-known authority. Remember, results are guaranteed with the very first package—or money refunded. At all druggists. Ironized Yeast Co., Inc., Dept. 5310, Atlanta, Ga.

"I have a hunch..."

Gentlemen:

Under the Recovery Act I'm now working less time and I have decided to devote a regular portion of my spare time to making myself more valuable to the company. I have a hunch the man who gets ahead tomorrow will use his head today. I'm interested particularly in mechanical engineering and will appreciate it if you will send me your free information on this subject. I want to get started right away.

Very truly,

INTERNATIONAL CORRESPONDENCE SCHOOLS

"The Universal University" Box 5530-H, Scranton, Penna.

Without cost or obligation, please send me a copy of your booklet, "Who Wins and Why," and full particulars about the subject before which I have marked X:

TECHNICAL AND INDUSTRIAL COURSES

- | | |
|--|--|
| <input type="checkbox"/> Architect | <input type="checkbox"/> Automobile Mechanic |
| <input type="checkbox"/> Architectural Draftsman | <input type="checkbox"/> Plumbing <input type="checkbox"/> Heating |
| <input type="checkbox"/> Building Estimating | <input type="checkbox"/> Air Conditioning |
| <input type="checkbox"/> Wood Millworking | <input type="checkbox"/> Sheet Metal Worker |
| <input type="checkbox"/> Contractor and Builder | <input type="checkbox"/> Steam Engineer |
| <input type="checkbox"/> Structural Draftsman | <input type="checkbox"/> Steam Electric Engineer |
| <input type="checkbox"/> Structural Engineer | <input type="checkbox"/> Civil Engineer |
| <input type="checkbox"/> Electrical Engineer | <input type="checkbox"/> Surveying and Mapping |
| <input type="checkbox"/> Electric Lighting | <input type="checkbox"/> Refrigeration |
| <input type="checkbox"/> Welding, Electric and Gas | <input type="checkbox"/> R. R. Locomotives <input type="checkbox"/> Air Brakes |
| <input type="checkbox"/> Reading Shop Blueprints | <input type="checkbox"/> R. R. Section Foreman |
| <input type="checkbox"/> Telegraph Engineer | <input type="checkbox"/> R. R. Bridge and Building Foreman |
| <input type="checkbox"/> Telephone Work | <input type="checkbox"/> R. R. Signalman |
| <input type="checkbox"/> Mechanical Engineer | <input type="checkbox"/> Highway Engineering |
| <input type="checkbox"/> Mechanical Draftsman | <input type="checkbox"/> Chemistry <input type="checkbox"/> Pharmacy |
| <input type="checkbox"/> Machinist <input type="checkbox"/> Toolmaker | <input type="checkbox"/> Coal Mining Engineer |
| <input type="checkbox"/> Inventing and Patenting | <input type="checkbox"/> Navigation <input type="checkbox"/> Boilermaker |
| <input type="checkbox"/> Patternmaker | <input type="checkbox"/> Textile Overseer or Supt. |
| <input type="checkbox"/> Heat Treatment of Metals | <input type="checkbox"/> Cotton Manufacturing |
| <input type="checkbox"/> Bridge Engineer | <input type="checkbox"/> Woolen Manufacturing |
| <input type="checkbox"/> Bridge and Building Foreman | <input type="checkbox"/> Agriculture <input type="checkbox"/> Fruit Growing |
| <input type="checkbox"/> Gas Engines <input type="checkbox"/> Diesel Engines | <input type="checkbox"/> Poultry Farming <input type="checkbox"/> Radio |
| <input type="checkbox"/> Aviation Engines | <input type="checkbox"/> Marine Engineer |

BUSINESS TRAINING COURSES

- | | | |
|--|--|--------------------------------|
| <input type="checkbox"/> Business Management | <input type="checkbox"/> Business Correspondence | <input type="checkbox"/> Signs |
| <input type="checkbox"/> Office Management | <input type="checkbox"/> Lettering Show Cards | |
| <input type="checkbox"/> Industrial Management | <input type="checkbox"/> Stenography and Typing | |
| <input type="checkbox"/> Traffic Management | <input type="checkbox"/> Civil Service | |
| <input type="checkbox"/> Accountancy and C.P.A. Coaching | <input type="checkbox"/> Mail Carrier | |
| <input type="checkbox"/> Bookkeeping | <input type="checkbox"/> Railway Mail Clerk | |
| <input type="checkbox"/> Secretarial Work | <input type="checkbox"/> Grade School Subjects | |
| <input type="checkbox"/> Cost Accountant | <input type="checkbox"/> High School Subjects | |
| <input type="checkbox"/> Salesmanship <input type="checkbox"/> Advertising | <input type="checkbox"/> College Preparatory | |
| <input type="checkbox"/> Service Station Salesmanship | <input type="checkbox"/> First Year College | |
| <input type="checkbox"/> Wallpaper Decorating | <input type="checkbox"/> Illustrating <input type="checkbox"/> Spanish | |
| <input type="checkbox"/> Salesmanship | <input type="checkbox"/> Cartooning <input type="checkbox"/> French | |
| | <input type="checkbox"/> Lumber Dealer | |

Name.....Age.....

Address.....

City.....State.....

Occupation.....

If you reside in Canada, send this coupon to the International Correspondence Schools Canadian, Limited, Montreal, Canada

When writing please mention Popular Mechanics

My Men Make Up to \$55 a Week with their Cameras



Big Profits in this Huge, Fascinating NEW Field

My students have learned how to take the kinds of Photos that bring real CASH. 34,487 magazines, newspapers, etc., buy 7 million photos a year—pay good money for them. YOU, too, can turn a hobby into a profitable spare or full-time business.

One of my students, L. Eldridge, St. Paul, Minn., got \$50 for his very first work. York McClary, Belvidere Ill., got 3 checks in one week! Olive Hastings, Dorchester, Mass., made over \$237.50 before she even completed my instruction. Write for my FREE BOOK. No obligation—and no salesman will call. S. F. Falk, President. UNIVERSAL PHOTOGRAPHERS, INC., Dept. 710, 10 West 33 St., New York City



FREE BOOK

"How to Make Money with Your Camera" tells of a money making opportunity. Write for it!

BE AN ARTIST

WE CAN TEACH YOU DRAWING in your own home during your spare time. Thirty-five years of successful teaching proves our ability. Artists receive large salaries.

Write today for Art Year Book **SCHOOL OF APPLIED ART**

Dept. 174, 10 E. Huron St., Chicago, Ill.



SONGS WANTED FOR RADIO BROADCAST
NEW WRITERS INVITED

Cash Payments Advanced. Writers of Songs Used and publication secured. Send us any likely material (Words or Music) for consideration today. Radio Music Guild, 1650 Broadway, New York.

LEARN in Los Angeles

AUTOS-DIESELS

You can qualify for these **GOOD JOBS**

Auto Electrician
Auto Mechanic
Battery Expert
Carburetor Expert
Diesel Diesel Mechanic
Fuel Injection Expert
Diesel Service Man
Machinist

High speed Diesels being rapidly developed for service in trucks, boats, airplanes, streamline trains, power shovels, etc. Trained men needed. Opportunities increasing for good jobs. The trained man must be master of all branches of auto repairing preparatory to entering the Diesel field.

Good Jobs for Trained Men

National Automotive School trains you in both trades—auto and high speed Diesels. Practical shop methods. Expert instructors. A million dollar school to train you by proven methods. Established 29 years.

Spend Winter in California

Learn auto and Diesel trades under ideal conditions in Los Angeles. Student body arranges delightful pleasure trips while you are training.

Railroad Fare Allowed

No matter how far you reside from Los Angeles, cost of enrollment is as low as if you lived in Calif. For a limited time National will continue to allow coach railroad fare from any part of United States to Los Angeles. This cost continued despite the fact that the new and enlarged high speed Diesel Engine course is offered including complete auto training at no extra cost.

Earn Room and Board while Learning

Majority of our students earn room and board while taking course. We assist students to obtain part time jobs. Men of all ages can enroll. You can take as long as desired to complete the course.

Free Employment Help

We assist students to make contacts for good pay jobs in automotive and Diesel fields.

Send Coupon for Free Auto Diesel Book

Gives full details about National courses. Explains what you will learn, how you will learn, and method for obtaining good pay job. Send coupon immediately.

NATIONAL AUTOMOTIVE SCHOOL Los Angeles

Dept. PMA-10, 4006 South Figueroa St., Send Free Auto Book and Special offer.

Name.....

Address.....

City.....State.....

Just as EASY as it looks

to become a popular musician this delightful, simple as A-B-C way

STOP cheating yourself out of musical good times. Stop thinking that learning music is nothing but one grinding session of monotonous exercises after another . . . days, months and years of difficult technique under the thumb of a private teacher.

Take a look at the above diagram. Looks easy, doesn't it? Well, it's every bit as simple as it looks. First a note, then a letter. Plenty of clear instructions tell you how each bar is played—lots of diagram pictures show you how, then you do it yourself and hear it. Everything to make learning a joy. In fact, the U. S. School of Music has made the reading and playing of music so simple that you don't have to know one note from another to begin.

Your first thrill comes with your very first lesson. For you are given a piece with a real melody to play by actual notes. Dreamy waltzes, stirring marches, sparkling sonatas follow in short order. No standing still. You become a capable performer months sooner than you could ever expect to by the old-fashioned way. Besides, you receive all the music you need at no extra cost.



found it as easy as A-B-C. Read the list of instruments in the panel, decide which one you want to play and the U. S. School will do the rest. No matter which instrument you choose, the cost in each case will average the same—just a few cents a day.

Our fascinating, illustrated Free Book and our Free Demonstration Lesson explain all about the remarkable method. Clip and mail this coupon today, and they will be sent to you at once. No obligation. U. S. School of Music, 710 Brunswick Bldg., New York City.



Play the "Blues" Away

How can you be content to sit around at party after party and listen to others do all the playing—see them showered with admiration, invitations—when your life-long ambition is now so easy to realize? Experience the personal satisfaction that comes from being able to play "when," "where," and "what" you like for your own amusement and the entertainment of others. Don't be afraid to begin your lessons at once. Over 700,000 people learned to play this modern way—and

Learn To Play By Note

Mandolin	Saxophone
Piano	'Cello
Organ	Ukulele
Violin	Cornet
Banjo	Trombone
Or Any Other Instrument	

U. S. SCHOOL OF MUSIC, 710 Brunswick Bldg., New York City

Send me your free book, "How You Can Master Music in Your Own Home," with inspiring message by Dr. Frank Crane; also Free Demonstration Lessons. This does not put me under any obligation.

Name.....
 Address.....
 Instrument..... Have you this inst.?

Learn Public Speaking

At home—in spare time—20 minutes a day. Overcome "stage-fright" gain self-confidence. Increase your salary, through ability to sway others by effective speech. Write now for free booklet, *How to Work Wonders With Words*.

NORTH AMERICAN INSTITUTE, Dept. 1357
 3601 Michigan Avenue, Chicago, Illinois

FREE

Add a New Word to Your Vocabulary Every Day!

This new device increases your vocabulary, strengthens your ability to use words more effectively, persuasively!

Each day the Winston "WORD-A-DAY" selects and presents one forceful, useful word so ingeniously (with definition, pronunciation, etc.) that it automatically becomes—during that same day—an unforgettable part of your vocabulary!

Write for your FREE copy! With it will come interesting facts about The Winston Simplified Dictionary. Address

THE JOHN C. WINSTON CO., 4010 Winston Bldg., Phila., Pa.

VOICE

100% Improvement Guaranteed

We build, strengthen the vocal organs—*not with singing lessons*—but by fundamentally sound and scientifically correct *silent exercises* . . . and absolutely guarantee to improve any singing or speaking voice at least 100% . . . Write for wonderful voice book—sent free. Learn WHY you can now have the voice you want. No literature sent to anyone under 17 years unless signed by parent.

PERFECT VOICE INSTITUTE, Studio 13-57
 308 No. Michigan Ave., Chicago

WANT A STEADY JOB?

RAILWAY POSTAL CLERKS

MAIL CARRIERS — POSTOFFICE CLERKS
 OFFICE CLERKS — CUSTOMS INSPECTORS

\$1700 to \$3000 a Year for Life

Sure pay—rapid advancement. Many other U. S. Government Jobs. Many Fall examinations expected.

STEADY WORK

MEN—BOYS

18 to 45

Use Coupon Before You Lose It

COUPON

FRANKLIN INSTITUTE, Dept. H174, Rochester, N. Y. Rush to me, free of charge, (1) A full description of the position checked below; (2) 32-page book, with list of positions; (3) Tell me how to get the position checked.

Railway Postal Clerk (\$1900 to \$2700) General Clerk (\$1260 to \$2500)
 Postoffice Clerk (\$1700 to \$2300) Customs Inspector (\$2100 to \$3300)
 City Mail Carrier (\$1700 to \$2100) Rural Mail Carrier (\$2100 to \$3000)

Name.....
 Address.....

NOW FIX ANY MAKE OF

AUTO

SIX BIG AUTO BOOKS ALL SHIPPED FREE

on approval; whether you want to qualify as garage owner, auto repair expert or merely wish to know how to keep your own car 100% efficient, look at these books—they are sent to you for free examination. This brand new edition has been prepared by a large group of America's greatest automotive engineers. Anybody who can read will understand them, for this great automobile encyclopedia is a veritable gold mine of valuable facts. Take advantage of this offer now; send in the Coupon for FREE examination. You don't pay us a penny, you don't obligate yourself to pay anything unless you decide to keep the books. Just tell us you want to see them and the full set of 6 great volumes, just off the press, will be sent to you! Read them, look them over and prove to your own satisfaction that one fact alone, which you will find in them, may save you an expensive repair, or help you to a better job.



Aviation Motors
Knee Action Wheels
Rear Engine Cars
Outboard Motors
Octane Selectors
Tractors
All Fully Covered

Imagine books which are so new that every page is right up to date—wiring diagrams, construction details, service problems—are all right up to the minute. Nowhere else can you get as complete and up-to-date information. Over a million dollars of resources have enabled us to give you the most authoritative books on the subject ever published. Everybody interested in automobiles in any way will welcome these books published by the world's largest publishers of Technical Cyclopedias (est. 1897) with agencies all over the world.

Very Latest Edition

Imagine books which are so new that every page is right up to date—wiring diagrams, construction details, service problems—are all right up to the minute. Nowhere else can you get as complete and up-to-date information. Over a million dollars of resources have enabled us to give you the most authoritative books on the subject ever published. Everybody interested in automobiles in any way will welcome these books published by the world's largest publishers of Technical Cyclopedias (est. 1897) with agencies all over the world.



Can You Fix It?

Can you take out "play" in differential? Can you kill the "shimmy" in steering? Can you reset TIMING? Can you put your finger on engine trouble without guessing or tinkering? Can you pull the starter off and fix it? Can you adjust and repair transmission, engine, rear axle, bearings?

These Books Tell How and tell you how to do any and every auto job right, the first time.

6 Big Volumes

Nearly 3,000 pages, over 2,000 illustrations, wiring diagrams, equipment charts, etc. De Luxe edition with gold-stamped flexible binding. Sent FREE for 10 days' use. If not wanted return express collect. If kept, send only \$2.00 after 10 days, then \$3.00 a month until special advertising price, \$24.80, is paid.

A Year's Consulting Membership FREE!

Privilege of consulting engineers of million-dollar American Technical Society on any automotive problem for one year without charge. If you mail coupon immediately we will include, free, extra volume 7 with complete information on 1934 cars, knee action wheels, etc.

SEND NO MONEY

American Technical Society, Dept. A-719
Drexel Ave. at 58th St., Chicago, Illinois.

I would like to see the brand new 6-volume edition of your automobile books but without any obligation to buy. I will pay the few cents delivery charges only and will examine the books and return them at your expense in 10 days unless I like them, in which case I will send you \$2.00 then and only \$3.00 per month until the special price of only \$24.80 is paid. You are to include free, consulting membership certificate in the American Technical Society. Send latest edition and also include volume 7 Free.

Name.....

Street.....

City..... State.....

Employer's Name.....

Employer's Address.....

Please give us, in addition, the name and address of one business man as reference.

When writing please mention Popular Mechanics

YES

NEW YORK ELECTRICAL SCHOOL

Opportunities for Men of All Ages!

Every phase of all branches of Practical Electricity taught by Actual Practice in America's Foremost Institution of Trade Training.

Special Course in Automotive Technique

Day and Evening Sessions Open All Year.

Write for FREE Booklets.

Visitors Welcome.

New York Electrical School
44 W. 17th St., New York City

MAKE MONEY

AT HOME!

Learn easy Koehne Method of coloring photos and miniatures in oil. New! No art talent needed. Big demand. Send for free booklet, *Make Money At Home*.

NATIONAL ART SCHOOL
3601 Michigan Ave., Dept. 1357, Chicago

FREE Book

on Prostate Trouble

If you have prostate disorder—bladder trouble—get up frequently at night, there should be positive and rapid relief for you—without drugs or massage—without pain or discomfort—privately at home. Our free book tells all. Doctors, Osteopaths, Physical Culture directors, Sanitarium experts use and endorse our method. Easily used. Very simple. No matter what you have tried or how old your case our methods will bring results or money back. Write for free illustrated booklet. Do it now. Relief is at hand.

THE ELECTRO THERMAL COMPANY
2182 Morris Ave., Steubenville, Ohio

don't WORRY

Why put up with years of needless discomfort and worry? Try a Brooks Automatic Air Cushion. This marvelous appliance permits the opening to close, yet holds rupture securely, comfortably—day and night.



Thousands report amazing results. Light, neat-fitting. No hard pads, metal girdle or parts to chafe or gouge. Patented in U. S. and 13 foreign countries. Try one 10 DAYS WITHOUT A PENNY'S RISK. You'll be delighted. Free book on Rupture and convincing facts mailed postpaid in plain sealed envelope. Address
BROOKS COMPANY, 111 State St., Marshall, Mich.



Amazing! Sensational!

REFINISHES AUTOS Like NEW!

No Polishing. Waxing. Rubbing or Painting

KAR-NU Pays You UP TO \$30 IN A DAY

JUST WIPE IT ON WITH A CLOTH LASTS 8 TO 12 MONTHS GUARANTEED

2,028 Other Uses

Besides refinishing automobiles, KAR-NU has hundreds of other uses in the home, office, factory, store and shop. It refinishes typewriters, adding machines, cash registers, scales, desks, chairs, file cabinets, furniture, book cases, safes, etc. — in fact, anything made of metal or wood on which the original finish has become dull or discolored.

A new miracle discovery! A transparent magic-like fluid with which anyone can refinish any color automobile easy, quickly and economically without polishing, waxing, rubbing or painting. **JUST WIPE IT ON WITH A CLOTH!** Immediately dullness, discoloration, shabbiness and sun fade **DISAPPEAR, INSTANTLY**, as if by magic, the old paint is covered with a tough elastic coat which is absolutely transparent, self-leveling and self-polishing. KAR-NU actually fills the pores and rebuilds the old finish. Paint or Duco is rejuvenated, restoring the lustre, life, glow and beauty of the original factory finish. As KAR-NU dries it seals the pigment and protects the finish from further wear. Lasts eight to twelve months. **GUARANTEED.**

SALES GALORE! BIG PROFITS!

Enormous demand! Millions want it! W. L. Morgan of Mass. earned \$10.61 in a single hour. Sell to individuals, fleet owners, garages, auto accessory stores, used car dealers, etc. No experience necessary. Send no money for sample and details. Get in on ground floor. Just mail coupon—NOW.

THE KAR-NU COMPANY

Dept. B-30, Oakley Station, Cincinnati, Ohio

MAIL COUPON TODAY!

NOT A WAX, POLISH OR PAINT

KAR-NU is entirely new and different—nothing in the world just like it. Now, no need to spend long, tedious, back-straining, muscle-tiring hours polishing, waxing and rubbing to produce a "mere shine" that is only fairly satisfactory—that lasts for only a short time, and that leaves the car looking worse than before when it wears off. KAR-NU is free from the labor and danger of so-called "cleaners" with acids and abrasives that remove some of the finish each time they are used. KAR-NU produces a result that is equal in beauty to a repaint or refinishing job which costs \$25.00 to \$75.00.



This Seal of Approval awarded by the Testing Laboratories of the Automobile Club of Illinois shows that KAR-NU is a product of merit and does all we claim for it.

FREE SAMPLE COUPON

KAR-NU CO., Dept. B-30, Oakley Station, Cincinnati, Ohio. Rush FREE SAMPLE to prove your claims about KAR-NU and Territory Offer.

Name.....
Address.....
Town..... State.....

CARTOON YOUR WAY TO SUCCESS!

DON'T COPY — LEARN TO ORIGINATE!

RAYE BURNS will teach you HOW to CREATE ORIGINAL CARTOONS at home that you can SELL! Course contains 26 lessons and over 600 illustrations. All for Only... **\$2.85**

Send name and address for free details. RAYE BURNS SCHOOL, Dept. M-X, BOX 2194, Cleveland, Ohio

RADIO ENGINEERING, broadcasting, aviation and police radio, servicing, marine and Morse telegraphy taught thoroughly. Nine months' engineering course equivalent to three years' college radio work. School established 1874. All expenses low. Catalog free. **Dodge's Institute, Ada St., Valparaiso, Ind.**

New Way to Improve YOUR ENGLISH

A command of effective English gives you added advantages and better opportunities. Poor English handicaps you more than you will ever realize. You can improve your English through Sherwin Cody's 100% self-correcting invention.

If you are ever embarrassed by mistakes in grammar, spelling, punctuation, or pronunciation, this new free book "How You Can Master Good English in 15 Minutes a Day" will prove a revelation to you. Send for it now. It is free. Address

SHERWIN CODY SCHOOL OF ENGLISH
510 Searle Building Rochester, N. Y.

INDIANA TECH DEGREE IN TWO YEARS

B. S. Degree in Electrical, Civil, Chemical, Radio, Mechanical or Aeronautical Engineering in two years. Located in Electrical Hub of West. Earn Board. Low tuition. Enter Sept., Dec., Mar. Catalog. **INDIANA TECHNICAL COLLEGE, 229 E. Washington St., Fort Wayne, Indiana**

Earn Money at Home

BIG FREE book in colors tells new easy way. You don't need experience. We show you how to decorate beautiful Art Novelties right in your own home by simple "3-step" method. No tedious study. Everything furnished including supply of Novelties for you to decorate and Homecrafters Outfit. Big profit per piece for decorating. Just sit at home and make up to \$25 to \$50 a week—full time or spare time.

First Lesson Now Free! Just mail coupon and get first lesson absolutely free. Start right in decorating Gifts, Bridge Prizes, Toys, etc. More like fun than work and you can earn as you learn. Hundreds making big money this fascinating way.

NO CANVASSING You risk nothing in sending for Free Lesson. Nothing to pay now or ever. So sure are you to succeed we give an absolute Warranty backed by \$1,000 Gold Bond. Costs nothing to find out. Opening for new workers now in every locality. Mail coupon immediately for Free Book and Free Lesson. Get started making money at once.

When writing to advertisers please mention Popular Mechanics



GIVEN YOU TO DECORATE



MAIL THIS

FIRESIDE INDUSTRIES, Dept. 66-P, Adrian, Mich. Please send big Free Book and FREE LESSON. This does not obligate me in any way.
Name.....
Address.....



\$1,000 Reward For the Capture of This Man

CONVICT 6138, escaped from the State Penitentiary; Name, Charles Condray; age 37; Height, 5 feet 8 inches; Weight, 141 pounds; Hair, light brown; Eyes, gray.

Easy enough to identify him from his photograph and this description, you may say — but, Condray took the name of "Brown," dyed his hair, darkened his skin, grew a mustache, put on weight and walked with a stoop.

Yet he was captured and identified so positively that he knew the game was up and returned to the penitentiary without extradition. How was it accomplished? Easy enough for the Finger Print Expert. They are the specialists, the leaders, the cream of detectives. Every day's paper tells their wonderful exploits in solving mysterious crimes and convicting dangerous criminals.

More Trained Men Needed

The demand for trained men by governments, states, cities, detective agencies, corporations, and private bureaus is becoming greater every day. Here is a real opportunity for YOU. Can you imagine a more fascinating line of work than this? Often life and death depend on finger print evidence—and big rewards go to the expert. Many experts earn regularly \$3,000 and more per year.

Learn At Home in Spare Time

And now you can learn the secrets of this science at home in your spare time. Any man with common school education and average ability can become a Finger Print operator in surprisingly short time.

FREE The Confidential Reports No. 38 Made to His Chief!

IF YOU ACT QUICK—We will send you free and with no obligation whatsoever, a copy of the gripping, fascinating, confidential report Secret Service Operator No. 38 made to His Chief. Mail coupon NOW!

Write quickly for fully illustrated free book on Finger Prints which explains this wonderful training in detail. Don't wait. Mail the coupon now. You may never see this announcement again! You assume no obligation. You have everything to gain and nothing to lose. Write at once. Address

Institute of Applied Science
Dept. 13-57 1920 Sunnyside Av., Chicago

INSTITUTE OF APPLIED SCIENCE,
Dept. 13-57 1920 Sunnyside Av., Chicago

Gentlemen: Without any obligation whatever, send me your new, fully illustrated, FREE book on Finger Prints and the free copy of the Confidential Reports Operator No. 38 made to His Chief. Literature will NOT be sent to boys under 17 years of age.

Name

Address

Age

When writing please mention Popular Mechanics

for Success in AVIATION

You Need
LINCOLN
Training

If you would like a fascinating career either as pilot or master mechanic, come to this world famous Lincoln School. Training planes and instructors are Government Approved. **Primary and advanced flying taught;** includes night flying, blind flying, acrobatics, cross country flying, etc. Master Airplane and Engine Mechanics Course prepares you for mechanic's position.

\$500 a Month—That's the kind of pay airline pilots earn. Airplane and Engine Mechanics also earn good pay. You need Lincoln's unexcelled training for these better aviation jobs. Government spending millions promoting aviation means thousands of new jobs. **Let Lincoln train you for sure success.** Government Approved School. 14 years teaching aviation. 24 years successful mechanics trade school. **Write.** State age. **LINCOLN AIRPLANE & FLYING SCHOOL**
207-D Aircraft Bldg. Lincoln, Nebraska

HIGH SCHOOL COURSE Biggest Bargain Ever Offered!

20 VOLUMES Teach yourself in spare time with the New Era High School Course.
20 SUBJECTS Lowest price in history. Authentic, accurate, up-to-date—prepared by experienced instructors. Complete in 20 volumes, only \$1.20 post-paid. No other payments. Self-teaching Study Outline and Reading Guide included FREE. Money back if not satisfied. Grab this chance—order the New Era High School Course today.

NEW ERA LIBRARY, Dept. 43, RACINE, WIS.

20
COMPLETE
COURSE
20 BOOKS
ONLY...

No JOKE TO BE DEAF

—Every deaf person knows that—
Mr. Way made himself hear his watch tick after being deaf for twenty-five years, with his Artificial Ear Drums. He wore them day and night. They stopped his head noises. They are invisible and comfortable, no wires or batteries. Write for TRUE STORY. Also booklet on Deafness.



Artificial Ear Drum
THE WAY COMPANY
729 Hofmann Bldg. Detroit, Michigan

Become a Radio Expert

GOOD JOBS



Learn RADIO-TELEVISION ELECTRICITY-TALKING PICTURES

Times are getting better. Trained men are getting jobs. National will quickly train you to qualify in all branches of radio, television, talking pictures, broadcasting, operating and general electricity. Thorough, practical training. Over \$100,000 in modern equipment. National graduates in demand. Regardless of age or education you can learn profitable trades in a few months.

QUALIFY AS A

Radio Repair Man
Television Expert
Control Operator
Station Technician
Sound Expert
Ship Operator
Broadcaster
Electrician
and many other jobs

EARN ROOM AND BOARD WHILE LEARNING

75% of our students earn living expenses while receiving training. We help you get a job. For limited time will allow your coach railroad fare to Los Angeles.

TRAIN IN LOS ANGELES

This is the Ideal City. Center of Greatest Activity in Radio, Talking Picture and Electricity. 30,000 successful graduates. School established 29 years. Send for free descriptive book and enrollment details.

NATIONAL RADIO & ELECTRICAL SCHOOL - Los Angeles

Dept. PMR-10, 4006 Figueroa St.
Send Book and full details of Courses.

NAME

ADDRESS

CITY

STATE



World's **LOWEST PRICED**

Automatic Oil Burner

SAVES 25% in Fuel Costs

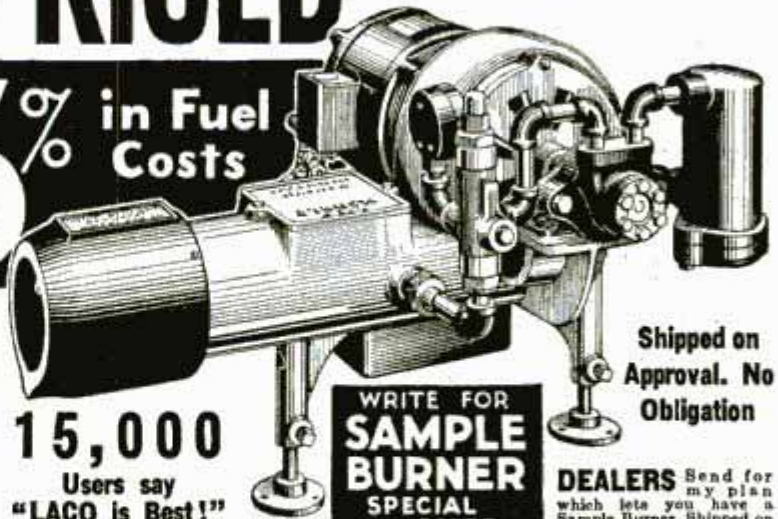

"Beats High Priced Burners," say thousands!

Why slave another winter with coal and ashes? . . . why risk ill-health with uneven heat? . . . when you can now own this sensational new LACO—Ford of oilburners—at the **WORLD'S LOWEST PRICE!** \$50 to \$60 less than any other!

Built and guaranteed by the largest exclusive oil burner Mfr. Fully approved by the Underwriter's Lab. Full size—full capacity—gives abundant heat. Highly improved in design. None more durable. Requires less servicing.

COSTS LESS for FUEL! Burns "heavy" oil which not only costs less, but delivers more heat. New way of burning oil—*Quiet-ised Flame*—uses 96% AIR, only 4% OIL. Every particle of heat is extracted from every drop of oil. Patented "High Pressure Carburetor" mixes oil and air thoroughly . . . creates a slow spiral floating flame in perfect suspension. More efficient and quiet than flame which shoots through furnace with a roar, wasting fuel up the chimney!

MANY NEW FEATURES! Fully automatic. Complete with thermostat and stack switch. Operates without attention. Maintains uniform warmth. Safest known. New-type packing-less pump—radio-proof coil—indestructible all-brass tubing—new steel long-life electrodes. Only 1 moving part. Easy to install in any heating plant.



One of world's most popular burners—**OVER 15,000 NOW IN USE!**

15,000
Users say
"LACO is Best!"

"I have had one of your Lacos 5 yrs. My father has had one 4 yrs. They work fine. No service calls in the last 2 years."
S. W. HOYT, (Conn.)
"My Laco in an 8-room house used only \$64 worth of oil last winter, the worst here in 25 years."
R. R. McCONCHIE (Wash. D.C.)
"After 11 yrs. experience with oil equipment, I find LACOS better than any other."
C. QUACKENBUSH (M4.)

LACO OIL BURNER CO.
1104 Union St.
GRISWOLD, IOWA

World's Largest Exclusive Builders of Oil Burners

WRITE FOR SAMPLE BURNER SPECIAL OFFER

Shipped on Approval. No Obligation

DEALERS Send for my plan which lets you have a Sample Burner, Shipped on Approval. Subject to Examination. Without Obligation.

Add to your regular line. Low price and special features make LACO a wonderful seller.

HOME OWNERS: Have your local LACO dealer quote you the very low price. If there is no LACO dealer near you, mail the coupon. **SEND NOW!** Get Low Price, full details **AT ONCE!**

LACO OIL BURNER CO.,
1104 Union St., Griswold, Iowa.

Please mail price, booklets and details of the Shipped-on-Approval Plan.

NAME.....
TOWN.....
STATE.....

BECOME AN EXPERT ACCOUNTANT

Executive Accountants and C. P. A.'s earn \$3,000 to \$15,000 a year. Thousands of firms need them. Only 12,000 Certified Public Accountants in the U. S. We train you thoroughly at home in spare time for C. P. A. examinations or executive accounting positions. Previous experience unnecessary. Personal training under supervision of staff of C. P. A.'s, including members of the American Institute of Accountants. Write for free book, "Accountancy, the Profession that Pays."
LaSalle Extension University, Dept. 1064-H, Chicago
The School That Has Trained Over 1,200 C. P. A.'s

\$2.30 Investment Brings \$16.00 Cash

\$61.60 daily profits making potato chips the Vita-Seald Way. \$16.00 worth (\$13.70 profit). Turned out in only an hour. Novel plan makes stores, grocers, restaurants, etc., your regular customers. Equipment requires only 52 x 20 inches. Write for easy term offer.
Vita-Seald Potato Chip Co., Dept. 510, 500 N. Dearborn, Chicago

LEARN WATCHMAKING

and become independent. We help you secure a position. Easy to learn. Send for **FREE CATALOG.**
ST. LOUIS WATCHMAKING SCHOOL DEPT. 5 ST. LOUIS, MO.

FREE How To Secure A Government Position

Tells About These and Other Positions
RAILWAY POSTAL CLERK \$1850 to \$2700 a year
POSTMASTER \$1200 to \$2500 a year
POST OFFICE CLERK \$1700 to \$2100 a year
R. F. D. MAIL CARRIER \$1800 to \$2300 a year

FREE BOOK tells how I can help you get a Government Job. For 8 years I was Civil Service Examiner—have helped thousands. If citizen 18 to 50, you may qualify. Get ready NOW for a Government position. Send for free book. Write or mail coupon TODAY.

A. R. PATTERSON, Civil Service Expert, 810 Wisner Bldg., Rochester, N. Y. Please send me your free book "How to Secure a Government Position."
Name.....
Address.....

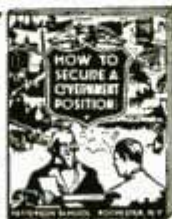

DRAFTING

BOOKS SENT FREE! **NRA**
ON APPROVAL
5 VOLUMES BRAND NEW EDITION

Only 15 minutes a day with these **WONDER BOOKS** will prepare you for a good drafting job in less than a year. Mechanical and architectural drafting from simple straight lines to important complex plans. *A step at a time!* Built especially for beginners, for men with only grammar schooling. Drafting room practice, **PLUS ENGINEERING**, made easy and clear. **Includes complete course in blue-print reading.**

Big Field Big Demand Big Pay
Competent draftsmen are urgently needed right now in all building and manufacturing lines at \$30.00 to \$75.00 a week. That's just the beginning—**FOR DRAFTSMEN HAVE THE BEST CHANCES FOR ADVANCEMENT.** Pleasant, fascinating work, easy to learn and do. Learn quickly with these books—send coupon for a set **FREE** and see for yourself.

A year's consulting membership in the American Technical Society now given free to all readers of this famous cyclopedia of drafting. Many say that it is worth more than the cost of the books.

Complete set of drawing instruments if you send for these drafting books **NOW.** These instruments are made of the finest of German silver, are absolutely accurate and are packed in velvet lined leatherette pocket case. Real \$10 value, but free to you with these books.
AMERICAN TECHNICAL SOCIETY
Dept. D-719, Drexel at 58th St., Chicago, Ill.

American Technical Society, Dept. D-719, Drexel at 58th St., Chicago, Ill.
Send for 10 days' free use New 5 volume set of drafting. I will pay the few cents delivery charge. If I wish, I may return books in 10 days and owe you nothing but if I decide to keep them, I will send \$2.00 after 10 days, then only \$3.00 a month until \$24.50, the special introductory price, is paid. Send latest edition and include drawing instruments.

Name.....
Address.....
Attach letter stating age, occupation, employer's name and address and that of at least one business man as a reference.

When writing please mention Popular Mechanics



Classified Advertisements

WORLD'S BEST WANT AD MEDIUM

Advertisements in this section, 35 cents per word, each insertion, minimum 10 words, payable in advance
To be inserted under proper classification in November issue, copy should be in our office September 17th

ADVERTISING AGENCIES

POWERFUL Classified and display ads placed. Forceful, convincing sales letters, broadsides, circulars, follow-ups prepared free. Carl O. Johnson, 203 South Dearborn, Chicago.

ADVERTISE Profitably: \$15 reaches 6,000,000 Sunday newspaper readers with 24 word ad. Newspaper, magazine rate-guide, free. Chicago Union Agency, 20 West Jackson, Chicago.

ADVERTISE In country weeklies. Lists free. Meyer Agency, 4112 Hartford St., St. Louis, Mo.

LEARN Advertising quickly at home. New easy practical plan. No text books. Interesting booklet free. Page-Davis School of Advertising, 3601 Michigan, Dept. 343-C, Chicago.

FREE—New Advertisers Rate Guide, 44 pages. Includes everything. Lowest rates. E. H. Brown Advertising Agency, 140 S. Dearborn, Chicago.

FOR ADVERTISERS

24 WDS. Monthly-weekly combination \$4.98. Magazine free. Darnell, Jackson, Tennessee.

30 WORDS Printed 10,000 advertising circulars and mailed to prospects \$1.00. Lee Agency, Sheridan, Ark.

ADVERTISE. 24 Words in 45 weeklies \$2.40. Goodall Adv. Co., Box 1592, San Francisco.

BLANK Gummed "Multicopy" addressing labels, \$1.00 thousand, postpaid. Mailmarts, Cincinnati.

ADVERTISE: 24 Words in 250 newspapers \$10. Lists free. Advertising Service Bureau, 4650 Drexel, Chicago.

BUSINESS SERVICE

ENGINEER Will attend your Detroit business, purchase, promote. Confidential, \$1.00. Larrow, 4368-W, Warren, Detroit.

INFORMATION

WHOLESALE Supply sources, half million items! Rush 10c. International Agency, Cincinnati.

DELAWARE Charters; fees small; free forms. Chas. G. Guyer, 901 Market St., Wilmington, Del.

INFORMATION About Florida, dime. Nothing to sell. Write now. Al Watson, Belle Glade, Fla.

WHERE To buy anything—Manufacturers, wholesalers. 25c coin. King, 3223 Sixth St., Harrisburg, Penna.

WHAT Shall I be? Information service. Fred Klotz, Reading, Pa.

AUTOMOBILES

SPEED In Auto Racing. Brand new book gives all speed records; drawings, pictures, full description of record cars. Tells how you can build 125-135 m.p.h. stock car and speedway racers. Midgets, conversions, fully described. \$1.00 postpaid; \$1.12 C.O.D. Ray F. Kuns, Dept. B-2, Madisonville, Cincinnati, Ohio.

MONOGRAM Your automobile and personal belongings with distinctive Old-English gold initials. Six sets of initials, transfer liquid and directions, \$1.00. Application simple; wonderful results. DuSac, 2519 62nd Avenue, Cicero, Ill.

AUTOMOBILES—Trucks—Tractors can be equipped to burn low priced stove oil or number one or two fuel oil instead of high priced gasoline. Fuel cost reduced more than 50% in most localities. Complete instructions \$2.00. C. P. Peyton, 919 Market St., Klamath Falls, Ore.

BEAUTIFY—Identify your auto. Two sets of three gold initials with full instructions for applying sent for 10c. Novelty, 224 N. High, Albuquerque, New Mexico.

AUTOMOBILE SUPPLIES

EIGHT Semi-spiral expansion reamers \$13.45. Catalog. W. Barnitz, 1701 N. Third, Harrisburg, Pa.

MOR-LITE No-Glare bulbs make night-driving safe. New light-ray control gives 100% more roadlight. \$1.00 pair. Specify year, car. Chas. F. Minor, Jr., 2306 Lincolnwood, Evanston, Ill.

PATENTED Paint striping tool, with wheels. Sensationally easy. Widths 1-16th, 1-32nd, 1-64th. \$5.00. Two sizes \$4.25. One size \$3.50. Scoles Inventions, 6701 Prospect, Kansas City, Mo.

PARTS: Passenger cars, trucks, tractors. Over ten thousand dismantled. Complete motors, transmissions, rear ends, clutches, or any part. No catalog. Write for prices. Unit Parts Rochester Corp., 1187 East Main Street, Rochester, N. Y.

PORTABLE Nickel plating outfits. Particulars free. Metalcraft, Louderman Bldg., St. Louis, Mo.

NICKEL Plating outfits, connect to your battery. No tanks used, thousands in use. \$3.00 prepaid. Gunmetal Co., Ave. J, Decatur, Ill.

AUTOMOBILE TRAILERS

BUY Or build! We'll help! We manufacture couplers, chassis and full line streamlined trailer coaches with independent wheel suspension. We supply parts, blueprints and book of designs. Write today for free literature. Dept. D-2, Trotwood Trailers, Inc., Trotwood, Ohio.

AUTOMOBILE SERVICE EQUIPMENT

DEMONSTRATORS. Compressor, test bench, 8-hour battery charger—arc welder. Guaranteed. Trial and terms. Ken's Equipment Exchange, Box M-1042, Troy, Ohio.

BARGAINS Used service station. Garage equipment. Fesco, 3117 Roosevelt, Chicago, Illinois.

MICROMETER: Measures outside every thousandths between 2 and 5 inches. Permanent accuracy guaranteed. \$1.00. Agents! Schaap, Laurelton, Long Island.

A.C. AUTO GENERATORS

TEN Practical and inexpensive changes converting Dodge 12-V, Ford T. A., Chevrolet Delco 6-V generators into 100-500 watt capacity a.c. generators, or into 32-110-V d.c. motor or generator. Dodge is 500-W self-excited. All in one book illustrated with complete simplified instructions and drawings for only \$1. Autopower, 408-B, S. Hoyne Ave., Chicago.

MOTORCYCLES, BICYCLES AND SUPPLIES

MOTORCYCLES \$25. New tires \$3.95, used tires \$2.50. Engines for airplanes, ice sleds, boats. Boys' automobiles \$10 to \$75. Pumps, frames, forks, cylinders, crankcases, handle bars, tanks, wheels, 3 speed assemblies, chains, \$1.50. Wheels for airplanes, boys' automobiles, motorcycles \$1.00. Bicycles \$11.50. Motor bicycles \$45.00. Bike tires 80c. Save you dollars at Deninger Price Cutter, Rochester, N. Y. Send 10c for bulletin.

PARTS. Send 10c for 24 page catalog, listing new and used parts for Indian, Harley, Henderson, Excelsior. Special prices on chains, batteries, accessories. Bootz, 622 E. Grand, Des Moines, Iowa.

BICYCLE Repair book—Tells everything. Send 25c. Parts catalog free. A. H. Harwell Cycle Works, Dept. 104-K, 6267 Gravois, St. Louis, Mo.

MOTORCYCLES—Direct to you at rock-bottom wholesale prices. Rebuilt, roadtested and guaranteed Indians, Harleys, etc. Send 10c today for "Bargain Bulletin 43." Crandall Hicks Co., 780 Commonwealth Avenue, Boston, Mass.

HENDERSON, Excelsior, Harley, Indian, used parts, alloy pistons, catalogue and wings pin 10c. Ballak, 100 N. 12th, St. Louis, Mo.

MOTORCYCLE Bargains, lowest prices, bargain sheet for stamp, motorcycle accessories, largest line in America, lowest prices. Largest motorcycle mail order house in the United States. Rochester Harley Davidson Corporation, 129 West Main St., Rochester, N. Y.

REPAIR With good used parts, save 1/2 or more, state parts needed, no lists. J. B. Dahl, 3661 Archer Ave., Chicago, Ill.

SEND 15c For illustrated used Motorcycle catalog. Large stock. Bargains. Indian parts. Accessories. Indian Motorcycle Sales, Kansas City, Mo.

BATTERIES

EDISON Storage batteries for power and lighting systems, non-acid, non-corrosive. Five year unconditional nitorized guarantee, 15 year life. Free illustrated literature. Plants, generators, etc. See Jay Battery Company, 82 Sterling Avenue, Yonkers, New York.

EDISON Storage batteries for all types of lighting systems. Uses no acid. Odorless. Long life. Guaranteed. Generating plants, motor bargains. Free interesting literature. Hawley Smith Company, 22 Washington Ave., Danbury, Conn.

AVIATION

AERO Blue Book gives specifications over 350 airplanes from 20 to 7000 horsepower and nearly 100 aero engines. Also second-hand value popular ships. Priceless to students, engineers, dealers. \$1.00 postpaid, with choice "How to Choose a Flying School" or "Points on Buying a Used Airplane" free if you order now! Aircraft Distributors, 924 Pine St., St. Louis, Mo.

NEW Aeroplanes, \$98.00. Quality propellers, \$3.98. Photos, leather bound flying manual, 25c. Hibbs, Ft. Worth, Texas.

GET into aviation. Air transport pilots get up to \$7,000 per year; mechanics, \$2,500. Learn at this government approved school. Write for complete information. State age. Lincoln Flying School, 2004 Aircraft Building, Lincoln, Nebr.

MODEL AIRPLANES

100 **AIRPLANES.** Repairable crackups \$30 up. Send 20c for Used Aircraft Directory, Athens, Ohio.

BOATS, OUTBOARD MOTORS, ETC.

PROPELLERS, Stuffing boxes, gear pumps, bearings, etc. Wm. Baker, Pond St., Quincy, Massachusetts.

CUT-TO-FIT Kayak, everything needed, \$5.95. Pictures for dime. Instructions for quarter, refunded with order. Boat Shop, Greenville, Pa.

FORD Propellers. J. Pettit, Seattle, Washington, 1852 Westlake Ave. North.

12 **FOOT** Flat bottom rowboat—complete plans 25c. Free boatbuilding catalog. The Rudder, 15 Murray Street, New York.

CARTOONING

SKETCH Or copy? Make money at home. drawings, instructions 25c. "Burns," Somerville, N. J.

If Interested sell your cartoons, sketches, write Paisley, 102 N. Broadway, St. Louis, Missouri.

CARTOON Students. Make real money. Definite plan. Something different. Bush Cartoon Service, 52 West Chippewa, Buffalo, New York.

LEARN Cartooning by new system. 225 illustrations and instructions—50c complete. Fraba Service, Cashton, Wis.

LEARN Cartooning:—30 lessons, 500 illustrations, with drawing pens and pencils. Postpaid complete \$1.00. Scovell Studios, Box 610-P, Hollywood, Calif.

SEND \$1.00 For 10 lessons in theatrical showcard and poster lettering. Phil Grant, 225 Bennett Avenue, New York City.

CHALK TALKS

LAUGH Producing program, \$1.00. Catalog free. Balda, The Cartoonist, Oshkosh, Wisconsin.

BOOKS AND PERIODICALS

SEND Postcard for free Little Blue Book catalog. Thousands of bargains. More than 350 books at 5c each. Address: Little Blue Book Co., Box 2001, Girard, Kans.

PROTECT Your books with Silvers bookplates. Send for free samples and special offer. "Silvers," 6327 Glenwood, Chicago.

300,000 ARTICLES. Wholesale directory 25c coin. Trial 500 circulars mailed \$1.00. E. Arnold, Box 64, Forked River, N. J.

MAGIC TRICKS AND JOKER NOVELTIES

250 TRICKS In magic 10c. Hindu coin vanisher 10c. Reeder, 104½ So. 4th St., Clinton, Iowa.

HERE'S The surprise of your life! A real magician's outfit. An instrument to make different animal sounds; Japanese handcuffs; a trick to tell peoples' age. This complete set only 15c. Mystic Wiz Company, 1145-86th Street, Brooklyn.

FIVE Professional tricks and latest catalogue, 25c. Frank Lane, 80 Boylston, Boston, Mass.

RAZZ-BERRIES!! Nose blower 10c. New shimmi dancer 10c. Menzel's, Oshkosh, Wisconsin.

FREE Magic catalog! South's largest line. Amaze—mystify your friends. Be popular. Earn money. Lyle Douglas, Station A-5, Dallas, Tex.

125 CARD Tricks 25c. Spelzer Service, 1449 Van Cortlandt, Schenectady, N. Y.

FUN! "13 Funny Love Letters," 10c. Stukes, 2112 Venus, Jacksonville, Fla.

MAGIC Catalogue 20c. Lynn, 105 Beach, Dept. 3, Jersey City, N. J.

LARGE Professional magic catalogue, 25c. Holden, 220 W. 42nd St., New York.

RADIO SETS AND SUPPLIES

RADIOS—World's cheapest. Sensation. No-cost sample. J-20th Century Co., Kansas City, Mo.

MICROPHONE 24K Gold buttons, complete with stand, \$3. Faas Research Laboratory, South Orange, N. J.

ALL-WAVE, Farm, auto. Large catalog 3c. Bart, Knoxville, Tenn.

ALL-ELECTRIC Table radios \$8.95! Auto radios \$19.85! Any make radio for less. Guaranteed! Write today. Fireside, Royal Oak, Mich.

RADIO Sets, kits. Factory prices. Thirty models. Free catalog. Radio City Labs., 1217-30 Rockefeller Plaza, New York.

RADIO Experimenters and set builders. Parts and kits of parts for the auto radio, Little Giant and portable battery sets described by Popular Mechanics. Lund Mfg. Co., Dept. CO, 1730 Foster Ave., Chicago.

NEW Improved Melody King radio. No batteries or tubes, yet reception over hundreds of miles reported. Postpaid \$1.00. Melomite, 77 Fairmount Station, Kansas City, Mo.

"POCKET Radio," \$2.15 C.O.D. Order immediately. Particulars free. Neil Tasker, Shamokin, Penna.

RADIO INSTRUCTION

STUDY Radio engineering in Washington. Modern laboratory equipment; trained instructors. Only advanced practical radio engineering course in America. One year residence course, home-study or both combined. Write for free illustrated catalog. Capitol Radio Engineering Institute, Dept. P, 14th and Park Road, Washington, D. C.

RADIO Engineering, broadcasting, aviation and police radio, servicing, marine and Morse telegraphy taught thoroughly. All expenses low. Catalog free. Dodge's Institute, Ames St., Valparaiso, Ind.

MAKE Simple tubeless radio. Crystal and instructions, 25c. Melomite, 77 Fairmount Station, Kansas City, Mo.

LOW Power three tube crystal controlled code transmitter diagram 25 cents. Simple, inexpensive. No stamps. R. L. Bentley, White Deer, Texas.

FOR BOYS AND GIRLS

HARMONICA Instructor, 25c. Play in one hour. G. Elsea, Bowling Green, Ohio.

NOVELTIES AND CURIOS

75 GENUINE Mexican jumping beans, 50c; 200—\$1.00, postpaid anywhere. Nature's most perplexing curiosity. You can also make money retailing at 3-10c; 8-25c. Wright Specialty Company, 1031 South Broadway, Los Angeles, Calif.

BABY Turtles 18c; pair 34c; 100 \$10. Food 8c. Beautifully painted 21c; pair 40c. Chameleons 40c. Catalog 3c. Smith Novelty Jobber, Miami Beach, Fla.

MAKE Big money molding plaques, novelties, etc. Details free. Sample mold 25c. Write today. Stewart's Studio, Dept. P9, 2102 W. 19th, Chicago.

STROBOSCOPE Complete with electric motor and neon lamp \$1. Powerful spectroscopic shows sun's double sodium line, brilliant spectra of elements. New invention, \$2.50. Kutting Sons, Campbell, Calif.

STAMP COLLECTING

BETTER Grade stamp bargain. The old Kingdom of Sardinia issued its last postage stamps 75 years ago. These classics, beautifully embossed are now so scarce that many collectors have never seen any. We were fortunate to secure a few at a London auction and offer two different superb copies together with the two highest values ever issued by Brazil, numbers 278—5000 reis and 299—10000 reis. Total catalogue value of these four stamps \$1.13. We will send all for only 10c to approval applicants. Globus Stamp Co., 268 - 4th Ave., Dept. 50, New York, New York.

FREE! Beautiful airmail and commem. stamps of Spain Mozambique pictorials, Abyssinia prince Ras Tafari now Emperor, Montenegro commem. Mosoleum of the Kings, Switzerland peace issue, Philippines, Salvador, Costa Rica, Russia epl. sets of hard to get provisionals and commem., Nicaragua, Nyassa. The entire lot free to approval applicants. Kindly send 10 cents for postage. Frasek Co., Lucerne, Switzerland.

RUSSIAN Murder set—3c to approval applicants. Merit Stamp Shoppe, Guilford, Connecticut.

1000 U. S. Including commemoratives, 20c. Wholesale Stamp Mart, Carroll, Iowa.

200 DIFFERENT, including 50 different British, with Fiji, Cyprus, Canadian commemoratives, 10c to approval applicants. Mantle Stamp Co., London, Canada.

NO Germany. Over 300 varieties. Lists. Approvals. 23c. J. E. Taylor, Mart Bldg., St. Louis.

COMMEMORATIVES 10 Different free with approvals. Wollaston Stampco, Wollaston, Mass.

PENNY Approvals, that satisfy. Neil Gronberg, Box 5441-P, Philadelphia, Pa.

500 U. S. assorted 25 cents, over fifty varieties. 1500 for 50 cents; 3500, over 100 varieties for \$1.00. All by weight, unpicked, sold as received commemoratives; obsolete and current; precancels, etc. Premium fine foreign every order. Royson, Box 23, Southampton, N. Y.

1000 ASSORTED U. S. 25c; 100 commemoratives, 25c; 125 revenues, 25c; 150 precancels, 25c. Jewett, 1204 West Onondaga, Syracuse, N. Y.

BEST One cent approvals in America. F. Hand, 1117 So. 60th St., Philadelphia.

COLOSSAL Bargain! Packet North Borneo, Cayman, Zanzibar, Sudan, old United States commemoratives and multitude other fine stamps. Everything only 10c to approval applicants. Sterling, Box 725-M, Battle Creek, Mich.

BUILD A worthwhile stamp collection of rare items, without expense to you. Write for agent's plan. We give large commissions in cash or stamps. Crest Stamp Company, 2194 Lombard St., San Francisco, Calif.

SCARCE Indo-China and Paraguay airmails; pocket album, hinges, watermark detector, and big packet stamps, only 5c to approval applicants. Penny Stampco, 633P Maryland, Glendale, Calif.

GREECE: 50 Different stamps of this interesting country, bargain at 10 cents to approval applicants. Ancher Stampco, Rutherford, N. J.

SKULL & Crossbones—Who'd think that a country would use this emblem of piracy on its stamp? Yet in 1914 Epirus issued some with this design. We enclose one of these in our special packet of beautiful and odd stamps, including the Belgian mourning issue for only 10c with approvals. Goldwater, 1827 Amethyst St., New York.

ALBUM Free—Spaces for 400 stamps, 2000 illustrations. Free to buyers of my approvals. F. Stern, 24-54 Chauncey St., L. I. City, N. Y.

SCARCE Iceland airmail triangle and fine packet of 65 different stamps including Jamaica, Inini, French Colonies, savages, boats, airplanes, and animal stamps. Big illustrated pricelist. Only 5c to approval applicants. Potomac Stamp Co., 3708 - 13th Street, Dept. P., Washington, D. C.

CONGO! Unusual stamps. Baluba, Babuendi natives, archers, weavers, etc. Six cents to approval applicants. References. Gordon Watson, Summit Avenue, Clifton, New Jersey.

IRAQ Pictorial set 5c postage. Approvals. McCullough, 7027 Gillespie, Philadelphia, Pennsylvania.

LIBERIA Packet free to approval applicants. Welsh, Elsmere, N. Y.

SOUTH Sea packet—All mint—Direct from mid-Pacific; Aitutaki, Papua, Tonga, etc., 10c silver with amazing offer of free stamps. No approvals—Nothing to buy. List with valuable illustrations included. South Sea Imports, Box 124A, Luke Field, Honolulu, Hawaii.

FREE Set to approval applicants. ½ catalogue. Stadler, Vineland, N. J.

FOUR Mint sets (30c value) 15c to serious approval applicants. L. Hicks, 1007 Reed, Joliet, Ill.

MAGNACROCIOUS Galaxy—Ten scarce stamps 10c with foreign approvals. Swalley Stamp Company, 1119 Trenton, Los Angeles, California.

ZANZIBAR! Packet queer freakish stamps from Zanzibar, Indore, Algeria, Malay States, Victoria, Goldcoast, Nigeria, British Colonies, Souamericans. Don't delay! Don't wait. This whooping packet free for 5c postage. Gray Stampco, Dept. PM, Toronto, Canada.

30 CANADA, 15 Newfoundland, 12 Ceylon, 13 Jamaica, 10 Trinidad, 15 Egypt all for 50c. 100 British Colonies 20c. Ask for approvals. British Colonies. Westminster Stampco, 5060 London, Canada.

TREASURE: 30 Different commemoratives 10c. N. Begin, 48, Sous Le Fort, Quebec, Canada.

TRIANGLE Stamps, 7 different 10c with approvals. Fort Dearborn Stampco, 5439 Aberdeen, Chicago.

500 Fine Mixed United States stamps with scarce cachet cover, 25c. Approvals. Wright, 1154 Hamilton, Hagerstown, Md.

WEIRD Flying Garuda with 100 different 5c. Approvals. Burke, Marshfield, Vt.

BARGAIN. Stamp wallet and 175 precancels 25c. Atlas, 128 Market, Newark, New Jersey.

CHEAPEST British and foreign approvals in Canada. Bennetto, 276 Lauder Ave., Toronto.

1,000,000 RARE, Common singles, packets. A Miller, 543 N. Ashland, Chicago.

FREE! Bargain pricelist. U. S. revenues, 250 mixed, 25c! Vanvorhis, Hyndman, Pa.

ECUADOR 15 Different 10c with approvals. Ephriam Stampco, River Forest, Ill.

MONGOLIA, Georgia, stamps from 50 other countries 6c with approval request. Ransom, 1333 Pontiac, Ann Arbor, Mich.

50 DIFFERENT U. S. commemoratives 30c. Becker, 5657 Highland, St. Louis, Mo.

FREE: 5 Diff. Jamaica to approval applicants. Behrendt, Glastonbury, Conn.

FREE Triangle with 55 different, including Abyssinia, Guiana, Hyderabad, Madagascar, etc., with approvals 5c. Crest Stampco, Box 2062M, Fresno, Calif.

ORIENTAL Covers, hand painted pictorially cancelled, 25c; 6 different \$1. 100 U. S. all different high value packet. 50c. 100 British colonies, \$1. Mercantile Stamps, Ventura, Calif.

LOOK! Gorgeous packet including Uruguay (Flying Horse,) Spanish airpost, triangle, and ship stamps, only 5c to approval applicants. Royale Stampco, South Pasadena, Calif.

EARN Cash, stamps. Sell my approval books. Ellison, 2841 West 37th Street, Brooklyn, N. Y.

UNBEATABLE Collection including airmails, Tanganyika, Rhodesia, Soruth, Nigeria, Gold Coast, Chakari and others—all for 10c providing you desire our bargain approvals. Lucas Stamp Service, Box 293PM, Los Angeles, Calif.

SCARCE Paraguay, Graf Zeppelin airmail triangle, pocket album, watermark detector, packet stamps from Africa, Asia, Canada, South America, etc., 6c to approval applicants. Glendale Stamp Company, 1342P Linden, Glendale, Calif.

INVERTED Postcard 25c. Hughes, 2563 Flower, Walnut Park, Calif.

UNITED States stamps on approval. Huber, 505 Hennepin, Minneapolis, Minn.

YOU'VE Tried the rest, now get the best! We have answered all advertisements, compared premiums, approvals, etc., and absolutely proven that ours are superior. Send 10c for "Challenge Offer" with approvals. Bargain Stamp Service, 1332 South Hope, Los Angeles, Calif.

UNITED States! World's lowest prices guaranteed! Box 114, Minneapolis, Minn.

FREE! Scarce triangle, packet handsome ship stamps, complete airmail set, watermark detector, lists and coupons—Absolutely free for 3c postage! Approvals included. Midwood Stampco, Midwood Station, Brooklyn, New York.

FREE! Costa Rican triangle, Piccard balloon, 50 picturesque stamps to approval applicants. Send 3c postage. W. P. Stamp Co., 1427 Franklin Ave., Bronx, N. Y.

UNITED States mission 50c pound; 5 for \$2.00. Canada 75c, 3 for \$2.00. Mission Company, 4512 No. Racine, Chicago.

MAGNIFIER, Stock book, stamp album, hinges, watermark detector, perforation gauge, millimetre scale, packet scarce stamps. Price 5c with approvals. Atlas Stamp House, Culver City, Calif.

SCARCE Morocco airmail, Eritrea camel stamp, maps of stamp countries, watermark detector, hinges, perforation gauge, pocket album, many scarce stamps. 5c with approvals. Superior-Stamp-Co., Palm Station, Los Angeles, Calif.

AMAZING Value—35 different U. S.: 1861, commemoratives, air-mail, etc., 10c to approval applicants. Stamp Shop, 809 Holland Bldg., St. Louis, Mo.

CARIB Archer, (Inini), map stamp, 1892 South American envelope included in quality packet, hinges, stamp wallet, 10c to collectors desiring approvals. United Pacific Philatelists, Box 25M, Ventura, Calif.

AIRMAILS—From Brazil, Chile, Colombia, Ecuador, Mexico—all for 10c, with double premium penny approvals. Progress Stamp Service, Franklin Park, Ill.

1c, 2c, 3c **APPROVALS**. A. R. Kalber, 452 Ewing Court, Akron, Ohio.

FREE Dollar packet to one cent approval applicants. Harlan, 5307 S. Marshfield Ave., Chicago, Illinois.

THIS Ad worth 25c. If you send for our approvals and buy 50c worth or more—large selection of U. S. and foreign—reasonable prices. Morton Stamp Co., 1121 Olive, St. Louis, Mo.

LIBERIA—Eight big bi-colored beauties showing water buffalo, hippopotamus, negro president, etc., only 6c with approvals. Garelson Stampco, Box 835, Calais, Maine.

SCARCE Panama triangle, octagon stamp, Confederate essay, and 50 others to approval applicants sending 3c postage. Phillips Stampco, D7, W. Springfield, Mass.

BASUTOLAND No. 1. This stamp from new country and list of 450 10c items free. Amity Stamp Service, 375D, Amityville, N. Y.

SCARCE Airmail and triangle. Beautiful Uruguay "flying horse" airmail and scarce Guatemala triangle (smallest in the world) are included in our big packet of 60 different stamps from Alouites, Grand Liban, Venezuela, British and French Colonies, etc. All for 5c to approval applicants. Big illustrated lists free with each order. Write today! Mystic Stamp Co., (Dept. 80), Camden, New York.

50 **OLD** Stamps 1c. Album 3c. Bullard, 446 Tremont, Boston.

SENSATION Packet: Coreas, Liberia, triangles, British Colonials 10c. Steele, Springdale, Pa.

ILLUSTRATED Album holding 4000 stamps to approval applicants 20c. Swan Stamps, 605 Swan, Dunkirk, New York.

STAMPS Wanted; for sale; to exchange. Write. C. Ritchie, Watertown, South Dakota. U. S. A.

FREE—\$1.00 U. S. Lincoln memorial stamp with request for 48 page illustrated price-list of U. S. and foreign stamps, also fine stamps on approval. References necessary. New Hussman Stamp Co., 1122 Pine Str., St. Louis, Mo.

1863 **LOMBARDY-VENETIA**, Charkhari, Turks Calcos Islands, \$5 U. S., Afghanistan, genuine Baden, and Imperforate Byrd—Absolutely free to approval applicants enclosing 3c postage! Viking Stamp Co., 1 Hanson Place, Brooklyn, N. Y.

FREE!!! Three Spain airmails or Russia Ethnographic set. Postage 3c. Roberts, 901F Fourth, Baycity, Mich.

200 **DIFFERENT** 10c. Big 60% approval. Covert Stamp, 39 State, Rochester, N. Y.

UNITED States stamps—40 different with pricelist 10c. Seidenberg, Baroda, Mich.

FREE! 30 Different Angola, Cape Verde, Guinea, Portugal, Mozambique, St. Thomas. Send return postage. Depraw, Ocean Park, California.

COMMEMORATIVES—10 Different and 30 other Canadian only 15c. World special—500 different 30c; 1000 diff. 85c; 2000 diff. \$2.50. Approvals with each order. Victoria Stamp Company, London 4, Canada.

FREE—To approval applicants. Five beautiful airmails from five different countries. Green & Co., Norwood, Ohio.

STAMPS, 200 Different, catalogue over \$4.00, and catalogue, 10c. Norman Shultz, Salt Lake, Utah.

SCARCE Zeppelin and triangle. Famous Russia Zeppelin stamp and beautiful Lithuania airmail triangle; also big packet of 53 different stamps including Azerbaijan, Epirus, new Martinique, etc., and illustrated lists—all for 5c to approval applicants! World-Wide Stamp Co., Box 600, Camden, New York.

STAMPS Sent on approval. 50% discount. Fred Herzberg, 197 Grantley Ave., Elmhurst, Illinois.

200 **DIFFERENT** Stamps, triangle, airmail, etc., 10c. R. H. Carlton, 209 W. Fourth, Los Angeles, Calif.

BYRD Commemorative and 34 different U. S. including early issues, high values, commemoratives, airmail, envelopes, special delivery, postage due and revenues cataloging over 85c. All for 7c to approval applicants. Illustrated pricelist free. Curban Stamp Co., Dept. P, Gloucester, Mass.

30 **DIFFERENT** Japan 10c. Fred Onken, 630 79th Street, Brooklyn.

NEWFOUNDLAND, 15 Different 5c with approvals. Hudson Co., Plainfield, N. J.

U. S. \$2 **Wine** 8c with approvals. Arrow Stamps, Plainfield, N. J.

ILLUSTRATED U. S. list, price 50c, large complete U. S. price list free. Stanley Gibbons, 38P Park Row, N. Y.

RARE COINS

\$5 TO \$500 Each paid for old coins. Keep all old money. Get posted! Send 10c for illustrated coin value book, 4x6. Guaranteed cash prices. We buy and sell. Coin Exchange, Box 5, LeRoy, N. Y.

10,000,000 **MILLION** Mark and list 10c. Greenclay, 1626 Washington, Denver, Colo.

WE Buy Lincoln head pennies. Will pay up to \$2.00 each if over ten years old. Indian head pennies worth up to \$51.00 each. Send 10c for buying catalog. Continental Coin Co., E-111 W. Jackson, Chicago.

COIN Book, over 800 illustrations, 100 pages. Biggest and best book for price, \$1. Money refunded if unsatisfactory. 100 foreign copper and nickel coins \$1. Dealers write for prices on rare coin book. Guttig Bros., 42 Stone Street, New York.

OLD Money wanted. Will pay fifty dollars for nickel of 1913 with Liberty head (no buffalo). We pay cash premiums for all rare coins. Send 4c for large coin folder. May mean much profit to you. Numismatic Co., Dept. H, Ft. Worth, Texas.

WHOLESALE Prices on American and foreign coin. Price list 3c stamp. Geo. Best, Cedar Rapids, Iowa.

12 **DIFFERENT** Coins 25c. List 3c. Brooks, 624 Cameron, Dallas.

CASH Paid: \$15.00 each for certain Indian-head pennies. Send dime for list of these wanted. Coin-Shop, "D," Springfield, Missouri.

HIGHEST Prices paid for Indian head cents. Send dime for list of those wanted. Coin Shoppe, Box 407-PM, Ottawa, Ill.

CALIFORNIA Gold quarter size 27c; 1/2 size, 53c; 3c piece and catalogue, 10c. Norman Shultz, Salt Lake, Utah.

UNITED States white cent and bargain selling price list 10c. Arcy, Box 483, Muskogee, Okla.

WE Buy 1907 Indian head cents. Full information one dime (coin). New Miss Mattick Co., Box 3450, Altoona, Pa.

11 **DIFFERENT** Coins, 3 bills and catalog, 25c. Creamer's, 1112 Somerset, Baltimore, Md.

UNITED States. Large cent, two-cent bronze, three-cent nickel and bargain list, 25c. Thirteen dates large cents, \$1.00. George P. Coffin, Augusta, Maine.

CAMERAS AND PHOTO FINISHING

NEW! Beautiful art panel prints 6c each. Sample with every "trial order" roll developed and printed, 25c coin. Ideal Photo Service, P. O. Box 2255, Paterson, N. J.

PRINT Snapshots on handkerchiefs, notepaper, etc., sensitized with photoprint fluid. Dark room unnecessary. Washable, permanent, guaranteed. Send \$1.00 for fluid to print 200 pictures. Park Specialty, 219 Park Place, Brooklyn, N. Y.

16MM **VICTOR** Sound projector, complete with amplifier \$85.00. Motograph standard projector complete \$55.00. DeVry Model E portable 35mm. projector complete \$45.00. 16mm. camera film \$2.50 100 ft. with processing. DeVry 35mm. still projector, new, \$9.50. camera for above \$6.50. DeVry 16mm. automatic camera \$11.75. Eastman 8mm. camera \$21.50 Tittler \$3.69. Passion Play 16mm. film rent, sale. 30"x40" beaded screen rollers \$4.86. Eastman film cement 20c, 400 ft. reels 38c, humidior cans 45c. Comedy, travel, educational films, all lengths 2-3c ft. Catalogue Soundisc, S.O.F., silent library. Graflex 3 1/4"x4 1/2" f 4.5 like new \$55.00. Spencer stereopticon \$22.00. Mogull Bros., 1944-J Boston Road, New York City.

MAKE Money—entertainingly—by developing and printing snap-shots at home with Winner's Experimenter Photographic Kit consisting of dark-room lamp, enameled trays, graduate, stirring rod, developer powders, fixing powders, printing frame, printing paper and reliable instruction book, only \$2.25 postpaid. Professional type set for the more advanced photographer, \$3.95. Mention size of camera when ordering. Winn Company, 124A West 23rd Street, New York.

MAKE Money in photography. Learn quickly at home. Spare or full time. New plan. Nothing like it. Experience unnecessary. American School of Photography, Dept. 3436, 3601 Michigan Avenue, Chicago.

6 **CHRISTMAS** Cards, envelopes to match, with every film developed and printed 25c. Newton, 4118-8 Overhill, Chicago.

TRADE In value! Your camera and photographic equipment will be taken in trade on anything photographic. Write us what you have to trade and what you want in exchange. Fair allowances made, backed by our 35 year reputation for square dealing. Central Camera Co., Dept. PM-10H, 230 S. Wabash, Chicago, U.S.A.

FILMS Developed and printed double size, 25c. Why have your snapshots developed and printed by old-fashioned methods when with the New Micro process you can get any roll developed and printed double size at no extra cost. You get big camera effects with small films. Complete satisfaction guaranteed. Miracle Film Studio, 412-C East 11th St., Kansas City, Mo.

COLORED Enlargement with each film developed—a professional enlargement painted in oils and eight Gloss-tone prints, deluxe finish, guaranteed not to fade, 25c. Super quality—Speedy service—Satisfaction or money refunded. LaCrosse Film Company, LaCrosse, Wis.

ENLARGEMENTS Suitable for framing, send negative and 35c. Rolls developed eight prints guaranteed, 25c. Universal Photo Service, Box 1134, U. P. Station, Des Moines, Iowa.

16 **BEAUTIFUL** Gloss prints and two enlargement coupons only 25c. Imperial Film Service, Unionville, Mo.

FILMS Developed 2 prints of each negative and two enlargement coupons 25c. Negatives printed 2c. Summers' Studio, Unionville, Mo.

KODAK Pictures enlarged, 5x7 10c, 3 for 25c. Send negative film. Stanley Studio, Des Moines, Iowa.

20 **REPRINTS** 25c. Films developed, two prints each negative, 25c. Skrudland, 4118-8 Overhill, Chicago.

HAND Colored enlargement with each roll 25c. Colorgraph-8, Dunning Station, Chicago.

ROLLS Developed. Two beautiful double-weight professional enlargements and 8 guaranteed Never Fade Perfect Tone prints, 25c coin. Rays Photo Service, LaCrosse, Wisconsin.

FILMS Developed 5c per roll; prints 3c each. Ask for special bargain list. Roanoke Photo Finishing Company, 161 Bell Ave., Roanoke, Va.

YOUR Favorite kodak pictures enlarged, size 5x7, 10c. Three for quarter, coin. Send best negatives (film) today. Address Darmer Photo Lab., Enlarging Dept. 9, Des Moines, Iowa.

INCOME From your camera instead of expense. Low cost home course teaches you to make photographs for magazines, newspapers, advertisers. Tremendous demand. Earn good money wherever you live. Free book. Universal Photographers, Dept. 104, 10 West 33rd St., New York.

ROLLS, Developed, printed, 25c. Mail your films to the biggest and best. Rolls developed and 8 good prints guaranteed plus 8x10 inch enlargement coupon only 25c. Reprints any size 3c each. Geppert Studios, Dept. 130, Des Moines, Iowa.

TWO Crystal stiple enlargements with each roll 25c. Photosop, 4112-8 Oriole, Chicago.

TRIAL Offer. Roll developed and 8 prints 25c. Reprints 3c each. Beautiful 10-inch enlargement 25c. Young Photo Service, 405 Bertha St., Albany, N. Y.

HAVE You a camera? Send ten cents for recent number of our big magazine, showing how to make better pictures and earn money. American Photography, 116 Camera House, Boston, 17, Mass.

MOTION PICTURES AND SOUND EQUIPMENT

MOTION Picture Cartoon Studio will train few artists, cartoonists in animation, for studio now in production. Send small samples. P. O. Box 565, Dept. P. Hollywood, Calif.

PHOTOPLAY Plots accepted any form for free reading and report. Our sales service selling consistent percentage stories to Hollywood studios—the most active market. Experienced writers revise, synopsis, copyright, submit to producers. Free booklet shows how. Universal Scenario Co., 254 Meyer Bldg., Hollywood, Calif.

16MM FILMS Rented anywhere. Covered Wagon—Lost World—Cristus—King Kings—Uncle Tom's Cabin—Chaplins—Mickey Mouse. Thousand feet 35mm film \$1.00. Excelsior Films, Cincinnati.

FREE New 16mm, 8mm bargain lists. Films 35c up. Art sample 25c. Home Movies, Box 32, Easton, Pennsylvania.

300 FEET 35mm 90c, 16mm cheap. Lowell Films, Allentown, Pa.

16MM FILMS—Rental, sale, exchange. Dime brings catalogue, two "end" titles. Eastin Films, Dept. 21, Galesburg, Ill.

TALKING Filmads for use in your local theatre. Sell these to merchants in your community. Substantial profits. Eastin Films, Galesburg, Ill.

WORLD'S Greatest "Passion Play" 16 MM. (new) 5 reels. Rent or purchase. Write Hemenway Film Co., 37 Church Street, Boston, Mass.

AMATEUR Cameramen: We buy 16mm. news shots, oddities, scenes, etc., for 16mm. newsreel. Stamp brings details. Peerless News, 1327-A North Highland, Hollywood, California.

35MM ODD Reels 80c. Bargain lists 3c. World's largest dealers in 35mm films. Hoffman Film Service, 57 Broad, Albany, New York.

BASS Offers for a limited time brand new 100 ft. Stewart-Warner 16mm Cine camera, complete with case, F:3.5 lens, worth \$50.00, at \$18.50 each. Hundreds of other bargains in Bass Bargaingram No. 212 mailed on request. Write to Value Headquarters, Bass Camera Company, 179 W. Madison St., Chicago, Ill.

35-MM FILMS, Projectors. Stamp for lists. Box No. 6, Rosedale, Kans.

BUSINESS OPPORTUNITIES

PLASTEX Industries offers industrious men an opportunity to start a business of their own, manufacturing art goods, novelties, souvenirs, etc., in Plastex and marble imitation. 5c material makes \$1 articles. Rubber moulds furnished for speed production. Small investment brings big returns. You are just in time for big Christmas business now starting. Write for interesting booklet mailed free. Plastex Industries, Dept. A, 1085 Washington Ave., New York.

CONQUER The depression. 100 real money-making ideas. Dime. Enterprise Bureau, Syracuse, N. Y.

MODELING Clay—Sample 10c. Curtis, 3329 Lafayette St., Denver, Colo.

\$5 To \$50 Weekly. Grow fancy "White Queen" mushrooms in cellar or shed. Free mushroom book tells how. American Mushroom Industries, Ltd., Dept. 766, Toronto, Ontario.

RELIABLE, Tested formulas. Latest manufacturing processes. Complete information. Scheld, Chemist, 535 Dixwell Ave., New Haven, Conn.

STEADY income from discarded inner tubes or drained auto oil. Instructions 20c. Charles, 12-A, Norwood, Ohio.

TWELVE New successful money-makers. J. Home, 3949 Metropolitan, Chicago.

FINANCIAL Success can be yours. Own a mail order or local business. "Catalog of Business Opportunities" sent for 3c stamp. C. Pearce, 427 Asia St., Baton Rouge, La.

BARGAINS—Paint spray outfit, gasoline engine drive. Terms—trial. Helmick Paint Spray Exchange, M-1043, Troy, Ohio.

LEARN All about casting marble novelties in rubber moulds. Cement secrets. Illustrated catalog and beautiful samples 3c. (So. Calif. business reserved.) John A. Payn, 945 Grande Vista Avenue, Los Angeles, Calif.

INVESTIGATE Big new field—Cleaning upholstery for homes. We furnish everything. Write Walter Degen, 7024 East End, Chicago.

SUCCESSFUL Business plans. Money making formulas. Gibson, Bandana, N. Car.

MAIL Order business your new deal! Opportunities limitless. No manufacturing, no stock to carry. Simply handle incoming orders, \$1.50 profit each. Details 20c. L. Ryan, 808 Security Building, Long Beach, California.

NEED Cash! Our suggestions proven practical. 500 ideas only 50c. Act now. Collins & Konecni, 9763 Dundee, Detroit.

"SCHEMER Magazine," Alliance, Ohio, prints schemes, ideas, business starters, formulas; winners—\$10,000 to \$50,000 reported. 36th year. Subscribe now! Six months special, only 30c.

MAIL Order course complete \$1.00. R. Cash, Hewlett, Long Island.

LIQUID Marble—Anyone can make! Colorful, glazed! Molded, brushed, sprayed. Rubberlastic molds. Composition flooring. Big money making these! Particulars free. Marbleizing Service, Edwardsville, Ill.

MAKE Products yourself. Tested formulas—catalog free. Grinstead Laboratory, Edwardsville, Ill.

BEAUTIFUL Cavern. Restaurant. Gasoline. Sell or partnership. Subterranean Attractions, Box 627, Buffalo, N. Y.

"KEY to Business Opportunities," 10c. Goodall, Box 1592, San Francisco.

SIGN Painting the easy way with letter patterns. Samples free. Clark, Ellwood City, Pennsylvania.

QUARTER Brings ten practical home work ideas. Goldenrod, Harrisburg, Ill.

FREE Circulars describing how you can make real, big money in mail order business at your home. Write today, Dept. 8, Mail Order Institute, 669 Marcy Avenue, Brooklyn, N. Y.

UP To \$100 weekly. Money making plans, schemes, business secrets, formulas, home work and spare time opportunities published in Golden Ideas Magazine, Berwyn, Illinois. 3c stamp for copy.

EARN \$5.00 Daily raising mushrooms in cellar, shed, attic. We buy crops. Guaranteed materials furnished. Odorless method. Book free. United, 3848-AF Lincoln Avenue, Chicago.

DOLLARS Daily with my plans. Complete 25c. Ladnar, Jefferson City, Mo.

100 PROFITABLE Mail order and local business plans. A. Pruitt, Elburn, Ill.

ANY Formula 30c or money back. Ogg Laboratories, Tampa, Florida.

EARN While learning—Men, women—Your own cleaning-pressing business. Easy home training. Free outfit. Write K-41, Business Ownership Institutes, 454 East 79th, Chicago.

WRITE And sell news items. Instructions \$1.00. H. A. Kelso, Walkerville, Mich.

RESILVER Mirrors. Plate auto fixtures, tableware. Portable outfits. Metalcraft, Louderman Bldg., St. Louis, Mo.

BARRELS Of mail, 25c. We list your name in 10,000 directories. Roservice, 4627 Glenshade, Cincinnati, O.

PURE, Spore cultured, bottle mushroom spawn. Any quantity. Best varieties. Wholesale prices. E. B. Speakman, (Manufacturer and distributor,) West Chester, Pa.

THERE'S Big money in the collection business. Write Cole Associates, Tower, Syracuse, N. Y.

MANUFACTURE Chipped glass house numbers. Beveridge, 160-22-P Locust, Jamaica, N. Y.

WIN Thousands cash! Send 10c. list, legitimate contests. World Contests Magazine, 6823A - 17th N. E., Seattle.

MAKE Your own molds. Use our Synthetic Rubber. (S R C.) Equals rubber. For undercuts and fine markings. Cheap as glue molds. Stands boiling water. Send dime or stamps, for miniature mold and cast and assorted marbled samples all about imitation marble. The Cowell Institute, Grayling, Mich.

STEADY income from old auto oil. Instructions 20c. International Agency, Cincinnati.

SUCCEED With your products. Learn how. Formulas. Processes. Analytical service. Catalog free. B. Thaxly Co., Washington, D. C.

MANUFACTURE For profit. Substantial income making today's biggest-selling popular necessities—all lines—from my world famous guaranteed formulas. Get my free "eye-opening" literature. Miller, Chemist, 1708 PMB, Tampa, Fla.

HANDY Men—Establish vacuum cleaner repair service. Big profits. Write National Distributing Co., Box 32, Washington, D. C.

SELL By mail. Books, novelties. Bargains! Big profits. Particulars free. B. Elco, 525 S. Dearborn, Chicago.

BIG Profits. Sell watches, fountain pens, razor blades, tooth paste, novelties, etc. Wholesale catalog 10c. Hagn Co., 223 Madison, Chicago.

CASH income daily resilvering mirrors at home. Replating autoparts, tableware, etc. Outfit furnished. Write Sprinkle, Plater, 127, Marion, Ind.

MAILING Secretaries wanted. Experience unnecessary. Contract—details, 3c postage. Nagel Enterprises, 1329 Olive, Indianapolis, Indiana.

BIG Money at home plating auto parts, reflectors, mirrors, chandeliers; by new method; experience unnecessary. Outfits furnished. Gunmetal Co., Ave. N, Decatur, Ill.

FREE Booklet describes 87 plans for making \$20-\$100 weekly, in home or office, business of your own. Elite Co., 214 Grand St., New York.

MAIL Order business is your opportunity. Many began small, now earn thousands yearly. No personal contact. Boundless opportunities. Have had over 30 years experience; will help you succeed. Send 25c for valuable booklets, none free. B. Breniser, 257 South 21st, Philadelphia.

CHARTERS: Delaware; best, cheapest; free forms. Colonial Charter Co., Wilmington, Del.

ARTIFICIAL Marble sanitary flooring, instructions covering wood or cement flooring 1/2 inch thick, fireproof, all colors, low cost. Ornamental casting, concrete plaster papier-mache decorations, garden furniture, statuary, flexible molds, particulars and illustrations free. Chris. Mahler, Elmont, N. Y.

CHEMICAL Expert will furnish formulas and trade secrets. All lines. Lists free. W. L. Cummings, Ph. D., 228 Gordon Ave., Syracuse, N. Y.

START Little business anywhere. Everything furnished. No canvassing. Maywood, PM.923 Broadway, New York.

FORMULAS AND TRADE SECRETS

3,000 FORMULAS, Facts, processes, trade secrets in Dr. Brown's Book of Formulas—380 pages. Price, postpaid \$1.00. Ogilvie Publishing Co., 57 Rose Street, Dept. 25, New York.

FORMULAS—32 Different solders 50c. G. Pennington, R1, Robbinsdale, Minn.

MONEY Making formulas 10c coin. Guaranteed. Chemical questions answered 25c. The B-O-K Chemical Co., 1459 Washington Ave., Bronx, New York City.

ABSOLUTELY Any formula desired \$1.00 each. E. Arnold, Box 64, Forked River, New Jersey.

FREE—Formula literature. Manufacture products yourself. Thomson, 7309 Pingree, Chicago.

ANY Guaranteed formula 50c; three \$1.00! Order direct. T-S-G Pub., P. Box Ten, Wilkinsburg, Pa.

BEAUTY Preparations. Ten formulas \$1. Cosmetic Products, 900 Manhattan, Dayton, Ohio.

MANUFACTURERS' Service, Box 628, Central Station, St. Louis, Missouri, furnishes formulas successful manufacturers use. Particulars free.

MANUFACTURERS Secret formulas. Big discounts. Guaranteed big money-makers. Thermo Works, Peoria, Ill.

PREEMINENT Analytical service. Twenty years successful experience. Atlantean Research Laboratory, 1501 Euclid Avenue, Cleveland.

BEAUTY Formulas—Ten for \$1.00. Complete instructions, source of supply included. Cumberland Publishing Co., Wallins Creek, Kentucky.

NEWEST Guaranteed formulas. Catalogue free. Special prices, leads. Gibson, Chemist, B D 4702 N. Racine, Chicago.

ANY Formula 30c or money back. Ogg Laboratories, Tampa, Florida.

500 MONEY Making formulas 25c. Descriptive circulars free. Harvey Teeple, Decatur, Ind.

TWENTY Latest money-making formulas, 20c brings all! International Agency Cincinnati.

GUARANTEED Formulas, best science can produce for making popular, biggest-selling specialties all lines. Don't buy formulas till you've received valuable eye-opening literature. Miller, Chemist, 706-F Jetton, Tampa, Fla.

FORMULAS, Plans, ideas. Literature free. Belfort, 4042 N. Keeler, Chicago.

SUCCEED With your product. Learn how Formulas. Processes. Analytical Service. Catalog free. B. Thaxly Co., Washington, D. C.

TESTED Formulas—Newest, guaranteed! Catalog free. Grinstead Laboratory, Edwardsville, Ill.

FORMULAS. All kinds. Guaranteed. Catalog free. Kemico, 31, Parkridge, Ill.

CHEMISTRY

HANDBOOK For chemical experimenters (revised 1934) illustrated, 50c. Experiment booklet 15c. Catalogue 10c. Reading Scientific Co., Reading, Penna.

CHEMISTRY Magazine. Experiments, handbook, research. Sample 15c. Brownlee, 218 Henry, New York.

ENJOY Thrill of chemist and magician. Lead in science. Send 25c for book with 130 fascinating chemical experiments. Chemicals at low prices. Safe-Chem, New Haven, Conn.

FREE! "Sciencecraft" magazine and other valuable scientific literature. Send stamp for copy and details. "Sciencecraft," P-5049 Bernard, Chicago.

NEW Pocket chemical outfit including chemicals, test tube, support and platform. Experiments free, 50c. KemeK, 132 West 14th Street, New York.

CHEMICALS. Laboratory glassware and apparatus. Catalog CP. Biological Supply Co., 1176 Mt. Hope Ave., Rochester, N. Y.

AGENTS WANTED

BEAUTIFUL Foil window sign letters. Penny each. Popular sizes. Easily applied. Samples, complete working equipment free. Atlas Sign Work, 7941 Halsted, Chicago.

SELL Changeable signs to stores. Six lines, 260 letters and figures. Cost 30c sell for \$1.50. Free particulars. National Sign System, St. Louis, Mo.

100% PROFIT In the mystery cigar lighter. No flint or friction. What makes it light? No wind can blow it out. Retail 25c. Sample and sales plan 25c. New Method Company, Desk PM-22, New Method Bldg., Bradford, Pa.

STRANGE Ironing cord. Prevents scorching. Saves electricity. Abolishes kinks, snarls. Approved by Good Housekeeping. For telephones also. 140% profit. Samples furnished. Neverknot, Dept. 10-A, 4503 Ravenswood, Chicago.

ORDERS. Repeat orders, good income assured workers. Kaessmann, Box 838, Lawrence, Mass.

NO Competition! Sell beauty, barber shops, agents. Free offer. Henkle Co., P420 Lexington Avenue, New York.

BE Independent. Own your business; experience unnecessary, selling \$10,000 accidental death, \$50 accident; \$25 sick weekly benefits—\$10.00 yearly. Other amounts proportionate. Guaranteed steady renewal income. \$250,000 deposited insurance department. Universal Policy, 716-A Lefcourt Bldg., Newark, N. J.

MECHANICS—Make \$1.00 an hour, assembling TidyShop Bench Cabinets at home. Plans 25c. Free literature. Page Mfg. Co., Dept. C, Liverpool, N. Y.

300% PROFIT Selling new "20-in-1" kitchen utensil. Retail 25c. Costs you \$1.00 a dozen. Sample 10c. New Method Co., PMM-22, Bradford, Pa.

DISTRIBUTORS: Represent a manufacturer. Sell Latex—self-sealing bandage that breathes. Great demonstrator. Lowest prices. 400% profit. Good repeater. Exclusive territory. Neway, 3815-BT Harrison, Chicago.

\$6.00 HOURLY. Amazing Karnu refinishes autos like new without rubbing, polishing, waxing or painting. Wipes on with cloth. Lasts 8 to 12 months. Free sample. Karnu, Dept. B-108, Cincinnati, Ohio.

NEW Changeable sign sells to stores for 75c. You make 200% profit. Particulars free. National Sign System, St. Louis, Mo.

MONEY In household items. Vel-A-Tex, perfect hand soap. Chlor-A-Tex, ideal laundry bleach. Make and sell them. Manufacturing instruction and business plan free. Raw materials, containers, labels, at wholesale. Liberal samples, proposition, ten cents. Chemoplate Company, Bloomfield, New Jersey.

INITIALING Automobiles biggest money maker today. New type requiring no varnish to apply. Write for samples. International Monogram & Transfer Co., Box 6365, Philadelphia, Pa.

REGULAR Income; home, office, no canvassing. McArthur Co., Desk 5, Butte, Mont.

CHRISTMAS Card salespeople. Absolutely finest assortment. Let us prove. Rush postal. Robinson Greetings, Clinton, Mass.

\$50.00 WEEKLY. Sell 5 glasses California orange jelly, 25c. 200% profit. 5 glass sample 25c. Cutter-Clarke, 5515M Ruthelen, Los Angeles, Calif.

LOCAL Agents wanted to wear and demonstrate free suits to friends. No canvassing. Up to \$12 in a day easy. Experience unnecessary. Valuable demonstrating equipment, actual samples free. H. J. Graves, Pres., 1301 Harrison, Dept. K-817, Chicago.

SALES Kit free. Write for our free offer and catalog of household deals, cosmetics, extracts, etc. Make big money selling your friends and neighbors. Clyde Collins Chemical Co., Dept. PM-9, Memphis, Tenn.

1000 BEST Sellers, blades 65c hundred, needle books 25c dozen. Free wholesale catalogue. Paty Company, 5P Elston, Somerville, Mass.

100% PROFIT. Sell beautiful new 1934 all-folder 21 Christmas card \$1 assortment. Also gift wrapping, everyday, birthday boxes. Samples on approval. Schwer Co., Dept. 410M, Westfield, Mass.

AGENTS Wanted. Men and women can make good profits selling new attractive office specialty. Pleasant work with splendid possibilities. Torit Mfg. Co., St. Paul, Minn.

BEAUTIFUL Imported oriental slippers. Big sellers. Send 65c for sample pair and proposition. American Specialty Company, 424 South Broadway, Los Angeles, Calif.

SURE Fire seller—first time in America—laughs galore—unusually quick profits. Be first in territory. Free circular. Write New Novelty, 161 Brookline Avenue, Boston, Massachusetts.

AGENTS—New discovery needed in every home, sells on sight, 100% profit. Sample 25c. Box 705, Oxford, N. Y.

CHRISTMAS Cards—21 card assortment sells fast at 60c! Send 30c for sample box, or particulars free. New England Art, North Abington, 86, Mass.

\$2.00 HOURLY With amazing invention. Old shoes made like new in five minutes. 6c a pair; not a polish or dye. Free sample. Sav-An-Upper, Dept. B-227, Cincinnati, O.

\$2.00 HOURLY With new, scientific cream that mends all cloth easily, quickly, invisibly, without needle and thread. Stands laundering. Free sample. Sew-No-More Co., Dept. B-744, Cincinnati, O.

MAKE Your own products. Employ agents yourself. Toilet articles, soap, extracts. We furnish everything. Valuable book free. National Scientific Laboratories, 1950W Broad, Richmond, Va.

INSTALL—Sell—Haling's 4 piece piston rings. Restore power, save oil without re-boring. Haling Co., Rochester, Minn.

WOULD \$1.50 An hour satisfy you? Then send me your name immediately. I'll give you a wonderful opportunity to make \$12.00 or more a day in home-operated business. Particulars free. Albert Mills, 4670 Monmouth, Cincinnati, O.

OUTSTANDING Easy selling products. No competition. Sample 10c. Mint Co., Baroda, Mich.

BIG Money. Sell 21-folder Christmas \$1 assortment. 100% profit. Everybody buys. Also gift wrappings, etching, everyday, humorous, religious boxes. Extra bonuses. Free sample offer. Wallace Brown, 225 Fifth Ave., Dept. 310, New York.

NO Competition, big profits, sure repeats. Exclusive new 1500-hour guaranteed electric bulb. Open territories. Hanover, 32 Union Sq., New York.

PROFITS On new goods. Make, sell them. Guaranteed formulas. Special prices, leads. Catalogue free. Gibson, Chemist, B D 4702 N. Racine, Chicago.

NEW Transparent day and night signs, 8"x14", cost 4c, retail 25c. Sample free. Clean up! Low, 8 West Broadway, New York.

MARRIED Man with spare time to distribute free samples coffee, flavoring, food products and make customers. Must devote at least two hours daily and be satisfied with up to \$3 in an hour. Permanent. Blair, Dept. DFS 16, Lynchburg, Va.

MAKE Dazzling glass name plates; Sun-flector Daylite signs. Write. Rapid Service, Edwardsville, Ill.

BIG Money selling to trade! Unbreakable socket wrenches, valve grinding machines, drill presses. Stamp reply. Howard's, 2417 N. Ashland Ave., Chicago.

"CLOTHESLINE Clamps," dozen 75c. O K Line Lock Company, Toledo, O.

SELL Made to measure raincoats. Outfit free. Goodyear Rainwear, 18 West 22nd, New York.

EARN Money at home. Easy dignified proposition. No canvassing. Hetzel, 802 Garden, Hartford, Conn.

SELL Ink-up in school, home and office. Fills fountain pen without soiling pen or using side lever, other valuable features. Sample and selling plan 35 cents. Universal Specialty Co., Mukwonago, Wis.

MAKE More money selling shirts, ties, underwear, dresses, hosiery, raincoats, sweaters, coveralls, pants, uniforms. Outfit free! Nimrod Company, Department 8, 4922-28 Lincoln Avenue, Chicago.

SELF-THREADING Needle packages. Sample 10c. Wm Oglesby, Vandalia, Ill.

MAKE Money selling our Indian remedies. Great repeat business, write for free booklet. Choctaw Medicine Co., Centerville, Mich.

NEW \$30.00 Value radio given in "free deal." Earn up to \$100.00 weekly. New sales plan. Also auto radios. Meritone Mfg. Co., 3857 North Hamilton, Chicago.

1000 BARGAINS—Drygoods, notions, toiletries, rubber goods. Agents undersell stores. Free catalog. Jobbers, Z-504 S. Crawford, Chicago.

STERLING Photo ring. Big profits. Photo medallions and jewelry novelties. Send for our retail catalogue. Medallion Novelty Co., Inc., 208 Bowery, New York, N. Y.

FREE Literature describing many money making plans. Belfort, 4042 N. Keeler, Chicago.

MAKE Money. Collect \$5, keep \$4. Two quick selling dollar per month "hard times" life policies. Write the Fidelity Mutual Benefit Association, Rockford, Ill.

SUCCEED With your products. Learn how. Formulas. Processes. Analytical service. Catalog free. B. Thaxly Co., Washington, D. C.

EVERYWHERE. Experience unnecessary. Large income. Market & Financial Adviser, Valley City, N. Dak.

CASH Income daily resilvering mirrors at home. Replating autoparts, tableware, etc., outfit furnished. Write Sprinkle, Plater, 128, Marion, Ind.

OPERATE Home mail order business, selling our products. Everything furnished. Superior Specialties, Springfield, Ill.

AGENTS: Smash go prices! Santos coffee 12c lb. 4-oz. vanilla 8 1/2c. \$1.00 size- tonic 14c. 60c size shampoo 8 1/2c. 100 sticks chewing gum 12c. Christmas cards, 21 in box, 14c. 150 other bargains. Experience unnecessary. Write Carnation Co., PO, St. Louis, Missouri.

MAKE Products yourself—Tested formulas. Catalog free. Grinstead Laboratory, Edwardsville, Ill.

AGENTS—Engraved name plates, number plates, signs, etc., easily sold, profits large. Brett Bros., Winthrop, Mass.

PORTRAIT Agents throughout the world, get my free catalog, portraits, frames. Lowest prices. Picture Man Friedman, Dept. 9, 528 Cornelia, Chicago, Ill.

BIG Money applying gold initials on automobiles. Easiest thing today. No experience needed. Free samples. "Raico," 1084 Washington, Boston, Mass.

MAN In each town to plate auto parts, reflectors, bathroom fixtures, refinish beds, mirrors, chandeliers; by new method. No capital or experience required. Simple plan of manufacturing at home starts you in big money-making business. Outfit furnished. Free particulars and proofs. Gun Metal Co., Ave. H, Decatur, Ill.

BIG Money and fast sales. Every owner buys gold initials for his auto. You charge \$1.50; make \$1.45. Ten orders daily easy. Write for particulars and free sample. American Monogram Company, Dept. 40, East Orange, N. J.

AGENTS—Opportunity to make money; book containing 87 successful business plans; home or office; send for free introductory booklet. Elite Co., 214 Grand St., New York.

AGENTS: Stamping names on pocket-key protectors. Sample check with your name, address, 25c. Stamping outfits. Emblem checks, check-fobs, name plates. Hart Mfg. Co., 303 Degraw St., Brooklyn, N. Y.

AMAZING Cleaner. Cleans everything. Sample free. Bestever, 5007P Irving Park, Chicago.

A BUSINESS Of your own making sparkling glass name plates, numbers, checkerboards, medallions, signs. Booklet and sample mailed free. E. Palmer, 512, Wooster, Ohio.

PROFITABLE Home business. Legitimate. No canvassing. Maywood Publishers, P-923 Broadway, New York.

GENUINE Gold letters for store windows. Easily applied. Free samples. Liberal offer to general agents. Metallic Letter Co., 438-B North Clark, Chicago.

SELLS Like hot cakes. Big profits. New laundry soapflakes. Perfumes clothes lastingly when washing. Territory given. Sunset Laboratories, Lynbrook, N. Y.

HIGH-GRADE SALESMEN WANTED

MEN Wanted by world-wide industry—Apply by letter only giving age, experience, references. Industry and reliability main qualifications. Man selected will become authorized Rawleigh dealer on our capital and taught how to establish a profitable business in over 250 farm and home necessities. Man with auto preferred to introduce products and travel steadily. Write immediately. Rawleigh Co., Dept. J-N-PPM. Write branch nearest you. Freeport, Ill., Memphis, Tenn., Richmond, Va., Chester, Pa., Albany, N. Y., Minneapolis, Minn., Denver, Colo., Oakland, Calif., Montreal or Winnipeg, Canada.

YEAR'S Income in 3 months! New federal, state and code laws create immense demand for simplified record system every businessman must have to protect himself against fines and penalties. Millions users must buy again now. Our men selling 5 to 25 daily our officially approved, copyrighted Liberty Tax Record. \$3.50 cash profit every sale. Repeat commissions without callbacks. Live leads furnished. Big season now. Choice territories going fast. Commonwealth Publishing Company, 508 So. Dearborn, Chicago.

MAKE Big money steady. High grade coveralls, shopcoats, pants, shirts, summer suits. Advertising on back. Fast sellers. Free outfit. Strong Mfg. Co., 901 West Jackson, Dept. N-8, Chicago.

DISTRIBUTORS: Represent original manufacturer. Bantex Modern Self-Sealing Bandage. Quality merchandise. Lowest prices. Profits enormous. Demonstration sells easily. Positive repeater. Beautiful displays. Territory available. Bantex, 443-D South Dearborn, Chicago.

AUTO Accessory salesmen: Complete line fastest sellers. Prices dealers want to pay. Big commission daily. Exclusive territory. National, 1910-BA Wentworth, Chicago.

SALESMEN: Everybody buys business stationery. New items. Highest quality. Lowest prices. Free cuts. Quickest delivery. Big commission daily. Experience unnecessary. New way self selling outfit free. Wilens, Dept. 57, 2132 Gladys, Chicago.

SEND Hose size for samples and opportunity for \$20 week job. Just show sensational guaranteed hosiery to friends. Dignified, pleasant, easy work. Everything supplied. Betterknit Hosiery, Outfit-3710, Columbus, Ohio.

BIG Money in tire patches. Sell new auto tire patch to service stations, garages, etc. Tiger-Grip patches guaranteed 10,000 miles. \$75 weekly for salesmen or distributors. Protected territory. Write Economy Rubber Co., 716 Burkhardt, Dayton, Ohio.

STRANGE Chemical sponge cleans cars like magic. Banishes auto-washing drudgery. Sells on sight. 150% profit. Outfit free. Kristee Mfg., Box 1440, Akron, Ohio.

TAILORING Sensation! Latest line men's 3 piece utility suits. Your price \$6.25. Commission \$3.00 on every order. Bonus. Suit furnished. Free outfit. Service Garment Co., 1615 N. Damen, Chicago.

\$5 SPOT Cash on every \$6 sale! Connect with a winner. Earn up to \$20 daily. New plan of protection at cost. Everyone a prospect. Free outfit explains fully. Provident Aid Society, Dept. M-526, South Bend, Ind.

MAN—Handle regular store route. Place nationally advertised 5c-10c counter card mdse. New aspirin deal. 16 tablets 10c. 85 more fast sellers. 100% profit. No investment. Catalog free. World's Products Co., Dept. 10810, Spencer, Ind.

WONDERFUL Opportunity. \$20.00 a day can be earned. No experience necessary. You can start at once. Showing the latest thing out. Self protection and home protection at cost. Ages 1 to 80. Not insurance but provides benefits up to \$1000.00 natural or accidental death. \$20.00 per week if sick or injured. Address National Aid Society, Dept. B, Springfield, Ill.

SHOE Manufacturer wants men. Big pay every day. Guaranteed quality. Low direct prices. No experience necessary. Sales outfit sent free. Write Consolidated Shoe System, Dept. C3, Chippewa Falls, Wis.

SALES Books and labels. Sell sales books in small quantities at attractive prices. Also "Allpurpose" pocket label that sells at every stop; good commissions. Technocraft, 79 Kingston, Boston.

GO Into wholesale business without investment. Call on stores with biggest line self-selling counter displays: Aspirin, razor blades, handkerchiefs, breathlets, household cement, 79 different items. Up to 125% profit for you. Experience unnecessary. Write for catalog and plans. Procopax, Dept. 36-BD, 1956 S. Troy, Chicago.

SALESMEN: Sell and install replacement shock absorbers. Large profits. Write Central Garage, Portland, Maine.

SALES Demonstrators. U-Kan-Plate with pure silver. 1 oz. polish 20c, 8 oz. \$1. Justice, 904 Walnut, Philadelphia.

BRAND New grab-bag deal. Going big everywhere—big profits—swift sales—fast repeats. No restrictions. All dealers buy. Act! K&S, 4373 Ravenswood, Chicago.

FREE Literature describes money making plans. Ladnar Agency, Jefferson City, Mo.

SELL Small duplicating device. Permits one to make their own rubber stamps, minus the rubber. Liberal commissions. Evedeady Duplilstamp, 132 West 46th, New York.

SALESMEN: Sell political candidates tire signs, bumper signs. Big commission. Whipple Co., Saginaw, Mich.

MEN Wanted. Sell shirts. No experience necessary. Free samples. Commission in advance. Free ties with shirts. Carroll Mills, 875 Flatbush Ave., Dept. E., Brooklyn, N. Y.

GREASE Gun salesmen—Exclusive industrial territories now open. Commission basis. Factory help. Demonstration kit furnished convinces prospects. \$25.00 deposit required. SSS Corporation, 138 Holden St., Minneapolis, Minn.

PENNY Each, popular sizes. Non-tarnishable window sign letters. Enormous profits. Free working equipment, samples. Record breaking offer. Atlas Sign Works, 7941 Halsted, Chicago.

MAKE More money selling shirts, ties, underwear, dresses, hosiery, raincoats, sweaters, coveralls, pants, uniforms. Outfit free! Nimrod Company, Department 65, 4922-28 Lincoln Avenue, Chicago.

SOMETHING New in fire extinguishers. Red Comet automatics. Proved in west five years. Exclusive territory. Low price opens pocketbooks. Write Red Comet, 404 Comet Building, Littleton, Colo.

SALESMEN: Acquainted with garages, filling stations, to handle local business. Write Colgra, 2623 N. Third St., Milwaukee, Wisconsin.

SELL 5c To 50c stunt gliders and real flying airplanes. Millions sold yearly. Sample free. Western Aircraft, 1269 South Norton, Los Angeles.

GIVE Profits—Up to \$170 weekly. \$500.00 punchboard firm announces new no investment plan. Season starting. K&S, 4326 Ravenswood, Chicago.

SALESMEN—Sell collection systems. 400% commission. Sayers Systems, 2801-123 Sheffield, Chicago.

STICK-ON Window sign letters. 500% profit. Free samples. Metallic Co., 438-A N. Clark, Chicago.

NEW Specialty—Sells every business and professional man. Four \$15 sales daily pay \$280 weekly. Foyer cleared \$4920 in three months. Write, F. E. Armstrong, President, Dept. PM, Mobile, Ala.

SELL Stores or homes—Scissors sharpeners, gas lighters, razor blades, aspirin, breath gum, chewing laxative, adhesive tape, polish, handkerchiefs, polishing cloths, shoe laces, many others. Attractive displays. Catalog free. Superba Co., S-303, Baltimore, Md.

HELP WANTED

GROW Mushrooms. We show how. Use cellar, shed, etc. Plant now. Overnight crops. Splendid income. Data free. Interstate, NC-7357 Cottage Grove, Chicago.

BIG Money growing mushrooms. Cellar, idle places. Supplies furnished. Free book. Mushroom Growers Association, M-453 N. Clark, Chicago.

STOP Worrying about money—I'll start you with regular weekly route supplying famous "Zanol" products to steady consumers. Routes pay up to \$60 a week. Earnings start immediately. Write Albert Mills, Route Mgr., 4669 Monmouth, Cincinnati, O.

EARN \$5.00 Daily raising mushrooms in cellar, shed, attic. We buy crops. Guaranteed materials furnished. Odorless method. Book free. United, 3348-AD Lincoln Avenue, Chicago.

AGENTS—Mosco corn and callous remover will build you a steady repeat business. Send today for pocket-size trial outfit. The Moss Company, 44 Searle Bldg., Rochester, N. Y.

\$100 PER Ton and up for certain common weeds, roots and barks. Particulars 10c. U. Merritt, 1752 Nicholson, St. Louis.

EDUCATIONAL AND INSTRUCTION

GET The position or job you want without payment of "service fees." Learn definitely how you can sell your personal services. Send immediately for free literature regarding our new, modern, effective system endorsed by hundreds. Stamp appreciated. Loben, Box 524, Dept. PM10, Savannah, Ga.

WORK For "Uncle Sam." \$105.00-\$175.00 month. Fall examinations expected. List positions free. Franklin Institute, Dept. H3, Rochester, N. Y.

LATEST Developments in arithmetic easily learned. Frederick A. Smith, 2410 Smalley Court, Chicago.

BECOME An investigator. Free particulars. Write International Secret Service Institute, PM-104, Hoboken, N. J.

GET U. S. government job—Start \$103-\$175 month. Men-women, age 18-53. Are you eligible for eligibility test? Get our free questionnaire—find out. No obligation whatever. Instruction Bureau, 101, St. Louis, Missouri.

LEARN Movie recording, projection, camera. The greatest professions available today. Opportunities everywhere for trained men. Big money. Pleasant work. Motion Picture Engineering Institute, Dept. A, 6605 Hollywood Boulevard, Hollywood, Calif.

BOOKBINDING Taught by mail. For information write Hartley, 156 Malone Ave., Belleville, N. J.

HOME Study courses leading to degrees: Writing; arts and sciences; education; psychology; chemistry; law; theology; home economics; engineering; business; agriculture. Many others. McKinley-Roosevelt University, Chicago.

BECOME A landscape architect. Easy to learn by mail. Wonderful opportunity for money-making. Earn while you learn. Write for free opportunity booklet and details. American Landscape School, 805 Plymouth Bldg., Des Moines, Iowa.

MYSTIC New language. Ordinary conversation in one week. Instruction book 25c coin. Zenda, Burbank, Calif.

WRITERS—Will teach you how to compose letters which bring you \$1 per letter. Steady income, opportunities everywhere, all or part time. Human nature appeal, easy to learn. Free booklet. Letter Scribes, 639 Wall, Ridgewood, N. J.

LEARN Chiroprody. Complete course by correspondence. Evans Foot Inst., Montgomery, Ala.

U. S. GOVERNMENT Positions. \$1700-\$1900 and up a year. Let our expert (former government examiner) prepare you for a position in the railway mail service, rural carrier, post office, customs and other branches. Write today for free booklet. Dept. 8, Paterson School, Rochester, N. Y.

SHORT STORIES

STORY Plot chart free. Stamp. Thos. L. Powis, Libertyville, Ill.

SHORT Stories revised, typewritten, marketed. Write for details. Hursh Service, Box P-1013, Harrisburg, Penna.

PRINTING, MULTIGRAPHING AND MIMEOGRAPHING

PRINTED Stationery and cards. Circular free. Samples 10 cents. Menten, 9313 Glenwood Road, Brooklyn, N. Y.

1000 LETTERHEADS, Envelopes, circulars \$2.95. Low prices leaflets, folders, catalogues. Samples. Frazer Press, Box 45-D, North Topeka, Kan.

IMPRINTED Stationery! \$1 brings you postpaid 200 sheets of bond note paper, 100 envelopes, all bearing your name and address in a beautiful imprint. Address, Haldeman-Julius Co., Box 2, Girard, Kans.

STATIONERY, Circulars, checks, loose-leaf, ruling, binding. Commercial Press, Batavia, Ohio.

1000 BUSINESS Cards \$1.00. Why pay more? Wright, 524 So. Spring St., Los Angeles.

1000 CARDS, Tickets, billheads \$1.40. Illustrations. Bradshaw, 3214 Huron, Chicago.

1000 BUSINESS Cards or 500 letterheads \$1.00. 6x9 circulars \$2.00. All sent postpaid. West Coast Printing, Five Points, Huntington Beach, Calif.

5000 ELEGANT Envelope slips—200 words—\$3.90 prepaid. Labels. Circulars. Stationery. Low prices. Samples. Goodprint, Harrisonburg, Va.

2000 BUSINESS Cards neatly printed \$1.50. Atlas Distributing Co., Roberts St., Pittsburgh, Pa.

PRINTING, Mimeographing, low prices. Free estimates. Hunt Co., Box 202, Trenton, N. J.

ENGRAVURE Printing. Lowest possible prices. Samples free. Sunko, Mohawk, N. Y.

BETTER Grade printing, reasonable priced. Free samples. Economic Press, Leonia, N. J.

1000 BUSINESS Cards, card case, \$1.50. Miller, Printer, Ambler, Pa.

UNIQUE Gummed labels; rubber stamps; engravings. McPherson Popular Print, Middletown, Conn.

PRINTING OUTFITS AND SUPPLIES

BUILD Your own press, costs small, illustrated instructions 15c. Earle Nason, 19 High, Somerville, Mass.

PRINTING Presses and supplies. Lists 3c. Popular Bargains, Richland, Pa.

REBUILT Presses. Advise size wanted. Send stamp. Exchange D-5, 480 East Main, Meriden, Conn.

PRINT Your own cards, stationery, circulars, advertising, etc. Save money. Easy rules furnished. Print for others, big profits. Junior press, \$5.90; job presses, \$11; power, \$149. Write for free catalog and full information. Kelsey Co., V-11, Meriden, Connecticut.

NEW Type 29c font. Catalogue dime. National Type Company, Jackson, Mich.

DUPLICATORS Rotary, new, guaranteed, \$14.50. Vari-Color Duplicator Company, Ottumwa, Iowa.

PRINTING Presses, type, supplies. Lawrence, 1426 South St. Francis, Wichita, Kans.

BARGAINS Used presses, type. Send stamp. Box 15, Cambridge, Mass.

PRINT Your own circulars, envelopes, with home made press costing less than \$1.00. Illustrated instructions 10c. Carl Edquist, Odessa, Minn.

PRINTING Outfits—Presses, type supplies, type novelties. Send stamp for catalog. Model Press, York, Penna.

TYPEWRITERS AND SUPPLIES

TYPEWRITER Ribbons 40c, three \$1.10! Guaranteed! T-S-G Co., Box Ten, Wilkesburg, Pa.

GUMMED LABELS

1,000 PRINTED: Name, business, address 50c. JBS Company, Box 93, Holyoke, Mass.

PRINTED; From your copy, 40c 1,000 up. Samples free. Wetzel, Valhalla, N. Y.

DUPLICATORS AND DEVICES

DUPLICATING Machines \$3.85 to \$95. Rotary stencil, clay composition, gelatin film. Most complete line in America. Photo-Litho folder free. Pittsburgh Typewriter Supply, Suite 577, Pittsburgh, Pa.

BUILD A duplicator. Costs less than dollar. Instructions dime. Paul Williscroft, Yakima, Wash.

LEATHER

LEATHERCRAFTSMEN—Write for free copy of Wildercraft and price list of leather, tools, etc. Visit our exhibit in the Home Workshop, Section T, 2nd floor, General Exhibits Bldg., Century of Progress, 1934. Wilder & Company, 1038 Crosby St., Chicago, Ill.

RUBBER STAMPS

RUBBER Stamps, regulation business sizes, not miniature. Fast service. Sent same day. Guaranteed. Northlake Evatyp, Peoria, Ill.

RED-RUBBER, 2 Lines 25c; 3 lines 35c. Fehlberg, 921 Farnam, LaCrosse, Wis.

NAME, Address, 2 lines 25c; 3 lines 35c. Stamp Works, Auburn, Nebr.

TOBACCO

REAL Northern grown leaf tobacco. Large trial package containing six kinds \$1.00. Farmers Exchange, Edgerton, Wis.

GUARANTEED Tobacco—Natural leaf chewing and smoking, 5 lbs. \$1.00; 10 lbs. \$1.50. Cigarette Burley, 5 lbs. \$1.00. Free gift. Howards Plantation, Mayfield, Ky.

RAZORS AND BLADES

RAZOR Blades honed correctly. 1c each. Petter Wetterquist, Rockford, Ill.

100 DOUBLE Edge blades \$1.10 postpaid. G. Pennington, Rt. Robbinsdale, Minn.

GILLETTE Type razors shave closer with Adjuston. 10c postpaid. Adjusto, 35 N 9th, Columbus, Ohio.

FIELD GLASSES, TELESCOPES AND MICROSCOPES

500X ACHROMATIC Raek and pinton microscope. The only instrument of this power priced under \$15 with an achromatic lens system which prevents color distortion. All refinements. Two pinions. Adjustable stand and mirror. Large stage. Not a toy but a scientific instrument whose low price is due to quantity purchase of a fine imported line. Slides and complete dissecting equipment. Send \$4.95 to Scientific Supply Co., Times Building, New York.

500X MICROSCOPE \$3.95. 30X telescope \$1.98. America's lowest prices. Optical catalogue free. Brownscope Co., 246 Fifth Ave., New York.

SEND 10c For new catalog listing chemical, microscope and photographic kits and supplies. Special 30 day offer to those who send immediately. Winn Company, 124B West 23d Street, New York.

CATALOG And new reduced price list on microscopes, telescopes, binoculars. Vure, 307 Throop Ave., Brooklyn, New York.

DIAMONDS, WATCHES AND JEWELRY

A BEAUTIFUL Wrist watch can now be yours. American made dust proof nonbreakable crystal, good time keeper, only \$5.00, but sold on easy payments. Also fountain pens, and books that satisfy. Postcard brings details. Edw. Abbott, Rochester, Vt.

AUSTRALIAN OPALS

HUGE Collection large opal specimens, \$5.00, \$20.00 each. Lists free. Norman Seward, Melbourne, Australia.

GUNS, FISHING TACKLE AND SPORTING GOODS

TARGET Pistols: 22 cal. Iver Johnson 9 shot 6"—\$7.95; Hi-Standard 6 1/2" single shot—\$7.95; Automatic 6 1/2"—\$17.95. Rifles: 22 cal. Remington Improved No. 6, take-down, single shot—\$4.95; Marlin model 50, auto-loading 6 shot—\$11.75; Marlin model 93, carbine or full magazine, 30/30 and 32 cal.—\$23.75. Spotting scope 20X guaranteed for small calibers to 100 yds.—\$8.95. Binoculars 8x25, fine imported genuine prism, case and straps—\$15.95. All above brand new. Send 3c stamp for catalog. W. Lee Sales Co., 35 West 32nd St., New York.

NATIONALLY Advertised new guns, delivered at bargain prices. Catalogue free. Hoyt's, Sac City, Iowa.

FISHERMEN—Make your own sinkers with our molds. Several styles, many sizes. Free folder. Reading Instrument Co., Box 78, Reading, Pa.

GLOWING New night fishing bait! Make, use, sell! Instructions 20c. International Agency, Cincinnati.

OPTICAL GOODS

ULTRA-LENS Pocket microscope 500X magnification (250,000 areas) 50c postpaid. Pfeigor, Milton, Pa.

ANTIQUES, WAR RELICS AND INDIAN GOODS

WAR Relics for clubhouse or den. Vickers aircraft machine guns; cost government \$700; rendered unserviceable without marring. Only \$7.75 each. Sent COD on payment of \$1.00. Weight 33 lbs. Flala Outfits, 47 Warren Street, New York.

INDIAN Relics. Beadwork. Coins. Curios. Catalogue and arrow, 6c. Vernon Lemley, Northbranch, Kans.

MUSIC AND MUSICAL INSTRUMENTS

COMPOSER Of diagram arrangements—Guitar, banjo. 4625 Wells, Milwaukee.

SONGWRITERS! Poems, melodies. Amazing opportunity. Hibbler, D1, 2104 Keystone, Chicago.

SONGWRITERS—Poems or melodies—50-50 collaboration. PM Herring, Franklinpark, Illinois.

MUSIC Composed to words. Wonderful proposition. Bauer Bros., Oshkosh, Wis.

COMPOSER Collaborates free! Stamp appreciated. Stein, Box 5437, Philadelphia, Pennsylvania.

SONGS Composed, published, royalty basis. Stevens, 2407 East Admiral, Tulsa, Oklahoma.

LATEST Song hits 30 cents postpaid. Catalogue free. Zerse Distributing Co., 210 Olive, St. Louis, Mo.

POEMS Wanted. Work guaranteed. We publish. Great Eastern Song Bureau, Dept. 27, Thomaston, Me.

DUO-FLEX Reeds for clarinets, and saxophones eliminate your reed troubles. Write for circular. Duo-Flex Reeds, 1204 1st Ave., Evansville, Ind.

SONG Writers. Send for our "Publishing Agreement." McKinley Music Printers, 1501 E. 55th St., Chicago.

NEW Deal. Write Sequoia Songrites Service, Sherman Branch, Los Angeles, California.

WANTED: Original poems, songs. MMM Publishers, Studio Building, Portland, Ore.

\$\$\$SONGWRITING\$\$\$. Good money being made from songs through talking pictures, radio, phonograph, music publishers. "Hit" writers revise, arrange, compose music to your lyrics, lyrics to your music. We submit to studios and other markets. Free reading. Send for booklet. Universal Song Service, 671 Meyer Bldg., Hollywood, Calif.

PATENT ATTORNEYS

INVENTORS: Send immediately for your copy of our big, new free book, "Patent Protection." Forty-eight pages of interesting facts. Tells how patent laws protect you; kind of sketch or model needed; simple steps to take without cost; how successful inventors have secured financial assistance; shows interesting inventions; illustrates important mechanical movements. Other men have read and profited by this book. With book we also send free Evidence of Invention form, that you can use to establish date of disclosure. Prompt service, reasonable fees, special deferred payment plan. Strictest secrecy. Thirty-six years' experience. Highest references. Write us today. The facts in our book are worth money to the man with a good invention. Address: Victor J. Evans & Co., Registered Patent Attorneys, 400-L Victor Building, Washington, D. C.

UNPATENTED Ideas can be sold. I tell you how and help you make the sale. Free particulars. (Copyrighted.) Write W. T. Greene, 907 Barrister Building, Washington, D. C.

REGISTERED—\$40.00. Samuel Goldstein, 275 East Gunhill Road, New York City.

PATENTS—Before too heavy an outlay of time or money is made on an invention, a search of the Patent Office records should be made to determine as nearly as possible whether or not the same idea has been patented before. The cost of this search is small, while the value of the facts it uncovers is often considerable. We offer inventors and manufacturers a thorough, prompt, confidential search service—plus experienced counsel and assistance in every phase of Patent and Trademark practice. Write for my free book containing valuable information relating to patent procedure. Clarence A. O'Brien, Registered Patent Attorney, 58-J Adams Building, Washington, D. C.

PATENT Lawyer. Sound protection given inventors—very reasonable. A. S. Bryant, 604 Grand Ave. Temple, Kansas City, Mo.

A NEW Deal for inventors: Combined patent attorney and development engineer service. Simple case attorney's charge \$50.00. Search \$5.00; trade-marks complete \$35.00; copyrights \$6.00. J. J. O'Brien, Patent Attorney-Engineer, Reg. 1909, 108 West 42nd St., New York City.

PATENT Lawyer—Formerly principal examiner in patent office. Satisfaction guaranteed. Charles Haden, 1004 N Street, Washington, D. C.

INVENTORS—Send for free booklet "Patent-Sense." Information based on 64 years experience. Lacey & Lacey, Dept. 5A, 635 F St., Washington, D. C.

INVENTORS May now market practical new ideas before patenting. For information, write Chartered Institute, 554 Barrister Building, Washington, D. C.

ESTABLISHED 1864. Milo B. Stevens Company. Free booklet. Patents. Trade marks. Copyrights. Offices: Monadnock Block, Chicago; American Security Building, Washington, D. C.

PATENTS—Proper service for manufacturers and individual inventors. Established 1895. Preliminary advice free. Reasonable charges. Consult Chandlee & Chandlee, Patent Attorneys, 902 F. Street, Washington, D. C.

PATENTS. Instructions "How to Establish Your Rights" and form, "Evidence of Conception"—sent free! Lancaster, Allwine & Rommel, 411 Bowen Building, Washington, D. C.

PATENTS Procured; trade marks registered—preliminary advice furnished without charge. Booklet and form for disclosing idea free. Irving L. McCathran, 790A International Bldg., Washington, D. C.

PATENTS. Booklet free. Highest references. Best results. Promptness assured. Watson E. Coleman, Patent Lawyer, 724 Ninth St., Washington, D. C.

"INVENTOR'S Guide," valuable information free. Frank Ledermann, Registered Attorney-Engineer, 220 Broadway, New York.

L. F. RANDOLPH, 302-B Victor Building, Washington, D. C. Low cost. Book and information free.

INVENTIONS WANTED

UNPATENTED Ideas—To make money, start right. Our 20 chapter book, "Your Invention—What to Do With It" tells how. \$1.00 postpaid. 5 day money back guarantee. Roesch & Associates, Inc., 933 University Block, Syracuse, N. Y.

HAVE Clients to invest in practical new inventions to manufacture and distribute patented articles. Write details. Denes & Willis, 18 East 41 Street, New York City.

INVENTIONS Wanted, patented, unpatented, any size, any material, for any legitimate purpose. Bosley Mfg. Co., 79 High Street, Torrington, Conn.

INVENTIONS Developed. Manufacturers: Models, special machines; photo-electric relays, applications. Machinery Engineering Co., 30 Church St., New York.

INVENTIONS Wanted—Patented, unpatented. If you have an idea for sale write Hartley's, Inc., Box 928-E, Bangor, Maine.

SMALL Inventions wanted. Stanley Hull, 7829 Euclid Avenue, Cleveland, Ohio.

FOR INVENTORS

INVENTORS: Send immediately for your copy of our big, new free book, "Patent Protection." Forty-eight pages of interesting facts. Tells how patent laws protect you; kind of sketch or model needed; simple steps to take without cost; how successful inventors have secured financial assistance; shows interesting inventions; illustrates important mechanical movements. Other men have read and profited by this book. With book we also send free Evidence of Invention form, that you can use to establish date of disclosure. Prompt service, reasonable fees, special deferred payment plan. Strictest secrecy. Thirty-six years' experience. Highest references. Write us today. The facts in our book are worth money to the man with a good invention. Address: Victor J. Evans & Co., Registered Patent Attorneys, 401-L Victor Building, Washington, D. C.

INVENTION Magazine. Sample 3c. 1620 W. First, Winston-Salem, N. C.

TO Inventors: We are in the market to purchase a good patent, preferably in the automobile accessory line. Will purchase outright or on royalty basis. Purchasing Agent, 241 Front St., New York, N. Y.

PATENTS—Small ideas may have large commercial possibilities. Write immediately for information on how to proceed and "Record of Invention" form. Delays are dangerous in patent matters. Clarence A. O'Brien, 38-H Adams Building, Washington, D. C.

INVENTORS, New worthwhile ideas published monthly. No hints or junk. 25c. Clair, Box 161, Granite City, Ill.

WE Help inventors to develop inventions and sell patents. 15 years experience. Roy J. Anderson, Consulting Engineer, 6140 S. Mansfield Ave., Chicago.

PATENTS Obtained; partial payments. Inventors Service, Winter Building, Washington.

IDEAS Developed, model making. Information, research. American Research Foundation, Box 817, Muncie, Ind.

COPY Of any patent sent for \$1.00. R. Burch, 904 F St., Washington, D. C.

MANUFACTURERS Everywhere seek new inventions to improve their product. List of wanted inventions sent free on request. Use our legal form for recording proof of invention. Write W. T. Greene, 944 Barrister Building, Washington, D. C.

INVENTORS Wanting to realize on new ideas before patenting, write Chartered Institute, 558 Barrister Building, Washington, D. C.

INVENTORS—Ideas developed into practical inventions and working models built. Electrical problems solved. Lowest prices and confidential service. Reo-Paul Engineering Co., 1208 E. Monument St., Baltimore, Maryland.

INVENTOR'S Universal Educator: contains 900 mechanical movements; 50 perpetual motions; instruction on procuring and selling patents and selecting an attorney, etc. Suggests new ideas. Price \$1.00 postpaid in U. S. A. Address Albert E. Dietrich, 602B Ouray Bldg., Washington, D. C.

INVENTORS: "Making Inventions Pay." our 32-page illustrated book, mailed upon receipt of 3c postage. Crescent Tool Company, Dept. Z, Cincinnati, Ohio.

PATENTS FOR SALE

TOY Monorail electric train, elevated system. Simple construction. 15765 Auburn, Detroit, Mich.

PATENTED Automatic self sealing cap for collapsible tubes. Market for millions. Investigate. R. E. Nichols, 10 Newman St., Jacksonville, Fla.

NEW Patent hose supporter on royalty. Box 202, Coconut Grove, Fla.

ENVELOPE, Stamp, tape and label moistener. Small, ornamental, excellent work. A. Egli, 1181 Martin Ave., San Jose, Calif.

640 PROMISING Inventions to manufacture. List free to manufacturers; others 6c. Chartered Institute, 555 Barrister Building, Washington, D. C.

BRONZE TABLETS

BRONZE Tablets, hardware, desk plates, wall plates, memorials, grave markers. Bronze, brass and aluminum casting. Wandkey Pattern & Foundry Co., Anderson, Ind.

MODELS AND MODEL SUPPLIES

MODEL Locomotives—Build your own, working live steam miniatures. Castings and prints. List 6c stamps. H. J. Coventry, 2701 Talbot Rd., Baltimore, Md.

SHIP Model fittings. Send 3c stamp for catalog. The Wilson Co., Bristol, Conn.

EVRAV'S Engine catalog No. 34 or supply catalog No. 35, postpaid 20c. Evraymesco, Box "C," 28 No. Clinton St., Chicago.

SCALE Fittings and woods, for clipper, motor and sailboats. Catalog P, 15 cents. Gene's, 510 East 11 St., New York City.

THE Modelmaker. The magazine for those interested in building model railroads, boats, engines. Send 15 cents for copy. Modelmaker Corp., 330P West 34 Street, New York, N. Y.

SHIP Models—Build 18" Flying Cloud, Constitution or Galileo. All materials including full-sized plans only \$1.50 from Hancock, 323 Douglass Ave., Portsmouth, Virginia.

SHIP And yacht model fittings. Send 15c (coin) for forty page illustrated catalog. See our display in the Homeworkshop—General Exhibits Building—Century of Progress, Chicago. A. J. Fisher, 1002-1 Etowah Ave., Royal Oak, Mich.

MODEL Ship fittings. Dime brings list. Anderson's, 301 Parliament St., Toronto, Ontario.

JAPANESE Model airplane tissue, 32 colors also wood veneer. 10c for working samples. Ask for Whitfield, Thinnest and brilliant. Whitfield Paper Works, 12 Vestry Street, New York City.

BRASS Gears and model supplies. Send for catalog. The Pierce Model Works, Tingley Park, Ill.

PATENTS. Low cost. Book and information free. L. F. Randolph, 302-C Victor Building, Washington, D. C.

MODELS—Your ideas developed into practical working models. 30 years' successful experience; thousands of satisfied customers. Confidential service guaranteed. Bank references. Send 3c postage for 32-page book—"Making Inventions Pay." Crescent Tool Company, Dept. Y, Cincinnati, Ohio.

FOR Sale—Hot dip and electro tinning equipment for manufactured articles, copper, milk cans, etc. Expert advice. Retinning Mfg. Co., 3021 Greenville, Chicago.

10"x5' QUICK Change Champion lathe \$125.00; 12" Hendey shaper \$75.00; No. 60 Head cylinder grinder \$175.00; all sizes and types of machine tools. Send for catalogue listing other bargains. Terms to suit. Cincinnati Machinery & Supply Co., 27 W. 2nd St., Cincinnati, Ohio.

SURVEYING INSTRUMENTS

FACTORY Rebuilt transits and levels. Sale or rent. Priced from twenty dollars up. Ten days approval. Your old instruments taken as part payment. Terms if desired. Write for list M-810. Warren-Knight Co., Makers of Sterling Surveying Instruments, 136 N. 12th Street, Philadelphia, Pa.

WELDING AND SOLDERING

DEMONSTRATORS, Electric arc welders. Money-saving prices. Used by the government. Trial and terms guaranteed. Hobart Welders, M-1044, Troy, Ohio.

WELDING Outfits, new and rebuilt \$15.00 up. Instruction book, prepaid, upon receipt of \$.75. Welders Supply & Mfg. Co., Cincinnati, Ohio.

BUY Oxyacetylene welding and brazing equipment, easy payment plan. Superior OxyAcetylene Company, Hamilton, Ohio.

ARC-WELDING Outfit \$1.25. Weld fenders, braze, solder. Lavrow, 4368-W. Warren, Detroit. Stamp appreciated.

HEATING AND VENTILATION

ELIMINATE Heat losses. Five proven plans \$1. Fuel-saver devices. 900 Manhattan, Dayton, Ohio.

ELECTRICAL EXPERIMENTS

BANKRUPT Stock—Electrical experimental kits. Kit makes motors, detectophones, arc furnace, telephones, etc. Salvage price \$1.99. Other outstanding electrical values. Catalog—stamp. Electrical Salvage Co., Box 524, Lincoln, Nebr.

ELECTRICAL SUPPLIES

INSULATION, Wire, varnishes, supplies, etc. Send 3c stamp for bulletin. Autopower, 408-B Hoyne Ave., Chicago.

MACHINERY, TOOLS, ETC.

HARD To get supplies, tools; specialties; motors; pumps; automobile parts. Catalog 10c. Kostka, 235 D-G South Crawford, Chicago.

BARGAINS, Demonstrators, electric arc welders, guaranteed, 30 days trial and terms. Write Ken's Equipment, Box M-1045, Troy, Ohio.

MANUFACTURING

MANUFACTURING. Models, dies, stampings, brasswork, moulds for castings, vulcanizing. Circular free. Baums Metal Specialties, Kansas City, Mo.

INVENTIONS Manufactured in any quantity at low cost. Stampings, dies, models, etc. Estimates and free catalog. Crescent Tool Co., Dept. X, Cincinnati, Ohio.

METAL Articles developed and manufactured. Model making. Reasonable price and first class workmanship. W. F. Meyer Company, Bedford, Indiana.

TATTOOING OUTFITS AND SUPPLIES

TATTOOING Outfits, plug in light-socket \$5.85. Big manual included. Exclusive stencil-method, only tracing required. Write Chicago Tattoo Supply House, 651A South State, Chicago.

TATTOOING Outfits, supplies, illustrated list free. "Waters," 965 Put-nam, Detroit.

ENGINES, MOTORS AND DYNAMOS

GASOLINE Engines, 1/8 to four horsepower. Bargain lists 10c. Columbia, 4020 West Lake, Chicago.

SPECIAL Bargains in generators suitable for welding. Also other generators and motors. Electrical Surplus Company, 1885 Milwaukee Ave., Chicago.

BARGAINS in new and used electric motors, generators, converters, fans. Tell your requirements. Queen City Electric, 1736 Grand Avenue, Chicago.

WINDING Data, 100 AC motors, various horsepower and voltage, \$1.00. Motor Data Co., 3002 Monroe, Kansas City, Mo.

1/2 HORSE Alternating motors \$12.90. 1/12 horse Universal motors \$2.75. Refrigerator air compressors \$4.50. Electrical Surplus Company, 1885 Milwaukee Ave., Chicago.

GOVERNORS Control auto engines—stationary or portable uses. New big discount. No cash down. Candee-Smith Governor Co., 215 North Los Angeles St., Los Angeles.

TREASURE FINDERS

BUILD Your own inexpensive radio-active detector. Complete drawings and instruction \$1. John Segee, Dover, N. H.

RADIO Treasure finder tricks exposed by original builder. Write G. O. Maher, Baton Rouge, La.

BUILD Your own treasure finder. Complete plans \$.50. Free offer. Clough, Grayling, Mich.

TAXIDERMY

TAXIDERMY Supplies—Quality artificial eyes, teeth, genuine Jonas head forms. Tools, materials, etc. Everything for the progressive taxidermist. Send for big illustrated catalogue—Free. Jonas Bros., 1049 Broadway, Denver, Colo.

FARMS AND FARM LANDS

INDEPENDENCE, Security assured, North Dakota, Minnesota, Montana, Idaho, Washington, Oregon farms. Bargain prices, easy terms. Descriptive literature, impartial advice. Mention state. J. W. Haw, 119 Northern Pacific Railway, St. Paul, Minn.

FARMS With harvested crops. A cozy home, abundant living, all bargains for you. Farms all sizes, all prices, many states. Write now for free copy new fall bargain bulletin. Strout Agency, 253-P 4th Ave., New York City.

THE "New Deal"—Good farms are cheaper and rents lower in Minnesota, North Dakota, Montana, Idaho, Washington and Oregon. A small investment at unprecedented low prices today will increase as normal conditions return. Write for free book and low homeseekers' rates. E. C. Leedy, Dept. 457, Great Northern Railway, St. Paul, Minn.

\$5 DOWN, \$5 Monthly, 20 acres in Missouri Ozarks, \$100. Fishing, hunting, trapping. Hubbard, 216 Grossman Bldg., Kansas City, Kansas.

GOVERNMENT Land millions acres. Buy homestead. Send 40 cents. Information all states. Special Michigan, 600A Majestic Bldg., Detroit.

POULTRY

POULTRY Tribune—Leading poultry magazine. Five years \$1.00; six months trial 10c in U. S. Poultry Tribune, Dept. C-93, Mount Morris, Ill.

WANTED—MISCELLANEOUS

MAIL Us your discarded jewelry, gold crowns and bridges, watches, diamonds, silver, platinum. Money promptly mailed. Goods returned if offer refused. United States Smelting Works (The Old Reliable.) This is not a government institution. 39 So. State St., Dept. 71, Chicago.

WE Purchase all Indian head pennies. Premium lists 10c. Photopennies, 100 Forsyth, New York.

OLD GOLD WANTED

CASH For gold teeth, jewelry, watches. 100% full gold value paid day shipment received. Satisfaction absolutely guaranteed or articles cheerfully returned. Licensed by United States government. Information free. Chicago Gold Smelting & Refining Co., 557 Mallers Bldg., Chicago.

DOGS AND PETS

REGISTERED Hound puppies, Redbones, English Blueticks, long eared Black and Tans. Cheap. Henry Halmline, Creston, Ia.

BEAUTIFUL Pure white police dogs. Ansonia Kennels, Mose, N. Dak.

FROG RAISING

"RAISE Frogs for Profit!" Turn your backyard into cash. Free book "Fortune in Frogs" tells how. American Frog Canning Company, (153), New Orleans, La.

BIG Profits raising jumbo bullfrogs. New industry. Easy. Interesting. Send 10c for literature. American Frog Industries, Box 336, Rayne, La.

ROOTS AND HERBS

JUST Out! World's Greatest "Herbalist Almanac." Beautifully illustrated in natural colors. Contains over 500 old-fashioned herb medicine recipes and Indian secrets for home use. 10c (coin) postpaid. Worth dollars! Botanics, 145 W. 112th St., Chicago.

CASH Monthly—Gathering common weeds! Details 10c. International Agency, Cincinnati.

LUMBER

WOODS, Veneers, at rock bottom prices. List P free. Mail Order Wood Co., P. O. Box 38, Station D, New York City.

AQUARIUMS

EASY To make. Breed fish. Instructions 10c. Aquarium, Fullerton, Pa.

PERSONAL

FREE—Root and herb medicine book. Remedies for many ailments. Write Choctaw Medicine Co., Centreville, Mich.

PALMISTRY! For fun and profit. Complete 25c coin. Scott, 3318 Dunham, Kansas City.

HANDWRITING Tells! Complete analysis \$1. Sample 25c. Russell, Graphologist, Portland, Oreg.

SWAP\$S Bulletin. Guns, typewriters, courses, property, hobbies. List 10c. Ads 1c word. Interstate Sales Service, Sturgis, Michigan.

HYPNOTIZE Instantaneously! New dollar book 25c. Lonk Institute Hypnotism, D-1613, Palatine, Ill.

RABBITS

RAISE Rabbits for us. We supply stock and buy what you raise, paying you highest prices. Established 20 years. Rabbit book, catalog and monthly market bulletin showing prices we pay our breeders, 10c. Address Outdoor Enterprise Co., Inc., Box 51, Holmes Park, Mo.

SILVER Fox rabbits: Enormous profits. Proposition 10c. Hickory-Dell, Glenbeulah, Wisconsin.

FITCH

GENUINE German fitch. Most profitable fur animal raised. Very low prices, Henry Halmline, Creston, Iowa.

BREEDERS Produce twice yearly; big profits, small expense, easily raised, instructions with order. \$10.00 each. Skunk Ranch, Hilbert, Wis.

MISCELLANEOUS

DETECT Fingerprints Complete fingerprinting kit, universally used by detectives 30c. Brownlee, 218 Henry, New York.

CUTS Anybody can make. Simple, cheap process \$1.25. Specimens, particulars for stamp. J. C. Day, Windfall, Ind.

SWAP! Anything, anywhere. Send swapping list, fair value, describing each item. Will find trade you want. Send stamp. Stewart Marshall, Rome, Ga.

COMPLETE Photographic outfit. Develop pictures yourself. Camera, films, developing chemicals, printing materials, directions. Complete \$1.00. Photographical Equipment, 100 Forsyth, New York City.

TEMPLATE Patterns for making period doll furniture, toys, novelties. Sample set with list 10c. Puzmak, Colorado Springs, Colorado.

GET 25% More gas mileage. Air-Flow Economizer, \$5.00. Agents wanted. Air-Flow Economy Co., R-1, Saline, Mich.

SWAPPER'S Friend, R4, Saline, Michigan. Interests swappers, collectors, sportsmen. 50c year, sample 10c.

YOU Are wanted to resilver mirrors at home. Profitable business plating autoparts, tableware, etc. Write Sprinkle, Plater, 288, Marion, Ind.

AMATEUR Cartoonists—Earn \$25.00 week, spare time, copying cartoons for advertisers. 3-M Syndicate, Argyle, Wis.

MATHEMATICS
the key to all technical success

made plain in these books

Help your advancement in technical or scientific work. Learn mathematics. Palmer's course makes it easy to master the essentials. Shows how to use them in your daily work. Over 216,000 copies sold.

A Self-Instruction Course for Practical Men Palmer's simple, step-by-step treatment carries you from first essentials to working knowledge of all mathematical methods. Even makes clear the practical use of calculus. Course based on Palmer's years of trade school teaching; gives thousands of exercises and problems with answers based on every-day questions practical men brought to him for solution.

Study at Home; Pay As You Go

A few minutes a day will give you practical command of this important subject. See entire course without sending a cent in advance. Pay only \$1.00 in 10 days and \$2.00 monthly for three months if you keep the books. If you have ever felt the lack of a working knowledge of practical mathematics, send the coupon at once and look over the Palmer Course.

Palmer's famous home study course available on easy terms



Covers:
ARITHMETIC
ALGEBRA
GEOMETRY
TRIGONOMETRY
CALCULUS

with practical applications

Sent for Examination
No Money Down
Small Monthly Payments

McGraw-Hill ON-APPROVAL COUPON

McGraw-Hill Book Co., Inc., 330 W. 42nd St., N. Y. C.
Send me the Palmer Practical Mathematics and Calculus Home Study Course (2 volumes) for 10 days' examination on approval. In 10 days I will send \$1.00, plus few cents postage and delivery, and \$2.00 monthly for 3 months, or return books postpaid. (We pay postage on orders accompanied by remittance of first installment.)

Name.....
Address..... Position.....
City and State..... Company..... PM-10-34

Be a Civil Engineer!



Cyclopedia of Civil Engineering

7 great volumes. 2,800 pages. 1,600 illustrations.

New revised edition by twelve of America's greatest engineers.

Includes: Surveying, bridges, railroads, steel structures, municipal engineering, water supply, road building, etc.

Spanish Grain Flexible Covers Gold Stamped

Loaned Free!

To prove you can learn Civil Engineering at home in your spare time. And because no description here could do it justice, to let you see for yourself the scope and simplicity, the authority and quality of this great home reading course. Cost and terms are within your reach. Send me money—just mail the coupon.

Earn \$5000

a Year—and Up!

Civil Engineers are wanted NOW. Enormous amounts are being spent in all kinds of public works and not a dime is spent until the Engineer has prepared plans. Then he must direct the work. It's a big job and there are not enough men to go around. Everywhere you go, you see road work going on—water and sewer systems being built—vast projects of all kinds. Here is Your Opportunity to get the necessary training right at home. These books are complete and simply written so anyone can understand them. Start now on our FREE examination plan. Mail the coupon without obligation.

American Technical Society
Dept. C719, Drexel at 58th St., Chicago

American Technical Society
Dept. C719, Drexel at 58th St., Chicago

I want to BORROW the CIVIL ENGINEERING Cyclopedia for 10 days FREE. I will gladly pay the few cents express, but I am to pay nothing for the loan of the 7 big volumes if I return them within 10 days. If I wish to keep them I will send you \$2 after the 10 days, then \$3 a month until special advertising price \$29.80 is paid. Send latest Edition.

Name.....
Address.....
(Attach letter stating age, occupation, employer's name and address)

DIESEL

THE NEW OPEN DOOR TO SUCCESS

Learn Diesel Engines NOW!

Don't Wait! Diesel Power is the big, new field for greater opportunities and bigger pay. GET OUT OF THE RUT! BE AN EXPERT DIESEL ENGINEER and advance with this great new industry that is sweeping the world. LEARN DIESELS in our big, nationally recommended DIESEL Schools and Shops. The original, exclusive DIESEL Schools of

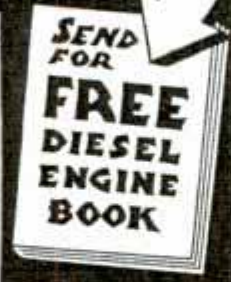

Book K Explains All Practical School Courses—Day and Night. Book H Explains Home-Study Combination Course.



New streamlined trains are DIESEL POWERED.

the United States and Canada . . . established many years and always ahead in training and equipment. More engines . . . more successful graduates . . . more Big Pay Jobs.

Send for your FREE copy of "Diesel News," containing up-to-the-minute information about the amazing opportunities everywhere for trained DIESEL men.

HEMPHILL DIESEL ENGINEERING SCHOOLS, INC.

2127 San Fernando Road, Los Angeles, Calif.
 P. O. Box 101, Chicago, Ill. P. O. Box 892, Oklahoma City, Okla.
 502 Westlake N., Seattle, Wash. - 1043 Pender St., Vancouver, B. C.

Nation-wide Employment Service is Free to all Hemphill Graduates

AMERICA'S ORIGINAL EXCLUSIVE DIESEL TRAINING SCHOOLS

BE A POULTRY EXPERT

Make \$40, \$50, \$60 a Week

Free book shows how to get started quickly. You'll be surprised at the amazing profit opportunities in the poultry business. Wherever you live—whatever you do—it is easy to start on a spare or full time basis. Free book tells all. Send for "How to Raise Poultry for Profit." You learn right at home in spare time by methods endorsed by colleges and leading poultrymen. Know how to get the maximum profits from interesting, healthy work. Iron-clad agreement protects you. We have prepared hundreds for good jobs and businesses of their own. Write now for free book. No obligation. National Poultry Institute, Inc., Dept. 411-J, 2005 15th St., N.W., Washington, D. C.

BUILD DUTCH WINDMILLS
 Beautify Your Garden—Make Money Selling to Others
 Easy to build from BLUE PRINTS. Model B10 (Hexagon style 30" high) 75c. Model B25 attractive Dutch Windmill operating DUTCH GIRL CHURNING BUTTER 50c. Knock Down Kit for Model B25 only \$4.00. Lawn cut out patterns sunbonnet girl, Dutch boy, Tulip Girl and Holland pair. 30c each. 4 for \$1.00. For Catalog send 10 cents Free with order.
 Craftsman's Model Co., Dept. P12, 2030 N. 41st St., Milwaukee, Wis.

LEARN CARTOONING

by the method that has developed hundreds successfully. Send name, address and YOUR age for free chart to test your ability. The Landon School, 1738 National Bldg., Cleveland, Ohio

Attend CHICAGO TECHNICAL COLLEGE

30th YEAR ACCREDITED

where you quickly get the training that will equip you for the new jobs, promotions and salary increases in fields now taking on new activities.

ARCHITECTURE DRAFTING
ENGINEERING
ELECTRICITY • BUILDING • RADIO

1, 2, 3 yr. Degree and shorter courses, days and evenings. A friendly college within reach of all. Send for Free Blue Book.

Address Pres. C. W. Morrey, B.S., M.B.
CHICAGO TECHNICAL COLLEGE
 Dept. N77, 118 E. 26th St., Chicago

Successful graduates, the country over. Opportunities to help pay board and room.

Get Smashing Strength with this Progressive BAR BELL and Professional Trainers Massive Muscle Building Outfit

STRENGTH DEFYING FEATS MADE EASY!



No excuse now for weaklings. Here's your opportunity to develop a herculean body. Get these complete illustrated muscle building instructions and 14 other features (listed below). A perfect home gym . . . build every part of your body inside and out. Realize your ambition and develop muscles of a super-man. Easily master feats which now seem difficult.



\$3.95 complete

Never has a progressive bar bell and home gym been offered for so little money . . . read entire bargain offer. ACT!

Build a Mighty Body in 90 Days!

Develop powerful arms . . . develop a chest of Samson . . . develop a back like village blacksmith . . . develop a crushing grip . . . develop legs of marathon runner . . . develop powerful muscles all over.

Look What You Get! Read Below!

1. 10 cable chest expander, adjustable to 200 lbs. resistance.
2. Pair of patented hand grips to develop grip and forearms.
3. Illustrated charts.
4. Wall parts permit to develop back, arms and legs.
5. Head strap.
6. Foot strap.
7. Foot pedal.
8. Skip rope.
9. Rowing machine attachment.
10. Muscle clock measures weight lifting and pulling strength.
11. Illustrated charts by famous strong man.
12. Health Book.
13. Progressive Bar Bell, adjustable to lift from 40 to 200 lbs.
14. Special picture charts by famous weight lifter . . . shows secrets of weight lifting. 100% or money back . . . rush order and get **HEALTH BOOK FREE.**



Don't Send a Cent!

Fill in coupon. We rush everything in Big 3 Foot Package described by return mail. Pay postman \$3.95, plus postage. Foreign orders \$5.00, cash with order.

WHITELY EXERCISERS
 Dept. 1810

122 Chambers St., New York
 Send big 3 foot package of muscle builders by return mail. Include free Health Book. I'll pay postman \$3.95, plus postage. If I'm not 100% satisfied, I'll return within 5 days and you'll refund my \$3.95.

Name

Street

City..... State.....

Note: You can paste this coupon on back of U. S. postcard and mail for 1c.



Physical Misfits Never Win!

THE most wonderful machine ever invented could not stand up and produce unless perfected. So it is with that even more wonderful machine, the human body. Are you dragging along, hoping for some miracle to overcome your physical defects, banish your ailments, and restore your vigor and vitality—but that miracle never happens.

DON'T LET THE MACHINE BREAK DOWN

Chronic ailments, dyspepsia, biliousness, rheumatism, pimples, acidosis, lassitude, headaches, are red light signals that the machinery isn't functioning right—somewhere a screw is loose—something is wrong—Busy men often don't bother with what they consider minor ailments. They put off from day to day doing something about them until the machinery (the body) breaks down.

REGAIN YOUR PEP AND POWER

Don't underestimate some chronic ailment, not realizing that it is sapping your strength, weakening vital organs, cutting off your chances of long life and success. Don't ignore Nature's warning. Heed her danger signals. Take the first step NOW!

SEND FOR THIS FREE BOOK

"Nature's Key to Abundant Health, Strength and Mental Efficiency" will show you how to build up your body and brain, and make yourself over into a red-blooded specimen of virile manhood. Write for your FREE copy TODAY!

BETTER HEALTH FOUNDATION

Princeton—In—The—Pines, W. Va.

----- Clip and Mail This Coupon -----
FREE CONSULTATION COUPON

BETTER HEALTH FOUNDATION, Dept. 103,
 Princeton—In—The—Pines, W. Va.

Without obligation, send me a copy of your free book "Nature's Key to Abundant Health, Strength and Mental Efficiency."

Name.....

Address.....

City.....State.....

Age.....Occupation.....

Ailments (Specify).....

Learn to Draw



beautiful girls' heads and figures for pleasure and profit. Be an artist and make big money. Amazing NEW easy way quickly starts you. No experience necessary.

FIRST LESSON FREE

Send name and address today and only 10c to cover mailing cost. TRY IT FREE!

TOWERTOWN STUDIOS, Dept. 1036
 111 North Canal St. Chicago, Ill.

MAIL FOR FREE INFORMATION

BEDFORD

YMCA TRADE SCHOOL

1115 Bedford Ave., Dept. PM-17
 Brooklyn, New York City, N. Y.

- Auto Mechanic Talking Pictures
- Aviation Mechanic Welding
- Aeronautical Engineering
- Refrigeration Machine Shop
- Oil Burner Commercial Art
- Air Conditioning Sign Painting
- Electrical Window Display
- Radio and Television Mechanic
- Architectural-Mechanical Drafting

Name.....

Address.....

LEARN THE THEATRE BUSINESS

Big opportunities for trained men to become theatre owners, managers and advertising men. Home-study training. Low tuition—Easy terms. Write TODAY for FREE catalog M.

THEATRE INSTITUTE, ELMIRA, N.Y.

LEARN TO DANCE

LEARN THE LATEST AT HOME LEAD AND FOLLOW
 BROADWAY STEPS Correctly, Gracefully



This new, simple method teaches you quickly and easily, 24 DIFFERENT STEPS FOR ALL MODERN DANCES, LATEST TANGO. The modern FOX TROT, The dreamy WALTZ. The latest SOCIETY STEPS will make you HAPPIER, HEALTHIER, MORE POPULAR. YOU'LL ENJOY DANCING. Money back if not satisfied after 10 days' trial. Don't be a wallflower. GET SOME ENJOYMENT OUT OF LIFE! Write for full particulars without obligation to

IRVING SCOLNICK, 1474 Broadway, New York

CIVIL SERVICE

VALUABLE INFORMATION FREE
 COLUMBIAN CORRESPONDENCE COLLEGE
 WASHINGTON, D. C.

NEW! SENSATIONAL SELLER

AGENTS WANTED to introduce

No. 473 deal consisting of 10 blue steel safety razor blades, 1 tube of shaving cream, 1 styptic pencil and 1 Goodrich hone, all quality merchandise. It's the outstanding seller of the day. At 49c it's a sell out. FREE, wholesale catalog.

SAMPLE DEAL 25c

Doz. 21c ea. deal, Gr. 19c ea. deal

Sports Co., 834 Main St., Le Center, Minn.



RAISE RABBITS FOR US

WE SUPPLY STOCK AND BUY WHAT YOU RAISE

PAYING YOU HIGHEST PRICES—Established 20 Yrs.

Rabbit book catalog and monthly market bulletin showing prices we pay our breeders, 10c. Address

OUTDOOR ENTERPRISE CO., Inc., Box 400, NEW CITY, N. Y.



HAVE YOU FOUND YOUR PLACE IN LIFE?



Do you long for complete success in business, in love, in personal living? Send at once for your free copy of Dr. Julius M. Magil's new booklet, "Finding Your Place in Life," which will point the way to realization of your fondest dreams. Dr. Magil is a vocational authority, a keen analyst of human nature, who can help you to achieve life's richest gifts. A student of Universities of Zurich, Berlin, and Leipzig; graduate in philosophy; lecturer and professor in United States and foreign colleges and universities; and authoritative adviser; Dr. Magil can help you to realize your life's ambitions. Send today for free booklet, addressing:

Dr. MAGIL'S STUDIO of
 SCIENTIFIC THOUGHT-ANALYSIS
 Dept. 1034-PM MUSKEGON, MICHIGAN

SEE WITHOUT GLASSES



The NATURAL EYESIGHT SYSTEM Gives Your Eyes a New Deal

If you wear glasses, or think you should, our FOUR MONTHS' TRIAL OFFER—containing the inspiring story of glasses discarded for Nearsight, Farsight, Astigmatism, Old Age Sight, Eyestrain, Weak Eyes, Eye Muscle Trouble, Etc., as told by USERS AT HOME of this Revolutionary System—will be mailed FREE upon request.

NATURAL EYESIGHT INSTITUTE, INC.
 Dept. 410-T Los Angeles, Calif.

Air Conditioning



Why don't you get into this profitable new line—replacing old-fashioned heating and ventilating systems in factories, offices, homes, etc., with modern air conditioning equipment?—and planning new buildings for air conditioning? Architects and Builders— heating and ventilating experts— steamfitters and plumbers— must meet this increasing demand for ways of

Controlling Winter and Summer

Made-to-order weather adds much to the comfort, health, and happiness of humanity. Air-conditioned working quarters materially reduce lost time due to illness and increase employe efficiency— air-conditioned homes insure comfortable inside temperatures regardless of the weather and cut down doctors' bills—air-conditioned apartments bring increased rentals that soon pay for the installation.

Air Conditioning offers you a real chance to get into a new and growing line where good-paying jobs are constantly opening up. Like the auto and radio, this new development is sweeping the country and revolutionizing industry.

What is the "Trade-In" Value of Your Present Job?

When changing conditions threaten to wipe out your present job, it's up to you to fit yourself for something else that will continue to provide well-paid employment during your working life. Usually a little additional information will adapt your experience to one of the new jobs— often offering more money and brighter prospects. Don't wait until your job is kicked out from under you— meet the changes as they come and ride the wave of progress to better times.



Our Air Conditioning Course will give you by home study, in a short time, thorough and up-to-date training in this profitable new line. All texts furnished—small monthly payments. Send TODAY for Free Bulletin. No obligation.

American School
Dept. AC745, Drexel Ave. at 59th St., Chicago



LEARN AUTO MECHANICS

in 8 weeks!

Earn \$35 to \$75 a week as an Auto Mechanic. Never in the history of the automotive business has there been such a demand for TRAINED men. 8 weeks training fits you for a job that's waiting for you or to open your own repair shop. Read what two McSweeney trained men have done. Hundreds of others can tell you facts equally interesting. Don't look for a job! TRAIN for it!

Farrell, Pa.
Dear Mac: Please forward me your catalog. I want it to add to my traveling souvenirs. I am working in a modern garage although I have been out of school only four weeks, thanks to McSweeney Training. My best regards to all. M. Klushauk

Rector, Ark.
Dear Mac: Just a few lines which might interest you. I left your school two years ago last May. Since I left I have not seen a day I could call "hard times." I have been working ever since I left and have averaged in my earnings \$173.00 a month, in spite of the hard times. Many thanks. Thos. J. Sharp

EIGHT WEEKS of Actual Shop Training

No books or lessons the McSweeney way. First you learn the "why" of everything you do; then under competent instructors, you DO the job. You work on real equipment and machines, with the real tools of the auto expert. In eight short weeks you are TRAINED to hold down a permanent BIG PAY job. Any man 16 to 50 can learn. Write today for New Low Tuition Offer.

AVIATION GROUND COURSE

Aviation is coming and coming fast! Prepare now for the wonderful opportunities of the future. Each plane needs many mechanics on the ground.

MONEY BACK GUARANTEE!

In eight weeks of intensive training; actual shop work with real tools on real equipment; you will be qualified to accept a Big Pay Job as an Auto Mechanic. If you are not satisfied with your qualifications, your tuition will be refunded.

FREE Write today for Big Free Book on AUTOS. Get the facts about jobs; and Low Tuition Offers. Mailing the coupon does NOT obligate you. It obligates ME to tell YOU how you can train for Big Money in eight short weeks. Address Dept. 10-10

McSWEENEY SCHOOLS AUTOMOBILE—AVIATION CLEVELAND, OHIO KANSAS CITY, MO.

Mail Coupon to Our School Nearest You

McSweeney Auto and Aviation School,
Dept. 10-10, Cleveland, Ohio. Kansas City, Mo.

Without cost or obligation, send me your Big FREE Book on Autos; also full information about your low tuition offer.

Name.....

Street.....

Town..... State..... Age.....

PHOTO-ENGRAVING LEARN IT AT HOME



We Furnish all equipment and materials including large photo-engraving camera complete with lamps, lens and screen. When you have finished the course you can establish a good paying independent business with the equipment furnished or work for others at a big salary. Photo-Engraving offers greater opportunities today than any other industry. Every picture in this issue of Popular Mechanics was engraved by the process we teach you. Earn good money while learning. Write today for our new illustrated catalog which was engraved on equipment such as we furnish. You will not be obligated in any way by writing.

A copper plate to print above picture size 8 by 10 inches sells for \$15.37.

Aurora School of Photo-Engraving, Dept. 1104, Aurora, Mo.

AERO BLUE BOOK

gives specifications over 350 different airplanes ranging from 20 to 7000 h.p. and nearly 100 aero engines. Also present second hand market value of popular ships. Only information of its kind ever compiled. Almost priceless to students, engineers, dealers, enthusiasts.

FREE! If you order now, your choice "How to Choose a Flying School" or "Points on Buying a Used Airplane." Send now! \$1.00 Postpaid.

AIRCRAFT DISTRIBUTORS \$1.00 Postpaid
922 PINE ST., ST. LOUIS, MO.

EASY WAY TO MAKE MONEY IN RADIO

Up to \$3 an hour easy in a short time. New training method and service equipment offer starts you earning quickly. Details of no-cost plan sent FREE. Write

Radio Training Association of America
Dept. PM-40, 4513 Ravenswood Ave., Chicago, Ill.



Homestudy Courses RADIO, PUBLIC ADDRESS, in—ELECTRICITY ELECTRONIC WORK

Homestudy Course No. 112 teaches theory and practice of electricity—very complete and understandable. Course No. 113 covers radio, public address, photo electric, electronic work. Unusually clear and up-to-date. Lowest cost—best value homestudy courses in America. Payment plan (\$1.00 per month). Write for Catalog.

LINCOLN ENGINEERING SCHOOL, 855-T S. 37th St., Lincoln, Neb.

MOVIE STARS Enthusiasm OVER THE New 1935 MIDWEST-16



World-Wide Entertainment
 Hollywood, Calif. "Until I received my new Midwest radio, I had never thought it possible to bring in entertainment from half way around the world so clearly!"
Jean Harlow
 (MGM-Goldwyn-Mayer Star)



Amazing All-Wave Performance
 Hollywood, Calif. "My Midwest is the best set I have ever tried. It gives me super foreign reception and new radio adventure. Its performance on all five wave bands amazes me!"
RICHARD ARLEN
 (Paramount Featured Player)



Thrilling Foreign Reception
 Hollywood, Calif. "Not until I tried out my Midwest 16 did I really appreciate what radio reception was. It thrills me to listen in distant foreign stations as clearly as local programs!"
 (Paramount Star) *Claudette Colbert*



Better Foreign Reception
 Hollywood, Calif. "I am quite enthused with my Midwest. Many friends who have heard it are delighted with its performance. It brings in, without a doubt, the finest all-wave reception I have ever heard!"
Maureen O'Sullivan

Thrill to Unequalled World-Wide Performance with this

Amazing NEW 1935 SUPER Deluxe 16-Tube ALL-WAVE Radio

9 TO 2,400 METERS (12,000 MILE TUNING RANGE)

30 DAYS FREE TRIAL



Guaranteed WORLD-WIDE RECEPTION!

BEFORE you buy any radio, write for FREE copy of the new 1935 Midwest "Fifteenth Anniversary" catalog. See for yourself the many reasons why over 110,000 satisfied customers have bought their radios direct from Midwest Laboratories . . . and saved from 1/4 to 1/2. Learn why Midwest radios out-perform sets costing up to \$200 and more. You, too, can make a positive saving of from 30% to 50% by buying this more economical way. Why be content with ordinary so-called "All-Wave", "Dual Wave", "Skip Wave" or "Tri-Wave" receivers when Midwest gives you more wave lengths in today's most perfectly developed 16-tube Super de luxe ALL-WAVE radio that are proven by four years of success . . . that carry an iron-clad guarantee of foreign reception! These bigger, better, more powerful, clearer-toned, super selective radios have FIVE distinct wave bands; ultra short, short, medium, broadcast, and long. Their greater all-wave tuning of 9 to 2400 meters (33 megacycles to 125 KC) enables you to tune in stations 12,000 miles away with clear loud speaker reception. Write TODAY for new FREE catalog!

Now, you can enjoy super American, Canadian, police, amateur, commercial, airplane and ship broadcasts . . . and derive new delight and new excitement from unequalled world-wide performance. Now, you can enjoy the DX-ing hobby and secure verifications from more of

the world's most distant stations. Thrill to the chimes of Big Ben from GSB, London, England . . . tune in on the "Marseillaise" from EYA, Pointoise, France . . . hear sparkling music from EAG, Madrid, Spain . . . delight in lively tangos from YVIBC, Caracas, Venezuela . . . listen to the call of the Kookaburra bird, from VK2ME, Sydney, Australia, etc. Send today for money-saving facts.

WORLD'S GREATEST RADIO VALUE

\$57.50 with New Deluxe Auditorium-Type SPEAKER
 . . . LESS TUBES . . .

TERMS AS LOW AS \$5.00 DOWN

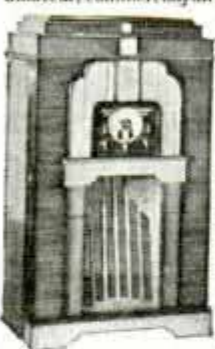

NEW STYLE CONSOLES
 The new, big, Midwest 30-page 1935 catalog pictures a complete line of beautiful, artistic de luxe consoles and chassis . . . in four colors . . . a model for every person. Hand made by master craftsmen, they harmonize beautifully with any furniture arrangement. Write for new FREE catalog today!

50 ADVANCED 1935 FEATURES
 Here are a few of Midwest's superior features: Controllable Expansion of Volume-Selectivity-Sensitivity (Micro-Tenuator) . . . Fidel-A-Frol . . . Triple Calibration Plus . . . Pure Silver Wire . . . Ceramic Coil Forms . . . Separate Audio Generator . . . Simplified Tuning Guide Lights . . . Compact Synchronized Band Switch . . . Amplified Automatic Volume Control . . . 7 KC Selectivity . . . Power Driver Stage . . . 16 Latest Type Tubes . . . etc. Read about these and 38 other features in the new FREE Midwest catalog. Never before so much radio for so little money. Write for FREE catalog.

DEAL DIRECT WITH LABORATORIES
 Increasing costs are sure to result in higher radio prices soon. Buy before the big advance . . . NOW! . . . while you can take advantage of Midwest's sensational values . . . No middlemen's profits to pay. You can order your radio from the new Midwest catalog with as much certainty of satisfaction as if you were to select it in our great radio laboratories. You save 30% to 50% when you buy direct this popular way . . . you get 30 days FREE trial . . . as little as \$5.00 down puts a Midwest radio in your home. Satisfaction guaranteed or money back. Write for FREE catalog.

SAVE UP TO 50%

Jean Harlow, Richard Arlen, Claudette Colbert, Neil Hamilton, Maureen O'Sullivan, Gloria Stuart and Ginger Rogers are some of the movie stars who prefer the Midwest radio because it gives them the super all-wave reception that they desire.

Try the Midwest for thirty days before you decide. Midwest gives you triple protection with: A one-year guarantee, foreign reception guarantee, money-back guarantee.

MAIL COUPON TODAY! FOR AMAZING 30-DAY FREE TRIAL OFFER AND NEW 1935 CATALOG

MIDWEST RADIO CORP., Dept. 614 Cincinnati, Ohio.
 Without obligation on my part send me your new FREE 1935 catalog, and complete details of your liberal 30-day FREE trial offer. This is NOT an order.

User-Agents Make Easy Extra Money Check Here for Details

Name
 Address
 Town State

MIDWEST RADIO CORP. DEPT. 614 - CINCINNATI, OHIO, U. S. A.
 Established 1920 Cable Address Miraco. . . . All Codes

All Power from the Sun

IT IS not what we know that is so important. It is what we do not know. Most of what we know can be found in libraries, in the minds of people and in processes as they exist today. But we have no conception of what a small percentage this is of what there is yet to know.

As an illustration, we perhaps do not recognize it, but everything that ever moved on the earth has been moved by energy which came directly from the sun. Our coal and oil deposits, our forests, our crops and everything that lives on the earth is simply an energy contribution from the sun.

We do not know, except in a very superficial way, how the energy which is given out by the sun is transmitted to the earth. This, when understood, will open up an entirely new conception of things that can be done. It is not difficult with this information in hand for even the most unimaginative person to predict the propulsion of airplanes by radiated energy with the power plants located on the ground.

Each year we discover new things, which a short time ago we did not even know existed. I cannot help but feel that in a very short time we are going to break loose another great piece of basic information which will keep us industrially busy for a great many years to come.

By CHARLES F. KETTERING,
Vice-President in Charge of Research,
General Motors Corporation.

Detroit, Mich.

Andrew Citroën, quai de Javel,
115, Paris France

Torsion Bars Support Car without Springs

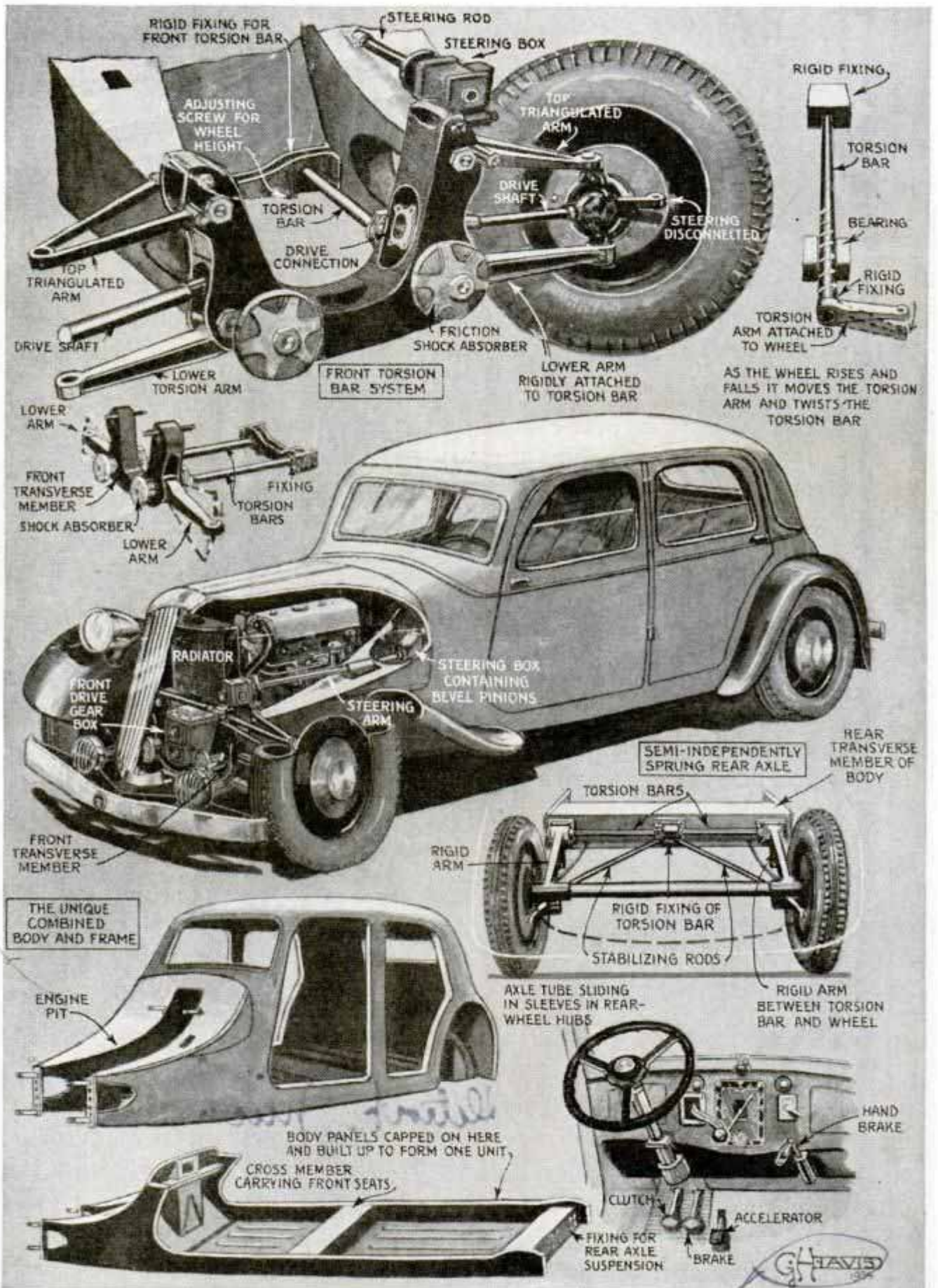

French Front-Wheel-Drive Car in Which Torsion Bars Replace Springs; There Are Two Longitudinal Bars at Front and Two Transverse Bars at Rear; Rods Attached to the Bars Tend to Twist Them When the Wheels Strike a Bump; Note the Single-Unit Body and Frame of Pressed and Welded Steel

Limousin & Helleide

Popular Mechanics Magazine

REGISTERED IN U. S. PATENT OFFICE AND CANADA

WRITTEN SO YOU CAN UNDERSTAND IT

Vol. 62

OCTOBER, 1934

No. 4

D967

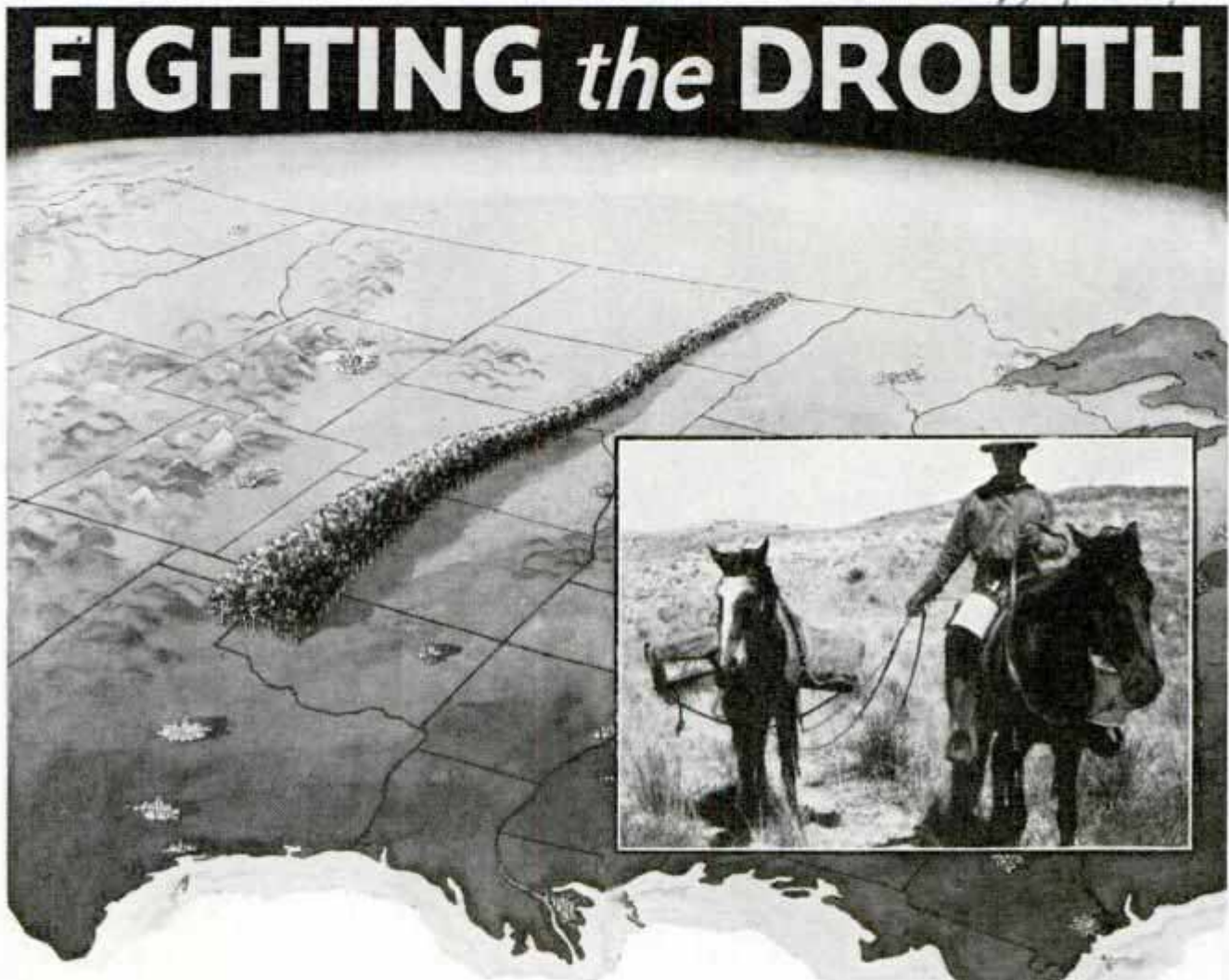

A SHELTER-BELT of trees 100 miles wide and 1,000 miles long reaching from the Canadian border to the Texas panhandle—this is President Roosevelt's answer to the greatest drouth the country has ever known.

Beginning at the northeastern corner of North Dakota this protection forest belt will stretch through the Dakotas, Nebraska, Kansas and Oklahoma into Texas. The area immediately affected approximates 20,000,000 acres. Of these, about 1,820,000 acres will be planted to trees in the form of windbreaks running north and south, planted one mile apart, making approximately 100 parallel tree rows each 1,000 miles long. Each windbreak will be seven

Sketch Showing Shelter Belt as Planned and Pack Horse Carrying 4,000 Young Trees for Planting

rods wide, covering fourteen acres out of each square mile.

"If we can establish this zone," says Dr. Raphael Zon, forest service expert in charge of the technical phases of the great project, "we establish practically a humid belt in this semi-arid region. For trees

Cont. John L. County
11 11 11 11 11



Photo Courtesy U. S. Forest Service
Forest Strips as Planned for Plains Section and a Fine Windbreak Which Has Been Very Effective in the Plains Country

create water. They draw deep from the soil and evaporate tremendous quantities of the precious fluid into the air. Seven-ninths of our rainfall is derived from land evaporation and only two-ninths from the ocean. The humidity of air among forest strips is from five to ten per cent higher than in open prairie country.

"Windbreaks check the velocity of winds sometimes thirty to thirty-five per cent. This has been shown in tests where tree strips 600 feet apart were used. Further, evaporation between the strips was reduced thirty per cent. This means that hundreds of thousands of tons of water

which would not have been delivered to the soil because of the winds are delivered and retained over a whole shelter-belt area.

"Windbreaks also act as snowbreaks. They catch the drifting snow of the sweeping winter winds and hold them for future moisture purposes. They also afford defense against the bitter, icy blasts that drive over the treeless countryside, and serve to

hold in check the 'black blizzards,' those terrible summer dust storms born of drouth conditions."

The Great Plains region is a region of virtually periodic drouth. Since colonization of the region, the ground-water level has dropped from eighteen to twenty feet. But more damaging, perhaps, is the loss of soil from the area due to the high winds that sweep in from the more arid regions to the west. In these storms the loam and fine sand are first to go. What is left is called "blowsand." A semi-desert condition prevails. Or the wind whips off the topsoil down to hardpan, leaving nothing

to which vegetation can root. These barren, wind-swept lands are exposed to the ravages of rainfall and melting snow. Rain rushes off them in torrents, carrying with it what little soil of value remains from the winds. Deep ravines and gullies are eroded over the land; wrecked farms follow in the wake, agriculture languishes, farms disappear, drouths soon establish themselves between long separated rains, misery and suffering become the lot of the once prosperous community folk.

One of the first steps in the establishment of the new experiment will be the setting up of a chain of nurseries where the forest seedling will be grown. Trees native to the section through which the forest grove runs will be used. Those for the northern area will be, green ash, burr oak, native cottonwood, red cedar, blue spruce and native western pine. In the southern extension of the line utilization will be made of the osage orange and the native oaks. Conifers and shrubs will be used on the outer side of the belt to take off the inner trees the first heavy onslaughts of storms.

The economic value of the shelter-belt may be summed up as three-fold. First, protection of farm lands adjacent to it. Second, supply of the country through which it passes with wood, a scarce article on the plains. Third, stoppage of wasting of land through erosion, both by wind and flood, creation of work and checking of drouths. To fence the windbreaks will be a great labor in itself. Thirty to fifty million fence posts will be required to hem in the forest, 30,000 to 50,000 railroad cars will be required to transport the posts to their destination, and 200,000 miles of fence wire will be needed.

Only land planted to timber will be acquired by the government. Strips of land between the shelters will remain in the hands of the farmers. The total cost of the project is set at \$75,000,000. Ninety per cent of this will go to the farmers, largely for labor in establishing the belt, plowing, fencing, planting and caring for the trees. Large-scale planting will begin in 1936 and the entire area, it is expected, will have been planted in the next ten years. The rate of planting will be about 180,000 trees a year. The total planting will run three and one-half million trees.

Memoranda, March

BABY CAB WITH VENTILATORS IS FREE OF DRAFTS



Perambulator with Small Windows Which Can Be Adjusted to Provide Ventilation without Drafts

Draftless windows in a streamlined baby cab prevent gusts of air from striking the little occupant. The windows are adjustable like those of the modern motor car, and allow ventilation in the perambulator but eliminate the drafts.

D953

DOGS HARNESSSED TO RAIL CAR HAUL BUILDING TIMBERS

How to transport building materials to a site far from good roads in northern Ontario, Canada, was solved by utilizing dog power to pull a small rail car. The dogs hauled the building materials in a fraction of the time it would have required to transport the loads over country trails.



Dog-Power Railroad Car Is Used to Haul Building Materials to Places Isolated from Highways

*Com. Leo H. Valiquette,
293 Esplanade*

D915

Magie



Drawing Showing How Tear Gas, Electric Alarm Signals, Sound-Sensitive Microphones, Safety Glass and Self-Closing Safes Aid the Human Guards in Protecting the \$2,500,000 Display of Diamonds at the World's Fair

D913

Shuman,

D920. 726 Cornelia Ave
Chicago

ROBOTS AID HUMAN WATCHMEN GUARD DIAMOND TREASURE

Thousands of visitors have viewed the \$2,500,000 display of diamonds at the World's Fair, but few have had any knowledge of the extraordinary precautions taken to guard these priceless stones. Visitors have seen an armed guard stationed on the floor and another guard peering through shatter-proof glass in an armored coop under the roof, but these human guards are only the first line of defense. Mechanical devices electrically controlled constitute the real protection for the collection. The display rests on two slabs set flush with the tops of two safes. The safes are enclosed in a glass case and inside the case of heavy shatter-proof glass is another glass case with sides and top more than an inch thick. By pressing a button, the man in the guard room can cause the gems to disappear and the safe doors to close in twelve seconds. In case of attack, another button in the guard room releases a mild form of tear gas intended to clear the room of visitors. A third button releases a gas so strong that no mask has been found to withstand it. The man in the guard house, by means of mirrors, commands a view of every occupant of the room at all times and is in a position to shoot down anyone tampering with the safe without danger to himself. Sound-sensitive apparatus connected to the safes also relays an alarm to the American District Telegraph company offices the instant the safes are tampered with and a squad of armed men can reach the diamond room from these offices in less than two minutes while a city police squad would be on hand in less than six minutes. The man in the guard house also can flash an alarm to both the A. D. T. and the city police instantly. The man in the guard house and the man on the floor change positions regularly, but the guard house door cannot be opened without setting off an alarm in the A. D. T. offices except when the guards, inside and out, press the proper signals. The guards are on duty day and night, but at night all entrances are locked and there is no way of getting to the diamonds in their safes set with time locks except through the guard house door which sounds an alarm in the A. D. T. offices if opened without the proper signals.

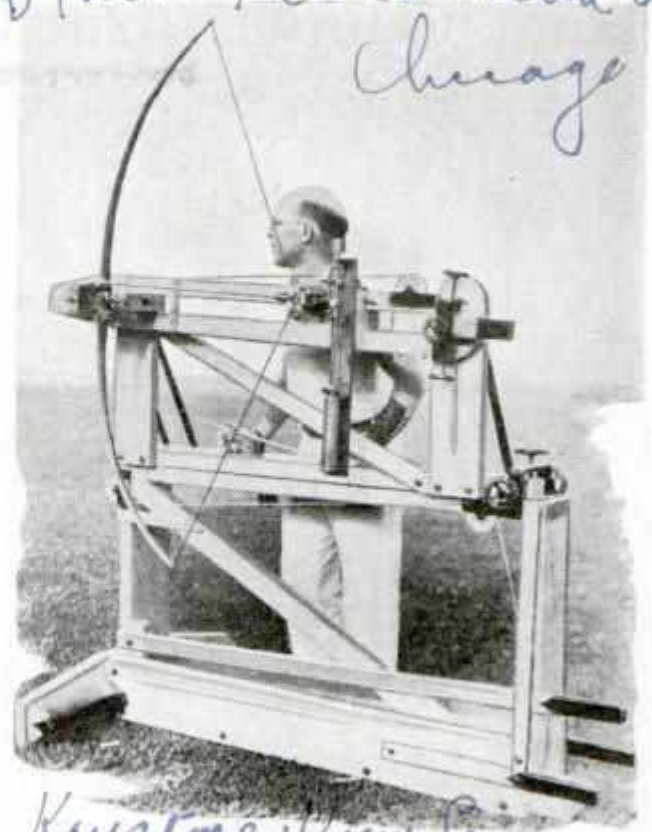

Kystone View Co

Mechanical Archer Which Was Designed to Test Individual Arrows for Straight Flight

ARROW TESTER SHOTS BETTER THAN THE BEST INDIAN

No Indian marksman could hope to compete with a mechanical archer, a machine designed to test arrows for straight flight. The apparatus is used to test arrows for archery enthusiasts and measures the degree of accuracy possible with each missile released from it.

D934.

COST OF GASOLINE IS SHOWN BY PRICE GAUGE ON PUMP

Motorists can tell at a glance the price of the fuel which has been pumped into the tank if the gasoline pump is equipped with a price gauge as well as a gallon gauge. Metal arrows with price tags indicate the cost of the gasoline when the level in the glass tank falls to any of these arrows.



The price cards are inserted in slots and can be changed if the price changes.

*usedak request
service station*

*U.S. Standard Oil Co.
Los Angeles, Cal.*

1500

Giant Plane To Cut U. S.-Argentine Time

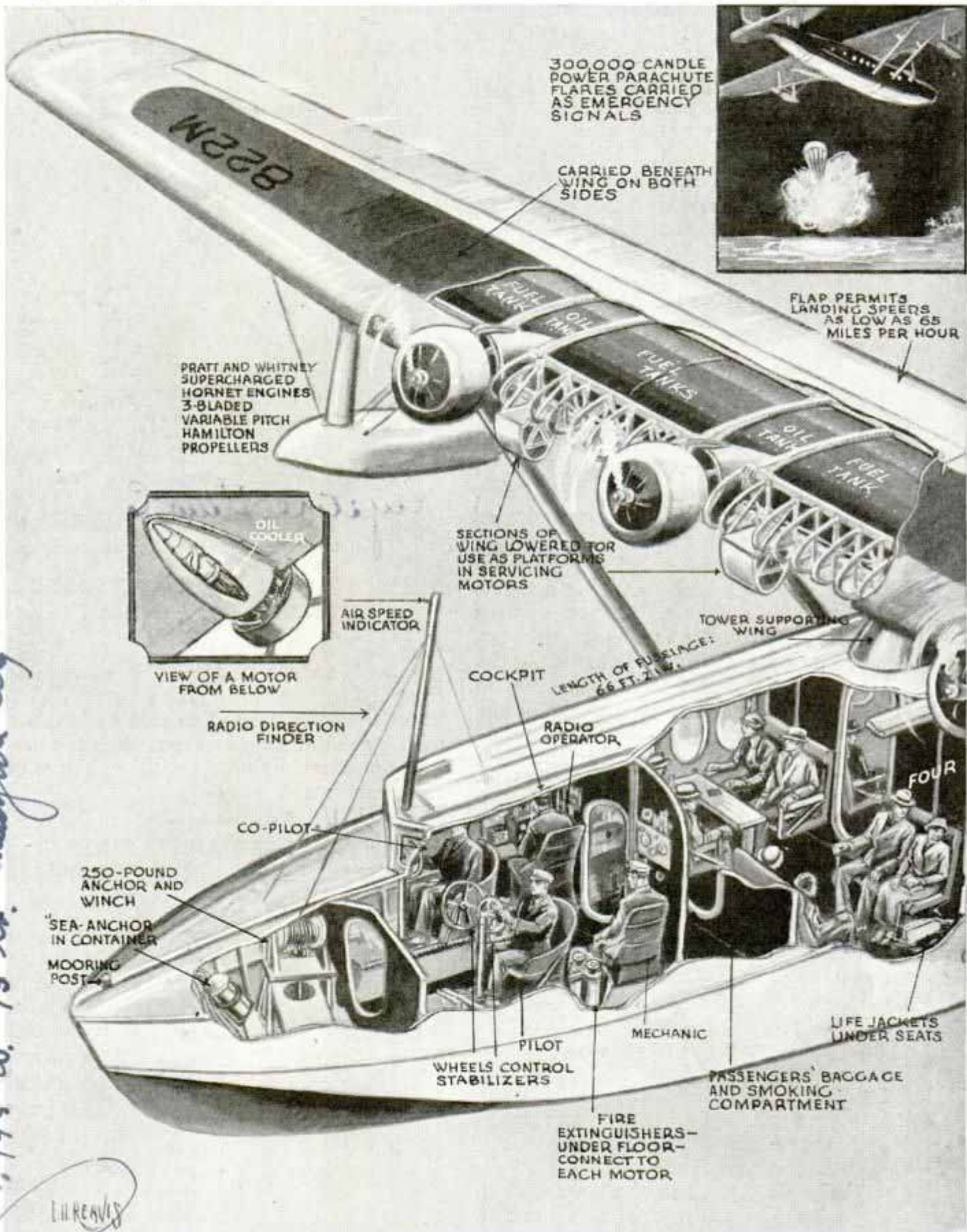

Flying Time between the United States and the Argentine Will Be Reduced by Two Days When the Giant Sikorsky S-42, Speedy Clipper Plane Goes into Service; Four Engines, Rated at 3,000 Horsepower, Drive the Loaded Ship at Speeds in Excess of 155 Miles per Hour

12000
 145 at 45 M. Chicago City
 LILREVIS

Air Clipper Seats Thirty-Two Passengers

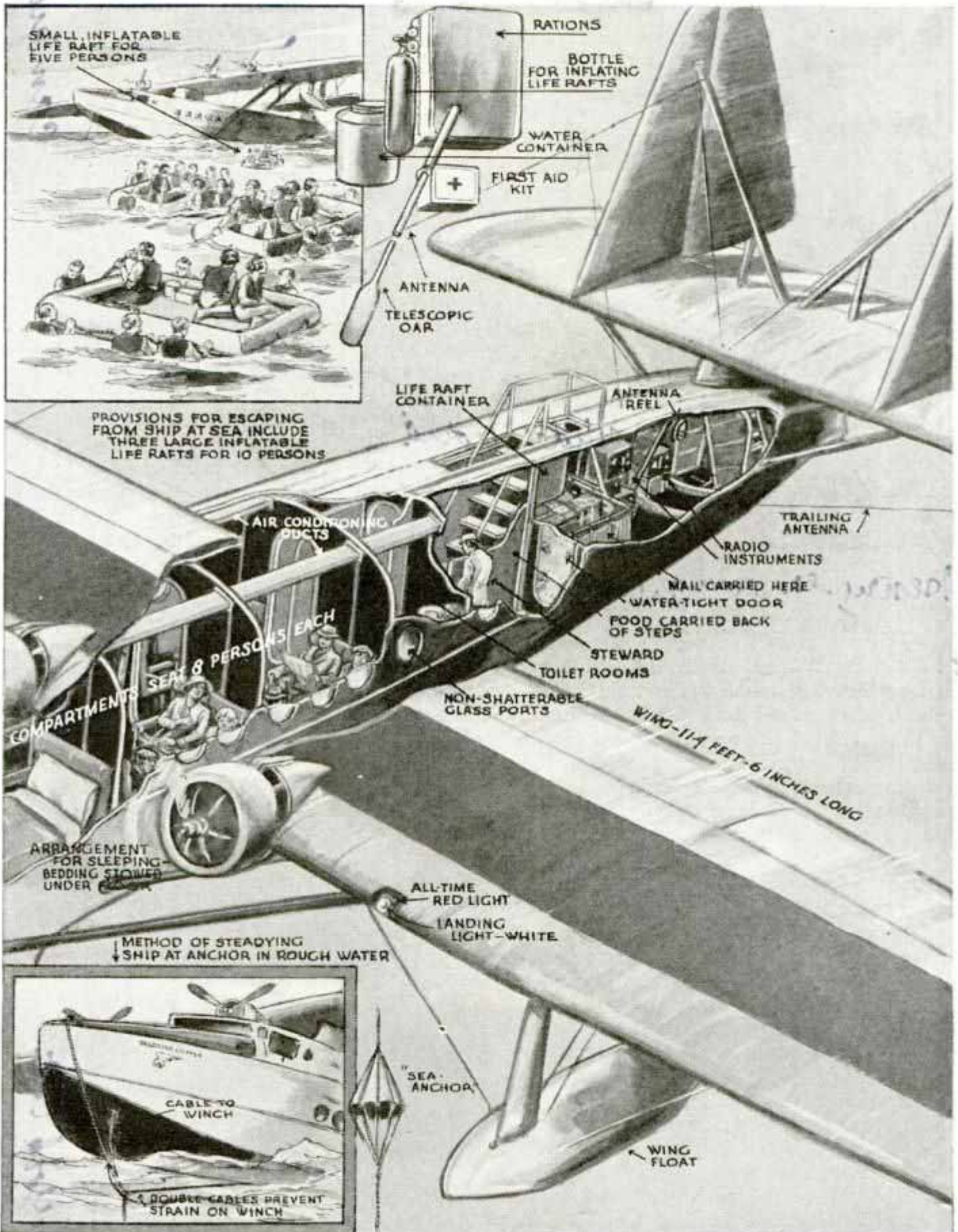

Greater Safety for Ocean Air Service Is Offered by the Giant Sikorsky S-42, Which Carries Thirty-Two Passengers and 2,000 Pounds of Cargo, Including Mail; Low Landing Speed, Powerful Emergency Flares, Inflatable Life Rafts, Radio and Special Anchors Are Some of the Safety Features

Fog Strained from Air by Chemical 'Curtain'

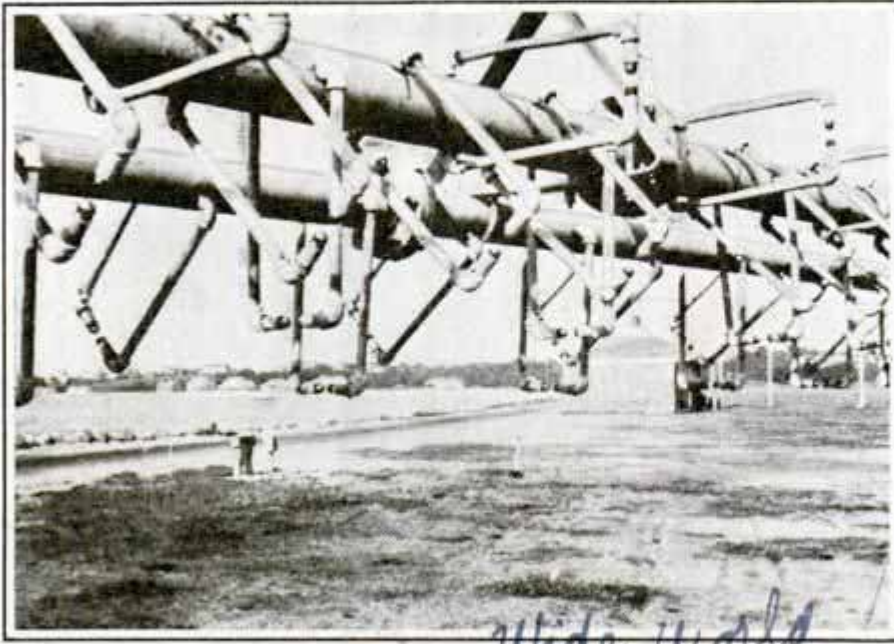

System of Nozzles Which Pour Liquid Chemical into Moving Air, Dissipating the Fog by Condensing the Water Vapor

the Massachusetts Institute of Technology. Nozzles were fitted into a pipe 100 feet long and poured a secret liquid chemical into a rolling fog which had enveloped an airport. Three minutes later, buildings 2,000 feet distant stood clearly revealed against the background of turbulent white vapor. The chemical employed collects or condenses water vapor in the air, causing it to be precipitated as raindrops fall. The method may be a major step in reducing the hazards of landing aircraft in fog for it opens

Fog, the deadliest menace to the aviator and the mariner, has been dissipated successfully with chemicals in experiments by Henry Es. Houghton, Jr.

a path of visibility through the vapor just as though a big plow were moving through it and pushing it to each side.

Windows of Diving Ball Are Three Inches in Thickness

When Dr. William Beebe, famous deep-sea explorer, resumed his submarine research this year off the coast of Bermuda, he descended to the ocean floor in a large metal ball, known as a bathysphere, the construction of which offered a knotty problem for engineers of the General Electric company. More than half a mile below the surface the pressure on this sealed globe is 980 pounds to the square inch. The sphere was made of steel with walls one and one-half inches thick but the big problem came when windows were discussed. Windows were essential to make the necessary observations but ordinary glass of sufficient thickness to withstand the great pressures would not be sufficiently transparent. Instead of glass, the windows were made of fused quartz eight inches in diameter and three inches thick. The quartz selected is more transparent than glass and has a compressive strength about six times as great. The three disks, after polishing and grinding, were sealed into cannonlike projections of the chamber. The middle window is for visual observation and for focusing a camera while

the side windows transmit into the ocean depths the light of powerful electric lamps, the rays of which meet in front of the middle window. The bathysphere is large



Dr. Beebe's Bathysphere, Showing the Windows Made of Fused Quartz Three Inches Thick

enough to accommodate two observers, but there is no extra room when all the equipment is taken aboard. It rests on a wooden

Sponsored by Dept. of Tropical Research, New York City

D914

Round Hill Mass

Cambridge, Mass

Wide World

New York City

base so it stands firmly on the ocean bottom. Access is gained through a "man-hole" in the top which is bolted tight from the outside. Observers breathe with the aid of a twelve-hour supply of oxygen contained in small tanks, the vitiated air being absorbed by trays of desiccating chemicals. The sphere weighs about 5,500 pounds and is lowered by means of a hooking device and steel cables attached to the top. There is also a cable supplying power for the lights and a telephone by means of which the occupants can converse with attendants on the surface.

BLADES INJECTED INTO RAZOR FROM METAL CLIP

Fresh blades are "pumped" into a safety razor by means of an injector in the form of a metal clip holding twenty thin blades. To fit a new blade, the injector key is inserted in a slot in the razor head and a slide is pulled back and pushed forward. This action ejects the used blade and inserts a fresh one from the clip. The razor itself is light and so shaped that it is balanced to shave at the lightest touch, making it possible to follow the contours of the face with the natural motion of the

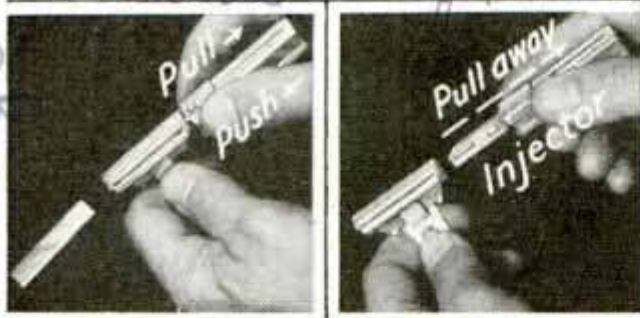

Injector Which "Pumps" Fresh Blade into Safety Razor from Metal Clip and Ejects Used One

hand, thus always presenting the beard squarely to the blade edge.

AIR FILTER REMOVES POLLEN AND RELIEVES HAY FEVER

Relief for hay-fever sufferers is offered by an air filter which, it is claimed, removes about ninety-eight per cent of the pollen grains from the air. It has a noiseless, motor-driven centrifugal fan which forces outside air through a filter screen into the room, removing not only the pol-

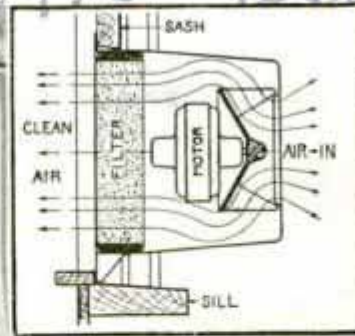

Air Filter Which Removes Pollen, Dust and Soot, and Diagram Showing How It Operates

len but soot, dust and dirt. The filter can be plugged into any light socket and occupies no space in the room. The motor and fan are on the outside and the filter rests on the window sill with the window lowered to hold it in place. A spacer is provided which is cut to fit windows of varying widths. Other windows and doors are kept closed, the filter building up a slight pressure sufficient to force out exhausted air through cracks. It supplies 11,000 cubic feet of air per hour.

WALNUT HUSKER IS OPERATED BY TURNING A CRANK

Husking black walnuts is made easy by using a small husking machine which is turned by a crank. It consists of a hopper to receive the walnuts and a husking wheel which rubs the outer shell from the walnuts as they pass through the machine. The husker does the work much faster than it can be done by hand, and also prevents staining the hands.



magazine Repeating Razor G 230 Park Ave. New York
 Schick \$1.50
 D946
 sold Jan. 2, 1934 - # 1,946,939

415 W. Oklahoma Ave
 D946
 Nutcracker

D908.

J. P. Hershey

WILEY POST

D866



at Curtiss-Reynolds airpark
Chicago! Sept. 1931

Acme newspaper
By WILEY POST
Famous Round-the-World Flyer

THE main objective of high-altitude flight is to increase the speed of travel. It is to develop practical methods of flying at as high as 50,000 feet, where the atmospheric pressure is only two pounds a square inch, that I have prepared a plane and special equipment.

To fly at extreme altitudes you first must have oxygen, and on top of that pressure to force it into your lungs and to keep down the tendency to bleed over the entire body. The thirteen pounds

differential pressure at high altitudes, compared with sea level, affects every cell in the unprotected body. Blood vessels in the eyes may rupture and cause permanent blindness. Heart action is affected, and other serious changes may result. Therefore, for all serious altitude flying, which we are coming to sooner or later, it is necessary to maintain pressure around the body by sealing off a space and pumping air into it. The same is true of certain parts of the plane itself.

In my opinion, to seal off the pilot's cockpit, sealing around all controls like the throttle, stabilizer adjustment and retractible landing gear

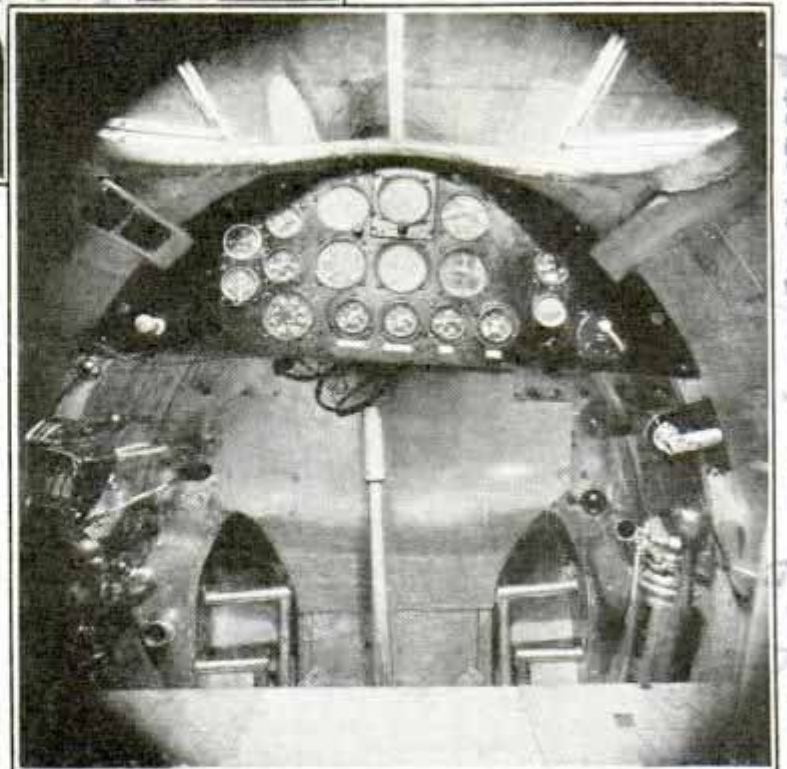

Wiley Post Demonstrating His High-Altitude Suit, and Instrument Panel of Stratosphere Plane

seeks NEW RECORD

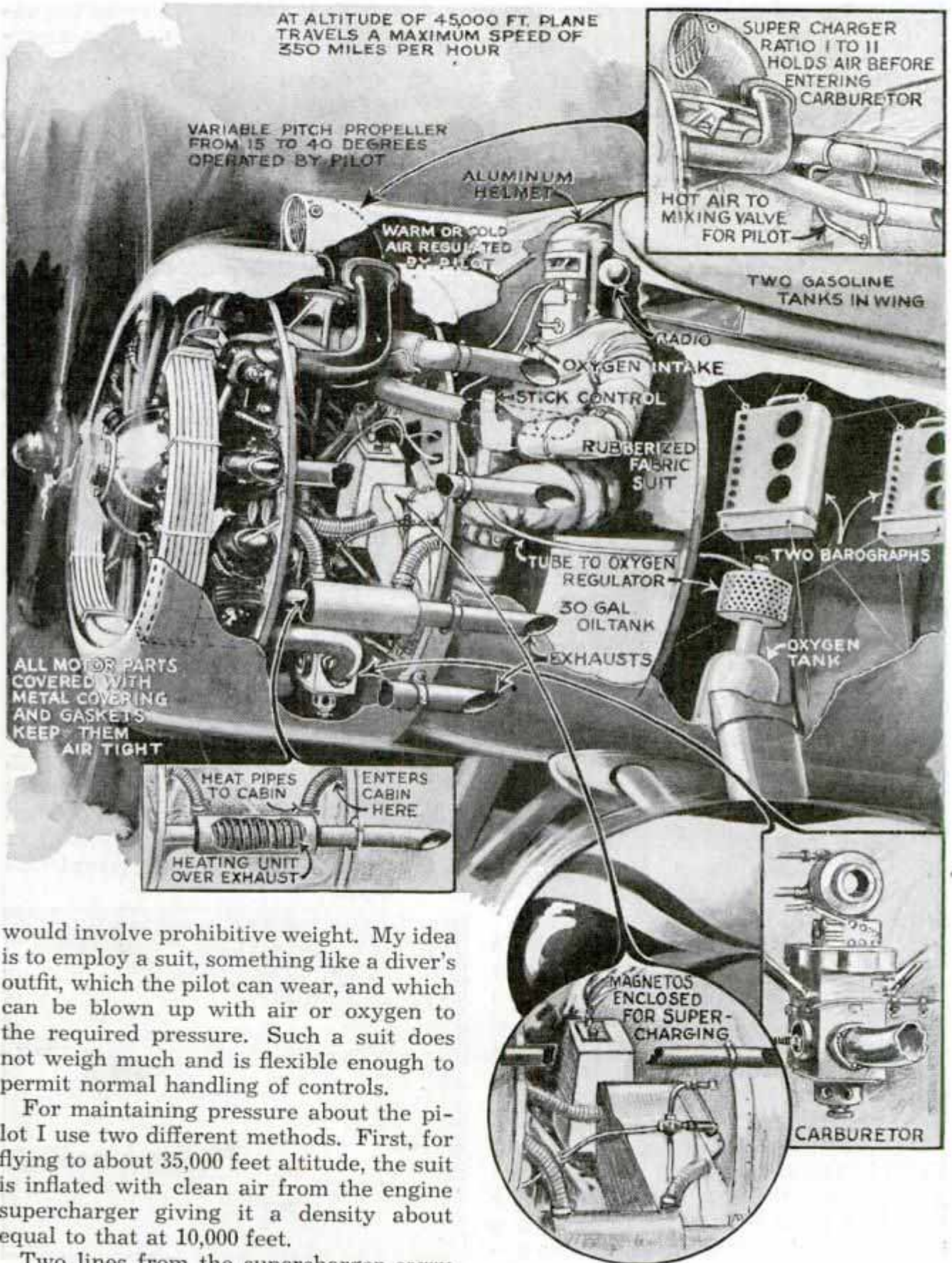

would involve prohibitive weight. My idea is to employ a suit, something like a diver's outfit, which the pilot can wear, and which can be blown up with air or oxygen to the required pressure. Such a suit does not weigh much and is flexible enough to permit normal handling of controls.

For maintaining pressure about the pilot I use two different methods. First, for flying to about 35,000 feet altitude, the suit is inflated with clean air from the engine supercharger giving it a density about equal to that at 10,000 feet.

Two lines from the supercharger carry air to the suit. One goes directly to a needle valve that can be controlled by hand.

Diagram Showing Method of Supercharging; Note That All Movable Parts Are Airtight to Prevent Being Affected by Stratospheric Conditions



percharger for inflating the suit for flying up to 35,000 feet, an auxiliary tank of oxygen is available in the event the engine stops or the supercharger fails to work for some other reason.

The airplane itself is equipped throughout for stratosphere flying. It is of standard design, a Lockheed, and is powered with a Pratt and Whitney engine that develops 775 horsepower at sea level. With both stages of the supercharger in operation, this engine could turn out 1,400 or 1,500 horsepower at sea level.

The entire ignition system is supercharged. The magneto, cables, spark plugs and other parts are fitted with a special airtight harness resembling somewhat a system of radio shielding. The entire system is pumped up by the supercharger to a pressure approximating that at 15,000 feet. Without such supercharging, the ignition would not function properly much higher than 25,000 feet because electrical dis-

The other makes forty turns around the exhaust, and then connects to a needle valve. Lines from the two needle valves merge into one that connects with the suit at the top of the helmet. From the lower end of one leg of the suit a line runs to an adjustable relief valve on the instrument panel. This valve can be set to any pressure. By adjusting the two needle valves much as you regulate the handles of a bathtub faucet, I can regulate the temperature and amount of air inside the suit. The second method of inflating the suit, used for extreme altitude flying, dispenses with the entire supercharger system and employs an oxygen generator.

Normally a pilot can fly with ease at 20,000 feet altitude without auxiliary oxygen for short periods. When wearing the suit, I fly up to about 18,000 feet with a trap door in the helmet open. Before going higher, I close the door and start the oxygen generator, which will operate five hours on one filling. When using the su-

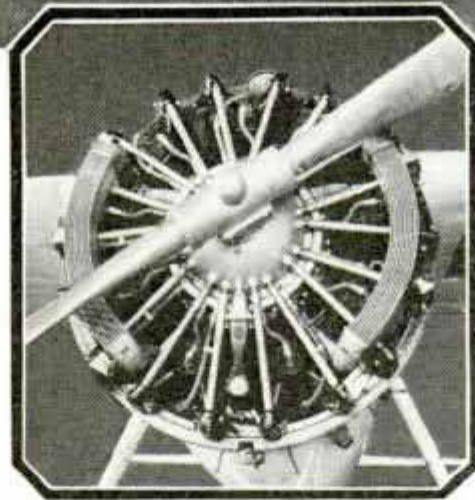

Top, Post's Plane, the "Winnie Mae," with Motor Covered for Stratosphere Flight; Center, Cooling System; Bottom, without Hood Covering

charges would occur in the rarefied air.

The plane uses a new gasoline having special properties preventing undue loss of fuel by boiling off at high altitudes. Ordinary gasoline boils when the temperature is 100 degrees Fahrenheit, and the pressure is seven pounds per square inch. At 50,000 feet altitude, the pressure is only two pounds. Therefore, such gasoline, which probably left the ground a half hour before at a temperature of seventy degrees, has not had time to cool sufficiently to prevent great loss by boiling.

I believe that, in the future, all flying will be done at altitudes of 50,000 feet or so when the distance is great enough to warrant climbing to that height. Transcontinental and trans-oceanic hauling of passengers and freight can be done in one-half the present normal time, simply by use of suitable supercharging of engine, pilot, and passenger cabin. No radical changes in plane or engine are necessary, but of course further refinement of plane and engine design and improved methods of streamlining will reduce the time even further.

BARREL TYPE OF BOAT RUDDER MAKES QUICKER TURNS

One water taxi boat in service at San Diego is equipped with a barrel-type rudder fitted over the propeller blades. It is claimed that with this kind of steering gear the boat answers her helm more quickly, due to the greater surface on which water pressure is exerted when making a turn, the device acting much like a double rudder. This type of steering gear also protects the delicately adjusted propeller blades from damage through contact with floating objects.



Boat with Barrel Rudder Fitting over Propeller

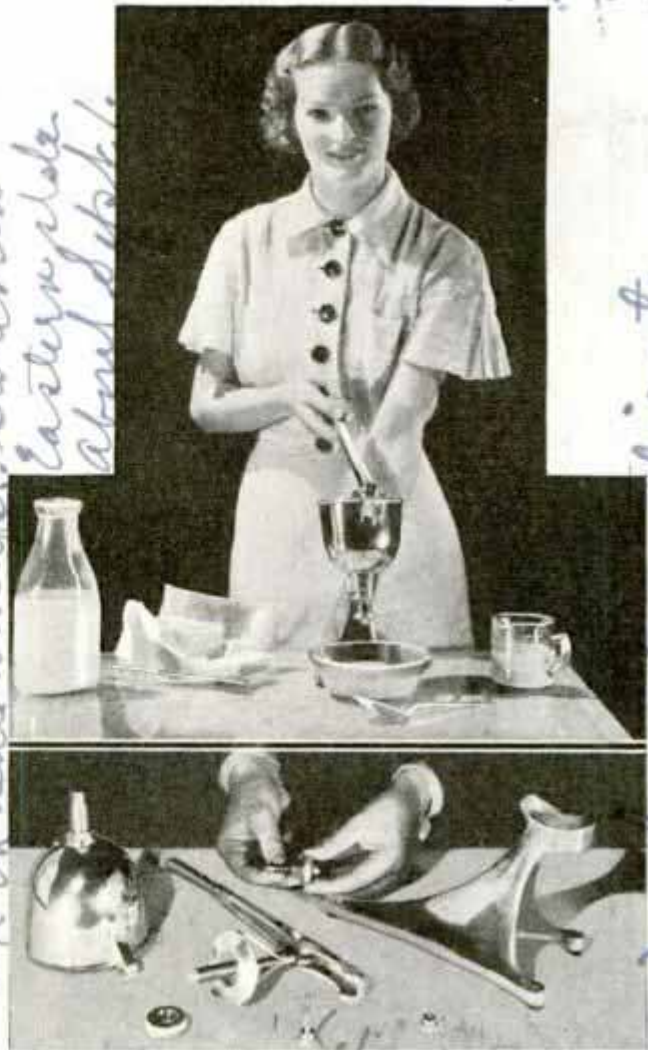

Hand-Operated Emulsifier Which Reverses Churning by Turning Milk and Butter into Cream

MILK CONVERTED INTO CREAM BY EMULSIFYING PROCESS

Reversing the process used in manufacturing butter, a small hand-operated emulsifier converts milk and butter into cereal or whipping cream at only a fraction of the dairy price. The economy appeal of the emulsifier lies in the fact that butter fat sells for less as butter than it does as cream, and skim milk or dried milk can be used. The same device can be used in mixing ice cream, salad dressings, egg, malt and milk drinks. Inside a bowl is a small pump with the piston attached to the handle. Operating the pump handle forces the liquid through narrow grooves, breaking it into jets which strike the walls of the emulsifying chamber with sufficient force to disrupt fat globules, forming a cream or emulsion. The adjustments can be altered to make cream of salt butter the salt first being washed out and then the cream is made in the usual way.

Emb. water Capt. Wm. H. no. 90 water taxi

to be on sale in left stream
Eastern globe
about 1000

45 Richmond St. W. Toronto, Canada
1/16 5/40s
Kittles with Empire
Premium higher indicates

No further data

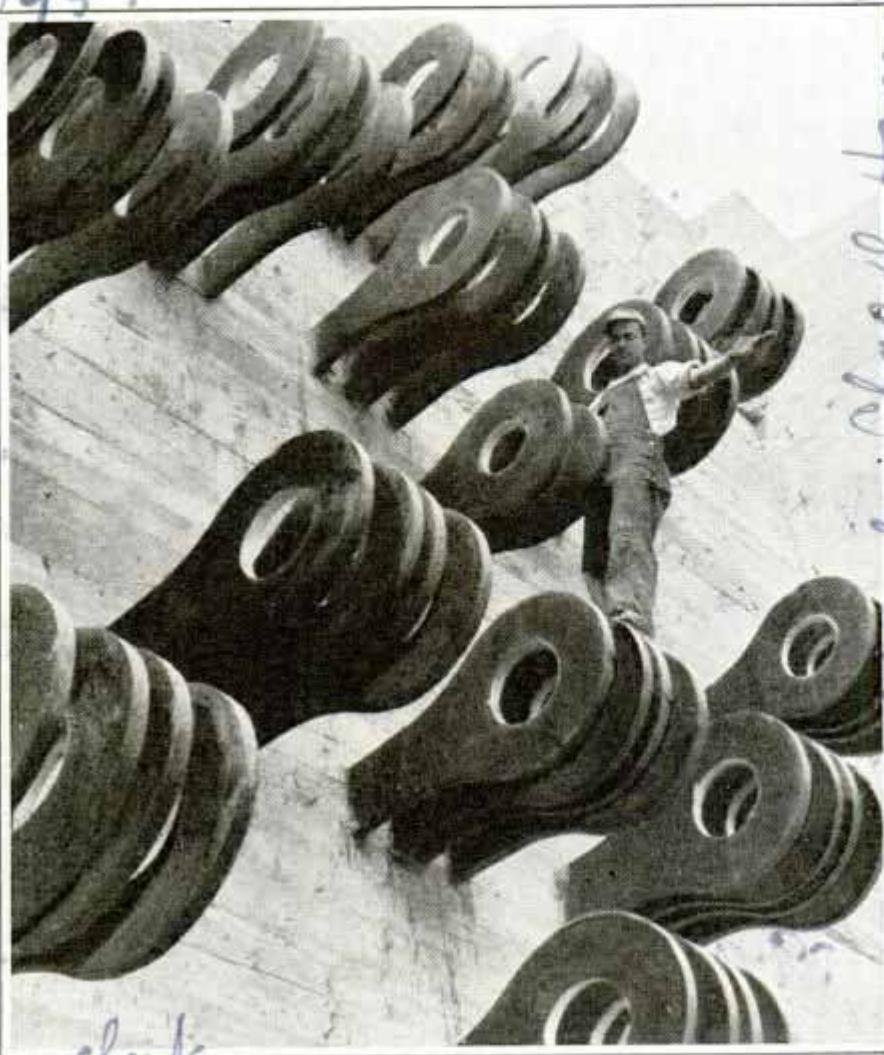

Steel Eyebars Set in Concrete Anchorages Which Will Hold Strands of the Giant Cables Supporting the Oakland-San Francisco Bridge

EYEBARS SET IN ANCHORAGE WILL HOLD BRIDGE CABLES

Giant cables which will support the great double-deck suspension bridge spanning San Francisco bay between Oakland and San Francisco will be "tied down" to sturdy concrete anchorages. Big eyebars are set in these anchorages and other eyebars will be attached to them. To the latter the two cables will be fastened. Each cable will be nearly twenty-nine inches in diameter and will consist of 17,464 parallel wires spun in strands, the strands being attached to the cable anchorages.

WINDOW PANE WITH AIR SPACE PREVENTS FROSTING

Heat loss through windows is reduced and frosting in cold weather is prevented by a double-glazed window consisting of two panes of glass so fitted to each sash as

to provide a dehydrated air space between the panes. This type of window also eliminates condensation on the glass unless the inside humidity is very high. By reducing the flow of heat and cold, about fifty per cent of the usual heat loss through windows is prevented by the double glazing, tests have indicated. It is also expected that the double-glazing idea will be used in refrigerator display cases that are now so generally employed in grocery and meat markets.

POWER BRAKE UNIT EASY TO INSTALL

Designed especially for light cars, a power brake increases the efficiency of the braking system and is easy to install since it can be bolted to the frame. It is of the diaphragm type, has a self-aligning pull rod without packing and does not freeze in winter. No change is made in the regular car brakes, power from the

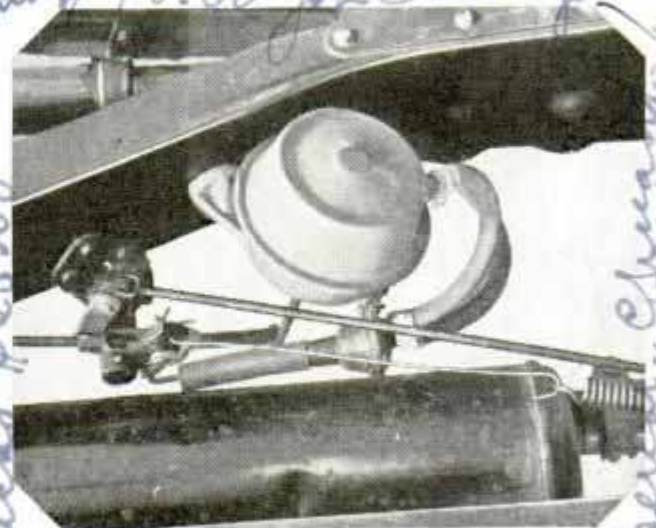

Simple Power Brake Unit Which Can Be Bolted to the Frame of the Lighter Cars

motor being applied and accurately controlled by the regular brake pedal.

Vertical handwritten notes on the left margin, including "D957", "193", and "Chicago".

Vertical handwritten notes on the right margin, including "Chicago" and "193".

Thermopane Co. 429 W

Safety Free 429 W

The MIRACLE of LIGHT

AT THE WORLD'S FAIR

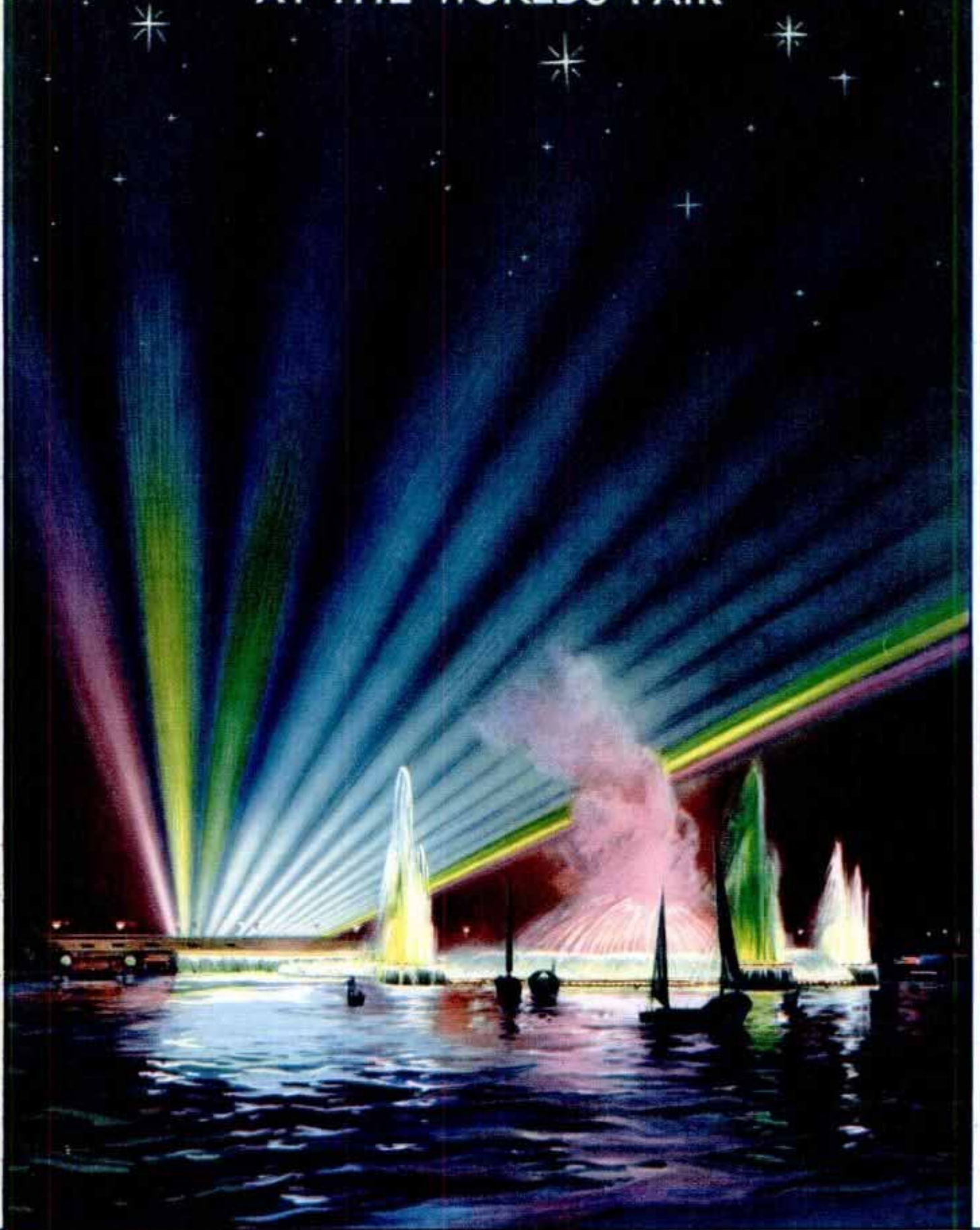

NIGHT illumination of giant fountain with searchlight Aurora Borealis behind it.

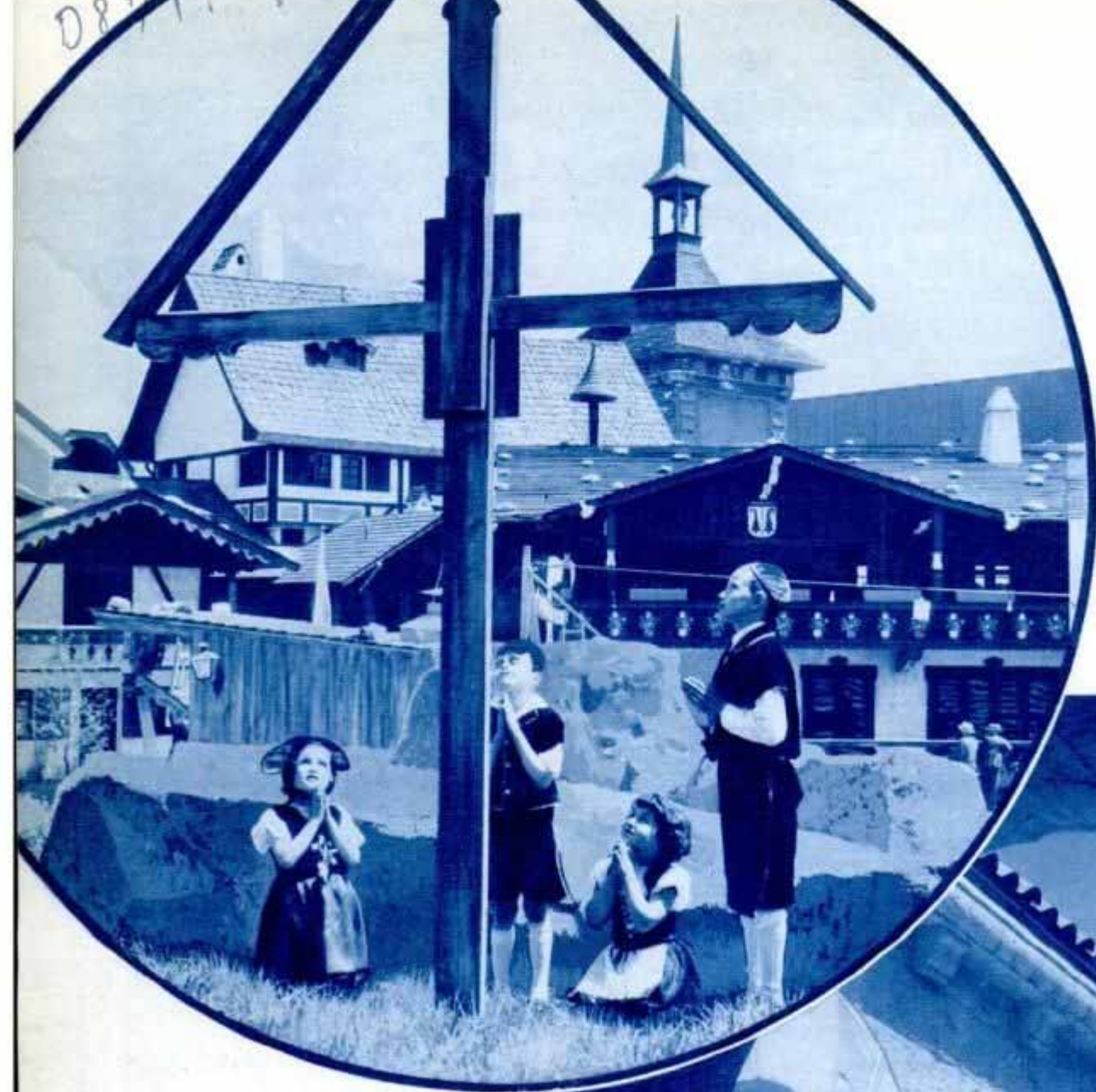

FOREIGN villages lend a cosmopolitan air to the 1934 Fair. There are nearly a score of these foreign centers, each a faithful reproduction of the architecture and customs of the land it represents. Above, entertainers of the Swiss village in native costumes. Right, the courtyard of the Spanish village.





BY NIGHT the Fair becomes a spectacle of ever-changing beauty under the magic hand of the illuminating engineer. Here you see the Sky Ride and the artificial Aurora Borealis, viewed through the rigging of the Byrd South Pole ship.



EVEN the historic ruins of the past, symbolical of the glories of an ancient civilization, are reproduced in the Old World villages. This is a scene in the Italian village, but the crumbling columns are so faithfully copied that it might well pass for a scene in Rome.



D 871

NIGHT scene at the Fair, showing some of the most spectacular lighting effects. Thirty-five miles of gaseous tubes and 250,000 incandescent bulbs contribute to this scene.

D871

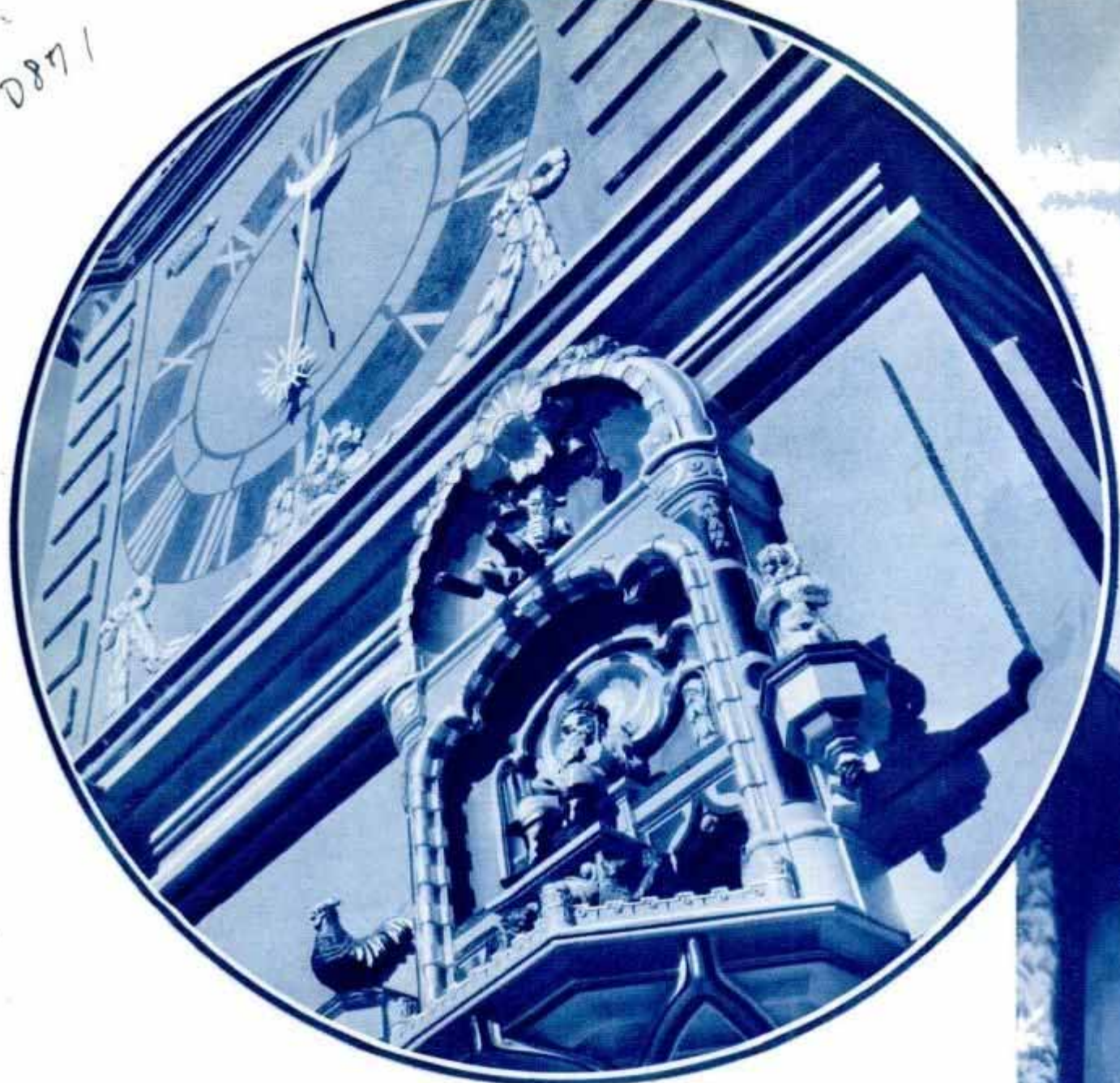

THOSE who admire Old World artistry will find it in the foreign villages. These figures adorn one of the buildings of the Swiss village.

ONE visitor to Chicago's Century of Progress summed up his impressions in these words:—
 "The buildings are crazy and the colors and lights are crazier," he observed, "but the whole is a peep into a fairyland transcending in beauty any dream that could be conjured up by the wildest imagination."

Perhaps he expressed the sentiment of a great many of the millions of visitors who have come to stare and to ridicule, then remained to admire. But whether you find the Fair gaudy or gorgeous, the fact remains that it represents the greatest spectacle of light and color ever achieved by man. Robbed of its brilliant colors and changing lights, it would be merely a collection of great ungainly structures, each no more attractive than a big barn. Paint and illumination transform these buildings and their surroundings into an ever-changing spectacle which impresses every beholder.

When it was decided that huge windowless structures



D871

WHAT would Switzerland be without its clocks and watches? Here is a courtyard of the Swiss village with the clock tower dominating the scene. Many of these villages contain reproductions of historic streets of some of the principal cities of the countries represented, others contain reproductions and models of world-famous buildings.



8
were best suited to exposition purposes, it was also realized that such buildings did not lend themselves to the usual forms of architectural ornamentation. So color and lights as decorative features were conceived as a part of each building, and color experts and light engineers sat with architects and designers as each structure was planned, suggesting the colors to be used and the troughs and recesses necessary for the lights. Thus the colors and lights were incorporated in the buildings instead of being

added haphazardly afterward.

The color experts and the light engineers were forced to pioneer in this form of decoration and each color and light combination of the hundreds which make up the exposition represents hours and sometimes months of tedious laboratory experiments with paints, pigments and light filters. Of necessity, these men were forced to devise and invent as they proceeded and when they were finished they found that many of the effects they had created can be applied, in modified



D871

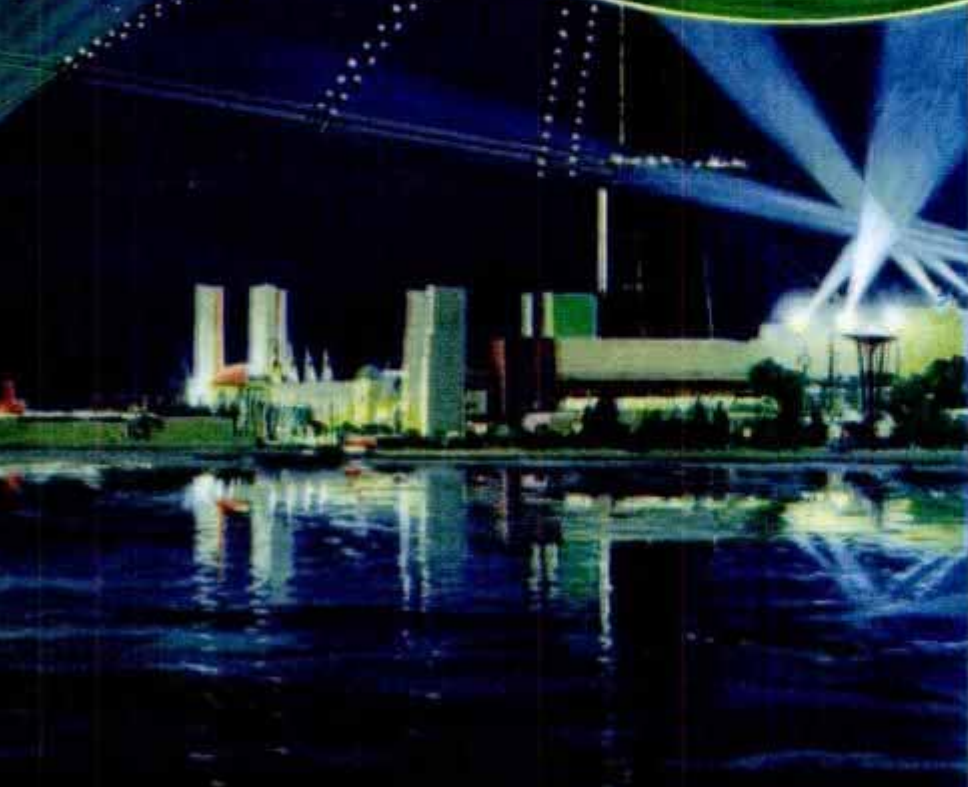

WHEN the sun goes down, the Fair becomes a fairyland of unbelievable beauty. At night the changing lights and softened colors transform the Century of Progress into an awe-inspiring spectacle which is never forgotten. Here is a night view of the Sky Ride and the artificial Aurora Borealis created by giant searchlights. Above, fireworks back of the lagoon fountain.

D871

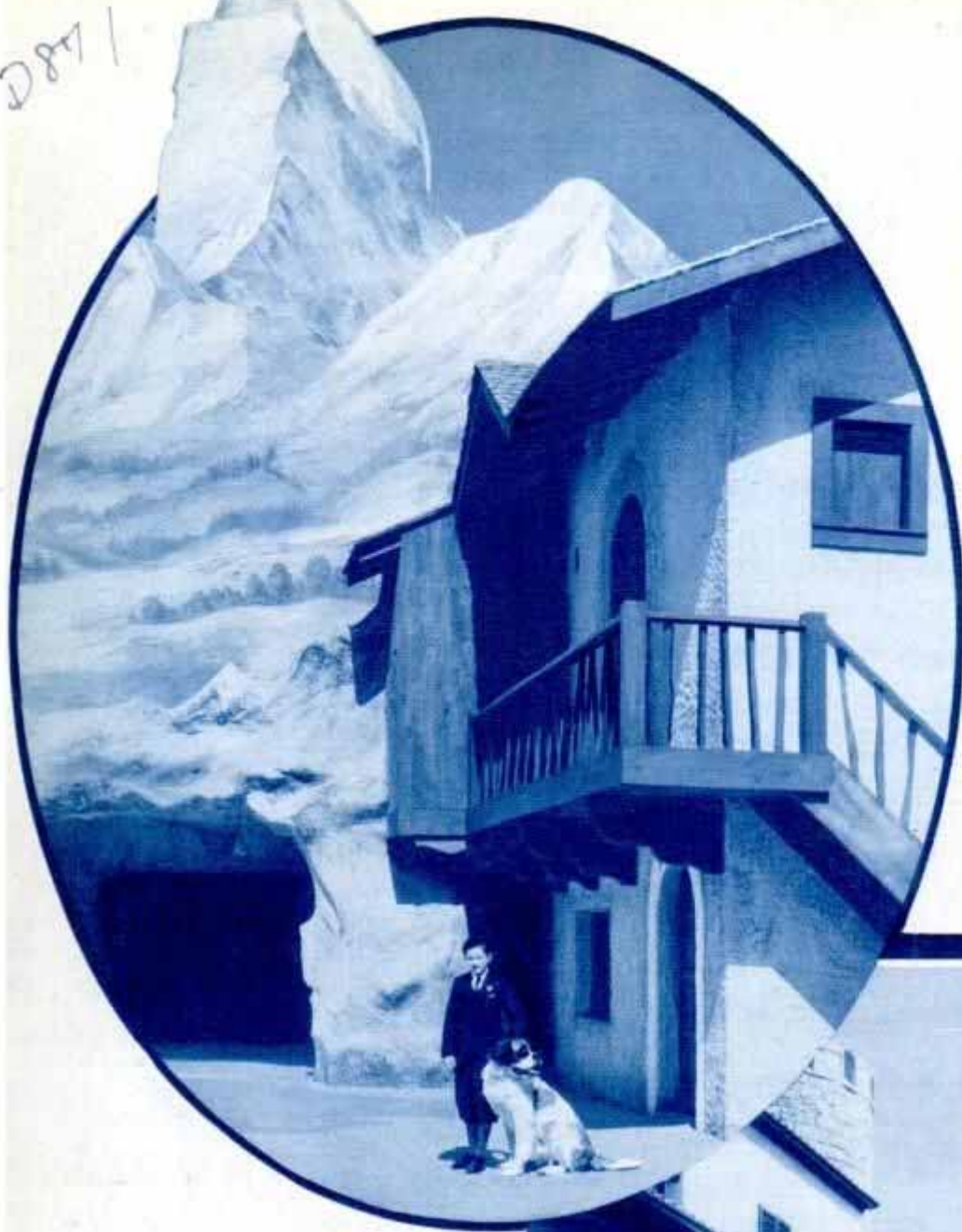

LEFT, the St. Bernard dog isn't lost. It's right at home in the Alps on the shores of Lake Michigan. The man-made mountains are a part of the lure of the Swiss village and the St. Bernards are always on hand to rescue anyone who gets lost in them.

WHEN one goes to Italy, one is expected to view crumbling columns, and when one visits the Italian village at the Fair, he can also see crumbling columns if that is what he came to look at. This garden and the ruins in the background are a part of the "atmosphere" of the village depicting the life and customs of sunny Italy.





SNOW on the mountains, snow on the roofs, icicles—made of glass—on the eaves, skating on the millpond—that is the visitor's impression of the German Black Forest village.

D891

form, to the average home.

One of the first things these men learned was that light and color have a psychological effect on men, and particularly on crowds. For instance, how would you coax several million tired visitors with sore feet to walk two or three extra miles without complaining?

The color and light men did it by substituting red paint and red lights for blue. Last year many visitors seemed to avoid Northernly Island, reached by bridges over a lagoon. Investigation disclosed such people walked



SINGING fountains illuminated from below. The lights are controlled by the music of a great pipe organ and the colors change with the organ notes. Above, left, a corner of the Spanish village. Above, right, statue to a robot in the court of the Hall of Science.

about the mainland until their feet ached. It looked like a long walk over to the island, so they went home instead.

Since it was impossible to move the island closer to the mainland, the next best thing was to make it seem nearer. Last year many island buildings were decorated in blue. This color, it was found, gave an illusion of exaggerated distance. So red was made a dominant color on the island this year. Red has a "drawing" effect and the red buildings appear nearer than they really are. Now people with

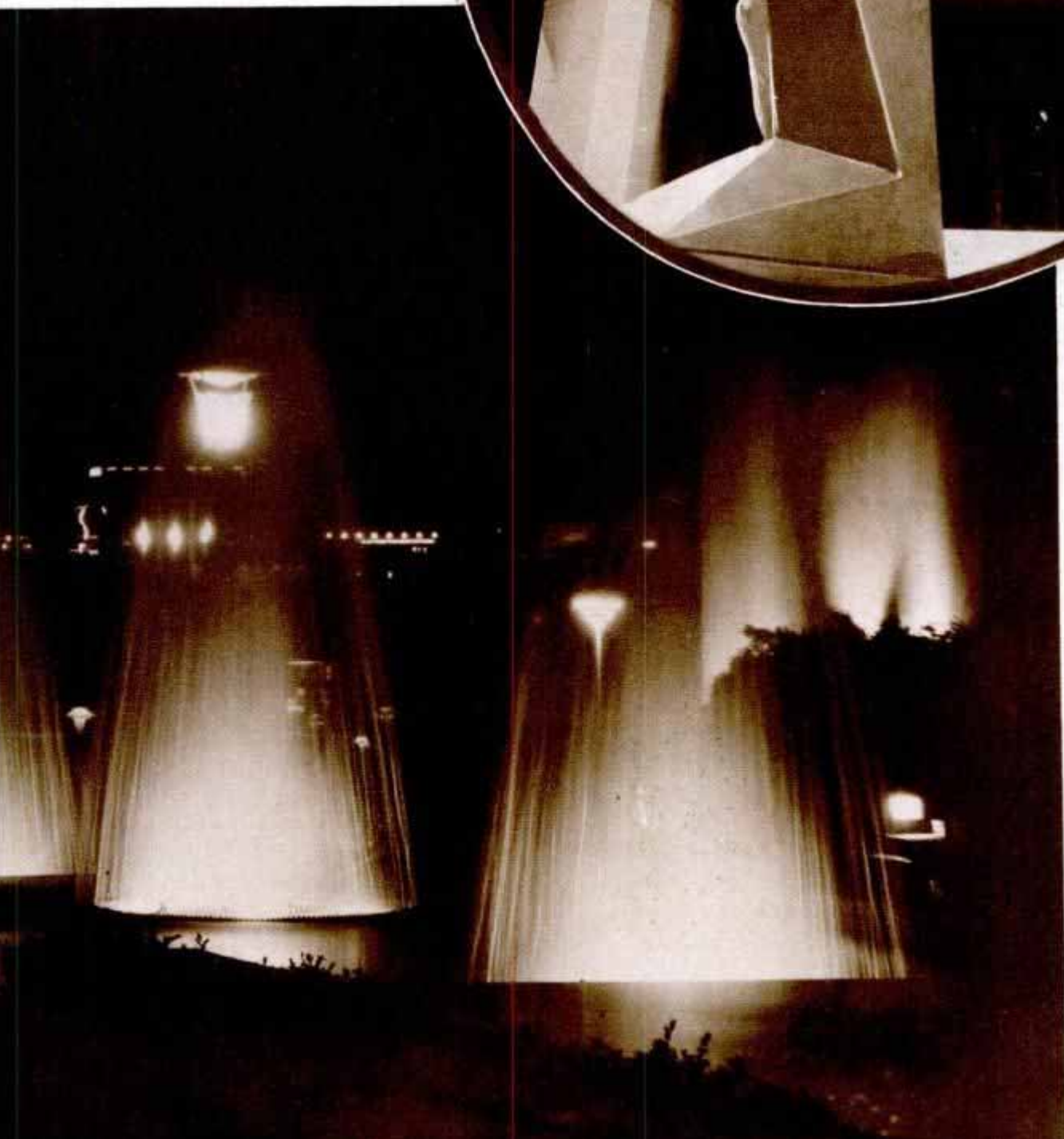



DS 71

TWO of the marvels of the Century of Progress as they appear at night—the tower and cables of the lofty Sky Ride and the illuminated fountain in the lagoon. This fountain is more than 800 feet long and has a flow of 68,000 gallons of water per minute.

sore feet hoof it over the bridges under the impression that the distance is less than is actually the case.

These experts also discovered that a bright light or a brilliant color attracts crowds of humans just as a light draws insects. If they want a crowd in any particular area, they simply make it brighter than surrounding areas. They also found that people believe that reds, oranges and yellows are warm and that blues and greens are cool. Gathering places such as the courtyards of the Hall of Science and Electrical building are painted in "cool" greens and blues for this reason.

The electrical illumination for the 1934 Fair totals 30,000,000,000 candlepower and for exterior illumination alone the power consumption is 5,000 kilowatts, enough electricity to supply the needs of a town of 10,000. The equipment necessary to produce this staggering amount of brilliancy includes thirty-five miles of neon, krypton, helium and mercury vapor tubes, 250,000 incandescent bulbs, forty are searchlights totaling 2,800,000,000 candlepower, 1,200 thousand-watt floodlight projectors, 2,200 200-watt projectors, eighteen three-kilowatt incandescent searchlights of 21,000,000

(Continued to Page 126A)

PART of the charm of the foreign villages lies in the native costumes worn by the villagers. This is a corner of the Tunisian village with native entertainers in costume.





ENTERING one of the foreign villages is like stepping back through the centuries. This courtyard in the Swiss village seems to radiate age and history.

Magic Insect Poisons Not Harmful to Man

Seemingly the bravest man on the government payroll is Dr. C. B. Smith, a federal scientist, who tastes poisons to determine if they are harmful to man. Actually his work is not as dangerous as it appears for the poisons he swallows are virtually magic potions. Chemical experts today are hunting insect poisons which will kill nothing but the pests for which they are intended and they have found several, including pyrethrum and nicotine. Nicotine is now being used extensively as the basis

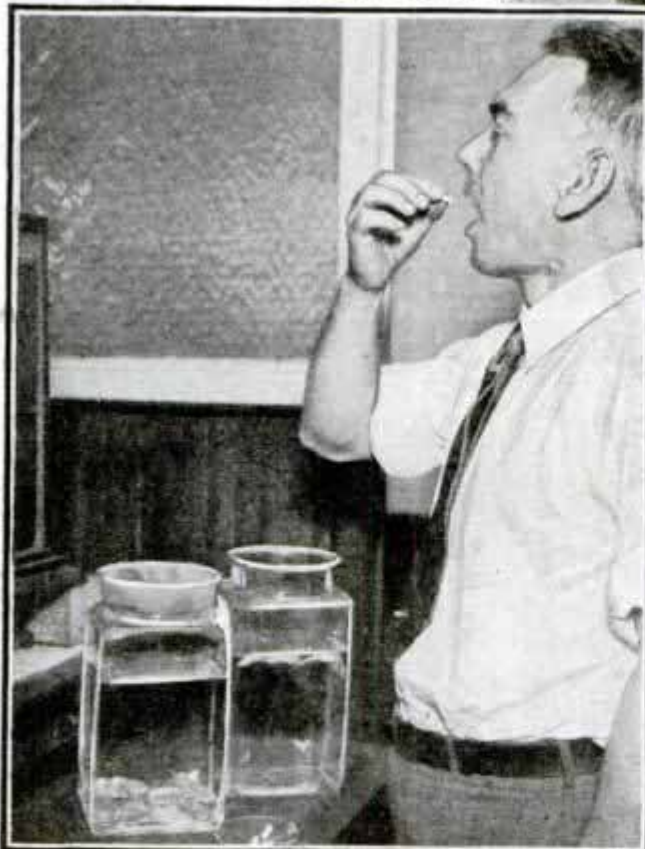
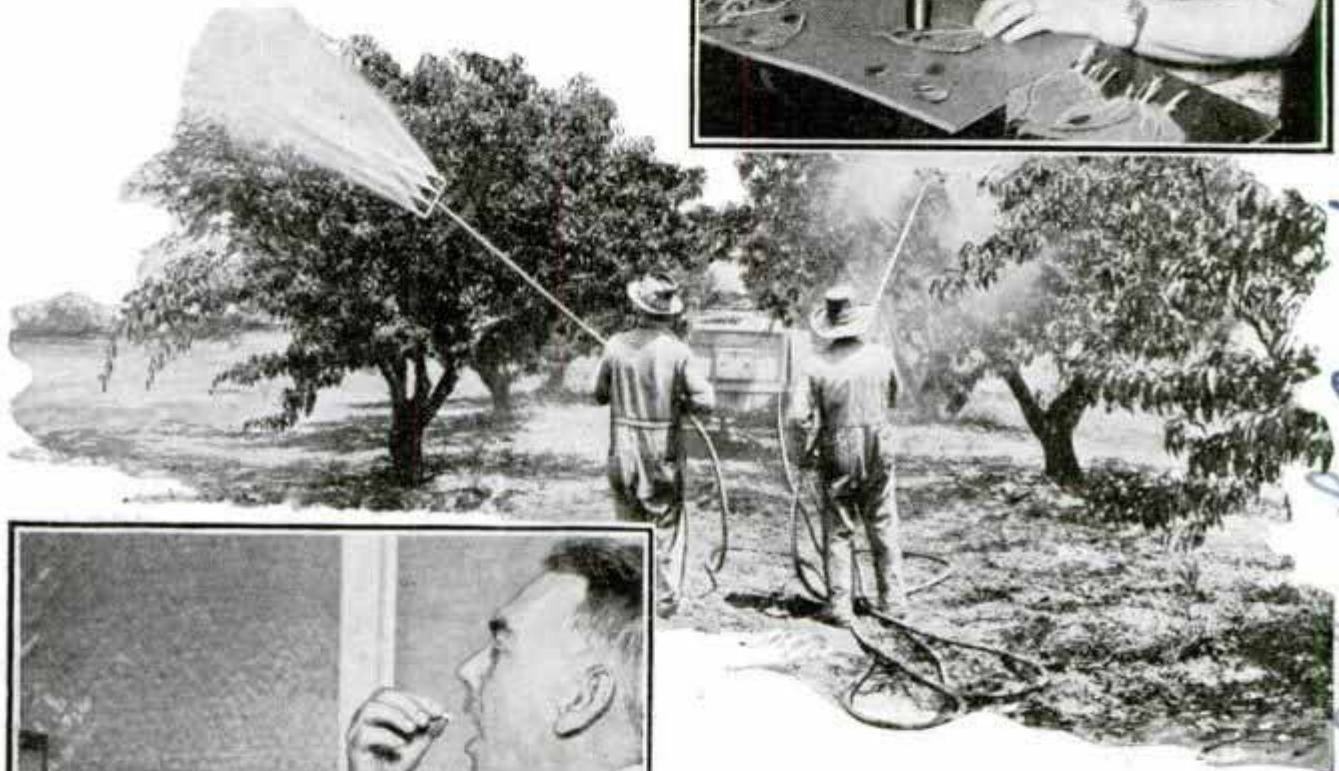

Top, Cutting Out Leaf Disks to Be Fed to Bugs to Find Kind They Prefer; Left, Testing Insect Poison

to man. It is insoluble in water and is not easily washed from fruits by rain. It is unusually effective against the codling moth but it is costly to produce. However, efforts now are being made to produce a tobacco with a very high nicotine content in order to supply this poison at low cost. Cultivation of pyrethrum, the flower heads of which yield a deadly insect powder harmless to man, is being tried successfully in both California and Pennsylvania. It has also been found that an American weed, the devil's shoestring, is an insect poison which does not injure man, and powder from the Derris root will kill fish but is harmless to man while red squill powder will kill rats but will not hurt man.

of a poison compound called nicotine-bentonite which is a fruit spray harmless

Agriculture, Washington, D.C.
 and Dr. C. B. Smith
 Cont John L. Coontz, 2107-19th St. N.W.

This ELECTRIFIED Home

D 828.



The Globe at the Left Contains Dust Filtered from the Air of the Electric Home in One Week While the Bowl Contains Water Evaporated from the Air of the House in One Day

HOMES so nearly automatic that they are almost ghostly in operation soon will be available to the public at moderate costs. In them, doors will open and close at the touch of a button, windows will shut themselves when the first raindrops splatter the sill, awnings will run up or down as the sun changes its position, beds will be raised or lowered by handy controls, temperatures will change from hot to cold or back again and all air will be cleansed and humidified or dehumidified by operating small levers and buttons.

A sample of the all-electric home, constructed by the Frigidaire corporation for exhibition purposes, is replete with things that run themselves or that start operating at the pressure of a button. Much of the equipment is ready for the market and the remainder of the electrical and automatic marvels will be offered when the public demands them.

Temperatures as you like them are manufactured for this house by air-condition-

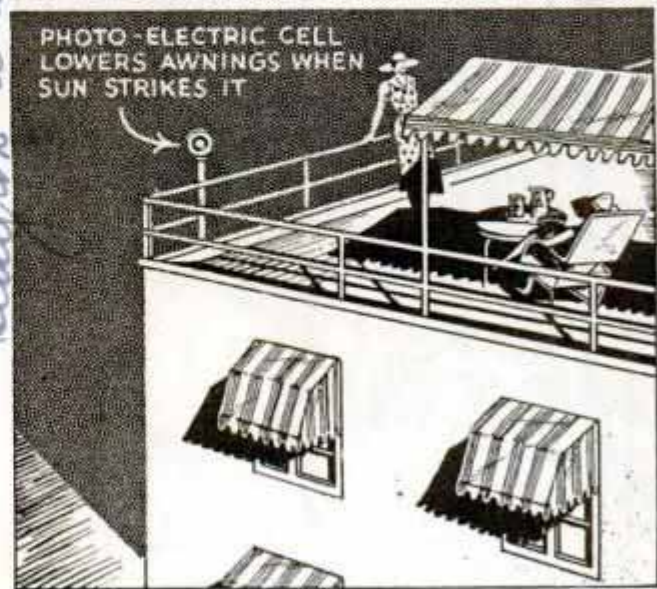
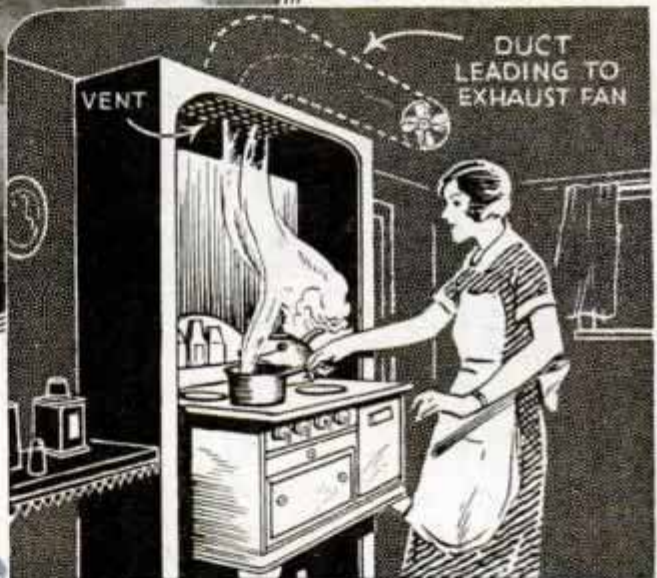

Diagrams Show How Kitchen Is Kept Free of Smoke and Odors and Electric-Eye Awning Control

D 828

Runs ITSELF *at World's Fair*

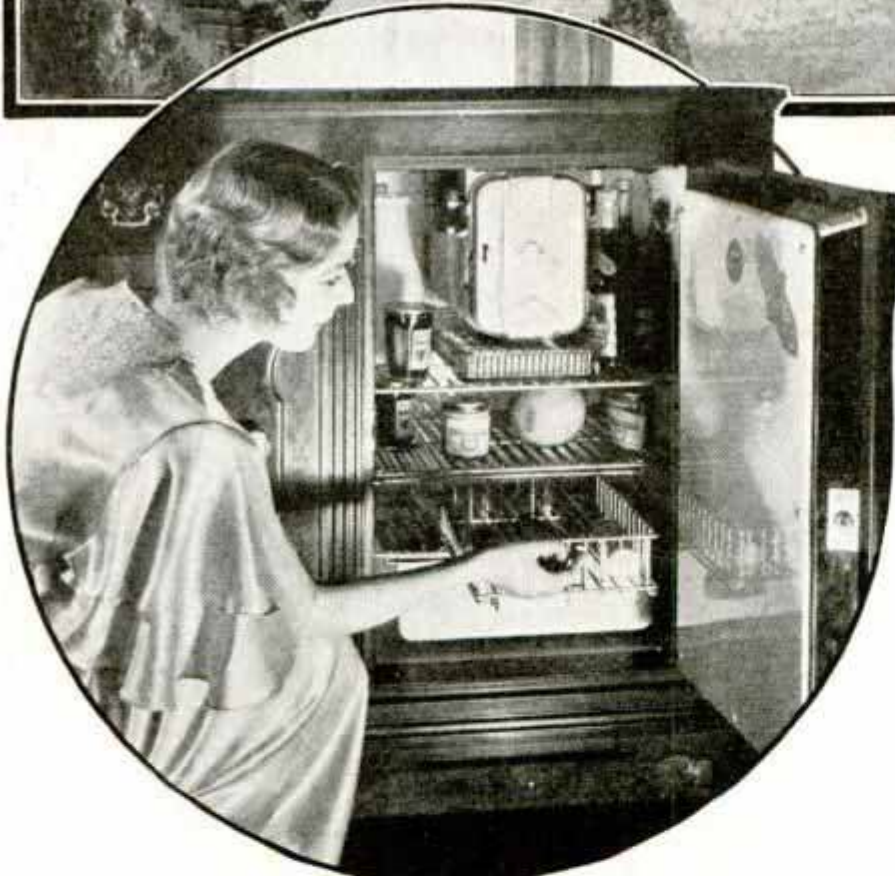
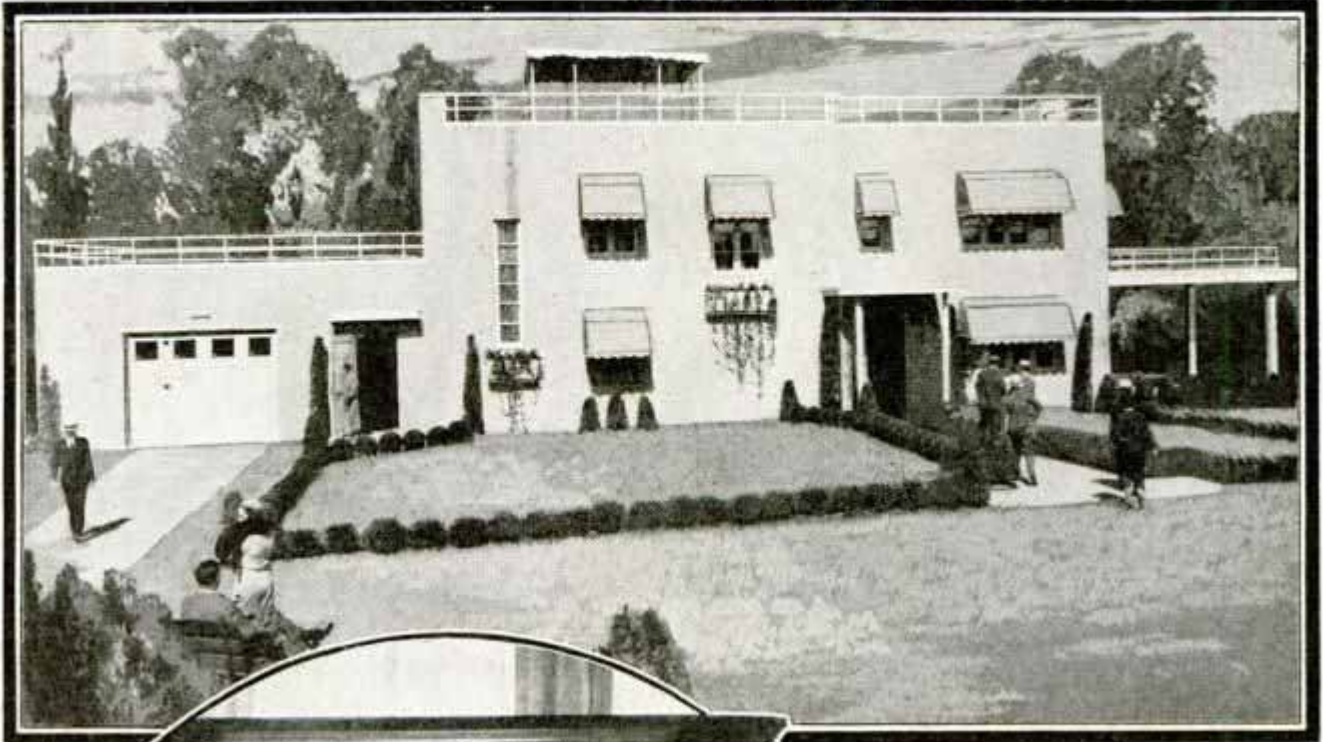

The Electrified House, and Electric Refrigerator in Ultra-Modern Cabinet for Master Bedroom

the sun comes out, and drawn up when the sun sets or hides behind a cloud. This is accomplished by means of a photo-electric cell and relays that operate electric motors. When bright sunlight reaches the "electric eye" located on the roof, it causes the controls to release the awnings, which lower of their own weight. When the light grows dim, the electric eye sets an electric motor to work, pulling the awnings to closed

ing equipment that can be installed for about ten per cent of the construction price of any home. The air-conditioning equipment filters and washes the air, removes or supplies moisture as required, and heats or cools it before circulating it to all parts of the house.

The house is also equipped with awnings that are lowered automatically when

position. Windows are equipped so that they close immediately when raindrops fall on a sensitive recorder, located on the window sill, an almost unnoticeable watchdog that acts when the residents are away or asleep. This recorder contains a small piece of wood that curls downward when a single drop of water falls on it, making contact with a switch that starts the small



Keyboard Controls for Windows, Doors, Bed and Air-Conditioning Plant

electric motor to closing the windows. One room of the house is designed especially for the man who demands comfort without expenditure of effort. Buttons on a small remote-control board actuate electric motors that raise and lower the bed, open the windows at night and close them in the morning, open or close the sliding door and regulate temperatures—all without moving from the bed.

If the screen is raised, none of the windows controlled by the electric motor at that point can be opened or closed, a safety switch holding them in position until the screen is lowered. This prevents the windows from slamming on the fingers and from being operated by remote control.

In the master bedroom is an electric refrigerator encased in a beautiful cabinet that matches the other furniture, offering the possibility of cooling drinks and midnight snacks without visiting the kitchen. Glass that is transparent or opaque, depending on which side you stand and on which side a light is placed, is a feature of one door at the top of the stairs. With the

light in proper position, the glass serves as a mirror while persons on the other side cannot see through it.

The kitchen contains an electric refrigerator, electric stove and other electrical equipment, also a powerful exhaust that pulls fumes and smoke from the vicinity of the stove to the outside.

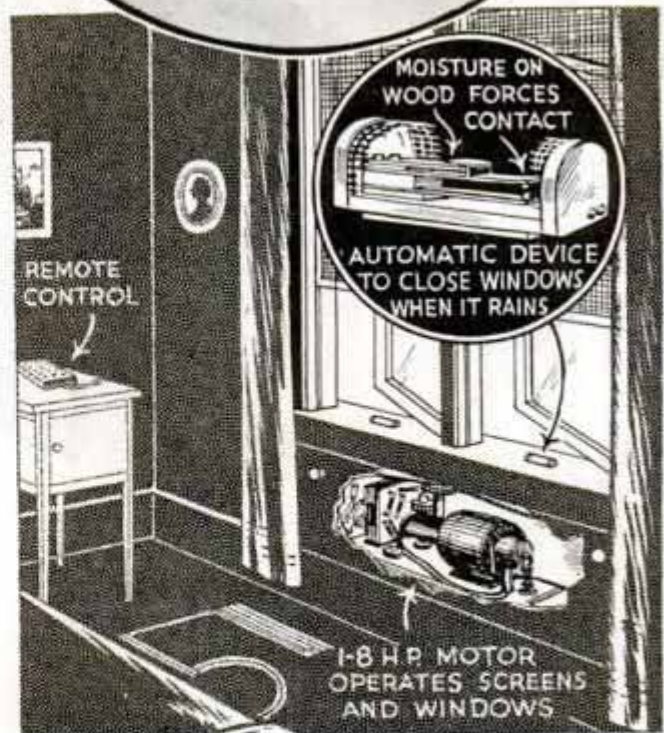
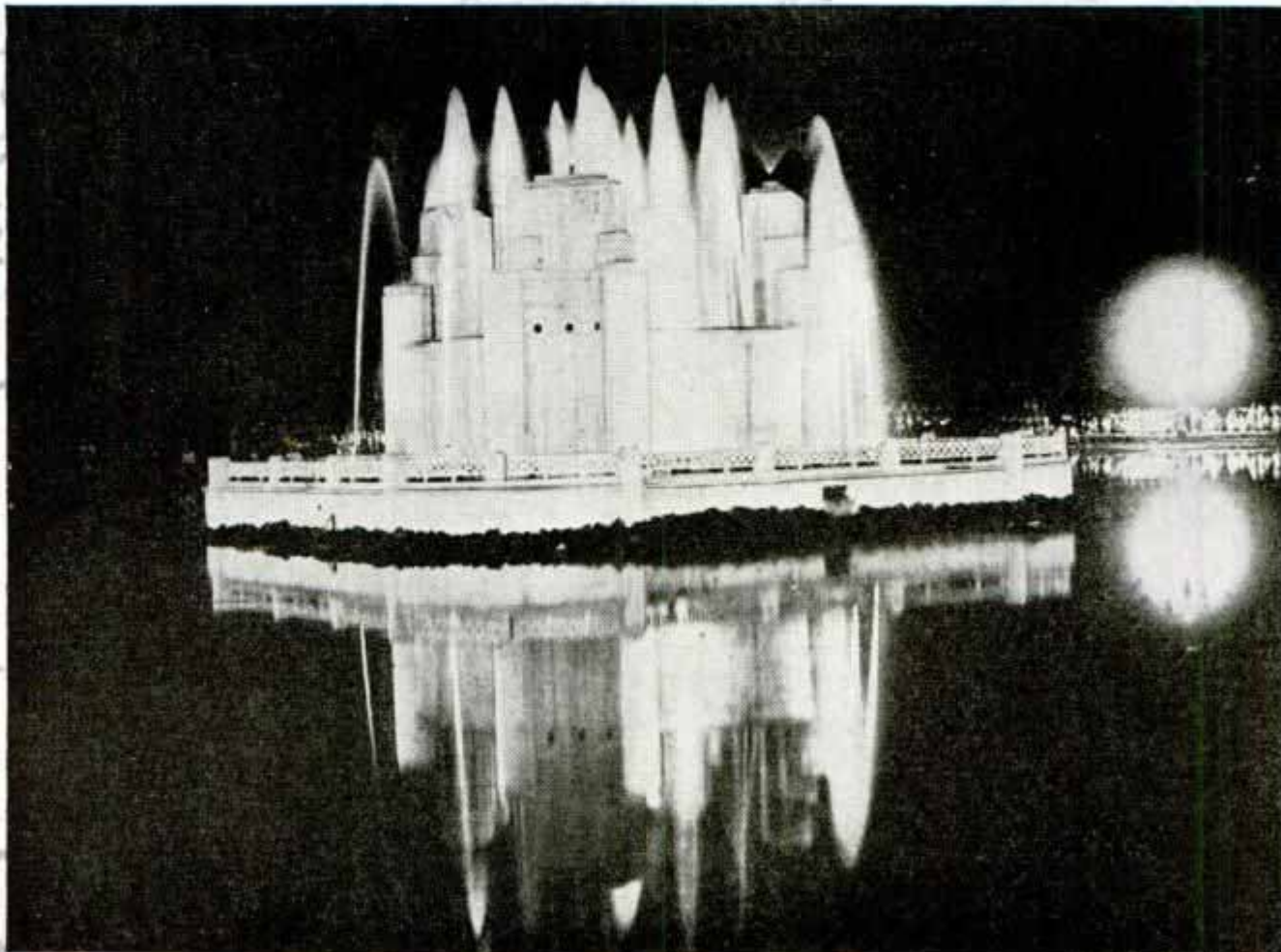

Diagram Showing How Windows Are Closed Automatically by a Small Motor When It Rains; Note Remote-Control Board

Fountain Like a Snow Castle Honors Sousa



Beautiful Fountain in a Philadelphia Park Which Appears Like a Huge Snow Castle When Illuminated at Night; It Was Erected in Memory of John Philip Sousa, the Bandmaster

In memory of the celebrated bandmaster, John Philip Sousa, a beautiful fountain has been erected at Willow Grove Park, Philadelphia, where he once played. The structural work of the fountain itself and the columns of water emanating from it appear like a great castle of snow when the whole is illuminated at night.

INVISIBLE LIGHT FROM STARS SHOWN BY PHOTOGRAPHS

Brilliant rays of light from some of the stars are invisible to the human eye, either because they are ultra-violet with wave lengths too short to be seen or infra-red with wave lengths too long to be seen. The most intense radiations of very hot blue stars are in the ultra-violet, Dr. Paul W. Merrill of Mt. Wilson observatory says, and the most intense light of the cool, red stars is in the infra-red. Improvements in photographic emulsions enable scientists

to photograph many of the invisible stars, thus adding to their knowledge of how the universe was put together.

SANDPAPER BLOCK HOLDS ABRASIVE IN PLACE

Sandpaper is held securely in position for use on a wooden block containing a



metal clip for fastening the paper. The paper is cut into three strips and one strip is inserted in a slot in the block and wrapped around it lengthwise. The metal fastener is then pressed down

to hold it in place. Each side of the block can thus be used and the narrow end is handy for sanding in close quarters.

Carnegie Institute

Inventor and manufacturer

Beach Arlington N.J. Pa. or Delaware County Pa. or Lincoln County Pa. or

See advertisement

091

D916

D149

#15/5/14



Wedge World
Baby Car, Equipped with One-Horsepower Motor and Carrying One Passenger, Now on Market in England

ONE-HORSEPOWER MIDGET CAR CARRIES ONE PASSENGER

So small that it can be run under a horse of average size, a midget motor car has made its appearance on the streets of London. The baby car, equipped with a one-horsepower motor and carrying one passenger, is being placed on the market in England.

ATOMIZER FOR ELECTRIC FAN KEEPS INSECTS AWAY

D904
Flies, mosquitoes and other insect pests can be driven away with an ordinary electric fan if it is equipped with a spray attachment which disseminates finely atomized particles of any liquid insecticide as the fan operates. It consists of a container for the insecticide which is attached to the top of the fan guard. In front of the fan is a flag which whips when the fan is running and causes a valve plunger in the bottom of the container to operate, thus releasing small quantities of

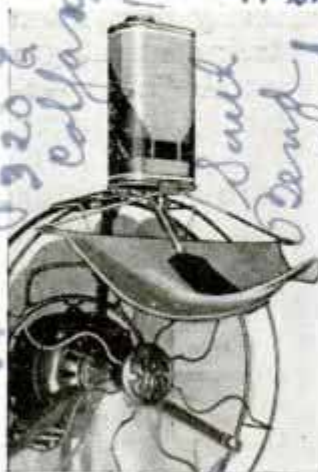

the liquid which trickles through a trough to a felt pad where it is blown into the air. An occasional refilling of the container is the only attention required and the same device can be used for the application to a room of perfume or other sprays.

D901
"GLARE METER" TESTS AUTO HEADLAMPS

Traffic officers in St. Louis are using a "glare meter" invented by a policeman to test automobile lamps for violation of regulations governing headlights. The instrument is so sensitive that a wisp of cigaret smoke passing between lamps and a photo-electric cell is registered immediately on the dials at the back of the tester. These dials are illuminated with bulbs burning current from dry cells contained in the board. The compact equipment is used to replace the bulky boards with black painted lines which formerly were carried to the boulevards when headlamps were to be tested. Levers control the movement of the photo-cell vertically

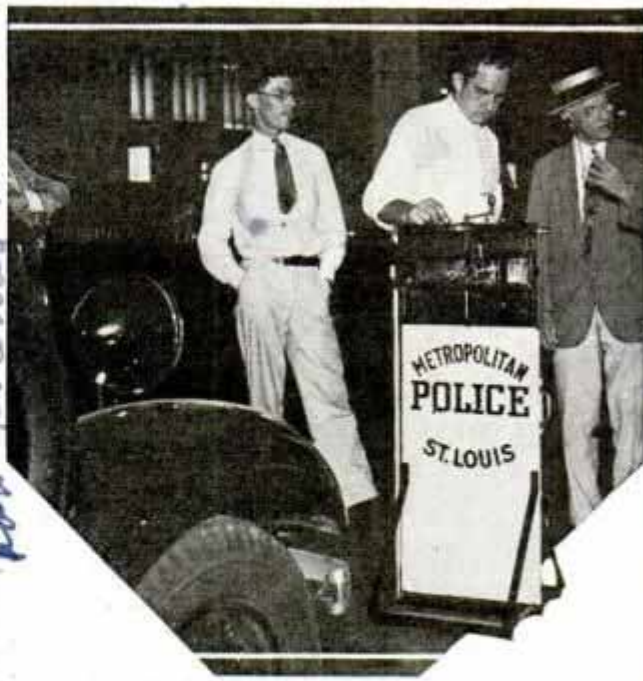

Portable "Glare Meter" Equipped with an Electric Eye for Testing Automobile Headlights

and horizontally and from readings on this movement, calculations of the angles of the light from headlamps are made, enabling the proper corrections.

Shiltax motor boat racer
Everett Greber
Electric spray for road
no longer made 1/17/48
colgan 320g
South
Band
Club
pat. patented (C)
Designed and built by Electric Sergeant in charge of radio broadcasting
Cmd. W. J. O'Neil
16 Commercial

Floating Seaplane Hangar Rests on Pontoons

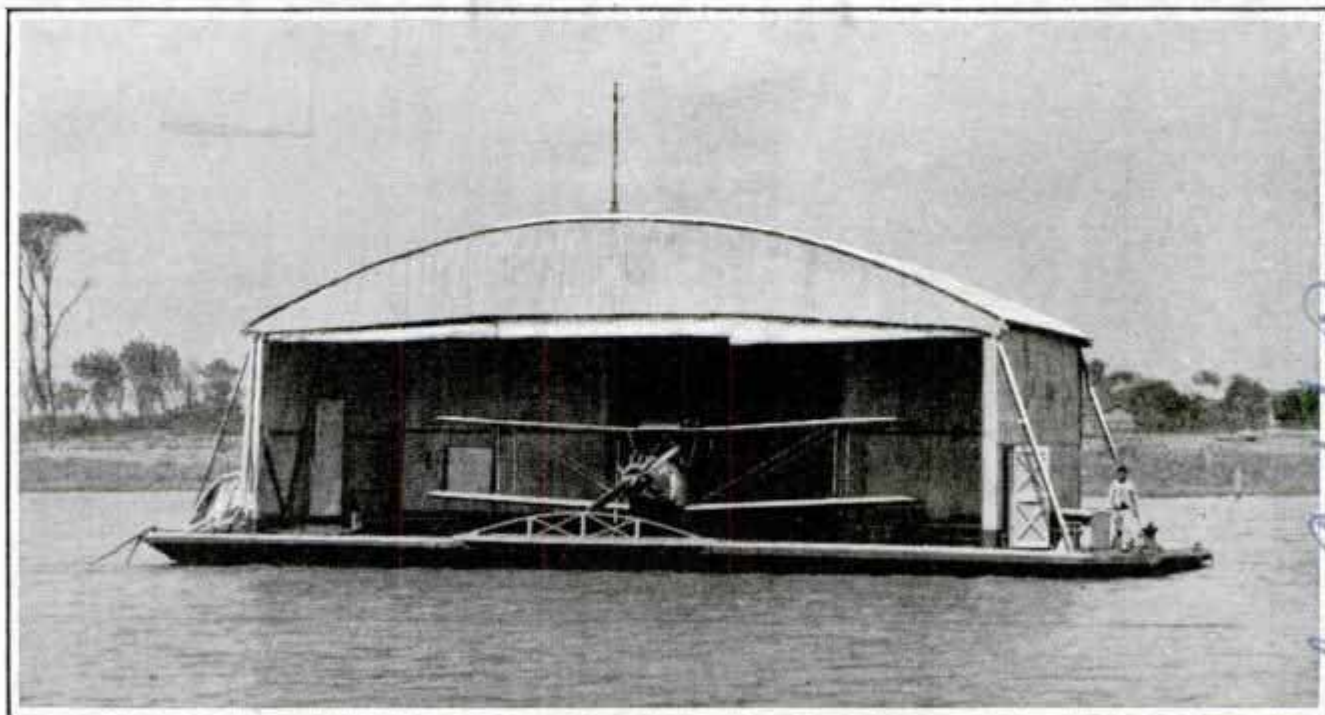

Floating Seaplane Hangar Built on Pontoons; the Hangar Can Be Lowered to Admit a Plane by Flooding Some of the Pontoon Compartments with Water

Designed on the principle of a floating dock, a floating steel hangar for seaplanes is anchored in the Yangtze river and can be towed anywhere as occasion demands. The structure is built on a hull consisting of two longitudinal pontoons held together by transverse girders and deck plating. Each pontoon is divided into five watertight compartments, the center one being the flooding compartment. In the center of the hull is a dock or trough in which

the floats of the seaplane normally rest. At the front of the trough is a hinged door which is watertight when closed. When the seaplane is not in use the hull rests at its normal water line, the trough door is closed and the bottom of the trough is above water. When the aircraft is to be launched, water is pumped into the flooding compartments and the hull is sunk to its low-water line, the door is opened and the trough is flooded with water.

Ten-Ton Door Made of Bronze Is Thirty-Five Feet High

Mighty doors of bronze guard the entrance to the new archives building in Washington, D. C. Each of the doors is thirty-five feet high, nine feet wide and one foot thick, and each weighs more than ten tons. They were made in Cleveland and hauled by truck to the capital.

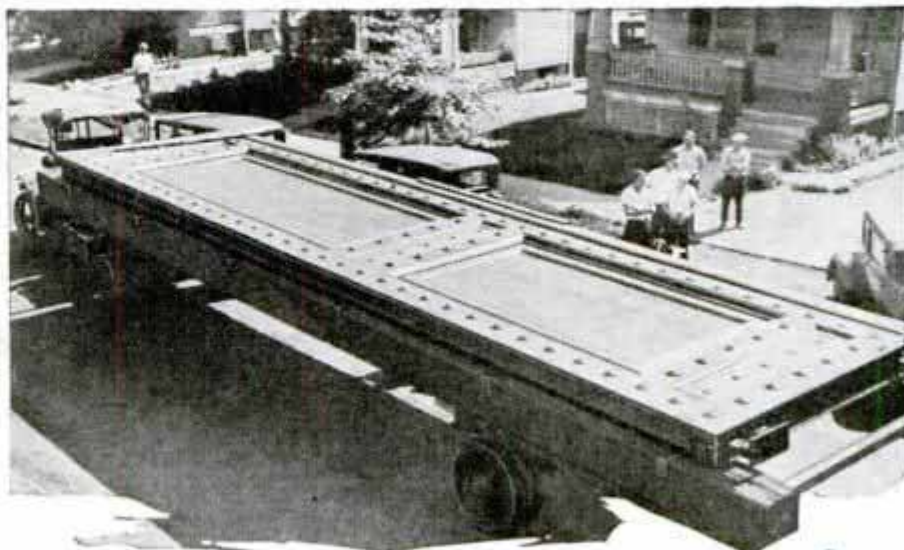

Bronze Door, Thirty-Five Feet Long and Weighing More Than Ten Tons, on Way to Washington to Guard Entrance to Archives Building

Our Bureau of Information will answer questions regarding articles in this magazine, if accompanied by return postage.

*made by John Haisch
116th and Madison*

FOG still Challenges

Anti-Aircraft Sound Detector Which Has Been Suggested for Ships to Aid in Locating Fog Signals; Below, the Fog Bell on a Lightship

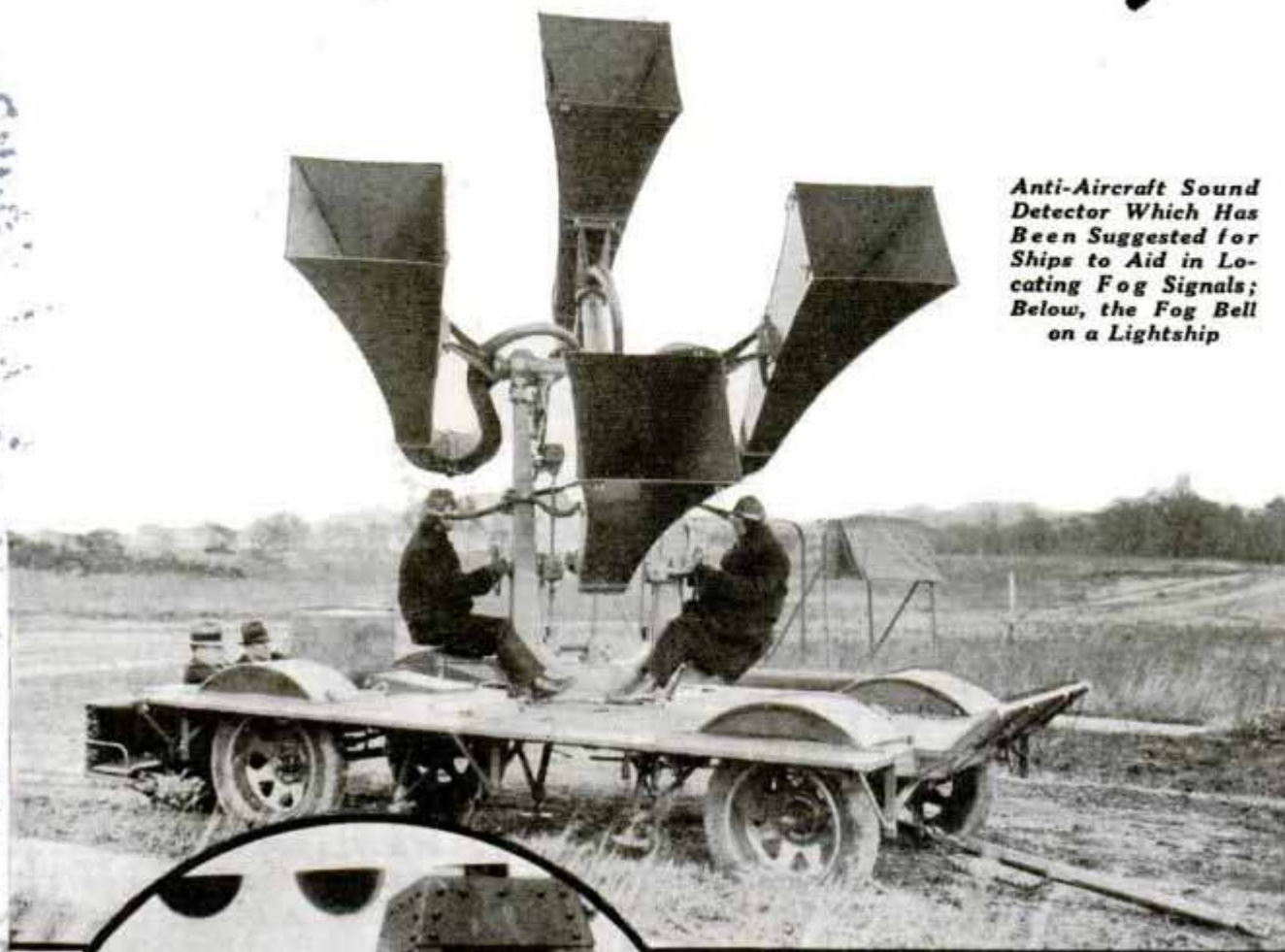

With the perfection of the radio beacon and direction finder it seemed that it would at last be possible for a ship to approach a harbor with safety, yet twice during the past spring the Nantucket lightship served as a magnet rather than a warning.

Many mariners prefer to trust their senses rather than new-fangled instruments, but the senses are notoriously unreliable. Especially is hearing apt to deceive one. A few years ago a ship run aground in a fog only 200 yards from a fog siren, no one aboard hearing the

wail that kept persons awake on shore twelve miles away. There was nothing wrong with the ears of those on the ship, for it has been proved that sound may be heard quite distinctly miles away and still be inaudible close at hand.

Dr. W. J. Humphreys of the weather

WITH 20,000 collisions due the fog during the past ten years, causing a total loss of more than 23,000 lives, inventors need not worry about no more worlds to conquer, for fog still remains the chief navigation hazard despite the many safeguards now available to all shipping.

INVENTORS

Vol. 22, No. 10, October 1915
of the Infantry Journal.
1115 17th Street
Washington, D.C.

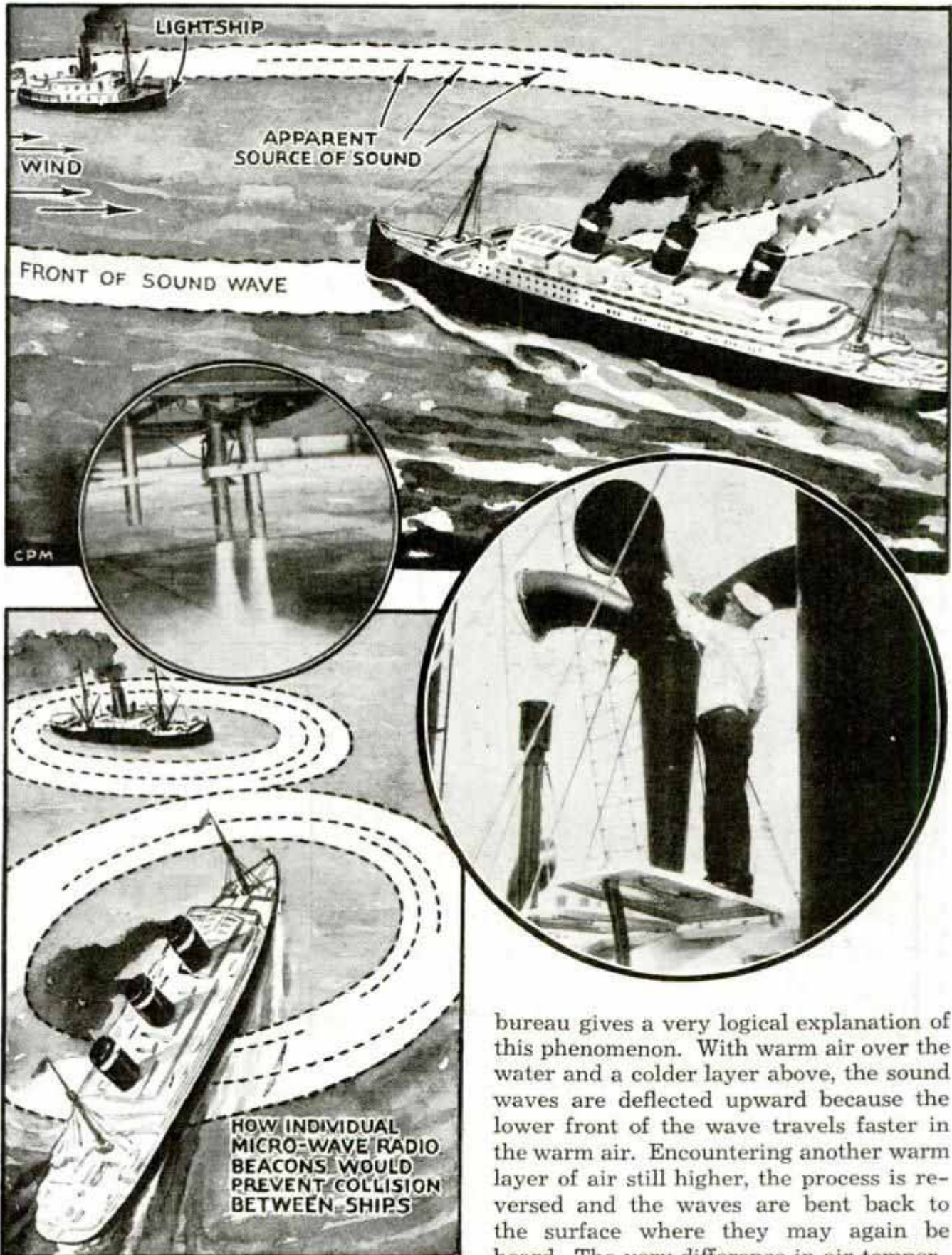

Top, How Wind Distorts Sound; Insets, Using Sand to Disperse Fog, and Foghorn on Lightship

bureau gives a very logical explanation of this phenomenon. With warm air over the water and a colder layer above, the sound waves are deflected upward because the lower front of the wave travels faster in the warm air. Encountering another warm layer of air still higher, the process is reversed and the waves are bent back to the surface where they may again be heard. The very difference in air temperatures that causes the distortion of sound also causes fog. Near-by land or even the

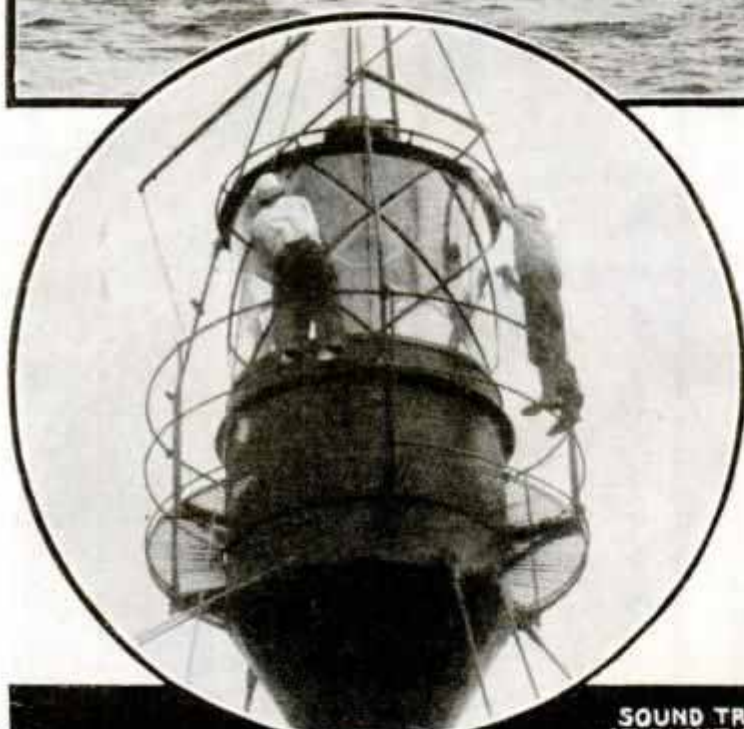
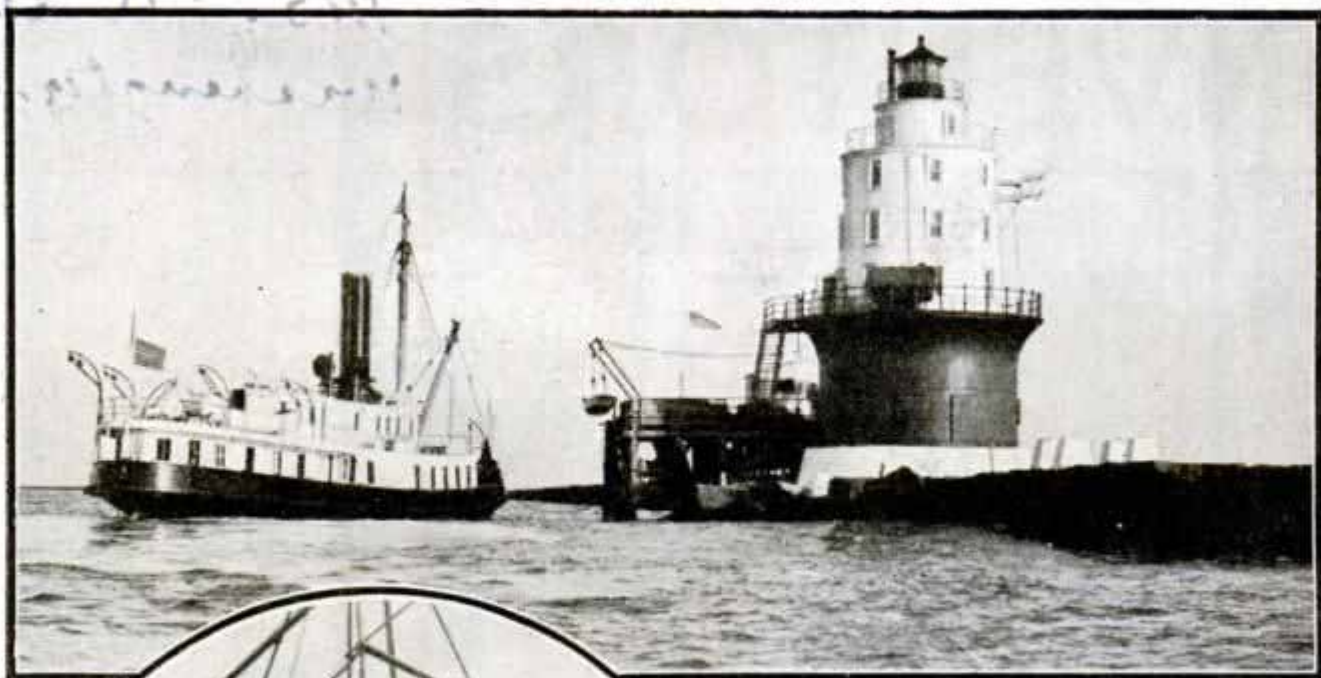

Lighthouse in Delaware Bay, Masthead Light of Lightship and Diagram Showing How Differences in Air Temperature Distort Sound

front of a fog bank may deceive a hearer by causing echoes. Ferry pilots operating between San Francisco and Oakland usually hear the San Francisco siren until half way to Goat island. The signal is then lost, to be heard again when coming close to the island, which then seems to be the source of the sound.

Wind can also distort sound waves so that their source is deceiving. In still air sound waves take the form of a rapidly enlarging circle, but wind tends to bend this circle into an ellipse. Since the source of sound appears to originate at right angles to the front of the waves, the distortion of this front will cause the hearer to misjudge the direction of the source. Even sound detectors similar to those used by anti-aircraft gun crews have a ten-degree probable error, but the unaided ear may be off as much as ninety degrees.

Radio beacons and direction finders are so accurate that with two or more cross bearings a captain may obtain his position in a few seconds when the sun, stars, lighthouses and other markers are blotted out by fog. Yet the full usefulness of radio in fog is still to be developed. Last year the lighthouse service tested a device that tends to prevent collisions between ships—something the present radio beacons cannot do. The idea is to equip each ship with its own individual radio beacon, which will broadcast a different signal in each quadrant of a circle. For instance, for forty-five degrees on

V887 Ardmore Pa.

SLEEPING BERTH IN TRUCK CAB FORMED BY LOWERING SEAT

each side of the bow it might broadcast a dash-dot, while in a similar angle aft the signal would be dot-dash. Two dots would be sent off the port beam and two dashes off the starboard beam. An approaching ship, hearing the signal, would not only have the bearing on the sending ship, but would be able to determine in what direction she was headed.

Practically all useful inventions for combating fog have been of an auditory nature—radio and sound signals. Try driving your car down the street some time with your eyes shut, depending upon your ears alone, and you will get an idea of the helplessness of a captain who must navigate his ship in fog; for a ship, to maintain steerage, travels at a rate of speed that makes stopping in less than four times its own length impossible. To do away with the menace of fog, an adequate visual signal must be developed. Dr. Humphreys says it is impossible to develop any light that will pierce fog for more than 300 feet. The glow of light reflected from fog droplets can be detected on a dark night at a greater distance, but the source of the light cannot be judged with accuracy.

(Continued to page 116A)



Adjustable Seat in Truck Cab Which Is Quickly Converted into a Comfortable Bed

SPRINT BLOCKS FOR RUNNERS PERMIT FASTER START

Aluminum foot brackets or sprint blocks enable the track runner to make a faster and more accurate start. The blocks have spikes for gripping the ground, giving the runner a positive thrust with his feet. Treads of the blocks are adjustable to forty-five and sixty degrees because the rear foot usually takes a sharper angle.

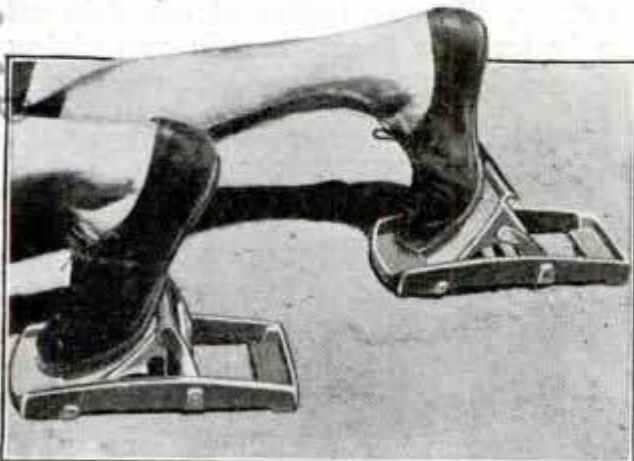

Sprint Blocks with Adjustable Treads Which Enable the Runner to Make a Faster Start

Comfortable sleeping quarters for a passenger or relief driver are provided in a truck cab equipped with an adjustable seat which allows the sleeper to recline in a position parallel to the movement of the truck and in a space where there is good ventilation. Such sleeping quarters are preferable to the stuffy shelf or cubby-hole, set at right angles to the truck, where a relief driver usually sleeps. The berth is made in two sections, one of which is a seat the back of which can be adjusted to any angle between the horizontal and vertical. The other section, which unfolds to form the foot and leg rest, is stored under the cowl out of the way when not in use. The berth is seventy-three inches long when fully extended, the back section being twenty-three inches wide while the front is sixteen and one-half inches in width. The sleeper does not interfere with the comfort or efficiency of the driver when being used as a seat or as a bed.

Pasadena Calif. Junior College

D898

Chas. Everett H. H. Day

Little Rock, L.T. New York

Pests Used in the Study of Man's Heredity

D886

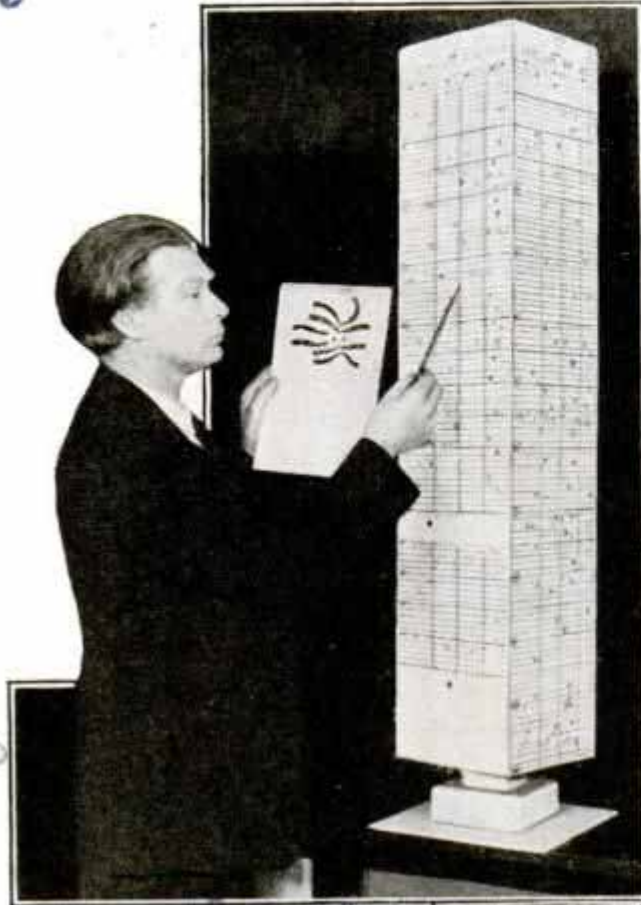

Home
Top, Chart Used in Study of Flies; Right, Bottles in Which Pests Are Studied



Research
Millions of flies are being used by Dr. Calvin Bridges of the Carnegie Institute of Technology in his study of hereditary traits at California Institute of Technology. Resembling man in their ability to transmit physical characteristics, the flies are exposed to an X-ray that speeds up their development 150 times, enabling the study of thirty generations in one year.

"SALLYING SHIP" HELPS FLOAT PRIDE OF BRITISH NAVY

When the battleship "Nelson," pride of the British navy, went aground recently, the crew helped to refloat it by jumping up and down. The 1,300 men and 100 officers lined up astern and jumped up and down to the time beats of a bandmaster. At the same time, a flotilla of destroyers cooperated by racing at ever-increasing speeds past the ship to create a wash. Tugs

strained at the hawsers of the "Nelson." Oil tanks and magazines were emptied and a dredger dug gravel from beneath the bow. As the tide rose, the combined efforts of crew, destroyers and tugs caused the "Nelson" to slip off the bank. "Sallying ship," as the crew's movement of jumping up and down is known, was employed long before the days of steam and steel ships. It consists usually of making the vessel roll heavily by having the crew run, all together, from side to side. At first the roll is very slight, but it gradually "builds up"

until the effect of a very heavy sea is simulated. This rolling breaks the suction of the mud or gravel in which a vessel may be stuck, literally bouncing the ship off the bottom for short periods and giving tugs and the ship's engines a chance to pull the vessel clear.

STEAM-DRIVEN MOTOR TRAIN BURNS COAL-TAR OIL

Germany is experimenting with a steam-driven motor train consisting of two articulated and streamlined coaches weighing less than 100 tons and seating 133 passengers. The train is driven by steam produced by two boilers of more than 1,700 pounds pressure. Each boiler has nearly

Paradise Calif.

D113

D767

Reported by General

Paradise Calif. California

0845
Com. Edgarson Jones
2901 Connecticut Ave
Washington
h.c.

Proving SHIPS

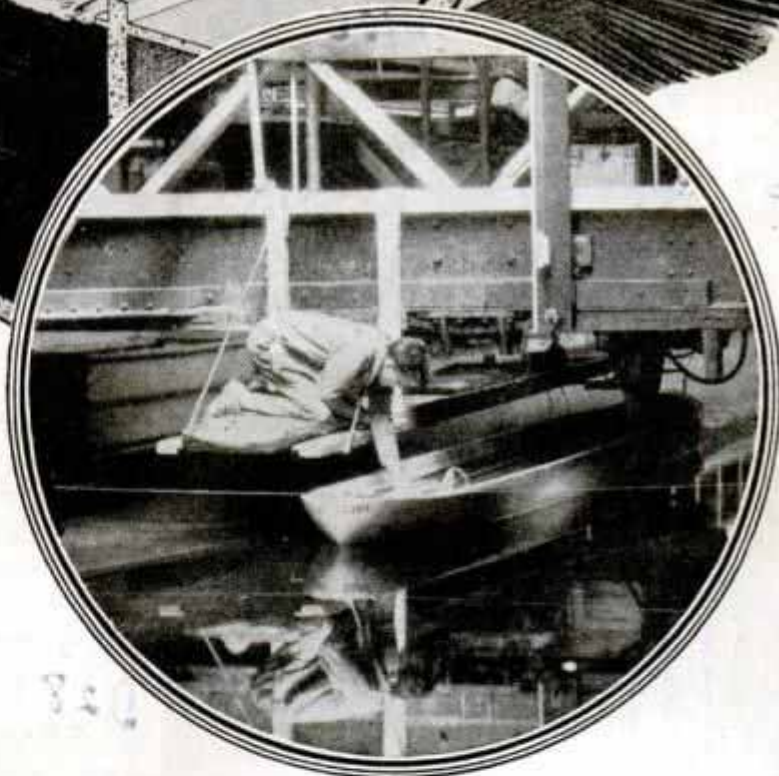
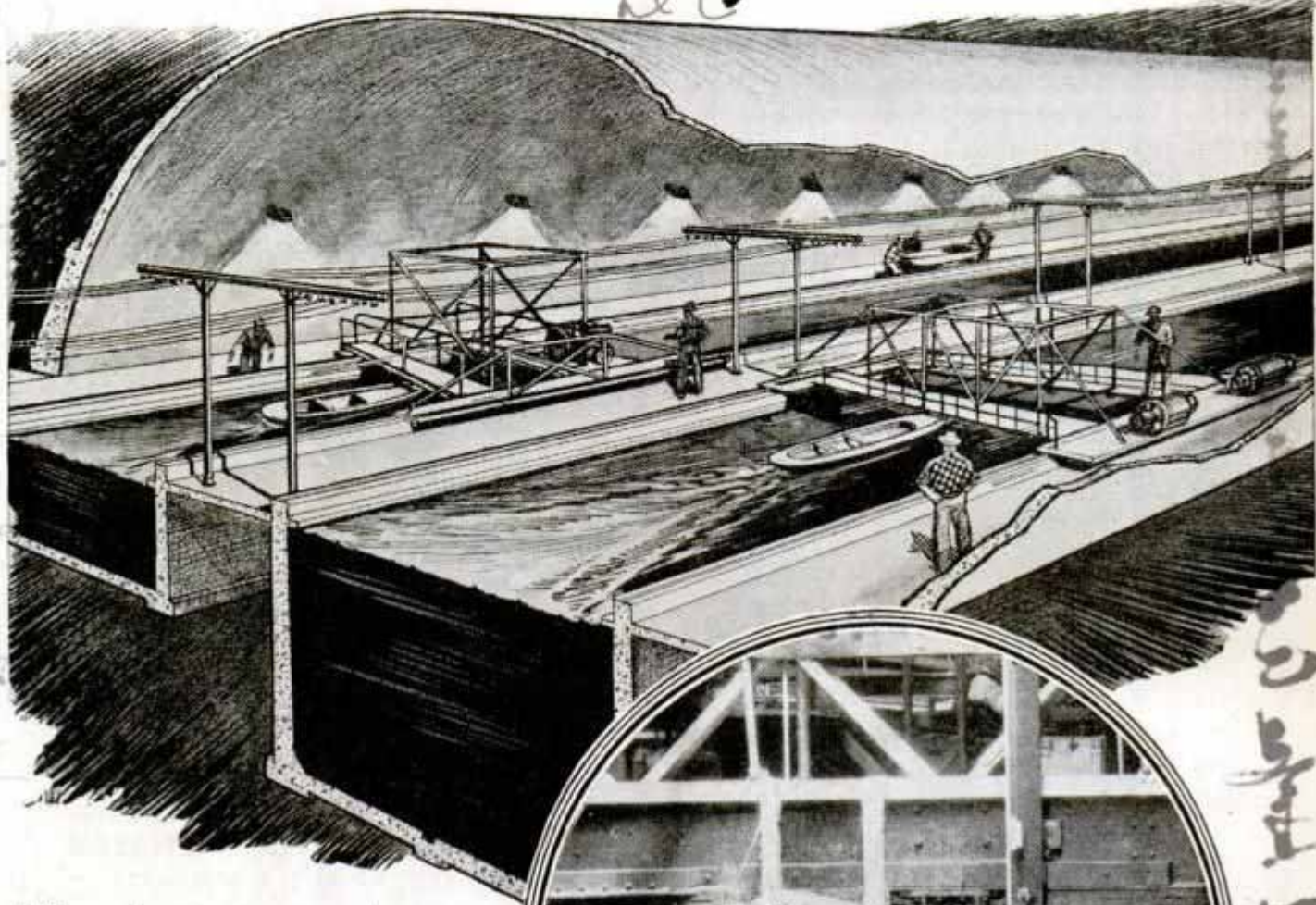

IT is no longer necessary to gamble the lives of men to test the practicability of radically designed ships, nor to spend thousands of dollars in proving new shipbuilding theories. Model ships are built to scale and tests are made in specially designed basins.

There are but two testing basins in the United States, one at the University of Michigan and the other at Washington. The Washington basin is operated by the navy department which conducts tests for any American shipbuilder who has a designing problem and is prepared to pay the costs. The present basins have proved inadequate to handle the needed volume of work, so the Navy has surveyed a site and drawn plans for the largest experimental basin in the world to be located at Cabin John, Md., on the outskirts of Washington.

When the naval architect and marine engineer are called upon to design a ship

which shall fulfill certain requirements their problem is twofold. They must first design a vessel which will meet within a reasonable margin the specified performance and they must limit the power, fuel consumption and initial cost of design to figures which will not handicap the ship when competing with other ships built to give the same performance.

2901 Connecticut Ave D 843
Washington, D.C. 20008

in TANKS



Right, View of Towing Dynamometer, Showing the Chronograph Drum Recorder

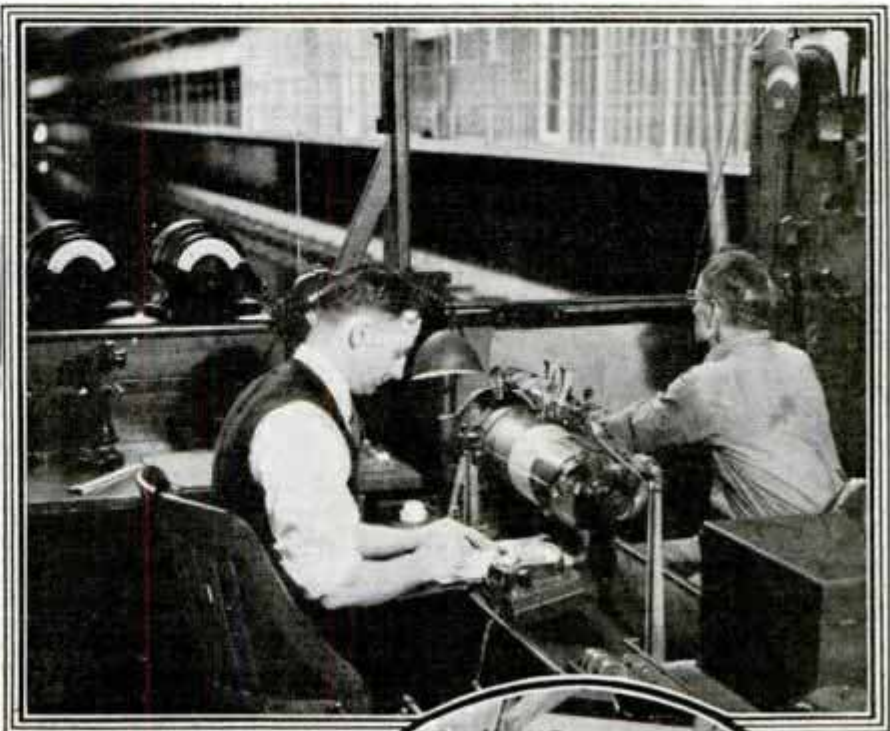

Models are made of wood. The exterior of the model represents the external shape of the vessel. The model is towed by a carriage which spans the basin and runs on rails at each side. A dynamometer, an instrument as delicate as a druggist's scales, is

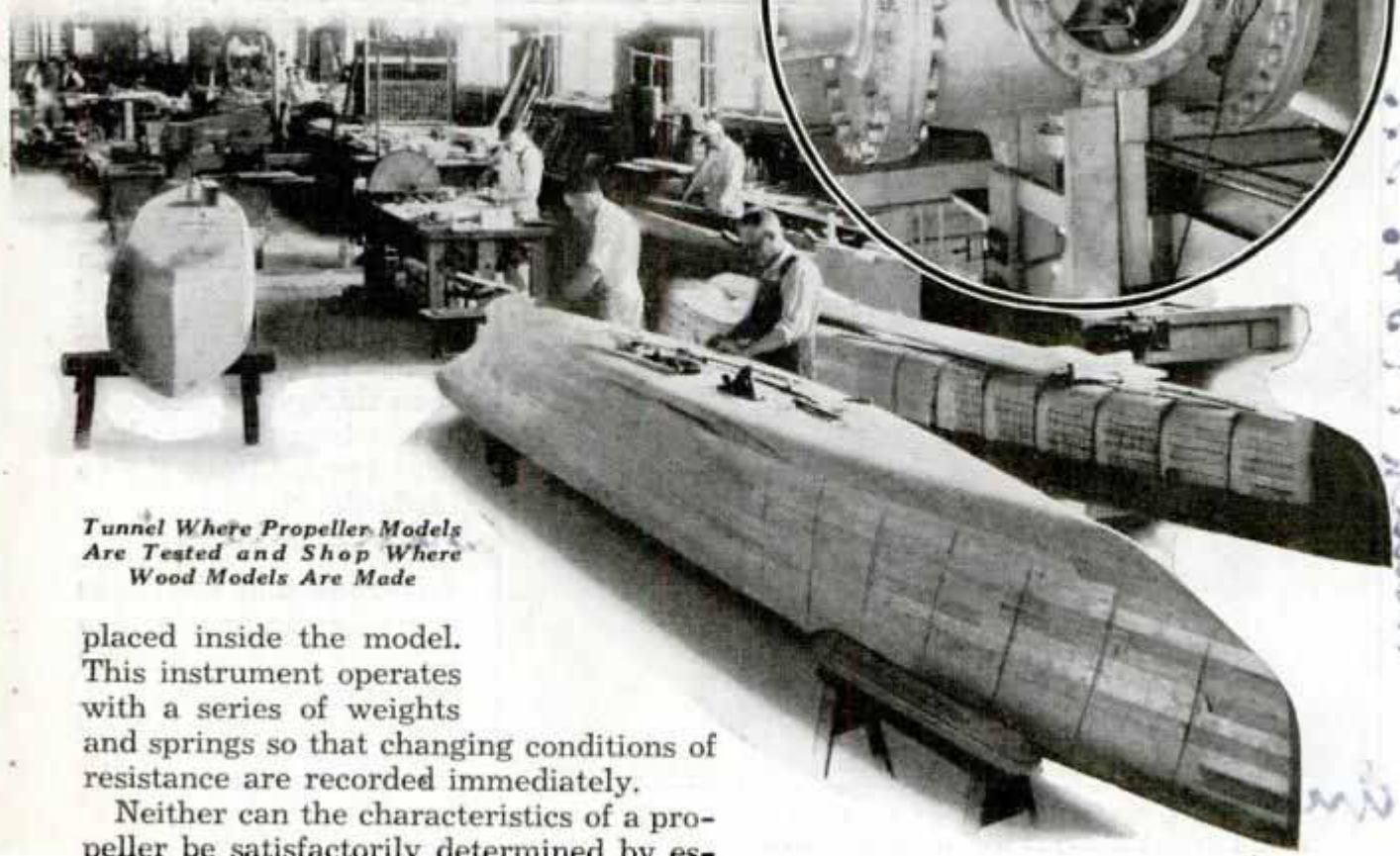
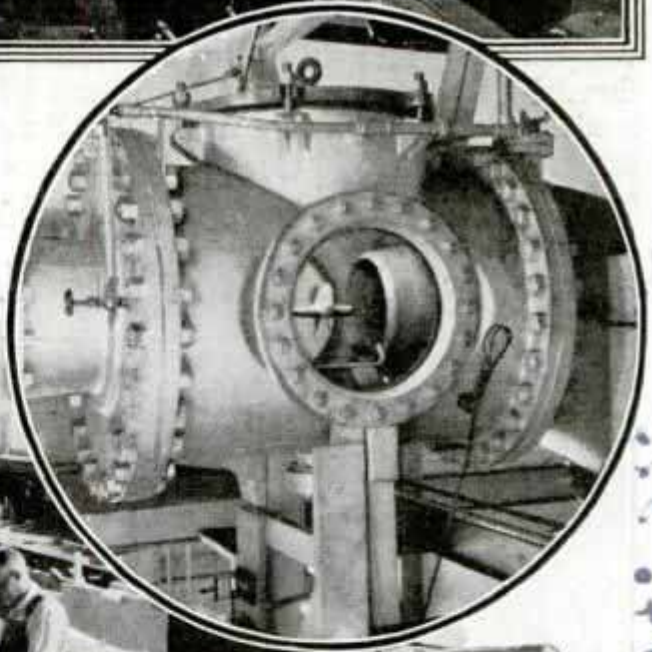

Tunnel Where Propeller Models Are Tested and Shop Where Wood Models Are Made

placed inside the model. This instrument operates with a series of weights and springs so that changing conditions of resistance are recorded immediately.

Neither can the characteristics of a propeller be satisfactorily determined by es-

Handwritten notes in blue ink on the right margin, including a vertical list of numbers: 075-7671, 075-7672, 075-7673, 075-7674, 075-7675, 075-7676, 075-7677, 075-7678, 075-7679, 075-7680, 075-7681, 075-7682, 075-7683, 075-7684, 075-7685, 075-7686, 075-7687, 075-7688, 075-7689, 075-7690.

imate or calculation. It is customary to obtain information by running the propeller alone in open or undisturbed water in the model basin.

Loss of efficiency in a ship after short service has been blamed on cavitation due to faults developed in the propellers. Cavitation is a condition of the water failing to completely close in behind a vessel, causing a decrease in the pressure against the propeller blades. It is thought that cavitation is by no means confined to propellers. It may and does occur around hubs, struts, and behind the plate laps of the hull. Much of the severe and annoying ship vibration is lumped together and thoughtlessly ascribed to the propellers.

To determine ways to minimize the development of cavitation and to study propellers in action there has been constructed a variable pressure water tunnel at the experimental basin. By placing model propellers in a stream of water circulating within a tunnel, high speeds can be developed safely and yet permit observation through glass ports. The performance of models of chipped and dented propellers has proved that keeping propellers smooth and true, especially in a high speed ves-

sel, is a matter to be treated with respect.

Wind resistance against the superstructure of a ship affects the vessel's speed, and in the last few years tests have been made to determine the amount of this resistance and how to overcome it. Models for tests of this type have a superstructure and are run like those for other tests except that the model floats bottom up. The resistance offered by water as the model is towed in the basin is converted into data on resistance by air.

Turning tests for naval ship models have acquired much importance since the world war. Admiral Scheer of the German fleet, at the battle of Jutland saved his ships by the narrowest of margins when his fleet performed a feat of turning right about in 180 degrees and completely outwitted and bewildered their British opponents. In naval maneuvers the turning ability of a ship is extremely valuable. Ships have to take a new direction at an exact location in relation to the rest of the fleet. The maneuver executed by Admiral Scheer's fleet would only be tried at the most critical of times but if his ships had not had the ability to make short turns, all would have been lost in the face of a superior fleet.

"Four-Leaf Clover" Propeller to Drive Giant Liner "534"

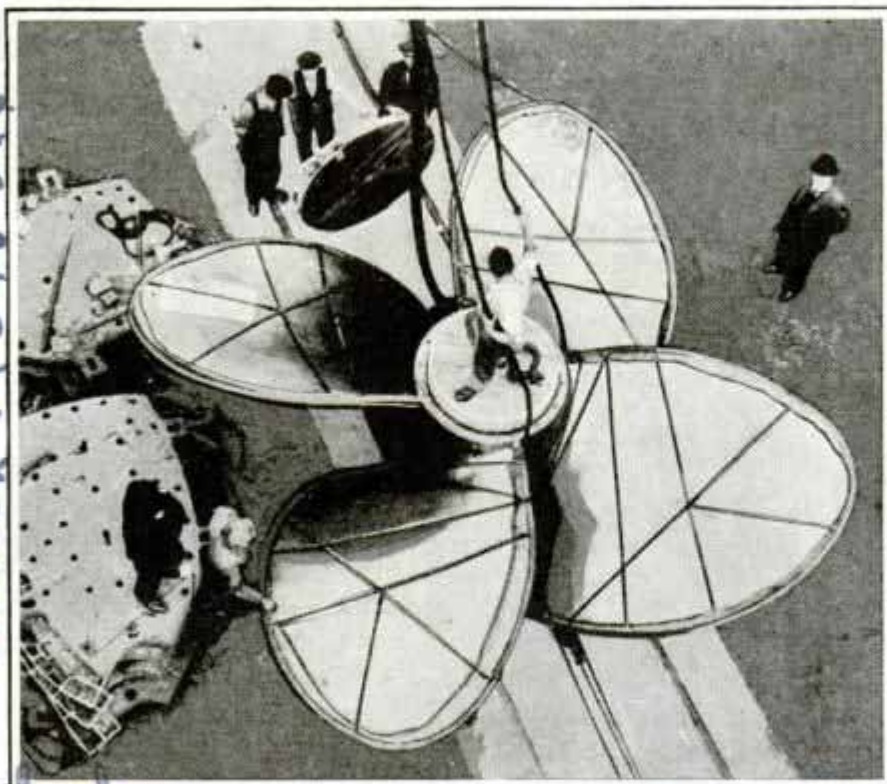

One of the Huge "Four-Leaf Clover" Propellers Which Will Drive the Latest British Liner; It Weighs More Than Thirty-Five Tons

One of the giant propellers has been completed for the great liner now under construction in England and known only as the "534." This propeller, one of four which will drive the craft, looks like a huge four-leaf clover. It is made of manganese, weighs more than thirty-five tons and is nineteen and one-half feet from blade tip to blade tip.

Queen Mary

Names and addresses of dealers in articles described, and any other details in our possession, will be furnished by our Bureau of Information upon request, accompanied by postage.

See an 1932. May 1934. 690 D927 March 1934. 326

Arc-Welded Steel Freighter Has No Rivets

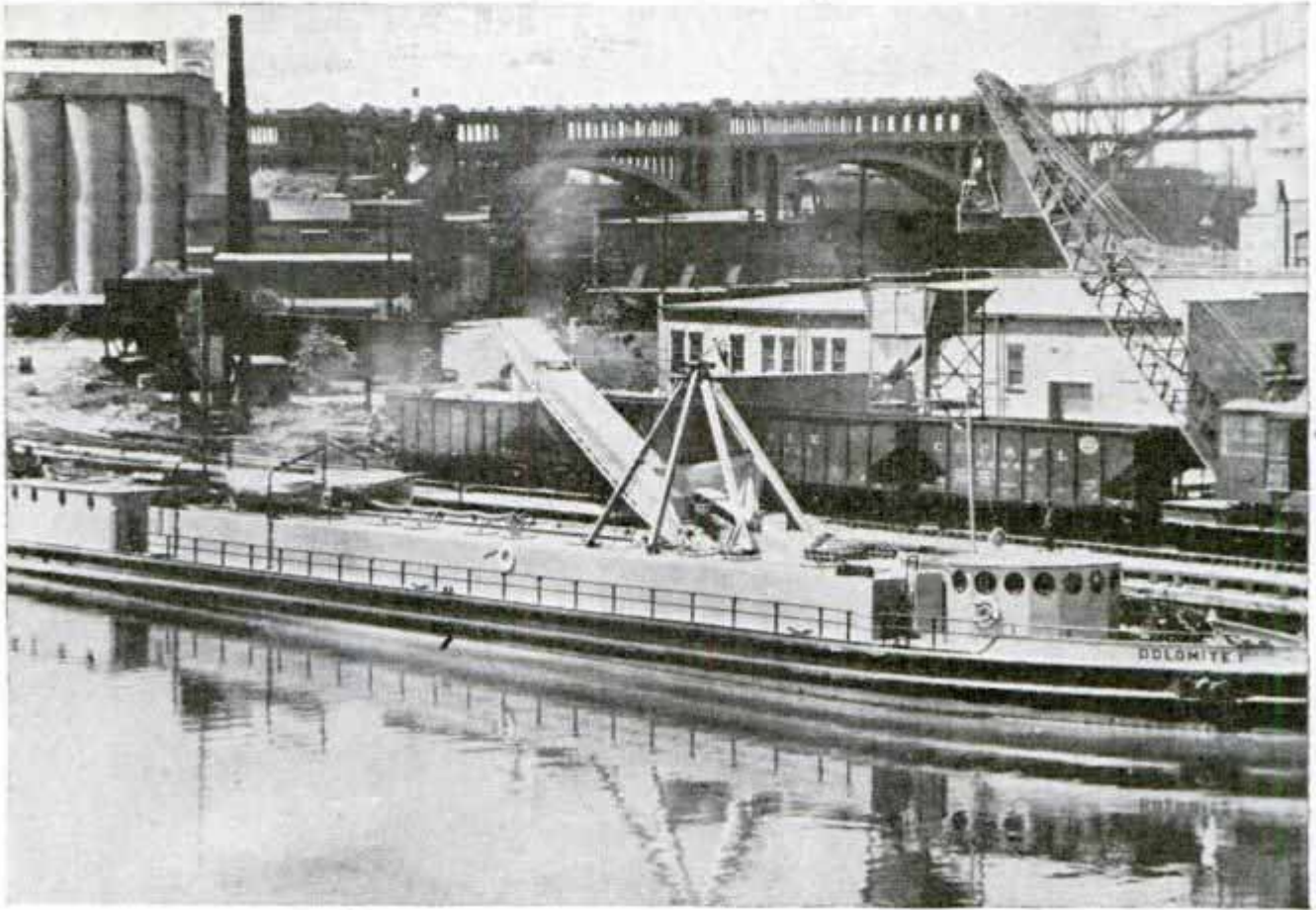

Arc-Welded Steel Freighter 214 Feet Long Which Can Be Converted into a Tanker of 300,000 Gallons Capacity; the Boat Has Fourteen Self-Cleaning Hoppers and Is Self-Unloading

Built for Great Lakes, barge canal and coastwise service, an all-welded steel freighter, "Dolomite," is attracting the attention of the shipping world in its first season. Its hull is built of twelve-inch channels formed in U-shapes and welded together. There is not a rivet in the ship. It is 214 feet long and propelled by Diesel engines. Early this spring the "Dolomite" hit a submerged wall while traveling six miles per hour without denting the prow. The ship is of the semi-submersible type, permitting increase in draft when entering the barge canal and thus facilitating its passage under low bridges. The "Dolomite" can be converted into a tanker within three hours and can take on 300,000 gallons of gasoline or other liquids. The boat, which is self-unloading, was not constructed in a shipyard. Practically no tools were used other than a crane, an electric winch, an air compressor, cutting apparatus and seven arc-welding machines. The channels were bent cold with homemade equipment. All welding was

done by the shielded arc process, using equipment manufactured by the Lincoln Electric company, of Ohio.

0850. — Cool Road 13010
**BOOK ENDS WITH ZIPPER BASE
 HOLD FIRMLY IN PLACE**

Adjustable to hold varying numbers of books, a new rack is equipped with a "zipper" base. The rack consists of two book ends of black walnut or mahogany on a

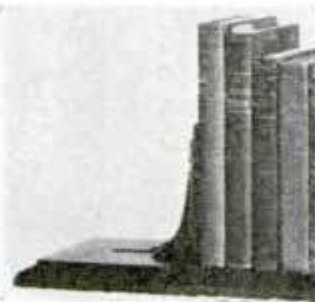

base of similar wood. On the under side of the base, which is slit down the middle, are two corrugated metal strips, running parallel to the slit. Each book end is fas-

tened to small blocks of wood that move back and forth in grooves on the metal strips, zipper fashion. When set at the position desired, the ends hold firmly.

H J Slumberg

Cleveland Ohio

54 1/2 Westendale Blvd
Los Angeles 188

THRILLS in

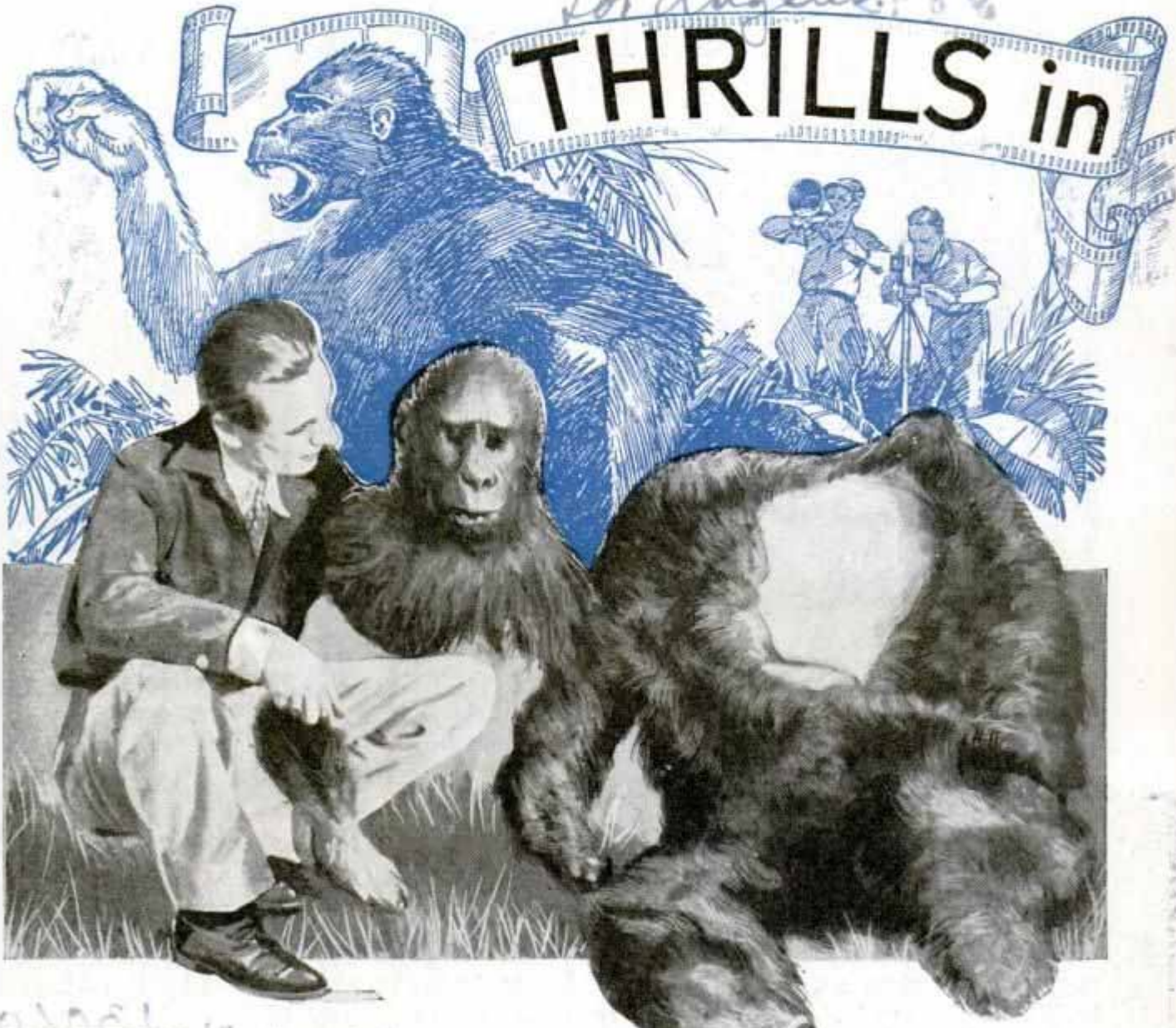

S NORTING tugs nosed a burning ocean liner into port the other day. Fireboats raced to extinguish the smoldering remnants of a wreck that had almost gutted the vessel.

As the gangplank was lowered, a man darted across the deck to the dock. Under his arm was a little leather case containing two reels of narrow-gauge movie film. A few hours later, airplanes were rushing a pictorial record of the sensational battle with fire at sea to all parts of the country. An amateur cameraman had scooped the world!

Every now and then a big story breaks, miles away from the nearest newsreel crew. The lucky amateur photographer



Gorilla Suit for Home Movie Film; It Is Made from a Bearskin Rug and Head Is Carved from Crude Rubber; Below, Amateur Movie Making

Homemade MOVIES

at U.S.C. in Angeles

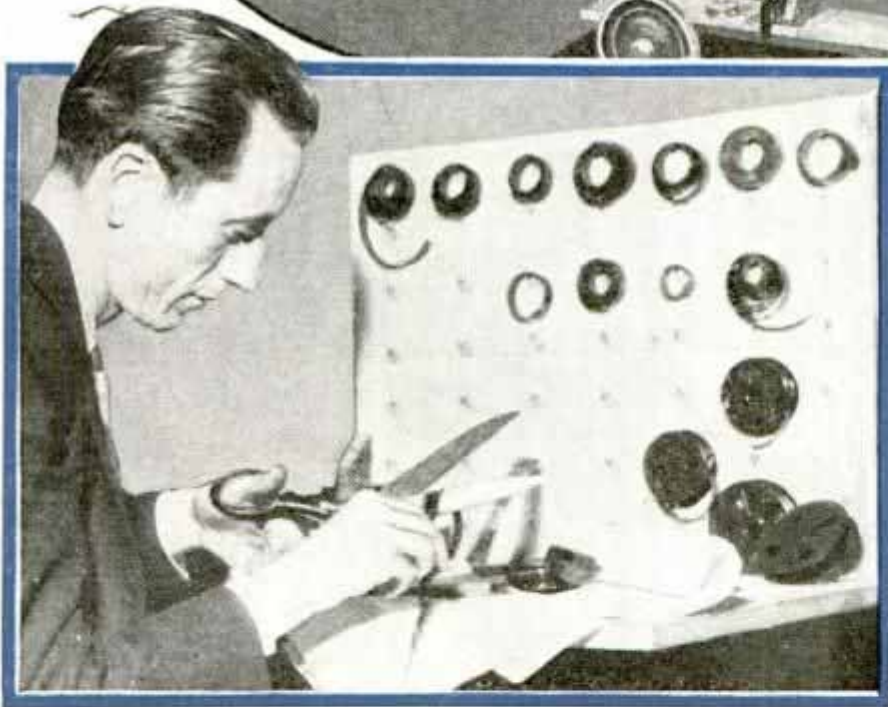
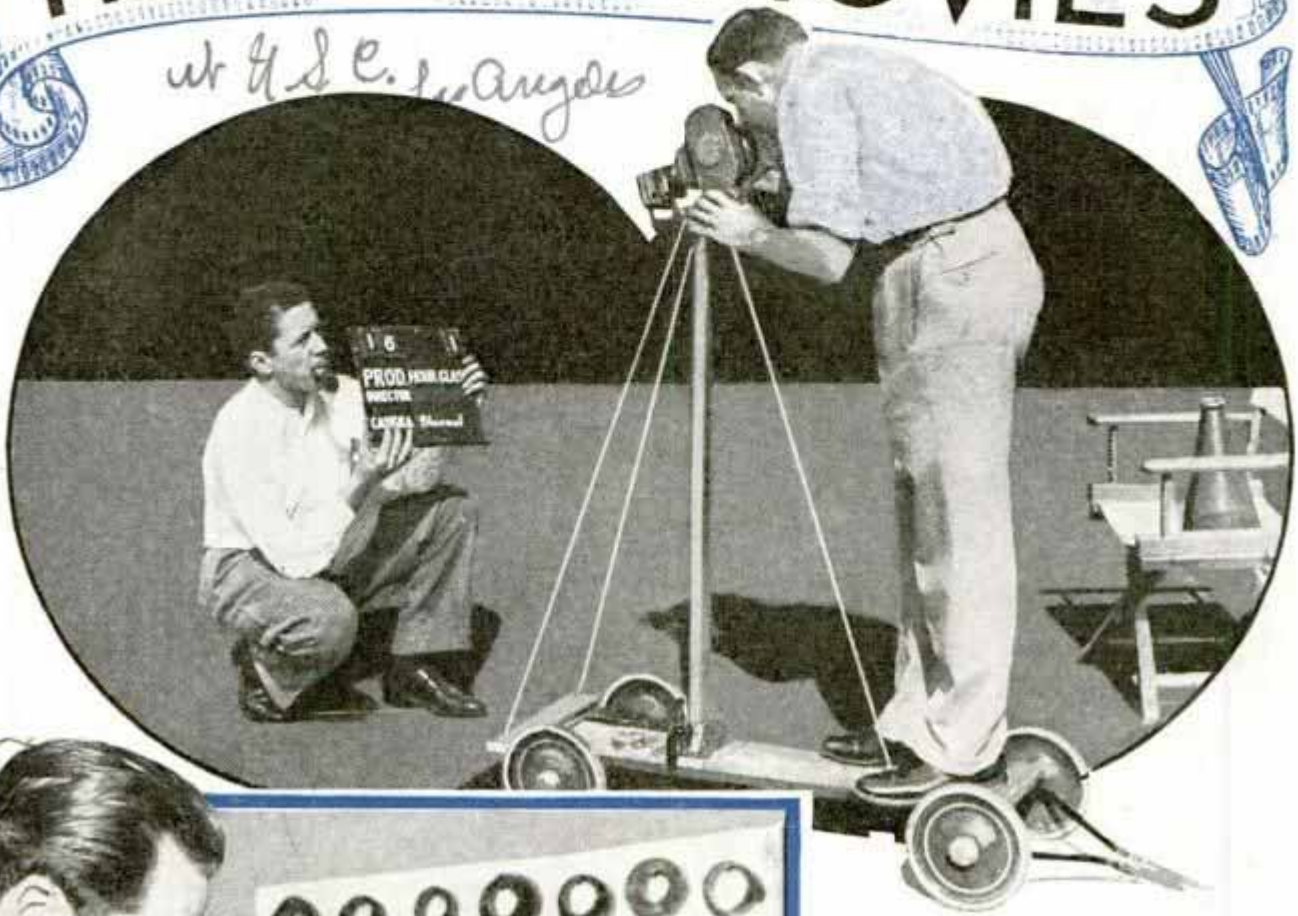

Above, Using a Homemade "Slate" to Record the Number of a Shot; Below, Editing Film at a Homemade Board

who happens to be on hand with his movie camera has the chance to make a "scoop" which may pay him handsomely. Newsreel companies are anxious to buy exclusive pictures of big news events missed by the regular news gatherers, and pay as much as a dollar per foot, or two dollars for foreign subjects.

Not only newsreels, but also feature pic-

tures and comedies are being produced by amateur movie enthusiasts, using improvised "props" and homemade equipment. More than a million sixteen-millimeter cine cameras are in use in the United States. Prizes are offered by clubs and by a national association, for outstanding amateur pictures. So many good ones are being filmed that a new company plans to buy and distribute amateur eight-reel features and two-reel comedies, paying on a royalty basis or buying them outright.

Two amateurs won a national contest last year with their film, "Tarzan, Jr.," shot in a boys' summer camp of which they had charge. Eighty boys ranging from eight to eighteen were in the cast.

"Animals of every kind figured in our scenario," said William Palmer, one of the amateur producers, "and we had to resort to many tricks. A partially submerged log,

W. J. Seaman

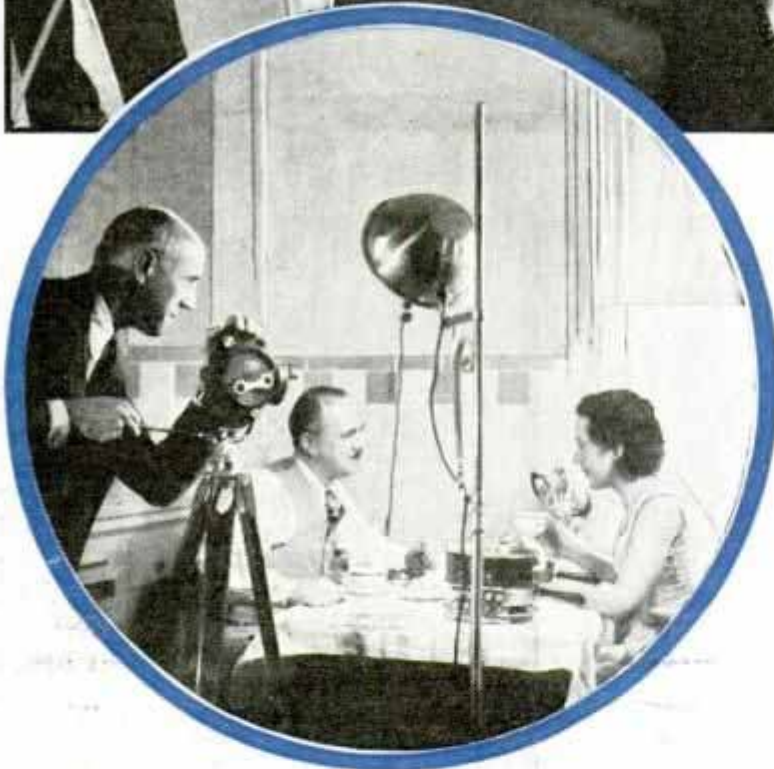
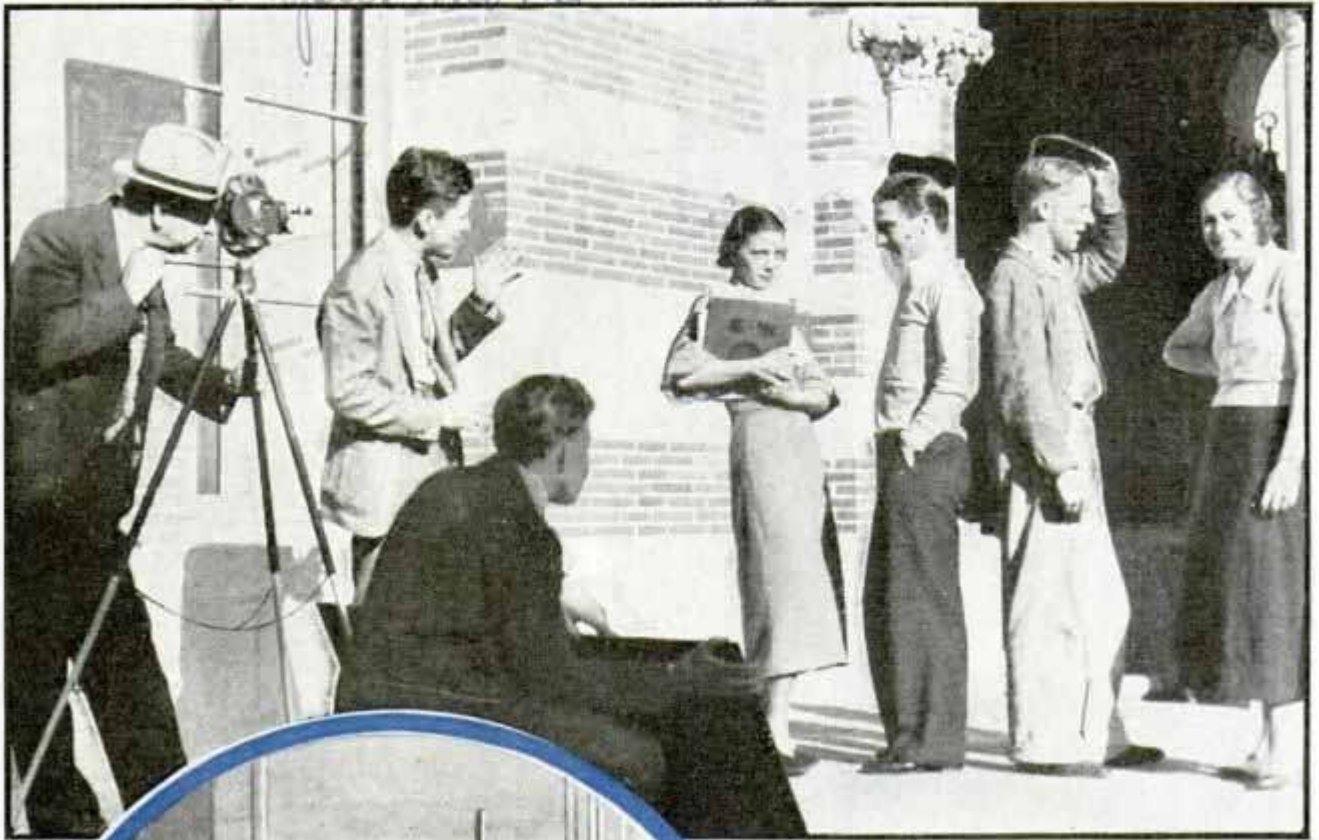
Campus movie at U.S.C.

Amateur Movie Company in Action; Below, Shooting an Interior Scene for an Amateur Production

propelled across the river by hidden wires, realistically played alligator. The hippo was an overturned canoe, its head shaped from chicken wire and covered with a sack. We rented a 'monkey' suit with interchangeable mask, so the boy who wore it could represent either a monkey or a lion. The boys painted whitewash stripes on a horse to convert it into a zebra. When they had finished, they discovered that on one side the stripes ran vertical; on the other, horizontal!

"Handling our animal actors was our biggest problem. A pet police dog was required to drive away a thief by springing at his throat, but the dog was gentle and steadfastly refused to attack his friends. Camera trickery solved our problem. The 'thief' on horseback held the dog up to his shoulders as if it were attacking him. Then he tossed the dog lightly to the ground. When the film was run backward in projection, the dog seemed to leap up at the rider."

In the home-produced photoplays, strategy and mechanical ingenuity take the place of costly equipment and high-priced

talent. Ambitious amateurs spare no pains in attempting to achieve professional effects. Many of the nation's 300 cine clubs have formed themselves into miniature movie companies. Amateur scenario writers huddle over scripts to produce continuities for shooting. Amateur directors wield megaphones and learn to handle mob scenes by actual practice. Technical work is divided among members of the camera crew, with cameramen, cutters, editors, and property men.

Bergen County Cine Club

At the University of Southern California, students in the department of cinematography produce feature pictures on a regular schedule. Newsreel cameramen cover important campus events with a weekly news release, shown at student assemblies. The amateur production company often goes "on location."

Miniature models ingeniously constructed duplicate many professional effects. Slow motion or fast, as occasion demands, aids realism. For example, a toy locomotive can be used to stage railroad wrecks, if the camera is cranked fast, so that the wheels do not spin too dizzily or the train lurch unnaturally.

Some amateurs make cartoon comedies like the Mickey Mouse pictures. Since even a short cartoon requires thousands of drawings, they use a "master drawing" as a basis, tracing the separate drawings from it, and making the necessary changes to show movement. Color is sometimes added for special effects—dark blue for night scenes, red for fires—simply by placing a disk of colored gelatin into the projector along with the film. Or, the film itself may be tinted with special dyes. Some amateurs have even made talkies, shooting the picture silent and later adding sound on home-recorded phonograph disks.

Travelogues, nature studies, and scientific features add variety to the home-movie menu. A Los Angeles banker noticed that rats would climb a tree in his yard to steal food placed there for a bird. Placing a remote-controlled movie camera in the tree, he secured interesting action pictures of the thieving rodents.

A Berkeley, Calif., amateur recently showed club members fascinating movies of life under the microscope, photographed with his miniature camera, and climaxing with a scene showing a deadly Protozoa, magnified to 1,000 diameters. One amateur has made himself a walking newsreel reporter by getting an oversize vest, with pockets to fit lenses, filters, and extra reels of film. This cine jacket is worn over an ordinary vest and under his regular coat.

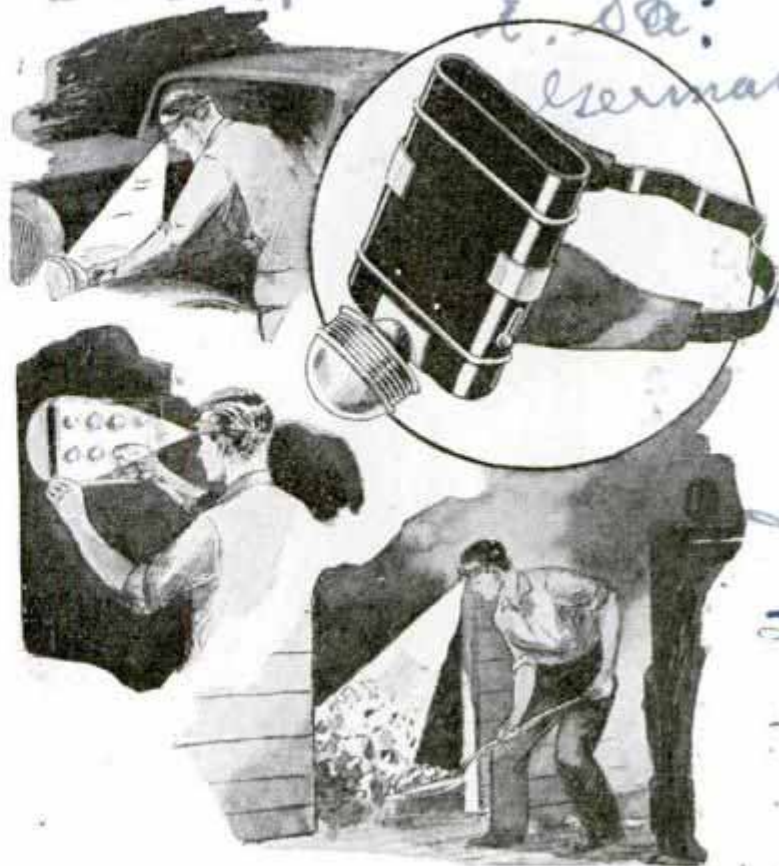

Pocket Flash Lamp Which Can Be Worn on the Head or Converted into a Table Light

POCKET LAMP WITH HEADBAND LEAVES HANDS FREE

Equipped with a headband so that it may be worn on the head, leaving the hands free, a pocket lamp introduced in Germany has many uses. An adjustable reflector gives the operator control over the degree of illumination desired. Removal of the headband converts the lamp to a pocket light, while another adjustment converts it into a table lamp.

FUNNEL WITH AIR GROOVE PERMITS FAST POURING



Liquids may be poured rapidly through a new funnel constructed with a shallow groove down the side. The groove permits air to escape from the bottle into which the liquid is poured. The funnel is unbreakable.

D850
lustr. pennierdal
E. S.:
Germany
no D. Sargent
D890
10x Bonny
1934 Wagner Am. Co.
Bryant Electrical



Bulletproof Shield for Use of Police Officers; It Can Be Handled Easily by One Man

ONE-MAN BULLETPROOF SHIELD USED IN WAR ON CRIME

For the protection of policemen battling criminals who are armed with machine guns or heavy revolvers, a one-man bulletproof shield has been devised recently by the Los Angeles, Calif., police department. Made of two pieces of bulletproof metal, it weighs only twenty-five pounds. The shield is six feet long when ready for use, but can be folded to three feet for carrying. Loops and hand grips facilitate its handling with one hand while the policeman fires his revolver through either of two apertures fitted with caps that close when the gun is withdrawn. Full vision is possible through a three-inch opening covered with bulletproof glass.

ⓂA "cold light" lamp enabling physicians to see through tissues clearly is expected to be valuable in diagnosing cancer.

ELECTRIC EYE COUNTS AUTOS BUT IGNORES PEDESTRIANS

Electric eyes, or photo-electric cells, count and record the automobiles entering the grounds of the Massachusetts Institute of Technology but ignore all pedestrians who pass by. Two light beams several feet apart are focused on two photo-sensitive cells and a counting relay registers each time both beams are interrupted by the passing of a large object like a car. Pedestrians shield but one light at a time and hence are not counted. A slight change permits the device to measure the speed of cars by noting the very small time between the interruption of the two light beams. For this purpose a mechanism for measuring minute time intervals is connected with the electric eyes.

COMPACT ROLLING RESTAURANT IS MADE OF ALUMINUM

Constructed of light aluminum alloys and mounted on rubber tires, a compact lunch wagon as complete as a modern kitchen is helping to solve the noonday food problem for people whose time for eating is limited. One man can manipulate the wagon, which weighs 425 pounds. There are twenty-seven compartments, including one for pies, a five and one-half gallon coffee urn and a four and one-half gallon



Compact Lunch Wagon Made of Aluminum and Containing Twenty-Seven Separate Compartments

insulated container. A hinged cover provides protection for food in the upper compartments.

Aluminum Company of America, 1356 Paul

Vertical handwritten notes on the left margin, including "Agent. Marine", "M.A. Booth, Precator", and "Illinois".

Vertical handwritten note: "D929"

Vertical handwritten note on the right margin: "Designed by Goodyear, Zeppelin Corp"

Cont: Charles J. Bauer, Aviation Writer, Dayton, Ohio

Gliding Parachute Lowers Balloon Gondola

Recent attempted or contemplated balloon flights to the stratosphere have resulted in the development of a huge parachute capable of lowering the spherical gondola of such a balloon safely to earth in case the craft encounters trouble. The parachute is eighty feet in diameter, its depth is fifteen feet and the length of each of its 184 ropes is eighty feet. It is triangu-

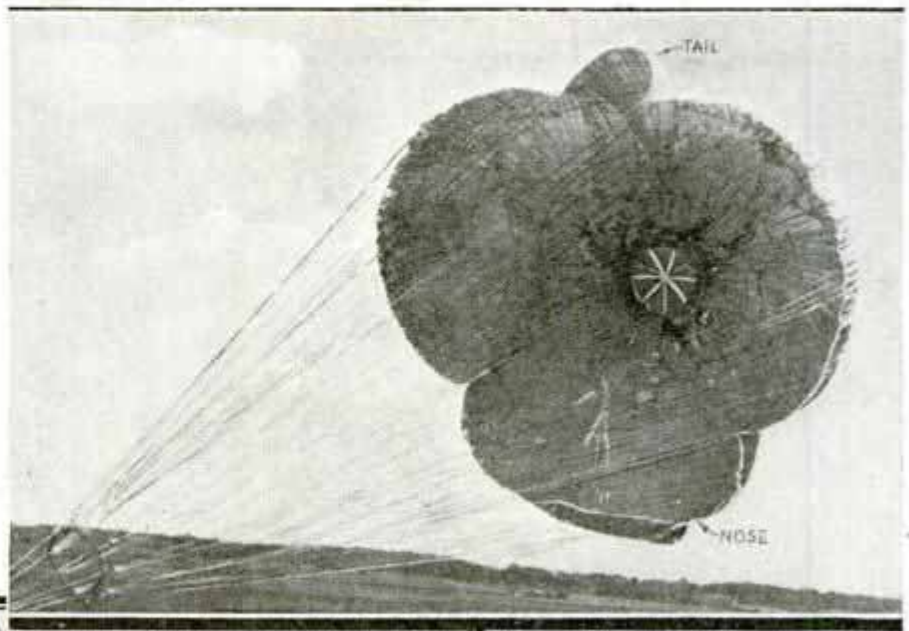

Triangular Parachute, and Diagram Showing It Gliding Instead of Descending Vertically

equipped with a smaller pilot chute but depends on its size and form of packing to open properly. It is claimed such a parachute can lower the gondola of a stratosphere balloon from a height of 40,000 feet without injuring the occupants or the instruments of the sphere. In its latest form, the parachute has a nose for biting into the air and a vent at the other side to permit imprisoned air to es-

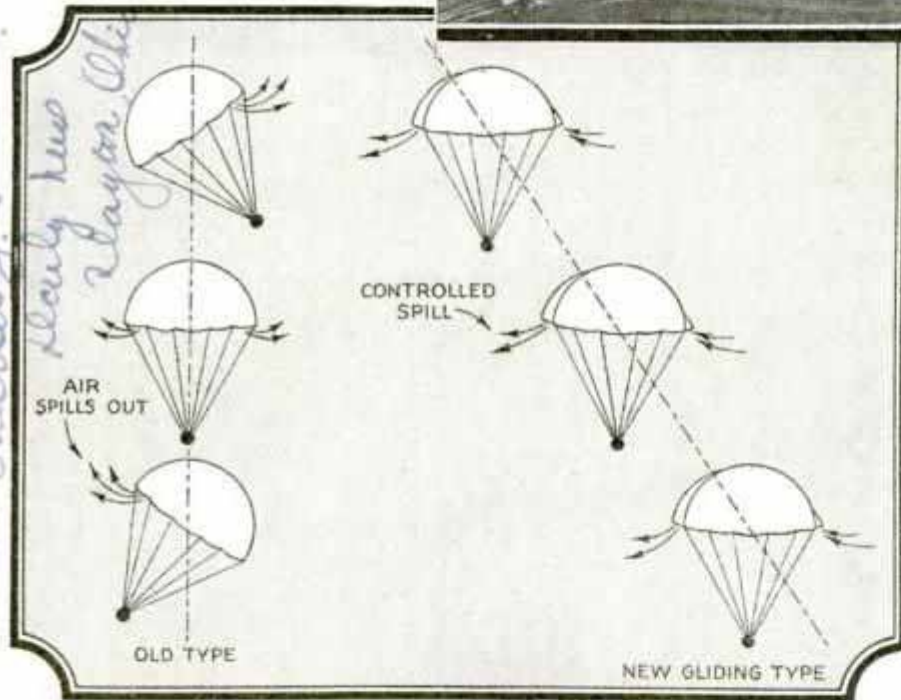

lar, its three curved sides resembling a big three-leaf clover when viewed from below. The folded pack of the parachute is not

cape, thus imparting a gliding effect which permits the descending body to fall at a steerable tangent to the earth's surface.

Holder for House Numbers Also Serves Other Purposes

Designed for displaying house numbers, a convenient holder also may be used for street and road signs and for displays on the lawn. Removing a bolt at one end permits the numbers or letters to slide out.



Holder for House Numbers or Road Signs

Projected air conditioning of deep gold mines in South Africa is expected to increase production by making it possible for miners to work at greater depths.

J.P. Estalder

D812

Capt. Harry Le Sue,
The Detroit News
Detroit, Mich.

The GADGET

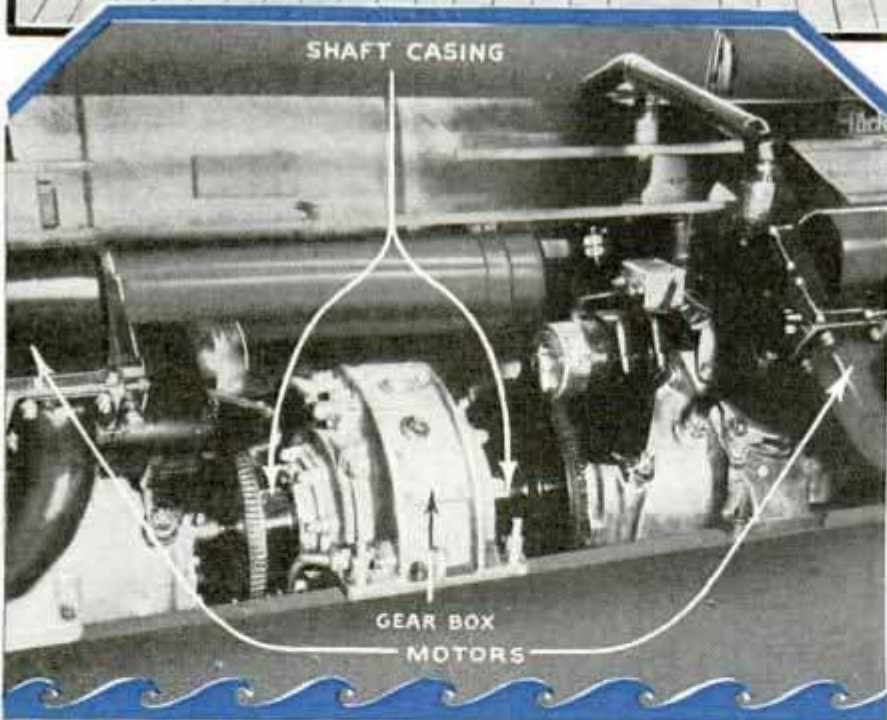
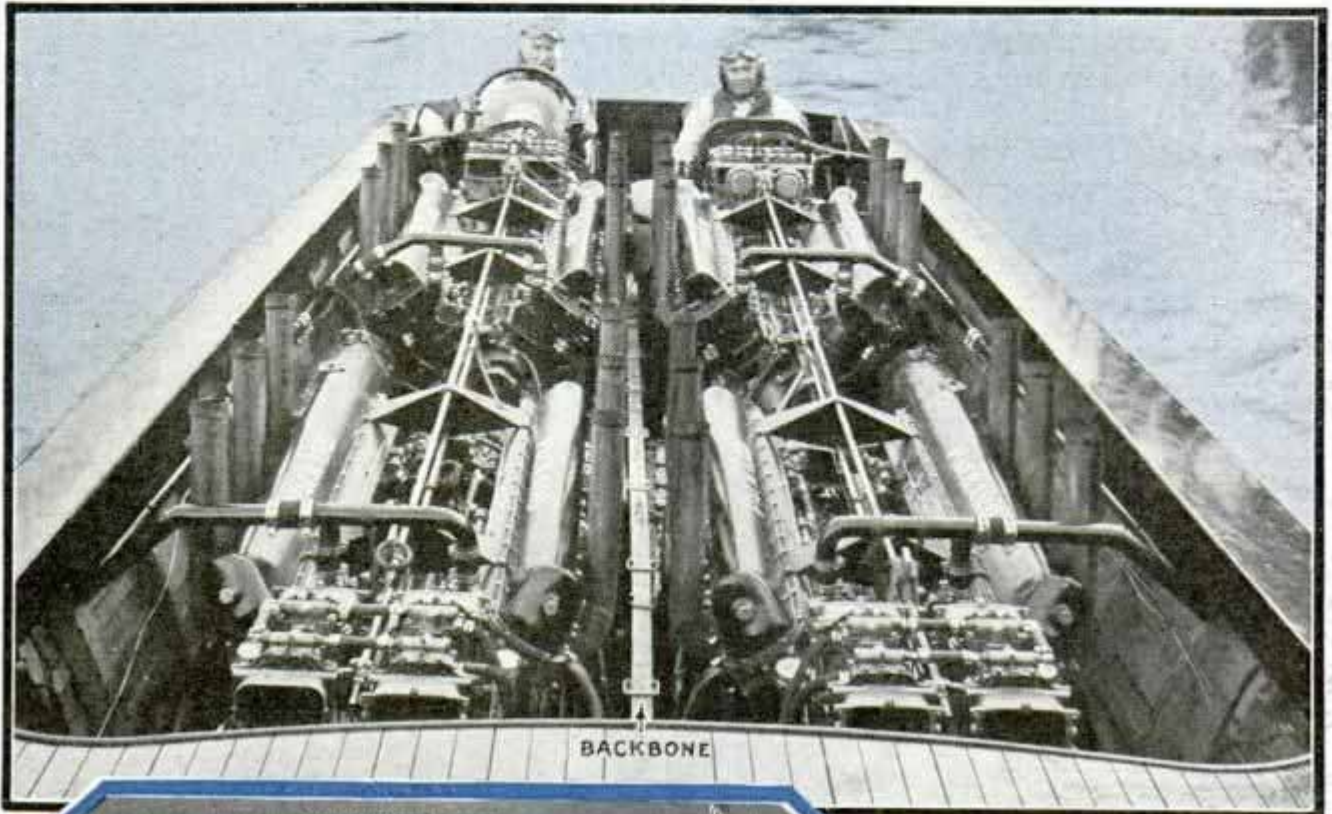

Engines and Gear-Box Arrangement of Miss America X; Note Timber, Above, Running Length of Boat to Form Its Backbone

news to divulge on a new and faster and more gadgeted Miss America.

The fifty-four-year-old, white-haired wizard of Michigan, who holds the world record for speed on water and the Harmsworth Trophy that England eight times has tried and failed to take away from him, was on the dock in front of the plant in which all the Miss Americas have been built.

Moored to the dock was a strange-looking power craft—a high-speed, pilotless target ship, controlled by a gyroscope and compressed-air cylinders

GAR WOOD had been suggested as the Gadget King of America. The appellation was taken to Algonac, Mich., to the Wood experimental plant with the thought that the crown might be accepted, a coronation held and, too, that perhaps the Gadget King of America might have some

inders and carrying a twenty-five foot iron mast with a six by eight red flag at the head. All of it had been devised or designed or invented and patented by Wood as a result of a visit to Fortress Monroe, Va., months before when coast artillery officers told him they needed something

KING of AMERICA

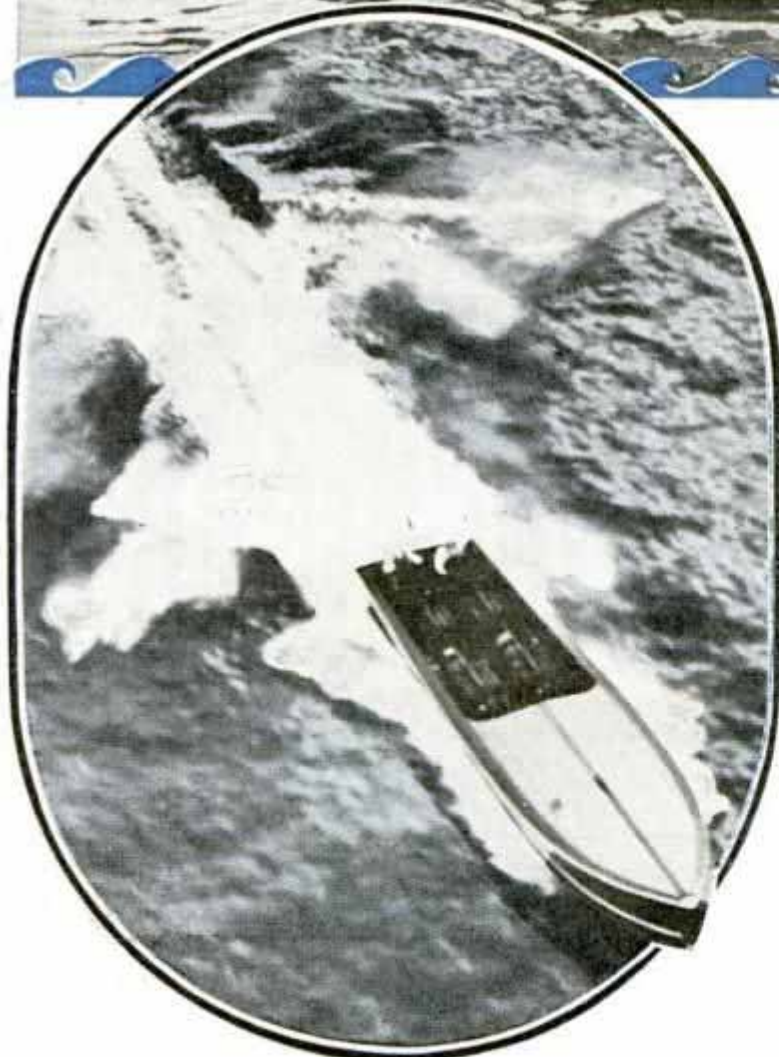
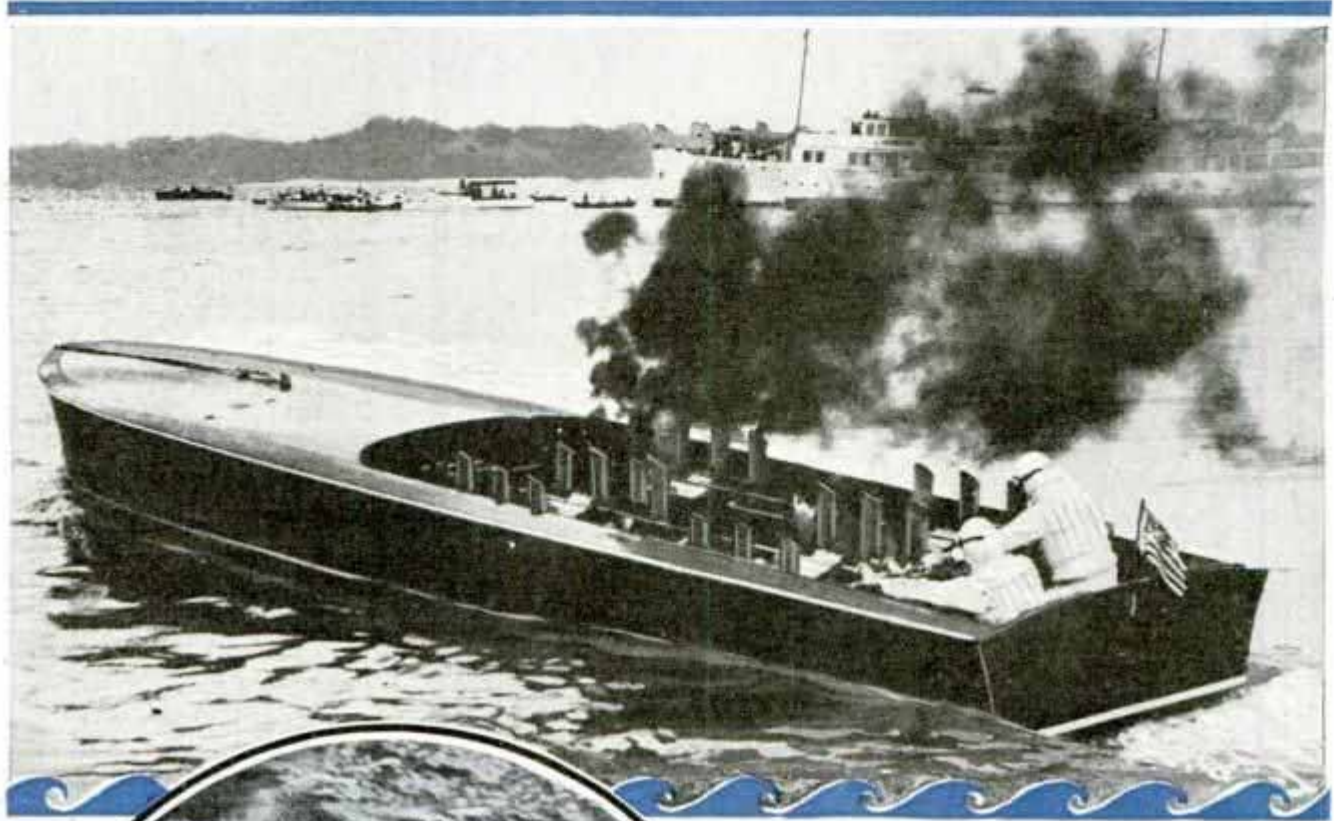

faster than four or five-mile-an-hour tugs for the towing of targets in gunnery practice. Wood made the target and war department experts authorized the purchase of one for trial purposes.

After Wood had shown that the pilotless boat could run forty miles an hour even on a rough river and hold its course without hand of man on either throttle or helm, he was interested in a discussion of things he has devised.

The title, Gadget King of America, was mentioned.

"I don't know what you mean by that," he laughed. "Gadgets aren't things produced and proved by laboratory tests and practical demonstrations. Gadgets are—well, here I'll show you one."

Wood walked over to a twelve-cylinder car. He removed from the dashboard an attractive, nickeled object that was about three inches long.

"It's an automatic cigaret lighter," he explained, "it lights and

Above, How Miss America X Looks When Starter Buttons Are Pressed; Below, the Racer Hits Her Stride

D 8 2



hour. It's just a gadget but I think I'll have it patented."

But the Miss America, were there not a lot of gadgets on her? Didn't gadgets play a large part in the final perfection attained in the assembly of four motors having a total of 6,400 horsepower?

"Not on your life," Gar replied emphatically. "The Miss America X is the result of long research, of many painstaking laboratory experiments and of repeated practical tests.

"I am not denying that there are gadgets here and there that fulfil their purposes, I would even call the self-bailers on the boat a 'gadget idea'—

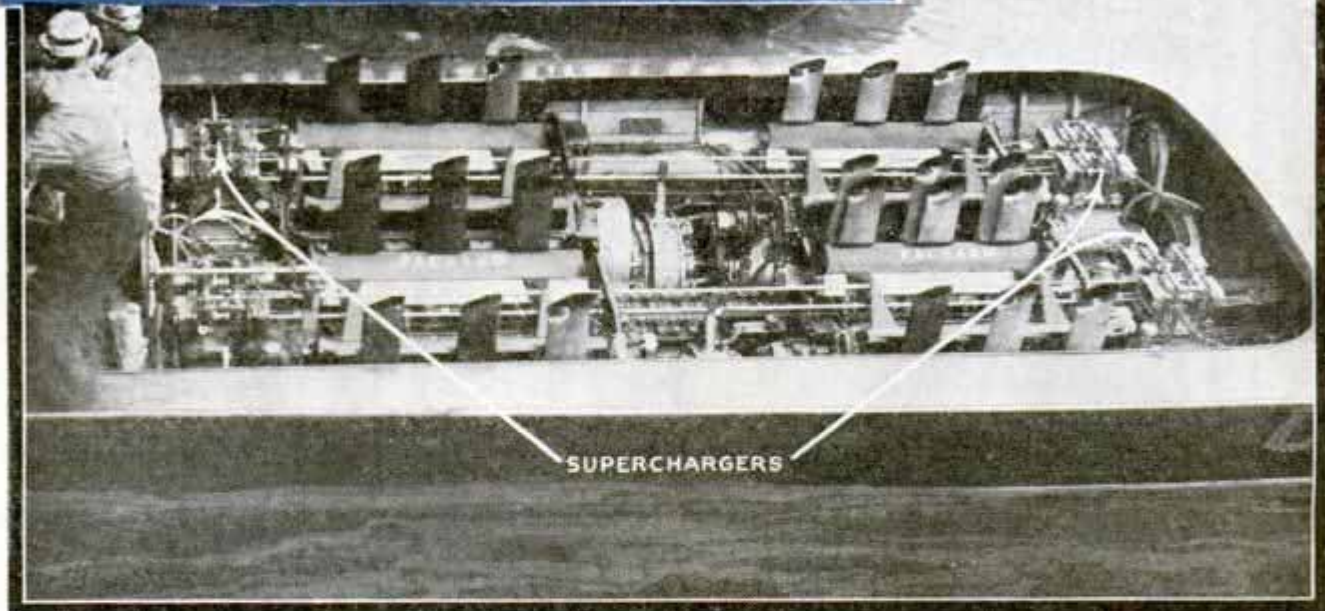

Above, Crew of Expert Mechanics Making a Last Minute Check-Up of Every Detail of Miss America X Before a Race; Below, the Big Power Plant and the Four Superchargers

breathes, inhaling and exhaling, just as you do. All you do is put your cigaret in it, press a button and your cigaret is lighted and puffed on until you take it out. Saves you taking your eyes off the road while driving eighty or ninety miles an

but the principal reasons for Miss America X's success lie in the gear-box assembly and the boat's variable step."

The gear-box assembly was the accomplishment of Wood's that astounded Detroit's gas-engine technicians. In powering



Miss America X it was Wood's idea to use four twelve-cylinder motors not as four distinct motors but as two power plants. He wanted them in banks, two in line on the starboard side and two in line on the port side. Four motors had been hooked together before but with clutches between and the gear boxes forward.

This arrangement required dangerously long propeller shafts at the speeds Miss America's propeller wheels were to be turned. Wood wanted the gear boxes in the middle of the banks, giving his boat short, sturdy shafts that would stand the strain. In effect, what Wood wanted was to make two motors function as a single unit, with the crankshafts of each bank synchronized and turning as one shaft! Engineers said the oscillations of the shafts would be so great as to wreck the gear boxes with the motors running at any appreciable speed. But Wood stuck to his idea which was to spline the engine shafts in each bank in a specially designed and specially constructed gear box. Each gear box was to be the heart of each tandem, with two shafts fitting into a main driving gear through a splined hub which was common to both. And it worked.

"You wouldn't call those gear boxes gadgets," said Wood. "I was sure I was right but it was never done before and

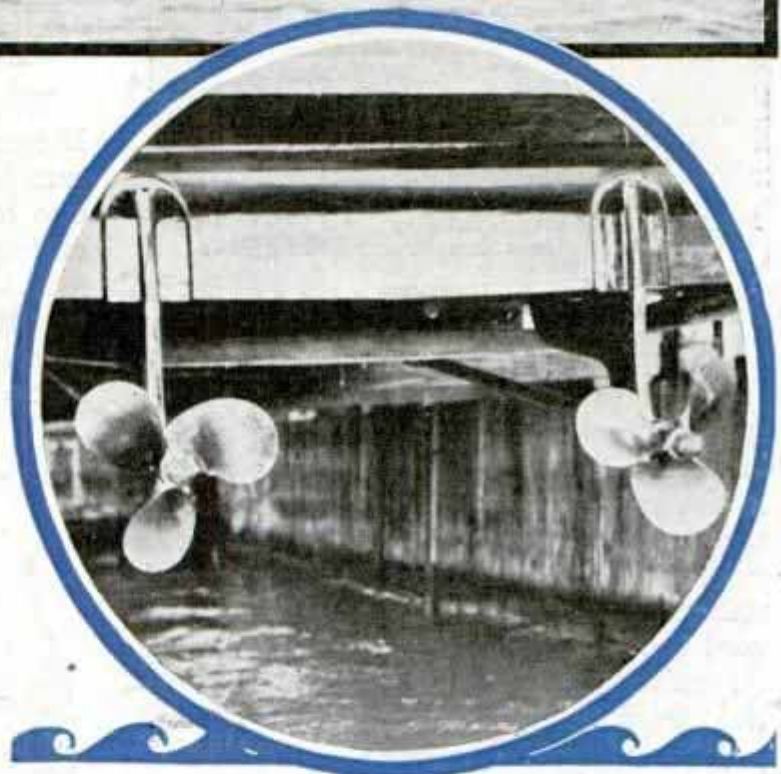

Above, Note How Bow Is Up and Stern Is Down at High Speed; Below, the Propellers of Miss America X

nothing is ever proved until it is done. Don't forget that the strain of 3,200 horsepower was on each gear box. It had to hold together. The case of each box was reinforced by steel rods of high tensile strength with a turnbuckle attachment."

Wood explained that the crankshafts turned through oil-sealed vents in twelve-inch races containing specially made bearings, each bearing "as big as a golf ball." The shafts were made of a specially heat-treated chrome-vanadium steel with a tensile strength of 260,000 pounds to the

(Continued to page 124A)

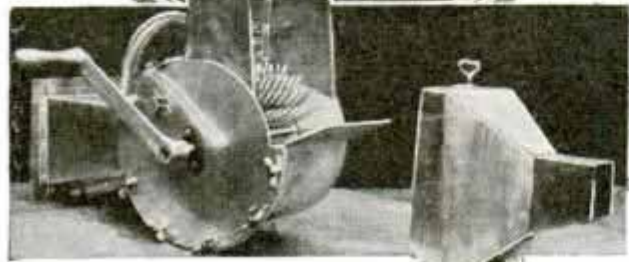

Plaster Spray Gun Which Applies a Uniform Coating and Gives a Smooth and Even Finish

SPRAY GUN APPLIES PLASTER IN UNIFORM COATINGS

Durable and easy to operate, a plaster spray gun developed in Germany applies the mortar in uniform coatings, resulting in the smooth finish desired by architects and builders. A rubber roller clad with steel combs agitates the mortar to give it uniform consistency. Rubber bearings prevent the mortar from clogging the spray. Its makers claim a large saving in materials from its use.

SMALL SOLDERING IRON USES ELECTRIC PLUG AS HANDLE



While supplying the power, an ordinary electric plug, such as used for an electric iron, serves as the handle for a small soldering iron now on the market. The prongs of the iron fit into the holes in the plug, which is then used as the handle.

AUTO EXHAUST GAS MADE SAFE BY FUEL VAPORIZER

Fatal properties of automobile exhaust gases are said to be eliminated by a fuel vaporizer that is attached between the carburetor and the intake manifold. The amount of carbon monoxide, the dangerous element in exhaust gas, is reduced from forty per cent to two per cent by the device, according to the maker. This percentage is not considered fatal. The device consists of a heavy brass casting, the inner side of which is machined with a channel cut in it. The channel is filled with a porous chemical mixture which minimizes the fatal properties of the exhaust gas.

MILK FOR QUINTUPLETS COOLED IN KEROSENE REFRIGERATOR

When quintuplets were born to the Dionne family a few months ago in a small farmhouse in the Canadian north woods, one of the first problems to be faced in caring for them was how to cool the human milk which it was necessary to bring to the remote home to keep the babies alive. There was no ice available and the home was without electricity or natural



Refrigerator Operated on Kerosene Used to Cool the Milk Fed to Quintuplets in Canada

gas. The problem was solved by a manufacturer of refrigerators using natural gas to start the refrigerating cycle. One of these refrigerators was rushed to the Dionne home and was operated by using kerosene instead of gas.

D85
540
no longer handle. Messrs Eugene Vogler Nachf. S. 1000 St. Kammerling, Germany
W.C. Pyce & Co. 62 Sarberia St. Francisco, Calif.
D86

secret read
11/8/40
165 Smith St. Winnipeg, Man., Canada

no longer handle

no longer handle, Mrs. Dionne, 1000 St. Kammerling, Germany

Electrolux Refrigerator
Sales \$42.00

Box 2419 Tulsa, Okla
Salt Well Taps Ocean of Brine Useful to Man
Subsidiary of Texas Oil & Refining Co
Tulsa, Okla

When one group of Oklahoma drillers started sinking a well, they tried to avoid striking oil. Success marked their efforts and at 3,500 feet, the well tapped an ocean of brine. Today, millions of gallons of natural brine are being brought to the surface to be converted into high-grade salts and other products. This particular brine is almost completely free from undesirable elements common to saline solutions taken from the earth, "gypsum" or calcium sulphate being absent. Day to day tests show that the brine is about 99.85 per cent pure



Well Which Pumps Natural Brine to Surface Where It Is Converted into High-Grade Salt and Other Useful Products

salt. Heat necessary to evaporate the water in the brine is obtained by circulating the brine, direct from the well, over the hot coils of a refinery near by, coils which otherwise would have to be cooled by using cold water. Geologists estimate that

there are more than one and one-half billion cubic feet of brine under each mile of surface at that particular spot, or approximately sixty million tons of brine from which ten million tons of salt may be taken, literally an ocean of brine.

Cmt. Gerald F. J. Benedich
1723 S. Peoria's Tulsa Okla

DP 37
High-Speed Streamlined Car Has a Motorcycle Engine

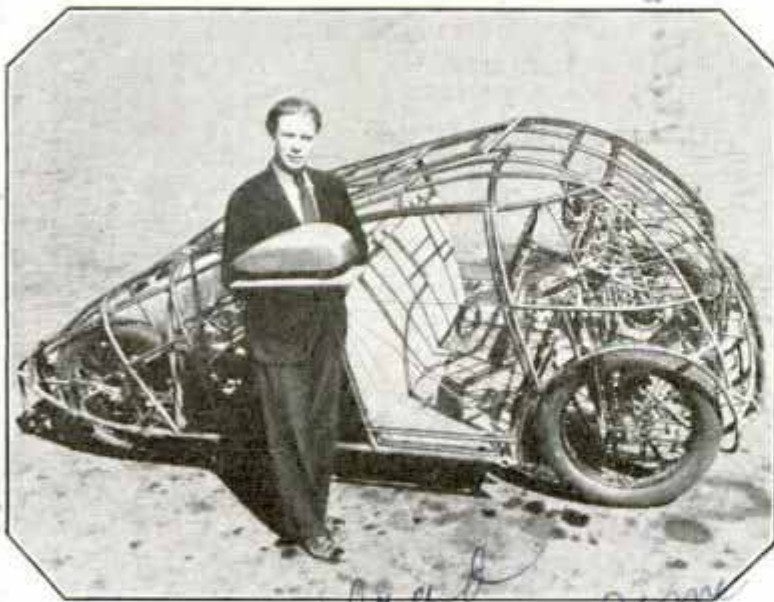

Small Streamlined Automobile Powered with a Motorcycle Engine; Wheels Are Independently Sprung

Constructed of steel tubing molded to shape with a blowtorch, a 700-pound streamlined automobile has been produced

at Pasadena, Calif., after its design was carefully chosen in wind-tunnel tests. Estimated performance of the four-passenger car, which is equipped with a special motorcycle engine, are: 100-mile-per-hour speed, fifty to seventy miles per gallon of gasoline and 600 miles to one tank of fuel. No glass is used, the windshield being made of a transparent composition material. The car is fireproof and non-capsizable, its center of gravity being less than twenty inches from the road. The wheels, each of which is independently sprung, have a wide spread.

Galvin B. Bridgman
no plan at present

Articulated Motor Coach Train Climbs Alps



Articulated Motor Coach "Train" Consisting of Two Units Joined by a "Concertina" Gangway; Only the Front Unit Is Motorized and the Conveyance Is Used in the Italian Alps

Intended for making trips through the Italian Alps, a type of articulated motor coach "train" was built and tested recently. It consists of two coach units joined by a "concertina" gangway which permits passengers to walk from one coach to the other while the train is in motion. Only the front coach is motorized, the rear one being a trailer. The design was made necessary to negotiate sharp turns and also because double-deck coaches were impractical for the mountain travel.

EGG COUNTER ON HEN'S WING KEEPS ACCURATE RECORD

How many eggs a certain hen lays during trap-nesting periods can be recorded

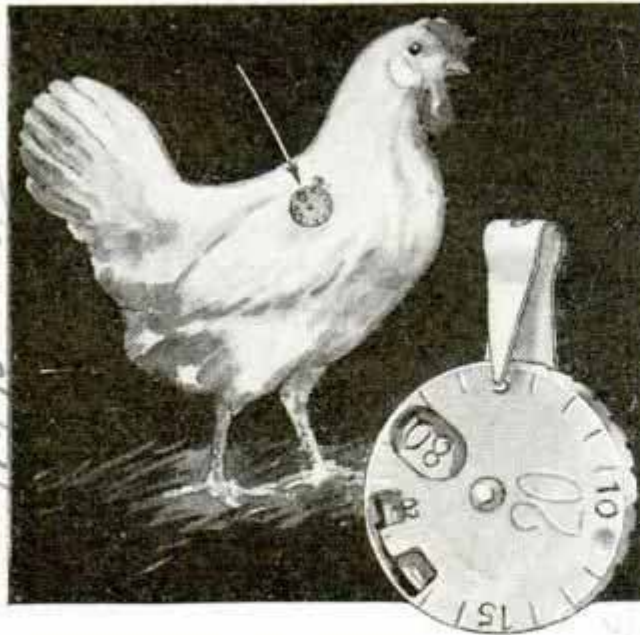

Egg Counter to Be Attached to Chicken's Wing, Thus Offering an Accurate Record of Each Hen

accurately by a small metal counter that is attached to the hen's wing. As the nest is visited and the egg removed, the poultry-

man turns the small dial one notch, the counter recording the laying of another egg. One complete circuit of the outer disk registers twenty eggs, while the inner disk records in larger series, twenty, forty and so on. When the hen has laid 240 eggs, she is provided with a leg ring.

WATER LOSS FROM RADIATOR ENDED BY SEALED COOLING

Containing two valves, a special filler cap for the automobile radiator increases the internal pressure of the cooling system and eliminates the constant addition of water. It also improves hot-water heater performance and high-altitude engine operation and reduces the loss of alcohol or other anti-freeze solutions. The development, called sealed cooling, consists of a cap in the upper radiator tank which closes the overflow pipe under ordinary operating conditions. Within the filler cap is a dual spring valve. The larger valve, equipped with a special sealing device, raises the internal pressure of the cooling system but releases fluid or vapor when internal pressures rise above three and one-half pounds per square inch. The inner and smaller valve eliminates undesirable vacuum. The sealing action raises the boiling point of water from 212 to about 225 degrees so the loss of water through the formation of steam and vapor is reduced to a minimum. The relatively low boiling point of alcohol is also raised when this liquid is used as an anti-freeze.



*Alfa Romeo's 800 cc. engine
D. G. M. Turbodiesel
902
J. G. Bechtold, Pawling
Lulu, etc. 1/18/46*

*D. 878
no longer made
1/18/46
m. l. w. h. e. e. c. o. m. p. a. n. y. 1349
m. l. w. h. e. e. c. o. m. p. a. n. y.*

204-7 N. Park Ave
Philadelphia

Box 21, Slalom Co
Portland Ore

**PEARLS FOUND IN AMERICA
ARE SHIPPED TO ORIENT**

Pearls have so long been considered as Oriental jewels that it will surprise many to learn that specimens from the United States have been sent to Europe and even to the Orient. The famous "Queen Pearl," valued at \$10,000 and now the property of an East Indian ruler, was found near Paterson, N. J. Pearls are found in mollusks in Maine, New Jersey, New York, Pennsylvania and the Mississippi valley. Artificial pearls are made in France from guanin, a pearl essence obtained from the scales of large herring.

D 739

**DETECTOR FINDS GAS LEAKS
AND SPEEDS REPAIRS**

D 873

Leaks in gas pipes are detected quickly by a device similar to a stethoscope. Vibrations set up by the escaping gas are picked up by the detector and carried to the operator's ears by a set of headphones. The detector is attached directly to the pipe. Vibrations from a three-foot-per-hour leak in a one-inch pipe can be heard forty feet away. Quick detection of small leaks speeds up the work of repairmen.

Ed. R. Lillmore, 214 E. 1st St. Topeka, Kans.

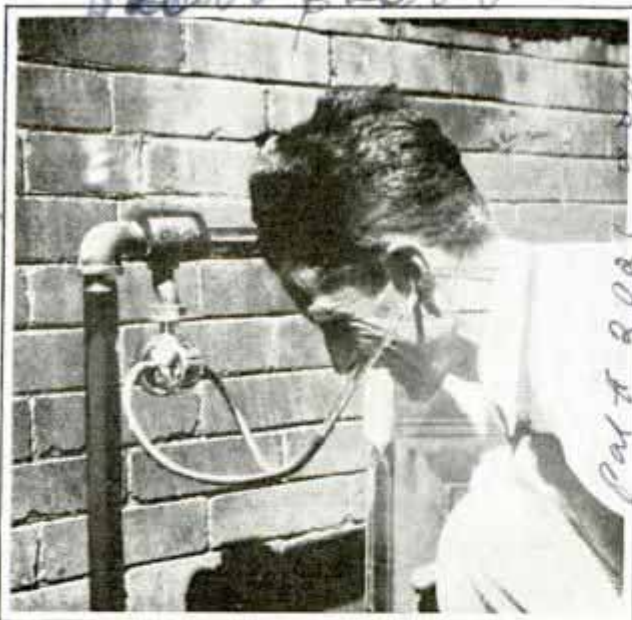

Detector Like a Stethoscope Which Quickly Locates Leaks in Gas Lines and Speeds Up Repairs

**HUGE LATHE ON ITS OWN TRACK
TURNS OUT GIANT MASTS**

D 882

Trees as long as 150 feet are turned into giant flagpoles, radio tower supports or ship masts on a huge lathe that runs on a



Big Lathe Running on Its Own Track and Converting a Big Tree into a Lofty Flagpole

small railroad track. As the tree revolves, the lathe creeps along trimming the great trunk to size. An electric motor drives the trimming knives, eliminating the old hand method of hewing the tree. The lathe does the job in one-tenth the time formerly required.

**ELECTRIC STAMP SEARS PAPER
AND PREVENTS FORGERY**

D 853

Imprinting a clear, brown signature or symbol on paper, an electrical stamp is operated without ink. The handle contains a filament resistance for the small current, which is taken from an electrical outlet by a plug-in socket. A small regulator prevents overheating of the metal characters

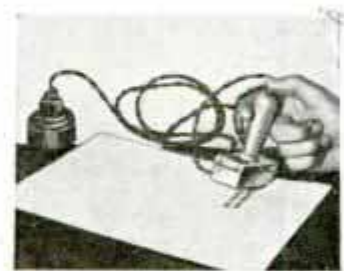

on the stamp face, saving the paper from being burned. After being placed on a document requiring the stamp, a push-button in the handle is pressed to switch on the current. Almost instantly, the imprint of the stamp is seared into the paper.

no. 2. v. agent h. m. m.

Box 5718, Home wood

Ed. R. Lillmore, 214 E. 1st St. Topeka, Kans.

Portland Spar Co, Attn. Mr. Murphy, Lumberman's Building, Portland Ore



Home
Homemade Gold-Mining "Machine" Consisting of Gallon Cans Attached to a Paddle Wheel

GOLD SLUCING WHEEL LIFTS WATER TO WASH PAY DIRT

Two Oregon school boys who have an inventive turn of mind are now sluicing from two to four dollars worth of gold per day from a small stream in that state with the aid of a homemade gold-mining "machine." Their invention consists of a paddle wheel with gallon cans attached to the paddles to carry the water to the tops of troughs and thence to shore where it is emptied into the sluice boxes into which the lads shovel the gold-bearing gravel. The pay dirt is recovered from the riffles in the sluice boxes.

401 SPEED OF LIGHTNING

Using a camera with two lenses revolving in a circle at opposite ends of a diameter, two experimenters photographed a number of lightning strokes between earth and cloud in an effort to deter-

mine the speed at which a thunderbolt travels. The lenses revolved at 1,500 revolutions per minute. Almost always, the experimenters found, the main flash was preceded by a faint "leader" which traveled from the negatively charged cloud to the positively charged earth at 810 to 19,900 miles per second. The main flash, from earth to cloud, traveled at 14,900 to 68,400 miles per second, the average being 28,500. The experiments were conducted for the South African Institute of Electrical Engineers.

8879 BIG WREN INDICATES RADIO STATION

Jenny
Radio station WREN at Lawrence, Kans., indicates its name with a huge wren erected at the entrance. The bird is of concrete and weighs about 1,500 pounds. The legs are of heavy steel and extend into the body. The body is made of a steel framework covered with metal lath, over which are two inches of cement built up like plaster. A sculptor modeled the outer surface which was painted in natural colors. The tip of the tail is about seven feet high.



Big Wren That Personifies the Name of Radio Station WREN

Floating Ball with Paddles Propels Swimmer

Buoyant enough to support the weight of one man, a new water-sport device is popular at German resorts. It consists of an air-filled ball with a short oar or paddle on each side. With its aid, a person can stroke through the water as though he were swimming, the ball supporting his weight. The apparatus has a floating seat for resting when the user becomes tired.

FERTILIZER FOR LAKE PLANTS MAY AID GROWTH OF FISH

Larger and more fish may be produced by using farm fertilizer in lake water, it is reported in connection with tests being conducted in Wisconsin. The fish do not eat the phosphorus and lime contained in the fertilizer. The gain in fish, both in size and in number, comes by the indirect route of first giving the fertilizer to the marine plants and then letting the



Air-Filled Ball with Paddle Attached Which Is Used to Support or Propel Swimmer

eight years. The cost for a whole summer of work in money spent for fertilizers amounts to only eighty-six cents an acre of lake surface.

ALUMINUM HOLDER FOR BAIT FASTENS TO FISHING ROD

For the angler who likes to fish in places not easily accessible, a bait holder has been developed which is attached quickly to the fishing rod.

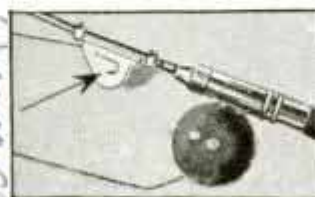

It is a light, aluminum box in which a worm, hook or fly is safe from damage. A rod so equipped can be tossed into a car without thought of harm to the bait.

New York Herald Tribune

Madison Wis

*Naumburg Saale Germany
no U.S. agent known*

*Made in U.S. Amerey Co
Cleveland, Ohio*

*Prof. & A. Berge and
C. ...
H. E. ...*

D 793

Cml. C. F. Salmar,
o/s The Pictograph Co
Box 840, Washington, D.C.

Things that LIGHTNING

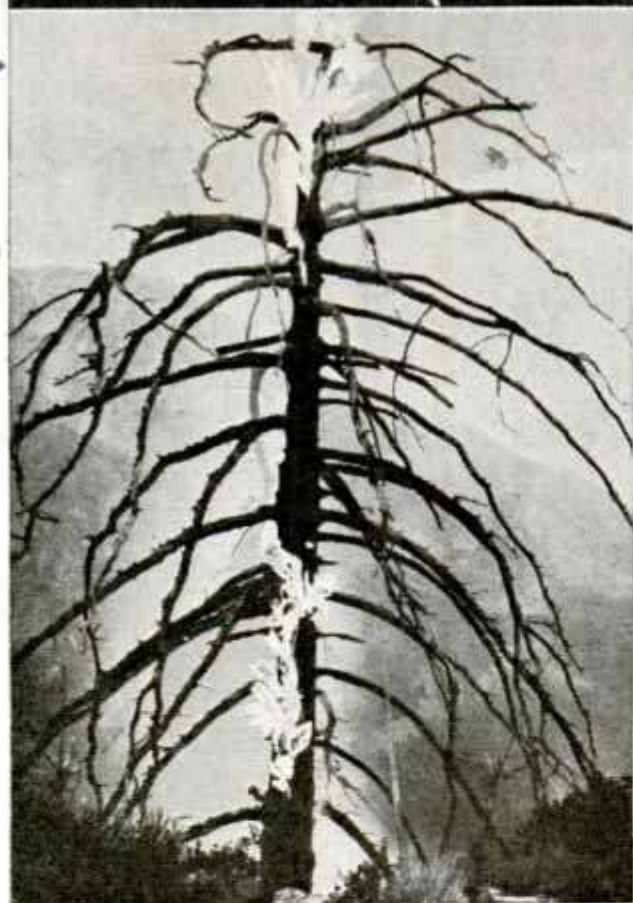

LIGHTNING performs many strange antics, but not all the capers attributed to it in all seriousness. For example, it does not make "fairy rings" on lawns and meadows, it does not impress photographic images of leaves and trees on the human skin and it does not smite the earth in the form of solid thunderbolts or thunderstones.

One popular belief, that lightning never strikes the same place twice, has been disproved definitely. Still another, that lightning is a single flash of high-voltage electricity between cloud and earth, has been found erroneous. Engineers of General Electric's laboratory staff—men who toy

Top, Brilliant Display of Lightning; Center, Tree in Flames after Being Struck; Bottom, "Fairy Ring," Once Blamed on Lightning

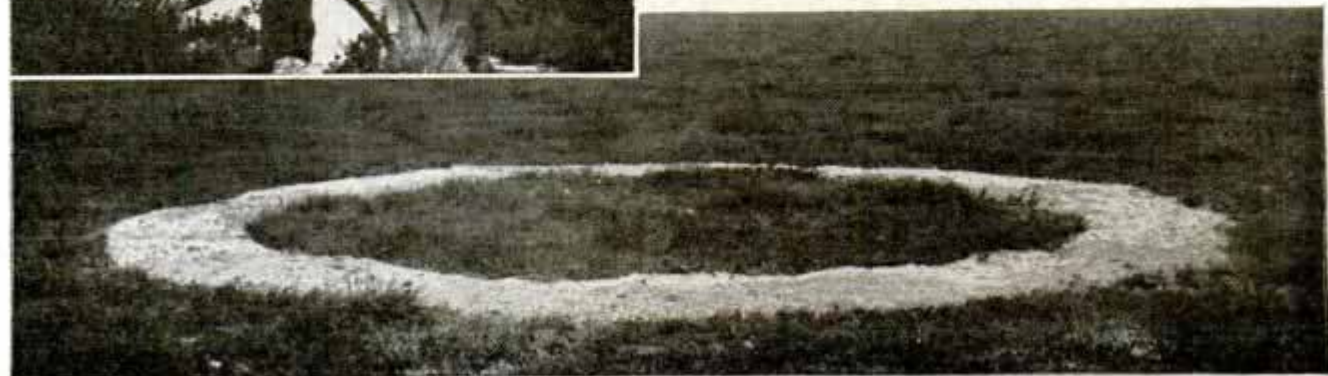

Handwritten notes on the left margin, including the number '60' and some illegible text.

Vertical handwritten notes on the right margin, including the name 'C. F. Salmar'.

DOES... *and Doesn't*



Right, Sidewalk Ripped by Lightning Traveling along an Abandoned Gas Main after Hitting Tree

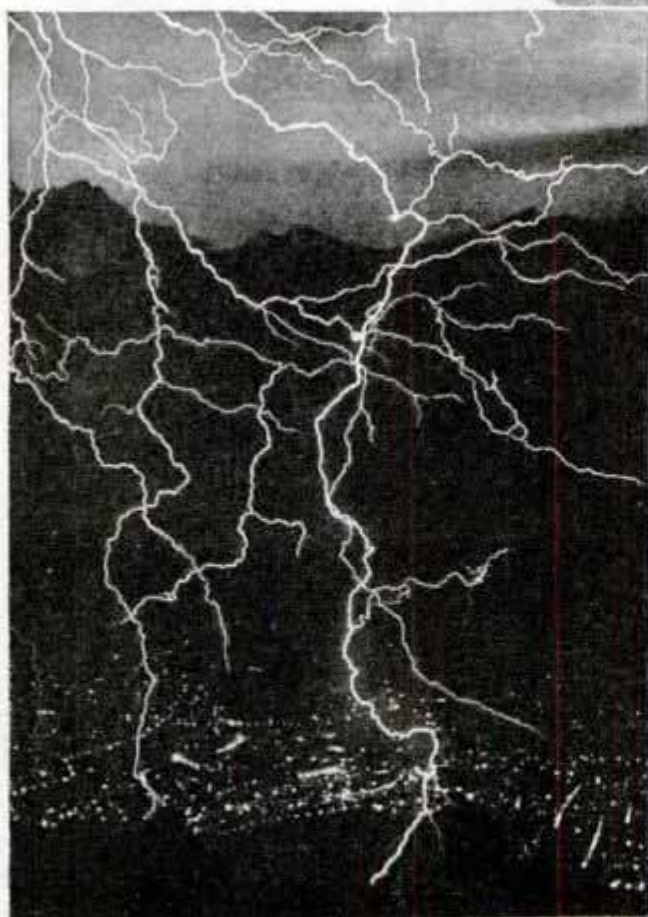

Lightning Display over City of Innsbruck, Austria

with ten-million-volt artificial lightning generators in the laboratory and who go into regions where severe storms occur to study the flashes at close range—have photographed lightning consisting of as many as ten separate strokes to the ground. One of these strokes was a multiple flash of ten recurrent discharges over the same path. The photographs were obtained with a special type of camera in which the film whirls past the lens at better than a mile a minute.

Fabulous tales about lightning still circulate throughout the world. In Europe, thousands of objects popularly identified as thunderbolts or thunderstones are preserved in the homes of country folk, who regard them as charms against a number of harmful agencies. Some are really prehistoric flint axes and arrowheads; others are natural stones of unusual shapes, or fossils. Among mineral formations resulting from lightning are fulgurites, or "light-



ning tubes," which are produced in the ground by the fusing of loose sand along the path of a lightning discharge. They are of various sizes, from a fraction of an inch to several inches in diameter, and sometimes twenty-five feet or more in length. The inner surface is smooth glass, while the outer consists of rough, incompletely fused particles of sand and often bears longitudinal ridges and furrows. The tubes are frequently twisted in spirals and are sometimes branched.

A so-called fairy ring is usually a narrow circular band of bare soil bordered by luxuriant vegetation. The ring grows from year to year and may become scores of feet in diameter. The familiar legend concerning such rings is that they are made by the footprints of fairies dancing in a circle. In the sixteenth century attempts to substitute a scientific explanation for this superstitious one led

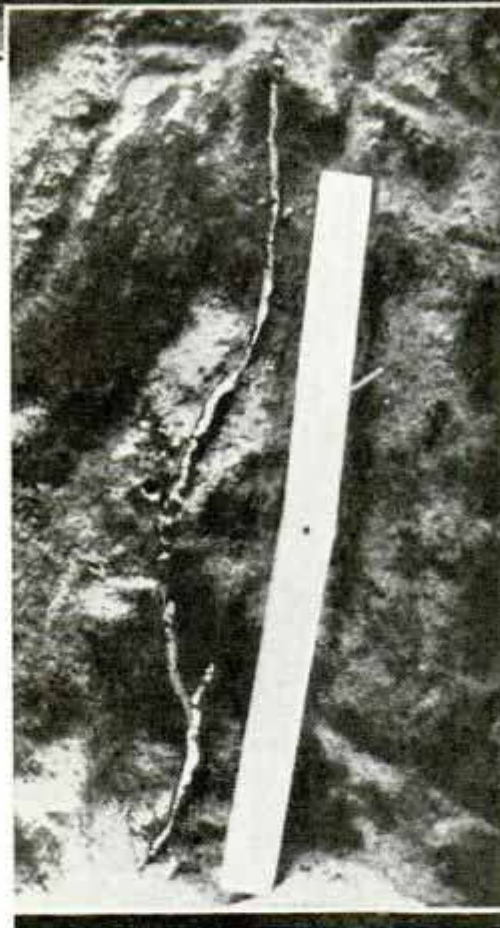

Top, Bolt of Man-Made Lightning Produced in General Electric Company's Laboratory; Discharge Is Ten Million Volts



Left, White Strip Indicates Length of Fulgurite Beside It; Right, Piece of Fulgurite Showing Rough, Winged Surface

to the equally erroneous belief that the rings are produced by lightning, and this belief was orthodox in the scientific world

(Continued to page 120A)

Giant Screw Propels Motor Sled over Snow



Motor Sled Which Is Propelled by a Giant Screw at a Speed of Twenty Miles per Hour

Equipped with a thirty-five horsepower air-cooled engine that turns a giant screw, a new motor sled is capable of fifteen to twenty miles per hour over the snow. The screw is a drum on which has been welded a spiral spring steel blade. As the engine turns this drum, the sled screws its way through the snow. The sled is capable of climbing steep inclines and of pulling a load of 5,000 pounds on crusted snow. Constructed of airplane tubing, sturdily welded, the sled weighs only 530 pounds. Three aluminum runners carry the load, the longer runner serving the purposes of steering by means of a wheel. The sled can be turned around in little more than its own length. On a test run, the 10,000-foot height of Lassen Peak in California was conquered.

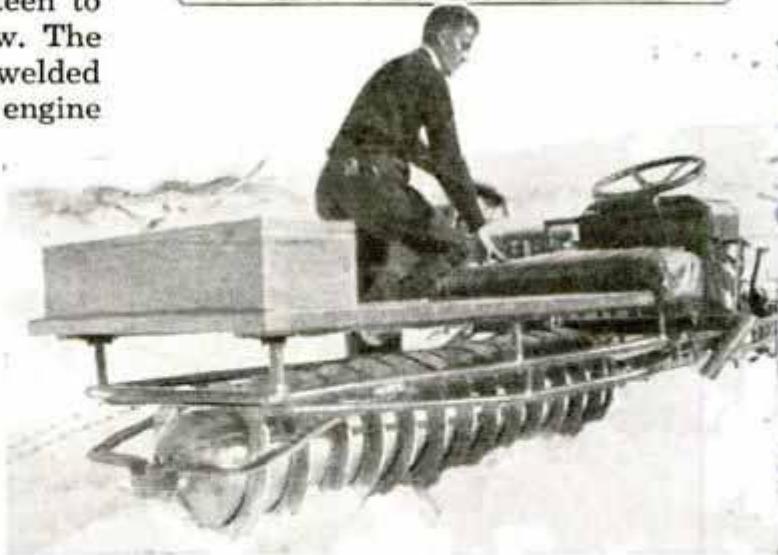

as though it had been drizzling. These drops are left by the honey bug, technically known as the aphid or aphid, a tiny plant louse. Tree spraying in spring with soapy water and nicotine sulphate is an effective means of eliminating the pest. Plant dusting with nicotine or tobacco dust also is recommended.

FIGHTING THE HONEY BUG

Motorists who park their cars under a shade tree in summer often return to find the windshield smeared with tiny drops,

Dr. Carlos E. Cummings, Director
Bull...

U.S. Mfg. Co. 1416-11 St. Sacramento, Calif. C.B.

20-25-26 Sacramento
20-25-26
20-25-26

893

Stores Fringed with Lights Illuminate Village



Market Place of a Village in the German Black Forest with Illumination Provided by Fringes of Lights Strung Along the Roofs of Shops

One of the villages in Germany's Black Forest has employed an unusual method for illuminating its market place. Fringes of lights are strung along the roof edges of buildings housing stores and shops and

these lights illuminate the structures while the reflected light is thrown down into the street below. Thus the decorative lights on the buildings also serve as street lights for pedestrians.

Rainmaker on Wheels Is Operated by a Water Motor

For sprinkling large lawns and gardens, an automatic rainmaker is now offered in the form of a sprinkler rotated by a water-

operated turn-motor which revolves the nozzle pipe from side to side as the sheet of water is thrown high into the air. The

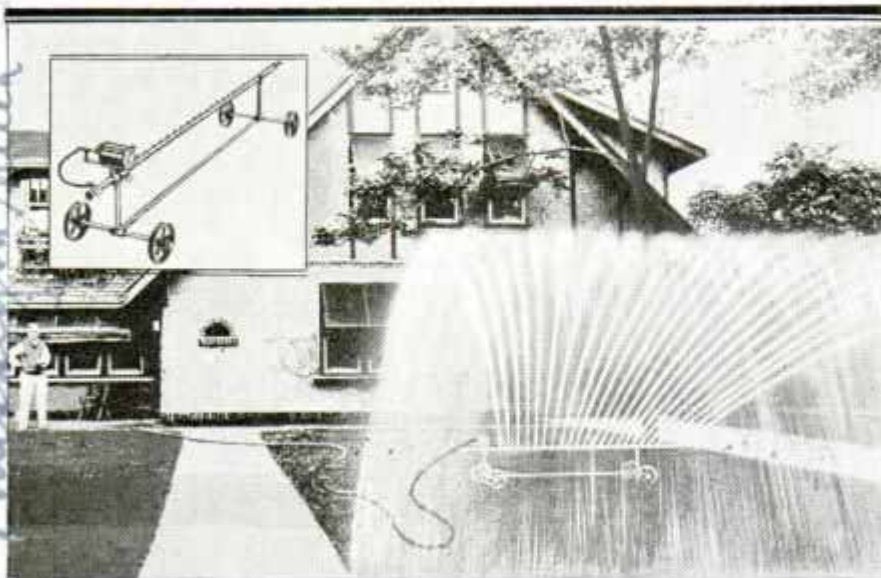

Lawn Sprinkler on Wheels Which Is Operated by a Water Turn-Motor Which Rotates the Perforated Pipe from Side to Side

largest size is capable of watering evenly an area forty by sixty feet, using from 400 to 750 gallons per hour depending on the pressure. The arc of throw is adjustable and it can be set for narrow strips or wide areas. Auxiliary screened tubes are available and may be inserted in the pipe for holding soluble fertilizer tablets or insecticide. It is claimed that the drops of water absorb nitrogen by being thrown into the air, giving the same effect as a natural rainfall.

*Freudenstadt
March Automatic Irrigation Co.
Mushersville*

AUTO RADIATOR FREED OF SCALE BY TABLETS IN WATER

Pills for your automobile are now being offered by one manufacturer who is making tablets like peppermint lozenges in appearance to be added to the water in the auto radiator to prevent the formation of scale. It is claimed the tablets, when dissolved, soften the water by precipitating the mineral salts and thus keep scale from forming. Two or three tablets are used the first time to remove scale, rust and grease, and thereafter a tablet a month keeps scale from forming.

LIGHT WAKES SLEEPING SEEDS AND SPEEDS GROWTH

Seeds that refuse to sprout when planted can be roused from dormancy by soaking and then exposing them to the proper colored light for a short time. Only the longer wavelengths of light have this stimulating power, Dr. L. H. Flint, of the U. S. department of agriculture, has found.



Exposing Seeds to Different Kinds of Colored Light in Order to Speed Up Sprouting

Seeds exposed to light at the blue-violet end of the spectrum refused to germinate. Even seeds that had been given the stimulating treatment with the longer wavelengths at the red end of the spectrum, and then were exposed to blue or green light, would not sprout. The treated seeds need not be germinated immediately. They can be dried out and planted later.



Handle with Suction Cups for Carrying Panes of Glass

VACUUM DISKS GRIP GLASS FOR EASY CARRYING

Large panes of glass can be handled easily with a vacuum-cup implement introduced in Germany. It consists of a handle with a rubber suction disk on each end. On the back of each disk is a small lever to prevent air from disturbing the vacuum. Pressing the disks against glass causes them to grip the pane tightly. Then the two levers are lowered and the glass can be picked up and carried by the handle.

BRAKE-SHOE STRETCHER AIDS ON RELINING JOB

Relining of automobile brakes is made easier by a stretcher that opens the shoe to the degree required. Adapters fit the device to various sizes, and slight pressure will readily open the brake shoe.



Severe Storm 6/16/34

Paul & Business 8/40

D 987

Washington 22 C

Wilhelmstrasse 133 Berlin

J. Stangenhaus 187 Arcade Station Los Angeles - Calif

Oringo Specialties 2140... Co

D813. *Count Jacob Aleschery*
R. 2240, 500, 5th Ave
New York City

A MILLION



equalled before or since. His collection, mounted on loose leaves in special binders, filled three walls of a large room in Paris. He spent \$10,000 a week on his hobby. The count died in 1917. When the collection was auctioned after the close of the World War, the proceeds amounted to more than \$2,000,000.

At that sale an American collector, the late Arthur Hind, Utica, N. Y., made sensational purchases including the one-cent black-on-magenta British Guiana, 1856, of which only one copy is known to exist, and for

THE small boy swapping some knick-knack for a batch of coveted postage stamps and the President of the United States poring over a stamp collection to which he has devoted a lifetime are members of a vast brotherhood which includes 9,000,000 devotees in this country alone. American stamp collectors spend annually \$6,000,000.

President Roosevelt began collecting stamps when he was only eight. When he remarked, "I can almost say I owe my life to my hobbies—especially stamp collecting," and when, on assuming the presidency, he directed that he wanted to see "every stamp that comes into the White House," he confessed that intense attachment to his hobby typical of philatelists everywhere.

Among noted stamp collectors are King George V of England, King Emmanuel of Italy and former King of Spain, Don Alfonso XIII.

The late Count Philipp la Renotiere von Ferrary amassed a stamp collection never



Courtesy Stamp Magazine

Top, Stamp Club Listens to Talk by Expert; Center, One-Penny and Two-Penny "Post Office" Mauritius; Bottom, \$50,000 One-Cent Stamp

Stamp + Coin Co. 1 W. 47 St. New York

Dollar HOBBY

Everyone Can Ride

which he paid an all-time record price for a single stamp of \$32,500. It is now worth \$50,000.

Every collector lives in the hope that some day, in old garrets, old trunks, courthouse records, the files of old business firms, and similar hiding places, he will come across a batch of old letters or papers bearing rare old postage stamps. Many fortunes are made by such chance discoveries. Take for example the most expensive stamp in the world today, the \$50,000 British Guiana one-center, now owned by Mrs. Hind. Printed in 1856 in Georgetown, Brit-



ish Guiana, it was withdrawn when it was discovered that the stamp had been colored red by mistake. But a Georgetown boy, rummaging in the family attic sixteen years later, found one on an old envelope. He sold it to a dealer for about \$1.50. The dealer sold his entire collection, including the precious prize of today, for about \$600. The purchaser, realizing the exclusive nature of the stamp, offered and sold it to Ferrary for \$700.

Trunks appear to be favorite places for important discoveries in rare stamp values. One woman, in going through an old trunk, found a packet of letters from which as she sorted them a few unused stamps slipped to the floor, later to be appraised by experts at \$100,000.

Because someone in 1847 made the error on Mauritius, an island situated off the

Courtesy Stamp Magazine

100.6th Ave
Top, Stamp Collecting Appeals to All Ages; Inset, Top, Five-Cent Unused Millbury Worth \$7,500; Bottom, \$6,000 Confederate Postmaster Stamp

New York City



Courtesy the Newark Museum



Top, Committee Preparing for Young Collectors' Exhibit; Bottom, Examining Watermark

coast of Africa, of printing the words "Post Office" instead of "Post Paid" on some one and two-penny stamps being printed and

because these stamps were immediately withdrawn from sale, they are today excessively rare. An envelope which bears both the one and the two-penny stamps recently sold for \$25,000 and was at one time valued as high as \$50,000.

The so-called "Postmaster" stamps, issued by the postmasters of several American cities before the Federal government took over the job, never fail to bring high prices whenever they are offered for sale. One of these, a Baltimore 10-cent stamp affixed to an envelope sold for \$10,500. In more recent times, there is the 1918 24-cent air-mail stamp with the inverted airplane center. Originally it consisted of a sheet of 100, which a young man

(Continued to page 118A)

Tractor "Trains" Move Freight in Far North

Fourteen hundred tons of mining machinery were moved 132 miles over muskeg and forest land in Canada's far north a few months ago with the aid of powerful tractors traveling as "trains." The first tractor started in a temperature fifty below zero, dragging twenty-eight tons of equipment on sleds behind it. Ten days later it reached its destination. Three months were required to move all the machinery after an airplane had surveyed a route which was cleared of trees and brush by gangs of men. Sixteen tractors were used, each carrying a crew of four men. One tractor was lost when it plunged through the ice over a lake but was recovered later. Often tractors were forced to "double up" to pull loads over slush ice and frequently the "bunting poles," logs more than ten feet long used to keep the sleighs apart, were snapped as the tractor train proceeded down grades.

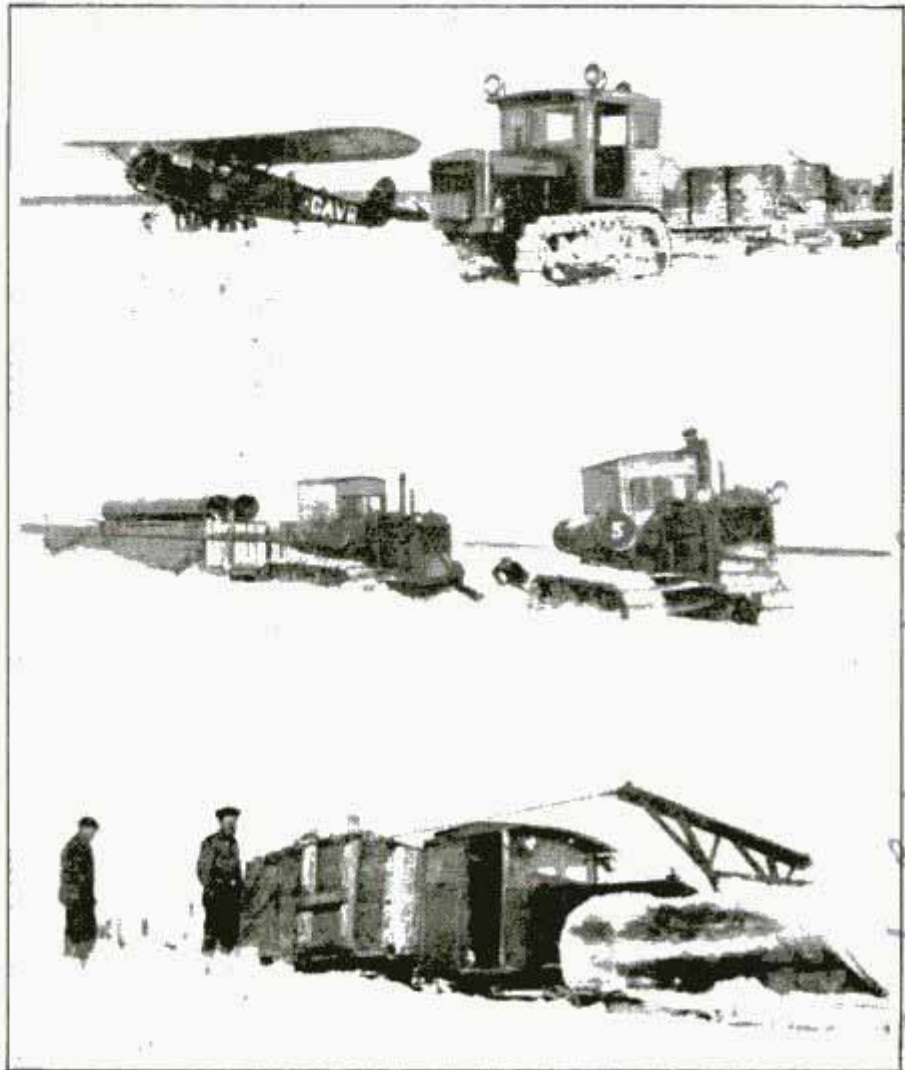

Using Tractors to Haul Tons of Heavy Mining Machinery in the Far North; the Tractors Dragged Sleds Which Were Operated in "Trains"

Calerpillar

About 55,000 gallons of gasoline and 2,000 gallons of oil were used.

Radio Installed on Cultivator Brings Music to the Farm

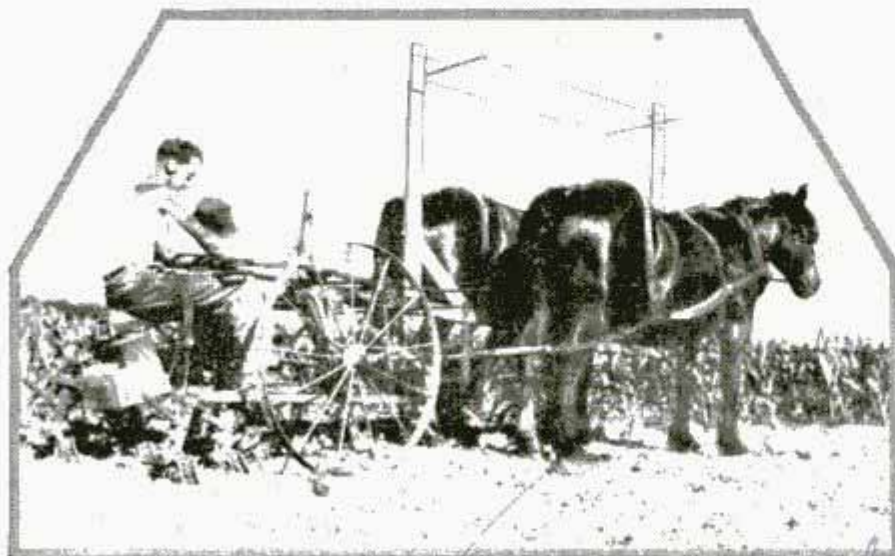

Radio programs to while away the hours of plowing are brought to an Ohio farmer's ears by a battery receiver attached to a cultivator. Two lath, nailed upright to the tongue of the cultivator, are strung with wire to serve as the antenna, while the two-tube receiver is fastened to the tongue in front of the seat. The battery is under the seat. Headphones pick up the programs.

Cont. Edward Loren, Carleton Place, Ontario, Canada

Cont. Edward Loren, Carleton Place, Ontario, Canada

DR/S

Washington, D.C.

**GARDEN LIGHT LIKE MUSHROOM
ALSO SERVES AS SEAT**



Combination Garden Light and Seat Made of Plaster and Cement and Shaped Like a Mushroom

Shaped like a huge mushroom, a combination garden lighting unit and seat offers the convenience of a sturdily built chair and the decorative effect of indirect illumination. It is made of plaster and cement and consists of two parts, the base and neck and a detachable top. The base is painted grass green and the neck and top a natural mushroom color. The top contains three holes on the under side and three one-half-inch pipes protruding from the neck fit into these holes to hold the top in place. Ideal illumination calls for a 100-watt or 150-watt clear lamp, but by using an extension socket, the unit can be lighted with forty-watt clear lamps. It can also be equipped with colored Cellophane rings or screens for colored illumination.

ETHYLENE GAS HULLS WALNUTS

Hulls of green walnuts may be loosened in thirty-six to eighty-four hours by means of ethylene gas. The walnuts are placed in a fairly tight room, with the temperature close to seventy degrees Fahren-

heit. Ethylene in the ratio of one part in 1,000 cubic feet of air is introduced. Rubber balloons, inflated with ethylene to a diameter which will secure the volume desired, are placed in the treating chamber to release the gas slowly. The chamber is ventilated twice each day and recharged with the gas after each ventilation. As a rule, the hulls do not split open, but must be removed by machine or by hand.

**OLD CLIPPER SHIP CONVERTED
INTO FLOATING MUSEUM**

Seattle boasts a floating marine museum and aquarium, the old clipper ship, "St. Paul," now being used for this purpose. A notorious "hell ship" of the eighties and one of the few surviving clippers on the Pacific coast, the boat itself is the outstanding exhibit. Tanks in the hold contain living specimens of northwest marine life and there are also sailing ship models, log books, old maps and ancient nautical instruments and gear.



Old Clipper Ship, "St. Paul," Which Has Been Converted into a Floating Museum and Aquarium

Handwritten notes:
Schmiedendorfer, in charge.
D869
D806
Seattle Wash.
Food Research Dept.
Dept. of Agriculture
Com. Emerg. Service
4617-24 and Co

Albert Portier
Paris France

METAL TESTED WITH VARNISH TO SHOW WEAK SPOTS

Varnish is used in a new method of testing metals and other raw materials to just below the point of permanent deformation, or the breaking point. The varnish has sufficient adhesiveness to share in any deformation, as well as being brittle enough to break or crack before the breaking point is reached. Extremely fine fissures appear in the varnished sample of metal under strain, running at right angles to the maximum tensile strain. In tests, these fissures first appeared at those points which eventually developed fissures as the metal broke down. By choosing a proper varnish, the scientist may use the process for microscopic work in determining the influence of minute flaws in metals and components, such as graphite in cast iron.

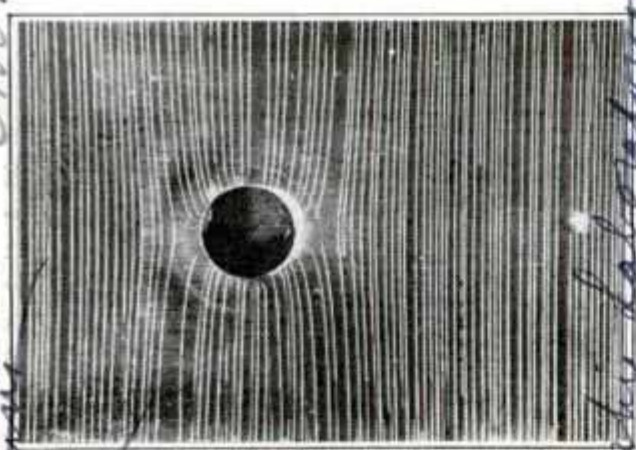

Note How Hole in This Metal Affects Its Strength under Strain as Revealed by Varnish Lines

PAPER OR FABRIC SENSITIZER SPEEDS PHOTO ENLARGING

Enlargement of photographs on all kinds of paper, canvas, fabric and other surfaces is made easy by a black-and-white sensitizer that does its work quickly. Even a wall twelve feet square can be sensitized to receive a picture that is projected on the wall while the sensitizer is wet. Then the photo is developed with a sponge and a bucket of developing fluid, the picture being in pure black and whites. The sensitizer is effective on ordinary newspaper print stock without sizing. It is offered also as a means of enlarging subjects to any size for the artist, saving hours of free-hand drawing and obtaining correct perspective. One example of its use is in a newspaper published at A Century of



Some Uses of Rapid Sensitizer for Paper or Fabric; Note Wall Printing Process

Progress, in Chicago. Wherever a photograph is to be printed, the paper is sensitized and four minutes after the picture is taken, the paper is printed, eliminating the time of making engravings. The process is recommended for small-circulation newspapers or magazines.

CYLINDER GAUGE SAVES TIME IN REFITTING PISTONS

Cylinders can be measured during the process of honing without removing the hone by using a new gauge that saves considerable time for the mechanic. In addition to speeding up the work of honing all cylinders to the same size by showing exact measurements quickly, the gauge enables the mechanic to show auto owners what size pistons to use without removing the old ones.

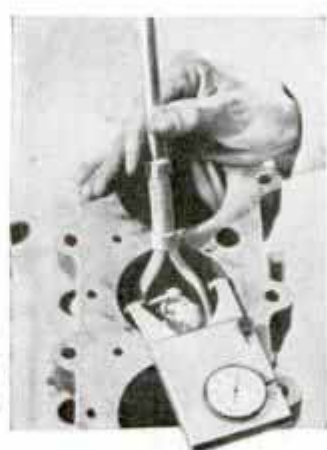

Chicken feathers have been dissolved to form a plastic suitable for making fountain pens, insulators and various novelties.

International Research Laboratories
228 Ave. of the Americas
New York City

Dissemination of
Patented
D. W. Jos. J. Jay
Research Laboratories
New York City

International Research

228 Ave. of the Americas
New York City

MIDGETS of the

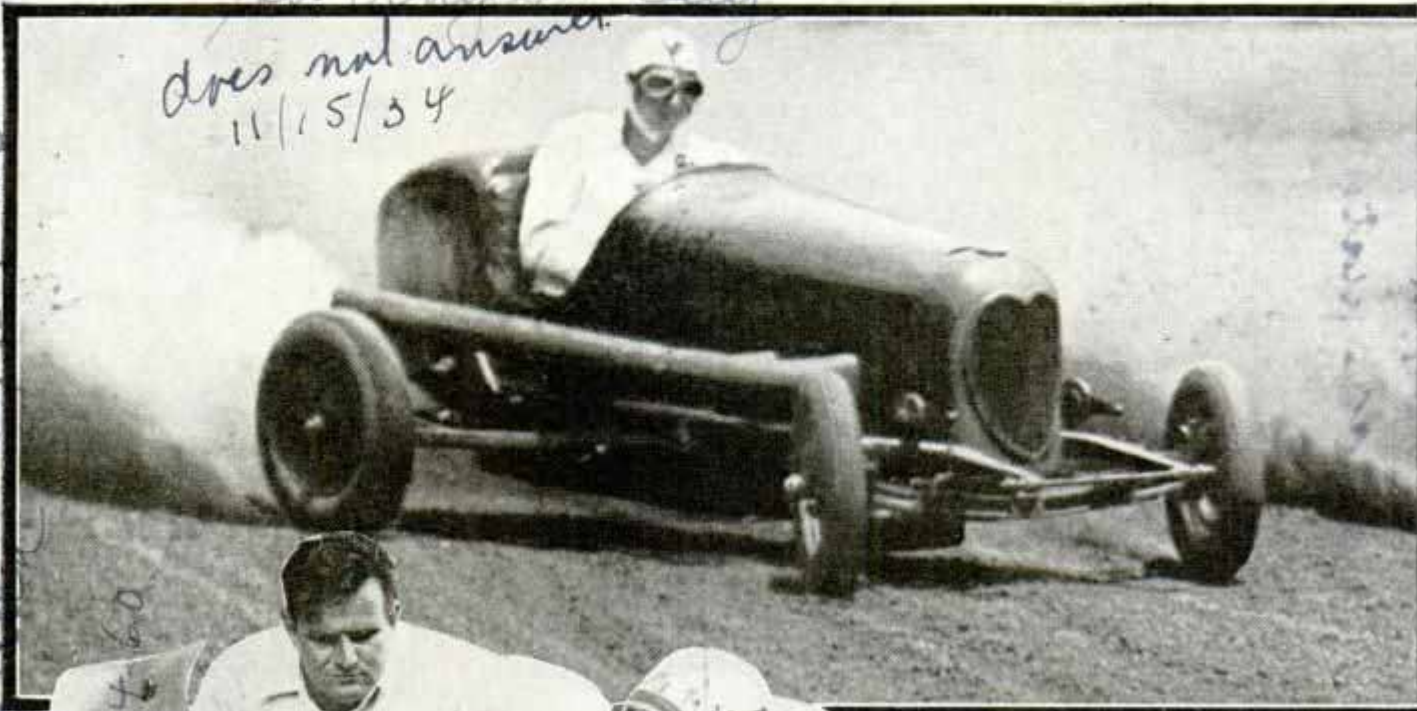

*does not answer.
11/15/34*



A NEW and fascinating sport, midget auto racing, has been elevated to a major attraction in California in the short space of ten months. The midget races are staged at Long Beach, Santa Ana, Fresno, San Jose, Sacramento and Los Angeles. The new Gilmore stadium in Los Angeles, erected at a cost of \$50,000, seats

26,000 persons and represents the last word in modern design and safety.

The races are run over an oval course measuring one-fifth of a mile in length, and are staged right in the laps of the spectators. The little speedsters spend half their time skidding around turns, but speeds of sixty miles per hour are often attained on the straightaways. This is accomplished by incorporating high-speed motors in the cars, some of them "wrapping up" to 6,000 revolutions per minute.

Skill on the part of the drivers, together with daring, is essential to success. While fast mounts are of paramount necessity, the ability of the driver to jockey for position is the chief factor in winning. Despite skidding, "bunching" on the turns and other hazards, accidents are surprisingly

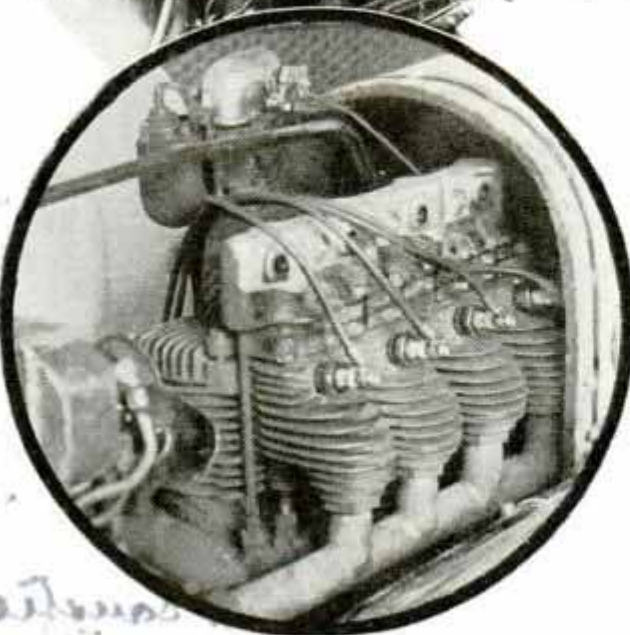

Midget Cars in Action and Outboard Boat Motor and Motorcycle-Engine Power Plants

Penderam

*Curly Miller, 1934
Chester Mortmore
Driver, Charles A. Miller, 1934
Allen*

4622 Crenshaw Blvd

Los Angeles, Calif

Allen 460

ROARING ROAD

Whitney Thuesen

Pete Vaccaro

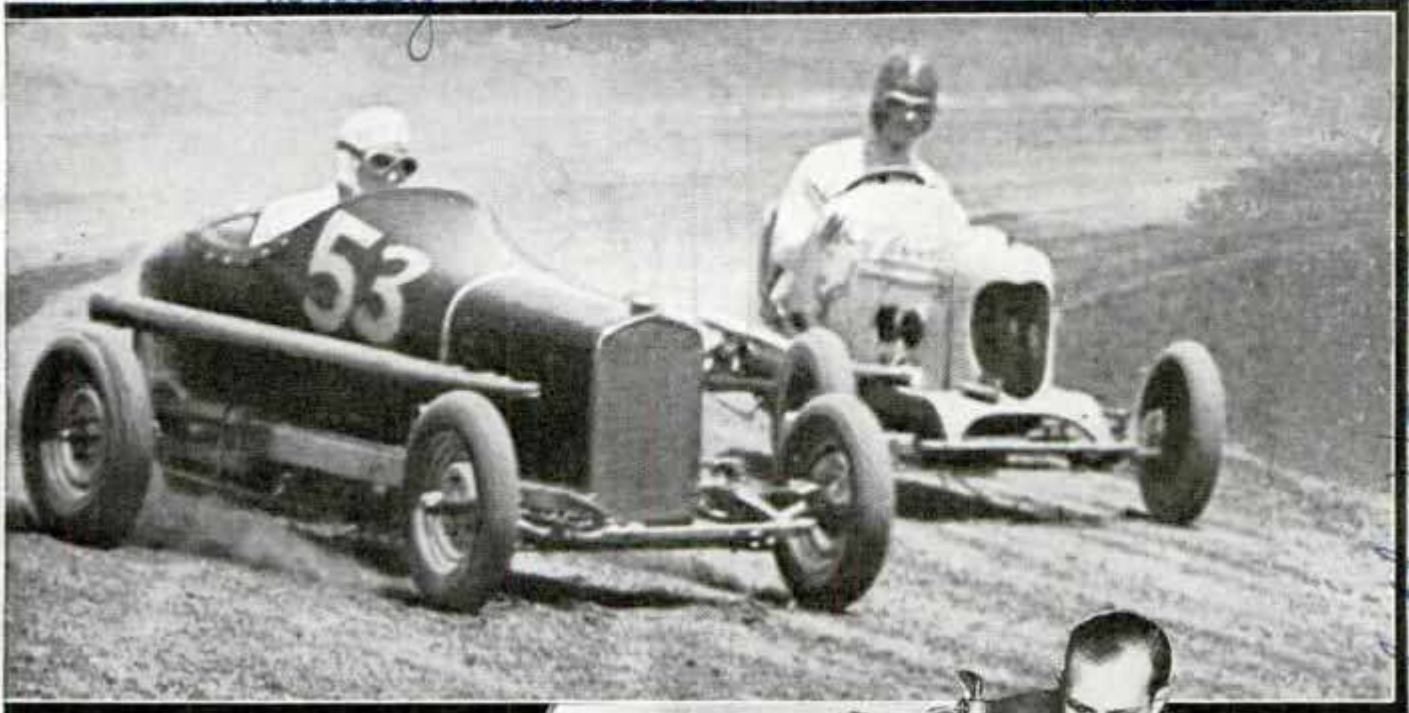

*both Hinderson
are special*

rare. Barring collisions, there has never been an instance of one of the cars capsizing and as yet there have been no fatalities among pilots.

The cars are of various sizes and shapes with the average wheelbase measuring seventy inches and the tread forty-two inches. The wide tread renders practically negligible the danger of turning turtle. The Midget Auto Racing association limits the piston displacement to 100 cubic inches but the most successful motor has only sixty inches displacement. The power plants are adapted from other vehicles, so one sees all sizes and types. The old 1915 Saxon pleasure car has contributed its motors to the midgets as has the Austin. The motorcycle motor has been converted with fair success and the Scripps-Booth four-cylinder marine motor has found its way into some of the "go-devils." The motor having most success at present is the 4-60 outboard boat motor. The average compression ratio is seven and eight-tenths to one and the gear ratio five and one-half to six to one. Small aeroplane wheels are used.



*Monie
Lestace
Mudge
An
son
Jin*



Cummer - Ken Brennan

Barney Oldfield Looking over a Midget and a Baby Racer Equipped with Front Drive

4031 S. Broadway

Engineering Dept., Seattle Wash

Portable Concrete Slabs Cut Paving Expense



Under heavy traffic conditions, there is a small amount of breakage and some rattling, particularly on hills where there is

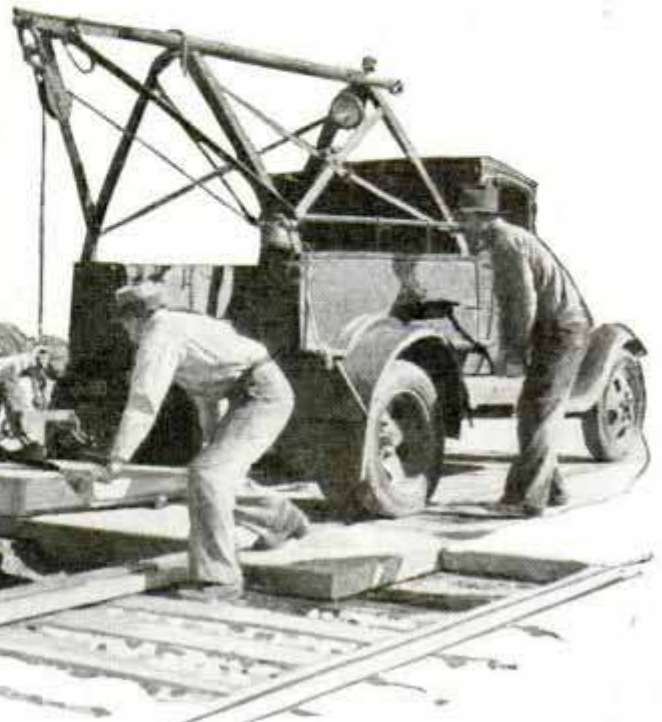

Laying Portable Concrete Slabs over Municipal Railway Tracks; Note How the Slabs Are Moved with the Aid of Small Cranes

Portable concrete slabs are being used as fill-in pavement around eight and one-half miles of track of the Municipal railway of Seattle. With the aid of federal funds, the city has manufactured 68,050 slabs, costing about one-half as much as permanent paving because new rails and ties are not required. The slabs can be removed at any time with a small portable crane, each block having a hole and steel center for lifting, for track adjustment.

a tendency to creep, but the slabs serve the purpose of eliminating traffic hazards at points where many auto accidents have occurred. Raw materials for the slabs go in at one end of the manufacturing plant and come out, finished, to waiting trucks at the other end. Three sizes of slabs are used, one outside the rail, another for the tracks and the third for the center slab. If it is later decided to lay permanent paving, the slabs can be salvaged.

Driver's Cab Is Placed at Front of Streamlined Engine

German Streamlined Locomotive with Driver's Cab Placed at the Front

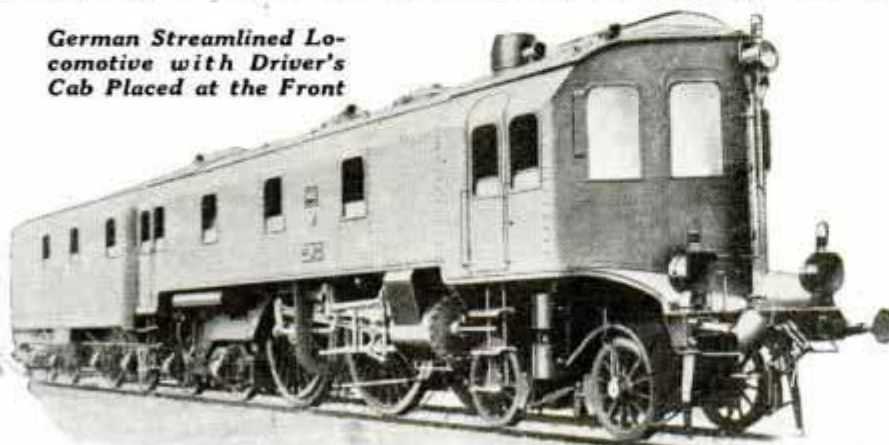

Germany, along with other countries, is experimenting with streamlined locomotives. The latest engine created in that country has a wedge-shaped front and the engineer's cab has been placed in this section so as to provide better vision for the driver. The engine is being used for fast passenger service.

*produced at Henrichel Works
Cassel, Germany*

*Cont. Robert C. Hill 1408 Marway St
Seattle Wash*

D 758

Periscopes Used at Races to See over Crowd

Periscopes have been introduced at German race tracks for the use of spectators far back in the crowd. By means of the simple arrangement of mirrors, the spectator can follow his favorite horse's dash around the track, his view unobstructed by the heads of fans nearer the rail. The device consists of reflecting mirrors so placed that when the operator looks into the mirror at the lower end, he sees the image of the race reflected by a mirror at the top.



Berlin
World
 Crowd at German Race Track Using Periscopes to See over the Heads of Those in Front and Follow the Progress of the Horses

REVERSIBLE PITCH PROPELLER ACTS AS A BRAKE

Adjustable and reversible in pitch, a new propeller enables the pilot to take off or land his plane in less



W.D. Longyear
W.D. Longyear
 Reversible Pitch Propeller Which Acts as a Brake When an Airplane Is Making a Landing

than fifty feet, ascent and descent being almost vertical. A feature of the air screw is that it can be pitched to any degree, in

contrast to the two degrees of pitch possible with other propellers. In making his landing, the pilot simply throws the propeller "into reverse," retarding the forward progress of the ship to make it come down in a gentle descent. Instead of pivoting, the propeller turns all the way and full speed astern becomes as easy to produce as full speed ahead. As a brake, the propeller is said to eliminate ground loops which sometimes result from application of brakes.

WATER VISIBLE IN MOISTENER WITH GLASS RESERVOIR

Fitted with a glass reservoir, an improved moistener for gummed surfaces or the finger tip keeps the water level visible. Metal parts are non-corrosive. Rubber feet keep the moistener in place on the desk.

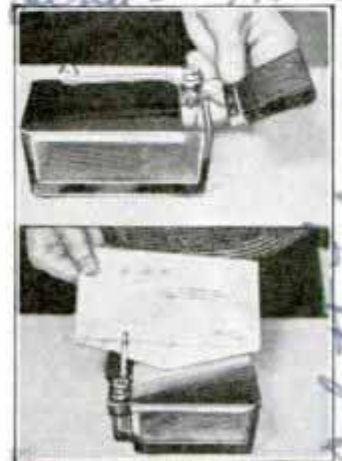

developed by group

send - moistener
The Colgate Laboratory
565 1st Washington

Thrills of FLYING

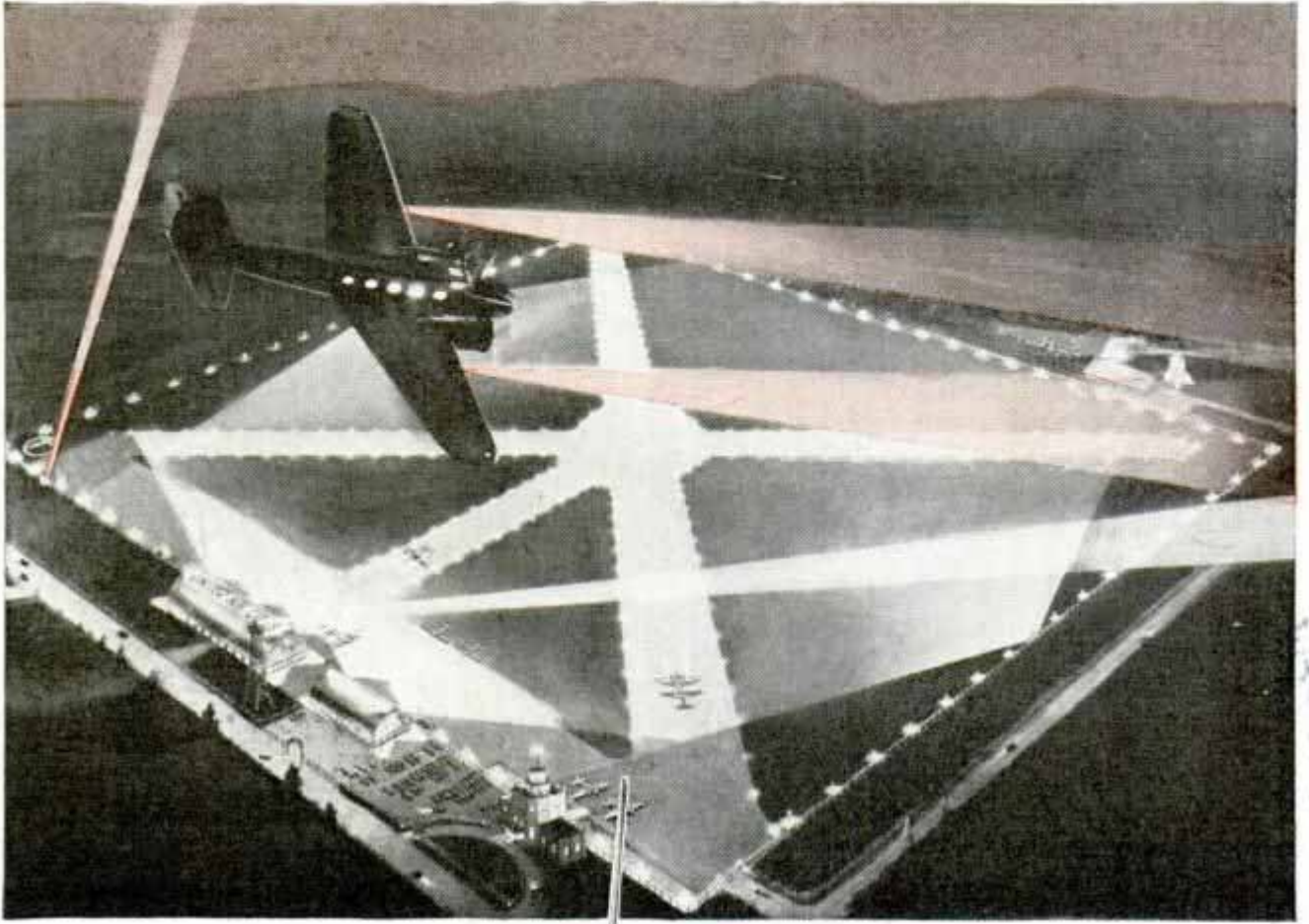

Above, Model of a Modern Air-Mail Landing Field and Airport; Below, Servicing a Big Air Liner

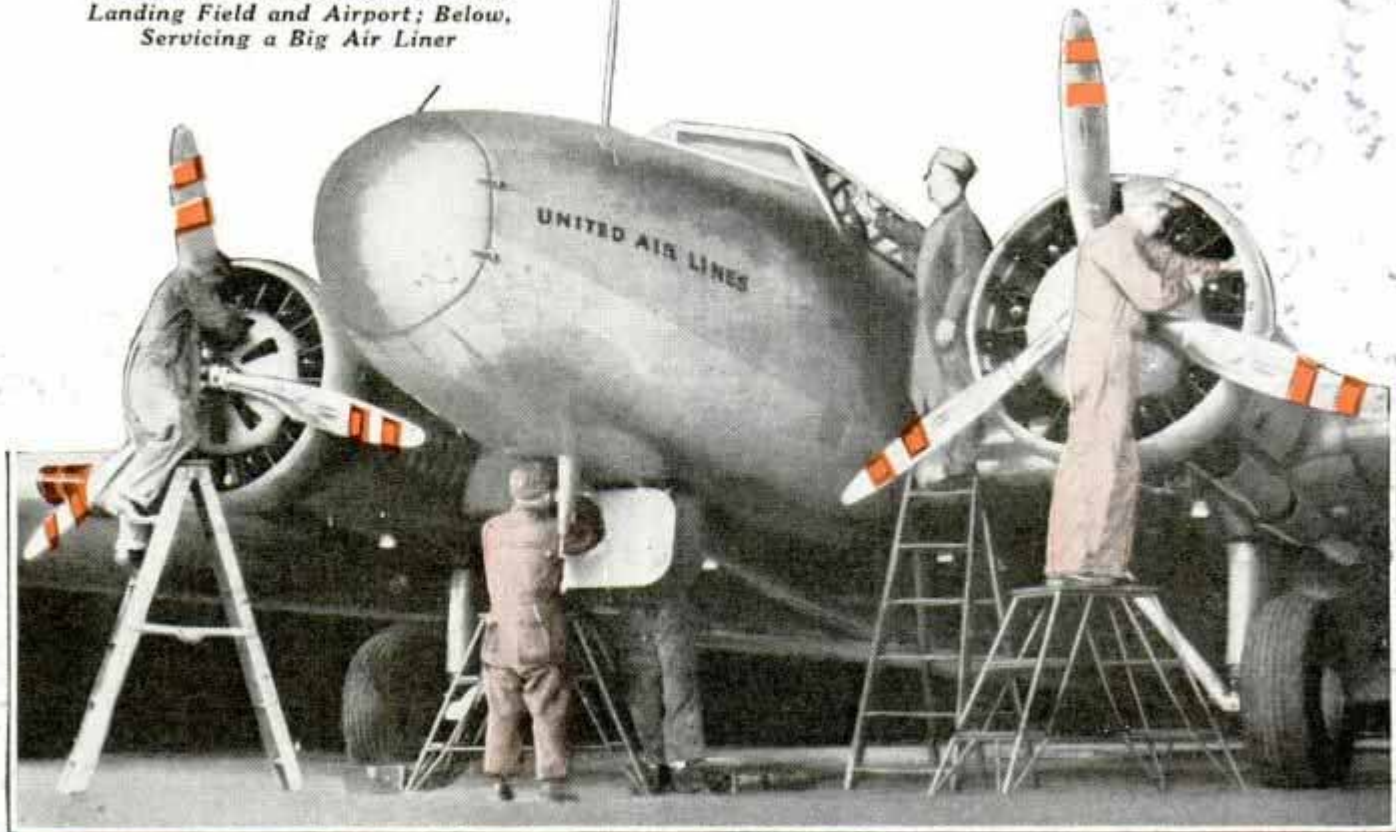

the MAIL

Right, Pilots Waiting for Weather Reports; Below, Servicing One of the Many Airway Beacons



By H. W. MAGEE

IT was in the days soon after two-way radio-telephones were installed on mail planes. A pilot battling snow and sleet gave his position to a radio dispatcher 200 miles distant and reported ice was forming on his wings. Suddenly the tense dispatcher heard the pilot's voice again.

"I'm losing altitude fast," he said, then, after a pause, "I'm coming down—count to me—count to me."

With a vision before him of a lonely mail flyer crashing in the storm and seeking the comfort of a friendly human voice as he fell, the dispatcher started counting.

"One—two—three—four—five—," he began and continued into the twenties. Then he stopped to listen. No reply came.

There is a happy sequel to this incident. The pilot stayed with his ship and mail and landed without serious injury. Later he met the radio man who did the counting.

"The first thing I heard after landing," he said, "was your voice still droning numbers in my ears. I couldn't tell you to quit because my radio was put out of commission. The reason for the counting? I couldn't see,





of its former dangers. A big trimotored plane thundered above a sea of shifting clouds one winter's night destined for the Pacific coast. For three hours pilot and co-pilot had navigated a compass course; for three hours they had not seen the ground. As the third hour passed they calculated they were over the broad Sacramento valley. By radio-telephone they learned a 3,000-foot ceiling prevailed over this region. So they began seeking a "hole" to come down for a landing.

At last they found the break in the clouds they sought and spiraled down through it. Beneath

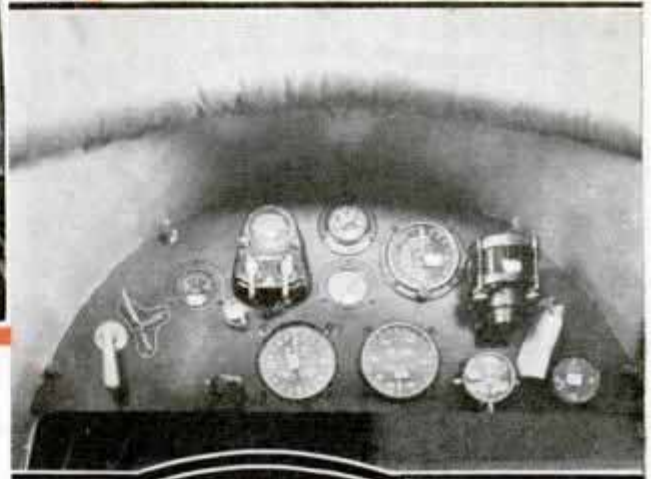

and wanted to gauge the time of my descent."

Because the mail pilot is not a fair-weather flyer, ice still is one of the hazards he faces, but many planes today are fitted with "overshoes" on the wings and with the other devices intended to prevent ice from logging down a ship. In addition, experienced pilots have learned how to dodge ice by seeking a different air strata when it threatens them.

It is difficult to visualize the dangers faced by the pioneer pilots who blazed the air-mail trails because we have been accustomed for so long to drop a letter marked "via air mail" into a corner box, certain that in some way it would reach its destination quickly and safely. High adventure still flies with the mail, but modern equipment, million-mile pilots and long years of experience have robbed the service of many



Above, Instrument Panel of Early Air-Mail Plane and Modern Ship; Below, Light Recessed in Mail-Plane Wing

them was a revolving beacon and the boundary lights of an airport. They landed, confident they were near Oakland. Instead they were in Nevada, more than 100 miles from Oakland. They had been swept off their course by a cross wind. Today directive radio beacons keep mail planes on their routes, the radio signals warning the pilots as soon as they begin deviating from the wide swath of airway.

These pilots would rather talk of the amusing experiences than the dangerous ones. One of them tells rather sheepishly of a rough trip from Omaha to Chicago years ago during which he saw little of the ground and finally flew by instinct alone. He got cold and opened a jug of coffee. His numb fingers dropped the top and it fell up. He looked up, and there were the lights of Chicago—above him. He had been flying on his back.

It would be difficult for an experienced mail pilot today to fly upside down unintentionally. On the instrument panel in front of him are a score or more of instruments, each supplying flight information. Included are three recently developed aids to "blind" flying; an artificial horizon to show when the ship is on an even keel, a directional gyro to record direction of flight regardless of any abrupt maneuver of the aircraft, and a sensitive altimeter whose "minute" hand registers changes of altitude in tens as well as hundreds of feet.

When Jack Knight, now a million-mile pilot for United Air Lines, participated in the first continuous mail flight across the continent thirteen years ago, he landed at Omaha by the light of bonfires and arrived over Iowa City out of fuel to find the airport hidden by darkness. He finally landed by the flare of a railroad fusee set by a night watchman.

That couldn't very well be duplicated today either. Ground crews are always on the job, landing fields are well marked and for an emergency landing today Knight's big monoplane is equipped with two 550,000-candlepower searchlights recessed in the wings. In addition he has parachute flares to illuminate a square mile of ground as bright as day. The same route over which he made that first trip today is part of a lighted air boulevard extending from the Atlantic to the Pacific

(Continued to page 122A)

QUICK TIMER FOR WATCHES SPEEDS UP REPAIRS



Instrument Which Tells in One Minute Whether a Watch Is Gaining or Losing Time and How Much

Watch repairs can be speeded up by a micrometer that determines accurately in one minute how fast or how slow a watch is running. The one-minute test reveals the gain or loss in time for a period of twenty-four hours. If the beat of the watch does not synchronize with the tuned revolutions of a numbered disk, lighted numerals on the disk show the degree of inaccuracy.

SOCKET LOCKS ELECTRIC LAMP PREVENTS THEFT

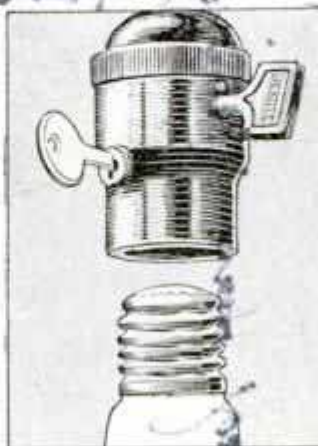

Theft of electric lamps is prevented by a socket lock that grips the bulb tightly until a key is used to permit removal. The lock is a part of the socket. When the bulb has been screwed into the socket, the key is turned, making the connection

theft-proof, as well as preventing the bulb from loosening. It lengthens the life of lamps because contact is always positive.

The Lockite Co. 416

Knock in Gasoline Measured by Test Engine

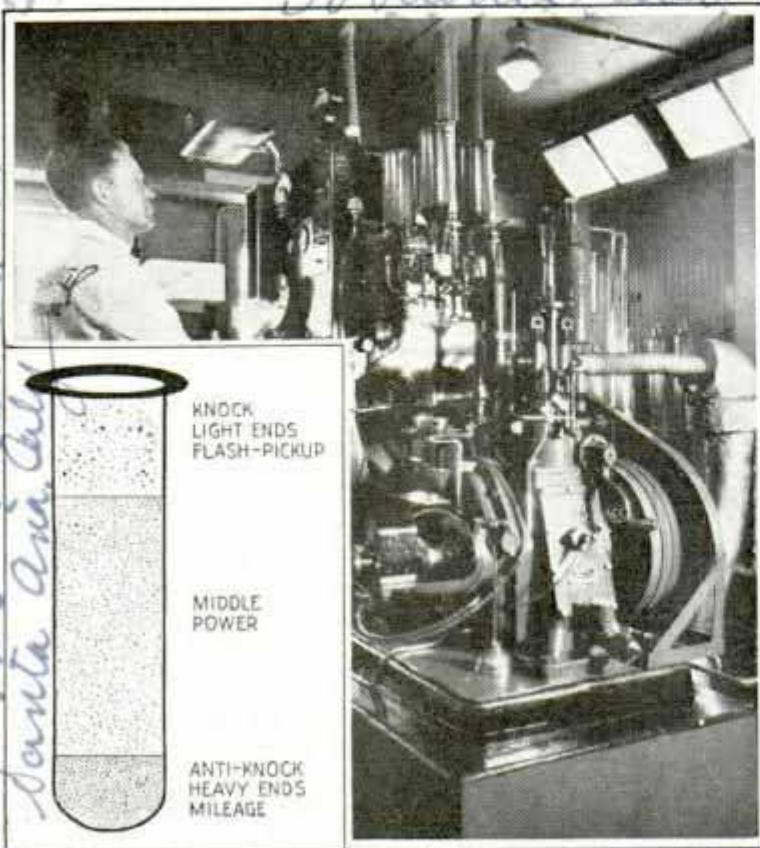

Test Engine for Measuring Gasoline Knock and Tube Showing the Heavy, Medium and Light Parts of Gasoline

exact balance in gasoline which is desired. Broadly speaking, gasoline is composed of three parts, heavy, medium and light. The heavy parts contain the mileage and anti-knock values, the middle parts constitute the body and provide the power while the light parts give flashy performance including quick starting and rapid acceleration. The ideal gasoline combines maximum mileage, power and flash with a minimum knock. The testing engine determines the point at which the balance between the heavy and light parts produces a knock. The gasoline is first separated in the laboratory into its various parts, or fractions. These parts are then fed into the mixing chamber of the engine. When the percentage of lighter parts reaches a certain point, the engine starts knocking. This point is given a numerical rating which is the octane or anti-knock rating of the gasoline. A

Gasoline is rated according to its anti-knock qualities by a testing engine employed by one oil company to produce the

gasoline with an octane rating of seventy, for instance, has a higher anti-knock value than a fuel with a rating of sixty.

Locomotive Has Six Engines but Will Run on Any Five

Fitted with six engines, any one of which may be disconnected in an emergency, a twelve-cylinder mountain-type steam locomotive has been built in England for use in the Andes of South America. The locomotive will operate on any five of its engines. The disabled engine can be disconnected in five minutes. Steam is produced in less than half the time ordinarily required. The boilers are constructed so that every part of each tube can be seen from the locomotive cab and can be cleaned easily. It is

claimed that this type of engine saves fifty per cent in fuel costs.



Mountain-Type Steam Locomotive for Use in Andes; It Has Twelve Cylinders and Six Engines but Can Operate on Five

Com. Ralph Barber, Valencia, Santa Ana, Calif. 12465

The Central Wagon Works, Ltd. Locomotive Works

add strength to the cylinders under the engine

Com. Welton

D818 Torrance Refinery General Petroleum Co. Torrance, Calif.

D852

**TRAIN OPERATES TUNNEL DOOR
WHEN IT APPROACHES**

Railway tunnels on a scenic route in the Swiss Alps are equipped with doors at each end to prevent the formation of ice on the walls and the seeping of snow through the entrances. The doors are opened automatically as an electric train approaches the entrance or exit and are also closed after the train has passed. The doors also contain two slots which open automatically to release the currents of air set up by the passage of the train through the tunnel. Colored lights indicate whether a tunnel door is open or closed. The approaching train makes contacts which start a two-horsepower motor, this in turn opening the door. As the train passes similar contacts cause the motor to reverse its action and close the door.

Engl. Walker



Doors at Entrance to a Railway Tunnel in Swiss Alps Which Open Automatically as Train Approaches

**FIRE PROVES FRIEND OF TREES
IN DESTROYING INSECTS**

Fire, normally the greatest enemy of timber growths, has been converted into a friend of trees in United States forestry work in Utah. Man-made pillars of flame



Setting Fire to a Tree Which Has Been Sprayed with Oil to Eradicate Insect Pests

envelop trees in valuable stands of timber as a part of the forest-service insect eradication work. Forestry workers carry tanks of oil and the tree is first sprayed with the oil, then the infested area is set afire. Each spraying crew is followed by men with shovels to prevent the spread of the blaze.

**PROTECTOR FOR GASOLINE TANK
PREVENTS THEFT OF FUEL**

Gasoline cannot be stolen from an automobile tank equipped with a protector which is installed permanently in the neck of the tank. The protector does not interfere with filling the tank, but a series of traps prevents siphoning. The protector can be installed in a few minutes.



Alpen, Utah

Diplo 50 cent

Other cars \$1.00

King's Gas Protector



Steam Rising from Water as Big Boat Was Being "Boiled" to Release Congealed Oil

STEAMER IS "BOILED" IN WATER TO FREE CONGEALED OIL

In a huge "kettle" 400 feet long and sixty feet wide, the 9,000-ton steamer, "Royal Star," recently was "boiled" in water like a big fish at a dock in England. The purpose was to release a large quantity of congealed oil which had accumulated in the false bottom of the boat. The dock was partly flooded with water and the water was brought to the boiling point with the aid of steam pipes extending into it, thus freeing the oil.

at North Shields, Eng.

from rattling or shaking loose and the danger of soiling upholstery or clothing is eliminated since the extra oil is under the hood instead of in the car with the passengers. Little time is required to transfer oil from the carrier to the crankcase.

D 823

AERIAL SWING LOOPS THE LOOP FORTY FEET ABOVE GROUND

Those who have wondered about the sensation of looping the loop in an airplane can now find out for themselves, without going more than forty feet off the ground, by climbing into a swinging gondola, California's latest ride thriller. The swinging gondola consists of a metal compartment, seating six persons, mounted between twenty-foot steel girders. It is attached to a cross bar on top of the girders in such a manner that it is free to revolve in a vertical plane. The passengers are strapped in with airplane safety belts and the gondola travels at a speed of fifty-

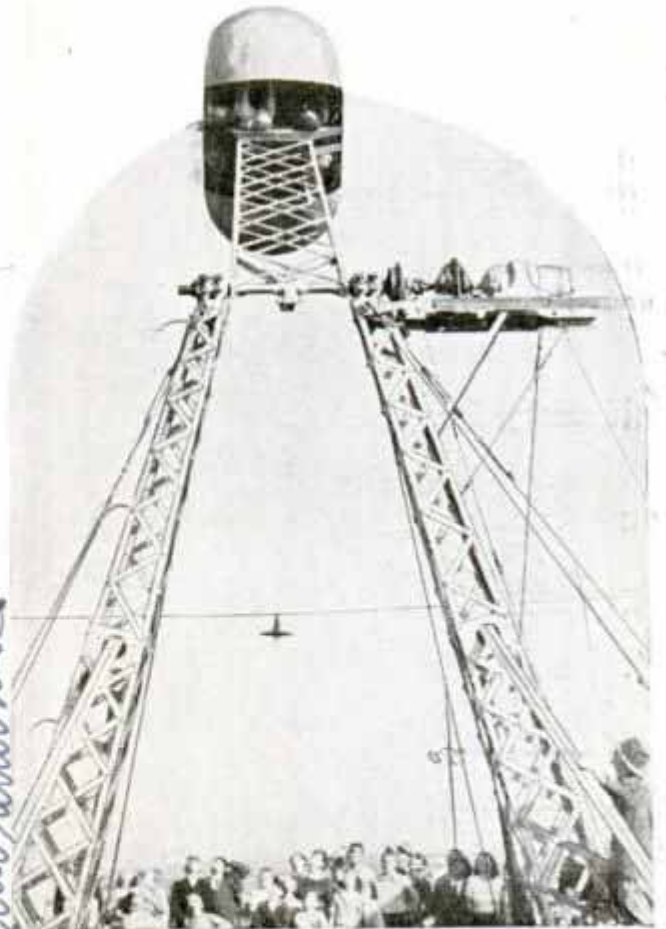

Passengers in Inverted Position as Aerial Swing Loops the Loop Forty Feet above Ground

HANDY CARRIER FOR MOTOR OIL CLAMPS UNDER HOOD OF CAR

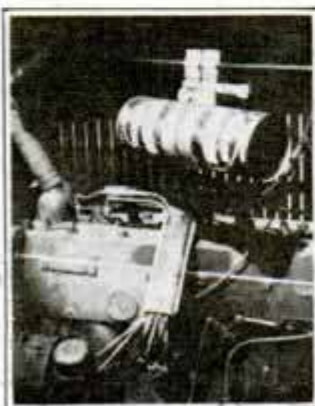

Taking extra motor oil on a long car trip is made a simple matter with the aid of a carrier which supports two quarts of oil and attaches to the braces which support the hood. Clamps prevent the carrier

Letter returned

five miles per hour, being forty feet above the ground and with the passengers upside down at the top of each swing.

Mr. Peter J. Garchi, Paul *Mr. John Branson*

Curhart, Marcon
Chis

MAGIC for Everybody

THERE were three queens. They were very chummy. Wherever you'd find one, you'd always find the others.

Do it like this. Locate the four queens in a deck of cards. Arrange them, with three indifferent cards, in the manner shown in Fig. 3. Conceal the odd queen behind one of the cards and exhibit the fan of cards to the audience. They will see three queens and three off cards. Now, place the cards face down on the deck. Deal off the cards in two piles, a card at a time to each pile. When you come to the sixth card, slip it under the two cards in the right-hand pile, as shown in Fig. 2, and return these three cards to the deck. Show the other pile. They are the three queens. Place the ladies on top of the deck and deal again, following the same procedure as before. You'll always find three ladies in the left-hand pile.

Here's a simple little stunt that



①



②



④



③

The Light and Heavy Match Packs

⑤





will keep them guessing for awhile. Show three packs of paper matches. Announce that your sense of touch is so delicate you can detect the removal of a match from any particular pack. Allow a spectator to remove a match from any clip to prove it.

It's very simple. You open each pack, and give the flap a bending twist, as shown in Fig. 4. When the pack is closed, this will result in a slight projection, as shown in the lower part of the sketch. If you insert the flap tightly, however, you can make it line up perfectly, or better, project a little on the opposite side. You can easily tell which pack the spectator opens by simply glancing at the telltale projection.

Can you do this one? Here are two glasses—one full and one empty—arranged as shown in Fig. 7. Can you drink the contents of the lower glass without touching the upper glass with your hands, or removing it from its place on top of the full glass? The stunt is done in the manner shown in Fig. 6. This fulfills all of the conditions.

Threading a needle is no trick at all.

Take a length of string and wrap it three or four times around your left thumb, as shown in Fig. 8. The end marked "A" is the end you start with; the end marked "B" is the end that is wound around. Make the eye of the needle as shown in Fig. 9. Notice that end "B" of the string makes the inside of the loop "C." Now, take the end, "A," and make a few stabs at the loop. Threading the needle is done in a jiffy by simply giving a little side jerk on "A" as you make the stab at the loop. Looking at the exposed view, Fig. 10, you can see that the end, "A," simply slides up the end "B" to find its way into the loop. It's rare fun when done quickly.

Here's a good chemical stunt and you can get all the stuff for a few dimes at the drug store. You need a jug or a bottle of at least one pint capacity, also four glasses. Fill the bottle with water, and add to it about as much sodium salicylate as you can heap on a quarter. Also, add about ten drops of



sodium hydroxide. Glass No. 1 contains two drops of ferric chloride; glass No. 2 contains about three drops of phenolphthalein; glass No. 3 has about ten drops of copper sulphate; glass No. 4 contains about twelve drops of strong oxalic-acid solution. Pour the contents of the bottle into the glasses and you will get sherry in the first glass, red wine in the second, green Chartreuse in the third, and water in the fourth. The fourth glass, of course, is the one on the Scotchman. When he

suggests that the four glasses be mixed together to give his some flavor, the contents of the whole bottle turn back to water again!

You have four little numbered cards, as shown in Fig. 13. On the reverse side of each card is another set of numbers, as shown in Fig. 14. All of the cards are different colors, the white card being known as No. 1; the red as No. 2; the yellow, No. 3, and the blue, No. 4. Now, exhibiting the cards as shown in Fig. 13, you request a spectator to pick up a card and mentally choose any number on the face of the card. The cards are then turned over so the numbers will form a circle, as shown in Fig. 14. The performer asks the spectator on which color he sees his number. The performer immediately calls out the selected number.

This is simple. Notice that when the cards are turned over to form a circle, the lowest number on each card makes up the four original numbers on card No. 1—the white card. In a similar manner, the second-lowest num-

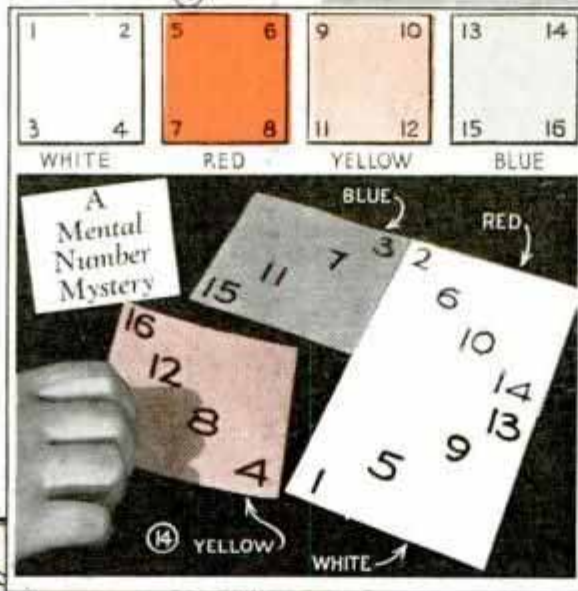

ber on each card makes up the four original numbers on card No. 2—the red card. Knowing which card the spectator picked up originally, you can easily tell him his number when he announces what color his number is in the circle.

Take a loop of string. Wrap it four or five times around a pencil, as shown in

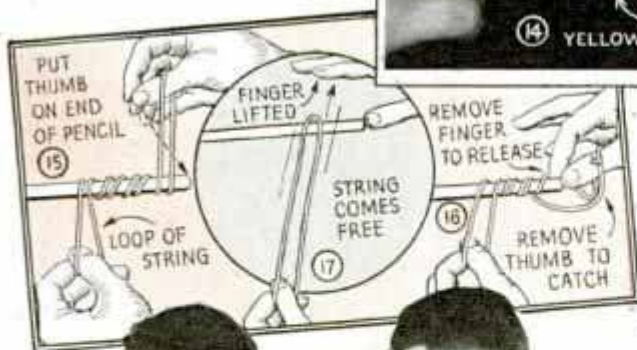

Fig. 15. Now, bring your thumb down between the two strings of the loop, as shown by the arrow in Fig. 15, and by the position thus taken, Fig. 16, grasping the end of the pencil lightly between thumb and forefinger. From this position, if you lift your finger from the end of the pencil, the loop will come free; if you lift your thumb, the loop will not come free. It's another of those things proving: "It doesn't pay to gamble with strange people."



Flies get the blues when they encounter blue colors, according to the findings of a British metal-box company. The company produces tins for kitchen supplies and discovered that flies appeared to shun all the boxes painted blue although no one could find the reason for their dislike.

Cook Montagues!



Combination Camera and Microscope Which Makes It Easy for Amateur to Make Microphotographs

CAMERA-MICROSCOPE OUTFIT READY FOR THE AMATEUR

Designed to give the amateur good results at moderate cost, a new camera and microscope outfit is on the market. The microscope is bakelite and chromium, equipped with the curved arm typical of instruments used in the laboratory. It may be used as a micro-projector and for photomicrography. Two objectives accompany the instrument, giving magnifications of seventy-five to 300 diameters. The camera is mounted so that it may be swung into position for taking the picture after the slide has been prepared. A booklet supplied with the outfit tells how to prepare slides of interesting subjects.

NON-SLIP GOLF CLUB TAPE GIVES POSITIVE GRIP

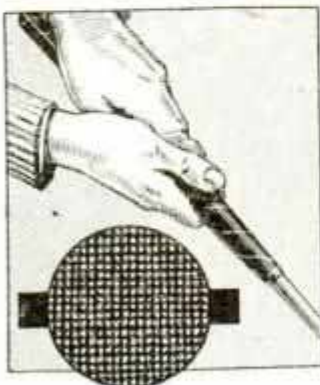

Special tape for wrapping the shaft of a golf club gives a positive grip when the hands are moist and thus allows the golfer to relax his hold when making a shot. Ridges and depressions in the tape mesh with

those of the hands so that when dry, friction keeps the club from slipping and when

wet, suction and vacuum give a secure hold. The tape is applied without glue by first wrapping the shaft with ordinary friction tape.

INDUCTION OVEN COOL TO MAN BAKES PAINT ON METAL

Cool to the human body but hot to metal, an induction oven is being used in Plymouth Motor corporation plant to bake the paint on metal parts, such as radiator shells and wheels. The oven is a method of heating iron or steel by causing the metal to be carried through a magnetic field. Electricity is generated at 360 cycles, 440 volts, three phase and transmitted through a series of wire coils wound around the interior walls of the oven. Baking requires fifty-five minutes, compared to three hours for the old type steam-heated ovens. The induction oven produces a temperature of 230 degrees in metal, but a person sitting beside the iron or steel bar will not feel uncomfortable.

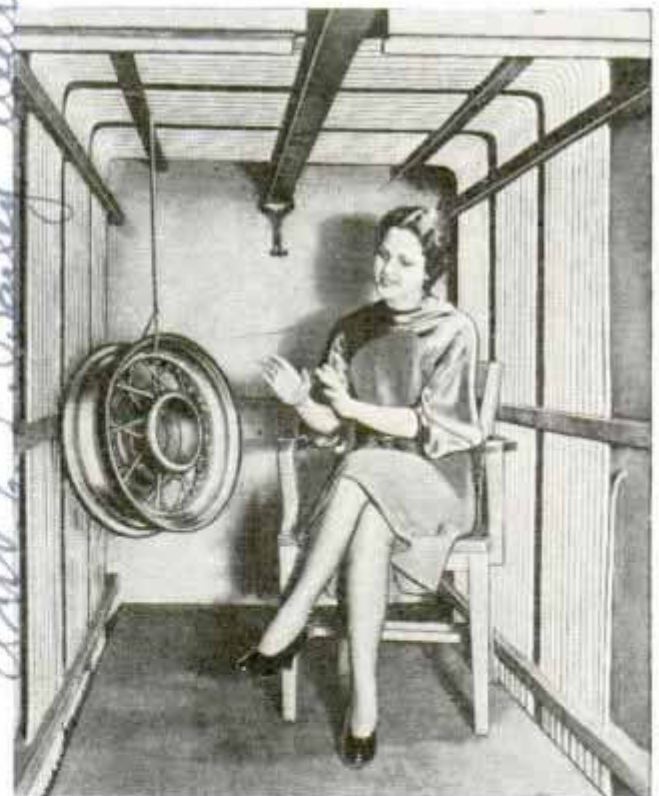

Induction Oven for Baking Paint on Metal; It Heats the Metal but Is Cool to the Human Body

Names and addresses of manufacturers and dealers in articles described in this magazine will be furnished by our Bureau of Information upon receipt of a stamped, self-addressed envelope.

Bausch + Lomb Optical Co. Rochester, N.Y.

Dun & Bradley Electrical Engineers

Kleber, Esq. Co. Atlanta, Ga.

Compressed-Air Stabilizer Stops Roll of Ship

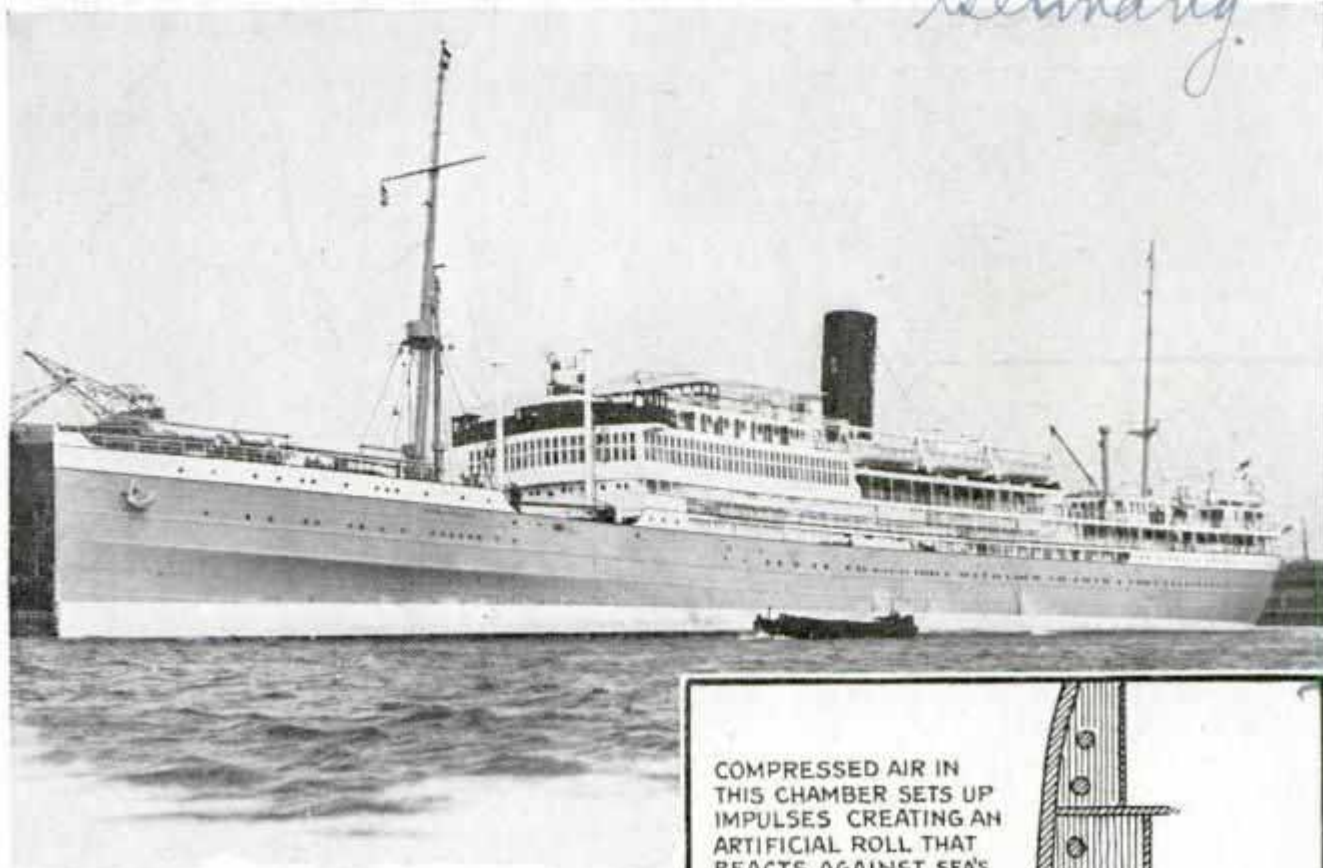

Ocean Liner Equipped with Compressed-Air Stabilizers; Shown at Right, to Prevent Rolling

By using a compressed-air stabilizer on each side of the hull, a Dutch liner eliminates the rolling of the vessel in a heavy sea by creating a counter roll to balance the ship. Steam or compressed air develops the counter impulses which are imparted to the water about the boat. The stabilizers consist of vertical tubes, one attached to each side of the liner, and open to the sea at their lower ends. The water level in the tubes is the same as in the sea outside but as the ship rolls, so that the water tends to rise in one tube, the compressed air comes into action and the force it exerts on the water tends to right the vessel. In permanent installations the tubes can be built into the hull instead of projecting from it amidships. In each tube a chamber of fourteen cubic feet capacity is fixed at the top, and an auxiliary air compressor supplies a pressure of 140 pounds per square inch, the air reaching the stabilizers through a pipe extending inside the hull. In permanent installations automatic valves would supply the compressed-air impulses to the tubes each time the vessel attempted to roll. It is

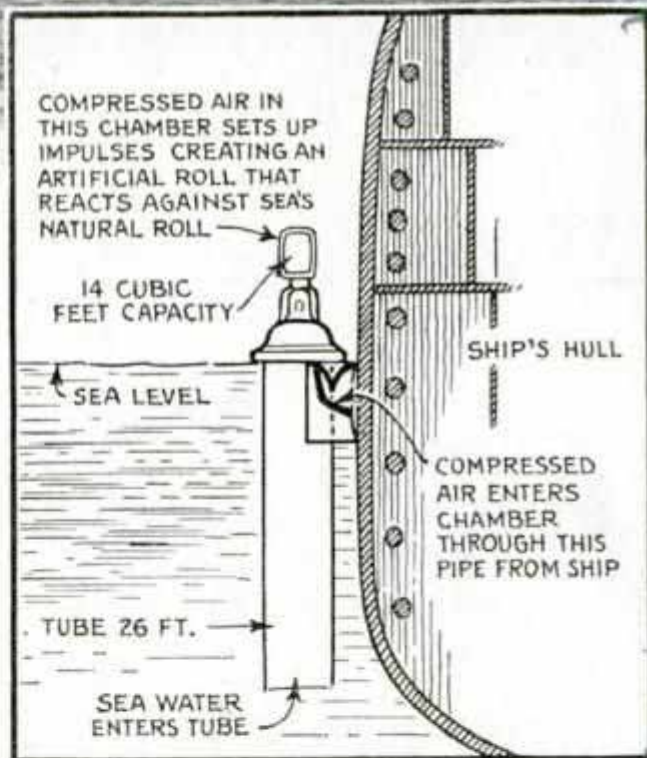

claimed the system is inexpensive to install and to operate.

SILVER USED AS DISINFECTANT

One part of pure silver in a quarter billion parts of water may replace chlorine and oxygen as a disinfectant for swimming pools, artificial ice and drinking water. A process for activating water with silver originated in Germany. The activation is accomplished by a small tank-like apparatus installed in the supply pipe.

N.V. Rotterdamse Katadyn process

Handwritten notes on the right margin:
 6/7/34
 45 lbs of silver
 1941
 1942
 1943
 1944
 1945
 1946
 1947
 1948
 1949
 1950
 1951
 1952
 1953
 1954
 1955
 1956
 1957
 1958
 1959
 1960
 1961
 1962
 1963
 1964
 1965
 1966
 1967
 1968
 1969
 1970
 1971
 1972
 1973
 1974
 1975
 1976
 1977
 1978
 1979
 1980
 1981
 1982
 1983
 1984
 1985
 1986
 1987
 1988
 1989
 1990
 1991
 1992
 1993
 1994
 1995
 1996
 1997
 1998
 1999
 2000

Mechanics of TEACHING

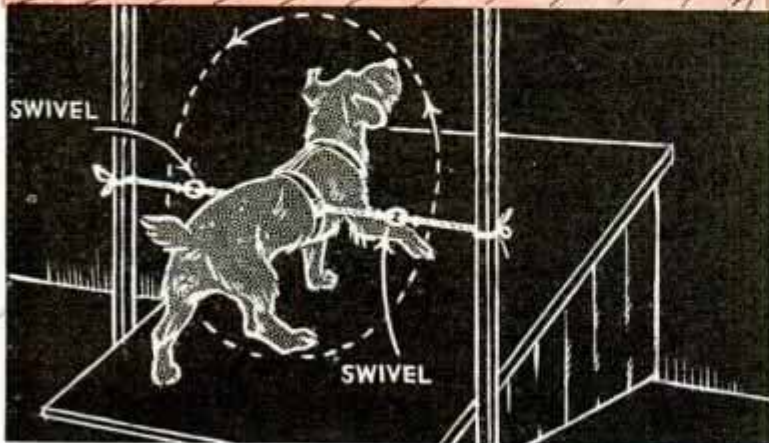
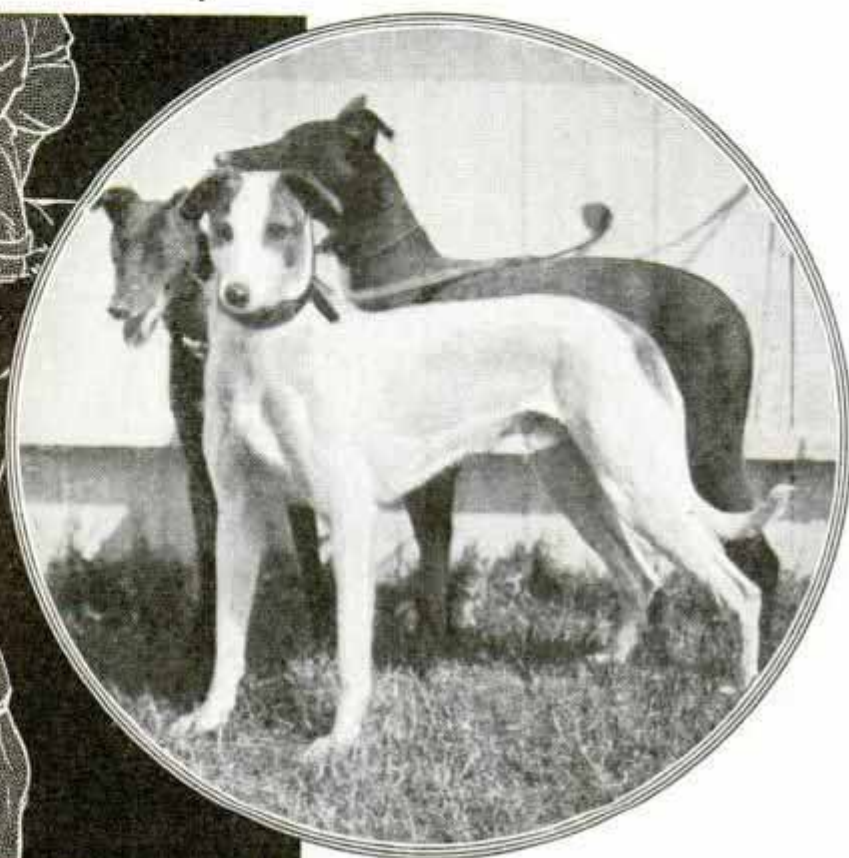
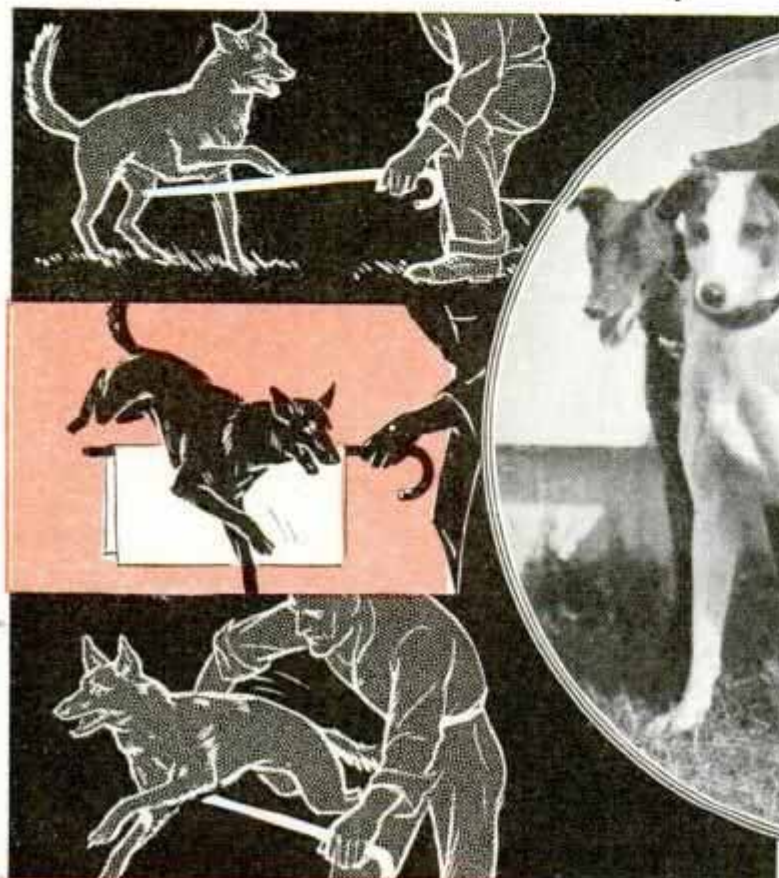

By FRED C. KELLY

A FRIEND gave me a large fishing reel, the kind used in catching tarpon, a while ago, but as I never fish for anything larger than brook trout, I used the reel to teach a dog to stop in his tracks on command.

A dog learns by association of ideas. If he discovers his master's whistle invariably means food, he is glad to come when he hears the whistle and forms this habit until he comes just as readily even though, later, he gets no food. He can be greatly encouraged to associate the whistle with the idea of running toward his master, by putting on him a collar having dull spikes on the inside, a training collar. The master yanks him by a long cord simultaneously with the sound of the whistle. Thus the dog can't well help associating the whistle with running toward his master, for if he fails

Racing Greyhounds and Teaching Dog to Jump through Arms, Refrain from Fighting and Back Somersault

Your DOG

"History Hills"
Pensacola, Ohio

Right, a Winner of Twenty-Three Championships; Below, Using a Fishing Reel to Teach a Dog to Stop When Ordered

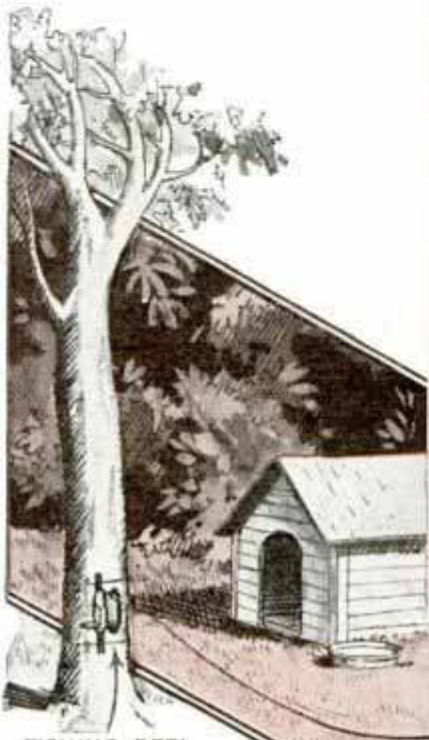

FISHING REEL

to do so promptly he finds himself compelled to come.

It was this kind of association I had in mind when I hit on a use for the tarpon reel. First, I attached the reel to the handle of a fishing rod and tied the rod to a tree. Then I wound on the reel a stout cord 100 feet long. I marked a spot where this cord would reach when completely unwound. I fastened the end of the cord to the dog's training collar, with the dull spikes inside, and we were ready to proceed with a lesson. Starting from the tree, I ran and called the dog to follow me. He gladly did so. As we approached the spot where I knew he would have to stop, at the end of his rope, I shouted "stop!" But he either did not think I was serious, or else was too intent on plans of his own, for he did



not slow down until he had to. We tried this over and over and it was surprising how slow he was to realize that it would be more comfortable and better to halt when I gave the signal. Gradually, however, he got the spirit of the thing and did actually stop just a little before the cord

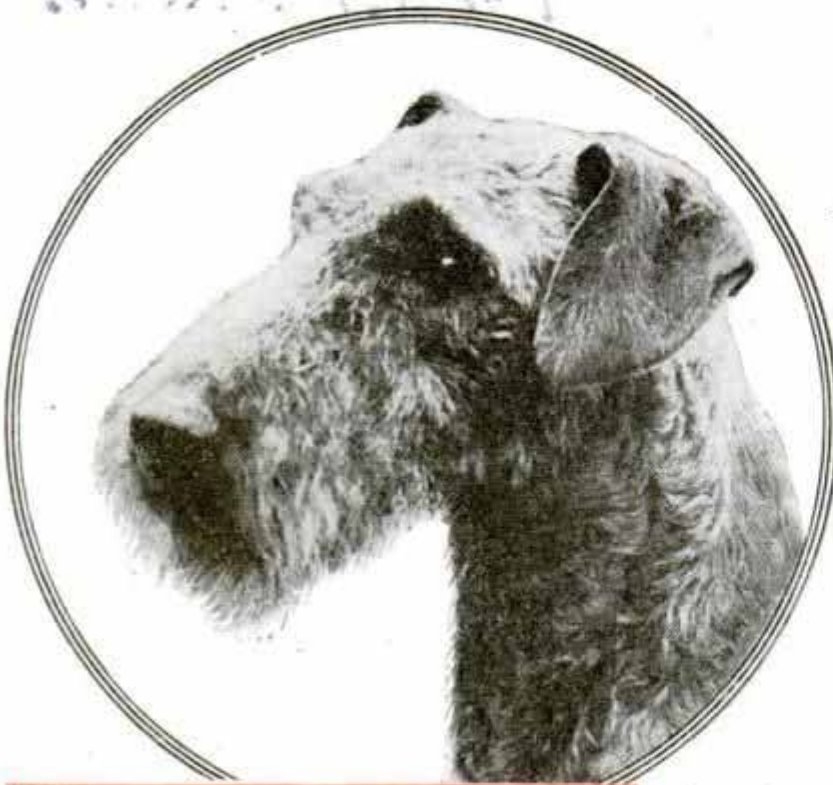

the dog knew what one desired him to do, the skill required would make the feat difficult enough. I used to feel ashamed of myself when trying to teach the trick to dogs when I reflected that I couldn't do it myself—even though I knew what I was supposed to do, and the dog did not. After years of curiosity about this trick, the last time I saw it done in a circus I hunted up the dog trainer after the show and asked him for an explanation.

Like most mysteries, it was simple enough when understood. The man showed me a little harness consisting of a girdle around the dog's body, on each side of which were two straps attached by swivels to permit the dog to turn over and over without twisting the straps. The trainer described how he would start the dog up a little inclined plane, holding these straps and turning the dog over in mid-air, after which he would reward him with a piece of meat. Of course, he carried out this training when the dog was hungry and consequently anxious to go to any length to obtain food. He made the dog wish to do the trick. The dog soon started to help



became taut. After a day or two of practice I had him in a frame of mind ready to follow orders instantly, even without any cord or collar. For years afterward I could make him stop instantly, even if he were rods ahead of me, just by shouting a command. Indeed, I once saved his life when he was chasing another dog. I saw that he would run in front of a rapidly approaching automobile. It is not easy to divert a dog's attention from another dog just ahead, but my shout of his name and "stop" got into his consciousness and he halted. He had never ceased, somehow, to think that when I said to stop, he must do so or else feel those jabs on his neck.

For years I wondered how performing dogs in circuses and traveling shows were trained to turn back somersaults. Even if



Photo by Fail

Top, a Thoroughbred; Below, Teaching Dog to Come at a Whistle, to Stop and to Beg

himself and would spring with his hind legs at the proper time to throw himself over backward. Gradually the straps could be dispensed with.

To make a dog jump through your hands may seem fairly difficult and yet I believe I can teach this trick to almost any dog in about ten minutes —by building associations, and in easy stages. First I make sure the dog is hungry; then I hold a cane in my hands only an inch or two above the floor, and make him walk over it toward food, temptingly displayed. Gradually I raise the cane a few inches. After I have increased its height, I drape a newspaper or cloth over it to make it more natural for the dog to go over it rather than under it. If he does not go over it, I refuse to give him the food. In a short time he recognizes that he must go over the cane to obtain the coveted chunk of meat. The next stage of training for this simple trick may be to hold the cane with my hands on it only a few inches apart; the final stage is to dispense with the cane entirely and clasp my hands together. The whole process, as I say, may be gone through in a few minutes.

John B. Watson, eminent psychologist, told me of an experiment in which he had two fighting pit bull terriers in an enclosure, the entire floor of which was covered by wire netting which could be electrically charged. Not enough current was used to hurt the dogs but only to startle them. Whenever they walked toward each other growling and intending to fight, an observer turned on the current. So long as they behaved politely toward each other and did not growl, they received no electric shock. Soon they learned to accept the evidence that it was unwise to fight. Thus observers had the amusing experience of seeing two able-bodied dogs eager to bite each other and walking about showing distrust of each other, but nevertheless disinclined to show any overt act of fighting, lest the mysterious sensation come upon them through their feet. They didn't understand it, but quickly discovered how to adjust their behavior.

John B. Watson, eminent psychologist, told me of an experiment in which he had two fighting pit bull terriers in an enclosure, the entire floor of which was covered by wire netting which could be electrically charged. Not enough current was used to hurt the dogs but only to startle them. Whenever they walked toward each other growling and intending to fight, an observer turned on the current. So long as they behaved politely toward each other and did not growl, they received no electric shock. Soon they learned to accept the evidence that it was unwise to fight. Thus observers had the amusing experience of seeing two able-bodied dogs eager to bite each other and walking about showing distrust of each other, but nevertheless disinclined to show any overt act of fighting, lest the mysterious sensation come upon them through their feet. They didn't understand it, but quickly discovered how to adjust their behavior.

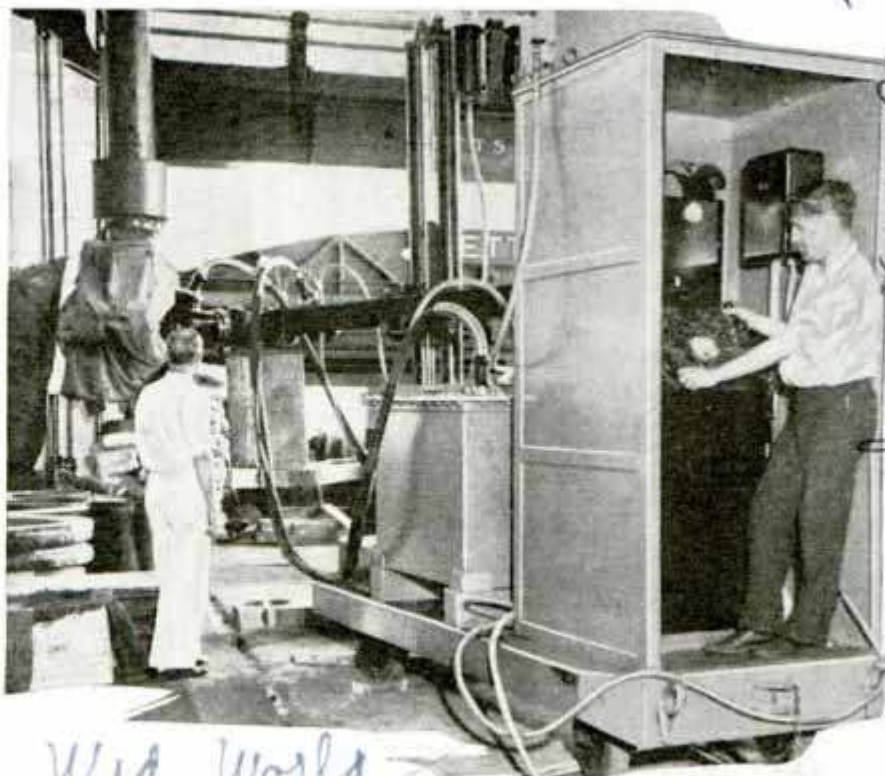

Wid. World
Using Portable X-Ray Equipment to Detect Any Hidden Defects in the Interior of Heavy Steel Castings

POWERFUL X-RAY ON WHEELS TESTS HEAVY STEEL

Hidden cracks in the interior of heavy steel castings are detected by a powerful X-ray machine mounted on wheels. The equipment takes pictures through four inches of steel. Gun carriages, armor plate and other forms of steel construction of the United States navy are subjected to the penetrating rays of the machine, which operates at 220,000 volts.

D814 *Washington*
NAIL FILE FOR CANARY BIRDS KEEPS THEM SINGING

Toenails of canary birds must be clipped regularly if the birds are to do their best singing but clipping by hand often injures the feet. An automatic nail file for the birds is now being offered which wears off the nails as the birds hop around in the cage. It consists of a stick coated with carborundum. The stick is placed in the cage as a perch and the birds do the rest as they hop about on it.



Canary Products Co.

see Jan-1935-96
Washington X-Ray Co
01-16
Industrial X-Ray
617 Washington

NEW CONVENIENCES



Left, Slip-On Cover for Ironing Board Eliminates Lacing, Tacking and Tying; Elastic in Hem Stretches Cover Smooth and Tight; Right, Ice Cream Freezer Is Equipped with Plug-In Electric Motor

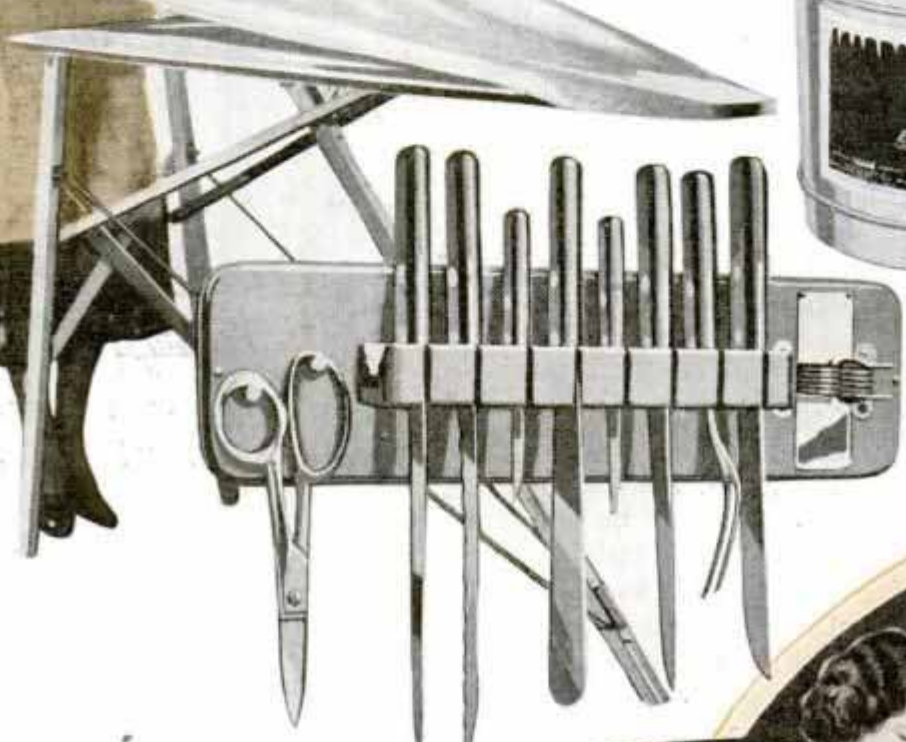

Center, Household Cutlery Rack for Attachment to the Wall Holds Eight Knives of Various Sizes; in Addition to Special Pegs for the Kitchen Shears, It Has a Disk-Type Knife Sharpener; Right, One-Legged Table Makes Convenient Writing Desk or Reading Table; It Uses Both Arms of the Easy Chair as Supports for the Other Side; the One Leg Is Adjustable to Any Height Desired by the User



Above, Paring Knife with Finger Rest Protects the User's Fingers from Soreness; It Is Washed Easily

FOR YOUR HOME

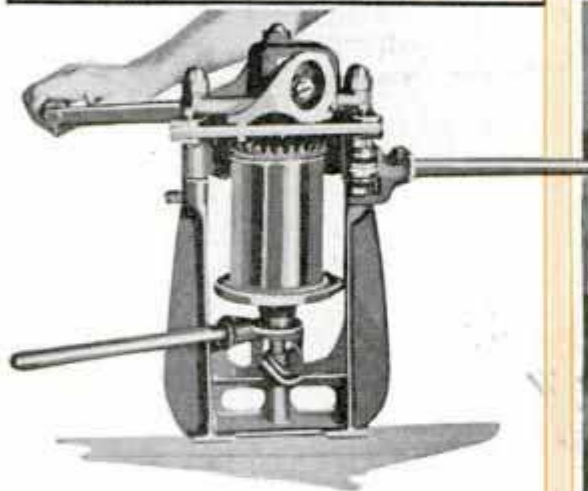

Above, Can-Sealing Machine for the Home Is Operated with One Hand; It Takes Cans of Three Sizes; Can Opener with Reflanging Device Makes Possible Repeated Use of Cans



Top, Double-Deck Bed Designed for Small Apartment; When Used as Illustrated, Stairs Are Required to Reach the Upper Bed; Left, Modernistic Oil Heater with Humidifying Feature May Be Taken from Room to Room; It Warms and Helps Keep Air at Proper Humidity

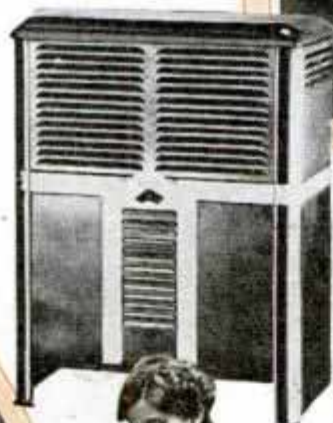

Left, Self-Wringing Mop Fits Any Mop Stick; It Is Lightweight and Easy to Use; Right, Upholstered High Chair Has Added Feature of Being Convertible into Play Yard for the Youngster; Turn of Knob Makes Change Quickly; Chair Is Recommended for the Small Home



no. U. Sagul kman



Portable Stitcher for Closing Bags or Cartons; It Converts Wire into Clips as a Reel Unwinds

PORTABLE STITCHER FOR BAGS AND CARTONS SAVES TIME

Time is saved by a portable stitching machine for closing bags and cartons. Developed in Germany, the device converts wire into clips as a reel unwinds. While one length of wire is fed into the machine by closing and opening a set of handles, one clip is pressed into place and its ends bent to penetrate the paper or cardboard a second time. This process produces a durable binding. The machine weighs less than twenty pounds. It is also adaptable to power operation.

BOLT CONNECTS TWO WIRES WITHOUT SOLDERING



Solderless connectors for current-carrying wires and cables have been developed to speed up the lineman's and electrician's work. The connector consists of a slotted bolt with lock washer, a combination which grips

the two wires to assure positive contact. The conductivity of such a connection, compared to an unspliced wire, is slightly above ninety-eight per cent.

PLACER MINE IS THAWED OUT BY DIVERTING RIVER

Changing the course of a river for gold-mining purposes is not unusual, but a new reason for this procedure was found in the Yukon territory of Canada where part of the flow of the Klondike river is being diverted from its course in order to take the frost out of gold-bearing gravel. Mining operations were hampered by the frozen ground and regular thawing methods were too costly, but the frost is being abstracted inexpensively by diverting a part of the river over the ground.

PONTOON BOAT WITHOUT HULL OFFERS MORE SAFETY

Claimed to be unsinkable, a new passenger boat has no hull, being built on three airplane pontoons. Each pontoon is divided into five separate water-tight compartments. The center pontoon carries an eighty-horsepower engine that propels the craft by means of a straight drive. Loaded to capacity, fifty adults or seventy-five to 100 children, the boat at-

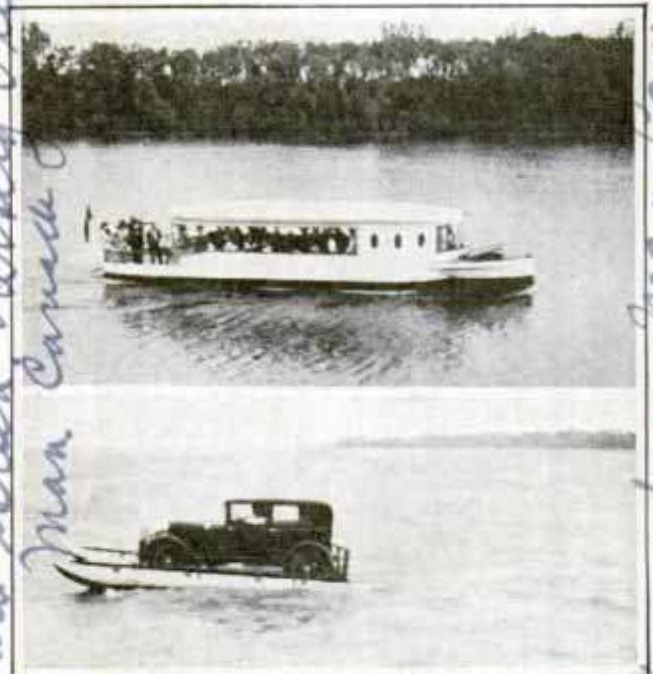

Passenger Boat Built on Airplane Pontoons and an Automobile Carrier of Similar Construction

tains a speed of ten miles per hour with a fuel consumption of four miles to the gallon. The designer sought to offer as much passenger space as possible without building too much weight into the boat, which weighs three tons.

James P. Kearny Corp.

Qual. by J. H. ... C. Slow

Edward Green Variety Club
Man. Canada
Winnipeg, Man. Canada

D 4576

1429 Lafayette Blvd
Blount, Miss

Kelly
1/24/48



AUTO SET

above Windshield

LOCATED at a sufficient distance from the motor to avoid interference, no spark-plug suppressors are required with this auto receiver which is shaped to fit in the top of the car. The hinged brackets at the forward end are adjustable for various contours of header panels and the bow supporting bracket is also adjustable.

Maximum performance is claimed because of the receiver's close proximity to a standard roof antenna and the elimination of losses in the usual shielded antenna



lead. A small speaker is built into the cabinet, which is easily installed, as shown in the photos. Two hinges on the windshield header may be seen in the center photo as the

unit is swung down for service and inspection. A pair of threaded studs in one of the wooden roof bows hold the set in position for operation and there are only three wires to be connected.

This set is a self-contained 5-tube variety with B-battery eliminator, dynamic speaker, tuning, volume and tone controls. A total weight of only 12½ pounds is indicated in the lower photo which also shows the location of the various controls. The dynamic speaker is a compact type designed for good volume and tone. A proposed 7-tube set of this type will require a chassis only 13¾ in. long.

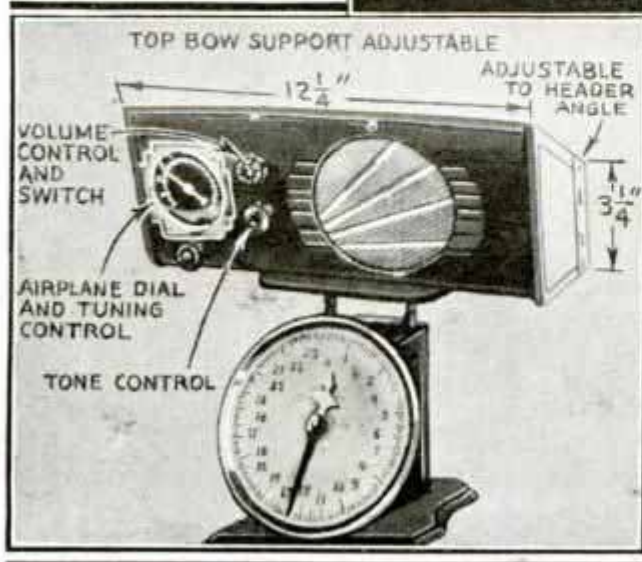

BEGINNERS' *for*



By
PERRY S. GRAFFAM

HERE is an opportunity for the beginner to construct a really efficient two-tube short-wave receiver, with no coils to wind. In a good location, round-the-world reception on head phones is possible with this simple little set. No freak circuit is employed; it consists of a regular regenerative detector and one impedance-coupled audio stage. The tubes are operated with a 2½-volt filament-lighting transformer plugged into the 110-volt house-lighting circuit. Two small 45-volt B-batteries, or an inexpensive B-eliminator,

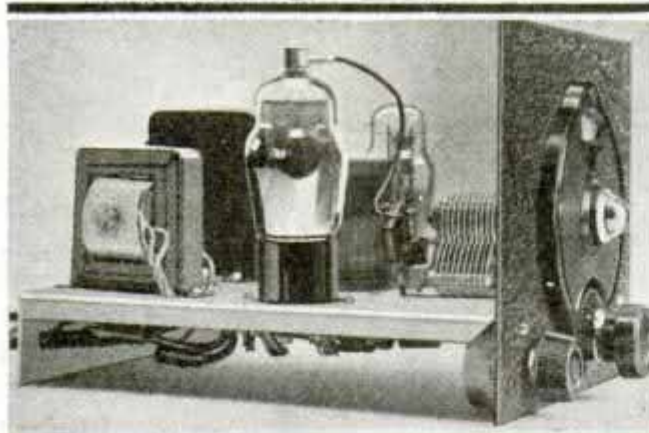
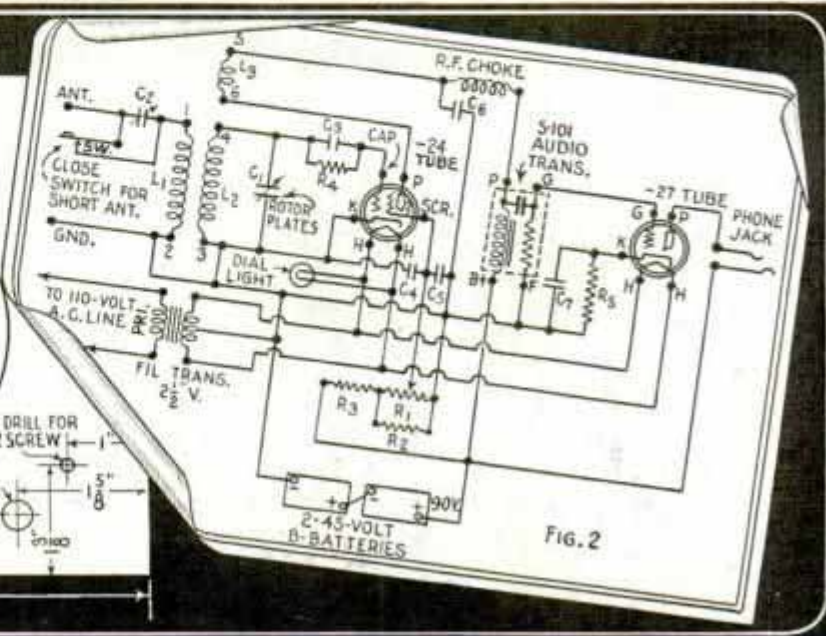
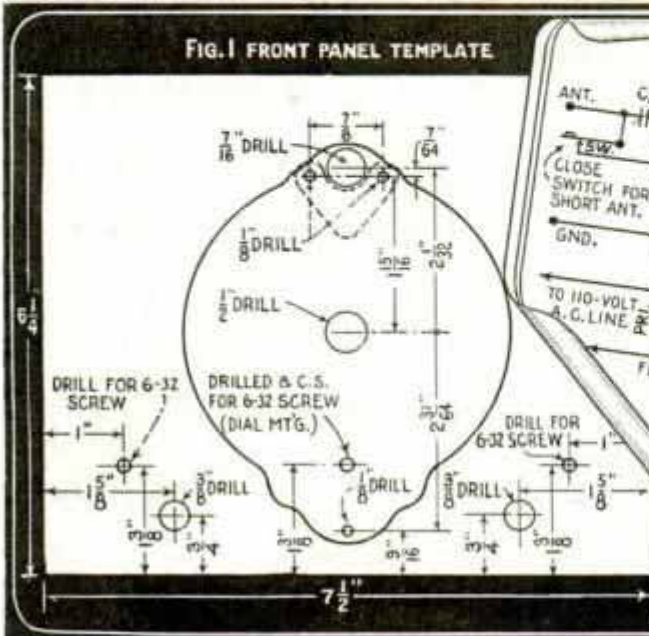

FIG. 1 FRONT PANEL TEMPLATE



TWO-TUBER Short Waves



may be used for the plate supply. However, B-batteries will last for many months and the cost of operation is quite low.

The builder will need a medium-size screwdriver, wire-cutting pliers, small fly-cutter, a hand drill and an electric soldering iron. If the drill and fly-cutter are not available, your local garage man or tin-smith will be willing to drill a few holes in the panel and base for you. Figs. 1 and 4 show the front panel and base layouts; $\frac{1}{16}$ in. eraydo or aluminum is recommended and may be bent to shape between blocks of wood clamped in a vise. They are also available formed and drilled for those who do not wish to make them. If the two side bends prove difficult they may be omitted as they are only for the purpose of reinforcing the base. If these bends are not made, two $\frac{1}{4}$ -in. metal bushings

(Continued to page 114A)

Simplified Wiring Diagram Fig. 3 Shows "X-Ray" View of All Connections Looking Down on the Base

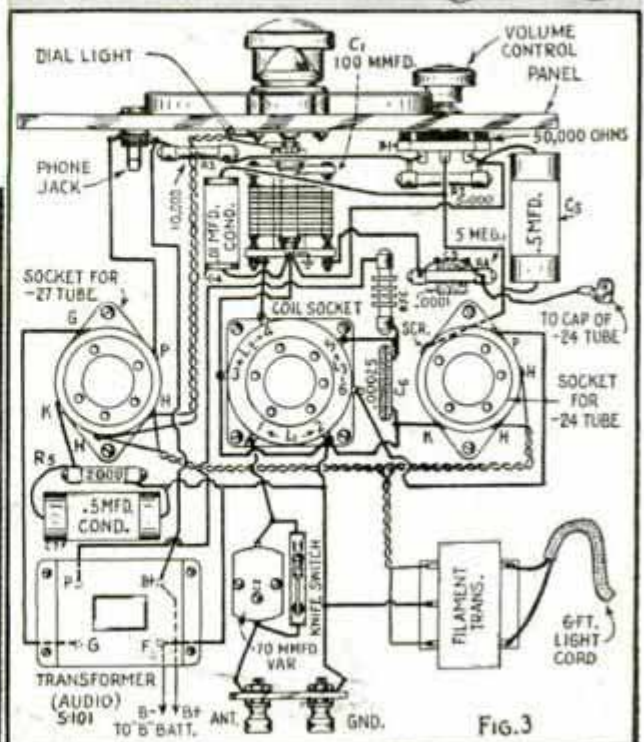
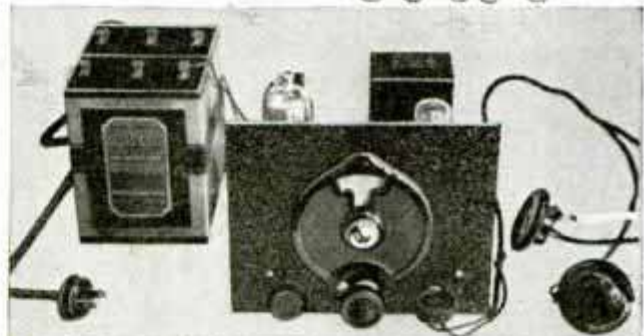

Easy Solutions for Common Radio Problems

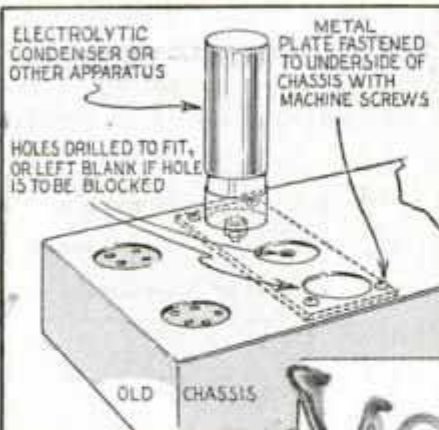

Left, Converting Old Radio Bases to New Uses by Means of Metal Plates for Blocking Out Large Holes; Below, Interference from Neon Signs Greatly Reduced by Fastening All Sharp Letter Points Together with Fine Copper Wire Connected to Ground; Right, Inexpensive Flat-Type Wire-Wound Voltage Divider



Panel Bushings Pressed into Position with Ordinary Vise; Hole Is Drilled for Force Fit; Below, Simple Remedy for Slipping Knobs



Below, Homemade Connector Bushing for Shielded Auto-Set Battery Cable

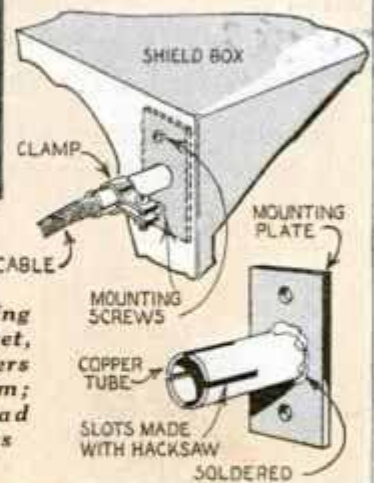

Above, Separable Form-Fitting Tube Shields for Midget, Portable and Auto Receivers Where Space Is at a Premium; Below, Handy Test-Lead Adapters from Scrap Parts

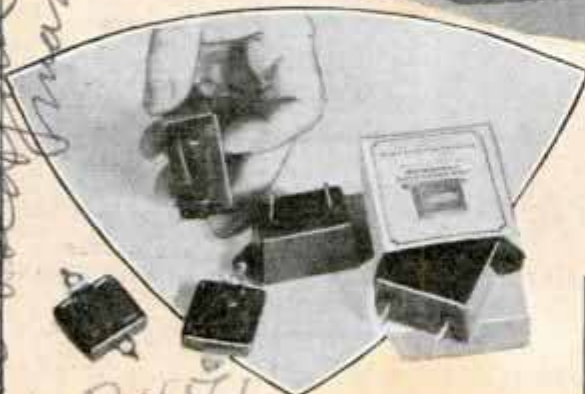

Compact Mica and Non-Inductive Low-Loss Fixed Condensers in Bakelite Cases, Recommended for Use in Damp Climates

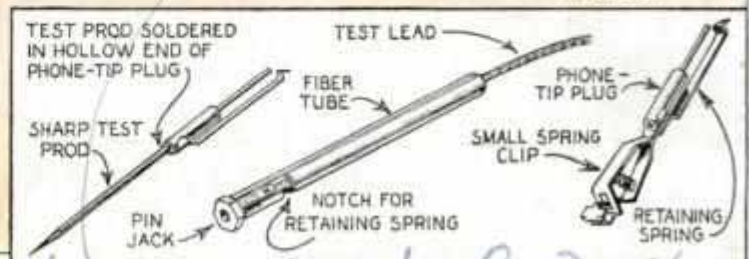

Vertical text on the left margin, possibly a name or address.

D 4584

D 4585

D 4561

Horizontal text at the bottom margin, possibly a name or address.

D4578 Sherman Malden Mass

Radio Corp
833 W. Jackson Blvd
Chicago

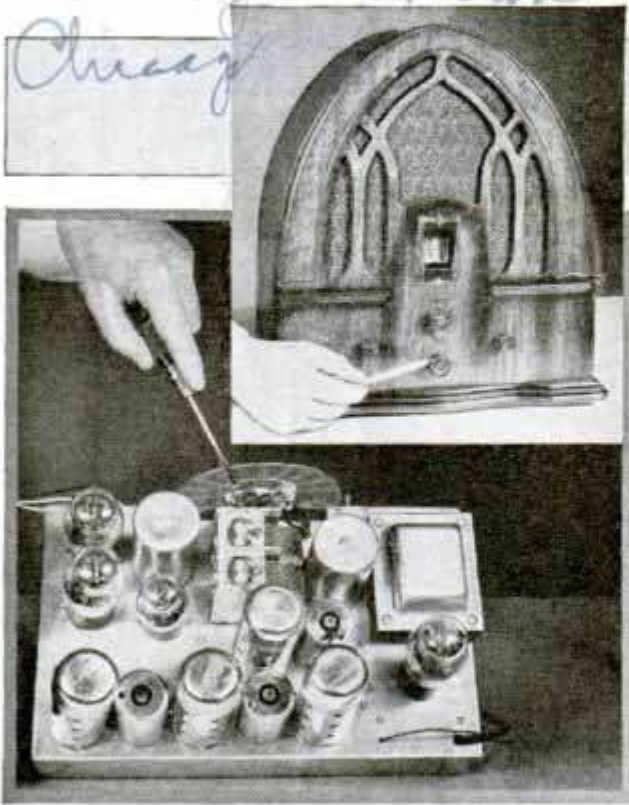

All-Wave Receiver with Band Selector and Vari-Colored Pilot Lights Indicated

Eight-Tube Receiver Covers Five Bands

This table-model superheterodyne receiver tunes from 13 to 2,500 meters covering the ultra-short, short, broadcast and ultra-long wavelengths on five bands. Selected by means of a multiple switch, each range is indicated by a different colored light behind the tuning dial. Automatic volume control insures uniform power when tuning the various bands.

Mirror-Drum Televisor in Kit Form

Assembled from a kit of parts, this English television scanner employs a 30-mirrored drum. In operation, with the usual television receiver, a light source is modulated by the incoming television signals, passed to a Kerr cell, and the resultant varying light-beam goes through an optical system to the revolving drum from which it is reflected to a screen to build up a black-and-white image.

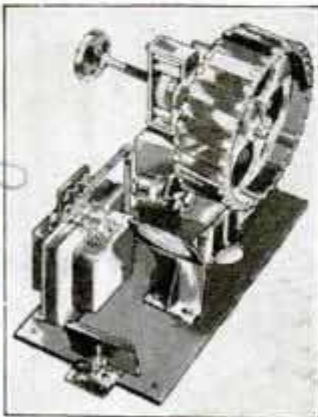

Cathode-Ray Oscilloscope for Amateurs

Most experimenters, service men and amateurs, particularly those interested in phone transmission, recognize the cathode-ray oscilloscope as an extremely useful piece of apparatus. Until recently, however, this equipment has been complicated and the tube rather expensive. The compact unit illustrated is now available and employs the RCA type-906 cathode-ray tube which costs no more than an ordinary medium-power transmitting tube.



D4575

Code Sender Is Semi-Automatic

The complete alphabet and numerals of the continental code may be transmitted by this keying device with only 51 motions instead of the usual 132. It is claimed to aid the inexperienced amateur in both sending and receiving. Four black keys, when depressed, send 1, 2, 3, 4 and 5 dashes respectively; four white keys send the same groups of dots in a similar manner.

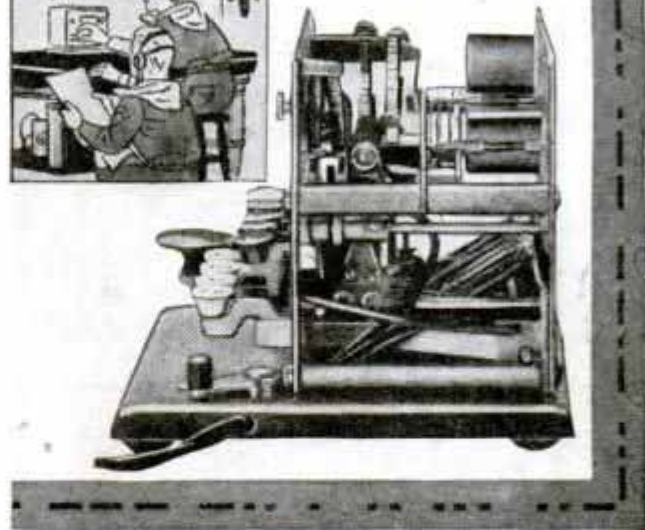

Keying Unit with Cover Removed; Insert Shows Method of Operation

Blueprints covering radio construction articles in past issues can be obtained for 25 cents each; when material lists are not included in the articles, these are available without charge on receipt of postage.

Baird Television Ltd. London, W.C.2, England.
133 Long Ave.
D4582

Chicago
D4578
D4575
D4582
Keying Unit
Blueprints

X 430



AMATEUR MECHANICS

Vikings SHIP MODEL



*a simplified job
for beginners*

By
JOSEPH MINAROVITCH

AS a decorative model, the Viking ship is one of the easiest types to build and is ideal for the beginner. The hull is carved first. Draw a centerline the length of both top and bottom. Then, $2\frac{3}{16}$ in. from each end of the top, a mark is made at the edges of the block. These marks indicate where the curves of bow and stern merge with the straight midship section. The curves are marked in and cut to shape with a coping saw. Paper patterns are made of the stem and sternpost, Fig. 9, and, on the sides of the block, these curves

are also marked in and later cut away. The block is then cut to shape and sanded. In the crosshatched drawings, each square represents 1 in. Next, paper patterns are used for the $\frac{1}{4}$ -in. stem and sternpost, which are cut to shape and fitted to the hull block. They are temporarily nailed in place and, with the hull bottom as a third side, the keel piece is marked for shape and size and is cut out. All three pieces are given a final sanding and are nailed and glued to the hull block with waterproof casein glue.

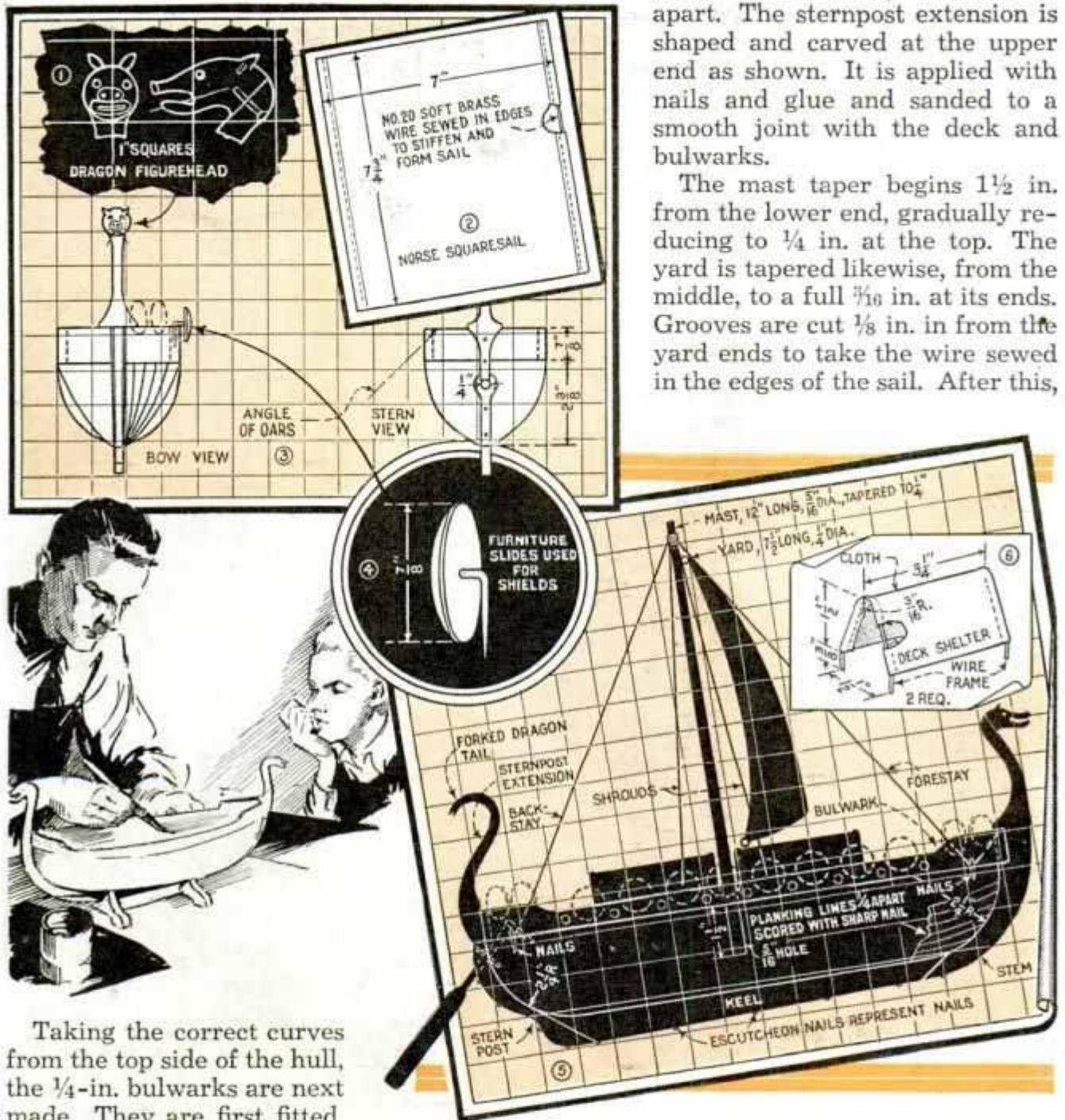

Taking the correct curves from the top side of the hull, the $\frac{1}{4}$ -in. bulwarks are next made. They are first fitted, then drilled at points indicated in the side and top views, Figs. 5 and 7, for oar holes, nailed and glued in place and finally sanded flush with the hull sides. In the stern view, a diagonal $\frac{1}{4}$ -in. hole is drilled for the rudder. Before doing this, two small blocks of wood are glued alongside the sternpost to provide the rounded section at this point. The hole should be drilled from the outside to prevent splitting the sternpost or getting the hole off-center. Halfway between stem and stern, a $\frac{1}{16}$ -in. hole is drilled $1\frac{1}{2}$ in. deep for the mast. Hull and deck are marked to represent planking. The hull lines are $\frac{1}{4}$ in. apart; those on deck, $\frac{1}{8}$ in.

apart. The sternpost extension is shaped and carved at the upper end as shown. It is applied with nails and glue and sanded to a smooth joint with the deck and bulwarks.

The mast taper begins $1\frac{1}{2}$ in. from the lower end, gradually reducing to $\frac{1}{4}$ in. at the top. The yard is tapered likewise, from the middle, to a full $\frac{7}{16}$ in. at its ends. Grooves are cut $\frac{1}{8}$ in. in from the yard ends to take the wire sewed in the edges of the sail. After this,

twenty seat blocks are made and they are glued to deck and bulwarks. Some of the painting should be done now. The hull is dull yellow; bulwarks dull red, inside and outside; the mast and spar white, except for a $\frac{1}{2}$ -in. black tip topping the mast, and the deck and seat blocks are shellacked. The stem, keel, sternpost and its extension are yellow. When the paint is dry, the hull is antiqued by applying a thin coat of burnt umber, which is wiped off when partly dry. The stem, keel, sternpost, extension and dragon's head are now stippled with red, green and black to represent serpents' scales. The nail points of



Soot Raked into Sheet-Metal Container That Fits into Cleaning Hole of Stove

Soot Removed from Stove without Soiling Floor

Accumulations of soot under an oven on a cookstove can be removed without mussing the floor by using this tin container and the cleaning hoe. The loop at the end of the hoe handle is straightened and a wood block is slipped over it and fastened in one end of the container. The assembly is then slipped into the opening under the oven and the soot is raked into the container which is then removed.

Large Envelope Made from Two Small Ones



If a large envelope is not at hand for mailing pictures, drawings, cards or similar items, one can be made by arranging two common envelopes as shown in the drawing. The item to be mailed is placed in one of the envelopes and the other one is put over it, placing it so that the gummed flaps are on oppo-

site sides. Both flaps are then sealed.—
Martin G. Winterton, Fort Lewis, Wash.

Simple Method of Removing Rind from Bacon

Many people who experience difficulty in removing the rind from a piece of bacon will find that the illustrated method solves their problem. Place the bacon, rind side down, on a flat surface and hold it down firmly with one hand. With the other hand, start the knife with a sawing motion between the fat and the rind, pressing the blade firmly against the rind. With this method, the knife will make a clean cut across the entire piece.



Canvas Seat for Child's Use at the Movies

When attending a movie with a small child, this canvas seat stretched between the arms of a theater chair will raise the



Heavy Canvas Seat Stretched between Arms of Theater Chair Enables Child to See Movies

child so that it can see over the heads of people in front. The seat can be folded and carried in the pocket, and consists of a square of heavy canvas with wire hooks sewed to the corners as shown.

HAVE A SMOKE

...if you can find the cigarettes!

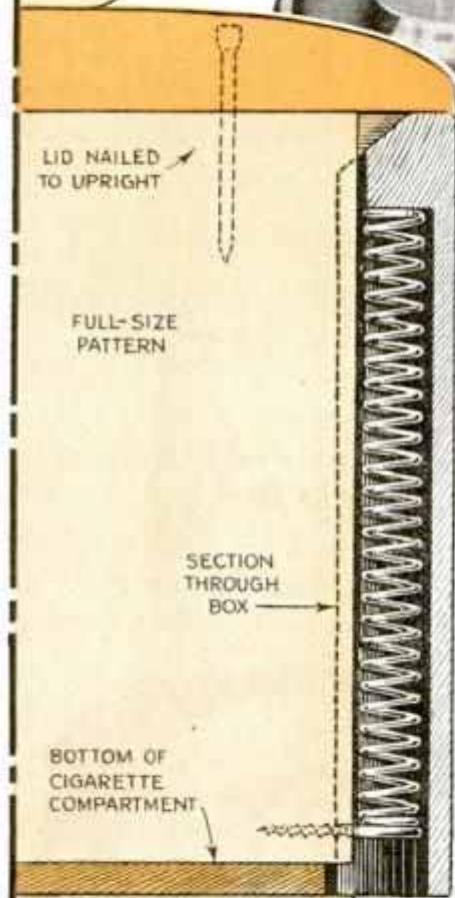
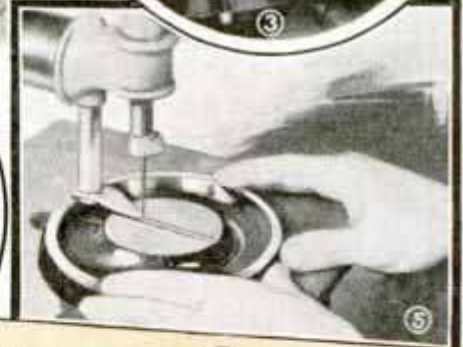
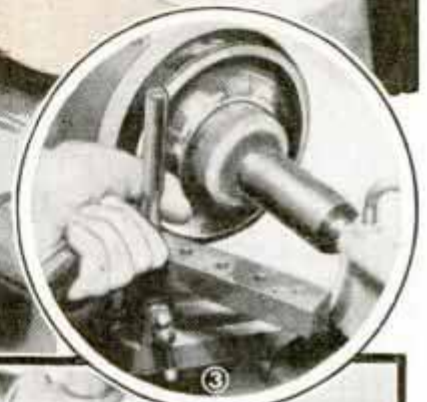
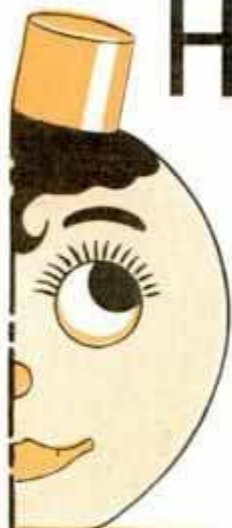

The lid won't come off but the coat does, Fig. 1. Turn down the top as in Fig. 2. The inside cut, in making the coat, and the slit in the base are cut on a band saw, Figs. 4 and 5, and sheet copper is then spun over the base as in Fig. 3.

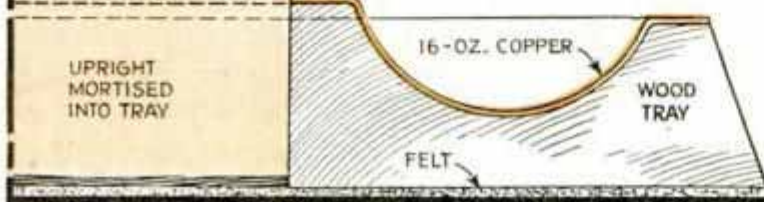

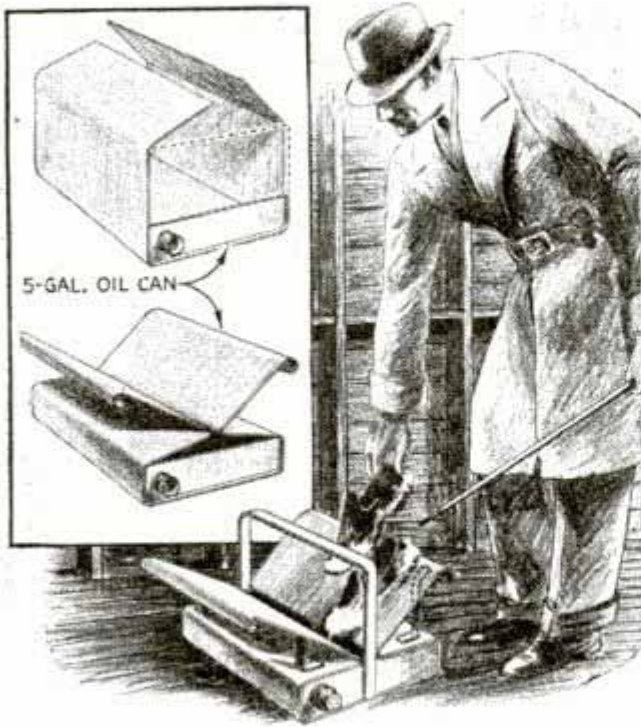

Wet Rubbers Prevented from Mussing Floor by Setting Them in This Drip Pan

Drip Pan Holds Wet Rubbers

To save the work of cleaning up water puddles from rubbers set on the floor, this drip pan will be found convenient. It is made from a discarded 5-gal. oil can. Portions of the top and bottom are cut out to leave a shallow pan, including the spout, which will be needed for draining. The sides of the can are evenly separated and are bent down to form a trough and are supported by four iron braces soldered in place. A $\frac{1}{2}$ -in. opening in the bottom of the trough allows water to drain into the pan. If desired, a flat-iron handle may be soldered to the ends of the pan.

Sanded Space on Glass Graduate Helps Prevent Errors



surface to indicate their respective measures.—G. E. Hendrickson, Argyle, Wis.

To prevent errors in measuring different kinds and quantities of chemicals, an amateur chemist sanded one side of his glass graduate, and, with a lead pencil, wrote code letters and arrows on the sanded surface

Repairing Leaky Iceboxes

If your icebox leaks, it can usually be repaired by coating the inside of the ice compartment with paraffin. Just take out the metal stand that supports the cake of ice, plug the drain with a cork, and then pour melted paraffin over the leaky part. After the wax has hardened, carefully remove the cork from the drain and replace the stand.—James W. Campbell, Hartford, Connecticut.

Pocketknife Holds Razor Blade While Stropping

To hold a safety-razor blade for stropping, or to handle it conveniently for cutting paper, open one blade of a pocketknife, place the razor in the slot, as shown, and close the blade.



Auto Window Cushioned to Prevent Injury to Dog

If your dog rides in a car with its head out of the window, cushion the edge of the lowered window glass so that the dog

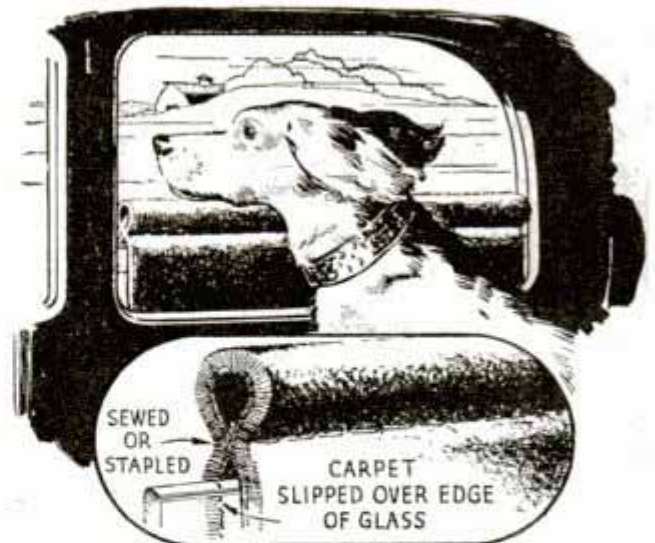

Strip of Old Carpet Folded over Car Window Protects Dog When Car Hits Bump

will not be injured when driving over rough roads. A good pad for cushioning the glass can be made by folding a strip of old carpet and stapling or sewing it as indicated in the detail.

Stencil Paper Used on Homemade Duplicator

Here is a homemade duplicator that is useful for printing invitations, handbills, menus, programs, etc. Practically all the

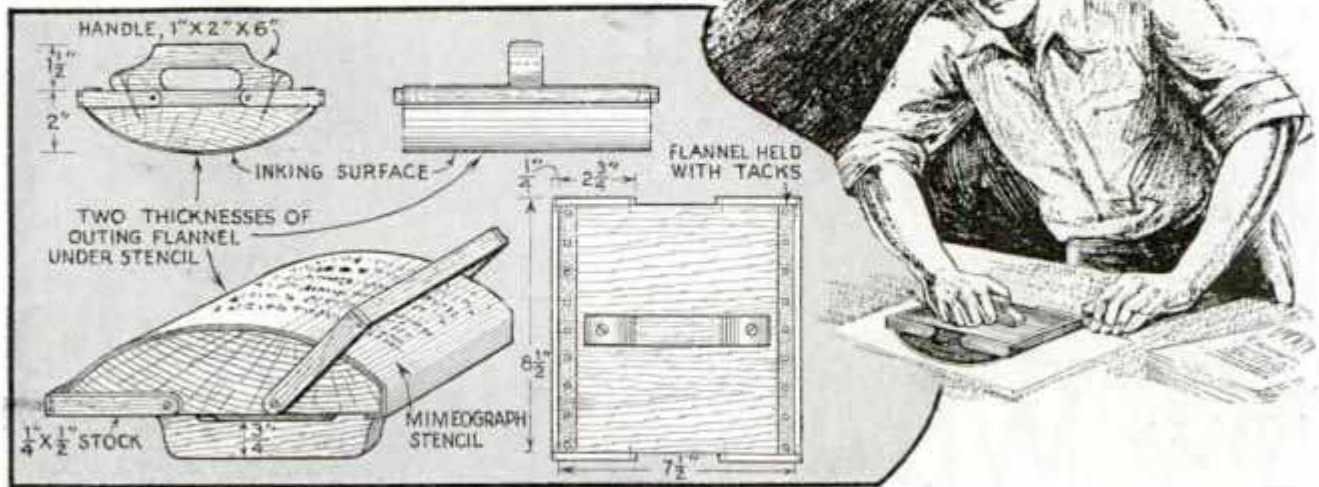

cost involved is ink and stencils. To make the duplicator, get a wood block and carefully shape one side to a curvature having a radius of about 6 in. The curved surface must be perfectly true so that in rocking it across a flat surface, all parts will touch. Then cover the block with two layers of outing flannel stretched tightly and tacked along the edge to the top side of the block. The fleece side of the cloth should be inside. Two clips are made of wood or flat metal and are pivoted to the block so that they will hold the mimeograph paper securely. A handle completes the job. Ink

and stencils can be obtained at mail-order houses or typewriter-supply concerns. Be sure to ask for duplicator ink. The stencil, cut on a typewriter or written by using a stylus, is attached to the duplicator after the pads have been inked. Ink the pad well but do not make it soggy. The stencil is placed over the inked pad with the side down that your typewriter keys struck. It should be possible to print at least two hundred copies before re-inking. If too much ink gets on the printing side of the stencil, wipe it off with a cloth moistened with alcohol.—Don Mayes, Carthage, Mo.

Canvas Pouch on Baby Carriage Holds Small Packages

To carry packages on her baby carriage, one woman made a pouch, or pocket, as shown in the detail. It consists of canvas sewed over lengths of heavy, stiff wire, the ends of which are bent to form hooks to be slipped over the handle and the rear edge of the carriage body. When making the pouch, cut out the sides to a radius large enough to give it considerable depth, and then sew them to the bottom. It is a good idea to slip short lengths of small rubber tubing over the hooks to prevent marring the finish on the carriage. The pouch will also serve as an extra seat for an older child by using heavier wire for the hooks and cutting a couple of slits in the bottom for the child's legs.—A. H. Waychoff, Tempe, Ariz.

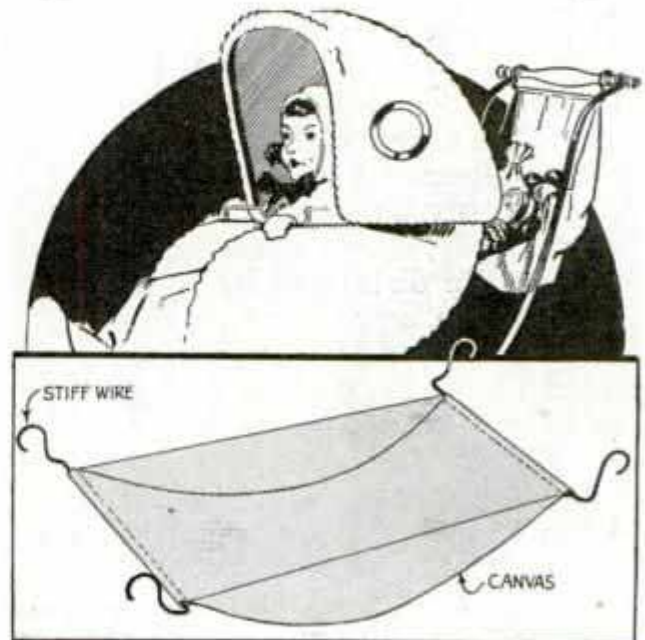

Special Crayons - Crayones - Amgenian Crayons
 Co., Sandusky, Ohio

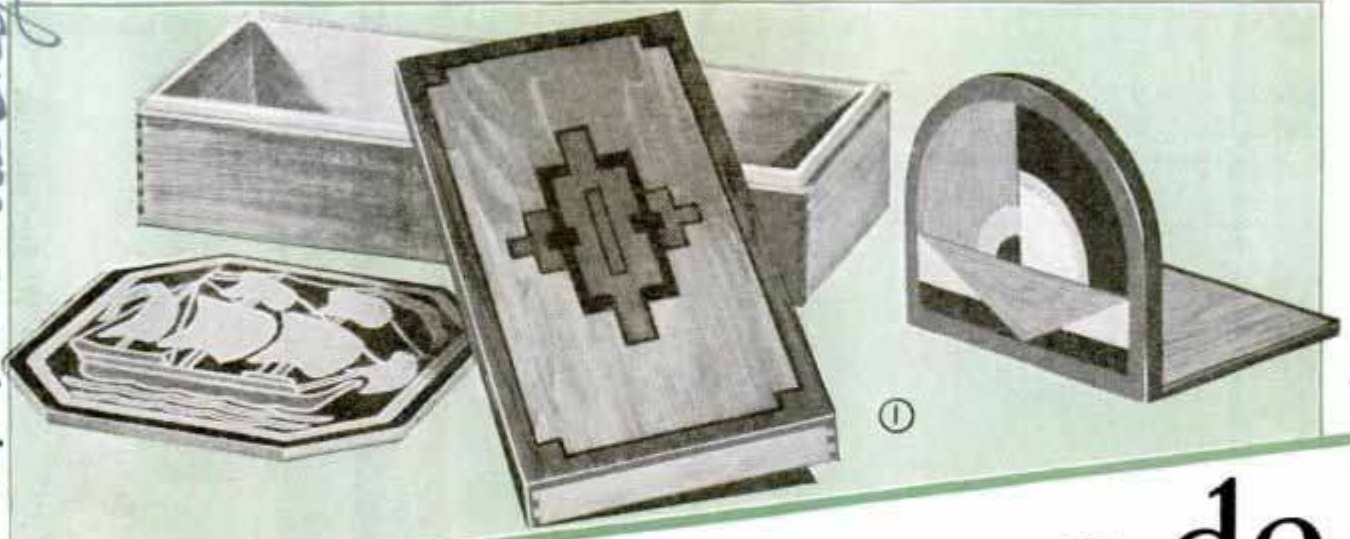

What you can do

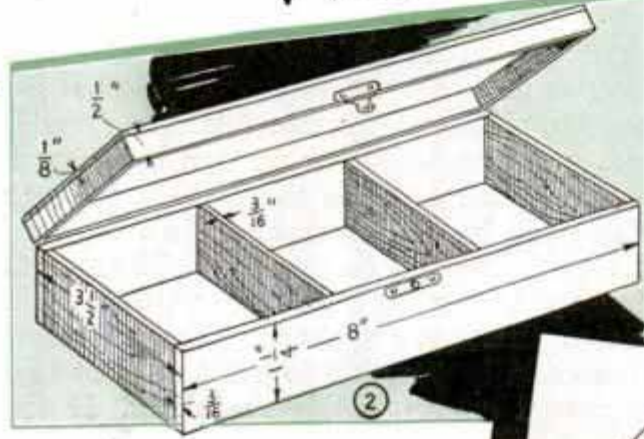

the photograph, then blended out to a tint with a bit of cotton dipped in carbon tetrachloride, or the color may be applied directly to the cotton. For small details, a brush may be substituted for the cotton and the color applied to the wet brush.

Small wood objects, as in Fig. 1, can be stained beautifully by covering the entire surface with the color selected, rubbing it in the direction of the grain where possible, then rubbing the surface with a soft cloth dampened with gasoline. The gasoline dissolves the crayon, thus setting the color in the wood and removing the excess wax. Further rubbing with a dry flannel cloth will produce a durable wax finish. Dimensions for a cigarette or trinket box

WAX crayons, such as children use to color pictures, have many other uses. Art training is not required to use this versatile and inexpensive material, as one need only follow a few simple directions to produce some of the beautiful effects that are illustrated.

For tinting photographs, Figs. 8 and 10, excellent results can be obtained by even a novice, especially on landscapes. The advantage of using this material is that it does not penetrate and can be wiped off if the results are not to your liking. Photographs to be tinted should be printed on dull paper. The surface is first cleaned by wiping it with a cloth on which talcum powder has been sprinkled, to remove any oiliness. The crayon may be either applied directly to





with WAX CRAYONS

are given in Fig. 2. If you wish to decorate the box, you may use the design shown in Fig. 3. Trace the design onto the surface with carbon paper, then fill in with the colors desired as in Fig. 14. A thin coat of white shellac is used to prevent the crayon from wearing off. The doorstep, Fig. 9, and the book ends in Figs. 5, 6 and 7, are suitable for this type of decoration.

Work carved in low relief is attractive when finished as follows: Brush a coat of a mixture of gasoline, 10 parts, to gray green oil paint, 1 part, over the surface. While the work is still wet apply the crayon to produce a two-tone effect. If unusual shades of stains are required for matching colors when patching fur-



Easy Method of Attractively Tinting Photos by Using a Wad of Cotton Dipped in Carbon Tetrachloride, and Ordinary Wax Crayons

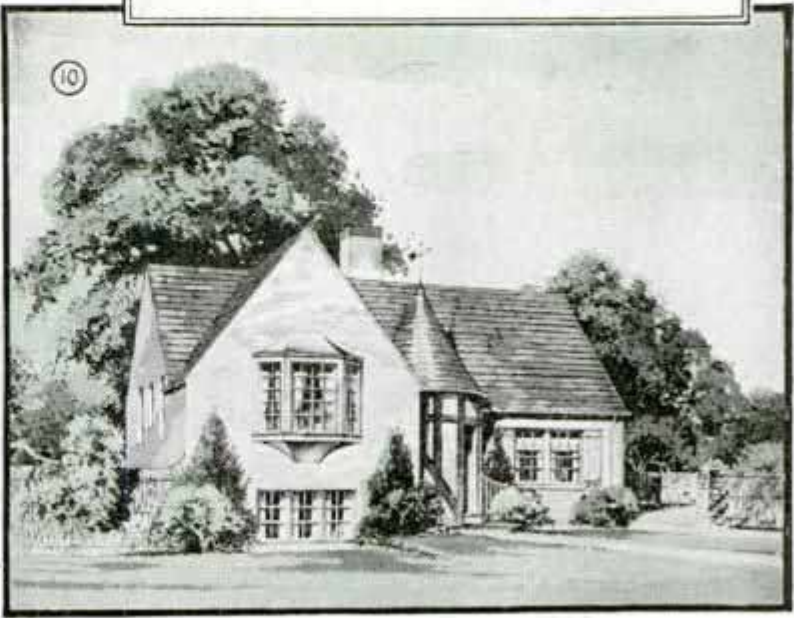
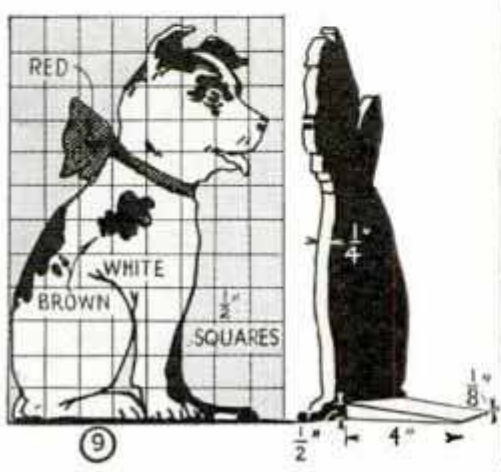

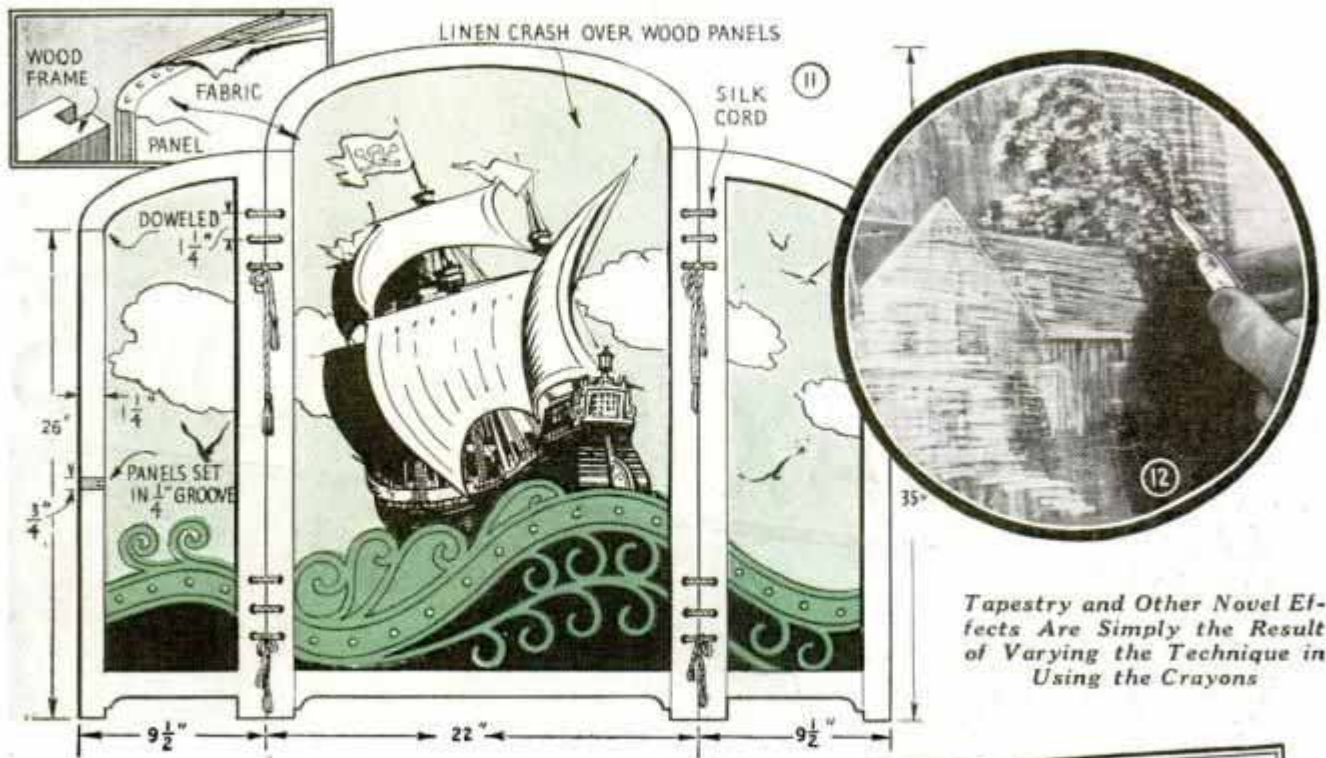

niture finishes, pottery, mirror frames, etc., they can be produced by mixing crayons. The shavings of crayon are dissolved in turpentine, which must be warmed in a double vessel and stirred thoroughly. With so many colors available, almost any shade can be obtained by mixing.

A beautiful tapestry-like effect

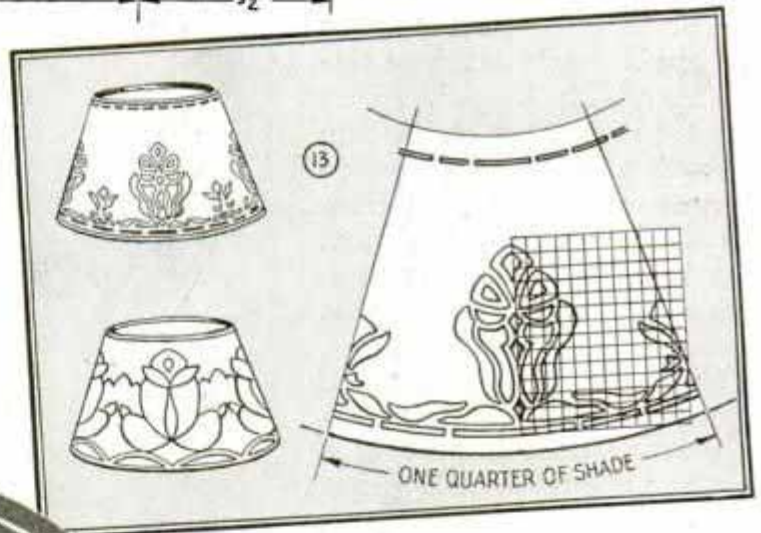

is shown in Fig. 16. The design is drawn on thin paper with orange crayon, pressing quite heavily. The paper is then laid, face down, on the fabric you wish to decorate and the design transferred to the fabric by pressing the back of the material with a hot iron. The next step is to stretch the fabric on a drawing board with thumb tacks and fill in the various colors of the design quite heavily with crayons. After the design has been colored as desired, the fabric is laid, face down, between sheets of newspaper and covered over with a damp cloth. The steam, produced by running a hot iron

over the cloth, as shown in Fig. 15, will dissolve the crayon, depositing the wax onto the paper but setting the colors into the fabric. The process is so effective that the material may be washed without destroying the design. Fig. 11 shows an attractive fire screen that can be made in this way. After the fabric panels are finished, they are stretched over wood panels and tacked along the edges as shown.

Lamp shades, Fig. 13, and antique maps,

(16)

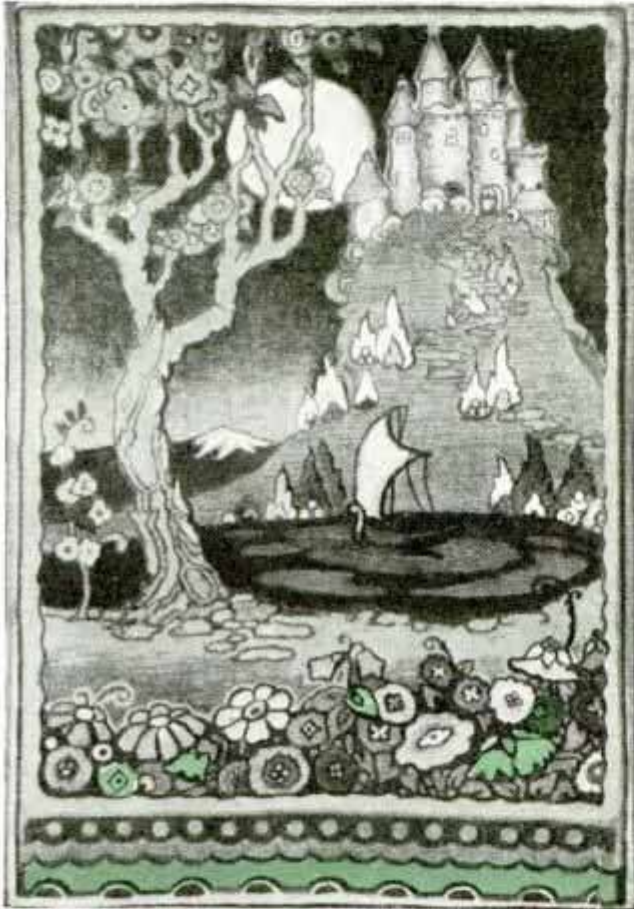
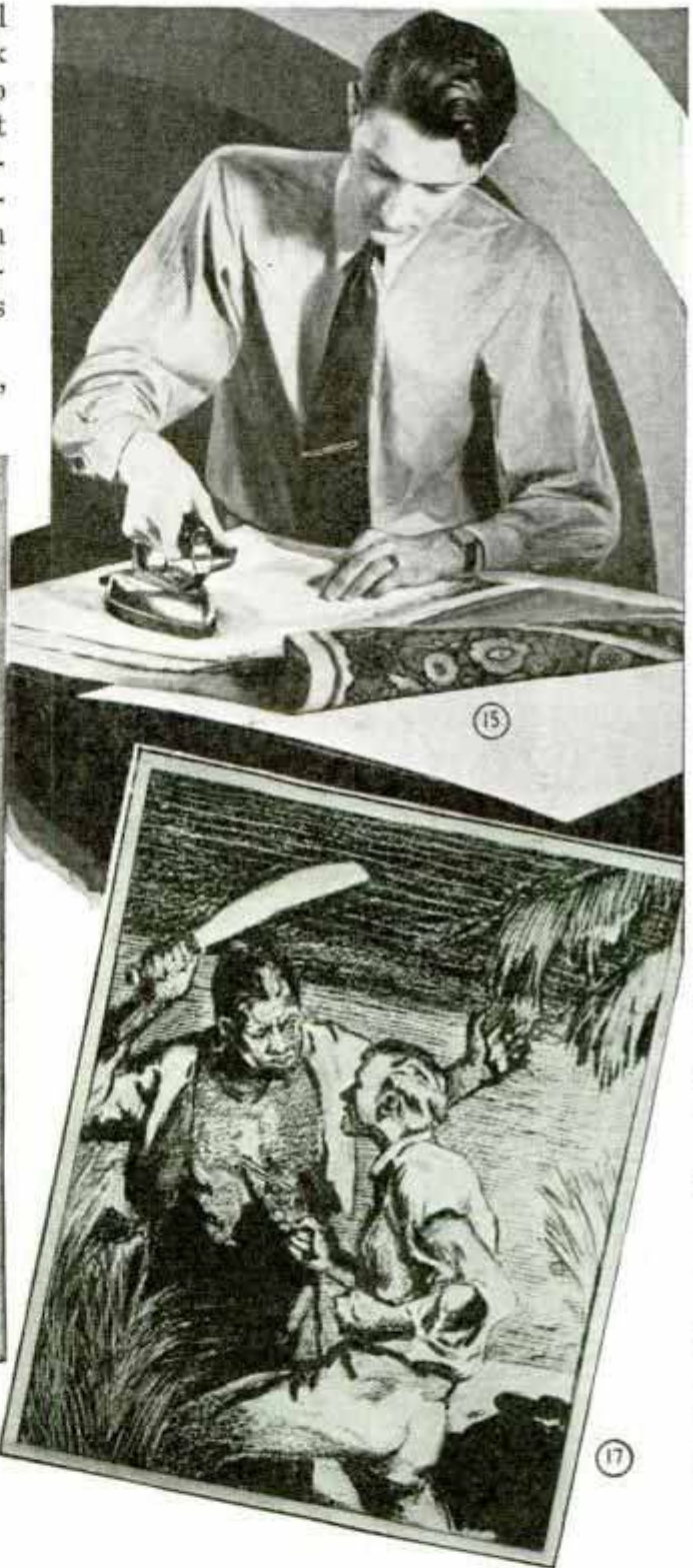

Fig. 4, present another field for the use of wax crayons. Both lamp shades and maps are made with a parchment-like oiled paper. This can be prepared by coating white drawing paper with a solution of boiled linseed oil mixed with a small amount of benzine. A smooth-surfaced paper will give an even tinted effect while a rough texture will produce a mottled one. The design, which must first be worked out in a pattern, is simply outlined on thin paper with a sharp crayon and transferred to the parchment paper by placing the pattern on the parchment and pressing with a hot iron, as before. The mass coloring is then filled in directly on the parchment with crayons. In order



to tone down the colors and give a soft, aged appearance, all that is necessary is to lay the colored portion on a piece of newspaper and go over the back with a hot iron, to remove the surplus crayon and wax.

Beautiful etching effects can be obtained on paper or linen-finished illustration board by a scraping process, Figs. 12 and 17. After the picture is drawn and shaded with crayon, take a penknife and scrape fine lines, exposing the paper underneath.



Section of Inner Tube Filled with Sawdust Makes Good Shoulder Pad for Carrying Ladder

Pad for Carrying Ladder Made from Inner Tube

A short section of inner tube filled with sawdust or shavings provides a good shoulder pad when carrying a ladder. The pad is nailed to the inside of one of the rails near the center so that the ladder can be balanced on the shoulder.

Simple Burglar Alarm Operated by Door Switches

Here is a method of putting in your home a burglar alarm which utilizes door switches to turn on the lights, sound a gong or even turn on the radio when a

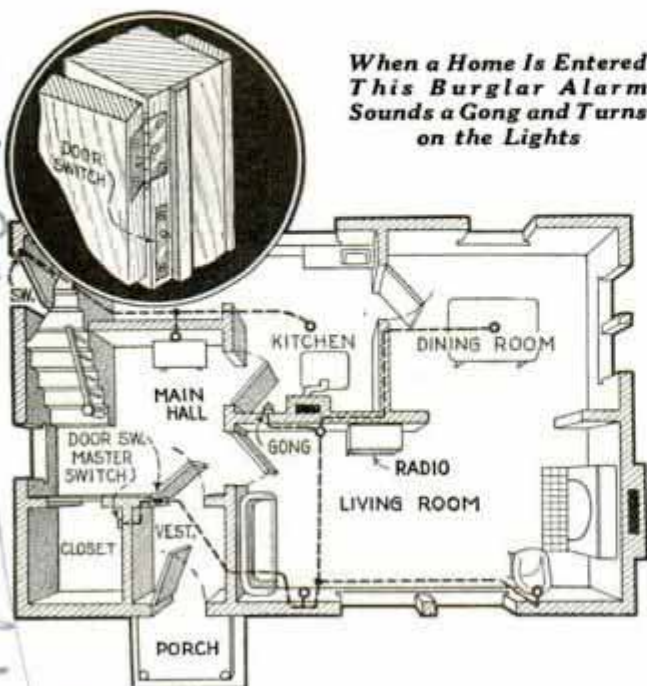

When a Home Is Entered This Burglar Alarm Sounds a Gong and Turns on the Lights

door or window is opened. A careful study of the drawing will show the method used. A switch is installed in the sill of each window and the casing of each outside door so that the circuit is closed when any one of them is opened. A master switch is used to cut out the alarm when not in use. The alarm circuit is connected into the lights between the wall switches and the lamps so that when the alarm is turned on the lights work independently of the regular house circuit.

Button Improves Smoker's Pipe

Placed in the bowl as indicated, a button will be found a great aid to smoking enjoyment. Small particles of tobacco are prevented from entering the pipe stem and the tobacco is kept dry



and mellow by being held above the bottom of the bowl, which is usually wet or damp when the pipe is in use.—Sigmund Sameth, New York City.

Drawing a Five-Point Star

Here is one of the simplest methods of accurately drawing a five-point star that I have ever found. With a compass, scribe a circle equal to the desired diameter of the star, and, inside of this, scribe a second circle one half the size of the first one. Then divide the distance CB into three equal parts to get distance CD. The distance AD now equals one-fifth of the circumference of the large circle, which, when divided, gives the five equal points of the star as shown.—T. F. Zimmerman, Beverly, N. J.

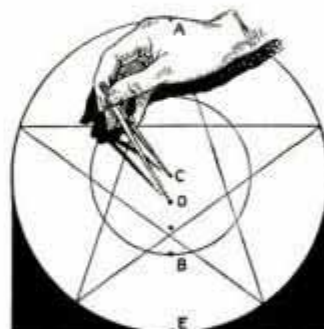

Tea stains on cups and saucers can usually be removed with damp salt.

Manhattan Electrical Supply Co.
 620 N. Orleans, Chicago
 Suppliers
 Auto Power

B.P. 10

Regulation Size TENNIS TABLE

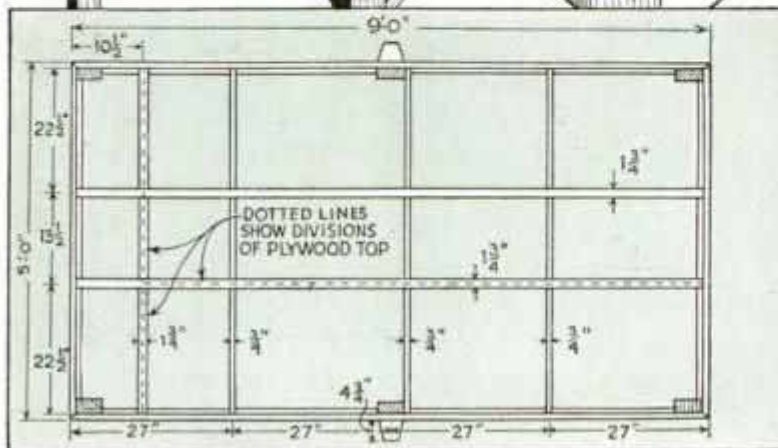
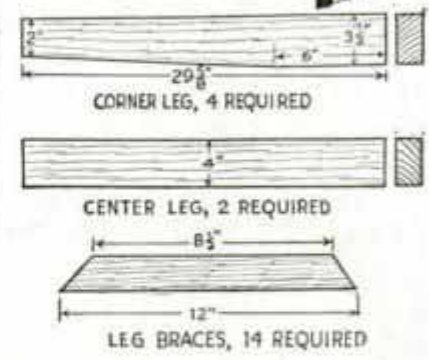
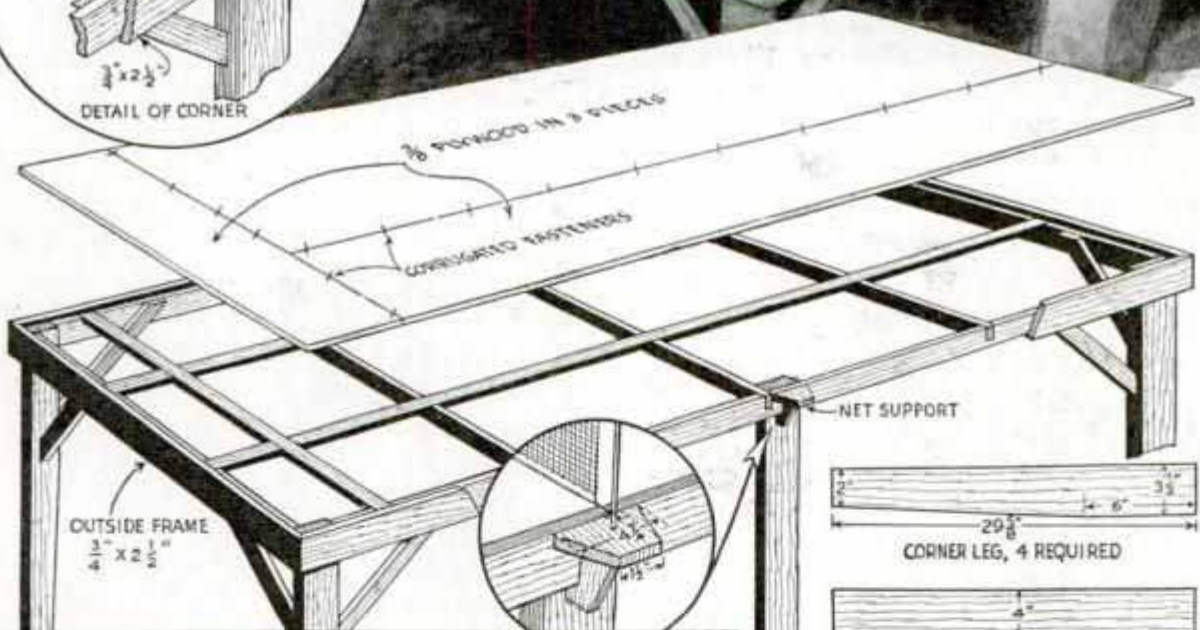
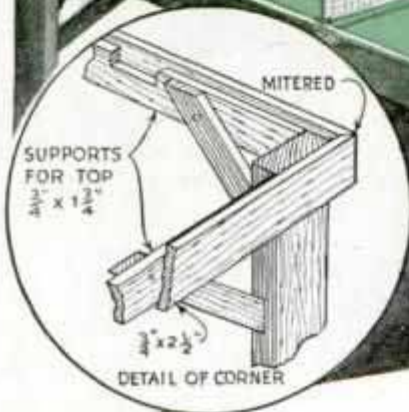
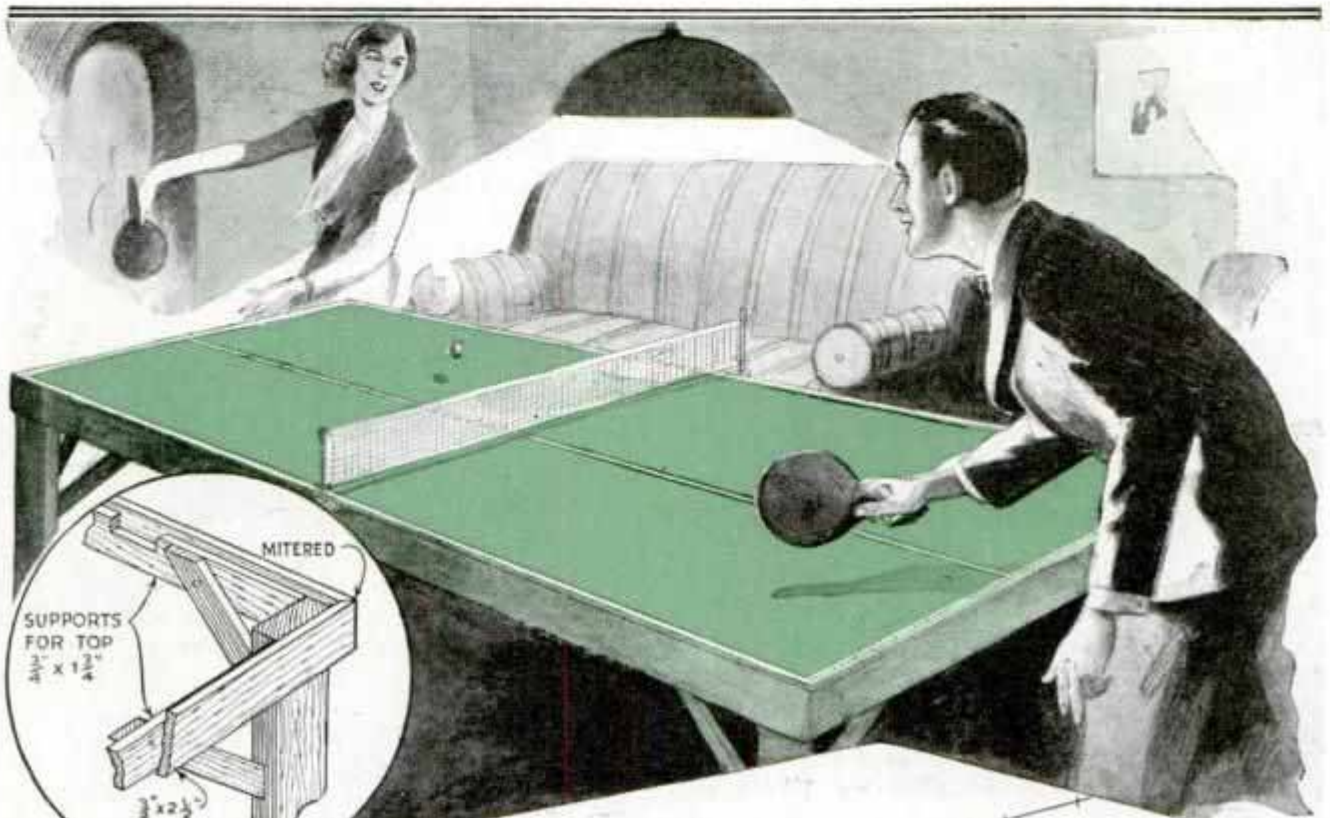

Well-Built Tennis Table of Regulation Size Has a $\frac{3}{8}$ -In. Plywood Top Made from Two 3 by 8-Ft. Sheets; It Is Fastened with $\frac{3}{4}$ -In. Screws at 6-In. Intervals; All Screw Holes Are Countersunk, Filled with Plastic Wood and Sanded Smooth; After Finishing the Top, It Is Painted a Dull Dark Green with a $\frac{3}{8}$ -In. White Stripe around the Edge and along the Center Lengthwise

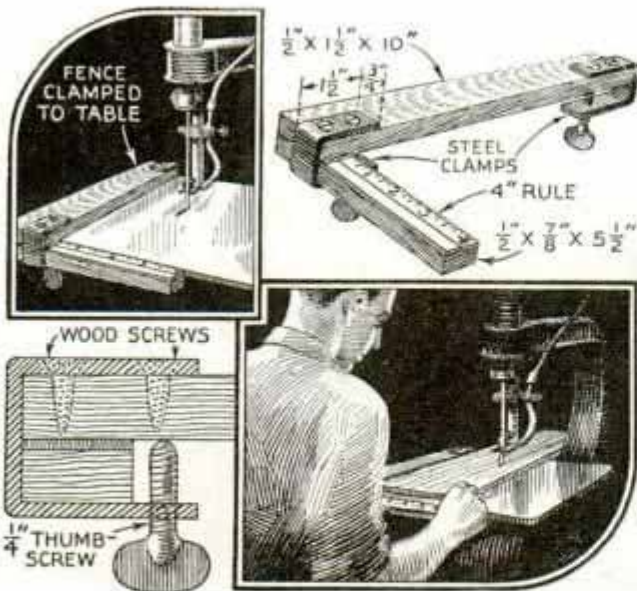

Ripping Fence Clamped to Jig-Saw Table Is Provided with Rule Which Is Set for Width

Ripping Fence for a Jig Saw

For use on any jig saw having a square table, this ripping fence is easily attached or removed, and is quickly set to the desired width. It consists of two wood blocks glued together at right angles, the shorter one of which has a 4-in. rule glued to the top surface. Two U-shaped steel clamps are screwed to the fence and are fitted with thumbscrews to hold it to the table.

Self-Cleaning Strainer Prevents Leaves from Entering Cistern

Home owners who have cisterns and have trouble in keeping the strainers in the eave conductor pipes from clogging will find this self-cleaning strainer a solution to their problem. A section of the conductor pipe is removed and an opening about 1 in. wide is made in one side.

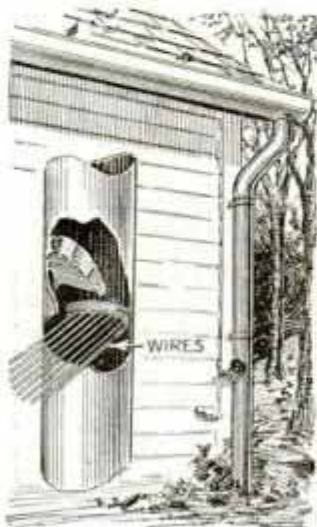

Directly above this a tin baffle plate is soldered inside of the pipe so that it rests at a 45° angle. The strainer, which consists of several stiff wires spaced $\frac{1}{4}$ in. apart and soldered at one end to a tin strip, is soldered to the opposite side of the conductor pipe so that the wires slope at an

angle, with the free ends projecting out of the opening. In this way, the baffle throws the water to one side of the conductor pipe where it passes through the strainer, while leaves and trash slide down the wires and out of the opening.

Improving an Ice-Pick Handle

To make an ice-pick handle more effective when using it to break up small chunks of ice, drive a couple of furniture slides into it near the end as shown. This makes the part of the handle contacting the ice more solid and also helps to prevent it from splitting. If a short section of rubber tubing is slipped over the point of the pick, a better grip for the hands will be provided.—F. W. Bentley, Missouri Valley, Ia.



Electric Clock on Lamp Shade

To add a touch of novelty to your table lamp, an electric-clock works can be installed on the shade. The hands are removed from the clock, which is then fastened inside of the shade with small staples or metallic cement.



The hands are put back on the shaft, which projects through a small hole made in the shade. The numerals are painted on the lamp shade with a paint that contrasts with the

color of the shade so that they are visible. The clock wires should be connected into the lamp circuit so that turning off the lamp will not stop the clock.—Richard Besocke, Highland Park, Ill.

☞ When painting or varnishing steps, it is a good idea to leave alternate ones to walk upon while the painted ones are drying.

Baby Clothes and Linen at Hand under Crib

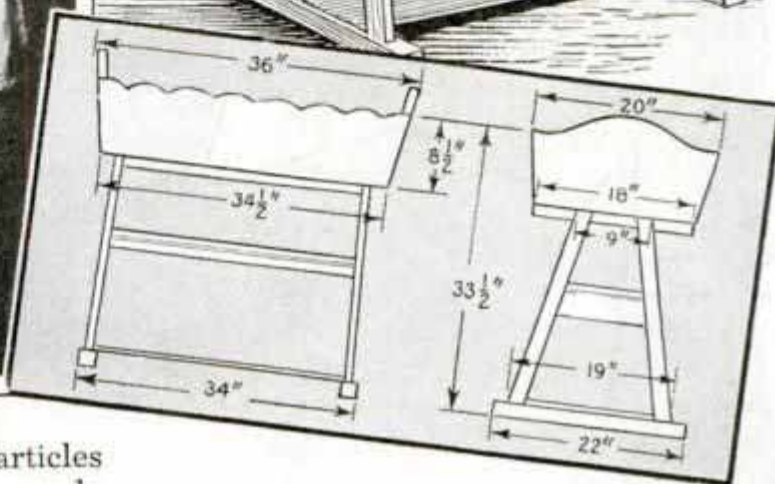
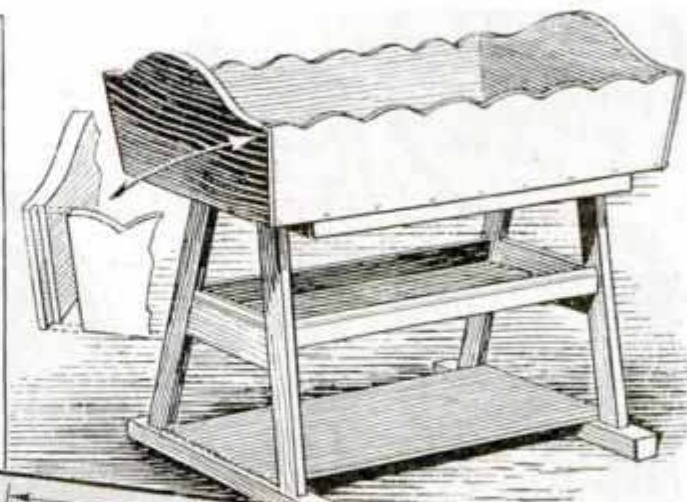
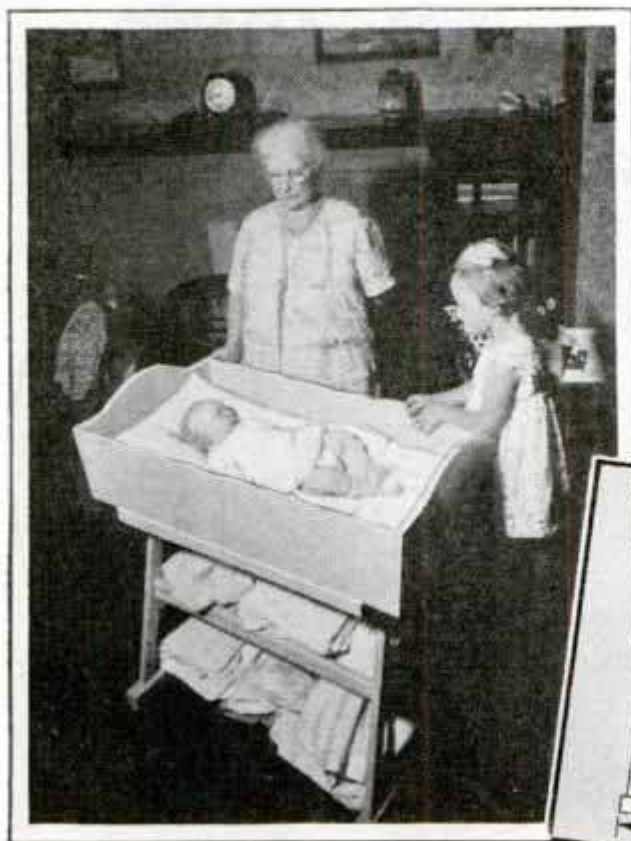

Baby clothes, linen and other articles are always at hand when kept on a couple of shelves located under this baby crib. The four legs extend at a sufficient angle to assure good support so that the crib cannot be tipped over. Crosspieces are used to brace the legs and to hold two shelves and the crib itself. To enhance the

appearance of the crib, the sides and end may be cut to a pleasing curvature. After sanding the surface of the wood, especially the edges of the crib, apply a coat of shellac to serve as a filler before painting.—C. E. Johnson, Chicago.

Old Vacuum Cleaner Motors Useful in Home Workshop

Motors from old vacuum cleaners may be used to drive small emery and light buffing wheels. An extension shaft is attached to the motor and the whole assembly is inclosed in a housing. The idea is to provide a suitable extra bearing, preferably a ball bearing, to take the strain of grinding and buffing. To do this, the bearing is inclosed in a brass tube and an extension shaft is attached to the motor. Another reason for the extension is to prevent emery dust from getting into the motor bearing.

☞ Growth of algæ (green scum) in a lily pool containing goldfish can be controlled by putting a few pennies or small pieces of copper in the water.

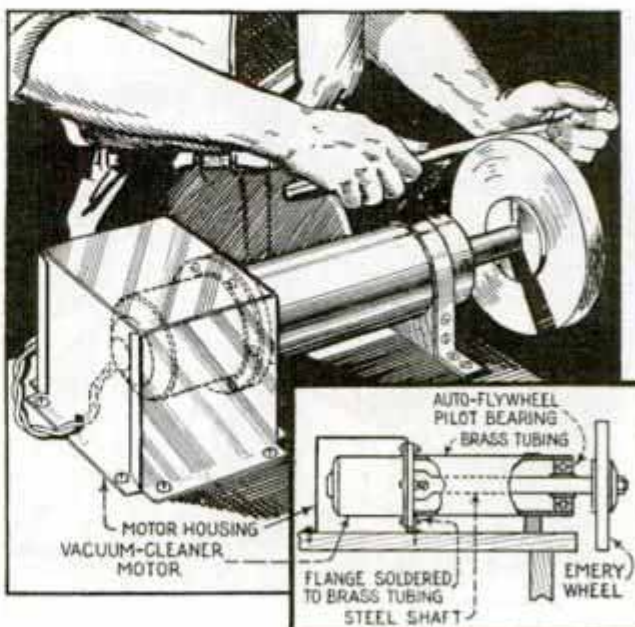

HOME

Opening the door of this kitchen ventilator automatically turns on the fan

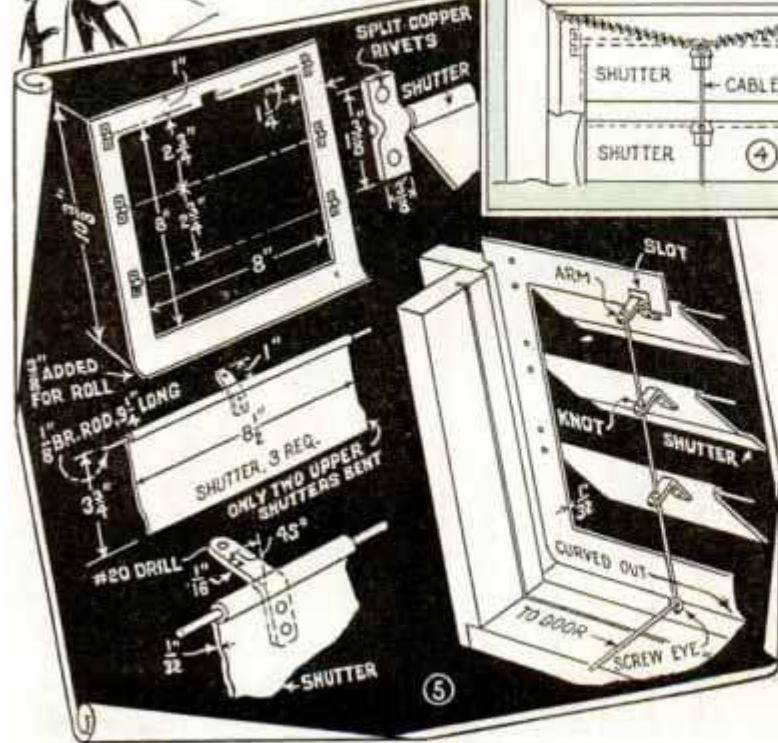
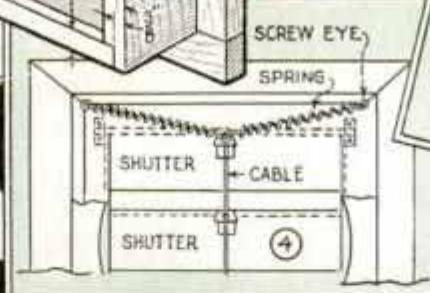
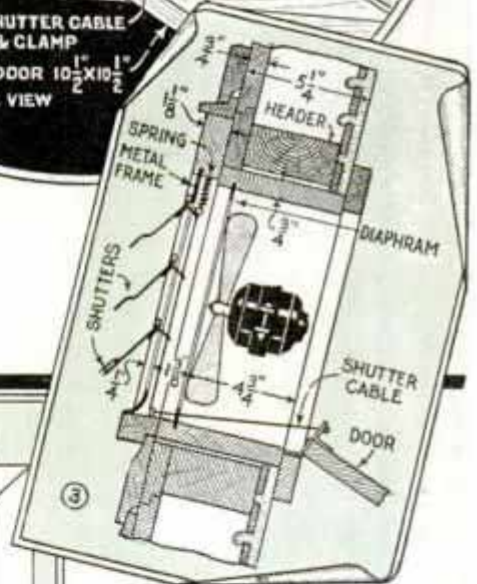
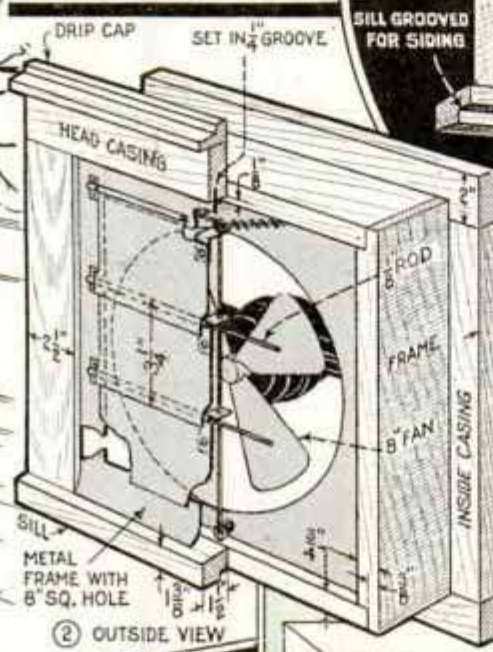
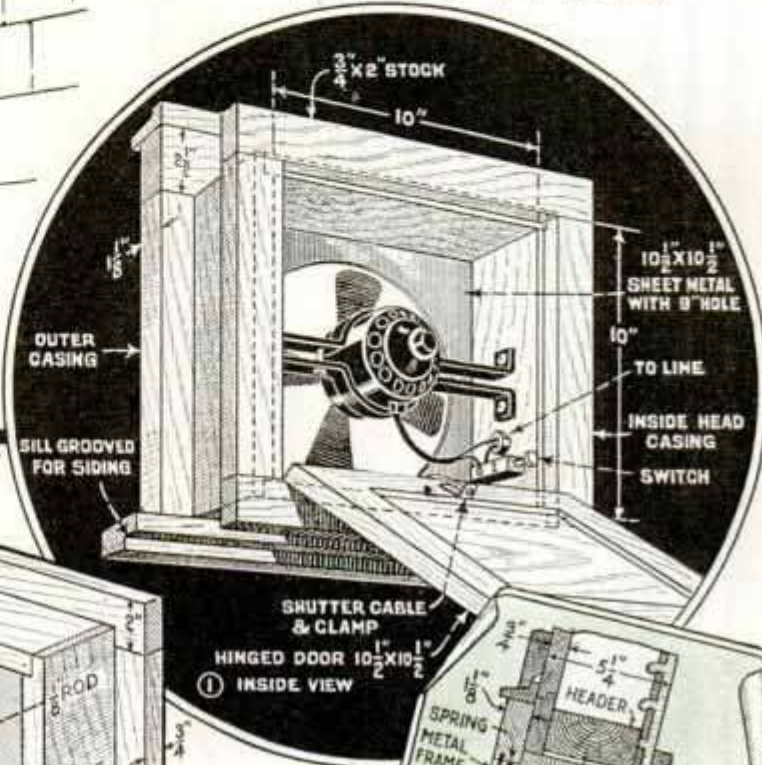

THIS efficient kitchen ventilator will quickly carry away cooking smoke and odors. First make the wood frame, Figs. 1, 2 and 3, which has $\frac{1}{4}$ -in. saw cuts to house the sheet-metal diaphragm and shutter frame. The diaphragm has a circular hole $\frac{1}{2}$ in. larger than the fan blades. The shutter leaves, Fig. 5, are made of sheet metal with one edge rolled over a piece of $\frac{1}{8}$ -in. brass rod, which will not rust and cause the leaves to bind. The bottom edge of the top and center leaves are off-set slightly so that they will

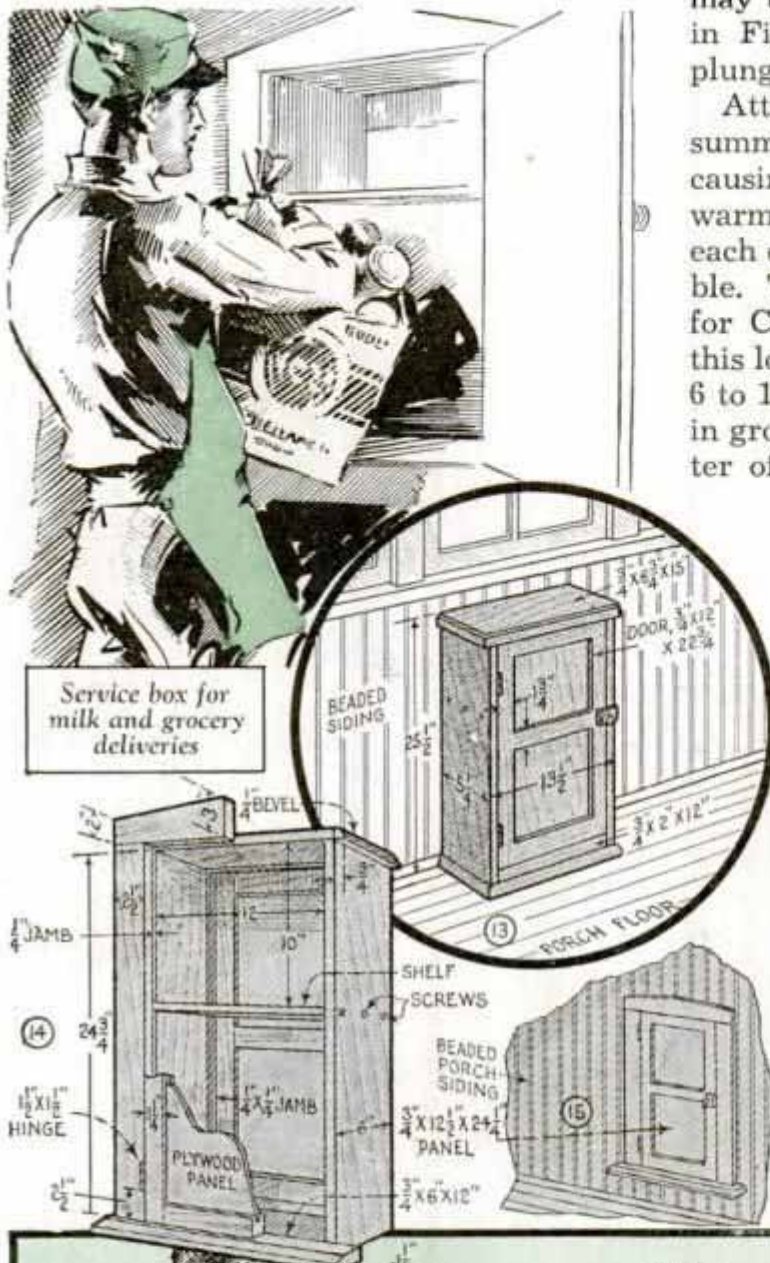

Service box for milk and grocery deliveries

may be purchased and installed as shown in Fig. 1. Closing the door pushes the plunger in and thus shuts off the fan.

Attics without ventilation become hot in summer, holding the heat over night and causing the rooms below to become very warm. Installing an attractive louver in each end of the attic will remedy this trouble. The type shown in Fig. 7 is suitable for Colonial houses. The construction of this louver is not difficult as shown in Figs. 6 to 10. The leaves and sill are all housed in grooves. If a chimney runs up the center of the gable, two quarter-round louvers, as in Fig. 12, may be used. For English-type houses, a long narrow louver as in Fig. 11 is most suitable. On this type, where many leaves are used, an angle of 30° gives the best appearance, but the leaves must be fitted with back strips to prevent the rain from driving in.

A service case, built into the back porch, provides for milk and grocery deliveries. Fig. 13 gives the inside arrangement and Fig. 15 shows how it looks from the outside. The dimensions given in Fig. 14 provide ample space.

Cement garbage containers may be built as in Figs. 16 and 17. Simply construct the outer and inner

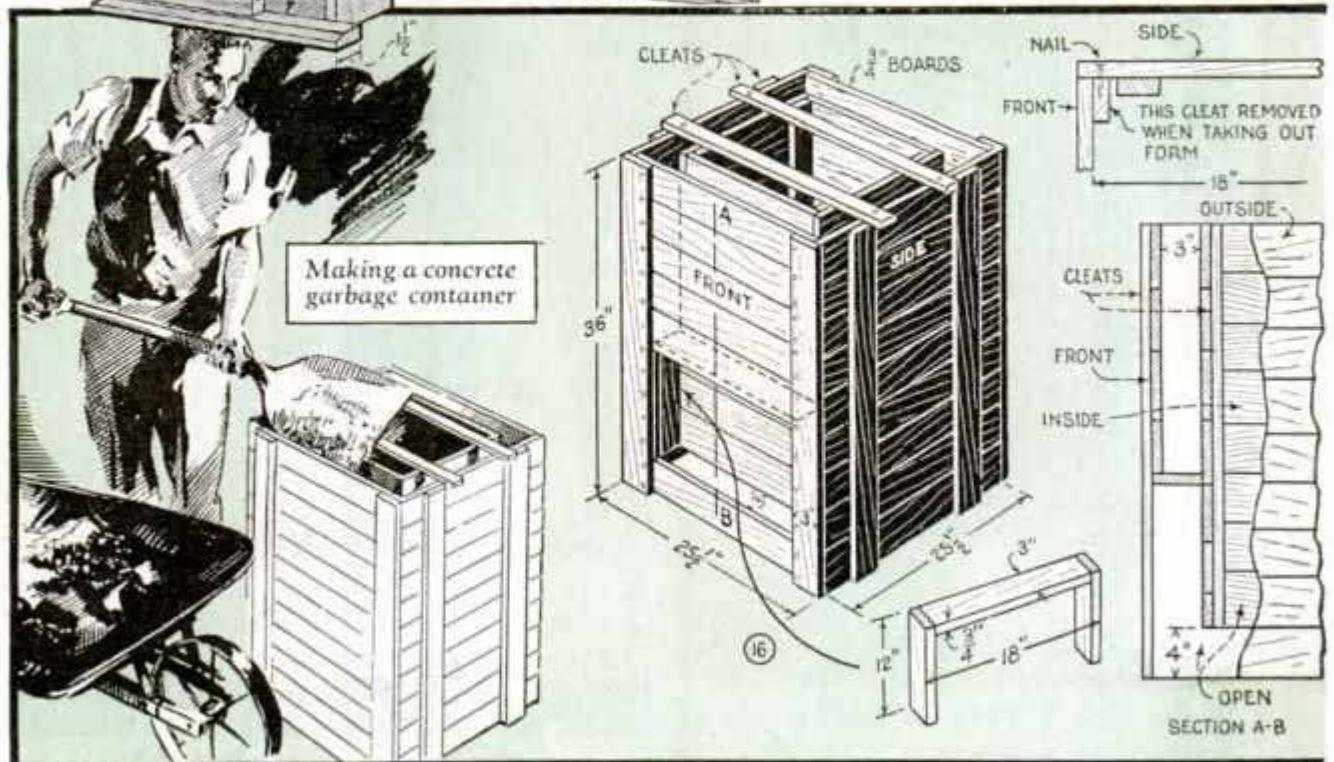

Making a concrete garbage container

wood forms, and you are ready to pour the concrete. The front opening is provided by a simple frame nailed to the outer front panel and fitting flush against the inner form. First set up the outer form and fill it with concrete up to the level of the bottom of the front opening, about 4 in. A mixture of one part of cement, two of sharp sand and four of medium gravel is about right. The inner form is hung from cleats across the top. Pour the concrete between the forms to a depth of 3 or 4 in. then tamp down, repeating the process until the form is filled to the top. It is advisable to reinforce the concrete by throwing in pieces of old wire at each tamping except the last. Allow the con-

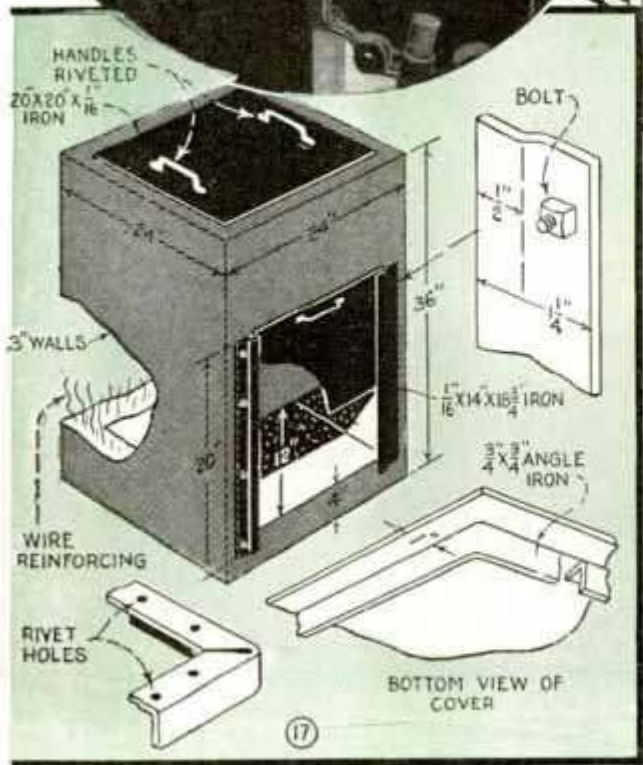
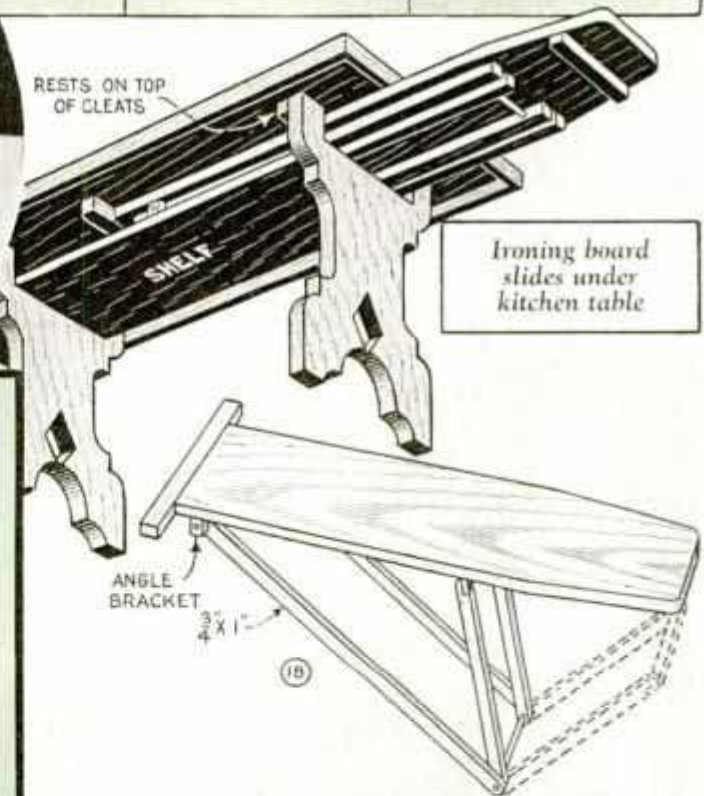
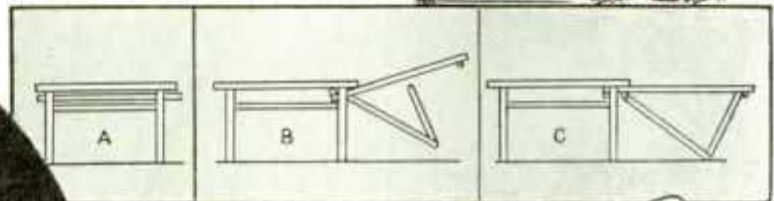

crete to set 48 hrs. before removing the forms. The inner one should be removed first by breaking out the key cleats and pulling the panels toward the center. A sheet-metal door is arranged to slide in metal guides to close the front opening. The top cover is also made of sheet metal with an angle-iron ledge, the size of the opening in the container, riveted to the



underside. Angle-iron frames can be easily made by cutting V-notches as indicated in the photograph.

Fig. 18 shows a small ironing board that slides under the breakfast-nook table when not in use. The top is cut the length of the table. The legs are made of $\frac{3}{4}$ by 1-in. stock with a bar hinge at the bottom and one pair of legs pivoted on angle brackets under the board. Another light ironing board can be made of $\frac{1}{2}$ -in. plywood, as in Fig. 19. The X-legs, attached to the board, can be folded up and laid flat between two parallel braces beneath the board. The legs are best made of spruce for strength and lightness. Bolts with countersunk heads secure one pair of legs under the large end of the ironing board and a chain is installed so that, when hooked up, the legs will not collapse when the end of the ironing board is lifted to slip a garment over it. A third type of ironing board is shown in Figs. 20 and 21. In homes not provided with a built-in ironing board this will serve as a good substitute and can be located in a convenient location with a wall plug near by. As can be seen from the illustrations, this board is a combination sliding and pivoting affair, and fits in a shallow case permanently attached to the wall.

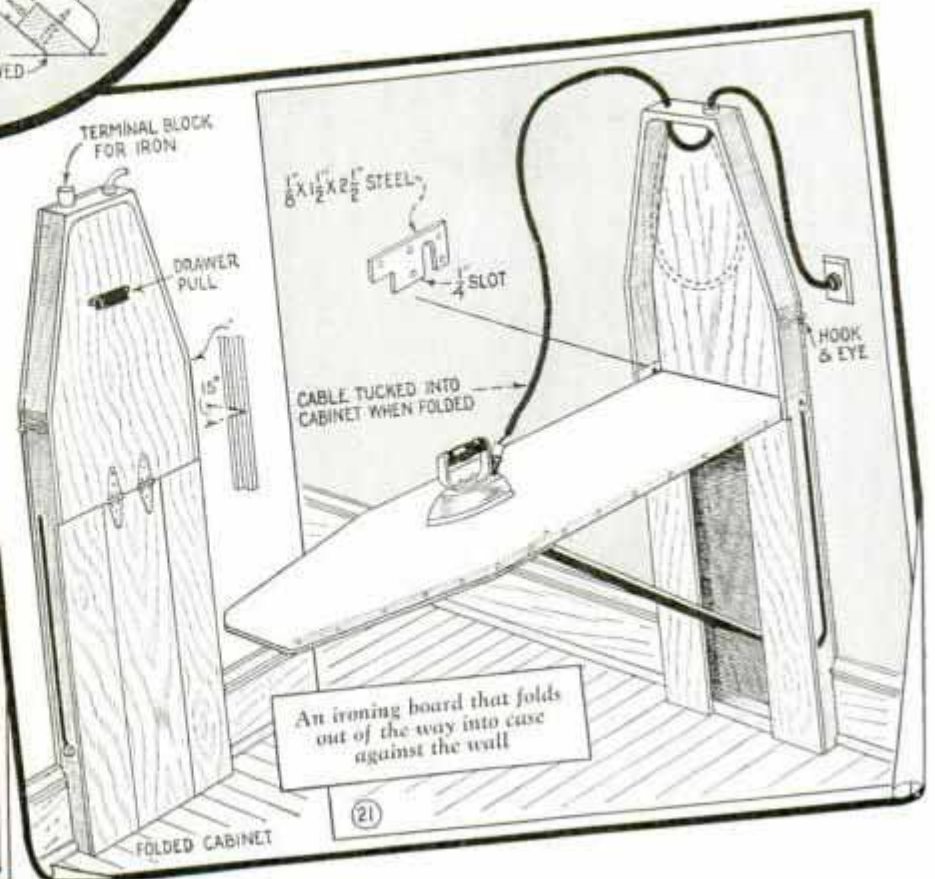
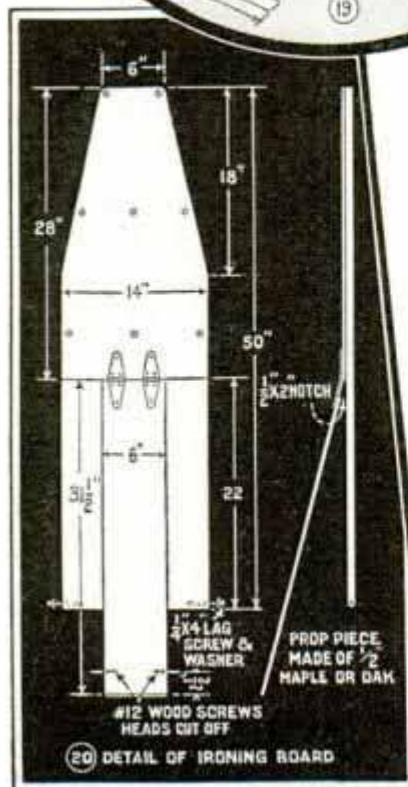
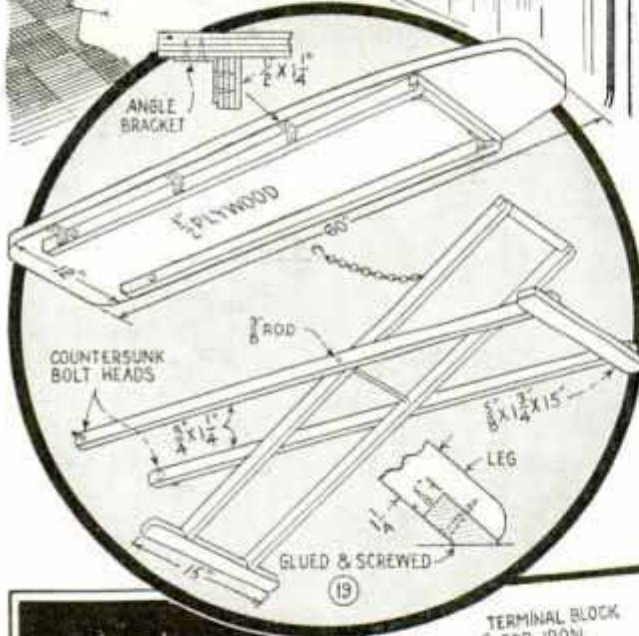

Novel, Artificial Flowers Made from Tin Cans

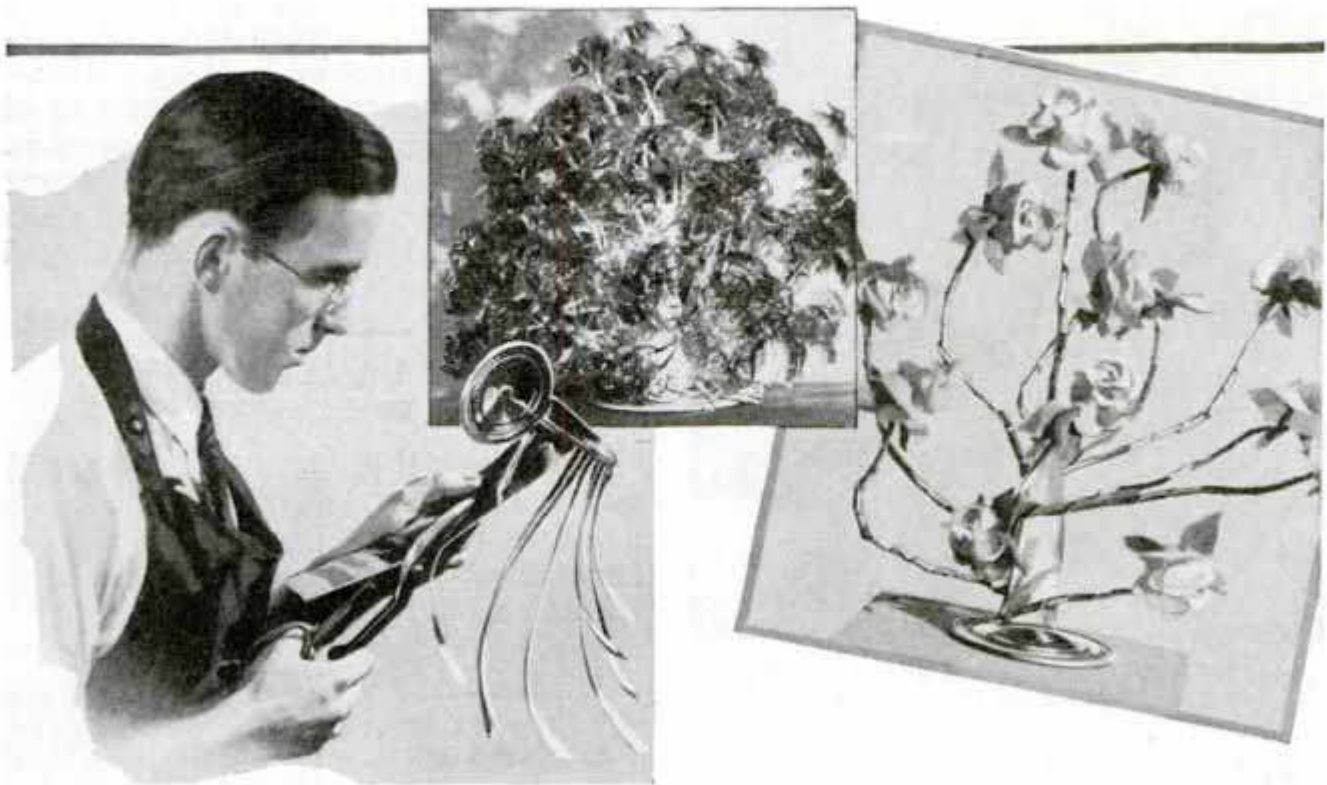

An interesting hobby is to make artificial flowers from tin cans. Select a bright clean can, remove the paper covering, and with a pair of tin snips or old scissors, cut down along the vertical seam to the bottom. After cutting off the rim at the top, which is discarded, cut the entire can into horizontal strips about $\frac{1}{16}$ to $\frac{1}{8}$ in. wide, stopping at the seam and leaving the bot-

tom intact to form a base. Then twist the strips to simulate stems, keeping the vertical seam well in the center so that it is hidden from view. Buds and flowers can be made from colored Cellophane and even gum drops; they may be fastened to the stems by bending the latter around them. A coat of clear lacquer will prevent the tin from tarnishing.

Preventing Entrance to Home through Milk-Door Opening

Entrance of a burglar through a milk-delivery opening of a home or apartment can be prevented if the inside door of the opening is made to slide up and down, and is provided with a bolt lock on the inside. To do this the door casing is removed and brass strips are bent and screwed to it, as shown, to serve as slides, after which the sides and bottom of the casing are replaced. The top part of the casing is provided with a lifting slot and is then screwed to the top of the door. It is a good idea to use a bolt lock of the concealed type so that the appearance of the casing will not be marred.

☐ If a cup in which molasses is measured is greased with butter or lard, every drop will run out and there will be no waste.

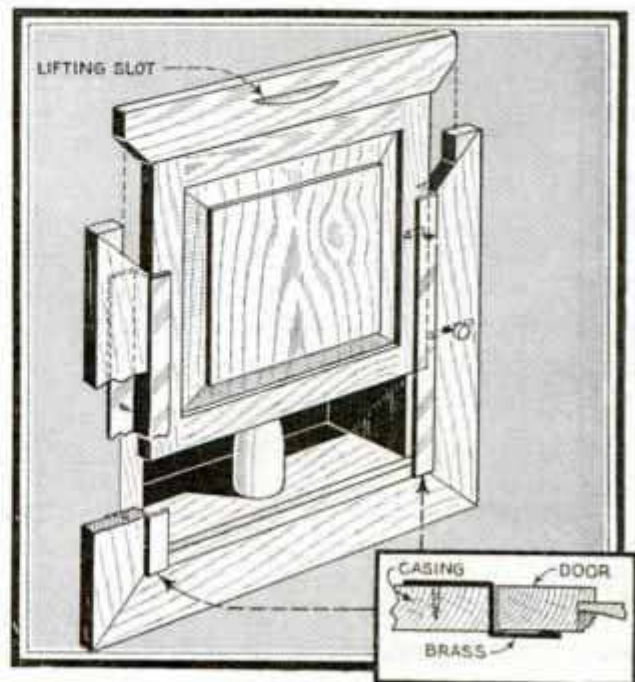

Shields of Light Metal Protect Legs of Cyclist



Leg Shields Clamped to Frame of Motorcycle Protect Rider from High Winds and Storms

A European army officer who rides a motorcycle when on duty, designed the leg shields shown here. They are made of sheet metal, and are bent to the curvature of the legs when the knees are bent, providing protection against cold winds. The shields are bolted to pieces of flat iron, which are clamped to the motorcycle frame.—T. A. Hodgson, Wilbraham, Mass.

Sections of Coil Spring Anchor Tubing or Electric Cord to Wall

Short sections of a coil spring taken from a window-shade roller make good anchors for fastening small tubing or electric cords to walls and ceilings. The end coils of each section are bent outward, after which the spring is slipped over the tube or cord, and tacked in place as shown.



How to Propagate Rose Bushes

Rose propagation as practiced by many expert gardeners and flower growers can be done easily by amateur gardeners. First cut a slit about 3 in. long in one of the long healthy trailers of the climbing vine.

Do not cut entirely through the trailer, but just about half way. Then bury the trailer 5 or 6 in. in the ground at the point where the slit is made, leaving the trailer attached to the parent bush. Keep well watered and cover with a thick coating of leaves and straw for winter protection. When spring arrives you will find a strong young plant at the point where you made the slit. The old trailer can then be clipped off, and the new bush transplanted.

Dustpan Aids in Fighting Fire with Buckets of Water

Held over the mouth of a bucket, a dustpan or similar article serves to make a wide stream for fighting a small grass fire. When poured from the bucket without being retarded, the water covers but little area.



Retriever for Articles Lost under Furnace Grating

Small articles lost under a grating can be recovered quickly with this retriever, which consists of a spring clothespin fastened to one end of a stick. The jaws of the pin are cut off as indicated. A wire ring holds the jaws open over the article to be retrieved, and a jerk on a string, tied to the ring, releases the jaws.

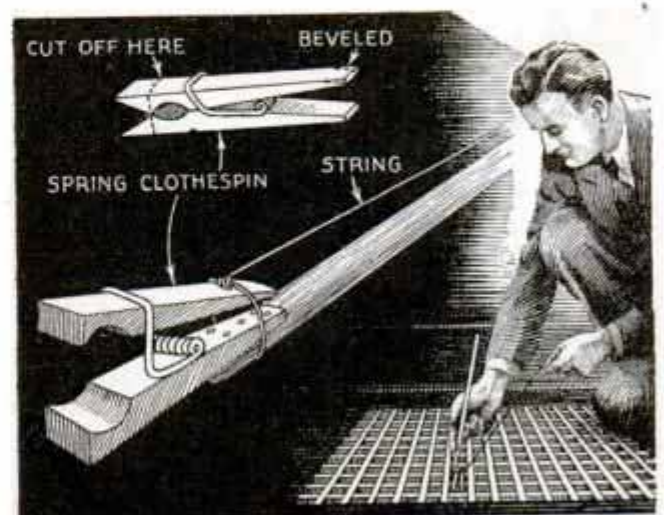

Spring Clothespin Fastened to Stick Makes Good Retriever for Articles Lost under Grating

Snug Dog House Has Adjustable Ventilator

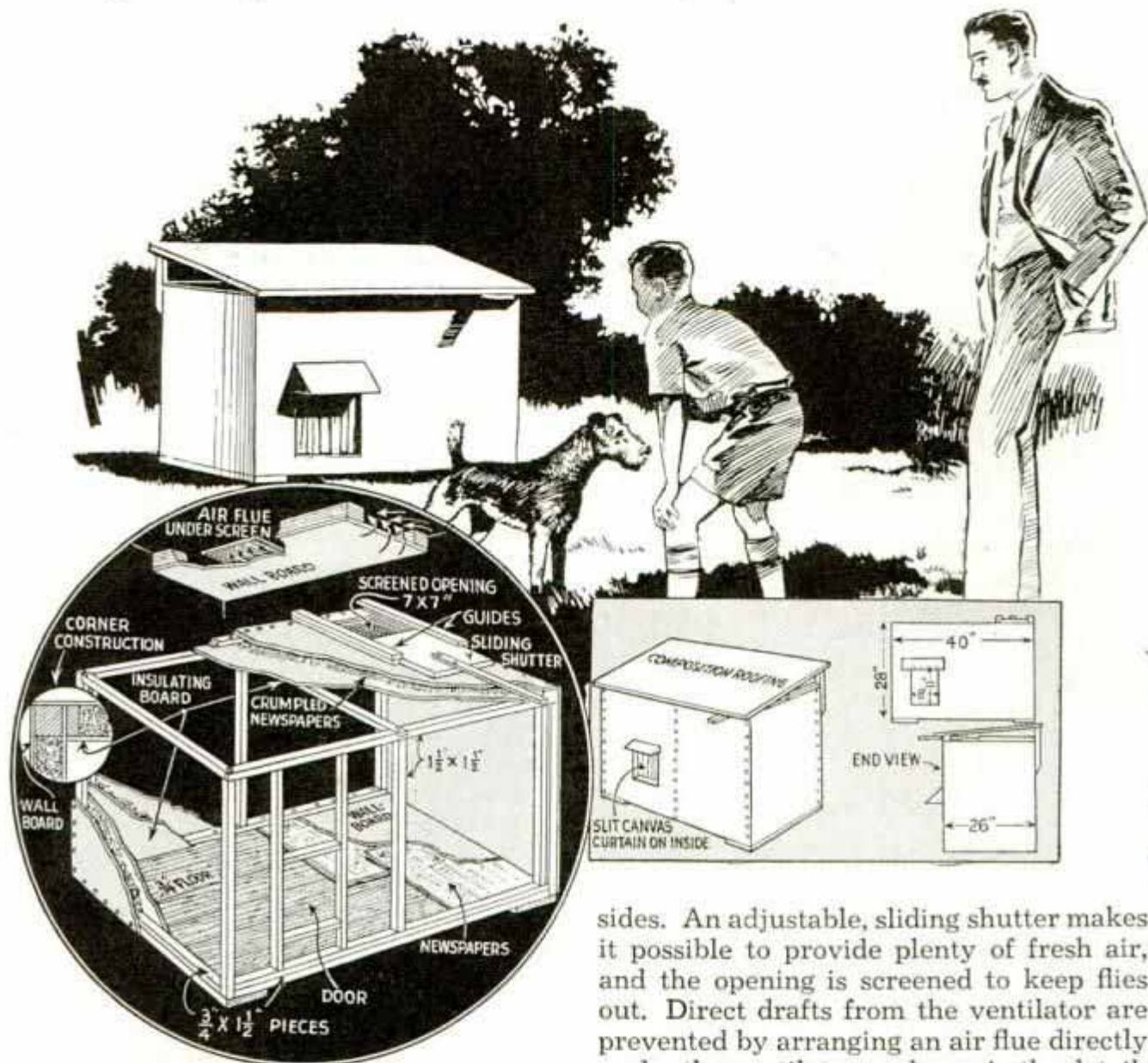

Snug and warm on cold winter days, and cool during hot summer months, on account of its efficient insulation between double walls and floor, this dog house is pleasing to the eye and pleasing to the dog. Although the method of construction shown is applicable to dog houses of any size, the dimensions given have been found suitable for two dogs of fox-terrier proportions. A wooden floor of $\frac{3}{4}$ -in. stock is first laid on two crosspieces, then the framework is set up, which is sheathed on both sides with hard pressed board. Crumpled newspapers are stuffed between the walls. The floor is similarly insulated by laying several layers of newspapers flat and then nailing down a piece of hard pressed board, fitting closely against the

sides. An adjustable, sliding shutter makes it possible to provide plenty of fresh air, and the opening is screened to keep flies out. Direct drafts from the ventilator are prevented by arranging an air flue directly under the ventilator as shown in the detail.

Water System for a Camp Trailer

Water-supply tanks are usually located in the tops of camp trailers to permit gravity feed to the sink faucets, which often makes it necessary to drain the tanks when touring so that the trailers will not be top-heavy. It is better to install the tank beneath the sink and use a small galley pump to raise the water to the faucets. In this way, it is not necessary to drain the tanks. A round or oval tank should be used and the pump connected to it by means of a short hose.

☐ If metal arm or wrist bands that discolor the flesh are coated with nail polish this trouble will be eliminated.

*E. J. Willis & Co. 85 Chambers
New York*

in Colonial Design

By R. O. BUCK

Lane Technical High School, Chicago

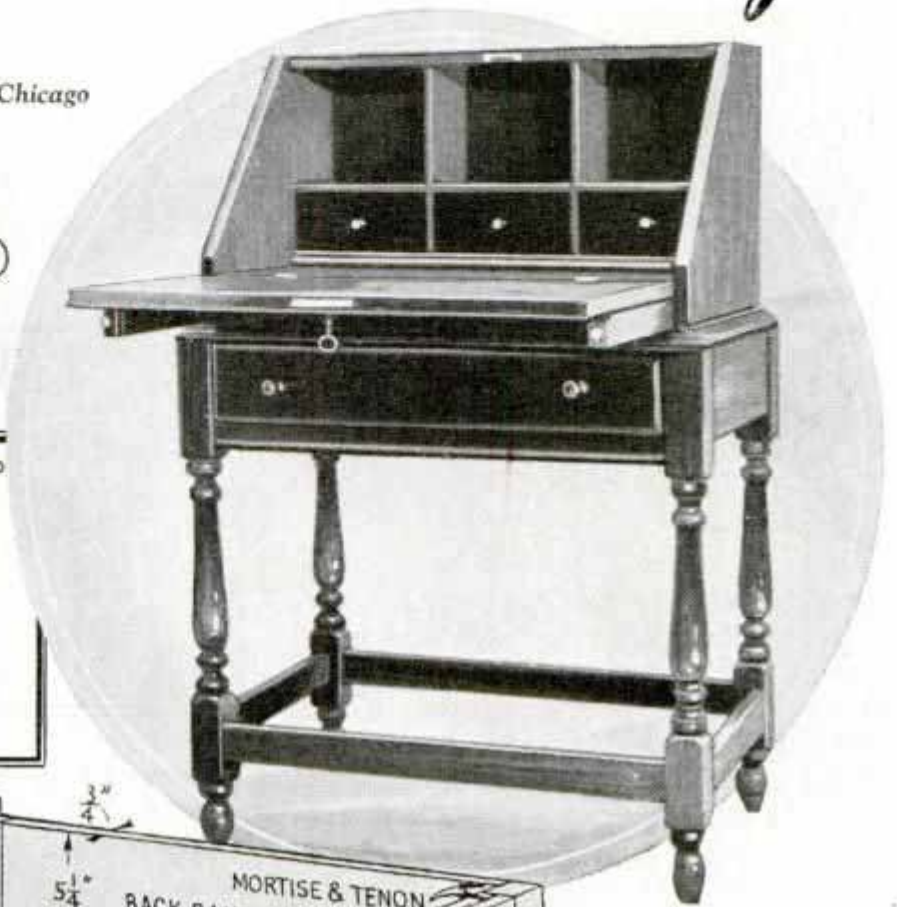

Courtesy of the
Metropolitan Museum
of Art

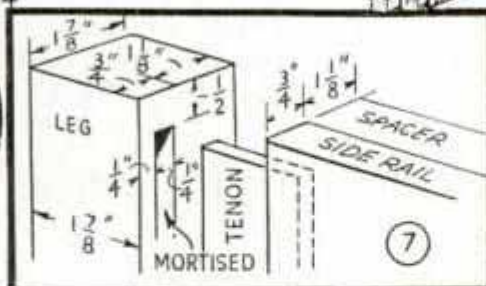
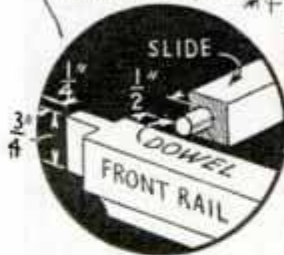
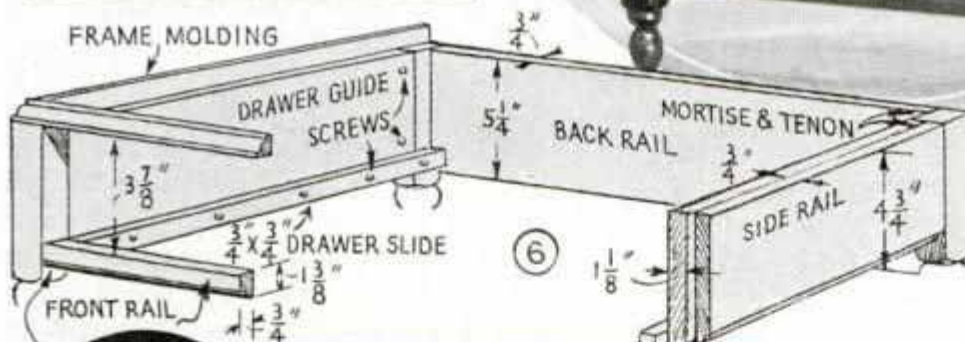
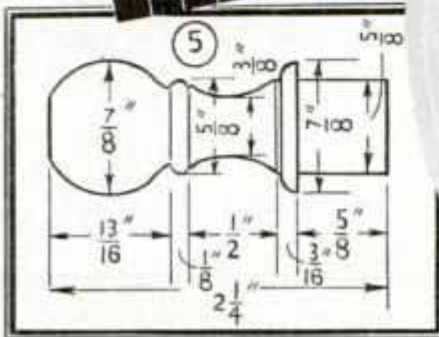
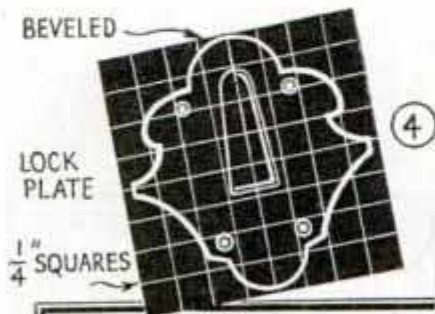

In making the tenons for the rails the shoulder cuts are made first, then the cheek cuts. The molded lower edges of these pieces can be done on a circular saw, if you have a molding head, or on a universal plane. The legs are turned as in Fig. 1 before mortising. After the joints are cut and fitted, the frame should be set up, glued and clamped. As there is no top rail at the front, a piece of scrap wood should be tacked across the tops of the front legs

to maintain the spacing. The frame molding should not be fastened in place until the upper section has been installed, as it is intended to cover the joint between the two and must fit snugly. The large drawer, Fig. 10, is framed up in the usual way except that the corners are all dovetailed, front and back. The upper section of the desk requires some wide stock which will probably have to be glued up.

The sides, top and writing bed should be cut to the finished size; then a 1/8-in. groove is cut on the inner faces of the side pieces to house the ends of the writing bed. The joints at the upper corners are dovetailed so that the dovetails are hidden on the sides. The dovetails should be laid out and cut on the ends of the top piece

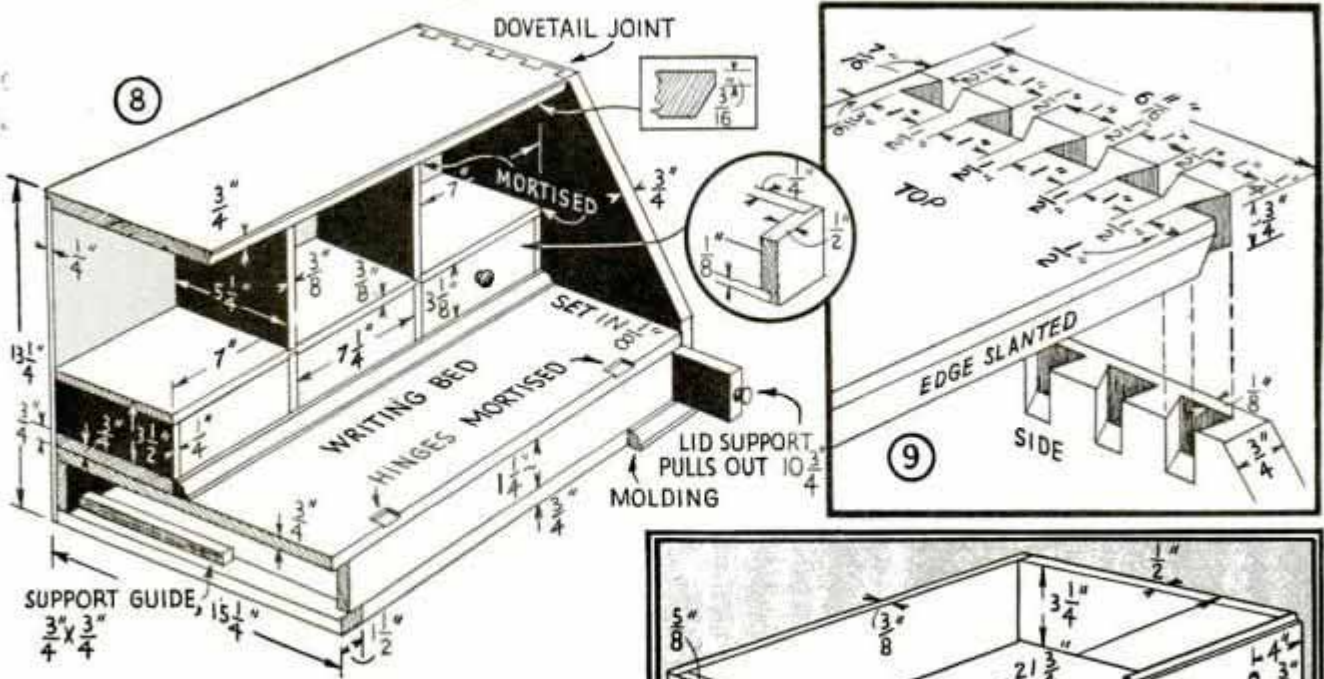

first, according to Fig. 9. A back saw is used to make the side cuts and a chisel for the bottom. If you place a piece of scrap wood under the piece and clamp both securely to your bench top, breaking out chips on the inner face when chiseling will be avoided. The blind dovetails on the side pieces are laid out by placing the top piece in position and marking out the dovetails with a sharp knife. Be sure to mark the portions that are to be cut away as it is somewhat confusing and one can easily cut away the wrong portion. When cutting the square end of the dovetail which leaves a wall only $\frac{1}{8}$ in. thick, it is advisable to support this wall by means of a cleat and hand screws.

The lid supports, pigeonholes, etc., are clearly shown in Fig. 8. To prevent the lid

supports from pulling out too far, a hole is drilled near the inner end in which a short piece of dowel rod is glued, to act as a stop. The front edge of the top piece is slanted so that it will receive the lid. When closed, the lip of the lid should be just slightly below the top. In the open position it will rest on the supports as shown in Fig. 2. Long clothespin type wood knobs, as in Fig. 5, are used on the large drawer. The hardware installed before painting consists of hinges, desk lock and a $\frac{1}{32}$ -in. sheet brass escutcheon, Fig. 4.

Water Pressure Digs Hole to Lay Pipe under Driveway

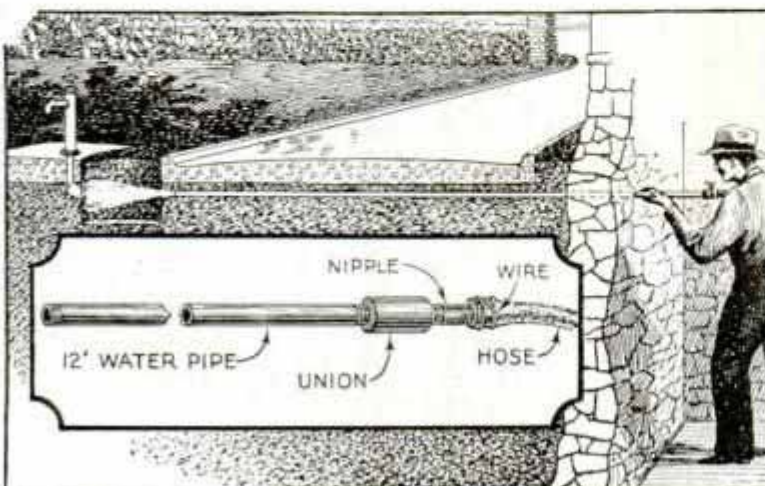

In order to lay a pipe from his basement to a hydrant in the lawn without tearing up part of the driveway alongside the house, one man utilized water pressure to dig the hole through the ground. The pipe was attached to a faucet with a length of garden hose as shown, and then inserted into a hole previously made in the basement wall. After turning on the water, the pipe was slowly pushed through the ground as the water washed the soil away.

Secret Electrical Hookup Opens Wall Safe

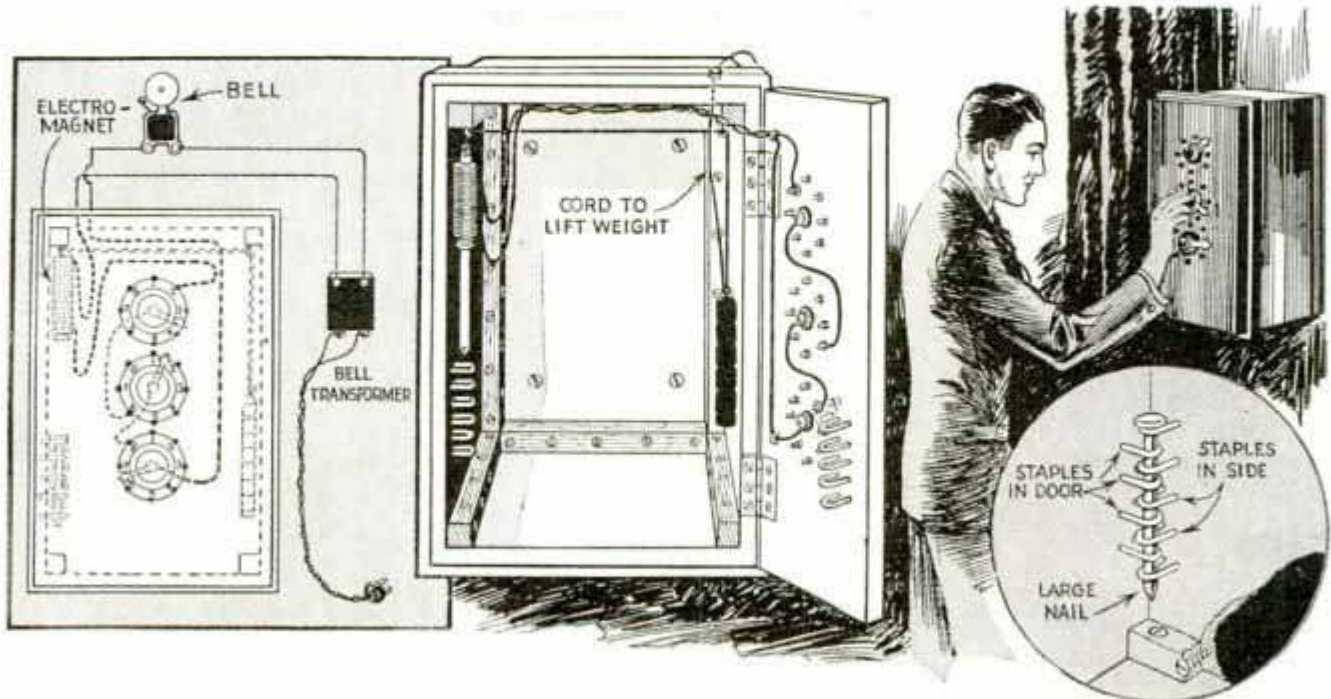

Only one who knows the right setting of the switches can open this wall safe. Unlike combination safes of the mechanical type, this one works by means of an electromagnet. When energized, it is lowered to pull the locking bar from its position in two rows of staples or screw eyes, one row attached to the door and the other to the wall of the safe. Three 8-point radio switches are fitted on the door and are wired in series so that a predetermined arrangement of the switch levers will close the circuit that energizes the electromagnet. You will notice that the electromagnet is suspended at the top directly over the large spike that is used as the locking bar, and that the magnet has a counterweight. A string attached to the counterweight comes out of the safe and this is pulled up to lower the magnet against the spike head. An electric bell or buzzer, cut in the circuit as indicated, will ring when the circuit is closed. If you desire to make use of the house-lighting current instead of dry cells, use a bell transformer to reduce the voltage.

Suction Pump Helps to Filter Chemical Solutions

When filtering large quantities of water or chemical solutions, much time can be saved by using this suction pump, which is attached to a water faucet. Water rush-

ing through the pump creates a vacuum inside of the filtering container and causes the liquid to pass through the paper faster than it would ordinarily. The fitting used to attach the pump to the faucet can be obtained at a plumbing shop. With the pump connected, the faucet should be opened slowly, as too much suction will sometimes break the filtering paper.

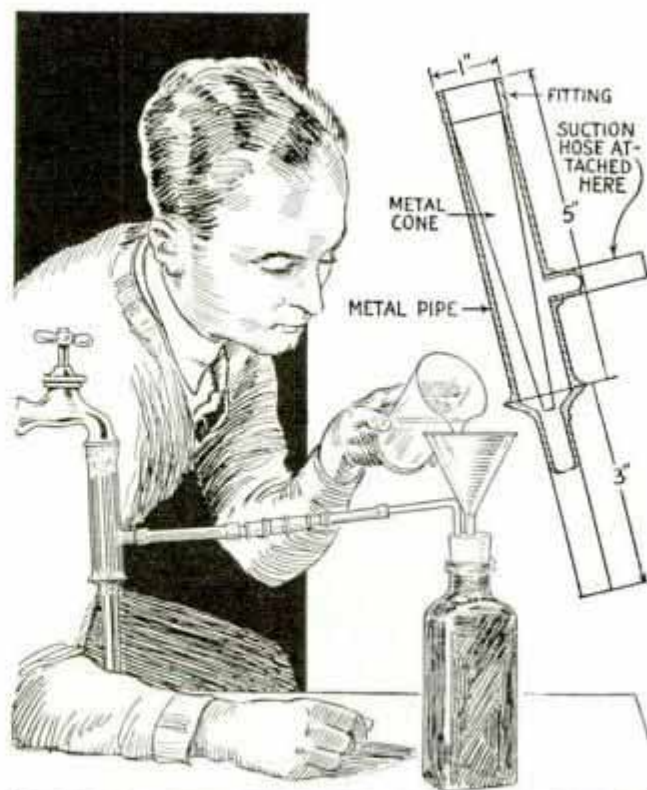

Filtering of Liquids Is Speeded Up by Suction Pump, Which Creates Vacuum Inside of Container

Cork Feet on Jewelry Boxes Prevent Marring Polished Surfaces

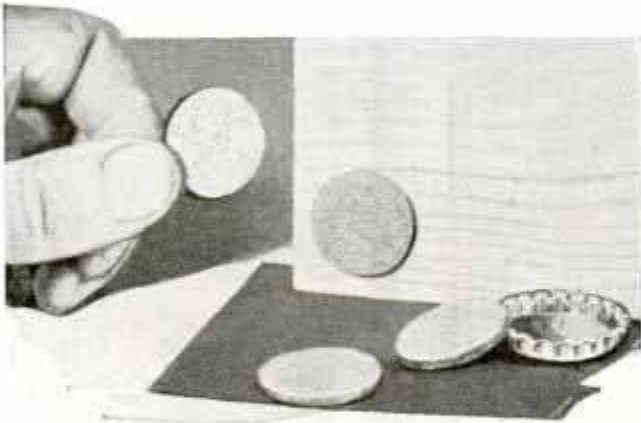

Cork Disks from Bottle Caps Glued to Decorative Boxes Prevent Them from Marring Furniture

Cork disks from bottle caps prevent jewel boxes, ash trays, vanity cases, etc., from scratching the surfaces of tables. The disks can be used whole, or they can be

cut into pieces and they are glued to the bottom of the box, one at each corner. Small disks cut from an old felt hat are also satisfactory for this purpose.

Rubber Clamps for Repairing Bowl-Shaped Mandolins

Two wood blocks and a couple of rubber bands provide good clamps for use when repairing a mandolin. The blocks are laid across the top of the instrument and the bands are slipped over the ends of the blocks and underneath the mandolin to hold the ribs.

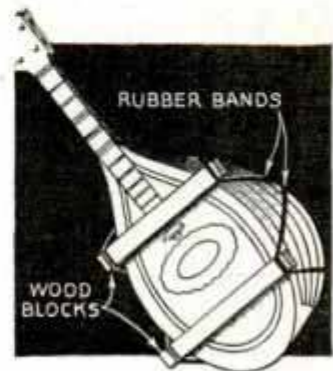

What Do You Want to Make?



"Sovereign of the Seas"

For Recreation

SHOOTING GALLERY—Moving targets for air-gun practice. 763—25c.

HOME BILLIARD TABLE—32 by 62 in. in size. Accurately built. Set of 3 prints (671 to 673)—75c.

COMPACT HOUSE TRAILER—Full size beds for four, running water, 5½ by 8 ft. Two-wheel chassis. Set of 3 prints (815 to 817)—75c.

Address Blueprint Department, Popular Mechanics Magazine, 200 East Ontario Street, Chicago.

400 POPULAR MECHANICS BLUEPRINTS that save time and effort by showing how numerous practical things should be made. This meets your hobby interests, pictures methods of home improvement and offers ideas to make money in your spare time. Send 3 cents to cover postage for complete, free list.

Models Worth While—(Selection of 39)

"ZIP"—A 50-in. yacht that meets requirements for racing tournaments. Set of 4 prints, (880 to 883)—\$1.00.

"SOVEREIGN OF THE SEAS"—Museum-type model completely dimensioned. 8 prints, (828 to 835)—\$1.50.

To Make for Children—(Also 32 novel toys)

DOLL HOUSE—41 by 23 by 24 in. in size. An unusually attractive design. Set of 2 prints, (507 and 508)—50c.

WOBBLE-GO-ROUND—Combination merry-go-round and see-saw. Made from standard wood stock. 564—25c.

8-FT. BOBSLED—Has auto-type steering gear and carries big load. Supports from pipe fittings. 632—25c.



Planking "Roamer"—Popular Mechanics' Outboard Cruiser (765 to 770)

The Secrets of making MARIONETTES



By RUFUS ROSE

PART III

PROPERLY staged, a marionette show creates an amazing illusion of size in the minds of the audience. Instead of seeming their actual height, the marionettes appear to be of almost human size, an effect which is greatly increased because the scenery is also made to correspond. For the home a small stage is preferable, as shown in one of the illustrations. Although its size is comparatively small, the arrangement is practically the same as that of the folding stage shown in Figs. 38 to 41, which is an excellent design for high-school use. This stage was made collapsible so that it can be readily stored or transported. The original one, made in this way, could be folded to form trunks in which much of the paraphernalia could be packed. Each of the two end sections of the bridge has four folding legs hinged inside. The center bridge section rests on the ends of the legs, which fold out from two outside bridge sections. These legs are hinged to lie between outside legs when they are collapsed. Steel tongues, fastened to the edges of the legs where the center section rests, hold that section in place. The three stage-floor sections have four folding legs, used for the high set-up. All legs, runners, wood braces, ladder, and



Photos Courtesy A. & P.

Refer inquiries to Paul Sutton

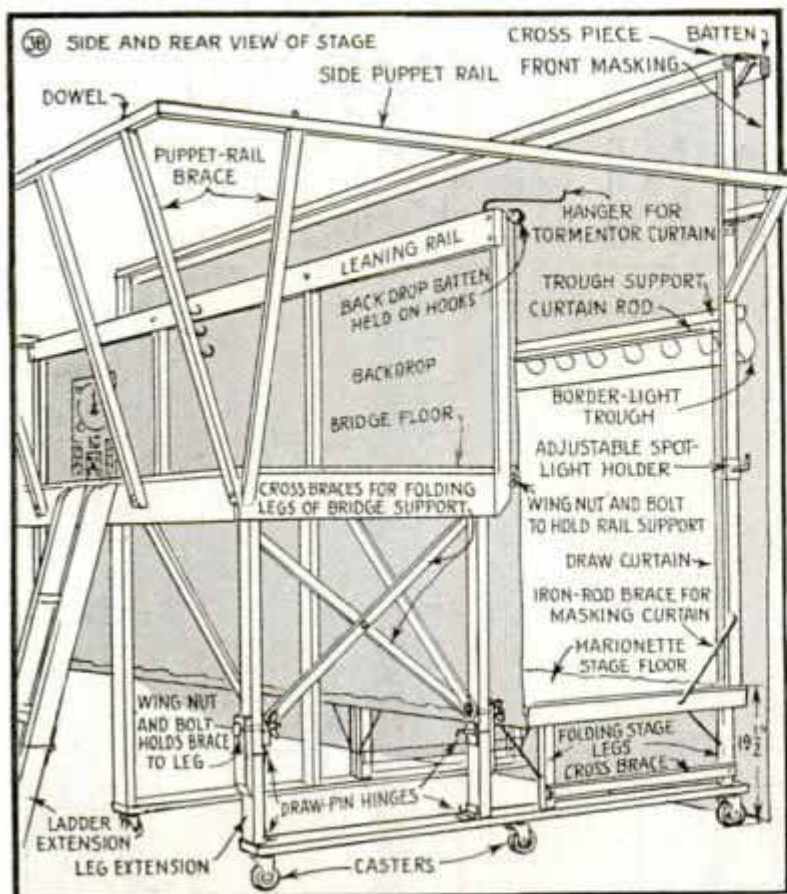

the leaning rail, are made of light-weight pine while puppet rails, masking-frame rails, and rail supports are made of oak. All attachments of collapsible and removable parts are fastened by either draw-pin hinges or wing nuts and bolts.

Fig. 41 shows diagram of draw-curtain assembly. Provision is made for curtains to overlap each other at the center when closed. The front masking is sewed in one piece from closely woven material such as velour or rep. It is cut long enough to reach the platform floor when high set-up is used. The stage opening in the front masking is $7\frac{1}{2}$ ft. long, and extends from points 4 ft. above the marionette stage floor to the platform on which the equipment is set up. The space from the stage floor to the platform is masked by an additional piece which is sewed to the front edge of the stage-floor cloth. When the low set-up is used, both masking cloths are folded back at the platform level and held with snaps. The stage-floor cloth and tormentor curtains are made from a neutral-colored cotton velvet. The floor cloth is tied to the stage floor by tapes which are sewed to the cloth at four corners and at two points in the back edge. The tormentors are held in position by the tormentor

hangers which swing from each end of the leaning rail.

The installation of lighting equipment should be done in accordance with regulations governing such equipment. This equipment includes: a rheostat or dimmer; at least one baby spotlight and one small floodlight with removable color frames and gelines; three 3-ft. border-light troughs; connectors, receptacles, and conduit. The border-light troughs are wired with three separate circuits for red, white, and blue lights. Use 60-watt bulbs. These fixtures are mounted on a panel which is attachable to the



back of the bridge for convenience of operation.

To be a good marionette operator or puppeteer you must first be interested in puppeteering and enjoy it. Hold the controller as shown in photo Fig. 27, with the main control bar firmly in the left hand, grasping it midway between the head crossbar and the back end, so that your thumb can reach the clip that holds the foot bar, and with the fingers of the left

hand in position to tighten the shoulder strings, which run through the screw eye. Grasp the foot bar firmly in the center with your right hand. First, have the marionette stand correctly. His feet should rest on the floor and his body be erect. Feel the weight of the figure as it is distributed between the shoulder, head, and back strings. Now lower the front end of the controller, so that with the puppet's feet flat on the floor you feel all of its weight supported by the back string. To move the head to either side, tighten the

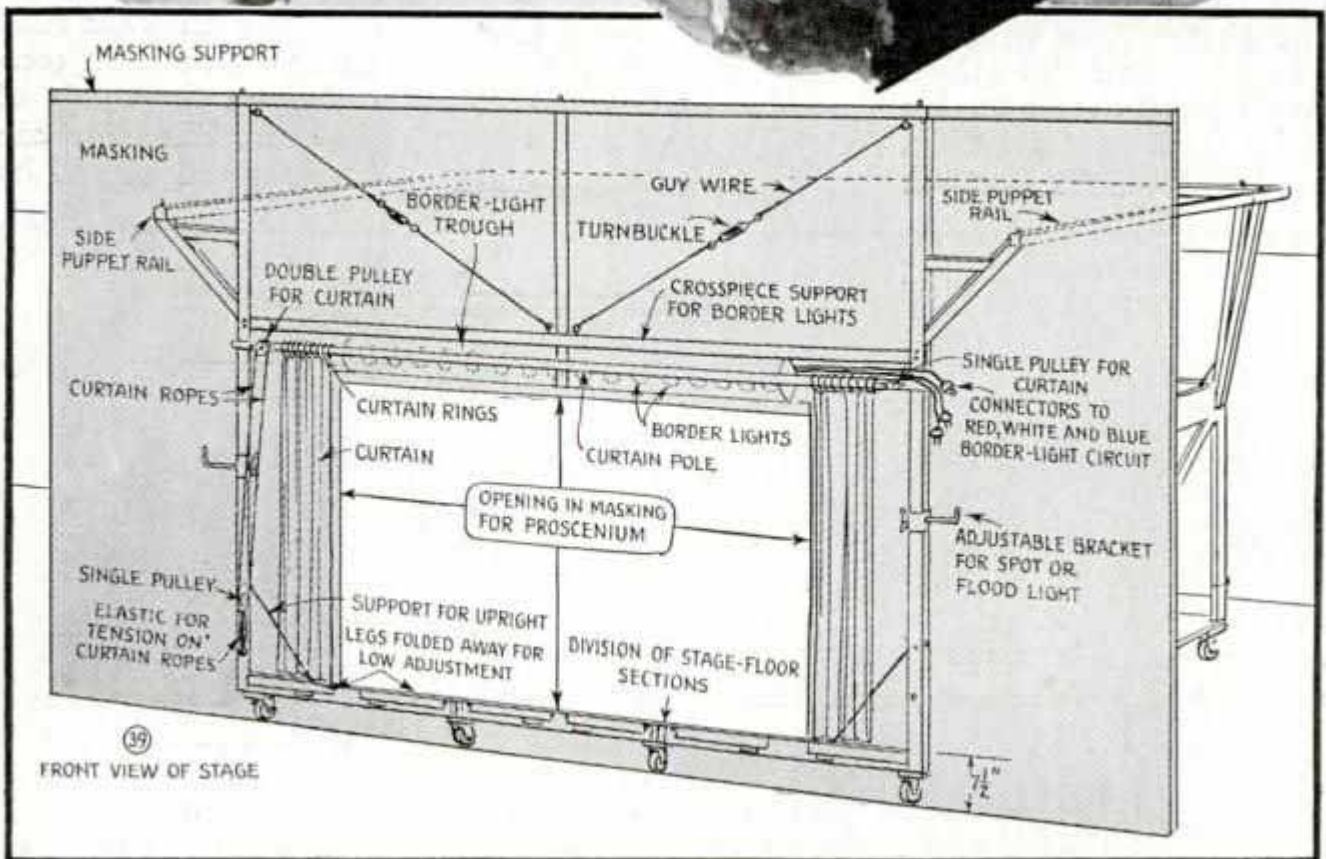
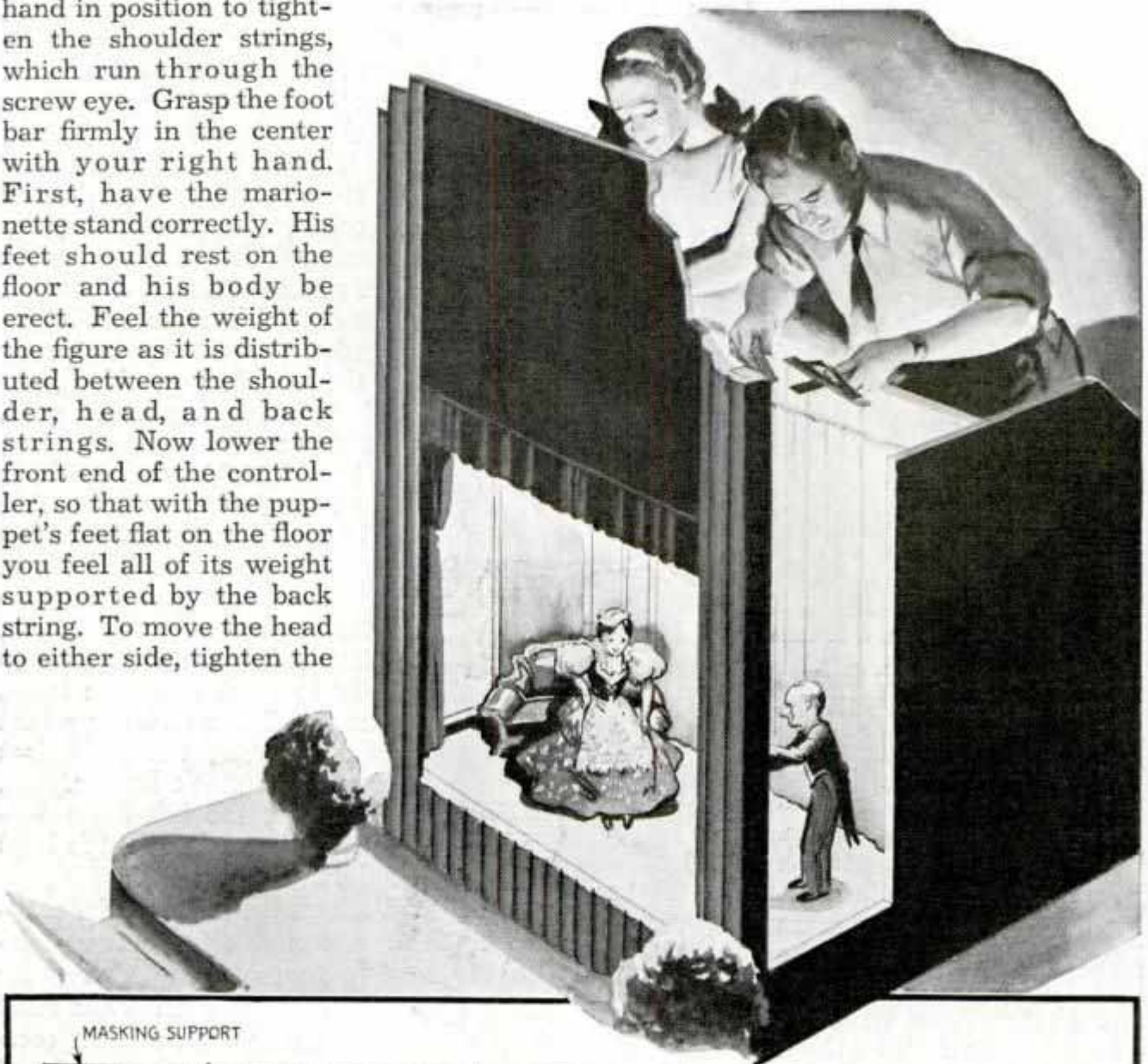



A. & P. Photo

shoulder strings with fingers of your left hand and tilt the head bar to one side and then to the other. To move the hands, grasp the hand strings at a point about 8 in. below their attachment with your right hand, while holding the foot bar at the same time. Feel the weight of the hands and make smooth sweeping gestures, with first one and then the other. Avoid jerky motions. To make the marionette walk, bend him slightly forward,

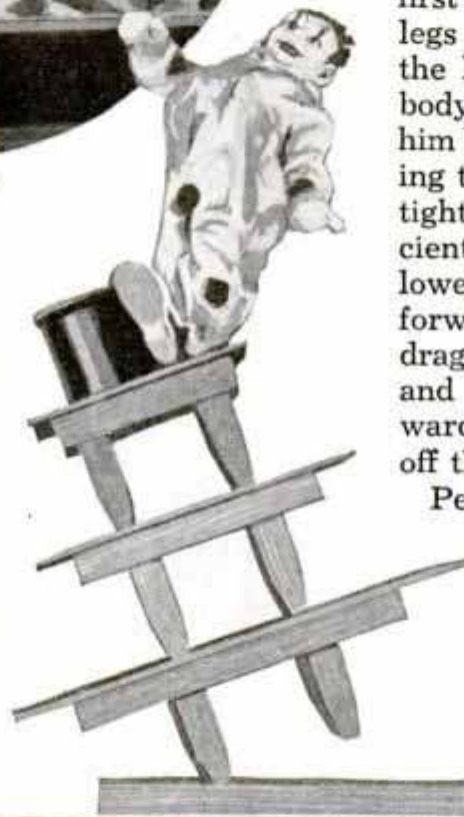

and practice his steps first by raising one end of the foot bar and dropping it, letting the foot slam down. Then raise the other end and drop it. When he can walk in place without getting his feet tangled, let him progress with his steps by a steady motion of the controller, always keeping the figure leaning slightly toward the direction in which he walks. The main controller should be raised and lowered slightly in even tempo with motion of the leg bar as the figure moves along in his rhythmic gait. When making a marionette sit down,

first bend him forward, bend his legs at the knees by tightening the knee strings, and lower his body into the chair. Then lean him back into position. In kneeling the figure to the right knee, tighten both knee strings sufficiently to start the knee bend, lower the figure and carry him forward, letting the right foot drag with a slack knee string, and pulling the left knee forward while the left foot is kept off the floor.

Perhaps the best way for marionettes to pick up objects is through regular manipulation of the hand string with a hook concealed on the inside of the hand. The object can be dropped at will by

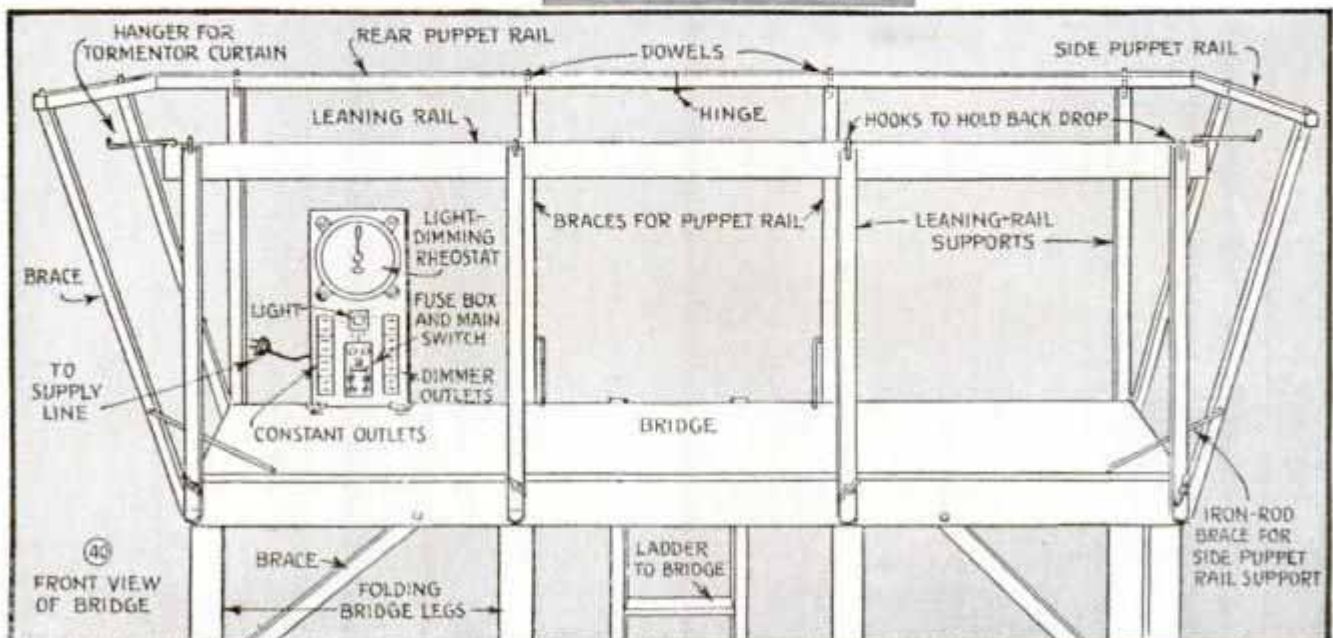

resting it on a table and letting the hook fall free. A marionette can very effectively use a cane in either hand at will by having control strings anchored to either side of the cane knob and running through holes in each hand on through a screw eye in the controller. The cane will be held by either hand at will by pulling the string on one side or other of the screw eye. A similar arrangement can be used for making a marionette take a handkerchief or other object from its pocket and replace it, by having strings run from one side of the screw eye in the controller down through a screw eye fastened in the marionette's body, just below the bottom of the pocket, thence through the bottom of the pocket and out through the pocket opening to the handkerchief or other object to which it is tied. The other side of the string runs from the controller screw eye through a hole in the hand to the object to which it is

"Hod" Lewis Photo

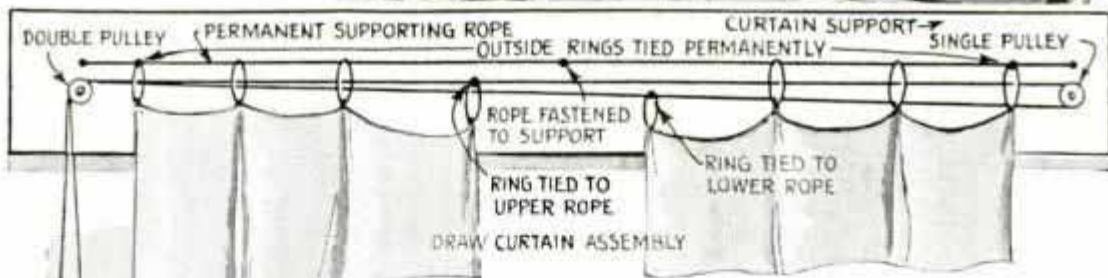

tied. The object is drawn into the hand or pocket by pulling strings on opposite sides of the screw eye. Marionettes, when properly strung and manipulated, can handle almost any miniature musical instrument. Such acts are very effective when playing gestures are carefully synchronized with

music produced backstage. When a marionette is required to place its hands on its hips or on any other part of the body, run extra hand strings through screw eyes which are fastened to the point where the hand is to go. When tricks require difficult manipulation, plan them so that two or even three operators are engaged.

Making File Tangs Safe

While a file handle is preferred for accurate filing, there are times when one is not available. In this case, the end of the file tang should be bent over to form a small loop on the end to prevent it from accidentally piercing the hand should the file catch in the work. It only takes a few minutes to heat the tang and bend it.

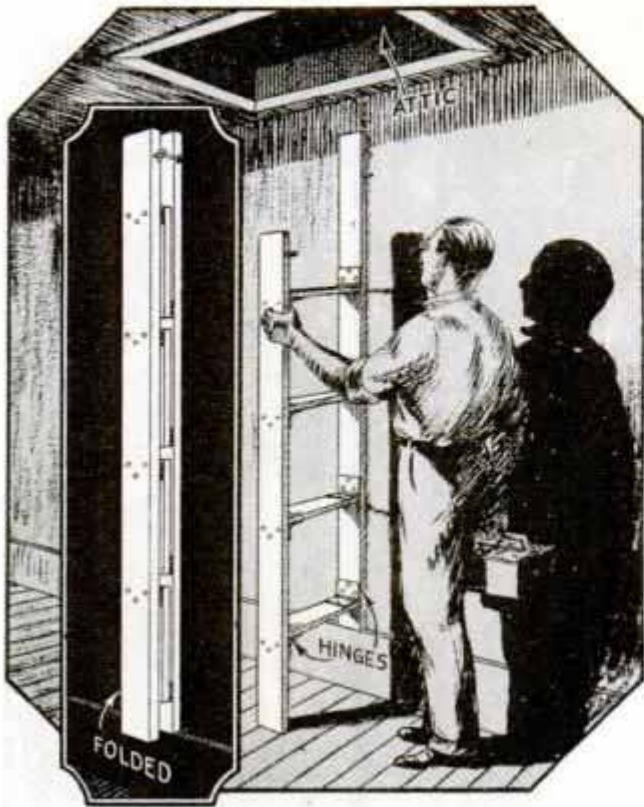

Ladder Fastened to Wall under Attic Trap Door
Folds Up When Not in Use

Folding Ladder to Attic Is Fastened to Wall

In small homes and cottages where an attic stairway is not provided and entrance is made through a trap door in the ceiling of a closet or hallway, a folding ladder can be fastened permanently against the wall under the trap door as shown. When not in use, the ladder is folded against the wall and held with a hook, in which position it takes very little space.

Emergency Lamp Shade Made from Corks and Paper

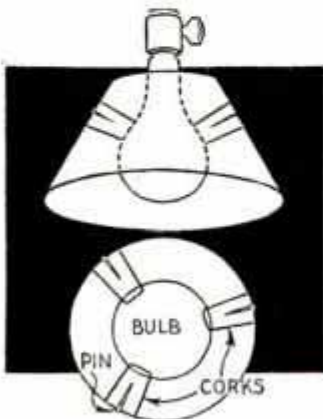

The corks can be attached to the paper cone with pins.

An emergency shade for an electric lamp can be had by slipping a conical piece of heavy paper over the bulb and using three corks as shown to hold the shade away from the bulb and prevent the paper from being burned.

How to Simulate Antique Wear on Ship-Model Parts

When painting parts of a ship model that is to be antiqued, a priming coat of dull ivory or light brown is first applied, and is followed by finishing coats of Japan colors. When the latter have dried, the worn sections of the hull, rails, wales, etc., are imitated by rubbing these areas briskly with a soft cloth until the under color begins to show through. Trials on waste stock, painted as above, are first made as a guide before the process is used on the actual model.

Ventilating a Room without a Draft

When you want to ventilate a room without a direct draft, take a 6-in. board

the same length as the width of the window in the room, hinge it in the center and then slip it under the bottom of the lower sash. This allows air to pass

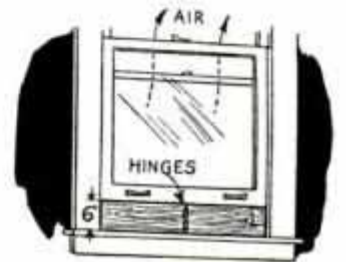

between the sashes at the center of the window as indicated by the arrows in the drawing.—R. W. Schneider, Evanston, Ill.

Rack Holds Tools on Arm of Jig Saw

Accessories for a jig saw, such as extra blades, sanding sticks, screwdriver, etc., can be stored conveniently in a small rack mounted on the upper arm of the saw, as

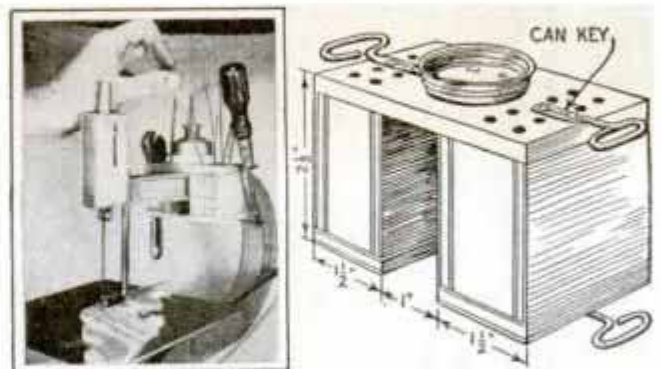

Made of Plywood, This Rack Keeps Tools Required
in Operating a Jig Saw within Easy Reach

illustrated. A fruit-jar lid, tacked to the center of the unit as shown, will be convenient for holding an oil can.—Ray J. Marran, Kansas City, Mo.



Soldering

with an
ELECTRIC
• • • **ARC**



WITH carbon-arc soldering equipment, designed to operate on a 110-volt, 60-cycle, a.c. circuit, there is no need of waiting for the soldering iron to heat. The large clip is simply attached to the work and the solder and carbon touched to the spot to be soldered. The carbon electrode gives no heat except at the moment it is in contact with the work; therefore it is invaluable for soldering work where the heat of an ordinary iron would be destructive to surrounding parts.

The main unit of the soldering outfit is a transformer, Fig. 2, which should be built carefully. Its core is made from any convenient gauge of transformer grade silicon steel. No. 26 gauge is satisfactory. The steel is cut into pieces 1 1/4 in. wide and 4 in. long. A pile of pieces of this dimension 7 1/2 in. thick will be required for an outfit to operate on 60 cycle a.c. About 10 lbs. of this steel will be needed for 60-cycle current. If your current supply is 25 cycles you will need about 30 lbs. of

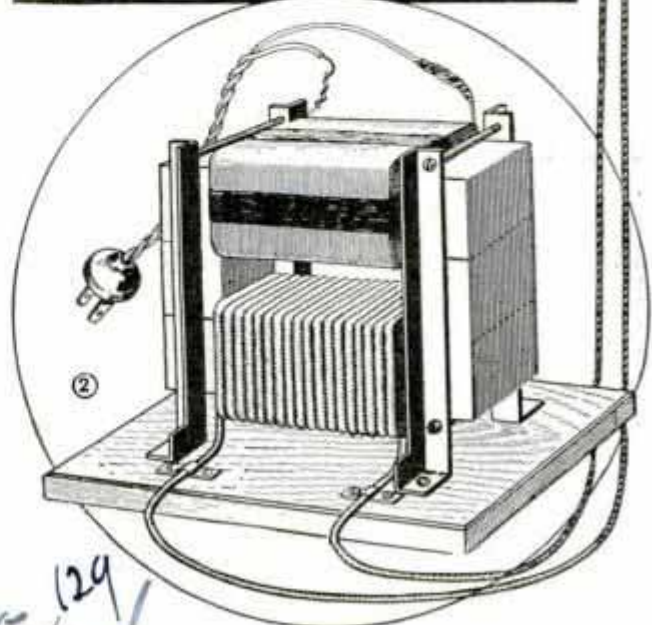
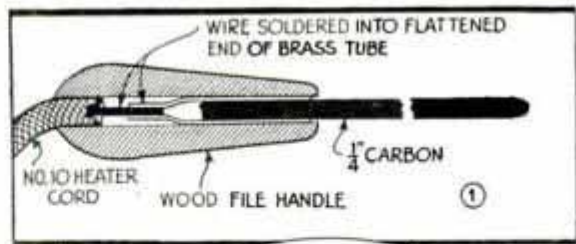

Steel Sales Corp. 129

408-3
 Chicago
 Chicago

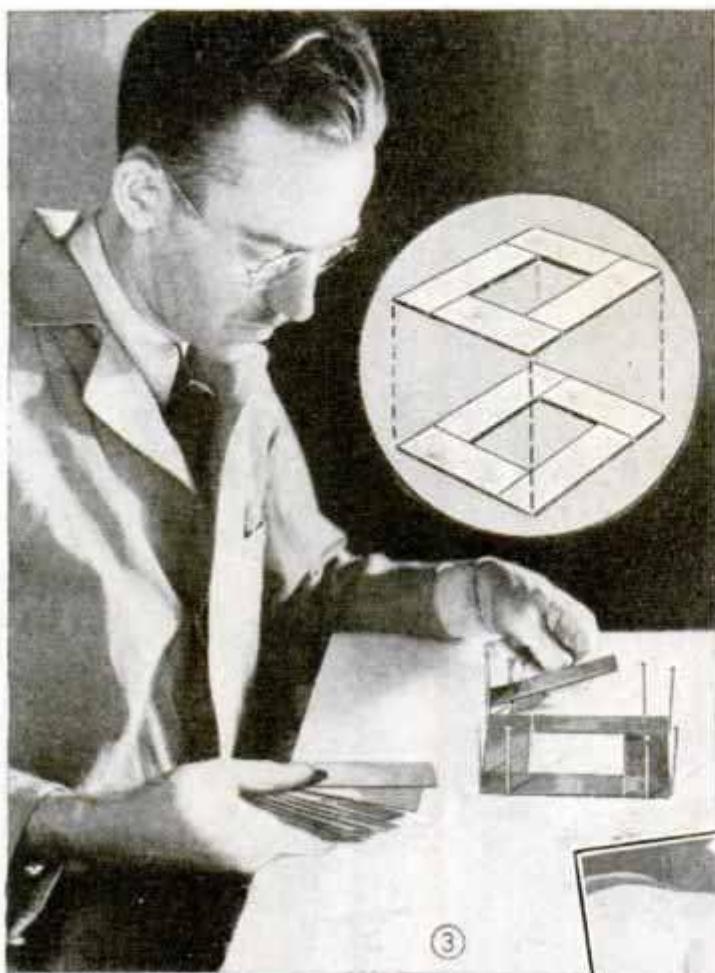

the insulating fiber is slipped off the form with them, and the extending ends are folded around the coil and taped in place. The primary consists of 250 turns of No. 12 double cotton-covered wire. The secondary coil, connected to the soldering electrodes, consists of 140 turns of No. 8 double cotton-covered wire. The number of turns of wire is the same for either 25 or 60 cycles. A 60-cycle transformer will require about 5 lbs. of No. 12 wire and about 8½ lbs. of No. 8 wire. The 25-cycle outfit will require approximately 7½ lbs. of No. 12 wire and 12½ lbs. of No. 8 wire. After the coils have been completed they should be immersed in orange shellac and allowed to absorb as much as they will.

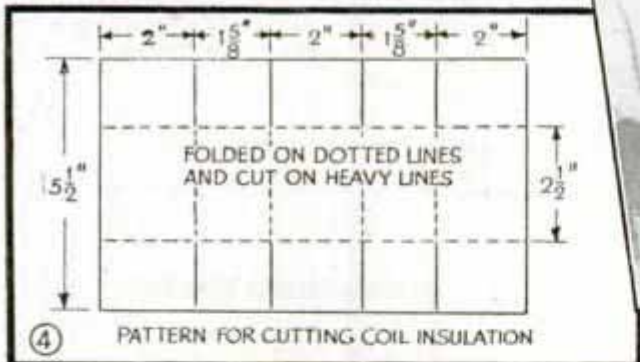
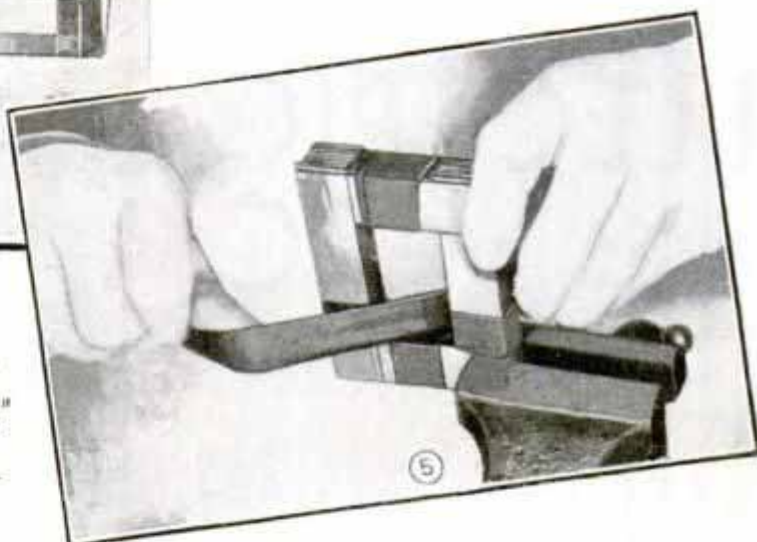

steel, and it should be cut into pieces 2 in. wide and 5 in. long. Fig. 3 shows a simple method of piling the pieces of steel, or laminations as they are called, to make the core. The detail shows the arrangement of adjacent layers. After the core has been stacked it is lifted from the jig, squeezed in a vise and taped tightly on three sides, Fig. 5. The fourth or untaped side is next temporarily removed piece by piece as in Fig. 6, so that the coils may be installed.

The coils are wound on a form as shown in Figs. 7 and 9. Fig. 8 gives dimensions for both 25 and 60-cycle outfits. Fig. 4 shows how to lay out and cut pieces of tough sheet fiber or flexible cardboard to be wrapped around the form before winding the coils. As the coils are completed

They are then allowed to drain and dry for several hours. The coils are next slipped on to the legs of the core and the removed pieces of the core are replaced and tapped down as in Fig. 10, after which they are bound with tape.

Details for the carbon holder are shown in Fig. 1. The file handle is drilled to a diameter slightly greater than the carbon to be used and lined with a copper or brass sleeve which makes good contact with the carbon and allows for easy change of carbons as they burn away in use. A large heavy-duty battery clip makes an ideal ground clamp. The completed outfit may be mounted above the bench either exposed or inside a large conduit box, Fig. 11, as best suits shop convenience. Another plan is to mount the outfit in a large electrical switch box fitted

with a handle so that the unit may be carried around for portable use. If the outfit is installed in a conduit box, the latter should be large so that there will be a clearance of several inches between the transformer and the box on all sides, top and bottom. To use the outfit, simply attach the ground clip to the metal to be soldered, plug the transformer into a convenient outlet and touch the carbon to the point to be soldered. The carbon will quickly become red hot. Cored solder is then applied to the spot and the carbon pulled away to form a hot flaming arc which will melt and flow the solder. The carbon may be moved along the seam to be soldered followed closely with the solder which will melt and flow into place. Plain

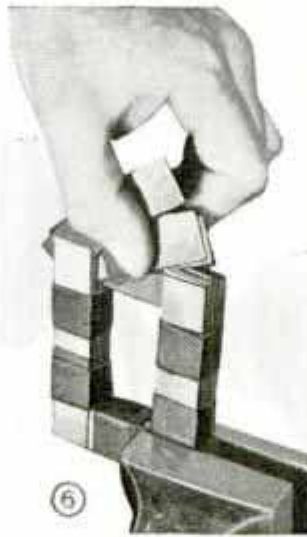

⑥



⑦

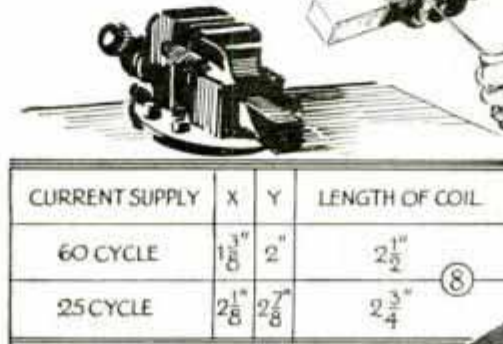

⑧

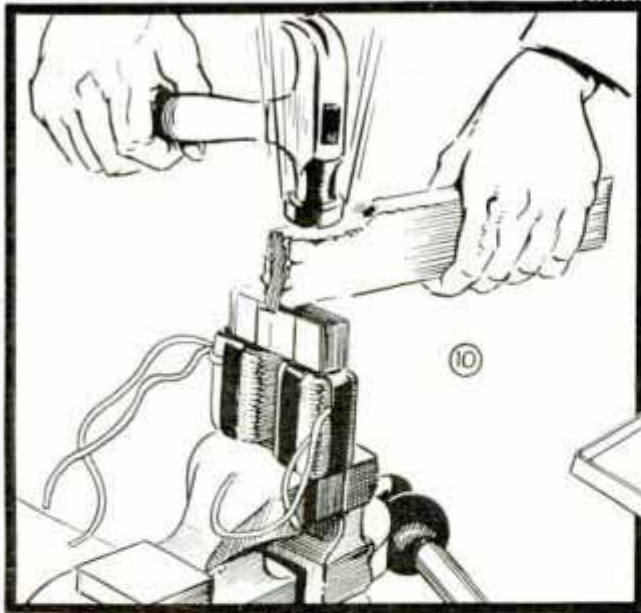

⑩

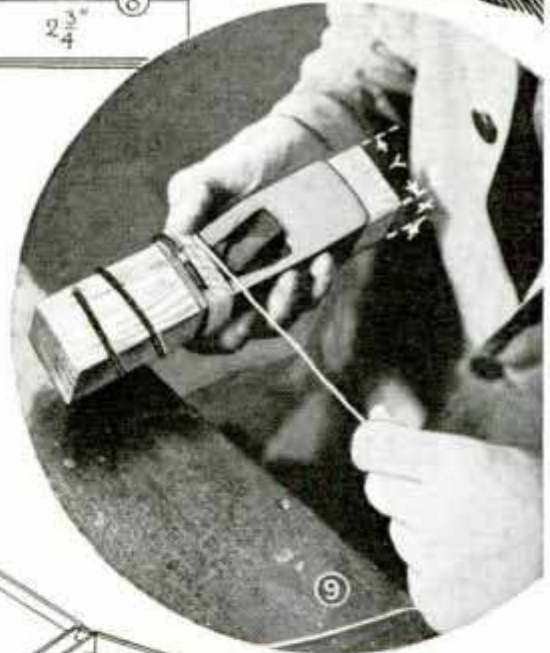

⑨

solder may be used if flux is applied before applying the carbon. About 450 watts are required to operate the outfit.

A Weather-Resisting Lubricant

Open gearing such as is found on cranes and similar machines requires a lubricant with good adhering qualities. Equal parts of soft white lead and plumbago, together

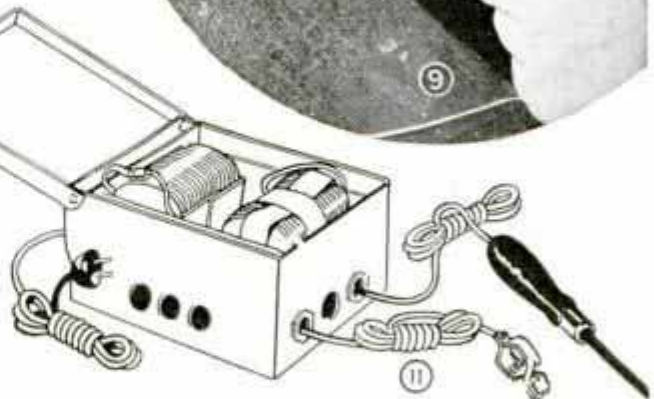

⑪

with cup grease, will be found satisfactory. The viscosity of the lubricant should be varied according to the temperature. If the mix is made up in the proportions of lead, 3 oz., and plumbago, 3 oz., to grease, 1 qt., it will be found about right.

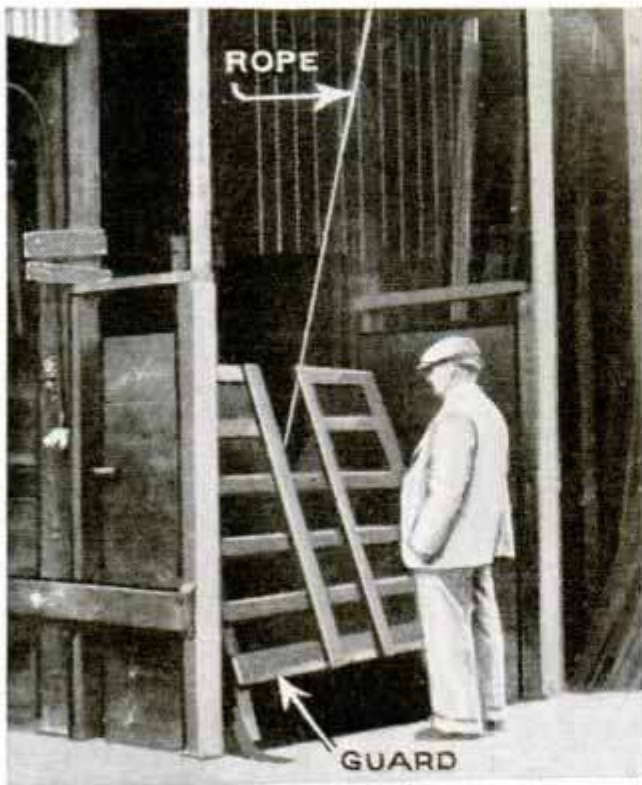

Guard in Front of Open Elevator Shaft Automatically Raised as Elevator Ascends

Automatic Guard for Open Elevator Shaft

A length of sash cord or small rope attached to the bottom of this elevator and to the safety guard below, lifts the latter into place as the elevator ascends, and lowers it over the pit as the elevator comes down. This arrangement permits the elevator to come flush with the runway to facilitate loading trucks.—Jos. C. Coyle, Los Angeles, Calif.

Holder for Re-Tapping Nuts in a Lathe

When nuts are plated or put through a rust-proofing process, the threaded portions on the inside are usually enlarged so that they cannot be screwed onto bolts and must be re-tapped, which can be done easily in a lathe by using this holder and a tap with a long shank. The holder consists of a rectangular piece of steel, which is slotted to form a trough slightly wider than the distance across the flats on the

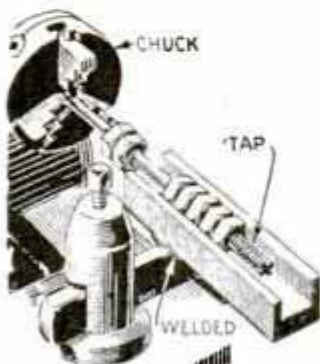

nuts, and welded to a piece of steel to fit in the lathe tool post. In use, the tap is held in the lathe chuck with the threaded end projecting about 2 in. into the trough. When a nut is dropped into the trough and pressed against the tap, it will run up the threaded part onto the shank. As soon as the nut has traveled far enough for the end of the tap to project through it, another nut is started.

Heating Water with a Blowtorch

Plumbers, tin-smiths and electricians who occasionally need small quantities of hot water or other liquids will find it can be heated conveniently with a blowtorch. Make a small wire bracket or holder similar to the one illustrated and use it to hold a small can in the torch flame as indicated.



Magnifying Glass on Flashlight Is Handy for Inspecting Work

Often work must be inspected with a magnifying glass in dark, restricted places where the only illumination is a flashlight. This is rather unhandy as both hands are occupied with the glass and light. To eliminate this trouble and have one hand free

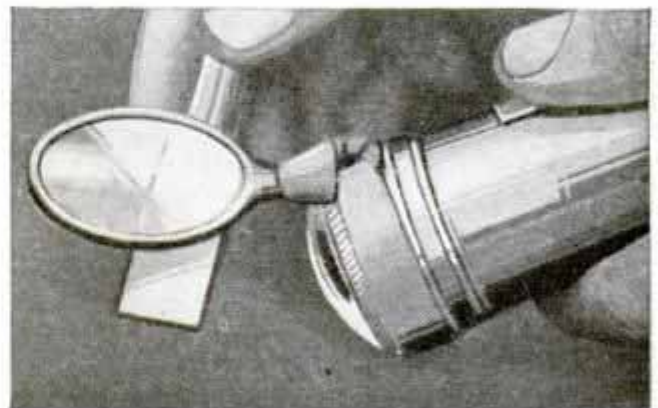

Magnifying Glass Attached to Flashlight Leaves One Hand Free When Inspecting Work in Dark Places

to manipulate the work, fasten the glass to the end of the flashlight with a rubber band as shown.

Labor-Saving Uses for Parallel, Pivoted Links

Many practical applications can be found for parallel, pivoted links. One use is the hoist shown in Fig. 1. A square frame

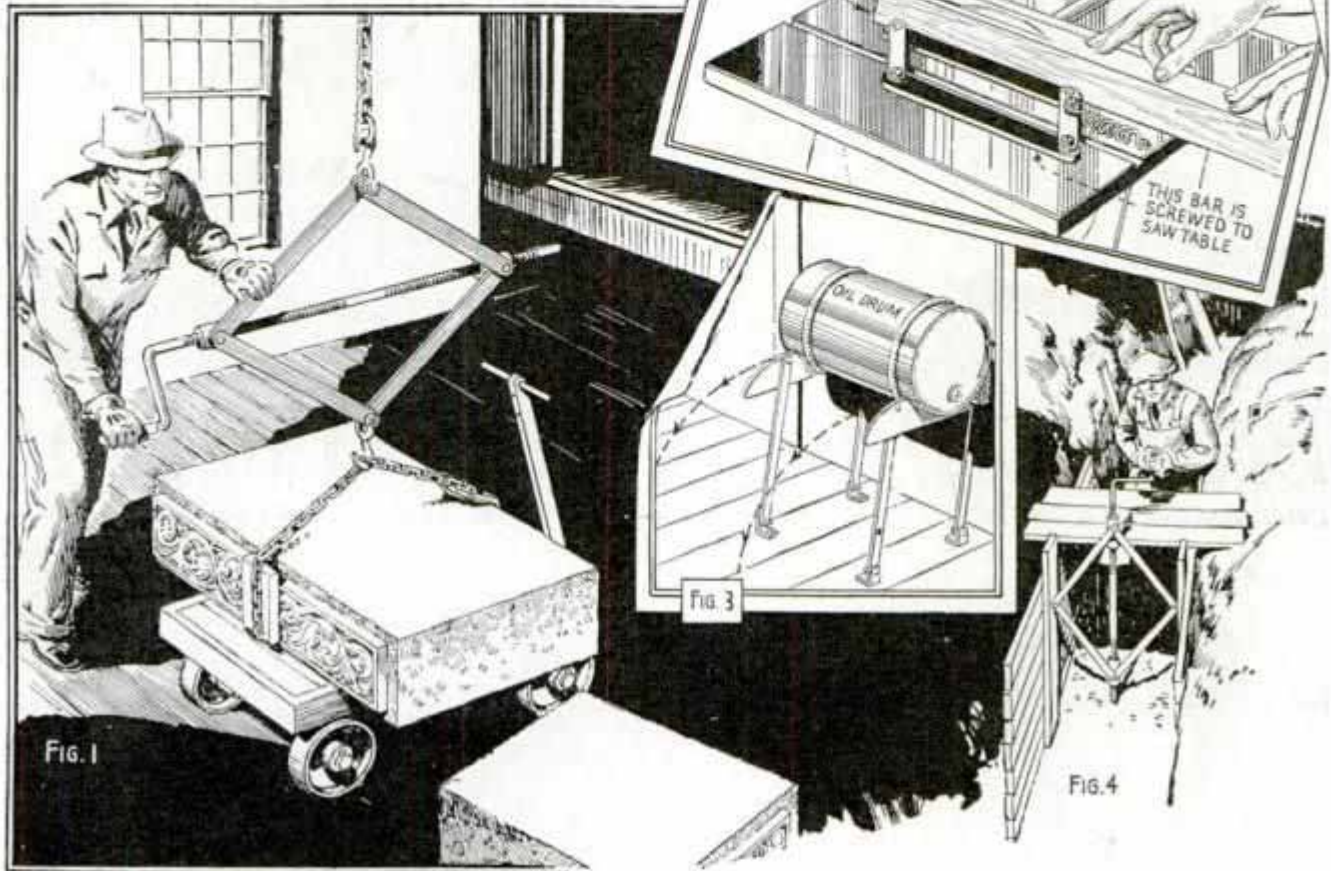

made up of sturdy steel bars pivoted together, is provided with a threaded crank, which runs in two tapped bushings as indicated. The threaded sections of the crank must be right and left so that when the crank is turned the bushings will travel in opposite directions. It is also necessary to turn down the unthreaded portions on both ends, before bending the shaft to form the crank, to enable the bushings to be slipped in place. In use, the action of turning the crank, to drive the bushings apart, will raise the lower end of the hoist, which is provided with a suitable hook. Powerful lifting force is exerted although the lifting distance is rather limited. With slight alteration, the hoist may be used to exert a pressure instead of a pull, and will therefore make an excellent trench brace, Fig. 4. In Fig. 2, parallel links are used to make a work support on a circular saw. One bar is fastened to the saw table and the movable portion is anchored to a coil spring, the tension of which determines

the pressure exerted against the work. When it is necessary to keep a drum of liquid at a certain height above the floor, the task of lifting it, to set it on a support, can be made easier by pivoting four angle-iron legs to the floor and to two cross-pieces made to hold the drum. This arrangement permits the top of the stand to be brought down against the floor, as indicated by the arrows, so that the drum can be rolled on the crosspieces, after which both drum and rack are pushed up. As will be seen from the dotted lines, less lifting movement is required than is necessary when hoisting the drum up on a stationary stand as only part of the movement is vertical, after which a pushing action raises the drum and rack in place. The rack should be leaned against the wall at a sufficient angle to keep it there without danger of tipping.

☛ Oil on a new file should be removed before using it on metal.



PROTECTING *the* BOAT *against*

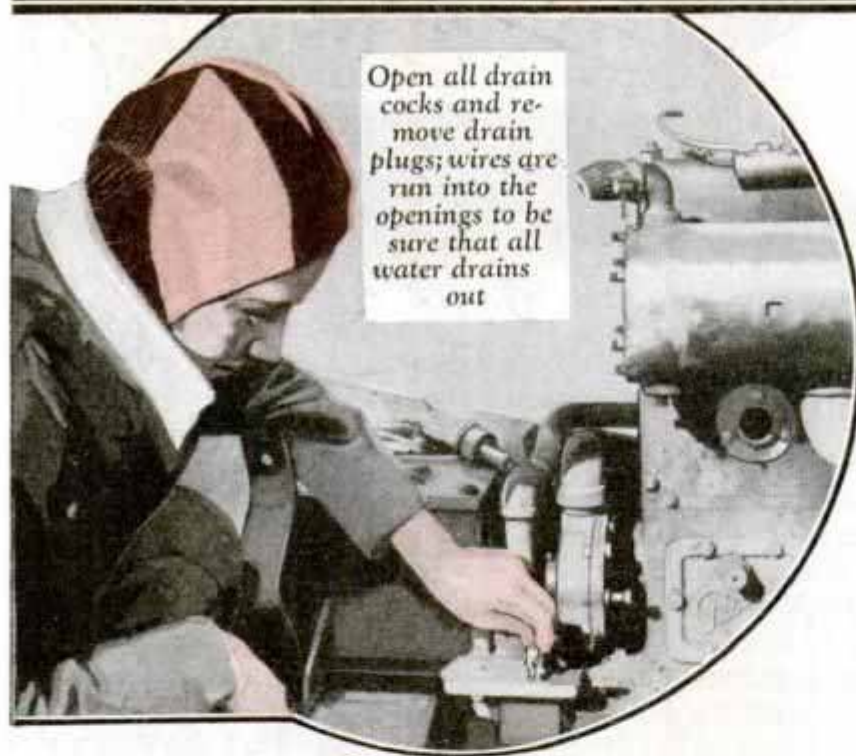

Open all drain cocks and remove drain plugs; wires are run into the openings to be sure that all water drains out

WINTER is hard on most boats, but a few precautions taken when the boat is put up will save much work and expense when putting it back in shape again. Boats stored in the open should be covered with canvas or tar paper. A common mistake is that of laying the covering material directly on the boat. This is better than nothing, but a frame to hold the cover from the boat will keep the cover from freezing to and damaging the painted or varnished surfaces. Inside of the boat all drains should be opened. If the boat is

so stored that there is no drain hole, at the lowest part of the hull bore a 1-in. hole. A plug can be fitted into this hole in the spring. Take up all floor boards and remove all waste, rags, paper and other matter that has found its way into the bilge. Then rinse out the bilge to remove most of the dirt. After this, scrub out the bilge with hot water and any good cleaning powder or soap and rinse thoroughly. Be sure that all limber holes (drain holes on the planking side of ribs near keel) are open and that all water drains from the bilge.

If it does not, sponge the bilge dry and then be sure that no rain can enter the boat.

After the bilge has had a couple of weeks in which to dry it should be painted unless the paint is in good condition. At this time the bottom should be rubbed down with steel wool and given a coat of special bottom paint. After this single coat, all seams should be inspected and any that are open should be calked. Then a second and final coat of bottom paint should be applied. This will retain about the right amount of moisture in the planking and

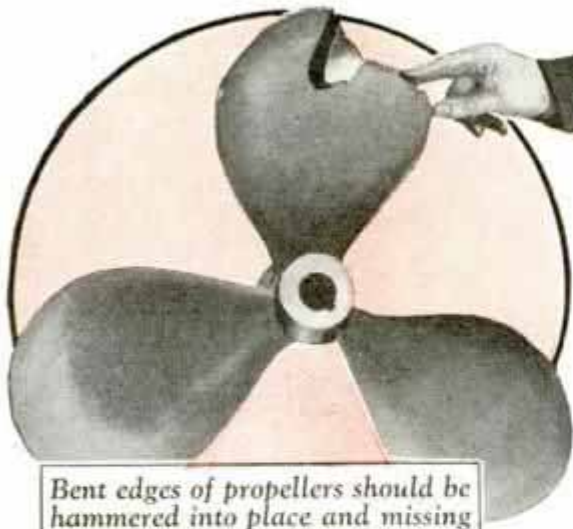

Bent edges of propellers should be hammered into place and missing metal built up by welding

WINTER

prevent excessive opening of the seams. Refinishing of sides, top, and interior should be left until spring in order that the boat will be as fresh as possible for the summer. The keel of any boat should be firmly blocked at all times, a support every 10 ft. being sufficient. The important thing to watch is the tightness of the blocks. The blocks should be stout pieces of wood wedged into place and checked every few weeks during the storage period to be sure that softening of the ground has not permitted them to loosen. Many a boat has lost speed as a result of careless storing which has permitted the keel to go out of shape. Proper shoring—as blocking up the boat is called—will prevent this. In addition to the keel blocks there should be two braces on each side.

If considerable mechanical work is needed on the engine it is best to remove the whole unit and take it to a place where warmth, room and light are available. If overhauling is not needed slight adjustments can be made right in the boat. But be sure that the engine is drained. Check it all over for water-jacket drains. Some have water-jacketed reverse gears which must be drained if damage is to be avoid-

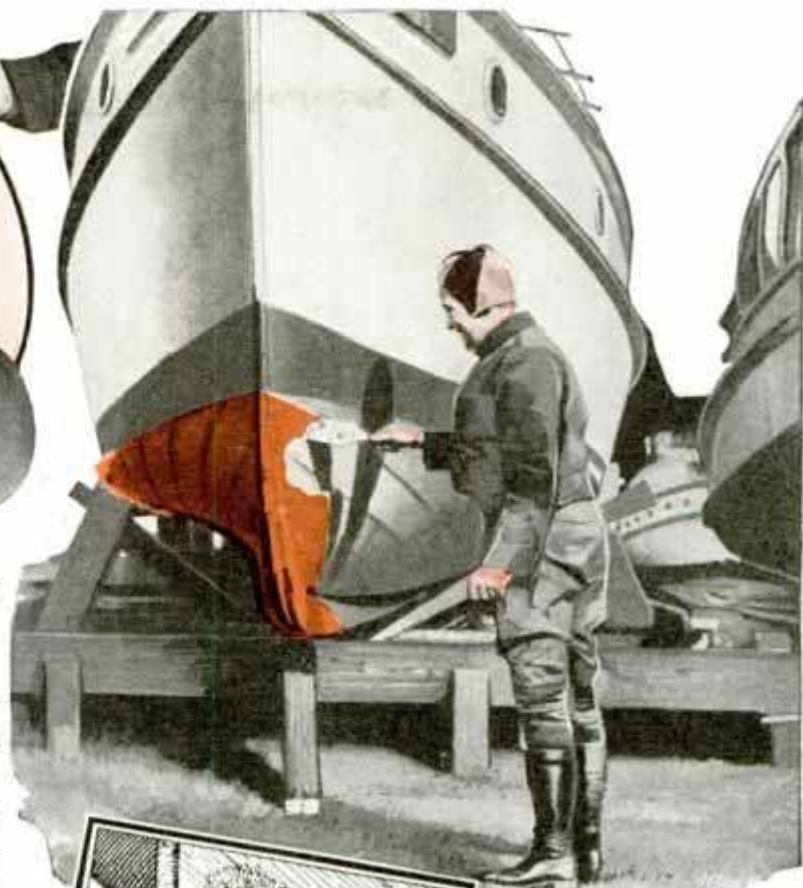

After a thorough rub-down with steel wool the bottom of the hull is painted



Above: Groove in shaft, caused by electrolysis, may be built up by welding and then ground to size

Right: Blocking adjusted by wedges keeps the keel true all winter



ed. It is also a good plan to drain off the old engine oil at the close of the season, refill with new oil and run long enough to thoroughly distribute the oil. Then take out all spark plugs, pour $\frac{1}{4}$ pt. of oil into each cylinder and screw the plugs in place loosely. Then during the winter, give the engine a turn or two every month. The storage battery should be removed and thoroughly charged, and every month or

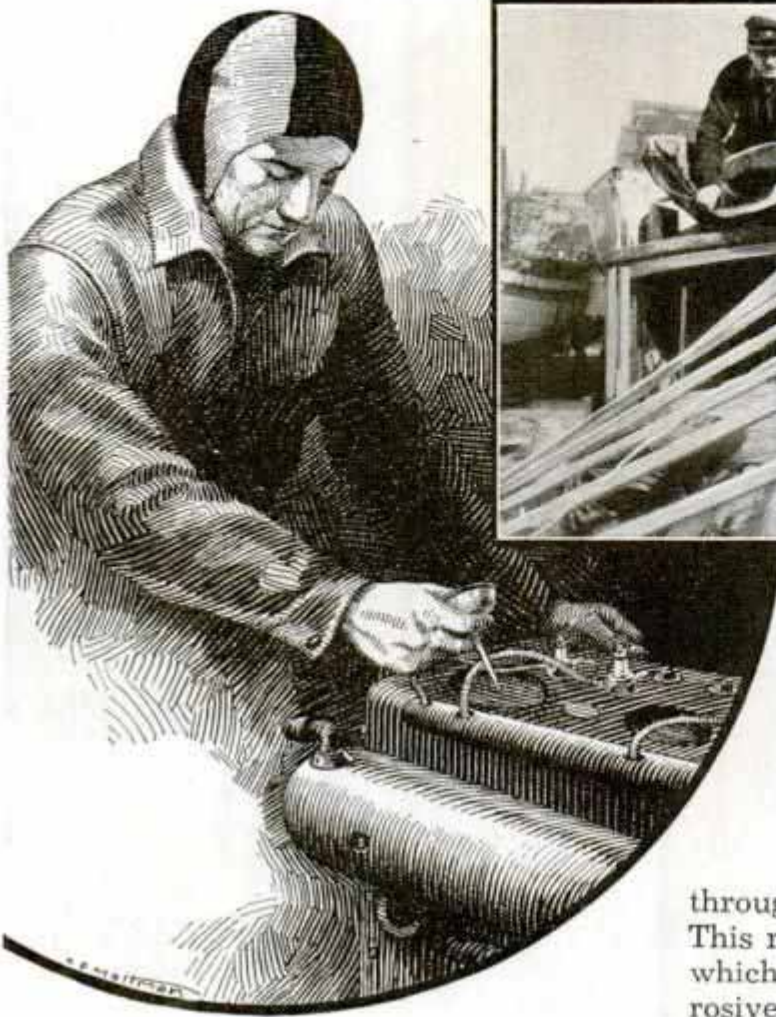

Left, a liberal application of oil on top of the pistons prevents rust inside the motor. Above, light wood frame holds tarpaulin off the upper surfaces of the boat

six weeks given a freshening charge to keep its specific gravity up around 1.280, or to the full charge mark on the hydrometer.

All ropes should be removed and stored in a dry place, but even with the best of care, ropes lose strength from year to year and need replacement. Removable instruments and equipment should also be taken to a place where they may be securely locked. Polished metal surfaces should be coated with vaseline to prevent corrosion. Many boat owners take advantage of the winter months to have their polished brass chromium plated to improve the appearance of the boat and to reduce the work of keeping things shipshape. Most damaged propellers can be repaired. On cruisers and slow boats, this work does not require quite the precision that is necessary on propellers that turn up at extreme speeds. Most damage consists of either bending the blades or tearing them on rocks. It is best to have this work done at a regular marine shop. However, many a damaged propeller has been put into good

condition by welding. Neglecting damaged propeller shafts has sent many a valuable propeller wheel to the bottom. Most boats in fresh water have steel shafts running through a bronze bearing or packing box. This results in an electro-chemical action which consumes the steel shaft. The corrosive effect is generally concentrated at the point where the shaft emerges from the stuffing box. The cheapest way to correct this trouble is to remove the shaft and have the groove filled with steel after which the repaired section is ground to size.

Holes in Shovel Aid in Handling Wet Mixtures

When shoveling mud as in ditching, river work, cofferdams, etc., and some of the water in the shovel drips back on the user, which is likely if the swing is the least bit cramped, much of this trouble can be eliminated by drilling a number of $\frac{1}{2}$ -in. holes in the shovel as shown. This allows the water to escape just as the shovel is lifted and before the swing is made. The shovel may still be used for other purposes as the holes are too small to allow dry earth or gravel to pass.



Threads Cut with Dies on Lathe

Threading the ends of small rods with a round die may be done accurately in the lathe by using a die holder, which releases automatically when the thread has been cut to the required length. The holder is turned from round stock and is recessed to take the die, which is held in place with two set screws as shown. The short spindle on the holder revolves in a tapered shank and is fitted with a transverse pin which engages a slot in the rear end of the shank. The latter is flanged as shown, and the taper fits the tailstock quill. Two pins set on the same radius, one in the holder and one in the shank, engage when the die starts cutting. As the thread progresses the holder moves outward from the flange until the pins disengage. This releases the die holder which then turns free with the work. When the lathe is reversed to back the die off, the cross pin in the end of the holder spindle engages the slot in the shank and holds the die stationary while it is backed off the thread.—Geo. A. Luers, Washington, D. C.

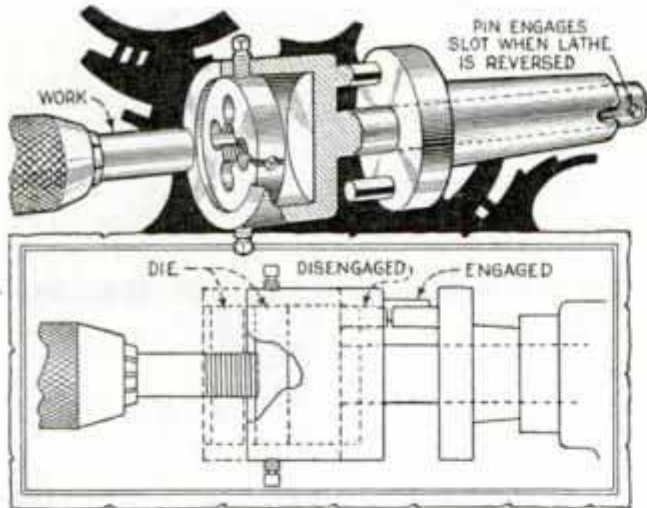

Simple Jig Enables You to Cut Threads with Round Dies in Lathe

Simple Arrangement Saves Time in Dry-Cleaning Shop

Here is an arrangement that aids in slipping paper covers over cleaned garments in a dry-cleaning shop. A sash cord, running over two pulleys fastened to the shop ceiling, has a weight tied to one end and a broomstick or dowel rod to the other. In use, the stick is pulled down through the opening in the top of the cover, which is then secured to a brad in the upper end

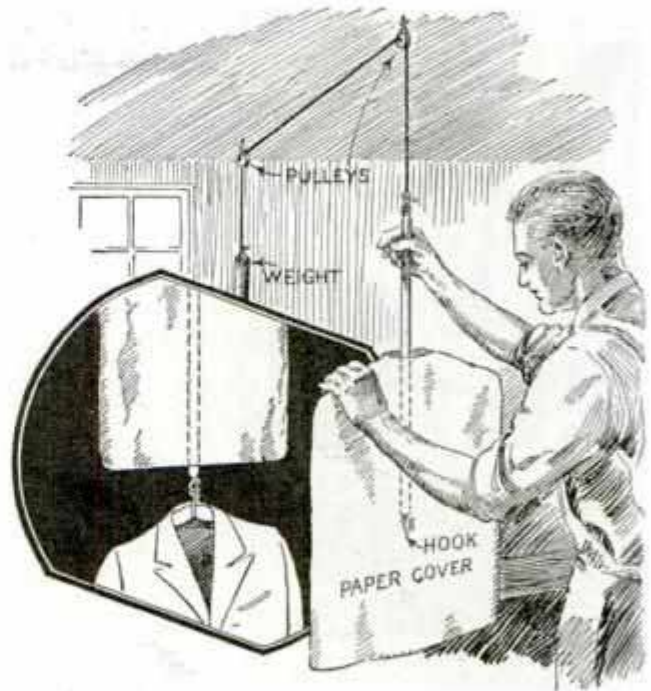

Cord-and-Pulley Arrangement That Aids in Putting Paper Covers over Garments in Cleaning Shop

of the stick. When the stick is released the weight raises the cover. The garment is then hung on a screw hook in the lower end of the stick and the cover is pulled down over it. The weight should be sufficient to hold large, heavy garments off the floor.—Martin G. Winterton, Ft. Lewis, Washington.

Feet Improve Drill-Press Vise

To prevent metal cuttings from interfering with movement of a vise on a drill press, I fitted the vise with feet, which raised it slightly above the top surface of the table. A steel plate was first squared and then the corners were bent down and ground off so that the vise would rest perfectly level on the table. The method of attaching the feet to the vise is shown in the drawing.—H. Moore, Hamilton, Ont.

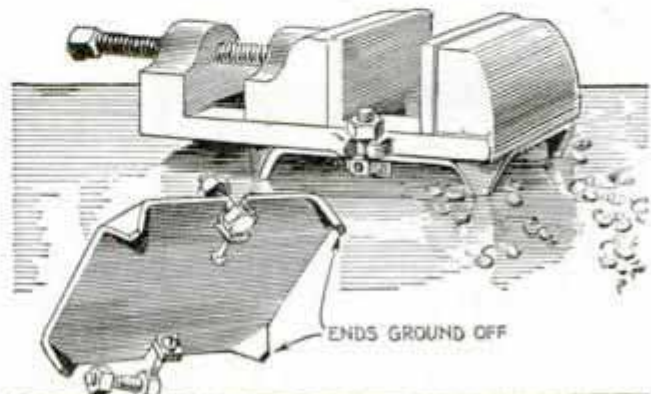

Feet on Drill-Press Vise Prevent Metal Cuttings from Interfering with Use of Vise on Table



Heavy Paper Placed between Layers of Stacked Package Goods Keeps Them from Falling Off

Paper Makes Stacks of Cans and Packages More Rigid

Grocers who arrange their canned and package goods in neat stacks will find that a sheet of paper placed between each layer, as the stack is built up, will help prevent the packages from falling away from the stack. The paper is especially handy when tall stacks are put on the floor or in a show window.

Casting Babbitt Bushings with Molds Made of Pipe

For casting babbitt bushings of odd size, the problem of getting suitable molds is quickly solved by using short sections of pipe or tubing of the required size. Each pipe is squared at one end and is split lengthwise with a hack saw. Pieces of tin or sheet asbestos are then folded and inserted in the cuts, after which the edges are folded back to seal the opening. When the mold is set on an asbestos gasket, and held in this position securely with a C-clamp,

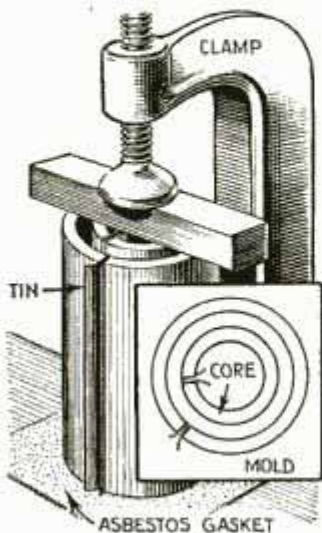

mold is set on an asbestos gasket, and held in this position securely with a C-clamp,

the molten babbitt is poured between the pipe forms, and can be driven out easily after it has hardened. The molds should be preheated to about 250° F. before pouring the babbitt to evaporate all moisture and to prevent the metal from chilling before it fills the mold properly.—O. D. Carter, Fresno, Calif.

Screen-Wire Shield Protects Hands When Carrying Hot Ladles

An emergency shield to protect the hands when carrying ladles of molten metal with a pair of tongs or pliers can be had by slipping a piece of screen wire over the handles.

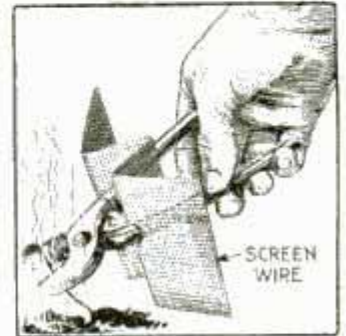

After punching holes through the screen, it is folded as shown, and slipped over the tong handles.

Suitcase Serves as Portable Desk for Traveling Business Man

For the business man who travels, a suitcase divided into pigeonholes with pieces of corrugated cardboard or thin plywood, is convenient. With this arrangement, an office can be set up temporarily



Suitcase Divided into Pigeonholes Serves as a Portable Desk and Filing Cabinet

right inside of your car as shown. The suitcase used for this purpose should be strong and should be made of stiff material.

☐ Brighten old pen points by dipping them in ammonia and rubbing with cloth.

USING YOUR

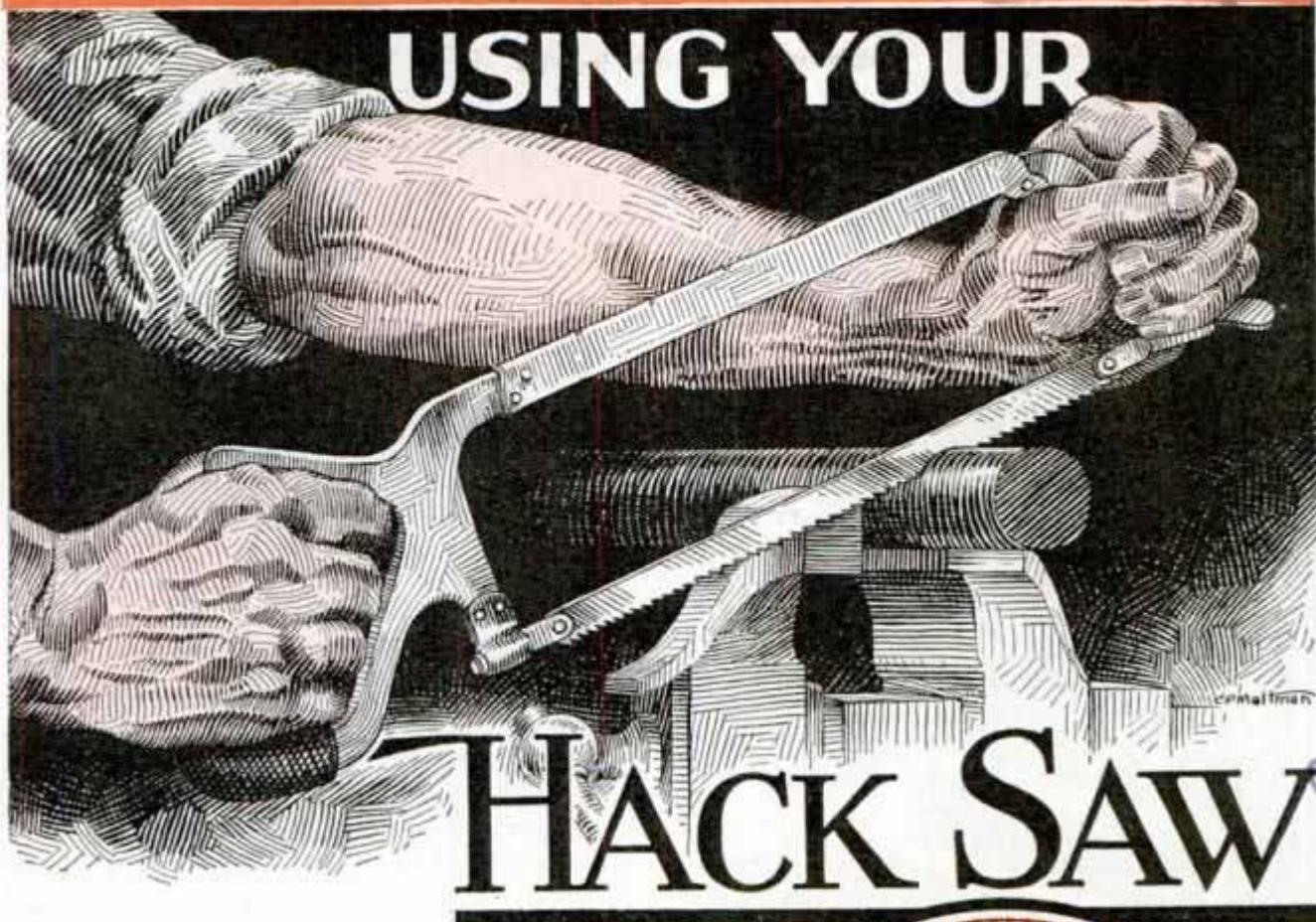

HACK SAW

By W. CLYDE LAMMEY

WHETHER it is used to cut small metal rods, pieces of flat stock, to slot the head of an improvised screw, or even to cut a keyway in a piece of shafting, the hack saw is one of the most useful tools in the workshop. Four types of hand hack saws are shown in Fig. 4. For general use, you will find the kind having a pistol grip most convenient as it permits one to hold the tool correctly. Most hack saws are adjustable so that blades of different lengths can be accommodated. You will find a medium-tooth blade, 12 in. long, the best for most purposes.

In simple cutting-off operations on solid stock, first measure and mark the work for length; then before attempting to start the blade on the line, take a small three-cornered file and notch the surface on the line to a depth of about $\frac{1}{16}$ in., as in Fig. 6. Be sure that the notch is square with the work, then set the blade in the notch as in Fig. 7, and take a light forward stroke, the left hand grasping the forward end of the saw frame in the manner shown in the illustrations. The left hand should always

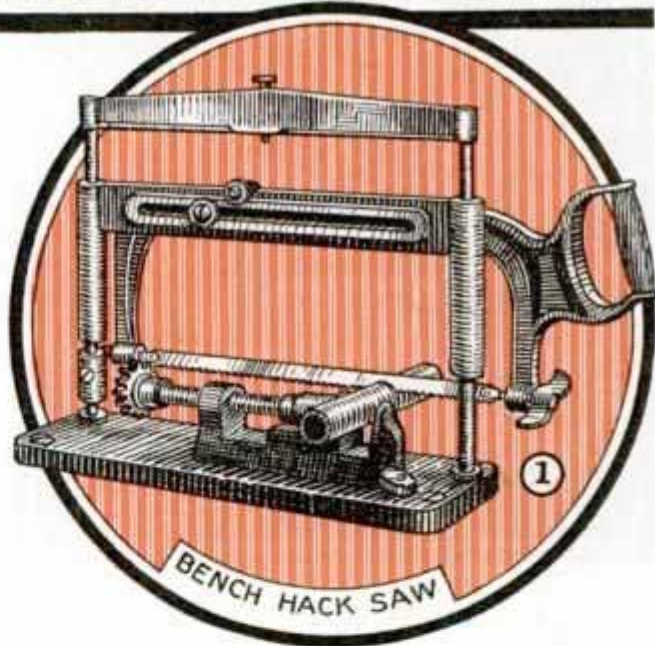

apply the greater pressure and at no time should this be excessive. Heavy pressure not only causes the blade to heat up rapidly, but loads the teeth with an excess of metal which invariably causes binding and breaking of blades. There is a tendency, even among many practical mechanics, to exert too much pressure with the right hand when cutting metal with a hack saw. This tends to force the rear end of the frame downward with every forward

*Handell Prath Con...
Greenfield Mass.*

Lacony - Phil

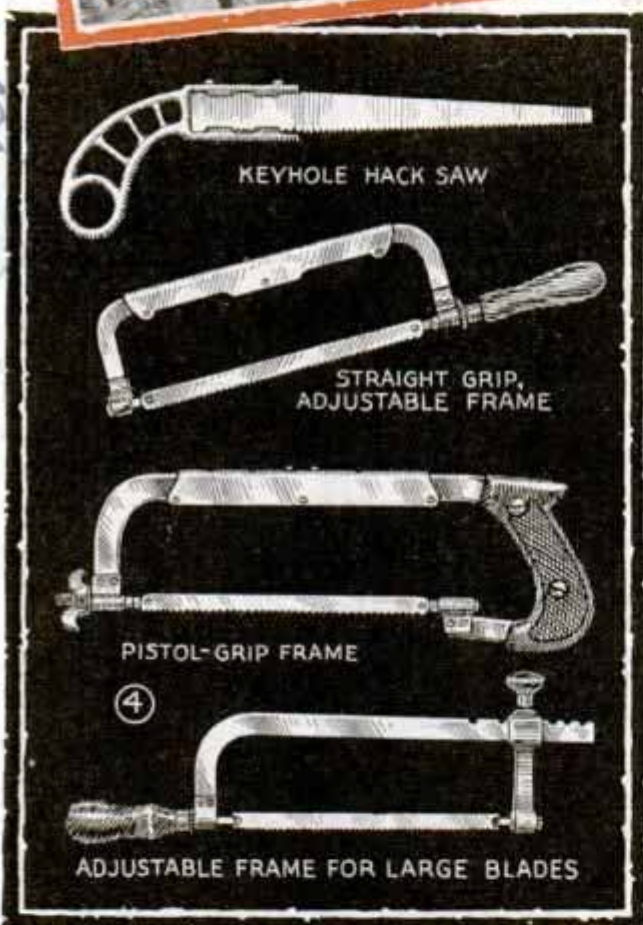
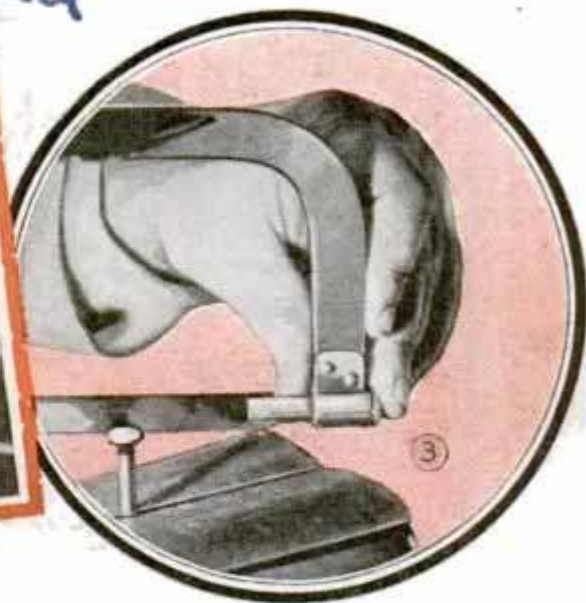

first scoring a guide line around the surface, filing a notch to start the blade and, after the cut comes through the wall, gradually dropping the handle of the saw as the cutting progresses, so that the cutting is done only on one wall. The tubing is turned in the vise until the cuts meet. Thin-walled tubing should be supported at the cutting point by plugging it with a close-fitting cylinder of hardwood. When this is done you can cut straight through both walls. Likewise, small pieces of thin sheet metal can be cut to size by clamping them between two blocks of wood, the size of the finished piece being laid out on one block. When cutting thin sheet stock, it is very difficult to follow guide lines if the blade is run at right angles to the work. This is often necessary due to the size of the material but should be avoided whenever possible and the saw run at an angle in the same manner as a handsaw when cutting through wood.

stroke, and at the same time springs the blade, which results in chipped teeth. The blade will cut much faster under uniform light pressure, will leave a smooth surface, and it is far easier to control the direction of the cut when following a line. Just before the cut comes through on solid stock, lower the forward end of the saw frame a trifle as each stroke is made to prevent the saw teeth catching in the thin metal and breaking out at the gullet or space between the teeth.

Tubing having a wall $\frac{1}{8}$ in. thick or more can be cut easily with a hack saw by

You can often save time by having an assortment of blades at hand, any of which can be slipped quickly into the hack-saw frame, Fig. 5. They come in a variety of thicknesses and degree of temper to suit varying conditions and type of work. The life of a hack-saw blade, its cutting speed, and the quality of work it does, depend entirely upon the manner of handling the tool, the material being cut, and the pitch of the teeth. For best results use a blade with 14 teeth per inch for cutting iron or steel rods and bars, and one of 20 teeth per inch for cutting pipe of any size, tubing or brass rods. A blade with 24 teeth

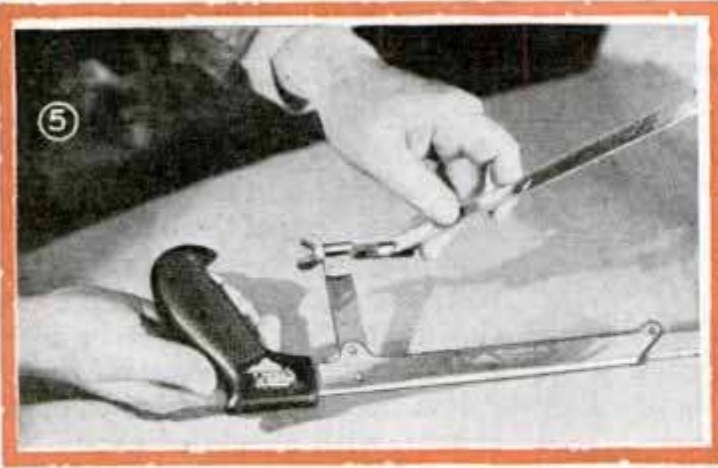

per inch is best for very light, thin-walled tubing and the softer metals generally, while a blade with 32 teeth per inch will perform best in cutting thin sheet stock in steel, brass or softer material. The standard blade is tempered all hard and is usually .025 in. thick. Certain types of work require a more flexible blade than the all-hard temper. These blades have hardened teeth and back with a soft center to withstand severe twists and side strains without breaking. Special short blades, 8 in. long, with fine, specially set teeth and thicknesses varying from .016 to .050 in. are available for use in fine work requiring accuracy and smooth finish. The model maker can make use of these blades on many operations in metal. Very fine coping-saw blades for cutting metal are also available.

The ordinary hack-saw blade can be used for slotting and channeling on flat work by clamping two equal-sized strips of hardwood to the blade as shown in Fig. 2. These give the blade the necessary rigidity and at the same time act as an accurate depth stop. By cutting a series of parallel slots, removing the waste and finishing with a file, one can form a channel or groove that compares favorably with machine work. Screw heads may be slotted as in Fig. 3 and several blades held side by side as in Fig. 8, to cut a wide slot. Many small shops will find a bench hack saw as shown in Fig. 1, a very useful tool. It permits accurate work when cutting off stock square or at an angle, and over a period of time will save considerable in blade breakage alone. The work is held in a vise which can be set at any angle from 45 to 90°.

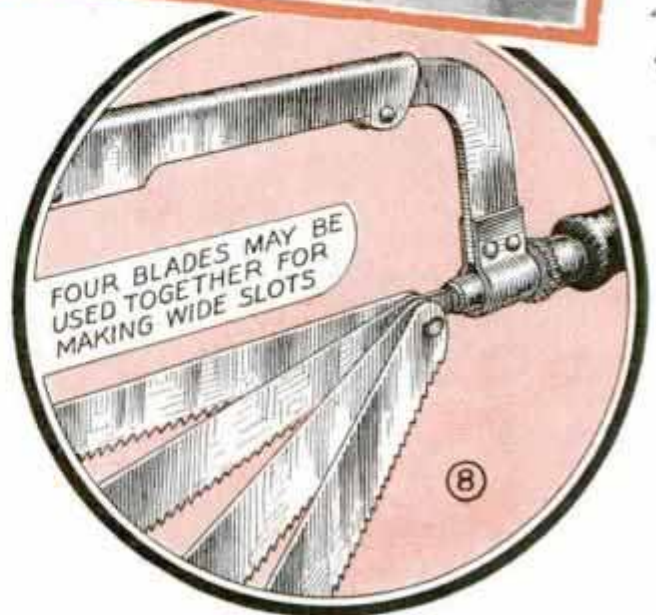
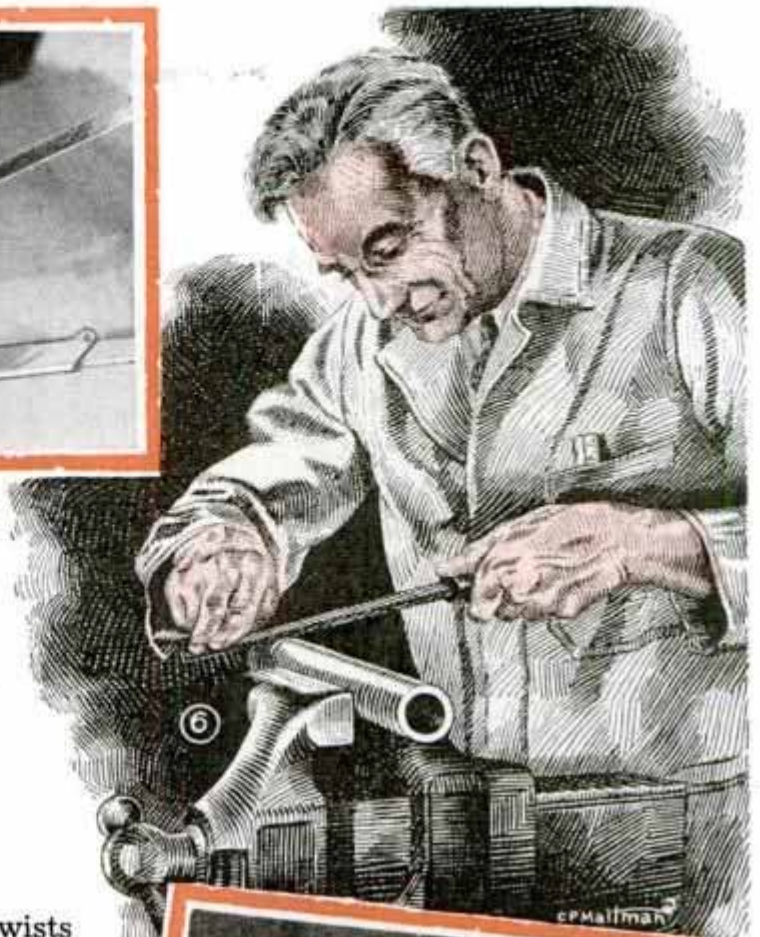

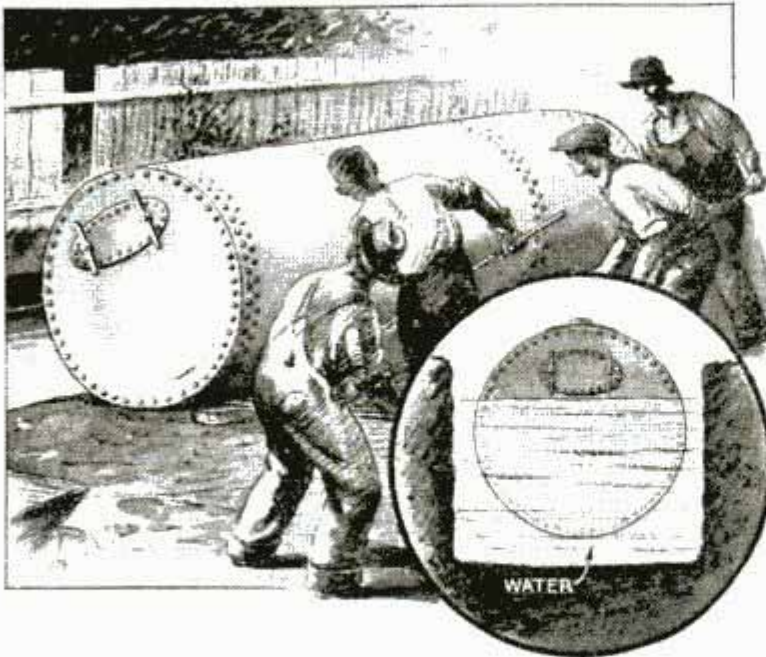

Heavy Storage Tank Lowered into Hole by Filling Excavation with Water and Then Pumping It Out

Storage Tank Lowered into Hole with Aid of Water

On a construction job we had a large storage tank to bury underground in a certain position. As there were no supports or falls at hand with which to lower the tank into the excavation, we filled the latter with water and rolled the tank into it. It was then an easy matter to maneuver the tank into position and pump out the water so that it would settle to the bottom of the hole.—Earl Pagett, Coffeyville, Kans.

Splicing Leather Belts

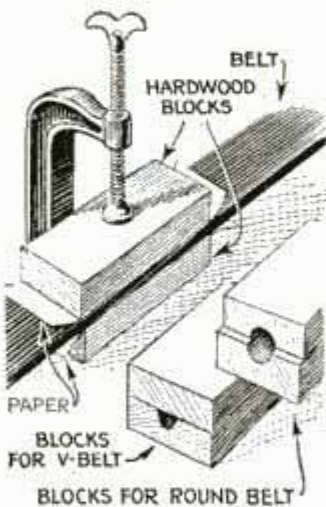

Leather belts work best and with the least noise when the ends of the splices are beveled and cemented together. A good adhesive for this purpose is made by dissolving high-grade cabinet-makers' glue, 1 part, in water, 4 parts, taking care not to

overheat the glue. In a separate container, dissolve tannic acid, 1 part, in water, 10 parts. A few drops of glycerine will help to dissolve the acid. This solution is heat-

ed and is added to the glue, after which the combined mixtures are heated in a glue pot until they are stringy. To prepare the splice for the adhesive, first bevel the ends of the belt and then roughen the inside surfaces of the beveled part. The prepared belt ends should be warmed slightly before applying the adhesive. Immediately after applying the adhesive, place the splice between blocks of wood as shown, with sheets of paper between the wood and the leather to prevent sticking, and apply pressure with a clamp. The cemented splice should be left clamped for a couple of days to assure a permanent job. When dry, the paper should be removed. Round and V-belts may be spliced in the same way by using grooved clamping blocks as shown in the lower detail.

Auto-Spring Leaf Keeps Wire Gate Taut When Closed

A barbed-wire gate can be kept taut by bolting the bottom leaf of an auto spring to the post holding the unattached end. Holes are drilled through the post in line

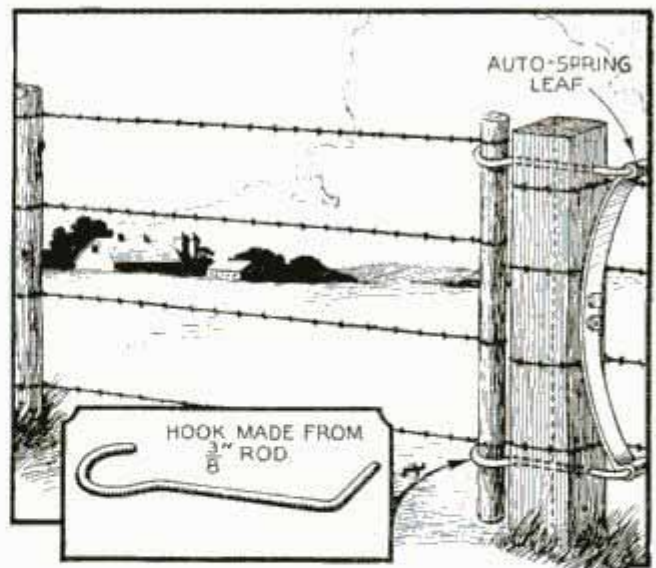

Old Auto Spring Bolted to Fence Post Takes Up Slack in Wire Gate

with the eyes of the spring, and a rod having one end bent to a hook is slipped through each hole, after which the other end is bent at right angles to engage the eye of the spring.

Jig to Hold Work in Lathe for Milling Cuts

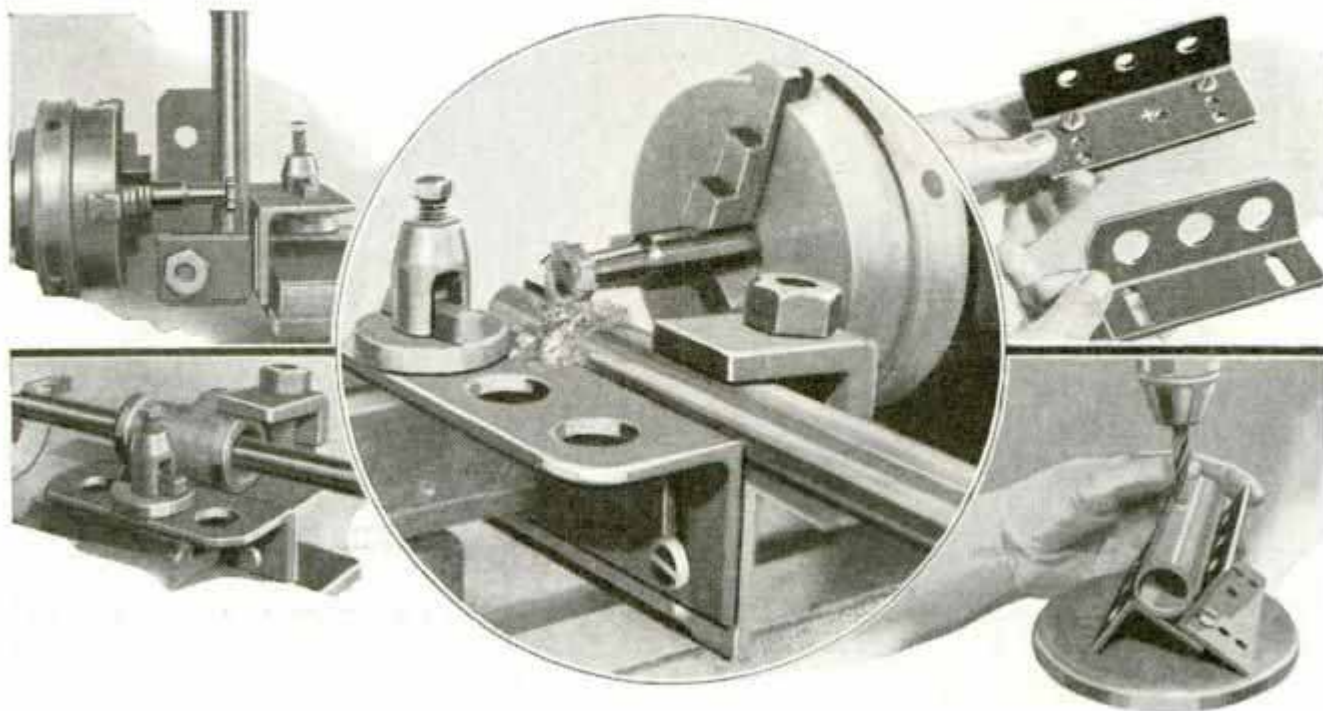

With this simple jig to be held on the lathe carriage, you can cut either straight or Woodruff keyways, besides many other jobs of grooving, facing and rabbeting. The jig is made of two pieces of $1\frac{1}{2}$ -in. angle iron, $3\frac{3}{4}$ in. long for use on a slide rest measuring 3 in. across the T-slot. The hole marked with a cross, in the upper right photo, must be located so that the clamp bolts will fit snugly in the slot of the other member, when the jig is arranged to support work in a vertical position. All holes should be reasonably snug fits and it is advisable to dress up the flat faces of the angle iron with a file so that they will draw firmly together. A "dog" for clamping work to the plate is made from a piece of $\frac{1}{4}$ by 1-in. stock with a $\frac{5}{8}$ -in. right-angle bend at one end. In use, for cutting a straight keyway, the jig is set up as in the center detail, being clamped under the toolpost ring, without the rocker. The work should be drawn into the cutter—not pushed against it. Shims of desired thickness are used to elevate the work for making successive cuts. The cutter should be kept wet with lard oil or other cutting compound such as a mixture of equal parts of lard oil and turpentine. It is best to run the lathe at about 100 r.p.m. Cuts for a Woodruff key are taken as shown in the upper left photo, the work being arranged vertically. With this ar-

angement the jig is supported with the toolpost through the center hole. To bore out a fitting that is rather difficult to chuck in the lathe, the jig is arranged as shown in the lower left photo, again with the toolpost through the center hole. The boring bar is mounted between centers and is driven with a dog. Shims are needed to center the work. The jig will also serve the purpose of a V-block to hold round work for drilling, scribing and center-punching as in the lower right photo.—R. G. Bullard, Monterey, Park, Calif.

Wire Used as Substitute Clamps for Radiator Hose

When using wire as a substitute for radiator hose clamps on a car, shape it as shown and it will be easier to get a tight joint without breaking the wire. After twisting the loose ends together, use a nail and

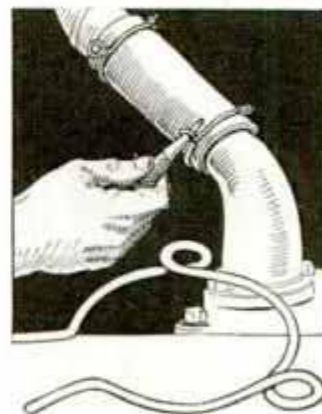

twist the small rings until the joint is tight. Care must be taken not to tighten the clamp too much as it will then cut the hose.—Joseph Gibbons, Albia, Ia.

How to SERVICE

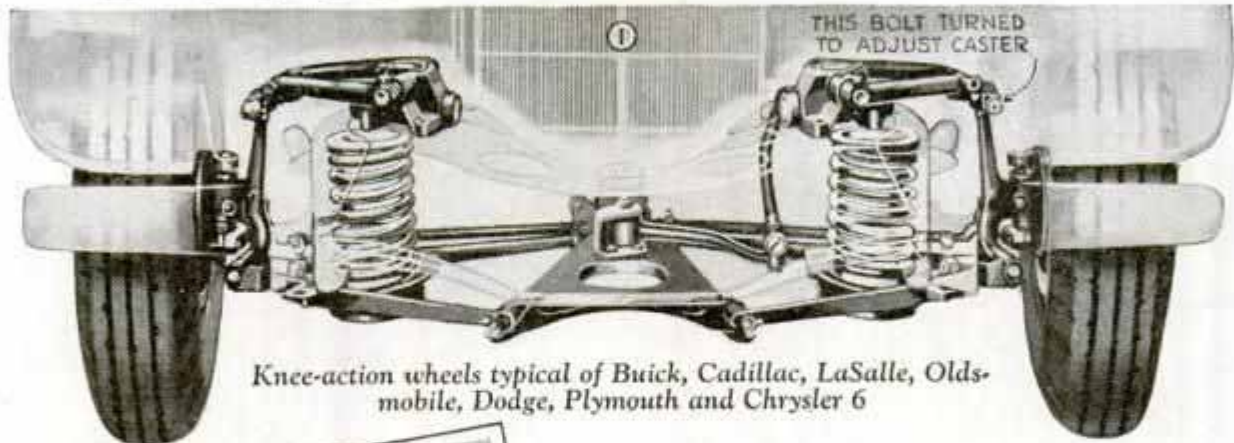

Knee-action wheels typical of Buick, Cadillac, LaSalle, Oldsmobile, Dodge, Plymouth and Chrysler 6

By JIM WARD

WHILE the average car owner is not equipped to service independently sprung, or knee-action wheels on his car, he can make a few minor tests and adjustments and keep the bearings of the suspension mechanism well lubricated. Lubrication is important as any undue wear in the bearings may get the front wheels out of alinement, which is dangerous when traveling at high speeds. For this reason, it is advisable to inspect the mechanism at intervals, and, if any wear or looseness is noticed, have your service man remedy it immediately. If this is neglected, it may soon lead to a large repair bill. Proper adjustment and lubrication of knee-action units cannot be over-emphasized, as they must be kept in first-class condition to get the benefits intended by the manufacturer.

Fig. 1 shows the wheel suspension used on Oldsmobile. A somewhat similar type is used on Buick, Cadillac, LaSalle, Dodge, Plymouth and Chrysler 6. With this type, the wheel spindles and knuckles resemble those used with the conventional axle, and are pivoted indirectly to the car frame by means of arms. Pontiac and Chevrolet have a different kind of suspension as shown in Fig. 7. It is an inclosed unit having a heavy coil spring which operates in oil, and the entire assembly turns with the wheel.

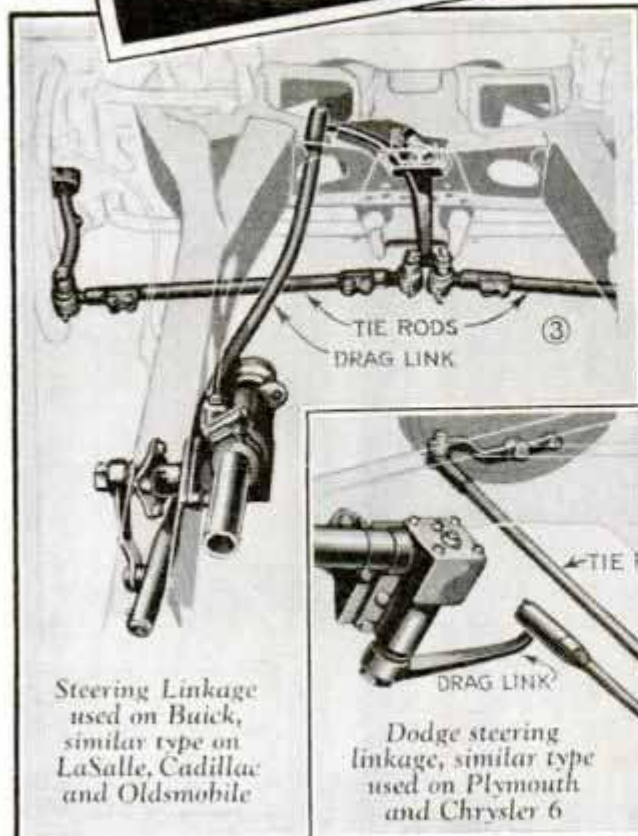

Steering Linkage used on Buick, similar type on LaSalle, Cadillac and Oldsmobile

Dodge steering linkage, similar type used on Plymouth and Chrysler 6

KNEE-ACTION WHEELS

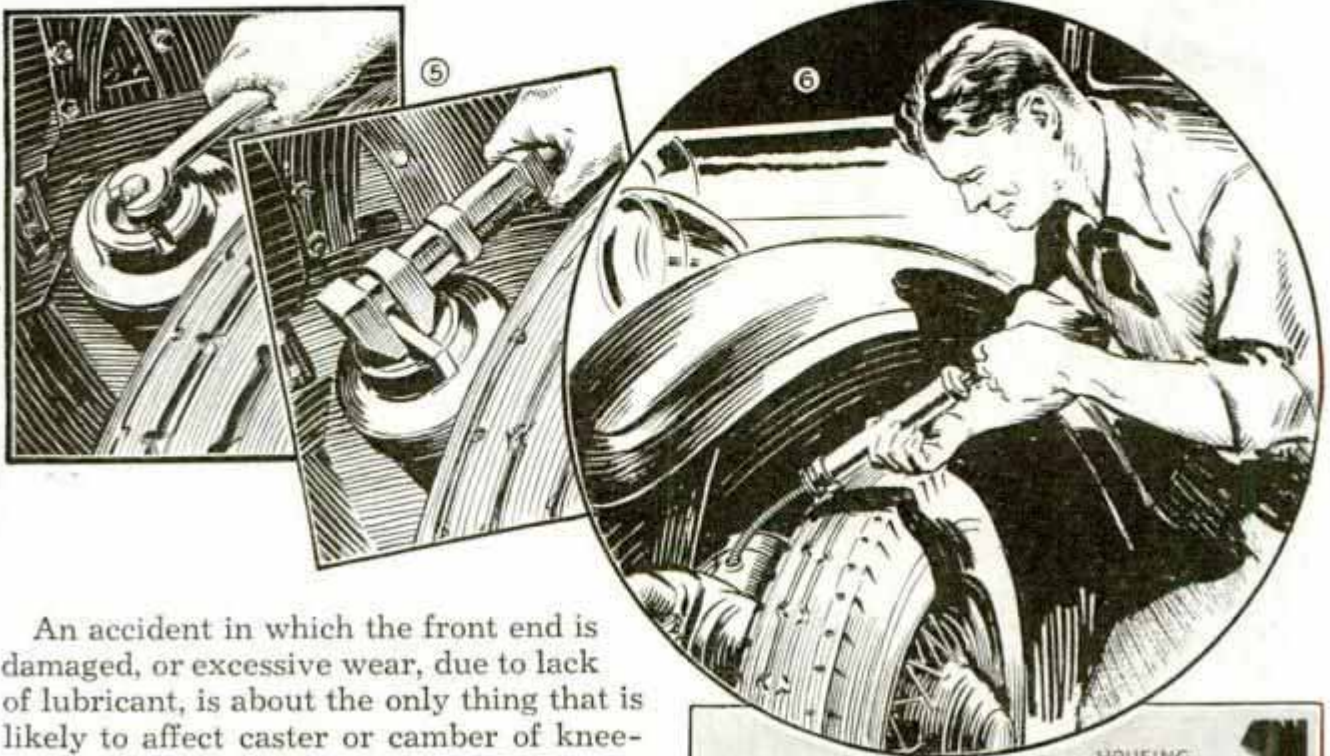

An accident in which the front end is damaged, or excessive wear, due to lack of lubricant, is about the only thing that is likely to affect caster or camber of knee-action wheels. Caster is adjusted on cars mentioned in Fig. 1 by turning the upper arm-control bolt as indicated, while camber is taken care of by adding thin shims at the points indicated in Figs. 8 and 9. Toe-in is, of course, adjusted by turning the tie rods in or out of the clevises at their ends in the same manner as is done on conventional steering gears. See Figs. 3 and 4.

The suspension assemblies used on Chevrolet and Pontiac are serviced as complete units. About the only thing the owner has to do is to see that the housings are kept filled with the proper kind of oil. The inspection and filler plug is located at the top forward side of each housing. A grease gun, Fig. 6, with a flexible hose, is handy for putting the oil in the housings. If one front spring on a Chevrolet or Pontiac sags slightly, it can be raised as shown in Fig. 5. To do this, remove the cap screw in the head of the housing, lift the lock arm, drop an axle key or a similar piece of steel in its place, and turn the head down a little with a wrench. After any major work has been done on the units, have the caster, camber and toe-in checked; also the wheels for balance. The tires have round and square balance marks. When checking, always put the square mark at the

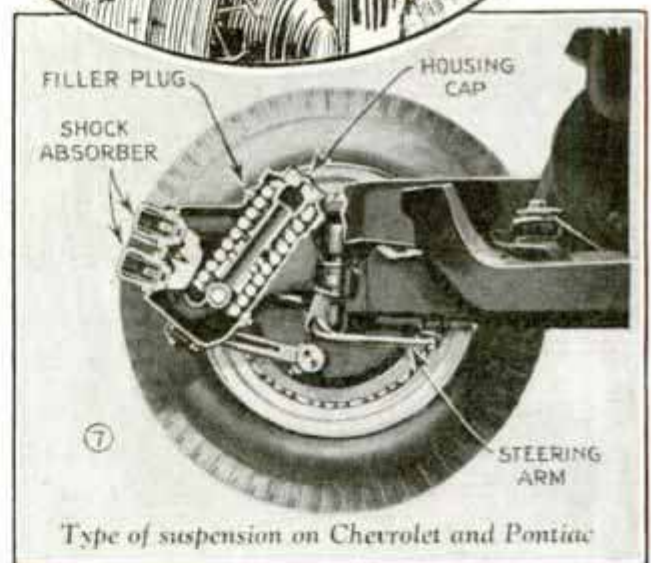

front, and put a tire on a wheel with the valve stem in line with the balance mark. Small weights, Fig. 2, which are attached to the rims, are used to balance the wheels. Correctly balanced wheels are important if the car is driven at high speeds as unbalanced wheels will cause excessive vibration known as "tramping."

The softness of the ride provided by knee-action wheels puts an added load on shock absorbers and makes their action more vital than it was with older cars. See that they are kept filled to the level of the filler plug with a special low-viscosity fluid. Be sure to use the fluids specified by the manufacturer as they are specially

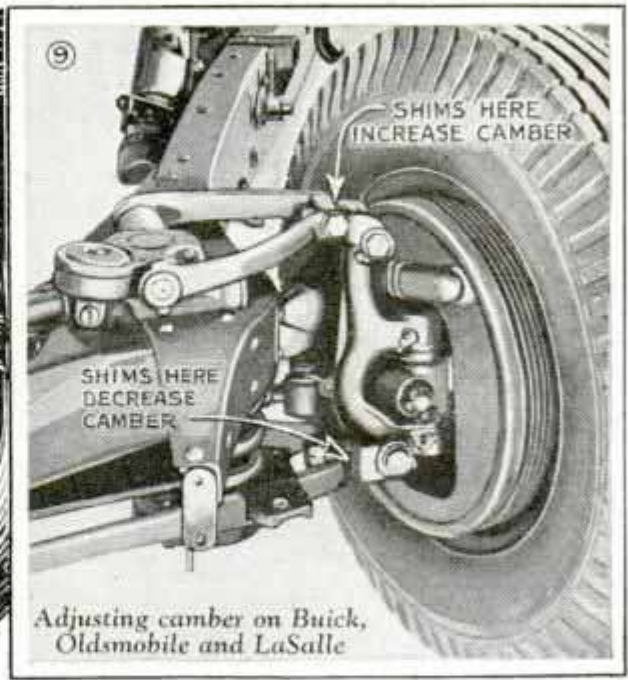
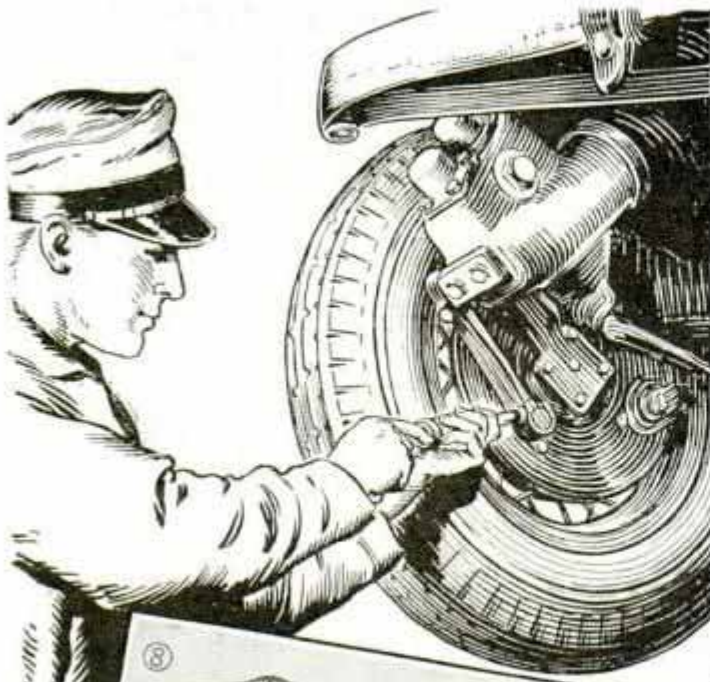

Adjusting camber on Buick, Oldsmobile and LaSalle

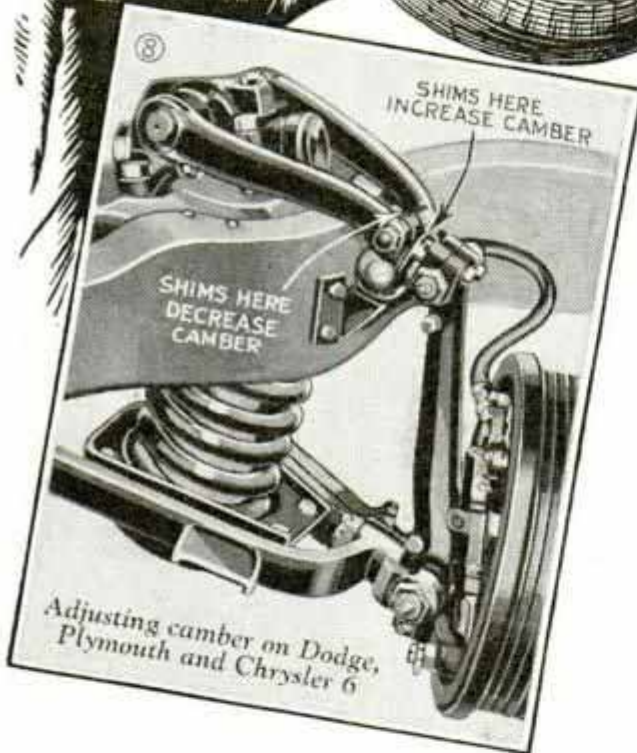

Adjusting camber on Dodge, Plymouth and Chrysler 6

treated to resist temperature changes as much as possible. Due to the soft front springs on cars with knee-action wheels, the rear shock absorbers must be kept correctly adjusted to prevent the rear part of the car from pitching when driving over rough roads. For this reason, it is important that the shock absorbers be checked at intervals. On some cars, they are located in such a position that it is almost impossible to fill them with any kind of an oil can. For this type, a hydrometer such as is used in testing batteries and radiators, will be found handy for putting in the oil. Before unscrewing the filler plug from the shock absorber, remove all the dirt with a wire brush. A

small particle of sand under a valve will make a shock absorber ineffective.

Because of the soft front springs on knee-action cars, proper brake adjustment is important as the application of brakes always throws the center of gravity of a car forward. The brake ratio on the front and rear wheels varies in different cars, which makes it advisable to have them accurately checked on a brake-testing machine at your service station.

Improved Method of Illuminating Free-Air Stand

A filling-station owner in Iowa has a method of illuminating his free-air stand that has been found a great improvement over the usual method of using a flood-lamp mounted on a standard above the stand. He has four lamps of low wattage mounted on standards located so that both sides of a car are fully illuminated. One lamp is left lighted at all times and a switch is mounted on the stand to automatically turn on the other three lamps when the air hose is removed from its holder, or in the case of a counterweighted stand, the switch is turned on when the pivoted half of the stand is pulled down. The fourth lamp is independently controlled so that it can be turned on at night to show the location of the stand. This method gives customers better illumination, yet takes less current than one strong lamp that is left turned on all night.

Lock Washers Prevent Sticky Valves

The use of several lock washers proved to be an effective remedy for sticky valves when all other methods failed. The valves were first removed from the motor and the stems and guides were thoroughly cleaned, after which a lock washer $\frac{1}{16}$ in. larger than the valve stem was slipped over each one. The valves were then replaced, leaving the washer between the valve head and guide. The action of the valve stems sliding through the washers kept the stems free of carbon deposits.—Vernon Harrison, Eaton, Ind.

Tool Box on Two-Wheeled Cart

Utilizing the chassis of a child's coaster wagon, one auto mechanic made a two-wheeled cart for his heavy tool box. This saved many steps as he could easily move the box around the shop or take it outside when making minor adjustments or repairs on a car at the curb. A large wood block was fastened to the chassis and a caster was substituted for the front axle and wheels as shown.—Paul Hugon, Los Angeles, Calif.



Child's Coaster Wagon Made into Cart for Auto Mechanic's Tool Box

Trouble Light Connected to "Live" Side of Generator

It is much easier to connect one lead of your trouble light to the live side of the generator cutout and ground the other lead to the motor than to remove the floor boards and connect the lead to the battery or reach under the instrument panel and



The "Live" Side of the Generator Cutout Is a Readily Accessible Place to Attach a Trouble Light

attach it to the ammeter. The live side of the cutout is the one to which is attached the wire that leads to the ammeter. A couple of battery clips soldered to the leads of the trouble light provide a quick means of attachment.—Fred J. Wensley, Nakusp, B. C., Canada.

Warning Flags Aid Drivers to Steer Trucks through Gateway

To aid drivers in steering large trucks through a narrow gateway, a factory foreman had holes drilled through the gate posts near the top to take lengths of stiff garden hose, which carried small warning flags. If the drivers steered the trucks a little too close to one side, no damage was caused to the flexible flag supports.

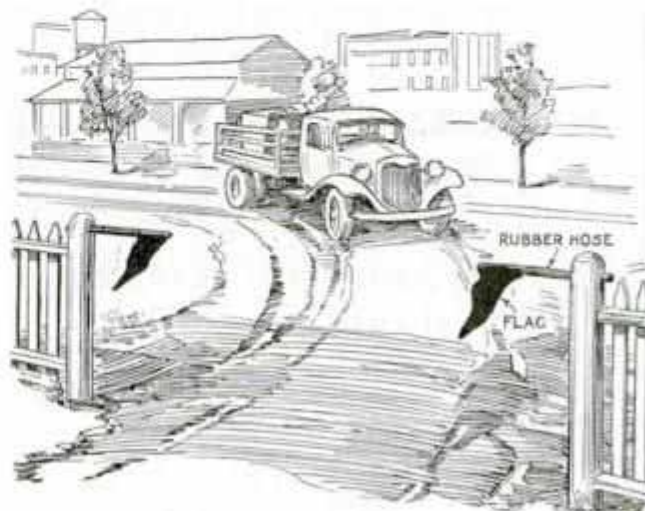

Trucks Driven through Narrow Gateways with Aid of Flags Fastened to Posts with Rubber Hose

An Adjustable Spacing Center Punch

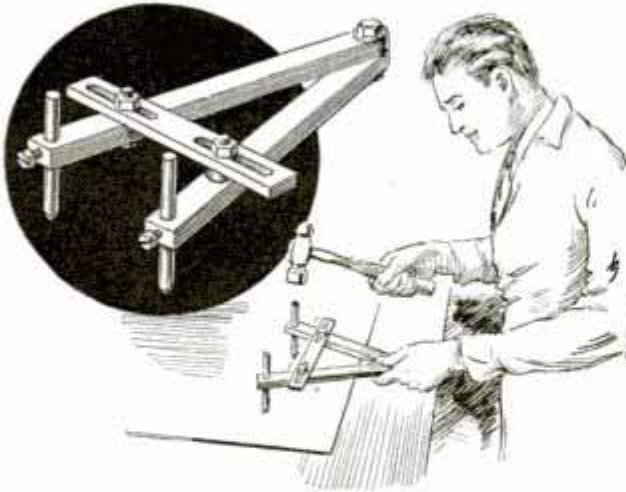

With This Device, Equally Spaced Holes Can Be Center-Punched in Work

When it is necessary to punch a number of equally spaced holes in long pieces of sheet metal, the device shown will be found highly satisfactory. It consists of two center punches and two short steel

bars, which are pivoted together at one end. Holes are drilled in the free ends of the bars to take the punches, which are held by means of set screws. To hold the punches at the desired spacing, a slotted clamping device is bolted across the bars as shown, a spacing washer being used between the clamping piece and the lower bar to keep the bars in alignment.

Grooved Pistons for Outboard Motors

Following the practice of some auto race drivers, outboard motorboat racers have adopted oil-grooved pistons. The problem of proper piston lubrication in an outboard racing motor is a serious one, due largely to the extremely high speeds attained. At this speed, good piston lubrication is essential to prevent "freezing" and melting of the piston heads. The grooves are cut around both ends of the piston and connected by a spiral groove.

The Next Issue

WHAT YOU CAN DO IN REWINDING MOTORS

Practical information that tells just what the average amateur can do in re-winding burned-out electric motors and restoring them to running condition.

SOMETHING NEW IN MASQUERADE COSTUMES

Striking disguises for masquerade parties; an imitation robot that creates a sensation, a human alarm clock and others equally fascinating.

DOING IT SAFELY WITH MACHINE TOOLS

Carefully designed and well made home-workshop machines can be used as safely as hand tools, but the worker must avoid carelessness and neglect.

PHOTOGRAPHIC CALLING CARDS

Different than the conventional type of card and bound to be impressive. Of value to professional people although the novelty appeals to everybody.

BUILD A MODEL OF "ROAMER"

A 32-in. copy of our 16-ft. cabin cruiser so popular with boat fans. Graceful sheer and cabin lines reproduced without tricky assembly of fine details.

USING A MICROSCOPE

Simple technique of using the instrument to best advantage, preparation of slides, illumination for transparent and opaque objects and use of color filters.

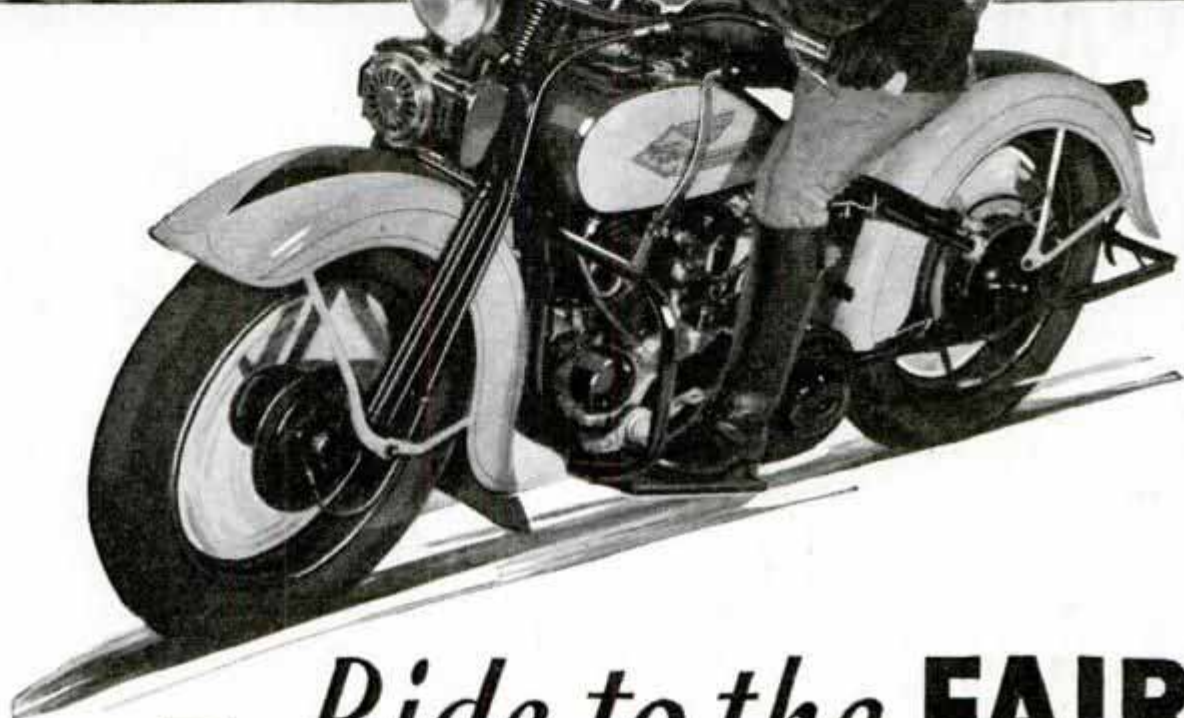

**SEE THE
SAVING!**



One cent per mile is nothing unusual with a Harley-Davidson ridden solo—and that includes everything. A little more with a sidecar, but always 'way under any other means of swift travel.

Ride to the **FAIR**

SWING into the saddle of a Harley-Davidson and breeze away to Chicago and the World's Fair. No matter where you live, it's a delightful ride on a Harley-Davidson—and think of the money you'll save! It will buy many an extra thrill at The Century of Progress.

No delays in traffic parades—the zooming getaway of your Harley-Davidson leaves them far behind. No parking troubles — there's always room for a motorcycle. And every mile shows a real saving.

See your nearby Harley-Davidson Dealer today. Look over the classy '34 models, and ask about his time payment plans that make buying so easy. Send the Coupon for latest literature.

Ride a **HARLEY-DAVIDSON**

Mail this Coupon

HARLEY-DAVIDSON MOTOR COMPANY
Dept. P, Milwaukee, Wis.
Interested in Motorcycling. Send illustrated literature.
Postage Stamp is enclosed to cover cost of mailing.

Name.....
Address.....
My age is 16-19 years, 20-30 years, 31
years and up, under 16 years.
Check your age group.

SEND FOR SAMPLE!



You can never appreciate the convenience and value of Drybak Band-Aid until you try it. Send 5¢ in coin for sample packet. Use one next time you have a small cut, burn, blister or skin eruption. You will see how easy wound dressing can be.



DRYBAK BAND-AID

Waterproof
Johnson & Johnson
New Brunswick New Jersey

SEND THIS COUPON ...

Johnson & Johnson
Dept. 258, New Brunswick, N. J.
I enclose 5c in coin for introductory packet of Drybak Band-Aid and the outline "First Steps to First Aid." For safe mailing fasten coin with adhesive tape.

Name

Street & No.

City State



FREE FALL CATALOG

Just Off the Press

Showing Hunting Shoes, Duck Hunting Boots, Sleeping Bags and other Leather and Canvas Specialties for hunters and campers.

L. L. BEAN, Mfr.
432 Main St.
Freeport, Maine

BEGINNERS' TWO-TUBER FOR SHORT WAVES

(Continued from page 583)

1½ in. long may be mounted under the base to obtain the same results, if desired.

The three small holes in the front panel should line up with three similar holes in the front end of the base as the dial covers the center hole. A flat-head screw and countersunk hole should be provided for the center. The tuning condenser C₁, phone jack, 50,000-ohm variable resistor R₁, dial and pilot light are mounted on the front

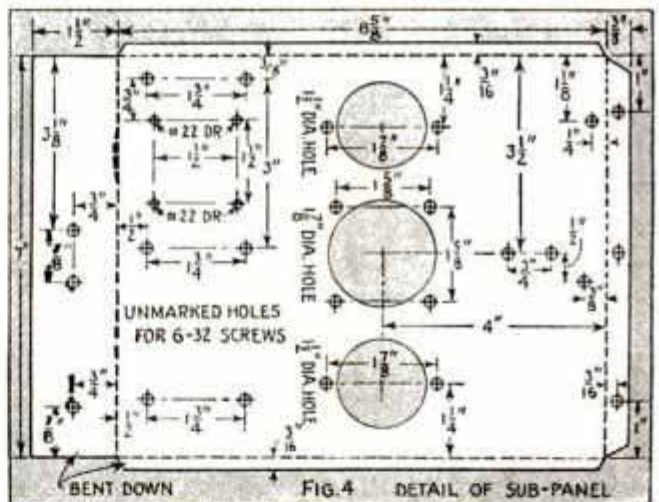
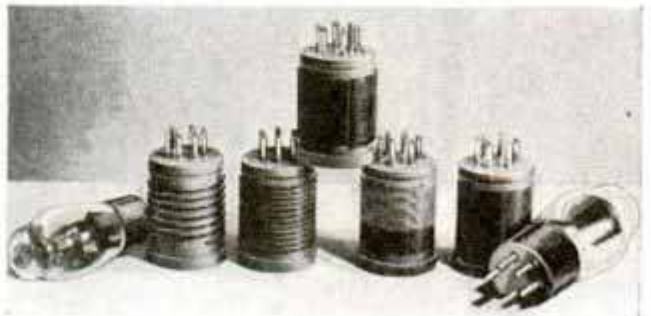

panel. The dial is fastened by small screws through the back. The rotor plates of the condenser are moved out as far as they will go, the dial is then set at zero, and the setscrew tightened. The twisted wires for the dial light are connected across the heater terminals of the socket.

Fig. 3 shows the arrangement of the various parts on, and below, the base. All fixed condensers, resistors and r.f. choke are provided with pigtailed leads which are easily soldered in position under the base. A complete material list of the standard parts used, and further operating data, may be obtained upon application without charge. The antenna and ground binding-post strip are mounted on the rear

(Continued to page 116A)

For exacting
amateurs

RECOMAR

... most versatile of Kodaks

A PRECISION camera... European type—the Kodak Recomar truly meets every photographic test.

Its Compur shutter splits a second into 1/250 (1/200 on the "33")... has a built-in self timer. The Kodak Anastigmat f.4.5 lens makes brilliant pictures under difficult light conditions.

Has double-extension bellows... micrometer screw focusing... hooded ground-glass focusing back... rising front... both eye-level and reflecting finders... spirit level. Supplementary long-focus and wide-angle lenses, extra.

Model "18"—for 2¼x3¼ inch pictures, \$46... model "33"—for 3¼x4¼ inch pictures, \$55.

The long, double-extension bellows allows you to make close-ups... copies. The hooded ground-glass back insures micrometer-sharp focus. Supplementary lenses cost \$3.50 each.



A WIDE CHOICE OF FILMS... Film packs, cut film, or plates may be used in the Kodak Recomars. Kodak Verichrome, "SS," or Panatomic film packs are available. Cut films and plates may be had in a complete range of emulsions. *Snapshots at Night*... The fast lens (f.4.5) lets you make snapshots indoors at night. Two or three inexpensive Photoflood bulbs... Kodak "SS" Film... and you're ready to make snapshots at NIGHT.



The wide-angle supplementary lens increases the angle of view 23% on the Recomar "33"... 17% on the "18."



Normally—the Recomars cover this field. The Recomar "33" has a 135 mm. lens... the "18"—105 mm. lens.



With supplementary lens A—Recomar "33" gives a 33% increase in the image size... the "18," a 28% increase.



With supplementary lens B—Recomar "33" gives a 70% increase in the image size... the "18," a 62% increase.

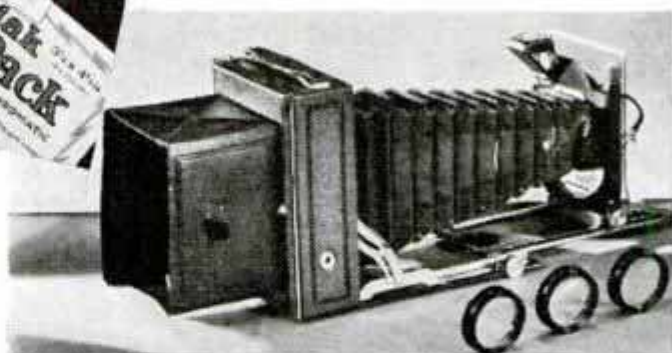

FREE... more details

Mail this coupon for complete information about the Kodak Recomars... other Kodaks... and Kodak equipment. Eastman Kodak Company, Rochester, N. Y.

Name _____

Street _____

City _____ State _____

IF IT ISN'T AN EASTMAN, IT ISN'T A KODAK

BEGINNERS' TWO-TUBER FOR SHORT WAVES

(Continued from page 114A)

of the base. The antenna post is insulated, and the ground connection to the base is made on the No. 2 terminal of the coil socket. This common ground connection can be taken to a soldering lug on any convenient mounting screw; another common grounding point is on the mounting screw of the tuning condenser, the rotor

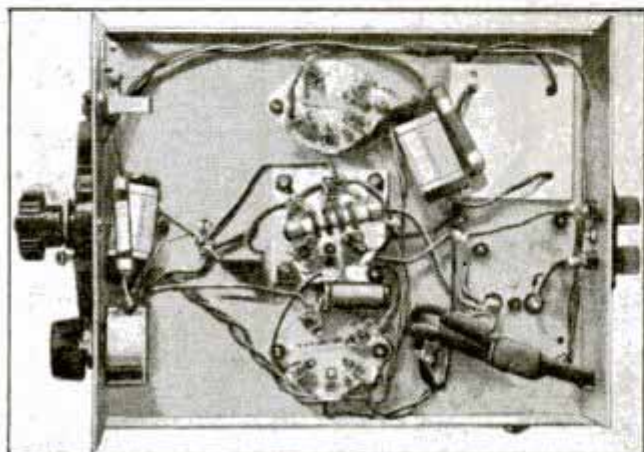

Underside View of Completed Short-Wave Receiver

plates of which are grounded to the frame. An enlarged blueprint of all wiring diagrams is available; those who wish it should specify blueprint No. 201. Five color-coded National plug-in coils are used to cover all wavebands from 13.5 to 200 meters. The B-batteries are connected in series to the two flexible leads soldered to the terminals indicated on the audio transformer. If there are any points not clear to the reader the radio editor will be glad to explain them in further detail.

GENERAL-PURPOSE AMPLIFIER USES RECEIVING TUBES

(Continued from page 584)

19 in. wide and 27 in. high. The amplifier unit has a main volume control in the grid circuit of the type-56 tube. Type-2A5 tubes are employed in the driver and push-pull output stages; these are of a sturdy variety that will withstand any reasonable amount of mechanical vibration. Simplified wiring diagrams of each unit, together with the schematic diagram shown, are available in blueprint form; if desired specify blueprint No. 202. As the amplifier is operated with a fixed bias, this can be obtained easily with small C-batteries.

FOG STILL CHALLENGES INVENTORS

(Continued from page 523)

Red neon lights have been used with some success to aid aviators in fog, for the red rays will penetrate farther than the longer white and blue rays, and by eliminating the glare of these longer rays the source of the red light is apparent at greater distances. Fog usually comes in comparatively thin layers, so a light on the ground that might easily be seen by an airplane pilot through a 200-foot layer of fog would not be strong enough to prevent a collision at sea. The lighthouse service is now installing yellow sodium vapor lamps in lighthouses and ships. These are superior to the white lights but are quite inadequate to pierce a fog at sea.

With lights unable to give the desired visibility, there still remains a challenge to inventors to develop some way of dissipating fog. Tests have shown that this is quite possible, but up to now impractical.

In 1921, three scientists equipped an army airplane with a sand hopper and a device for charging this sand with electricity. Flying over a rather light cloud, they sprayed their sand upon it, and in a few minutes the cloud had disappeared. With the sand all gone the pilot then flew through a similar cloud and it likewise disappeared. When the men had descended it was noticed that clouds not tampered with at all were likewise breaking up, so the test became meaningless.

Subsequent tests have shown that ionized particles such as sand, dust and water vapor, really are capable of cutting a swath in a cloud but it would take nearly a ton of these particles a minute to keep an acre of surface clear of a wet fog 300 feet deep—an entirely impractical operation. A Harvard professor suggested that fireboats discharge electrified water into the air to clear a harbor of fog. These electrified streams of water really would dissipate any fog, but it would close in immediately.

Heat would also dissipate fog, but Professor Humphreys' figures show that it would take 140 tons of coal every minute for each square mile, even if this test could be evenly distributed over the area without loss.

The challenge of fog is still open and a fortune awaits the one who can meet it.

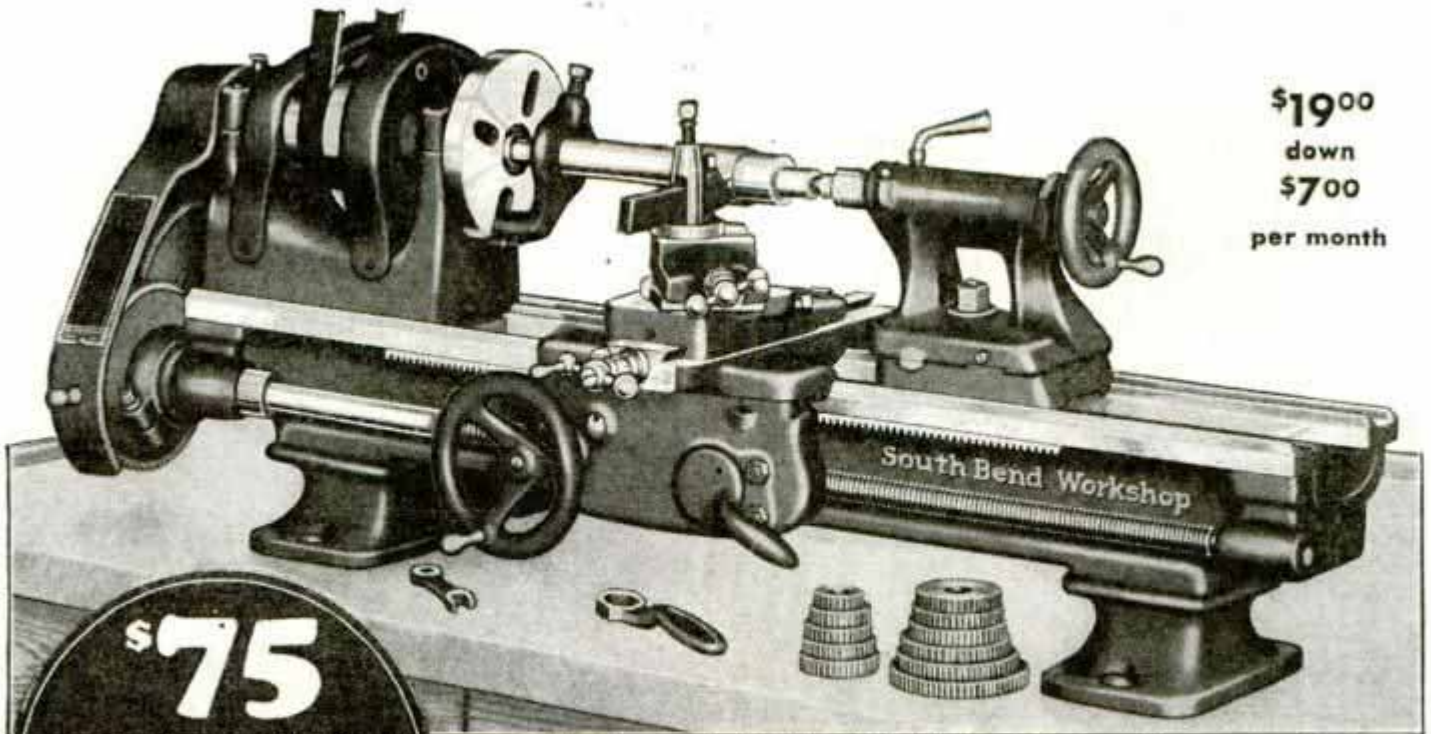

\$19⁰⁰
down
\$7⁰⁰
per month

\$75
For This 9" x 3'
"WORKSHOP"
Bench Lathe
Back-Gear'd
Screw Cutting

9 1/2" swing x 3' bed "WORKSHOP" Bench Lathe, without motor **\$75**
drive as shown, wt. crated, 240 lbs.,.....

The new 9-inch swing "WORKSHOP" Lathe shown above is a Back-Gear'd Screw Cutting Metal Working Lathe and will handle all general metal working operations, such as turning, facing, drilling, boring, reaming, cutting-off, knurling and screw-thread cutting. Also recommended for wood turning, for machining compositions, etc. This lathe is a genuine South Bend Lathe and is used in repair shops, home workshops, auto service shops, electrical shops, laboratories, model making, manufacturing production, vocational schools. Hundreds are now in use all over the World.

Over 35 Modern Features

The 9-inch "WORKSHOP" Lathe is the product of more than twenty-eight years experience in lathe building and has more than 35 practical modern features. These features include: back-gear'd headstock with six spindle speeds; automatic longitudinal power feed to carriage; wide range of turning feeds; reverse gear for left-hand threads and feeds; graduated compound rest which swivels to any angle; hollow steel headstock spindle with 3/4" hole for handling chuck and bar work.

The "WORKSHOP" Lathe will cut standard screw threads, right and left-hand, from 4 to 40 per inch, including 11 1/2 pipe thread. The power of the lathe is remarkable, being capable of reducing the diameter of a steel shaft 3/4" in one cut. The 3' bed size Lathe takes 18" between centers. Lathe is also available with 3 1/2' and 4' beds. The 9" x 3 1/2' Motor Driven Lathe is the most practical and most popular size. Countershaft Drive and Motor Drive Models in floor leg and bench leg types are available in 20 different combinations to suit every need.

Easy Terms—12 Months to Pay

Hundreds of "Workshop" Lathes are being sold on our Easy Payment Plan as the lathe is income producing equipment paying for itself out of profits. A small down payment places the lathe in your shop and you pay the balance monthly. The lathe is guaranteed—30 days trial in your own shop—your money back if not satisfied.

Write for 24-page Bulletin No. 5-W describing the new 9-inch "WORKSHOP" Lathe and the work it does. Also describes and prices attachments, chucks and tools which can be shipped with the lathe, or later when needed. Mailed free, postpaid, on request, to any address.

Other Sizes and Types of Lathes

South Bend Back-Gear'd, Screw Cutting Precision Lathes are built in 96 other sizes and types from 9" to 36" swing, with countershaft drive and with individual motor drive, price range \$108 to \$1500.

New revised 31st Edition of "How to Run a Lathe", 160 pages, is just off the press, ready for mailing. Price per copy, 25c postpaid. Coin or stamps of any country accepted.

SOUTH BEND LATHE WORKS
640 E. Madison St. South Bend, Ind. 



Operates from lamp socket for 2c per hour

9 1/2" swing x 3' bed "WORKSHOP" Lathe complete with 1/4 H.P. reversing motor and reversing switch, as shown. Wt. crated 300 lbs.,..... **\$94**
\$24.00 down, \$7.00 per month

Use Coupon or Write

SOUTH BEND LATHE WORKS
640 E. Madison St., South Bend, Ind., U.S.A.
Please send me the booklets checked below.

"Workshop" Bulletin No. 5-W (Free)
 31st Edition of "How to Run a Lathe" (25c)

Size of Lathe interested in.....
Class of Work.....
Name.....
Address.....
City.....State.....



This fall give that youngster the gift of freedom from the cramping slowness of his own handwriting.

A Corona speeds words, thought, mind. Try it. Borrow a Corona at your dealer's for a week. Ask about the partial-payment plan.

About Corona: All Coronas are portable—but not all portables are Coronas. Models from \$24.50 to \$60. The longest experience in portable typewriters back of every one. Interesting booklets sent free on request—or ask your dealer for them.

L C SMITH & CORONA TYPEWRITERS INC
SYRACUSE NEW YORK

CORONA

THE FIRST PORTABLE TYPEWRITER

L C SMITH STANDARD TYPEWRITER • CORONA PORTABLE
• VIVID DUPLICATOR • CORONA ADDING MACHINE

A MILLION DOLLAR HOBBY

(Continued from page 554)

bought at a post office with no thought of collecting. Being stamp-wise, however, he knew this error in the stamp meant money. A dealer paid him \$10,000 for the sheet, and later a collector paid \$20,000 for it. Eventually the sheet was broken up in blocks, one of which, consisting of four, was sold for \$12,000.

Rubbish piles of old papers have a strong fascination for the stamp collector, and for good reason. Once, a buyer of scrap paper saw a pile of old letters, books and other papers on the floor of a banking firm which was vacating the premises. He paid \$15 for the lot. On examining the "rubbish" he found, besides autographs of famous men, hundreds of cancelled and unused stamps worth more than \$75,000.

In the United States, the post office department reports that \$1,800,000 was realized from the sale of stamps to collectors during the fiscal year ending June 30. About \$800,000 of this went for commemorative issues sold through the Philatelic division, a branch of the post office established in 1921 for the sole purpose of catering to stamp collectors.

Collectors have paid, and with pleasure, for stamps of Mexico for the financing of a war on grasshoppers and locusts; stamps of Ecuador for the building of post offices; stamps of Portugal for the rearing of a monument to a national hero; stamps of Austria to promote athletics, and stamps of Belgium for the benefit of flood sufferers.

Where lies the lure of stamp collecting? Veterans at the hobby stress the fun and knowledge to be found in it, pointing out that not only does it include the study of geography, customs, history, government, literature and languages of various countries, but that it leads to familiarity with color nomenclature, engraving and printing methods, and associated fields.

Collections have been started with nothing more than a cheap album and a few stamps, but experts agree that in the long run it is best to start with the proper equipment. A prominent stamp dealer who has had many years experience in steering beginners on the right road, advises those embarking on a stamp-collecting career to pick one dealer and stick to him. Membership in a stamp club, of which there are many in this country, is worth while.



**GET OUT
YOUR
KNIFE**

YOU never run out of uses for a good pocket knife! When you're hunting, fishing, working around the house, making models, or toys for the kids—you've got to have a good knife! And experienced pocket knife users always say: "Remington's the knife for me!" because it's built sturdily; blades of special carbon steel, with razorlike edges that hold longer and give more satisfactory service.

Send 3c stamp with name and full address to Remington Arms Co., Inc., Cutlery Division, Department E2, Bridgeport, Conn., for "Things to Do With a Pocket Knife,"—the encyclopedia of whittling.



Remington
DU PONT

BURN YOUR NAME ON TOOLS WITH THE ARKOGRAF

PROTECT YOUR TOOLS FROM THEFT
Write with electricity any name or design on the hardest and finest tools and instruments, or any metal, like writing on paper with pen or pencil.
Complete Outfit \$3.50 — Prepaid Anywhere
Interesting illustrated circulars free. Write today.
Agents wanted.
ARKOGRAF PEN CO., 3927 S.E. Stark St., Portland, Ore.

LIFEBUOY
STOPS "B.O."—PROTECTS HEALTH

DO YOU WANT a new business profession of your own, with all the trade you can attend to? Then become a foot correctionist, and in a few weeks earn big income in service fees,—not medical nor chiropody—easy terms for home training, no further capital needed, no goods to buy, no agency. Established 1894. Address Stephenson Laboratory, 1 Back Bay, Boston, Mass.

LOG SAWS

MAKE MONEY—BE YOUR OWN BOSS
Turn Your Trees Into Cash
Be independent, start a wood sawing business, have money coming in all the time. Use the portable engine year 'round. Pays for itself. Low factory prices. Big FREE Catalog.

WITTE ENGINE WORKS
6747 OAKLAND AVE. KANSAS CITY, MO.

Like ENLARGING the WORKSHOP WITHOUT ALTERATION

Genuine MASONITE PRESWOOD

THE size of a work-bench is determined by the amount of work that can be turned out on it, not by its physical dimensions. Homecrafters are learning that Masonite PRESWOOD makes it possible to build many *more* things with their present equipment, and build them *better*.

All-wood, this grainless material is moisture and fire-resisting. Will not warp, chip or crack. Can be cut, sawed or beveled with ease. Its natural warm brown surface gives a beautiful final appearance . . . or can be varnished, lacquered or enameled with any standard finish.

PRESWOOD is ideal for the home craftsman. You can even repair and modernize your own home with it. On request we'll send a sample to try out in your shop. Send coupon for booklet of plans and specifications for many useful articles.

MASONITE CORPORATION PM-10-34
111 W. Washington Street, Chicago, Ill.

Please send me the free booklet entitled "You Can Make These Useful Things." Who is my nearest lumber dealer selling Masonite PRESWOOD?

Name _____
Street Address _____
City _____ State _____

When writing please mention Popular Mechanics

When you're building MODELS

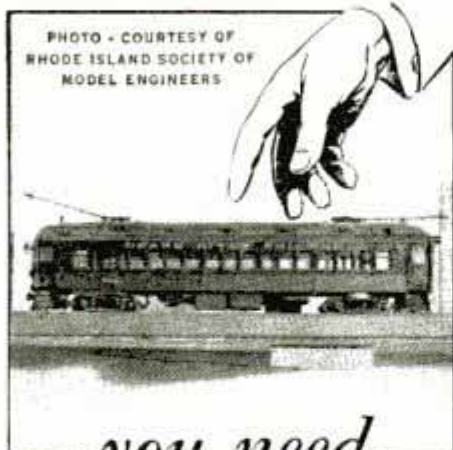

you need
Nicholson Files

Fred Williams, who built this model of the Grand River Railway, says that he used Nicholson Files for 60% of the work. He adds that he used Nicholson Files because he found them best qualified for both the coarse filing and finishing work.

For all types of modeling, you need Nicholson Files. They are the most generally useful tools for woodworking as well as metal working. No home workshop is complete without them.

Each Nicholson File is a tested quality file, made to meet the requirements of industry as well as the home workshop. Each one represents the best file value money can buy. At hardware and mill supply dealers'. Nicholson File Company, Providence, R. I., U. S. A.

Nicholson Files are exhibited in "The Home Workshop" at A Century of Progress, Chicago, Building 3, second floor.

Genuine



NICHOLSON FILES
A FILE FOR EVERY PURPOSE

SELL PLAYING CARDS

Make Extra Money

New easy way to earn money taking orders from friends and others for new **Initial** Playing Cards. Also, many other smartly styled decks not shown in stores. Popular low prices. *Start earning at once.* Thousands of prospects near you. No experience needed. Men or women, write for **sample outfit—FREE.** General Card Co., 1201 W. Jackson Blvd., Dept. 41, Chicago, Ill.

ARMATURE REWINDING



Cleaner Cleaver Armatures
Exchanged \$1.40 ea. 6 or more, 1.30 ea. No Exchange 1.75 up

Hoover, Eureka, Hamilton Beach, Premier Duplex, Super Royal, \$1.50 ea. Washer Motors, \$3.50; 1-8" Drill Armatures, \$2.40; 1-4" \$3.35; 3-8" \$4.50; 5-5" to 1", \$5.50. Rock Bottom Prices on Refrigerators, Fans, etc. All Work Unconditionally Guaranteed. 24 hour service. Complete stock Cleaner and Washer Parts.

Get Our **FREE 32 Page Catalog**

TRIANGLE APPLIANCE COMPANY
3252 Tyler Ave. Detroit, Mich.

THINGS THAT LIGHTNING DOES AND DOESN'T

(Continued from page 548)

until a century or so ago. These rings are now known to be due to the growth of fungus colonies, which start at a central point and gradually spread outward. A real effect of lightning is seen in the large roundish patches of dead and injured vegetation sometimes found after thunderstorms in fields of growing crops.

Lightning frequently imprints upon the bodies of persons struck by it, with or without fatal results, ramifying pink marks, which generally fade in a few days if the victim recovers. The marks are merely burns produced by a branching electrical discharge passing through the tissues.

The effects of lightning on the object it strikes are sometimes very conspicuous and at other times quite the reverse; the difference depending mainly on the degree of resistance encountered by the discharge.

When lightning enters a house it sometimes takes a strange and devious course, which can subsequently be traced by its visible effects. A case of this kind was reported a few months ago in England. The flash struck a chimney, and deviated to the head of an iron bedstead in an upper room, upon which two boys were lying, followed the iron frame underneath the bed, setting the bedding on fire, but without injuring the occupants, descended the further leg of the bedstead, making a hole in the floor into which one's finger could be inserted, and penetrating to the room below. There it traveled straight downward in the corner until half-way to the floor, when it turned sharply at right angles and passed horizontally along the wall to the next corner, making a blackened score in the wall paper. Again it pierced a hole, big enough to put a finger into, through the wall into a larder behind, fused together some cake tins which lay on a shelf, fitted one inside the other, and then it passed through the open door of the larder, across the kitchen and out through the open entrance door of the cottage. In the kitchen four persons were seated around a square table at supper. The flash passed across the table and burned to a blackened cinder a piece of ham which was on a dish in the center, and on which lay the carving knife and fork, again no one was injured.



HERE'S THE LATHE for the Coming Home- Workshop Season, \$79.

It's ready to run, this 9' Atlas Lathe. Self-contained counter-shaft, all belts included in the price. Set a motor on the bracket, plug into a light socket and it's ready to go. No outside shafting to place. No extras to buy.

A real lathe, running-tested to .001" accuracy before it's shipped. Six speeds with compound device that cuts out complicated back gears. Efficient V-belt drive. Automatic reversible feed; hollow headstock spindle; graduated compound rest. Cuts 4 to 72 threads.

18" bed (also larger sizes up to 36") of heavily ribbed cast iron machined and ground on precision equipment. IMMEDIATE SHIPMENT for 2 weeks' trial with guarantee of money back if not satisfied. Write for Easy Terms and free illustrated catalog of the ATLAS FULLY EQUIPPED LATHE.



ATLAS DRILL PRESSES \$13.95 to \$33.45

Small, medium and big—for bench or floor. Quality-built tools with more and bigger bearings at prices below what you've had to pay up to now. Special construction prevents side-play in quill.

ATLAS PRESS CO.
1843 N. Pitcher St.
Kalamazoo, Mich., U. S. A.



REMINGTON ONLY 10¢ A DAY PORTABLE



A new Remington Portable. Carrying case free. Use 10 days without cost. If you keep it, pay only 10¢ a day. Write. Say: How can I get a Remington Portable on 10-day free trial offer for only 10¢ a day. Remington Rand Inc., Dept. 152A10, Buffalo, N. Y.

SHAW DU-ALL TRACTOR



Hurry! Low prices still in effect but can't be guaranteed! Amazing money-maker for farms, truck gardens, nurseries, etc. Plows, discs, mows, cultivators, mowers, rakes, hoes; runs belt driven machines. Gear shift models, 1 to 5 H. P. Costs 30¢ per hour to run. Write for FREE CATALOG and 10 DAY TRIAL OFFER. Also SPECIAL OFFER to AGENTS. Address nearest office.



SHAW MFG. CO., Dept. 4510
Galesburg, Kansas Columbus, O.

Print Your Own

Cards, stationery, circulars, tags, labels, advertising, etc. Save money. Print for Others, Big Profits; easy rules sent. Will do popular Raised Printing like Engraving. Junior press \$6.00, job presses \$11 up, power \$140. Send for free catalog and all details. THE KELSEY COMPANY, E-37, Meriden, Conn.

DOUBLE YOUR MONEY BACK If this battery terminal corrodes within a year!

Avoid winter starting troubles this year—get full power from your car battery all the time. Install X-ee! Battery Terminals now and have a winter of trouble-free operation. X-ee! terminals are made of same material as battery posts. Actual tests show nearly two years use without sign of corrosion.

X-ee! battery terminals sell on demonstration. Quick sales and unusual profits. Earn your own net free. Send \$1 for two sets, sell one at installed price of \$1 and get your own set FREE. (Offer limited to U.S.A.) Money back if not satisfied. Details of liberal agents franchise sent with each set. Park Metalware Co., Inc., 101 Bank Street, Orchard Park, N. Y.

Agents Wanted!

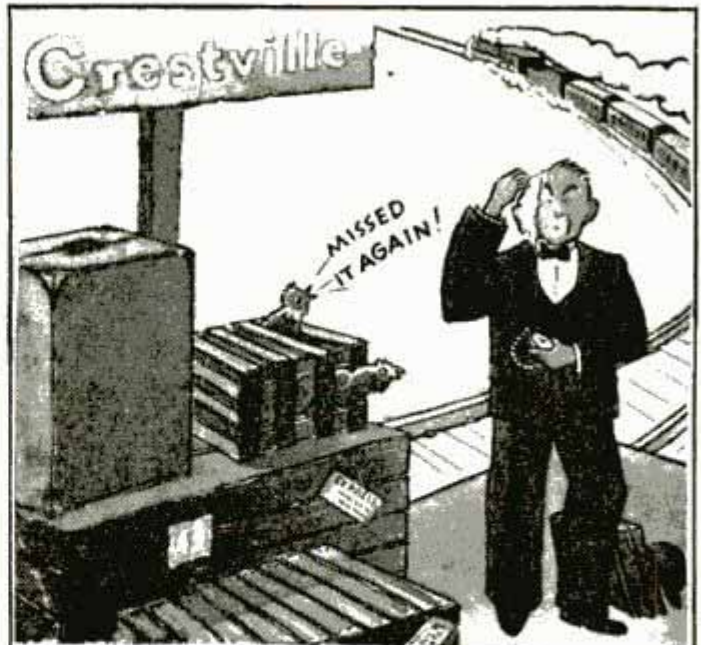

"My watch pinions need oilstoning"

IF the ticking pace of your watch falls behind only one tick in 10,000, it will lose a minute per week.

From five to seven pinions in your watch have jewel bearings, including that important member, the Balance Staff. Others, as you know, rest on metal bearings. Ticking pace accuracy every second, week after week, depends on these pinions being *oilstoned*. A Norton Pike Hard Arkansas oilstone file is used in all fine watch factories. No other will do.

Your jeweler has one on his bench. He will tell you that machines to make the delicate parts of a watch cost a fortune, but, strange to say, this inexpensive little tool is what puts the final accuracy into the watch.

Chisels, gouges, plane knives, scalpels—and other everyday cutting tools are given a keener, longer lasting edge on Norton Pike *oilstones*. Expert workmen wouldn't be without them. It takes a booklet with pictures and diagrams to tell all their various sharpening knacks. Send for a copy of *How to Sharpen*. Fill out the coupon before you turn this page.

NORTON PIKE Products

Use what Experts use

BEHR-MANNING CORP., U. S. Sales Representatives
Dept. Q, Troy, N. Y.

Send me free, Norton Pike Book, "How to Sharpen."

Name.....

Address.....

SECRETS of SCIENCE REVEALED THROUGH A MICROSCOPE!



New Model R

Fly's
Compound Eye

EVERY pond, every leaf, every insect hides amazing miracles of nature that a good microscope will reveal in endless variety to your astonished eyes. This free book tells much you ought to know—about the newest and finest amateur microscope, Bausch & Lomb's Model R; New Gem Microscope, \$14.50, but wonderfully clear; new outfit for taking photos through microscope as easy as snapshots; Gem Science Kit, complete portable laboratory for mounting specimens; other interesting facts.

Photomicro-
graph outfit

Mail post card for
free copy NOW

BAUSCH & LOMB OPTICAL CO., 761 St. Paul St., Rochester, N. Y.

BAUSCH & LOMB

EXTRA Sell Personal Christmas Cards

MONEY
for You!

Full or spare time. Daily pay, and extra bonus. Exquisite cards, at easy selling prices. Box assortments at half price and less. Novel samples free—write today!

CYPHERS CARD CO., 22 Cyphers Bldg., Buffalo, N. Y.

GLOVER'S WORM MEDICINES

Periodic worming is a vitally important health measure for your pet. Worm puppies from six weeks of age, monthly; grown dogs, two to four times a year. Use GLOVER'S—the standard for over 60 years. They are—For Puppies and Kittens; GLOVER'S PUPPY CAPSULES, GLOVER'S VERMIFUGE (Liquid), GLOVER'S ROUND WORM CAPSULES.

For Dogs, Large Puppies, Cats:



GLOVER'S TETRA-CHLORETHYLENE CAPSULES, GLOVER'S VERMIFUGE (Liquid), GLOVER'S ROUND WORM CAPSULES. Safe and sure. Sold everywhere.

FREE!
GLOVER'S
NEW
DOG BOOK

Glover's new Dog Book is the most complete and instructive manual on Care, Training, Feeding, etc., ever published. Contains many interesting illustrations. Covers in colors. Send for a copy today. Address

H. CLAY GLOVER CO., Inc., Dept. Y
119 Fifth Avenue, New York City

THRILLS OF FLYING THE MAIL

(Continued from page 565)

and marked every few miles by 2,000,000-candlepower revolving beacons.

Nearly a decade ago an air-mail pilot started out over a barren country on his regular run to a city 200 miles distant. He failed to arrive and overdue minutes dragged into overdue hours. Searching parties failed to find him. Two days later he arrived at an isolated ranch house with his mail, cold, hungry and exhausted. A leaking gas line forced him down and a snowstorm camouflaged his plane so searching ships passed it by. A pilot in difficulty today reports his position by radio and those going to his assistance know exactly where to look.

Another mail flyer was breezing along between New York and Washington one night when he saw a mountain looming up where no mountain ever had been before. He knew it could not be real and determined to keep on his course. At the last minute he decided perhaps there had been an earthquake and a mountain had bobbed up overnight, so he zoomed over. After he passed, he looked back. The "mountain" was a giant dirigible, head on and at such an angle that its lights did not show. Today radio would have warned him the dirigible was in his vicinity.

One of the hazards feared by mail flyers before adequate weather reports and audible radio beacon signals minimized the danger was being caught far above the earth with a blanket of fog between the plane and any possibility of landing. A few years ago a pilot flying from Cleveland to New York came through a pass in the Alleghenies and found it necessary to climb above fog and rain to get out of the mountains.

At last he saw an opening in the clouds and down he came over the Susquehanna river to find clouds only about 200 feet above the water. Then began a zigzag trip downstream between the high banks of the narrow river at a speed of 100 miles an hour and with a visibility of about 100 yards. Finally he found an opening through which he could climb and continued on.

For the early flyers, such experiences were all in the day's work, but the dangers they faced helped to build up the air-mail service to a standard of efficiency where it has come to be taken for granted.



Crosman SILENT .22 Rifle

NO CLEANING

LOW COST AMMUNITION

ADJUSTABLE POWER

PEEP SIGHTS

Grooves inside barrel make the Crosman a real rifle with all the hair-splitting accuracy this term implies. Shoots bullet same size as .22 powder rifle, but silently, powerfully, with no recoil, using the terrific force of compressed air—same force U. S. Navy uses to drive 2000 lb. torpedoes. Marvelous for target, small game. Single and 20 shot repeater models. No license required.

FREE booklet containing important target and game shooting facts. Also free Crosman Catalog—or ask your dealer.

Crosman Arms Co., 407 St. Paul St., Rochester, N. Y.

MAKE MONEY building this 32" absolutely accurate 100% flying scale model.



STINSON RELIANT \$2.50
AIRLINER COSTS
SELLS FOR \$15

An unusual money-making opportunity and a fascinating hobby for men and boys. Build this Stinson Reliant Airliner at home and sell to stores and individuals at a big profit. Big demand for display and decorative purposes. Guaranteed to fly, easy to build, the most complete kit you ever saw. Send \$2.50 today for Stinson kit. Other models at 50c, \$1.75, and \$2.00. Ask for FREE folder full of latest plane models, 26 West 19th St., New York City, N. Y.

IDEAL AEROPLANE & SUPPLY CO. INC.

ANY PHOTO ENLARGED

Size 8x10 inches or smaller if desired. Same price for full length or bust form, groups, landscapes, pet animals, etc., or enlargements of any part of group picture. Safe return of original photo guaranteed.

SEND NO MONEY Just mail photo or snapshot (any size) and within a week you will receive your beautiful life-like enlargement, guaranteed fadeless. Pay postman 47c plus postage—or send 49c with order and we pay postage. Big 16x20-inch enlargement sent C. O. D. 78c plus postage or send 80c and we pay postage. Take advantage of this amazing offer now. Send your photos today. Specify size wanted.

STANDARD ART STUDIOS, 104 S. Jefferson St. Dept. 384-M, Chicago



AMAZING AUTO COMPASS

Don't lose time and money by taking the wrong road and going many miles out of your way. This new AIRPLANE TYPE COMPASS constantly tells your direction of travel. Sticks to windshield. Base 1 3/4" diameter. ONLY \$1.95 POSTPAID, including Compensator. SATISFACTION GUARANTEED or your money refunded if returned within ten days.

AGENTS WANTED!

HULL MFG. CO., Box 245-D10, WARREN, OHIO

5,000 to 10,000 Additional SAFE Miles from Smooth Tires Cuts new pattern back. Used world's largest tire factories, U. S. Govt. New non-skid.

KWICK-KUT MFG. CO., 3830 Arsenal St., St. Louis, Mo.

Start a New Business for only

\$6.50

Nothing else to buy!!

Owners pay \$1.00 per tire. Less than half hour's work. Many operators do fifteen and more daily. Nothing to sell but service. Full easy instructions sent. Send money order. Get started. Pleasant new business of your own.



MAKE MONEY at HOME!

EARN UP TO \$25 A WEEK, OR MORE

Grow Mushrooms in your cellar or shed. Big demand. Experience unnecessary—we tell you how. Illustrated book free. Start NOW—write today.

AMERICAN MUSHROOM INDUSTRIES, Ltd.

Dept. 764 Toronto, Ont.

THIS BOOK FREE



For the first time a stove that

DIRECTS

the heat where you choose

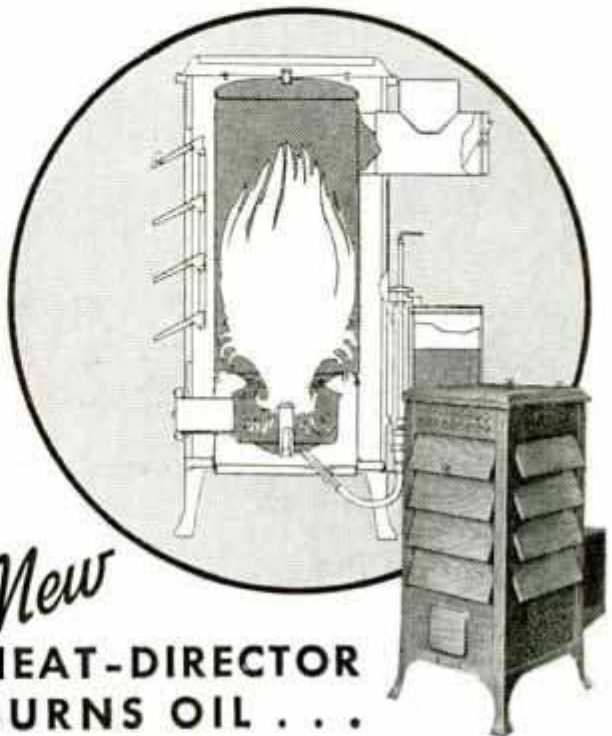

New

HEAT-DIRECTOR BURNS OIL . . .

Now you can enjoy winter-long comfort through directed heat! Radiant heat rays that warm every surface they touch, are directed by the patented shutter-like heat projectors on three sides of the new Heat-Director. This radiant heat warms floor, footstool or easy chair, according to the angle at which you open the heat-projectors.

Heat-Director No. 1007. Listed as standard by the Fire Underwriters. Diagram shows vaporizing burner, patented heat projectors and removable fuel tank.

The Superfex Heat-Director is simple, practical, trouble-free. Set it up and connect to a flue like any stove. There are no moving parts, nothing to get out of order. The powerful vaporizing burner responds instantly to a turn of the valve, giving a wonderful heat volume in a hurry. It is easily regulated for milder weather. With the Heat-Director's flexible control, there are no sudden changes or extremes of temperature.

The removable fuel tank holds enough oil for as many as forty-six hours of comfort. Connections for outside fuel storage are also available.

See your dealer's display of Superfex oil burning heating stoves. There are seven models, three Heat-Directors and four Radiating Heating stoves. Send today for our free booklet illustrated in color.

For one-room chilly spots, get a portable Perfection oil burning room heater.

SUPERFEX

Oil Burning The Mark of Quality

HEATING STOVES

PERFECTION STOVE CO., 7710-A Platt Ave., Cleveland, O.

Please send booklet on clean oil heat without a furnace

Name _____

St or R F D _____

Post Office _____

State _____

FREE BOOKLET FOR YOU

LOWER PRICES



Made by DISSTON in U. S. A.

Either Cross-cut, Rip, or Combination

6" 1/2" hole....\$1.00 8" 1/2" 5/8" hole.\$1.40
 7" 1/2" hole....\$1.25 10" 5/8" 3/4" hole.\$1.80

Made only in above sizes and holes.
 Prices slightly higher in Canada.

Think of it—these special Disston Keystone Circular Saws, now all at reduced prices at hardware dealers. See them. If your store does not have Disston-made Keystone Circular Saws, write us—we will see that you are supplied at these prices. Write for "Disston Saw, Tool and File Manual", FREE,—how to choose, use and care for saws and tools.

HENRY DISSTON & SONS, INC.
 1011 Tacony, Philadelphia, U. S. A.
 Canadian Factory, Toronto

NEW! STEREOSCOPIC CAMERA—ONLY \$2.95



Complete with Viewer and Mounting Cards.

The DUO-VEX

Uses nationally advertised films—10c per roll.—On sale everywhere. Extreme simplicity of operation. Designed especially for amateurs and beginners. New simplified method of mounting pictures—no pasting. DUO-VEX pictures are three dimension pictures—totally different. Subjects are portrayed as seen in actual life. Direct to you, postage prepaid, on receipt of \$2.95 (money order or check). DEALERS WANTED.

three dimension pictures—totally different. Subjects are portrayed as seen in actual life. Direct to you, postage prepaid, on receipt of \$2.95 (money order or check). DEALERS WANTED.

PACIFIC COAST MERCHANDISE CO.,
 704 So. Spring St., Los Angeles, Calif.
 (Branches—New York, San Francisco)

BUILD IT YOURSELF-PLANS

Jim Dandy Cabin Trailer
 Classy! Roomy! Easy to build in any size at low cost! Accommodates 2 to 4. Plans and instructions, only \$1.00—include all diagrams, sketches, photos, material list, etc. Big value for all interested in camp trailers of any kind.

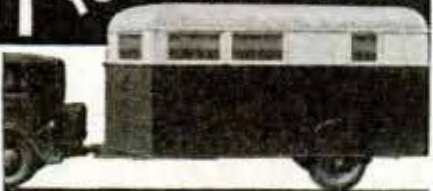

ALL PLANS AND INSTRUCTIONS FOR \$1.00

Rush your dollar for the Jim Dandy trailer plans today!
 MAIL DOLLAR BILL to JIM DANDY, Box 125-A, Wausau, Wis.

Sell 7 Big Bars



Of Finest Toilet Soaps
 Seven cakes of finest toilet soap in hand—some package, the kind of soap used in every home. Selling price marked on box

for only 25¢

EARN UP TO 40¢ a week!

\$1. You sell for only 25c. Housewives buy on sight. Up to 150 per cent profit for you. Write for money-making details and facts about other sensational Victor Soap deals. For quick action send 25c for actual full size sample. VICTOR SOAP CO., Dept. PM-104, DAYTON, OHIO

THE GADGET KING OF AMERICA

(Continued from page 539)

Dan

square inch. For perfect balance and so they wouldn't oscillate at 7,500 revolutions, the shafts were ground to a diameter accurate to a half-thousandth of an inch.

Wood is equally enthusiastic about the success of the boat's step—the secret to the application of the world record-holder's 6,400 horsepower.

"There is a point at which a hydroplane makes her best speed," he said. "We call it the point of oscillation. In practice runs, when Miss America began to oscillate we knew that a point just this side of oscillation was her best speed. We knew that if we couldn't feed her the revolutions we knew she had to take without getting that oscillation, her step needed adjustment. The step was designed to be variable by putting a duralumin plate across the full width of the step with shims between.

"The first time we took her out the angle of the step was too great to permit the expected speed. We knew that quickly because the bow rode high, even before oscillation was felt. We took out half an inch of shims. Then we went out again, and found we had taken out too much. We kept on experimenting until we had her running along absolutely even."

Finally the subject of a new Miss America was broached.

"We don't need a new boat yet," Wood said, "but when we do we'll have one. And if you think this boat is fast we'll be able to show you something. We've been thinking about it for a long time. It won't be the huge boat the Tenth is. The motors will be much smaller and so will the hull. But boy, it will be fast!"

Gar ran his fingers through his heavy shock of silver hair. Eyes twinkling but with a note of seriousness in his voice, he added:

"But before we race it we'll have to do a lot of work on blueprints, hold a whole lot of laboratory tests and do plenty of practical experimenting. The new one won't be a gadget, or a collection of them, any more than is the Miss America X."

(Names and addresses of manufacturers and dealers in articles described, and any other details in our possession, will be furnished by our Bureau of Information upon request, accompanied by postage.

Fortune in Frogs



RAISE TWO-POUND BULLFROGS!

SPECIAL BREED "NUFOND GIANTS." Breeder lays 10,000 eggs each year. Bullfrogs sell \$3.00 dozen. Backyard pond starts you. Most profitable crop known! Raised in any climate anywhere. Get started now! FREE, illustrated book "A Fortune in Frogs" tells how. Write today!
AMERICAN FROG CANNING CO., Dept. 133, NEW ORLEANS, LA.
Originators of CANNED Frog Legs and Frog a la Queen.

Catch Fish!

Eels, Mink, Muskrats with our new folding galvanized

STEEL WIRE TRAP. Write for our **FREE TRAP OFFER** and Bargain Catalog.
WALTON SUPPLY CO., Dept. 1, ST. LOUIS, MO.



Employment for 500 Men at Once!

A REVOLUTIONARY Chemical Sponge has just been invented that cleans cars like magic. Banishes auto-washing drudgery. Also cleans linoleum, woodwork, windows without work! Auto owners and housewives wild about it!

The manufacturer wants 500 men and women at once to help him introduce this strange chemical sponge. He has a special No-Risk Trial Offer for the first person in each locality who writes him. Send in your name today—also ask for full particulars on how you can get the Agency and without experience or risk have a **BIG STEADY INCOME.** Address: **KRISTEE MFG. CO., 1360 BAR ST., AKRON, OHIO**

Stoves AT FACTORY PRICES!



Send for **FREE** Catalog

Over 200 Styles and Sizes of Stoves, Ranges, Furnaces—174 ranges, 12 heating stoves, 22 furnaces. More Bargains than in 20 Big Stores. New styles, new features, new colors. Cash or easy terms. Year to Pay—30 days free trial—360 days approval test—\$100,000 Bank Bond Guarantee—24-hour shipments. **Over 850,000 Satisfied Users**
34 Years in Business

Write for **FREE** Catalog
The Kalamazoo Stove Co., Mfrs,
201 Rochester Ave., Kalamazoo, Mich.

**"A Kalamazoo
Direct to You"**

HOME OWNERS:— This was written for you and is sent



FREE

Get your
copy!

DO your own simple home, auto and motorboat repairing and be independent of outside repair men. You will avoid delays, save much money, and have the satisfaction of knowing that the work is well done.

The booklet contains clear diagrams and directions for correct procedure for hundreds of common jobs, and enables any home worker to get dependable results, *easily*, on any of the following:

Stopping leaks in pipes, heaters, boilers, tanks, radiators, air ducts, smoke pipes, pails, etc., at connections, seams, cracks, rivets or holes.

Tightening or anchoring loose hinges, locks, handles, screws, bolts, nuts, bases, stems, tops, casters, etc.

Making waterproof joints at skylights, roof cracks and flashing.

Making wet cellars dry from the inside, making concrete floors hard, water and oil proof, and non-dusting, making masonry walls waterproof.

On the car:—Stopping leaks in the radiator, at hose connections, or in oil and gasoline lines, patching cracked water jackets, crank, gear and differential cases, tightening loose rivets, mud guards, lamp standards, hub caps and lubricator connections, loose moulding screws, etc.

Smooth-On Iron Cement with which this work is done is applied without heat, without special tools, and so easily and inexpensively that half a dollar to half a hundred dollars is saved in each instance.

Smooth-On has been widely used in industrial work for over 35 years and its use is standard practice by power plant engineers and repair men.



Get the booklet by mailing the coupon and buy Smooth-On No. 1 in 7-oz., 1-lb. or 5-lb. can from your hardware store or if necessary from us.

Do it with SMOOTH-ON

SMOOTH-ON MFG. CO., Dept. 37
574 Communipaw Ave., Jersey City, N. J.

Please send the free Smooth-On Repair Book.

Name.....

Address.....

10-34.....

**USE 3-IN-ONE
AND SAVE ON
SHOP EXPENSE**

Keep all your tools in service longer—save equipment repairs and replacements—by using the oil that *cleans and prevents rust* as it lubricates. 3-in-One is specially blended for this triple job. Try 3-in-One now; on sale everywhere.



**HANDY CANS
AND BOTTLES**



**Ball Joint
Auto Trailer Coupler \$1.95**

ADJUSTABLE BUMPER HITCH \$1.35

Write for
Circular

This hitch can be put on, taken off, or adjusted to 6 different positions with no other tool but a wrench. Postpaid, \$1.35.

ZAGELMEYER AUTO CAMP CO.
710 S. Henry St., Bay City, Mich.



Stop Working for Others

**WE START MEN
IN BUSINESS—**

supply stocks and equipment on credit—teach Sales Methods that have enabled inexperienced people to acquire wealth, fine homes, farms, automobiles. Many in same locality over 25 years—hundreds average \$3000-\$5000 annual business year after year. People must buy Rawleigh's 250 Home Necessities or pay more for inferior substitutes. Our 45 years reputation and "try-before-you-buy" plan makes easy sales. Nearly 40 million sold last year proves enormous demand. Now openings for more new Dealers. First come, first served. Only reliable men selected. Age 25 to 50. First send for convincing proof.

THE W. T. RAWLEIGH COMPANY

Dept. J-35-PPM Write branch nearest you
Freeport, Ill., Memphis, Tenn., Richmond, Va.,
Chester, Penn., Albany, N. Y., Minneapolis, Minn.,
Denver, Colo., Oakland, Calif.,
Montreal or Winnipeg, Canada



THE MIRACLE OF LIGHT

(Continued from Roto Section)

candlepower each and 575 underwater floodlight projectors.

As for colors, even the casual observer notices a vast difference between this year's color scheme and last year's. Last year twenty-five brilliant hues of paint adorned the buildings. This year the number has been reduced to eight, exclusive of black and white. Thirty per cent of the paint this year is white, with green, red and blue following in order. But that is not all. This year the grounds were divided into areas and seldom are more than three principal colors employed in any single area. The reason for the change is explained by Shepard Vogelgesang, the color expert.

"We found," he said, "that it is seldom effective to combine more than three really separate colors because people become confused. That's something to remember when decorating your home. The eye does not study each shade of color separately, but takes them as a group. And the eye does not recognize more than about three colors at a time. So we have a dominant color for each area with different vistas to accentuate the color schemes."

The Fair has employed gaseous tubes for extensive floodlighting for the first time. In combination with paints of many hues, these tubes give whole towers and broad surfaces a jewel-like glow. Paints which have a fluorescence under night lights also were developed, offering a weird radiance which often changes the entire appearance of a building at night.

Relief, outline and decorative lighting is accomplished with the gaseous tubes. Neon gas in red tubes gives a ruby color, krypton in a clear glass shell makes a violet blue, helium in a yellow shell shows yellow and krypton in a green bulb offers emerald hues. The use of hot-cathode tubes for lighting at the Fair shows their vast possibilities in the future floodlighting of buildings in color. The tower of the Hall of Science with its gaseous conductor tubes in colors is an example of this form of illumination.

"Lighting the Fair," modestly proclaims J. L. McConnell, the lighting engineer in charge, "was simply a matter of superimposing colored lights on colored surfaces.

(Continued to page 128A)

Cheaper HEAT Without COAL



EARN \$60 A WEEK!

Write for FREE Burner offer and protected territory

Men and women wanted to demonstrate and take orders for this wonderful invention. This year's sales are tremendous. Make big money. Experience unnecessary.

TRY 30 DAYS AT OUR RISK

Low introductory price and 30 day trial. Write for free catalog, AGENTS and spare time workers: Oil heat saves money this year; people buy to save! Write immediately for free burner offer that starts you in business for yourself. Act NOW!

BRIGHAM OIL BURNER CO.

2927 Clark Ave.

St. Louis, Mo.

Ideal TRAILER HITCH BALL JOINT

CAN'T LET GO!

MOST PRACTICAL HITCH MADE!

Trailer House Blue Prints 36x24: Ideal or DeLuxe, \$3 for 3 sheets. Over 5,000 words instructions. Free with parts sets or rebate when ordered. Guide to trailer building, 25c. C. P. De Luxe Model at World's Fair.

HAMMER BLOW TOOL CO., 606 Third St., Wausau, Wis.

BIG PROFITS FOR MEN AND WOMEN



Have your own business with a full line of the finest cosmetics under your own name. New course gives easy, step-by-step directions, tested formulas and complete information for making all types of cleansing creams, tissue builders, tonics, rouges, brillantines, etc. No manufacturing experience or expensive equipment required. Start right in your own home. If you want to get into a profitable business with unlimited possibilities and repeat sales, write me today and get my FREE Booklet giving complete information.

INA DEL MARVIN

1958 David Whitney Bldg., Detroit, Mich.

WRITE TODAY

A GOOD PAYING BUSINESS of YOUR OWN



Raise Guinea Pigs for us. No experience necessary. We supply breeders and buy the young, paying up to \$2.00 a pair. Use your cellar, spare room or barn. Write today for FREE book. Research Supply Corporation, Dept. R-1, 2436 West York St., Philadelphia, Pa.

EARN UP TO \$50 A WEEK



GROW MUSHROOMS

We show you how; use cellar, idle space; plant all seasons; overnight crops. 540% profit; our service free. Act quick.

INTERSTATE MUSHROOM INDUSTRIES

MM-7357 Cottage Grove Ave.

Chicago, Ill.

IF YOU'RE INTERESTED IN ARC WELDING PROFITS



This new Hobart "Simplified" Welder lets you start big paying business of your own—lets you make hundreds of dollars extra profit each month. Unusually low prices lets you easily pay for it out of increased profits it brings.

**30 DAYS TRIAL
AT OUR RISK
\$30 MONTHLY!**

Thousands of shops are earning big money with Hobart—cash in on the profitable jobs and construction work it lets you handle. Comes in 125, 200, 300 and 400 ampere sizes, Electric, Belted or Gas Engine Drive. Write us today for new low prices and FREE ARC WELDER MANUAL.

HOBART BROS.

Box M-1041

Troy, Ohio



I FIXED GRANDPA'S MOULDING WITH PLASTIC WOOD



WOOD IN CANS

Handles Like Putty
Dries to Hard Wood

Makes 1001 Home, Workshop Repairs

Here is one of the greatest scientific marvels of the age—a preparation that makes thousands of home and workshop repairs easy for anyone. Even an amateur handy-man can use it and make an expert looking job, too! If you want to repair damaged wood (knot-holes, splinters, cracks, nicks, rot, gouges), broken furniture, broken picture frame moulding, build up bottoms of table legs, fill cracks along baseboard and in floor, reset loose casters and drawer pulls—get yourself a can of Plastic Wood.

Easy to Use

Plastic Wood can be shaped or molded easily and quickly . . . with the hands or a putty knife. It handles just like putty and when it dries it becomes hard, permanent wood—wood that is actually a part of the surface to which it is applied. It becomes wood that takes and holds screws or nails without splitting, wood that can be sanded, planed or carved, wood that can be painted, varnished or lacquered—in fact, it can be handled and treated just like real wood. Buy it today and try it—comes in 25c tubes or 35c cans at hardware, paint or department stores.



PLASTIC WOOD

Forms to cast Lead Soldiers, Indians, Trappers, Hunters, Wild and Farm Animals. 239 different forms to select from. Every form guaranteed to cast perfect figures. Send 5c stamp for illustrated catalogue.

HENRY C. SCHIERCKE Spencer Rd. GHENT, N.Y.



get this NEW Arc Welding Book FREE

MORE POWER

WITH A
WITTE

2 to 10
H-P.

ENCLOSED
SELF-OILING
ROLLER-BEARING

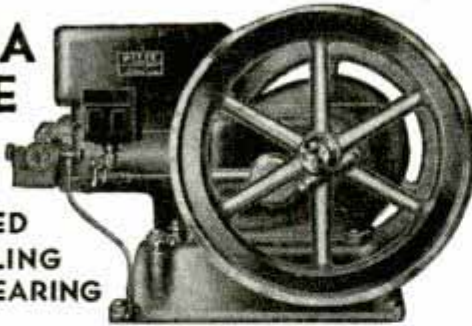

FAMOUS WITTE ENGINES

Furnish portable or stationary power for farms, factories, machine shops, home workshops, etc. Simple in operation and construction, they operate on any refined liquid fuel or natural gas. Throttling governor controls fuel automatically! Weather-Proof high tension ignition. Oiling is automatic, one filling of the crankcase lasts for 60 hours of operation. Timken Roller Bearings guaranteed for life. There is no other engine like it.

BUY DIRECT from a POWER SPECIALIST

Since 1870 WITTE has specialized in power equipment. The complete WITTE Line has an engine for every power need and includes Heavy Duty Engines 15, 20, 30 H-P., Power Saws, Pumps, Meal and Feed Mills. Low prices are assured as we sell direct to you.

WRITE TODAY FOR FREE CATALOG

208-9 Carson St.
PITTSBURGH, PA.

WITTE
ENGINE WORKS

1747 Oakland Ave.,
KANSAS CITY, MO.

MAKE MONEY PRINTING

letter and billheads, circulars, cards, for friends, spare time. Easy to learn, easy to get jobs. Printing Presses \$12; new type faces, complete supplies, lowest prices. Send stamp for catalog. PEIFFER CO., 1-A; 6 Columbia St., Newark, N. J.



BIG MONEY!

THIS QUICK SELLING HEATER

You'll find big profits falling in your lap—letting your friends see this marvelous **SUNSHINE RADIANT HEATER**. Every home a hot prospect. Gives clean, live gas heat no matter where you live for 1½¢ an hour. No servicing; no installation—no investment nor stock. You collect profits in advance. Thousands in use!

FREE Most startling offer ever made! Try one in your own home 15 days. Write quick for full details and make territory reservations.

SUNSHINE PRODUCTS CO.
Dept. 5011 5127 W. 65 St., Chicago, Ill.



Makes and burns its own GA gas. No smoke, dirt or soot.

BEFORE Buying Microscope Read these Helpful Facts

How to select a microscope wisely, told in "Revealing Nature's Wonders," 20-page book, sent FREE by Wollensak, world-famous lens specialists. Endless hours of exploring strange worlds, if you choose microscope well. Illustrates and describes these models:

No. 425—Magnifies 100 to 425 diam. \$18.50
No. 235—Magnifies 110 to 235 diam. 15.50
No. 150—Magnifies 70 to 150 diam. 12.50
No. 100—Magnifies 100 diameters. 5.00
Slide Set—Make slides at home. 3.50

Your dealer can show you above microscopes or shipped by us prepaid. Or C. O. D., if you prefer. Our money-back guarantee protects you. Write for free book today—now.

BUY AMERICAN

WOLLENSAK OPTICAL CO.
869 Hudson Ave., Rochester, N. Y.



THE MIRACLE OF LIGHT

(Continued from page 126A)

The man or woman with some artistic ability can duplicate some of the color effects we obtain in the home or garden."

Lighting is mostly a game of hide and seek when used for decorative purposes. It is a matter of throwing the light on the surface to be illuminated without revealing its source. Examples of this can be found everywhere at the Fair. Light sources are hidden in troughs and recesses or screened with translucent material and certain areas difficult to reach are illuminated by inconspicuous floodlights and searchlights atop the towers of the 600-foot Sky Ride. Flowers are used more extensively than last year to lend color by day, and by night the flower beds are lighted by mushroom lamps on short standards. The light from these sources, while not concealed, is indirect and gives the visitor the impression of walking waist deep in a diffused radiance—certainly an idea worth considering for the home flower plot.

The amateur will require practice to blend the proper lights with the proper colors unless he has marked artistic ability, but he will find that a white surface is safe to begin with. It also will not take him long to discover the Fair's secret of changing purple-red surfaces to flame color at night. They simply turn a red light on the blue. In like manner green light changes light blue buildings to green at night.

Lighting of paths, walks and bridges at the Fair also may point to a new method of street illumination for the future. Some of these lamps are simply translucent cylinders mounted on lattice masts, others are indirect luminaires and still others are sea-shell reflectors or "telegraph-pole" standards. The latter are tubular lamps projecting horizontally from the tops of steel poles. These lamps are of the vacuum type and give a diffused glow without glare, being suitable for outdoor service.

One of the most spectacular lighting effects is seen in the lagoon fountain, 810 feet long, which combines electric lighting and color in a manner never before attempted. There are no statues or other art work as a part of the fountain. It depends entirely on water and light for its appearance. Its flow of water, 68,000 gallons per minute, several times as much as

(Continued to page 130A)

Cash Daily Making Do-Nuts!

Big Profits in Your Own Business at Home



You can make steady, daily profits, more than double your cost, making electric-baked GREASELESS do-nuts at home with the Ringer Electric Do-Nut Baker. It makes delicious, large do-nuts that SELL! "In my store demonstration Friday and Saturday, I sold over 80 dozen. I am more pleased every day" writes R. Sutton, Mont. "Am building up a nice store and restaurant business," reports Marcella Wood, Mass. "It is no trouble to sell the Do-Nuts,—they sell themselves," H. E. Burns, West Va.

No Canvassing Grocers, drug stores, lunch counters buy all you make. Many operators have regular routes to private customers or sell by boys.

Free Plan shows you how to start this fine-paying home business. No experience needed. \$25 starts you. Total investment less than \$50. Begin at home in your spare time. Send a post-card today for full information. No obligation, no salesman will call.



RINGER DO-NUT COMPANY
142 Main Street, N. E. MINNEAPOLIS, MINN.

HOW TWO IDEAS Earned Bob a Raise

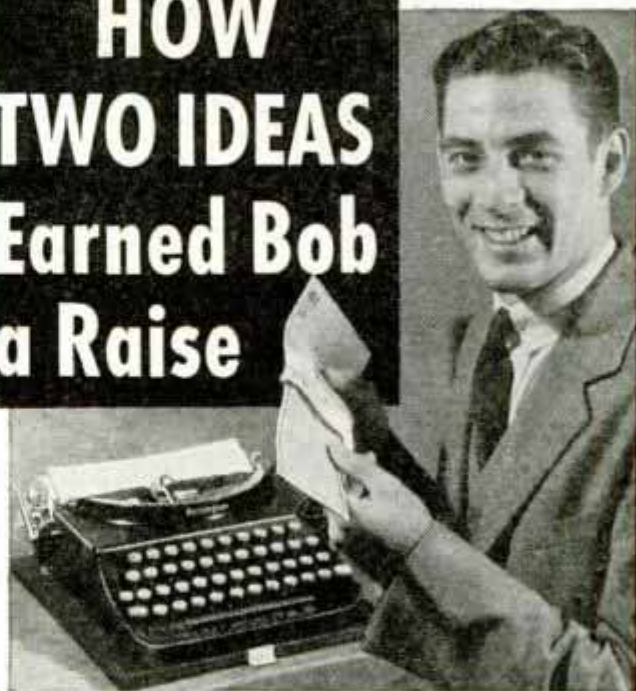

BOB is just like any of the other fellows at the office ... but he has two important ideas. The first is to keep his eyes open for ways to save his company money, to make suggestions for improvements. His second idea is to put those suggestions down in neat, easy-to-read black and white with the aid of a portable typewriter ... so that no matter how tired or busy his boss happens to be, Bob's suggestions always get a hearing. While the rest of the fellows are waiting for "better times" ... the other day Bob got a raise.

Your boss is looking for men with ideas too ... ideas for improving sales, methods, office routine, every phase of big business. Are you getting credit for yours? A Remington Portable typewriter at home will help organize your thinking ... help your ideas get attention. Get started now ... mail the coupon today for full details on our special offer.

NEW REMINGTON PORTABLE ONLY 10¢ A DAY

Low price model, complete with carrying case, standard keyboard, most big machine features ... only 10¢ a day. Practical model writing capital letters only, just \$17.95 cash. Mail coupon for special offer.



Remington Rand Inc., Dept. 152-10, Buffalo, N. Y.
Please tell me how I can buy a new Remington Portable typewriter for only 10¢ a day. Also enclose your new catalog.

Name _____
Address _____

OILOMETER

CHANGE-OIL

The cleverest Change-Oil Reminder you ever saw. Neat, attractive! Screws on to gear-shift of any car. Eliminates the sticker nuisance once and for all.



REMINDER

Complete with shift ball, \$1.00. Specify make of car. At your accessory dealer's or order direct from us. Oilometer Sales Corp. 1st National Arcade St. Paul, Minn.

EARN UP TO \$25 OR MORE

weekly, growing mushrooms in cellars or outbuildings, all fall and winter. We instruct you. Ready market. Booklet free.

ADANAC MUSHROOM CO. Dept. 147 TORONTO 10, CANADA

Information on any book free. Write Popular Mechanics Press, Chicago, Ill.

Boys BUILD THIS CAPE COD COTTAGE \$1



Send NO MONEY

WE FURNISH EVERYTHING to build this authentic model: 100 ft. lumber, roofing, nails, glass, glue, rule, saw. Step-by-step instruction plan, easily followed. 11x12x8'. Ideal project for manual training. Fascinating and a challenge to your skill. Amazing value. Pay postman \$1 and 25c. c. o. d. fee or if you prefer send \$1 and 15c. postage. Satisfaction guaranteed or money back. **MINIATURE HOMES CO., 104 Greg Av., Mt. Carmel, Ct.**

STEP INTO THE *Spotlight*



Banish Boredom... Earn Extra Money START TO PLAY VERY FIRST DAY

Picture the joy of playing a snappy foxtrot, dreamy waltz or mellow old favorite on the Xylorimba. No reason why you shouldn't! Xylorimba is **easiest** of instruments to play and yet the most spectacular. In constant demand by orchestras, radio stations, at lodge meetings and parties. Marvelous opportunity to increase popularity, make big spare-time money. No bothersome practice or exercises. With Free easy lessons you actually **Start to Play Very First Day**.

BIG FREE BOOK tells all about Deagan line, liberal trial offer and easy payments. Send coupon today for your free copy.

J. C. Deagan, Inc., Dept. 7457, 1770 Berteau Ave., Chicago

Send me, without obligation, full details of Free Trial offer and easy-payment plan on the Deagan Xylorimba.

Name.....

Address.....

CHEAP OIL BURNER INVENTED SWEEPING THE COUNTRY



**AGENTS,
SALESMEN
BIG MONEY**

Here's a REAL one. Clark of Ind. sold 93 in 30 days. O'Toole of Mass. sold 164 in July. Get YOUR OWN oil burner FREE and Make REAL Money. Write quick.

Beats Coal or Wood

Slips Into Any Old Stove, Range or Furnace. No Dirt, Ashes—Twice the Heat, Half Cost

COOKS A MEAL for 1c

Beats any oil burner ever gotten out for low cost, perfect performance. Slips into any old stove, range or furnace; burns cheap oil a new way, without generating or clogging up. Intense heat instantly BY SIMPLE TURN OF VALVE.

TRY AT OUR RISK —30 DAY TRIAL— prove it ends drudgery and dirt of coal or wood; cuts fuel bills in half, pays for itself quickly by what IT SAVES.

**FREE SAMPLE
TO AGENTS**

offered to one energetic man or woman in each locality who will demonstrate and take orders. Write quick, be first to learn how to make REAL MONEY right now, spare or full time—mail 1c postcard today. UNITED FACTORIES, 102 Exchange Bldg., Kansas City, Mo.



AGENTS Make \$380 Monthly

selling 10 CARTER WINDOW WASHERS daily. Cleans, dries, polishes. No mess. Good Housekeeping approval. Restricted territory. Write today. Carter Products Corp., 998 Front Ave., Cleveland, Ohio

Laboratory Supplies at School Prices!

You can buy from us the same high quality laboratory supplies we furnish schools and colleges—AT OUR SCHOOL PRICES.

Send 10c for new 32-page catalog listing more than 1,500 items of chemicals, apparatus, glassware, microscopes, books and accessories. Deduct price of catalog from payment for first order. Source of Scientific Supplies for schools and colleges.

New York Biological Supply Co., Dept. 15, 34 Union Sq., N. Y.



THE MIRACLE OF LIGHT

(Continued from page 128A)

the next largest fountain in the world, and enough to supply a city of 1,000,000 people, is illuminated with concealed floodlights of changing color. The fountain, the floodlights and the bank of searchlights use enough electricity to supply a city of 150,000 population. Underwater floodlights for this fountain are not water-tight, the water being allowed to play over them and keep them cool, a revolutionary procedure in water illumination.

Another remarkable effect never before attempted is the neon Niagara which cascades down the front of the Electrical building. This is produced by using illuminated gas tubes for the waterfall while searchlights behind it create an artificial Aurora Borealis.

Louis Skidmore, assistant general manager in charge of design and construction, believes the lights and colors of the Fair will be reflected in the homes and gardens a few years hence.

"Every fair has left its architectural imprint on succeeding generations," he observed. "This Fair has shown people how color and light can be employed successfully for decorative purposes. Why should a big office building remain a dirty gray for the forty or fifty years of its useful life when it can be given a fresh face as often as desired with the use of light and color? Why should the four walls of a room be painted one solid color without regard to the diffusion of light or the decorative possibilities?"

Mr. Vogelgesang, the color expert, visions rooms with surfaces which do not seem to hold the occupants to the confines of four walls.

"We know new lighting effects to produce if we had the materials with which to work," he says. "With the proper materials illuminated in the proper manner, we should like to produce walls with no wall feeling. We know how to produce the lighting effects but not how to increase the area affected by light to larger proportions than in present use at the Fair. The nearest we have come to it is a wall of polished black glass which can be so illuminated that it does not appear to be a confining wall but seems like a black void in which shimmer flecks of color like constellations in space."

Electric Telegraph Set

BOYS! A private Electric Telegraph Set of your own for **15c**. Lots of fun sending messages to your friends. Better still get two sets, hook them up as shown in the directions, for **TWO-WAY MESSAGES** (sending and receiving). No trouble at all to operate with the simple instructions that accompany each set. Operates on any standard dry battery obtainable everywhere. With this outfit you can learn to transmit and receive messages by the Morse International Code, and in a very short time become an expert operator. Mounted on wooden base measuring 4 x 3 in., first class construction throughout, complete with key, sounder, magnet, miniature Western Union blanks, packed in neat box with full illustrated instructions —

15c



The Boy Electrician **10c**

Add 10c for 64 page book all about electricity written especially for boys. Tells how to make batteries, dynamos, motors, radios, telegraph apparatus, telephones, lights, electric bells, alarms, coils, electric engines. **PRICE 10c ppd.**

ALL FOR 15c (without battery) **postpaid** (Canada and Foreign 20c.)

Big, new catalog of novelties, jokes, tricks, puzzles, books, etc. 10c.

CAMERA with Complete Outfit **35c**

(10c extra for postage)

Although this apparatus is so **MARVELOUSLY CHEAP**, it is quite efficient, and will take **SPLENDID PICTURES**. It is just the thing for beginners in photography. It takes pictures not quite 2x1 1/4 inches with clearness, sharpness and distinctness. Daylight loading. It has a **VERY GOOD LENS**; **BRILLIANT VIEW FINDER**, a simple yet effective **SHUTTER**, time

and instantaneous, leatherette handle, and it comes complete with 4 **FILMS**, 1 package **PRINTING PAPER**; a neat little **PRINTING FRAME** with glass top, and a **SUPPLY OF CHEMICALS** for developing, fixing and turning out the finished picture. Full printed instructions. **CAMERA AND COMPLETE OUTFIT ONLY 35c** (Canada and foreign 50c) with 10c extra for postage and packing. Extra **FILM 10c** per package of 5 Films. Extra **Printing Paper 10c** pkg.



BIG ENTERTAINER **15c**



326 Jokes and Riddles, 25 Magic Tricks, 10 Parlor Games, 73 Toasts, 13 Fairy Tales, 105 Money-making Secrets, 22 Monologues, 21 Puzzles and Problems, 5 Comic Recitations, 10 Funny Readings, 11 Parlor Pastimes, 13 Flirtations, 1110 Girls' and Boys' Names and their Meanings, 10 Picture Puzzles, 69 Amusing Rhymes, 37 Amusing Experiments, Deaf and Dumb Alphabet, Shadowgraphy, Gypsy Fortune Teller, How to Tell Fortunes with Cards, Dice, Dominoes, Crystal, Coffee Cup, etc. Hypnotism, Ventriloquism, Cut-outs for Checkers and Chess, Dominoes, Fox and Geese, 9 Men Morris, Spanish Prison Puzzle, Game of Anagrams, 25 Card Tricks, Crystal Gazing, etc. **ALL FOR 15c.** Novelty Catalog 10c.

HORNED TOADS **50c EACH**

Horned Toads—most interesting pets. Head, back and scales armed with long horny spikes. Although of apparently sluggish nature, when in search of food it runs like lightning. Watch it pounce upon flies. Amusement by the hour. No trouble at all to keep. Feed it on meal worms or let it seek its own food. Will live for years and years. Shipped by mail to any address in U. S. A. or Canada for 50 cents.



LIVE DELIVERY GUARANTEED

BLANK CARTRIDGE PISTOL

REVOLVER STYLE



25c
50c
\$1.00

Three new models now out. **25c, 50c and \$1.00.** Well made and effective. Modelled on pattern of latest type of Revolver. Appearance alone enough to scare a burglar. Takes 22 Cal. Blank Cartridges obtainable everywhere. Great protection against burglars, tramps, dogs. Have it lying around without the danger attached to other revolvers. Fine for 4th July, New Year's, for stage work, starting pistol, etc. **SMALL SIZE 4 in. long 25c. MEDIUM SIZE 5 in. long 50c. LARGE SIZE 6 in. long \$1.00.** **BLANK CARTRIDGES 50c per 100.** **HOLSTER (Cowboy type) 50c.** Shipped by Express only, not prepaid.

REAL LIVE PET TURTLES



25c

Sent by Mail for only

25 Cents

A Fascinating and Interesting Pet

Live Delivery Guaranteed

If you want a fascinating and interesting little pet, just risk 25c and we will send you a real live Pet Turtle by mail postpaid. Thousands sold at Chicago World's Fair. No trouble at all to keep. Just give it a little lettuce or cabbage or let it seek its own food. Extremely gentle, easily kept and live for years and years. Need less attention than any other pet. Get one or more. Study their habits. You will find them extremely interesting. **Price 25c.** **SPECIAL TURTLE FOOD 10c pkg.**

CHAMELEONS — **25c**

LIVE, SAFE DELIVERY GUARANTEED

Watch it change its color!



Get one of these most wonderful of all creatures. Watch it change its color. Study its habits. Wear one on the lapel of your coat as a curiosity. Watch it shoot out its tongue as it catches flies and insects for food. No trouble to keep. Can go for months without food. Measures about 4 inches in length. Shipped to any address in U. S. A. by mail. We guarantee safe arrival and live delivery. **PRICE 25 CENTS POSTPAID.**

LIVE BABY ALLIGATOR \$1.50

Safe Delivery Guaranteed

How would you like a real live Baby Alligator for your very own? A rage for Baby Alligator pets has swept the country. We have arranged, at great expense, to supply you with a **GENUINE LIVE BABY ALLIGATOR**. Just hatched in the deep marshlands of the South, at an amazingly low price. These corking little pets will be shipped to you by mail, carefully packed—safe arrival guaranteed. Think of the fun, the thrills you will have with one of these Baby Alligators. Read how fascinating they are, how interesting. Study nature. Remember, the alligator comes down to us from prehistoric days, from the age of dinosaurs! Do you want a Baby Alligator? You bet you do. What boy wouldn't? **PRICE \$1.50 postpaid.**

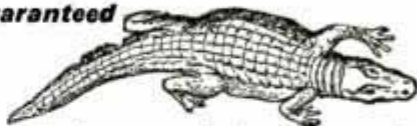

BOYS! THROW YOUR VOICE



Into a trunk, under the bed or anywhere. Lots of fun fooling teacher, policeman or friends.



THE VENTRILO

a little instrument, fits in the mouth out of sight, used with above for Bird Calls, etc. Anyone can use it. **Never fails.**

A 16 page course on Ventriloquism and the Ventrilo. All for 10 cents postpaid. **JOHNSON SMITH & CO., Dept. 842, RACINE, WIS.**



JOHNSON SMITH & CO.

Dept. 842 RACINE, WIS.

A copy of our **NEW CATALOG** mailed on receipt of 10c., or the De Luxe Edition with cloth binding 25c. Bigger and better than ever. Only book of its kind in existence. Contains all the latest tricks in magic, the newest novelties, puzzles, games, sporting goods, rubber stamps, unusual and interesting books, curiosities in seeds and plants, etc., unobtainable elsewhere. Remit by Cash, Money Order, Check or unused U. S. Postage Stamps, for all articles listed above. Canadian money, stamps and Postal Notes accepted.

INVENTORS
Get this
FREE Book

PATENTS AND TRADEMARKS

Patent Your Ideas This Free Book Shows How

YOUR idea for a practical article or an improvement upon an old one should be patented NOW. Frequently many of the thousands of applications filed in the U. S. Patent Office each year are for the same or almost the same idea. In such a case, the burden of proof rests with the last application filed. Sometimes a delay of even a few days in filing the application means the total loss of the patent. Lose NO TIME.

The entire time of my large and experienced organization is devoted exclusively to patent and trademark cases. We know the rules and requirements of the Patent Office. We understand the technicalities of Patent Law. We can proceed in the quickest and safest ways in preparing an application for a patent covering your idea.

The book shown here contains valuable information that every inventor should know. It tells you just how to go about obtaining a patent for your idea. With the booklet I will send you my "Record of Invention" form on which you may sketch your idea and establish its date before a witness. If a dispute arises this will be valuable to you. Send the coupon TODAY! You will receive the FREE book, the "Record of Invention" form, and full information regarding costs.

Strict Secrecy Preserved

All communications, sketches, etc., are held in strictest confidence and protected by steel files. Your idea will be in trustworthy hands. I have the highest references. It is probable that I can help you. Send the Coupon AT ONCE.

Personal Service

Your case will be handled by a specialist selected for knowledge and experience in certain lines of inventions. His personal attention will be given to your idea.



Above is a view of our drafting and specification rooms. These important departments are made up of men of demonstrated skill and aptitude for the particular phases of patent and trademark procedure to which they give their attention.

**How to Obtain
A PATENT**



ALSO FREE

"Record of Invention" Blank: On request I will send you FREE a copy of my "Record of Invention" blank. On the blank you can sketch and describe your invention and have it witnessed in such manner that it may be of value to you as evidence. Send coupon now and receive this form together with my free book.

**Rush
this
Coupon
to**



CLARENCE A. O'BRIEN
REGISTERED PATENT ATTORNEY
70-Y Adams Building
WASHINGTON, D. C.

Please send me your FREE BOOK, "How to Obtain a Patent," and your "Record of Invention" form, without any cost or obligation on my part.

NAME.....

ADDRESS.....

(Important: Write or print name plainly.)

When writing to advertisers please mention Popular Mechanics

Books on Many Practical Subjects

Popular Mechanics Press specializes in supplying the outstanding best books on many subjects. As new books of merit appear, we will revise the list accordingly.

- AIR CONDITIONING**
Complete, authoritative. \$4.00
- ARITHMETIC**
New, time, space saving methods of figuring. \$1.50
- ARMATURE WINDING and Motor Repair**..... \$3.00
- AUTO ENCYCLOPEDIA**
Dyke's. Latest Edition Covers Recent Improvements..... \$6.00
- AUTO GENERATORS CHANGING TO 110V.**
A. C. Generators..... \$1.00
- AUTO KINKS**
for Owners, Tourists (2 vols.)..... \$1.00
- AUTO TRAILER**
Building..... \$1.00
- BIRD HOUSES**
How to Make..... \$1.00
- BLUE PRINT READING**
For Machine Trades... \$1.50
- BOAT BUILDING**
New Edition of Popular Mechanics book..... \$3.00
- BOOKKEEPING**
Complete Course, Single and Double Entry.... \$3.50
- BOY MECHANIC**
Famous 4 Vol. Library, 4000 Things to Make. \$7.00
- BUILT-IN FURNITURE**
Complete Instructions.. \$2.50
- CALCULATOR**
Ropp's Mathematical.. \$1.00
- CARPENTRY**
Hand book of 336 Kinks. \$1.50
- CHEMICAL MAGIC**
Fun and Education.... \$1.00
- CHEVROLET SIX**
Complete Book
Covers 1932 Models \$2.00
- CONCRETE**
173 Ways of Using.... \$1.00
- DANCING**
Modern Ballroom..... \$2.00
- DOG TRAINING**
For Home, Stage and Moving Pictures.... \$1.50
- FARMER'S BOOK**
of 861 Kinks and Book for Farmers' Wives.. \$1.00
- FORD MODELS V8, B and A**
Excellent new book.... \$2.50
- FORMULAS**
10,000 Money Making.. \$4.00
- FROG INDUSTRY**
New book on profit making in..... \$2.00
- FURNITURE MAKING**
42 Popular Pieces..... \$2.50
- GARDEN GUIDE**
New edition..... \$2.50
- GLASS**
Working..... \$1.75
- LATHE WORK (METAL)**
and Drilling and Thread Cutting..... \$1.00
- LOCOMOTIVE**
Modern Passenger Lithographic Model Shows Every Part..... \$1.00
- LOG CABINS**
How to Build..... \$2.50
- MAKE IT YOURSELF**
900 Different Articles.. \$3.00

- MATHEMATICS**
Made Easy for the Practical Man..... \$1.50
- MECHANICAL DRAWING**
Practical Course in... \$1.00
- MONEY MAKING IDEAS**
1000 Spare Time..... \$1.00
- OCEAN LINER**
Europa, Lithographic Model, Shows Every Part.... \$1.00
- OUTDOOR OPPORTUNITIES**
for Making a Living... \$2.00
- OUTDOOR SPORTS**
for All Year 'Round
New Edition..... \$2.00
- PAINTING**
House (Best Methods).. \$2.00
- PAPER MAGIC**
by Houdini..... \$2.00
- PLUMBING**
500 Plain Facts for Every Homeowner... \$1.50
- POULTRY**
Breeding and Management..... \$2.00
- PROSPECTOR'S HANDBOOK**
Practical Methods.... \$3.00
- RADIO**
Amateur's Handbook... \$1.00
- RADIO SERVICING**
How to make money at it..... \$1.75
- REFRIGERATION**
Modern Electric and Gas (Just Out)..... \$4.00
- REWINDING SMALL MOTORS**
Fractional H. P. \$2.50
- ROCK GARDENS**
How and Where to Build..... \$1.00
- SHIP MODEL MAKING**
Sovereign of the Seas... \$1.00
- SHOP NOTES**
8 Vols. of 3600 Valuable Kinks..... \$3.50
- SLIDE RULE**
How to use..... \$1.75
- STEEL SQUARE**
Pocket Book, Practical. \$1.00
- STORAGE BATTERIES**
(New work) Building and Repairing..... \$2.50
- TELESCOPE MAKING**
Amateur..... \$3.00
- TOYS**
Easy to Make..... \$1.44
- UPHOLSTERY**
Easily Followed Instructions..... \$1.60
- WALL DECORATION**
(Interior) Newest Methods..... \$3.00
- WELDING ENCYCLOPEDIA**
All Methods..... \$5.00
- WHITTLING**
Only Book on Subject.. \$1.35
- WIRING**
House (New Book).... \$2.50
- WOOD TURNING**
Course in Practical... \$1.50
- WOODWORKING SHOP**
Motor-Driven (3 vols.) \$3.00
- WRIGHT WHIRLWIND ENGINE**
Lithographic Model Shows Every Part... \$1.00

48 Pages of Facts for INVENTORS

HAVE you an invention—or an idea for one—that will save time, save labor, make money or give pleasure? If you have, then this interesting, new **FREE BOOK**, was meant for you. Tells how the Patent Laws protect you and why you need a Patent at all; what kind of a sketch or model is needed; how to make a disclosure of your idea right away, to help establish your claims; how some successful inventors have secured financial assistance; tells about interesting inventions that have proved successful and shows you 115 different mechanical principles that inventors have used in working out ideas; also gives much other information that every man who has an invention—large or small—can use to his advantage and profit.

The Big Age of Invention Is Still Ahead

Below is one of our newest trains. It's the crack, streamlined express of the Union Pacific. Does 110 miles an hour. This is only a glimpse of what's ahead. C. F. Kettering, Vice President of General Motors, says: "We're only entering the great period of inventive advancement." But remember that many of the largest fortunes have been made—and will be made—from simple things. For example, shown here is another recent invention, a simple attachment to fit under the cap of a ginger ale, beer or soft drink bottle. When pulled out, as illustrated, the bottle cap comes off. Simple idea, but the inventor has a patent and it may prove a big money-maker for him. Your first step, if you have an invention, is to get the facts about Patent Protection. We gladly supply them **FREE** to serious, interested men.



Thirty-Six Years of Service to Inventors

This firm was founded over a third of a century ago. We have helped thousands of inventors protect their rights. We represent you personally before the U. S. Patent Office. We have a large staff of Patent Specialists to serve you quickly, economically, effectively. **What you write us, or send us, is held in STRICTEST SECRECY.** Our book also tells you about a three-payment fee plan that many inventors have found helpful. Write us a card, letter or send in the convenient coupon. **Decide NOW to know the facts. Do that today.**



VICTOR J. EVANS & CO.

Registered Patent Attorneys,
Main Office, 500-L Victor Building,
Washington, D. C.

Branch Offices: 1640-N Conway Building, Chicago;
1007-N Woolworth Building, New York; 514-N Empire Building, Pittsburgh; 1010-N Hobart Building, San Francisco.

Kindly send me a **FREE** copy of your book, "Patent Protection" and other facts of interest to an inventor.

Name.....
Street and No.....
City..... State.....

Books sent C. O. D. anywhere in U.S.

Just check the books you want, write your name and address below, and mail the advertisement. It is your order blank. When post-man hands you books, pay him the price and few cents postage. If outside the U. S. remit when ordering and include 10 cents per book extra for postage. We have many other books on these and 2,000 other subjects. Catalog free.

Name.....
City..... State.....
Address.....

Mail to Popular Mechanics Press,
Room O 4—200 East Ontario St., Chicago, Ill.

MAIL COUPON BACK TO WASHINGTON, D. C. Now!

When writing please mention Popular Mechanics

INVENTORS PATENT YOUR IDEAS

MAIL COUPON TODAY



MILLER & MILLER
REGISTERED PATENT ATTORNEYS
FORMERLY IN EXAMINING CORPS U. S. PATENT OFFICE

Your Patent Application Must be filed for Examination by the Examining Corps in the U. S. Patent Office. Choosing your Patent Attorney is an important matter. Why not select a Registered Patent Attorney having had personal experience in the Examining Corps of the U. S. Patent Office? **MAIL COUPON TODAY for FREE PATENT BOOK and RECORD OF INVENTION Form.**

1638 Woolworth Bldg., Dept. 104A, New York City
MILLER BUILDING, Dept. 104A, WASHINGTON, D. C.

Please send me your Free Book, "How to Obtain a Patent," and your "Record of Invention" form.

NAME.....

ADDRESS.....

DO YOU INVENT - for fun, or for profit?

L. F. Randolph, 302-D Victor Bldg., Washington, D. C.

Please send me at once, free of charge, your 72-page booklet and "Record of Invention" form.

Name.....

Address.....

Even simple inventions may have large commercial possibilities. If you are inventing to make money, and not just as a hobby, you should take extreme care to properly protect your ideas. Write today for my 72-page free book and full information about my personal, confidential

patent service. Or send model and description of your invention and \$5.00 for an immediate search and report as to its patentability. Book and information free, anyway. (Registered Patent Attorney—over 37 years experience.)

DONT DELAY, USE THE COUPON, NOW

3/4 HP. New 4 CYCLE ENGINE

For shop, farm, garage. Many uses. Ideal for Separators, Washers, Pumps, Grinders, Generators, Lathes and many others. Just use water for making boys' auto. Easy starting—smooth flow of power. The "Colt" is comparable to modern automobile engines in these features. Get a "Colt"—if not satisfied after 10 days' trial your money is refunded. Write today for details.

ASSOCIATED MFGRS. CORPORATION 500 Mullan Ave., WATERLOO, IOWA
Engine Builders Since 1898

only \$35.95

Inventors! WE GIVE RESULTS!

SEND FOR **FREE BOOK** "PATENT SENSE"

PATENTS

Protect yourself by retaining a legal firm that has been in good standing before the Patent Office over sixty years. . . Preliminary advice FREE . . . estimate of costs submitted. Write full particulars to Dept. 5—635 F St. N. W. Washington, D. C.

ESTABLISHED 1869

Lacey and Lacey

COMPLETE ELECTRIC PLANTS

\$99= ONAN A. C. PLANTS furnish the same current as city service. Operates Radio, Water System, Refrigerator, all Household Appliances.

SIZES 300 WATTS UP

Direct Current Models as low as \$99. No battery used to start the engine. Easy to install. Available from stock. Ideal for farms, camps, lake homes, and commercial purposes.

D. W. ONAN & SONS, 937 Royalston Ave., Minneapolis, Minn.

FREE

BB MAGIC THE SHOOTER'S DELIGHT

The NEW BENJAMIN 25 SHOT REPEATER with BOLT ACTION—HAMMER FIRE—HAIR TRIGGER—PRICE \$7.50 is the most sensational improvement in airgun history. Send name—address—see kind of gun you now have—if any—for your copy of BB MAGIC—FREE—A real gun manual based on U. S. Army regulations, etc. Also ask for details of 1934 BENJAMIN SUPER SINGLE SHOT—PRICE \$5.50 and our SPECIAL INTRODUCTORY OFFER. WRITE NOW.

BENJAMIN AIR RIFLE CO., 695 N. Broadway, St. Louis, Mo., U. S. A.

PATENTS—TRADE MARKS

All inventions submitted held confidential and given personal attention by members of the firm.

Form, "Evidence of Conception" and instructions, "How to Establish Your Rights"—FREE!

LANCASTER, ALLWINE & ROMMEL
Patent Law Offices
412 Bowen Bldg. Washington, D. C.

BUCHSTEIN'S FIBRE LIMB

is soothing to your stump—strong, cool, neat, light Easy payments. Brace for all deformities.

D. BUCHSTEIN CO.
610 3rd Ave., So., MINNEAPOLIS, MINN.

Send for Catalog Today

PATENTS

Booklet Free Highest References
Promptness Assured Best Results
Send drawing or model.

ALL BUSINESS GIVEN PROMPT AND PROPER ATTENTION

Listed Patent Lawyer in the latest editions of the Rand-McNally Directory of Bankers and Bank-Recommended Attorneys, published by Rand-McNally & Co., Chicago, Ill.; The Baggott & Ryall Directory of Guaranteed Attorneys, published by Legal Directory Corporation, Boston, Mass.; Flugel's Law List, published by Legal Directory Publishing Co., St. Louis, Mo.; American Lawyers Annual, published in Cleveland, Ohio; Bankers Service Legal Directory, published by Bankers Service Co., Boston, Mass.; Byre's Law List, 9 Park Place, New York City; Walters Legal Directory, Omaha, Nebraska, and the National Directory of Attorneys, Baltimore, Maryland.

WATSON E. COLEMAN,
REGISTERED PATENT LAWYER

Victor Building, 724 Ninth Street, N. W.
WASHINGTON, D. C.

1935 MODELS DRIVER POWER TOOLS

Dozens of New Features . . . Added Conveniences
Remarkably Low in Price

Latest and finest of power tools. . . New standards in design and quality. . . New values in utility and performance. . . The 1935 DRIVER Line is ready! Lathes, bench saws, drill presses, band saws, jointers, shapers and jig saws—three different lines in three price ranges—designed and built for professional or amateur craftsmen.

Drop in at your local hardware dealer today and ask to see the new models, or if more convenient, fill out the coupon below for new descriptive circular.



NEW BOOKS ON WOODWORKING

To enable every new DRIVER tool purchaser to get added satisfaction from his shop a 72 page book of instructions is supplied free with each new major machine. Book one covers the Bench Saw, Jointer and Shaper, the second the Drill Press, the third the Lathe and the fourth the Band Saw and Jig Saw. They are also available to craftsmen in general at .50 for each book, \$1.50 for the set of four, postpaid.

WALKER-TURNER CO., INC.
1104 Berckman St., Plainfield, N. J.

Please send me at once—

- Free folder covering new tools.
 Book 1, Book 2, Book 3, Book 4.

I am enclosing .50 for each book (\$1.50 for set of four) postpaid.

Name _____

Address _____

HEAT 1½¢ Per Hour!



AMAZING INVENTION—New Radiant Heater. Burns 96% air. Makes its own gas. No piping. No installation. Gives roomful of clean, healthful, penetrating heat, like sunshine, for 1½ cents an hour. Hotter than gas or electricity, at 1-10th the cost. Easy to light and operate. No smoke. No soot or ashes. No odor. Portable—carry it anywhere. **Low priced. Guaranteed.**

AGENTS!
Make big money. New easy plan. Write quick for territory and Outfit Offer!

30-DAYS' TRIAL

Liberal Offer. Try it 30 days at our expense. Write at once for special, introductory, low-price offer and no-risk trial opportunity. No obligation. Send today.

THE AKRON LAMP CO.
1200 High Street, Akron, Ohio

New Toy Sensation WORKS LIKE MAGIC!

"LOP-EAR LOOIE"

AGENTS!
Over 20,000 toys sold—best unworked territories are available in every section. FREE details of demonstrating plan that pays up to \$10.00 a day. Send 25¢ for working sample.

See LOP-EAR LOOIE wiggle his ears—flap his arms—bow politely to the ladies—even dance—APPARENTLY WITHOUT THE AID OF HUMAN HANDS—just like he is alive. Of course there's a trick to operating him, but folks looking on wouldn't guess the secret in a thousand years. No Motors—no springs. Stands seven inches high—gorgeously colored. Looks like a \$1.00 seller, yet retails for only 25¢. Made entirely from wood. Hours of enjoyment for young and old alike. Send 25¢ for full sized working sample—be the life of the crowd.

FISHER-PRICE TOYS, Inc.
Dept. P-10.
East Aurora, New York

Get PAID HOURLY

MAKE BIG MONEY!

Showing my sensational, new, personalized Hat and Cap Sample Line—fits in pocket—displays values men grab for—rich felts—exclusive styles—superior qualities. Priced as low as \$1.95. Nothing to deliver. Just write orders and pocket your profits. Fit and Satisfaction Guaranteed.

COMPLETE OUTFIT SENT FREE!

You don't invest a penny to get this money-making opportunity. I even give hats and caps to sincere salesmen. Send me your head size and name—get the facts. You can start pocketing cash in five minutes with my plans. Rush name.

TAYLOR HAT & CAP MFRS., Dept. 12-K
15-17 W. 6th St. Cincinnati, Ohio



MADE TO MEASURE

Exclusive maker of nationally famous Taylor Rain-proof Caps, the classy head-wear. Smart new patterns—lower prices—no experience needed to make big cash profits hourly—Elliot, Utah, took five orders the first 15 minutes.

ZIP AND IT'S STRIPPED!

NEW—NOVEL—SIMPLY INSERT WIRE AND PULL—INSULATION STRIPPED OFF CLEAN—IN A FLASH!

Here's the latest time and labor saver for anyone interested in electrical work—auto, radio or electrical repair shops, factory or home. The ingenious Majestic Wire Stripper eliminates forever the messy, time-wasting job of stripping wires by knife or pliers. Does the work in one-tenth the time—does it cleaner. Strips any size wire up to 12 MM diameter. Adjustable stop for stripping wire to any length. A strong, substantial tool, accurately made. Has two screw holes for fastening to bench—also easily portable. Blades of hardened steel hold their edge, give long wear. Thoroughly tested and proven. Once used, you will never strip wire any other way. Order yours now!

MAJESTIC HANDLE CO.
2515 S. Wabash Ave., Dept. 10
CHICAGO, U. S. A.



Complete in box with mounting screws. Sent postpaid a year ago, money with order. Money back guarantee. Extra pair grooved blades for wires over 12 MM 45¢ per pair additional.

\$2.00
Each

MAJESTIC WIRE STRIPPER

AMAZING TYPEWRITER BARGAIN

New Remington Portable only 10¢ a day!

10-DAY FREE TRIAL OFFER

Only 10¢ a day buys this latest model machine. Not a used or rebuilt typewriter. Not an incomplete machine. A beautiful brand new regulation Remington Portable. Standard 4-row keyboard; standard width carriage; margin release on keyboard; back spacer; automatic ribbon reverse; every essential feature found in standard typewriters. Carrying case free. Now reduced 25%... absolutely the biggest typewriter value ever offered! Try it in your home or office 10 days free. If you do not agree that it is the finest portable at any price, return it at our expense. Don't delay. We pay cost of shipment direct from the factory to you. You save on the purchase price and you do not risk one penny. Write today!



FREE TYPEWRITER COURSE

Write Remington Rand Inc., Dept. 152-10, Buffalo, N. Y.

BUILD YOUR OWN OIL BURNER



We sell all parts, automatic oil burner, machined ready to assemble. For hot air furnaces—hot water and steam boilers. Guaranteed to heat any size home or small apartments. Complete instructions. Set up in 30 minutes. Big Saving. Money Back Guaranty. Send for Catalog and prices.

RUSS OIL BURNER CO.
Rock Island, Illinois



AGENTS 500% PROFIT
GUARANTEED GOLD LEAF LETTERS
For Store fronts and office windows. Anyone can put them on. Free samples. Liberal offer to general agents.
METALLIC LETTER CO. 438 N. Clark St. Chicago

"Nobody Loves Me"

Your dog will never feel this way if you give him an occasional treatment of **SERGEANT'S CONDITION PILLS**. Sold by dealers everywhere.

Our Free Advice Department will answer questions about your dog's health. Write fully.

Feed your dog **SERGEANT'S DOG FOOD** for strength.



Write for your Free Copy of "SERGEANT'S DOG BOOK" on the care of dogs.

POLK MILLER PRODUCTS CORPORATION
2664 West Broad Street - Richmond, Virginia

Sergeant's

DOG Medicines and Food



The most amazing "ALL-PURPOSE-KITCHEN-TOOL" ever invented. Slices, cuts, grates, cubes, shreds vegetables of all kinds, cheese, sausage, etc. Nothing like it anywhere. Patented on 12 exclusive points. Every housewife, restaurant, hotel, etc., buys on 2-minute demonstration. Sells for \$1.50. Up to 150% profit. Agents, Distributors, Crew Managers, Window Demonstrators, etc., can make fortunes. Send \$1.00 for sample or write quick for free information and territory reservation.

STARRETT MFG. CO., 442 N. Oakley Blvd., CHICAGO

New METLMACH



THE MODERN MACH

Made of metal, never burns up, no burnt ends, ashes or stubs to discard. Absolutely waterproof. One mach guaranteed to light 1000 times or more, lights only on itself thus saving the marring of clothing and furniture.

HAVE YOU SEEN IT?

If not, send \$1.00 for 15 maches and counter display easel together with salesman's terms, convince yourself how readily they sell and make 50% profit. Single sample 15c. Every store a prospective customer. Every person a prospective user. Exclusive territory and steady business guaranteed industrious salesmen.

METALMATCH CORPORATION, 115 Water St., Warsaw, Ill.

NEEDED in EVERY HOME-USED by EVERYBODY EVERYWHERE!



CHEMISTS NEW CATALOGS

Catalog listing 10,000 chemicals, drugs, flavors, etc., and 1,700 Scientific Books, sent for 25c. Catalog with 3,000 illustrations of laboratory apparatus, 50c. Glass Still as illustrated, Cap. 1 Qt., \$9.00.
LABORATORY MATERIALS CO., 639 E. 71st St., CHICAGO, ILL.



ELECTRIC FUN!

Make things spin, buzz, shoot, flash, mystify, with electricity! Book of 200 stunts with 110 volts. Postpaid \$1.

CUTTING & SONS, 104 M St., CAMPBELL, CALIF.

EARN UP TO \$10.00 a day **NEW LOW PRICED "PINLESS" CURTAIN STRETCHER!** **NO INVESTMENT REQUIRED!**
Just what every housewife is looking for—no pins that tear costly curtains—no heavy wooden frames—just two triple cadmium rods and a hanger. Sells at give away prices. Write for FREE money making details.

THE EVANS MANUFACTURING CO. Dept. PM-104, Cincinnati, Ohio

ONE MAN WANTED No selling—no canvassing—no solicitors showing the Wig-L-Bob in action. Pays \$20 to \$35 weekly. Sensation World's Fair—now being introduced everywhere. Send 15c for sample and copy exclusive contract—act quick—one man only **WIG-L-ROL, 1255-A-Fullerton Ave. CHICAGO EACH TOWN**



Toolmakers — Patternmakers — Machinists —
You will be proud to own and to use a **Better, Finer GERSTNER Tool Chest.** Free Catalog shows Many Sizes and Styles.
GERSTNER TOOL CHESTS
434 Columbia St. Dayton, Ohio

RAIN-O-STAT

The marvelous mechanical robot that actually shuts your windows when it rains. Installed by anyone in three minutes. Fits any sliding (double hung) window. Send for sample—50c plus 10c for postage. Huge profits for agents.
Wm. WINBERG, 2724 Ericsson St., Corona, N. Y.—Sole Distributor

WOULD YOU PAY US \$64 TO GET A JOB EARNING \$25 A WEEK?

and work twelve hours a week. Just a case of knowing what's going on in 1934; help yourself without waiting for others. Read full details written by customer who paid us \$64 for 16 pairs PR Ex WK, how he makes \$25 a week selling PR ROYAL squabs at 40-50 cts. each, one lb. weight 25 days old; does regular farm work, too—Another at 25 years, best crop on his 185-acre farm; woman's 12 years' profitable experience; \$75 a month with small flock—Many more 1934 facts, all new, illustrated. Write today, ask for free Squab Library #, send three-cent U.S. stamp. Responsible market men in U.S. cities taking all our customers can ship, at double chicken prices. Get started. Learn what why, how, where, prices. Our 34th year.
PLYMOUTH ROCK SQUAB CO., 634 Howard Street, Melrose, Massachusetts

Red Bakelite
Leak-Proof Cap
4 Fluid ozs.



FOR ROD AND GUN



Esso Handy Oil contains no acid-forming element or other corrosive ingredient... no graphite-bearing kerosene... to gum up. 100% a cleaner, polisher, and lubricant... a true rust-preventive. Fine for rod and gun.

ESSO INC., 26 BROADWAY, NEW YORK CITY

CRYSTAL-CLEAR • 100% LUBRICATING PREVENTS RUST

G. E. MOTORS

made by General Electric Co., originally intended for large manufacturer. Specifications: 1-30 H. P.—4800 R. P. M. Universal A. C. and D. C. 110 volts instant reverse. Size: Diameter 3 inch, length 5 inch. Shipping wt. 3 lbs. Add 25c for packing and mailing. Original price \$12.00. Bargain price, while they last. Send for Catalog of Paint Spray Equipment.

\$2.45
Each



NATIONAL ELECTRIC TOOL CO.
560 W. Washington Dept. 3210 Chicago, Ill.

SAVE PRINTING COSTS



with the COPY-STAMP
Do your own printing of typewritten or hand-written work, postcards, drawings, letters, notices, addresses, endorsements, menus, tags, labels, price lists, etc.
THE STAMP OF A THOUSAND USES
Write your copy once on the stenciled paper. Insert in the automatic-inking COPY-STAMP, and print instantly as many copies as wanted. Saves not only money but the vital element of time. Five sizes: \$5.00 and up.

The Stencil-Stamp Co. Inc., 53 Park Row, New York, N. Y.

Take off any PROFILE

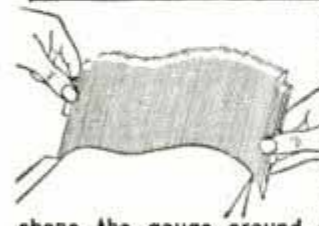

WITH THIS NEW LOW PRICED GAUGE!

Here is a quick and accurate method to obtain a temporary or permanent template of any profile or curve. Simply loosen the tension nuts and shape the gauge around the object. Excellent for duplicating mouldings, furniture legs or any irregular shapes. Tear out this ad and mail with check or money order.

STOCKTON PROFILE GAUGE CORPORATION
174 Jackson St., Lowell, Mass.

THESE PRICES INCLUDE DELIVERY
No. (4 inch) \$1.50
200
No. (5 inch) \$2.00
201
SEND CHECK OR MONEY ORDER NOW

K.O.'D BEFORE HE LEFT HIS CORNER!



STAGE-FRIGHT? No, sir. Dirty work in the dressing room? No, sir. Two or three whiffs of that over-stale pipe and heavyweight tobacco did what fifty-seven opponents couldn't do... floored him!

A good pipe, like a good athlete, should be kept in good condition. A few moments' daily exercise with a pipe cleaner and a steady diet of mild, gentle Sir Walter Raleigh Smoking Tobacco will keep any man's briar right in the very pink. We think we've found a milder combination of fragrant Kentucky Burleys. We think we've discovered a cooler, slower-burning blend. A large and growing army of contented pipe-smokers think so, too. Try one tin of Sir Walter and see what *you* think!

Brown & Williamson Tobacco Corporation
Louisville, Kentucky. Dept. P-410.

Send for this
FREE BOOKLET



It's 15¢
—AND IT'S
MILDER

Sooner or Later Your Favorite Tobacco

Send No Money GUARANTEED UNDERWOOD

Regular Model ~~\$100~~
Only \$39⁹⁰
Cash
or On Easy Terms
10 Day Trial
No Money Down



Famous No. 5 Refinished

Positively the greatest bargain ever offered. A genuine late model Underwood No. 5 for only \$39.90 (cash) or on easy terms. Has up-to-date improvements including standard 4-row keyboard, backspacer, automatic ribbon reverse, shift-lock key, 2-color ribbon, etc. The perfect all purpose typewriter. Completely refinished and FULLY GUARANTEED.

Learn Touch Typewriting
Complete (Home Study) Course of the Famous Van Sant Speed Typewriting System — fully illustrated, easily learned, given during this offer.

Money-Back Guarantee

Send coupon for 10-day Trial—if you decide to keep it pay only \$3.00 a month until \$44.90 (term price) is paid. Limited offer—act at once.

INTERNATIONAL TYPEWRITER EXCHANGE
231 West Monroe St., Chicago, Ill., Dept. 1001

Send Underwood No. 5 (P. O. B., Chicago) at once for 10-days' trial. If I am not perfectly satisfied I can return it express collect. If I keep it I will pay \$3.00 a month until I have paid \$44.90 (term price) in full.

Name..... Age.....
Address.....
Town..... State.....

CASH INCOME DAILY Resilvering Mirrors At Home
Replating Autoparts, Tableware, Etc. Outfit Furnished. Write—**SPRINKLE, PLATER, 129, MARION, IND.**

30 Days Trial!

NOW you can ride a genuine Mead bicycle 30 days without "buying for keeps." Return it at our expense if not satisfied. Write quick for FREE color Catalog, marvelous new prices, special offers. SAVE 1/2 buying direct from MEAD!



\$19⁹⁵
Mead's Sentinel bike only \$19.95—Rangers a few dollars more. America's finest quality bicycles at rock-bottom prices.

RIDER AGENTS WANTED
Ride and exhibit sample of our new Balloon-Tire RANGER. and make money. Opportunity of lifetime. Special Offers on our entire line of quality bicycles—if you hurry! Send no money—write.

TIRES —Save One-Half on lamps, wheels, tires, equipment. Drop us a postal.

Mead CYCLE COMPANY
DEPT K-114 CHICAGO

FREE!
Great new Color Catalog, sent FREE. Hurry!



INCREASE PROFITS *without* INVESTMENT

This money-making equipment will bring you \$150 to \$300 profit monthly. Requires no experience to operate . . . comes on 30 Days' Trial. Shouldn't cost a cent . . . will pay for itself on EASY MONTHLY PAYMENTS as low as \$10. Used by U. S. Govt. Write for details, no obligation, to
HOBART BROTHERS CO. Box M-104 Troy, Ohio

EASY to Play

WITH an easy-playing Conn band instrument, you can be ready for band or orchestra in 4 to 6 weeks. A sure road to popularity if you start on a Conn. Choice of the world's greatest artists. Magnificent tone. Many exclusive features—yet they cost no more.

Write for Free Book
Ask to see the marvelous new models now being displayed by Conn dealers. Home trial. Easy payments. Write us for free book on whichever instrument interests you most. Mention instrument.
C. G. CONN, Ltd.
1031 Conn Bldg., Elkhart, Ind.

CONN

World's Largest Manufacturers of
BAND INSTRUMENTS

DEAFNESS IS MISERY

Many people with defective hearing and Head Noises enjoy conversation, go to Theatre and Church because they use Leonard Invisible Ear Drums which resemble Tiny Megaphones fitting in the Ear entirely out of sight. No wires, batteries or head piece. They are inexpensive. Write for booklet and sworn statement of the inventor who was himself deaf.

DRUM

A. O. LEONARD, Inc., Suite 699, 70 5th Ave., New York

PANTS MATCHED TO ANY SUIT

DON'T DISCARD Your OLD SUIT
Wear the coat and vest another year by getting new trousers to match. Tailored to your measure. With over 100,000 patterns to select from we can match almost any pattern. Send vest or sample of cloth today, and we will submit **FREE** Sample of best match obtainable
MATCH PANTS CO.
20 W. Jackson Blvd., Room 1142, CHICAGO

New Dual Ray Health Lamp Unit combines ULTRA VIOLET and IN-FRA RED RAY in ONE LAMP. Indorsed by Physician of leading University. Fits lamp socket Reflectors and Henters. Health giving, Prevents Rickets, gives Sun-tan. Produces Vitamin "D." Automatic safety control. 110 Volt AC or DC current. Free Details.
BEYER MFG. CO., 4655 Lincoln Ave., Dept. A, Chicago, Ill.

COMPLETE with Goggles only
\$3⁵⁰
postpd.

MAN IN EACH TOWN To Plate auto parts

reflectors, mirrors, etc., by new method; no capital or experience required. Outfits furnished. Free particulars. Write Today!
GUNMETAL CO., Ave. M, Decatur, Ill.

30 DAYS TRIAL

Learn to Re-Seat Your Chairs



Have you a chair, stool or bench that you would like to re-seat? We will teach you how to do it. Use either Cane, Rush, Reed, Splints, Fibre R sh, Cane Webbing or Grass.

Instruction Book Only 10c

Send 10c today for our illustrated Instruction Book

and price list explaining how to do Seat Weaving.

The H. H. PERKINS CO., 254 Shelton Ave., New Haven, Conn.

SPECTACULAR INVENTION CUTS GASOLINE BILLS up to 35%—EMBODIES ENTIRELY NEW PRINCIPLE



Introducing — Leen-A-Mix — Sensational New Thermostatic Air Control Valve. NOW comes a new discovery which has been long awaited by automobile owners—**A Real Gas Saver!** Based on scientific principles, endorsed by motor experts. Leen-A-Mix gives cars more speed—extra power and pep—yet slashes gas costs. Ford driver reports mileage boosted 50%—from 15 to 23 miles per gallon. Amazing results have been obtained on all makes.

MAKE UP TO \$40.00 DAILY!

Every car owner is potential market for Leen-A-Mix. No wonder Kellar, Illinois, made over \$50.00 in one day. You can do as well—maybe better. Write for money making sales plan and liberal free test offer.

METAL SPECIALTIES MFG. COMPANY

Dept. 10-P 3200 Carroll Avenue Chicago, Illinois

FINDS GOLD CONFIDENTIAL

Plans for constructing world-famous ore locator and treasure finder. Traces ore veins, locates treasure, old tunnels, pipe lines, buried metals. Absolutely guaranteed to detect gold, silver, copper and other metals. Anyone can construct this marvelous instrument with our plans, blue prints, specifications, etc. Free consultation your treasure or mining problem our experts. Invest a few dollars and win a fortune. Write for free interesting information.

THE GOLDAK CO.

Dept. P 1031 South Broadway Los Angeles, Calif.

Profit from Books

Popular Mechanics Press specializes in supplying books on any subject. Look over this list. Check the books you want, and mail this advertisement as your order blank. Catalog with lists on 2,000 subjects free.

- | | |
|---|---|
| AUTO RACING
How to Build Dirt Track Racers.....\$1.00 | LANDSCAPE GARDENING
Practical.....\$2.50 |
| AUTO REFINISHING
Latest Methods.....\$1.50 | LEATHER WORK
Artistic.....\$1.50 |
| BRICKLAYING
Plain and Fancy.....\$1.50 | LOCKSMITHING
Revised Edition.....\$2.00 |
| CAMPS AND LOG CABINS (Building).....\$2.00 | MODEL MAKING
Many Kinds.....\$3.00 |
| CARBURETORS (All Makes)
New, Revised Edition..\$2.50 | MUSHROOMS
Raise for Market.....\$1.75 |
| CARPENTRY
All Forms.....\$2.00 | PATTERN MAKING
Excellent New Book...\$1.50 |
| CHEMICAL FORMULARY
5000 New Formulas...\$6.00 | PHOTOCELLS
What They Are and How Used.....\$2.50 |
| DIESEL HANDBOOK
New, Latest Information.....\$5.00 | PLASTERING
Best Instruction Manual.....\$1.25 |
| DRAWING
Freehand and Perspective.....\$1.50 | RADIO PHYSICS COURSE
Most Complete.....\$3.75 |
| DRY CLEANING (Practical) and Dyer.....\$3.00 | REFRIGERATION SERVICE
Manual (All Makes)...\$5.00 |
| ELECTRICAL DICTIONARY
Practical.....50c | RUBBER ARTICLES
How to Make.....\$2.00 |
| ENGINEERS' VESTPOCKET
Reference Book.....\$1.50 | SHEET METAL
Construction Work....\$2.00 |
| FURNITURE REPAIRING
Finishing and Decoration.....\$3.00 | Steam Engineer's License
How to Obtain.....\$2.00 |
| HANDY MAN'S HANDBOOK
Repair Work.....\$3.00 | WELDING ENCYCLOPEDIA
All Methods.....\$5.00 |
| HYPNOTISM
Science of.....\$2.00 | WOOD, COLORING
Finishing and Painting..\$3.50 |
| INVENTIONS
How to Make Pay.....\$2.50 | WROUGHT IRON WORK
Practical.....\$1.35 |

-----SEND NO MONEY-----

Just check the books you want, and mail the whole advertisement. It is your order blank. When postman hands you books, pay him the price and few cents postage. If outside the U. S. remit when ordering and include 10 cents per book extra for postage.

POPULAR MECHANICS PRESS, Room P-10, 200 East Ontario St., Chicago, Ill.

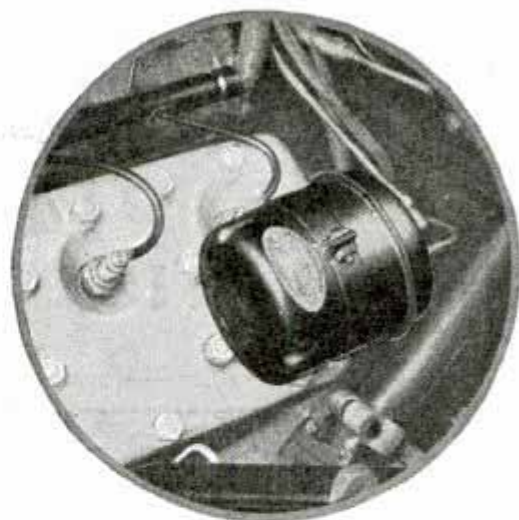

"YES! FORDS AND CHEVROLETS CAN HAVE PUROLATOR PROTECTION"

This is in answer to the many inquiries that come to us from Ford and Chevrolet owners.

Fords and Chevrolets are not equipped with an oil filter at the factory . . . but your own service garage is now prepared to furnish and install a Purolator Oil Filter . . . especially designed and engineered for these two jobs.

AND YOU COULDN'T MAKE A BETTER INVESTMENT

If you are using a good grade of oil a genuine Purolator Filter will keep it so clean and effective you can safely lengthen the time between crank case drainings.

Your Purolator will catch and hold the dirt and grit and fine metal particles and hard carbon that settles in crank case oil . . . will keep these grinding, abrasive substances out of the oil stream and away from your engine . . . will lengthen its life and its smoothness of operation.

It is these destructive settlements that wear out bearings, score cylinder walls . . . cause costly repairs and replacements . . . send many a car to the junk heap, long before its time.

The cost of a complete Purolator Filter, especially designed for Ford and Chevrolet passenger cars or trucks and including all the necessary fittings, is only \$5.00, plus a small charge for installation.

It will pay for itself many times over . . . both in actual dollar savings and in satisfaction.

If your own favorite service garage hasn't yet been supplied with this material, just clip and mail this coupon.

We will tell you how you can be promptly served, and will also send you an "Auto Almanac" . . . an unusual booklet . . . interesting and instructive.

PUROLATOR

The Oil Filter on Your Motorcar
Licensed Under Sweetland Patents

MOTOR IMPROVEMENTS, INC.,
Newark, New Jersey.

I am interested in a Purolator for
(check here)FordChevrolet
Send me without any obligation, further detail,
together with a copy of "AUTO ALMANAC."

Name.....

Address.....

City..... State.....

Note: Trucks and passenger cars take same model.

WANTED!

YOUR OLD TYPEWRITER!

Fill out this coupon—detach—mail today!

Royal Typewriter Company, Inc.
Department PM-10.
2 Park Avenue, New York City

I (We) own a (insert Make) _____ Typewriter,
Serial Number _____ Please send me the details
of your special allowance on typewriters traded in this
month.

Name _____

Street _____

City _____ State _____

ACT QUICKLY! Have you a standard or a portable in your home—one that even long ago may have ended its days of usefulness? Or perhaps a newer typewriter that hasn't proved entirely satisfactory? If so, mail in the above coupon at once. This special offer good for limited time only.

ROYAL PORTABLE

Finest of home-sized typewriters

You don't have to learn to use a Royal. At its keys you type easily, naturally—faster than you write by hand. Standard 4-bank keyboard. Many exclusive features. Handsome. Sturdy. 3 models . . . 3 prices. Convenient monthly payments.



Only **\$33⁵⁰** to \$60

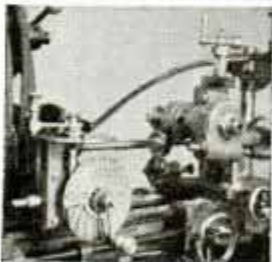

HERE IT IS!

The UNIVERSAL MILLING ATTACHMENT for your lathe. Has spiral head. Cuts—spur, bevel and spiral gears. Differential and compound indexing. We show you how

to make this "LATHE UNIVERSAL MILLER" on your own lathe by using our PLANS and CASTINGS. All kinds of milling and dividing can be done with this machine. There is nothing like it on the market. Write for information and price. You will be surprised at the simplicity of construction and low cost of castings.

CULVER ENGINEERING CO.

1420-30 N. Spring St.

Los Angeles, Calif.

There's A GOLD MINE FOR YOU IN EVERY HOME

The opportunity of a lifetime is now yours! This responsible company, licensed by the U. S. Government has barrels of money to

PAY CASH FOR OLD GOLD

In practically every home you'll find old watches, chains, rings, brooches, trinkets, etc. They are worth big money to-day. We want you to buy them for us and YOU GET HUGE PROFITS in return. Remember, you have NOTHING TO SELL and you are welcomed everywhere. Simply send your name for FREE complete information.

ROMLEY & CO.
915 BROADWAY
Dept. J. New York

**ABSOLUTELY
NOTHING TO SELL!**



MAKE MONEY CASTING LEAD TOYS

Get this complete outfit. Full equipment for casting. Moulds for three different figures. Paints for coloring. Make all the toys you want. Earn handsome profits selling them. Ask dealer for JUNIOR CASTER, or send \$2.50 money order and outfit will be shipped (postpaid in U. S.). State choice of U. S. Soldiers, Wild West Cowboys, U. S. Machine Gunners. Large Illustrated Casting Book sent FREE on request.

**Rapaport Bros., 703 W. Ohio St., Chicago
FREE — 24 PAGE BOOK**



ICE-BOATS

Portable, Fast, Sturdy, Low-priced. Winter's Greatest Thrills are yours with a MEAD ICE-YACHT. **SAVE MONEY** by building yours with our Complete Kit—easily, quickly, and with sure success. Start NOW and have your ship ready for the season's first ice. Pay as you build. Rush time for illustrated circular, prices and complete list of materials, fittings, spruce, etc.

MEAD GLIDERS

Dept. 10B, 12 S. Market St., Chicago



WILL YOU WEAR THIS SUIT and Make up to \$12 in a Day!

Let me send you this fine all-wool tailored suit **FREE OF COST**. Just follow my easy plan and show the suit to your friends. Make up to \$12 in a day easily. **No experience—no canvassing necessary.**

Write today for **FREE** details, **ACTUAL SAMPLES** and "sure-fire" money getting plans. Send no money.
H. J. Collins, Progress Tailoring Co., Dept. K-216
500 S. Throop St., Chicago, Ill.

Glazed Pottery Made Without Molds

Make beautiful, colored, glazed concrete pottery. Washable, everlasting. No experience needed. Complete pottery plants using no molds, power or costly tools, making 2,500 different designs bird baths, vases, jars, etc., cost less than one mold by old methods. Use only sand and cement. Money making business. Book, color plate, etc., 10c.

NATIONAL POTTERIES COMPANY

1115 Hawthorne, Room 1, Minneapolis, Minn.



EARN BIG MONEY AT HOME!

Experience unnecessary. Grow year 'round, in basement, cellar, garage, idle places. **FREE BOOK.**

MUSHROOM GROWERS ASSOCIATION, K-433 N. Clark St., Chicago

SHIP MODELS

Get this dandy catalog of true-scale models of Flying Cloud, Viking, Blue Nose, Golden Hind, deluxe fittings. Send 15c (in coin) for your copy.
ROY HANCOCK, 323 Douglas Ave., Portsmouth, Virginia

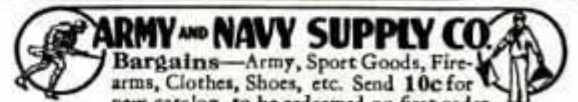

ARMY AND NAVY SUPPLY CO.
Bargains—Army, Sport Goods, Firearms, Clothes, Shoes, etc. Send 10c for new catalog, to be redeemed on first order
Army & Navy Supply Co. 4772 Lester St. Richmond, Va.

Boys - here's fun with Chemistry!



Only **10¢**

Get CHEMCRAFT Junior and surprise your friends with chemical stunts; make ink, dye cloth, pour colored liquid from a glass of plain water, and many more thrilling experiments that will show you facts about Chemistry. It's lots of fun. Send 10c now for CHEMCRAFT Junior; it will introduce you to the things you can learn with a large CHEMCRAFT outfit.

The PORTER CHEMICAL CO.
3410 Prospect Ave., Hagerstown, Maryland

HAND-EE GRINDER



QUICKER BETTER JOBS

Weights one pound. Plug in any light socket and do 1001 jobs. Do away with slow hand work. Remove burrs, take out nicks, sharpen tools, etc. Grind where files won't reach. For shop, home or tool kit. (Model A.) A. C. or D. C. operation, 110v., 13,000 r. p. m. Order on 3 day trial... satisfaction guaranteed.

Ask for **FREE Booklet**

100 SHAPES AVAILABLE

CHICAGO WHEEL & MFG. CO.
108 S. Aberdeen St., Chicago, Ill.

(Model A)
\$11.50
Postpaid U. S. A.
With 3 wheel shapes Free Order today

LARGER SIZE,
Hi-Power (Model B) weighs 3 lbs. 17,000 r.p.m. \$35, F.O.B. Chicago

NYOIL

A MOST HIGHLY REFINED OIL

For fishing tackle, firearms, and household appliances, prevents rust. A perfect furniture polish, never gums, is odorless, stainless. A handy can, 35c, postpaid if dealer cannot supply.

Wm. F. Nye Inc. Dept. M, New Bedford, Mass.

HIGH POWERED TELESCOPE

GENUINE BROWNSCOPIES AT AMAZING PRICES

Most powerful in America for the money! 15 power long range telescope. Can see moon's craters or time on pocket watch a block away. 5 sections. Approx. 3 ft. long. Fine lenses. Brass bound. Can be used as powerful microscope. Vol. magn. 512X. Only \$1.69 postpaid. C. O. D. 24c extra.

\$1.69

Special Super-Power 30X Telescope. Similar to above but more powerful. Guaranteed to see 900 times larger in surface and 30 times closer. 31 mm. objective 4 powerful lenses. Large field. Includes powerful microscope features. Only \$1.98 postpaid.

BROWNSCOPE CO. Dept. 11-M 234 Fifth Ave., New York

STUCCO SPRAYING MACHINE

FUSES A PLASTIC MIXTURE ON TO ANY MASONRY SURFACE. It waterproofs and fills all cracks. It can be applied in any thickness desired and 30 colors. For over six years in use under all conditions and in practically every climate.

OFFERS BIG EARNINGS Operators report costs of 8c to 10c per sq. yd. Sell for 20c to 35c. The profit offered in your territory by increasing demand for color and big government renovating campaign. Machine furnished on free trial and easy payments. Territory protected. Write today for complete details.

Colorcrete Industries, Inc.
570 Ottawa Ave. Holland, Mich.

Now EVERY HOME Can Have This marvelous AIR CONDITIONER

AT LOW COST!

Better Health
Freedom from Colds
WARNING!
Avoid Hot Dry Air
and You PREVENT
Sickness



Fits Any Radiator
ORDER Yours Today! ● **2 WEEKS TRIAL**
WE PAY POSTAGE ● **MONEY-BACK Guarantee**

The CAPLAIR automatically supplies needed moisture by continuous evaporation. The hotter the air the more moisture you need. Bacteria lurk in hot air. That's the reason colds and sickness are common in winter. SAVES money on your coal bills.

Distributors Wanted—Wonderful Opportunity

MAIL THIS COUPON TODAY

LANDON & WARNER, Dept. C 39
360 N. Michigan Ave., Chicago, Ill.

Check Radiator Thickness
6 7 8 9 10 11 inches

Gentlemen:
Send me one CAPLAIR Air Conditioner. I will try it for 2 weeks under terms of my Money-Back if not satisfied.
 \$4.65 enclosed. Send C. O. D. \$4.65.

Name.....
Street.....
City..... State.....
P. S.—You save money by ordering 2 CAPLAIRS for \$9.00.

9 HOURS TO BUILD NEW SPORTSMAN'S BOAT!

For FISHING CAMPING HUNTING SAILING

MEAD Sportsman's Ki-Yak is the most sensational boat development in years. Exclusive new structural features sets new standard for lightness, strength, durability, beauty and ease of assembly. Easily portable. Low introductory price! Don't deny yourself the pleasure of knowing all about it. Rush 10c for Catalog, \$6 Paddle now given with your Sportsman's Ki-Yak Kit—if you hurry!

MEAD GLIDERS 12 So. Market Dept. B-10 **CHICAGO**

BE A WAGON MAN

We Furnish Capital

A great responsible, successful, 45 year old company now makes this surprising offer to honest men. **Invest no capital in merchandise!** Let us start you in a permanent business that YOU own and control for yourself. Become an **Authorized McConnon Dealer** and handle the complete McConnon Line—no red tape. **We finance you with complete stock.** You extend credit to your friends and customers when and if you please. Only a certain number of these "stock furnished" propositions are open. Each one offers a good living with a chance to put some money in the bank every week. Honest, steady men who write promptly are assured of first consideration. Write TODAY and ask for special offer. Address **McCONNON & COMPANY**, "The House of Friendly Service", Desk 66 KD, Winona, Minnesota.



BUY NOW and SAVE!

**Watches and Diamonds
At All-Time Low Prices**

ACT QUICKLY!

**When Present Supply Is
Gone Prices Must Go Up
BUY NOW—PAY LATER**

We plan for the future, so sometime ago we contracted for enormous quantities of Watches and Diamonds at lowest depression prices. Heavy taxation, difference in foreign exchange costs, big advances in labor costs, and higher commodity prices have already forced prices up—and they must go higher. BUT WE BOUGHT BEFORE PRICES ADVANCED, and we pass this saving on to you—but you must act promptly before these watches and diamonds are gone.

**We Sell Nationally Advertised
Watches, Diamonds
and Silverware Direct-To-
You on Easy Payments**

Think of it—even with these low prices you can still use our easy payment plan to buy a watch or diamond. There is no reason now why you cannot own jewelry which you know is the best, and which you can be proud to own through the years to come.

**\$3.50 a Month
Makes It
Easy For
You To Own a Valuable
Watch or Diamond**

We trust the people who buy here and as a result you can enjoy the pride of owning a really fine watch, diamond, or silverware while you pay by our special easy "Santa Fe Way." We have removed every obstacle. Send now for our FREE catalog while our stocks last at these prices.

**Write for FREE Catalog and FREE
beautiful circular Illustrating Fine
Watches, Diamonds, and Silverware.**

SANTA FE WATCH COMPANY

Dept. A-6, Thomas Bldg., Topeka, Kansas.

**SANTA FE WATCH CO.,
Dept. A-6, Thomas Bldg., Topeka, Kansas.**

- Please send me the catalog I have checked.
- Railroad and Dress Pocket Watches.....
 - Ladies' and Men's Wrist Watches.....
 - Ladies' and Men's Diamond Rings.....

NAME

ADDRESS

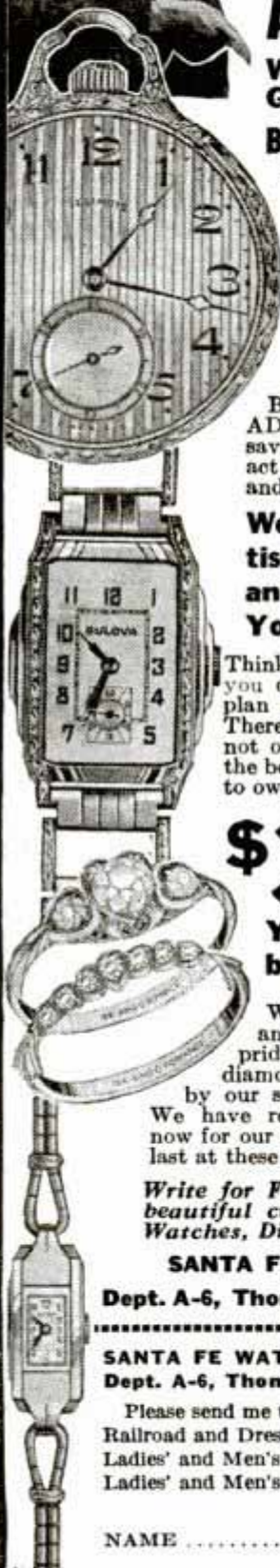

When writing please mention Popular Mechanics

Increase Your Earning Power

Apply time and labor-saving kinks to your work. Your efficiency will soon be recognized and you will be in line for advancement.

If you do machine shop work of any kind, sheet-metal work, painting, carpentry, auto repairing, farming, concrete work, plumbing, electrical work, welding, building-glass work, general repairing, tool-making, poultry raising, masonry or home repair work, get this

LIBRARY OF 3600 TIME AND LABOR SAVING 'DEAS FOR SHOPMEN AND HANDYMEN

RECENTLY PUBLISHED

SHOP NOTES for 1934

480 Articles
580 Illustrations
224 Pages
Price 50c
See partial list
of
contents below

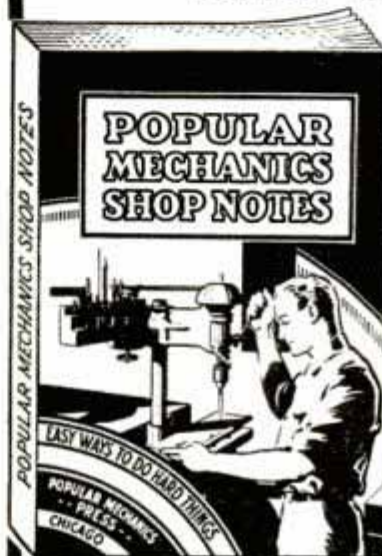

Including the new 1934 issue illustrated above, there are eight volumes in the Shop Notes Library of 3600 easily understood short cuts to every-day jobs. Here are just a few of the subjects taken from the latest issue.

- Auto Generators Converted into Motors
- Air Compressor, Small
- Bandaw Blades, Tricks of Coiling
- Bandaw, Homemade, for Workshop
- Car Transmission as Clutch on Power Unit
- Coffee Table, Dutch-Foot
- Drillpress, What You Can Do With
- Electroplating with Lead, Zinc and Cadmium
- Farm, Practical Suggestions for
- Flower Stands, Bent Iron
- Furnace Draft Control, Electric
- Garden Tractor, Simple
- Handles, Personal, for Better Hammering
- Hedge Trimmer, Electric
- Jigsaw, Profits from
- Knives and Other Straight Edge Tools, Tricks of Sharpening
- Lathe Tools, Sharpening
- Metal Turning on Wood-working Lathe
- Nails, Mechanics of Using
- Painting Your Home, Tricks of
- Punch, Accurate Hole Rafter Framing Table
- Routing, Jigs and Fixtures for
- Spray-Painting Booth with Forced Draft
- Screws, Tricks of Driving
- Sandblasting Light Work, Simple Gun for
- Sanding Machines, Motor Driven, for Small Shop
- Sawhorses for all Purposes
- Serving Cabinet, Martha Washington
- Steel Ball Uses in Machine Shop
- Surface Grinder for Finishing Metal
- Smoking Stand, English
- Steadyrest, Ball-Bearing
- Scrollsaw, Heavy Duty
- Saw-Filing Table, Modernized
- Screw-Top Table, Chairside, for Living Room
- Vise, Quick Acting
- Veneering, Hand
- Welder, Electric Arc, for Small Shop

Each volume contains approximately 450 articles and 500 illustrations and has 192 or more pages. This unrivaled library of shop helps may be secured for a limited time only. After the present supply of books is exhausted the offer must be withdrawn.

*** Send No Money ***

**POPULAR MECHANICS PRESS,
200 E. Ontario St., Room 1034, Chicago, Ill.**

Send me, as per your offer, the following books. I will pay postman price and small amount of postage. My money will be refunded if I am not satisfied. (Check what you want.)

- 1934 Shop Notes and Lathe Handbook, both for 98c.
- Shop Notes Library (8 vols.) \$3.50.

Name.....

Street and No.....

City..... State.....

* C. O. D. applies to U. S. and possessions only. If you reside elsewhere, remittance must accompany order.

7 Tools in One

Mortising, Routing, Drilling, Carving, Sanding, Shaping and Surface Grinding

This remarkable new "Delta" Bench Type Drill Press is really seven tools in one! These are the major operations you can perform efficiently on this amazing 7-in-one motor-driven tool which is built to stand up under heavy production work—yet is priced so low as to be within the reach of every home workshop owner. A brand new "Delta" model, a quality tool throughout—with numerous interesting features. For full details mail the convenient coupon TODAY!



SHAPING



SANDING



BORING - DRILLING



MORTISING

A Complete Line of Motor-Driven Woodworking Tools!

"Delta" Woodworking Units are convenient, portable and compact. All are available in a large variety of combinations and at prices to fit all needs. The "Delta" line includes: Jointers, Band Saws, Scroll Saws, Circular Saws, Woodturning Lathes, Drill Presses, Boring, Routing, Sanding, and Mortising Attachments—and a full line of accessories.

MAIL COUPON TODAY

So your name will be placed on the mailing list to receive the 1935 Delta catalog without delay. Enclose only 10 cents at same time for Book of Practical Delta Projects, 32 pages of new and novel things to make, with over 100 blue prints, working drawings, photographs and illustrations—and complete directions.

DELTA MANUFACTURING CO., Dept. A1034
3775 W. Holton St., Milwaukee, Wis.



Special Features Include:

- Free-Floating Spindle
- Self-Sealed Ball-Bearings
- Husky Tilting Table
- Sturdy Steel Column
- Heavy Graduated Quill
- Adjustable Depth Pointer
- Micrometer Depth Stop
- Interchangeable Spindles

You'll be astonished at the remarkably low price of this fine quality tool— one-third of the price at which machines of this calibre were offered.



NEW BOOK FOR WOODWORKERS



32 page book "Practical Delta Projects"—crowded with new and "out of the ordinary" things to make—with over 100 working drawings, photographs, and easy-to-understand illustrations. Simple, complete instructions make every project easy to follow. Every woodworker should have this book. Send only 10 cents with coupon. Book and 1935 Delta catalog, will be mailed postpaid.

DELTA MANUFACTURING CO., Dept. A1034
3775 N. Holton St., Milwaukee, Wisconsin

I enclose 10c (stamps or coin), for which please send me one copy of "Practical Delta Projects." Also place me on your mailing list to receive 1935 Delta catalog of quality motor-driven woodworking tools.

Name..... Age?.....
 Address.....
 City..... State.....

When writing to advertisers please mention Popular Mechanics

RADIO

● holds great rewards for trained men



Almost in a decade radio has become a giant industry. The opportunities created will be enjoyed by trained men. The International Correspondence Schools Radio Course, prepared by leading authorities and constantly revised, will help make you a trained man! A fascinating book—FREE.

ELECTRICAL ENGINEERING

—A Great Industry with a Great Future

The new course in Electrical Engineering covers this fascinating field thoroughly. If you are just starting or are partly on the way to a real paying position in this industry, this new course brings the broader knowledge necessary for advancement. The coupon brings complete information.



MECHANICAL ENGINEERING

—A Field with a Future



This course has meant advancement to hundreds of ambitious men, mechanics, draftsmen, blacksmiths, foundrymen, patternmakers, apprentices, and mechanical engineers—men who wanted to get ahead and to earn more money. You will find, as they have found, that enrolling for an I. C. S. Course is an investment in a Bigger Future. Use the coupon!

AUTOMOBILE EXPERTS

are always in demand

The rapid progress in manufacture and service of the modern automobile brings new opportunities to thousands of ambitious and forward-looking men. There's always a demand for trained men. The new I. C. S. Automobile Course will make you a trained man! The time to act is now. Use the coupon.



INTERNATIONAL CORRESPONDENCE SCHOOLS

BOX 5531-H, SCRANTON, PENNA.

Without obligation, send me full information on subject checked below:

- RADIO AUTOMOBILE COURSE
 ELECTRICAL ENGINEERING
 MECHANICAL ENGINEERING

- | | | |
|--|--|--|
| <input type="checkbox"/> Architecture | <input type="checkbox"/> Drafting | <input type="checkbox"/> Accounting |
| <input type="checkbox"/> Concrete Construction | <input type="checkbox"/> Good English | <input type="checkbox"/> Salesmanship |
| <input type="checkbox"/> Reading Shop Blueprints | <input type="checkbox"/> Advertising | <input type="checkbox"/> Show Card Lettering |
| <input type="checkbox"/> Civil Engineering | <input type="checkbox"/> Diesel Engines | <input type="checkbox"/> Civil Service |
| <input type="checkbox"/> Gas Engine Operating | <input type="checkbox"/> Refrigeration | <input type="checkbox"/> High School Subjects |
| <input type="checkbox"/> Chemistry | <input type="checkbox"/> Highway Engineering | <input type="checkbox"/> Air Conditioning |
| <input type="checkbox"/> Poultry Farming | <input type="checkbox"/> Poultry Farming | <input type="checkbox"/> Inventing and Patenting |
| | | <input type="checkbox"/> Aviation Engines |

Name _____
 Address _____

ELECTRIC WELDING OUTFITS

Empire Electric Now Offers a New "Electrark" Light Socket Operated Electric Welder Capable of Doing Practical Electric Welding, Operating from Any 110 Volt 60 Cycle A.C. Light Socket!

The new transformer type ELECTRARK welding outfit uses a special transformer of high efficiency, built to our specifications by WESTINGHOUSE. The transformer is cooled by an air blast from a motor driven fan, allowing high overloads without damage. A brief welding current of 125 Amperes is available, with a continuous rating of 75 Amperes. Demand from line averages 10 to 15 amperes or less.

The ELECTRARK welding outfit is COMPLETE, everything needed is included, such as: Welders goggles, assortment of carbon and metallic electrodes, special fluxes for welding and brazing, mild-steel and other filler rod material, bronze brazing rod, special quick-way solder, etc. A complete ILLUSTRATED INSTRUCTION BOOK enables anyone to operate the outfit simply, quickly, easily. You can't lose on buying Electrark for—ELECTRARK IS GUARANTEED SATISFACTORY OR YOUR MONEY REFUNDED!

A written guarantee is supplied with each Electrark Welding Outfit.

The Electrark Welding Outfit is Priced At—
ONLY \$35.00 EACH

(As a special concession to those ordering direct from this advertisement we will pre-pay shipping charges until Sept. 20. No C.O.D. orders.)

Order direct from the manufacturer or send stamp for circulars.

EMPIRE ELECTRICAL PRODUCTS CO.,
 Box 265, Spokane, Washington

MARVELOUS NEW LAMP

Cuts Electric Bills
 BRINGS BIG PROFITS

Science has produced this "MUSHROOM" lighting bulb that gives the illumination of a 150 watt lamp, yet uses only 100 watts of current. Every store, office, factory buys six to several dozen at a time. Cuts lighting bills by one-third. Guaranteed for 1000 burning hours. Regular price \$1.25. You sell for 85c. Cost you only 45c. Send 25c for Sample and Details.

THE MASTERLITE CO.
 Dept. GK 14 110 E. 23rd St., N. Y.



METAL WORKING LATHE..



Precision equipment for the small shop. New designs and manufacturing processes make this amazing bargain possible. Complete metal-working lathes with compound slide-rest, 3-jaw chucking device; 6" swing; 24" length, 20 lbs. Send \$1.00. Balance plus postage C. O. D. Lathes for wood-turning alone \$4.50. Catalog free, complete line low-priced power tools. Attachments for milling, grinding, sanding, saw-table, etc., available at low prices. Order from ad at once and have a complete machine shop.

AMERICAN MACHINE & TOOL CO., Dept. P, 200 Broadway, New York

NOW anyone with TELL TALE TESTERS can test motor, locate troubles instantly, can't fail, tests each cylinder separately. For all autos, tractors, boats, engines. Save time, trouble, money. Set for 4 cyl. motor \$1.00; 6, \$1.50; 8, \$2.00; 12, \$3.00. Order yours today. Agents wanted, TELL TALE TESTER CO., 5158-A, Buchanan St., Los Angeles, Calif.

Make up to \$150 Weekly
 GIVING AWAY
 FREE RCA LICENSED RADIOS



AND 10 STAR "SPECIALS"

R.C.A. Licensed Home Model and Automobile Radios and our 10 STAR items including Chest of Silver, Man's Wrist Watch, Electric China Coffee Set, Fishing Tackle Outfit, Cocktail Shaker Set, Bridge Table and Chairs, 2 Clocks, Lady's Wrist Watch and Traveling Bag all given away absolutely FREE with our new sensational unique PUNCH SALES CARD PLAN. This is the opportunity of the year—make up to \$150 cash each week for yourself. Every home, carowner, store, office, factory, lodge, club or individual wants these marvelous new FREE R.C.A. LICENSED RADIOS or any of the valuable 10 STAR items.

WRITE TODAY FOR OUR 3 NEW STARTING OFFERS
 Start at once making money with our unique sales plan. Write for full information how you can secure any or all of these plans.
 DELUXE MFG. CO., Dept. 104, 173 W. Madison Street, Chicago, Ill.

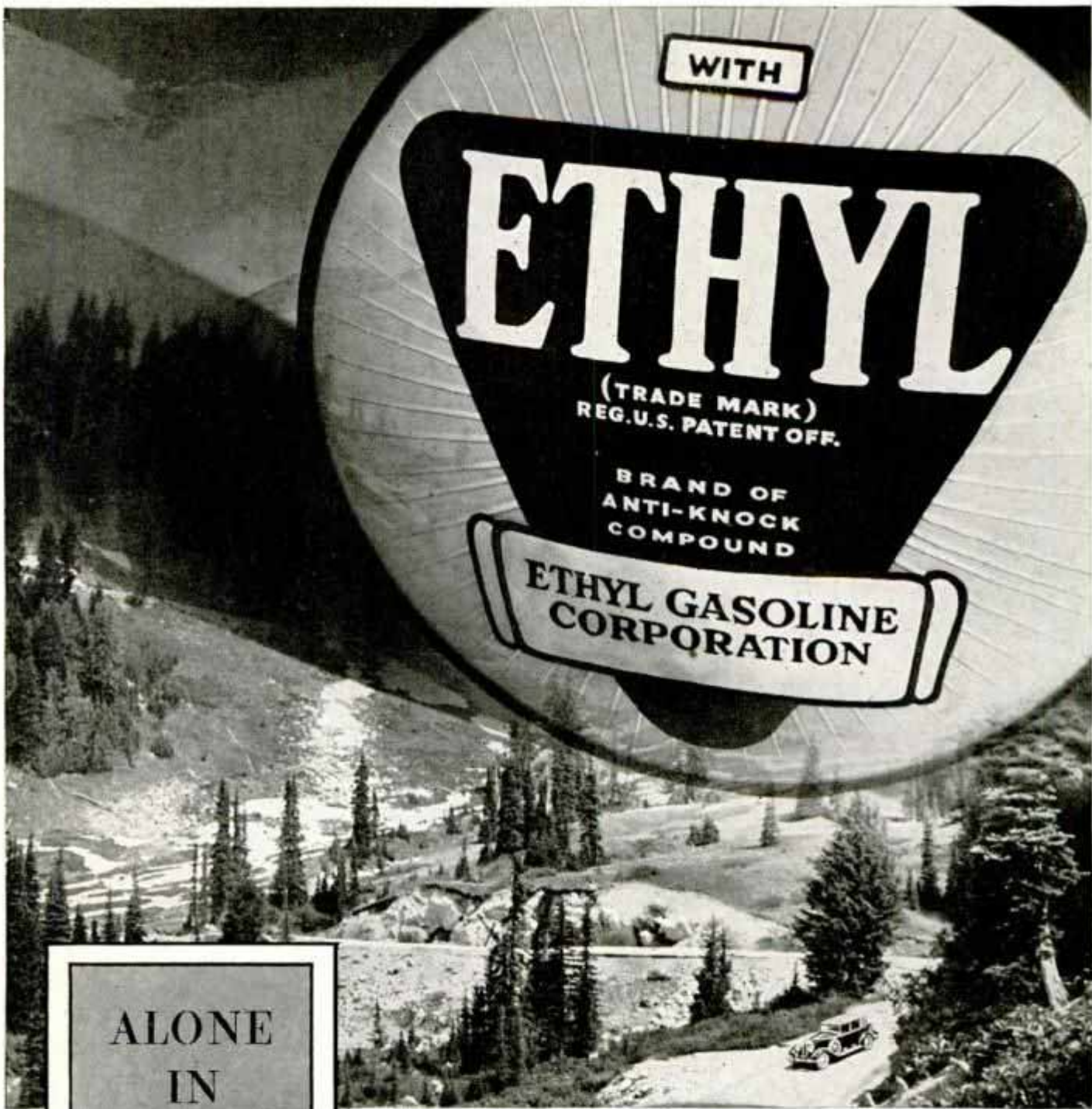

ALONE
IN
QUALITY

The Ethyl pump stands side by side with other pumps, but it stands alone in quality. The only way to get Ethyl performance out of your car is to put Ethyl Gasoline into the tank . . . **NEXT TIME GET ETHYL!**



ETHYL CONTAINS SUFFICIENT LEAD (TETRAETHYL) TO MAKE IT THE WORLD'S QUALITY MOTOR FUEL

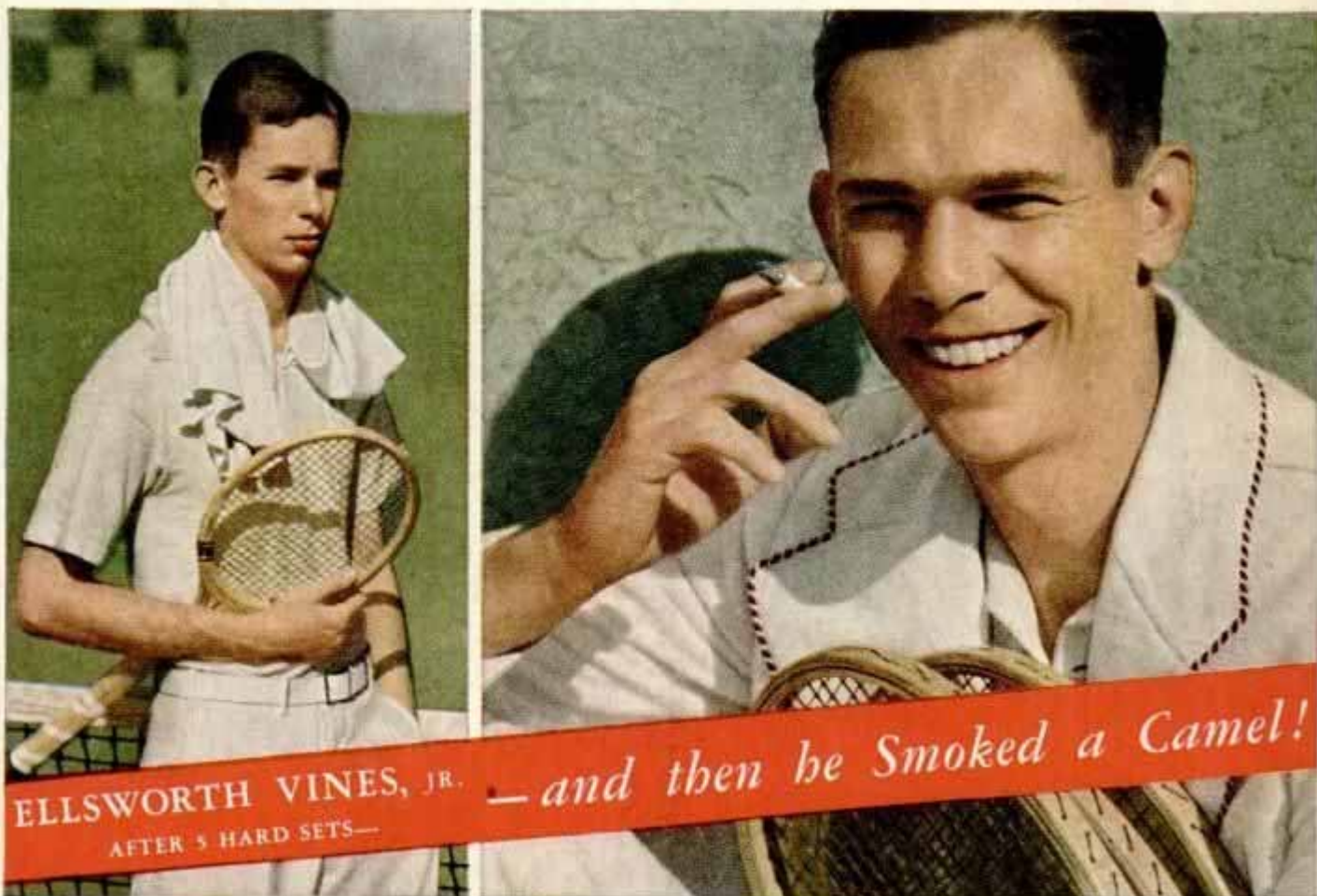

ELLSWORTH VINES, JR.
AFTER 5 HARD SETS—

— and then he Smoked a Camel!

ELLSWORTH VINES, JR., the spectacular young Pasadena athletic star who holds the U. S. National Championships for 1931 and 1932, and has now swept through the 1934 professional ranks as well!

YOU'LL enjoy this pleasing "Energizing Effect"

When you've used up your energy—smoke a Camel and notice how you feel your flow of natural energy snap back.

This experience, long known to Camel smokers, has now been confirmed by a famous New York research laboratory. Camel smokers enjoy a positive "energizing effect"...a healthful and delightful release of natural, vibrant en-

ergy. Millions have found this to be true. A typical Camel experience is this, Ellsworth Vines, Jr. speaking—

"Championship tennis is one of the fastest of modern sports. After four or five sets, you sometimes feel that you just can't take another step. That's when a Camel tastes like a million dollars. Camels have a refreshing

way of bringing my energy up to a higher level. And I can smoke all the Camels I want, for they don't interfere with my nerves."

So, whenever you want a "lift," just smoke a Camel. You can smoke them steadily. For the *finer, MORE EXPENSIVE TOBACCOS in Camels never get on your nerves.*

**CAMEL'S
Costlier Tobaccos
never get on
your Nerves**



● Camels are made from finer, **MORE EXPENSIVE TOBACCOS** than any other popular brand.

**"Get a LIFT
with a Camel!"**

Copyright, 1934, R. J. Reynolds Tobacco Company