

SEPTEMBER

25 CENTS
30¢ IN CANADA

POPULAR MECHANICS

MAGAZINE

WRITTEN SO YOU CAN UNDERSTAND IT

REGD. TRADE MARK GREAT BRITAIN No. 4042E

REG. U.S. PAT. OFF.

SEE PAGE 359



Courtney Ryley Cooper
Boyden Sparkes Attilio Gatti

Copyrighted material

Champion's*

PATENTED EXTRA RANGE



ENABLES YOU TO SCALE NEW PERFORMANCE HEIGHTS

① Note scientifically proportioned nose. Heat in this area is automatically controlled by this exclusive shape, which always keeps the nose cool enough to prevent overheating and pre-ignition.

② Note scientifically proportioned neck. Heat in this area is likewise automatically controlled by this exclusive shape, which always keeps the neck hot enough to prevent carbon and oily deposits that bring about fouling.

THE new Champion Patented Extra Range Spark Plugs top with ease all of the obstacles common to ordinary spark plugs.

The kind of service and quality of performance the new patented Champions induce, need only be experienced to be recognized as revolutionary.

Extra power, extra speed, extra acceleration are all achieved, together with easier starting and

the dependability which is universally and inseparably linked with the name Champion.

In extremes of service these new Champions prove their mettle. Put them to the test with sustained high speeds, long idling, or climbing some familiar hill or garage ramp in high. Install a full set in your car now and feel the difference . . . Champion Spark Plug Company, Toledo, Ohio · Windsor, Ontario · London · Paris.

* Champion Won Ninth Consecutive Victory at Indianapolis 500-Mile Race, Equipping All Winners



Three Chicago food experts invent a delightful new food that is revolutionizing the doughnut business

Here's an Amazing New Business That Pays \$1,000 a Month Up to....

Here is a surprising new opportunity. Now you can immediately become the owner of a big business that is paying others from \$75 up to \$250 a week. There is no "Red Tape"—no delay. Wherever you live there are quick, easy profits waiting for you to grab them. Just mail the coupon for full details.

Individual Plans to Fit Every Need

FULL TIME

You can start a Brown Bobby shop with floor space as little as 6 by 6 feet. Sell retail and wholesale.

Thos. Minch, Fla., made \$3,000 his first 3 months.

PART TIME

Invest a few dollars in this new business and get someone else to run it for you. A few hours of your time each week can easily bring you \$50 up to \$150 a week extra cash.

SPARE TIME

Start at home. Make money like Mrs. Nelson, Ill., who sold 50 dozen Brown Bobbys at retail in one week, then went out to triple her profits through wholesale business.

MEN, this is absolutely new! A real red-hot money-making opportunity! Something every red-blooded man has always longed for. It's a chance to jump into business for yourself and make more money every week than the average man makes in a month!

Surprising, yes, almost incredible as it may sound, we actually start you in a **proven business!** The first day's profits often run from \$18 to \$55—and a business of \$350 to \$600 the first month is not exceptional for ambitious men or women.

A Sensational Big-Money Plan

There is just one thing you need to make a "go" of this business, and that is the ambition to make real money. We give you all the plans, advice and help needed to make a big success right from the jump. We supply you with the equipment to make an amazing new food—a **greaseless** doughnut baked by electricity! You sell to homes, bakeries, delicatessens, groceries, restaurants, etc., at a profit of 150% to 600%! No wonder the dollars simply pour in!

A New Food Secret

The **greaseless** doughnut is altogether novel and unique. It's a crispy, flaky, delicious new kind of doughnut cooked without one drop of oil or grease. Easily digested by everyone. More appetizing than old-style doughnuts ever were. Yet costs you less to make. This new business is copyrighted under the trade name "BROWN BOBBY," so there is no competition.

Everyone likes doughnuts. Millions of old-style doughnuts are sold every day. Now you can bake and sell the perfect doughnut—the toothsome **BROWN BOBBY greaseless** doughnut that sells four times as fast as any other.

Start At Once—Anywhere

In this limited space I am able to suggest only the bare possibilities. The details are even more sensational than the facts given here can indicate. I am looking for sincere, ambitious, wide-awake men. I offer such men a plan that is a real eye-opener. The first week's profits usually amount to more than your entire investment. After that it is up to you entirely whether you will make \$300 or \$1,000 a month clear profit.

Men and women start in this business daily. You do not obligate yourself in any way by mailing the attached coupon. So get the details of this amazing new idea at once. Decide for independence! Fill out and mail the coupon today—**now**—**THIS MINUTE!**

This One



ZJLA-2H4-6WJP

Address.....

City..... State.....

FOOD DISPLAY MACHINE CORP.

Dept. 39, 500-510 N. Dearborn St., Chicago, Ill.

When writing to advertisers please mention Popular Mechanics

"I Saved Six Orders And Made 2 Weeks' Pay in One Day"



Thanks To This Pocket Volume!

IN my first five years as a salesman, I never made more than \$45 a week. I knew I ought to make more. But I was ignorant—untrained—didn't really know how to sell. I was commencing to despair of ever learning by experience. It wasn't until one day, when I was reading a certain magazine, that I ever knew there was any other way to learn.

What I read gripped my imagination. I wrote to find out more about the sensational training mentioned, and the amazing new Free book, "The Key to Master Salesmanship," which was promised. When the book arrived, however, it had a companion—a tiny pocket volume called "Mistakes Commonly Made in Selling."

Do you know, that little book was alive with ideas for me! Just one page tipped me off to a bad mistake I was making. Moreover, it showed me how to save at least six recent prospects—turn them into sales, although I thought my chances were gone. In one day, just calling on those six old, supposedly hopeless prospects, I got every one of them—and made \$90—two ordinary weeks' pay!

You bet I enrolled for the full course of training after that! Today I am making \$4200 a year more than I did then. I've lost my envy of the "born" salesman; this training made a successful salesman out of me, as it can out of anyone with ordinary brains and education.

Two Books FREE!

Whether you are plugging along unsuccessfully as a salesman, or are down in the rut in a routine job, send in the coupon today for your Free copies of these two wonderful books. See why so many men, who read these books, have since mounted into the big-pay ranks of successful salesmen, through this easy form of training. No cost; no obligation. Act now!



NATIONAL SALESMEN'S TRAINING ASSOCIATION

Dept. M-105, 21 W. Elm St., CHICAGO, ILL.

National Salesmen's Training Association
Dept. M-105, 21 W. Elm St., Chicago, Ill.
Without obligation to me, please send me "Mistakes Commonly Made in Selling," as well as "The Key to Master Salesmanship," and full details of your various service features, including your FREE Employment Service.

Name.....
Address.....
City..... State.....
Age..... Occupation.....

When writing please mention Popular Mechanics

ENGINEERING DEGREE IN 2 YEARS



B. S. Degree in Civil, Electrical, Mechanical, Chemical, Aeronautical Engineering in 2 years. Non-essentials eliminated. Technical training in least time and at lowest cost consistent with thorough preparation. For ambitious, earnest students. Those who lack high school training may make up work. Courses also in scientific business training. Students from all over the world. Graduates successful. Enter September, January, March, June. Write for catalog.

492 College Ave.

Angola, Ind.

TRI-STATE COLLEGE



FREE

Book Gives You Valuable Information!

Should be read by every man from 16 to 60.

Book is **Yours** for the Asking!

No cost whatsoever. No conditions. Just reply promptly. This offer is open to all who speak up now. Men trained by me in practical drafting work at home are making \$60, \$70 and even \$100 per week. Get busy. Be ready when your turn comes. Get your Drafting Tools and Drafting Table just as soon as you begin training. Write today for the New Free Book—"My Pay Raising Plan."

ENGINEER DOBE,
1951 Lawrence Avenue, Div. 16, Chicago

Learn to Dance

You can learn all the modern dances the—latest Tango steps, the new Fox Trots, dreamy Waltzes, smart Collegiate Steps, and popular Society Steps at home, easily and quickly. New chart method makes dancing as simple as A-B-C. No music or partner required. Don't be a wallflower. Learn to dance. Complete course—285 pages, 54 illustrations, sent on 5 Days' Free Trial. Equals \$20.00 course. Send no money. Pay costless only \$1.35, plus postage upon arrival. Money back if not delighted. Catalog Free.



Franklin Pub. Co., 800 No. Clark St., Dept. 9438, Chicago

EASY WAY TO MAKE MONEY IN RADIO

Up to \$3 an hour easy in a short time. New training method and service equipment offer starts you earning quickly. Details of no-cost plan sent FREE. Write

Radio Training Association of America
Dept. PM9, 4513 Ravenswood Ave., Chicago, Illinois

STAMMERERS

Write for Free List of ethical schools that successfully correct all speech defects.
STAMMERERS' GUILD
38 Newbury St., Suite 400, Boston, Mass.

Mysterious Power of Pelmanism

Let us send you a free copy of "Scientific Mind Training." An instructive book which explains an amazing system of mind training already used by more than 750,000 people. It will show you how and why Pelmanism is the only system of teaching for developing all the mental powers at the same time. Endorsed by such world leaders as Frank P. Walsh, Edgar Wallace, Sir Harry Lauder, Prince Charles of Sweden, and hundreds of others. Write TODAY to

THE PELMAN INSTITUTE OF AMERICA
271 NORTH AVENUE, DEPT. 69, NEW ROCHELLE, N. Y.

Popular Mechanics Magazine

200 E. Ontario Street, Chicago, U. S. A.

H. H. WINDSOR, Founder

H. H. WINDSOR, Jr., Editor and Publisher

London: Messageries Hachette,
3 La Belle Sauvage, Ludgate Hill, E. C. 4

Paris: Hachette & Cie.,
111 Rue Reaumur

Melbourne: Gordon & Gotch
509-513 Little Collins St.

Vol. 58

September, 1932

No. 3

Special Features

The Home, Sweet Home of Tomorrow?	353
One Man vs. the British Empire	362
The Boy Who Grew Up with Radio	370
The Art of Taking a Tumble	378
Backyard Telescopes Conquer Space	386
The Mystery of Frozen Life	392
Among Pygmies and Gorillas	418
The Motor Car of the Future	440
Agriculture	
erosion steals hundred tons from acre each year	327
germs turn farm waste into money	461
Airplanes	
all controls in stick	454
amazing motor doubles power	406
dives faster if motor is shut off	460
light tunes plane's motors to stop vibration	369
Animals—mechanical lung saves apes	407
Archaeology	
bones of Eskimos' ancestor found in Minnesota	375
sacrificial mound yields victims' bones	414
Astronomy—sunlight studied for proof of Einstein's theory	383
Automobiles	
permanent license tag reduces chance of theft	460
roller gear helps steering of low-pressure tires	361
to wear gas masks in "odorless city"	416
Automobiles, Accessories	
cigaret holder acts as humidifier	414
handy rack for driver's hat	369
luggage carrier folds under running-board mat	416
Automobiles, Design—chassis on rubber pads has no springs	455
Automobiles, Racing—latest rocket car uses power in steering	360
Automobiles, Repairing—portable cylinder boring machine	358
Automobiles, Testing—magnet measures cylinder walls	423
Automobiles, Tires—electric car used in sing-ing tires	430
Aviation	
"blind" flying is made safer by gyro horizon	408
electric flares discharged from plane to aid night landings	456
flying boat twice "Do-X" size to carry forty tons	412
folding raft for airplanes eliminates carrier ship	408
seaplanes tested in tunnel with towing carriage	461
Bagdad—modern flying carpet visits	364
Batteries—storage, use iodine	383
Birds—"cafeteria" for protected from storms	454
Boats and Boating	
fin increase speed of racing	431
midget ferryboat of steel	423
rowboat propeller run by hand	461
Building Materials—machine measures tensile strength	377
Cement—grains "float" on air for grading by size	406
Clocks—talkie clock gives the time over telephone	460
Coal—slate removed from coal by magnetic separator	423
Diamonds—electric power in, revealed by light bath	384
Electric Plug—rotating, stops kinking of cord	368
Fire Fighting—auto pump against forest fires	384
Fireproof—safety tests measure crowd's force	376
Flashlight—lenses of plastic material used in	407
Food—colored wrappers for, prevent spoilage	368
Glass—machined like metal with new tool	422
Gliders—glider pilots stab balloons to show skill	414
Gold Mining—gas motor helps miner in new "rush"	401
Golf—electric tee measures drive at two miles a minute	417
Grandstand—safety tests measure crowd's force	376
Hot Air—Devices	458
Insecticide—compound is deadly to insects but safe to man	455
Inventions—fortunes from little ideas	424
Lamps—gas and zinc-vapor arc lamp gives red and blue light	460
Lighthouse—cover on lighthouse lenses protects against sun	375
Locomotive—wind valve tests locomotive for waste of energy	375
Logs—endless chain to strip bark cuts cost of	384
Metals	
magnesium alloy to take place of duralumin	417
"ring" of metal aids search for better alloys	368
Milk—citric acid mixed with, is aid to digestion	384

[Continued on Page 4]

ISSUED MONTHLY

SUBSCRIPTION

SINGLE COPY, 25 CENTS

In United States and its possessions, per year, postpaid \$2 50
To all other countries in the Postal Union 3.00
All subscriptions are discontinued at expiration. Please examine date printed on your wrapper.

Entered as Second Class Matter Sept. 15, 1903, at the Post Office at Chicago, Illinois, under Act of March 3rd 1879.
Entered as Second Class Matter at the Post Office Department, Canada.

Published monthly by POPULAR MECHANICS CO.

Copyright, 1932, by Popular Mechanics Co. Copyright in Australia. Copyright in France.

Auto trailer, electric brakes 368

Grass substitute - sweeping
Home rights tell temperature in 408
Home, plywood portable 396
Home of tomorrow (metal) 353
Hook lamp 379
Home - arch roof for 385

Copyrighted material

3, 10 acts on Plug rotary electric name antenna 269

Camera

368

377

Zeppelin, self propelled street

Moving Pictures	
camera hunters in auto "catch" zebra in action	413
noise brought within reach of all	357
noise hounds' chase sounds in talkie studios	422
talkie films made of paper	416
Museum—poison gas guards "health" of art treasures	376
Navy, U. S.—model of "pocket battleship" helps navy draftsmen	417
Ocean—to yield more power by removal of gases	401
Oil—splitting of oil drops to save fuel	414
Paste Tube—self-closing cap keeps contents fresh	358
Photography—photographs of air flow taken by movie camera	457
Photography, Aerial—"zoom" lens gives close-up at great height	449
Pipe Line—dynamite blasts trench for pipe line in river	356
Powder—looks like grass	353
Puzzles	320
Radio—practical radio suggestions	467
Radio, Aerial—coil prevents power loss through masts	114A
Radio, Apparatus	
condenser microphone is easy to build	468
ready-made all-wave signals for lining up receivers	462
Radio, Coils—protecting from moisture	114A
Radio, Construction	
clip-jack simplifies wiring	464
how to find resistance values	464
Radio, Loud Speakers—organ pipes, but music comes from speaker	464
Radio, Receivers—midget receiver uses high-gain tubes	465
Railroads—fitting rubber tires to American railways	432
Razor Blades—last longer with cylinder sharpener	355
Rivet—bolt for steel work stops noise	407
Roads—concrete breaker for, has steel teeth	436
Rubber—paving on highways applied like asphalt	356
Salvage—divers' drill and rescue tank	358
Secret Service—secrets of the master spies	409
Ships and Shipping	
coal dust and oil drive ship in test of fuel mixture	355
protecting the modern liner from fire at sea	413
"Seatrains" called most unusual ship afloat	374
Signs—theater's program in lights also serves as ad	361
Silver—invisible coating for, prevents discoloration	358
Skill—how skillful are you—and why?	402
Smuggling—hijacking liquor cargoes	450
Soot—five tons per mile fall yearly in London	413
Stairs—rolling, keep office open during moving	408
Steel—soap bubbles test strength of big beams	353
Talcum Powder—use in fifty different ways by modern industry	456
Tennis—guide on racket teaches correct grip	355
Thermometer—lights tell temperature in colors	408
Toys—toy inventions aid training of modern children	417
Trailers—electric brakes on, aid to quick stopping	358
Trees—truck moves whole trees with windlass frame	453
Vehicles—foot-propelled "street Zep" runs six miles an hour	377
Vest—holds tear-gas shells for prison guard	431
Wood—sliced into thin sheets for printing	361
X-Ray—that takes pictures of mummies	454

AMATEUR MECHANICS

Alloy—how to make a plastic metal alloy	475
Automobiles, Accessories	
dash control of carburetor needle valve saves gas	486
increasing effectiveness of door locks on closed cars	481
Automobiles, Repairing	
emergency repair for gasoline line	475
hole in engine crankcase patched with sheet lead	493
Baby Carriage—extra seat on	500
Bluing—make your own liquid bluing	494
Boats and Boating	
ideas for the small-boat owner and builder	499
one-man rubber fishing boat is portable	480
plank aids in shaping boat hull	476
Boxes—adhesive tape helps in gluing small boxes	498
Brass—solution for bluing and blackening	471
Camping	
auto lights rid tent of bugs	476
emergency repairs on the camp stove	494
Diving Helmet—homemade, to find lost motors	483
Doors—breaker spring improves door latch	473
Electrical Appliances—consumption of, measured with watch	482
Engine, Gasoline—broken belt stops	482
Fence—ornamental wooden fences	483

Fish and Fishing—how to stain a bamboo fishing rod	492
Furniture—plywood, assembled without screws or nails	472
Games—horseshoe players use illuminated stakes at night	494
Garage—keeping doors open	492
Grinder—old bicycle used as power supply for	498
Hose, Garden—roller guard set at house corner protects	482
Ice Cream—anchoring the ice-cream freezer	471
Labels—handy method of typing	487
Lawnmower—car aids in sharpening	486
Model Ships	
material to use for	500
wire rigging for	471
Motor—synchronous, made of scrap parts	474
Paints and Painting—hands kept clean when handling paint can	481
Photography—hints for successful development of double-coated films	471
Playground—fitting the backyard playground	488
Rope Anchor—from auto casing	478
Rule—safety pin makes guide on	487
Sanding—oil aids in sanding varnish work	120A
Saws and Sawing—cork grips on coping-saw blade for use in tight places	498
Shoes—converted to roof creepers	494
Shovel—jump breaker on the coal shovel	476
Springs—rotating lawn sign quickly noticed	473
Skid Chains—diagonal links make skid chain safer	473
Sleeping Bag—fur-lined, is light and warm	493
Soap Slicer—from coffee can lid	492
Spinning Wheels—model, turned on your lathe	495
Toys	
helicopter toy is propelled by shade roller	476
mechanical fish a riot in the pool	469
Upholstering—for the home craftsman	477
Ventilator—installed in attic window	500
Water Float—for children, made from inner tube	481
Weather Vane—fitted with roller bearings	486
Weeds—noxious, killed by spraying	476
Wharf—oil drum provides floating support for	494
Wire—tools for forming wire novelties	487

SHOP NOTES

Annealing—high-speed steel easily annealed in hot water	
Automobiles, Accessories—extension on the auto jack	12
Automobiles, Repairing	
dust collector for cylinder hone	5
simple method of locating misses in eight-in-line motor	5
Books—old books and magazines easy to rebind	5
Clamps—two handy clamps for light work	517
Clocks—colonial mantel clock fitted with electric movement	509
Coils—hacksaw frame makes good holder for winding	519
Cotter Key—self-locking	511
Drilling	
jig for drilling concentric holes in ends of dowel rods	502
wire depth gauge for small drills	508
Drillpress—built from auto parts	501
Drip Pans—for overhead bearings	508
Electroplating—with gold and silver	513
Fence Posts—steel, driven with pipe	512
Flagpole—counterweight holds up pivoted flagpole	507
Fuel Containers—metal gauze prevents explosions in	503
Gib Key—wooden disk covers gib-key head	503
Lathe—back-face truing tool for work in	519
Machines—folding tables on, save space in shop	503
Magnet—paper removes filings from	512
Metal—molten, kerosene prevents from spattering	507
Packing Hook—pistol grip on, saves workmen's hands	507
Photography—photo floodlamps improve enlarger	512
Pipe Hanger—adapter converts large pipe hanger into small size	508
Punch Press—detachable rest supports wide work on	518
Reamers—making reamers cut oversize	517
Sandpaper—holder keeps taut while sanding work in lathe	508
Scraper—multi-edged, saves time	512
Screws—driving screws in finished work	519
Solder—wire solder made with metal pan	517
Tools—a family tool kit for home repairs	504
Tracings—lacquer thinner used to erase pencil	518
Water Trough—bogs step on platform to fill	511
Wrench—socket, paper wad in, helps start bolts and nuts	503

Larry Campbell
Student of
GEORGE F. JOWETT
from Drawing by
PRYOR

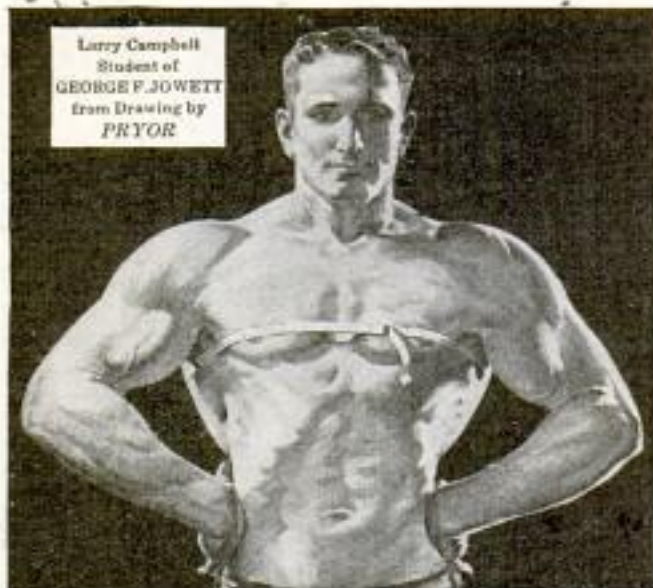

»I will add **3 INCHES**
TO YOUR CHEST
...or it won't cost you one cent!"

Signed: GEORGE F. JOWETT

YES SIR! Three inches of muscle added to your chest and at least one inch to your biceps, or it won't cost you a penny. I know what I am talking about . . . I wouldn't dare make this startling guarantee if I wasn't sure I could do it.

All I want is a chance to prove it! Those skinny fellows that are discouraged are the men I want to work with. I'll build a strong man's chest for them and do it quickly. And I don't mean cream puff muscles either—you will get real, genuine, invincible muscles that will make your men friends respect you and women admire you.

For the past ten years it has been my sole purpose in life to develop he-men and give them the strong, husky bodies that nature meant them to have. When I look over my records I find that in a great majority of cases I have added MORE than THREE INCHES to the chests of my pupils, so I now make it a part of my unqualified guarantee! Test my course—if it does not do all I say—it won't cost you one penny! *You are the judge!*

I want you to make me prove my claims and SEND TODAY FOR MY FREE BOOK "NERVES OF STEEL"

MUSCLES like IRON"

It describes my rise from a puny boy to be one of the world's strongest athletes. It explains all of my secret methods of development—it is bristled with pictures of famous strong men. It will reawaken within you that desire for a strong, powerful body that is within the heart of every man and it will show you how easy it is for you to be as strong as I am.

Complete Book on Chest Building

25¢



In one inexpensive book you can get a complete course that will show you how to develop a Herculean chest. The greatest analysis of vital, vigorous chest development ever written—complete with illustrations.



JOWETT INSTITUTE of PHYSICAL CULTURE

Dept. 47b, 422 Poplar Street, Scranton, Pa.
Dear Mr. Jowett: Please send me the books I have checked below:

Enclosed find 25c, please send me the complete book "MOULDING A MIGHTY CHEST" also a free copy of "NERVES OF STEEL, MUSCLES like IRON"

Send without cost full details of your chest developing guarantee and your free book "NERVES OF STEEL, MUSCLES like IRON"

Name _____

Address _____

LEARN RADIO TALKING PICTURES TELEVISION



Dr. Lee De Forest

Investor of Radio Tube
found which industry is
built. The technical lessons
were prepared under his
supervision and bear the
stamp of his genius.

You learn quickly by lessons which were prepared under the supervision of Dr. Lee De Forest, often called the "Father of Radio" and by rapid method—motion pictures, shown right in your own home. Laboratory Training in Chicago is offered those who desire it. Students learn 19 per cent more and remember 12% more by motion pictures in the report of educators.

STEADY JOBS—BIG FUTURE

Those who have steady employment, now are trained men, those who will profit most in the next era of prosperity will be trained in these newest and fastest developing industries, Sound Engineering and Television. Now is the time to start—not after opportunity passes you by. DeForest's Training will prepare you fully in the shortest possible time. Investigate today. It costs you only a stamp to get all the facts.

LOW TUITION—EASY PAYMENTS

To make it easy for you to get ahead, even under present conditions, the cost of this remarkable method of training has been reduced. Payments are easy. Many students are making more than enough to pay for tuition while learning. Employment service without extra cost. Your opportunity is waiting for you. WRITE:

De FOREST'S TRAINING
Dept. P9, 537 S. Dearborn St. CHICAGO, ILL.

for MORE PAY learn From An ENGINEER DRAFTING

Practical Home training UNTIL IN POSITION. Salary paid Draftsmen \$50 to \$75 per week and up. I'll train a number of selected students on practical work as Draftsmen, or improve your present job to get a raise. I furnish you all tools and drawing table. Write for FREE PAY-RAISING Drafting Book. ENGINEER DOBE, 1951 Lawrence Ave., Div. 516, CHICAGO

LEARN CARTOONING at Home—In Your Spare Time

The famous Picture Chart Method of teaching original drawing has opened the door of success for hundreds of beginners. Whether you think you have talent or not, send for sample chart to test your ability, and examples of the work of students earning from \$50 to \$300 per week. Please state your age.

THE LANDON SCHOOL
1438 National Bldg. Cleveland, O.



GOV'T. POSITIONS SPLENDID SALARIES

MEN - WOMEN

WE HELP YOU GET ONE

- | | |
|-------------------|------------------|
| Ry. Mail Clerk | Steno Typist |
| P. O. Laborer | Immigrant Insp |
| H. F. D. Carrier | Seamstress |
| Special Agent | Auditor |
| Customs Inspector | Prohibition Agt. |
| City Mail Carrier | U.S. Border |
| Meat Inspector | Patrol |
| P. O. Clerk | Chauffeur |
| Pile Clerk | Watchman |
| Statistical Clerk | Skilled Laborer |
| Matron | Postmaster |
| | Typist |

Obtain instruction Bureau, Dept. 111, St. Louis, Mo. Send me FREE particulars "How to Qualify" for positions marked "X". Salaries, Locations, Opportunities, etc. ALL SENT FREE.

Name _____
Address _____

AGE RANGE 18 to 50

When writing to advertisers please mention Popular Mechanics

Accountancy Home-Study

made interesting and practical thru problem method

YOU know as well as we do that Accountancy fits many men for positions that pay one and five and ten thousand dollars a year—gives many other an unusual opportunity to start profitable growing business of their own.

The only question is—just how practical is it for you to train yourself adequately in Accountancy through home study?

And the answer lies in the LaSalle Problem Method.

For this modern plan of training not only makes Accountancy study at home thoroughly practical but makes it interesting as well.

And here's how:

You Learn by Doing

Suppose it were your privilege every day sit in conference with the auditor of your company or the head of a successful accounting firm. Suppose every day he were to lay before you in systematic order various problems he is compelled to solve, and were to explain to you the principles by which he solves them. Suppose that one by one you were to work these problems out—returning to him every day for counsel and assistance—granted that privilege, surely your advancement would be faster by far than that of the man who is compelled to pick up his knowledge by study of theory alone.

Under the LaSalle Problem Method you pursue, to all intents and purposes, an identical plan. You advance by solving problems.

Only—instead of having at your command the counsel of a single individual—one accountant—you have back of you the organized experience of the largest business training institution in the world, the authoritative findings of scores of able auditing specialists, the actual procedure of the most successful accountants.

Thus—instead of fumbling and blundering—you are coached in the solving of the very problems you must face in the higher accounting positions or in

an accounting practice of your own. Step by step, you work them out for yourself—until, at the end of your training, you have the kind of ability and experience for which business is willing and glad to pay real money—just as it was glad to pay these men.

Five Men Who Tested and Proved It for You

For instance, there was the plumber who started Accountancy training with us in 1916. After a short period of study, he took a position as bookkeeper for a year, and then became accountant for a leading automobile manufacturer—with two bookkeepers under him. Today he is auditor of one of the foremost banks in his state and his salary is 325 percent larger than when he started training.

He writes, "My training is the best investment I've ever made, showing a cash value running into five figures."

And the young clerk, earning \$75 a month eleven years ago and now getting many times that as general auditor for an outstanding, nation-wide organization. Within six months after he began our training, he was earning \$125 a month and within four years, he was earning \$250.

Do you wonder that he writes, "While LaSalle ads once seemed like fairy tales to me, now I know from personal experience that they are true!"



Send for This Book

*Names and addresses given on request.

Or let us tell you about two men—one a stenographer and the other a retail clerk—neither of whom knew more than the simplest elements of bookkeeping. One is now the comptroller and the other the assistant comptroller of a large company.

"LaSalle training in Higher Accountancy," write both, "was the important factor in our rapid climb."

And if you are thinking about the C. P. A. degree and a public accounting business of your own, read about the pharmacist who was earning \$30 a week eleven years ago when a LaSalle registrar secured his enrollment for Accountancy training. Eight months later he left the drug store to take a bookkeeping job at \$20 a week—less money but larger opportunity. Three years later he passed the C. P. A. examination and a year later yet he was earning \$5,000 a year. Now he has his own highly successful public accounting firm for which he says, "My LaSalle training has been largely responsible."

One-Tenth of All C. P. A.'s Are LaSalle Trained

If you want still more proof, remember that 1,000 C. P. A.'s—approximately one-tenth of all those in the United States who have ever passed the difficult examination for this coveted degree—are LaSalle trained.

Or remember that in our files—accessible on request—are thousands of letters from our Accountancy graduates reporting material increases—double, triple, quadruple—and even more—over their original earnings.

And knowing these facts, ask yourself if there can be any further question about the practicability of this training for you—ask rather if the real question is not about the size of your own ambition and the quality of your determination.

For Accountancy is no magic wand for the lazy or the fearful or the quitter—it offers success only to the alert adult who has the courage to face the facts and the will to carry on till the job is done.

If you are that individual, the coupon below, filled out and mailed, will bring you free the information that can open up to you the future of which you have dreamed—ability and income and success.

Is it not worth getting that information?

LaSalle Extension University

LaSALLE EXTENSION UNIVERSITY, Dept. 964-HR Chicago, Ill.
Please send me, free of all cost or obligation, your 64-page, illustrated book, "Accountancy, the Profession That Pays," telling about the profession of accountancy and your training for success in that field.

Name.....
Address.....City.....
Position.....Age.....

When writing to advertisers please mention Popular Mechanics





Follow this Man

Secret Service Operator 38 is on the job

FOLLOW him through all the excitement of his chase of the counterfeit gang. See how a crafty operator works. Telltale finger prints on the lamp stand in the murdered girl's room! The operator's cigarette case is handled by the unsuspecting gangsters, and a great mystery is solved. Better than fiction. It's true, every word of it. No obligation. Just send the coupon and get—

FREE!

**The Confidential Reports
No. 38 Made to His Chief**

And the best part of it all is this. It may open your eyes to the great future for YOU as a highly paid Finger Print Expert. More men are needed right now. This school has taken men just like you and trained them for high official positions. This is the kind of work you would like. Days full of excitement. Big salaries. Rewards.

Can you meet this test?

Can you read and write? Are you ambitious? Would you give 30 minutes a day of your spare time preparing yourself for this profession? Answer "yes" and I'll show you how to attain all this. Send the coupon and I'll also send the Free Reports.

INSTITUTE OF APPLIED SCIENCE
1920 Sunnyside Ave., Dept. 13-56 Chicago, Illinois

Institute of Applied Science
1920 Sunnyside Ave., Dept. 13-56 Chicago, Illinois

Gentlemen:—Without any obligation whatever, send me the Reports of Operator No. 38, also your illustrated Free Book on Finger Prints and your low prices and Easy Terms Offer. Literature will NOT be sent to boys under 17 years of age.

Name _____

Address _____

Age _____

When writing please mention Popular Mechanics

Come to Chicago and Study DRAFTING Architecture OR ENGINEERING during WORLD'S FAIR

Chicago's World's Fair will be a liberal education in itself . . . a wonderful supplement to technical college training. Prepare now for splendid opportunities in Drafting, Architecture, and Electrical, Civil, Mechanical or Radio Engineering. At this 29 year old College of Engineering you save time and money on B. S. Degree, Diploma and Short-cut courses. Enroll days or evenings. Earn while learning. Eminent teaching staff. Employment service for students and graduates. Full Term begins Sept. 12. Send for FREE 66-page Book which gives complete details. State subject that interests you. If you prefer to study at home, please mention this when writing.

CHICAGO TECH COLLEGE
DEPT. M-75
118 East 26th St. Chicago, Ill.



FREE LESSON Home Art Craft



GOOD MONEY FOR SPARE TIME

A new easy way. Art novelties in big demand. Get free lesson and quickly learn to decorate Gifts, Bridge Prizes, Toys, etc. No Experience necessary. Anyone can succeed with simple "3-step" method and you earn as you learn. Everything furnished including supply of Novelties for you to decorate and Homecrafters Outfit.

NO CANVASSING

Just sit at home and make up to \$50 a week spare time or full. Write today for big illustrated book and FIRST LESSON FREE. Absolutely no cost to pay. Lesson is free. Openings in every locality. Write quick.

FIRESIDE INDUSTRIES
Dept. 66-M, ADRIAN, MICH.

NEW! MAGIC CHEESE CHIPS!

Only six months on the market, yet taking hold so fast with the public that we already have National Distribution! Distributors have standing orders of thirty to hundred and fifty pounds a week. You make 67c profit on every dollar you take in. 100 pounds a week easy in a good spot.

THE MORE THEY EAT THE MORE THEY WANT

MAGIC CHEESE CHIPS are big, fluffy, giant-size, chips, bigger than potato chips. They have an irresistible taste that makes them act like an appetizer, and the more you eat the more you want to eat, and you never get filled up. Stand at a MAGIC CHIP Booth and watch the same people come back time after time for more. It's a revelation! Nothing like it. Get it while it's new. \$8.50 investment puts you in a red hot business. Write now for information, and complete records of others' sales.

FLUFF-O MFG. CO.
Dept. G, 110 South Main St., St. Louis, Mo.

LEARN AVIATION



Attractive Opportunities

are in store for men who prepare themselves now for a career in Aviation. Air transportation has substantially increased during the past year, while other lines of business have been standing still. Let us train you at this Lincoln School for one of the best positions as pilot or mechanic. Highest type of equipment and instructors. Aircraft factory in connection. Our graduates are holding many of the higher positions of responsibility in Aviation. Both Ground and Flying School Government Approved. If interested, write today for catalog, stating your age.

**LINCOLN AIRPLANE
& FLYING SCHOOL**

202B Aircraft Bldg., Lincoln, Nebr.





TO MEN WHO WANT TO MAKE **more money**

You don't "get" raises these days—you earn them!

THESE are strenuous times in which we are living. Competition is keen . . . the demands for efficiency are constantly increasing.

The day is gone when you can "hit the boss" for a raise and get it "on your nerve."

You get raises these days on your ability — and your training!

Today a man must think about himself — and his future. Remember this: If you're just getting by, you're falling behind. Tomorrow your present job may be only a memory. The way to be sure of the future is to be sure of yourself!

Men are realizing this — a new era in the utilization of spare time to acquire specialized training is here! Men who a few years

ago thought they were "sitting on top of the world" today are coming to International Correspondence Schools for additional training. Still more are enrolling because they see the handwriting on the wall. They want to make more money.

Do you want to make more money? If you do, we challenge you to mark and mail this coupon! It has been the beginning of success for men all over the world.

But don't bother if you're a quitter! It takes fight and hard work to get ahead these days—and weak-kneed, spineless men have no more chance of helping themselves by spare-time study than they have of getting a raise tomorrow!

If you have the old fight, if you're willing to risk a two-cent stamp on yourself—mark and mail this coupon *today!*

INTERNATIONAL CORRESPONDENCE SCHOOLS

"The Universal University"

BOX 5615-G, SCRANTON, PENNA.

Without cost or obligation, please send me a copy of your booklet, "Who Wins and Why," and full particulars about the subject before which I have marked X:

TECHNICAL AND INDUSTRIAL COURSES

- | | | | |
|--|--|--|--|
| <input type="checkbox"/> Architect | <input type="checkbox"/> Telegraph Engineer | <input type="checkbox"/> Automobile Mechanic | <input type="checkbox"/> R. R. Bridge and Building Foreman |
| <input type="checkbox"/> Architectural Draftsman | <input type="checkbox"/> Telephone Work | <input type="checkbox"/> Plumbing <input type="checkbox"/> Steam Fitting | <input type="checkbox"/> Air Brakes <input type="checkbox"/> Train Operation |
| <input type="checkbox"/> Building Estimating | <input type="checkbox"/> Mechanical Engineer | <input type="checkbox"/> Heating <input type="checkbox"/> Ventilation | <input type="checkbox"/> Chemistry <input type="checkbox"/> Pharmacy |
| <input type="checkbox"/> Wood Millworking | <input type="checkbox"/> Mechanical Draftsman | <input type="checkbox"/> Sheet Metal Worker | <input type="checkbox"/> Coal Mining Engineer |
| <input type="checkbox"/> Contractor and Builder | <input type="checkbox"/> Machinist | <input type="checkbox"/> Steam Engineer | <input type="checkbox"/> Navigation <input type="checkbox"/> Boilermaker |
| <input type="checkbox"/> Structural Draftsman | <input type="checkbox"/> Toolmaker | <input type="checkbox"/> Steam Electric Engineer | <input type="checkbox"/> Textile Overseer or Supt. |
| <input type="checkbox"/> Structural Engineer | <input type="checkbox"/> Patternmaker | <input type="checkbox"/> Civil Engineer | <input type="checkbox"/> Cotton Manufacturing |
| <input type="checkbox"/> Electric Wiring | <input type="checkbox"/> Pipefitter <input type="checkbox"/> Tinsmith | <input type="checkbox"/> Surveying and Mapping | <input type="checkbox"/> Woolen Manufacturing |
| <input type="checkbox"/> Electrical Engineer | <input type="checkbox"/> Bridge Engineer | <input type="checkbox"/> Refrigeration | <input type="checkbox"/> Agriculture <input type="checkbox"/> Fruit Growing |
| <input type="checkbox"/> Electric Lighting | <input type="checkbox"/> Bridge and Building Foreman | <input type="checkbox"/> R. R. Locomotives | <input type="checkbox"/> Poultry Farming <input type="checkbox"/> Radio |
| <input type="checkbox"/> Welding, Electric and Gas | <input type="checkbox"/> Gas Engines <input type="checkbox"/> Diesel Engines | <input type="checkbox"/> R. R. Section Foreman | <input type="checkbox"/> Marine Engineer |
| <input type="checkbox"/> Reading Shop Blueprints | <input type="checkbox"/> Aviation Engines | <input type="checkbox"/> Highway Engineering | |

BUSINESS TRAINING COURSES

- | | | | |
|---|--|--|--|
| <input type="checkbox"/> Business Management | <input type="checkbox"/> C. P. Accountant | <input type="checkbox"/> Lettering Show Cards <input type="checkbox"/> Signs | <input type="checkbox"/> Grade School Subjects |
| <input type="checkbox"/> Office Management | <input type="checkbox"/> Bookkeeping | <input type="checkbox"/> Stenography and Typing | <input type="checkbox"/> High School Subjects |
| <input type="checkbox"/> Industrial Management | <input type="checkbox"/> Secretarial Work | <input type="checkbox"/> Complete Commercial | <input type="checkbox"/> College Preparatory |
| <input type="checkbox"/> Personnel Management | <input type="checkbox"/> Spanish <input type="checkbox"/> French | <input type="checkbox"/> Civil Service | <input type="checkbox"/> Illustrating |
| <input type="checkbox"/> Traffic Management | <input type="checkbox"/> Salesmanship <input type="checkbox"/> Advertising | <input type="checkbox"/> Mail Carrier | <input type="checkbox"/> Cartooning |
| <input type="checkbox"/> Accountancy <input type="checkbox"/> Cost Accountant | <input type="checkbox"/> Business Correspondence | <input type="checkbox"/> Railway Mail Clerk | <input type="checkbox"/> Lumber Dealer |

Name..... Age..... Address.....

City..... State..... Occupation.....

If you reside in Canada, send this coupon to the International Correspondence Schools Canadian, Limited, Montreal, Canada

When writing to advertisers please mention Popular Mechanics



BE an ARTIST Earn a Fat Income

WHAT would you give to be thoroughly trained in Modern Art on which magazines, newspapers and publishers are spending millions every year? Many Federal Students who already have this training are earning from \$2500 to \$6000 a year—some even more.

More than fifty famous artists making big incomes themselves have contributed exclusive lessons and drawings to the Federal Course in Illustrating. Through these lessons you may get the benefit of their long experience in Illustrating, Cartooning, Lettering, Poster Designing, and Window Card Illustrating. You learn at home in spare time. Earn while you learn if you wish.

TEST YOUR TALENT—FREE

Fill out the coupon below and get the Free Book "A Road to Bigger Things," and our Free Vocational Art Test to measure your ability. When you fill this out and return to us our instructors will go over it and give you a frank opinion as to your ability.

FEDERAL SCHOOL of ILLUSTRATING

9132 Federal Schools Bldg., Minneapolis, Minn.

Please send your free book, "A Road to Bigger Things," together with Test Chart.

Name.....

Age..... Occupation.....

Address.....

When writing please mention Popular Mechanics



Play the Hawaiian Guitar like the Hawaiians!

Only 4 Motions used in playing this fascinating instrument. Our native Hawaiian instructors teach you to master them quickly. Pictures show how. Everything explained clearly.

Play in Half Hour

After you get the four easy motions you play harmonious chords with very little practice. No previous musical knowledge needed.

Easy Lessons

Even if you don't know one note from another, the 62 printed lessons and clear pictures make it easy to learn quickly. Pay as you play.



GIVEN when you enroll
—a sweet toned

HAWAIIAN GUITAR, Carrying Case and

Playing Outfit—

Value \$18 to \$20

No extras—everything included

WRITE AT ONCE for attractive offer and easy terms. You have everything to gain. A postcard will do. ACT!

COURSES | Tenor Banjo, Violin, Tiple, Tenor Guitar, Ukulele, Banjo ukulele Under well known instructors.

FIRST HAWAIIAN CONSERVATORY of MUSIC, Inc.

9th Floor, Woolworth Bldg., Dept. 548 New York, N. Y.

Approved as a Correspondence School Under the Laws of the State of New York - Member National Home Study Council

BE A RAILWAY TRAFFIC INSPECTOR



Steady,
Profitable
Work

Standard Business Training Institute, Box 208, Buffalo, N. Y.

EARN BIG MONEY—

S. B. T. I. trained men—19 to 55—make good as Passenger Traffic Inspectors. Many reach executive positions. Interesting, outdoor work—travel or remain near home. Meet high officials.

After completion of our home-study course in a few weeks, we will help place you at salary of \$1200 to \$1500 per month up, plus expenses, to start, or refund tuition. Splendid opportunities for trained men in the Transportation Field. Costs little—terms.

CARTOON YOUR WAY TO SUCCESS!



DON'T COPY—LEARN TO ORIGINATE!

RAYE BURNS will teach you HOW to CREATE ORIGINAL CARTOONS of items that you can SELL! Course contains 26 lessons and over 600 illustrations. All for Only...

\$2.85

Send name and address for free details.

RAYE BURNS SCHOOL, 838 Lakeview Rd., M-X, Cleveland, Ohio

LEARN MECHANICAL DENTISTRY

Earn big Money—Steady Work
Prepare now for prosperity. Learn this money-making business in a few months in this LARGEST, OLDEST, "Lab" training center in New York. Day or Evening sessions. Big Demand. Practical Training. Individual instruction.

Write NOW for free catalog P and reduced rate.
NEW YORK SCHOOL OF MECHANICAL DENTISTRY
125 West 31st Street New York

SEND FOR
FREE BOOK
*YOUR
SUCCESS*

TRICKS WITH ELECTRICITY

Make electric lights obey voice, make things spin, jump, kick, run, vibrate, buzz, shoot, shock, flash, mystify—all by electricity. Make window novelties, floating rings, spirit rapping, all kinds amusing and practical devices. Book tells how to do 200 stunts with 110 volts A.C. Postpaid \$1.00.

CUTTING & SONS 92 M St. Campbell, California

VOICE

100% Improvement Guaranteed
We build, strengthen the vocal organs—not with singing lessons—but by fundamentally sound and scientifically correct silent exercises... and absolutely guarantee to improve any singing or speaking voice at least 100%... Write for wonderful voice book—sent free. Learn WHY you can now have the voice you want. No literature sent to anyone under 17 years unless signed by parent.

**PERFECT VOICE INSTITUTE, Studio 13-56
308 No. Michigan Ave., Chicago**



BROADCASTING
TELEVISION
TALKING PICTURES
WIRELESS OPERATING

WIN FAME and FORTUNE in RADIO!

Don't spend your life slaving away in some dull, hopeless job! Don't be satisfied to work for a mere \$20 or \$30 a week. Let me show you how to make MONEY in RADIO—THE FASTEST-GROWING, BIGGEST FIELD ON EARTH—where opportunities are many for the trained man.

JOBS LEADING TO SALARIES OF \$50 A WEEK AND UP!

Jobs as Designer, Inspector and Tester—as Radio Salesman and in Service and Installation work—as Operator or Manager of a Broadcasting Station—as Wireless Operator on a Ship or Airplane, or Sound Reproduction Operator—HUNDREDS of OPPORTUNITIES for fascinating, well-paid Jobs!

Ten Weeks of Shop Training AT COYNE IN CHICAGO

You are trained in all branches of Radio at Coyne—in 10 short, pleasant weeks—by actual work on actual Radio, Television and Sound Equipment. No useless theory. We give you the practical training you'll need.

All Practical Work at Coyne

Coyne is NOT a Correspondence School. We don't teach you from books. We train you on a great outlay of Radio, Television and Sound equipment—on scores of modern Radio Receivers, huge Broadcasting equipment, the very latest Television apparatus, Talking Picture and Sound Reproduction equipment, Code equipment, etc. You don't need advanced

H. C. Lewis, Pres. Radio Division Founded 1899

Coyne Electrical School
500 S. Paulina St., Dept. 62-3H, Chicago, Ill.

education or previous experience. We give you—right here in the Coyne Shops—the actual practice and experience you'll need.

TELEVISION Is Now Here

And TELEVISION is already here! Soon there'll be a demand for THOUSANDS of TELEVISION EXPERTS! The man who learns Television NOW can have a real future in this great new field. Get in on the ground-floor of this amazing new Radio development! Learn Television at COYNE on the very latest, newest Television equipment.

Talking Pictures A Great Field

Talking Pictures and Public Address Systems offer golden opportunities to the Trained Radio man. Here is a great new field of Radio that has just started to grow! Prepare NOW for these marvelous op-

portunities! Learn Radio Sound work at Coyne, on actual Talking Picture and Sound Reproduction equipment.

COYNE Is 32 Years Old!

You get Free Employment Help as long as you live. And if you need part-time work while at school to help pay expenses we'll gladly do all we can to get it for you if you will tell us your problems. Coyne is 32 years old! Coyne training is tested—proven beyond all doubt. You can find out everything absolutely free. Just Mail Coupon for My Big Free Book, telling all about jobs—salaries—opportunities. Mail coupon now!

■ H. C. LEWIS, President
 ■ Radio Division, Coyne Electrical School
 ■ 500 S. Paulina St., Dept. 62-3H, Chicago, Ill.
 ■ Dear Mr. Lewis:
 ■ Send me your Big Free Radio Book and
 ■ all details of your Special Offer.

Name.....

Address.....

City..... State.....

When writing to advertisers please mention Popular Mechanics



High School Course in Two Years!

You Want to Earn Big Money!

And you will not be satisfied unless you earn steady promotion. But are you prepared for the job ahead of you? Do you measure up to the standard that insures success? For a more responsible position a fairly good education is necessary. To write a sensible business letter, to prepare estimates, to figure cost and to compute interest, you must have a certain amount of preparation. All this you must be able to do before you will earn promotion. Many business houses hire no men whose general knowledge is not equal to a high school course. Why? Because big business refuses to burden itself with men who are barred from promotion by the lack of elementary education.

Can You Qualify for a Better Position

We have a plan whereby you can. We can give you a complete but simplified high school course in two years, giving you all the essentials that form the foundation of practical business. It will prepare you to hold your own where competition is keen and exacting. Do not doubt your ability, but make up your mind to it and you will soon have the requirements that will bring you success and big money. **YOU CAN DO IT.**

Let us show you how to get on the road to success. It will not cost you a single working hour. Write today. It costs you nothing but a stamp.

American School

Dept. H-447 Drexel Ave. and 58th St., Chicago

American School

Dept. H-447 Drexel Ave. and 58th St., Chicago

Send me full information on the subject checked and how you will help me win success.

- | | |
|-----------------------------|---------------------------|
|Architect |Business Law |
|Building Contractor |Lawyer |
|Automobile Engineer |Machine Shop Practice |
|Automobile Repairman |Mechanical Engineer |
|Civil Engineer |Shop Superintendent |
|Structural Engineer |Employment Manager |
|Business Manager |Steam Engineer |
|Cert. Public Accountant |Foremanship |
|Accountant and Auditor |Sanitary Engineer |
|Bookkeeper |Surveyor (& Mapping) |
|Draftsman and Designer |Telephone Engineer |
|Electrical Engineer |Telegraph Engineer |
|Electric Light & Power |High School Graduate |
|General Education |Wireless Radio |
|Vocational Guidance |Undecided |

Name.....

Address.....

When writing please mention Popular Mechanics

ELECTRICAL ENGINEERING

Complete Course in One Year

A CONCISE, comprehensive course in Electrical Engineering to prepare ambitious young men of limited time for new opportunities in the electrical field. 39 years' experience assures you maximum training in minimum time.

Theory and Practice Combined

Theory and practice are closely interwoven in classroom and laboratory. Mathematics, Engineering Drawing and Intensive Shop Work. Students construct motors, install wiring and test electrical machinery. Fireproof dormitories, dining hall, laboratories and shops.

Prepare Now

Bliss men hold responsible technical and executive positions. Catalog on request.



BLISS ELECTRICAL SCHOOL

119 Takoma Ave., Washington, D.C.

EARN MONEY AT HOME

YOU can make \$15 to \$50 weekly in spare or full time at home coloring photographs. No experience needed. No canvassing. We instruct you by our new simple Photo-Color process and supply you with work. Write for particulars and Free Book to-day.

The IRVING-VANCE COMPANY Ltd.
356 Hart Building, Toronto, Can.

LAW STUDY AT HOME

Legally trained men win high positions and big success in business and public life. He independent. Greater opportunities now than ever before. Big corporations are headed by men with legal training. Earn \$5,000 to \$10,000 Annually

We guide you step by step. You can train at home during spare time. Degrees of L.L. B. conferred. Successful graduates in every section of the United States. We furnish all text material, including fourteen-volume Law Library. Low cost, easy terms. Get our valuable 66-page "Law Guide" and "Evidence" books FREE. Send for them NOW.

LaSalle Extension University, Dept. 964-L Chicago
The World's Largest Business Training Institution

1000 POULTRY SECRETS

Our famous home-study Poultry Course teaches how to get more eggs, cut feed bills, avoid losses. Methods used by successful Poultry raisers the world over. FREE Book tells all about Course. Write today for your free copy. National Poultry Institute, Dept. 411-R, Washington, D. C.



LEARN WATCHMAKING AND ENGRAVING

BY OUR PROFIT-SHARING PLAN OUR GRADUATES SUCCEED

One of our Iowa students started in a very small way—now doing over \$20,000 a year. Another in Wisconsin, over \$10,000 the first year. Day or night classes. Call or write for FREE BOOK.

Chicago School of Watchmaking, Dept. 8801, 155 N. Clark St., CHICAGO

Learn Photography at HOME

Make money taking pictures. Prepare quickly during spare time. Also earn while you learn. No experience necessary. New easy method. Nothing else like it. Send at once for free book, OPPORTUNITIES IN MODERN PHOTOGRAPHY, and full particulars.

AMERICAN SCHOOL OF PHOTOGRAPHY
Dept. 1356, 3601 Michigan Avenue Chicago, U. S. A.



J. E. Smith, Pres., Nat'l. Radio Institute, the man who has directed the Home Study training of more men for the Radio Industry than any other man in America.

BE A RADIO EXPERT

Many Make \$50 to \$100 a Week

I'll Train You at Home in Your Spare Time
for **RADIO · TELEVISION · TALKING MOVIES**



Set Servicing

Spare-time set servicing pays many N. R. I. men \$200 to \$1,000 a year. Full-time men make as much as \$65, \$75, and \$100 a week.



Broadcasting Stations

Employ trained men continually for jobs paying up to \$5,000 a year.



Ship Operating

Radio operators on ships see the world free and get good pay plus expenses. Here's one enjoying shore leave.

Aircraft Radio

Aviation is needing more and more trained Radio men. Operators employed through Civil Service Commission earn \$1,620 to \$2,800 a year.

If you are dissatisfied with your present job, if you are struggling along in a rut with little or no prospect of anything better than a skinny pay envelope—clip the coupon NOW. Get my big FREE book on the opportunities in Radio. Read how quickly you can learn at home in your spare time to be a Radio Expert—what good jobs my graduates have been getting—real jobs with real futures.

Many Radio Experts Make \$50 to \$100 a Week

In about ten years the Radio Industry has grown from \$2,000,000 to hundreds of millions of dollars. Over 300,000 jobs have been created by this growth, and thousands more will be created by its continued development. Many men and young men with the right training—the kind of training I give you in the N. R. I. course—have stepped into Radio at two and three times their former salaries.

Get Ready Now for Jobs Like These

Broadcasting stations use engineers, operators, station managers, and pay up to \$5,000 a year. Manufacturers continually employ testers, inspectors, foremen, engineers, service men, buyers, for jobs paying up to \$6,000 a year. Radio Operators on ships enjoy life, see the world, with board and lodging free, and get good pay besides. Dealers and jobbers employ service men, salesmen, buyers, managers, and pay up to \$100 a week. My book tells you about these and many other kinds of interesting Radio jobs.

Many Make \$5, \$10, \$15 a Week Extra in Spare Time Almost at Once

The day you enroll with me I send you material which you should master quickly for doing 28 jobs common in most every neighborhood, for spare-time money. Throughout your course I send you information on servicing popular makes of sets! I give you the plans and ideas that have made \$200 to \$1,000 a year for N. R. I. men in their spare time. My course is famous as the course that pays for itself.

Talking Movies, Television, Aircraft Radio Money-Back Agreement

Special training in Talking Movies, Television and Home Television experiments, Radio's use in Aviation, Commercial and Merchandising Sets, Broadcasting, Commercial and Ship Stations are included. I am so sure that N. R. I. can train you satisfactorily that I will agree in writing to refund every penny of your tuition if you are not satisfied with my Lesson and Instruction Service upon completion.

64-page book FREE

Get your copy today. It's free to all residents of the United States and Canada over 15 years old. It tells you where Radio's good jobs are, what they pay, tells you about my course, what others who have taken it are doing and making. Find out what Radio offers you without the slightest obligation. ACT NOW!



Talking Movies

An invention made possible by Radio. Employs many well trained Radio men for jobs paying \$75 to \$200 a week.



Television

The coming field of many great opportunities is opened by my course.



Special Free Offer

Service Manual on Trouble Shooting in Radio Sets Sent Free

Act now and receive in addition to my big free book "Rich Rewards in Radio," this Service Manual on D. C., A. C., and Battery Operated sets. Only my students

could have this book in the past. Now readers of this magazine who mail the coupon will receive it free. Overcoming hum, noises of all kinds, fading signals, broad tuning, howls and oscillations, poor distance reception, distorted or muffled signals, poor Audio and Radio Frequency amplification and other vital service information is contained in it. Get a free copy by mailing the coupon at right. ACT NOW.



THIS COUPON IS GOOD for
One FREE COPY OF MY BOOK

mail it
now

J. E. SMITH, President
National Radio Institute, Dept. 2JP
Washington, D. C.

Dear Mr. Smith: I want to take advantage of your Special Offer. Send me your two books, "Trouble Shooting in D. C., A. C. and Battery Sets" and "Rich Rewards in Radio." I understand this request does not obligate me.

Name.....

Address.....

City..... State.....

"M"

When writing to advertisers please mention Popular Mechanics

"LAST NIGHT

I came home with great news!"



"I'd TELEPHONED Nora that I had a surprise for her and she could hardly wait for me. You should have seen when I told her the Boss had given me a \$25 increase in salary.

"It's wonderful," she said, "just wonderful!" Now we can pay some of those bills that have been worrying us and even put a little in the bank each week.

"Remember the night we saw that coupon and you decided to take up an I. C. S. course? It made a new man of you, Bob. We certainly owe a lot to the International Correspondence Schools."

How about you? Are you always going to work for a small salary? Are you going to waste your natural ability all your life? Or are you going to get ahead in a big way?

Don't let another precious hour pass before you find out what the I. C. S. can do for you. It doesn't cost you a penny or oblige you in any way to ask for full particulars, but that one simple little act may be the means of changing your entire life.

INTERNATIONAL CORRESPONDENCE SCHOOLS

"The Universal University" Box 5616-G, Scranton, Penna.

Without cost or obligation, please send me a copy of your booklet, "Who Wins and Why," and full particulars about the subject before which I have marked X:

TECHNICAL AND INDUSTRIAL COURSES

- | | |
|--|--|
| <input type="checkbox"/> Architect | <input type="checkbox"/> Automobile Mechanic |
| <input type="checkbox"/> Architectural Draftsman | <input type="checkbox"/> Plumbing <input type="checkbox"/> Steam Fitting |
| <input type="checkbox"/> Building Estimating | <input type="checkbox"/> Heating <input type="checkbox"/> Ventilation |
| <input type="checkbox"/> Wood Millworking | <input type="checkbox"/> Sheet Metal Worker |
| <input type="checkbox"/> Contractor and Builder | <input type="checkbox"/> Steam Engineer |
| <input type="checkbox"/> Structural Draftsman | <input type="checkbox"/> Steam Electric Engineer |
| <input type="checkbox"/> Structural Engineer | <input type="checkbox"/> Civil Engineer |
| <input type="checkbox"/> Electric Wiring | <input type="checkbox"/> Surveying and Mapping |
| <input type="checkbox"/> Electrical Engineer | <input type="checkbox"/> Refrigeration |
| <input type="checkbox"/> Electric Lighting | <input type="checkbox"/> R. R. Locomotives |
| <input type="checkbox"/> Welding, Electric and Gas | <input type="checkbox"/> R. R. Section Foreman |
| <input type="checkbox"/> Reading Shop Blueprints | <input type="checkbox"/> R. R. Bridge and Building Foreman |
| <input type="checkbox"/> Telegraph Engineer | <input type="checkbox"/> Air Brakes <input type="checkbox"/> Train Operation |
| <input type="checkbox"/> Telephone Work | <input type="checkbox"/> Highway Engineering |
| <input type="checkbox"/> Mechanical Engineer | <input type="checkbox"/> Chemistry <input type="checkbox"/> Pharmacy |
| <input type="checkbox"/> Mechanical Draftsman | <input type="checkbox"/> Coal Mining Engineer |
| <input type="checkbox"/> Machinist <input type="checkbox"/> Toolmaker | <input type="checkbox"/> Navigation <input type="checkbox"/> Boilermaker |
| <input type="checkbox"/> Patternmaker | <input type="checkbox"/> Textile Overseer or Supt. |
| <input type="checkbox"/> Pipefitter <input type="checkbox"/> Tinmith | <input type="checkbox"/> Cotton Manufacturing |
| <input type="checkbox"/> Bridge Engineer | <input type="checkbox"/> Wooden Manufacturing |
| <input type="checkbox"/> Bridge and Building Foreman | <input type="checkbox"/> Agriculture <input type="checkbox"/> Fruit Growing |
| <input type="checkbox"/> Gas Engines <input type="checkbox"/> Diesel Engines | <input type="checkbox"/> Poultry Farming <input type="checkbox"/> Radio |
| <input type="checkbox"/> Aviation Engines | <input type="checkbox"/> Marine Engineer |

BUSINESS TRAINING COURSES

- | | |
|--|--|
| <input type="checkbox"/> Business Management | <input type="checkbox"/> Business Correspondence |
| <input type="checkbox"/> Office Management | <input type="checkbox"/> Lettering Show Cards <input type="checkbox"/> Signs |
| <input type="checkbox"/> Industrial Management | <input type="checkbox"/> Stenography and Typing |
| <input type="checkbox"/> Personnel Management | <input type="checkbox"/> Commercial |
| <input type="checkbox"/> Traffic Management | <input type="checkbox"/> Civil Service |
| <input type="checkbox"/> Accountancy and C. P. A. Coaching | <input type="checkbox"/> Mail Carrier |
| <input type="checkbox"/> Bookkeeping | <input type="checkbox"/> Railway Mail Clerk |
| <input type="checkbox"/> Secretarial Work <input type="checkbox"/> Spanish | <input type="checkbox"/> Grade School Subjects |
| <input type="checkbox"/> Cost Accountant <input type="checkbox"/> French | <input type="checkbox"/> High School Subjects |
| <input type="checkbox"/> Salesmanship <input type="checkbox"/> Advertising | <input type="checkbox"/> College Preparatory |
| <input type="checkbox"/> Wallpaper Decorating | <input type="checkbox"/> Illustrating |
| <input type="checkbox"/> Salesmanship | <input type="checkbox"/> Cartooning |
| | <input type="checkbox"/> Lumber Dealer |

Name..... Age.....

Address.....

City..... State.....

Occupation.....

If you reside in Canada, send this coupon to the International Correspondence Schools Canadian, Limited, Montreal, Canada



Play "JAZZ"—on the Saxophone

Become a musician so quickly as to astound everyone. Learn by playing real music—instead of tiresome "exercises." You'll soon become the most popular person in your "set." Our easy method is a revelation. Nothing else like it for thoroughness and rapidity. So simple that young and old find it easy to play with amazing skill. No "trick music"—but actual notes learned quickly right in your own home.

FREE BOOK and Demonstration Lesson offer this wonderful musical opportunity. Send for them today before copies are exhausted. You'll be astounded by this easy, rapid way to become a veritable master of your favorite instrument.

U. S. SCHOOL OF MUSIC 79 Brunswick Bldg. N. Y. CITY

Put Professional SNAP into your



DANCING Why be stiff, awkward, amateurish, when it is easy to learn to dance correctly, beautifully, technically, by this remarkable new scientific method—The Dancegraph—in 10 easy lessons! Send only \$1.98 for complete course. 5 day trial. Money back if not satisfied. **Free Rumba Dance** with order. Mark X for course desired.

Ballroom Tango Tap and Clog
DANCEOGRAPH DANCE ART, Inc.
555 Sutter St., San Francisco, Calif.

LEARN Electricity By Actual Work at COYNE

Practical Shop Work. Average time to complete course 12 weeks. Free **ELECTRICAL REFRIGERATION** Course if you enroll now. Free Employment Service. Write today for **BIG FREE ELECTRICAL BOOK.**

COYNE ELECTRICAL SCHOOL, Dept. 62-72
590 South Paulina Street - - - - - Chicago, Illinois

SONG WRITERS

Don't fail to read "Song Requirements of Talking Pictures, Radio and Records" an explanatory, instructive book **SENT FREE on request.** New writers may mail song-poems for free examination. We revise, compose and arrange music, and secure copyrights, guaranteeing approval.

P. M. Newtomer Associates, 1674 Broadway, New York

"The TRUTH about VOICE"

SENT FREE No Obligation to Buy if you act quick—we will send you postpaid—for 30 days free reading—new Voice Book disclosing startling **FACTS** that may save hundreds of dollars to every man or woman seeking a strong, rich voice for either singing or speaking. 30 days free reading—then send \$1. Otherwise, return it.

Prof. E. Feuchtinger 308 North Michigan Avenue
Studio 13-58 Chicago, Ill.

"BECOME A LIGHTNING TRICK CARTOONIST"

Send \$1.00 for Laugh Producing Program of 20 Trick Drawings with Instructions. Catalog of Chalk Talk Supplies Free.

BALDA ART SERVICE, Dept. 1, Oshkosh, Wis.



Wonderful, new device, guides your hand; corrects your writing in a few days. Big improvement in three hours. No failures. **Complete outline FREE.** Write **C. J. Osment, Dept. 34, St. Louis, Mo.**

Would YOU Gamble 3¢ to Win a Body like Mine?

By CHARLES ATLAS

Holder of Title:
"The World's Most Perfectly Developed Man"

The most you can lose by mailing the coupon is a 3c stamp! The odds are all in your favor that you'll win a magnificent body of tremendous muscular power. *Dynamic-Tension* made my body as you see it here. It has given handsome, powerful bodies to my hundreds of pupils. Let me PROVE within 7 days that it can do the same for YOU! Mail the coupon for my Free Book.

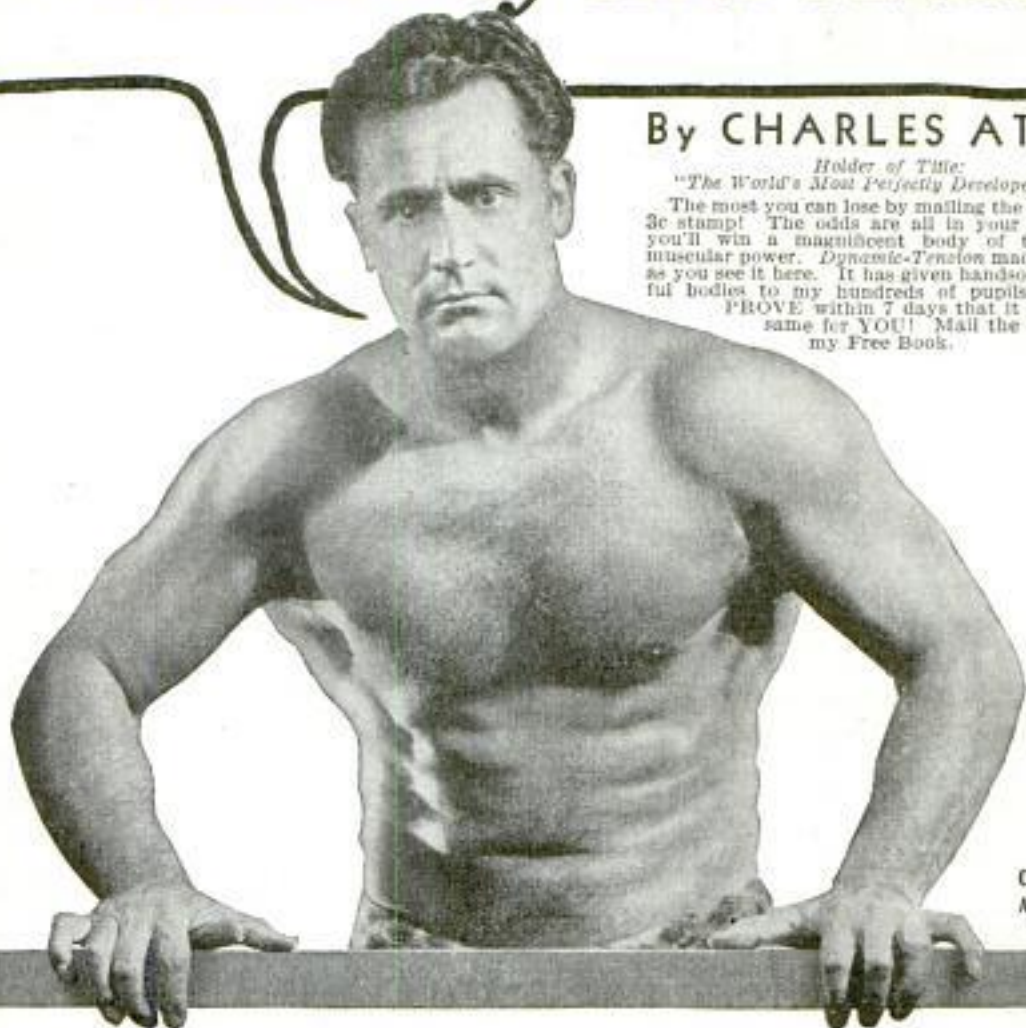

CHARLES ATLAS
As He Is Today

HOW does your body stack up against mine? Will you give me a chance to PROVE that my method, *Dynamic-Tension*, will do for you what it has done for me and hundreds of my pupils?

I'm so sure of what *Dynamic-Tension* can do that I can make you an Offer which other Physical Instructors don't DARE to make. I agree to show you definite results *in 7 days*, to give you conclusive PROOF *within* a week that I can transform you, too, into this NEW MAN of mighty energy and strength.

I used to weigh only 97 pounds. I was sick more than half the time. Then I discovered *Dynamic-Tension*. This system changed me from a weakling into the man who was acclaimed

in two international contests as "The World's Most Perfectly Developed man."

My *Dynamic-Tension* method works hand in hand WITH Nature. There's nothing artificial about it, no pills, special foods, or any tricky apparatus that may strain your heart and other vital organs.

"Everlasting Health & Strength"—FREE

Let me tell you all about it in my free book. You can win a body like mine, as my hundreds of pupils have done —by risking only a stamp to mail the coupon for my free book! Fill in the coupon *right now* and send it to me personally, CHARLES ATLAS, Dept. 8-Y, 133 East 23rd St., New York City.



CHARLES ATLAS

Dept. 8-Y,
133 East
23rd Street,
New York City.

I want the proof that your system of *Dynamic-Tension* will make a New Man of me —give me a healthy, husky body and big muscle development. Send me your free book "Everlasting Health and Strength."

Name.....
(Please print or write plainly)

Address.....

City.....

State.....

© 1932 C. A. Ltd.

When writing to advertisers please mention *Popular Mechanics*

Come to Los Angeles!

4 full courses at price of single course



LEARN RADIO-ELECTRICITY TELEVISION-TALKING PICTURES and BROADCASTING

Save money by enrolling in National Now. For single tuition fee, we now offer the four complete radio, electrical, television-talking picture and broadcasting courses. Four courses for price of one.

A bargain offer! No longer is it necessary to pay several tuitions. Now, for the first time in history, National offers complete training in Radio, Electricity, Television-Talking Pictures and Broadcasting all at single tuition fee for one course. When you enroll at National, these four full and unlimited courses of training will be given, enabling you to qualify for good jobs. We train you in four big pay trades; award you a life scholarship and help you to get a job that will start you on the road to BIG PAY and independence for the rest of your life. Individual, practical instruction. Right NOW, while jobs are almost impossible to "land" by the untrained man, you can get Training for the lowest tuition fee ever offered. This is a limited offer, but you must act NOW! Come to Los Angeles, the center of radio and electricity—and where the great American television laboratories are located—where hundreds of trained sound engineers and mechanics are employed in talking picture studios. Thousands of dollars invested in new training equipment, by National for you to work on.

Largest and Oldest Trade School in West

For 27 years National has successfully trained men by practical shop methods. Previous education unnecessary. More than 25,000 graduates.

Railroad Fare Allowed to L. A.

For a limited time we will allow coach railroad fare to Los Angeles from any point in the United States. This is deducted from tuition, so the trip costs you nothing.

FREE EMPLOYMENT SERVICE

Spare time jobs while at school. We help you get a job to pay living expenses while learning. Our unlimited employment service will help you get a JOB after you graduate. Four delightful months of training and you are qualified.

NATIONAL RADIO & ELECTRICAL SCHOOL

Including Television, Talking Pictures & Broadcasting
Dept. 94-E, 4006 S. Figueroa, Los Angeles, Cal.

MAIL THIS COUPON FOR FREE DETAILS

This coupon will bring you our big, free training book if you are interested. It gives full details of the 4 big courses—radio, electrical, television-talking pictures and broadcasting; also details about railroad fare offer.

Name.....

Address.....

Town..... State.....

When writing please mention Popular Mechanics

GOOD POSITIONS

IN
HOTELS
CLUBS
SCHOOLS
COLLEGES
HOSPITALS
RESTAURANTS
INSTITUTIONS

Well-paid opportunities for trained men. Luxurious surroundings, salaries of \$1,800 to \$5,000 a year, living often included. Previous experience proved unnecessary. National Employment Service FREE of extra charge.

Write name and address in margin, check positions in which you're interested and mail today for FREE Book.

() Manager () Auditor
() Assistant () Chief Engineer
Manager () Room Clerk
() Steward () Purchasing Agent
() Sports Director () Chief Clerk

LEWIS HOTEL TRAINING SCHOOLS
Room EP-344 Washington, D. C.



LEARN TO WELD AT HOME

We send you this Complete Outfit with Greatest Course of Instruction ever offered. Get in business for yourself quickly. Steady work and big profits in fast-growing industry. Pay us weekly while you learn.

NEW ATTRACTIVE SUMMER PRIZE
Write now for full particulars.
Coleman Electrical School
1620-Y Main St. Kansas City, Mo.

HOT PIANO



Ultra-modern Piano
Jazz taught by mail. Note or ear. Easy rapid lessons for adult beginners. Also Self-instruction system for advanced pianists. Learn 358 Bass Styles, 976 Jazz Breaks, hundreds of Trick Endings, Hot Rhythms, Sock, Stomp and Dirt Effects; Symphonic and Wicked Harmony in latest Radio and Record Style. Write for Free Booklet.

WATERMAN PIANO SCHOOL, 1828 N. Adams St., Los Angeles, Calif.

LEARN WATCH REPAIRING



AT HOME You can learn by our modern and original system of instruction every part of the Watch Repairing Trade at home as good or better than at a shop. You can earn money while learning and secure a well paying position or start in business after completing our course of instruction. Good watch repairers are always in demand and earn from \$50 to \$75 per week. For particulars apply to the Wisconsin School of Watch Repairing
824 E. Mason St., MILWAUKEE, WIS.

ELECTRIC REFRIGERATION LEARN AT HOME IN SPARE TIME

Prepare for jobs in installing, servicing, engineering, etc. Practical home training endorsed by Kelvinator, Copeland, Servel, etc. Earn up to \$35 and \$75 a week. Easy to learn. Low fee, easy terms. Free Employment Service.

FREE BOOK If you are mechanically inclined and employed at present, send for "Rich Rewards in Electric Refrigeration." Write NOW! Utilities Engineering Institute, Dept. 192, 484 N. Wells St., Chicago, Ill.

For as little as

\$5 down and \$5 a month

you can have the Britannica in your home for daily use
Write for particulars and 62-page FREE Booklet

Encyclopaedia Britannica, Inc., 342 Madison Ave., New York

CRIME DETECTION
SECRET SERVICE
AND
FINGER PRINTS

SECRET SERVICE BOOK
FREE

Sent to you

For 30 Days Reading
No Money Down—Actual Crime Cases—
If You Act Quick!—We will send you this stirring
book on Crime Detection, Secret Service and Identification
Work for 30 days free reading. Send no
money. If you decide to keep it, then send only
\$1.00. If not, return it. WRITE TODAY. Not
sent to boys under 17 years of age.

T. G. Cooke, Book Dept. 13-56 1920 Sunnyside Ave., Chicago

The Season's Big Radio Sensation!

16-TUBE ALL-WAVE

only



39.95

Completely Assembled with Large DUAL SPEAKERS

All the NEW 1933 Features

WHAT a radio! One complete 16-tube chassis with one dual-ratio dial — new Super-Heterodyne circuit with a range of 15 TO 550 METERS—No plug-in coils—No trimmers—Large acoustically matched Dual Speakers—New CLASS "B" PUSH-PUSH Super Power Amplifier with six times the power of ordinary tubes—Full band AUTOMATIC VOLUME CONTROL — COLOR-LITE Multi-Wave Band Selector — STAT-O-MIT TUNING SILENCER — Full FLOATING VARIABLE CONDENSER — Complete Scientific Shielding—Absolute tone fidelity—Image Frequency Suppressor—Fractional Microvolt

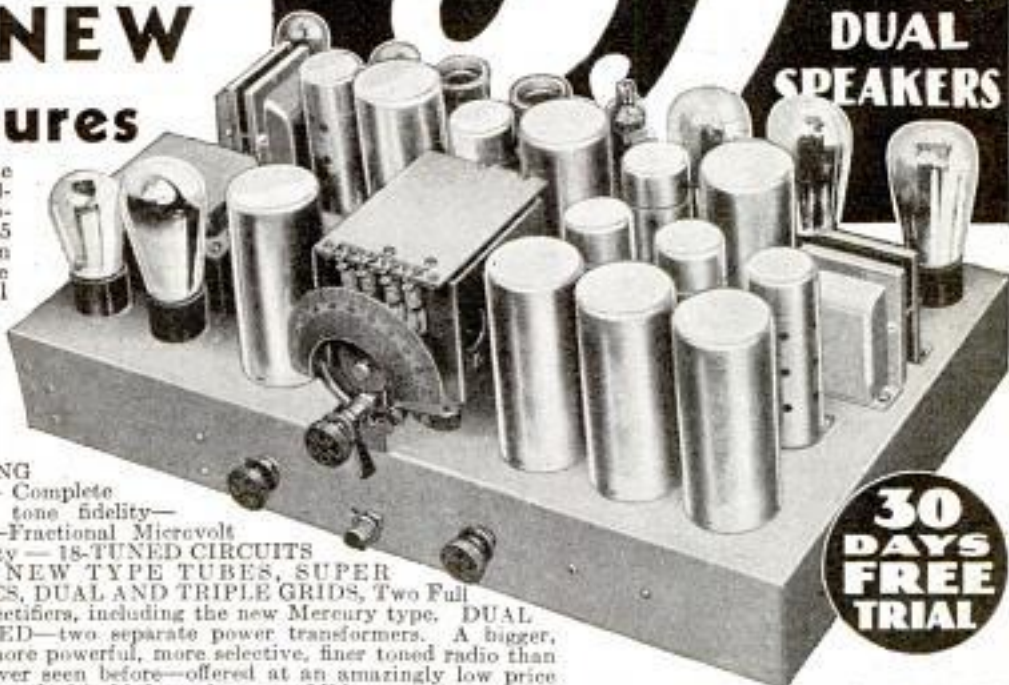

30 DAYS FREE TRIAL

Sensitivity — 18-TUNED CIRCUITS — ALL NEW TYPE TUBES, SUPER TRIODES, DUAL AND TRIPLE GRIDS, Two Full Wave Rectifiers, including the new Mercury type, DUAL POWERED—two separate power transformers. A bigger, better, more powerful, more selective, finer toned radio than you've ever seen before—offered at an amazingly low price direct from the big Midwest factory. Midwest engineers have far outdistanced all past performances in perfecting this new set.

Deal Direct with Factory! —SAVE UP TO 50%

Don't be satisfied with less than a Midwest 16-tube A.C. radio. A receiver covering only the regular broadcast waves is only half a set. Improvements in short-wave programs have made ordinary broadcast sets obsolete. The Midwest gives you regular, foreign, police and amateur broadcasts in one single dial set. No converter or any extra units required.

Investigate! Mail the coupon. Get the Midwest catalog. Learn the facts about Midwest 9, 12 and 16-tube ALL-WAVE sets. Learn about our sensationally low factory prices, easy payment plan and positive guarantee of satisfaction or money back.

TERMS as Low as \$5 DOWN

Read This!

Just one of thousands of letters praising Midwest Radios.

Gets France, Spain, Italy, Japan

"Have received foreign short-wave stations such as FYA, France; RAQ, Madrid, Spain; 12 RO, Rome, Italy; and last but not least, J1AA, Tokyo, Japan. I really think the Midwest set is a miracle." A. F. GRIDLEY, Sarasota, Fla.

Don't buy any radio until you get the big new Midwest catalog. Just sign and mail the coupon or send name and address on a postal.

Remember, you buy DIRECT FROM THE MAKERS. No middlemen's profits to pay. You get an absolute guarantee of satisfaction or money back. You try any Midwest 30 DAYS before you decide to keep it. Then, if you wish, you can pay in small monthly amounts that you'll scarcely miss. Mail coupon for full details or write us a postal.

RUSH THIS COUPON FOR AMAZING FREE TRIAL OFFER AND BIG BEAUTIFUL CATALOG

Midwest Radio Corp., Dept. 95, Cincinnati, Ohio.

Without obligation on my part send me your new 1933 catalog and complete details of your liberal 30-day free trial offer. This is NOT an order.

User Agents Easy EXTRA MONEY! Check here for details.

NAME.....
ADDRESS.....
TOWN.....
STATE.....



COMPLETE LINE OF CONSOLES

The big new Midwest catalog shows gorgeous line of artistic consoles in the new styling designs. Mail the coupon now. Get all the facts. Learn how you can save 20% to 30% on a big powerful radio by ordering direct from the factory.

BATTERY RADIOS

Using the New AIR CELL BATTERY

Two essential values: a 4 tube super-bat for standard wave reception and a 9-tube ALL-WAVE, both using the new AIR CELL "A" battery that never needs recharging. Low factory prices. Coupon brings details. Mail to 909/1.

MIDWEST RADIO CORP.

Dept. 95

(Est. 1920)

CINCINNATI, O.

When writing to advertisers please mention Popular Mechanics

Two Years
ago a
traveling
agent—



Now He Heads
His
Own Business!

In 1928, Charles T. Spencer, now head of the Spencer Agencies, Winnipeg, was traveling over western Canada as agent for an insurance company—earning a very modest salary.

Several years before, he had learned of LaSalle training—had investigated it—and had put it off, planning always to do it tomorrow. Finally, he awoke to the fact that in thus doing, he was simply putting off a better job and more money. Then as he writes, "I decided to put it over instead, and I enrolled with LaSalle for training in Modern Salesmanship.

"Before completing the training, my earnings increased 33½ percent, and the knowledge derived, plus the confidence gained, soon enabled me to strike out for myself.

"I now have my own successful insurance business, and naturally cannot afford to take chances. I am, therefore, working now on LaSalle's Business Management training.

"As a two course member of LaSalle, I think I am in a position to judge its great worth, and for the man who is dissatisfied with his present earnings, I should urge him to put it over instead of putting it off."

Set Your Goal—Then Start Today

In what field do you hope to gain success? Study the coupon below—then check the training that most clearly meets your needs, enter your name, address and present position, and mail the coupon to LaSalle.

It will bring you promptly—and without obligation—an interesting book descriptive of that field, together with a copy of "Ten Years' Promotion in One," the inspiring story that has set Spencer and thousands of men on the shorter route to greater earning power.

Show your will to succeed by what you do with this coupon—NOW.

----- Find Yourself Through LaSalle! -----

LA SALLE EXTENSION UNIVERSITY

The World's Largest Business Training Institution
Dept. 964-R Chicago

Gentlemen: Send without obligation to me information regarding course indicated below.

- | | |
|---|---|
| <input type="checkbox"/> Business Management | <input type="checkbox"/> Law: Degree of LL. B. |
| <input type="checkbox"/> Modern Salesmanship | <input type="checkbox"/> Commercial Law |
| <input type="checkbox"/> Higher Accountancy | <input type="checkbox"/> Modern Business Correspondence |
| <input type="checkbox"/> Traffic Management | <input type="checkbox"/> Modern Foremanship |
| <input type="checkbox"/> Railway Station Management | <input type="checkbox"/> Personnel Management |
| <input type="checkbox"/> Railway Accounting | <input type="checkbox"/> Expert Bookkeeping |
| <input type="checkbox"/> Telegraphy | <input type="checkbox"/> C. P. A. Coaching |
| <input type="checkbox"/> Industrial Management | <input type="checkbox"/> Business English |
| <input type="checkbox"/> Banking and Finance | <input type="checkbox"/> Commercial Spanish |
| <input type="checkbox"/> Credit and Collection | <input type="checkbox"/> Effective Speaking |
| <input type="checkbox"/> Correspondence | <input type="checkbox"/> Stenography— |
| <input type="checkbox"/> Paper Salesman's Training | <input type="checkbox"/> Stenography |

Name..... Age.....

Present Position.....

Address.....

New York Electrical School

teaches PRACTICAL ELECTRICITY
by its own distinctive method of

"Learn by Doing"

No previous preparation or electrical knowledge is necessary. Every step is guided by expert instructors. Individual attention.

SPECIAL COURSES IN
AUTO MECHANICS AND AUTO
ELECTRICITY

Day and evening classes open all year.
Start any day.

Write for FREE School Booklet.
Visitors Welcome

New York Electrical School

Established 1902 44 West 17th St., N. Y.

FREE The Book That has helped Thousands get Government Jobs!

Just send your name and address for my 32-page book, "HOW TO SECURE A GOVERNMENT POSITION." Tells all about CIVIL SERVICE: If you are a citizen, 18 to 30, you can get a steady government job at \$1850 to \$3300 a year. I was official examiner for 8 years. You pick the job you want; I'll help you get it. Get ready NOW for the next Railway Postal Clerk Examination! Write today for a copy of my Free book. Address

A. R. PATTERSON, Civil Service Expert,
89 Wisner Building, Rochester, N. Y.



GET INTO ELECTRICITY

FREE
ELECTRICAL
REFRIGERATION
COURSE

If you enroll now I'll include my big new Refrigerator Course absolutely FREE

BY ACTUAL WORK IN THE
GREAT COYNE SHOPS

Say fellows, if you're making less than \$50 a week I've got a message for you. I'll take you in my shops here at Coyne for 12 weeks and I'll give you a training that will put you in a big pay field. I'll give you this training on actual electrical machinery by my Learn by Doing method. You don't need advanced education or previous experience. Many earn while learning. Free employment service for life. Mass coupon today for all the facts and my big Free Book.



M. C. Lewis, Pres., COYNE ELECTRICAL SCHOOL
500 S. Paulina St., Dept. 62-72C, Chicago, Ill.
Dear Mr. Lewis: Please send me your big Free Book.
Name.....
Address.....
City..... State.....

When writing to advertisers please mention Popular Mechanics

WANT A STEADY JOB?

TRAVEL for "UNCLE SAM"



MANY OTHER U. S. GOVERNMENT POSITIONS STEADY WORK

MEN—BOYS 18 TO 50

Short Hours Pleasant Work
Rapid Advancement Permanent Employment

Mail Coupon Now. Act at Once.

DO IT TODAY, TOMORROW YOU MAY FORGET.

Name

Address

FRANKLIN INSTITUTE, Dept. A174, Rochester, N. Y.

Rush to me entirely free of charge: 32 page book, with list of Post-depression U. S. Gov't Jobs and particulars telling how to get the job here checked.

..... Railway Postal Clerk	(\$1900-\$2700)
..... Post Office Clerk	(\$1700-\$2300)
..... City Mail Carrier	(\$1700-\$2100)
..... Rural Mail Carrier	(\$2100-\$3400)
..... Prohibition Agent	(\$2300-\$2800)
..... Inspector of Customs	(\$2100-\$3300)
..... Immigrant Inspector	(\$2100-\$3000)

VALUABLE COUPON

CHIROPODY

A PROFESSIONAL EDUCATION

High School Education or State Department of Education equivalent required for admission. High scholarship standards, modern instruction, wide recognition, complete scientific equipment, three buildings, Foot Clinics treating 30,000 annually. Excellent faculty of chiropodists, physicians, surgeons, chemists, orthopedists. 20th year; College privileges. Degree: Doctor of Surgical Chiropody. For bulletin write Department 2148

ILLINOIS COLLEGE OF CHIROPODY AND FOOT SURGERY

1327 North Clark Street, Chicago, Illinois

ENGINEERING and ARCHITECTURE

INTENSIVE PRACTICAL TECHNICAL COURSES in Electrical, Mechanical, Structural, Architectural Engineering. Degree in 2 yrs, diploma in 1 yr. Also shorter courses in Electricity, Power Plant, Radio, Television, Electric Refrigeration, Drafting, Welding. Non-essentials eliminated. LOW TUITION. Expert instructors. Extensively equipped laboratories. Free life-time employment for graduates. Part-time work during attendance. 32nd year. Write for catalog. FINLAY ENGINEERING COLLEGE

1001 A Indiana Avenue

KANSAS CITY, MO.



CHEMISTRY

COMPLETE, practical home-study courses prepared by some of the best-known chemists in this country, including ALLEN ROGERS, B.S., M.S., Ph.D.—Head of Department of Industrial Chemistry, Pratt Institute; L. M. TOLMAN, Ph.D.—Formerly Chief Chemist, Wilson & Co. Now Vice-president, United Chemical and Organic Products Co.; BRADLEY STOUTON, B.S.—Head of the Department of Metallurgy, Lehigh University, and OWEN L. SMITH, Ph.D.—Professor of Applied Chemistry, University of Pennsylvania.

INTERNATIONAL SCHOOL OF CHEMISTRY

Associated with the International Correspondence Schools
Box 5619-G, Scranton, Penna.

Without cost or obligation, please send me full details of your home-study course in—

- Analytical Chemistry Metallurgical Chemistry
 Chemical Engineering Short Chemistry Course
 Industrial Chemistry Pharmacy

Name

Address

PATENTS

Protect Your Ideas

If you have a useful, practical, novel idea for any new article, or for an improvement on an old one, you should communicate with a competent Registered Patent Attorney at once. Every year thousands of applications for patents are filed in the U. S. Patent Office.

Frequently two or more applications are made for substantially the same idea (though inventors may be entirely unknown to one another). In such a case the burden of proof rests upon the last application filed. Delays sometimes mean the loss of a patent. So lose no time. Get in touch with me at once by mailing the coupon below.

No Charge for Information on How to Proceed



INVENTORS

Write for this FREE

Book The booklet shown here contains valuable information

relating to patent procedure that every inventor should have. And with it, I will send you my "Record of Invention" form on which you can sketch your idea and evidence its date before witness. Such evidence may later prove valuable to you. Simply mail the coupon and I will send you the booklet and the "Record of Invention" form, together with detailed information on how to proceed and the costs involved.

CLARENCE A. O'BRIEN REGISTERED PATENT ATTORNEY WASHINGTON, D. C.

19-A, Adams Building, Washington, D.C.
Please send me your free book "How to Obtain a Patent," without any cost or obligation on my part.

Name

Address

City State

When writing please mention Popular Mechanics

Classified Advertisements

WORLD'S BEST WANT AD MEDIUM

Advertisements in this section, 35 cents per word, each insertion, minimum 10 words, payable in advance
To be inserted under proper classification in October issue, copy should be in our office August 18th

ADVERTISING AGENCIES

ADVERTISE—Bargain value—24 words in 24 representative Sunday newspapers \$15; Free assistance with your ads, sales letters, literature. Helpful Ad-Guide showing best paying newspapers, magazines, rates, mailing lists, etc., free. Chicago Union Agency, Great Northern Bldg., Chicago.

ADVERTISE in rural weeklies. Lists free. Meyer Agency, 4112 Hartford, St. Louis, Missouri.

FREE—New 1932 Advertisers Rate Guide, 44 pages. Includes everything. Lowest rates. K. H. Brown Advertising Agency, 140 S. Dearborn, Chicago.

FOR ADVERTISERS

SAVE Money on your advertising. Write for big combination offer. Bucknam, 177 State Street, Boston, Mass.

24 WORD Ad 60-85 weeklies, \$3.98. Stamp brings list; dollar coupon. Stout, Warm Springs, Ga.

ADVERTISE 53 Magazines, 3 months, \$6.00 incl. List, special offers, free. Evans King Co., Box 672P, Wilmington, Delaware.

ADVERTISING—20 Words, 50 magazines, 60c; three insertions, \$1.20. Inch display, three months, \$6.00; year, \$24.00. Mailing Bureau, Lawndale, Calif.

INCH Ad in 10,000 opportunity directories, \$1.00. Sample directory 10c. Nepco, Roseland, Fla.

MAILING LISTS

AGENTS—Opportunity seekers directory, 250 names, 10c. Nepco, Roseland, Fla.

FREE Catalogue guaranteed mailing lists, lowest prices. Carl Torrey Company, Marblehead, Mass.

SALES PROMOTION

SALES Letters that sell. \$3.00 each; or plus \$2.00 to one of your sales letters, send to us today and we'll revise and re-write. Chamon Salesletter Service, Suite 206-7 Jergin's Trust Bldg., Long Beach, California.

INFORMATION

INSTRUCTION At home or camp or wherever you are. Lessons in all subjects and suited to your individual needs by regular teachers of highest reputation. Fees, \$1 per month for each subject. Write and tell us your troubles. Prof. Wm. F. Tarnhill, Room 619, 7 East 42nd St., New York, N. Y.

ANY information desired 25c coin and up. Fred Klotz, Reading, Pa.

AUTOMOBILES

AUTOMOBILE Racing book. How to build dirt track racers, championship racers, fast road cars. New, 10 chapters, 137 illustrations, track records, winning drivers, contest rules, speed, "rest," balance—Postpaid \$1.00. Ray Kuns, Dept. B, Madisonville, Cincinnati, Ohio.

PATENTS—Small ideas may have large commercial possibilities. Write immediately for free book, "How to Obtain a Patent" and "Record of Invention" form. Delays are dangerous in patent matters. Free information on how to proceed. Clarence A. O'Brien, 58-M, Adams Building, Washington, D. C. See page 125A.

FRONT Wheel shimmy removed in fifteen minutes. No parts to replace. Instructions 25c. Love, 282 E. Center St., Orange, N. J.

AUTOMOBILE SUPPLIES

BARGAINS—Excellent reprocessed compressors, battery chargers, test benches, car washers. Terms, Trial. Write Ken's Automobile Service, Box M-922, Troy, Ohio.

FUN Shocking people who touch your car. A personal protection while in car. Instructions with illustrations tell how. \$1.00. Austin, Box 2504, Tampa, Florida.

NICKEL Plate your auto, faucets, hardware without removing parts. Our outfit connects to your battery, no tank is used. \$1.00 pre-paid. Write for free particulars. Gunmetal Co., Ave. J, Decatur, Ill.

RADIATORS—Guaranteed. All standard makes. Save 40% to 75% buying at wholesale prices. Give models. Write for prices. Independent Radiator Co., 1119 So. Wabash, Chicago.

AUTO SERVICE EQUIPMENT

"PRICES Slashed." Garage supplies, auto accessories, household equipment, store specialties, etc. Write us first. Wholesale only. Keystone Service, 75 E. Eagle St., Buffalo, N. Y.

SUBSTANTIAL Savings—reprocessed compressors, battery chargers, test benches, car washers. Terms, Trial. Write Ken's Automobile Service, Box M-922, Troy, Ohio.

MOTORCYCLES, BICYCLES AND SUPPLIES

USED Motorcycles and parts, all makes, lowest prices, 50 motorcycles to choose from, motors rebuilt, save money. Send 25c for catalogue. Mid-City Cycle, 1110 Jackson, Chicago, Ill.

USED Motorcycles and parts. Circulars 5c. Tesser Cycle, 4165 Prairie, St. Louis, Missouri.

HENDERSON, Excelsior, Harley, Indian, used parts, conversions. Catalogue and wings pin 10c. Ballak, 100 N. 12th, St. Louis, Mo.

REPAIR With good used parts, save 1/2 or more, state parts needed, no lists. J. B. Dahl, 2681 Archer Ave., Chicago, Ill.

"JUST Off the press"—New catalogue, 12 used bargains—New low prices. Send 6c stamps. Knuths', 2525 Fond du Lac Ave., Milwaukee, Wis.

SEND 15c For Illustrated used Motorcycle catalog. Large stock. Bargains. Indian parts. Accessories. Indian Motorcycle Sales, Kansas City, Mo.

MOTORCYCLE Bargains. Lowest prices, bargain sheet for stamp, motorcycle accessories, largest line in America, lowest prices. Largest motorcycle mail order house in the United States. Rochester Harley Davidson Corporation, 129 West Main St., Rochester, N. Y.

BATTERIES

EDISON Lighting plant storage batteries. Non-acid, non-sulphating. Odorless. Guaranteed 15 year life. Lowest prices. Lighting plant, motor bargains, interesting literature. R. Hawley Smith, 22 Washington Ave., Danbury, Conn.

GENUINE Edison batteries for farm and boat lighting systems. Cheaper than lead. Free illustrated literature. See Jay Battery Company, 82 Sterling Avenue, Yonkers, New York.

AVIATION

QUICK Sale: Buhl six-place Alredan; almost new; Wright J-6 300; price \$3,500. Buhl eight-place Alredan, excellent condition; powered with Cyclone type R1750E, price \$2,750. Used Bull Pups from \$450 each. Box 245, RR No. 2, Buhl Field, St. Clair, Michigan.

BUILD Karl gliders, simplest construction, blueprints \$1.00. Gliders, 61 Fifth Ave., Ottawa, Canada.

BARGAINS—J-5 Propellers, Saekely engines and parts, 5 cylinder Warner engine, new Continental A40, new aircraft material all descriptions. Box 245, RR No. 2, Buhl Field, St. Clair, Mich.

SPRUCE—Finished to size for airplanes, gliders, lifeboats. Highest quality. Lowest prices. Mail sizes for quotation. Pike-Dial Lumber Co., 2257 Loomis, Chicago.

LEARN To fly where Lindbergh learned at this flying school with highest government approval. Airplane mechanics school connected with aircraft factory. Big opportunity—write today for complete information. Lincoln Flying School, 2003 Aircraft Building, Lincoln, Nebraska.

PATENTS—Small ideas may have large commercial possibilities. Write immediately for free book, "How to Obtain a Patent" and "Record of Invention" form. Delays are dangerous in patent matters. Free information on how to proceed. Clarence A. O'Brien, 58-M, Adams Building, Washington, D. C. See page 125A.

BIG New catalog of lowest prices on model airplanes. Materials, supplies 5c. Ideal Company, 19 West 18th Street, New York.

WRITE For free sample of balloons and kite list. Aero Shop, 3054 Huribut Ave., Detroit, Mich.

BOATS, OUTBOARD MOTORS, ETC.

BOATS!!! Build your own boat now, taking advantage of your spare time and save two-thirds regular builders cost using our ready-cut semi-assembled materials. Cruisers, runabouts, outboards, sail and row, 38 designs as well as complete assortment fittings. Send 10c for catalog. Brooks Boat Co., Inc., Box B20, Saginaw West Side, Michigan.

BUILD A boat from Welch parts. Send 10 cents for catalog. 44 models, boat hardware and equipment. Buy direct from factory and save money. Welch Boat Company, 3142C North 31st Street, Milwaukee, Wis.

BOATBUILDING Plans—20 foot cruiser-runabout—Rudder July and August 70c. Free catalog. Rudder, 15 Murray Street, New York.

NEW Racing hull for class C hydroplane. Recently perfected design gives great increase in speed. Special three point suspension insures stability at all speeds and faster speed on turns. Length 13'6"; width 4'6". Blueprint, \$1.00. Marine Service, Inc., 3207 Detroit Street, Flint, Michigan.

PROPELLERS. Gear pumps, stuffing boxes, bearings, etc. Wm. Baker, Pond St., Quincy, Mass.

BUILD A boat from Welch parts. Send 10 cents for catalog. Shows 44 models, boat hardware, canvas adhesive cement, waterproof glue, plastic caulking cement, etc. Buy direct from factory and save money. Welch Boat Company, 3142C North 31st Street, Milwaukee, Wis.

BRAND New Indian outboard motors half price—\$85. Few left. Crandall-Hicks Co., 780 Commonwealth Ave., Boston, Mass.

ARCHERY

BEST Woods for the finest bows and arrows are plentiful in the Missouri Ozarks. Here, in America's largest plant, exceptional "old time" master woodcrafters produce the most scientifically accurate archery equipment...you get the best at low cost. Send 4c today for instructive new catalog "H-1." Dealers—write for most attractive discounts and new sales plan. Outdoor Amusement Co., Clinton, Mo.

CHALK TALKS

LAUGH Producing program, \$1.00. Catalog free. Balda, The Cartoonist, Oshkosh, Wis.

BOOKS AND PERIODICALS

HUNDREDS Unemployed panning gold! Youth pans \$1700 gold in 45 days. Another \$6555 in 5 days. Big placer-deposits still untouched. Learn prospecting—placer mining. New Illustrated (copyrighted) treatise; covers everything, panning, sluicing, locating, etc.; also gives maps showing localities; reported earnings, rich stakes. Only \$1.00 postpaid. Frelch, A-5842 Highland, St. Louis, Mo.

BOYS. Subscribe to "Boyhood." Sample 5c. Vana Press, Box 13, Utica, N. Y.

NOW Ready—"Poorman's Modern Gold Mining and Prospecting Methods," with pay-dirt localities, maps, "digging" data, West, Alaska. Thousands waiting for this large, illustrated, indispensable book. Includes small-scale quartz, placer-mining apparatus—understandable prospecting lore. Postpaid \$2.00. Outdoorhams Bookery, Box 652, Coeur d'Alene, Idaho.

FOR BOYS

HARMONICA Instructor, (16 pages) 25c. Play in one hour. G. Elisea, Bowling Green, Ohio.

GAMES, ENTERTAINMENTS AND PLAYS

PLAYS, Operettas, musical comedies and minstrels, comedy and talking songs, black-face skits, vaudeville acts, monologs, dialogues, recitations, juvenile plays and songs, musical readings, entertainments, make-up goods. Catalog free. T. S. Denton & Co., 623 So. Wabash, Dept. 11, Chicago.

MAGIC TRICKS, BOOKS AND JOKER NOVELTIES

LYLE Douglas' new 240 page magic catalog now ready. One of world's largest, containing many new tricks at lowest prices. 25c copy. Quarter refunded first dollar order. Send today! Lyle Douglas, Station A-4, Dallas, Texas.

PICTURE Puzzles, Materials and Instructions. Details for stamp, Puzzle Makers, Colorado Springs, Colo.

MYSTERIOUS Jumping fleas 15c, hula dancer 15c. Catalog 5c. Reeder, 733 4th Ave., Clinton, Iowa.

MAGIC Handbook and catalogue, just published. Valuable information, new ideas and more, price 25c. Ireland Magic Company, 431-PM No. Clark, Chicago.

GREEN Bungalow picture puzzles. Literature, samples free. Leonard Goodall, Warrensburg, Missouri.

MAGIC Catalogue, Wonderful knockout cardtrick, Dime, Singer, 535, Hancock, Wisconsin.

MAGIC Tricks, catalog 10c. Geo. Fenner, 2401 Jefferson, Louisville, Ky.

MAGIC Catalog 20c, Lynn, 195 Beach, Dept. 3, Jersey City, N. J.

SPHINX, Magiclans' magazine, 35c. Large illustrated catalog of magic, 25c. Holden, 235 W. 42nd St., N. Y.

RADIO SETS AND SUPPLIES

GUARANTEED Microphone repairs—Any make or model—24-hour service. Stretched diaphragm double button repairs \$7.50. Others \$3.00. Single button repairs \$1.50. Write for 1932 catalog with diagrams. Universal Microphone Co., Ltd., Inglewood, Calif.

SHORT Wave construction kits, sets, supplies. Wholesale catalog, 10c. Federal Radio, 4220 Clifford Road, Cincinnati.

EDISON Element storage "B" batteries for radio, 140 volt unit, \$8.00. Other sizes. Free literature. See Jay Battery Company, 82 Sterling Avenue, Yonkers, New York.

SHORT Wave converters—10,000 miles reception possible; smooth operation. \$3.95 with order, balance \$5.00 C.O.D. Mango Short Wave Laboratories, 325 S. Orange Ave., Newark, N. J.

SENSATIONAL, "Pocket radio," \$2.00. Catalogue, 10c. Nell Tasker, Shamokin, Pa.

1 TUBE Load speaker radio or B power park for auto radio, Diagram and instructions 25c. Charles Styl, 5056 Caniff, Detroit, Mich.

STAMP COLLECTING

STILL Biggest Dollar—1000 mixed U. S. containing over 100 different varieties for 75c; 1000 mixed foreign for 25c; 100 different British Colonies for 25c; 100 different French Colonies for 25c; 100 different Latin-Americans for 25c; 100 different stamps from 50 different countries for 15c; and 1000 hinges. All above for only \$1.00. New England Stamp Co., Inc., Est. 1893, 53-P Bromfield St., Boston, Mass.

APPROVALS to fit Scott's Junior Albums will be sent to serious collectors on application. New England Stamp Co., Boston, Mass.

OUR 3rd Edition 1932 U. S. price list is now ready. New England Stamp Co., Boston, Massachusetts.

TWENTY-ONE Unusual old stamps from seventeen Central, South American countries, including triangles. 7c. Approval applicants. Military Stampco, Box 245, Post San Houston, Texas.

FREE: For many years collectors have looked for an intelligent guide book on stamps. "The Lore of Stamp Collecting," our new illustrated booklet, is just that and more. It tells exactly how to derive the greatest benefits from your collection, what stamps are most profitable to collect, how to judge values of stamps and a wealth of interesting facts, information and stamp stories, etc. No book, even those selling as high as \$5.00, is more to the point, or offers as many benefits to the collector. We will send it free to approval applicants who send 5 cents to cover mailing expenses. Globus Stamp Co., 268-4th Ave., New York.

SCARCE Airmail and triangle. Beautiful Uruguay "flying horse" airmail and scarce Guatemala triangle (smallest in the world) are included in our big packet of 60 different stamps from Abouites, Grand Liban, Venezuela, British and French Colonies, etc. All for 5c to approval applicants. Big illustrated lists free with each order. Write today! Mystic Stamp Co., (Dept. 80), Camden, New York.

IMMENSE Triangle stamp! The largest in the world, an album giant (Spain 1930 Columbus commemorative) included in amazing packet of thirty-four scarce varieties from queer far-off lands: Rodi, Kouang-Teheou, Gwallor, etc. Absolutely no common European varieties to mar the high quality of this wonderful packet. Only 10c (coin) to approval applicants. Vogue Stamp Co., Dent, P. 3, Port Chester, N. Y.

500 DIFFERENT Stamps for 30c. Big collection including Argentina, Andorra, Fiume, Spanish Morocco, Kenya, Liberia, Memel, Nigeria, Quelimane, Syria, Victoria, Vatican City and other hard-to-get countries. Catalog value over \$10.00. Price only 30c to approval applicants. Illustrated lists free. Loma Stamp Company, 4231 42nd St., San Diego, Calif.

100 DIFFERENT Foreign stamps from 100 different foreign countries, including Africa, Asia, Australia, Europe, West Indies, etc., for only 20c. Free with each order, our pamphlet telling "How to Make a Stamp Collection Properly," together with our price list of albums, supplies and hundreds of bargains in sets, packets, etc. Queen City Stamp Co., Room 35, 604 Race St., Cincinnati, Ohio.

U. S. 4000 Unpicked, many bi-centennials, 55c. Returnable. Carpenter, Wyalusing, Wisconsin.

NEW Manchurian stamps—Send one dollar. Japan Stamp Company, Kobe, Japan.

QUALITY Stamps on approval 1/2c up. Free premium. Keigwin Stampco, Vineland, New Jersey.

ANCHER'S \$\$\$ Outfit—only 12c. Fine triangle stamp, set German stamps (pre-war) value millions dollars, perforation gauge and mme. scale, airmail set, interesting stamp smallest republic, newspaper set, packet good stamps Travancore, Malay, Dutch Indies, etc., fine pocket stock book. Entire outfit 12c to approval applicants. Ancher Stamp Company, Rutherford, N. J.

24 VARIETIES Cuban stamps, 10 cents. List of stamps free. Chambers Stamp Co., 111P, Nassau, New York City, N. Y.

ONLY 5c. 33 Different stamps including scarce Latvian triangular airmail stamps, 10 airmail, 12 United States (early issues, commemoratives, etc.) and 10 Canada. Approvals and illustrated pricelist sent with each order. Curhan Stamp Company, Gloucester, Mass.

PACKET Triangles, German Neuguinea, Altutaki, Tanganyika are just few of the many dandies in our wonder lot. All for only 10c to approval applicants. Stone, 4317 Vermont, Los Angeles, Calif.

FREE—Two diff. unused U. S. Commemoratives, with surprise packet 15c only. To general approval applicants. Geo. Haba, Colfax Ave., Roselle Park, N. J.

100 DIFFERENT 10c Approvals. Wood Stampco, 2015 Stafford, Pittsburgh, Pa.

1000 MIXED U. S. old and new 25c. Weatherby, Elyria, Ohio.

ABSOLUTELY Free! Brunel (Native Scene), Tanganyika, Grenada, Nyasaland Protectorate, Kedah, Charkhari, Weird Corea, Johore, and scarce genuine Baden. This splendid packet free to those requesting our famous approvals and enclosing 3c postage. Viking Stamp Co., Sheepshead Bay Station, Brooklyn, N. Y.

FREE 100 Different stamps to approval applicants. John Cooley, Fishers Island, N. Y.

FREE—Thrilling jungleland packet! Iraq (Winged Bull), Tunis (Fighting Arab), Liberia (Jungle Village), Congo (Explorer Stanley), many others, also lists, valuable coupons, dandy penny approvals—everything 4c postage. Midwood Stampco, Midwood Station, Brooklyn, N. Y.

BUILD A worthwhile stamp collection of rare items, a collection that will be of real value, without spending a cent of your own money. Write at once for agents' plan. Large commission in good stamps. Stamp Collectors Service, 534 Douglas Bldg., Los Angeles, Calif.

FREE—50 All different rare airmail stamps worth \$3.00 to regular approval customers. Rush your application. Barvain Stamp Service, 1332 So. Hope, Los Angeles, California.

5-COLOR Stamp, smallest Uruguay, Pinhead Land, Boy King, Waterfall, William Tell, and 50 others for 9c with approvals. Pacimpeo, Box 532A, Glendale, Calif.

RARE Greece airmail! Exceptionally large brilliantly colored! Only stamps in world in five colors! Also packet fine stamps from India (new country), British and French Colonies—ship, map, scenery, animal stamps, etc! All for 5c to approval applicants! Extra: Package of hinges free with order! Western Philatelists, 6023 Harper, 9M, Chicago.

FREE! 307 Stamps with year's subscription: 10c! "Stampist," Hyndman, Pennsylvania. Approvals?

100 DIFFERENT Unused 10c. List free stamps. Box P231, Brookline, Mass.

EARN Cash, stamps, album. Sell my nickel stamps packets. Ellison, 2341 West 37th Street, Brooklyn, New York.

CASH For old stamps. I pay cash for old U. S. and Confederate stamps and envelopes used before 1880. Also foreign stamps used before 1890. \$1 to \$10 each for Civil War envelopes with pictures of flags, soldiers, postoes, on them. Information postpaid free. P. Stein, 7360 N. Seeley Ave., Chicago, Ill.

MEXICO: 14 Varieties 5c to approval applicants. Allison, Angola, Indiana.

U. S. STAMPS, Complete stock, from 1c to \$250.00 each. Price list free. Uptown Stamp Co., 140 P. West 42nd St., New York.

TWO Rare old Hawaii stamps, only 10c with approvals. Western Stamp Co., 121 West Second, Los Angeles, Calif.

BUILD A worthwhile stamp collection of rare items, without expense to you. Write at once for agents plan. We give large commission in good stamps. Stamp Collectors Service, 534 Douglas Bldg., Los Angeles, California.

FREE Premium with 50 different British Colonies 10c. Approvals? Herrick Smith, Box 93, Tuckahoe, N. Y.

COLLECTORS! For exchanging stamps, illustrated postcards with 2500 collectors. Ask American booklet 10c, Registre Echangelites, 51 Passage Bureau, Paris, France.

GIVEN! Borneo, Abyssinia, Fiume, Zanzibar, New Guinea airmail, triangles, useful article, special gift, etc. All only 10c to approval applicants. Paramount Stamp Co., 5229 Pershing, St. Louis, Mo.

ZANZIBAR! Packet queer freakish stamps from Zanzibar, Indore, Algeria, Malay States, Victoria, Gold Coast, Nigeria, British Colonies, Souamericans. Don't delay! Don't wait. This whooping packet free for 5c postage. Gray Stampco, Toronto, Canada.

UNITED STATES—Nine stamps cataloging \$1.00. Special 10c. Superior, Box 4518, Kansas City, Mo.

500 HINGES 5c. Stamp bargains and approvals sent. Harvey Teeple, Decatur, Ind.

145 BETTER Kind \$1. Mogeil, 2077 Wallace Ave., New York City.

1000 ASSORTED U. S. stamps—27c. Midland Stamp, 112 Dearborn, Syracuse, New York.

STAMPS, 100 All different. Postage 3c. Lists free. P. M. Quaker Stamp Co., Toledo, Ohio.

FREE! World's smallest stamp and watermark detector.—3c postage. Bargains in United States packets (all different stamps) 25—10c; 50—25c; 100—50c; 150—\$2.00. Tatham Stamp, West Springfield, Mass.

U. S. 25 DIFF. air mails, commemoratives, reverses; 10 South America; all 5c with approvals. Hudson & Co., Plainfield, N. J.

BRITISH Colonies; 50 different given approval applicants sending 3c postage. R. D. Davis, Silver Lake, Indiana.

121 DIFFERENT United States 50c. G. Reitter, Box 718, Kansas City, Mo.

WORTHWHILE Stamps, 300 different 20c; 500, 40c; 1,000, \$1; 2,000, \$2.75; 3,000, \$6. Catalog free. Craig Dare, 670E42, Brooklyn, N. Y.

FREE Premium to new approval applicants. Wellaston Stampco, Wellaston, Mass. 240 DIFFERENT Stamps, including Abyssinia, airmail, etc., 10c. H. H. Carlton, 1211 W. 57th Place, Los Angeles, Calif.

FINE Penny approvals; write Stearns, 915A Sybil, Ann Arbor, Michigan.

WHOLESALE Catalog for dealers. Illustrated. Postage 5c. Frank Company, 4900 Chalmers, Baltimore, Md.

CONFEDERATE Stamp free with 2,500 U. S. Many old issues, commemoratives, airmails, precancels, revenues—\$1.00. Fluck, 245 Mercer, Trenton, N. J.

AMAZING Mystery set 12c. Globe Stamp Co., 515 Guardian Building, Cleveland, O.

GRAVEYARD Stamps. Remains of collections and approvals, slightly damaged rare stamps. A handful, ten cents. Approvals. Gasser, 1221 California, Cincinnati, O.

301 DIFFERENT 10c To approval applicants only. Free list of bargain packets. Kansas City Stamp Co., Lee Bldg., Kansas City, Mo.

FREE!! 15 Pictorial stamps. Postage 3c. F. Roberts, 991 Fourth, Bay City, Mich.

300 DIFFERENT Stamps 10c. Approval applicants only. Ohio Stamp, Box P249, Cleveland, Ohio.

400 DIFFERENT 15c To approval applicants. Mantle Stamp Company, London, Canada.

STAMPS Sent on approval, at 50% discount. Fred Herzberg, 197 E. Grantley Ave., Elmhurst, Ill.

SAN Marino set, smallest stamp and 50 different 10c to approval applicants. Malboro Stamp Co., 1630 E. 5th St., Brooklyn, N. Y.

200 DIFFERENT 10c, 25 Japan 10c, 60% discount approvals. Covert Stamp, 39 State, Rochester, N. Y.

STAMPS Sent on approval at 70% discount. Reference required. Emory Bennell, Hanover, Pa.

SCARCE Belgium airmail, pocket album, commemorative set, 40 scarce stamps from South America, Canada, etc., for 5c to approval applicants. Glendale Stamp Co., 1342 Linden, Glendale, Calif.

UNITED States stamps on approval. Huber, 3551 Penn Ave. No., Minneapolis, Minnesota.

SEVEN Sets! Three packets! 10c. Approvals. Deering, 164 Albee, Somerville, Mass.

CANADA Surcharged airmail free with 25 different airmails or 30 different Canada, either packet 15c; both packets 25c. Lists free. Special: 500 different 25c; 1000 different 15c; 2000 different \$2.00. Approval selection with each order. Victoria Stamp Company, London, 4, Canada.

UNPICKED Stamps from foreign missions, \$1 per pound or 25c per sample thousand. Approvals sent unless forbidden. Elmer, 192A Washington Street, Boston.

STAMP Hunters' Club, magazine, membership, hobby bound, 10c. Edgar Snyder, Printer, 3 Churchill, Youngstown, Ohio.

105 (CHINA, Etc.) 2c. Album (500 illustrations) 3c. Bullard, 446 Tremont, Boston.

PACKET 52 Different from Alascites, Lebanon, St. Louis, etc., also watermark detector and rare old Hawaiian stamp—all for only 5c to approval applicants. Highland Stamp Co. Newton Highlands, Mass.

ILLUSTRATED United States list, price 5c, large complete United States price list, 1932, free. Stanley Gibbons, 38P Park Row, N. Y.

500 DIFFERENT Stamps 20c; 600 50c; 1,100, \$1; 2,000, \$3. Fred Oaken, 636 79th St., Brooklyn, N. Y.

PENNY Approvals, 5,000 Sudan, Congo, Nyassa, Liberia, etc. Also 14,000 averaging 15c. Philatelic Exchange, Huntington, W. Va.

BEST One cent approvals in America. F. Hand, 1117 So. 60th St., Philadelphia.

QUALITY Stamps on approval 5c up. Free premium. Kelgwin Stampco, Vineland, New Jersey.

"ALTHOUGH My stock of stamps is adequate to take care of business for years to come, yet results were so far beyond my expectations that with the help I had, I was unable to take care of further new customers." Such are the reports received from advertisers using space under this classification. Your offer should do equally as well. For further information as to rates, closing dates, etc., write M. L. Rund, Manager, Classified Advertising, Popular Mechanics Magazine, 209 E. Ontario St., Chicago, Ill.

RARE COINS

OLD Money wanted. Do you know that coin collectors pay up to \$100.00 for certain U. S. cents? And high premiums for all rare coins? We buy all kinds. Send 4c for large coin folder. May mean much profit to you. Numismatic Co., Dept. H, Ft. Worth, Texas.

GET Profit and pleasure in collecting old coins. Send 10c for large illustrated coin catalog. You'll be delighted with it. Send for it right now. H. Max Mehl, Numismatist, Mehl Bldg., Dept. P, Fort Worth, Tex. Largest Rare Coin Firm in the U. S.

CALIFORNIA Gold—Quarter size, 27c; 1/2 size 53c; 3c piece and catalog, 10c. Norman Shultz, Box 748, Salt Lake, Utah.

AMERICAN Half dime, one piece ancient Eskimo money and catalog 15c. Geo. Best, Cedar Rapids, Iowa.

SEND 10c For 4 different coins and catalog or 50c for 25 different. Troyer Coin Co., La Fontaine, Ind.

RARE United States, foreign coins, war medals. Catalogue 10c. Mengelle, Colorado Springs, Colorado.

\$5 TO \$500 Each paid for old coins. Many very valuable. Keep all old money. Get posted. Send 10c for illustrated coin value book, 4x6. Guaranteed prices. We buy and sell. Coin Exchange, Box 5, Le Roy, N. Y.

UNITED States. Large cent, two-cent bronze, three-cent nickel and bargain list, 25c. Thirteen dates large cents, \$1.00. George Coffin, Greenwood Mountain, Maine.

7 DIFFERENT Coins, 11 bills and catalog, 25c. Creamer's, 1112 Somerset, Baltimore, Maryland.

CAMERAS AND PHOTO FINISHING

PHOTOGRAPHERS—Newspapers, magazines, advertisers pay millions yearly for the right kind and need more. Make good income with your camera. U. P. training in journalistic photography shows how. Delightful spare-time occupation, quickly learned at home. Low cost. Many earn while learning. Write for free book today. Universal Photographers Corporation, Dept. 6, 10 West 33rd St., New York.

BARGAINS—Hundreds of them listed in our new bargain book just off the press, in cameras for still and motion pictures, lenses and other photographic supplies. All guaranteed and sold on ten days' trial or money back if not satisfied. Write for your copy now, it's free. Central Camera Co., 230 South Wabash Ave., Dept. 9FA, Chicago, Ill.

GRAFLEX (\$260.) C F 2.5 Cook lens \$145. Also others in bargain list No. 48. Norman Willets Co., 318 W. Washington St., Chicago.

SEND Your beloved friends or relatives favorite 25 super-value photos—\$1.00 or 50—\$1.50. Perfect copies from any size photo or snapshot, beautifully finished. Postpaid. Send 5c in coin for samples and circular. Maxfield, Granville, N. Y.

I PAY Two dollars each for photographs of unusual epitaphs on tombstones. W. Bethell, 166 W. Van Buren, Chicago, Ill.

FILMS Developed—2 prints each negative, 25c. Photographer, Unionville, Mo.

SAMPLE Enlargement 10c. Send negative. Beautiful leatherette photo case 10c. Get price list. Photo Enlarging Shoppe, Chattanooga, Tenn.

FILM And twelve prints developed 25c. Reprints 3c. Skrudiant, 4118 Overhill, Chicago.

KODAK Films developed 5c roll, prints 3c each. Trial offer. Beautifully mounted 5x7 enlargement 50c. Enter the \$500.00 Master-Snap Photo Contest. Young Photo Service, 465 Bertha St., Albany, N. Y.

MAKE Money in photography. Learn quickly at home. Spare or full time. No plan. Nothing like it. Experience unnecessary. American School of Photography, Dept. 3431, 3601 Michigan Avenue, Chicago.

SPECIAL Trial offer: Developing any size roll 5 cents; prints 3 cents each. Beautiful 7 inch enlargement 20 cents. Send for special bargain list. Roanoke Photo Finishing Company, 269 Bell Avenue, Roanoke, Virginia.

HAVE You a camera? Write for free sample of our big magazine, showing how to make better pictures and earn money. American Photography, 116 Camera House, Boston, 17, Mass.

YOUR Favorite kodak picture enlarged, size 5x7, 10c. Three for quarter, coin. Send best negative (film) today. Address Darmer Photo Lab., 221 Securities Bldg., Des Moines, Iowa.

MOTION PICTURES AND SOUND EQUIPMENT

BASS Camera Bargain Headquarters, offers 100-ft. capacity Peko automatic spring driven 16mm. motion picture camera with f:3.5 lens and water-proof case, worth \$50.00, at \$22.50, with money back guarantee. Fresh Eastman film, 100 ft., panchromatic reversible, includes developing at \$4.80. Hundreds of other bargains listed in the great Bass Bargaingram No. 209. Copy on receipt of 5c in stamps. Bass Camera Company, 179 W. Madison Street, Chicago, Ill.

\$1.250 FOR Original photoplay story. Our sales department sold unknown author's first story for above amount. We revise copyright and submit to studios stories for talking pictures. Being located in the heart of motion picture industry we know production requirements. Established 1917. Free booklet. Universal Scenario Company, 206 Meyer Bldg., Western and Sierra Vista, Hollywood, Calif.

TALKIE And movie producers are clamoring for new short story ideas, plots, etc. Perhaps you can write one that we can shape and sell for you. One writer (V.M.) received \$3,000. New York best market. Write now for free booklet, without obligation—How To Write For The Talkies! Daniel O'Malley Company Inc., Suite F, 1776 Broadway, New York.

100' PANCHROMATIC Including processing \$3.44. 16mm comedies 2c foot. Sound-silent library. New Victor camera \$75. Victor \$200 projector special \$125. Simplex camera \$35. DeVry 'G' projector \$26.50. New lists free. Megull, 1914J Boston Road, New York City.

FILM Features, comedies, machines reasonable. Lists, Merit Amusements, Springfield, Ill.

35MM FILM Bargains. Lists free. Williams, 317 Grove, Johnstown, Pa.

FOTO-CLEAR 16mm Reversal safety film takes guess work out of your movie making. Cannot overexpose. 100 feet processed and postage \$3.85. Art Movie Service, Dept. Z, 44 West 33 St., Bayonne, N. J.

16MM FILMS, 100 Ft., \$2.25. Send dime for big catalogue and usable souvenir films. Eastin Films, Galesburg, Ill.

35MM. AND 16MM. Bargains odd reels \$1.00. Lists 2c. Hoffman Film Service, 57 Broad, Albany, New York.

CAMERA—\$345. Victor No. 5 demonstrator with 3 lens in turret \$215. Also others in bargain list No. 28. Norman Willets Co., 318 W. Washington St., Chicago.

FILMS—Machines—2c stamp for lists. Box No. 6, Rosedale, Kansas.

16-35MM FILMS. Low prices. Lowell Film Exchange, Allentown, Pa.

16MM MOVIE Equipment. Send for bargain list A-9. Elder, Chelsea, Massachusetts. "PERSONAL MOVIES" Magazine—interesting monthly publication for those who "shoot" and "show" their own. \$1.00 year, 10c copy. Personal Movies, Sippo Lake, Canton, Ohio.

DEVRY 16M camera \$30, projector \$30, 16M comedy \$2.50, 100 foot 16M negative \$4.50. 35M cameras \$25, projectors \$35, comedies \$2.50, 35M negative stock \$2 foot, kodaks \$3, stereodion \$20. Ray, 820 - 8th Ave., New York.

WORLD'S Greatest "Passion Play" 16 MM. (new) 5 reels. Rent or purchase. Write Hemenway Film Co., 37 Church Street, Boston, Mass.

16 M.M. FILM. Every description, sacrificed 2c foot. Home projectors \$8.00, 1000-ft. 35m.m. film \$1.00. Excelsior Films, Cincinnati.

LEARN Theatre management at home. Unusual opportunities. Free catalog. Theatre Managers Institute, Elmira, New York.

TRADE AND TECHNICAL SCHOOLS

LEARN Watch repairing. Hiles School, 5330 Mission St., San Francisco.

BUSINESS OPPORTUNITIES

PLASTEX Industries offer industrious men an opportunity to start a business of their own, manufacturing art goods, novelties, souvenirs, etc., in Plaster and Marble imitation. 5c material makes \$1 articles. Rubber moulds furnished for speed production. Small investment brings big returns. Since the crash, low-priced goods are needed and this line meets the demand. Interesting booklet mailed free. Plastex Industries, Dept. A, 1085 Washington Avenue, New York.

EARN Up to \$25 weekly or more growing mushrooms in your cellar or shed. Illustrated booklet free. American Mushroom Industries, Ltd., Dept. 177, Toronto, Ont.

LEARN Marbleizing. Start business. Make anything resemble polished marble. Applied with brush or in molds. For statues, novelties, tables, floors, garden furniture. Flint-like hardness. Granite formula. Practical mold making. Semi-plastic mold formula. allows undercut. Eight inch sundial mold free with courses greatly reduced. Send dime for marbleized samples. Cowell Institute, Grayling, Mich.

START In business in your own kitchen. Cake doughnuts—fastest selling food product. Baked by electricity—new kinds and flavors. No canvassing. Sell outright to stores. Strictly cash year-round business. Big profits. Less than \$40 total investment. Free catalog. Ringer Co., 55 Main St., Minneapolis, Minn.

OWN Your business, repairing vacuum cleaners. Write for free illustrated catalog. Replacement parts, armature rewinding, renewed vacuum cleaners at wholesale prices. Quick action. Big profits. Sell from catalog, no capital needed. Re-New Sweeper Co., G-2262 Gratiot Ave., Detroit, Mich.

WOODWORKERS—Beautiful your lawns and gardens with life-like birds and small animals; particulars free. Clark System, Ellwood City, Pa.

MAKE Colored pottery and garden furniture for quick returns. Everlasting. Easily made. Sell on sight for 6 times cost. Booklet free, describing this and seven other manufacturing opportunities. Colorcrete Industries Co., Holland, Mich.

DIRECTORY—Tells where to buy thousands of articles at wholesale. Price \$1.00. Circular free. Harley Snell, 1057 Freeman Ave., Cincinnati, O.

MAIL Order and light manufacturing business—300% profit selling typewriter ribbons. Patented machine makes best \$1.00 ribbon for 18c. Every office a repeating prospect. monthly. Send 50c for sample and complete mail order plan. Ribbon Ink Corporation, 369 N. Michigan, Chicago.

FREE Subscription—unique magazine. Write for information. Democratic Youth, West Liberty, Kentucky.

NEW Fascinating home work. Make men's "hand-tailored" ties, big profits. Pattern, practice tie, selling plan \$1.00. Handcrafters, 6314-K "U" Way, Seattle, Wash.

DEPRESSION Novelty mail order business. Actual photograph "attention grabbers" for sales, collections letters, etc. Complete plan and twenty photos \$1. Tom Davis, 1268 Broadway, Cincinnati, Ohio.

SELL By mail. Books, novelties, bargain! Large profits. Particulars free. B. Eifen, 525 S. Dearborn, Chicago.

YOUR Own business—making and selling profitable products. Write for free list. Industrial Institute, A9, 369 N. Michigan, Chicago.

EXTERMINATING Business—Formulas for rats, roaches, beetles, bedbugs, moths, termites, etc. How to proceed in business, \$10 bill. Any formula \$1.00 bill. Guarantee Exterminating Co., Inc., Salt Lake City, Utah.

BUILD A traveling spray shop. Paint furniture anywhere. Wonderful new business. Illustrated information free. Spraycraft Co., 10269 Shoemaker Street, Detroit, Michigan.

MANUFACTURE Chipped glass house numbers. Beveridge, 160-22 Locust, Jamaica, New York.

NEW. Make-sell foot remedies. Set approved formulas \$1.00. Information for dime. Bates Laboratory, Orthopedic Specialties, Oakland, Calif.

MONEY Making own art products. Send quarter for instructions and articles to start. Platz, Drexel Hill, Penna.

SIGNS And showcards easily painted. If you use Letter Patterns. Write for free samples. John Bahn, G2120 Nova Ave., Chicago.

THOUSANDS Earning \$100 weekly operating coin amusement games. Started with \$25 investment. Write today for inside facts. Empire Coin Machine Corporation, 2232 Fourth Ave., New York.

PATCHING Plaster, large profits, \$1.00 brings secret formula, manufacturing, application instructions, marketing list. American Process, 310 Citizens Bldg., Cleveland, Ohio.

NEW. Fast, practical method, big profits manufacturing modern designs ornamental mantle lamps, book ends, ash trays, plaques, etc., large market list, free particulars. Modern Process Casting, 310 Citizens Bldg., Cleveland, Ohio.

YOUR Own spare time business. 300 plans. Folder free. Home Industries, Irvington, Nebraska.

LEARN Silk screen sign making at home. Huge profits. We furnish complete equipment. Aurora Photo Engraving School, Aurora, Missouri.

BARGAINS—Paint spray outfits, gasoline engine drive, one and two gun models. Liberal trial. Easy terms. Fully guaranteed. Will pay for themselves. Ira C. Helmick, Box M-926, Troy, Ohio.

GET Barrels of mail. Your name in 10,000 opportunity directories, 25c. Sample directory 10c. Nepeco, Roseland, Fla.

MIRRORS Reilvered at home. Costs near 5 cents per square foot; you charge 50 cents. Profitable business plating like new heavy worn-off autsparts, reflectors, tableware, stoves, etc. Outfits furnished. Details free. Spinkite, Plater, 127, Marion, Ind.

HERE'S Steady, satisfactory income; making latest popular specialty—necessities. Have others selling them. Investment small. Profits great. Successful people everywhere are gaining independence using my service. Interesting formula literature, fully explaining. Free! Miller Chemist, BP-1706, Tampa, Florida.

BIG Money at home plating auto parts, reflectors, mirrors, chandeliers; by new method; experience unnecessary. Outfits furnished. Gunmetal Co., Ave. N. Derator, Ill.

FORMULAS—Our literature will surprise you. Belfort, 4042 N. Keeler, Chicago.

OPERATE Money-making spare time business. Send 4c postage for our "Big Opportunity Envelope." It's full of opportunities. Highlander Brothers, Orange, Virginia.

DOUBLE Your income. Make ornamental and building products. Sell ten times cost. Used everywhere. Modest capital starts you. Complete information free. Colorcrete Industries, Inc., Holland, Michigan.

INDEPENDENT. Traveling business carried by automobile. Our portable electric machines re-level butchers' chopping blocks. Easy to operate. Big earnings. Heath Company, 216 Lafayette Street, New York.

START Little business anywhere. Everything furnished. No canvassing. Maywood, PM 223 Broadway, New York.

WHOLESALE Directory 300,000 articles 10c. Other valuable information. Moran Company, Wareham, Massachusetts.

FREE Booklet describes 87 plans for making \$20-\$100 weekly in home or office business of your own. Elite Co., 214 Grand St., New York.

SUCCESS With your own products. Make-sell them yourself. Formulas, processes, trade-secrets. Analytical service. Catalog free. B. Thaxly Co., Washington, D. C.

CHEMICAL Expert will furnish formulas and trade secrets. All lines. Lists free. W. L. Cummings, Ph. D., 228 Gordon Ave., Syracuse, N. Y.

THAXLY Formulas produce perfect products. All lines. Catalog free. B. Thaxly Co., Washington, D. C.

LEARN The collection business. Good income, quick results. Interesting booklet, "Skillful Collecting" free. National Collectors Assn., Long St., Newark, Ohio.

CHARTERS: Delaware; best, cheapest; free forms. Colonial Charter Co., Wilmington, Del.

EARN Large income with "churn" of peanut-chewing-gum vending machines. Start small capital. Particulars free. Robbins Corp., DeKalb and Broadway, Brooklyn, N. Y.

POP-CORN Machines \$15 up. Money makers. Northsides Co., 2117 Harding, Des Moines, Iowa.

OPERATE Chain of vending and amusement machines. Be independent for life. Start small, grow big. P. Goodbody, 1826 East Main Street, Rochester, N. Y.

ARTIFICIAL Marble sanitary flooring. Instructions covering wood or cement flooring 3/4 inch thick, fireproof, all colors, low cost. Ornamental casting, concrete plaster papier-mache decorations, garden furniture, statuary, flexible molds, particulars and illustrations free. Chris. Mahler, Elmont, N. Y.

A BUSINESS Of your own making—Sparkling Glass Name and Number plates. Checkerboards, signs. Big book and sample free. E. Palmer, 540, Womster, Ohio.

200 TRICKS You can do—Mystify your friends; have loads of fun. This collection of tricks has been selected by Thurston for the average person. Neither unusual skill nor elaborate apparatus are required. Send for this 200-page illustrated book. Pay postman \$1 plus postage when delivered. If outside U. S. remit when ordering. Popular Mechanics Press, Room 802, 200 E. Ontario St., Chicago.

MAKE Artificial marble, colorful glossy tiles, no polishing; rather uncanny. Novelties, tabletops, bookends, floors, whetstones. Hard, inexpensive, fireproof, enamels wood. Secret cement methods. Amazing samples 2c. John A. Pynn, 943 Grande Vista Drive, Los Angeles, Calif.

MAKE Your own products. Employ agents yourself. Toilet articles, soap, extracts. We furnish everything. Valuable book free. National Scientific Laboratories, 1950 W. Broad, Richmond, Va.

CHEMISTRY

SEND 25 Cents for new illustrated chemical experiment book with 207 formulas and tests. Catalog of apparatus and chemicals free. Winn, 2255A B'way, New York.

SEND For our free 1937 bargain list covering 2000 laboratories and 100 chemicals. Laboratory Materials Company, 643 73rd Street, Chicago, Illinois.

HANDBOOK For chemical experimenters. Hundreds of experiments, illustrated, 50c. Booklet of experiments 15c. 1932-33 chemical apparatus catalogue 10c. Lowest prices. General Chemical Co., Reading, Penna.

JOIN—American Amateur Chemists Society. Journal, particulars, 10c. Lansing, Michigan.

FORMULAS AND TRADE SECRETS

CHEMICAL Analysis; send sample particulars and \$5.00. Medicine formulas, suppositories, etc. Reliable service guaranteed. David Brothers, 541 W. 68th St., Chicago.

"NO Monkey business" I supply samples of goods my foremost formulas produce—that's insured service—why waste money—time on uncertainties? Eye-opening interesting offer, free! Miller, Chemist, FP-1706, Tampa, Florida.

BE Your own boss produce cosmetics—500% profit, 25 guaranteed formulas, 5 easy selling methods, complete \$1.00. Bond Processing Company, Washington, D. C.

FORMULAS All kinds. Catalog free. Clover Laboratories (P), Park Ridge, Ill.

MAKE Your own products. Employ agents yourself. Toilet articles, soap, extracts. We furnish everything. Valuable book free. National Scientific Laboratories, 1950W, Broad, Richmond, Va.

500 VALUABLE Formulas 25c; circular free. Harvey Temple, Decatur, Ind.

EXTERMINATE—Cockroaches, beetles, etc. Best formulae, \$1.00 bill. Guarantee Exterminating Co., Inc., Salt Lake City, Utah.

TESTED Formulas. Newest—guaranteed. Catalog free. Grinstead, Chemist, Edwardsville, Illinois.

TEN Profitable chemical formulas, and remarkable experiment—See your own brain. Weir, harmless, 25c. Arthur Ishen, 3984 Drexel, Northside, Pittsburgh, Pa.

COOK'S Tested auto formulas. Stamp brings list. Geo. Cook, Box 281, Oyster Bay, L. I.

101 MONEY-MAKING Formulas, spectacular chemical tricks and novelties 50c. Postpaid. Precision Scientific Co., Stockton, Calif.

REGULAR \$5.00 Vanilla extract formula \$1.00. Ralph Brooks, Arkansas, Wis.

FORMULAS, Business plans. Literature free. Belfort, 4042 N. Keeler, Chicago.

FORMULA For presenting runs in silk hosiery \$1.00. M. Diaso, 1546 C St., Fresno, Calif.

FREE Formula catalogue, Analysis. Hertzstein, Chemist, 206 Prospect, Grand Rapids, Michigan.

500 FORMULAS And big illustrated catalog 25c. Ideal Book Shop, Park Ridge, Ill.

FORMULAS: Beverages, flavors, syrups, extracts and other processes. Valuable information free. Formula Company, 5th Ave. and Broad, Seattle, Wash.

SUCCESS With your own products. Make-sell them yourself. Formulas, processes, trade-secrets. Analytical service. Catalog free. B. Thaxly Co., Washington, D. C.

SUPERIOR Auto top dressing formula \$1.00. C. S. Clifton, 7030 Harrisburg, Houston, Texas.

BULLFROG Raising. Investigate this new and thriving industry. Can be successfully carried on in all parts of the United States and Canada. Complete, illustrated book by the industry's outstanding authority tells you all about it. Price \$1.00. Sent postpaid anywhere upon receipt of price or C.O.D. anywhere in U. S. Popular Mechanics Press, Room 806, 200 E. Ontario St., Chicago.

AGENTS WANTED

EJECT-A-PAK. New invention. Ejects cigarettes from original package. Smokers amazed. Sell stores, individuals. Non-competitive, useful, popular. Big profits. Gross \$60. Dozen \$5.50. Sample 60c. James Mahoney, 1508 Spring Place, Washington, D. C.

PERFUMES And cosmetics are easy to sell at 1/4th price. Ray, 829 8th Ave., New York.

ELECTRIC Fan and ventilator blows in or out, fits windows 24 to 36 inches. \$6.95. Agents wanted. Hatecke, 5434 Kenmore, Chicago, Ill.

AMAZING New cloth. Dusts, cleans, polishes everything. Big profits. Sell every autoist. Sample. Lus-Tro, Salem, Mass.

300% PROFIT Selling new "20-in-1" kitchen utensil. Retail 25c. Costs you \$1.00 a dozen. Sample 15c. New Method Co., Desk PM-9, Bradford, Pa.

300% PROFIT Selling mystery gas lighter. Retail 25c. Costs you \$1.00 dozen. Sample 10c. Square Deal Mfg., Desk PM-23, Bradford, Pa.

BIG Profits selling groceries, motor oils, paint, stock minerals. Sample case free. Lovern & Browne, 1602-K So. State, Chicago.

APLENTY New and different—Fast selling 5c and 10c merchandise on attractive counter cards. 100% comm. for you and dealers. Advertised by radio. No investment required. Catalog free. (Estab. 1921.) World's Products, 815 Central, Spencer, Ind.

PRIZE Winning \$1.00 box, 21 Christmas cards, most remarkable assortment in America. Pays 100% profit. Marvelous Xmas line 25c to \$2. Patterson E-Co., 4111 University, Des Moines, Iowa.

AGENTS: New, patented discovery resolves shoes for 9c pair. Big repeater. Amazing profits. Easily applied. Free test sample. Universal, 431 W. Randolph, Dept. 163, Chicago.

BIG Profits taking orders, shirts, ties, underwear, dresses, hosiery, raincoats, sweaters, leathercoats, coveralls, pants. Outfit free! Nurod Co., Dept. 8, 4922-28 Lincoln Ave., Chicago.

MAKE Money. Sell exclusive all-folder assortment of 21 Christmas greetings. Sells \$1. Costs 50c. Also beautiful personal cards. Lowest prices. Big commissions; bonus. Graybell, 35P East 19th, New York.

SELL Personal Christmas cards. Names embossed in gold. \$1 dozen up. Highest commission. Sample free. Also assortments. H. Dunbar Co., New Brunswick, N. J.

IF You want a wonderful opportunity to make \$15 profit a day and get a new Ford sedan besides, send me your name immediately. No experience necessary. Particulars free. Albert Mills, 1765 Monmouth, Cincinnati, O.

YOU are wanted to resilver mirrors at home. Profitable business plating auto parts, tableware, etc. Write Sprinkle, Plater, 128, Marion, Ind.

BIG Money in hosiery. Start taking orders spare time. Cash daily. Sample loaned without deposit. We deliver. Carlene, 324 1/2 Market, Chicago.

MOTH Tabs; new large size; costs 4c, sells for 15c. Sample and information free. National Fibre Broom Co., St. Louis, Mo.

RELIABLE Man to take care store route; distribute and collect; new product, protected territory; earn excellent weekly income. Berland Peanut Products, St. Paul, Minn.

SELL Annual service \$10.00 including magazine. Your commission \$5.00. Everybody a prospect. General Columbian Co., 1270 Broadway, New York City.

NEW, Profitable—Sell auto step mats. Quality rubber with owner's name molded white. Details free. Ebonite Products, Dept. J-40, 895 Main, Akron, Ohio.

400% PROFIT Selling signs used everywhere. Largest selection, wonderful repeat business. \$1.00 worth samples. 25c. 50 signs \$3.00. 100 signs, \$5.00. P. Franklin Co., 3322 Third Ave., N. Y.

WANTED Men who can organize and manage sales crew. New patented article. Big money for hustlers. Car and some investment required. Sunshine Products Company, 5127-C West 65th, Chicago.

STRANGE Ironing card. Prevents scorching. Saves electricity. Abolishes kinks, snarls. Approved by Good Housekeeping. For telephones also. 100% profit. Samples furnished. Neterknot, Dept. 9A, 4503 Ravenswood, Chicago.

25c PER Thousand. Tinfoil window sign letters. Make 'em yourself. Dollar bill brings complete details of press, cutter, printer, formulas, sketches, plans, blueprints, trade secrets, etc. Make own equipment under \$2.00. Makes any size, style or design. Information worth a fortune. Atlas Sign Works, 7941 S. Halsted, Chicago.

NEW Kind of lock locks all four Ford wheels—baffles thieves. Easily installed. Get sample offer. Chicago Lock Co., 2426 N. Racine Ave., Chicago, Ill.

NEW invention makes any faucet sanitary drinking fountain. Gold mine for agents. Write—Dept. 11N, Drinkwell Fountain Co., Cincinnati, Ohio.

MANUFACTURER Wants energetic salesmen. Brand new needed specialties. Red hot sellers. 100% repeaters. Protected territory. Home Products Laboratories, Minneapolis, Minn.

AGENTS—Salesmen—Something new—Amazing household seller. Three samples postpaid \$2.00. Particulars free. Seal Manufacturing, 110 West Eleventh, Los Angeles, California.

SELL New No-Rub Wax—for linoleum, corgoleum, dyes bright. Quick sales, dime brings sample, big profit proposition. Kuenzel Laboratories, Guttenberg, Iowa.

AGENTS, Crew managers. Best house to house specialty proposition out. Exclusive territories. Reliant, C-952 So. 57th St., Milwaukee, Wis.

BIG Money at home opportunities. No canvassing. Particulars 10c. Hetzel, 802 Garden, Hartford, Conn.

CALIFORNIA Perfumed beads, selling like hot cakes. Agents earning money. Catalog free. Mission Factory, P, 2328W Pico, Los Angeles, Calif.

MAKE Your own products. Employ agents yourself. Toilet articles, soap, extracts. We furnish everything. Valuable book free. National Scientific Laboratories, 1950W Broad, Richmond, Va.

PATENTED 1931—Bug shampoo—Home economy demands. Get the cream. James MacComb, 223 East 78, New York.

10 REPEAL Amendment signs 25c. Hussman, 2240 Blackrock, New York.

AMAZING Radio invention. Agents \$20 a day, hurry. 3436 California Ave., N. S. Pittsburgh, Penna.

500,000 ARTICLES Wholesale. Directory 1500 jobbers \$1.00. 300—25c. Arts. B-1611-M, Denver.

MAKE Our formulas, exterminate termites, cockroaches, moths, ants, rats, bedbugs, \$1.00 each. Sell hotels, apartments, all institutions. Guarantee Exterminating Co., Inc., Salt Lake City, Utah.

CONDENSED Milk can perforator-sealer. Patented. Agents sample 50c. Sarcansseal Co., 1039 Bayview, Wilmington, Calif.

NEW Rubber goods line, 47 revolutionary inventions. Homes, offices buy instantly. Agents cleaning up \$90 weekly. Outfit free. Krister Mfg., Box 1439, Akron, Ohio.

100% PROFIT Selling Cosmo razor blade holder. Everyone a prospect. Sample 25c. Cosmo Co., 410 So. 19, Omaha, Nebr.

CREW Managers! Agents! Outstanding 1932 money-maker. Xmas cards. Low as 20c box. Amazing proposition. Write immediately. Lake—351 W. 42nd, New York.

SELS Like hot cakes, big profits, new laundry soap flakes, perfumes clothes lastingly while washing, house to house canvassers. Sunset Laboratories, Lynbrook, New York.

NEW invention: Beautiful automobile radiator accessory. Produces revolving colored light. Free introductory offer. Propell-o-lite Company, Newtown, Ohio.

FLAVORING Extract sensation. \$1 vanilla, \$1 lemon, 60c almond, 60c maple, \$3.20 value in attractive sample case 99c. Your profit 50c. Every home uses. Sales easy. Crema Folks, St. Paul, Minn.

POLMET Polishing cloth removes tarnish from all metals without the use of liquid, paste or powder. Our agents say it sells like "hot cakes." Retail 25c; sample free. Gale & Co., Inc., 15 Edinboro St., Boston, Massachusetts.

100% PROFIT In the Everlasting Match. No flint or friction. What makes it light? No wind can blow it out. Retail 5c. Sample and sales plan 25c. New Method Co., Desk PM-9, Bradford, Pa.

500% PROFIT! Gold and colored sign letters for store windows, offices, trucks, signs, Monogram letters, Emblems. Easily applied. Permanent business. Neonite, Akron, Ohio.

AGENTS: Stamping names on pocket-key protectors. Sample check with your name, address, 25c. Stamping outfits, Emblem checks, check-fobs, name plates. Hart Mfg. Co., 303 Degraw St., Brooklyn, N. Y.

"SOMETHING Different"—Smart, new felt rugs. Sample \$1.39 postpaid. Garland Mills, Chelsea, Mass.

BIG Proposition, no canvassing. Aseo, Box 1081, Washington, D. C.

IN New York and New Jersey states. Agents make big money with our new specialty. Get the details quick. Unusual opportunity. Le Roy Trading Co., Le Roy, New York.

THIS Advertisement can make you thousands of dollars if you'll write today for "eye-opening" literature describing Miller's Foremost Formula Service for easily producing world's latest, best-selling specialties. All lines. Investment small. Profits great. Make that good money you're entitled to. Miller, Chemist, AP-1706, Tampa, Florida.

SELL information by mail. Details free. Terrill, 100B, Brookfield, Mo.

KOEHLER'S Blue stock and changeable signs, every description. Propositions free. Lowest prices. Write quick. Koehler's, 717 North Fourth, St. Louis, Mo.

MARVELOUS chemical cloth, cleans, polishes, all metals instantly without liquid, paste, powder; record-breaking seller to housewives, stores; 300% profit; sample free. Shef D. Mfg. Co., Union City, N. J.

MYSTERIOUS Liquid; Solders, repairs, metal, wood, glass, porcelain, marble, aluminum, without heat. Whirlwind seller. 150% profit. Convincing sample free. Bestever, 4317PM Irving Park, Chicago.

GENUINE Gold letters for store windows. Easily applied. Free samples. Liberal offer to general agents. Metallic Letter Co., 45-B North Clark, Chicago.

FAST Mail seller—Free sample. Plans. Circulars furnished. Seesagon, 2328 West Pico, Los Angeles, Calif.

ENGRAVED Name plates, signs, number plates, desk plates, window signs, etc., profits large. Brett Bros., Winthrop, Mass.

BIG Money applying gold initials on automobiles. Easiest thing today. No experience needed. \$1.45 profit every \$1.50 job. Free samples. "Raleo," X-1043 Washington, Boston, Mass.

PROFITABLE Home business. Legitimate. No canvassing. Maywood Publishers, P-923 Broadway, New York.

GUARANTEED "Run-Proof" hosiery. Men's latest fancy hose—doz. \$1.25-\$1.90; ladies' fashioned hosiery—doz. \$1.90-\$2.90. Catalog free. Superior Hosiery Company, Dept. 34, New Haven, Conn.

NEW Changeable sign sells to stores for \$1.00, agent's profit 300%. Particulars free. National Sign System, St. Louis, Mo.

NEW Discovery. Washes clothes without rubbing. Whirlwind seller. Great repeater. Splendid profit. Sample free. Besco, 4315P Irving Park, Chicago.

MAKE Sell your own products. Formula catalog free. "Kemico," BW, Parkridge, Illinois.

SUCCEED with your own products. Make-sell them yourself. Formulas, processes, trade-secrets. Analytical service. Catalog free. B. Thaxly Co., Washington, D. C.

THAXLY Formulas produce perfect products. All lines. Catalog free. B. Thaxly Co., Washington, D. C.

FREE "Booklet of money making opportunities," new ideas, original plans, money making secrets and other valuable information. None require peddling or outfits. Elite Co., 214 Grand St., New York.

MAKE Your own products. Employ agents yourself. Toilet articles, soap, extracts. We furnish everything. Valuable book free. National Scientific Laboratories, 1950W Broad, Richmond, Va.

A BUSINESS of your own—Making sparkling glass name and number plates, checkboard signs. Big book and sample free. E. Palmer, 512, Wooster, Ohio.

AGENTS—Clearer invention! Inkspoon makes every pen a fountain pen. Fast office seller; big profit, demand increasing everywhere. Exclusive territory offered. Sample free. H. Marui Company, Tribune Bldg., New York, N. Y.

MAN In each town to plate auto parts, reflectors, bathroom fixtures, refinish beds, mirrors, chandeliers; by new method. No capital or experience required. Simple plan of manufacturing at home starts you in big money-making business. Outfit furnished. Free particulars and proofs. Gun Metal Co., Ave. B, Decatur, Ill.

NEW Midget mike inter-communicating systems \$7.50. Territories now open. Miles Reproducer Co., Inc., Dept. P-10, 244 West 23rd Street, New York, N. Y.

AGENTS Everywhere making money with our line of kitchen specialties, demanded in all homes. Big earnings possible. Write today for details. P. Seed Filler Co., 353 Broadway, New York.

BIG Money and fast sales. Every owner buys gold initials for his auto. You charge \$1.50; make \$1.45. Ten orders daily easy. Write for particulars and free samples. American Monogram Co., Dept. 40, East Orange, N. J.

AGENTS—Opportunity to make money; book containing 87 successful business plans; home or office; send for free introductory booklet. Elite Co., 214 Grand St., New York.

SOMETHING The housewives want. A signed guarantee to save money and time in cooking. No competition. 400% profit. No license required. Station C. Box 23E, San Diego, Calif.

MAKE Your own products. Employ agents yourself. Toilet articles, soap, extracts. We furnish everything. Valuable book free. National Scientific Laboratories, 1950W Broad, Richmond, Va.

SALESMEN! Be successful. Get the Montgomery sales formula, a valuable aid to selling and other helps from "What a Master Salesman Should Know," by L. L. Montgomery. Price \$2.50. Sent postpaid upon receipt of price or C. O. D. anywhere in U. S. Popular Mechanics Press, Room 808, 200 E. Ontario St., Chicago.

SELL Men's neckwear—wonderful proposition. Astor M., 39 East 28th, N. Y.

FLAVORING Extracts—Bottle yourself! Labels furnished. 600% profits! Whirlwind money-makers! Repeaters! Free offer. Thomas Manufacturing Company, Indianapolis, Ind.

15,000 PROFIT Making formulas. Following and many others: Accidents and emergencies, agriculture, alloys and amalgams, artist's materials, beverages, cements, glues, pastes, mottages, bleaching, renovating, coloring metals, dyeing glass, heat treatment of metals, household formulas, ice cream, confectionery, chesing gum, lapidary work, exterminating vermin, lubricants, paints, varnishes, photography, condiments, canning formulas, rubber, soap, candles, soldering, toilet preparations, perfumes, waterproofing, fireproofing, writing materials. Just write for "Scientific American Encyclopedia of Formulas." When postman hands you book pay \$5.50 and postal charges. Popular Mechanics Press, Room 802, 200 E. Ontario St., Chicago, Ill.

HIGH-GRADE SALESMEN WANTED

DON'T Be a job hunter—start your own city business on our capital; no hard times, no lay-offs, your own boss; hundreds average \$5,000 annual sales year after year; we supply stocks, equipment on credit; some 250 home necessities; selling experience unnecessary; wonderful opportunity to own pleasant, diversified, profitable business backed by \$17,000,000 world-wide industry; for complete information write Rawleigh Co., Dept. 1-11-PPM, Freeport, Ill.

SALESMEN—Sell Strickler's unusual collection stickers and business builders to business concerns and professional men. Copyrighted. Nationally advertised. Experience unnecessary. Reference required. Carl Strickler Co., 628 Judson Ave., Evanston, Ill.

\$18 TO \$25 Daily! Biggest selling line of men's suits. Meets present day conditions. Amazing values at \$11.95, \$14.50, \$16.95, \$18.95. Also raincoats, slippers, topcoats and boys' suits. Biggest commission paid in advance. Liberal bonus. Free outfit. State age and selling experience. "Jim" Foster, Inc., Dept. 29, 2250 South Spaulding Ave., Chicago.

LEADING Tailoring firm announces new line. All wool 2 pants suits as low as \$16.50, \$5.00 profit. Many repeats. Union made. \$25.00.00 guarantee. Bonus sample suit. Outfit free. Williams Bros., 879 Broadway, Dept. M-17, New York.

SALESMEN-DISTRIBUTORS. New auto tire patch; guaranteed 10,000 miles. Repairs blowouts permanently. Sells garages, gas stations, tire shops. Salesmen's profit 100%. Up to 300% to dealers. Easy seller. Exclusive territory. Economy Rubber, 661 Burkhardt, Dayton, Ohio.

BUILD Up a business of your own, part or full time, selling nationally known automobile necessities. Quality products. Write today for territory and particulars. Tourist Pride Mfg. Company, E-9, Minneapolis, Minnesota.

AUTO Self-locking gas tank cap offers to \$10 daily; cap cannot be lost; gas cannot be stolen; every motorist wants it; low priced; demonstrator offer. M. Betmoll, 682 Wrigley Bldg., Amher, Chicago.

SELL Novelties to schools in school colors for football games. Megaphone Novelties, Wade and Denman Sts., Cincinnati, Ohio.

BIG Profits taking orders, shirts, ties, underwear, dresses, hosiery, raincoats, sweaters, leathercoats, coveralls, pants. Outfit free! Nimrod Co., Dept. 65, 4922-28 Lincoln Ave., Chicago.

SALESMEN To represent established firm selling most complete and effective window display advertising service ever offered retail stores and banks. Entirely new and selling now. Give full particulars in first letter. Elliott Service Company, 244 W. 35th St., New York, N. Y.

SHOE Manufacturer wants salesmen. Big pay every day. Guaranteed quality. Low direct prices. No experience necessary. Sales outfit sent free. Write Consolidated Shoe System, Dept. A-30, Eau Claire, Wis.

30 DAILY—Brand new trade stimulator. No merchandise for merchants or customers to buy. Stimulators, Dept. 18-H, 4311 Ravenswood, Chicago.

SCREW-HOLDING Screw drivers! Not magnetic. Remove, insert screws. Factories, garages, electricians, carpenters, mechanic, radio owners buy. No competition! Millen, 3045 Winthrop Bldg., Boston.

SALESMEN: Big daily profit showing new auto gas tank cap lock; protection against gasoline and car thieves makes sales easy. New-Lux Company, 130 So. 2nd St., Rockford, Illinois.

SALESMEN, Representing national manufacturer selling tickets, checks to hotels, theaters, restaurants, clubs, buses. Liberal commission. Elliott Ticket Co., 12 Vestry Street, New York City.

VENTILATION—The coming industry. Get in early. Establish your own business with Myers Aerofool fans. Big profits. Every store and factory a prospect. Your auto and small amount cash starts you. Choice territory available. Act quickly. Shattuck, Fourth Avenue, Pittsburgh, Pa.

AUTO Seat covers \$1.95. Amazing possibilities. Free outfit. Colorzone Co., Des Moines, Iowa.

SALESMEN: Largest line business stationery; highest quality \$2.80 thousand; quickest delivery; biggest comm. Free cuts. Experience unnecessary. Outfit free. Lionel, 312 So. Hamilton, Dept. 561, Chicago.

PART Time work calling on banks and business houses—selling filing and mailing supplies. Liberal commission. Ames Safety Envelope Co., Boston, Mass.

SALESMEN—Four \$15.00 sales to stores net you \$10.00 daily. Sayers Systems, Est. 1895, 2801-123 Sheffield Ave., Chicago, Ill.

EXPERIENCED Salesmen. Wonderful opportunity selling full line accident and health policies. Sell easy. Liberal commissions. Twenty-four-year-old legal reserve company. Write for special offer. Inter-State Business Men's Accident Co., Dept. 18, Des Moines, Iowa.

SELL Carded razor blades, aspirin, violet breath gum, chewing laxative, polishing cloths, shoe laces, handkerchiefs, rubber goods, etc. Large line. Big repeat profits. Attractive displays. Superba Company, 8260, Baltimore, Md.

WONDERFUL Opportunity. Twenty dollars per day can be earned. Experience unnecessary. Home protection at cost. Ages one to eighty. \$250 to \$1000 at death. Net insurance. You make \$5 for each member secured. Childless of Virginia, sent in 54 one day. National Aid Society, Myers Building, Springfield, Illinois.

GIVE Profits—Up to \$170 weekly. \$500.00 punchboard firm announces new no investment plan. Season starting. K&S, 4328 Ravenswood, Chicago.

SALESMEN—Become independent. Own your business; experience unnecessary. Selling our \$10,000 accidental death; \$50 accident; \$25 sick weekly benefits—\$10.00 yearly. Other amounts proportionate. Guaranteed steady income from renewals. \$250.000 deposited insurance department. Universal Policy, Dept. A, 716 Lefcoubt Bldg., Newark, N. J.

NEW Specialty—Sells every business and professional man. Four \$15 sales daily pay \$280 weekly. Foyer cleared \$4920 in three months. Write, P. E. Armstrong, President, Dept. PM, Mobile, Ala.

PLANS For smoking stand with turned legs and built-in ash receiver. Hermit 25c for blueprint SN 521, Dept. B. P., Popular Mechanics, 200 E. Ontario, Chicago.

HELP WANTED

IF You want to make money quickly in a pleasant business of your own, send me your name immediately. Wonderful opportunity to make \$15 a day without risking a cent. Particulars free. Albert Mills, 1706 Monmouth, Cincinnati, O.

AGENTS—Moose corn and callous remover will build you a steady repeat business. Send today for pocket-size trial outfit. The Moss Company, 204 Searle Bldg., Rochester, N. Y.

BUILD Your own boat. Save over 1/2 and have fun besides. Simplified instructions in Popular Mechanics New Boat Book, just out, are easy to follow. Every type of small boat covered, outboard, inboard, sailing and hand-propelled craft. In addition complete information on all phases of boating needed by every boating enthusiast. 269 pages. Fully illustrated. Postpaid upon receipt of price, \$3.00 or will be sent C.O.D. anywhere in U. S. Popular Mechanics Press, Room 807, 200 E. Ontario St., Chicago.

EDUCATIONAL AND INSTRUCTION

WORK For "Uncle Sam." \$105.00 to \$250.00 month. Many post-depression jobs. Steady. Prepare now. Men-women, 18-50. Common education usually sufficient. Experience unnecessary. List positions and particulars—free. Don't wait. Write today sure. Franklin Institute, Dept. A3, Rochester, N. Y.

DON'T Prepare for any civil service examination without seeing our catalog. Free. Columbia Correspondence College, Washington, D. C.

MEN—Women, qualify now for government openings. \$100-\$250 monthly, when depression subsides—may be soon. Be ready. Particulars free. Instruction Bureau, 101 St. Louis, Mo.

LEARN Commercial, portrait, motion picture photography. Home or resident instruction. Catalog free. New York Institute of Photography, Dept. 49A, 10 West 33d St., New York.

LEARN Watchmaking at home, complete course \$1.00. Watchmaking School, 1107 N. Mayfield, Chicago, Ill.

U. S. GOVERNMENT Wants men. \$1,700-\$1,900 and up at start. Railway mail clerk examination coming. Let our expert (former government examiner) prepare you for this and also rural carrier, post office, customs, internal revenue, and other branches. Write today for free booklet. Dept. 8, Patterson School, Rochester, N. Y.

LEARN Photo-engraving at home by experience. Equipment furnished. Earn while learning. Aurora Photo-Engraving School, Aurora, Mo.

CARTOONING—Let the world's most successful cartoonist tell you how to draw cartoons. Briggs in his new book gives every step in cartoon work and answers every question a beginner might ask. Elaborately illustrated. Pay postman price of book, \$3, and small amount of postage when he delivers the package C. O. D. Popular Mechanics Press, Room 802, 200 E. Ontario St., Chicago, Ill.

BECOME A landscape architect. Uncrowded profession; wonderful opportunity for money-making. Easily mastered by mail. Earn while you learn. Est. 1916. Write for details. American Landscape School, 7 Plymouth Bldg., Des Moines, Ia.

LEARN Blue print reading. Catalog free. Columbian School, Drexel Building, Philadelphia.

SPOOK Creaks! "Inside dope" about fortune tellers, astrologers and fake spirit mediums! Menstrous fakes and incredible tricks exposed! Explains how—to become a fake spirit medium—to be a fire eater—to read sealed messages—fortune tellers work—spirits rap—slates predict future—spirits write and dozens of other uncanny secrets. 300 pages. Illustrated. Cloth \$1.15 postpaid. Popular Mechanics Press, Room 808, 200 E. Ontario St., Chicago.

ELECTRICAL EXPERIMENTS

ELECTRICAL Experimenters salvage equipment. Depression bargains—Hand driven alternating current generators. (Perform many magnetic and electrical experiments.) With instructions, 91c—Experimental kit, eleven valuable pieces. (Countless experiments, demonstrations, uses. Educational.) Complete with instructions, \$3.27. Bargain bulletin, 3c stamp, Engineering Service Company, 1718 South 14th Street, Lincoln, Nebraska.

ELECTRIC REFRIGERATION

MEN—Learn to service electric refrigerators. Jobs open. Big opportunity. Write for booklet. National Tech., 4309 Euclid Ave., Cleveland, O.

HOME Repairs. Every home owner will find this book a mine of suggestions. Its 390 pages are packed with information on how repairs of all kinds can be made and save delay and expense. Fully illustrated. Price \$2.50. Will save its cost 10 times over. Sent postpaid upon receipt of price or C. O. D. anywhere in U. S. Popular Mechanics Press, Room 808, 200 E. Ontario St., Chicago.

REFRIGERATION Compressors, with fan pulley \$9.00, refrigeration supplies. Clow, 1944 Iglehart Ave., St. Paul, Minn.

SHOP Notes for 1932. Get your copy now. Only a limited edition. Contains all the articles published in the Shop Notes department of Popular Mechanics Magazine during 1931. Send 50 cents. If you want the set of Shop Note books consisting of 7 volumes including the 1932 number and 6 others issued previously we will send them C. O. D. for \$3.50. Popular Mechanics Press, Room 808, 200 E. Ontario St., Chicago.

SHORT STORIES

SHORT Stories revised, typewritten and marketed. Details free. Hursh Service, Box P-1013, Harrisburg, Penna.

RADIO Amateur's Handbook. We heartily endorse and recommend this famous book to anyone who wishes to participate in amateur radio activities but does not know how to get started. This manual of amateur short-wave communication is the standard reference work for members of the American Radio Relay League. Price \$1.00 postpaid. Popular Mechanics Press, Room 808, 200 E. Ontario St., Chicago.

TYPEWRITERS AND SUPPLIES

TYPEWRITERS, Radios, motorcycles, \$4.99—\$24.99. T. W. ribbons 15c. Knights, 1517B Olive, St. Louis, Mo.

ADDING Machine \$10, typewriter \$8.50, multigraph printer \$22.50, duplicator \$20.00. 2 days trial. Money back guarantee. Pruitt, 190 North LaSalle, Chicago.

PRINTING, MULTIGRAPHING AND MIMEOGRAPHING

200 LETTERHEADS, (6x7), 150 Envelopes, \$1.00; 250 letterheads (8½x11), 250 envelopes, \$2.00; 500 of each \$3.00; 500 cards \$1.15; 500 statements \$1.50. Hoosier Print Shop, Portland, Indiana.

5000 ENAMEL Envelope folders, 1200 words, \$12.50. Catalogs, booklets—all printing—low prices. Samples. Goodprint, Harrisburg, Va.

250 HAMMERMILL 8½x11 Letterheads and envelopes—\$1.50 postpaid. Modern Press, 2216 Thome, Chicago.

50 PERSONAL Cards, 10c; business cards, 1000—\$1.30; 500—\$0.75. Apollo, 34W Balsam, Buffalo, N. Y.

NEARGRAVURE—500 Each letterheads and envelopes \$1.65 postpaid. Solidays, Knox, Indiana.

500 LETTERHEADS \$1.00, Classy two color \$1.75. Postpaid. Taylor Printery, Olny, Ill.

LETTERHEADS (8½x11) And envelopes, 500 of each \$3 postpaid, 4th zone. Send stamps for special offer. Quality Press, Bay City, Mich.

STATIONERY Printing, catalogs, circulars. Samples, Ruling, loose-leaf binders. Commercial Press, Batavia, Ohio.

1000 BUSINESS Cards, card case, \$1.50. Miller, Printer, Narberth, Pa.

250 BOND Letterheads, envelopes, billheads, cards, \$1.35 each. Economic Press, Leonia, N. J.

GUMMED LABELS

BETTER Labels for less. Samples. Rex, 6618M Quimby, Cleveland, Ohio.

1,000 PRINTED; Name, business, address 50c. JBS Company, Box 93, Holbrook, Mass.

PRINTING OUTFITS AND SUPPLIES

BUILD \$x10 Press for \$1.00. Instructions 10c. Kenneth Wise, Red Lion, Penna. **USED Type bargains.** Showings for stamp, Box 15, Cambridge, Mass.

PREUSED Printing presses and supplies. Lists 3c stamp. Popular Bargains, Richmond, Pa.

USED Press bargains. What size do you want? Send stamp for reply. Exchange, D-1, 480 E. Main, Meriden, Conn.

PRINT Your own cards, stationery, circulars, advertising, etc. Save money. Easy rules furnished. Print for others, big profits. Junior press, \$5.99; job presses, \$11; power, \$149. Write for free catalog and full information. Kelsey Co., 8-11, Meriden, Conn.

PRINT Your own circulars, envelopes, with home made press costing less than \$1.00. Illustrated instructions 10c. Carl Edquist, Odessa, Minn.

PRINTING Outfits—Presses, type supplies, type novelties. Send stamp for catalog. Model Press, York, Penna.

DUPLICATORS AND DEVICES

"ROTARY Stencilgraph"—Prints thousands of copies. Anything you type, write or draw. Guaranteed, \$37.50. Easy terms. Free literature. Write. Mailorder Supply, 235 East 42nd, New York.

"EXCELLOGRAPH" Rotary stencil duplicator \$39.00. "Two-Faced" film duplicator \$8.00. Booklet free. Pittsburgh Typewriter Supply, Dept. 601, Pittsburgh, Pa.

RUBBER STAMPS

3-LINES, Air-cushion mounted 50c. Swivel G-114 Huntington, New Brunswick, New Jersey.

NAME, Address, 2 lines 25c; 3 lines 35c. Stamp Works, Auburn, Nehr.

FOR THE HOME

FIVE Types of ornamental wood fences described on blueprint SN 640 for 25c. Dept. B. P., Popular Mechanics, 200 E. Ontario, Chicago.

LAWN Chair, southern style, fully covered on blueprint SN 529 for 25c. Dept. B. P., Popular Mechanics, 200 E. Ontario, Chicago.

REFRIGERATING Machine, homemade. Inexpensive to build. Gives better service than ice. This and 328 other practical articles in our book "Home Mechanics." Just ask for this and "Handbook for Women," containing 394 valuable household helps and pay postman 98 cents and postage for the two books. Popular Mechanics Press, Room 802, 200 E. Ontario St., Chicago, Ill.

ELECTRIC CLOCKS

"SPLIT Second" electric clock movement, only \$1.99. You get \$5 to \$10 for it—send dime for "Make Big Money Electrifying Clox.", Kuepfer, Guttenberg, Iowa.

INTERIOR Wall decoration is a valuable new book covering all the modern methods of artistic wall treatments. Practical working instructions for both plain and decorative finishes are given. 451 pages, illustrated. Delivered to your door C. O. D. Simply pay postman \$4 and postage. Popular Mechanics Press, Room 802, 200 E. Ontario St., Chicago.

FIELD GLASSES, TELESCOPES AND MICROSCOPES

BINOCULARS, Field glasses, telescopes—slightly used, \$1.75 up; 8x prism binoculars, \$11.00. All makes. DuMaurier, Busch, Lemaire, Colmont, Megaphos, etc., 3 to 24 power. World's largest assortment. Catalog free. DuMaurier Importers, Dept. 209A, Elmira, N. Y.

EIGHT Mile binoculars—\$7.50. Twelve mile telescope—\$1.49. Free trial. Catalog. Tarra, 3139 Natrona, Philadelphia.

DIAMONDS, WATCHES, CLOCKS AND JEWELRY

USED Watches—7 jewel Elgins, Walthams, \$2.50 each. Fleischman's, 16 S. Jefferson, Chicago.

RAZORS AND BLADES

LATEST Gillette type blades, ten 25c; fifty \$1.00. Hall, 25 Fuller Place, Brooklyn, N. Y.

"HONEY HANDY" (copyrighted) renews dull blades. Price 25c. Harrington, 649 Second Ave., New York.

GUNS, FISHING TACKLE AND SPORTING GOODS

TENNIS. String your own racket. Complete instructions, enough excellent split gut and trimmings. Send \$1.00, \$1.50 or \$2.00. R. F. Landgraf, 2047 W. 28th St., Los Angeles, Calif.

ANTIQUES, WAR RELICS AND INDIAN GOODS

INDIAN Relics, beadwork, coins, curios. Catalogue and arrowhead 8c. Vernon Lemley, Northbranch, Kansas.

SEND 5c For fine new list Indian relics, antique firearms. F. E. Ellis, Webster Groves, Missouri.

MUSIC AND MUSICAL INSTRUMENTS

FORTUNES Being made from songs through talking pictures, radio, phonograph, music publishers. "Hit" writers revise, arrange, compose music to your lyrics. We submit to studios and other markets. Free reading. Send for booklet. Universal Song Service, 625 Meyer Bldg., Hollywood, Calif.

SONG Poets, write Sequola Songwriters Service, Sherman Branch, Los Angeles, Calif.

SONGWRITERS—Free booklet. Eddie Applegate, 1309 First, Ashbury Park, N. J.

SONG Writers. Send for our "Publishing Agreement." McKinley Music Printing, 1501 E. 55th St., Chicago.

BIG Money in songwriting. Free folder. Stan Tucker, 1619 Broadway, New York.

DUO-Flex reeds for clarinets and saxophones eliminate your reed troubles. Write for circular. Duo-Flex Reeds, 1204 1st Ave., Evansville, Ind.

SONGWRITERS—Music composed \$3.00. Guaranteed. Phillips, Pine Bush, N. Y.

POEMS Wanted. Work guaranteed. We publish. Great Eastern Song Bureau, Dept. 27, Thomaston, Me.

SYSTEM Complete \$1.00. Address "Music Shortland," Plismo Beach, California.

SEND Song poems, 50-50 plan. Indiana Song Bureau, (Brookside), Salem, Ind.

"MUSIC Composed" to words. Bauer Bros. (formerly of Sousa's Band), Oshkosh, Wis.

PATENT ATTORNEYS

PATENT Your idea now. Send for free book, "How to Obtain a Patent," and free "Record of Invention Blank." In business since 1898, specializing in patent matters, we have successfully served thousands of inventors. Little ideas may have big commercial possibilities. Delays are dangerous in patent matters—act at once and protect your idea. Reasonable charges. Deferred payments. Write us today. Victor J. Evans & Co., 601-J Victor Bldg., Washington, D. C.

PATENTS—Small ideas may have large commercial possibilities. Write immediately for free book, "How to Obtain a Patent" and "Record of Invention" form. Delays are dangerous in patent matters. Free information on how to proceed. Clarence A. O'Brien, 58-M, Adams Building, Washington, D. C. See page 125A.

LACEY'S Patent Sense. Valuable book free. See ad page 126A.

TRADE-MARKS. Copyrights—exclusively. Protect almost anything! See "Wade" ad page 126A.

INVENTORS: Send for booklet telling how to patent and sell your inventions at lowest cost. Ralph Burth, Patent Lawyer, 900 F St., Washington, D. C.

LEADING Manufacturers now buy practical inventions before patenting, if first protected under modern, inexpensive plan. For information, write Chartered Institute, 354 Barrister Building, Washington, D. C.

L. F. RANDOLPH, 302-B Victor Building, Washington, D. C. Low cost. Book and information free.

"INVENTOR'S Guide," valuable information free. Frank Ledermann, Registered Attorney-Engineer, 220 Broadway, New York.

WHAT To Invent: Names of manufacturers and wanted inventions sent free on request. Use our legal form for recording proof of invention. Write W. T. Greene, 946 Barrister Building, Washington, D. C.

PATENTS. Booklet free. Highest references. Best results. Promptness assured. Watson E. Coleman, Patent Lawyer, 724 Ninth St., Washington, D. C.

LANCASTER, Allwine & Rommel, Suite 411, 815 - 15th St., N. W., Washington, D. C. "Originators of the Form Evidence of Conception." Before disclosing your invention to anyone send for blank form to be signed and witnessed. Form and patent information bulletin free.

PATENTS Procured; trade marks registered—preliminary advice furnished without charge. Booklet and form for disclosing idea free. Irving L. McCathran, 706A International Bldg., Washington, D. C.

PATENTS. Send sketch or model for advice. Free book, "How to Obtain a Patent." Established thirty years. Highest references. Prompt service. Reasonable charges. Chandice & Chandice, 908 F Street, Washington, D. C.

ESTABLISHED 1864. Milo S. Stevens Company. Free booklet. Patents. Trade marks. Copyrights. Offices. Menadnock Block, Chicago; Barrister Bldg., Washington, D. C.

PATENTS—Write for free information. How to Obtain a Patent and Record of Invention—or send drawing or model for examination. Miller & Miller, Patent Attorneys (former Patent Office Examiners), 1006-A Woolworth Building, New York; 673 Earle Building, Washington, D. C.

FOR INVENTORS

INVENTORS: Sell your invention, show it to manufacturers and patent buyers, win \$500.00 in awards and a certificate for distinguished accomplishment by exhibiting your invention at the Exposition of American Inventions to be held at Broadway Auditorium, Buffalo, October 12 to 19, 1932 under auspices of the American Society of Inventors, Inc. If your invention has been sold, leased, has patent pending, or is unpatented, it is eligible to compete for an award and merit certificate. Selection of winners by a committee appointed by the Buffalo Engineering Society. Exposition sponsored by leading industrialists. Write for complete details to Exposition of American Inventions, Seventy-First Euclid Building, Cleveland, Ohio, or Crosby Building, Buffalo.

ENTERPRISING Manufacturers now want better inventions, patented or unpatented, to meet keen competition. What have you? Write Chartered Institute, 556 Barrister Building, Washington, D. C. "World's largest organization of inventors."

READ The inventors own magazine! Sell your invention! Write "Inventive Age & Patent Market," Desk A, 718 East 4th, Brooklyn, N. Y., for free information every inventor should know! (Write today!)

BLUEPRINT On 12-ft. flat-bottom rowboat (SN 707) 25c. Also plan of 15-ft. rowboat (SN 644) 25c. Dept. B. P., Popular Mechanics, 200 E. Ontario, Chicago.

PATENT Your invention: Send for free book, "How to Obtain a Patent," and "Record of Invention" blank. Consult us about how to protect your ideas. Reasonable charges. Deferred payments. Victor J. Evans & Co., 602-J Victor Bldg., Washington, D. C.

PATENTS—Small ideas may have large commercial possibilities. Write immediately for free book, "How to Obtain a Patent" and "Record of Invention" form. Delays are dangerous in patent matters. Free information on how to proceed. Clarence A. O'Brien, 58-M, Adams Building, Washington, D. C. See page 125A.

LACEY'S Patent Sense Valuable book free. See ad page 126A.

LOW Cost manufacturing. Large plant completely equipped for blanking, drawing, stamping and wire forming in any finish. Can save you money on your products. Our figures will convince. Eastern States Products, Box 721, New Haven, Conn.

INTERESTED—Promotion of unpatented and patented ideas. Continental Distributors, 1401 Merchandise Mart, Chicago.

TO Inventors: We are in the market to purchase a good patent, preferably a five and ten cent store item. Will purchase outright or royalty. Purchasing Agent, 241 Front St., New York, N. Y.

GET Your own patents; legal blanks, complete instructions \$1. Cutting Sons, Campbell, Calif.

MANUFACTURERS Everywhere seek new inventions to improve their product. Names of manufacturers and wanted inventions sent free on request. Write W. T. Greene, 944 Barrister Building, Washington, D. C.

GET Started on De Witt Clinton prize contest. Six blueprints on the locomotive for \$1.00. Ask for SN 806 to 805. Dept. B. P., Popular Mechanics, 200 E. Ontario, Chicago.

INVENTOR'S Universal Educator: contains 800 mechanical movements; 30 perpetual motions; instruction on procuring and selling patents and selecting an attorney, etc. Suggests new ideas. Price \$1.00 postpaid in U. S. A. Address Dietrich Co., 602B Ourray Bldg., Washington, D. C.

MANUFACTURERS Will now buy inventions. Rubber and toy inventions wanted. Valuable circular free. Patents prepared, prosecuted \$75.00. 20 years experience. Crude ideas developed. J. J. O'Brien, 105 W. 42nd St., New York.

BRASS Gears and model supplies. Send for catalog. The Pierce Model Works, Tinley Park, Ill.

INVENTORS—Hundreds of manufacturers everywhere are constantly on the look-out for new money and labor-saving patents. Now is the time to offer your patent for sale. Don't delay its sale any longer. Send today for a free copy of our specially prepared booklet "Turn Your Patent Into Money." It contains helpful information for all inventors! M. L. Rund, Mgr., Classified Advertising, Popular Mechanics Magazine, 200 E. Ontario St., Chicago, Ill.

PATENTS FOR SALE

ANTIGLARE Shield, Patent 1,790,985 for sale. Alvah L. Wyatt, Nora Springs, Iowa.

MANUFACTURERS Wanting profitable new inventions, write Chartered Institute, 555 Barrister Building, Washington, D. C.

TROLLING Spoon, something new. Outright or royalty, Wm. Eggleston, Box 520, Walla Walla, Washington.

INVENTORS—Hundreds of manufacturers everywhere are constantly on the look-out for new money and labor-saving patents. Now is the time to offer your patent for sale. Don't delay its sale any longer. Send today for a free copy of our specially prepared booklet "Turn Your Patent Into Money." It contains helpful information for all inventors! M. L. Rund, Mgr., Classified Advertising, Popular Mechanics Magazine, 200 E. Ontario St., Chicago, Ill.

MANUFACTURERS Looking for new inventions should write W. T. Greene, 939 Barrister Building, Washington, D. C.

INVENTORS—Cash in on your invention now! Don't delay the sale any longer! Send for a free copy of our specially prepared booklet, "Turn Your Patent Into Money," today! It contains helpful information for all inventors. M. L. Rund, Mgr. Classified Advertising, Popular Mechanics Magazine, 200 E. Ontario St., Chicago, Ill.

BACKSTOP For cars and two others. Any offer accepted. Apply A. Bjork, 401 Kamloops, B. C., Canada.

MODELS AND MODEL SUPPLIES

INVENTORS: Send us sketch or crude model of your idea. Crescent craftsmen will develop it into a practical working model. 30 years of successful experience and thousands of satisfied clients. Confidential service guaranteed. Bank references furnished. Free illustrated book: "Making Inventions Pay." Crescent Tool Co., Dept. 8-9, Cincinnati, Ohio.

PATENTS—Small ideas may have large commercial possibilities. Write immediately for free book, "How to Obtain a Patent" and "Record of Invention" form. Delays are dangerous in patent matters. Free information on how to proceed. Clarence A. O'Brien, 58-M, Adams Building, Washington, D. C. See page 125A.

LEAD Solders, accurate reproductions. Send 15 cents for sample and catalogue. Toy Solder Shops, 735 Monticello Street, Evanston, Illinois.

BRASS, Copper, steel, rods, tubes, sheets, bars, screws for home mechanics. Pricelist free. National Home Workshop Supply Co., 299-G North Ave., New Rochelle, N. Y.

PATENTS. Low cost. Book and information free. L. F. Randolph, 302-C Victor Building, Washington, D. C.

DEWITT Clinton Materials list free. Ship and yacht model fittings. Catalog 15c. A. J. Fisher, 1002 Etowah Ave., Royal Oak, Michigan.

SANTA Maria model blueprint SN 759 for 25c. Dept. B. P., Popular Mechanics, 200 E. Ontario, Chicago.

"REAL" Motor, gasoline, for model airplanes, boats, $\frac{1}{8}$ " x $\frac{1}{4}$ " $\frac{1}{8}$ h.p., weight 1 lb., 3200 r.p.m. Catalog "Real Boats," motors, fittings, 26c coin. Leutrol, 96 McDonough St., Brooklyn, N. Y.

MODEL Steam and gasoline engines, catalog 15c. Anton Bohaboy, 212 Price St., Rahway, New Jersey.

WE Make working models for inventors and do experimental work and carry a complete stock of brass gears and model supplies. Send for catalog. The Pierce Model Works, Tinley Park, Ill.

MODEL Of Wright "Whirlwind" 300 radial engine. Size 13x22 inches, lithographed in colors. By means of an ingenious arrangement of flaps, this model can be practically disassembled and put together again. Shows and names every part. Of great value to aviation students, mechanics and air-minded men and boys. Durable. Sent prepaid upon receipt of price, \$1.00. Popular Mechanics Press, Room 805, 200 E. Ontario St., Chicago.

MANUFACTURING

INVENTIONS Manufactured in any quantity at low cost. Stampings, dies, models, etc. Estimates and free catalog. Crescent Tool Co., Dept. X, Cincinnati, Ohio.

GENERAL Manufacturing. Wood, metal patterns. Aluminum, brass, iron castings. Machine work. Models made. Modern Machine & Pattern Co., Terre Haute, Ind.

ECONOMICAL Manufacturing from sheet, bar, wire or tubing. Models, dies, special machinery. Swanberg, 5124 N. Kildare Ave., Chicago.

STAMPING. Blanking, forming, drawing, dies, jigs and fixtures. Prices reasonable. All work confidential. Lewis Metal Stamping Co., Sharon, Pa.

RUBBERWARE Molded to specifications. Ebonite Products, Dept. 44, 895 Main, Akron, O.

MANUFACTURING. Models, dies, stampings, brasswork, moulds for castings, vulcanizing. Circular free. Bauma Metal Specialties, Kansas City, Mo.

LOW Cost manufacturing. Large plant completely equipped for blanking, drawing, stamping and wire forming in any finish. Can save you money on your product. Our figures will convince. Eastern States Products, Box 721, New Haven, Conn.

METAL Articles developed and manufactured. Model making. Reasonable price and first class workmanship. W. F. Meyers Company, Bedford, Indiana.

SURVEYING INSTRUMENTS

SAVE Money by buying our rebuilt transit and levels. All fully guaranteed—sold subject to field test. Cash or easy terms. Write today for list M09. Warren-Knight Co., (Makers of "Sterling" Surveying Instruments), 136 N. 12th Street, Phila., Pa.

WELDING AND SOLDERING

BARGAINS—Excellent reprocessed arc welders. Entirely rebuilt—guaranteed. Trial, Terms. Write Ken's Service, Box M-924, Troy, Ohio.

NEW 16th Edition of Dyke's World Famous Auto Encyclopedia—right up-to-date with free wheeling, synchro-mesh, down-draft carburetion, front-wheel drive, etc. The book auto repairmen swear by, 1339 pages, 4480 illustrations. Cloth binding \$6.00, flexible Morocco \$7.50. Postpaid upon receipt of price or C.O.D. anywhere in U. S. A. Popular Mechanics Press, Room 805, 200 E. Ontario St., Chicago.

ELECTRICAL

BURGLAR Alarm relay in oak cabinet, complete \$5. Supplies, diagrams. Midnight Alarm, Fenton, Mich.

MYSTERY Motor, 110-volt novelty, \$1.00. Cutting Sons, Campbell, Calif.

ELECTRICIANS: Address—Frank Goff, 727 Merrick Avenue, Collingswood, N. J.

BUILD Your own fans. 20 inch aluminum propellers for airplane fans \$3.85. Will ship collect. Michael Electric Co., Ft. Worth, Texas.

ELECTRICAL Trouble shooting on the motor car and airplane. Don't trust to luck or guess work. Learn to make every motion count in testing and repairing. Send for our standard 493-page book for electricians and mechanics. 300 diagrams. Hundreds of practical tests. Pay postman \$4.00 plus postage when delivered. If outside U. S. remit when ordering. Popular Mechanics Press, Room 805, 200 E. Ontario St., Chicago.

MACHINERY, TOOLS AND SUPPLIES

16"x36" NEW Motor driven screw cutting bench lathe complete \$129.00. 18"x19" Boye-Emmes lathe \$175.00. 14" Smith Mills crank shaper \$125.00. No. 60 Head cylinder grinder \$160.00. 14" Barnes drill press \$35.00. air compressors; battery charger; etc. Write for catalog. Terms to suit. Cincinnati Machinery & Supply Co., 27 West 2nd St., Cincinnati, Ohio.

SUBSTANTIAL Savings—used are welders, platers, compressors, paint sprays. Entirely rebuilt; guaranteed. Trial and terms. Write Ken's Equipment, Box M-925, Troy, Ohio.

LATHE Bargains—Factory rebuilt and demonstrators. Screw cutting lathes, 9", 13" and 16" swing. Also few used lathes in good condition. Write South Bend Lathe Works, 203 Madison, South Bend, Ind.

KELLOGG Air compressors, excellent condition, \$6.00. Refrigerator compressors, \$6.00. Building instructions, 50c. Taylor, 105 East 102nd Street, New York City.

START Business of your own, doing chromium, nickel, copper, silver plating. Also silvering mirrors. Big profits. Information free. Electro Platers Supply Co., 28 West Second St., Cincinnati, Ohio.

ENGINES, MOTORS AND DYNAMOS

GAS Engines, 2 cycle, 1/4 h.p. Unusual value, \$12.00. S. & B. Sales Co., Newton, Iowa.

MOTORS Rebuilt—1/4 110, \$3; 1/2 220, \$5. N. F. & M. Wks., 1367 Niagara St., Buffalo, N. Y.

BRAND New 1/4 hp. ac. motors \$6.00. Many bargains in 32 volt machinery. Write for quantity prices. Queen City Electric, 1156 Grand Avenue, Chicago.

1/4 HORSE Repulsion induction alternating motors \$12.75. 24 inch exhaust fans \$21.00. Many other bargains. Electrical Surplus Co., Dept. 12, 1885 Milwaukee Ave., Chicago.

PORTABLE Motor base for small motors. Every home work shop needs one. Eliminates line shafts. Belt tension instantly adjusted without screws or bolts. Price \$1.00 postpaid. Satisfaction or money back. Send for folder. Otto Koenigslow Mfg. Co., 3501 Perkins Avenue, Cleveland, Ohio.

MECHANICAL Models, new and novel. Everyone is familiar with the "anatomical chart" method of teaching the physiology of the human body. Popular Mechanics has developed similar accurate models in the mechanical field. Models now ready are Wright "Whirlwind" 300 Engine and Ocean Liner "Europa." Others to follow. Every part clearly shown and the name given. Invaluable to students and all who are mechanically inclined. Price \$1.00 each. Sent postpaid anywhere upon receipt of price. Popular Mechanics Press, Room 804, 200 E. Ontario St., Chicago.

FARMS AND FARM LANDS

FREE Books on opportunities in Minnesota, North Dakota, Montana, Idaho, Washington, or Oregon. Complete information on climate, crops, location for farm or suburban tract for grain, livestock, dairying, fruit, poultry—a home, independence, plenty of food, clothing, continuous employment. No occupation offers more to industrious capable men. Write E. C. Leedy, Dept. 257, Great Northern Railway, St. Paul, Minn.

NEW, Low prices. Just out. Strouts big illustrated fall catalog nearly 1000 bargains, equipped farms, gas stations, auto inns, country stores. Free. Strout Agency, 255-P Fourth Ave., N. Y. City.

FINE 200 Acres, good improvements. 20 timber, balance crops, \$4500. Van Hill, Mt. Vernon, Ill.

INDEPENDENCE, Security assured on North Dakota, Minnesota, Montana, Idaho, Washington, Oregon farms. Bargain prices. Easy terms. Write for descriptive literature, impartial advice, mentioning state. H. W. Byerly, 119 Northern Pacific Railway, St. Paul, Minn.

861 PRACTICAL Ways to Reduce Farm Labor and Expense and Increase Income. One farmer writes he would not part with this information for \$100, if he could not duplicate it. Nothing experimental. These ideas have all been put to test and proven practical. Send today for a copy of our Handbook for Farmers and get ready to put these ideas into operation for your own benefit. Pay postman only 98 cents and the postage when he hands you the package Popular Mechanics Press, Room 802, 200 E. Ontario St., Chicago, Ill.

SELL Your property quickly for cash, no matter where located. Don't pay big commission. Particulars free. Real Estate Salesmen Co., Desk B, Lincoln, Nebr.

\$5 DOWN, \$5 Monthly, 20 acres in Missouri Ozarks, \$100. Fishing, hunting, trapping. Hubbard, 216 Grossman Bldg., Kansas City, Kansas.

OLD GOLD WANTED

CASH Mailed immediately for old gold, teeth, bridgework, crowns, and old gold jewelry. Goods returned if not satisfied. Beebe Company, 510 Central Ave., Cincinnati, Ohio.

WANTED—MISCELLANEOUS

MAIL Us your discarded jewelry, gold crowns and bridges, watches, diamonds, silver, platinum. Money promptly mailed. Goods returned if offer refused. United States Smelting Works (The Old Reliable) 39 So. State St., Dept. 71, Chicago.

WANTED To buy: Old envelopes, folded letters, with stamps or postmarks on them, that were mailed before year 1880. All kinds. High cash prices paid. Northern and southern envelopes used during Civil War and those sent to and from California during gold rush, 1850 to 1865, especially wanted. Search through your old family letters—then write at once for interesting information free. Address R. Rice, 2652 Asbury Ave., Evanston, Illinois.

BEST Books for \$1. Formerly \$2.50 to \$5. Get these best sellers you have wanted to read: Abraham Lincoln (The Prairie Years) by Sandburg, Houdini by Kellogg, Henry the Eighth by Hackett, Napoleon by Ludwig, Meet General Grant by Woodward, Omnibus of Crime by Sayres, Vagabond Journey Around the World by Franck, Royal Road to Romance by Halliburton. Postpaid upon receipt of price or C.O.D. by mail anywhere in U. S. Popular Mechanics Press, Room 801, 200 E. Ontario St., Chicago.

FOR SALE—MISCELLANEOUS

200 ASSORTED Key blanks—\$1.00—postpaid. Bivrian Company, 146 Front Street, New York.

NECKTIES! 35c. Five, \$1.35. Quimette's, 81 Holly D20, New Bedford, Mass.

DOUBLE-EYED Self-threading needles, size 3/8, blind people thread them, 15c package. Wm. Oglesby, Vandalia, Ill.

WATCHMAKERS Lathe for sale at a bargain. R. Jaegermann, 5815 Easton Ave., St. Louis, Mo.

THE Business Guide—a book that fills a definite need in every home. Treats on—Bankruptcy, Bonds, Bookkeeping, Broker, Chattel Mortgages, Citizenship, Contracts, Copyrights, Corporation, Deeds, Husband and Wife, Insurance, License, Lease, Letters, Notes, Partnership, Patent, Sale, Shipping, Trademark, Taxes, Will, Weights and measures, Business and Legal Forms and many other subjects. Write for "Business Guide." Pay postman \$2.50 plus few cents postage when book is delivered. Popular Mechanics Press, Room 807, 200 E. Ontario St., Chicago.

RABBITS

RABBIT Supplies—America's oldest Rabbit supply house. Free catalog. Desk 11, National Rabbit Supply Company, 1126 North Dearborn Street, Indianapolis, Ind.

GENUINE Angora wool rabbits, Reasonable. Sunnyside Fur Ranch, Vaughn, Mont.

RABBITS And supplies, Complete descriptive literature 10c. Facey Corporation, X-30, Wallkill, New York.

TROPICAL FISH

MAKE Money at home raising beautiful tropical aquarium fishes. Valuable information ten cents. Vineland Tropical Fish Hatchery, Vineland, New Jersey.

DOGS AND PETS

50 TREE Hounds, all breeds. Real northern gamegetters. Pictures, individual descriptions, terms, price list. Send dime. Lakeland Fur Exchange, Salem, Michigan.

SELLING 1000 Raccoon, Barcoon book 75c. William Maple, Leipsic, Ohio.

ST. Bernards!! Thoroughbred, heavy type, reasonable, duty free. Crown Kennels, Box P, Napierville, Qua.

FERRETS

FERRETS, Young, \$2.00 pair, Yearlings \$1.00 pair. C.O.D. Allen Clemens, Port Clinton, Ohio.

ROOTS AND HERBS

JUST Out! Beautifully illustrated 64 page medicine (gan almanac). Contains over 500 old-fashioned herb medicine recipes and Indian secrets for home use, 10c postpaid. Worth dollars! Botanic, 145 West 112th St., Chicago.

PERSONAL

HANDWRITING Analyzed by expert. Particulars. A. Levesque, B. A., B. Sc., North Bay, Ontario.

FOOT Odors and perspiration positively cured. Od-ora-way treats shoes as well as feet. Special offer \$1.00. Aitken, Box 2075, Hollywood, Calif.

10 YEAR Astrology reading \$1.00. Covers all personal affairs. Psychology reading included. Birthdate, National, Desk 104F, Hunter, N. Y.

WHAT'S Ahead? "Yourlife" horoscope and "What 1932-33 Forecasts for You." 50c. "YourLife" calendar, with "Yo-Lucky-Da" guide—shows every date in your past, future—50c. Give birthdate, Caloscope, 2075-C11, Atlanta, Ga.

BUNIONS Actually reduced without pain. Booklet free. Eugene Eaton, D105, Bandon, Oregon.

CONTRACT Bridge expertly taught. Ten lessons—one dollar. N. B. Moore, Vanderbill, Pa.

YOU Need a better grip on mathematics? Ask us to send you a copy of "Mathematics for the Practical Man," only \$1.50. By common sense methods it removes the mystery and difficulties so algebra and calculus are made simple. Assuming your knowledge is limited to arithmetic you quickly and easily gain a working knowledge of algebra, geometry, Trigonometry and calculus. Simply pay postman when he hands you the package. Address Popular Mechanics Press, Room 802, 200 E. Ontario St., Chicago, Ill.

MISCELLANEOUS

INDEX Your formulas, shop notes, etc. Quit pawing over magazines to find what you want. Three-cent stamp brings details. Bichel, 4644 Telegraph, Oakland, Calif.

NEW Ford—V8—B four—BB truck. New, practical book, just out, tells how these cars and trucks are constructed as well as how to perform all upkeep, adjustment and repair operations. Over 250 pages. Illustrated fully. Price \$2.00. Sent postpaid anywhere upon receipt of price or C.O.D. anywhere in U. S. A. Popular Mechanics Press, Room 809, 200 E. Ontario St., Chicago.

AUTOMATIC Metal siphon, Unbreakable. For aquariums, tanks, etc., \$1.00; or 25c for blue print. A. C. Massie, Lake Pocatello, Middletown, N. Y.

A LIQUID Transfers pictures, Print off bills, papers, etc. 35c bottle. Formula 75c. Both 50c. Gordon Clinch, Brielle N. J.

TATTOOING Supplies, guaranteed remover, Illustrated list. "Waters," 965 Put-nam, Detroit.

CAN You draw? Something different, Sample—particulars 10c. "Straley," 134 Main, Springfield, Ohio.

AMATEUR Cartoonists—Earn \$25.00 week, spare time, copying cartoons for advertisers. 3-M Syndicate, Argyle, Wis.

TATTOOING Outfits, Catalog free. Chicago Tattoo Supply House, 434 So. State, Chicago.

TATTOOING Outfits, electric and hand. Circulars sent anywhere. Sergt. Bouzey, 367 So. Main, Providence, R. I.

OUTDOOR Sports for everyone—Enjoy them all year round with aid of book published by Popular Mechanics. This veritable encyclopedia not only furnishes hundreds of ideas for new and popular sports for every season of the year, but also gives complete instruction for making the necessary equipment at very small cost. 350 pages and 650 illustrations. Send today as book is full of thrills and excitement for winter sport enthusiasts. Mailed postpaid anywhere for \$2, or will be sent C. O. D. to any address in U. S. Simply pay postman when delivered. Popular Mechanics Press, Room 802, 200 East Ontario St., Chicago.



Men and Boys Everywhere Here is a delightful

Learn to Mount
Birds and
Animals.
Be a Taxidermist.
Learn in
your SPARE
TIME at HOME.
A WONDERFUL
business. Send
COUPON for
free book.

MOUNT WILD-GAME and COMMON ANIMALS

Make beautiful, unique, USEFUL articles, using common birds and animals, like those shown—Squirrel-lamp, Rabbit-ashtray, Frog clock, Book-ends and dozens of other ideas. Hundreds of similar things, easily made. They SELL AT SIGHT—BIG PROFITS and a world of fun.

This splendid NEW HOBBY is sweeping the country. Send NOW for

FREE BOOK! 48 pages, 200 pictures. Tells all about Taxidermy. All secrets of Taxidermy NOW revealed. Men and boys, learn easily, quickly in SPARE TIME. Greatest hobby on earth. Interesting, fascinating, FINE FUN. Mounted specimens attract instant attention.

Mail Coupon

for this great FREE BOOK. Send TODAY

New Hobby!

Novelty Taxidermy
Fascinating, Fun and Very PROFITABLE

**Do You Want \$50 to \$150 a Month
Extra Money? Here It Is!**

Mount wild-game for hunters and anglers. Sell your own mounted game. MOUNT AND SELL ALLURING Novelty Taxidermy pieces from COMMON ANIMALS. Positively the GREATEST SPARE TIME MONEY-MAKER ever discovered. Our old reliable school with 100,000 graduates GUARANTEES to teach you successfully. Need extra money? Want a marvelous HOBBY that will make you well known? Then INVESTIGATE TODAY. Mail the COUPON now for the splendid FREE BOOK. State your age.



**FREE
BOOK
COUPON**

Name.....

Address.....

Age.....

Northwestern School of Taxidermy
3376 Elwood Bldg., Omaha, Neb.
Send me your free illustrated book,
"How to Mount Game." Also tell
me how I may learn this fascinating
art easily and quickly by mail. No
obligation.

Get
into
RADIO
REAL
JOBS
REAL
PAY

Earn While Learning at Home!
Television, Sound Pictures,
Photo-Cell Work

Radio needs trained men. Broadcasting, ship radio, aircraft, television, servicing jobs pay \$40-\$100 a week and more. Learn at home, quick EASY H. T. L. way endorsed by 22 leading Radio Manufacturers. Book of Big Opportunities FREE. Write today for your copy!

RADIO AND TELEVISION INSTITUTE, Inc.
2130 Lawrence Ave., Dept. 16, CHICAGO, ILL.



**U.S.
GOVERNMENT
JOBS**

\$1260 TO \$3400 YEAR

Men—Women—18 to 50
STEADY WORK

Thousands Post-
depression Jobs
Common Education
usually sufficient

Mail Coupon
Today—
SURE

FRANKLIN INSTITUTE
Dept. A178, Rochester, N. Y.

Gentlemen: Rush to me FREE list of U. S. Government big pay steady positions now obtainable. 32-page book describing salaries, hours, work, and how to get a position.

COUPON—
Name.....
Address.....



AUTO
BOOKS SENT FREE



ON APPROVAL. Just mail the coupon and we'll send you a set of these remarkable auto books, just off the press. Whether you are a mechanic or helper, expert or apprentice, auto owner or driver, if you're interested in knowing all about automobile mechanics, then take advantage of this FREE OFFER.

DON'T SEND A PENNY!

A better job—in the gigantic auto industry. BIGGER PAY—a chance to go into business for yourself and get a share of the huge profits are waiting for any man who even half tries to improve himself. Learn Auto Engineering with these wonder books a new way—without studying or memorizing. Simply use the JIFFY INDEX to look up the answer to any auto problem. Built by eleven of America's greatest automobile engineers and written in simple language so you can understand it!

[FREE! Privilege of consulting Automobile Engineers of American Technical Society for one year without cost if you mail coupon immediately.]

AMERICAN TECHNICAL SOCIETY
Drexel Avenue & 58th Street
Dept. A-619, Chicago, Ill.

CAN YOU FIX IT?

These wonder books tell step by step HOW to take out "kinks" in differential — to kill the shimmy in steering — to set TIMING—how to put your finger instantly on engine trouble and then the quick expert way to FIX it. Newest improvements fully covered. Equal to a complete trade course at less than a fourth the cost.

6 Big Volumes Latest Edition

2500 pages, 2000 illustrations, wiring diagrams, etc., including Aviation Motors. Deluxe edition, gold-stamped flexible binding.

AMERICAN TECHNICAL SOCIETY,
Dept. A-619, Drexel Ave. & 58th St., Chicago, Ill.

I would like to see the new 6-volume edition of your AUTO BOOKS. I will pay the few cents delivery charges only, but if I choose to I may return them express collect. If after 10 days use I prefer to keep them, I will send you \$2 and pay the balance at the rate of only \$5 a month until \$24.50 is paid. Please include free consulting membership as per your offer above.

Name.....
Address.....
Employer's Name.....
Employer's Address.....

NOW YOU CAN TRAIN FOR COMMERCIAL ELECTRICAL ENGINEERING In One Year!

Men of Action with mechanical talent can assure future advancement by combining skill with practical electrical knowledge. Every year modern industry demands more trained men for positions that pay well.

Now in one year you can get complete training in Commercial Electrical Engineering, normally requiring 2 years. Intensive 18 months' course for non-high school graduates. Special 3 and 6 month courses in REFRIGERATION, AIR-CONDITIONING, MASTER ELECTRICIAN, RADIO, TELEVISION.

You Study
Electricity
Right From
The Start



Electrical
Engineering
B.S. Degree
In 3 years
(36 months)

GREAT INDUSTRIAL COOPERATIVE PROGRAM

Leaders of Milwaukee's industries have joined us in a gigantic program of Industrial Cooperation. These valuable contacts insure students a practical training geared to the needs of some of the nation's greatest organizations.

29 YEARS OLD— this school has successful graduates in all parts of the world. Famous "Unit System" of training has proved most efficient for 29 years. Each 3-month term a complete unit of training—you advance according to your ability.

Many students earn a portion of living expenses. Scholarship Loan Fund for those who need help. Daily broadcasts over WISN and Western Key Station W9SO. Social and athletic activities.

EARN LIVING EXPENSES

FREE! Mail the coupon for Photo-Story and details of "Earn While You Learn Plan"

SCHOOL of ENGINEERING of Milwaukee

Founded in 1903 Dept. P.M. 932 Milwaukee, Wis.

Please send without obligation, FREE Photo-Story and details about courses checked with "X."

- Com. Elec. Eng., 1 yr. Com. Radio Eng., 1 yr.
 Elec. Engr., 3 yrs. B.S. Degree Elec. Refrig.
 Air Conditioning. Radio, Television.
 Armature Winding. Practical Elec.
 Home Laboratory Service. "Earn While You Learn" Plan

Name..... Age.....

Address.....

City.....State.....

Education.....

THERE'S REAL MONEY in Commercial Photography



Fine pay. Pleasant work. Advertising, business, industry needs photographers. Learn Photography quickly, thoroughly. Ask about our new system of individual coaching by mail, or by personal attendance at our completely equipped, modern training studios. Same expert instructors; same effective methods in either case. Particulars free. Write today. No obligation, of course.

NEW YORK INSTITUTE OF PHOTOGRAPHY
Dept. 491 10 West 33rd St. New York, N. Y.

- Still Photography (Commercial), News Portrait and Photo Finishing.
 Motion Picture Photography and Projection.

Name.....

Address.....



Be a DENTICIAN

Learn at home to make Crowns, Plates, Bridgework, etc., for Dentists. Easy practical way to learn mechanical dentistry at home in spare time. Full equipment of tools and materials included with course FREE. Low tuition. Easy terms. Write for FREE BOOK about this money-making profession and our easy-to-learn home-study course and special offer.

McCarrie School of Mechanical Dentistry

316 S. Wabash Avenue

Dept. E-505

Chicago, Ill.

LEARN WATCHMAKING

and become independent. We help you secure a position.

Easy to learn. Send for FREE CATALOG.

ST. LOUIS WATCHMAKING SCHOOL

DEPT. 5

ST. LOUIS, MO.



DO YOU WANT TO

STOP TOBACCO?

Banish the craving for tobacco as thousands have. Make yourself free and happy with Tobacco Redeemer. Not a substitute, no habit forming. Write for free booklet telling of injurious effect of tobacco and dependable, easy way to relieve the craving many men have.

Newell Pharmacal Co.
Dept. 900 St. Louis, Mo.

FREE BOOK

RAISE JUMBO BULLFROGS

FOR PROFIT



Send for complete illustrated book fully explaining the industry and its possibilities. Price \$1.00 postpaid.

POPULAR MECHANICS PRESS
Room P9, 200 E. Ontario St., Chicago, Illinois

Information on any book free. Write Popular Mechanics Press, Chicago, Ill.



DRAFTING

Learn at home

F. E. KROG was "a poorly paid clerk" when he enrolled for the home-study Drafting Course of the International School of Drafting. Through study and perseverance he became Chief Draftsman of the U. S. Steel Furniture Co. He is now earning more in a day than he used to earn in a week.

A. J. Hutchins became Chief Draftsman for the American Strawboard Company and increased his salary 300%—also as a result of our training.

There is no doubt that Drafting offers a real opportunity to ambitious men and it will pay you to investigate it. Mail coupon for free booklet.

INTERNATIONAL SCHOOL OF DRAFTING

Division of the
International Correspondence Schools
Box 5618-G, Scranton, Penna.

Without cost or obligation, please send me full details of your home-study course in

- Mechanical Drafting Structural Drafting
 Architectural Drafting Ship Drafting

Name.....

Address.....

When writing to advertisers please mention Popular Mechanics

Re-Soles Shoes **AS LOW AS** 4½ CENTS

Amazing New SAVASOLE "Plastic"

Pays Agents **UP TO \$42 a Day**

Ends costly shoe repairs—saves buying new shoes. Spreads on worn soles and heels like butter on bread. Hardens overnight. Half-soleing costs as little as the pair—patches, one cent. Savasole fills in all cuts, holes, cracks, forming a smooth, flexible, waterproof, non-skid surface. New low price makes everybody buy. Agents cleaning up. Mail coupon today for Free Sample on leather and money-making agents offer showing how you can make up to \$42 a day.

1001 USES Savasole also repairs auto tires and tops, boats, rubbers, harness, garden hose, tarpaulins, sporting goods. Anything made of leather, rubber or cloth can be easily, quickly and cheaply repaired with Savasole.

Mail Coupon for FREE Sample on Leather

Mail coupon and get exclusive territory offer and learn how you can have the same opportunity that made Kimura of Cal., over \$60 in a day and a \$500 cash bonus; that made Lewis of Kansas \$30.10 his first morning. Everybody buys Savasole to save money. It's a marvelous "hard times" seller. Territories going fast. Mail coupon at once.

SAVASOLE CO.

J-30 Daylight Bldg., Cincinnati, Ohio

Spreads on Soles Like Butter on Bread—Dries Hard Overnight

Mail for FREE Sample

SAVASOLE Co.,
J-30 Daylight Bldg.,
Cincinnati, Ohio.

Gentlemen: Rush Free Sample Savasole on leather and your agents proposition where I can earn up to \$42 a Day. I am not obligated.

Name.....

Address.....

City..... State.....



PHOTO-ENGRAVING LEARN IT AT HOME



We Furnish all equipment and materials including large photo-engraving camera complete with lamps, lens and screen. When you have finished the course you can establish a good paying independent business with the equipment furnished or work for others at a big salary. Photo Engraving offers greater opportunities today than any other industry. Every picture in this issue of Popular Mechanics was engraved by the process we teach you. Earn good money while learning. Write today for our new illustrated catalog which was engraved on equipment such as we furnish. You will not be obligated in any way by writing.

Aurora School of Photo-Engraving, Box 228, Aurora, Missouri

Learn ADVERTISING at Home

Greater opportunities now in advertising. Learn easily and quickly in spare time. Practical work. No text books. Old established school. Low tuition—Easy terms. Send for free booklet of interesting information.

Page-Davis School of Advertising
Dept. 1356, 3501 Mich. Ave., Chicago

Wrestling Book FREE



Wrestling taught at home, by mail, by greatest of all world's champions—Farmer Burns and Frank Gotch, in a wonderful white. Handle bigger, stronger men with ease. Learn the secrets of experts, Jiu-Jitsu, Physical Culture. Have perfect health, fame, a perfect body admired by both sexes.

FREE 32 page illustrated prospectus, sent free. Tells how we teach expert wrestling at home. Send 2c to cover postage. Write now for your copy. State age.

FARMER BURNS SCHOOL
3376 Courtney Bldg., Omaha, Neb.

MAIL FOR FREE INFORMATION

BEDFORD

1115 Bedford Ave., Dept. PM-9
Brooklyn, N. Y.

YMCA TRADE SCHOOL

Send me without obligation complete information on (check subjects).

- Caterpillar Tractor Mechanic
- Aviation Mechanic
- Machine Shop
- Welding
- Auto Mechanic
- Radio and Television Mechanic
- Talking Pictures—Double Western Electric Equipment
- Electrical
- Starting, Lighting, Ignition
- Window Dressing
- Commercial Art
- Sign Painting
- Architectural Drafting
- Mechanical Drafting

Name.....

Street & No.....

Town..... State.....

LEARN REFRIGERATION and Air Conditioning

Experts needed everywhere; service millions of electric refrigerators and cooling plants now in use. Short, practical course. Write TODAY for Bulletin. **SCHREIBER INSTITUTE OF REFRIGERATION**, 31st and Oak, Kansas City, Mo.

OIL HEAT Cheaper than Coal

LACO Improved Oil Burners Low as

Mineral Wick Burns Oil NEW WAY!

Amazing discovery turns oil to gas... mine gas with 95% air—produces hotter, cheaper flame than coal! Patented—no other in the world like it. Now as low as \$85! Fully AUTOMATIC. Quiet. Clean. Better than a stove. Listed Standard by Underwriters Lab. No electric ignition. Easy to install. Goes right into any heating system, instantly, without change. Send for complete facts, price.



\$85



World's Lowest Priced POWER OIL Burner

Just out—revolutionary small power burner—Ford of the industry. Positively lowest priced, cheapest-cooperate. AUTOMATIC. Quiet. Safe. Uses cheap heavy oil at tremendous savings. No roaring, shooting flame that blows heat up the chimney. Instead, a lazy, low-pressure flame that delivers utmost heat with little fuel. LACO's high-capacity, standard size power burners famous for low cost and fuel economy.

World's greatest oil burner bargain. Guaranteed. Famous LACO mineral wick type. For parking furnaces, small stores, bars, bars, etc.

\$1250
SPECIAL OFFER! Get amazing low price introductory offer... easy payment plan. Complete literature showing 20 sizes and models. Give number rooms to heat and type heating plant. Send NOW!



LACO OIL BURNER CO., 192 Union St., GRISWOLD, IOWA

World's Largest Exclusive Oil Burner Manufacturer Announces **NEW LOW PRICES**

Dealers WANTED!

LACO offers dealers big money. Sales ahead of 134 other makes. Lowest priced, cheapest to operate, advertised, reputation. \$5,000 to \$17,250 in easy first year. Some have made \$50,000. Remarkable SPECIAL OFFER if you act quick. Ask for dealer offer!

B1236

Magie

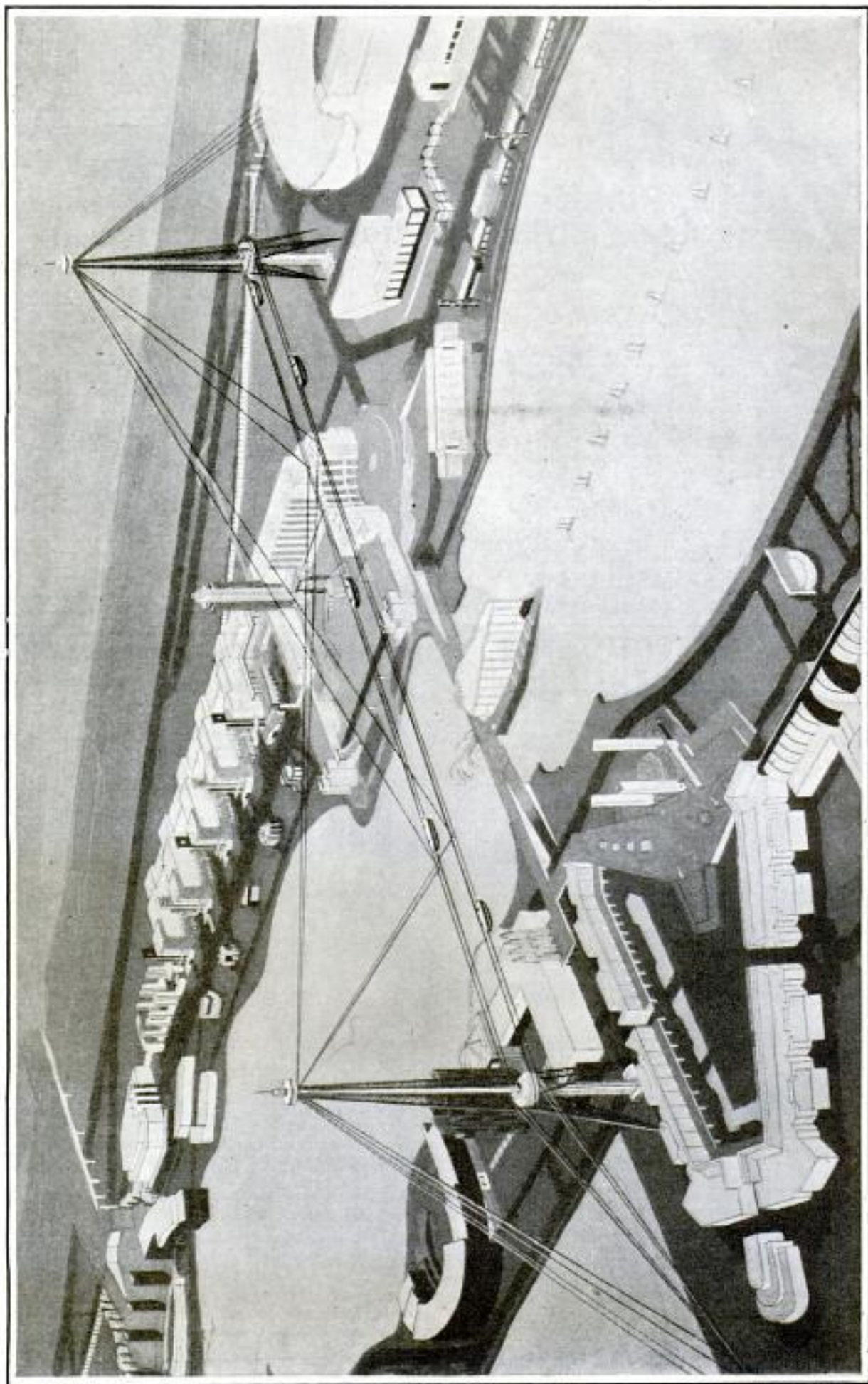

Drawing of the "Sky Ride," a Feature of the Chicago World's Fair; Passengers Will Travel in Rocket Cars Running on Cables between Towers, 600 Feet High and 2,000 Feet Apart; High-Speed Elevators Travel to Observation Platforms at the Tops of the Towers



A TRULY GREAT HOTEL

When you visit Detroit next time stop at Hotel Fort Shelby. You'll enjoy its thoughtful, efficient, unpretentious service . . . its savory foods and cozy, cheerful, charming rooms. ¶ Hotel Fort Shelby's location in the heart of Detroit's shopping, theatre, financial, insurance and wholesale districts is a happy one . . . no other large hotel in the metropolitan area is so near the principal railway terminals, airports and boat piers. And if you drive to Hotel Fort Shelby competent, courteous attendants will relieve you of your car . . . and return it at your command, free of charge. Nominal garage tariffs. ¶ 900 rooms . . . all with private bath, circulating ice water and servidor. Many as low as \$2.50 per day. Radio for every room. Three popular priced restaurants. Music and dancing every evening in the Main Dining Room . . . no covert charge.

Write for free road map, and your copy of "Aglow With Friendliness," our unique and fascinating magazine.

HOTEL Fort Shelby

"AGLOW WITH FRIENDLINESS"

E. J. BRADWELL, *Managing Director*

DETROIT

When writing to advertisers please mention *Popular Mechanics*

RADIO

(Continued)

Coil Prevents Antenna Power Loss

Metal antenna masts are often of such dimensions that their fundamental frequency is near that to which the transmitter is tuned. Considerable power is thus absorbed, and the efficiency of the trans-

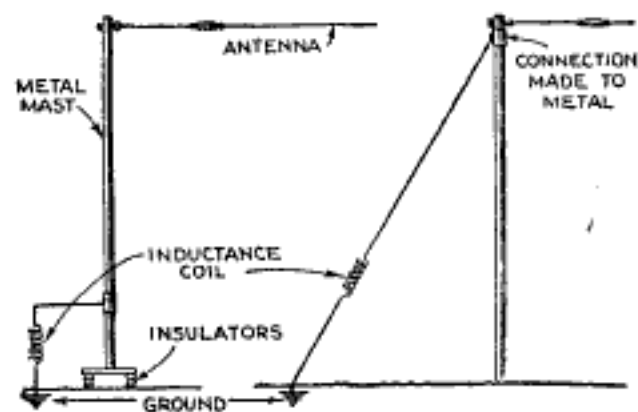

Two Methods of Preventing Power Loss through Antenna Masts

mitter radiation is decreased in certain directions. The drawing at the left shows the method used to overcome this trouble when the mast is insulated from the ground. The coil consists of ordinary stranded insulated fixture wire, wound on a wooden form several inches in diameter. To select the proper size of coil, it is best to connect a r.f. ammeter, of the thermocoupled type, in series with the connections shown to the mast and ground, and increase the number of turns in the coil until no current is indicated by the meter. The mast is now tuned sufficiently far from the frequency of the transmitter to prevent any loss of energy. The meter is then removed from the circuit, and the finished coil boiled in paraffin. At the right is shown the same idea for masts not insulated from the ground.

Protecting Coils from Moisture

A good grade of shellac may be used to protect radio coils from moisture effects. In order to hasten the rather slow drying process, the coils may be placed in a moderately hot oven. As soon as the coils are thoroughly heated, they should be removed and the drying process finished in the open air.

For further information on any radio construction article write to the radio department; this service is free.

THE BOY WHO GREW UP WITH RADIO

(Continued from page 373)

INTO THE FIELD OF THE UNKNOWN, WE EXTEND KNOWLEDGE MANY TIMES THAT INTO THE FIELD OF THE KNOWN. And this is particularly true in the vast and obscure realms of radio. For instance, a few years ago, in order to send transatlantic messages, we had to have ten square miles of ground on Long Island and a great row of towers, 400 feet high, with 200 kilowatts of power, sending off wavelengths of 20,000 meters; then a little of this mystery of radio was solved in the great discovery of the short wave, and today, in place of these great towers and high-powered stations, we use poles thirty feet high, with only a few kilowatts of power and a plot of ground 100 feet square. That's what the discovery of the short wave alone has done."

Then he continued: "It's the whole unknown science of radio that stirs my imagination. You see, I don't care a rap about yesterday and very little about today, it's tomorrow that grips me. And if the radio business didn't have a great tomorrow—hundreds of times greater than its yesterday I'd resign and let somebody else be president here. YOU SEE, WE REALLY KNOW SO LITTLE ABOUT RADIO. WE KNOW HOW TO BUILD A SENDING SET AND A RECEIVING SET, BUT NO ONE IN THE WORLD KNOWS WHAT ACTUALLY HAPPENS IN BETWEEN."

And then we fell to talking about certain phases of this new world of deflation, and he said: "This is a new test for many men. When things are going well, anyone can order a thousand men hired, but only a man of wisdom and heart can humanely fire a thousand men. And even then his job is not done and his conscience not discharged unless he does something worth while toward helping to solve the problem created by such unemployment. Only men of character and depth can stand again in the face of the fear that comes with periods of depression. Men who have built within themselves courage and character crumple up before the hardships and terror of days like these. Courage and character both start with the same letter." And David Sarnoff has both of these.

Increase Your Earning Power

Apply time and labor-saving kinks to your work. Your efficiency will soon be recognized and you will be in line for advancement.

If you do machine shop work of any kind, sheet-metal work, painting, carpentry, auto repairing, farming, concrete work, plumbing, electrical work, welding, building-glass work, general repairing, tool-making, poultry raising, masonry or home repair work, get this

LIBRARY OF 2600 TIME AND LABOR SAVING IDEAS FOR SHOPMEN AND HANDYMEN

A NEW VOLUME READY

SHOP NOTES for 1932

462 Articles
493 Illustrations
192 Pages
Price 50c
See partial list
of
contents below

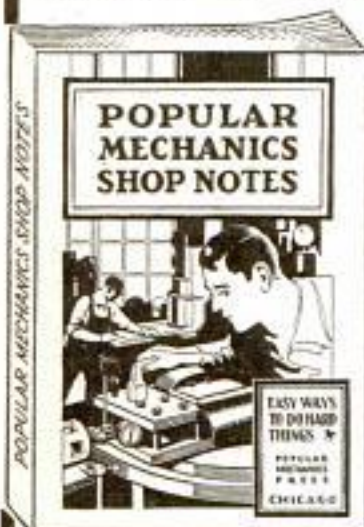

Including the new 1932 issue illustrated above, there are seven volumes in the Shop Notes Library of 2600 easily understood short cuts to every-day jobs. Here are just a few of the subjects taken from the latest issue.

Angle Iron, Uses for
Anchors, Easy Method
of Laying Out
Band Saw Blades, Sharp-
ening
Band saw, Shortcuts for
Sawing Iron Work
Clamps for Miter Joints
Drafting Board for Out-
door Sketching
Drum Sander for Work-
shop
Electric Drill, Portable
Electric Feeder for
Poultry
Flashlight Photography,
Improved
Forge, Homemade Post-
able
Furnace, Gas-Fired
Melting

Furniture Upholstering
Glas, How to Use Properly
Hardware, Hand-
Wrought
Home Workshop Shaper
Jigsaw, Heavy-Duty
Laths for Large-Diam-
eter Work
Laths, Mounting Work
on
Lathe Tools, Grinding
Log Cabin, Built in Attic
Mirrors, Re-silvering
Motoring Problems,
Solving
Piston Rings, Improved
Method of Fitting
Septic Tank for Farm
or Cottage
Soldering Iron, Electric

Soldering Iron, Home-
made Gas
Staging, How to Rig
Stereoscopic Photos
With Any Camera
Table, Double Capacity
of Circular Saw
Table, Drop-Leaf Pivot-
Top, Making
Tee Cart, Rubber-Tired
Tools, Hardening and
Tempering
Wall Outlets, Installing
Water Heater, Instant
Electric
Weather-vane, Noiseless
Ball-bearing
Wood, Beading
Woodturning, Unusual
Jobs in
Woodworking Ideas

Each volume contains approximately 400 articles and 400 illustrations and has 192 or more pages. This unrivaled library of shop helps may be secured for a limited time only. After the present supply of books is exhausted the offer must be withdrawn.

COUPON

POPULAR MECHANICS PRESS,
209 E. Ontario St., Room P9, Chicago, Ill.

Send me, as per your offer, the following books. I will pay postman price and small amount of postage. My money will be refunded if I am not satisfied. (Check what you want.)

1932 Shop Notes and Home Mechanics, both for 33c.
 Shop Notes Library (7 vols.) \$3.50.

Name.....

Address.....

Street and No.....

City..... State.....

DO YOU KNOW of a tool that will cut anything from SILK THREAD to STOVE PIPE or LINOLEUM? .

Crescent's new Booklet il-
lustrates such a tool, and
tells how to use it.



Every household and home workshop should have a copy of this helpful little booklet—"CRESCENT TOOLS, their Use and Care." Profusely illustrated, it describes many "short-cuts" and easy ways of doing everyday jobs.

Householders, amateur and professional mechanics may secure a copy of this interesting booklet without obligation either from their local hardware dealer or by mailing the coupon below.

CRESCENT TOOL CO.
JAMESTOWN, N. Y., U. S. A.

FREE ..This Booklet



CRESCENT TOOL CO.
Dept. P-9, Jamestown, N. Y.,
U. S. A.

Please mail me a copy of your
new booklet.

Name.....

Address.....

My hardware dealer is.....

When writing to advertisers please mention Popular Mechanics

LOOSE HANDLES QUICKLY MADE TIGHT

Mix a little Smooth-On No. 1 into a putty, put this into the opening, force parts together, and in a few minutes metallizing of the Smooth-On produces lasting tightness. Such repairs save many dollars otherwise spent for renewals that are no better.



Write for
FREE BOOK



Smooth-On No. 1 also stops leaks at cracks and joints in pipes, radiators, boilers, tanks, in automobile radiators, engine water jackets, hose connections and in gasoline and oil lines.

Smooth-On No. 1 after set and metallized holds water, steam, gasoline, oil, etc., and may be applied to any metal. Use it also for anchoring and taking up looseness. Makes loose bolts, nuts, screws, etc., permanently tight. Holds in masonry, tiled walls, slate, wood, etc.

Keep Smooth-On No. 1 ready for emergencies. Repair Book gives full instructions.

Get Smooth-On No. 1 in 7-oz., 1-lb. or 5-lb. tins at nearest hardware store.

SMOOTH-ON MFG. CO.,
Dept. 37, 574 Communipaw Ave.,
Jersey City, N. J.

Do it with **SMOOTH-ON**

DEPENDABLE POWER—Lower Prices!

Costs 3c per hour to run. **SHAW DU-ALL GARDEN TRACTOR** Does all farm work. Easy to attach. **Shaw Tractor Equipment**

Plows, seeds, harvests, runs belt machinery, etc. Shaw Tractor Equipment makes powerful tractor of old Ford, Chevrolet or other old auto. Write for FREE literature. Reduced prices to suit them.

10-DAY TRIAL OFFER—on either or both machines!

SHAW MFG. CO.,
Dept. PM 9
Galesburg, Kansas

Happy Garden-er Du-All \$87.00 **\$88.00**

MOST EASILY BUILT MODEL ON THE MARKET

Simplified construction makes this realistic 12-in. copy of the best single-engine British biplane the most easily built scale model sold. A steady flyer. Will rise from ground by own power and fly 150 ft. or more.

Gives more real satisfaction than expensive models. Set includes aluminum propeller, brass shaft, special rubber motor, streamlined disc wheels, lubricated nose block, ready-cut struts, etc., with full building and flying directions. No tools needed. Mailed in unbreakable container, postpaid in U. S., only 50c. Canada 65c. Order yours today.

THE MIDLAND MODEL WORKS, Dept. S, Chillicothe, Ohio
(No stamps. No c. & P. No catalogue. Please give full address.)



Radio for Your Car...New Low Price The CROSLLEY ROAM-IO



YOU have wanted a radio in your car—you have been waiting for the cost to come within reason—here it is—the Crosley Roam-IO—the new 6-tube superheterodyne automobile radio receiver. Can be placed in any car in any location desired. Priced exceptionally low. Installation quickly made. Equipped with full dynamic speaker. Send for Booklet or see the nearest Crosley dealer.

Priced complete with tubes, tax paid.
Western price slightly higher.

only
\$39.50

THE CROSLLEY RADIO CORPORATION
Dept. A 121 Cincinnati, Ohio

BACKYARD TELESCOPES CONQUER SPACE

(Continued from page 389)

have been made by the members of one amateur society.

Two theories have been advanced to explain the light pulsations from the variable stars, but neither has yet been proved. One is that such a star is a thin disk that revolves on poles, and the other, that the star actually expands and contracts.

Many of the most famous scientists began their careers as amateurs. Dr. George Ellery Hale, who developed the spectroheliograph with which to study the sun, made his first telescope when he was fifteen years old. The late Doctor Barnard was previously a commercial photographer. The actual discovery of the planet Pluto, whose existence had been suspected for years, was only recently made by the keen eyes of Clyde Tombaugh at the Flagstaff observatory. Tombaugh was another who began as an amateur, and he had been employed as an astronomer only a few months when he discovered the planet.

As craftsmen in the grinding and polishing of lenses, and in devising new instruments, amateurs are also held in high regard. Strange as it seems, small mirrors can be ground more perfectly by hand than by machines. The regular strokes of a machine leave tiny ridges on the surface that distort the image. The irregular, overlapping strokes of the hand make a more perfect surface. Amateurs grind their mirrors so accurately that imperfections five one-millionths of an inch high can be detected through a simple test.

When one amateur astronomer had completed his telescope, he took it to the top of a hill to test it. After adjusting the mirrors, he was able to watch people boarding a steamer at a dock forty miles away. Some of the telescopes at the Harvard University observatory are equipped with mirrors that were made by an amateur star gazer for his own use. Two boys in Los Angeles have proved to be so adept at grinding mirrors that they have been asked to grind the lenses for a new eyepiece for the big telescope at Mt. Wilson, that will double the visual scope of that instrument.

[Note—Full details on how to build a telescope will be given in an early issue.—Editor.]

New Tools for Woodworkers

Save Time, Money, Labor

THE latest line of "Delta" motor-driven tools includes many new tools and startling improvements that are of great interest to all woodworkers. Despite their compactness and unusually low cost, "Delta" Quality Tools are making amazing records of performances in thousands of home workshops and factories all over the country.

10-Day Trial EASY TERMS

"Delta" Tools are always available for a 10-Day Trial without the slightest risk. Satisfaction is guaranteed. For full details of this liberal offer and also of convenient Easy Payment Plan, send the coupon below TODAY!

Send Today for FREE Catalog

Contains illustrations and descriptions of complete "Delta" line, and is crowded with valuable information for all woodworkers. No obligations. Just mail the coupon below.

DELTA MFG. CO.
3775 N. Holton St. Dept. A932 Milwaukee, Wis.

DELTA MFG. CO., Dept. A932
3775 N. Holton St., Milwaukee, Wisconsin

Please send me, without obligation, 1932 Catalog of "Delta" woodworking tools. Also send full details of your 10-Day Trial Offer and Easy Payment Plans.

Name.....Age?.....

Address.....

City.....State.....



New "Delta" Scroll Saw

New and radically different from any Scroll Saw on the market. Runs at full motor speed—1800 strokes a minute—with *absence of vibration*. Produces smooth, accurate work. Has many special features. The New "Delta" Scroll Saw can be used for filing, sanding, and honing.

"Delta" Combination Unit

Circular Saw, Jointer, and Mortiser, all mounted on a convenient, portable stand. Each tool can be operated separately or all together. No interference.

New "Delta" Drill Press

Large Capacity. Ball-bearing spindle. Automatic leveling, accurate tilting table. This new Drill Press has many special features.



BUILD YOUR OWN AUTOMATIC ELECTRIC REFRIGERATOR

Why pay \$200.00 and upwards? Use your present ice-box. We supply parts. Can be built for only \$34.50. Easily made. No special tools necessary. Operating cost, quality and size of machine same as well known makes. Complete blue-plate and instructions—\$1.50. Circular "B" on request.

B. & L. ENGINEERING CO., 706 Bergen Ave., Jersey City, N. J.

FREE Get BB Magic at once. A wonderful shooter's digest—tells how to hold, aim and handle rifles; become a crack shot. The principle of compressed air action that made the Benjamin Single Shot world famous has been applied to 25 shot automatic firing. Learn all about both rifles. **SEND NOW!**

Benjamin Super Single Shot now \$5.00 postpaid. Benjamin Automatic 25 Shot now \$9.00 postpaid. WRITE for exclusive agency details.

BENJAMIN AIR RIFLE CO. 649 N. Broadway St. Louis, Mo.

Do Your PRINTING

Cards, stationery, circulars, tags, labels, advertising, etc. Save money. Print for others, big profits; easy rules sent. Will do popular Raised Printing like Engraving. Junior Press, \$5.90. Job Presses \$11 up. Power \$149. Write for free catalog. THE KELSEY CO., Y-37, Meriden, Conn.

PROFITS \$160 to \$300 Monthly—WITHOUT INVESTMENT

<p>AUTOMATIC AIR SERVICE</p> <p>Bring bigger business to you without investment. Balance, space saving, always ready. \$12 Monthly.</p>	<p>ARC WELDER</p> <p>Profits \$300 to \$400 monthly with new "SIMPLIFIED" Welder. Electric, belt, gas engine drive.</p>	<p>8-HOUR BATTERY CHARGING</p> <p>Put your shop above competition. Makes electric bills. Double profits. Only \$10 Monthly.</p>	<p>20 MINUTE Car Washer</p> <p>Big profits washing cars—aver 2/3 time, does better job. Balance pay for it. Only \$17 Monthly.</p>	<p>Tear out and mail this ad. Check items of interest—no obligation.</p> <p>HOBART BROTHERS Box M-92, Troy, Ohio</p>
--	--	--	---	---

WRITE TODAY » Only \$16 Monthly—30 Days Trial to Prove it « **OBLIGATION**

BURN YOUR NAME ON TOOLS

WITH THE ARKOGRAF

PROTECT YOUR TOOLS FROM THEFT
Write with electricity any name or design on the hardest and finest tools and instruments, or any metal, like writing on paper with pen or pencil. Complete outfit \$3.50—Free! Ask for interesting illustrated circular free. Write today. Agents wanted. ARKOGRAF PEN CO., 1171 E. Stark St., Portland, Oregon



ONLY \$5.00

Down for a **3 H. P. WITTE** (Throttling Governor) EASY On Best TERMS Engine Built.



Uses Gasoline, Kerosene, Distillate or Natural Gas. Removable Die-Cast Bearings, Grease Cup Lubrication. Waterproof-Troubleproof Magneto. Easy starting device. Big surplus power with lowest fuel and oil expense. Other sizes and styles, 1 1/2 to 30 H.P. Also Saws and Pumps. Shipped from Kansas City, Mo., or Pittsburgh, Pa.

FREE Write today for My Big Engine Book—No Obligation.

210-B Carson St. Pittsburgh, Pa. **WITTE ENGINE WORKS** 1746 Oakland Av. Kansas City, Mo.

Make Money Making DO-NUTS!

**\$75 a Week
and More
in Your Own Business!**

Make and sell Ringer's delicious Do-Nuts. Double your money every day! Hundreds of men and women are making more money in a week than they used to in a month!

Everybody likes do-nuts! Ringer's way makes them electrically—greaseless—easy to digest. Cash in now on the demand for these tasty, healthful, delicious do-nuts!

An investment of less than \$60 can make you independent! Investigate! Find out what others are doing! You can do as well. Easy to operate. No experience needed. Work right in your own kitchen. We teach you, furnish all recipes, guide you to success. Write today for free plan.

RINGER DO-NUT CO.

Minneapolis, Minn.
147 Main St. N. E.



READ WHAT OWNERS SAY:

"RINGER Do-Nuts sell themselves. People who taste them once come back for more."

"Was out of a job—now making over \$75 per week—expect to order more machines soon."

BUILD YOUR OWN OIL BURNER

\$1 Now, Saves \$300. Not a cheap wick type, size and operating cost equal to those selling \$300 or more. Heats any house 2 to 20 rooms. Easy to build in spare time. We supply special parts. Can be built for as little as \$31.25.



Detailed blue prints, complete with instructions \$1.

J. G. MANUFACTURING CO.
A-61 Monona Ave., Rutherford, N.J.

16 MM. MOVIE CAMERA and PROJECTOR ONLY \$7.50 FOR BOTH

Other BIG BARGAINS. Complete line of film with Exchange Service. Big FREE Catalogue—Write Now.
PARAMOUNT MFG. CO., Dept. G-52, Boston, Mass.



Make Money at Home!

Earn up to \$25 a week or more, growing Mushrooms in your cellar or shed. Big demand. We tell you how. Illustrated book and details free. Start NOW—write today.

AMERICAN MUSHROOM INDUSTRIES, Ltd., Dept. 175, Toronto, Ont.

ELECTRIC REFRIGERATION

AT LESS THAN HALF COST

1/2 to 1/3 regular advertised prices using your refrigerator. Our plans & instructions show you how.

**BUILD
YOUR
OWN**

ELECTRIFY

YOUR PRESENT ICE BOX

Don't discard it. With our guidance electric refrigeration is so simplified that the most inexperienced can assemble and install modern and efficient electric unit... one that will rival the best of today's standard makes.



Send only
\$1 for

Complete blue-prints and instructions... also price list of parts and other valuable information.

DOMESTIC UTILITIES CORP.
LEBANON, IND.

AMONG PYGMIES AND GORILLAS

B 716

(Continued from page 421)

several minutes to repeat the gorilla's feat.

But why did Kasciula hate this particular gorilla which he called "Moami Ngagi." As soon as we were back in camp, I was told the story. A few years ago, six of Kasciula's subjects, one of them his own son, were passing through the forest when Moami Ngagi suddenly jumped upon them. The son of Kasciula and another pygmy were seized together in the gorilla's arms and crushed to death, while the others fled in terror. Not satisfied, Moami dropped the lifeless victims and pursued the fugitives. The pygmies followed their hunting tactics, about a hundred-to-one shot in such a circumstance, but their only hope of escape. Running at top speed, they plant a spear in the ground, at an angle, the point facing toward their pursuer. This they do without slackening their pace. The spear is almost diagonally placed and is easily concealed by the heavy grass so that ngagi, advancing in his fury, beating his breast and howling with rage, is often impaled by the spear.

This is what happened to Moami Ngagi, one spear penetrating deeply into his belly. Mad with pain and rage, the gorilla disappeared in the bushes and no hunter saw him again for months and months until one day he reappeared fully recovered.

I didn't know whether to believe this tale or not. Several weeks later, however, I had clear proof of the truth of Kasciula's story when this monstrous beast, having attacked me at close quarters and fallen at a few paces from me with two 10.75 bullets in his heart, I had the opportunity to examine the huge body. A black hairless spot showed where the pygmy spear had penetrated deeply a few years before.

Meanwhile I was better able to understand the formidable strength of this gorilla. Measuring six feet eight inches in height, the animal weighed 530 pounds. When we began the skinning of the body in order to prepare it carefully for a museum, we were lost in admiration of the arms. Exactly similar to human arms, but without a single ounce of fat, they measured one foot eight inches in circumference at the biceps. And I must admit that I felt a chill of fear at the thought of what might have happened had I missed.



ENJOY Outdoor Sports

The Year Round
With the Aid of This
Great Book

THE new, revised and enlarged edition of **Outdoor Sports the Year Round**, just published by Popular Mechanics Press, contains hundreds of ideas for new and popular sports and pastimes as well as the old favorites. Attractive to Young and Old Alike is the interesting variety for all seasons.

The intensive follower of a few sports will appreciate the wealth of suggestions that render the pursuit of any hobby more enjoyable. For example, for the hunter there are important details on the care and handling of guns; for the swimmer, complete instructions in fancy diving; for the camper, ideas that tend to make camping one hundred per cent comfortable and convenient; for the fisherman, many practical hints, etc.

SPORT ENTHUSIASTS

will be amazed at the large number of devices that furnish thrills and excitement. Probably the most unique feature of the book is the fact that it contains complete instructions that enable any handy man or boy to make sport devices or equipment at very little cost.

352 Pages (large size, 7 x 10 in.) Price \$2.00
650 Illustrations, Cloth Binding

Mailed Postpaid upon receipt of price anywhere in the world. Will be sent C. O. D. anywhere in U. S. Simply pay postman price plus postage when he delivers the package.

POPULAR MECHANICS PRESS

(Room P-9) 200 East Ontario St. Chicago, Ill.

BUILD YOUR OWN BOAT AT SMALL COST

IF you are a boating enthusiast you have long felt the need of a really good book on boating; one that would explain in comprehensive, step-by-step form all the details of boating, boat-building and boat-maintenance.

It is for the amateur builder and small boat owner that



The New Popular Mechanics BOAT BOOK

is written. Here are boats that are really worth building and so thoroughly explained that any amateur craftsman can build them well. The designs include both inboards and outboards, fast boats, safe boats, sailing boats and hand-propeller craft.

The One Book Needed
By Every Boating
Enthusiast

Besides boat building information, there is everything you want to know about the operation, equipment, care, repair and maintenance of boats. This includes seamanship, boating sense, navigation, rules of the road, handling sailing craft, government regulation of motor boats, knots, storm signals, useful boat kinks of various kinds, glossary of terms, tables, etc.

269 Pages (Several in Color)—Profusely Illustrated. Large Size (7 x 10 in.) Cloth, Price \$3.00. Sent postpaid upon receipt of price or by parcel post C. O. D. anywhere in the U. S. A.

POPULAR MECHANICS PRESS

Room P-9

200 E. Ontario St.

Chicago, Ill.



Two new BRIGHT SPOTS in the budget!

● IF ECONOMY is your watchword, here is cheering news for you. Think of buying genuine Eveready *Wireless-Electric* Lights for less than 50 cents apiece!

The new Eveready Spotlight Lantern, No. 10, is one of the most convenient little lights that was ever built. No bigger than the palm of your hand, and an inch and a quarter in thickness, it fits easily into a coat pocket. But don't think because of its size that it's a toy! Press the switch and it shoots out a straight, sharp beam of light of surprising brilliance. The new type solid glass spotlight lamp acts as a lens, intensifying the light-beam and increasing its range. And because of the thick glass construction it is practically unbreakable.

With its nickel-plated handle, this brightly enameled little red lantern can be hung on a hook wherever it's needed, or carried in your hand. Useful indoors and out. At all leading stores. Only 49 cents, complete with batteries!

● Then there's a new Eveready Flashlight, No. 2639, that is amazingly low in price. It's a handsome two-cell light of the fixed-focusing type, regulation size. The black and silver striped metal tube is equipped with cadmium (rust proof) fittings. It's strong and sturdy in construction, suitable for all ordinary flashlight uses. At all leading stores, complete with batteries, for only 39 cents! Ribbon marking on case covered by trade-mark.



● Eveready Flashlight Batteries have longer life because of the metal top. No old-fashioned wax-compound seal. Only 10c.

EVEREADY Flashlights & Batteries

NATIONAL CARBON COMPANY, INC.

General Offices: New York, N. Y.

Unit of Union Carbide  and Carbon Corporation

When writing to advertisers please mention Popular Mechanics

Copyrighted material

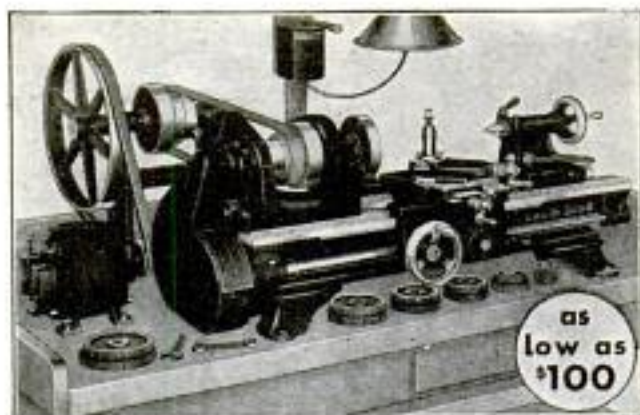

8" x 36" Horizontal Motor Driven Lathe Complete with compound rest and regular lathe equipment as shown. Weight 275 lbs..... \$148.25

8" REPAIR SHOP LATHE

A Back Geared, Screw Cutting Precision Lathe

Other sizes—9", 11", 13", 15", 16", 18", 36" swing, 2' to 16' beds, \$160 to \$759

Factory Rebuilt Lathes

Bargain prices on a few Factory Rebuilt South Bend Lathes in sizes from 9-in. swing to 18-in. swing. Countershaft and Motor Drive. All carry our regular guarantee. Bargains while they last. Write for List

Has six spindle speeds—cuts screw threads 4 to 40 per inch—hollow steel spindle—automatic screw feed to carriage—bed lengths 24" to 48"—countershaft and motor drive types—price range \$100 to \$217—convenient, easy pay terms.

Free Booklet No. 35

describing full line of Repair Shop Lathes, 8" to 36", mailed free on request, postpaid. Write to

SOUTH BEND LATHE WORKS
609 E. Madison Street
South Bend, Indiana, U.S.A.
Lathe Builders for 25 Years



18 in. Flying Model

Build This IDEAL Designed SUPERMARINE

The S.E.B. 408 m.p.h. record holder. IDEAL Construction kit with everything required to complete the Model \$1.10

Send for yours now! Postpaid.

New Catalog Paris, Models, 5c pp.
IDEAL AEROPLANE & SUPPLY CO.
26 West 10th St., New York, N. Y.

DO YOU

in a few weeks earn big income in service fees,—not medical nor chiropody—easy terms for home training, no further capital needed, no goods to buy, no agency. Established 1894. Address Stephenson Laboratory, 1 Back Bay, Boston, Mass.

WANT a new business profession of your own, with all the trade you can attend to? Then become a foot correctionist, and

in service fees,—not medical nor chiropody—easy terms for home training, no further capital needed, no goods to buy, no agency. Established 1894. Address

CROSLY Electric REFRIGERATOR Latest Features... Full Family Size

Now Within the Reach of All

A FULL size 3½ cubic ft. net capacity electric refrigerator bearing a nationally known and recognized name at a phenomenally low price. Not a midget. Incorporates all latest features—self contained and removable unit, temperature control for quick freezing, defrosting switch, flat bar shelves, perfect insulation, flat top, broom high legs, white porcelain interior, plenty of ice cubes. Also two other sizes: 4½ cu. ft. net capacity, \$99.50; 5½ cu. ft. net capacity, \$129.50. All prices F. O. B. factories, tax extra. Send for Booklet or see nearest Crosley dealer.

\$89.50

THE CROSLY RADIO CORPORATION

Dept. E 121

Cincinnati, Ohio

ALL-WAVE SIGNALS FOR LINING UP RADIO RECEIVERS

(Continued from page 463)

tions in the coil base, not in the socket. A simple means of making sure that the circuit is oscillating with any coil is to insert a pair of phones in series with the B-battery. If oscillating, a loud click will be heard when the finger is touched to the grid of the tube; if not, the coil connections should be reversed in the coil-plug prongs. When oscillating, tune in a station at 1,500 kilocycles and tune the signal generator until its signal beats against that of the station. Note the signal-generator dial setting and locate a point on graph paper at the intersection of a horizontal line representing 1,500 kilocycles and a vertical line representing that dial setting. Repeat this, so that, when the whole dial has been covered, a point will have been located for each 50 kilocycles, then draw a smooth line through these points in the usual manner. As space does not permit further calibrating details, a sample chart, together with additional data and material list, is available upon application.

The bracket and coil assembly for a low-frequency coil is shown in Figs. 8 and 9. This coil is for peaking and lining up intermediate-frequency transformers in superheterodyne receivers. Most intermediate-frequency transformers are made for 175 kilocycles; therefore the receiver is tuned to 700 kilocycles, this being the third harmonic of this frequency. To be sure that enough energy is transferred on this harmonic, wrap a few turns of wire around the signal-generator coil and connect one end to the grid of the first tube in the set. There will be many harmonics, but the one sought for will be the loudest.

The 40 to 80-meter short-wave coil is made exactly like the coil shown in Fig. 3, but only a few turns of No. 22 enameled wire are required. Start the turns ¼ in. from the top of the tube in the same manner as before and wind 9 turns. The start and finish ends are soldered in the small prongs. These coils are wound in the same direction as the broadcast coil. The tickler is started ¼ in. lower and consists of 6 turns, with the ends soldered in the large prongs. This coil is calibrated against a short-wave receiver in the same manner as the broadcast coil.

MIDGET RECEIVER USES HIGH GAIN TUBES

(Continued from page 466)

antenna coil, wind 151 turns of No. 32 silk enamel copper wire, beginning about $\frac{1}{4}$ in. from the end. Now remove the 19th, 20th and 21st turns, to provide the proper coupling space between the primary and secondary. The terminal leads are soldered to lugs riveted to the lower end of the coil form. The high end of the primary, the lower 18-turn winding, and the lower end of the secondary are connected and soldered to a grounding lug that is connected to the 1-in. brass mounting bracket that supports the coil form as shown. The high end of the secondary goes out through the top of the shield to the cap on the tube, and also to the lug below for the connection to the first stator section of the ganged condenser.

The two r.f. coils are identical. Starting $\frac{1}{4}$ in. below the top of the coil form, wind 130 turns of the same-size wire to form the secondary. The lower end of this winding is grounded to the mounting bracket. The high end goes to the cap on the tube and one stator section as before. A strip of thin cardboard, $1\frac{1}{8}$ in. wide, or cardboard tubing that will fit snugly over the secondary winding, is prepared for the primary winding. This consists of 45 turns of No. 36 s.e. copper wire, or No. 32 can be used if desired. The ends of this winding should be anchored to the cardboard tube with flexible collodion or by passing the wire through small holes. It is a good idea to paint these coils with flexible collodion. The primary coils fit over the secondary coils so that the top turn of the primary is even with the middle of the secondary winding. The r.f. choke coil, mentioned as optional, may be a commercial type or the builder may make it. The spool is turned from wood or fiber stock, $\frac{7}{8}$ in. in diameter; a groove is cut, $\frac{1}{8}$ in. wide and $\frac{3}{16}$ in. deep, for the winding. The winding consists of 500 turns of No. 36 single-silk enamel wire, jumble-wound.

Enlarged layout and wiring diagrams are available if desired.

When completed, the chassis is placed near the cabinet and the speaker plugged in for testing and balancing as shown in the upper photo on page 466.

A wooden spudger is used to adjust the trimmer condensers.

Yours WITHOUT Cash

Rings 'O Romance
Bridal Pair \$9485
the Set

Miss America \$3750

BULOVA WATCHES

Now you can wear a nationally advertised diamond "Ring O' Romance"—a beautiful 18 kt. white gold modern ring set with a genuine diamond of generous size, and a nationally advertised Bulova watch — your faithful timekeeper for years to come.

SEND NO CASH!—Just mail coupon! Nationally Advertised Cash Price on liberal Credit—and you can wear your jewelry without delay! The name "Ring O'Romance" inside the ring and "Bulova" on the Dial are your guarantee.

Diamond Rings Priced as Low as \$15.00

Write for our New Diamond Catalogue showing marvelous new designs in both ladies' and men's diamond rings. Never have we been able to offer such beautiful diamond rings at such low prices. The catalogue is sent FREE!

Railroad Watches

Let us send you our beautiful watch catalogue showing the Famous Santa Fe Mogul Railroad watch, and the 21-jewel Santa Fe Special in both 16 and 12 sizes. Also the new 60 hour Bunn Special. Catalogue sent FREE. Ask for our Special Spot Cash Offer. Good for 30 days only.

SANTA FE WATCH COMPANY
Dept. 96 Thomas Building TOPEKA, KANSAS

To SANTA FE WATCH CO.,
Dept. 96, Thomas Bldg., Topeka, Kans.

Please send me catalog I have checked.

Railroad and dress Pocket Watches.....

Ladies' and Men's Wrist Watches.....

Ladies' and Men's Diamond Rings.....

Name.....

Address.....

Tone Eagle
\$3750

NEW HALF SOLES

AS LOW AS **9¢** A PAIR

Patented by U. S. Pat.

Fully Guaranteed **PAY AGENTS UP TO \$47 A DAY**

Re-Sole spreads like butter in a minute, dries hard and smooth over night. Hard time product puts soles on shoes as low as 9c per pair. Now shoe soles need never wear out.

FREE Sample Sent on leather and details how men and women are earning up to \$15 to \$47 a day. Everyone buys to save money. A. T. Wilson of Wisconsin made \$81.25 in one day. Hundreds' clearing up with Re-Sole. Write quick for proof and free sample. No obligation. **Universal Laboratories, Inc., 431 Randolph St., Dept. 751, Chicago**

AGENTS! SELLS LIKE WILD FIRE



\$380 monthly selling 10 improved patented Carter Window Washers daily. Cleans, dries, polishes. Eliminates all muss. Good Housekeeping approval. Restricted territory. Write today. **CARTER PRODUCTS CORPORATION 938 Front Ave., Cleveland, O.**

A. C. Electric Plants



ONAN A. C. PLANTS furnish the same current as city service—110 Volt, 60 cycle A. C. Operates Radio, Water Systems, Refrigerators, all Household Appliances.

Sizes 300 to 10,000 Watts Available from stock. No battery used except to start the engine. Ideal for farms, camps and lake homes.

Ask a complete line of D. C. Models. **D. W. ONAN & SONS 912 Royalston Ave., Minneapolis, Minn.**

EARN \$2500 A DAY

Sell Rubber Motor Supports for Model "A" Ford Cars Make the Model "A" Run Like the New Ford

Reduces Motor Vibration and entirely eliminates transmission vibration. Sells for \$9.75. Agent's Cost \$4.75. Send Money Order or Postage today for your Sample. A Few Territories Still Open.

The Motor Rim Mfgs. Co., 1835 East 24th St., Cleveland, Ohio

Operator No. 35



FOLLOW THIS MAN

Secret Service Operator No. 35 is on the job! Keeping down dangerous Counterfeit Gang. Tell tale finger prints in murdered girl's room.

Free The Confidential Report Operator No. 35 made to his chief. Write for it. \$3000 a year and up

YOU can become a Fingerprint Operator at home, in your spare time, at small cost. Write for confidential full report and details. Literature will NOT be sent to boys under 17 years of age.

INSTITUTE OF APPLIED SCIENCE 1920 Sunnyside Ave. Dept. 93-55 Chicago, Ill.

Ideal TRAILER HITCH

BALL JOINT Can't Let Go!

Made of steel; can't rattle, wear or detach. Simple to install; easy to hitch or unhitch in any position. Order one with money back guarantee. Write for circulars at S. B. line of Trailers, Tongues & Parts. **HAMMERBLOW TOOL CO., 606 Third St., Wausau, Wis.**

ONLY \$3 POSTPAID

CONDENSER MICROPHONE

(Continued from page 468)

on. If the builder wishes, he can enlarge the hole in the frame with a reamer and insert a piece of copper screen. The diaphragm in the microphone acts as the

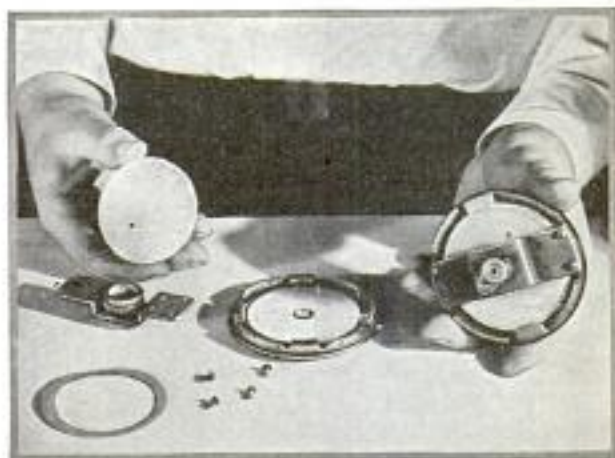

front plate of the condenser, and the disk as the other. A small hole is drilled in the disk, as shown in the photo, to maintain constant air pressure on both sides of the diaphragm. The disk is insulated from the diaphragm by means of a narrow paper-ring washer, cut from blueprint or letter paper. The mike is now reassembled, and the disk is held in position by the part of the carbon-button cup that was not discarded. Enough pressure is applied to the disk to make the gap between it and the diaphragm as small as possible without touching. The metal frame makes the grounded contact on the metal container, and the other circuit connection is at the lug on the bracket at rear.

Fig. 1 shows the simplified wiring diagram and Fig. 2 the schematic. All parts values are given, and further information is available if desired. If a 10-megohm resistor is not available, use two of 5-megohm resistors in series. The schematic diagram is given in Fig. 2. The metal container is 6 by 6 by 8 in. A wafer-type socket is mounted in the rear panel for the battery plug. The G-lead should be shielded in the cable or run out as a separate shielded lead directly from the transformer. Three 45-volt B-batteries and a 6-volt A-battery are required. The output is taken directly to the speech-amplifier input. Construction details for building an inexpensive speech amplifier, suitable for use with this condenser microphone, will appear in an early issue.

ANNOUNCING—NEW, INGENUOUS — MECHANICAL MODELS —

MODERN TYPE OCEAN LINER

Sectional View of Model of Transatlantic Liner "Europa" showing interior of ship in detail.

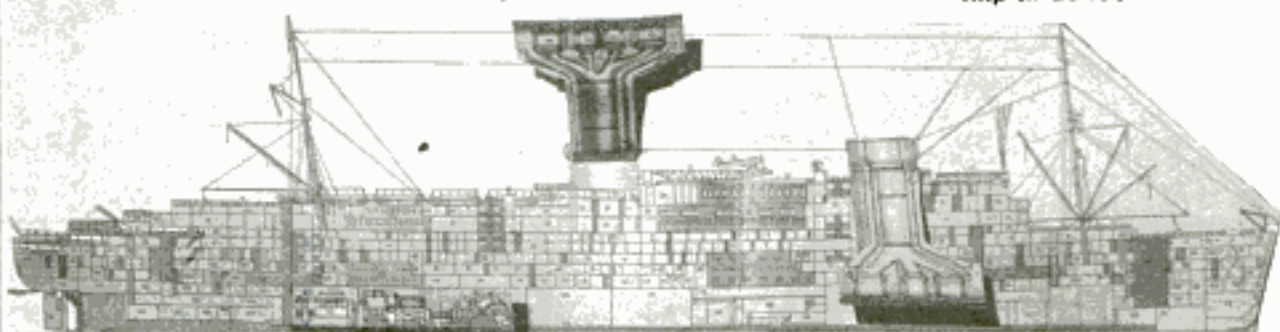

Size of Model, unfolded, 10x43 inches.
All parts are shown in colors.

Everyone is familiar with the "anatomical chart" as a means of teaching the physiology of the human body, the most complex and intricate "machine" known. POPULAR MECHANICS takes pleasure in announcing the development of similar exact models in the mechanical field.

The first models developed and now ready are

Latest Type Ocean Liner "EUROPA" Speed Marvel and Transatlantic Record Holder and WRIGHT "WHIRLWIND" 300 RADIAL ENGINE

Famous Maker of Records in the Air

Every Part Is Clearly
Shown by
Name and Number

Actual Size
of Model
13x22 Inches



WRIGHT "WHIRLWIND" ENGINE

Illustration of
Wright Engine
Model
Unfolded

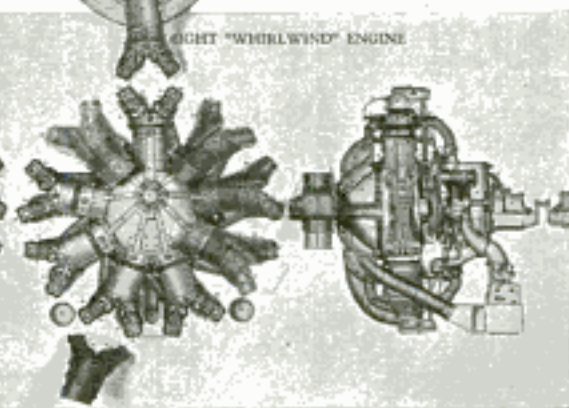

Additional models such as a
MODERN TYPE, SPEEDY, POWERFUL LOCOMOTIVE

and other subjects are in preparation and will be announced as soon as the vast amount of detail work can be completed.

Model makers and those who are mechanically inclined will appreciate the value of this clever combination of engineering skill with the lithographer's art.

Teachers and students seeking material for classes in travel study will especially value the

Ocean Liner Model, while instructors and students of aviation will find the Wright Engine Model a great aid to the understanding of its intricate mechanism.

The illustrations above convey only a faint idea of the vast amount of accurate detail shown by these models. The ingenious way in which all the interrelated mechanism is clearly shown can only be appreciated by seeing and examining the models themselves. The ease with which the detail may be studied will be readily understood as by raising the different flaps the models can be practically disassembled and put together again. The use of many colors has been cleverly employed to make each part stand out clearly by itself. Each part is numbered to correspond with its name found on a printed key. In addition, every important fact of interest about the machine is given.

You can get more information about the construction and operation of these machines by use of the models than in any other way. No detail is omitted. Everything is accurate and in true proportion and they have the approval of the manufacturers. They are not mere toys but are educational in character and worth many times their cost.

AND THE PRICE—Not \$5.00 or \$10.00 each as might be expected on account of the skill, patience and accuracy required to produce them, but

\$1.00 EACH, POSTPAID. Durably mounted to withstand much usage. Reduced prices will be quoted to schools, libraries or dealers wishing to order in quantities.

POPULAR MECHANICS PRESS, Room P5, 200 E. ONTARIO ST., CHICAGO, ILL.

car runs 745 MILES WITHOUT OIL

On July 9, 1932, at Halifax, N. S., Canada, a Jewett car ended a world record-breaking run of 745 miles with absolutely no oil in the crankcase. Supervised by His Worship, the Mayor of Halifax, Official of Auto Legal Assn., Police, Canadian National Express and others. This car had previously been conditioned for 1000 miles by adding PYROIL to regular gasoline and oil supply. Write for full facts.

PYROIL PROTECTED



Men!

Make Big Money selling PYROIL. Greatest lubrication discovery of the age. (Simply Add to Regular gas and oil.) Positively reduces noise, wear, vibration. Saves gas and oil. Frees valves, seals rings. Increases power and performance. Protects all metal surfaces. National publicity program creates big demand everywhere. (See Sat. Eve. Post, Aug. 27, 1932). Easy sales, big profits. No big investments. Start small as you wish. WRITE AT ONCE.



PYROIL COMPANY

W.V. KIDDER President

592 LA FOLLETTE AVE. LA CROSSE WIS. U.S.A.

SHOWS the driver
IF HEADLIGHT
GOES OUT

SHOW-LITE

REFLECTS BACK to the driver
PER PAIR 25¢



AGENTS MAKE 100% TO 300%
BRAND new invention insures against fines, delays and accidents due to failure of headlight. Clip on OUTSIDE of headlights in an instant. Thirty million prospects. Carded or bulk. Get proposition today. Send 25¢ for sample pair. A-E-C MFG. CO., 222 S. 4th St., QUINCY, ILL.

SQUAB BOOK FREE



Breed PR Royal squabs, sell high trade. Raised in 1 month. Sell for double chicken prices. Grain cheap. Start now. We ship breeders everywhere on three mos. trial, insuring satisfaction. Established 31 years. Customer writes: "Squabs selling fast, sold all I had last week, and to turn people away. Another: 'Have always been successful with chickens, but squabs are 'way ahead of them. Another: 'I am sold up on squabs two weeks ahead, getting richly credit a period. Am also buying squabs of others to fill my own orders. Ship me 150 pairs more, Extra Waste Kings.' Write now for free big 64-p. book sending four cents stamps for postage; learn how to breed and profit by fast sales plan. Plymouth Rock Squab Co. 624 N St., Melrose, Mass.

YRAISE FUR RABBITS

FOR US
CHINCHILLAS & NEW ZEALAND WHITES
WE BUY WHAT YOU RAISE—HIGHEST PRICES PAID
—Established 19 years. Illustrated book, catalog and Fur Farming Magazine, also Monthly Market Bulletin showing prices we pay. All for 10c. Two large rabbits, address one nearest you.
STAHL'S OUTDOOR ENTERPRISE COMPANY
Dept. 141D, NEW CITY, N. Y. or HOLMES PARK, MO.

HOME FUN GALORE!
TAKE YOUR OWN VOICE
TO THE PARTY!
"MIKE" MARKO
3205 BOSTON BLVD
DETROIT, MICH.

A GUN for Large or Small Game The FAMOUS 30-40
Krag
Manufactured at the Springfield Armory. None better. A favorite among sportsmen. Magazine holds 3 cartridges. Bolt action, all qualities of a high priced rifle. In fine used condition, working parts guaranteed for 3 year. Send 4 cents in stamps for catalog of arms, ammunition, camp, athletic and military goods. Satisfied customers all over the world. \$9.75.
W. STOKES KIRK, Dept. P. N.-9, 1627 N. 10th Street, PHILADELPHIA, PA.

UPHOLSTERING AT HOME

(Continued from page 479)

screws that hold it in place. It is then a simple matter to take off the old cloth. A new top covering of cotton batting should be fitted in place; then the new cover can be fitted and tacked. In tacking the finishing cloth, the material should be pulled at the center of each side, and then worked to the corners, where the surplus cloth can be taken in in small pleats. The tacks should not be driven home until after the cloth has been perfectly stretched so that it is without wrinkles.

Modern overstuffed furniture can often be repaired by removing the under cover, as shown in Fig. 21. This will expose the springs and the webbing, either cloth or wooden slats, which hold the springs in place. The first break on this type of furniture is along the center row of springs. Working carefully, broken springs can be retied and the springs restored to their proper positions. Very often you will find that, while no strings are broken, the whole center has fallen back. This can be easily remedied by attaching a length of twine to the forward spring, as in Fig. 22, and pulling the whole line forward, tacking to the wood framework. Again, one or more springs may have broken loose from the staples which hold them to the wooden slats. In this case, it is simply a matter of resetting the springs and inserting new fastenings. Where the nature of the bottom does not allow this, the spring can be tied by drilling two or more holes through the wood and stringing a length of twine or wire through these to catch the coil (see Fig. 23).

Each upholstering job must be regarded as an individual piece of work. There are no set rules which can be applied to every piece. This article has shown the basic principles used in typical construction—simple upholstering which the average home craftsman can do successfully.

Water Softener for the Bath

Water-softening salts suitable for use in the bath may be made by intimately mixing 2 lb. of baking soda, 1½ lb. of tartaric acid and 1½ lb. of starch or rice flour. If desired, a perfume may be added. A few tablespoonfuls in the bath will increase the lathering ability.

INVENTORS

Write today
for this

FREE BOOK ON PATENTS

Small Ideas May Have Large Commercial Possibilities

Don't let delay rob you of your invention. **ACT AT ONCE:** Remember that *inventing* is one thing and *owning* is another. Unless you have a patent on your idea, it may be difficult for you to prevent some other inventor from patenting it or some commercial concern from exploiting it. Failure to secure the proper patent protection has meant disheartening loss to many inventors.

I Can Serve You Promptly, Efficiently, Secretly

Prompt, efficient, secret service may be expected from my large organization of patent lawyers, solicitors, and draftsmen of long experience, all of whom devote their entire time and attention to patent and trade-mark cases.

Reasonable Fees and Convenient Terms

I have served thousands of inventors in all parts of the United States, and I am able to serve you very reasonably and extend liberal terms of payment. So don't waste valuable time.

Get the Facts Today

Send at once for my FREE BOOK, "How to Obtain a Patent." It gives you all the vital facts about patents and about my service, tells what to do and how to do it. No inventor should be without this book, so, for your own sake, **SEND THE COUPON TODAY.**

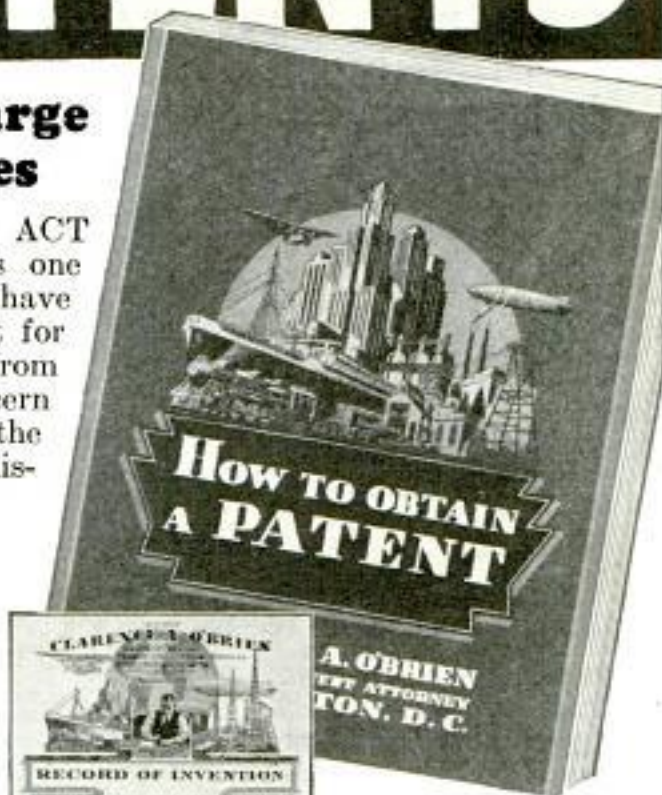

A. O'BRIEN
REGISTERED PATENT ATTORNEY
WASHINGTON, D. C.

ALSO FREE "Record of Invention" Blank

On request I will send you FREE a copy of my "Record of Invention" blank. On this blank you can sketch and describe your invention and have it witnessed in such manner that it may be of value to you as evidence. Send coupon now and receive this form together with my free book.



My Washington Location

Above is a view of my drafting and specification offices, where a large staff of experienced experts is in my constant employ. My offices in Washington are convenient to the Patent Office and I and my assistants can, therefore, appear promptly before the officials and examiners.



CLARENCE A. O'BRIEN REGISTERED PATENT ATTORNEY WASHINGTON, D. C.

Clarence A. O'Brien
Registered Patent Attorney
702, Adams Building, Washington, D. C.

Please send me your Free Book, "How to Obtain a Patent," and your "Record of Invention" form, without any cost or obligation on my part.

NAME.....

ADDRESS.....

(Important: Please Write or Print Plainly.)

When writing to advertisers please mention Popular Mechanics

PATENTS

PROTECT YOUR IDEAS

Write today for FREE BOOKLET, HOW TO OBTAIN A PATENT and RECORD OF INVENTION—or send Drawing or Model of your Invention for Examination.

Promptness Assured with Best Results

MILLER & MILLER

REGISTERED PATENT ATTORNEYS
Former Members Examining Corps U. S. Patent Office
Dept. A-1006 Woolworth Bldg. New York
200 Earle Building Washington, D. C.

PATENTS—TRADE-MARKS

Terms reasonable. Personal attention.

Send model or drawing for FREE advice.
Book "HOW TO GET YOUR PATENT" sent on request.

L.F. RANDOLPH, formerly RANDOLPH & CO.
Registered Patent Lawyer
303 Victor Building WASHINGTON, D. C.

PATENTS—TRADE MARKS

All cases submitted given personal attention by members of the firm.
Information and Booklet Free

LANCASTER, ALLWINE & ROMMEL
Patent Law Offices
815-15th St. N. W. Suite 412 Washington, D. C.

PATENTS

TO THE MAN WITH AN IDEA

Preliminary advice gladly furnished without charge. Booklet of information and form for disclosing idea free on request.

IRVING L. McCATHRAN, Patent Lawyer
Formerly with and successor to RICHARD B. OWEN
750 International Bldg. Washington, D. C.
41-E Park Row New York City

TRADE-MARKS

Trade-Marks—Copyrights EXCLUSIVELY
Protect almost anything!
Registration protects many varied subjects. Investigate! Information folder—FREE. Fixed low prices. Please send description. Associate Attorneys in: Washington, D. C., and Ottawa, Canada
WADE SERVICE CO., 2274-N Brooklyn Station, CLEVELAND, OHIO

INVENTORS who derive largest profits know and heed certain simple but vital facts before applying for Patents.

Our book *Patent-Sense* gives those facts; sent free. Write LACEY & LACEY, 635 F Street N. W., Dept. 5, Washington, D. C. Estab. 1869.

MOST INVENTORS FAIL: Consult me before you patent your idea. My engineering and marketing advice enables you to avoid loss on impractical ideas, helps adapt good inventions to commercial requirements, advice in making surest, most profitable sale, often without patent. This service not duplicated elsewhere. F.S. Pressell, Inventor's Consultant
Write for Free descriptive booklet. 129 E. Broad St., Columbus, Ohio

NO JOKE TO BE DEAF

—EVERY DEAF PERSON KNOWS THAT

George P. Way made himself hear, after being deaf for 25 years, with Artificial Ear Drums—his own invention. He wore them day and night. They stopped head noises and ringing ears. They are invisible and perfectly comfortable. No one sees them. Write for his true story, "How I Got Deaf and Made Myself Hear." Also booklet on Deafness. Address
George P. Way, Inc., 729 Hofmann Building, Detroit, Michigan



Artificial Ear Drum

HOMEMADE DIVING HELMET

(Continued from page 484)

the gap between the collar and the frame should be wrapped with cotton string coated with white lead. A piece of flat iron can be bolted to the helmet at the top for fastening a life line, which should project below the helmet within easy reach of the diver. A hole is drilled through the lead ring at the base, to take a pipe nipple. This is fitted with an elbow, another short nipple and a union, as indicated, for attachment of the air hose. Non-kinking garden hose may be used. A 1/4-in. hole is drilled on the opposite side, through the base of the helmet, to allow the air to escape evenly. Both intake and exhaust openings are located at the bottom of the device, to assure a supply of air in case of breakage of pump or hose. The hose is tied to the handle with the free end of the life line, to take the strain off the couplings.

The operating crew above should consist of one man to handle line and hose, one to pump, and one for relief. The original helmet, shown in the photo, was used in Lake Michigan, at Evanston, Ill., to depths of 30 ft., but the novice would do well to practice in about 6 ft. of water, until he is familiar with the special circumstances of diving. At greater depths, breathing becomes more difficult and the water is usually colder. The outfit is entirely safe, for, in emergency, the helmet, ordinarily held up straight, can be tilted over and dropped from the head permitting the diver to rise to the surface. He should always descend and ascend slowly, as this puts the least strain on the respiratory system. Although the weight above water is considerable, this is greatly decreased when the helmet is submerged. The air pressure inside keeps out the water, so no seal is needed at the base.

Oil Aids in Sanding Varnished Work

Trouble is often experienced in removing old varnish with a disk sander, by having the heat generated between the disk and the work soften the varnish so that it gums up the sanding belt. It can be overcome by brushing the work with common machine oil. The oil will not penetrate into the wood, as it is removed almost instantly by the sander and combines with the removed varnish.

Delays May Be Costly PATENT Your Idea Now

Little Ideas May Have Big Commercial Possibilities

Don't Lose Time—Send for Big Free Book

ACT AT ONCE—and protect your idea. Remember, to get the benefits of your invention, you not only have to invent it—you have to PATENT it. Many men spend years perfecting an invention, only to find that someone else thinking along the same lines has already received a patent on the idea. When we think of all such cases that have come under our personal observation, we cannot urge too strongly that you take step to protect your idea IMMEDIATELY. Delays of only a few days may be vitally important to you. Do not lose all the benefits of your hard work in planning and perfecting your invention.

Mail the Coupon for FREE Book Today

It is of tremendous importance that you file your application for a patent at once. Our free book tells you how to proceed, what you need to know about patents in general and gives you an estimate of our reasonable fees. We also send you a "Record of Invention" blank free. Take the first step toward getting your patent now. Mail the coupon at once. If you send along a sketch and description of your invention, we will promptly write you what, in our opinion, ought to be done in order to protect it, and for which service there will be no charge.

Highest References—Strictest Secrecy 33 Years of Proven Service

The members of the firm of Victor J. Evans & Co. are registered Patent Attorneys. Our legal and technical forces include lawyers, registered patent attorneys, patent draftsmen and searchers. Our Patent Office and Federal Court practice is confined to patents and trademarks. We specialize in these two subjects to the exclusion of all others. In our 33 years of patent practice, we have successfully served thousands of inventors to whom we can refer. It is a distinct advantage to an inventor to employ an attorney located in Washington as the U. S. Patent Office has no branches.

Here's How We Operate

As soon as the description of your invention comes into our office it is immediately put in charge of an attorney, who is particularly familiar with the kind of invention you have perfected. Under his close personal supervision, patent searchers and skilled draftsmen work. He personally sees your case through to its conclusion. You have the advantage of highly skilled and experienced service. Reasonable charge. Deferred payments.

Here's What the Coupon Brings Mail It Now

Mail the coupon today and take the first step toward protecting your idea. You will receive the FREE Book, a FREE Record of Invention Blank, and information on our fees. You create no obligation by mailing this coupon. Our service is complete, our fees reasonable, and our terms convenient. Don't waste priceless time; mail the coupon NOW.

**MAIL
THIS
TODAY**

VICTOR J. EVANS & CO. Established 1898 REGISTERED PATENT ATTORNEYS

MAIN OFFICE, 600J Victor Building, Washington, D. C.

BRANCH OFFICES: 1640 J Conway Building, Chicago; 233 J Broadway, New York; 828 J Fidelity Philadelphia Trust Building, Philadelphia; 514 J Empire Building, Pittsburgh; 1010 J Hobart Building, San Francisco.

Please send me your free book, "How to Obtain a Patent," and your "Record of Invention Blank."

Name.....

Street and No.....

City..... State.....



**FREE VALUABLE RECORD
OF INVENTION BLANK**

Mail the coupon today, and in addition to the free book, we'll send you without charge a Record of Invention Blank. This form, when properly filled out may be of value to you as evidence should occasion require it. There is no charge or obligation for this service. Mail the coupon NOW.



\$200 first Week in OWN Business!

L. A. Eagles took in \$200 his first week. Harry Hill says: "Paid for home with H-B Rug-Washer. Earned \$86 first day." H. I. Riley averages about \$35 a day. C. R. Bergseth writes, "My profits run about \$400 every month." Many others make \$125 to \$200 per week. C. J. White says: "\$100 business in 6 days—never a complaint." Thousands earning quick, easy profits. Electricity does the work. Finishes rugs like new, on customer's floor. Write today for booklet.

EASY TERMS Inexpensive equipment. No shop necessary. Hundreds of customers in your vicinity and in nearby towns. Backed by \$58,000,000 Company. Used by the United States Government and Statler Hotel System. Every machine guaranteed.

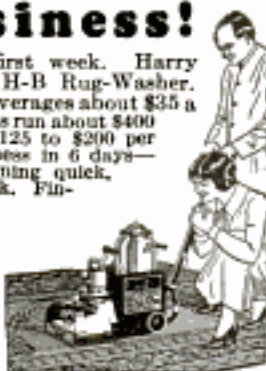

FREE Book Send today (no obligation) for booklet illustrating Rug-Washer and telling how you can earn large profits at prices below other methods; how you can build a permanent year around business; and how you can pay on easy terms. Enjoy a larger income. Mail a postcard or letter today—NOW.

H-B CO., 6096 H. B. Bldg., Racine, Wis.

New CROSLLEY RADIO Superheterodyne at New Low Price



The NEW Crosley PUP

YOU have been waiting for this great performing set for the whole family or as a second or third set—a personal receiver for any individual—one that can be moved from room to room—at an unheard-of low price. Plus into any A. C. light socket. Incorporates many new features. Full dynamic speaker. Other Crosley radio receivers in both table and console models using 6, 8, 10 and 12 tubes—some with Dual Dynamic speakers—range in price up to \$119.50. All prices complete with tubes, tax paid. Send for Booklet or see your nearest Crosley dealer.

only
\$26⁰⁰

Western price slightly higher.

THE CROSLLEY RADIO CORPORATION
Dept. R 121 Cincinnati, Ohio

CRIME DETECTION SECRET SERVICE AND FINGER PRINTS

SECRET SERVICE BOOK FREE

For 30 Days Reading
No Money Down—Actual Crime Cases—If You Act Quick!—We will send you this stirring book on Crime Detection, Secret Service and Identification Work for 30 days free reading. Send no money. If you decide to keep it, then send only \$1.00. If not, return it. WRITE TODAY. Not sent to boys under 17 years of age.

T. G. Cooke, Book Dept. 93-56 1920 Sunnyside Ave., Chicago

DEAFNESS IS MISERY



Many people with defective hearing and Head Noises enjoy conversation, go to Theatre and Church because they use Leonard Invisible Ear Drums which resemble Tiny Megaphones fitting in the Ear entirely out of sight. No wires, batteries or head piece. They are inexpensive. Write for booklet and sworn statement of the inventor, himself deaf.



A. O. LEONARD, Inc., Suite 699, 70 5th Ave., New York

Beautify Your Garden

Build artistically designed DUTCH WINDMILLS to beautify your garden. Easy to construct from our blueprints, complete details with full instructions. Model B20—\$1.50. Model B100—75c. Dutch Gate mills 35c Ea., 6 for \$1.50. Lawn Animals 50c Ea., 6 for \$2.25.

CRAFTSMAN'S MODEL CO., 2030 N. 41 Street, Milwaukee, Wis.

Forms to cast Lead Soldiers, Indians, Trappers, Hunters, Wild and Farm Animals. 239 different forms to select from. Every form guaranteed to cast perfect figures. Send 5c stamp for illustrated catalogue.

HENRY C. SCHIERCKE Spencer Rd. GHENT, N. Y.

COLONIAL MANTEL CLOCK

(Continued from page 510)

to sufficient depth to house these pieces. Because of its slenderness, each finial should be turned separately. Dimensions are given in Fig. 4. Many of the old clocks had brass finials on them. These can be purchased if you wish to use them or are not equipped to turn them out of wood. Button feet are used on the bottom of the case to elevate it from the shelf. These may be turned up as shown in Fig. 7, sawed apart and tacked and glued into place, or they may be omitted. Two $\frac{5}{8}$ -in. hinges and a $\frac{3}{8}$ -in. knob of brass are required for the door.

After the case has been filled, stained and varnished, you are ready to install the glass, dial and movement. The face may be made of bristol board securely glued to a thin board or piece of zinc. The numerals and graduations of the dial should be made with black drawing ink. Strips are glued to the sides of the case to hold the face in position. The lower glass in the door of the original has a conventional wreath in gold painted on the inside. The whole inner surface of this glass was then painted black. If preferred, a decalomania transfer of flowers or a colonial scene may be substituted. In this case, the transfer is put onto a piece of black paper, which in turn is securely pasted to the glass with transparent varnish. The finished clock is shown in Fig. 3.

Extension on Auto Jack Increases Its Utility

When using an auto jack to exert pressure in two directions, to straighten auto fenders, etc., a socket welded to the bottom of the jack to take a length of 2 by 4-in. stock will be of considerable utility. The socket can be made from two pieces of angle iron. To adapt the jack to various conditions, extensions of suitable lengths are used.

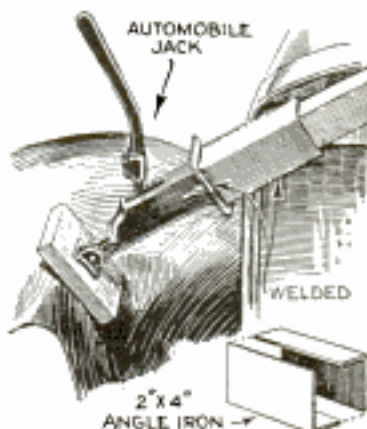

PATENTS

Booklet Free Highest References
Promptness Assured Best Results

Send drawing or model.

ALL BUSINESS GIVEN PROMPT AND PROPER ATTENTION

Listed Patent Lawyer in the latest editions of the Rand-McNally Directory of Bankers and Bank-Recommended Attorneys, published by Rand-McNally & Co., Chicago, Ill.; The Baggott & Ryall Directory of Guaranteed Attorneys, published by Legal Directory Corporation, Boston, Mass.; Flugel's Law List, published by Legal Directory Publishing Co., St. Louis, Mo.; American Lawyers Annual, published in Cleveland, Ohio; Bankers Service Legal Directory, published by Bankers Service Co., Boston, Mass.; Eyre's Law List, 9 Park Place, New York City; Walters Legal Directory, Omaha, Nebraska, and the National Directory of Attorneys, Baltimore, Maryland.

WATSON E. COLEMAN,
REGISTERED PATENT LAWYER

Victor Building, 724 Ninth Street, N. W.
WASHINGTON, D. C.

"At 61"

"I thought I was through. I was half-living—getting up nights—constantly tormented with aches and pains. At 62 my condition became almost intolerable. Then at 63, I shook off 20 years almost overnight."



"How I Licked Wretched Old Age at 63"

IN 65% of all men, the vital prostate gland slows up soon after 40. Pain may not appear instantly. But gradually symptoms often develop that lead to sciatica, backache, bladder weakness, constipation, etc. But now a new, safe way has been discovered by a simple home treatment to restore the prostate to normal health. The reports on many cases are amazing. Many physicians use and recommend it. No drugs, medicine, surgery, or electric rays.

FREE! A 24-page illustrated book fully describes it. The edition is limited. Send for a free copy. Every man past forty should know the meaning of these frank facts. Simply write The Electro Thermal Co., 2157 Morris Ave., Steubenville, Ohio. Western Address: Dept. 21-L, 303 Van Nuys Bldg., Los Angeles, Cal.

DO YOU WANT TO STOP TOBACCO?

Banish the craving for tobacco as thousands have. Make yourself free and happy with Tobacco Redeemer. Not a substitute, not habit forming. Write for free booklet telling of injurious effect of tobacco and dependable, easy way to relieve the craving many men have.

Newell Pharmacal Co. FREE BOOK
Dept. 900 St. Louis, Mo.

CRESCENT
Only **\$22.50**
with 1/2 h.p. Motor **\$36.50**

CRESCENT 4" BENCH JOINTER
A high efficiency machine, affording extraordinary value. Accurately built for regular production work. Ideal for school shops and amateur use. Portable—takes power from light socket. Two-knife round safety head mounted in ball bearings. Two-knife round flaps. Automatic guard. Tables in perfect alignment are adjusted independently. Satisfaction guaranteed or money back.

THE CRESCENT MACHINE CO.
93 Columbia St. LEETONIA, OHIO

Send for FREE BULLETINS

FREE! FREE! TIRE GAUGE

New LOW PRICES ON GOOD YEAR GOODRICH-U.S.-FIRESTONE FISK AND OTHER TIRES

LOWEST Prices on Earth!
Thousands of satisfied tire users all over the U. S. A. will vouch for the LONG, HARD SERVICE... great road conditions of our standard tires... reconstructed by the ORIGINAL... PRO-CESSE. To introduce this genuine tire value to you, this big responsible company offers, **ABSOLUTELY FREE** a modern tire gauge with each 2 tires ordered—now take pressure through side wall of tire in a jiffy—no fuss—no dirt. **OUR 16 YEARS IN BUSINESS** makes it possible to offer tires at **LOWEST PRICES** in history. **Guaranteed to give 12 months' service**

Don't Delay — Order Today

CORD TIRES		BALLOON TIRES	
Size	Tires Tubes	Size	Tires Tubes
20x3	\$1.90 0.75	20x4.50	\$2.00 0.90
20x3.50	2.05 0.85	20x4.00	2.10 0.95
20x4	2.10 0.90	20x4.50	2.15 0.95
20x4.50	2.25 0.95	20x4.75	2.20 1.00
20x5	2.35 1.05	20x4.75	2.25 1.00
20x5.50	2.45 1.10	20x4.90	2.30 1.10
20x6	2.55 1.15	20x5.00	2.35 1.10
20x6.50	2.65 1.20	20x5.25	2.40 1.15
20x7	2.75 1.25	20x5.50	2.45 1.20
20x7.50	2.85 1.30	20x5.75	2.50 1.25
20x8	2.95 1.35	20x6.00	2.55 1.30
20x8.50	3.05 1.40	20x6.25	2.60 1.35
20x9	3.15 1.45	20x6.50	2.65 1.40
20x9.50	3.25 1.50	20x6.75	2.70 1.45
20x10	3.35 1.55	20x7.00	2.75 1.50
20x10.50	3.45 1.60	20x7.25	2.80 1.55
20x11	3.55 1.65	20x7.50	2.85 1.60
20x11.50	3.65 1.70	20x7.75	2.90 1.65
20x12	3.75 1.75	20x8.00	2.95 1.70
20x12.50	3.85 1.80	20x8.25	3.00 1.75
20x13	3.95 1.85	20x8.50	3.05 1.80
20x13.50	4.05 1.90	20x8.75	3.10 1.85
20x14	4.15 1.95	20x9.00	3.15 1.90
20x14.50	4.25 2.00	20x9.25	3.20 1.95
20x15	4.35 2.05	20x9.50	3.25 2.00
20x15.50	4.45 2.10	20x9.75	3.30 2.05
20x16	4.55 2.15	20x10.00	3.35 2.10
20x16.50	4.65 2.20	20x10.25	3.40 2.15
20x17	4.75 2.25	20x10.50	3.45 2.20
20x17.50	4.85 2.30	20x10.75	3.50 2.25
20x18	4.95 2.35	20x11.00	3.55 2.30
20x18.50	5.05 2.40	20x11.25	3.60 2.35
20x19	5.15 2.45	20x11.50	3.65 2.40
20x19.50	5.25 2.50	20x11.75	3.70 2.45
20x20	5.35 2.55	20x12.00	3.75 2.50
20x20.50	5.45 2.60	20x12.25	3.80 2.55
20x21	5.55 2.65	20x12.50	3.85 2.60
20x21.50	5.65 2.70	20x12.75	3.90 2.65
20x22	5.75 2.75	20x13.00	3.95 2.70
20x22.50	5.85 2.80	20x13.25	4.00 2.75
20x23	5.95 2.85	20x13.50	4.05 2.80
20x23.50	6.05 2.90	20x13.75	4.10 2.85
20x24	6.15 2.95	20x14.00	4.15 2.90
20x24.50	6.25 3.00	20x14.25	4.20 2.95
20x25	6.35 3.05	20x14.50	4.25 3.00
20x25.50	6.45 3.10	20x14.75	4.30 3.05
20x26	6.55 3.15	20x15.00	4.35 3.10
20x26.50	6.65 3.20	20x15.25	4.40 3.15
20x27	6.75 3.25	20x15.50	4.45 3.20
20x27.50	6.85 3.30	20x15.75	4.50 3.25
20x28	6.95 3.35	20x16.00	4.55 3.30
20x28.50	7.05 3.40	20x16.25	4.60 3.35
20x29	7.15 3.45	20x16.50	4.65 3.40
20x29.50	7.25 3.50	20x16.75	4.70 3.45
20x30	7.35 3.55	20x17.00	4.75 3.50
20x30.50	7.45 3.60	20x17.25	4.80 3.55
20x31	7.55 3.65	20x17.50	4.85 3.60
20x31.50	7.65 3.70	20x17.75	4.90 3.65
20x32	7.75 3.75	20x18.00	4.95 3.70
20x32.50	7.85 3.80	20x18.25	5.00 3.75
20x33	7.95 3.85	20x18.50	5.05 3.80
20x33.50	8.05 3.90	20x18.75	5.10 3.85
20x34	8.15 3.95	20x19.00	5.15 3.90
20x34.50	8.25 4.00	20x19.25	5.20 3.95
20x35	8.35 4.05	20x19.50	5.25 4.00
20x35.50	8.45 4.10	20x19.75	5.30 4.05
20x36	8.55 4.15	20x20.00	5.35 4.10
20x36.50	8.65 4.20	20x20.25	5.40 4.15
20x37	8.75 4.25	20x20.50	5.45 4.20
20x37.50	8.85 4.30	20x20.75	5.50 4.25
20x38	8.95 4.35	20x21.00	5.55 4.30
20x38.50	9.05 4.40	20x21.25	5.60 4.35
20x39	9.15 4.45	20x21.50	5.65 4.40
20x39.50	9.25 4.50	20x21.75	5.70 4.45
20x40	9.35 4.55	20x22.00	5.75 4.50
20x40.50	9.45 4.60	20x22.25	5.80 4.55
20x41	9.55 4.65	20x22.50	5.85 4.60
20x41.50	9.65 4.70	20x22.75	5.90 4.65
20x42	9.75 4.75	20x23.00	5.95 4.70
20x42.50	9.85 4.80	20x23.25	6.00 4.75
20x43	9.95 4.85	20x23.50	6.05 4.80
20x43.50	10.05 4.90	20x23.75	6.10 4.85
20x44	10.15 4.95	20x24.00	6.15 4.90
20x44.50	10.25 5.00	20x24.25	6.20 4.95
20x45	10.35 5.05	20x24.50	6.25 5.00
20x45.50	10.45 5.10	20x24.75	6.30 5.05
20x46	10.55 5.15	20x25.00	6.35 5.10
20x46.50	10.65 5.20	20x25.25	6.40 5.15
20x47	10.75 5.25	20x25.50	6.45 5.20
20x47.50	10.85 5.30	20x25.75	6.50 5.25
20x48	10.95 5.35	20x26.00	6.55 5.30
20x48.50	11.05 5.40	20x26.25	6.60 5.35
20x49	11.15 5.45	20x26.50	6.65 5.40
20x49.50	11.25 5.50	20x26.75	6.70 5.45
20x50	11.35 5.55	20x27.00	6.75 5.50
20x50.50	11.45 5.60	20x27.25	6.80 5.55
20x51	11.55 5.65	20x27.50	6.85 5.60
20x51.50	11.65 5.70	20x27.75	6.90 5.65
20x52	11.75 5.75	20x28.00	6.95 5.70
20x52.50	11.85 5.80	20x28.25	7.00 5.75
20x53	11.95 5.85	20x28.50	7.05 5.80
20x53.50	12.05 5.90	20x28.75	7.10 5.85
20x54	12.15 5.95	20x29.00	7.15 5.90
20x54.50	12.25 6.00	20x29.25	7.20 5.95
20x55	12.35 6.05	20x29.50	7.25 6.00
20x55.50	12.45 6.10	20x29.75	7.30 6.05
20x56	12.55 6.15	20x30.00	7.35 6.10
20x56.50	12.65 6.20	20x30.25	7.40 6.15
20x57	12.75 6.25	20x30.50	7.45 6.20
20x57.50	12.85 6.30	20x30.75	7.50 6.25
20x58	12.95 6.35	20x31.00	7.55 6.30
20x58.50	13.05 6.40	20x31.25	7.60 6.35
20x59	13.15 6.45	20x31.50	7.65 6.40
20x59.50	13.25 6.50	20x31.75	7.70 6.45
20x60	13.35 6.55	20x32.00	7.75 6.50
20x60.50	13.45 6.60	20x32.25	7.80 6.55
20x61	13.55 6.65	20x32.50	7.85 6.60
20x61.50	13.65 6.70	20x32.75	7.90 6.65
20x62	13.75 6.75	20x33.00	7.95 6.70
20x62.50	13.85 6.80	20x33.25	8.00 6.75
20x63	13.95 6.85	20x33.50	8.05 6.80
20x63.50	14.05 6.90	20x33.75	8.10 6.85
20x64	14.15 6.95	20x34.00	8.15 6.90
20x64.50	14.25 7.00	20x34.25	8.20 6.95
20x65	14.35 7.05	20x34.50	8.25 7.00
20x65.50	14.45 7.10	20x34.75	8.30 7.05
20x66	14.55 7.15	20x35.00	8.35 7.10
20x66.50	14.65 7.20	20x35.25	8.40 7.15
20x67	14.75 7.25	20x35.50	8.45 7.20
20x67.50	14.85 7.30	20x35.75	8.50 7.25
20x68	14.95 7.35	20x36.00	8.55 7.30
20x68.50	15.05 7.40	20x36.25	8.60 7.35
20x69	15.15 7.45	20x36.50	8.65 7.40
20x69.50	15.25 7.50	20x36.75	8.70 7.45
20x70	15.35 7.55	20x37.00	8.75 7.50
20x70.50	15.45 7.60	20x37.25	8.80 7.55
20x71	15.55 7.65	20x37.50	8.85 7.60
20x71.50	15.65 7.70	20x37.75	8.90 7.65
20x72	15.75 7.75	20x38.00	8.95 7.70
20x72.50	15.85 7.80	20x38.25	9.00 7.75
20x73	15.95 7.85	20x38.50	9.05 7.80
20x73.50	16.05 7.90	20x38.75	9.10 7.85
20x74	16.15 7.95	20x39.00	9.15 7.90
20x74.50	16.25 8.00	20x39.25	9.20 7.95
20x75	16.35 8.05	20x39.50	9.25 8.00
20x75.50	16.45 8.10	20x39.75	9.30 8.05
20x76	16.55 8.15	20x40.00	9.35 8.10
20x76.50	16.65 8.20	20x40.25	9.40 8.15
20x77	16.75 8.25	20x40.50	9.45 8.20
20x77.50	16.85 8.30	20x40.75	9.50 8.25
20x78	16.95 8.35	20x41.00	9.55 8.30
20x78.50	17.05 8.40	20x41.25	9.60 8.35
20x79	17.15 8.45	20x41.50	9.65 8.40
20x79.50	17.25 8.50	20x41.75	9.70 8.45
20x80	17.35 8.55	20x42.00	9.75 8.50
20x80.50	17.45 8.60	20x42.25	9.80 8.55
20x81	17.55 8.65	20x42.50	9.85 8.60
20x81.50	17.65 8.70	20x42.75	9.90 8.65
20x82	17.75 8.75	20x43.00	9.95 8.70
20x82.50	17.85 8.80	20x43.25	10.00 8.75
20x83	17.95 8.85	20x43.50	10.05 8.80
20x83.50	18.05 8.90	20x43.75	10.10 8.85
20x84	18.15 8.95	20x44.00	10.15 8.90
20x84.50	18.25 9.00	20x44.25	10.20 8.95
20x85	18.35 9.05	20x44.50	10.25 9.00
20x85.50	18.45 9.10	20x44.75	10.30 9.05

Build it Yourself

You've always wanted one and now Heath makes it easy. You can take advantage of your leisure time to build your own ship. With Heath parts your home assembled plane will be eligible for a Department of Commerce License. Twenty-three years experience in building light planes and in working with those who like to build their own ships, has resulted in the new approved model L.N. Heath and the New Assembly Kit.

SOON READY TO FLY

Your part is simple, the hard work is all done at the factory. Fuselage, tail, rudder and stabilizer come completely assembled. All you have to do is assemble the ready built parts, cover and paint your plane. Ordinary tools and two or three weeks work will complete your ship.

By using your own labor you can have a Heath for only \$299.00. First shipment comes for only \$10.00. Balance may be ordered as desired and paid for as shipped. Model L.N. may be licensed with Heath B & Motor, \$300.00 or Continental A40, \$450.00.

For those who prefer, Model L.N. B-4 can be had. Fly-away, Niles, Michigan, \$1,074.00. Powered with Continental A40, \$1,224.00. Flyer speed 75-85 m.p.h. Heath has an attractive rental plan for schools and clubs which will be sent on request. Send for complete literature and details will be forwarded promptly. Specify what you are most interested in.

HEATH AIRCRAFT CORPORATION

Dept. P.-29

NILES, MICH.

HEATH AIRCRAFT

DRIVE SAFELY AT NIGHT

New 67,000 candlepower Speedlight ends all glare danger yet prevents dim-light crashes. Drive 60 miles an hour safely! Agents cleaning up big with it. Write for particulars to SPEEDLIGHT CO., Dept. 16-M, 1731 Belmont Ave., Chicago, Ill.

The man who studies gets ahead. Popular Mechanics Press will advise you what books to read to advance in your trade. 200 East Ontario Street, Chicago, Illinois

A PRACTICAL COURSE IN MECHANICAL DRAWING

By WM. F. WILLARD

An ideal book for home study. Each exercise is clinched in the mind of the student by practical application to every day practice. 160 Pages, 157 Drawings. Cloth. Price \$1.00 Postpaid.

POPULAR MECHANICS PRESS 200 E. Ontario St. CHICAGO

Oh, You Skinny!



DON'T be laughed at for your lack of flesh and muscle. Don't be an object of ridicule wherever you go, at the dances, in the swimming pool or on the field of sport—don't let them call you "Skinny." Don't suffer this humiliation. You can turn it to admiration by the simple method of betting Lionel Strongfort, the world's foremost physical instructor, take hold of you and build you up through Strongfortism, into a real he-man—with a body to be proud of. Away with weakness. In less time than you think you will rid yourself of vitality sapping ailments and be admired and respected for your fine physique and robust physical powers.

Come on—be a manly man. Just write for my illustrated book giving priceless secrets about the human body. Send 10 cents for postage, etc.

STRONGFORT INSTITUTE

LIONEL STRONGFORT, Director
PHYSICAL AND HEALTH SPECIALIST.
Dept. 61, London, S. W. 19. ENGLAND.

ELECTROPLATING WITH GOLD AND SILVER

(Continued from page 315)

and then goldplated. Gold over nickel produces a very beautiful light-yellow color, characteristic of fine gold. Goldplating may be done satisfactorily at room temperature, but a greater variety of tones and shades can be produced if the bath is heated. This heating should be done by immersing the plating tank in a bucket of water kept warm by a burner. The temperature of the water in the bucket should not be allowed to rise beyond 170° F. Care must be taken to avoid the inhalation of poisonous hydrocyanic-acid fumes, which may be liberated while the solution is hot. Green goldplate is made by adding a small quantity of the silverplating solution previously described to the gold bath. To obtain the desired color, add the silver solution to the gold bath in small quantities (about ½ oz. at a time). Red gold is produced by dissolving a small quantity of copper acetate in the gold bath. A very small quantity (a little on the point of a knife) is worked into a paste with a few drops of the gold solution, and is then added to the bath by stirring.

Gold and silverplated work may be polished with cloth buffers and jewelers' rouge. When the luster has been developed, the work may be cleaned with ordinary household ammonia, after which a last polishing with a dry felt buffer will produce the final finish.

IMPORTANT

IN plating with gold and silver where it is necessary to use deadly poisonous cyanides, great caution should be exercised to prevent accidents. Handle the chemicals so that the solutions will not spatter. These cyanides can enter the body through the eyes, skin abrasions and, perhaps, through the pores of the skin after a period of time. When cyanide comes in contact with acids, deadly hydrocyanic-acid fumes are generated. Do the work where a draft will carry all fumes from the plating bath or hot cyanide solutions out of doors. To dispose of the solutions, pour them into a sink into which a quantity of lye water has just previously been poured. Rinse out the sink with copious quantities of water. Gloves used while plating from cyanide solutions should be placed in the sink and thoroughly rinsed by allowing water to run over them. To make sure that all cyanide has been removed, put the rinsed gloves in a pan of diluted vinegar out of doors. This will decompose any small amount of cyanide that may remain. Plating tanks should be thoroughly rinsed with several changes of clean water to remove the cyanide. As a final precaution rinse the cleaned tanks with vinegar, out of doors, where the wind will blow any fumes away from you.

HI, JACK!

(Continued from page 453)

"There's been a shift in the coast guard, Cap," apologized a broad-shouldered man in the stern. "We gotta get the load through early."

"His hand was extended showing against the palm half of an ace of hearts. He was permitted to mount the rail and four armed men were right behind him. Suddenly the leader pretended to lose his balance. The false card token slipped from his fingers, was caught by a breeze and fluttered to the tossing water. With mock concern he yelled to his men in the little boat to recover the card. Two other searchlights were turned on. Members of the crew ran to the side and looked down into the blackness trying to spot the lost token. Suddenly they heard a savage voice say:

"'Nobody'll be killed who minds. Hands up! Quick!"

"There were nine men in the crew of the rum ship. They were herded into the cabin, bound hand and foot, and gagged. But the hijackers had to divide their force then in order to handle the liquor they proposed to steal. Consequently, some were in their own boat, some on the deck of the big one and some below deck when the holders of the legitimate token arrived. The men in this boat were unsuspecting of the other speed boat. They came alongside, clambered up the Jacob's ladder and the leader had his genuine half of the ace of hearts in his hand to surrender it, when a shot was fired. Then there was a real battle.

"Hijackers and runners were firing revolvers everytime a head showed. Men took cover behind windlasses, in companionways and on the bridge. Three men had been killed in the first exchange of shots. Two others knifed each other in a hand-to-hand scrap. The hijackers' boat had pulled away from the ship's side at the first sounds of trouble—and then a new force entered the fighting. One of the rumrunners made his way into the cabin and freed the captain. In short order, all of the crew were free and came rushing on deck carrying rifles. Quickly they gained the upper hand and made prisoners of all the visitors, rumrunners and hijackers alike. Both speed boats van-

(Continued to page 132A)

Do You Want? Money Now!

Get Into This
Thriving
Business

A
Chance

for Quick Success
with **CRISPETTES**



Never before have pop-corn confections been so popular. Right now the business is amazingly prosperous in spite of times. Hundreds are making big money making and selling CRISPETTES—the original nationally famous pop-corn confection. Young and old buy them. Taste them—love them—buy again and again. They're tasty, tempting, delightfully delicious. Demand enormous and you can share in the big money awaiting operators.

Start Anywhere . . . Open a Shop or Start in Your Home

Wholesale or retail Crispettes anywhere—city, town or village. Open a little retail store or make them at home and do a big wholesale business to stores, grocers, druggists, confectioners, parks, picnics, roadside stands, highways, etc. Easy to make. Raw material plentiful and cheap. Profits big.

We Help You to Start

Anyone can follow simple easy plan. Takes but little capital. We supply complete equipment—machines, secret, original formulas, materials, tell you just what to do and how to do it to make immediate big cash profits.

FREE "Book of Facts"

Sent for the asking. Shows how others are making big money in this sensational business—how you can do it, too—easily, quickly. Tells how to start. Shows all equipment. Gives all particulars. Explains most successful method and easy terms. Mail coupon today. No obligation.

LONG-EAKINS CO.,

Originators
928 HIGH STREET
SPRINGFIELD
OHIO



JUST MAIL THIS COUPON

LONG-EAKINS COMPANY,
928 High St.,
Springfield, O.

Gentlemen: Send me "Book of Facts" all about the Crispette Business.

Name.....

Address.....

The UNIVERSAL MENDER

Is Here At Last! A STRANGE new liquid metal called METALLIC-X binds all kinds of materials together as if welded—even glass to glass—MENDS ANYTHING! Easier to use and stronger than glue, liquid cements or solders. Write today for FREE sample of work done with Metallic-X and details of AMAZING MONEY-MAKING OPPORTUNITY FOR AGENTS!

Write
Today for
FREE
SAMPLE

LUX-VISEL, INC. Dept. M-5000 ELKHART, IND.

"Yes..sez I"



"I'M a high-class radio sev, see? And I'm telling you I don't like the idea of being fixed with any second-rate solder after I'm damaged! I'm used to Kester Radio Solder! That's what the builder used on me, and he knows his business. Why don't you get next to yourself, brother? Kester would be a lot easier for you to use. With the flux inside, all you have to do is apply heat, and it's so simple that you can get professional results the very first time. Kester's flux is a non-conducting, non-corrosive plastic rosin and is the one rosin core solder that doesn't "spoil" on the dealer's shelves. Buy a handy can of Kester Radio Solder for radio and electrical repairs. Be sure and ask for Kester. And write for 'The ABC of Soldering'."

Kester Solder Company, 4201-04 Wrightwood Ave., Chicago, Ill.
 Eastern Plant, Newark, N.J.
 Canada, Kester Solder Company of Canada, Ltd., Brantford

KESTER RADIO SOLDER

— easy to use —

AIRJECTOR

An auxiliary carburetor producing a secondary stage of aspiration.

20% to 40% Mileage Increase Guaranteed
 More power—quicker acceleration. Price \$4.00 complete, postpaid. Easily installed in a few minutes' time. Money back guarantee. Agents, write for attractive money-making proposition.

AIRJECTOR CO. Sta. C Dept. 6 Buffalo, New York

Big 3 ft. Telescope Five Sections. Brass bound. Powerful 8-X Lenses. 10-Mile range. Special Eye Piece for looking at the Sun, included FREE. Can be used as a Microscope. Guaranteed. Big value. Postpaid. \$1.75. C. O. D. 15c extra. **Banner & Company, 1-48, Trenton, N.J.**

EASY

You'll advance faster with an easy playing Conn. Choice of the world's greatest artists. Many exclusive features yet they cost no more. Home trial. Easy payments. See your dealer or write for free book. Mention instrument.

C. G. CONN, Ltd.
 931 Conn Bldg., Elkhart, Ind.

CONN

World's Largest
 Manufacturers of
 BAND INSTRUMENTS

HI, JACK!

(Continued from page 131A)

ished, the skipper, raging mad, dumped the dead overboard and loaded the survivors of both groups into a lifeboat and set them adrift. With a couple of pairs of oars they finally made shore only to be arrested. None would explain what had happened to the injured men, and after a few days, since no charges could be placed against any of them, the two groups were released."

For a long time small gangs of hijackers preyed on the small boats engaged in running liquor ashore. This kind of fighting still continues on both coasts. It was the hazard of hijackers quite as much as the menace of coast-guard patrols that impelled the liquor runners to acquire the speediest boats that money would buy.

"We had three Liberty motors in our forty-foot boat," one of these men confided lately. "She cost \$25,000. Nothing could touch us, and so the hijackers tried to put over a fast one. They must have stowed away when the boat was in the yard to be tuned up before each run.

"Coming up New York harbor without lights, low in the water from the weight of our sacks of rye, one of the engines began to miss. The skipper went below but soon came on deck. He was a tough egg, but he was scared white. He had seen a man's foot sticking out of some gear stowed below. Then he went back with a gun. When he returned he was herding three stowaway hijackers. We tied 'em with wire around their wrists back to back. Just below Bedloe's island the skipper kicked one of them overboard into sixty feet of black water. We threw their guns overboard, too."

It was matters like these that finally resulted in the organization of the big liquor ring that absorbs the cargoes of the rum fleet that lies off Long Island and New Jersey nowadays. Eleven gangs merged under this arrangement into one gigantic syndicate. As a consequence hijacking practically lost its former temptation. For one thing, hijackers were hunted down relentlessly, and it became next to impossible to sell liquor stolen from the syndicate without detection. Even the speed boats that bring the stuff ashore around New York, in recent times, have been immune to all but Uncle Sam's men.

NEW BOICE-CRANE MACHINES COMING

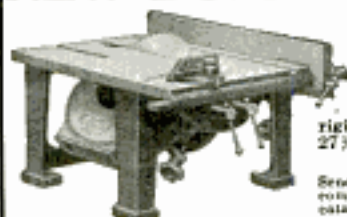

Attachments for boring, mortising, sanding, moulding.

Here is the first, a low cost Oscillating Spindle Sander. Sands edges of curved or straight work. Oscillates vertically $\frac{3}{4}$ in. Rotates 3000 r.p.m. on ball bearings. Drums 3 in., 2 in. and 1 in. diam. Driven by $\frac{3}{4}$ to $\frac{1}{2}$ h.p. motor and vee belt.

TILTING ARBOR SAW

Do your sawing, bevelling, dadoing, etc., on a table that is always level and rigid. The arbor tilts, raises and lowers. Table 15 in. by 17 $\frac{1}{2}$ in., or 20 in. by 27 $\frac{1}{2}$ in. Bronze or ball bearing.

SEND FOR CATALOG

Send 10c in stamps or coin (which only partly pays mailing cost) for big 52-page catalog. Shows complete line of circular saws, band saws, planers, jointers, lathes and worktops. If you have catalog "E," circular on Spindle Sander sent free.

W. & J. BOICE DEPT. PM-9H TOLEDO, OHIO



Table 20 in. x 27 $\frac{1}{2}$ in., 20 in. dia. Spindle 2 in. High.

AERO SHORT WAVE RECEIVER.....\$ 6 45
AERO AUTO RADIO, Complete..... 39.50
AERO SHORT WAVE CONVERTER..... 12.50
 Send for Complete Catalog
CHAS. HOODWIN CO., Dept. W-2, 4240 Lincoln Ave., Chicago, Ill.

BUCHSTEIN'S FIBRE LIMB



Send for Catalog Today

Is something to your stump—strong, cool, neat, light. Easy to put on. Brace for all deformities.
B. BUCHSTEIN CO.
 800 3rd Ave., So. MINNEAPOLIS, MINN.

The SCOTT ALL-WAVE

15-550 METER—Superheterodyne

Brings in stations 5,000 to 10,000 miles away with full volume and clarity. Major stations all over U. S. come in like locals. Write now for particulars.
THE E. H. SCOTT RADIO LABORATORIES, Inc.
 4450 Ravenswood Avenue Dept. P-92 CHICAGO, ILL.

NEED A BETTER GRIP ON MATHEMATICS?

SEND for a copy of "Mathematics for the Practical Man," only \$1.50. By common sense methods it removes the mystery and difficulties so that algebra and even calculus are made simple.

Assuming your knowledge is limited to arithmetic you quickly and easily gain a working knowledge of Algebra, Geometry, Trigonometry and Calculus. Simply pay postman price of book plus the postage when he hands you the package.

Popular Mechanics Press
 Room P9
 200 E. Ontario Street, Chicago

BOW LEGS?



THIS GARTER (Pat'd)
 Makes Trousers Hang Straight
 If Legs Bend In or Out
 Free Booklet—Plain Sealed Envelope
THE T. GARTER CO., Dept. E
 South Bend, Ind.

FREE PLAPAO FOR RUPTURE

A remedial factor in system—Stuart's Plapao-Pads—that has proven amazingly effective. Patentably different from trusses. No straps, buckles or springs attached. Easy to apply—inexpensive. **Plapao Co., 66 Stuart Building, St. Louis, Mo.,** is sending FREE Plapao to all who write now.

Strange Invention SAVES Up to 50% on Gas Bills

New, amazing rings fit around gas range burners. Give full heating power in about half the time. Keeps utensils clean. Thousands now in use and saving money to consumers.

AGENTS - - 200% PROFIT

Every home buys. No competition. Saves its cost on first month's gas bill. Agents needed at once. Exclusive territory. Earn up to \$20 a day showing people how to save money by cutting their gas bills up to 50%. Write at once for complete details, exclusive territory proposition and free demonstrator offer.

ECONOMY APPLIANCES 1213 VAN BUREN STREET
 Dept. 245, CHICAGO, ILLINOIS

When writing to advertisers please mention Popular Mechanics



Retail \$1.00 Per Set of Four

\$300 to \$400 Profit monthly in ARC WELDING

BUILD YOUR OWN PORTABLE - SAVE HALF

Connect up your own motor or gas engine to this Hobart Belt Drive Welder. Costs but fraction of ordinary portable job. Repair shops, garages, mechanics are making hundreds of extra dollars profit monthly.

\$30 MONTHLY

Try at our risk—pay for out of profits. No previous experience needed with Hobart Simplified Welder. There's big profit in every job. Write today for complete details.

Hobart Bros. BOX [M-92] Troy, Ohio



EASY MONTHLY TERMS



42 in. TELESCOPE only \$135



Here's a great big, 10 power 4 draw Micro-Telescope that extends 42 inches, closes to 11 $\frac{1}{2}$ in. When closed it is a wonderful microscope, for big objects 4 times. Beautifully finished—black fibre body trimmed in satin brass. An exceptional value at only \$135, postage prepaid. Money back if you are not delighted.

MICRO-FLOSCOPE 50c

There are a thousand uses for a microscope like this. Also small and compact, it will cover a wide range of microscopic research. It is fascinating to study the interesting secrets of insects and plant life, and to examine mineral, animal and vegetable specimens, and many other objects. This Micro-Florescope is made of brass and is a wonderful bargain at only 50c, postage paid.

BARGAIN CATALOG FREE

Write today for catalog of amazing, low priced telescopes, binoculars, barometers, thermometers and a host of unique, clever and useful imported specialties. If you are looking for items that are "different," fascinating, yet low in price, you should write for catalog today.

SHOPS IMPORTING CO. 19 N. Wabash Avenue
 Dept. 10, Chicago, Ill.

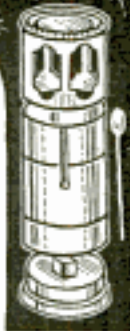

NICKEL PLATE YOUR AUTO

FAUCETS, HARDWARE without removing parts. Our outfit connects to your battery, no tank is used. \$3.00 prepaid. Write for free particulars.

GUNMETAL CO., Ave. T., DECATUR, ILL.



SHIP MODELS

Get this dandy catalog of true-scale models of Flying Cloud, Viking, Blue Nose, Tall-y-ho, Conch, deluxe fittings. Send 15c (in coin) for your copy.
ROY HANCOCK, 323 Douglas Ave., Portsmouth, Virginia



Works Like Magic!

AGENTS

Men and Women make up to \$6 and \$8 in an hour, full or spare time. Big, worthwhile commissions on every sale. Exclusive Territories. Send quick for NO-RISK TEST OFFER.

At last! An automatic, simple little can opening machine for the home! This revolutionary invention in only a few short months has banished old can openers from over 100,000 kitchens. And no wonder! Imagine an amazing, lifetime device that holds the can and cuts out the top leaving can rim slick, smooth and clean. Just turn a crank, that's all. Approved by Good Housekeeping Inst., Modern Priscilla, etc. Write today for special introductory advertising offer. Central States Mfg. Co., Dept. L-716, 4500 Mary Ave., St. Louis, Mo.

THEY LOVE IT **PUT YOURSELF OVER . . . BIG**

NOW is the Time

In idle hours, learn to play a Buescher. Be ready, in 3 months, for a big pay job. Success! Live on the cream of life.

You can master any Buescher, quickly, easily. No talent required. Play popular tunes, first week. Many join dance bands in 90 days. See your Buescher dealer about easy terms. Or send postal direct for beautiful catalog. *Easy to Play—Easy to Pay.* This is your big chance.

BUESCHER

Treat yourself to the "honey" of social popularity. Mix with the best **BAND INSTRUMENT CO.** 910 Buescher Bldg., 1115, Elkhart, Ind.

450 Miles in a Gallon of Gas
POTENTIAL GASOLINE MILEAGE

The president of the world's largest motor research laboratory stated there is enough energy in a gallon of gas if converted 100% in mechanical energy to run a four cylinder car 450 miles. A marvelous device into accelerated winds in utilizing a portion of the waste energy. It saves gasoline, reduces carbon formation, creates more power, quicker starting, safety pickup, smoother running pistons. Free samples (valued over \$100) sent. Write for this free sample and up to \$100 weekly money-making offer. **WHIRLWIND MFG. CO.** Dept. 886-A Station C MILWAUKEE, WIS.

BABY CALCULATOR
CHICAGO ILL.
LATEST MODEL

VEST POCKET ADDING MACHINE

Adds, Subtracts, Multiplies, Divides. Does work of \$200 machine. Not a toy. Million dollar capacity. Simple and accurate. Guaranteed 5 years.

FREE TRIAL **\$2.50**
—SEND NO MONEY— **Total Cost**

Just name and address. We will ship Calculator immediately. On delivery pay postman \$2.50 (plus few cents postage). (If outside U. S. send cash.) 10c additional in Leatherette Case. If not satisfied after 10 days' trial you get your money back. **THOUSANDS OF SATISFIED USERS.** Write for Agency Proposition. **BABY CALCULATOR MACHINE CO.** (Invs.) P. O. Box 1119, Dept. 31, CHICAGO, ILLINOIS

BLUEPRINT READING
For the Machine Trades

An entirely new book that explains in an unusually easy-to-understand manner the reading and analyzing of blueprints for the machine trades.

Blueprint Reading starts with the fundamentals, and by a gradual step-by-step process works up into the higher phases of the subject. The book contains examination questions and answers.

Ideally adapted to home-study.
154 pages—89 illustrations
Cloth—Size 5 1/2" x 8 1/2"
Price \$1.50 postpaid

Popular Mechanics Press
Room P8

200 E. Ontario St. Chicago



ONE MAN VS. BRITISH EMPIRE

(Continued from page 367)

ing company, has found it possible to almost double the speed of water craft up to fifty feet in length.

Frictional resistance in water is 800 times the wind resistance of the same surface in air, Doctor Tietjens says, because water is 800 times as dense as air. For the same reason the lifting force of a submerged plane is 800 times as great as for the same plane in air, area and speed being equal. In water, the frictional resistance of drag of present type high-speed craft is one-sixth of the buoyancy or lifting effect of the water. For the new type this drag is only one-twentieth of the lift.

Other designs to make the boat free from the drag of disturbed water have appeared from time to time, one of the most remarkable in the larger boat hulls being that of the ill-fated Gold Cup challenge boat, "Jersey Lightnin'," designed by George F. Crouch, whose boats frequently beat Gar Wood's in that classic contest. This boat had a single step in the shape of a tongue, and a tunnel stern. Thus she traveled on three points, one forward and two aft, and in speed had the smallest proportionate wetted surface of any hydroplane or step boat yet developed.

Gar Wood's new defender, "Miss America X," is between thirty-five and thirty-eight feet in length, the largest he has built for the contest and nearly ten feet longer than "Miss America IX." "Miss England III" is thirty-five feet long with a beam of nine and one-half feet. In her recent try-outs, the British challenger was reported unofficially to have stepped at 131 miles an hour. The British have reduced their propeller speed from 12,500 revolutions per minute of last year to about 7,500, and Wood is said to be contemplating a higher gear ratio to give his propellers more than the 4,050 revolutions per minute of "Miss America IX."

At lower speeds, "Miss America IX," present holder of the world's speed record of 111.712 miles an hour, raises her bow very high, her stern sinks deep, and the water washes about in white swirls. Gar Wood at such times stands nearly erect to see over the high bow, motions to his veteran racing companion, Orlin Johnson, for more speed.

(Continued to page 136A)

All Parts Necessary for Only 10c
Runs on No. 6 Dry Battery

10c

ELECTRIC MOTOR

An Electric Motor for Only 10 cents. Sounds almost unbelievable but it is perfectly true. For ONLY 10 cents we send you all the parts necessary packed in a neat box, with full printed and illustrated directions for assembling. No trouble at all putting the parts together. In fact it is FUN. Just follow a few simple instructions and in a few minutes the motor is ready to run.

Actual Size

AN EDUCATIONAL NOVELTY

OH BOY! Isn't it speedy. Runs on a No. 6 or similar dry battery. It is an education in itself (not putting it together, and you can perform many novel and interesting experiments with it. Remember the price—ONLY 10 cents. JOHNSON SMITH & CO., Dept. 832, Racine, Wis.

BOY AMATEUR ELECTRICIAN 10c



The HOW and WHY of electricity fully told in simple language that any boy can understand. Scores of plans and instructions for making—dry batteries, dynamo, electric motors, telegraph apparatus, telephones, electric lights, electric door bells, alarms, electric engine, rheostat, mail box alarm, electro-magnets, automatic incandescent flash, electric shocking machine, wireless telegraph apparatus, induction coil, arc light, current meter, etc. Tells all about electric wiring, static electricity, magnets and magnetism, conductors and insulators, electrostatic induction, electrocutor, electrophorus, condensers, Leyden jar dynamo electricity, the voltaic cell, electromagnets, electrolysis, electro-plating, electro-typing. How to build a radio for a few cents, etc. 64 pages, 100 illustrations. 10c. postpaid. JOHNSON SMITH & CO., Dept. 832, RACINE, WIS.



250 Magic Tricks
An excellent little book containing nearly 200 tricks for parlor or stage that anyone can do. Tricks with cards, coins, handkerchiefs, eggs, bottles, strings, etc. Also Second Sight, Shadow-graphy, etc. Profusely illustrated. 10c p. pd.

BIG ENTERTAINER
180 Jokes and Riddles, 21 Puzzles and Problems, Gypsy Fortune Teller, 60 Money Making Secrets, 26 Experiments in Magic, 58 Verses in Comic Poetry, 7 Parlor Games, 15 Card Tricks, 13 Funny Readings, 71 Tomes, Cut-outs for Checkers and Chess, Dominoes, Fox and Goose, 9 Men Morris, Anagrams, etc. All for 15c.

125 CARD TRICKS and sleight of hand. Contains all the latest and best card tricks as performed by celebrated magicians, with exposure of card tricks used by professional gamblers. Price 25c postpaid.

GREAT CURIOSITY
Prestidigitate in the World. Size of a postage stamp etc. 200 Pages. Said to bring good luck to the owner. A genuine work of art. Must be seen to be appreciated. Mass good money selling them to friends, church organizations, etc. PRICE 15c each, 3 for 40c, 12 for \$1.35, 100 for \$7.50. Also obtainable in Leather Binding, with gold edges. Price 50c each, 3 for \$1.25, \$4.50 per doz. Magnifying Glass for use with Midget Bible 15c.

BUILD YOUR OWN RADIO. Booklet tells how to build efficient radio sets at minimum cost. Everything explained in simple language anyone can understand. 15c postpaid.

MIDGET BIBLE
Must be seen to be appreciated. Mass good money selling them to friends, church organizations, etc. PRICE 15c each, 3 for 40c, 12 for \$1.35, 100 for \$7.50. Also obtainable in Leather Binding, with gold edges. Price 50c each, 3 for \$1.25, \$4.50 per doz. Magnifying Glass for use with Midget Bible 15c.

BOOK ON RABBITS. How to breed and raise rabbits. Begins here for absolute profit. Many boys have netted a good living through the aid of this book. Illustrated. 15c. postpaid.

STAGE MONEY

With a bunch of these bills, it is easy for each person of limited means to appear prosperous by flashing a roll of these bills at the proper time and peeling off a genuine bill or two from the outside of the roll, the effect created will be found to be all that can be desired. Prices: 15 Bills 10c, 40 Bills 20c, 120 for 50c or \$3.50 per thousand postpaid.

HOW TO FITCH CUBS. Contains lessons by "Marty," Ed. Walsh, "Doc" White, Walter Johnson, "Nap" Barker, "Smoky Joe" Wood. Pitch the Fitch-o-way, Spitter, Knicker, Smoke Ball, etc. Clearly described, 16 illustrations. 25c postpaid. Johnson Smith & Co.

STAR TOY MAKER
Greatest boys' book written. Tells how to make a Pinhole Camera, a Cannon, model Railroad, a Telephone, Boomerang, Telegraph Instrument, Box Kite, Talking Machine, Microscope, Electric Door Bell, Water Wheel, Paddle Boat, a pair of Skis, a Dog Sled, Bird House, Rabbit Yard, etc. 64 pages. 100 illustrations. PRICE 10c.

BOY'S OWN TOYMAKER. A new book—Tells how to make chemical toys, electrical toys, galvanic toys, mechanical toys, paper toys, cardboard toys, boats, traps, etc. 200 illustrations. Price 25c postpaid.

BOOK ON BOATS. How to build rowing, sailing boats. Everything pertaining to boats explained in plain terms so anyone can understand. Illustrated. 10c p. pd.

5-MINUTE HARMONICA COURSE. A new easy self-teaching method. Teaches how to play, to see the tongue, tremolo, fully illustrated. Price 15c postpaid.

MONEY MAKING SECRETS. Golden opportunities for everyone. 64 page copyrighted book chock full of money-making ideas, recipes, formulas, wrinkles, trade secrets, etc. Business that can be started with little or no capital at home in spare time. 10c postpaid.

WONDERFUL X-RAY TUBE
A wonderful little instrument producing optical illusions both surprising and startling. With it you can see what is apparently the back of your fingers, the lead in a lead pencil, the interior contents of a pane glass, and many other similar illusions. Price 10c, 3 for 25c.



Good Luck Ring

Very striking, quaint and unusual. Silver finish skull and crossbones design, two brilliant flashing gems sparkle out of the eyes. Said to bring good luck. Only 25c p. pd.

JOHNSON SMITH & CO.
Dept. 832 RACINE, WIS.
A copy of our NEW CATALOG mailed on receipt of 10c, or the De Luxe Edition with cloth binding 25c. Bigger and better than ever. Only book of its kind in existence. Nearly 800 pages of all the latest tricks in magic, the newest novelties, puzzles, games, sporting goods, rubber stamps, unusual and interesting books, curiosities in seeds and plants, etc., unobtainable elsewhere. Remit by Cash, Money Order, Check or United U. S. Postage Stamps, for all articles listed above. Canadian money, stamps and Postal Notes accepted at 15% added for Exchange.

Little Wonder Crystal Radio Receiver



Say what you will about Electrical and Battery Sets, a CRYSTAL set has them all beat for simplicity and clearness of tone. There is absolutely no noise and no distortion—no batteries to buy—no tubes to wear out—no maintenance expense whatsoever. Cost nothing to operate and will last indefinitely. Reception is loud and clear. This Receiver is guaranteed to work equal to the most expensive Crystal Set you can buy. Has a receiving radius of over 25 miles, or under favorable conditions up to 100 miles. Constructed of the finest materials throughout, including compressive crystal, assuring quick results. PRICE of Receiver only \$1.00 postpaid. Or complete with Ear Phone and Aerial Kit—everything all complete—nothing more to buy. \$2.95 postpaid. JOHNSON SMITH & CO., Dept. 832, RACINE, WIS.

Repeating and Single Shot Air Pistols

Just what you've always wanted. A powerful high grade Air Pistol, shaped like an Automatic, pocket size. Fires B. B. shot obtainable anywhere. Very powerful yet perfectly safe for boys to handle. Two styles—Single Shot Pistol or Repeater. The Repeater fires 50 shots in one loading. The Single Shot Pistol shoots Air Rifle Darts in addition to B. B. Shot. Well made and durable; all metal parts nickel plated; natural grain wood stocks. Front and rear sights. Weighs about 10 ounces. Better than an air rifle. No license required. By Express only. PRICES: Single Shot Pistol . . . \$2.50 50-Shot Repeating Pistol . . . \$3.95 JOHNSON SMITH & CO. Dept. 832 RACINE, WIS.



Uses BB. Shot

BLANK CARTRIDGE PISTOL

Protection against Burglars, Tramps and Deeps. Prices 50c \$1.00
Well made and effective; modelled on latest type of Revolver; appearance alone is enough to scare a burglar. When loaded it may be as effective as a real revolver without danger to life. It takes standard 22 Cal. Blank Cartridges obtainable everywhere. Price 50c. Superior quality, \$1.00. Blank Cartridges, 50c per 100. Holster (Cowboy type) for Blank Cartridge Pistol, 50c. Shipped by Express only. JOHNSON SMITH & CO. Dept. 832 RACINE, WIS.

BOYS! THROW YOUR VOICE

Into a trunk, under the bed or anywhere. Lots of fun fooling teacher, policeman or friends. THE VENTRILO a little instrument, fits in the mouth out of sight, used with above for Bird Calls, etc. Anyone can use it. Never fails. A 16 page course on Ventriloquism, the Ventrilo and novelty catalog. All for 10c. JOHNSON SMITH & CO. Dept. 832 RACINE, WIS.

MICROSCOPE and FLOROSCOPE

There are few things so interesting and valuable as a Microscope. It enables you to minutely examine mineral and vegetable specimens, to test cotton, wool, silk, seeds, water, flour, cheese, milk, and in fact nearly all articles of food. Unwholesome meat can be readily detected and ferments can be slowly watched. It is exceedingly interesting to examine the spores of ferns, seeds, sugar, salt, slum and other crystals, the dust (scum) from moth and butterfly wings, human hairs, flies and insects, while the animalcules in water are a never-failing source of wonder. Most interesting experiments can be performed with an instrument such as this. Place a small piece of cheese in a box and allow insects to feed on it for a day or two. Then examine a tiny portion of the cheese under the Microscope and you will see little animals, magnified to the size of large beetles; you can count their legs and the joints in them. The talons or claws upon each foot, also the hair or bristles upon their bodies. Or, obtain some stagnant water; deposit a small portion of scum upon the object glass of the Microscope with a pin's head, and you will see beautiful animalcules swimming about with as much freedom as though they were fish in the boundless ocean. It is a truly wonderful sight and an endless source of interest and enjoyment for everybody. The Microscope is made of brass and is capable of magnifying 150 times, and although small and compact, it will cover a very wide range of microscopic research. PRICE ONLY 50c Postpaid. Add 10c for new booklet on MICROSCOPE—a study of microscopic worlds. Use it in conjunction with above. 30 chapters tell all about microscopes, how to examine all kinds of foods, three, scum, paper, wool, silk, cotton, plants, flowers, insect life, mold, fungi, pond scum, etc., microscopic examination of many compounds in pantry and medicine cabinet, etc. Fascinating and absorbing. 30 illustrations. 25c. postpaid. JOHNSON SMITH & CO. Dept. 832 RACINE, WIS.



Electrically Resilverers Auto Headlight REFLECTORS



New Portable \$17.50 Machine Wholesale to Agents for Only \$8.75 Complete

Here is an amazing compact silver-plating machine that can be operated in the home or anywhere, yet, does a job superior to the old commercial bath. Resilverers Reflectors like new. Does a perfect job on old tableware, musical instrument trimmings, searchlights, etc.

MAKES YOU UP TO \$15.00 DAILY

Five million car owners need their headlight reflectors resilvered. Enormous profits for you if you have this new machine. Easy to operate. Works quickly and perfectly—nothing to get out of order. Write for free particulars today.

P. J. Batenburg Company, Dept. 700, Racine, Wisc.

DKCQ—YNKO—MWTL—JQDA—LUXO SECRET CODE LETTER WRITING MACHINE

For Governments secret files and messages, for Army, Navy, Police, Secret Service, Banks, Newspapers, Financiers, Cable and Telegraph Cos., Inventors and also Lovers. Nobody can read these Code Messages except having the right Key Combination.

With the experience of Secret Code Reading and Writing you are qualified for well paid and steady positions. Mighty few people know anything about this opportunity. **SECRET CODE LETTER WRITING MACHINE.** Complete, prepaid \$2.00. Can be used for any language. **FIVE HUNDRED DOLLARS (\$500.00) paid** for translation of above five word code message. **Consent not required to purchase or pay anything.** Detailed information free upon request.

TREASURE SALES CO., 1690 Boston Road, NEW YORK

Let us recommend the best books to study on any subject. Popular Mechanics Press, Chicago, Illinois

Make Decorative Metal Articles

Pictures and instructions for making: book ends, desk sets, jewelry, desk clocks, drawer pulls, hinges, bookmarks, stationery rack, candlestick, letter holder, whisk broom holder, and many similar articles. Send no money. Just write a postal for "Metal Work and Etching", our 88-page book. Pay postage and 98c to postman.

Popular Mechanics Press, Room 710, 200 E. Ontario St., Chicago, Ill.

NEW FORD—V-8 B-FOUR—BB-TRUCK

**[A New and Practical Book for Everyone
Interested in the Construction, Adjustment,
Upkeep and Repair of The New Fords]**

THIS NEW BOOK tells you in a practical and easily understood manner how the New Ford Cars and Trucks are constructed as well as how to perform all upkeep, adjustment and repair operations on them. The complete story is told in over 250 pages and with 125 illustrations. The book is pocket size with a flexible leatherette binding. A complete cross index permits immediate location of any technical item or service operation.

There is little to compare between the former Ford Cars and the new V-Eight and Improved Four—the latter are totally new and different cars in appearance, performance and construction.

Send anywhere postpaid upon receipt of price, or C.O.D. **\$2.00** in U.S.A. PRICE.....



Popular Mechanics Press
Room P9
200 E. Ontario St. CHICAGO

ONE MAN VS. BRITISH EMPIRE

(Continued from page 134A)

Wood and Johnson are beyond question the most perfect, the most closely synchronized team in the history of motor-boat racing.

In 1928, Gar built "Miss America VI." She was launched and tested. A preliminary run was made. Gar beamed at Orlin Johnson. "I think we can run a half mile wide open," he said. And Orlin nonchalantly replied, "I can hold the throttles open if you can steer her." So they started.

"We rode like a storm for about a half mile," says Gar, "when suddenly we stopped as though we had hit a stone wall. I didn't know what had happened. Suddenly I realized I was in water, sinking down and down. I looked up and in the light coming through the water I could see tanks, pieces of deck and planks of frame whirling around above me. The water pressed on me. I began to suffocate, and then, in my agony, I struck out and clawed my way to the surface. I got hold of a gas tank and looked around for Johnson. Finally he rose to the surface, unconscious. We were both pulled in."

Last year Kaye Don led across the line and both "Miss England II" and "Miss America IX" roared down to the first turning wide open. Gar Wood swung wide, Kaye Don hugged the buoys. Gar had swung so wide he came dangerously close to the Detroit shore. Kaye attempted to cut across Wood's wake, to the inside, and make up some of the distance he was behind.

Suddenly the six-ton hull of the British boat skidded and leaped into the air, its sharp bow pointing skyward. The bodies of Don and his mechanics were seen hurtling through the air as "Miss England" sank from sight. Gar Wood was disqualified for beating the gun at the start and "Miss America VIII," another of Gar's boats driven by his brother, continued on to win at an average speed of less than sixty miles per hour.

What will the next Harmsworth race bring forth? Kaye Don has a new "Miss England III" reputed to be capable of 130 miles per hour. Gar Wood has a new "Miss America X," larger, more powerful and faster. Can he keep the Harmsworth trophy?

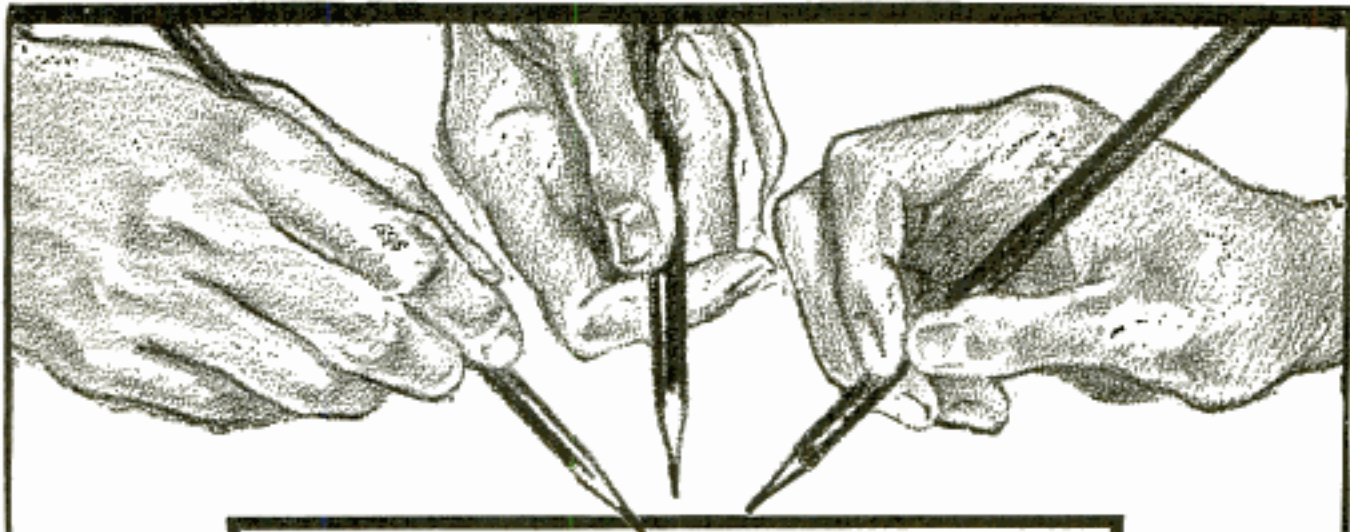

Amazing Chart FREE

Send your letter today—without delay—and I shall send you, also, FREE a chart that will make it easy for you to learn the most astonishing things about your friends. This chart is exactly like the one used by Dr. Bunker in reading your handwriting, and you will be astounded by the truths it tells about your friends. This chart is absolutely FREE—Write today.

I Will Pay \$250 Cash

For the Most Interesting Specimen of Handwriting

Can you write? Are you over sixteen? Can you use \$250.00? If you can say "yes" to these three questions, you may win this wonderful Cash Prize, for they are the only conditions. Just write a short sentence—20 words or less, in your regular handwriting. Use the coupon, a post card, or write a letter. Style does not count. What you say does not

count. **THE MOST INTERESTING HANDWRITING WINS.** Write with a pencil, a pen, or a goose quill—it makes no difference. Just a few lines of handwriting is all that's necessary for someone to receive this prize of \$250.00 Cash. Now that you know how simple and easy it is, write those few words and mail them today.

Your Report FREE

Just as soon as I get your letter I shall submit it to the American Institute of Grapho-Analysis (directed by Dr. M. N. Bunker, D. C. S., Ph.D., N. D., for a brief report on what your handwriting says about you. This will surprise you—fairly amaze you—in the way it reveals traits of character which you have. This report is FREE to everyone, over 16, answering my advertisement.

Is this prize yours?

Just Writing These Few Words Qualifies You For Opportunity To

Win \$3,500.00 Cash
Or a Studebaker 8 Sedan and \$2,000.00 Cash Besides

This huge prize is extra and separate from the Cash Prize offered for the most interesting specimen of handwriting. Picture for yourself—\$3,500.00 to use just as you like—for education, home, furniture, clothes, family, to pay your mortgage—you CAN use it. Rush your handwriting to me now. Yours may be the winner. All replies become the property of Richard Day, Manager.

Hundreds Have Won

During the past year we have given financial help to hundreds of people all over the United States—we have given away hundreds and thousands of dollars. Beemer won \$5,700.00—We paid Lutz \$3,000.00—Harriet Robertson won \$1,100.00—Mary Hanford, over \$900.00—and hundreds of others have been made happy with big prizes and cash awards. This is YOUR CHANCE. Perhaps you may be the happy winner this time. Write me today!

BE PROMPT! I WILL SEND YOU A \$100 Cash Certificate AT ONCE!

To make it worth your while to be prompt in sending in your handwriting analysis—if you will see that your letter is postmarked not more than three days after you read this offer, I will send you a Cash Promptness Certificate entitling you to an extra \$100.00 in Cash should yours be the most interesting specimen of writing submitted.

RICHARD DAY, Mgr.
909 Cheapside St. Dept. BW-605-R, Cincinnati, Ohio

RULES

\$250.00 Cash will be paid for the most interesting specimen of handwriting. Send me a specimen of your handwriting today for a brief character analysis and, in addition, a FREE Character Analysis Chart. Style, neatness or legibility mean nothing, for the American Institute of Grapho-Analysis may find the poorest specimen to be the most interesting. All replies must bear a postmark not later than January 20, 1933. Duplicate prizes will be awarded in case of ties.

\$250.00 PRIZE COUPON

RICHARD DAY, Manager
909 Cheapside St., Dept. BW-605-R, Cincinnati, O.
Here's my handwriting for a brief character analysis:

Name

.....

.....

Address

Town..... State.....

Date I Read Your Offer.....

I am to receive FREE a brief character analysis from my handwriting and a FREE Character Analysis Chart.

ARMATURE REWINDING

Armature rewinding. Every armature completely re-wound to original factory specifications. 24-hour service. No patching—all work unconditionally guaranteed. Vacuum cleaner and portable electric drill armatures a specialty at these new wholesale prices. High-grade wringer rolls for all makes of washers. \$1.00 each and up—sent in whole roll for exact duplication. 17 years in business.

SPECIAL—Renewed Vacuum Cleaners—Hoover, Premier-Duplex, Royal Electric and Eureka, etc.—guaranteed 1 year—\$4.75 and up. Attachments and replacement parts for all makes of cleaners. Free descriptive folder and price lists on request.

Dealers—Agents—Get Our Money-Making Plan
RE-NEW SWEEPER COMPANY
 Factory—2260 Gratiot Avenue, Detroit, Mich.

\$1.65
 EACH
 In Quantities
 of 6 or more
\$1.50
 EACH

Strange Chemical Sponge

Washes Windows Without Work

JUST OUT! Strange Chemical Sponge that washes windows without work. Revolutionizes window washing. Banishes hated drudgery of old methods. Women wild about it. Ideal also for autos. **700 Agents wanted at once.** Hustlers cleaning up. No experience needed. Selling Outfit **FREE.** Write quick! Kristee Mfg. Co., 1359 Bar St., Akron, Ohio.

NEW 3 in 1 No. 10 PEN-PENCIL With COMPASS Guaranteed for Life

Makes carbon copies. Mr. Chal EARNED \$6,240 selling our pens. You can too. Sells for \$1.25.

Write for **FREE** wholesale catalog, showing over 1000 Fast Sellers.

SPORS IMPORTING CO.
 732 Main St., Le Center, Minn.

Send Only 39c

HOWARD RACER

5" scale. Span 13" length 13 1/2" weight 1.3 oz. Colored glazing white. Complete Kit \$1.48, postage only.

Just Off The Press!

"Cleveland Model Engineers News" Everybody's reading it. Nothing ever like it before. Rush your name, address and \$c (no stamps) for your copy.

GEE-BEE

5 1/2" in. scale. Colored yellow and black. Span 17 1/4 in.; length 12 in.; weight 1.5 oz. Complete Kit \$-F-37, postage, ONLY \$1.50

● CLEVELAND MODEL & SUPPLY CO. 1685-79 West 57th St. CLEVELAND, OHIO, U. S. A. ●

GIANT TELESCOPE

5 SECTIONS—3 FT. LONG

See Miles Away! Distant people and objects seem close. Over 3 ft. long, brass bound. Made in Europe. Bbls. of fun. Thousands pleased.

Send No Money! On arrival pay Postman special price, only \$1.75, plus postage. Two for \$3.25. (Or send price and we pay postage.) Satisfaction guaranteed or money back. Send today.

FREE with Order Strong leatherette Carrying Case and Solar Eye Piece to view the sun.

Bargain House, 427 Randolph St., Dept. 12, Chicago

G. E. PHONOGRAPH MOTOR

Synchronous 110 Volt, 60 Cycle, 80 R. P. M. Motor

Can be installed in place of old fashioned hand wind spring motors. Many other uses. These G. E. motors are all brand new in original factory cartons. Fully guaranteed. \$12 val. only \$2.95. Shipped Prepaid. Order today before too late.

\$12.00 Value ONLY \$2.95

NATIONAL ELEC. TOOL CO. 111 W. Lake St., Dept. 109 CHICAGO

You Can Print

Cards, stationery, circulars, tags, labels, advertising, etc. Make big profits spare or full time. Do Your Own Printing. Save Money. Easy rules sent. Will do popular Raised Printing like Engraving. Junior press \$5.90, job presses \$11 up, power \$149. Send for free catalog. The Kelsey Co., N-37, Meriden, Ct.

ELECTRIC SAW "Little Cut-Up"

AS LOW AS \$9 READY TO ATTACH MOTOR

SEND FOR COMPLETE LIST INCLUDING TILTING TABLE MODELS

Blows for every need... from home shops and schools to industrial plants. Does work of hand saws, band saws, scroll saws. Cuts wood, bakelite, soft metals, etc.; curves, straight, angles, bevels, inside crookedly. Thousands in use. Dealers in printed circles. Literature free. Manufactured and distributed by

BEBE BROS., Inc.
 2726 6th Ave., So. SEATTLE, WASH. THE BIGGEST LITTLE SAW IN THE WORLD

HOME, SWEET HOME OF TOMORROW

(Continued from page 354)

groups have been experimenting with steel homes in one form or another.

Without a doubt, the frame of the home of the future will be of metal, although not necessarily of steel. It will be rust-proof and light in weight, whether it is stainless steel, aluminum or some other metal. The walls will be about three inches thick instead of from twelve to eighteen inches. The outer walls may be of colored enameled metal made in sections that clip to the frame. Inner walls will be attached to metal lath and may be of enameled metal, plasterboard or precast plaster. Insulation between the walls will be as effective as an eighteen-inch brick wall.

Floor and roof supports may well consist of steel-trussed joists. The roof will be of rustproof metal sheeting underlaid with an inch-thick layer of insulation. The rough flooring may consist of sheet steel with interlocking channels.

Windows will be more to see out of than to admit light. Illumination will be by neon tubing or ultraviolet tubing emitting therapeutic rays and these will be concealed in walls and ceilings.

Buildings such as this can be constructed today for about thirty cents per cubic foot of space, exclusive of accessories and home appliances. This is in contrast to forty-five or fifty cents, and sometimes more, for the small home built of materials and by methods now used.

The lumber industry is awakening to the need for a revision of building methods and practices, and already is turning out homes cut to shape at the factory.

By far the most important result of this change in building methods is that it will enable hundreds of thousands of families who are renters today to become home owners tomorrow. Harvey Wiley Corbett, chief architect of the Chicago fair, visions a country dotted with small houses, sold ready-made, like suits of clothes, for nomadic America. "An American family," he asserts, "wants three things—a house to live in, a car to drive in, and a garage for the car. Ninety-nine out of a hundred Americans would rather have a three-room house and a six or eight-cylinder car, than an eight-room house and no automobile."

Hotter than Coal and no dirt



FITS ALL FURNACES

**A New
Invention**

Do away forever with the drudgery of wood and coal. The most simple and economical invention on the market is now giving perfect satisfaction to enthusiastic users everywhere. This new invention is a new type of oil burner that takes the place of wood or coal and automatically and silently changes cheap oil into one of the quickest and hottest fires known.

Burns 96% Air and 4% Cheap Oil

The International Oil Burner fits in the fire box of your present range, stove, or furnace. It can be installed in a few minutes by anyone. There is nothing complicated about the International Oil Burner. It gives you all the heat you want—when you want it. Starts instantly with a match. No soot, smoke, or odor. Costs less than coal.

Costs Only a Few Dollars

International Oil Burners heat just as well as burners costing \$400 or \$500. Simply turn 1 valve and you have all the heat you want. Cleaner and better for heating or cooking. Approved by the National Underwriters' Laboratories and engineers everywhere. Over 150,000 have been sold.

30 Days' TRIAL OFFER

Try this wonderful automatic oil burner right in your own home at our risk. Act quickly and get our special low introductory price. Sold under absolute money-back guarantee. Write at once for free booklet on home heating and our free burner offer.



FITS ANY COOK-STOVE



FITS ANY HEATING-STOVE

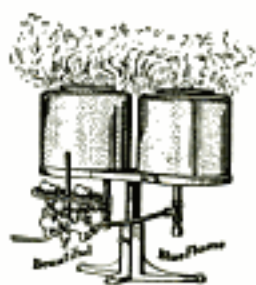

Double Blue Flame Burner for cook stoves, ranges, and parlor circulators. Burns with beautiful clean blue flame.

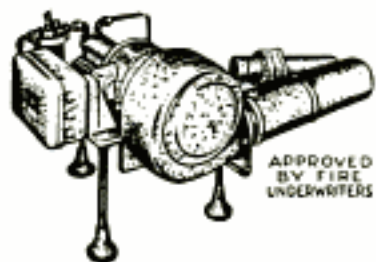

All-Electric Power Burner designed for larger houses, apartments, etc.

APPROVED
BY FIRE
UNDERWRITERS

The Burner Advertised Coast to Coast
Over World's Leading Radio Stations

AGENTS—DEALERS— DISTRIBUTORS

Our free burner offer starts you in business. Big money to be made. Demand is enormous. We also want spare or full time workers immediately. If \$500 a month and more interests you, write or wire us for protected territory offer.

INTERNATIONAL OIL HEATING CO.

3800-10 Park Ave., Dept. 501-S, St. Louis, Mo.

10 YEAR GUARANTEE

CLIP THIS COUPON

International Oil Heating Co.,
3800-10 Park Ave., St. Louis, Mo.
Dept. 501-S

Send your free booklet and free details on home heating for stove.....furnace.....
Also free burner offer.

Date.....

Name.....

Address.....

City and State.....

Check if interested in making money as an International representative with protected territory.

When writing to advertisers please mention Popular Mechanics

"I WONDER WHAT THE BOSS

thinks

OF ME"



Of course that thought has passed through your mind! It's natural for you to speculate on the opinion your superiors hold about you.

Listen —

The boss' opinion of you is based on the *kind* of work you do! Remember, there are other executives over him, and they judge your boss by results. And he must look to you for these results! That's why he promotes *trained* men — they are prepared for greater responsibilities, which mean more pay, and the efficient performance of their duties helps the boss move forward too. So he is vitally interested in the fact you are considering enrolment for a spare-time study course with the International Correspondence Schools. Ask him and see! It is likely the same Schools gave him his start.

Thousands of successful men cheerfully attribute the real beginning of their careers to spare-time study of I. C. S. Courses. Denied expert training in earlier days, they turned to I. C. S. for what they needed most. So can you! The coupon will bring you complete information. Mail it today!

INTERNATIONAL CORRESPONDENCE SCHOOLS

"The Universal University" Box 5617-G, Scranton, Penna.

Without cost or obligation, please send me a copy of your booklet, "Who Wins and Why," and full particulars about the subject before which I have marked X:

TECHNICAL AND INDUSTRIAL COURSES

- | | |
|--|--|
| <input type="checkbox"/> Architect | <input type="checkbox"/> Automobile Mechanic |
| <input type="checkbox"/> Architectural Draftsman | <input type="checkbox"/> Plumbing <input type="checkbox"/> Steam Fitting |
| <input type="checkbox"/> Building Estimating | <input type="checkbox"/> Heating <input type="checkbox"/> Ventilation |
| <input type="checkbox"/> Wood Millworking | <input type="checkbox"/> Sheet Metal Worker |
| <input type="checkbox"/> Contractor and Builder | <input type="checkbox"/> Steam Engineer |
| <input type="checkbox"/> Structural Draftsman | <input type="checkbox"/> Steam Electric Engineer |
| <input type="checkbox"/> Structural Engineer | <input type="checkbox"/> Civil Engineer |
| <input type="checkbox"/> Electric Wiring | <input type="checkbox"/> Surveying and Mapping |
| <input type="checkbox"/> Electrical Engineer | <input type="checkbox"/> Refrigeration |
| <input type="checkbox"/> Electric Lighting | <input type="checkbox"/> R. R. Locomotives |
| <input type="checkbox"/> Welding, Electric and Gas | <input type="checkbox"/> R. R. Section Foreman |
| <input type="checkbox"/> Reading Shop Blueprints | <input type="checkbox"/> R. R. Bridge and Building Foreman |
| <input type="checkbox"/> Telegraph Engineer | <input type="checkbox"/> Air Brakes <input type="checkbox"/> Train Operation |
| <input type="checkbox"/> Telephone Work | <input type="checkbox"/> Highway Engineering |
| <input type="checkbox"/> Mechanical Engineer | <input type="checkbox"/> Chemistry <input type="checkbox"/> Pharmacy |
| <input type="checkbox"/> Mechanical Draftsman | <input type="checkbox"/> Coal Mining Engineer |
| <input type="checkbox"/> Machinist <input type="checkbox"/> Toolmaker | <input type="checkbox"/> Navigation <input type="checkbox"/> Boilermaker |
| <input type="checkbox"/> Patternmaker | <input type="checkbox"/> Textile Overseer or Supt. |
| <input type="checkbox"/> Pipelitter <input type="checkbox"/> Tinsmith | <input type="checkbox"/> Cotton Manufacturing |
| <input type="checkbox"/> Bridge Engineer | <input type="checkbox"/> Woolen Manufacturing |
| <input type="checkbox"/> Bridge and Building Foreman | <input type="checkbox"/> Agriculture <input type="checkbox"/> Fruit Growing |
| <input type="checkbox"/> Gas Engines <input type="checkbox"/> Diesel Engines | <input type="checkbox"/> Poultry Farming <input type="checkbox"/> Radio |
| <input type="checkbox"/> Aviation Engines | <input type="checkbox"/> Marine Engineer |

BUSINESS TRAINING COURSES

- | | |
|--|--|
| <input type="checkbox"/> Business Management | <input type="checkbox"/> Business Correspondence |
| <input type="checkbox"/> Office Management | <input type="checkbox"/> Lettering Show Cards <input type="checkbox"/> Signs |
| <input type="checkbox"/> Industrial Management | <input type="checkbox"/> Stenography and Typing |
| <input type="checkbox"/> Personnel Management | <input type="checkbox"/> Commercial |
| <input type="checkbox"/> Traffic Management | <input type="checkbox"/> Civil Service |
| <input type="checkbox"/> Accountancy and C. P. A. Coaching | <input type="checkbox"/> Mail Carrier |
| <input type="checkbox"/> Bookkeeping | <input type="checkbox"/> Railway Mail Clerk |
| <input type="checkbox"/> Secretarial Work <input type="checkbox"/> Spanish | <input type="checkbox"/> Grade School Subjects |
| <input type="checkbox"/> Cost Accountant <input type="checkbox"/> French | <input type="checkbox"/> High School Subjects |
| <input type="checkbox"/> Salesmanship <input type="checkbox"/> Advertising | <input type="checkbox"/> College Preparatory |
| <input type="checkbox"/> Wallpaper Decorating | <input type="checkbox"/> Illustrating |
| <input type="checkbox"/> Salesmanship | <input type="checkbox"/> Cartooning |
| | <input type="checkbox"/> Lumber Dealer |

Name.....Age.....

Address.....

City.....State.....

Occupation.....

If you reside in Canada, send this coupon to the International Correspondence Schools Canadian, Limited, Montreal, Canada

Books on Many Practical Subjects

Popular Mechanics Press specializes in supplying the outstanding best books on many subjects. As new books of merit appear, we will revise the list accordingly.

- | | |
|--|--|
| ARMATURE WINDING
Excellent new book..... \$2.00 | LATHE WORK (METAL)
and Drilling and Thread Cutting..... \$1.00 |
| ATLAS
New 1930
Census Edition..... \$2.50 | LETTER WRITING
Social and Business
Only..... \$1.00 |
| AUTO ENCYCLOPEDIA
Dyke's. New 16th Edition
Covers Latest Improvements..... \$6.00 | LETTERING
Modernistic..... \$2.00 |
| AUTO KINKS
for Owners, Repairmen, Tourists (3 vols.)..... \$1.50 | MAGIC
200 New Tricks for Amateurs..... \$1.00 |
| BIRD HOUSES
How to Make..... \$1.00 | MAKE IT YOURSELF
900 Different Things to Make..... \$3.00 |
| BLUE PRINT READING
For Building Trades..... \$1.25 | MARKETING BY MAIL
Science of..... \$2.00 |
| BOAT BUILDING
New Edition of Popular Mechanics book..... \$3.00 | MATHEMATICS
Made Easy for the Practical Man..... \$1.50 |
| BOOKKEEPING
Complete Course, Single and Double Entry..... \$3.50 | MECHANICAL DRAWING
Practical Course In..... \$1.00 |
| BOY MECHANIC
Famous 4 Vol. Library,
4000 Things to Make..... \$7.00 | MODEL AIRPLANES
Building and Flying..... \$2.50 |
| BUILT-IN FURNITURE
Complete Instructions..... \$2.50 | MONEY MAKING
Formulas (10,000)..... \$4.00 |
| CALCULATOR
Mathematical Ropp's..... \$1.00 | OCEAN LINER
Europa, Lithographic Model,
Shows Every Part..... \$1.00 |
| CARPENTRY
Hand book of 336 Kinks..... \$1.50 | OUTDOOR OPPORTUNITIES
for Making a Living..... \$2.00 |
| CHALK TALK
How to..... \$1.00 | OUTDOOR SPORTS
for All Year 'Round
New Edition..... \$2.00 |
| CHEVROLET SIX
Complete new Book
Covers 1932 Models..... \$2.00 | PAINT SHOP PRACTICE
New, very complete..... \$5.00 |
| CONCRETE
175 Ways of Using
New Edition (Cloth)..... \$1.00 | PAINTING
House (Best Methods)..... \$2.00 |
| DOGS (All Breeds)
Training..... \$2.00 | PLUMBING
500 Plain Facts for
Every Homeowner..... \$1.50 |
| ELECTRICITY
for Beginners..... \$1.50 | POULTRY RAISING
Battery Brooding..... \$2.00 |
| ENGLISH
Self-Improvement in..... \$1.60 | PUZZLES
Amusing Mathematical..... \$1.50 |
| ETIQUETTE
New 560-Page Book,
Only..... \$1.00 | RADIO
Amateur's Handbook..... \$1.00 |
| FARMER'S BOOK
of 861 Kinks and Book
for Farmers' Wives..... \$1.00 | ROOF FRAMING
Made Easy..... \$1.50 |
| FORD V8
Excellent new book,
Just Out..... \$2.00 | SHOP NOTES
7 Vols. of 2600 Valuable Kinks..... \$3.50 |
| FROG RAISING
A new industry..... \$1.00 | SLIDE RULE
How to use..... \$1.75 |
| GARDEN (Home)
Planning and Planting..... \$3.50 | STAMP ALBUM (Modern)
12,000 Varieties..... \$1.50 |
| GLASS
Working..... \$1.75 | STEEL SQUARE
Pocket Book, Practical..... \$1.00 |
| GLIDING
A B C of..... \$2.00 | STORAGE BATTERIES
(New work) Best
on subject..... \$3.00 |
| HOME MECHANICS
329 Kinks..... 50c | TOY MAKING
Complete instructions..... \$1.50 |
| HOME REPAIRS
Practical Book of..... \$2.50 | WALL DECORATION
(Interior) Newest
Methods..... \$4.00 |
| IGNITION
(High Speed) For
Garage Mechanics..... \$3.50 | WHITTLING
The Art of..... \$1.35 |
| INVENTION
Popular History of
American..... \$1.00 | WIRING
House (New Book)..... \$2.50 |
| KITES THAT FLY
How to Make..... \$1.25 | WOOD TURNING
Course in Practical..... \$1.50 |
| LANDSCAPING
Practical..... \$2.50 | WOODWORKING SHOP
Motor-Driven (3 vols.)..... \$3.00 |
| | WRIGHT WHIRLWIND ENGINE
Lithographic Model
Shows Every Part..... \$1.00 |

Books sent C. O. D. anywhere in U.S.

Just check the books you want, write your name and address below, and mail the advertisement. It is your order blank. When postman hands you books, pay him the price and few cents postage. If outside the U. S. remit when ordering and include 10 cents per book extra for postage. We have many other books on these and 2,000 other subjects. *Catalog free.

Name.....

City.....State.....

Address.....

Mail to Popular Mechanics Press,
Room P9—200 East Ontario St., Chicago, Ill.

Popular Mechanics Magazine

REGISTERED IN U. S. PATENT OFFICE

WRITTEN SO YOU CAN UNDERSTAND IT

Vol. 58

SEPTEMBER, 1932

No. 3



By C. W. FARRIER

Assistant Director of Operations, Chicago Century of Progress

WHEN newlyweds a few years hence start out to buy a home, they probably will find the task as simple as purchasing a car today. After picking a location, they may go to a dealer and inspect the current models, selecting the one that suits their fancy and fits their purse. The following week, they will find the house completed and ready to occupy.

This home, however, will be entirely

different in appearance and construction from houses of today. It will be constructed almost entirely of metal or of materials new to the building industry. Its parts will be prefabricated and cut to size at the factory and it will be assembled merely by "buttoning" together the numbered sections with clips and bolts.

It will be complete in every detail, including air-conditioning system and heat-

Probably designed by C. Lawrence Foster

Mr. C. Long
Chicago

Sharon at Sears Roebuck
Thermon
Potter's work

131088
131088
Cnd. Sophie & Geoffrey 318 N W 23rd St
Oklahoma City, Okla

W. 53 rd. M

Jan. 1933 see
may 1932 1753
and American Rolling Mill Co
maddison, Ohio

Co. of project - insulated Steel
Floors Wall Co. Cleveland



Developed by Miller & Clark
insulated Steel

Your Future Home

IT will cost about half as much as a similar home built of materials now in use.

It will be intended to last only fifteen or twenty years.

It will be erected in a week by "buttoning" it together with clips and bolts.

It will be sold complete, with refrigerator, air-conditioning unit, washing machine, radio and other appliances installed.

Its frame will be of rustless metal, its walls—three inches thick—of enameled metal, its floors of sheet metal and it will be covered by a metal roof.

It will be virtually windowless, artificial light being furnished by ultraviolet tubing.

Developed by Miller & Clark, Cleveland

This Metal House, Erected in Cleveland, Gives an Idea of the Future Trend in Building

size constructed of building materials now in general use.

This ultra-modern home will be designed to last only as long as its appointments are likely to endure without becoming hopelessly out of date and obsolete. It will be built with the idea of salvaging its parts and replacing or rejuvenating it in fifteen or twenty years. This standardization does not mean that homes will look alike, for individuality can still be expressed. It does mean, however, that frames, walls, floors, interior surfaces, roofing and other parts will be factory-made in standard sizes and shapes.

In the past two years a dozen different

ing and cooling plant, electric refrigerator, washing machine, radio, and other home appliances. And it will offer, at moderate cost, more comforts and conveniences than were available in a mansion a few years ago, for it is estimated that factory methods and mass production will bring the price down to about half that of a house of the same



Two Workmen Set Up This Factory-Made Metal Home in a Single Day (Continued to page 138A)

Columbian Steel Tank Co
1401 W. 12th St Kansas City Mo

SOAP BUBBLES TEST STRENGTH OF BIG STEEL BEAMS

When engineers at the University of Michigan want to find out whether the steel beams of a bridge will carry the load expected to flow over it, they ask a soap bubble. These bubbles reveal the strength of the beams so accurately that they are being used in a mathematical formula to picture the stress in metal parts of complicated shapes. The procedure is explained by Dr. P. Allerton Cushman, of the college of engineering, who says that by mapping the contour of a flimsy soap film over the cut-out model of a cross section of a machine or skyscraper beam, engineers can determine quickly just how much twisting or bending stress will affect the original of the model. The apparatus that records these findings is surprisingly simple. Halfway down in a square box, a brass sheet is sealed with a portion of the metal cut out in copy of the cross section of the article to be tested. Topping the box is a glass plate, inset with a depth gauge. A film of soap solution is drawn across the cut-out design, and water is forced into the lower part of the box, causing the confined air beneath the plate to push up the film, and with the depth gauge the varying level of the film is measured from the glass top. Many readings are taken, curves are plotted between points, and a contour map results, which locates stress points easily interpreted by the designer of metal work.

Science Service 6/26/32

ref. James 6/21/32

COAL DUST AND OIL DRIVE SHIP IN TEST OF FUEL MIXTURE

On a recent test run, a mixture of coal dust and fuel oil was used in the engines of an ocean liner. The coal is pulverized so finely that it passes freely with the crude oil through the nozzles of fire jets under the boilers. The combination used on the test voyage is such that thirty to forty per cent of the pulverized coal will remain suspended in the oil for months.

Leonard Saylor

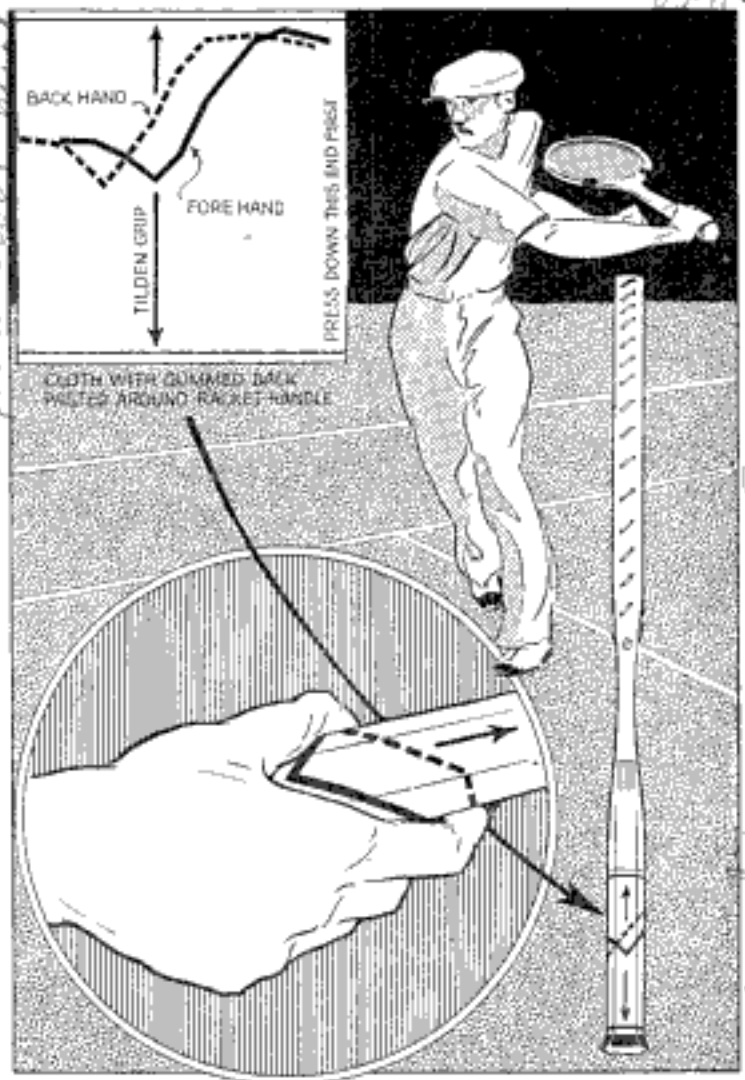

Marked Tape Showing Where the Fingers Should Be Held Is Pasted on Tennis Racket to Teach Correct Grip

HAND GUIDE ON TENNIS RACKET TEACHES CORRECT GRIP

Designed to teach tennis players the correct grip for fundamental strokes, an adhesive tape, carrying guide lines for the hand, is available. The guide is placed on the handle of the racket. Lines on the tape show the player where and how to place his fingers to hold the racket correctly in making forehand and backhand drives. Three types are offered, the Tilden, the Continental and the Western.

POWDER LOOKS LIKE GRASS

By sprinkling green-colored sweeping powder over the public parking lot, the owner gave the grounds a grasslike and more inviting appearance. The powder also keeps down the dust and is an improvement over the usual cinder covering.

Cont. - L. B. Holm
Cannot locate maker

Dr. 1160
A. L. Spalding & Bros. 105 Nassau
Chicago 211 S. State
new York City

Emb. suggest grocery store as source

Cont. Albert J. Archer, 75 Columbia

001145

Hughes, Brooklyn, N.Y.



Right, Cable to Which Dynamite Is Attached Is Shown Being Laid in River; Top, Water Hurling into the Air When Explosive Digs Trench on the River Bottom for a Pipe Line

DYNAMITE BLASTS TRENCH FOR PIPE LINE IN RIVER

Digging a trench for pipe lines on the bottom of rivers has been made less dangerous by laying and discharging a dynamite cable. Bundles of dynamite are attached to the cable, end to end, and small bowlders at intervals help hold the cable on the river bed. When the explosive is in place, the charge is shot, throwing thousands of tons of water, dirt and rocks into the air. A trench large enough for the pipe line is the result.

RUBBER PAVING ON HIGHWAYS APPLIED LIKE ASPHALT

Rubber paving that can be applied like asphalt is promised in experiments with latex at Singapore and in investigations in America. Another use for latex, the milk of the rubber tree, is in compositions for covering athletic grounds and for filling expansion joints. Latex is invading many industries, its uses extending to music, radio, photography, motion pictures, aviation and automobiles. Rubber-impregnated wood for violin manufacture is the result of treatment with latex, while the

raw rubber is used in medical manufacture as an anatomical injection fluid. Bookbinding with latex is feasible, while it may even be of service as a lubricant when mixed with petroleum. The helium of the United States' newest dirigible the "Akron," is retained by fabrics of very low permeability, in the preparation of which latex entered. One of the largest uses for latex is in the manufacture of adhesives, sealing compounds and cements. In the automobile world, sponge-rubber



seats in certain English cars are made of latex, as also is the rubber base for the mohair upholstery in some autos.

RAZOR BLADES LAST LONGER WITH CYLINDER SHARPENER

Used safety razor blades can be sharpened quickly by rubbing them on the inside of a cylinder now available. The blade is placed with its edges on the curving wall of the sharpener, and the operator places his finger at the center of the blade. By twisting or rubbing half-way around four or five times, one edge of the blade is sharpened. Then the blade is turned over and the other edge sharpened in the same way.



before American Chemical Society 49 4th Ave New York

Amalgamated by J. H. Morris and W. Asreeup. Diapstone Pure Rubber Co. Akron, Ohio

Greek Athletics Corp, 4518 Lexington St. Chicago

B1172
358

Cedar Rapids Engineering Co.
POPULAR MECHANICS
Cedar Rapids, Iowa.

see picture opposite

Kirkway

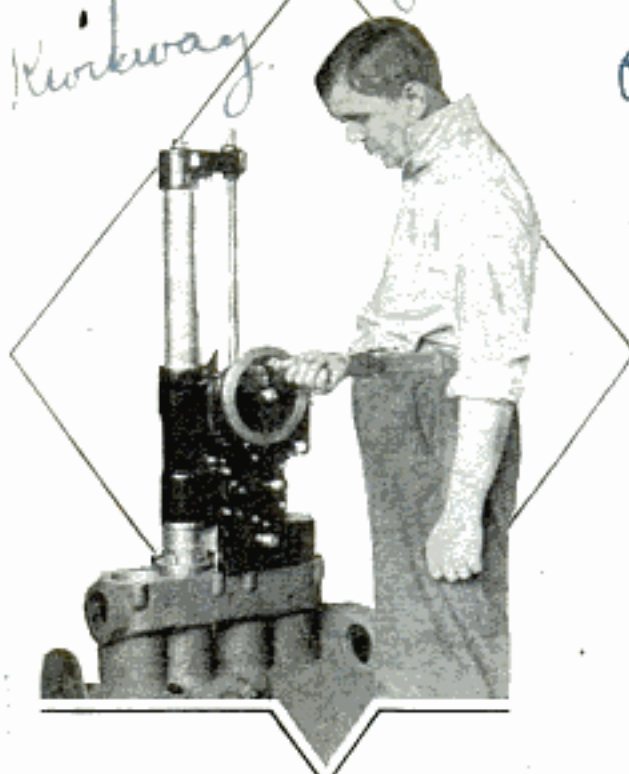

Easy to Move, This Cylinder Boring Machine Is an Aid to the Small Auto Repair Shop

PORTABLE CYLINDER-BORER TIP MORE COSTLY THAN GOLD

Tipped with a material almost as hard as a diamond and costing thirteen times as much as gold, a portable boring machine for automobile-engine cylinders has been introduced. The boring tip does not heat the cylinder walls at highest speed, resulting in so nearly perfect work that inaccuracies do not exceed one or two ten-thousandths of an inch. Powered by a quarter-horsepower motor, the machine operates at high or low speed. It weighs less than 150 pounds. A measuring and lapping device is included with the machine. The lapping disk is made of treated iron impregnated with diamond dust on which the cutting tip can be sharpened.

INVISIBLE COATING FOR SILVER PREVENTS DISCOLORATION

To protect silver and other metals from discoloration, and, in a measure, also from scratches, a German chemist has invented a coating which adheres so firmly that even a sudden change in temperature causes no breaking or peeling. The composition is invisible and heat-resistant and can safely be used for household silver.

No answer ready says B1176
Ernst Krause, Berlin, Steglitz, Germany

DIVERS' DRILL AND RESCUE TANK FOR SALVAGE OPERATIONS

To speed up the rescue of crews of sunken submarines and the salvaging of wrecked ships, a Chicago inventor has designed two units for deep-sea work—one a divers' drill shaped like a torpedo, the other a releasing tank to enable removal of a submarine crew. The drill rig is held in suspension by a cable from the mother ship and contains an electric motor to drive the propeller, air pump and drill shaft. It is fitted with spring-steel skids on which two divers are supported when the rig is descending, and has tools, lights, phones, metal-cutting equipment, torches, air and oxygen tanks and hand lights. Magnet pads on the skids grip the hull of a boat, and the cruising radius of the rig depends on the depth at which it is held in suspension. A drill chuck that can be adjusted to any angle is mounted on a shaft running through the torpedo-shaped body. The propeller, air pump and drill can all be driven by the same motor simultaneously or separately. This rig is intended particularly for salvage work and for quickly supplying air and food to the crew of a sunken sub. The releasing tank can be lowered to a sunken vessel by means of stabilizing weights and attached to the sub with a connection which fits any angle. From inside the tank, a diver then cuts an opening into the boat and the imprisoned crew escape, one at a time, to the tank. Here each man dons a diving suit and is raised to the surface.

B3847

SELF-CLOSING PASTE-TUBE CAP KEEPS CONTENTS FRESH

Contents of collapsible tubes, such as are used for toothpaste and shaving cream, are kept fresh and free from contamination by a self-sealing cap operated by a spring. When squeezing the tube, a telescoping member at the end is moved forward and a slotted port is opened to emit the paste. When the pressure is removed, the port closes through action of the spring.



Serial 615232
Dr. J. A. Wilson
3408 Whiteside Ave
Los Angeles, Calif

03847 U.W. K.P. Johnson 6154
S. Racine Ave

Build to order only

Chicago

Speeding Sub Rescues and Treasure Hunts

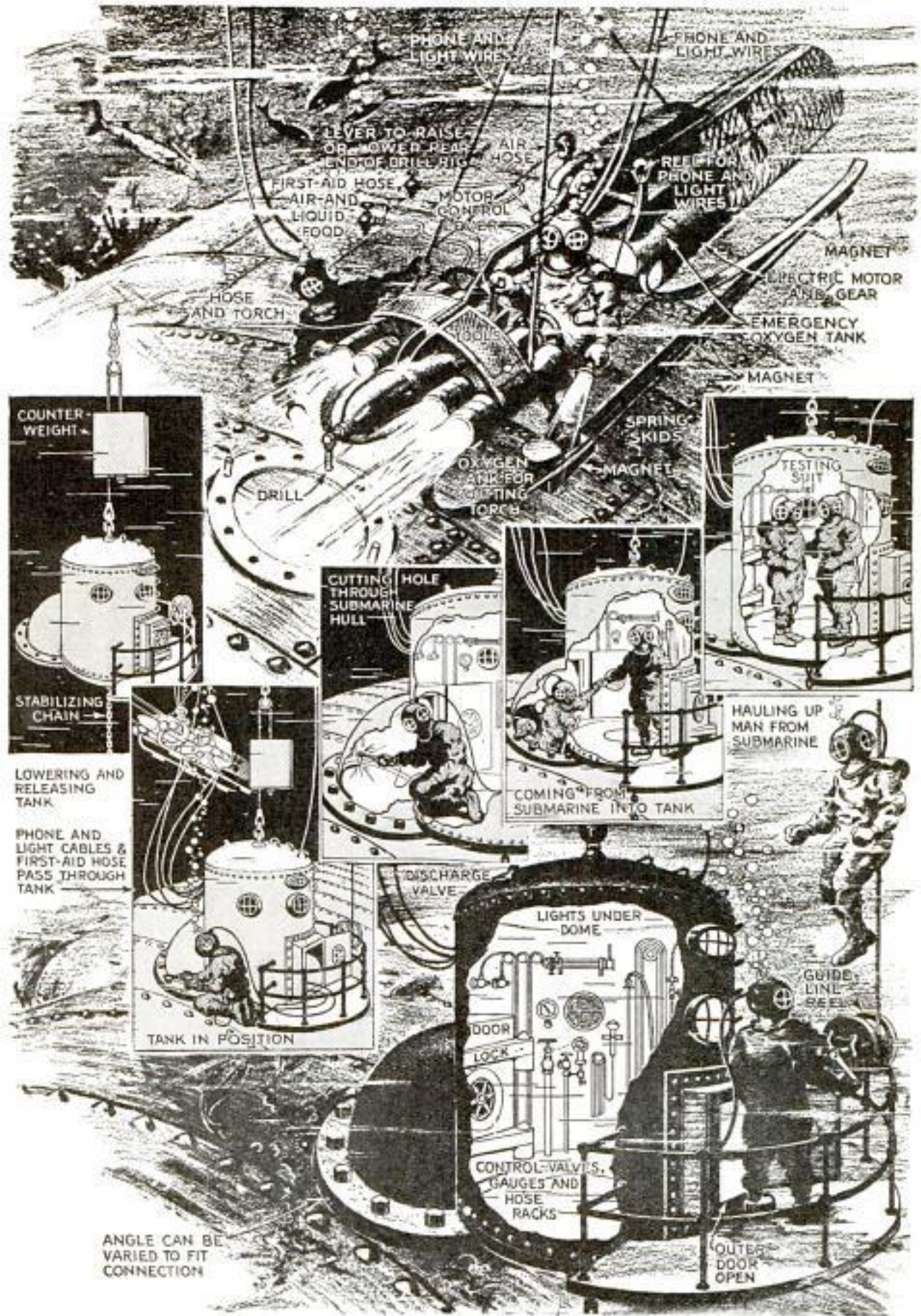

See description. 358

Built by Sig Haugdahl (Waytonia)
 POPULAR MECHANICS *Revel. The*
at Jobert. d. l.

360

B 1162

Latest Rocket Car Uses Power in Steering

Curb H. & Patton 2112 - S
 Waco Ave. Wichita Kans



Sig Haugdahl, Veteran Race Driver, with His Rocket-Powered Race Car; the Rocket Tubes Are Located along the Sides and below the Body and May Be Discharged Independently

scarcely practical for racing because of the smoke and sparks from the discharging explosives, Haugdahl's car theoretically could compete with gasoline-powered speedsters even on circular tracks. In appearance, the rocket car differs but

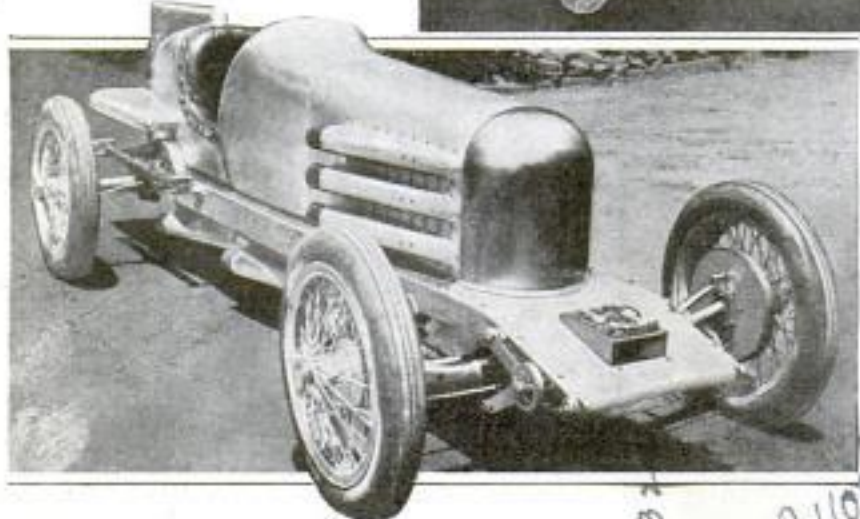
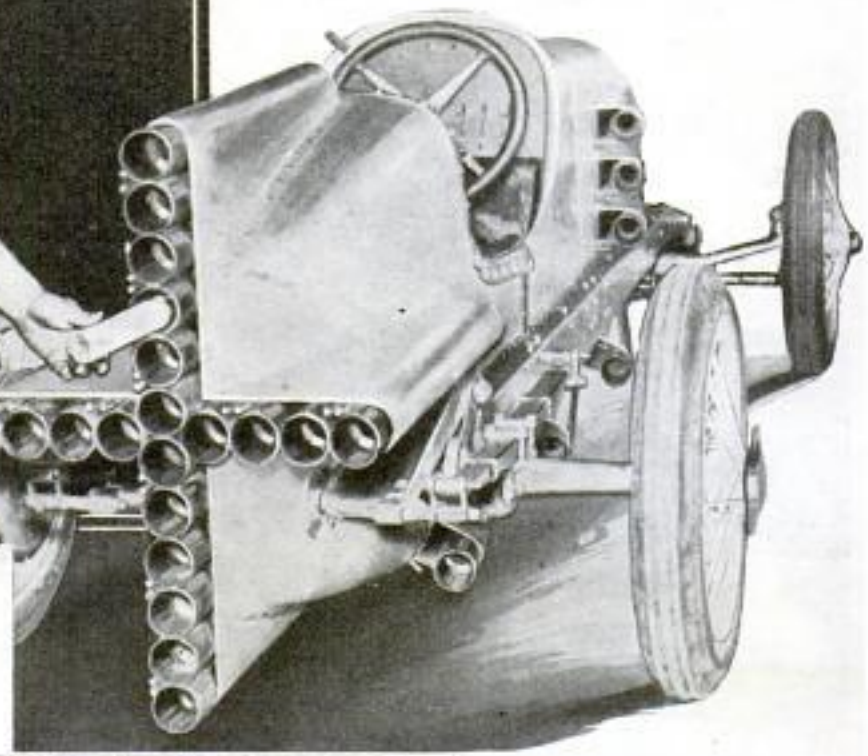

little from the familiar type of racer. It is 144 inches in over-all length and weighs 1,650 pounds. The thirty-two rocket tubes are wired in such a way that they may be discharged singly, in pairs, from either side or simultaneously.

BATHTUB INJURIES ARE FEW

Using explosive power to increase maneuverability as well as for propulsion, a rocket car, designed and driven by Sig Haugdahl, veteran of the dirt tracks, has made its appearance in exhibition runs on mid-western race courses. The car differs from previous rocket cars principally in that, through controlled discharge, the rockets may be utilized to aid conventional steering, especially on turns. Although injuries from falling in the bathtub are relatively few. Out of 2,317 falls in the home, only nineteen occurred in bathtubs, insurance statistics show. Slippery floors, unsafe stairs, skidding rugs and shaky ladders are the most hazardous things in the home. Burns cause over one-fourth of home injuries, while the remainder are due to cuts and wounds from edge tools and to bites of cats and dogs.

Science Digest 4/31
B 1109
 Metropolitan Life
 Copyrighted material

B1129

B918 Cont. Harry H. Rutenbach
Schwarzhafergerstr. 5,
Berlin-Lankwitz, Germany

POPULAR MECHANICS

361

WOOD SLICED INTO THIN SHEETS FOR PRINTING

Wood can be sliced in paper-thin sheets ready for printing with type or engravings under a new process. Green softwoods, such as spruce, Douglas fir, hemlock and cedar, are cut into blocks and placed on a machine fitted with a very sharp knife. The product is a sheet one-hundredth inch thick, shaved in "books" by leaving a half-inch binding or portion of the block solid at the edge. The sheets can be torn off as needed. Hardwoods can be sliced in thin sheets that include the finely drawn forms of burls and knots. A motor revolves a large wheel, driving the knife with a piston movement at high speed. In addition to its usefulness for printing, the sheets of wood are practical in the manufacture of lamp shades, candy boxes, etc. As plywood for airplane manufacture and as veneer for furniture, it is steadily gaining favor. By storing the veneers in books, the quality is higher than under the usual methods.

Shelwood Corp. 4738 University Way, Seattle, Wash.



This Chinese Theater Puts Program and Actors' Names in Lights; Sign Also Serves as Advertisement

THEATER'S PROGRAM IN LIGHTS ALSO SERVES AS AD

Serving as an advertisement and also as a program, an electrically lighted sign on the roof is used by "Tien Sern," a theater in Foochow road, Shanghai, China. The sign contains the name of the theater, the title of the play that is being produced, and the names of the actors.

ROLLER GEAR HELPS STEERING OF LOW-PRESSURE TIRES

With the arrival of low-pressure, or super-balloon, tires, automotive engineers have been faced with as many steering problems as when balloons superseded the high-pressure tires. One concern has met this situation by making an improved steering gear especially for light models using the big tires. Easier steering is afforded by using flexible steel rollers of small diameter extending virtually the entire length of the cross shaft. These take the place of bronze journal bushings, lessening the physical effort required to steer the low-pressure tires.

B1180



Book with Leaves Sliced from Block of Wood

Perfected by James E. Scherley, Seattle, Wash.

Esmeralda Inf. Co. 6400 Mt. Elliott Ave. Detroit, Mich.

B3986

Com. H. S. Wilkins, Esq., 29 Ocean
Road, Coleraine

One Man Vs.

Gar Wood, Right, Holder
of the Harmsworth Tro-
phy for the Past Twelve
Years, and His Mechanic,
Orlin Johnson, in "Miss
America IV"



Courtesy Detroit Mirror

By HENRY C. FOSTER

ONE man against an empire! Imagine contending single-handed against a nation of millions and winning! Yet that is what has happened in the struggle for the world's speed crown on the water. The man is Gar Wood of Detroit. The nation is the mighty British empire, where the government is actively assisting British sportsmen to gain and keep supremacy of air, land and water.

This is in line with the age-old British policy of maintaining leadership in the avenues by which the isles and the far-flung empire may be invaded by foreign foes. In all these aspects of British policy, the major factor has been creation of more powerful engines in proportion to their size and weight. At the cost of more than \$5,000,000 such motors have been developed by government engineers, and with them British sportsmen have won all three motor-speed championships. They

the British Empire

have kept firm hold on their lead on land and in air, and not content to hold the records, they have raised them amazingly.

But on the water the situation is decidedly different. One man, almost single-handed, thwarts imperial England. Three times he has been defeated in speed trials, and three times he has snatched back the crown. Despite the fact that he receives absolutely no support from his own government and is practically unaided by anyone save a little band of a half dozen loyal retainers, Gar Wood—for the time at least—again wears the speed crown coveted by an empire.



Kaye Don, British Challenger for Trophy, and His Last Year's Craft, "Miss England II"



On Labor Day week-end, Sept. 3 and 4, Wood will again defend the British International (or Harmsworth) trophy, held by him since 1920, emblematic of the world's championship in unlimited power. The contest of this lone American sportsman

against the combined technical genius and financial resources of imperial England, has brought the annual defense of the trophy into the forefront of world events.

The life of Gar Wood is replete with romance and drama. As the son of a fer-

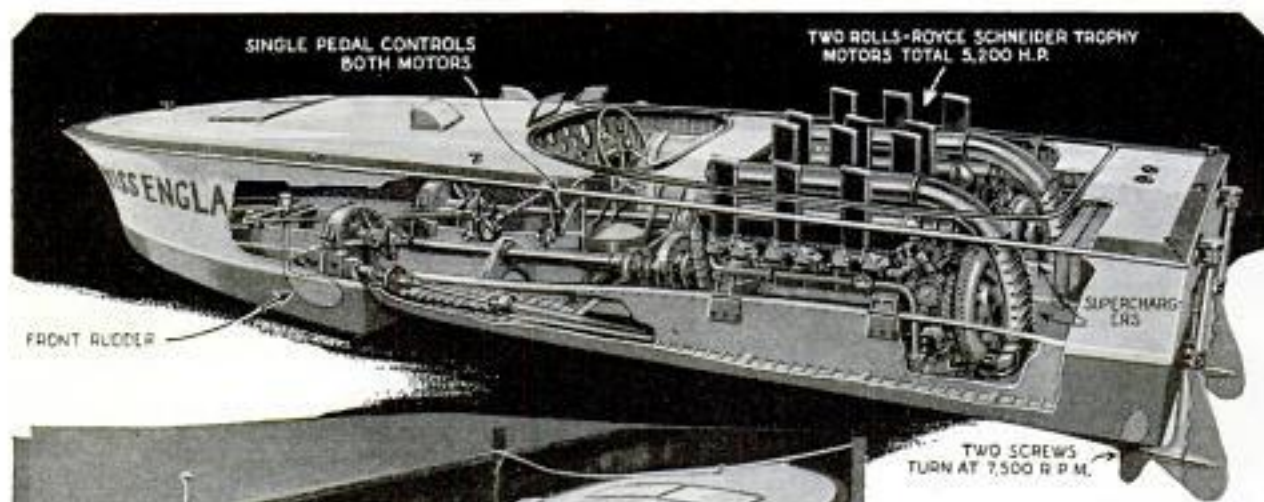

Courtesy Yachting World

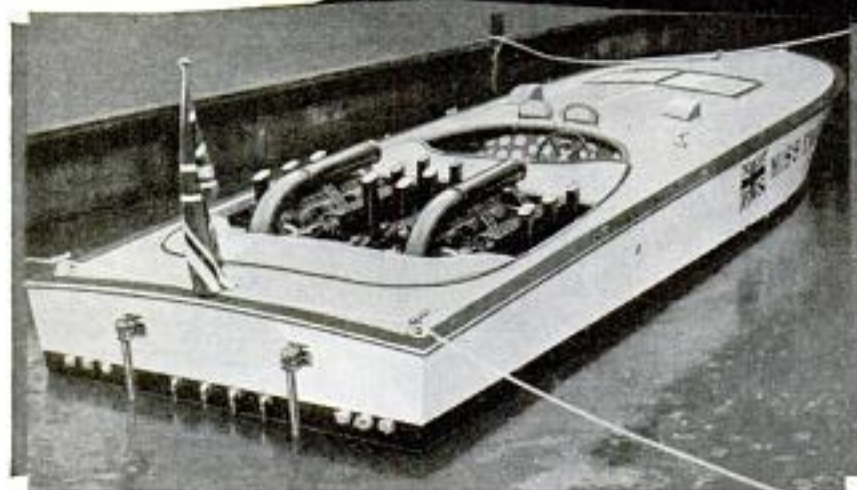

Diagram and Photo of "Miss England III." This Year's Challenger: Its Top Speed Is Estimated at 130 Miles an Hour

predicting such dizzy going. He was also the first to drive a boat at 100-miles an hour officially, and he is acknowledged to be among the best—some say the best—drivers of tricky racing boats which are just as dangerous as planes or racing motor cars, in the world. And this at fifty-one years of age.

ryboat captain on a lake in Minnesota, young Garfield Arthur Wood served as crew, until, at thirteen years of age, he got a job operating the first internal-combustion motorboat in Duluth, because nobody else could make it run.

Twenty-one years ago, he was a mechanic in a St. Paul garage. There he conceived the idea of a hoist for dumping loads from trucks, the hoist to be driven by the truck motor on the hydraulic principle. He made one and sold it for \$200, and has been making them and selling them ever since. Gar Wood is a student of naval architecture, of gas engines, an enthusiastic amateur astronomer with a private observatory in a Moorish tower of his Florida home. Gar loves cruising as well as racing, flying (he owns a Dornier cabin plane and flies it himself), big-game hunting, and deep-sea fishing.

Wood's boat was a power dinghy which he contrived to give a maximum speed of 130 miles an hour—when that was fast time. He was the first man to drive a boat at mile-a-minute speed, and he remembers when he was hooted for

Helmholtz, inventor of optical instruments and renowned physicist, proved that the average speed at which a nervous message is carried to and from the brain is about 108.4 feet per second. In his "Miss America IX," which he drove at 110.785 miles an hour to regain the speed championship, Gar Wood was going over the water at 161.33 feet per second—almost half again as fast as the human nervous system acts! And on one occasion, in narrow Indian Creek, Fla., the veteran drove "Miss America IX" over the measured mile nine consecutive times at more than 100 miles an hour—without the slightest error of eye, nerve or judgment.

In his struggle with Great Britain in September, he must meet the redoubtable Kaye Don, who is only thirty-eight years of age, with long experience as a driver of racing motor cars, and who has three times driven "Miss England II" to beat him in the rivalry between the nation and the man. Gar Wood is handicapped for powerful engines in his back-to-the-wall defense of his speed crown and the trophy this autumn. Packard aviation motors of

Britain's Four World's Speed Records



SIR MALCOLM CAMPBELL

AIRPLANE
408.8
MILES AN HOUR



FLIGHT LIEUT.
G. H. STAINFORTH

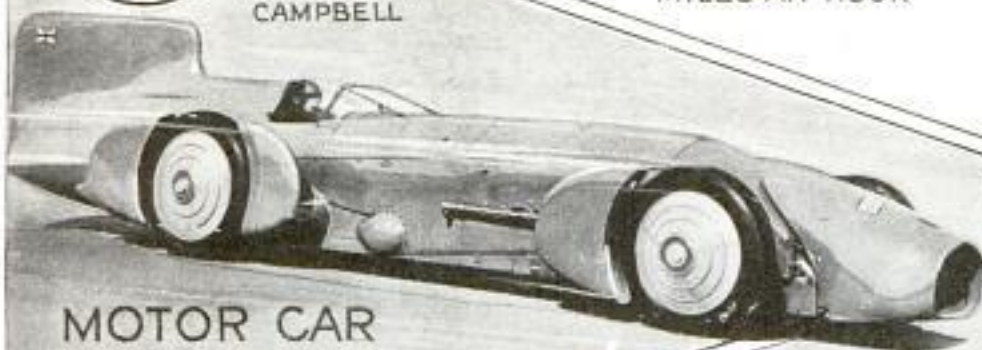

MOTOR CAR
253.97
MILES AN HOUR



J. S. WRIGHT

MOTORCYCLE
150.7
MILES AN HOUR

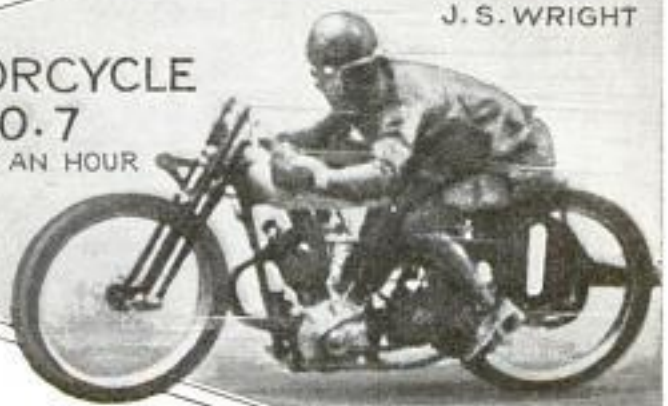

RAILWAY
81.6
MILES AN HOUR

(THE CHELTENHAM FLYER)

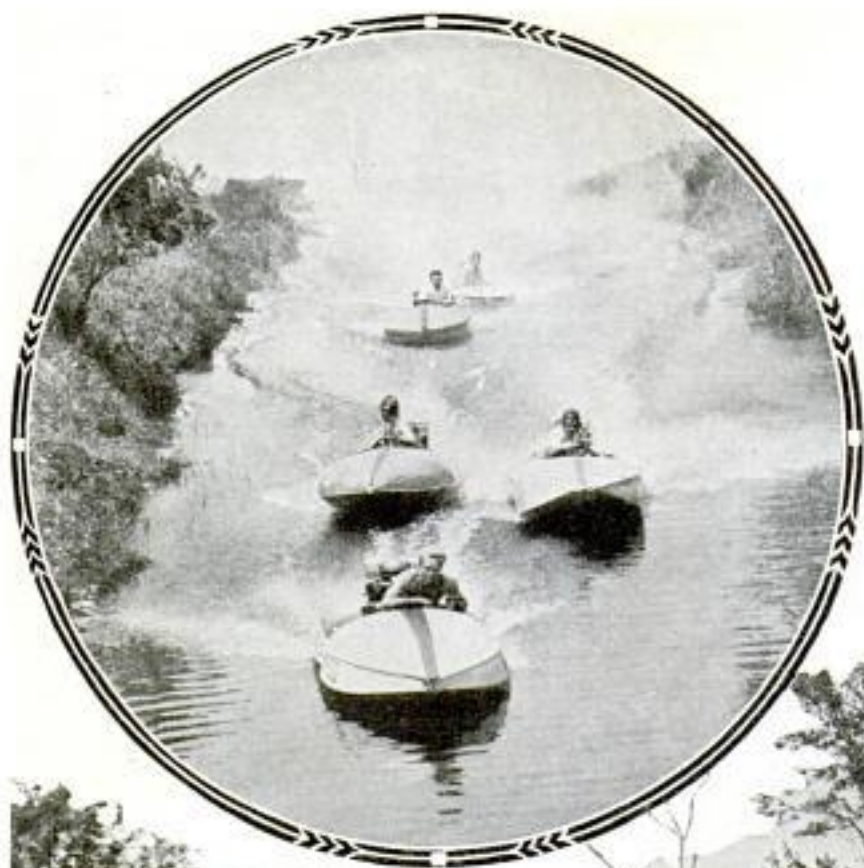

Above, Steeple-Chase Water Race in Which Outboard Drivers Are Navigating a Shallow Creek; Below, Taking a Canvas Hurdle at Full Speed in an Obstacle Race for Small Craft

850 horsepower are the biggest he can get in this country. His various "Miss Americas," since "Miss America V," have been powered with two of these. He has speeded them up, raised their compression ratio, and now he has supercharged them, until it is said they produce about 1,600 horsepower.

With a total of 3,200 horsepower, he must race against a boat powered by twin motors which were rated in the Schneider Cup aviation races at 2,600 horsepower each—a total of 5,200 and a difference of

2,000. But—and it is a big word this time—naval architecture, while an old art, is a new science. To design, build and power a successful 100-mile-an-hour boat, or even a fifty-mile boat, is a task of which few engineers are capable.

Fine balances of weight disposition, finely drawn underbody lines, position of rudders, propellers, of tanks, and scores of oth-

er interrelated factors all combine to make up the fast, slow, dangerous or safe boat. And those of the veteran Gar Wood are all fast and remarkably safe. The winner must be not only fast enough to run away from the rival, but it must be steady enough in speed and on turns to keep right side up throughout the grueling sixty nautical miles.

Here is Gar Wood's superiority—in design. Although he has never towed a model in a test tank, his boats are remarkable for their scientific accuracy. Where-

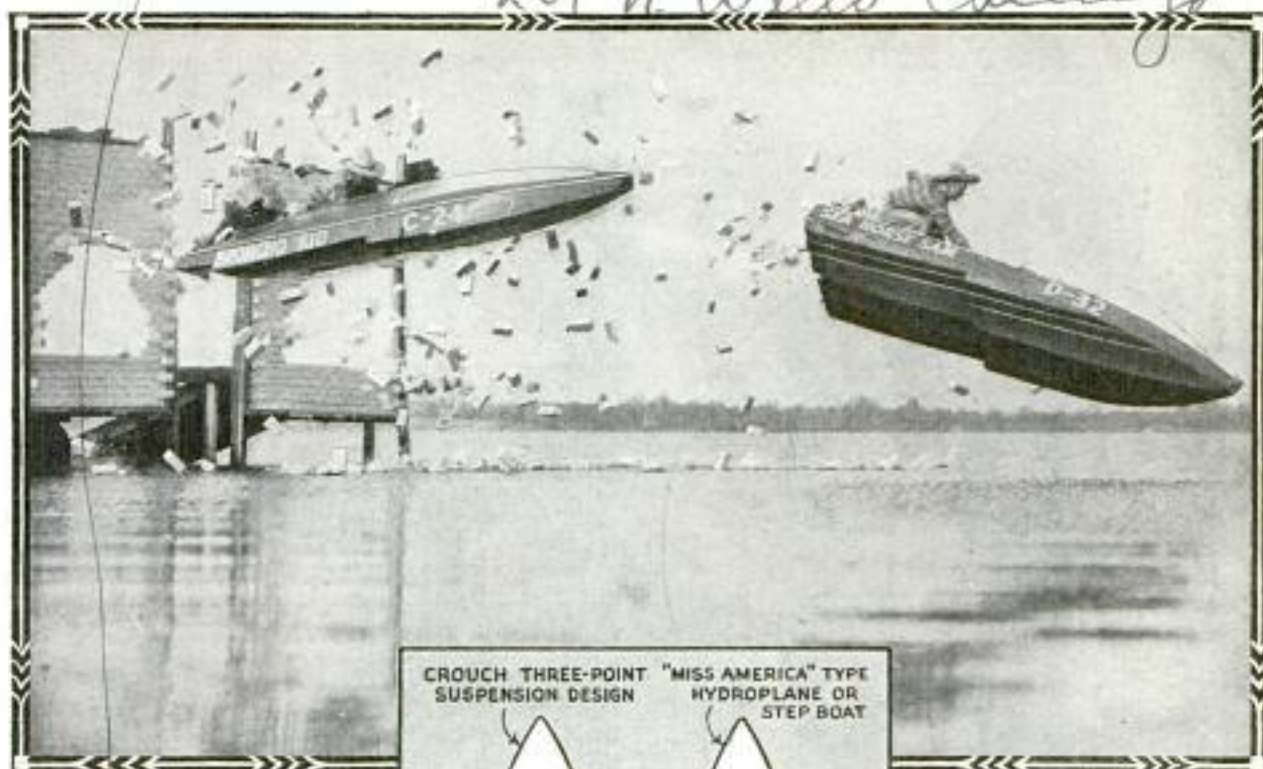

Top, Two Outboard Drivers Crashing through Brick Walls after Climbing an Inclined Plane; Below, Steeple Chasers Clearing the Wall-of-Fire Hazard; Right, Three-Point Suspension Design Compared with Original "Step" Boat; Note Reduction of Wetted Surface in Former

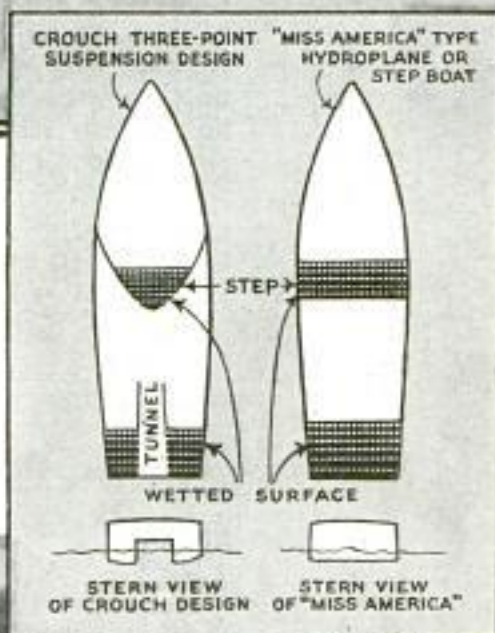

copied Gar Wood's lines as closely as they could in most cases. The task of making a boat go fast is to lift it as far out of the water as possible, leaving as little of its underbody in contact with the water as can be. The job is to reduce what is called "the wetted surface," which is the part of the underbody on which the boat actually rides. The steps in a boat's bottom are for this purpose, to take away as much of that surface as possible. Gar Wood says: "The secret of speed on the water—besides ample power—is to design a boat that will sneak over the sur-

face without any more disturbance to the water than necessary." In his latest creation, it is said he has reduced this wetted surface to six square feet.

By reducing resistance instead of increasing power, Dr. Oskar G. Tietjens, of the Westinghouse Electric and Manufac-

(Continued to page 134A)

In underbody design the British have

POPULAR MECHANICS
COLORED WRAPPERS FOR FOOD PREVENT SPOILAGE

*Carl. Rathbone A. Smith
1739 N. St. Washington, D.C.*



Placing Food in Protective Colored Covering of Cellophane That Prevents Spoilage

Color has been found to have a practical as well as an aesthetic value in wrapping foodstuffs to be stored for some time. Most colors permit the passage of rays of light which promote spoilage, but grass-green and black shut out these rays. The effect of light on the deterioration of oil-bearing foods has been demonstrated by placing two samples of food side by side, one in a glass bottle exposed to light and the other in a dark bottle. Meal so tested was found still fresh in the black bottle after a year, while that in the unprotected bottle was spoiled. Butter was also tested with like results, and the same effect was obtained from cellophane wrappers of various hues, the grass-green and black containers preserving the contents better than other colors.

"RING" OF METAL AIDS SEARCH FOR BETTER ALLOYS

B 1173

Delicate instruments that accurately measure the properties of metals by the "ring," set up when a metal is struck or dropped, are aiding scientists in their search for new and improved alloys. It long has been known that a genuine coin

*described by
Dr. R. I. Wegel, Bell Telephone Laboratories, 195 Broadway, New York.*

No Charge

can be detected from a counterfeit by dropping the two on a table and listening to the ring. This has been carried a step farther by the instruments that reveal hidden properties or impurities in a bar of metal. In addition, it now is possible to study the internal mysteries of metals through devices that measure the loss of magnetic properties while a metal is subjected to strain. In the cold-rolling of sheet metal this characteristic is particularly well revealed by the test.

ELECTRIC BRAKES ON TRAILERS AID TO QUICK STOPPING

B 1169

Electric brakes have been installed and successfully used on trailers. Exceedingly rapid in action, the brakes are adapted especially to trailer trains on account of the ease with which the electric-cable connection between tractor and trailers can be made. A slight pressure on the brake pedal of the tractor or truck immediately sends an electric current to energize a magnet which automatically sets the brakes of all the trailers. While the electric brake was produced several years ago its latest use has resulted in the manufacture of a lighter but more rugged type with an unusually large lining area.

Warner Electric Brake Co. Detroit, Mich.

ROTATING PLUG STOPS KINKING OF ELECTRIC CORDS

B 1164

Twisting and kinking of electric cords are prevented by a rotary contact which can be used in a wall receptacle or at any intermediate point along a cord where there is provision for a connection. It is adaptable to all standard straight-type contacts. The rotary part of the connector turns in the outer covering and is so shaped that a connection can be made merely by pressing against the rotary contact with the prongs, since it automatically lines itself. This enables the user to make an immediate contact in a dark place without difficulty.

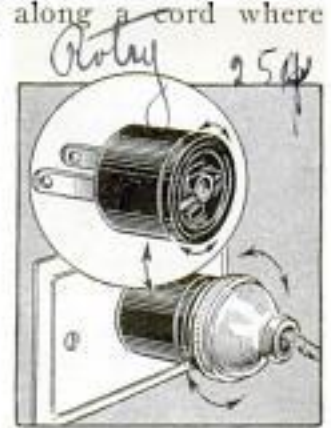

*Rotary Electric Co
Salem, Oregon*

021131

Modern Flying Carpet Visits City of Bagdad



Bringing Tales of Arabian Nights Up to Date. Two Americans Are Shown in Their Plane over Bagdad, the Magic City; Note Kadaimain Mosque in Square Where Only Moslems May Enter

On their 50,000-mile trip around the world, two Americans, Richard Halliburton and Moye Stephens brought the tales of "Arabian Nights" up to date by passing over Bagdad in their airplane, the modern flying carpet. In the center of the "Magic City" is the Kadaimain mosque into which none but Moslem worshipers have ever set foot.

annoying sound was gone. An arrangement of mirrors now shows the pilot how to put his engines in tune.

HANDY RACK FOR DRIVER'S HAT FASTENS IN TOP OF AUTO

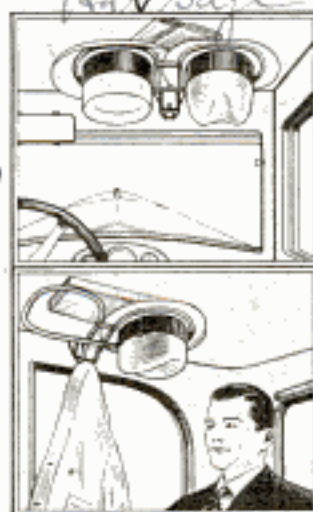

Attached to the inside top of the automobile, a handy rack holds the driver's hat, coat, gloves and newspapers. A clamping device keeps road maps in sight. The hat holder can be fastened to the front or side of the car, or may be installed in the unused space on the inside of closet doors. The frame is made of plated, lacquered and rustproof wire.

As many as 3,000 radio receiving sets may now be operated on the same antenna without interfering with each other.

St. Joseph News Press 6/2/32

LIGHT TUNES PLANE'S MOTORS TO STOP VIBRATION

Bars of light are used to tune or synchronize the engines of multi-motored aircraft, eliminating that "whoop-whoop-whoop," so disturbing to passengers and so expensive to air lines because of deterioration by vibration. It had been almost impossible to synchronize the motors until a chief pilot noticed that across the disk formed by each whirling propeller there was a bar of light, and that these bars were at different angles. By speeding up or slowing down each engine, he found that the light bars moved with varying speed. When the speed of each motor was such that the light bars were parallel, all the engines were running at the same speed and the

George Craigher
Western Ind. Post American

Superior Spring
Welding Tool Co.
2218 N. 3rd Milwaukee

370 2.
South Gate, Alger Court, Brimfield, New York

The BOY who

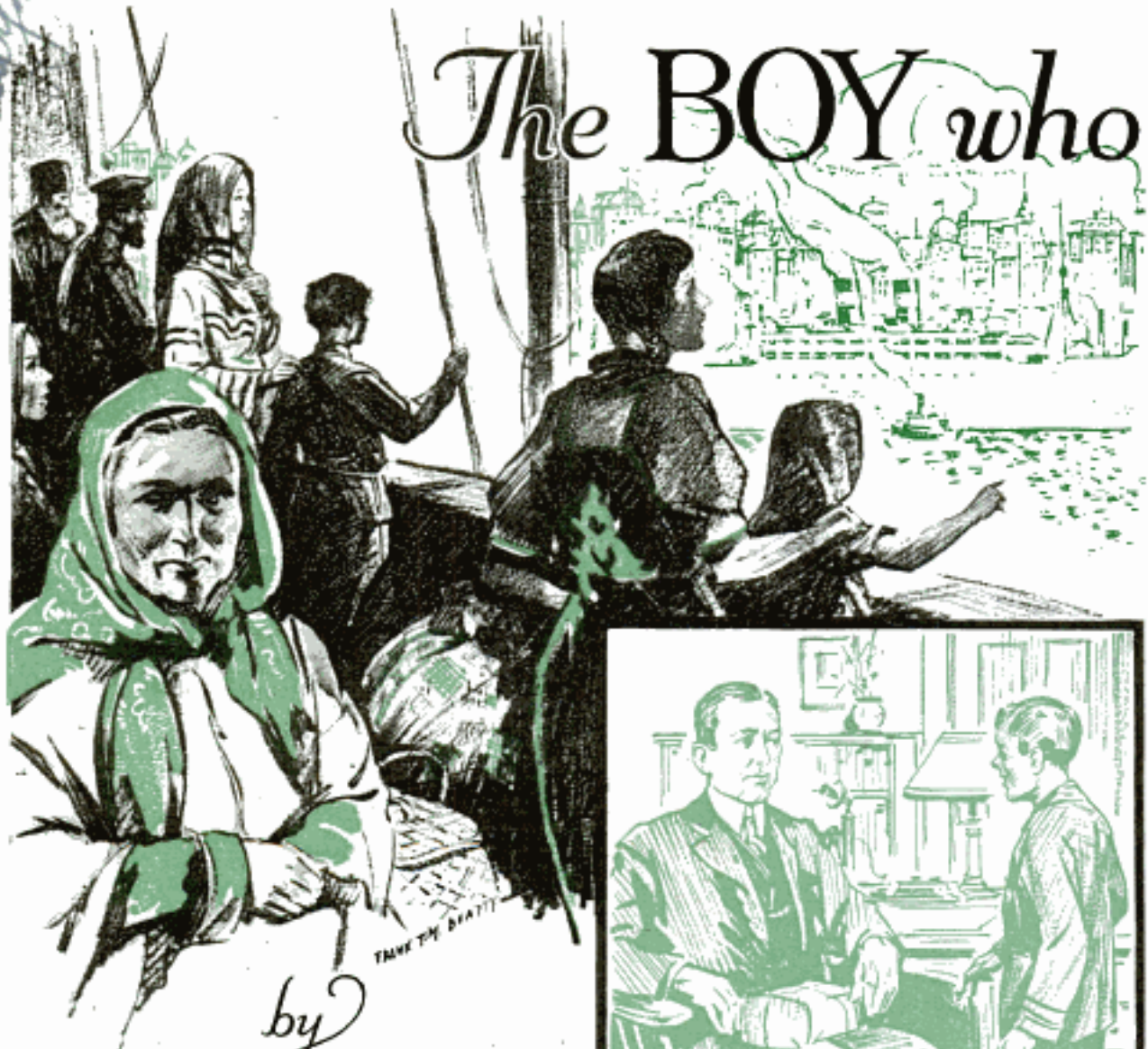

by

Frazier Hunt

South Gate, Alger Court, Brimfield, New York

THE great man pushed a button of his desk and asked his secretary to send in one of the office boys.

A sturdy, bright-eyed, eager lad of sixteen, born in a little village in central Russia but living in New York since he was nine, entered with his cap in his hand. He had often seen the great man pass in and out of the Marconi offices, and he had worshipped him from afar, but this was the first time he had been alone with him.

In a gentle voice the great man directed the boy to take a package to his hotel. And then he asked him how long he had been working for the Marconi company, and whether he was really interested in wireless—as radio was called a quarter of a century ago.



"I'm studying nights to learn how to be an operator, sir," the Russian-American boy answered.

"That's good—you'll make it all right," the great Marconi answered encouragingly.

The boy did make it all right. Today he is the president of the Radio Corporation of America and head of half a dozen other subsidiary companies, and the great Marconi is his intimate friend whom he visits each year. The boy's name was David

GREW UP *with* RADIO



Sarnoff. To me his life reads like an exciting adventure—a study in action and character development that could come true only once in this fantastic age and in this fantastic country of ours. David Sarnoff's father was a poor and struggling little merchant in the farming village of Uzlian, Minsk, in the center of European Russia. He had a wife and three children; and work and save as he might, he couldn't get ahead. Four or five thousand miles

away was the magic land of America. There he was sure the good life would open for him. Finally he could

resist the call no longer, and he sold his little stock of goods, and in third class and steerage made his way to New York City. But it took six years of hard work and desperate saving to get enough money together to bring over his family, even by the cheapest passage.



he arrived David had to go to work. His first job was selling newspapers, and all during his boyhood he'd be up at four o'clock in the morning and often would work after school until midnight.

The streets of New York, and the endless flow of human beings that he sharpened his wits on, were his university courses. Eventually he finished in a New York City public school, and then he went to work full time as a Marconi messenger boy. At night he studied telegraphy on a little instrument he bought to practice on at home. When he was sixteen he was made a junior operator, and then, the next year, he was a full-fledged operator, assigned to the Siasconset station at Nan-



tucket island, Mass. Already the gigantic dream of wireless and radio had caught him in its inexorable web. Circumstances were taking charge of his life.

That next year when he was nineteen, he was wireless operator on the S.S. "Beothic" off Newfoundland, and then

he built the wireless on a seal-fishing vessel and made a trip as operator in the ice fields of the Arctic. Now for a time he was operator on the S.S. "Harvard." Steadily he forged ahead. For two years he was wireless operator in John Wanamaker's store. Then his night study and his dreams began to take shape. He attended an evening class in electrical engineering at Pratt's institute in Brooklyn. Following his

completion of this course, he was made a radio inspector for the Marconi company and then an instructor at the Marconi institute. When he was twenty-two, he became chief radio inspector and assistant chief engineer.

Two other heroes had entered his life by this time. One was Edward J. Nally, vice president and general manager, who had come to the Marconi company in 1913. Nally it was who took a keen interest in pushing this eager boy ahead, and the boy, David Sarnoff, paid it back by using this man as his guide and goal. The second inspirer was ex-Governor John W. Griggs, president of the Marconi company, whose gracious personality and genius in handling people, touched deep and responsive chords.

Each year now saw rapid advancement in the career of this ambitious, hard-working, hard-studying immigrant boy. When he was twenty-six he was made commercial manager of the Marconi company; and then in 1919, when the Radio Corporation of America was formed and absorbed the Marconi interests, he became its commercial manager.

And now he fell under the inspiring influence of his fourth great hero,

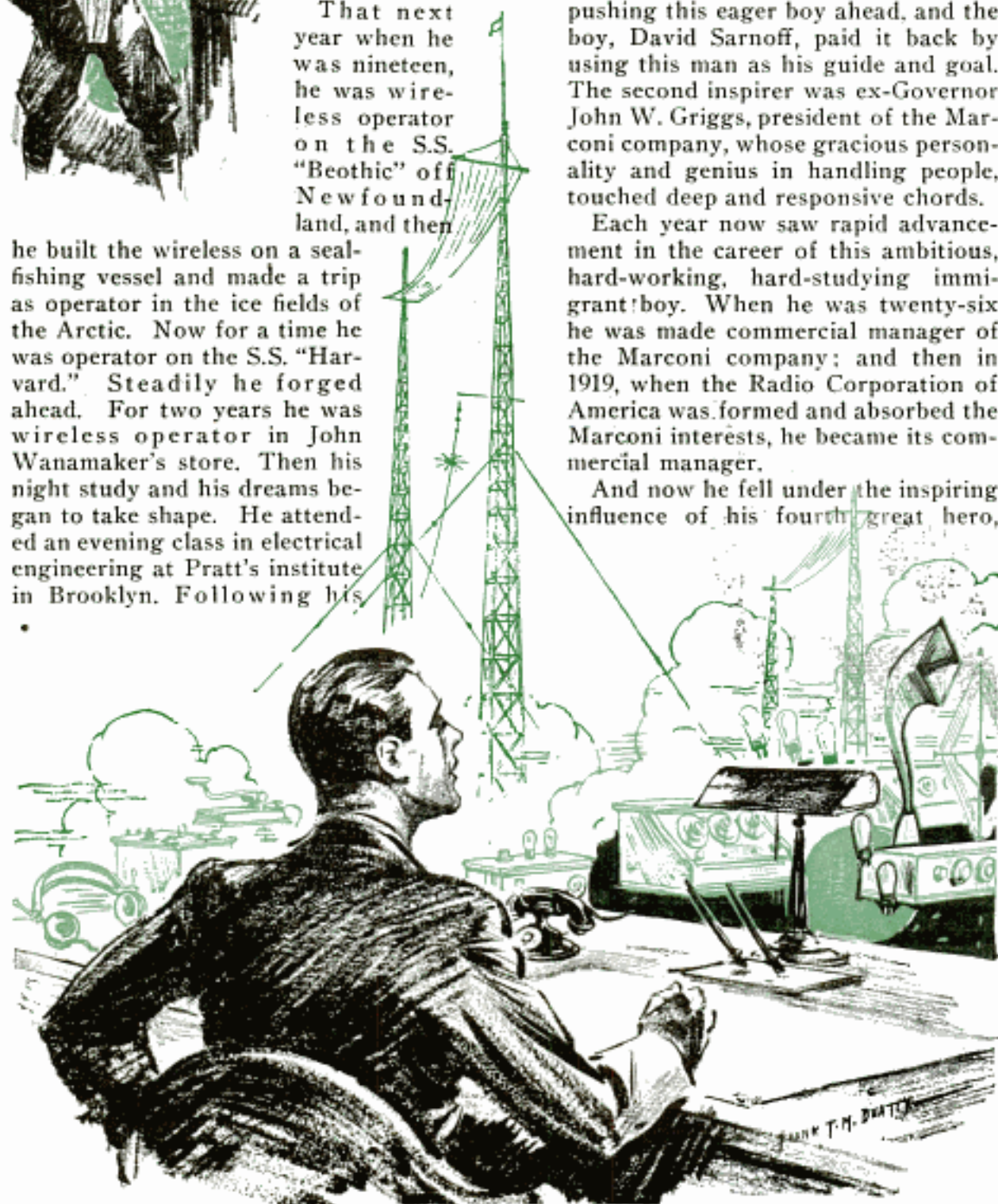

Owen D. Young. Sarnoff's eyes shone with a strange light—almost of worship—the other day when he spoke to me of Mr. Young. He was a young man of twenty-eight when he first met this older and wiser and more experienced great man. That was thirteen years ago, and through those years there has grown up a comradeship and an affection between these two men that is indeed a rare and beautiful thing.

David Sarnoff was really on his way now. In 1921, he was made general manager of the radio corporation, and a year later its vice president; and then in 1925 its executive vice president and on January 3, 1930, its president. He had grown up with the great radio business. He had marched hand in hand with its magic de-



velopment. As it had gained in importance and size so had he gained in power and stature. Its opportunity was his opportunity. And the other day, in talking to him about all this and what part luck might have had in it, he said to me:

"I think many men, when they more or less arrive, unconsciously work up a theory of what luck and early wisdom have had to do with their youthful successes. Personally I think they have very little to do with them—I think men are the creatures of circumstance. It was only circumstance that permitted me to grow up with radio. As I grew older and developed, it grew older and developed; and it was



the most natural thing that I should ride along with it. It was circumstance, too, that put me in touch at the right moment in my life with such inspiring men as Marconi, and Nally, and Griggs—and later Owen D. Young and General Harbord, the present chairman of the board of directors of the radio corporation. Each came at the time in my life when he could do the most for me. These were all pure circumstances."

And then this sturdy, broad-shouldered, blue-gray-eyed man, whose youth synchronizes with the birth of radio, went on talking about this fascinating art.

"Radio is only started," he explained; "that's what still makes it so fascinating to me. It is still a thing of mystery—of the unknown. YOU SEE, THE SUM TOTAL OF KNOWLEDGE IS INFINITESIMALLY SMALL COMPARED WITH THE SUM TOTAL OF IGNORANCE. AND AS WE ADVANCE OUR KNOWLEDGE ONE PER CENT

(Continued to page 114A)

"Seatrain" Called Most Unusual Ship Afloat

gantic crane. Beneath this crane, whose two arms are raised high into the air, a tankerlike steamship is docked, the "Seatrain." This vessel is only a train ferry

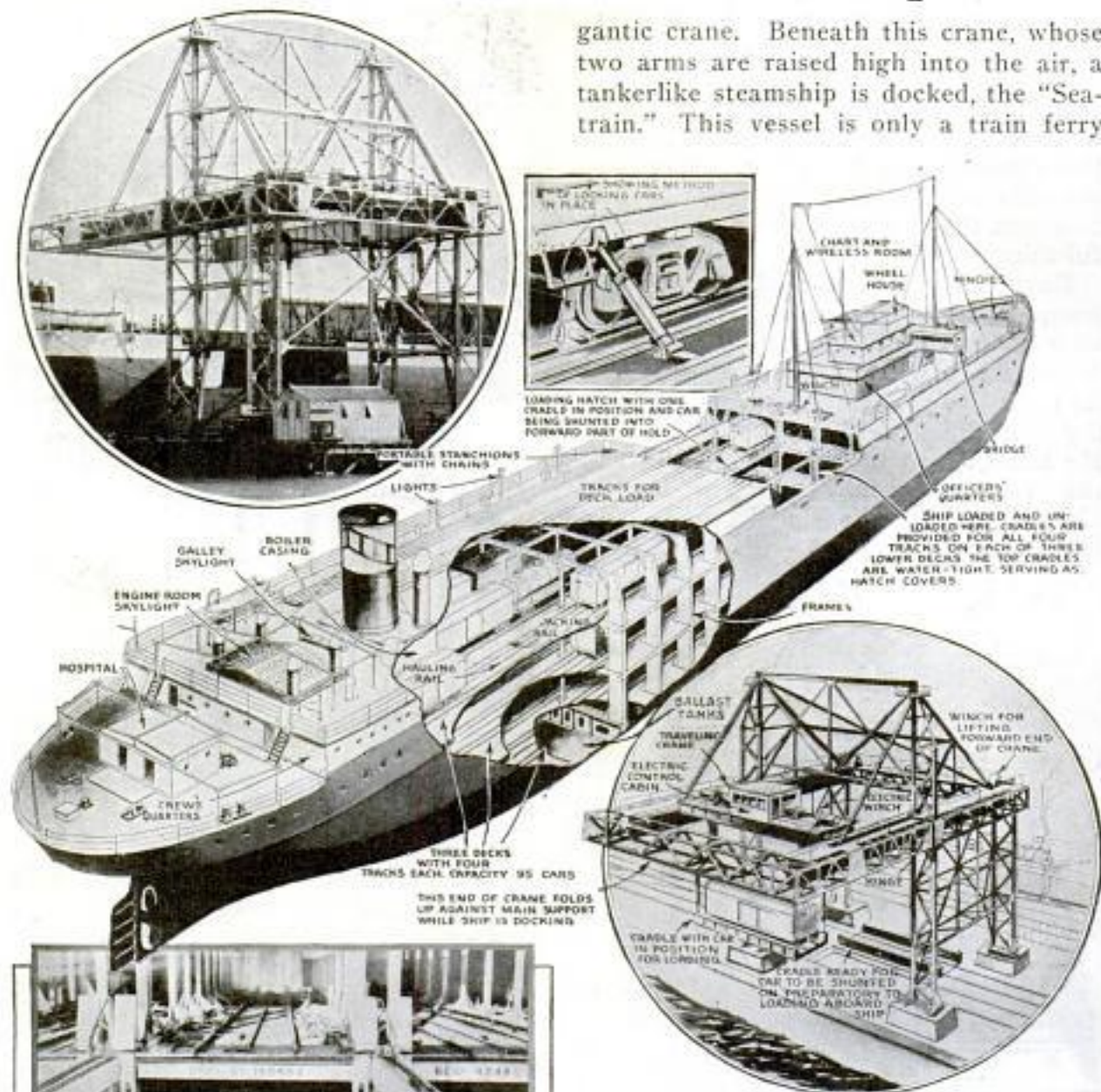
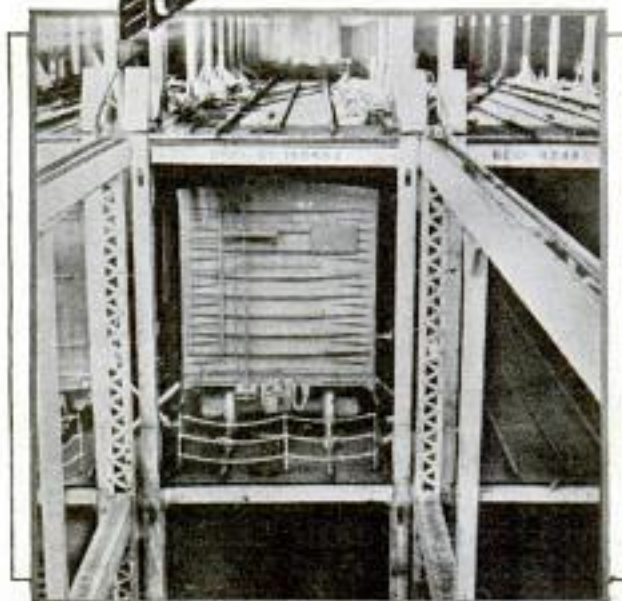

Diagram of Boat Which Carries Ninety-Five Railroad Cars, and Crane That Lifts Them; Left, One of Cars in the Hold



SOME ten miles below New Orleans, La., is a large freight yard, belonging to the Missouri Pacific railroad, facing a long dock, which is overtopped by a gi-

with a capacity of ninety-five cars. But it differs from others in that it plies between New Orleans and Havana, Cuba, separated by one half of the Gulf of Mexico, which has to be crossed weekly. In the freight yard a number of switching engines are busily engaged in sorting the cars, ready to be stowed aboard the "Seatrain." Each time a car is placed on a cradle—a bridgelike structure on the loading track—the crane raises the whole bridge with the secured car and gently lifts it until the top is reached. Running on eight wheels, the crane carries the cra-

B 1100. Cmt. Clayton R
 Slawter, 1361
 Connecticut Ave N W
 Washington
 2000

POPULAR MECHANICS

dle to the center of the hold, and slowly lowers it until the proper deck has been reached. Then the fastenings, which held the car on the cradle, are loosened and the car is pulled into its destined place on the deck and there secured. The wheels are locked by four powerful steel clamps, which prevent any forward motion. To relieve the strain on the main springs of the car, jacks raise it. Strong chains, with turnbuckles on each side, pull the car firmly on the jacks. In this way, the car becomes practically an integral part of the vessel and even in heavy seas there is no danger of its breaking loose. The loading operation is done at the rate of one car in four minutes, while, if loading and unloading are done simultaneously, twenty cars can thus be taken care of in one hour. The value of the services rendered by the "Seatrain" is very great. A freight car may be loaded at a certain manufacturing town and unloaded at its destination in Cuba without any further handling. Two similar ferries will be built for operation between New York and Havana.



Lighthouse Keeper Shrouding Lenses of Lamp to Guard Mechanism against Sun's Rays

COVER ON LIGHTHOUSE LENSES PROTECTS AGAINST SUN

For protection against the sun, a cover must be placed over the lenses of lighthouse lamps. If exposed, the lenses become giant burning glasses that focus the sun's rays on the inside of the lamp. In a few hours, the lantern becomes so hot that the lighthouse keeper cannot enter it to clean and polish, and there is danger of serious damage to the mechanism.

B/087

WIND VANE TESTS LOCOMOTIVE FOR WASTE OF ENERGY

To determine what influence the wind has on the waste of energy, a weather vane is mounted on German locomotives. Performance under varying weather conditions and the resulting consumption of coal, oil or electricity are tested, the vane showing the wind's direction and velocity. A recording instrument in the locomotive cab is connected to the vane, which is placed at the front of the engine.

State

BONES OF ESKIMOS' ANCESTOR FOUND IN MINNESOTA

B 1113

That men have inhabited America at least 18,000 years is the conclusion of scientists who have examined a skeleton unearthed in Minnesota. It lay twelve feet beneath layered silt, formed in the glacial age. As the ice sheet retreated, the silt flowed into and filled lakes in Minnesota. This happened, geologists estimate, 18,000 to 20,000 years ago. The skeleton is pronounced that of a twenty-year old youth, with protruding jaws, unusually large teeth and apelike nose. Measurements indicate its relationship to the Eskimos rather than the Indians. A crude antler dagger and a large shell pendant, each punctured for tying on the owner, were found beside the bones.

Science Service 6/9/32

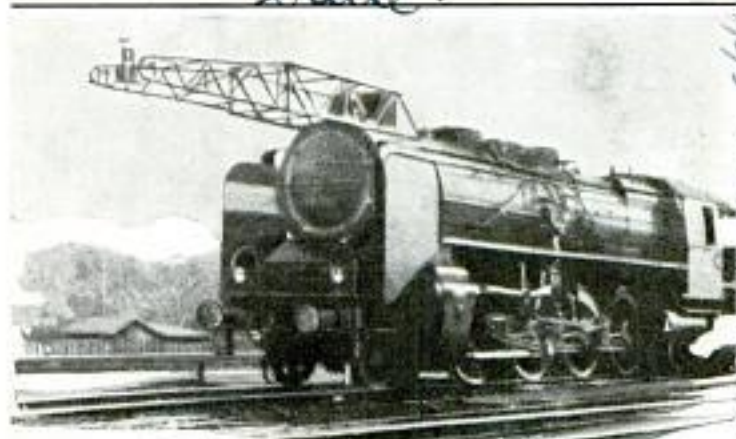

Frame Attached to Front of Locomotive Contains Wind Vane; Dial in Engine Cab Records Weather Conditions on Test Runs

Carl Oeye Lemhardt
 H. A. Zimmerberg, Berlin
 Steplitz, Germany

Dr. A. E. Jenks,
 Prof. Anthropology,
 University of

Dr. Paul Meritt

03/10

Poison Gas Guards "Health" of Art Treasures

Before foreign art treasures can enter Berlin museums, they must go through quarantine at the port of entry. The quarantine was established for the protection of art in the museums. When antiques, paintings, statues and other works are



© New York Times

carried into Germany from America, Africa, Australia and Asia, each object is subjected to poison gas that destroys moths, wood worms and germs of sleeping sickness and tropical diseases. The quarantine officers wear gas masks.

Top, New and Old in Masks; Bottom and Right, Workers Wear Gas Masks While Fumigating Art Treasures in the Museums of Berlin, Germany

SAFETY TESTS OF GRANDSTAND MEASURE CROWD'S FORCE

When the home team's hero hits a homerun and the roaring crowd jumps to its feet, a force of at least five pounds is exerted against each square foot of space in the grandstands. To resist such a strain, the stands must be built strongly, well over prescribed limits for safety. Tests on a steel platform, six feet square, show the stress of crowd movements and the part

of the grandstand on which the greatest force is applied by the fans. More lateral force is developed by men in a sitting position than when standing. Greater forces are produced by three men than by nine, a capacity number for the steel platform which was suspended on rods like a lawn swing. A standard three-row portable steel grandstand, four feet long and erected on the suspended platform, helped to show the maximum strain a grandstand would be expected to meet. If such struc-

Scene done. 6/10/32
03-1112
Conducted by Wayne Iron Works Wayne, Pa
in coop. American Standard Association

tures can take care of thirteen pounds per square foot or twenty-four pounds per linear foot of seats, they are considered well within the limit of safety.

EROSION STEALS HUNDRED TONS FROM ACRE EACH YEAR

U.S. Daily 6/17/52

Erosion steals over 100 tons of soil from each acre of moderately sloping fields every year. In a test by the department of agriculture, 105 tons were lost from corn land in twelve months, though the slope was only 146 feet long and no more severe than the average land in the corn belt. A one-inch rain removed nineteen and one-half tons of rich topsoil from an acre under test, while forty per cent of the rain ran off the ground instead of soaking in. From some slopes, the experimenters found, fifty per cent of the rain ran off, carrying enormous loads of rich soil. As a result, the corn production on badly eroded land is only fourteen bushels, as compared with fifty-one bushels on soil attended by erosion experts. Many farms have been abandoned because wasteful erosion has reduced production so much that it is unprofitable to operate them.

FOOT-PROPELLED "STREET ZEP" RUNS SIX MILES AN HOUR

Propelled by pedals, a vehicle that resembles the rail "Zeppelin" has appeared on the streets of Berlin. Its four occupants can maintain a speed of six and one-half miles an hour. Four unemployed men built the car for touring Germany.



This Zeppelin-Like Vehicle Is Driven by Foot Power; Its Operators Pedaled the Car along Berlin Street on Tour of Germany

at Ascherleben, Germany.

MOST POWERFUL "NUTCRACKER" GIVEN SHOCK ABSORBERS

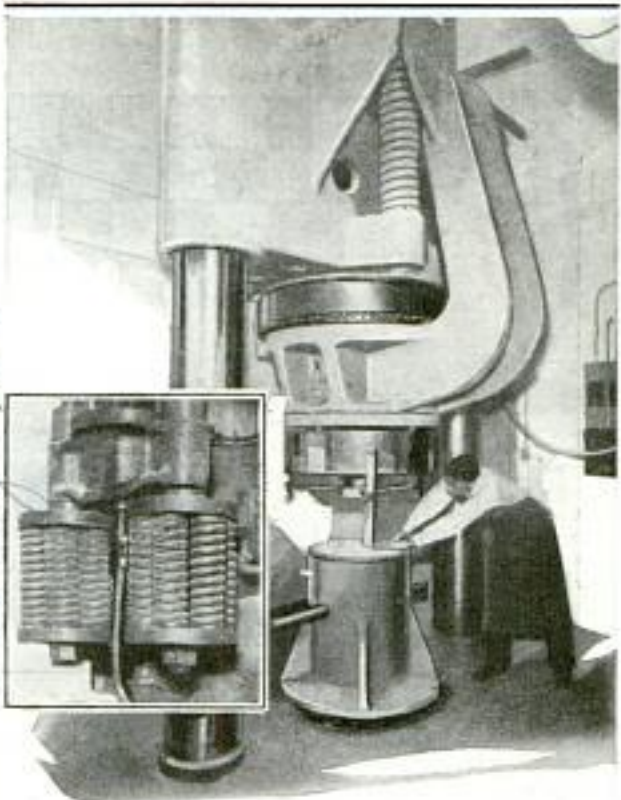

Machine Capable of 4,000,000-Pound Crushing Power and Its Set of Shock Absorbers

So violent were the "strong-arm" operations of the giant "nutcracker," used in testing materials in building Hoover dam, that government engineers were forced to provide it with shock absorbers to prevent it from seriously injuring the Denver federal building in which it is installed. Weighing 100 tons and capable of exerting a crushing power of 4,000,000 pounds, this testing machine measures the tensile

strength of building materials. In crushing tests, it produced shocks equaling an earthquake which shook the building and threatened to loosen its own foundation. Shock absorbers, in the form of huge coiled springs and heavy cork pads under the footplates of the machine, solved the problem. Now, the most stubborn of materials may be crushed without disturbing even the office workers on the floor above.

Denver, Colo

Carl Edwin H. ... Copyright 1939 ...

*Refredo
Coccolina
62/1023*
Rungling Bros and
Barnum & Bailey Circus

The ART of

By COURTNEY

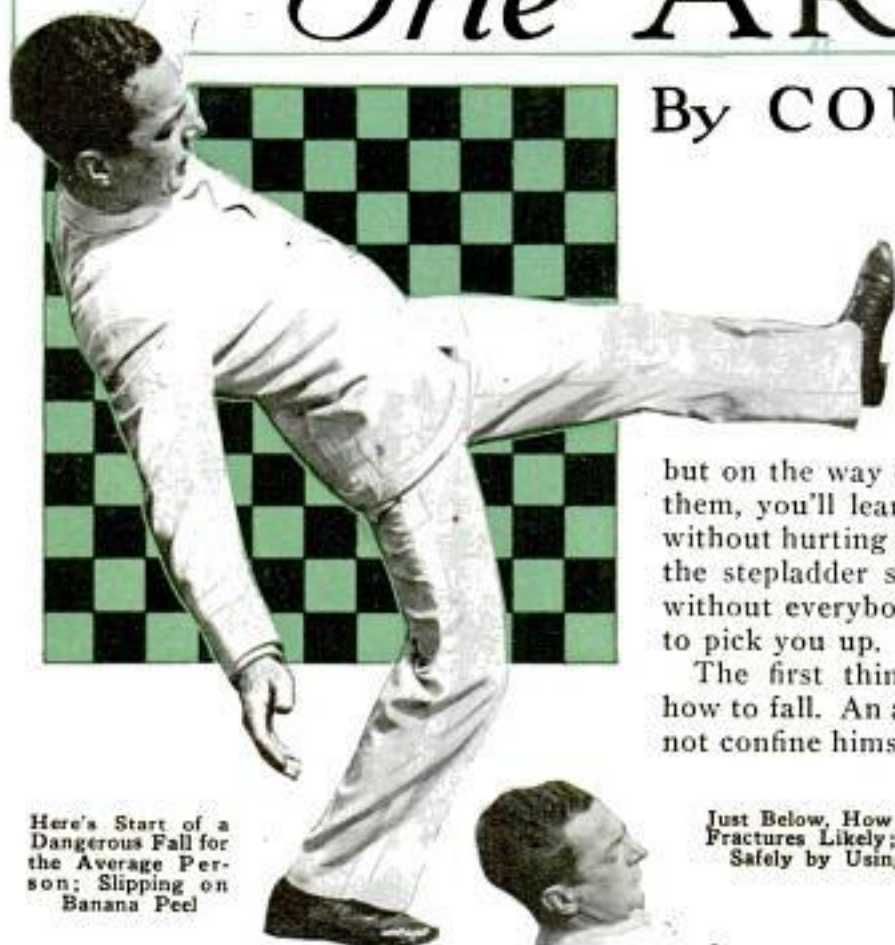

Here's Start of a Dangerous Fall for the Average Person; Slipping on Banana Peel

right now is that the one ticket "ta-a-a-king you-u-u a-a-l-l-l the way-y-y through-h-h" means much more than a circus performance. By proper concentration, not on the acts,

but on the way circus athletes accomplish them, you'll learn how to fall downstairs without hurting yourself; what to do when the stepladder slips, and how to stumble without everybody on the street hurrying to pick you up.

The first thing circus people learn is how to fall. An aerialist, for instance, does not confine himself to his trapeze in learn-

Just Below, How Not to Fall; Wrist Fractures Likely; Bottom, Alighting Safely by Using Knee as Brake



DID you ever think of your circus ticket as cheap insurance against fractured bones and a hospital bill?

For instance, when the band is playing, and the stages are occupied by "perch performers," one of whom balances a long pole, while the other, at the top of that pole, proceeds to stand on his head, there may seem slight association with that dangerous operation known as taking a bath. Yet there is a distinct connection. A far greater percentage of persons die from falls in a bathtub than by falling from the top of a perch. The man on top of the perch knows his business and the bather doesn't. But the principles are exactly the same.

This will be explained later. The important fact



Taking a TUMBLE

RYLEY COOPER

67 Park Ave New York

ing his act. He first practices falling into the safety net, advancing gradually from a slight tumble to a big one. A circus performer can fall with a forty-foot ladder and not even be scratched, where the uninitiated might be crippled or killed. It is not essentially because the performer is an athlete. He simply knows how to take a tumble.

When the clown on the aerial bars pretends to fall over backward, he does exactly what the average person would do. He spreads his legs, he throws back his head and sprawls his arms. Thus he adds to the momentum of the fall. But while the audience shrieks, he suddenly shifts his stance—and doesn't fall at all! And when another clown stumbles, flapping "flat on his face,"



To Fall Safely, Learn Secrets of Balance; Here's a Circus Performer on the Tight Wire

he doesn't risk that face in the least and the face does not hurt him.

The person who takes a tumble without injury, in the circus or out, does so without flailing about with his arms. Alfredo Codona illustrates it by falling from a rail in two photographs. One shows him busily trying to break his neck by the usual method of falling. The other shows him merely taking a harmless swing. And as for the clown who falls flat on his face, all he does is fall without scrambling, with his arms straight ahead and slightly forward, and his head turned to one side. Thus he distributes his fall over his whole body and doesn't get hurt. Simple, isn't it?

If You Stumble, Do Not Sprawl; Take It Easy as Shown in Photo at Right



B31023 380

Lulu Waverford



Rider Ready for a Somersault or Roll if She Should Slip from Horse

never releases his handholds until he is safely balanced. Neither should a bather.

Have you ever seen those collapsible steps in a circus? Where they suddenly give way and the clown has no footing? There's little difference between them and tripping on the steps at home. Except at home one sprawls, grabs wildly for aid that isn't there, or flops back and fractures the base of the skull. Many children tumble all the way downstairs and are only slightly bruised. They merely bump along or roll. In this regard, it is possible for a person with no knowl-



Left, Start of Fall from Rail; Bottom, Grabbing Rail Turns Fall into a Swing

Naturally, one questions why Lillian Leitzel, the circus world's greatest woman aerialist, should have been killed by a fall in Copenhagen, two seasons ago. It was not because she fell, but the way she fell. A swivel had broken on one of her rings. This broke her grip on the other, and threw her sprawling as she started downward. If the fall had been greater, she might be living today. But it was less than twenty-five feet, and in that space, the little "Queen of the Circus" did not have time to right herself, and "take it rolling." She crashed, head down, to the floor. Her skull was fractured. A fall of five feet more might have saved her.

The circus insists that one who falls should "go with the fall." Gravitation cannot be beaten, but it can be circumvented. There's that matter of the perch performer and the fall in a bathtub.

If a perch performer standing on his head must not fall, the same rule applies to a bathtub. The way to do it is to emulate the perch performer. That man never lets go until he knows his balance. Bathtub falls are largely caused by lack of that essential quality. The perch performer

edge of acrobatics to jump from a swiftly moving train, stumble, fall and not be hurt beyond scratches and bruises. All that is necessary is to tuck in the head, raise the arms, double up the body as much as possible and roll. The speed will attend to the rolling process, and the rolling prevents serious injury.

If this sounds ridiculous, watch the act of Clare Bruce, the famous riding clown of the Reiffenach family. In one portion of his act, he leaps for a horse. He misses it, apparently so badly that he catapults



If Horse Should Fall, Rider Goes with It as Far as Possible, then Rolls

entirely over it, headed for injury on the hippodrome track. But when he strikes, he extends his arms and legs only enough to form the contact and to throw him into a straight, spinning motion, his body stiffened, his arms raised to cover his face. Over and over he goes, turning with al-



When Your Foot Slips, as Above, Turn and Fall into Position Like That Shown at the Left

most dizzying speed. Then he sits up, waves gaily to the audience and goes back to the ring. It's part of his living. He does it twice a day.

Here indeed is the true principle of the right kind of a tumble. A rough fall would break bones, but a ball can roll a long time without injury. The rolling motion takes up gravitation easily and gradually. A collision smashes an automobile, but there are billions of gradual stops every day on America's highways.

To defeat gravitation—that is the real art of taking a tumble. Codono knows how to fall. He simply puts down the foot

that is in the air, turns and, in turning, breaks a big part of the pull of gravitation, and then goes to his hands and thighs on the ground—in the opposite direction to which he was going. As for the slip of the heel on a banana peel, he pulls back the leg that was taking the step, jerks forward his body, instead of forcing it backward by grabbing and sprawling, bends his knees and crouches. The average man shoots both legs in the air, falls flat backward, hits his skull or gets a double fracture of the wrists. The usual person goes against the fall and adds to the momentum. The circus performer goes



If You Stumble on Stairs, Don't Follow Center Photo's Example; Sit Down and Slide, as at Bottom

All Harry Rittley does is ride the fall until the chair is within a few feet of the floor. He has pulled his legs back so that they touch the floor a second before the tables and chair strike. Then he does three backward roll-overs, comes to his feet and takes the applause.

When the uninitiated man has been tipping back his chair until he is off balance, he flails wildly, throws back his body and goes on over. But a circus performer shoots his body and arms forward, thus defeating gravitation by putting a brake against it. Instead of pushing out his legs, he pulls them back hard. The chair goes to the floor, and he remains in a bent, standing position. In other words, he has balanced his whole body against a fall, in-

stead of adding to overbalance. As for a stumble, don't sprawl. Hinge your knees quickly and go down to a position like a runner awaiting the gun.

Thus the list goes on. The girl who falls from a falling horse, goes with the horse as long as she can, then doubles up and rolls. The performer with a tectery step-ladder doesn't grab for an

with the fall and subtracts from it. Is that clear? Perhaps the example of not being injured by a tipped-over chair will make it easier.

In the Ringling Brothers and Barnum and Bailey circus, is Harry Rittley, whose main stunt is to climb to the top of six tables placed one on the other, sit on a chair, and then topple the whole affair over backward. It seems terribly risky. It would be for anyone but a circus man. But any person could do it with one or two tables and a chair simply by holding hard to the rules of falling.



imaginary picture, but remains standing on the top of the ladder until it nearly touches the ground, then, well-balanced, jumps off and runs a few steps to overcome the effect of the jump. The average stepladder is only about six feet high, and the average person can take a six-foot jump without injury. Besides it isn't a six-foot jump. The arc of that stepladder in going down reduces the height.

Alfredo Codona and his brother Lalo were returning last spring from California to the opening of the big show in Madison Square garden. They were driving a car at sixty miles an hour. A front tire blew out, throwing the automobile into a ditch. Immediately both men braced themselves and went with the car. They did not stretch their arms loosely or swing their legs about in an effort to get out. They simply held tight and became a part of that car, as much a fixture as the upholstery itself. Everywhere that automobile went, they went also.

The car leaped forward, staggered drunkenly and hit a log. It catapulted, riding high in the air for two complete forward revolutions. When it had settled down, Alfredo looked at Lalo.

"Hurt?" asked Alfredo.

"No, are you?"

"Not a bit," answered Alfredo, unconsciously lying.

He had a slight bruise on his forehead.

SUNLIGHT STUDIED FOR PROOF OF EINSTEIN'S THEORY

By testing the deflection of light during a total eclipse of the sun, astronomers hope to reconstruct proof of Einstein's



Member of Astronomers' Colony at Telegraph Mountain, Potsdam, Germany. Studies Stars through One of the Giant Telescopes

theory of relativity. The calculations from which the proof will be taken will result from years of studying sun and star light through the giant telescope at Telegraph Mountain, Potsdam, Germany, as well as at other observation points throughout the world. About 100 scientists, dedicated to a life of studying the stars and the stratosphere, live at Potsdam, apart from the rest of the world.

STORAGE BATTERY USES IODINE

Iodine, commonly used as an antiseptic, is the active material in a storage battery that is superior to the lead or nickel-iron battery now on the market. It looks like a primary dry cell and gives off no dangerous vapors.

announced by the Academy of Sciences Paris

Science Service 6/9/32
31057
Accumulators
Electricite's Codona
3. Square de l'Opera
9^e 2^e rano
Paris
Wich. Wall
© New York Times
31091
Dr. Francis Borspeler

Metallwerke Frankenberg
 Frankenberg,
 384
 B1093 Germany
**ENDLESS CHAIN TO STRIP BARK
 CUTS COST OF LOGS**

Dr. Robert Robertson
 Chief Chemist to Peruvian
 government, at
 meeting of Royal Society
 research showed that the best results are
 obtained from mixing one part of Texas
 or California orange with three parts milk,
 as contrasted to two parts Florida orange
 to three parts milk. The Texas and Cali-
 fornia oranges are equivalent to a three-
 per-cent solution of citric acid. Milk con-
 taining this amount does not curdle.

No. 1 agent known



Sharp Knives on Chain Slice
 off Bark; Operator Holds
 Handles as Trimmer Auto-
 matically Moves Ahead

B1139

**ELECTRIC POWER IN DIAMONDS
 REVEALED BY LIGHT BATH**

By bathing a certain type of diamonds
 in polarized light, ultraviolet or extreme
 red rays, enough electric current to pro-
 duce a deflection in a galvanometer is re-
 leased. The "electric" diamond is rare,
 only five such stones out of 250 possessing
 the power of generating current. If the
 diamond producing the power in ultra-
 violet rays, 2,300 units long, is subjected
 to light, 3,650 units long, the electricity is
 quenched.

Service
 U.S. 16/15/22

**AUTO PUMP FOR FIGHTING FIRE
 PROTECTS FORESTS**

Designed for fighting forest and farm
 fires, a water pump that can be mounted
 on an automobile or truck is driven from
 the crankshaft by a long fan belt. The
 pump is bolted to the auto or truck en-
 gine, the fan belt connected and the en-
 gine started. Water for fighting the flames
 can be carried in a tank or sucked through
 a hose from stream or pond. In addition,
 the pump can be used by farmers and nur-
 serymen for spraying. It weighs only six-
 teen pounds and puts no more strain on
 the auto engine than ordinary driving.

**CITRIC ACID MIXED WITH MILK
 IS AID TO DIGESTION**

If fresh milk is treated, or mixed with,
 citric acid, it is much easier to digest, con-
 trary to the general impression of a few
 years ago. Research in connection with
 treatment of ulcers of the stomach shows
 that curd from milk is much softer when
 treated with orange juice, which contains
 the citric acid and a high proportion of
 vitamin C. Other citrus fruits would have
 the same effect in correct proportions.
 Since Florida oranges are slightly less acid
 than the California and Texas variety, the

B113

Prof. H. L. Templeton and
 Dr. A. C. Blankenship,
 Univ. of Wisconsin, Madison



Bolted on Auto Engine, Water Pump and Hose Help
 in Fighting Forest and Home Fires

Panama Machinery
 + Supply Co.
 Panama City Fla.

FACE POWDER OF WHITE LEAD WAS USED IN ANCIENT GREECE

N.Y. - June 7/4/32

White face powder was produced in ancient Greece 400 years before Christ by methods identical with contemporary processes. This has been established by analysis of the cosmetics found in the grave of a woman at Corinth by Prof. T. Leslie Shear, of Princeton University. The cosmetics were found to be cubes of carbonate of lead which had been manufactured by the Greeks through basic methods similar to those today used in the production of white lead. Pliny describes the process.

Princeton, N.J.



Form of Arch Roof Construction Intended to Lower Building Costs; the Walls Extend into the Roof

RUBBER CLOTH RETAINS SHAPE AND RESISTS WEAR

Woven from yarn treated with rubber, a new cloth springs back to its original shape after stretching, reducing wear almost to a minimum. The elastic material is not affected by the strain put on certain parts of the clothing. Trousers made of the cloth never would appear baggy, the makers claim, since the material would return to the crease built into the garment.

U.S. Rubber Co

2 marked Passaic, N.J.



Made from Rubber-Treated Yarn, This Cloth Stretches, Then Springs Back to Its Original Shape

ARCH ROOF FOR HOME LOWERS COST OF CONSTRUCTION

Known for centuries as one of the strongest forms of construction, the arch has recently been made the basis of a new type of dwelling that is expected to lower building costs. The lintel method, spanning two uprights with a crossbeam of stone or wood, has been used almost uni-

versally in the past. The latest method discards this in favor of an arch deriving its strength from its shape rather than from cross bracing. There is no break at the line where the walls join the roof, thus permitting stronger and lighter structures. The roof and sidewall form a continuous unit, the only difference being in surface covering, roof shingles giving way to siding without the use of overhanging eaves or rain spouts. Interior lines follow those of the outside, the rooms having arched ceilings, which provide greater air volume and lend themselves to unusual decorative treatment. In building such a home, the framework of wood is erected first, the members being built up of three layers, so the straight sidepieces can be carried without a break into the curving roof. A layer of insulating material is then applied to the outside, followed by weatherboarding or shingles. The same general construction is used for partitions, with wires and pipes built in. The framework and insulating material combine to form a paneled effect for the interior. The method is being used for both one and two-story houses, and tests have indicated that an arched house in a tornado will roll over before it will collapse. The design is being applied to permanent dwellings, summer cottages, garages and filling stations. A four-room house can be built complete by this method, with plumbing and lighting fixtures, for \$750.

*Clevelanda Clark
Mills, Shelby, N.C.*

B 1008
Cml. Thos. E. Stinson, Jr.
145 1/2 Spring St.
Los Angeles, Calif

Backyard

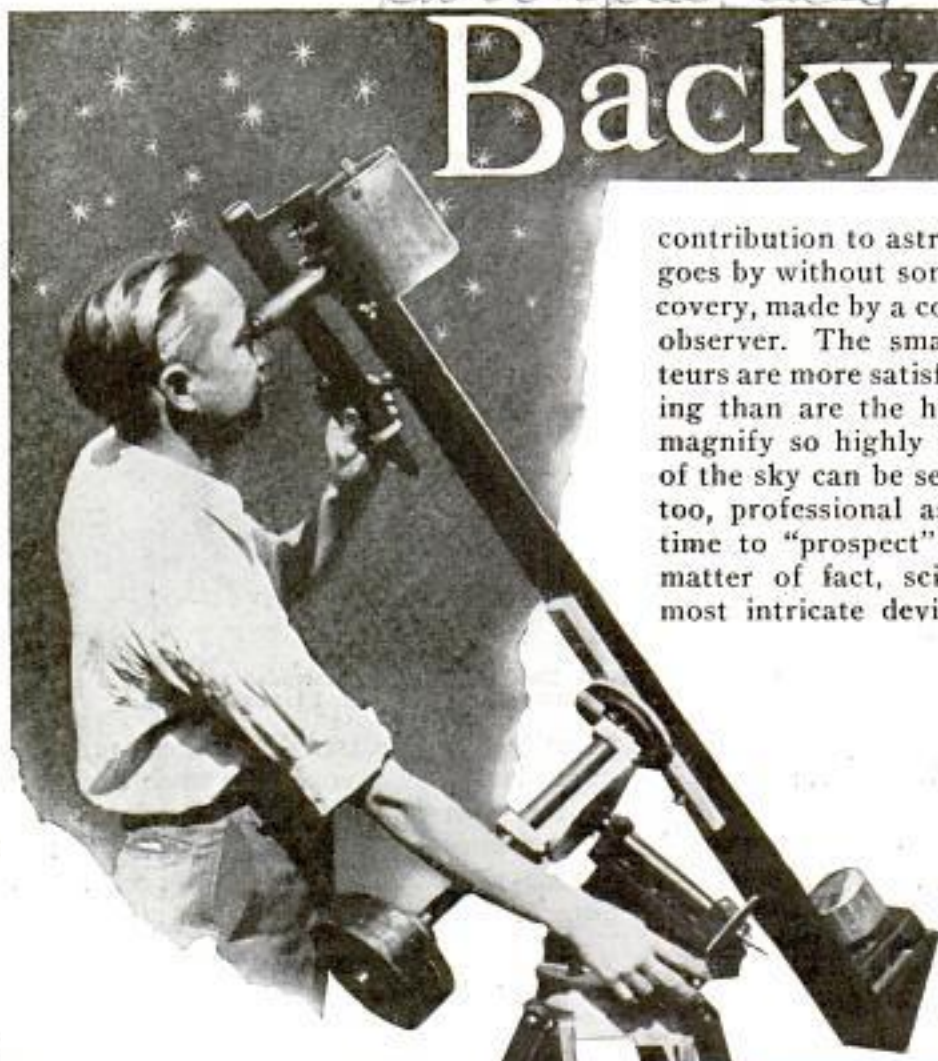

contribution to astronomy. Hardly a year goes by without some such important discovery, made by a comparatively untrained observer. The small telescopes of amateurs are more satisfactory for comet hunting than are the huger instruments that magnify so highly that only a small area of the sky can be seen at one time. Then, too, professional astronomers have little time to "prospect" for new stars. As a matter of fact, scientists who have the most intricate devices of astrophysics at their command are calling upon amateur astronomers with their home-made instruments to help them study the stars. So important is the work of the amateurs considered that observatories collect their reports from all over

WHEN the director of the observatory unfolded the telegram, he found a request from an amateur astronomer to investigate a new comet. Late that night the shutters of the observatory dome were rolled back. Dials were turned, and the ponderous telescope moved into position. Finally the mirror was focused on the object.

The astronomers were ready to confirm the discovery, but no one on the observation platform peered into the eyepiece. Instead, a photographic plate was strapped on. Then, by a careful comparison of the photograph with a star chart, the existence of the object was definitely affirmed. Other instruments were coupled to the telescope, and within a short time the distance, size and orbit of the celestial visitor were determined. Meanwhile, the work was checked at other observatories. Next day the newspapers announced that an amateur had again made an important

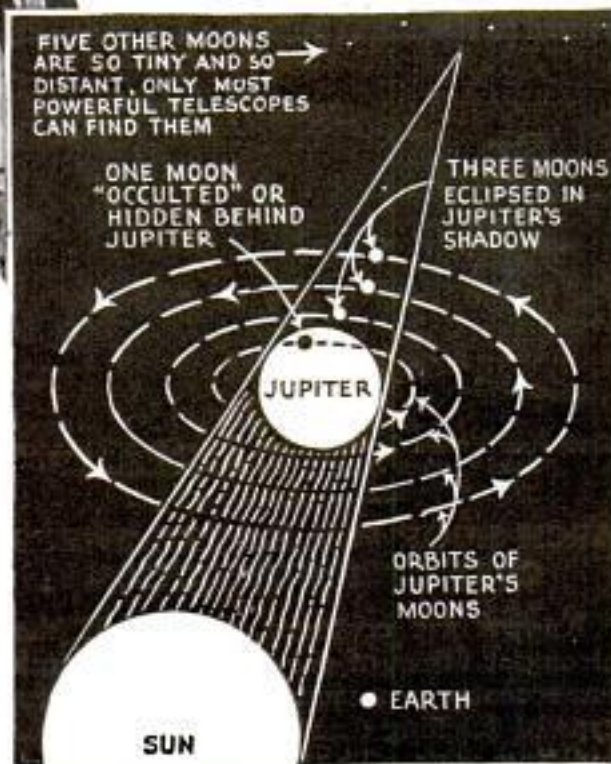

the world. Instead of investing a fortune in a telescope, the average amateur makes

Article on making telescopes Oct. 1932

Telescopes Conquer Space

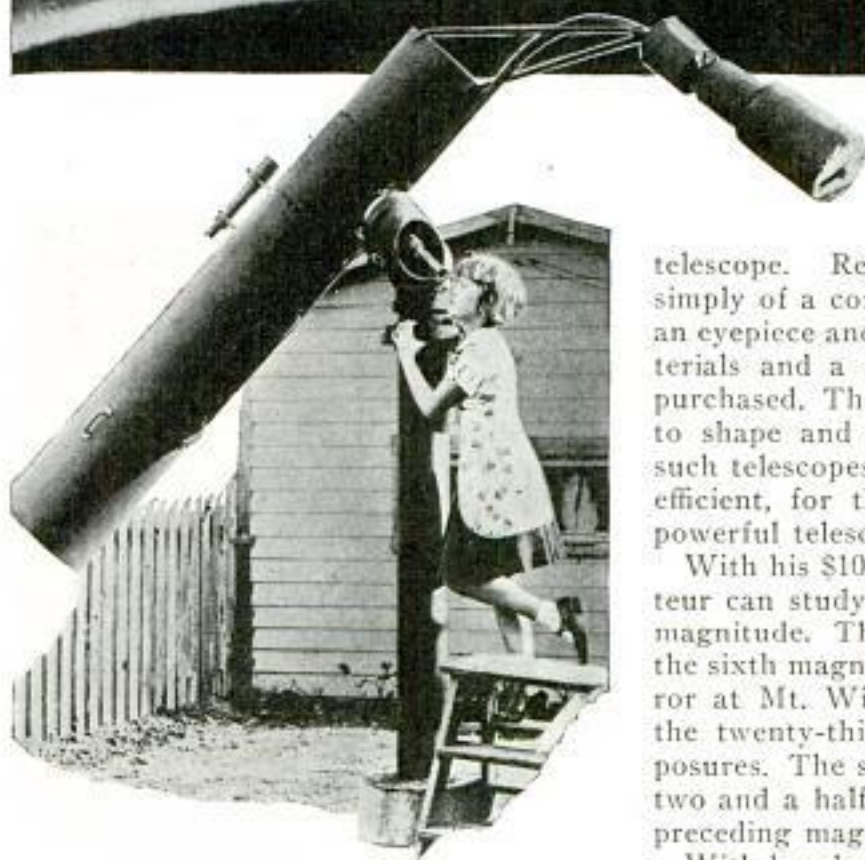

Photo of Sun's Surface, Showing a Prominence 140,000 Miles High; White Disk Represents Earth's Size

his own at a cost of a few dollars. It may be a surprise to know that you can build a reflecting telescope like those in the largest observatories with less trouble than it takes to grind the lenses of a refracting

telescope. Reflecting telescopes consist simply of a concave mirror, a flat mirror, an eyepiece and a mounting. The raw materials and a few inexpensive parts are purchased. The mirror glasses are ground to shape and polished by hand. Many such telescopes made in spare time are as efficient, for their size, as are the most powerful telescopes built.

With his \$10 or \$15 instrument an amateur can study stars down to the twelfth magnitude. The naked eye sees stars of the sixth magnitude, and the 100-inch mirror at Mt. Wilson has detected stars of the twenty-third magnitude by time exposures. The stars in each magnitude are two and a half times dimmer than in the preceding magnitude.

With hundreds of homemade telescopes in the United States sweeping the sky every night, the large observatories have practically given over several branches of study to the amateur societies. Members of these make regular observations of

31008
388

Gardeners, school-teachers and clerks have had their names enrolled in the astronomical hall of fame because of the work they have done. One star gazer in Ohio is credited with the discovery of twelve new comets. Through the assistance of amateurs, Prof. E. W. Brown, of Yale University, has determined that the moon is not keeping accurate time. His unofficial assistants noted the exact second at which certain stars disappeared behind the rim of the moon, and from these reports it was calculated that the moon fails to meet its appointments by one second every hundred years.

Right now, amateurs are being called upon to help solve one of the outstanding mysteries of astrophysics—the nature of the variable stars. One typical variable, in the constellation of Cygnus, remains a dim light point for long periods. Then it rapidly grows in brilliance until it seems

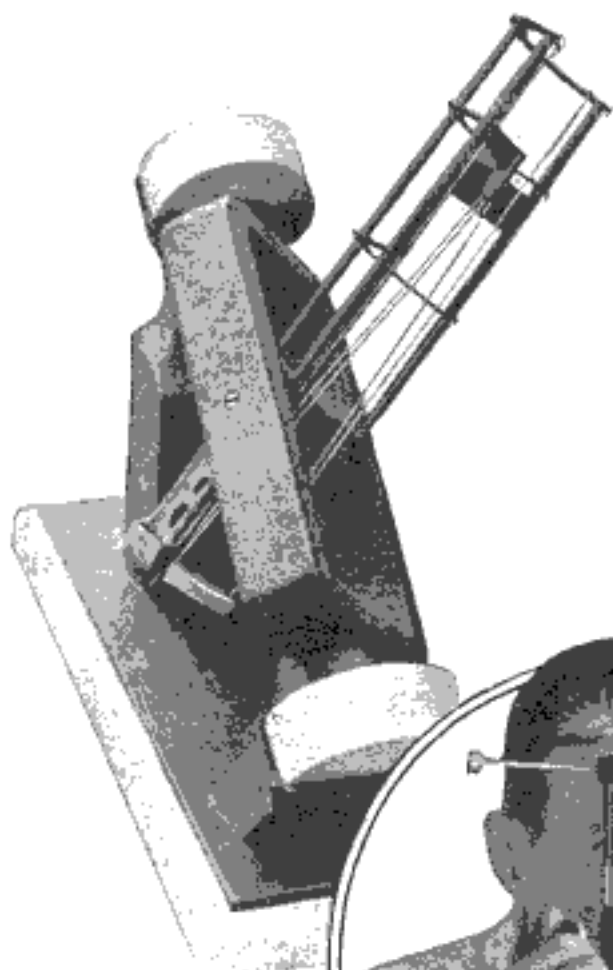

Model of 100-Inch Mirror with White Lines Showing the Path of the Light Rays

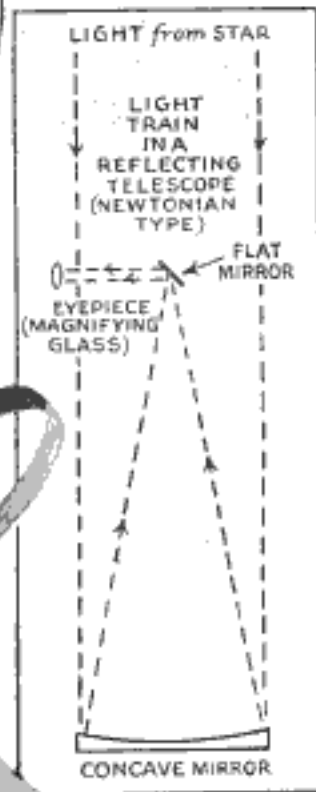

the moon, comets and shooting stars, and compile reports that can be studied by astronomers at their leisure. When an observatory needs special information on a certain star, its request is forwarded to amateurs all over the world. If clouds or poor visibility hinder the scientists, reports are gathered from amateurs in areas where the weather is favorable for observations. Hundreds of reports are collected after each eclipse of the sun.

Practically all of the comets that have been discovered during the last twenty years were first found by amateurs, and the returns of many previously known comets were first announced by them.

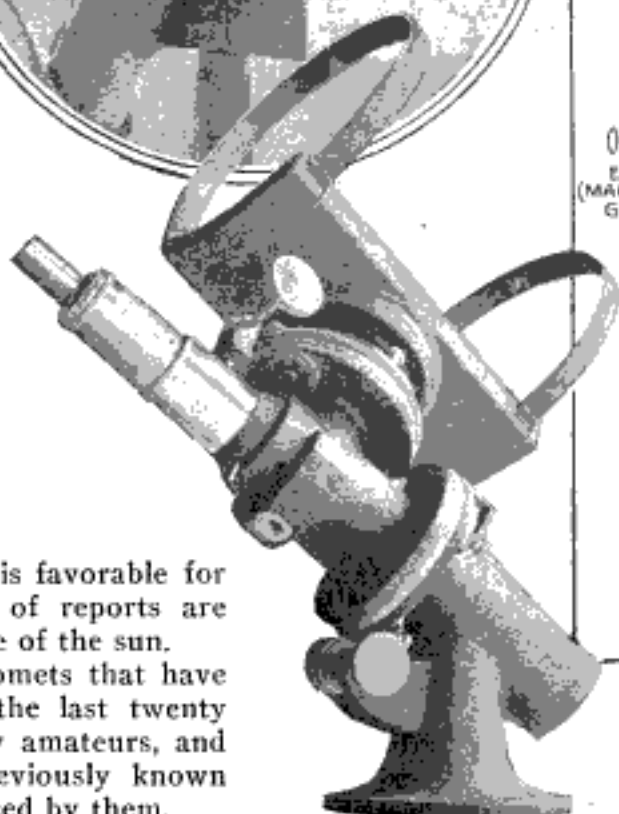

Center, Testing a Mirror; Bottom Left, Pasadena Mounting Designed by Amateur Astronomer

several hundred times its previous size. Finally it fades again. Some of these stars pulsate in definite cycles, but others seem to flare and die on erratic schedules. In studying the strange behavior of the long-period variables, amateurs are working shoulder to shoulder with scientists.

Dr. Paul W. Merrill,

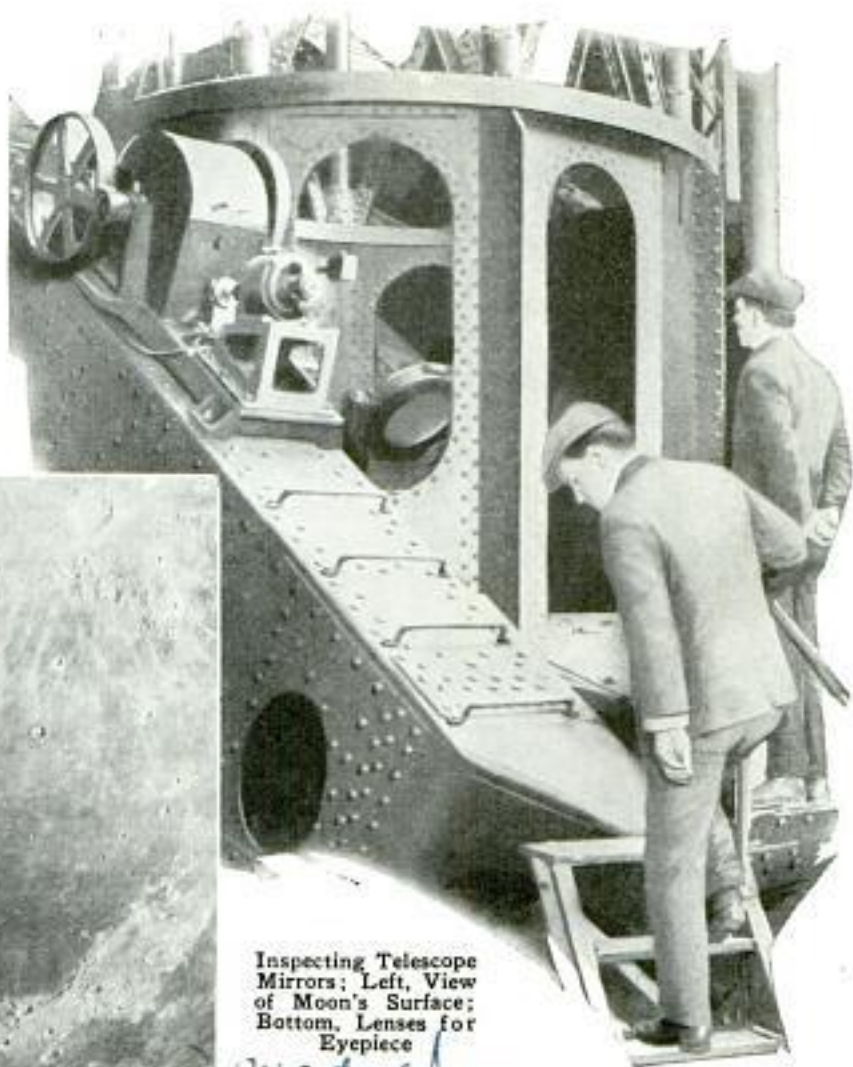

Inspecting Telescope Mirrors; Left, View of Moon's Surface; Bottom, Lenses for Eyepiece

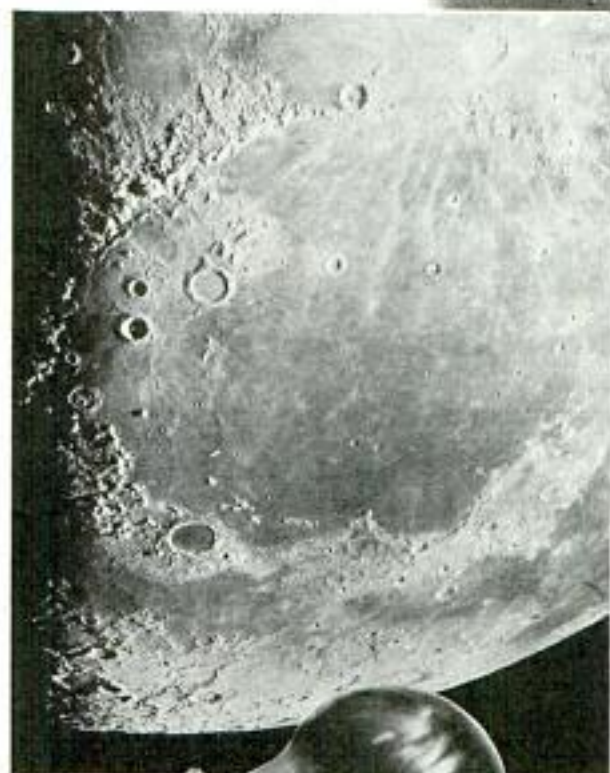

Merrill

the Mt. Wilson telescope, uses amateur observations to learn when the variables are at the peak of brilliance. He explains that each amateur who has the inclination is asked to report on two or three variable stars, keeping track of their brilliance by comparison with near-by stars of fixed size and light. From past observations, the peak of brilliance of each variable is known, and as the star approaches this point, a report is sent to Harvard University, and thence to the observatories.

"By studying a variable star through the spectroscope," says Doctor Merrill, "some facts about its speed in the line of sight and the materials of which it is composed are learned. It is expected that eventually this will lead to some definite idea as to why its light varies. Determination of the light curves of the long-period variables, is an extremely necessary part of this work." Nearly half a million different observations on variable stars

(Continued to page 116A)

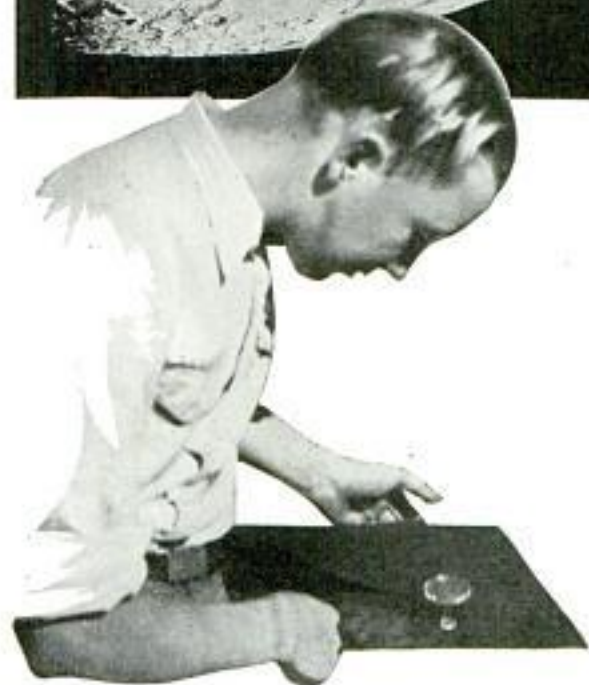

who is completing spectrographs on several hundred variable stars with the aid of

B1214

Ernest Parker, Danville, Ill.
on journey to Marchfield, W. Va.



Here is a Covered Wagon of 1932; Goat in "Rumble Seat" Supplies Milk

COVERED WAGON ROLLS AGAIN BUT ON PAVEMENT

Pioneer days of the middle west were recalled when a covered wagon was used to transport an Illinois family 160 miles to a town in Wisconsin. Eight days were required for the trip. Two goats, in a pen attached to the back of the wagon, furnished milk, while other necessities were carried in the wagon. But instead of rumbling over the prairie, the family, in contrast to the earlier migrants, traveled on excellent roads, all paved.

WIRE ONE-TENTH OF HAIR SIZE USED IN ELECTRIC LAMPS

One-tenth the size of a man's hair, tungsten filament wire used in the Westinghouse six-watt incandescent lamp is so fine that it is practically invisible. The exact size is four-ten-thousandths of an inch in diameter. This wire is formed by pass-

Electric & Mfg. Co
E. P. Allsburgh, Pa.

ing a bar of tungsten, three-eighths inch square and twenty-four inches long, through ninety-five dies, each slightly smaller than the one preceding. By this process, the bar is stretched into a wire 207 miles long, enough to provide filament for 666,666 lamps. Two weeks are necessary to turn one bar into wire.

B1209

BUILDING IS RAZED BY HAMMER AND CRANE

Contractors faced with the task of tearing down the heavy stone walls of the Terre Haute, Ind., post-office building used a "swinging hammer" to accomplish the job much more rapidly than could have been done by hand. The hammer was nothing more than a heavy iron weight swinging on a cable from the long boom of a crane. By skillful manipulation of the swaying boom, blows were struck in the proper places to fell large sections of the walls at one time, and always inward, as desired.



Battering Down the Stone Walls of a Building with Swinging Hammer Attached to Crane

Cont. H.C. Whitney Co
National Strapping Co
220 Rose Desperary Bldg

Terre Haute, Ind.

Life Net on Elevator for Rookie Fire Fighters

Injuries to recruit firemen during periods of training are prevented in one city by the use of a life net fitted to a frame on the practice tower where the rookies climb

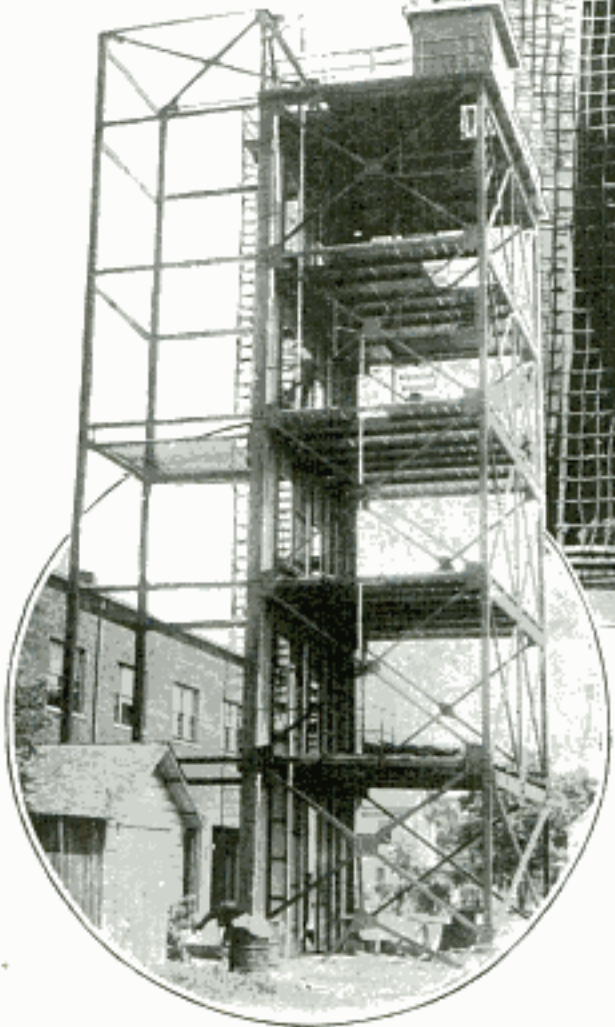

Recruit Fireman on Practice Tower with Net beneath Him; Left, Tower with Net in Position

and learn the rudiments of fire fighting. The net can be moved up or down the walls so it is always in place to catch the unskilled man who loses his balance while trying to scale a wall. It has been found that the net speeds up training, as the novices have more confidence and are willing to attempt the more dangerous feats at an earlier period.

B11874
ELECTRIC BANKNOTE COUNTER HELPS DETECT BOGUS BILLS

Operated by a small electric motor, a counter and sorter for banknotes has been produced in Germany. As each bill passes under the counting rollers, it is exposed to a penetrating light that helps to detect counterfeit currency. The machine's capacity is 4,000 notes per hour. When enough currency to form a bundle of a certain size has passed through the counter, the motor automatically stops. Only one note at a time can pass through the

register, the rollers being adjustable to currency of any thickness.

B1146
STARCH FROM SWEET POTATO

Extraction of a high-quality starch from sweet potatoes has solved the problem of disposing of culls, which make up ten to thirty per cent of the entire crop. A new process of producing the starch removes the objectionable color that had been a hindrance to commercial use of starch from this source. The product is adapted especially to use by the textile industry.

*Lucrative 21.
 No. 11. Agent known*

*neue Iseldzahlmaschine
 Gesellschaft Berlin, N. W. F.,
 Germany.*

*A. S. Coover
 Bureau of Chemistry
 and Soils*

*Sept. 1906
 Washington, D. C.*

03392. Carl Haus J. Kutschbach,
Schwarzhaferberger Strasse 5,
Berlin, Prankent, Germany

also
es. W. Leray
Spartill.
Mf.

The MYSTERY

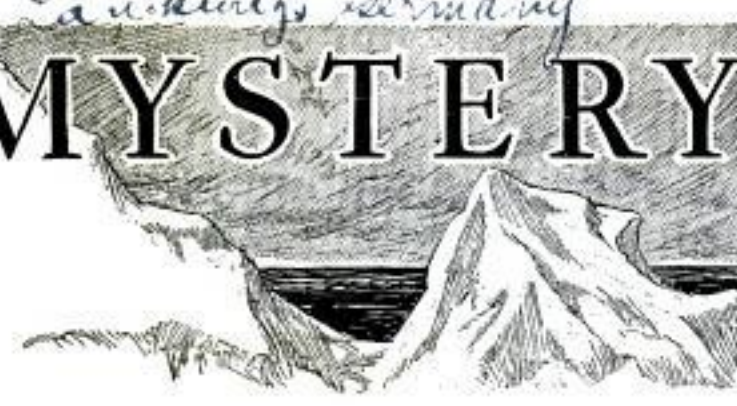

That problem may be summed up in the question: How much can life stand? It is a very practical question to breeders seeking to improve the quality of live stock, to milk producers and fruit and meat packers and medical men fighting bac-

A GRAIN company had wheat stored in its elevators, and before it could be shipped weevils developed. The elevator managers had heard of a strange radio tube that would induce fever in the human blood stream, and kill grasshoppers or even larger creatures. Could it do anything for the weevil problem? They went with that question to Dr. W. R. Whitney, director of the General Electric research laboratory at Schenectady.

Doctor Whitney put some weevils in a glass tube and turned on a thirty-meter radio wave. In less than a minute they were dead. Then he let some grain fall rapidly through an intense radio field. To the insects the radiation was indeed a death ray. Inspection showed that all were killed, and germination tests showed the wheat had not been injured. But in a few days baby weevils hatched out in the treated grain. While the insects were easy prey to the short waves, the dormant life of their eggs was not seriously affected. "And so," concluded Doctor Whitney, "the real problem is not solved."



SNAILS MAY BE COOLED TO -140° FAHRENHEIT YET DO NOT DIE



A FROG CAN STAND -20° FAHRENHEIT



A CARP WILL DIE AT -10° FAHRENHEIT

Top, Weevil-Infested Grain Undergoing Short-Wave Treatment; Below, Examples of Frozen Life

teria, to farmers and orchardists and foresters fighting destructive pests.

A government bureau was anxious to

of FROZEN LIFE

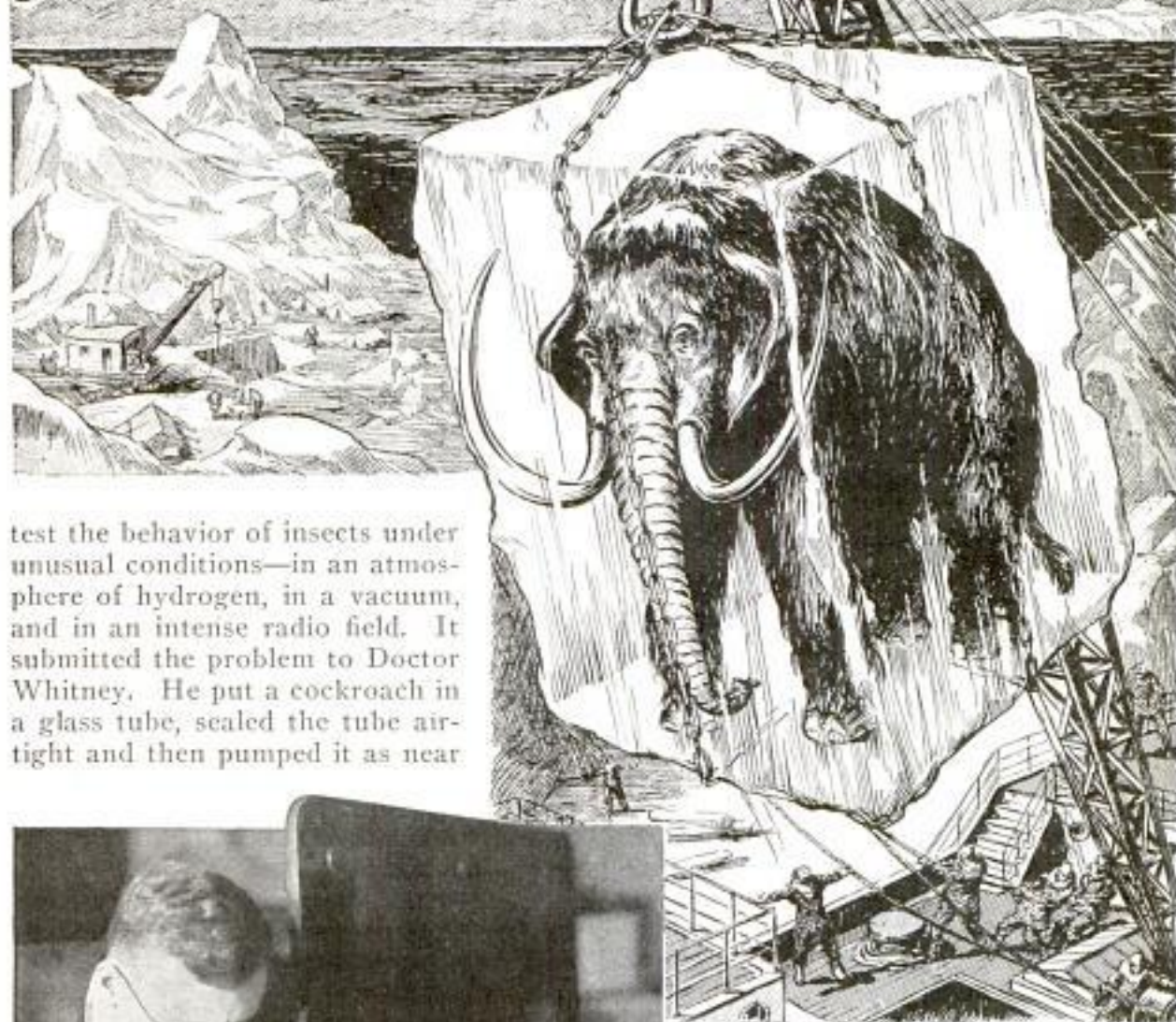

test the behavior of insects under unusual conditions—in an atmosphere of hydrogen, in a vacuum, and in an intense radio field. It submitted the problem to Doctor Whitney. He put a cockroach in a glass tube, sealed the tube airtight and then pumped it as near



Popping Corn between Iced-Water Electrodes, Which Are Connected to a High-Frequency Heater

a vacuum as possible. The bug swooned and lay motionless. For a full minute it was left in that airless world, but when the tube was opened and the air gushed in, it quivered, stretched its legs, stood up and ran away.

"I repeated the experiment," related Doctor Whitney, "increasing the time to two minutes, five minutes, and finally a full hour. In each case the cockroach apparently died and came to life.

"Then we put the insects in a tube filled with hydrogen at normal pressure. They soon lay down and rested. When they were

*E. L. Manning
General Electric Co.
Schenectady. NY*

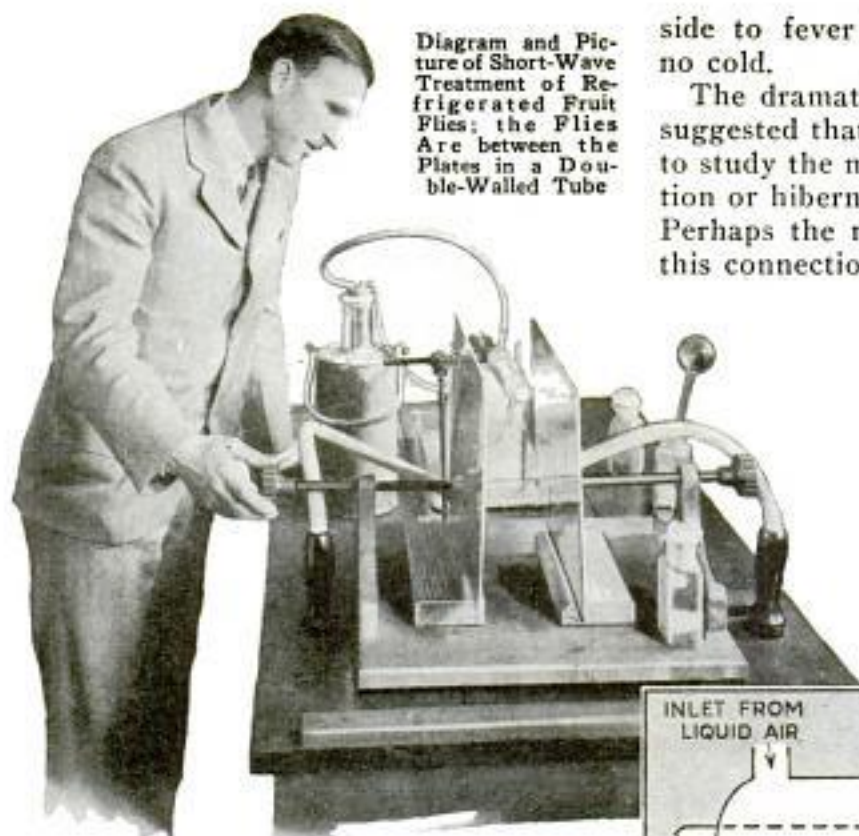

Diagram and Picture of Short-Wave Treatment of Refrigerated Fruit Flies; the Flies Are between the Plates in a Double-Walled Tube

brought into the air again, they woke up and crawled away. Nitrogen gas was tried next, and here we found that insects would wander around for two days without suffering any fatal or serious effect."

But how do the insects behave under the influence of radio waves? Doctor Whitney took some fruit flies and put them in a large glass tube. The tube was closed, but so connected that it was possible to circulate a current of air through it. He began to lower the temperature of this air, and the insects huddled on the glass floor, an apparently frozen mass.

When the winter temperature had prevailed for some minutes, the thirty-meter radio generator was started. It is the same powerful vacuum tube that had been found to bring on fever in men working near it. The question was: Could it recall life to the frozen insects or would it kill them outright?

After the tube had been working about one minute, oscillating at the rate of ten million times a second, the frozen mass gave a feeble stir. In another minute some were crawling, and soon they were flying or buzzing their wings. The freezing breeze was still blowing through the tube, but the radio waves had heated them in-

side to fever temperature and they felt no cold.

The dramatic result of this experiment suggested that radio waves might be used to study the mystery of suspended animation or hibernation as it occurs in nature. Perhaps the most startling suggestion in this connection is one which came out of

Germany recently—the proposal that the icefields of northern Siberia or of the Arctic islands be explored for a mammoth preserved in the ice. It is not impossible that extinct creatures may exist in frozen preservation, for some of the ice in the polar regions is of great

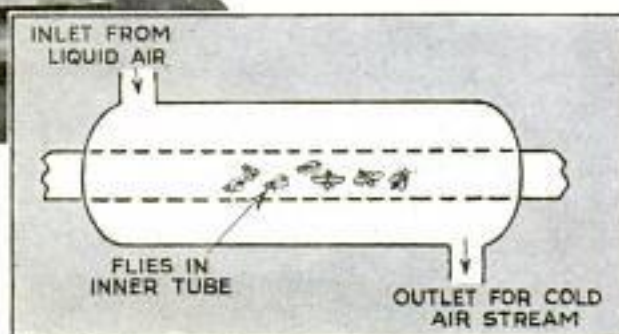

age. Mammoths have been found imbedded in the soil of Siberia, some of them standing erect, with fleshy parts and hairy covering still adhering to the bones. But to expect that radio waves, oxygen injections, or any other stimulus can recall life to a thousand-year-old carcass is—in the opinion of all the biologists who would discuss so fantastic a subject—"highly improbable."

Cold can be endured by many creatures with a very high degree of immunity. An instance is on record in which a boy found a frozen snake on an icy road. He picked it up, used it as a walking stick, and when he arrived home, set the "cane" in a corner of the kitchen. Half an hour later the warmed serpent was sluggishly dragging itself across the floor.

Quite apart from the ordeal of cold is the ordeal of hunger. The bear, the groundhog, the hedgehog and the dormouse grow exceedingly fat during summer, and it is this surplus food stored up in their body tissues that sustains them during the long winter sleep. When they

revive in the spring, they have lost from a third to nearly a half of their weight.

Animals in a complete state of hibernation show scarcely any signs of breathing; so, it is not strange that the cockroaches were able to get along without oxygen. A dormant hedgehog was immersed in water for twenty-two minutes without injury, whereas when awake and active three minutes immersion drowned him.

Even more spectacular is the sleeping lung fish at the laboratory of the New York University medical school. In its native tropics, the lung fish endures the annual dry season by burrowing into the mud and its skin exudes a parchmentlike cocoon which incloses it. The New York fish retired into its cocoon in 1928, and in the summer of 1932 it was still asleep. So far as the fish knows, the dry season is still on.

Apparently, life can stand a great deal. The shell of an Egyptian desert snail was brought to the British Museum as a specimen. Four years after it was put on public view, an attendant noticed a trace of slime on the card. The mount was immediately immersed in water, and presently the awakened snail stuck out its feelers and began to crawl.

There are tales innumerable of toads and frogs found sealed up in solid masonry walls many years old, but none of these finds has ever been scientifically checked at the time of the discovery, and so science remains critically skeptical of all such reports.

Better certified is the long life of certain bacteria recently found in coal. The German coal seam from which these microscopic bits of life were taken is rated by the geologists as millions of years old. Apparently the microbes have been in the coal ever since it was laid down. They are completely entombed and are all of one luminous type, giving off a soft glow like fireflies. To have withstood the enormous pressure of overlying rock and soil and to have endured for so many thousands of centuries without free oxygen, is a demonstration of what life can survive.

An interesting experiment would be to submit these microbes to the influence of short-wave radiation—to see what this new tool of science may do to the oldest living creatures on our planet.



*Emb. Robert Boyd, Wis
Lake Geneva, Wis*

Mail Box Like House with Electric Lights Which Serves as Marker for an Estate at Night

RURAL MAIL BOX WITH LIGHTS IS MARKER FOR GUESTS

Although there are no night deliveries, an ornate mail box equipped with electric lights stands at the entrance of an estate in Wisconsin. The box is constructed like a small house and is surrounded by a tiny fence, the receptacle and the grounds having been made to conform to the architecture of buildings on the estate. In the daytime the little house serves merely to receive mail, but at night the lamps are turned on to mark the entrance for guests, the name "Green Gables" appearing in lights at the top of the building.

*Lake Geneva
Wrigley*

FASTEST TURBINE BLADES SPIN THIRTEEN MILES A MINUTE

Traveling faster than anything in the nature of machinery or vehicle except a bullet, the blades of a giant turbo-generator whirl thirteen and one-half miles a minute, or 810 miles an hour, in providing electrical power for New Jersey. The machine weighs more than thirty tons, and the rotor holding the turbine blades attains 3,600 revolutions per minute, which is claimed to be a record speed for heavy machinery.

B1081

Emb. Vehicle

*For Carlin
Service Co*

*Manufactured by Westinghouse
Electric & Mfg Co, Pittsburg
Copyrighted material
PC*

New Haven, Conn B1213 Miller
Cereal Melts
1533 S 22nd
St. Omaha
Nebr.

POPULAR MECHANICS

DISEASES TRAVEL THROUGH AIR AT AMAZING SPEED *B1230*

Science Service 7/11/32

Diseases travel through the air at what is considered an unusual speed, thirty-five feet in five minutes. It has been known for a long time that microorganisms are carried about on droplets of moisture, but Dr. Merl G. Colvin, of Yale medical school, has found that at least one group of contagious diseases can travel independently. Contrary to the general belief, these diseases move fast, that is, fast for microorganisms so small that the common microscope does not show them. In addition to measuring the speed, Doctor Colvin found that the germs remained in the dust of his room for eighteen days. After a thorough sweeping and mopping, he discovered that there were more germs in the air than before. Since viruses are hard to handle in the laboratory, Doctor Colvin substituted bacteriophages, about the same size. The group studied includes measles and chicken pox, both of which are known as virus diseases.



Movie "Snow" Emerging from the Spout in a Cereal Mill; It Is Made of Ground Corn

MOVIE SNOW IS MADE OF CORN AND SHIPPED TO STUDIOS

Midwest farmers grow the snowstorms that are seen in the movies. This movie "snow" is made of corn and prepared to simulate snowflakes at a cereal mill in Omaha, where belts, wheels, presses and knives cut the kernels into flakes, after which the corn is packed in burlap sacks and sent to Hollywood. It takes three carloads of corn to produce a first-class storm, and the snow costs about \$4 per hundred pounds.

AIR LOG RECORDS FLYING TIME AS CHECK ON PLANE *B1103*

Automatically recording flying time, an air log has been produced to meter flying charges, to prevent unauthorized use of airplanes, and to check on maintenance and overhaul routine. The log is controlled by air pressure from the air-speed indicator and functions only when the speed of the plane is sufficient to support it in the air. One indicator on the log's dial records the time flown since the last resetting, while another records the total flying time. The action of resetting the first indicator automatically rewinds the time-recording mechanism.

TRUNDLE SEAT FOR THE LAWN IS LIKE WHEELBARROW *B1217*

Made like an elongated wheelbarrow, a garden seat that is easily trundled about can be converted to a chaise-longue, arm-chair or settee simply by dropping or raising a side or end. At one end are handles, and at the other, the wheels for moving it about the yard. It is built of wood enam-



Garden Seat Resembling a Wheelbarrow That Can Be Trundled from One Position to Another

eled in green, and its padded cushions are shower-proof.

Lewis + Conger
45th St. and 6th Ave
New York City

Thornton Harris
Air Log Co., of Esodbold's
Ltd., 1. Clement Inn
London, W. C. 1. Eng

This Amazing Police Car Conquers



Ready for Any Emergency of a Great City, This Amazing Police Car's Crew Wages a Constant Battle against Death and Crime; Drawings Show Some of the Perilous Situations

All the Hidden Perils of Great City

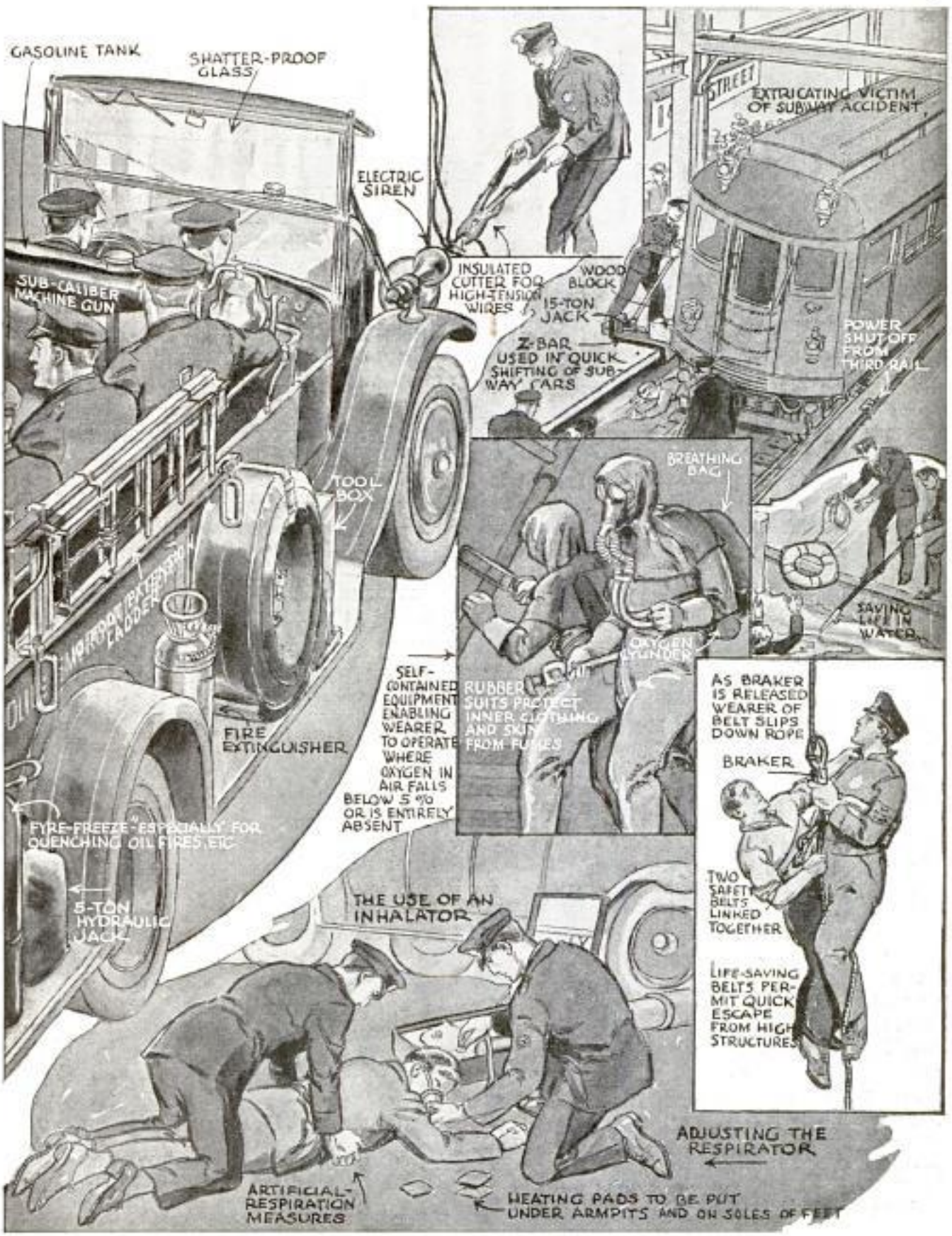

Every Known Life-Saving Device Is in the Latest Police Car's Equipment; First-Aid Kits, Ropes, Oxygen Bottles, Grappling Irons and Life Belts Are Used by the Seven-Man Crew

Chas. L. R. Hutchinson,
126 Clakwood Ave

400

POPULAR MECHANICS

New Clerics Bldg, 116
Hanover Square,
London, W!

GROCERIES DISPENSED BY TUBE
TO SPEED UP HANDLING

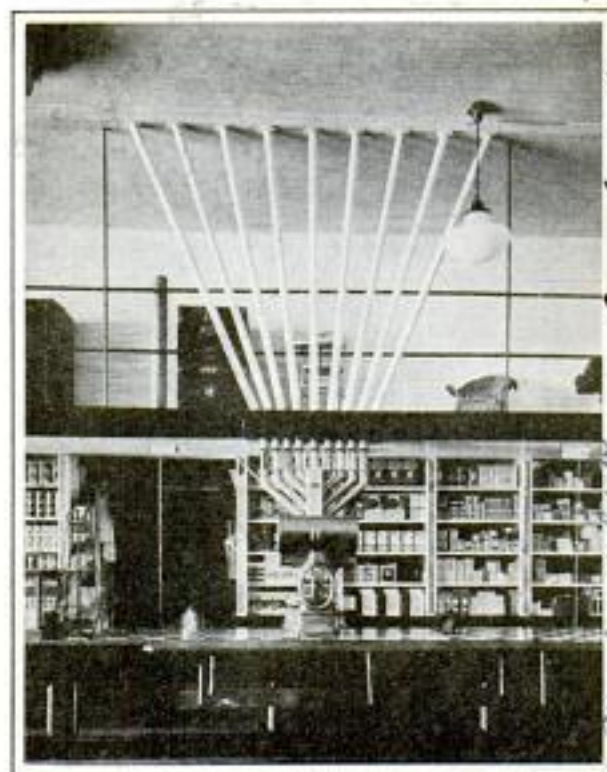

This Tube System Releases Any One of Several Varieties of Bulk Groceries into Bag on Scales

Loose groceries can be handled faster and in a more sanitary manner by a tube dispensing system that also serves as a display device. The apparatus consists of covered bins that hold 300 pounds each, metal tubing from the bins to the dispenser and heavy glass display tubes just above the valves that release the groceries into bags or other containers. Located just above the grocer's scales, the dispenser spout can be raised or lowered to reach any size bag. When the correct weight has poured into the bag on the scales, a valve is closed, stopping the flow as simply as drawing a glass of water from the cooler. The device is adapted to rice, ground or whole-bean coffee, peas, beans, chick feed, and similar wares that ordinarily are handled by scoop. The bins can be placed on the floor above the store, to give more space, with only the tubes extending to the proximity of the scales.

GAS RIDES GOLF GREEN OF ANTS

Ants are being exterminated from golf greens with poison gas. This gas, which does not injure the grass, has been tested

by the experimental farms system of the Canadian Government, and is formed by releasing liquid carbon bisulphide, which turns into a heavy vapor. One method of application is to place a small quantity of bisulphide on each anthill. A wet sack about a foot square, left over the hill after it has been treated, will hold the gas in the soil and make the destructive effect more thorough. The gas is highly inflammable

WINDSHIELD CHANGES COLOR
AT PRESS OF LEVER

Colored fluid flowing between a double glass windshield protects the driver from glare of approaching automobile lights. A small pump containing the fluid forces the glass plates apart, flooding the windshield with a color that reduces glare. When pressure is released, the pump sucks the fluid back into the reservoir, leaving the windshield clear. The fluid can be produced in any color, and the arrangement can be adapted to headlamps to produce a fog-penetrating light, to shop windows for protection of delicate fabrics, and to many other uses.

CHILD'S PORTABLE PLAY YARD
QUICKLY ERECTED

Taken down, moved to another spot and erected again in a short time, a play yard has been devised for the protection of young children. Special clips hold the corners together, while legs on the sections are pushed into the ground to give stability. The play inclosure has a gate. Erection of the yard requires only fifteen minutes.



This Pen for Protection of Children at Play Can Be Moved around Easily in the Yard

Cmt. James Montagues
608 Harbor Commission Bldg.
Toronto 2, Ont. Canada

Prof. J. S. W. E. R. E.
W. J. S. W. E. R. E.
308 Terrace
Buffalo, N.Y.

grad pens

England

B/119

no resident Chicago

no resident Chicago

152

B/120.

small. 715.00 with trailer
POPULAR MECHANICS 401
665.00 without trailer

Gas Motor Helps Gold Miner in New "Rush"

mine & motor supply Co 1422-17 St. Denver, Colo

Gasoline motors are helping thousands of men make a living in the gold fields of the west by turning machines for separating precious flakes from the sands of "diggings" that have been worked before. While few expect a fortune, many hope to wash a daily wage from the streams and gulches in the vicinity of old-time camps. The small motor pumps water, relieving the miner of bailing with a tomato can at



Amray Centrifugal Gold Separator Co. 1344-12 St. Denver, Colo



Instead of Bailing with Can, as in Bottom Photo, Prospectors Now Use Gasoline Motor in Placer Mining

er engine also is seen in the gold fields. Since the water for washing the gold-bearing sand can be used over and over, the panner is adapted to semi-arid regions. The machine can be packed in its water tank, all except the motor, and may be carried in the back seat of an auto. Another mining device operated by gasoline motor is a one-man separator that works like a cream separator, whirling the sands in a bowl provided with riffles that catch the gold flakes. This device can be transported on a two-wheel

the end of a broom handle. A mechanical panner, operated by a one-half-horsepower

trailer. One gallon of gasoline runs the separator six to eight hours.

OCEAN TO YIELD MORE POWER BY REMOVAL OF GASES

By adding a water-gas remover to his equipment for taking power from the sea, Prof. Georges Claude believes he will be able to increase the output. Before this

improvement, the greater part of the energy taken from the ocean was consumed in extracting the gas. Professor Claude not long ago succeeded in sinking a mile-long tube in Matanzas bay, by which power to light forty electric bulbs of 500 candlepower each has been produced.

see Dec. 1930-881
Sep. 1930-448

Arba.

New York Times 6/6/32

001005 Cont. Emile C. Schurmacher.
228 69 St. New York

How Skillful are You



Skill Comes with Practice. So It Is Possible for a Person Who Knows How to Drive a Boat to Develop into a Race Pilot; Below, Simple Maze Puzzle for Children

ARE you skillful with your hands or are your fingers all thumbs, thus causing you to forgo employment or many hobbies that require skill? Just how skillful are you?

Scientists now say that if you are an average human being with normal intelligence, you can develop your latent or "sleeping" skill to do such widely diversified things as playing the piano, riding an aquaplane, making a chair or cabinet, darning socks and making a card or a coin disappear.

You can do all of these things, and many more if you wish, in spite of the fact that in music alone, according to the findings of one scientist, Prof. Carl E. Seashore, of Iowa, you may be employing as many as thirty or more talents, all of which may have only an accidental connection with one another.

Good mechanics, eminent surgeons, and other professional men, are admired for their skill which many believe was born in them. However, this and many other common beliefs that prevent young men and women from taking up certain lines of endeavor, have been disproved.

The hand is not quicker than the eye.



A good magician does not need a "spiel" or patter. Card sharpers and gamblers do not need long tapering fingers and poker faces. A skillful surgeon or dentist may have clumsy-looking hands. You do not have to be a born musician. Practice doesn't necessarily make perfect. And the

-and Why?

fact that your father and grandfather were good farmers or painters doesn't necessarily mean that you can become a good farmer or artist any more than the belief is correct that a preacher's son will become a black sheep or that a woman is less mechanical than a man.

These are but some of the things that scientists have been finding out lately as they are focusing their attention on the human body as a machine whose production can be improved upon. Many novel instruments for this study have been devised so that certain actions and reactions may be charted and greater efficiency obtained.

Even the butter-fingered man is now coming in for his share of attention. Prof. Alexander Forbes, of the Harvard medical school, has shown that this man may have nerves that act quicker than his who is skilled. In experimenting, he discovered that a cat stepping on a thorn with its hind foot would jerk that paw away three or four-thousandths of a second before the nerves carried the sensation of pain to the brain. In human beings he found that quick-acting nerve reflex performs likewise, and that the quickness of this reflex in various people is independent of the skill of their hands.

Nerve orders to hands and arms have actually been photographed by Dr. D. W. Bronk, of the University of Pennsylvania,

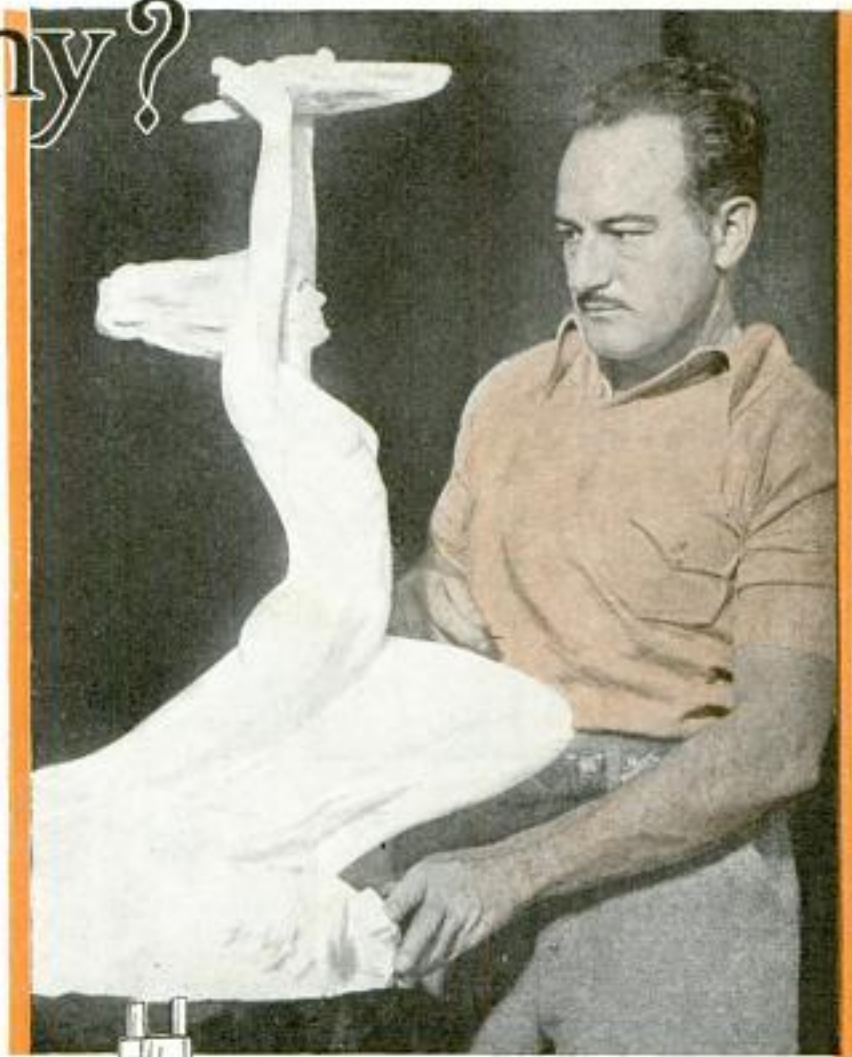

MCClelland Barclay, Painter, Makes Sculpture His Hobby; Skill in One Art Makes for Latent Ability in Another Which Can Be Developed

Cambridge Mass



who recently took pictures electrically, showing nerves transmitting a man's will to keep his nerves tensed, the nerve orders arriving in jerks at the rate of twelve to a second.

The correct training in any field of endeavor requiring skill is largely the reason why you can become skillful in that line, but the training must be correct, for, no matter how much you practice, if you practice the wrong thing with a view of improving yourself, you may make it all the harder to get on the right path.

One of the world's greatest psychologists, Prof. Harry L. Hollingsworth, of Barnard, has made the statement that "any average human may acquire average skill in such diversified fields as carpentry, piano playing, needlework and aquaplaning." Besides that, with special

Phila.

New York City

10/005



in their hands the principal requirements. "The boy who fools around with wood-working tools when young," says Mr. Brill, "is very likely to become a skilled carpenter or cabinetmaker later on. At the same time, if he is clever with his hands, he will likely make a success of any skilled trade, the skill he develops in one line being applicable in another when supplemented by the required knowledge."

There are, of course, several industries and hobbies where the skill developed has to be supplemented by bodily structure, lack of fear and other mental traits. A man who can go through all of the motions of flying perfectly on the ground may, on finding himself alone in the

practice, a man engaged in one trade or profession will readily acquire skill in another. A dentist, for example, may become a painter, a sculptor or a cabinetmaker, the skill developed in his hands being readily adaptable to other things.



No greater skill in the hands is demanded than that necessary for a good magician even in such apparently simple tricks as palming a card or making a coin disappear. One of the most skillful magicians of the present day, Julien J. Proskauer, trustee of parent assembly number one of the Society of American Magicians, a member of the International Brotherhood of Magicians, of the Syndicat International des Artistes Prestidigitateurs, of Paris, and a magician of many years' standing, says: "The average person, with practice may become a magician and a good one."



Vanishing Coin; Top, Preparing to Start the Trick; Center, Note Size of Hand and Amount of Movement on Ruler; Bottom, Back of Hand After Coin Disappears

Harry V. Brill, superintendent of the New York Trade School who, for thirty-five years has been observing young men of seventeen years of age and upward take up such skilled trades as carpentry, cabinetwork, electrical work, sign painting, tin working and bricklaying, found that a great many of them succeeded, with a public-school education and a sleeping skill

air in a glider, suddenly become frightened and not be able to fly. The same thing is true with a skilled painter who suddenly must undertake a job on the upper stories of a building wall, and many other similar incidents. That is one reason why many tests for flying cadets have been discarded along with aptitude tests in many other lines where skill is required with bodily risk.

Bodily structure—the ability to stand fatigue, exposure, strain, etc., must also be reckoned with. Prof. John B. Morgan, of Northwestern University, recently invented a very ingenious device—a mechanical "sandman" that reproduced a humlike noise similar to that made by whirring

212 E 67th St, New York

Ewanston. C.H.



machinery which hits the ears of many engaged in such skilled trades as woodworking and other industries.

The machine, made of electrical measuring devices

with a phonograph attachment to produce the hum, was tried on a girl, an electrode being strapped to her wrist to register nerve activity, a bulb was placed



in her hand to record pulse and blood pressure, and breathing was also measured. The dials showed her foot going to sleep as well as her entire body.

This mechanical sandman thus is a means of registering how greatly the hum of machinery impairs the efficiency of skilled workers.

Have you taken stock of your own "live" skill as yet to see how clever your hands are? Can you, for example, tie a bow tie correctly, shave with a barber's razor without cutting yourself, wash a window so it won't have "art work," and neatly press your trousers? These are all simple examples of skill that has been acquired more or less consciously with practice from youth. By as diligently practicing other things, your cleverness with your hands and the extent of your sleeping skill will give you a pleasant surprise.



Disappearing Card; Left, Top to Bottom. First Movement; Bending Fingers; Twisting to Flip; Back of Hand After Card "Vanishes"; Above, the Magician

Henry Dreyfuss, one of the art directors of Radio City, and a stage designer as well as consulting engineer at the age of twenty-seven, is making an enormous income. His bent was fixed before he was six years old when he used carrots to design ornaments for women's hats. Helen Wills Moody, the well-known young tennis player, acquired skill in pen-and-ink sketching to such a degree that she held an exhibition. McClelland Barclay, the well-known painter, found that his skill could be applied to sculpture. Julien J. Proskauer, as an army aviator, found that the sureness of his hands at the controls aided him in prestidigitation when he started to practice magic.

These are but a few examples of transference and development of sleeping skill, a subject which science is now investigating with a great deal of interest.

Is there some sport, business or hobby which you would like to engage in? May be your sleeping skill can be developed in that line. There is latent skill in every normal person. And you don't know how skillful you really are in anything until you try.

Trustee, Parent Assembly
No. 1, Society America
Magicians

B3 1117

Leeble Motors Ltd
212 Pacific Southwest Bldg
Long Beach Calif

406

POPULAR MECHANICS

Amazing Airplane Motor Doubles the Power

Here Is Plane in Which Double-Action Engine Was Tested Successfully, Producing Ninety Per Cent More Power Than Ordinary Motors; at Right, Phantom View of Construction Details



entirely separated, it is necessary to use dual ignition, dual carburetors and dual manifolds. Smoothness of power, lack of vibration and speed of acceleration are features of the power plant, which does not differ from other six-in-line inverted air-cooled motors with the exception that the cylinders appear to be slightly longer and look like two sets of short

and Gray Leeble.

By applying the double-action principle of steam engines to an airplane motor, the power has been increased ninety-two per cent without added weight. The new motor really does the work of two, its six cylinders driving the plane 130 miles an hour at 1,500 revolutions and 160-miles-an-hour top speed at 1,850. Each cylinder fires at both ends, the primary explosion of fuel forcing the piston downward, as in other motors, and the secondary explosion forcing it upward. This second explosion occurs within the piston, by means of a slot that admits fuel, and the arrangement is such that no exhaust gases can escape to the firing chamber above the piston. Since the two firing chambers are

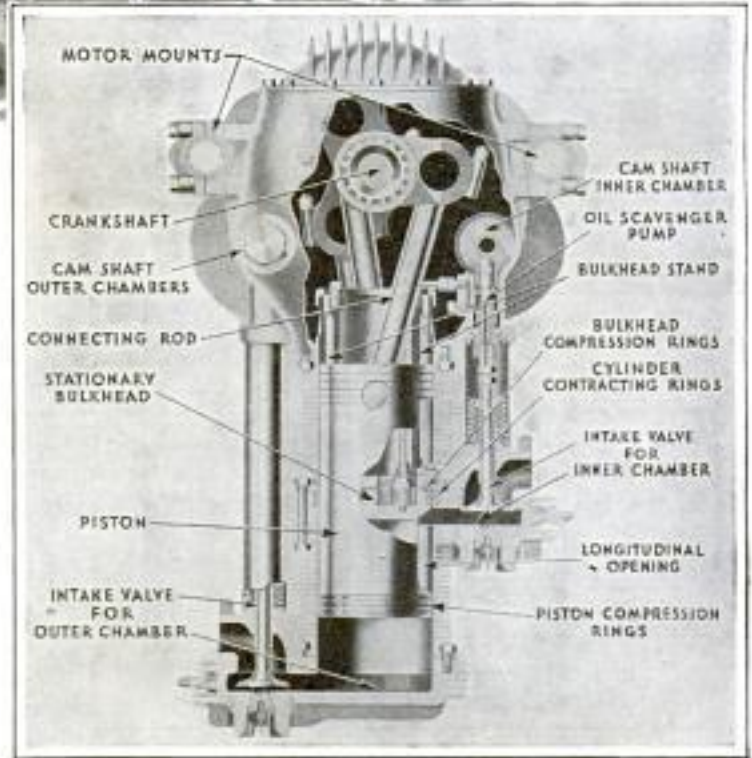

ones. Fuel consumption in tests has been about the same as for similar engines.

CEMENT GRAINS "FLOAT" ON AIR FOR GRADING BY SIZE

Floating on air, cement grains are graded by size in a separator that is regarded

as more accurate than the common sieve arrangement. To meet specifications, seventy-eight per cent of cement must pass through a sieve having 40,000 holes to the square inch. The largest cement particle

B1127

Built in laboratory of Portland Cement Association
33 W. Grand Ave Chicago

Raymond Wilson, Conservation
 Engineer, Portland Cement Association
 33 W. LaSalle Ave Chicago

407

B1130

that can pass this test is about 100 microns (.004 inch) in diameter. Under the new grading system, a small quantity of cement is placed in a tall cylinder with a cone-shaped base into which air is pumped. Air, rising one-half foot a minute, carries off only those cement particles below five microns in size. These are collected in an air filter. As the speed of the air is increased, larger particles are lifted, so that adjustment will result in accurate separation. To check the accuracy, particles are placed on a glass slide and projected on a screen by an apparatus that magnifies 1,000 times. Measurements are taken from the screen.



Acme

This Improved "Lung" Helped Stop an Epidemic of Colds in Monkey Cages; One of the Patients Is Shown under Treatment

RIVET-BOLT FOR STEEL WORK STOPS NOISE

Riveting noises in structural-steel work can practically be eliminated by a rivet-bolt that is driven with a hand hammer and fastened with a nut. It needs no heating, and since it is driven in cold, there is no shrinkage, resulting in a tight fit. Regardless of vibration, the lock thread holds the bolt tight, but when the time comes for dismantling the structure, it may be loosened easily with a wrench without damage to the steel work. The bolt has a standard rivet head, a body ribbed as far as the thickness of the steel plates and the usual threads for screwing on the nut.

also at Detroit and Cleveland

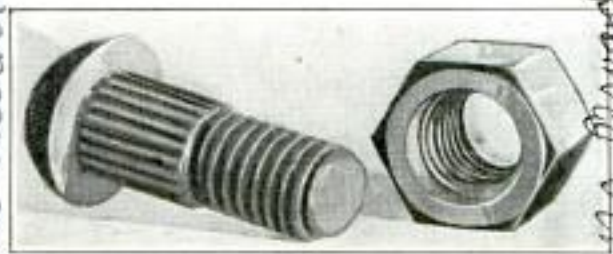

Rivet Is Driven In by Hand and Made Fast with Nut; No Heating Is Necessary

MECHANICAL LUNG SAVES APES IN EPIDEMIC OF COLDS

When an epidemic of colds developed in the monkey house at a New York zoo, a mechanical "lung" was constructed to save the apes. The lung consists of a large boxlike compartment in which the ape is placed. Outside, a kettle containing a pine solution is kept at boiling point. Vapor from the kettle flows into the cage through a tube, so that the animal's cold is treated with every breath. Monkeys are highly susceptible to colds, and great care is required to prevent fatal results.

Under direction of Mr. Charles V. Trobach, Chief Veterinarian

LENSES OF PLASTIC MATERIAL USED IN FLASHLIGHTS

Replacing glass, a new plastic material has been used successfully for flashlight lenses. The material is a solution of formaldehyde. Its main use is for clock casings and similar articles, and it can be made in a variety of colors.

cannot locate maker

Farnica P. Co. 4614 Spring Grove Ave. Cincinnati, Ohio

Hayden Threadlock Corp. 205 Wacker Drive Chicago

B1097

no heating necessary

B1048

Chas. G. Sprigg, 56 Fleet St. London E.C. 5

ROLLING STAIRS KEEP OFFICE OPEN DURING MOVING



This Stairway on Wheels Rolled Along as Building Was Moved, Avoiding Interruption of Business

Wheeled stairs helped to keep business going in a two-story building that moved several blocks in Boston. As the building moved, the staircase rolled along, providing access for employes and customers. A regular flight of stairs was built and made fast to the door, which was raised several feet above the street level during the moving operations. The lower end of the stairs was set on a pair of rubber-tired wheels. This plan also eliminated the necessity of reinforcing the stairs each time the building was moved a few inches, as well as avoiding the dangers of ladders. A telephone-installation expert provided uninterrupted service over six trunk lines, two private wires and ten inside stations as the building moved.

LIGHTS TELL TEMPERATURE OF HOME IN COLORS

B1136

If the temperature rises or drops too much in your home, a new electric thermometer will warn you by flashing colored lights or by going dark completely. The warning lights can be placed any distance from the thermometer. When the tem-

perature is within the limits at which the thermometer is set, a white light shows. If the temperature rises, a red light flashes, below normal, all lights go out.

FOLDING RAFT FOR AIRPLANES ELIMINATES CARRIER SHIP

Eliminating expensive carrier ships, folding raft for landing airplanes has been tested in the Mediterranean. It consists of a ramp and raft made of wood and canvas that can be unfolded and run out from the stern of warship or merchant vessel. The surface, as large as the deck of airplane carriers, is strong enough to withstand the landing shock of the heaviest plane in the British navy. The raft can be unfolded rapidly while the battleship or liner moves at full speed. Another suggested use for the raft is as a "folding aerodrome" for a ship-to-shore service of passenger and mail vessels.

B1101
developed by Fleet Air

Article, Day at Air Force, will send you much information

"BLIND" FLYING IS MADE SAFER BY GYRO HORIZON

B1084

"Blind" flying is made safer by an instrument called the gyro horizon. In addition to simulating the natural horizon, showing the plane's position longitudinally and laterally, the instrument gives the exact degree of a bank. This added feature results in more accurate banking and in keeping the plane level laterally when climbing or diving blind.

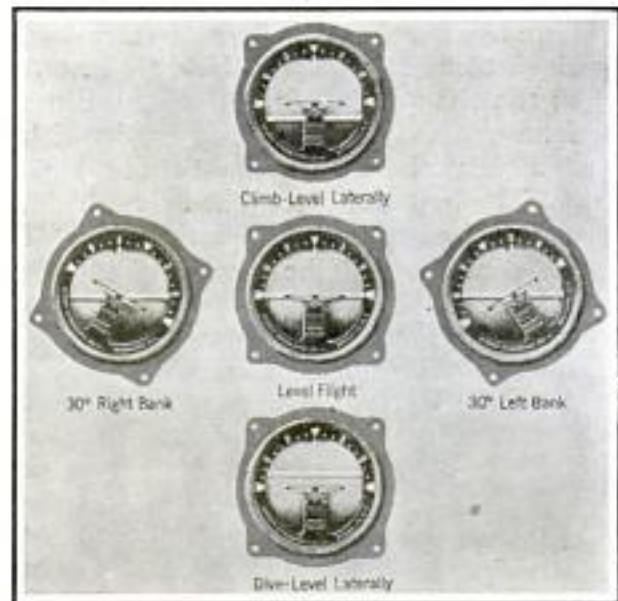

Flying at Night or in Fog Is Easier with This Instrument That Shows Level of Ship

The Hehling Instrument Sperry Gyroscope Co. Inc. 21 Vesper St. Paterson, N.J. Manhattan Bridge Plaza Brooklyn, N.Y.

Copyrighted material

Secrets of the Master Spies

By THOMAS M. JOHNSON

420 W. 116 St. New York

THE last day of the Hindu plotters' trial was ending. Spectators were leaving the San Francisco courtroom where they had heard the sensational story of a conspiracy to start a bloody revolution against the British in India.

A world-wide conspiracy, which involved hundreds, including the famous poet Tagore, Japanese statesmen and Chinese mandarins, Russian bolsheviks and American reds, in plans for an uprising in Tibet, bomb explosions in New York and California, and an armed expedition to India from our Pacific coast.

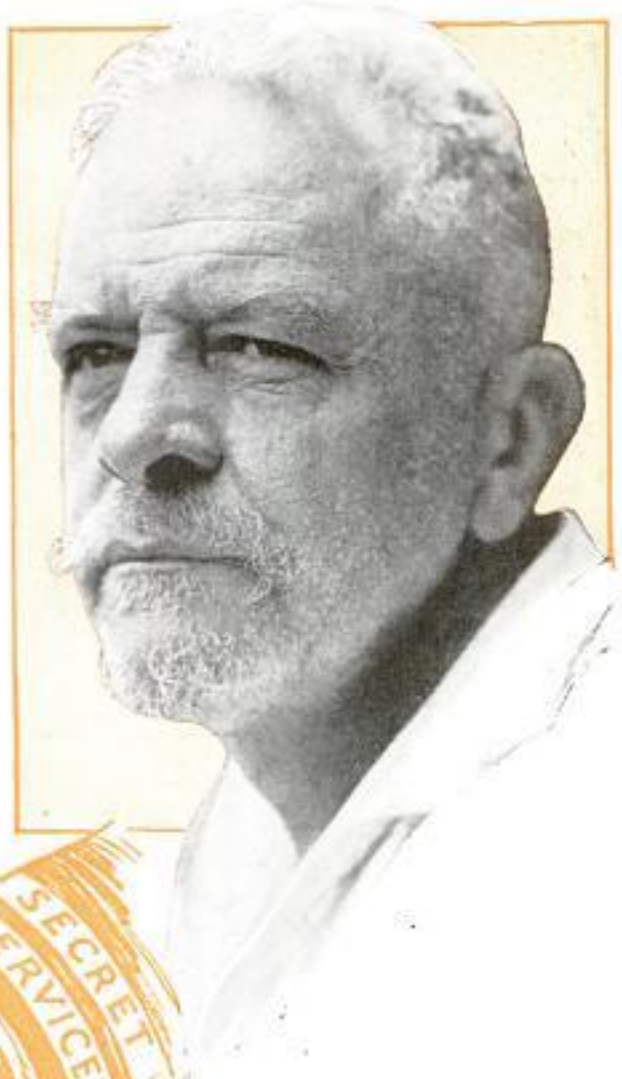

Colonel George Fabyan, in Whose Laboratory the Secret Messages of the Hindu Plotters Were Decoded



American and British secret services had thwarted the conspiracy, captured the conspirators, of whom thirty—some white-skinned, some dark—were on trial. One of their number, Dr. Chandra Chakravarty, caught in New York by Inspector Thomas J. Tunney, had recently confessed. Ram Chandra, best-known Hindu in America, had given testimony that enraged some of his fellow conspirators. One of these,

Ram Singh, now forced his way toward Ram Chandra, through the crowded courtroom.

Suddenly, the brown man's arm darted forward. There was a flash, a crash. Ram Chandra fell, clutching for support at the witness chair. Over him stood Ram Singh with a smoking pistol. But instantly, his triumphant smile turned to a hideous grimace. He spun about and fell beside his victim, his neck broken by a .45 bullet. A second shot had rung out, over the heads of the frightened throng, fired by Marshal James B. Holohan. Justice had been swift. Next day the twenty-eight surviving plotters were found guilty.

The prelude to those scenes was another, also startling and dramatic, that showed the amazing results of the work of that

B/1015

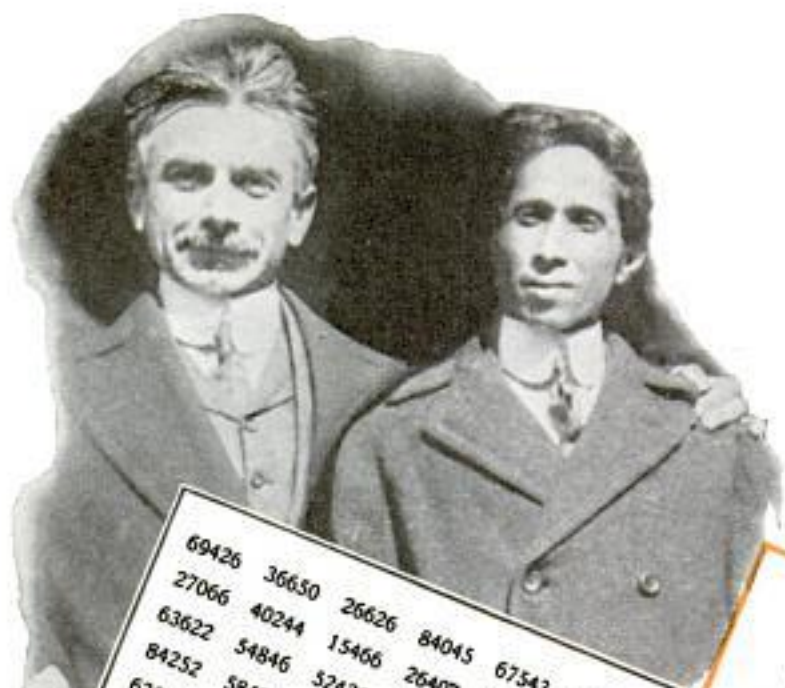

that he had solved that code without the dictionary.

Calmly Major Friedman showed messages that the Hindus had sent one another and the British mail censors had intercepted—rows and rows of figures, apparently meaningless, but he read off their meaning unhesitatingly. The dark prisoners started, wriggled uneasily, then glowered at one another. Had one of them sold out this secret? Or had the American used some eastern

69426	36650	26626	84045	67543	63857	66
27066	40244	15466	26407	95926	43664	04
63622	54846	52426	24947	52415	93637	41
84252	58474	76247	40374	15837	26606	77
63664	73843	68403	86154	56383	84761	53
75222	52475	93339	43363	84049	40455	24
55684	75926	59694	04662	47392	75766	40
35956	27425	43826	68545	92670	63622	74
61264	15961	32576	96022	53463	94251	57
56179	39425	36361	35536	36733	42684	63
74364	65843	47257	06362	58616	93746	41
22653	68505	53943	51266	24750	26436	63
37674	93353	49514	25347	69534	17447	41
54133	67476	13257	69602	25346	39425	15
1616	85948	61686	94263	53365	24166	46
166	26406	84633	61796	73241	59694	21
\$ 25856	45415	85638	41766	04737	61	
38476	16951	53375	96126	40545	22397	
26067	36384	04459	33414	86047	37684	
9612	75766	67323	76867	22536	84025	
151	49404	73759	69466	35869	42634	
4	62262	68404	54954	72		

"Your letter via Norway received. Regret you did not give names committee members. During tension between America and Germany we requested Foreign Office wire you fifteen thousand dollars. Do not know if this was paid you. Subsequently came telegram asking money. We wired five thousand dollars. Trust you have received this. When you want more money state exact sum wanted in dollars and brief statement for what wanted. Will get any sum you ask.

Chatterji."



Top, Dr. Ernst M. Sekunna and Dr. Chandra Chakravarty, Who Confessed Plotting against British; Below, Code Message and Translation

mysterious yet scientific detective, the code and cipher man, the cryptanalyst. Maj. William F. Friedman, now the leading American authority on secret writing, had sat in the same witness chair and testified that the Hindu plotters had corresponded with one another in a dictionary code that they believed unbreakable, but

trick? They vowed vengeance, Ram Singh muttering to himself.

There was neither treachery nor trick. Now for the first time can be told the story behind those tragic courtroom scenes, the true story of how Major Friedman solved the secret dictionary code, and not only without the dictionary, but without even

3932 Military Road
Washington, D.C.

Relative Frequency of English Speech Sounds - Harvard Press 1923

knowing what dictionary the Hindus had used. He followed a rule of cryptanalysis that may be simply stated: Some words are more popular than others.

That is the mystic key that opened to him the hidden places of the Hindus' plotting. That mystic key means simply, that if a man sits down to write a letter, a telegram, a message, anything, there are some words that he is more likely to use than others. There are 400,000 words in the dictionary, but close, painstaking study has shown which of those words, and even letters, are most popular, most used in written English, and even the relative frequency with which they are used. The results of this study have been charted, put on paper as "frequency tables." By carefully checking the words, letters, even the mysterious hieroglyphics of code and cipher messages, against these frequency tables, their hidden meaning has many times been interpreted.

Only recently, a new and powerful weapon was placed in the hands

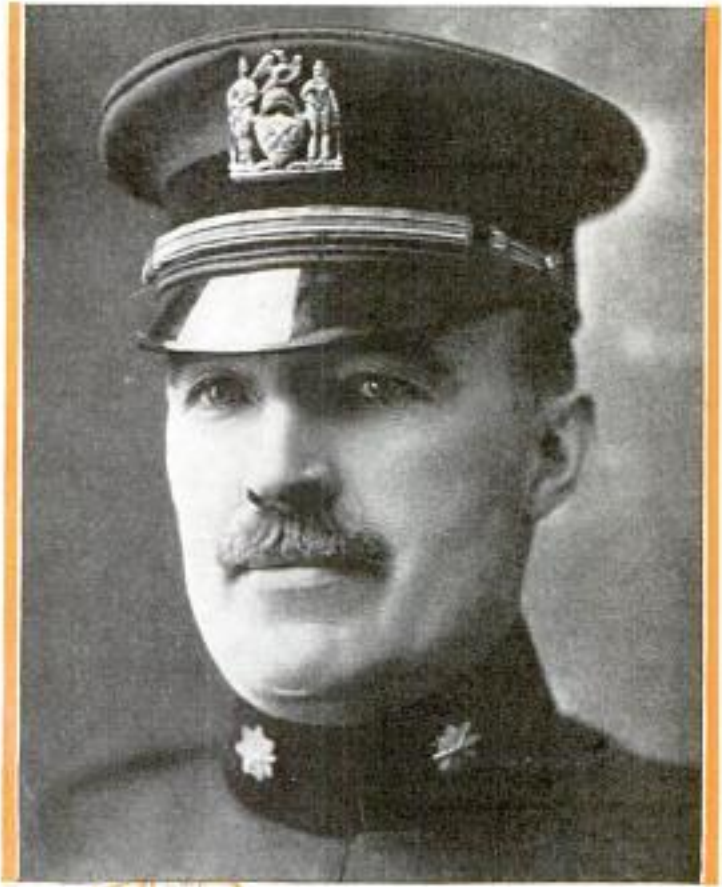

Inspector Thomas J. Tunney Helped Break Up Plot; Left, Drawing of Trial during Which Two Conspirators Were Shot

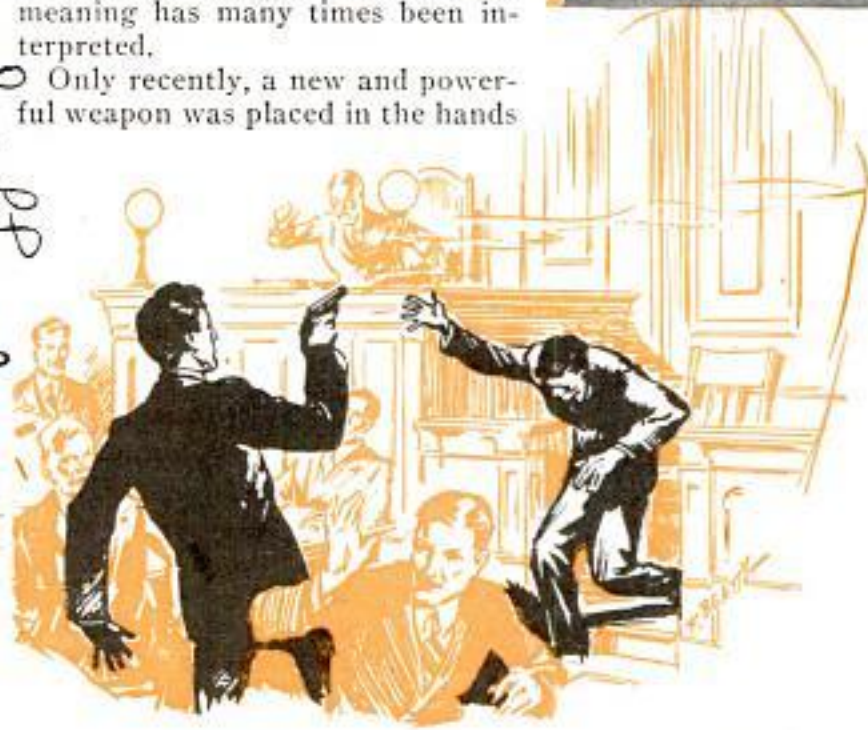

and 1,000 made up 78,336 of the 100,000 words.

He found, too, that the ten words most used were, in order of frequency: THE, OF, AND, TO, A, IN, THAT, IT, IS and I.

The relative frequencies of letters of the alphabet in different languages and in different classes of correspondence, have been studied by cryptologists for years. Col. Parker Hitt says that Americans use letters in this order: E, T, A, O, N,

I, S, H, R, D, L, C, U, F, M, P, W, G, Y, B, V, K, X, Q, J, Z.

Then there are common pairs of letters, like ER and RE, and common word endings, like ING, ENT and TION.

So although, to you and me, most code or cipher messages may appear like a blank door, the cryptanalyst holds a key

of code and cipher experts when Prof. Godfrey Dewey counted, listed and analyzed all the 100,000 words in a rather long book. He found there were 10,161 different words. He also found that:

10 words made up 26,677 of the 100,000 words;

100 made up 54,303 of the 100,000 words,

Faculty of Harvard University
Cambridge, Mass

that he is quick to try to fit into the hole afforded by the words and letters listed first in the frequency tables, or upon the word STOP that people like to put into telegrams. That was the key Major Friedman used, one day in the stirring year 1917, when he was director of the cipher department of the Riverbank laboratory, at Geneva, Ill., headed by Col. George Fabyan. It was a war-time secret, but that laboratory did some very delicate work for the United States government. It solved the secret messages, whether in invisible inks or simply in codes and ciphers, that fell into the hands of various branches of the secret service, showing the work of hostile plotters within our borders. This was Colonel Fabyan's important contribution to the national defense. When he received the first of the Hindu messages, he turned it over to Major Friedman.

"What can you make of this?" he asked.

It was a long sheet of paper, filled with nothing but numbers, long rows and columns of numbers, arranged in short groups. Major Friedman studied them, then pointed out three consecutive groups that were typical: 78-2-46; 35-1-17; 122-1-52.

"There are two clues," he said. "In each of the three groups, the second and central figure is always a one or a two; the groups are of three numbers. Both clues indicate a dictionary code, by which people having the same dictionary communicate by writing groups of numbers, giving that word's exact location in the dictionary. So, the first number is usually the page, the last, the word itself. A second number means the dictionary page is divided into columns, and as here the second number is always one or two, our Hindus

used a two-column dictionary—but there are hundreds, thousands of those. Let's read the message first, then find what book was used."

"It wasn't so hard as it sounds," Major Friedman explained afterward, "thanks to



Zimmerman, German Minister of Foreign Affairs, Who Was Accused of Fomenting Hindu Uprising

the principle of frequency. Since each number group meant a word, we recognized favorite words by frequent recurrence of the same number groups, and by the relative positions of the various number groups in the whole sequence of groups. For example, in any dictionary, AND comes before THE, so the code group for AND will be smaller than for THE, but the group for YOU, at the back of the dictionary, will be larger. We can even block off a dictionary into twenty-six sections, corresponding to the number of words begin-

ning with each different letter of the alphabet. Andre Langie has discovered that, in Webster, words beginning with A form 6.43 per cent; words beginning with B, 5.35 per cent; words beginning with C, 9.82 per cent, and so forth.

"Now, suppose that in a cipher message, the numbers extend from 1 to 100," Major Friedman continued. "Then, following the above scheme, a number between 1 and 6 will represent a word beginning with A; a number between 7 and 12 will represent a word beginning with B, and so on to Z on page 100 and a few preceding."

Then began a process of thrilling interest—the search for the first weak spot in the plotters' armor, common words like THE, OF, AND, STOP, betrayed by the position and frequency of number groups occurring over and over again. Triumphant the cryptanalysts got the first break—99-2-14 means YOU, which is on

11/42 Cont. H. W. Johnson,
152 Esrove Road

POPULAR MECHANICS

413

London, S. W. 12, England.

FIVE TONS OF SOOT PER MILE
FALL YEARLY IN LONDON

page 99, column 2, fourteenth word, of the dictionary the Hindus used. And now here is 99-2-17. Must be a different word, but only a few beyond YOU and in the same page and column. The searchers feverishly consulted several dictionaries, and found the only words between YOU and YOUR are YOUNG, YOUTH, etc. So the second discovery, 99-2-17, is probably YOUR.

One discovery led to another, as following patiently, relentlessly the principles of frequency, the Riverbank staff under Major Friedman worked out the message. It began: 78-2-46—35-1-17—122-1-52, meaning COME AT ONCE.

They had solved a message in a dictionary code, not only without a copy of the dictionary used, but without knowing what dictionary it had been!

By such work, Major Friedman helped British and American secret service break up a dangerous plot and convict many of the plotters.

B68 7

CAMERA HUNTERS IN AN AUTO
"CATCH" ZEBRA IN ACTION

Making moving pictures of wild zebras in action presented unusual difficulties to a recent expedition in west Africa because of the great speed of these animals. A remarkable series of action photographs finally was obtained by using two autos. The camera was set up in one, while the other chased the animals bringing them within range of the movie apparatus.

Angola, Portuguese East Africa



Making Moving Pictures of a Wild Zebra from a Speeding Automobile After Another Car Had Chased Animal into Camera's Range

U. U.



Observer Removing One Month's Catch from Soot-and-Dust Gauge in London

Dust and soot from London's air is trapped by a funnel-shaped device and dropped into a bottle for chemical analysis and measuring. The gauges have aided in determining that five tons of soot fall over each square mile of the London area every year. Dry or mixed with rain, the dust can be measured accurately by placing the gauges at a number of observation points.

FLYING BOAT TWICE "DO-X" SIZE
TO CARRY FORTY TONS

B1107

Designed to have a loaded weight twice that of the German "Do-X," the world's largest flying boat is under construction in Holland. A payload of forty-two tons will be the craft's capacity. Ten engines of 1,000 horsepower each will drive the boat at 130 miles per hour, turning three air screws through an arrangement of shafts. So large are the dimensions of the hull that work will be done at a shipyard instead of in the airplane builders' shops.

Koolhoven Aircraft Works
Rotterdam, Holland.

03705

Am. Herbert Klein, Jr
Associated Press
Post Tribune Bldg
Jefferson City, Mo.

Hollywood Riviera glider course



Glider Pilot Demonstrating His Skill at Bursting a Balloon with a Lance after Swooping Down on the Target

GLIDER PILOTS STAB BALLOONS TO SHOW THEIR SKILL

Glider pilots in California recently engaged in a balloon-bursting contest to demonstrate their skill in handling their craft. Each flyer glided down a mile-long course aiming at a balloon attached to the end of a lofty support. As he passed the target, he attempted to stab the balloon with a lance in the manner of the jousting knights of old. The sport was introduced as part of the qualifying work in selecting a team to represent this country against foreign gliders in a meet planned by the American Glider association.

SACRIFICIAL MOUND OF INDIANS YIELDS VICTIMS' BONES

That the ancient Indians practiced human sacrifice has been proved by the finding of four skeletons in a Missouri mound. A seven-by-nine-foot pit was found, with the bones at the bottom. The bones, all small, are believed to indicate that the vic-

near Arrow Rock

tims were women, perhaps offered as a sacrifice to the fire god, whom the early Indians worshipped. Boulders, so heavy that each taxed the strength of four men to move, were in such a position that they probably were used to pin the living sacrifices to the floor of the pit. The rocks had been burned red by intense heat. Charcoal in the burial mound was that from oak wood. Backs of the victims' skulls were not burned, indicating that they were laid face up. Construction of the sacrificial vault shows that the Indians knew the principle of the arch. Rocks used to build the walls and roof were so well fitted that only cement was lacking for perfect construction.

SPLITTING OF OIL DROPS TO SAVE FUEL

Globules of furnace oil, no larger than match heads, have been broken into 100,000,000 particles by a process recently developed by engineers of the General Electric company, which promises great fuel economy. The achievement is the result of five years of study which ended in the staging of an elemental "battle" between oil and air under pressure. They are then brought into a collision which causes a fine atomization, so that the tiny particles are more readily converted into a gaseous hydrocarbon which burns more completely than fuel oil heretofore used.

CIGARET HOLDER FOR AUTOS ACTS AS HUMIDOR

Keeping cigars fresh, a combined container, dispenser, humidifier and ash tray has been designed for automobiles. The capacity is twenty cigars, which are dispensed by touching the bottom of the container.

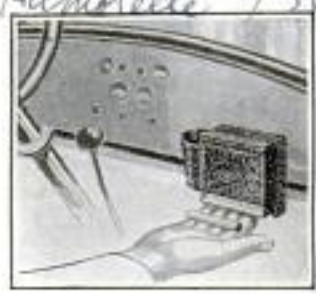

Marden Mfg Co.
11-15 Main St. N. E.
Minneapolis, Minn

arranged at Wisconsin of. will be
him. engineering

W. J. James 6/17/32

Wide World

101089

Protecting the Modern Liner from Fire at Sea

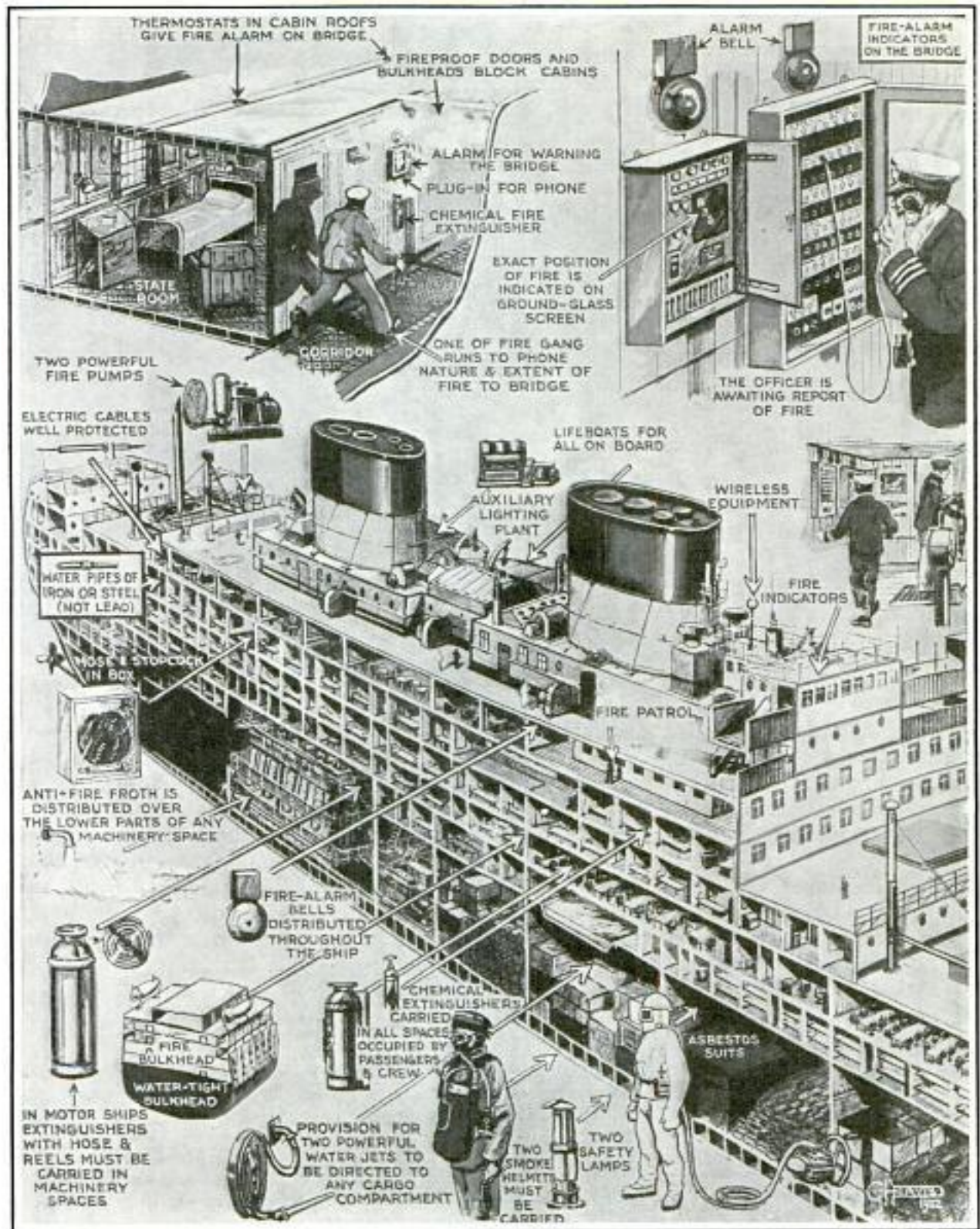

Courtesy The Illustrated London News

MODERN ocean liners are equipped with fire-fighting systems as complete as that of any up-to-date city. Here are shown the protective appliances on one British vessel, including thermostats

in each cabin to give automatic warning to the officer on the bridge. One of the crew investigates the fire and reports back to the officer who can call the fire patrol or ring alarm bells throughout the ship.

Precautions required by Board of Trade London, England

Copyrighted material

031056

Experiment conducted by the
I. S. Farben (German dye
Trust) at their new works

Autos to Wear Gas Masks in "Odorless City" in Cranienburg

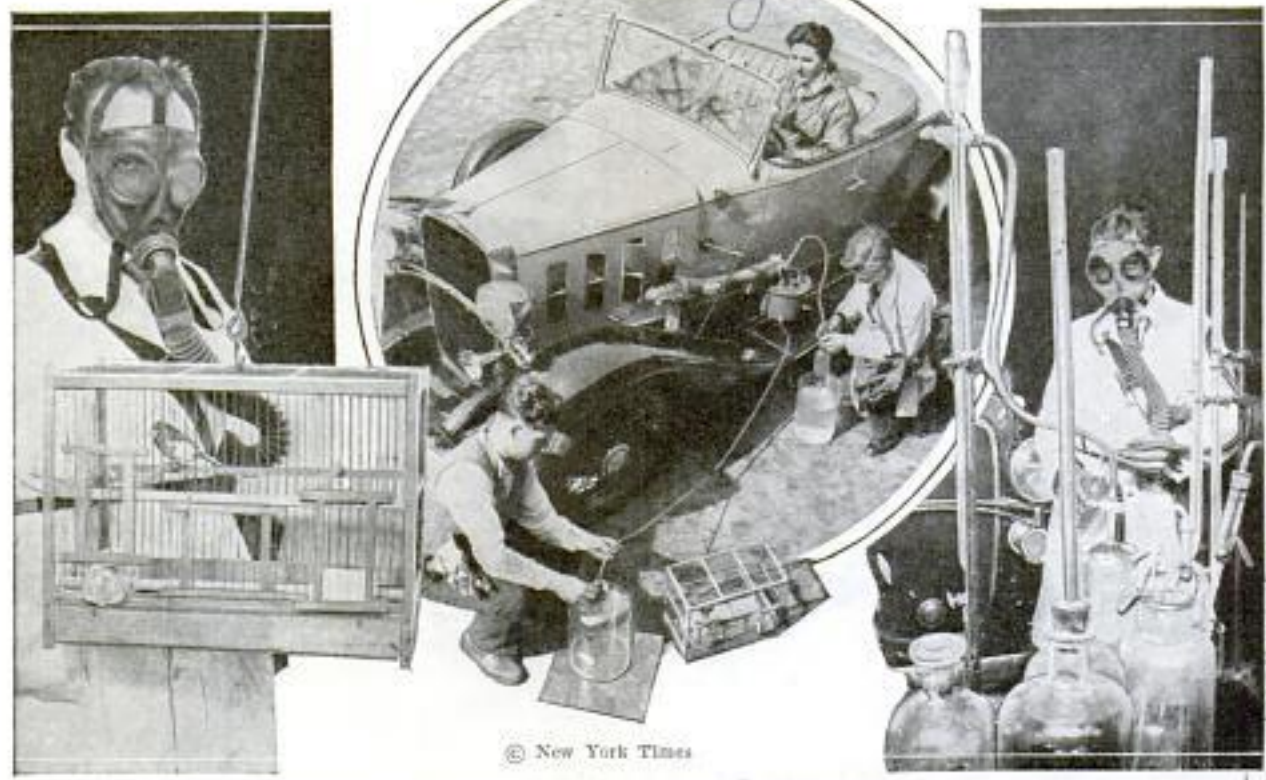

© New York Times

Left, the Canary, Little Martyr of Gas Experiments, Is Used in Testing Exhaust from Auto; Center, Apparatus for Purifying Exhaust Gases; Right, Experimenter Wears Gas Mask in Fight to Cleanse City's Air

In the "odorless city" of the future, automobiles will wear gas masks. Poisonous and disagreeable fumes from gasoline and oil-propelled vehicles will disappear, making it unnecessary for a city's inhabitants to wear gas masks, as has been suggested. Already, research laboratories are working to this end, testing the effectiveness of filters that may be found suitable for use on automobiles. By running an engine in a tightly closed room, experimenters protected by gas masks are seeking to determine how much poisonous matter must be removed from an automobile's exhaust gas to make it harmless and inoffensive. Canaries are used to warn the workers when the gases become too concentrated.

TALKIE FILMS MADE OF PAPER CUT COST AND FIRE RISK

Reducing production costs and fire risk, a method of making sound film or "talkies" on paper has been tested successfully in Germany. Any number of copies can be made from the original celluloid film, a

photographic copy of which serves to make electros of the voice tracings. The record is printed in rows, side by side, on paper strips. These rows form a continuous record. Since four rows are printed on each strip, a 1,000-foot strip contains 4,000 feet of record, sufficient for a forty-eight-minute performance. The method is applicable also to radio broadcasting.

AUTO LUGGAGE CARRIER FOLDS UNDER RUNNING-BOARD MAT

Carried under an aluminum mat on the running board, a new luggage carrier unfolds along the side of the automobile to hold suitcases and bundles. When not in use, the rack is folded back under the mat, making it invisible. Opening or closing requires only a minute.

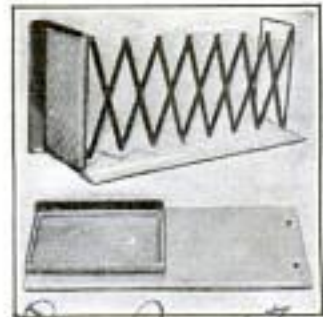

Die Wiener Selenophongie
Gesellschaft.
Wien, Austria

The Mel Co., Box 17
Station A, New Haven
Conn.
Copyrighted material

6-11-35
 1110
 1151
 1110

03716 Cont. U. Clairouin, 90, rue de
Isrenelle, Paris (VII)
France



Close-Up Shows Huge Chest and Menacing Face of Gorilla

By **COMMANDER ATTILIO GATTI**

Leader of Seven Expeditions to Africa

"SARANGA, Saranga," the pygmy witch doctor intoned, "Saranga, god of the rain, take away the clouds, do not throw all your water on the poor Mambuti." And the diminutive man waved his spear commandingly toward the great black cloud which we could see through a small opening in the green dome of the equatorial forest.

The scene really was impressive. And numerous experiences had given me so much faith in the magic of the blacks that I surprised myself by looking open-mouthed at the stormy heavens, expecting

to see at any moment a flash of blue sky appear and a beautiful sun peep through to lighten that heavy, oppressive atmosphere in which I felt lost and depressed.

"Saranga! Saranga!"

But evidently that day the god of travelers wasn't in the mood to give me a nice little story on black magic. And Saranga, the rain god, certainly must have been very busy elsewhere. For both of them deluged us with such a rainstorm as I never saw before.

This was my first intimate glimpse into the working of the pygmy mind in the earliest few days of my life with the Mambuti in the Tchibinda forest where I had come to study the gorillas and the pygmies. But, in spite of this introduction, I began to like and to admire these diminutive caricatures of men whose tiny stature and apparent physical weakness are in such a shocking contrast

to the immense and threatening world in which they live, and to the powerful, gigantic apes which are their only neighbors.

The pygmy kingdom is the infinite equatorial forest, where, no matter how fit we feel nor how well-trained we are, we cannot walk except with enormous difficulty and without becoming at once exhausted by the rarefied atmosphere at 8,000 to 10,000 feet of altitude, and drunk from the heavy miasma rising from an entire world in putrefaction. To advance costs a terrible effort as one must open his way through the matted entanglement of lux-

Among the

Pygmies and Gorillas

uriant vegetation, among trees and vines, brambles and thorns and rank undergrowth of every kind.

But the little pygmies, merely helping themselves with the hook of their characteristic machete, weave in and out through every smallest opening, their miserable naked bodies sliding through seemingly impenetrable thickets, going forward with a speed which their small thin legs would never lead one to expect. Fresh, untiring, they push on indefatigably, always maintaining a perfect sense of direction.

The impression of dramatic contrast is increased when one thinks that the tiny Mambuti for centuries and centuries have been the only natives daring to hunt the gorilla, the absolute master of the equatorial forest

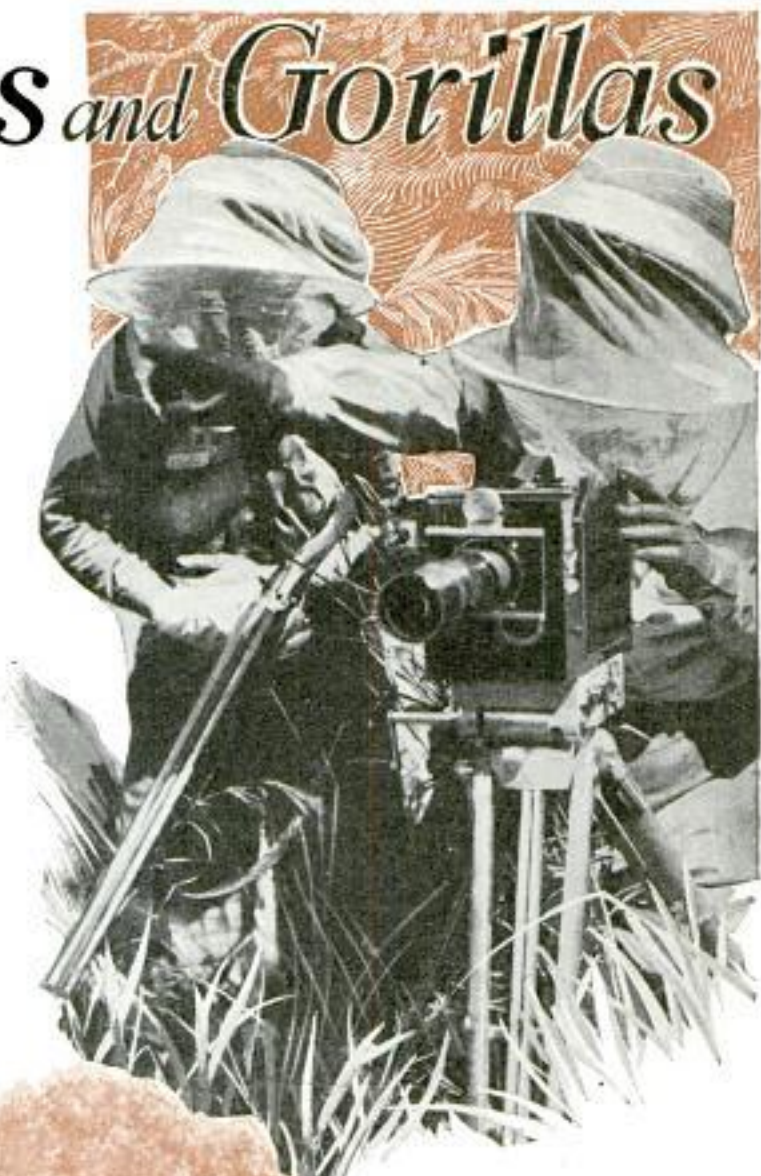

Above, Taking Pictures of Gorillas with a Gun Handy; Below, on the Way to the Jungles Inhabited by Gorillas and Pygmies

and the biggest and most powerful and ferocious of all the apes.

Not only is "ngagi" the greatest of the apes, but it is one of the rarest and least known of African animals, and surrounding it are innumerable stories and legends of the most ghastly character.

I do not know how true are all the stories one hears of natives carried off prisoners by the gorilla and sent back a few days later with the nails of their fingers and toes torn off by their captors, and of kidnaped women,

B916



Examining Body of a Gorilla for Marks of a Pygmy Spear Which Injured It When It Attacked These Little Men Years Before

But the experiences I myself had during some months spent in the forest proved to me very clearly that, when in a fury, he is a very dangerous beast, probably the most dangerous of all African animals. And his strength is really terrifying.

One day the pygmies had guided me very near to a family of ngagi which, in a small clearing, were avidly devouring some bushes, a sort of wild onion which is their favorite food. Among the curtains of the vegetation I was watching the

movements of the group and preparing myself to take some photographs when—"S-c-c-c-h," the attacking cry of the leopard, sounded at my left. I turned quickly. It was Kasciula, chief of the tribe, perfectly imitating the leopard's cry, resorting to that strategy which I afterward learned was a common one with the pygmies to infuriate the gorilla.

That sound let loose a pandemonium in the small clearing. Females and young, with surprising agility and swiftness, climbed to the branches of the trees, while three males jumped to their feet and, long arms hanging below their knees, shoulders hunched, swayed on their short wide-spread legs, slowly turning their monstrous heads from side to side with the air of stupid ferocity of powerful animals ready for the most desperate defense or the most audacious attack.

Leading the other males, his head towering above the rest of the group, the leader of the tribe waved one enormous fist threateningly in the air and beat upon his chest with the other, making a booming sound like a large drum.

"Bwana, kill the great ngagi! Kill Moami Ngagi!" the diminutive pygmy chief whispered to me



White Explorer of the Jungles and His Pygmy Guides Who Possess Uncanny Sense of Direction

in a tone of concentrated hatred, "Pum, pum, Bwana!"

"Pum pum" is not a word of Mambuti origin. The pygmies got it from me, since I, not knowing how to express to them the idea of discharging a gun, made the gesture of firing and shouted an energetic "pum pum."

On my refusal, the old chief once more repeated the cry of the leopard. He was immediately answered by a terrible howl of hate from the giant ape which, wild with fury, closed his deadly fingers around a small tree near by. Without moving his gaze from our direction, without giving the impression of any effort, just with a simple move-

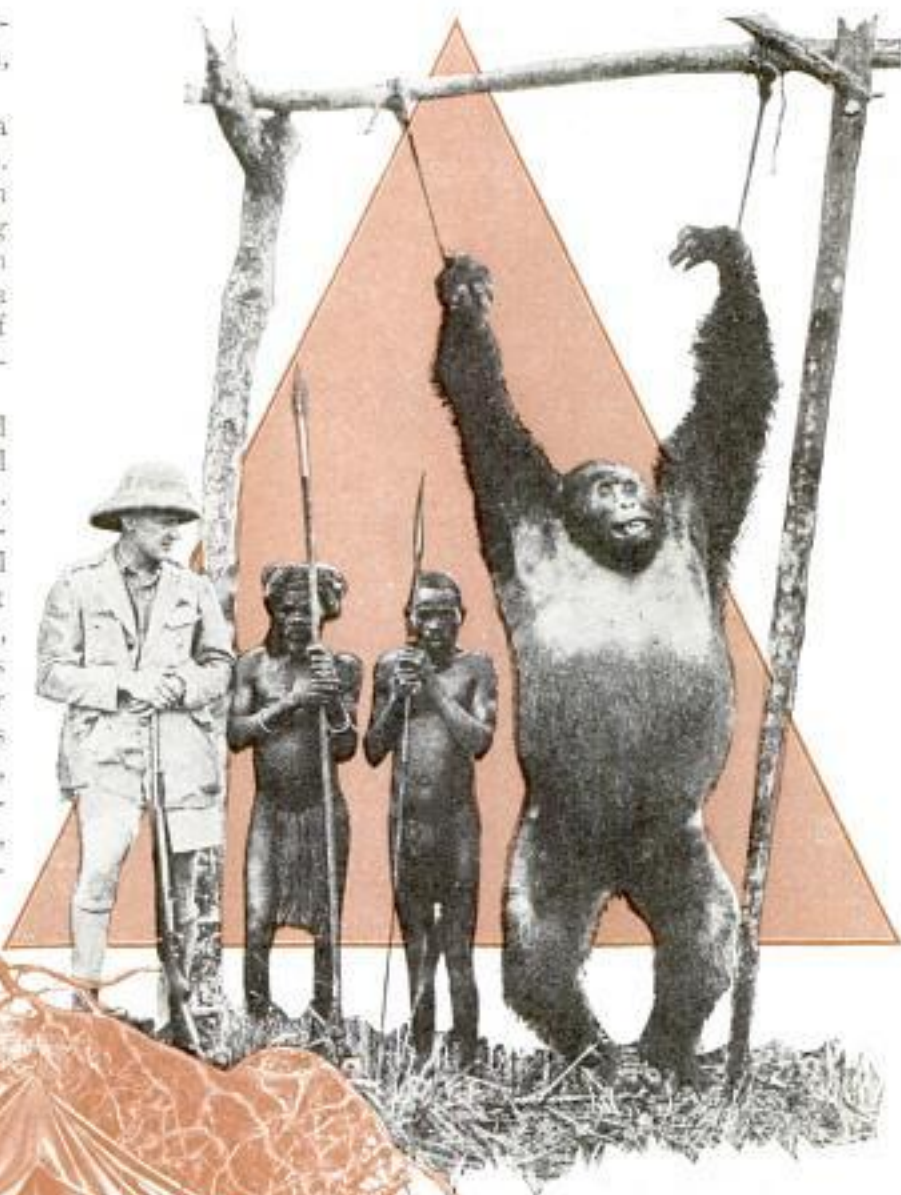

Giant Specimen of Gorilla Shot during the Jungle Expedition



ment of his hands, he snapped the trunk in two with a crackling sound like a cannon shot. Then, brandishing this formidable weapon, he advanced a few steps emitting another howl but of a very different character. It must have been an order, for the other gorillas trotted away.

As soon as all of them had disappeared, the giant ngagi tore his club to pieces and threw it away; then dropping down on all fours, he walked into the brush, slowly and defiantly.

When he had vanished, I approached the tree from which the animal had so easily broken away the upper part. It was not a very large tree, but it was of extremely hard wood. And when, just to make an experiment, I wanted to test the comparative value of human strength, it took me and all twelve of the Mambutis

(Continued to page 118A)

B 1119.

Asram Is. m. & H., Komml. Ges. O-17,
Ehrenbergstr. 11
Berlin, Germany

422

POPULAR MECHANICS

Glass Machined Like Metal with New Tool

from vibration as possible must be used, since the slightest variation will cause a defect or ruin the whole block of glass. All dimensions can be kept to the utmost accuracy if the operator is careful, and a

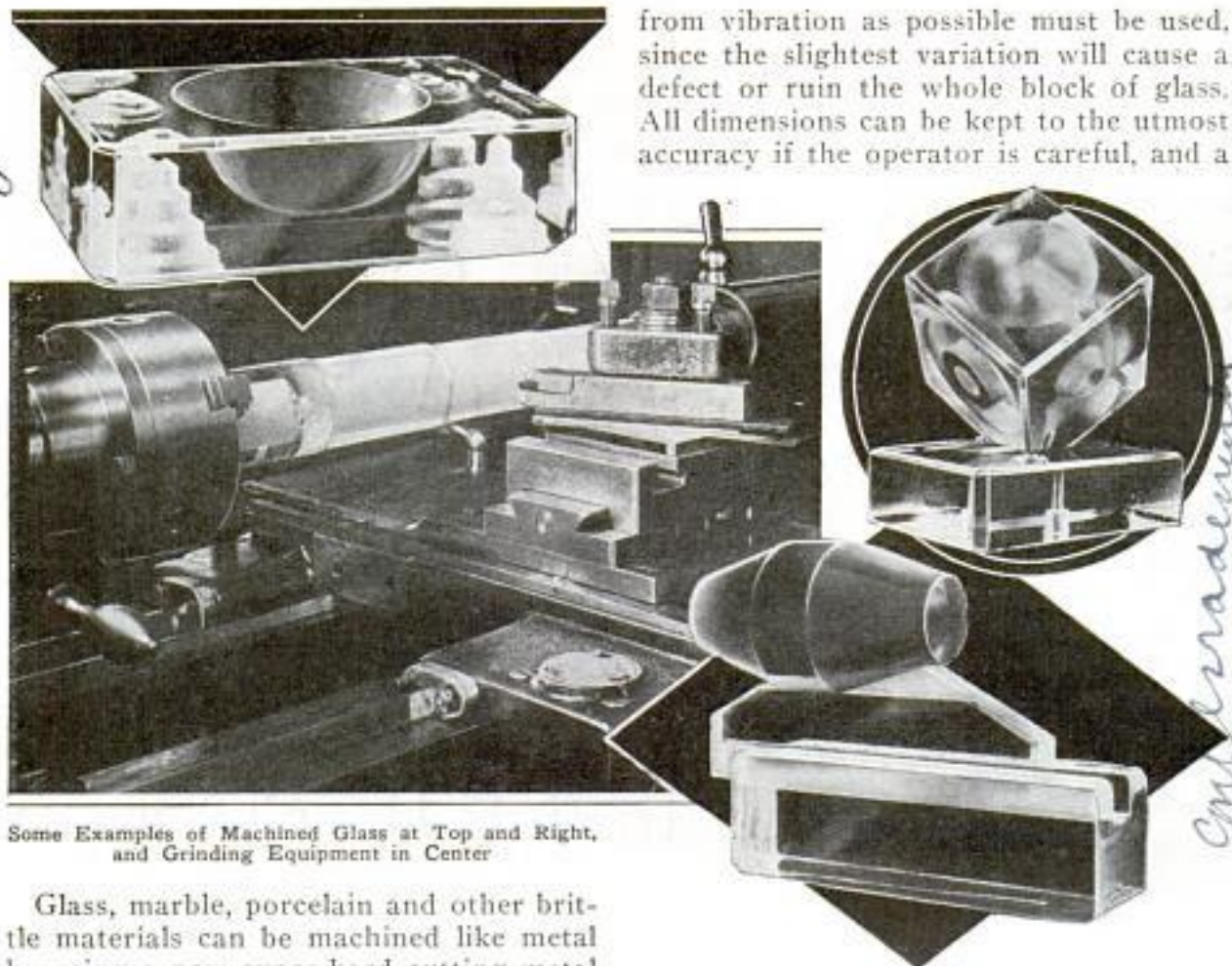

Some Examples of Machined Glass at Top and Right, and Grinding Equipment in Center

Glass, marble, porcelain and other brittle materials can be machined like metal by using a new super-hard cutting metal called "widia." The process is different, however, since no shavings are split off. Instead, only very slight edges and bits are torn from the glass surface as the tool is applied to the rotating block with extreme caution. Machine tools as free

glass tap turned on the lathe will fit so closely as to be inserted or withdrawn only with considerable effort. Glass vessels in many shapes already have been produced, while the process and the super-hard metal enable the execution of novel decorations.

U.S. - Thomas Prosser & Co., 1520 1st Street

"NOISE HOUNDS" CHASE SOUNDS IN TALKIE STUDIOS

B 1157

One of the strangest jobs in the talking-picture studios is that of the "noise hound." He does not make noise but hunts it down and eliminates it. It is his job to find the unwanted sounds that seem always to be echoing about the studios and remove the causes. For this purpose, he uses a voltmeter testing apparatus and an ear trumpet. Whenever the man who regulates the sound apparatus reports some extraneous noise that interferes with recording, the sound detective goes to work. Time was wasted not long ago when

a gurgling sound was heard while one picture was being made. It finally was traced to a drinking fountain just outside the camera's vision, difficult to find because it was heard only when an actor or workman took a drink. Sometimes a "bug," brought on by electrical vibrations, causes the trouble, and once a cricket stopped work on a picture until it could be located and removed. A toad caused trouble in the making of one film, and the hiss from a valve in a fire-protection sprinkler system made some objectionable noise in another picture. When animals are used in scenes, some sudden noise, like the clapping together of two boards, is

Clp. column by John Scott. (Cont. Shackwell)

FRIED. KRUPP
AKTIENGESELLSCHAFT
Gußstahlfabrik
ESSEN
 W-RRB 9310b.

POPULAR MECHANICS

Built by United Steel
 Works Corp. 423
 11 Broadway
 New York

them quiet if no sounds from them are wanted. Flies often stop work on a set, and sometimes a chaser is employed to find places on a set where echoes originate.

B1143

MAGNET MEASURES CYLINDER WALLS

Resembling the "potato-masher" grenades used in the world war, an electromagnet device measures the thickness of cylinder walls in an automobile engine. Heretofore, irregularities in iron castings could not be discovered except by cutting open the engine block. The tester is lowered into each cylinder. If the wall is above or below normal thickness, a pointer on an indicator reveals the variation, giving a check on foundry operations. Variations in thickness result in uneven heating and warping of the engine.

Between Piermont and
 Aronson in
 Hudson



This One-Man Ferryboat Has Capacity for Twelve Vehicles; Note Operator's Tower on Stilts; Entire Craft Is Built of Steel

MIDGET FERRYBOAT OF STEEL IS WELDED WATER-TIGHT

Made of welded steel plating, a pair of ferryboats are plying the Hudson river. Welded tight like bottles, the boats are declared non-sinkable. Steering and control of the seventy-horsepower engine are done by one man in the pilothouse, which is supported on steel stilts above the deck. Each ferry has space for twelve cars.

Internal steel crusing system
 and J. Bjekstad

SLATE IS REMOVED FROM COAL BY MAGNETIC SEPARATOR

B1154

Improving purity and reducing costs, a magnetic separator that combines great capacity with high intensity of separation of ores has been produced. Its uses include removal of slate from coal, mica from feldspar, iron oxide from bauxite, dolomite from gypsum, and oxides of iron and imbedded oxide particles from silica sand. The separator subjects ore to a powerful magnet that pulls magnetic minerals from rock and useless minerals. For such materials as silica sand, it has a capacity of eight tons an hour. All material is passed through the magnetic zone four times, each trip reducing the amount of magnetic minerals.



Thickness of Cylinder Walls Is Measured Quickly by Inserting Tester in Engine

Cont. John W. Bombardier
 742 Dan Leijhara
 Leetrot Truck

850 S. W. Wash
 Leetrot Truck

developed and used
 by Israhim. Paige
 Motors Corp

Smiths magnetic
 Separator Co. 600
 Smith St. Milwaukee
 Wis

a2127 Cont Joseph H Kraus
43-24 169th St
Duluth, Minn

FORTUNES from

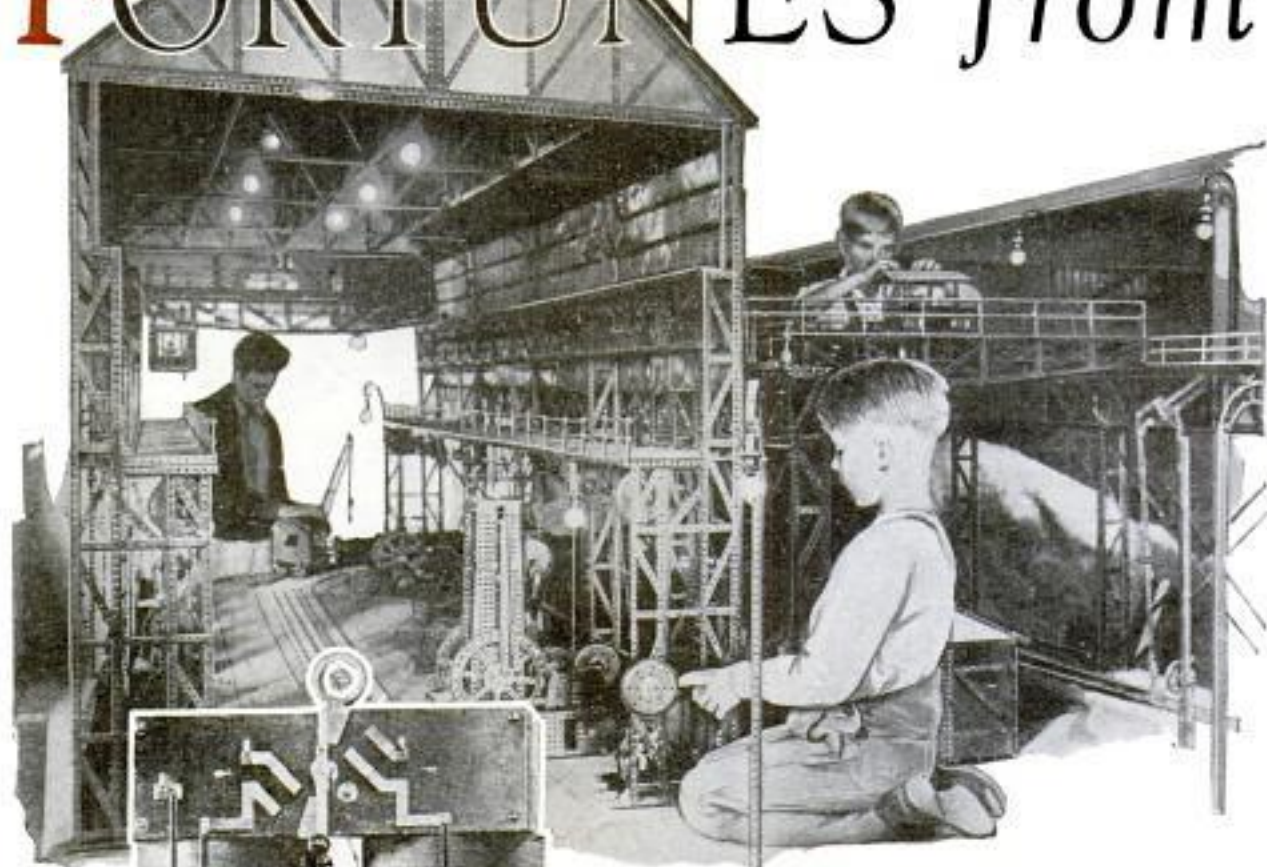

Top, Boys of a Los Angeles Playground Constructing Model of Famous Krupp Steelworks in Germany; They Have Spent Two Years and \$2,000 Building This Model, Which Is Twelve Feet Long, Five Feet High and Contains a Traveling Crane, Drill Press, Planer and a Dozen Other Tiny Machines, All Electrically Operated; an Electric Train Runs through the Works; Left, Edison's First Generator

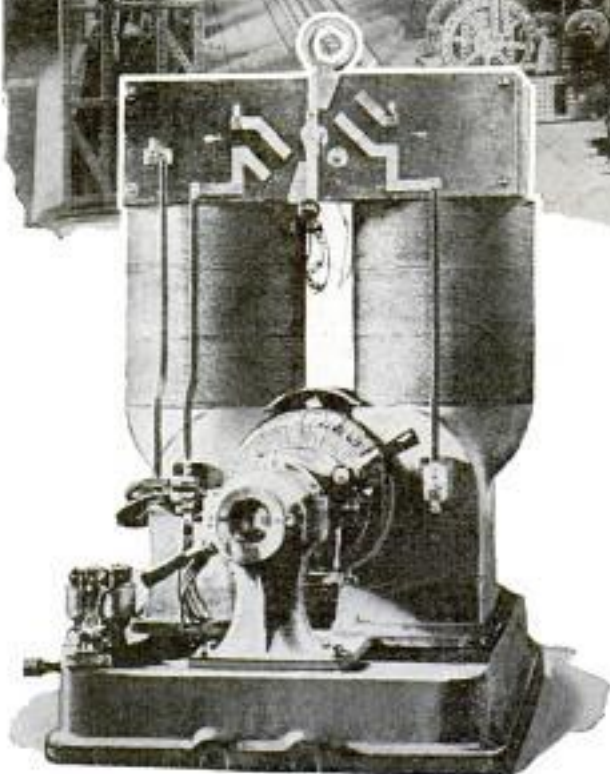

By JAMES M. CHALFANT

NCESSITY is not always the mother of invention. Many discoveries have been purely accidental, or hinged directly on some slender thread of circumstance.

Something goes wrong. The expected fails to happen, but the unexpected points the way to something better. Occasionally, even in some blunder or misfortune, somebody gets a lucky break—gets it be-



Built for Soviet power station in Elznifer Petr. assembled at Schenckladg

LITTLE IDEAS *planned*

Es. & Co

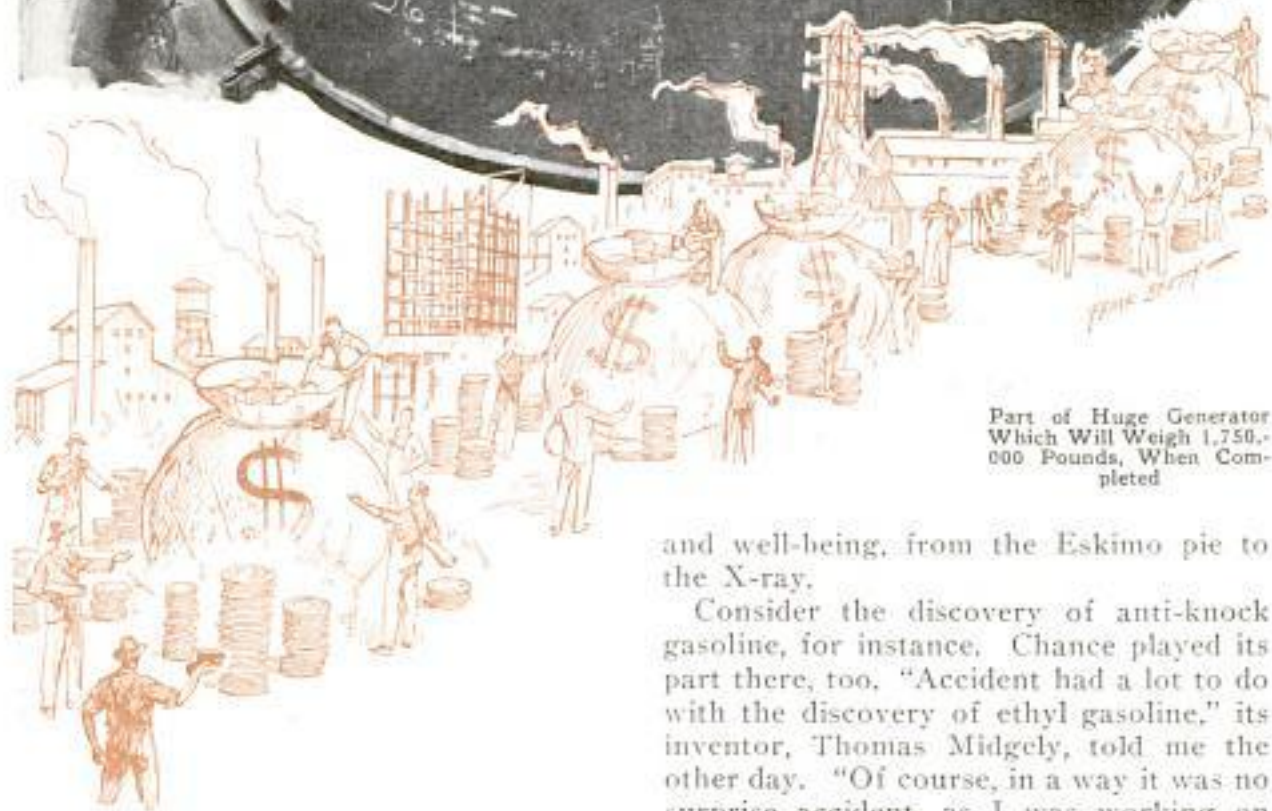
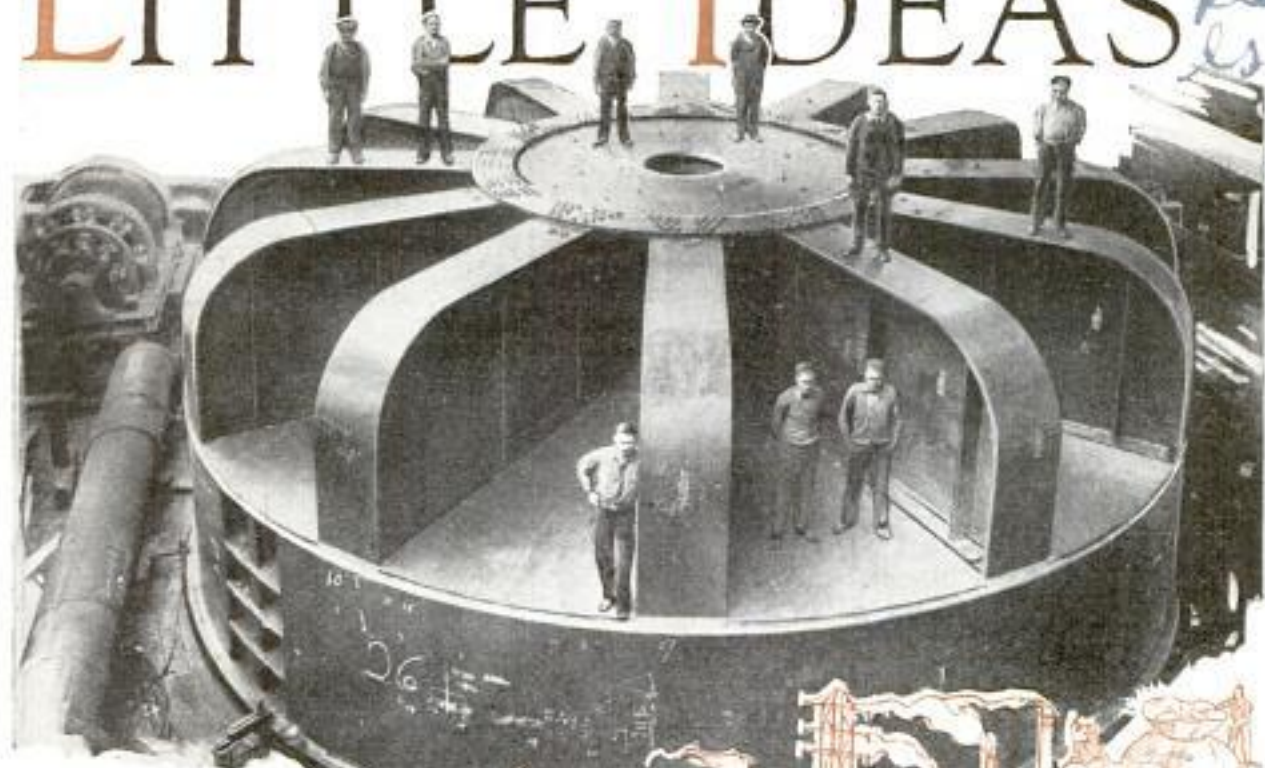

Part of Huge Generator Which Will Weigh 1,750,000 Pounds, When Completed

cause he is able to recognize it when it comes along.

The classic example, of course, of the successful failure is Christopher Columbus failing to find a western route to the Indies but discovering a whole new world. In the world of science and invention, the happy blunder has been responsible for many things contributing to our pleasure

and well-being, from the Eskimo pie to the X-ray.

Consider the discovery of anti-knock gasoline, for instance. Chance played its part there, too. "Accident had a lot to do with the discovery of ethyl gasoline," its inventor, Thomas Midgely, told me the other day. "Of course, in a way it was no surprise accident, as I was working on the theory that an anti-knock gasoline could be made.

"You know, there are accidents and accidents. One kind you have no control over whatever. The other you more or less invite and encourage to happen to you. Charles Kettering, of the General Motors research laboratories, puts it in this way: 'You go into a dark room. You know there is a chair there somewhere in

Q2127
426

Seldert

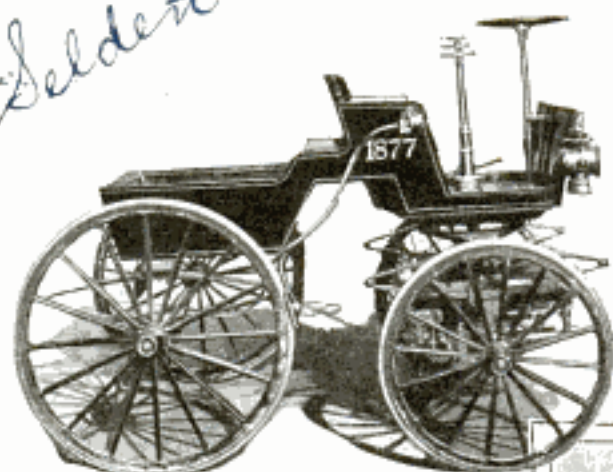

glycerine. And as he watched the sticky substance slowly hardening to an elastic film on his finger, the thought came to him that may be this substance would do. He mixed the extra collodion with nitroglycerine. It set to a jelly. Thus blasting gelatin was discovered.

Many men believe that substantial profits from inventions have only been forthcoming from projects which required fabulous capitalization. The converse of this

the blackness. If you stand perfectly still, you'll never find it, but you know that if you start wandering about, sooner or later you're bound to run into it. The finding of anti-knock gasoline was that kind of accident.'

"I was working on the theory that a colored gasoline would not knock. That isn't true, but of course I had no way of knowing that at the time. I took some kerosene to the chemical laboratory and told the man in charge of the chemicals that I wanted an oil-soluble dye.

"What do you want to color?" he asked.

"I want to color some kerosene," I said.

"Well, there aren't any oil-soluble dyes in the stockroom," he replied, "but if you want to color kerosene, this iodine will do it."

"Of all the thousands of chemicals he might have picked, by sheer chance he picked the one that turned the trick, for when we used the iodine to color the kerosene, took it back and ran the motor on it—the knock was gone. Then it took seven years of hard work to find out why it killed the knock and to find the tetraethyl lead used today as an anti-knock."

There would seem to be no connection between a cut finger and the high explosives of modern warfare, but there is. Alfred Nobel, the Swedish chemist, cut his finger one day in the laboratory. Dissolving some guncotton in ether alcohol, he swabbed the cut. He had been searching for an absorbent and solidifier of nitro-

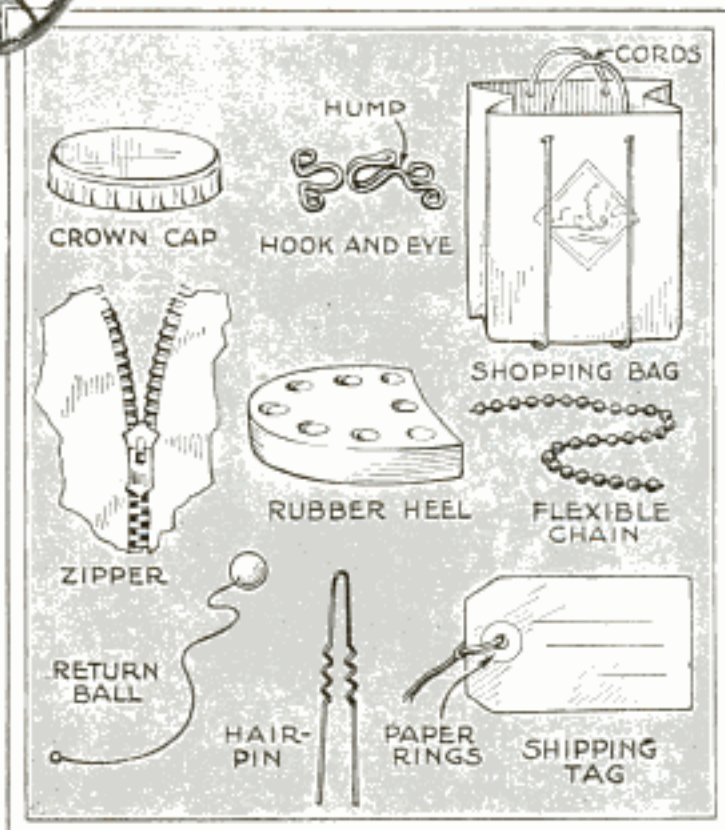

Top, Early American Motor Car; Note Front Wheel Drive; Below, Some Little Ideas That Made Big Money

statement is nearer the truth. Some of the simplest of inventions have made a fortune for the inventors, and, frequently, served as the foundation of an entirely new industry.

It is not necessary that a budding inventor devise an entire system of locomotion, in order to become financially independent. He need not develop an entire plant to make his product, nor design all of the machinery to manufacture the item.

The present generation well remembers when Lee De Forest introduced a small grid of wire into an exhausted tube of glass, containing two elements and known at that time as the "Fleming valve." The Fleming valve had a filament which could

Q2127

be heated to incandescence, and a circular plate surrounding this filament. Had it not been for the introduction of this grid, broadcasting would probably not exist today.

This wire grid put the radio set into your homes. It made fortunes for broadcasting companies. It was the beginning of a new industry. Without it, we would have no talking pictures in our movie houses. Without it we would not have a Rockefeller development of \$250,000,000 now being erected in New York popularly called the Radio City. We would not even be thinking about television. Verily, a many billion-dollar industry was founded on this little grid of wire.

galathea

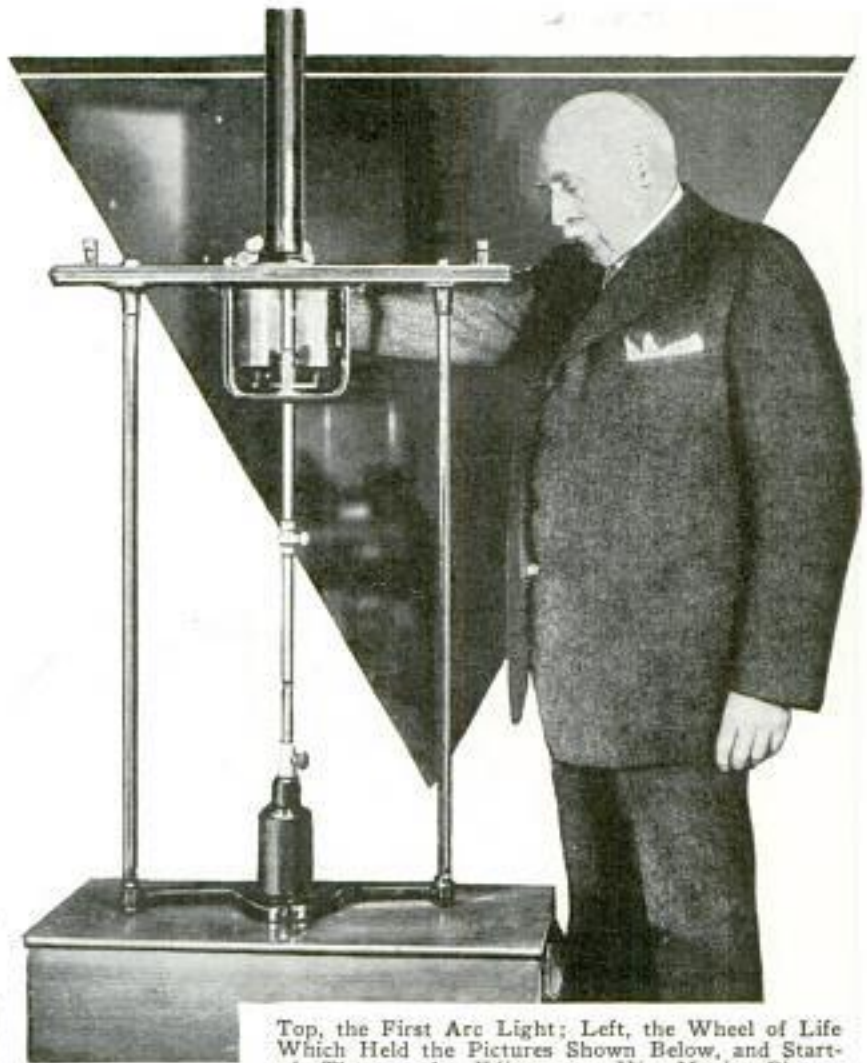

Top, the First Arc Light; Left, the Wheel of Life Which Held the Pictures Shown Below, and Started Thomas A. Edison on His Moving-Picture Inventions

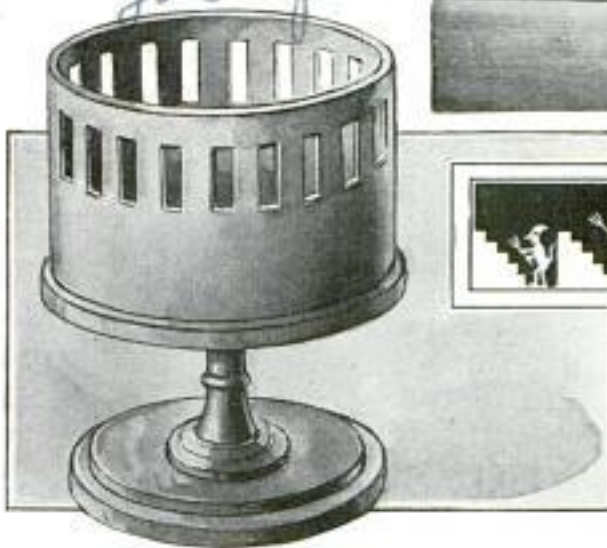

Many will remember the magnesia bottles with their rubber-covered glass stoppers, held in place with a leverlike wire arrangement. De Quillfeldt is said to have made \$15,000,000 out of this idea. Then along came William H. Painter, the son of a poor Quaker farmer living in Montgomery county, Maryland. After investigating the prior art in the field of stoppers, something which the inventor ordinarily does not do, Painter, then for-

ty-three years old, in 1883 invented a cork of rubber, cloth and a wire staple which was to be forced into an annular groove around the neck of the bottle. This was not a success. But Painter did not give up the ship. After two years of experimenting, he brought forth the metal cap with corrugated edges and a cork insert, now seen on almost every bottle of pop. In 1892, a new company was formed under the name of the Crown Cork and Seal company, with Painter as president at a salary of \$20,000 per year and royalties of one cent on every gross of the caps. Not much of a royalty, to be sure, but today, one company alone manufactures the staggering quantity of 80,000,000 gross per year.

*Used on telegraph line
built by S. H. B. Morse*

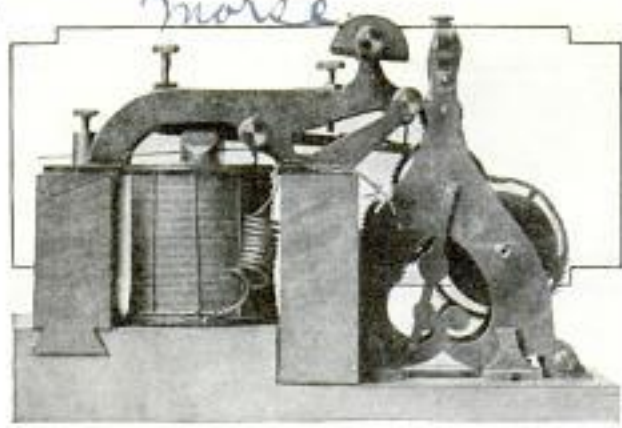

L. Gates. Gates invented what was called an electrical questioner. This is a small board with a number of pins projecting therefrom. A card, punched with holes, is printed with a series of questions on one half of the face of the card, and answers on the adjacent half. A pin projecting through one of the question spaces is wired to an answer pin. Two terminals, held in the hands, are then applied to different pins. When the proper pair are

touched, a buzzer sounds. The game is educational. The student touches the question pin and must then find the proper answer pin to make the buzzer sound.

This product was first made by the Electrical Questioner company which failed. David W. Knapp took over the idea in 1890. He paid the inventor fifty cents royalty for each one sold. Three or four years later, Mr. Knapp purchased all rights to the inven-

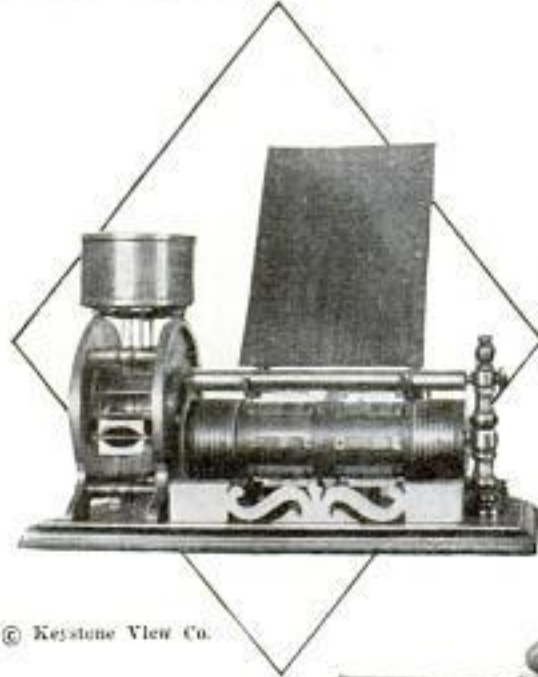

© Keystone View Co.

At the age of twenty-one, Humphrey O'Sullivan landed in New York fresh from the County of Cork, Ireland. He had a fair knowledge of the printing trade. After working at it for three years, he found that he was not getting much better off. He then joined his brother in Lowell, Mass., in a shoe-store business. For twenty-one years both brothers worked at a salary of \$15 per week. At the end of that time they had the finest store in Lowell, with stock valued at \$45,000, and \$25,000 invested in real estate. One day Humphrey heard that a man was selling heels for shoes, made of rubber. He bought a pair, but they were thick, hard and heavy. They had to be screwed to the shoes, and after walking on them for a day, the rubber was worn down to the screws. In 1899, Mr. O'Sullivan took out a patent on the rubber heel which made him famous. This had countersunk metal washers in the rubber. But there was no market for the heels. O'Sullivan believed in high-pressure advertising methods. He made the public demand the rubber heel. Today, many companies are making rubber heels. Another million-dollar industry, but here, the first market had to be created.

A demonstration of a case where the inventor did not make as much as the man who converted the invention into a salable article is found in the patent of Waldo

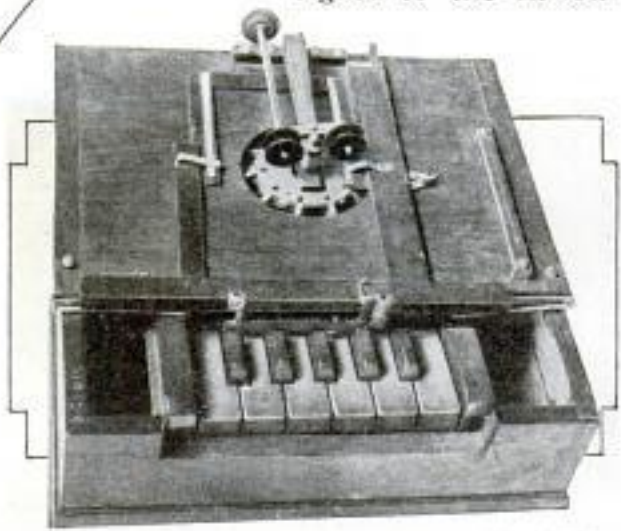

Top, Morse Telegraph Register; Center, Edison's Voting Machine; Below, First Typewriter That Worked
and shoes and Associates
tion. This was the beginning of the Knapp Electric company, which later went into many other fields. The electric questioners are still being manufactured and sold at a rate of 150,000 a year.

A traveling salesman for the Crown Cork and Seal company, King Camp Gil-

*3029 E Washington
Indianapolis, Ind.*

lette, was once told that he should try to invent something which, when once used, would be thrown away. In 1895, Gillette had the good fortune to try to shave himself with a dull razor. He hit upon the idea of a safety razor and made a model of brass and clock spring. For six years after the invention, nothing was done with it. The path was not an easy one. Finally W. E. Nickerson, a technology graduate, was called in. He not only perfected the razor, but also designed much of the machinery to manufacture it. Two young lads, who had to borrow \$3,000, became the agents for the razor. Three years later, the Gillette company bought them out for \$300,000. In less than seventeen years after the patent was allowed, this little contribution to modern man was earning \$4,500,000 a year in profits.



Courtesy Goodyear Rubber Co.



Top, Charles Goodyear Discovering How to Vulcanize Rubber in 1839; Below, First Well That Produced Oil

The paper shopping bag, with the piece of cord running through holes in the top and down the sides of the bag and under the bottom to reinforce it, was the product of Walter Henry Deubener. He made the

hooks had a habit of coming undone. The hook with a hump monopolized the industry, and is still being so advertised. The hairpin with a hump also made a fortune for its inventor.

Col. E. L. Drake oil struck Aug. 27
 (in self hat) in charge
 9 drilling
 1839

Electric Ear Used in War on Singing Tires



ment, pavement roughness and clatter of tire design on the pavement. Any motorist who has paid attention to the noises made by his tires will recognize most of these conditions. Of the new tires tested, those having plain ribbed treads—grooves running around the circumference—were the quietest. Next came treads having center ribs. Those with the most broken-up designs were most noisy, although it was found that, by staggering designs, such tires could be made quieter. After 1,000 miles of run-

Chart Shows Relative Measurements of Noises; Right, Apparatus Used in Reducing Sound of Auto Tires

There is no such thing as a noiseless tire, a recent study indicates. Even the plain ribbed type of tread, the nearest practical approach to no tread at all, has its peculiar set of noises. As the tread design is increased in roughness, the noise becomes greater. These and other facts were revealed by means of an "electric ear" built into a test car. The car consisted of a microphone mounted in a padded steel box anchored on the rear seat of a sedan after the cushion had been removed. A tube, fitted closely about the microphone, protruded through the bottom of the car and had its opening at a point a foot to the right of the left rear wheel. Sound picked up by the microphone was led through a filter that removed effects of wind noises, leaving only tire sounds, which were measured in terms of decibels of sound. The electric ear demonstrated that tire noises come from three main sources: impact of the tire on the pave-



ment, all tires had become more noisy, the causes including such defects as bad heel and toe wear. At the end of 3,000 miles, all noise readings were less than for 2,000 miles, where only one tire had showed a decrease, the result of rapid tread wear. The tests, conducted by B. F. Goodrich Rubber company engineers, may lead to

Cmd. Walter E. Burton
 1092 Florida Av Akron Ohio

Science Service
6/22/32

Federal Laboratories, Inc.
195-41st St.
B1132 Pittsburgh, Pa

POPULAR MECHANICS

431

eventual elimination of tires that sing and produce other objectionable noises; but at the same time the electric ear has found that tires refuse to remain absolutely noiseless.

SIX HUNDRED MILES AN HOUR
TOP RATE OF FLYING B1171

Ultimate top speed for airplanes with present wing characteristics is 600 miles per hour, according to conclusions reached by the National Advisory Council for Aeronautics following a series of experiments in the world's highest speed wind tunnel at Langley field, Va. These tests, run at air speeds as high as 800 miles per hour, demonstrated that racing-airplane wing designs now employed develop prohibitive "drag" above 600 miles per hour. Present-day propellers which turn at 1,800 revolutions per minute also may waste power, the experiments showed. At that speed, the tip of the blade is traveling so fast that it hinders rather than aids performance.

B1152
FINS INCREASE SPEED OF BOAT
WITHOUT ADDING TO POWER

Increasing the speed without adding to the power plant of racing boats is possible in a new design produced by Dr. O. G. Tietjens, of the Westinghouse Electric and Manufacturing company. An arrangement of fins causes the boat to rise completely out of the water as it gains speed without losing stability. The speed is said to be almost doubled.



Tests of Speed-Boat Models Built with Fins Reveal Surprising Increase in Speed

VEST HOLDS TEAR-GAS SHELLS
FOR PRISON GUARD

\$6.00



Guard, Wearing Vest Filled with Tear-Gas Shells, Is Loading Riot Gun for Emergency

Designed for use in prison mutinies, a vest containing the proper assortment of tear-gas ammunition has been produced for guards. Hung up in the gun room, the loaded vest is available instantly. The cartridges with which the vest is loaded shoot tear gas from fifty to 500 feet. There are pockets for eight gas grenades and eight gas shells for use in riot guns. Elastic holds the cartridges in place. Relieved of carrying the grenades and shells in his hands, the guard is free to operate his riot gun or to throw gas bombs.

MISPLACED IONS FORM HABITS
BY ACTION IN NERVES B1190

Habits are formed by the action of ions, infinitely small units that are a part of the electrical impulses by which the nerves carry messages to and from the body. Dr. John N. Washburne, of Syracuse University, in presenting this explanation of how habits are formed, says that when a message is delivered by the nerves, two or three ions become misplaced. Afterward, when a familiar event or stimulus reaches these ions, they forthwith repeat their first mission—and so a habit is formed.

Mr. W. L. ...
Director, ...
Research Foundation, Phila.
Copyrighted material

Designed by Dr. Walter M. Thayer
State Commissioner of Correction, New York

Mr. Gerald Intire 6/22/32

B 1127
432

Edward G. Budd Mfg Co
Budd-Michelin Rail Car Mfg
POPULAR MECHANICS

25th and Hunting Park Ave

Fitting Rubber Tires to American Railways

Phila.

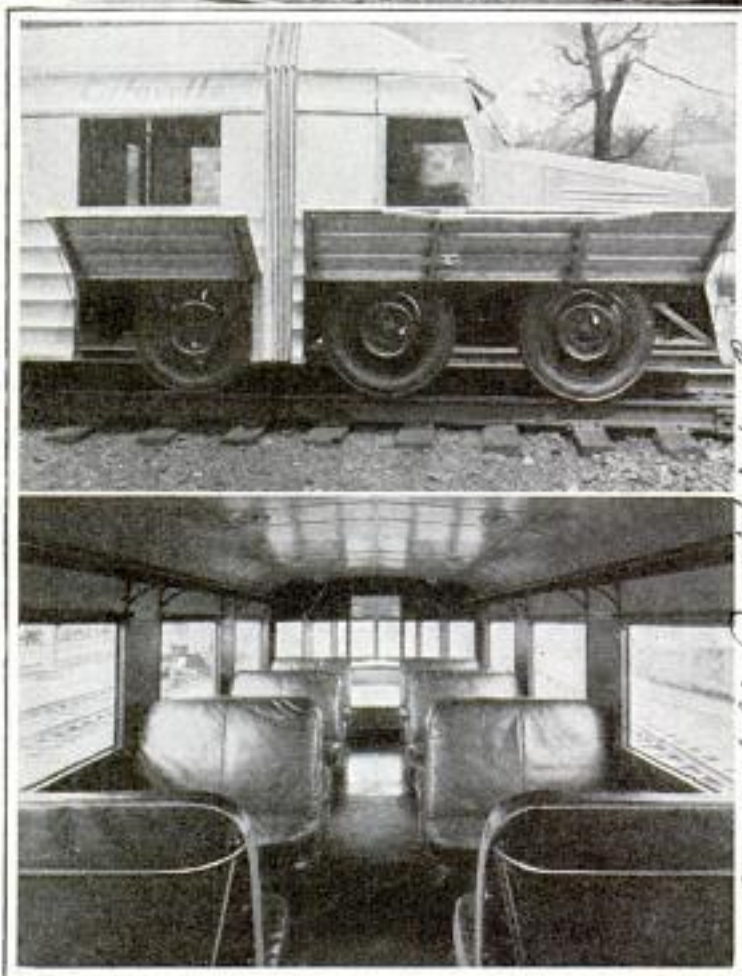

Top, Stainless-Steel Rail Car with Rubber Tires; Below, View of Front Trucks and Interior of the Coach

Only a little over a century has passed since the first steam trains filled the hearts of early settlers with astonishment. From the crude wood-burning locomotives and small wooden coaches, great strides have been made by the railroads. And yet, until last year, the basic principles of railroad coaches were little removed from their first ancestors. True, the cars were larger, more comfortable and luxurious, but their

weight increased correspondingly. The expense of moving the coaches had risen in the same proportion. Then, last year, M. Michelin, the famous French tire manufacturer, built a car which differed from anything heretofore used on rails. A very light coach was constructed and equipped with rubber tires. The results were astounding, well-nigh unbelievable. Another noted pioneer, Edward G. Budd, of Philadelphia, American licensee of various Michelin motor-wheel patents, saw this car and, realizing its importance, began to adapt it for high-speed transportation on American railways. Engineers developed a system of stainless-steel welding, as it was found riveting lacked strength, added weight and increased the expense. Ordinary welding methods destroyed the most im-

portant feature of stainless steel, namely its rust-resisting power, and so the new system was devised. Thus the Michelin tires and the stainless-steel construction jointly succeeded in producing something which promises to revolutionize rail traffic. The average railroad car weighs from 130,000 to 240,000 pounds, for the movement of which some 300 to 900 horsepower are needed, at an operating cost

Budd Shot-Weld system

Copyrighted material

00 118 Dept. of Water and Power 433
 Los Angeles, Calif

ranging between thirty-five to sixty-five cents per mile. The new rail car weighs only approximately one-ninth of the average coach. The power required to move it at the same speed, amounts to merely ninety horsepower and the cost is only eleven to twelve cents per mile. Due to the greater lightness of the cars, together with the superior traction of rubber on steel, the acceleration is far greater than that of ordinary cars. At a speed of sixty miles per hour, the cars can be stopped within 400 feet. Besides the attractive features of quietness and smooth riding, of soft diffused light and comfortable seats, another new feature promises to increase the popularity of these cars. It is the air-conditioning process, so successfully applied on dining cars and several crack trains of an eastern railroad.

Auto Topics 5/7/32
FLUID FLYWHEEL GIVES POWER THROUGH OIL FLOW

Performing the functions of both flywheel and clutch, and contributing greatly to increased performance flexibility and operating ease, the fluid flywheel is gaining acceptance among European automotive engineers. It consists of two members, driving and driven, but the two members do not make direct contact. Instead, torque is transmitted by the force of oil flow thrown off by the driving member upon the driven member. At idling speed of the motor, the force of the flow is not sufficient to actuate the driven member, but as the engine is accelerated, the force

M. A. Sagen

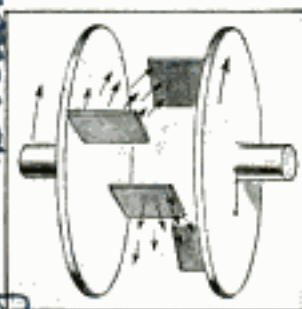

of impingement becomes so great as to overcome the resistance, and the car moves off just as when the conventional clutch is engaged. In a recent demonstration of the advantages of this power engagement, it was proved impossible to produce jerky clutch action. No matter how sharply the motor was accelerated, the car gathered speed smoothly. In a test of minimum speed performance, the car demonstrated its ability to idle in high gear at less than one mile per hour rate.

*Claimer Co (England)
 26, Store St. Ludm,
 W.C., England.*

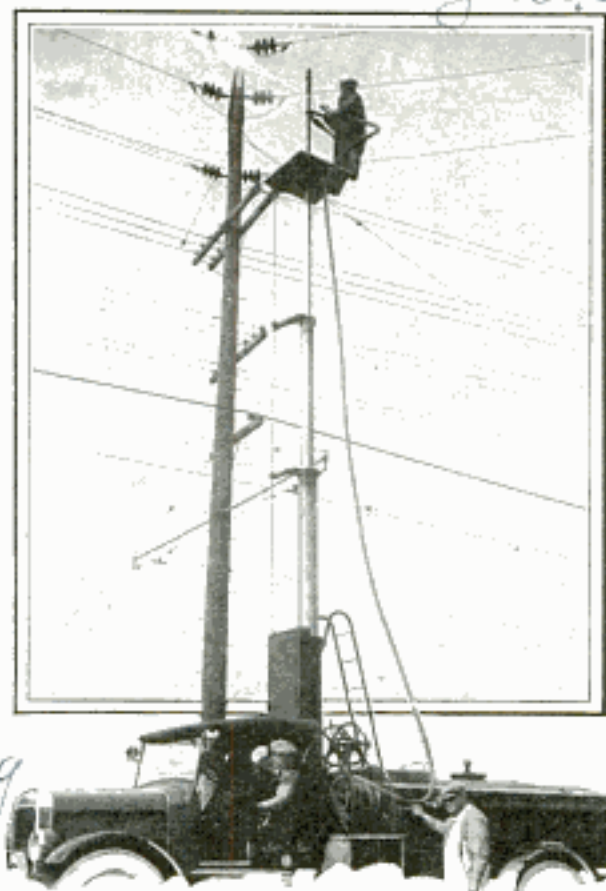

Fighting Fire at Top of Power-Line Pole from Tower Truck That Carries Own Water Supply

POLE-TOP FIRES FOUGHT IN AIR FROM HIGH TOWER

Rising from a specially built truck, an extension tower carries the fight to fires on top of power-line poles. When a pole catches fire from short circuits or failure of insulators, several trucks speed to the scene. In four seconds, the tower on each truck rises to the height of the pole, carrying men to pour water or chemicals on the flames. The truck carries a tank containing 650 gallons of water and fifty feet of hose, in addition to chemical extinguishers, so it is unnecessary to hunt fire hydrants or to attach the hose. Fifty gallons of water per minute are pumped onto the fire. The towers operate like hydraulic elevators. A platform on top of each is large enough for two men. So speedy is the equipment that insulators on five poles can be drenched with water and chemicals in eight minutes. Another use is for cleaning insulators quickly, eliminating the tedious process of climbing each pole.

(A coal-tar and stone substitute for asphalt has been developed abroad.

Prague Iron Works, Prague, Czechoslovakia

Cmd. George A. Pasquier Box 2672 Los Angeles, Calif

03/00 4 Cmt. John C. Reinhardt,
944 Manzanita St
Los Angeles, Calif.

SLOW MOVIES AID

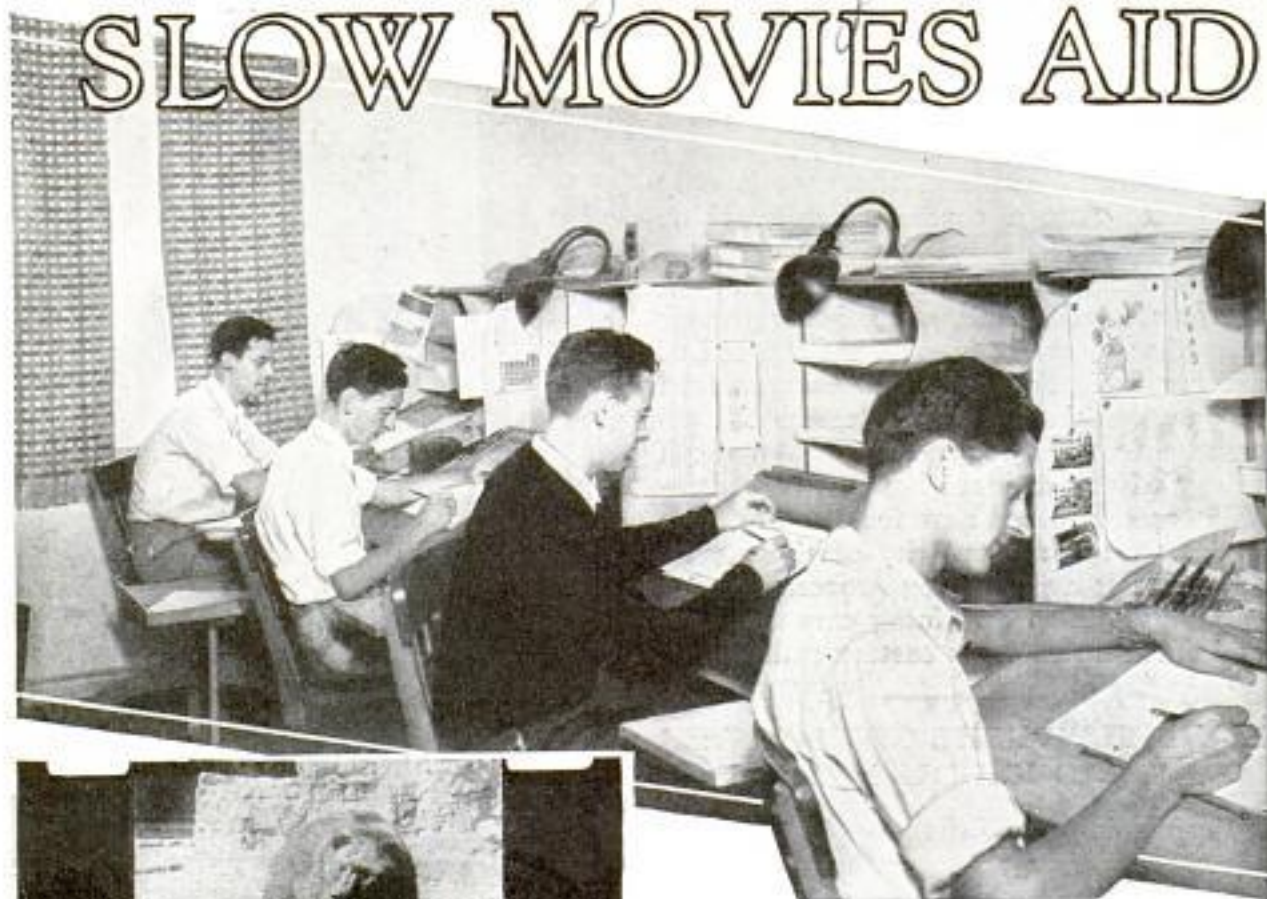

Top, Cartoon Animators at Work; Below, Film of Grizzly Which Animators Watch in Slow Motion to Study Muscle Action

WHAT positions do the leg muscles of an animal—say a big grizzly bear—take when it is galloping? Just walking? What gives it that ungainly gait? How do certain birds, swans, for instance, achieve their grace of movement, and others, like the pelican and the secretary bird, their comical carriage?

To answer these *studios* questions visually, "Walt" Disney, creator of "Mickey Mouse" and "Silly Symphonies," is making an interesting series of slow-motion pictures, showing living animals and birds in action.

Such a series, when complete, says Disney, will not only permit his animators to analyze the muscular movements of beasts and birds scientifically, but it will also provide a permanent source of reference and study for his staff. Thus "gag" men watching the films can garner new ideas for comic sequences while animators can produce hilarious effects by exaggerating the correct muscular action, though keeping their subjects reasonably believable.

At present the series consists of bears, swans, pelicans, owls, macaws, turtles, and others, all of which have characteristics

MICKEY MOUSE



which lend themselves to comedy. With some it is an air of injured dignity; with others, solemn importance. Slow-motion pictures accentuate the carriage of the individual animals, making it easier for artists to reproduce their traits in ludicrous caricature.

"The secretary bird, with its long strides and grave demeanor, is a comic strip in itself," Disney said. "Put a little silk hat on him, give him a briefcase, get that important walk of his into your sketches, and you have a riotous cartoon character right there."

What future pictures will compose the series, Disney has not decided. Whether he will select the common or barnyard variety of birds and animals, or those which are already nature's caricatures in the flesh, is yet to be determined.

The original reels of the series were shot in zoos during a vacation trip in the east, Disney said. He made them merely for his own amusement, and with no thought of starting a "reference library." Upon his return to Hollywood, however, he showed them to his animators and studio staff. Their keen interest and enthusi-

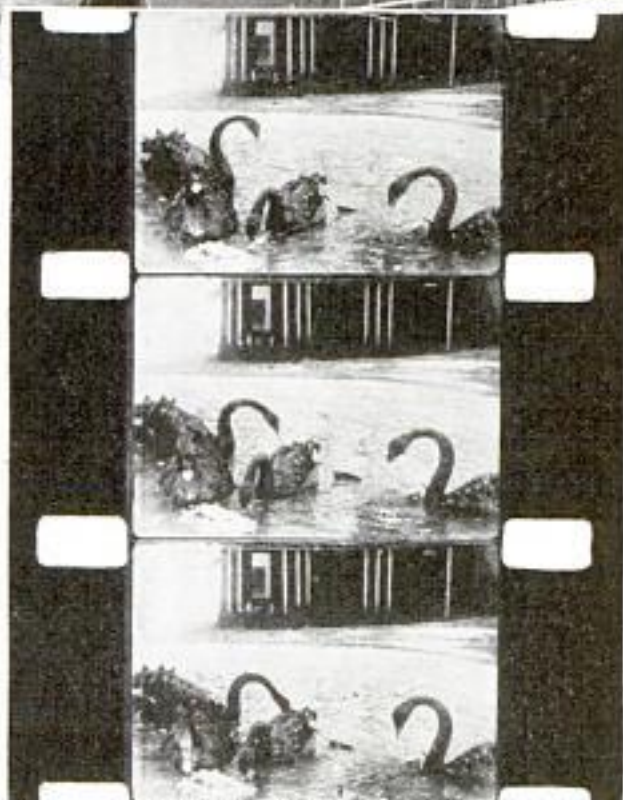

Above, Producing Sound Effects for Animated Movies; Below, Movie Strip of Water Fowl

astic comment convinced him of the worth of adding to the series.

Animated cartooning as practiced today is a highly organized endeavor. To meet exacting schedules pictures are turned out in two weeks or less month after month, although 10,000 to 12,000 drawings must be made for each seven-minute picture.

B/1210

National Drain Tile Co.

Com. Roger Hawthorne City Room, Washington June 1, Washington, D.C.

MILK NOT SOURED BY THUNDER

Contrary to popular belief, thunder does not turn milk sour. Chemists of the department of agriculture found the belief to be erroneous after making careful experiments to determine the effects of climate on milk. They found that, just before a thunderstorm, the atmosphere is usually warm or even uncomfortably hot. Such conditions are favorable to the forming of bacteria and sour milk may result, but it is the heat and not the thunder that does the trick.

B/1212

BRACKETS SUPPORT BATHTUB AND TIE IT TO WALL

Preventing bathtubs from pulling away from plaster or tile and lessening the possibility of cracks where the rim and wall meet, a bracket that holds and ties the tub to the wall has been devised. The bracket, made of tough metal, will support a weight of 750 pounds. It is designed to be fastened to a stud or two-by-four upright by a heavy bolt. An adjustable screw makes it possible to give the right amount of support at each point, so the tub rests evenly not only on its base, but also on the brackets. For a corner bath, three brackets are used, one on the end and two at the rear. Four are used for a recess tub, one on each end and two in the rear.

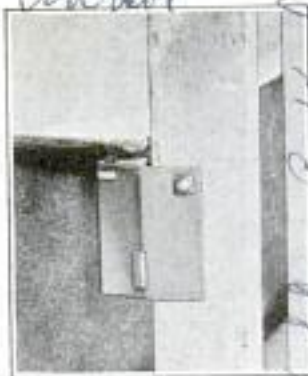

Whenever you find that you wish to know more about any article in this magazine, write our Bureau of Information.

Siphon designed by Paul Bloch, installed by Paul Bloch and Charles S. Terre Haute, Ind. Siphon designed by Harry Harbulak, Engineer, American Pipe & Foundry Co. Terre Haute, Ind. also consulted.

How Water Is Drawn from Open Quarry, at Left, through the Siphon and Dropped into Mine Shaft at Right

SIPHON SUCKS QUARRY WATER INTO "BOTTOMLESS" HOLE

Solving an expensive pumping problem, a siphon is keeping an Indiana shale quarry clear for excavation by sucking the water into an apparently bottomless hole. Although the siphon draws 1,000 gallons per minute from the eight-acre quarry and empties it into the shaft of an abandoned mine 300 feet away, the water level in the shaft remains the same. The old mine is 400 feet deep, while the shaft has a constant water level of 173 feet, regardless of seasons of rain and drouth and of the 1,400,000 gallons of water poured into it daily. Until the siphon, consisting of a six-inch iron pipe with a twenty-foot lift, a 300-foot level and an eighty-foot discharge, was installed, it was necessary to maintain expensive electric and steam pumps to keep the quarry dry. Now the operation is done without any power cost. The fall of the water from the siphon to the level in the shaft exceeds the fall of Niagara by thirteen feet. The siphon can be primed and started by one man in thirty minutes simply by operating a lever.

Com. N.C. Whitney, of National Drain Tile Co. 220 Rose Dispensary Bldg. Terre Haute, Ind.



Wind Machine Developed for the Movies Being Used to Blow Out a Brush Fire; Dirt and Sand Are Shoveled into the Air Stream from the Propeller to Smother the Flames

WIND MAKER USED BY MOVIES FIGHTS FOREST FIRES

Blowing out a brush fire as easily as a person might snuff out a match, a powerful wind machine, developed for a Hollywood motion-picture studio, has been used successfully in combating forest fires by the Los Angeles county forestry department. Tests proved that the machine is capable of putting out any small blaze quickly, best results being obtained when

dirt and sand were shoveled into the stream of air from the propeller, thus smothering the flames. The wind machine may be particularly valuable where no water is available, and, if mounted on a tractor, could be taken into heavily overgrown territory. It is also proposed to direct the blast of air through a funnel-like nozzle and, with the compressed air, blow out by the roots brush and dry grass to cut fire breaks. A similar use might be found in cleaning the sides of highways of litter.

THERMOMETER LIKE A CLOCK HAS DIAL AND POINTER

Shaped like a clock, a desk thermometer with a dial and pointer is exceptionally easy to read and neat in appearance. It contains no mercury but is controlled by a piece of thermostatic metal which is so



*Thermo clock Mfg Co
Springfield, Ohio*

sensitive to changes in temperature that it moves the hand forward as it expands and backward as it contracts.

SCREEN-DOOR SAG PREVENTED BY ADJUSTABLE BRACE

Permanent cure for sagging screen doors is provided by an adjustable brace which takes much of the strain which ordinarily distorts the light joints. The brace reaches from the top of the door on the hinge side to the bottom of the swinging side, and is equipped with a ratchet take-up to preserve proper tension of the bracing wire.

*Wrest Bros 930
W. Hill St.
Louisville, Ky*

B 1185

Huge Tree Is Moved Like House on Rollers



was taken from a hillside where the dirt was four feet lower on one side than the other, but it now rests on level ground in a perpendicular position. There were sixty-four eight-inch hickory rollers under the tree at all times, eight of these rollers being moved with every eight inches of progress. These rollers revolved over a solid carpet of two-inch timbers on which a three-inch oak track was laid crosswise. In some places trestle work, seven feet high, was required as it was necessary to keep the tree's base virtually level at all times. At several points, power and telephone lines were encountered, and it was necessary to raise these wires and pull down the branches of the maple. Thirty large timbers were buried under the tree and will not be removed, but the tub around the roots was taken away before lowering the weight

Right. Sixty-Foot Tree Being Moved on Rollers to a New Location, Shown Above

Using methods similar to those employed by contractors in moving houses, a century-old hard-maple tree, sixty feet tall, has been moved in an upright position for a quarter of a mile by placing it on rollers. This unusual feat was accomplished on the estate of W. A. Sheaffer, at Fort Madison, Iowa, where from twenty to forty men labored for several months to roll the 150-ton weight of tree, dirt and timbers upgrate over a rough pasture to a point overlooking the Mississippi river. The tree, with branches spreading fifty-two feet, was raised from its original location with its roots incased in a huge dirt ball, which was held in place by a giant tub constructed around it. This ball was thirty-two feet in diameter and about four feet thick. The maple



Cont

W.A. Sheaffer
Pen Co

Tulsa Okla for B 1195 skipper Capt William Lindley

*Cont. W. P. Steven. Tulso Tribune
J. E. Swartz Spring Suspension*

into the ground. The tree has thrived since being placed in its new location, leafing out as well as ever and making a growth of from four to six inches of new wood.

B 1126
FIGHT OIL FIRE WITH WATER

Directed against the heated walls of burning oil tanks, water turns into steam that helps extinguish the fire. Discovered by accident, this method has been effective in two fires. If water is poured on burning oil, it spreads instead of checking the flames, and firemen usually are helpless when a blaze starts. Quick action is necessary because the water must be turned onto the hot tank and the fire be smothered by the resulting steam before there is an explosion.

B 1144
SPRINGS SUSPEND AUTO LOAD FOR EASY RIDING

Automatically holding in suspension the load when an automobile strikes a bump, a new spring arrangement is offered to increase riding comfort, prevent broken springs, reduce jar and shock to a minimum, prevent wheel shimmy and eliminate sideway. With the new suspension, the auto body is allowed to fall by gravity

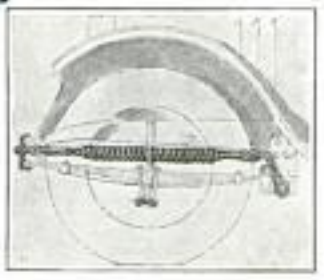

into a non-bottoming spring system, automatically controlled according to the severity of the fall. This keeps the body and load from separating. Shock not only is absorbed, but is distributed evenly throughout the spring system.

*Truck Equipment Co Inc
1791 Fillmore Ave
Buffalo, N.Y.*

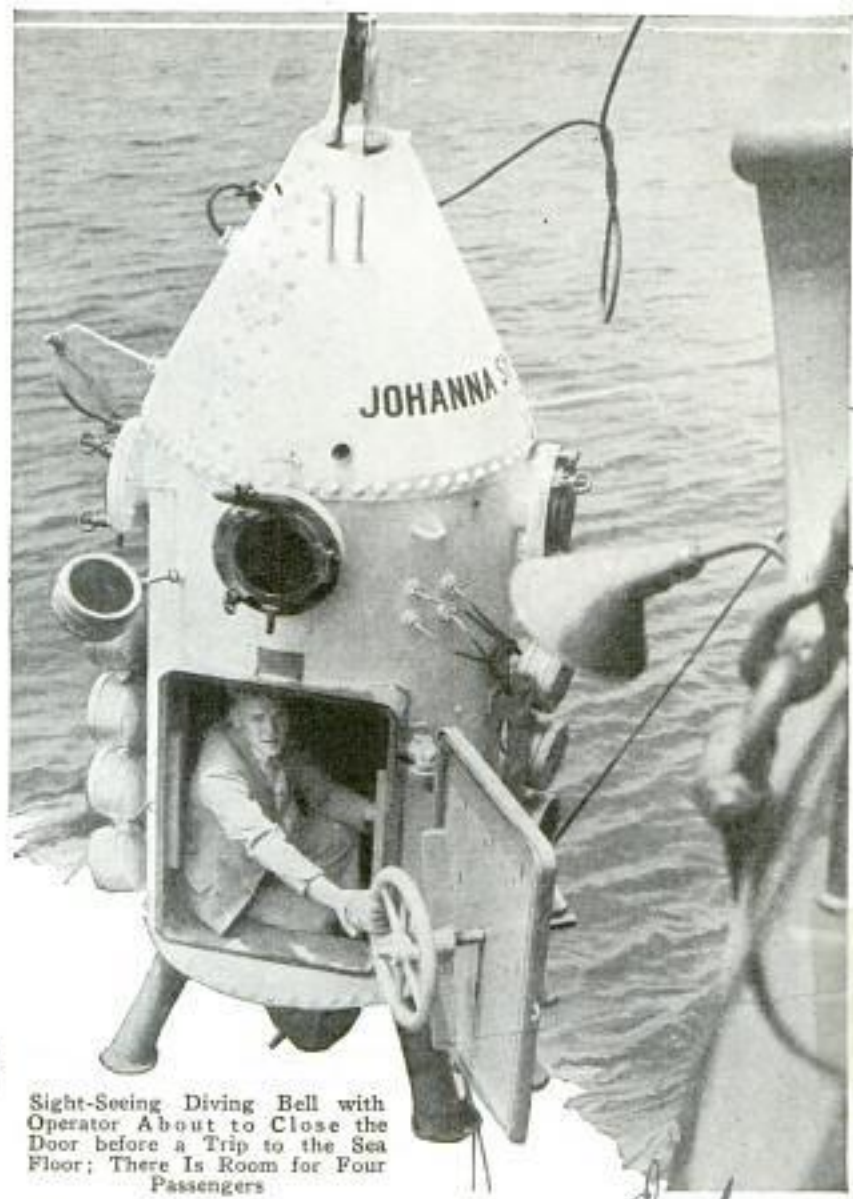

Sight-Seeing Diving Bell with Operator About to Close the Door before a Trip to the Sea Floor; There Is Room for Four Passengers

*Installd aboard the Johanna Smith
Calif 12 miles off coast of Southern*
PASSENGERS RIDE DIVING BELL TO BOTTOM OF SEA

Seeing the sights on the ocean floor is made possible by a passenger-carrying diving bell in use off the coast of California. Four persons at a time may visit the bottom of the sea, sinking 150 feet in the bell, which is attached to a ship. Oxygen tanks and an air purifier protect the passengers, and enable the bell to remain submerged for sixty hours. Twenty powerful lights illuminate the water and ocean floor during night descents, so that passengers will not miss the strange scenery.

For the first time in nearly thirty years, documented sail yachts increased in number in the first nine months of the fiscal year ended June 30, 1932.

*Bureau of Navigation
Dept. of Commerce*

B1205

Pres, Stout Engineering Laboratories
2124 A Telegraph Road,
Clearwater, Fla

The MOTOR CAR

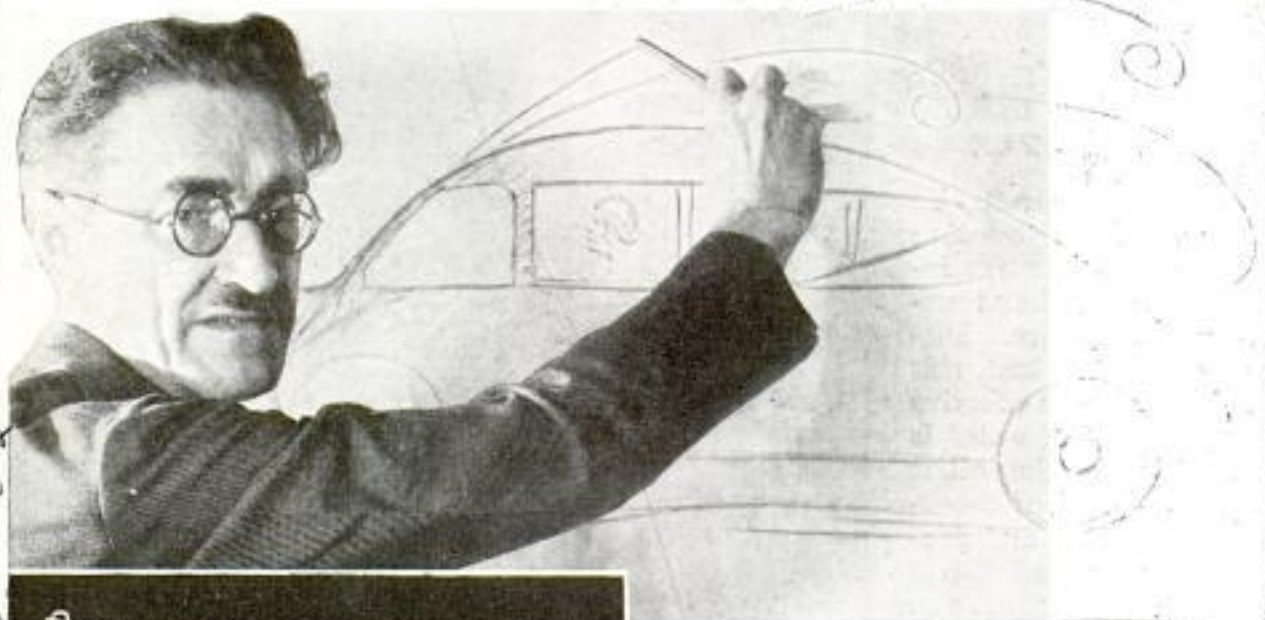

Famous Aeronautical Designer Visualizes an "Ideal" Automobile

By WILLIAM B. STOUT

row's car will be new and radically different, but it will be sane—saneer than today's, and safer.

To meet it, you present-day motorists must first revise all your conceptions of motoring; lay away your assumptions of what motor cars should look like along with your old-fashioned goggles and duster. This is a NEW automobile.

Briefly, here is what you may expect for your motor money tomorrow—or, at least, some day:

Acceleration from standing start to sixty miles per hour in eight seconds or less; higher usable top speed than any present car.

Twice the usable inside space for the wheelbase and tread of present cars.

Twice as much milcage per gallon of gasoline.

Engines weighing not more than five

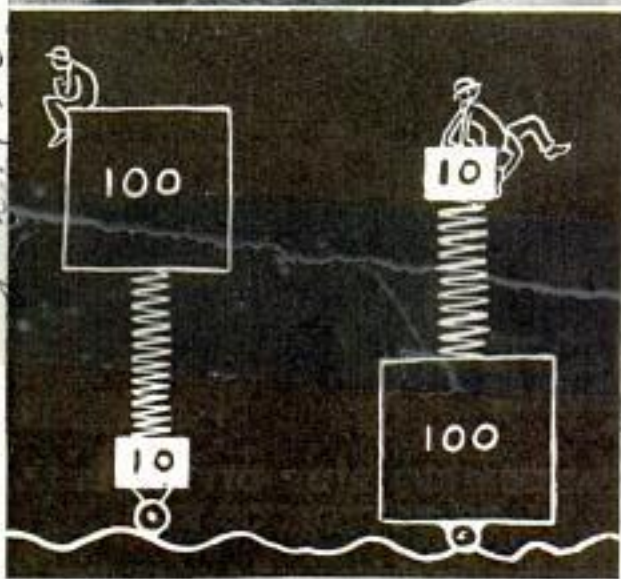

Simple Visualization of the Virtue of Low Unsprung Weight in Striking One-Inch Bump; "Passenger" at Left Is Bounced One-Tenth Inch; Same Bump Bounces Passenger at Right Ten Inches

WHEN the "ideal motor car," the fabled automobile of the future, becomes a reality—if ever—it will come literally from the sky.

That does not mean, however, that tomorrow's motor car will be merely an airplane minus wings, mounted on four wheels and equipped with steering gear. Rather, it will be a new interpretation of highway transportation, designed and built to aeronautical standards of structure and performance efficiency. Tomor-

Stout Scarab Rear Engine Car - 327
-62
- Jan 1936
March 1935

of the FUTURE

pounds per horsepower; rear-mounted so that sound, odors and vibration can be effectively insulated from the body.

Streamlined bodies with forced ventilation for summer driving, forced heating in winter; non-glare windshield and windows.

Total weight of less than 1,000 pounds.

Simplified control; no gear shift, no clutch pedal, effortless steering at all speeds.

Cost: about half of the present-day car of comparable quality.

Tomorrow's car will be streamlined, of course, but not after the pattern of airplanes, birds or fish. To follow their example would be highly disastrous. Birds, airplanes, fish float in their respective mediums of travel; with them, pressure always comes directly from in front, no matter whether they are going with, against or across the current. The automobile,

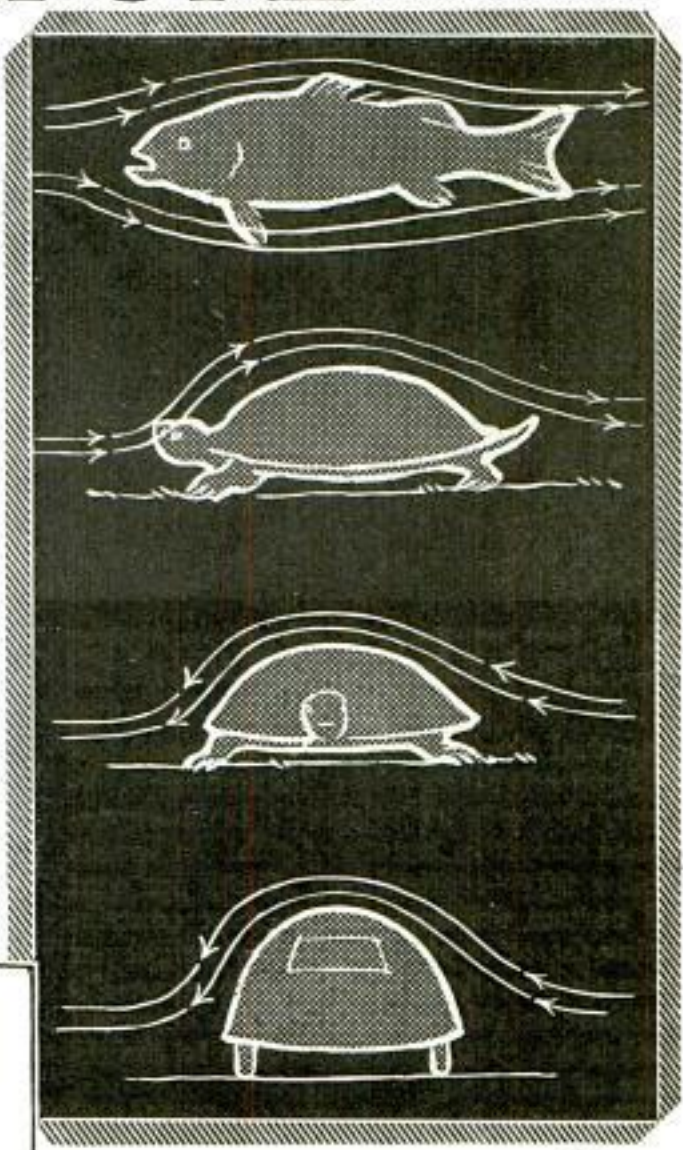

"Slide-Rule Minds"

TO the world at large, William B. Stout is best known as an aeronautical engineer and enthusiastic disciple of air travel. To those who know him best, "Bill" Stout is preëminently an ardent opponent of all forms of the "slide-rule intelligence."

"Precedent and tradition are among the greatest handicaps to progress," he recently told the Society of Automotive Engineers. "Too often, they squeeze ideas into a jelly. Real progress comes from new assumptions; new viewpoints. Engineering that depends on slide-rule and mathematics for creation is doomed to failure."

A decade ago, Stout was regarded as a "radical." Today, he is hailed as a "genius." Planes bearing his name are flying wherever air travel is known. But Stout is still a "radical." He still believes in the "fallacy of past experience." He still preaches the doctrine of the open mind—new perspectives and new vision.

Turtles Offer Best Models for Motor-Car Streamlining; Fish Travel with Pressure from the Front; Automobiles, like Turtles, Are Subject to Cross Currents

however, is fixed to the road, and air pressure may come from any quarter. Designed like a fish or an airplane, an automobile might fare well enough in a direct headwind, but an unexpected air current on the quarter would probably blow the "fishy" car right off the road.

So, for a streamline model, engineers must seek in nature some shape streamlined in all directions; for example, the turtle or the crab. They have been designed by nature to walk along the bottom of a river undisturbed by the current no matter which way it flows. Theirs is efficient dual-medium streamlining—highly

B1265
442

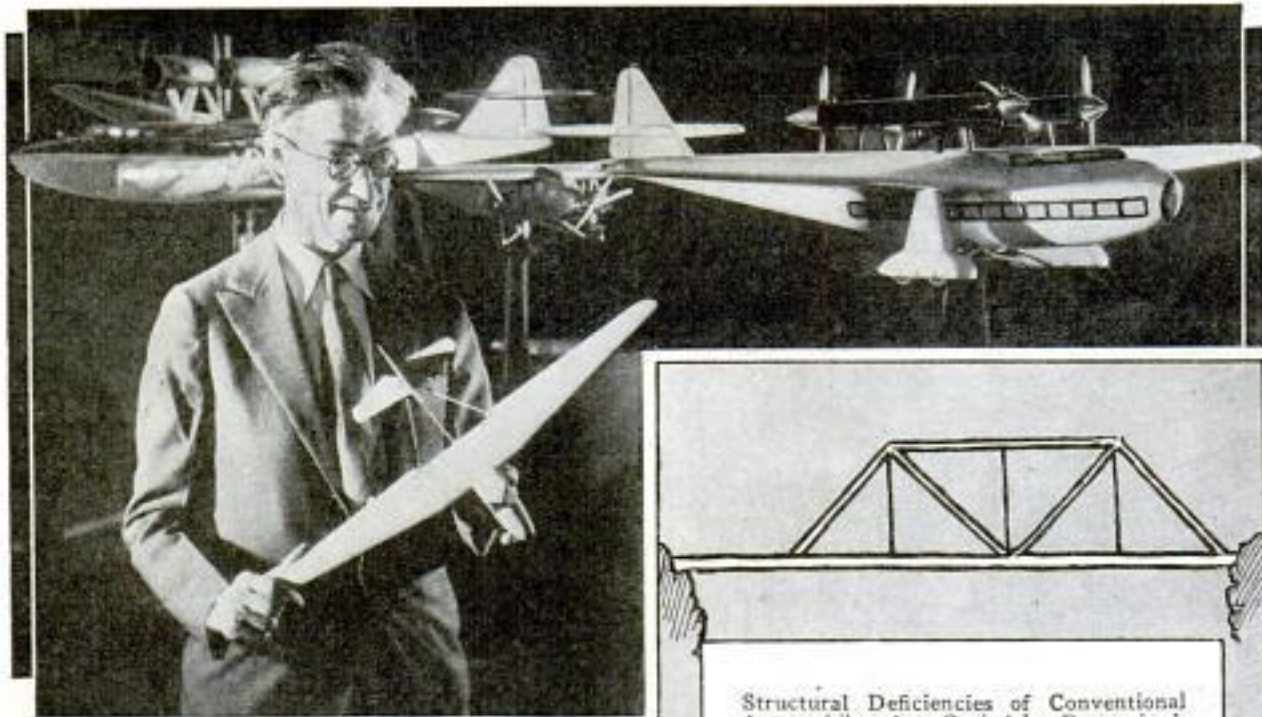

W. B. Stout and Models of Some of the Airplanes Which Have Made His Name Famous along the Skyways; in His Hands He Holds the Sky Car, His Latest Creation.

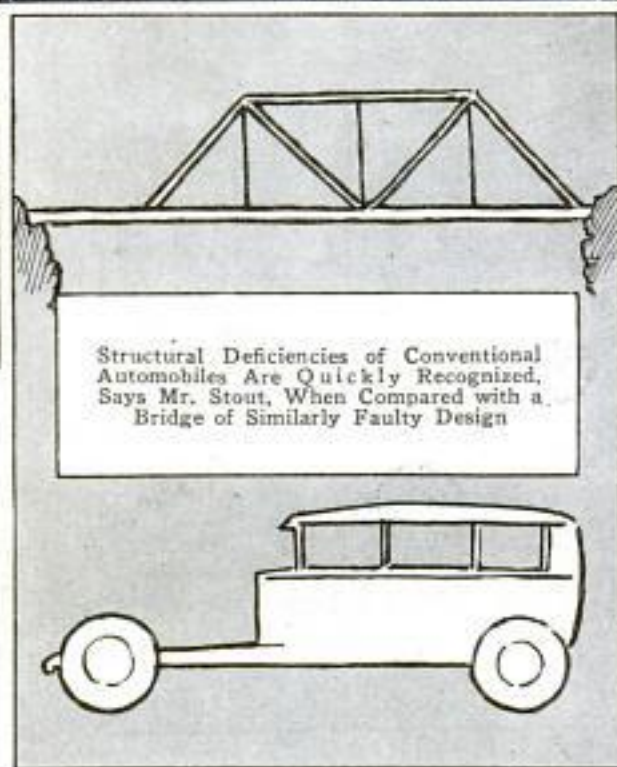

practical for application to automobiles.

At speeds below fifty miles an hour, however, shape is of relatively little importance except in beauty of line. At speeds below fifty—representing ninety per cent of normal driving—the greatest contributing factor to efficiency is low weight per horsepower. And, in holding down weight without sacrificing strength, the aeronaut makes his greatest contribution to the future of motoring.

The public is accustomed to thinking of airplanes as flimsy, simply because they are light. On the contrary, airplane structures are the strongest known, pound for pound. My own little "sky car," weighing approximately 1,200 pounds, will support a load of 12,000 pounds of sand in its wings—in fact, it must pass this test before it is given government license. Show me any structure—automobile, bridge, skyscraper, or what-have-you—that will support a burden of ten times its own weight without injury.

In promoting structural strength, the turtle-back shape will be just as important as in its contribution to streamlining. It affords an ideal opportunity for a simple truss construction of the body, conserving weight and permitting a high degree of rigidity without resorting to the

frame of the present car. To the uninformed, the idea of building a motor car without a frame may seem like building a house without a foundation. To the aeronautical engineer, however, the automobile frame appears as evidence of faulty structural design.

Imagine a bridge which for three-quarters of its length across a river is built of conventional truss construction and the rest of the way is supported merely by a couple of horizontal girders. How would you like to drive across it? Yet, in effect, that is the design of your present sedan.

Another essential of the present car, which will be conspicuous by its absence (some time) in the future, is the spring. Springing now is fundamentally wrong in theory. By adding shock absorbers you modify the basic fault, but you do not correct it. Stiffen the shock absorbers so that they restrict spring rebound and, to

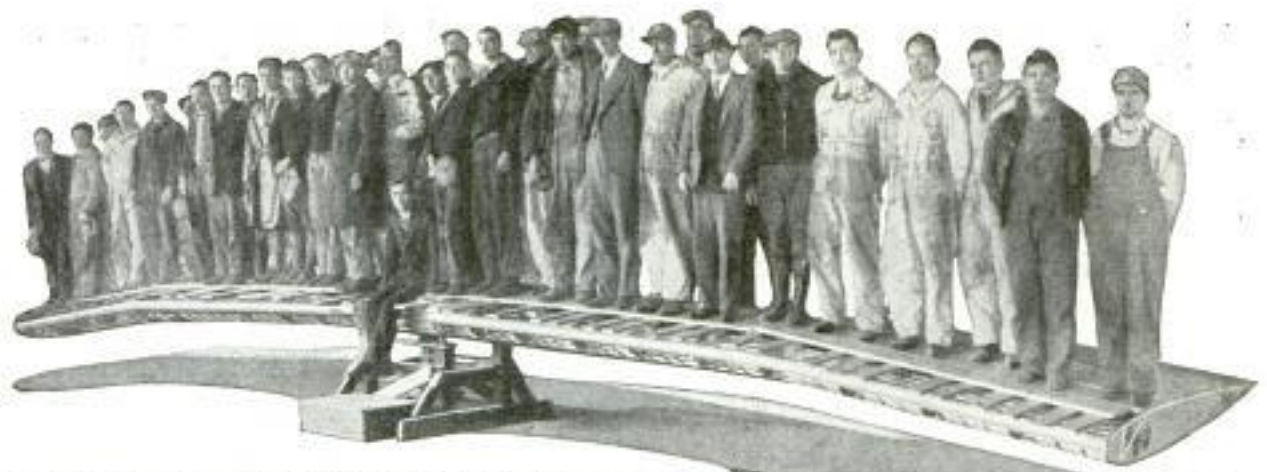

In Proportion to Weight, Airplane Structures Are the Strongest Known; This Wing Easily Carries the Load of Thirty-Eight Men without Evidence of Failure

a degree, you tie up wheels and body into one unit—the passenger becomes, in a sense, the only item of sprung weight.

Watch a modern transport plane land on the rough outfield of an airport; watch it taxi across to the apron. The wheels may be going through a veritable dance—but the fuselage rides evenly. Drive your car over the same route and note how differently it behaves.

So, you'll find tomorrow's car equipped with modified airplane tires of large air capacity at low pressure—from four to ten pounds. Instead of springs, it will have an adaptation of airplane shock absorbers, each wheel acting independently.

Believe it or not, the lighter the car, the greater the potential factor of comfort. And, most important of all is the matter of unsprung weight. Low center of gravity is not necessarily an indication of roadability. Indeed, some of the present cars actually are swung so close to the road that skidding tendencies are vastly increased. The center of mass must be so disposed that the side thrust created in turning corners, presses downward on the outside wheels, thus increasing traction and preventing skidding.

When will this ideal "dream car" become a reality? Frankly, I don't know—nor does anyone else.

Probably the greatest single obstacle will be the direct beneficiaries—the public. Because the automobile always has looked just about the same, they assume that it must continue to do so.

Unquestionably, one of the principal reasons for the progress made in aviation is the fact that "John Public" has had no

Stout Sky Car Must Support Ten Times Its Weight on Wings to Pass Government Test; Proper Balance, Not Merely Lowness, Is the Key to Roadability

preconceived ideas of what any airplane should look like. If Mr. Public were to judge automobiles by what they do and how well they do it rather than by exterior things, the engineer's "dream car" would become a reality almost overnight.

I am reminded of a young man who once evolved a radically different windmill, on sound aerodynamic lines. He showed his plans to a manufacturer who carefully examined them, then said:

"Young man, farmers have used windmills all their lives. They have become self-acknowledged authorities on windmills. When you design a new and better windmill, bear this in mind: It matters little how much more water it pumps or how much cost you save, but IT MUST LOOK LIKE A WINDMILL."

03/121

These Triplet Lenses Are Worked by Time Devices That Turn the Camera so Photos of Any Particular Star May Be Taken

Arms of Norman Lockyer Observatory Sidmouth, England

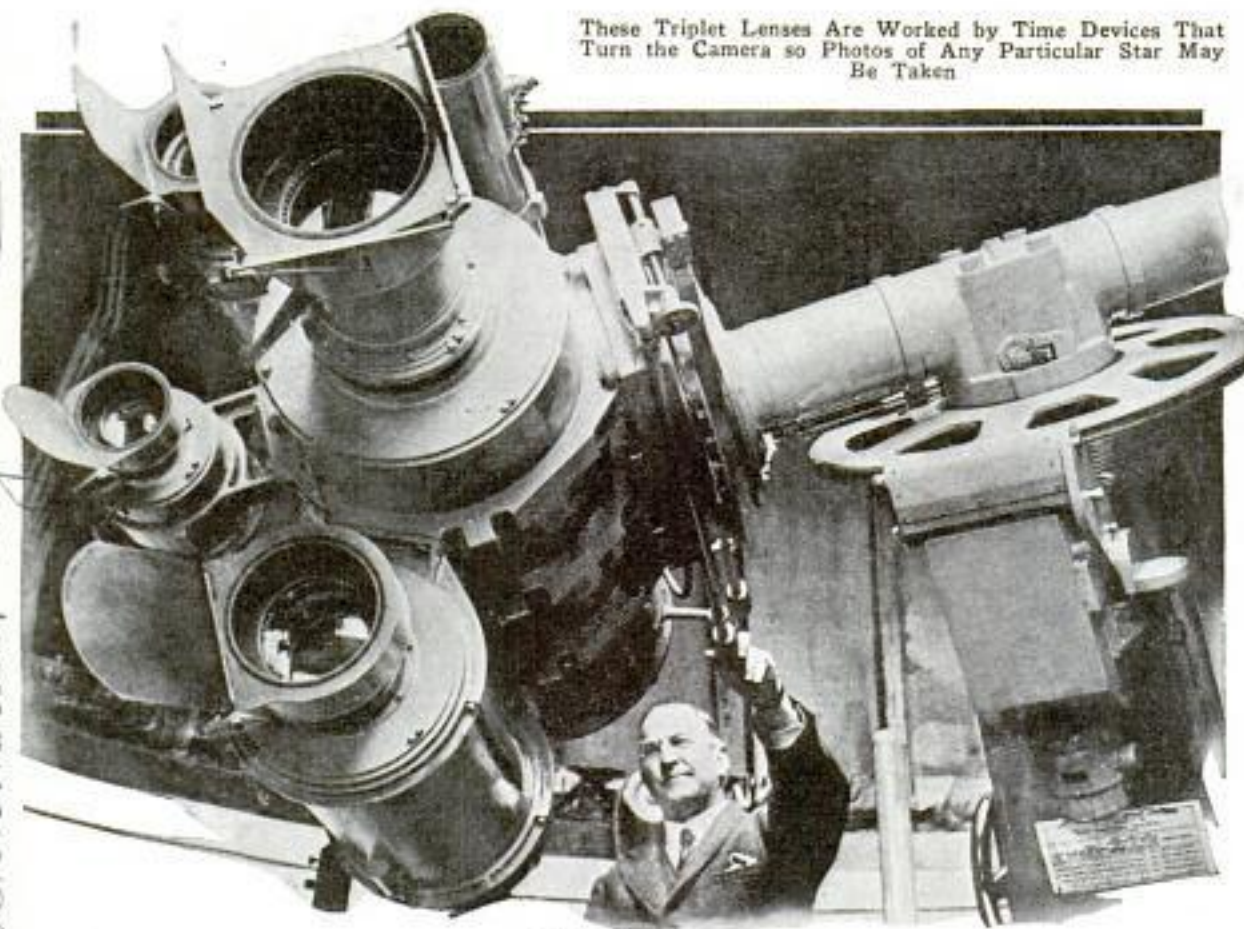

GIANT LENSES FOLLOW STARS BY CLOCKWORK

Operated automatically by clockwork, four triplet lenses keep watch on the heavens as the camera in which they are mounted follows the movement of stars for hours. The new camera is on duty at an observatory in England.

RADIATIONS FROM HUMAN BODY KILL YEAST GERMS

Living human tissues have been found to produce deadly radiations strangely reminiscent of the "evil eye" of superstition. Rays emitted from human blood, finger tips, the ends of noses or flashes from eyes are known to kill yeast and presumably other microorganisms. Prof. Otto Rahn, bacteriologist of Cornell University, has carried on these experiments with human radiations which, in some respects, seem to parallel scientifically the old superstitions that the human body can exert an evil influence on its surroundings. Yeast, such as is used in making bread, was killed in five minutes by radiations

from the fingertips of one person. When a quartz plate was placed between the fingers and the yeast, it took fifteen minutes for the yeast to die. It was likewise found that the end of the nose and the eye can kill yeast. The human chest, however, does not produce the radiation. In the tests of fingers, it was found the right hand is stronger than the left, even in the cases of left-handed persons. The experiments show that the blood and saliva emit the rays, but that the radiation varies with different persons, some having the power of producing effective radiations, while others do not. The radiations may even vary with the same person under different conditions. It was also demonstrated that the human body as a whole sends out rays. The exact nature of the radiation is not known, but it is suspected that it is some form of ultraviolet rays, because both the ultraviolet and the human radiations are effective after being passed through quartz. Several years ago, it was found that active muscles of the human body emit a very weak ultraviolet radiation which stimulated the growth of microorganisms. Resting muscles and most of the

Severna Service 6/24/32

Alhaca, NY

other body tissues do not produce these rays, but blood from healthy, normal people was found to radiate. The human radiations have been found to be mostly destructive, and when better understood, it is believed they may be found to affect the studies of germ diseases.

DB 114 5

IMPROVED HIGH-POWER LAMP IS SMALLER AND STRONGER

More rugged, yet smaller, than the old incandescent lamps, an improved high-wattage bulb has been designed and constructed in the General Electric company's laboratories. Fewer parts and simplicity in building are two advantages that are expected to revolutionize electric-lamp designing. Starting with two copper prongs, to which a special heat-resisting glass cup is sealed, the internal structure is built up from the prongs, that take the place of the ordinary base. The bulb containing the filament is sealed to the glass cup as the final operation. This method of construction is said to eliminate many weaknesses of the older type of lamp. Through elimination of the base, the heavy lead-in wires and the large stem of the common high-powered bulbs, the new lamps are considerably lighter in weight and shorter than their predecessors. The radical change in design came as the result of a demand for higher-wattage lamps. Since the largest incandescent lamps contain as much as three pounds of tungsten, the matter of weight was a factor in building the new lamp.

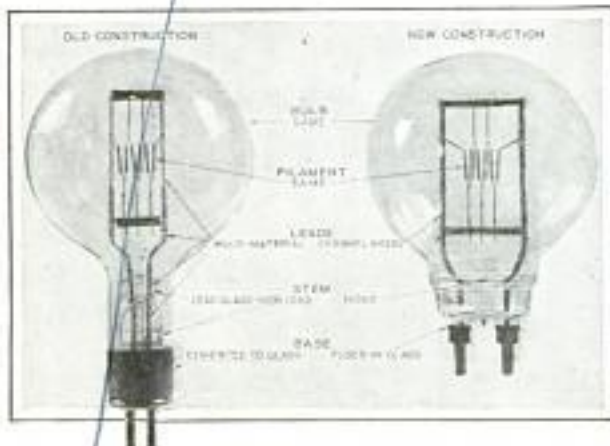

Photos Contrast Old and New High-Wattage Electric Lamps; Bulb at Right Is More Rugged

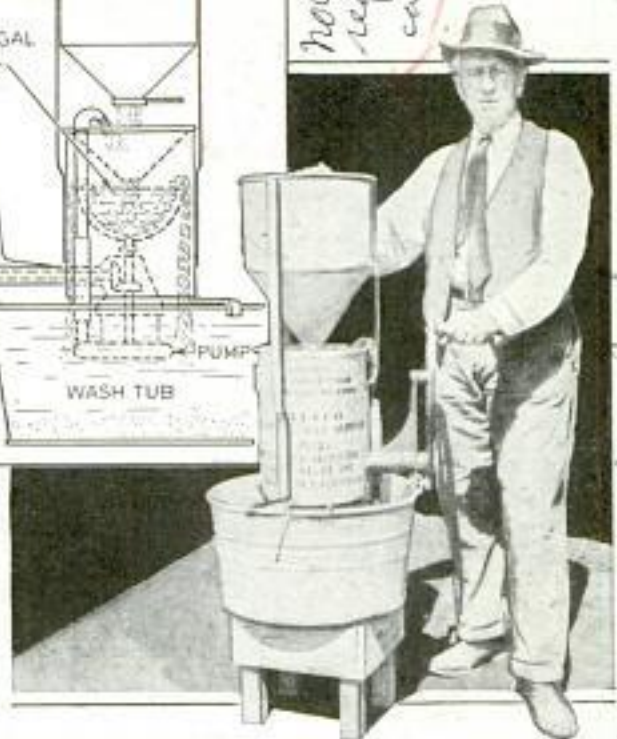
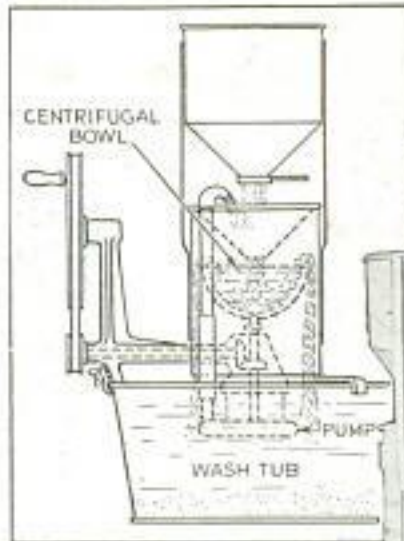

Little Water Is Required to Operate This Gold Washer Which Works Like a Cream Separator

WATER-SAVING GOLD WASHER OPERATED BY HAND

Operated like a cream separator, a wet gold washer that is run by hand is particularly adapted to arid gold fields because it uses little water. The washer can be clamped to an ordinary washtub or other convenient tank. The detachable bowl, at the upper end of a vertical shaft, is revolved at sufficient speed to throw heavy metallic particles against its side where they are caught in grooves that form the riffles. Lighter materials are washed on over the edge with the flow of water, which is maintained by the centrifugal pump at the lower end of the shaft. The pay dirt is first screened, and the screenings can be washed to an extreme concentration at the rate of half a ton an hour, it is claimed. No water is lost except that due to evaporation and the amount required for wetting the gravel. Three barrels of water are considered sufficient to handle four tons of screenings. The machine also is made in a power-driven model.

Every gallon of gas sold in France is taxed at least fourteen cents.

no answer required for calculating 1/19/34

The Jeffrey Gold Separator Co. 345 Santa Fe Ave. Fullerton Calif.

Mela Park Engineering Dept. Cleveland, Ohio

Dept. of Commerce Copyrighted material

Com. E. J. Baker,
 320 E. Grand Blvd.
 446
Detroit Mich
POPULAR
CARE OF SPARK PLUGS SAVES
FUEL AND HELPS MOTOR

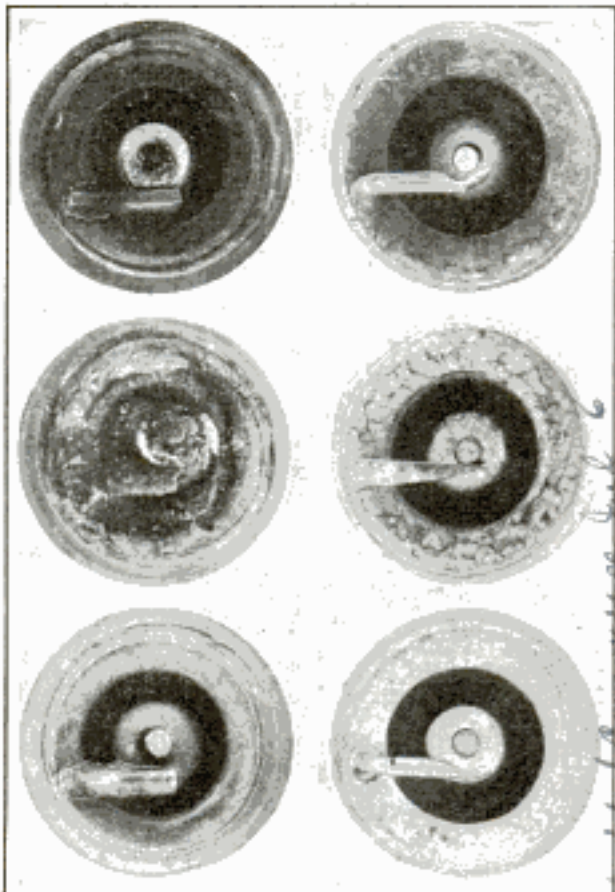

Inattention to Spark Plugs Results in Carbon Formations and Wearing Away of Side Wires

Proper care of spark plugs will save money for the motorist by reducing fuel consumption and improving the engine's performance. If the plugs are in good condition, general wear and tear on the motor is retarded, more speed and power is produced, and gasoline and oil do their work more efficiently. There are many things that can happen to spark plugs if inspection is made infrequently: The center and side wires may burn away completely; insulation may be cracked as a result of the plug being screwed insecurely into the cylinder, destroying the plug's usefulness, and excessive films of carbon may form, making it difficult for the spark to complete its circuit.

RAPID VIBRATING OF CONCRETE MAKES STRONGER PAVEMENT

Tests made by road engineers have shown that the strength of a concrete pavement is increased by high-speed tamp-

Designed by R.W. Barry and constructed by Barry-Island Corp
MECHANICAL
 16 S. Broad Philadelphia
 ing or vibrating of the paving slabs. The latest method of imparting the vibrations involves subjecting the strike-off board to blows at the rate of 3,500 a minute by means of an electric machine. It was found that the concrete becomes plastic, tends to flow to position and expels entrapped air. It has also been discovered that little hand-finishing is required after the vibrator has been used, and tests of cores taken from pavement so treated were stronger than untreated samples.

*Barry-Island Corp
 16 S Broad Phila.*

RECORD NUMBER OF PATENTS GRANTED LAST YEAR

Granting 52,572 patents during the last fiscal year, the United States patent office established an all-time record. The number of cases awaiting action was reduced 44,000 in the last two years, while the number was reduced from 90,274 to 76,723 last year. The increase in number of patents granted for the year is 8,255, or 18.6 per cent, over the previous twelve-month period. Examining divisions have speeded up their work until all sixty-five are less than six months behind. These gains represent a big timesaving for the inventor, who usually waits for patent papers before trying to market his invention.

JAPAN TURNS TO MOTORCYCLE TO SPEED DELIVERIES

Replacing the rear wheel, a two-wheeled package carrier converts the American motorcycle into a merchandise-hauling vehicle in Japan. The carrier is bolted to the motorcycle after the rear wheel and mudguard have been removed. Loads of 500 to 800 pounds can be hauled at a speed of thirty-five miles an hour. The two-wheeled cart is known as a "sanrinsha."

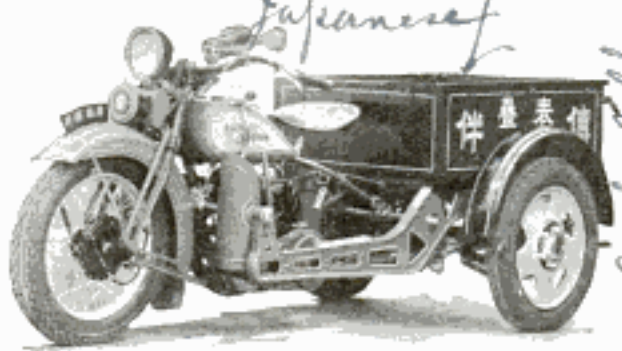

Two-Wheeled Package Carrier in Place of Rear Wheel on Motorcycle Used in Japan

Harley-Island Motor Co
 3700 W. Johnson Ave
 Milwaukee, Wis

031981
 Engineering News-Record
 6/23/32

031219
Dept. of Commerce

031200

Alfred R. Child
Yamashiro, Kama-hara, Japan

Copyrighted material

B1067 New York Polytechnic Medical
School and Hospital

POPULAR MECHANICS

447

Taking 'Ocean Voyage' on Roof of a Hospital



There's No Seasickness aboard the "S.S. Polytechnic" on the Roof of a New York Hospital; Fitted Like a Ship from Lifeboats to Gangplank, the Surroundings Give the Patient All the Pleasures and None of the Discomforts of an Ocean Voyage

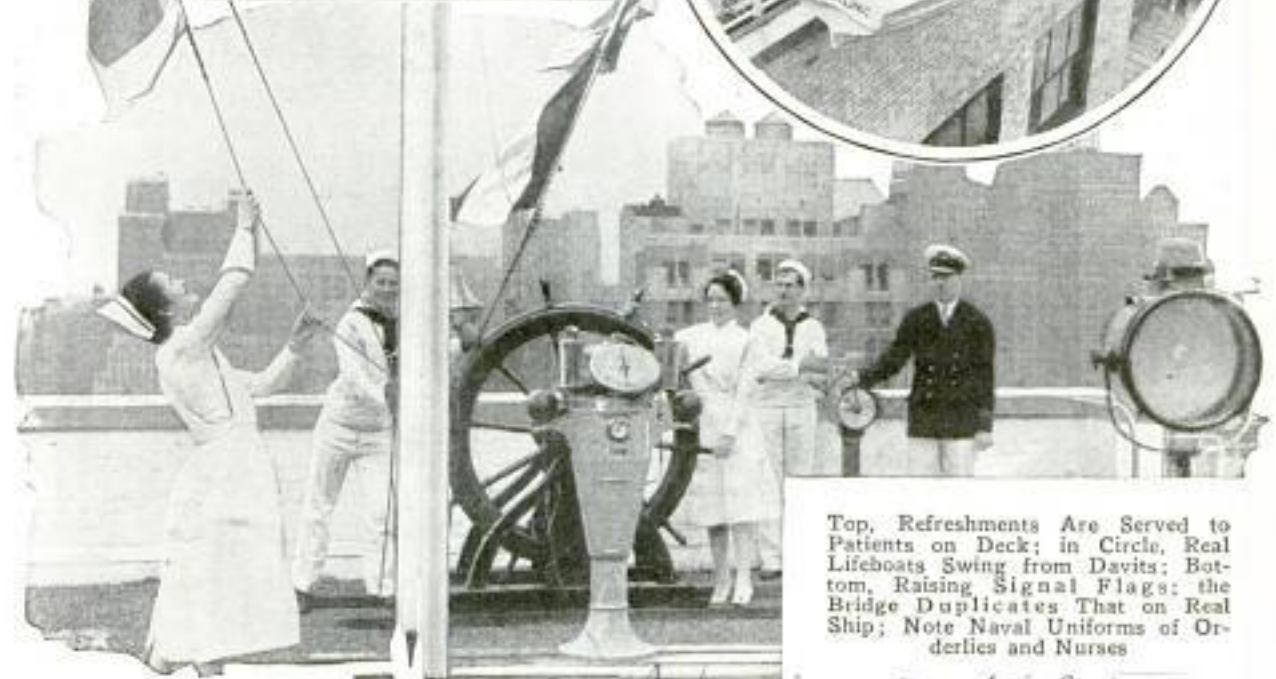
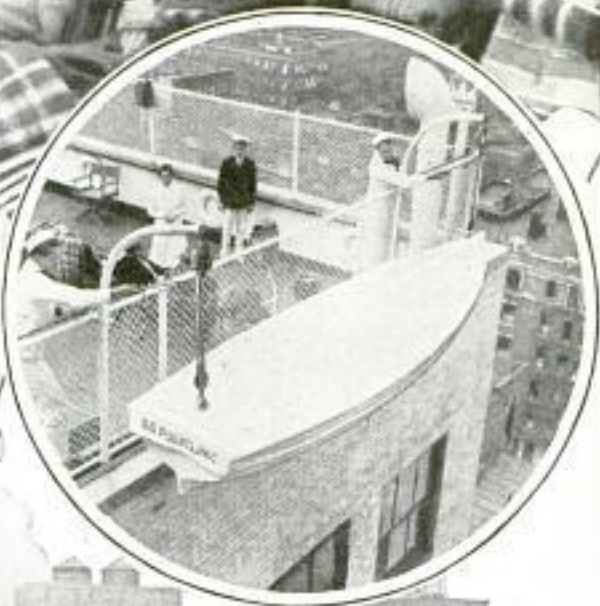

Top, Refreshments Are Served to Patients on Deck; in Circle, Real Lifeboats Swing from Davits; Bottom, Raising Signal Flags; the Bridge Duplicates That on Real Ship; Note Naval Uniforms of Orderlies and Nurses

Cmt. Andrew Halbram 725
Riverside Drive New York

B31194

shown at Royal Air Force pageant
desiderium



Glass Cage over Gunner's Cockpit of British Fighting Plane; the Dome Protects the Occupant and Increases Accuracy of Fire

GLASS CAGE FOR AIR GUNNERS INCREASES ACCURACY

British airplane gunners now do their fighting in glass cages. Gunners' cockpits in the fighting ships are being inclosed in glass domes which are windproof. The gunner thus is protected from the elements and it is claimed this protection increases the accuracy of his fire.

INVISIBLE LIGHTS HELP PILOTS AND AUTOISTS AT NIGHT

Relieving eye-strain of piloting a plane or driving an auto at night, invisible light for the instrument board has been produced. By coating dials with luminous radium paint and illuminating them with invisible ultraviolet rays, direct and intense illumination is eliminated. This makes it possible for pilot or motorist to read all the instruments at a glance without being blinded momentarily. Under the old system of dash lighting, reflections in the windshield often increased the autoist's confusion. J. H. Kurlander, engineer of the Westinghouse Lamp company, devised

150 Broadway
New York.

this method of suppressing glare and maintaining keen vision for the night pilot or driver.

OIL FURNACE CUTS FUEL COSTS BY LESS WASTE

Eliminating waste by using every heat unit in the fuel, an oil-burning furnace with a new principle of combustion has been effective in reducing heating costs. In an eight-month heating season, savings in homes have ranged from fourteen to fifty-three per cent. The furnace is the result of five years of research by General Electric company engineers. In one instance, the furnace replaced a hand-fired coal boiler in a fourteen-room house with a reduction

from \$555 to \$262 for the winter. The new plant was called on to maintain a temperature of seventy-two degrees night and day, whereas the old furnace was banked at night.

PENCIL CONTAINS KNIFE BLADE AND FILE IN TOP

Three handy pocket tools are included in a refillable pencil which also contains a finger file and knife blade. The file and blade fold into the upper part of the pencil and so do not interfere with writing.



Refillable Pencil Which Contains a Finger File and Knife Blade

It is estimated there are more than 4,000,000 electric clocks now in use in the United States.

Cattaraugus Cutlery
Co. Little Valley, N.Y.

see also Nov. 1932, 788

Harry L. Warren
W. Warren

Copyrighted material

03815

'Zoom' Lens Gives Close-Up at Great Height

Lieut. Geo. W. Goddard, of the army air corps at Rantoul, Ill., has just completed a series of photographic tests of a new "zoom" lens in flights over Chicago which gave very interesting results. It was established that, in wartime, observers could fly over enemy lines at 30,000 feet and obtain large photographs of important points, or smaller pictures of large areas for observation purposes. The large-scale photographs have the appearance of being shot at about 5,000 feet. In peace times, photographers can fly high above the minimum altitude of 3,000 feet set by traffic rules and get pictures equivalent to those taken at 500 or 600 feet.



BOTH PICTURES TAKEN AT ALTITUDE OF 4,000 FEET



Aerial Pictures Taken over New York with "Zoom" Lens Which Enables Photographer to Obtain Close-Ups of Important Points Included in the Large Area Exposed to Camera's Eye



NOW and again the men of the coast guard, who singly or in pairs patrol lonely stretches of beach sand along the far-flung seacoast of the United States, make a grim find. Somewhere between the margins of high and low tide they discover the body of a man that has been washed ashore. Generally it is suspected that the flotsam is a souvenir of a rum smugglers' fight. The chief cause is "hijacking," the act of robbing a liquor smuggler of his contraband wares. At sea it is piracy—no less.

Pirates they are at heart and pirates they are legally, these desperate men who prey on the ships of the rum fleet and on the satellite speed boats that run their cargoes ashore. Hijackers is the mildest term applied to them. The men of the coast guard call them murderous thieves. The contrabandists who smuggle the liq-



Hi, By

uor ashore call them rats and like rats they drown them, when they get the chance.

Time and again the bold forays of hijackers have forced those engaged in the illicit handling of liquor cargoes to change their practices. Out there, just beyond sight of land, where the liquor ships lie hove to in all kinds of weather, there have been some desperate fights in the last dozen years. Ships have been robbed of



Jack!

Boyden Sparkes

199. Puritan Ave Forest

their cargoes. There have been savage battles, and many unexplained gang killings ashore have been repercussions of these affairs. There is no twelve-mile limit to the frontier of bootleg vengeance.

Nevertheless that is where much of the trouble starts, out there beyond the twelve-mile limit. It is a vast fleet taken altogether. In the Atlantic ocean there are ninety-one ships engaged in the traffic, most of them hovering off Long Island

Hills Gardens, New York City

and New Jersey, safe beyond the authority of the coast guard to interfere. In the Gulf of Mexico there are forty-seven and in the Pacific thirty-three ships. The total is 171. Nowadays the ships protect themselves pretty well; it is the rumrunners in speed boats who suffer most from the depredations of hijackers. Yet the rum fleet itself has had bitter experiences.

Formerly each rumrunner who went out to the fleet was an independent trader, or else some boat owner paid, at the rate of \$10 a case, to bring liquor ashore. Then rum row was a kind of marine bazaar. The men of the small boats, manned sometimes by fishermen, sometimes by waterfront thugs, were permitted to go aboard the large vessels and dicker with the captains or the supercargoes. Then.....

She was a fishing schooner that had cleared from Miquelon, one of three tiny

13940



"All told, there were eight men in the gang. The crew were herded into the fore-castle. We two, the captain and the mate were kept in the cabin. They treated us all right, but we were prisoners for three days. They worked the ship eastward somewhere and ran the remainder of the cargo ashore. Then, on a dark night, they dumped all of us ashore on a dock in Boston harbor. Afterward the schooner was picked up at sea, a derelict stripped of ev-

French islands off the coast of Newfoundland. Under her hatches were 60,000 cases of "Pol Roget." Each case of the champagne had cost \$35. A little arithmetic will show you that this represented an investment of \$2,100,000. Taken ashore into the United States, that same cargo, at the retail price of \$90 a case, had a value of \$5,400,000. That would be enough to tempt any pirate that ever lived.

Yet there had been no wholesale hijacking up to that time. The captain, who had been a fisherman all his life, had rifles for his crew, but was not expecting trouble. He was in the cabin dickering with two men who had come out in a speed boat when there were yells on deck. According to one of his two visitors, the vessel was seized within the space of minutes.

"First thing we knew," he said, "four men came plunging down the companion-way into the cabin. One of them carried a sub-machine gun. 'It's a stick-up,' he said. 'Be good and you won't get hurt.'



everything of value." Other ships in rum row were robbed by gangs which came aboard in the guise of liquor buyers. There was no authority on shore that could be appealed to, since the whole business was offensive to the United States government. Finally the ships of rum row began to display signs on their hulls, advertising the brands of liquor they carried and the sale prices. All rumrunners were forced to keep off the big boats. The steamers did the best trade, for at night they advertised their wares and prices with illuminated signs slung between their masts.

This made it difficult for the hijackers, but did not in the least discourage them.

They began to lie in wait for the captains of the rum fleet, some of whom were obliged by their owners to steal ashore every few days with the proceeds of the sales. They could trust the captains a little, with \$50,000 or \$100,000, but they would trust no one with \$1,000,000. There was a bank near Broadway in New York, which had a great many bootlegger customers. In the safe-deposit-vault section in the basement, cabinets were maintained for the convenience of visitors. One day, a rum-fleet captain brought in \$75,000 in bills. That was the next line of attack of the hijackers. They began to waylay these treasure-carrying captains. Several were murdered. Again the big bootleggers ordered a change of procedure.

Thereafter liquor sales were consummated on shore. The captains handled no money whatever. Their employers began giving them tokens by which they could recognize the rumrunners who were entitled to receive their cargo when these rascals came out in speed boats. Commonly these tokens were half of a playing card or a piece of water-marked paper. If the piece presented matched a jagged half held by the captain, the cargo was surrendered. Quickly the hijackers devised a scheme to foil this precaution.

How it worked was told for my benefit by a New York lawyer who does a great deal of legal business for the present-day syndicate that dominates the liquor traffic into New York harbor.

"A small Brooklyn syndicate," he said, "made a deal for 1,000 sacks of rye whis-

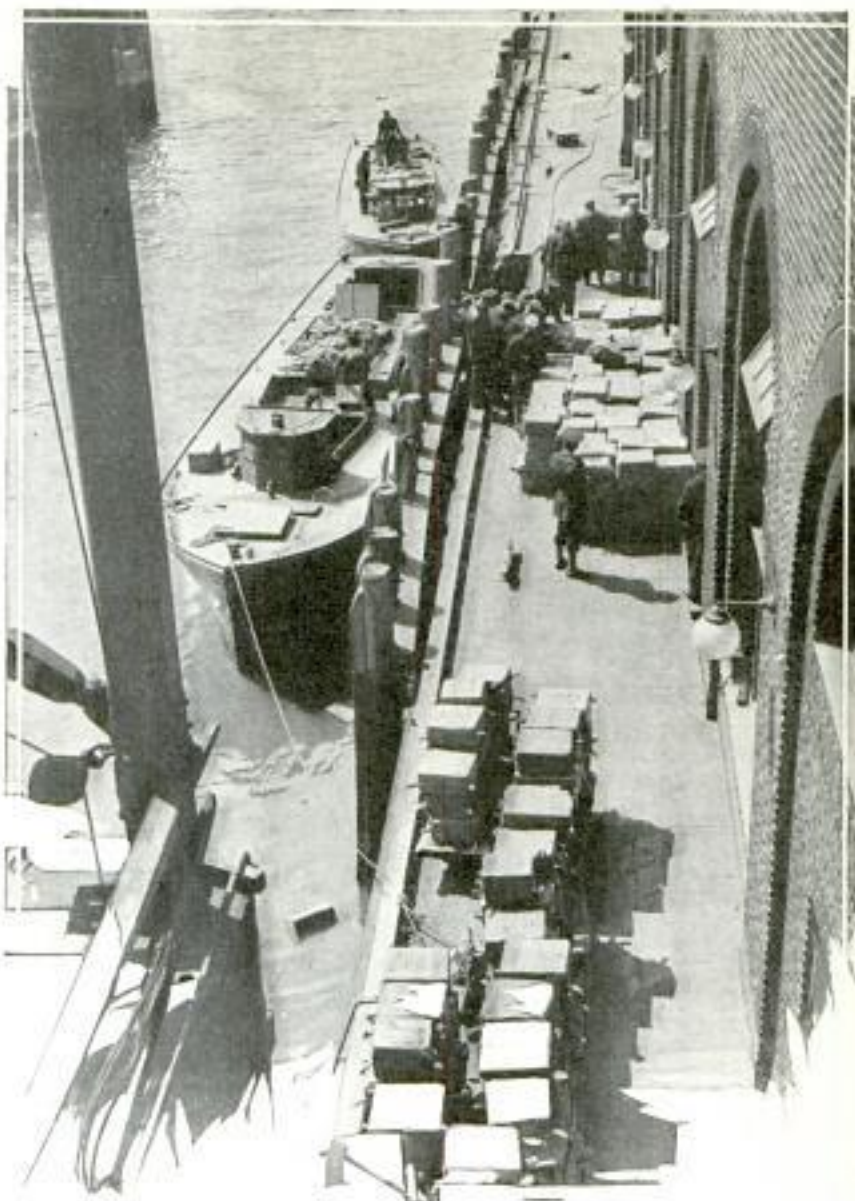

ky. The owners of the cargo gave the syndicate representative a token. It was made by tearing the ace of hearts across the middle, not smoothly but with a twist. One half was sent out to the captain; the other half was to be presented to him by the speed-boat crew which came out to get the liquor. One o'clock in the morning was the agreed time.

"But it was just midnight when a long, narrow speed boat arrived under the rail of the ship. It had traveled the last half mile of its journey in a cone of silvery illumination focused on it from the searchlight of the big ship. The skipper was standing at the rail with a megaphone.

"What's the idea of coming ahead of time?" he demanded suspiciously.

(Continued to page 131A)

Portable X-Ray Looks through Case at Mummy in Modern Science's Study of Diseases among Ancient Egyptians; Every Part of Mummy Is Photographed

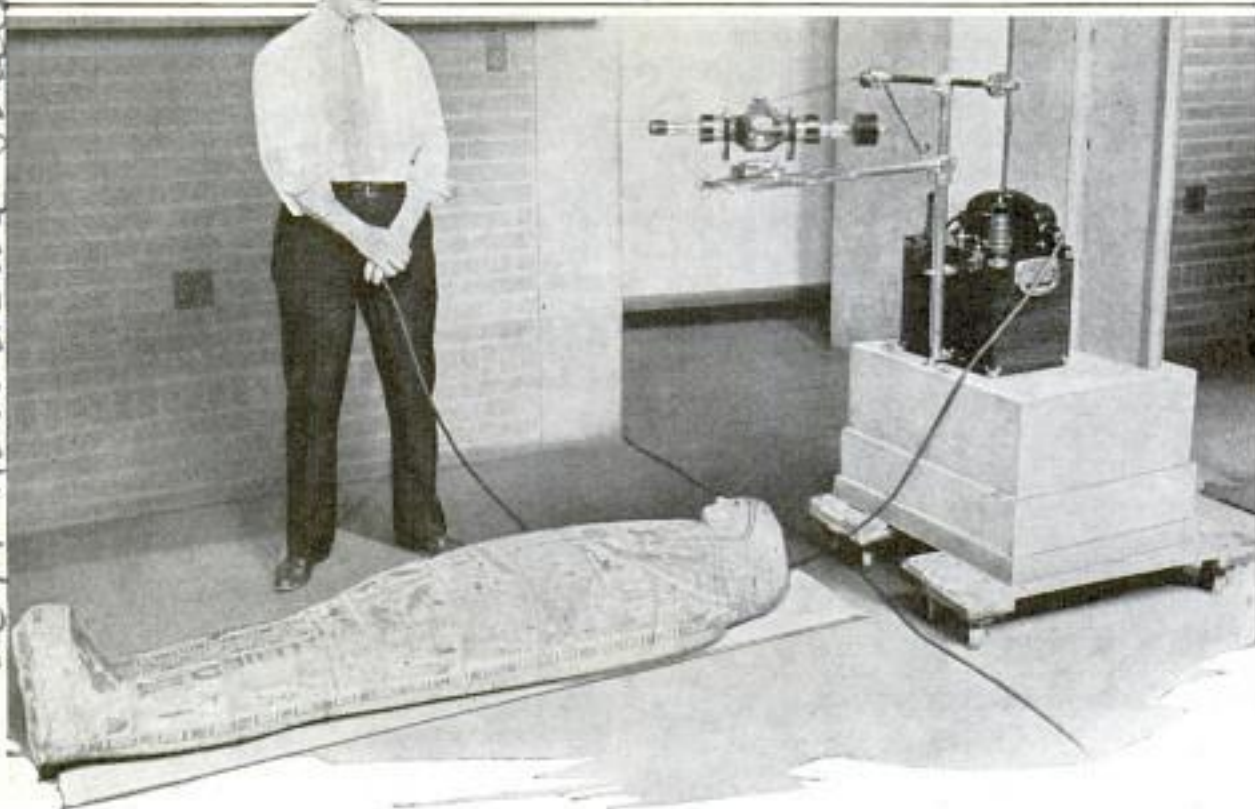

*Mrs. H. Eckhardt,
 2047 N. Park Ave Phila*

X-RAYS PROVE MODERN ILLS AFFLICTED THE ANCIENTS

Study of health conditions of the ancient Egyptians is made possible by a portable X-ray that takes pictures of mummies. While everyone has heard of mummies and has seen them in museums, few realize that what is seen most often is the mummy case, which contains the body. Since the case and the mummy are very fragile, it is impractical to examine the bodies except by X-ray. The mummy case is laid on the X-ray plate and exposed to the rays. In this way, every part of the mummy is photographed without opening the case. The portable machine makes it possible to do this work in the museum. Already results have been obtained that show the Egyptians suffered from diseases once regarded as modern in origin.

or side-to-side motion of the stick, while a steering wheel, mounted on and moving with the stick, controls the rudder. The three-in-one stick eliminates the fatigue and cramp caused by the pilot having to keep his feet on the rudder bar constantly on extended flights.

BIRD "CAFETERIA" PROTECTED FROM STORMS

B31049



postpaid \$1.95

Protection from stormy weather is given the birds by a feeding house that turns with the wind. The "cafeteria," built of cypress and wire glass, is triangular in shape with one side open. It revolves on a pole so that the open side is always away from the wind, protecting the birds and keeping the food from being blown or washed away. A reed perch gives the birds a lighting and resting place.

ALL CONTROLS IN PLANE STICK FOR EASIER PILOTING

B31106

Relieving the pilot of rudder-bar strain, a stick incorporating all controls has been produced for the airplane. Elevator and aileron control is obtained by to-and-fro

Middlesex, England

(Capt. C. Spragg, 56, Fleet St. London, Eng)

H. Mercum, River Road, Willoughby, Ohio

*W. J. Willard Aircraft Co. Ltd
 509, 511, 513, Edgware Rd*

Dr. R.C. Roark, U. S. B 826
 Bureau of Chemistry
 and Soils, Dept. of Agriculture
 POPULAR MECHANICS
 Washington, D.C.
 B 1096

455
 Williams Brothers, Lincoln, Neb.
 near Nebraska State Agricultural Station

COMPOUND IS DEADLY TO INSECTS BUT SAFE TO MAN

Deadly to insects but harmless to man and domestic animals when taken by the mouth, a compound that approaches requirements for the ideal insecticide is being tested. It has been found fifteen times as toxic as nicotine as a contact poison, and thirty times as toxic as lead arsenate to certain caterpillars. This means that spray residue would not have to be removed from fruits and vegetables before they were put on the market. On exposure to direct sunlight, the compound becomes yellow with a loss of almost all of its insecticidal properties. Experiments are being made to prevent loss in poisoning power. The compound's base element is found in an East Indian vine and the South American shrub "cube."

RADIO FIREPLACE FLICKERS TO MUSIC

Concealed in a portable fireplace, a radio, with its loud speaker in the firebox, plays while light flickers around the natural logs. The logs, cut from birch, are supplied loose so that they may be arranged to suit the individual. Two fans, resting on electric bulbs, cause a flicker that resembles flames, giving the appearance of burning logs. The dials are located at one side of the fireplace.



Harmony Instead of Heat Comes from This Fireplace; Radio Speaker Is Concealed in Firebox

J. Craft, 225 5th Ave
 New York City



Whole Trees Are Picked Up and Moved by a Nurseryman Who Built This Windlass and Frame on a Truck

TRUCK MOVES WHOLE TREES WITH WINDLASS FRAME

Large trees are transplanted, roots and all, with a truck with a windlass frame invented by Nebraska nurserymen. After the tree is dug up, a web belt is placed around the ball of earth clinging to the roots. Then the roots and lower trunk are pulled into the truck by a cable until only the top branches remain on the ground. The operation takes less than an hour. The windlass also is handy for pulling over the tree after the roots have been freed from surrounding earth.

AUTO CHASSIS ON RUBBER PADS HAS NO SPRINGS

Springs and other shock-absorbing devices are eliminated from a French automobile that has its chassis suspended on rubber pads. The chassis consists of two deep-section tubes in which are carried four radius rods. Each rod is attached to a road wheel and bears against two rubber pads in the tube. All movement of the radius rods produced by road shocks is cushioned and absorbed by the pads, one of which takes the direct stresses and the other the rebound. Equally good suspension at all speeds, elimination of steering-wheel shimmy through independent suspension of each wheel, and suspension without rebound or periods, are some of the car's advantages.

Harris Leonaerone
 Autos, Paris, France

Copyrighted material

03836 Cmt. H.W. Johnson, Esq
152, Essex Road

456 London **POPULAR MECHANICS**
England



Speeding Up Destruction of Old Roads.
This Machine Smashes Concrete with
5,000-Pound Blows from Its Sharp Teeth

Vermont and New York
lead in production of talc,
or hydrous magnesium
silicate.

031074
**ELECTRIC 'CHUTE
FLARES HELP IN
NIGHT LANDING**

Flares for night landings are fired by electricity from an airplane under a new arrangement for illuminating the ground without the aid of airport lights. A switchboard on the plane panel enables the pilot to release the flares by remote control. A spring ejects the cartridge from its case, a small charge of electricity setting it off.

Each flare is equipped with a large silk parachute to make it drop slowly, giving the pilot time to select a suitable spot. The flares are made in one and three-minute sizes. Five are carried in cases sunk flush with the plane's fuselage. In tests, large tri-motored ships landed with no illumination other than two flares, one dropped from about 2,000 feet and the other at 1,200. An area of about one square mile is lighted brightly enough by the two flares to permit selection of the best landing place. The flares can be used more than once.

London

**CONCRETE BREAKER FOR ROADS
HAS STEEL TEETH**

In England a concrete-breaking machine is being used successfully to tear up old pavements rapidly. The road is broken by eight powerful steel teeth biting into the surface. These teeth meet the concrete with a pressure of 5,000 pounds and smash it like so much clay.

**INDUSTRY USES TALC POWDER
IN FIFTY DIFFERENT WAYS**

Talcum powder is used in fifty different ways by modern business, in addition to that of beautifying women. The paper on which these words appear probably contains talc as filler. Many paints contain talcum powder in the place of whiting or clay. Asphalt roofing and automobile inner tubes are dusted with talc to prevent sticking and to reduce friction and wear. The soap you used today probably had talc filler, while your shoe polish has its quota. Rice, peas, coffee beans and other food products are cleaned and polished with the powder. It also is used in manufacturing cotton textiles. Some strange uses are making of match heads for explosives, polishing glass, dressing leather, packing eggs, dusting castings in foundries and making electric-wire insulation.

Sold at United Airport, Burbank, Calif.



Set in a Special Frame, Electric Flares Are Discharged
from Plane to Aid Night Landings

Sent to Logan National Airport, Wash. D.C.

Cmt. John C. Blinchaux
044 Manganite St.
Los Angeles, Calif

International Flare
Signal Co. Springfield
City, Ohio

PHOTOGRAPHS OF AIR FLOW
 TAKEN BY MOVIE CAMERA

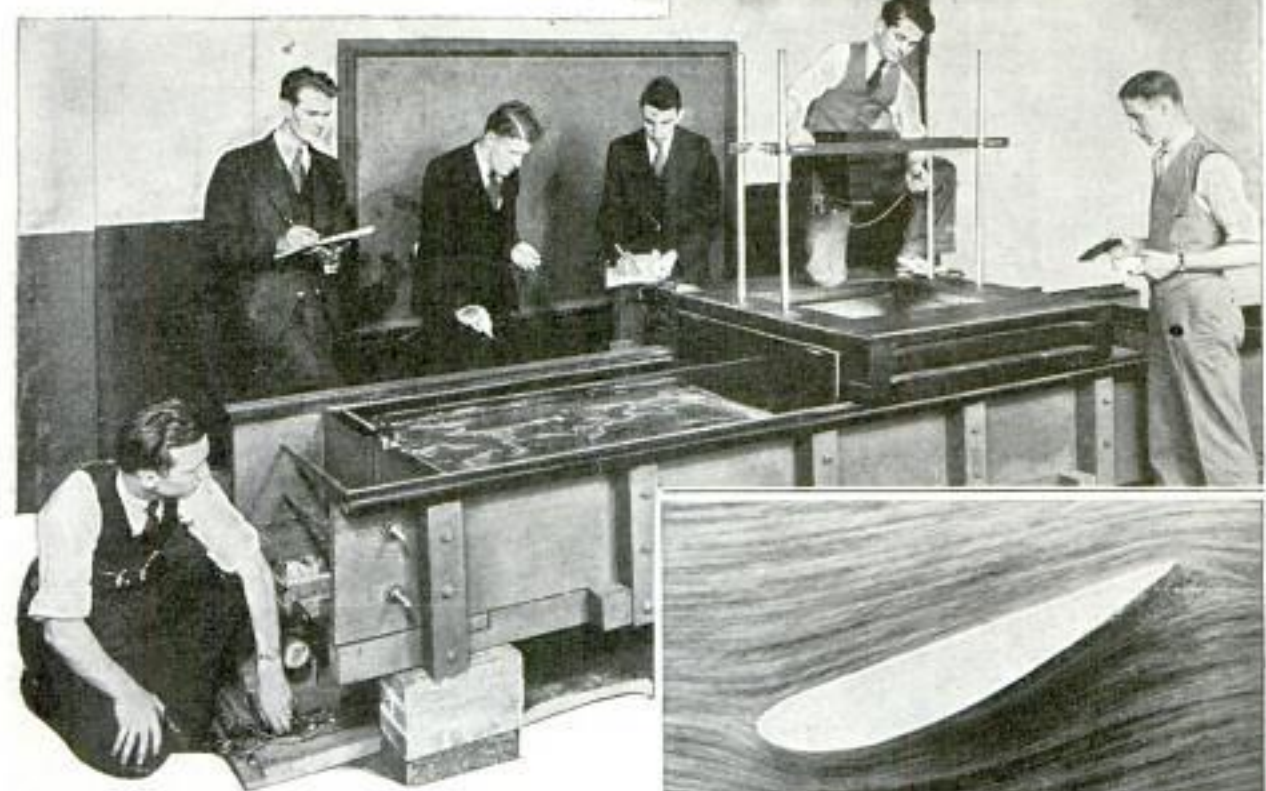

Camera on Moving Carriage over Tank Photographs Flow of Liquid around Objects Tested for Streamlining

Accurate pictures of the disturbance of air around a moving body, such as an automobile or an airplane, have been made by using a movie camera mounted on an electrically driven platform. Small wooden models of airplane wings, seaplane hulls and midget cars are towed through water whose surface is coated with a chemical. The movement of these models through a fluid, whether water or air, produces flow effects which, when photographed, are faithful simulations of what happens when a regulation airplane speeds through the air or an auto races along the highway. The water in the tank is colored with potassium permanganate while a light powder, lycopodium, is blown over the surface. It prevents coagulation and aids in reflecting the light so that the streamline flow around the models may be photographed satisfactorily. One dozen large electric bulbs, mounted on the bottom of the moving platform, provide illumination. The effect of making photos of the fine dots of powder on the water surface reproduces those dots on the film as a series of lines, just as the air would appear if it were visible. A view camera,



How Air Flows around Plane Wing and Speeding Auto

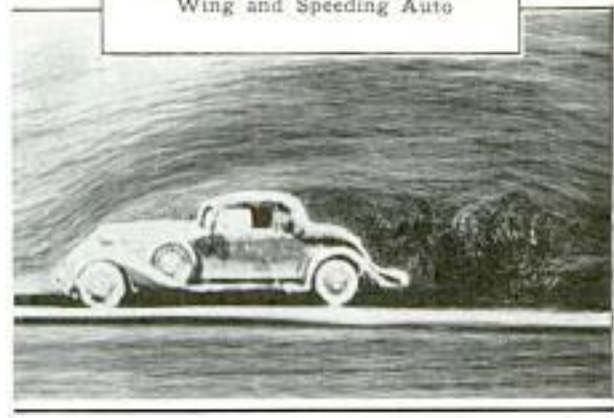

with a fast lens and a dependable shutter, is loaded with high-speed film for the photographs. The models are hooked to the moving platform, which reverses when the end of the track is reached, moving back and forth until the desired number of exposures has been made. The camera was designed to help the airplane and automobile builder overcome the drag of air by streamline construction.

Names and addresses of manufacturers of articles described in this magazine will be furnished free by our Bureau of Information.

*view camera.
 fast lens, very high
 speed film.*

*Com. Co. H. Slacy, 4639 Montgomery
 Ave., Bethesda, Md.*

Making Home Tasks



Above, Electric Press Weighing Forty Pounds Which Can Be Used on Any Table; It Has Hook Inside Base so It Can Be Hung on Wall When Not in Use, and Puff Iron for Ruffles

Right, Screw with Luminous Head Which Fits All Switch Plates and Makes It Easy to Find a Wall Switch in the Dark



Above, Dustproof Fiber Bag for Vacuum Cleaner Which Is Discarded When Filled

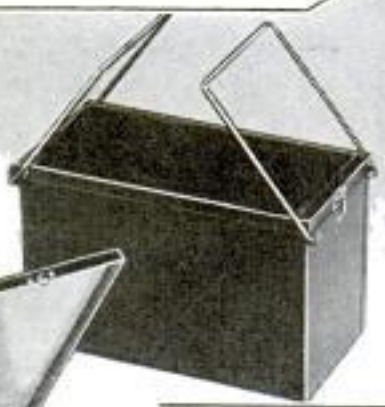

Picnic Box with Watertight Ice Compartment and Space for Milk Bottles; the Cover Serves as a Table When Open



Right, Nozzle for Garden Hose Equipped with Container for Fertilizer or Insecticide



A Pleasure

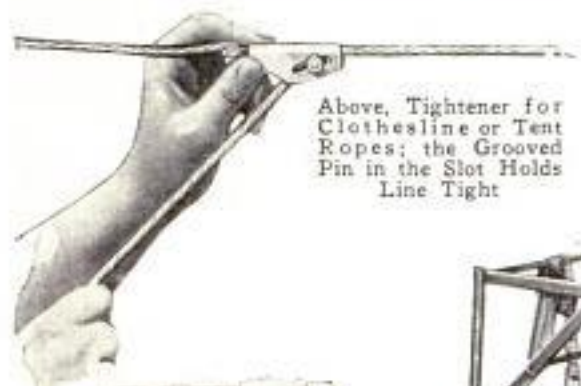

Above, Tightener for Clothesline or Tent Ropes; the Grooved Pin in the Slot Holds Line Tight

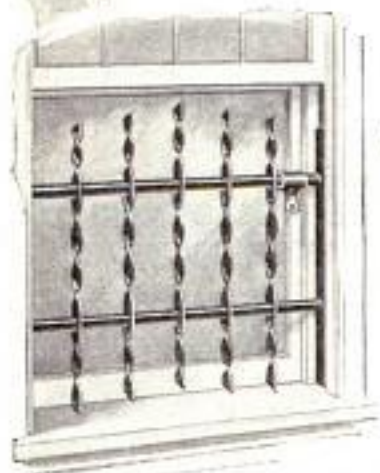

Above, Metal Window Guard That Locks in Position with a Key; the Sliding Bars Are Adjusted to Fit Tightly against Window Facings in the Slot below Upper Sash



Left, Duster with Extension Tube to Reach High Fixtures; Right, Air-Cooling Unit That Holds 300 Pounds of Ice; Small Fan Draws Air through Front and Forces It Out through Controlling Damper Openings at Top; Capacity, 400 Cubic Feet a Minute

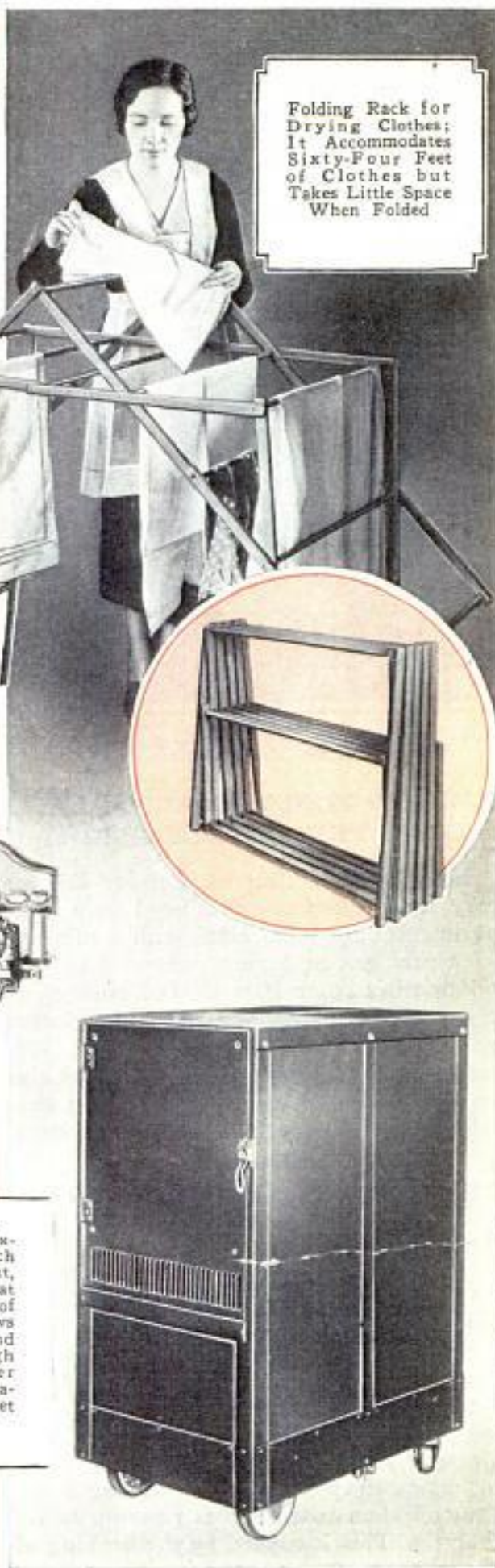

Folding Rack for Drying Clothes; It Accommodates Sixty-Four Feet of Clothes but Takes Little Space When Folded

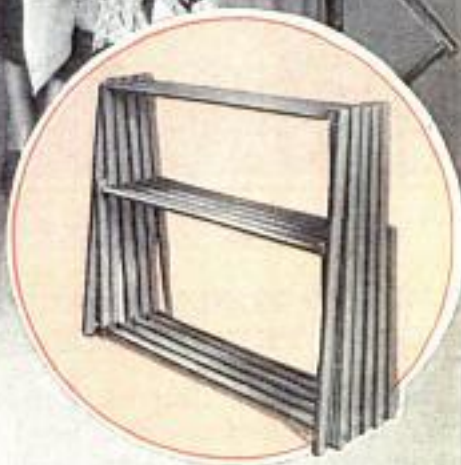

*Esclapart, Director
Observatoire de Paris*

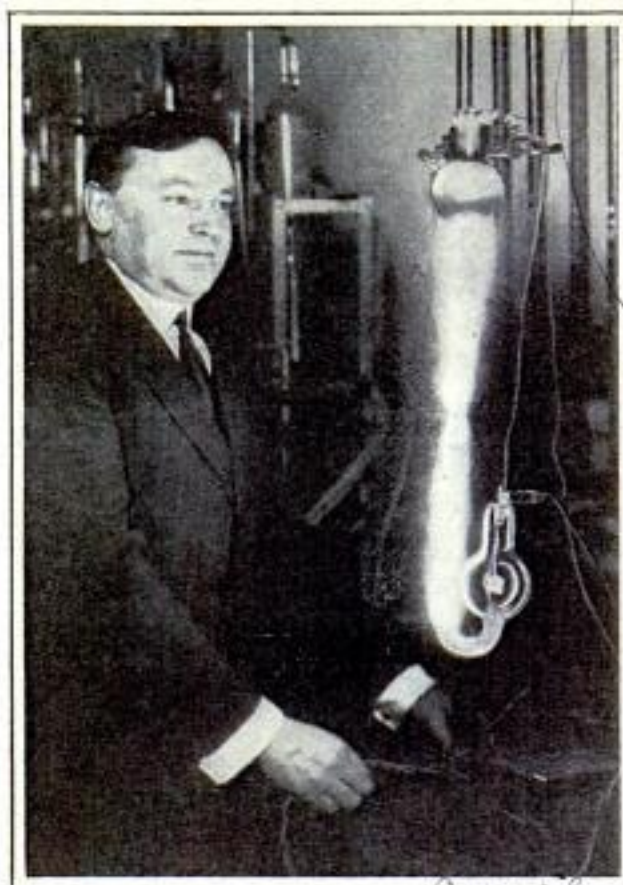

Giving Red or Blue Light. This Lamp Is Filled with a New Vapor Mixture

GAS AND ZINC-VAPOR ARC LAMP GIVES RED AND BLUE LIGHT

Red and blue illumination for laboratory work has been produced in an experimental arc lamp filled with a mixture of argon gas and zinc vapor. The predominating color is red. Dr. Harvey C. Rentschler, of the Westinghouse Lamp company, directed the research into efficiency of hot-cathode lamps, with the zinc vapor giving the best results when an electric current was passed through the lamp.

PLANE DIVES FASTER IF MOTOR IS SHUT OFF

Testing the maximum velocity at which a new pursuit plane could dive, a British pilot attained a speed of 403 miles per hour—over six miles a minute. The dive started at 30,000 feet, the maximum speed was reached at 20,000 feet and the plane slowed up as it dove through the denser air near the earth. The pilot found that his plane dropped faster with the motor shut off than when it was running at full throttle. This is caused by the braking ef-

fect of the propeller at maximum speed, since the propeller is designed for the plane's maximum horizontal speed of 231 miles an hour.

Science 6/3/32

TALKIE CLOCK GIVES THE TIME OVER TELEPHONE

Requiring no operator, a talking clock that gives the correct time over the telephone has been introduced in Paris. The clock is used in connection with a film on which every minute of the day is recorded for reproduction in sound. When a subscriber dials the time number, the speaking apparatus is started automatically, giving the hour and the minute. Controlled by one of the master clocks of the Paris observatory, the talking clock always speaks with authority.

PERMANENT AUTO-LICENSE TAG REDUCES CHANCE OF THEFT

Georgia is experimenting with a permanent automobile-license tag which has been designed for the purpose of reducing the cost of manufacturing and distribution, and also to minimize the chances of theft. The metal tag consists of two parts, one permanent plate which remains with the car as long as it is operated in Georgia, and a small year strip, issued annually. After the first year, the large one need not be replaced by a new one, except by purchasers of new cars or owners transferring cars from another state. The tag goes with the car when it is sold, and



Large License Plate Is Permanent; Small One Is Issued Each Year, Reducing State's Expense

hence will prevent transfer of tags. Besides, the purchaser of a stolen car would be unable to obtain a complete tag or a year strip for the tag previously issued to the car, if the theft has been reported.

*Universal Tag Cars
604-5 Canfield Bldg.
Atlanta, Ga*

50 Broadway, New York

*Flight Lieutenant
Chris Standa*

031075

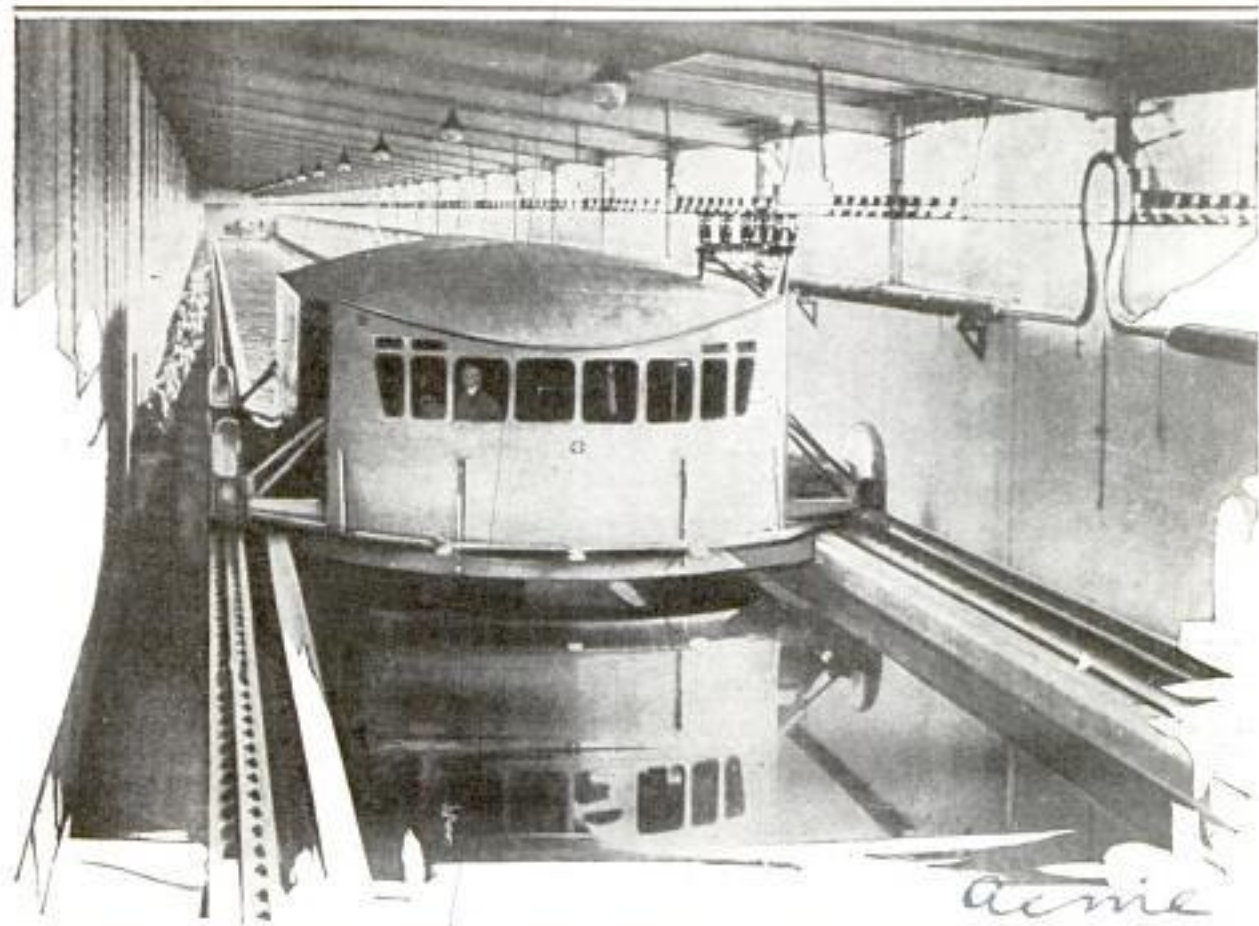

This Towing Device Pulls New Seaplanes along the Water Channel in Experimental Tunnel in Germany; Note How Carriage Rides on Special Tracks, Taking Power from Overhead Wires

SEAPLANES TESTED IN TUNNEL WITH TOWING CARRIAGE

Designs and materials of seaplanes are tested in a long tunnel at Hamburg, Germany. A towing carriage pulls the seaplane along the tunnel's water channel to determine what form of construction is best for taking off, landing and riding the waves.

BOAT PROPELLER RUN BY HAND ELIMINATES OARS

Oars are not necessary for a rowboat equipped with a propeller that can be turned with one hand. The propeller is run with a crank and can be attached to the bow, stern or even side in half a minute with one thumb-



Pat. ap
no change
\$1.50
Propeller Mfg. Co.
Connersville, Ind.

screw. It weighs sixteen pounds and will move the craft forward or backward as desired. It is particularly handy for fishermen, since it leaves one hand always free for other activity.

GERMS TURN FARM WASTE INTO MONEY

By substituting bacteria for chemicals and by adding city sewage to farm waste, such as cornstalks, straw and hulls, chemists have advanced another step in solving an agricultural problem. A process for producing building-board fiber and fuel and lighting gas from farm waste is being worked out on a commercial basis. Corn-cobs, stalks, straw and cereal hulls contain a high percentage of carbohydrates. The addition of nitrogenous city waste increases the bacterial activity in the farm-waste products, producing a large volume of fuel gas and releasing the fiber for board making. Products of the distillation of oat, cotton and rice hulls and of cornstalks are being studied in a search for more useful by-products.

agriculture, Washington, D.C.
Re Sept. 1934 33-4

Low State College
Amer. Jour. of
Bureau of Chemistry and
Physics



Ready-made for Lining

EVER since radio receivers passed the single-tube stage, owners, builders and service men have realized that an unbalanced receiver is a poor performer. Any radio set is subject to this condition, and many weak signals are completely

does not produce the maximum efficiency. Many unmodulated signal generators have been made, but the modulated generator described in this article covers a much wider range of usefulness. For example, when lining up a receiver, the r.f. or first part of the circuit, composes about one-half of the complete receiver and an unmodulated signal generator is useful only for this part. After the detector, the signal must be of an a.f. or audio nature to be helpful. Either type '99 or '30 tubes may be used. Flashlight batteries supply the filaments and small B-batteries the plate voltage.

The base is made of $\frac{1}{8}$ -in. sheet aluminum, drilled and bent as shown in Fig. 1. The front panel, of the same material, is shown in Fig. 2. The .00035-mfd. variable condenser is mounted on the base first and lined up with the dial, as shown in Fig. 7.

An X-ray view, looking down on the completely wired unit, is given in Fig. 6. Enlarged diagrams are available if desired. The leads and parts under the base are all shown by dotted lines, but the dotted line at the rear of the base merely indicates the bend. The audio transformer is a 3-to-1 receiver type. If the audio note is too high-pitched, it may be lowered by shunting a fixed condenser across the transformer secondary from G to chassis. Note that one side of the transformer secondary is grounded on the chassis and the other goes to G on the a.f. tube socket.

The negative-A and

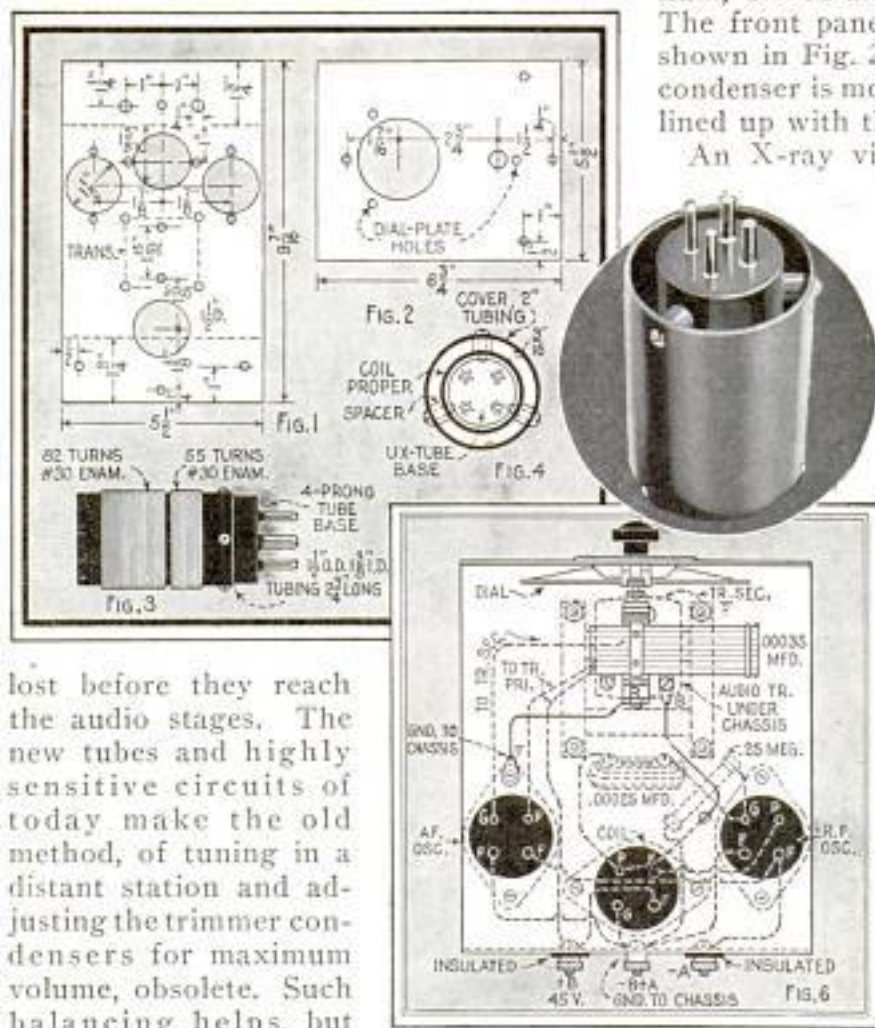

lost before they reach the audio stages. The new tubes and highly sensitive circuits of today make the old method, of tuning in a distant station and adjusting the trimmer condensers for maximum volume, obsolete. Such balancing helps, but

ALL-WAVE SIGNALS

Up Receivers

by
S.H. Burns

positive-B posts are insulated from the base. The center post is mounted directly on the metal base. The 500-ohm resistor, marked X in the schematic diagram, is optional, but will improve modulation.

The broadcast-band coil covers from 550 to 1,500 kilocycles. Fig. 3 shows the construction of this coil. It may be wound with 82 and 55 turns or 70 and 40 turns of No. 30 wire, either coil working equally well. The bakelite tubing is fastened to an old tube base with three machine screws in drilled and tapped holes. A small hole is drilled $\frac{1}{2}$ in. down from the top of the tube; the No. 30 enameled-copper wire is bared of insulation at the starting end and run through the hole and down into one of the small prongs in the coil base and soldered. The 82-turn clockwise winding is then made, and the end passed through a hole and soldered into the other small prong. The 55-turn tickler coil is started $\frac{1}{4}$ in. from the first winding in the same manner and wound in the same direction; the start and finish ends are soldered in the large prongs.

The bakelite coil shields, detailed in Fig. 4, are optional, but afford protection to the coil windings. Three fiber-tubing spacers and machine screws at top and bottom support the shield. A bakelite ring may be inserted, if desired, at the top as shown in the photo on page 462.

We are now ready to calibrate this coil from any good receiver. The batteries are connected and a small knife switch is connected in series with one of the A-battery leads. The tubes and coil are inserted in

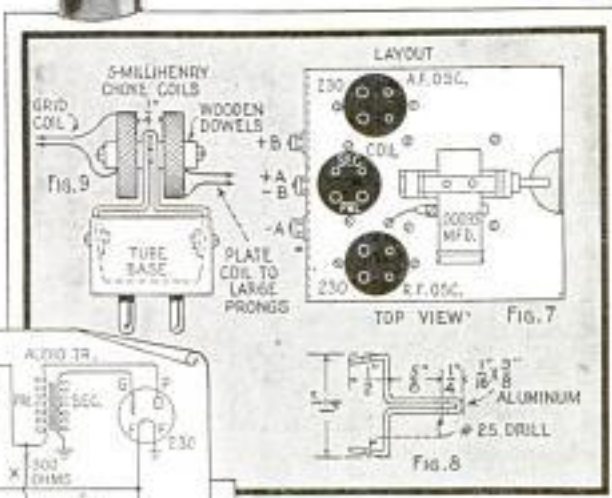

their respective sockets, and the signal generator is placed near the receiver. Move the signal generator dial slowly over the entire scale. If the signal is not heard in the speaker, reverse the tickler-coil connec-

(Continued to page 120A)

Wright-DeCoster Inc.
2233 University Ave
St Paul, Minn

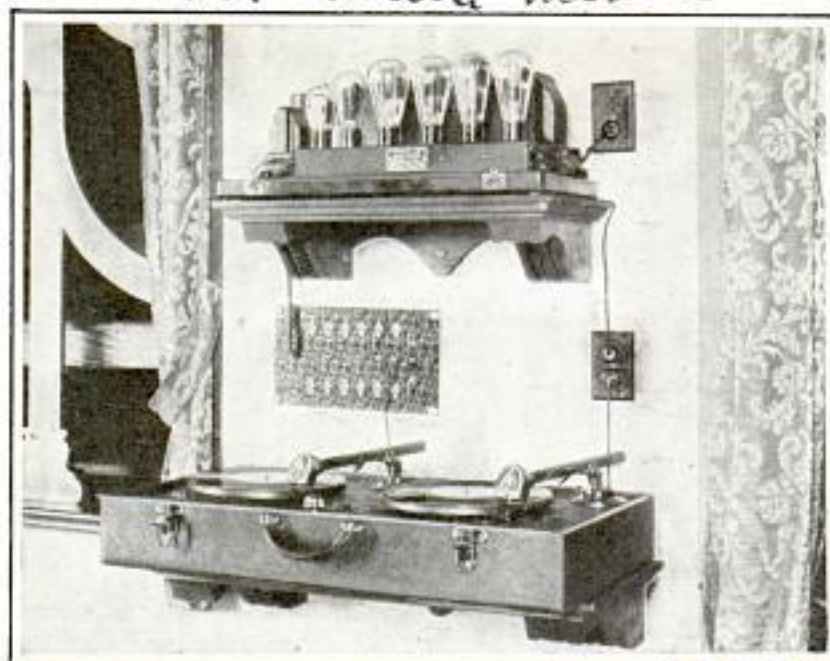

Above, Amplifier with Phonograph Turntables and Control Panel; Right, Organ Grill Baffle

Organ Pipes But Music Comes from Speaker

Pipe-organ effects for chapels or other small public places, where a large pipe organ is not practical, may be obtained by the use of dummy organ pipes and a suitable speaker baffle, together with an audio amplifier and phonograph turntables. A large dynamic speaker of the Wright-DeCoster type is mounted behind the grill at center, and the other apparatus is installed in an adjoining room. Organ records, suitable for any occasion, are faded from one turntable to the other in the usual manner. The large audio amplifier is mounted on the shelf above. Additional loud speakers may be operated in halls or adjoining rooms, and a microphone can be plugged in to amplify the speaker's voice. The speaker baffle proper should be the equivalent of at least 3 ft. square and should be made of close-grained wood at least 1 in. thick. Pressed-wood stock is used for the background. The pipes may be made of cardboard tubing.

How to Find Resistance Values

Instead of wasting time and money with cut-and-try methods, the radio experimenter can easily find resistance values, that are needed for any circuit requirement, by the application of Ohm's law. This simple method may be used to de-

termine resistance, voltage or current values in any given circuit. The law states that the resistance of a circuit may be found by dividing the voltage by the current. On the other hand, the current value may be found by dividing the voltage by the resistance. If the resistance and current values are known, their product gives the voltage. The law is more

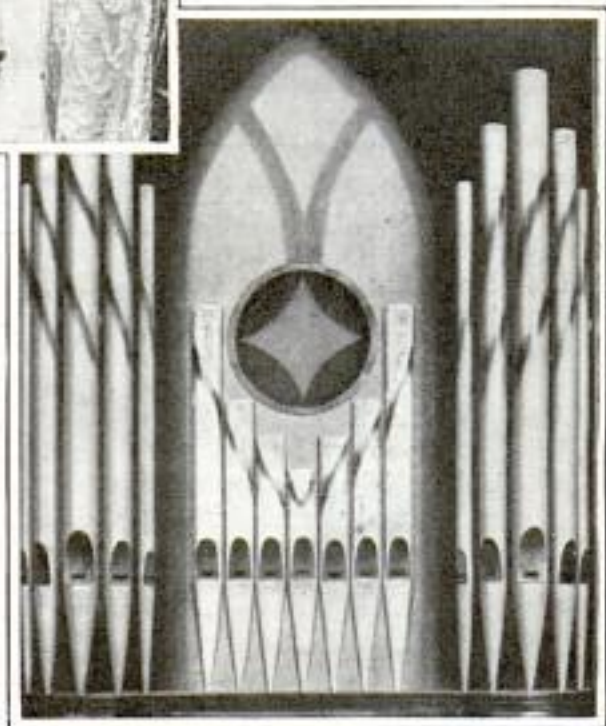

easily memorized in the form of symbols. Let the resistance in ohms, be represented by R, the current, in amperes, by I and the voltage by E. Then R equals E over I; I equals E over R, and E equals R times I.

Clip-Jack Simplifies Wiring

When trying out experimental hookups on breadboard layouts, an open-circuit jack is usually employed for the output to the phones or speaker. The wiring to this jack may be greatly simplified by soldering a Fahnestock clip to each terminal.

Blueprints covering radio construction articles in past issues can be obtained for 25 cents each; material lists are always available without charge.

MIDGET RECEIVER

Uses High-Gain Tubes

AFTER the chassis has been drilled and the holes cut for the sockets and coil terminals, the parts are mounted as shown in the layout diagram on page 297 of the August issue. We are now ready for the wiring, which is practically all done under the chassis, as shown in the simplified wiring diagram below. This diagram together with the underside photo on the following page should enable anyone to wire the set with very little difficulty. The simplified diagram shows the parts in their relative positions and the value of each part is given.

Each wafer-type socket should be mounted with the terminals exactly as shown, and if they are not indicated, the builder should mark the chassis opposite each lug with a pencil to avoid errors. Stiff-wire leads on the small "cub"-type fixed condensers and resistors greatly simplify the wiring, and make these units self-support-



Part 2.

ing. The coil leads, indicated as grounded to the rotor, run through holes in the chassis near the three-gang variable condenser and are soldered to lugs on the shield plates between the condenser units. The grid lead is shown paralleling the grounded lead in each case, and these leads go to the condenser stators, or stationary plates.

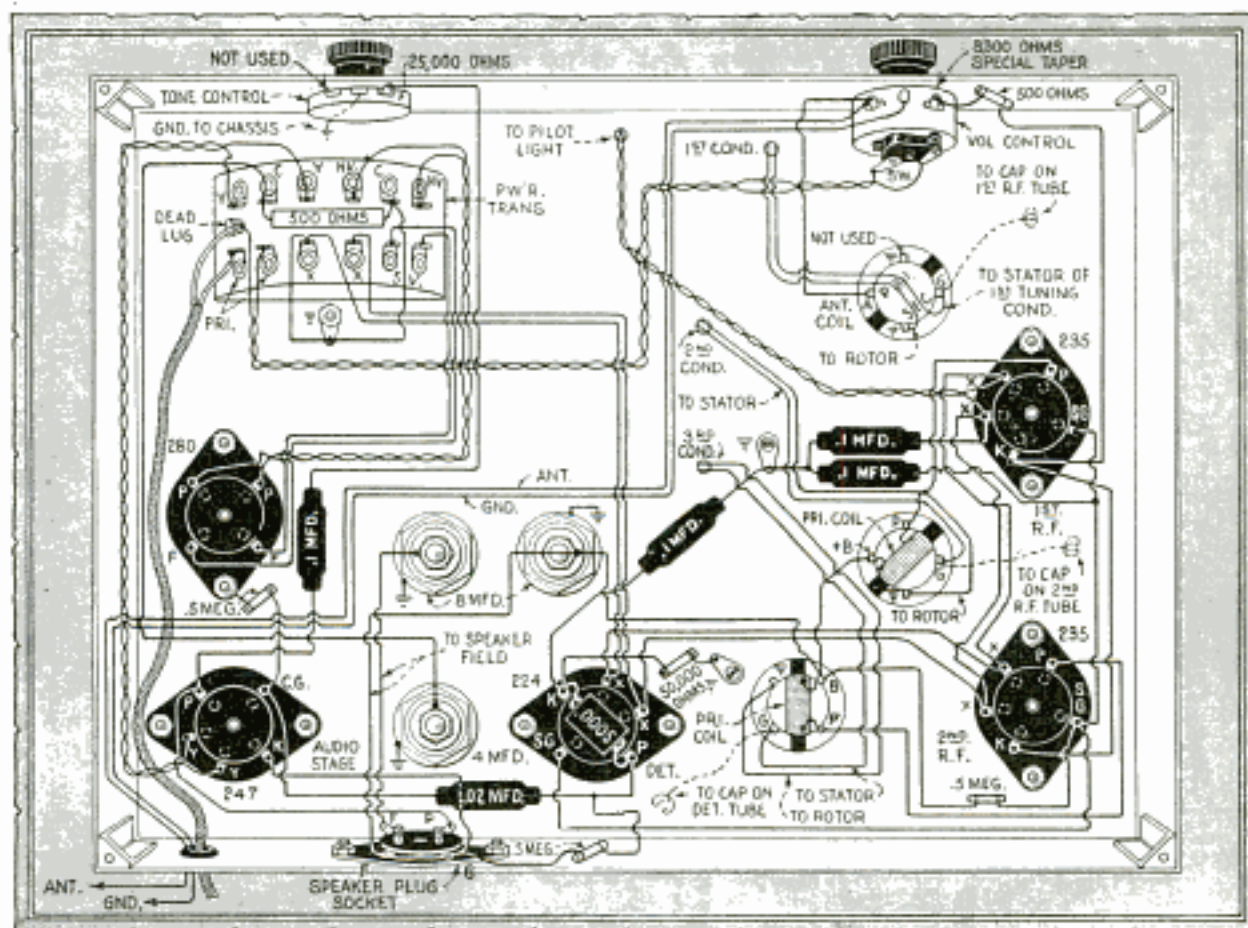



Regular push-back hookup wire is used for all connections except those from the power-transformer to the tubes. These filament and plate leads should be made with well-insulated stranded hookup wire.

The coupling rings, indicated on the schematic diagram, are built into the commercial coils and are already connected to the plate terminals of the r.f. coils and the antenna lug on the antenna coil. It will probably be necessary to trace out the primary and secondary leads on these coils as they are seldom marked. The terminal positions, however, are as shown in the simplified diagram.

The 2½-volt filament terminals, indicated by Y on the transformer, are for the 247 pentode tube and those marked X are for the filament supply to all other 2½-volt tubes. A separate 5-volt winding is also provided for the 280 rectifier tube. All of these leads should be twisted, even though they are not so shown in the diagram. The 500-ohm resistor is connected to ground and filament center-tap and bypassed by the 4-mfd. electrolytic conden-

ser. The .5-megohm resistor in the lower right-hand corner, near the second r.f.-tube socket, is the dropping resistor for the screen voltage. The value of this resistor is not given on the schematic diagram. Care should be taken that this resistor does not touch the chassis. This also applies to the .5-megohm coupling resistor, from the detector plate to the high-voltage connection G on the speaker-plug socket, and to any other resistor not indicated as grounded. Terminals F and G on this socket are connected together. The control-grid resistor from control

grid on the 247-tube socket, may be either 1 megohm or .5 megohm. One end of this resistor is grounded to the chassis under the mounting screw that holds the 280-tube socket. The 50,000-ohm biasing resistor for the detector tube is connected at K and the other end to a lug screwed to the chassis. The flat mica-type .0005-mfd. fixed condenser is connected directly across this socket from P to K. It will be noted that the r.f. choke, shown in the schematic diagram, is omitted in the simplified wiring

diagram. This choke is optional and the set was found to work just as well without it.

The small dynamic speaker is a midget type with a built-in transformer to match the single 247 pentode output tube. Cabled leads for the speaker field, which also acts as a filter choke, the pentode plate and high voltage, terminate in a plug for the socket located at the rear of the chassis.

Homemade coils may be used instead of the commercial type, and can be mounted in ten-cent aluminum salt shakers as shown in the center photo on this page. The coils are wound on bakelite tubing, 1 in. in diameter and 2¼ in. long. For the

(Continued to page 121A)

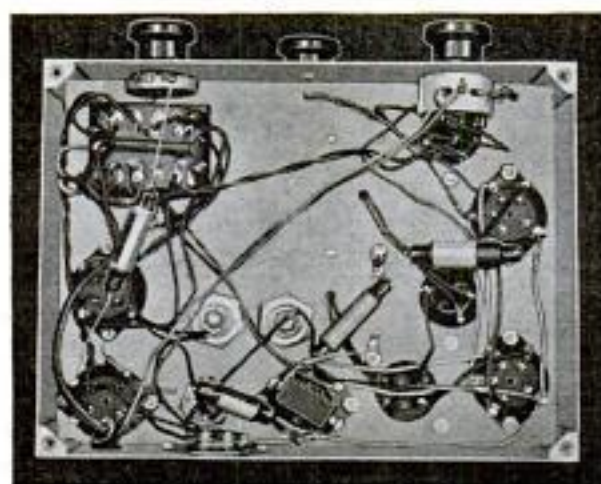

National Co. Inc.
61 Sherman St
Malden, Mass

Practical RADIO SUGGESTIONS

John Steutemann Co
Boston
Mass



Completely Enclosed Heater Transformer Will Deliver Up to 10 Amp. at 2.5 Volts with Good Regulation for Experimental Multi-Tube Receivers



Interference Analyzer Contains Several Standard Filter Circuits Any of Which May Be Switched In or Out to Determine the Proper Filter to Use



Left, Disappearing Map or Station Log; Guide Is Screwed to $\frac{1}{2}$ -In. Block at Bottom of Cabinet, so Map on Slide Will Clear When Raised or Lowered

TWO DESIGNS FOR THE SLIDE

Handy Automatic Ground Connection on Power Plug for A.C. Receivers; the Plug Is Drilled as Shown, and the Ground Lead from the Set Inserted and Connected to a Brass Machine Screw That Holds the External Grounding Strip

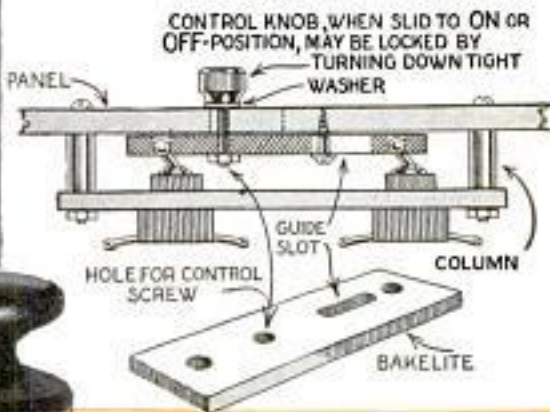

Above, Toggle Switch Ganged for Linking Two or More Experimental Circuits for Simultaneous Operation; They May Be Arranged to Close Together or to Close One Switch and Open the Other; an Escutcheon Plate May Be Made for Front-Panel Operation, and Many Other Variations Are Possible; Left, Isolantite Form for Winding Short-Wave Coils; the Handle at the Top Is Convenient for Inserting and Removing the Coil; the Flat Top Provides a Surface for Labeling; the Small Groove at the Bottom Is for Primary or Ticker Winding

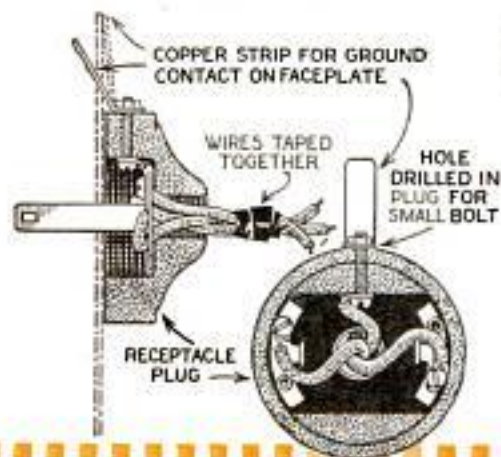

Hammilard Lugg⁴⁶⁷ Co
424 W 3rd St
New York

CONDENSER MICROPHONE

By
Marion B. Pickett

Is Easy to Build

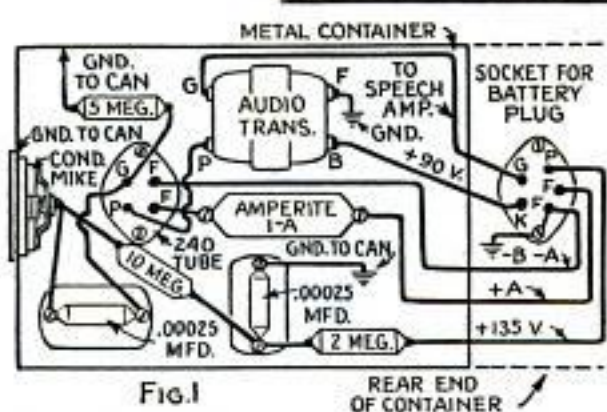

Fig. 1

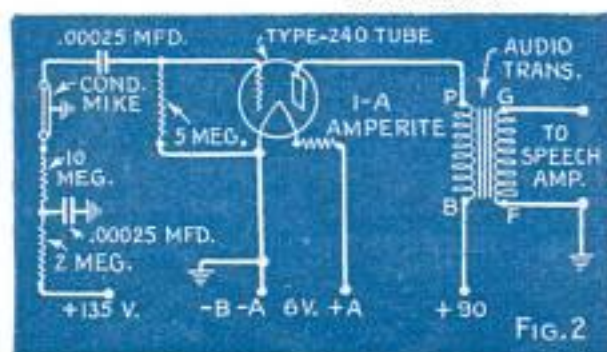
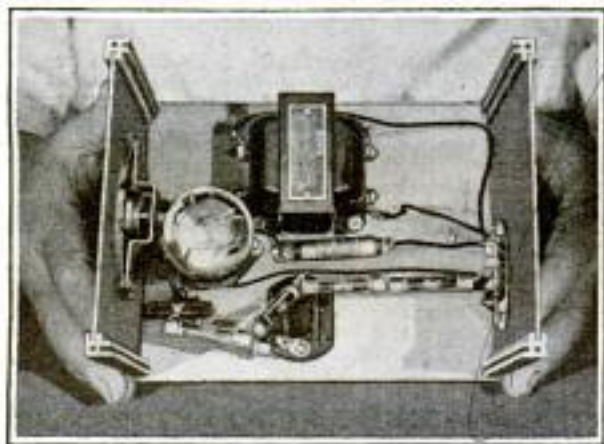

FIG. 2



CONDENSER microphones, generally conceded to have the best response of any type of audio pick-up known at this time, have been far beyond the pocket-book of the average experimenter. This homemade microphone, however, can be built and installed at very little cost by anyone equipped to make his own phonograph records, or operate speech-amplification equipment of any description. It shows remarkably good musical range without any bad resonance points.

The parts required can be purchased for less than \$5. The main item is the head, or single-button carbon microphone, from an old telephone. This is taken apart, and a copper or aluminum disk, about 1/8 in. thick and the same diameter as the diaphragm, is then prepared. The disk must be heavy enough to stand some pressure at the center with very little give or spring. The carbon button is removed, and the carbon dust discarded. The part of the button that makes contact with the diaphragm is removed and the ring, which holds the button together, is screwed back

(Continued to page 122A)

*Universal Microphone Co
Inglewood, Calif*



Mechanical FISH

a Riot in the

POOL

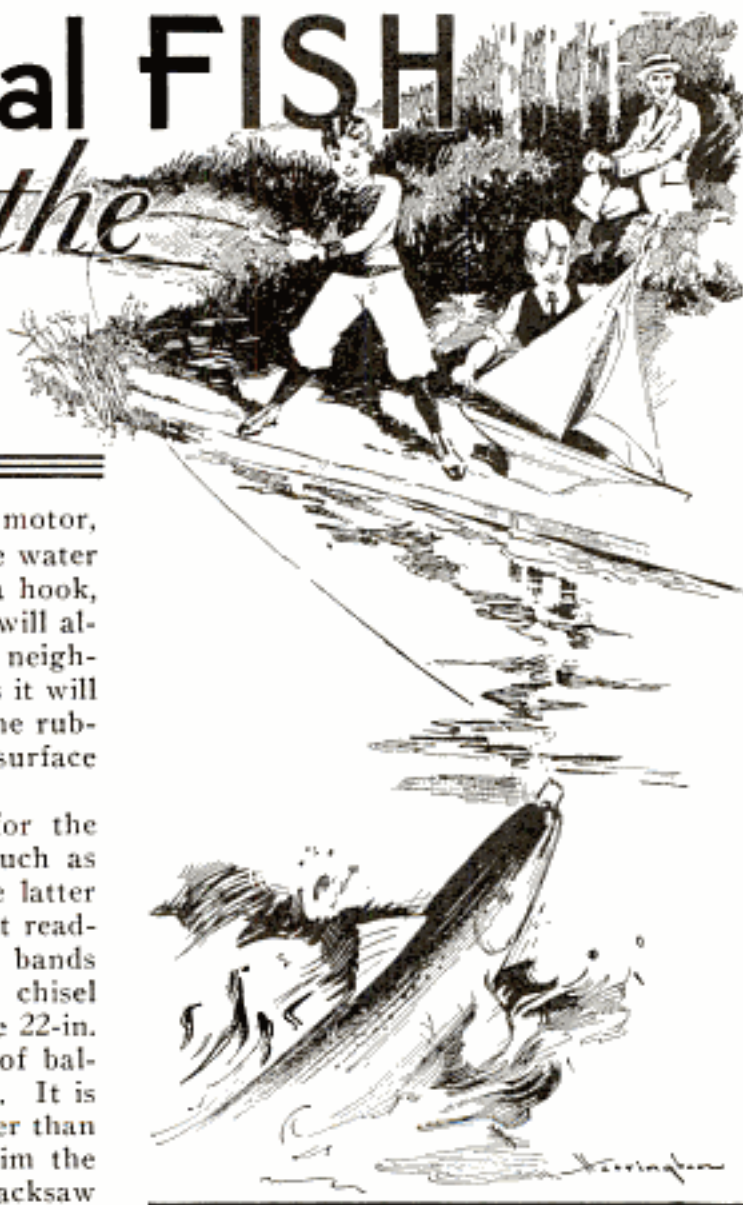

PROPELLED by a rubber-band motor, this mechanical fish churns the water like a black bass trying to shake a hook, and when turned loose in a pool, will almost make the goldfish climb the neighboring trees. By adjusting the fins it will swim at quite a depth and, when the rubbers are unwound, will rise to the surface quite naturally.

Saw out two matched halves for the body, using light, soft material, such as redwood, cedar or white pine, the latter being preferable as it does not split readily. Cut a groove for the rubber bands down the center of each half and chisel out a well for the lead ballast. The 22-in. model illustrated required $1\frac{1}{4}$ lb. of ballast or just half of its total weight. It is better to have the ballast a little over than under weight, as it is easier to trim the surplus away with a rasp and hacksaw than to add more lead. Tests in the water will show just exactly how much ballast is needed. The fish should float at rest with only the back fin and a very small area of the body above the surface. Then, when wound up and with the submerging fins tilted down slightly, it will dart toward the bottom like a real fish when danger threatens. Fasten the halves of the body together temporarily, plane to shape

and sandpaper to a smooth finish. Drive in four $1\frac{1}{8}$ -in. flat-head wood screws before taking apart, countersinking the heads. The fins and tail are nailed to one side only and, for a neat job, the wood should be recessed slightly to receive the fins, so that the halves will fit together snugly. Before installing the tail permanently, complete the propeller assembly.

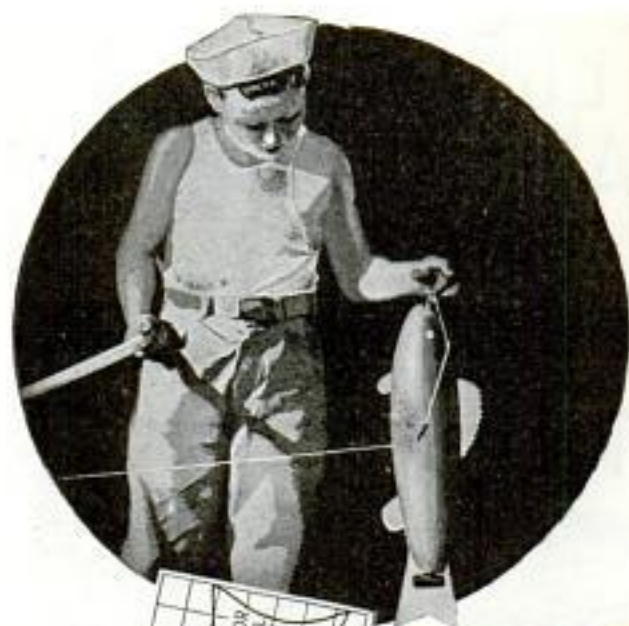

You can now test the fish in the water. See that it floats at the proper depth. If not, correct this by trimming or adding to the ballast. Do not add weights to the outside as they will drag and retard the speed. A hand drill, clamping a wire hook, can be used to wind up the motor. Draw out the rubbers, by means of the rubber hook in the mouth, to twice normal length and give about 40 turns with the winder. Experiment will determine the proper amount of dip to the fins, and the tail can be bent to make it go right or left. After the first few trials, the motor can be wound up to 75 or 100 turns. Artists' oils

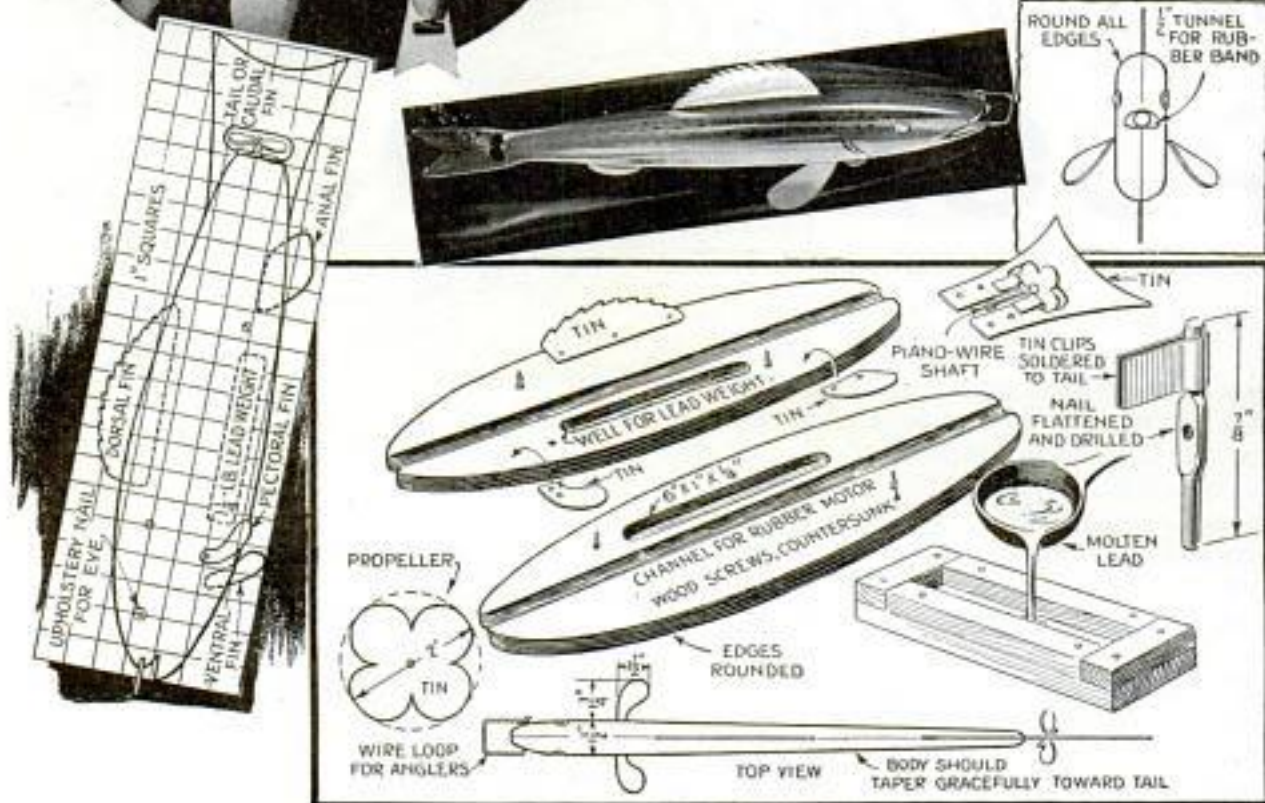

Make a four-blade propeller from a 2-in. tin disk, giving the blades a 30° pitch to prevent the propeller from spinning too fast and unwinding the rubbers too soon. Use about $\frac{3}{16}$ -in. piano wire for the shaft, bent over and soldered to the propeller as shown. The shaft bearing is made from a nail, flattened and drilled for the shaft to turn freely. This bearing is soldered to the tail by means of small tin clips, and the assembly is nailed permanently to the body. Then apply two coats of paint to both the inside and outside, string the rubber bands in place and finally screw the halves together.

with turpentine are used to color the fish. Upholstery nails, painted white with a black center, make good eyes. A wire nose hook is added to afford a means of catching the fish with a hook and line while in motion.

Improving the Flavor of Pears

Recent experiments have shown that the general idea of leaving pears on the tree to ripen in order to improve their flavor, is erroneous. It was found that, when taken off the tree and ripened indoors, they developed a far better flavor.

Solution for Bluening and Blackening Brass Ware

Brass articles may be given a blue or black color by first cleaning and then immersing them in a solution made by dissolving hypo, $\frac{1}{2}$ lb., and lead acetate, 2 oz., in 1 gal. of water. More lead acetate may be added to deepen the color and to speed up the action. To use the solution, heat it almost to the boiling point and immerse the work, watching carefully to remove it when the color is of a suitable shade. Brass wire should be used to suspend the work in the solution, and the finished work should be protected with clear lacquer to preserve the finish.

Wire Rigging for Ship Models

Copper-wire shrouds simplify the work of rigging ship models and give a more realistic effect than tied threads. The shrouds and ratlines are drawn to scale on a board, allowing extra length for attachment to the model. A brad is driven into the board at the lower end of each penciled shroud line, and at the top where they join. The wire is stretched over each of the lines and wrapped around the brads. The ratline wires are then soldered across the shroud wires over the pencil lines. A hot iron will keep the solder from beading at the joints, and though the heat expands and loosens the wires, they will draw tight after cooling. When completed, the shroud is removed from the board and fastened in place on the model. Each ratline wire should be bent between the shroud wires to represent a slight sag,



Wire Shrouds and Ratlines Simplify Construction of Ship-Model Rigging and Add Realistic Effect

after which the assembly is given a coat of dark-brown paint.



Turning the Ice-Cream Freezer Made Easier by Anchoring It to the Floor or Table

Anchoring the Ice-Cream Freezer

Ice cream can be made more easily if the freezer is anchored so that it cannot move around when the cream begins to freeze. Four hooks screwed into a board or table top, with corresponding screw-eyes driven into the freezer, will hold it securely so that the user can turn the crank with one hand, leaving the other free to add ice and salt.—Truman Greenwalt, Litchfield, Ill.

Hints for Successful Development of Double-Coated Films

Amateur photographers who have trouble in developing the new double-coated films can improve their work by following these suggestions: Soak the film about twice the usual time before developing, to let the water thoroughly saturate the coating, which permits an even penetration of the developer. This type of film should also remain in the developer longer than standard film. The detail does not appear until the last minute or so of development. The film should be washed carefully and then fixed for at least five minutes before turning on the lights. This extra time is necessary as the inner coating of the film does not fix as rapidly as the outside. Be sure the final washing is done thoroughly.—Ronald L. Ives, Upper Montclair, N. J.

Plywood FURNITURE



ALL DIAGRAMS LAID OUT IN 1" SQUARES



WASTE baskets, magazine racks and small tables that can be pulled apart in a moment for transportation or storage, and reassembled just as quickly, can be cut from plywood. First make cardboard templates that will fit correctly, and then trace the outline on $\frac{1}{4}$ -in. plywood. The finished pieces can either be stained or lacquered, and in the latter case, decalcomania transfers may be used for ornamentation. Although the wood may be cut with a hand scrollsaw, jobs such as these can quickly be turned out on a pow-

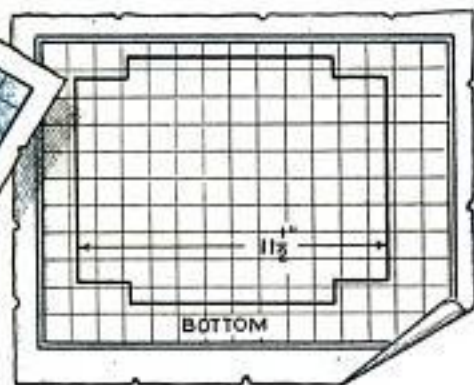
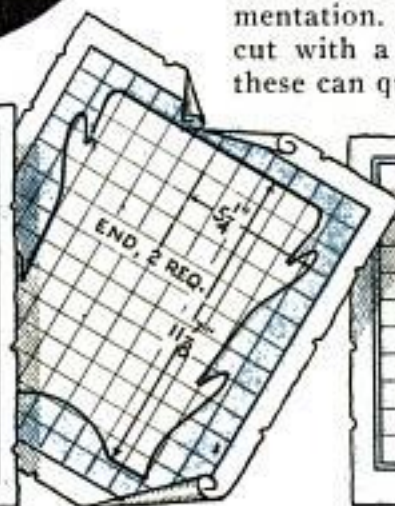
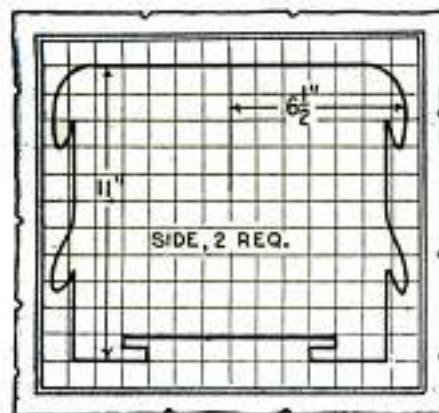

assembled without **SCREWS** or **NAILS**

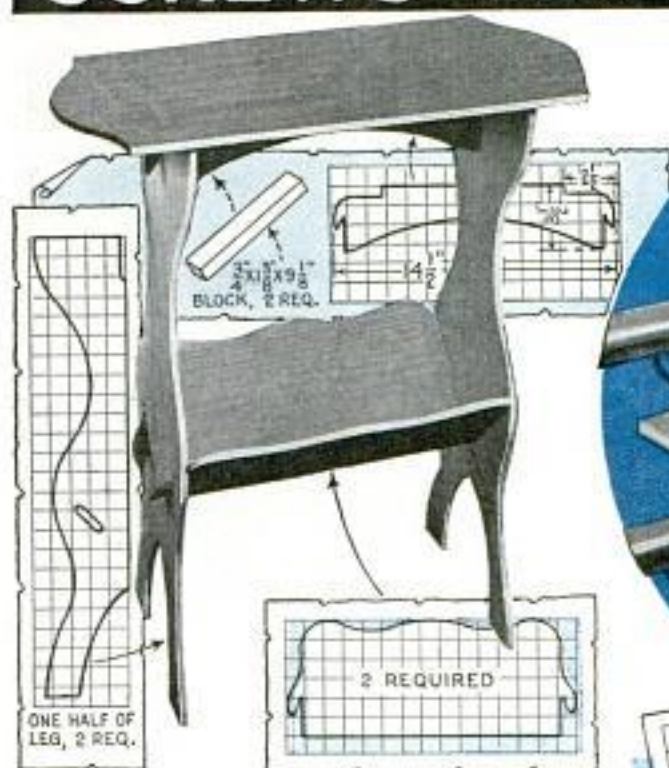

er-driven saw of the same kind. In the case of the magazine rack, you will notice that increasing the weight by loading the rack with books and magazines, tends to make the pieces hold together more securely, which, of course, makes the whole unit more rigid. There is only one exception in the use of plywood and that is with the table top, as it is advisable to glue two wooden cleats to the underside. You can get the material from a lumber dealer, or buy it in kit form.

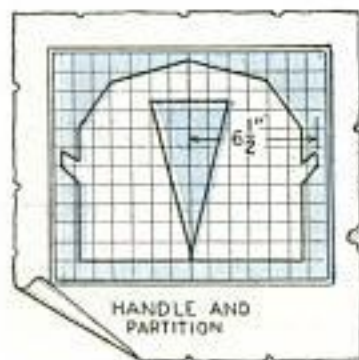

Toy Synchronous Motor Made of Scrap Parts

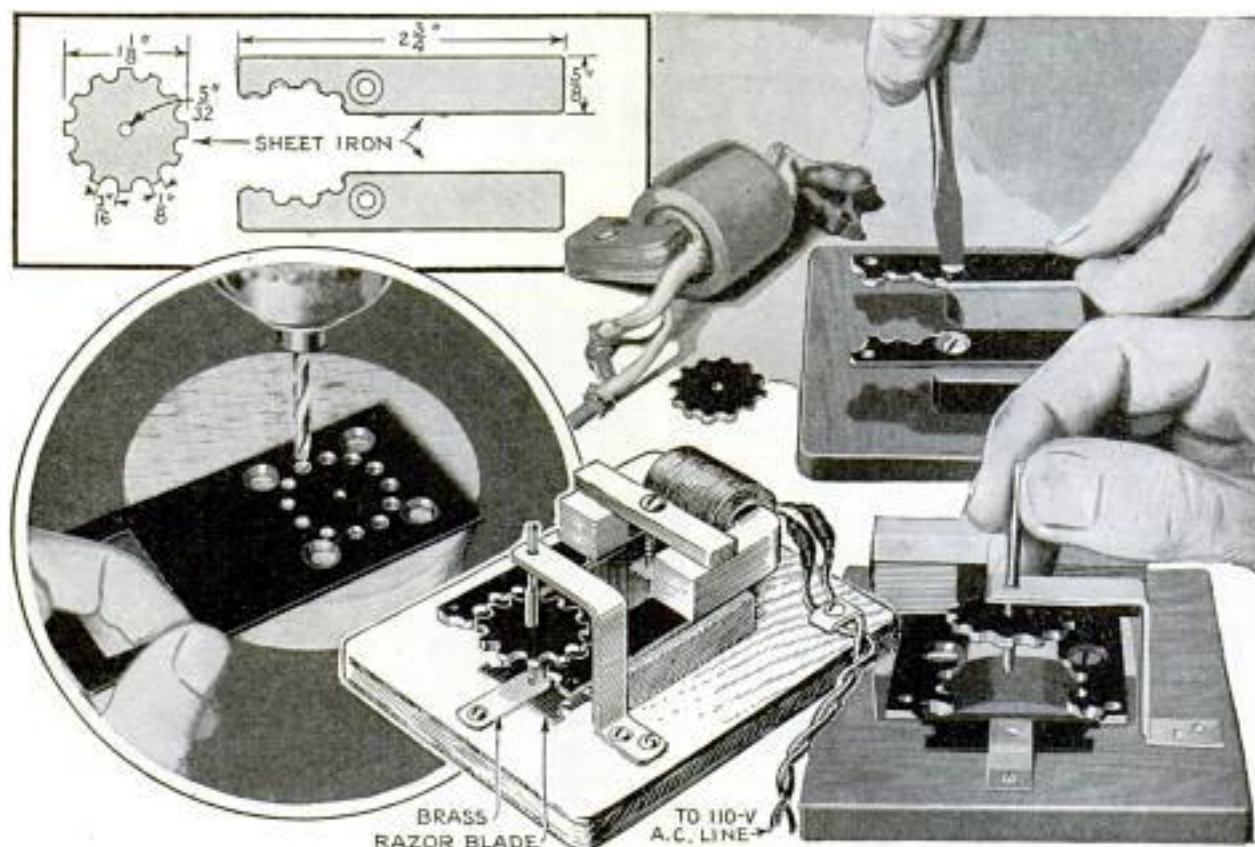

This simple synchronous motor, which is interesting and instructive as a toy, can be made from an a.f. radio transformer with the primary winding intact. Remove the cover and cut sections from the laminated-iron core so that the two poles are separated and will no longer make a closed magnetic circuit. Test the coil by connecting its primary terminals to a 110-volt a.c. line, without resistance. An iron nail held against the core should vibrate. Obtain a piece of soft iron, about $\frac{3}{16}$ in. thick, and cut from it a 1-in. disk. First prick-punch for a small hole to receive a nail that serves as the shaft, and with this mark as a center, scribe a 1-in. circle. Then divide it into twelve equal parts. At the division points, drill holes of a diameter about half that of the distance between the centers of the holes. Then, with a scrollsaw, fitted with a jewelers' blade, cut the disk out completely. Saw this piece off so that you will obtain two strips or pole pieces, each ending in three projecting teeth. Mount these on a block so that the disk, when attached to its shaft, will rotate between them without touching. It may be necessary to true up the disk and

pole pieces with a file. The disk shaft is about 2 in. long and is made from a nail. Cut off the head and file one end to a point while the nail is rotating. The point rests in a bearing made by punching a small hole in a strip of sheet copper or brass, mounted directly over an old razor blade, which makes a good bearing surface. The upper bearing is a hole drilled in a similar strip of sheet brass, bent and attached as indicated. The transformer coil is mounted so that each end of the core rests on one of the iron pole pieces which are pivoted to the base with wood screws. Adjust the pole strips so that the slight clearance between them and the rotating disk is uniform and connect the primary to the a.c. line. The ends of the secondary winding can be cut off or tucked out of the way, where they cannot be touched accidentally. The speed of a 12-pole disk on a 60-cycle current supply will be 300 revolutions per minute.

☛ Melted sealing wax poured on the portion of a broken glass stopper that is in a bottle will, when dry, serve as a handle for removing it.

How to Make a Plastic Metal Alloy

A plastic amalgam which sets in about 10 minutes can be made from copper and mercury, and is softened for use by heating it a little above the boiling point of water. The alloy can be used as a cement on some metals and for molding small objects. It will readily take a polish that is hard enough for many practical purposes. Copper for making the amalgam must be precipitated from copper sulphate. To do this, dissolve 3 oz. of copper sulphate in water and add zinc scraps, stirring constantly. When the solution loses its blue color, all the copper has been precipitated, and the unused zinc should be removed and the clear liquid poured off. Next, pour a few drops of sulphuric acid over the moist red copper and add 2 oz. of mercury. Stir the mixture vigorously until a thick, even paste is formed. The amalgam may then be washed to free it of acid, by stirring it in warm water. It can be worked with the fingers to any desired shape. It will set and completely harden in about 12 hours. If a harder amalgam is wanted, soften a portion of it and squeeze out a part of the mercury. To render the alloy softer, add more mercury and work it in with the fingers or with a mortar and pestle.

Rotating Lawn Sign Quickly Noticed

A lawn sign that rotates in the wind can be made from a 1/2-in. board, a small iron rod, a wooden stake and two pieces of tin. The rod is fitted into the top of the stake



to serve as a pivot, which engages with a hole drilled through the edge of the board. The pieces of tin are tacked to the edges of the sign and are bent as indicated to catch the wind.—Bert Ruthenberg, Wauconda, Illinois.

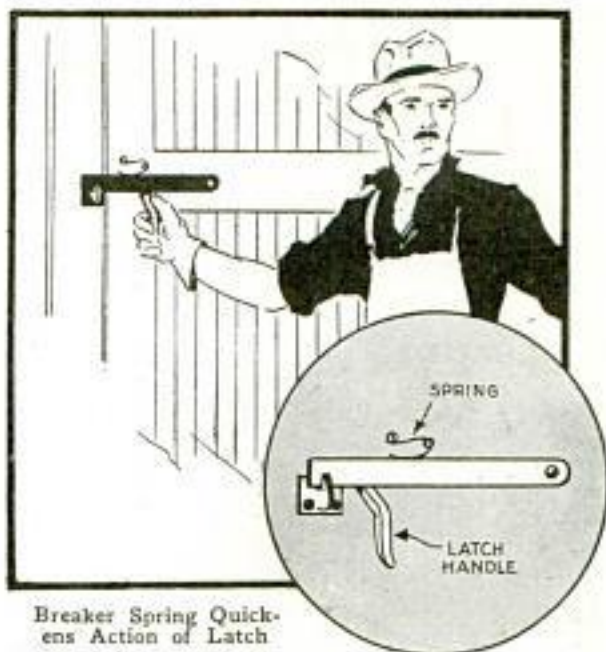

Breaker Spring Quickens Action of Latch

Breaker Spring Improves Door Latch

A breaker spring, such as used in practically all automobile distributors, will cause the ordinary barn-door latch to act quickly. The spring is held in tension above the latch by two screws driven into the door as illustrated.

Diagonal Links Make Skid Chain Safer

Slipping of a car on muddy roads can be reduced considerably by fastening links diagonally across the skid chains as shown. They should, of course, be slightly longer than the regular cross links, but the ordinary hooks can be used for fastening them.



Emergency Repair for Gasoline Line

When the gasoline feed line on my car broke and nothing was available to make a temporary repair, I removed the hose from the tire pump and connected this to the broken ends of the line. One end of the rubber tubing was pushed inside the copper pipe, and the union at the other end was screwed on the pipe, the latter being soft so that the threaded end of the coupling could be twisted on tightly.—William Elder, Oakland, Calif.

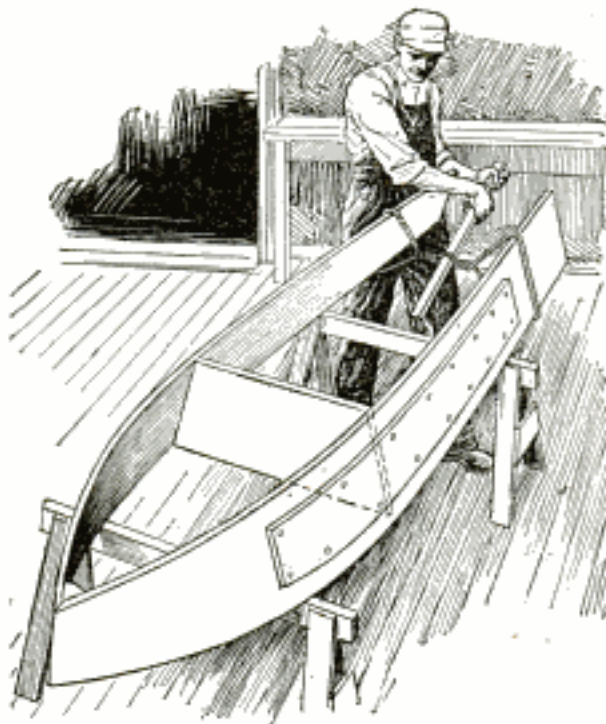

Board Temporarily Nailed to Weak Side of Boat Aids in Getting Correct Curvature

Plank Aids in Shaping Boat Hull

Bending both sides of a small boat symmetrically is made easy by temporarily nailing a light plank to the side that has a tendency to bend the most. Sometimes it is necessary to put more than one board on the weak side to hold it in position until it is securely fastened to the framework.

Helicopter Toy Is Propelled by Shade Roller

Driven by an old window-shade roller, this flying toy will reach unusual heights. A propeller is made and cut out in the center to fit over the flat end of the roller-spring rod as shown. The ratchet pawl is

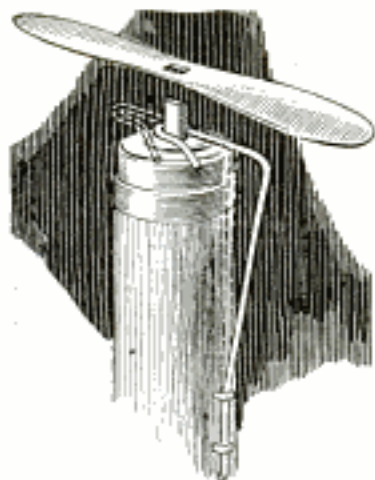

removed from the end of the roller and a wire stop or trigger substituted, to hold the rod when the spring is wound tight. The wire is bent at one end to hold the rod, and the other end

is stapled to the roller. In use, the propeller is placed over the projecting end of the rod, the spring wound and the wire allowed to come back into locking position. Then, by pressing on the wire, the propeller is projected into the air.

Noxious Weeds Killed by Spraying

Experimental tests completed by the farm-crops department of a mid-west agricultural college, indicate that noxious weeds, such as poison ivy, quackgrass, Canada thistles and others can be exterminated by spraying them with a solution of sodium chlorate, 1 lb., and water, 1 gal. This treatment is especially desirable in places where it is difficult to dig out the weeds. An ordinary hand sprayer can be used. Two or three applications are necessary to kill the weeds, the first being given when the plants are ready to bloom, and the second when they have started a new top growth. The third application is necessary only if growth begins again. Clothing saturated with the spray becomes inflammable when dry and should be washed out before it dries.

Lump Breaker on the Coal Shovel

A short piece of steel, drilled and ground to a point and riveted to the inside edge of a coal shovel will enable you to break large lumps of coal without battering the edge. When attached in this way, the breaker will not interfere with the use of the shovel.



Auto Light Rids Tent of Bugs

Bugs that have entered the tent during the day, can be killed after dark by turning the auto lights against the window from the outside or by placing a lamp so that it shines on the window from the outside. This will cause the bugs to fly against the lighted window where they can be killed.—Edgar Sherman, Tucumcari, N. M.

UPHOLSTERING

for the Home Craftsman

A TYPICAL upholstery job, featuring many of the operations common to present-day work, is the ottoman shown here. As in most other cases, the building-up commences with the webbing, as pictured in Fig. 3. A good grade of material, of standard 3½-in. width, should be used for this first operation, spacing the various webs so that at no place is there an opening wider than 2 or 3 in. To properly stretch the material, a webbing stretcher, Fig. 1, should be used. The webbing should not be worked to the utmost limit, as some slight measure of elasticity must be left so that it will give a little under pressure, but not so much that it will spring with the tying down of the springs. Both ends of each

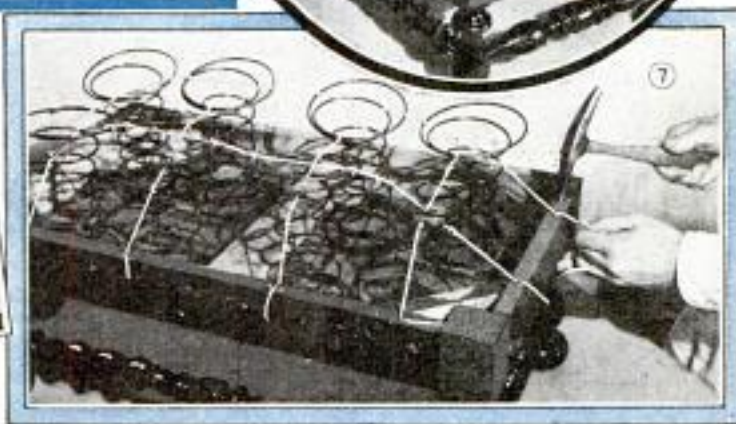

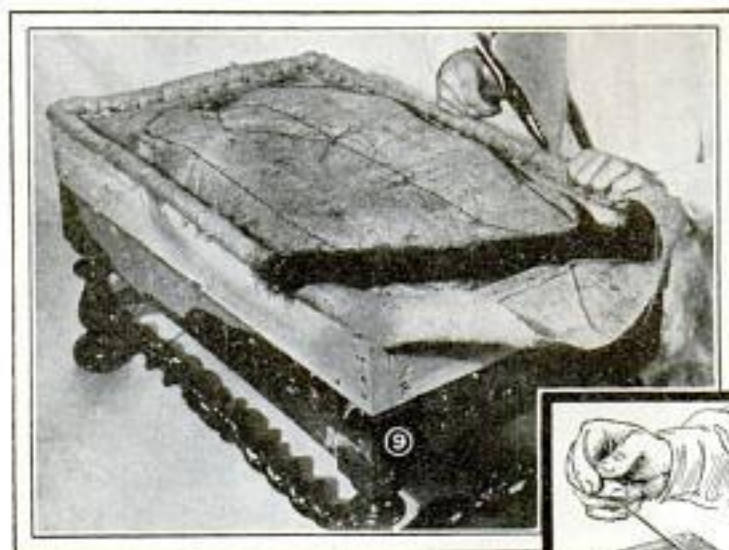

web should be folded double before tacking. Naturally, the stretched end must be tacked through a single thickness first and then retacked on the doubled web after the material has been cut off, as in Fig. 2. Tacks of 8 to 14-oz. weight should be used, dependent upon the nature of the work.

With the webbing in place, the springs can be sewed in, Fig. 4, using a good grade of sewing twine. Each spring should be looped three or four times, with the stitches so arranged that the final loop will be next to the following spring, as in Fig. 5. Nothing but standard spring twine should be used in the tying down, Fig. 7. In this operation, it is important that each of the springs is compressed equally and in a perfectly perpendicular line. For the average piece, crosstying, as shown in Fig. 7, is usually sufficient, but good work is often tied diagonally in addition to this. Strings are sometimes added to hold the springs out to the edge of the seat, working on the theory that all strain tends to push the springs inward. In any case, it is always wise to test the ty-

ing by roughly pressing each spring downward with your foot before proceeding with the burlap covering, as in Fig. 8. This covering should be neatly tacked in place with 6-oz. tacks, and the springs should again be sewed in place as shown.

Fig. 8 shows the upper box frame in place and the stitched edge being applied. The edge, in this case, is simply a narrow width of burlap, tacked along either long edge to form a tube in which is packed the moss filling, Fig. 9. After tacking the edge, it

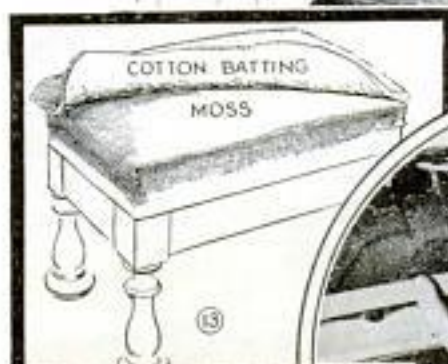

should be sewed evenly with heavy linen thread, using the packing needle with short stitches, Fig. 10. For the main filling, moss is invariably used in good work, but tow can be substituted for the under filling, as shown in Fig. 11, using moss for the center body, Fig. 12, and cotton batting for the top, Fig. 13. It is important that no loose strands should stick out and show at the edges of the finishing cloth which goes on next.

Referring to the picture of the finished ottoman, you can see that

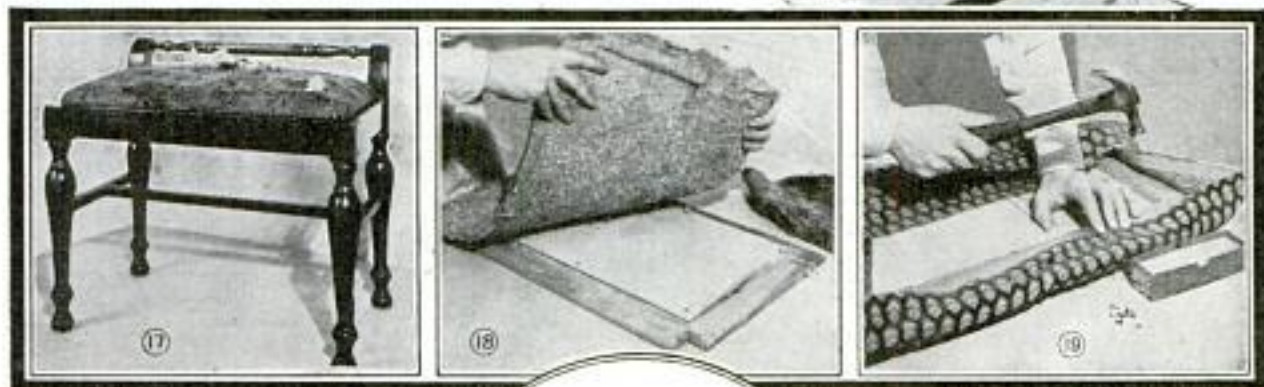

there are two rows of beading, with pockets between them. The beading is simply a narrow length of the finishing cloth, doubled over a length of cotton rope and stitched. This is fitted in place at the proper level line and tacked all around, as shown in Fig. 14. The pocket is blind-tacked, using a strip of cardboard under the cloth, as in Fig. 15, so that, when the material is pulled down, it will form a straight edge, tight against the beading. Moss is used for filling in the space thus formed, enough being inserted to give the cloth a pleasing roundness, Fig. 16. A second row of beading and a second pocket applied in the same manner, complete the upper finish, the final end of the cloth

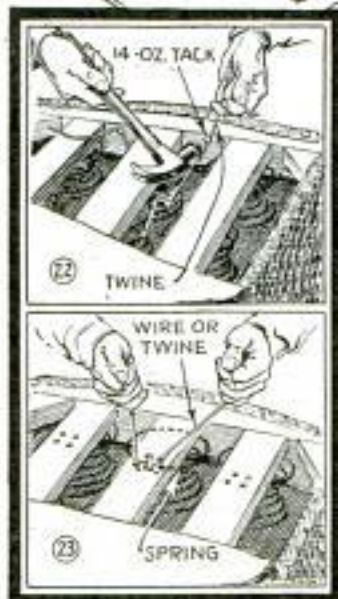

being carried to the underside of the stool and tacked. Any close-woven cloth in black or dark gray can be used for the bottom.

The simplest form of upholstering is the slip seat (see Fig. 17). This is common construction for fireside benches, dining chairs, etc. To repair the vanity bench shown here, the top should be removed by loosening the four

(Continued to page 124A)

One-Man Rubber Fishing Boat Is Portable



Fishermen who hike to isolated lakes where boats are not available, can carry this light, portable boat along, which, although it does not have the comfort of a regular rowboat or canoe, will nevertheless enable them to fish in the open. The boat consists of an inner tube of extra-large size, as those used on trucks and busses, a circular sheet of waterproof canvas that will fit around the greater portion of the tube when it is inflated, and a large pressed-wood disk, slightly smaller than the inflated tire. The latter may be cut into two or three pieces and these

hinged together for convenience in carrying. To assemble, lay the canvas down, then the pressed-wood disk and finally the partly inflated tube.

Grommets should be provided along the hemmed edge of the canvas, to take a rope with which the edge can be drawn snugly over the tube. Then the tube is inflated as much as advisable, to hold the floor in place. The seat and back of a light chair may be used for increased comfort.

Cleaning Dusty Prints and Etchings with Water

Dusty or discolored prints and etchings can be cleaned by soaking them in a pan of pure, cold water, large enough to allow them to lie flat. No chemicals or additions of any kind should be used. If the print is just dusty, leave it in the pan for ten or fifteen minutes, when most of the dust particles will have floated off into the water. Do not rub the print while it is immersed, but rinse it so the water carries off the dirt. After draining thoroughly,

lay the print flat between two pieces of white blotting paper, and weight them down. If the print is glued to a mounting, it should be left in the bath until it comes off. Rubber erasers, art gum and other abrasives should not be used to clean a print. If it is not thoroughly dry after twenty-four hours, renew the blotting paper. A print should not be glued or pasted to a mount, but should be held in place with gummed paper hinges, such as are used for stamp albums, or white-linen gummed tape.

Drillpress Used to Fit Crystals in Watches

An unbreakable watch crystal can be replaced in its mount with the aid of a drillpress. The crystal is inserted by applying pressure to its center so that the circumference becomes slightly smaller. Drill a shallow hole in a piece of wood, the diameter of the hole being about three-fourths that of the crystal. Insert a length of $\frac{1}{2}$ -in. dowel rod, one end of which is rounded, in the drill chuck. Lay the crystal over the hole, concave side up, and place the metal ring of the watch on it. Then lower the drillpress spindle until the rod touches the center of the crystal, pressing moderately until it springs into place in the ring. If a little celluloid cement, airplane-wing dope or acetone is applied around the edge of the crystal, it will be held more firmly.

Increasing Effectiveness of Door Locks on Closed Cars

The effectiveness of door locks on closed cars can be greatly increased by doubling a suitable length of



a suitable length of $\frac{1}{2}$ -in. angle iron to fit over the handles as shown. The ends are split and turned out at right angles, so that a snug-fitting padlock can be slipped over them.

This will prevent a piece of pipe from being slipped over the door handles to break them off.

Cleaning the Chimney Chemically

A mixture consisting of 10 lb. of sal ammoniac, and $3\frac{1}{2}$ lb. of sulphur thrown into a furnace or stove will burn out the soot in the chimney. Too large a quantity of this compound should not be used at one time. Before throwing it into the fire, close all drafts and watch for burning particles of carbon falling on the roof.



Seat Suspended from Inflated Inner Tube Makes Water Float for Children

Inner-Tube Water Float for Children

A water float for children can be made by suspending a seat from an inflated inner tube with straps, as shown in the detail. Curved pieces of tin should be placed around the tube to carry the straps and prevent them from wearing the tube.—Fred A. Beard, Detroit, Mich.

Hands Kept Clean When Handling Paint Can

By wrapping a piece of inner tube around a paint or varnish can the contents can be kept from running down the side where it gets on the hands. Cut two bands from the tube. Double one and snap it around the can near the top. Then wrap a wide piece of tube around the can, so that it projects over the top edge. Snap a third band over this piece to hold it in position, the latter being placed a little below the first band. This causes the top of the rubber to flare out and catch all paint that else would run down the side of the can.





Hose Protected against Sharp Edges of House Corner by Vertically Mounted Roller

Roller Guard Set at House Corner Protects Garden Hose

Here is a simple method of using a roller to protect a hose when pulling it around the corner. The roller is set vertically so that it is free to revolve, and in this way prevents chafing of the hose, which usually results from contact with rough foundation stones.—C. E. Wittenbrook, Toledo, Ohio.

Keeping the Garage Doors Open

A neat arrangement for holding barn or garage doors open can be made by screwing a block of wood to the upper inside corner of each door and fastening a chain bolt to the block as shown in the drawing. Attached in this way, the bolt rises as soon as the door is opened and rests against the upper casing, holding the door open until the chain is pulled to release the bolt.

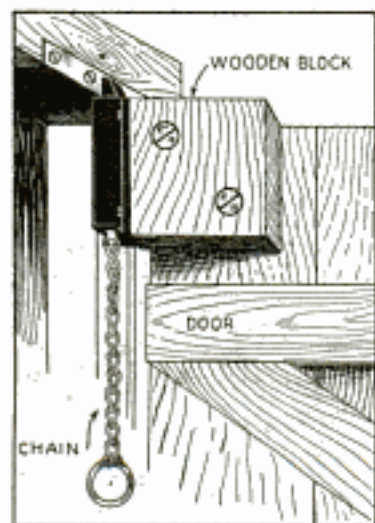

Consumption of Electrical Appliances Measured with Watch

Current consumption of electrical devices, such as radios, and soldering and curling irons, which are not rated in watts, can be estimated with a fair degree of accuracy as follows: First turn on a lamp of known voltage, being sure that no other lamps or appliances fed through the meter are in use at the same time. Then take a watch and time one revolution of the rotor disk in the meter. Multiply the wattage of the lamp by the number of seconds for one revolution of the disk. Turn off the lamp and turn on the appliance to be rated, timing the disk rotor as before. Then divide the number obtained from the lamp by the number of seconds in which the appliance turns the disk once, and the result will be the wattage of the appliance. For example, if a 100-watt lamp turns the disk in 24 seconds and the appliance turns it in 40 seconds, divide 2,400 by 40 and the result is 60 watts.

Broken Belt Stops Gasoline Engine

In order to stop an ungoverned engine when the belt broke or came off, the illustrated arrangement was found effective. Two vertical posts were set on each side of the belt and strips of spring brass were bent and fastened to one of the posts to form contacts, which were held together with strings running underneath the belt and tied to the other post. Wires from the battery or magneto on the engine were attached to the spring contacts and run back to the ignition system to complete the circuit. In this way, one or both of the strings were broken, and the contacts opened when the belt came off.

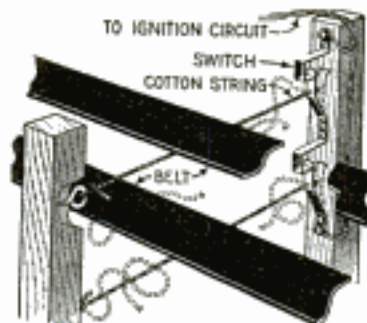

☛ A mixture consisting of equal parts of oil of anise, oil of caraway and oil of rhodium smeared on traps will prove effective in attracting rabbits.

Homemade Diving Helmet

to find LOST MOTORS

By William B. Park

DESCENDING beneath the surface of a lake in a diving helmet is a new experience for the adventurous individual besides being of practical use at summer resorts in recovering lost outboard motors and salvaging wrecks in water not deeper than 25 or 30 feet.

The materials needed are: A heavy 5-gal. white-lead can; lead, about 50 lb.; a heavy plate-glass disk; a 50-ft. length of garden hose; a balloon-tire pump, and screws and a few pipe fittings. The can must be of a size to fit over the head with the edge resting on the shoulders and yet allow ample headroom. With the can so placed, the center of the window should be just a little below eye level. Punch-mark the center and scribe two concentric circles, 6 and 8 in. in diameter. The area between the two circles is scraped and tinned with solder. The frame for the window is then cast of lead, a mold be-

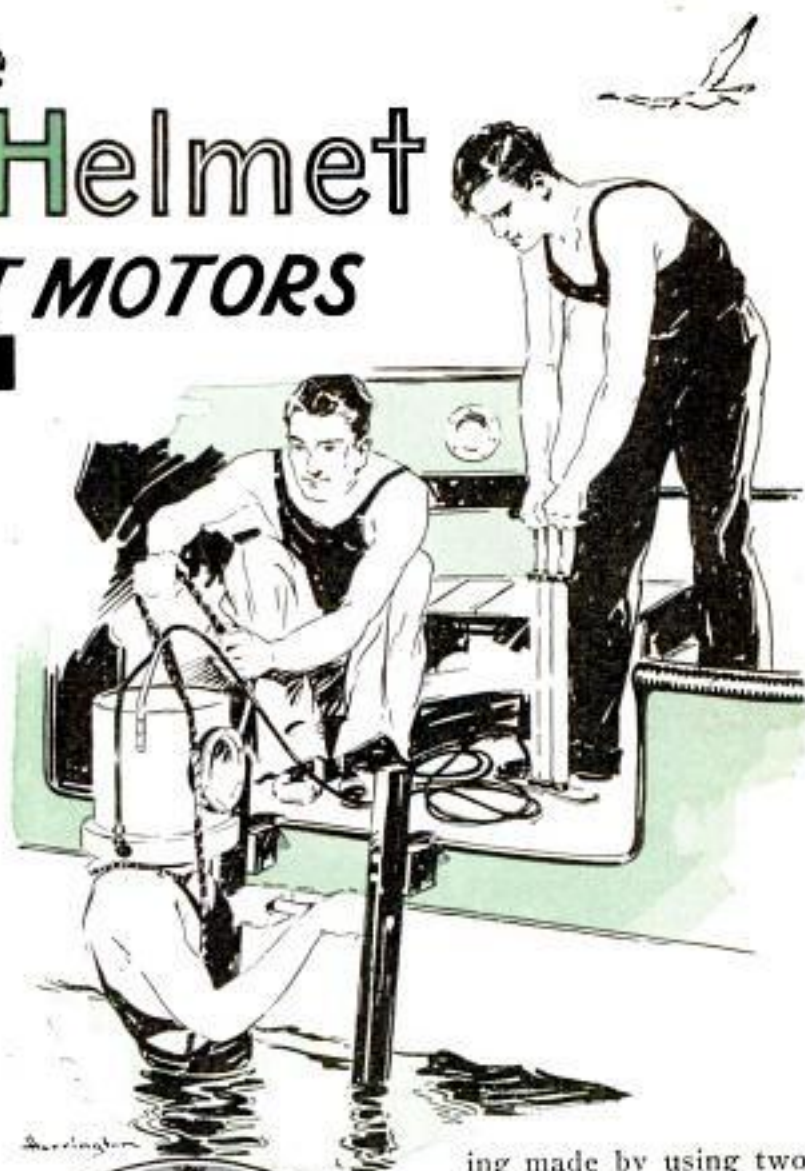

ing made by using two cardboard strips, 4 in. wide, which are glued at the ends to form rings. The rings are trimmed to make a snug fit at the window location, and plaster of paris is used to hold them in place. After the plaster has hardened, the helmet is set in a warm place to dry. Do not pour lead



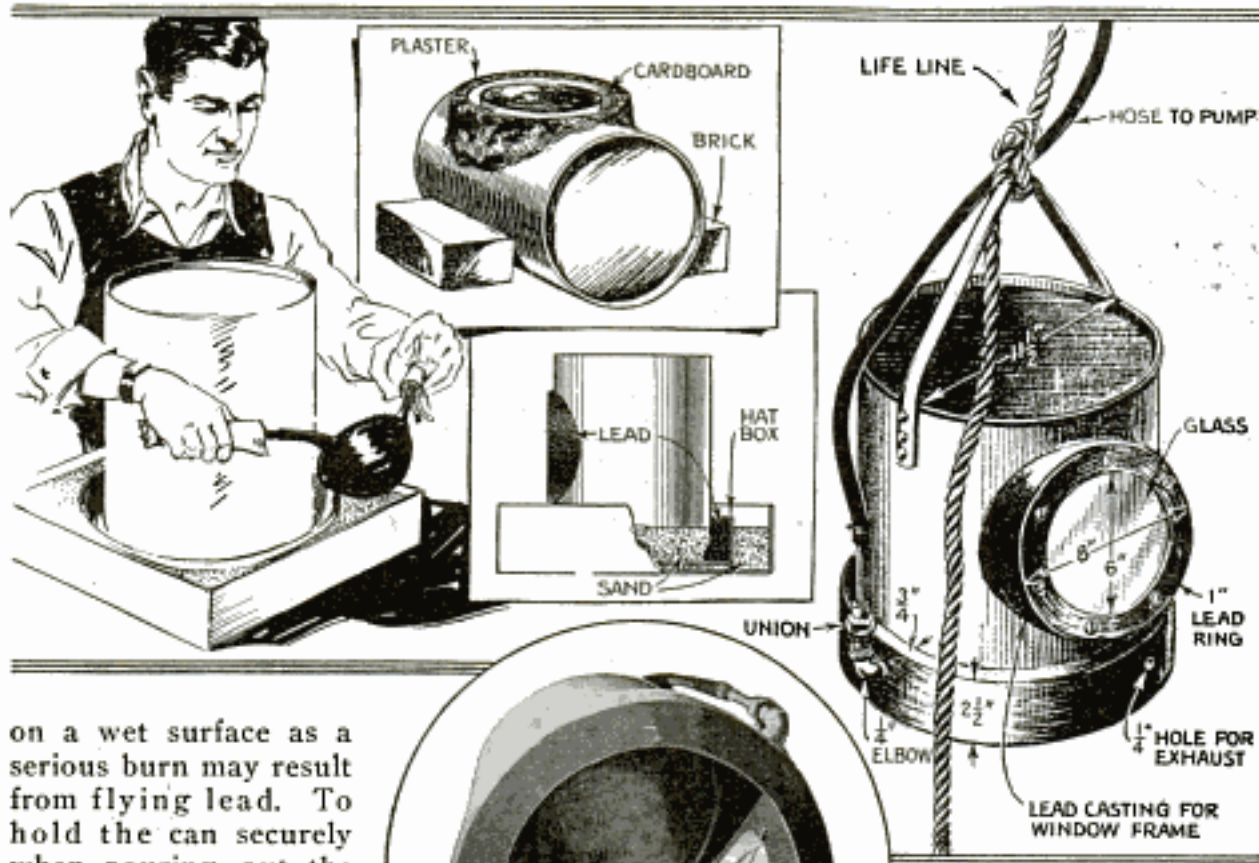

on a wet surface as a serious burn may result from flying lead. To hold the can securely when pouring, put the top of the mold in a level position and block the can with bricks. About 15 lb. of lead are required for the window frame. Always heat the ladle before dipping it in the lead pot. The lead is poured when it is just above the melting point, keeping your face at a safe distance. When the shallowest point of the pour is $\frac{1}{2}$ in. deep, the casting is finished. The inside of the window may then be cut out with a hacksaw.

The lead ring, or collar, which holds the glass in the frame, is made in a similar manner. It is poured about $\frac{1}{2}$ in. deep. A 7-in. disk of heavy plate glass is fitted to the lead casting, a carpenter's block plane being used to dress the lead down flush with the surface of the glass. A sharp blade should be used and thin shavings taken off until the surfaces match perfectly. In order to make sure of a tight fit, use a thin piece of paper as a gauge and try it between the glass and the planed surface.

Now the big casting at the base of the can must be made. Get a round hat box about 2 in. larger in diameter than the

can. Place the box in a larger case of corrugated cardboard and set the helmet inside the hat box, with the open end down, adjusting it to a concentric position.

Weight the top with bricks to hold the can down firmly. Then, with the aid of a paper funnel, pour sand through the window inside of the helmet, being careful to keep the sand out of the bottom of the mold. Pack the outside of the hat box with more sand and then pour the lead to a depth of about 2 in. About 30 lb. of lead will be needed for this purpose.

After the base of the helmet has been poured, place the glass disk on the lead frame and mark six holes at regular distances around the circumference. Drill holes to take stove bolts through the glass and window frame, using a camphor-and-turpentine cutting fluid. White lead is then smeared on contacting surfaces liberally, after which the glass is set in place and the collar put on. Pull the glass down slowly and evenly by tightening the bolts. As an extra precaution against leakage,

(Continued to page 126A)

Ornamental WOODEN FENCES

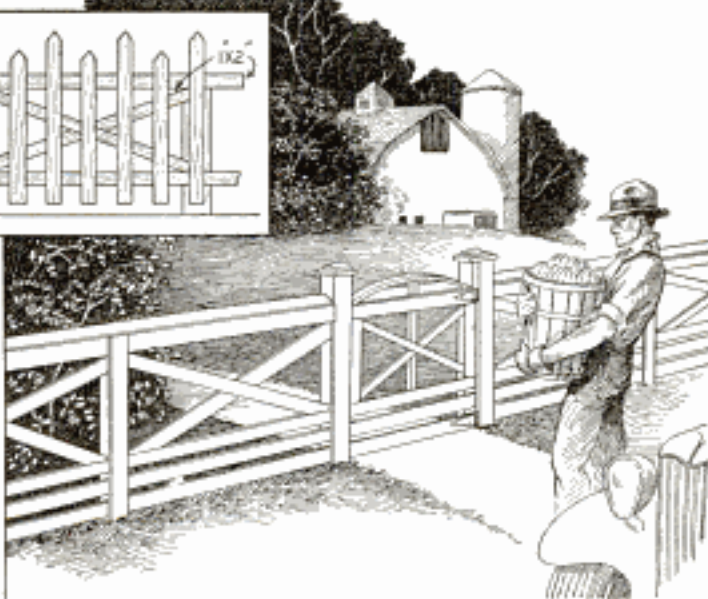
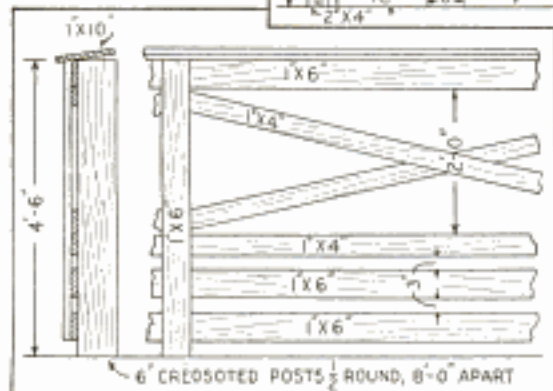
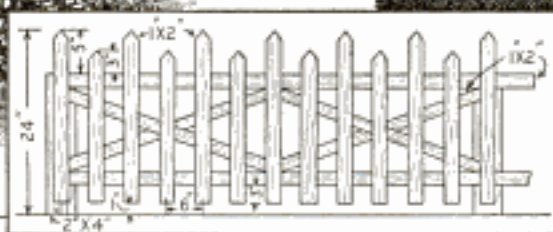
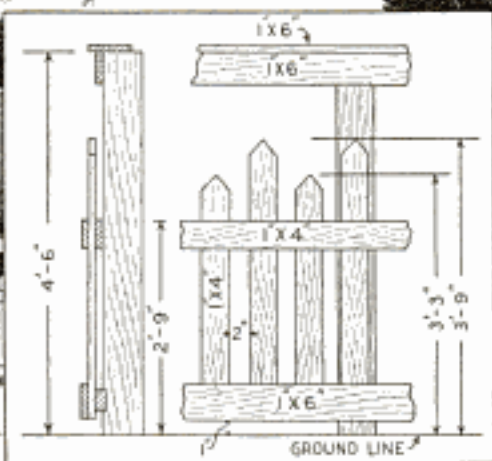
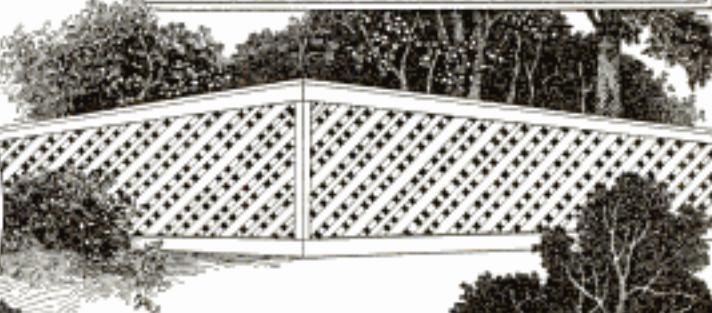
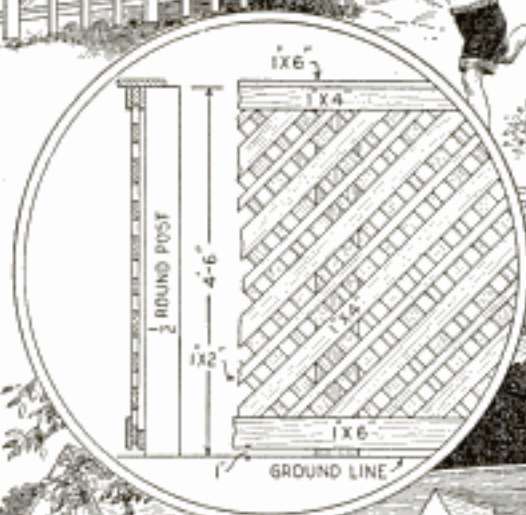
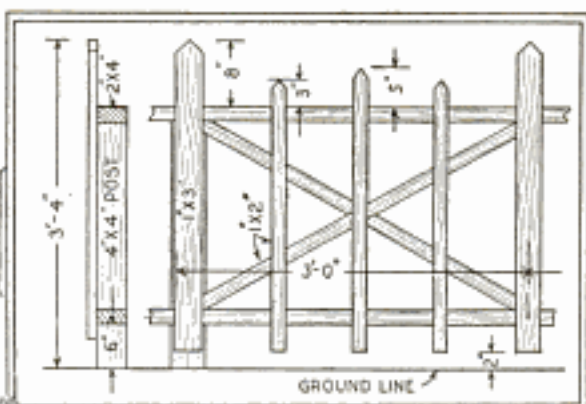

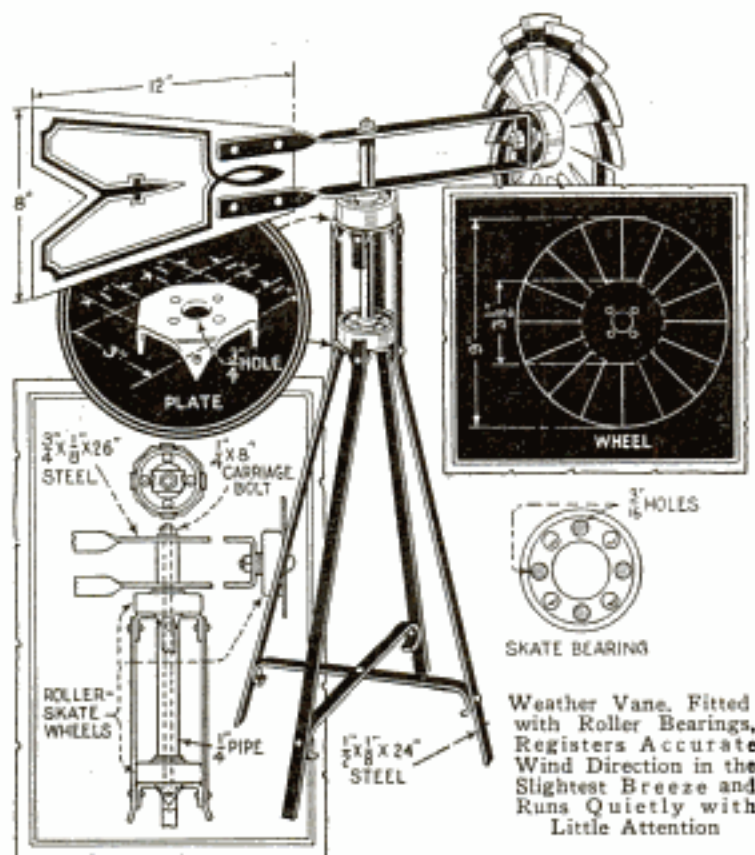

An All-Metal Windmill Weather Vane

With three skate wheels, bar and sheet iron, you can make a ball-bearing windmill weather vane that will indicate the wind direction in the slightest breeze. First make two sheet-metal plates as indicated, and rivet four flat-iron legs to them, crossbracing the legs at the bottom to make a rigid support. Four of the holes found on one side of the skate wheels are then extended entirely through to take round-head stove bolts for attachment to the plates, which are also drilled in the center to take a carriage bolt. The latter is inserted through the skate wheels and serves as a pivot shaft for the vane. Spacers of $\frac{1}{4}$ -in. pipe are used between the plates and between the frame. The wheel and vane are cut from sheet metal. A skate wheel is mounted to the wheel and attached to the frame with a carriage bolt. The completed weather vane is painted and mounted in a suitable place where it will run with little attention except an occasional oiling.

☛ The luster of shellac can be increased by adding 2 to 4 fluid oz. of Venice turpentine or Canada balsam, thinned with an equal quantity of alcohol, per gallon.

Dash Control of Carburetor Needle Valve Saves Gas

After carefully checking the fuel consumption against the recorded mileage of my car, I found that by controlling the carburetor needle valve from the instrument panel, in order to use the leanest possible mixture at all times, I could average approximately six miles more to the gallon of fuel. To do this, I inserted the flexible shaft from an old speedometer cable into a suitable length of $\frac{1}{4}$ -in. copper tubing to reach from the panel to a point just above the needle valve, where it was anchored with the manifold bolts, while the other end was inserted through a hole drilled in the panel. I then soldered a knob from a gear-shift lever to the panel end of the shaft, and soldered the other end to the top of the adjusting nut on the valve. By turning the knob on the panel, the needle valve can be adjusted while driving.—Arthur Walrath, Cohoes, N. Y.

knob on the panel, the needle valve can be adjusted while driving.—Arthur Walrath, Cohoes, N. Y.

Car Aids in Sharpening Lawnmower

Here is a good way of using a car for sharpening a lawnmower by changing the dog in one wheel so that the knives turn backward, and then applying an abrasive. The mower is tipped up on the roller and the wheel allowed to come in contact with the rear wheel of a car, which is jacked

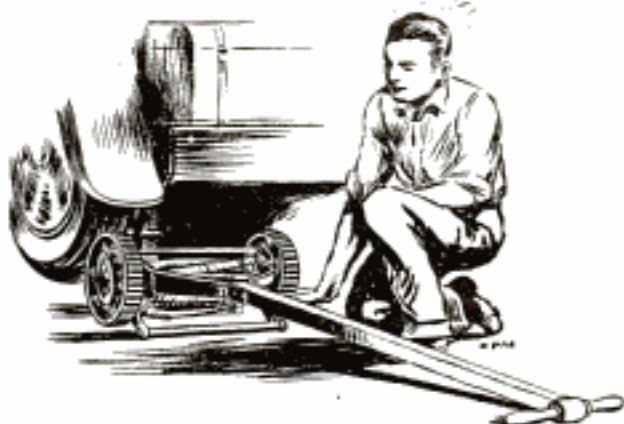

Lawnmower Sharpened by Applying Abrasive to Blades and Revolving Them with Rear Wheel of Car

up and run in low gear.—H. W. Loop, West Branch, Mich.

Cleaning Rusted Golf Irons

If an ordinary cotton buffing wheel or wire scratch brush does not clean badly rusted golf irons, use coarse emery cloth on a sanding drum run at high speed. This quickly removes all rust and scale and leaves the irons in a clean, but dull condition. Next polish them with a cotton buff or solid-felt wheel, the latter being preferable. When new, a felt buffing wheel is rather expensive, but a second-hand one, obtained from the buffing room of a metal-working or plating shop, can be cut down to suit your needs. A little rouge or crocus powder should be applied to the felt for the final polishing, which gives a fine satin finish. Fine emery cloth will clean an iron when it is dull, but it is too slow for removing rust and stains. If two felt wheels are available, the edge of one may be covered with liquid glue and then rolled in fine emery while the glue is wet. The felt is then tapped lightly to force some of the powder into the fibers, and when dry, makes a good cleaner. A coat of clear lacquer should be applied to the irons after polishing to retain the luster.—H. Caldwell, Toronto, Can.

Safety Pin Makes Guide on Rule



A hook for holding the end of a rule flush with the edge of work that cannot be conveniently reached with the hand, can be made from a safety pin. Cut off the head of the pin and bend $\frac{1}{8}$ in. of the pointed end at right angles so that it can be pressed into the side of the rule, when placed in position as indicated in the photo.

Tools for Forming Wire Novelties

Here are two tools with forked ends that are useful for bending wire when making trellises or any other wire novelties in the home workshop. Both tools are made of $\frac{1}{2}$ -in. steel rod, one consisting of two pieces welded together to form a tee, while the other is bent only at one end to an L-shape. A slot to fit the wire



Wire Novelties Made in the Home Workshop with Aid of These Two Simple Bending Tools

is cut in the working end of each, as indicated. By using these tools you can obtain almost any leverage on the wire in order to bend it to the desired shape. For trellis work, small steel bands may be used to hold the wire together at the joints.

A Handy Method of Typing Labels

Labels can be quickly typed by sticking their upper edges to a strip of adding-machine paper and running it through the typewriter as indicated in the photo. After the typing is completed it is an easy matter to strip the labels from the paper. The much greater ease and speed at which the work can be done more than makes up for the time required to put on and remove the labels.—J. Newton, Beaumont, Tex.

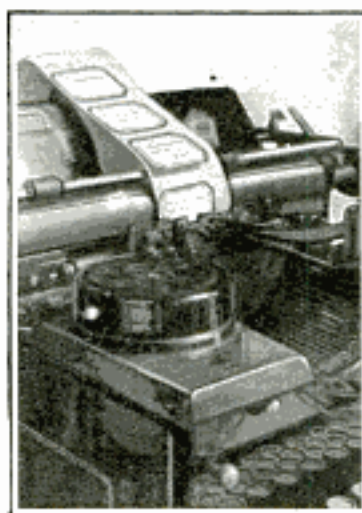

FITTING THE BACK-



THAT boy or girl of yours will find plenty to stay home for if you tackle the problem with hammer, saw and nails, to provide a variety of playground equipment that is safe and sound. Let's start on the Ferris wheel. Despite its 10-ft. crossarms, this is a perfectly safe way to go aloft, the necessary power being supplied by each passenger giving a lusty kick as he swings around to the ground position. The two wooden frames should be made first. These are from standard 2 by 6-in. stock, half-lapped together at the center and tapered to 3 in. wide at the ends. A $1\frac{1}{8}$ -in. hole is drilled in the center to take a short $1\frac{1}{4}$ -in. pipe nipple, and similar holes are drilled 4 in. from each end, as shown in Fig. 3. Wooden braces of 1 by 4-in. stock are toe-nailed into place to give each frame sufficient stiffness.

The rest of the construction is largely pipe work. The main axle is a length of 1-in. pipe,

The rest of the construction is largely pipe work. The main axle is a length of 1-in. pipe,

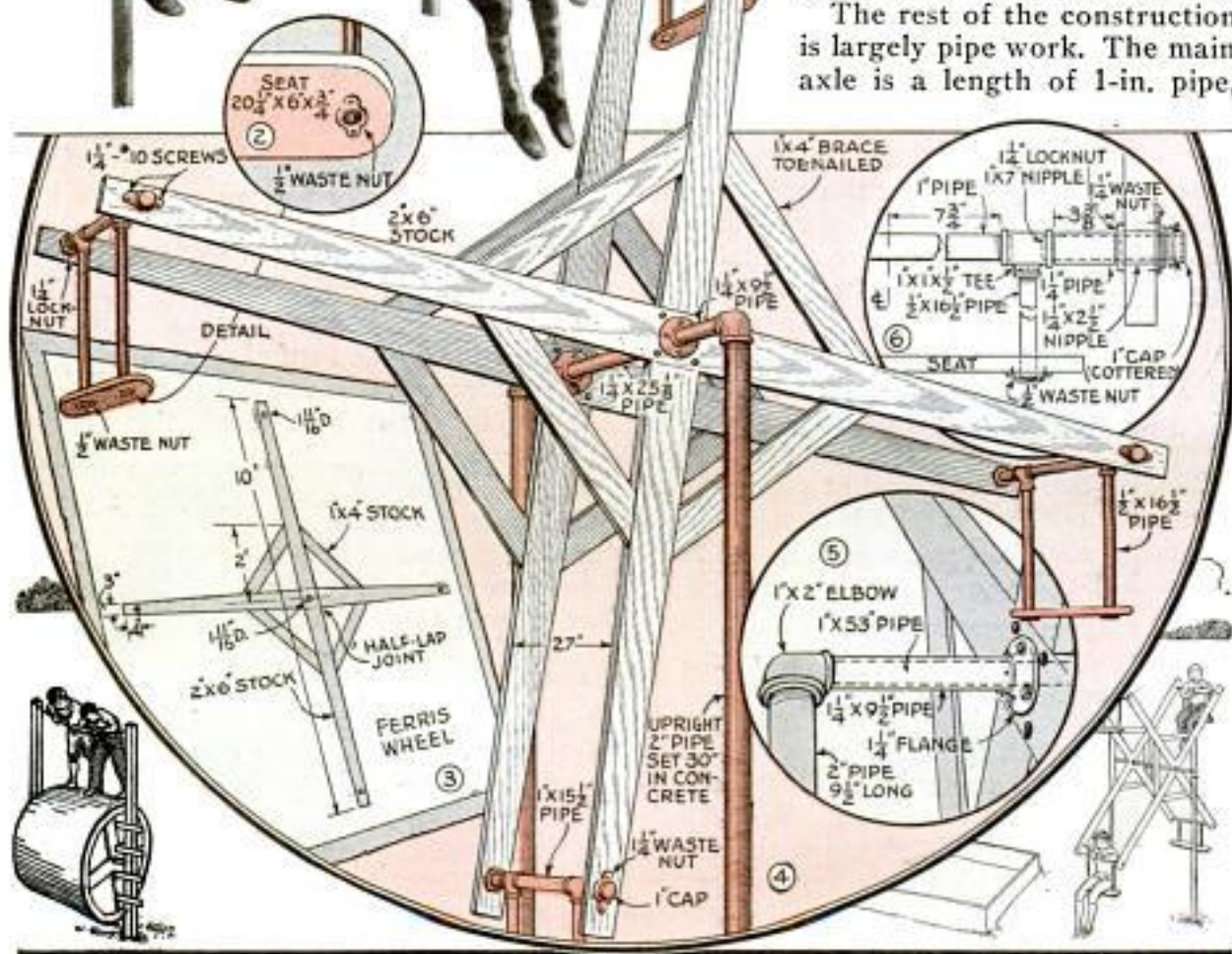

YARD PLAYGROUND

OR A SCOOTING RIDE OVER THE HUMPS OF THE ROLLER COASTER

53 in. long. Pipe nipples, $1\frac{1}{4}$ by $2\frac{1}{2}$ -in., are fitted at the center holes on each frame and capped with floor flanges to form a substantial bearing. Additional lengths of $1\frac{1}{4}$ -in. pipe are used to form the proper spacers, as shown in Figs. 4 and 5. The axle ends are coupled to suitable elbows, which make connections with the two, 2-in. uprights. These are $9\frac{1}{2}$ ft. long, allowing 30 in. to be set in concrete. A good idea of the swings can be gathered from Figs. 4 and 6. Bearings are provided on the wooden frame, the 1-in. pipe neatly slipping through the $1\frac{1}{4}$ -in. nipples used. You will notice that the 1-in. cap at each end is fitted with a cotter key to prevent it from working loose.

The roller coaster is a popular ride. The construction is almost entirely wood with the exception of a little job or two in connection with the car. The track should be made first, using 2 by 4-in. stock. All humps should be neatly smoothed off, as indicated in Fig. 8. Stop blocks should be provided at the high end to prevent the

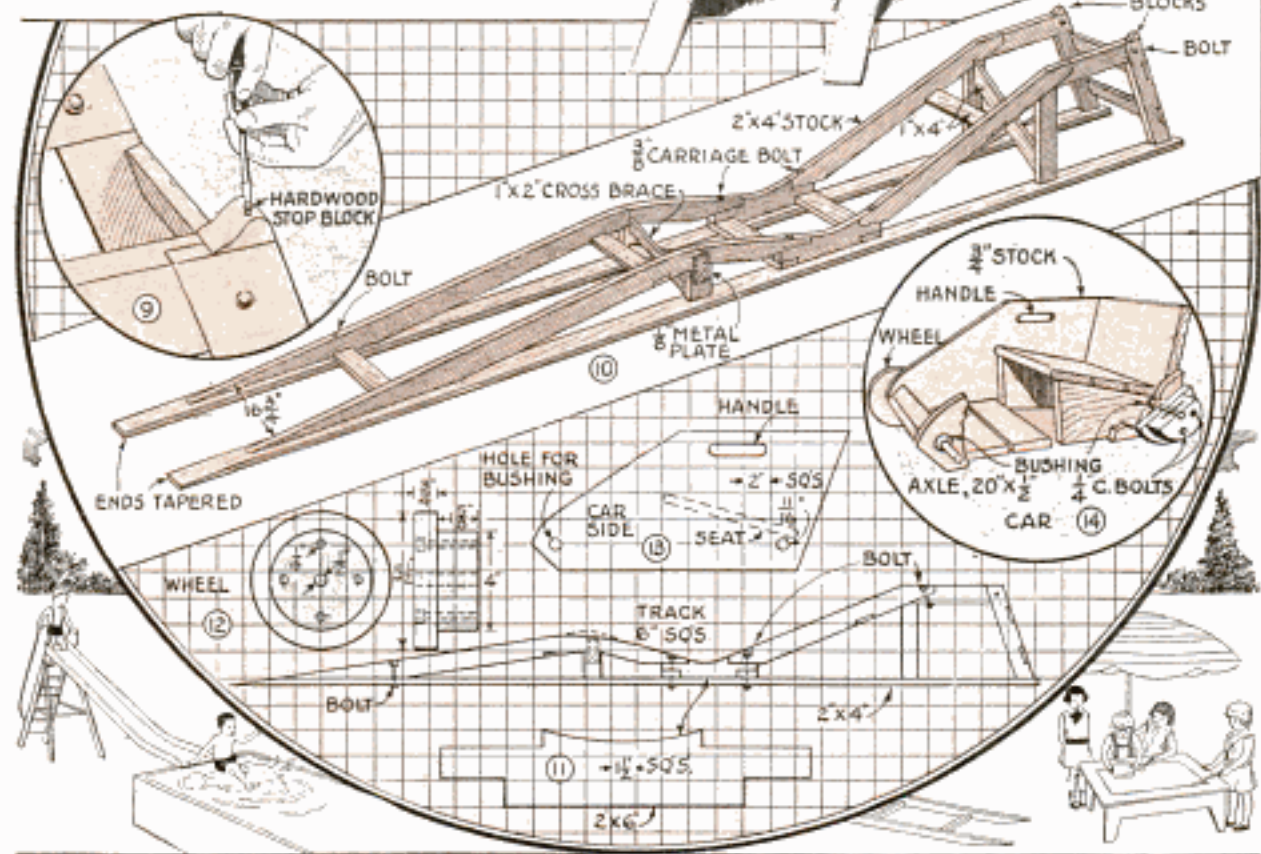



car from going off backward. All of the necessary dimensions can be obtained from the side elevation, Fig. 11. Most of the joints feature bolt construction. The little hump, however, does not lend itself to this type of fitting and must be fastened with a metal plate, which should be securely screwed in position. Details of the car construction are given in Figs. 12, 13 and 14. It is quite obvious that some care must be exercised in order that the finished car may show the proper clearance when placed on the track—about $\frac{1}{8}$ in. at each wheel. The bushings indicated in Fig. 14, which furnish the bearings for the $\frac{1}{2}$ -in. axle, are from a Ford model-T triple gear. To prevent the wheels from coming off, a $\frac{1}{8}$ -in. hole is drilled through the axle at each end, and these holes are lined up with similar holes through the outer wheels and stopped with a long finishing nail.

Paint the track green and the car red for a colorful combination.

On this page are two reliable standbys of the back-yard playground, the rocker swing and the sandbox. Both of these are rather elementary in construction and demand no detailed description. The rocker is particularly simplified if you can get an old wagon wheel to do duty for the curved pieces; otherwise they must be made up as for the treadmill, which will be described later. A half-circular rim, 4 ft. in diameter, makes the ideal rocker swing. The 1 by 4-in. timber, which supports the 1 by 2-in. seat slats, should be extended some 6 in. beyond the curved piece on either side, as shown in Fig. 16, in order to furnish a safety stop for the too ambitious youngster.

Standard flooring stock goes nicely together with 1 by 8-in. boards to make the sandbox shown in Figs. 17 and 18. The lids of the box are fitted with 5-in. strap hinges, bent



Two Reliable Standbys of the Playground Are the Rocker Swing and the Sandbox Shown Above

up on the underside. Exact dimensions are much a matter of preference. The one shown is 8 in. deep, 60 in. long and has two 15-in.-wide lids hinged to sidepieces 9 in. wide. Cross supports of 2 by 2-in. stock should be provided on the bottom, to keep the box a little above the ground, or, if desired, 12 or 18-in. legs can be added to lift the box completely free of the soil.

This is very often done when the box is lined with galvanized metal to serve the dual purpose of a sandbox and a bathing pool. In any case, it is best to have an awning of some kind if the box is continually exposed to direct sunshine.

For real honest-to-goodness exercise, there's nothing that quite equals the treadmill, shown in Figs. 19 to 24, inclusive. Any youngster will gladly run to the store a hundred times when the running is converted into revolutions on this big drum. Here again, wagon wheels would simplify the construction, but as these are neither common nor inexpensive, we may as well work from raw lumber. Imagining that a 4-ft. wheel will suit your requirements, start by cutting 32 sections like the one dimensioned in Fig.

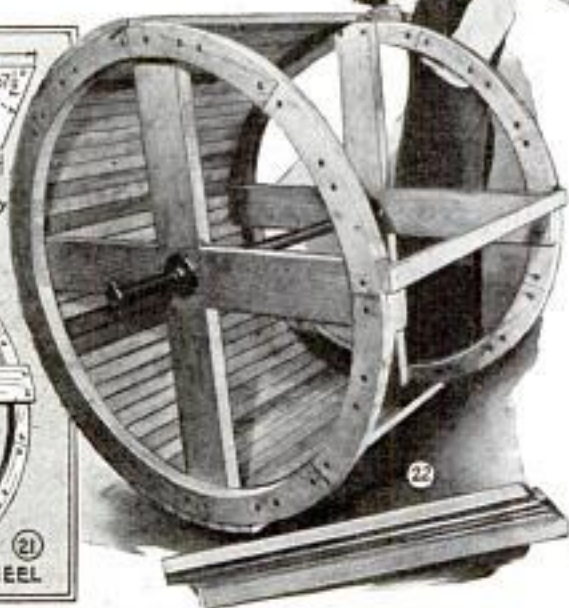
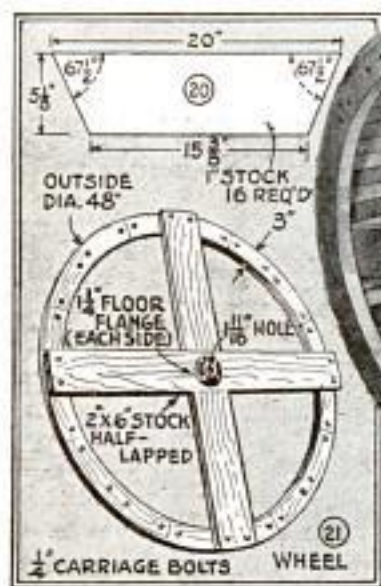
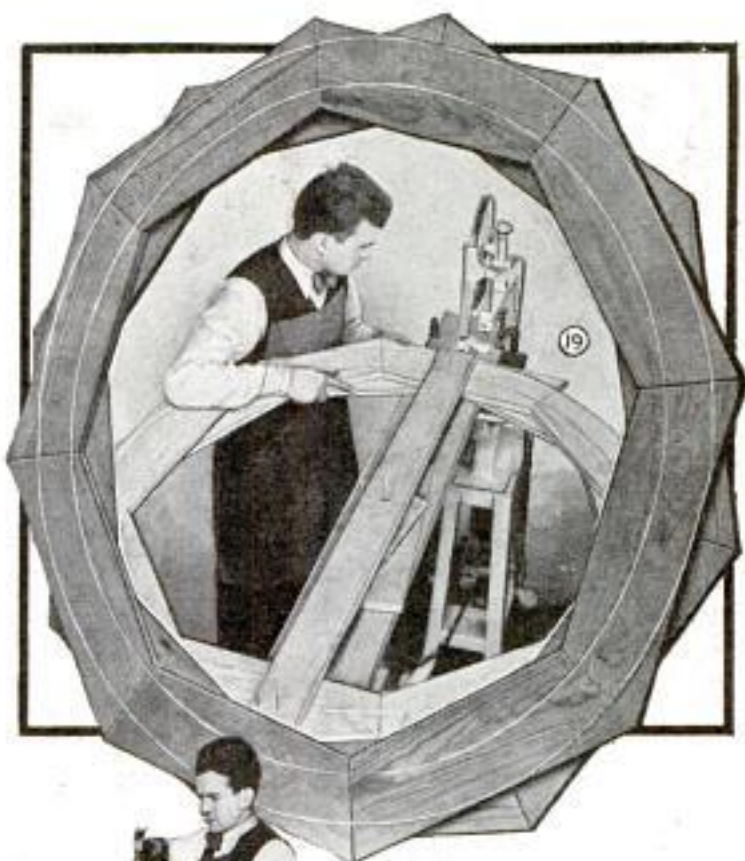

shows the second stage of each wheel. The joint is bolted securely with $\frac{1}{4}$ -in. carriage bolts. Cross-pieces of 2 by 6-in. stock, half-lapped at the center, furnish the spokes. The bearing follows along the same lines as the Ferris wheel, a short nipple with floor flanges being bolted on either side. Fig. 22 shows 1 by 2 by 36-in. slats being applied, one nail and one screw to each end. A 48-in. length of 1-in. pipe serves as the axle, with $6\frac{3}{8}$ -in. pieces of $\frac{1}{4}$ -in. pipe outside the flanges to take up end

The Treadmill Makes Fun of Exercising; This One Is an Outside Wheel, but an Inside Tread Can Be Made by Increasing the Diameter

20, 16 of these being required for each of the two wheels. Eight of these sections, when butted together end to end, will make up a complete circle; a second layer of eight will lap the joints and make everything quite solid. With the sections nailed together, the wheel can be easily cut on the bandsaw, as in Fig. 19, in the usual manner followed for cutting circles. The inside cut can be made by opening up one of the joints to admit the blade. Fig. 21

play. Each end of the axle is fitted with a 1-in. waste nut, and these are bolted directly to the 4 by 4-in. oak uprights, as in Fig. 24. Fig. 23 shows the finished treadmill. You will notice that the oak uprights are left sufficiently long to enable fastening a life-saver rope across the top. Four steps screwed to one of the posts provide an easy way of getting to the top of the mill; there is never any difficulty in getting off.



The treadmill just described is the outside tread, that is, you do your running on the outside. By making the wheel 8 or 9 ft. in diameter and following the same construction, you can make an inside treadmill. This offers a particularly thrilling ride, since the passenger, once the wheel is going at top speed, can grip the axle, press his feet tightly against the slats and go right on, head over heels, for a complete somersault. Then, too, you need not stop at the few pieces described in this article. Naturally enough, there will be seesaws, swings, the reliable high bar, and so on.

How to Stain a Bamboo Fishing Rod

You can easily imitate the popular brown color on bamboo fishing rods, with a good grade of stain. Although some of these rods are made in factories by a tempering process, the greater number are stained or are given several coats of col-

ored gloss varnish. Either a solution of permanganate of potash in water, or aniline dye with clear grain alcohol as a solvent, can be used as a stain. The former is recommended if the glued strips show hairlike openings between them, as the dye works into these cracks and injures the rod. To stain the rod, remove all windings and then rub off the old varnish with fine steel wool. Next polish with pumicestone and water, using a light piece of soft felt. Then rub the rod until it takes on a high polish. The stain should be applied with a cotton swab, going over each section carefully to leave no breaks. It is then left to dry and rubbed to a high polish with a piece of felt. Apply as many coats of stain as may be necessary to obtain the desired color. Then give the rod a coat of rod varnish. When it has dried, the windings are put on and the rod is given successive coats of varnish until they are well protected.

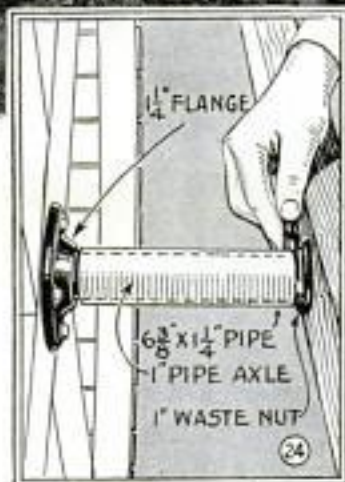

Rotating Soap Slicer from Can Lid

A tin lid from a coffee can was used to make the illustrated soap slicer. The lid was cut in three places and the tin on one side of each slit pushed down to form the blades. A large nail through the center of the lid holds the cutter to the cake of soap, while a cork or spool is used for a handle. Rotating the cutter chips off the soap in slices, the thickness of which is regulated by the pressure against the soap and the angle to which the blades have been adjusted.



Fur-Lined Sleeping Bag Is Light and Warm

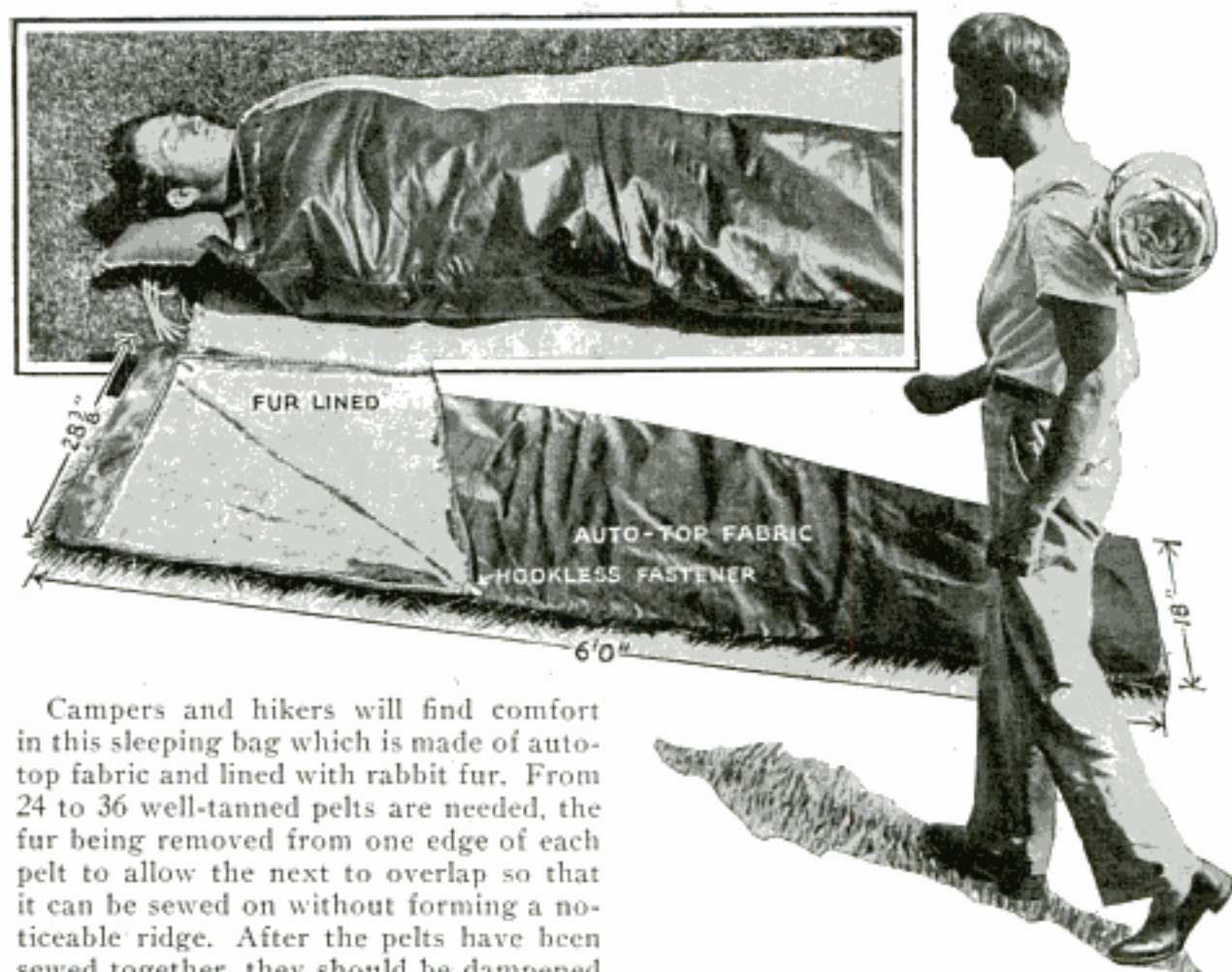

Campers and hikers will find comfort in this sleeping bag which is made of auto-top fabric and lined with rabbit fur. From 24 to 36 well-tanned pelts are needed, the fur being removed from one edge of each pelt to allow the next to overlap so that it can be sewed on without forming a noticeable ridge. After the pelts have been sewed together, they should be dampened and stretched over a frame to dry, in order to prevent the bag from coming out of shape later. The entire assembly is sewed to a strong backing of airplane silk at 3 or 4-in. intervals, to keep it in place and to prevent tearing. Silk is warmer and stronger, and causes less discomfort from perspiration, than any other cloth, although heavy linen may be used. The pelts and lining are then sewed to the edges of the auto-top fabric, and the bag is sewed together, leaving one end and about 36 in. of the right-hand side open as

shown, to be fitted with hookless fasteners. A heavy netting may also be sewed to the top to pull over the head as a protection against insects. If desired, a small air pillow and mattress can be used to make the bag more comfortable, either purchased or made by vulcanizing inner tubes together. Properly made, this bag is comfortable, waterproof and weighs about 12 lb. It can be rolled into a compact bundle and strapped to the shoulders when hiking.—Elmer L. Brown, Folsom City, Calif.

Holes in Auto-Engine Crankcase Patched with Sheet Lead

A sheet-lead patch over a hole in an engine crankcase can be made as follows: Place the lead over the outside of the hole and hammer it lightly to make it conform to the irregularities of the casting, being careful not to fracture it. Then drill holes

through the lead and the case, about 1 in. apart, and fasten it in position with $\frac{3}{16}$ -in. stove bolts. Use flat washers between the lead and the nuts to prevent them from pulling through the soft metal. As an added precaution against leakage, use a heat-resisting cement as a bond between the patch and the crankcase.—James Scotland, Cleveland Heights, Ohio.

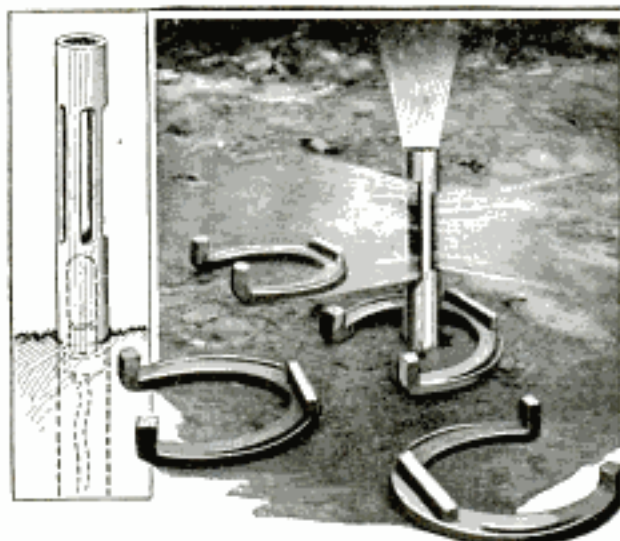

Electric Lamp Placed inside Slotted Pipe Provides Light for Playing Horseshoes at Night

Horseshoe Players Use Illuminated Stakes at Night

Horseshoe fans in Chicago are using illuminated stakes so they can continue playing after dark. Each stake consists of a length of 2-in. pipe with three slots cut in the sides, as shown in the detail. A socket and electric lamp mounted inside of the stake near the base provides the illumination. Electric current for the lamp is carried through an underground conduit to which the stake may be either temporarily or permanently attached.

Oil Drum Provides Floating Support for Light Wharf

An oil drum has sufficient buoyancy to support the floating end of a light wharf, such as is often used at summer camps. Two iron straps are put around the drum and bolted to the wharf to hold it in position. The shore end is pivoted to two posts set in the bank.

Buoyancy for Floating End of Light Wharf Furnished by Large Oil Drum

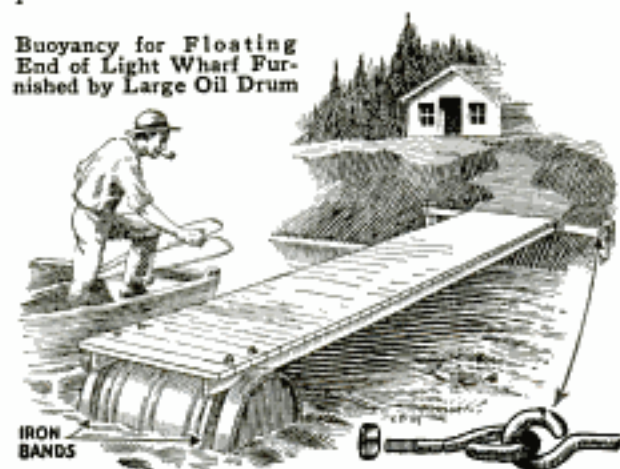

Emergency Repairs on the Camp Stove

While on a camping trip, the generator on my gas stove refused to work, and, being several miles from any place where parts could be obtained, I took out the long pin inside and cleaned off the carbon so it would go through the tube easily. Then I cleaned out the hole in which the needle fits, taking care not to enlarge it. After reassembling the parts, the stove worked like a new one. Next, I replaced a worn-out burner screw with a strip of sheet metal, $\frac{1}{2}$ in. wide and 9 in. long, in which two rows of holes were punched down the center with a small nail. After punching the holes, I rolled the piece into a cylinder-shape of approximately the right diameter, and riveted the ends together, forming a screen that worked successfully until I could replace it with a new one.—Ward Skeen, Chicago.

Shoes Converted to Roof Creepers

By driving several small nails through the edge of the soles on your shoes, as shown in the photo, so that they project about $\frac{1}{4}$ in., it is an easy matter to walk on sloping roofs. The nail points grip composition or wood shingles firmly and can be removed without noticeable damage to the shoe sole.



Make Your Own Liquid Bluing

For washing purposes, liquid bluing can be prepared at home. Dissolve 4 oz. of oxalic acid (poison) and 1 lb. of prussian blue in $\frac{1}{2}$ gal. of water. The oxalic acid should be dissolved completely before the blue is added. To use the bluing, add the desired quantity to the wash water in the usual manner. Oxalic acid is an efficient bleaching agent, therefore this type of bluing will greatly aid in producing pure white laundered goods.

☛ Gasoline poured over the ground will drive out worms that are near the surface.

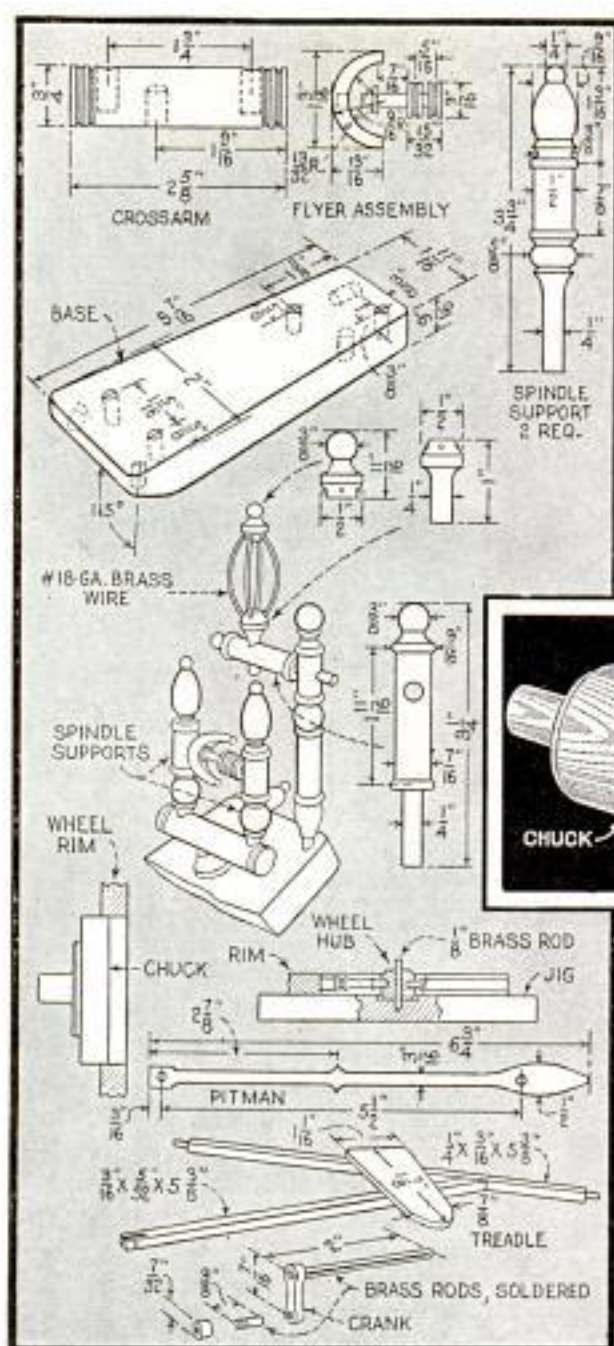

waste at both ends. Then the pieces are chucked individually, the chuck being turned out of a piece of hardwood screwed to the faceplate. A square hole is formed at the center of the chuck, the hole taking one end of the piece to be turned. This hole should be at least $\frac{1}{4}$ in. deep and must hold the piece firmly without play. The tailstock center supports the outer end of the work. In turning, care should be taken to duplicate the form and dimensions of the spokes. After the spokes have been turned out, the wheel is assembled on a jig. First a circle, the exact diameter of the rim, is scribed on one face of the jig, and a hole is drilled at the center to

take the projection of the wheel hub, as in the sectional view. The center hole is then counterbored with a $\frac{1}{8}$ -in. drill to take a piece of $\frac{1}{8}$ -in. brass rod, as shown. Next, the wheel rim is clamped in place, the diameter coincident with that of the scribed circle, and the hub, with all the spokes in place, is set over

the rod. The spokes are then marked and cut to such length that they fit snugly in the rim, and are then glued in place.

All other parts are then turned to the dimensions given. Care must be taken to bring the tenons to exact size. The base is made from hardwood, carefully sanded and waxed, and the holes taking the various turnings are located and bored at the approximate angles shown. The wheel is mounted on the supports and, by lightly tapping the ends of these alternately, it may be made to run true with the frame. Next, the spindle crossarm and supports are turned out, and the holes bored as indicated. The hole in the crossarm taking the base tenon must be very carefully located at an angle so that, when assembled on the base, the spindle supports will stand upright. The flyer and pulleys are carried on pivot pins cut from No. 18 gauge brass wire and inserted in the $\frac{1}{16}$ -in. holes drilled in the supporting uprights. The pins are driven into small holes drilled in each end of the flyer assembly and serve as the shaft. The distaff is then finished by turning out the three remaining parts and assembling as shown. A treadle and pitman complete the wheel.

drying between coats. Next, the wheel hub is turned, and the $\frac{1}{8}$ -in. hole for the spindle is drilled. To locate the spoke holes, a center line is scribed on the hub and eight equidistant points are stepped off with dividers. Then the hub is set in a V-block on the drillpress table, and $\frac{1}{4}$ -in. holes are drilled to a depth of approximately $\frac{3}{16}$ in. A suitable V-block may be made from a piece of hardwood if no other is at hand.

The material for the spokes is first ripped into square strips, the sectional size of which should be slightly larger than the greatest diameter of the finished turning. Also, the length should allow for sufficient



Old Bicycle Used as Power Supply for Driving Grinders and Other Rotary Tools

Bicycle Drives Grinding Wheel

Belted to the rear wheel, a grinder, mounted on the frame of an old bicycle, can be turned at high speed. The front wheel is removed and the frame fastened on a base as shown, using one support for the fork and one on each side of the rear wheel. The grinding wheel is mounted on a table which is clamped to the frame. The same idea can be applied to the driving of other small rotary tools.—A. Wurz, Jr., Rockyford, Alta., Can.

Cork Grips on Coping-Saw Blade for Use in Tight Places

Two large corks, cut halfway through and slipped over a coping-saw blade, enable you to grip it with the fingers and

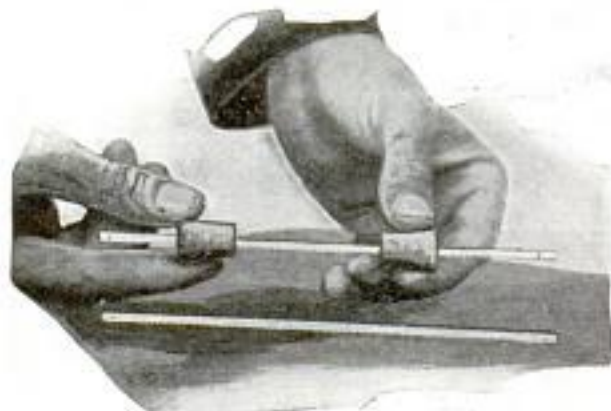

Corks Enable Use of Coping-Saw Blade in Places Where Frame Cannot Be Handled

use it in places where a saw frame cannot be handled. The corks may be placed anywhere on the blade so that it can be held rigidly when drawn back and forth across the work.

Tartar Emetic Poisons Ants

Some ants eat greasy food while others like sweets. Tartar emetic has been found the most effective poison for either kind. For grease-eating ants, mix tartar emetic, 1 part, with grease, 20 parts, and for those that like sweets, mix tartar emetic, 1 part, with honey or sirup, 20 parts. Smear the bait on objects near the runways or other places where the ants are known to be. Care should be taken in spreading the mixture to see that only the ants can get it, and it should be removed as soon as they have disappeared.

Rope Anchor from Auto Casing

When it is necessary to tie or fasten a small rope in places where it is impractical to use a projecting hook or a nail, a piece of auto casing or leather, cut to the shape shown and nailed or screwed in place, makes a good anchor. The rope can be tied on securely and there will be no danger of injury or torn clothes to persons accidentally rubbing against it.



Adhesive Tape Helps in Gluing Small Boxes

When gluing small boxes and similar articles, a convenient method of holding the joints together is to bind them with adhesive tape. Ordinary medical tape can be used, but friction tape is better. In gluing the sides of a box having mitered corners, lay out the pieces end to end on a flat surface, and fasten them together with strips of tape laid over the joints, on the outside surface. Apply the glue and fold the sides into place, the tape strips acting as hinges. Let the tape remain in place until the glue has set.

Ideas for the Small-Boat Owner and Builder

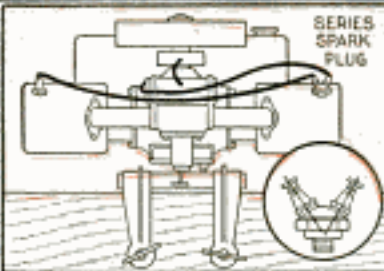

SERIES SPARK PLUG

Left, Old-Style Series Plug Will Synchronize Spark in Racing Twin. It Must Be Turned Down and Rethreaded to Fit. Right, a Neat Method of Preventing Drawers from Sliding Out. Play at Top Permits Drawer to Be Opened by Lifting It to Free Catch

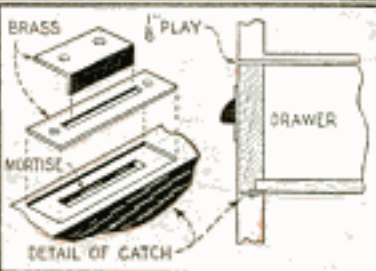

BRASS
MORTISE
DETAIL OF CATCH
DRAWER

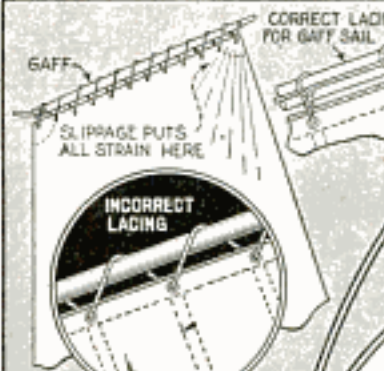

GAFF
CORRECT LACING FOR GAFF SAIL
SLIPRAGE PUTS ALL STRAIN HERE
INCORRECT LACING

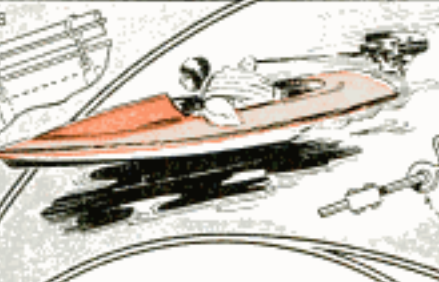

PIPE
EYEBOLT
CLAMP
LOCKNUTS
EYEBOLT
CABLE
SPRING WASHERS

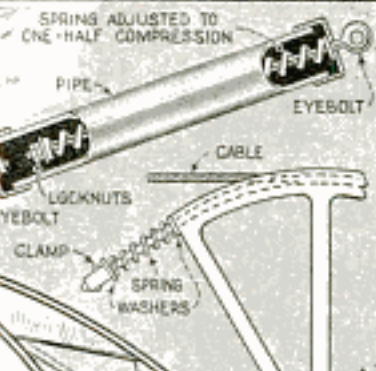

SPRING ADJUSTED TO ONE-HALF COMPRESSION
QUADRANT

Left, Above, Gaff Sails Laced with a Hitch at Each Turn to Distribute Strain Equally. Right, For Standard Installations of Rope Tillers, a Spring Tensioner Inclosed in Length of Pipe, Keeps Line Tight; Spring Should Exert a 25-Lb. Pressure When Half Compressed. If a Quadrant Is Used, the Tensioner Can Be Made a Direct Part of the Unit. Lower Left, Serviceable Buoy Turned from Wood. Three Wood Sections Are Held Together with a Through Bolt Capped with a Screwed-On Ring; and Three Lengths of 1-In. Rubber Hose Are Nailed around the Central Portion as a Fender. Lower Right, Propeller Pitch Checked by Using the Pitch-Board Method; Wooden Templates, to Fit the Contour of One Blade, Should Fit All of the Others as Nearly as Possible; Slight Imperfections May Be Disregarded but It Is Absolutely Necessary That Any Serious Misalignment Should Be Carefully Corrected

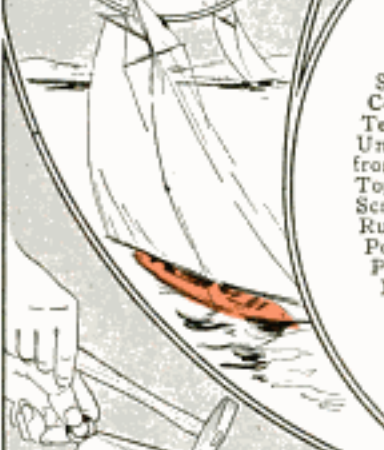

1" HOSE
SCREWED ON RING FITTING



EYE-BOLT
1" HOSE
NUT & RING

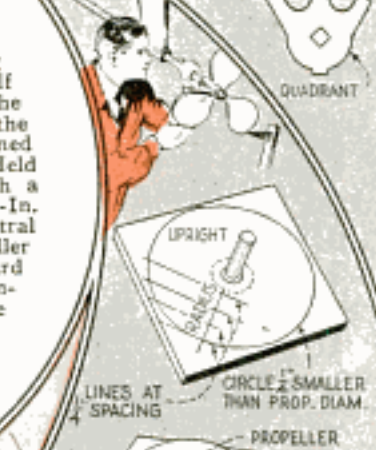

UPRIGHT
BLADES
CIRCLE 1/2" SMALLER THAN PROP. DIAM.
PROPPELLER
WASHER
TEMPLATES

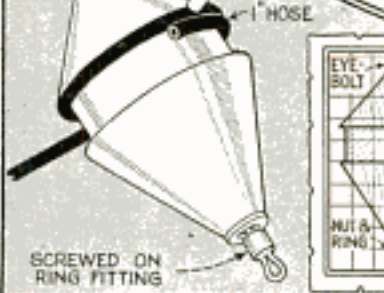

1" HOSE
SCREWED ON RING FITTING

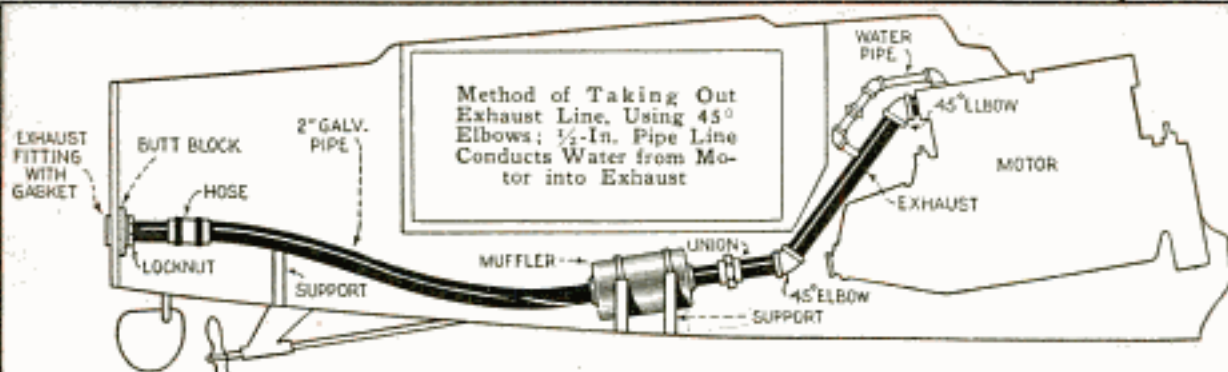

Method of Taking Out Exhaust Line, Using 45° Elbows; 1/2-In. Pipe Line Conducts Water from Motor into Exhaust

WATER PIPE
45° ELBOW
MOTOR
EXHAUST
45° ELBOW
SUPPORT
UNION
MUFFLER
SUPPORT
EXHAUST FITTING WITH GASKET
BUTT BLOCK
HOSE
LOCKNUT
2" GALV. PIPE

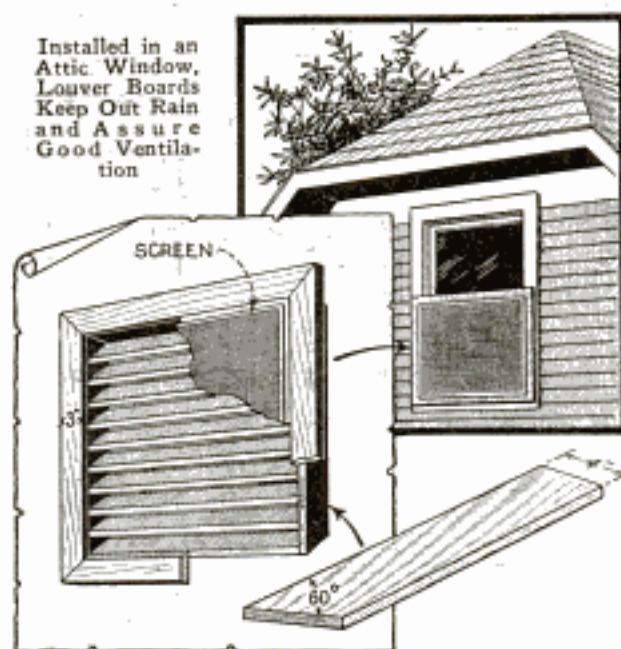

Installed in an Attic Window, Louver Boards Keep Out Rain and Assure Good Ventilation

An Efficient Ventilator for the Attic

Louver boards, set at a 60° angle in a special frame fitting a window casing, permit ventilation of an attic, yet keep out rain. Screen wire should be tacked over the frame to prevent the entrance of insects. By providing such a ventilator, the attic cools off quickly after a hot day.—Henry R. Zelle, Paulsboro, N. J.

Material to Use for Model Boats

Next to good tools and equipment, the most valuable asset in building model boats, is to use the best materials obtainable. For the rib-and-plank method of hull construction, sugar pine and mahogany have been found superior to other woods. The simpler and quicker way is the "bread-and-butter" method, the hull being built up in layers. Sugar pine and basswood are recommended for this purpose. In either case, the wood selected should be straight-grained and clear. The most desirable wood for decks is white cedar, mahogany or white pine, while spruce is the accepted stock for spars. Lead is customarily used for the ballast; scrap lead will do, but care must be taken when casting, to remove all impurities. Aluminum and wood are the most widely used materials for rudders. While aluminum is strong and light, it lacks buoyancy, and therefore many model makers prefer mahogany. Balloon cloth, in light weights, and "lonsdale" cambric are widely used

for sailcloth. Running rigging may be braided from fine fishline. On models 4 ft. long and over, standing rigging is made up of wire that will not rust, while fishline is used on the smaller boats. Paints and varnishes must be of good quality.—J. A. Waring, Jr., Minneapolis, Minn.

Styptic Pencil Relieves Ivy Poisoning

After the usual remedies had failed to relieve a severe case of ivy poisoning, I dipped my styptic pencil in water and applied it gently to the inflamed surface, and within a few minutes the burning sensation stopped. I continued the treatment for about 15 minutes and, without washing off the dry sediment, went to bed. The next morning all the itching was gone, many pimples had disappeared and others had turned brown. I continued the treatment for the next two days with complete relief, and have found application of the pencil effective also for sumac poisoning.—C. H. Robinson, Chicago.

Extra Seat on the Baby Carriage

An extra seat on the baby carriage can be provided by suspending an infant's swing from the handle as shown. This arrangement provides a place where an older child can ride comfortably without disturbing the baby.

Suspended from the Handle of a Baby Carriage, a Swing Seat Provides Transportation for Older Child



¶ Ten parts of alcohol and 90 parts of benzol, mixed together, will make a solution for removing dried printers' ink from type and furniture.



A DRILLPRESS

from Auto Parts

DRIVEN by means of a $\frac{1}{4}$ -hp. electric motor, this homemade drillpress, built mostly from old auto parts and a few items obtainable from your local dollar store, is sturdy, accurate and smooth in operation.

A cut-off portion from an axle housing is bolted to a brake drum, which, in turn, is bolted to the bench top. The spindle bearing is a small grinder head and is clamped to the housing by means of two

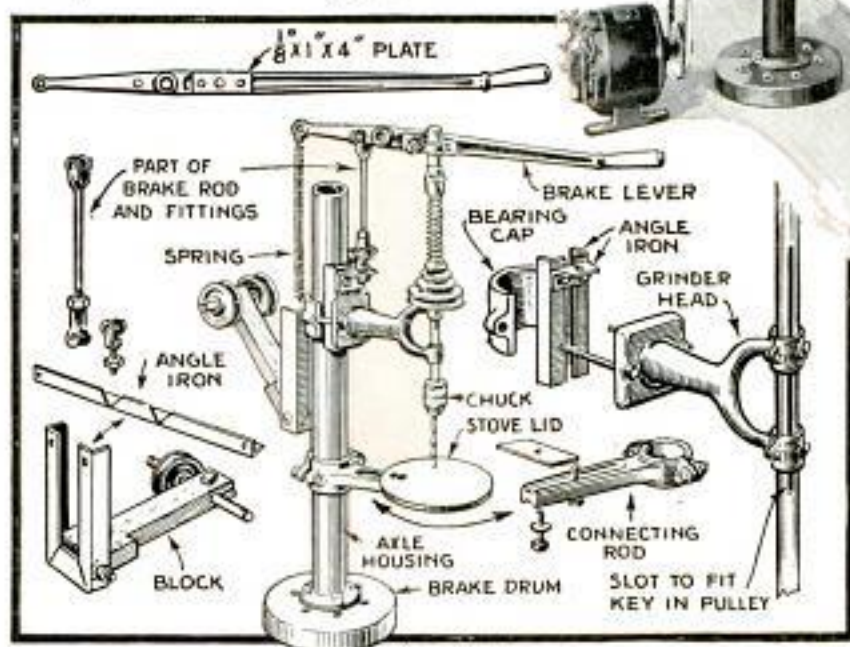

dle, being attached to the upper end of the spindle and pivoted directly above the base of the grinder head, part of a brake rod and fittings being used for this purpose. A coil spring, attached to the end of the handle and to the assembly below, keeps the spindle up when not in use. Two small V-pul-

lengths of angle iron and a connecting-rod bearing cap, as shown in the detail. A groove is milled in the spindle to take a key of a step pulley, permitting the spindle to be raised and lowered while the pulley is rotating. The drillpress table consists of a stove lid bolted to a connecting rod, which is clamped to the axle housing. An old brake lever provides a convenient han-

leys are slipped on a short piece of drill rod, which is held in a wooden block that is pivoted in an angle-iron frame attached to the axle housing as shown. The lower end of the spindle is threaded for a suitable chuck, which must be purchased.

Another design for a drillpress made from auto parts is also given. In this case, a pipe flange is substituted for the

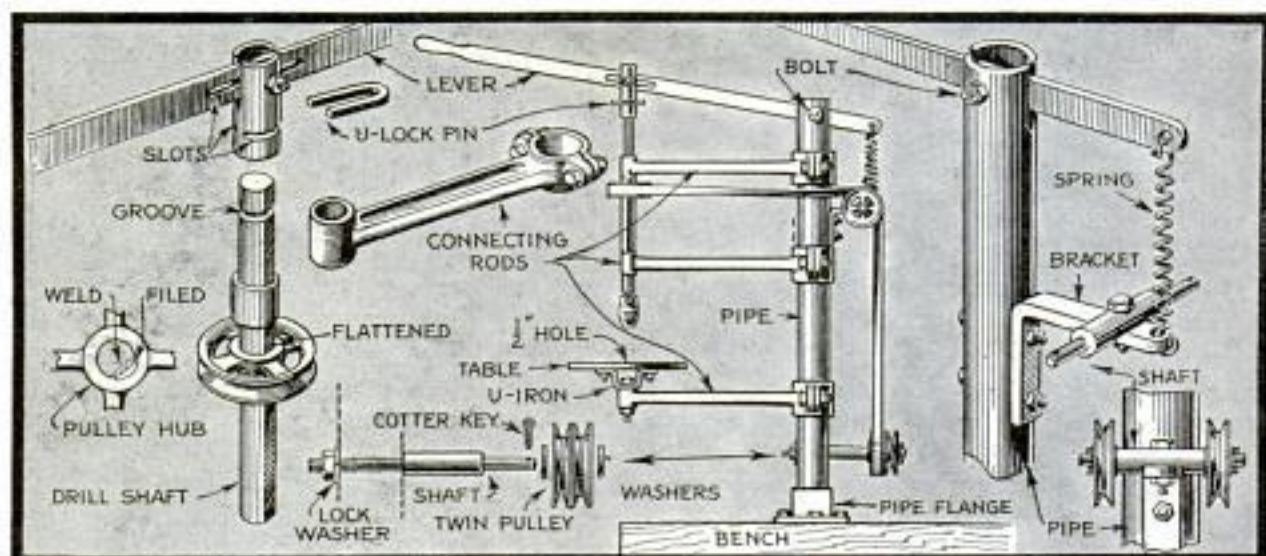

brake drum and a length of pipe for the axle housing. Two connecting rods are used instead of the grinder head, to provide a double head for the spindle. Also, the lever is pivoted in a slot at the top of the pipe frame. Other points of difference in the construction and assembly can be gathered from the illustrations. If you have an old electric motor, or can readily obtain one, such a drillpress will involve very little expense, depending, of course, on the parts used in its construction. For a chuck, it is best to get one of the better-known and well-made brands, as a great deal of the accuracy of a drillpress depends on the chuck. One up to $\frac{1}{2}$ -in. capacity is suggested.

High-Speed Steel Easily Annealed in Hot Water

High-speed steel, which is usually difficult to anneal, can be softened sufficiently for easy working as follows: Heat a pail of water to 150° F. and hold it at this temperature if possible. Next, heat the piece to be annealed to a very dull red, discernible only by holding it in a dark corner of the room, and then quench it in the water.—Robert Duncanson, Rochester, N. Y.

Removing Rust Stains

Undyed goods may be freed of rust stains by soaking the spot in a solution of tin chloride in water. As soon as the spot has vanished, rinse the material thoroughly in large quantities of clear water.

This method should not be used on colored goods, as the chemical is likely to fade such fabrics.

Jig for Drilling Concentric Holes in Ends of Dowel Rods

Concentric holes can easily be drilled in the ends of dowel rods with this jig, which consists of an electric hand drill and a wooden block for holding the rods, both being fastened securely to a bench top as indicated. A hole is drilled through the center of the block lengthwise, part of the hole being of suitable diameter to receive the dowel rod, while the rest is just large enough to take the drill, as shown in the lower detail. The large end of the hole is countersunk so that the rod can be inserted more easily.—John E. Hyler, Peoria, Illinois.



Simple Method of Locating Misses in Eight-in-Line Motor

Locating missing cylinders in an eight-cylinder engine is a comparatively easy matter if the following procedure is followed. As the usual division of an eight-in-line type is such, that the combination of the two front cylinders with the two rear ones will form one four-cylinder engine with even firing impulses, while the four center ones will form another, the plug wires may be removed from either of these two portions and grounded to the cylinder head, allowing the four operating cylinders to be tested in the same manner as an ordinary "four." It may be found necessary to open the throttle slightly in order to keep the engine running.

Wooden Disk Covers Gib-Key Head

The danger of having the clothing catch on the head of a gib key, commonly used for keying wheels and gears on the end of shafts, can be overcome by screwing a wooden disk to the shaft as shown. The thickness of the disk should be slightly greater than the distance the key head projects beyond the end of the shaft, which is drilled and tapped for a machine screw to hold the disk in place. If the edge of the disk is rounded, clothing can hardly be caught by the key when the shaft turns.

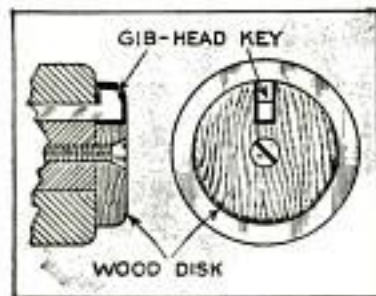

Metal Gauze Prevents Explosions in Fuel Containers

To prevent explosions that often occur inside of liquid-fuel containers due to the collection of explosive vapors, solder pieces of fine metal gauze over the inside of all openings. The fire always starts on the outside of the container and follows the vapor through the opening and inside where the explosion occurs. The gauze does not interfere with pumping or pouring the liquid, but will effectively prevent the vapor flash from passing, as is the case in the Davy mine lamp.

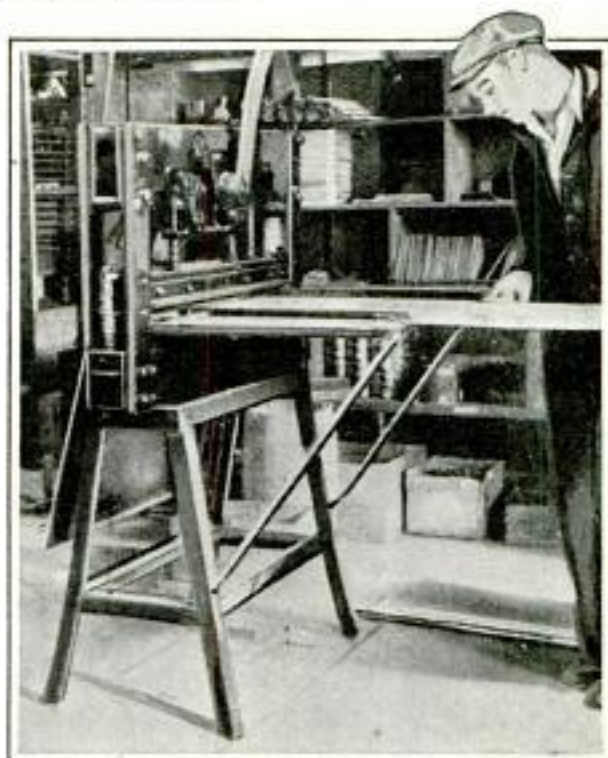

Machine Tables That Fold Down against the Legs Save Space in Crowded Shops

Folding Tables on Machines Save Space in Shop

Considerable space can be saved in a shop if the tables on large machines are made to fold down against the legs when not in use. The tables can be made of sheet metal fastened to two lengths of angle iron, which are hinged to the side of the machine and supported at the other end by iron rods fitting holes drilled through the legs of the machine and at the outer table edge as shown. When not in use, the rods are removed to allow the table to fold down against the legs.

Paper Wad in Wrench Socket Helps Start Bolts and Nuts

Paper wadded into the end of a socket wrench will be found helpful when starting bolts or capscrews, as it keeps them from sinking down into the socket too far. In this way, only the head enters the end of the socket, where it is held firmly, so that the screw can be driven home.



A family TOOL KIT



PART II

FOR making minor repairs about the house and building some of the many articles described in *Popular Mechanics*, only a few elementary tools are required, and these can be obtained without much expense.

The one tool that has most use around the house is a hammer. A good hammer has balance, is properly tempered, correctly ground and will drive a nail straight and true. Of course, as you must take the maker's word on the matter of temper, you will want to buy one of the well and favorably known brands. While it is possible to pound one's fingers with even a good hammer, a poorly balanced hammer is often the cause. The tools that require the greatest care in the selection are the saws. It is best to obtain two saws, one for ripping and one for crosscutting, as the common practice of using a crosscut saw for ripping soon takes the set out of the teeth and causes the saw to bind and eventually buckle. A seven-point rip saw and a ten-point crosscut saw with 22-in. blades will serve your purpose very well. It is difficult to keep shorter saws in the kerf, while a longer saw soon tires the arm of one unaccustomed to swinging it. Try the heft and balance of the saws, and be sure the handle fits your hand comfortably, before you purchase them. A plane is rather a complicated device but fortu-



for Home Repairs



nately is pretty well standardized, so that it would be difficult to go wrong on any of the better brands. You can get along very well with just one of them if you get a jack plane. It is sufficiently short to be used for end work or smoothing, and long enough to plane the edges of screen frames, storm sash, etc., reasonably true. While on the subject of edge tools, a few chisels should not be forgotten. You may want to make various articles in which a mortise-and-tenon or half-lap joint is used, and four chisels, $\frac{1}{8}$, $\frac{1}{4}$, $\frac{1}{2}$ and $\frac{3}{4}$ in. in width, will be found the most useful sizes.

A rubber mallet is superior to the old wooden type in many ways, aside from the fact that it is less likely to split the chisel handles. It serves the purpose of a general utility tool for doing anything from chiseling to pounding dents out of car fenders. Auger bits are convenient and fairly inexpensive tools, and you should have at least five of the common sizes, ranging from $\frac{1}{4}$ to 1 in. They may be purchased separately or in sets, but should be of good quality. A countersink bit for setting flat-head screws flush with the surface, and a $\frac{1}{8}$ -in. wood drill for making holes for larger-size

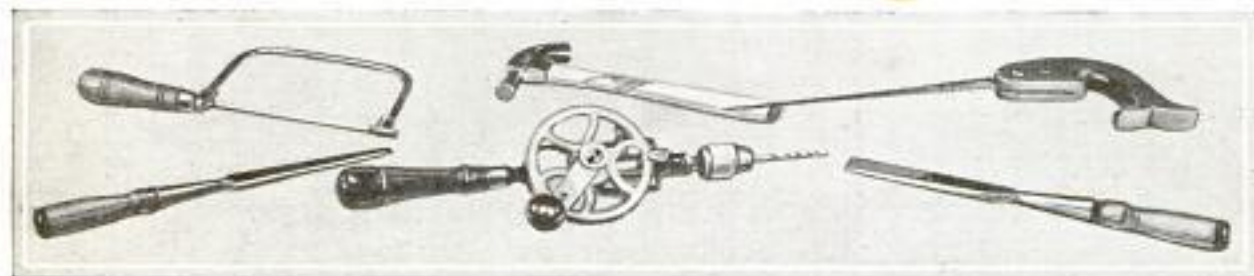
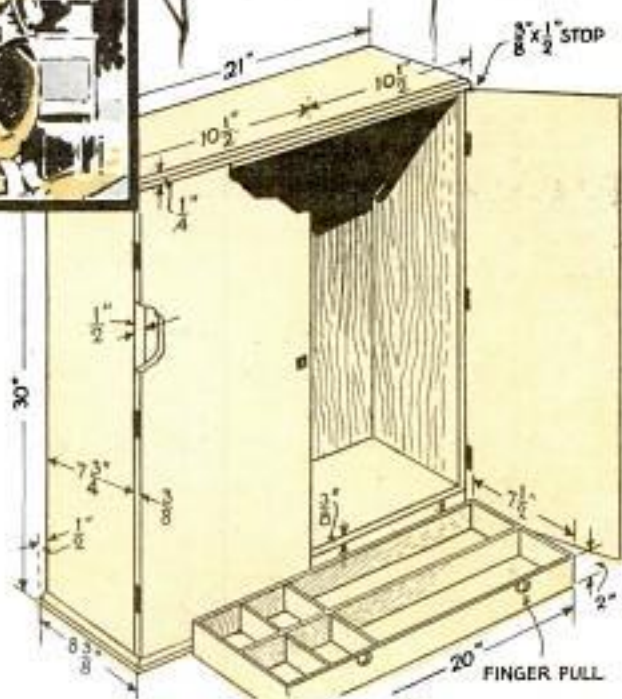
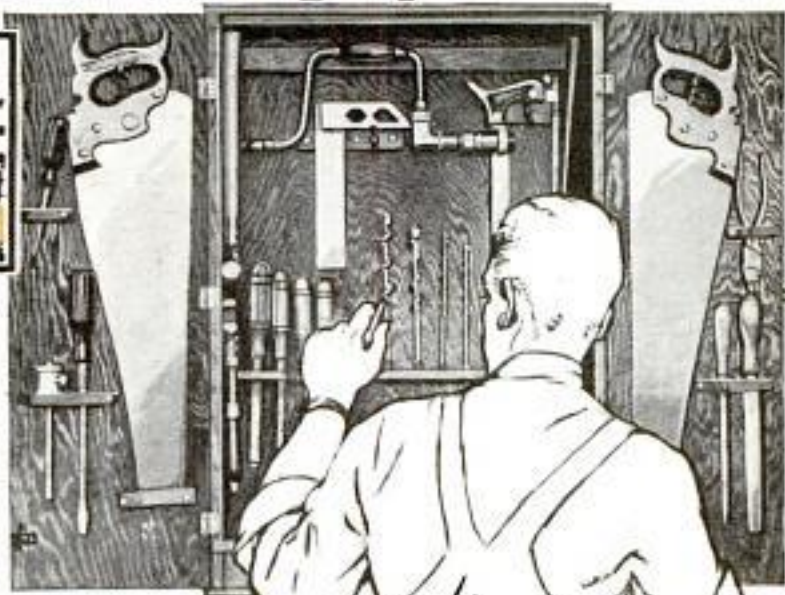



screws will also be handy. For smaller screw and nail holes, an automatic or spring drill is convenient, although a small hand drill may be substituted for the automatic drill, as it has the advantage of taking drills that will cut through either metal or wood, and the cost is only slightly greater. There are so many places around a home where a hole must be drilled in a corner or next to a wall, that it will pay you to buy a good ratchet brace. A bit brace having a 10-in. sweep is suitable. For measuring tools, the first suggestion is an all-metal try-square with a miter gauge on the end of the handle. This type has the advantage over a wood-handled type that it is not so apt to get out of true when dropped on the floor, and has a convenient miter gauge. A marking gauge is also a handy and inexpensive tool for mortising hinges, gauging thickness, and many other uses. Add to these a 2-ft. rule. You will find it convenient to have two or

three screwdrivers of various sizes. For general use, a 6-in. and a 10-in. screwdriver will serve if your wife will lend you one from her sewing machine when a small size is needed. A good combination oilstone, with one side fine and the other medium, will be needed to sharpen chisels and plane irons. For holding small work, a vise is also of importance, although you can add this when you desire to equip your workshop more completely.

The handy man around the house must sometimes be a plumber, electrician, machinist and carpenter all in one, and a home shop is not complete without at least the commonest tools of these various trades, so it is well to add to your list an adjustable hacksaw frame and a dozen assorted blades, a pair of good side-cutting pliers of the type electricians use, two files with handles, one good-quality pipe wrench for pipes up to and including 1 in., and a good monkey wrench for bolt heads up to 1½ inches.

A handy tool cabinet to be hung on the wall is shown with all necessary dimensions.

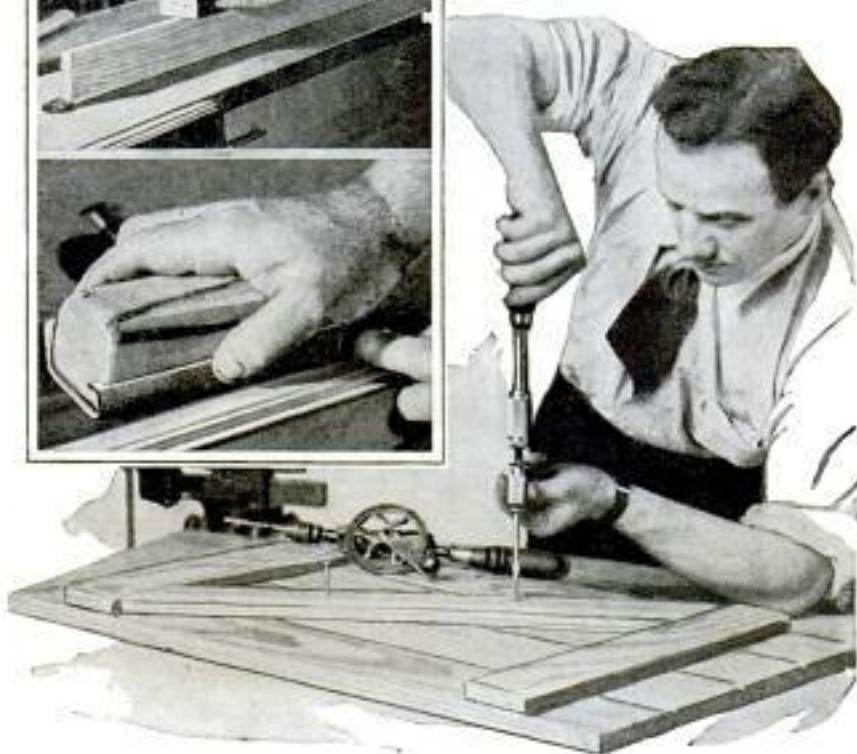
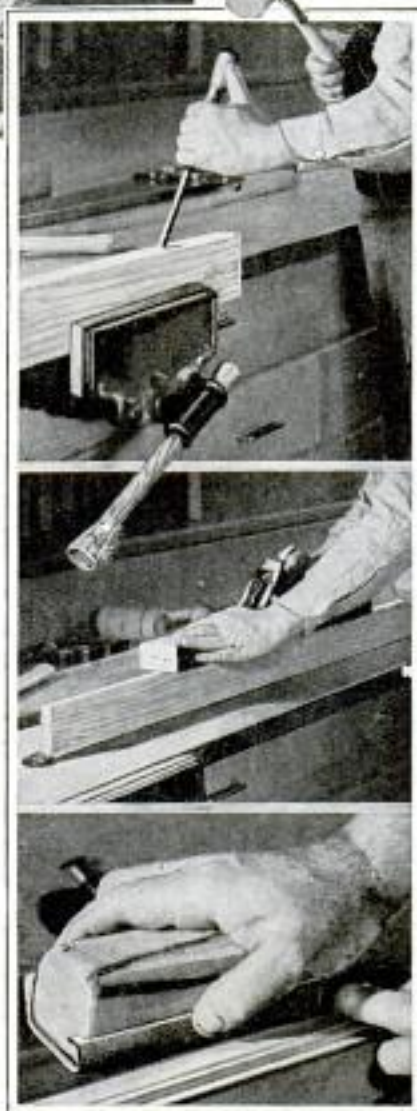

Counterweight Holds Up Pivoted Flagpole

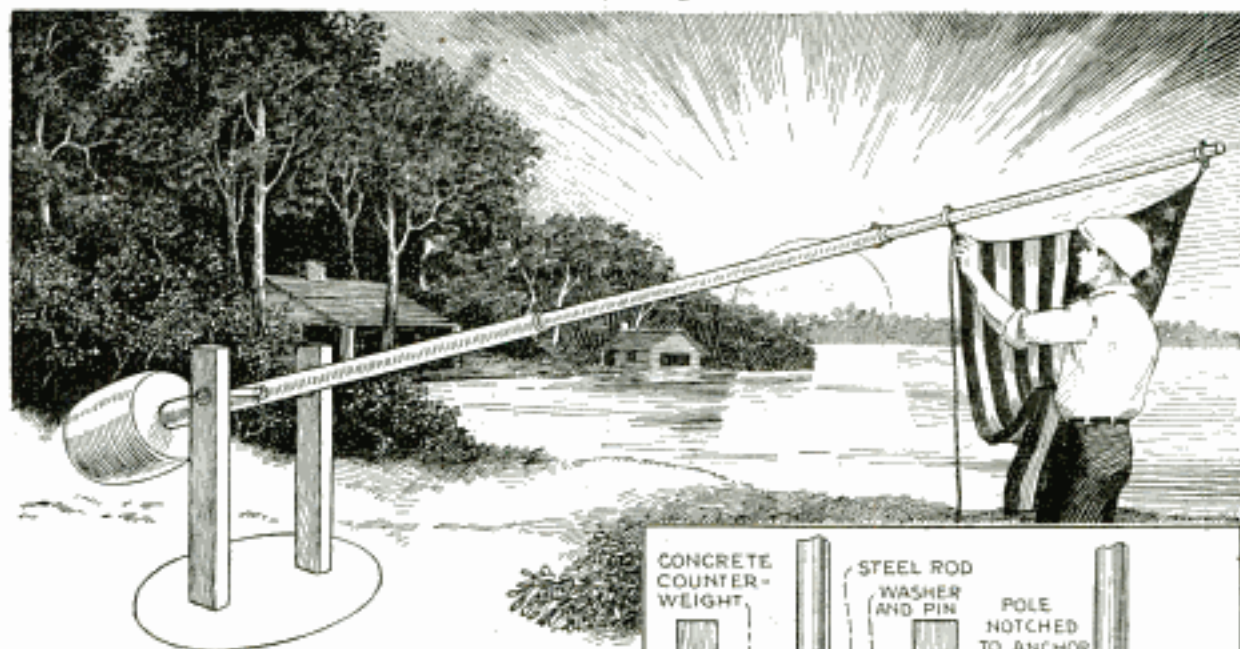

Counterweighted at the bottom and pivoted between two posts, this flagpole is easily pulled down for attachment or removal of the flag, eliminating the use of reeve pulleys and a rope. The posts are set in a concrete base and are drilled at the top for a steel rod, on which the pole swings. The rod is threaded at both ends for nuts, while iron washers and cotter keys, inserted through holes in the rod, keep the pole in the center. Notches are cut in the pole near the bottom to anchor the concrete counterweight. In making the weight, the bottom end of the pole is centered in a small barrel or keg, which serves as a form, and the concrete poured into it. Suitable reinforcing material should be placed in the form before pouring. The pole consists of telescoping pipes, the joints being secured with bolts.

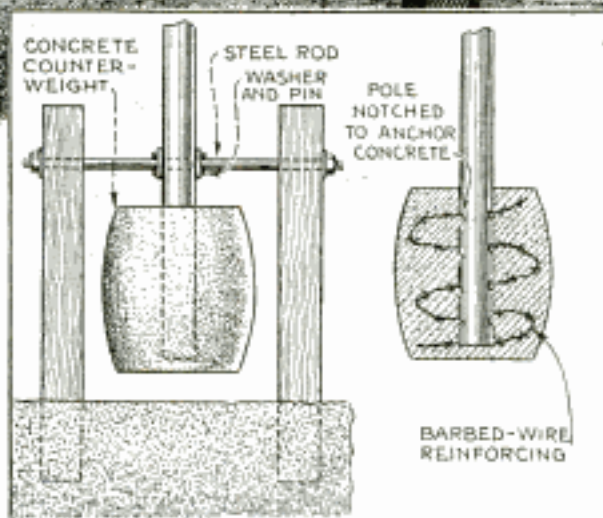

journal boxes on railroad cars, can be overcome by forming a pistol grip on the hook as indicated. Short sections of garden hose, slipped over the end and center of the hook, make the tool more comfortable to handle.

Pistol Grip on Packing Hook Saves Workmen's Hands

Trouble often experienced by having your hands cramp from the continuous gripping of a hook in repacking

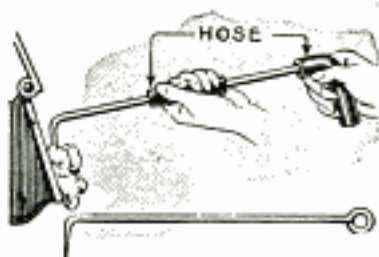

Kerosene Prevents Molten Metal from Spattering

To overcome the danger of hot metal, such as lead or babbitt, from spattering when poured on concrete or other damp places, moisten the surface with kerosene by either brushing or spraying it on. This forms a film over the pores of the concrete and keeps the metal from coming in direct contact with the moisture.

Oil on a new file should be removed before using it on metal, but is helpful when filing fiber.

Holder Keeps Sandpaper Taut While Sanding Work in Lathe

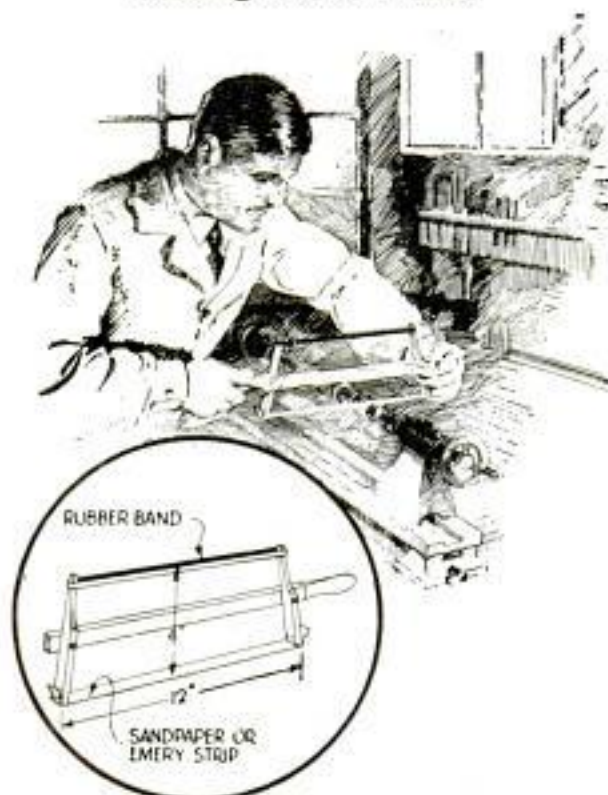

Frame Holds Sandpaper Strip Taut When Finishing Spindle Work

This frame for holding strips of sandpaper or emery cloth will be found useful when sanding work in a lathe. The holder consists of a wooden handle to which two other pieces are pivoted, the lower end of each being fitted with headless brads to hold the end of the paper or cloth. A rubber band across the upper ends of these pieces holds the strips taut. The construction is clearly shown in the detail.

Adapter Converts Large Pipe Hanger into Small Size

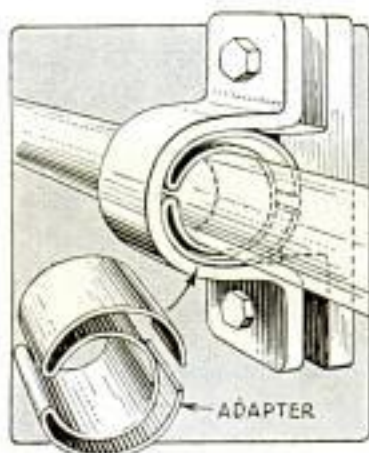

Workmen on a large office building used the illustrated adapter for converting large hangers into use for small pipe on the heating system rather than wait several weeks for

proper-size hangers to arrive. The adapter is simply a piece of sheet metal bent to the contour of the pipe, doubled back and placed between the pipe and hanger.

Wire Depth Gauge for Small Drills

Model makers will find a depth gauge, made by wrapping fine wire round a drill shank, useful when a number of holes of uniform depth are required, or when there is danger of breaking through the other side of the work. The end of the wire is given two or three turns around the drill near the end of the shank and chucked in a hand drill, which is then clamped in a vise. By turning the drill, the wire can be wound around it very easily, and the loose end firmly anchored by turning it under the last few turns of wire. Care should be taken to wind the wire around the drill in the opposite way to that in which it cuts. Heavy thread can be substituted for wire, but will not last so long.

Drip Pans for Overhead Bearings

Oil drip pans for use on overhead countershaft bearings, etc., can be improvised from square 5-gal. oil cans by cutting them in two diagonally as shown. Two lengths of wire, placed over each bearing, hold the pan in place. A drain hole should be made near the bottom and stopped with a cork when the pan is in use.—Chas. H. Willey, Concord, N. H.

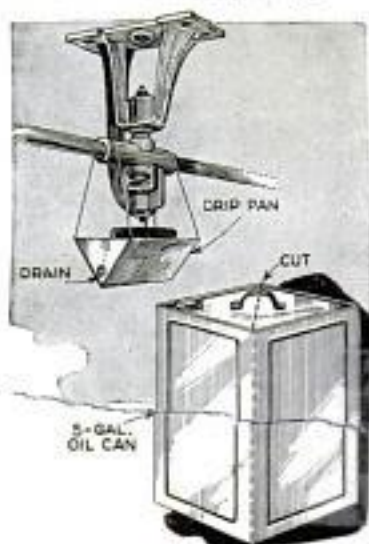

An Effective Caterpillar Destroyer

Caterpillars and crawling insects may be trapped by smearing the vines and plant stalks with a sticky mass prepared by mixing 6 oz. of venice turpentine, 5 oz. of linseed oil and 75 gr. of melted paraffin. Heat helps make a smooth mixture.

Hammond Clock Co
2915 N. Western Ave
Chicago

E. C. Shiel Co
3838 N. Ashland
Chicago

Colonial MANTEL CLOCK



REMINISCENT of the Gothic, or steeple, clocks of 1830, this mantel type, in appearance like its prototype, has been brought in keeping with modern conveniences by fitting it with an electric movement. As the latter varies somewhat in exact size, it is well to purchase this before starting the work on the case, which is designed to take a 5-in. dial.



fitted with
**Electric
Movement**

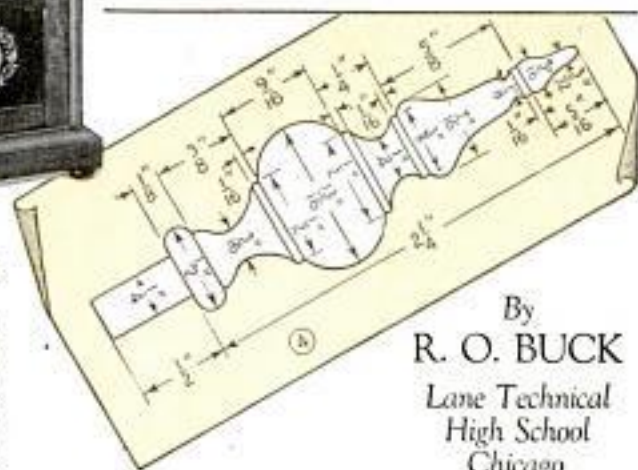

By
R. O. BUCK
Lane Technical
High School
Chicago

With the exception of the white-pine back and bottom, mahogany was the wood generally used in the clock cases of the time. The dimensions of the parts shown in Fig. 2 can be obtained from the drawings. The sides and top, base and bottom pieces, are all $\frac{5}{8}$ in. thick. A half-round molding is formed on the front edge of the sides and top with a hand plane and sandpaper, or may be done more quickly with a molding head on your circular saw. A $\frac{1}{4}$ by $\frac{1}{4}$ -in. rabbet is also cut into the rear edge of these pieces to house the backing. A full-size layout of the case should be made as in Figs. 5 and 6, from which the angle at the meeting of the side and top can be determined. After the bottom ends of the two sidepieces have been squared, they are held firmly against the crosscut gauge of your saw, and the miter cuts for which the saw is set are done as in Fig. 1. Be sure that the groove for the backing comes on the inside and that your sides are cut to form a pair. If the inner

faces are marked with a cross at the beginning, you will be less likely to make an error. The top pieces are made in a similar manner. The lower miters are the same angle as that on the sidepieces, but the joint at the top is a 45° miter. The bottom piece, which is raised a trifle above the base molding to form a sill for the door, extends all the way across the frame at the front, to square out the rounded edge where it goes below the base molding, as in Fig. 8. The assembly of the framework is started with the joint at the top. A triangular block is glued and tacked into the top to reinforce this joint while it is being glued and nailed. Liquid glue may be used for the joints, but it should be put on both pieces and the two

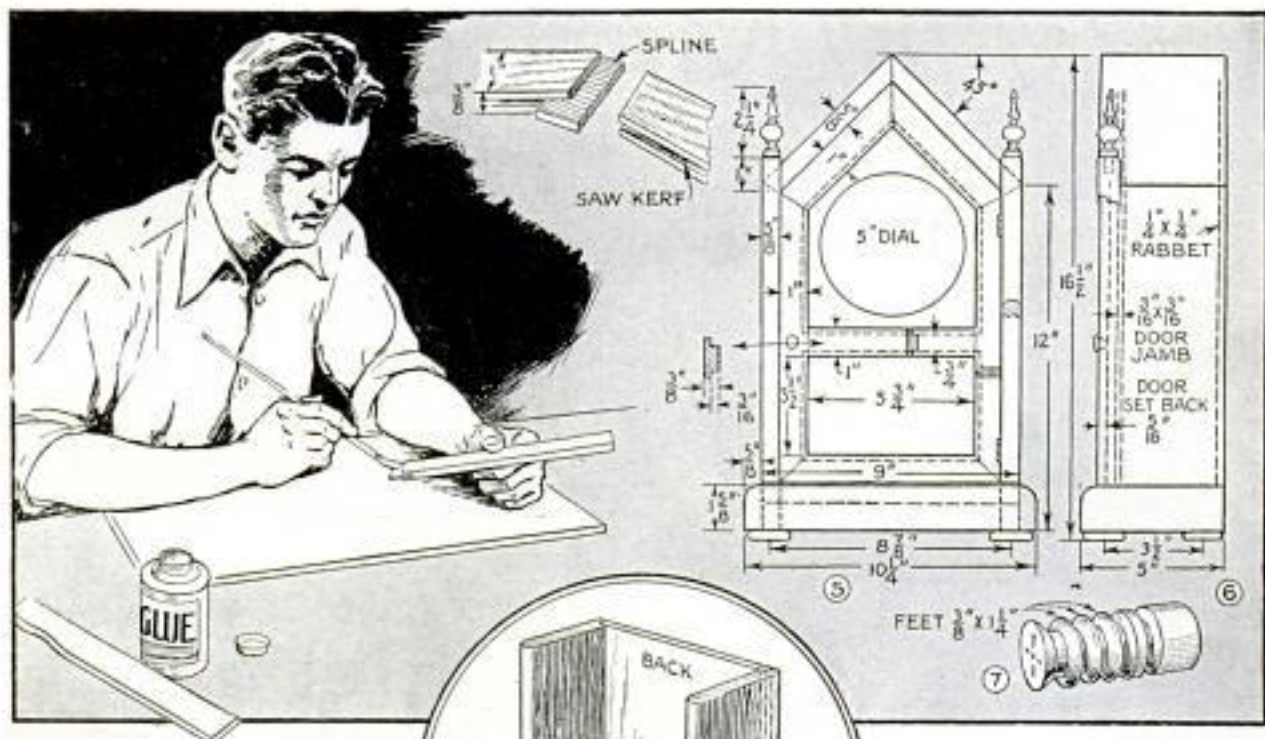

rubbed together, before nailing. If a sidepiece is held in the vise while the top assembly is being fastened to it, the process will be easier. After the top and both sides are assembled, the bottom is fitted into the grooves and is securely glued and nailed into place. The back is made of $\frac{1}{4}$ -in. stock, either plywood or solid, and is fastened with brads.

A simple base molding is used to finish the bottom of the clock. This quarter-round edge may be made with a plane and sandpaper, but the same molding cutter that was used to make the half-round molding on the edges can also be set for this work. The corners are mitered, another process that can be done nicely on the circular saw, if the gauge is set at 45 degrees.

The construction of the door is just as easy. After the stock for all the pieces has been cut to size, the corner joints should be mitered and the pieces fitted into the case. When all the joints are completed, the top face of each piece should be marked with a pencil to identify it. With the circular saw set for a depth of $\frac{3}{8}$ in., and the fence so that the cut will come at the approximate center, make a saw kerf on the inner edge of each piece,

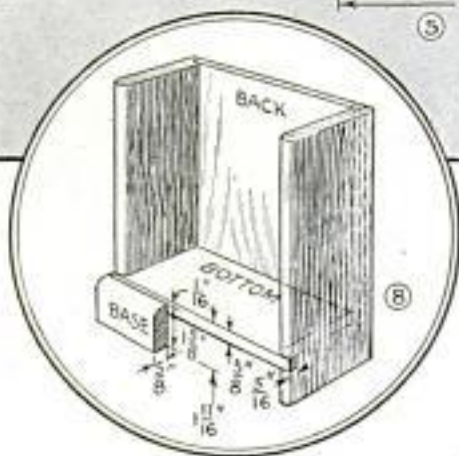

including the center bar, which will have a kerf on both edges. Now set the saw to a depth of $\frac{3}{8}$ in. and make a cut along the mitered edges. The latter cuts are for the purpose of splining the frame together. The grain of the pieces used for splines must run across the joint and should fit fairly snugly. Only glue is used to fasten the pieces of the door together. The rabbet that carries the glass is cut after the glue joints of the frame are dry. In the meantime, the frame should be laid on a flat surface and clamped, or held by some heavy object, to prevent warping. The method of cutting the rabbet is to mark out the lines of the cuts with a gauge and then chisel away the stock down to the saw kerf previously made. Little strips of stock are run on the saw to form glass strips. These may be mitered at the corners with a sharp knife. Strips are also made and glued and nailed into place, to form jambs for the door. The face of the door should be set back $\frac{5}{16}$ in. from the front, which is the point where the curved edge ends.

A block and finial are set at each of the front corners. Notice that the block extends $\frac{1}{16}$ in. in front, but is flush on the side. The front molding is chiseled away

(Continued to page 128A)

Hogs Step on Platform to Fill Water Trough

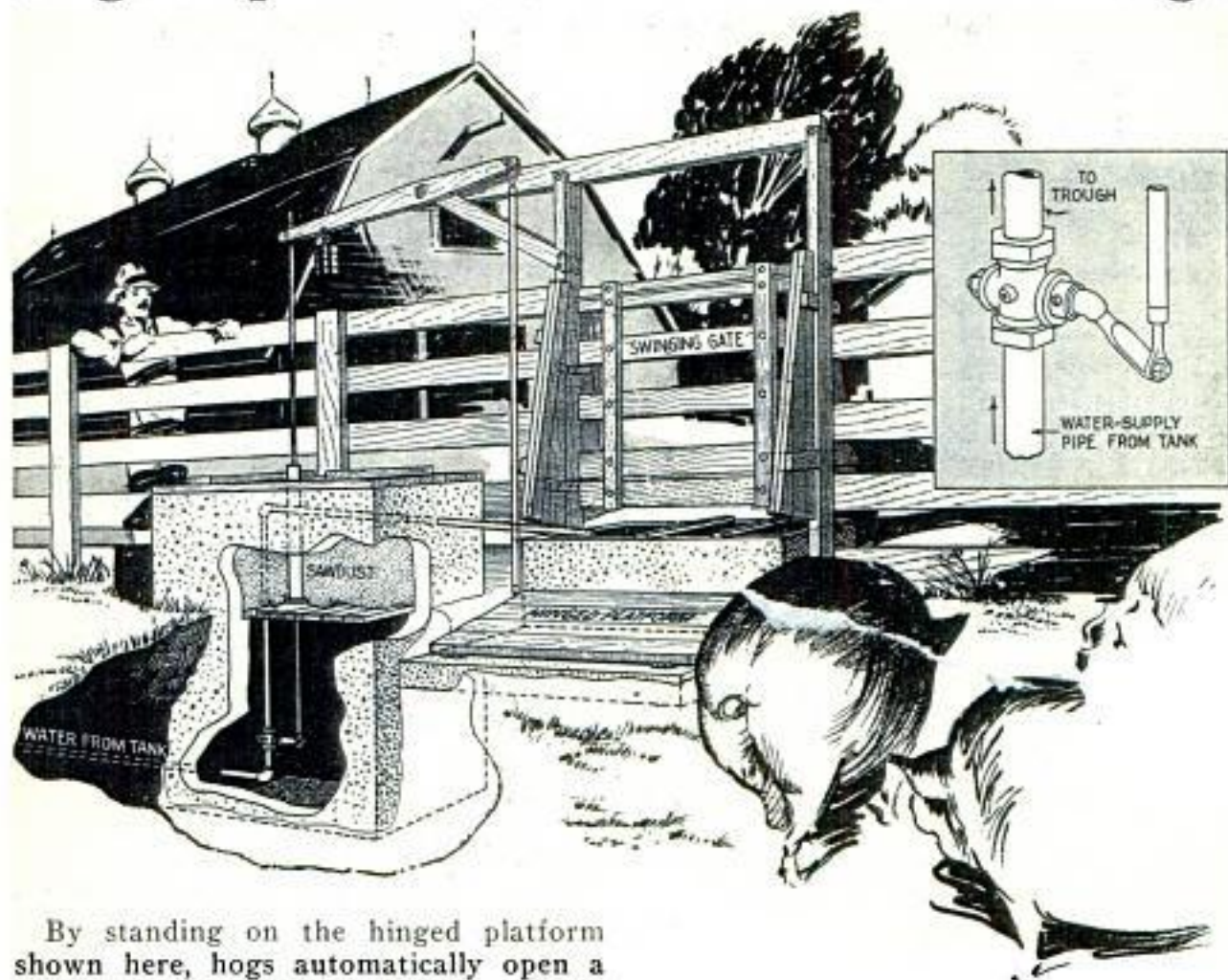

By standing on the hinged platform shown here, hogs automatically open a three-way valve so that water runs into the trough. As soon as they get off the platform, the valve closes and the pipe leading to the trough drains. The concrete inclosure for the valve is 4 ft. square, extending 4 ft. below the surface and 3 ft. above. The lower part of the wall is 6 in., while the upper part is 5 in. thick, the resulting ledge being utilized to support boards on which a heavy layer of sawdust is piled, to keep the cold from reaching the valve. A 1-in. pipe line from the supply tank is laid below the frost level, and the pipe that runs to the trough is set at an angle, so that no water will remain inside where it would freeze. Dimensions of the trough are 8 by 30 by 6 in. deep. Control of the valve is obtained by means of the lever arrangement illustrated, the walking beam being pivoted about two-thirds the distance from one end, so that the weight of this end will close the valve when the weight on the platform is removed. It may be necessary to add a counterweight to the beam as shown. If the trough is

located at a fence, a swinging gate will make it accessible from both sides, and in this case an extra hinged platform and operating mechanism should be provided. Only occasional attention is required.

A Self-Locking Cotter Key

By bending a length of machine steel to the shape of a cotter key and filing the ends as shown, a self-locking key can be made that is easily removed when necessary. Such keys are useful on the ends of pins, yokes and levers that are subjected to severe vibration and have to be dismantled frequently.

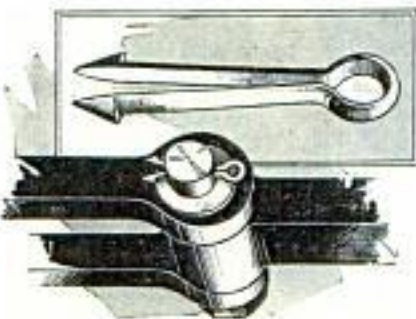



Steel Fence Posts with the Aid of a Pipe Containing Steel Shafting

Steel Fence Posts Driven with Pipe

Steel fence posts can be driven into the ground quickly by the use of a 3-ft. pipe having a piece of steel shafting riveted or bolted inside at one end, as indicated in the detail of the drawing. The open end of the pipe is slipped over the upper end of the fence post. This method is handier than the use of a sledge hammer on account of the height of the posts.

Paper Removes Filings from Magnet



When the magnet is not in use, a small steel bar should be placed across the poles to make the magnetization last longer.

When using a magnet to pick up small objects such as tacks and steel filings, a piece of paper held over the poles, as shown, will prevent them from becoming clogged and will make it easy to remove the filings quickly. When the

Photo Floodlamps Improve Enlarger

Though their effective life is only 120 minutes, photo floodlamps will be found economical for use in an enlarger, as they are lighted only a small portion of the time and have several advantages over the usual lamp. Due to the brighter light furnished by these lamps, dense negatives are more easily focused on an enlarging easel, with the models that require focusing. They also permit the use of a smaller stop, thus making a much sharper enlargement. Another advantage is that they enable the use of chloride paper, which, although slower than bromide paper, is offered in a greater variety of surfaces and is less expensive. When employing these lamps in an enlarger, it is a good idea to use a pressure switch to reduce the tendency to burn them longer than is necessary. A starter switch from an auto is good for this purpose. When using the photo floodlamps, the exposure naturally will be much shorter than with other lamps.—Roland J. Swedlund, Boulder, Colorado.

Multi-Edged Scraper Saves Time

On rush jobs the illustrated scraper will be found handy. The handle is pivoted to the center of a four-edge blade, which is also drilled near each edge to receive the end

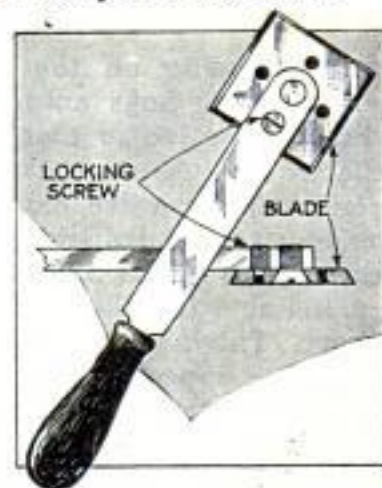

of a locking screw. When one edge is dull, the locking screw is loosened, the blade turned to prevent a sharp edge, and the screw tightened.—C. M. Wilcox, Torrington, Conn.

Preventing Wood from Molding

One gallon of formaldehyde added to 40 gal. of water serves as an effective spray or wash to prevent mold on doors and wood fixtures in damp cellars and basements. The solution should be applied whenever signs of mold appear.

be kept in a glass container, as it will attack metal. To use it, the clean copper-plated work is immersed in the solution by a copper wire attached to the work, as in Fig. 1. In a few seconds, the work will take on a dull grayish-white appearance, due to a coating of mercury deposited on its surface. The amalgam of mercury and copper makes an exceptionally good base for the deposition of a firm, adherent silverplate. The work should never be allowed to remain too long in the quicking solution, because too much mercury in the amalgam is detrimental to the silverplate.

Silver and gold solutions should be used in glass or stoneware containers. To make the silverplating solution, dissolve sodium cyanide (poison), 2 oz., in water, 1 qt. To this add silver chloride, $\frac{3}{4}$ oz., and stir with a stick until dissolved. Sheets of silver or silver foil are suspended from the positive bars, which are laid across the

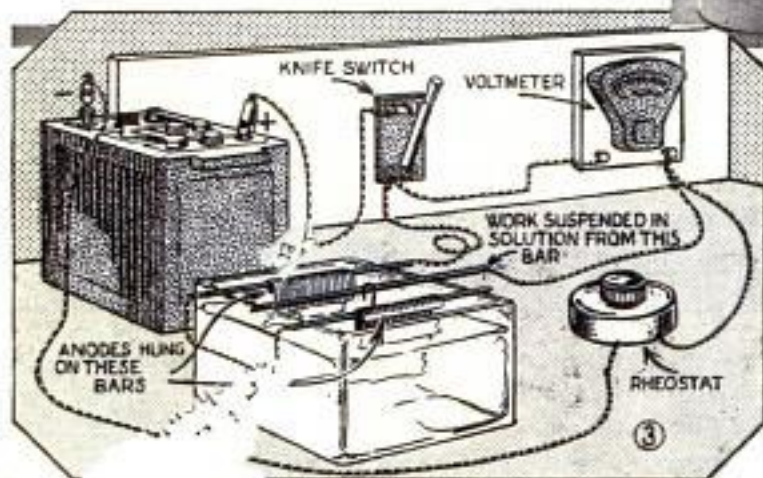
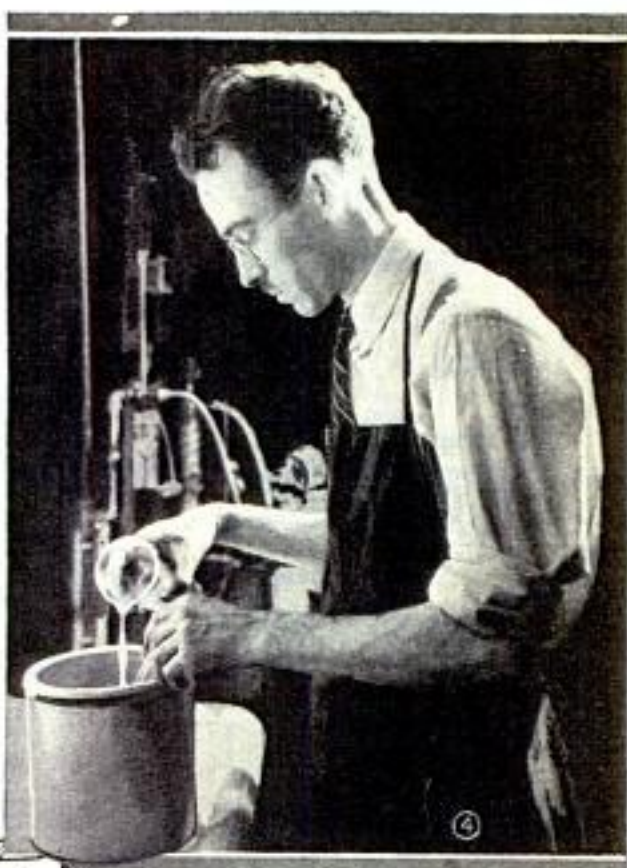

of distilled water. This solution should be allowed to stand for several days before it is used. The same method is followed as in the silver bath. The anodes—the electrodes suspended from the bar connected to the positive pole of the battery—should be gold foil or hard, coreless electric-arc carbons. Goldplating solution deteriorates in use with carbon anodes and accordingly will have to be replaced from time to time. When

work and the anodes have been suspended in the solution, close the switch and adjust the rheostat until the voltmeter reads 5 volts. The color of the plated metal can be varied by changing the current slightly. It is impossible to list all the colors and tones that can be obtained, as there are so many other factors that influence the result. The use of chemicals in the solution between the anodes and the work is also a factor.

Old Books and Magazines Easy to Rebind



knife along the inside of the covers next to the back. All traces of cloth and glue are scraped off the back so that a strip of cheesecloth can be glued on, as in the left-hand detail. The cloth should be wide enough to project about an inch along each edge. After the cloth has dried thoroughly, it is glued to cardboard covers, which, when placed against the sides of the book with the back edge flush, will project about $\frac{3}{16}$ in. beyond the other edges. A strip of cardboard is also cut a trifle narrower than the width of the back. This is not glued to the back but is merely laid between the sides when the covering is applied. Select some imitation leather,

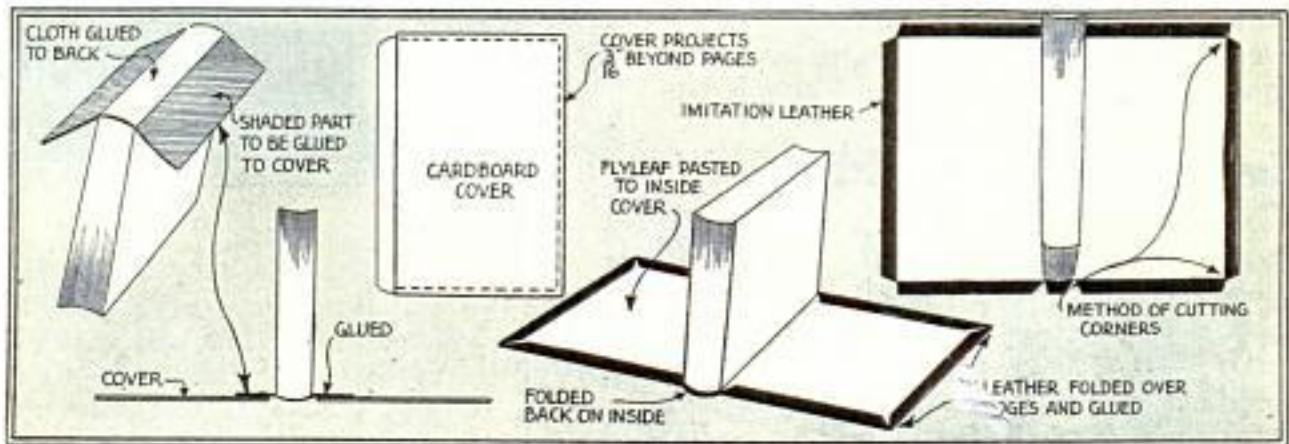

It is a comparatively simple job to renew old books with torn, soiled and broken covers, and a little effort at rebinding such volumes will go a long way in giving your library a neat appearance. Besides, if you have any books or magazines with paper bindings, these can be bound following the same method. First remove the old cover carefully, with a utility knife, loosening the sections, by

cutting along the inside of the covers next to the back. All traces of cloth and glue are scraped off the back so that a strip of cheesecloth can be glued on, as in the left-hand detail. The cloth should be wide enough to project about an inch along each edge. After the cloth has dried thoroughly, it is glued to cardboard covers, which, when placed against the sides of the book with the back edge flush, will project about $\frac{3}{16}$ in. beyond the other edges. A strip of cardboard is also cut a trifle narrower than the width of the back. This is not glued to the back but is merely laid between the sides when the covering is applied. Select some imitation leather, and cut it to the size indicated in the right-hand detail so that it overlaps the cardboard about $\frac{1}{2}$ in. The corners are cut off at an angle to fit together. The leather is then folded over the edges and glued. Gluing the covers with the pieces of cardboard being used as spacers, the binding being finished as shown.

A Sanitary Shaper for

In order to eliminate
of sharp
his.

Growing Winter Crops of Potatoes

Taking advantage of climatic conditions, farmers in the Gulf coast area have been able to grow winter crops of Irish potatoes. Seed potatoes are planted late in August or early in September and grow to maturity about the middle of November, when the vines are cut off at the level of the ground and the potatoes banked in rows with a turning plow. They are allowed to remain in the ground and will be found in a perfectly fresh condition when they are harvested in December and January.—W. D. Robinson, Pass Christian, Miss.

Two Handy Clamps for Light Work

Here are two clamps that are easily made and will be useful for light work. The single-screw clamp consists of two wood blocks, cut as shown and drilled for a $\frac{3}{8}$ -in. carriage bolt, which is threaded its entire length for a wingnut. The other clamp is capable of a greater pressure and consists of two blocks and two bolts, one of which is fitted with nuts between the blocks to keep the jaws parallel, while the

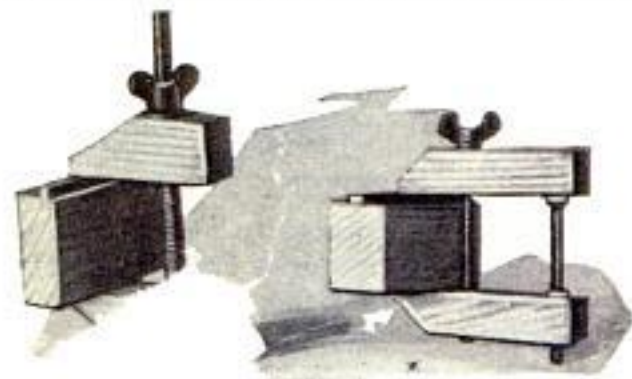

Carriage Bolts, These
Light Work

nut for tighten-

will

up.

Castor Oil as Bearing Lubricant

Wear of electric motors, due to friction, can be overcome by employing oil reservoirs and refilling them with castor oil. This lubricant will prevent excessive heating, no matter how long the motor is in operation. Many barrels of castor oil were used by the artillery during the world war for this purpose.—W. C. Lecky, Galena, Ill.

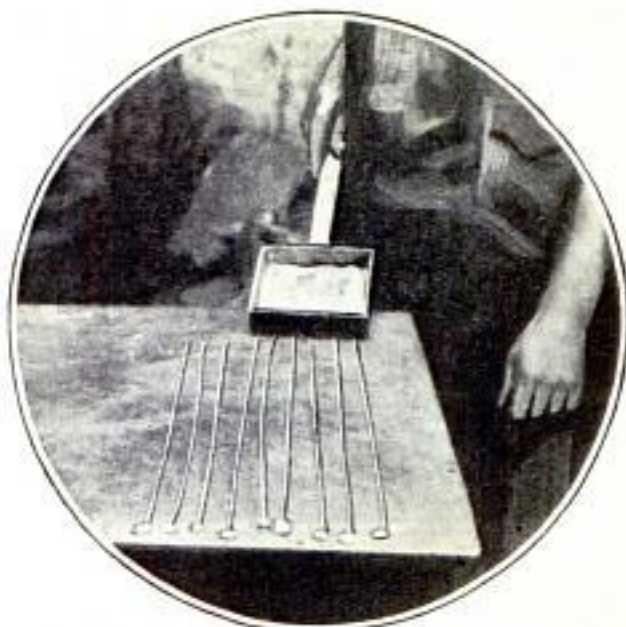

Solder Running through Holes in Bottom of Pan
Forms Wire Solder When Dragged across Table

Wire Solder Made with Metal Pan

Wire solder is easily formed by pouring the molten solder into a shallow metal pan, having a number of holes drilled in one side near the bottom, and then drawing the pan quickly across a metal table, tipping it while it is moved as shown. The solder will run through the holes leaving the solder in lengths of wire, except for a small button at one end which can be cut off and remelted. The size of the holes may be varied according to the size of wire desired. The pan should have a long metal handle, and is heated before pouring the melted solder into it. Just enough solder to run out before it cools should be used at a time.

Making Reamers Cut Oversize

Solid reamers can be made to cut a few thousandths of an inch more than their diameter by laying a strip of thin shim stock over the edge of one blade, as shown. Start with thin shim stock and use heavier, or additional pieces with each cut. This keeps the reamer from digging and insures accuracy when enlarging a hole.





Angle-Iron Support for Wide Work on Punch Press Is Provided with This Detachable Rest

Detachable Rest Supports Wide Work on Punch Press

Additional surface for supporting wide sheets of material on a punch press can be provided by attaching a length of 3 by 4-in. angle iron to the edge of the machine bed. The latter is tapped for short studs to hold the rest in place. When working on small material, it may be removed.

Lacquer Thinner Used to Erase Pencil Tracings

Effective results can be obtained by using lacquer thinner as an erasing agent on pencil tracings. Place a blotter under the portion of the drawing to be erased, moisten a piece of cotton batting with the thinner and rub it lightly over the lines until the graphite has been entirely dissolved. Before the paper dries, the operation is

repeated with a clean swab. The same treatment is given the back of the tracing. A blotter is not essential but will hasten drying, especially if the tracing is punctured by dividers and compass-point holes. The thinner is not injurious to tracing paper, vellum or cloth, and has no effect on india ink, but will remove printer's ink and, for that reason, should not be brought into contact with the margin liners, title and material blocks.

Dust Collector for Cylinder Hone

When using the dry-hone method of re-finishing auto cylinders, the abrasive dust can be removed from the motor with a vacuum cleaner. The cleaner brush is taken off and the nozzle closed with a tight-fitting wood block, which is drilled in the center for a $\frac{3}{4}$ -in. pipe. One end of a length of garden hose is slipped over the pipe, and

the other end is fitted with a rubber cup from a sink plunger, the handle socket in the cup being extended to the inside. The cup is fastened

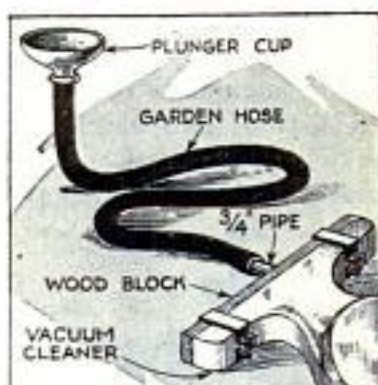

against the bottom of the cylinder to be honed. In use, the cleaner motor is started and the dust is drawn into the nozzle. R. Butcher, Des Moines, Ia



350 BL'

for Home Crafts.

Grandfather clock, smoking stand, ornamental fences, lattice support, ship and airplane models, and numerous other projects. A sample and complete list of prints will be sent to anyone upon receipt of 6c to cover mailing costs. Prices of prints are 25c each, six for \$1, or a collection of thirty-five for \$5 postpaid.

Address Blueprint Dept.

A Whitewash for Interior Use

For the dairy barn or milk house, the University of Nebraska recommends the following whitewash: Slake $\frac{1}{2}$ bu. of lime in boiling water, keeping it covered during the process to retain the steam. Then strain the liquid through a fine sieve or strainer and add to it, salt 1 pk., previously dissolved in warm water. Next boil 3 lb. of ground rice to a thin paste and stir it in while hot, and add hot water, 5 gal. This solution can be applied either hot or cold with a spray pump. The walls and ceiling, of course, should be swept clean before applying the wash.

Back-Face Truing Tool for Work in Lathe

Here is a tool that is handy for truing the back face of work in a lathe chuck. A length of bar iron, to fit into the toolpost, is slotted across one end and drilled lengthwise for a pin, which pivots a rectangular piece of steel in the slot. This piece is tapped at the other end for a thumbscrew with which to clamp a scriber in a hole drilled near the center. In use, the tool is mounted in the lathe toolpost as shown, with the scriber point against

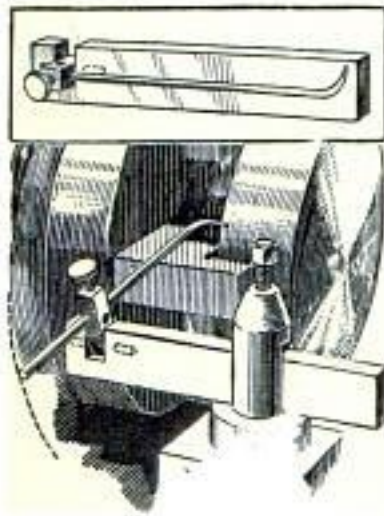

and in-
oppe
in

the back face of the work, and the lathe is turned by hand. The scriber rises over the chuck jaws as they come around and permits perfect truing of the back. When packing it in a tool kit, the scriber is removed and drilled through the slot piece, as shown

Holder

frame
coils
their



Fitted with Centers and Clamped in a Vise, Hacksaw Frame Holds Core for Winding Coils

entire length to take locknuts, are ground to form centers and fitted into the ends of the frame, as shown. In use, the coil is placed between the centers and the locknuts tightened to hold it in position.—John Davis, Albany, Ga.

Driving Screws in Finished Work

To protect the surface of finished work from being scratched by the screwdriver slipping off the head of a screw, the illustrated attachment has been found effective. It consists of a metal sleeve, with a leather washer glued or cemented to the lower end, placed over the shank of the screwdriver and the head of the screw. The washer keeps the sleeve from scratching the surface of the work, while the sleeve prevents the screwdriver from jumping off the screwhead. The hole in the sleeve should be approximately the same diameter as the screw head, and for this reason it is a good idea to have a number of sleeves on hand to fit the various sizes of screws that are used in the shop.

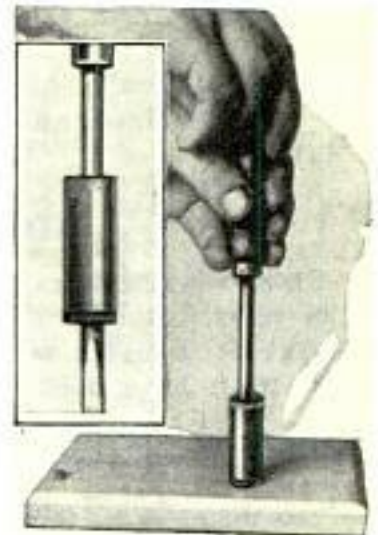

01034

Can You Solve *these* Puzzles?



IF the clock hands are set 20 minutes apart, at $54\frac{11}{11}$ minutes past 2 o'clock, the lines formed by the hands indicate a two-to-one division of the hour-number values as well as of dial area, the smaller section containing the numbers 11, 12, 1 and 2, and the larger part the numbers 3, 4, 5, 6, 7, 8, 9 and 10, with respective totals of 26 and 52.

Now, at what other exact times of the day will the clock present that same oddity—the dial divided into two parts, one twice the area of the other, the lesser containing numbers which total 26, and the larger with numbers summing up 52? The fact of figures obtruding slightly upon dividing line, as do 11 and 3 in our sketch, is to be disregarded.

ON their double birthday, MacKenzie said to MacGregor; "I want to con-

gratulate you on having been my partner during two-fifths of your lifetime." MacGregor then pointed out that since MacKenzie was MacGregor's junior by twelve years, his term in the partnership had existed one-half of his life.

Can you tell how long they have been partners?

A MOVIE star handed a bank note to a Hollywood paying teller and said: "Please give me change for this. I will have some one-dollar bills; twice as many twos as ones; four times as many fives as twos; eight times as many tens as fives, and the balance in fifties." What is the smallest U. S. banknote the customer could have given for the change?

153 By SAM LOYD
Halsey P. Brooks

Answers to Last Month's Pu

Perkins is $32\frac{1}{4}$ years of age. His wife is $21\frac{3}{4}$ years. At the time Perkins was six years older than his wife's present age, his wife must have been $16\frac{3}{4}$ years and he $27\frac{3}{4}$. Then they each advanced $5\frac{1}{4}$ years to their present ages.

The 100 gems costing \$1,000 consisted of

5 diamonds, 1 sap
The earrings co
5 carats eac
exchang
2-cara
a tr
wot
of

oises.
'han

Climb down inside your Engine

SEE *the difference Ethyl makes*

FOR the most important act in its life, gasoline has always hidden behind steel walls. But Detroit engineers put a quartz window in the top of an engine and took high speed photographs of the actual combustion of motor fuels. Now you can SEE the difference Ethyl makes.

Look at the pictures below. On the left, ordinary gasoline—wasting power in a violent explosion that hammers against the cylinder walls, causing harmful knock, overheating, and engine wear-and-tear.

On the right, you see how Ethyl Gasoline delivers power smoothly, driving your car with an even stride—you see why it delivers *more* power and leaves *less* waste heat.

Now stop at an Ethyl pump, fill up with the new, higher standard quality Ethyl Gasoline and *feel* the difference it makes. Instead of irritable, half-hearted power, Ethyl will give you the thrill of flowing, steam-pressure smoothness—plenty of power when you need it and freedom from harmful knock. Ethyl Gasoline Corporation, New York City.



Ethyl fluid contains lead



Slow-motion movies of the actual combustion



Photograph through a quartz window shows the wasteful explosion of ordinary gasoline. See how short its life is in contrast to the picture at the right.



Notice the smooth combustion of Ethyl Gasoline—the greater spread of power. The Ethyl fluid in it controls the action of gasoline inside the engine.

Buy **ETHYL GASOLINE**

© E. G. C. 1912

FRESH!

Never parched or toasted

Camels burn slow and cool because they're fresh. Made fresh and kept fresh in the Camel Humidor Pack, they bring you the full fragrance and aroma of choice Turkish and mild sun-ripened Domestic tobaccos in prime condition. Switch to Camels for just one day, then leave them—if you can.

R. J. REYNOLDS TOBACCO COMPANY
Winston-Salem, N. C.



CAMELS

Made FRESH—Kept FRESH

• Don't remove the Camel Humidor Pack—it is protection against perfume and powder odors, dust and germs. Buy Camels by the carton for home or office. The Humidor Pack keeps Camels fresh.

© 1952,
R. J. Reynolds
Tobacco Company

Copyrighted material