

APRIL

25 CENTS

# POPULAR MECHANICALS

MARCH 1934



Thirtieth Anniversary Issue



# ARE YOU THIS KIND OF A MAN ?

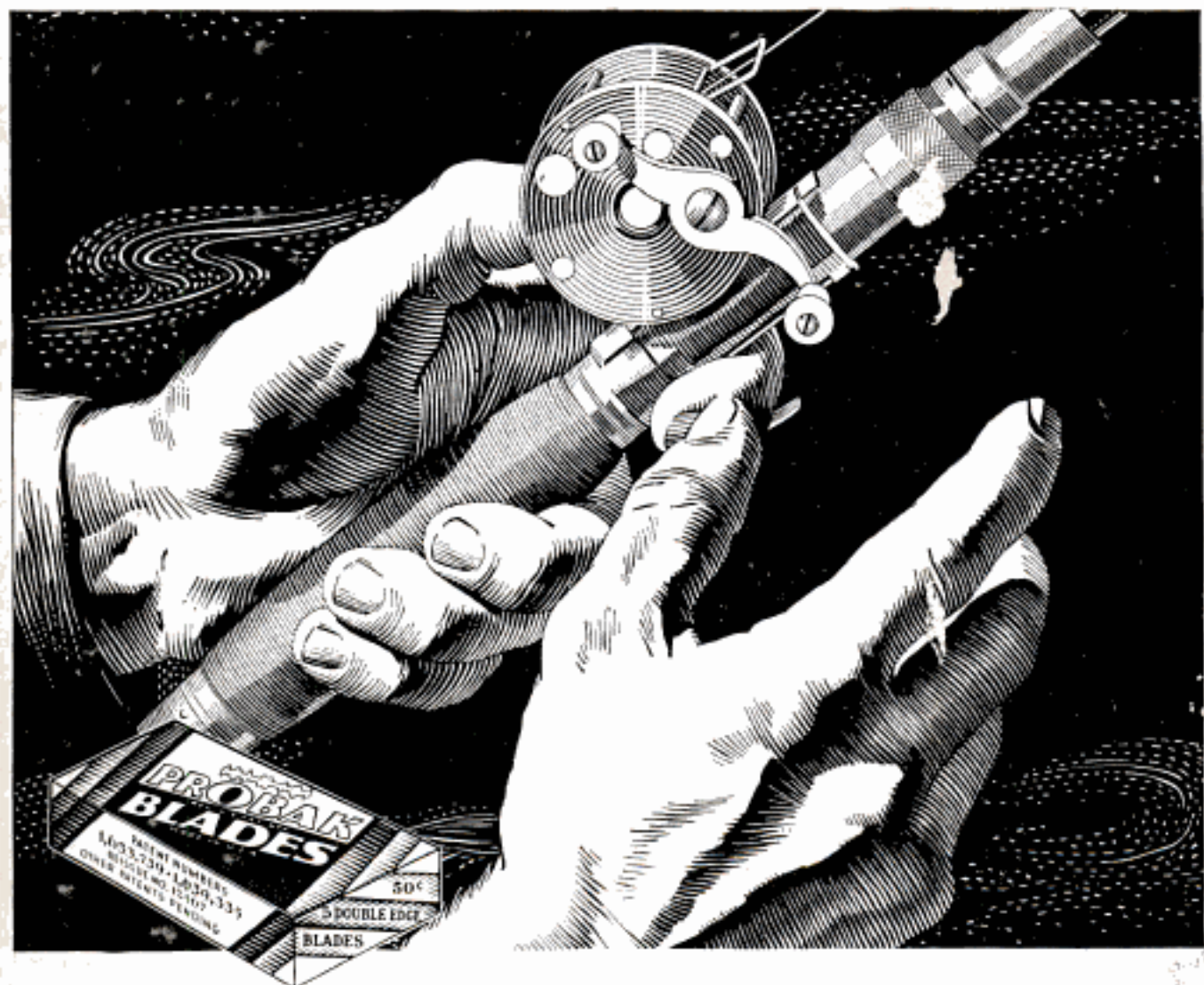

● We're talking to you regular men, whether you're chained to a desk or work outdoors. You'd rather hear the splash of a bass than listen to the Moonlight Sonata. Your beard is tough and you find it hard to shave. The double-edge Probak blade is designed for bristles like yours. You can feel it on your face. This is why hundreds of thousands of he-men say "Probak is a far better blade." Join the army of "regular guys" who get real shaving comfort with Probak. Buy a

package on our guarantee and match a blade or two against your beard. See how it mows down the stubble, cutting every hair cleanly at the base. Make the test tomorrow morning. If Probak doesn't measure up to your expectations—return the package with the unused blades to your dealer and he'll refund the full price.

**PROBAK BLADES**  
THE BLADE FOR MEN THAT ARE MEN



# Mystery "TWIN-RAY" Light Tested— Reads Newspaper At 1,000 Feet!

## SEVERE TEST GIVEN NEW SAFETY LIGHT

June 8th: A demonstration of the new Auto Safety Light, designed for safe night driving, was given at the Boston inn, on Friday night before an interested gathering of pilots and automobilists. The first test was the ability to read any part of a newspaper at a point of 1,000 feet in front of the light and a foot above the ground, proving that while the ground in front of the light was perfectly illuminated, the rays from the light were at no point above the center of the light itself. Consequently there would be no glare to an on-coming car, showing the light powerful enough to penetrate the lights of the on-coming car and show clearly the road beyond and any obstacles in it.

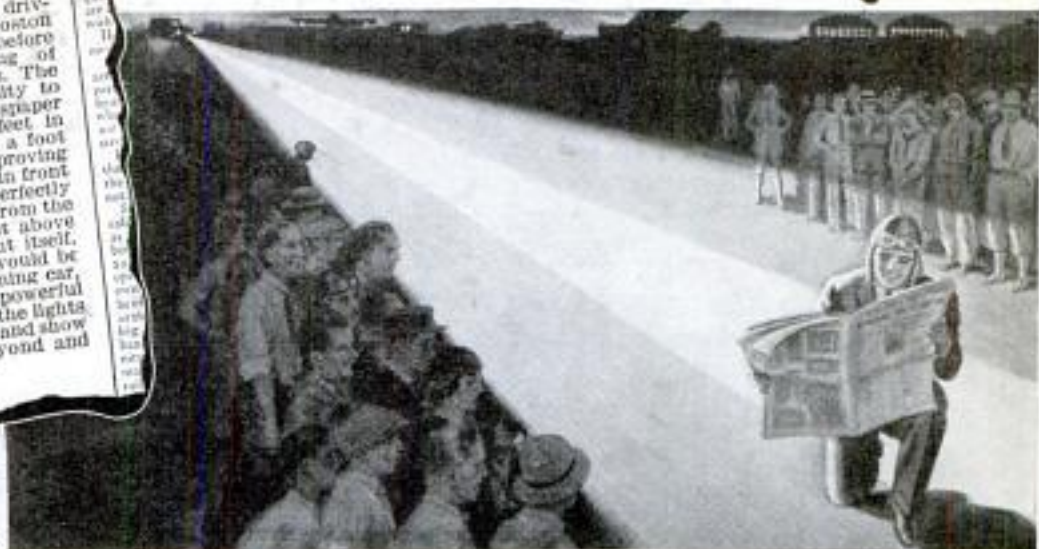

## Lights Highway Ahead With 67,000 Candle Power Beam

Reporters for the Boston Sunday Post witnessed a demonstration of this light and above is a reprint of their report.

Now—judge for yourself what you can do with a light like this on your automobile—a light that throws a 67,000 candle power beam, for over 1,000 feet—lights up all road signs and curves long before you reach them. Makes the road ahead of you as bright as day yet absolutely can't glare in the eyes of approaching drivers. A road light that literally takes the light

out of the sky—all light on the highway. Fast night driving now safe with this amazing Speedlight—you can drive 50-60—even 70 miles an hour with perfect safety. On a road as brilliantly lighted at midnight as at mid-day. Cuts through fog, rain, and darkness. This "twin-ray" road light not only can't glare itself but it cuts through on-coming brights. No wonder it was awarded the grand prize and two gold medals in world competition.

## AGENTS Cleaning Huge Profits

Agents and distributors from coast to coast are making big money equipping passenger cars, busses and trucks with this brand new road light. This is your opportunity to make up to \$10-\$20-\$30 per day. Some agents make even more. Kinney made \$96 in a few hours. Frost made \$150 in one day. Burroughs sold fifty lights to Richmond fire and police departments. Over 20 million cars need

this wonderful light to protect human lives and property against glaring lights, fog, rain and darkness. Hundreds of men have made big fortunes out of makeshift spot lights and painted bulbs that only did half the job. Send the coupon and find out how you can use this great device to build up a crew of your own—and double your earnings—earnings which by themselves will be bigger than you ever saw before. Do it now, before you turn this page.

67,000 BEAM CANDLE POWER  
ONE FIFTH OF MILE OF LIGHT  
NO GLARE



### Cuts Through London Fog and Darkness Like a Knife

Tests in England have proved this. With this light you need have no more fear of fog, rain or darkness. There is no light like it in the world. It is not a spot. It embodies an absolutely new principle in headlighting discovered by a famous light engineer. NOT A PAINTED BULB—But a real scientifically constructed road light with a concentrated 67,000 candle power beam of light on the road for over a thousand feet and no glare. Think of it! Over a fifth of a mile. Put one on your car and see for yourself what you can do with a light like this. Send the coupon today for our introductory offer.

**SPEEDLIGHT COMPANY**  
1731 Belmont Ave., Dept. 10-D, Chicago, Illinois

TO GET THIS LIGHT  
**FREE** of Extra  
Cost  
DON'T TURN PAGE—  
MAIL THIS COUPON FIRST



SPEEDLIGHT COMPANY,  
1731 Belmont Avenue,  
Dept. 10-D, Chicago, Illinois.

With  
Spec **This One**

NAME

ADDRESS

CITY



0166-6Z2-091Z

STATE



# PRICELESS

are the voices of those we love



WHAT PRICE COULD BE SET ON THE VOICE AND LAUGHTER OF A LITTLE CHILD A THOUSAND MILES AWAY? WHAT PRICE ON THE BRIEF AND REASSURING PHRASE, "WE'RE ALL WELL"? WHAT PRICE ON A HUNDRED WORDS BETWEEN SEPARATED LOVERS?

WHAT price on a doctor's midnight directions, on the swift response of the fire department, on the relief of anxiety, the cementing of friendship, the unexpected greeting after a long silence?

What price on speed in business, on the smooth running of a household, on leisure or rest without neglect of duty, on shelter in a day of storm?

How can any one say what the telephone is worth to you? We set a value on such visible, physical things as wires, poles, switchboards, instruments, operation. We set a price on telephone service based on what it costs us to render it and to assure its continued growth.

These considerations are fairly exact. But they have little relation to the actual worth of the telephone in your home or office. That is frequently a thing of the spirit and cannot be measured in terms of money.

When you buy telephone service you buy the most nearly limitless service the world affords. Because of it you receive the thoughts and emotions of other people and express your own thoughts and emotions to them. There are no hindering handicaps of time or distance, place or circumstance. For a few pennies a day, you move out of your own little corner in the kingdom of ideas and are free to range where you will.

AMERICAN TELEPHONE AND TELEGRAPH COMPANY



*When writing to advertisers please mention Popular Mechanics*

Copyrighted material



# Popular Mechanics Magazine

200 E. Ontario Street, Chicago, U. S. A.

H. H. WINDSOR, Founder

H. H. WINDSOR, Jr., Editor and Publisher

London: Messageries Hachette,  
La Belle Sauvage, Ludgate Hill, E. C. 4

Paris: Hachette & Cie.,  
111 Rue Reaumur

Melbourne: Gordon & Gotch  
509-513 Little Collins St.

Vol. 57

April, 1932

No. 4

## Special Features

Catch 'Em Alive-O'!	562
Tricks of Packing	570
Master Carver Whittles Way to Fortu	586
"Pan!" Rules the Airways	594
Where did you Get that Hat?	601
Even If It's Gold—Look Out!	610
A Vest-Pocket Submarine	618
Cotton Magic!	627
Secrets of the Master Spies	636

Agricultural Implements	
first four-wheel disk plow is self-sharpener	615
plow cuts furrow forty-two inches deep	592
Airplanes	
"Do-X" power is raised by engine changes	579
giant safety-first air liner takes shape in England	629
glider is started like a kite	615
huge supercharger drives plane to new record	591
steam cooling for airplane speeds up take-off	616
tail would help lift plane propelled by rockets	624
Airships—framework of the giant "ZRS-5"	604
Astronomy	
count of stars shows changes in universe	582
meteoric "hall" seen to fly hundred miles a second	624
Automobiles, Accessories	
auxiliary front spring reduces road shock	635
car owner's name imbedded in running board plate	576
car prevented from backing by automatic brake	575
chromium-plated piston pin lasts life of auto	583
portable car or truck lift runs on house current	621
signal posts on fenders have mirrors and lights	604
way to prevent "vapor lock" in autos is found	599
Automobiles, Design—autos without axles promise easier riding	623
Automobiles, Repairing—spark plugs cleaned by air in blast chamber	616
Automobiles, Truck	
locknut for wheels cuts accident costs	593
painted circus on truck attracts crowds	561
Aviation	
air express carries parcels to speed deliveries	630
airplanes "bomb" Indian villages with food	634
anti-stunting rule is most violated by flyers	616
heated suit protects pilot daily at three miles up	629
many airships cross ocean on office chart	641
tery Filler—with a light saves garage man's time	626

Brick floating	569
Bricks—glass	561
Birds—crop of pheasants raised on Iowa farm	598
Blacksmith Shop—on wheels gives quick service	616
Blindness—blind read any printed book with aid of electric eye	605
Boats and Boating—portable outboard motor runs boat at six cents an hour	626
Bricks—floating, are moisture proof	569
Bridges	
bridge unites Mount Vernon and nation's capital	576
that can submerge in flood are cheapest	630
Buddha—eighty-foot image of, rests in Burmese city	608
Building Construction—steel floor that interlocks will speed building	632
Building Material—boards are made from moss to insulate houses	633
Calculator—contract-bridge, speeds up the game	603
Cards (Playing)—machine deals bridge cards in ten seconds	598
Chain Hoist—easily portable, weighs thirty pounds	603
Checkerboard—for air or rail trips, has magnetized pieces	629
Children—guards put on baby walker to prevent tipping	578
Electricity—loss of, stopped by superconductor	626
Exploration—adventure school for tomorrow's explorers	574
Extension C—winder for, saves time and wear	578
Fish and Fishing—secrets of fishes' meals sought at lake bottom	635
Flashlight—movable head on, throws beam anywhere	609
Flowers—spray gun replaces insects in pollenizing	628
Fog—obstacles in fog revealed by echoes	624
Fountain—Spanish fountain has all hues of rainbow	631
Games—magnetic game for teaching children the alphabet	630
Hats—Mexico's walking hat store	641
Heating and Ventilating—fireplace gas heater keeps even temperature	579

BATTERY SYPHON

[Continued on Page 4]

ISSUED MONTHLY

SUBSCRIPTION:

SINGLE COPY, 25 CENTS

In United States and its possessions, Cuba, Mexico, and all countries in the Pan-American Postal Union, per year, postpaid } \$2.50  
To all other countries in the Postal Union } 3.00  
All subscriptions are discontinued at expiration. Please examine date printed on your wrapper.

Entered as Second Class Matter Sept. 15, 1903, at the Post Office at Chicago, Illinois, under Act of March 3rd, 1879.  
Entered as Second Class Matter at the Post Office Department, Oct.

Published monthly by POPULAR MECHANICS CO.

Copyright, 1932, by Popular Mechanics Co.

Copyright in Australia. Copyright in France

Copyrighted material



[Contents—Continued]

*Supercapacitor ex-havel driven 591*

Horses	
farm demand for, beyond supply	591
photo-cell protects, by giving right of way	626
race horse flies to track to save time	622
House—built out of coal even to the shingles	622
Household Devices	606
Industry—streamline used in	608
Lamps—most efficient light known is sodium-vapor lamp	575
Lawns—nozzle fertilizes the lawn while you sprinkle it	600
Masks—in medieval tortures like Halloween faces	585
Mathematics—mechanical brain solves difficult problems	591
Micrometer—in watch shape is easier to operate	615
Milk—"sunshine" foods put vitamins in milk	622
Models—six-foot cathedral is cut out with scrollisaw	600
Moving Pictures	
how the "diving" plane is filmed in safety	633
magnetic letters as titles for amateur movie fan	583
movie camera has stop watch to time workers	568
Music—robot that listens to, is orchestra critic	641
Necktie—of rubber, is soil-proof	640
Ocean—submerged peak in sea believed two miles high	615
Paints and Painting—"electric eye" for paint gun turns spray on and off	635
Patents—speeded to save time of inventor	604
Pipes—cement mortar pipe coating prevents corrosion	574
Police—motorcycle equipped with compact radio receiver	583
Puzzles	704
Radio	
dark light promises way to talk with Mars	584
practical ideas for the experimenter	649
Radio, Aerials—iron-pipe standards for apartment	644
Radio, Apparatus	
a drum dial for the junior experimenter	650
homemade resistance bridge for amateurs	645
power amplifier employs hand-made parts	642
Radio, Batteries—radio set for car is powered by B-eliminator	608
Radio, Construction	
avoiding poor contacts	650
space winding coils	643
Radio, Loud Speaker—ornamental baffle for auditorium dynamic	643
Radio, Reception—power-line static reduced by research	625
Radio, Repairing	
sneaker cords repaired	644
trouble traced to connectors	650
Radio, Television	
television disks you can make	647
television set is self-contained	644
Railroads	
aluminum freight car saves ten tons in weight	593
bulk freight boxed in steel wins carload rates	605
electric switchman rules train movements	617
when the law is reversed on rope railway	593
Roads—holes under pavement filled by mudjacks	625
Salt Desert—to become lake for migratory birds	609
Ships and Shipping	
"electric sailors" man yacht that has four masts	569
shipbuilding taught with models	580
Statues—wooden, restored by anti-decay method	585
Sugar—windows made from	632
Telephone—teletype messages sent through switchboard	577
Theaters—where you hear best in the talkie theater	599
Tobacco—silica gel sweetens smoke from rank tobacco	592
Trees	
big trees are transplanted to improve Capital	632
poisoning saves money and time in weeding out	629
Valve—electric, of ball type submersible in water	621
Walls—life-time trim for, made like linoleum	576
Windmills—like spider webs supply power in Greece	609
Windows—that open silently have springs, no weights	633

AMATEUR MECHANICS

Aquarium—handy tool for the	679
Automobiles, Accessories	
curtain rod holds packages on back of seat	679
hinged seat of sedan forms comfortable bed	673
Automobiles, Tires—locating small objects imbedded in casing	663
Automobiles, Trailer—completely equipped for touring	675
Balsa Wood—tool for cutting into thin strips	663
Bazaar—colorful booths increase sales	651
Birds—metal cup traps bird lice	653
Blowtorch—toy balloon supplies compressed air for	684
Caricatures—it's fun to make these bent-wire	678

*Tring table 658*

Carving—unusual woodcuts carved with a jackknife	659
Ceiling—rack holds lath while working on	665
Cellar—counterweights help raise heavy doors	674
Chalklines—bow holder for short	678
Clothes Hanger—silent valet holds coat, trousers and shoes	683
Colonial Chest—you can make	661
Doll House—furniture, will please your girls	680
Flashlight—substitute for ring on	674
Funnel—eggshell serves as	683
Guns—how to shoot small-gauge shells in large-gauge gun	663
Homes—fitting the home game room	655
Humidor—homemade, for cigars	672
Knots—can help to untie	684
Lathe—portable home-workshop wood lathe	660
Level—improvised from plumb bob and folding rule	674
Milk—flavor of, retained by use of amber-colored glass	683
Models—De Witt Clinton train, Part IV	666
Paints and Painting	
phonograph motor rotates round objects while paint dries	674
rolling guide for paint striping	658
Photography	
cheap method of doing copy work with camera	672
developing machine is driven by clockwork	654
screen for use in developing new high-speed photo plates	653
sponge-rubber pad applied to platen of photo printer	684
Picture Frame—paper clamps hold, while gluing	674
Roofing—hints on applying steel	679
Saws and Sawing—tobacco tin aids in ripping stock	679
Screweyes—metal plate keeps tight	678
Shelves—tape on shelf brackets holds glass from slipping	673
Shoes—how to keep sand or gravel out of your shoes	684
Spoon—clothespins hold large	677
Stilts—mounted on wheels attain high speeds	663
Sugar Bin—handy addition to your pantry	660
Suitcase—hinged holder for lid made from old rule	653
Telescope	
camera tripod used as support for	678
made from mailing tubes	679
Threads—internal, how to find the pitch and diameter of	665
Tool Box—handle made from auto steering wheel	654
Toys—multiple connectors on track improve operation of toy trains	654
Walls—metal-foil wall decoration you can apply	664

SHOP NOTES

*Grader 675*

Automobiles, Repairing—testing compression of motor	703
Automobiles, Tires—tire spreader for small garage is portable	694
Batteries—rejuvenating tungar rectifying bulbs	695
Belts	
cloth-covered idler pulley removes oil from leather belt	690
eliminating static electricity in	701
Bench—improved bench for fabric workers	695
Block and Tackle—folding tripod for	687
Brick Veneer—wire hooks hold	701
Brushes—corrugated paper holds	687
Carboy—containing acid swings on angle-iron frame	701
Carpets—clamps hold carpet on stone stairs	689
Cash Register—raised key saves time for store clerks	703
Clocks—electric hall clock is easy to build	691
Electroplating—electro-chemist tells secrets of plating	696
Engine, Gasoline—automatically stopped when water tank is full	689
Handtruck—portable crane on, to move heavy loads	690
Hooks—triple, for crane or fall block	694
Hydraulic Press—make your own, at a small cost	690
Lathe	
accurate tool-post grinder for your	685
faceplate clamps hold irregular work in	702
Level—extra glass improves	695
Microscopes—how to adjust small	693
Pictures—reduced size of, obtained by optical illusion	703
Pipe Fitting—chart aids in determining amount of pipe for job	703
Sandpaper—helps run self-feeding press	689
Smokestack—dismantling without damage	688
Stand—equipped with rollers supports angular work	694
Tractor—homemade heater for cab	689
Truck—screen-bottomed, for steam cleaning small parts	687
Washer—lock, from sheet metal has fine adjustment	688
Workbench—and ladder combined	702

*Chromium Plating 696*

*Billiard table 658*





Three Chicago food experts invent a delightful new food that is revolutionizing the doughnut business.

# Here's an Amazing New Business That Pays \$1,000 a Month Up to....

Here is a surprising new opportunity. Now you can immediately become the owner of a big business that is paying others from \$75 up to \$250 a week. There is no "Red Tape"—no delay. Wherever you live there are quick, easy profits waiting for you to grab them. Just mail the coupon for full details.

## Individual Plans to Fit Every Need

### FULL TIME

You can start a Brown Bobby shop with floor space as little as 6 by 6 ft. Sell retail and wholesale.  
Minch, Fla.,  
\$3,000 his first 3

### ART TIME

Invest a few dollars in this new business and get someone else to run it for you. A few hours of your time each week can easily bring you \$50 up to \$150 a week extra cash.

### SPARE TIME

Start at home. Make money like Mrs. Nelson, Ill., who sold 90 dozen Brown Bobbys at retail in one week, then went out to triple her profits through wholesale business.

**MEN**, this is absolutely new! A real red-hot money-making opportunity! Something every red-blooded man has always longed for. It's a chance to jump into business for yourself and make more money every week than the average man makes in a month!

Surprising, yes, almost incredible as it may sound, we actually start you in a **proven business!** The first day's profits often run from \$18 to \$55—and a business of \$350 to \$600 the first month is not exceptional for ambitious men or women.

### A Sensational Big-Money Plan

There is just one thing you need to make a "go" of this business, and that is the ambition to make real money. We give you all the plans, advice and help needed to make a big success right from the jump. We supply you with the equipment to make an amazing new food—a **greaseless** doughnut baked by electricity! You sell to homes, bakeries, delicatessens, groceries, restaurants, etc., at a profit of 150% to 600%! No wonder the dollars simply pour in!

### A New Food Secret

The **greaseless** doughnut is altogether novel and unique. It's a crispy, flaky, delicious new kind of doughnut cooked without one drop of oil or grease. Easily digested by everyone. More appetizing than old-style doughnuts ever were. Yet costs you less to make. This new business is copyrighted under the trade name "BROWN BOBBY," so there is no competition.

Everyone likes doughnuts. Millions of old-style doughnuts are sold every day. Now you can bake and sell the perfect doughnut—the toothsome **BROWN BOBBY greaseless** doughnut that sells four times as fast as any other.

### Start At Once—Anywhere

In this limited space I am able to suggest only the bare possibilities. The details are even more sensational than the facts given here can indicate. I am looking for sincere, ambitious, wide-awake men. I offer such men a plan that is a real eye-opener. The first week's profits usually amount to more than your entire investment. After that it is up to you entirely whether you will make \$300 or \$1,000 a month clear profit.

Men and women start in this business daily. You do not obligate yourself in any way by mailing the attached coupon. So get the details of this amazing new idea at once. Decide for independence! Fill out and mail the coupon today—**now—THIS MINUTE!**

Food Display Machine Corp., Dept. 34,  
500-510 N. Dearborn St., Chicago, Ill.

Rush me details of your plan for a "Brown Bobby" business of my own.

Name.....

Address.....

City..... State.....

**FOOD DISPLAY MACHINE CORP.**  
Dept. 34, 500-510 N. Dearborn St., Chicago, Ill.

When writing to advertisers please mention Popular Mechanics





"By all means advise the young man of today to study accounting as a requisite to a successful business career."

—R. E. CONNOLLY,  
Treasurer, Illinois Central  
Railroad Company

Send for **Free Booklet**—

Train Yourself in

## Accounting—the Sure, Well-Paid Road to the Top

**I**F you want to get ahead in a profession which is uncrowded and in which the rates of pay are well above the average, this free booklet contains a message of great personal importance to you.

It shows you why the man trained in accounting goes on and up in good times or in bad—how before him lies an open road to such influential, well-paid positions as chief accountant, auditor, and treasurer, or, if he wishes, to a lucrative practice of his own.

And it explains a practical way by which, without sacrificing your present interests, you can secure in spare time the training which, with proper experience, will fit you for a responsible position in accounting.

For this purpose, it offers you, in a form suited to HOME STUDY, the famous *Complete Accounting Course* developed by Northwestern University, one of the great educational institutions of the Midwest.

Thousands of successful accountants and executives have secured their grounding from this course. It is used by over a hundred schools and colleges.

### A Complete Course at a Fraction of the Usual Cost

Under the plan the booklet outlines, you receive exactly the same lecture notes and practice assignments (with solutions) which the resident student follows over three years. By easy steps, you go through the whole subject, from elementary accounting to advanced auditing.

Material of any comparable scope, presented in the usual correspondence school form, would cost you \$150 or more. This way you get it complete, so organized and graded that you have no trouble in working through it entirely by yourself—for less than one-sixth that amount.

### Mail the Coupon Now for Your Copy

and we will send you, without cost or obligation, the little book which tells all about the training the course offers and the easy terms of payment. No salesman will call. This booklet may have an important bearing on your business future. Send for it now.



#### USE THIS FORM

The Ronald Press Company, Dept. M 490  
15 East 26th Street, New York, N. Y.

Please send me, without cost or obligation, a copy of the little book giving full information about the use for Home Study of the *Complete Accounting Course* developed at Northwestern University.

Name.....  
(Please print)

Firm..... Title or  
Position

Address.....

City..... State.....

When writing to advertisers please mention *Popular Mechanics*

## Play the Hawaiian Guitar like the Hawaiians!

Only 4 Motions used in playing this fascinating instrument. Our native Hawaiian instructors teach you to master them quickly. Pictures show how. Everything explained clearly.

**Play in Half Hour**  
After you get the four easy motions you play harmonious chords with very little practice. No previous musical knowledge needed.

**Easy Lessons**  
Even if you don't know one note from another, the 12 printed lessons and clear pictures make it easy to learn quickly. Play as you play.

**GIVEN** when you enroll  
—a sweet toned

**HAWAIIAN GUITAR, Carrying Case and Playing Outfit—Value \$18 to \$20**  
No extra-anything included

WRITE AT ONCE for attractive offer and easy terms. You have everything to gain. A postcard will do. **ACT!**

**OTHER COURSES** Tenor Banjo, Violin, Tiple, Tenor Guitar, Ukulele, Banjo Ukulele. Under well known instructors.  
**FIRST HAWAIIAN CONSERVATORY OF MUSIC, Inc.**  
9th Floor, Woolworth Bldg. Dept. 548 New York, N. Y.  
Approved as a Correspondence School Under the Laws of the State of New York—Member National Home Study Council

## ELECTRICAL ENGINEERING

A CONCISE, comprehensive course for men of limited time, complete in one year. Mathematics, engineering drawing, shop-work. Students construct motors, install wiring, test electrical machinery. Modern buildings. 39 years' successful experience. Catalog on request.



**BLISS ELECTRICAL SCHOOL**

134 Takoma Ave., Washington, D. C.

## CARTOON YOUR WAY TO SUCCESS!



DON'T COPY—LEARN TO ORIGINATE!

RAYE BURNS will teach you HOW to CREATE ORIGINAL CARTOONS at home that you can SELL! Course contains 26 lessons and over 600 illustrations. All for only...

**\$2.85**

Send name and address for free outline.  
**RAYE BURNS SCHOOL, 326 Lakeview Rd., A-7, Cleveland, Ohio**

## Learn Photography at HOME

Make money taking pictures. Prepare quickly during spare time. Also earn while you learn. No experience necessary. New easy method. Nothing else like it. Send at once for free book, OPPORTUNITIES IN MODERN PHOTOGRAPHY, and full particulars.

**AMERICAN SCHOOL OF PHOTOGRAPHY**  
Dept. 1254, 3601 Michigan Avenue Chicago, U. S. A.

### MAIL FOR FREE INFORMATION

**BEDFORD**

1115 Bedford Ave., Dept. PM-4a  
Brooklyn, N. Y.

**YMCA  
TRADE  
SCHOOL**

Send me without obligation complete information on (check subjects).

- Caterpillar Tractor Mechanic
- Aviation Mechanic
- Flying
- Welding
- Auto Mechanic
- Radio Mechanic and Television
- Talking Pictures—Double Western Electric Equipment
- Electrical
- Machine Shop
- Starting, Lighting, Ignition
- Window Dressing
- Commercial Art
- Sign Painting
- Architectural Drafting
- Mechanical Drafting

Name.....

Street & No.....

Town..... State.....



# \$16,200<sup>00</sup> Difference



## Between Them!

Take a good look at these two men—

—they weigh the same—wear the same size hat—  
look a good deal alike—were born in the same year.

But one man draws \$1,800 a year and the other  
makes \$18,000 every twelve months. Why?

**T**AKE the most successful man you know—forget his money and position—measure yourself against him as man to man. Try to find the difference between yourself and him—nine times out of ten you'll be puzzled.

Without flattery, you may be his equal in education, alertness, personality, and the other factors that are supposed to count.

He has something you haven't, something that makes his income many times what you gain from your work.

And that "something" is this—

—he has specialized knowledge and executive ability—he has taken himself out of the job-filling masses into the position-holding classes—he has equipped himself for those higher phases of business where the supply of men never equals the demand for them—he has trained.

Can you do this?

This depends partially on you. But the way has been blazed for you by thousands upon thousands who have made the original dim trails into a broad, paved highway. And what so many have done, you should be able to do.

Here—take yourself as you are today—check up with the starting points of the men whose true stories are briefly told below—then—mark their rise.

**"Once I Thought Advertisements Like This Were Fairy Tales—Now I Know They Are True"**

So says O. D., in telling of his own climb from a job as a clerk to his present position as general auditor of a nation-wide concern doing more than \$20,000,000 a year of business.

"We can't promote you," his boss had told him, "for you are not ready for any job ahead. And we can't pay you any more because you are now getting all the job is worth. In fact, we could fill your place at a lower salary."

Yet in six months, because he enrolled for Accounting and began to apply what he learned, this same boss raised his pay 66 per cent and in the next four years increased his pay check over 230 per cent. Today, his income is six or seven times larger than when his boss told him it was useless to ask for any raise.

And as he puts it, "An increase in salary now is the least of my worries."

**"My Dream Came True—Thanks to LaSalle Training"**

E. A. B.'s life dream was to become a lawyer. But poverty, sickness, and family cares seemed to make it impossible. Yet at twenty-five years of age, married, and the father of two children, clerking in a little retail store for \$12 a week, he enrolled for LaSalle Law training. Three years later, he took and passed the Bar examination and hung out his shingle.

Today, he is a prominent, successful attorney with an income larger than he ever dreamed of getting when he started training.

**"You Have to Wait Until Men Ahead of You Die"—said His Bosses—But He Proved Them Wrong**

When C. B. O. asked his division superintendent how soon he could hope for promotion from his station agent's job in a town of 500, he was told that he must wait his turn, maybe a long while.

Yet a few months later, after his LaSalle training in Traffic Management began to show in his work and reports, the seniority rule was forgotten and he was promoted and his wages raised 100 per cent. Two years later, he was moved up and eight months later, again.

Today, he is Traffic Manager of a great corporation—and his salary is in proportion.

**If You Have the First Requisite to Success—**

One trait that always marks the successful man as against the failure or the mediocre man is his desire to get the facts about anything that may help him progress.

And your first step toward a more successful career is to find out about this LaSalle training that has helped these five men above—is to get the facts.

You have been doing a lot of thinking about your future—now is the time to do some acting. You can't lose by sending the coupon and you may gain—gain a lot. Delay kills opportunity. ACT!

## LaSalle Extension University

DEPT. 464-R

CHICAGO, ILL.

I want the facts about your training in the business field I have checked below. I understand you will send them without cost or obligation.

- Business Management  
 Higher Accountancy  
 Traffic Management  
 Modern Salesmanship  
 Railway Station Mgmt.

- Law: Degree of LL.B.  
 Commercial Law  
 Industrial Management  
 Modern Foremanship  
 Personnel Management

- Business Correspondence  
 Banking and Finance  
 Expert Bookkeeping  
 C. P. A. Coaching  
 Railway Accounting

- Commercial Spanish  
 Business English  
 Effective Speaking  
 Telegraphy  
 Credit and Coll. Corres.

Name.....Address.....City and State.....

When writing to advertisers please mention Popular Mechanics

Copyrighted material



**My Pay-Raising Plan**  
Engineer Dobe

**Free**

YOURS for the asking! No cost whatsoever! No conditions. Just reply promptly. This offer is open to all who speak up NOW!

**BETTER JOB BETTER PAY**

Mail Coupon NOW!

If you earn a penny less than \$50 a week, rush the coupon to me for my PAY RAISING PLAN. I have doubled and tripled the pay of many hundreds of men, who now earn \$60, \$70 and even \$100 a week. Here is an opportunity you must look into. Get started NOW and be ready when your time comes. I furnish without extra charge, drafting tools, drafting table and other equipment WHEN YOU START.

Drafting is the field of greatest opportunity. It gives you the chance to break away from the slavery of low wages and uncertain employment. There is always a demand for draftsmen with PRACTICAL TRAINING and many opportunities for quick promotion and exceptionally GOOD PAY. Will you answer the call?

## Don't Send Money

Don't let lack of ready cash hold you down and rob you of success. It's men I want—not a lot of money. I want you if you mean business, and I am ready, not only to train you for a good pay position, but to help you in other ways, even to earn extra money while learning. For over 30 years I have been training and helping men to success in drafting. Let me do the same for you. With my practical methods you can quickly complete my entire course and be ready before you know it, for an important position in engineering or industrial work.

Take a look at these tools. Not a student's outfit at all but an imported set of professional drafting instruments.

**FREE**

of all extra cost. You also get an engineer's drafting table and other standard supplies when you start.

Send coupon for "Pay-Raising Plan."



**FREE PAY RAISING PLAN**

**ENGINEER DOBE, Div. 14**  
1951 Lawrence Avenue, Chicago

Send me free and postpaid, your book, "My Pay-Raising Plan," also Practical Draftsmanship Book and Special Offer on all Drafting Tools and Table furnished to me without extra cost.

REPLY PROMPTLY

Name

Address

City

Age

In writing please mention Popular Mechanics

## BIG OPPORTUNITIES in PHOTOGRAPHY



### TO MAKE MORE MONEY

Interesting work, splendid demand everywhere for men and women. No previous experience needed. Expert instructors prepare you for the branch you like best—at home in spare time, or in our great New York studios.

#### Send for FREE Book

It tells all about the varied opportunities. Check which interests you most:

- Motion Picture Photography and Projection.
- Still Photography (Portrait, Commercial, News) and Photo-Finishing. WRITE TODAY.

NEW YORK INSTITUTE OF PHOTOGRAPHY  
Dept. 49 10 West 33rd St. New York, N. Y.

## EARN MONEY AT HOME

YOU can make \$15 to \$50 weekly in spare or full time at home coloring photographs. No experience needed. No canvassing. We instruct you by our new simple Photo-Color process and supply you with work. Write for particulars and Free Book to-day.

The IRVING-VANCE COMPANY Ltd.  
356 Hart Building, Toronto, Can.



## HOT PIANO

Ultra-modern Piano

Jazz taught by mail. Note or ear. Easy rapid lessons for adult beginners. Also Self-instruction system for advanced pianists. Learn 358 Bass Styles, 976 Jazz Breaks, hundreds of Trick Endings, Hot Rhythms, Sock, Stomp and Dirt Effects; Symphonic and Wicked Harmony in latest Radio and Record Style. Write for Free Booklet.

WATERMAN PIANO SCHOOL, 1625 W. Adams St., Los Angeles, Calif.

## "The TRUTH about VOICE"

SENT FREE No Obligation to Buy

If you act quick!—we will send you postpaid—free 30 days free reading—new Voice Book disclosing startling FACTS that may save hundreds of dollars to every man or woman seeking a strong, rich voice for either singing or speaking. 30 days free reading—then send \$1. Otherwise, return it.

Prof. E. Feuchtinger 308 North Michigan Avenue Studio 13-24 Chicago, Ill.



WHY NOT spend Spring, Summer and Fall gathering butterflies, insects? I buy hundreds of kinds for collections. Some worth \$1 to \$7 each. Simple outdoor work with my instructions, pictures, price-list. Send 10 cents (post stamps) for my illustrated Prospectus before sending butterflies. MR. SINCLAIR, DEALER IN INSECTS Dept. 6, Box 1424, San Diego, Calif.

## How To Secure A Government Position

Why worry about strikes, layoffs, hard times? Get a Government job! Increased salaries, steady work, travel, good pay. I'll help you become a Custom House Clerk, Railway Postal Clerk, Post Office Clerk, City Mail Carrier, Rural Carrier—or get into any other Government job you want. I was a Secretary Examiner of Civil Service Commission for 8 years. Have helped thousands. Get ready NOW for the NEXT Railway Postal Clerk Examination! Open to citizens from 18 to 50.

**Now FREE** My 22-page book tells about the job open—and how I can help you get one. Send the coupon for your copy TODAY.

A. R. Patterson, Civil Service Expert  
PATTERSON SCHOOL, A-24 Wisner Bldg., Rochester, N. Y.  
Please send me, without obligation, your free book "How to Secure a Government Position."

Name.....  
Address.....





# I. C. S. STUDENT SPARETIME WINS



IN 1930 the Standard Sanitary Manufacturing Company of Pittsburgh started a movement for better architectural designs in bathrooms. Prizes were offered, in two classes, for the best plans and specifications. Architects from all parts of the United States and the world competed. Eminent architects served as judges.

Class A Prize—\$5000—was won by Edgar Thompson, of Detroit, a draftsman associated with Albert Kahn, Inc., architects and engineers.

After returning from overseas military service, Mr. Thompson, then in his early twenties, enrolled for a course with the International Correspondence Schools. Here is what he says: "I. C. S. study is the foundation of what little I have thus far done in my line, and I hope with the years to make it more."

Most likely you need a technical foundation for your own native talents. Ambition must follow a framework of training! Spare-time study of I. C. S. courses has given this training to thousands of men—it will give it to you! Return the coupon—today.

## INTERNATIONAL CORRESPONDENCE SCHOOLS

"The Universal University" BOX 5592-G, SCRANTON, PENNA.

★ Without cost or obligation, please send me a copy of your booklet, "Who Wins and Why," ★ and full particulars about the subject before which I have marked X:

Architect  
 Architectural Draftsman  
 Building Estimating  
 Wood Millworking  
 Contractor and Builder  
 Structural Draftsman  
 Structural Engineer  
 Electric Wiring  
 Electrical Engineer  
 Electric Lighting  
 Welding, Electric and Gas  
 Reading Shop Blueprints  
 Telegraph Engineer

Telephone Work  
 Mechanical Engineer  
 Mechanical Draftsman  
 Machinist  Toolmaker  
 Patternmaker  
 Pipefitter  Tinsmith  
 Bridge Engineer  
 Bridge and Building Foreman  
 Gas Engines  
 Diesel Engines  
 Aviation Engines  
 Automobile Mechanics  
 Plumbing  Steam Fitting  
 Train Operation

Highway Engineering  
 Chemistry  Pharmacy  
 Coal Mining Engineer  
 Navigation  
 Icebreaker  
 Textile Over-seer or Supt.  
 Cotton Manufacturer  
 Woolen Manufacturing  
 Agriculture  
 Fruit Growing  
 Poultry Farming  
 Radio  
 Marine Engineer

Business Management  
 Office Management  
 Industrial Management  
 Personnel Management  
 Traffic Management  
 Accountancy  
 Cost Accountant

C. P. Accountant  
 Bookkeeping  
 Secretarial Work  
 Spanish  
 French  
 Subv. Management  
 Advertising

Railway Mail Clerk  
 Grade School Subjects  
 High School Subjects  
 College Preparatory  
 Illustrating  
 Cartoning  
 Lumber Dealer

Name..... Age..... Street Address.....

City..... State..... Occupation.....

If you reside in Canada, send this coupon to the International Correspondence Schools Canadian, Limited, Montreal, Canada



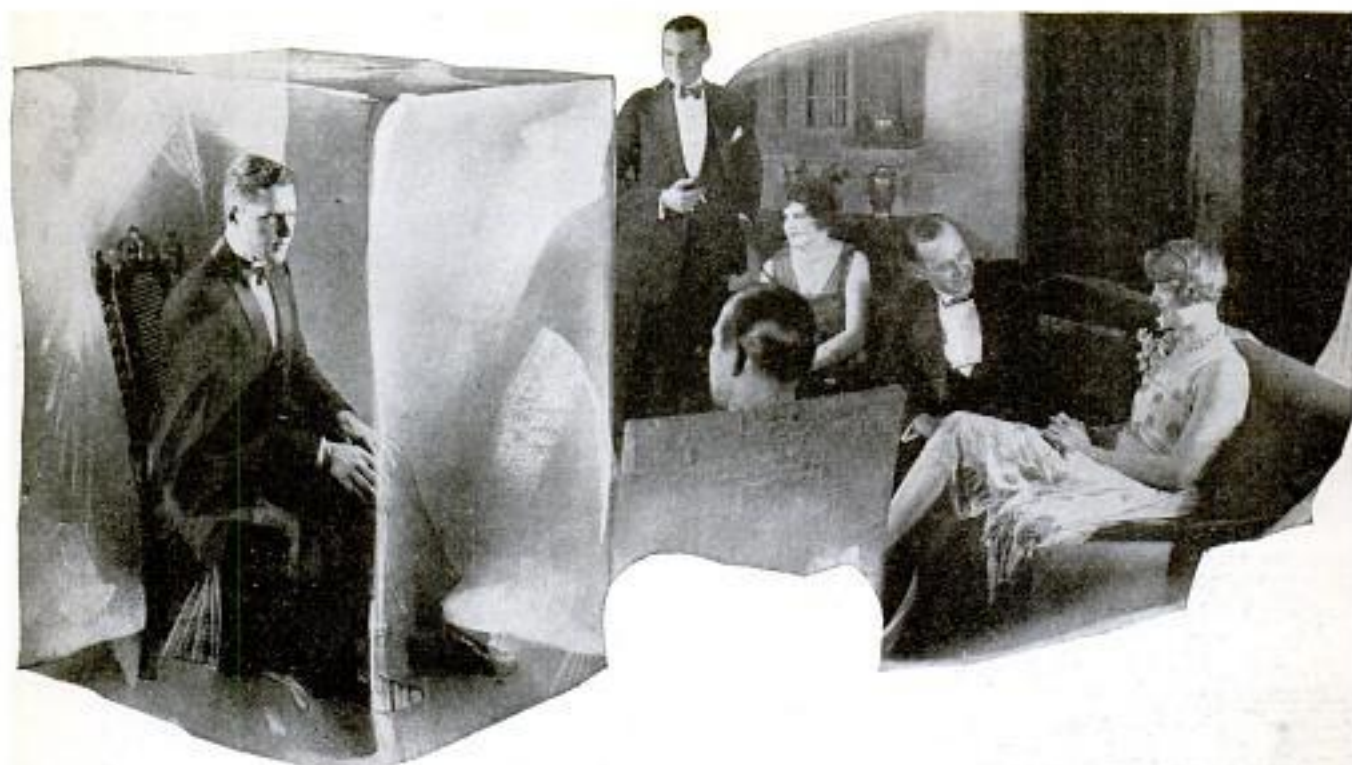

# I Turned To Ice When I Tried To Talk

## -But Now I Can Sway An Audience of Thousands!

I HAD always been painfully bashful. When trying to carry on even the most commonplace conversation my voice would sound unnatural and my hands and knees would tremble. Often I would listen to an argument among a group and become so keenly interested that I would want to voice my own opinion—yet timidity would keep me silent. I never had the courage to stand up for what I knew to be my rights—I was always afraid of "what people would say," of ridicule. Since my childhood I had had a secret desire to appear in public—to be active in politics—but my shyness was so great that I turned to ice when I tried to talk—in even the smallest gathering!

My inability to talk was also affecting my business success. I dreaded going in and asking for a raise—I was afraid of any situation that meant using my voice—having to express myself. I didn't know how to present the ideas which I was sure the firm could use. I was just a plodder—a truck horse, capable of doing a lot of heavy work but of no use where brilliant performance was required. Often I would see men who were not half so thorough nor so hard working as I, promoted to positions where they made a brilliant showing—not through hard work, but through their ability to talk cleverly and convincingly—to give the appearance of being efficient and skillful.

### What 20 Minutes a Day Will Show You

How to talk before your club or lodge  
 How to propose and respond to toasts  
 How to address board meetings  
 How to tell entertaining stories  
 How to make a political speech  
 How to make after-dinner speeches  
 How to converse interestingly  
 How to write letters  
 How to sell more goods  
 How to train your memory  
 How to enlarge your vocabulary  
 How to develop self-confidence  
 How to acquire a winning personality  
 How to strengthen your will-power and ambition  
 How to become a clear, accurate thinker  
 How to develop your power of concentration  
 How to become master of any situa-

### In Twenty Minutes a Day

And then suddenly I discovered a new easy method which made me a forceful speaker almost over night. I learned how to dominate one man or an audience of thousands—how to say just the right words at the right time, how to win and hold the attention of those around me, how to express my thoughts simply and clearly, yet in a pleasing, interesting and amusing way. In just a few months I was able to make campaign speeches for a

local candidate—I who a short time before had turned to ice when I tried to carry on an ordinary conversation!

Soon I had won salary increases, promotion, popularity, power. Today I always have a ready flow of speech at my command. I am able to rise to any occasion, to meet any emergency with just the right words, to approach all types of people with ease and fearlessness. And I accomplished all this by developing the natural power of speech possessed by everyone, but cultivated by so few—by simply spending 20 minutes a day in my own home on this most fascinating subject.

### Send for This Amazing Book

This new method of training is fully described in a very interesting and informative booklet which is now being sent to everyone mailing the coupon below. This book is called, *How To Work Wonders With Words*. In it you are shown how to conquer stage fright, self-consciousness, timidity, bashfulness and fear—those things that keep you silent while men of lesser ability get what they want by the sheer power of convincing speech. Not only men who have made millions, but thousands have sent for this book—and are unstinting in their praise of it. You are told how to bring out and develop your priceless "hidden knack"—the natural gift within you—which will win for you advancement in position and salary, popularity, social standing, power and real success. You can obtain your copy absolutely free by sending the coupon.

Now Sent  
FREE



**NORTH AMERICAN  
INSTITUTE**

3601 Michigan Ave. Dept. 1354  
CHICAGO, ILLINOIS

North American Institute,  
3601 Michigan Ave., Dept. 1354, Chicago, Illinois.

Please send me FREE and without obligation my copy of your inspiring booklet, *How To Work Wonders With Words*, and full information regarding your Course in Effective Speaking.

Name.....

Address.....

City.....State.....



# Get Into One of These BIG PAY FIELDS

Below are a Few Scenes in the  
Coyne Shops



A Small View of Our Alternating  
Current Dept.



Real Radio Broadcast and Control Equipment  
in Coyne Radio School



Latest Television Equipment in  
Television Dept.



Actual Talking Picture Projectors in  
Talking Picture Dept.

# RADIO-TELEVISION SOUND REPRODUCTION OR ELECTRICITY

Coyne offers you the opportunity to get into two of the best pay fields in the shortest possible time. You don't have to be a small pay untrained man. Here at Coyne you can get a training in 10 weeks in Radio, Television and Talking Pictures and in 12 weeks in the great field of Electricity.

Either of these fields offers you untold opportunities—opportunities to earn \$50.00 a week and up. Now is your chance to prepare for the great prosperity which is on its way. Only as a trained man can you expect to get ahead.

Don't be satisfied with \$20 or \$25 a week all your life. Get into a field where there are opportunities by the hundreds to make real money. Get into a line of work which offers you the chance to make much more than a mere living which will enable you to have the better things of life, where you won't have to worry about layoffs and small pay at man-killing work all your life.

## In the GREAT SHOPS of COYNE NOT BY BOOK STUDY... BUT BY ACTUAL WORK

Here at Coyne you are trained on real electrical machinery—on huge motors, generators, power plants, switchboards, etc., and in Radio you are trained on scores of Radio Receivers, Huge Broadcasting equipment in both Radio and Television and on Talking Picture equipment, etc.

You don't need advanced education or experience at Coyne. Many of my students earn while learning. After graduation you get lifetime employment service and lifetime service to help you hold success after you have gotten it. Our thousands of successful graduates are my greatest proof of what Coyne can do for you.

## GET the FACTS!

I've published a catalog on each subject. Mail coupon today for the subject you are interested in. I'll send you the Free book and the proof of how thousands before you have made a success with my training. Don't delay. Mail coupon now before you turn this page.

## COYNE ELECTRICAL and RADIO SCHOOL

500 S. Paulina St. Dept. 42-3H Chicago, Illinois

Coyne Electrical & Radio School, H. C. Lewis, Pres.  
500 S. Paulina St., Dept. 42-3H, Chicago, Ill.

Please send me the book I've checked below:

{ Radio, Television, Name.....  
Talking Pictures  
 Electricity Address.....  
Town..... State.....



# FIND OUT FREE If You Can Become a Successful DRAFTSMAN



**Get Free Test-Lesson**  
—investigate how  
to get a permanent  
position paying  
**\$40 to \$75 a week**

Men say—the most thrilling and interesting work in the world—is building machinery and railroads, highways and skyscrapers, autos and 1001 other manufactured products—on PAPER, in the drafting room. How would you like to be a Draftsman for an Architect, Contractor, factory, railroad or under Civil Service? Mail coupon for free test-lesson—you'll be surprised at how easy Drafting is to learn right in your home, in spare time.

**You have the ability to become a well-paid Draftsman, if you can meet these simple requirements:**

- 1. HAND** Any man in office or factory who can do semi-skilled or skilled work with his hands, such as working to dimensions, or adjusting valves on an auto, or even laying out a business chart—has the necessary skill of hand to become a Draftsman. Drafting is mechanical drawing, with tools, and requires no artistic talent.
- 2. BRAIN** If you can add, subtract, multiply and divide, we can teach you the rest of the mathematics you will need in Drafting. You only need grammar schooling, and you must be under 35 years of age.

## A GOOD JOB

—as soon as you are ready

Right now we are looking for more ambitious men, under 35, to prepare for and help place in good Drafting positions. Men with office, factory or building construction experience, men who know how things are done, make exceptionally successful Draftsmen. Mail coupon for free book about the opportunities in Drafting and free test lesson.

### American School

Drexel Ave. and 58th St., Dept. D-447, Chicago, Ill.  
Without the slightest obligation, please send free test-lesson to prove I can learn Drafting at home in spare time, also free Drafting book.

Name..... Age.....  
St. No.....  
City..... State.....



## Follow This Man

Secret Service Operator No. 38 is on the Job!

**F**OLLOW him through all the excitement of his chase of the counterfeit gang. See how a crafty operator works. Tell-tale finger prints on the lamp stand in the murdered girl's room! The operator's cigarette case is handled by the unsuspecting gangster, and a great mystery is solved. Better than fiction. It's true, every word of it. No obligation.

## FREE The Confidential Reports No. 38 Made to His Chief

And the best part of it all is this. It may open your eyes to the great future for YOU as a highly paid Finger Print Expert. More men are needed right now. This school has taken men just like you and trained them for high official positions. This is the kind of work you would like. Days full of excitement. Big salaries. Rewards.

**WRITE** and I'll send the Free Reports—also a wonderful illustrated book telling of the future awaiting you as a Finger Print Expert. Literature will NOT be sent to boys under 17 years of age.

**Institute of Applied Science, 1920 Sunnyside Avenue, Dept. 13-54 Chicago, Ill.**

## ENGINEERING and ARCHITECTURE

**INTENSIVE PRACTICAL TECHNICAL COURSES** in Electrical, Mechanical, Structural, Architectural Engineering. Degree in 2 yrs., diploma in 1 yr. Also shorter courses in Electricity, Power Plant, Radio, Television, Electric Refrigeration, Drafting, Welding. Non-essentials eliminated. **LOW TUITION.** Expert instructors. Extensively equipped laboratories. Free life-time employment for graduates. Part-time work during attendance. 32nd year. Write for catalog. **FINLAY ENGINEERING COLLEGE**  
1001 A Indiana Avenue KANSAS CITY, MO.



## Learn Public Speaking

At home—in spare time—20 minutes a day. Overcome "stage-fright," gain self-confidence, increase your salary, through ability to sway others by effective speech. Write now for free booklet, *How to Work Wonders With Words*.

**NORTH AMERICAN INSTITUTE, Dept. 1354**  
3601 Michigan Avenue, Chicago, Illinois



Wonderful, new device, guides your hand; corrects your writing in a few days. Big improvement in three hours. No failures. **Complete outline FREE.** Write C. J. Osment, Dent, 34, St. Louis, Mo.



## VOICE

### 100% Improvement Guaranteed

We build, strengthen the vocal organs—not with singing lessons—but by fundamentally sound and scientifically correct silent exercises... and absolutely guarantee to improve any singing or speaking voice at least 100%... Write for wonderful voice book—sent free. Learn WHY you can now have the voice you want. No literature sent to anyone under 17 years unless signed by parent.

**PERFECT VOICE INSTITUTE, Studio 13-54**  
308 No. Michigan Ave., Chicago





# BE AN ARTIST

## Earn a Big Name and a Fat Income

**WHAT** would you give to be this artist—earning a big income—enjoying studio life? He has learned the secret of forming simple lines into finished illustrations.

It was only a short time ago that this young artist filled out a coupon like the one below and mailed it to the Federal School of Illustrating. Now he is not only trained in modern art on which magazines are spending millions every year, but he has also had thorough instruction in all branches of illustration. Careful training by Federal Instructors has taught him to turn simple lines into dollars.

More than fifty famous artists—making big incomes themselves—have contributed to the Federal Course, giving you the benefit of their experience in illustrating, cartooning, lettering, poster designing, window card illustrating, etc.

Why drudge at routine work? Opportunities for artists have never been better. Drawing is easy to learn the Federal Home Study way. Earn while you learn, if you wish. Many students find a market for their work after a comparatively short time of study.

### Test Your Drawing Talent

If you like to draw, train your talent. Open the way to success and a fine income. Write your name, age and address on the coupon and get our Free Book, "A Road to Bigger Things," illustrated below. With it, you will receive our Free Vocational Art Test to find out your ability. Hundreds of successful artists got their start by sending for these. This is your opportunity—grasp it. **MAIL THE COUPON NOW.**



## FEDERAL SCHOOL of ILLUSTRATING

4132 Federal Schools Bldg.  
Minneapolis, Minnesota

COUPON

FEDERAL  
SCHOOL of  
ILLUSTRATING

4132 Federal Schools Bldg.  
Minneapolis, Minn.

Please send me free book "A ROAD TO BIGGER THINGS" and Standard Art Test.

Name \_\_\_\_\_

Age \_\_\_\_\_ Occupation \_\_\_\_\_

Address \_\_\_\_\_

When writing to advertisers please mention Popular Mechanics

Copyrighted material



NOW FIX ANY MAKE OF

**AUTO****SIX BIG AUTO BOOKS ALL SHIPPED FREE**

on approval; whether you want to qualify as garage owner, auto repair expert or merely wish to know how to keep your own car 100% efficient, look at these books—they are sent to you for free examination. This brand

new edition has been prepared by a large group of America's greatest automotive engineers. Anybody who can read will understand them, for this great automobile encyclopedia is a veritable gold mine of valuable facts. Take advantage of this offer now; send in the coupon for FREE examination. You don't pay us a penny, you don't obligate yourself to pay anything unless you decide to keep the books. Just tell us you want to see them and the full set of 6 great volumes, just off the press, will be sent to you. Read them, look them over and prove to your own satisfaction that one fact alone, which you will find in them, may save you an expensive repair, or help you to a better job.

**Aviation Motors  
Free Wheeling  
Synchro-Mesh  
Outboard Motors  
Motorcycles  
Tractors  
All Fully Covered**

**Brand New 1932 Edition**

Imagine books which are so new that every page is right up to date—wiring diagrams, construction details, service problems—are all right up to the minute. Nowhere else can you get as complete and up-to-date information. Over a million dollars of resources have enabled us to give you the most authoritative books on the subject ever published. Everybody interested in automobiles in any way will welcome these books published by the world's largest publishers of Technical Cyclopedias (est. 1897) with agencies all over the world.

**CAN YOU FIX IT?**

Can you take out "play" in differential? Can you kill the "shimmy" in steering? Can you reset TIMING? Can you put your finger on engine trouble without guessing or tinkering? Can you pull the starter off and fix it? Can you adjust and repair transmission, engine, rear axle, bearings?

**These Books Tell How**

and tell you how to do any and every auto job right, the first time.

**6 Big Volumes**

Nearly 2,000 pages, over 2,000 illustrations, wiring diagrams, equipment charts, etc. Six Luxe edition with gold-stamped flexible binding. Sent FREE for 10 days' use. If not wanted return express collect. If kept, send only \$2.00 after 10 days, then \$3.00 a month until special advertising price, \$24.50, is paid.

**A Year's Consulting Membership FREE!**

Privilege of consulting engineers of million-dollar American Technical Society on any automotive problem for one year without charge, if you mail coupon immediately.

**SEND NO MONEY**

American Technical Society, Dept. A-419,  
Drexel Ave., at 58th St.,  
Chicago, Illinois.

I would like to see the brand new 6-volume edition of your automobile books but without any obligation to buy. I will pay the few cents delivery charges only and will examine the books and return them at your expense in 10 days unless I like them, in which case I will send you \$2.00 then and only \$3.00 per month until the special price of only \$24.50 is paid. You see to include free, consulting membership certificate in the American Technical Society. Send brand new 1932 edition.

Name.....

Street.....

City..... State.....

Employer's Name.....

Employer's Address.....

The coupon must be filled out in full. If not employed write us a letter explaining your work.

When writing to advertisers please mention Popular Mechanics

**LEARN AVIATION** —at Lincoln

Where "Lindy" Learned!

Qualify for a high-paying Pilot's position. Learn at Lincoln. Seasoned, government-licensed instructors teach you to fly all types of planes. You learn everything necessary to qualify for Private, Limited Commercial or Transport Pilot's Dept. of Commerce License. Complete mechanics' course, including aerial radio, given with each pilot's course, without extra charge.

GOVERNMENT APPROVED AS PRIVATE, LIMITED COMMERCIAL AND TRANSPORT; BOTH GROUND AND FLYING SCHOOL. \$250,000 worth of buildings and equipment. \$100,000 airport; with all-weather runways, lighted for night flying. Connected with large plane factory—Mechanic students get practical training. Also Aerial Radio and Welding Courses. REASONABLE TUITION. Part time employment to help pay room and board.

Lincoln is World's Best Known Aviation School. Graduates get best jobs. Write for details today, stating age and present occupation.

**LINCOLN AIRPLANE & FLYING SCHOOL**  
209A AIRCRAFT BLDG. LINCOLN, NEBR.

**OPPORTUNITIES IN TRAFFIC MANAGEMENT**

Conditions point to an unusual demand for trained traffic men, by transportation companies and industrial organizations. Men with scientific traffic training effect big savings for their firms—command big salaries.

**Three Detroit Firms Pay Their Traffic Managers Over \$20,000 a Year**

Prepare at home in your spare time, under supervision of traffic experts. Low cost; easy terms. "I would not take \$50,000 for my knowledge of traffic management," writes H. E. Stiffler, Traffic Manager, Marion Steam Shovel Co., Marion, Ohio. Send now for 64-page book—

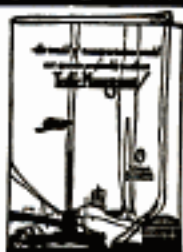

**FREE!**  
**LaSalle Extension University, Dept. 464-T Chicago**

**13 TRUE DETECTIVE STORIES**

**FREE** to those signifying their interest to become **FINGER PRINT EXPERTS**

IF—you would like to become a **Finger Print Expert** and **Secret Service Operator**—tell us and we will show you how you can now train for this time-honored profession, at home, in your spare time at very low cost with easy terms. We will also send you 13 true detective stories—free! Real secret service operators' stories, giving you "inside dope." Write TODAY. Nothing sent to boys under 17 years.

**INSTITUTE OF APPLIED SCIENCE**  
1920 Sunnyside Ave., Dept. 93-54, Chicago, Illinois

**FREE CATALOG OF PRACTICAL BOOKS...**

Complete description of Drake books, covering RADIO, AVIATION, ENGINEERING, AUTOMOBILE WORK, BATTERY WORK, ELECTRICITY, BUILDING, SHEET METAL WORK, PAINTING, SIGN MAKING, LETTERING, COMMERCIAL ART, will be sent to you on request.

**Frederick J. Drake & Co.**  
181 N. Michigan Blvd. Chicago

**Minstrels**

Unique First Parts for complete show with special songs and choruses. Make-up. Catalog Free.

**T. S. Denison & Co., 623 S. Wabash, Dept. 19 Chicago**

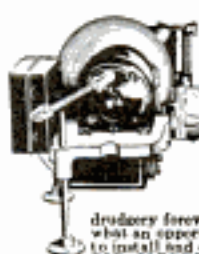
**OIL HEAT**

**AT AMAZING LOW COST**

**Dealers Wanted**

Now! New Models, World's Lowest Priced, Compact to Operate. Pressure Type Oil Burner. Quiet. Automatic. Ends Fuel Waste. Fits all heating plants. Ends furnace draught forever. Beautifully finished. **DEALERS WANTED QUICK.** Think what an opportunity for dealers. Sells instant because lowest priced, cheapest to install and operate. Liberal discounts. Exclusive territories. Opening for **BIG JOBBERS.** Make up to \$30,000 annually. Listed as Standard by Underwriters. Write for **SPECIAL OFFER** and complete Leco Line. Oil heat as cheap as \$12.50.  
**LACO OIL BURNER CO., 145 Union St., Griswold, Iowa, U. S. A.**



# I Will Show You Too

## How to Start a Spare Time or Full Time

# Radio Business of Your Own

# Without Capital



J. E. SMITH, President  
National Radio Institute

The man who has directed the Home-Study Training of more men for the Radio Industry than any other man in America.

Here are a few examples of the kind of money I train "my boys" to make

### Started with \$5. Now has Own Business



"Can't tell you the feeling of independence N. R. I. has given me. I started in Radio with \$5, purchased a few necessary tools, circulated the business cards you gave me and business picked up to the point where my spare-time earnings were my largest income. Now I am in business for myself. I have made a very profitable living in work that is play."—Howard Houston, Route No. 2, Box 454E, Tucson, Ariz.

### Made \$700 in 5 Months Spare Time

"Although I have had little time to devote to Radio, my spare-time earnings for five months after graduation were approximately \$700 on Radio sales, service and repairs. I owe this extra money to your help and interest. Thanks for the interest shown me during the time I studied and since graduation."—Charles W. Linsay, 537 Elati St., Denver, Colo.



### \$7396 Business in two and one-half Months

"I have opened an exclusive Radio sales and repair shop. My receipts for September were \$2,332.16; for October, \$2,887.77, and for the first half of November, \$2,176.32. My gross receipts for the two and one-half months I have been in business have been \$7,396.25. If I can net about 20 per cent this will mean a profit of about \$1,500 to me."—John F. Kirk, 1514 No. Main St., Spencer, Iowa.

My Free book gives you many more letters of N. R. I. men who made good in spare time or full time businesses of their own

The world-wide use of receiving sets for home entertainment and the need for well-trained men to sell, install and service them have opened hundreds of splendid chances for spare-time and full-time businesses. Automobile radio, short wave, and television will open hundreds more in the future. "Rich Rewards in Radio" gives detailed information on these opportunities. It's FREE.

### Many N. R. I Men Have Made \$200 to \$1,000 in Spare Time While Learning

Many of the more than sixteen million sets now in use are only 25% to 40% efficient. The day you enroll I will show you how to do 28 jobs common in most every neighborhood for extra money in your spare time. I will show you the plans and ideas that have made up to \$1,000 for others while taking my course. G. W. Page, 2210 Eighth Ave., S., Nashville, Tenn., writes: "I made \$935 in my spare time while taking your course."

### Get Ready Now For Jobs Like These

Broadcasting stations use engineers, operators, station managers, and pay up to \$5,000 a year. Radio manufacturers use testers, inspectors, foremen, engineers, service men, and buyers for jobs paying up to \$6,000 a year. Shipping companies use hundreds of operators, give them world-wide travel with board free and good pay besides. Radio dealers and jobbers continually need good service men, salesmen, buyers, managers, and pay up to \$100 a week. Talking Movies pay as much as \$75 to \$200 a week to the right men with Radio training. My book tells you of opportunities in Television, Aircraft Radio and other fields.

### I will train you at home in your spare time

Hold your job until you're ready for another. Give me only part of your spare time. You do not have to have a high school or college education. Hundreds have won bigger success. J. A. Vaughn jumped from \$35 to \$100 a week. E. E. Winborne seldom makes under \$100 a week now. The National Radio Institute is the Pioneer and World's Largest organization devoted exclusively to training men and young men by correspondence for good jobs in the Radio industry.

### You Must Be Satisfied

I will give you an agreement to refund every penny of your money if you are not satisfied with my Lessons and Instruction Service when you complete my course. And I'll not only give you thorough training in Radio principles, practical experience in building and servicing sets, but also Advanced Training in any one of five leading branches of Radio opportunities.

### 64-page Book gives the Facts

Clip and mail the coupon now for "Rich Rewards in Radio." It tells of the opportunities for a spare-time or full-time Radio business of your own; also of the many fine jobs for which my course trains you.

J. E. SMITH, Pres.  
Dept. 2DP  
National Radio  
Institute  
Washington,  
D. C.

Get my new book It points out what Radio Offers You



## Special Free Offer

Service Manual on Trouble Shooting in Radio Sets Sent Free

Act now and receive in addition to my big free book "Rich Rewards in Radio," this Service Manual on D.C., A.C., and Battery operated sets. Only my students could have this book in the past. Now readers of this magazine who mail the coupon will receive it free. Overcoming hum, noises of all kinds, fading signals, broad tuning, howls and oscillations, poor distance reception, distorted or muffled signals, poor Audio and Radio Frequency amplification and other vital information is contained in it. Get a free copy by mailing the coupon at right.

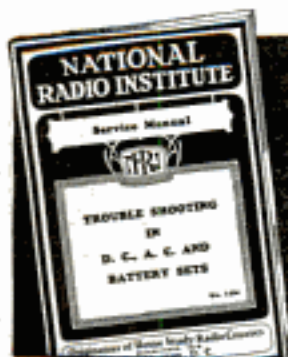

THIS COUPON IS GOOD FOR ONE FREE COPY OF MY NEW BOOK

mail it TODAY

J. E. SMITH, President  
National Radio Institute, Dept. 2DP  
Washington, D. C.

I want to take advantage of your special free offer. Send me your two books "Rich Rewards in Radio" and "Trouble Shooting in D.C., A.C., and Battery Sets." I understand this request does not obligate me and that no salesman will call.

NAME.....

ADDRESS.....

CITY.....STATE....."M"

Get the facts on my Lifetime Employment Service to all Graduates

When writing to advertisers please mention Popular Mechanics



# DON'T BE AN



# OFFICE OSTRICH

BECAUSE you won't face facts does not change the facts! And furthermore, you will have to face them sooner or later. You can "kid" yourself, wear good luck charms and hope everything will come out all right—it doesn't matter which ostrich turn you take, fate is still a self-made fact!

In his heart of hearts, the office ostrich knows everything is not all right. He is worried about his job. He doesn't see any promotion ahead. He wonders what the boss thinks of him. He needs more money. But—

Mr. Office Ostrich needs more training! If he'll face the facts for a moment, he will admit this is true.

Thousands of men, in all professions and trades, have faced the facts—and solved their problems by spare-time study of International Correspondence Schools' Courses. They have acquired the training which made it possible for them to progress and earn more money. So can you! The coupon will bring you complete information.

## INTERNATIONAL CORRESPONDENCE SCHOOLS

Box 5594-G, Scranton, Penna. "The Universal University"

Without cost or obligation, please send me a copy of your booklet, "Who Wins and Why," and full particulars about the subject before which I have marked X:

### TECHNICAL AND INDUSTRIAL COURSES

- |  |  |
|--|--|
| <input type="checkbox"/> Architect   | <input type="checkbox"/> Automobile Mechanic                                 |
| <input type="checkbox"/> Architectural Draftsman                             | <input type="checkbox"/> Plumbing <input type="checkbox"/> Steam Fitting     |
| <input type="checkbox"/> Building Estimating                                 | <input type="checkbox"/> Heating <input type="checkbox"/> Ventilation        |
| <input type="checkbox"/> Wood Millworking                                    | <input type="checkbox"/> Sheet Metal Worker                                  |
| <input type="checkbox"/> Contractor and Builder                              | <input type="checkbox"/> Steam Engineer                                      |
| <input type="checkbox"/> Structural Draftsman                                | <input type="checkbox"/> Steam Electric Engineer                             |
| <input type="checkbox"/> Structural Engineer                                 | <input type="checkbox"/> Civil Engineer                                      |
| <input type="checkbox"/> Electric Wiring                                     | <input type="checkbox"/> Surveying and Mapping                               |
| <input type="checkbox"/> Electrical Engineer                                 | <input type="checkbox"/> Refrigeration                                       |
| <input type="checkbox"/> Electric Lighting                                   | <input type="checkbox"/> R. R. Locomotives                                   |
| <input type="checkbox"/> Welding, Electric and Gas                           | <input type="checkbox"/> R. R. Section Foreman                               |
| <input type="checkbox"/> Reading Shop Blueprints                             | <input type="checkbox"/> R. R. Bridge and Building Foreman                   |
| <input type="checkbox"/> Telegraph Engineer                                  | <input type="checkbox"/> Air Brakes <input type="checkbox"/> Train Operation |
| <input type="checkbox"/> Telephone Work                                      | <input type="checkbox"/> Highway Engineering                                 |
| <input type="checkbox"/> Mechanical Engineer                                 | <input type="checkbox"/> Chemistry <input type="checkbox"/> Pharmacy         |
| <input type="checkbox"/> Mechanical Draftsman                                | <input type="checkbox"/> Coal Mining Engineer                                |
| <input type="checkbox"/> Machinist <input type="checkbox"/> Toolmaker        | <input type="checkbox"/> Navigation <input type="checkbox"/> Boilermaker     |
| <input type="checkbox"/> Patternmaker  | <input type="checkbox"/> Textile Overseer or Supt.                           |
| <input type="checkbox"/> Pipefitter <input type="checkbox"/> Tinsmith        | <input type="checkbox"/> Cotton Manufacturing                                |
| <input type="checkbox"/> Bridge Engineer                                     | <input type="checkbox"/> Woolen Manufacturing                                |
| <input type="checkbox"/> Bridge and Building Foreman                         | <input type="checkbox"/> Agriculture <input type="checkbox"/> Fruit Growing  |
| <input type="checkbox"/> Gas Engines <input type="checkbox"/> Diesel Engines | <input type="checkbox"/> Poultry Farming <input type="checkbox"/> Radio      |
| <input type="checkbox"/> Aviation Engines                                    | <input type="checkbox"/> Marine Engineer                                     |

### BUSINESS TRAINING COURSES

- |   |  |
|---|--|
| <input type="checkbox"/> Business Management                                  | <input type="checkbox"/> Business Correspondence                             |
| <input type="checkbox"/> Office Management                                    | <input type="checkbox"/> Lettering Show Cards <input type="checkbox"/> Signs |
| <input type="checkbox"/> Industrial Management                                | <input type="checkbox"/> Stenography and Typing                              |
| <input type="checkbox"/> Personnel Management                                 | <input type="checkbox"/> Complete Commercial                                 |
| <input type="checkbox"/> Traffic Management                                   | <input type="checkbox"/> Civil Service <input type="checkbox"/> Mail Carrier |
| <input type="checkbox"/> Accountancy <input type="checkbox"/> Cost Accountant | <input type="checkbox"/> Railway Mail Clerk                                  |
| <input type="checkbox"/> C. P. Accountant                                     | <input type="checkbox"/> Grade School Subjects                               |
| <input type="checkbox"/> Bookkeeping  | <input type="checkbox"/> High School Subjects                                |
| <input type="checkbox"/> Secretarial Work                                     | <input type="checkbox"/> College Preparatory                                 |
| <input type="checkbox"/> Spanish <input type="checkbox"/> French              | <input type="checkbox"/> Illustrating <input type="checkbox"/> Cartooning    |
| <input type="checkbox"/> Salesmanship <input type="checkbox"/> Advertising    | <input type="checkbox"/> Lumber Dealer                                       |

Name.....Age.....

Address.....

City.....State.....

Occupation.....

If you reside in Canada, send this coupon to the International Correspondence Schools Canadian, Limited, Montreal, Canada

## New York Electrical School

teaches PRACTICAL ELECTRICITY by its own distinctive method of

## "Learn by Doing"

No previous preparation or electrical knowledge is necessary. Every step is guided by expert instructors. Individual attention.

### SPECIAL COURSES IN AUTO MECHANICS AND AUTO ELECTRICITY

Day and evening classes open all year. Start any day.

Write for FREE School Booklet. Visitors Welcome

New York Electrical School  
Established 1902 44 West 17th St., N. Y.



## TRICKS WITH ELECTRICITY

Make electric lights obey voice; make things spin, jump, kick, run, vibrate, buzz, shoot, shock, flash, mystify—all by electricity. Make window novelties, floating rings, spirit rapping, all kinds amusing and practical devices. Book tells how to do 200 stunts with 110 volts A. C. Postpaid \$1.00.

CUTTING SONS 42-M-St. Campbell, Calif.

## Learn to Dance

You can learn all the modern dances—the latest Tango steps, the new Fox Trots, dreamy Waltzes, smart Collegiate Steps, and popular Society Steps at home, easily and quickly. New chart method makes dancing as simple as A-B-C. No music or partner required. Don't be a wallflower. Learn to dance. Complete course—265 pages, 34 illustrations, sent on 5 Days' Free Trial. Equals \$29.95 value. Send no money. Pay postman only \$1.98, plus postage upon arrival. Money back if not delighted. Catalog free.

Franklin Pub. Co., 800 No. Clark St., Dept. 9354, Chicago

Learn  
ADVERTISING  
at Home

Greater opportunities now in advertising. Learn easily and quickly in spare time. Practical work. No text books. Old established school. Low tuition—Easy terms. Send for free booklet of interesting information. Page-Davis School of Advertising Dept. 1354, 3601 Mich. Ave., Chicago

## LEARN THE JEWELRY BUSINESS WATCHWORK, JEWELRY AND ENGRAVING

Send for free catalogue  
Bradley Watchmaking School, Dept. P, Peoria, Illinois



Learn Write  
Begin Today. Write for my Free Book, "How to Become a Good Penman." It contains specimens and tells how others learned to write in spare time. Your name elegantly written on a card if you enclose stamp for postage. Write today. F. W. TADLYN, 418 Ridge Bldg., Kansas City, U. S. A.

When writing to advertisers please mention Popular Mechanics

Copyrighted material





## They Told Him Salesmen Were "Born" But Now He Makes \$10,000 a Year ...Thanks to This Little Book

It was just a little free book that made the difference between Ed Pinkham and the rest of the men in our shop. Nobody ever imagined that Ed would land, even in the \$5,000-a-year class, let alone be making \$10,000 before he was thirty. Ed didn't know himself the abilities he had in him as a money-maker.

But one day, a strange occurrence changed his whole life. During his lunch hour Ed started to read a little book he had brought to work with him.

"It's a book called 'The Key To Master Salesmanship,' Bill," he told me. "It's the most amazing thing I ever read. I never dreamed there was so much in salesmanship. You ought to send for a copy yourself. It's free."

"Huh!" said Luke Jones. "Does that book tell you how to become a salesman?"

"It sure does," replied Ed, enthusiastically.

"Don't waste your time," advised Luke. "You can't learn how to be a salesman. A fellow has to be 'born' that way to be a good salesman."

Ed just smiled at that, but he said nothing. Soon afterward he quit the shop and we forgot about him. And then last night, I met Ed again—driving a snappy new sedan and dressed like a million dollars.

"For Pete's sake," I said, "What are you doing nowadays, Ed?" He smiled. "City Salesmanager for the Steel Castings Company," he told me. "What are you doing?"

"Still at the shop," I replied. "But what I want to know is, how do you come to be salesmanager for Steel Castings? They're one of the biggest firms in the business."

Ed smiled again. "Remember that book on Salesmanship that Luke Jones was kidding me about one day? Well, when I finished my Salesmanship training the Association I took it from gave me a choice of a number of jobs through their Free Employment Department. I got a wonderful job, and I had wonderful training, so I've had a pretty successful time of it. They made me City Salesmanager three months ago at ten thousand dollars a year."

"Good night!" I said. "And Luke and I are still punching the old time clock!"

Ed looked at me seriously. "See here, Bill," he said. "Are you sport enough to risk two cents that you can do as well as I

did? Then spend the two cents to write to the National Salesmen's Training Association tonight and get their free book. Then take their course. When you are qualified, their Free Employment Department will help you get a good sales job. Not only will they help you get the job, but they agree under an iron-clad money-back penalty that you must be satisfied with the training received—or they refund your tuition!"

### FREE—TO EVERY MAN

A book—but what a book! Just seven ounces of paper and printer's ink—but it reveals facts and secrets that have led hundreds of men to success beyond their fondest expectations! See for yourself—FREE—why thousands have increased their earning capacities, after reading "The Key To Master Salesmanship." A. L. Galbraith of Detroit, Michigan, went from a bank teller's job to the position of branch manager of a large insurance company, after this book opened his eyes. You can understand how it helped A. A. Fidler of Montgomery, Alabama, to raise his pay 700%. You'll know how it made C. B. Sterling of Boldman, Kentucky, an officer and manager of his Company, raising his pay to ten times what it was. Learn for yourself the REAL TRUTH about salesmanship. You do not risk one penny or incur the slightest obligation. And since it may prove the turning point in your career it is certainly worth your while to fill out and mail the coupon below. Do it now!

### NATIONAL SALESMEN'S TRAINING ASSOCIATION,

Dept. D-104, N. S. T. A. Bldg.,  
Chicago, Ill.

## Now Sent FREE



National Salesmen's Training Association,  
Dept. D-104, N. S. T. A. Bldg., Chicago, Ill.

Without cost or obligation please send me my free copy of "The Key To Master Salesmanship," including details of your FREE EMPLOYMENT Service.

Name.....  
Address.....  
City..... State.....  
Age..... Occupation.....

When writing to advertisers please mention Popular Mechanics



# COLUMBIA UNIVERSITY HOME STUDY COURSES



## You Can Choose If You Will

**C**HANCE governs the general trend of too many lives. By chance many people live in a certain place, attend a certain school, take the opportune job; they chance upon certain associates, books, and thoughts. . . . But by courage and determined effort they could choose oftentimes where to live, what to study and, to a large extent, what to accomplish. . . . Hundreds of thousands of ambitious people are studying at home in their leisure time. Increased earning capacity is the objective that many are attaining. But whether the attainment be greater efficiency in business, or a more interesting social life, or the real joy of developing a more cultured point of view, the studies that lead to these objectives are available, wherever one lives, through Columbia Home Study Courses. The range of subjects is wide. . . . A bulletin showing complete list of home study courses will be sent upon request.

### PARTIAL LIST OF HOME STUDY COURSES

ACCOUNTING	INVESTMENTS
AGRICULTURE	ITALIAN
AMERICAN GOVERNMENT	JUVENILE STORY
APPLIED GRAMMAR	LATIN [WRITING]
BANKING	LIBRARY SERVICE
BUSINESS ADMINISTRATION	LITERATURE
BUSINESS ENGLISH [TION]	MACHINE DESIGN
BUSINESS LAW	MAGAZINE ARTICLE
BUSINESS ORGANIZATION	WRITING
BUSINESS PSYCHOLOGY	MARKETING
CHEMISTRY	MATHEMATICS
CHILD PSYCHOLOGY	MUSIC—HARMONY
CLASSICS	PERSONNEL ADMINISTRATION
CONTEMPORARY NOVEL	PHILOSOPHY [TION]
CORPORATION FINANCE	PHYSICS
DRAFTING	PLAYWRITING
ECONOMICS	POETRY
ENGLISH COMPOSITION	PSYCHOLOGY
ENGLISH LITERATURE	PUBLIC HEALTH
ESSAY WRITING	PUBLIC SPEAKING
FIRE INSURANCE	REAL ESTATE
FOREMANSHIP	RELIGION
FRENCH	SECRETARIAL STUDIES
GEOMETRY	SELLING
GERMAN	SHORT STORY WRITING
GRAMMAR	SOCIOLOGY
GREEK	SPANISH
HIGH SCHOOL COURSES	STENOGRAPHY
HISTORY	TYPEWRITING
INTERIOR DECORATION	WORLD LITERATURE, ETC.

(Pop. Mco. 4-32)

COLUMBIA UNIVERSITY, Home Study Department, 15 Amsterdam Avenue, New York, N. Y. Please send me full information about Columbia University Home Study Courses. I am interested in the following subjects:

Name..... Occupation.....

Street and Number.....

City and County..... State.....

When writing please mention Popular Mechanics

## Play BANJO Guitar-Mandolin

this  
**FREE BOOK**

shows the way to Popularity,  
Pleasure, Increased Income.  
Send for your copy now.

**Gibson Inc.**

403 Parsons Street, KALAMAZOO, MICH.



## FREE HELPFUL CATALOGUE OF AVIATION RADIO ELECTRICITY AUTO BOOKS

Send your name for free catalogue of famous "Willcox" **PAV** RAISING books for home use. Practical help for good pay jobs in four live fields. Used by hundreds of s-books. Up-to-date. Authoritative. Simplified and practical. **WRITE NOW.**

Goodheart-Willcox Co., Inc., Dept. 14, 2009 Michigan Ave., Chicago

## Don't Envy The Plumber—BE ONE!

**\$11.00—\$16.00 PER DAY** and work **EVERY** day, in the Plumber's wage.

**LEARN IN 8 to 12 WEEKS** without previous experience.

If you are making less than \$50.00 a week, you owe it to yourself to investigate. Get **FREE** catalog that tells in pictures and words how we teach this trade. Special rates now.

**UNIVERSAL PLUMBING SCHOOL, 2030 Trent Avenue, KANSAS CITY, MO.**

Be a  
**Civil  
Engineer!**

Learn  
at  
Home!



### Cyclopedia of Civil Engineering

7 great volumes,  
2800 pages,  
1600 illustrations.  
New edition just  
off the press, by  
twelve of America's  
greatest engineers.  
Includes: Surveying,  
bridges, railroads,  
steel structures,  
municipal engineering,  
water supply,  
road building, etc.

Spanish Grain Flexible  
Covers Gold Stamped

## Loaned Free!

To prove you can learn Civil Engineering at home in your spare time. And because no description here could do it justice, to let you see for yourself the scope and simplicity, the authority and quality of this great home reading course. Cost and terms are within your reach. Send no money—just mail the coupon.

Earn  
**\$5000**

a Year—and Up!

"CIVIL ENGINEERING" — in plain English written so you can understand it, even if you have only a limited education. Prepares you for a well-paid railroad structural or public works position. Covers every branch of Civil Engineering practice. An easy reading course for the ambitious student and an authoritative reference work for the experienced engineer. Borrow a set—free. Look over the text questions which help you master each subject quickly. Mail the coupon without obligation today!

**American Technical Society**  
Dept. C-419, Drexel at 58th, Chicago

American Technical Society,  
Drexel at 58th,  
Dept. C-419, Chicago

I want to BORROW the CIVIL ENGINEERING Cyclopedia for 10 days FREE. I will gladly pay the few cents express, but I won't pay nothing for the loan of the 7 big volumes if I return them within 10 days. If I wish to keep them I will send you \$2 after the 10 days, then \$3 a month until special advertising price \$29.50 is paid. Send New Edition.

Name.....

Address.....  
(Attach letter stating age, occupation,  
employer's name and address)



# LEARN RADIO BY PRACTICAL SHOP WORK IN LOS ANGELES

Come to National in sunny California and learn all branches of Radio in 4 happy months—Service Work, Broadcasting, Television, Talking Pictures and Code Practice. No correspondence! All practical shop work in the oldest and largest Trade School of the West. Prepare now for the good jobs constantly opening up in the great Radio, Television and Talking Picture Fields!

## RAILROAD FARE ALLOWED

Don't worry about the expense of trip. For a limited time we are making a Special Free Railroad Offer to Los Angeles. This is deducted from your tuition, so the trip costs you nothing extra. Take advantage of



This student is getting actual experience before the "mike" in our own sound proof Studio Room.

this opportunity to visit Los Angeles and Hollywood and prepare for a good job at the same time!

# TELEVISION AND TALKING PICTURES

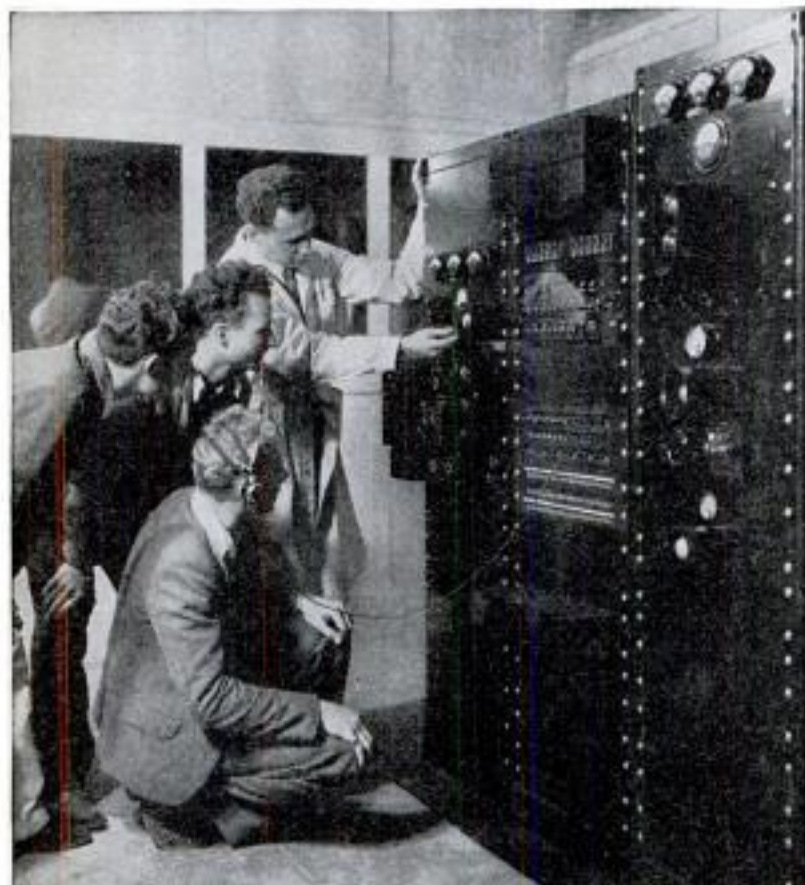

Here the Instructor is explaining the Input equipment of our 50-watt, crystal-controlled, Broadcasting Transmitter.

Eight stations are already sending out regular Television programs! 10,000 Theaters are equipped for sound and yet the job is only half done. 600 Broadcasting Stations are employing trained Operators and Mechanics. 10,000,000 radio sets must be constantly serviced and repaired. New jobs are always opening up—scores of golden opportunities for the Trained Man!

## FREE EMPLOYMENT SERVICE Spare Time Jobs While at School

If you are short of money, we will gladly help you get part-time work while at school, to pay your room and board. Fully 70 percent of our students pay their living expenses that way. Then when you graduate we'll render you every assistance in getting just the job you want. National has been training fellows like you for 27 years. Let National train you for an interesting, good-paying Radio Job! Mail the coupon below for full details and a Free Copy of our big Television, Talking Picture and Radio Book. No cost or obligation. Just mail the coupon!

## NATIONAL TELEVISION, TALKING PICTURE and RADIO SCHOOL 4006 So. Figueroa St., Dept. 44 E Los Angeles

National Television, Talking Picture  
and Radio School,  
Dept. 44 E 4006 So. Figueroa St.,  
Los Angeles, Calif.

Please send me your big new Free Book on  
Television, Talking Pictures and Radio, and  
full details of your Free Railroad Fare offer.

Name.....  
Street No.....  
City..... State.....





SENT  
FREE—  
Ask for  
it NOW!

## THIS NEW BOOK

shows how AMERICA'S

UNIVERSITY OF THE AIR trains you for

## AVIATION SUCCESS

**R**EAD "Skyward Ho!" if you're looking toward a future in aviation. See the world's largest commercial aviation school vividly pictured and described—learn how Parks Air College training has helped hundreds of graduates to succeed—and can do the same for you.

This new 1933 edition of "Skyward Ho!" completely explains every angle of modern aviation instruction. It fully covers

Transport Pilot's Courses.  
Executive Training for Aviation as a business.  
Limited Commercial Course.  
Mechanics and Master Mechanics Courses.  
Ground School Courses

and many other features. It shows how the Parks system of grading rates each graduate at his true value to aviation—and why the industry accepts Parks men on that rating.

Many Parks graduates are already in responsible, highly-paid executive positions—many others will reach success in the next year or two. Will you be one of them? If you've got the determination to win through honest, sincere effort, Parks Air College can give you the start you need. And "Skyward Ho!" tells you, shows you, how. Ask for your free copy today!

MAIL THIS COUPON AT ONCE  
FOR THE NEW "SKYWARD HO!"

### PARKS AIR COLLEGE

WORLD'S LARGEST COMMERCIAL FLYING SCHOOL

Section  
4-P.M.

East St. Louis, Ill.

Send me the 1933 "Skyward Ho!" I am.....  
years old, and am interested in

- Transport Pilot's Training.  
 Master Mechanic's Training.

Name .....

Address .....

City ..... State .....

## A NEW WAY TO MAKE MONEY IN YOUR FULL or SPARE TIME at HOME

Learn how to make beautiful one-piece Cement Fireplaces in any color, effect or design at a cost for materials of less than four dollars!

Learn how to make both plaster and cement molds.

Learn how to reproduce in colored cement pictures, designs, scrolls, coat-of-arms, etc., from your own molds.

Learn how to reproduce in colored cement the effect of marble, brick, granite, tile, Travertine, Terrazzo, etc. How to make colored cement garden benches, portable garage blocks, etc. How to do all of the above without the use of any machinery whatever!

The time to act is NOW—Write for details of personal instruction or home study courses and easy payment plan.

ORNAMENTAL CONCRETE INSTITUTE

Dept. B 246 Fifth Avenue New York City

**Anyone CAN LEARN**

No talent or experience necessary. Fascinating work. Pays big money. Complete instruction book tells about: Alphabets, Colors, House Fir Paints, Show Cards, Window Board and Wall Signs, Handy Trade Letters, Gilding, Tricks of the Trade, also gives 100 Alphabets and Designs. Book bound in flexible imitation leather-gold edges, and four ball-bearing Show Card Press. Sent postpaid \$3.00. (C.O.D.) 10c extra. Ogilvie Pub. Co., 57 Base St., Dept. 20, N. Y. City

**EARN MONEY IMMEDIATELY—  
WE FURNISH EQUIPMENT TO START!!**

## Radio Noises and Their Cure

62 ARTICLES—200 ILLUSTRATIONS—Send 50c for your copy today (75c for Canada and foreign countries.)

Newark Electric Co., 230 W. Madison St., Chicago, Ill.

**"BECOME A LIGHTNING TRICK CARTOONIST"**

Send \$1.00 for Laugh Producing Program of 28 Trick Drawings with Instructions. Catalog of Chalk Talk Supplies Free. BALDA ART SERVICE, Dept. 1, Oshkosh, Wis.

**High School Course in 2 Years**

This simplified, complete High School Course, specially prepared for home study by leading professors, meets all requirements for entrance to college, business, and leading professions.

**20 Other Courses** Over 200 noted Engineers, Business Men, and Educators helped prepare the special instruction which you need for success. No matter what your inclinations may be, you can't hope to succeed without specialized training. Let us give you the practical training you need.

**American School**  
Drexel Ave. and 58th St.  
Dept. H-447, Chicago

### Money Back When You Finish If Not Satisfied

American School, Dept. H-447, Drexel Ave. and 58th St., Chicago

Send me full information on the subject checked and how you will help me win success in that line.

- |                          |                           |
|--------------------------|---------------------------|
| .....Architect           | .....Electrical Engineer  |
| .....Building Contractor | .....General Education    |
| .....Automobile Engineer | .....Lawyer               |
| .....Civil Engineer      | .....Mach. Shop Practice  |
| .....Structural Engineer | .....Mechanical Engineer  |
| .....Business Manager    | .....Steam Engineer       |
| .....C. P. A. & Auditor  | .....Draftsman & Designer |
| .....Bookkeeper          | .....High School Graduate |

Name.....Age.....

St. and No.....

Town.....State.....

When writing to advertisers please mention Popular Mechanics



# EASY AS A GAME

to learn to play  
any instrument  
in a few months this  
delightful new ABC way

**I**F you can hum a tune, you can now quickly learn to play your favorite instrument! That's actually true. A delightful new method makes it positively *easy* to become a capable performer within just a few *months*. And the cost is only a *fraction* of what people used to spend on the old, slow methods!

You don't need a private teacher, this new way. You study entirely at home, in the privacy of your own room, with no one to interrupt or embarrass you. Practice a lot or a little, as you like—according to your desire to get ahead and *enjoy every minute of it!* For, strange as it may seem, the new method is *agreeable* as well as *rapid!*

## You Needn't Know a Thing About Music to Take This Pleasant, Rapid Course

Even if you don't know one note from another now, you can easily grasp each clear, inspiring lesson of this surprising course. The things you must know are presented in such a concise, graphic way, that even a child can understand them. The lessons are delightfully *human*. You *like* them. You get ahead fast because everything you have to do is so *reasonable* and so *pleasant*. Even scale practice, the old bugaboo, is reduced to a minimum and made interesting! Almost before you know it, you're playing many of your favorite pieces.

## No Tricks or Stunts—You Learn from "Regular Music"

Yes, the new way teaches you to play from notes, just like the best musicians do. There are no trick "numbers," no "memory stunts." When you finish the U. S. School of Music course you can pick up any piece of regular printed music and *understand* it! Think what that means. You'll be able to *read* music, popular and classic, and *play it from the notes*. You'll acquire a life-long ability to please your

friends, amuse yourself, and, if you like, make money (musicians are highly paid for their pleasant work).

## The Surest Way to Be Popular and Have a Good Time

Are you out of things because you can't play? Many, many people are! It's the person who can play who claims attention. If you play, you are *always* in demand. Many invitations come to you. Amateur orchestras offer you wonderful afternoons and evenings. And you meet the kind of people you have always wanted to know.

Never before have you had such a chance as this to become a musician—a really good player of your chosen instrument—without the drudgery and expense that were such drawbacks before. At last, you can start right in and get *somewhere* quickly, cheaply, thoroughly.

## How You Learn Any Instrument So Easily This Way

The amazing success of students who take the U. S. School course is largely due to a newly perfected method that makes

reading and playing music almost as simple as reading aloud from a book. You simply can't go wrong. First you are *told* how a thing is done, then a picture shows you how, then you do it yourself and *hear* it. No private teacher could make it any clearer.

Whether you take up piano, violin, guitar, tenor banjo, accordion, saxophone, or *any other* instrument you find that every single thing you need to know is explained in detail. And

the explanation is always *practical*. Little theory—plenty of *accomplishment*. That is why students of this course get *ahead twice as fast—three times as fast*—as those who study old-time plodding methods!

## Send Now for the Free Book and Demonstration Lesson

The whole interesting story about the U. S. School course can not be told on this page. So a booklet has been printed—"How You Can Master Music in Your Own Home." You can have a copy *free* for the trouble of filling out the coupon below—and you will find an offer that makes the U. S. course available to you at a *very low price*. With it will be sent a Free Demonstration Lesson which shows better than words how delightfully quick and easy this newly perfected method is. This booklet will also tell you all about the amazing new *Automatic Finger Control*. If you are really anxious to become a good player on your favorite instrument, mail the coupon now—today. Instruments supplied when needed, cash or credit. U. S. School of Music, 74 Brunswick Bldg., New York City.

Thirty-fourth Year (Established 1898)

U. S. SCHOOL OF MUSIC,  
74 Brunswick Bldg., New York City, N. Y.

Please send me your free book, "How You Can Master Music in Your Own Home," with inspiring message by Dr. Frank Crane, Free Demonstration Lesson and particulars of your easy payment plan. I am interested in the following course:

Have You  
..... Instrument.....  
Name.....  
Address.....  
City.....State.....

### Pick Your Instrument

Piano	Violin
Organ	Clarinet
Ukulele	Flute
Cornet	Saxophone
Trombone	Harp
Piccolo	Mandolin
Guitar	Cello
Hawaiian Steel Guitar	
Sight Singing	
Piano Accordion	
Voice and Speech Culture	
Italian and German	
Accordion	
Harmony and Composition	
Drums and Traps	
Automatic Finger Control	
Banjo (Plectrum,	
5-String or Tenor)	
Juniors' Piano Course	







## There's Quicker, Bigger MONEY for YOU—in POULTRY

**Earn \$2,000 to \$5,000 a Year or Have a Business of Your Own!**

Whether you want a job at good pay or a highly profitable business of your own—the Poultry Industry offers you more than any other. There's a shortage of poultry meat and eggs — a shortage of trained poultrymen. I'll train you quickly at home—to fill a good job in Poultry—and our FREE Students' Employment Dept. will help you get one!

### Spare Time or Full Time YOU Can Cash—in Big

No matter where you live—city, town or country—or what you do now, my proved methods will assure your success right from the start. I'll help you make from \$2,000 to \$5,000 a year and UP! And, if you choose to start your own business, I'll show you how to make your tiny investment multiply itself automatically. What I've done for thousands of others—I can do for you.

### FREE Book Shows Way to Big Pay and BIG Profits

Mail coupon below TODAY—for my Big NEW FREE Book, "How to Raise Poultry for Profit." My forty years of experience are yours. The Poultry Industry needs YOU. You need my book. Get it—and get in line for the BIG Money that's waiting for you in POULTRY.

## Mail NOW for FREE Book

NATIONAL POULTRY INSTITUTE, Dept. 411-H  
Washington, D. C., Att'n: Harry M. Lamon, Pres.

Dear Mr. Lamon: Send me your FREE Book, "How to Raise Poultry for Profit." I want to know more about my opportunity to make \$2,000 to \$5,000 a year, spare or full time.

Name .....

Address .....

## Jobs for Auto-Mechanics Open Here's Why

1931 shows repairs on autos were 25% MORE than previous year, proving old cars are being fixed up and run; and gasoline consumption shows increase of 20%, proving there's MORE USE OF CARS, MORE WEAR AND TEAR. What a BIG CHANCE FOR AUTO REPAIR MEN. I have taught 25,000 men and have now consented by popular request to Give My Personal Course of Instructions by Mail—also diagnose motor troubles and how to cure them. Let me help you.

**FREE BOOK SENT**—write for it—explains all successfully correct all speech defects.  
Chas. H. Spah, Automotive Institute, 1919 Commerce Bldg., Kansas City, Mo.

## STAMMERERS

Write for Free List of ethical schools that successfully correct all speech defects.  
STAMMERERS' GUILD  
Suite 619, 260 Tremont St., Boston, Mass.



### How to Obtain A Better Looking Nose

Improve your personal appearance. My free book tells you how I guarantee to improve the shape of your nose by remodeling the cartilage and fleshy parts, quickly, safely, and painlessly, or refund your money. The very fine, precise adjustments which only my new patented Model 25 Nose Shaper possesses, make results satisfactory and lasting. Worn night or day. Over 100,000 users. Send for free book to  
M. TRILETY, Pioneer Nose Shaping Specialist  
Dept. 288  
BINGHAMTON, N. Y.

## BASHFUL?

"Shame on you!" Are you nervous, embarrassed in company of the other sex? Stop being shy of strangers. Conquer the terrible fear of your superiors. Be cheerful and confident of your future! Your faults easily overcome as you can enjoy life to the fullest. Send 25c for this amazing book.  
RICHARD BLACKSTONE, B-474, FLATIRON BLDG., N. Y. C.

## WIN THIS BICYCLE

Oh, boy! Here's your chance to win a speedy new motorbike! Latest model, fully equipped with headlight, horn, coaster brake, and other big features. Besides, you can win a Keystone Movie Machine with standard size film, or your choice of 300 other dandy prizes. Also earn your own SPENDING MONEY.

It's easy! Join the Crowell Club and deliver three well-known magazines to regular customers in your spare time; this will not interfere with school or play. No experience necessary. Mail the coupon now—and we'll start you on the happy road to MONEY and PRIZES.



### Mail This Coupon

Mr. Jim Thayer, Dept. 256  
The Crowell Publishing Co.,  
Springfield, Ohio

Dear Jim: I want to earn MONEY and PRIZES. Start me as a salesman at once.

Name .....

Address .....

City .....

State .....

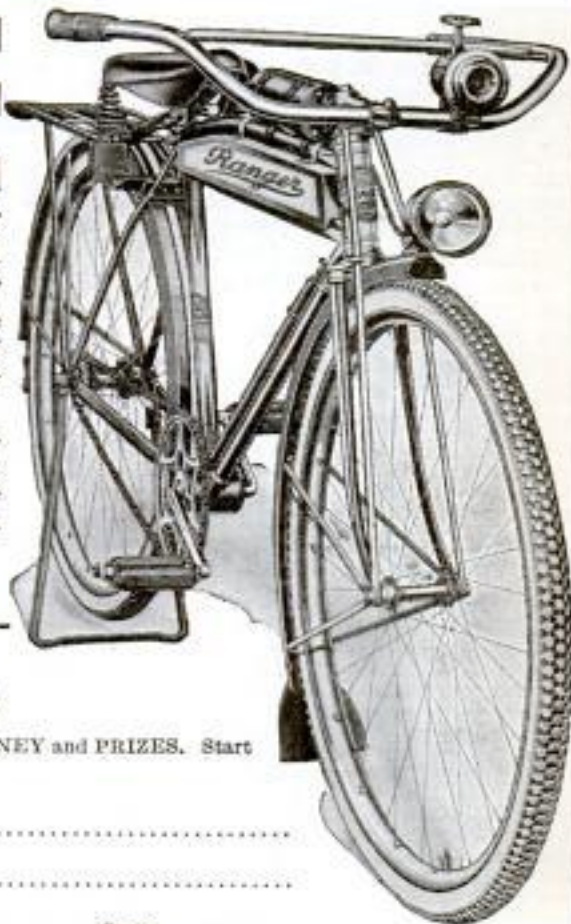





**YOU WANT TO EARN MORE MONEY — YOU WANT TO BE SURE OF STEADY EMPLOYMENT— YOU WANT TO BE CERTAIN OF YOUR FUTURE —HERE THEN IS THE OPPORTUNITY YOU HAVE WAITED FOR.**

# Start Now-Learn **RADIO** at Home

—and get into the world's fastest growing and best paying industry.

Here is a blazing message to real, red-blooded he-men.

"Broadcasting stations use engineers, operators, and maintenance men and pay \$40 to \$100 a week and up.

"Manufacturers and their jobbers and dealers employ thousands of men as engineers, foremen, inspectors, testers, service men, salesmen and managers and pay \$40 to \$150 and \$200 a week.

"Sound picture concerns and public address systems use engineers, installation and maintenance experts, etc., and pay \$40 to \$200 a week and up.

"Manufacturers of photo-electric cell equipment (Radio's electric eye) use designers, adaption engineers, installation men and salesmen at salaries ranging from \$40 to \$200 a week and up.

"Steamship companies employ hundreds of Radio operators, give world-wide travel, at salaries of \$85 to \$200 a month and all expenses.

Why, then, slave away at \$20 or \$25 or \$30 a week on a back-breaking no-future job, when Radio offers you such wonderful opportunity for good pay and early advancement?

## The Opportunity of a Lifetime

Never before in the history of American industry has such a chance been available to the average working man. And the opportunity is open to any normal, ambitious man—regardless of age, schooling or experience—to any man who is willing to spend an average of 30 minutes a day for a few months time, in learning the theory and practical application of all Radio devices, old and new. You will be taught at home, in your spare time, easily and quickly, and your training will be under the actual supervision of a group of Radio's most prominent business men and engineers. Your training will be practical, too, and right up-to-the-minute.

**TELEVISION  
TALKING PICTURES  
SOUND SYSTEM  
PHOTO CELL WORK**

## 21 Manufacturers Endorse.

This course of home-training is unqualifiedly endorsed by twenty-one of Radio's oldest, largest and most progressive manufacturers, among whom are—

Brunswick	Majestic
Crosley	Stromberg-Carlson
Fada	and
Philco	Zenith

The constant and ever-increasing demand for trained men in this field has been brought about by the almost unheard of rapid growth of Radio and its sister industries—SOUND PICTURES, PUBLIC ADDRESS SYSTEMS, PHOTO-ELECTRIC CELL EQUIPMENT and TELEVISION.

## Jobs—Exceptionally Good Pay—Big Future

Where only hundreds of men were employed a few years ago, thousands are employed today. Where a few years ago a

hundred jobs paid \$50 to \$75 a week, there are thousands of such jobs today. And there will be thousands more of such jobs for trained men in the next few years to come, because Radio is growing tremendously fast.

That's why this call for trained men.

That's why this chance for ambitious men to train at home, in their spare time, for this important work.

Badly as the Radio Industry itself needs these trained men, it has no time to train them. It is too busy with its more important problems of manufacture and distribution.

So the actual training of men for Radio's better-paying jobs has become the task of the Radio and Television Institute, of Chicago.

Men are being enrolled for this training NOW.

## Now, Then

If you are interested in bettering your position—if you want to get out of a small-pay, no-future job, into good-pay, big-future work—fill in the coupon below and send it to us at once.

There will be no obligation. And it will certainly pay you to investigate.

## FREE OPPORTUNITY BOOK COUPON

**RADIO AND TELEVISION INSTITUTE,  
Dept. 14, 2130 Lawrence Ave., Chicago.**

Please send me a copy of your Opportunity Book and full particulars of your plan for helping men into good pay positions in the Radio field.

NAME.....

ADDRESS.....

CITY.....STATE.....



**U.S. GOVERNMENT JOBS**

**\$1260 to \$3400 a Year**  
**PICK YOUR JOB**  
**Men, Boys—18 to 50**

These are steady positions. Strikes, poor business conditions, or politics will not affect them. Government employees get their pay for twelve full months every year.



**\$1900 to \$2700 a Year**  
 Railway Postal Clerks get \$1,900 the first year, being paid on the first and fifteenth of each month. \$79.17 each pay day. Their pay is quickly increased, the maximum being \$2,700 a year. \$112.50 each pay day.

Railway Postal Clerks, like all Government employees, have a yearly vacation of 15 working days (about 18 days). On runs, they usually work 3 days and have 3 days off duty or in the same proportion. During this off duty and vacation their pay continues just as though they were working. They travel on a pass when on business and see the country. When they grow old, they are retired with a pension. Many Spring examinations expected.

**City Mail Carriers, Post Office Clerks**

Clerks and Carriers now commence at \$1,700 a year and automatically increase \$100 a year to \$2,100 and \$2,300. They also have 15 days' paid vacation. City residence is unnecessary.

**Customs and Immigrant Inspector**

Salary \$2,100 to \$3,300. Men 21 to 45. Work connected with examining immigrants and merchandise entering the country from foreign ports.



**Is Your Job Steady?**

Compare these conditions with your present or your prospective position, perhaps changing positions frequently, no chance in sight for PERMANENT employment; frequently out of a position and the year's average salary very low. DO YOU GET \$1,900 EVERY YEAR? HAVE YOU ANY ASSURANCE THAT A FEW YEARS FROM NOW YOU WILL GET \$2,100 TO \$2,700 A YEAR?

**You Can Get Them**

Experience is usually unnecessary and political influence is not permitted. Let us show you how.

**Get Free List of Positions**

Fill out the following coupon. Tear it off and mail it today—now, at once.

This investment of two cents for a postage stamp may result in your getting a government job.

**FRANKLIN INSTITUTE, Dept. P 173, Rochester, N. Y.**

Rush to me entirely free of charge (1) a full description of the position checked below; (2) Free Copy of 32-page book, "How to Get a U. S. Government Job"; (3) A list of the U. S. Government Jobs now obtainable; (4) Tell me how to get a Government Job.

- Railway Postal Clerk..... (\$1,900-\$2,700)  
 Post Office Clerk..... (\$1,700-\$2,300)  
 City Mail Carrier..... (\$1,700-\$2,100)  
 Rural Mail Carrier..... (\$2,100-\$3,400)  
 Government Clerk—File Clerk..... (\$1,260-\$2,500)  
 Inspector of Customs..... (\$2,100-\$3,300)  
 Prohibition Agent..... (\$2,300-\$2,800)  
 Immigrant Inspector..... (\$2,100-\$3,000)

Name.....

Address.....

Use This Coupon Before You Mislay It

When writing please mention Popular Mechanics

**Assemble a Boat—We Furnish the Parts**



**YOU SAVE TWO-THIRDS THE COST**

We furnish complete plans and boat parts accurately machined and ready for assembly, according to the Welch system of boat building. Send 10c for catalogue showing 27 models.

**J. B. Welch, Inc.**

3142 N. 31st Street Milwaukee, Wis.

**Learn Autos At Home**

Famous 'Job-Way' method quickly makes you a modern, efficient auto expert. Get started now. Write for FREE Catalog.

**MOTOR INSTITUTE OF AMERICA**  
 Dept. 5164, Motor Institute Bldg., Evanston, Ill.

**Wireless (Radio)**

and Morse telegraphy taught thoroughly. School, oldest and largest; endorsed by Telegraph, Radio, Railway and Government officials. Unusual opportunities. Expenses low—can earn part. Catalog free.  
**DODGE INSTITUTE, Jones St., Valparaiso, Indiana.**

**LEARN WATCHMAKING**

and become independent. We help you secure a position. Easy to learn. Send for FREE CATALOG.  
**ST. LOUIS WATCHMAKING SCHOOL Dept. 5, ST. LOUIS, MO.**

**ELECTRIC LIGHTS ANYWHERE**

**Complete Lite Plant**  
 ready to run. Supplies 300 watts, 110 volt Direct current. Operates 1/2 H. P. motor, flat iron, electrical appliances.

**\$99**

Fine for Lake Cottage, Camp, Farm, Ranch or Portable Concession.—Wiring complete and ten lights \$12. Also other D. C. and A. C. models. Write D. W. ONAN & SONS 906 Royalston Ave., Minneapolis, Minn.



**DRAFTING**  
**BOOKS SENT FREE!**  
 ON APPROVAL

**For Beginners**

Written, so you can understand every word, by 22 famous engineers and architects. DeLuxe flexible binding, nearly 2,000 pages, 1546 blueprints, charts and diagrams; prepares you for a good drafting job in mechanical or architectural lines. Sent for 10 days' free use if you mail coupon immediately.



**5 Volumes Brand New Edition**

Only 15 minutes a day with these WONDER BOOKS will prepare you for a good drafting job in less than a year. Mechanical and architectural drafting from simple straight lines to important complex plans. A step at a time! Built especially for beginners, for men with only grammar schooling. Drafting room practice, PLUS ENGINEERING, made easy and clear. Includes complete course in blue-print reading.

**Big Field Big Demand Big Pay**

Competent drafters are urgently needed right now in all building and manufacturing lines at \$50.00 to \$100.00 a week. That's just the beginning—FOR DRAFTSMEN HAVE THE BEST CHANCES FOR ADVANCEMENT. Pleasant, fascinating work, easy to learn and do. Learn quickly with these books—send coupon for a set FREE and see for yourself.

A peer's convincing membership in the American Technical Society now gives free to all readers of this famous cyclopedia of drafting. Many say that it is worth more than the cost of the books.

Complete set of drawing instruments if you send for these drafting books NOW. These instruments are made of the finest of German silver, are absolutely accurate and are packed in velvet lined leatherette pocket case. Real \$10 value, but free to you with these books.

**AMERICAN TECHNICAL SOCIETY**  
 Dept. D-419, Drexel at 58th St., Chicago, Ill.

American Technical Society, Dept. D-419, Drexel at 58th St., Chicago, Ill. Send for 10 days' free use New 5 volume set of drafting. I will pay the free costs delivery charges. If I wish, I may return books in 10 days and owe you nothing but if I decide to keep them I will send \$2.00 after 10 days, then only \$3.50 a month until \$10.00, the special introductory price, is paid. Send New edition and include drawing instruments.

Name.....

Address.....

Employer's.....

Address.....



**New**

SAVASole  
PAT.  
APPL.  
FOR

**SOLES 4 1/2 CENTS**

Heels <sup>as low as</sup> 1 cent

**New Improved SAVASole Pays You \$42 a DAY**

Up to

No more costly shoe repairs. No more wearing worn-out shoes with leaky soles that are harmful to health. This amazing invention—now perfected—saves your money. It's called Savasole, a scientific, plastic, repair set that puts new soles on worn-out shoes. Makes them like new for as low as 4½ cents a sole. Rebuilds run-down heels for as low as 1 cent. New way of applying. Just take a spoonful out of the can and roll it out. Trim it to size. See picture below.

Then it cements on to the old sole and hardens overnight. You have a solid, non-skid, waterproof surface that covers all cuts, holes, cracks.

**Cash In Now On This HARD TIMES NECESSITY**

**Now! So Easy!**



Before

No muss. Just roll out the plastic Savasole to a thickness of about 1/4 inch. Trim it to the size of your sole. (See picture.)

Then apply cement to Savasole and shoe. Press together firmly and let harden overnight. Wears better than ordinary soles—and can't come off.



This sensational specialty has captured the country and is filling distributors' pockets with gold. Even in hard times it has proved a gold mine for agents! We give you quick, one-minute demonstration that amazes prospects and compels them to order. Sure repeat business. Good territory still open. Rush coupon for Free Sample on leather and new exclusive territory plan.

**AGENT Makes \$135 in a Week**

*Hundreds of Other Letters Like This*

G. C. Miller writes:

"I gave up my former connection where I ranged in earnings from \$315 to \$386 per month. I started out with three gross of Savasole. Since that time, my earnings have netted me over \$135 a week and I am sure that I will soon hit \$200 per week. Savasole has solved my financial problems, and you are the whitest bunch of people to work with I ever saw."

**It's GUARANTEED!**

Do not confuse Savasole with cheap imitations that spread on with a knife, sometimes drying rough and uneven. Savasole alone is applied in one "plastic" piece and dries thick, smooth and even. And Savasole is the only one that has the Bollman Double-Action Cement process that means Savasole **cannot** come off. It actually out-wears the uppers. My money back guarantee protects you and your customers.

**Mail for FREE SAMPLE**

R. R. Bollman, Pres.  
PERFECT MFG. CO., D-30 Daylight Bldg., Cincinnati, O.

Dear Mr. Bollman: Please send me a Free Sample of Savasole applied to miniature leather sole and tell me how I can make up to \$42 a day. I am not obligated.

Name .....

Address .....

Town ..... State .....

Territory preferred .....

THE PERFECT MFG. CO., D-30 Daylight Bldg., Cincinnati, Ohio

When writing to advertisers please mention Popular Mechanics



# FREE The Road to Understanding For Men Past 40



W. J. KIRK

**WHY** is 40 the "dread age" for many men? What is the "intimate" disorder that often robs them of vitality, vigor, joy of living? This daring free book answers these vital questions. Mail coupon for Free Copy.

**WHY** are many men past 40 suddenly afflicted with a dangerous ailment, that if neglected, may lead to wretched old age or perhaps grave surgery? The Free book answers this and other questions every man past 40 should know.

**WHY** do so many middle aged men suffer backache, leg and foot pains, sciatica, bladder trouble, night vision, chronic constipation and other so-called old-age ailments? Find the answer in the Free book.

**HOW** can one again frequently know the joy of living, get swift, lasting relief and feel 10 years younger in 7 days? Mail the coupon and learn how an amazing new drugless treatment is used and endorsed by prominent specialists.



## The Truth About Prostate Gland Trouble

Many men mistake these dangerous and distressing ailments for approaching old age and live lives of misery, when by simply re-stimulating a tiny gland—called the prostate—they might be enjoying youthful pep, vim, and health. Already 100,000 men have tested the merits of a new drugless method of gland stimulation perfected by a scientist with offices in Ohio, California and England. Now many physicians, specialists, hospitals and sanitariums use and endorse it, for prostate gland failure. It is not a medicine, drug, massage, diet, exercise or violet ray. Its relief is not only usually quick—but lasting. Many users say it cleared up their distressing symptoms and made them feel 10 years younger in 7 days. Now it will be sent to you on a guarantee that if it doesn't do the same for you, pay nothing. If you want to know the joy of living, mail the coupon for your Free copy of "The Destroyer of Male Health."

**W. J. KIRK, President**

2152 Morris Ave. STEUBENVILLE, OHIO

If you live West of the Rockies, address The Electro Thermal Co., 303 Van Nuys Building, Dept. 21-F, Los Angeles, Calif. In Canada, address The Electro Thermal Co., Desk 21-F, 53 Yonge St., Toronto, Can.

**W. J. KIRK, President**  
2152 Morris Ave., Steubenville, Ohio.

Send free copy of your daring book, "The Destroyer of Male Health." Also facts about your Free Trial.

Name.....  
Address.....  
City..... State.....

When writing to advertisers please mention Popular Mechanics

## Amazing Mystery Perfume SLAYS MOTHS!



**Pays Agents Up to '10-'15  
In a Day** Men — Women — Here's

the money making opportunity of a lifetime. A daintily colored, delicately scented tablet called PURO evaporates into gas which is positively deadly to moths but harmless to human beings. Also banishes unpleasant odors and freshens stagnant air. No fuss, no mess—no messy, expensive spraying—just hang it up and forget it. Automatic renewal feature assures steady repeat business. Amazing low price makes easy sale—4 to 12 in every house—over 150% profit per sale—agents simply coin money everywhere! Write at once for details of big money opportunity.

THE PURO CO., INC.  
Dept. D291, 3107 Pine St., St. Louis, Mo.

## DANCE WITH PROFESSIONAL SKILL



Don't be an amateur! Put professional snap into your dancing by this remarkable new scientific method—the Danceograph—complete in 10 easy lessons. Send only \$1.98 for complete course on 5 day trial—money back if not satisfied.

BALLROOM  
 TANGO  
 TAP and CLOG

Mark X for the course desired

RUMBA  
Dance  
FREE  
with  
each  
order

Danceograph Dance Art, Inc.  
555 Sutter St., San Francisco, California

## FREE Radio Handbook

Write today for your copy of the new Radio Association handbook. Shows you easy ways to make money in Radio. Tells you how our members are earning up \$3.00 an hour spare time. Write for Membership Plan which need not cost you a cent and FREE RADIO HANDBOOK.

RADIO TRAINING ASSOCIATION OF AMERICA  
Dept. PM-4 4513 Ravenswood Ave., Chicago



**BUCHSTEIN'S FIBRE LIMB**

is soothing to your stump—strong, cool, neat, light. Easy payments. Brace for all deformities. D. BUCHSTEIN CO., 650 3rd Ave., St. MINNEAPOLIS, MINN.

Send for Catalog Today

## \$60 a Week in AVIATION

Write now for FREE Book that gives all details about this training and a FREE FLIGHT. BIG SAVINGS ON FLYING INSTRUCTIONS. Walter Hinton, Pres., Aviation Institute of U. S. A., Inc., Suite 601-L, 1115 Connecticut Ave., N. W., Washington, D. C.

## RUPTURES

**Need firm but comfortable support**

The patented Brooks Appliance retains securely without annoying springs or hard pads. Allows full body freedom. Worn and praised by active men and women in every walk of life. Over 3 million sold. Sent on 10 days' trial. Not obtainable through any store or agent in U. S., but made to individual measurements and sent direct from Marshall. Full information and free 28-page Rupture booklet sent in plain sealed envelope. Send for trial offer.



C. E. Brooks, Inventor

**BROOKS APPLIANCE CO., 107J State St., Marshall, Mich.**



# Would YOU Gamble 2¢ to Win a Body like Mine?

By CHARLES ATLAS

*Holder of the Title:*

*"The World's Most Perfectly Developed Man"*

The most you can lose by mailing the coupon is a 2c stamp! The odds are all in your favor that you'll win a magnificent body of tremendous muscular power. *Dynamic-Tension* made my body as you see it here. It has given handsome, powerful bodies to my hundreds of pupils. Let me PROVE within 7 days that it can do the same for YOU! Mail the coupon for my Free Book.

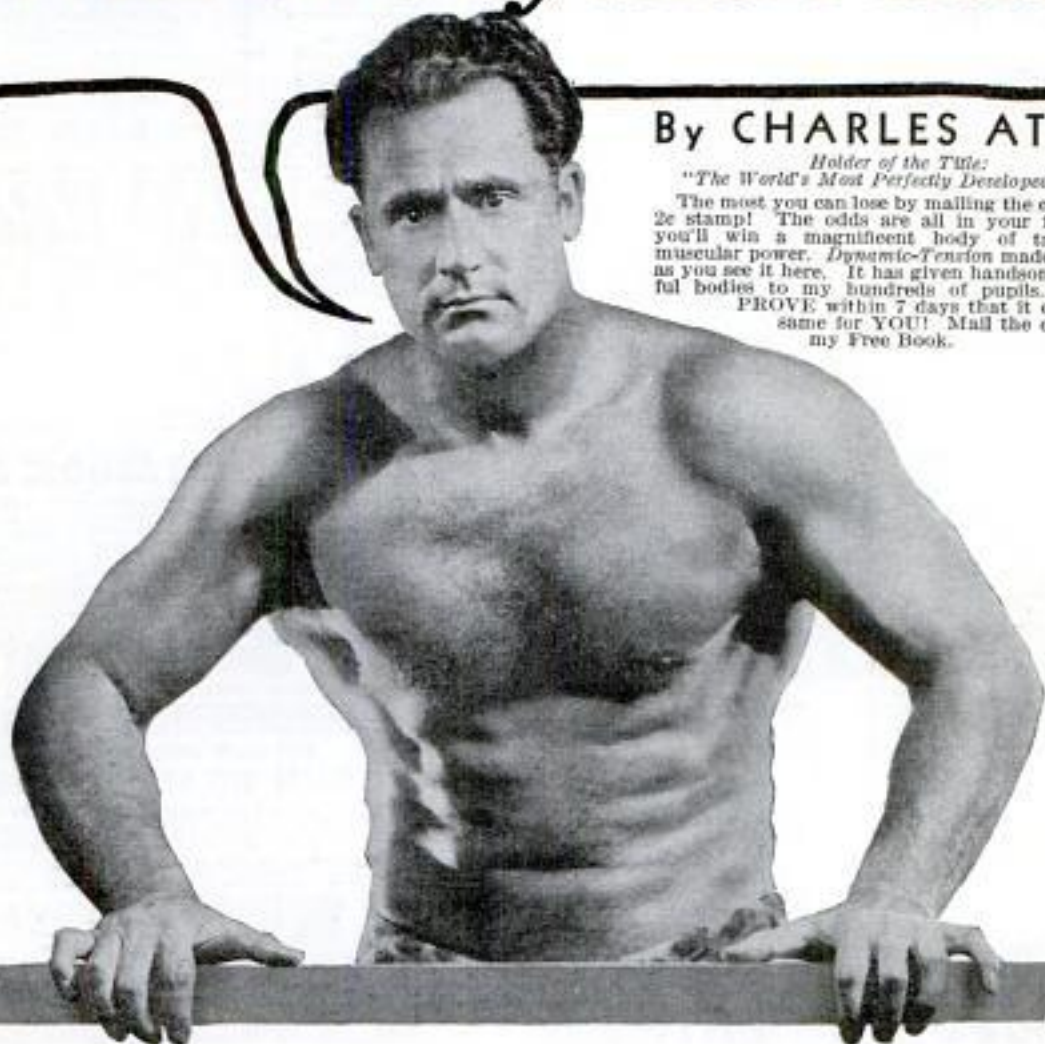

**H**OW does your body stack up against mine? Will you give me a chance to PROVE that my method, *Dynamic-Tension*, will do for you what it has done for me and hundreds of my pupils?

I'm so sure of what *Dynamic-Tension* can do that I can make you an Offer which other Physical Instructors don't DARE to make. I agree to show you definite results *in 7 days*, to give you conclusive PROOF *within a week* that I can transform you, too, into this NEW MAN of mighty energy and strength.

I used to weigh only 97 pounds. I was sick more than half the time. Then I discovered *Dynamic-Tension*. This system changed me from a weakling into the man who was acclaimed

in two international contests as "The World's Most Perfectly Developed Man."

My *Dynamic-Tension* method works hand in hand WITH Nature. There's nothing artificial about it, no pills, special foods, or any tricky apparatus that may strain your heart and other vital organs.

**"Everlasting Health & Strength"—FREE**

Let me tell you all about it in my free book. You can win a body like mine, as my hundreds of pupils have done — by risking only a 2c stamp to mail the coupon for my free book! Fill in the coupon *right now* and send it to me personally, CHARLES ATLAS, Dept. 8-S, 133 East 23rd St., New York City.



CHARLES ATLAS,  
Dept. 8-S,  
133 East  
23rd Street,  
New York City.

I want the proof that your system of *Dynamic-Tension* will make a New Man of me — give me a healthy, husky body and big muscle development. Send me your free book, "Everlasting Health and Strength."

Name.....  
(Please print or write plainly)

Address.....

City.....

State.....

When writing to advertisers please mention Popular Mechanics

Copyrighted material



# HOW I STEPPED Into A Big Pay HOTEL JOB

*Without Previous Experience, A. L. Cummin  
Becomes Hotel Manager in 4 Months with a  
90% Increase in Salary.*

"I can hardly believe it is true. A garageman, knowing nothing about hotel work before enrolling, yet I secured my first hotel position after completing only one-third of the Lewis Course. In less than 4 months I was made MANAGER with a 90% increase in salary. My success is due to the Lewis Hotel Training Schools. I shall never regret the day I clipped the coupon and sent for their literature."

### Hotels Call for Trained Men

Hotel, club, restaurant and institutional field calling for trained men. Positions open as Manager, Assistant Manager, Steward, Room Clerk, and many other important positions paying \$1,800 to \$5,000 a year. Living expenses often included. Previous experience proved unnecessary. Lewis Trained men of both young and mature age winning success. Good grade school education plus Lewis Personal Coaching Plan qualifies you. Send for FREE Book which tells you about this fascinating profession and how to secure a well-paid position. Explains how you are registered FREE of extra cost in the Lewis National Employment Bureau which covers the country at 70,000 points through special arrangement with Postal Telegraph.

### Mail Coupon Now!

Lewis Hotel  
Training Schools  
Room ED-386  
Washington  
D. C.



## OPPORTUNITY COUPON

Lewis Hotel Training Schools,  
Room ED-386, Washington, D. C.

Send me the Free Book, "Your Big Opportunity," without obligation, and details of your Personal Coaching Plan.

Name.....

Address.....

City..... State.....

# BIG MONEY IN ELECTRIC REFRIGERATION

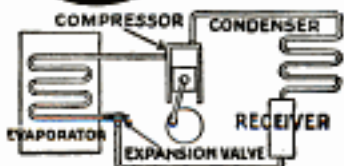

America's biggest new industry — Electric Refrigeration—needs men to fill jobs paying \$50 to \$75 a week or more. General Motors, General Electric, and others investing billions. Millions of machines being sold to homes, theaters, factories, stores, etc. Many jobs open

in production, installation, service and sales which ordinary mechanics can't fill without special training in electric refrigeration.

### EASY TO LEARN AT HOME

Learning electric refrigeration is now amazingly simple thru a new easy home training praised by authorities. Endorsed by Servel, Kelvinator, and other leading refrigerator manufacturers. GET FREE BOOK.

### UTILITIES ENGINEERING INSTITUTE

404 No. Wells St. Dept. 142 Chicago, Ill.

Utilities Engineering Institute,  
404 No. Wells St., Dept. 142, Chicago, Ill. **FREE!**

Without obligation, send me valuable free book.

Name.....

Address.....

City..... State.....

# BE A RAILWAY TRAFFIC INSPECTOR

## Bus and Railway—Rapid Pay Advances

Trained  
MEN  
Needed  
NOW!  
Prepare  
for  
OPPOR-  
TUNITY

S. B. T. I. Trained men—19 to 55—make good as Passenger Traffic Inspectors. Many reach executive positions. Interesting, outdoor work—travel or remain near home. Meet high officials.

We'll train you for this uncrowded profession and on completion of a few weeks' home study help place you in a position paying from \$120 to \$150 per month up, plus expenses, to start, or refund tuition. Free booklet explains 13 years' experience and tells of the big opportunities for trained men in the Transportation Field. Costs little—terms easy.

Standard Business Training Institute  
Div. 204 Buffalo, N. Y.



# SONG WRITERS

Don't fail to read "Song Requirements of Talking Pictures, Radio and Records" an explanatory, instructive book SENT FREE on request. New writers may mail song-poems for free examination. We revise, compose and arrange music, and secure copyrights, guaranteeing approval.

P. M. Newcomer Associates, 1674 Broadway, New York

# Wrestling Book FREE



Wrestling taught at home, by mail, by greatest of all world's champions—Farmer Burns and Frank Gotch. Be a wonderful athlete. Handle bigger, stronger men with ease. Learn the secrets of experts, Jiu-Jitsu, Physical Culture. Have perfect health, fame, a perfect body admired by both sexes. **FREE** 32 page illustrated prospectus, full of thrilling information, sent free. Tells how we teach expert wrestling at home. Send 2c to cover postage. Write now for your copy. State age.

FARMER BURNS SCHOOL  
3374 Courtney Bldg., Omaha, Neb.

# LEARN WATCHMAKING AND ENGRAVING

## BY OUR PROFIT-SHARING PLAN OUR GRADUATES SUCCEED

One of our Iowa students started in a very small way—now doing over \$20,000 a year. Another in Wisconsin, over \$10,000 the first year. Day or night classes. Call or write for FREE BOOK.

Chicago School of Watchmaking, Dept. 3301, 155 N. Clark St., CHICAGO

# LAW STUDY AT HOME

Be independent. Earn \$5,000 to \$10,000 annually. We guide you step by step—furnish all text material, including fourteen-volume Law Library. Degree of LL. B. conferred. Low cost, easy terms. Get our valuable 64-page "Law Guide" and "Evidence" books free. Send for them NOW.

LaSalle Extension University, Dept. 464-L, Chicago

# WHY STAMMER?

Don't be a failure. Master perfect speech. Live a healthy, normal and happy life. Send for free book which tells you how.

THE LEWIS INSTITUTE, 12050 Woodward Ave., Detroit, Mich.

# GOV'T. POSITIONS SPLENDID SALARIES

- WE HELP YOU GET ONE**
- |                   |                  |
|-------------------|------------------|
| Ry. Mail Clerk    | Steno Typist     |
| P. O. Laborer     | Immigrant Insp   |
| R. F. D. Carrier  | Seamstress       |
| Special Agent     | Auditor          |
| Customs Inspector | Prohibition Agt. |
| City Mail Carrier | U. S. Border     |
| Meat Inspector    | Patrol           |
| P. O. Clerk       | Chauffeur        |
| File Clerk        | Watchman         |
| General Clerk     | Skilled Laborer  |
| Matron            | Postmaster       |
|                   | Typist           |
- Concrete Instruction Bureau, Dept. 111, St. Louis, Mo.**  
Send me FREE particulars "How to Qualify" for positions marked "X" Salaries, Locations, Opportunities, etc. ALL SENT FREE.
- Name.....  
Address.....

MEN - WOMEN

AGE RANGE 18 to 50



Only \$ **37.50**

**Pentode  
Variable-Mu  
and Real  
Automatic  
Volume  
Control**

**COMPLETELY  
ASSEMBLED  
WITH LARGE  
DYNAMIC  
SPEAKER!**

## 11-TUBE Super- Het.

**RADIO FANS!** What a radio! A powerful new 11-tube super-het at an unbelievably low price. Reception equal to fifteen ordinary tubes—in a perfectly balanced, non-oscillating, non-radiating, super-heterodyne TEN-TUNED circuit with real automatic volume control that holds those powerful locals down to the same volume as the distant stations and counteracts that annoying fading on weak stations. Two Push-pull Pentode power output tubes with twice the power and four times the sensitivity of ordinary 45's—and Multi-Mu tubes, together with a -24 first detector, gives you SIX SCREEN GRIDS. These six screen grids, together with the -27 oscillator, second detector, first A. F., and automatic volume control—the -80 tubes—gives total of ELEVEN TUBES. The use of a band-pass or pre-selector stage, together with Multi-Mu full range tubes, makes this radio actually surpass 10 K. C. selectivity. Absolutely eliminates those noisy singing "birdies" and annoying cross talk. You'll be positively amazed and delighted when you see this sensational new set—hear the beautiful mellow, cathedral tone—know what it means to have that pin-dot selectivity and unequalled sensitivity together with true tone fidelity.

Be convinced—TRY A MIDWEST 30 DAYS BEFORE YOU BUY. Don't send a penny. Mail coupon right now for amazing FREE trial offer and complete details. You'll be surprised.

### ALL-WORLD—ALL-WAVE



Midwest now offers, if desired, ALL-WORLD—ALL-WAVE reception. The new self-powered Midwest Converter with a powerful 9 or 11 tube super-heterodyne brings in short and long wave broadcasts from everywhere—15 to 550 meters.

### Buy Direct--SAVE UP TO 50%

Never before in the history of radio have such powerful sets been offered at Midwest's amazing low prices. Deal direct with the big MIDWEST factory and save the jobber's profit. Your outfit will reach you splendidly packed, rigidly tested with everything in place ready to plug in. No assembling! Entertain yourself for 30 days absolutely FREE—then decide. Save up to 50 per cent in buying direct from factory—insure satisfaction—deal direct with the world's veteran radio builders—MIDWEST. And don't forget—every MIDWEST outfit is backed by an absolute guarantee of satisfaction. You take no risk.

## MIDWEST RADIO CORP.

Dept. 63

(Est. 1920)

CINCINNATI, O.

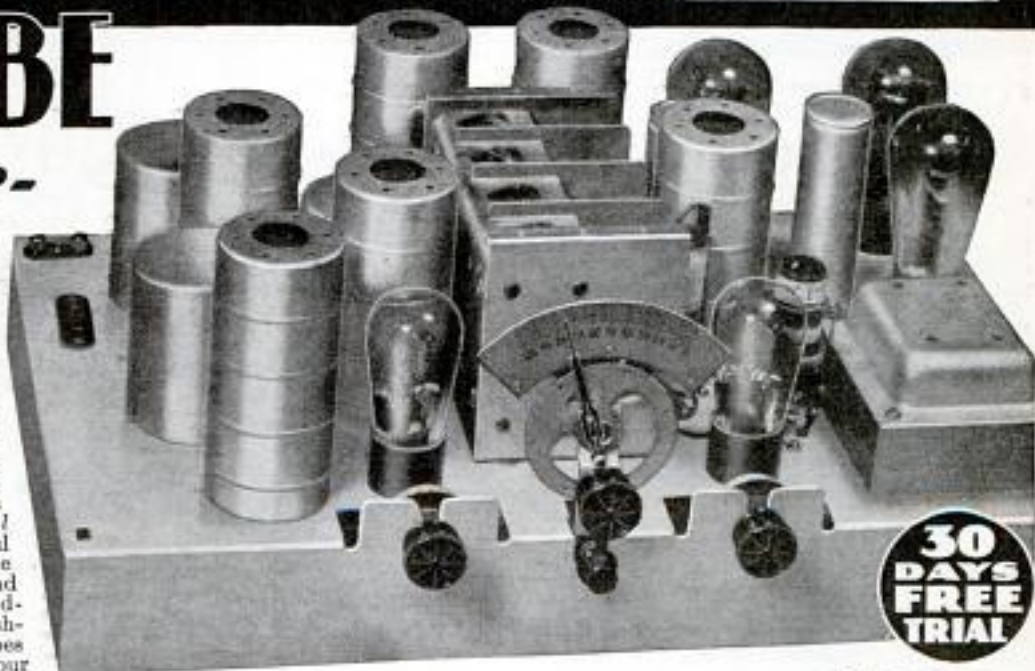

**30  
DAYS  
FREE  
TRIAL**

### TERMS

as low as  
**\$5.00 DOWN**

### Read This!

**New Zealand User Hears New York  
and Other Stations Eight Thou-  
sand Miles Distant**

"I would stack my Midwest up against any other make of set on the market. I have a log of 141 stations. 'Midwest gets 'em all over the world.' 36 stations in New Zealand, 34 Austrian, 10 in Japan, 1 in China, 2 in India, 1 in Czechoslovakia and Bratislava, 2 in Honolulu, and a total of 56 stations in the U. S. A., including New York, Cincinnati and Los Angeles. I have received WTIC on two different frequencies . . . also Siam 'Radio Bangkok.' This is a log which would be hard to eclipse by any other set of any power."

FRED W. MORLEY,  
Hawke's Bay, New Zealand.



**Complete Line of  
Consoles**

The big FREE catalog beautifully illustrates the complete line of gorgeous Midwest Consoles. "Deluxe," Highboy and Lowboy models.

### Mail this Coupon for Complete Details and Big FREE Catalog!

Midwest Radio Corp.,

Dept. 63

Cincinnati, Ohio.

Without obligation on my part send me your new 1932 catalog, and complete details of your liberal 30-day free trial offer. This is NOT an order.

Name.....

Address.....

Town.....State.....

Send me SPECIAL USER AGENTS PROPOSITION.

#### USER AGENTS

We pay you BIG MONEY just for showing your radio to friends and neighbors. Easy EXTRA MONEY! Check coupon for details.

When writing to advertisers please mention Popular Mechanics

Copyrighted material





## "WE SET OUR GOAL AT \$5000 A YEAR"

"SIX YEARS AGO we sat down to figure what we wanted from life—Margaret and I. And to reach the comfortable scale of living we had set our hearts on, we found it would take \$5000 a year! That seemed impossible, it was so much more than I was making, but Margaret had faith that I could do it.

"I enrolled with the International Correspondence Schools and started studying at home. At once I gained a new and wider view of my job—did better work. After four months the boss asked what had happened to me, and I told him. That day I got the first of my promotions.

"We passed the \$5000 mark this year and we're going right on. Thanks to my I. C. S. training I can give my family an attractive home, a good car, all the comforts they need. It means school and college for the boys, more leisure for Margaret, and vacation trips for all of us. Do you wonder we're boosters for the I. C. S.?"

Is your family budget cramped by your salary? In one hour a day of your spare time, the I. C. S. can help you to climb out of the rut and into a bigger, better-paying job. Set your own goal. We can help you reach it. Today take the first step.

**MAIL THE COUPON FOR FREE BOOKLET**

**INTERNATIONAL CORRESPONDENCE SCHOOLS**

"The Universal University" Box 5595-G, Scranton, Penna. Without cost or obligation, please send me a copy of your booklet, "Who Wins and Why," and full particulars about the subject before which I have marked X:

### TECHNICAL AND INDUSTRIAL COURSES

- |  |  |
|--|--|
| <input type="checkbox"/> Architect   | <input type="checkbox"/> Automobile Mechanic                                 |
| <input type="checkbox"/> Architectural Draftsman                             | <input type="checkbox"/> Plumbing <input type="checkbox"/> Steam Fitting     |
| <input type="checkbox"/> Building Estimating                                 | <input type="checkbox"/> Heating <input type="checkbox"/> Ventilation        |
| <input type="checkbox"/> Wood Millworking                                    | <input type="checkbox"/> Sheet Metal Worker                                  |
| <input type="checkbox"/> Contractor and Builder                              | <input type="checkbox"/> Steam Engineer                                      |
| <input type="checkbox"/> Structural Draftsman                                | <input type="checkbox"/> Steam Electric Engineer                             |
| <input type="checkbox"/> Structural Engineer                                 | <input type="checkbox"/> Civil Engineer                                      |
| <input type="checkbox"/> Electric Wiring                                     | <input type="checkbox"/> Surveying and Mapping                               |
| <input type="checkbox"/> Electrical Engineer                                 | <input type="checkbox"/> Refrigeration                                       |
| <input type="checkbox"/> Electric Lighting                                   | <input type="checkbox"/> R. R. Locomotives                                   |
| <input type="checkbox"/> Welding, Electric and Gas                           | <input type="checkbox"/> R. R. Section Foreman                               |
| <input type="checkbox"/> Reading Shop Blueprints                             | <input type="checkbox"/> R.R. Bridge and Building Foreman                    |
| <input type="checkbox"/> Telegraph Engineer                                  | <input type="checkbox"/> Air Brakes <input type="checkbox"/> Train Operation |
| <input type="checkbox"/> Telephone Work                                      | <input type="checkbox"/> Highway Engineering                                 |
| <input type="checkbox"/> Mechanical Engineer                                 | <input type="checkbox"/> Chemistry <input type="checkbox"/> Pharmacy         |
| <input type="checkbox"/> Mechanical Draftsman                                | <input type="checkbox"/> Coal Mining Engineer                                |
| <input type="checkbox"/> Machinist <input type="checkbox"/> Toolmaker        | <input type="checkbox"/> Navigation <input type="checkbox"/> Boilermaker     |
| <input type="checkbox"/> Patternmaker  | <input type="checkbox"/> Textile Overseer or Supt.                           |
| <input type="checkbox"/> Pipefitter <input type="checkbox"/> Tinsmith        | <input type="checkbox"/> Cotton Manufacturing                                |
| <input type="checkbox"/> Bridge Engineer                                     | <input type="checkbox"/> Woolen Manufacturing                                |
| <input type="checkbox"/> Bridge and Building Foreman                         | <input type="checkbox"/> Agriculture <input type="checkbox"/> Fruit Growing  |
| <input type="checkbox"/> Gas Engines <input type="checkbox"/> Diesel Engines | <input type="checkbox"/> Poultry Farming <input type="checkbox"/> Railro     |
| <input type="checkbox"/> Aviation Engines                                    | <input type="checkbox"/> Marine Engineer                                     |

### BUSINESS TRAINING COURSES

- |   |  |
|---|--|
| <input type="checkbox"/> Business Management                                  | <input type="checkbox"/> Business Correspondence                             |
| <input type="checkbox"/> Office Management                                    | <input type="checkbox"/> Lettering Show Cards <input type="checkbox"/> Signs |
| <input type="checkbox"/> Industrial Management                                | <input type="checkbox"/> Stenography and Typing                              |
| <input type="checkbox"/> Personnel Management                                 | <input type="checkbox"/> Complete Commercial                                 |
| <input type="checkbox"/> Traffic Management                                   | <input type="checkbox"/> Civil Service <input type="checkbox"/> Mail Carrier |
| <input type="checkbox"/> Accountancy <input type="checkbox"/> Cost Accountant | <input type="checkbox"/> Railway Mail Clerk                                  |
| <input type="checkbox"/> C. P. Accountant                                     | <input type="checkbox"/> Grade School Subjects                               |
| <input type="checkbox"/> Bookkeeping  | <input type="checkbox"/> High School Subjects                                |
| <input type="checkbox"/> Secretarial Work                                     | <input type="checkbox"/> College Preparatory                                 |
| <input type="checkbox"/> Spanish <input type="checkbox"/> French              | <input type="checkbox"/> Illustrating <input type="checkbox"/> Cartooning    |
| <input type="checkbox"/> Salesmanship <input type="checkbox"/> Advertising    | <input type="checkbox"/> Lumber Dealer                                       |

Name.....Age.....

Address.....

City.....State.....

Occupation.....

If you reside in Canada, send this coupon to the International Correspondence Schools Canadian, Limited, Montreal, Canada



## Using Tobacco

Perhaps you've tried to stop using tobacco only to find that the habit has such a hold on you that you gave up trying.

You know, better than anyone else, whether tobacco is hurting you, and if it is, that sooner or later, it will undermine your health. Heart trouble, indigestion, dyspepsia, nervousness, insomnia, poor eyesight—these and many other disorders can often be traced directly to the use of tobacco, according to good medical authority. Besides it is an expensive, utterly useless habit.

## Let Us Help You To Banish The Habit

No matter how firm a grip tobacco has on you—no matter whether you've been smoking cigars, pipe or cigarettes or chewing plug or fine cut for a month or 50 years—Tobacco Redeemer will in most cases remove all craving for tobacco in any form in a very few days. It does its work so quickly that all tobacco "hunger" is gone almost before you know it. The desire for a smoke or chew usually begins to decrease after the very first dose.

Tobacco Redeemer contains no habit-forming drugs of any kind—it is in no sense a tobacco substitute. It does not cause the slightest shock to the nervous system; on the contrary, it often helps to quiet the nerves and make you feel better in every way.

### SEND for PROOF

Get our free booklet. It tells you all about the deadly effects of tobacco and how easy it is now to quit. We will also send you copies of letters from confirmed users telling how this simple, home-treatment freed them absolutely from the habit. Just mail coupon—or a postal will do.



### NEWELL PHARMACAL CO.

Dept. 999 St. Louis, Mo.

Send me without obligation to me in any way, proof that Tobacco Redeemer will positively free me from the Tobacco habit or my money will be refunded.

Name.....

Street and No.....

Town.....State.....

When writing to advertisers please mention Popular Mechanics



# Learn All About Autos AT McSWEENEY'S

Just A Few Weeks  
To Prepare For A Big Pay Job

**N**OW is the time to learn a trade that will insure your future, that will make you independent of hard times, that will put you on the ladder of success—to climb to any heights of big earnings—limited only to the extent of your ambitions. Get into the nation's biggest industry where there are more opportunities than trained men to fill them. Learn autos at McSweeney's—all about them—in just a few short weeks—a trade that will never be replaced by mechanical equipment. Learn the practical end of the business—the end that



made men like Ford and Chrysler, leaders of the industry. With 25 million autos on the roads of the nation—everyone needing service and repair—the demand for trained, highly skilled, auto experts is greater than ever. It's all made easy and quick for you at McSweeney's. It's the sure way to a business of your own.

## Learn by Doing No Books—No Lessons

You get practical, individual, shop-work training at the McSweeney school. No books to read—no dry lectures to listen to. You work on real equipment, with real tools. You do the actual work in each branch of the trade, with expert instructors at your elbow to guide you, show you how to do the job right. **No previous experience needed** . . . just a liking for mechanics and ambition for success . . . and you are assured of a prosperous future. 50,000 McSweeney trained men attest to the advantage of McSweeney training.

### SPECIAL TUITION OFFER

Right now I have a surprise offer that makes it amazingly easy for you to get this training. It's your one big chance to get out of the low pay rut into a trade that can bring you big money and independence. Write me now. I'll send you all particulars of the most sensational school offer ever made in America—an offer that makes it possible for any man any where to get this training.

#### TRAIN FOR THESE JOBS

McSweeney training fits you for these positions. Jobs waiting in the auto business for men who know.

**General Auto Mechanics**  
**Garage Managers**  
**Bus and Auto Transportation Experts**  
**Service Station Owners and Operators**  
**New and Used Car Dealers and Salesmen**  
**Trouble Shooters**  
**Auto Electrical Experts**  
**Battery Service Men and Station Owners**  
**Bus Drivers and Mechanics**  
**Tractor Operators and Service Men**  
**Aviation Motor Mechanics**



Hundreds of McSweeney trained men own successful Auto Agencies and Service Garages—are independent, happy, prosperous. Plenty of opportunities open—if you want a business of your own. McSweeney training includes management of businesses like this.

#### Money Back Guarantee

If, after completing my training, you are not satisfied, if you are not qualified to accept a big-pay job, your tuition will be refunded. You take no risk—no chances.



My big auto book brings you all the particulars of this great school—shows you every step in the training that starts you on the road to become an expert in this greatest of trades. Just send your name and address or mail the coupon. My surprise tuition offer will be mailed with catalog. Don't wait—offer limited—WRITE NOW!

**McSWEENEY SCHOOL**  
CLEVELAND, OHIO

**AMERICA'S  
GREATEST  
INDUSTRY  
NEEDS YOU**



When writing to advertisers please mention Popular Mechanics

## Big Auto Book FREE

Mail This Coupon  
for FREE Book

J. H. McSweeney, Pres.  
Dept. A-10-4, Chester at 30th St.,  
Cleveland, Ohio

Without cost or obligation, send me your big FREE book on **AUTO MECHANICS** and full details of your Special Low Tuition and Surprise Offer.

Name.....

Street.....

Town..... State..... Age.....





By the FRASER SYSTEM

## "STRAD" SECRET OUT!

Famous modern violin-maker shows you how to make artist violins at home by Stradivari's own method. Something new! Something marvelous! Fascinating work for craftsmen! Instruction book, perfect patterns, woods, parts—everything needed, at low prices. Write now!

C. C. FRASER, Station C, Grand Rapids, Mich.

**LEARN**  
**Tool & Die Making**

**MACHINIST TRADE. AUTOMATIC SCREW MACHINES**

Learn these big paying trades in our big shops, days or even. We teach you shop methods on actual work. No books. No Lessons. You get unlimited training and free employment help. Don't delay. Write for FREE catalog and Free Railroad Plan. Special rates to Allied students on room and board.

**ALLIED SCREW MACHINE CO., INC.**  
School of Mechanical Trades  
518-24 W. Monroe St., Chicago, Ill. Dept. 1024

Learn to **PAINT**  
**SIGNS and SHOW CARDS**

We quickly teach you by mail, or at school, in spare time. Escape from dreary. Big future. Interesting work. Object and forepost school.

**EARN \$50 TO \$200 WEEKLY**

Otto Wagner, Md., home-study graduate, made \$12,000 from his business in one year. John Vasos, N. Y., gets \$25 for a show card. Crawford, B. C., writes: "Earned \$200 while taking course." Write for complete information.

**DETROIT SCHOOL OF LETTERING**  
154 Stinson Ave. Est. 1877 Detroit, Mich.



## "Pick YOUR Government Job"



Work for Uncle Sam. Get good pay, regular increases, vacations and sick leave with pay, steady advancement, pension. Send for my free book "How to Secure a Government Position"—tells about all jobs, near home or traveling, the money, what you need to know and how to get posted. Forget "job hunting." Open to citizens 18 to 50. **IMPORTANT—Get ready NOW for the next Railway Postal Clerk Examination!** Yearly pay with allowances averages \$2759.06. Prepare yourself NOW. Send coupon at once.

A. R. Patterson, Civil Service Expert, PATTERSON SCHOOL, 84 Winer Bldg., Rochester, N. Y.  
Please send me, without obligation, your free book "How to Secure a Government Position."  
Name.....  
Address.....

**LEARN MECHANICAL DENTISTRY**

**Earn Big Money—Steady Work**

Don't waste the best years of your life. Prepare now for prosperity. Learn this money-making business in a few months in Day or Evening sessions. Big Demand. School is highly endorsed. Practical training. Individual instruction. Easy terms. Write NOW for free catalog P and reduced rate.

**New York School of Mechanical Dentistry**  
125 West 31st Street New York

SEND FOR FREE BOOK  
*Your Success*

**SOMETHING DIFFERENT**  
**The EVERLASTING MATCH**  
**MAKE \$25 A DAY**  
**UP TO**

Sells on sight. What Makes It Light—A Mystery Lighter—a scientific marvel. New Principle of Ignition—no flint or friction. Simple and money-making sales plan 25c. Gold, silver or chromium plated sample \$1. Agents write for proposition.

**NEW METHOD MANUFACTURING CO.**  
DESK P-4 New Method Bldg. BRADFORD, PA.



**Men and Boys Everywhere**  
**Here is a delightful**  
**Learn to Mount**  
**Birds and**  
**Animals.**  
**Be a Taxidermist.**  
**Learn in**  
**your SPARE**  
**TIME at HOME.**  
**A WONDERFUL**  
**business. Send**  
**COUPON for**  
**free book.**



### MOUNT WILD-GAME and COMMON ANIMALS

Make beautiful, unique, USEFUL articles, using common birds and animals, like those shown—Squirrel-lamp, Rabbit-ashtray, Frog clock, Book-ends and dozens of other ideas. Hundreds of similar things, easily made. They SELL AT RIGHT—BIG PROFITS and a world of fun.

This splendid NEW HOBBY is sweeping the country. Send NOW for

**FREE BOOK!** 48 pages, 200 pictures. Tells all about Taxidermy.

All secrets of Taxidermy NOW revealed. Men and boys, learn easily, quickly in SPARE TIME. Greatest hobby on earth. Interesting, fascinating, FINE FUN. Mounted specimens attract instant attention.

### Mail Coupon

for this great FREE BOOK. Send TODAY

# New Hobby!

**Novelty Taxidermy**  
**Fascinating, Fun and Very PROFITABLE**

**Do You Want \$50 to \$150 a Month**  
**Extra Money? Here It Is!**

Mount wild-game for hunters and anglers. Sell your own mounted game. **MOUNT AND SELL ALLURING** Novelty Taxidermy pieces from COMMON ANIMALS. Positively the **GREATEST SPARE TIME MONEY-MAKER** ever discovered. Our old reliable school with 100,000 graduates **GUARANTEES** to teach you successfully. Need extra money? Want a marvelous HOBBY that will make you well known? Then **INVESTIGATE TODAY.** Mail the **COUPON** now for the splendid **FREE BOOK.** State your age.



**FREE BOOK COUPON**

Northwestern School of Taxidermy  
3374 Elwood Bldg., Omaha, Neb.  
Send me your free illustrated book, "How to Mount Game." Also tell me how I may learn this fascinating art easily and quickly by mail. No obligation.

Name.....  
Address.....  
Age.....



# YOU can be one of these Men!



**Aircraft Draftsmen**  
Salary, \$50 to  
\$100 a week



**Airport Managers**  
At \$100 to  
\$150 a week



**Airplane Salesmen**  
Make \$50 to \$100  
a week and UP



**Pilots**  
Earn \$3000 to  
\$6000 a year



**Aircraft Mechanics**  
Make \$50 to  
\$100 a week

## I'll show You how..

### to earn \$50 to \$100 a week in Aviation!

**YOU MEN** who are sick of small pay and hard, grinding work—here's your chance! Edward Dick took my course and received an immediate offer of a fine job as Chief Mechanic and Assistant Manager. Paul Boehn connected with a big airplane manufacturer. Ira Bergen left his old job to become Chief Draftsman with an aeronautical concern in Brooklyn—And many more have turned their backs on low-paid drudgery to take *real jobs in Aviation.*

#### All You Need Is Ambition

If you've got red blood and an ounce of grit in your make-up, then you'll like the fascinating, active, adventuresome life that Aviation offers. I'll train you for it—right in your own home. Don't give up your job! Don't go to a strange city! Stay right where you are: I'll bring the whole Aviation Industry to you. My course is written in easy, simple language—hundreds of photos and charts make everything clear. You don't need a high-school education; many of my most successful students never finished the grades—in Aviation you need *practical knowledge only!* I teach you practical facts

#### I Showed Mengel

"I am now working as a motor mechanic for the Wright Aeronautical Corp. I am sure that without the training your course gave me, it would be impossible for me to hold this job. The rich rewards go only to the man who uses his head and learns the theory on which the practice is based." Warren Mengel, 1301 N. 11th St., Reading, Pa.

#### I Showed Money—penny

"I'm mighty glad I tied up with Hinton. Your organization has always been ready to help me in every way. Before actually completing your course I was able to obtain and hold the responsible position of chief engineer with the Airedale people." C. H. Moneypony, Cedarville, Mich.



**Walter Hinton**

Former Navy flier, first to pilot a plane across the Atlantic (The NC-4), first to use an airplane in exploration work, instructor of war-time fliers at Pensacola, Florida. His proven home study Course, endorsed by prominent fliers and aircraft manufacturers, prepares you for a real future in Aviation—as a Field Superintendent, Airport Manager, Plane Mechanic, Engine Mechanic, Air Traffic Manager, Pilot, Engine Expert, Airplane Assemblyman—or in any one of forty other highly paid jobs on the ground or in the air.

about airplanes, engines, airports, mechanical details and shop kinks that you can use right on the job.

#### Employment Service FREE of Extra Cost

Just as soon as you are trained, my Nationwide Employment Department will help you find the job you want. This service comes to you absolutely FREE of any extra cost. It's getting results, getting real jobs, for other ambitious men, and can for YOU.

#### Save \$50 to \$450 on Your Flying Time

I've arranged with flying schools all over the country to give special discounts to graduates of my ground school. Often these discounts save you much more than the whole cost of my course! You get a discount check worth actual CASH as soon as you graduate.

#### Get the Facts—FREE

Send for my big book of facts about YOUR OPPORTUNITY in Aviation TODAY. It's free—you don't obligate yourself in any way. This book has been the turning point to success for many other fellows—it will show YOU, too, the way to *big success and big pay* in Aviation. Just mail that coupon NOW!

## Aviation Institute of U.S.A., Inc.

WALTER HINTON, Pres.

1115 Conn. Ave., N.W. Washington, D. C.

Please send me your FREE book, "WINGS OF OPPORTUNITY," showing how I can train at home for a place in Aviation. 601-L

Name.....  
Please Print Your Name  
Address..... Age.....  
Please Print (Use to 10 or over)  
City..... State.....



When writing to advertisers please mention Popular Mechanics



# Classified Advertisements

## WORLD'S BEST WANT AD MEDIUM

Advertisements in this section, 35 cents per word, each insertion, minimum 10 words, payable in advance  
To be inserted under proper classification in May issue, copy should be in our office March 18th

### ADVERTISING AGENCIES

**ADVERTISE**—Bargain value—24 words in 21 representative Sunday newspapers \$15; Free assistance with your ads, sales letters, literature. Helpful Ad-Guide showing best paying newspapers, magazines, rates, mailing lists, etc., free. Chicago Union Agency, Great Northern Bldg., Chicago.

**GET** Into advertising. Learn quickly at home. Experience unnecessary. New easy plan. No text books used. Practical work. Old established school. Send name and address for interesting free booklet. Pace-Davis School of Advertising, Dept. 3432, 3601 Michigan, Chicago.

**TIME** Counts in applying for patents. See page 129. Clarence A. O'Brien, Registered Patent Attorney, Washington, D. C.

**ADVERTISE**. Inch display, 50 magazines, three months \$8.00. Pennell Standard, Covington, Kentucky.

**ADVERTISE** in rural weeklies. Lists free. Meyer Agency, 4112 Hartford, St. Louis, Mo.

**BEFORE** Advertising get our catalog. No charge. 26 years in business. The largest classified agency in the world. Ankrum Advertising Agency, 100 N. LaSalle St., Chicago, Ill.

**FREE**—New 1932 Advertisers Rate Guide, 44 pages. Includes everything. Lowest rates. E. H. Brown Advertising Agency, 140 S. Dearborn, Chicago.

**INCH** Display advertisement 50 magazines year \$21. Wood's Popular Services, Atlantic City, N. J.

### FOR ADVERTISERS

**LETTERS** Worded to sell anything worth buying. Name your business. Evidence. Jed Scarborough, Maplewood, New Jersey.

**24 WORDS**—70-95 Southeast weeklies, \$1.95. S. Stout, Warm Springs, Ga.

**ADVERTISING**: 20 Words; 48 magazines 60c; three insertions, \$1.20. Inch display, three months \$4.00; year \$21.00. Mailing Bureau, Laundale, Calif.

**ADVERTISE** 53 Magazines, 3 months, \$6.00 inch. List, special offers, free. Evans King Co., Box 672P, Wilmington, Delaware.

**ADVERTISE** in 250 country town newspapers 28 words, \$10. Lists free. All states. Keator, Hartford Bldg., Chicago.

### SALES PROMOTION

**LETTERS**—written, revised, analyzed, duplicated, typed. Low prices. Samples. Complete advertising service. Advertisers Letter Co., 410 So. 19th St., Omaha, Nebr.

### INFORMATION

**BUSINESS** Advice about California. Send questions and \$1.00. Clinton Davidson, National City, California.

**INFORMATION**, Authentic, covering, any field or subject. Accurate data and helpful information gathered on any contemplated business enterprise. Just send account of information desired and \$1 bill. James Vance, 221 Monadnock Bldg., San Francisco, Calif.

**SCIENTIFIC** Information. Bachelor of Science. Save bother searching. Small fee. "Sciinfo," 2018 N. 34th St., Milwaukee, Wis.

### BUSINESS ADDRESSES

**FOR** Personal or business purposes. New York address is an asset to you. Prompt, reliable service. \$1.00 monthly. (Remailed daily). New York Mail Service, 15 Park Row.

### WRITERS SERVICE

**THOUSANDS** Of dollars for Genie plots! Scores of writers making big money! You stand the same chance. Write for free information. The Gazette Company, 773 Union Insurance Bldg., Los Angeles, Calif.

### AUTOMOBILES

**AUTOMOBILE** Racing book. How to build dirt track racers championship racers, fast road cars. New, 10 chapters, 137 illustrations, track records, winning drivers, contest rules, speed, "revs," balance—Postpaid \$1.00. Ray Kuns, Dept. B, Madisonville, Cincinnati, Ohio.

**RACING** Cars, 130 mph. 1932 sensational designs. Photographs and building plans free. Newton, Box 944, Victoria, B. C.

**TIME** Counts in applying for patents. See page 129. Clarence A. O'Brien, Registered Patent Attorney, Washington, D. C.

**BUILD** Your own trailer at home spare time. Complete line of parts and body hardware. Also trailers complete \$33.50 up. Locke Pattern Works, Detroit, Mich.

### AUTOMOBILE SUPPLIES

**ALL** Steel trailer hitch. Best on market. Hagstrom Mfg. Co., Kansas City, Mo.

**BARGAINS**—Excellent reprocessed compressors, battery chargers, test benches, car washers. Terms. Trial. Write Ken's Automobile Service, Box M-422, Troy, Ohio.

**PISTON** And connecting rod aligning tools. Also soft metal hammers. W. I. Wilhelm, 144 Rose Street, Reading, Pa.

**EIGHT** Semi-spiral expansion ramers \$13.35. Catalog. W. Barnitz, 208 Harris, Harrisburg, Penna.

**CHROMIUM** Plating powder plates iron, steel, brass, copper and nickel, without electricity or machinery. Guaranteed not to tarnish; ½ pint can \$1.50 prepaid. Gunmetal Co., Ave. J, Decatur, Ill.

**RADIATORS**—Guaranteed. All standard makes. Save 40% to 75% buying at wholesale prices. Give models. Write for prices. Independent Radiator Co., 1119 So. Wabash, Chicago.

### AUTOMOBILE SERVICE EQUIPMENT

**SCIOTO** Battery chargers cost less and earn more money for you. Adams-Barr, Columbus, Ohio.

**SUBSTANTIAL** Savings—reprocessed compressors, battery chargers, test benches, car washers. Terms. Trial. Write Ken's Automobile Service, Box M-422, Troy, Ohio.

### MOTORCYCLES, BICYCLES AND SUPPLIES

**MOTORCYCLES** \$25 Up. Easy terms. New Federal tires \$4. Used tires \$2.50. Engines for motorcycles, ice sleds, airplanes, boats, \$15 to \$75. Frames, forks, cylinders, saddles, handle bars \$3. 3 speed assemblies, crank cases, pistons, generators, magnets, wheels for motorcycles, airplanes \$1. Good bicycles \$9.50. Save dollars. Oldest house in U. S. Send 25c for catalogue. Price Cutter Daninger, Rochester, N. Y.

**MOTORCYCLES**, All makes and models; best bargains in the U. S. \$10 and up. Used parts. Send postage for list. Office Motorcycle Sales Co., 1409 Olive St., St. Louis, Mo.

**REBUILT** Motorcycles, all makes. New and used parts. Send 10c for catalog. Western Motorcycle Company, 911 East 15th St., Kansas City, Missouri.

**"JUST OFF THE PRESS"**—New catalogue, 12 used bargains—New low prices. Send 6c stamps. Knuth's, 2525 Fond du Lac Ave., Milwaukee, Wis.

**SPEED!** Enjoy sport, make money, riding Hillclimbs this year. Tune your motor into special fast road job or Hillclimber. Book, drawings, shows how. Price \$2.00. Motorcycle Publishers, Box 265, Holyoke, Mass.

**SEND** 15c For illustrated used Motorcycle catalog. Large stock. Bargains. Indian parts. Accessories. Indian Motorcycle Sales, Kansas City, Mo.

**MOTORCYCLE** Bargains, lowest prices, bargain sheet for stamps, motorcycle accessories, largest line in America, lowest prices. Largest motorcycle mail order house in the United States. Rochester Harley Davidson Corporation, 129 West Main St., Rochester, N. Y.

**LOW** Prices—Special bargains in Harley-Davidson's 14 models. Send 6c stamps for catalog. Knuth's, 2525 Fond du Lac Ave., Milwaukee, Wis.

**REPAIR** With good used parts, save ¼ or more, state parts needed, no lists. J. B. Dahl, 5651 Archer Ave., Chicago, Ill.

### BATTERIES

**15 YEAR** Life non-acid Edison nichel storage batteries for sale. Any voltage or amperage for boats, farm lights, etc. Hold charge indefinitely, non-sulphating, odorless. Priced less than acid types. Unconditionally guaranteed. Complete generating plants, motors, etc., for farm and boat uses. Unbelievable low prices. State your wants. We can save you many dollars. B. Hawley Smith Co., 29 Washington Ave., Danbury, Conn.

**GENUINE** Edison farm lighting batteries. Reconditioned, good as new. The lifetime battery. Free literature, 225 ampere cell, \$2.50, 300 ampere, \$3.00. Guaranteed five years. See Jay Battery Company, 1302 Bos-cobel Avenue, New York City.

### AVIATION

**OBTAIN** Airplane pilot or mechanic license. Offering booklet of three hundred typical examination questions with correct answers. Send one dollar. E-Z Aviation System, Box 6 M, Rosedale, N. Y.

**FORD** Propellers, hubs and conversion parts. Send 10c for circulars. Helmo Motor Works, Orwigsburg, Pa.

**TIME** Counts in applying for patents. See page 129. Clarence A. O'Brien, Registered Patent Attorney, Washington, D. C.

**AIRCRAFT** Directory 50c. Thousands bargains. Invaluable. Aerobuilders Service, 1207-15 So. 12th, Lincoln, Neb.

**BE** Sure that the motor you purchase for your light plane will fly it. Heath B-4 and Heath Henderson motors are guaranteed to fly and 7 years of constant performance prove it. For economy and reliability these motors cannot be equaled. Send 10c for large illustrated booklet. Heath Aircraft Corp., Dept. KP-4, Niles, Michigan.

**ASSEMBLE** Your own 25 h.p. 2 cyl. motor. Weight 94 lbs. Finished parts \$50.00. Blue print and data \$1.50. Information 25c. Aireffo Co., Miami, Fla.

**CONSTRUCT** Double seater 16 h. p. airplane. Two world records. Exceptional proven performance, economy and safety. Landing less 20 miles. Easily flown. Blue print and data \$1.50. Information 25c. Parts or fly away. Aireffo Co., Miami, Fla.

**HANDIEST** Guaranteed electric soldering iron. Postpaid only 79c. Perryiron, Peru, Indiana.

**PARACHUTES**, Miniature \$1 each postpaid. Also man carrying parachutes, balloons, etc. Thompson Bros. Balloon Co., Aurora, Illinois.

**MOTOR**—New, \$50.00 takes it. Address Clarence Paulson, Hutchinson, Miss.

**COLLECTORS** Of photographs of airplanes! Send 2c for complete list. Pilot-Plane Photos, Gen. Postoffice Box 560M, New York.

**USED** Sportplane bargains. Literature 10c. Federal Equipment Co., Box 911, Cincinnati.

**SB PROPELLERS** Give better performance. Send stamp for new price list. Sen-senich Brothers, Litzia, Pa.

**AERODRIVE** Propeller boat attachment, blueprint, 25c. Ostergaard Aircraft, Dunning, Chicago.

**SPRUCE**—Finished to size for airplanes, gliders, iceboats. Highest quality. Lowest prices. Mail sizes for quotation. Pike-Dial Lumber Co., 2237 Loomis, Chicago.

**METAL** Tipped Henderson propellers, \$9.95; Fords, \$12.50. Hibbs, Ft. Worth, Texas.

**SEND** 5c For bundle of balsa, reeds and price list on supplies. Aero Shop, 3050 Huribut Ave., Detroit, Mich.

### BOATS, OUTBOARD MOTORS, ETC.

**FITTING** Out number—March—The Rudder, price 50c. The world's oldest boating publication. Handsomely illustrated throughout. Diesel yachts, express cruisers, sail craft. Also complete illustrated list "Boats for sale"—all types. The Rudder, 15 Murray Street, New York.

**PROPELLERS**, gear pumps, stuffing boxes, etc.; used reverse gears. Wm. Baker, Pond St., Quincy, Mass.

**BOAT** Blueprints. Rowboat \$1.00, speedsters \$1.00. Catalogue 10c. Blueprint Company, Wayne, Mich.



## CARTOONING

**COLORED** Comic cartoon from your photo 50 cents. Reply-3-Dix, New Brunswick, New Jersey.

**AMATEUR** Cartoonists—Sell your cartoons. Write, Cartoonist's Service, Franklin, Ky.

## ARCHERY

**MAKE** Your Bow and Arrows. We sell materials. Send 25c for working instructions and catalogue. Sidney Archery Co., Sidney, Ohio.

## MANUSCRIPT SERVICE

**MANUSCRIPTS** Typed and revised by experienced English teacher. Terms on request. Kate L. Prousch, Slidell, Louisiana.

## CHALK TALKS

**LAUGH** Producing program, \$1.00. Catalog free. Balda, The Cartoonist, Oshkosh, Wis.

## BOOKS AND PERIODICALS

**ALL** Outdoors—An outing magazine, broad as its name, plain and outspoken as the common folk it represents. Many fine departments, prospecting, mining, outdoor photography, game bird and fur-farming, etc., etc. Monthly, colored cover, profusely illustrated. A real up-to-the-minute outdoor sports, outdoor vacation and touring magazine. Regular subscription price \$1.00. Special get acquainted offer—One whole year 50c. Six months 25c. Sample copy 10c. All Outdoors, P.M.534 Douglas Bldg., Los Angeles, Calif.

**WOODWORKER'S** Hand book, 20 projects, 128 pages. Nearly 100 illustrations. Full of workshop hints. Bound green cloth, gold stamped cover, 50c. Walker Turner, Dept. 2-A, Plainfield, N. J.

**WANTED**—Publication for a book, True Tale of the Old Covered Wagon Days. W. A. Swanson, Wilpen, Minn.

**GOOD** Books, magazines; stamp brings circulars. Goldenrod Company, Harrisburg, Ill.

**SELL** Books from our catalog. Earn big money. World famous house. Particulars free. Meador Publishing Co., 470-A Atlantic Ave., Boston, Mass.

## GAMES, ENTERTAINMENTS AND PLAYS

**PLAYS**, Operettas, musical comedies and minstrels, comedy and talking songs, black-face skits, vaudeville acts, monologs, dialogues, recitations, juvenile plays and songs, musical readings, entertainments, make-up goods. Catalog free. T. S. Denison & Co., 623 So. Wabash, Dept. 11, Chicago.

**MARVEL** Silhouettes—just out. Everybody enjoys them; fascinating and entertaining. Twenty-five puzzles in one. Only 10c coin. D. T. Beck, Ft. Wayne, Ind.

## MAGIC TRICKS, BOOKS AND JOKER NOVELTIES

**MAGIC**—Tricks, Books and Supplies. For amateurs as well as the great professionals. Anyone can learn through our instructions. Feature Acts in Mind-Reading, Spiritualism, Rope Ties, etc. Large illustrated professional catalog, 20c. Chicago Magic Co., 140 So. Dearborn St., Dept. B, Chicago, Ill.

**CARD** Tricks, coin tricks, ventriloquism, 4 instructive books, 10c each. Geo. Ferner, 2401 Jefferson, Louisville, Ky.

**TEN** Tricks with fire. Instructions, chemicals. Complete outfit 25c. Gray, 3310 Herndon, Chicago.

**TWENTY** Clever tricks 10c. Map of moon 10c. Curiosities of sky 10c. Arthur Hansen, 3384 Drexel, Northside, Pittsburgh, Pa.

**AMAZING** Magic cards 10c, catalog free. Davis, 2099 East Allegheny, Phila., Pa.

**"1000 WONDERS"** Amaze and mystify! This famous magic book and catalog postpaid 10c. Largest line. Lowest prices. Send today! Lyle Douglas, Station A-5, Dallas, Texas.

**MAGIC** Catalog 20c. Lynn, 105 Beach, Dept. 3, Jersey City, N. J.

**TRICK** Catalogue, illustrated, 10c. Oaks Magical, Dept. 548, Oshkosh, Wis.

**SPHINX**, Magicians' magazine, 55c. Catalogue of magic, 10c. Holden Magic, 233 W. 42nd St., N. Y.

## MINERALS AND GEMS

**MINERALS**, Gems, rocks, ores, for study or cabinet display. Splendid values. Gem Shop, 15C, Kohrs Block, Helena, Montana.

## RADIO SETS AND SUPPLIES

**SENSATIONAL** New "Melody King" radio delights everyone. Uses no batteries or tubes, yet reception over hundreds of miles reported. Ordinary receiving range of 10 to 25 miles easily extended by proper hookup. Ideal bedside radio. "Melody King" set only \$1.00, postpaid. Illustrated catalog, 10c. Melomite Company, Dept. P-20, Fairmont Station, Kansas City, Mo.

**TIME** Counts in applying for patents. See page 129. Clarence A. O'Brien, Registered Patent Attorney, Washington, D. C.

**SHORT** Wave receivers, transmitters \$7.50 up, free list. Radio Exchange, Richland Springs, Texas.

**TRANSFORMERS**, Primary 110, secondary 1100, each side, 100 watts. Cased \$7.50. W. E. Christnagel, Little Falls, Minn.

**SHORT** Wave conversion for regular set. Complete plans, drawings, 15c. Federal Radio & Telegraph Co., Box 911, Cincinnati.

**GUARANTEED** "Pocket Radio," \$2.00. Catalogue, 10c. Neil Tasker, Shamokin, Pennsylvania.

## STAMP COLLECTING

**IMMENSE** Triangle stamp! The largest in the world, an album giant (Spain 1939 Columbus commemorative) included in amazing packet of thirty-four scarce varieties from queer far-off lands; Rodd, Kouang-Tseou, Gwallor, etc. Absolutely no common European varieties to mar the high quality of this wonderful packet. Only 10c (plus to approval applicants). Vogue Stamp Co., Dept. P3, Pori, Chester, N. Y.

**SCARCE** Airmail and triangle. Beautiful Uruguay "flying horse" airmail and scarce Guatemala triangle (smallest in the world) are included in our big packet of 60 different stamps from Alouites, Grand Liban, Venezuela, British and French Colonies, etc. All for 5c to approval applicants. Big illustrated lists free with each order. Write today! Mystic Stamp Co., (Dept. 80), Camden, New York.

**ANCHER'S** \$38 Outfit—only 12c. Fine triangle stamp, set German stamps (pre-war) value millions dollars, perforation gauge and name scale, airmail set, interesting stamp smallest republic, newspaper set, packet good stamps Travancore, Malay, Dutch Indies, etc., fine pocket stock book. Entire outfit 12c to approval applicants. Ancher Stamp Company, Rutherford, N. J.

**JUST** Arrived, a brand new issue of Abyssinia which is so extraordinarily beautiful, artistic, and colorful, that every collector will be proud to possess them. That issue is limited and will advance in price. A real good investment. We offer 3 values together with the scarce Curacao No. 50 which is missing in most collections all for only ten cents to approval applicants. Gio's Stamp Co., 263 Fourth Avenue, New York City.

**THE** Biggest Dollar—1000 mixed foreign incl. Newfld., Fr. Col., etc., for 50c; 100 different U. S. and 1851 cover for 50c; 10 Afghanistan for 50c; 100 different Latin-Americans for 15c. All above with 1000 hinges for \$1.00. Approval selection is sent with each order. New England Stamp Co., 53 Bromfield Street, Boston, Mass.

**200** ALL Different good U. S. for \$1.00. New England Stamp Co.

**200** STAMPS from 200 countries for \$1.00. New England Stamp Co.

**200** ALL Different Asiatic for \$1.00. New England Stamp Co.

**200** ALL Different Africa for \$1.00. New England Stamp Co.

**10** DIFFERENT Afghanistan for 50c. New England Stamp Co.

**APPROVALS** To 50 Int. Jr. Album. New England Stamp Co.

**SEND** For new 1932 U. S. price list. New England Stamp Co.

**20** DIFFERENT Abyssinia for only 50c. New England Stamp Co.

**38** DIFFERENT Persia for only 50c. New England Stamp Co.

**BRITISH** Colonies: 25 different given approval applicants sending 2c postage. R. D. Davis, Silver Lake, Ind.

**GRAVEYARD** Mixture. Remains of collections and approvals, slightly damaged rare stamps. A handful, ten cents. Approvals, Gasper, 1221 California, Cincinnati, O.

**100** DIFFERENT Stamps from 100 different countries, 10c to approval applicants. Bares, Box 1054, Detroit, Michigan.

**100** DIFFERENT For this Ad and 2c to approval applicants. Evanston Stamp Shop, 2412 Noyes, Evanston, Ill.

**BIG** Collector's outfit! Magnifying glass; stamp tongs; perforation gauge and millimetre scale; watermark detector; package hinges; fine packet of stamps including scarce Penryn, Latakia (new country!), Lebanon (Bible-Land), French Colonies, etc. Everything for only 10c to approval applicants! Send today! Hornell Stamp Company, Dept. 9, Hornell, N. Y.

**2,500** MIXED \$1.00. Hiawatha, 600 University Avenue, Syracuse, N. Y.

**FREE!** 3 U. S. A. Commemoratives, 300 stamps, with 3 months subscription—10c. "Stampist," Hyndman, Pa.

**ATTRACTIVE** Approvals, United States, etc. Noemus Stamp Co., 312 East 23rd Street, New York.

**POPULAR** Approvals, 1c each, regardless catalog value. F. Koontz, Middletown, Va.

**NEWFOUNDLAND** 1933 Industrial set. Price \$1.07 for \$2.10. Rev. Butler, St. Georges, Newfoundland.

**TANNOU** Touva triangle! This scarce triangle and packet Vatican, Andorra, Liberia, etc., 5c with lists and approvals. Seminole Company, 121-Druid, Baltimore, Md.

**LINDBERGH** Costarican stamps, \$1.00, covers \$7.50, special Fierro cancellation \$10.00. Stepe, Apartado 1213, San Jose, Costa Rica.

**25** URUGUAY; 4c To applicants! Gordon Davison, 755 Hanover, Manchester, N. H.

**600** ZANZIBAR, North Borneo, Liberia, Congo, Sudan, Cuba, Albania, etc. Valued \$18.50. Only \$1.00. Empire Stamps, 222 Fulton Street, N. Y.

**FREE**, Fine British Colonial packet, 5c postage. Lighthorn, Southsea, England.

**DOUBLE** Value \$1.00 packet 25c. All different with premium same amount approvals 50% off. Leonard, 1818 Park Ave., Minneapolis.

**URUGUAY**, Extraordinary offer. Scott numbers: 350 to 303, 374 to 389, 614 to 623. Lightly cancelled \$1.50 each series. Unused, good centered, original gum, \$2.00 each series. The three complete unused series \$5.00 U. S. currency. Address: Manuel Garcia, Casilla Correo 841, Montevideo, Uruguay.

**SELL** Stamps! \$20.00 mounted and priced \$5.00. Satisfaction guaranteed. Fred H. Kenner, Eugene, Oregon.

**UNPICKED** Stamps from foreign nations, \$1 per pound or 25c per sample thousand. Approvals on request. Elmer, 191A Washington Street, Boston.

**SYRIA** Christmas seal and lists 12c. Dunning, Box 571, Wilmington, N. C.

**TRIANGLES** From Fiume, Nyassa, scarce Tansanyika, etc., 10c to approval applicants. Philip Parker, Marblehead, Mass.

**WONDERFUL** Packet of 40 stamps from strange countries—Pitj, Tasmania, Mozambique, Stam, etc., including smallest stamp, 10c. (No Europe) 25 Newfoundland and Canada 10c, 10 Andorra 10c. Bargain Stamp Co., 277 P West 23 St., New York.

**STUPENDOUS** Offer. Beautiful triangles, Nyassa, Abyssinia, Liberia, Venezuela, many others, 75c. Cat. to approval applicants only 10c. La Rue, Hammon, N. J.

**FREE!** Five different, rare souvenir stamps. Halcyon Press, Erie, Penna.

**FREE** Dollar packet to applicants for one cent approvals. Harlan, 5307 South Marshfield Ave., Chicago, Illinois.

**NINE** Unused Nyassa Triangles, 20 cents (coins). Importers Stamp Co., Room 210, 200 Broadway, New York.

**UNITED** States \$1.00 postage due stamp only 10c to applicants for better grade approvals. De Lisle, 702 Harding, San Jose, Calif.

**PENNY** Approvals that satisfy. Neil Gronberg, Box 5441, Philadelphia, Pa.

**FREE!** 100 Stamps to approval applicants. Brown, 181 Linden St., Everett, Mass.

**1,000** STAMPS For 25c! The biggest bargain of the year! Borell's giant packet of 1,000 stamps, including Abyssinia, Spanish Morocco, French Colonies, etc., etc. Price only 25c to approval applicants! Extra: 1,000 stamp hinges if you order today! W. A. Rowell, 58 Cornhill, Boston, Mass.

**100** U. S. Commemoratives 30c. Alvin Johnson, Storm Lake, Iowa.

**REYMOND'S** Key arranges 700 "hard-to-classify" U. S. stamps—twelve charts. You can find the right Scott catalog number every time. 50c. Raymond's, 1093 Haskell, Rockford, Illinois.

**3** PERSIAN Air mail 10c to approval applicants. C. A. Leeson, 266 Sheldrake Blvd., Toronto, 13, Canada.

**RABOTONGA**, 15 U. S. (air mail commemoratives, etc.) with approval. 10 South America 5c. Hudson Co., Plainfield, N. J.



**A BIG Bargain**—All for only 50c. Stamp album, providing spaces for 2200 stamps with 700 illustrations, packet of 500 different stamps, 500 hinges, and millimeter measure. Free with each order our pamphlet which tells "How to Make a Stamp Collection Properly," and our 80 page price list of albums, supplies and hundreds of bargains in sets and packets. Queen City Stamp & Coin Company, Room 30, 604 Race Street, Cincinnati, Ohio.

**FREE** Boy King packet to penny approval applicants, 2c postage. Knapp Stamp Company, Geneva, Ohio.

50 ALL Different U. S. 5c. 200 all different U. S. \$1.00. Tri City Stamp Co., Rock Island, Ill.

75c DISCOUNT Off Scotts, many hard to get nineteenth century stamps. References, please. Hubert Codwise, Garland Street, Lynn, Mass.

**SURPRISE** Packet with 100 different foreign, 12c. Danal, 527 Crescent, Covington, La.

SCOTT'S 1932 Stamp catalogue \$2.00, approvals. Stanley Ciesielski, Terryville, Conn. (25) DIFFERENT Good United States 10 cents to approval applicants. Herrick D. Smith, P. O. Box 93, Tuckahoe, N. Y.

**BIG** Package, at least 2000 stamps with Papua, Aitutaki, Abyssinia, Penryn, Nauru, Zanzibar, Triangles, etc. Only \$1.00. Longacre Shop, 106 West 42 Street, New York.

1000 MIXED Stamps, 25c. Stearns, 915 8th St., Ann Arbor, Michigan.

**FINE** Penny approvals. Write Stearns, 915 8th St., Ann Arbor, Michigan.

**FINE** Foreign coin before 1800, three large crisp notes and catalog 10c. M. Flagg, Box 283, Cedar Rapids, Iowa.

**FINE** Foreign copper and nickel coins, large crisp note, premium list and catalog 10c. Geo. Best, Cedar Rapids, Iowa.

**BEAUTIFUL** Picture stamps sent free. Paul Cornish, Schenectady, N. Y.

**BRUNEL** (Native Scene), gigantic bi-colored Persian airmail, Johore, Charkhari, Tananarika, French Guiana, Provisional, Grenada, Eritrea, Foreign Revenue, Kedah, Orange River Colony, Nyasaland Protectorate, and scarce genuine Baden, all for 5c to introduce our famous approvals! Viking Stamp Co., Sheepshead Bay Station, Brooklyn, N. Y.

**BARGAIN** of a century! Look at these peaches: Zambesia, New Guinea, Inhambane, Lourenco Marques, Ubangi, Monaco and multitudes others. All only 10c to approval applicants. Goldwater, 1827 Amethyst Street, Bronx, New York.

**FIRST** Issue Honduras, 3c, approvals. Stanley's Stamps, Heyworth Bldg., Chicago.

**BARGAIN** Of lifetime: Packet Triangles, packet Liberia, Niue, Penryn Islands, Azerbaijan, etc. All 10c to approval applicants. Emze Stamp Co., 1807 Ocean Ave., Brooklyn, N. Y.

**GREAT** Advertising offer: Approval sheet high grade stamps worth \$1.00, surprise packet listing over \$1.00; all for 20c. Tropical Stamp Exchange, Pinellas Park, Fla.

**JAPAN**—40 Varieties 10c to approval applicants. Allison, Angola, Ind.

**LIECHTENSTEIN** Two complete sets, enclose 5c. Requesting approvals. Trenton Stamp, 788 Beatty, Trenton, N. J.

**GET** Big collection free. Information and 1000 mixed stamps, 25c. Stark, 4554 Oakwood, Chicago.

**FREE** 50 Stamps, postage 2c. Approval applicants. Box 893, Bury Hill, Flagstaff, Arizona.

**STAMPS** Sent on approval at 70% discount. Reference required. Emory Remoll, Hanover, Pa.

**FIFTY** French Colonies 12c; with approvals 10c. Pope, Arondale, Georgia.

U. S.—50 Different (commemoratives, airmail, etc.) 10c. 100 Borneo, Malay, etc. 5c; lists free. Moseley, 4932 Forest Park, St. Louis, Mo.

**THIRTY** Varieties United States besides 100 fine foreign six cents. Approvals. Hoyce, Carlisle St., Springfield, Mass.

**KENTIA** 10 Varieties 10c to approval applicants. N. Carter, Elkhorn, Wisconsin.

6,500 STAMPS, U. S. and foreign for dollar bill. Ace Stampo, 1000 So. 15th, Maywood, Illinois.

**LIBERIA** Packet, 2c to approval applicants. Welsh, Elsmere, N. Y.

**FREE**—Rare 1829 French cover to applicants for approvals, 60% discount. Charles Cleveland, 806 No. Humphrey Ave., Oak Park, Illinois.

100 DIFFERENT U. S. including commemoratives, air mails, 19th century, 25c. Carson Supply, 415 Dwight Bldg., Kansas City, Mo.

**CONFEDERATE** Stamp, Nauru, Papua, Johore in packet of 100 different stamps 15c to approval applicants sending references. Laurence J. Heyman, Chaffee, Mo.

**MONTERRAT** Scarce set 8c with approvals. K&L, 2118 Cortez, Chicago.

**TRIANGLE** Stamps free! To approval applicants—2c postage. B. Abell, Box 112, Chelsea, Mass.

**FRENCH** Colonies, 50 different 10c. Browns, 90 Kemper, Wollaston, Mass.

500 DIFFERENT Stamps 25c. Approval applicants only. Ohio Stamp, Box P249, Cleveland, Ohio.

**LARGEST** Stamp in the world! Rare China Wild Goose special delivery stamp (value 75c) for only 5c to approval applicants. Supply limited. Positively only one to a customer. Western Philatelists, 6021 Harner, N-55, Chicago.

**HEJAZ** Free with orders. U. S. Mission 35c lb. Foreign 75c lb. Popular Co., 4512 North Racine, Chicago.

**UNITED** States stamps on approval. Haines Stamp Co., 251 Market St., Lowell, Mass.

400 DIFFERENT 15c; approvals included. Mantle Stamp Company, London, Canada.

**MOUNT** Your stamps the new way without injuring the glue. Junior nuAee Corners do the trick and allow maximum visibility of stamp face. Eight colors. Sold where photo goods are sold and at 5 and 10 cent stores. Dealers name and dime brings package and samples. Made only by Ace Art Company, Reading, Mass.

1,000 FOREIGN Stamps 17c to approval applicants. Fulmen, Columbia, Missouri.

**SENSATIONAL** Clearance packets 12c. You'll want more! Aircraft, Chillicothe, Mo.

102 DIP, Including triangle, diamond-shaped stamps, 7c with approvals. Ransom, 1323 Pentlar, Ann Arbor, Mich.

**CAICOS** Islands—Also early United States, Uzanda, Lourenzmarques, Congo's Salvador, Monte Carlo, Prince Islands, Canada, Ubangi—Countries collectors haven't got"—Free for 5c postage. Harry! For yours, now. Empire Stamp Company, Toronto, Canada.

100 STAMPS From 100 different countries, 25c. Reimers, 30 N. LaSalle, Chicago.

**FOUR** Beautiful bi-colored Persian airmails for only 8 cents to approval applicants. Chippewa Stamp, 42 W. Chippewa, Buffalo, N. Y.

**REQUEST** Selections on approval at half other dealers prices. Curious set Azerbaijan free with request. Biedell, Greensburg, Pa.

**FREE**—Thrilling jungland packet! Iraq (Winged Bull), Tunis (Fighting Arab), Liberia (Jungle Village), Congo (Explorer Stanley), many others, also lists, valuable coupons, dandy penny approvals—everything 4c postage. Midwood Stampo, Midwood Station, Brooklyn, N. Y.

1000 DIFFERENT 60c With approvals. U. S. list free. Hollinbeck, 312 Marquette, Minneapolis.

**PAPUA**, Zanzibar, Iraq, Johore, Lebanon, Transvaal, etc. In our packet 57 different, 5c with approvals and lists. Monumental Stampo, Arlington-263, Baltimore, Md.

**ABYSSINIA** Rhinoceros (catalogs 45c), also packet Andorra, Oltre Giuba, Epirus, Nigeria, Mozambique, etc., 5c with approvals and lists. Pilgrime Stampo, Mount Washington, Md.

50 FRENCH Colonies, Alauites, Gabon, Caledonia, etc., with approvals 6c. Hollinbeck, 312 Marquette, Minneapolis.

**FREE!** World's smallest stamp! 2c postage, 10 different triangles, 18c. Scott's International Junior Album (cloth bound edition; 21,000 spares!) \$2.95! Approvals sent. Tatham Stampo, West Springfield, Mass.

**CANADA** Airmail stamp free if you ask for approvals and send 15c for 25 different airmails or 30 different Canada; both packets only 25c. We list 350 countries in our dime packets. Lists free. Special bargains, 500 different, 25c; 1,000 different, 75c; 2,000 different, \$2.50. Victoria Stamp Co., London, Ontario, Canada.

500 DIFFERENT Stamps for 25c. Big collection including Armenia, Andorra, Flume, Spanish Morocco, Kenya, Liberia, Memel, Nigeria, Quelimane, Syria, Victoria, Vatican City and other hard-to-get countries. Catalog value over \$10.00. Price only 25c to approval applicants. Illustrated lists free. Loma Stamp Company, 4231 42nd St., San Diego, Calif.

**FREE**—\$1.00 U. S. postage Lincoln memorial free, if you write for our 56 page price-list of U. S. and foreign stamps, 2,000 illustrations and fine stamps on approval. Hussman Stamp Co., 629-3 Olive St., St. Louis, Mo.

**ONLY** 5c. 33 Different stamps including scarce Latvian triangular airmail stamps, 10 airmail, 12 United States (early issues, commemoratives, etc.) and 10 Canada. Approvals and illustrated pricelist sent with each order. Curhan Stamp Company, Gloucester, Mass.

301 DIFFERENT 10c To approval applicants only. Free list of bargain packets. Kansas City Stamp Co., Lee Bldg., Kansas City, Mo.

50 DIFF. United States, including \$2 tax, 10c; 30 Canada 10c. Robert Haynes, Point Place, Toledo, Ohio.

100 BELGIUM Parcel post 25c. King Stampo, Webster Groves, Mo.

**STAMP** Hunters' Club, friendship, mystery, adventure; trial membership 10c. Edgar Snyder, 3 Churchill Rd., Youngstown, Ohio.

**STAMPS** Sent on approval at 50% discount. 50 all different U. S. 25c; 100 all different \$1.00, mostly old issues and commemoratives. Fred Herzberg, 207 So. Washington St., Wheaton, Ill.

**NOSSIBE**, Volta, Indore Travancore, Mexico Revolution, Mozambique, Benin and others, catalogue \$1.37. Yours for 5c and request for 50% discount approvals. Parimpo, Box 552M, Glendale, Calif.

**FREE**—Sample copy unique weekly stamp paper. Stamp Collector, Mill City, Oregon, 105 (CHINA, Etc.) 2c. Album (500 illustrations) 3c. Bullard, 446 Tremont, Boston.

**FREE!** 25 French colonies with approvals, postage 2c. Potomac Stamp Company, 3708 Thirteenth St., Washington, D. C.

**LIBERIA**—Four varieties 2c to approval applicants. William Calkins, Cleveland, O.

1000 ASSORTED U. S. stamps, 25c. Auburn Stamp Co., Syracuse, N. Y.

**FORTY** Different United States and pricelist 12c. 60% approvals. Seidenberg, Baroda, Mich.

**WHOLESALE** Catalog for dealers; 4c postage. Grossman, 102 W. 42nd, New York.

**SCARCE** Belgium airmail, pocket album, commemorative set, 40 scarce stamps from South America and Canada for 5c to approval applicants. Glendale Stamp Co., 1342P Linden, Glendale, Calif.

500 DIFFERENT Stamps 20c; 500, 35c. Michael, 942 So. 23rd, Bellwood, Ill.

**FJI**, Brunel, Airmail, Zanzibar, Tananarika, Mauritius, Kenya, in packet 49 different "hard-to-get" stamps, 6c only to approval applicants. Kenwood Stamp Company, 528 Kenwood, Glendale, California.

**BICENTENNIAL** Offer—10c! Airmail and six other attractive sets. Three packets, approvals. Deering, 164 Albion, Somerville, Mass.

**EUREKA**. What is it? Write. Ask. Box 1089, Vancouver, Canada.

**QUALITY** Stamps on approval 1/4c up. Free premium. Kelgwin Stampo, Vineland, N. J.

**UNITED** States on approvals. Huber, 3551 Penn Ne. Minneapolis, Minn.

**TRIANGLES**—Eight different triangle stamps including Guatemala (world's smallest), Latvia (air mail), Liberia, Nyasa only 10c to approval applicants. Paul Reverse Stamp Co., Box 40, Astor Station, Boston.

200 DIFFERENT Triangle, airmail, etc., 10c. R. H. Carlton, 1211 W. 37 Place, Los Angeles, Calif.

**SAN** Marino set and 50 different stamps, 5c to approval applicants. Malboro Stamp Co., 1630 East Fifth Street, Brooklyn, N. Y.

**ILLUSTRATED** Album holding 3500 stamps to approval applicants 20c. Swan Stamps, 603 Swan, Dunkirk, New York.

**NYASALAND** Protectorate and 25 other British Colonies 4c to approval applicants. Frank Ewing, Box 493, Cleveland, Ohio.

100 DIFFERENT British Colonies including scarce old New Brunswick, Newfoundland Canada commemoratives 25c to approval applicants. Reid Stamp Company, 608 Yonge Street, Toronto.

1000 MIXED U. S. 25c, pound U. S. 50c. Weatherox, Lakewood, Ohio.

200 DIFFERENT 10c, 25 Japan 10c, 60% discount approvals. Covert Stamp, 39 State, Rochester, N. Y.

100 DIFF. 10c; 1000 Mixed 60c; 23 diff. U. S. 25c; 1000 hinges 15c; album 60c. Price list and approvals sent with every order. C. Stegman, 5941 Cote Brilliant Ave., St. Louis, Mo.

1000 UNIVERSAL Hinges 10c; lists free. Harvey Teeple, Decatur, Indiana.

24 VARIETIES Cuban stamps, 10 cents. List of stamps free. Chambers Stamp Co., 111P, Nassau, New York City, N. Y.



**PACKET 52** Different from Alaouites, Lebanon, Stam, etc., also watermark detector and rare old Hawaiian stamp—all for only 5c to approval applicants. Highland Stamp Co., Newton Highlands, Mass.

**FREE 6** Different Luxembourg to approval applicants. E. D. Stamp Co., 3903 Forest Park Ave., Baltimore, Md.

**ILLUSTRATED** United States list, price 50c. Large complete United States price list, 1932, free. Stanley Gibbons, 38P Park Row, N. Y.

**300 DIFFERENT** Stamps 20c; 600 50c; 1,100, \$1; 2,000, \$3. Fred Onken, 630 78th St., Brooklyn, N. Y.

**PENNY** Approvals, 5,000 Sudan, Congo, Nyassa, Liberia, etc. Also 14,000 averaging 1 1/2c. Philatelic Exchange, Huntington, W. Va.

**BEST** One cent approvals in America. P. Hand, 1117 So. 60th St., Philadelphia.

**FREE!** Loose leaf postage stamp album at rate of 8 pages each month given with subscription to monthly journal. Send 2c stamp for prospectus. United Stamp Co., Marquette Bldg., Chicago, Ill.

**RELIABLE** Boys. Sell our dandy approvals. Excellent pay. We trust you. Nice free premium if you write today. References please. Le Roy Stamp Co., B20 W. Jackson Blvd., Chicago.

**FREE** Outfit! 52 stamps, hinges, pocket wallet. Postage 4c. Approvals. United Philatelists, South Berkeley, Calif.

**27 LICHTENSTEIN** 4c To approval applicants. Hagen, Box 129, Sioux Falls, S. Dak.

#### RARE COINS

**100 FOREIGN** Coins \$1.00; 10 Civil War cents 60c; 10 historical medals 60c; 10 large copper cents \$1.00; 1/2 cents 25c; 10 Confederate bills 50c; 10 attractive foreign bills 30c; 10 Indian arrowheads 60c; 10 historical newspapers, Civil War news \$1.00; historical medals Washington Valley Forge, Marshall, Franklin, Lincoln, Roosevelt, Harding, each 30c. World War medal 50c. Nagy, 8 South 18th Street, Philadelphia.

**SIX** Interesting coins, (two ancient silver) classified, and monthly bargain bulletins, one dollar. Southampton Coin Exchange, 5427 Nottingham, St. Louis.

**OLD** Money wanted. Will pay \$100.00 for 1894 dime, S. mint; \$50.00 for 1913 Liberty head nickel (not Buffalo). Blz premiums paid for all rare coins. Send 4c for large coin folder. May mean much profit to you. Numismatic Co., Dept. H, Ft. Worth, Tex.

**\$5** To \$500 Each paid for old coins. Many very valuable. Keep all old money. Get posted. Send 10 cents for illustrated coin value book, 4x6. Guaranteed prices. We buy and sell. Coin Exchange, Box 5, Le Roy, N. Y.

**5 DIFFERENT** Mexican coins and catalog, 25c. David C. Howard, Devine, Texas.

**10 WHITE** Cents 65c; 10 U. S. 2c pieces 75c. Send your card and get on my mailing list. S. Drutz, Box 749, Saranac Lake, N. Y.

**FLYING** Eagle cent 9c, three cent 12c, twenty coins 50c, list 4c. Lloyd, 1821P Main, Dallas, Texas.

**THREE** Washington medalets, 20c each; Lincoln medalets, 25c; Washington Bust Cent lapel pin, 50c; three celluloid buttons Washington, 15c each; Roman coin, 25c. Rollo Gilmore, 4243-PM, Sheridan, Chicago.

**5 DIFFERENT** Pieces foreign paper money and bargain selling price list 10c. Arcey, Box 483, Muskogee, Okla.

**25 COINS** And bills 25c. Oddehon, Box 681, Kansas City, Mo.

**PAPER** MONEY—100 Different Confederate, Mexico, etc., 79c! Stamp and coin approvals sent. Tatham Stamps, West Springfield, Mass.

**UNITED** States. Large cent, two-cent bronze, three-cent nickel and bargain list, 25c. Thirteen dates large cents, \$1.00. George Coffin, Greenwood Mountain, Maine.

**7 DIFFERENT** Coins, 11 bills and catalog, 25c. Creamer's, 1112 Somerset, Baltimore, Maryland.

**2 COINS,** 5 Notes and catalogue 10c. Lester White, Box 60, West Newton, Mass.

**RARE** United States and foreign coins, war medals and decorations. Selling catalogue, 10c. Alexis Mengelle, Colorado Springs, Colorado.

**SEND** 10c For 5 different coins and catalog or 50c for 25 different. Troger Coin Co., La Fontaine, Ind.

**GET** Profit and pleasure in collecting old coins. Send 10c for large illustrated coin catalog. You'll be delighted with it. Send for it right now. R. Max Mehl, Numismatist, Mehl Bldg., Dept. P, Fort Worth, Tex. Largest Rare Coin Firm in the U. S.

**CALIFORNIA** Gold—Quarter size, 27c; 3/4 size 52c; 2c piece and catalog, 30c. Norman Shultz, Box 746, Salt Lake, Utah.

**20 DIFFERENT** Coins 25c; 68 different, \$1.00. Bishoff, No. Kansas City, Mo.

#### CAMERAS AND PHOTO FINISHING

**"EXPO."** The watch pocket detective camera, \$3.95 new. Small and compact, fits the vest pocket like a watch. Loads in daylight. Practically new 2 1/2x3 1/4 Eastman Kodak with f:7.7 lens \$10.50. Eastman Kodak 3 1/4x5 1/4 single lens \$5.75. Eastman Kodak 3 1/4x5 1/4 with f:7.7 lens \$11.50. Eastman Kodak Special with f:6.3 lens, Optimo shutter \$24.50. All guaranteed. Send for our free bargain book. Central Camera Co., 230 S. Wabash, Dept. PM-4FB, Chicago, Ill.

**WANT** Extra money? Earn splendid income with your camera right where you live taking photographs for newspapers and magazines. A fascinating money-making spare-time occupation easily learned at home! Possible to earn full price of course while learning. Write today for free book. Universal Photographers, Dept. 6, 10 West 33rd Street, New York.

**"CASH** From your camera" \$1.50. This book has shown hundreds of amateur photographers how to make money in their spare time. (Special offer)—2A Eastman Kodak that sells regularly at \$11.00; we are offering this camera with complete developing and printing outfit for only \$9.95 with one roll of film. Central Camera Co., 230 S. Wabash Ave., Dept. PM-4FA, Chicago, Ill.

**STAMP** Photos 1c each. Size of postage stamp. Minimum quantity 100. Reproduced from any size photo or snapshot. Wonderful clear, sharp pictures, gummed and perforated, ready for use. Apply them to letters, postals, envelopes, etc., for business or social use. Original returned unharmed. Send \$1.00 for one hundred postpaid. Art now, satisfaction guaranteed. Philadelphia Badge Co., 912 Market St., Phila., Pa.

**MAKE** Money in photography. Learn quickly at home. Spare or full time. New plan. Nothing like it. Experience unnecessary. American School of Photography, Dept. 3431, 3001 Michigan Avenue, Chicago.

**COLOR** Enlargement with first roll 25c. Wallace Studio, Clarion, Iowa.

**PHOTOGRAPH** School scholars—pleasant profitable. Full instructions 25c. Gillett, Musroda, Wis.

**SNAPPY,** Glossy enlargements, 5x7—10c coin. Send negative today. Mangel's Jr., 2825 Ocean Parkway, Brooklyn, N. Y.

**PEN** And ink etching of yourself. Photographic likeness—size 5x8 inches. High grade parchment. Send any size photo and five dollars. Photo returned unharmed. Lval Adams, Artist, 1520 No. Edgemont, Hollywood, Calif.

**QUARTER** Buys three enlargements (one negative.) Force, 2007 Eye, Washington, D. C.

**SNAPSHOTS** Wanted. Highest prices. Rush quarter for 1932 purchasing list. Imperial Laboratories, Kewanee, Ill.

**MOUNTED** Colored enlargements that are different. 5x7, 25 cents; 8x10, 50 cents. Send negative. Gibson Photo Co., 833 Gravesend Avenue, Brooklyn, N. Y.

**HAVE** You a camera? Write for free sample of our big magazine, showing how to make better pictures and earn money. American Photography, 116 Camera House, Boston, 17, Mass.

**YOUR** Favorite kodak picture enlarged, size 5x7, 10c. Three for quarter, coin. Send best negative (film) today. Address Darmer Photo Lab., 221 Securities Bldg., Des Moines, Iowa.

**SPECIAL** Trial offer: Developing any size roll 5 cents; prints 3 cents each. Beautiful 7 inch enlargement 20 cents. Send for special bargain list. Roanoke Photo Finishing Company, 209 Bell Avenue, Roanoke, Virginia.

#### MOTION PICTURES AND SOUND EQUIPMENT

**16MM** MOVIE Cameras and projectors, for the home, school, church and business organization. Literature free. D. F. Elder & Company, Dept. A-4, Chelsea, Mass.

**FILMS** Cheap. Lists free. Williams, 837 Grove Ave., Johnston, Pa.

**MACHINES**—Westerns, Chaplins. Mix. Perfect prints. Minot Films, Bingham, Me.

**READY!** No. 208 B Bass bargaining mailed on receipt of 4c in stamps. World's best bargains. Motion picture cameras and projectors. New and used, 16MM or 35MM. Accessories, text books. You want a copy. Bass Camera Company, Motion Picture Apparatus Headquarters, 179 West Madison Street, Chicago, Ill.

**ALBERT** Calderara, 5119 S. St. Louis Ave., Chicago, Ill. Bargains.

**MOVIE** Supplies: Films bought, sold and exchanged. Chapmans', 56 Godwin Avenue, Ridgewood, N. J.

**FILM** Sale—Lists. Smith Films, Celina, Ohio.

**CLIFTON** Motion Picture Club, Clifton, N. J. 16MM films.

**TIME** Counts in applying for patents. See page 129. Clarence A. O'Brien, Registered Patent Attorney, Washington, D. C.

**WESTERNS** \$1.75. Reel 500 ft. \$1.00. Comedies \$2.50. Jersey Films, 2013 Waterbury, Lakewood, Ohio.

**16mm. PICTURES,** \$3.65. Movie cameras, projectors. Levens Pictures, Madison, Ind.

**16MM** FILMS, 100 Ft. 35mm cartoon, 90c. Lowell Films, Allentown, Pa.

**ALL** New merchandise—400 foot-16mm film. Travel, comedy \$8—in sound \$14.49. 10mm projector \$3.95, with motor \$10.49. Keystone, 100 foot camera \$9.85. Pathex \$3.5 camera \$9.85. Pathex deluxe projector \$16.50. "Our Gang," "Aesop" film 49c. Lists, Mougill Bros., 19443 Boston Road, New York City.

**16MM** FILM Every description sacrificed. Odd lengths two cents foot. Home projectors \$7.50. Thousand feet 35MM film \$1.00. Excelsior Films, Cincinnati.

**CLEAN** Up sale. Odd reels \$1.15 plus postage. Lists 2c. Hoffman Film Service, 57 Broad, Albany, N. Y.

**NEW** Releases 16mm one hundred to four hundred ft. comedies, westerns, cartoons, \$3.75 per hundred. Motor driven projectors \$21.00. Metropolitan Motion Picture, Newark, N. J.

**\$1.250** FOR Original photoplay story. Our sales department sold unknown author's first story for above amount. We revise copyright and submit to studios stories for talking pictures. Being located in the heart of motion picture industry we know production requirements. Established 1917. Free booklet. Universal Scenario Company, 266 Meyer Bldg., Western and Sierra Vista, Hollywood, Calif.

**TALKIE** And movie producers are clamoring for new short story ideas, plots, etc. Perhaps you can write one that we can shape and sell for you. One writer (V.M.) received \$3,000. New York best market. Write now for free booklet, without obligation—How To Write For The Talkies! Daniel O'Malley Company Inc., Suite P, 1776 Broadway, New York.

**16mm. MOVIE** Exchange Plan. 50 cents to exchange 100 foot film, 30 cents to exchange 50 foot film. Send for large lists of films. Exclusive Movies, 732 S. Wabash, Chicago, Ill.

**16MM** FILM Every description sacrificed. Odd lengths two cents foot. Home projectors \$7.50. Thousand feet 35MM film \$1.00. Excelsior Films, Cincinnati.

**SPECIAL** DeVry G 16M millimeter projectors. List \$88.00. Our price including 100' Chaplin films \$32.50. Factory packed. Brand new. Milton Mendelwager, 192 Ave. B., Bayonne, N. J.

**DE VRY** 16M Cameras \$30.00, projectors \$28.00. Special wholesale price to dealers. 100 foot 16m negative \$4.50. 16m films 2c foot. 35m cameras \$25, projectors \$35, comedies \$1, 35m negative stock 2c foot, kodak \$1. Rex, 820 - 8th Ave., New York.

**FILMS** \$1.00. Projectors \$25.00, 10c coin for lists. Box No. 6, Rosedale, Kansas.

**16MM** CHAPLIN, Mix, Fairbanks films, 75c each. Lists. Home Movies, Box 32, Easton, Pa.

#### TRADE AND TECHNICAL SCHOOLS

**BLUE** Print reading. Easy to learn. Write Columbian School, Drexel Building, Philadelphia.

**GUSTAS** School trains thoroughly in shoe rebuilding, hat renovating, clothes pressing in short time. Gustas, 7 W. Division, Chicago.

**LEARN** Watch repairing. Hiles School, 5330 Mission St., San Francisco.

#### TELEGRAPHY

**LEARN** Wireless (Radio) and Morse Telegraphy. School, oldest, largest; endorsed by telegraph, radio and government officials. Expenses low—can earn part. Catalog free. Dodge's Institute, H Street, Valparaiso, Ind.



## BUSINESS OPPORTUNITIES

**LEARN** Marbleizing with various cement. We teach scagliola making the precast way. The cast stone work the newest building material. Initiating granite perfectly, also monolithic, and other roofs inexpensive. Sanitary floors, for all uses, also practical mold making. With the brush enameling system our own invention produces best glossy marble effect, all colors and veining, over any concrete products, garden furniture, burial vaults, statues, novelties, wallboard, iron, etc. Send dime for samples and illustrated literature. Cowell Institute, Grayling, Mich.

**THIS** is not ballyhoo—At last you can make the best insulating board at home. Line your attic and save plenty on coal bills. Keep your building warm in winter and cool in summer. Any adult can make it. It's fun. Insulate other buildings and make money. Raw material costs almost nothing. Your equipment consists of a few boards nailed together. Make a warm plaster base too. Mail a dollar bill to The Insulating Man, Mitchell South Dakota, for complete instructions. Remember, nearly two-thirds of your heat loss is through your roof.

**YOU** Can sell by mail or any other way if you know "The Six Motives That Open the Hearts and Minds of Men." The profusely illustrated edition of "Ego-Dynamics" tells this and many other secrets from the private notes of big-business men. "Knowledge is Power." This knowledge made the B-BM succeed. It will make you succeed. Ten thousand dollars worth of information for one dollar. Be independent. Send that little dollar now to The Ego-Dynamic Press, P. O. Box 442 MP, Cincinnati, O.

**MAKE** Trillises for profit or pleasure. Every home a prospect. 24 modern designs, details and instructions \$1.25 postpaid. Contractors Service Bureau, 2645 No. 8th Street, Milwaukee, Wis.

**EARN** Up to \$25 weekly or more growing mushrooms in your cellar or shed. Illustrated booklet free. American Mushroom Industries, Ltd., Dent, 880, Toronto, Ont.

**MECHANICAL** Merchandising business opportunities—Send dollar for subscription. Durand, Hinsdale Pa., Newark, N. J.

**FREE** Booklet describes 87 plans for making \$20-\$100 weekly in home or office business of your own. Elite Co., 211 Grand St., New York.

**SUCCEED** With your own products. Make-sell them yourself. Formulas, processes, trade-secrets. Analytical service. Catalog free. B. Thaxly Co., Washington, D. C.

**2c STAMP** Brings booklet about starting little mail-order business. Hadwilt, 15A-74 Eastland Street, N. Y.

**SPARE** Time selling magazine, bristful of practical moneymaking plans and schemes, 8-12 months 25c (coin). Promote, 794 E. 125, Cleveland, Ohio.

**MAKE** Latest guaranteed automobile necessities, newest cleaners, best advertised food products, modern, latest toilet specialties, medical preparations, meritorious household necessities. Using Miller's foremost formulas and trade secrets. Easy to start anywhere. Investment small, profits quick and liberal. Miller, Chemist, 706-L, Tampa, Fla.

**600,000 ARTICLES** Wholesale—Directory 10c. Maize, 1801-10 Memorial, Williamsport, Pa.

**MIRRORS** Resilvered at home. Costs near 5 cents per square foot; you charge 75 cents. Profitable business plating like new brassy worn-off autoparts, reflectors, tableware, stoves, etc. Outfits furnished. Details free. Sprinkle, Plater, 127, Marion, Ind.

**CANOE**—Go in business for yourself re-canvasing canoes. Big profits! How to canvas canoes and get started, sent complete for \$1.00. Calumet Indian Canoe Co., Johnston, Rhode Island.

**CHEMICAL** Expert will furnish formulas and trade secrets. All lines. Lists free. W. L. Cummins, Ph. D., 228 Gordon Ave., Syracuse, N. Y.

**NEW** Unusual money making proposition. Big profits. Literature free. Doe's Exchange, Ada, Okla.

**1932 MONEY** Maker, New. Surprising. Delightful. Particulars free. Guaranty Co., 1229 W. Maple, Enid, Okla.

**DISTRIBUTORS**—Agents—Everywhere. "Dragon-Fly" crash-proof 50c flying model airplanes amaze everyone. Sell on sight. Enormous profits. Exclusive territory. No competition. Western Aircraft, 4137 W. Pico, Los Angeles.

**"SCHEMER,"** Alliance, Ohio, 32p monthly, prints big \$-getters. Subscriber reports \$50,000 from one tip; another \$25,000 from three schemes; another \$10,000 from one formula. Get wise! Year, only \$1.00; 3 months, 25c.

**START** Mail order business of your own. Earn large income. Little capital required. No canvassing, nor personal contact. Send dime for book. Bristful successful mail order propositions. S. Rosen, 123 N. Central Ave., Baltimore, Md.

**I MADE** \$50 weekly, renewing colors in upholstery, rugs, etc. Free booklet. Dr. W. Abell, Alhambra, Calif.

**LARGE** Size, 32 page book of money makers for spare time workers 10c. Terrill 32B System, Brookfield, Mo.

**BUYERS** Guide, 10,000 items wholesale, also selected formula list \$1.00. Superseal, Westington, South Dakota.

**TIME** Counts in applying for patents. See page 129. Clarence A. O'Brien, Registered Patent Attorney, Washington, D. C.

**NEED** Money? Stamp brings interesting literature on money-making stunts. Albert Freilich, K5842 Highland, St. Louis, Mo.

**\$100 MONTH** Raising caviar. Folder, contract 10c. Shady Willow Caviary, Mansfield, Penna.

**MONEY** Mailing circulars at home. 15c rings, particulars, samples, magazines, year. Pennell Standard, Corington, Kentucky.

**BARGAINS**—Paint spray outfits, gasoline engine drive, one and two gun models. Liberal trial. Easy terms. Fully guaranteed. Will pay for themselves. Ira C. Helmick, Box M326, Troy, Ohio.

**JUST-OUT**, Not patented, useful and ornamental article, easily made, with simple tools. Cost to manufacture 10c. Sell 50c. Instruction 50c, with sample \$1.00. Ralph Moore, 764 - 60 St., Brooklyn, N. Y.

**FORGE** Ahead with your own business. Literature describing mail order and manufacturing enterprises free. Secretary, 1531 Grand Central, Tampa, Florida.

**ENORMOUS** Profits manufacturing chocolates. Samples, formulas, instructions, other moneymaking plans, 25c. Valles, 23 W. 114th, New York.

**LEARN** To make men's ties. Pattern complete instruction. No canvassing. Send \$1.00. Hty Bitty Tie Shop, 350 Montgomery Street, Portland, Oregon.

**EARN** Big money daily. \$2.00 will start you. Ott's, 1903 Elm St., Toledo, O.

**EARN** Money at home. Send only 25c (no stamps) for 60 page book of successful plans and ideas for making money at home. B. V. Stahl, Islington, Ontario.

**ENTER** Collection work, represent coast to coast service, pleasant earn at home business. Atlas, 509 Fifth Ave., New York City.

**LOOKING** For work? Start your own business. Stamped envelope brings information. Box 1023, Wallace, Idaho.

**PLASTIC** Leather, resoling compound. Complete formula, instructions, \$1.00. First sale pays for formula. L.L.J., Box 1023, Wallace, Idaho.

**250 ASSORTED** Collection letters, reminders and business builders, \$1.00 postpaid. Maryland Specialty Co., 2712 Maryland Ave., Baltimore, Md.

**ARE** You old at forty? See our advertisement on page 26 of this issue. The Electro Thermal Company, 2152 Morris Ave., Steubenville, Ohio.

**MAKE** Products yourself. New tested formulas. Catalog free. Chemist Grinstead, Edwardsville, Illinois.

**BUILD** Your own floor sanding machine; sanding drums sold separate, six, seven, eight inches wide, aluminum construction, knurled clamp rods tighten paper, rubber covered, complete with shaft. Ghu, Box 2582, Boston, Mass.

**\$25.00 PER** Week—25 Money-making stunts—10c (stamps). Robt. Poulson, Hutchinson, Minnesota.

**CARAMEL** Corn, crispettes and peanut brittle formulas—\$1.00 (enclose bill). Robert Poulson, Hutchinson, Minn.

**CHEMICAL** Expert furnishes manufacturing formulas with complete working directions. Reliable individual services. Charges reasonable. Dr. Vanheeden, 3856 Lakespark, Chicago.

**SIGNS** And showcards easily painted. If you use Letter Patterns. Write for free samples. John Bahr, G2129 Neva Ave., Chicago.

**RESEARCH** Expert supplies superior formulas, manufacturing processes, trade secrets, all lines. Write and get free estimate on your requirements. H. Newman, Box 313 Madison Square Station, New York City.

**MAIL** Order light manufacturing business. Patented machine makes typewriter ribbons 18c. Send 50c for sample dollar ribbon and complete mail order outline. Ribbon Ink Corporation, 300 North Michigan Avenue, Chicago.

**A SURE** Living repolishing furniture, hotels. Dealers need you! Remove scratches and get glass like finish without removing original finish. Morrison, 15 Park Row, Suite 1228, New York.

**THAXLY** Formulas produce perfect products. All lines. Catalog free. B. Thaxly Co., Washington, D. C.

**LEARN** The collection business. Good income, quick results. Interesting booklet, "Skillful Collecting" free. National Collectors Assn., Long St., Newark, Ohio.

**RARE** Opportunity for few experienced circulation and advertising representatives in every locality to connect with a publishing corporation. Naden, Lothrop Building, Detroit, Mich.

**ELECTRIC** Lawn mower sharpener. Blue print \$2.00. Central Tool Works, Ave. C, Houston, Texas.

**MAKE** Legal beer. Start beer, sandwich, free-lunch buffet. Quick trade, large profits. Details, Rolec Laboratories, Lents Sta., Portland, Oregon.

**OPERATE** Chain of vending and amusement machines. Be independent for life. Start small, grow big. P. Goodbody, 1826 East Main Street, Rochester, N. Y.

**INCORPORATE** Delaware preparatory financing invention, business. Retain perpetual control. Booklet, forms free. Universal Corporators, Dover, Del.

**SUCCEED** Making, selling your own products, using our guaranteed formulas. List 10c. Timbor Products, Box 596, Station A, Champaign, Ill.

**OPPORTUNITIES**, Unusual, fascinating, profitable. Particulars free. Economy Sales Co., Manchester, Iowa.

**NEW** Mail-order opportunity. Excellent profits. Address Roland System, Wareham, Mass.

**TATTOOING** Outfits, supplies. Illustrated list free. "Waters," 905 Putnam, Detroit.

**108 MONEY** Making opportunities. Write Jenison, 4967 Race Ave., Chicago.

**CHARTERS:** Delaware; best, cheapest; free forms. Colonial Charter Co., Wilmington, Del.

**EARN** Large income with "chain" of peanut-chewing-gum vending machines. Start small capital. Particulars free. Robbins Corp., DeKalb and Broadway, Brooklyn, N. Y.

**WANTED** Reliable men or women for indoor work. Puffert Enterprises, Douglas, Wash.

**POPCORN** Machines \$15 up. Money makers. Northshades Co., 2117 Harding, Des Moines, Iowa.

**MAIL** Order business fascinating and profitable. Many earn thousands yearly. Begin small. No canvassing, nor personal contact. Inside pointers from 30 years experience. Send quarter for book, also batch of mail order information. R. Brenner, 257 S. 21st, Philadelphia.

**WHOLESALE** Directory 300,000 articles 10c. Other valuable information. Moran Company, Wareham, Massachusetts.

**A BUSINESS** Of your own making—Sparkling Glass Name and Number plates. Checkerboards, signs. Big book and sample free. E. Palmer, 540, Wooster, Ohio.

**MAKE** Your own products. Employ agents yourself. Toilet articles, soap, extracts. We furnish everything. Valuable book free. National Scientific Laboratories, 1950 W. Broad, Richmond, Va.

**FIFTY** Successful mail-order propositions. Address, K. Home, 2949 Metropolitan, Chicago.

**AMATEUR** Cartoonists: Sell your work. Write Smith's Service, PW1191, Wenatchee, Wash.

**SELL** By mail. Books, novelties, bargains! Large profits. Particulars free. B. Elfen, 525 S. Dearborn, Chicago.

**ARTIFICIAL** Marble sanitary flooring, instructions covering wood or cement flooring 1/4 inch thick, fireproof, all colors, low cost. Ornamental castings, concrete plaster papier-mache decorations, garden furniture, statuary, flexible molds, particulars and illustrations free. Chris. Mahler, Elmont, N. Y.

**BIG** Money at home plating auto parts, reflectors, mirrors, chandeliers; by new method; experience unnecessary. Outfits furnished. Gunmetal Co., Ave. N, Decatur, Ill.

**MAKE** Artificial marble, colorful glossy tiles, no polishing; rather uncanny. Novelties, tabletops, bookends, floors, whetstones. Hard, inexpensive, fireproof, enamels wood. Secret cement methods. Amazing samples 2c. John A. Pryn, 945 Grande Vista Drive, Los Angeles, Calif.



## CHEMISTRY

**ANALYSIS.** Chemical consultation, processes, manufacturing plans. Guaranteed formulas. Small investment. Write, Associated Chemists, Indianapolis, Indiana.

**BECOME** Trained chemist. Thousands of opportunities—fascinating career. Learn at home. Complete experimental laboratory outfit given. Write for big free book, Chemical Institute, 19 Park Place, Dept. P-432, New York.

**JOIN** The American Amateur Chemists Society. 10,000 word journal and particulars 10c. 323-B, North Swamsee, Lansing, Mich.

**HANDBOOK** For chemical experimenters, illustrated 50c. Experiment booklet 15c. 1932 chemical catalogue 10c. General Chemical Co., Reading, Pa.

**CATALOG** listing 2,500 illustrations chemists' supplies, 5,000 chemical, 1,000 scientific books sent for 50c. Laboratory Materials Company, 643 E. 71st St., Chicago, Ill.

## FORMULAS AND TRADE SECRETS

**3,000 VALUABLE** Formulas prepaid \$1.00. National Service, 3636 Tamarack, Cincinnati, Ohio.

**AUTOMOBILE** Specialty formulas, 14 for 50c. Octave Verret, Raceland, Louisiana.

**MANUFACTURE**—Twenty of our formulas 25c. Noel Sales, Logansport, Indiana.

**SUCCEED** With your own products. Make sell them yourself. Formulas, processes, trade-secrets. Analytical service. Catalog free. B. Thaxly Co., Washington, D. C.

**SUCCESS** Is sure with Miller's guaranteed formulas; best science can produce for making popular, biggest-selling goods. All lines. Don't buy formulas till you've received my latest literature. Miller, Chemist, 1706-H, Tampa, Fla.

**500 SELECTED** Formulas, 10c postpaid. Levine, 41 Station B, New York.

**TAKE**—Print off bills, funnels, newspapers, etc. Formula 35c, no stamps. Clinch, Brielle, New Jersey.

**FORMULAS:** Beverages, flavors, syrups, extracts and other processes. Free information. Formula Company, 5th Ave. and Broad, Seattle, Wash.

**MIRROR** Resilvering formula \$1.00. Instructions for home made portable electro-nickel platers \$2.00. Custer, 85 Leslie, Highland Park, Michigan.

**MONEY** In spare or full time. Formula and instructions 50c. Harold Peacher, 3310 Kenwood, Indianapolis, Ind.

**FREE** Formula catalog. Dictionary of drugs 10c. Western Chemical, Salem, Oreg.

**INDIVIDUALLY** Prepared formulas \$1.00 each. Guaranteed. Stenton Laboratories, D2122 Griffith Street, Philadelphia, Penna.

**PRINTED** Formulas. Newest—guaranteed. Catalog free. Grinstead, Chemist, Edwardsville, Illinois.

**500 FORMULAS** And big illustrated catalog 25c. Ideal Book Shop, Park Ridge, Ill.

**TEN** Money-making formulas \$1.00. Belle Laboratories, 812 Superior, Fort Wayne, Ind.

**GUARANTEED** Formulas, recipes, processes. Expert analysis. Catalogue free. Industrial Institute, Dept. 204, 360 N. Michigan, Chicago.

**MAKE** And sell beauty requisites—Cream, hair waver and four others all 50 cents postpaid. P. Dorn, 7125 Bennett, Chicago.

**EXTRA** Money making photo frames with wood formulas and instructions guaranteed, \$1. Tinker-Wood Works, 1823 Payne Ave., Cleveland, Ohio.

**500 VALUABLE** Formulas 25c; circular free. Harvey Tessler, Deratur, Ind.

**FREE** Catalogue, formulas, analysis. Hertstein, Chemist, 206 Prospect, Grand Rapids, Mich.

**LATEST** Improved formulas, \$1.00 each. List free. Persian Laboratories, Bay City, Mich.

**FORMULAS**—Our literature will surprise you. Belfort, 4042 N. Keeler, Chicago.

**FORMULAS** All kinds. Catalog free. Clover Laboratories (P.), Park Ridge, Ill.

**MAKE** Your own products. Employ agents yourself. Toilet articles, soap, extracts. We furnish everything. Valuable book free. National Scientific Laboratories, 1950W, Broad, Richmond, Va.

**USE** Shortcuts in Figures. Save valuable time. The quickest ways of working all problems. Instructions for drilling yourself to be come rapid with figures. Complete, yet simplicity itself. Just write a postal for "Shortcuts in Figures." Pay postman \$1.25 and postage. Popular Mechanics Press, Room 802, 200 E. Ontario St., Chicago, Ill.

## AGENTS WANTED

**LITTLE** Dry cleaning machine for the home! New principle. Works like a vacuum cleaner. Amazes everyone. Cleans everything. Gloves, shoes, men's suits, rugs, draperies, car upholstery, etc. Spots and stains vanish in a couple of seconds. Inexpensive, costs almost nothing to use. Always ready. No more big cleaning bills. No dangerous, make-shift cleaning with rags, sponges and dishes, to ruin hands. Needed in every home. Also clubs, barber shops, offices, stores, etc. Big profits, exclusive territory. Introductory free test offer lets you judge for yourself. Write quick. The Dry-Vak Co., 1301 Main St., Steubenville, Ohio.

**MAKE**—Sell these guaranteed, specialty-necessities: Plastic wood; evergreen insect spray; chlorox; handy solder; Silco water paint; ice-saving blankets; Pure moth tablet; Mangle dish wash; Water-Wax floor polish; Plastex-Compellit-liquid marble; using Miller's foremost formulas. Easy to start anywhere investment small, profits, immediate and great. Dr. Lescom Miller, Chemist, Tampa, Fla.

**AGENTS** Wanted to supply famous "Zanol" products to steady customers on regular routes. Routes pay \$27.50 weekly up. Pay begins immediately. Write Albert Mills, Route Mar., 1095 Monmouth, Cincinnati, O.

**ALL-SCRAPER.** Cleans everything from dishes to windshields. New. Sample 15c. Frostholm Bros., 1909 S. Clinton St., Syracuse, N. Y.

**JIFFY** Pocket cigaret maker. Everybody buys. Dollar a dozen. Trehle your money. Jiffy, 1625 Prospect, Cleveland, Ohio.

**MIRRORS** Resilvered at home. Costs near 5 cents per square foot; you charge 75 cents. Profitable business plating autoparts, reflectors, tableware, stores, refinishing metalware, etc. Outfits furnished. Details free. Write, Sprinkle, Plater, 128, Marion, Ind.

**NEW** Invention! Makes any faucet a drinking fountain. Sample \$1.25. Specialty Service, Livernood, Ill.

**AGENTS**—Big profits selling new item to take the place of "B" batteries on auto radio. Write at once for full particulars. Bright, 5054 N. Drake, Chicago.

**MARVELOUS** Chemical cloth, cleans, polishes all metals instantly without liquid, paste, powder; reword-breaking seller to auto-writes, stores; 300% profit; sample free. Shef D. Mfg. Co., Union City, N. J.

**SELL** Raincoats for men, women, children; \$3.95; big weekly income. Outfit free. Goodyear Rainwear Co., 18 West 22nd St., New York City.

**MEN, Women,** demonstrate flexible steel belts on sewing machines. Columbia Steel Belt, 620 Maple, Avondale, Cincinnati, Ohio.

**DOUBLE** Eyed self-threading needles, blind people can thread them with little practice, size 3/8, 10c packet. Agents wanted. Wm. Oglesby, Vandalia, Ill.

**300% PROFIT.** Sample 25c. Five for \$1. 4-R-Razor, Hutchinson, Kas.

**DISTRIBUTORS**—Agents—Everywhere. "Dragon-Fly" crash-proof 50c flying model airplanes amaze everyone. Sell on sight. Enormous profits. Exclusive territory. No competition. Western Aircraft, 4135 W. Pico, Los Angeles.

**HIGHJENE** 25c Moth paddles selling like wildfire. Cost distributors 5c each. Make up to \$18 daily. Free Samples. CeeDar Co., 1814 N. Western, Chicago.

**SELL** New products wholesale to stores. Logan Pharmaceutical, Logan, Utah.

**BRAND** New household necessity—eliminates icebox odors—prevents contamination of foods. Retail \$1.00. No competition. Big profits. No risk offer starts you. Refrigerator Accessories, 612 North Michigan, Chicago.

**REPRESENT**—Large manufacturer direct in this territory. Men's shirts, ties, underwear, hosiery. Amazingly low prices. Large earnings daily. Extra cash bonuses. Free shirts, ties to producers. No experience necessary. No investment required. Large Deluxe outfit free. Dept. J-4, Quaker, 1239 Broadway, New York.

**DON'T** Choke me! Hot Shot new elec. wizard starts car without choke; saves gas, oil. Delivers 11,000 volts, \$1.50 seller. Pays for self immediately. Hustlers gold mine. Beardon Mfg., Dept. 4-HS, Peoria, Ill.

**FACTORY** Representatives appoint authorized service stations. "Protex-Elec" new liquid insulation. 50c item. Protects cars, trucks against rain, bad weather. Protex-Elec Co., Dept. 4P, Peoria, Illinois.

**NEW.** Profitable—Sell auto step mats. Quality rubber with owner's name molded white. Details free. Ebonite Products, Dept. D-10, 895 Main, Akron, Ohio.

**LOCAL Representative** wanted for large manufacturer, maker to wearer fine shirts, ties, hose, underwear below store prices. Sensational free offers bring easy orders. Big cash commissions. Free shirt, tie offer cash bonuses. Outfit free. Write Dept. A-29, Albert, 860 Sixth Ave., New York.

**GUARANTEED** Hosiery—Lowest market prices. Men's latest fancy hose—doz. \$1.25-\$1.90. Ladies' fashioned hosiery—doz. \$1.90-\$2.90. Catalog free. Superior Hosiery Company, Dept. 34, New Haven, Conn.

**CAN** You sell a beautiful quality 3 piece toilet set including pair of Superb hosiery—for \$1.00? Paris Laboratories, 3145 Locust, St. Louis, Mo.

**"FLEXIRIGID"** Steel rules, 39" to 72", \$1.00 up; special lot, vest-pocket type—also \$2.50 50lb. rule. Durand, 61 Hinsdale Pl., Newark, N. J.

**MONEY** Maker for hustlers. Dime brings complete information, sample. George Paro, 11 Badger St., Nashua, N. H.

**MEN**—Women, \$3 to \$6 daily. Selling 25c household necessity that repeats. Three to ten sold in every home. Free sample. Write Pure Company, Dept. D-271, 3107 Pine St., St. Louis, Mo.

**FREE** "Booklet" describes money making opportunities," new ideas, original plans, money making secrets and other valuable information. None require peddling or outfits. Elite Co., 214 Grand St., New York.

**FREE** "Booklet" of money making opportunities," new ideas, original plans, money making secrets and other valuable information. None require peddling or outfits. Elite Co., 214 Grand St., New York.

**AGENTS.** Wanted to sell Cuban stamp packets. Liberal commissions. Dale, Box 714, Havana, Cuba.

**MAKE**—Sell your own products. Formula catalog free. "Komico," BW, Parkridge, Illinois.

**SUCCEED** With your own products. Make sell them yourself. Formulas, processes, trade-secrets. Analytical service. Catalog free. B. Thaxly Co., Washington, D. C.

**EASY** Money, applying gold initials on automobiles. Self-inking sign letters; anyone can apply. Agents coining money. Free samples. Write quick. "Balco," X-1043 Washington, Boston, Mass.

**FOR** A permanent, profitable business Reid Cream Metal Polish is the answer. It's great. Tubes for home and auto—bulk for larger users. Rapid seller, immense profits and out of the ordinary repeat business. A rare opportunity for go-getters and sticklers. Reid Laboratories, 1914 Chouteau Ave., St. Louis, Mo.

**NEW** Kind of shoe sole—taking country by storm. Costs only a fraction of leather soles. Outwears leather three to one. Just stick 'em on—no nailing. Comfortable, water-proof, agents cleaning up. Outfit free. Write Kristee Mfg. Co., Box 1434, Akron, Ohio.

**MANUFACTURER** Wants local representative fine shirts, ties, underwear, hosiery; exceptional values, maker to wearer, large earnings daily. Extra cash bonuses regularly. Free shirt, tie. We start you without investment. Thousands successful. Expense outfit free. Write Dept. K-4, Roscliff, 1237 Broadway, New York.

**"DUKET"** Vest pocket size cigaret roller. Newest and greatest little invention for rolling cigarettes. Agent's commission 200%. 25c brings sample. Leonard Sales Company, Dept. A, Toledo, Ohio.

**WISE** Agents grab these household specialties. One agent sold 160 one day. G. Ercin, 2113 Harrison St., Chicago.

**SELL.** 25c Kitchen article. Sample 15c. Jandl Can Perforator Co., 3513 North 25th, St. Louis, Mo.

**AGENTS.** Profits 100%. Needed new automobile accessory, easy demonstrator, great sales appeal, sample and sales plan 50c silver. Manufacturer, Box 141, Ocean City, New Jersey.

**MEN** Buy direct from factory. Trusses, belts, suspensories, surgical splints, dekolpers. We save you money. Illustrated circular sent free. Surgical Co., 1906 San Pablo, Oakland, Calif.

**MAKE** Up to \$18 daily introducing men's, women's, children's finest hosiery. Guaranteed 6 months or replaced. Amazingly low prices, 128 styles, colors. Auto and hosiery given producers. Write quick! Wilkmit Hosiery Co., C-374 Midway, Greenfield, Ohio.

**RELIABLE** Man, each county, to mail advertising, supervise agents, pack and deliver merchandise to stores. International Laboratories, 1101-A Butler Bldg., Chicago.

**500% PROFIT!** Gold and colored sign letters for store windows, offices, trucks, signs. Monogram letters. Emblems. Easily applied. Permanent business. Neonite, Akron, Ohio.



**BARGAIN** Store supplies. Everything furnished. Jobbers, 504 S. Crawford, Chicago.

**HIG** Profits selling groceries, in tin oils, paints, stock minerals. Sample case free. Lovern & Browne, 1602-D So. State, Chicago.

**CASH** Paid for butterflies, insects. See **Sinclair Display Advertisement** on page 8.

**MAKE** Your auto look like new. Dri-Cleanit removes mud, grease, all one operation. No soap or water used. Cleans car for about 10c. Free sample. Agents wanted. American Accessories Co., Desk E31, Cincinnati, Ohio.

**300% PROFIT** Selling Mystery Gas Lighter. Retail 25c. Costs you \$1.00 doz. Sample free. Square Deal Mfg., Desk PM-30, Bradford, Pa.

**300% PROFIT** In new "20-in-1" kitchen necessity. Retail 25c. Costs you \$1.00 a dozen. Sample 15c to cover cost of mailing. New Method Co., Nu-Method Bldg., Desk PMM-4, Bradford, Pa.

**100% PROFIT** In new everlasting match. No sput or friction. What makes it light? No wind can blow it out. Retail 50c. Sample and sales plan 25c. New Method Manufacturing Co., Box PM-4, Bradford, Pa.

**ELECTRIC** Water heater—New. Heats water instantly. Pocket size—retails \$1.75. Two minute demonstration makes you \$1.95 profit. Lux-Viel, Dept. 47, Elkhart, Ind.

**SELLS** Like hot cakes, big profits. New laundry soap, perfumes clothes lastingly while washing. Territory given. Working outfit 10c. Sunset Laboratories, Lynbrook, New York.

**NEW** Kind heat boils water instantly. Make \$25 daily. Pocket-size. Minute demonstration. Pays to \$1.95 profit. Free offer. Dept. C, Luxco, Elkhart, Indiana.

**JUST** Out! New 25c kitchen necessity. Every housewife buys several. Locatite percolator tops—prevents breakage of dishes, measures amount of coffee to use per cup. Simple to use—easy to sell. Sample furnished. Locatite, Detroit, Michigan.

**MEN, Ladies, students**—Sell incense, part or full time. No competition. Profit 100-300%. Free samples. Write. Oriental Incense, 515 E. 47th St., Chicago.

**NEW** Wonderful absorbent lintless dish towel. One million sold. Sample 20c. Act quickly, exclusive territory. Field, 402-7 Ave., New York.

**MAKE** Products yourself. Newest tested formulas. Catalog free. Chemist Grinstead, Edwardsville, Illinois.

**RAZOR** Blades, hollow ground, improved, double edge, ten cent packages, carded, easy selling. Sold everywhere. Standard Safety Razor, Pittsburgh, Penna.

**HIG** Men's steady. High grade coveralls, shopcoats, pants, shirts. Advertising on bark. Fast sellers. Great demand. Prospects everywhere. Free outfit. Strong Mfg. Company, 211 West Jackson, Chicago.

**MANUFACTURE** Glass house numbers and signs. Complete course \$2.00. Hadank, 1707 Alden, Detroit, Mich.

**PROPELLIGHT**: Free offer. Beautiful automobile ornament. Revol es producing circle of colored light. Catalogue 5c. Propellight Co., Newtown, Ohio.

**"DEPRESSION** Stimulators." Send dime. "Sweet," 26 Maple Ave., Williamette, Conn.

**MARVEL** Self-starting cream siphons are marvelous sellers. Big cash commissions. Sample postpaid 30c. Marvel Mfg. Co., Los Angeles, Calif.

**AGENTS** For handiack; original powdered handsoap. Approved Good-Housekeeping. Everybody customer. Fine opportunity for hustler. Sample free. Solar Products, J-2144 So. Troy, Chicago.

**MOTORISTS** Delighted with Ever-Klear—semi-annual application provides clear vision through entire windshield when it rains. Send 50 cents for regular dollar package, specifying territory wanted. Unconditionally guaranteed. Ever-Klear Company, Box 1297, Memphis, Tenn.

**JIM-MIN-IE!** Christy's Polishing Cloth works like magic. Easy to demonstrate. Everybody buys. Big profits. Write for free sample. Christy, 6667 Lakeway, Newark, New York.

**START** Little business anywhere. Everything furnished. No canvassing. Maywood, PM 923 Broadway, New York.

**NEW** Combination tool, indispensable to householder or mechanic. Hit brace and hand screw driver set, four sizes screwdriver, one countersink. Equivalent of ten tools. Guaranteed. \$1.25 postpaid. Murmac Mfg. Co., Gloucester, Mass.

**EARN** \$1,000 To \$25,000 with new emergency electric heater. Buy \$12 demonstrator. P. Schoenborn, 104 Market St., Newark, N. J.

**AGENTS**—Make \$5 to \$10 or more a day Z-Baying auto lights to end glare and double road light. New development; converts headlights into non-glaring floodlighting searchlights in 5 minutes without wiring or change of bulbs. Won't wear out. Guaranteed. Amazing performer. Write quick for money-making proposition. Z-Ray Co., A-60 Balemoy Bldg., Kansas City, Mo.

**NEW** Improved Electric Water Heater. Heats water instantly. Sells fast—\$2.95. Pocket size. Bestever, 4317P Irving Park, Chicago.

**NEW** Door-Stop. Every home must have. Agents can sell it everywhere and make big money. Sample 10c. K. J. Mfg., 648 N. Vermont, Los Angeles, Calif.

**MAKE** Money by mail. Real opportunity. Profit, "G," Brookfield, Ill.

**QUICK** Seller. Big repeater. Every automobile owner wants it. 100% profit. Central Sales Service, Jacksonville, Ill.

**CLOTHESLINE** Holder, sample 35c postpaid. Agents wanted. M. McCormick, Streator, Ill.

**PITCHMEN**—Specialty men. It's new. It's different. E-Z cigarette roller. Use any kind of tobacco; carry in vest pocket. Lowest price roller on market. Demonstration sells it. Boys now cleaning up. Send 25c for two samples. Rush Sales Co., 1134-P E. 43rd St., Chicago.

**MAGICLOTH** Polishes all metals. Fast seller. Big profits. Sample free. MagicCloth, 1502 Washington, Kansas City, Mo.

**\$50-\$200 A WEEK.** Genuine gold letters for store windows. Easily applied. Free samples. Liberal offer to general agents. Metallic Letter Co., 438-B North Clark, Chicago.

**100 GILLETTE** Type blades—\$1.00. Applebaum-J, 1258 Brook, New York.

**"DUAL"** Razor blade sharpening invention, hones, strops, hollow grinds, one operation. See page 265 Popular Mechanics February. Fast sales. Big profit. Dual, A-3213 Wentworth, Chicago.

**BIG** Money selling shirts, ties, underwear, dresses, hosiery, raincoats, coveralls, pants, belts, play-suits. Sales kit free. Nimrod Co., Dept. 8, 4222-28 Lincoln Ave., Chicago.

**THAXLY** Formulas produce perfect products. All lines. Catalog free. B. Thaxly Co., Washington, D. C.

**NEW** Principle lifetime stropper for safety razor blades. Latest out. Costs few cents. No cranking—no effort. Amazing free offer to workers. Park Specialties, 219 Park Place, Brooklyn, N. Y.

**NEW** Hemstitcher, rugmaker, darter, embroidery-guide. Fits any sewing machine. Retail 50c and dollar. Sample dime. Agents, demonstrators wanted everywhere. K. J. Manufacturing, 648 N. Vermont, Los Angeles, California.

**SELL** Blades, notions, novelties, toiletries. Our sensational prices challenge world. Free catalogue. Mills Sales Co., 901 Broadway, New York, or 37 South Wells Street, Chicago.

**\$10 EARN** \$20 Weekly. Presto shaper puts keen edge on dullest scissors. Quick demonstration sells it. Dar's supply carried in your pocket. Sells 25c. Cost \$1.20 dozen. Gross \$10. Williams Corp., 32 Williams Bldg., Montclair, N. J.

**FAST** Sellers! Metallic polishing cloth, new can opener, gas lighters. Other big profit items. New low prices. Superba Company, A103, Baltimore, Md.

**100% PROFIT** Selling signs used everywhere. Largest selection, wonderful repeat business. \$1.00 worth samples, 25c; 50 signs \$3.00; 100 signs, \$5.00. P. Franklin Co., 3222 Third Ave., N. Y.

**EVEN** Poor people must keep clean. Brushes, brooms, mops sold by the millions. Sell them in your own name. 300 per cent profit. Write for proposition. Wire-Grip Sanitary Brush Corp., 41 E. 11th St., New York.

**NEW** Discovery. Washes clothes without rubbing. Cleans everything. Sells 25c. Profit 17c. Sample free. Besco, 4315P Irving Park, Chicago.

**"POWDERED** Silk" America's best hand cleanser sells fast to everybody. Removes grease, stains, ground-in dirt. Big profits. Sample free. Adams Manufacturing Co., Dent, A. Boone, Iowa.

**BIG** Profit putting our genuine gold leaf sign letters on store windows. Experience unnecessary. Samples. Consolidated, 69-T West VanBuren, Chicago.

**NEW** Changeable sign sells to stores for \$1.00. Agent's profit 300%. Particulars free. National Sign System, St. Louis, Mo.

**MAKE** Your own products. Employ agents yourself. Toilet articles, soap, extracts. We furnish everything. Valuable book free. National Scientific Laboratories, 1950W Broad, Richmond, Va.

**SELL** Hasty-Cake maker, the greatest staple food discovery in 20 years. Enough in 25c package for delicious three-layer cake. Two flavors, devil's food, oriental spice. A fast, sure repeater. Average home uses two cakes per week. Half million packages sold in last month. You can earn up to \$10 per day. No experience needed. We furnish capital, free canvassing license, guarantee 100% satisfaction to everybody concerned. 3000 territories already assigned. Write today for your town. Hasty-Cake, A2307 Archer, Chicago.

**MAKE** Your own products. Employ agents yourself. Toilet articles, soap, extracts. We furnish everything. Valuable book free. National Scientific Laboratories, 1950W Broad, Richmond, Va.

**OUR** Free gift deals with our toilet goods assortments, food products, polishes, etc., get the business. 150 repeaters—100% profits. Also cash prizes to best producers. E. M. Davis, Dept. 260, 500 Randolph, Chicago.

**EARN** Extra money at home. No canvassing. Hetzel, 802 Garden, Hartford, Conn.

**SELL** Stores carried razor blades, etc. Lorrac Products, Albany, N. Y.

**A BUSINESS** on your own—Making sparkling glass name and number plates, checkboard signs. Big book and sample free. E. Palmer, 512, Wooster, Ohio.

**AGENTS**—Clever Invention! Inkspoon makes every pen a fountain pen. Fast office seller; big profit, demand increasing everywhere. Exclusive territory offered. Sample free. H. Marui Company, Tribune Bldg., New York, N. Y.

**AGENTS** Everywhere making money with our line of kitchen specialties, demanded in all homes. Big earnings possible. Write today for details. P. Seed Filter Co., 353 Broadway, New York.

**MAKE** Your own products. Employ agents yourself. Toilet articles, soap, extracts. We furnish everything. Valuable book free. National Scientific Laboratories, 1950W Broad, Richmond, Va.

**PHOTO** Medallion men and women, the largest line of photo novelties in the world. Lowest prices, quickest service. Send for catalog showing over 200 money makers. Gibson Photo Jewelry Co., Inc., 833-837 Gravesend Ave., Brooklyn, N. Y.

**WOULD** You like to make \$10 to \$15 a day selling our line of toilet preparations? We want agents in every town; men, women, students; whole or part time. Write for free sample outfit offer. Hinda Perfume Co., 515 E. 47th St., Chicago, Ill.

**MAN** in each town to plate auto parts, reflectors, bathroom fixtures, refinish beds, mirrors, chandeliers; by new method. No capital or experience required. Simple plan of manufacturing at home starts you in big money-making business. Outfit furnished. Free particulars and proofs. Gun Metal Co., Ave. H, Decatur, Ill.

**BIG** Money and fast sales. Every owner buys grid initials for his auto. You charge \$1.50; make \$1.47. Ten orders daily easy. Write for particulars and free samples. American Monogram Co., Dept. 40, East Orange, N. J.

**AGENTS:** Stamping names on pocket-key protectors. Sample check with your name and address, 2c. Stamping outfits, Emblem checks, check-books, name plates. Hart Mfg. Co., Desk 2, 303 Degraw St., Brooklyn, N. Y.

**REPLATE** Brass worn-off automobile parts, reflectors, bath room fixtures, worn spoons, forks, etc., with pure silver. Looks like new. Use U-Kan-Plate Polish. Positively no mercury; \$1.00 half pint. Postpaid. Satisfaction guaranteed. Agents wanted. Dept. A, U-Kan-Plate Co., Philadelphia.

**SOMETHING** The housewives want. A signed guarantee to save money and time in cooking. No competition. 400% profit. No license required. Station C, Box 25E, San Diego, Calif.

**AGENTS**—Engraved name plates, signs, number plates etc., easily sold with large profits. Brett Bros., Wintbron, Mass.

**CALIFORNIA** Perfumed beads, selling like hot cakes. Agents coinng money. Catalog free. Mission Factory, P. 2323W Pico, Los Angeles, Calif.

**WE** Start you without a dollar. Soaps, extracts, perfumes, toilet goods. Experience unnecessary. Carnation Co., 641, St. Louis, Mo.

**SELL** Men's neckwear—wonderful proposition. Astor-M, 29 East 28th, N. Y.

**FLAVORING** Extracts—Bottle yourself! Labels furnished. 600% profits! Whirlwind money-makers! Repeaters! Free offer. Thomas Manufacturing Company, Indianapolis, Ind.



## HIGH-GRADE SALESMEN WANTED

**BUILD A route** Sell the original Vino Sano grape bricks, orange bricks; all flavors: port, sherry, burgundy, orange, lemon, fruit-cocktail, etc. One brick equals one gallon juice. Take orders, give service, build a trade. Unlimited profit possibilities for crew organizers. Every home, hospital, physician, roadstand, gasoline station, barber and auto-camp, grocer, druggist, soft drink stand a prospect. Beware of imitations flooding country since Vino Sano had nationwide publicity. Vino Sano has never been duplicated; it's a secret process. Legality twice established in Federal courts. Vino Sano Co., Dept. 8-245, San Francisco, Calif.

**MEN Wanted**—by world-wide industry—Apply by letter only giving age, experience, references, industry, reliability, main qualifications. Man selected will become authorized Raleigh dealer on our capital and taught how to establish \$5,000 annual business in some 250 farm and home necessities. Man with auto preferred to introduce products and travel steadily. Write immediately. Hawleigh Co., Dept. D-N-PPM, Freeport, Ill.

**REPRESENT**—Large manufacturer direct in this territory. Men's shirts, ties, underwear, hosiery. Amazingly low prices. Large earnings daily. Extra cash bonuses. Free shirts, ties to producers. No experience necessary. No investment required. Large desire outfit free. Dept. H-4, Quaker, 1239 Broadway, New York.

**SALESMEN**—Genuine Neon, outdoor, double face sign selling at \$15.00. Hurry while it's hot. Ben Kerns Sign Company, Greenville, S. C.

**\$25 DAILY** Possible selling merchants printing, novelties, specialty items at half price. Quick delivery. Union label. 40% commissions advanced. Experience unnecessary. Elaborate outfit free. Northwestern, 625-C, Jackson, Chicago.

**SALESMEN-DISTRIBUTORS**. New auto tire patch; guaranteed 10,000 miles. Repairs blowouts permanently. Sells garages, gas stations, tire shops. Salesmen's profit 100%. Up to 300% to dealers. Easy seller. Exclusive territory. Economy Rubber, 634 Burkhardt, Dayton, Ohio.

**GOOD Paying Job** open as local representative, old successful manufacturer selling direct to wearer. Sensational values pants, breeches, coveralls, shopcoats. Largest line in field. Belt free with every 3. Big cash commissions. Outfit free. Longwear, Dept. P4, 489 Broome St., New York.

**SELL 2-Pants suits** \$21.95. You can make \$6 an order. Pure wool fabrics. Celanese lining. Fine tailoring. Union label. Guaranteed satisfaction. Many repeats. Sample suit. Big sales outfit free. Write Dept. P-45, MacRae Tailors, 275 Seventh Ave., New York.

**PLENTY** New and different—Fast selling 5c and 10c merchandise on attractive counter cards. 100% comm. for you and dealers. Advertised by radio. No investment required. Catalog free. (Estab. 1921.) World's Products, 195 Central, Spencer, Ind.

**SALESMEN**—At last! New feature sells punchboards everywhere. Dealers wild with joy—prosperity back again. Profits enormous. Samples free. Paritan Co., 1407 Jackson Blvd., Chicago.

**\$18 TO \$25 Daily**; biggest selling line of men's suits. Meets present day conditions. Amazing values at \$11.95, \$14.50, \$16.95, \$18.95. Also raincoats, slickers, topcoats and boys' suits. Biggest commission paid in advance. Liberal bonus. Free outfit. State age and selling experience. "Jim" Foster, Inc., Dept. 24, 2250 South Spaulding Ave., Chicago.

**BUILDING Trades** salesmen. Improved patented adjustable cash balance. Easy sales. Big profits. Duplex Mfg. Co., 634 N. La Perre, Los Angeles.

**BUSINESS Stationery**. Largest line. Highest quality. Quickest delivery. Biggest commissions. Bonuses. Free copyrighted-cuts. Experience unnecessary. Outfit free. Willens, 2150 Gladys, Dept. 541, Chicago.

**SALESMAN**—Dynamic trade stimulator, beautiful 6 foot Stutz Junior automobile, free to merchants; \$15 advance commission each \$50 sale. Drimmer, 927F Broadway, New York.

**WELL Known** manufacturer wants district salesmen and others to introduce Dim-A-Glars, new state approved invention for headlights. \$1 pc. Nothing like it. Board sold 2,000 first order. Going big. Liberty Metal Co., Johnstown, Pa.

**USE** And sell Maxpax sanitary napkins for men. Particulars free. Maxpax, Dept. 15, 1341 Saintclair, Cleveland.

**SUPERSEAL** Steps radiator leaks. Profit maker. Sample 25c. Superseal, Wessington, South Dakota.

**EARN Big, steady cash**, representing old established manufacturer, selling fine shirts, ties, underwear, hosiery direct to wearer. Free shirt, tie offer. Free besides cash bonuses regularly. No investment required. Expensive sales outfit free. Write today. Dept. L-4, Rosecliff, 1237 Broadway, New York.

**REPRESENT** Manufacturer of shirts, ties, hose, underwear. Beat store competition on price and value both. Startling free offers make orders come easy. You earn big money. Cash commissions, free shirt offer, cash bonuses. Write today for giant outfit free! Dept. A-30, Albert, 850 Sixth Ave., New York.

**EXPERIENCED Salesmen**. Wonderful opportunity selling full line accident and health policies. Sell easy. Liberal commissions. Twenty-four-year-old legal reserve company. Write for special offer. Inter-State Business Men's Accident Insurance Co., Dept. 18, Des Moines, Iowa.

**FREE Booklet** describes 87 plans for making \$20-\$100 weekly in home or office business of your own. Elite Co., 214 Grand St., New York.

**WANTED**: Man with car to demonstrate and do service work for large Ohio manufacturer. Earning \$50 to \$75 weekly. Fyr-Frter Co., Dept. 4, Dayton, Ohio.

**SALESMEN!** Twenty-three-year-old progressive calendar and advertising specialty house has need for live salesmen with proven sales record, on liberal commission basis. Write fully. Klein Advertising Co., Dept. D, Quincy, Ill.

**SALESMEN**—Make \$40 weekly. Sell garage, filling station workers our patented non skid \$2.98 work shoe. Free sample. Arthur Shoes, 1050 West Newton, Mass.

**GILMORE, Calif.**, made \$20.00 in 30 minutes. Johnson, Minn., \$40.00 in half day. Make \$5.00—\$100.00 on originals. Same on repeats. Our premium system costs merchant 1/2 percent. Knocks competition out. Experienced coupon and premium salesmen only. Retailers' Service, Dept. 1-V, 4313 Ravenswood, Chicago.

**DISTRIBUTOR**—Pays hand soap and auto accessories. New plan makes instant appeal. Credit arranged. Write for details and free sample. Pays Hand Soap, 410 New Park Ave., Hartford, Conn.

**AMAZING Tailoring** values pay you up to \$60 weekly. Virgin wool 2 pants suits \$17.50. \$5.00 profit. Union tailored. Leads furnished. Sample suit to producers. \$25.00 outfit free. Williams Bros., 879 Broadway, Dept. W-22-AA, New York.

**WORLD'S Best** razor sharpener (new). Attractive display cards. Quick sales everywhere. Big profits. Repeat protection. Particulars, sample 25c. Burnishap, 122 South Michigan, Chicago.

**SELL Carded** razor blades, aspirin, violet breath gum, chewing laxative, polishing cloths, shoe lacers, handkerchiefs, rubber goods, etc. Large line. Big repeat profits. Attractive displays. Superba Company, 8203, Baltimore, Md.

**FLAVORING Extract** sensation. \$1.00 vanilla, \$1.00 lemon, 60c almond, 60c maple, \$3.20 value in attractive sample case 99c. Your profit 50c. Every home uses. Sales easy. Order C.O.D. Creme Folks, St. Paul, Minn.

**Big Money** selling shirts, ties, underwear, dresses, hosiery, raincoats, coveralls, pants, belts, playsuits. Sales kit free. Niurod Co., Dept. 65, 4922-28 Lincoln Ave., Chicago.

**\$15.00 DAILY** Selling Union Label business stationery, \$2.70 per 1000; cards and blotters 1990 for \$1.30. Free cut service. Big commission. Large profit. National, 108-28 N. Jefferson, Chicago.

**BIG Profit** putting our genuine gold leaf sign letters on store windows. Experience unnecessary. Samples. Consolidated, 69-V West VanBuren, Chicago.

**SALESMEN**—Four \$15.00 sales to stores net you \$18.00 daily. Sayers Systems, Est. 1895, 2801-123 Sheffield Avenue, Chicago, Illinois.

**SALESMEN**—Become independent. Own your business; experience unnecessary, selling our \$10,000 accidental death; \$50 accident; \$25 sick weekly benefits—\$10.00 yearly. Other amounts proportionate. Guaranteed steady income from renewals. \$250,000 deposited insurance department. Universal Policy, Dept. A, 716 Lefcourt Bldg., Newark, N. J.

**WONDERFUL Opportunity**. Twenty dollars per day can be earned. Experience unnecessary. Home protection at cost. Ages one to eighty. \$250 to \$1000 at death. Not insurance. You make \$5 for each member secured. Childress, of Virginia, sent in 54 one day. National Aid Society, Myers Building, Springfield, Illinois.

**NEW Specialty**—Sells every business and professional man. Four \$15 sales daily pay \$280 weekly. Foyer cleared \$1920 in three months. Write, F. E. Armstrong, President, Dept. PM, Mobile, Ala.

## HELP WANTED

**STOP Worrying** about money! I'll start you with a regular weekly route supplying famous "Zanol" products to steady customers. Routes pay \$27.50 weekly up. Pay begins immediately. Write Albert Mills, Route Mgr., 1036 Monmouth, Cincinnati, O.

**AMAZING** New electric trouser presser good for \$25 daily; puts razor edge in pants in 10 seconds, sells for \$2.50; your commission \$1.00. Sample fits pocket. Munny Mfg. Co., Dept. CSD, 817 Main St., Cincinnati, Ohio.

**CASH Paid** for butterflies, insects. See Sinclair Display Advertisement on page 8.

**AGENTS**—Mosco corn and railous remover will build you a steady repeat business. Send today for pocket-size trial outfit. The Moss Company, 204 Searle Bldg., Rochester, N. Y.

## EDUCATIONAL AND INSTRUCTION

**REFRIGERATION Service**; repairing; design; invention; new industry; highest wages; steady employment; easily learned, with tools, not books; practical shop work and theory; all makes. Write for free bulletin PM. Herkimer Institute of Refrigeration, 1819 Broadway, New York.

**U. S. GOVERNMENT Jobs**, \$105 to \$250 month. Steady. Men—women, 18—50. Paid summer vacation. Short hours. Common education sufficient. Experience usually unnecessary. 25 coached free. Full particulars and list positions free. Write today sure. Franklin Institute, Dept. P3, Rochester, N. Y.

**COMPLETE Course** in press, commercial, and aerial photography only five dollars. Details free. Walter Johnson, 1515 L St. N. W., Washington, D. C.

**HELP Yourself** by writing good business letters. Complete course—50c. Dunbar, 112 E. White, Champaign, Ill.

**LEARN Commercial**, portrait, motion picture photography. Home or resident instruction. Catalog free. New York Institute of Photography, Dept. 49A, 10 West 33d St., New York.

**GAIN Word** mastery quickly through our "Popular Vocabulary-BUILDER." Speak effectively, write convincingly. Increase your language power. Book only 50c. Spruen, 5108-W 18th, Cicero, Ill.

**MAKE Money** lettering show cards. We teach you how! Personal course. Individual instruction by artist of 12 years experience. Write for details. Modern Show Card School, 303 S. 8th Ave., Wausau, Wis.

**LEARN Watchmaking** at home, complete course in bookform \$1.00. Watchmaking School, 1107 N. Mayfield, Chicago, Ill.

**LEARN Photo-engraving** at home by experience. Equipment furnished. Earn while learning. Aurora Photo-Engraving School, Aurora, Mo.

**BECOME A landscape** architect. Uncrowded profession; wonderful opportunity for money-making. Easily mastered by mail. Earn while you learn. Est. 1916. Write for details. American Landscape School, 7 Plymouth Bldg., Des Moines, Ia.

**PHOTOPLAY** Talking picture and magazine stories wanted for revision, development and copyright. Sell on commission. Established 1917. Booklet free. Universal Scenario Company, 405 Meyer Bldg., Western and Sierra Vista, Hollywood, Calif.

**WANTED**, Men-Women, 18-50, qualify for steady Government Jobs. Salary range, \$105-\$250 month. No Government experience required. Paid vacations. Common education. Thousands appointed yearly. Write Oxment Institute, 101, St. Louis, Mo., immediately.

**U. S. GOVERNMENT** Wants men, \$1,700-\$1,900 and up at start. Railway mail clerk examination coming. Let our expert (former government examiner) prepare you for this and also rural carrier, post office, customs, internal revenue, and other branches. Write today for free booklet. Dept. 8, Patterson School, Rochester, N. Y.

## SHORT STORIES

**LEARN** To write short stories at home. News writing, the approved foundation training, taught by practical experts. Send for free writing test. Newswriter Associates, 7407A So. Harvard Blvd., Los Angeles.

**SHORT Stories** revised, typewritten and marketed. Details free. Hursh Service, Box P-1013, Harrisburg, Penna.



## TYPEWRITERS AND SUPPLIES

**TYPEWRITERS:** All makes repaired, cleaned, overhauled. Low prices. Murphy Typewriter Co., Hastings, Nebr.

ADDING Machine \$10, typewriter \$8.50, multigraph printer \$22.50, duplicator \$20.00. 2 days trial. Money back guarantee. Pruitt, 190 North LaSalle, Chicago.

**TYPEWRITERS**—All makes, \$1 to \$30. Guaranteed Catalog free. Typewriter Works, Ada, Okla.

REMINGTON Typewriter. 14" carriage. Good condition. \$42.50. Wiederhold, 3861 Robins, Detroit, Mich.

## ADDING MACHINES

NEW \$1.75 Automatic Adding Machine. Fully guaranteed. Bassett, 1458-D, Hollywood Avenue, Chicago.

## PRINTING, MULTIGRAPHING AND MIMEOGRAPHING

250 LETTERHEADS, Envelopes, cards, statements, billheads, blotters, \$1.00 each. Fine stock. Cape Cod Printers, Box 991, Fall River, Mass.

LETTERHEADS \$2.95, Envelopes \$2.50 thousand prepaid. Depression-buster price-list. Pound samples dime. Large linotype office. Webb-Print-Press, Gettysburg, Penna.

NOTEHEADS, Envelopes, statements, 500, \$1.00, Samples, Marvel Sales, Davenport, Iowa.

COMMERCIAL Printing, Bargains. Quality, 3103 E. 18th, Kansas City, Missouri.

PUBLICATIONS Wanted of any size. E. V. Frey, Fayetteville, Pa.

500 LETTERHEADS, Envelopes, statements or blotters, \$1.75, 1,000 either \$2.75. Prepaid. Artcraft, Chillicothe, Missouri.

LETTERHEADS, Envelopes, 500, \$1.10; 1,000, \$2.00; 5,000, \$8.00, plus postage. Samples, Circulars, Coyle & Kimballs, Newport, N. Y.

500 LETTERHEADS, 500 Envelopes \$2.85. Ware, Box 357, Ft. Madison, Iowa.

PICTURES Make printing powerful. Cut catalog 10c. Colorotype, 1102 - 3rd, Detroit.

250 MIMEOGRAPHED Letters, \$2. Miller Advertiser, 432 Berwick, Easton, Pa.

STATIONERY Printing, catalogs, circulars. Samples, Ruling, loose-leaf binders. Commercial Press, Batavia, Ohio.

250 LETTERHEADS, 125 Envelopes \$1.00. C.O.D. Abbott Printery, Oswego, Kansas.

200 LETTERHEADS, 100 envelopes, \$1.00; 200 letterheads, 8 1/2 x 11, 150 envelopes, \$2.00; 250 cards, \$1.00. Hoosier Print Shop, Portland, Ind.

2,000 BUSINESS Cards printed \$1.50. Canterman Bros., Tanshill St., Pittsburgh, Pa.

200 SHEETS, 100 Envelopes, 9c. Applebaum-P, 1278 Brook., New York.

500 LETTERHEADS, 250 Envelopes \$2.95. Print anything. Lowest prices. Free cut service. National, Goshen, Indiana.

1000 LETTERHEADS, Envelopes, post-cards, 6x9 circulars, \$2.95; 5,000, \$9.95. 5,000 attractive colored folders, \$11.45. All printing low prices. Samples. Goodprint, Harrisonburg, Va.

1000 BUSINESS Cards, card case, \$1.50. Miller, Printer, Narberth, Pa.

250 BOND Letterheads, envelopes, bill-heads, cards, \$1.35 each. Economic Press, Leonia, N. J.

## PRINTING OUTFITS AND SUPPLIES

PRINT Your own cards, stationery, circulars, advertising, etc. Save money. Easy rules furnished. Print for others, big profits. Junior press, \$5.00; job presses, \$11; power, \$149. Write for free catalog and full information. Kelsey Co., S-11, Meriden, Conn.

BUILD 8x10 Press for \$1.00. Instructions 10c. Kenneth Wise, Red Lion, Penna.

PRINT Your own circulars, envelopes, with home made press costing less than \$1.00. Illustrated instructions 10c. Carl Edmunt, Odessa, Minn.

PRINTING Outfits—Presses, type supplies, type metal. Send stamp for catalog. Model Press, York, Penna.

## GUMMED LABELS

COLORLED Stickers pay. Economical, too. Samples, Rex, 6018P Quimby, Cleveland, Ohio.

1,000 PRINTED; Name, business, address 50c. JBS Company, Box 93, Holyoke, Mass.

## DUPLICATORS AND DEVICES

"EXCELLOGRAPH" Rotary stencil duplicator \$39.00. "Two-Faced" Rim duplicator \$6.00. Booklet free. Pittsburgh Typewriter Supply, Dept. 001, Pittsburgh, Pa.

## RUBBER STAMPS

NAME, Address; two lines 25c, 3 lines 35c. Newman, 120 So. 15th, Lincoln, Nebr.

RUBBER Stamps—3 lines to your copy, postpaid, 35c. Argus, Culver City, Calif.

NAME, Address, 2 lines 25c; 3 lines 35c. Stamp Works, Auburn, Nebr.

## ELECTRIC CLOCKS

"SPLIT Second" electric clock movement, only \$1.00. You get \$5 to \$10 for it—send dime for "Make Big Money Electrifying Clocks". Kuempel, Guttenberg, Iowa.

## ELECTRIC REFRIGERATORS

BUILD Your own electrical refrigerator. Plans \$1.00. Book Eng., 17 Custer Ave., Pittsburgh, Pa.

## FOR SMOKERS

CUT Your cigarette cost. Smoke milder, more tasty, flavorful cigarettes for less. Sample free—no obligation. Write! Pete Moberly, Box 813, Owensboro, Ky.

SEE Display ad on page 122. Automatic Cigarette Machine Works.

## FOR MECHANICS

BUILD Your own wind-driven electric plant. Blueprints cheap, particulars free. Kingsdek Co., Optima, Okla.

COMPLETE Directions for electro silver-plating 35c. Reason Newton, Murray, Ky.

## FIELD GLASSES, TELESCOPES AND MICROSCOPES

IMPORTED Microscopes magnifying 500 times, 75c. R. Valles, 23W 114th, New York.

\$1.50 UTAH Breastplate microphone with pair earphones. Cost government \$20.00. Selection government radio, binoculars, musical instruments. Well's Curiosity Shop, 20 South Second Street, Philadelphia.

## DIAMONDS, WATCHES, CLOCKS AND JEWELRY

ELGIN Watches \$2.50, 21 jewel Bunn \$10.00. Watch movements for experimental work 25c. Lists free. Stewart's Jewel Shop, 500 N. 6th St., St. Louis, Mo.

## RAZORS AND BLADES

ALL Makes of razor blades resharpened. Double edge 1c each. Edw. Heppner, Melrose-Park, Ill.

ANY Razor blade resharpened, 1c each. Pettei Wetterquist, Rockford, Ill.

GET 100 Shares per blade with Master-Hone! \$1.00. Meyer, Box 94, Newnan, Ga.

HALF-POUND Can best nonlather shaving cream 20c. Don't let price scare you. Write! We pay postage. 2 Mint, 111 Monroe, Chicago.

## GUNS, FISHING TACKLE AND SPORTING GOODS

TENNIS, Top-Flite with super special \$12.75, \$7.50 restringing job \$5.50. Write James Bateman, 744 Camelia, Baton Rouge, La.

## ANTIQUES, WAR RELICS AND INDIAN GOODS

INDIAN Belle sale:—Bird arrow and price list 10c. R. Helke, Pontiac, Ill.

ANTIQUA Firearms, swords, daggers, Indian relics, curios. Lists free. Nagy, 8P South 18th, Philadelphia.

INDIAN Relics, firearms, coins, curios. List 10c. N. Carter Co., Elkhorn, Wisconsin.

SEND 5c For fine new list Indian relics, antique firearms. F. E. Ellis, Webster Groves, Missouri.

## MUSIC AND MUSICAL INSTRUMENTS

FORTUNES Being made from songs through talking pictures, radio, phonograph, music publishers. "Hit" writers revise, arrange, compose music to your lyrics. We submit to studios and other markets. Free reading. Send for booklet. Universal Song Service, 625 Meyer Bldg., Hollywood, Calif.

WRITERS Of songs, poems, melodies. Opportunity. PM1616 No. Harding, Chicago.

MUSICIANS, Singers—make money transposing (re-arranging) music. All instruments having chromatic scale. Complete—foolproof—method, \$1. Chromatic Publishing Company, P. O. Box 48-A, San Diego, Calif.

CATCHY Music to your words, \$1.00. A. Leresque, 117 McIntyre, West, North Bay, Ontario, Canada.

SONG Writers. Send for our "Publishing Agreement." McKinley Music Printers, 1501 E. 35th St., Chicago.

SONGWRITERS! Poems, melodies. Astounding offer. Hibbeler, D1, 2104 Keystone, Chicago.

COMPOSERS—Verse or music. Brilliant opportunity. Write VanBuren, 2672 McClurg Bldg., Chicago.

SEND Song poems to Hollywood's oldest songwriter's service. Clifford Studio, 4362 Hollywood Blvd., Hollywood, Calif.

SONGWRITERS. Brilliant opportunity. Submit scores. Brennen, Song Specialists, Suite-J, 1656 Broadway, New York.

SONGWRITERS—Read "song requirements of talking pictures, radio and records" an explanatory instructive book sent free to aspiring writers of words for songs. We compose, arrange music and secure copyrights. Write today. P.C. Newcomer, Associates, 1674 Broadway, New York.

SONG Poets, write Sequela Songwriters Service, Sherman Branch, Los Angeles, Calif.

SONGWRITERS Service. Lee Arranging Studios, 109 Judson, Syracuse, N. Y.

POEMS Wanted. Work guaranteed. We publish. Great Eastern Song Bureau, Dept. 27, Thompson, Me.

DUO-Flex reeds for clarinet and saxophones eliminate your reed troubles. Write for circular. Duo-Flex Reeds, 1204 1st Ave., Evansville, Ind.

SYSTEM Complete \$1.00. Address "Music Shorthand," Pismo Beach, California.

"MUSIC Composed" to words. Bauer Bros. (formerly of Sousa's Band), Oshkosh, Wis.

SEND Song poems, 50-50 plan. Indiana Song Bureau. (Brookside), Salem, Ind.

## PATENT ATTORNEYS

PATENT Your idea now. Send for free book, "How to Obtain a Patent," and free "Record of Invention Blank." In business since 1898, specializing in patent matters, we have successfully served thousands of inventors. Little ideas may have big commercial possibilities. Delays are dangerous in patent matters—act at once and protect your idea. Reasonable fees. Convenient terms. Write us today. Victor J. Erans & Co., 601D Victor Bldg., Washington, D. C.

ALL Matter transferred in patent cases; especially difficult cases. Apply for free information on how to proceed. M. H. Ford, registered patent attorney, 225 Broadway, New York.

PATENTS Obtained for inventors. Fee refunded unless granted. Time payment. Write for the plan. Inventors Finance Corporation, 700 Insurance Building, Washington.

LACRY'S Patent Sense. Valuable book free. See ad page 130.

TIME Counts in applying for patents. See page 129. Clarence A. O'Brien, Registered Patent Attorney, Washington, D. C.

PATENTS Secured. Low cost. Write for book, "How to Get Your Patent" and "Record of Invention Certificate." Personal, skillful service assured. 25 years experience. Preliminary advice free. L. F. Randolph, 382A Victor Building, Washington, D. C.

WORLD'S Largest organization of inventors. Helpful information for inventors. Booklet free. Chartered Institute, 1135 Barister Building, Washington, D. C.

INVENTIONS Patented and Exploited. Former patent office examiner; Master patent law. Bend Webster, Esq., No. 15 East 25 Street, New York.

PATENTS, Booklet free. Highest references. Best results. Promptness assured. Watson E. Coleman, Patent Lawyer, 724 Ninth St., Washington, D. C.

LANCASTER, Allwine & Rommel, Suite 411, 815 - 15th St., N. W., Washington, D. C. "Originators of the Form Evidence of Conception." Before disclosing your invention to anyone send for blank form to be signed and witnessed. Form and patent information bulletin free.

PATENTS Procured; trade marks registered—preliminary advice furnished without charge. Booklet and form for disclosing idea free. Irving L. McAthran, 700A International Bldg., Washington, D. C.



**PATENTS.** Reasonable rates. Write, The Ramsey Company, World Patent Attorneys, 273 Bank St., Ottawa, Canada.

**WHAT to invent.**—Names of manufacturers and wanted inventions sent free on request. Write W. T. Greene, 946 Barrister Building, Washington, D. C.

**"INVENTOR'S Guide,"** valuable information free. Frank Ledermann, Registered Attorney-Engineer, 1713 Woolworth Bldg., New York.

**INVENTORS:** Send for booklet telling how to patent and sell your inventions at lowest cost. Ralph Burch, Patent Lawyer, 900 F St., Washington, D. C.

**PATENTS.** Send sketch or model for advice. Free book, "How to Obtain a Patent." Established thirty years. Highest references. Prompt service. Reasonable charges. Chandler & Chandler, 908 F Street, Washington, D. C.

**ESTABLISHED 1864.** Milo S. Stevens Company. Free booklet. Patents. Trade marks. Copyrights. Offices. Monadnock Block, Chicago; Barrister Bldg., Washington, D. C.

**PATENTS—Write for free information.** How to Obtain a Patent and Record of Invention—or send drawing or model for examination. Miller & Miller, Patent Attorneys (former Patent Office Examiners), 1006-A Woolworth Building, New York; 673 Earle Building, Washington, D. C.

#### FOR INVENTORS

**MANUFACTURING** Company interested in absolutely new and novel invention in confectionery line. Must be absolutely new and unique. Will buy outright or on royalty basis for manufacture in U. S. and Canada. Forward full particulars, with application, to: Board of Research, S. M. C. Ltd., New Toronto, Ontario, Canada.

**MANUFACTURERS** Everywhere seek new inventions to improve their product. Names of manufacturers and wanted inventions sent free on request. Write W. T. Greene, 944 Barrister Building, Washington, D. C.

**PUT Your invention across now!** Advertise it in "Inventive Age & Patent Market"—only \$2.50 an inch, 4 lines \$1.00. Hundreds of manufacturers now buying new inventions. Valuable information monthly. "What the inventor needs." \$2.00 yearly, 6 months trial \$1.00. Publishers, Room 300—718 East 4th St., Brooklyn, N. Y. (Manufacturers inquiries invited.)

**NATION** Wide search for best inventions. American Society of Inventors, Crosby Bldg., Buffalo.

**PROVE—Priority** on your inventions. Protect yourself while waiting to finance patents. Safeguard your ideas for two years with my ironclad copyrighted "Evidence of Conception" form. Large size 4 for \$1.00, (35c each). Small size 6 for \$1.00, (25c each). Harry Johnston, 1636 Beaubien St., Detroit, Michigan.

**GET Your own patents;** legal blanks, complete instructions \$1. Cutting Sons, Campbell, Calif.

**PATENT Your invention:** Send for free book, "How to Obtain a Patent," and "Record of Invention" blank. Consult us about how to protect your ideas. Victor J. Evans & Co., 602D Victor Bldg., Washington, D. C.

**TIME** Counts in applying for patents. See page 129. Clarence A. O'Brien, Registered Patent Attorney, Washington, D. C.

**LACEY'S Patent Sense.** Valuable book free. See ad page 130.

**LIST Your inventions immediately.** New Inventions Exposition, William Taylor Hotel, San Francisco, April 23rd to 30th, 1932. National Inventors Congress.

**GET Help** on your ideas from trained technicians. Write to J. Coleman, 1012 7th Ave., Boulder, Colo.

**HELPFUL** Information for inventors. Booklet free. World's largest organization of inventors. Chartered Institute, 1136 Barrister Building, Washington, D. C.

**IDEAS** Bring fortunes. Patents prepared, filed, \$3.00 up. Canadian patents filed \$1.00 up. Valuable circular free. J. J. O'Brien, Patent Attorney-Engineer, 100 W. 42nd St., New York City.

**INVENTORS!** Copyright a description or drawing of your invention or patented article in our magazine. This will help secure you direct evidence for priority patent claim. Promoters! Your advertisement will put you in direct touch with the inventor you are seeking. Advance Publishing Company, 405 Lankershim Bldg., 3rd and Spring Sts., Los Angeles, Calif. Established 1911. Sample copy of magazine 10 cents.

**BRASS Gears** and model supplies. Send for catalog. The Pierce Model Works, Tinley Park, Ill.

**INVENTIONS** Patented and Exploited. Former patent office examiner; Master patent law. Benj. Webster, Esq., No. 15 East 23 Street, New York.

**LOW Cost manufacturing.** Large plant completely equipped for blanking, drawing, stamping and wire forming in any finish. Can save you money on your product. Our figures will convince. Eastern States Products, Box 721, New Haven, Conn.

**INVENTOR'S Universal Educator:** contains 900 mechanical movements; 50 perpetual motions; instruction on procuring and selling patents and selecting an attorney, etc. Suggests new ideas. Price \$1.00 postpaid in U. S. A. Address Dietrich Co., 602B Ouray Bldg., Washington, D. C.

#### PATENTS FOR SALE

**TRAY** With forks attached. Holds down fowl or meat when carving. Wm. L. Stonehouse, 5103 Canton, Detroit, Mich.

**OUTRIGHT.** Electric mouse trap, \$10.00. 606 Haynes Street, Daxton, Ohio.

**TIME** Counts in applying for patents. See page 129. Clarence A. O'Brien, Registered Patent Attorney, Washington, D. C.

**CURTAIN** Support. Billions sales possible. Eugene Ditzman, Byrne City, Mich.

**CASH** Or royalty. Auto bed and screens. C. Heumader, St. Joseph, Mo.

**NEW Invention.** "Automatic Milk Cap Lifter." Entire U. S. patent rights for sale. Cost 2c—retails 25c. Sold \$5,000 to date. Sample 30c. Robt. Paulson, Hutchinson, Minn.

**INVENTORS—Cash in on your invention now!** Don't delay the sale any longer! Send for a free copy of our specially prepared booklet, "Turn Your Patent Into Money," today! It contains helpful information for all inventors. M. L. Rund, Mgr. Classified Advertising, Popular Mechanics Magazine, 200 E. Ontario St., Chicago, Ill.

**MANUFACTURERS** Wanting profitable new inventions, write Chartered Institute American Inventors, 1221 Barrister Building, Washington, D. C.

**MANUFACTURERS** Looking for new inventions should write W. T. Greene, 939 Barrister Building, Washington, D. C.

#### COPYRIGHTS—TRADE MARKS

**COPYRIGHTS, Trade-Marks.** Protect almost anything! Low charges. Wade Service, 2274-N Brooklyn Station, Cleveland, O.

#### CASTINGS

**CASTINGS** For home shop machinery. Lynn Peitcher, Ocean Beach, Calif.

#### DRAWING INSTRUMENTS AND DRAFTING SUPPLIES

**DRAFTSMEN—**Beam compass, nickel plated, micrometer adjustment, 9" steel beam, 2 extensions, radii 1 1/2" to 37". Send money order. Porter, Rhodes Ave., Hempstead, N. Y. Agents write. Attractive terms.

**DRAFTING.** Learn at home. American Training School, 203 Davis Ave., Kearny, N. J.

#### SURVEYING INSTRUMENTS

**SAVE** Money by buying our rebuilt transit and levels. All fully guaranteed—sold subject to field test. Cash or easy terms. Write today for list M-61. Warren-Knight Co., (Makers of "Sterling" Surveying Instruments), 136 N. 12th Street, Phila., Pa.

#### BLUEPRINTS

**FOOT-STOOL** With compartment for slippers. 17"x22" blueprint plus descriptions and reproduced photographs, 10 cents complete. Home Craftsman, Dept. 1-A, Plainfield, N. J.

**COMBINATION** Bridge table-end table, 17"x22" blueprint with descriptions and reproduced photographs, 10 cents complete. Home Craftsman, Dept. 1-B, Plainfield, N. J.

#### MODELS AND MODEL SUPPLIES

**MINIATURE** Storage batteries for working models. Description and prices free. Model Railroad Supply Company, 2815 Sunset Blvd., Los Angeles.

**SHIPMODELER.** Magazine of the ship model makers' club. Sample copy 20 cents. 55A, Middach St., Brooklyn, N. Y.

**BRASS.** Copper, steel, rods, tubes, sheets, bars, screws for the home mechanic. De Witt Clinton locomotive parts \$4.75 postpaid, tender parts \$2.00. National Home Workshop Supply Co., 299-C North Ave., New Rochelle, N. Y.

**MODEL** Ship builders. Give your hulls beautiful green corroded copper appearance without using copper. Applied brush. Supply for \$1.00. Model Shop, 33 Lexington St., Waltham, Massachusetts.

**POWER** Models. Gasoline steam engines. Railway, steamship, boiler fittings, metals. Big catalog 35c. Charles Cole, Ventura, Calif.

**RAILWAY** Model supplies—Track, signals, locomotives, cars. List 10c. Crovan Railway Models, Greenwich, Conn.

**MODEL** Speed boat hulls and steam engines, aluminum and brass castings. Doland, 312 West 123rd St., New York.

**SUPPLIES** For model making. De Witt materials, etc. Send for list. Seefeld Co., 57 Seefeld Ave., Bridgeport, Conn.

**CASTINGS** And blueprints for passenger-carrying locomotives. Catalogue 20c coin. Model Railway Supply, 630 Folk St., Pueblo, Colo.

**SMALL** Milling cutters for light milling. Straight and angular. Prices are right. Get my list. Kren, 2322 Forestdale, Cleveland, Ohio.

**INVENTORS:** Send us sketch or crude model of your idea. (Present craftsmen will develop it into a practical working model. 30 years of successful experience and thousands of satisfied clients. Confidential service guaranteed. Bank references furnished. Free illustrated book: "Making Inventions Pay." Crescent Tool Co., Dept. S-4, Cincinnati, Ohio.

**TIME** Counts in applying for patents. See page 129. Clarence A. O'Brien, Registered Patent Attorney, Washington, D. C.

**LATEST** Cat. 16 for model engines, castings, blue prints, supplies. 20c. Howard, 2117 N. Ashland Ave., Chicago.

**WE** Make working models for inventors and do experimental work and carry a complete stock of brass gears and model supplies. Send for catalog. The Pierce Model Works, Tinley Park, Ill.

**GASOLINE** Engine, two cycle type, 3/8"x3/8". Steam engines, boilers for model boats. Propellers, fittings. Catalog 15c. Anton Bohaboy, 213 Price St., Rahway, New Jersey.

#### MACHINE DESIGNING

**DESIGNS** Developed—Computations drawings made. Confidential. Draftservice, Dolgaville, N. Y.

#### MANUFACTURING

**MANUFACTURING.** Tools, dies, stampings, models. Low rates. Edw. Persberg, Northfield, Ohio.

**ECONOMICAL** Manufacturing from sheet, bar, wire or tubing. Models, dies, special machinery. Swenberg, 5124 N. Kildare Ave., Chicago.

**MANUFACTURING.** Models, dies, stampings, brasswork, moulds for castings, vulcanizing. Circular free. Bauma Metal Specialties, Kansas City, Mo.

**LOW Cost manufacturing.** Large plant completely equipped for blanking, drawing, stamping and wire forming in any finish. Can save you money on your product. Our figures will convince. Eastern States Products, Box 721, New Haven, Conn.

**METAL** Articles developed and manufactured. Model making. Reasonable price and first class workmanship. W. F. Meyers Company, Bedford, Indiana.

**WIRE** Goods made to order. Cooley Mfg. Co., 3210 Carroll Ave., Chicago.

#### WELDING AND SOLDERING

**BARGAINS—**Excellent reprocessed arc welders. Entirely rebuilt—guaranteed. Trial Terms. Write Ken's Service, Box M124, Troy, Ohio.

#### ELECTRICAL

**CLOCK** Switch automatically turns radio or electrical appliances on or off at any desired time. One dollar, postpaid. Brownlab, 415 Union, Traverse City, Mich.

**MYSTERY** Motor, 110-volt novelty, \$1.00. Cutting Sons, Campbell, Calif.

#### ELECTRICAL EXPERIMENTS

**ELECTRICAL** Experimenters salvage equipment. Depression bargains. April special—Two way telephone kits, commercial parts, complete instructions \$1.32. Microphones 41c, with polished stand \$1.02. Electrical laboratory experimental kit \$2.48. Bargain bulletin, send stamp. Engineering Service Company, 1718 South 14th Street, Lincoln, Nebraska.



## ENGINEERING INSTRUMENTS

**VESTPOCKET Slide rules** for technical calculations—Anyone can learn. Each rule, leather case, directions, \$2.50 postpaid—\$2.02 C.O.D. Durland, 61 Himsdale Pa., Newark, N. J.

## MACHINERY, TOOLS AND SUPPLIES

**SMALL Pulleys, hangers, patterns, castings.** Write, Porter Morrow, Utica, Ohio.

**SUBSTANTIAL Savings**—used are welders, platers, compressors, paint sprays. Entirely rebuilt; guaranteed. Trial and terms. Write Ken's Equipment, Box M-423, Troy, Ohio.

**NEW 1/2 HP. Emerson 110v. 60 cycle, 1-ph. motors, 1200 rpm. \$7.50.** Brown Machinery Co., 2323B North 9th, St. Louis, Mo.

**12"x5" SHEPARD** Gap lathe, \$60.00. **18"x8" Monarch** lathe, \$190.00. No. 0 Owens milling machine, \$175.00. 29" Jungst crank shaper, \$180.00. No. 60 Heald cylinder grinder, \$450.00. 14" Barnes drill press, \$35.00. New Quincy air compressor, complete with motor, tank, etc., \$74.25. Hobart battery charging outfit, \$35.00. Write for catalog. Terms to suit. Cincinnati Machinery & Supply Company, 27 West 2nd St., Cincinnati, Ohio.

**ELECTRIC Drill and vacuum cleaner** armatures re-newed, any size or make, \$7.50, eight light 32 or 110 volt slightly used light plants \$28.50. General Distributing Company, Duluth, Minn.

**KELLOGG Air compressors, excellent condition, \$6.00.** Refrigerator compressors, \$8.00. Taylor, 105 East 102nd Street, New York City.

**MORSE Lathe, 12x30, \$50.00.** 12" arbor press \$15.00. Hilet, Orange, N. J.

**USED And rebuilt lathes.** Several South Bend back-geared screw cutting lathes. First class condition. Bargains, \$75 up. Countershaft and motor drive types. Cash or terms. N. P. Jackman, 445 E. Madison, South Bend, Ind.

**START Business of your own, small investment required, doing chromium, nickel, copper, silver plating.** This work in big demand. Information free. Electro Platers Supply Co., 28 West Second St., Cincinnati, Ohio.

## ENGINES, MOTORS AND DYNAMOS

**FOR Sale**—Several reconditioned Harley-Davidson stationary gasoline engines. Factory demonstrators. 3 h.p. up. Write for free catalog. Save two-thirds. Harley-Davidson Motor Co., Milwaukee, Wis.

**GOVERNORS** For all auto engines used for stationary or portable power. Flyball, \$8.50; electrical \$35.00. No cash down. Candee-Smith Governor Co., 215 North Los Angeles Street, Los Angeles.

**TIME** Counts in applying for patents. See page 129. Clarence A. O'Brien, Registered Patent Attorney, Washington, D. C.

**AIR Compressors \$10.83.** Complete electric spray machine \$65. Near \$31. Guns, pullers, gauges, hose. Factory prices. Folders free. Lohley, 603 Washington Blvd., Chicago.

**1/12 HORSE 110 Volt Universal motors.** Double shaft, emery wheel and ground pulley, mounted, \$2.95. 1/2 horse alternating motors \$4.50. Other bargains. Electrical Surplus Company, Dept. 12, 1885 Milwaukee Ave., Chicago.

**1/2 HP. A.C. Motors \$4.50.** Motors, generators, converters at equally low prices. Queen City Electric, 1736 Grand Avenue, Chicago.

## FARMS AND FARM LANDS

**FREE Books** on opportunities in Minnesota, North Dakota, Montana, Idaho, Washington, or Oregon. Complete information on climate, crops, location for farm or suburban tract for grain, livestock, dairying, fruit, poultry—a home, independence, plenty of food, clothing, continuous employment. No occupation offers more to industrious capable men. Write E. C. Leedy, Dept. 257, Great Northern Railway, St. Paul, Minn.

**1000 FARM Bargains.** Nearly 1000 pictures in Strouts big new spring catalog country real estate and money-making farms for sale in many states. Saves you time and money. Just out. Free. Write today. Strout Agency, 255-P Fourth Ave., N. Y. City.

**SELL Your property quickly for cash, no matter where located.** Don't pay big commission. Particulars free. Real Estate Salesmen Co., Desk B, Lincoln, Nebr.

**ORCHARD Homes.** Easy terms. Suburban Orchards, Dept. M, Hlox, Mississippi.

**OWN A farm** in Minnesota, Dakota, Montana, Idaho, Washington or Oregon. Crop payment or easy terms. Free literature; mention state. H. W. Beyerly, 119 Northern Pacific Railway, St. Paul, Minn.

**MISSOURI Ozarks "Big Springs Country"** ranches, farms, timber lands. Wonderful colonization acreage. Literature. C. M. Seaman, Eminence, Mo.

**FREE Homesteads;** some improved, forfeited; Ark. West: Maps, "700 facts"—40c. Hitchcock, 43221 Coliseum, New Orleans.

**CASH For your farm, business, residence, etc., no matter where located.** Free information. Clark's Realty Co., Box 32, Chipewna Falls, Wisconsin.

**OZARKS**—Timbered river lot, cabin; fishing, hunting, trapping, boating, pearling; \$299, \$10 monthly. Hubbard, 219 Grossman Bldg., Kansas City, Kansas.

## OLD GOLD WANTED

**SEND Us your old gold teeth, bridges, crowns, discarded jewelry, and receive check by return mail.** Standard Gold Refining Company, Indianapolis, Ind.

**WANTED: False teeth.** We pay high as \$10 for full sets. Any condition. We buy crowns, bridges, jewelry, gold, silver. Western Metal Company, Department C, Bloomington, Illinois.

**SEND Your discarded gold jewelry, watch cases, crowns, bridges, etc., for cash offer.** Goods returned promptly if offer is unsatisfactory. Old State Metal Co., Box 51, Shrewsbury, Mass.

## TROPICAL FISH

**MAKE Money** at home raising beautiful tropical aquarium fishes. Valuable information sent free. Vineland Tropical Fish Hatchery, Vineland, New Jersey.

## WANTED—MISCELLANEOUS

**MAIL Us your discarded jewelry, gold crowns and bridges, watches, diamonds, silver, platinum.** Money promptly mailed. Goods returned if offer refused. United States Smelting Works (The Old Reliable) 39 So. State St., Dept. 71 Chicago.

**CASH For old gold, broken jewelry, bridge-work, crowns, etc.** Money mailed immediately. Beebe Co., 519 Central Ave., Cincinnati, Ohio.

## FOR SALE—MISCELLANEOUS

**REAL Four-leafed clovers, mounted pocket-pieces, 50c.** Phyllis Bath, Upper Darby, Pa.

**WATCHMAKERS Lathe** for sale at a bargain. R. Jaegermann, 5815 Easton Ave., St. Louis, Mo.

**NECKTIES! Hosiery! Shirts!** Reasonable prices. Folder free. Quimette's, \$1 Holly 1920, New Bedford, Mass.

## LUMBER

**SOLID Black-Walnut turning squares, 8 pieces, 1 1/2" x 1 1/2" x 30", \$1.50; 4 pieces, 2" x 2" x 30", \$1.00.** Cherry, maple, oak, walnut boards, blocks, squares. Write. Complete lower-price list. David Glenn, Toledo, Illinois.

## POULTRY

**READ America's best!** "American Poultry Journal." Year 25c. Shinn's, Bellflower, California.

## RABBITS

**SILVER Fox rabbits;** enormous profits. Convenient payments. Proposition 10c. Hickory-Dell, Glenbeulah, Wisconsin.

**PEDIGREED New Zealand whites \$1.00** per month of age. Fur Bearers, Inc., Watertown, N. Y.

**RABBITS And supplies.** Complete literature, 10c. Albert Farey, Inc., 115-N. Valley Stream, New York.

**STANDARD Rabbit Journal, Milton, Pa.** Special year 25c; sample dime.

## MINK

**LAST Chance** this year to buy bred female mink. Underwood Minkery, Eyota, Minn.

## ROOTS AND HERBS

**HERBS And Indian remedies.** For all diseases. Send 10c for valuable Herb and Indian Doctor Book. Indian Gardens Co., Centreville, Mich.

**JUST Out!** Beautifully illustrated 61 page medicine man almanac. Contains over 500 old-fashioned herb medicine recipes and Indian secrets for home use. 10c postpaid. Worth dollars! Botanics, 145 West 112th St., Chicago.

**NEW! 64 Page Herbalist almanac.** Send 10c for valuable recipes and herb cures. Colored illustrations. Cent Herb Products, 1968 Winnetka, Chgo.

## DOGS AND PETS

**WHITE Rats, Breeders, \$1.00 trio.** Black and white, \$1.00 pair. Sterling Breeders, 506 - 12th Ave., Sterling, Ill.

**FOR Sale.** Minks, squirrels, raccoons, foxes, ferrets, muskrats, ginseng, rabbits, skunks, wolf pups, opossums. B. Tippman, Caledonia, Minn.

**BEAUTIFUL Registered bull pups, \$15.** Bulldogs, 591 Rockwood, Dallas, Texas.

## PRECIOUS STONES

**(DIAMOND'S Rival) genuine Zircons.** Full information 10 cents. Goetz Gem Co., Galien, Ohio.

## PERSONAL

**HANDWRITING Reveals character and talents, 50c** for complete individual analysis. Harry Yoder, Racine, Wis.

**STOP Tobacco craving** the easy way. Guaranteed. Gerwin, Branch, Arkansas.

**DO Your feet sweat, smell or itch?** Instant relief. Full size treatment one dollar. Recommended by physicians. Roche, Renaud Co., Fairhaven, Mass.

**CORRECT Astrological data** by world-known astrologer Dr. George Smallwood, Pepperell, Mass.

**SWEATY, Tender, bad smelling feet easily, quickly, permanently cured** at home, no expense, dollar bill tells how. George M. Germany, Box 1512, Detroit, Michigan.

**YOU Owe it to yourself to know what your handwriting reveals.** Practical, dependable, startling. Lewis, 6:15AM Benson St., Huntington Park, California.

**SUCCESSFUL? Your handwriting points way.** Detailed personality analysis and vocational chart, 25c. Graphologist, Box 686, Dallas, Texas.

**HIGH Blood pressure inexpensively relieved.** Send address. Thomas Stokes, Mohawk, Pa.

**10 YEAR Astrology reading \$1.** (1932 to 1942). Special monthly forecast for 1932 and "Lucky Day" chart free. National Pub. Co., Desk 101-B, Hunter, N. Y.

**YOUR Handwriting revealed!** Send \$1.00 for complete individual analysis. C. Victor, 24 East 42nd St., New York.

**ARE You old at forty?** See our advertisement on page 24 of this issue. The Electro Thermal Company, 2152 Morris Ave., Steubenville, Ohio.

**GREAT Strength easily obtained.** Particulars free. Prof. Dryer, Box 1850-P, Chicago.

**STOP Fingernail biting habit.** Guaranteed cure. Complete treatment \$2.00, plus postage. Dr. Clayton Westbrook, Wilmington, N. C.

**MY Instructions "Fortune telling by cards,"** palmistry, clairvoyant crystal gazing, \$1.00 complete. Miss. Clair, 2611 W. 36th St., Los Angeles.

## MISCELLANEOUS

**DRUMSTANDERS, Mitre boxes, various sizes.** Write free circular. Box 57, Yankee Specialties, New Rochelle, N. Y.

**AMATEUR Cartoonist:** Sell your work. Write Smith's Service, PX1194, Wenatchee, Wash.

**USED Press bargains.** What size do you want? Send stamp for reply. Exchange, D-2, 480 E. Main, Meriden, Conn.

**MIRRORS Redivided at home.** Costs near 5 cents per square foot; you charge 75 cents. Profitable business plating autographs, reflectors, tableware, stoves, refinishing metalware, etc. Outfits furnished. Details free. Write, Sprinkle, Plater, 288, Marion, Ind.

**ELECTRIC Tattooing outfits** from \$12.85 up. Free catalog. Chicago Tattoo Supply House, 434 So. State, Chicago.

**CASH Pay for butterflies, insects.** See Sinclair Display Advertisement on page 8.

**TRANSFERRING Liquid—Takes pictures or print off bills, magazines, funnies, etc.** Formula and instructions, 25c. L.L.J., Box 1023, Wallace, Idaho.

**TRANSFERRING Liquid—Takes any pictures or print off bills—magazines—funnies, etc.** 25c bottle, formula 35c, both 50c. No stamps. Clinch, Brielle, New Jersey.

**AMATEUR Cartoonists—Earn \$25.00 week, spare time, copying cartoons for advertisers.** 3-M Syndicate, Argyle, Wis.



# NEW KIND of ROADLIGHT!

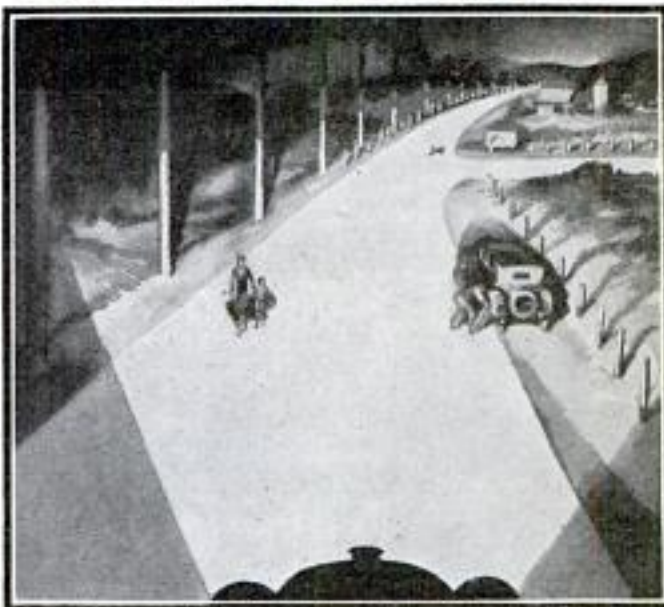
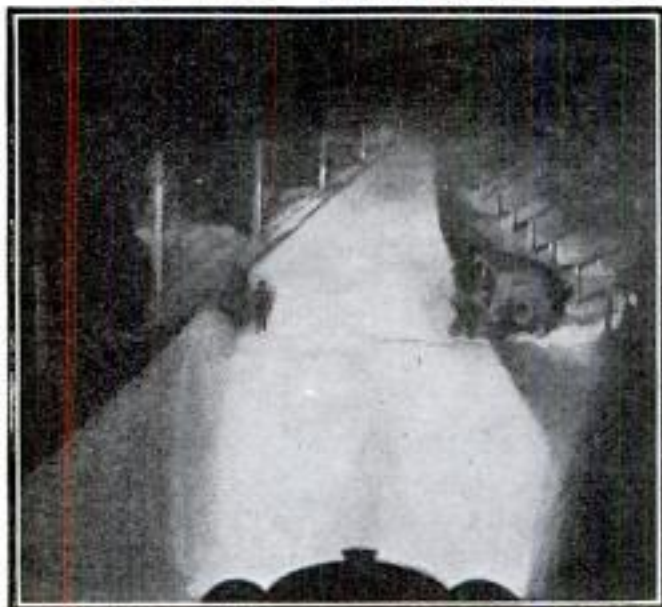

## TINY INVENTION NOW TURNS HEADLIGHTS INTO SEARCHLIGHTS

### -INSTANTLY!



PERFECT-O-LITE astonishes expert and layman alike! Science at last has conquered the grief of night driving!

At last! An invention that makes any headlights give at least twice the road illumination! Shoots an entirely new kind of "infused" light that banishes glare! So new and uncanny that it amazes everyone. Now offered for introductory test to all who mail the 10-DAY TRIAL COUPON promptly!

## DOUBLES ROADLIGHT.. BUT ENDS DIMMING!

IT is a well-known fact that motor car manufacturers have solved every big problem except one. As soon as the sun goes down at night, the highways of America break forth into a constant rushing stream of "dimming and damning." Speed is cut down one-third to one-half. Every Monday morning finds the highways littered with broken glass, wrecks, cars in the ditch, overturned, shattered against telephone posts. Every man who ever groped dizzily down the highway in traffic at night knows the horrible sensation of being half-blinded by cars on his left, unable to see the ditch on his right, his own lights seeming dim and shadowy and practically worthless. Now, in a twinkling, this curse of night driving is lifted completely and inexpensively from the shoulders of the entire motoring world!

### Fits Any Headlight

This new lighting discovery is called Perfect-O-Lite. It is a little invention that replaces the ordinary "bulbs" in your automobile headlights. No extra wiring or installation. Millions of motorists have invested from \$10 to \$25 or more in so-called "Spot" Lights and "Driving"

Lights which at best are only makeshifts. This new lighting method costs only a tiny fraction as much, yet actually DOES double road illumination. Banishes need for Glare Shields. Cuts through the other fellow's light, yet absolutely cannot glare in his eyes. Makes ruts, animals, children, detour signs, etc., far easier to see. Now night driving at 40 to 60 miles an hour is safe and easy.

### Make Your Own Test Free

The secret of the amazing things this new light does is in the kind of "beam" or "ray" that it throws. Instead of ordinary light, this new invention pours a solid beam of double-reflected or "infused" light down the entire roadway. Shows up ditches at the side, as well as distant objects, absolutely clear. Space here limits further discussion of the facts about this discovery. Under an introductory offer you are now invited to be the judge without risking one penny. The coupon brings full details of the invention, offer of a set on FREE TEST and facts about agents' money-making opportunities. Mail it TODAY!

**PERFECT-O-LITE**  
HACHMEISTER-LIND CO.,  
Dept. D-31 Pittsburgh, Pa.

### AMAZING PROFITS OFFERED TO AGENTS!

Here actually IS that chance for \$8 to \$14 your FIRST hour, \$6,000 to \$10,000 THIS year, with no limit WHAT-EVER for Distributors! Ranney, Mo., orders 1,000 sets. Hoffman orders 555 sets. Bradner, Ariz., orders 500 sets. Big profits on every sale. Fleet owners buy quantities. Sacks, W. Va., made \$236 on one order. Wallace & Tiernan, N. J., trucks just equipped. Blue and Gray Bus Line orders for fleet. Other big orders flooding in. Start full time or spare time. Use coupon for FREE TEST OFFER and get full details of Territory, etc. Guaranteed Sales Plan. Mail coupon QUICK!



HACHMEISTER-LIND CO.,  
Dept. D-31, Pittsburgh, Pa.

Rush details of Free Test Offer, also facts about agents' money-making opportunities, without obligation.

Name.....

Address.....

Town..... State.....



## "He used to work at a machine"



"THAT man is head of our engineering department. He worked at a machine for a long time. One day he told me he didn't want to do that kind of work all his life and that he had enrolled for an International Correspondence Schools course to get the training he figured he needed.

"In less than a year the superintendent had chosen him as his assistant. And when the superintendent left he stepped right into his shoes. That course was certainly what he needed to get going and to help put him where he is today."

Spare-time study has helped many men advance from routine jobs to executive positions. Their promotions do not come by luck—they are the rewards of practical training and hard work. You, too, can get ahead—can earn more money! Find out what an hour or two of spare-time study each week will do for you.

Mark and mail the coupon today

### INTERNATIONAL CORRESPONDENCE SCHOOLS

"The Universal University" Box 5593-G, Scranton, Penna.

Without cost or obligation, please send me a copy of your booklet, "Who Wins and Why," and full particulars about the subject before which I have marked X:

#### TECHNICAL AND INDUSTRIAL COURSES

- |  |  |
|--|--|
| <input type="checkbox"/> Architect   | <input type="checkbox"/> Automobile Mechanic                                 |
| <input type="checkbox"/> Architectural Draftsman                             | <input type="checkbox"/> Plumbing <input type="checkbox"/> Steam Fitting     |
| <input type="checkbox"/> Building Estimating                                 | <input type="checkbox"/> Heating <input type="checkbox"/> Ventilation        |
| <input type="checkbox"/> Wood Millworking                                    | <input type="checkbox"/> Sheet Metal Worker                                  |
| <input type="checkbox"/> Contractor and Builder                              | <input type="checkbox"/> Steam Engineer                                      |
| <input type="checkbox"/> Structural Draftsman                                | <input type="checkbox"/> Steam Electric Engineer                             |
| <input type="checkbox"/> Structural Engineer                                 | <input type="checkbox"/> Civil Engineer                                      |
| <input type="checkbox"/> Electric Wiring                                     | <input type="checkbox"/> Surveying and Mapping                               |
| <input type="checkbox"/> Electrical Engineer                                 | <input type="checkbox"/> Refrigeration                                       |
| <input type="checkbox"/> Electric Lighting                                   | <input type="checkbox"/> R. R. Locomotives                                   |
| <input type="checkbox"/> Welding, Electric and Gas                           | <input type="checkbox"/> R. R. Section Foreman                               |
| <input type="checkbox"/> Reading Shop Blueprints                             | <input type="checkbox"/> R. R. Bridge and Building Foreman                   |
| <input type="checkbox"/> Telegraph Engineer                                  | <input type="checkbox"/> Air Brakes <input type="checkbox"/> Train Operation |
| <input type="checkbox"/> Telephone Work                                      | <input type="checkbox"/> Highway Engineering                                 |
| <input type="checkbox"/> Mechanical Engineer                                 | <input type="checkbox"/> Chemistry <input type="checkbox"/> Pharmacy         |
| <input type="checkbox"/> Mechanical Draftsman                                | <input type="checkbox"/> Coal Mining Engineer                                |
| <input type="checkbox"/> Machinist <input type="checkbox"/> Toolmaker        | <input type="checkbox"/> Navigation <input type="checkbox"/> Boilermaker     |
| <input type="checkbox"/> Patternmaker  | <input type="checkbox"/> Textile Overseer or Supt.                           |
| <input type="checkbox"/> Pipefitter <input type="checkbox"/> Tinsmith        | <input type="checkbox"/> Cotton Manufacturing                                |
| <input type="checkbox"/> Bridge Engineer                                     | <input type="checkbox"/> Woolen Manufacturing                                |
| <input type="checkbox"/> Bridge and Building Foreman                         | <input type="checkbox"/> Agriculture <input type="checkbox"/> Fruit Growing  |
| <input type="checkbox"/> Gas Engines <input type="checkbox"/> Diesel Engines | <input type="checkbox"/> Poultry Farming <input type="checkbox"/> Radio      |
| <input type="checkbox"/> Aviation Engines                                    | <input type="checkbox"/> Marine Engineer                                     |

#### BUSINESS TRAINING COURSES

- |   |  |
|---|--|
| <input type="checkbox"/> Business Management                                  | <input type="checkbox"/> Business Correspondence                             |
| <input type="checkbox"/> Office Management                                    | <input type="checkbox"/> Lettering Show Cards <input type="checkbox"/> Signs |
| <input type="checkbox"/> Industrial Management                                | <input type="checkbox"/> Stenography and Typing                              |
| <input type="checkbox"/> Personnel Management                                 | <input type="checkbox"/> Complete Commercial                                 |
| <input type="checkbox"/> Traffic Management                                   | <input type="checkbox"/> Civil Service <input type="checkbox"/> Mail Carrier |
| <input type="checkbox"/> Accountancy <input type="checkbox"/> Cost Accountant | <input type="checkbox"/> Railway Mail Clerk                                  |
| <input type="checkbox"/> C. P. Accountant                                     | <input type="checkbox"/> Grade School Subjects                               |
| <input type="checkbox"/> Bookkeeping  | <input type="checkbox"/> High School Subjects                                |
| <input type="checkbox"/> Secretarial Work                                     | <input type="checkbox"/> College Preparatory                                 |
| <input type="checkbox"/> Spanish <input type="checkbox"/> French              | <input type="checkbox"/> Illustrating <input type="checkbox"/> Cartooning    |
| <input type="checkbox"/> Salesmanship <input type="checkbox"/> Advertising    | <input type="checkbox"/> Lumber Dealer                                       |

Name.....Age.....

Address.....

City.....State.....

Occupation.....

If you reside in Canada, send this coupon to the International Correspondence Schools Canadian, Limited, Montreal, Canada

When writing please mention Popular Mechanics

## Be a DENTICIAN

LEARN AT HOME

To make Crowns, Plates, Bridgework, etc., for Dentists. Easy practical way to learn mechanical dentistry at home in spare time. Full equipment of tools and materials included with course FREE. Low tuition. Easy terms. Write for FREE BOOK about this money-making profession and our easy-to-learn homestudy course and special offer.



McCarrie School of Mechanical Dentistry  
316 S. Wabash Avenue Dept. E-496 Chicago, Ill.

### ELECTRIC PANTS PRESSER

Illinois Man Makes \$88 one Week

Pennsylvania agent cleared \$76 in 4 days. Texas live wire started with earnings of \$144. Profits like these easy for you with amazing new invention—just out. Pants Pressed in 10 Seconds by ELECTRICITY

Millions waiting for this wonderful RED LION ELECTRIC Trousers Presser. Puts razor edges across in pants by electricity. As easy to use as a clothes brush. Only presser in the world that will crease pants while being worn. Will last years. Sample fits in pocket. Take orders, 100% profits. Experience unnecessary. Write for amazing sample offer. SENT FREE.

MUNNY MFG. CO.  
Dept. 8-D 817 Main Street Cincinnati, Ohio

## NO JOKE TO BE DEAF

—EVERY DEAF PERSON KNOWS THAT

George P. Way made himself hear, after being deaf for 25 years, with Artificial Ear Drums—his own invention. He wore them day and night. They stopped head noises and ringing ears. They are invisible and perfectly comfortable. No one sees them. Write for his true story, "How I Got Deaf and Made Myself Hear." Also booklet on Deafness. Address George P. Way, Inc., 729 Hofmann Building, Detroit, Michigan



Artificial Ear Drum

## Save Your Feet

When all else fails end your suffering with the flexible "no metal" Heelner ARCH SUPPORT

WRITE FOR FREE BOOKLET

HEELNER ARCH SUPPORT CO. 688 N. E. TAYLOR BUILDING, LOUISVILLE, KY

## STOP FATAL NIGHT CRASHES

Night driving now safe! A new scientifically constructed spheroidal condenser heavily plated with solid silver—not a painted bulb. Increases light of headlights 50% without glare. Instantly installed. No dimming—no tilting—penetrates fog, rain, mist and snow. Low retail price. Undercuts all competition. Big commissions.

AGENTS UP TO \$50.00 A DAY

New plan of demonstrating Marvelight rolls agent's sales up to \$50.00 a day. Write for details of free offer today.

MARVELIGHT CO. 3223 N. Ashland Ave. Dept. 10-D, Chicago





# HURRAH!

## A Way To Open Jars And Bottles

### *Without Breaking Your Arm*

It's here—the simple, automatic, safe jar opener you've wished for! Banishes danger—ends work, waste, worry! Hangs on the wall—just push the handle. Adjusts automatically to all types, sizes. Ends broken jars, cuts. Saves food from spoiling. Pays for itself!

## AGENTS! Every Housewife Wants It *Instantly!*

**T**HE kitchen's toughest and most dangerous job is ended! Now, at last, thanks to the genius of a St. Louis inventor, anyone can instantly and automatically open or seal any type or size jar and bottle like magic—at the twist of the wrist! Imagine a little machine that hangs on the wall. That automatically adjusts itself to any size or type container! You just push the handle and presto! The job is done for you like magic. Even the toughest anchor vacuum top is removed instantly and put on again! And without danger! For this marvel ends broken jars and cuts. Saves food from spoiling, too—pays for itself quickly. Beauti-

fully finished and guaranteed for 5 years!

### **A Lifetime Opportunity**

With every home eager to enjoy the benefits of this timely discovery—and with no competition—ambitious folks everywhere are pocketing earnings daily up to \$5 in an hour, full and spare time! If you, too, want this kind of money, act quick while this invention is brand new and selling on sight. Send no money. The coupon brings you full details of this and 3 other big money-makers that pay up to **FOUR PROFITS**. Also liberal **FREE TEST** offer and guaranteed sales plan! Mail it **TODAY SURE!** **Central States Mfg. Co., Dept. D-415, 4500 Mary Ave., St. Louis, Mo.**



**Great For Sealing, Canning,  
Preserving**

On top of bringing priceless relief and safety in opening jars and bottles, the new Speedo Jar Opener is indispensable for sealing mason jars in preserving and canning. Saves food. That's why every woman wants it the minute she sees it! The coupon below brings you the full facts and liberal **FREE TEST OFFER**.

**Central States Mfg. Co., Dept. D-415  
4500 Mary Ave., St. Louis, Mo.**

Rush full details about the new Speedo Jar Opener and liberal 4-PROFIT PLAN and FREE TEST Offer on this and 3 other big money-makers, without obligation.

Name.....

Address.....

City..... State.....

( ) Check here if interested only in one for your home.

When writing to advertisers please mention Popular Mechanics

Copyrighted material



## Make BIG Profits

—in your own steady cash business at home



Men and women all over the U. S. are earning good, steady money in their own business making delicious greaseless do-nuts with the NEW

### RINGER ELECTRIC DO-NUT MACHINE

Everybody is simply delighted with these new electric made do-nuts—they're tasty, easily digested, healthful, satisfying. They melt in your mouth. Easy to make . . . no fuss or bother . . . no frying fat or oil used. Everything furnished for less than \$60, including Ringer Electric Do-Nut Machine, recipes for plain, sugared, whole wheat and chocolate-covered do-nuts, and complete instructions. A steady repeat business, cash every day. Grocers, restaurants, drug stores, etc., buy all you can make.

**FREE PLAN** shows you how to start this big-paying, steady business at home. Write us today.

**RINGER DO-NUT CO.** 145 Main St. N. E. MINNEAPOLIS, MINN.

## RADIO is EXCITING!

... get into it!

Learn at



THERE is no more fascinating a career than one in radio. How would you like to become associated with this great and growing industry? There are many different branches . . . among them one you will like.

You can learn it . . . and any other . . . at RCA Institutes, America's oldest radio school. This training, thorough, complete, is offered at four big resident schools—New York, Chicago, Philadelphia, Boston—or through extension courses for home

study. Elementary and advanced courses. Instructors of experience and ability teach you on equipment that is of the latest type.

There are no "cut and dried" courses. You choose one fitted to your own needs. New classes (day and evening) commence about every six weeks. Start extension courses any time. Mark and mail the coupon now—before you forget—for general catalog and full description of all courses.

A Radio Corporation of America Subsidiary



### RCA INSTITUTES, INC.

Dept. PG-4, 75 Varick St., New York

Please send me your General Catalog. I am checking below the phase of radio in which I am interested.

- Microphone Technique     Aviation Radio     Talking Pictures  
 Radio Operating     Broadcast Station or Studio  
 Servicing Home Entertainment Equipment     Television

Name.....

Address..... Occupation..... Age.....

FREE! FREE!  
TIRE GAUGE



WITH EACH ORDER FOR 2 TIRES

NOW TAKE TIRE PRESSURE THROUGH SIDE WALL OF TIRE



SAVE ON TIRES



12 MONTHS SERVICE GUARANTEED

Send only \$1.00 deposit with each tire ordered. We ship balance C. O. D. Deduct 6 percent if cash in full accompanies order.

TUBES BRAND NEW - GUARANTEED

Tires failing to give 12 months' service replaced at half price.

**YORK TIRE & RUBBER CO., Dept. 1009-A**

3855-59 Cottage Grove Ave. Chicago, Ill.

New LOW PRICES ON GOOD YEAR GOODRICH-U.S.-FIRESTONE FISK AND OTHER TIRES

### LOWEST Prices on Earth!

Thousands of satisfied tire users all over the U. S. A. will vouch for the LONG, HARD SERVICE, under severest road conditions of our standard brand tires reconstructed by the ORIGINAL SECRET YORK PROCESS. To introduce this genuine tire value to you, this big responsible company offers, ABSOLUTELY FREE a modern tire gauge with each 2 tires ordered—now take pressure through side wall of tire in a jiffy—no fuss—no dirt. OUR 16 YEARS IN BUSINESS makes it possible to offer tires at LOWEST PRICES in history.

Guaranteed to give 12 months' service

Don't Delay - Order Today

CORD TIRES		BALLOON TIRES	
Size	Tires Tubes	Size	Tires Tubes
81x3	\$2.20 \$1.00	22x4.40	\$2.30 \$1.10
81x3 1/4	2.25 1.00	22x4.50	2.40 1.15
81x4	2.30 1.15	22x4.75	2.45 1.20
81x4 1/4	2.35 1.15	22x4.75	2.45 1.20
81x4 1/2	2.40 1.15	22x4.75	2.45 1.20
81x4 3/4	2.45 1.15	22x4.75	2.45 1.20
81x5	2.50 1.15	22x4.75	2.45 1.20
81x5 1/4	2.55 1.15	22x4.75	2.45 1.20
81x5 1/2	2.60 1.15	22x4.75	2.45 1.20
81x5 3/4	2.65 1.15	22x4.75	2.45 1.20
81x6	2.70 1.15	22x4.75	2.45 1.20
81x6 1/4	2.75 1.15	22x4.75	2.45 1.20
81x6 1/2	2.80 1.15	22x4.75	2.45 1.20
81x6 3/4	2.85 1.15	22x4.75	2.45 1.20
81x7	2.90 1.15	22x4.75	2.45 1.20
81x7 1/4	2.95 1.15	22x4.75	2.45 1.20
81x7 1/2	3.00 1.15	22x4.75	2.45 1.20
81x7 3/4	3.05 1.15	22x4.75	2.45 1.20
81x8	3.10 1.15	22x4.75	2.45 1.20
81x8 1/4	3.15 1.15	22x4.75	2.45 1.20
81x8 1/2	3.20 1.15	22x4.75	2.45 1.20
81x8 3/4	3.25 1.15	22x4.75	2.45 1.20
81x9	3.30 1.15	22x4.75	2.45 1.20
81x9 1/4	3.35 1.15	22x4.75	2.45 1.20
81x9 1/2	3.40 1.15	22x4.75	2.45 1.20
81x9 3/4	3.45 1.15	22x4.75	2.45 1.20
81x10	3.50 1.15	22x4.75	2.45 1.20
81x10 1/4	3.55 1.15	22x4.75	2.45 1.20
81x10 1/2	3.60 1.15	22x4.75	2.45 1.20
81x10 3/4	3.65 1.15	22x4.75	2.45 1.20
81x11	3.70 1.15	22x4.75	2.45 1.20
81x11 1/4	3.75 1.15	22x4.75	2.45 1.20
81x11 1/2	3.80 1.15	22x4.75	2.45 1.20
81x11 3/4	3.85 1.15	22x4.75	2.45 1.20
81x12	3.90 1.15	22x4.75	2.45 1.20
81x12 1/4	3.95 1.15	22x4.75	2.45 1.20
81x12 1/2	4.00 1.15	22x4.75	2.45 1.20
81x12 3/4	4.05 1.15	22x4.75	2.45 1.20
81x13	4.10 1.15	22x4.75	2.45 1.20
81x13 1/4	4.15 1.15	22x4.75	2.45 1.20
81x13 1/2	4.20 1.15	22x4.75	2.45 1.20
81x13 3/4	4.25 1.15	22x4.75	2.45 1.20
81x14	4.30 1.15	22x4.75	2.45 1.20
81x14 1/4	4.35 1.15	22x4.75	2.45 1.20
81x14 1/2	4.40 1.15	22x4.75	2.45 1.20
81x14 3/4	4.45 1.15	22x4.75	2.45 1.20
81x15	4.50 1.15	22x4.75	2.45 1.20
81x15 1/4	4.55 1.15	22x4.75	2.45 1.20
81x15 1/2	4.60 1.15	22x4.75	2.45 1.20
81x15 3/4	4.65 1.15	22x4.75	2.45 1.20
81x16	4.70 1.15	22x4.75	2.45 1.20
81x16 1/4	4.75 1.15	22x4.75	2.45 1.20
81x16 1/2	4.80 1.15	22x4.75	2.45 1.20
81x16 3/4	4.85 1.15	22x4.75	2.45 1.20
81x17	4.90 1.15	22x4.75	2.45 1.20
81x17 1/4	4.95 1.15	22x4.75	2.45 1.20
81x17 1/2	5.00 1.15	22x4.75	2.45 1.20
81x17 3/4	5.05 1.15	22x4.75	2.45 1.20
81x18	5.10 1.15	22x4.75	2.45 1.20
81x18 1/4	5.15 1.15	22x4.75	2.45 1.20
81x18 1/2	5.20 1.15	22x4.75	2.45 1.20
81x18 3/4	5.25 1.15	22x4.75	2.45 1.20
81x19	5.30 1.15	22x4.75	2.45 1.20
81x19 1/4	5.35 1.15	22x4.75	2.45 1.20
81x19 1/2	5.40 1.15	22x4.75	2.45 1.20
81x19 3/4	5.45 1.15	22x4.75	2.45 1.20
81x20	5.50 1.15	22x4.75	2.45 1.20
81x20 1/4	5.55 1.15	22x4.75	2.45 1.20
81x20 1/2	5.60 1.15	22x4.75	2.45 1.20
81x20 3/4	5.65 1.15	22x4.75	2.45 1.20
81x21	5.70 1.15	22x4.75	2.45 1.20
81x21 1/4	5.75 1.15	22x4.75	2.45 1.20
81x21 1/2	5.80 1.15	22x4.75	2.45 1.20
81x21 3/4	5.85 1.15	22x4.75	2.45 1.20
81x22	5.90 1.15	22x4.75	2.45 1.20
81x22 1/4	5.95 1.15	22x4.75	2.45 1.20
81x22 1/2	6.00 1.15	22x4.75	2.45 1.20
81x22 3/4	6.05 1.15	22x4.75	2.45 1.20
81x23	6.10 1.15	22x4.75	2.45 1.20
81x23 1/4	6.15 1.15	22x4.75	2.45 1.20
81x23 1/2	6.20 1.15	22x4.75	2.45 1.20
81x23 3/4	6.25 1.15	22x4.75	2.45 1.20
81x24	6.30 1.15	22x4.75	2.45 1.20
81x24 1/4	6.35 1.15	22x4.75	2.45 1.20
81x24 1/2	6.40 1.15	22x4.75	2.45 1.20
81x24 3/4	6.45 1.15	22x4.75	2.45 1.20
81x25	6.50 1.15	22x4.75	2.45 1.20
81x25 1/4	6.55 1.15	22x4.75	2.45 1.20
81x25 1/2	6.60 1.15	22x4.75	2.45 1.20
81x25 3/4	6.65 1.15	22x4.75	2.45 1.20
81x26	6.70 1.15	22x4.75	2.45 1.20
81x26 1/4	6.75 1.15	22x4.75	2.45 1.20
81x26 1/2	6.80 1.15	22x4.75	2.45 1.20
81x26 3/4	6.85 1.15	22x4.75	2.45 1.20
81x27	6.90 1.15	22x4.75	2.45 1.20
81x27 1/4	6.95 1.15	22x4.75	2.45 1.20
81x27 1/2	7.00 1.15	22x4.75	2.45 1.20
81x27 3/4	7.05 1.15	22x4.75	2.45 1.20
81x28	7.10 1.15	22x4.75	2.45 1.20
81x28 1/4	7.15 1.15	22x4.75	2.45 1.20
81x28 1/2	7.20 1.15	22x4.75	2.45 1.20
81x28 3/4	7.25 1.15	22x4.75	2.45 1.20
81x29	7.30 1.15	22x4.75	2.45 1.20
81x29 1/4	7.35 1.15	22x4.75	2.45 1.20
81x29 1/2	7.40 1.15	22x4.75	2.45 1.20
81x29 3/4	7.45 1.15	22x4.75	2.45 1.20
81x30	7.50 1.15	22x4.75	2.45 1.20
81x30 1/4	7.55 1.15	22x4.75	2.45 1.20
81x30 1/2	7.60 1.15	22x4.75	2.45 1.20
81x30 3/4	7.65 1.15	22x4.75	2.45 1.20
81x31	7.70 1.15	22x4.75	2.45 1.20
81x31 1/4	7.75 1.15	22x4.75	2.45 1.20
81x31 1/2	7.80 1.15	22x4.75	2.45 1.20
81x31 3/4	7.85 1.15	22x4.75	2.45 1.20
81x32	7.90 1.15	22x4.75	2.45 1.20
81x32 1/4	7.95 1.15	22x4.75	2.45 1.20
81x32 1/2	8.00 1.15	22x4.75	2.45 1.20
81x32 3/4	8.05 1.15	22x4.75	2.45 1.20
81x33	8.10 1.15	22x4.75	2.45 1.20
81x33 1/4	8.15 1.15	22x4.75	2.45 1.20
81x33 1/2	8.20 1.15	22x4.75	2.45 1.20
81x33 3/4	8.25 1.15	22x4.75	2.45 1.20
81x34	8.30 1.15	22x4.75	2.45 1.20
81x34 1/4	8.35 1.15	22x4.75	2.45 1.20
81x34 1/2	8.40 1.15	22x4.75	2.45 1.20
81x34 3/4	8.45 1.15	22x4.75	2.45 1.20
81x35	8.50 1.15	22x4.75	2.45 1.20
81x35 1/4	8.55 1.15	22x4.75	2.45 1.20
81x35 1/2	8.60 1.15	22x4.75	2.45 1.20
81x35 3/4	8.65 1.15	22x4.75	2.45 1.20
81x36	8.70 1.15	22x4.75	2.45 1.20
81x36 1/4	8.75 1.15	22x4.75	2.45 1.20
81x36 1/2	8.80 1.15	22x4.75	2.45 1.20
81x36 3/4	8.85 1.15	22x4.75	2.45 1.20
81x37	8.90 1.15	22x4.75	2.45 1.20
81x37 1/4	8.95 1.15	22x4.75	2.45 1.20
81x37 1/2	9.00 1.15	22x4.75	2.45 1.20
81x37 3/4	9.05 1.15	22x4.75	2.45 1.20
81x38	9.10 1.15	22x4.75	2.45 1.20
81x38 1/4	9.15 1.15	22x4.75	2.45 1.20
81x38 1/2	9.20 1.15	22x4.75	2.45 1.20
81x38 3/4	9.25 1.15	22x4.75	2.45 1.20
81x39	9.30 1.15	22x4.75	2.45 1.20
81x39 1/4	9.35 1.15	22x4.75	2.45 1.20
81x39 1/2	9.40 1.15	22x4.75	2.45 1.20
81x39 3/4	9.45 1.15	22x4.75	2.45 1.20
81x40	9.50 1.15	22x4.75	2.45 1.20
81x40 1/4	9.55 1.15	22x4.75	2.45 1.20
81x40 1/2	9.60 1.15	22x4.75	2.45 1.20
81x40 3/4	9.65 1.15	22x4.75	2.45 1.20
81x41	9.70 1.15	22x4.75	2.45 1.20
81x41 1/4	9.75 1.15	22x4.75	2.45 1.20
81			



# WANT A STEADY JOB?

## TRAVEL for "UNCLE SAM"



**MANY OTHER U. S. GOVERNMENT POSITIONS STEADY WORK**

**MEN—BOYS 18 TO 50**

Short Hours Pleasant Work  
Rapid Advancement Permanent Employment  
Long Vacation with Pay

Mail Coupon Now. Act at Once.

**DO IT TODAY. TOMORROW YOU MAY FORGET.**

**FRANKLIN INSTITUTE, Dept. P174, Rochester, N. Y.**

Write me entirely free of charge: 32 page book, with list of U. S. Gov't Jobs obtainable and particulars telling how to get the job here checked

... Railway Postal Clerk	(\$1900-\$2700)
... Post Office Clerk	(\$1700-\$2100)
... City Mail Carrier	(\$1700-\$2100)
... Rural Mail Carrier	(\$2100-\$3400)
... Prohibition Agent	(\$2300-\$2800)
... Inspector of Customs	(\$2100-\$3300)
... Immigrant Inspector	(\$2100-\$3300)

Name.....

Address.....

## TRI-STATE COLLEGE

DEGREE IN 2 YEARS

B.S. Degree in Civil, Electrical, Mechanical, Chemical, Aeronautical Engineering in 2 years. Those who lack high school may make up work. Living costs, tuition low. Students from all over the world. Write for catalog

442 College Avenue, Angola, Ind.

School of Engineering 49th Year

## Stop Making Mistakes in English

Wonderful new way to improve your English. No rules to memorize. No hard study. Grammar, spelling, punctuation, and expression, taught in 15 minutes a day—at home. Self-correcting feature makes it fascinating as a game. Write today for free booklet, "How You Can Master Good English in 15 Minutes a Day."

Sherwin Cody School of English, 54 Searle Bldg., Rochester, N. Y.



## LEARN WATCH REPAIRING

**AT HOME** You can learn by our modern and original system of instruction every part of the **Watch Repairing Trade** at home as good or better than at a shop. You can earn money while learning and secure a well paying position or start in business after completing our course of instruction. Good watch repairers are always in demand and earn from \$50 to \$75 per week. For particulars apply to the Wisconsin School of Watch Repairing 524 E. Mason St., MILWAUKEE, WIS.



## GO TO HIGH SCHOOL AT HOME

MAKE up the education you missed. Study at home in spare time. Your choice of subjects. Expert instruction. Personal service. You make quick progress because you are in a class by yourself. Diploma. Mail coupon today for interesting FREE BOOKLET.



### INTERNATIONAL CORRESPONDENCE SCHOOLS

"The Universal University" Box 5506-G, Scranton, Pa. Without cost or obligation, please send me full particulars about the course I have checked—

- |  |   |                                      |
|--|---|--------------------------------------|
| <input type="checkbox"/> English       | <input type="checkbox"/> High School Course | <input type="checkbox"/> Accounting  |
| <input type="checkbox"/> Civil Service | <input type="checkbox"/> Bookkeeping        | <input type="checkbox"/> Advertising |
|  | <input type="checkbox"/> Salesmanship       |                                      |

Name.....

Address.....

## MUSIC LESSONS IN YOUR HOME

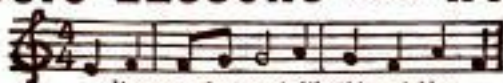

You can play music like this quickly.

Write today for our **FREE BOOKLET AND DEMONSTRATION LESSON**. It tells how to learn to play Piano, Organ, Violin, Mandolin, Guitar, Banjo, etc. Beginners or advanced players. You pay as you learn. Costs you only a few cents a day. Thousands of satisfied students.

**AMERICAN SCHOOL OF MUSIC, 51-D Manhattan Bldg., CHICAGO**

## LEARN CARTOONING

AT HOME DURING SPARE TIME

with the course that has trained HUNDREDS of beginners successfully. The Landon Picture Chart Method of teaching ORIGINAL drawing by mail makes cartooning easy to learn. This school is a Member of The National Home Study Council. Write today for sample picture chart to **TEST YOUR ABILITY** and examples of the work of successful students now earning from \$50 to \$200 and more per week. Enclose 6c in stamps and **STATE YOUR AGE**.

**THE LANDON SCHOOL, 2838 National Bldg., Cleveland, Ohio**







## L O O K I N G   F O R W A R D

**T**HIRTY years ago a new magazine made its appearance, telling for the first time in simple language, and with the aid of pictures, the progress of science and mechanics.

Today, Popular Mechanics is celebrating its thirtieth anniversary and reviewing the events of its lifetime. In doing so, we are deeply indebted to the leaders of science, industry and government for their kindness in assisting us to recall the past, speak of the present and forecast the future.

In their words you will find supreme faith and confidence that human destiny will surmount all obstacles and that the future triumphs of civilization will be even greater than those of the past.

*H. W. Windsor Jr.*

Editor and Publisher



03-98

# Popular Mechanics Magazine

REGISTERED IN U. S. PATENT OFFICE

WRITTEN SO YOU CAN UNDERSTAND IT

Vol. 57

APRIL, 1932

No. 4

## Thirty Years of PROGRESS

By *MERLIN H. AYLESWORTH*

President, National Broadcasting Company

**I**T would seem that Popular Mechanics Magazine was established with an uncanny foresight that the Twentieth Century would witness scientific, artistic and industrial developments on a scale never before realized. During the past three decades this periodical has, in lay terms, chronicled the progress of a world that might otherwise have been too preoccupied to record its own achievements to the public at large.

Of the many arts and industries that have developed during the past three decades, none is more romantic or more spectacular than radio. The rapid rise of this technology has been coincidental with that of Popular Mechanics. Although Clerk Maxwell predicted the existence of electromagnetic waves as early as 1865, and Heinrich Hertz demonstrated such waves in 1887, radio or the transmission of intel-

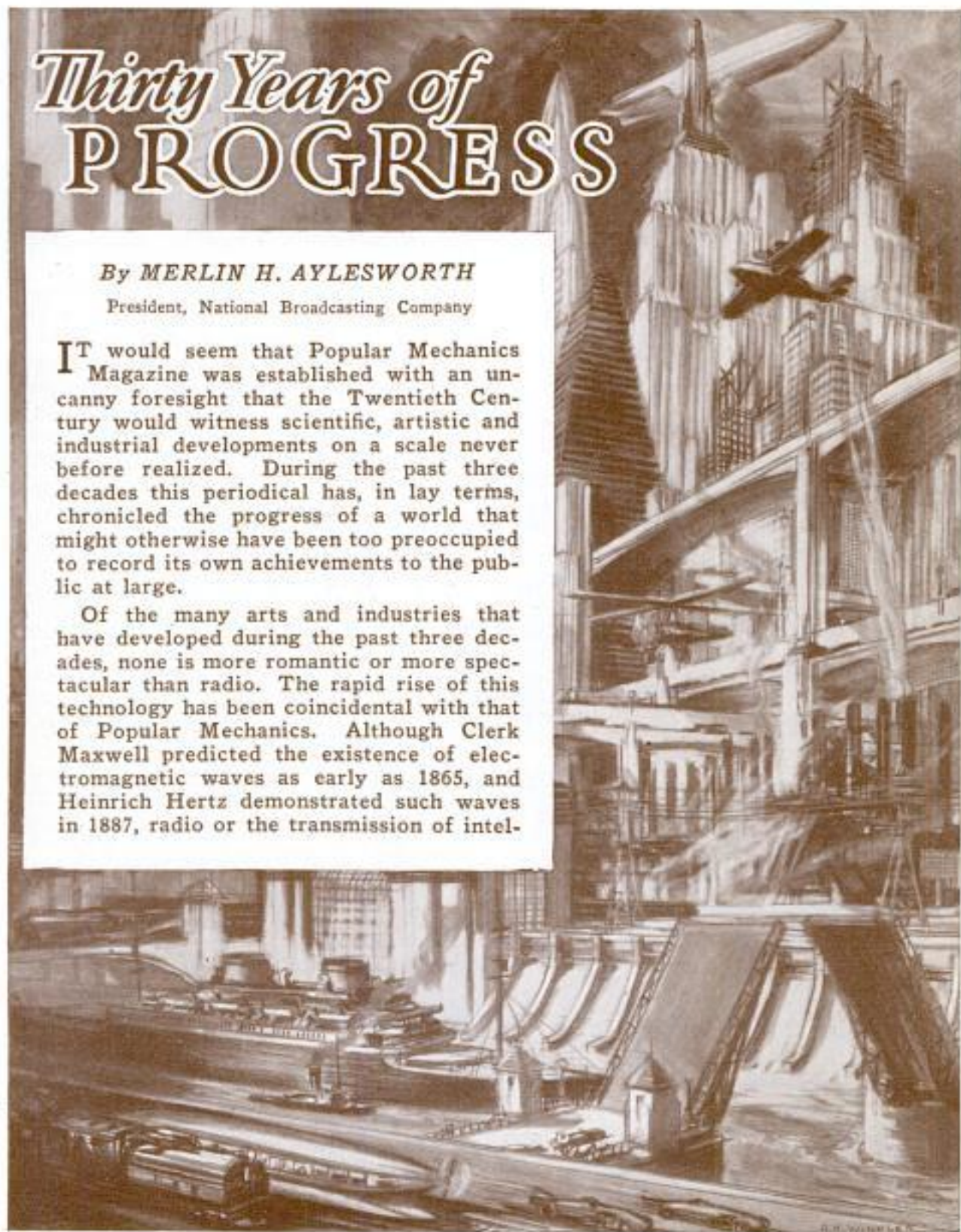

*Made World Photos (2)*

Copyrighted material



# Popular Mechanics

ligence through space began only with the practical experiments of Marconi in the closing years of the last century, leading to the spanning of the Atlantic with test signals in 1901. This event we recently celebrated with a round-the-world tie-up of broadcasting stations and distinguished speakers.

The intervening thirty years have seen the radio art, struggling against seemingly insurmountable obstacles, gradually gaining ground in passing from a mere experiment to a medium for commercial communication. Crashing spark transmitters of early wireless telegraphy have given way to the powerful Alexanderson alternator which in turn has made way for the silent vacuum tube transmitter. The first call for help, flashed by the steamer "Republic" in 1909 and resulting in the saving of 1,500 lives, has been repeated almost innumerable times in marine radio chronicles.

The first feeble signals across the Atlantic have been but the forerunners of an endless flow of traffic across oceans and continents to the four corners of the globe, linking all civilized nations into a worldwide chain. Radio has gone into the skies where, aboard airplanes and airships, it is bringing added safety to passengers and crews flying the air ways.

And yet the real climax of radio is to be found not in the workaday world, where its technique is in the hands of professional workers, but rather in the home, where lay hands guide its greatest destiny. That such an intricate science and art could have been reduced to a means of home entertainment and enlightenment must always remain an outstanding triumph of our scientific age.

From sputtering arc telephone transmitter to the modern vacuum tube, the radio telephone has covered much ground in the past quarter century. It has



Telephone Office of 1895,  
Showing Early Type of  
Switchboard



Modern Operator Translating Cable  
Signals from Moving Tape and  
Typewriting in Message Form

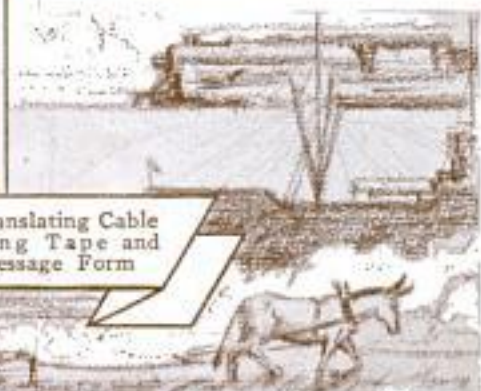

Y E S T E R D A Y



# Popular Mechanics

reached its climax in the nation-wide and indeed the international networks that join tens of millions of listeners into one vast audience. Ever since the inauguration of the National Broadcasting Company's service in the fall of 1926, the future of the broadcasting institution has been assured, thereby removing the purely experimental and uncertain status of broadcasting obtaining prior to that time.

Today radio broadcasting brings to poor or rich, city dweller or farmer, an unending fund of entertainment such as no potentate in all history could command. Entering its second decade of public service, broadcasting brings the entire world to the very finger tips of the average man, woman or child, while making that entire world a single audience for the truly universal message of peace and good will.

## WONDERS TO COME

By EDWIN G. HATCH, M. E.

**W**HILE, in my opinion, the thirty years which have passed since the founding of your magazine have witnessed great advances in scientific knowledge and the development of great inventions of far-reaching application, I am just as certain that the next thirty years will see vastly greater developments still and of things so fundamentally great that it is hard to even imagine or conceive of them today.

The atom, the last stronghold of matter, will soon yield its tremendous secrets. The art of flying is still capable of great advances, and I venture to say that if those of us who are celebrating your present birthday could be here thirty years hence we would see a world so changed that we would hardly recognize it.

In the front rank of this advance will be, as in the past, the shock troops—our American inventors.



The Same City Corner  
Shown Below as It Ap-  
pears Today

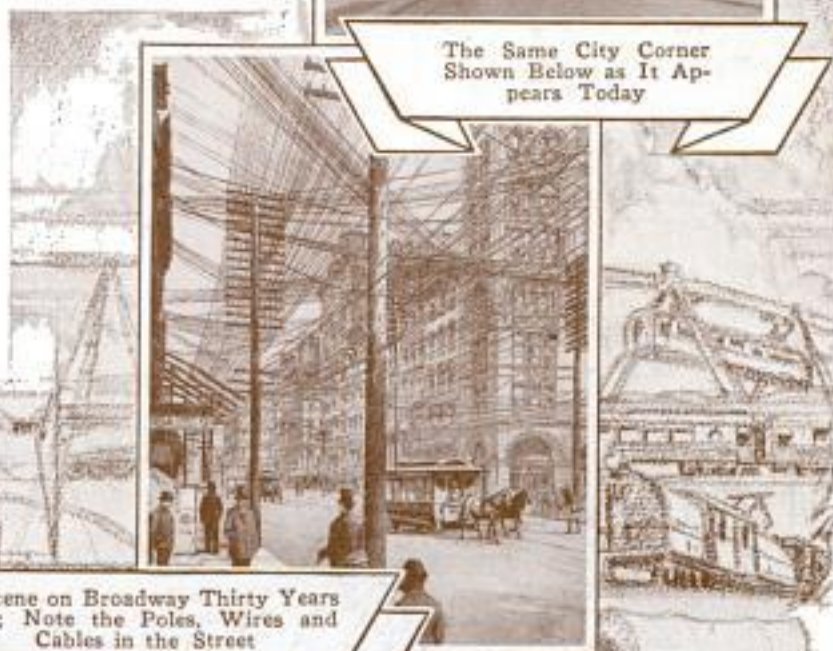

A Scene on Broadway Thirty Years  
Ago; Note the Poles, Wires and  
Cables in the Street

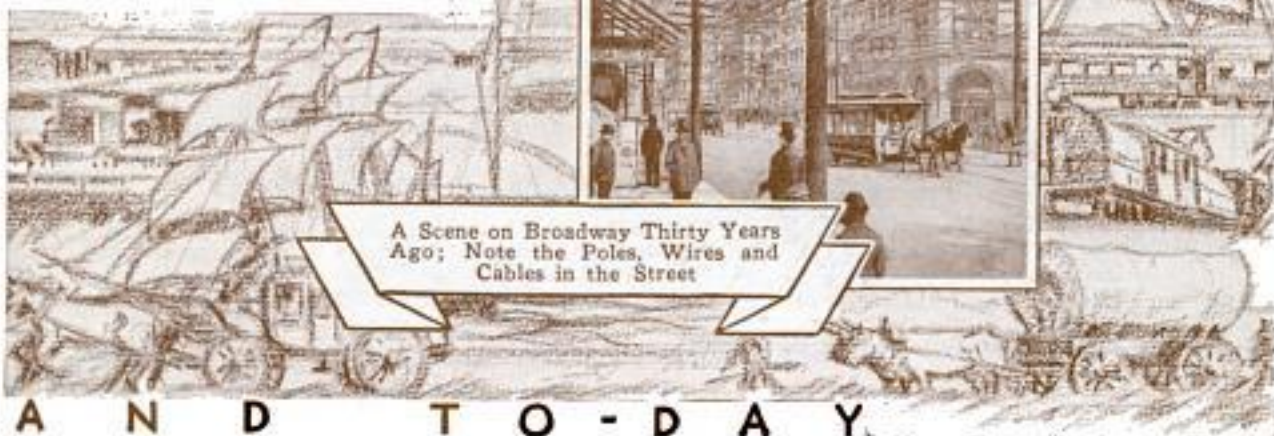

A N D T O - D A Y



# Popular Mechanics

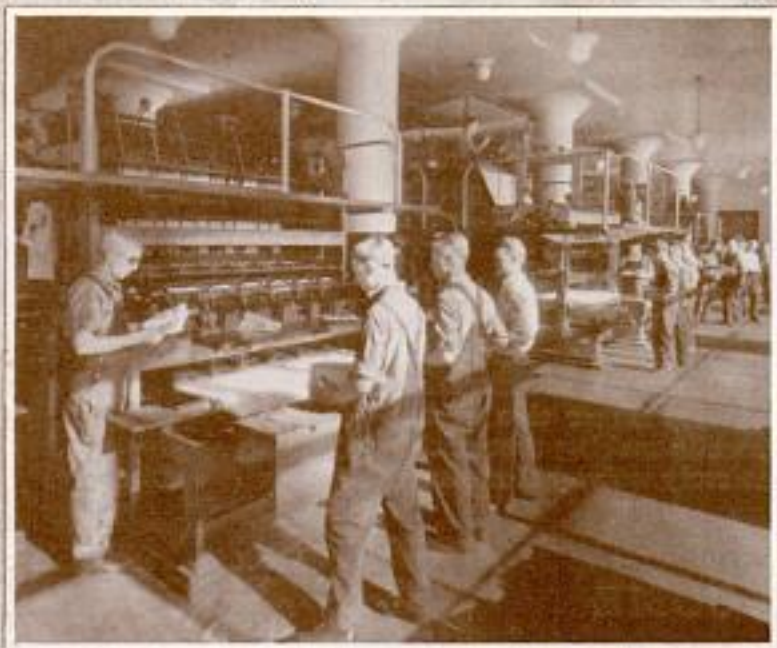

Left, Part of the Battery of Presses That Print Popular Mechanics in One of the World's Finest Publishing Plants



Right, a Scene in the Bindery in the Popular Mechanics Building; Steel Fingers Almost as Agile as Human Ones Here Assemble the Various Sections



A Corner of the Magazine's Art Department; a Staff of Artists and Photographers Here Prepares the More than 400 Illustrations Appearing in Each Issue



## *Invention*—the REAL Estate of Man

By MILLER REESE HUTCHISON

*Famous Inventor and Head of the Hutchison Laboratory*

**MOST** values are founded upon Invention.

Real estate, as its name implies, is the alleged foundation of true values.

It is not, because—The ground itself is tilled by—**INVENTED** implements.

**INVENTED** fertilizers enrich the soil.

**INVENTED** machines reap and thresh the grain and transport it to distant points, where it is made into **INVENTED** bread by **INVENTED** devices.

**INVENTED** conveyances deliver bread to your **INVENTED** doors; it is sliced by **INVENTED** knives, served upon **INVENTED** plates, and, in many instances, actually masticated by **INVENTED** teeth.

Man's advent into the world is materially assisted by—**INVENTED** surgical instruments.

The cradle that receives him; the clothes he wears; the house in which he lives; every dollar he makes or spends; everything with which he comes in contact in his daily life—are either **INVENTED** products or are dependent upon **INVENTION** for their usefulness to him.

When his allotted time has passed, he is embalmed by **INVENTED** liquids, incased in an **INVENTED** coffin, conveyed by an **INVENTED** hearse to, and is lowered by **INVENTED** ropes into, a grave which has been dug by—**INVENTED** tools.

One who would become dissociated from all **INVENTION** would have to live in a primeval forest, utterly nude, and subsist on roots and herbs!

Truly, the *real* estate of man is—**INVENTION**.

It is therefore apparent: There is nothing on earth for which there is a greater commercial demand than for—**INVENTIONS**.

Anyone who conceives a new means, instrument or method for increasing the usefulness of himself or his fellow man—is an **INVENTOR**.

Rockefeller, Morgan, Schwab and other commercial geniuses are entitled to be reckoned inventors as are Edison, Bell, Marconi and others of their kind. The former invent industries; the latter—devices.



# Popular Mechanics

## NEW INDUSTRIES TO RISE

By JULIUS KLEIN

Assistant Secretary of Commerce

**P**OPULAR MECHANICS certainly has performed a very significant function these last three crowded decades in keeping our people fully aware of the scientific developments that have played such a tremendous role in the advance of American industry and business. The wide dissemination, through this periodical, of knowledge about inventions and the other notable scientific achievements of our generation has formed an incentive to further research and has heightened the buying public's receptiveness to novel, ingenious devices when these have been placed upon the market.

The opportunities for such useful service have never been so great, so significant, as they are now; and they promise to increase with the passage of time. If our present experience is anything like that of our predecessors, it is certain that we shall see the recovery of business sharply accelerated by the rise of many new industries upon the basis of inventive genius. Inevitably, the future chronicle of these trying times will show that the foundations of great new businesses, thanks to the mechanical ingenuity of our people, had been laid in the rock-bottom stages of the slump.

In my work at the Department of Commerce I have been impressed, on countless occasions, by the fact that business men simply *must* keep in touch with what is happening in the world of science; because, almost

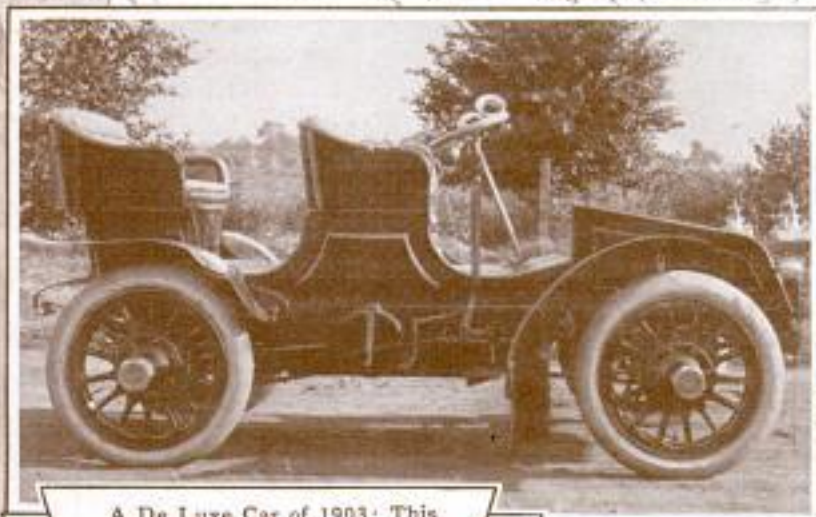

A De Luxe Car of 1903; This Packard, Ready to Drive Away, Sold for \$7,000

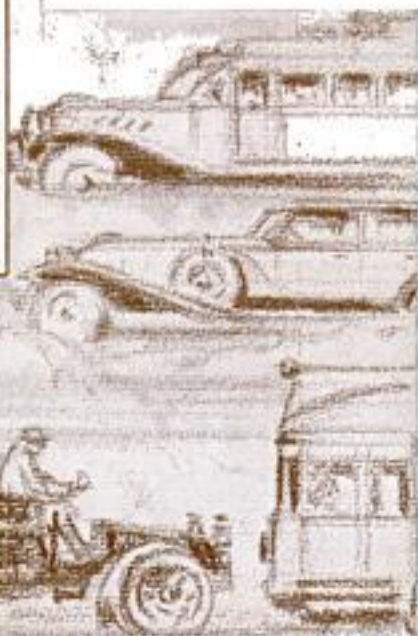



# Popular Mechanics

overnight, some startling new discovery may make any given activity virtually obsolete. Obsolescence is a grave menace; but, conversely, its avoidance is a harbinger of hope. Information as to vital events and trends in science and industry is a business factor of great potency, and Popular Mechanics has become a synonym for just such information.

## LABOR FREED BY INVENTION

By WM. GREEN

President, American Federation of Labor

**B**ACK of mechanical inventions are the scientists in their laboratories and the practical engineers who put service to use in our every day world. In our work shops, our factories and our great service agencies are the workers who put inventions to work producing the things that the world wants. During the past two decades there has been extraordinary productivity both in the laboratories and in the field of applied science.

The tools and the materials of the work shops have been revolutionized. In other civilizations leisure was gained by using slaves to do the work. Mechanical power and machine perfection have given us mechanical slaves. Reckoning in the terms of man power, a Yale professor estimates these power machines put at the command of each individual the equivalent of *one hundred and sixty-*



The First Factory of the Ford Motor Company Which Was Organized in 1902



One Section of the Dearborn Plant of the Ford Company as It Appears Today





# Popular Mechanics

THE WHITE HOUSE  
WASHINGTON

My dear Mr. Windsor:

I am interested to learn that Popular Mechanics Magazine has reached its thirtieth milestone. As a record of progress, achievement and education its career has been one of constant usefulness. In conveying my congratulations on the anniversary I express the hope that it may go forward to even greater usefulness in a significant era of national development.

Yours faithfully,



Mr. H. H. Windsor, Jr.,  
President,  
Popular Mechanics Magazine,  
Chicago, Illinois.

*five slaves.* The mechanical crane has lifted heavy loads off men's backs; the steam shovel has taken them out of the ditch; power switches give them long distance control; the teletype enables them to write messages in a far distant office. These machines are symbolic of the revolution that has come in work habits. Obviously these mechanical slaves should be providing our industrial workers with that leisure necessary for wider interests and greater activity in public affairs.

## WIRELESS TO SUPPLY FUTURE POWER

By A. W. ROBERTSON

Chairman of the Board, Westinghouse Electric & Manufacturing Co.

**H**ISTORY has no precedent for the fifty-year growth of the electrical industry! This progress was made possible by the alternating current system. The electrical appliances which are seen at every turn and the power plants and transmission lines which dot the landscape are living tributes to Westinghouse, Edison and other pioneers who had the foresight and ability to make practical application of electrical knowledge.

Today, we stand on the threshold of television. Already, radio broadcasting stands somewhat blocked for lack of sufficient channels. The entrance of television with its even greater requirements of wave channels complicates the situation. Who will free this jam!

Artificial lighting is in great need of improvement. To get three or four percent of visible light we throw away ninety-six or ninety-seven percent of invisible radiation as heat.

The transmission of electrical power through space without the use of wires remains to be accomplished. Radio transmission of power may solve this problem. One application alone, the delivery of radio power to operate airplanes, would completely revolutionize our present systems of transportation!

The electrical industry is well aware of its responsibility to the public of continuing the electrical progress started by early pioneers. It promises in the next half century, advancements which will dwarf into insignificance its developments of the past.

The electrical industry will fulfil this promise!



## "OUR RACE MOVES FORWARD"

By DR. WILLIS R. WHITNEY

*Director of Research, General Electric Co.*

**T**HERE have probably always been people who complained of too much "mechanics" in our civilization. I imagine that when some early pack-carrier, his load on his back, lagged on the way enough to be overtaken by the ox-team which resistlessly followed his path, he hung his load on the tail of the wagon and perhaps even climbed aboard.

The ox-drivers, in their turn, when canal boats were an innovation, anticipated the doom of "bull whackers" and worried about their future. But they climbed aboard the canal boat because a thousand tons of freight could now be carried as easily as one was before. Later some of them opened service stations of one kind or another along the canal.

Later on, worry came to canal-boat men when the mechanics of railroading rose over the horizon. Railroads carried more per man than any other device. They expanded so rapidly as to create demands for more and better men.

Now the train crew in turn, like the original porters, see new carriers pass, and they say, "Those lazy automobile drivers, always sitting down, without having to fire the boiler or work the brakes, are the scourge of our race. They spell idleness." But each railroad man gets an automobile as soon as possible and is happier than ever.

As the mechanics of flying grow more popular, it is quite probable that many of us will climb aboard, while others clear new landing fields or set up along the way service stations of one kind or another. That seems to be the way things actually happen on progressive main highways.

Always the best of men, possibly too lazy to do things as they have been done for generations, are finding new means to broaden their horizons and enrich their souls, and always the rest of us condemn their idle ways—but soon adopt them. And so, condemning and accepting, with a frown and a sigh at the inevitable in prospect, with a smile and a laugh at its consequences, our race moves forward.



# DO YOU REMEMBER WAY BACK WHEN-



Land Boat Propelled by Sails Described in Popular Mechanics in 1902



The Joys of Motoring Back in 1902; the First Electric Chair

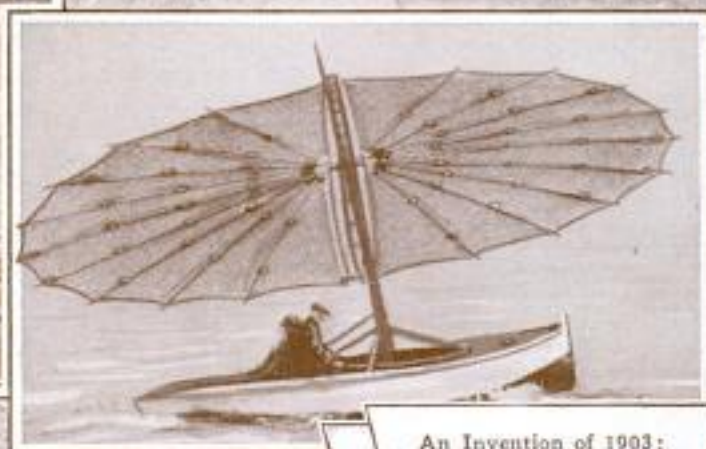

An Invention of 1903; It Is a Boat Propelled by an Umbrella Sail

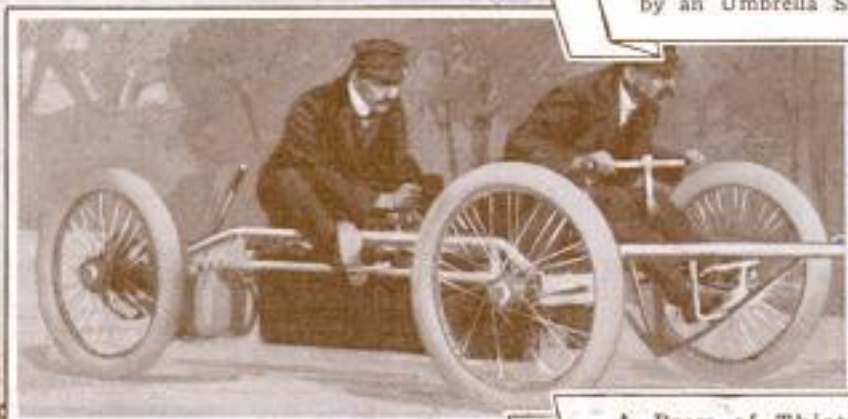

A Racer of Thirty Years Ago; It Made a Mile in Sixty-three Seconds





# From the First Issues of Popular Mechanics

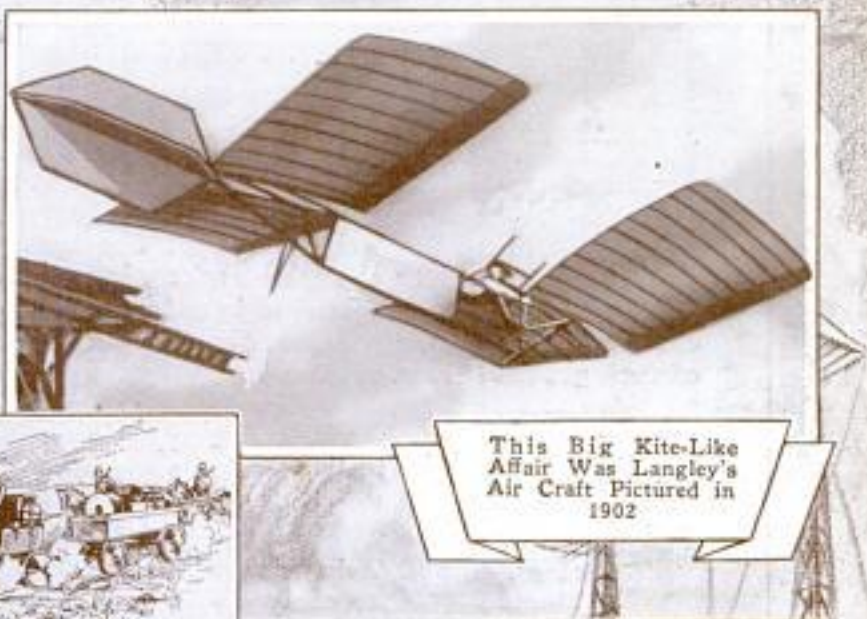

This Big Kite-Like  
Affair Was Langley's  
Air Craft Pictured in  
1902



A Steam Auto-  
mobile That Was  
Used in the Boer  
War

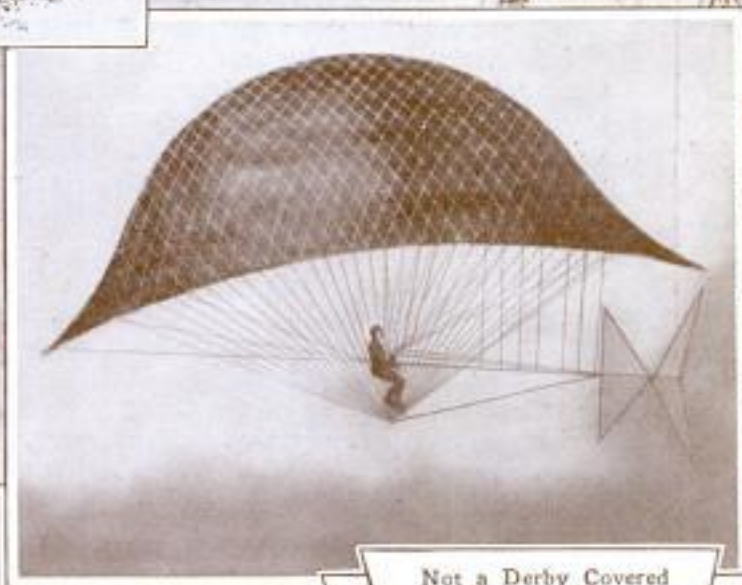

Not a Derby Covered  
by Mosquito Netting,  
but a "Sky Cycle" in  
Action



Signor Marconi, Wire-  
less Inventor, from a  
Picture in the Maga-  
zine in 1902



## MACHINES TO RAISE WAGES

By H. W. BUCK

Viele, Blackwell & Buck, Engineers

**M**UCH abuse has been heard lately of this mechanical world in which we live and of its alleged displacement of human labor. If, however, some of the critics of our present civilization could bring back conditions of one hundred years ago, which they appear to admire so much, it would be interesting to see how they would provide jobs for those engaged at present in work which is the result of mechanical invention. A few of such groups given for the year 1930 might be cited:

Chemical Industries	-	621,000	Employees
Woodworking	"	1,827,200	"
Textile	"	1,187,300	"
Electrical	"	378,500	"
Railway	"	1,583,300	"
Telegraph and Telephone	-	578,300	"
Automobile Industries	-	1,827,200	"
Steel and Metal	"	2,716,796	"

All of the above industries have been developed from mechanical inventions and labor saving devices and yet the very saving of labor has allowed an economic expansion of industry to take place sufficient to provide far more employment as a whole than the labor displaced by the individual labor saving machines.

A few years ago, for instance, ditches were dug by manual labor with pick and shovel. Today the steam shovel and the trench digging machine have displaced a large amount of such labor. However, the resulting inexpensive ditch has enabled more ditches to be dug and the old ditch digger has been promoted to the building of the labor saving machines used and to making the pipe, electrical cables, conduits, cement, etc., to be laid in the ditch and is receiving much higher wages therefor. The economic world could not possibly afford to pay him as much for mere manual labor.

Two of the greatest labor saving machines of all time have been the stone crusher and the air driven rock drill. Hundreds of men who had formerly done the work by hand were apparently thrown out of work by those inventions. But today we have the enormous road building industry employing thousands of men all made possible by the air drill and rock crusher.

In the long run wages will be proportional not to the amount of labor expended in a day's work but to the amount a man can actually accomplish. Wages are higher today than fifty years ago because men produce more. The two primary elements that make this result possible are machinery invention and mechanical power. It would greatly clarify economic thought if the term "labor saving machinery" could be abolished and



some expression such as "production increasing machinery" substituted.

Mechanical invention has not reached its limit. The country will continue to grow in the future with its aid as it has in the past if governmental throttling does not prevent. Many inventions will be of a nature to create entirely new occupations without displacing any labor, such as the radio.

At times there will undoubtedly be temporary displacements of labor and derangements due to new inventions during the interval required for re-employment of such labor in new and higher paid employment. Such problems can, however, be successfully handled by intelligent leadership.

## OIL INDUSTRY MOVES FORWARD

By *W. C. TEAGLE*

President, Standard Oil Company of New Jersey

**F**EW industries have aided, and at the same time been helped by, the progress of science as has the oil business. Were it not for science, petroleum would not be available in the hundreds of different forms in which it is sold today. Were it not for petroleum, numerous scientific discoveries—particularly in the mechanical field—would have died in the laboratory.

A modern oil refinery is a monument to the progress of science. Metallurgy, welding and riveting have combined with improved thermodynamics and the genius of the mechanical engineer to give the refiner of today great cracking towers, capable of withstanding working pressures up to 750 and 1,000 pounds, and temperatures as high as 900 to 1,100 degrees F.

Rotary drilling has extended the search for oil to a depth of nearly two miles in some fields. Powerful valves and fittings choke off pressures as high as a ton or more per square inch suddenly released at the bottom of the hole. Diesel engines and improved high pressure steam give the oil man more efficient tankers to transport his product on the seas. High carbon steel, seamless pipe and improved welding methods, not to mention powerful gas compressors, enable us to send invisible fuel from Texas to Chicago—nearly 1,000 miles.

The mutual interdependence of science and petroleum along many lines promises interesting developments for the future. Hydrogenation and improved refining processes not only have assured us of an adequate supply of motor fuel but point the way to gasolines of better anti-knock quality. This in turn is matched by the automotive engineers' promise of more powerful engines and cars of greater flexibility in operation.

In the industrial field, the oil industry is compounding and otherwise improving its lubricants to meet the challenge of greater friction, larger, heavier and more powerful machinery and high gear and bearing pressures in the modern factory.



# Popular Mechanics

## LUXURIES FOR EVERYONE

By CHARLES DAVIS

President, National Highways Association

**S**INCE Popular Mechanics Magazine was established science has given us air navigation, wireless and radio communication, moving pictures, television and the countless mechanical devices making labor easier and life richer.

The productive activities of mankind are divided between two great classes, (a) necessities—food, water, clothing, heat, habitations and all things needed to maintain and care for life; and (b) luxuries—meaning everything else. The volume of goods that are necessary varies little save by increase in population. But the capacity of man to produce and consume luxuries appears to have no limit save the means to buy. Why not give him all the means he wants? For then he will prosper and continue to prosper.

More roads, more inventions, more luxuries, more new industries, more wages, more credit, means more buying power, thus using our savings and not wasting them in idleness. We now have much over twenty billion such idle savings. Debts do not impoverish; idle capital does, for it means no borrowers and so no buyers.

The more capital saved the less goods produced and therefore the less employment. Spending less and saving more means a lower standard of living, because less is produced to be consumed. Living standards can never be extravagant. Real extravagance is production below possible consumption. Raising the living standard of others raises your own. Lower theirs and

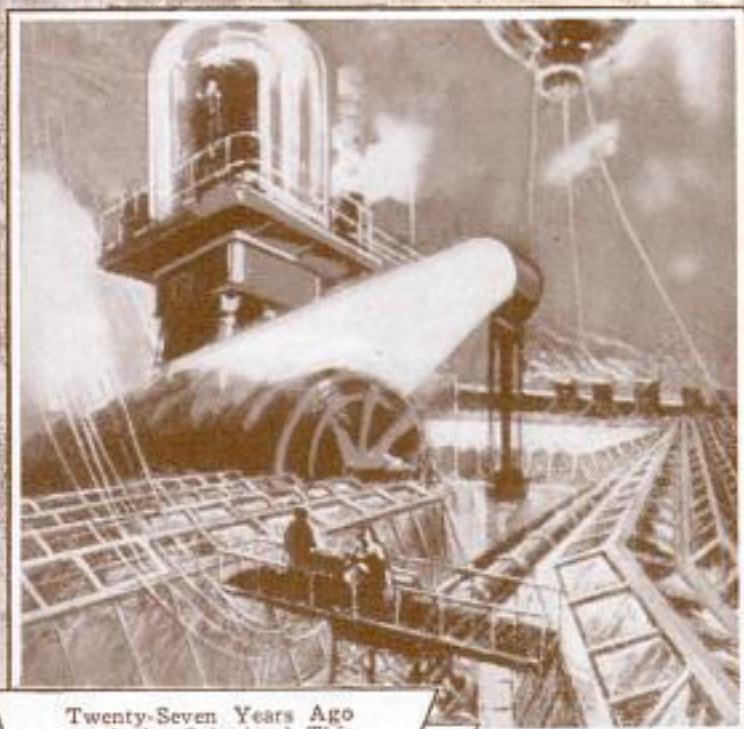

Twenty-Seven Years Ago an Artist Submitted This Conception of an Electrical Farm Which Appeared in the Magazine



# Popular Mechanics

you lower yours. So bring those of others up to ours and not ours down to theirs.

We can do all this and more by letting dollars reach markets as fast as goods, and we have yet to find how to produce more goods than we can consume if we also provide the dollars. In other words, we cannot have too many goods or too many dollars. We did this to get 25,000,000 motor cars; otherwise we could not have had them. Why not do it for everything else we can produce?

## THE MARCH OF PROGRESS

By *EDGAR S. BLOOM*

President, Western Electric Company

**T**HE dawn of science established a new rate of progress for civilization. The last century was more fruitful of invention and discovery than all the ages that preceded it. And in turn the first 31 years of the present century have resulted in still greater achievement.

The comforts and conveniences which we have come to consider part of the standard of living today are, relatively speaking, of recent birth. We owe most of them to science.

Speeding along a modern highway, any motorist boasts a swifter conveyance than the richest monarch of all ages. Pressing a switch, he floods his



Reproduction of Photograph of a Farm Tractor Described in Popular Mechanics Thirty Years Ago

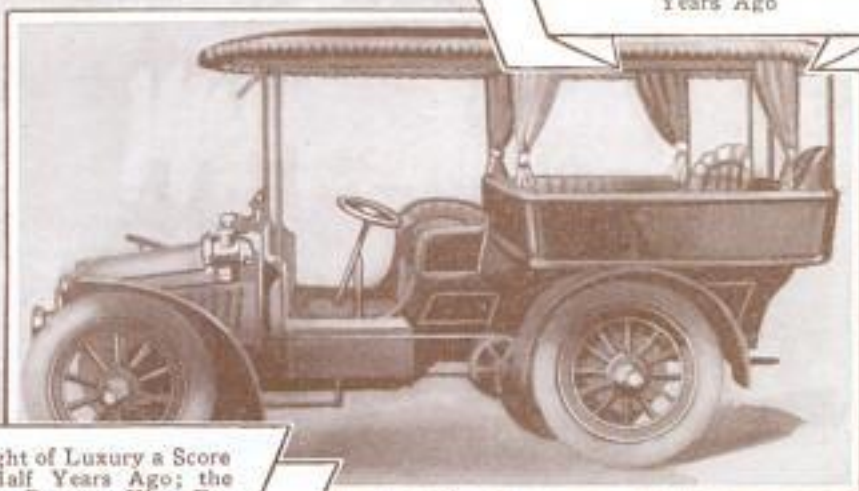

The Height of Luxury a Score and a Half Years Ago; the Horseless Buggy Was Entered from Rear



home with light such as only an occasion of state in some kingly mansion would have justified 100 years ago. Taking the telephone in his hand, he summons a magic which, with the speed of light, outstrips the fleetest messenger and, more than that, conveys his message in his living voice.

Such instances of the forces now at the command of the humblest citizen can be multiplied endlessly. The accomplishments of science in power, in illumination, in transportation and in communication have found a host of applications in the home, in industry and in every walk of daily life. Seeing how new and better ways have always crowded out the old, we realize that in the future the course of events will lead us forward in the same manner. The candle is replaced by oil, oil by gas, gas by electricity. The foot messenger is passed by the horseman, the horseman by the signal tower, signalling by the telegraph. And now by telephone and radio our voices circle the globe and bring the farthest land within speaking distance.

These triumphs of human ingenuity go on. Often before this, the march of progress has halted. But only temporarily. Always it has set off again to climb to higher goals. While we are adjusting ourselves to present economic difficulties, the foundations are being laid for a new ascent.

In the industrial laboratories of today, men who are scientists in many fields have joined forces. While this mass attack upon the riddles of nature is relatively new, it has already proved far more productive in invention and discovery than any previous method.

Countless realms remain to be explored. The more we progress, the more opportunity we see ahead for progressing. The future will yield a harvest of technical developments which we can now scarcely vision. Science has just started the work of harnessing nature to do the bidding of man.

---

## THE FUTURE LEADERS OF MEN

By **JOHN PAUL LUCAS**

President, American Engineering Council

**Y**OU are arousing and stimulating in *Popular Mechanics Magazine* the desire on the part of your readers to weigh and appraise things and training them to judge men and situations with greater accuracy.

Men familiar with the mechanics of material are better able to judge the abilities and the capacities of men; and in breeding in men a desire to know something of the mechanics of things in general, something of the strength and qualities of materials, and of the strength and qualities of men, you are promoting their capacity and their ability as leaders of men. The successful executive must know the capacity and the break-







# Popular Mechanics

decades we have passed from being worshippers of matter to being worshippers of energy.

And, in thirty years' time, we have learned to popularize science so that even he who runs may read and understand. We have learned that abstract mathematics and physical and chemical theory are useful, but that, after all, their deductions are, when transferred from the intangible to the tangible and made serviceable to mankind, understandable in their everyday language.

## EDUCATION AND PROGRESS

By R. H. FERNALD

Dean of the Towne Scientific School,  
University of Pennsylvania

**A**S we think of the great inventions with which we are personally familiar, it is hard to believe that a Commissioner of Patents, before the Civil War, advised the Government officials that the Patent Office could soon be closed as everything had then been developed that man could possibly invent.

It takes but a glance at the latest edition of "Who's Who in America" to realize the influence of technically trained men not only upon industry, commerce, and transportation, but on the political and social life of this country. "Who's Who" reveals the fact that of 3,000 graduates in science or technology, over 1,100 are presidents of major commercial, industrial, manufacturing and transportation

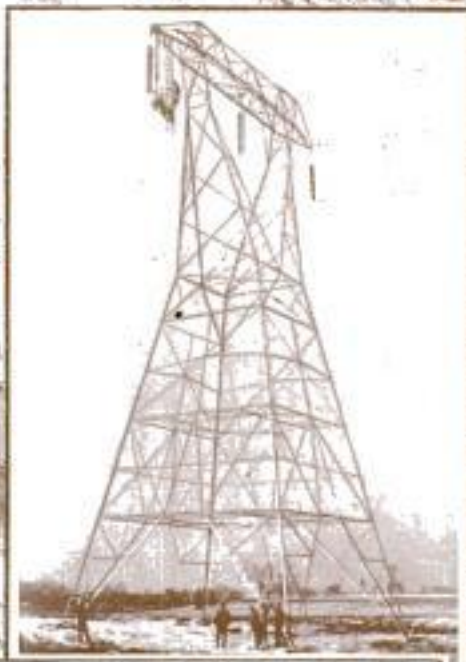

One of the Latest Types of Towers for Power Transmission Lines; Compare It with the Picture at the Bottom of This Page



Modern Motor Coach Containing Seating and Sleeping Accommodations for Twenty-Six Passengers; Its Engine Can Be Quickly Removed

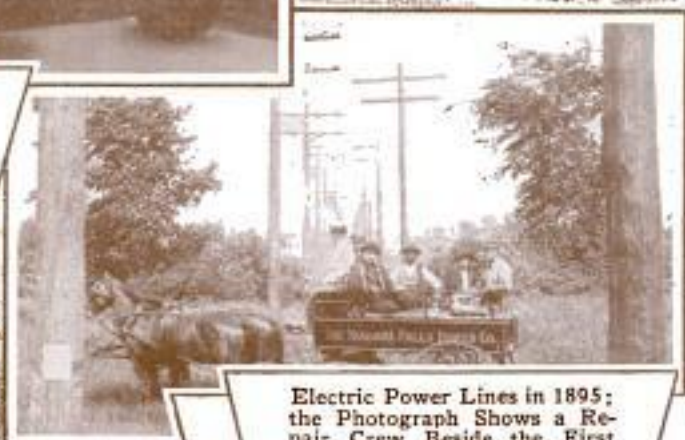

Electric Power Lines in 1895; the Photograph Shows a Repair Crew Beside the First Buffalo Transmission Line, Strung on Poles



# Popular Mechanics

organizations and companies, seventy-odd are presidents of consulting engineering and construction firms, seventy are presidents of banks and trust companies, between twenty and thirty are presidents of universities. Governors of several states and the President of the United States are among the distinguished representatives of the engineering profession who have responded to the call to render important public service. The higher executive positions throughout this country are calling for men with a scientific or technical educational background.

Ultimately, this means placing our scientific and technical courses upon a graduate basis, the Bachelor of Arts degree being required as a prerequisite.

For the time being, it means reducing our technical requirements to the strictly fundamental courses and enriching the educational program by the introduction of subjects that have a broader and more cultural significance.

We are slowly approaching the time when engineering will be truly recognized as a profession and not a trade—a profession vital to world progress.

## NOSTRUMS NO CURE

By F. A. MERRICK

President, Westinghouse Electric and Manufacturing Co.

**I**NDUSTRY must recognize this as a period of wholesome reconstruction. Those who first recognize the situation in this light will be the ones who profit most largely. They will profit in the way of better returns from the actual business of the immediate present



A 1909 Blériot Flying Machine, the First Plane to Cross the English Channel; It Was Flown Again Under Its Own Power in 1928



Giant Press That Takes a Bite of Metal and Stamps Out a Car Fender Ready for Trimming; This Big Machine Weighs 255,000 Pounds



The Owner of This Car in 1903 Probably Was No Prouder Than the Owner Today, for the Auto Is Still Running in London





and still more largely in the future when the efficiency and strength developed in making ends meet under adverse conditions can be applied to serving the enormous needs of this country and of the world when the dammed-up buying power is released.

Present lines of production are being revamped, new and useful lines are being sought out, research is busy, manufacturing processes are being refined for higher quality and reduced cost, distribution means and methods are being analyzed, markets, both present and possible for development, are under close study. Industry will come out of the depression more fundamentally organized than ever before. This is the only way out. No nostrums will serve.

The electrical industry is especially typical in this respect—possibly more than typical because of the great fields of adaptability still in view ahead. Electrical industry is fortunate in that its service is a foundation stone of every industrial structure. Electricity serves every individual of the modern community—in his home, in his travels, in the manufacture of every article which he uses, in the transport of these articles, in turning the hours of darkness into light, in furnishing heat, in aiding the searches after health—in fact, in universal service.

The position of these industries is unquestioned and their growth is to be measured only by the assuredly returning prosperity of the relatively near future.

---

## PREPARING FOR THE FUTURE

*By W. M. KINNEY*

General Manager, Portland Cement Association

**T**HIRTY years ago, when Popular Mechanics was founded, there were only 23,000 automobiles in the United States and not a single motor truck. Electric washing machines, cream separators and milking machines, the radio, reliable can openers and fire-safe homes were unknown. Comparatively few had developed a liking and appreciation for things mechanical and scientific that saved time and money.

In the years that followed, Popular Mechanics unfolded the story of the most productive period the world has ever known. The magazine, itself, played an important part in this drama of mechanization and scientific progress. It has not been long since a full century or more was required for a new idea to permeate the civilized world. This was true not only because of limited communication but also because of a fear of things new and a loathness to abandon traditional customs. Popular Mechanics, as an interpreter of science in its application to everyday life, has been a public servant of inestimable value.

The future for Popular Mechanics is none the less alluring.



There is still much to be done. The last quarter of a century may be regarded as a preparatory period for, in the years to come, discoveries even more amazing will be revealed, and more than that, there will be an exceedingly wide application of these disclosures.

## RAILWAYS SAFER THAN HOMES

By C. R. GRAY

President, Union Pacific Railroad Co.

**I**N their efforts to provide the traveling and shipping public with more comfortable, convenient and safer service and at the same time to overcome rising taxes and increased wages, American railroads in the past thirty years have greatly depended upon the engineering and scientific fields.

Thirty years ago the "Consolidation Type" locomotive was the heaviest and most generally used power plant in freight service. This locomotive weighed 300,000 pounds and had a pulling power capable of handling thirty-four average loaded freight cars on an average one per cent grade. Today, without considering the Mallet type, used for helpers, which run even higher, locomotives are in use which weigh 803,000 pounds and which are capable of handling eighty-five average loaded freight cars on an average one per cent grade.

The advancement in locomotives has been accomplished in several stages, designed to make possible not only the handling of larger trains but also to reduce the operating and maintenance costs and particularly to reduce fuel expense. In this connection, during the past thirty years there has been developed the superheater which saves twenty per cent in fuel and the feed water heater which saves ten per cent in fuel. At the same time the mechanical stoker, mechanical lubricator, power reverse gears and other improvements have been perfected.

Along with the advancement in locomotives and to make their use possible, the 80-pound rail which was in general use in 1901 has been supplanted by the 130-pound average of today. With the heavier rail there has come improved rail fastenings, better ties, heavier ballast and more permanent structures.

In passenger service the all-steel car has completely supplanted the wooden equipment formerly used with the result that there has been a great advancement in comfort and safety. Numerous improvements have taken place which add to the attractiveness of traveling, principal among these being improved seating, better lighting, heating and ventilating and modernized sanitary equipment.

Today safety in railroad travel has been developed to such an extent that accident insurance companies write policies on the premise that a traveler is four times as safe on the railroad train as he is at home or on the street or driving his own car.







# Popular Mechanics



Some of the Ink Rollers in the Popular Mechanics Press Room



Placing Color Plates on One of the Fast Rotary Presses

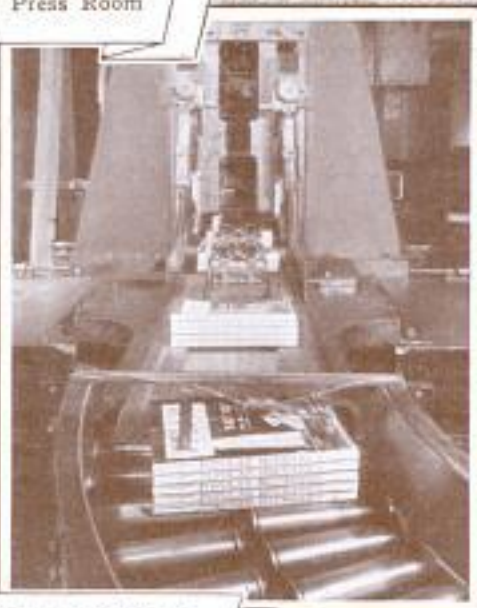

Finished Magazines Traveling Along a Conveyor in the Bindery



Home of Popular Mechanics, One of World's Most Modern Printing Plants





idea crept into this as well as other leading industries—the standardization idea. The whole thing was based on the thought that we had reached the millennium, that it was no longer desirable to create new things but make thousands of the old products to sell more cheaply. And the whole world became sick from over-production of articles which it was thought were permanent.

We have convalesced for two years. And, consciously or unconsciously, the world has been purged of the idea standardization germ. I honestly believe that today we have a healthier outlook than ever before. People were never so receptive to new things. We enter the new year with better organized means of getting new ideas and new products into existence.

Nearly every business has its research department—a procurement department for new ideas. And 1932 will go down in history as one of originality—a constant striving to break away from the stereotyped.

## THIS CHANGING WORLD!

By *EDWIN C. ECKEL, C. E.*

Mining and Engineering Geology

**E**ACH great war period brings vast loss and vast extravagance. From 1789 to 1815 the whole civilized world engaged in savage wars; from 1853 to 1871 another war period involved all the leading nations in turn; from 1912 to 1920 our recent experience, counting in the preliminary Balkan wars and the post-war Russian and other civil wars—made up in intensity what it shortened in time. In every case the world has come out of such a period with high prices, inflated currencies, great material and human losses. And in each case, after a decade or so of deflation and difficulty, the world has regained slowly its sanity and its sense of economy, and has gone ahead to new prosperity by the aid of new processes, new products, and new raw materials.

Each time that a new period of prosperity has come to a temporarily impoverished world, it has come in a new form, not in a mere copy of the old or pre-war type. The world before the Napoleonic wars, for example, was a world of hand labor; it had no steam engine, it had practically no machinery of any sort, steel was a rare metal and iron was made chiefly in cold-blast charcoal furnaces. The world which, after Napoleon, came again to life around 1825 did so with the help of the steam engine, coke, fuel, the hot blast, railways, steamships and textile machinery.

In similar fashion the great war period 1853 to 1870 killed some industries and some processes; the post-war prosperity was based on entirely new things. Some of these new things, we may recall, were Bessemer and open hearth steel, the devel-



opment of electric power, the telephone, refrigeration, cables, coal tar products, the Lake Superior ore ranges, by-product coking, the trolley car and the motor car.

So today if you look for the first signs of renewal growth, it will be idle to look for them among the older mines and processes and products. For the one thing of which you can be sure is that the main features of our next period of world prosperity will be new things. In the two industries with which I am most closely acquainted such signs of new progress are I believe quite clearly apparent, though as yet masked by general trade depression. For unless I am utterly mistaken as to conditions and probabilities, the steel industry in its next boom will not be concerned so much with common steels as with the newer alloy steels, and the cement industry is likely to rise to new heights not on the older types of product but on the new high-strength and high-speed cements which are coming rather broadly into use even now. So in other industries the people who wait for old processes and old products to reach their pre-war importance are likely to wait forever in hopeless discontent, and this applies to great corporations as well as to individuals. Those who will attain success in the next period of prosperity will be those who are expecting to use new ways of doing things, who are willing to make and use new products of better type. Carnegie made steel rails, not wooden cart wheels, and Rockefeller wasted no time on whale oil.

It is absolutely certain that in the near future the world will again begin using annually increasing quantities of necessary raw materials, manufactured products and services; that is a corollary of normal increase in world population. It is to my mind at least almost equally clear that such increase in consumption will begin very soon, probably in 1932 for many lines of activity, and that in many lines, notably ferro-alloys and certain chemical products, we will be making new records in annual output before 1935. In all that development the United States, being exceptionally favored as regards supplies of foods and raw materials, will have the opportunity to take the lead, not merely in quantity production but in technical advance. And that, after all, is the only real base of all our modern civilization. We can very easily do without lawyers and politicians; we cannot realize a modern world without artisans and technicians.

Accepting the practical certainty of an American revival in tonnage outputs beginning slowly in 1932 and reaching new levels by 1935, we must guard against expecting two other things, which the mentally inert will expect to accompany trade revival as matters of course. I am referring to rising prices and to revival of *old* industries. As to the one, average prices will probably rise again, but not to the extravagant heights of 1921-1929; profits will be made best out of increased outputs at moderate price levels. As to the other, I have already expressed



# Popular Mechanics

my conviction that the coming period of prosperity will be marked by progress along new lines; there may be many old mines and mills which will never re-open, as partial offset to the many new ones which will come into existence as new raw materials are found, new processes invented, new products offered to a waiting market.

## THE MAGIC OF SCIENCE

By DOYLE E. CARLTON

Governor of Florida

STORIES like those of Aladdin's Lamp, the Magic Carpet, and Open Sesame, cultivated the imagination in the East when progress was in its swaddling clothes. The marvelous things which were reputed to be accomplished by magicians, by fairies, by the use of talismans, by magical words or by the mythical gods of Greece and Rome drew heavily on imaginative credulity for centuries.

But when alchemy was dropped for chemistry, astrology for astronomy, magic for mechanics, and mythology for physics, the wand of science brought forth more wonders than were ever dreamed of in the Arabian Nights, the adventures of Baron Munchausen, the stories of Hans Andersen or the speculative romances of Jules Verne.

The mastery of steam, steel and electricity has brought more changes in the history of man than all the "Fifteen Decisive Battles of the World." Measured by the effect on the lives of the teeming millions now living, the advance made in the me-



Fields Were Better Than Roads in Kansas in 1904; the Car Shown Was the First Automobile to Cross the Continent Under Its Own Power



It Would Not Be Considered Very Elaborate Today, but This Street Car Was the Last Word in City Transportation Early in This Century



# Popular Mechanics

chanical arts has done more than all the theories of all the philosophers of the past. The continents have been transformed by the genius of man. Civilization has been metamorphosed by the march of progress during the last few centuries more than during any previous thousand years.

The next move should be to render progress the common heritage of all; not by communizing wealth but by synchronizing production and consumption, to synchronize man's economic life. This is the task of the political economist, sociologist and the statesman.

## SIGN POSTS OF PROGRESS

By WILL H. HAYS

Motion Picture Producers and Distributors of America

**H**AS scientific progress been too rapid for our powers of organization? Has technical achievement offered more problems than we can solve? Has education given us more theories than facts? There are those who feel that our present difficulties are due to the problems which rapid progress has raised.

To me such developments are the sign posts of advancing civilization. From the laboratory will come the technical solutions to the problems that technology has created; achievement will find the way, and education will light the road to further progress.

To all of these achievements Popular Mechanics Magazine has been and will be a definite contributing factor.



First Radio Set to Be Constructed for the Readers of Popular Mechanics; It Was Described for Pioneer Fans in the Magazine in 1919

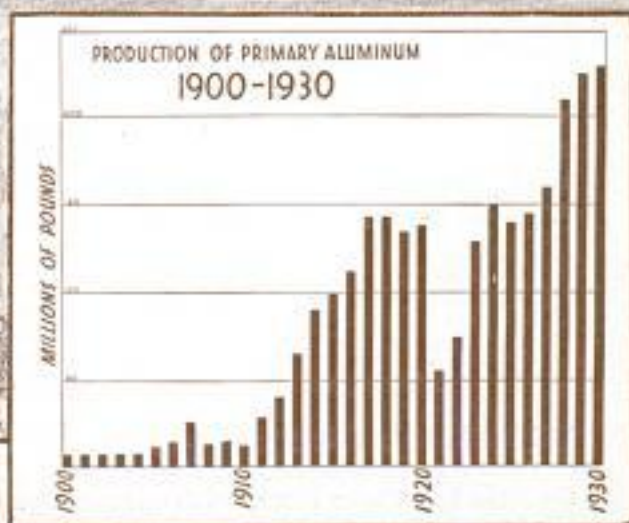

Industrial Progress Can Almost Be Gauged by This Chart Which Shows the Production of Primary Aluminum for Thirty Years



This Car Burned up the Dust on Some of the Early Tracks to Give an Idea of the Speed Autos Might Attain; It Is a Ford Racer



## "ON WHEELS AND WINGS"

By EDWARD G. SEUBERT

President, Standard Oil Company (Indiana)

**T**HE thirty years since Popular Mechanics Magazine was founded have seen marvelous progress in the oil industry, resulting largely from application of science to all phases of its operations. Many of the steps in this advance have been described and pictured in the magazine as they developed.

We have only to contrast the United States production of 88,767,000 barrels of crude petroleum in 1902 with production which probably reached 853,000,000 barrels in 1931 to realize how science has aided the oil industry to march on.

In 1902 about ten per cent of the crude petroleum was unavoidably being made into gasoline, and refiners were wishing there were some use for it besides in gasoline stoves and lamps. Kerosene for lighting was nearly fifty per cent of the output. With development of the use of the automobile, engineers and chemists have made the oil refinery a complicated chemical plant which today has no trouble in converting kerosene and gas oil or fuel oil into gasoline, now in much greater demand, and a gasoline so different from the gasoline of thirty years ago that it is practically another product. Today the general yield from petroleum is about forty-two per cent gasoline, five per cent kerosene and the remainder, fuel oil, lubricants and other products.

In making motor fuels and lubricants available in abundance and at low prices, industrial science has put America on wheels and wings. Science was mainly responsible for creating both the demand for and supply of motor fuel and hundreds of other petroleum products. Popular Mechanics has aided this development like many others by broadening the public conception and understanding of the advanced facilities put at its disposal by science.

---

1902—1932—1962

By HEBER D. CURTIS

Director, the Observatory of the University of Michigan

**I**N 1902, only thirty years ago, we felt, and with some reason, that we were nearly at the apex of scientific progress. The electric light was here, with electric power; the telephone was fairly usable; the bicycle was a finished product. Education was almost universal. Transportation seemed amply rapid, though outside the larger cities there were but few roads over which it was possible to drive a mule at eight miles per hour. Chemistry appeared fairly settled; physics was practically a closed book, as finished and as complete as the indivisible atom which formed its ultimate element.



## Popular Mechanics

We were a century, instead of thirty years, ahead of 1872, as progress is measured; science, transportation, government, all seemed to need only a few finishing touches. A few curiosities had appeared in the years just before 1902, but no prophet could have been so bold as to imagine them factors in changing the world. The X-ray was six years old; the first paid wireless message had been sent for a few miles in 1898; three years were to elapse before the first moving picture theater would be opened in Pittsburgh. True, 9,000 autos were produced in 1902, and a total of 23,000 were registered in the United States and Canada.

If, thirty years ago, we felt ourselves a full century ahead of 1872, we must now, in 1932, reckon ourselves a thousand years ahead of 1902. The auto, good roads, the celluloid films, airplanes, radio, have wrought more change in the life of man in these thirty years than did all the progress of the tens of thousands of years which preceded.

We are today living in the most wonderful age of history which has eventuated—yet. Chemistry is finding new worlds to conquer; physics has long since thrown away its old and final atom, and is starting afresh, with universes to subdue. Astronomy, formerly content with a cosmos perhaps thirty thousand light-years across, now talks of average Milky Ways at distances of hundreds of millions of years of light travel. Preventive medicine is constantly scoring wonderful triumphs, and many of the worst diseases are dying.

An even greater change may be noted between the scientific viewpoint of 1932, as compared with that of 1902—vital and far-reaching. The science of 1902 still felt that it was complete, inerrant, supreme. It was more than a little arrogant, autocratic, orthodox, intolerant. Today it is a more humble body of thought, as it has observed so many of its former inspired tenets go by the board, displaced by newer theories astounding in their wonder. Here and there it is even coming to admit that there may be more in this universe than mere matter and force. Science now feels itself just a youth—humble, receptive, eager for what the next few decades may bring.

And what of 1962 as it shall look back on 1932? Of one thing only can we be certain—that our present achievements will then seem as crude as those of 1902 now do to us. For 1962 will certainly be ten thousand years ahead of 1932 in scientific progress; no limit whatever can be set to that phase of man's development. Happy are those who are youngest among the back-numbers of 1932, in that they will live to see the wonders of 1962!

Will man continue to be fit to live in the new universe his brain is creating, or will he be crushed by his Frankenstein? We think and hope that man, who has been made by his tools, will continue to be their master. The pessimist, it is true, can point to the occurrence of the most destructive war of history



# Popular Mechanics



Popular Mechanics  
Radio Laboratory  
Where Sets Are  
Built and Tested



Camera Room with a  
Photographer Mak-  
ing a Picture for the  
Magazine

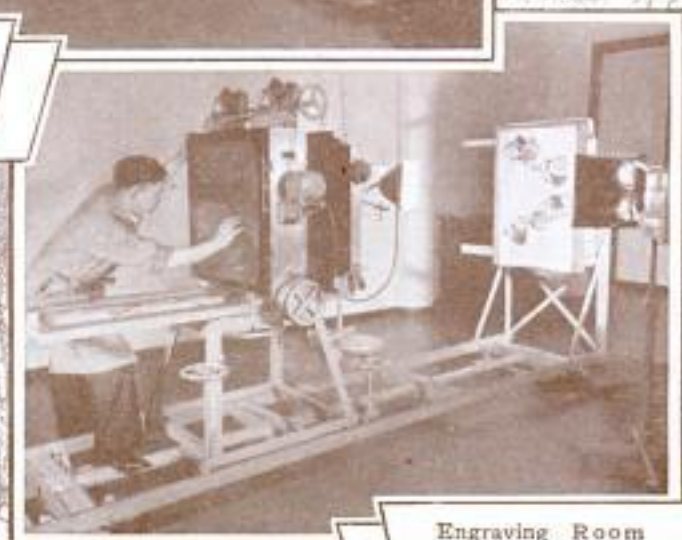

Engraving Room  
Where a Drawing  
Is Being Photo-  
graphed





during the past thirty years of progress—a struggle which came uncomfortably close to destroying civilization, and whose effects will still be apparent in 1962. The optimist can point to man's wonderful adaptability, in all climates and to all external conditions, and to the truth that the thoughts of man are widened with the progress of the years.

"Yet instant to fore-shadowed need  
The eternal balance swings;  
That winged men the Fates may breed  
So soon as Fate hath wings."

(Kipling)

It is self-evident that our souls must grow with science or die by science, but no one doubts that man will meet the changing world he is making.

---

## THE FOUNDATION OF PROGRESS

By *GEORGE M. VERITY*

Chairman, The American Rolling Mill Co.

**P**OPULAR MECHANICS, visualizing as it does from month to month, the scientific, inventive and constructive accomplishments of the nation, helps to lay a firm foundation of Progress.

Progress must be a part and parcel of the consciousness of our people, just as much as they must be air-minded before aviation can meet the success which it deserves.

Progress itself, the mainspring of industrial activity, is simply reaching out into the seemingly impossible and carving it into fact.

Even in these days of readjustment Science is proceeding apace and Efficiency, the ultimate end of Progress, is having its greatest development.

---

## A SOURCE OF INSPIRATION

By *R. W. SCHROEDER*

President, Sky Harbor, Inc.

**I** AM proud to say that when I was a boy, Popular Mechanics (then a weekly) was my greatest enlightenment, it fired my ambitions with knowledge of what was going on in the world and it was written in a way, as it still is, so that you could understand it.

I can say without question that my entry into aviation was a result of knowledge and ambition, fired by the constant reading of Popular Mechanics; which was then as it is now, the best magazine for the young as well as the older men of America.

Any small contribution which I have made to aviation can be credited to Popular Mechanics as having been my prime mover in this vocation.



## THE GROWTH OF ELECTRICITY

By *HENRY KREISINGER*

Combustion Engineering Corporation

**T**HE last twenty-five years brought a marked development in the production and the use of electrical power. In the production of power both the size and the efficiency of the units have been greatly increased. Whereas twenty-five years ago a turbo generator of 6,000 kilowatt capacity was considered an exceptionally large unit, today units of 100,000 kilowatt capacity are common. In the same period the efficiency of turbo generators has about doubled.

Twenty-five years ago the generation of a kilowatt hour on twenty pounds of steam was considered very good performance. Today a kilowatt hour is generated on ten pounds of steam. It is interesting that at an engineering conference during the Centennial Exposition in Philadelphia a boiler horsepower was defined as the generation of thirty pounds of steam, because this amount was required to produce a mechanical horsepower by the engine. At this rate of steam consumption a kilowatt hour would require about forty pounds of steam. That is, today we can generate about four times as much electrical power with a given amount of steam as was generated about fifty-five years ago.

The size and efficiency of the steam generating units as well as the working pressure have also greatly increased. Twenty-five years ago a boiler rated at 200 horsepower and generating approximately 6,000 pounds of steam per hour was considered a good size unit. The working pressure was about 100 pounds per square inch. The size of the unit has increased so that today one boiler unit generates over 1,000,000 pounds of steam per hour and is capable of supplying all the steam required for a turbo generator of 100,000 kilowatt capacity. The small boilers of twenty-five years ago were operated with an efficiency of about sixty per cent. Today the large steam generating units operate with an efficiency of eighty-five to ninety per cent. The working steam pressure has been also tremendously increased. There are a number of power plants operating with a pressure of 1,400 pounds per square inch, one plant with 1,800 pounds and one with 3,200 pounds pressure.

---

## IDEALISM OF THE FUTURE

By *DR. CALVIN W. RICE*

Secretary, The American Society of Mechanical Engineers

**T**HROUGHOUT the life of Popular Mechanics great technological progress has taken place. Even during the last few years of depression it has been steadily advancing.

I am confident that a distinct change for the better is taking







horsepower electric. What controversies raged over the respective merits of these competing types!

In 1902 if one were in just the right spot he might be a spectator in one of the first motion picture houses put in operation.

In 1902 artificial ice was being introduced to insure a product free from contamination for use in drinking water. This was in reality the forerunner of our modern electric refrigeration.

All of the above examples and many others could be cited to prove that modern life is in a sense thirty years old today. The past thirty years have witnessed many large developments and those who are intimately associated with the present trend have no hesitation in affirming that the coming thirty years will see an equally great advance.

---

## KNOWLEDGE IS A NECESSITY

By *JAMES W. WADE*

Tintic Standard Mining Company

**P**OPULAR MECHANICS serves a dual purpose. It entertains and it stimulates the mind. I enjoy the evening I spend once a month with it; I get ideas that in some form or other, I put into use. Your magazine relates in common English, the outstanding achievements in science and their application to every day life. To appreciate the comfort, convenience and luxury with which we are surrounded, we must have a knowledge of science. The greater our knowledge, the greater our appreciation.

The increased standard of living in America can only be maintained by reducing the unit cost of output. This means the increased use of power and machines per worker. In our industry, horsepower of energy produced by man working at shoveling costs \$460 per month; the same horsepower produced electrically and applied to the work by ingenious mechanical devices costs \$6—very nearly.

The problem that confronts management in the United States is the proper division of products of labor and capital equitably, in order that labor may consume its products and that capital may be induced to accumulate and invest in industry. On the accuracy and understanding with which this is done, much of the future happiness of the American family depends.

---

## IN THE VAN OF PROGRESS

By *ROGER W. BABSON*

Noted Business Statistician

**W**E call this a machine age; actually we are only on the threshold of inventions and discoveries which in the years ahead will further revolutionize civilization and life. The establishment of Popular Mechanics thirty years ago when I was



# Popular Mechanics



A Corner of the Magazine's Model Workshop; This Is the Woodworking Section



Another Picture of the Workshop; the Metal Working Equipment Is Shown

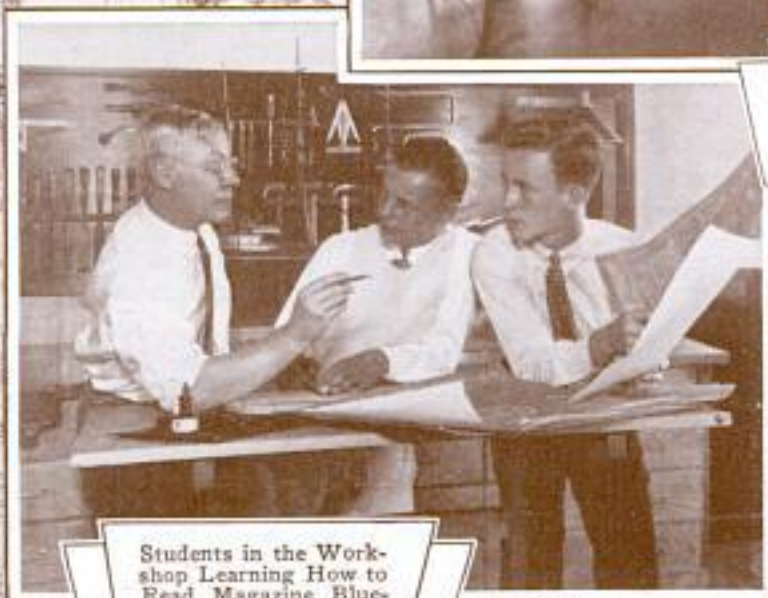

Students in the Workshop Learning How to Read Magazine Blueprints



The page is framed by a decorative border of intricate line drawings. On the left, there's a tall tower, gears, and a ship. On the right, there's a ship, a crane, and a building. At the bottom, there's a factory with smoking chimneys and a car. The title 'Popular Mechanics' is centered at the top in a stylized font.

# Popular Mechanics

a young man just out of Massachusetts Institute of Technology was the recognition by a forward looking editor of the need and trend of the times.

It is peculiarly fitting that your magazine should be established in America which, in the years that followed, has been in the van of world mechanical progress. I congratulate you on the thirtieth anniversary of your great publication, on the courage and vision shown, and on its achievements.

Looking ahead I can see that all phases of business and finance are to be increasingly dominated by invention and discovery, *provided balanced by spiritual development*. The field in which Popular Mechanics has done so much pioneer work is one which is destined to occupy a place of increasing importance to every business man, banker, investor, and, in fact, to every member of the intelligent public.

---

## PROGRESS NEVER STOPS

By E. H. KITTREDGE

Hornblower & Weeks

**W**HO can view what has been accomplished during the past thirty years in science, industry and the progress of humanity and still lack faith in what the future holds in store for those alert to the opportunities all around them. Progress knows no definite deterrent. It may seem to stand still at times but even such periods as the present, when viewed in retrospect, prove that the world moves forward with new inventions, scientific, medical and educational advancement, and though like the glacier it seems not to move, its progress is irresistible. It is not only a fair assumption, it may be said with certainty, that in the forthcoming thirty-year cycle Popular Mechanics will record just as many interesting accomplishments in all fields of endeavor as it has during the past. The trend of time and permanence is ever onward.

---

## KNOWLEDGE IS POWER

By SILAS H. STRAWN

Chamber of Commerce of the United States

**W**E are living in an age when a knowledge of the sciences and of mechanics seems to be not only desirable but necessary to a successful career in any vocation. Any lawyer in general practice realizes the great advantage of even a superficial knowledge of mechanics and a more extensive knowledge of mechanical principles is a condition precedent to the success of a patent lawyer. The lucrative and permanent positions in almost every industry are available in these times only to those who have a well grounded technical education.



## THE MAGIC OF RESEARCH

By C. L. BARDO

President, New York Shipbuilding Company

**F**OR thirty years Popular Mechanics has recorded the advancement of the machine age faithfully and well. During this time many new creative forces have entered American industry. Science and invention have become powerful allies in disclosing to humanity numberless discoveries and in devising many new applications of old principles.

Today, imagination is a sovereign quality and research has become a magic power. We have paper from corn-stalks, ice from gas, rubber from goldenrod, plant food from the air, lights that pierce fog, machines that take the place of salesmen, ships at sea in touch with the land, photographs flashed across miles of ocean, and radiograms hurled through space.

At this very moment, somewhere in our land, a patient research worker, scientist or inventor is evolving new facts, concocting strange compounds or testing some odd device that may not only lead to the development of great industries but that may at the same time ease human burdens and minister to human pleasures. American genius in industry is not wholly materialistic when properly estimated in relation to service rendered. The benefits of mechanical aid in every department of life so completely encompass us as to admit of no return to an age when these inventions were unknown.

Countless new records have been made in almost every field of invested human interest and America has attained the most advanced position ever before reached by any people. In fact we have become so accustomed to the ever increasing wonders of human triumph over the resistance of nature that we have ceased to marvel.

It is true that we are in the midst of readjustments necessitated by a war which caught the Western World in a transition stage between a nineteenth century industrial era dragging to its close, and the beginning of a new industrial age to which scientific research and invention had given birth on the American continent. It is also true that for the moment international trade is suffering from the disorganization of great areas of peoples whose consuming power has been severely injured. But this condition is temporary.

All over the world there is restlessness that may in its economic aspects be traced to the fact that many areas are desirous of becoming greater consumers of the wealth and delights of higher and more comfortable civilizations. All the eagerness for new adjustments will organize itself with a rapidity greater than it is easy to realize now and there will be as a natural and inevitable result a demand for these things which the industries and business enterprise of America can best supply. Since the beginning of the present century Pop-



ular Mechanics has educated us concerning this moving record of progress and achievement. It is to be congratulated on thirty years of successful effort. And as we continue to read its pages we shall expect to absorb some of the zest and enthusiasm of those who are recording the continued progress in science and invention—a progress that is a promise of prosperity.

---

## GREATEST OPPORTUNITY AHEAD

By *WALTER KIDDE*

Walter Kidde Constructors, Incorporated

**W**HILE Popular Mechanics has taken a leading place in the advancement of civilization and industry during the past thirty years, it seems to me that its greatest opportunity lies in the years just ahead. It is my firm belief that the way back to prosperity is going to come about through development and marketing of new devices, new methods and new thinking.

We are on the threshold of a new era that has been made possible by the pause in industry created by the depression of the past two years. This temporary slowing up of the wheels of progress has given us all time and the incentive to think out new ways of doing old things. I say again that out of this will come a fresh viewpoint that will once again launch us into another, and I trust, more extended period of advancement.

I am certain that Popular Mechanics will, as in the past, be one of the leaders for its editorial policy of the past fits well into this policy for the future.

---

## ACHIEVEMENTS TO COME

By *COLIN G. FINK*

Consulting Metallurgist and Research Engineer

**T**HE year 1902 is a significant one in the American electrochemical industry. Although hydro-electric power at Niagara Falls became available in 1895, and although shortly afterward the commercial production of carborundum, calcium carbide, phosphorus and ferro-alloys was undertaken, it was not until 1902 that these and other electrochemical industries became thoroughly established and universally recognized.

Fully appreciative of the economic importance of commercially applied electrochemical and electrothermal reactions, a small group of chemists and engineers met at Philadelphia early in 1902 and founded the Electrochemical Society—an international organization which has contributed so largely to the progress and development of pure and applied electrochemistry. In that same year, 1902, the technical journal, "The Electrochemical Industry," was founded. Few of us stop to realize



# Popular Mechanics



Health Laboratory  
Where Popular Me-  
chanics Employees  
Receive Free Treat-  
ment

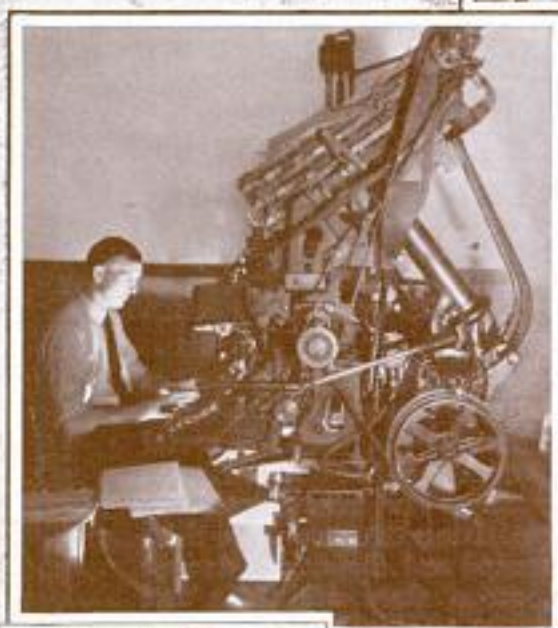

Setting Up Type for  
the Magazine on a  
Modern Linotype Ma-  
chine

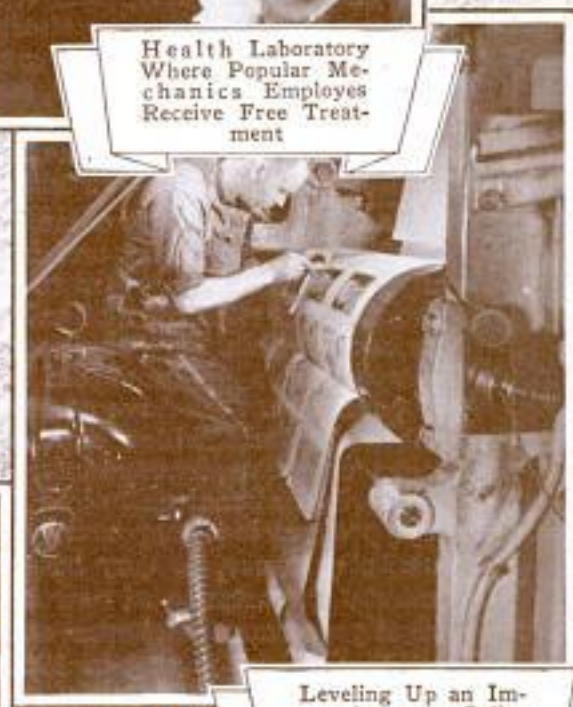

Leveling Up an Im-  
pression on a Cylin-  
der of One of the  
Rotary Presses



Examining the Mag-  
azines as They Come  
from the Trimmer in  
the Bindery





## Popular Mechanics

how much of our present economic structure is based upon the products of electrochemistry. The electrical industry—electric power, electric traction, electric lighting, electric communication, etc.—is, in reality, built upon electrolytic copper as a foundation. The world's production of electrolytic copper in 1902 amounted to 400,000 tons. Today it approaches 2,000,000, and by far the greater proportion of this is consumed by the electrical and automobile manufacturers.

It was thirty years ago when the first large-scale plant for the fixation of atmospheric nitrogen started operation and announced the glad tidings to the whole world that thereafter humanity was no longer dependent upon the rapidly depleting nitrate deposits of Chile as a source of nitrogen fertilizer.

Numerous electrochemical products and processes are so common today that we fail to realize that thirty years ago they were either non-existent or of comparatively little importance: The chlorine industry, many chapters could be written on that alone; carborundum, phosphorus, carbon bisulfide, electrolytic zinc, nickel and chromium, graphite, metallic sodium and calcium, ferroalloys, aluminum, magnesium and many more. Without these electrochemical products, basic industries, such as the automobile or aeroplane industries, or the vacuum tube industry, would be non-existent today.

As to the future, we often hear the remark made, "The days of the big discoveries and inventions are over. What could anybody find in the years to come comparable with the metal aluminum or with the audion?" My own belief is diametrically opposed to this. We engineers, scientists and investigators of today are in a thousand-fold better position than we were thirty years ago. We have at our command and disposal a deeper knowledge and wider experience, more elaborate tools and more sensitive instruments, numerous research laboratories with often almost unlimited facilities, and, finally, many alert and progressive corporations and industries whose directors are fully aware, as they have never been before, of the commercial importance of new and better products, or more efficient processes. And what may we expect to see by the end of another thirty years—in 1962? We marvel and glory over some of the present-day products, hardly realizing how much room for improvement there still remains. Over ninety per cent of the electrical energy required in lighting is wasted as useless heat. We build vehicles and conveyances weighing many tons to transport a few hundred pounds. We use materials for our buildings and bridges that are entirely unsuited for the specified purpose, being readily attacked by sun, air and rain. We pollute our rivers and lakes with so-called waste materials that can be converted into valuable products. Yes, we feel most optimistic as we look into the future. We firmly believe that we are at the very threshold of the greatest era in science and engineering.



## “CENTURY OF PROGRESS”

By *RUFUS C. DAWES*

President, Century of Progress

**I**T is an interesting coincidence that Chicago received its charter just as the world was entering into what might be called the Age of Science. The period beginning about 1800 was one of great activity. It began with the discovery of the Voltaic cell, which was followed by the discovery of electrolysis and by the announcement of the wave theory of light; then came the discovery of the connection between electricity and magnetism, and the epoch-making announcement by Faraday in 1831 of the laws of electromagnetic induction.

In brief, these were the foundations upon which the Century of Progress we shall celebrate were established. The enormous increase in man's knowledge of nature's laws was accompanied by the realization that the forces of nature might be applied to the purposes of man. Prior to this time man had never made use of steam or electricity, and had only the most imperfect conception of chemical energies. By the use of all these forces, the living conditions of all men in all parts of the world have been materially modified. Science now profoundly affects us all, and those who work for the advancement of science, or for the explanation of science to the popular reader, are the ones who work most effectively for national wealth and for the comfort, as well as the enlightenment, of men.

---

## AN EPOCH IN HISTORY

By *WALTER DILL SCOTT*

President, Northwestern University

**T**HE last few decades constitute an epoch in the history of civilization. This epoch is not characterized by any single line of progress but at least one of the most outstanding aspects is the progress that has been made in the natural sciences.

The most profound discoveries have been those made in our universities' laboratories. During previous decades many such discoveries have been made in laboratories but they lay dormant for decades or even centuries. The steam engine was invented in the laboratory of the University of Glasgow by James Watt in 1769. But the locomotive did not become a practical reality and in general use until a half century had elapsed.

At the present time worth while inventions and discoveries are utilized immediately. Popular Mechanics is one of the most effective of all agencies in shortening the "lag-time" between the discovery of important scientific phenomena and their application to promoting the welfare of mankind.



## THE "EYE" OF MILLIONS

By *BARRON COLLIER*

**F**OR thirty years Popular Mechanics Magazine has supplied the eye through which millions have watched the astounding progress of our scientific developments.

In addition, this magazine has constantly fanned the latent spark of inventiveness in thousands of minds, thus bringing to the world new inventors and new inventions without number.

That its great work may continue, is the wish of every earnest disciple of man's progress.

---

## MAN'S LIFE BROADENED

By *GEO. W. BURPEE*

Consulting Engineer

**T**HE thirty years during which Popular Mechanics has been published have, without doubt, witnessed greater progress in the application of science to human activity than any 100 years up to that time.

I believe that the application of science will continue at a rapidly accelerating rate in the future (even though it may be interrupted from time to time by periods of depression like that through which we are now passing) and that the public needs information about developments such as Popular Mechanics provides.

I cannot believe but that it is a waste of human life for men to do what machines can be made to do, and for that reason I feel confident that the future will witness more and more extensive use of mechanical appliances and the release of human beings from mechanical labor for purposes which we may not now clearly see but which we feel will result in greater intellectual and spiritual growth and, therefore, greater happiness.

In addition to the increase in leisure time made possible by mechanical means, man's whole life is broadened by increased facilities for travel and communications and growth of knowledge of the universe about us, and our great problem now is to adapt this increasing ease of living, possible only through the development of mechanical means, so as to increase the sum total of happiness.

---

## UNLIMITED POWER

By *LEE DEFOREST*

**T**HE past thirty years has seen radio, or wireless, grow from nothing to one of the most important factors in the daily life of mankind. Its science has been developed from the Maxwell and Hertz equations to many ponderous volumes of intricate mathematics and involved theories.

These three decades have witnessed our first actual acquaint-





# Popular Mechanics

ance with the electron, and a knowledge of its basic importance in almost every branch of science, an awakening realization of its gigantic possibilities in industry.

In the field of electricity this period has been especially marked by the development of the electron tube which, more than any other instrumentality, has made possible our most significant researches in physics, as well as the entire industry of radio and long-distance communication. It has greatly enlarged the horizons of man's thoughts, and the scope of his living.

Yet these thirty years, magnificent as they have been in achievement and progress, are but a promise of what the remainder of the century may witness in the ascent of man from the dark depths of the past.

Now begins the search for new sources of power, unlimited in volume, and at costs so low that freedom from heat and cold, hunger or numbing fatigue, leisure for thought, a realization of the best in life and living, will become the heritage and right of every man.

---

It is a safe statement to make that of all the people interested and active in aviation today at least ninety per cent have at one time or another been ardent and earnest readers of Popular Mechanics Magazine and that aviation owes your magazine a very real and sincere vote of gratitude for all it has done during the past thirty years to record and express in a popular way to a tremendous group of people the various developments and advancement that have been made in aeronautics.—*Porter Adams, National Aeronautical Ass'n.*

The last thirty years have achieved the work of centuries in the freeing of man's spirit and in his conquest of material forces. Popular Mechanics has recorded this great history with extraordinary fullness and fascination. It has had an enormous influence in waking and keeping alive the interest of multitudes in the development of human power in numberless ways, great and small.—*Rupert Hughes.*

Popular Mechanics during the thirty years of its existence has performed a worthy public service by giving to the people in popular form an account of the outstanding inventions, developments and scientific discoveries which have brought to all nations manifold benefits whereby burdens have been lightened and comforts for homes and communities have been distributed.—*C. F. Bailey, Newport News Shipbuilding and Dry Dock Co.*

There could have been no finer record of the progress and achievement of this country than your magazine. I have known it since its first issue and I had the very great privilege of knowing the founder and from talking with him of knowing some of his aims in the publication. No magazine founded on the principles which he had in mind could have done other than be the success that your magazine is.—*Ray Long.*



# Popular Mechanics

## SPEED AND PROGRESS

By W. H. COVERDALE

Consulting Engineer

**F**ROM small beginnings and through a development which has occurred largely during the lifetime of Popular Mechanics Magazine we in the United States and Canada have arrived at a point where we can now see business joyriding on the wing of an aeroplane, flashing on a radio spark across continents and seas, and following chemists to the brink of worlds newer than Columbus ever discovered.

Today the most backward nations, whose customs have not changed since before the Christian era, are those where man is still the beast of burden and the ox cart is still the unit of transportation—who depend upon creaking water wheels instead of steam turbines, and

upon hand scythes instead of harvesters! What a far cry from their simple requirements of food and shelter to our highly complex and intricate life as typified by the vacuum cleaner, the electric refrigerator, the wireless telephone, the motor, the radio, and the aeroplane! Man power, animal power, wind power, steam, electric, and gas engines—from 100 pounds of metal per horsepower to five horsepower per pound of metal—from less than four miles per hour to more than four miles per minute!

And just as the railroads fifty or sixty years ago bound the continent together and made it possible for California and Oregon to join the Union, just as their construction and operation made us nationally minded, so, today, the aeroplane and



Contrasting the Old and the New Method of Cooking; the Modern Kitchen Range Has Superseded the Old Coal Stove in a Few Years

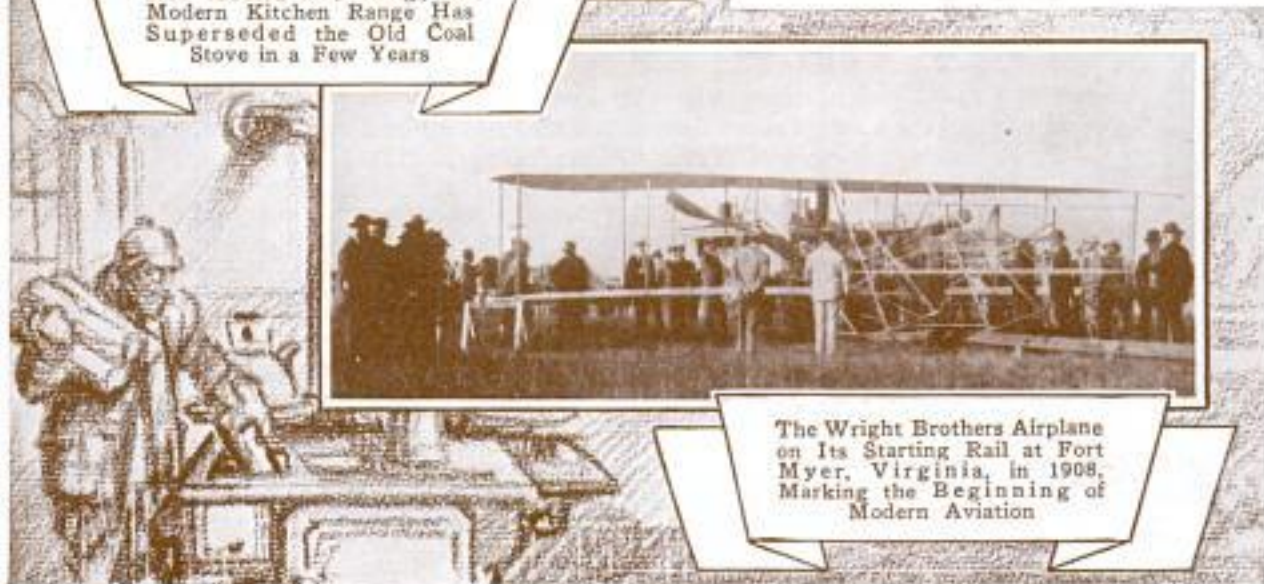

The Wright Brothers Airplane on Its Starting Rail at Fort Myer, Virginia, in 1908, Marking the Beginning of Modern Aviation



# Popular Mechanics

wireless telegraphy by their further annihilation of distance and time, are making us internationally minded—our isolation is a thing of the past; we are quickened with a new activity, a new life; and we must broaden the scope of our mental view to meet the new conditions as quickly as air speed broadens our geographical horizons.

Everywhere the old barriers between nations which caused diversity of interests are being torn down by faster communications which produce community of interests. The old Biblical question, "Who is my neighbor?" can no longer be answered with only a local meaning, because air travel has made New York and San Francisco as neighborly today as New York and Philadelphia were a couple of generations ago; and it is not too much to say that the further progress in the science and practice of air talk and air travel which reasonably may be expected in the next few decades will make neighbors of all human inhabitants on this earth, and will contribute more to our knowledge of the inhabitants of other planets than all previous conquests of mind over matter which history records.

The events of the last thirty years since Popular Mechanics Magazine was first conceived in the mind of its founder, bear out, as never before, the tradition that the history of the world's advancement is the history of the science of communication. Speed and progress go hand



Entrance to Popular Mechanics Building; the Structure Was Completed in 1922 and Is Classed as One of the Most Modern of Its Kind



A Modern Steam Turbine Plant; Such Sources of Power Have Come as a Development of the Past Thirty Years with the Growth of Industry





in hand— where one is, there you shall find the other also. The wise Lord Bacon told Queen Elizabeth that a nation required but three things to make it great and prosperous, namely, a fertile soil; busy workshops, and easy conveyance of men and commodities from place to place; and the historical Macauley wrote, "Of all inventions, the alphabet and the printing press alone excepted, those inventions which abridge distance have done the most for civilization."

The crude "horseless carriage" of thirty years ago—regarded principally as a plaything of the rich—has become a highly perfected piece of transportation, utilized by almost every family in the country. Greater strides than ever before have been made in conquering disease and in alleviating suffering and in countless ways we are constantly served by the products of modern science. The next thirty years will witness advances even more amazing than the wonderful accomplishments of the past three decades.

—F. H. Payne, Assistant Secretary of War.

I recall with what pleasure I read Popular Mechanics in the early years of its career. I have been a constant reader ever since and would not wish to miss an issue, even though I am a subscriber to several highly technical journals in chemical engineering and related subjects.

—W. D. Turner, Columbia University.

Throughout the three decades of the twentieth century through which we have passed, an era preeminent in history for mechanical, scientific, and educational advancement, Popular Mechanics has kept the record of inventional attainment.

—Franklin D. Roosevelt, Governor of New York.

Not the least wonderful thing that has happened in those thirty years, in my opinion, has been the all-around success of Popular Mechanics Magazine. It has been more than an interesting record; it has been an inspiration to its thousands upon thousands of readers.—Senator Arthur Capper.

As a faithful and intelligent interpreter of the march of science, Popular Mechanics for thirty years has stimulated the inventive genius of the average American and encouraged his study and research along scientific lines.

—Patrick J. Hurley, Secretary of War.

Popular Mechanics Magazine has not only served in disseminating information regarding the progress of science during the most remarkable period of its development, but has been a stimulant to greater achievement.—Senator J. T. Robinson.

Popular Mechanics is the one magazine that symbolizes the age in which we live.—Lowell Thomas.



B. 222 *and I. C. Popper, construction and designing engineer,*  
 POPULAR MECHANICS  
*12 Broadway and 110 5th St*  
*New York City*

**Wingless Aircraft to Fly with "Rotor Planes"**

*Principles discovered by John B. Slocum, Pacific Coast Physicist and inventor*

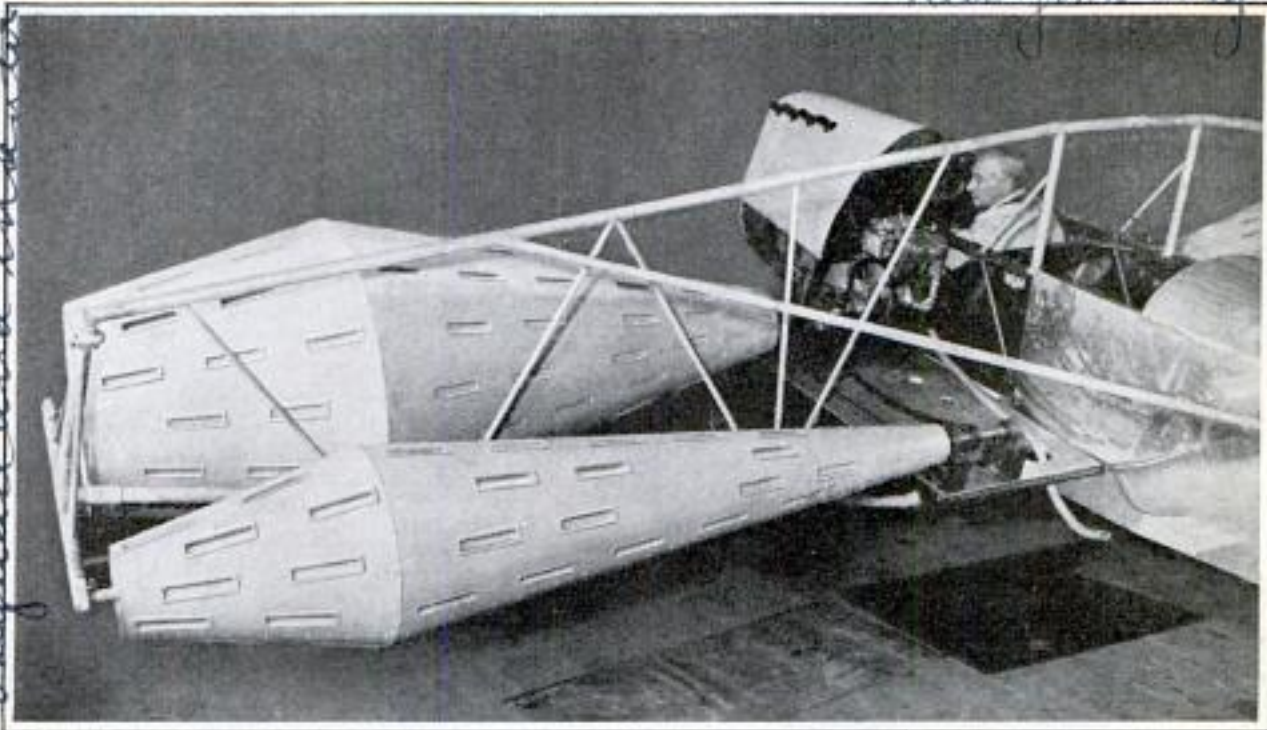

Left, Rotors of the Wingless Plane; Note Construction of Pockets in Rotor Surfaces Which Eliminate the Drag by Throwing the Air behind in Typical Slip Stream

Working months in a secret laboratory, two New York engineers have completed a wingless aircraft, the invention of a Pacific coast designer. The plane uses a modified form of rotor for lifting surfaces and is driven by three engines. One power plant provides the propulsion, while two smaller ones drive the lifting rotors on the right and left of the fuselage. The heavy drag of previous types of rotors is minimized, first, by the double-conical shape of the modified types and, second, by pockets formed in the conical skins to catch the air as they revolve and throw it backward with great force. Fuselage and tail control surfaces are conventional in form. The rotors can be turned at different speeds for lateral control.

land Rugby match in Europe. When "Speed" Holman, American flyer, fell to his death before 20,000 spectators, an announcer, Jim Ewing, thundered at the crowd through a Western Electric public-address system, holding the spectators in check until the band began playing and other planes went into the air.

**CLOGGED DRAIN PIPES CLEANED BY TURNING A CRANK**



Clogged drains can be cleared by turning the crank handle of a cleaner now on the market. A spring-steel cable connects the crank and cleaner head so that the cleaner will follow bends in drain pipes.

Practically all waste will be gripped and removed easily.

**LIVES SAVED BY GIANT VOICES IN PUBLIC-ADDRESS SYSTEM**

Giant voices from public-address systems have prevented crowd panics and saved lives when the announcers remained cool-headed at crucial moments. Roaring through a loud speaker, an official stopped a stampede of 50,000 people when a grandstand collapsed during the Belgium-Hol-

Water-power plants increased their capacity by nearly 700,000 horsepower in 1931.

*Western Electric Co*  
*50 Church St*  
*New York.*

*Scovel Mfg Co*  
*Waterbury Conn*



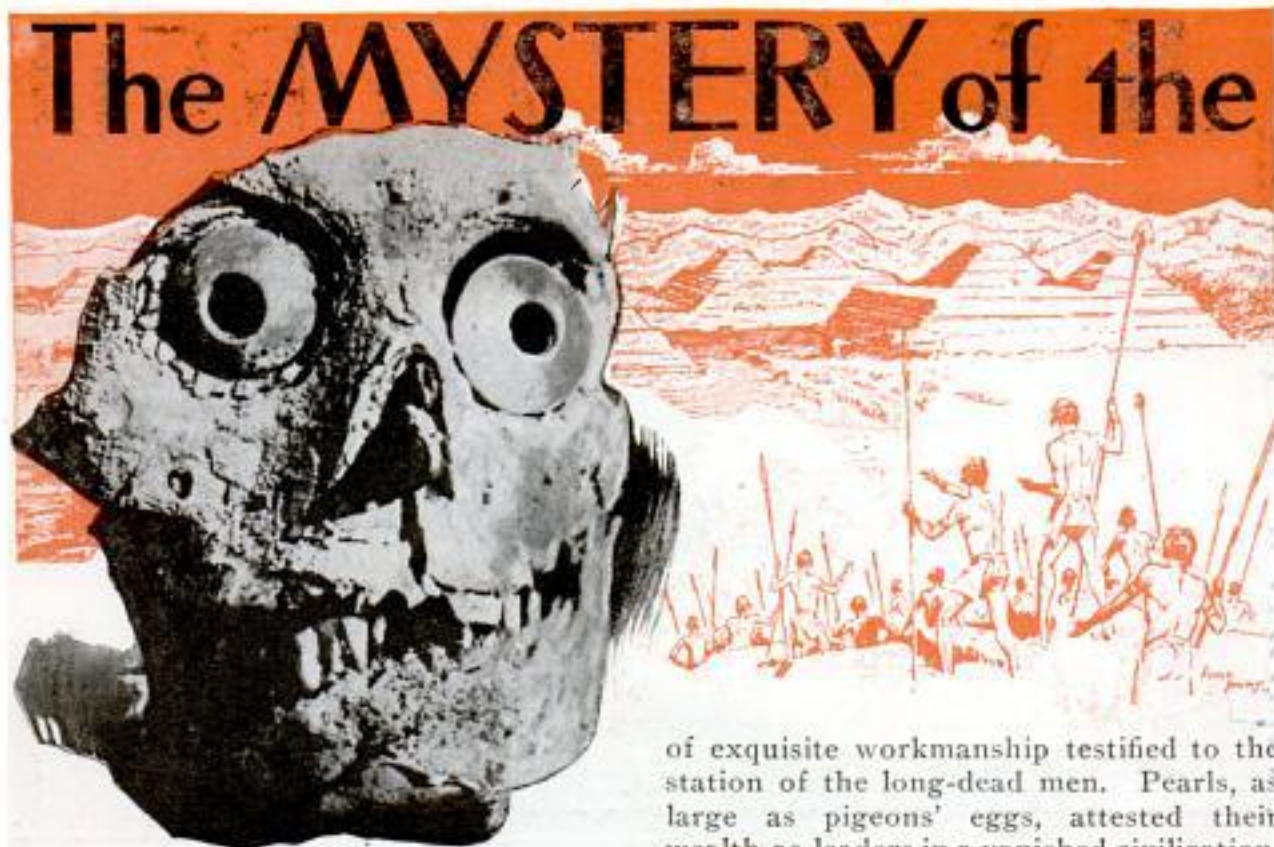

One of Finds in the Tomb, a Skull Decorated with Carved Seashells Plugged into Eye Sockets

By JOHN F. COGGSWELL

**A** LONG-BURIED treasure, dazzling in its splendor and worth a king's ransom, has been recovered from one of Mexico's lost cities, built centuries ago by the earth's most mysterious people.

Two years ago, a Mexican expedition, under the leadership of Alfonso Casco, a government archaeologist, started excavating and reconstructing the ancient ceremonial city of Monte Alban, located near the modern city of Oaxaca. Recently they reached the end of a long passage, terminating in a sealed tomb, far below the floor of a temple.

Breaking into the sepulcher, their lights revealed a breath-taking sight. On the floor lay the mummies of ten warriors, or feudal chiefs. Over the mummies was strewn a glittering pile; they were literally buried in gold, silver, costly gems and semi-precious stones. Ten heavy, solid-gold crowns

of exquisite workmanship testified to the station of the long-dead men. Pearls, as large as pigeons' eggs, attested their wealth as leaders in a vanished civilization.

Golden ornaments of every description—rings, necklaces, chains, earrings, masks, incense burners, basins and plates—littered the floor of the tomb. Jade, the pride of antique collectors, was there in abundance. Glistening baubles of amethyst and rock crystal gave back the rays of the searchers' lights. Watching over the rich pile, stood a great eagle modeled in solid gold and holding a silver chain in its beak.

The entire treasure—estimated by Senor Casco at over \$1,000,000 and said by experts to equal in value and importance the entombed wealth of the Egyptian king Tutankhamen, which was unearthed several years ago—will be placed in a mu-



Incense Burners in Form of Gods, Carved by Ancient Sculptors



# JEWEL-COVERED WARRIORS

Treasures are Found in Ancient Tomb in Lost Mexican City



seum in Oaxaca, which will this summer celebrate its 400th anniversary, by putting the collection on public view.

Dr. Alfred M. Tozzer, of Harvard University's Peabody Museum of Archaeology and Ethnology, world-famous authority on the ancient peoples of Mexico and Central America, explains why this find is considered by experts to be the most important discovery of the sort that has ever been made in North America.

"The producers of the treasure found at Monte Alban were the Zapotecs," said Doctor Tozzer. "They were the master goldsmiths of the ancient Mexican race. Just to the north of them lived the Mixtecas, a powerful breed, great agriculturists and great warriors. To the south lived the Mayas, great builders of cities and temples, in which were preserved, in stone, records of their past that will be of



Close-Up of Mexican Monolith, Elaborately Carved; behind It Lay a Sacrificial Altar upon Which Human Offerings Were Made to the Gods of the First Settlers of America





Top, View of the Great Steps and Platform, Probably the Acropolis of the Ancient City; Below, Jade Jars Made by the Skilled Artisans

great importance when they are fully understood. The history of these three great people were intertwined.

"We have long known that any important find, such as that at Monte Alban, would probably come out of the tomb of an ancient leader, for it has been established that the burial customs of the ancient Mexicans demanded that a leader's wealth be buried with him; they believed that the spirits of the dead returned and decked themselves in the clothing and ornaments that they had worn in life.

"As a further basis of our expectations, we have the accounts and detailed descriptions, by the Spanish invaders, of the loot that they sent back to Spain. Many old historical manuscripts contain illustrations in color of the handiwork of the native Mexicans. Furthermore, many exca-

vated tombs have given up small collections of ancient Mexican materials, but, aside from the Mayan discoveries, this recent one is the first find of sufficient size to promise to divulge really important information.

"Of course, the civilization in pre-Columbian Mexico was of a date much more recent than that of ancient Egypt. Some of the ruins and the jade and stone ornaments and carvings date, we believe, back to the year 500 A. D. The works in gold are still later, dating, probably, to the early thirteenth century.

"The so-called lost city of Monte Alban really wasn't a city at all in the modern sense of the term, nor can it rightly be called a 'lost' city. It was not a dwelling place of the natives, but rather a place for religious ceremonies, inhabited only by the high priests and their assistants, and for the burial of the dead of high degree. The existence and locations of such places have been known for a century and more,



so they were hardly lost, although they were abandoned for many years before their locations were learned. It is probable that they were abandoned at the time of the invasion to save them from desecration by the Spaniards.

"Monte Alban is located within five miles of the city of Oaxaca, through which is operated a line of railroad; it is rather hard to imagine a city being lost within five miles of a railroad station. However, the mission that made the recent find is



"In the building of their ceremonial cities, the ancient Mexicans faced and solved engineering problems comparable with those of the Egyptians, who built the pyramids. They erected long avenues of huge stone monoliths or stela. These stela were elaborately carved



the first to undertake serious attempts to unravel the mysteries buried in the ancient ceremonial cities.

"The building of Monte Alban must have been a long and involved task. Then, its location was far from any large settlement and in the midst of high mountain peaks. In fact, Monte Alban is on top of a high mountain. To build their temples, the Zapotecs leveled off the top of the mountain until they had an immense plaza, about a mile long and a quarter of a mile wide. Down the center and on the sides and ends of this plaza, they built their temples, in pyramidal form, of stone and earth, with great chambers inside and tombs below. There were wide, level courts and long terraces. The layout gives evidence of careful advance planning.



Top, Ceremonial Dagger; Left, Drawing of Entrance to Tombs; Bottom, Some of the Carvings

and were of one single piece. Some of them were eighteen feet high and weighed over twenty tons; their erection must have been a big problem for people with no machinery—but erect them they did.

"The Monte Alban find is likely to prove of extraordinary importance in learning the past of a wonderful people."



B. 266

Dr. Andrew Isood  
instructor in printing

534

Journal College  
Fullerton Calif. High School



This Typesetting Machine, Fitted with a Typewriter Keyboard, Makes Work Easier for Operator

### KEYBOARD FITTED ON LINTYPE WORKS LIKE TYPEWRITER

Greater ease of operation is claimed for a linotype machine fitted with a typewriter keyboard. All the intricate series of capital letters, lower-case letters and small capitals, and even the auxiliary letter keyboard on either linotype or intertype machines are operated from the single typist keyboard. The long period of training necessary in learning to operate the linotype machine is eliminated by the ease of operation with the simplified keyboard, its inventor claims. The "typewriter" is operated by electricity and may be installed in a few moments without making any changes in the typesetting machine. A California instructor in printing spent five years in perfecting the device.

### SKIN GOOD RADIATOR OF HEAT BUT POOR CONDUCTOR

As an insulator against radiated heat, the human skin is almost a perfect agency, while the body itself makes an excellent heat-producer and the outer covering serves as a radiator. This information has resulted from a study conducted at the

by L. B. Aldrich  
Washington, D. C.

Smithsonian Institution in connection with problems in the heating and ventilating of schoolrooms and similar places. After measurements had been taken of the heat radiated by a number of human subjects, it was suspected that all the heat might not be radiating from the skin surface, but that some might be coming directly through it. Tests on excised skin however, showed that it would almost completely stop heat waves. It appeared therefore, that the heat from the interior of the body must be transmitted to the skin through the medium of the circulating blood and then radiated from its surface after the skin has become sufficiently warm. The studies have considerable practical value in the spacing of occupants of halls or schoolrooms for maximum heating efficiency.

S. S. S. 2/6/32

B-135

### TOOL BOX UNDER AUTO'S HOOD SWINGS OUT FROM DASH

Double automatic locking is provided on a tool box that swings from the dash under the hood of the automobile. A lock is provided on the inside of the dash and a second lock acts as soon as the box is placed in position. The equipment is designed to fit most of the popular-priced automobiles, is quickly and easily installed, and since it is bolted also to the frame of the car, causes no strain on the dash. It is sufficiently strong to bear a man's weight.



Heavy Mounting Sufficient to Bear Man's Weight Shown in This View of Tool Box

Dr. J. M. Hooper  
Franklin, Idaho  
Box 982

is arranging for manufacture.

8/21/32

10.50  
1932  
Ford-Cher. 1928-1932

Pat. of 556,178 Mar. 6, 1917



# Stop-and-Go Lights on Dash to Control Autos

Driving through the crowded streets of the future, auto-ists will stop, wait for cross traffic to clear, then start again without the aid of today's signal post on the corner. Stop-and-go light signals, installed on the automobile dash, will control tomorrow's traffic, a glance at his instru-

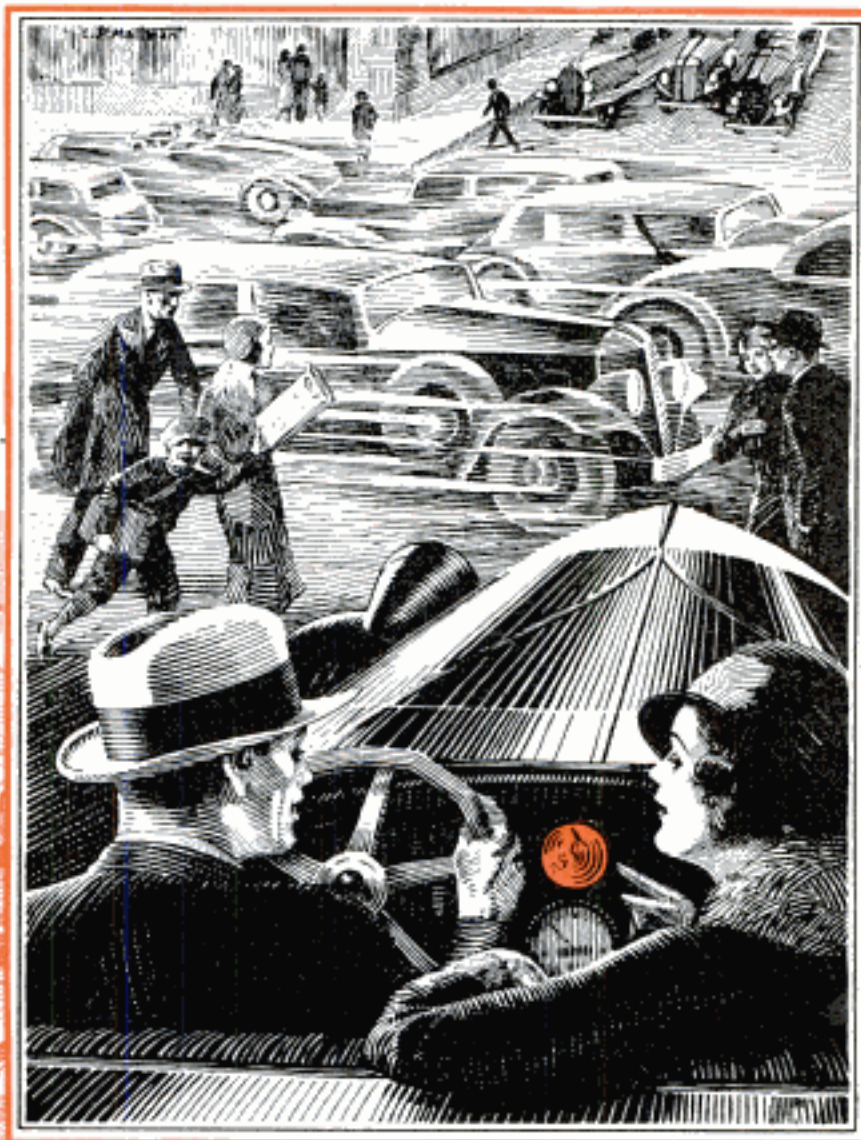

Artist's Drawing of Traffic Conditions of the Future Shows Red Signal on Dash; Note Today's Signal Post at Left

ments showing the driver whether the way is open long before he reaches the next street intersection. That is the picture drawn at the American Institute's annual meeting by O. H. Caldwell, magazine editor, in a prediction of a new application of the vacuum tube. Such a system of auto-traffic control is not far distant, for modern railroads already are able to signal engineers by flashing lights in locomotives as the train speeds along. For automobiles, this can be accomplished by laying a high-frequency cable along the curb. As long as this cable from traffic headquarters is energized, a detector tube on the auto dash will keep the green lamp lighted, indicating "go ahead." When cross

traffic is to pass, the cable would be switched off, all dashboard lights changing from green to red as the detector tube ceased to function. This would be the "stop" signal. Meanwhile, cables on cross streets would be switched on, signaling cars on those streets to move.

## PROJECTOR GIVES CLEAR VIEW OF LABORATORY WORK

Details of experiments in a German technical school are reflected on a large screen by a projector called the "epidiascope" so that more students can see the work. The projector is used to picture work in laboratories so that the experiments may be explained there.

*Electronics, 330 W  
42nd. New York*

*Dr. Alfred Stock  
Karl's rube. Freytag  
The Zeiss Co. Jena, Germany*

*Science Service 2/4/32  
Referring. and S. to Carl  
Zeiss, 455. 5th Ave New York*



B-260  
536

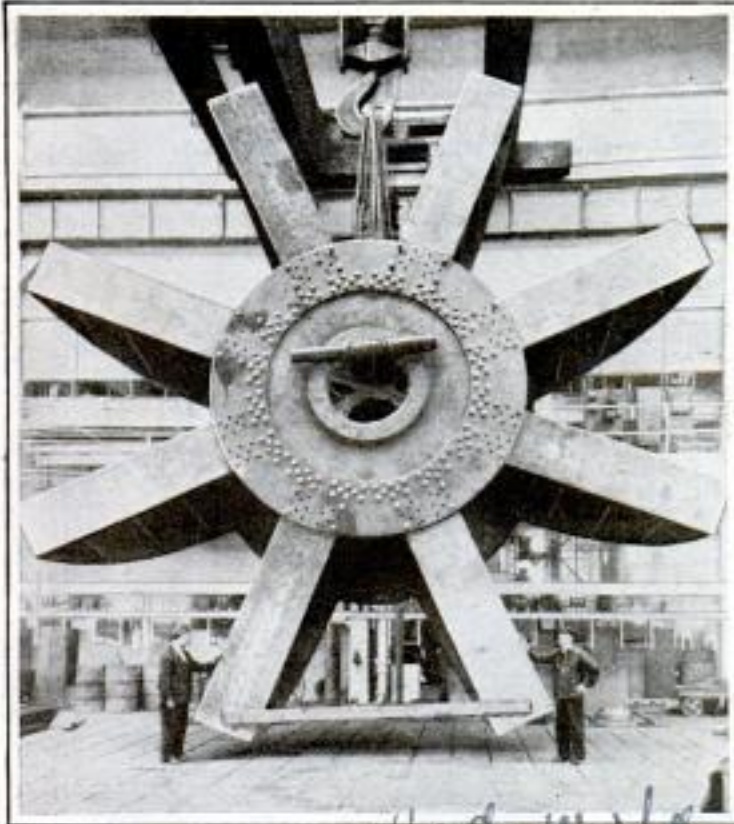

Workmen Turning Over the Giant Hub of Water-Wheel Generator with Aid of Crane; It Weighs Ninety-Two Tons

on Dnieper river.

### RUSSIAN "SPIDER" TO CONVERT WATER INTO POWER

Termed the "spider" by the men who built it, a giant bearing bracket, weighing ninety-two tons, has been completed by the General Electric company for a Soviet power plant. The huge hub and spokes will be part of a water-wheel generator which the company is building for the Russian hydroelectric plant on the Dnieper river.

### WHEN FREIGHT IS MISHANDLED SHOWN BY RECORDER

Designed for detecting the time and place of rough handling of freight shipments, a new type of impact recorder has been developed and found to have many more uses, including the effect of weather and air pockets in air transport. It also is employed in taxicabs, autos, Pullman cars, busses, mail cars, motorcycles, highway trucks and for express shipments. The difference between the various types lies principally in the timing—the speed with which a paper tape unrolls under a vibrating pencil or pen. In the center of the paper tape are the figures indicat-

Chas. Ed. Stout  
Burlington, Iowa

ing the minutes of the hour, and crosswise are graduations showing the speed at which the vehicle, be it train, car or airplane, travels when the bump occurs. It is expected the speed-recording feature will save hundreds of thousands of dollars in damage claims. The recorder is fastened in the vehicle and sealed. At the end of the trip, the tape is removed and the whole history of all bumps or shocks during the trip is made plain.

B-173

### ELECTRIC FAN ALSO IS SAFER TO USE

Electric-fan blades without noise or vibration were demonstrated recently by Prof. W. L. Upson, of the Washington University school of engineering, who declares the blades are much safer to use than the ordinary kind. They are shaped somewhat like a palette or flattened tadpole, this pattern permitting the tip to strike the air at the lowest velocity instead of at high velocity as with the ordinary fan. This motion, it is claimed, gives the air constant acceleration until it leaves the tip of the blade in a continuous stream. The blade has a tendency to push away the hand or other object brought in contact with it.



Electric Fan with Palette-Shaped Blades Which Make No Noise and Are Safer to Use

St. Louis, Mo



03-206 Emb. G. O. Wilson  
1331 Es. St. N.W.

POPULAR MECHANICS

Washington, D.C. 537

## Here's What Speed of Mile a Minute Means

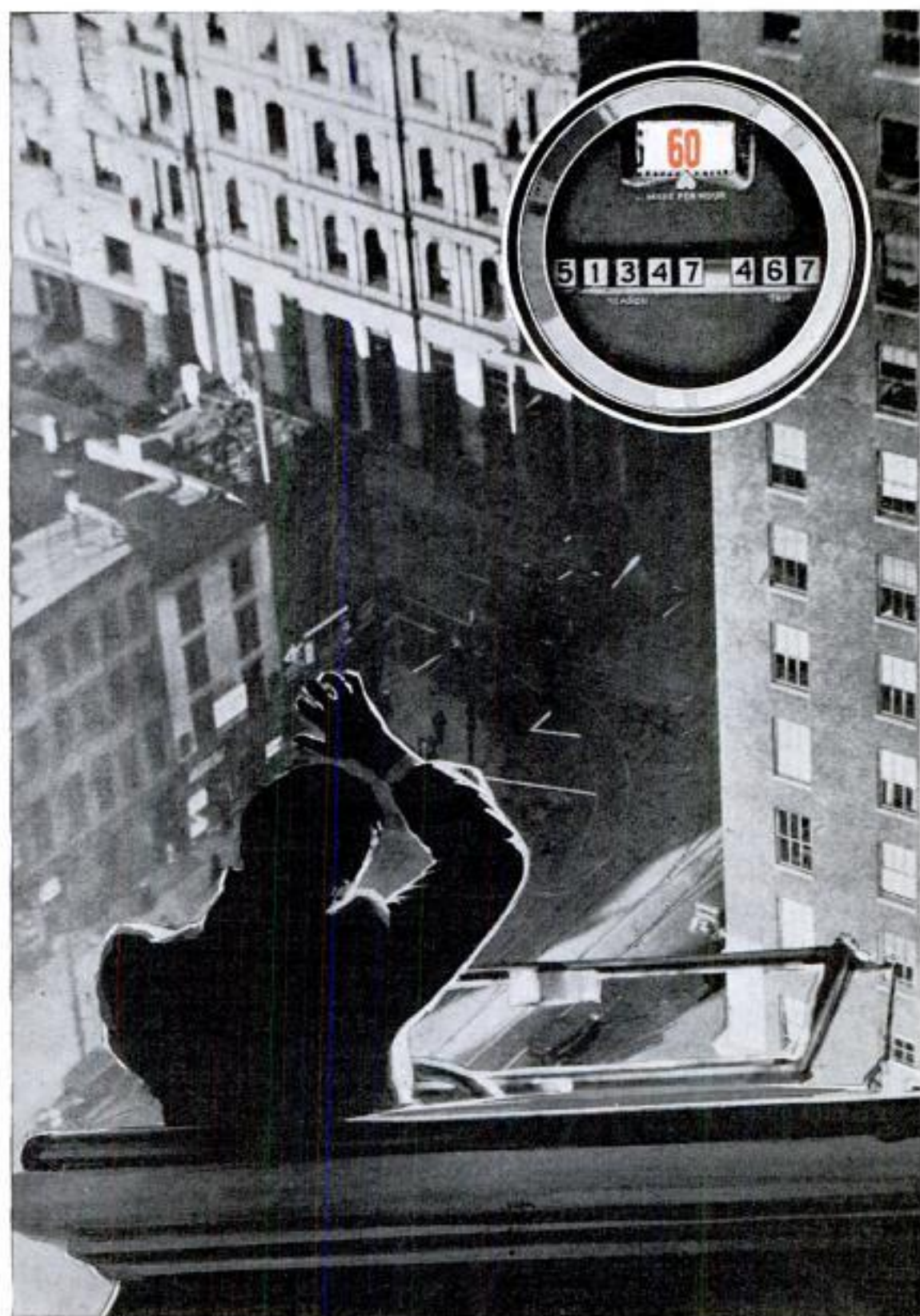

An Auto Traveling Sixty Miles an Hour Has the Same Capacity of Inflicting Damage That It Would Have if Driven off Top of Ten-Story Building, 120 Feet High



# Feathering of Blades Increases Gyro's Speed

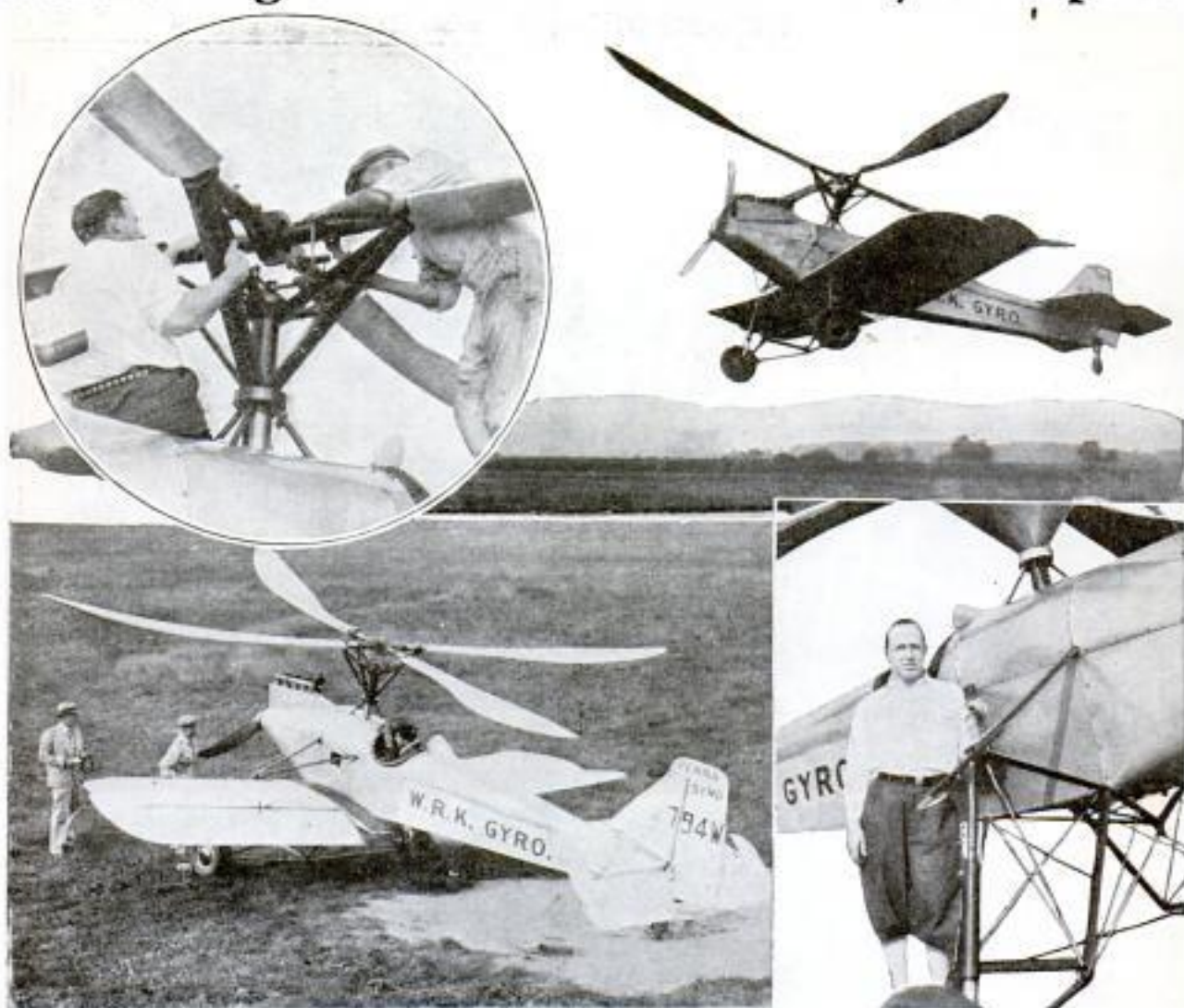

Gyroplane with Feathered Rotor Blades in Flight, Upper Right, and on Ground. Lower Left; Rigid Construction of Rotor, Improving Control, Is Pictured at Upper Left and Lower Right

Control of the autogyro at low speeds has been improved by designing the rotor blades like a feather and by joining opposite blades rigidly. A gyroplane equipped with feather blades has been found easier to handle at speeds where normal airplane controls are useless. Less danger of breakage of rotor blades is gained through rigid structure and inner connection of oppo-

site blades. This method of construction allows the centrifugal forces of the blades to oppose each other so that the balance of the rotor, or "windmill," on top of the plane is a simple matter. Speed of rotation of the blades can be increased. The feathered blades have grooves or creases on the underside to improve their lifting capacity.

## HEAVY CLOTHING AIDS HEARING BY ABSORBING SOUND

Sound waves are absorbed by heavy clothing, making it easier for orators to be heard by men audiences than women. Dr. Paul R. Heyl, of the bureau of standards, has found that silks and chiffons worn by women reflect sound waves and

result in vibrations "treading on each other's heels," and interfering with the hearing capacity of the audience. Experiments in a soundproof vault fitted with one window, which was opened to test absorption of sound by various materials, showed that a woman dressed in typical garb absorbed 2.3 as much sound per square foot as the open window. With

Washington, D. C.



her coat on, four times as much sound was absorbed. A man without his overcoat absorbed 4.1 as much, and with the overcoat, 4.8 as much. A mixed audience seated on cane-bottom chairs absorbed 3.2 as much sound, while on heavily padded theater chairs the absorption was 3.9. The tests also showed that rectangular rooms provide the best acoustics.



© Fox Photos  
Member of Oxford Rowing Crew Watching Himself in a Mirror as He Rows; in This Way He Observes His Mistakes and Acquires Correct Form

**TRAP NESTS GIVE  
PEDIGREED  
EGGS B-210**

Eggs that are numbered for breeding are being used to produce better chickens. A battery of nests, constructed like traps, aids in the selection of eggs. When a hen has entered one of the nests and laid, she and the egg are taken out, and the number on her leg band is placed on the egg. In this way, eggs of a known pedigree are obtained for setting purposes, and strains of fowls with qualities

**MIRROR HELPS ROWING CREW  
TO ACQUIRE FORM**

Members of the rowing crew at Oxford practice their strokes in front of a mirror, not because they are vain, but to improve their form. The oarsman sits in a boat facing a long mirror and watches his motions as he pulls on the oars. In this manner mistakes are observed by the person making them, and he also sees when he has corrected his errors.



Nests That Trap the Hens Are Used in Producing Better Chickens

**SAFETY RUG HAS RUBBER BASE  
TO PREVENT SLIPPING B-317**

To prevent slipping on highly polished floors, a safety rug now on the market is manufactured with a sponge-rubber base. There have been many accidents to bathers who switch on electric lights while standing on a damp floor. This rug, with its rubber back, prevents such an occurrence. The ease with which it may be reconditioned by washing under normal laundry conditions is another feature adding to its value.

the breeder can guarantee, such as high egg-laying ability, may be produced.

taken on a farm in  
Portage County, Ohio  
on 8/22/24

Sidney Blumenthal  
& Co., Inc. 1 Park Ave.  
New York



# Weird Forms of Submarine Life Are Found

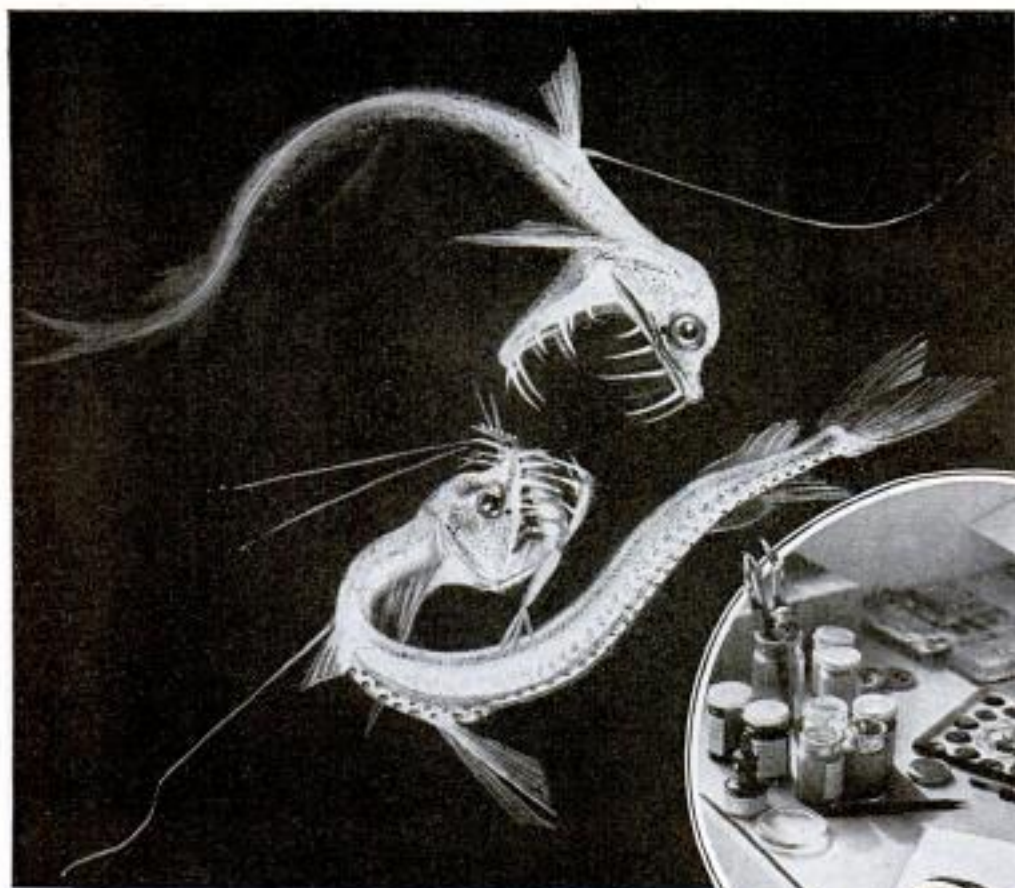

Above, Painting of a Pair of Deep-Sea Dragons Quarreling over a Meal Half a Mile beneath the Surface; in Circle, Hand of Artist Delineating Species of Sea Monster



Left, William Beebe Coming to Surface after a Dive to Study Sea Life in Bermuda Waters; Right, Studying Rare Migrant Wading Bird from a Blind with Aid of Binoculars

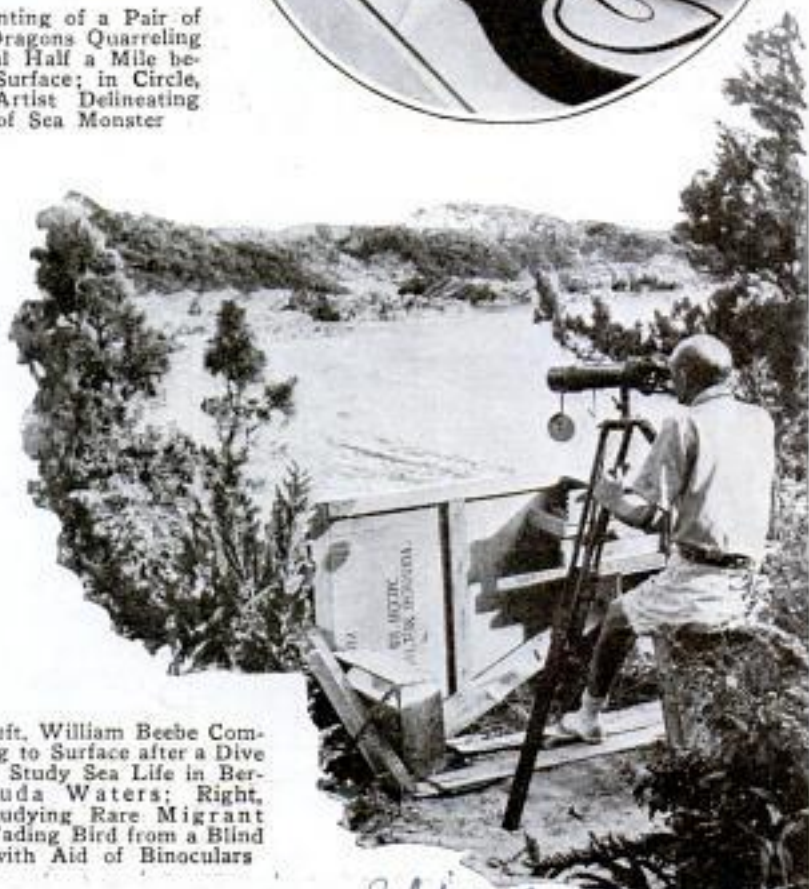

Wide World Photo ©



B-169

# in Tropical Waters by the Beebe Expedition

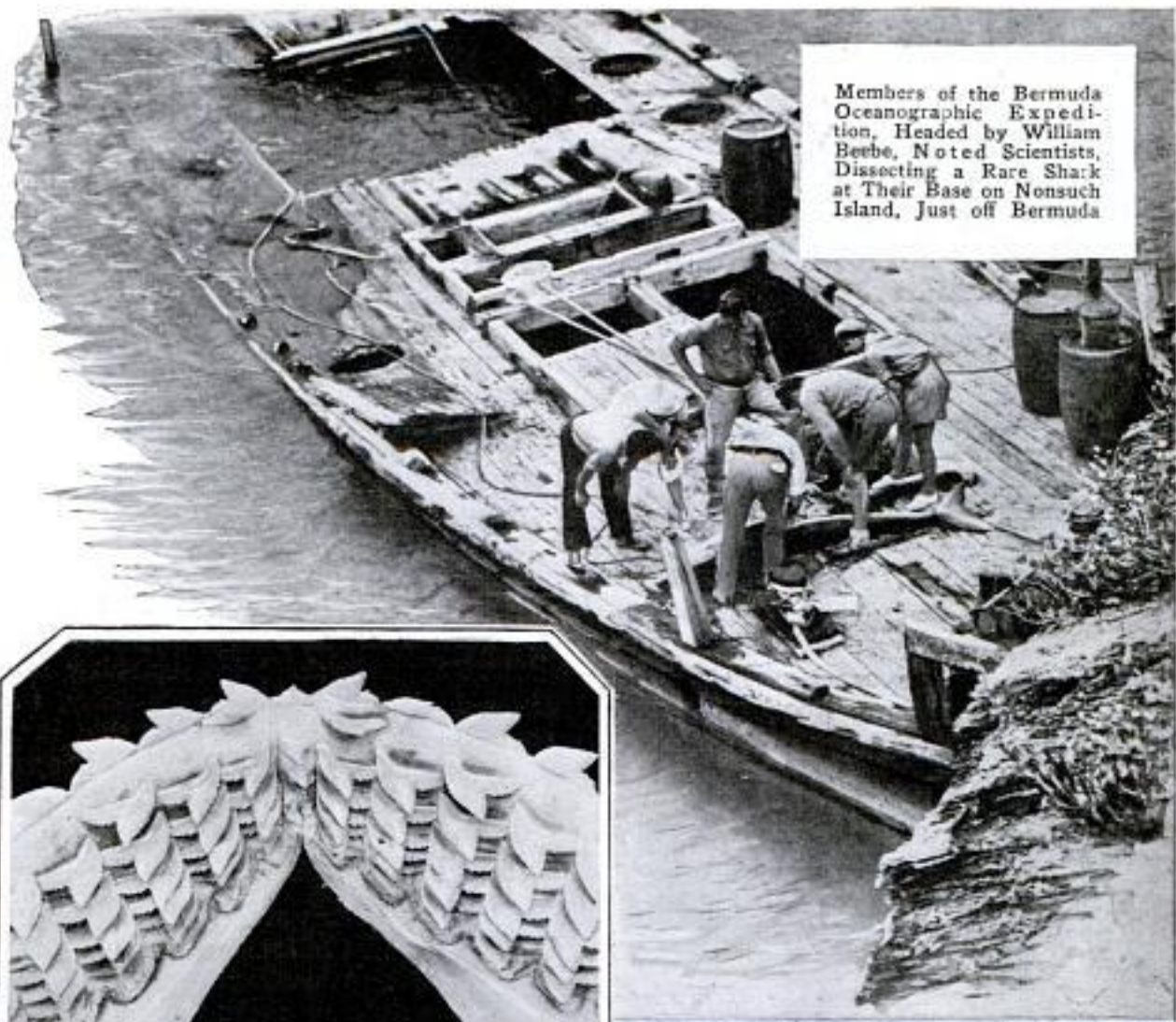

Members of the Bermuda Oceanographic Expedition, Headed by William Beebe, Noted Scientists, Dissecting a Rare Shark at Their Base on Nonsuch Island, Just off Bermuda

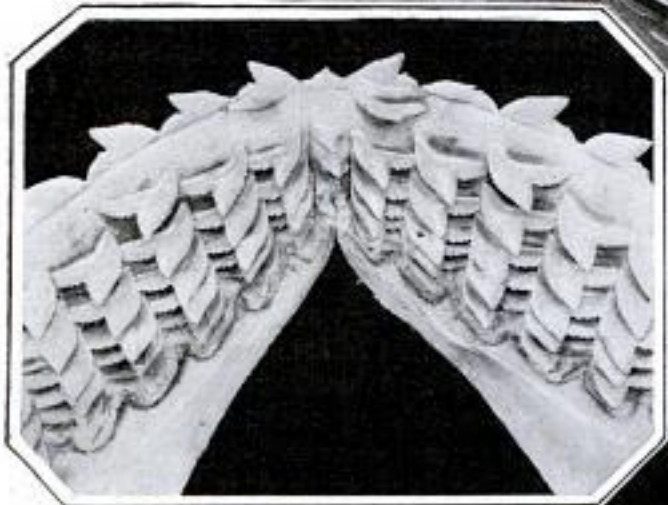

Above, Upper Jaw of a Tiger Shark Caught by Expedition; as Soon as a Tooth on Upright Row is Lost, Another Rises to Take Its Place

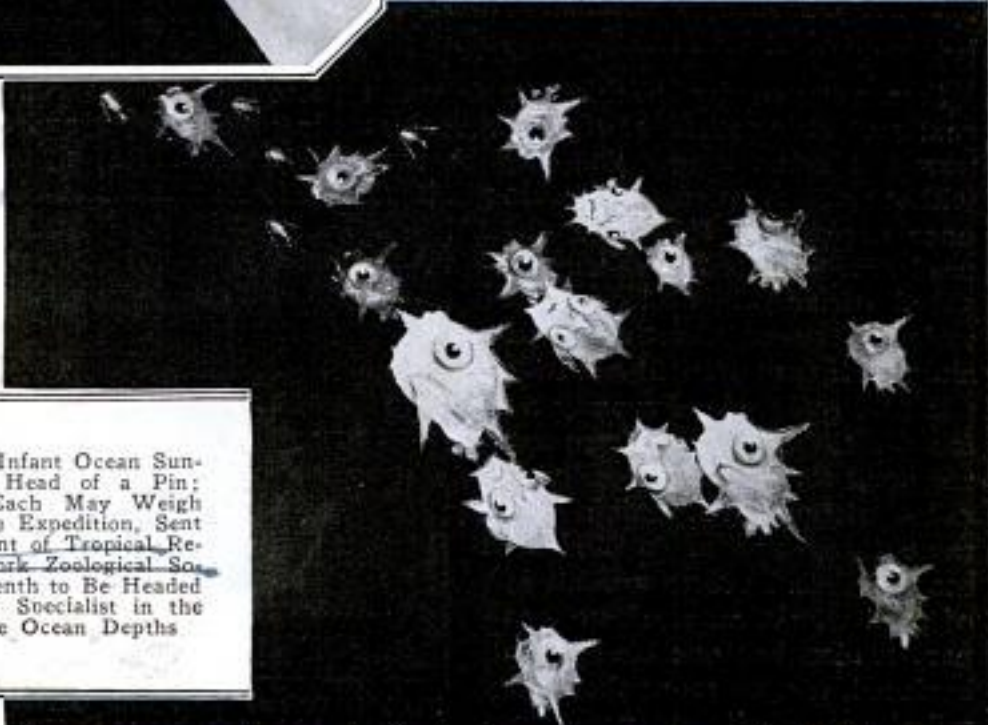

Painting of School of Infant Ocean Sunfish, About Size of Head of a Pin; When Full-Grown, Each May Weigh Well Over a Ton; the Expedition, Sent Out by the Department of Tropical Research of the New York Zoological Society, Was the Fourteenth to Be Headed by William Beebe, Specialist in the Study of Life in the Ocean Depths

William Beebe

and members of Bermuda Oceanographic Expedition

Copyrighted material





© International News  
 Sliding Down a Snowless Chute on Wooden Blocks, Novices Learn to Ski Indoors; Instructor Is Shown on Slide in a Berlin Gymnasium

**SKIING IS TAUGHT INDOORS ON SNOWLESS CHUTE**

How to ski is being taught indoors on a snowless chute by a Berlin instructor. The slide and skis, which are short sticks of wood, are planed smooth so that the students may glide rapidly down the chute for their jump.

**TEETH OF ROAD MACHINES LAST LONGER IF HARD-COATED**

Strengthened by a thin, hard metal coating, cutting surfaces of road machines now last much longer and may be used without the frequent sharpening once necessary. The teeth on a road scarifier used on heavy oil-caked surfaces in California had to be sharpened about every mile and a half, and after fifteen miles, must be replaced. Properly surfaced with hard metal, these teeth are good for sixty to seventy-five miles without sharpening. The same thing applies to blades of road graders. A sixty-mile stretch of road would require four ordinary blades, but one blade, hard-surfaced, can do more than sixty miles' work without resharpen-

© International News

als and alloys have little elasticity, they should not be applied to steel that is too ductile, or they will tend to pull apart.

B. 250

**FOLDING RACKS SHOW WARES OF ROADSIDE GROCERY**

Roadside grocery stores are making their appearance in California, where all kinds of canned and package goods are displayed on folding racks along the highways to attract the passing public. A large car trailer is equipped with eating and sleeping accommodations for the traveling storekeeper and also holds the extra supplies. The only fee is a dealer's license.



Roadside Grocery Store with Canned and Package Goods Displayed on Racks Where Passers-By Will Notice Them

Rods and welding made by  
 Stoddy C. Wheeler, Calif. 42nd St. 642nd St. 1750  
 Air Reduction Sales Corporation  
 3 Bldg New York  
 35

Los Angeles

Cont Francis Westbrook  
 R. 1010, Graybar Bldg  
 New York

Carl Wesley Melgiani  
 4730. 12/5 St. Class  
 Place, Los Angeles, Cal



# Rounding the Zigzag Turn of a Bobsled Run

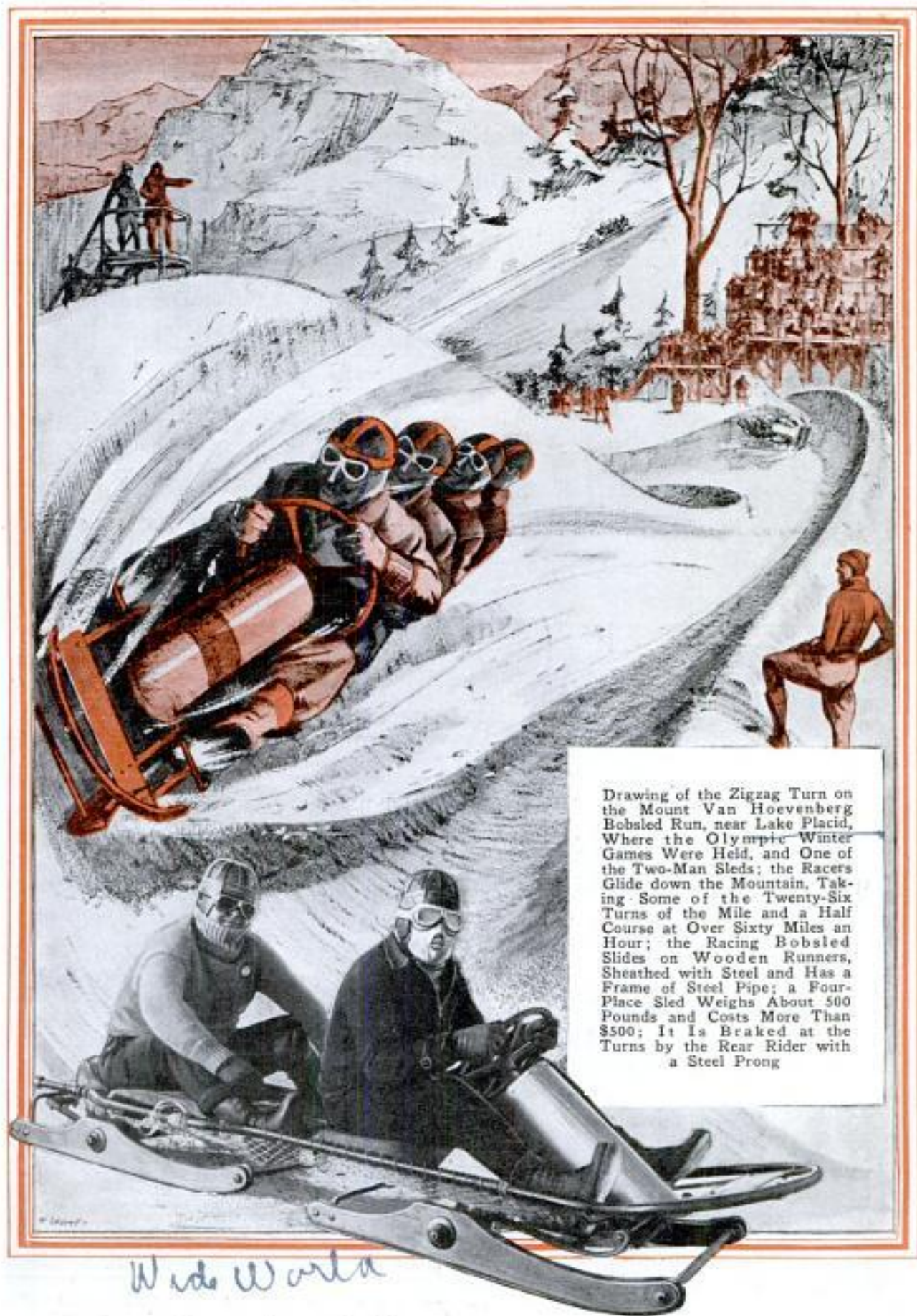

Drawing of the Zigzag Turn on the Mount Van Hoevenberg Bobsled Run, near Lake Placid, Where the Olympic Winter Games Were Held, and One of the Two-Man Sleds; the Racers Glide down the Mountain, Taking Some of the Twenty-Six Turns of the Mile and a Half Course at Over Sixty Miles an Hour; the Racing Bobsled Slides on Wooden Runners, Sheathed with Steel and Has a Frame of Steel Pipe; a Four-Place Sled Weighs About 500 Pounds and Costs More Than \$500; It Is Braked at the Turns by the Rear Rider with a Steel Prong

Wide World



**PLASTER MODEL WHITE HOUSE  
TWO YEARS IN MAKING**



Two Years Work Is Represented by This Model White House, Made of Plaster by War Veteran

Complete in every detail, windows, landscaping and architectural decorations, a model White House made of plaster was constructed for exhibition at the George Washington bicentennial celebration. Jacob A. Toussounian, world war veteran, spent two years on the model.

**IS OUR CLIMATE CHANGING?  
CENTURY TO TELL**

Whether the abnormally warm winters of the past two years presage a real change in climate is something that will not be known for another century. This country, however, has known genuine changes of climate, winters so severe for hundreds of centuries that ice piled up half a mile thick as far south as the Ohio river. The conditions necessary to produce an ice age again were described recently by Prof. J. Harlan Bretz, of the University of Chicago. To get glaciation started, he explained, most of the precipitation must be in the form of snow, the summers being so short and cool that not all of the preceding winter's snow is melted. Thus the snow piles up and packs down year after

year. What occurs today in mountain glaciers may be presumed to have occurred on a grand scale in the ice age, but what started the long chill is still a mystery. However, it is known that the climatic change which causes the ice age was an interruption, because fossil records show that animals and plants living before the glaciation in the northern half of what is now the United States were temperate-climate forms. The growth of the ice sheet was slow, probably only a mile in twenty years, so generations came and went during the refrigeration, and even plants had the opportunity to migrate southward. As the arctic climate progressed, many forms of life moved southward, where some gradually became extinct while others adapted themselves to the change, although some animal forms made the 2,000-mile trip south, then moved back as the ice melted.

**B. 261  
BIG AUTO SERVES AS MARQUEE  
FOR FILLING STATION**

One Minneapolis service station advertises its business by means of its marquee which has been constructed to resemble a giant automobile, elevated for a grease job. The wheels and supports are of brick and the imitation car serves as a second-story porch for the building.



Marquee of a Gas Station Made to Resemble a Big Auto; the Upper Deck Serves as a Porch

Cont. Ives Pommer Jr.  
4311 Dearfield Ave  
Minneapolis, Minn

*Science Service man  
report 2/6/32*



B-147

# On the EASTERN FRONT



Fourth Regiment, United States Marine Corps, Parading at Shanghai Where the Body Is Guarding American Property and Lives in the International Settlement; the Thirty-First Infantry from Manila Has Joined These Troops, Cheered Madly on Landing by Thousands of Chinese and Foreign Residents of the Area



Swathed in Furs and Wearing the Smile of Victory, These Japanese Troops Are Seen Waving the Flag of Their Country as They Occupied the Government Building at Chinchow, Manchuria, in Their Drive toward Harbin



Wide World 545



B. 147

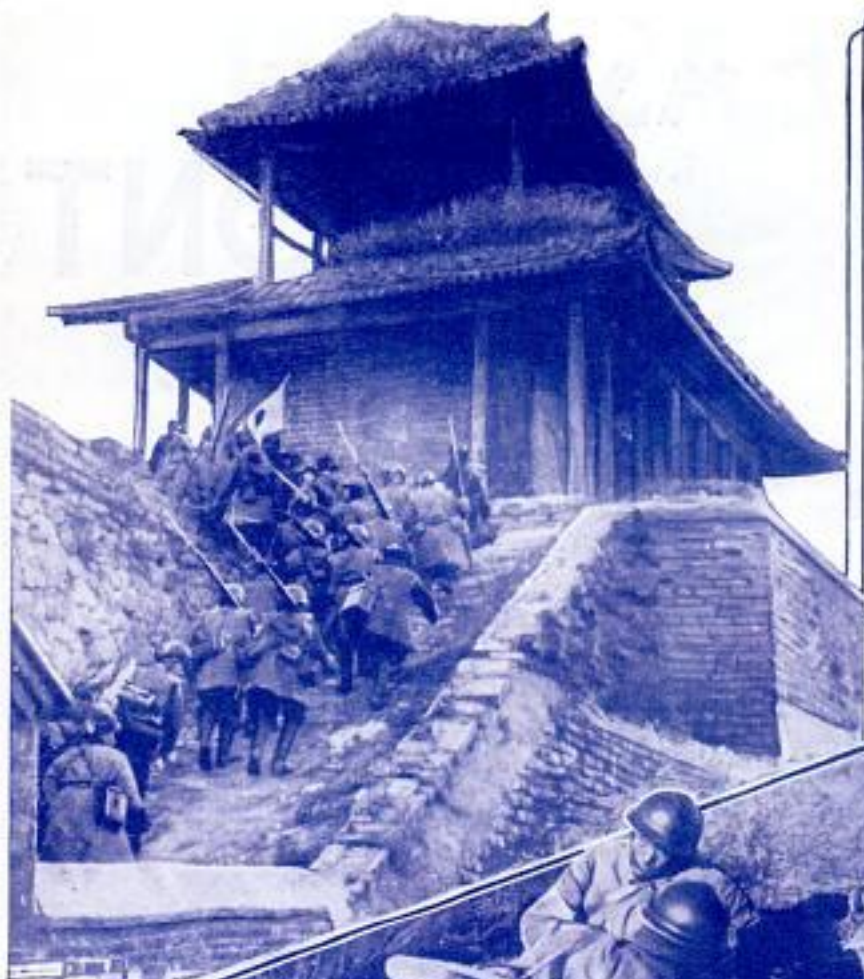

Japanese Infantry Swarming up the Steps of the Great Wall of China toward the Main Entrance of Chinchow, Manchuria, in the Campaign against Chinese Irregular Forces; Below Is a Section of the Japanese Communications Corps, Advancing Carefully in Action near Tsitsihar; the Advance Caused the Chinese to Move the Seat of Government from Nanking to Honanfu; Far-Inland Chinese Fled from Harbin, Leaving Japan in Possession of Almost All of Manchuria, an Area Greater than Pre-War Austria and Germany Combined and Rich in Natural Resources; About 165 Americans Lived in Nanking, and the Destroyer "Simpson" Was Stationed in the River to Evacuate Them if Necessary



Japanese Armored Cars and Motorcycles Inspecting the Gordon Road Industrial District in Shanghai, Following the Suppression of Rioting; the Patrols Worked All Day to Disperse the Mobs

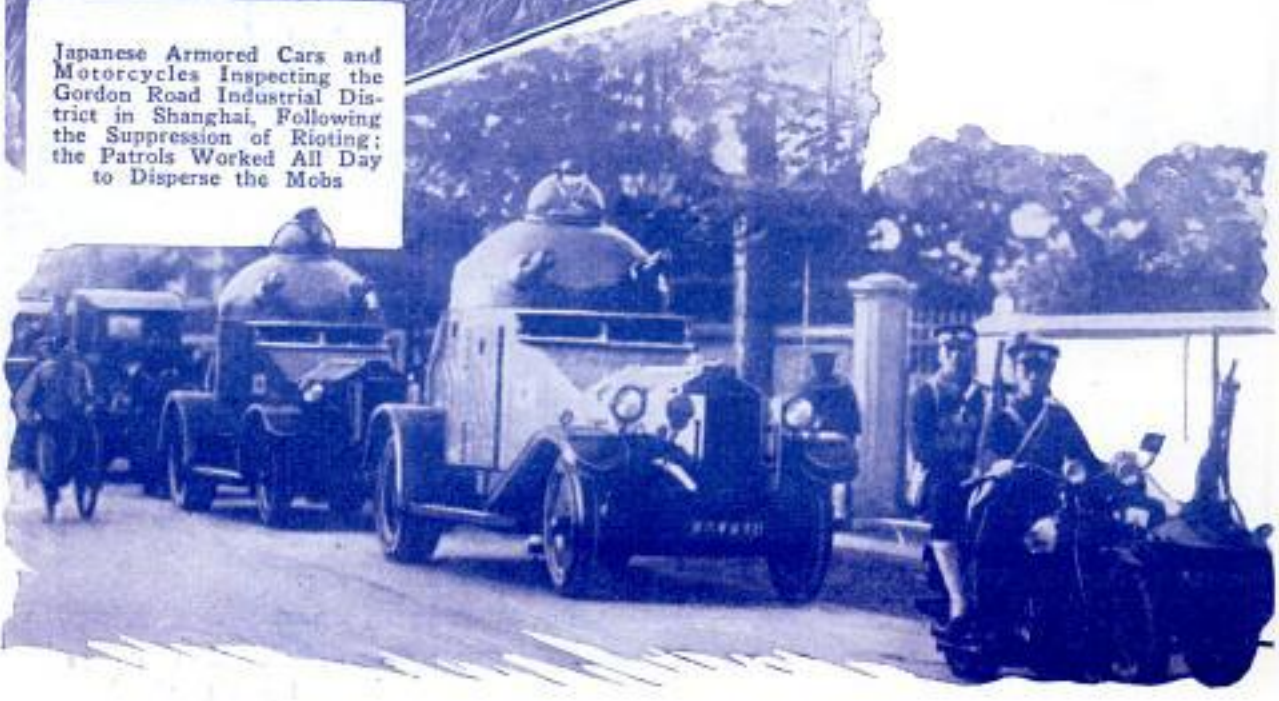



B-147



Top, Barricades, Thrown Up in Shanghai Streets by Japanese Several Years Ago, Are Placed Again, This Time by Chinese Soldiers after Bombardment of Chapei



American Sailors behind Sand-Bag Parapets and Barricades Guarding the International Settlement in Shanghai from Attack by Either Chinese or Japanese Soldiers, Above; Type of Chinese Child in the Native Section of Shanghai; It Was This Area That Suffered Almost Complete Destruction by Aerial Bombs and Fire; Right, the Navy Transport "Chaumont," Loaded with American Troops En Route for the Orient; the Thirty-First Infantry, Crack Aggregation of War Veterans, Was Sent to Shanghai aboard This Vessel to Help Protect Americans

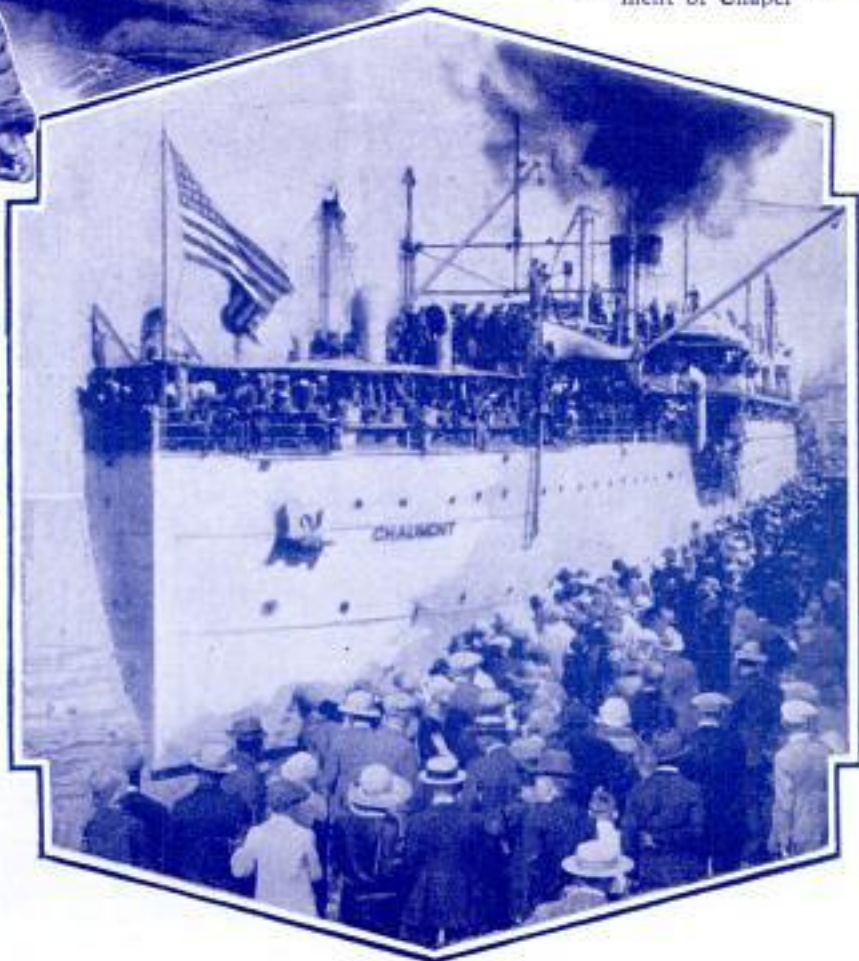



B 1477

# POPULAR MECHANICS



Japanese Officers Standing on the Walls of Chinchow Looking over This Chinese City after a Bloodless Battle during Which the Chinese Retreated as Japanese Advanced



Here Is How China Looks from the Air to Japanese Eyes; This Picture of the Walled City of Chinchow Was Taken from a Japanese Airplane After Chinese Forces Had Left





American Sailors of the Asiatic Fleet Visiting a Chinese Tea House in the Heart of Shanghai; Such Crowded Sections as This Suffered Heavy Damage in the Aerial Bombing of the Chapel District, Resulting in Fire



Japanese Soldiers along the Intensely Cold and Snow-Covered Shanhaikuan Front as They Prepare to Fire a Stokes Mortar-Type of Gun in the Drive against Bancits





Machine-Gun Squads of American Marines from the U. S. S. "Pittsburgh," Passing in Review on a Race Course at Shanghai; These and Additional American Forces Took over the Patrol of a Ten-Mile "Front" along the Boundaries of the International Settlement, to Protect Foreign Residents against Drives by Either Chinese or Japanese Combatants; at Left Are Seen American Sailors Guarding a Bridge across Soochow Creek, Which Forms a Section of the Boundary between the Settlement and the Native District of Chapei

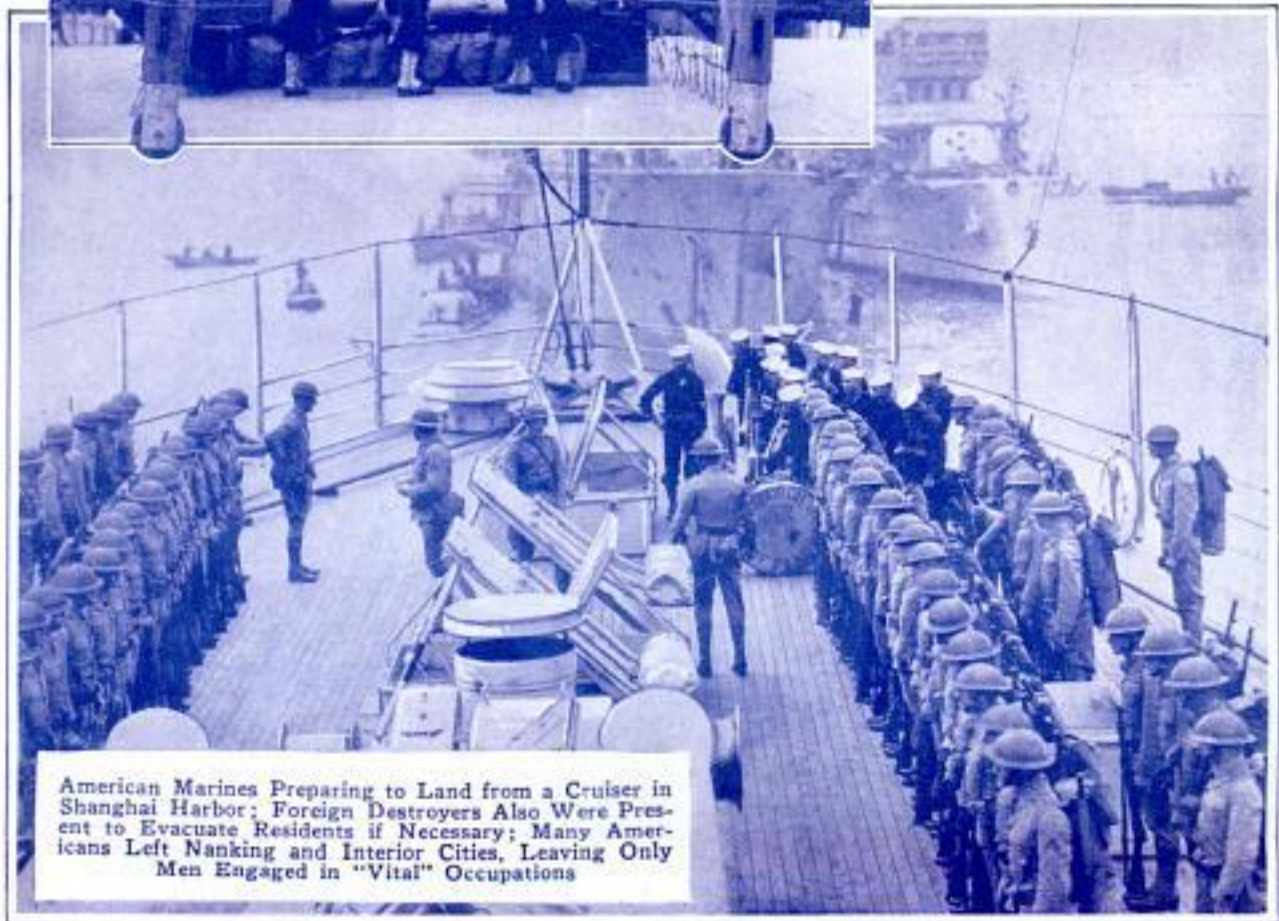

American Marines Preparing to Land from a Cruiser in Shanghai Harbor; Foreign Destroyers Also Were Present to Evacuate Residents if Necessary; Many Americans Left Nanking and Interior Cities, Leaving Only Men Engaged in "Vital" Occupations



03-147



British Soldiers Bringing a Six-Inch Howitzer by Tractor into the International Settlement Where They Have Been Quartered Since 1927. When Chiang Kai-Shek's Nationalist Forces Threatened Shanghai; American Marines, British Army Forces and Chinese Volunteer Police Guarded the Boundaries of the International Settlement as the Japanese Entered the City from the North, to Avoid Any Possibility of Conflict; at the Right Is Seen a Barricaded Outpost of "Leathernecks," Prepared to Protect Property in the Foreign Concession; Below Is Seen the U. S. Destroyer "Truxtun," Anchored off the Scarred City





03-147

Japanese Garrison at Shanhaikuan in Manchuria Standing at Attention on the Great Wall of China in a Salute to Emperor Hirohito; the Wall Separates Inner Mongolia from China



Japanese Troops Riding on the Front of a Locomotive in the Manchurian Drive Resulting in the Capture of Mukden and Territory as Far North as Tsitsihar; at the Right Is Seen a Typical Chinese Infantryman from One of the Better Equipped Divisions; in the Background Is Seen the Barbed-Wire Boundary between the Native and Foreign Quarters of Shanghai





Chinese Troops on the Siberian Frontier at Manchouli; Note the Heavily Padded Uniforms, Necessary in the Intense Cold; at Right Is Seen the Motorized or "Gasoline" Cavalry of the Japanese Army, Employed for Fast Reconnaissance Work, Advance Guards and Similar Purposes in the Manchurian Campaign; Each Motorcycle Is Armored, and Carries a Crew of Three, with Machine Gun Mounted in the Sidecar; Below Is a View of Japanese Machine Gunners Stationed on the Roof of a Dwelling in Shanghai Watching for Chinese Snipers Who Harassed the Mikado's Troops in One of the Drives on the Native City of Chapei; China Has Fought Wars with Great Britain, France and Japan in Attempts to Prevent Foreign Domination







Japanese Marines Landing in Shanghai, Wearing Nose Masks as a Guard against Possible Infection

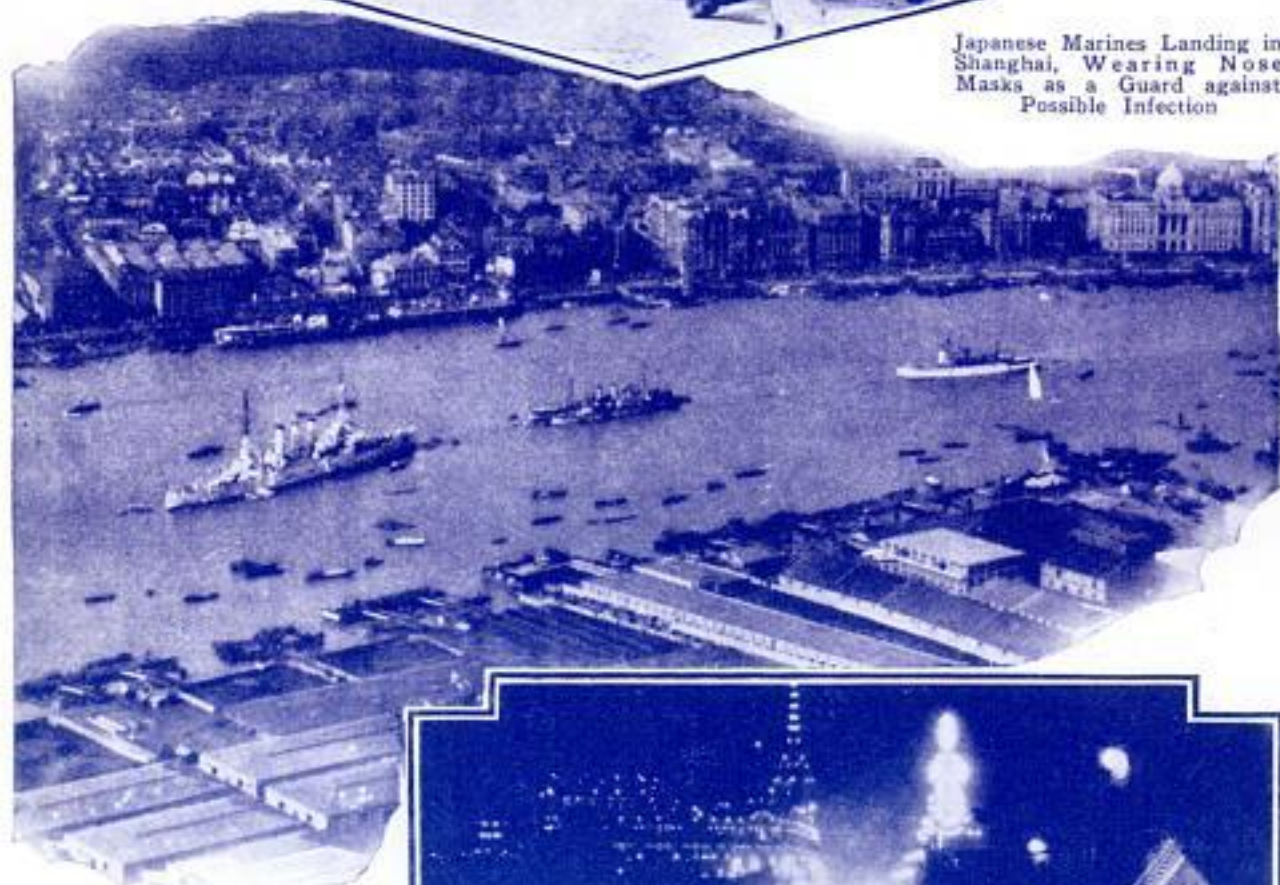

Aerial View of China's Great Seaport City, Shanghai, Showing "Man-of-War Row" in the Whangpoo River, Dividing the Native City in the Foreground from the French, British and American Foreign Settlements; Battleships of Many Nations, Including the United States, Are in the River, across Which Can Be Seen, along the Waterfront, the Bund, the Famous "Main Street" and Promenade of the Foreign Settlement; at Right Is Shanghai's Broadway, Nanking Road, a Night Photo of the Orient's Gay White Way







Below, Machine-Gun Patrol of American Marines Waiting for Orders to Take Up Patrol Position on the International Boundary; Above, United States Marines Being Given Final Inspection before Landing in Shanghai; the Thirty-First Infantry Also Was Sent to China to Back Up the "Leathernecks"; Inset Shows a British Barricade in Shanghai against Japanese Advances





03-14-17  
556



British Army Plane at Shanghai;  
Right, North Gate, Leading to  
Chapei from Shanghai; the In-  
ternational Settlement Is on This  
Side of the Gate; the Chapei Dis-  
trict Beyond Has Been the Scene  
of Intensive Struggles



Armored Cars of the Royal Tank  
Corps Lumbering through the  
British Concession at Shanghai;  
the British Took Over a Large  
Section of the International Set-  
tlement Boundary Adjoining That  
Patrolled by Americans; France  
and Italy Also Took Part



03-147



Captured Chinese Citizen, with Hands Tied, Is Seen Surrounded by His Captors Who Seek to Obtain Information; the Picture Was Taken during the Japanese Occupation of Mukden; at the Right Is a Japanese Soldier Bringing to Headquarters a Pair of Captured Chinese Bandits



Camouflaged Japanese Armored Troop Train Leaving Mukden on the Peiping-Mukden Railroad in Manchuria; Employment of Camouflage for Such Purposes Is Strongly Reminiscent of the World War to Those Residents of the Orient Who Were Engaged in That Titanic Struggle



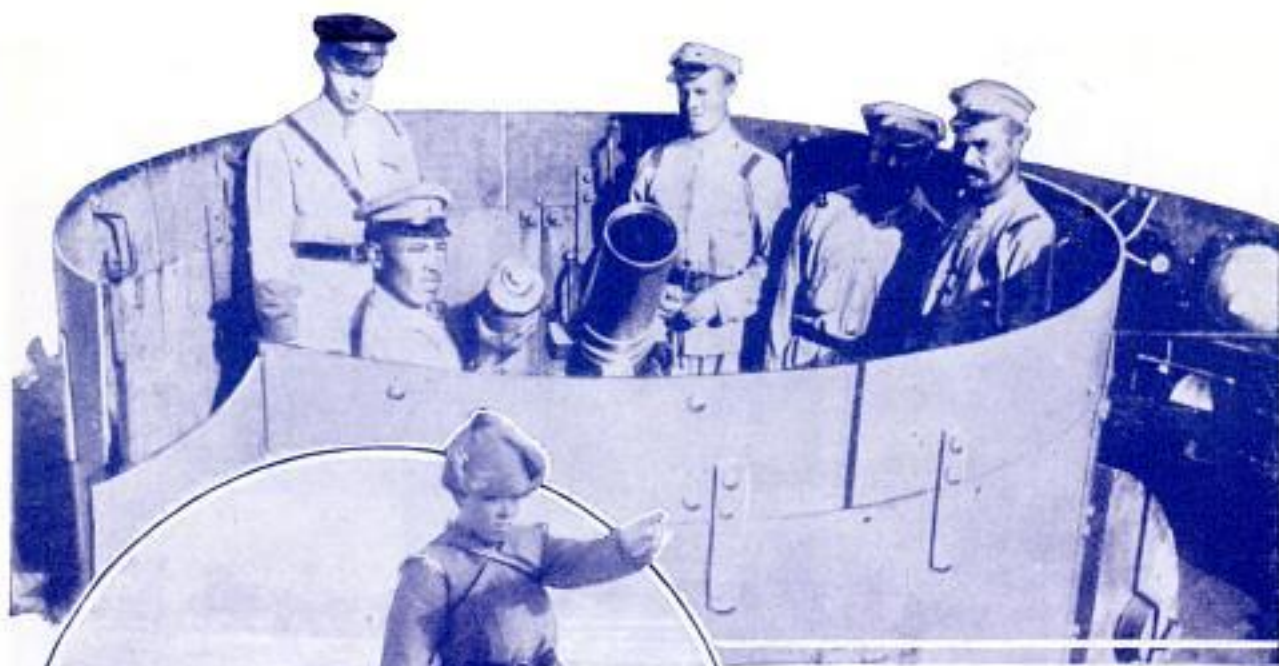

"Rub-a-Dub-Dub, Five Men in a Tub" Might Be the Title of This Picture, Showing White Russian Troops in a Curious-Looking Gun Emplacement; the Gun Apparently Is a Trench Mortar, While the Tublike Shield Is a Knockdown Type



Railway-Car Observation Posts Were Favorites with the Japanese in the Manchurian Campaign; the Photo in the Circle Shows Two Observers Scanning the Terrain from the Roof of an Armored Car as It Moves along the Peiping-Mukden Railway; Note the Near-Eskimo Uniforms; at Right Are Seen Troops of General Chang Hai-Peng, of the Chinese Army, Which for Several Weeks Opposed the Advance on Tsitsihar; Note Long-Haired Mongol Ponies





In Order to Blend with the Surrounding Country, the Japanese Camouflaged All Armored Troop Trains in the Manchurian Campaign; the Photo Above Shows One of the Trains Arriving at the Paichipao Station on the Peiping-Mukden Railway; Illustrating the Modern Methods of the Japanese, an Armored Railway Tank at Chinchow after the Japanese Occupation is Shown Below; Note Tires Strapped to the Side; These Can Be Placed on the Wheels, Converting the Tank in a Few Moments to Use on the Highway or across Country; the Rolling Fortress on the Right is a Japanese Armored Train Car

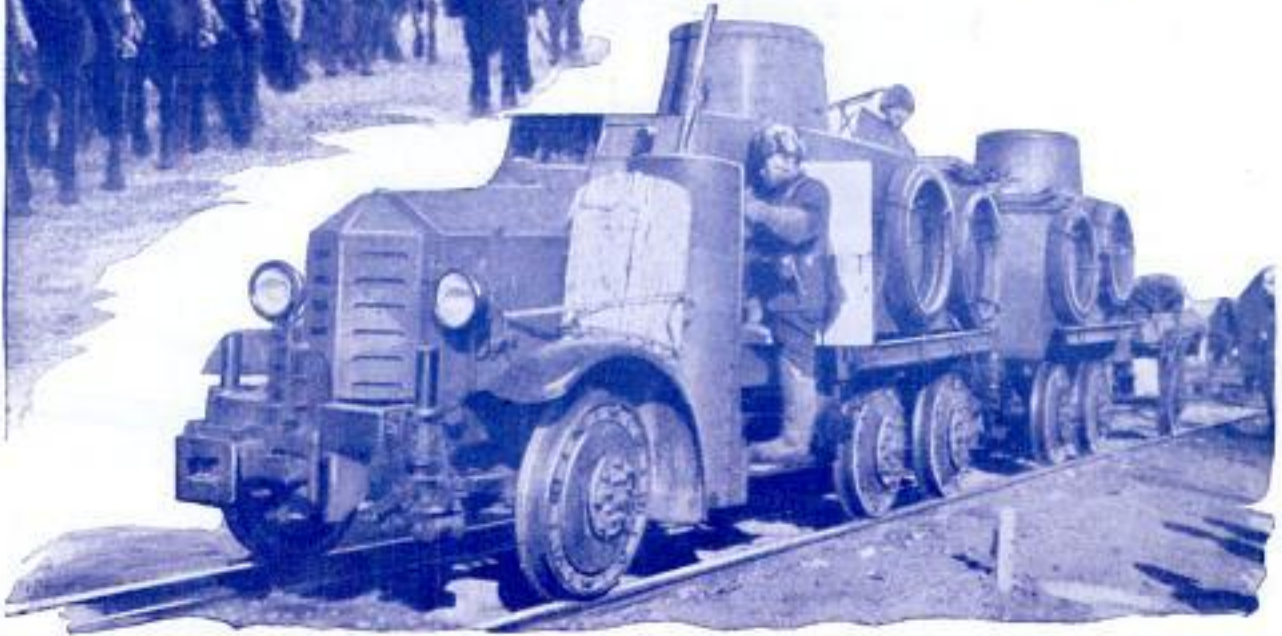



63-14-7



Accommodating an Air Fleet of 110 Planes, the Most Modern of Japanese Aircraft Carriers Are Seen at Top; They Carry Eight-Inch Guns



Japanese Aviation Officers Receiving Orders, Center; These Are the Flyers Who Made the Non-Stop Trip to Formosa; Such Men and Vessels Prove the Modernization of the Japanese Fighting Forces

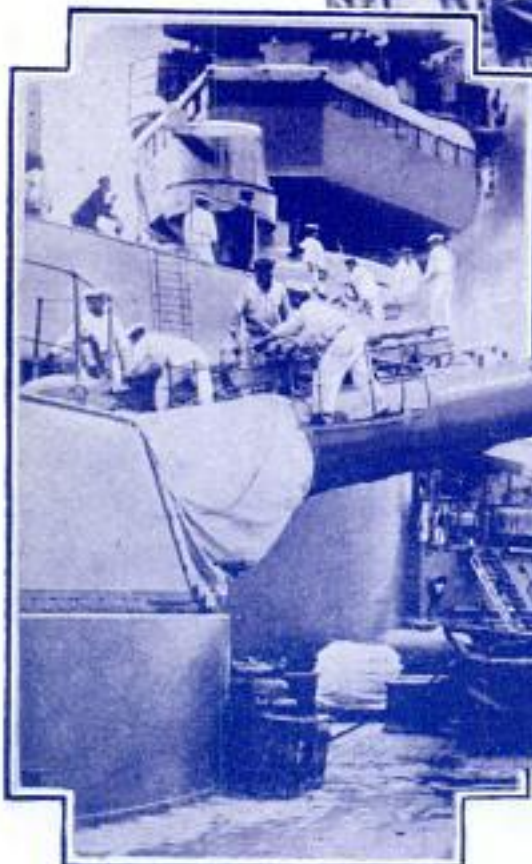

Japanese Battleship Preparing for Action; Guns Such as These Hammered the Woosung Ports at the Junction of the Whangpoo and Yangtse Rivers for Days, but Were Stubbornly Resisted by the Chinese Garrisons, Although Nothing Larger Than Old-Style Six-Inch Cannon Were Mounted There

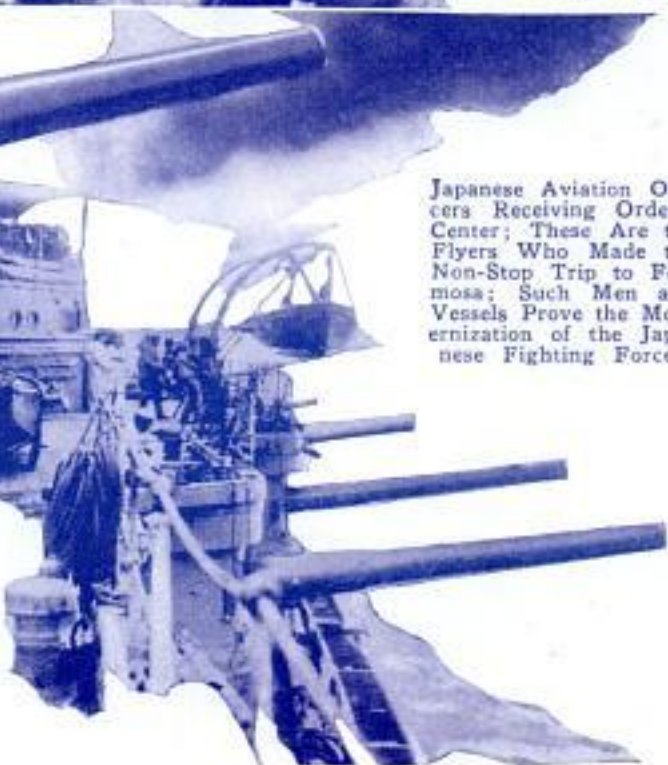



merchant marine  
statistics for 1931

B-10 1

Bureau of POPULAR MECHANICS  
Navigation B. 20  
MOTOR SHIPS SHOW BIG GAINS  
IN AMERICAN REGISTRY

Popularity of motor-driven ships has shown a steady increase since the first two were licensed in 1893, a recent report of the American merchant marine discloses. At the close of the fiscal year, 1930-31, there were 12,346 registered motor vessels of 1,053,266 gross tons, as compared with 12,124 ships, totaling 981,858 tons, at the close of the previous twelve months. The number of steam, motor and sailing ships, canal boats and barges in the American marine was 25,471, totaling 15,908,256 tons. This represents slightly more than 200 increase over the previous year, showing that most of the additions during the period were of the motor-driven type.

used in building of  
Syracuse  
lighting Co  
Syracuse  
N.Y.



Corning Glass Works and  
Corning Inc  
Corning, N.Y.

Transparent Glass Brick Like Those Used in Interior of Building to Improve Lighting

PAINTED CIRCUS ON TRUCK  
B. 7 ATTRACTS CROWDS

Galloping circus animals, painted on the sides of a truck and double trailer, attract the attention of children and grown-ups alike as the big truck and its burden of baby food roll over the highways between Fremont, Mich., and Chicago. The outfit with its animal decorations consists of a truck, semi-trailer and rear trailer with an over-all length of fifty-eight feet, a weight of 28,000 pounds and a load capacity of 50,000 pounds. Eighteen wheels carry the burden, and the cab is equipped with a bed and has room for four persons, including two, and often three, drivers. The trailers are fastened with heavy hooks and also with chains, and the truck is equipped with a sander to blow grit under the wheels whenever the train encounters slippery road conditions.

SOLID-GLASS BRICKS TRANSMIT  
VARIED LIGHTING EFFECTS

Bricks made entirely of transparent glass are used in the construction of an office building in Syracuse, N. Y. The bricks are said to be as strong as steel, but their main purpose is to make possible modernistic lighting effects which could not be done without transparent material.

BALLOONS TO SOAR TEN MILES  
FOR DATA ON COSMIC RAY B-188

Small balloons carrying delicate measuring instruments are soon to be sent ten miles above the earth, and from the data brought back, man may find out whether he is living in a universe that is dying or in one that is growing. Dr. Robert A. Millikan, famous physicist, wants to find out whether these rays have their origin in the building up of the universe, or signal its destruction, as held by Sir James Jeans, while he believes they originate in the formation of matter because they are unaffected by the sun, which could not be true in the opposite case.



Truck and Trailer Decorated with Galloping Circus Animals; the Painted Scenes Are Used to Attract the Attention of Children

Fremont Canning Co  
Fremont, Mich

California Institute  
of Technology  
Pasadena Calif



# CATCH

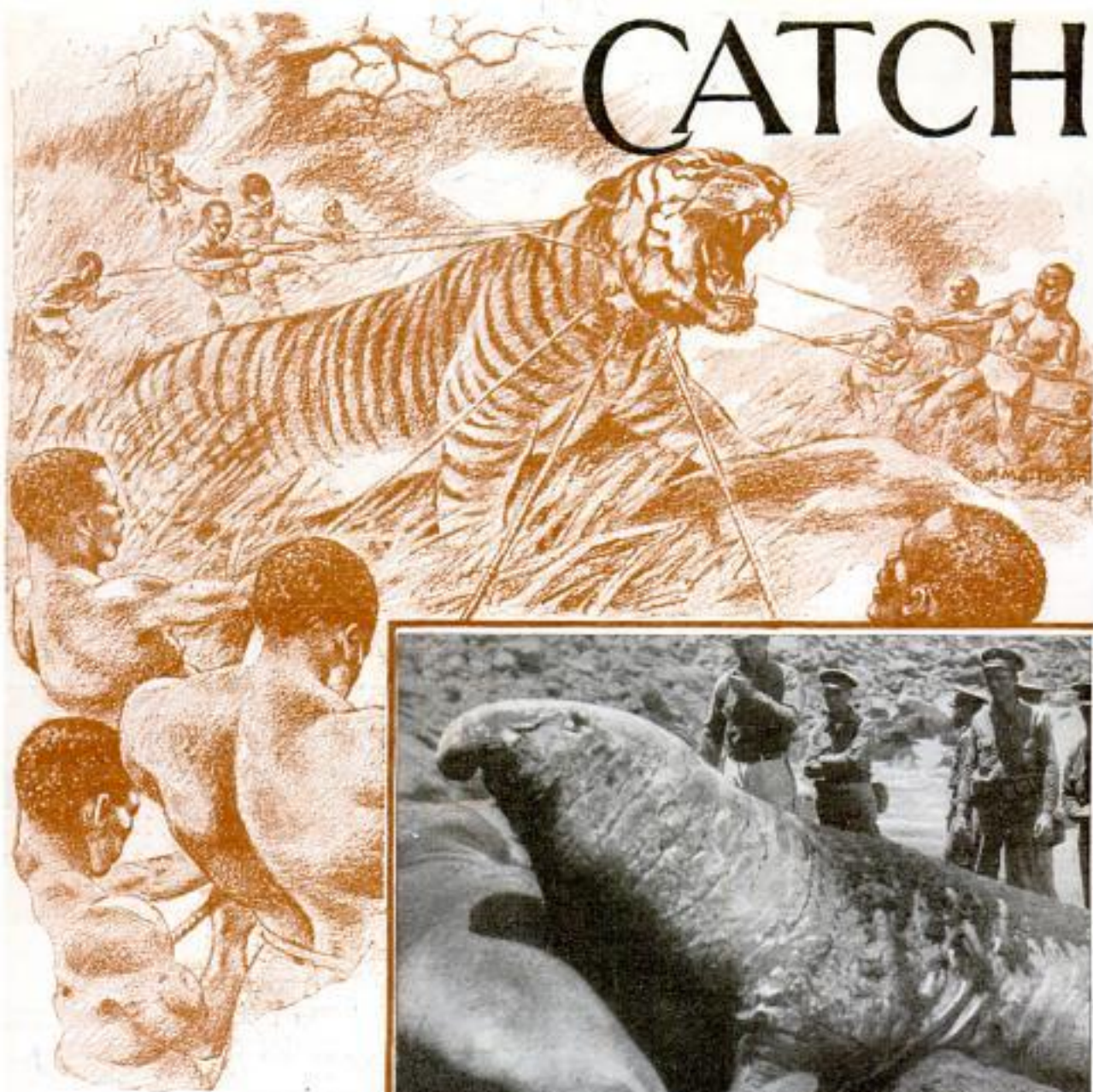

Right. Sea Elephant on Guadalupe Island off the Coast of California

**T**HE majority of visitors to zoological gardens are usually so interested in the animals themselves that they forget all about the untold dangers that have, in many cases, been encountered by the men who made the captures possible.

Supplying of zoos and menageries with suitable inhabitants is a highly specialized business. At the great ports of Europe, such as London, Liverpool, Marseilles and Hamburg, you will find recognized animal dealers who trade in this curious merchandise. Their depots are nothing more than vast animal emporiums, where you can purchase all kinds of beasts and birds,

just as you can buy a suit of clothes or a hat from the big stores.

Some of these dealers send out their own men to hunt and trap the animals, and will even organize special expeditions to secure the rarer species. Then there are the animal hunters who work independently, for the most part British sportsmen. These men will lose themselves in the bush for months at a time and then turn up with their caravans and dispose of their catches to agents in Nairobi, Khartoum, Stanleyville and Salisbury in Africa, Singapore in





# 'EM ALIVE-O!

Trapping Wild Animals for the  
Zoos of the World — Behind the  
Scenes in a Dangerous but  
Profitable Industry

By

Harold J. Shepstone Esq.

139, Broomwood Road,  
Clapham Common,  
West Side

London  
S.W. 11  
England

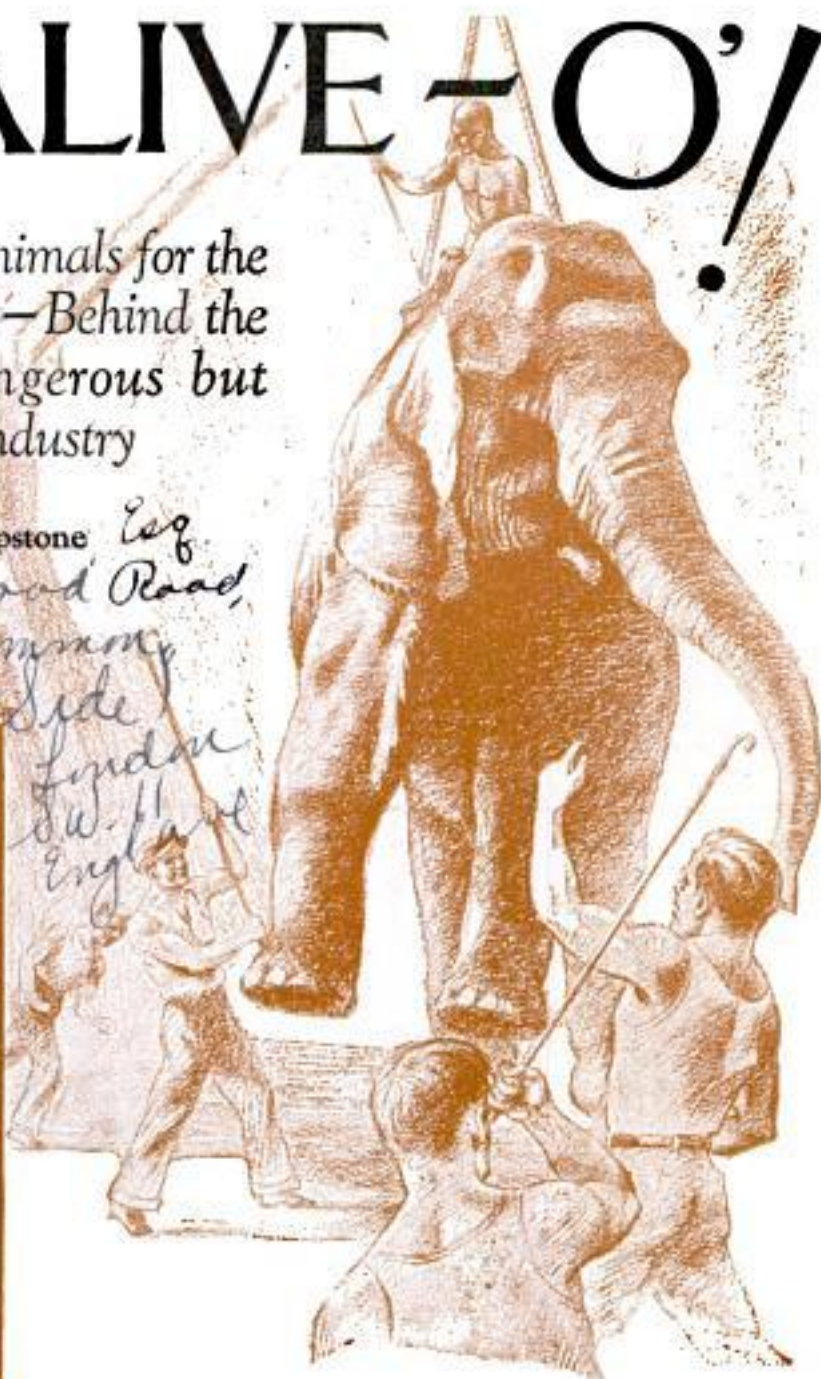

the Malay states, Calcutta in India, and so on. These agents, in turn, sell the animals to the dealers in Europe or to the zoos direct.

Those who imagine that catching wild creatures of the forest and plain is a fairly simple matter should remember that, after securing his quarry, the animal hunter has to transport it alive for many hundreds of miles, often across trackless and practically unexplored country. A dead beast is of no use to him. The big-game trapper's gun is for use only in the last emergency, and on numerous occasions men have sacrificed their lives because

they refrained too long from using the rifle.

Naturally, it is the rarer species, such as the okapi, rhinoceros, hippopotamus, giraffe, boschbok and gorilla that the dealers most prize. And here a word of explanation is necessary. A traveler returning from the wilds of Africa will tell you how he detected hippos floating down the streams and spotted giraffes on the horizon; he will also relate to you how many had been shot in the district only a short while before by some famous sportsman. Yet, if you wished to procure a live okapi today, which is only to be found in the





birth? The reason is simple. No hunter would dream of trying to capture a full-grown hippo or rhino. Indeed, it would be practically impossible to hold such an animal, and, even were it possible to entice one into a cage, it would probably only kill itself in its frenzied efforts to escape, or refuse to eat, and so die of starvation.

This applies to nearly all the bigger species of wild life. Captured adults will die of a broken heart, apart from the fact of the difficulty of transporting them. A full-grown adult hippo will turn the scale at from two to three tons, not a light weight to be conveyed across rough country. What the hunter endeavors to do, therefore, is to secure the young



Feeding Animals on Board Ship on Way to Dealer's Depot; the Boat Trip Is Always a Hazard for the Trapper

depths of the mysterious Congo forests, you would probably have to pay \$10,000, or even more. The recognized market price of a rhinoceros is \$6,000, a hippopotamus \$5,000, a giraffe \$3,000 to \$3,500, and other animals in proportion, according to their rarity and the difficulty of taking them alive. Why, one may well ask, this enormous price for a single specimen of these creatures when they appear to be fairly plentiful in the land of their



ones. This he does by hunting along the river banks until he happens to discover a female hippo and her young. The thing then is to capture the calf.

Fully three-fourths of the hippos for-



merly brought to Europe were secured by the Havati or water-hunters of the Sudan by means of the harpoon. A special kind of weapon was used, fashioned in such a way that it did not make a deep wound. Not only were hippos taken in this way, but also crocodiles. Happily this undoubtedly cruel method is a thing of the past, and the plan now followed by the modern collector is to trap young hippos in nets after frightening the mother away.

Next comes the feeding of the prize. Now a baby hippo will drink fifteen pints of milk a day and bellow for more. The nutriment is supplied by goats, which have to be brought along with the expedition. This means, of course, that the hunter's caravan is an unwieldy affair, and can only move across country very slowly.

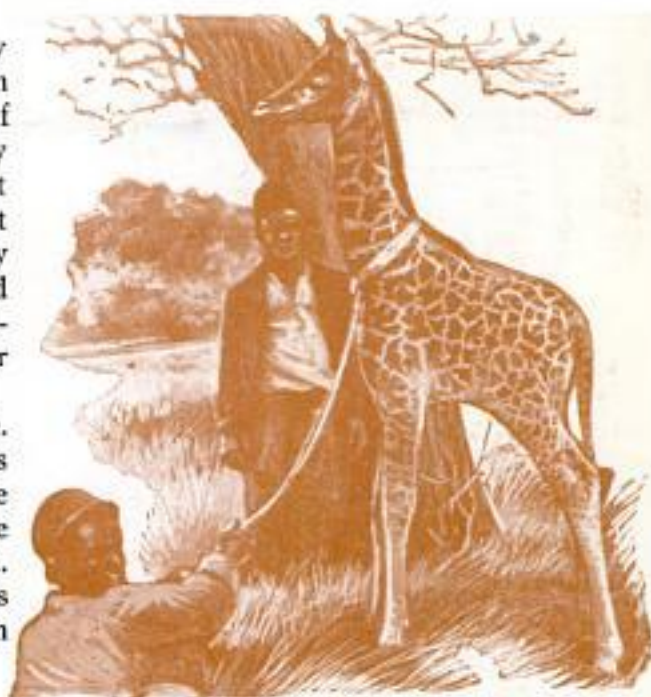

Above, a Newly Caught Giraffe; Below, Taking a Recently Captured Elephant to Water with the Rest of the Herd, to Induce Him to Drink

In catching giraffes, the hunter engages only natives who are expert horsemen; he may recruit as few as a dozen or a couple of hundred. Scouts are sent out until a herd is sighted, and then off go the natives on their speedy Abyssinian ponies. Having come up with the herd, with yells and shouts they dash toward the animals. Frightened out of their wits by the din, the long-necked creatures turn and bolt for dear life. For

some time the chase is kept up at furious speed until, one by one, the young ones fall behind exhausted. Instantly these are cut off from the others by a couple of men on horseback, and headed toward the camp, soon becoming entirely exhausted and falling easy preys to their captors. Halters are then fastened round their heads, and they are led to the camp. They are fed principally on goats' milk, corn, and various kinds of green stuff.

While it is true to say that many animals, when first captured, experience a period of fear and uncertainty as to their



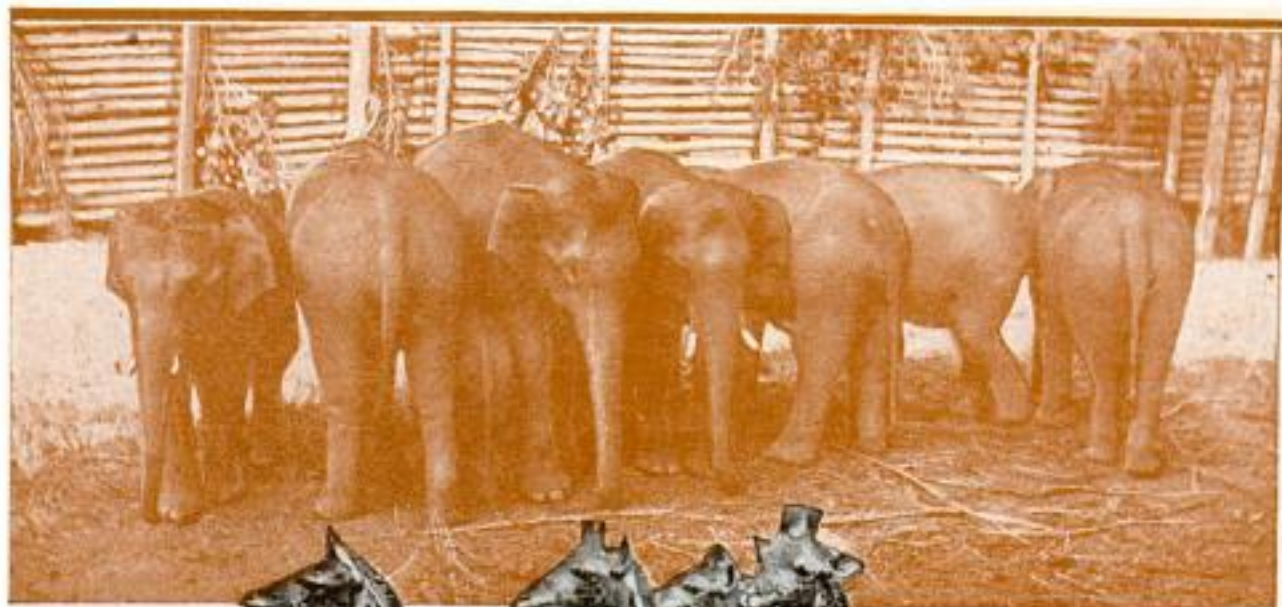

Above, Young Elephants That Have Become Accustomed to Captivity; Right, Four Giraffes Separated from a Herd and Captured Simultaneously



These men track the lioness to her den, rushing in suddenly and raining spears upon her till she is dead.

Sometimes, when the cub hunters visit a den, they find both parents away, and their task is easy. Should the mother then return, however, there is at once a fierce fight, and unless she is quickly overpowered, it goes hard with the natives.

There is no creature

fate, they soon realize that their captor is their friend, and, if well fed and cared for, quickly settle down to life in captivity. Curiously enough, the big cats, such as lions, tigers and

more fierce than one of these big cats when it comes to protecting her young, and the cries of the infuriated mother will sometimes bring her mate to the scene, and an enraged male lion strikes terror to the stoutest heart.

Lions vary very much in price, ranging from as low as \$250 to \$500 and more apiece. The finest lions were those obtained from the Atlas mountains, in north Africa, but this species is now practically extinct. Then we have the black-maned lion, seldom seen in captivity. Its mane is a jet-black, which is said to turn grey as the animal grows old.

Tigers are captured as cubs and also when fully grown; often the animal hunter, to the delight of the natives, will en-



leopards, do not give the hunter so much trouble as some of the hoofed animals. In the case of lions, they are mostly taken when cubs. This work is done by the natives; the collector merely tells them that he is wanting lions, and in a short time they return with the desired number.





Above, Wild Zebras at a Watering Place; Left, Transporting an Untamed Elephant from the Docks to the Zoo Requires Plenty of Horsepower



trap some much dreaded man-eater. Tigers are caught in large pitfalls, and various methods of securing the animals when once they are in the pit are practiced. In some cases, a strong wooden trap is fixed in the pit, and when the animal falls through the lightly covered mesh at the top, it traps and cages itself automatically. In others, it merely falls into a big hole, and has to be secured and dragged out by ropes.

In certain parts of India, the natives are so daring that they will place a collar, from which hang a number of twenty-foot ropes, round the neck of a newly caught tiger. To the end of each, a man will hang for dear life, and by pulling against each other guide the infuriated brute along the path they wish it to follow. In this way, they literally walk the

tiger to market.

Monkeys and the smaller apes are caught in specially constructed traps.

These are, as a rule, set up near the waterhole which the creatures are in the habit of frequenting. There is a ready market for young chimpanzees, from \$250 to as much as \$500 being given for them. The only drawback with these creatures is that they are liable to succumb to lung troubles. It is the same with the gorilla. They usually live only a few months.

There is probably no calling where attention to little details is so essential or disaster will result. When a dealer sends out an expedition, he is never sure of what the result will be. He may reap a fortune or he may lose heavily.



*B. U. Howell,  
180 Lachmout  
Avery*

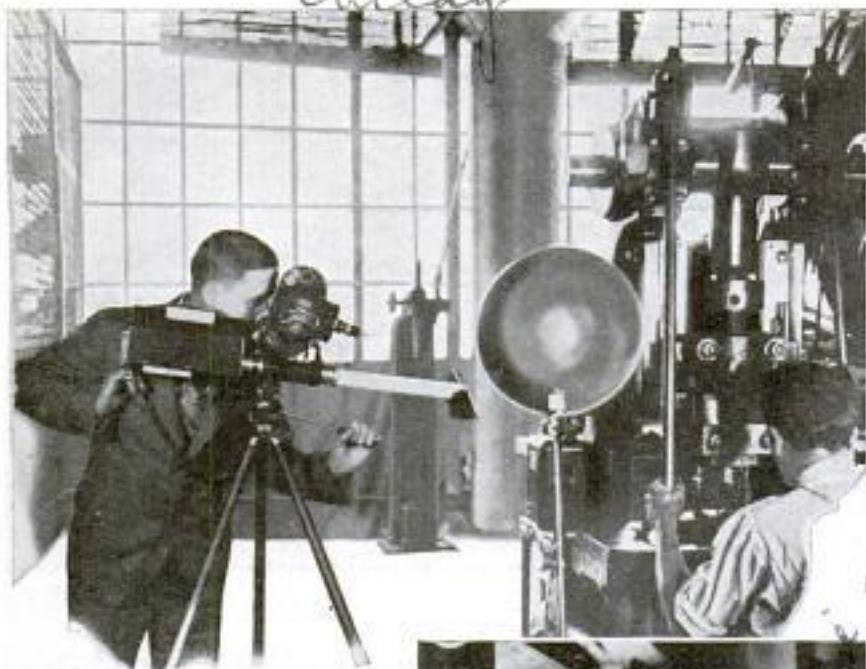

Taking Time Movies of Factory Operators at Work; Right, Record as It Appears on the Film

### MOVIE CAMERA HAS STOP WATCH TO TIME WORKERS

Time and motion study by industrial engineers is aided by motion pictures. Movies of this sort sometimes are photographed with a stop clock appearing in the picture, but the best results often are not obtained because the worker becomes "clock-conscious" and may not work at his natural speed. To solve this problem, a new apparatus containing a lamp, stop watch and record card is attached to the base of the camera. The images of the watch and card pass through a series of lenses, which can be calibrated by the operator to correspond with the camera focusing dial, and appear on each frame of the movie film.

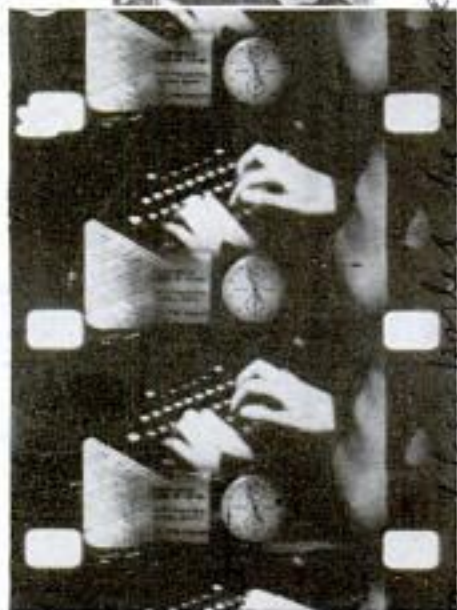

\$3,400 and education at \$50, the latter figure including only minor items met by parents, as public-school education is covered in shelter in the form of taxes included in rent. Health expense is placed at \$284, recreation at \$130, insurance at \$54 and sundries at \$570, bringing the total to \$7,238, based on expenditures of an average family whose earnings total \$2,500 a year.

*B-129* *see note*  
**GLASS AND CHINA SUBSTITUTE IS UNBREAKABLE**

An unbreakable substitute for glass and porcelain called "festellan" has been developed as a by-product of an insulation plant at Henningsdorf, Germany. The material, which can be colored by the addition of dyes comes in the form of an amberlike powder. It is heated in steel molds and placed under high pressure until it is made fluid when it will fill the tiniest cavities in the mold.

It solidifies in a few moments, and when the mold is removed, it appears as a hard, almost insoluble and non-fusible mass with a smooth, mirrorlike surface which needs no finishing treatment. Not only can the material be colored in all the shades of the scale, but several colors at the same time can be employed. Tests have shown the material to be water, acid and heat-proof, and it is such a poor heat conductor that a vessel of festellan filled with a hot liquid remains cool on the outside. All kinds of dishes and utensils are being manufactured of it, as well as many other objects, ornamental or useful.

### RAISING CHILD COSTS PARENTS SEVEN THOUSAND DOLLARS

Raising an average child in an average home from birth until it is eighteen years old costs about \$7,200, according to estimates prepared by an insurance company. The cost of being born is placed at \$250, food at \$2,500, clothing and shelter at

*B-147*

*Metropolitan Life  
New York*

*Camera for study of high duty  
Hardoll recording the same*

*Registered Owner*  
A gasoline pump for the auto-service station prints a receipt for the customer and keeps a record for the vender.

*Welding & Supply Co  
1110 Uichinola  
Cincinnati, Ohio*

*General Electric  
Electrothe  
Allyment  
no P's agent*



Thos. & Lyona, Ass't. B 80

Chief, Transportation

POPULAR MECHANICS

Chief, Dept of Commerce

OIL PAPER STOPS SHRINKING OF APPLES B-203

Oiled paper is being used in Switzerland to prevent apples in storage from shrinking. Experiments were made both in ventilated and unventilated cellars, and it was found the fruit kept best in the former. The apples were placed in boxes and covered with oil-paper scraps, but it is more advantageous to wrap each separately. Previously, the apples were packed in ground peat which was unsatisfactory because it stuck to the fruit.



Four-Masted Bark with Giant Auxiliary Motor; Rigging on All Four Masts Is Operated Electrically

*Friedrich Krueger works Kiel, Germany*

FLOATING BRICKS ARE MOISTURE PROOF B-86

Bricks so buoyant they will float in water and requiring only twelve hours, instead of three weeks, to make have been produced recently. Although as light as wood, they are both water and fireproof, hence no insulation against moisture is needed in the walls of buildings constructed with them. Because they are light, they can be laid faster than ordinary bricks, and the cost of constructing a house with them is slightly less than for the same building made of wood. They are made of clay in any desired shape, either smooth or rough finish, and can be sawed. It is claimed they are virtually indestructible.

"ELECTRIC SAILORS" MAN YACHT THAT HAS FOUR MASTS

Built in Germany for an American yachting enthusiast, a four-masted bark with a sail spread of about 35,000 square feet has recently been completed. The sails are manned by electricity. In addition to the four masts, the ship is equipped with four generators, each coupled with an 800-horsepower Diesel engine, to supply power for a giant electric auxiliary motor. If the sails are employed to drive the vessel, it is possible, through an ingenious arrangement, to reduce the resistance by letting the propellers run.

*Will not be a market for year*



Brick So Light It Floats in Water; It Is Made of Clay and Is Waterproof and Fireproof

JUG OF WATER STARTS A FIRE B-205

Water is probably the last thing most persons would consider as a fire hazard, but a five-gallon bottle of drinking water recently set fire to a California home. The glass container had been set outside the house two hours before the blaze started. Rays of the sun were focused by it on the wall, finally creating heat intense enough to ignite the wood.

*Los Angeles Daily News 1/22/02*

*perfected by Dr. C. J. Burgess Burgess Laboratories, Madison, Wc*

*Dr. I. S. I sawed, 1536 Loma Vista, Hermosa Beach Calif*



a 1159. Cont. Carl W. Isage  
Asheville N.C.

# Tricks of PACKING

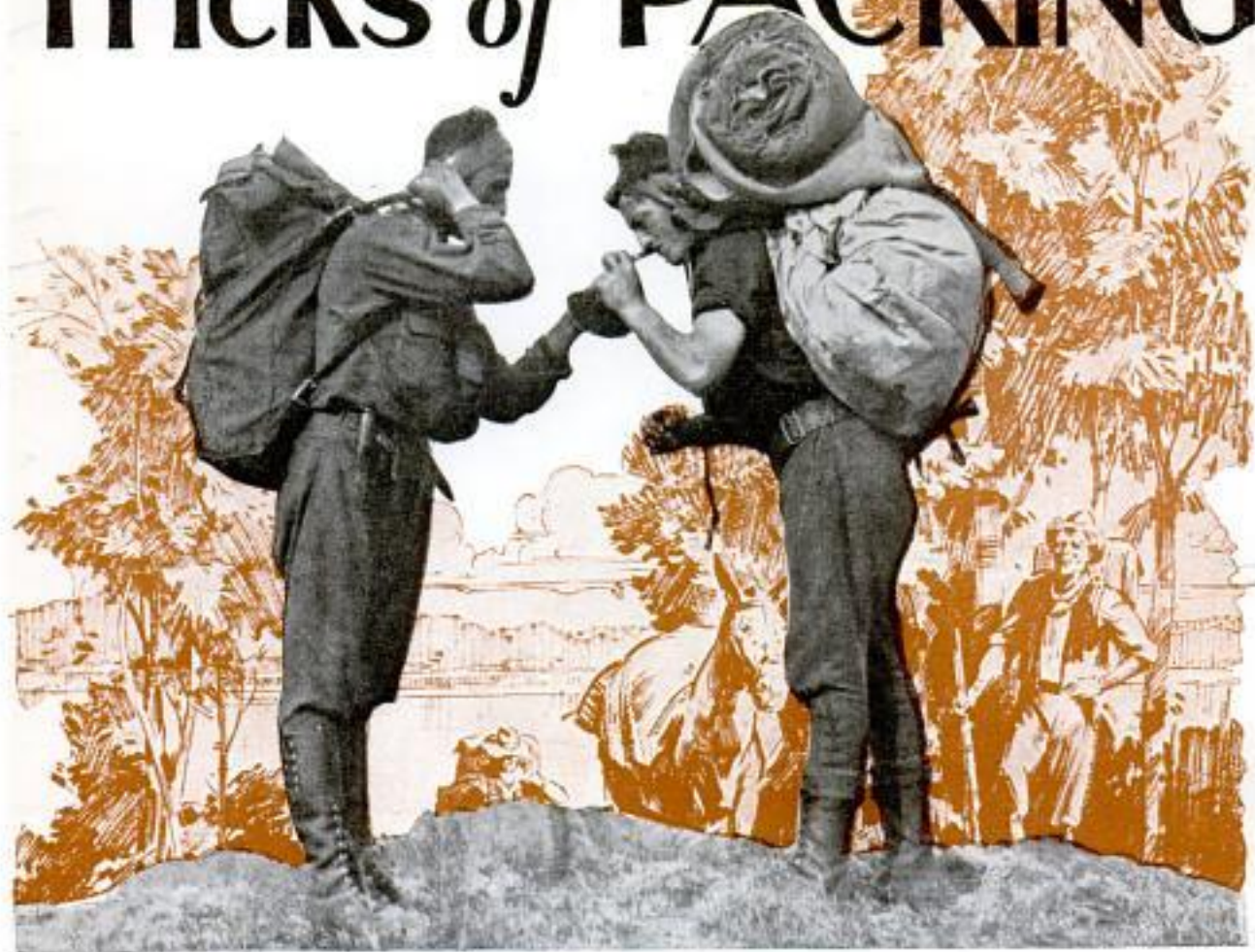

Hunters in Quebec Demonstrating the Proper Method of Packing Supplies; They Are Using Canvas Sacks and the Bedding Roll Is Held with the Aid of a Head Strap

"**C**ARRY what you need easily," is the slogan of the veteran outdoor man, who uses several tricks unknown to the amateur, to tote his load of equipment and food supplies. Every day in the year, hunters, campers, surveyors, woodsmen, trappers and scientists somewhere turn their backs on civilization and follow the ancient trails, packing supplies to last several days, weeks or months.

Man packing is most difficult and arduous, but is made easy by use of the canvas sack with straps. Used high on the back, larger loads are toted comfortably. Extra clothing and personal equipment are best carried in a heavy canvas duffle bag, fitted with a loop or handle at one end and with another at the side; the top has an inside waterproof hood, and the bag is closed with a drawstring or bar lock passed through the eyelets at the open end.

The pack board also is widely used.

This has a flat wooden frame with shoulder straps. The load is lashed to it or suspended in a sack into which the frame is built. One of the commonest devices, if used with some skill, is the old-timers' bedroll and straps. The blanket is folded lengthwise, about two feet wide, with the edges lapping over the food and small articles first laid compactly in the center near one end. The roll is begun at this end, producing a cylindrical bundle with all hard articles in the center. Straps or cords around each end hold this firm, and to these the shoulder straps are attached, together at the top and separated a foot or more at the bottom to prevent swaying.

Gunnysack and overalls furnish a variant of the above, actually preferred by many. The leg bottoms of a pair of old soft overalls are tied to the bottom corners of a gunnysack with a chip or pebble in each corner so the string will not slip off. The





load is placed in the sack, the top of which is then brought as close to the load as possible and there lashed with a string to the overalls gathered exactly at the crotch, the legs forming the shoulder straps.

It is best always to use a method of suspending even a light pack from both shoulders. Anything on one shoulder, even a long slender blanket roll, is uncomfortable. Be sure that the straps are not too wide, narrow, tight, loose or hard. Keep the pack as high as you can without binding arms or chest, or it will tire the back by swaying. Packers avoid non-essentials and duplicate articles in a party. Anything above thirty-five or forty pounds is too heavy. A four-day trip may be made comfortably with less than thirty pounds per man.

One of the secrets of man packing is to carry the load high. The tump line is fastened around the bottom load, the sweat band crossing the forehead, and the straps must be carefully arranged so as to prevent excessive neck strain. Usually there are additional loops for the arms.

The character of the country determines the manner of transport. If it is low and swampy, a winter party might travel bet-



Ready for the Hunting Trip with a Burro Carrying the Load, Evenly Distributed on the Animal's Back

ter by use of dogs and toboggans. If the country has sufficient hay and not too much bog and swamp, the pack horse solves the problem. A dog can be depended on to haul 100 pounds twenty miles a day over bush trails, while, on a level stretch, a five-dog team can pull as much

Here Is the Proper Way to Portage, Showing an Easy Method of Carrying the Canoe





51159  
572

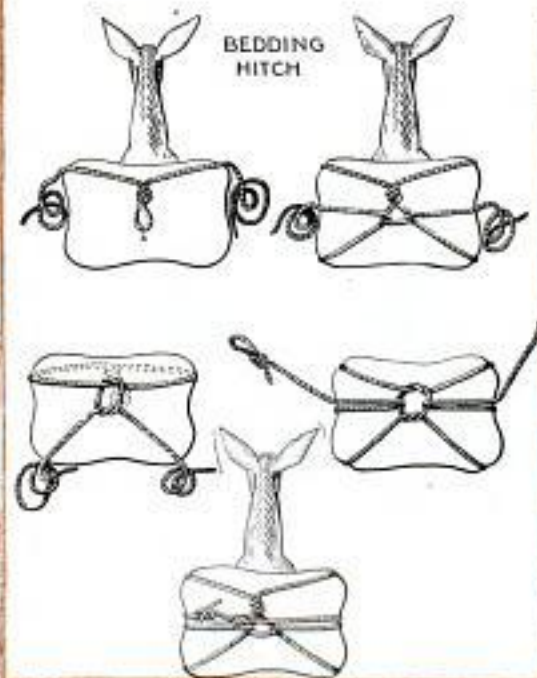
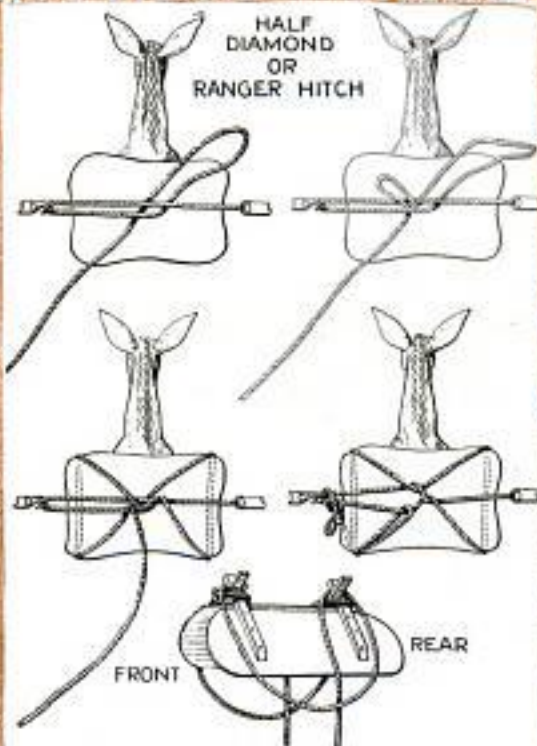
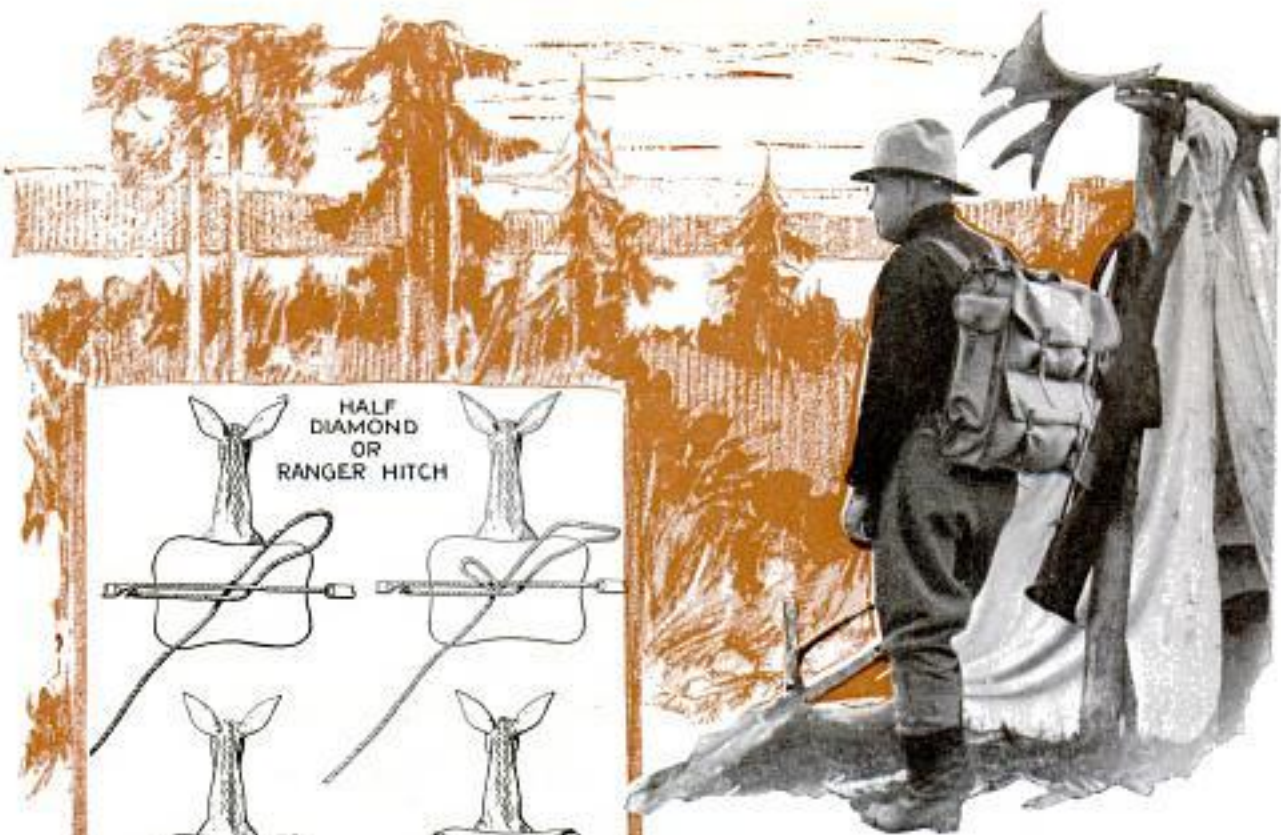

as 750 pounds. A pack horse carries from 100 to 250 pounds, depending on the animal, trail and distance.

The pack horse knows how to negotiate a muskeg, leaping from clump to clump; how to cross narrow, swaying bridges; what distance is needed between tree trunks to let him pass with the pack, and when you have picked up a stick to shy at him. The pack saddle is firmly cinched to the horse, portions of the outfit suspended on it, and the whole secured by a rope with a cinch attached which is so tied as to bind the load to the horse. The usual pack saddle is a sawbuck, consisting of two back plates, to which low cross-trees are bolted in place of horn and cantle. Pack saddles should be double rig, with breast pad and crupper or breeching. The articles, save bedding and bulkier pieces, are tied in sacks, which are suspended from the saddle by sling ropes.

In slinging the load, two half-hitches are taken in the middle of the rope and

Top, Canvas Packsack Slung Too Low on Back for Comfort; at Left, Packing Hitches Are Illustrated



a1159



Hunters Breaking Camp after a Night's Rest and Packing for the Day's Journey; the Load Is Distributed Carefully Among Men and Beasts

dropped over the front crosstree. The ends are then looped over the rear crosstree to form the slings, which are adjusted to the proper position and kept there by taking a turn with the ends around the sling loop. When both side packs have been slung, the ends of the rope are tied together across the center of the saddle.

Then the sacks are piled on. The bedding may be rolled up, forming a bundle, or it may be folded once and spread across the pack. Long, slender articles, like fishing rods, shovels and rifles go on top. "Kyacks"—sacks furnished with a pair of loops to hook over the crosstrees—are especially useful for packing many loose articles. It is important that the two sides of the pack are evenly balanced. If the weight cannot be balanced, the heavier side should be slung higher. Make the load fast by use of the cinch or lash rope. The diamond hitch has no equal, but it is difficult to remember. The one-man, squaw, or Basco hitches are best for ordinary purposes. One of the simplest may be thrown single-handed, and is illustrated. This is known as the half-diamond or rangers' hitch.

The bedding hitch, also shown, may be used to pack bedding and cooking utensils, neither pack saddle nor cinch rope being required. The bedding is folded and

laid full length across the riding saddle, the loose articles placed on top beneath outer layers of bedding, and the hitch thrown as illustrated. This hitch forms a triangle on top of the pack and a diamond on the underside. If carefully thrown, it may be drawn very tight without danger of injury to the horse.

Canoe transportation is the best of all packing methods, if there are not too many portages. An eighteen-foot freighter, loaded high above the gunwales, carries as much as four or five horses. A twelve-hour paddle against a headwind is a small matter to the veteran. A ducking is all in the day's work. Only when rapids or falls bar the way, or the lake comes to an end, calling for man portaging, is the weakness of canoe travel known. Then each man carries his full share, often more, across the trail, be it a sheet-iron stove, dunnage bag, cooking kit or tents, weighing anywhere from 100 pounds on a long hard trail, to twice that on an easy short one.

Portaging the canoe is an art. The average bark, cedar or canvas-covered canoe can be carried by one man under the middle thwart easier than by two. Lacking the middle bar, the paddles are lashed lengthwise to the thwarts and far enough apart to admit his head.



# Adventure School for Tomorrow's Explorers

How to explore unknown regions is being taught students in the only school of its kind, the Institute of Geographical Exploration, at Harvard University. The school instructs the student in the leadership of exploring expeditions, or the student may concentrate on one particular branch of exploration work with the view

*Cambridge, Mass*

Record Wind Vane, at Right, Aids in Weather Forecasts; Left, Below, Student Studies Compasses; Right, Below, Recorder for Checking Wind Velocity and Direction

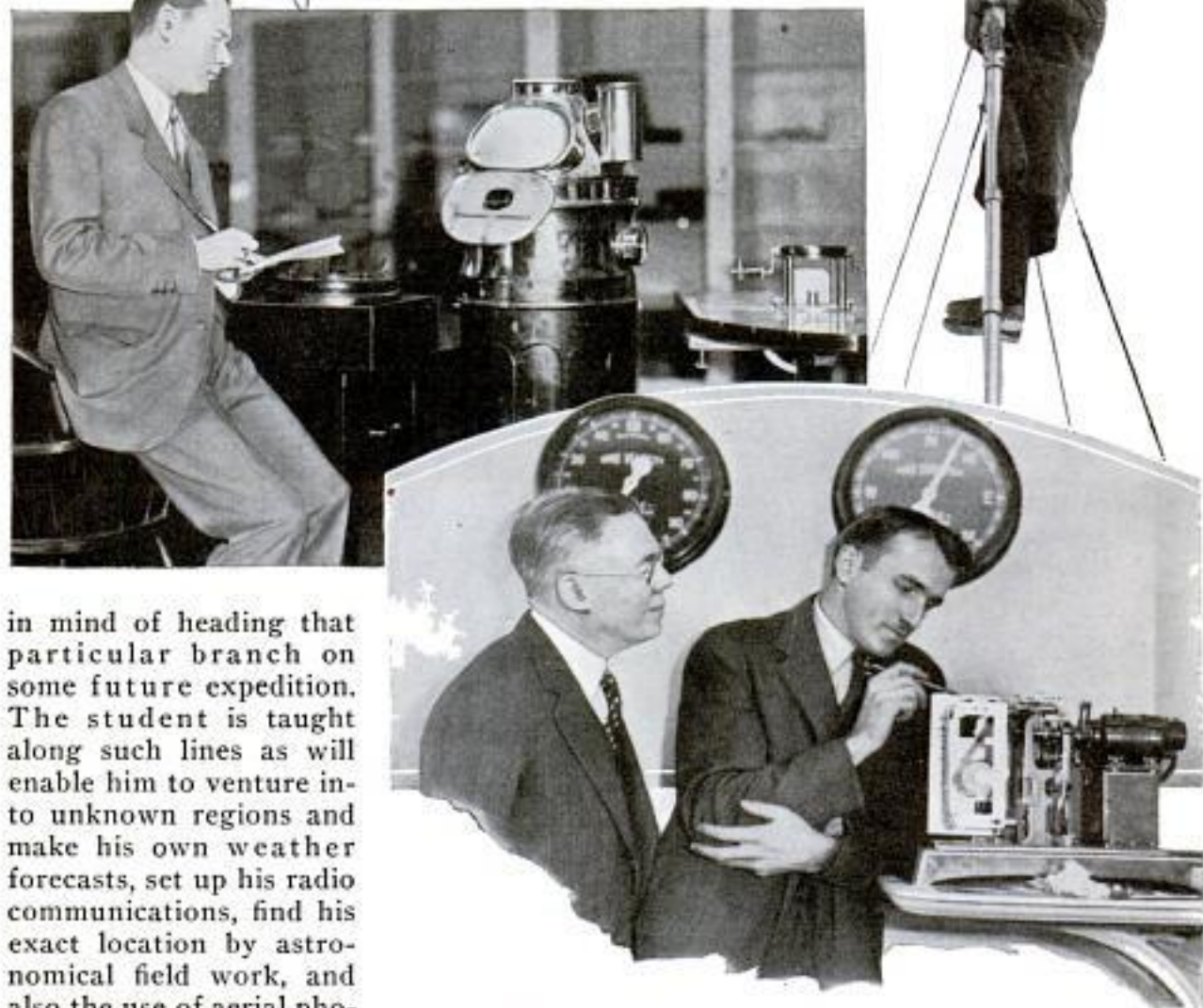

in mind of heading that particular branch on some future expedition. The student is taught along such lines as will enable him to venture into unknown regions and make his own weather forecasts, set up his radio communications, find his exact location by astronomical field work, and also the use of aerial photography for mapping. Dr. Alexander Hamilton Rice, noted explorer, is director.

B-155

## CEMENT-MORTAR PIPE COATING PROTECTS FROM CORROSION

To prevent corrosion of the steel pipe carrying water across the San Joaquin valley to San Francisco, the line, about five feet in diameter, has been covered with a half-inch layer of cement mortar held in place by a wrapping of cotton fab-

ric. Wire mesh is imbedded in the mortar for reinforcing. It was found that coatings of paint or other plastic materials applied to keep corrosive agents away from pipe buried in the ground are not entirely effective, because the movement of the soil in shrinking or expanding exerts a pull on the coatings, tending to disturb them and expose the steel. Rigid coverings of cement or mortar are able to resist this action, but in the past no practical method had been found to apply such pro-

*Hetch Hetchy Aqueduct*



Cont. E. J. Rawcliffe,  
630 S. Austin Blvd  
Oak Park, Ill.

B-97

tection. With this process, a crew of six men cover a thirty-foot section of pipe in a few minutes. The pipe is supported by two rotary heads beside a track on which the wrapping machine runs. The coating is applied in a twelve-inch spiral, the motor which rotates the pipe also advancing the wrapping carriage, making a uniform overlapped winding. The layer of mortar is deposited on the pipe from a mixer above the carriage. After wrapping, the pipe is sprayed with a coating to seal in the moisture necessary to the chemical reaction in the cement.

B-140

**ALL-WELDED OIL LOCOMOTIVES BUILT FOR TERMINAL**

Said to be the first of their type ever constructed, seven Diesel-electric locomotives have been completed by the General Electric company for the Bush terminal at New York. While the engines and electrical equipment follow the usual standards in design, a number of new features are incorporated in the framework, because all joints are welded instead of being riveted. The entire structure of cab, underframe and trucks is fabricated from all-welded steel shapes and plates.

*Schenectady, N.Y. B-89*  
**CAR PREVENTED FROM BACKING BY AUTOMATIC BRAKE**

*Smear's A B C Transmission*  
Designed to prevent backing of motor vehicles on grades or hills, a safety accessory has been developed that is quickly fitted to the driveshaft. It consists of a roller bearing that revolves one way and is locked against rotation in the other direction.

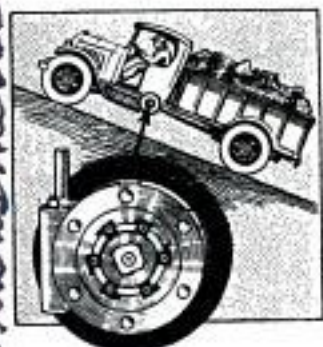

A cage keeps the rollers symmetrically located, placing the weight of the car, it is claimed, evenly on the shaft at the dead center of inertia. It is said that this condition prevents shock to any parts of the transmission. A fitting connecting it with the reverse change of the gear lever locks it out when the driver intends to reverse his car.

*John L. Leonard,  
Hudson Terrace,  
Englewood Cliffs, N.J.*

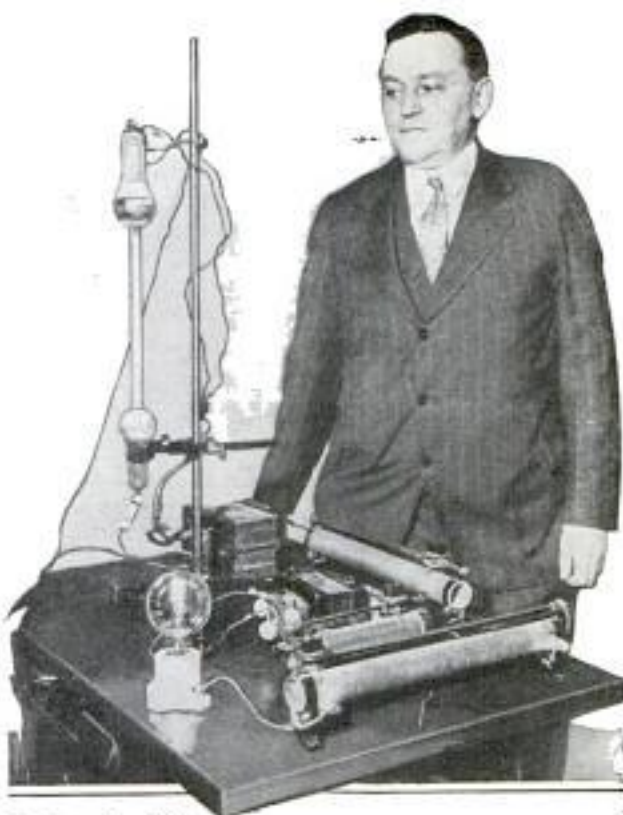

© International News  
Better Light Is Produced by This Sodium-Vapor Lamp, Shown Being Tested

**MOST EFFICIENT LIGHT KNOWN IS SODIUM-VAPOR LAMP**

Highest efficiency known to lighting experts is claimed for the hot-cathode sodium-vapor lamp recently demonstrated by Dr. Harvey C. Rentschler, of the Westinghouse Lamp company. Ordinary incandescent lights have a low percentage of efficiency. Mercury-vapor lamps have been developed, raising the efficiency of lights, but the sodium-vapor bulb is declared the best light source ever devised.

**RADIO GROWING IN POPULARITY AS HOBBY FOR AMATEURS**

Radio is becoming increasingly popular as a hobby for amateurs. This is indicated by the big increase in the number of amateur radio operators licensed in this country in the last half of 1931 as compared with the same period of the preceding year. During July to December of last year, 8,676 licenses were issued as against 5,633 in the same period of 1930. Young men and boys compose most of the enthusiasts. The movement is being encouraged, since the study necessary for a license examination is of distinct educational value.

*Director W. H. Terrell, Radio Div., Dept. of Commerce*

*Director of Research*

*50 Broadway  
New York  
A. 202.*

*A B C Transmission*

Copyrighted material



B-95  
576

Eugene W. Surber  
"Controlling Vegetation  
in Fresh Pools with Sodium  
Arsenate. Price 10¢"



Aerial View of the Arlington Memorial Bridge Spanning the Potomac River at Washington; Lincoln Memorial in Background

### BRIDGE UNITES MOUNT VERNON AND NATION'S CAPITAL

Visitors to Mount Vernon now travel from the capital to the home of the first president over a \$21,000,000 bridge and highway constructed as a memorial to George Washington. The route begins at the Lincoln memorial in Washington, passing over the recently completed Arlington memorial bridge, a beautiful white span over the Potomac river linking the District of Columbia with Virginia. Past the bridge, the road, a broad ribbon of concrete, leads directly to Washington's home and is known as the Mount Vernon memorial highway.

### LIFE-TIME TRIM FOR WALLS MADE LIKE LINOLEUM

Life-time wall covering and decorating material, made of composition cork, linseed oil and pigment, backed by fabric, has been developed. It is cemented to the wall, actually becoming part of it when dry. Wiping with a damp cloth is all that is necessary to clean it and restore its luster, while it has certain insulating and sound-absorbing qualities not usually obtained in homes. Patterns in many differ-

Chicago  
New York  
San Francisco  
B-124

Congoleum - Hair in glue.  
Kearny, N.J.

ent effects are available and novel results are easily achieved by the use of panels and inserts. It also adapts itself readily to moldings and other designs. The material is made in six-foot widths and is applied direct to existing decorations.

### POND WEED CROPS KILLED WITHOUT INJURING FISH

Pond fish farmers may be saved between \$50 and \$100 an acre in expense by a harvesting treatment developed by the bureau of fisheries to clear ponds of weeds. Previously these weeds have been raked together by hand as the water level was

lowered, at a cost of \$60 to \$125 an acre. The latest method consists in spraying the water surface with a solution of sodium arsenite, producing concentrations of arsenious oxide of about two parts per million. This destroys the weed crop without injuring the fish or the insect larvæ and other aquatic life upon which the fish feed. The cost of such treatment, applied twice a year is about \$10 an acre.

### CAR OWNER'S NAME IMBEDDED IN RUNNING BOARD PLATE

Identification of your automobile is made easy if it is equipped with a foot plate on which your name is imbedded in white rubber. The plate is attached to the running board under the door, the rubber mat thus serving a double purpose.



Ninety-two per cent of the world's telephones are now interconnected, enabling forty nations to talk with America.

H.L. McBride  
1021  
Copyrighted material  
Evanston, Ill.



03-158

175 Broadway  
New York  
577

# Teletype Messages Sent Through Switchboard

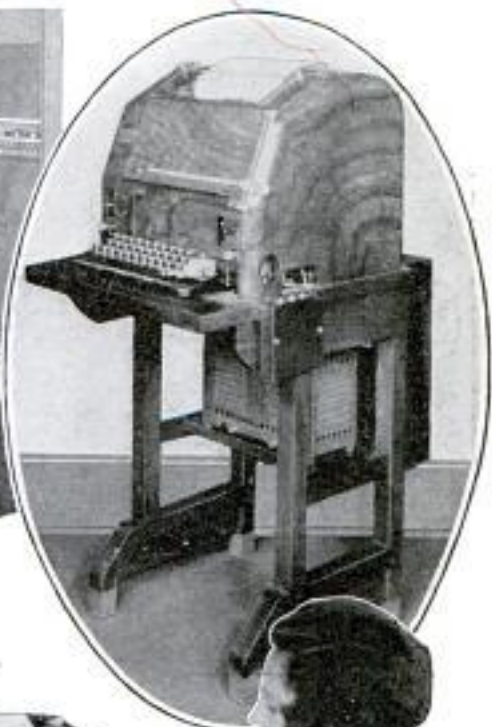
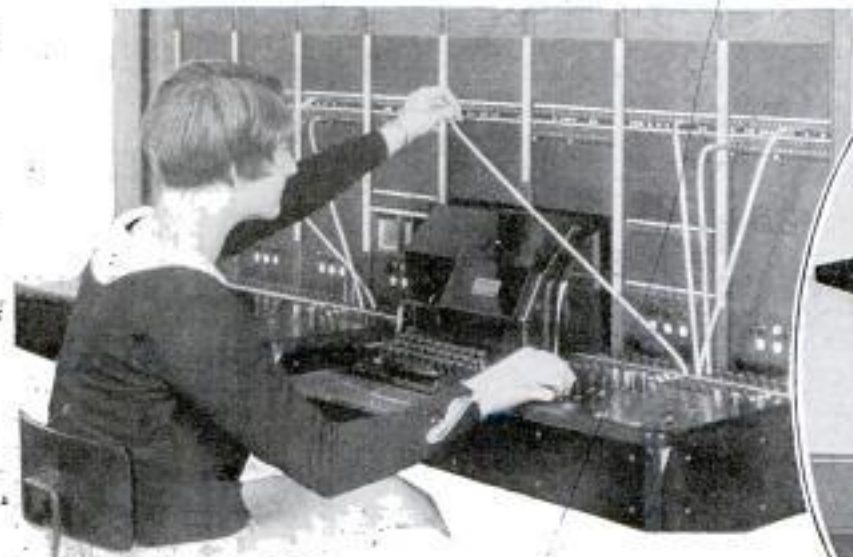

Teletypewriter Machines and Switchboard Making Possible a Two-Way Message Service between Subscribers

The recent inauguration by the American Telephone and Telegraph company of teletypewriter switchboard service for the first time makes available to the public generally this means of transmitting messages electrically over wires to any other subscriber, so that whatever is typed at one end of a circuit appears practically the same instant at the distant end, also in typewritten form. This permits a two-way service, allowing inquiry and reply to be made on the same connection. The teletypewriter operates much as a telephone service, with the difference that a subscriber is connected to a teletypewriter exchange, in which the board is modeled after telephone switchboards but contains many features necessary to teletypewriter service. On the keyshelf of the board for the operator's telephone set is substituted a teletypewriter. Like the subscribers, the operators communicate over the system exclusively by printing equipment, never by voice. When the subscriber signals the central-office operator, calling lamps light over the jacks in the exchange. The operator plugs in and types "opr" on her teletypewriter, these letters appearing simultaneously on the subscriber's writer. The subscriber then



types the number of the desired station, and the operator proceeds to complete the call in much the same manner as for a regular telephone message. When the called subscriber's bell rings and his motor is started, he answers by typing his number and firm name. When the communication has been completed, the originating subscriber sends a stop signal from his teletypewriter. This signal cuts out the motors of both subscribers and illuminates the supervisory lamps in the cord circuit at the switchboard. The operator then pulls down the cords. In order to provide this new service, teletypewriter exchanges have been established at various points throughout the country.

Ans. A. L. White, 226 1/2 - 6th Ave North  
St. Petersburg, Fla



B-143

C. R. Eaton,

Illustrated Technical  
1/15/32

578

POPULAR MECHANICS  
*Sterling, Kans*



*C. R. Eaton, Kans  
Sterling, Kans*

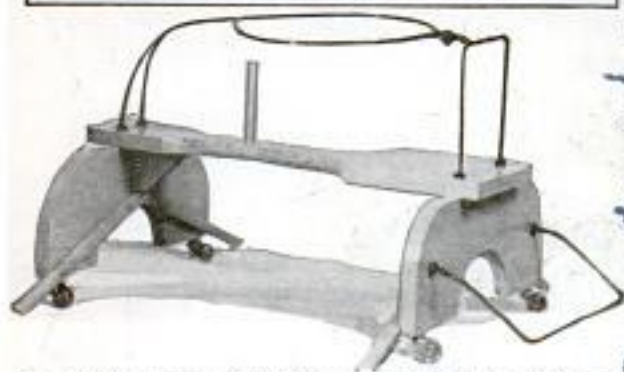

Protected by Wire Guards, Baby Learns to Walk in This Runabout That Will Not Tip Over

**GUARDS PUT ON BABY WALKER TO PREVENT TIPPING**

Safety for the baby is provided by a walker on which guards have been fitted to prevent tipping. The child cannot get out of the protecting harness, cannot pick up anything from the floor, but is taught to walk.

**SUN OUTSHINES ALL THE STARS HUNDRED MILLION TIMES**

On a clear day, the sun at noon gives 465,000 times as much light as the full moon at its zenith, and provides the earth with nearly 120,000,000 times more light than all the stars in the sky on an unclouded night. These are the calculations of relative illumination given in the fifth revision of the meteorological tables of the Smithsonian Institution. This table, prepared by Dr. Herbert H. Kimball of the weather bureau, takes for its unit of measure the foot-candle—the illumination received from a standard candle a foot

*Washington  
12/21/32*

*4/31/32*

away. The noonday sun, it is calculated, has an intensity at the earth's surface of 9,600 foot-candles. For the sky at sunset, this falls to thirty-three foot-candles. The full moon at its zenith provides two-hundredths of a foot-candle, which is ten times as much light as comes from the quarter moon.—Starlight amounts to only eight-thousandths of a foot-candle.

*B-231*

**METAL YOU CAN SEE THROUGH IS MADE OF ALUMINUM**

Transparent aluminum has been produced by a German chemist by substitution of substances in preparing an alloy which retains all the properties of the original metal, yet permits the passage of light. So far, the emerging light has a yellowish tinge, but the chemist is working to eliminate this color and make a glass-clear product. Use of the perfected alloy for window panes, roofing, skylights, household utensils and other purposes is expected by interested companies.

*do not answer*

*Herbert H. Kimball  
Director, Smithsonian Institution  
Washington, D.C., January 1, 1932*

**WINDER FOR EXTENSION CORDS SAVES TIME AND WEAR**

With a radius of forty feet, providing an unusually wide field of action, a mechanical extension-cord winder has recently been placed on the market. The cord always is in direct electrical contact, no rotary wipe connection being necessary because the cable is wound on the drum by an arm, the drum remaining stationary. The arm is held under spring tension, and a ratchet is provided to hold the cord at any desired length. The hand lamp is protected by rubber and is provided with guard and hook. As soon as the operator is through, the winder wraps the cord around the drum up to the determined point.

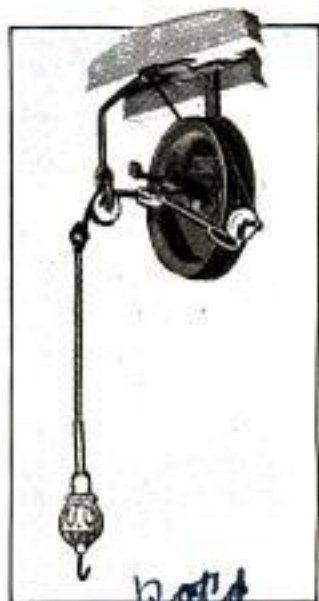

*patd*

*Packard Electric Co  
Warren, Ohio*



# "DO-X" Power Is Raised by Engine Changes



The "Do-X" in "Drydock" for Overhauling at Long Island, Above, and, at Right, Reinstalling the Engines After the Power Had Been Increased

After a thorough overhauling by expert aircraft engineers, the twelve engines of the "Do-X," huge German flying boat, were replaced while the ship was in "drydock" at North Beach, L. I. A number of points were checked during the vessel's stay at the airport, the most important, however, being the increase in horsepower of the engines. Instead of the 7,200 horsepower delivered by the twelve power plants before they were removed, they now provide a total of 7,920 horsepower.



*Wide World*

## FIREPLACE GAS HEATER KEEPS EVEN TEMPERATURE

Uniform temperature for the living room of the home is maintained, without forcing the house-heating plant, by using a fireplace gas heater that is entirely automatic in operation. The heater is intended to rest in the fireplace and is equipped with a thermostat which is set at the desired room temperature. As the regular plant's



*Z. J. P. Burner*

output is reduced, the thermostat opens the gas supply to increase the blaze of the gas heater, and when the furnace heat is increased, the gas heater is automatically turned down. This saves fuel because it is unnecessary to heat the entire house in order to maintain a comfortable living-room temperature, which usually is a few degrees more than is required for other parts of the home.

## SILVER FINISH FOR DULL METAL COMES IN PASTE FORM

*B-233*

Tarnished silver or dull metal can be given a bright finish by applying a paste three times the fineness of powdered aluminum. Mixed with either lacquer or varnish bronzing liquid, the paste is put on with a soft brush. The finish can be restored to tarnished silver, or new silvering can be done equaling the plating method.

*Adams Bros. Mfg. Co. Inc.*  
1500 North Ave. W.,  
Pittsburgh, Pa.

*Atter. A. Bath Corp.*  
50 Hartford  
Boston, Mass.



# Where the Art of Shipbuilding Is Taught

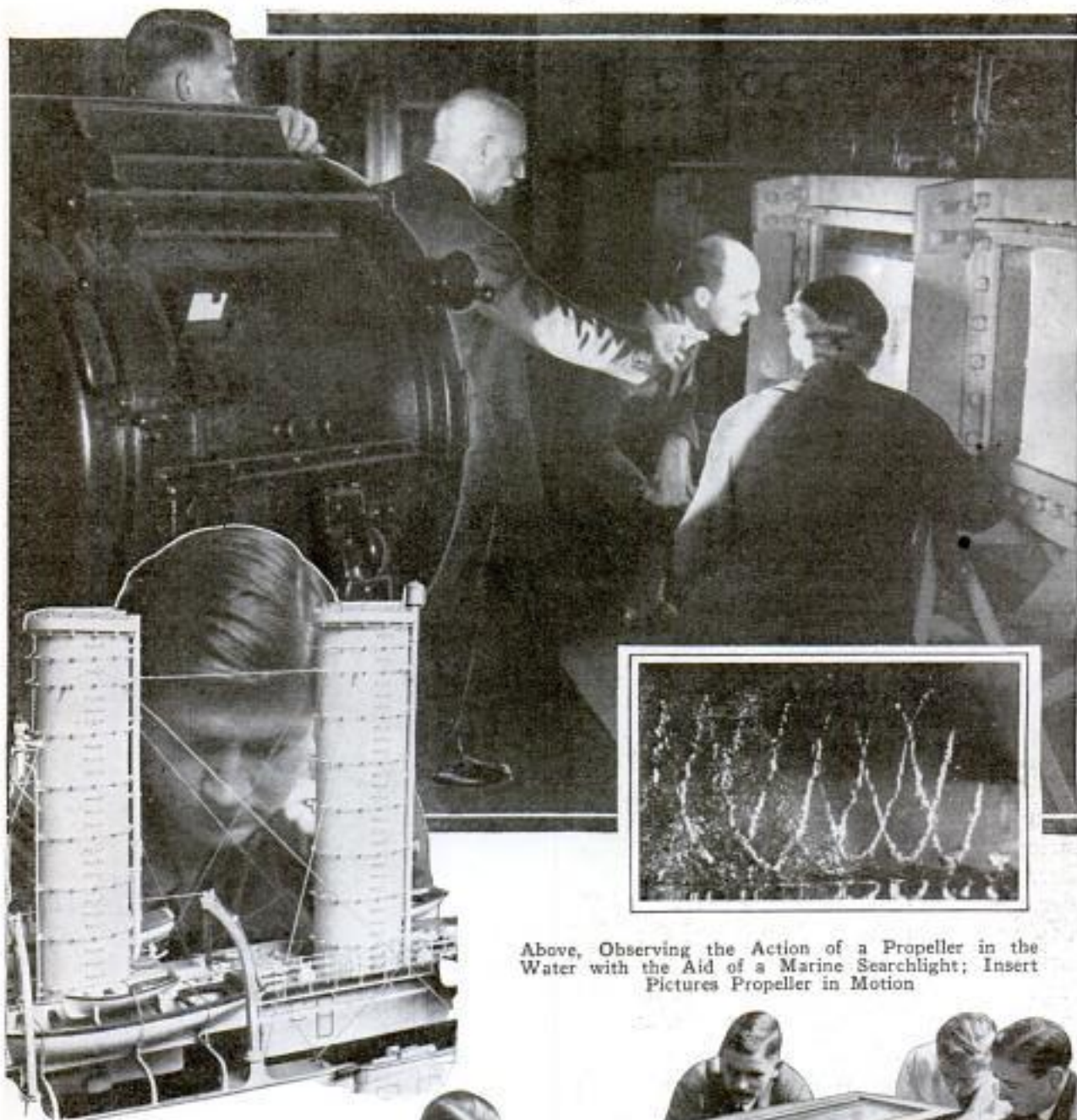

Above, Observing the Action of a Propeller in the Water with the Aid of a Marine Searchlight; Insert Pictures Propeller in Motion

Students of the Technical High School in Berlin study the art of shipbuilding and commercial and war-navigation principles by experimenting with models in illuminated tanks; most of the builders of Germany's fleet had their early training in this school, the only one of its kind in that country; above, a student is shown studying a model of the small cruiser "Leipzig," one of Germany's best ships used during the war

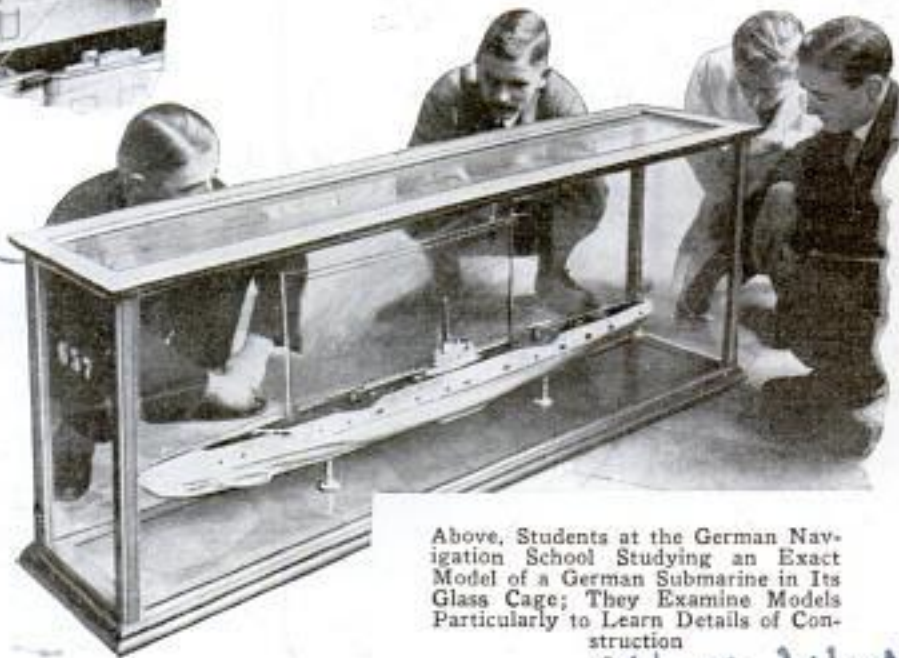

Above, Students at the German Navigation School studying an exact model of a German submarine in its glass cage; they examine models particularly to learn details of construction

*Wick Works*

Copyrighted material



## with Models and Electrically Lighted Tanks

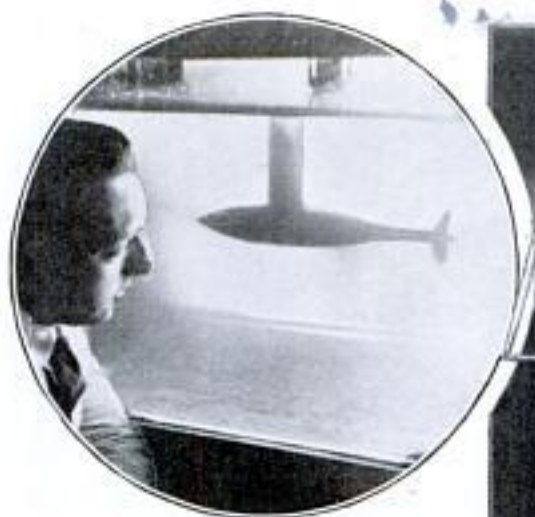

Above, Trial Tank Where New Types of Propellers Are Tested; It Has Walls of Glass and Is Illuminated by a Big Searchlight so That the Propeller Can Be Observed Clearly, Because Watching the Action of the Propeller Aids in Determining Its Efficiency

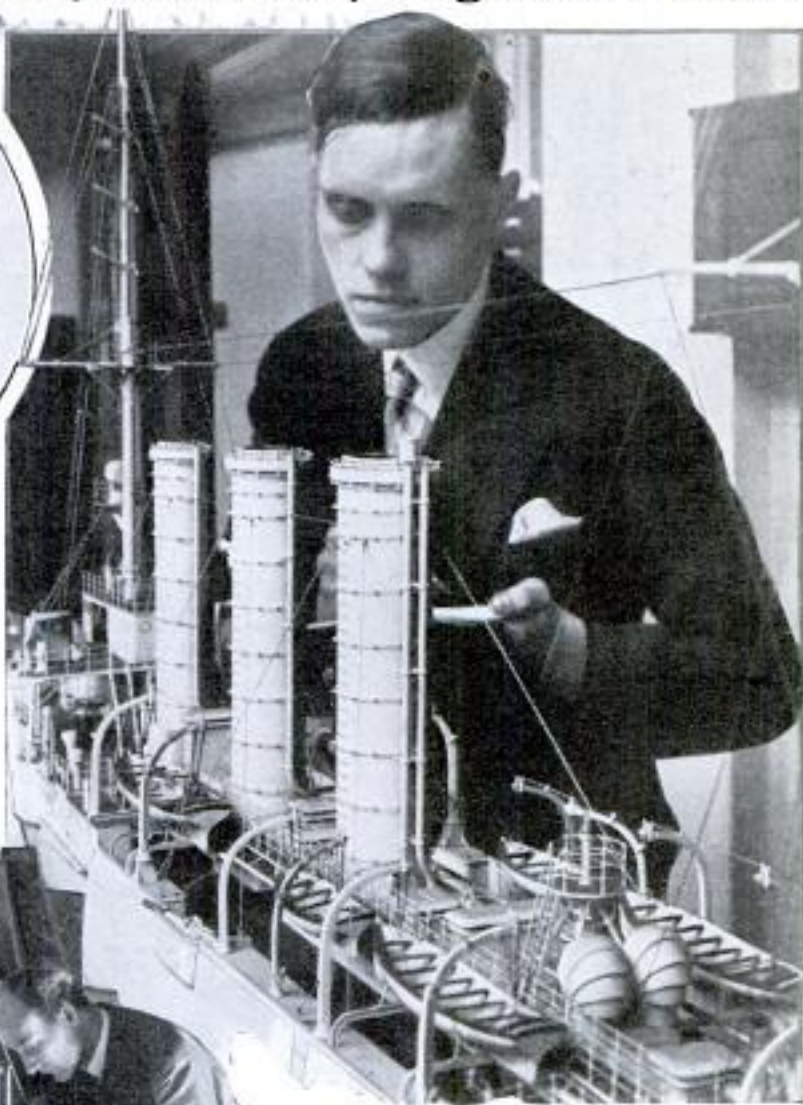

Above, Examining Model of Small Cruiser; Below, Student at Work on Plans for Boat Because He Is Required to Be Able to Build a Ship at Examination Time; the School Is Experimenting with a Special Propeller Which, If Successful, Would Allow Coupling of Accelerating Machinery Directly to the Screw

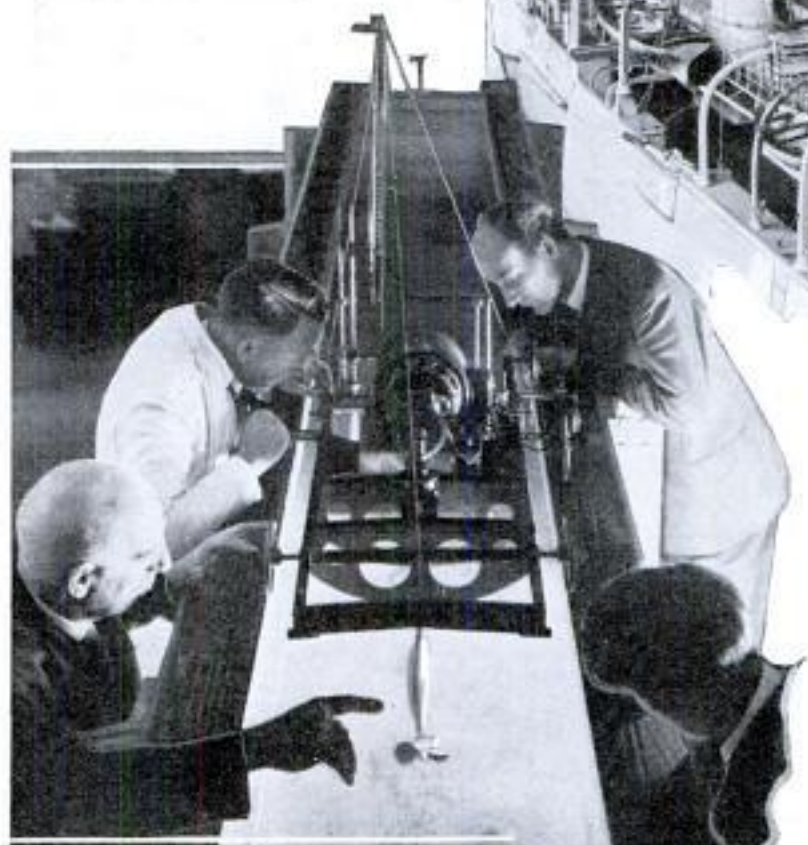

Above, Trial Car in Which the Propeller Is Installed under Water; the Propeller Is Moved by an Electric Motor on the Car Which Drives It Forward at Great Speed While Observers Watch the Action of the Blades in the Water





*Cont. Messrs Clarence Fetterli  
and Douglas White*

582

POPULAR MECHANICS

*12 3 7 Michigan Pasadena Calif*  
Count of Stars Shows Changes in Universe

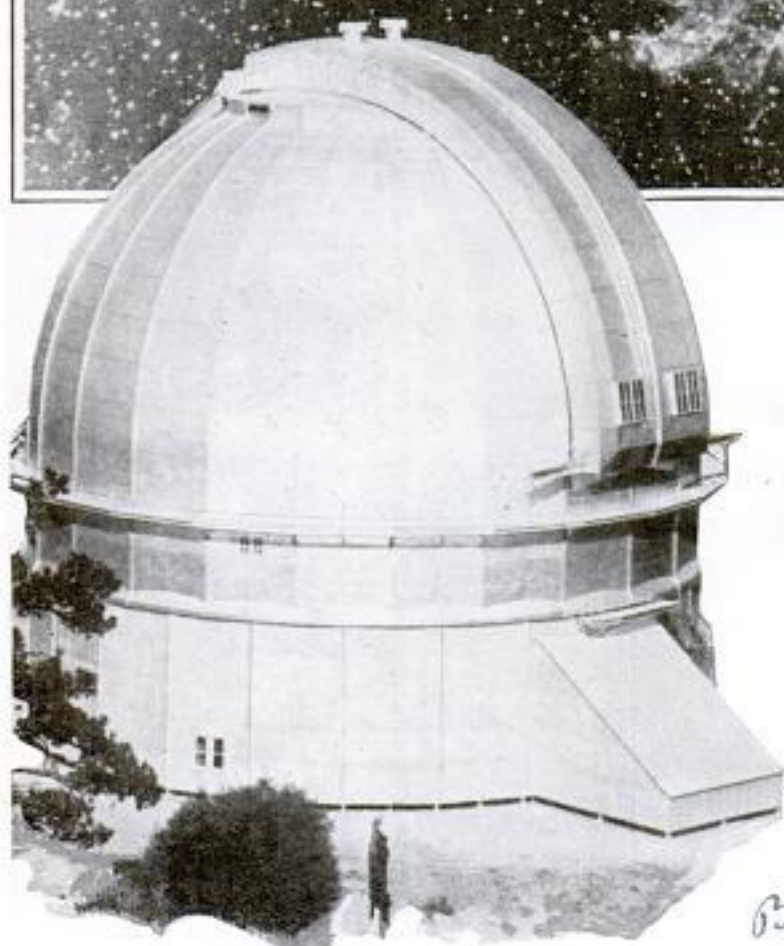
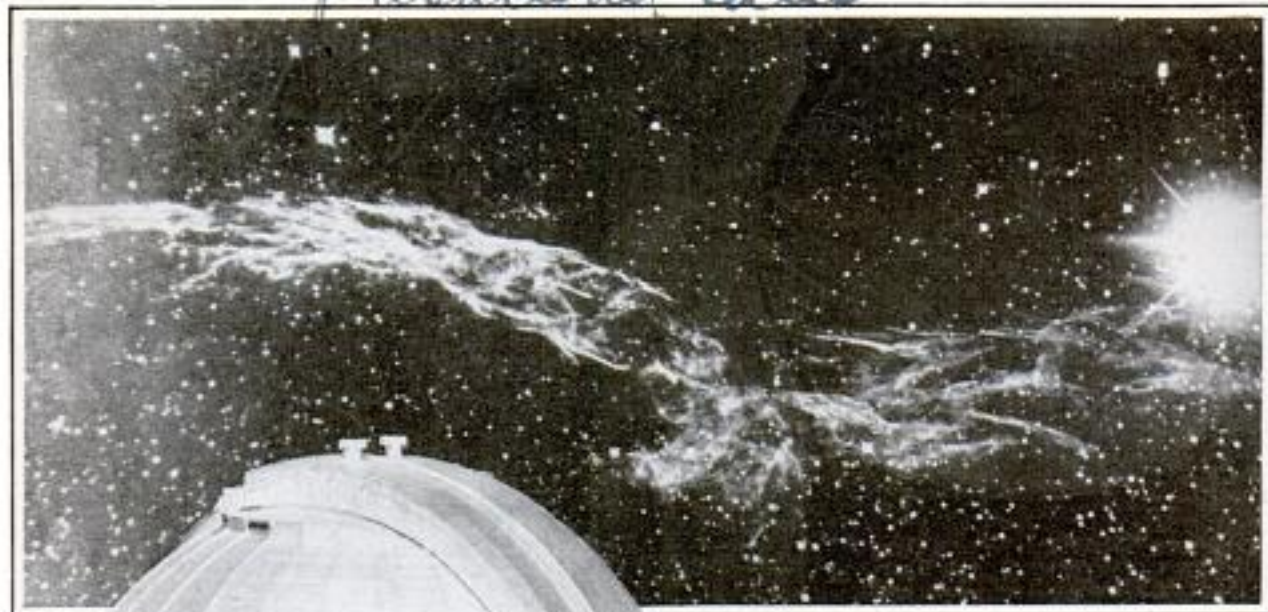

Above, Section of Sky Such as That in Which Stars Were Counted;  
Below, Mount Wilson Observatory

urement was done with the aid of the 100-inch telescope at Mount Wilson, California. Through the powerful lenses, Doctor de Sitter's colleagues were able to count the number of stars in a definite sector of the heavens, thus giving him a basis for his calculations. "If you know the density, you can figure out the radius," he said. "It was like measuring the grains of sand on a beach. First a square foot of sand could be taken up and the individual grains counted. Then, by measuring the entire beach, the approximate number of grains in it could be determined."

*35 245*

**COLOR, NOT ODOR, OF  
FLOWERS ATTRACTS  
BUTTERFLIES**

Measuring stars of the universe is the stupendous task recently completed by Dr. Willem de Sitter, famous Dutch astronomer at the California Institute of Technology. According to the professor, the universe is constantly changing, and from year to year varies both in form and size. Figures compiled by extensive research and calculations set the present extent of the universe at between two and twenty billion light years. The meas-

It is the color, and not the odor, of flowers that attracts butterflies. This was proved in tests in Germany where paper flowers were scattered in a garden with blooming ones. It was found that the insects settled indiscriminately on both kinds to seek food. The experiment further revealed that different species displayed preferences for special colors, some yellow and blue, others blue and purple, but none of them was attracted by green.

*Pasadena  
Calif*

*Lie Woche. 1/9/02*







# Dark Light Promises Way to Talk with Mars

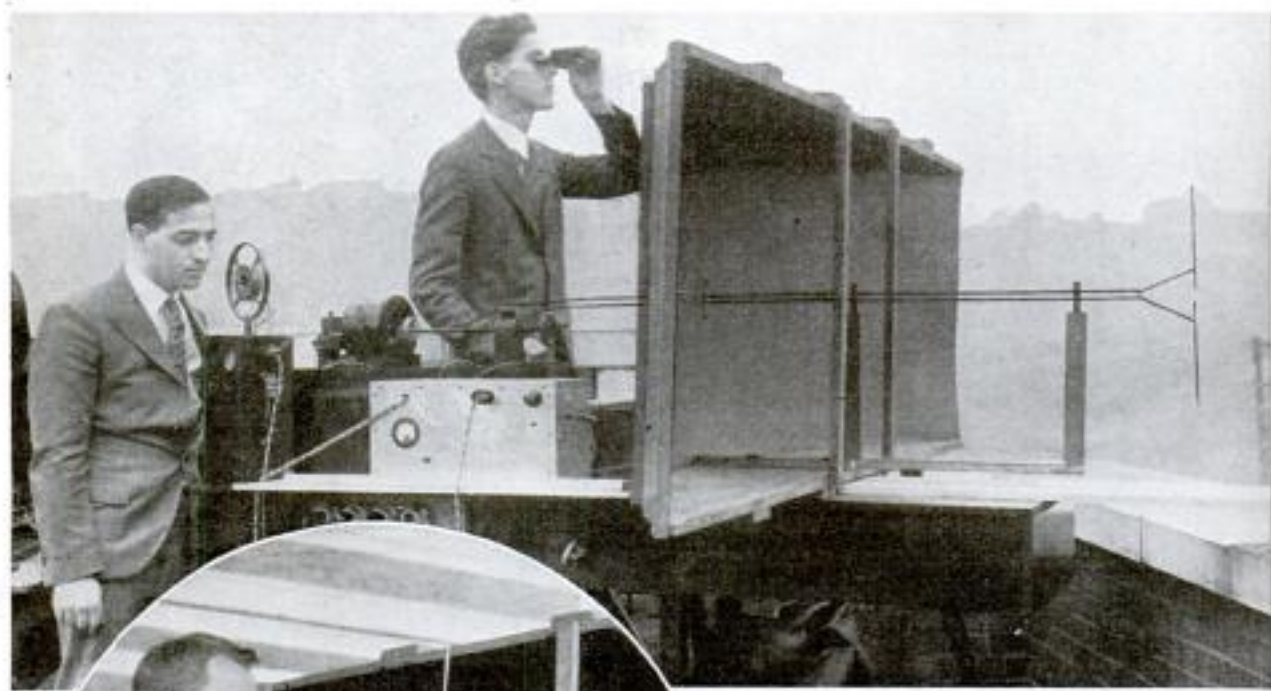

Ultra-Short Wave Broadcasting and Receiving Plant, Such as Is Believed Feasible for Signals to Mars; Receiver Details, Left

as audible sound waves are only a few of the possible frequencies. Nature has been very kind to humans to impose these limitations, he believes, as all would be chaos and confusion were we able to see and hear everything. If there ever is to be any sort of communication between the earth and Mars, he believes it will be borne on the medium of this dark light, because only the waves less than seven meters

long can penetrate the Heaviside layer. He believes it quite possible that the forty-two-centimeter beam can pierce the layer and travel the 35,000,000 miles to Mars.

Development of ultra-short-wave radio has convinced I. E. Mourontseff, research engineer of the Westinghouse Electric and Manufacturing company, that light waves and radio waves are identical in every respect except length. With the transmission of beam radio of forty-two centimeter wave, he finds, furthermore, that science actually has produced "dark light." The longest radio wave now in use is a hundred million times as long as the shortest radio wave known, while the shortest radio wave is only about a thousand times as long as the longest visible light ray. Visible light rays are but a very small percentage of the whole range, just

## SAFER RAILROAD-CAR COUPLING 1931'S NEEDED INVENTION

Some inventor may reap a fortune this year if he can devise an automatic railroad-car coupling that is safer and better than any other inventor can make. To obtain such a device, a competition is being conducted by the International Railway Union, 10 rue de Prony, Paris. The union is an association of nearly all the

*and I. W. Chubb, Director of Research.*

*East Pittsburgh Pa*

*see elec. 1931-925*



railway administrations of Europe and has set up a technical committee which has drawn up the requirements that an automatic coupling should satisfy, and has fixed the procedure to be followed in the submission and testing of proposed coupling systems. The specifications are furnished to inventors by the railway union in either French or German, but not in English. While not concerned with the contest itself, the International Labor office at Geneva has named a committee to collaborate with the railway union.

Science Service 1/26/32



Wooden Statue, at Left, Shown Before Restoration; at Right, Statue After Anti-Decay Treatment

**WOODEN STATUE IS RESTORED BY ANTI-DECAY METHOD**

Anti-decay chemicals were used in restoring a wooden statue of St. Paul which stood under the gable of St. Paul's chapel in New York for 165 years. Arthur Smith, who has restored many pieces of art to their original beauty, did the work. The statue, nine feet high, was treated with a wood-preserving compound containing chemicals to prevent decay. Then decayed parts were filled with a liquid wood. When dried, the statue was sandpapered to receive a base for the finishing.

Restored 1st objects 1907-1908  
 Greenbush Road, Japan, N.Y.

**RUBBER THAT ABSORBS WATER HAS COMMERCIAL VALUE**

Full of pores invisible under the most powerful microscope, a new kind of rubber that absorbs sixty per cent of its volume of water is to be offered for commercial uses. Storage-battery separators, bearing oilers, surgical sponges, surfacings for metal, and other articles of similar nature, can be made of this rubber. Subjected to great pressure, its power to absorb liquids disappears. It is made from coagulated and vulcanized rubber.

B-228

**MASKS IN MEDIEVAL TORTURES LIKE HALLOWEEN FACES**

Masks resembling the face coverings worn by Halloween celebrators of today were used in tortures of the Middle Ages. A collection of pain-producing instruments has been on exhibit at a Vienna museum. Some of the masks were equipped with spikes on the inside, while others locked the face into a painful position.

B-126

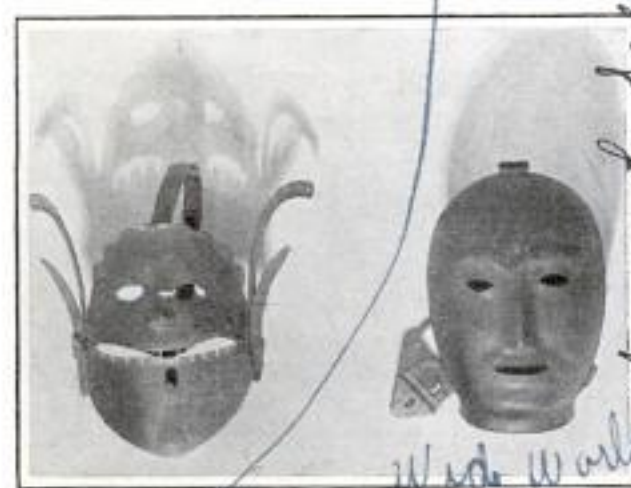

Iron Masks Resembling the Halloween Faces of Today Were Used by Torturers in the Middle Ages

**LACQUER TO GIVE PEARL FINISH MADE FROM FISH SCALES**

Pearl finishes which are being used on the interior fittings of some automobiles are made possible by a lacquer obtained from a secretion in the scales taken from herring. When the fish are caught, they are allowed to toss about in the bottom of the boat until they cast their scales, which are gathered and put through a process that extracts the secretion which is manufactured into the lacquer. It has been found that only herring caught off the northeast Atlantic coast and in one spot on the northwest Pacific coast have the essential element in their scales.

Chicago La Salle St. W. 47

Control patents  
 655-6th Ave  
 New York

Prof. H. Bickmann  
 Hannover Technical Univ.  
 Germany

Zaponi Lacquer Co. Stamford Conn.



B. 43 Cont. Waller & Burtov,  
1032 Florida Ave  
Akron, Ohio

# MASTER



Above, Early and Modern Locomotives Carved in Wood; Below, Walnut Cane with Carved Balls inside the Cage

**I**N the little town of Dover, Ohio, is a man who has attracted world-wide fame by whittling, from ivory, ebony, black walnut, pearl and bone, moving models of famous locomotives.

With only a knife and a few saws and files, Ernest Warther has just completed an eighteen-year task—the carving on exact scale from the original drawings of the history of the locomotive in model form.

Some idea of the intricacy involved in the work may be secured from the bell cords on the models. These are not bent, as ivory cannot be bent, but are cut to the curve after using a shellac-covered thread as a template. Even the strands are cut into the rope. The bell cord on the largest model is so fine that, if held by either end, the weight of the free end would cause it to break.

The lettering on the base of each model, as well as that on the tender sides, is of ivory inlaid in the walnut. The models are driven by electric motors, connected by leather belts. The ivory used in these models came from elephant tusks. The walnut used was grown near the home of the carver. The frames of the models are made of apple wood, inlaid with mother of pearl. The bolts and rivets are made of bone, and there is real ebony in the wheels, cylinders and tender frames. The drivewheels consist of fifty-two pieces. In building the models, no lathe was used. The interiors of the cabs are complete in every detail—even the brakes operate. The largest of the engines has 7,597 pieces, including the base.

If you were to inspect one of Warther's models, you would swear that the wheels



# CARVER

## Whittles Way to Fortune with a Pocket Knife

and many of the other parts had been turned on a lathe, so perfect are they. Yet the only power tool that the carver uses is a drill press for making holes. In forming, say, a drivewheel flange of ivory, Warther cuts a slab from an elephant tusk with a meat saw, and then, with a special carving knife of his own design and make, shapes the wheel. He employs a few files to remove material here and there, until his micrometer tells him that the piece is an exact model of the original wheel.

The first model in the locomotive series is the Sir Isaac Newton engine. The man who worked out the law of gravity drew plans for a locomotive in 1680, but the engine never was built. After his death, these drawings were found in his desk. It is from them that Warther created his ivory-walnut-and-ebony reproduction.

After this came models of every outstanding locomotive known to railroading, until the total had reached nineteen. Greatest of all of his creations is a reproduction of the Mallet articulated triplex-compound engine, of which only two have been built by the Baldwin Locomotive Works. This engine is a giant having twenty-four driving wheels and six cylinders. The model is so heavy that two men are needed to handle it.

Warther was born forty-six years ago in Dover. From his ancestors in Switzerland he inherited his carving ability. When he



1855



1870

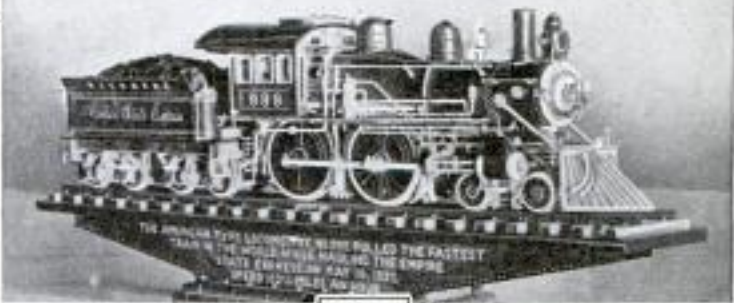

1893



1904

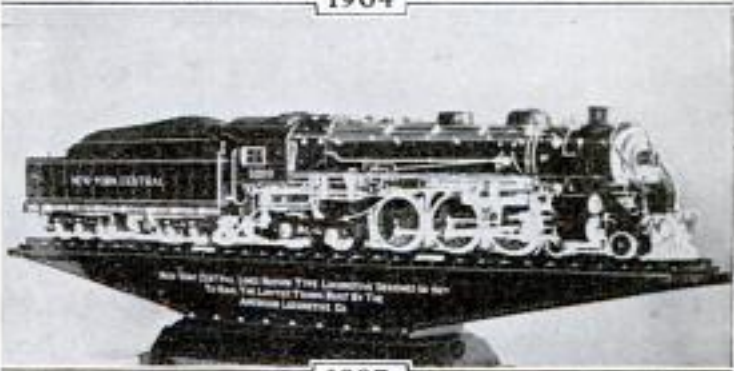

1927



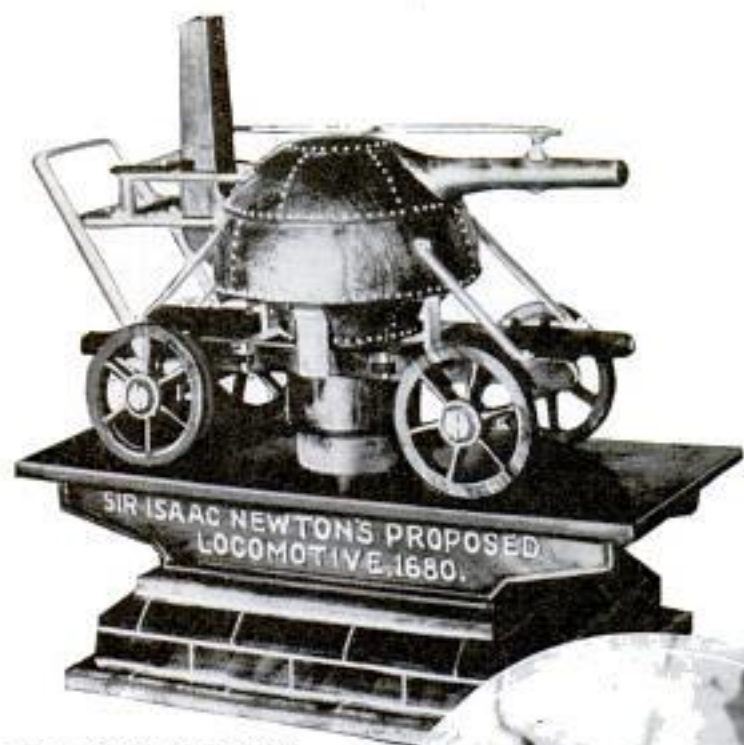

was fourteen years old, he began working in the steel mills. For over twenty-one years he labored as a shear man, a task that is not particularly kind to hands that must work with utmost precision. Often he would handle 30,000 pounds of steel a day.

After working for eight to ten hours a day, he spent all his spare time in carving. The shaping of pliers from one piece of wood became a passion with him at one period of his career. Even today, he likes to take a piece of soft pine or walnut, and, with a few deft cuts with his knife, convert it in less than a minute into a little set of pliers that open and shut, yet, being made of one piece, cannot be taken apart. He made these pliers in groups, until he succeeded in attaining a record of whittling 511 pairs out of one piece of wood.

Another of Warther's favorite pieces is a Lincoln-head cane made about fifteen years ago. He started with a block of walnut and

carved a likeness of Abraham Lincoln, even to the wart on his cheek. Then, below the head, he formed a hollow cage whose bars are but a fraction of an inch apart. Inside this is a ball inclosed in a spherical cage, the two parts being free to move about inside the cane. No human hand has ever touched the inner ball, and Warther has offered to give the cane to anyone who can accomplish this without breaking the wood.

As carving absorbed more of his attention, Warther retired from the steel mills, and now devotes all of his time to whittling.

To secure isolation, he built a small shop in his back yard. But what a shop! It resembles a tiny dwelling. The visitor—and he entertains an average of thirty-five callers a day—is impressed first by the giant padlock that secures the door. This lock, of unknown

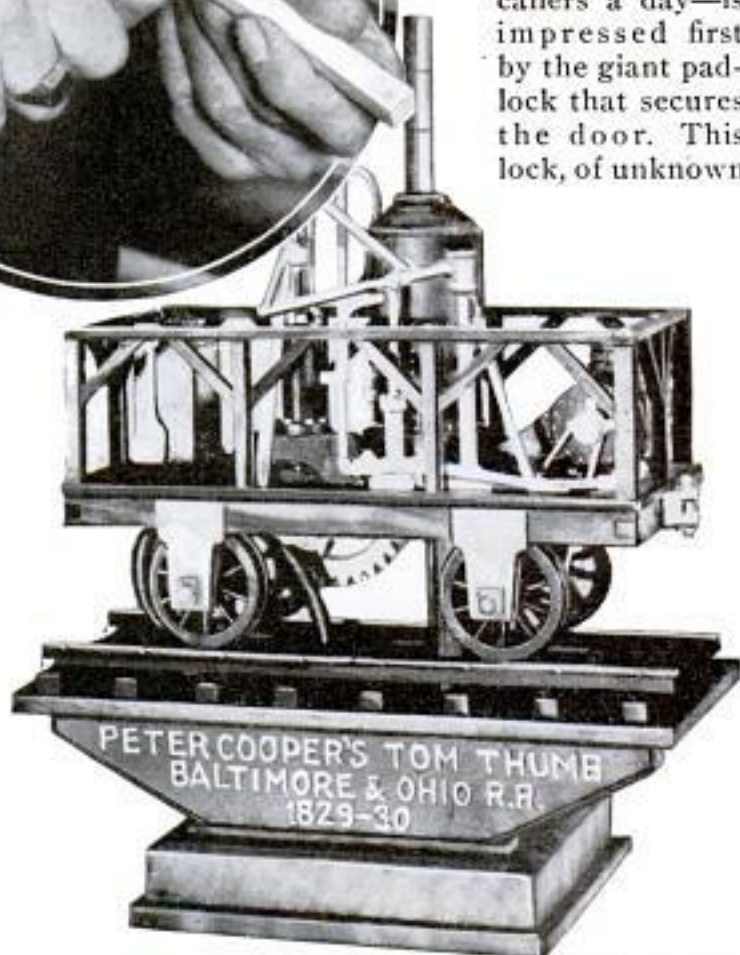

Other Examples of the Expert Carver's Art, and, in Center, Starting Work on a Piece of White Pine



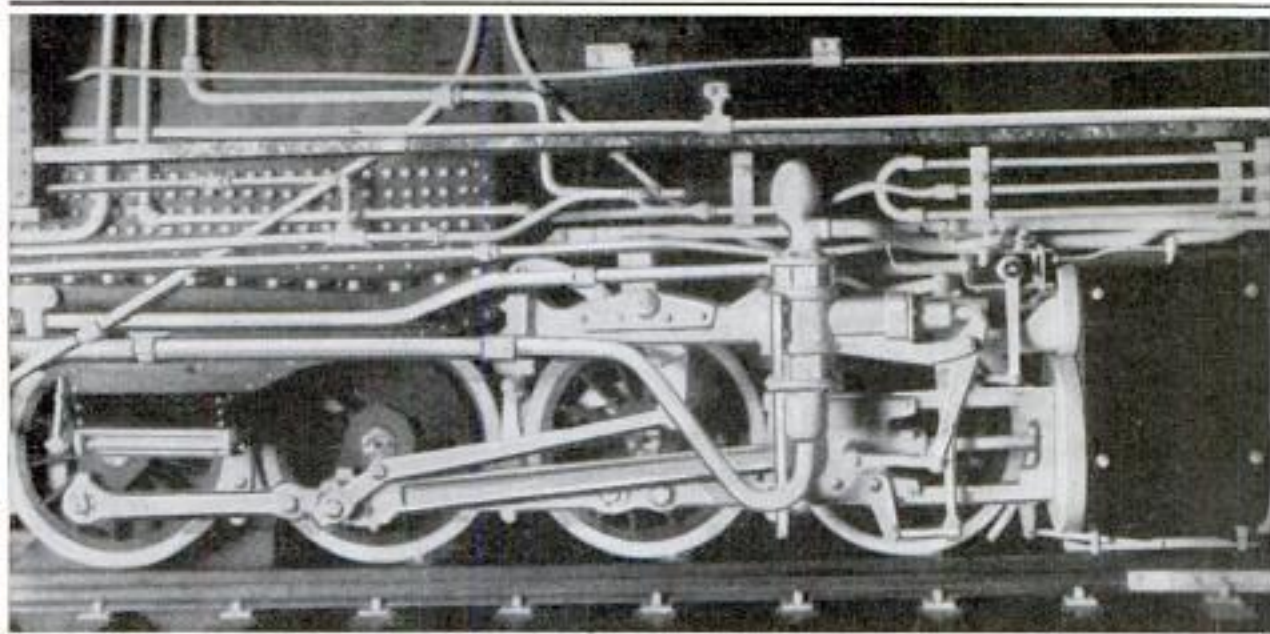

A Close-Up Showing Some of the Intricate Carving on a Locomotive; All the Ivory Pipes Are Whittled to Shape Because the Material Cannot Be Bent; Even Bolts and Nuts Are Cut

age, came from an old German castle. It is fully as large as a good-sized flatiron.

After Warther opens the lock with a key of corresponding proportions, the visitor steps through a door into the strangest workshop that could be imagined. The walls and ceilings are covered with Indian arrowheads and other flint implements, arranged in artistic patterns, historical documents and fragments, pictures and relics. The glass-covered panels in which these specimens are displayed can be swung out to reveal drawers in which tools and supplies are kept.

This shop is the Mecca for all the boys and many of the grown-ups in the neighborhood. These callers do not bother Warther in his carving simply because he does most of it when they are in bed.

"The happiest moments I have," he says, "are in the morning, after two o'clock, when I come out to the shop, build a fire if the weather is cold, and carve. The colder the weather the better I carve."

Carving is a tedious and energy-consuming pastime, and even Warther becomes weary of it. Then, for recreation, he pulls an anvil out into the center of the shop, gets out some steel, heats it in the coals of the fireplace, and proceeds to hammer out an exquisite knife. These knives have become so popular that he sells large quantities of them as souvenirs.

Another specialty, turned out during his "recreation" periods, is a set of ebony or bone-handled kitchen knives with high-speed steel blades that will last a lifetime.

In building the Mallet triplex, Warther took a huge elephant tusk and sawed sixteen and one-half inches off the base. This he converted into wheels, valves, bolts, coupling devices, and other parts. From the tropics came ebony, small logs weighing about seventy pounds, which were fashioned into the boilers, cylinders and other engine parts, and into imitation coal. From tropical waters he obtained abalone shells which, when polished, are beautiful in texture. These were used for forming letters, numerals, and for trimming.

In the meantime, he obtained from the Baldwin Locomotive Works a complete set of blueprints, made from original tracings, of the new engine. Those were his working drawings, and he followed them closely in making parts. He learned to read blueprints "by doing it," for it is only by employing these basic drawings that he could create his faithful models.

Then began the actual carving. Most of the work was done with a special knife that he made himself. It fits the hand perfectly, and has a number of blades that can be changed quickly. Extra blades are kept in the handle. The characteristic form of a carving blade is tapering to a fine point, from a base that is heavy



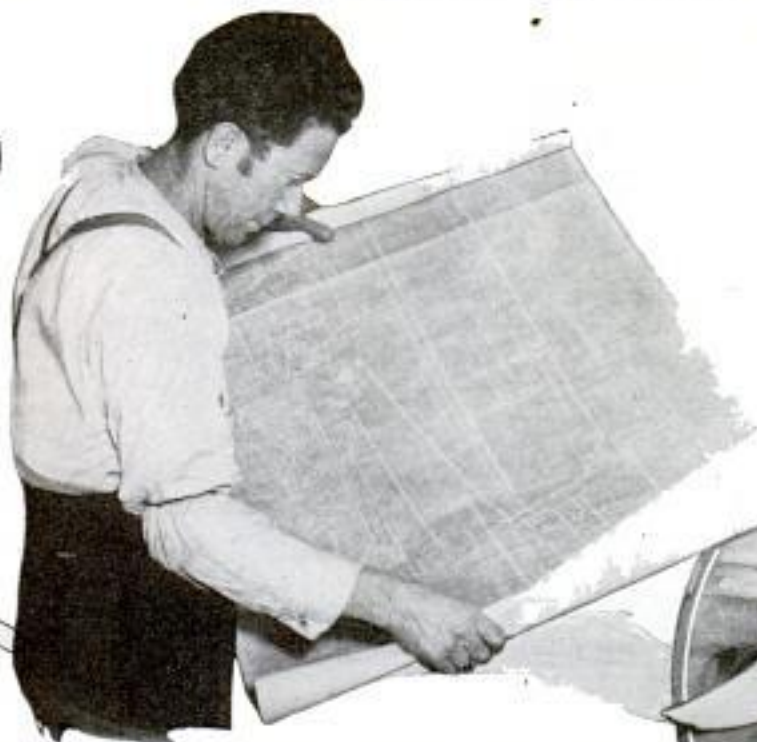

Studying Blueprint of Real Locomotive; Right, Pliers Made in Minute and Tool That Did It

enough for large cuts. The bolts and nuts that hold parts of the model together are made of ivory, and the nuts actually screw on the threaded bolt and form the only means of securing the parts. The bolts are about the diameter of a common pin. Yet, in all this work, Warther employs no magnifying glass. And he does not wear glasses.

A frequent question asked about the Warther models concerns the bearings. It is difficult for experienced model makers to understand why he does not employ the usual bronze-and-steel combination, with oil for a lubricant.

Warther uses the oil-bearing Arguto wood, and the bearings never need other oiling. Friction of the rotating shafts causes the oil in the wood to become liquid enough to flow and lubricate the shaft thoroughly.

For two years and five months Warther's collection of engine models was in the Grand Central terminal in New York City, each locomotive running sixteen hours a day at the rate of sixty-six revolutions a minute for the drivewheels. In all this time, they were never oiled. Measurement of some of the shafts at the end of the period revealed that those carrying the greatest load had worn one three-thousandths of an inch, while the others exhibited no wear at all. Even the bear-

ings were not worn perceptibly. The models, incidentally, do not travel on a track. They are elevated slightly until their wheels clear the section of carved track above which they rest, so that the drivers, connecting rods and other moving parts can be set in motion. The nineteen models are in-



sured for \$250,000, and have been viewed by more than 7,000,000 persons.

#### BULLET FOR USE AGAINST TANK PIERCES ARMOR PLATE

Bullets capable of piercing armor plate have been made by a German engineer who claims they are likely to discount the utility of army tanks as the spearhead of attack in infantry warfare. At a range of fifty yards, the bullets bored five-eighths of an inch into thick armor plate, and smashed through compound chrome-nickel armor half an inch thick, leaving holes twice the size of the bullets themselves. It is claimed this bullet has a velocity of 5,800 feet a second. It consists of a soft-lead core covered with a thin iron jacket, enabling it to blast out the armor plate. In the past, such high-velocity bullets have eroded and worn out rifle barrels after a few rounds, but it is claimed a way has been found to protect the barrel by plating the interior with a chromium alloy. The explosive used is described only as a "commercial nitro-cellulose propellant."

Heer Iserlich  
Kiel, Germany

03-4-13  
 Bearings & Arguto Cillies  
 Wayne Junction Phila-



at 20th Annual Fair  
and Home Counties  
at Lexington Ky

B-146

FARM DEMAND FOR HORSES BEYOND SUPPLY

B-262

At present there is a definite tendency to increased use of horses on farms, and as a result the supply of work horses does not meet the demand. This is the assertion of Renick W. Dunlap, assistant secretary of agriculture, who is advising farmers to breed more horses. Economic conditions, he declared, forced many farmers to use horses because they did not have the means to buy tractors. In 1931, the price of horses dropped only half as much as the prices of all farm products.

U.S. Daily 1/20/32

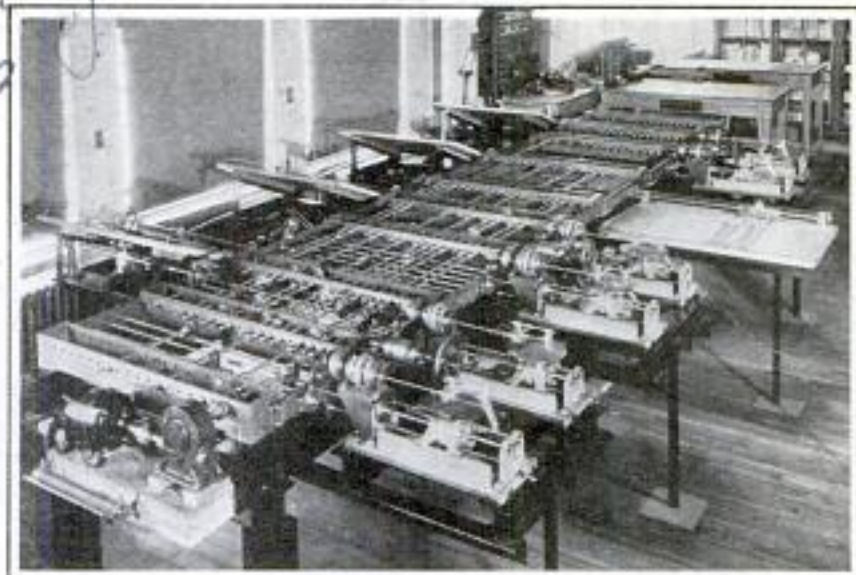

Mechanical Brain That Solves the Most Intricate of Problems in Calculus, Saving Weeks of Hard Work Computing Them

LATEST OF "ELECTRIC BRAINS" SOLVES EVEN CALCULUS

Following closely his announcements of the integrator and the photo-electric integrator, "electric brains" for the solution of scientific problems, Dr. Vannevar Bush, of the Massachusetts Institute of Technology, has developed a still more amazing machine, called the differential analyzer. It solves quickly and accurately complex differential equations which, by ordinary methods, would take weeks of hard work to compute. The analyzer is made up of electrically driven and controlled mechanical units which perform not only the fundamental operations of addition, subtraction, multiplication and division, but the advanced integration processes as well. Operators stand at tables placed along one side of the machine and guide it through the intricacies of variable coefficients and other mathematical labyrinths, while from the central system of units the answer is picked off and plotted on a large table on the other side of the apparatus. It is said the machine can be set up in a few hours to perform almost at once these calculations.

Cambridge Mass.

HUGE SUPERCHARGER DRIVES PLANE TO NEW RECORD

B-117

Flying at an altitude of 25,000 feet, an army aviator, Capt. Reuben C. Moffat, set a new record for a Dayton, Ohio, to Washington, D. C., flight at an average speed of 266 miles an hour. He covered the distance in one hour, twenty-six minutes. A Curtiss pursuit plane with exhaust-driven supercharger was used.

General Electric supercharger



Here is Capt. Reuben C. Moffat, Army Aviator, pointing to Supercharger on the Plane in Which He Set a Speed Record

Wright Field Dayton Ohio

roy of Electric Engineering

Copyrighted material



B 163  
592

Dr. W. Paul Plavan  
rancher, at Huntington  
Beach, Calif.  
POPULAR MECHANICS

# Plow Cuts Furrow Forty-Two Inches Deep

Emb. Neil Stanley, 1457  
Orange Ave. Santa Ana, Calif.

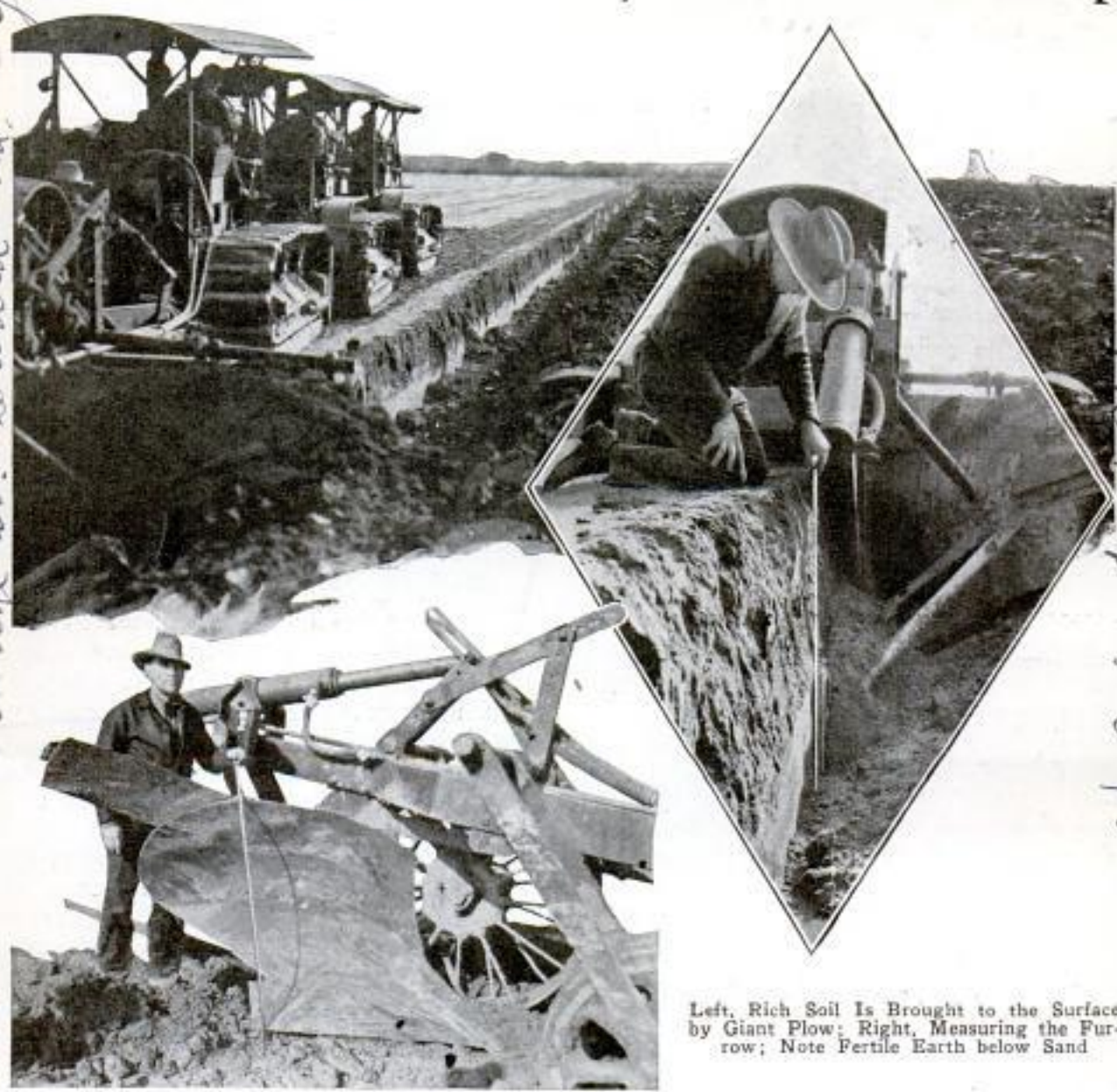

Left, Rich Soil Is Brought to the Surface by Giant Plow; Right, Measuring the Furrow; Note Fertile Earth below Sand

Cutting a furrow forty-two inches deep and thirty-six inches wide, a giant plow is bringing to the surface rich soil which was buried when the Santa Ana river overflowed thousands of acres in California many years ago. So deep was the sand deposited by the flood that farmers could raise only the poorest of crops. To overcome the handicap, a super-plow was designed and constructed with parts from old tractors, trucks, scraps of boiler plate and other junk. Weighing four tons, this giant plow cuts a furrow several inches deeper than the sand deposit, turning up the rich soil which will increase productivity. Three tractors pull the big plow, turning over an acre of ground every two

hours. Most of the sand is turned under in the first plowing.

## SILICA GEL SWEETENS SMOKE FROM RANK TOBACCO

Smoke from rank tobacco can be sweetened by inserting a tube of silica gel in pipestems and cigaret or cigar holders. Prof. J. Traube, of Germany, has found that silica gel, a common chemical widely used as an adhesive and as an egg preservative, removes from tobacco smoke harmful tarry materials and coloring matter as well as nicotine. Even the "scratchy" quality of the rank tobacco grown in the German Palatinate is eliminated.

B 301  
Cornfield drainage

Trust Biology 19910  
Prof. J. Traube  
Silica gel  
Palatinate, Germany  
2/2/33  
Silica gel  
Palatinate, Germany

reported in Zeitschrift  
für angewandte  
Chemie



*Schenectady*

*B-122*

**ELECTRIC HUM TRAPS MOSQUITOES**

*B-189*

Electric mosquito sirens to lure the insects to their death by imitating the "hum" of the females may be developed to rid homes of these pests as the result of a chance discovery made recently by Prof. Elihu Thomson, of the General Electric company. He was operating an electric furnace in fusing a sixty-six-inch quartz disk for making an astronomical mirror and noticed that thousands of mosquitoes swarmed over the furnace pit, only to be killed by the scorching air. An investigation indicated that the male mosquitoes were being attracted by the hum of the electric equipment which was mistaken for the song of the females. Professor Thomson said that it is not necessary to have an electric furnace to catch mosquitoes, however, for it is easy to build an electromagnetic "hummer" which, at small expense of energy, will spread over a large area the peculiar noise that attracts the males, perhaps at the same time repelling the females which do the biting. Once attracted, the insects might be killed in various ways, resulting in curtailing the egg laying of the females.

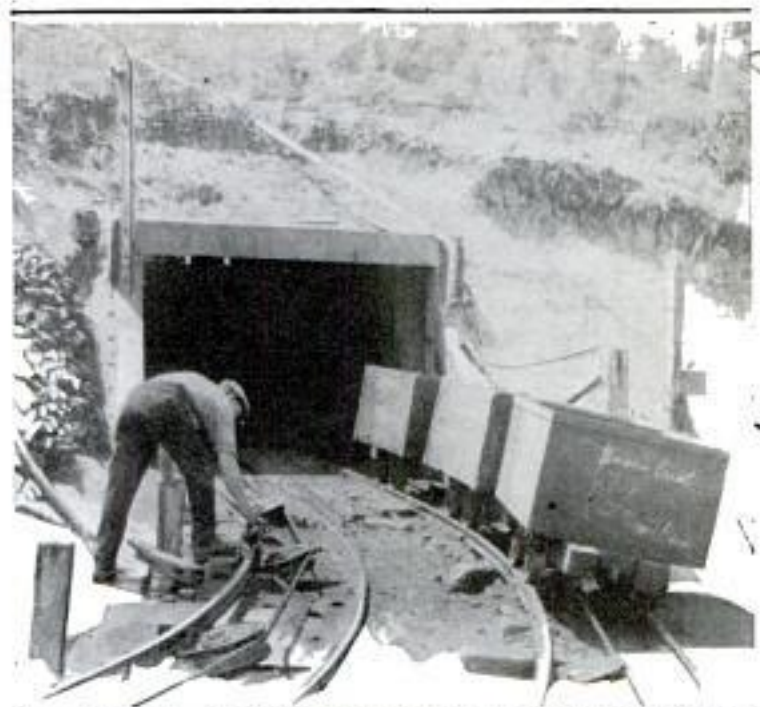

Rope Railways Are Built with the Tracks Tilted the "Wrong" Way on Curves. This One Is in Australia

*Pulse Mine Coal Mines*  
**WHEN THE LAW IS REVERSED ON ROPE RAILWAY**

Tilting the outer edge higher than the inner on curves in roads and railroads is a common enough experience, made necessary by the centrifugal force of a body moving on a more or less circular track, but tilting the banking the other way about is a phenomenon. Although it might give reason for one to doubt his own vision, it is a necessary provision on rope-hauled railways such as are used in mining operations. If the trucks are hauled on tracks tilting inward there is danger of the rope pulling them off the track.

*B-88*  
**LOCKNUT FOR TRUCK WHEELS CUTS ACCIDENT COSTS**

Reduction in the number of costly delays to which automotive trucks are subject by wheels coming off may be obtained through use of a self-locking nut which holds the wheel firmly. The locking device prevents loosening of the wheel nut from vibration and road shocks are absorbed before they reach the nut.

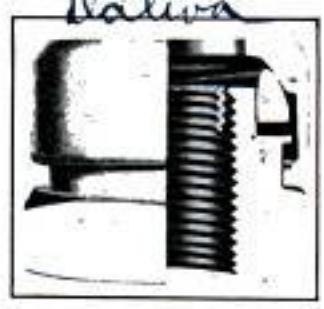

Our Bureau of Information will answer all questions regarding articles appearing in this magazine.

**ALUMINUM FREIGHT CAR SAVES TEN TONS IN WEIGHT** *B-200*

Several aluminum freight cars have recently been built for testing purposes, in the hope that they may help solve part of the financial problem facing the railways. They are hopper-bottom cars constructed almost entirely of this one metal, and on a standard-size car with a capacity of 140,000 pounds the aluminum construction results in a weight saving of 21,000 pounds. In a sixty-car train, this would represent a reduction of over 600 tons in material, which is equal to nearly nine additional cars.

*The International Safety Lock Nut Corp. 67 Broad Street, New York.*

*For Aluminum Company of America Aluminum Division Pittsburgh, Pa.*

*near Auckland, New Zealand*



Q 255 4

Acme Newspictures, Inc.  
220 & 4 2nd  
New York

# "PAN!" Rules



Above, Pilot Talking with Radio Dispatcher; Left, Examining Weather Reports at a Ground Station

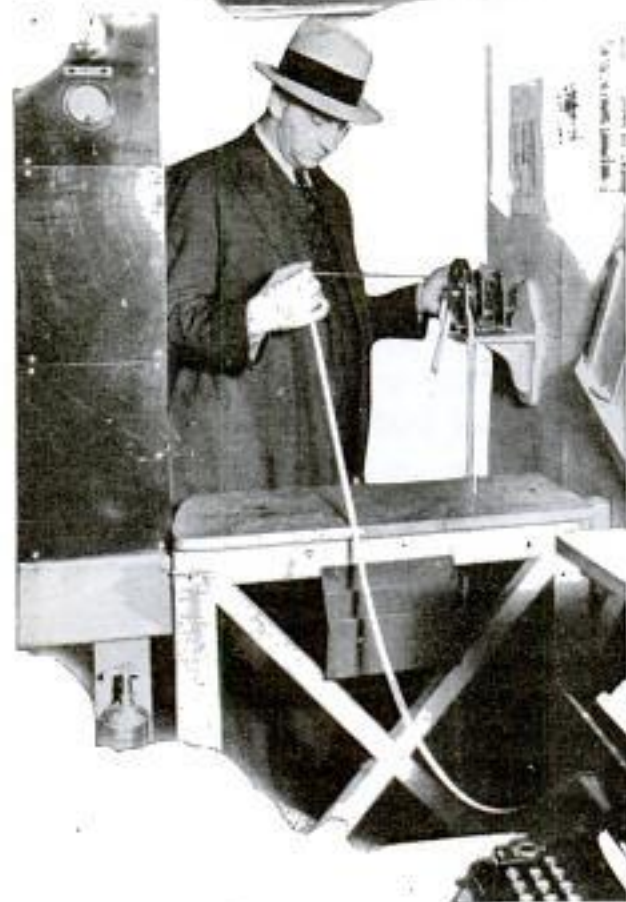

**I**N a soundproof cage suspended under the roof of a United Air Lines hangar at Chicago, a young man with headphones clamped to his ears sits at a desk talking into a microphone. He speaks a strange jargon of seemingly meaningless words into the transmitter, then stops and listens. In a moment the pilot of a transport plane, 300 miles away and 5,000 feet up, replies to his message.

The second hand of a clock moves over a face containing letters instead of numbers, and a minute later the young man is conversing with another flyer out on the airways who has been awaiting his turn to talk. The man at the mike is a radio operator of station WUCG, the busiest radio station in the world. He and others like him are engaged in a new profession, born with the advancement of air transportation.

The radio-telephone man is the modern evolution of the railroad dispatcher. Like the key pounder of the past who ordered the crew of the local freight to take a sid-





# the Airways

*How Distant  
Dispatcher's Voice  
Guides Destiny of  
Great Air Liners*



Above, Clock That Governs Conversations of Dispatcher. Below, over Airway Radio

is soundproofed to keep out noises from the airport, and the floor rests on springs to reduce vibration. The coop itself is filled to overflowing with radio equipment, and in the midst of the instruments sits the operator. On the desk before him is his microphone and facing him is a clock which regulates his work. Each plane and each ground station has a specific time for reporting, and, except in emergency, this time is kept to a fraction of a second.

ing for the night express, the radio man transmits to transport pilots the orders and information supplied by his superiors, and in turn receives from the flyers reports on the progress of scheduled planes.

About the face of the clock are letters, each representing a plane or ground station. As the second hand indicates the minute represented by one of these letters, the radio man begins talking with the pilot who has been advised beforehand when he is to report. The conversation must be limited, for the operator has another speaking engagement with another pilot in sixty seconds.

Radio today rules the airways just as telegraph wires govern the rails. From coast to coast and from California to Mexico, a network of ground stations keeps a constant check on every transport plane in the air, the communication system between planes and ground enabling the radio operator at any time to tell within twenty miles the location of any ship in his territory.

Each ground station is responsible for ships within a radius of about 300 miles, and when a plane passes out of this radius or division, it begins reporting to a succeeding ground station. At frequent intervals, the ground stations communicate with each other, this time also being specified on the radio clock. A message from Chicago, for instance, about a departing plane is relayed from one ground station

The radio operator does his job in surroundings as drab as those of the train dispatcher. Station WUCG, for instance, roosts in a little coop under a hangar roof, reached by a stair and catwalk. The cage



92554  
596

to another, and back over the air to the sending station will come weather reports from the ground stations in sequence, or other information. Such a relay usually consumes a minute or less.

Every minute of every day and night, one of three operators at these ground stations has on the headphones and is listening for possible trouble. The two words that galvanize the operator to action are "May day" and "Pan." "May day" is an Americanization of the French "m'aidez" meaning "help me," and is spoken by a pilot only when his ship is out of control and is believed to be crashing. It is followed by the pilot's location. "Pan" is the aviator's way of saying "Stand by." It indicates that the pilot is in difficulty of some sort and wants the operator to listen for him until he gets out of it. The

word is always a signal for other communication to cease and turn the ether over to the pilot and his problem. Like the SOS for ships, it is very rarely used, and in two years only two "Pans" have been transmitted over one airway's communication system.

Words are golden over the radio telephone and the brief time available to perform the necessary communications has forced adoption of a language of abbreviations although no code is employed, because it has been found that pilots usually are too busy to try to decipher code in the brief space allotted them to talk. A typical message from a pilot running into bad weather to his ground station might read like this:

"Gravis 111 south bound 10 S Waterman 500 10 S Waterman ceiling 500 visibility

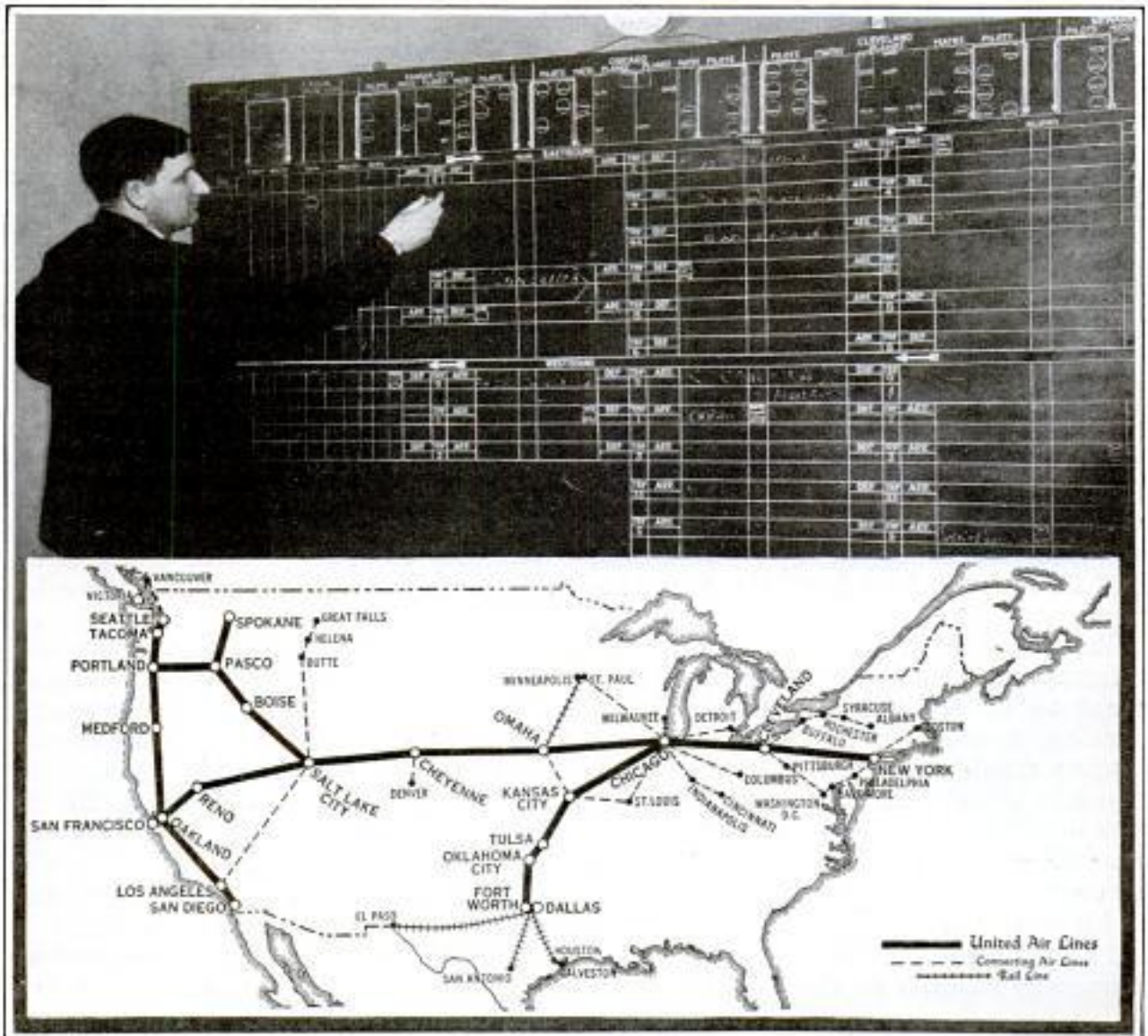

Above, Flight Board of a Transport Line on Which the Position of Each Pilot Is Checked as He Reports by Radio Several Times Hourly; Below, United Air Lines Route Map



a 2554

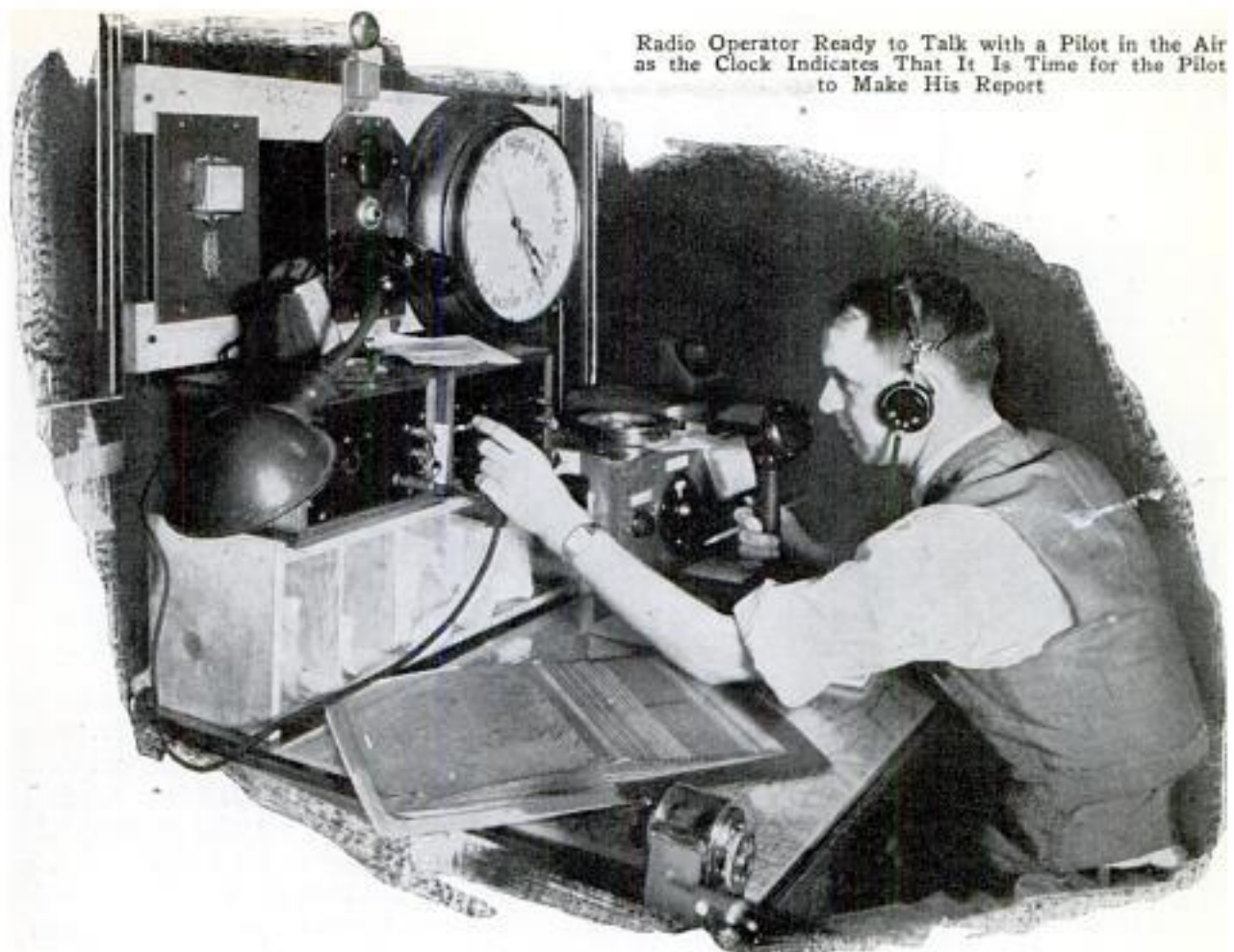

Radio Operator Ready to Talk with a Pilot in the Air as the Clock Indicates That It Is Time for the Pilot to Make His Report

I weather becoming worse returning Chicago." Translated into ordinary terms, this report shows that it comes from Pilot Gravis in ship number III, proceeding south and at a point ten miles south of Waterman, Ill. At this point the flyer is at an altitude of 500 feet where he has encountered clouds and can see for only a radius of one mile. He has advised the operator that he is turning back because of the bad flying weather.

The weather is the chief and all-important subject of conversation on the airway radio. When one plane calls another, it is usually to report on weather conditions encountered. Each regular communication between a pilot and a ground station includes a brief summary of weather conditions. In good weather, each pilot reports to the ground station of the division checking him at intervals of twenty minutes. When he encounters bad weather the time between reports is cut to ten minutes. Often the Chicago station is following half a dozen planes in the air at once, and on special occasions when traffic is heavy, there are often twenty-

five or more ships reporting in the space of an hour. Every twenty-four hours, the station follows twenty-four mail and passenger planes along their routes with weather reports at twenty-minute intervals, and every hour the operator speaks to thirty-four ground stations. The pilot reporting from the air always gives his name, number of his ship, position, altitude and condition of the weather, his motor and his plane. In return he receives weather reports, instructions and information about reservations.

While the pilot must follow instructions, when possible, he is supreme as far as his ship is concerned. He may be ordered to make a landing at a certain field to take aboard a passenger, but he can disregard the instruction if he considers it dangerous to come down, or if some other emergency arises to make a landing inadvisable. The pilot himself keeps no log of the information given him by radio or of that he transmits, but a careful record of both is preserved by the ground station to which he reports.

In some instances, radio operators have



Q 2554

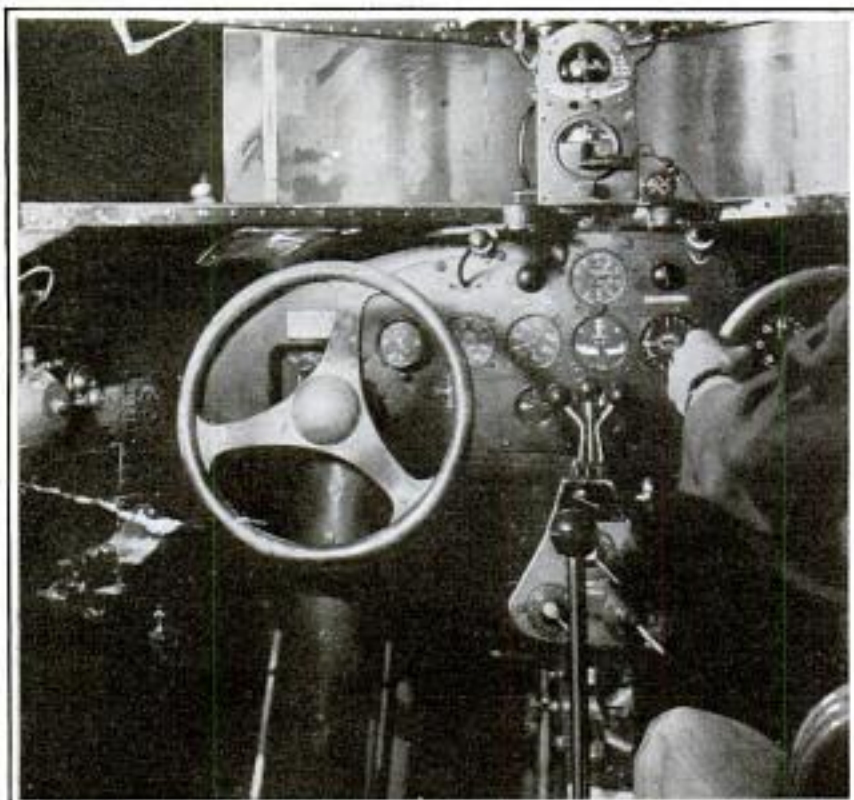

Pilot's Cabin of a Large Transport Ship, Showing the Instrument Board; Radio Controls Are at the Extreme Left

each for the latter and an average of \$2.50 each for his birds. In one season, he sold 1,800 birds and 28,000 eggs. Ten acres sufficed to raise them. The only fixed charge was \$2 a year for a game breeder's license. Bantam hens are kept to mother the little pheasants so their mothers will continue to lay. The farm now is experimenting with wild turkeys.

B-142  
**MACHINE DEALS  
BRIDGE CARDS IN  
TEN SECONDS**

Offered to prevent the embarrassment of a "misdeal," a mechanical dealer for playing cards is now on the market. All the cards can be dealt in

ten seconds, thirteen to each player, by making thirteen complete turns of a small knob on top of the device. The cards are said to last much longer if the machine is used than when shuffled and dealt by hand. Old and new cards are handled with the same accuracy.



Delivering Thirteen Cards to Each Player in Ten Seconds, This Machine Makes No Misdeals

Book kept. can supply "Outdoor Appliances" which has immediate

acted as the eyes as well as the ears for pilots in trouble. In tests, pilots flying over a field invisible to them because of fog have been maneuvered, by the radio operator, into a position making it safe to land. The operator simply listened to the motor as the ship hovered overhead out of sight, giving the pilot instructions as to his location. This, of course, cannot be done if the visibility is zero, but where the fog or clouds are 100 feet or more high, the pilot is directed to the proper position, then takes charge of the landing himself as he comes low enough to see the field.

H. F. Faulkner, once a seagoing commercial operator, is in charge of WUCG. He estimates that sixty per cent more schedules are kept since pilots are directed by radio telephone, than before.

**CROP OF PHEASANTS RAISED  
ON IOWA FARM**

An Iowa farmer has converted his land into a game-breeding preserve. His biggest and most lucrative "crop" is ring-necked pheasants which he sells to state game and conservation departments and hunting estates. He sells both the "stock" birds and the eggs, receiving twenty cents

B-200

Carl Benson  
near Lamaille, Iowa

The Card Dealer Co. Mail  
Box 1045



B. 77 Jay Brier Chapman, The Writers  
 6700 Sunset Blvd. 599  
 Hollywood, Calif  
 POPULAR MECHANICS

# Where You Hear Best in the Talkie Theater

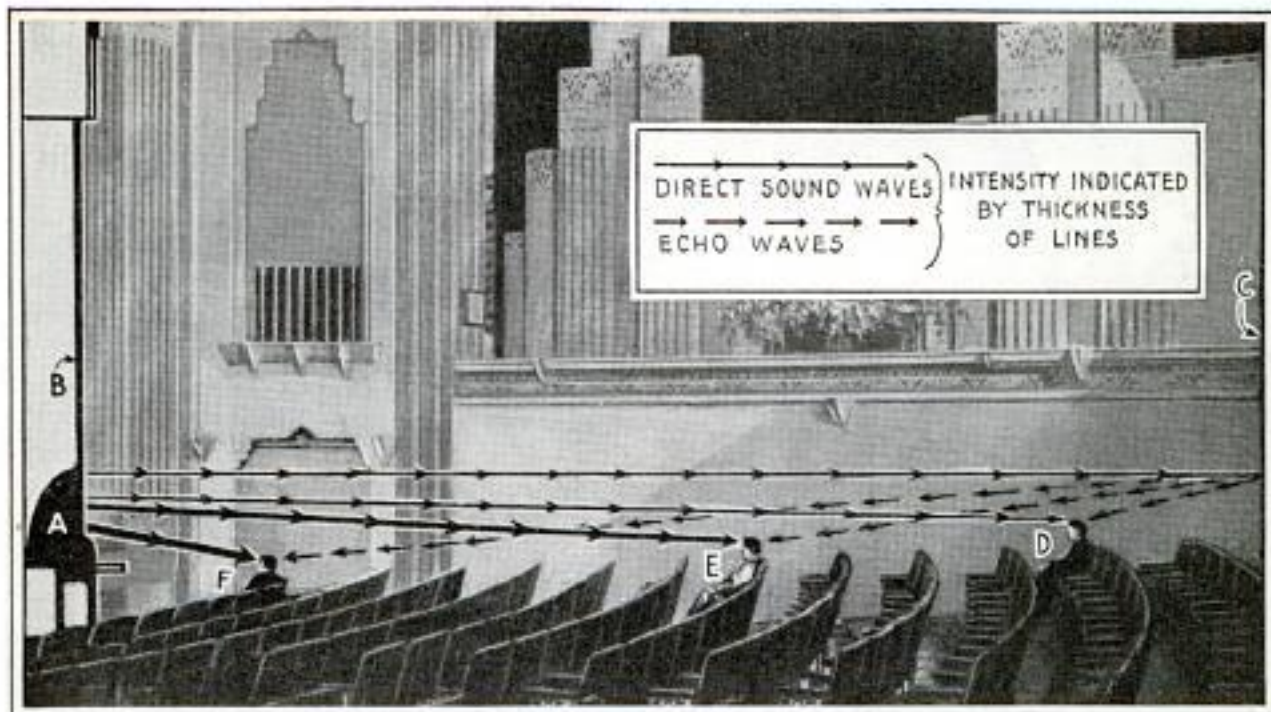

Arrows Indicate How Sound Waves Echo in the Talkie Theater, Showing That Persons Seated at Front or Rear Are Likely to Hear Better Than Those near the Middle

Few movie patrons know that the position of their seats in many theaters affects the clearness of the sound they will hear from the screen. Except in houses built to muffle echoes, a "mushy" or blurred sound comes to the ears of those near the middle section. It is caused by the fact that sound, delivered from the stage by the loud speaker, echoes from the rear wall of the theater. The words or music travel to the spectator in the middle of the theater, then bounce off the rear wall and return again to his ears. The human ear does not detect the distinct echo, but the interval between the sound and echo is sufficient to cause a slight blurring. This blurring is more noticeable near the middle of the theater than at either front or back. The patron seated well forward gets a loud volume from the speaker and an echo so faint as to be imperceptible. The person at the rear receives a lesser volume, but the echo comes so quickly afterward as to be unnoticeable. In a well-filled theater, the mushiness is not so disturbing to the sensitive ear as in one only partly full. Theaters built since the advent of the talkies usually are constructed to take care of the echo problem by providing sound traps and broken an-

gles as well as by the use of non-reverberating materials.

## WAY TO PREVENT "VAPOR LOCK" IN AUTOS IS FOUND B 90

"Vapor-lock," one of the bugbears of modern motoring, resulting in surging, stumbling, "flat spots," jerking, hard starting and many other engine ills, has been obviated, according to the makers of a



new accessory, quickly installed on any car. Vapor lock is the result of heating the modern highly volatile gasoline in the fuel line. At spots in the line where there is excessive heat, the fluid gasoline vaporizes, forms bubbles and sets up resistance to the even flow of the fuel. The new accessory makes use of a principle well known in the installation of hot-water heating plants in the home, and places an expansion chamber and vent in the fuel line near the carburetor. It works equally well on all feed systems, it is claimed.

Craver Co

Copyrighted material  
 Phila.



B-84

Mr. Charles A. Whitehouse  
337 Beacon St  
Somerville, Mass

Building of This Model Cathedral Occupied the Young Artist More than a Year



**SIX-FOOT CATHEDRAL IS CUT OUT WITH SCROLLSAW**

Intricate designs which decorate a miniature cathedral built by a St. Louis youth were cut with a scrollsaw. More than a year was spent in building the six-foot model. Three-sixteenths-inch veneer of white pine wood was used for the designs.

**MONKEYS TAKE SUNSHINE MILK AS CURE FOR RICKETS**

Monkeys at the New York zoological park now get synthetic sunshine in their milk, this form of treatment for rickets taking the place of the sun lamps previously used. The feeding of sunshine milk is still in the experimental stage, but if it proves entirely successful for occupants of the monkey house, children in the slums eventually may receive artificial sunshine from the same diet. Monkeys in captivity always have been a source of trouble because of rickets, but the advent of ultra-violet-ray lamps brought a new era of light to the monkey houses in zoos. The lamps were placed outside the cages and the lights turned on the occupants. The monkeys liked the novelty entirely too well, and crowded to the bars to stare into the reflectors with the result that many developed inflammation of the eyelids. About six months ago, the sunshine-milk

Dr. W. Reid Blair,  
director

Ernest Ferraris

New York Herald Tribune  
1/18/02

diet was started. The milk is dehydrated and spread out in powder form on rollers. As it passes along the rollers, the ultra-violet light is turned on to impart a sort of synthetic vitamin D.

**ELEVATORS FOR "RADIO CITY" MAKE RECORD PURCHASE**

Builders of "Radio City" in New York have awarded what is declared to be the largest contract for elevators ever placed in the world's history. For the main building of seventy stories alone there will be eighty-two miles of steel elevator cable and eleven miles of copper cable, the combined weight of which will be more than 150 tons. The machine-room equipment for the twenty-eight "high rise" elevators will weigh about 33,000 pounds, and that for the thirty-two "low rise" cages about 23,000 pounds. The combined weight of this and the elevators, not including cables, will be over 1,000 tons. The signaling systems are said to be the largest and most ornate ever developed.

**NOZZLE FERTILIZES THE LAWN WHILE YOU SPRINKLE IT**

Practically all the effort is removed from fertilizing the lawn and the task is said to be done more efficiently by a new spray device that attaches to the water hose when you sprinkle the grass. It consists of a solid brass nozzle to which is attached a small rubber tube. The tube is placed in a container of fertilizer and the force of the water draws it up and distributes it in the correct proportion as the lawn is sprayed. Any kind of fertilizer can be used. In addition to its advantages in fertilizing lawns, the apparatus is effective in the spraying of insecticides, disinfectants, lime or oil emulsions in chicken houses, brooders and similar places.



pend. \$1.50

A. B. C. Mfg. Co.  
Quincy, Ill.



Q 2487

Cont. Leslie Greer, 1522 E

65th Place

Chicago

# Where did you

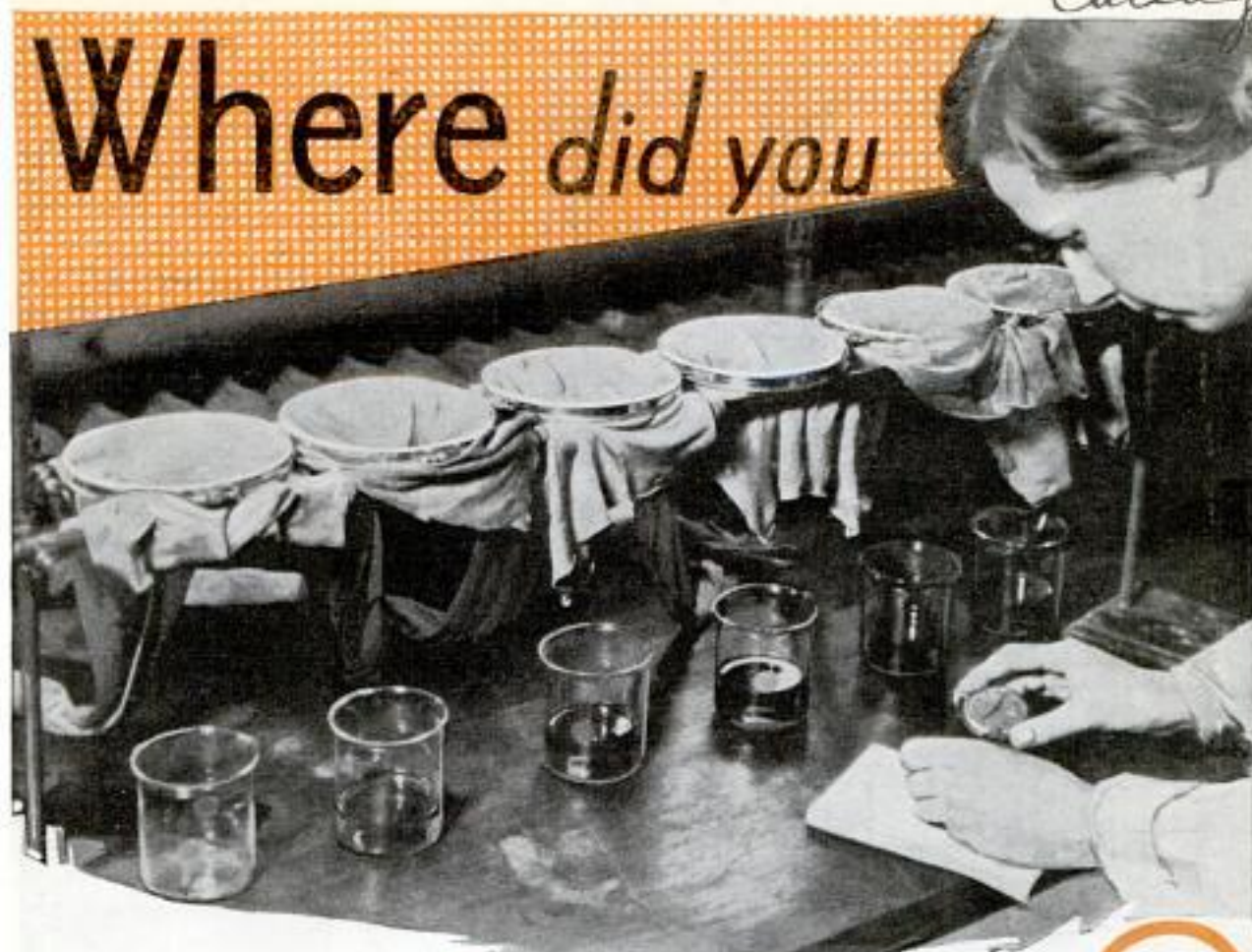

Perspiration Destroys Silk Hose by Eating Away the Tin with Which Silk Is Weighted; Here Hose Samples Are Taking the Water Test; Note That Sample at Left, Treated by Sealing Process, Retains Water Longer Than Others through Which Liquid Leaked in Thirty Seconds

# get that Hat

By JOHN DRAPER

"YOUR price is too high," you tell the storekeeper. He does not argue with you, because value is a hidden quality only revealed by use, but he does tell the manufacturer.

"All right," says the manufacturer, "I have got to give people what they want, or my workers will have no jobs. Here is something that looks just as good, but it only costs half as much."

Which helps to explain why you may appear in an "ash-can" hat, part of someone else's cast-off suit, silk hose composed of fifty-five per cent tin and a beautiful shirt filled with starch or clay. "It pays to buy the best you can afford, and things are usually worth just about what you pay for them," declares Dr. E. H. Harvey, whose business it is to find the hidden

values in merchandise. Despite its slovenly name, the ash-can hat is a fact—one hat out of every eight sold having been rescued from the ash barrels of the nation, or from other places where old headgear are left as worthless, according to Warren S. Smith, an official of the Hat Institute of America. Forty-five factories in the United States are turning out 250,000 dozen such headpieces each year.

So clever is the manipulation given to the alley tramp that very close inspection, and some knowledge of hats, are necessary for its detection. New hats are made from a double handful of some kind of fur, ranging from the fur of the coney to that of the beaver. The felts made from these furs last for a long time and, when

Montgomery Ward Co

Chicago



Q 2409  
602

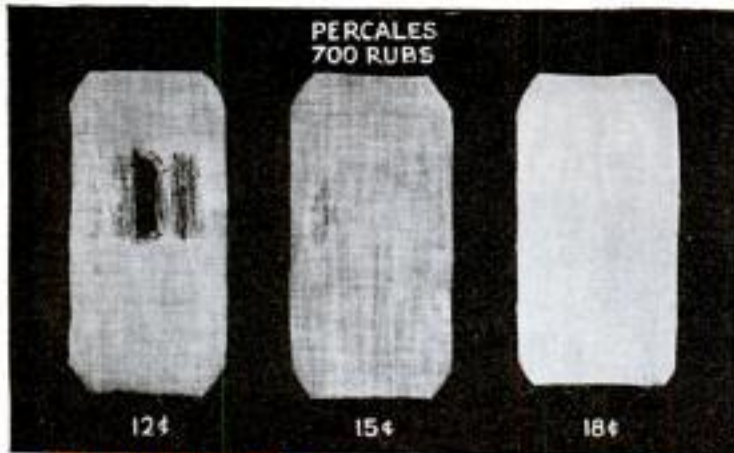

originally from high-grade virgin wool, leads a longer and more varied life than the hat. After one or two trips to the secondhand man, the old suit is collected by the rag picker in whose hands it is joined by other suits of similar quality, and sent to textile mills for reworking. The number of times the wool in an old suit can be used to make a new suit depends entirely upon the original length of the fiber.

"It's just about as hard



discarded, may be turned inside out, cleaned thoroughly, doped with powders and shellac, reblocked, relined with showy silk, adorned with a new sweat band and put back on the market.

Aside from price and reliability of the dealer, the best safeguard against becoming the owner of an ash-can hat is to compare the underside of the brim with the outer part of the crown. Almost invariably there will be a difference both in shade and texture, due to the action of the sun in fading the color, and the wear that the cleaning process has entailed. The average hat of this kind cannot stand more than two visits to the cleaners. The last trip will break the felt beyond the power of powder and shellac to mend. Such relics then leave the field of male millinery and enter that of female headgear. They are sold for use in making flowers and other ornamental finery.

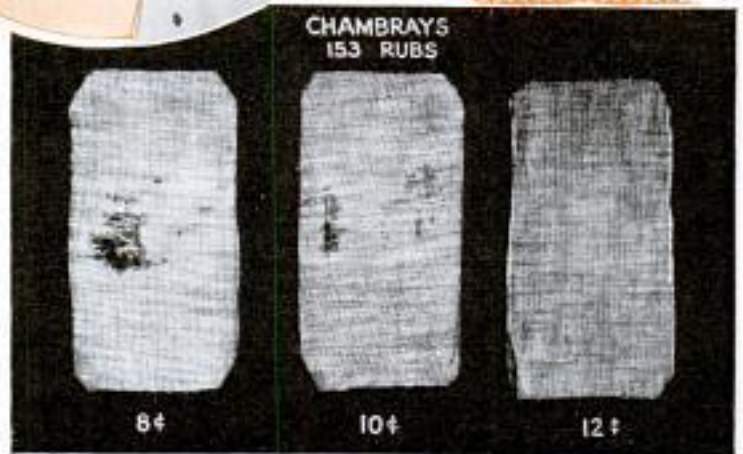

Machine Which Tests Wearing Quality of Cloth, and Charts Showing Result of Rubbing Test for Materials

to tell 'how old is Ann' as to tell how many lives a good woolen suit has," declares Doctor Harvey. "After the fiber becomes too short to be reworked into cloth, it is called 'mungo.' This is used chiefly as a filler to add strength to cheap felted material. It also may be used in insulation. Woolen fibers that are too short for that purpose are known as 'flocks,' and frequently find their way into roofing pa-

*Precision Wear Test Meter - designed and made by A. Wyzenbeek and staff, Mechanical Engineers, 566 W. Washington Blvd. Chicago*



B-194 The W. H. Mathew Corp 3722  
 Morel Park Blvd  
 St Louis, Mo

POPULAR MECHANICS

per or similar material." But if things are not always what they seem in men's clothing, they even more frequently are something else in women's material. Many a new silk garment contains far more tin than silk, and maybe some rayon or cotton, too. Indeed, a dainty garment may have the feel of purest silk, yet contain one-fourth more tin than raw silk by weight. It is true that this ratio is higher than that adopted by most reputable manufacturers, but fifty-five per cent tin in silk is quite acceptable.

And there are other strange facts. Feathers are almost always present in down, for example. The old idea was that it came from the eider duck, and that all feathers had been picked out by hand. Such a pillow no longer is standard. Under present methods of manufacturing, no matter whether the down is from the eider or any other water fowl, as all true down must be, the presence of a maximum of twenty per cent of feathers is expected and permitted in a down cushion, under a ruling of the federal trade commission. A pillow stuffed with down alone is less buoyant than one which contains a limited quantity of feathers.

The lesson in all this is first to deal with a reputable merchant and then to consider quality before first cost.

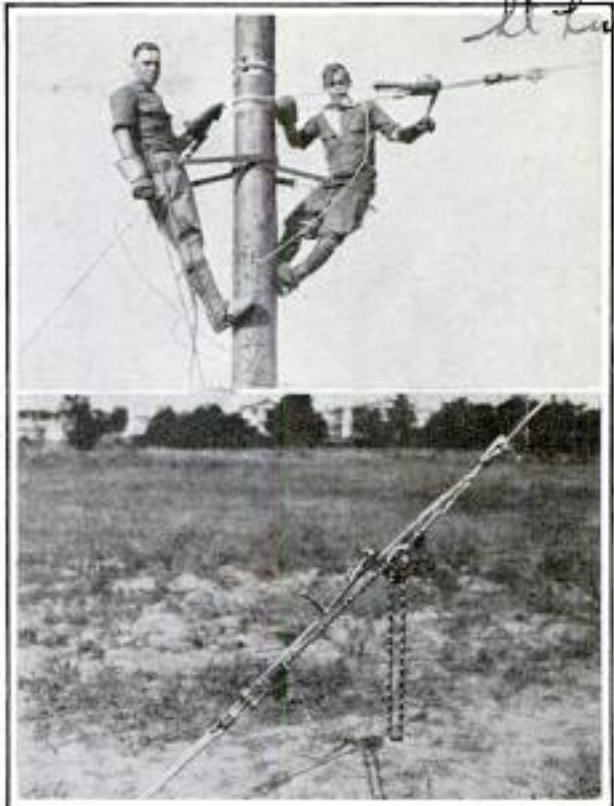

Guy Wires and Telephone Lines Are Easily Stretched with This Light-Weight Chain Hoist

EASILY PORTABLE CHAIN HOIST WEIGHS THIRTY POUNDS

Although weighing only thirty pounds, a portable chain hoist recently developed is capable of exerting a pull of several thousand pounds. It is operated by a hand-crank and double-wormgear arrangement, and the load can be held at any point without a catch of any kind. A ratchet is provided in either direction for operating positions in which a full turn of the crank is impossible, such as close corners. The hoist has found particular favor with road and repair crews in such work as pulling guy wires, stretching lines, tightening fences and by mechanics for lifting engines from autos and trucks.

B-128  
 CONTRACT-BRIDGE CALCULATOR SPEEDS UP THE GAME

Speeding up the game by saving players the trouble and time of figuring their scores, a calculator for contract and auction bridge is now on the market. It is combined with a score pad.



It's Easy to Score Contract and Auction Bridge with This Calculator

RAILWAY STATION HAS MOVIES TO AMUSE TRAVELERS B-307

One Paris railway station has installed movies for the entertainment of travelers forced to wait for trains. The entertainment is continuous and consists mainly of news reels and short comic films. The little railway theater makes a small charge, and the innovation has proved popular among those having half an hour to kill before train time.

Walter Haynes,  
 608 Dearborn, Chicago

Sub. D. ts.  
 1/30/32  
 Copyrighted material



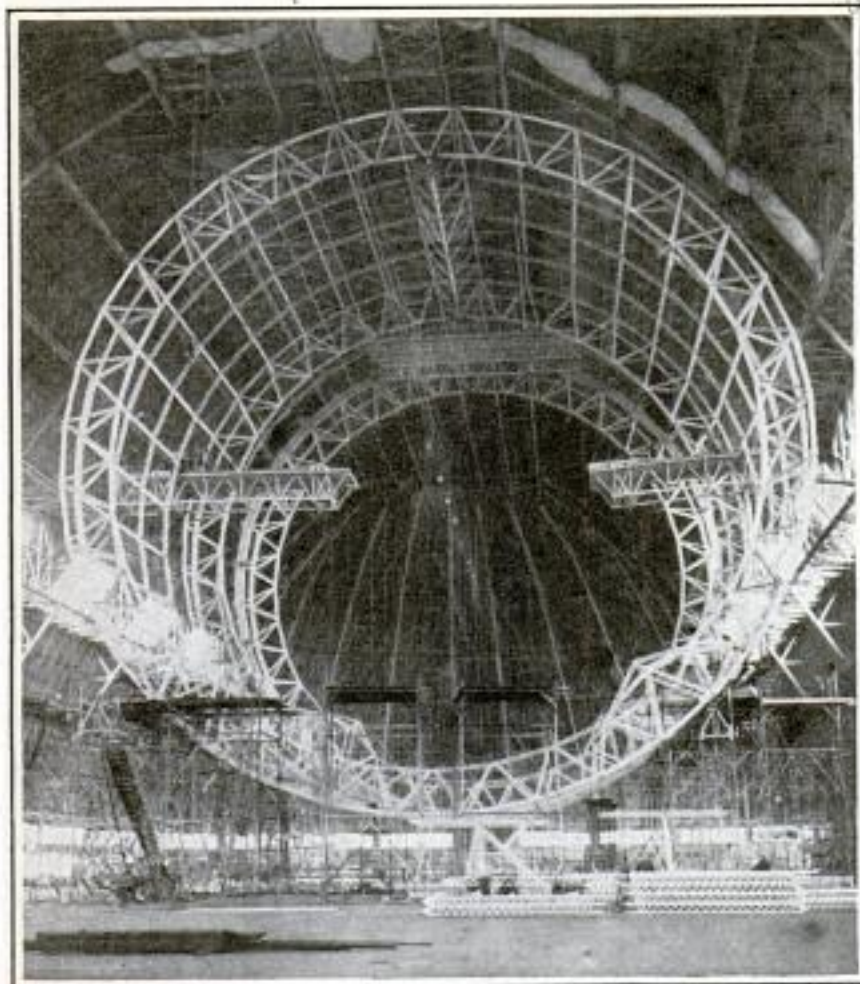

© International News

Like a Giant Spiderweb, the Metal Skeleton of the Dirigible "Akron's" Sister Ship, "ZRS-5," Is Taking Shape in the Construction Hangar

### SKELETON OF GIANT DIRIGIBLE RAPIDLY TAKING SHAPE

Framework of the giant "ZRS-5," sister ship of the "Akron," is rapidly being placed in position at the builder's dock in Akron. The third of the main rings recently was raised, giving the inside of the hangar the appearance of a huge metallic spiderweb. The second of the navy's super-zeps is to be approximately the twin of the first, according to the original specifications, with only such minor changes as may be suggested by the actual testing of the "Akron" in flight. Such tests have been held regularly since the launching of the first air cruiser. The main rings of the "ZRS-5" are 133 feet in diameter.

Popular Mechanics Magazine does not publish the name of the maker or seller of any device described in its pages, but this information will be furnished free upon application to our Bureau of Information.

B-119

### PATENTS SPEEDED TO SAVE TIME OF INVENTOR

During 1931, the patent office passed on 20,128 more applications than were received in that period, doing fourteen months' work in twelve in order to cut down by two months the period of time an inventor must wait for official action on his application. At the beginning of 1931, there were 110,402 applications awaiting action, and at its close, the number was 90,274. This progress was made despite an incoming 20,000 amended applications per month, an increase of 2,000 a month over the number received two years ago. The decrease in applications for new patents, amounting to less than 10,000 in 1931 as compared with 1930, did not compensate for the increase in the number of amendments filed.

Applications for new patents in 1931 numbered 79,513. All work of the patent office is now less than seven months behind applications, compared with nine months a year ago.

B-87

### SIGNAL POSTS ON CAR FENDERS HAVE MIRRORS AND LIGHTS

One pair of auto fixtures now combines half a dozen separate accessories, including fender guides, driving mirrors, parking lights, side floodlights, trouble lights and signal lights. All these are incorporated in two upright frames, one for the outer edge of each front fender. The frames rise high enough to serve as fender guides. At the base of the posts are floodlights which can



The Autopark Co.  
225 W. 57th St.  
New York



B-81 and M. Thomas  
French engineer 605

be operated separately to direct rays to either side of the road. Above the floodlights rectangular frames are mounted, containing mirrors at the rear and fender parking lights at the front. The parking lights can be turned and focused on any part of the car to serve as trouble lights. The signal lights are in the form of flashing arrows, at both front and rear of the signal posts. The rear arrows flash red and the front amber, to indicate turns.

*Suggested by the author*

**BULK FREIGHT BOXED IN STEEL WINS CARLOAD RATES**

Designed particularly for the transportation of sand, cement and similar bulk commodities, a new type of all-metal container was recently demonstrated on the Pennsylvania railroad. Development of this type is the latest step in the extension of container service, now available for general merchandise between the larger stations. More than 4,000 of the containers are in service. The method provides shippers with the means to move less-than-carload shipments on schedules comparable with carload lots. Twelve containers are loaded on the standard "gondola," placed and unloaded by giant cranes. The boxes have dump bottoms.

B-7

*at 31 Standard Chestnut*



These Steel Containers for Freight Are Carried at Low Rates by One U. S. Railroad

*St. freight yard  
Ohio*

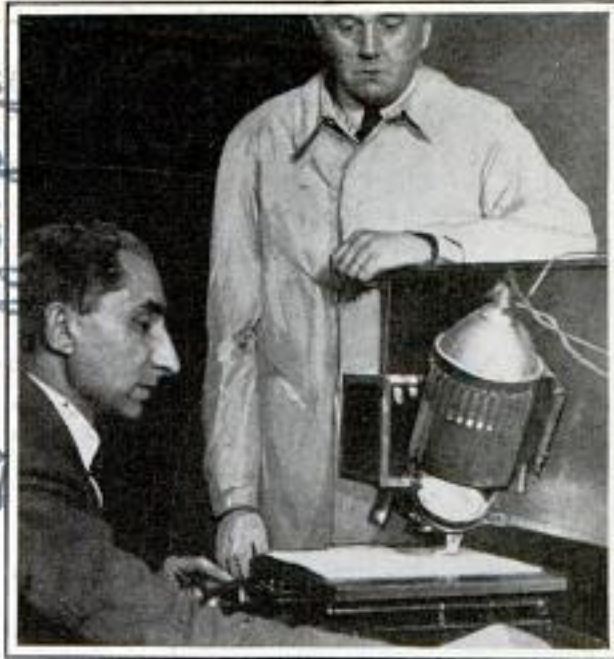

© Keystone View Co. Print in Books Is Translated into Raised Letters by a Photo-Cell for Reading by the Blind

**BLIND READ ANY PRINTED BOOK WITH AID OF ELECTRIC EYE**

Blind persons can read any printed book with the aid of the "photoelectrograph," a machine which uses the photo-electric cell, or "electric eye," to pick out each letter and establish connection with the blind reader's board, which is read by contact with the fingers. Thus, a "B" on the printed page is flashed to the blind person's fingers through the board and is read as it appeared in the book. The machine was invented by a blind French engineer.

*and built by M. Thomas  
9. Rue de la Sève Paris  
France*

**TRICKS OF CUTTING GOLD BARS ENRICH PARIS JEWELERS**

B-123

As a result of the huge gold surplus held in the vaults of the bank of France, the government recently began selling ingots of the precious metal to its citizens in exchange for silver and paper money. Immediately upon receiving the gold at the bank, a jeweler is sought. The owner often is overjoyed to find the jeweler willing to cut the brick into portions without any charge whatever. When the bar has been divided the jeweler casually sweeps the dust on the floor and bows his patron out. The saw he uses in such cases is unusually coarse and thick, and the average amount of gold dust retained and resold amounts to about \$20.

*Cont. Louis Duncan Ray,  
92 Erskine St.  
Detroit, Mich*



# NEW CONVENIENCES



Motor-Driven Kitchen Mixer That Has Attachments for Cleaning Bottles and Polishing Cut Glass and Silver; It Also Whips Cream and Even Puts Gloss on Fingernails



Cloth Impregnated with Silver Dust Which Keeps Tableware from Tarnishing; Below, Cork Shoes for Ladders to Prevent Slipping



Metal Cabinet Top Which Fits Any Bathroom or Kitchen Radiator



Above, Bumper for Dust-Mop Handle Which Cleans Mop by Vibration



Electric-Cord Reel in Base of Floor Lamp; the Cord Can Be Held at Any Desired Length and Reels In Automatically



**SALT DESERT TO BECOME LAKE FOR MIGRATORY BIRDS**

*B-102*

Oklahoma's great salt desert, extending over 40,000 acres, is to be transformed into a lake and refuge for migratory fowl. It has long been an enigma to scientists and a wonder to visitors. On its sun-blistered surface of salt, only four forms of life exist, two insects and two plants. At one time it was believed the salt plain represented old lake bottoms, but now some authorities believe the expanse of salt is the result of the weathering of soil that will not support enough vegetation to prevent excessive erosion. Millions of years ago, it is believed, the salt was laid down by shallow seas. Being soluble, it does not appear on the surface as rock, but "sweats up" out of the ground, covering a large area of prairie with a white frosting varying in depth from a thin coat to several inches. The plains have been used for outings because it is cool there at night, and flies and mosquitoes are absent. Farmers also have collected salt there for cattle. When the region is turned into a lake and becomes a bird refuge, the body of water will represent the largest artificial salt lake in the United States.

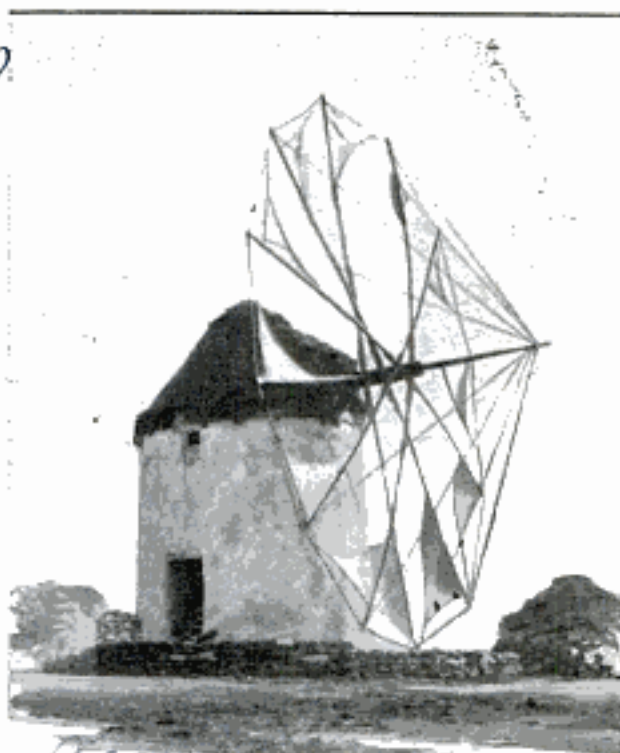

Some of the Oldest Sources of Power in Greece Are Windmills Like That Above

**WINDMILLS LIKE SPIDER WEBS SUPPLY POWER IN GREECE**

Although Holland is known as the country of windmills, some of the oldest and most picturesque of these sources of power are to be found in Greece, particularly in Myconos, the windmill town on the isle of the same name. These primitive windmills bear little resemblance to those in Holland, but look like giant spider webs and are run on short towers.

**MOVABLE HEAD ON FLASHLIGHT THROWS BEAM ANYWHERE**

*B-71*

Beams from a flashlight with a turnable head can be thrown in any direction with the light standing in an upright position, merely by moving the lens. The current is carried by two side arms that support the movable head, and standard sizes of light batteries are used. The lens is of the universal-focus type, and the light is particularly useful to mechanics and electricians who must use both hands at their tasks, since the beam can be focused directly on the work from any near-by point.

**CHILDREN PREFER RED COLORS AND GROWN-UPS BLUE**

*B-103*

Red is the favorite color of infants, and the average baby will give a red toy preference over yellow, blue or green, which follow red in the order named. This is the conclusion of a psychologist who conducted a series of color experiments with children. As they grow older, they continue to prefer red until they reach school age when a preference for blue asserts itself, yellow dropping far down the scale. In adults, the general preference for blue is very strong, with yellow even lower as a choice color. The tests to show that color likes and dislikes are modified by age also indicated that infants respond to colors when only three months old.

*Article in Journal of Experimental Psychology.*



Flashlight with a Movable Head, Making It Easier to Focus the Beams in Any Direction

ians who must use both hands at their tasks, since the beam can be focused directly on the work from any near-by point.

*Pines Winterfront Co.,*  
*1135 N. Cedar Ave.*  
*Chicago*

*Dr. Arch. Staples of*  
*Univ. of Nebraska,*  
*Lincoln Neb*



A. 2562.

Joseph W. Mountain  
650 Elmwood

Drive, Los Angeles Calif

## Even If It's Gold—

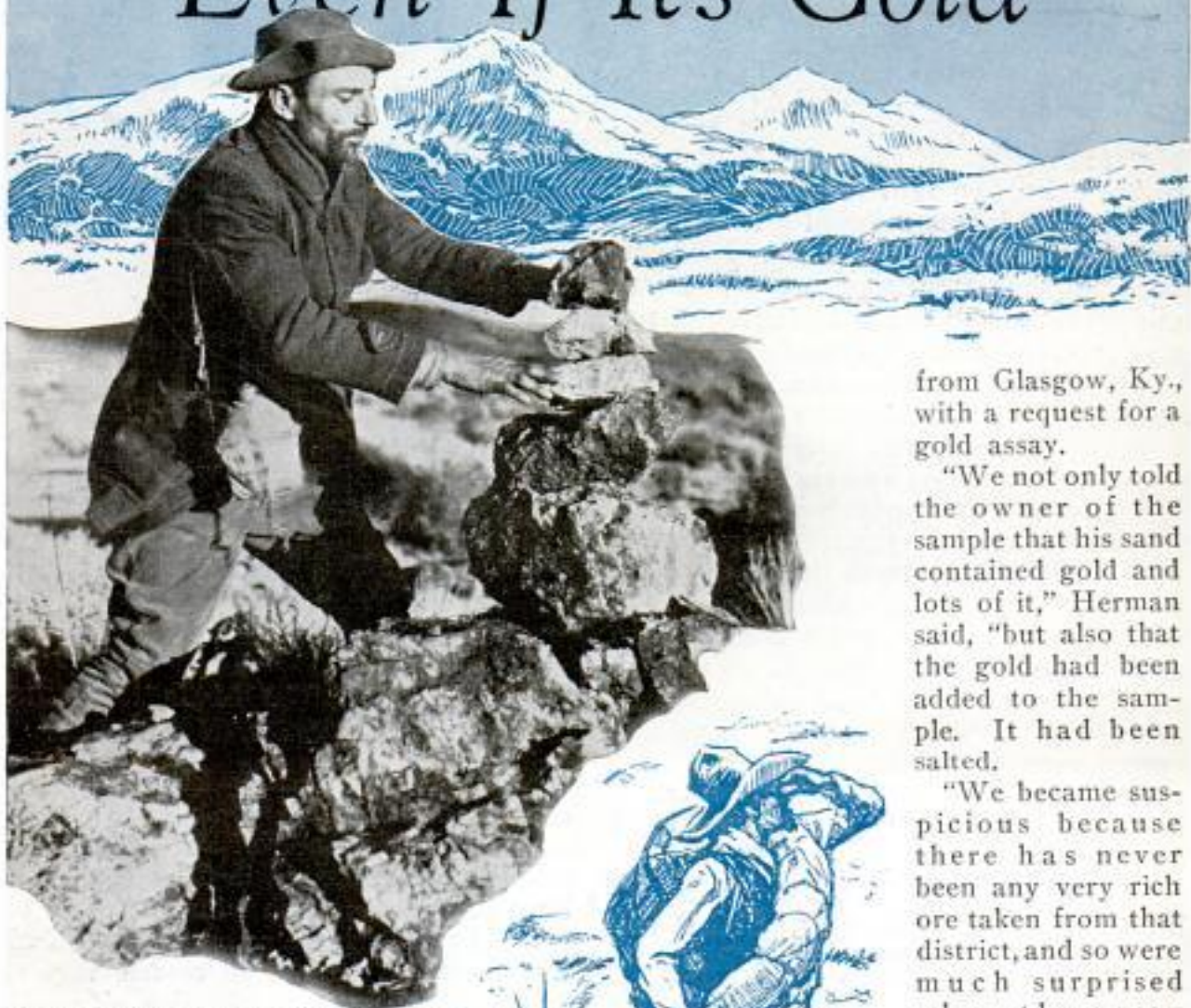

Prospector Placing a Pile of Stones on a Claim He Has Staked Out for Himself

"ALL that glitters is not gold," runs the old saying, but even if it is gold, be careful when you buy a mine.

Unscrupulous owners, dishonest promoters, and sometimes even overzealous citizens, add "a pinch of salt" in a desperate effort to close a sale. Mine salting, the secret addition of gold to mine samples in order to increase their value, has reappeared with the reawakening of the Mother Lode, the Randsburg, and other gold-mining districts in California, Arizona and elsewhere in the west.

John Herman, a Los Angeles assayer, recently received a sample of black sand

from Glasgow, Ky., with a request for a gold assay.

"We not only told the owner of the sample that his sand contained gold and lots of it," Herman said, "but also that the gold had been added to the sample. It had been salted.

"We became suspicious because there has never been any very rich ore taken from that district, and so were much surprised when the assay showed a gold value of about \$1,800 per ton. Although I felt certain the sample had been salted, to prove it was a different matter.

"Our first job was to separate some of the original gold from the sand without melting it as in the fire assay. We accomplished this by panning in the same way a prospector does in the hills. Some of the sand is swirled in a pan with water. The gold, being heavier than the sand, settles to the bottom of the pan while the water carries away the worthless gangue. We separated in this way enough of the gold to complete our tests.

"Under the microscope, the gold parti-



# LOOK OUT!



cles appeared as small, bright, sharp-edged chips, not rounded like placer gold which has been tumbled over sandy creek bottoms, nor rough like free gold from quartz rock. By careful study under the microscope, I was able to see file marks on some of the chips—proof positive that the gold in that sand did not belong there. But in order to be doubly sure before reporting to our client, we analyzed some of the gold particles washed from the sand. The result

Two Veteran Prospectors of the Alaskan Gold Fields Who Came to California to Try Their Luck; They Staked a Claim and Began Scooping Up Dirt Paying a Dollar a Pan



Above, Putting Crucible Containing Sample for Fire Assay into Furnace; Left, Weighing a Tiny Bit of Gold on a Delicate Balance

was ninety per cent gold and ten per cent copper, exactly the same composition as United States gold coin."

Two errors usually trip the mine swindler: putting too much salt in the sample and putting in the wrong kind; placer gold in quartz samples, coin gold in placer gravel, for instance. Another Los An-





92582

geles assayer tells his experience about misfit gold.

"I assayed a lot of samples from a placer property and the results gave the engineer who owned them 'the smile that doesn't come off.' Additional samples taken later showed only traces of gold—twenty to forty cents per ton. The original samples, which I had preserved, were washed down carefully in the gold pan—yes, sure enough, there was the gold, but it just didn't look right, because it was in little round spongy globules of various sizes. Under the microscope, I saw that the spongy effect was caused by escaping gases. We made many surmises as to the origin of the gold before I compared the gold in the pan with some from roasted Cripple Creek ore. The samples had been salted with gold from cabinet specimens of roasted telluride ores from Cripple Creek, Colo. This was almost as surprising as it would be for a fisherman to catch a herring already kippered."

Many things are used for salting. Among them are placer gold, gold from quartz veins, gold leaf, gold coin, jewelers' sweeps, dental gold and even liquid gold in the form of gold-chloride or gold-cyanide solution. The gold-solution method of salting is one of the easiest, but is de-

tected quickly. An engineer was investigating a property in Arizona, the sale of which was to involve nearly \$500,000. Because of the previous production of the mine, the samples were expected to run about \$6.50 to \$7 gold per ton, but instead they ran from \$12 to \$14 per ton.

Although at first not suspicious, the engineer took his usual precautions against salting. The first lot of samples assayed were from the property he was investigating. The second lot, which showed nearly as much gold as the first, were samples of barren rock taken from a different location. The third lot of samples were of blacksmith coal. The salters had done a thorough job. Gold ore, barren rock, and blacksmith coal all ran about \$12 per ton! A hypodermic-needle full of gold-cyanide solution had been injected into each sample bag.

Perhaps the oldest method of mine salt-

Washing Down a Hill of Gold-Bearing Dirt with a Four-Inch Stream of Water under Pressure



© Underwood & Underwood

ing is to load a shotgun shell with gold dust and fire the charge into the face of the tunnel or the wall of a stope. But soon engineers became wary. Instead of



taking their samples directly from the face of the rock, they would pick off a layer of the surface. If the rock was too hard for that they would drill a round of holes and blast out some of the rock before taking their sample. But the mine salters were only a step behind.

An engineer was told by the owners of a mine he was investigating, "We want you to take your samples all by yourself. You will find plenty of powder in the boiler house."

Reassured by this attitude, the engineer shot out some rock using the dynamite belonging to the mine. When assayed, the samples were considerably higher in gold content than the engineer thought they should be. He went



Above, Taking Sample in Tunnel for Assay; Below, Working a "One-Man" Gold Mine in Glacier National Park

back to the mine, carefully took other samples without blasting and brought back a few sticks of the dynamite. These new samples had much less gold in them, but the dynamite had a little pinch of powdered gold in the end of each stick. When the shot was fired, gold was sprayed all over the rock.

Another trick, similar to the salted dy-

namite, was used in the Buffalo Hump country in Idaho. Instead of putting the gold dust into the dynamite, the salter put it into the hole in the center of the drill steel, then plugged the hole with plumbago, or something else the same color as the steel. When the steel was hammered in drilling the powder hole, the plug of gold dust and plumbago came out in the hole, the shot scattered the gold, and the sample was thoroughly salted.

Even though his work is successful, the salter is not always the winner. Some years ago, two men who owned a claim near Leadville, Colo., took a little gold out of their mine, but got it so slowly that they could not keep up their grocery bill. So they brought to their grocer some

salted samples. Although the salting was crudely done, the grocer, a greenhorn in the mining business, cleared their bill and gave them a few dollars in cash for their claim. Then he sent a couple of men to start taking out ore. They needed only a few days to detect the swindle; but, because jobs were scarce, they kept on digging. In a few days they uncovered a vein



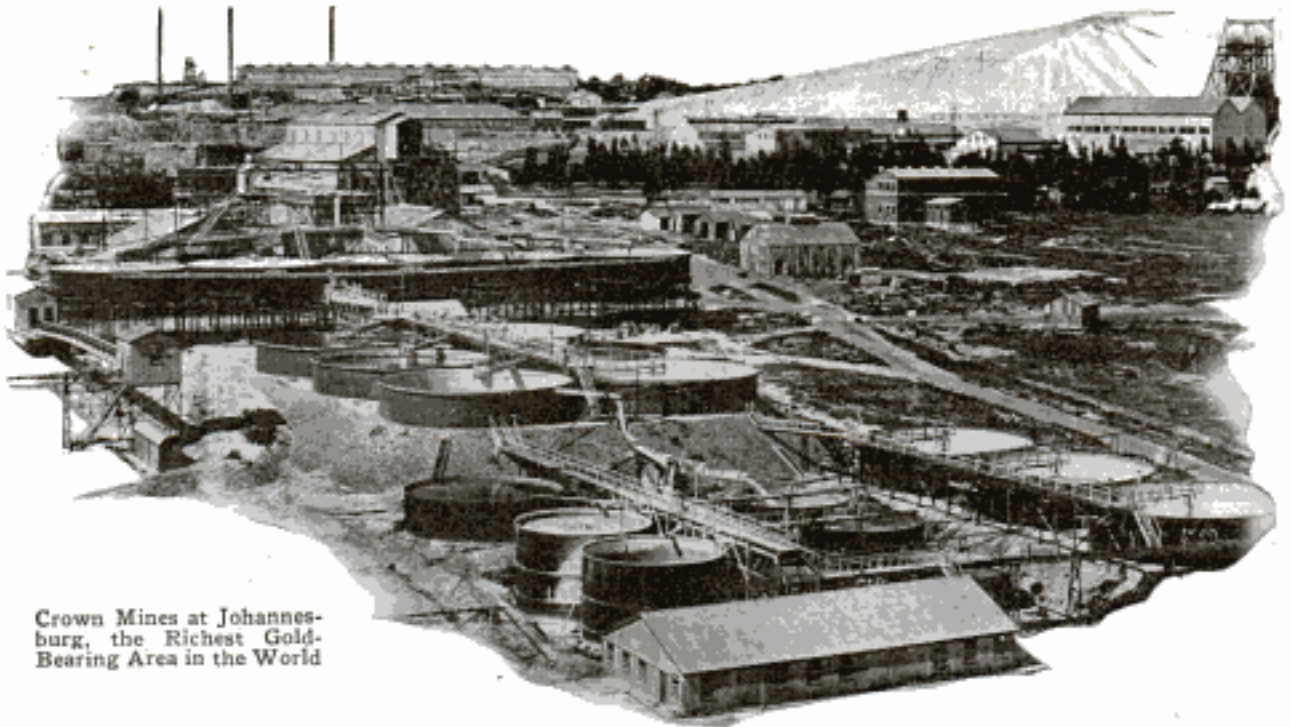

Crown Mines at Johannesburg, the Richest Gold-Bearing Area in the World

of rich silver, and later the grocer was able to retire a multimillionaire on the profits from his salted gold mine.

Placer gold, the metal which has been washed down from a higher lode by erosion, is often used for salting. Although placer ground is more difficult to salt than a lode mine, a Los Angeles mining engineer almost brought about the purchase of a salted property.

"I was sent out to look at some property in Nevada," said the engineer. "Being in the middle of the winter, the ground was frozen solid. After several vain attempts to dig out enough gravel for samples, I built several fires to thaw out the ground. The sacks of samples were sealed and packed in wooden boxes. Values of about \$4.50 to \$5 per cubic yard were indicated, which made it a rather valuable property—worth about \$225,000. I recommended the purchase, but because of some financial difficulty, my clients did not close.

"The next spring, after the ground had thawed out, I was in the same country again, so, just for fun, I took another set of samples. Much to my dismay, these turned out to be 'skunks.' They showed no trace of gold. Looking for a reason for this astonishing disagreement, I took samples of the wood pile. When these were assayed, they showed that all the gold was in the fire wood where the salters had put it. It was lucky for me the deal

did not go through." Many tricks are used to introduce the gold into the sample. Cigaretts are soaked in gold-chloride solution and dried. When they are smoked, the ashes, flicked into a sample, raise its value considerably. Gold dust mixed with clay is caked under the finger nails of the man doing the panning. It is a simple matter to release into the pan a charge of gold which will give a "good string of colors."

"Mental salting" is the term given by Kent Knowlton, a mine and claim dealer of Randsburg, Calif., to certain kinds of swindles. The usual procedure is for "geologists" to prepare subsurface-structure maps which show that a rich vein of ore traverses the promoter's claim. Stock is sold, but only about one-third of the money is spent in sinking a shaft. The rest goes into the promoter's pocket. A mine near Randsburg was sunk to a depth of 1,400 feet at a cost of \$350,000 without finding gold.

Gold mines are not the only ones salted. Tungsten, platinum, silver; anything of high value may be salted. The plains of Montana were once salted with diamonds and other gem stones.

"Many and devious are the ways of mine salters," a western consulting engineer says, "but if the examining engineer and the assayer are honest and careful, it is almost impossible for mine salting to go undetected."



Dept. of Navy.  
Jan. 20, 1932

B-116 J. W. Enoch &  
Davis, Bellingham  
Wash

POPULAR MECHANICS

B-174

**SUBMERGED PEAK  
IN SEA BELIEVED  
TWO MILES HIGH**

Hydrographers are searching for a submerged mountain, 10,000 feet high, in the Pacific ocean about 300 miles west of the Costa Rican coast as the result of soundings that have been taken in this territory, known as Guardian bank, an under-water plateau. A naval vessel recently reported a sounding indicating a shoal there, but other vessels were unable to relocate the spot, as has been the case previously. This has led to the belief that the sounding is directly over a mountain peak that may be a menace to navigation, particularly since some vessels in the area have reported tide rips and disturbed waters. Every effort is being made to chart this towering peak of the seas by hydrographic-survey ships because its location will not only aid navigation, but will interest geologists who may study phenomena like those which resulted in the formation of the American continent.

U.S. Navy 1/22/32



Easier Cultivation of All Kinds of Land Is Possible with This Plow; Note the Four Disks Which Speed Up Work

**FIRST FOUR-WHEEL DISK PLOW  
IS SELF-SHARPENER**

Fast and economical in operation, the world's first four-wheel disk plow has been patented and tested. Hard and stony soil is no obstacle to it, and it cuts evenly through wet and clay fields. Self-sharpening disks, absolute control of the four wheels in any movement, floating axles which cause only the frame to rise when the disks strike some obstacle, and a fast power hoist are some features of the plow. The hoist, by a three-fourths turn of the power wheel, lifts the plow completely out of the ground.

**GLIDER IS STARTED LIKE A KITE  
TO AVOID CATAPULT SHOCK** B-133

By starting his glider like a kite, a German flyer has found a way to avoid the sudden shock of catapulting the craft into the air. A steel wire, 500 feet long, is attached to the glider, which is headed into a strong breeze. Then, with the wind gently lifting the craft, the wire is payed out as the glider rises until the flyer has reached a suitable altitude. Then the wire is disconnected and dropped, and the glider soars away in free flight.

**MICROMETER IN WATCH SHAPE  
IS EASIER TO OPERATE** B. 197

Shaped like a watch, a micrometer that is easier to operate than the commonly used form is now on the market. The instrument is equipped with a dial and pointer for quick and accurate reading. Its size is calculated so that it will fit the operator's hand nicely.



Whenever you find that you wish to know more about any article in this magazine, write our Bureau of Information.

DeLogan & Co.  
538 Clark  
Chicago

Mertschert

Copyrighted material

Wissen und  
Vergessenheit.  
Jan. 1932



03-68  
616

Comd Edgar C.  
McMullen  
POPULAR MECHANICS  
4310 W. 4th St  
Denver, Colo



Denver Horseshoer Who Has Equipped a Truck as a Blacksmith Shop and Now Hauls His Forge to the Horses

### BLACKSMITH SHOP ON WHEELS GIVES QUICK SERVICE

One Denver horseshoer has placed his shop on wheels to speed up his service to customers. He found that his business was falling off because owners of high-spirited horses objected to driving the nervous animals into town and over congested paved streets. The blacksmith therefore equipped a truck with a forge, a motor-driven bellows, an anvil and all the needed tools. He answers calls within a radius of 100 miles.

### STEAM COOLING FOR AIRPLANE SPEEDS UP TAKE-OFF

Three new fast bombing planes and a powerful new flying boat have been experimentally equipped by the British air ministry with steam cooling plants and the results pronounced highly satisfactory. It is expected that the system, if further tests are successful, will be adopted for all military planes with which the force is now being equipped. The cooling apparatus means a considerable decrease in weight and results in quicker warm-up and take-off. No radiator is necessary, as a lighter and more compact steam condenser takes its place. The amount of water needed for the cooling process is considerably less. While steam cooling has been receiving attention in England,

Royal Air Force

American planes have been experimenting with ethylene glycol as a cooling fluid, a liquid that has a higher boiling point than water, acts as an anti-freeze, and has a higher heat-transference rate.

### ANTI-STUNTING RULE IS MOST VIOLATED BY FLYERS

Acrobatics, or stunt flying, led the list of offenses among the 331 violations of air-commerce regulations during the last three months of 1931. There were 102 fewer violations in that period than for the same period in 1930, however. Fifty-eight violations of the acrobatics clause and fifty-two cases of too low flying were reported. Other violations in-

involved unlicensed pilots flying licensed planes and flying without navigation lights or without identification numbers. Breaking the rules resulted in the imposition of fines, reprimands, suspensions and revocation or denial of licenses.

### SPARK PLUGS CLEANED BY AIR IN BLAST CHAMBER

Spark plugs are quickly and easily cleaned when inserted in a new device operating on the principle of the sand blast. The plug end is inserted in a gasketed hole at the top of a small chamber, air is connected to a fitting alongside it, and in a second or two the plug is clean and ready for re-installing. Sufficient cleaning compound is furnished with each apparatus to take care of more than a thousand plugs. The chamber has a false bottom, perforated to allow the air current to flow upward and bombard the plug end and points with the compound on the chamber floor.



Eddie Mfg Co  
102 E. South W. Wis.  
Copyrighted material

Thomas C. Malony

Science Service  
1/11/32

0310

1/10/32  
A. J. Malony



## Electric Switchman Rules Train Movements

Tiny levers, similar to ordinary light switches, have supplanted written orders and the heavy work of throwing cumbersome switches by hand on 159 miles of track on the Boston and Maine railroad.

"There is an average of over 100 trains a day passing through my 'block,'" said Arthur Killam, towerman at Winchester, "and I can control them easier than a telephone

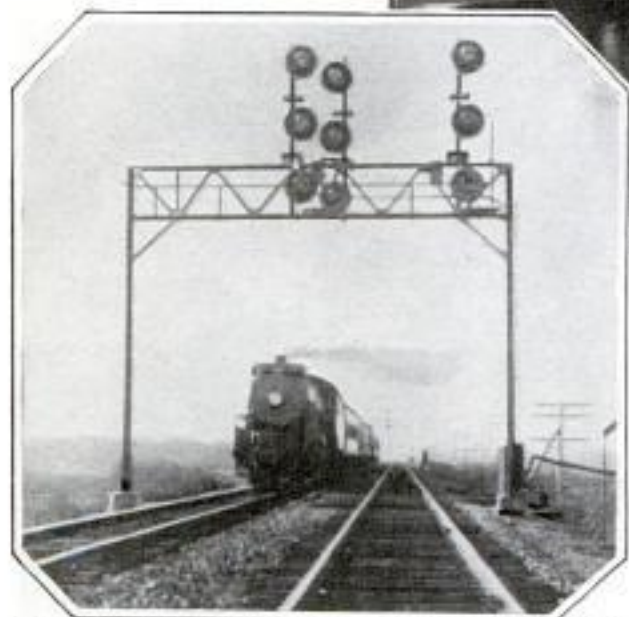
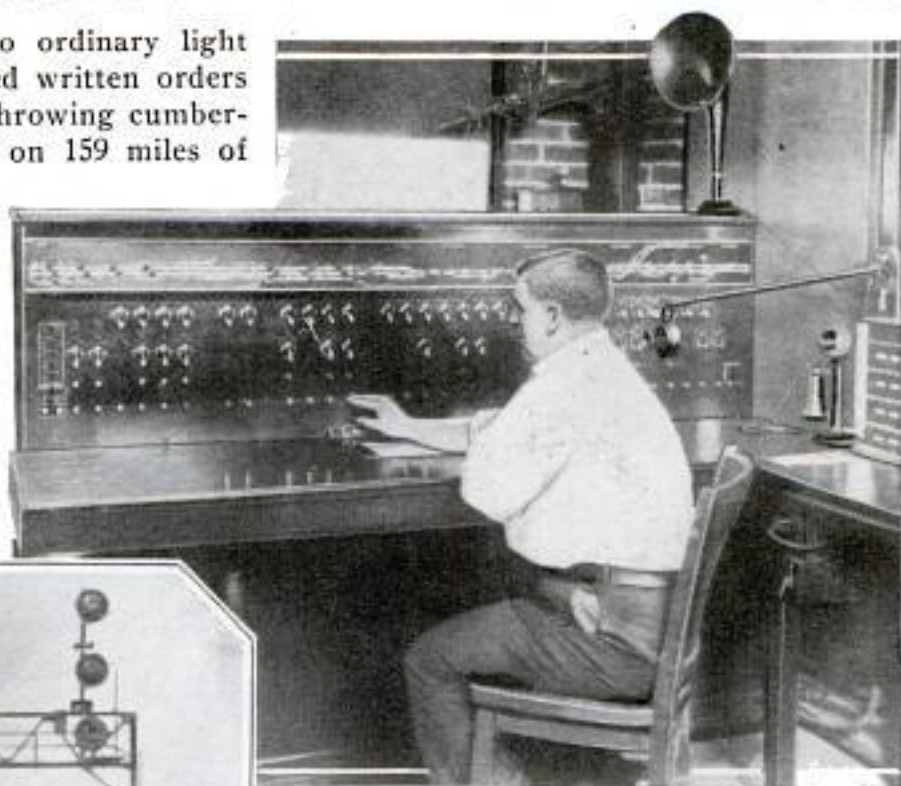

Top, Operator at the Remote Control Switchboard; Above, Signals Operated by Remote Control

operator can get you a number. It isn't even necessary for me to see the trains. I could operate the switches and signals just as well from a downtown office building. And the system is foolproof."

He pointed to a cabinetlike control box, about five feet long, which is, in reality, a switchboard. Near the top of the board, in front of him, is a miniature layout of the signals, switches and rails in the district which his tower controls, the whole thing looking surprisingly like a toy railroad. Tiny electric lights give the location of all trains in, and approaching, the control section, the position of each switch and the indication shown on each signal light along the tracks. On this miniature railroad, the operator sees just what is

happening when he throws a switch or light out of sight, many miles away.

"It's just as if I had an electrical man," continued Killam; "a little fellow who was right here ready to do the job for me. When I want to change a signal or a switch, I move the lever, push the button, and this little man runs down the track, does the job and comes back and tells me it's done. And at the farthest switch he's back in eight seconds.

"You can't fool him either. When I move a lever and route a train through, it's impossible for me to put another train in its path. Once a train enters a route set for it, this equipment will not permit another train to be set against it. No matter how much I move the lever, nothing will happen until the train passes safely by. Furthermore, when a lever is moved and a switch changed, it cannot be changed back for two minutes. That's so the switch can't be thrown under a train."

By this amazing method of remote control, and with telephone and loud speaker replacing the old-time telegraph keys, Killam is able to control all signals, switches and trains much the same as a youngster his Christmas toy trains, which start and stop under his hand.

*H. Case, Jr. 25 March Ave  
West Roxbury, Mass*

*And George*



A 2376  
Capt. John F. Coggswell,  
16. Edgemount Road,  
Belmont, Mass

# A Vest-Pocket

sub will be used in a great hunt for sunken treasure. A more practical occupation, however, will be making available hitherto unreachable huge supplies of sea foods of a quality far surpassing anything on the market at present.

"From the hundreds of letters that I have received," Mr. Lake said, "there



By JOHN F. COGGSWELL

**S**IMON LAKE, inventor of submarines, has just launched a vest-pocket-size under-sea boat that is entirely different from any craft now in commission. Even beside the smallest naval submarine, it appears like a plaything, so diminutive is it. It is mounted on driving wheels so that it may roll along the ocean floor as an automobile along a highway. In fact, the vessel looks more like a crudely built "dinkey" locomotive than a ship.

However, Mr. Lake regards this submarine as being of far greater importance to the world than all the war craft he has built. It is the first under-sea boat constructed solely for commercial and scientific purposes and is the result of thirty years of study. For thrills, the "baby"

Baby Submarine Equipped with Wheels so It Can Roll over the Sea Floor Like an Automobile

Bridgeport, Conn



# SUBMARINE

seems to be a general impression that the new submarine has been developed as a sort of pleasure craft to give owners opportunity for new thrills cruising beneath the surface of the waters. Nothing could be farther from fact. The boat is designed for strictly utilitarian and scientific purposes and not for pleasure.

"The bottom of the ocean holds large beds of shellfish sufficient to supply the world with a great variety of low-priced food, if a method of gathering it cheaply can be found. This submarine is my answer to that problem. Our present supply of oysters, clams, scallops, mussels, lobsters and other shellfish comes

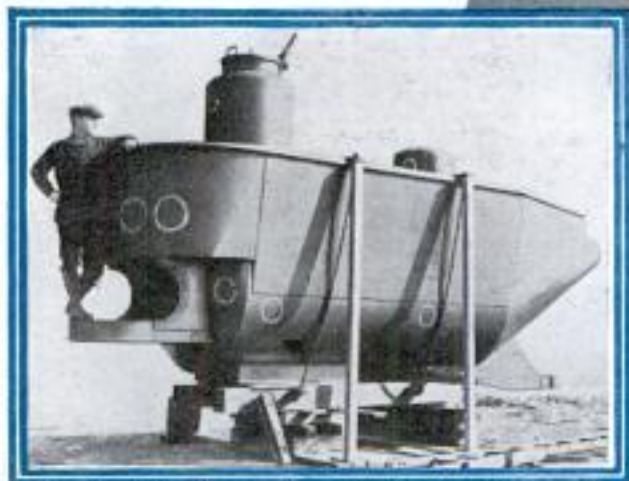

Top, Looking Down through Diving Compartment; Above, a View of Partly Completed Craft

only from the small expanse of beds that lie in shallow water. Men, in surface boats, lower dredges of various kinds to the bottom and bring up whatever luck gives them.

"Literally, these fishermen work in the dark. They cannot see what lies beneath

the water; they can make no selection of what they bring up. Beyond a certain limited depth, they cannot work at all, yet many of the finest beds of shellfish, except oysters, lie deeper. Lying on the bottom in over a hundred feet of water, I have reached out through the diving door and picked up soft-shelled clams weighing a pound and a half each, which, when brought to the surface and cooked, proved far superior to the small clams gathered from mud flats near shore. I have seen beds of these giant clams stretching for miles.

"Among the features of the new submarine, all of which are protected by patents, are efficient dredges that, attached to the bow of the craft, will enable two men operating it to gather the shellfish in these deep-lying beds just as cleanly as a farmer harvests his grain with a binder. Furthermore, they will be able to see



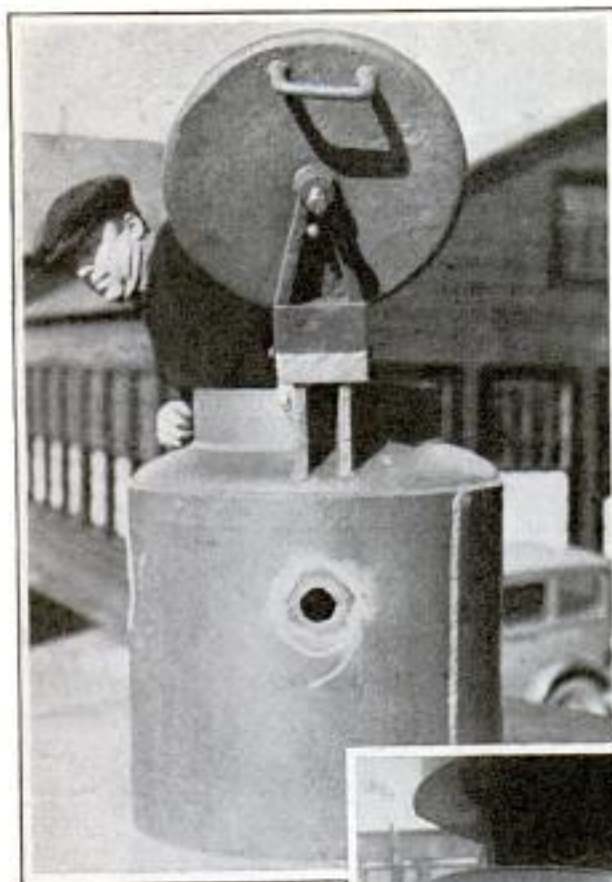

what they are taking, and thus harvest only those portions of the beds holding the choicest quality shellfish. The dredges will load the product into carriers for conveyance to a surface craft.

"The sponge and pearl fisheries of the tropics are today operated as they were centuries ago. Native divers, with no equipment save a knife and a basket, plunge to the bottom, snatch a few sponges or pearl shells and carry them to the surface. The absolute limit of depth to which these swimmers can dive is fifty feet and their time of submergence is a minute and a half at the most. Attempts to use divers equipped with modern apparatus in these jobs have not been successful, the rough bottoms making it extremely difficult to get about. The new submarine will be able to locate the beds and gather more sponges or pearl shells in a few hours than all the native divers could in a week. Furthermore, the boat will be able to work beds lying at a

depth impossible for the divers to reach.

"Those strictly utilitarian jobs await the little craft. But in another field, often styled the greatest gamble in the world, I expect it to afford me the greatest thrills. One of my reasons for building this submarine was to have a craft capable of locating wrecks more easily and more quickly than by present methods.

"Oceanographers, naturalists, makers of under-sea pictures will find the new craft an ideal vehicle in which to pursue their investigations. They will be able to move it about as they wish and leave it for close study of marine growths whenever they desire. In the laying of submerged foundations, pipe lines and other structures, the craft should prove a valuable instrument.

"In both size and shape, this submarine is entirely different from any under-sea craft now in operation. It differs in operation also. This is not a cruising, but an auxiliary, vessel. It will receive from a mother ship on the surface, over a cable,

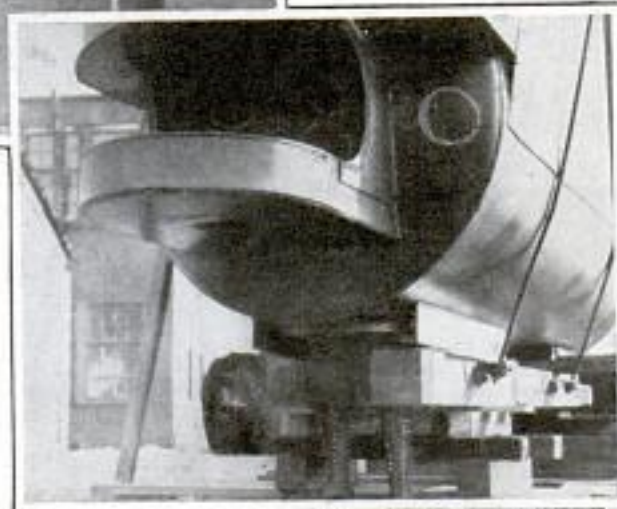

Top, the Conning Tower; Center, the Diving Door, and, Below, One of the Front Wheels of the Sub



B-151

electric current for moving the submarine and operating its machinery.

"The little craft is twenty-two feet long and seven feet deep and has a beam of seven feet. It will stand submergence to depths well over 200 feet. Small as it is, the interior has sufficient room for four men, although but two are needed for its operation. Whenever the man in the diving compartment so desires, the turn of a valve will raise the pressure in it to that of the surrounding water. Then he can open a door in the bottom, without water entering the craft. The door opens between the two front wheels. When he desires to get out and investigate any object at close range, the operator will simply don a diving helmet connected with a supply of compressed air—or an entire diving suit, if he is to stay out for some time—put on weighted shoes and slip down through the door onto the bottom."

B 109

**ELECTRIC VALVE OF BALL TYPE SUBMERSIBLE IN WATER**

Remote control at any distance is easily accomplished with an electric valve for gas or liquids recently developed. No motor is needed for operation of the valve, as it is of the ball type, actuated by magnets. No heavy pull is necessary as in most plunger-type valves, six-to-one leverage is available without friction, all parts are waterproof and the whole assembly can be operated under water if necessary.



One of its particular fields of usefulness, according to the makers, is in automatic gas water-heater installations. The valve is provided with a thermostat on the pilot flame which closes it should the flame be extinguished. This eliminates the possibility of escaping gas. The valve can be operated by standard lighting switches, three or four-way, if necessary, and can be supplied in two sizes, the larger of which accommodates ordinary 110-volt house current.

*In. A. J. Hoffner  
107 S. Capital Ave  
Indianapolis, Ind*

**PORTABLE CAR OR TRUCK LIFT RUNS ON HOUSE CURRENT**

*Bee Line*

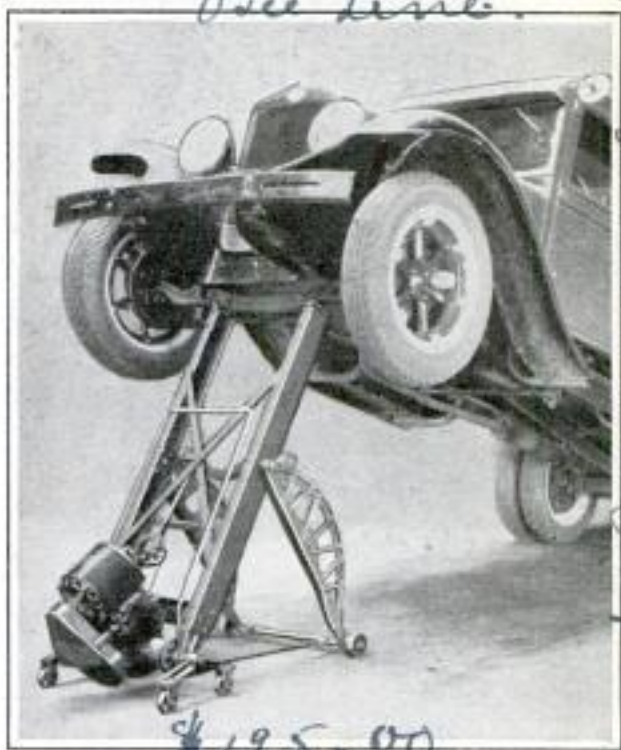

Powered by House Electric Current, This Jack Lifts Auto or Truck in One Minute

Requiring no pit, air pipes, couplings or connections, a portable auto and truck lift has been developed, powered with an electric motor that operates on ordinary 110-volt house current. The lift merely is wheeled under the front or rear axle, the power turned on, and the car rises. Trestles are available that will hold either end in the air while the other end is being elevated. The average car can be fully lifted in approximately one minute. All vital parts move on ball and roller bearings, and power is applied through worm gearing. Capacity is 7,000 pounds and lift limits are from five to sixty-one inches.

**ALL-PURPOSE ALUMINUM PAINT RESISTS HEAT AND ACIDS**

Resisting heat and acids, an aluminum paint intended to protect wood, metal, fabric and stone is on the market. The paint is moisture-proof and withstands all weather elements. Surfaces coated with the liquid reflect between sixty and seventy per cent of the total light that falls on them, brightening up interiors. The coverage is said to be twice that of ordinary paints.

*Permite Resabun  
Alumina Industrial  
2438 Bellmore  
Cincinnati*

*Smith Automobile Equipment Co.  
11017 Howard St. Cleveland  
Ohio*



B-46

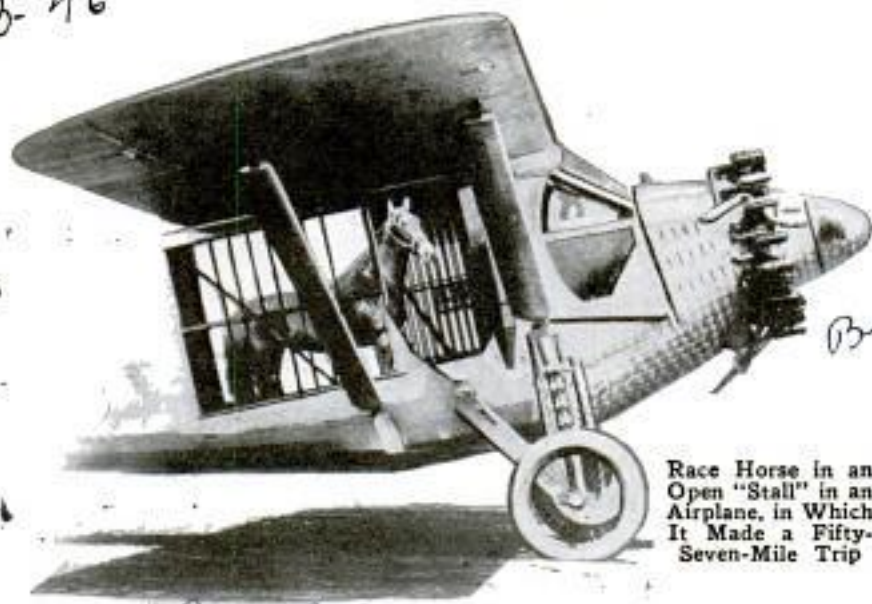

Race Horse in an Open "Stall" in an Airplane, in Which It Made a Fifty-Seven-Mile Trip

*Aerme*

**HORSE FLIES TO RACE TRACK TO SAVE TIME**

One race horse recently traveled fifty-seven miles in thirty minutes, but the trip was made in an airplane. It was desired to get the horse to the Mexican track at Agua Caliente in time for a workout the same day. The trip by van usually required three hours, so a large monoplane was pressed into service and the horse was placed in an improvised stall. The horse was on the track and working fifteen minutes after the ship landed.

**BOILING GEMS IN HONEY ADDS TO THEIR BEAUTY**

Heat treatments are being used to make many gems more beautiful. Semi-precious stones in particular are subjected to various degrees of heat to enhance their color and sparkle. Agates, for instance, when boiled in honey, will absorb the substance. Then, when heated, the honey in the pores of the agate is carbonized, and black or brown veins and spots are produced, making the stone more beautiful. The deep-yellow topaz is greatly enhanced in value by its change to a delicate rose-pink under heat. Zircon is second only to the diamond in fire and brilliancy when its color is removed by heating. Zircons, after treatment, often are used to incrust watch cases. Diamonds are sometimes changed by heating. Yellow stones may acquire the rose tint so eagerly sought if

subjected to certain temperatures, but the yellow color usually returns after a few days.

**"SUNSHINE" FOODS PUT VITAMINS IN MILK**

Foods rich in vitamins are being fed to cows in an effort to produce milk which will contain all elements essential to growth and protection against certain diseases. Large amounts of vitamin D, known as the "sunshine" vitamin, are contained in

the light-treated foods given the cows at experimental dairies. In theory the experiment is simple. It is merely the feeding of irradiated yeast to the cows, the vitamin content of the yeast being transferred from the food to the cow's udder. This vitalization of milk is a development of Dr. Harry Steenbock's discovery of a way to introduce vitamins in food by treating it with certain light rays.

**HOUSE IS BUILT OUT OF COAL EVEN TO THE SHINGLES**

Ten tons of coal were used by a dealer in Ohio recently to build a house for advertising purposes. Large blocks form the walls, the hollow square being filled with smaller lumps. Coal "shingles," flatter blocks, were nailed to the roof frame and an oblong piece representing the chimney completed the building.



The Only Wood Used in This House Made of Coal Was in the Roof Frame and Door

*Coal Edward Salt*

1727 Seneca Ave.

Albany, Ohio

*from Viejas ranch of Baron Leary*

*see Scientific American Supplement*

*Curator of Minerals, Academy of Natural Science, Phila*

*Brookhill Logging Works, Seneca, Ohio*



92557

Cml. Harold F. Blanchard  
40 Motor 57th and 8th Ave  
POPULAR MECHANICS 623

# Autos Without Axles Promise Easier Riding

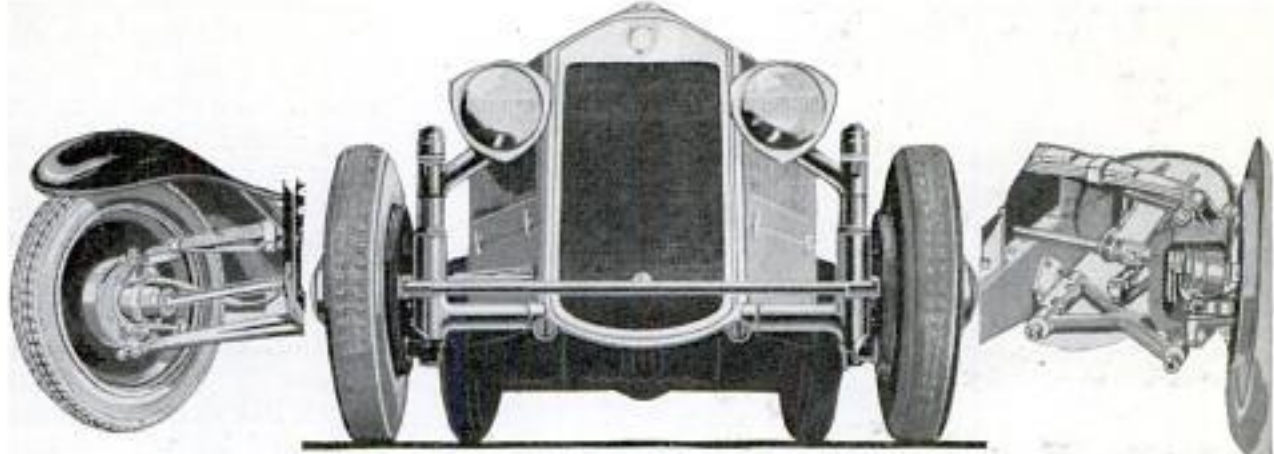

Above and Below, Individually Sprung Wheels; Right and Left, Two Different Spindles for Front-Wheel Drive

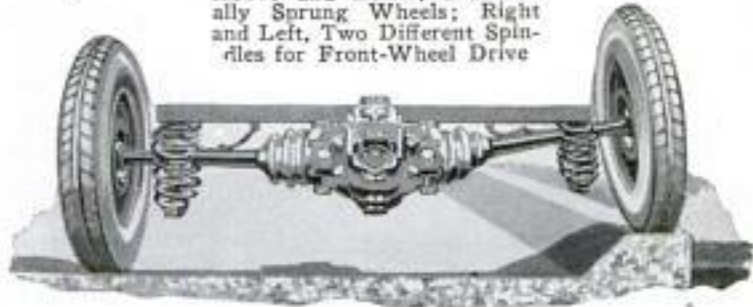

In Europe, axles for automobiles are decreasing in popularity. Instead of axles each wheel spindle is attached directly to the spring by various ingenious methods. The primary advantage is greatly improved riding quality due to the fact that unsprung weight is considerably reduced. Unsprung weight refers to all parts between the springs and the road. Obviously the more these parts weigh, the more severe the blows they exert on springs and body. Since axles are heavy, a marked improvement in riding quality can be obtained by eliminating them. The leader in this development, insofar as front axles are concerned, is the well-known Italian Lancia. Instead of a front axle there is a tubular framework, its lower member securely bolted to the frame and the upper member bracing the radiator and fenders. At the ends of these members are vertical members which support the wheel-spindle mechanism. The kingpin is a long tube supported by suitable guides. When the wheel is turned to left or right, the whole pin rotates in its guides. Likewise, when the wheel strikes a bump, the spindle and kingpin assembly moves upward, compressing the heavy coil spring which takes the place of the usual leaf spring for supporting the car. The mechanism inside the kingpin provides shock-absorber action as the interior is filled with oil. With the Lancia

type of construction not only is riding quality improved but the car is much steadier at high speeds, especially on rough roads. So far as steadiness is concerned, a car spring should be thought of as a device for holding the wheels down into contact with the road. With large unsprung weight, the springs haven't sufficient stiffness to hold the wheels and axles on the road under all circumstances, unless these springs are objectionably stiff from a riding-quality standpoint. On the other hand, with the greatly reduced unsprung weight obtained with the Lancia construction, the springs are adequate to hold the wheels to the road even if the surface is quite rough and the speed high. Another advantage of the Lancia construction is that it eliminates high-speed shimmy. This phenomenon in conventional cars occurs because the front wheels are rigidly tied together so that road irregularities may start the wheels flapping in sympathy with each other and the shimmy results, whereas, with the Lancia design, the wheels move up and down independently of each other and therefore shimmy cannot occur. Braking is also simplified as the caster angle is constant regardless of brake application.

☐ The average radio set is used 4.04 hours daily, a recent survey shows.

*Lancia & Co. Turin, Italy  
Via Mangione 101, d'Ally*

*Fabbrica Automobili  
Lancia & Co. Turin, Italy  
Via Mangione 101, d'Ally*



Chicago Post  
1/10/32

624

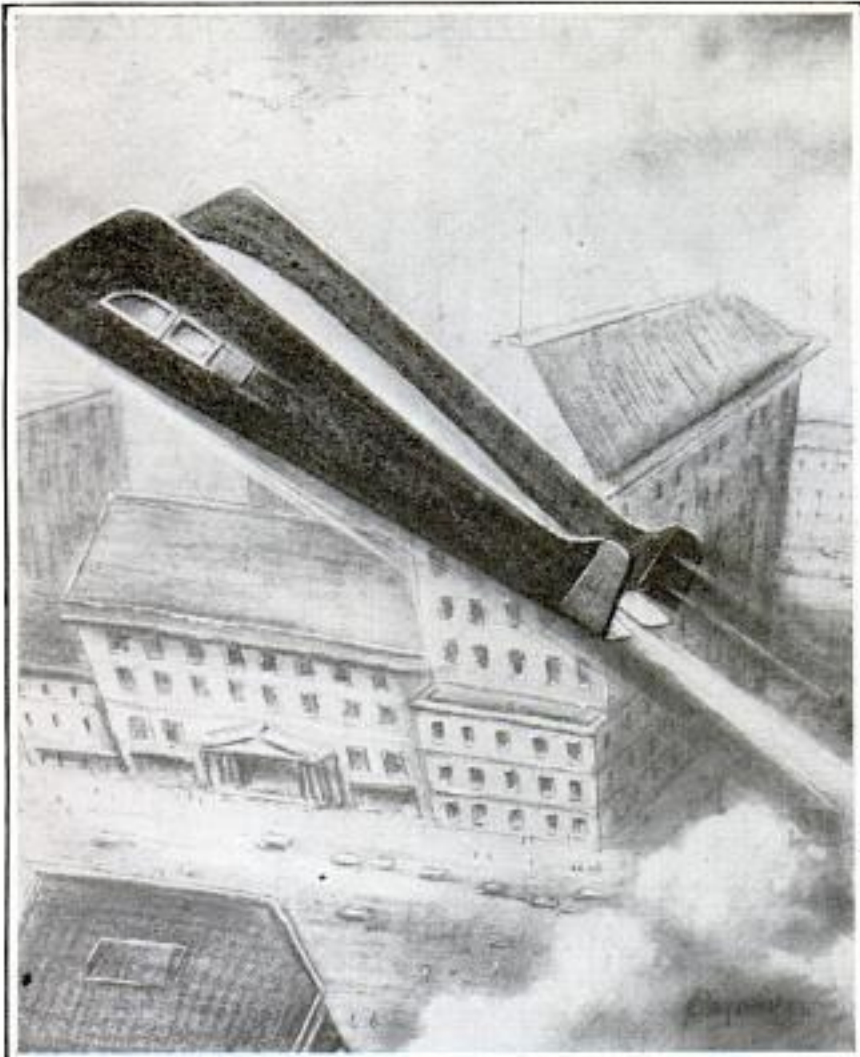

miles a second have been measured in the study of the phenomenon, indicating that the particles are visitors from interstellar space. The observation is considered proof that at least part of the earth's surface is made of substances originating at vast distances in the outer universe. Studies thus far indicate that the little stones fly in formations much like earthly storms. Harvard University has four astronomers watching the antics of meteors. They spend nights in half-open shelters in deep snow. In three months they have catalogued the peculiarities of more than 6,000 meteors.

B-93

### OBSTACLES IN FOG REVEALED BY ECHOES

"Bullets of sound," that bound back to the boat from which they are sent and warn the pilot of fog-screened obstacles in his path, are used in a

Design for a Rocket Plane Intended for a Trip to the Stratosphere; Note Unusual Streamline Treatment and the Odd Sides

### TAIL WOULD HELP LIFT PLANE PROPELLED BY ROCKETS

Rockets are to furnish the power for an airplane designed by a German engineer for a flight to the stratosphere, but the rockets will not do all the lifting of this artificial comet. Instead, the whole tail is developed as a lifting surface which is expected to enable the ship to pull itself up by its own boot straps. The absence of propellers, the streamlining and the odd sides give the design a decidedly unusual appearance.

blind-navigating apparatus which has been developed by Chester W. Rice, of the General Electric company. A sending megaphone mounted on the boat projects short blasts of a high-frequency whistle, much as bullets might be shot from a gun. These blasts strike objects ahead and rebound as echoes. The number of seconds elapsing during this interval determines the distance of the objects from the boat, in plenty of time for the pilot to avoid hitting them. The device has been tested under various weather conditions, the wind ranging from calm to twenty miles an hour and the sea from very smooth to choppy with whitecaps. A typical shoreline, 1,700 to 2,700 feet away, was picked up in three to five seconds from a boat moving twelve miles an hour. A rowboat containing three occupants was detected at a distance of more than 800 feet.

### METEORIC "HAIL" SEEN TO FLY HUNDRED MILES A SECOND

Tiny meteors, so numerous as to form a meteoric "hail," recently were observed by Cornell University astronomers in Arizona. Speeds of approximately 100

Dr. W. Alfons Pretzel

Athaca, N.Y.

36  
Athaca, N.Y.

Mr. S. L. Boothroyd

Chemically. No.



# Holes Under Pavement Filled by Mudjacks

Liquid mud and cement, forced under the paved surface by mudjacks, saved postponement of the formal opening of the Mt. Vernon Memorial highway, from Washington, D. C., to George Washington's home in Virginia. Heavy rains caused several new fills on the highway to sink so much that traffic could not be permitted. When it was found that ordinary methods could not repair the road for several months, the bureau of public roads



face. Given time to set, the cement in the mixture hardens the whole mass, making a permanent filler for the sinkhole.

## POWER-LINE STATIC ON RADIO REDUCED BY RESEARCH B-28-7

Radio listeners close to high-voltage power lines soon should enjoy much clearer reception as the result of studies conducted by an Oregon state college professor who has proved that leakage of current across insulators is the source of troublesome noise. It is explained that the leakage sets up oscillations of radio frequency, and, in tests conducted in a darkened room, every time a leakage from a high-voltage line was observed, noises occurred in a radio set. Often the noise was heard before the leakage became visible. The leakage and the interference can be done away with, it was pointed out, by designing the insulators so the air near their surfaces is not electrically overstressed. It was also said the stresses could be overcome by coating portions of the insulator with a conductor.

Center, Mudjack at Work; Top, Hose Nozzle beside Hole in Pavement; Below, Pipe Cast in Road to Receive Hose

offered the use of mudjacks. A crew drilled openings in the road surface wherever there were sinkholes, a mud and cement mixture was forced under the paving by the jack and the highway was made level in time for the formal opening. A pressure of one to two pounds is used in raising the concrete slabs with the mud mixture. The raising is done carefully, usually about one-fiftieth of an inch at a time, to prevent cracking of the road sur-

Cent. Donald W. March.  
 3208 Eastern Ave. N.E. Washington, D.C.

F.O. McMillan  
 Corvallis, Ore  
 Copyrighted material

Science Service  
 2/1/37



B. 125 Sunbeam  
626 motor car Ltd  
12 Princes St  
SIX CENTS AN HOUR RUNS BOAT  
DRIVEN BY PORTABLE MOTOR

Capt. Roger Hawchorn  
3330 2 St N.W.  
Washington D.C.

no U.S. agent known

Seagull lightweight outboard



Weighing Thirty-Three Pounds, This Motor Drives a Boat for Six Cents an Hour

Weighing only thirty-three pounds, an English outboard motor for small boats can be operated for only six cents an hour. The one-and-one-half-horsepower engine is capable of driving small craft containing three persons.

**PHOTO-CELL PROTECTS HORSES BY GIVING RIGHT OF WAY**

Horses traveling a bridle path in Washington's park system are protected from automobiles at a busy intersection by an "electric-eye" traffic signal that gives the animals and riders the right of way. The signal operates only when horse and rider pass through an invisible beam of light. At the approach to an intersection are two sets of photo-electric cells placed on opposite sides of the bridle path. They are four feet above the ground and thirty-two inches apart. The horse's body intercepts the first beam of light, then the second. To operate, the two units must be intercepted at the same time, if only for a second, and the horse's body does this because of the distance between them, but a man's body does not. As both circuits

are broken, the photo-cells operate to flash a warning and then a stop light in the street, this remaining on long enough for horse and rider to cross. The apparatus does not function when a horse goes through the beam in an opposite direction because the beams must be intercepted in proper sequence. When a pedestrian strolls through, he does not operate both beams simultaneously, and hence the device does not work.

**LOSS OF ELECTRICITY STOPPED BY SUPERCONDUCTOR**

Loss of energy in transmission of electricity may be stopped by development of a superconductor. Experiments by Prof. J. C. McLennan, of the University of Toronto, show that lead, the chief insulating metal used by the electrical industry, may be transformed into a possible superconductor of high-voltage current which would transmit power very cheaply without loss of energy en route. Because of the present resistance of all known conductors, there is a considerable loss of electrical energy all along the line of power transmission.

**BATTERY FILLER WITH A LIGHT SAVES GARAGE MAN'S TIME**

Saving time for garage or service-station operator, a handy auto-battery filler, equipped with a built-in flashlight, has been placed on the market. The light for illuminating battery cells for accurate filling is attached near the end of a hose from a distilled-water bottle. An air-compressor bulb keeps the water under pressure, while a push button provides instant flow or cut-off of water.



Filling the Auto Battery Is Easy with Siphon Which Has Light at End of Tube

B. 20

Hand of physicist B. 18

San Diego Tribune 1/19/32

New York Times 4/8/32

Pines Winterfront Co  
1135 N. Cicero Ave  
Chicago



a2534

# COTTON MAGIC!



Courtesy Bakelite Corp.

Even Airplane Propellers Are Made from Cotton; Above Are the Built-Up Layers of Cotton Fabric Which Are Impregnated with Resinoid to Produce the Propeller Shown Below

By ALBERT FANCHER

*75 Columbia Heights, Brooklyn, NY*

SCIENCE is touching cotton with the magic of invention, and amazing things are happening.

More and more we work with it, live with it, wear it and use it, in one form or another—120,000,000 of us. The homely cotton bale plays a major role in industry, too, as seventy per cent of the annual crop goes for industrial uses. Let's see what some of them are.

Cotton roads, for example; in 1932, we shall ride over several miles of these canvas-and-asphalt highways. They are even planning to use cotton in constructing some of the levees along certain rivers. A sharp modern contrast to the ancient dikes of Holland.

Truck tires and wheels of cotton. Yes, and casters, gears and pinions—even tool handles. Cotton forms an excellent base to work with.

Safety boats for naval airmen are being made of rubberized canvas. And that airplane speeding overhead—don't be surprised if you find that its flashing powerful propeller is made of

cotton and synthetic resin, laminated. Then there's cotton wallboard and cotton finish for desks, with the sheen and grain of the finest veneer. It is veneer, mounted on cotton for flexibility, yet costing only one-fifth as much.

Cotton letterheads have been on the market about a year, but already we have used some 3,000,000 square yards of fabric for this purpose. The next few months will see cotton envelopes, calling and greeting cards and more and more advertising broadsides. Since alkaline soils are

ruinous to pipe, specially prepared cotton is now being employed to protect it. An order has recently been placed for enough of this material to wrap 200 miles of pipe.

Bathing pools are going cotton, and so are shoes, both men's and women's. And there's a cotton hat for men coming on the market that looks exactly like a straw Leghorn—but isn't.

Examine the "Akron," pride of the navy, and the world's greatest aircraft. You'll find thousands of yards

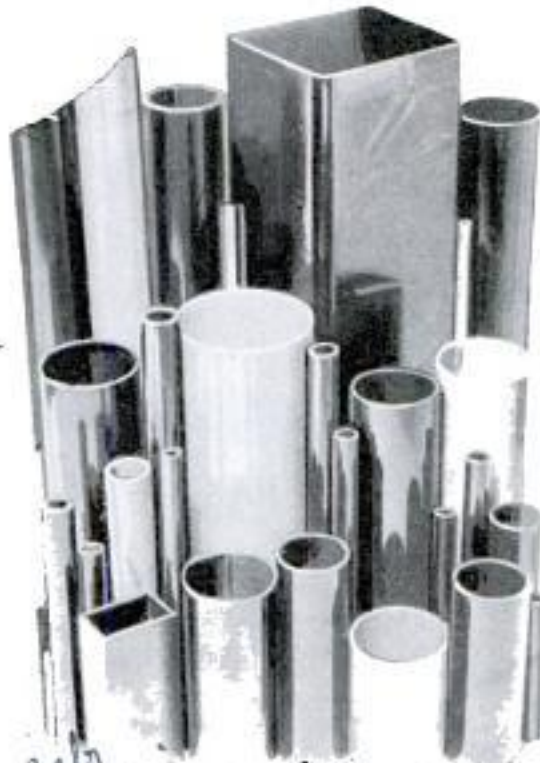

Courtesy General Electric Co. Cotton Played a Part in Making These Laminated Rods and Tubes Used for Industrial Purposes

*Schenectady*  
*Bakelite and mica tubes*



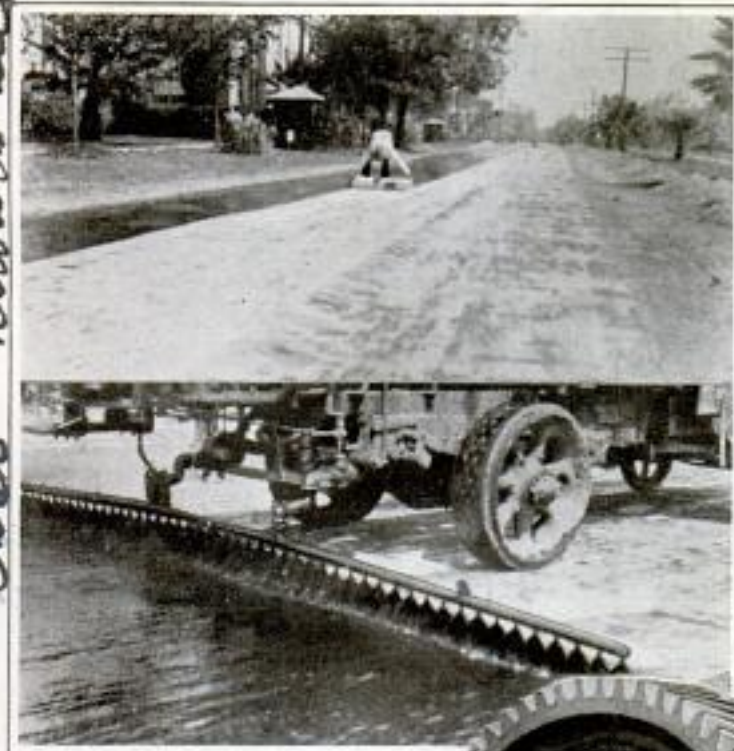

Courtesy Cotton Trade Institute  
Above, Laying the Canvas and  
Applying Asphalt in Making Cotton  
Road; Right, Timing Gear  
Made with Cotton



Courtesy General Electric Co.

of cotton in that huge ship.

Science has just perfected some fast-dye printing inks to use on cotton fabric. That means a lot more banners and advertising displays for filling stations and barns. And in 1932 they're going to have cotton posters on the billboards, plenty of them. Fishing-reel frames, ash trays, spark-plug caps, trays for cafeterias—the list of products in which cotton takes an active part is long and growing.

There are, today, nearly a thousand major uses for this commonplace but important commodity.

Then take cellophane. In case you have been wondering about how it's made, cellophane is just synthetic silk socks which were sidetracked in the laboratory. Both started from the same source, Dixie cotton fields.

Cellophane is the invention of a Swiss chemist, J. E. Brandenberger. He was engaged in the dyeing, printing and dressing of cotton fabrics, and became interested in the idea of applying cellulose so-

lutions to cotton fabrics to obtain brilliant and shining designs.

Later, he tried to produce a cellulose film, believing if such a product could be developed, it could be applied on the textile material through sizing or pasting, and thus a fabric would be obtained which would remain flexible and at the same time have the qualities which he sought. In trying to produce this film, the idea of cellophane was born.

Cellophane and rayon, or synthetic silk, are first cousins. They are made in practically the same way, except that cellophane is formed into a sheet and rayon is drawn into threads.

Cotton linters, or evergreen-spruce wood pulp, are treated in a caustic solution, and carbon bisulphide is added to disintegrate the fibers completely. The result of these and other chemical operations is a sticky amber-colored liquid.

This liquid is forced mechanically through a narrow slit into a chemical bath which instantly solidifies it into a thin film of cellophane. The cellophane film then passes through a series

of purifying and bleaching operations to remove all impurities. After drying thoroughly, it becomes a transparent film.

In addition to being transparent and pliable, it is oil-proof, grease-proof, germ-proof, moisture-proof, odorless, non-porous, durable and strong.

### SPRAY GUN REPLACES INSECTS IN POLLENIZING FLOWERS

B 131 Instead of leaving the pollenization of flowers to insects or the winds, or resorting to the laborious process of using tiny brushes for the purpose, some growers are now employing spray guns. Orchardists and tomato growers gather the pollen with a miniature vacuum siphon, a vibrating needle loosening the pollen dust.

Wessten und  
Forbschulte Jan. 1932

National Vulcanizing  
 Fibre Co. & Manufacturing  
 Colorii - Continental - Shammond Fische &  
 East Kewar's Steel



Subjected to rigid tests at every step in its construction, a giant flying boat that will be larger than Germany's famous "Do-X" is taking shape in England. Safety-first methods are being used in the expectation that the craft will be the first of a series of air liners to travel across the Atlantic without danger to its passengers. Back of the project is the conception of an England-to-United States air route. Thousands of dollars have been spent in making machines to try to smash important parts of the ship, such as the bulkheads. When a piece of metal fails, it goes back to the metallurgist for further experiment. Another testing device is a tank of acid in which metals are immersed for five minutes. The acid has the effect of six months' exposure to Atlantic weather. Six engines will drive the flying boat, while the design calls for only the boat or hull to be subjected to the pounding of waves. Engines and other vital parts will be high above the water, and the craft is expected to ride the heaviest waves without shipping water. Stainless steel will cover the great skeleton.



*Wearing This Heated Suit, Wensinger Flies Three Miles High for Weather Information*

**HEATED SUIT PROTECTS PILOT DAILY AT THREE MILES UP**

Protected by a specially heated suit, Pilot Ralph Wensinger climbs 17,000 feet high in his plane each day to gather information for the United States weather bureau at Cleveland, Ohio. The temperature often is above freezing when he takes off, but at the three-mile altitude which he must attain, it may be sixteen below.

**CHECKERBOARD FOR AIR TRIPS HAS MAGNETIZED PIECES**

Magnetized checkers, which cling to the board even though it is overturned, permit games that will not be interrupted by the jolting of airplane or train. A folding board with highly magnetized metal checkers is now on the market. The pieces can be moved about easily. "Jumps" are



If the Board Overturns, the Checkers Won't Fall Off Because They Are Magnetized

*306 Van Buren St.*  
*made by lifting each checker with the finger nail, while the pieces stick together for making "kings."*  
*Beulah Novelty Co.*  
*3 Liberty St.*  
*Brooklyn, N.Y.*

**TREE POISONING SAVES MONEY AND TIME IN WEEDING OUT**

Money and time can be saved in forestry work by weeding out undesirable trees by poisoning. A. L. MacKinney, of the U. S. forest service, and Prof. C. F. Korsfian, of Duke University, in a series of experiments, have found that the use of a mixture of white arsenic and lye, applied to young trees in a "frill" made by chopping into the bark, results in a higher percentage of outright deaths among weed trees than the cutting or girdling methods. One workman wields the ax while a second follows with the poison pot. This weeding-out process was used to give more desirable species of trees a chance to grow properly. A strict account of all costs and time was kept by the two experimenters as they used the three weeding methods side by side.

*Duke Forest.*  
*Cherham.*  
*(see Misc. J. forestry)*

*United World*  
*constant*  
*Archeval. n. 2*  
*Journal of Forestry*  
*Archeval. n. 2*



B. 166

Century Air Lines Monroe 10 3 11



Packages Assembled in Netting Bags for Shipment by Air to a Central Point of Distribution by Rail

### AIR EXPRESS CARRIES PARCELS TO SPEED DELIVERIES

In order to speed up its deliveries, one Chicago mail-order house is combining a parcel air-express system with its railroad mail service. Big transport ships are loaded at Chicago with parcels and flown to Cincinnati where the packages are placed in the mail for distribution by post. It has been found that considerable time is saved by taking parcels by air to a central mail-distribution point, then forwarding them from there by rail in the usual manner.

### BRIDGES THAT CAN SUBMERGE IN FLOOD ARE CHEAPEST

Bridges built to be submerged by floods have been found cheapest in India, where almost all the rainfall is from June to September. Many rivers that trickle through dry beds half a mile wide during the other months become raging torrents in the rainy season, the water often rising forty or fifty feet. To build a bridge that would always be above flood level would be too costly. So highway spans that permit the flood waters to pour over, through and around were tried and pronounced suc-

cessful. In designing these bridges, their foundations must be anchored to resist the scour of flood waters. The handrails must be collapsible so that they give under the pressure and are not torn away. The arches must be big enough to allow large trees to be carried through them, while piers must be buttressed from the downstream side to hold the structure firm. Brick, stone and concrete are the only suitable materials, steel being too light.

### MAGNETIC GAME FOR TEACHING CHILDREN THE ALPHABET

B. 20

Designed for teaching the alphabet and the names of domestic animals to small children, a game with magnetized pieces is now on the market. It consists of a number of animal cut-outs and an assortment of disks with letters printed on them. Each piece is magnetized so that it may be stuck to a lacquered metal plate which is a part of the outfit. The game teaches by sticking the cut-out of an animal on the plate, then spelling out its name with the letters.



Magnetic Letters and Metal Pieces Help Teach the Alphabet in This Game for Children

B. 20

Tab Bats 1/30/32

Brooklyn, N.Y.  
Beylah Novelty Co.  
3. Liberty St. N.Y.  
Copyrighted material  
264



a 2-4-40- Cont. S.W. Clatworthy, Esq. 54,  
 Rubblesdale Road

POPULAR MECHANICS

of Treatham Lndm SW 16 631

# Spanish Fountain Has All Hues of Rainbow *Eng*

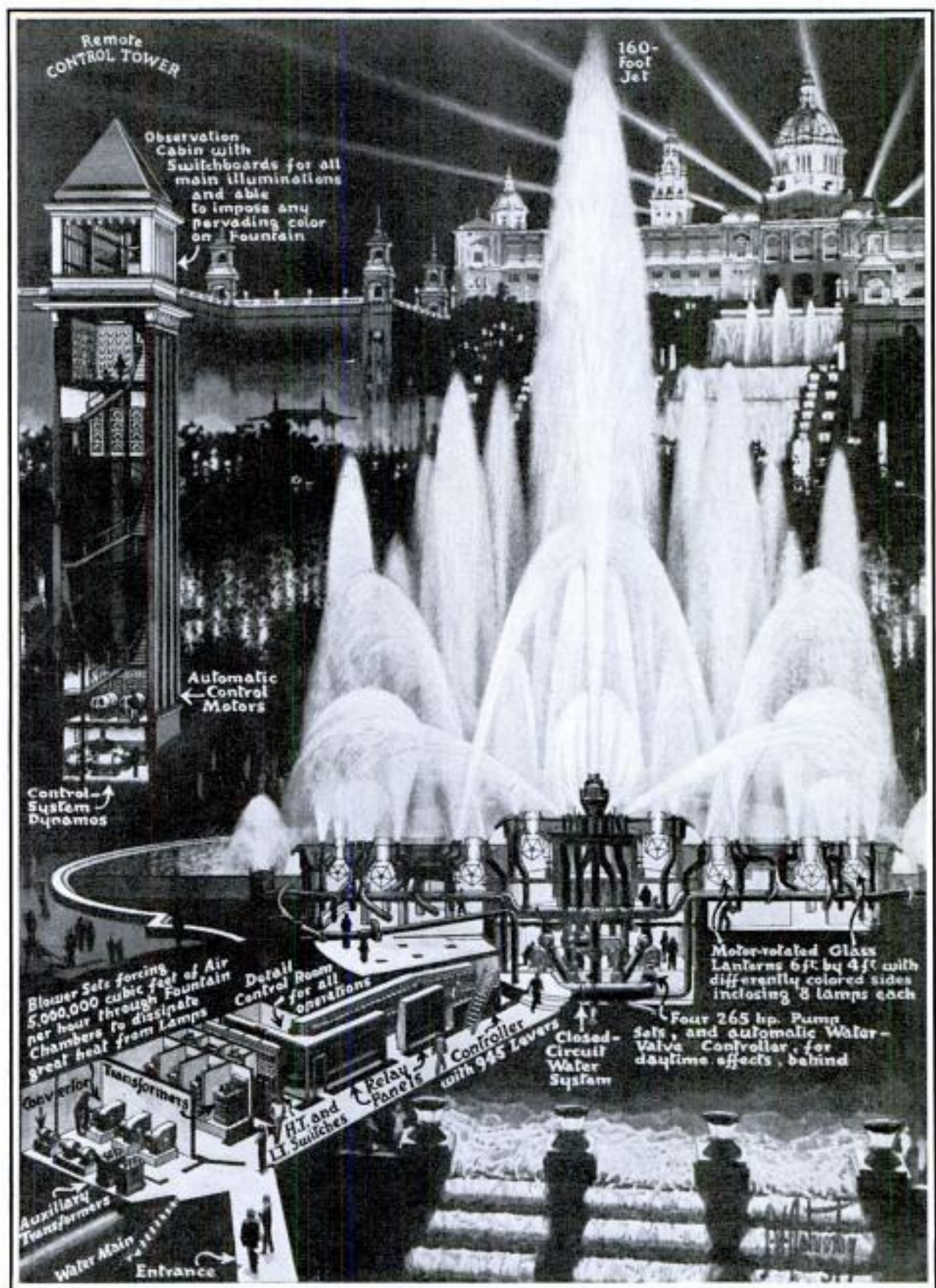

Operation of Giant Fountain at Barcelona; Pumps Force 2,000,000 Gallons of Water an Hour through 1,700 Jets to Form Forty Different Colored Patterns



60-154

Jul 13th  
1/28/32

B-303

Carl. Robt. Jr. Perkins 1327 Linn  
U. S. N. S. Washington, D. C.



Here's How a Big Tree Is Transplanted; Note the Wooden Supports Built around the Base Where the Roots Had Spread

### WINDOWS MADE FROM SUGAR

Crude sugar in the form of molasses, or treacle, can be converted into a substance as hard and as transparent as glass through a process recently developed by an English scientist. The material can be blown, molded or rolled, just like glass, and also has the valuable property of passing ultraviolet rays which are stopped by ordinary glass. It is claimed that the product, utilizing the surplus sugar, can be used for windows or for any other purpose for which glass is employed.

B-152

### STEEL FLOOR THAT INTERLOCKS WILL SPEED BUILDING

Interlocking steel channels have been produced by a steel and iron organization for flooring in skyscrapers and other large projects where speed and absence of fire hazards are major factors. The contractor can fabricate the plates at the same time as the skeleton, thereby saving time. The method furnishes the builder with a rugged, tight, fire-safe working structure at each floor level, upon which not only the building can be constructed, but heavy and bulky materials can be stored. Its use eliminates all temporary floor planking, wood forms, shores and props.

### BIG TREES ARE TRANSPLANTED TO IMPROVE CAPITAL

Transplanting large trees is one of the most difficult jobs in the program for improving the Mall, at Washington, D. C. An old magnolia, said to be one of the early trees of the department of agriculture grounds, was dug up and moved to a new location along the edge of the Mall, which will be a treeless greensward under the improvement program. A huge mass of earth, through which the magnolia's roots had spread, was cut loose around the tree before moving it, in order to insure that it would not decay or die in its new place. Other large trees will also be transplanted.

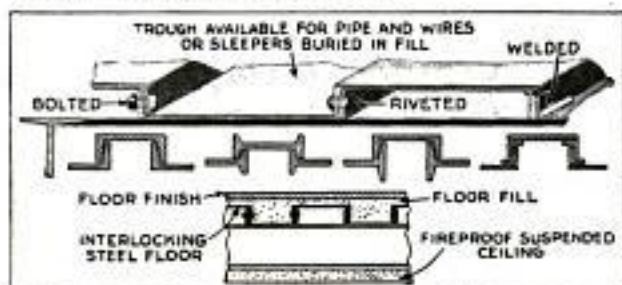

Methods of Fastening and Forming Interlocking Floors

O. Belvoir Iron Works  
22nd + Washington Ave  
Bellevue



# How the "Diving" Plane Is Filmed in Safety

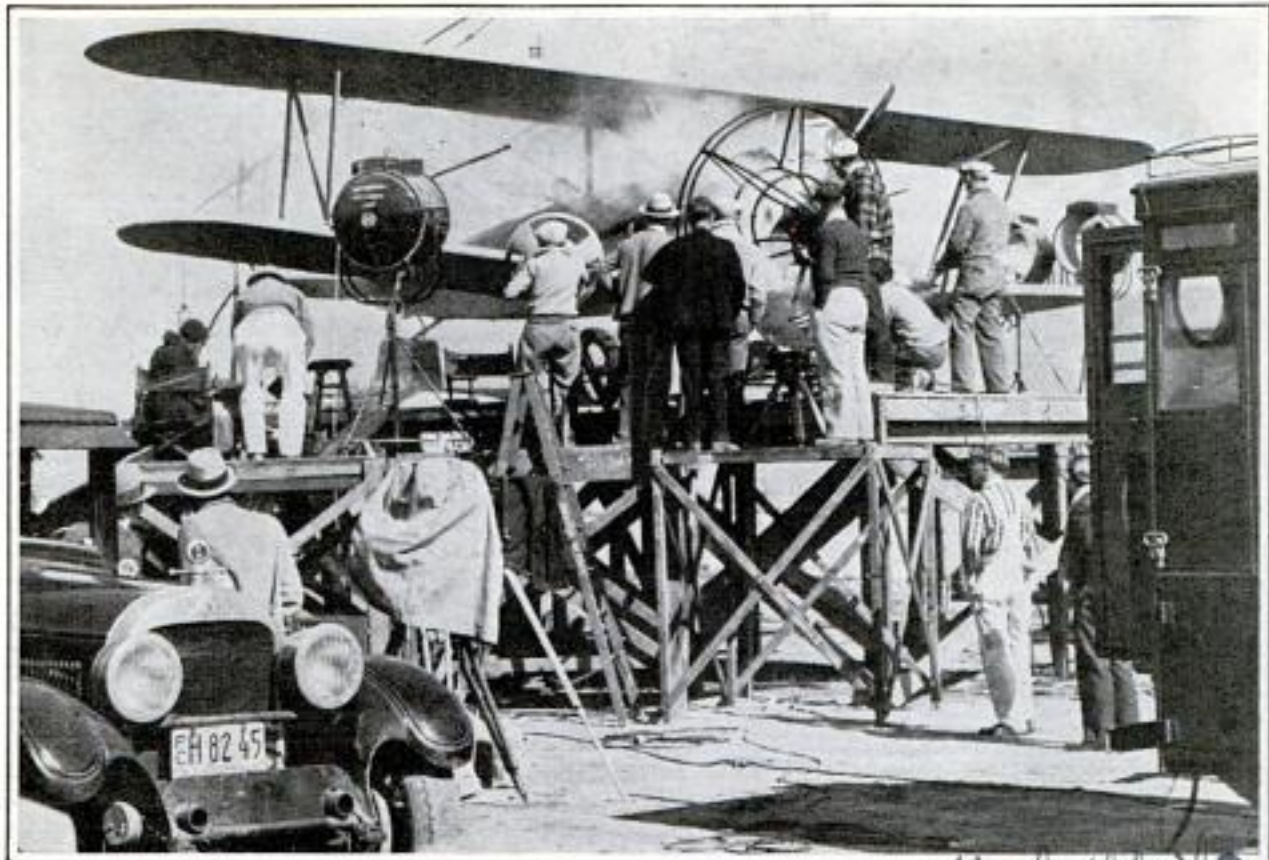

Making a Movie of an Airplane "Falling" in Flames; the Ship Is Stationary, a Revolving Camera Supplying the Motion, While Smoke Pots Furnish the Illusion of Burning

Making moving pictures of a falling airplane is not the hazardous task for the pilot and cameraman that might be assumed, for the camera can be made to supply the motion while the craft remains stationary. When one California film company was called on to portray the plunge of a burning plane with the pilot fighting for his life, the airplane was mounted on a platform with the pilot in the cockpit. Smoke pots and fans supplied the illusion of burning, and a camera that revolved as it was operated furnished all the action.

*Universal B-294*  
**BOARDS ARE MADE FROM MOSS TO INSULATE HOUSES**

Canadian moss, compressed into boards, has been found an excellent insulating material for building purposes. The boards weigh 1.7 pounds per square foot, and are odorless. Heat as high as 392 degrees Fahrenheit does not affect it. The surface readily stains or may be painted. For finished walls, the slabs are sanded or put through a planer. The cost of production

*At nos. Victor and Arthur Carlson, Edmonton, Alta, Canada*

is exceptionally low, since the moss is fed into hoppers, subjected to 150 pounds pressure per square inch and air or kiln-dried. Then it is ready for use. The material is known as "muskeg litter," and practically unlimited supplies are available in the vast areas of northern Canada.

*Art. C. K. Kenden, 187 Broadway Parkway, Valley Stream, N.Y.*

## WINDOW THAT OPENS SILENTLY HAS SPRINGS, NO WEIGHTS *B-176*

Noiseless in operation, a window which has springs instead of weights, cords and pulleys is now on the market. The window is fitted with bronze weatherstrips on which the sash slides, to prevent air leakage. Another feature is a storm sash with a vent, to admit adequate ventilation without opening the sash. Unusually loose stops are provided to avoid sticking in wet weather.



*Curtis Door Sash Co. 1414 S. Western Ave Chicago*



# Airplanes "Bomb" Indian Villages with Food

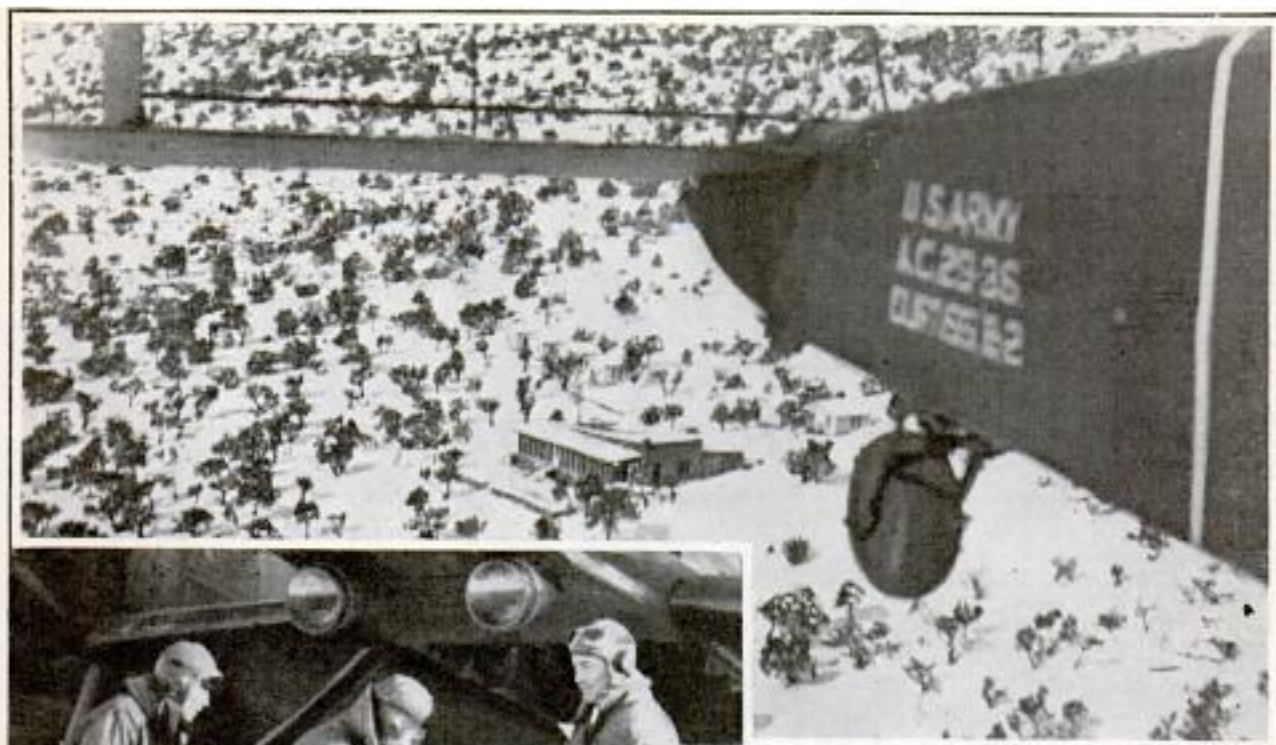

Top, Army Bomber above Snowbound Indian Village; Left, Preparing the Food "Bombs"

by army planes which "bombed" the Navajo villages with packages of food. Six ships were used and more than five tons of rations rained out of the skies on the villages of mud and brush that had been cut off from the outside world. Beans, flour, coffee, sugar and salt pork were dropped in convenient snow banks by the planes as they swooped low over the settlements, while the Indians were watching where the packages fell and digging them out of the fifteen-foot drifts.

Snowbound Indians in Arizona were supplied with provisions after a big storm

ages fell and digging them out of the fifteen-foot drifts.

## FRESH AIR BY ELECTRIFICATION ↑ SOUGHT IN HEALTH TESTS

Fresh, invigorating air, obtained by electrification of the atmosphere, is the possibility held out by public-health authorities following experiments which show that "deadening" air contains the fewest of those electrical particles known as ions. Further research is being made to find if the atmosphere may be freshened by injecting ions into stale air. Prof. C.

P. Yaglou, who conducted the experiments, says that, while it may not be possible to freshen the air by electric apparatus, his tests indicate that highly ionized air is fresher than air of low ionic content. Professor Yaglou found that the common rate of ventilating buildings is insufficient to maintain the normal ionic content of the air in a crowded room. But with electrical apparatus, it was found possible to keep the content in such a room at a high figure when outdoor air

*Science Service*  
1/25/02

*Harvard School of Public Health*  
Copyrighted material  
00 atm. maps



*See Works. P. 57, Jan 9, 1932*

was entering at the usual rate of ventilation. The concentration of ions in the air changes both seasonally and daily. More electrical particles are in summer air, and the concentration is higher during the day.

**YOU CAN HEAR GRASS GROW WITH AID OF RADIO**

*B. 230*

You can actually hear the grass grow through the aid of an instrument developed by a German professor and recently demonstrated. A sprouting seed is placed between two plates, so arranged that they can be pushed apart by the slightest pressure. The plates are connected in the field of two alternating currents, one of which has a constant cycle while the other is varied by the distance apart of the two plates. As the seed grows, the distance increases by fractional parts of one-thousandth of a millimeter, much too minute for physical measurement. Radio amplifying tubes placed in the circuit, however, give the tone pitch of the fixed cycle, from which as a base the changes of pitch in the variable cycle give the comparative measurements. The instrument has been used to measure the growth of a blade of grass or a metal rod exposed to heat sources at varying distances.

*B. 150*

**AUXILIARY FRONT AUTO SPRING REDUCES ROAD SHOCKS**

Mounted on rubber cushions, an auxiliary front spring for Ford automobiles and trucks has recently been developed. The spring fits between the standard spring and the axle and smooths out road shocks, provides a certain degree of snubbing action, allows greater loads to be carried and adds to the life of the spring. The apparatus is quickly installed, using only the U-bolts already on the car.

*See directory only. 450. 454. 547. 548. 549. 550. 551. 552. 553. 554. 555. 556. 557. 558. 559. 560. 561. 562. 563. 564. 565. 566. 567. 568. 569. 570. 571. 572. 573. 574. 575. 576. 577. 578. 579. 580. 581. 582. 583. 584. 585. 586. 587. 588. 589. 590. 591. 592. 593. 594. 595. 596. 597. 598. 599. 600. 601. 602. 603. 604. 605. 606. 607. 608. 609. 610. 611. 612. 613. 614. 615. 616. 617. 618. 619. 620. 621. 622. 623. 624. 625. 626. 627. 628. 629. 630. 631. 632. 633. 634. 635. 636. 637. 638. 639. 640. 641. 642. 643. 644. 645. 646. 647. 648. 649. 650. 651. 652. 653. 654. 655. 656. 657. 658. 659. 660. 661. 662. 663. 664. 665. 666. 667. 668. 669. 670. 671. 672. 673. 674. 675. 676. 677. 678. 679. 680. 681. 682. 683. 684. 685. 686. 687. 688. 689. 690. 691. 692. 693. 694. 695. 696. 697. 698. 699. 700. 701. 702. 703. 704. 705. 706. 707. 708. 709. 710. 711. 712. 713. 714. 715. 716. 717. 718. 719. 720. 721. 722. 723. 724. 725. 726. 727. 728. 729. 730. 731. 732. 733. 734. 735. 736. 737. 738. 739. 740. 741. 742. 743. 744. 745. 746. 747. 748. 749. 750. 751. 752. 753. 754. 755. 756. 757. 758. 759. 760. 761. 762. 763. 764. 765. 766. 767. 768. 769. 770. 771. 772. 773. 774. 775. 776. 777. 778. 779. 780. 781. 782. 783. 784. 785. 786. 787. 788. 789. 790. 791. 792. 793. 794. 795. 796. 797. 798. 799. 800. 801. 802. 803. 804. 805. 806. 807. 808. 809. 810. 811. 812. 813. 814. 815. 816. 817. 818. 819. 820. 821. 822. 823. 824. 825. 826. 827. 828. 829. 830. 831. 832. 833. 834. 835. 836. 837. 838. 839. 840. 841. 842. 843. 844. 845. 846. 847. 848. 849. 850. 851. 852. 853. 854. 855. 856. 857. 858. 859. 860. 861. 862. 863. 864. 865. 866. 867. 868. 869. 870. 871. 872. 873. 874. 875. 876. 877. 878. 879. 880. 881. 882. 883. 884. 885. 886. 887. 888. 889. 890. 891. 892. 893. 894. 895. 896. 897. 898. 899. 900. 901. 902. 903. 904. 905. 906. 907. 908. 909. 910. 911. 912. 913. 914. 915. 916. 917. 918. 919. 920. 921. 922. 923. 924. 925. 926. 927. 928. 929. 930. 931. 932. 933. 934. 935. 936. 937. 938. 939. 940. 941. 942. 943. 944. 945. 946. 947. 948. 949. 950. 951. 952. 953. 954. 955. 956. 957. 958. 959. 960. 961. 962. 963. 964. 965. 966. 967. 968. 969. 970. 971. 972. 973. 974. 975. 976. 977. 978. 979. 980. 981. 982. 983. 984. 985. 986. 987. 988. 989. 990. 991. 992. 993. 994. 995. 996. 997. 998. 999. 1000.*



RIDE ON RUBBER CUSHIONS

Longer Spring Life and Easier Riding Are Achieved with This Auxiliary Installation

*Margaret Mfg Co  
J. Ashland and  
17th Chicago*



Small Clamshell Scoop Used by Bureau of Fisheries to Collect Samples from Lake Bottoms

**SECRETS OF FISHES' MEALS SOUGHT AT LAKE BOTTOM**

To determine what kind of nourishment certain types of fish receive in natural surroundings, the bureau of fisheries has constructed a small clamshell scoop to collect samples from the bottoms of rivers and lakes. It is lowered to the bottom and closed, and brings up a load of soil which is bottled for later analysis.

**"ELECTRIC EYE" FOR PAINT GUN TURNS SPRAY ON AND OFF**

Turning the spray on and off, the photo-cell, or "electric eye," has been combined with ordinary paint guns to speed up spraying jobs. The work is moved along on conveyors and when the part to be sprayed cuts through the path of the photo-cell, paint is discharged. As the work passes on, another electric eye turns off the spray. Back, front, sides, top and bottom of the work may be painted as the conveyor moves along by arranging paint guns in series with photo-cell control.

Tires to match color combinations of motor cars are the latest innovation in the tire industry.

*B. L. Isadorich Co  
Akron, Ohio*

*Emb. Ted Osery, 2758 Y. Kimball Ave Chicago*

*B. 141  
at 1401 Taylor St. Carol  
Chicago  
125 Army St. N. Prairie*



B-26  
Cvt. Thomas M. Johnson  
420 W. 116 St  
New York

# SECRETS of the Code and Statecraft



showered torn papers and books that the crew hoped to save from allied hands. Far in the interior of France, the disabled Zeppelin "L-49" was making a forced landing. It was the last of the air armada which, trying to bomb Paris and London, met disaster so crushing that after that October day in 1917, the Germans virtually gave up dirigible raids. Thereby hangs the story of how that victory of the air brought to the allies a far greater victory of the sea.

Sergeant Meyers won his race. He was waiting when the Zeppelin landed. Pistol in hand, he confronted the crew, sinister in gnomelike caps, goggles and black leather jackets.

"Stop shooting into that machinery," he commanded the captain, "or I'll shoot into yours."

After the French foresters had marched the prisoners away, the American secret agent turned to search the airship's gondola. He found a large book, and a glance at its contents sent him chugging for Chaumont, General Pershing's headquarters. There he delivered the book to Lt. Col. N. W. Cam- chief of espionage, with this report:

panole,

"Sir, this looks to me like a German secret-code book!"

And it was. The book contained the German navy's code for wireless communication between the Zeppelins and Ger-



Top, Radio Station in Front-Line Trenches Listening for Enemy Messages; Below, Examining Letters for Secret Ink

By THOMAS M. JOHNSON

**S**ERGEANT MEYERS, of the American secret service, drove his motorcycle at break-neck speed, for he was racing against an airship.

From the dark bulk settling earthward,



# MASTER SPIES

## Cipher Stories of and Battle

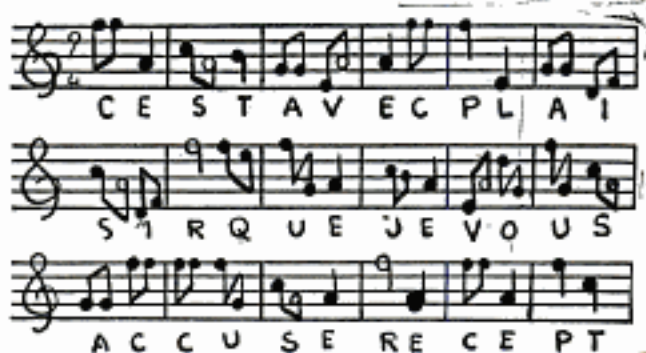

Music for the song entitled "Myopia d'Alsace"



man submarines prowling the North sea for allied and neutral victims. Then Capt. S. T. Hubbard entered, muddy and bedraggled, bearing torn slips of paper.

"They threw these overboard," he said, "but I picked 'em up, and I'm going to put 'em together."

Map and code book were rushed to the British admiralty in London, where, in the seclusion of "Room 40," their secrets were extracted.

Then began a new effort against German submarines. Obeying wireless orders in their own code, they fell into innumerable traps.

That was one of the greatest American victories in the realm of codes and ciphers, those mysterious means of hidden communication that have played, usually unknown, a great part in determining the fate of nations, of battles and of statesmen.

Russia began the war with a splendid army, the "steam roller" that twice invaded Germany. But it was vanquished—and

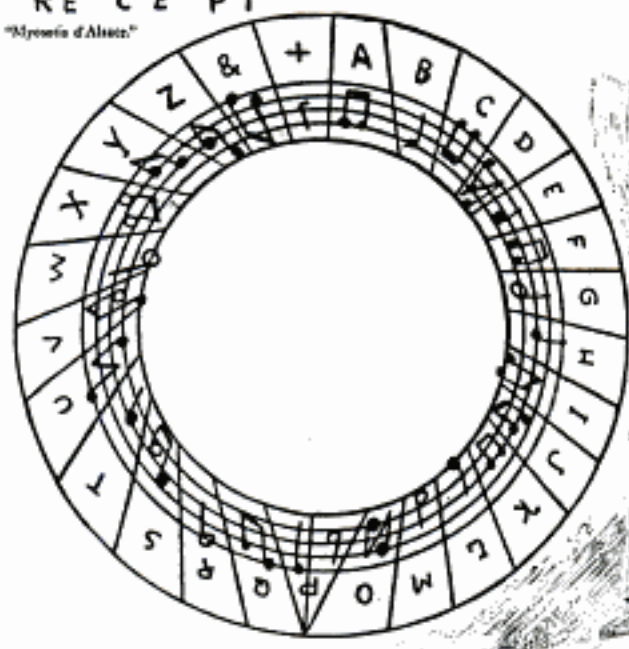

Above, Showing How Music Was Employed in One Code; Right, Monument to Famous French Woman Spy



TRAPÈSE DE BETTIGNIES

From "On Special Missions," by Charles Lucifeto; Courtesy Robert McBride & Co.

why? Principally, because the Germans had the secret of the Russian wireless code.

Then there came the greatest of all German onslaughts against the British on the western front, on March 21, 1918. With crushing superiority, the gray-clad wave almost burst through—almost, but not quite. This time, it was the British who read the Germans' wireless messages, thanks to a dramatic stroke of luck and the alertness of an American wireless op-





Above, Base Censor's Office of American Forces in Paris during World War; Here Mail Was Searched for Evidence of Spy Work, Disloyalty or Discontent, Including Letters in Code, Cipher or Secret Ink; Right, Paper Balloon Containing Spy Messages and Maps, Shown Below, Which Fell behind American Lines; It Had Been Sent by an Enemy Agent



They had asked the Americans to help solve the mystery, so when this young Yankee heard a German sending in the new code, he took down the number groups.

"And now what?" he asked himself.

At that instant, came another German message, evidently in reply to the first. But he realized, with a thrill, this second message was in the old code, which he knew.

"Haven't received new code book yet," it said. "Please repeat in old code."

And then, to the American's incredulous delight, the German sending station did just that. So now he had the same message in both codes—and he knew the old one! Soon the crypt-analysts had the meaning of every code group in the message, and the system used. When the battle

erator. On March 11, 1918, he was eagerly trying to pick up messages in a new code that the Germans had just started using. That indicated the offensive the allies feared, was near, but they could not read the new code that would tell more.



started, the allies were reading the German wireless all along the line.

Over the great naval battle off Jutland, codes and ciphers hovered like perverse spirits, exercising a strange influence.

At five o'clock the afternoon of May 30, 1916, British intercept stations picked from the air a code message from the German admiralty ordering its fleet to "carry out the plan already agreed upon." That must mean a sortie, and the British grand fleet steamed with fierce joy to meet it. But after giving that inadvertent warning, the Germans evened up. From

just off their coast, they sent fake messages indicating that the fleet had not yet sailed—which the British believed, until they almost ran into it at sea! Some authorities believe only this surprise prevented a great British victory.

How could the British so easily read the important secrets that clever cryptographers hid within baffling arrangements of seemingly meaningless words, phrases or numbers? Well, first, because, early in the war, the British got a code book from the stranded German cruiser "Magedburg"; second, because later a British diver, named Miller, at peril of his life, searched every sunken submarine for code books; third, because of the remarkable British "Black Chamber" whose experts seemed able to solve any code or cipher in the world, given enough time and sample messages.

In this secluded room, fifty cryptographers deciphered daily as many as 2,000 intercepted messages that the Germans had tried to hide in dozens of codes or ciphers, including that which Ambassador Von Bernstorff used for confidential messages from Washington to Berlin. To break that code, Room 40 worked six months, with thousands of bits of paper containing each a word or number.

But a blank postcard from Turkey stumped the experts. It was addressed

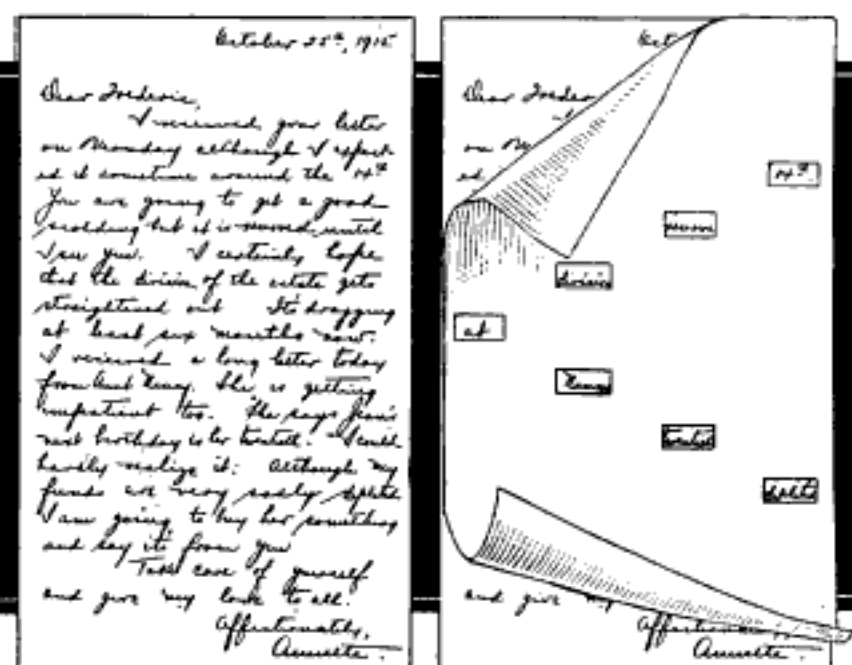

From "Spy and Counter Spy," by Richard Wilmer Rowan. Copyright, 1928, by the Viking Press, Inc., New York

Showing How an Apparently Harmless Letter Was Used to Convey a Secret Message with the Aid of the Slotted Paper to Select Key Words

"Sir Henry Jones, 184 King's Road, Tignabruaich, Scotland." There is no King's Road in the crossroad hamlet of Tignabruaich. A Scotch Presbyterian minister found the solution in the Bible: Kings, Chapter XVIII, verse 4;

"Obadiah took an hundred prophets and hid them by fifty in a cave, and fed them on bread and water."

Thus Sir Henry Jones' son had sent from prison camp the first news of what had happened to the British officers the Turks captured at Kut-el-Amara—they needed food.

The most ingenious secret message Room 40 solved was conveyed by a comb, about whose teeth thread was interwoven. Spaces between the teeth represented letters of the alphabet, and the whole message was spelled out, by unwinding the thread carefully, noting the course it followed. That feat led to discovery of a whole nest of German spies.

Interesting men, the staff of Room 40, but not wizards or necromancers. The keenest code breaker is said to have been an Oxford Greek professor; others were mathematicians, scientists. One was recently elected head of a leading British scientific society. Admiral Sir Reginald Hall, head of the work, is world-famous. Most leading American cryptographers today are army officers.



B-26



American Censors in Chemical Laboratory Testing Letters of a Suspicious Nature in the Doughboys' Mail for Secret Ink

In spectacular fashion, luck once aided an allied code expert. The allies' intercept stations recorded every intercepted enemy wireless message on a regular phonograph record, which later was put on the machine for experts to listen to. But none could make anything of some apparent gibberish, broadcast at top speed by the great Nauen station. One day, the phonograph began to run down. Slower and slower went the record. One of the experts jumped to his feet.

"Don't wind that up!" he cried. "That's no gibberish—it's a code!"

Radio code experts have become so clever, that in the next war the air will not be used at all as path of secret messages, unless, by that time, there has been found the secret wireless many are now seeking. Late in the last war, the allies asked their scientists to find some means of invisible signaling, perhaps by infra-red rays.

But the secret services found means even more ingenious to transmit the messages concocted by their cryptographers. There was the sweater trick, unsuspected when everyone was knitting. The spy first tied knots in the yarn at irregular intervals, then knitted the yarn into a sweater which he sent to his superior. That superior turned it over to his crypt-analyst, who unraveled the sweater, and matched

the knots in the yarn with a yardstick on which were marked the letters of the alphabet, reading, perhaps:

"Ten thousand troops arrived here this week."

A woman's clever ruse brought heavy loss to the Germans, when the famous Louise de Bettignies smuggled to the British a report on the positions of German artillery and ammunition around Lille—which was promptly blown sky-high. The woman spy had written the information with a microscopic pen, in invisible ink, on translucent paper, which she pasted over the lens of an eyeglass. German searchers missed

that, and also the messages she hid in a bar of chocolate—to be eaten if she were captured.

Secret inks hid many spy messages, and made still more diabolical torment for the crypt-analysts. The American secret service, here and in France, had special laboratories to solve them, for the world war saw devices far subtler than that whereby the first secret-ink message was transmitted when the Greek Histaeus wrote his message on a slave's shaved head, let the hair grow, then sent the slave to a co-conspirator with instructions to say simply, "Shave my head."

Almost everything was used for secret ink, from lemon juice to fake perfumery. Spies wrote between the lines, or across the lines of seemingly innocent letters. To avoid leaving telltale scratches, they used blunt or ball-pointed pens of rustless gold.

B-269

**RUBBER/NECKTIE IS SOIL-PROOF**

Tired of searching through a rack of ties to find one that was unsoiled, an inventor recently placed on the market rubber neckties that are said to be soil-proof. The rubber-composition ties can be obtained in various colors and are claimed to hold their shape indefinitely.

*Handwritten:* J.C. Necktie Co  
2805 51st St  
2 Leo Manso, L.A.  
Copyrighted material

*Handwritten:* and for museum



### MANY AIRSHIPS CROSS OCEAN ON OFFICE CHART

B. 91

More than 500 ocean flights have been made by aviators, navigators and scientists without the use of any craft, and without seeing either the Pacific or the Atlantic ocean. These flights were purely imaginary and were made from the offices of the Goodyear-Zeppelin corporation in Akron, the purpose being to assemble data that will make safe real crossings. The imaginary ships are navigated in accordance with actual weather conditions of past dates. Official weather reports are closely studied, as are the logs of steamships, so that the air mariners know exactly what conditions would have been encountered. Data obtained from these "flights" are worked over in an effort to so schedule and route the ships that voyages could have been made in less time. The world's major wind systems are the guide for such trips. A chart of the system embraces the north circumpolar winds, prevailing westerlies, horse latitudes, northeast trades, equatorial calms, southeast trades, south horse latitudes and the south circumpolar winds.

B. 72

### ROBOT THAT LISTENS TO MUSIC IS ORCHESTRA CRITIC

Listening in on the music of the Philadelphia symphony orchestra and rendering an impartial verdict on what he hears is the job of a dummy equipped with automatic ears who serves as sound critic, particularly at rehearsals. This robot makes his report, without fear or favor, to engineers sitting beside him. He is known as "Oscar," and the ears are twin microphones connected to an amplifying system. Engineers first listen to the orchestra through their own ears, then through Oscar's by means of earphones. The robot is tuned until the sound heard without the robot's aid is exactly like that heard when listening through the dummy's ears.



Wash World  
Oscar



Wearing Dozens of Hats at a Time, This Indian Girl Peddles Sombreros in Tampico

Photo by Thos. F. Lee, from Ewing Galloway

### MEXICO'S WALKING HAT STORE IS INDIAN GIRL PEDDLER

Forty big straw hats are not too many to be worn at the same time by Mexico's walking hat stores, the Indian girl peddlers. In addition, the girls often carry a dozen large baskets in their arms. This sombrero trade is plied in Tampico and other Mexican cities, catering to natives and tourists alike.

### GRAY IS NOW OFFICIAL WHITE FOR THE MOVIES

Undesirable contrasts produced in motion pictures by pure white fabrics, such as tablecloths and shirt fronts, will be eliminated by the use of a "Pickford gray." Research has shown that a certain pale shade of gray gives the best results, so the new gray has been adopted as the standard shade to replace white. Various pale colors were used in the experiment.

report to Society of Motion Picture Engineers  
33 W. 42nd St. New York  
Copyrighted material

Emb. Es. H. Eckhardt.  
4528 Walnut, Phila







condenser is mounted in the same manner.

The leads from the power transformer are brought down through the chassis, and each pair of a.c. heater, or filament, leads should be twisted. The 10-ohm center-tapped resistance across the filament posts of the 227-tube socket is not shown in the assembly view, but is to be soldered directly across these posts. Provision has been made for the speaker field as one section of the filter; otherwise the double, center-tapped choke described in the October article will be used. The two 1-mfd. condensers mounted under the chassis and marked "see text" are for by-passing the various voltage taps on the divider resistance, in case the builder wishes to use them. The 2-mfd. by-pass condenser across the 2,500-ohm bias resistor is made by connecting two of the 1-mfd. 200-volt condensers in parallel. No by-pass condenser is used across the bias resistor in the push-pull stage.

Two complete voltage dividers are used in this unit. One of them supplies the amplifier with current and this is mounted on the underside of the chassis. The resistance values are not critical; therefore

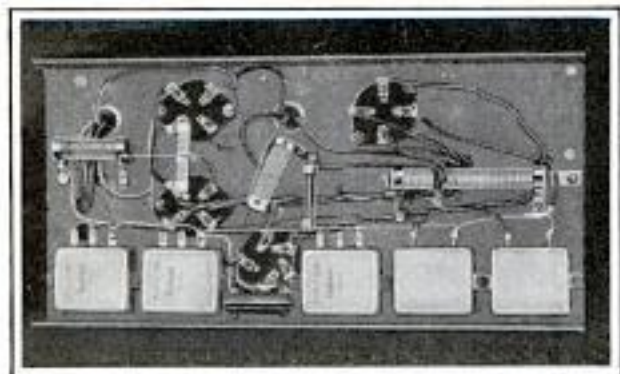

Underside View of the Completed Amplifier and Power-Supply Unit

a standard 30,000-ohm truvolt type with a slider may be used to approximate the 20,000 and 7,000-ohm sections. Voltages for the tuning unit or set will be obtained from the divider mounted on top of the chassis. The .0002-mfd. condenser marked "see note" is optional, and in most cases adds little to the quality of the output.

The push-pull input and output transformers are of the usual type. The use of two voltage dividers gives the amplifier a constant and predetermined voltage, and the current drawn from the taps of the upper divider will have little effect.



Large Speaker Baffle, Showing Cloth-Covered Grill at the Center

### Ornamental Baffle for Auditorium Dynamic Speaker

This attractive baffle was designed by me for use in clubs, dance halls, amusement parks and for public-address systems where a large baffle is required for best results. It is 92 in. high, 52 in. wide and 12 in. deep, and is made of maple and oak with carved decorations fastened with waterproof glue. It weighs about 300 lb. The dynamic speaker is mounted on a shelf directly back of the temple at the center. I devoted my spare time over a period of about 18 months to the construction and decoration of the baffle. The finish is in ivory with the landscape in natural colors. The baffle may be fastened to the wall with hooks or anchored to the floor in easel fashion.—Walter Evans, Buffalo, N. Y.

### Space Winding Coils

When a space-wound coil is required, and a lathe is not available, the experimenter can make a double winding with string and the wire, removing the string when the coil is completed. If the specifications call for spacing the width of the diameter of the wire, a double winding is made with two spools of the same-size wire. In either case, the completed winding is coated with collodion or shellac, and the spacing turns are removed before the binder dries.



C. J. Jenkins  
 died June 8, 1934.



Combination Television Receiver in Operation, and Interior View Showing the Arrangement of Parts

### Television Set Is Self-Contained

Offering a choice of either broadcast or short-wave reception, in addition to television, this attractive console set contains an all-wave receiver and a projector-radiovisor. An interchangeable tuning system is provided for each purpose. Sharp selectivity is claimed for the reception in the broadcast and short-wave bands, and broad tuning is made available for television. The necessary plug-in coils for the various wave bands are matched for convenient handling. The receiver is fully a.c. operated, and the output stage consists of two type-45 tubes in parallel, to provide the distortionless current necessary for the operation of the new crater lamp used in the projector type of radiovisor. A loud speaker, concealed from view, is provided for broadcast programs, and a pair of jacks permit the use of the audio system for reproducing phonograph records if desired. A 60-line disk is used in the radiovisor, and the pictures are projected on a ground-glass screen held in a frame in front of the console. The image may be adjusted and focused for any size up to  $8\frac{3}{8}$  by 10 inches.

For further information on any radio construction article write to the radio department; this service is free.

### Repairing Speaker Cords

Frayed and broken speaker cords of the tinsel-conductor type are often discarded because of trouble encountered in soldering the delicate strands. A soldering iron or flame from an alcohol lamp may be used to remove the broken end of the cord from the tip. The frayed end of the cord to be connected is then trimmed, and the insulation cut back  $\frac{1}{4}$  in. A sewing needle put into this end serves to support some turns of fine copper wire around the tinsel. A strand of wire removed from ordinary lampcord will do for this purpose.

The needle is then removed and the prepared end of the cord is coated with solder. It is then inserted in the tip, which is again heated to obtain a good soldered connection.

### Iron-Pipe Standards for Apartment Antennas

In providing antenna standards for an apartment building,  $1\frac{1}{2}$ -in. iron pipe was used thereby avoiding the unsightly masts, yet supplying individual antennas for the tenants. The lead-in wires are taken from either end according to the location of the apartment and are brought down through conduit.—John B. DeHoff, Baltimore, Md.

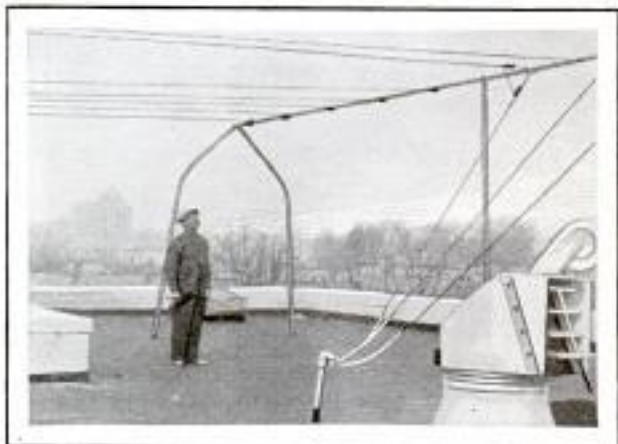

Antenna Installation Showing Lead-In Wires for Three Apartments at the Right



# Homemade RESISTANCE BRIDGE for RADIO AMATEURS

By H. C. McKay

THIS simplified and compact Wheatstone bridge enables the radio experimenter to make accurate resistance measurements of the various units in his circuits. It has a range from .01 ohm up to 11,100,000 ohms. With this bridge and an accurate voltmeter and milliammeter, the amateur is in a position to wind and measure his own resistances from scrap wire taken from commercial resistance units. He may also make his own resistances from carbon rod and other high-resistance compounds. By so doing, the experimenter can duplicate this bridge, without the galvanometer, for about \$5.

The bridge consists of a bank of decade resistances, and a multiplier or ratio bank, connected in the usual bridge circuit. The 10-ohm, 100-ohm and 1,000-ohm unit groups constitute the decade resistances and the multiplier group is indicated with the letter M. Fig. 1 shows the simplified wiring diagram and subpanel layout to correspond as near as possible with the actual photo shown above. The resistance units are available in kit form and are threaded on

brass rods for convenient mounting. The four switches are of the usual inductance type and it will be necessary to add the calibrated zero points indicated. A small case, such as a small overnight bag or large vanity case, may be used, and the size of the panel will depend on the case selected. Wooden cleats or a light wooden frame should be provided to support the panel above the bottom of the case to clear the units above and below. The re-



sistance banks are held 2 in. below the panel by means of metal strips forming a four-bar grid, to allow plenty of room under the panel for the switches and necessary wiring. The top photo on page 646 shows how this wiring to the various switch

points is completed before the rods carrying the resistors are placed in position.

Fig. 2 is not followed exactly as shown in the actual wiring diagram Fig. 1, but the reversed connections give the same result. In Fig. 2, the 1,000-ohm resistances T and K, shown in Fig. 1, are the same, and the actual balancing values will be those indicated by the dials.

The bridge should be tested with resistors of known value. Provide one resistor of



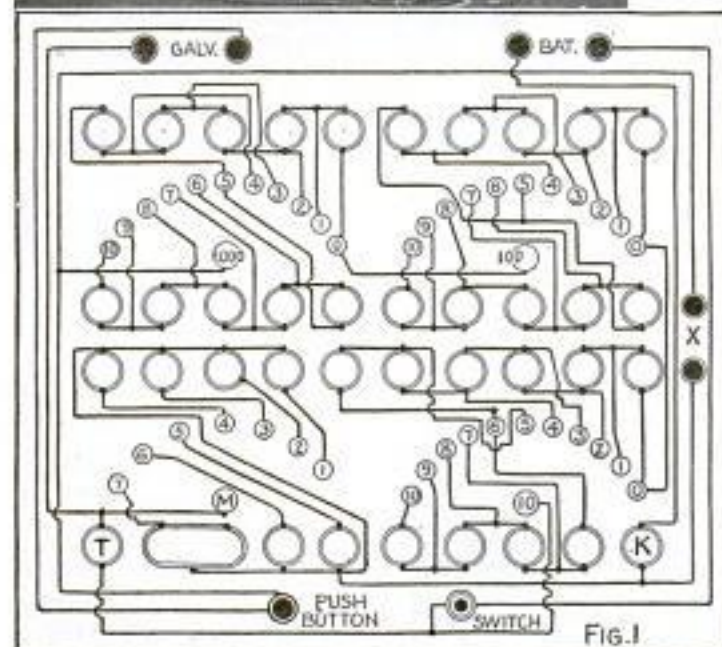
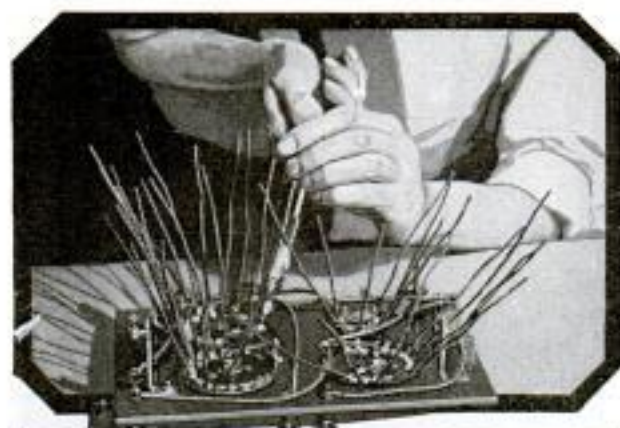

a value between 1,000 and 10,000 ohms and another between 100,000 and 500,000 ohms for this purpose. A small  $4\frac{1}{2}$ -volt battery is connected to the battery binding posts as shown in the photo on page 645, and the galvanometer to the posts indicated. The smaller resistor is then connected to the X-posts. This resistor, we will say, has a rated resistance of 5,000 ohms. To check this value, set the multiplier upon point 4 and the 1,000-dial at 5. Press the push button and notice the direction in

which the galvanometer pointer swings. Now set the 1,000-dial at 4 and see if the direction is the same, then set it at 6 and try again. Points 4 and 6 should give deflections in different directions. If the pointer should swing to the right for 5 and 6 but to the left for 4, you will know that the resistance lies between 4,000 and 5,000 ohms. Now return the dial to 4, set the 100-dial to 5, and try again. This time, let us assume, the swing is to the left. Then try 8 on the 100-dial and, if the pointer still swings left, try 9. If at this point the pointer swings right, replace this switch at 8. Then set the 10-switch at 5 and try it. If the swing is right, shift to 4, and with another right swing, go to 3, and if there is now a very slight left deflection, the value of the resistance X is not exactly 5,000 ohms, but between 4,830 and 4,840 ohms. In a resistance, this range is less than  $\frac{1}{4}$  per cent, which is sufficiently close for all amateur purposes.

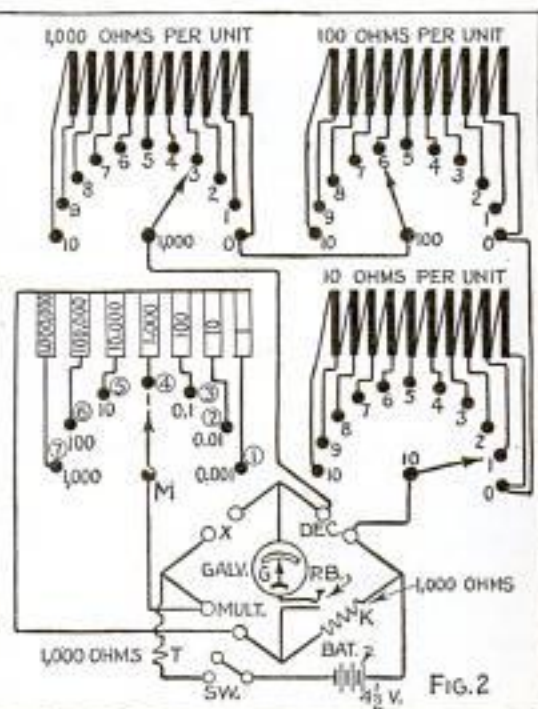

The second resistor rated at, we will say, 250,000 ohms is now checked. The 1,000-dial is set at 2, and the 100-dial at 5. This setting is for a reading of 2,500 ohms, but as 250,000 are wanted, the multiplier switch M is placed on the 6 point, which multiplies all readings by 100. The readings are now taken in the same manner as before and checked to the closest possible value as indicated by the galvanometer.



# TELEVISION DISKS YOU CAN MAKE

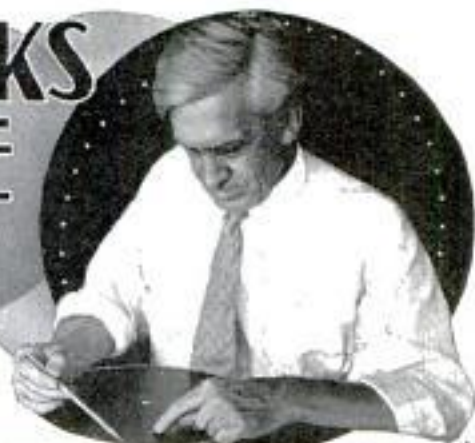

THESE indexing gauges for laying out television disks are subject to variation according to the requirements of the builder. No matter what size of disk or number of holes is used, a slight alteration of the indexing gauge will meet the requirements. For practical purposes, this is quite necessary, as no fixed standards have been set at this time and different scanning methods are in use in various parts of the country. Television disks may be made of cardboard or, preferably, from sheet aluminum. The metal should be as thin as possible consistent with strength, because if thick metal is used the walls of the holes often act as reflectors. However, this may be remedied by counter-sinking the holes. Aluminum about .125 in. thick is very good for experimental purposes.

Several stations broadcasting television programs in the middle west are employing a three-spiral 45-hole scanning method, and the gauge for laying out this type of disk will be discussed first. The enlarged details of the indexing plate and clamps for holding it in position on the gauge are shown in Fig. 1. The length of the gauge,

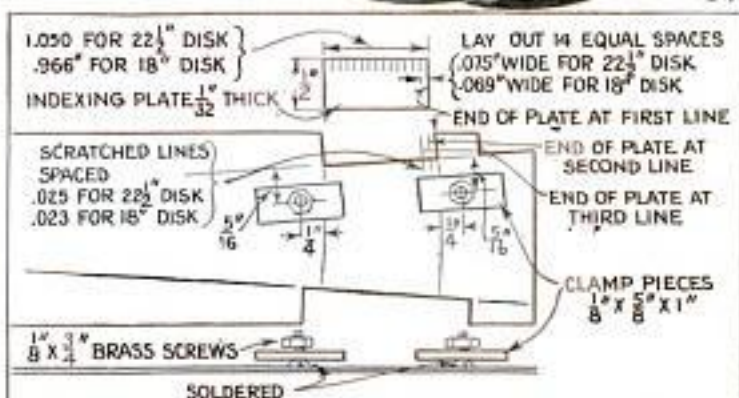

FIG. 1

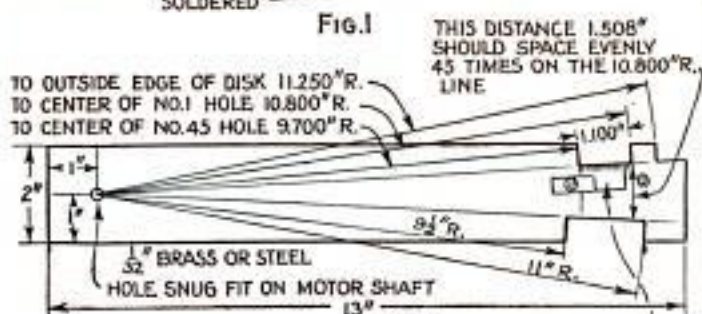

FIG. 2

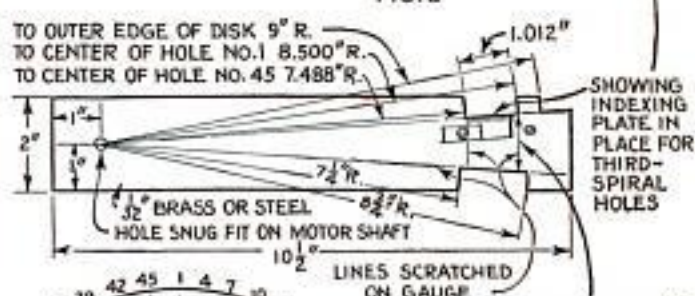

FIG. 3

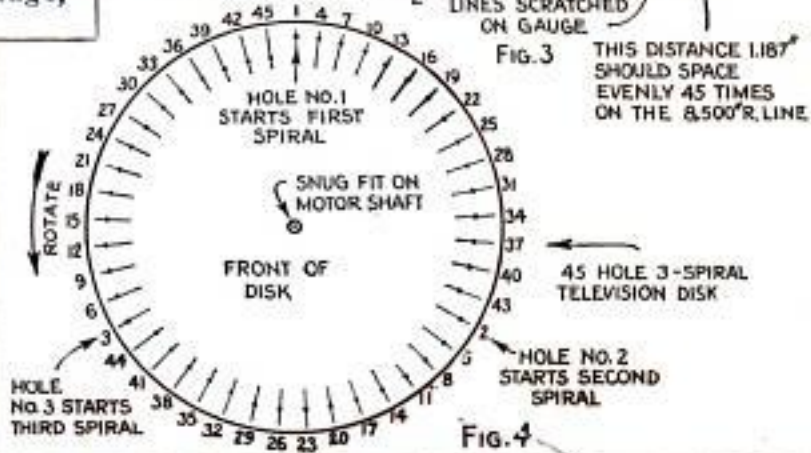
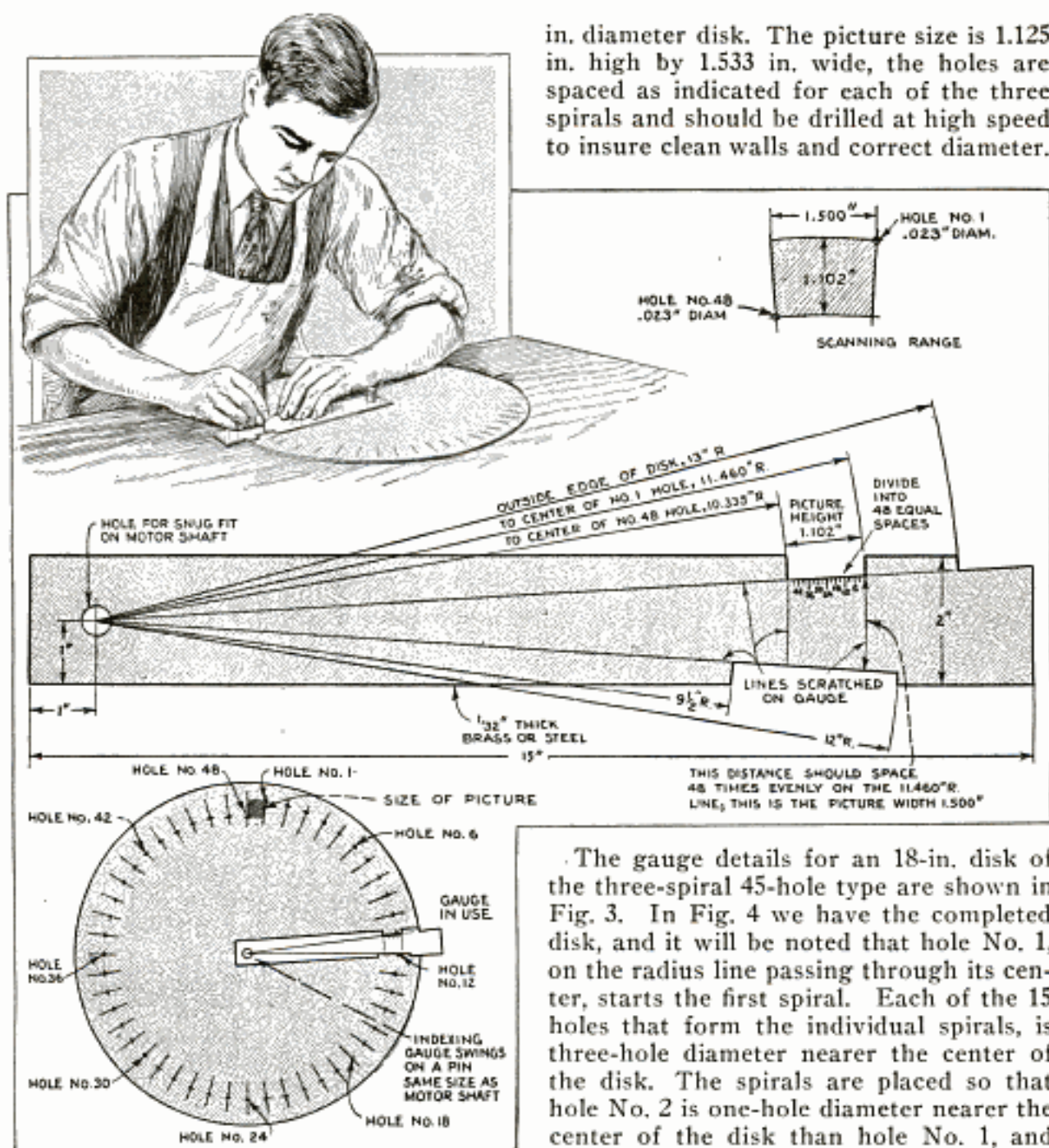

FIG. 4





in. diameter disk. The picture size is 1.125 in. high by 1.533 in. wide, the holes are spaced as indicated for each of the three spirals and should be drilled at high speed to insure clean walls and correct diameter.

indexing plate and the divisional spacing for both 18 and 22½-in. disks are given. The holes are spotted on these divisions, and the diameter of the hole is the same as the spacing.

The 22½-in. disk scans a picture about the size employed in moving-picture film, and a lens may be used to enlarge this image several times without distortion. It should be understood that, when holes are mentioned, it means the center point of each hole and these points must be clearly defined with a marking tool when the disk is laid out. The complete gauge dimensions are given in Fig. 2 for the 22½-

The gauge details for an 18-in. disk of the three-spiral 45-hole type are shown in Fig. 3. In Fig. 4 we have the completed disk, and it will be noted that hole No. 1, on the radius line passing through its center, starts the first spiral. Each of the 15 holes that form the individual spirals, is three-hole diameter nearer the center of the disk. The spirals are placed so that hole No. 2 is one-hole diameter nearer the center of the disk than hole No. 1, and the third spiral begins one-hole diameter nearer the center of the disk than hole No. 2.

The single-spiral 48-hole gauge and disk are shown on this page and this single-spiral disk scans a picture about the same size as the 22½-in. three-spiral 45-line disk previously described. In this case it will be noted that the entire number of equal divisions are not shown on the indexing space, as the lines would be too close together for illustrating purposes. The divisional lines are scribed directly on the gauge instead of a separate plate, and no clamps are required, as no shifting is necessary for the single spiral.



# Practical Ideas for the Radio Experimenter

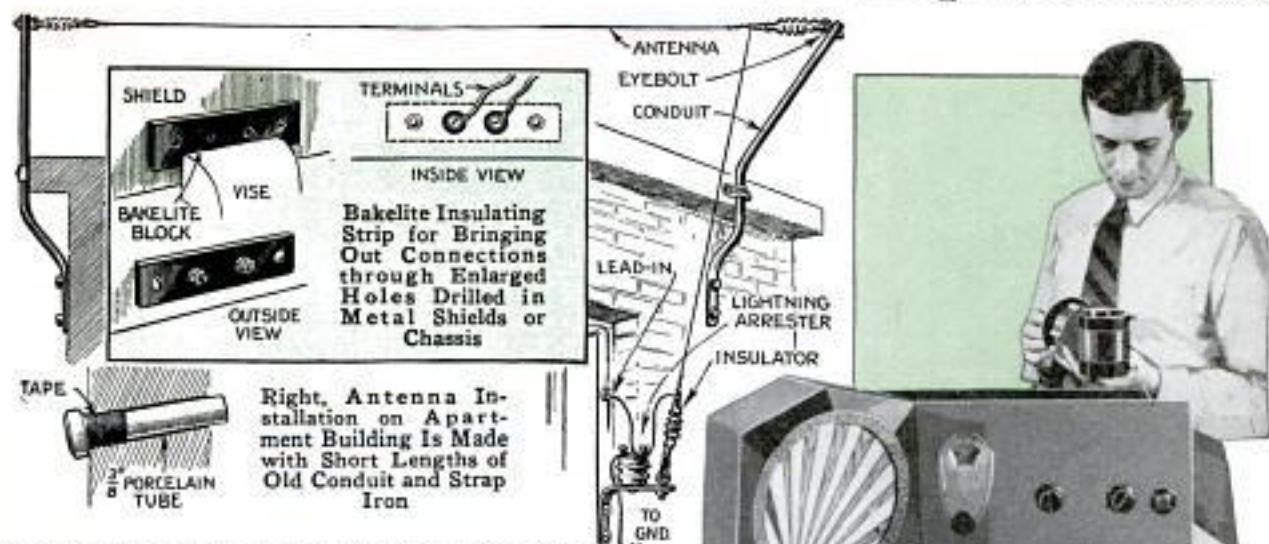

**Bakelite Insulating Strip for Bringing Out Connections through Enlarged Holes Drilled in Metal Shields or Chassis**

**Right, Antenna Installation on Apartment Building Is Made with Short Lengths of Old Conduit and Strap Iron**

**Insulating Tube for Bringing Lead-In Wire into Building Should Be Slanted Upward to Keep Out Rain; Tape Holds Tube in Position**



**Above, 2 In. of Pencil Lead Makes Filament Resistor for 5-Volt Battery-Operated Tubes, Adjusted for Correct Voltage; Below, Small Fuse Protects Meter**



**R. F. Choke Coil Wound on 199-Tube Base with Terminals Brought through Prongs and Connected with Busbar**



**Above, Measuring Range of Coil Shunted with Variable Condenser; Hold Coil Close to Coil in Receiver Using Dial Calibrated in Kilocycles; Click in Speaker Indicates Both Coils Tuned to Same Frequency; Left, Baking-Powder Can Makes Good Coil Shield**

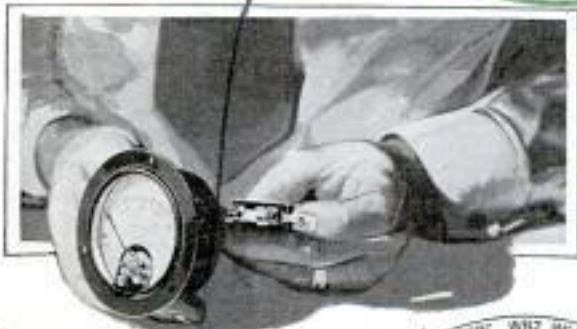
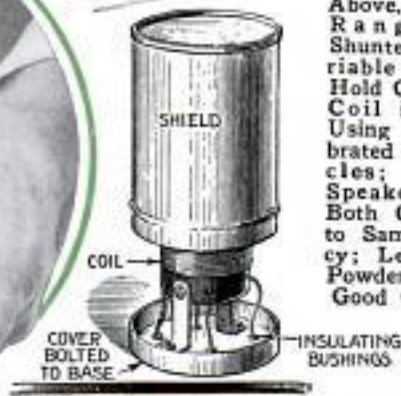

**Right, Cover Plate, Held with Brass Bushings and Machine Screws, Protects Sub-Base Wiring Where Experimenters Use Aluminum Baking Pans for Metal Chassis**

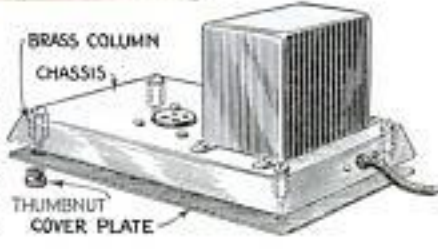

**Two Cardboard Disks Pivoted at Center Make a Handy Station Log**

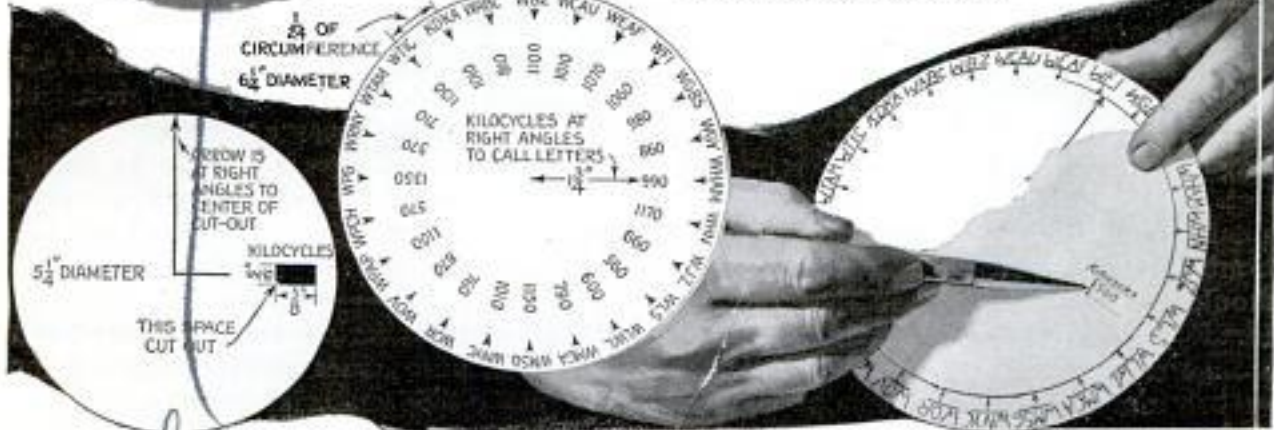



## A Drum Dial for the Junior Experimenter

A serviceable drum dial and escutcheon plate can be made from the bottom of a coffee can

length of pencil which forms the shaft. The ends of the cord are given one turn around the spool, then up on each side of the dial for two turns around the shaft in

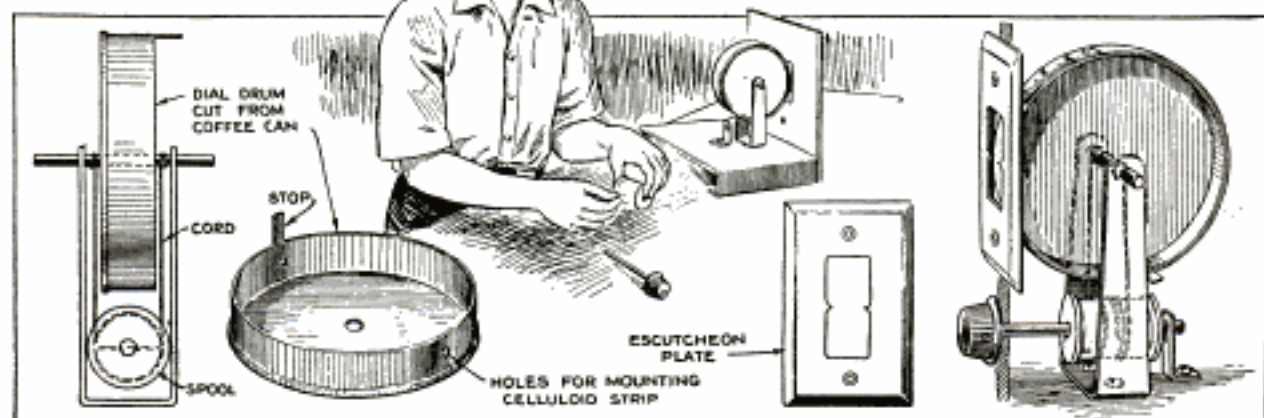

Section of Coffee Can and an Old Switch Plate Make a Good Drum Dial; the Completed Assembly, with Plate Mounted on Panel, Is Shown at Right

and an old brass switch plate. A 3-in. length of  $\frac{1}{4}$ -in. brass rod is required for the shaft and the hanger is made from a strip of metal bent and drilled as shown. The width of the dial section is  $\frac{3}{4}$  in. A  $\frac{1}{4}$ -in. hole is drilled through its center to take the brass rod, and the can is soldered securely to the rod at center. The drum is rotated by means of a waxed cord around a large spool as detailed at the right. The cord is threaded through a small hole drilled through the spool and

opposite directions. The ends are threaded through small holes drilled through the shaft, and knotted. A strip of white paper, reaching halfway around the dial, is divided into 100 equal parts and covered with clear celluloid of the same size. These strips are fastened to the dial by means of two small machine screws or paper clips. A knob from an old rheostat and the switch plate, cut out at center as shown, complete the assembly.—E. E. Youngkin, Altoona, Pa.

### Trouble Traced to Connectors

Separable connection plugs, used in many types of a.c. receivers, often become loose or corroded, and the result is a baffling fading effect.

The connections carrying the filament current are the chief cause of the trouble. The male portion of the plug should be inspected to see that the soldered connections are secure and the prongs free from corrosion. They should be brightened with fine sandpaper and slightly spread with a screwdriver, as

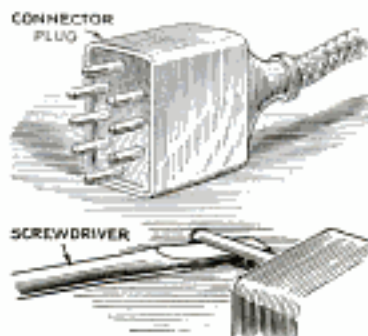

shown in the lower sketch, to insure a good, tight contact. The socket end of the connector should be polished, inside the terminal bushings, with a bit of fine sandpaper on a toothpick.

### Avoiding Poor Contacts

Sheet aluminum should not be used for any parts which make up the electrical circuit of a set. Brass or copper sheet is best for this purpose and may be easily soldered to insure good electrical connections. Aluminum oxidizes quickly and is difficult to solder.

Blueprints covering radio construction articles in past issues can be obtained for 25 cents each; material lists are always available without charge.







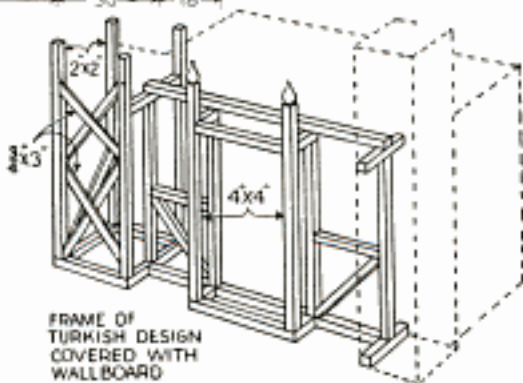
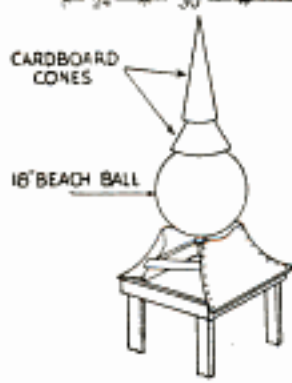
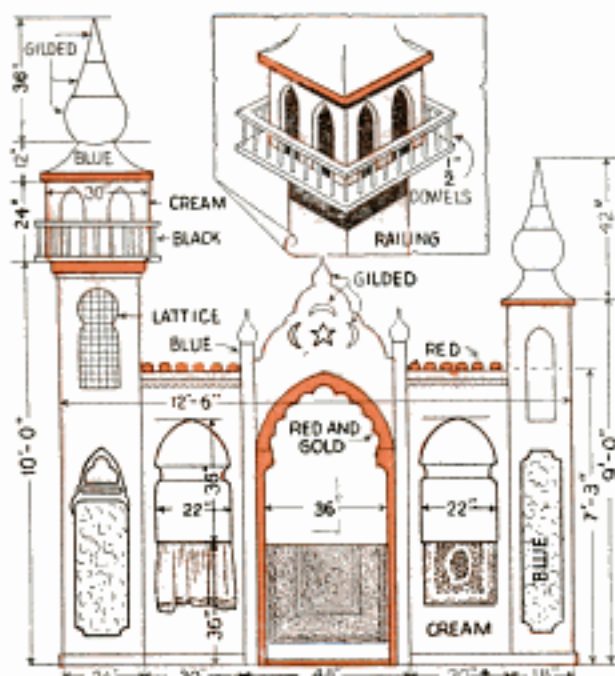

are 4 by 4 in., while 2 by 4-in. stock is used for the main framing, with lighter pieces for rafters, etc. Corrugated pasteboard can be laid over the wallboard to give a bamboo or tile effect. By going to some extra expense and covering the wallboard with roll roofing, the pagoda could be made suitable for outdoor use as a summer house for the children, after it has served its purpose. Jigsaw panels of plywood or wallboard are set in the cupola frames, and wallboard is used for panels beneath the serving counter. The color scheme is important, and should be rich, bright oriental colors; for example, a jade-green on the roofs with gilt trimmings, red posts, and orange panels beneath the counter, ornamented with black and gold dragons or other figures. Decorated with Chinese lanterns, temple bells and gongs, it will be an outstanding feature at any bazaar.

The Turkish building is also constructed of wallboard over a light wood framing. The spire on each tower is built up of a large beach ball and two bristol-board cones, painted as indicated. The

case the caves curve up at the corners, which requires bent members, over which light wallboard can be fitted without breaking the material. The corner posts

"iron" railing around the main tower consists of a hand rail drilled for 1/2-in. dowel spindles, spaced 3 in. apart and painted black. Windows should all be laid out and

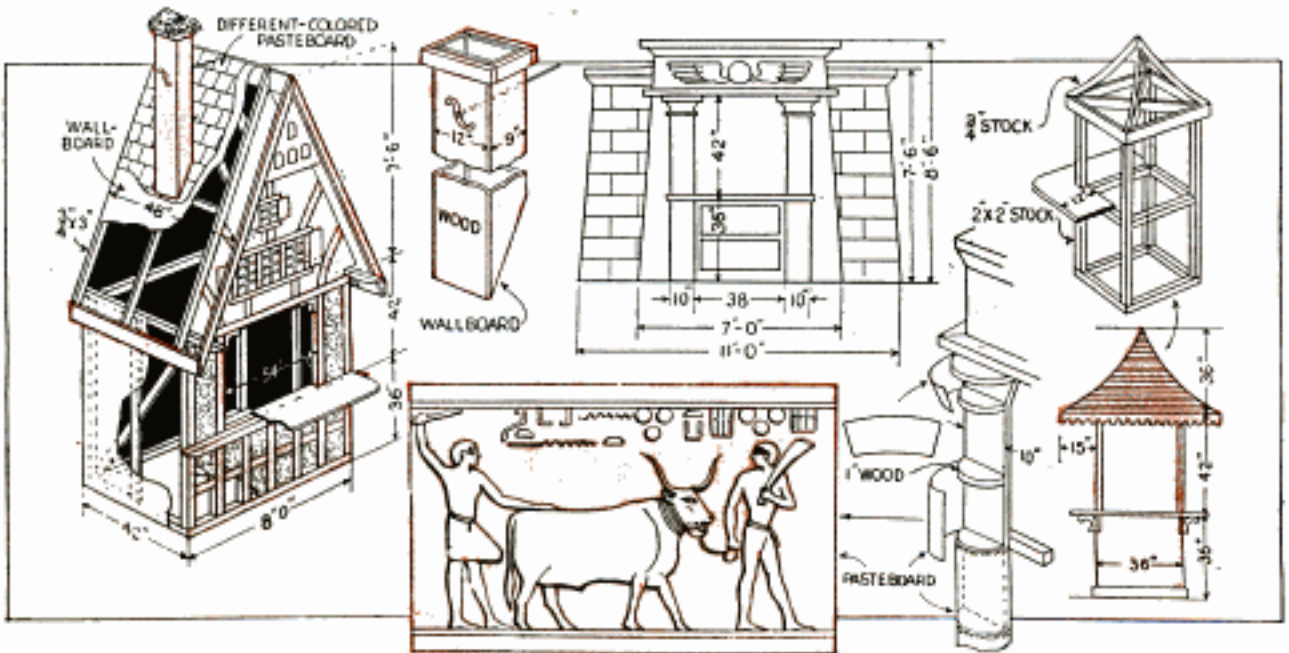



cut with a keyhole saw or sharp knife before the panels are nailed to the framing. Over the central opening, which corresponds to a doorway, the serrated arch pieces are cut separately and nailed in place, and a light lattice or grill is made of wood strips and nailed inside the window opening in the taller tower. This design lends itself admirably to a varicolored paint job, with orange, blue, gold, black and red used generously, as indicated, the walls being left the natural cream color of the wallboard.

Other models that are effective but of simpler construction are also shown. A comic touch may be lent by drawing modern scenes in the style of ancient Egypt. A stuffed heron from the local taxidermist, nesting atop a tall chimney, is also effective. Mullioned windows are simply painted in black panes with white frames, and bright green blinds are cut from wallboard. Sills, lintels and timber work are of  $\frac{1}{4}$ -in. wood, given a walnut oil stain before nailing in place. For a tile-roof effect, glue on pieces of colored cardboard.

#### Hinged Holder for Your Suitcase Lid Made from Old Rule



Sturdy holders for suitcase or tool-chest lids can be made from two sections of a folding rule. Small bolts are used to fasten the ends of the rule to the

lid and bottom rim of the case. When the lid is closed the rule folds inside the case.

#### Fuller's Earth Restores Oily Shoes

Oil-soaked shoes can be restored to normal dryness with fuller's earth. Cover the bottom of a suitable box with the earth, set the shoes on this and sprinkle more of the earth over them, both inside and out. Allow the shoes to remain in the earth overnight, when it will have absorbed all the excess oil.

☛ Stuck caps on paint tubes may be loosened by heating them.



Developing Panchromatic Plates behind Screen Placed in the Light of Green Safe-Light

#### Screen for Use in Developing New High-Speed Photo Plates

Trouble is often experienced by the amateur when developing the new panchromatic photographic plates, as they are sensitive to all colors of light. By using the illustrated screen between a green safe-light and the plates, there will be sufficient illumination to see the image and govern the developing. The screen consists of a piece of cardboard nailed to a block of wood heavy enough to hold it vertically. Keep the plates and developing trays in the shadow of the screen as shown in the illustration.—K. F. Keith, New Orleans, La.

#### Metal Cup Traps Bird Lice

Packed with cotton and fitted with a wire-mesh cover, a small metal cup makes a good trap for bird lice. The lice leave the birds during the day and crawl into cracks and crevices. When one or more of the traps are placed on the cage, at the ends of the perches, the lice get into the cotton and become so entangled that they cannot escape. The cotton should be changed once a week.





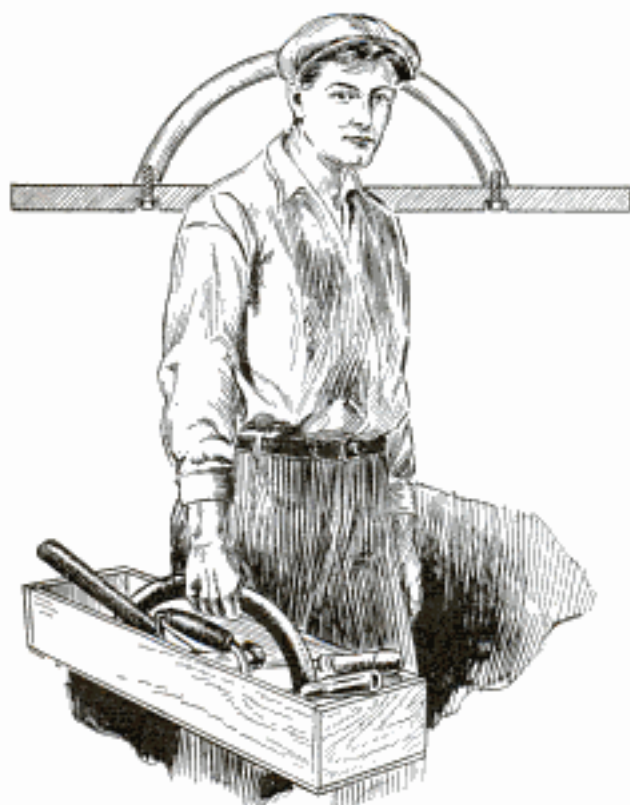

Rim from Auto Steering Wheel, Cut in Half, Makes Good Handle for Tool Tray

#### Tool-Box Handle Made from Auto Steering Wheel

The rim from an old steering wheel, cut in half, makes a good handle for a tool tray. Drill and tap the ends of the handle for  $\frac{1}{4}$ -in. studs, which are inserted through corresponding holes drilled and countersunk in the bottom of the tray as shown.—W. C. Wilhite, Hornsby, Ill.

#### Multiple Connectors on Track Improve Operation of Toy Trains

The ends of the rails on a toy-train track often become enlarged after repeated connecting and disconnecting, which results in variable or high-resistance joints and irregular operation of the electric engine as well as a flickering of the lights on the system. This trouble can be remedied by using several electrical connectors from the transformer, spaced at intervals around the track so that the engine will at no time be more than a few track sections from one of them. The terminals of the connectors are then all wired together with lampcord, which may serve as the supply source, or they may be wired together separately to bridge the poor connections in the track.

#### Roach Trap from Glass Tumbler

Here's a good trap for cockroaches: Cover the bottom of an ordinary glass tumbler to a depth of about 1 in. with freshly ground coffee. Then smear butter or lard inside the sides of the glass and place it in a corner. At night, the roaches will come out of their hiding places and will be attracted by the odor of the coffee. They crawl into the glass but are unable to get out again as their feet slip on the greasy surface of the glass. A number of these traps placed where the roaches are known to be, will prove effective in quickly exterminating them, besides being much cleaner than the usual powders used for the purpose.—Dominick J. de Caesar, New York City.

#### Developing Machine Is Driven by Clockwork

This film-developing machine utilizes an old phonograph motor or clockwork to turn the film through the bath. The motor is belted to a double pulley which drives the upper film roller. This is fastened to one end of a pivoted arm, counterweighted to keep the proper tension on the film. With this device, it is possible to

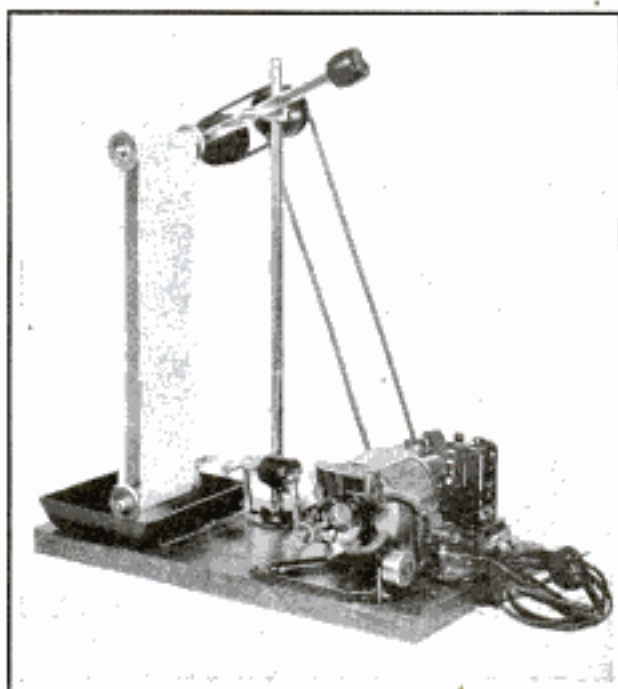

Spring-Wound Motor Keeps Film Moving in Developing or Washing Bath

develop and wash the films without touching them.



# FITTING THE HOME



① The Average Attic Is Comparatively Easy to Transform into a Game Room

③ Paint and Stained Lattice Strips Add Greatly to the Finished Appearance



# GAME ROOM



## Converting Idle Attic or Basement Space Into an Attractive Recreation Spot

**B**ESIDES its distinct social advantage, real fun and health radiate from a game room, which may be added to the average home with little expense. There is usually plenty of waste space in either the attic or the basement to be utilized for this purpose. If the basement is comparatively dry, it may be the most advisable location for the recreation room, especially as it is kept warm during the winter months, whereas the attic does not have this advantage. If the latter location is chosen, arrangements should be provided for heating it adequately.

The first consideration is careful planning of the available space. In a basement, a partition should be built to shut off the furnace room. In doing this, first

nail a length of 2 by 4-in. stock on the ceiling, either across the first-floor joists, or directly over one of them. Lay a similar length on the floor and then proceed to insert studs between them, cutting these to a tight fit so that they must be driven plumb. Center-to-center distance between studs should be 16 in. in order that the 4-ft. widths of wallboard or plasterboard, to be applied later, will join directly on the studs. For basement use, where humidity varies considerable during summer and winter, plasterboard and fiber-composition board have been found more suitable than ordinary wallboard, as they do not contract and expand appreciably, which would result in a buckled surface. If you desire, the outside walls of the



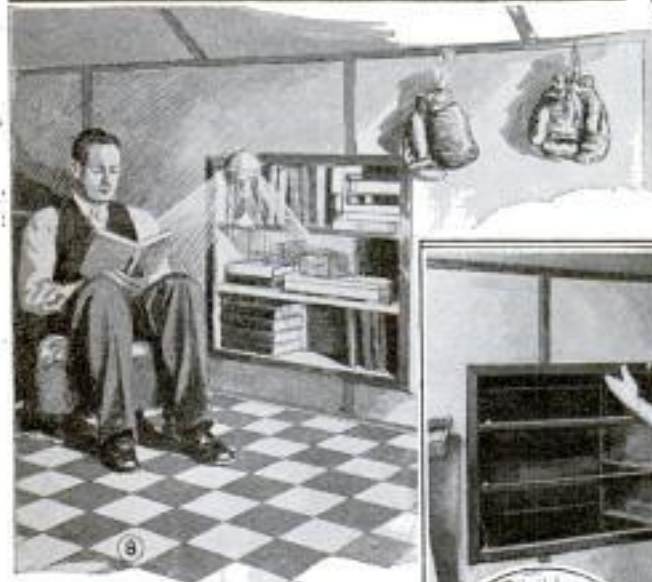
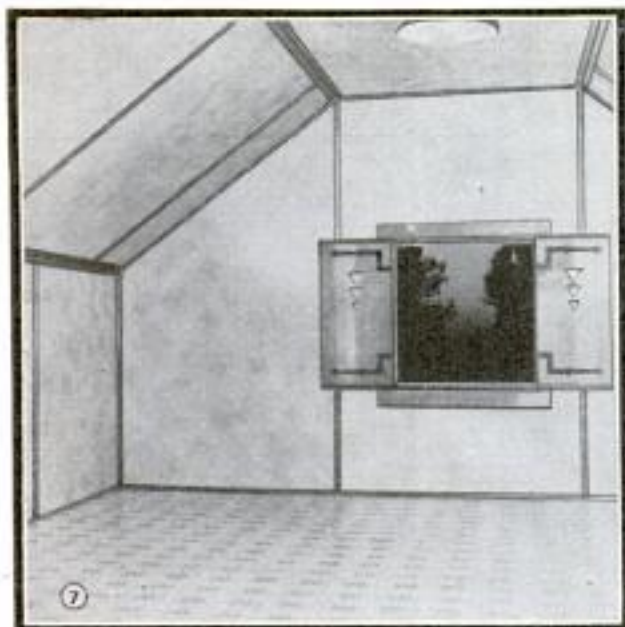

Ornamental Wooden Shutters with Imitation Hinges Can Be Used to Dress Up Bare Windows, While Built-In Bookshelves and Drawers Utilize Waste Space to Advantage Besides Providing Valuable Storage Space

basement can also be covered in this way, using 2 by 2-in. studs, but the wall, when calcimined, will usually be satisfactory. If wallboard or plasterboard is used to cover the walls, it is advisable to first treat the concrete and brick surface with a good grade of manufactured waterproofing mixture. Of course, the ceiling is also covered with wallboard or plasterboard for the sake of appearance. The wiring should preferably be done before the wallboard is applied, unless extension cords are used, as these should be installed so that they can be readily removed.

In the attic of the usual gable-type house, as in Fig. 1, the studs for the side walls are set up in a manner similar to that already described, except that the distance from the floor to the ceiling should be exactly 4 ft. to accommodate standard pieces of wallboard as shown in Figs. 4 and 5. The carpentry is quite simple and can be done by anyone handy with tools. After the wallboard has been applied, the surface may be calcimined or



given a thin coat of paint with a small hand-operated spray gun, as in Fig. 3. Lattice strips, stained or painted a contrasting color or shade, are tacked over joining edges of the wallboard to hide the seams and give a finished appearance, as in Fig. 6.

Linoleum is invariably used for the flooring. No great amount of detail on the actual room construction is given here, as you can get such information from your local lumber dealer. One or two odd points, however, are worthy of consideration. Notice, in Fig. 7, that the use of inside shutters takes away the bareness of the usual small single window. Fitted



Furnishings for the Game Room Depend on Your Fancy; Besides Exercising Equipment, Ping Pong, Billiards and Shuffleboard Are Popular

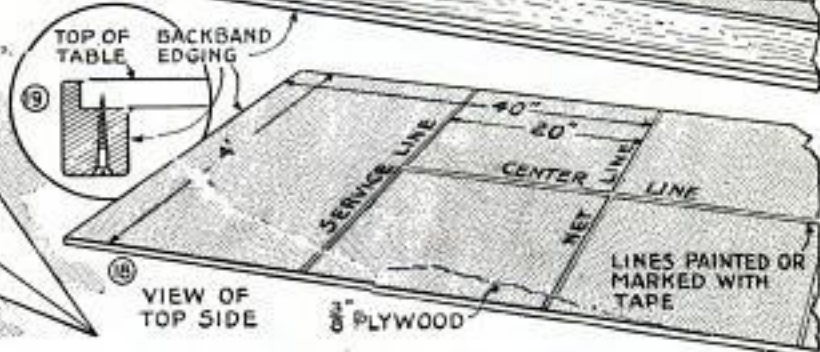
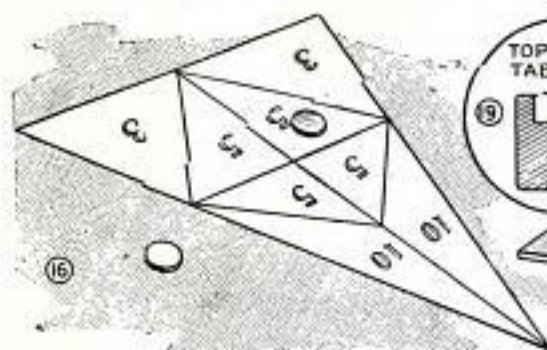
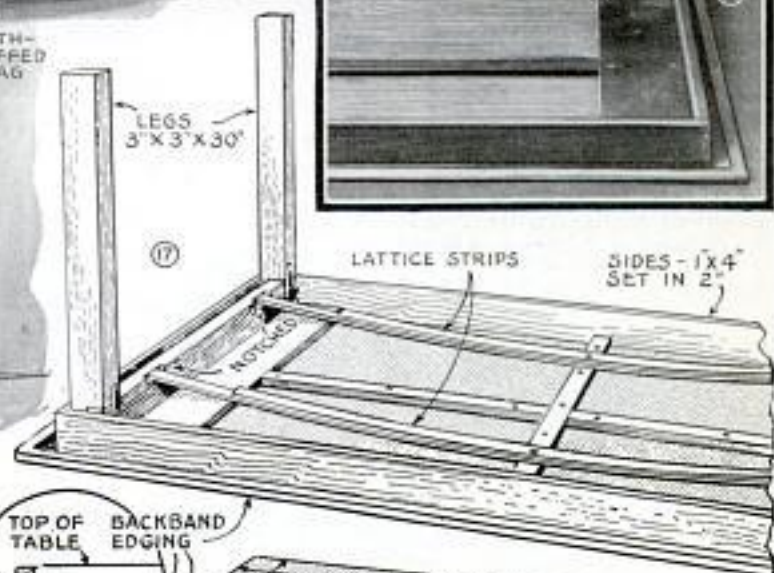
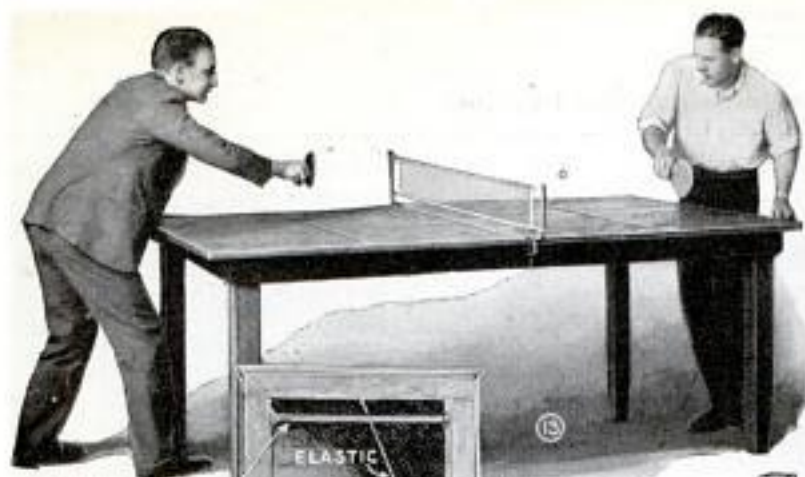

with "dummy" hinges, cut from linoleum and painted black, they can be made highly attractive. Then, too, what about that extra space beyond the 4-ft. sidewall? The answer is to build simple bookshelves, as shown in Fig. 8, to make use of this valuable room. Balance a bookshelf on one side of the room with a chest of drawers on the opposite wall, as in Fig. 9. This unit may be an old dresser, with the top cut off flush and the drawer stops set forward  $\frac{5}{8}$  in., as shown in Fig. 10, in order to keep the drawers flush with the wall when the wallboard and lattice strips are added; or the bookshelf and the drawers may be fitted on one side and the opposite side utilized as an attic proper by hinging one of the panels so that it will swing

outward. Equipment for the game room is largely a matter of your particular choice. One family gets along nicely with a ping-pong table, while another needs a considerable number of toys and games. A few standard pieces, which can be easily made in the home workshop, are given here, not, in any way, striving for completeness, but just to give you an idea. Take the game of shuffleboard as played on board ocean liners. That's a good game and easy to make. All you need is two sticks shaped somewhat like the one shown in Fig. 11, and four round disks of wood, the size of the equipment depending on the room and the persons who will play the game. The rest is simply a matter of painting a court at one end of the



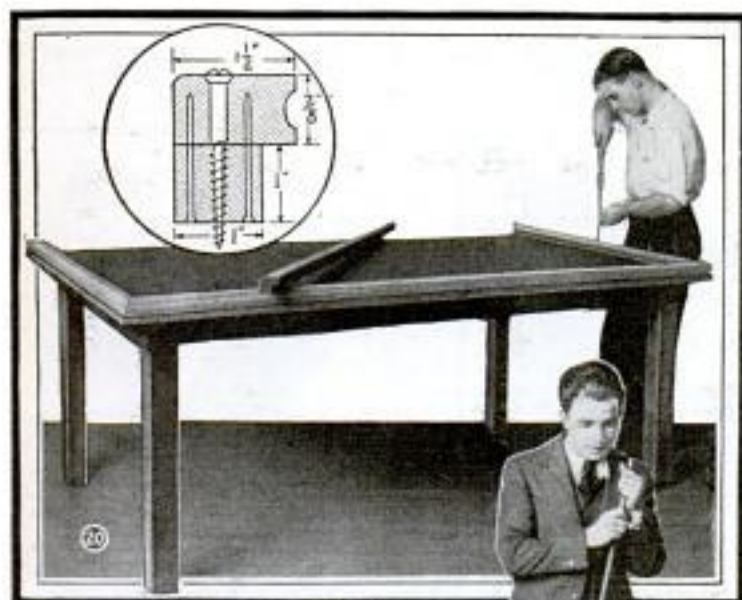

Simple Billiard Table Having a Wooden Bank Provided with a Length of Rubber Tubing Tacked On to Serve as Rebounding Strip; Pockets May Be Added or the Bank May Be Removable for Ping Pong

room, as shown in Fig. 16. The object of the whole thing is to get a "big push" and zip your puck down to the court so that it lands in one of the ten-spots. And half-way in is out!

By all means reserve a small corner for exercising equipment. If you don't feel like buying any, you can get along nicely with a pair or so of dumbbells, a simple wall exerciser made from old inner-tube rubber, a cloth-stuffed punching bag and a chinning bar, as shown in Fig. 15. Of course, that's only a suggestion.

Ping pong and billiards are perhaps the two most popular home games for the teens and twenties. These two are mentioned, as it were, in the same breath because the construction for the simple ping-pong table (Figs. 13, 14, 17 and 18) is the basis for the home billiard table shown in Fig. 21. Naturally enough, the plywood base is not the equal of more solid materials, but it is light and easily handled—an important consideration. You will notice that the table legs, Fig. 17, are held in place by means of lattice strips, sprung

from end to end and fitting into notches cut in each end cross-piece. When the table is not in use, the strips can be snapped upward, thus allowing the legs to fold inside the table top. If a billiard table is desired, the same construction may be followed with the addition of a felt covering, which should be glued to the table top over several layers of building paper, likewise glued. The bank is made from two strips



of wood, fastened together with finishing nails and fitted all around the table with round-head wood screws, which represent the usual diamonds. The round cut-out on the bank, as shown in the detail of Fig. 20, is fitted with a continuous length of rubber tubing, which is glued and bradded into place, as in Fig. 22. The nails should be hammered lightly until they pierce the outer layer of rubber in order to get a uniform rebounding surface. Pockets can be added to the table by cutting out the corners and fitting with nets in the conventional manner. If a billiard table alone is desired, the bank can be made portable by attaching it with small wing-nuts. Complete details on the construction of a small billiard table for the home were published in the October, 1931, issue of Popular Mechanics.

#### Rolling Guide for Paint Striping

With the use of an ordinary caster and a wooden block, you can make a rolling guide for striping with a brush. The block holds both the brush and caster, the latter rolling along the edge of the work.



# Unusual Woodcuts Carved with a Jackknife



Coarse-Grained Oak Used for Woodcuts Gives Unusual Effect, Somewhat Similar to Crayon Work; Either the Subject or the Background Is Cut Away, Depending on the Particular Design Selected for This Purpose

**O**AK lends itself particularly to use for woodcuts as it shows the grain. The design can be taken from a newspaper or magazine, or you may sketch some original design. This is transferred to the surface of a flat piece of oak by means of carbon paper, and the parts not to be reproduced are cut away with a sharp jackknife. You can either bring the subject in relief by carving away the background, or you can show the wood grain on the background by cutting out the design.

After the cutting has been finished, get a tube of printers' ink, a roller and a piece of plate glass or marble. Squeeze some of the ink on the plate, and work it out evenly with the roller. Next run the roller over the

cut, being sure to cover the surface completely and evenly. Place the paper on the inked surface of the block and press

it down with the curved portion of a large tablespoon, taking care that you rub every part of the block. A Japanese paper has been found to give excellent effects, although any kind of paper will do, preferably one that has a rather rough surface. Even the reverse side of certain kinds of wallpaper has been found suitable for this purpose. When printing, you must, of course, be careful to prevent the paper from moving. The illustrations on this page show a design of two cockatoos, the cutting of the block and the finished effect when printed on paper.

## \$1,000 in Cash For Best Models of Whittling

1st prize .....	\$250
2nd prize .....	\$100
3rd prize .....	\$75
4th prize .....	\$50
5th prize .....	\$25

BESIDES this, there will be twenty-five \$10, fifty \$5 prizes, and one thousand high-grade jackknives.

### Rules for "Knife-Craft" Contest

Anyone except employes of Popular Mechanics and members of their families can enter this contest, which closes July 1st, 1932. Awards will be made by a competent board of judges and in the event of a tie for any prize offered, a prize identical in all respects with that tied for will be awarded to each tying contestant.

1. One or more entries may be made. Models must be entirely of wood, and cut with no other tools than a jackknife.
2. No adhesives may be used.
3. Carvings submitted must not be painted, silvered or gilded, and will remain the property of Popular Mechanics after the contest closes.

All models must be shipped, prepaid, in suitable packages to avoid breakage. Be sure to affix tag giving your name and address on the outside wrapper of the package.

Address "Knife-Craft" Editor

POPULAR MECHANICS MAGAZINE  
200 E. Ontario St. Chicago, Ill.



Sugar Bin Has Visible Gauge and Is Fitted with Sliding Stopper for Releasing the Sugar

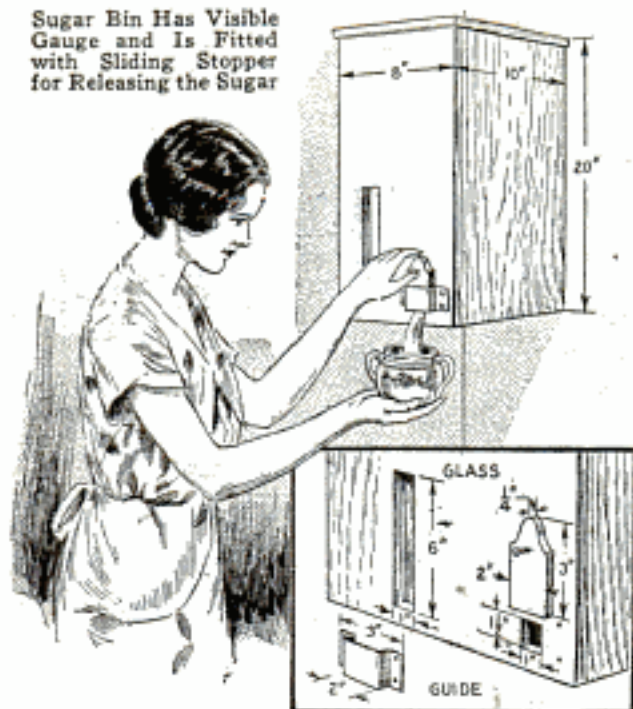

### This Sugar Bin Is a Handy Addition to Your Pantry

Here is a sugar bin that occupies little space and is convenient to use. It is made of  $\frac{1}{4}$ -in. wood cut to the dimensions given. In the lower right-hand corner of the front piece, a hole is cut and fitted with a cover sliding in a metal strap. To provide a gauge, a long, narrow hole is cut in the front and covered with a piece of glass on the inside. A hinged lid on top makes the bin readily accessible for refilling. It may be set on a shelf attached to a wall.

### Metallic Wicks Increase Brightness of Candles

With candles again becoming popular, an old scientific novelty has been revived, namely, a wick on which little globules of lead form as the candle burns. These collect on the wick and bend it down, thus increasing the brightness of the flame. To make these wicks, melt tallow, 100 parts, and add to it carbonate of lead, 5 or 10 parts. The lead easily unites with the tallow when stirred. Soak the wicks in this mixture while it is melted, and when cooled, proceed to make the candles in the ordinary way.

☐ Lights placed under the bed illuminate the room but do not strain the eyes of a sick person.

### Portable Home-Workshop Wood Lathe

With a discarded sewing-machine stand and a few small parts, the woodworker, who has no power facilities, can build this portable foot-power wood lathe at little expense. First substitute a board, 20 by 30 by 2 in. in size, for the original top of the machine, and brace the stand well to withstand the vibration. Then make the tailstock from half of a small bench vise, using the half that contains the screw, which is reversed and pointed to serve as an adjustable center. The screw should also be provided with a locknut to keep it from turning. Next, a bed is constructed of 1 by 10-in. stock, the same length as the stand, and a crosspiece of 1 by 4-in. stock is screwed to it for attachment of the improvised tailstock as shown. It may be necessary to shim the vise to obtain alignment with the headstock. The bed is held to the table top so that it can be moved forward or backward for long or short work. An adjustable toolrest is made as shown in the lower detail and bolted to the bed. The headstock consists of a grinding head, one end being fitted with a  $\frac{1}{4}$ -in. chuck and a grinding wheel, which serves as a flywheel, while buffing wheels can be fitted to the other end. The headstock is belted to the treadle wheel of the

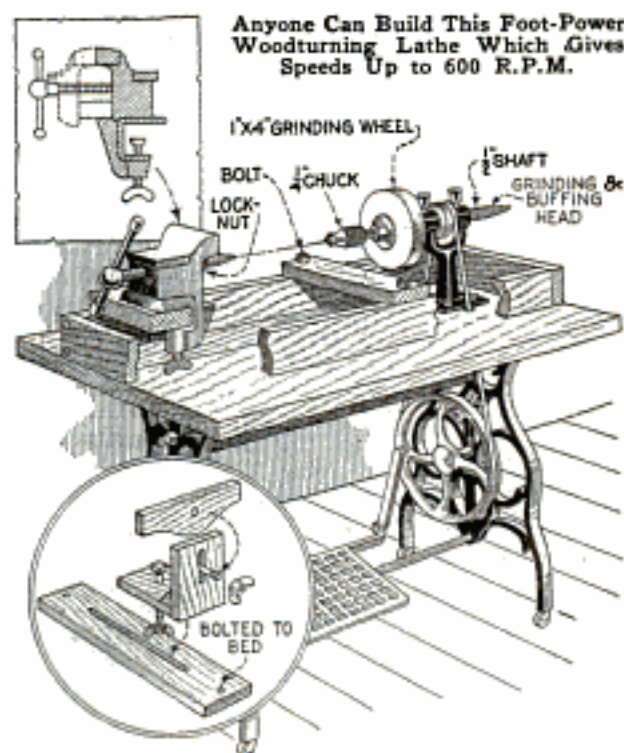

Anyone Can Build This Foot-Power Woodturning Lathe Which Gives Speeds Up to 600 R.P.M.

machine. Speeds up to 600 r.p.m. are obtainable.



well sanded, it is ready for painting. The ground color is a greenish black. This can be imitated by adding dry lampblack to orange shellac, a little at a time, stirring thoroughly until well dissolved. Sandpaper between coats and apply at least four, allowing each to dry for a day. The last coat should be dulled with pumice and water. The decoration is then painted in oil colors. Fig. 2 shows a half pattern for the front as nearly as it can be discerned from the original model, and the design has also been touched up in the photograph. The ends are similarly decorated but all other surfaces are left plain.

### How to Shoot Small-Gauge Shells in Large-Gauge Gun

Did you ever go on a hunting trip and discover you had inadvertently taken some 16-gauge shells along with your 12-gauge shells? If so, and you run out of the No. 12 shells, try the following method of shooting the No. 16 shells: Cut the caps off some of the larger shells that have been discharged, slip the empty shells over the smaller ones so that the latter are centered in the barrel, and it is then an easy matter to fire them in the gun.

### Tool for Cutting Balsa Wood into Thin Strips

Balsa wood can be cut into thin strips by using the illustrated tool, which is simply a safety-razor blade held in a clamp attached to a grooved base, as shown.

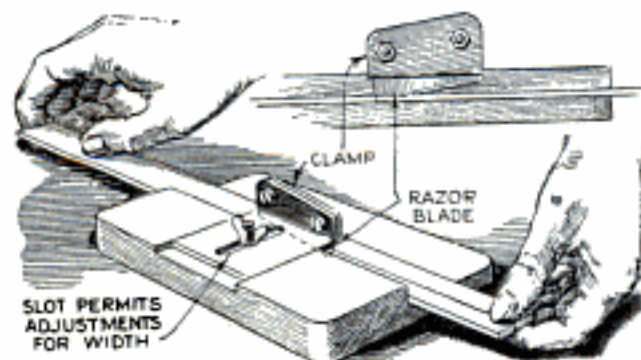

Balsa Wood Cut into Thin Strips with Tool Made from Razor Blade

The clamp is slotted to take a bolt projecting from the base, and a wingnut is used to hold the clamp securely in any desired position.

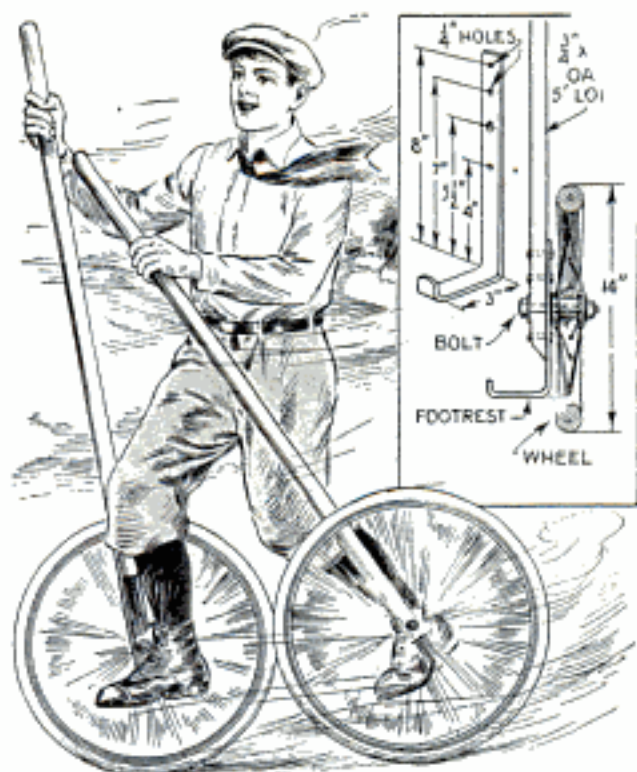

High Speeds Can Be Attained with These Wheeled Stilts When You Learn to Balance Them

### Stilts Mounted on Wheels Attain High Speeds

Used in a manner similar to roller skates, you can attain high speed on these wheeled stilts, the construction and dimensions of which are clearly shown in the drawing. The operator stands on the footrests, keeping one wheel slightly ahead of the other to aid in balancing.

### Locating Small Objects Imbedded in Auto Casing

Small objects, such as thorns and headless tacks, that bed themselves in an auto casing and cause punctures, are sometimes rather difficult to locate. After removing the casing from the rim, lay it flat on the ground. Then remove the inner tube, being careful not to shift its relative position in the casing, and lay it flat on top of the casing. Next, mark the two so that they may again be assembled in the same position. When the puncture has been paired, place the two together, and mark the spot on the casing where the puncture occurred. If the sharp point of the object cannot be felt on the inside of the casing with the finger tips, carefully examine the outside with a sharp pointed tool for the hole left by the object.



## Metal-Foil Wall Decoration You Can Apply



should be spread only over an area of four squares at a time, as it dries quickly, and the work of applying the foil must be done fast and accurately. Start at one corner and allow the square to make contact gradually, without pulling or shifting it. Once applied, the piece cannot be shifted or removed. Keep a cheesecloth rag soaked in gasoline handy for cleaning the walls, tools and hands. The surface may be left as it is, or may be stenciled or striped in flat colors in any patterns or tints desired. A dead finish suitable for this work can be made from any good enamel under-

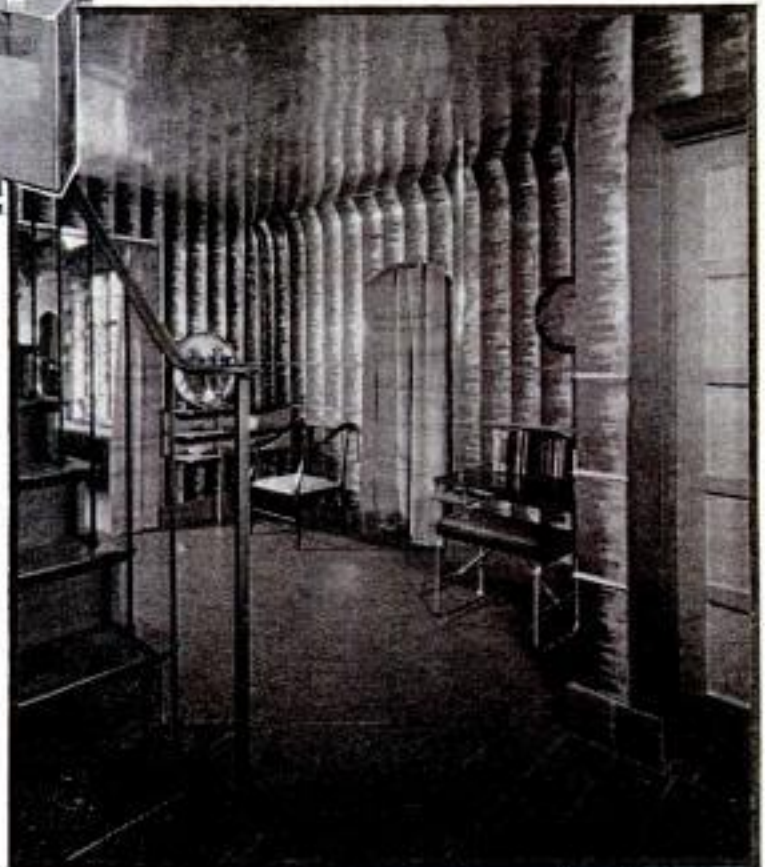

Distinctive Modernistic Effect in Wall Decoration Obtained with Metal Foil, Which Is Easy to Apply

Metal foil on a paper backing lends itself admirably to decorative purposes for walls and ceilings, especially those requiring a distinctly modernistic touch. In the work shown in the photos, the metal used was aluminum. Before applying it, prepare the walls by sandpapering the surface smooth. Then give the walls a coat of sizing, composed as follows: Soak  $\frac{1}{2}$  lb. ground gelatin glue overnight in enough hot water to cover it, then dilute the solution with 4 qt. of hot water to which is added a half cupful of Venetian turpentine. Apply this with a calcimine brush, taking care to avoid runs. After drying, the walls are again gone over lightly with No. 1 sandpaper. It is best to have the foil cut into sheets of convenient size at the factory. The pieces used in the room illustrated were 14 in. square. The adhesive, which is bakelite cement, is spread over the walls evenly with a 4-in. paper scraper after dabbing it on at 6-in. intervals with a small paintbrush. The layout of the squares should be calculated carefully before applying them, as part of the attractiveness of this wall covering is the hair lines of the butt joints. Adhesive

coating. Thin it one-third with turpentine and add the color. A sponge dipped in a solution consisting of 1 gal. of benzine and two cupfuls of varnish remover, will quickly remove the paint, when repainting is desired.

☐ A small cork with a groove cut lengthwise and slipped on the back of a paring knife will prevent a sore finger owing to constant pressure on the back of the knife.

Bakelite Corp., 247 Park Ave  
New York City

News, Borough & Co.  
525 S. Wabash Chicago



### How to Find the Pitch and Diameter of Internal Threads

Diameter and pitch of internal threads can be found by screwing a square soft-wood plug into the hole. The diagonal cross section of the plug should equal the approximate outside diameter of the threads. After removing the plug, the number of threads per inch can readily be determined, and the diameter of the hole approximates the diagonal of the plug. In this way, different sizes of screws are found without trial.

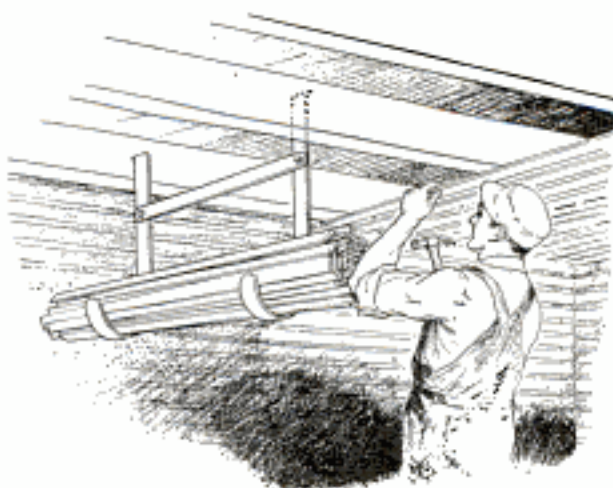

Flat-Iron Rack Holds Lath near Ceiling in Convenient Position for the Workman

### 10. Rack Holds Lath While Working on Ceiling

Stooping to pick up material from the scaffold, when lathing a ceiling, is unnecessary if the illustrated hooks, made from three lengths of flat iron, are used. One piece is a crosspiece pivoted between the other two, which have sharp points formed at their upper ends as indicated,

while the lower ends are curved into large hooks to hold the lath. In use, the hooks are spread apart so that the pointed upper ends can be inserted between the joists. By pulling the hooks together at their lower extremity the points are forced into the joists and hold the rack securely in position.

## \$2,500 in Cash for De Witt Clinton Models

POPULAR MECHANICS offers cash awards for the best models of the DeWitt Clinton train made by persons residing in the United States and Canada.

*First Prize*, \$1,000 in cash, and a week's visit to New York via the New York Central's Twentieth Century Limited.

*Second Prize*, \$500 in cash, and a week's visit to New York.

*Third Prize*, \$250 in cash, and a week's visit to New York.

In addition, there will be five prizes of \$50 each, and ten of \$25 each for the next best models. In the event of a tie for any prize offered, a prize identical in all respects with that tied for will be awarded to each tying contestant. Should the winners reside in the east, a trip to Chicago may be substituted for the New York trip. The judges of the contest will be Mr. Reginald H. Claudius, H. H. Windsor, Jr., editor and publisher, and officials of the New York Central railroad. The date for closing the contest is 12:00 p. m., Dec. 31, 1932.

Contestants are required to submit photographs of their models and, in case of necessity, the model itself may be requested for inspection, but will be returned. Models must be built to the scale and of the material prescribed in the Jan., Feb., March and April, 1932, issues of Popular Mechanics. All parts must be finished as specified and the painting scheme in the last installment must also be followed. Blueprints of the locomotive, tender and coaches are available. As a special service to those building this model, Popular Mechanics will furnish No. 0-80 screws and nuts per package of 100 each for 75 cents. A material list, and information concerning cost of materials, where to obtain them, etc., will be sent free upon request.



# WOODEN COACH *Completes*

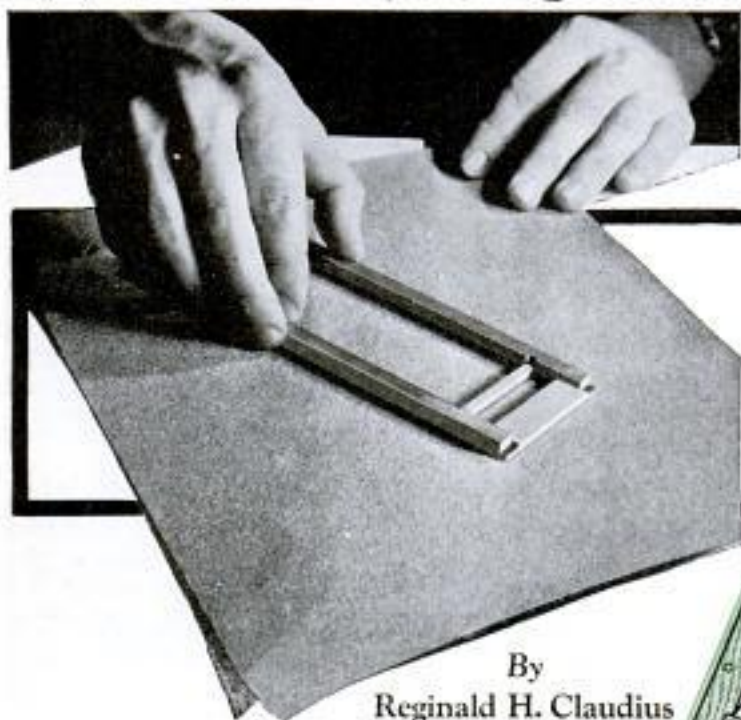

By  
Reginald H. Claudius

## PART IV

THE wheels, axles and axle boxes of the coach are the same size as those on the tender. After these parts have been made, the frame is constructed. All wooden parts are made of mahogany joined with a waterproof glue as shown in Figs. 59 and 60. The end crosspieces are joined to the side members with a lapped corner joint, while the first inner crosspieces are cut  $\frac{1}{8}$ -in. square and mortised into the side members. The four remaining cross-

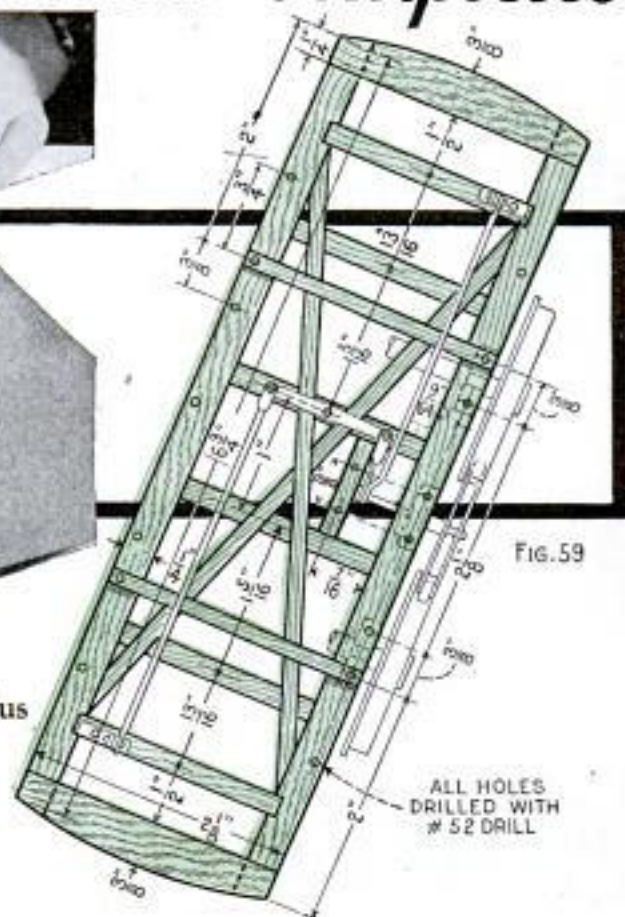

FIG. 59

pieces are glued in with close-fitting butt joints. The diagonals or X-members are cut  $\frac{1}{8}$ -in. square, halved at the center, and let into the four crosspieces to a depth of  $\frac{1}{8}$  in. Angle braces are bolted to the four corners with No. 0-80 screws, the latter turned up in the wood.

Fig. 60 details the construction and as-

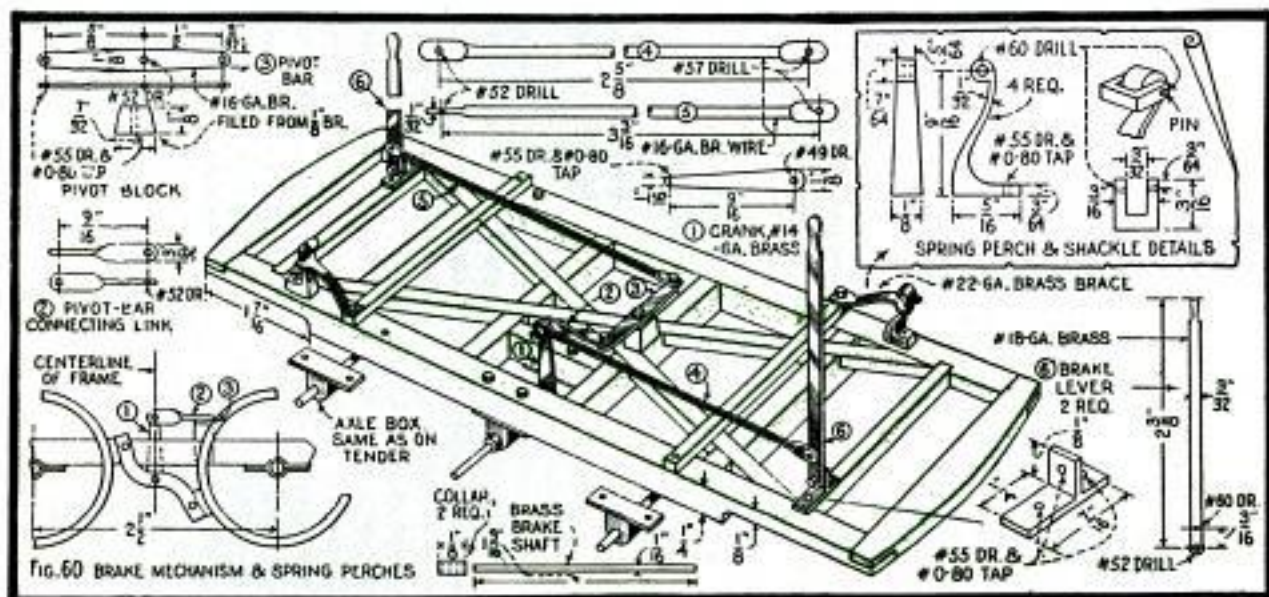
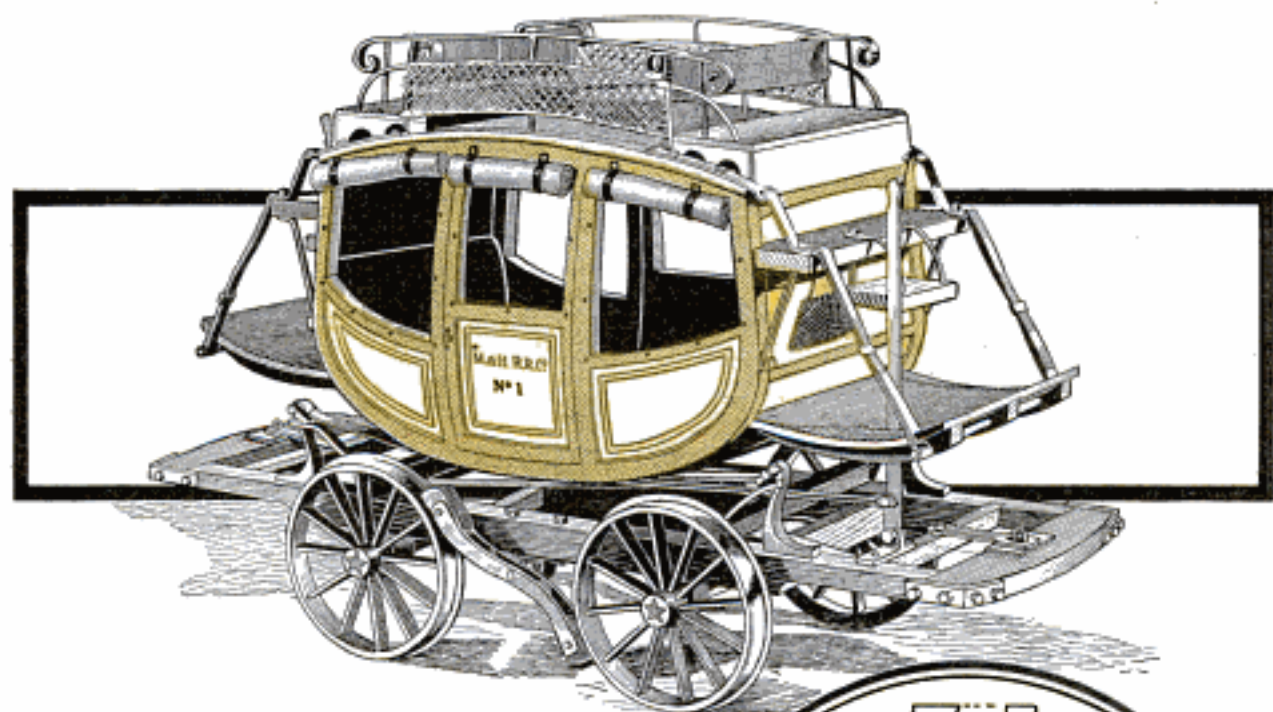

FIG. 60 BRAKE MECHANISM & SPRING PERCHES



# DE WITT CLINTON *Model*



sembly of the brake mechanism and the four spring perches on the frame. The two bearings carrying the brake shaft are of the same construction as the axle boxes, but are only  $\frac{1}{8}$  in. wide. They are drilled with a No. 49 drill to take the shaft, and are bolted to the frame with No. 0-80 screws. The shaft is cut to the length given from  $\frac{1}{16}$ -in. brass wire, and two collars are made from brass tubing, drilled if necessary, to fit over the shaft. The crank, part 1 of Fig. 60, is made to the dimensions given, and the shaft is slipped through the outer bearing. The crank is placed on the shaft and the latter is then slipped into the inner bearing, beyond which it projects  $\frac{1}{8}$  in. The collars are placed on the shaft and soldered, and the crank is soldered to the shaft, the position of the former allowing approximately  $\frac{1}{8}$ -in. clearance from the frame member supporting the inner brake-shaft bearing. Next, the pivot bar, part 3, the brake levers, part 6, and the two brackets pivoting the levers on the frame, are made. Both ends of the pivot bar are drilled and tapped. A No. 0-80 screw is passed through the center of the bar, turned into the tapped hole in the block, and into a No. 52 hole at the center of the frame member. The screw should be adjusted to allow the bar free move-

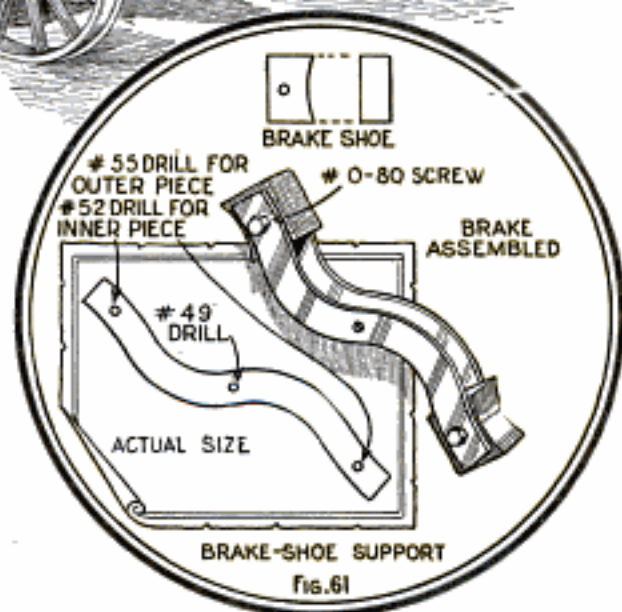

ment, after which the nut is turned home. The shorter half of the pivot bar, measuring from the pivot point, connects to the link, part 2. Parts 2, 4 and 5 are then made as detailed and assembled as shown, the brake rods aligning with the side members of the frame as in Fig. 59. The No. 0-80 screws holding the brake-lever brackets, are turned into tapped holes from the underside of the frame, and the lever is pivoted to the bracket with a No. 0-80 screw, the end of which is cut off and filed flush, after which it is lightly checked with a punch to prevent its backing out due to the motion of the lever. The rods



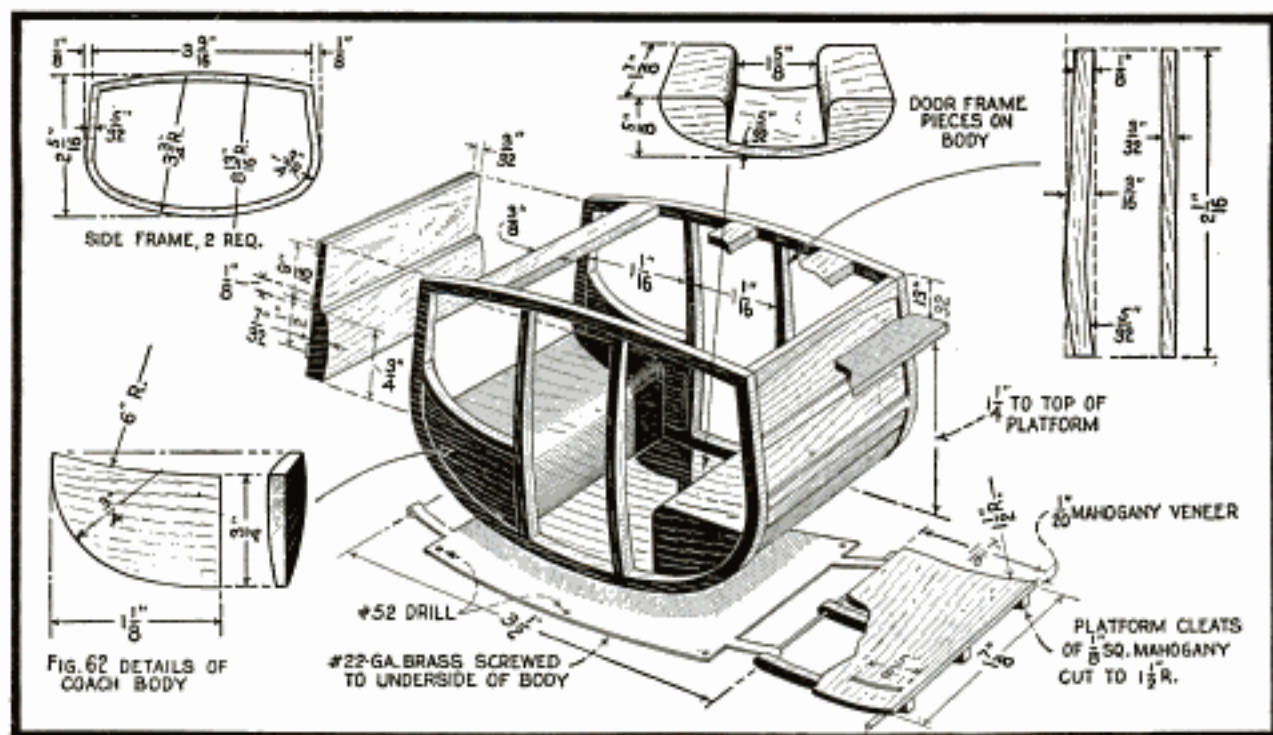

FIG. 62 DETAILS OF COACH BODY

are riveted to the levers with ordinary pins.

Next the spring perches are made as in the upper right-hand detail, the curved upright being sawed and filed to shape from  $\frac{1}{8}$ -in. brass, while the shackles are made from No. 16-gauge brass. The latter are riveted to the perch with pins to allow a slight movement. The perches are bolted to the frame with No. 0-80 screws turned up from the underside, the projecting ends of the screws being cut off and filed flush. The four axle boxes are put in place on the axles and bolted to the frame with a single No. 0-80 screw for each box. The screws pass through the four inner holes nearest the center of the frame. Two bolsters,  $\frac{1}{8}$  by  $\frac{1}{8}$  by  $2\frac{1}{8}$  in., are then cut and the ends drilled with a No. 52 drill. Four braces are made from No. 22-gauge brass, one end drilled with a No. 52 drill and the other notched to fit the perch. The brace is bent to the form shown, and the single No. 0-80 screw which holds it in place passes through the bolster, the side frame and into the tapped hole in the axle-box plate. The braces must be cut to such length that, when bent to the shape shown and bolted in place, the notched end will bear against the perch at a point approximately  $\frac{1}{8}$  in. below the center of the eye.

Fig. 61 gives a full-size drawing of the

brake arms, and from this the outline may be traced on a piece of No. 22-gauge brass, sawed to form and used as a template. Two S-shaped arms are required, both ends of one piece being drilled and tapped for No. 0-80 screws. No. 52 holes are drilled through the second arm and also through the shoes, which are made of mahogany. No. 49 holes are drilled at the center of both pieces. Do not assemble them on the brake shaft until the coach body has been mounted on the frame.

Fig. 62 shows the first steps in building the coach body. The side frames are cut from  $\frac{1}{8}$ -in. mahogany to the dimensions given in the upper-left detail, and also the door frames as shown in the upper right-hand detail. The latter are spaced as indicated and glued in place. Four curved panels are made as in the lower-left detail, by sawing the pieces from  $\frac{3}{8}$ -in. mahogany to the dimensions given, plus  $\frac{1}{8}$ -in. allowance in height, bringing this to  $\frac{7}{8}$  in. instead of  $\frac{3}{4}$  in. as given. The panel pieces are fitted in the frame as shown. With the latter on a flat surface and the panel pieces in place, the curve of the door frames is marked and a pencil mark is run around the lower edge to indicate the thickness of the side frame. The waste is pared off to the line, giving the surface a rounded contour back from the door frame besides retaining the vertical curve



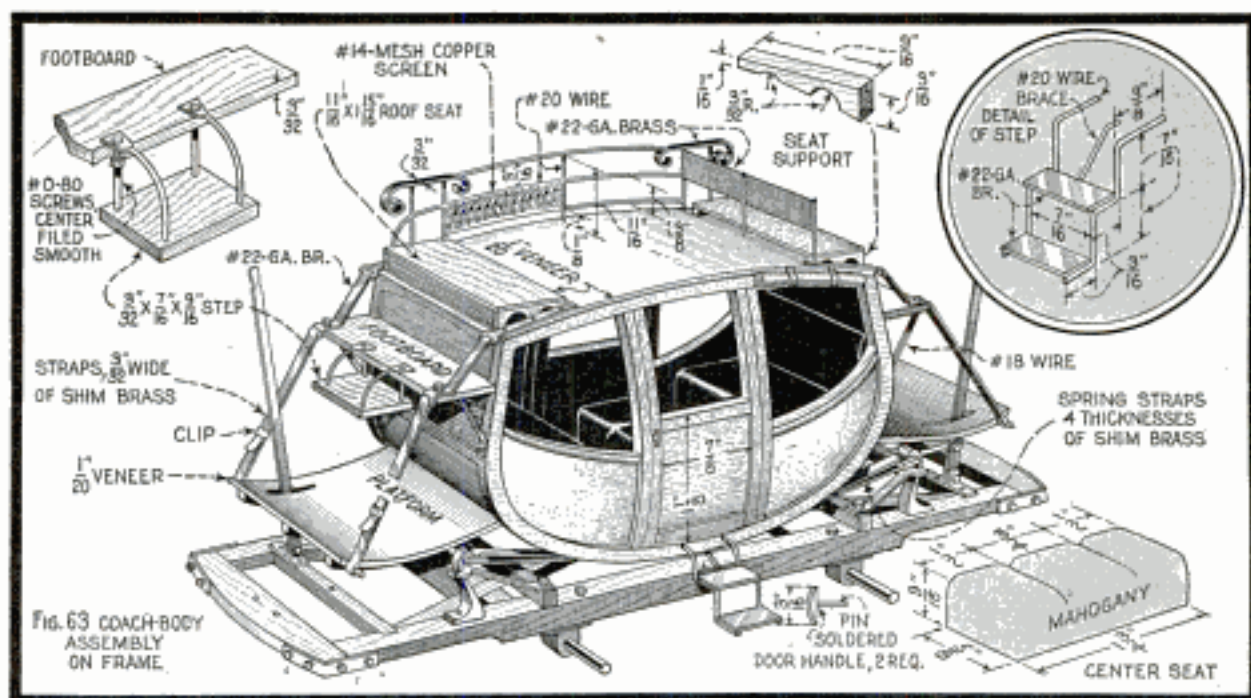

which coincides with that of the door frame. The top edge of the back face is cut away, to bring the thickness to approximately  $\frac{1}{8}$  in., giving the window sill an outward and downward curve, as can be seen from the center view, which shows the finished panel in place. Gluing the four panels into the frames is next, after which the parts are sanded flush on the back by rubbing them on a sheet of fine sandpaper. The top edge of each panel is finished by paring it down to an approximate width of  $\frac{3}{4}$  in. where the panel joins the door frame. This will shorten the original radius somewhat, giving a sharper downward curve from the point where the panel joins the end of the frame. To better represent the original panel, the edges of the four panel pieces are undercut to a depth of about  $\frac{1}{32}$  in., all around, a vertical knife cut being made  $\frac{3}{32}$  in. below the curved top edge. Also, the panel surface is pared down to meet this cut as well as the edge of the door frame to form the strips. This can be seen from the body assembly in Fig. 63.

The single piece that forms the bottom of the coach body and the end seats, is shown in the central top detail in Fig. 62. The radius at the ends should be  $\frac{1}{32}$  in. shorter than that of the side frame, so that, when assembled, the latter will project to form the paneled ends of the body, as shown in the center detail. Saw the

bottom to shape from solid wood, sand the seats smooth, their height being slightly less than  $\frac{5}{8}$  in. as given, and then glue the sides to the bottom. When glued in place, the ends form the backs of the seats. Allow  $\frac{1}{32}$ -in. projection of the sides when gluing the ends, so that the panel strips may be glued in, three on each end. These are cut  $\frac{1}{8}$  in. wide from veneer, and are spaced approximately  $\frac{5}{8}$  in. apart. The lower edge of the top strip is curved slightly. Glue three  $\frac{1}{8}$  by  $\frac{3}{8}$ -in. roof supports in the position shown, then cut a piece of  $\frac{1}{20}$ -in. mahogany veneer  $\frac{1}{8}$  in. larger each way than the over-all size of the top, with the grain running lengthwise. Dampen one side of this to facilitate bending, and glue in place, after which the projections at the ends are trimmed off and sanded flush. The door panel is made from one piece and the top and bottom panel strips are represented by recessing the panel to form a narrow strip at the top and bottom. The top rail is cut  $\frac{1}{8}$  by  $\frac{3}{32}$  in. The stiles are cut  $\frac{3}{32}$  in. thick and are sanded until the door is a snug fit in the frame.

Next, four  $\frac{7}{8}$ -in. strips are cut to  $\frac{5}{32}$ -in. wide, from No. 22-gauge brass. An eye is formed at one end of each,  $\frac{3}{32}$  in. long and  $\frac{3}{64}$  in. wide, and the remaining portion is then filed to  $\frac{3}{64}$ -in. width. Two No. 52 holes, equally spaced, are drilled through each strip, which is bolted to the roof



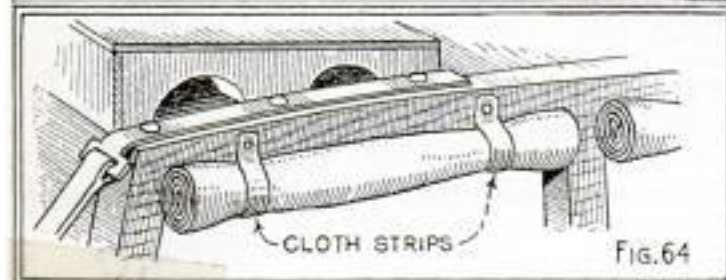
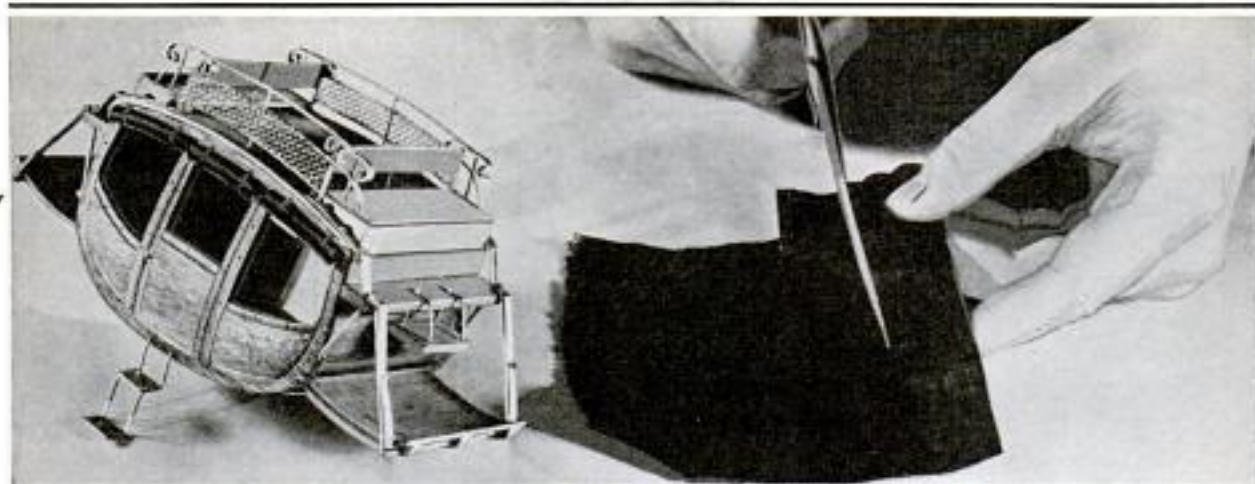

corners with No. 0-80 screws turned into the wood. The strip is set so that the eye overhangs the edge of the roof as shown

in Fig. 63. The heads of the screws are filed back to about two-thirds of their original size before they are inserted. The four corner posts supporting the top railing are cut from No. 18 brass wire and are soldered to the roof strips and the seat backs, which are  $\frac{5}{16}$  in. wide. The center stay is forced into a drilled hole in the wood and is soldered to the back. The remaining posts of

## PAINT SPECIFICATIONS

### LOCOMOTIVE

**Olive Green:** engine frame, pedestals, pedestal tie-rods, tapered sections of side rod, also truss rods, engine platform and supports, spokes and inner faces of wheel rims, and wheel hubs.

**Unpainted and Polished:** crossheads and guides, connecting rods and straps, axle cranks and eccentrics, safety valve and arm, throttle-valve handle and arm, eccentric rods and rocker arms, hand-wheels of "tee," fitting at front of boiler, mechanical-feed and hand-pump pistons, handles on hand pump, and valve rod and block.

**Silver:** outer edge of driving-wheel rims and the running surface of tread and flange, stars on wheel hubs.

**Flat Black:** all remaining parts of locomotive, stripes on engine frame, outline of stars on wheel hubs, and circular stripe on wheel hubs.

### TENDER

**Olive Green:** frame, spokes, hubs, and inner faces of wheel rims, conductor's seat except arm rests or supports, water tank, barrels except hoops, and entire roof.

**Unpainted:** barrel hoops, and wood pile.

**Silver:** outer edge of wheel rims and running surface of tread and flange; stars on wheel hubs.

**Flat Black:** all remaining parts of tender and outline of stars on wheel hubs.

**Tan:** lettering on tank sides.

### COACH

**Olive Green:** frame, spokes, hubs, and inner faces of wheel rims, roof seats and supports, footboards, steps and platform, including edges.

**Silver:** outer edge of wheel rims and running surface of tread and flange.

**Black:** entire inside of coach body, including inner edges of windows and doors; all remaining metal parts on frame and body roof, including edge, and hair stripes on body and door panels.

**Yellow:** coach side panels and door panels, end panels, and bottom of coach body.

**Tan:** panel or trim strips on sides and ends, door frames, stiles and crossrails, and lettering on doors.

*A chart showing the exact colors will be furnished on request*



the railing and the scrolled seat arms are then soldered in place, and small-mesh copper window screen for the sides is cut diagonally.

The footboards,  $\frac{7}{16}$  in. wide and as long as the body is wide, are glued in place. The supports and lower braces are assembled on the footboard as shown, using No. 22-gauge brass for the support, the lower end of which forms an eye, and No. 18-gauge wire for the brace. The upper end of the latter is tapped for a No. 0-80 screw, and the lower end drilled to take a screw turning up into the wood. The step is then bolted to the footboard as in the upper-left detail. No. 0-80 screws pass through clearance holes in the flattened ends of the wire supports, through the footboard and into tapped holes in the step. The ends of the wire supports are forced into holes in the wood, and nuts are run up on the bolts to hold the parts in place.

Both front and rear platforms are hinged to a plate cut from No. 22-gauge brass, the hinge pin being formed from a piece of fine wire, which passes through the three cleats that are glued to the lower side of the platform. The platform is curved only on the front half. The  $1\frac{1}{2}$ -in. radius given is only approximate, as is the distance between the eyes of the bottom plate, these dimensions being determined after the parts have been made. The plate is cut  $\frac{1}{8}$  in. less than the width of the body, and is screwed to the latter with No. 0-80 screws turned up in the wood. The straps supporting the outer end of the platform are cut from shim brass, .003 to .005 in. thick, their lower ends being bent around a wire rod as shown. A drop of solder prevents the straps from slipping off, and the small clip, resembling a buckle, may also be soldered. Owing to the light weight of the platform, it is best glued to the body to hold it in position

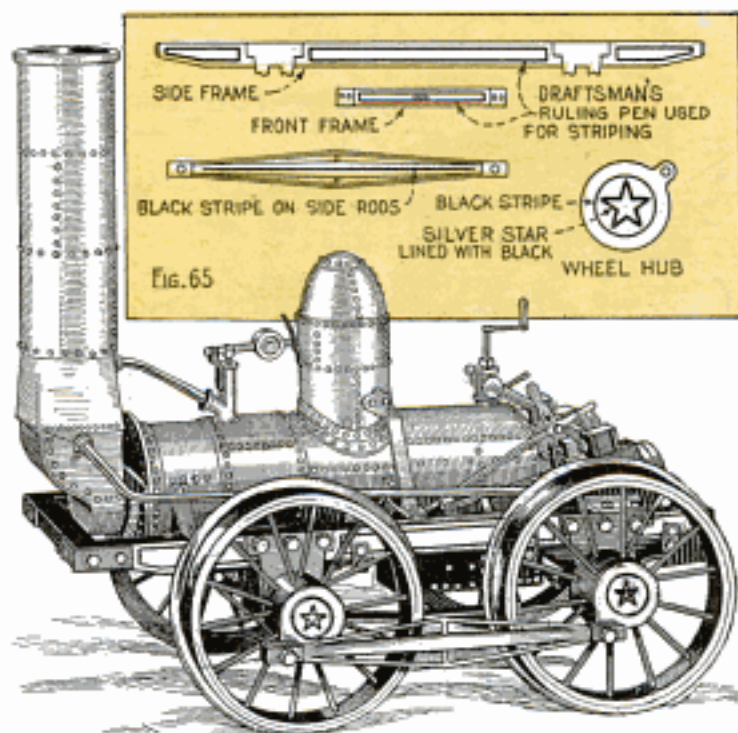

better. Addition of one step, door handles, a center seat, made according to the lower right-hand detail, and curtain fasteners made from cut-off pins with the heads flattened, completes the assembly of the coach body. The door and window curtains are put on after the body has been painted.

Solder the four wheels to the axles, file the projecting ends flush and solder the assembled brake to the shaft with the brake levers inclined a trifle forward, and the shoes bearing only slightly on the wheel treads. The projecting end of the shaft is filed off. The body is supported on spring straps cut from shim brass soldered first to the brass plate on the body. The free ends are run through the shackles, the body is adjusted so that the bottom plate just clears the brake pivot bar, and the free ends are bent under and soldered near the center of the body. The frame and body should be painted, however, before the latter is mounted. Leave the edges of the bottom plate unpainted, as about  $\frac{1}{8}$  in. of these must take solder.

For finishing, lacquer or paint may be used.



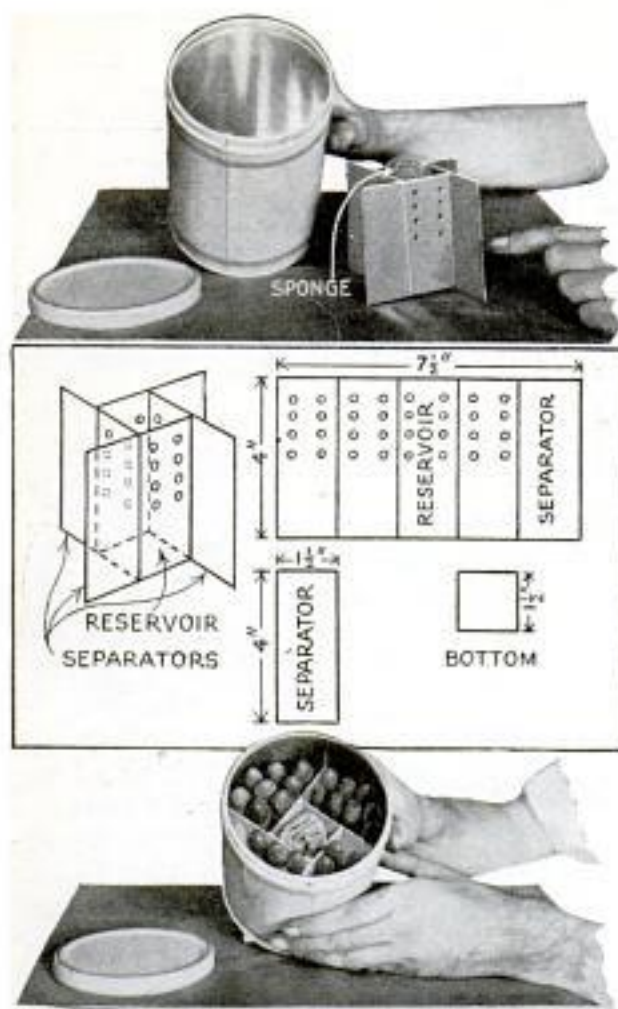

Fitted with a Water Pan and Sponge Compartment, a Coffee Can Makes Good Humidor

### Homemade Humidor for Cigars

An efficient humidor for cigars can be made from an ordinary coffee can. The water pan and sponge holder is made of sheet brass and is perforated to allow circulation of moisture-laden air through the can. The edges of the water pan are extended to fit snugly against the side of the humidor, which holds the cigars in a vertical position.—John S. MacClary, Pueblo, Colorado.

### Releasing Bendix Starter with Crank

When a bendix starter becomes stuck on the gear teeth of the motor flywheel, it can be loosened by placing the crank in the starting position. Then have someone push the car, and at the same time put your entire weight on the crank. In this way, the slack in the gears is taken up, and the starter can usually be loosened with one shove on the car.—R. C. Norton, Hamilton, Ontario, Can.

### Cheap Method of Doing Copy Work with Camera

If you have a camera, particularly one that uses cut films, you have a cheap means of making copies of printed matter and drawings, or even photographs. Get a quantity of glossy bromide enlarging paper, single weight, and cut it into sheets to fit the magazine of the camera, or if it is the roll-film type, cut the paper in strips and roll it on spools. For copy work, the contrast grade of paper is preferable as it gives sharper results, while the normal grade is best for outdoor pictures. Of course, this paper must be handled in a dark room, in which the illumination is from a suitable light. The finished copies will be reversed, that is, white on the copy will be black and vice versa. Positive reproductions can be made by using the paper negative in a manner similar to that of regular film or plates. Linseed oil applied to the surface, and then rubbed off, will increase the transparency of the paper when printing. For making outdoor pictures on this paper, give as much exposure as possible,  $\frac{1}{25}$  second at a lens opening of  $f:4.5$  usually being sufficient in a well-lighted place. Prints made from bromide-paper negatives are not sharp, as it is necessary to print through the paper, but the resulting picture often is highly pleasing in spite of its diffusion. The chief advantage of this method over regular photographs is the low cost of the bromide paper as compared with that of photographic films or plates. Copies made directly with a camera will be reversed, and must be read with the aid of a mirror.



Copy Work Cheaply Done with Camera by Substituting Bromide Paper for Regular Films or Plates



# Hinged Seat of Sedan Forms Comfortable Bed

Simple Alteration on Front Seat of Sedan Transforms Interior to Convenient Sleeping Quarters

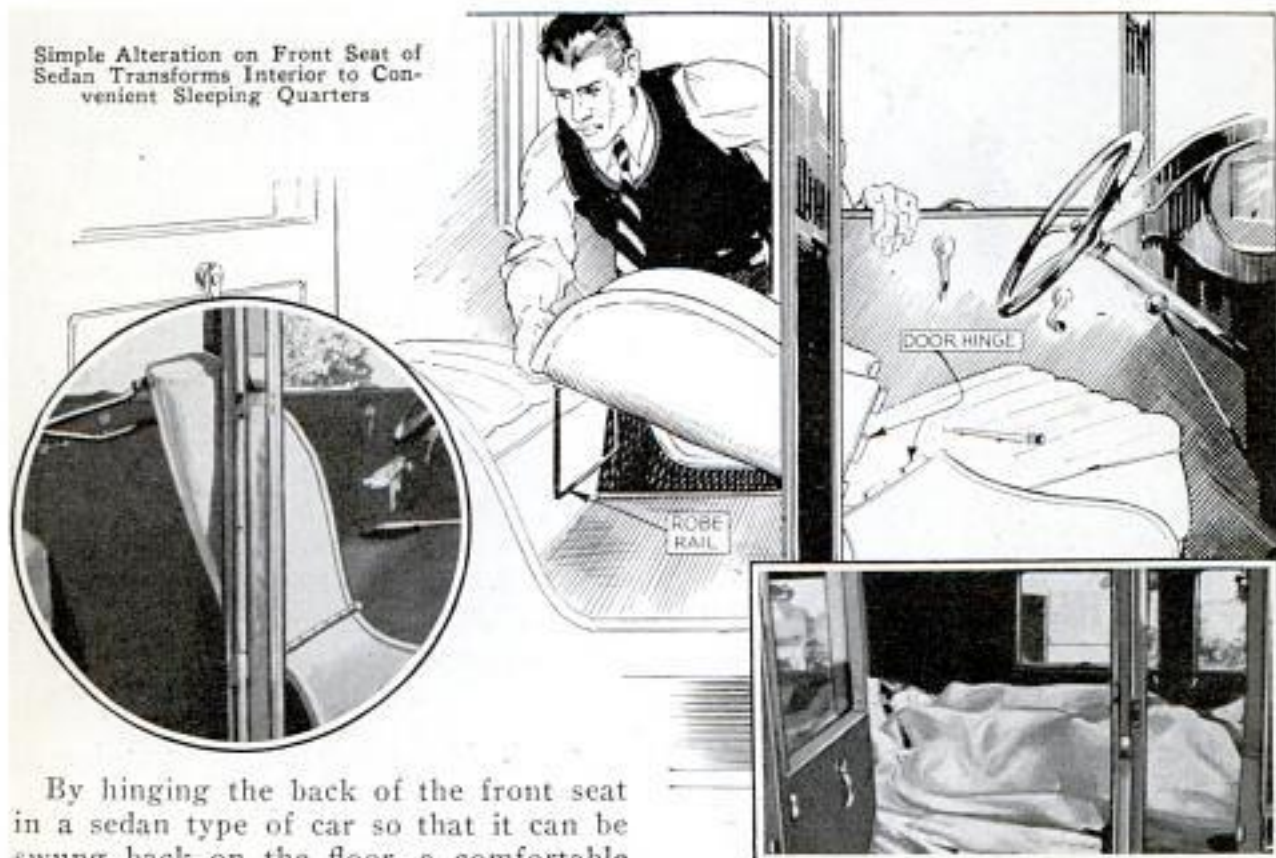

By hinging the back of the front seat in a sedan type of car so that it can be swung back on the floor, a comfortable bed can be made without marring the appearance of the car. Cut the seat straight across even with the top of the cushion. Then join the upper and lower part of the seat at the back with large butt hinges. Next, screw one-half of a similar hinge on each side, as shown in the upper right-hand illustration. When the pins of the side hinges are in place, the seat is rigidly held in its normal position as shown in

the left-hand photo. To complete the job, attach a robe rail to the back of the seat to hold it in a horizontal position when swung down on the floor. To make up the bed, let down the back of the front seat, reverse the front and rear cushions to make the bed level, and put on the linen and comforters. All cut metal parts should be painted to prevent rusting.

## Tape on Shelf Bracket Holds Glass from Slipping

Some of the less expensive glass shelves are not provided with any means of fastening them securely to their brackets and often slip off and break. To overcome this trouble, remove the shelf and wrap the brackets with adhesive tape, gummed



side out, as shown, and press the glass upon them. The gum on the tape will adhere to the glass and prevent it from slipping.

## Preventing Breakage of Towrope

When a car becomes mired in the mud and no rope strong enough to tow it out is available, the car can often be pulled out with a fairly light rope by utilizing a simple mechanical principle. While it will be broken quickly by a sudden jerk, it will stand a hard strain on a steady pull. To enable this, take up the slack in the rope between the mired car and the tow car by having someone pull out on the middle of the rope until it is stretched tight.





Counterweighted Cellar Doors Can Be Made to Operate Easily Enough for a Child to Open Them

### Counterweights Help Raise Heavy Cellar Doors

Heavy cellar doors can be easily opened if they are fitted with the counterweight arrangement shown. It consists of three lengths of flat or angle iron and a hook holding the weights. The two longer pieces are fastened together at one end, while the shortest piece is bent at right angles and is screwed to the underside of the door. The method of attachment is clearly shown in the drawing. In order to have the doors work independently, each is fitted with a separate counterweight.

### Paper Clamps Hold Small Picture Frames While Gluing

When gluing small picture frames, spring paper clamps of the type shown in the photo will be found useful for holding the ends together while the glue dries. Their jaws are strong enough to grip the joints tightly, and will open far enough to prevent marring the frame when putting them on or taking them off.



### Phonograph Motor Rotates Round Objects While Paint Dries

When painting small, round parts, difficulty is often experienced where the surface must be smooth and touching up is impossible. One remedy for this trouble is to rotate the parts sufficiently fast to prevent the paint from running, but not so fast as to throw it off. An ordinary phonograph motor rotates slowly enough for this purpose. By turning the phonograph on its side and mounting the object on a cork carefully centered on the shaft, a satisfactory drying lathe can be made. This method recently saved me hours of time in a crackle-finish job on a number of sunshades. A fan and heater mounted near by will speed up the drying process.—Ronald L. Ives, Upper Montclair, N. J.

### Level Improvised from Plumb Bob and Folding Rule

Fastened in a triangular shape as shown, a 3-ft. section of a folding rule makes a good frame to hold a small plumb bob when it is necessary to improvise a level. The ends of the rule are drilled to receive small bolts by which it is held in shape. The center of the horizontal section is marked as shown in the photo. When the bob is hung up, a true level is obtained when the point of the bob is directly over the marked center on the base.



### Substitute for Ring on Flashlight

A good substitute for the ring on the bottom of a flashlight can be made by bending a piece of  $\frac{1}{16}$ -in. wire into a "U" with the ends about 1 in. apart. Remove and punch two holes in the bottom cap of the light to take the ends. Then sweat a washer over each end of the wire to keep it from pulling through the cap, and bend them over at right angles. If the flashlight is to be used constantly, a hook fastened to the user's belt will provide a convenient means of carrying it.—Herbert Johnson, Woodbury, N. J.



# Small HOUSE TRAILER

## Completely Equipped for Touring

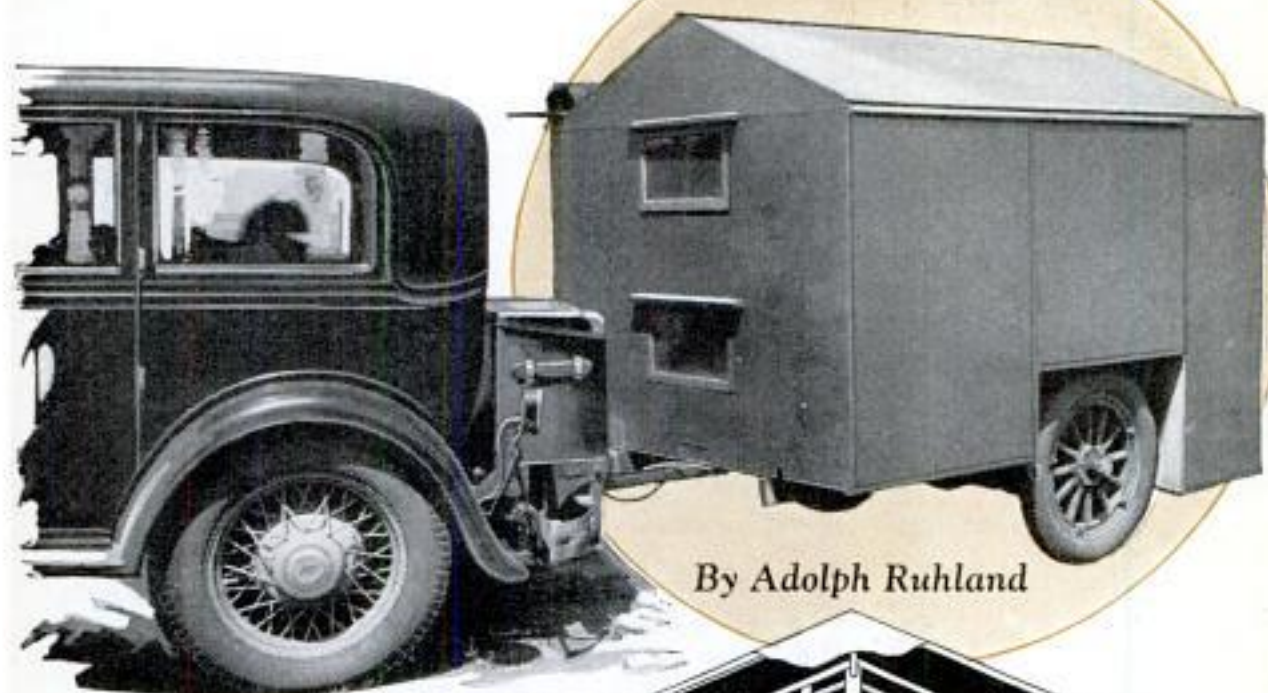

By Adolph Ruhland

### PART II

**V**ENTILATION in the trailer is obtained by opening the front windows and the glass panels of the rear door, all openings being, of course, well screened to prevent the entrance of flies and mosquitoes. As may be seen from several of the views, a separate window is provided at the head of each berth, insuring plenty of fresh air for the sleepers. The window construction is detailed in Fig. 18, which gives a view from the inside of the trailer. A simple frame is built to hold both screen and window, the former screwed or hooked on the inside, and the latter hinged to the top member of the frame with small butt hinges. A 16-in. hook holds the window in the open position, the hook passing through a slot in the screen frame to engage with a screweye driven into the latter. A piece of sheet rubber, slitted and tacked over the slot, keeps flies out effec-

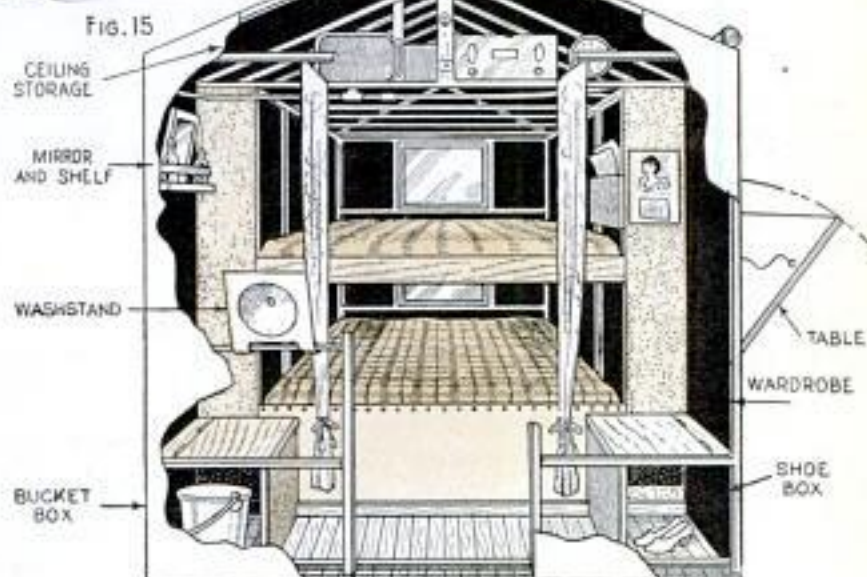

tively. The door details are given in Fig. 16. After making the frame to fit the door opening, and dividing it into four sections of equal size, the lower half of the door is covered with pressed wood and the upper half with screen. Two window sashes are then made to fit into the sections, and turnbuttons are used to keep them in place, although it is a good idea to nail strips over the crosspieces to project about  $\frac{1}{2}$  in. above them, and then a turnbutton is needed only at the top. This



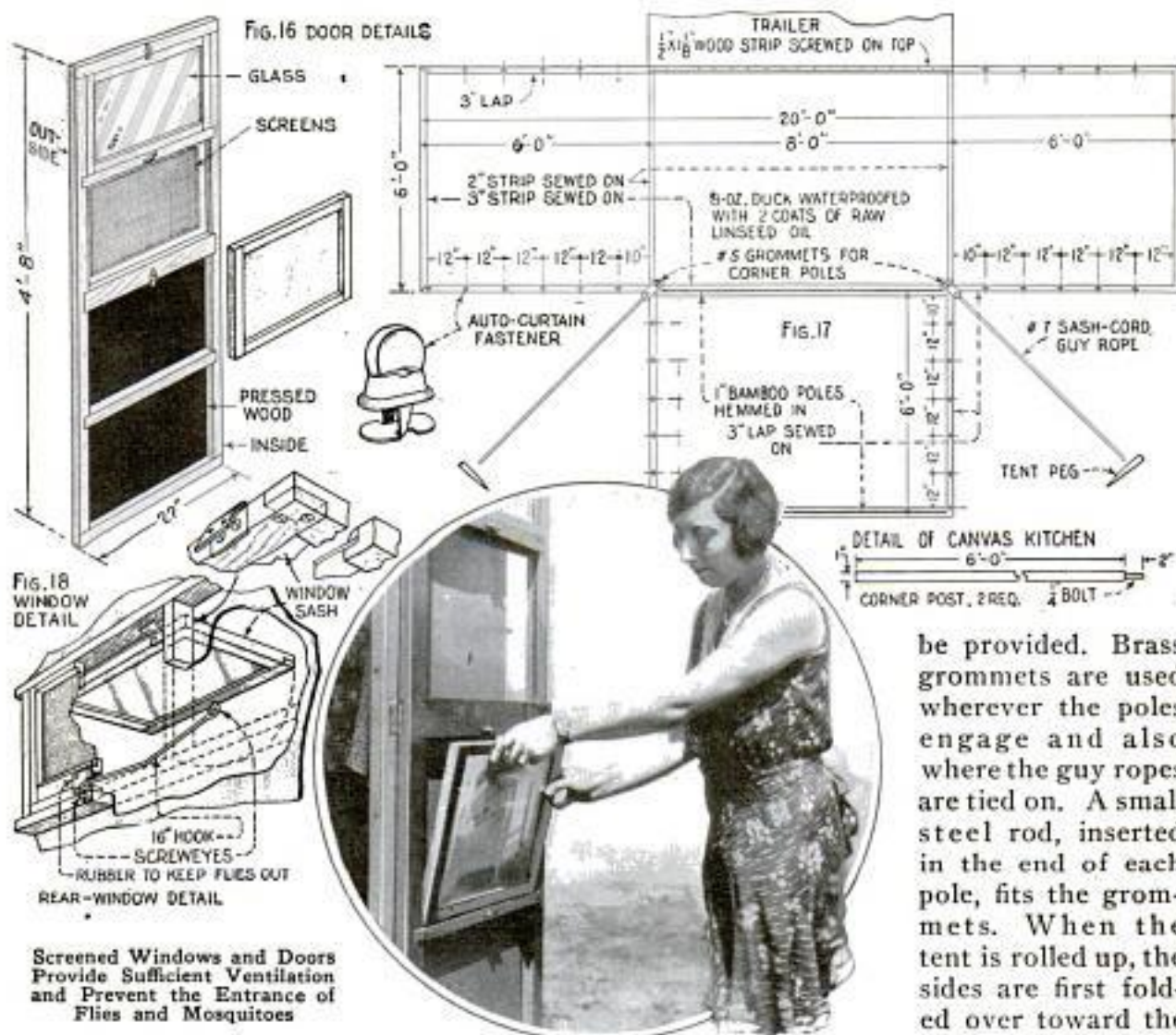

arrangement allows the sash to close the screened portion of the door. When full ventilation is desired, the sash are slipped into the lower sections, as shown in the photo, where they are entirely out of the way. Strips to shed rain are screwed above each window, over the door and along the edge of the roof. These strips are pieces of molding with a rounded lower edge that makes the water drip off instead of creeping around to the surface below the strips.

The dimensions for the tent are given in Fig. 17, showing how bamboo poles are sewed in the hems for rigidity, the points where sash-cord guy ropes are attached for bracing, and where auto-curtain fasteners are placed for closing the tent tightly at all corners. The edges of the canvas are doubled to provide strength before attaching the fasteners. Also, the size of the corner poles is given in the lower detail. If desired, a center pole may

be provided. Brass grommets are used wherever the poles engage and also where the guy ropes are tied on. A small steel rod, inserted in the end of each pole, fits the grommets. When the tent is rolled up, the sides are first folded over toward the center, the poles

laid in place and the canvas rolled up evenly and tightly. Three straps attached to the edge of the trailer roof hold the roll in place securely while traveling. Now the trailer is complete except for the wiring and the hitch. A highly satisfactory universal joint is shown in Fig. 19. It consists of two pieces of steel tubing, placed at right angles and welded together, both of the pieces being notched to fit each other, whereupon one is drilled and tapped for a grease fitting, which makes it easy to keep the joint well lubricated. The vertical piece fits a U-iron drilled for a 1/2-in. bolt, which holds the two pieces together securely. The horizontal piece similarly fits the end of the trailer tongue, which is a suitable length of channel iron of the right size, bolted to the trailer crosspiece and screwed to the underside of the trailer floor. The U-iron is connected to the car by means of a drawbar, which is a length of heavy channel iron



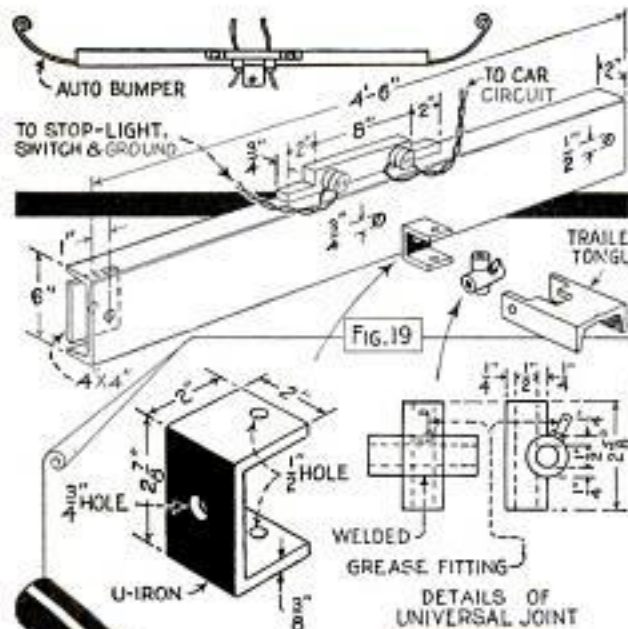

Trailer Load Should Be Well Balanced to Avoid Excessive Strain on Universal Joint

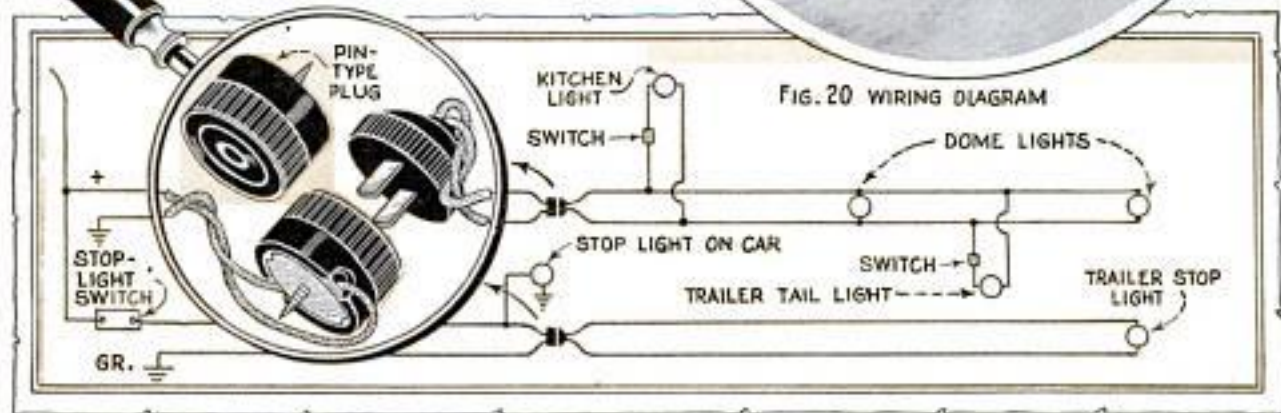
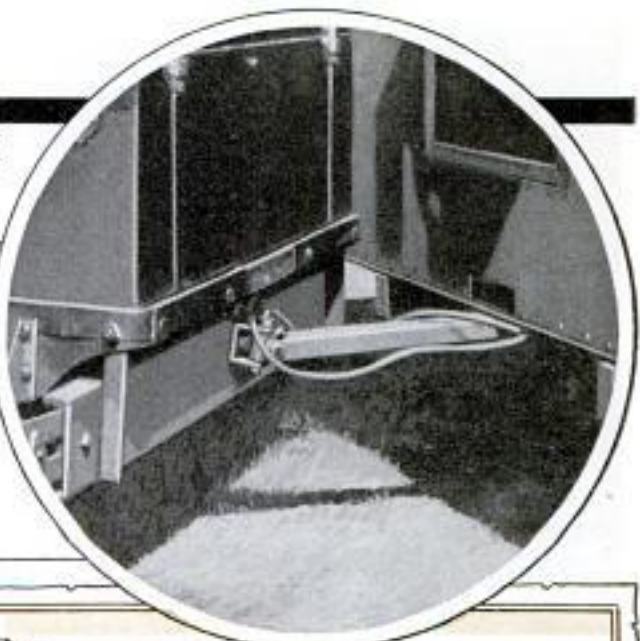

fitting over the bumpers of the car, a  $\frac{3}{4}$ -in. hole being drilled through both U-iron and drawbar for a  $\frac{3}{4}$ -in. bolt which holds the two pieces together. Iron plates,  $\frac{3}{8}$  by 4 by 4 in., straddle the inside of the bumpers, and both the plates and the drawbar are then drilled for  $\frac{1}{2}$ -in. bolts which hold the assembly securely in place. A piece of hardwood is bolted to the upper edge of the drawbar, at the center, to serve as a base for mounting two pin-type plugs, which are used to provide a detachable connection between the wiring circuits of the car and trailer. One side of one of these plugs is connected to the positive line of the electrical system on the car, while the other side is grounded. The other plug is similarly connected to the wire leading to the stop-light switch and to the ground. Fig. 20 shows the wiring diagram of the trailer. The upper circuit supplies the dome lights, placed wherever desired in the trailer, and also the kitchen and tail lights, switches being cut in in

the latter two branches. The lower circuit connects direct to the trailer stop-light switch. It is advisable to shield the leads between the car and trailer with loom or flexible metal tubing, allowing sufficient looseness in the cable to prevent any strain. The weight of the trailer should be distributed evenly so that it practically balances on the wheels. So balanced, there will be no undue strain on the car and its riding qualities will not be affected.

#### Clothespins Hold Large Spoon



Two spring clothespins, clipped on the edge of a pail or other container, form a convenient holder for a large mixing spoon. This is a timesaver when it is necessary to keep the spoon at hand.



## It's Fun to Make These Bent-Wire Caricatures

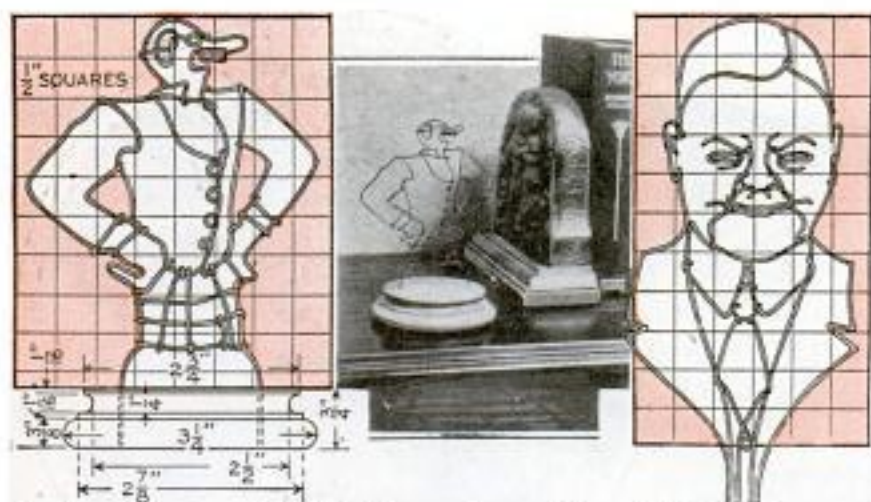

Bending Caricatures from Soft Iron or Copper Wire to Fit Desk Ornaments and Paper Weights, Is a Pleasing Pastime

Caricatures of your friends, or any other figures you desire, can be bent from soft wire and mounted on wooden bases to form pleasing desk novelties and paper weights. A photo or drawing showing either a front view or profile may be se-

lected and it can be traced by means of carbon paper or a pantograph. The sheet is ruled in squares for guide lines, and the wire portions of the figure are then bent to shape. Soft copper wire, enameled or bare, has been found handy to work with. You can shape gradual curves with the fingers, but for sharp corners and small curves, a pair of narrow-nose pliers is useful. The miniature buttons are readily formed by bending the wire to a row of small loops. In finishing the figure, two or three vertical lengths of wire are left to project for attachment to the base, which may be either square or circular, suitably stained and polished.

### Camera Tripod Used as a Support for Telescope

Small telescopes can be adapted for use on a camera tripod by making a holder, 1 in. wide and slightly longer than the largest section of the instrument, from a piece of 1/4-in. iron or brass, which is tapped in the center for a 1/4-in. 20-thread screw, the telescope being fastened to it with two radiator hose clamps. The holder should be notched to take the clamps, and either bent or grooved to fit the curvature of the instrument. If, in addition, the tripod is fitted with a ball-and-socket head, the instrument can be easily swung into any position.—Guy Bartlett, Schenectady, N. Y.

### Metal Plate Keeps Screweye Tight

Small screweyes, that have become loose and are then likely to be pulled out of the wood, especially if subjected to strain, can be kept tight by the following method: Drill two holes through a small metal plate, one to admit the shank of



the screweye, and the other to receive a wood screw as shown. In this way the plate, being securely anchored, takes the side strain which is usually responsible for loosening the screw.

### Bow Holder for Short Chalkline

Snapping short chalklines can be done easily with a bow as shown. A 3-ft. length of dowel rod is bent to the shape of a bow by tying a line to each end. The line, after it has been chalked, is snapped on the surface, leaving a mark on it.



### Easy Way to Empty Canned Foods

When emptying a can of semi-solid foodstuff, it is a good idea to turn the can upside down and punch a hole in the bottom to enable air to enter. You will find that the contents will slide out much more freely after this is done.



### Hints on Applying Steel Roofing

Corrugated-steel roofing will last indefinitely if it is laid so that water cannot collect between the sheets and cause rust. Place the first sheet so that the turned-down edge is at your left. This will bring the other edge to the correct position for the next sheet. After nailing down two-thirds of the first sheet, the second is lapped 2 in. over it and nailed at the joint, thus fastening both sheets at that point. It is best to use hardwood sheathing, as it holds the nails better than soft wood when the metal expands and contracts. Use lead-headed nails for this purpose, and drive them in the ridges of the corrugations. In order to have the lower edge of the roof even, fasten a butting board at that line for a guide before starting to nail on the sheets, as the ends are not always square with the corrugations. It is best not to drive many nails in the upper end of the sheets until you are ready to nail the ridge roll in position.

### Tobacco Tin Aids in Ripping Stock



When ripping work with a saw, it is often necessary to have a slender wedge to prevent the saw from binding. An ordinary tobacco can with the lid removed and the end flattened makes a good wedge.

### Curtain Rod Holds Packages on Back of Car Seat

Practically all cars of the coupe type have a narrow ledge behind the seat on which small packages may be carried safely if an extension curtain rod is fastened across the back of the top, just under the window. Small packages can be stored securely inside the rod, which is easily slipped from the brackets and put away.

MAILING TUBES

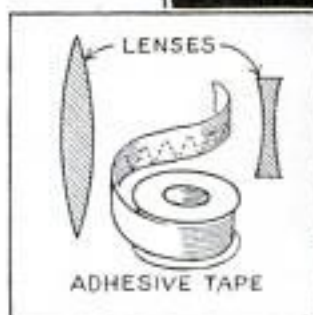
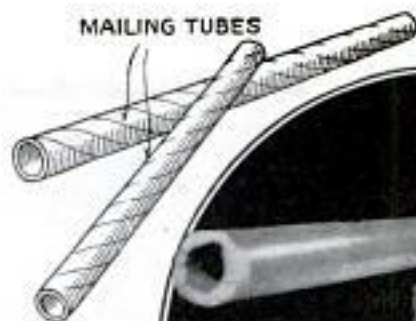

Improved from Mailing Tubes and Spectacle Lenses, This Telescope Is Handy for Boy Scouts



### Telescope Made from Mailing Tubes

You can quickly improvise a telescope from two 24-in. mailing tubes, one to fit inside of the other, and two spectacle lenses, one a 1.75-diopter magnifying lens for the large tube, and the other, a 12.00-diopter reducing lens for the eyepiece or small end of the tube. The lenses are mounted in the ends of the tubes with adhesive tape.

### A Handy Tool for the Aquarium

By riveting a safety-razor blade to the slotted end of a suitable handle as shown, you can make a handy scraper for removing scum that forms on the inside of a glass aquarium. This little tool is also useful for trimming the aquarium plants, and for scraping paint and other foreign matter from windows.—R. G. Bullard, Monterey Park, California.



☛ To pick the right paint bucket when a number of them are placed in a row on a shelf, is easy if the color each contains is painted on the outside.

*Journal Laboratories 3017  
Wheeler St. Berkeley, Calif.  
Sullivan Optical Co  
491 E 163rd St New York*



# DOLL-HOUSE

## Will Please

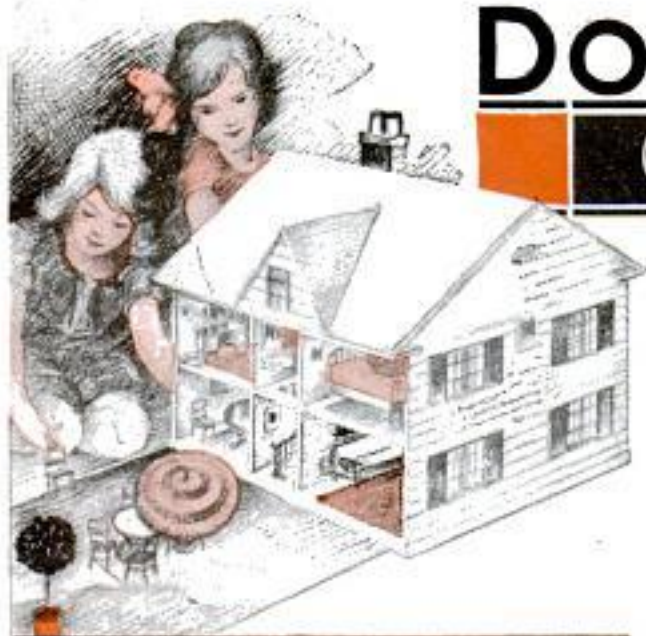

**M**OST of the doll-house furniture illustrated can be cut out with a jack-knife, although turned pieces can best be made on a small woodworking lathe.

The overstuffed chairs and sofa in Figs. 2 and 3, each consist of four blocks, covered with light-weight silk cloth which is glued to the wood so that it overlaps on the bottom edge. The dining table, Fig. 12, is really a lathe project. In the center support,  $\frac{1}{4}$ -in. holes are drilled at right angles, and these are shaped into slots with a chisel, file and sandpaper, after which the parts are glued together. In the buffet, Fig. 1, use  $\frac{1}{16}$ -in. mahogany for top and panels, and  $\frac{3}{8}$ -in. square pieces for the legs. Build up the front of  $\frac{3}{16}$ -in. pieces for the drawer and side-door openings, but do not set the top permanently until the hinge pins are inserted for the side doors. Drawer pulls can be turned from dowel rods.

The spool bed, too, Fig. 5, is essentially a lathe job. For the frame of head and foot  $\frac{1}{4}$ -in. maple dowel stock is used, while  $\frac{3}{16}$ -in. dowels are suitable for the spindles. Side rails are of any  $\frac{1}{8}$ -in. material if the bed is to be enameled. If it is to be stained, maple or other close-grained hardwood should be used. A bedroom rocker is easily made of pine, as

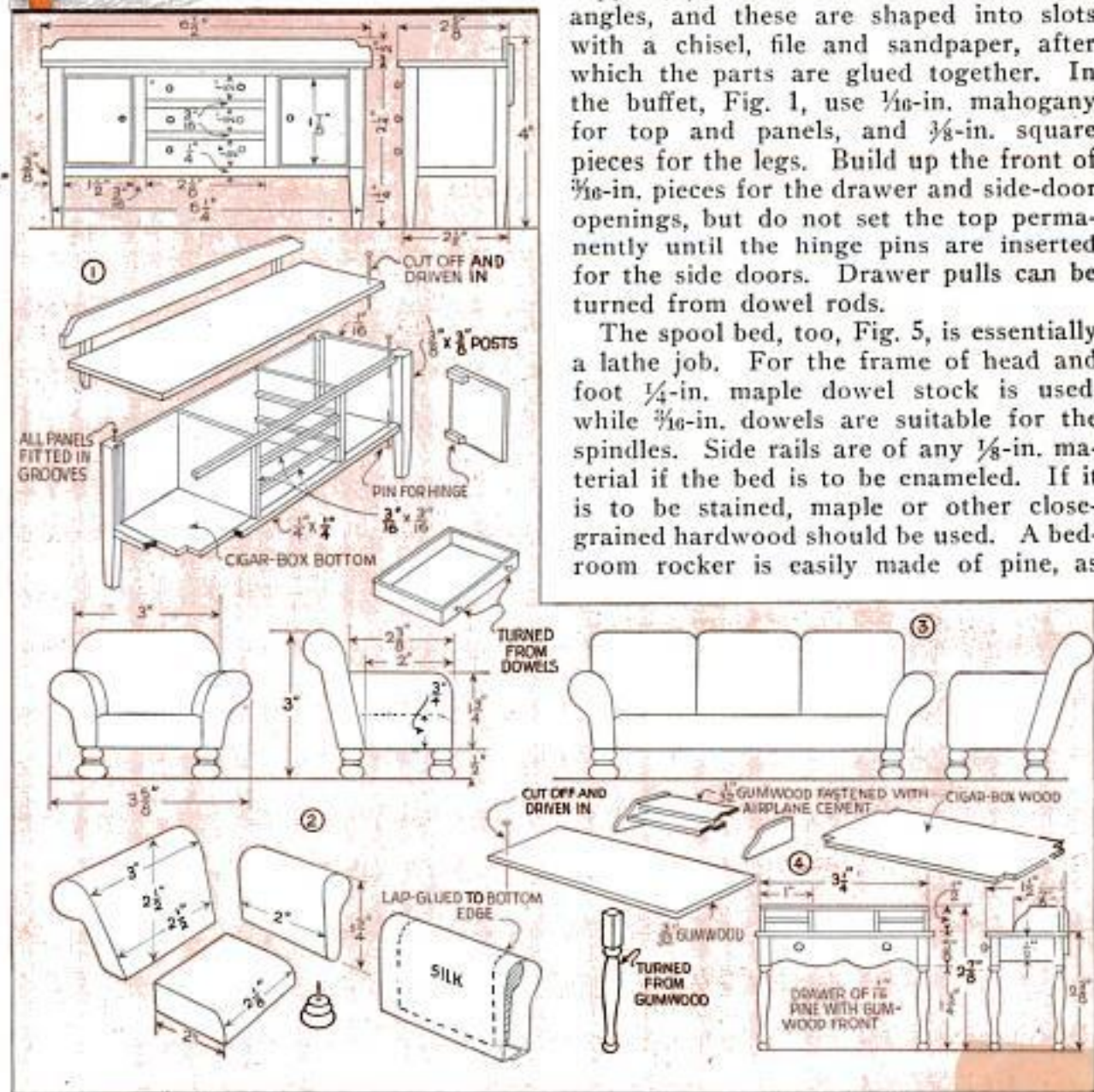



# FURNITURE

## Your Girls

shown in Fig. 6. The small spindles at the back are  $\frac{1}{16}$ -in. dowels, ordinary throat swabs being used for this purpose.

The dressing table, shown in Fig. 8, is an easy model to copy. As it is to be painted, cigar-box wood is used for top and bottom, with  $\frac{1}{16}$ -in. pine for the single drawer and  $\frac{1}{32}$ -in. wood for the curved side panels. This must be well soaked in water and wrapped around a cylinder of some kind until dry. Although fitted with pulls, the side panels do not open. A small vanity-case mirror is fitted into a turned frame of sugar pine. Make the shoulder just wide enough to retain the mirror, and back it with  $\frac{1}{16}$ -in. wood or pasteboard. The low-back chair, Fig. 9, goes with the dressing table. For dining chairs follow the same construction, but increase the height of the back and use turned front legs.

The floor lamp, Fig. 10, consists of a spindle and a disk bottom, with a music-wire frame for the shade support. The piano, Fig. 11, is a job for jigsaw and sandpaper. The curved section should be laid out on a piece of 1-in. sugar pine, cut out and finished down to a width of about  $\frac{1}{4}$  in. It is nailed to a base of cigar-box wood, with other blocks for keyboard, etc. Pedals are pointed strips of sheet alumi-

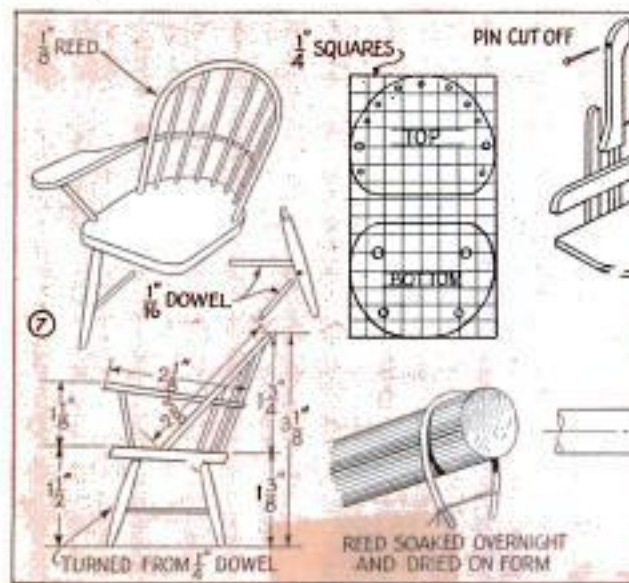
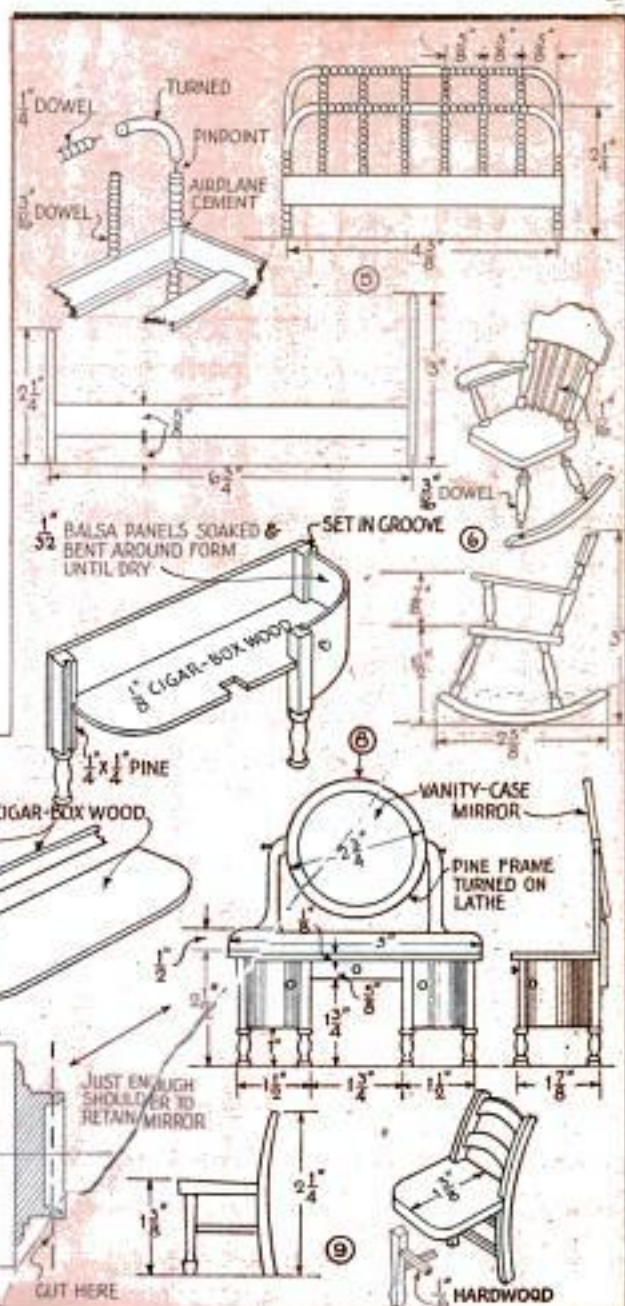



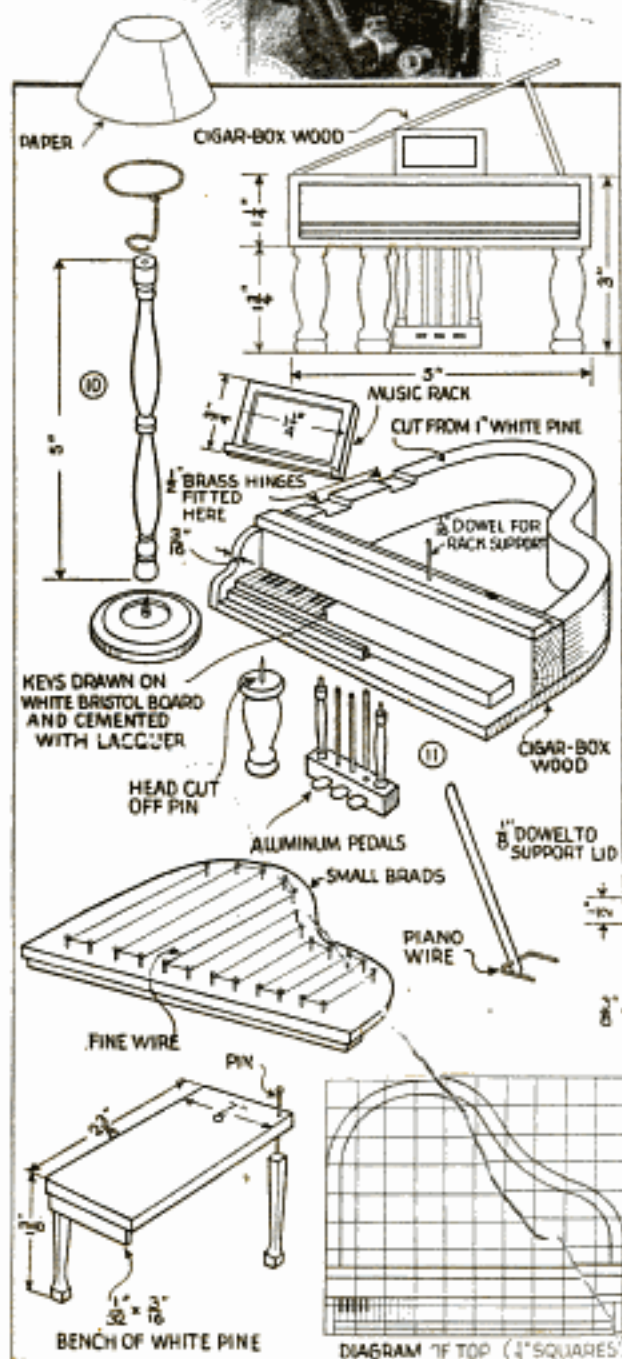

num or tin pressed into the base block. Small brass hinges, not over  $\frac{1}{2}$  in. long, are fastened to the lid by riveting small tacks to it and are attached to the piano with cigar-box nails. A lid support is made from a length of  $\frac{1}{8}$ -in. dowel, pivoted on a piece of piano wire which is bent to a U-shape and pressed into the piano box. The strings, of fine wire, are stretched over small brads as shown. For the keys, a strip of bristol board or the edge of a glossy photo print, marked off in black ink with a ruling pen, is used. This is glued in place after the final coat of black brushing lacquer has been applied.

In Fig. 4 is shown a writing desk done in gumwood and finished in walnut oil stain. The small stationary shelves require very thin wood, and the top should be stained and finished before the former are cemented on. The only pins used in this and similar jobs are at the corners to anchor the legs, cement being used also. Drive the pins in about  $\frac{1}{4}$  in., then cut them off close to the desk top and drive the rest of the way in, taking care not to inflict hammer marks.

Probably the most difficult piece of the entire set is the Windsor chair shown in Fig. 7. In preparation, the reed is soaked overnight in water, then bent around a form and left there until completely dry. It is next set temporarily in the chair bottom and holes located for the spindles. These holes should not be over  $\frac{1}{32}$  in. deep, or just sufficient to hold the spindle in place after the cement has set. Chair bottom and arms are of gumwood, with walnut stain to match the desk, and legs and spindles of dowels.

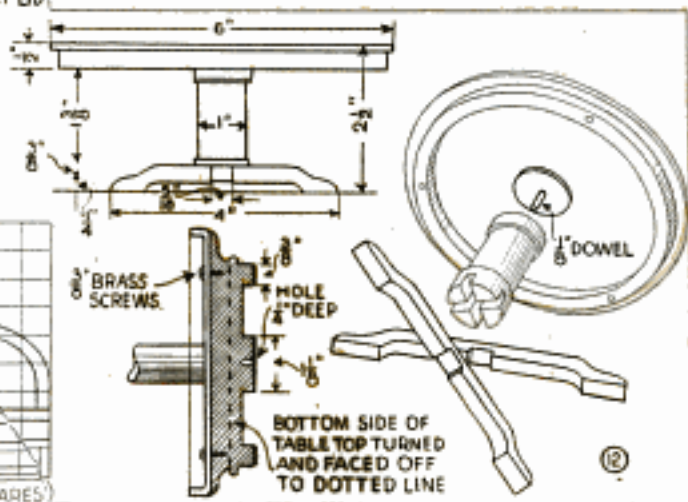



## Silent Valet Holds Coat, Trousers and Shoes

Here's a brand-new novelty that you may want to make—a portable clothes hanger to be placed at the side of your bed to hold coat, vest, trousers and shoes. The construction of such a "valet" requires only ordinary tools, as the round members are made of  $\frac{3}{4}$ -in. dowel rods obtainable at most hardware stores. Shoulders are cut on the dowels so that the tenon, or part entering the hole, is only  $\frac{1}{2}$ -in. diameter. All the joints are of the mortise-and-tenon variety, although simple lap and screwed joints can be used without seriously detracting from the appearance of the object.

Squared-off patterns, shown in the upper details, give the sizes and shapes of the formed members, so that paper patterns may be laid out and the design transferred to the wood. The cutting may be done with a hand scrollsaw or on a bandsaw. All edges must be nicely smoothed down with a spokeshave or file, and then sanded. The edges of the top piece should be well rounded and perfectly smooth, as this

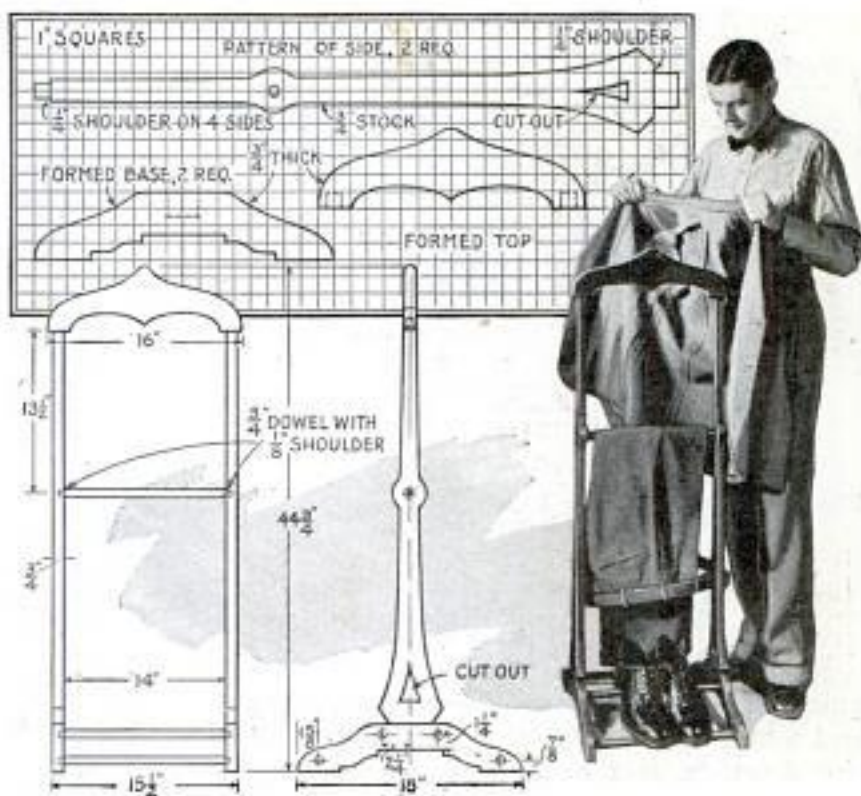

piece serves as the coat and vest hanger. The highest cross rod is used to hold the folded trousers, while shoes are placed with the heel hooked over one of the higher base rails. Other articles of clothing may also be hung over the trousers rail, or hooks may be added on the sides of the uprights if desired. The valet should be finished to match the other furniture of the room if possible.

### Eggshell Serves as Funnel

One half of an eggshell having a small hole pierced in the end, makes an emergency funnel for pouring liquids, in case no regular funnel is available or if acid is poured and a metal funnel cannot be used. The width of an eggshell affords a large enough opening to catch the liquid, and



if one is careful, there is no need of spilling it over the mouth of the bottle.

### Flavor of Milk Retained by Use of Amber-Colored Glass

Experiments made by the department of agriculture show that milk should be kept in a dark place to retain its flavor and freshness. When exposed to sunlight, it quickly develops a bad taste and disagreeable odor. This is caused by the light, which promotes oxidation. By keeping the milk in a box with a hinged door, covered with dark amber-colored glass, its freshness will be prolonged.—R. Heim, Oak Park, Ill.





Blowtorch Made from Toy Balloon, Medicine Dropper and Alcohol Lamp Is Useful for Light Work

### Toy Balloon Supplies Compressed Air for Improved Blowtorch

For light work, a blowtorch can be quickly improvised from a rubber balloon and a medicine dropper. Heat the end of the dropper and draw it out to a fine point, leaving a very small hole in it. Then cut off the tip of the rubber bulb and push the dropper into the neck of the balloon, holding it there securely with a rubber band after the balloon has been inflated. The air escaping slowly through the small hole in the end of the glass, makes a hot flame when used with an alcohol lamp. Air from this source can also be used for mixing liquids as shown.

### Can Helps to Untie Knots

If there is a tobacco can handy, you can use this to advantage for loosening hard knots. Catch a portion of the knot between the cover and body of the can,



between the cover and body of the can, being careful not to cut the cord. In this way, you can get a good grip on the cord to pull the tight section loose after which it will be an easy matter to untie the knot.

### Filing Ignition Breaker Points

One of the most important jobs tried by the average motorist, yet most often improperly done, is the filing of the breaker points in the distributor. The proper method of doing this is to first file them with a coil file, then put a small drop of fine valve-grinding compound between them and loosen the anchor bolts on the movable arm about one-half turn. Rub the points together with an up-and-down motion, with the pressure toward the stationary arm. This will give them a smooth finish and assure that no rough surface, which would cause them to pit and corrode quickly, will prevent them from making a good electrical contact. Make sure that all the compound is wiped out of the mechanism and the anchor bolts tightened before replacing the distributor cap.

### Sponge-Rubber Pad Applied to Platen of Photo Printer

Felt pressure pads on photographic printers are often badly worn by continuous contact with the hands. This trouble may be overcome by substituting a sponge-rubber pad, which has sufficient resiliency to equalize the unevenness of badly buckled negatives. While not adaptable to all types of printers, it has given satisfactory results on one of the hand-pressure type.—M. E. Hanna, Albuquerque, N. Mex.

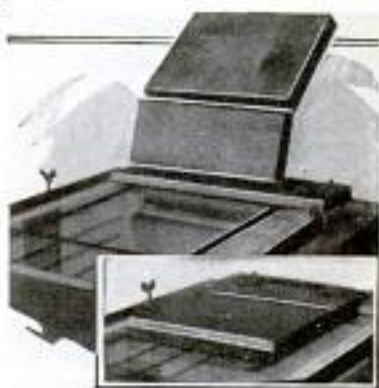

### How to Keep Sand or Gravel Out of Your Shoes

A good method of keeping grain, sand or gravel out of your shoes is to wear guards or shields made from a pair of old socks. Slit the bottoms of the socks from heel to toe and slip them over the socks you are wearing. Then put on your shoe and tie a string on one side of the sock, bring it under the instep, pull it tight and tie it to the other side of the sock.





## An Accurate TOOL-POST GRINDER

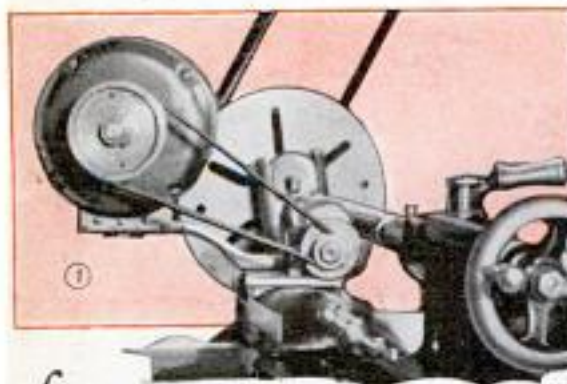

for your  
**LATHE**

By L. D. Richards

ALMOST as versatile as a universal grinder, a good tool-post grinder greatly increases the utility of your lathe, enabling accurate finishing of hardened work, both inside and out—operations that are impossible with cutting bits. Such a grinder, shown in Figs. 1, 2 and 3, has the advantage of being small, and allows the use of interchangeable spindles of different lengths and diameters to handle work of either small inside or large outside diameter. In addition, it is practically free from vibration, which would leave marks on the work.

Get a  $\frac{1}{8}$  to  $\frac{3}{16}$ -hp. motor of small size having a speed of not less than 3,000 r.p.m. Next, obtain ball bearings for the grinder spindle, as you will have to fit

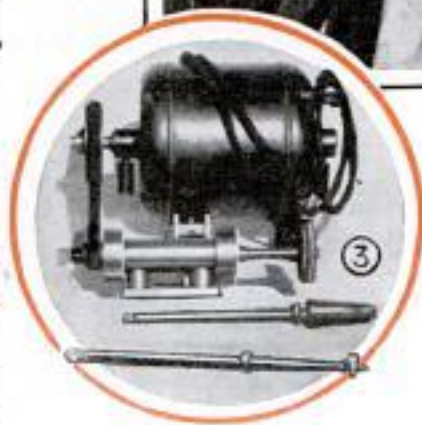

them to the quill and spindle housing. As precision work is to be done with the grinder, it is not advisable to use secondhand bearings. The tool-post plate is made from  $\frac{1}{4}$ -in. cold-rolled steel to the dimensions given in the right-hand detail of Fig. 7, with holes drilled as indicated, the center one to fit the tool post. Then comes the motor-support arm, made of  $\frac{5}{16}$ -in. stock, bent and drilled as in Fig. 4. The slot at one end allows the motor base to slide for adjustment of belt tension. It is fastened to the tool-post plate with two flush rivets, holes in both parts being countersunk. A motor base, Fig. 7, is provided with two curved pieces on the upper side to fit the motor, to which it is attached with screws, and two cleats on the underside to fit snugly on each side of the support arm.



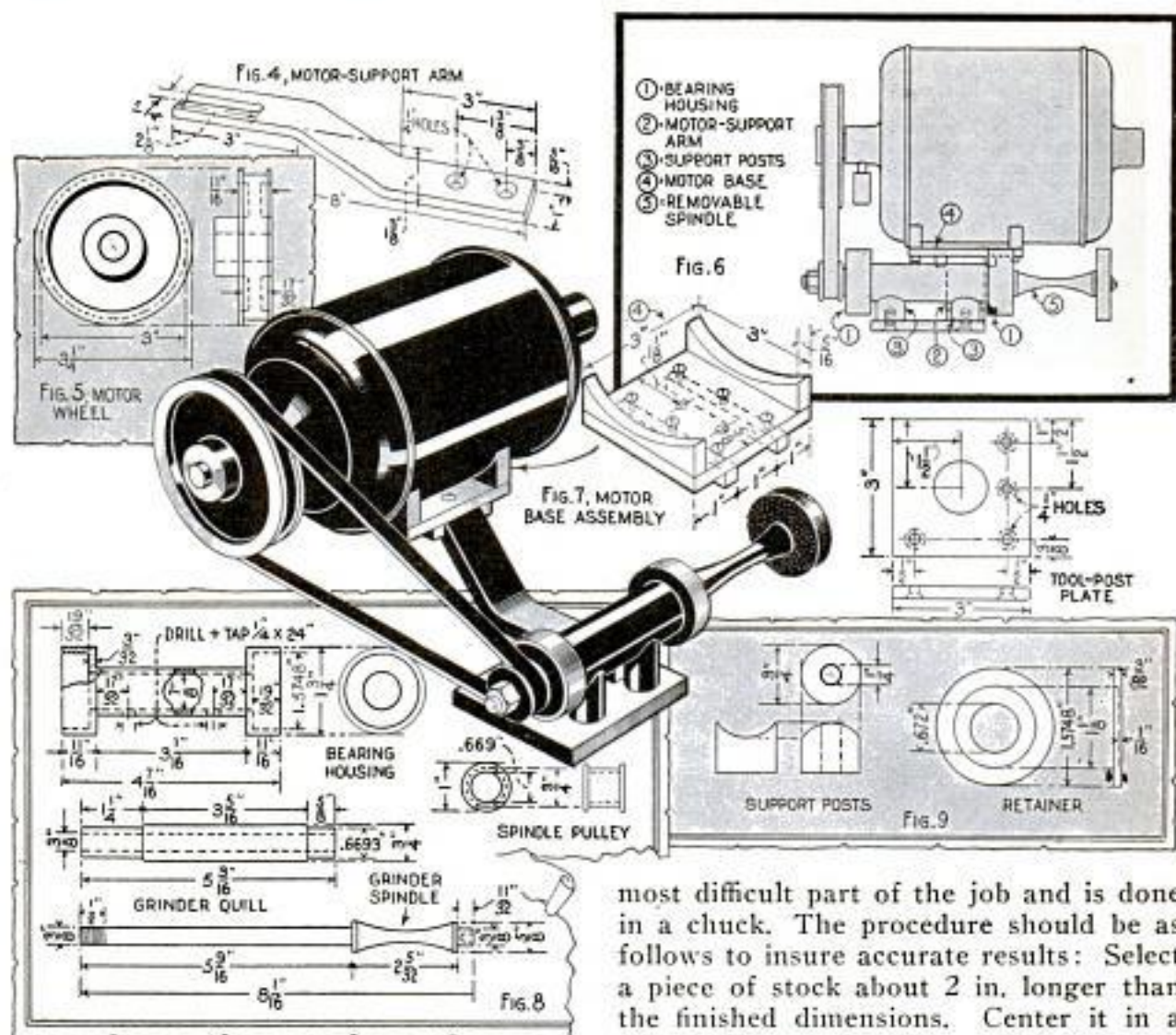

You are now ready to turn out the spindle, spindle quill, bearing housing, retainers and support posts for the bearing housing, besides two pulleys, these parts being shown in Figs. 5, 8 and 9. The spindle is turned between centers and finished to size with the exception of the end to which the stone attaches. This end must be at the head end of the lathe. Do not cut it off but leave the dog in place and lay it aside to be used as a mandrel on which to turn the hollow quill, so that the latter will be accurately centered.

The quill is made from a piece of  $\frac{3}{4}$ -in. (outside diameter) seamless steel tubing having a  $\frac{7}{16}$ -in. wall. The bearings must be a firm push fit and accurately spaced on the quill. Spacing between the shoulders should be a trifle too wide rather than too close. Shims can be used if an error is made. Turning the bearing housing from seamless steel tubing of  $1\frac{3}{4}$ -in. outside diameter with a  $\frac{1}{2}$ -in. wall, is the

most difficult part of the job and is done in a chuck. The procedure should be as follows to insure accurate results: Select a piece of stock about 2 in. longer than the finished dimensions. Center it in a four-jaw chuck and take a finishing cut over the outside. Bore the inside to the required  $\frac{3}{8}$ -in. diameter. Bore the bearing recess in the exposed end, fit the bearing carefully and cut the piece off just a trifle longer than necessary. Reverse it in the chuck and center accurately. This can be done better in a four-jaw chuck than in a three-jaw, especially if a micrometrical test indicator is available. Fit the other bearing and then remove the piece from the chuck. From a piece of scrap, make a plug to fit snugly into one bearing recess, which will afterward be used to make bearing retainers, center and countersink it and cut it off. It is to be pushed into one of the bearing housings. Next, chuck up the scrap end of  $1\frac{3}{4}$ -in. tubing. Turn about  $\frac{3}{4}$  in. of its outside diameter to fit tight in the remaining bearing recess. Do not force it tight enough to spread the metal and destroy the bearing fit but, without removing the piece from the chuck, fit the two parts together



so that the piece in the lathe serves as an arbor for turning the outside of the bearing housing. Drill and tap the oil hole and the screw holes. Oil and not grease is to be used for lubrication.

Two support posts are used to hold the bearing housing to the tool-post plate. The height of these posts depends on the vertical distance between the top surface of the compound rest and the center line, but must be such that the center of the grinder spindle aligns accurately with the lathe centers. The bearing-retainer washers are flat disks, dished to give clearance to the inner bearing race, and are permanently held in place by equally spaced punch marks around the rim of the bearing housing. If the speed of your motor exceeds 3,500 r.p.m., it is advisable to make this pulley larger in order to provide more belt-friction surface and larger belt-flexing radius. Although the diameter of the motor pulley is given, in Fig. 5, as 3 in. for a motor running 3,000 r.p.m., the size must be varied if the motor speed differs. To determine the correct pulley size, multiply the spindle r.p.m. (12,000) by the spindle-pulley diameter, and divide the product by the motor r.p.m. To this figure add about 20 per cent for belt slippage, reduction of motor speed due to load, etc. The belt must be of the endless type, preferably leather.

In grinding on the lathe, the motor should be wired to rotate so that the cuttings will fly downward. Also be sure to protect the working parts of your lathe by spreading an oily rag under the stone. See that the jib screws of the rest are set firmly enough to prevent shifting due to the running motor. Avoid taking deep cuts and keep the spindle well oiled.

#### Corrugated Paper Holds Brushes



should be exposed to form individual grooves for the brushes, and a rubber band slipped over the roll,

For carrying small show-card brushes, a roll of corrugated paper makes a good case. The cor-

rugated side



Small Parts Placed in Screen-Bottomed Truck Are Pushed over Drain and Quickly Cleaned with Steam

#### Screen-Bottomed Truck for Steam Cleaning Small Parts

For holding small parts of machinery while steam-cleaning them, the illustrated truck is useful. It has an 18 by 36-in. frame made of 1-in. angle iron which is fastened to an axle and wheels. The bottom is covered with  $\frac{1}{2}$ -in. mesh wire, held taut by means of metal strips and stove bolts as shown. The handle is a length of  $\frac{3}{4}$ -in. rod or pipe, one end being welded to the frame, while the other is fitted with a crossrod.

#### Folding Tripod for Block and Tackle

By bolting three poles together at one end, a tripod for holding a block and tackle can readily be improvised. The poles may be of any suitable size for the work, and they should be bolted together loosely so that they can be spread at the bottom. The bolt used for this purpose should, of course, be strong enough to support the weight of the load to be lifted.



## Dismantling a Smokestack Without Damage

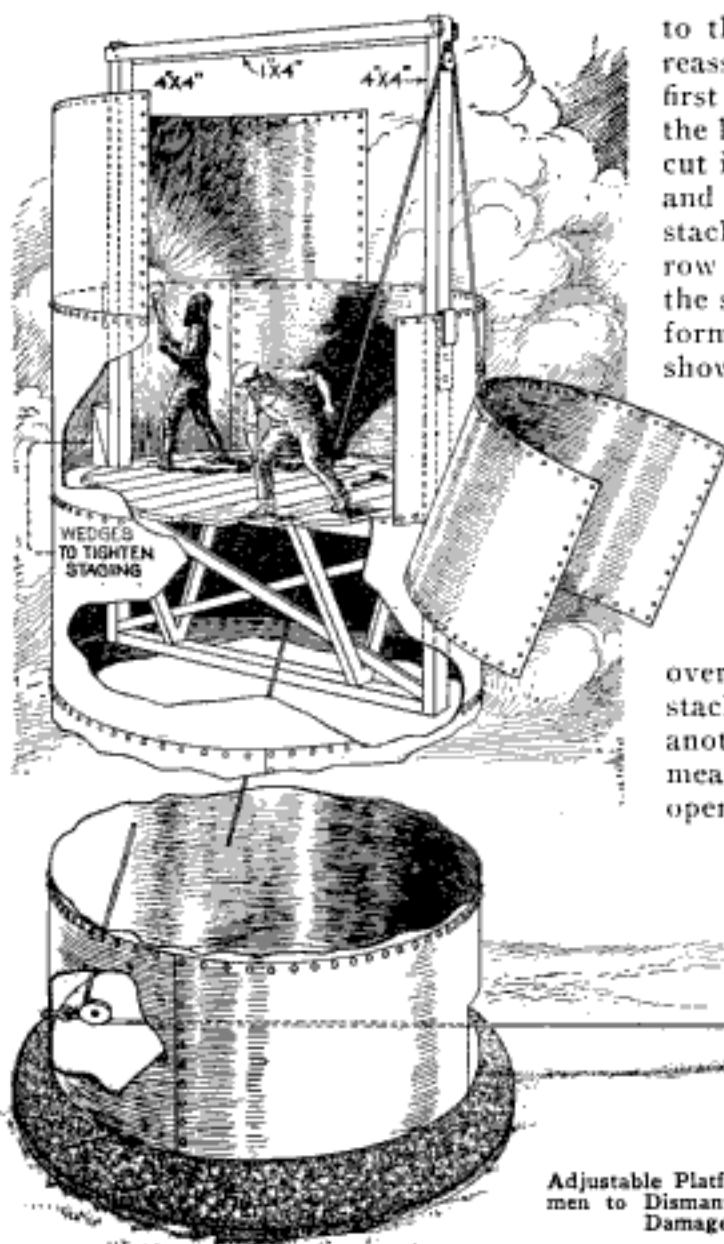

to the plates, so that the stack could be reassembled. An adjustable platform was first built inside of the stack, entrance to the latter being made through a large hole cut in the side near the bottom. A block and tackle was hooked over the top of the stack and the platform raised to the first row of rivets. Hooks were provided on the side members of the frame of the platform to slip over the edge of the stack as shown in the drawing, wedges being used to hold the platform rigidly in position. As a means of lowering the plates after they had been removed from the stack one by one, a pulley was fastened to the top of the platform frame, and for this reason the frame should project 6 ft. above the hooks. A strong cable was run over this pulley down to the bottom of the stack on the inside, where it was run over another pulley, fastened to the stack by means of an eyebolt, and out through the opening to a winch. As each section was

Adjustable Platform Built inside Huge Smokestack Allows Workmen to Dismantle It in Sections, Which Are Lowered without Damage by Means of a Strong Cable and Winch

In dismantling a huge smokestack, 7 ft. in diameter and 180 ft. high, professional steeplejacks were confronted with the problem of doing the job without damage

removed, the platform was lowered to the next row of rivets, a few of them being removed and the metal sprung apart to admit the hooks over the edge of the stack.

### Lock Washer from Sheet Metal Has Fine Adjustment

Here is a washer that has a fine adjustment. To make one, scribe two concentric circles on a piece of sheet metal, the diameter of one equal to the width of the nut across the flats, and the other  $\frac{1}{2}$  in. larger. Then, between these lines, cut out the metal to form tabs, cutting five tabs for hexagonal nuts and seven tabs for oc-

tagonal nuts. A projection should be left in the washer to fit the key slot on the shaft to prevent the washer and nut



from turning. For shafts not fitted with a slot, an extra tab can be formed on the outside edge of the washer to be turned back against some part of the mechanism to hold it.



### Sandpaper Helps Run Self-Feeding Press

When operating a self-feeding platen press, I was troubled by the sheets of paper sticking together so that two or three of them would pass through at the same time. As a remedy, I glued strips of fine sandpaper, bent out slightly at the top, to the front guide. As the suction cups lift the paper, any extra sheets clinging to it are raked off by the sandpaper. If the table is too close to the front guide to enable the insertion of the sandpaper, it may be necessary to put a strip of cardboard under the guide at each wingnut.—Fred H. Birch, Glendive, Mont.

### Clamps Hold Carpet on Stone Stairs

To hold carpets tightly on stone and metal stairs, the illustrated clamps have been used successfully. Take a short length of pipe or tubing and insert an iron rod that is threaded for a nut as shown in the detail. A steel washer is placed between the nut and pipe. In use, the carpet is folded over at the bottom, the pipe placed on it and the rod is screwed up against the underside of the next step.—R. M. Rodgers, Brooklyn.

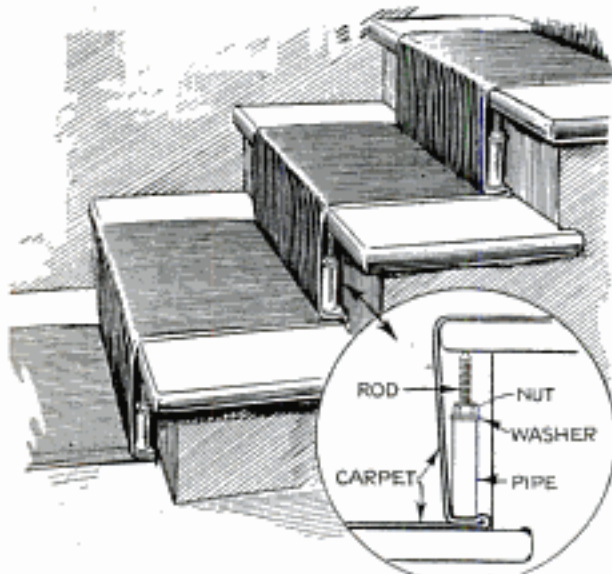

Clamps That Resemble Small Jacks Hold Carpet on Stone and Metal Stairs

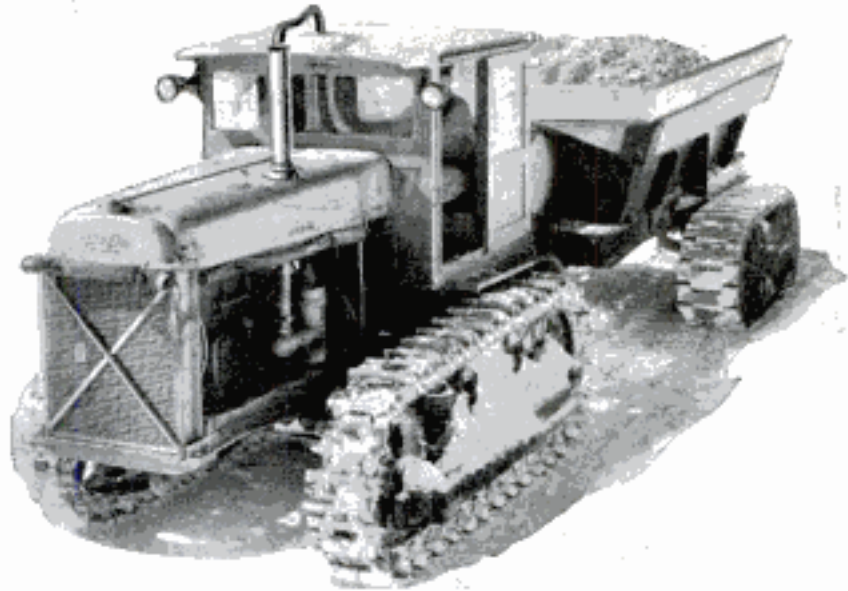

Driver Made Comfortable in Tractor Cab That Is Heated by Running Exhaust through Flexible Pipe Coiled Inside of Cab

### Homemade Heater for Tractor Cab

A gold-mining company near Alma, Colo., that runs a tractor in extremely cold weather, utilizes the exhaust heat to keep the driver warm. A length of flexible pipe is inserted into the exhaust pipe, run through the top of the cab and out through the side near the bottom. The pipe does not give off fumes and the temperature inside the cab can be regulated by making a few coils in the part of the pipe that runs inside the cab.

### Engine Is Automatically Stopped When Water Tank Is Full

When pumping water with a magneto-equipped gasoline engine, it can be automatically shut off when the tank is filled by running an insulated wire from the magneto terminal to the tank. Scrape the insulation from the end of the wire and fasten it in position on the tank so that the bared portion just reaches the desired water level. When the water reaches the end of the wire, the magneto will become grounded and stop the engine. At all other points the wire must, of course, be well insulated to prevent it from being grounded.—F. Mix, Chicago.

☞ Draftsmen who use hard and soft pencils alternately, or pencils of varying hardness, can save time by fastening two short pencils together by means of a brass or aluminum tube.



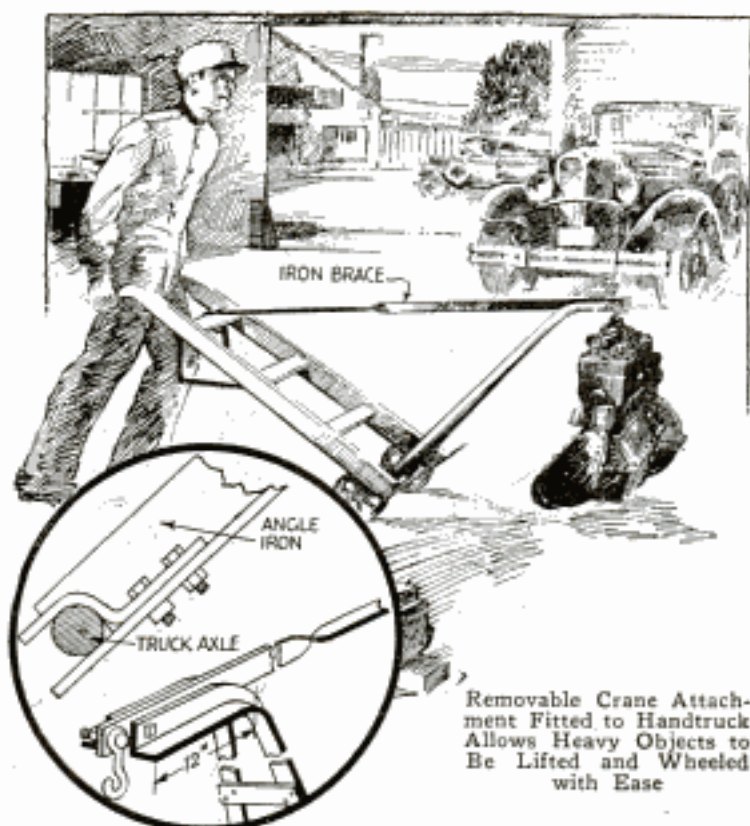

### Portable Crane on Handtruck to Move Heavy Loads

When moving heavy objects that are awkward to manage with a handtruck, a detachable crane for the truck makes the task comparatively easy. It consists of two 3-ft. lengths of angle iron, supported on the truck axle by a flat-iron brace. A heavy iron hook is bolted to the end.

### A Babbitting Putty That Keeps

To make babbitting putty that will keep indefinitely and always be ready for use, take some fuller's earth, or any dried ground clay, and add enough glycerine to form a stiff dough. This putty can be used over and over again, and should be kept in an air-tight container.

### Cloth-Covered Idler Pulley Removes Oil from Leather Belt

Oil can be removed from a leather belt by allowing it to run over an idler pulley around which six or eight turns of cloth, such as canvas or blanketing, has been wrapped tightly and the ends sewed together. The belt should be allowed to run over the pulley for a few days, then be re-faced and arranged to run on the oppo-

site side of the belt for a few more days, after which most of the oil will be absorbed.

### Make Your Own Hydraulic Press at Small Cost

At small cost you can make a hydraulic press that will be useful in your shop. The hydraulic part is a small auto jack that works inside a framework of 1½-in. angle iron, which consists of four uprights and eight cross-braces, fastened together with stovebolts. The bottom braces are drilled for wood screws for attaching the frame to a workbench, while the top braces are drilled for mounting a wooden top, which covers the sharp edges of the frame and serves as a tool rack. The jack is supported by two angle-iron pieces, which are placed diagonally across the bottom of the frame. Notches are cut in these pieces where they rest on the edges of the crossmembers, to prevent slipping. In order to accommodate objects of varying thickness, the press is made adjustable by a movable table of angle iron, against which a hardwood top is placed to provide a smooth surface for the work. The table is supported on ½-in. steel cross rods that are passed through opposite holes in the uprights.

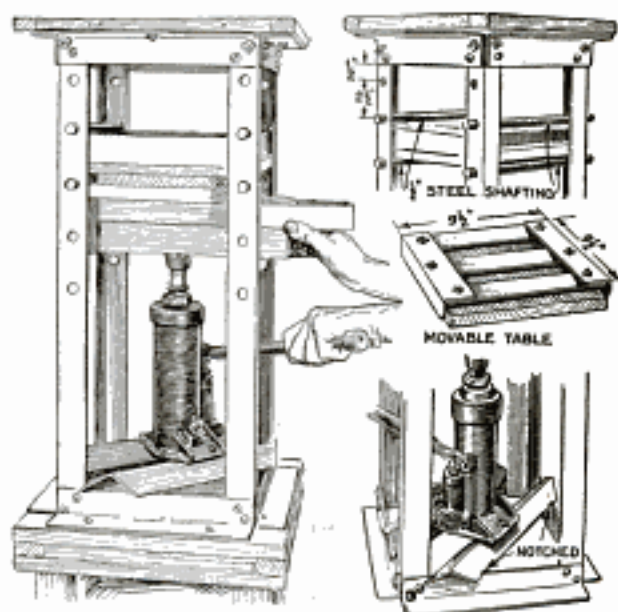

Hydraulic Auto Jack Fitted with Angle-Iron Frame  
Makes Press for Light Shop Work



# Electric HALL CLOCK is Easy to Build

by W. Clyde Lamme

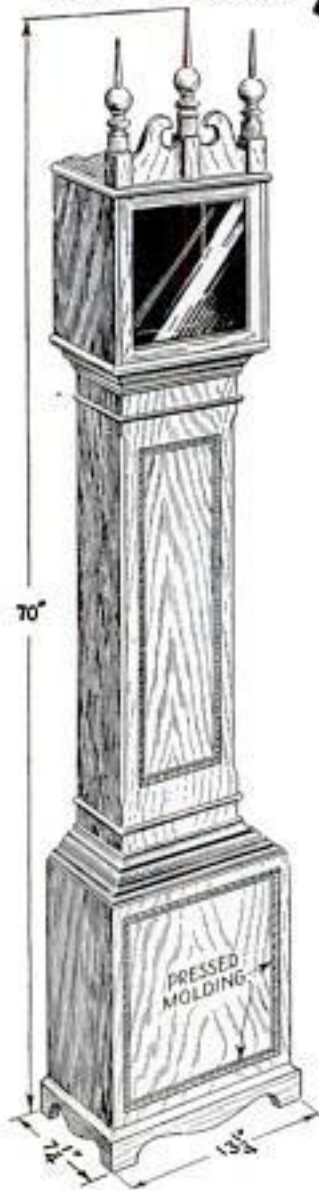

**E**QUIPPED with electric movement, this "grandmother" type of clock makes a pleasing addition to your hall furniture.

First purchase the movement with its dial, as the shape and size of the latter partly determine the exact dimensions. The size indicated in the drawings takes a dial  $8\frac{3}{4}$  in. square.

Beginning with the base, Fig. 5, rip a piece from  $\frac{9}{16}$ -in. mahogany stock to  $7\frac{1}{4}$ -in. width and cut off to  $13\frac{1}{4}$ -in. length, which size allows  $\frac{1}{2}$  in. for the molding on three edges, the latter being made as in the lower right-hand detail. Next, bandsaw the feet, shown in the detail B of Fig. 1 and in Fig. 4, from  $\frac{13}{16}$ -in. mahogany plywood, with the grain running the short way. Miter the joining ends and fasten the feet of the base with screws and glue, as shown in the upper photo on

page 692. The front base compartment or plinth is built up as shown in Fig. 5. Edge-gluing without dowels will be amply strong if the edges are joined true, waterproof casein glue being used. Rip out several triangular blocks from  $1\frac{1}{4}$ -in. stock and fasten them in the inside corners with a rubbed-glue joint, which is made by spreading glue and rubbing the block over the surface until the glue sets sufficiently to hold it in place. Square the joining ends so that the compartment stands perfectly upright when placed on the base. Then fasten with screws and glue. The waist or column, Fig. 3, is built from mahogany stock cut to the dimensions indicated and joined in the same way as the parts of the plinth. Before assembling, the edges of the front piece are chamfered as shown, and one edge of each side is rabbeted  $\frac{1}{4}$  by  $\frac{1}{4}$  in. to take a plywood back panel. The top compartment or hood is shown in Fig. 2. Both top and bottom pieces are molded on three edges as indicated. Besides rabbeting the back edge of the sides as in the waist and

*referring and dry battery movements*

*Kneipfel also electric movement, also*



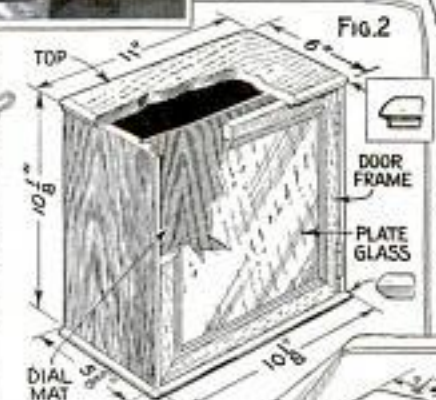
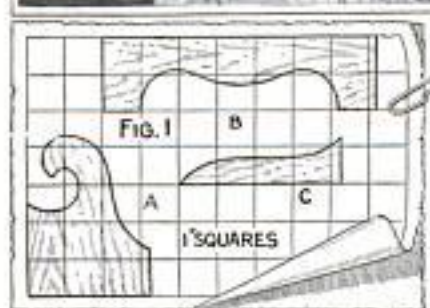

er waist molding. Bore a hole near the back edge of the plate of sufficient size to allow the plug on the movement cord to drop through, and another hole through the lower plate of the hood. For the hood door, the dimensions given in the upper details of Fig. 7 will be found satisfactory enough for the average dial, the idea being to give full view of the dial at an angle as well as directly before it. The ends are mitered and center-slotted, with a saw kerf to take a key or tongue. Before joining them, a rabbet,  $\frac{3}{8}$  by  $\frac{5}{16}$  in., is run on each piece to take the glass as in the frame section. The parts are then joined with glue and keys in each joint and drawn tight, to dry, with bar clamps across the four corners. Do not fit the door until the case is completely assembled.

Next, the upper and lower waist moldings must be applied, as in Fig. 7. If you have no molding-cutter head for the saw arbor, moldings may be made by hand with the aid of the saw, as indicated in the lower detail, the waste being pared off with a gouge. After smoothing with sandpaper wrapped around a length of  $\frac{3}{4}$ -in. dowel, you will have a good cove

plinth, the front edge is also rabbeted,  $\frac{5}{16}$  by  $1\frac{1}{16}$  in., to take the door frame, the depth of the rabbet leaving the stock project  $\frac{1}{8}$  in. beyond the door frame, which is rounded to form a bead. The position of the groove that takes the dial mat (of birch plywood), Fig. 2, is determined by the projection of the post carrying the hands of the movement. Make sure of this measurement, then run the grooves and assemble the sides to the bottom plate with screws and glue. Leave the top piece off until the case is assembled.

The case is then set up as in Fig. 6. The plinth is joined to the waist with screws driven through holes in the blocks, which are placed as shown, and secured with glue and screws. The partly finished hood is then fastened to the top end of the waist in the same way. When placing the parts, make equal allowances for upper and low-

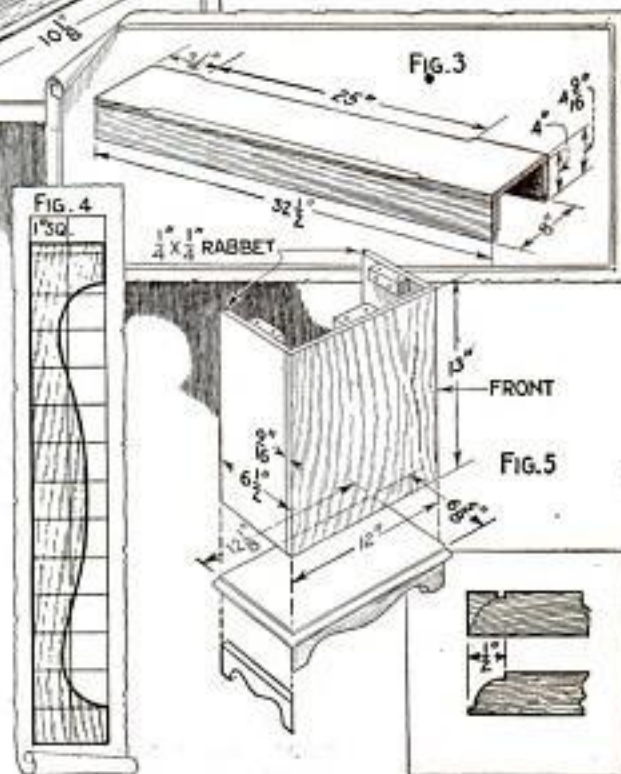



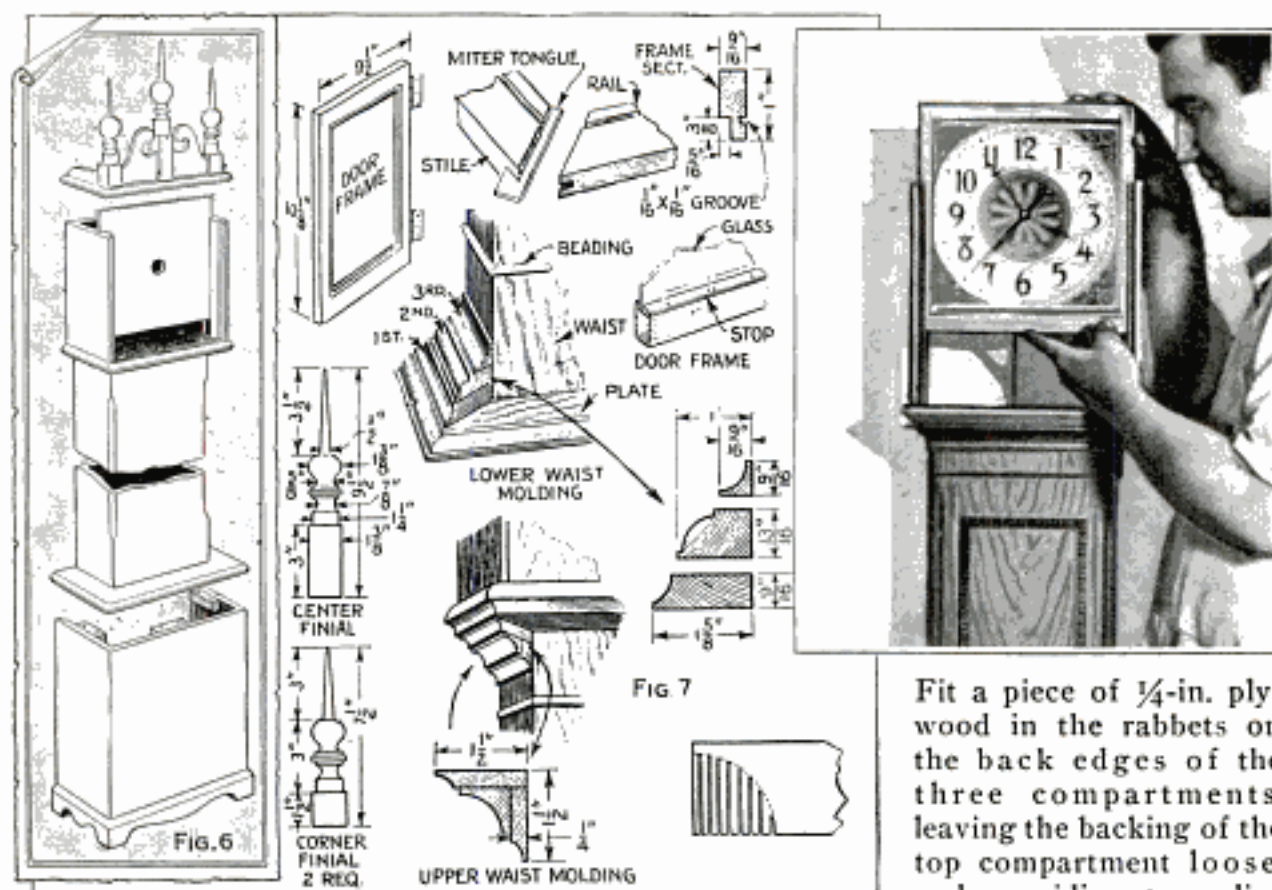

molding. The molding pieces are laid up as shown, mitered carefully at the corners and secured with glue and  $\frac{3}{8}$ -in. brads, the heads of the latter being set in. The upper waist molding is assembled on the case in the same way. Pressed molding, about  $\frac{5}{8}$  in. wide, is used on the front of the waist and the plinth about  $1\frac{1}{4}$  in. from the edges. Be sure to get it parallel with the edges and square across the ends.

Next, bandsaw the scrolled parts A and C, Fig. 1, two of each, with the grain running as indicated. Also turn the three finials. Then assemble the parts on the top piece of the hood, and fasten with screws driven up from the underside of the top piece. These two parts give the false front a better appearance when viewed from the side. Then locate the movement with the hand post projecting through the center hole in the mat. In some cases it is necessary to scrollsaw a rectangular opening to take the movement, which is screwed directly to the dial. Screw the dial to the mat and slide the latter in the grooves. Screw the top in place last, making certain that the sides of the hood are exactly the same distance apart. Then fit the door and hinge, providing it with spring latch and small pull.

held with screws, to keep it in place. Drill a hole through the backing of the plinth and lead the movement cord down through the case and out the back.

Sand all parts of the case with progressively finer grits, either by hand or with an electric belt sander, until the surface is smooth. Then stain the wood with brown mahogany oilstain, rubbing out the centers of all flat surfaces to give an antique finish. Allow to dry thoroughly, fill with paste filler colored to match, fill nail and brad holes carefully, sand lightly and apply two coats of white shellac or spirit varnish. Sand lightly between coats and rub down the last with powdered rottenstone and oil. Then finish with two coats of furniture wax, rubbing down to a polish.

#### How to Adjust Small Microscopes

Most small microscopes are adjusted with the lens, which is not always accurate. To get the best results, merely loosen the main objective lens so that it can be turned in both directions. The turning of this lens gives a nearly perfect adjustment without altering the instrument in any way.—B. Woolsey, Ridgefield Park, N. J.



## Tire Spreader for Small Garage Is Portable

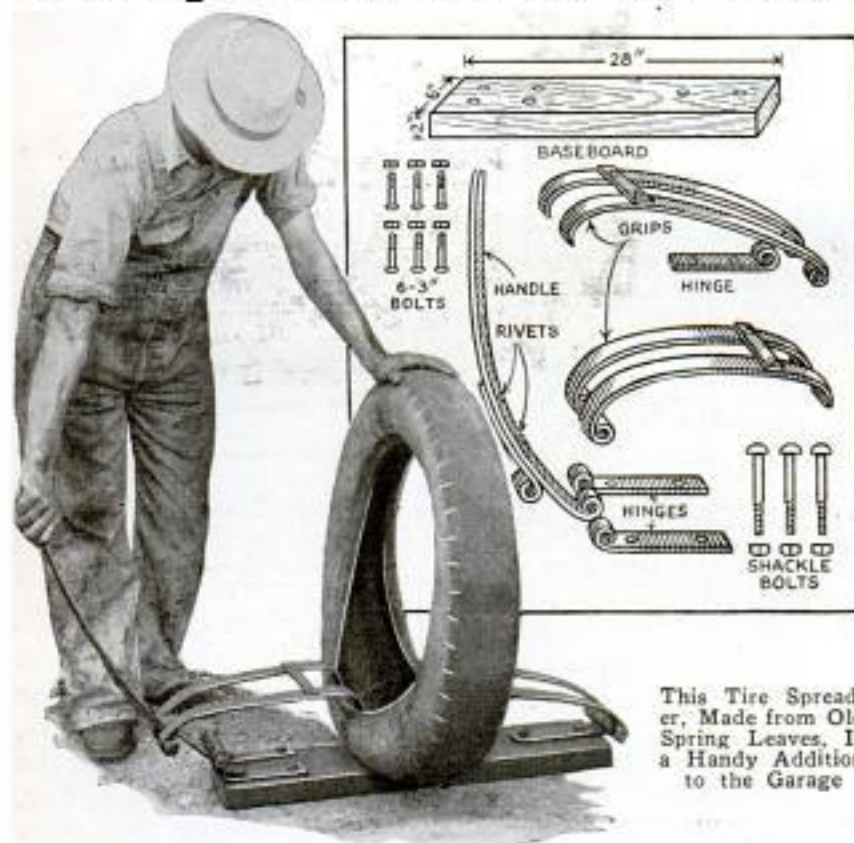

This Tire Spreader, Made from Old Spring Leaves, Is a Handy Addition to the Garage

Made from the leaves of an old car spring, this portable tire spreader will be found useful in the small garage. Four

of the leaves are formed to make two grips, an eye being bent on one end of each leaf to take a shackle bolt, which serves as a hinge pin, while the other end is bent to form a hook. One of the grips is hinged to one end of a suitable baseboard by means of a short leaf, and the other grip is hinged to a handle, also made from one of the longer spring leaves, which is in turn hinged to the base between two shorter leaves, as indicated. In use, the tire is set on the baseboard, and the grips hooked over the beads. By pushing down on the handle, the tire is opened with little effort. If desired, the spreader may be mounted on a bench, or it can be carried about.—Archie S. Welch, Springfield, Ohio.

### Abrasive Compound Renews Bolt Threads

When the threads on a bolt become rusty and the nut is hard to unscrew, apply a little valve-grinding compound to the inside of the nut and run it back and forth on the threads. These will be cut and the rust removed in a short time.

### Triple Hook for Crane or Fall Block

This triple hook for carrying castings, or broad-surfaced metal articles, is made from three lengths of  $\frac{3}{4}$  by  $1\frac{1}{2}$ -in. bar iron. Each bar is given a quarter twist and the end is then bent to form a hook. A number of holes are now



drilled in the shank of the longer hook to enable adjustment for width, the three bars being held together with a bolt, to which a clevis is also attached.

### Stand Equipped with Rollers Supports Angular Work

A V-shaped holder, fitted with rollers to facilitate the sliding of stock, is handy for supporting lengths of angle iron. It is welded to the end of a rod which telescopes into a pipe welded to a suitable base. After adjustment for height, a large cotter key is inserted in one of the holes drilled through the rod as shown.





### Adapting Power Hacksaw Blades to Hand Work

Power hacksaw blades are often handy for making wider slots than can be cut with a handsaw. As they are too long to fit in the frame of a hacksaw, they can be used by fitting them with a special handle. Such a handle is made by bending double a piece of metal of a suitable size, and fastening it to the ends of the saw blade.

### Extra Glass Improves Level

Attached to one end at a 45° angle, an extra glass will increase the usefulness of a level. One end of the level is beveled at exactly 45° and the glass attached. The angle may be checked by standing a 45°



triangle or try-square on a level surface and laying the bottom of the level along the diagonal side. Any deviation can be corrected by inserting paper or shim stock under the end

of the glass if it has to be raised.—W. C. Wilhite, Hornsby, Ill.

### Breaking Cast Iron with Water

In France, advantage has been taken of the non-compressibility of water in breaking up large masses of cast iron. The method is simple, and consists in drilling a hole in the mass of iron to a depth of about one-third of its thickness. The hole is filled with water and closed with a steel plug. A ram is then permitted to fall on the plug, and the impact splits the iron.

## 300 Blueprints for Home Craftsmen

**IN ORDER** to supply our readers with workable drawings of large size (17 by 22 in.) for convenience in making the projects published in *Popular Mechanics Magazine*, we have prepared blueprints on almost everything that is of interest to the home craftsman. Prices: Single prints, 25 cents; six prints, \$1, postpaid.

For more information, and a complete list of all our blueprints kindly write to Blueprint Dept., *Popular Mechanics Magazine*, 200 E. Ontario Street, Chicago.



Recess in Edge of Bench Aids Machine Operator When Cutting and Sewing Heavy Fabrics

### Improved Bench for Fabric Workers

Cutting and sewing broad strips of heavy fabric can be made easier for the operator, if the machine is mounted on a wide bench with a deep recess in the side as shown. This provides a larger surface for supporting and turning the material. The recess should be made several inches wider near the machine to provide ample room for movement of the arms. The corners and edges should be rounded off smoothly to prevent injury to the clothing.—Jos. C. Coyle, Englewood, Colo.

### Rejuvenating Tungar Rectifying Bulbs

Rectifying bulbs that have good filaments, but do not deliver their rated amperage, can be rejuvenated as follows: Connect the secondary terminal of a model-T Ford coil to the top terminal of

the bulb, then connect the upper side and the bottom terminals of the coil to the poles of a 6-volt storage battery. Also run a separate wire from the upper side terminal of the coil, and touch it alternately to the filament connections of the bulb for about two minutes at a time, until each one has been thus connected for four minutes.—Erle C. Freeman, Portland, Ore.



9/10 Technical Service Bureau  
6803 N. Clark  
Chicago

# Electro-Chemist tells

By Clyde A. Crowley  
Consulting Chemical Engineer



HYDROCHLORIC ACID FOR THE BRIGHT DIP SHOULD BE CAREFULLY MEASURED

**C**HEMICALLY clean work is the first requirement in electroplating, and this can best be obtained by putting all articles to be plated through a systematic cleaning routine.

First, wash the work in gasoline or carbon tetrachloride to remove grease and oil. A mixture of equal parts of these two solvents is effective and practically non-inflammable. Lacquer remover is necessary if the work to be plated has been finished in that manner. A final scrubbing with hot soapsuds, to which a small amount of washing soda has been added, will remove the last trace of grease and oil. The cleaned article should be rinsed first in hot and then in cold water to rid



SOAPSUDS TO REMOVE LAST TRACE OF GREASE

it entirely of soap. Second, if the work is of iron or steel, all scale and oxide must be removed by pickling in a sulphuric-acid bath. This consists of one part of commercial sulphuric acid and ten parts of water by volume. Do not pour the water into the acid, but pour the acid into the water slowly. This should be done in a stoneware crock. Glass is not suitable, because considerable heat is generated when the acid is poured into the water. Cast iron should be dipped several times, rinsing and brushing between dips. To remove heavy oxide coatings from brass and copper a "bright dip" is effective. The work should be quickly dipped into the solution, removed, and thoroughly rinsed in hot and then in cold water. Too long a time in the bright dip will cause deep pitting. A good bright dip is made by adding 1 lb. of commercial nitric acid and  $\frac{1}{2}$  oz. of commercial hydrochloric (muriatic) acid to 3 qt. of water in a stoneware crock. To this add slowly 2 lb. of commercial sulphuric acid. Allow to cool before using. Crock containing the bright dip and the pickle solution may conveniently be set in the sink while in use. If cold water is allowed to run into the sink while the work is progressing, spilled acid will be diluted and safely carried away before it can attack the plumbing. The bright dip will give off nitric-oxide fumes while it is in use. These fumes may be removed by proper ventilation. The surface of soldered or brazed work usually has a hard scale, together with crystallized borax or flux. This can be removed by pickling the work in 1 gal. of water to which has been slowly added 1 oz. of sodium dichromate and 10 oz. of sulphuric acid. After the scale has been removed by this treatment, the work may be bright-dipped as previously described. In using any of these chemical cleaning baths, it is important to rinse the work first in boiling-hot, then in cold water im-



# Secrets of PLATING

with  
Copper,  
Nickel  
and  
CHROMIUM



mediately after its removal from the bath. The hot water will aid in forcing the metal to give up any hydrogen gas which it has absorbed and which would cause brittle electroplates. Besides, pitting will result if any acid is left on the work.

The third step in cleaning is that of polishing and buffing the surface of the work to render it smooth and lustrous. In the case of castings, it may be necessary to use a grinding wheel before the work is finished with finer abrasives. The plater must decide for himself just how many grades of abrasives are to be used in the polishing operations. Emery powder is available in a large variety of fineness. For most purposes No. 120 emery is adequate for the first polishing. If the powder is used, it should be run onto a cloth buffing wheel which has been previously sized with a good grade of glue. It is more convenient to buy the abrasives in stick form (abrasive mixed with a suitable grease binder). In this form they vary from fairly coarse, such as No. 120, to very fine, such as No. 150. To use, the stick abrasives are brought in contact with a rotating cloth buffing wheel. The heat generated will melt a portion, which will adhere to the surface of the cloth. The work is polished by moving it in contact with the wheel.

Finer grades of abrasive may be used progressively until the surface has the desired polish. Many abrasives other than emery are available, and most of them can be obtained in stick form. A number of these, listed in order of fineness, are emery, tripoli, pumice, crocus, lime, and jewelers' rouge. The last is the finest and softest. The importance of polishing and buffing will be realized when it is understood that the plated work will be no smoother than the polished work before the plating.

After the surface of the work has been buffed and polished to the desired finish, the film of polishing grease must be



WEIGHING COPPER  
CARBONATE FOR  
ELECTROPLATING BATH

*Should have shown  
copper cyanide* <sup>697</sup>





WORK CLEANED  
IN A SOLUTION  
OF GASOLINE  
AND CARBON  
TETRACHLORIDE

should be used as hot as possible. When the proper cleaner has been selected, the work should be suspended in it and the rheostat adjusted until a large volume of gas is being liberated from the work suspended from one of the rods. Reverse the current every few seconds with the switch. The work need be left in the electro-cleaner only a few minutes. If it contains solder, the time must be very short to prevent its being dissolved. Remove the work and rinse in hot and cold water. If, after thorough rinsing, the water tends to form globules on the surface rather than flow smooth, the cleaning is incomplete. In this case, it will be found most satisfactory to scrub the work with finely powdered lime. Then, after rinsing, repeat the electro-cleaning operation, and after the work has been thoroughly cleaned, dip it in the acid or bright dip and rinse as before.

removed. This is best accomplished by electro-cleaning. This is carried out by hanging the work from copper or brass rods in an electro-cleaning solution in a crock or battery jar. Two rods must be used. Work may be hung from both rods, but if only one piece is to be cleaned, any piece of scrap lead or iron may be hung from the other rod to complete the circuit. The supporting rods are connected to a storage battery and rheostat through a reversing switch, as in Fig. 1. The proper cleaning solution to use depends upon the kind of metal of which the work is made. For iron or steel, dissolve one-half can of lye and a quarter of a bar of good laundry soap in 1 gal. of water. For brass and similar alloys, dissolve 4 oz. of washing soda, 2 oz. of trisodium phosphate, one-eighth of a bar of soap and  $\frac{1}{2}$  oz. of lye in 1 gal. of water. For articles made from aluminum or zinc, use a solution made by dissolving 3 oz. of washing soda and 3 oz. of baking soda in 1 gal. of water. All of these solutions

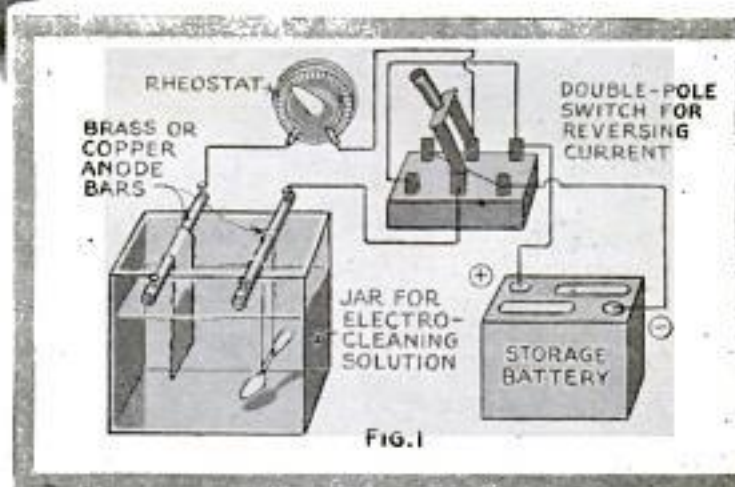

The work is now ready for its first electroplating bath. If the solution is not ready, the work should be kept suspended in clean water. This will prevent oxidation and accumulation of dirt, either of which is ruinous to plating. To prepare a good chromium-plating solution, dissolve 33 oz. of chromic acid in 1 gal. of water. To this solution add  $1\frac{1}{2}$  fl. dr. of concentrated sulphuric acid. This solution is very corrosive to skin and organic matter. It should be kept in a glass-stoppered bottle and protected against spilling or breakage. If desired, you can use one of the patented chromium-plating solutions which can be purchased ready for use.



They are very effective and the cost is not high. Although this solution will plate fairly well at room temperature, it works better if it is kept at a temperature of about 100° F. This may be accomplished by setting the glass or stoneware plating tank on blocks of wood in a larger container, such as a pail, in which enough water is kept to surround it as shown in one of the photographs. The assembly can then be heated without danger of breakage or overheating. A thermometer can be immersed in the water surrounding the plating tank. The chromium comes from the solution; therefore inert anodes of sheet lead or steel are used. These are suspended from heavy brass or copper bars resting across the plating tank and connected directly to the positive pole

CHROMIUM-  
PLATING BATH  
WORKS BEST  
AT 100° FAHR.

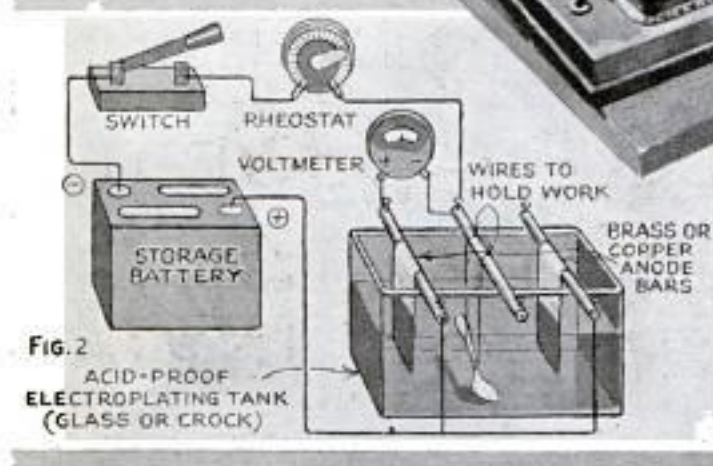

of the battery. Another bar is placed between the two anodes. From this bar, or cathode, the work is suspended by means of copper wires. It is connected to the rheostat, which may be an old radio-filament rheostat or a salt-water rheostat. The other binding post of the rheostat is connected to the negative pole of the battery through any kind of switch, which is handy for turning off the current while removing or inserting work. A voltmeter, reading from 0 to 10 volts, should be connected to one anode and to the cathode bar of the tank. When the outfit is assembled, newspapers are spread over the top of the plating tank to absorb the corrosive

acid fumes which will be liberated, and the switch is then closed. The rheostat is adjusted until the voltmeter reads about 4 volts. After a few seconds, the current is turned off and the work examined for plate. If no plate has formed, it will be necessary to vary the voltage up and down until results are obtained. Some patience will be required here, as

the temperature, the purity of the chemicals and the kind of work all have influence on the formation of the chromium plate.

In four to five minutes a chromium plate adequate for most purposes can be deposited. If the plate does not form on the work directly under the suspension wires, the wires must be shifted so as not to interfere. If a defective plate is produced, it may be quickly stripped off by immersing the work in dilute hydrochloric (muriatic) acid. After rinsing, another trial may be made. Chromium may be plated directly on iron, but the deposit is likely to be porous and will offer little



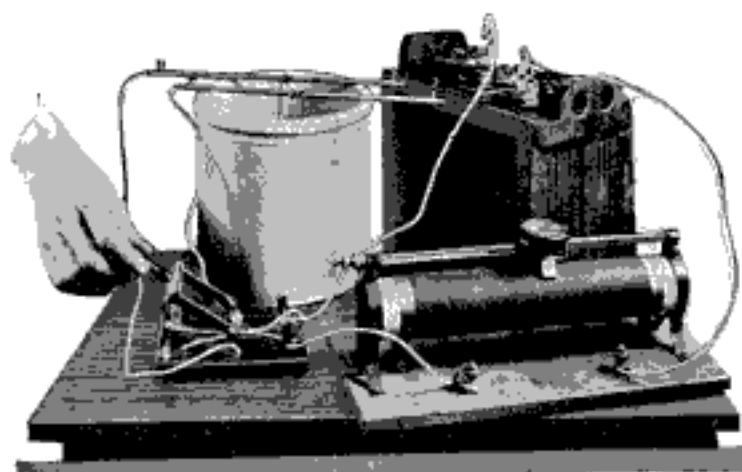

REVERSING CURRENT DURING ELECTRO-CLEANING PROCESS

protection against corrosion. When mechanical durability, such as is needed for golf clubs or tools and dies, is desired, this method should be used. For protection against rust and for the best finish, undercoats of copper and nickel are necessary. For decorative purposes steel articles should first be plated with a heavy coat of copper, then with a medium-heavy plate of nickel. Chromium may then be plated over the nickel in the same manner as before. To produce the copper plate, connect the apparatus exactly as for chromium, except that pieces of sheet copper are to be used as anodes. The solution is the dangerous cyanide-copper solution. It is a deadly poison, and its fumes must not be inhaled. If any abrasions exist on the hands, wear rubber gloves while handling it. It can be absorbed through cuts, the eyes, or other tissues; therefore prepare it in a draft which carries the fumes away from you and avoid contact with it. To prepare the solution, dissolve 1 oz. of sodium carbonate in 1 gal. of water. Then add  $3\frac{1}{2}$  oz. of sodium cyanide (poison) and stir with a stick until dissolved. Weigh out 3 oz. of copper cyanide (poison). To a small portion of the above solution, add the copper cyanide and work it into a paste with a stick. Add this paste to the rest of the solution and stir care-

fully until it dissolves. Add  $\frac{1}{8}$  oz. of hypo, and the solution is ready to use. It should be used at room temperature. The rheostat should be adjusted so that the voltmeter reads about 4 volts. Be sure that the work is well rinsed before placing it in this bath; also avoid spilling acid or other solutions in the bath, as this would cause the liberation of large quantities of hydrocyanic-acid gas. An immersion of thirty minutes will produce a good plate on the work.

After plating with copper, rinse the work thoroughly and nickelplate it in a solution made by dissolving 12 oz. of nickel sulphate, 4 oz. of nickel chloride and 2 oz. of boric acid in 1 gal. of water. Use sheets or bars of pure nickel as anodes. Adjust the rheostat until the volt-



COMMERCIAL ANODES

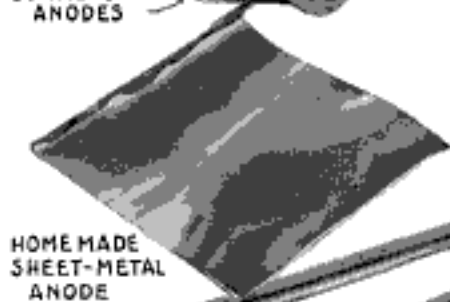

HOME MADE SHEET-METAL ANODE

BRASS RODS WITH SCREWS TAPPED INTO ENDS

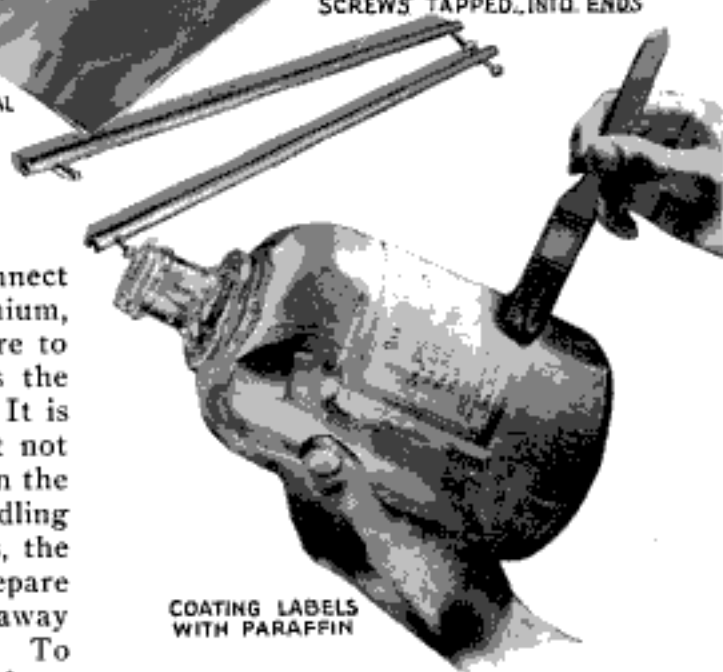

COATING LABELS WITH PARAFFIN

meter reads 5 volts. After a few minutes, readjust the rheostat without opening the switch until the voltmeter reads a little less than 2 volts. For a heavy plate, let the current flow for about forty minutes; for a thin plate, fifteen minutes will suffice.

The completed nickelplate should be rinsed thoroughly, dried and polished with



gentle pressure, using fine Vienna-lime paste on a soft muslin buffing wheel. After the nickel is polished, the work should be rinsed in hot and cold water and electro-cleaned as before to remove the polishing grease. It should then be immersed in the acid dip and rinsed again with hot and cold water. The work is now ready for the chromium, if this is desired. Plate on the chromium as previously described for three to four minutes. After rinsing, the chromium may be polished to a brilliant luster with any good grade of chromium-coloring paste applied with a soft muslin buffing wheel. Chromium may be effectively plated onto well cleaned copper. Brass, zinc and silver articles should be nickelplated before attempting to plate them with chromium. The nickelplate in these cases should be polished exactly as for steel.

If you intend to do considerable work in plating, standard commercial anodes may be used, obtainable at any electroplating-supply house, or homemade sheet-metal anodes can be employed. Convenient hangers from which they are suspended are made from lengths of brass tubing of sufficient strength to hold the anodes. To make it easy to connect your wiring to them, drill and tap the ends for a small 6-32 machine screw as shown. Bottle labels of paper, which may be quickly eaten off by acid, can be protected by coating them with melted paraffin.

### Wire Hooks Hold Brick Veneer

When laying veneer bricks, wire hooks like that illustrated should be placed over the studs and cemented between the bricks, a few in each row. These hooks



will hold a large surface of brick veneering securely, and prevent it from pulling away from the studding. Medium-heavy fence wire is used to make them, and a bending jig will form a large number quickly. They should fit around the studs tightly.

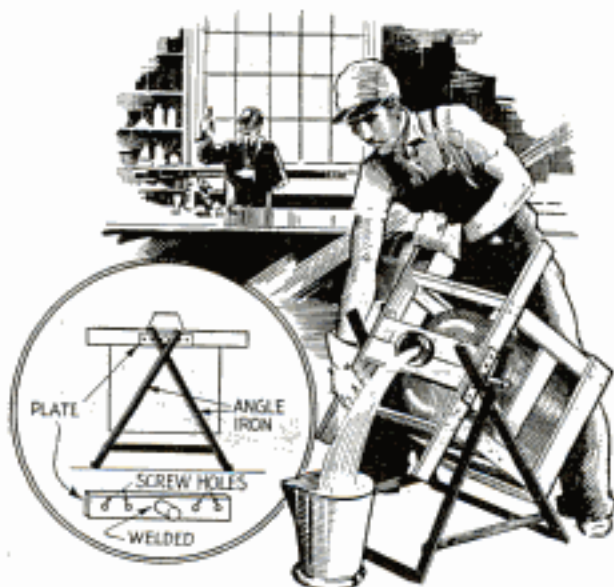

Contents of Large Carboy Safely Poured by Pivoting It to Angle-Iron Stand

### Carboy Containing Acid Swings on Angle-Iron Frame

Large carboys containing acid, which are rather dangerous to tip when filling smaller bottles, can be safely handled by pivoting them on an angle-iron stand as shown. Lengths of 1-in. rod are welded to metal plates, which are drilled so that they can be screwed to the carboy frame and serve as pivots.—R. M. Thomas, Denver, Colo.

### Eliminating Static Electricity in Belts

Where belts are used near explosive or highly inflammable material, caution is necessary to prevent the accumulation of static electricity, which is generated by belt slippage and the continuous making and breaking of contact between the belts and the pulleys. It is also generated by friction between the belts and the surrounding air. To ground it, one large powder manufacturer coats the belts with a graphite solution, while another keeps the belts automatically moistened with a solution of water and glycerine in equal parts. Either of these solutions makes the belts conduct electricity and allows it to escape through machines provided with metal pulleys. On wooden pulleys a band of copper may be attached to the face and connected to the shaft. Another method is to use good non-slip high-friction belts that are smooth on both sides and have good conductivity.



### A Paperhangers' Combination Table and Ladder

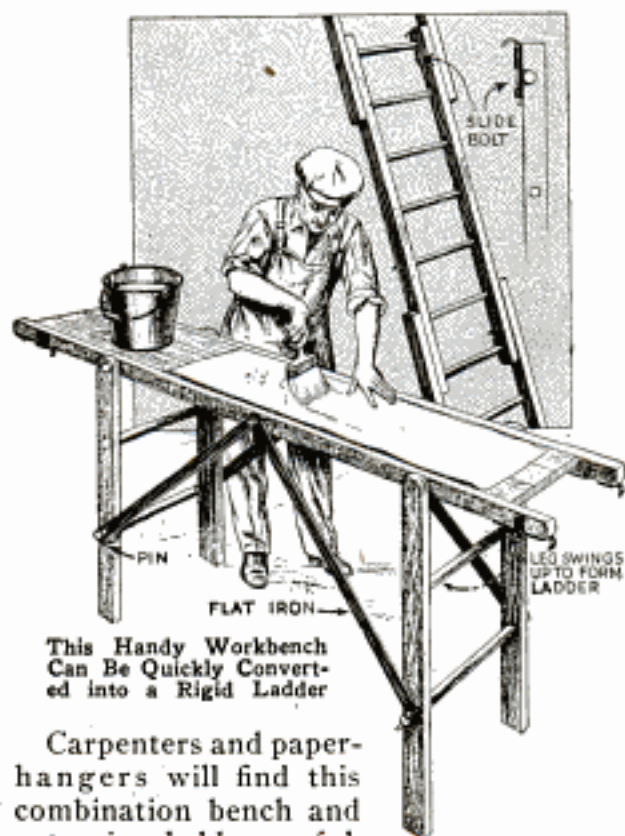

This Handy Workbench Can Be Quickly Converted into a Rigid Ladder

Carpenters and paperhangers will find this combination bench and extension ladder useful.

It consists of three lengths of ladder pivoted together as shown, the middle section being longer than the end sections. For use as a bench, the latter are swung down to serve as legs, and are held in position by means of flat-iron braces pivoted to the middle section and slipped over the ends of the extending lower rungs on the legs. Lengths of 2 by 6-in. stock are placed over the rungs of the horizontal piece to form the top of the bench. For use as a ladder, the iron braces are disconnected and the legs swung up, the upper rungs fitting into notches cut in the ends of the middle section. Slide bolts are fitted over the notches and, when fastened, these hold the legs firmly, making a rigid ladder.

### Paint for Hot Surfaces

One of the cheapest ways of painting surfaces that reach temperatures above 350° F., such as smokestacks, is to give them a coat of black asphaltum varnish. Although this may not last very long if the temperature is high, the cost of renewal is not high, as asphaltum varnish is inexpensive. Oil paints are not satisfac-

tory at temperatures above 350 because the heat is harmful to the linseed-oil binder.

### Faceplate Clamps Hold Irregular Work in Lathe

Some types of work that is hard to hold either in a chuck or faceplate is easily held with clamps consisting of a square piece of cold-rolled stock and a capscrew. A jaw, or prong, is formed at one end of the piece by cutting a slot, ending in a hole, across one end as shown in the upper detail. The jaw can be pushed forward by means of a capscrew in a hole drilled and tapped through to the slot from the opposite end of the piece. The screw should have a movement of no more than  $\frac{1}{16}$  in. when driven down, to prevent breaking the jaw, which is rounded off at the corner near the bottom of the slot, and also sideways so that it can be used internally. The block is then drilled and tapped in the side for a capscrew to hold it to the faceplate. In use, the clamps with the screws turned back, are run up to the work, and there attached firmly to the faceplate. The screws are tightened, forcing the jaws against the work. As the clamps can be turned in any direction, they are adaptable to work of any shape which can be held from the side. The lower detail shows how irregular work can be clamped to the faceplate.

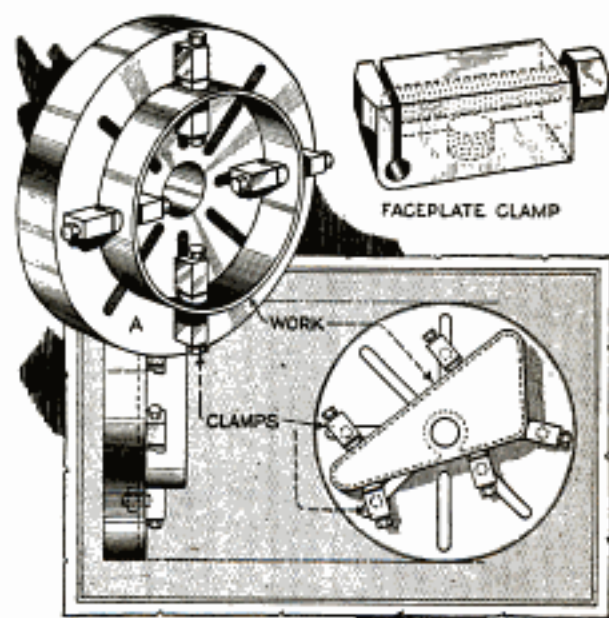

Round and Irregular Work Can Be Held to a Faceplate with These Clamps



### Monel-Metal Oil Strainer

Designed by an engineer, an oil screen that eliminates the perforated pipe usually employed to hold the screen rigid, is made of fine-mesh monel-metal wire cloth, which is strong enough to withstand any ordinary strain on the screen without any protection. Monel metal is easily soldered and quickly cleaned. With such a screen, more surface is obtained for the oil to flow through, thus eliminating clogging where a large quantity of oil is to be strained.—W. F. Schaphorst, Newark, N. J.

### Chart Aids in Determining Amount of Pipe and Fittings for Job

Often a puzzling job of pipe fitting can be simplified by laying it out on a piece of paper ruled in squares. For example, the pipe necessary for fitting a round tank with coils can be determined by drafting

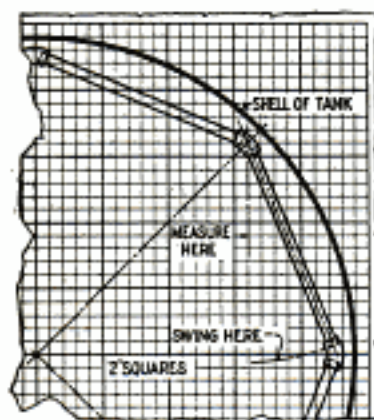

it out as shown, measuring a connection to get the proper allowance at the angles. The coil can be located any desired distance from the sides of the tank, and the length of pipe needed

is determined by counting the squares on a side where the pipe runs parallel to the ruling of the paper. If it is not parallel, the distance can be set on a compass and swung onto one of the rulings.

### Testing Compression of Auto Motor

Loss of compression in one or more cylinders of an auto engine often can be detected by the sound of the starter gears when they are engaged. If the compression is equal on all cylinders the sound or growl of the gears will be evenly spaced, but if one cylinder has little compression or none at all, the sound will be irregular.

☛ To retard the setting of shellac mix a teaspoonful of lard to each gallon.



Method of Determining the Finished Size of Pictures for Use on Page of Type

### Reduced Size of Pictures Obtained by Optical Illusion

The exact appearance and size of a picture, after its reduction for use on a page of type, can be closely approximated by the following method: Cut out the portion of the page that the picture is to occupy. Tack the latter to a wall and hold the page between the eye and the picture. By moving the page back and forth, the size of the image as it appears through the cut-out, can be varied and the needed reduction in size determined.—Kenneth M. Manning, Lemoore, Calif.

### Raised Register Key Saves Time for Store Clerks

Much time can be saved in stores having a popular unit of sale by raising the key on the cash register which represents the price of the article. A small round piece of wood is taped to the top of the key, which is then easily found. The method helps to prevent errors, especially when the clerks are rushed by many buyers.

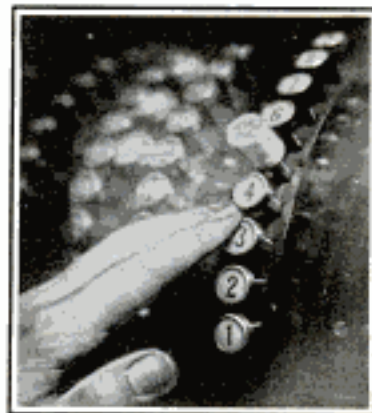



*a 258 + Sam Lloyd.*  
*153 Wafey h*  
*Brooklyn N.Y.*

# Can You Solve these Puzzles?



**T**WO motor busses make a run in opposite directions over the same highway between two towns 127 miles apart. They don't change speed all the way. One hour after they pass the meeting point, one bus has arrived at the end of its journey. The other bus has to travel four hours after it leaves the passing point to complete its journey. What was the comparative speed of the two busses?



**H**ERE is a practical problem, submitted by a garage manager to a group of applicants for a job, that called for original thinking:

"This continuous chain of thirty links I want cut up to get six pieces of five links each. How much will it cost, on the basis of paying 10 cents for cutting through a link and 15 cents for soldering a link together? If I can buy new five-link pieces at 25 cents



Tackle that one. Remember, you have to arrive at your answer by reasoning and not by trying out guesses. If you guess right, you must be able to show why.

each, will it pay to have this chain cut up? What is the most economical method?

Better not give snap judgment on that fellow's proposition; think it over a bit.

## Answers to Last Month's Puzzles

*a 1988*  
 A total of 119 groups (three disks in straight line) can be found in the formation shown last month.

In the puzzle "farming on shares," similar quantities of wheat and rye being worth, respectively, \$54 and \$64.80, it is clear that their relative values are as 5 to 6. Now let us deal with the information that if twelve bushels of rye are worth \$5.04 more than six bushels of wheat, and since six bushels of wheat would be of the same value as five bushels of rye, then that

\$5.04 must be the value of seven bushels of rye, which figures out at the rate of 72 cents per bushel.

Wheat, being worth five-sixths of rye, is established at 60 cents per bushel. They shared on the basis of three parts to landlord and four parts to tenant. Therefore, to offset the farmer's \$54 worth of wheat, the landlord would be entitled to \$40.50 worth of grain. As he wanted his share in rye, we have to divide \$40.50 by 72 cents in order to find that he was to receive  $56\frac{1}{4}$  bushels.



# Balance!-in tools

*... Something you've heard of all your life*

HERE is "balance" in screw-drivers: "Yankee" No. 90—balanced for husky work, in blade lengths up to *thirty* inches! And "Yankee" No. 95, a slender tool, proportioned for finest cabinet work.

Blades are individually tested and twice tested—by "Yankee" toolmakers. Will not twist or bend; cannot loosen, turn or wobble. "Yankee" comfort-grip handle saves muscles of hand and wrist.

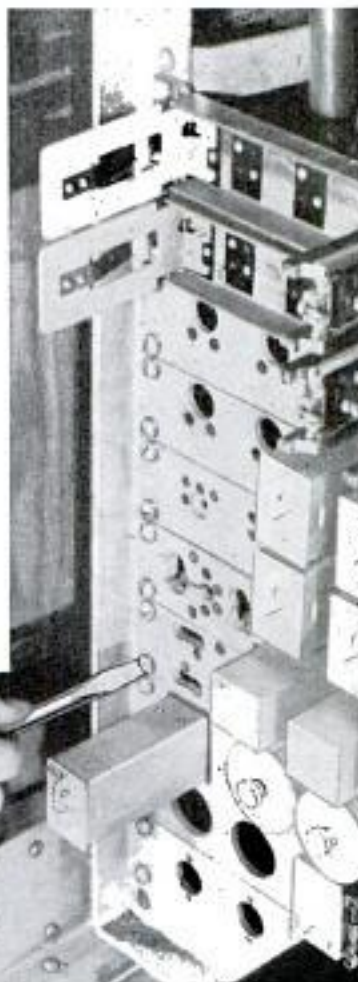

**"Yankee" Ratchet Tap Wrench**

Ratchet and sliding cross-bar mean easier tapping. No. 250—Length 3½". Holds ⅜". Price, \$1.85. No. 251—Length 5". Holds ½". Price \$2.45.



**"Yankee" Vise No. 1993**

Removable from base for holding work on drill-press or other machine. Trued all sides. Open, 3¼ in.; \$9.90. Sizes, \$3.75 up.

Ask tool dealer for  
**"Yankee" Plain Screw-drivers**

**No. 90.** Standard Style; Fifteen sizes, 1½" to 30" blades. Price for 5" blade, 50c; 6", 55c; 7", 65c; 8", 75c; 10", 95c; 12", \$1.10.

**No. 95.** Cabinet Style; Eleven sizes, 2½" to 15½" blades. 4½" blade, 40c; 5¼", 45c; 6½", 50c; 7¾", 60c; 8½", 65c; 9½", 70c.



# YANKEE TOOLS

TO HELP YOU MAKE THINGS

NORTH BROS. MFG. CO., Lehigh Avenue, Philadelphia, U. S. A.

Send me now "Yankee" Tool Book, illustrating quick-action tools: Two-speed (11-inch) Hand Drills, Quick-Return Spiral Screw-drivers, Adjustable-Tension Push Drills, Ratchet Breast, Hand and Chain Drills, Automatic Bench Drills, Ratchet Tap Wrenches, Removable-base Vises, etc.

NAME.....

ADDRESS..... (pm)

When writing to advertisers please mention *Popular Mechanics*



**DON'T**  
*... tear up the floors*  
*... break the plaster,*  
*or touch a single wire!*



**EXTRA  
 ELECTRIC  
 LIGHTS... WITHOUT  
 ANY MUSS OR FUSS!**

THE Eveready Wallite hasn't any wires, and doesn't need any! Put it up with two screws, or hang it on a nail as a portable light. Perfect for closets, attics, garages, and stairways!

The Wallite is powered by two of the new, *extra long life* Eveready Flashlight Batteries that have metal tops, instead of the old-fashioned, wax-compound seals. Their *all-armed* construction keeps the power-producing ingredients fresh... stores up hours of bright, certain light! (Renewal batteries cost 20c a set.) See a Wallite today... at all leading stores. Only \$1.50, without batteries.

The new Eveready Pocket Light. Novel mechanism. Convenient size for vest-pocket or hand-bag! Beautiful red and black buffed French enamel finish. Bright, clear light. 85c, without batteries.



**EVEREADY  
 WIRELESS-  
 ELECTRIC  
 LIGHT**

NATIONAL CARBON CO., Inc.

General Offices:  
 New York, N. Y.

Unit of Union Carbide



and Carbon Corporation

When writing to advertisers please mention Popular Mechanics

**CUT YOURSELF A  
 PIECE OF LAKE!**



Push the prow of an Old Town Boat out in a rippled lake. Let the point of it part a pretty furrow along the bee-line to your favorite hass-hole. She glides without a shiver... gets you there in a wink. For Old Town Boats are built to knife the water at a speedy clip... light, easy to handle... reinforced for powerful out-board motors. Sturdy and steady and trouble-free.

Whether water is choppy or glassy-smooth, an Old Town glides on an even keel... banks beautifully on the turns. Get a free catalog. See the many models for every use. Sporting boats. Big, fast, all-wood seaworthy types for family use. All kinds of canoes; rowboats; dinghies. Lower prices. Write today. Old Town Canoe Co., 1344 Middle St., Old Town, Maine.

*"Old Town Boats"*

**A BIG NEW WOOD LATHE**

AT A SENSATIONAL LOW PRICE

Turns 8" Diameter  
 30" Between Centers

**\$4.95**

CASH



Extra heavy steel bed 45 inches long. Heavy duty headstock with 3 step cone pulley for V-belt. Extra long reservoir oiler bearing. Spur center and 4 in. face plate screw onto spindle. Tailstock spindle has screw movement of 1 1/4 in. Tool rest 8 in. long. Price \$4.95 f.o.b. Factory includes all equipment pictured above. Accessories: 3 step cone motor pulley, 50c. V-belt, 50c. Set of 4 turning chisels, \$2.00. Cash with order. Net weight 27 lbs. Shipping weight 30 lbs. Order direct from this ad. Sold direct to user only at wholesale prices. Not acid through agents or chain stores. **Blue Star Lathes, 480 Main St., FAIRFIELD, IOWA.**

**GUARANTEED TO FLY  
 100 Ft. if Built Properly**

A realistic, 12-in. r. c. g. model of the fast single-engine British Spitfire fighter. A steady 3-sec. indoors or out. Set includes aluminum propeller, shaft, rubber band motor, streamlined wheels, a combi-block ready-cut struts, etc. Full building and flying directions. No tools needed. Simplified construction—most easily built scale model on market. Can be built in 2 hrs. and will give more real satisfaction than expensive sets. Mailed in unbreakable container, postpaid in U. S. and Canada, only \$9c. Order one or more now.



**THE MIDLAND MODEL WORKS, Dept. 5, Chillicothe, Ohio**  
 (No stamps. No r. c. g's. No royalties. Please give full address.)

**You Can Print**

Cards, stationery, circulars, tags, labels, advertising, etc. Make big profits spare or full time. **Do Your Own Printing.** Save Money. Keep rules set. Will do popular Raised Printing like Engraving. Junior press \$5.95, job presses \$11 up, power \$149. Send for free catalog. **The Kelsey Co., N-37, Meriden, Ct.**

**A. C. Electric Plants**

ONAN A. C. PLANTS furnish the same current as city service—110 volt, 60 cycle, A. C. Operate Radios, Water Systems, Refrigerators, all Household Appliances. **Sizes 500 to 1800 Watts** Available from stock. No battery used except to start the engine. Ideal for farms, camps and lake homes. **Also a complete line of D. C. Models.**  
**D. W. ONAN & SONS**  
 907 Royalston Ave. Minneapolis, Minn.





CHANGE SPARK PLUGS EVERY 10,000 MILES FOR BETTER ENGINE PERFORMANCE

# CHAMPIONS ALL AND ALL USE CHAMPIONS



Louis Schneider



Fred Frame



Ralph Hepburn



Russ Snowberger

Jimmie Gleason  
(deceased)

*These race drivers are rated, in the order pictured, America's 1931 racing champions by the A. A. A. Contest Board. All used Champion Spark Plugs exclusively throughout the year*

"Sbooty"  
Cantlon

Ernie Triplett



Lou Moore



Chet Miller



Bill Cummings

## Champions give your car the same Championship performance

The official 1931 championship standing of the A. A. A. Contest Board lists the most consistent point winners of automobile racing in America. All of the first ten winners used Champion Spark Plugs.

To all motorists this, together with eight years of supremacy in both America and Europe, clearly points the way to better spark plug and engine performance.

All of these racing champions use Champions for maximum performance, and install new Champions for every major race to enable them to get that extra power and speed so necessary to win.

You can do no better than follow the footsteps of these experts on engine performance, by insisting on Champion Spark Plugs for maximum engine performance and dependability.

CHAMPION SPARK PLUG COMPANY, TOLEDO, OHIO; WINDSOR, ONT.

## CHAMPION SPARK PLUGS



# A Cabin in the Woods

*Build it Yourself  
this Summer*

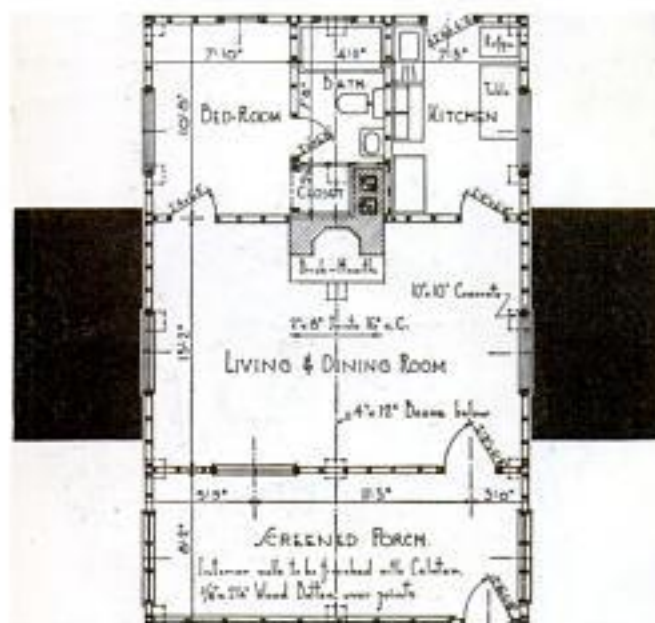

Somewhere there is a favorite nook where you have always wanted to build a summer cabin of your own.

Now you can build it, and at an inexpensive figure, too, by using Celotex cane fibre insulation—big, strong boards to make the cabin cool and comfortable in hottest summer, secure against moisture, warm and snug in winter.

Celotex is so simple and easy to handle that you can do much, if not all, of the building yourself.

Send the coupon right away for your choice of Celotex cabin plans, then see your lumber dealer about the materials. You will be amazed to learn how inexpensively you can build with Celotex. Send for the Celotex Children's Playhouse Plans, too.

The Celotex Company, 919 North Michigan Avenue, Chicago, Illinois. Sales distributors throughout the world. In Canada: Alexander Murray & Co., Ltd., Montreal.

## CELOTEX

BRAND  
INSULATING CANE BOARD

THE CELOTEX CO.,  
919 N. MICHIGAN AVE., CHICAGO, ILL.

Name \_\_\_\_\_

Street \_\_\_\_\_

City \_\_\_\_\_ State \_\_\_\_\_

Please send me plans for 1 Room Celotex Vacation Cabin ( )

2 " " " " ( )

3 " " " " ( )

4 " " " " ( )

(Check the ones  
you want)

Children's Playhouse ( )

# Thompson BEATS the World on BOATS

THOMPSON BOATS

## CATALOG FREE!

**Canoes \$45 and up**  
Some all wood, others canvas covered, Light, swift, safe, strong and durable. Many color combinations.

**Rowboats \$35 and up**  
Most complete line ever offered, at real money-saving prices.

**Motor Boat \$495**  
Thompson's new world beater in Motor Boats. 16 ft. TVT Model with full length spray rails. 4-cylinder engine with electric starter installed.

**Onboard Boats \$48 and up**  
TVT Onboard Motor Boats. The very fastest and most seaworthy Boats for family use. Full length spray rails keep these boats perfectly dry, as shown above.

CATALOG FREE—SAVE MONEY—PROMPT SHIPMENT  
Please state the kind of boat you are interested in (5¢)

TWO LARGE FACTORIES  
**THOMPSON BROS. BOAT MFG. CO.**  
213 Ann St. [Write to] 113 Elm St.  
PESHIGO, WIS. [Either Place] CORTLAND, N. Y.

## Learn to Re-Seat Your Chairs



Have you a chair, stool or bench that you would like to re-seat? We will teach you how to do it. Use either Cane, Rush, Reed, Splints, Fibre Rush, Cane Webbing or Grass.

Instruction Book Only 10¢

Send 10¢ today for our illustrated Instruction Book and price list explaining how to do Seat Weaving.

The H. H. PERKINS CO., 254 Shelton Ave. New Haven, Conn.

## SHIP MODEL FITTINGS

Extensive line Authentic quality fittings Construction sets for Sailing Ships, Whalers, Steamships, Destroyers, Yachts. Books, blueprints, model supplies. Send 10¢ for big, illustrated catalog.

A. J. FISHER, 1002-1 Etowah Ave.

Royal Oak, Mich.

CATALOG 15¢

# FREE The Book

## That has helped Thousands get Government Jobs!

Just send your name and address for my 32-page book, "HOW TO SECURE A GOVERNMENT POSITION." Tells all about CIVIL SERVICE: If you are a citizen, 18 to 50, you can get a steady government job at \$1850 to \$3300 a year. I was official examiner for 8 years. You pick the job you want; I'll help you get it. Get ready NOW for the next Railway Postal Clerk Examination! Write today for a copy of my FREE book. Address

A. R. PATTERSON, Civil Service Expert,  
B-84 Wisner Building, Rochester, N. Y.





# After a bout with the hacksaw

**DO YOU  
FEEL  
LIKE?  
THIS**



**. . . you  
don't have to!**

Cutting metal may take longer, but it needn't be a bit tougher on the muscle and the disposition than cutting hard wood.

Properly done, a hacksaw job can give you the same sort of satisfaction — the same feeling of getting somewhere — IF — you have the right hacksaw blade and the right frame.

The name STARRETT on a hacksaw blade means exactly what it means on a micrometer — the very best available. Made from special alloys, heat-treated by veteran toolmakers, Starrett Blades



are right. They cut faster, easier; hold their cutting edges longer. Strain one in a Starrett frame and you have the perfect saw

If you're genuinely interested in getting real hacksaw performance, send the coupon for your copy of the Starrett Hacksaw Booklet AP. It describes and prices the three types of Starrett Blades — the High-Speed Steel, the Tungsten and the Semi-Flex — tells how to get the most out of them. Use the coupon now — your good right arm will thank you!



## Use Starrett H

THE L. S. STARRETT CO., ATHOL, MASS.

Please send me Starrett Hacksaw Booklet AP.

Name \_\_\_\_\_ Address \_\_\_\_\_ City \_\_\_\_\_ State \_\_\_\_\_

When writing to advertisers please mention Popular Mechanics

ES96



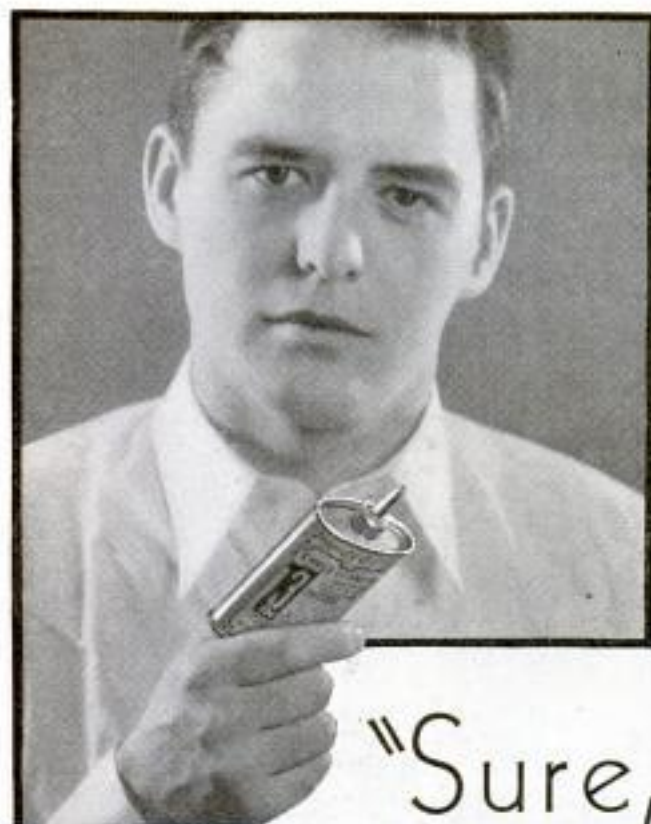

"Sure,  
I know I could use  
cheaper oil—"

"Cheap oil is no bargain! I found that out years ago. So I always use 3-in-One on my tools, and all other workshop equipment. Sure, I pay a few cents more for it. But I spend a whole lot less for repairs!"

Why does 3-in-One protect better than ordinary oils? Here's your answer. It's no mystery! Three different oils are scientifically blended in 3-in-One to make it do three jobs at once. As it *oils*, it also *cleans* moving parts of dirt; then *protects* them against rust. No plain mineral oil can ever do these jobs so efficiently.

All stores; handy cans and bottles. For free "Dictionary of Uses" write Three-in-One Oil Co., 170 Varick Street, New York, N. Y.



**3-IN-ONE OIL**  
CLEANS - LUBRICATES - PROTECTS

When writing to advertisers please mention Popular Mechanics



#### SOUSA SAYS

"Complete Conn equipment enhances the musical value of any band at least 50%."

## SOUSA'S Choice

and the choice of the world's greatest artists. Conn Band Instruments offer overwhelming advantages to both professionals and amateurs. Easier to play. Magnificent tone. Many exclusive features yet they cost no more.

#### Home Trial Easy Payments

Ask your dealer to show you the marvelous new models. Or write us for free book and details of special home trial—easy payment offer. Mention instrument.

C. G. CONN, Ltd.  
431 Conn Building, Elkhart, Ind.

**CONN**  
World's Largest  
Manufacturers of  
BAND INSTRUMENTS



## FREE CATALOG

Just Off the Press

Fully illustrated showing footwear, clothing, camping and fishing specialties for camper and fisherman.

**L. L. BEAN**

46 Main St., Freeport, Maine

## DO YOU

WANT a new business profession of your own, with all the trade you can attend to? Then become a foot correctionist, and in a few weeks earn big income in service fees,—not medical nor chiropody—easy terms for home training, no further capital needed, no goods to buy, no agency. Established 1894. Address Stephenson Laboratory, 1 Back Bay, Boston, Mass.

**Big 3 ft. Telescope** Five Sections. Brass bound. Powerful Lenses. 10-Mile range. Special Eye Piece for looking at the Sun, included FREE. Can be used as a Microscope. Guaranteed. Big value. Postpaid. \$1.75. C. O. D. 15c extra. **Benner & Company, 1-43, Trenton, N.J.**



## "FLYING CLOUD"

Get clean-cut parts and clear blueprints for 20" model. Readily made in spare hours as hull fully shaped and sanded. Set includes anchor, bell, capstan; dead eyes, wheel, rigging line, etc. Complete for \$11. Postage 5 lbs. White metal figurehead 50c. Send 15c (coins) for beautiful catalog of ships and coaches.

**ROY HANCOCK**

323 Douglas Ave. Portsmouth, Va.



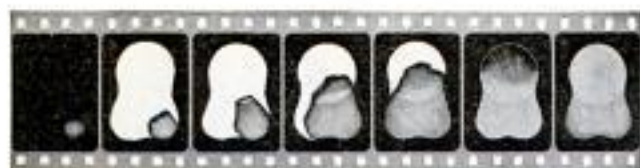

ORDINARY GASOLINE is in the cylinder. You see the spark in the picture at the left. In the next the gasoline vapor starts to burn. More—more—more burns. Then suddenly, in the sixth picture—BANG! The remaining gasoline explodes. That is KNOCK. The last picture shows nothing but after-glow. Knock wasted the gasoline that should be working now.



ETHYL GASOLINE starts from the spark in the same way—as shown in the first three pictures. But Ethyl can burn at only one speed: *the right speed*. See how its flame spreads evenly from start to finish. It is not all burned until the last picture—delivering its greatest power when the piston is going down—when power counts most in the performance of your car.

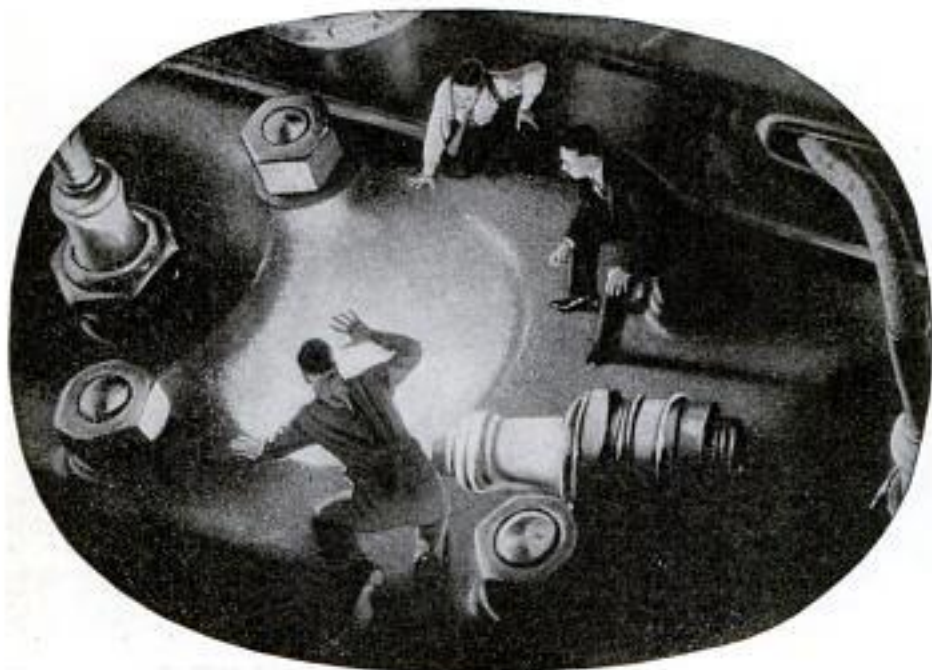

## Look *INSIDE* the engine There's where Ethyl proves its value

SEEING is believing. You can now see the difference Ethyl makes in gasoline. By the use of special instruments and high-speed photography, engineers have made pictures of the actual combustion of motor fuels.

Look at the two strips above. They show what happens in that important 1/100th of a second after the spark plug fires.

At the left, you see ordinary gasoline failing under the strain of a modern high compression engine. You see the uneven explosion that causes harmful knock, overheating and loss of power when you use ordinary

gasoline in your car. At the right you see how Ethyl Gasoline burns smoothly, evenly, powerfully—in the test engine or in any engine—at any load.

That is why car manufacturers now offer high compression engines as either standard or optional equipment. These engines are *designed* to take greater advantage of the quality of Ethyl. Car manufacturers know it makes *any* car run at its best.

Look for the pump with the Ethyl emblem on it next time you buy—and *feel* the difference. Ethyl Gasoline Corporation, New York City.



The quality of Ethyl Gasoline is maintained by laboratory inspection of samples collected daily in all parts of the country. Ethyl fluid contains lead.

© N. G. C. 1932

# Buy ETHYL GASOLINE

When writing to advertisers please mention Popular Mechanics

Copyrighted material



## STOPPING LEAKS WHERE THE METAL IS THIN

**T**HIS is the easiest kind of a Smooth-On repair to make and anyone can get good results.

Merely mix the Smooth-On with water until it forms a putty. If the leak is at a seam, pry open a little, clean off, and force the Smooth-On in with the finger or a knife blade. At a rusted spot, scrape off the rust, force the Smooth-On through and press it to anchor on both sides. At small holes, put the Smooth-On between washers inside and out and use a small machine screw and nut for drawing up tight.

Smooth-On No. 1 forced into seam openings, between rivets, or into the holes quickly metallizes and thereafter is tight against hot or cold water, steam, smoke, oil, gasoline, gas, etc. It holds in any metal and can be used as well to stop leaks at joints and cracks in cast or wrought metal pipes, radiators, boilers, and furnaces. Use it also to tighten loose handles and to anchor loose bolts, screws, etc., in metal, concrete, tile and wood.

By following the simple directions in the Smooth-On Repair Booklet, you can make dozens of home and automobile repairs at a very small fraction of what a repair man would charge, and if you keep a small can of Smooth-On ready for emergencies, you also avoid annoying delays.

Get Smooth-On No. 1 in 7-oz., 1-lb. or 5-lb. tins at any hardware store or if necessary direct from us.



SMOOTH-ON  
Radiator



Leaky Pail



Leaky Kettle



Leaky Tank



Stove Pipe



Oil Leaks



Write for  
**FREE BOOK**



Do it with **SMOOTH-ON**

SMOOTH-ON MFG. CO., Dept. 37,  
574 Communipaw Ave., Jersey City, N. J.

Please send the free Smooth-On Repair Book.

Name.....

Address.....

4-32.....

When writing please mention Popular Mechanics

## FREE CATALOG!

### FACTORY PRICES Slashed

Send today for new free Kalamazoo catalog! Stove, Range and Furnace factory prices drastically reduced. Save 1/3 to 1/2 by buying direct from the factory. You'll see values beyond belief—bargains never known before. Kalamazoo quality—famous for 31 years—is rigidly maintained.

**200 Styles and Sizes**

800,000 satisfied customers! 200 styles and sizes: Beautiful Porcelain Enamel Ranges in sparkling colors. Coal and Wood Ranges, Gas and Combination Gas, Coal and Wood Ranges, Heaters, Furnaces, Household Goods.

**Only \$5 Down**

Easy terms—only \$5.00 down on any Kalamazoo. A year to pay. 30 days trial. 360 days approval test. 24 hour shipments. \$100,000 bank bond guarantee of satisfaction. 5 year guarantee against defects in materials and workmanship. Don't miss this big free bargain catalog. Write today.

**KALAMAZOO STOVE CO., Mfrs.**  
391 Rochester Ave., Kalamazoo, Mich.



Ranges **\$3750**  
up



Furnaces **\$5785**  
up

**"A Kalamazoo  
Trade Mark  
Registered  
Direct to You"**

### BUILD YOUR OWN AUTOMATIC ELECTRIC REFRIGERATOR

Why pay \$200.00 and upwards? Use your present ice-box. We supply parts. Can be built for only \$34.50. Easily made. No special tools necessary. Operating cost, quality and size of machine same as well known makes. Complete blue-prints and instructions—\$1.00. Circular "B" on request.



B. & L. ENGINEERING CO., 706 Bergen Ave., Jersey City, N. J.

**To Make  
Every  
Shot  
Count**

Clean your rifle bore with **HOPPE'S NO. 9**. Removes leading, prevents rust. All Dealers, or send 10c for sample and Gun Cleaning Guide.

**FRANK A. HOPPE, INC.**  
2309 N. 8th St., Philadelphia



**World's Lowest Priced  
Quality,  
Home!**  
**\$498**



Buy direct from Mill. Save \$200 to \$300. Price includes all lumber ready-cut, millwork, windows, doors, interior woodwork, hardware, roofing, glass, nails, paints, varnish and stains. **We pay freight.**

**BUILD IT YOURSELF**

Aladdin's famous Ready-cut System saves labor costs and lumber waste. Complete plans for quick, easy erection.

**FREE Catalog** shows many designs in Homes, Summer Cottages, Garages, Filling Stations, Tourist Cottages and Roadside Stores. Write for it today. Address nearest office. Ask for Catalog No. 482.

**THE ALADDIN CO.** BAY CITY, MICHIGAN  
PORTLAND, OREGON

Copyrighted material



# You'll get amazing results repairing and modeling with this **PLASTIC WOOD**



## handles like putty . . . quickly hardens into wood

Science has perfected an amazing preparation that handles like soft putty and quickly hardens into wood—wood that lasts longer than natural wood—wood you can carve, paint and turn in a lathe. Wood that never dries out, never rots nor warps after it hardens. It is the best thing you can use for

repairing breaks, hiding nicks, sealing cracks. It does an expert job in a jiffy. **BUT BEWARE.** There's only one original. So avoid accepting imitations. If you want the very best at no additional cost—**DEMAND PLASTIC WOOD.** It is sold in 9 colors by all paint, hardware and department stores.

## marvelous for modeling

Thousands of folks who never before worked with their hands are discovering what skilled artisans have known for a long time. With Plastic Wood they are making a thousand and one useful things—from fanciful woodpeckers and proud galleons to book-ends and mirror frames. Many are now making extra money this way. If you want some fun—try your hand at modeling with Plastic Wood. You'll get a thrill!



## BIG 48-PAGE BOOK FREE

We'll send you **FREE** for the asking—a 48-page, profusely illustrated book crammed full of facts about Plastic Wood. Tells how to use this amazing preparation.

### MAIL COUPON TODAY

The A. S. BOYLE CO., Dept. PM-4, Cincinnati, O.

Send me—free—Big Book of Uses for Plastic Wood.

Name.....

Street & No.....

City..... State.....

THIS OFFER GOOD IN UNITED STATES ONLY

When writing to advertisers please mention *Popular Mechanics*

Copyrighted material



# PYROIL



GIVES  
*New  
Life*

## TO ALL MOTORS

Valuable  
Openings  
for  
**DISTRIBUTORS**

Millions of autos, trucks, tractors, buses, motor boats, airplanes, need this amazing new Lubricating Process. Tremendous repeat seller.

### NO RISK OFFER

Big Season at hand. Make Big Profits "over-night" and quickly build a year round successful business. 100% co-operation. You risk nothing. WRITE AT ONCE FOR FULL DETAILS.

**PYROIL**—sensational new Lubricating Process—has revolutionized the lubrication end of the motor industry. Industrial brains of the country agree that **PYROIL** does what oil alone cannot do. It builds lubrication into the metal.

A Pyroil-processed motor has run 206.8 miles without oil. Another, 161 miles. An airplane motor for 28 minutes!

**PYROIL** positively reduces noise, cuts repair bills, frees valves, seals rings, ends hard carbon, saves oil, saves gas—saves 10 times its small cost. Genuine **PYROIL** is identified by the winged Pyroil label and signature of W. V. Kidder on every label. Money back guarantee.

Write today for the amazing Story of Pyroil.

### PYROIL COMPANY

W. V. Kidder, Pres.

542 Pyroil Bldg., La Crosse, Wis.

## NEW! HOME AUTOMATIC CIGARETTE MACHINE

Truly amazing invention. Automatically rolls a pack of perfectly made cigarettes in 5 minutes! Easy—simple. Just turn the crank. Enjoy your favorite tobacco—any cigarette paper can be used. Not a cliché ribbon machine. No special gummed papers required. Saves many dollars. Sturdily constructed. Fully guaranteed. Ask for free illustrated folder. Automatically seals.

### AGENTS!

Big demand for this remarkable machine. Thousands now "roll their own." You can clean up Big Cash Profits. Marvellous Big MONEY MAKING PLAN sent you. Don't delay.



Size 8 in. x 6 in. x 8 1/2 in.  
If handsome enamel and nickel finish. Build to last a lifetime.

**AUTOMATIC CIGARETTE MACHINE WORKS**  
1058-57 Sheridan Road Dept. 4 CHICAGO

# DUBLIUM

TRADE MARK REG. U.S. PAT. OFF.

PATENTED NOV. 25, 1930

## CLEANING and POLISHING MITTS

KEEPS THE HANDS CLEAN



Furnished in several colors and weights scientifically designed and made to meet all cleaning and polishing requirements. Dublium Mitts are rubberized and treated so as to "protect the hands" simply apply polish to one side of the mitt and rub on article, then reverse the hand in the mitt, and polish to a brilliant finish with the other side.

Attractively displayed in boxes of one dozen each, samples will be mailed for 25c each. Distributors wanted for exclusive territory.

CONSOLIDATED SALES & MANUFACTURING CORPORATION  
89 STATE STREET, BOSTON, MASS.

DISTRIBUTORS WANTED

## Rider Agents Wanted

Select from many styles, colors and sizes of Mead Bicycles. Many recent improvements. Ride and exhibit sample RANGER and make money.

**Direct to Rider:** We ship on approval for 30 Days' Trial—genuine Mead bicycles from \$18.85 up. Get our marvelous offers and terms.

**Tires** lamps, horns, wheels, parts, equipment, and repairs at half usual price. Established 39 years.

**Mead CYCLE COMPANY**  
DEPT. M-112 CHICAGO

Write us today for free catalog



Forms to cast Lead Soldiers, Indians, Trappers, Hunters, Wild and Farm Animals, 239 different forms to select from. Every Form guaranteed to cast perfect figures. Send 5c stamp for illustrated catalogue.

HENRY C. SCHIERCKE SPENCER RD. GHENT, N. Y.

## PANTS MATCHED



### Don't Throw Away That Coat and Vest!

Save \$15 or more! Let us match your coat and vest with new trousers tailored to your measure. Save the price of a new suit. Over 100,000 patterns. Mail sample of suit, or your vest which will be returned with FREE SAMPLE Match Pants Co. 20 W. JACKSON BLVD. Dept. A-16 CHICAGO

Cal. 30-40 Six Shot

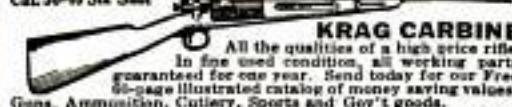

Price

\$9.75

**KRAG CARBINE**  
All the qualities of a high price rifle. In fine used condition, all working parts guaranteed for one year. Send today for our Free 60-page illustrated catalog of money saving values; Guns, Ammunition, Cutlery, Sports and Gov't goods.

Deposit required on all orders. Money refunded if not satisfactory.  
W. Stokes Kirk, Dept. P. M.-4, 1627 N. 10th St., Phila., Pa.

## Now! Do Your Own Electric Nickel Plating

COMPLETE  
INTRODUCTORY  
OUTFIT ONLY  
**\$6.50**

Plate with  
Nickel, Brass,  
Copper, Silver,  
Gold, etc.



## A REAL MONEY-MAKING OPPORTUNITY

NO EXPERIENCE REQUIRED. Do YOUR OWN Electro Plating in Your Home; Garage, Office, or Place of Business. Electrically Deposit Metal—Nickel, Brass, Copper, Silver, or Gold. You can successfully do all the plating on your Automobile, Electric Fixtures, Faucets, Spoons, Forks, Chandeliers, Tools, Coffee Urns, Surgical and Dental Instruments, Utensils, large or small, Iron Stoves, Music Instruments; recondition worn plating or plate New Work; do it instantly without interrupting the Service or without removing the parts to be plated with the

## ALADDIN PORTABLE ELECTRO-PLATER

Simple and Economical to operate. Not a toy, but a practical Plating Outfit with which Perfect and Durable Work can be done. Positively Guaranteed to do as we claim. BE YOUR OWN BOSS! Build up a Profitable Aladdin Electro-Plating Business of your Own. This offers wonderful ECONOMY to users and BIG MONEY-MAKING possibilities to AGENTS. Thousands in Service since 1924. Write today for FREE PARTICULARS AND TESTIMONIALS.

P. J. F. BATENBURG CO. Dept. 281 RACINE, WISCONSIN

—AGENTS—  
WANTED EVERYWHERE





## PLAN NOW *for a* MOTORCYCLE VACATION

RIDE to Vacationland this summer. Let older folks have the crowding cars and stuffy trains.

The Open Road for you — with a swift, powerful Harley-Davidson Motorcycle to zip you over roads and trails, free as the birds.

Of all happy, healthy outings there is none that can equal a Motorcycle Vacation. And it costs so little.

Plan yours now—great riding weather is just around the corner . . . . . Step into your nearest Harley-Davidson Dealer's. Look over the 1932 models.

*Ask about his Pay-As-You-Ride Plan.*

### Prices as low as \$195

That's right!—\$195 at-the-factory buys a completely equipped motorcycle—the wonderful Harley-Davidson Single, speedy, powerful, economical.

Mail the Coupon for literature showing our full line of motorcycles and sidecars.

Ride a  
**HARLEY-DAVIDSON**

HARLEY-DAVIDSON MOTOR COMPANY  
Dept. P., Milwaukee, Wis.

Interested in your motorcycles.  
Send literature.

Name \_\_\_\_\_

Address \_\_\_\_\_

My age is  16-19 years,  20-30 years,  31 years and up,  under 16 years.  
Check your age group.





**OWN A  
CARMELCRISP  
POP CORN  
STORE**

MAKE UP TO  
**\$200** PER WEEK

Here's your chance for independence and quick success. Open a store like this and do a big business at big profits from first day. West Virginia store did \$178.45 in one day. Ohio store did \$1200 first 30 days, at gross profit of over \$800.00. Other records still more astonishing! Small town reports sales of \$118.00 in single day! Store in town of only 8,000 does \$200 sales in 5 days. Greatest success in years. Get in while it's new and best.

**Right In Your Town.** Big opportunity waiting in any city, town or village. Best locations available now at lowest rentals. Wonderful time to start.

Trade **Carmelcrisp** Mark

### The New Carmel Pop Corn

Most sensational confection in years. Plump, tender, healthful pop corn coated with delicious, savory carmel candy, prepared according to a secret time-tested formula. Crowds attracted by its mouth-watering, appetizing aroma, jam your store . . . buy and come back for more. Profits start first day and grow bigger daily.

#### No Experience Necessary

We start you in business. Help you finance if necessary. You need but little money . . . we supply equipment, formula, plans, layouts help you locate, tell you every step to big success. Should bring cost all back and big profit in few weeks.

### FREE Book of Facts — "Golden Kernels of Profit"



Brings you all the facts. Shows how others are making big money . . . and how you can do it. Don't delay getting in this sensational business. Carmelcrisp has taken the country by storm. Act now. Get in on ground floor. Just send name and address. No obligation.

**LONG-EAKINS COMPANY**  
428 High Street Springfield, Ohio



## STERLING HOME only \$979

### Fire-proof Cellar Ceiling

Rosewood, above, only \$979, double construction, 5 rooms, bath. Freight paid. We cut lumber at mill, saving expensive time of carpenters. Detailed plans enable easy erection—large savings. We will furnish "Steelcase" joists for first floor with fire-proof "Gyplap" cellar ceiling, making your home safe against any fire from your cellar. Also—Thermodil Insulation, bronze weather stripping, paint, hardware, 1-panel de luxe doors, etc. 84 low-priced modern, attractive homes for your selection. Build now! Also garages, summer cottages. Send 25 cents today for catalog in color. Estab. 1906. International Mill & Timber Co., 245 Wenzon Ave., Bay City, Michigan.

STERLING HOMES HAVE STYLE

When writing to advertisers please mention Popular Mechanics

# 100 Shaves

from EACH Blade

The Master-Hens puts a hair-splitting edge on the dullest razor blade—ANY make—in 5 seconds. Many get 100 shaves per blade. W. F. Walsh, Windsor, Ontario, used same blade daily 8 months. Only honing can give a NEW edge on a blade. This patented, accurately beveled hone of special abrasive makes each blade worth \$2.00 in service. MONEY REFUNDED if not delighted.

**YOURS FREE** We will send you a lovely free MASTER-HENS razor absolutely free WITH FIRST ORDER of 12 for \$3.00, or send 50c for 1 or \$1.00 for 3, POSTPAID. Or, send no money and pay postman plus postal charges. But send today. These are Agents' prices. Regular retail price \$1.00.

WISCONSIN ABRASIVE CO.  
Dept. 7094, Sta. A, Milwaukee, Wisconsin



**Agents**

net up to \$30 a day. Mr. Earl Smith made \$59 in 8 hours.

## ANY PHOTO ENLARGED

Size 8x10 inches or smaller if desired. Same price for full length or bust form, groups, landscapes, pet animals, etc., or enlargements of any part of group picture. Safe return of original photo guaranteed.

**47c**



**SEND NO MONEY** Just mail photo or snapshot (any size) and within a week you will receive your beautiful life-like enlargement, guaranteed fadeless. Pay postman 47c plus postage—or send 40c with order and we pay postage. Big 12x20-inch enlargement sent C. O. D. The plus postage or send 80c and we pay postage. Take advantage of this amazing offer now. Send your photos today. Specify size wanted.

STANDARD ART STUDIOS, 908 W. Lake St., Dept. 362-D, Chicago, Ill.

## AGENTS! SELLS LIKE WILD FIRE

FILL RESERVOIR WITH WATER. HOLD LONG ENOUGH TO CLEAN AWAY DIRT.



REMOVABLE RUBBER TUBES DO NOT CLEAN. POLISH WITH ONE STROKE.

WATER FEELS SOFT TO WINDOW FRAME.

BUST-PROOF FOOL. PROOF LASTS FOR YEARS.

SEARCH CAP AND INSERT BROOD HAVOLES FOR WASH WINDOWS.

\$380 monthly selling 10 improved patented Carter Window Washers daily. Cleans, dries, polishes. Eliminates all mud. Good Housekeeping approval. Restricted territory. Write today. CARTER PRODUCTS CORPORATION 998 Front Ave., Cleveland, O.

## DEAFNESS IS MISERY



Many people with defective hearing and Head Noises enjoy conversation, go to Theatre and Church because they use Leonard Invisible Ear Drums which resemble Tiny Megaphones fitting in the Ear entirely out of sight. No wires, batteries or head piece. They are inexpensive. Write for booklet and sworn statement of the inventor, himself deaf.



A. O. LEONARD, Inc., Suite 699, 70 5th Ave., New York

## Walsh Garden Tractor



and Power Mower  
For Gardeners, Florists, Fruitmen, Suburbanites  
Plows, Seeds, Cultivates, Mows Lawns and Hay  
Single and Twin Engine-Belt Jobs—Walk and Ride  
**SPECIAL OFFER—PAYMENT PLAN**  
New Improved Models—Catalog Free  
Minneapolis, Minn.  
**WALSH TRACTOR CO.** 3328 Talmage Av. SE.

## Get Rid of Athlete's Foot Use R C R

This powder is a most effective means for the successful treatment of various forms of tinea trichophyton such as "Athlete's Foot" or other ring worm infections.

Affords relief almost instantly. Composed of superior healing, soothing and antiseptic ingredients. Scientifically blended by skilled pharmacists. Large size shaker top box sent postpaid for \$1.00. Money back if dissatisfied.

R C R Pharmaceutical Co.  
202 St. Paul St. Rochester, N. Y.



# Prices On Lathes Reduced

Back to the Old Low Prices of Five Years Ago—1926-27

This price reduction is effective on all South Bend Standard Change Gear and Quick Change Gear Lathes, Countershaft Drive and Silent Motor Drive, Bench and Floor Leg Types, from 9" to 18" swing, with bed lengths from 2½' to 14'. At these low bargain prices more value per dollar is offered than at any time in the past. The South Bend Lathe will never again be sold so low. You get new, modern, and improved 1932 model lathes at 1926 and 1927 prices.

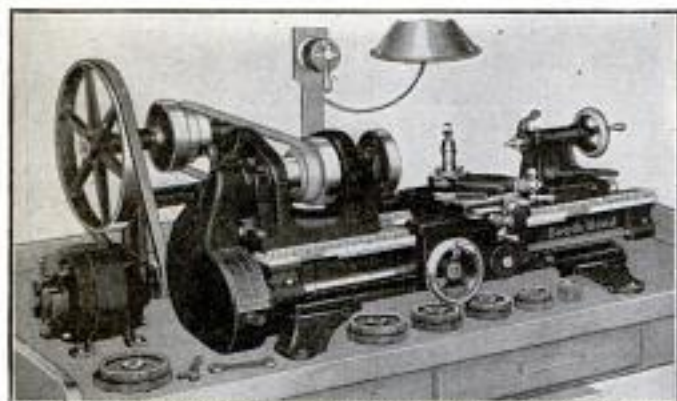

8" x 36" Junior South Bend Back-Geared, Screw Cutting, Precision Bench Lathe with Horizontal Motor Drive, complete as shown, weight 224 lbs Price..... **\$143.40**

The 8" Junior Lathe is a real back-geared, screw cutting precision lathe. Can be used for the finest tool work in the manufacturing plant. Send for 12-page booklet describing this lathe in all types and in all bed lengths.

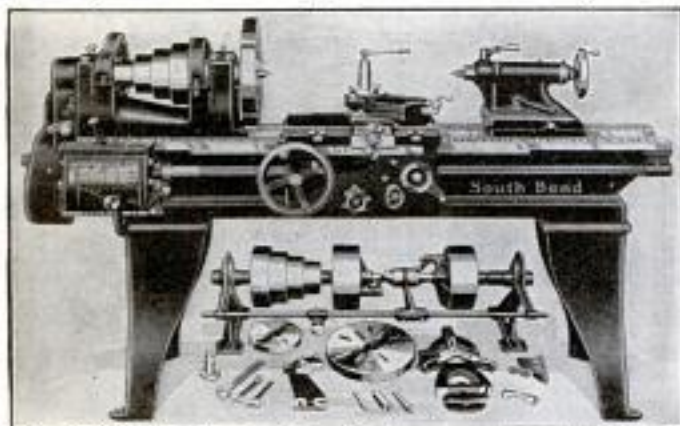

16" x 6" Quick Change Gear Lathe complete with Double Friction Countershaft and Equipment as shown, weight 1875 lbs. Price..... **\$540.00**

### On Display in Fifty-Four Leading Cities

New York Store—A. C. Colby Machinery Company  
Chicago Store—C. B. Burns Machinery Company  
San Francisco Store—Herberts Moore Machinery Company  
Los Angeles Store—Eccles & Davies Machinery Company

## SOUTH BEND LATHE WORKS

604 E. Madison St., South Bend, Ind., U. S. A.

LATHE BUILDERS FOR 25 YEARS—55,000 USERS  
96 SIZES AND TYPES—8" TO 18" SWING

### NEW REDUCED PRICES

#### 8" Swing—\$100 to \$165

depending upon length of bed, type of drive, equipment and attachments wanted. Bed lengths from 24" to 48". Easy payment terms.

#### 9" Swing—\$150 to \$454

depending upon length of bed, type of drive, equipment and attachments wanted. Bed lengths from 2½' to 4½'. Easy payment terms.

#### 11" Swing—\$231 to \$566

depending upon length of bed, type of drive, equipment and attachments wanted. Bed lengths from 3' to 5½'. Easy payment terms.

#### 13" Swing—\$287 to \$731

depending upon length of bed, type of drive, equipment and attachments wanted. Bed lengths from 4' to 8'. Easy payment terms.

#### 15" Swing—\$412 to \$873

depending upon length of bed, type of drive, equipment and attachments wanted. Bed lengths from 5' to 10'. Easy payment terms.

#### 16" Swing—\$415 to \$1000

depending upon length of bed, type of drive, equipment and attachments wanted. Bed lengths from 6' to 12'. Easy payment terms.

#### 18" Swing—\$575 to \$1303

depending upon length of bed, type of drive, equipment and attachments wanted. Bed lengths from 6' to 14'. Easy payment terms.

### Write for Price Bulletin 92-R

which contains new reduced prices on 96 sizes and types of South Bend Lathes. Indicate the size and type of lathe you are interested in and the class of work you intend to do. We will make you an itemized quotation suitable for the work. Sent free, no obligation. Use coupon below.

#### SOUTH BEND LATHE WORKS

604 E. Madison St., South Bend, Indiana, U. S. A.

Gentlemen: Please send me new reduced price bulletin No. 92-R, free postpaid. I am interested in

\_\_\_\_\_ size of lathe

for the following \_\_\_\_\_

\_\_\_\_\_ class of work

Name \_\_\_\_\_

Address \_\_\_\_\_

City \_\_\_\_\_

State \_\_\_\_\_

When writing to advertisers please mention Popular Mechanics





**TRAINER:** Believe me, a sprain won't ever keep you awake if you use Sloan's.

**ATHLETE:** Boy, it certainly made that ankle of mine feel like new in a hurry!

## BRUISES, SPRAINS

*Ease the pain—Sleep!*

Never neglect a bruised ankle or pulled tendon. Pat on Sloan's—it keeps swelling down, prevents loss of sleep. No rubbing is needed—for Sloan's brings fresh blood to the injured part in less than a minute. Pain gives way to healing, soothing warmth. You don't lose sleep... Get a fresh bottle today at your druggist's. Only 35¢.

# SLOAN'S Liniment

WARMS LIKE  
SUNSHINE



## SQUAB BOOK FREE



Breed PR Royal squabs, sell rich trade. Raised in 1 month. Sell for double chicken prices. Gain ahead. Start now. We ship breeders everywhere on three mos. trial, insuring satisfaction. Established 31 years. Customer writes: "Squabs selling fast, sold all I had last week, had to turn people away." Another: "Have always been successful with chickens, but squabs are way ahead of them." Another: "I am sold up on squabs two weeks ahead, getting slightly over a pound. Am also buying squabs of others in all my own orders. Ship me 150 pairs more Extra White Kings." Write now for free big 64-p. book sending four cents stamps for postage; learn how to breed and profit by fast sales plan. Plymouth Rock Squab Co. 634 N 5L, Melrose, Mass.

## SUPER-FILTERMATIC

The Modern Indoor Aerial

Can also be used in conjunction with your regular aerial. Thousands of satisfied users, praised by radio experts. Replaces unsightly outside aerials, reduces static and noises. Especially good on distance reception. Helps to separate stations, is absolutely non-directional and non-directional. Does not connect in light socket (therefore eliminating hum and line noises) installed in one minute, no tools needed. Will never wear out. Eliminates lightning arrester. Money back guaranteed after 5 day trial. **\$2.00** Price only.

Send for information about "SUPER-TONE" tone control, and "FILTERMATIC" Aerial Isolating Coil and Station Separator. Dealers and Service Men write for information and FREE advertising service. FILTERMATIC MFG. CO. (Dept. B-7), 4459 Frankford Ave., Philadelphia, Pa.

## AERO WORLDWIDE SHORTWAVE RECEIVER

**\$6.45**

Listen in DIRECT to London, Paris, Berlin, Buenos Aires and other broadcasting stations throughout the world via short waves. Your ordinary receiver cannot tune in these low wave stations. WORLD-WIDE RECEIVER gets 14 to 250 meters.



### AERO SHORT WAVE CONVERTERS

Convert Your Present Set Into a Short Wave Super-Heterodyne  
**A. C. MODEL \$12.50—D. C. MODEL \$11.50**  
**AT LAST! The Perfect Auto Radio .. ONLY \$20.00**  
Built by pioneers in the manufacturing of Auto Radio. We guarantee 1,000 miles radius of reception. A masterpiece of Radio engineering. Latest model 4 Tube Aero Pentode Auto Radio. Price of set only \$20.00. Set complete with tubes, batteries, dynamic speaker, antenna equipment and noise suppressors, \$39.00.



### NEW AERO MIDGET

Using the Latest Type Pentode and Multi-Mu Tubes  
**Price \$16.50**

**We guarantee COAST TO COAST RECEPTION**



Wonderful tone quality and selectivity. Full dynamic speaker. Full vision dial. Beautiful walnut cabinet. 5 Tube Set \$16.50, less tubes. Complete set of 5 matched tubes \$4.50 extra.

SEND FOR COMPLETE CATALOG  
**CHAS. HOODWIN COMPANY**  
Dept. R-2 4240 Lincoln Avenue Chicago, Illinois



**GET THIS** Free new No. 23 Edition of our **RADIO SERVICE TREATISE**. Contains some 75 new hookups, circuit diagrams; over 350 illustrations. **POSITIVELY THE GREATEST BOOK EVER PUT OUT.**

CONTENTS: VACUUM TUBE TREATISE with many illustrations; Vacuum Tube Average Characteristics Chart; How to Take Care of Your Tubes; Photograph Pick-ups; Connecting Additional Loud Speakers; all fully illustrated with diagrams. Modernizing Old Radio Sets; How to Convert Battery to Power Sets; Voltage Dividers; Selecting and Installing Replacement Parts in Radio Sets. **WRITE TODAY!** Enclose 2 cents for postage. Treatise sent by return mail.  
**RADIO TRADING COMPANY**  
29 West Broadway New York City

## Put a RADEX on Your Radio

Send for it now. Try it two weeks. If it doesn't **25¢**  
**Double Your Pleasure**

Send it back. We'll return your quarter and add a dime for trouble. **YOU WIN EITHER WAY.**  
**RADEX, 5000 Euclid Avenue, Cleveland, Ohio**

## The SCOTT ALL-WAVE

15-550 METER—Superheterodyne

Brings in stations 9,000 to 10,000 miles away with full volume and clarity. Major stations all over U. S. come in like locals. Write now for particulars.  
**THE E. H. SCOTT RADIO LABORATORIES, Inc.**  
4450 Ravenswood Avenue Dept. P-42 CHICAGO, ILL.



Biggest value ever offered: IDEAL 3-in-1 Kit contains everything required to build these 3 Flying Models, including Plans and Instructions. Easy to build.  
**IDEAL AEROPLANE & SUPPLY CO.**  
26 West 19th Street N. Y. City



High grade, moderately priced hand saw for light work; affords all the accuracy, convenience and efficiency of large band saws. Ball bearing. Self contained motor operates from light socket; or may be driven from line shaft. Machine finished table, with graduated scale, tilts any angle to 45 degrees. Quick locking device. Saw, with spring tension, is fully guarded. We make wide line of light machines for cabinet makers, woodmen, and amateurs, also heavy machines for factories.

**THE CRESCENT MACHINE CO.**  
93 Columbia St. Leontia, Ohio

Send for **FREE BULLETINS**



Send for advance literature on  
**THIS NEW 100 LB. SAW**

DIRECT FROM FACTORY TO YOU

From every standpoint the sensation of the year. A high speed, heavy duty machine. Solidly constructed, beautifully made, designed by engineers who have perfected every detail. **\$35.00**

Table 16x20—double bronze bearings, 500-hour lubrication, tilting table, adjustable saw cut, idler pulley drive. Nothing like it ever attempted at the price. Fully illustrated and described in our No. 75 advance bulletin DG 4.



20"x16"  
Table

**Sypher-Arcon**  
1524 Fernwood Ave.  
TOLEDO, OHIO

America's Pioneer Small Tool Factory

**Husky Reco Motors** ~~\$1.55~~

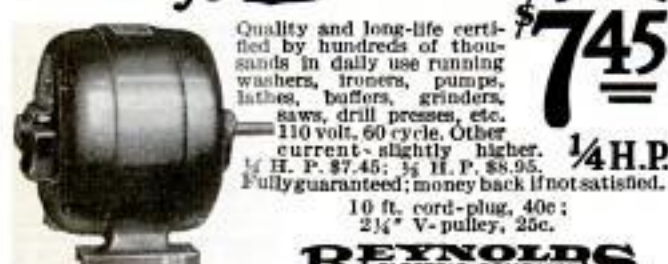

Quality and long-life certified by hundreds of thousands in daily use running washers, ironers, pumps, lathes, buffers, grinders, saws, drill presses, etc. 110 volt, 60 cycle. Other current slightly higher. **1/4 H.P.**  
1/4 H. P. \$7.45; 1/2 H. P. \$8.95.  
Fully guaranteed; money back if not satisfied.

10 ft. cord-plug, 40c;  
2 1/4" V-pulley, 25c.

**REYNOLDS**  
ELECTRIC COMPANY

Splash-proof, rugged design, big oil reservoir 2610 W. Congress St., Chicago

**BURN YOUR NAME ON TOOLS**

WITH THE  
**ARKOGRAF**

**PROTECT YOUR TOOLS FROM THEFT**

Write with electricity any name or design on the hardest and finest tools and instruments, or any metal, like writing on paper with pen or pencil. Complete Outfit \$3.50—Free! Anywhere Interesting Illustrated circular free. Write today. Agents wanted.

ARKOGRAF PEN CO., 1171 E. Stark St., Portland, Oregon



**KINKADE GARDEN TRACTOR**  
and Power Lawnmower

A Practical, Proven Power Cultivator for Gardeners, Suburbanites, Truckers, Florists, Nurserymen, Fruit Growers and Poultrymen.

Low Prices—Easy Terms

**AMERICAN FARM MACHINE COMPANY**  
1058 33rd Ave. SE. Minneapolis, Minn.



Catalog Free



**GERSTNER TOOL CHESTS**

A favorite with machinists and Toolmakers for 25 years. Free Catalog.

**H. GERSTNER & SONS**  
404 Columbia St., Dayton, Ohio

**Sport Bodies for Fords** At Factory Prices

This Model in Grey Prime **\$38.50**

Send 10c for catalog showing all models of bodies and other equipment for Ford and Chevrolet. Hi-compression heads, underslung parts, 3-1 gears, headlights, fenders, Cut across body on Model A Ford. Also made for Model T Ford.

Make Your Ford Into Classy Car

**Sport Factories, Dept. B-2, Aurora, Illinois**

**FREE** Get BB Magic at once. A wonderful shooter's digest—tells how to hold, aim and handle rifles; become a crack shot. The principle of compressed air action that made the Benjamin Single Shot world famous has been applied to 25 shot automatic firing. Learn all about both rifles. **SEND NOW!**

Benjamin Single Shot now \$4.50 postpaid. Benjamin Automatic 25 shot now \$7.50 postpaid. WRITE!  
**BENJAMIN AIR RIFLE CO.**  
649 N. Broadway St. Louis, Mo.



Now **\$1.50**

Was **\$2.00**

The personal autograph of Fayette R. Plumb on this Autograf hammer is guarantee that it is the finest hammer.

A fancy pattern hammer for tool lovers who take pride in their work and their tools.

Young, straight-grained hickory handle, subjected to a strength-test by a 400-lb. dropping weight. Octagon throated handle, with flattened sides to insure a firm grip.



Now—a fine hammer costs so little

**EVERY ONE** may own a fine hammer, now... at so little cost! Every one may have a perfectly balanced tool which works smoothly with the hand and arm.

Plumb's nationally advertised hammers have been drastically reduced: The Autograf from \$2.00 to \$1.50; the Red Handle and Black Head from \$1.50 to \$1.

Two models that are beautiful in finish and efficient in performance; that have *Plumb Quality* built into them, from the special analysis steel, hardened and tempered electrically, to the young, straight-grained hickory handles, which are strength-tested by a 400-lb. weight.



Ask your neighborhood hardware man. Fayette R. Plumb, Inc., Phila., U. S. A.

Now **\$1.00**

Was **\$1.50**

The Plumb Advertiser Finish (Red Handle and Black Head)—the largest individual seller at the \$1.50 price.

Has that natural "fall" which Plumb balance imparts to a tool.

Equipped with patented screw wedge which retightens the handle by a turn of the screw, after hard work and shrinkage have loosened it.

Nipper claws "bite in" and pull the slimmest headless Brad.





## AS SAWING WOOD! Kester Solder for Repairs

Something to be soldered? Do the job yourself and save that money! You can . . . because soldering with Kester Metal Mender is absolutely child's play. Simple as sawing wood, and a good deal easier because it doesn't take any muscle! Kester carries a scientific flux inside itself . . . you simply apply heat, then do the job. And from the first time on, you'll get results that an expert would be proud of. Use Kester Metal Mender in your home. Buy Metal Mender from good stores near you. Write for "The ABC of Soldering."

Kester Solder Company, 4201-04 Wrightwood Ave., Chicago, Ill. Eastern Plant, Newark, N. J.; Canada, Kester Solder Company of Canada, Ltd., Brantford.

# KESTER

## METAL MENDER

easy to use

**R**UN ERRANDS, ride to work, visit pals in distant towns—put "wings" on your bicycle with this new, 5 to 30 mile-an-hour Speedibike motor. Over 100 miles to the gallon. Easy, pedal starting. Speed control on handle bars. RIDER AGENTS wanted. Write Evinrude or Elto, Manufacturers, 502 N. 28th St., Milwaukee, Wis.

**BIKE MOTOR**  
for only  
**\$49.75**

Easy Terms



## "KEENFIRE" AIR PISTOL

**A LOT OF FUN** for indoor or outdoor target practice or small game. Strong, powerful pneumatic. No noise or powder. Nickel-plated barrel; walnut stock. Single shot; 7 in. overall; wt. 1 lb.

**FREE**—300 pellets with each "KEENFIRE"  
—\$2.50. Extra pellets 10¢ box.

"SUREFIRE"—50 Shot Repeater  
300 Pellets Free—\$5.00

LEE SALES CO., W-35 W. 32nd St., N. Y. City



\$2.50

## STRING YOUR OWN RACQUET

Same Quality String As in Expensive Racquets **Outfit \$1.65**  
Complete with Directions.

Easy to restring racquets—better than new. Saves real money. Send for this professional outfit today. Good profits made restringing other players' racquets. 37 ft. string. Colors Purple, Green, Red or White. Money back guarantee.

**MAKE MONEY TOO!** Send check or Money Order \$1.45 which includes Postage and Ins. Sent C. O. D., if desired.  
Pro Tennis String Co., Dept. F, Harmon, N. Y.



## Get Into A Business of Your Own—EARN \$150 to \$300 Monthly

**AUTOMATIC AIR SERVICE**  
Dependable, space saving compressors bring customers to your door. Only \$12 Monthly. 30 Days' Trial.

**PAINT SPRAY PROFITS**  
Paint autos, houses, furniture. One man does work of 5—highly profitable. Only \$12 Monthly will pay its own way.

**8-HOUR BATTERY CHARGING**  
Recommended by leading battery makers. Halves cost, doubles profits. No special experience required.

**20 MINUTE Car Washer**  
Big profits washing cars—save 2/3 time, does better job. Savings pay for it. Only \$17 Monthly.

**30 Days' Trial, to prove it. Easy Terms. Check items of interest and mail to**  
**HOBART BROTHERS**  
Box M-42, Troy, Ohio

**WRITE TODAY » Only \$16 Monthly — 30 Days Trial to Prove it « NO OBLIGATION**

**RAISE CHINCHILLA AND NEW ZEALAND WHITE FUR RABBITS** Make Big Money We Supply Stock AND CONTRACT FOR ALL YOU RAISE paying up to \$5.00 each. Large illustrated book, catalog and contract, also copy of Fur Farming Magazine, all for 10¢. **STAHL'S OUTDOOR ENTERPRISE CO.,** Box 141A, Holmes Park, Missouri

**BOW LEGS?**  
THIS GARTER (Pat'd) Makes Trousers Hang Straight If Legs Bend In or Out  
Free Booklet—Plain Sealed Envelope  
**THE T. GARTER CO.,** Dept. E South Bend, Ind.

**New Driver Workshop BOOK** with free blueprint

If you own a workshop, or hope to own one some day—this new **how-to-make-it** book will be the biggest help you've ever had. Never before have craftsmen been offered such a complete workshop manual! For only 50 cents this 1932 book is yours. Bound in beautiful green cloth, title stamped in gold leaf. Has 128 pages full of ideas. Nearly a hundred illustrations. Complete, easy-to-follow working drawings. Clear descriptions. New uses for your machines. Helps you get more out of your shop. Twenty projects by one of America's finest furniture designers. Drop-Leaf Side Table, Italian Console Cabinet (used for radio cabinet, desk, telephone), Chair and Mirror Frame. Lathe projects. Pier cabinet for books, bric-a-brac, or china. Inlaid Humidor or Jewel Box and many other projects. On sale where you buy Driver Tools.

**WALKER-TURNER CO., Inc.,** Dept. D, Plainfield, N. J.  
Editor: Here is 50¢ for "Woodworkers' Hand Book" with free blueprint.

**YOUR FREE BLUEPRINT**  
The full size blueprint of a practical workshop set-up is free with each copy of "Woodworkers' Hand Book"—just off the press. Send the attached coupon today.

NAME.....  
ADDRESS.....

When writing to advertisers please mention Popular Mechanics



# A FREE BOOK about PATENTS

## For INVENTORS

### Small Ideas May Have Large Commercial Possibilities . . . Delays Are Dangerous in Patent Matters

The FREE BOOK shown here was prepared for inventors, to show them exactly what steps they must take to secure a PATENT. If you have an idea, you should send for this book AT ONCE. It will tell you exactly how an application for a Patent is made, what information you must furnish your attorney, and what steps he must take in order to protect your interests. Remember, inventing an article in one thing—securing the exclusive right to manufacture it, use it or sell it is another. Without a U. S. Patent, you cannot expect to reap the profits that your invention may make possible. Send at once for this book. After you get that, you'll know exactly what to do to protect yourself.

### I Serve You Quickly and Secretly

Anything you write me or send me is strictly confidential between us. All letters and drawings are kept in strong, steel, fire-proof files, which are open only to myself or authorized members of my staff. I have secured patents for inventors located in every state in the Union. My organization is a large and efficient one. My practice is confined entirely to Patents, Trade-marks and Copyrights. I have had years of experience in Patent Matters. When you place your idea in my hands, I am in position to proceed at once to secure protection for you. My fees are reasonable, and if you desire, I can arrange convenient terms of payment.

### This Book Tells

How your Patent Application is made; what kind of sketches or drawings are necessary; what other papers must be made out; how the Patent Laws protect you; why it is important to avoid loss of time in getting your application filed; and many other important points. Even a very simple idea, if new and useful, may prove very valuable. You may have much to gain and nothing to lose by sending for this book TODAY.

### IMPORTANT:

Please understand that you are not under the slightest obligation in sending for this book. I will mail it, together with the Record of Invention form the same day I receive your request. Use the coupon below to save yourself time and trouble. After that, you will be in position to proceed or not as you choose, to make your application for a patent.

**MAIL  
Now**



### My Location in Washington

My offices in Washington are convenient to the Patent Office, and I and my assistants can, therefore, appear promptly before the officials and Examiners.

### FREE Record of Invention Blank

Along with my book, I will send you my Record of Invention form, also FREE. This blank will enable you to make a sketch of your idea in proper legal form and have it witnessed in such manner that it may be of value to you as evidence should the occasion for evidence arise. In my book, I tell you how to use this form to protect your interests.

## CLARENCE A. O'BRIEN REGISTERED PATENT ATTORNEY WASHINGTON, D. C.

**Clarence A. O'Brien**  
Registered Patent Attorney  
70-W, Adams Building, Washington, D. C.

Please send at once your book, "How to Obtain a Patent" and your "Record of Invention" form.

NAME \_\_\_\_\_

ADDRESS \_\_\_\_\_

(Be sure to write or print name clearly.)

## Don't Risk Delay - MAIL COUPON TODAY



# PATENTS

Booklet Free      Highest References  
 Promptness Assured      Best Results

Send drawing or model.

## ALL BUSINESS GIVEN PROMPT AND PROPER ATTENTION

Listed Patent Lawyer in the latest editions of the Rand-McNally Directory of Bankers and Bank-Recommended Attorneys, published by Rand-McNally & Co., Chicago, Ill.; The Baggott & Ryall Directory of Guaranteed Attorneys, published by Legal Directory Corporation, Boston, Mass.; Flugel's Law List, published by Legal Directory Publishing Co., St. Louis, Mo.; American Lawyers Annual, published in Cleveland, Ohio; Bankers Service Legal Directory, published by Bankers Service Co., Boston, Mass.; Eyre's Law List, 9 Park Place, New York City; Walters Legal Directory, Omaha, Nebraska, and the National Directory of Attorneys, Baltimore, Maryland.

**WATSON E. COLEMAN,**  
 REGISTERED PATENT LAWYER

Victor Building, 724 Ninth Street, N. W.  
**WASHINGTON, D. C.**

# PATENTS

## PROTECT YOUR IDEAS

Write today for FREE BOOKLET, HOW TO OBTAIN A PATENT and RECORD OF INVENTION—or send Drawing or Model of your Invention for Examination.

Promptness Assured with Best Results

**MILLER & MILLER**  
 REGISTERED PATENT ATTORNEYS

Former Members Examining Corps U. S. Patent Office  
 Dept. A-1006 Woolworth Bldg. New York  
 672 Earle Building Washington, D. C.

# PATENTS

## TO THE MAN WITH AN IDEA

Preliminary advice gladly furnished without charge. Booklet of information and form for disclosing idea free on request.

**IRVING L. McCATHRAN, Patent Lawyer**

Formerly with and successor to RICHARD B. OWEN  
 750 International Bldg. Washington, D. C.  
 41-E Park Row New York City

## TRADE-MARKS

# PATENTS—TRADE MARKS

All cases submitted given personal attention by members of the firm. Information and booklet free. Patent Office and Federal Court Practice.

**LANCASTER, ALLWINE & ROMMEL**

PATENT LAW OFFICES  
 Suite 412-815 15th St., N. W. Washington, D. C.

# PATENTS

**COMPLETE SERVICE**  
 A personal confidential service for serious-minded inventors, having worth-while practical ideas.

Patents—Trade-Marks—Designing and Drafting—Working Models—Automatic Labor-Saving Machinery. Manufacturing (small and large quantities.) Preparation and prosecution of patent applications, trade-marks, etc. COMPLETE FACILITIES for inventors to develop, perfect, or to patent their inventions. Facilities—10 engineers, draftsmen and patent experts, 50 mechanics and supervisory staff. All or any part of the above service is available. Complete service for those desiring it.



Send for FREE Book

**D. M. HELLER**

Reg. Patent Attorney  
 Consulting Engineer

31 EAST 17<sup>TH</sup> ST., NEW YORK, N.Y.

# PATENTS

Trade Marks, Copyrights, Patent Litigation Handbook with illustrations, 100 mechanical movements. Sent free on request.

**ALBERT E. DIETERICH**

Successor to Fred G. Dieterich & Co.  
 formerly member Examining Corps. U. S. Patent Office

REGISTERED  
**PATENT LAWYER and SOLICITOR**

621-A, Ouray Bldg.  
 30 Years' Experience Washington, D. C.

# INVENTORS

who derive largest profits know and heed certain simple but vital facts before applying for Patents.

Our book *Patent-Sense* gives those facts; sent free. Write LACEY & LACEY, 635 F Street N. W., Dept. 5, Washington, D. C. Estab. 1863.

Information on any book free. Write Popular Mechanics Press, Chicago, Ill.

# PATENTS SECURED TRADE-MARKS REGISTERED

A PATENT secured for a novel invention may prove to be valuable to you. I have had thirty-five years of experience in the practice of the patent and trademark law. Every case submitted to me will receive prompt personal attention.

Write to me for FREE book HOW TO GET YOUR PATENT and RECORD OF INVENTION CERTIFICATE. All business will be kept strictly confidential. Send me a model or sketch and description of your invention for my free opinion whether it comes within the provisions of the Patent Law. Delays are dangerous.

I ASSIST MY CLIENTS TO SELL THEIR INVENTIONS

**L. F. RANDOLPH, Registered Patent Lawyer, 302 Victor Building, Washington, D. C.**



# Delays May Be Costly PATENT Your Idea Now

## Don't lose time - Send for Big FREE BOOK



**FREE VALUABLE RECORD  
OF INVENTION BLANK**

Mail the coupon today, and in addition to the free book, we'll send you without charge a Record of Invention Blank. This form, when properly filled out may be of value to you as evidence should occasion require it. There is no charge or obligation for this service. Mail the coupon NOW.



### Little Ideas May Have Big Commercial Possibilities

**ACT AT ONCE**—and protect your idea. Remember, to get the benefits of your invention, you not only have to invent it—you have to PATENT it. Many men spend years perfecting an invention, only to find that someone else thinking along the same lines has already received a patent on the idea. When we think of all such cases that have come under our personal observation, we cannot urge too strongly that you take steps to protect your idea IMMEDIATELY. Delays of only a few days may be vitally important to you. Do not lose all the benefits of your hard work in planning and perfecting your invention.

### Mail the Coupon for FREE Book Today

It is of tremendous importance that you file your application for a patent at once. Our free book tells you how to proceed, what you need to know about patents in general and gives you an estimate of our reasonable fees. We also send you a "Record of Invention" blank free. Take the first step toward getting your patent now. Mail the coupon at once. If you send along a sketch and description of your invention, we will promptly write you what, in our opinion, ought to be done in order to protect it, and for which service there will be no charge.

### Highest References—Strictest Secrecy 33 Years of Proven Service

The members of the firm of Victor J. Evans & Co. are registered Patent Attorneys. Our legal and technical forces include lawyers, registered patent attorneys, patent draftsmen and searchers. Our Patent Office and Federal Court practice is confined to patents and trademarks. We specialize in these two subjects to the exclusion of all others. In our 33 years of patent practice, we have successfully served thousands of inventors to whom we can refer. It is a distinct advantage to an inventor to employ an attorney located in Washington as the U. S. Patent Office has no branches.

### Here's How We Operate

As soon as the description of your invention comes into our office it is immediately put in charge of an attorney, who is particularly familiar with the kind of invention you have perfected. Under his close personal supervision, patent searchers and skilled draftsmen work. He personally sees your case through to its conclusion. In short, you have the advantage of highly skilled and experienced service.

### Here's What the Coupon Brings Mail It Now

Mail the coupon today and take the first step toward protecting your idea. You will receive the FREE Book, a FREE Record of Invention Blank, and information on our fees. You create no obligation by mailing this coupon. Our service is complete, our fees reasonable, and our terms convenient. Don't waste priceless time; mail the coupon NOW.

**MAIL  
THIS  
TODAY**

## VICTOR J. EVANS & CO. Established 1898 REGISTERED PATENT ATTORNEYS

**MAIN OFFICE, 600D Victor Building, Washington, D. C.**

**BRANCH OFFICES:** 1640 D Conway Building, Chicago; 233 D Broadway, New York; 828 D Fidelity Philadelphia Trust Building, Philadelphia; 514 D Empire Building, Pittsburgh; 1010 D Hobart Building, San Francisco.

Please send me your free book, "How to Obtain a Patent," and your "Record of Invention Blank."

Name.....

Street and No.....

City..... State.....



## Steady Work—Big Profits in the KEY BUSINESS

TODAY more money than ever before is to be made in the key business. Homes, offices, factories, schools, garages, cars, luggage, boats, desks, cash registers—keys for all of these are lost and replaced or duplicated for spares every day. A steady stream of business, all cash, awaits the man who is ready to handle it right. Now it is easy for you to get into this profitable work—with a

## FOLEY AUTO- MATIC KEY MACHINE



It is SIMPLE to make perfect, smooth-fitting keys with the Foley—it does better work than an expert locksmith by hand. Cuts all kinds of keys—flat keys, cylinder keys, bit (house) keys, automobile keys by code.

Make \$2 to \$6 a day in your spare time or build up a good-paying, full time permanent business. The Foley is sold on easy payments if desired. Only a small investment starts you in this steady, money-making work. Get all the facts now. Write today!

### FOLEY MANUFACTURING CO.

4412 Foley Bldg. 11 Main St. N. E., Minneapolis, Minn.

## TESTS ANY VOLTAGE BURNT-OUT FUSES and Other Electrical Trouble LOCATED QUICKLY, SAFELY

## TEST-O-LITE

Out go your lights; your electric iron doesn't heat; the washing machine stops; the vacuum cleaner doesn't start; the radio goes dead. Why? Something wrong electrically, but where? TEST-O-LITE, with its tiny Neon Lamp locates the trouble INSTANTLY and SAFELY—no shocks, no burns!

TEST-O-LITE tests any voltage from 100 to 550 A. C. or D. C. It is a household necessity and should be in every home where such electrical emergencies are common. Keep one in your fuse box or tool kit.

Electricians find it indispensable for locating live or grounded wires and thousand other uses. They carry one in their pocket like a fountain pen.

Electrical and hardware stores sell TEST-O-LITE. If your dealer does not carry it mail us \$1.50 with your name and address.

**L. S. BRACH MFG. CORP.**

Pat. Oct. 21, 1900  
#1,779,853  
Manufacturers of Electrical Instruments for Over 25 Years  
Dept. E, 65 Dickerson Street, Newark, N. J.

TESTS ANY VOLTAGE

Established 71 Years

## Mason, Fenwick & Lawrence

REGISTERED PATENT ATTORNEYS

728 Woodward Bldg. Washington, D. C.

Other Offices  
New York—Chicago

Send description and  
sketches. Prompt service

## AGENTS MAKE UP TO \$15 A DAY

which makes it write better than any other on the market.  
Money Back If Not Pleased.

Sample  
Only 39¢

With No. 8 Fountain Pen Guaranteed for Life—Has Adjustable  
Ink Feed and Rubber Sponge



FREE WHOLESALE CATALOG, showing  
over 1000 face sellers. Send for your copy now.  
SPORTS IMPTG. CO., 232 Main St., LE CENTER, MINN.

## Catch Fish!

Eels, Mink, Muskrats with our new folding galvanized STEEL WIRE TRAP. Write for our FREE TRAP OFFER and Bargain Catalog. \$1 Box of our famous Fish Bait FREE to introduce our traps. WALTON SUPPLY CO., 3502 JUNIATA AVE., ST. LOUIS, MO.

Mortising attachment  
if desired



## CHROMIUM PLATING POWDER

PLATES IRON, STEEL, NICKEL, BRASS and COPPER without electricity or machinery. Guaranteed not to tarnish; dispenses with polishing. Half pint can \$1.50, prepaid. Particulars FREE. GUNMETAL CO., Ave. T, Decatur, Illinois

## Tilt the Saw—Not the Table

We have never designed a more popular power tool than this improved Handisaw. Note how table is level, yet saw is tilted 45 degrees. Table always level. No chance for lumber to slide down and bind blade. Other features are: polished 15"x17½" table; rick rip guide; indexed scales for setting rip guide, swinging arbor and mitre guide. Bevels, mitres, dados, sands, rabbets, etc. Wt. 80 lbs. Big 20"x27½" table extra. Full description in catalog. Price only..... **\$32.50**

### SHAPER S49

Has 17" table cast solid to base. Spindle raises and lowers. High constant speed—7000 R. P. M.—at all loads. Weighs 80 lbs. Electrically reversible motor if desired.



Buy  
Now  
Pay  
Later

### Workshop Catalog

Send 10c in stamps or coin (which only pays part of mailing cost) and obtain large 52 page Workshop Catalog. Contains complete information on saws, jointers, mortisers, lathes, jig saws, band saws, shapers, and workshops. If requested, a free booklet telling how to make window screens will be sent.

### Be Our Demonstrator

While you use Boice-Crane Machines on your work, you can also be earning commissions by demonstrating your machines to others. We do the selling and collecting. Details of this plan sent only on request.

### Ball Bearing Lathe . . \$29

Nothing better. Does beautiful work. 11" swing, 42" c. to c. only \$29. Also made in 11"x30" size. We make a full line of lathes. See catalog.



**W. B. & J. E. BOICE**  
DEPT. PM-4H TOLEDO, O.





## FLY YOUR OWN EASY TO BUILD — EASY TO BUY

(Approved and eligible for Federal License)

You want a plane of your own, now is the time to get it. The famous Heath, which year after year wins in its class at the National Air Races, is offered within the easy reach of the modest income. Sporty, reliable, fast, inexpensive—the easiest and most economical plane in the world for the novice to master and operate. Buy it ready to fly—or assemble it at home from the Heath Kits. Low prices and partial payments!

Send 15c for Complete Facts and Figures today.

**HEATH AIRCRAFT CORPORATION**  
DEPT. P-24 NILES, MICHIGAN

Only  
**50¢**



**BEST LEVEL EVER DESIGNED**

New SAND'S-STEVEN'S No. 555 LINE & SURFACE LEVEL. Ideal for Home Work-Shop, Factory, Road Builders, Oil Burner Installations, etc. Compact, sturdy, accurate. Length 3 1/4". Send us 50 cents or ask your hardware dealer. *Sand's Levels Tell The Truth.*

Sand's Level & Tool Co., Dept. "E" Detroit, Mich.



## GEARS

In Stock—Immediate Delivery

Gears, speed reducers, sprockets, thrust bearings, flexible couplings, pulleys, etc. A complete line is carried in our Chicago stock. Can also quote on special gears of any kind. Send us your blue prints and inquiries.

Write for Catalog No. 10

**CHICAGO GEAR WORKS**  
769-773 W. Jackson Blvd., CHICAGO, ILL.

## Ideal TRAILER HITCH BALL JOINT Can't Let Go!



Made of steel; can't rattle, wear or detach. Simple to install; easy to hitch or unhitch in any position. Order one with money back guarantee. Write for circulars to H. B. line of Trailers, Tongues & Parts

**HAMMERBLOW TOOL CO., 605 Third St., Wausau, Wis.**

ONLY  
**\$3**  
POSTPAID



## SHIP MODELS WHALE SHIP Wanderer

Build a beautiful scale model of the last of the famous New England Whalers (illustrated). We can supply special construction sets or special parts, such as semi-finished hulls, blocks, deadeyes, anchors, steering wheels, figureheads, etc. Similar sets and parts for models of Flying Cloud, Constitution, Spanish Galleon, U. S. Destroyer Preston, Mayflower, and many others; model steam engines, books, blueprints, special tools, etc. New large 64 page photographically illustrated booklet contains valuable information and hints for building ship models, in addition to prices and full description of the above articles. A copy will be sent postpaid upon receipt of 15c (coin). Be sure to send for this booklet before starting your model.

**MODEL SHIP SUPPLY CO., Dept. E MINEOLA, N. Y.**



## "Another Bulls Eye— Beat That If You Can!"

Keen competition—that's what sets the blood racing in your veins.

When Junior puts 9 out of 10 shots close to or even into the bulls eye, it gives his honored parent something to think about, if he's going to hold up the prestige of the older generation.

A father who hasn't forgotten his own boyhood can find with a Daisy Air Rifle, the real answer to the problem, "How can we keep our son from running around outside with the wrong kind of boys?"

Make up your mind to get a Daisy Pump Gun soon, and give it a trial. You'll be surprised to see what a fine rifle the Daisy Pump Gun really is. It's the finest boys' gun made, with polished walnut pistol-grip stock, and slide-action, a true replica of the rifle used by big-game hunters and explorers.

A 50-shot repeater for only \$5.00. A safe gun, and remarkably accurate in its range. Other Daisy models, \$1.00 to \$5.00.

Fill out the coupon below, get the Daisy Target, and a copy of the Daisy Manual, which tells boys how to shoot and drill. It's free to any boy who sends this coupon.



### For Indoor Shooting

To make your shooting outfit complete, get one of the new Daisy Targets, made of sheet steel, with patented device to stop shot from flying. Folds to fit pocket, and can be set up anywhere, for rainy day practice, in house, cellar, or garage. Only 50 cents—extra cards 100 for 25 cents. See our special offer on coupon below.

# DAISY AIR RIFLES

DAISY MANUFACTURING COMPANY  
Plymouth, Michigan, U. S. A.

DAISY MFG. Co., Plymouth, Mich.

P. M.

Gentlemen:

Enclosed find 50 cents for which please send me one of your Daisy Folding Steel Targets. I am to receive absolutely FREE, a dozen extra target cards, a tube of Bulls Eye Steel Shot, and a copy of the Daisy Manual, containing instructions for drill and target practice.

Signed .....

Address (Street and Number) .....

City and State .....

When writing to advertisers please mention Popular Mechanics



**Buy DIRECT**  
*on credit  
 at New*  
**Low Prices**  
*Our 1932 Cut-Price  
 Offers a Remarkable  
 Opportunity to Own  
 A 21 Jewel ~*  
**Santa Fe  
 Special**



*Send for  
 Catalog  
 Now!*

*Compare  
 the Santa Fe Special  
 with other Watches costing  
 30% to 50% more ~*

**Send No Cash** In addition to our NEW LOW PRICE, I will send for your approval one of these Standard Watches, guaranteed for a lifetime of satisfactory service, not only by the Santa Fe Watch Company, but by the Great Illinois Watch Factory. So accurate, Government officials carry them; so perfect and beautiful, jewelers say they are worth 1-3 to 1-2 more than we ask for them. I will send you one to see WITHOUT ONE PENNY DOWN—allow you to wear it 30 days FREE—then sell it to you on easy payments.

**Diamond Rings—Wrist Watches**

Write for our New Diamond Ring of Romance and Bulova Wrist Watch Catalog, showing marvelous new designs. Never have we been able to offer such beautiful diamond rings and artistic dependable watches at such low prices. The catalog is sent FREE.

Ask for our Special Cash Offer. Good for 30 days only.

**Santa Fe Watch Co.**  
 46 Thomas Bldg.,  
 TOPEKA : : : KANSAS

To SANTA FE WATCH CO.,  
 46 Thomas Bldg., Topeka, Kans.  
 Please send me catalog I have checked.  
 Railroad and dress Pocket Watches.....  
 Ladies' and Men's Wrist Watches.....  
 Ladies' and Men's Diamond Rings.....

Name.....  
 Address.....

**THE** Manufacture of Colored Concrete Ornamental Products offers a local industry that is NEW, FASCINATING, and HIGHLY PROFITABLE. The beautification of homes and surroundings is TO-DAY'S VOGUE. Every home-owner & customer.

**8 OPPORTUNITIES for LOCAL Manufacturing OFFER Substantial PROFITS**

**Now! Permanent Color!**  
 Over 30 colors and shades. Beautiful. Sell themselves. Kauble of Iowa shows \$2,000 profit with only 3 designs. Crockett of Tex. \$1,331 as side-line, etc.

**7 Other Mfg. Opportunities**  
 Each one offering substantial earnings and a leader in its field. Each one with a stable and growing market, utilizing low-cost local materials. No special building required. Learn all about these 8 exclusive opportunities that can be started as low as \$50. Send for illustrated booklet to-day.

**W. E. DUNN MFG. CO.** 570 Ottawa Ave. and Affiliated Companies. Holland, Mich.



**FUN LOADS OF LAUGHS!**  
 Fool your Friends! Pranks, tricks, jokes—For April 1st or anytime. Trick matches, rubber gum and cigars, surprise letter, etc. ALL GLOOM AND DEPRESSION CHASERS. Money's worth or money back—Send Today For Fourteen Six For Fifty cents.

**OLD DOMINION SPECIALTY CO.,** Box 1094, Highland Springs, Va.

**BUILD DUTCH WINDMILLS**  
 Build and Sell Windmills. Beautifully designed Windmills beautify any garden. Can be easily constructed with our complete set of blue prints (21x24). Drawings mechanically correct to scale, with full instructions. Price \$6.00

**CRAFTSMAN'S MODEL CO.,** 2630 N. 41st St., Milwaukee, Wis.



## Does Your Rupture Mean Less Work?



An article in a medical journal written by a prominent physician says: "The working efficiency of individuals with rupture is thereby impaired from 15 to 50 per cent."—why handicap yourself? Stacks of sworn endorsements report success by using

**Stuart's Adhesif Plapao-Pads—without delay from work.**

Plapao-Pads cling to the body without straps, buckles or springs. Easy to apply—economical and comfortable.

Convince yourself by actually testing Plapao at our expense. Send coupon today. Test of Factor "PLAPAO"

**FREE! ACT SPEEDILY**

MAIL COUPON BELOW TO-DAY

Plapao Laboratories, Inc.,  
 1190 Stuart Bldg., St. Louis, Mo.

Send me FREE Trial Plapao and 48-page book on Rupture. No charge for this now or later.

Name.....

Address.....



Your  
**BIGGEST BARGAIN**  
in  
*Outboard Motors*  
is  
**JOHNSON**  
*Dependability*



**JOHNSON**  
MOTOR COMPANY  
400 PERSHING ROAD, WAUKEGAN, ILL.  
Canadian Johnson Motor Co., Ltd., Peterboro, Canada

# Write for the Handy Chart

The Johnson SEA-HORSE Handy Chart gives complete specifications of the entire line of 1932 Johnson motors—and describes the new refinements that make this year's SEA-HORSES better than ever. Johnson prices are down to the lowest point in Johnson history—but the quality is up to the highest peak Johnson has ever achieved. This is the year to buy. Your dealer will give you a "Johnson" ride without obligation. Try it—and feel the difference.



**SEA-HORSE SERIES**  
**\$115<sup>00</sup>** From the world's lightest outboard to the super power of the SEA-HORSE 32, this series offers you a brilliant and dependable motor for every outboard need.

**STANDARD MOTORS**  
as low as **\$97<sup>50</sup>** Light Twin, 3 normal h.p. at \$97.50. Standard Twin, 7 normal h.p. at \$135. Built for grueling service. Equipped with underwater exhaust.

Please send me a copy of the SEA-HORSE Handy Chart, giving specifications of the 1932 Johnson line.

Name \_\_\_\_\_

Address \_\_\_\_\_

City \_\_\_\_\_

State \_\_\_\_\_

**\$20 A DAY**  
for AGENTS

Every home, store, factory, garage, etc., buys 12 or more. 150% profit. Agents making \$500 to \$1000 a month selling the new, improved, patented

**6-in-1 Fuse Plug**

Think of it! 6 fuses in 1 plug. "A turn to the right brings back the light." Most necessary invention in years. Approved by Board of Fire Underwriters. Demonstration outfit given. Easy seller. Write at once for proposition and free demonstrator offer.

**6-in-1 FUSE CO.**  
801 W. Madison St. Dept. 178 Chicago, Ill.



## BELLO FOR DULL BLADES

Wonder-working machine—10 days' free trial

BELLO, the Hollow Grinder, grinds a new edge for every shave, changing all blades of Probak and Gillette type to hollow ground concave.

A hundred years ahead of any stropper.

Price \$3.75. Pays for itself two to three times a year on blade cost alone.



E. S. PETERSON, *Durant*  
dealer at Portland, Me., has  
used one blade for more than  
500 shaves.

TO THE NEW  
A sensation in America

You have given your wife every modern device to ease her domestic burdens. If she has not alleviated your one great grief, "shaving torture," by giving you a Bello for a birthday or Christmas gift, get one for yourself.

Dr. R. J. Dice, Okla.: "One blade over a year."  
A. W. Stubbs, Iowa: "350 shaves, one blade."

If you cannot secure Bello locally, send us \$3.75 (your money back if not satisfied), or we will forward on 10 days' trial if you attach this ad to your letterhead and check here

FREE — A generous size 35c tube of Bello Bubbles, the new Danish shaving cream, absolutely free, if you send cash with order.

FROM THE OLD WORLD  
6 solid years of European success.

### BELLO SALES PLAN

F. A. Ward of Montpelier, N. D., a town of 176 people, has sold over 500 to date. If interested in selling Bello, check here  and pin this advertisement to your letter.

THE "BELLO" CORPORATION  
Desk 1211, Bello Bldg., Gardner, Mass.

Name \_\_\_\_\_

Address \_\_\_\_\_

## BE FIRST IN YOUR TOWN

Make money fast. Be an expert in new field. Fascinating, dignified business. Nothing like it. Be first in your town to represent

### McClain National Lawn Service

The McClain Study Course and Lessons tell you how at no cost to you. Earn as you learn. Free advice. Full answers to all lawn problems. Fine proposition for tree surgeons and landscape men. Write today. Be first. McClain Bros. Co., Dept. P-42, Canton, O.

## INCREASE YOUR BUSINESS

by using the NEW \$5.95 "Two-Faced" Film Duplicator to make 100 copies, in 1 to 5 Colors each time. Or the \$37.05 "Excelligraph" Rotary Stencil Duplicator to Print Copies of Anything Typed.

Penned, Drawn or Traced in numbers up to 3000 each operation, as Price Lists, Hand Bills, Special Sales Announcements, Bulletins, Menus, Quotations, or "what have you?" Write—

Easy Terms

**PITTSBURGH TYPEWRITER & SUPPLY CO.**  
Suite 552, 339 Fifth Avenue, Pittsburgh, Pa.



# Now the Newest in ECONOMICAL TRANSPORTATION

with a **MUNCIE  
BICYCLE MOTOR**

In less than 45 minutes your bicycle is transformed into a sturdy, reliable motorcycle capable of speeding 25 miles per hour going 80 miles to the gallon.

**\$29<sup>50</sup>**



This Muncie Bicycle Motor lists at \$55.00 but for a limited time only can be purchased for \$29.50. Act now, send coupon for further information.

**MUNCIE GEAR COMPANY  
MUNCIE, INDIANA**

Send complete information on your Muncie Bicycle Motor.

Name.....

Street.....

City..... State.....

**PLUMBING SUPPLIES**  
Lowest FACTORY PRICES

Send for Catalog E and preferred discount sheet. Complete Plumbing—Heating Outfits and supplies. No order too small; none too large—every want filled. Bargains beyond belief. Well-known Johnson Quality rigidly maintained through. Overnight shipments. Write TODAY.

**Johnson Plumbing Supply Co.**  
3647 S. Halsted St. Chicago, Ill.

FREE BOOK

## For Economy.. Buy— For Income.. Sell—

**EIFEL-PLIERS, PLIERENCH KIT**  
The "Pocket Machine Shop"



**An Automatic Lock-Grip Ratchet Wrench and Ton-Grip Pliers and Speed Vise!**

It does the work of \$50 worth of best other tools and the things no other tools can do! Buy this "Pocket Machine Shop" and save all kinds of Money and Energy 'round Car, Home, Shop, Farm, etc.



Make up to \$125 Weekly Selling these Wonder Kits. People Buy at sight at new LOWER Price.

**AMERICAN PLIERENCH CO.**  
PMD—4809 N. Ashland Ave., Chicago, Illinois

When writing please mention Popular Mechanics

# VICTOR CONVERTIBLE HAMMER

SOFT FACED

**A NECESSITY FOR  
MACHINE WORKER  
AND MECHANIC**

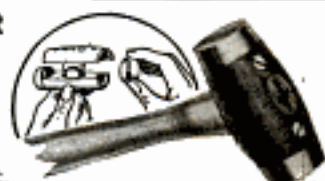

For efficiency and economy the VICTOR has no equal. Two hammers in one. Faces removable—changed to lead, brass, copper, as wanted, in one minute. Scientifically, ruggedly made. Accurately balanced. Recommended by foremost engineers. Fully guaranteed.

**SPECIAL OFFER**

Send only \$2.00 at once for Rabbit-faced style. Extra faces, 25c. Brass, 45c; Copper, 50c. Money back if not satisfied. Or write for details.

This is the hammer described on page 86—January 1932, Popular Mechanics.

**VICTOR PRODUCTS CORP.**  
2631 Belmont Ave., Dept. PM-4, Chicago

**AGENTS!**

Get our Money Making Offer at once. Exclusive Specialty.

# A BRAND NEW BOAT SAVE 2/3 the Builder's Prices



YOU can build any one of our 38 cruiser, runabout, outboard, sail or rowboat designs. We furnish all materials cut and shaped ready to assemble, including fastenings and complete assembling instructions. Your Brooks Knock-Down boat is sturdier, huskier, faster and more of a pleasure to you because you've handled every plank and fastening yourself. It's easy—the Brooks Way! Every part is numbered. Our master craftsmen do the hard work, you have the fun of assembling a brand new craft that will make you the proudest boat builder that ever lived. Our handsome catalog illustrating 38 distinctive designs, also complete line Boat Fittings, mailed anywhere on receipt of 10c.

SEND  
10c  
FOR BIG  
CATALOG

**BROOKS BOAT COMPANY, Inc.**  
Dept. 10-S, Saginaw West Side, Michigan

# RADIO NOISES AND THEIR CURE

62 Articles—200 Illustrations

Every article complete, gives all types of Radio noises and tells how they may be cured. 76 full size pages, 8 1/2 x 11. Only book of its kind ever published. Written in question and answer form so every one can understand it. Send 50c for your copy today. (75c for Canada and foreign countries.)

**NEWARK ELECTRIC CO., 228 W. Madison St., Chicago, Ill.**

# 450 Miles in a Gallon of Gas!

says noted Engineer

According to a recent article by the president of the world's largest motor research corporation, there is enough energy in a gallon of gasoline if converted 100% in mechanical energy to run a four cylinder car 450 miles.

**NEW GAS SAVING  
INVENTION ASTONISHES  
CAR OWNERS**

A marvelous device, already installed on thousands of cars, has accomplished wonders in utilizing a portion of this waste energy and is producing mileage tests that seem unbelievable. It saves gasoline, reduces carbon formation, creates more power, quicker starting, snappy pick up, and a smoother running motor.

**Make Up To \$100 a Week and More**  
To obtain national distribution quickly, men are being appointed everywhere to help supply the tremendous demand. Free samples furnished to workers. Write today for this free sample and big money making offer.

**WHIRLWIND MFG. CO.**  
Dept. 367-A, Station C, Milwaukee, Wis.





# Don't Burn Coal

~ use cheap oil



An amazing new BLUE FLAME Oil Burner that simply sets in the fire box of your present cook stove or range. Makes cooking and baking a pleasure. Cheaper than coal. Burns 96% air and 4% cheap oil. No noise, dirt or odor. Absolutely safe and quiet. Costs only a few dollars. Sold on money-back guarantee and guaranteed for ten years.

**30 Day Free Trial Offer**  
Try this wonderful Blue Flame Burner in your own home at our risk. Special low price to first user in each locality. Write at once for free booklet and 30 day trial plan. AGENTS! Our free burner starts you in business with protected territory.

International Oil Heating Co., Dept. 402A, St. Louis, Mo.

# JOIN THIS EXPERIMENT

and get a Famous

## HOOVER CONDITIONER

Here is your chance to own this aristocrat of home Rowing Machines at a SENSATIONAL BARGAIN. Only limited number to be distributed under experimental HALF PRICE offer. Mail coupon for details.

FOR  
LESS than  
**1/2**  
PRICE!



## TRY IT 10 DAYS!

USE the Hoover Conditioner ten full days in your own home. You'll feel like a new person! Five minutes' FUN a day will do wonders for your health, your figure. See how entirely DIFFERENT this Rowing Machine is. No awkward tugging on jerky coil springs or rubber cables, but the full, rhythmic sweep of the racing shell stroke, as light or as strong as you want it—the finest, most enjoyable exercise in existence.



Walter M. Hoover, former national and world's champion sculler, winner of the famous Diamond Sculls

## Gain Health, Strength, Energy

Walter Hoover, champion oarsman, designed this rowing machine to duplicate the TRUE sport of rowing. Exercises every muscle, strengthens internal organs. Instantly adjustable to strength of a child or an athlete. SAFE for every member of the family.



HERE IS THE SECRET

of the Superiority of the "HOOVER CONDITIONER"

A different type of exercise for every purpose. A turn of the handy screw adjusts the tension to any desired degree—for light, rapid, reducing exercise—or heavy, muscle-building exercise.

**FREE** Mail coupon or write for full information about this amazing experimental offer and how you may participate without obligation—how you may try the genuine Hoover Conditioner for 10 days—how you may own it at LESS THAN HALF PRICE. Get the facts FREE, before you buy any rowing machine.

**THE HOOVER CONDITIONER, Inc., Dept. 124**  
52 East 19th St., New York, N. Y.

MAIL THIS COUPON

The Hoover Conditioner, Inc. (Dept. 124)  
52 East 19th Street, New York, N. Y.  
Send me FREE details of special limited offer on Hoover Conditioner at LESS THAN HALF PRICE.

Name.....  
Address.....  
Town.....State.....  
Copyright 1932

## FOR FIXIT SHOPS

# Free Foto Guide

and Vacuum Cleaner Parts Catalog. Most complete ever published. Lists over 800 items and special tools. 32 pages. Illustrated. Standard material at lowest cost. Valuable source data on obsolete parts. Big help to all repair shops.

## WASHING MACHINE PARTS

Combined washer, vac, and small motor servicing attracts trade and reduces operating expense. We can supply most replacement parts. Uniformity to highest standards guaranteed. Lowest known prices with saving on transportation and trouble. Consolidated orders earn maximum discounts. Instructive catalog free.

Uron Industries, Inc. 1225 W. 6th St. Cleveland, Ohio

**BABY CALCULATOR**  
ADD, SUBTRACT, MULTIPLY, DIVIDE. Does work of \$300 machine. Not a toy. Million dollar capacity. Simple and accurate. Guaranteed 5 years.

**FREE TRIAL**  
—SEND NO MONEY—

**\$2.50**  
Total Cost

Just name and address. We will ship Calculator immediately. On delivery pay postman \$2.50 (plus few cents postage). (If outside U. S. send cash.) 30c additional in Leatherette Case. If not satisfied after 10 days' trial you get your money back. THOUSANDS OF SATISFIED USERS. Write for Agents' Proposition. **BABY CALCULATOR MACHINE CO., (Mrs.) P. O. Box 1118, Dept. 31, CHICAGO, ILLINOIS**

## Do Your PRINTING

Cards, stationery, circulars, tags, labels, advertising, etc. Save money. Print for others, big profits; easy rules sent. Will do popular Raised Printing like Engraving. Junior Press, \$5.00. Job Presses \$11 up. Power \$149. Write for free catalog. **THE KELSEY CO., Y-37, Meriden, Conn.**

# FREE How To Secure A Government Position

Tells About These and Other Positions

**RAILWAY POSTAL CLERK**  
\$1850 to \$2700 a Year  
**POSTMASTER**  
\$1200 to \$2500 a Year  
**CUSTOMS HOUSE CLERK**  
\$1140 to \$2700 a Year  
**INTERNAL REVENUE MEN**  
\$1140 to \$2700 a Year  
**R. F. D. MAIL CARRIER**  
\$1800 to \$2300 a Year

**FREE BOOK** tells how I can help you get a Government Job. For 8 years I was Civil Service Examiner—have helped thousands. If citizen 18 to 50, you are qualified. Get ready NOW for the NEXT Railway Postal Clerk Examination! Send for free book. Write or mail coupon TODAY.

**A. R. Patterson, CIVIL SERVICE EXPERT, C-84 Wacker Bldg., Rochester, N. Y.**  
Please send me your free book, "How to Secure a Government Position."

Name.....  
Address.....

When writing to advertisers please mention Popular Mechanics



## How to Minimize After-effects of Tobacco

To an Amazing Degree by  
Doing One Simple Thing



### "SMOKER'S FAG"

Now Found 90% Correctable  
According to Scientists

Every day the average person who smokes too many cigarettes notices it. Head heavy and dull—a pressing down over the eyes; across the back of the head. Scientists now call it "Smoker's Fag."

Now Science points a way out. A way that minimizes the after-effects of tobacco to a marked and amazing extent.

It's excess acid in your system that makes tobacco intolerable. Keep your alkaline balance and you minimize any after-effects from smoking.

**JUST DO THIS:** Take 2 teaspoons of Phillips' Milk of Magnesia in a glass of water every night before bed; or take 2 Phillips' Milk of Magnesia tablets, which is an equivalent amount.

Don't let heavy smoking "get" you. This small, daily dosage of Phillips' Milk of Magnesia tends to neutralize excess acids and to alkalize your system against the after-effects of tobacco. Your head stays clear; your mouth sweet; you have fewer headaches.

Demand genuine Phillips' Milk of Magnesia; either the familiar liquid form or the new, convenient tablets.

**TWO FORMS NOW AT STORES**—You can now get genuine Phillips' Milk of Magnesia in tablet form, as well as ordinary liquid form. Each tablet is the equivalent of a teaspoonful of Milk of Magnesia. Carry the tablets with you wherever you go. They taste like mint candy.

# PHILLIPS'

## Milk of Magnesia

Neutralizes the acid that causes  
tobacco headaches and depression

When writing please mention Popular Mechanics

## The New Featherweight CAILLE at \$79<sup>00</sup>



**H**ERE'S a motor that's packed with power—just the outboard for the sportsman—ideal for hunting and fishing—drives a heavy rowboat 8 to 9 miles per hour—planes a light speed dink 16 miles per hour. It weighs only 34 pounds—can be carried, portaged or transported anywhere, is stoutly built for long life and rough usage. Precision built of finest quality materials—Caille offers you this easy starting motor on A FIVE DAY FREE TRIAL. Prove to yourself that it's the world's greatest outboard value at \$79.00. In addition Caille build seven other outboard models from 10 to 23 H. P. Write today for new booklet.

Weights 34 lbs. Develops 4 H. P.

### CAILLE

MOTOR COMPANY

6457 Second Boulevard  
DETROIT :: MICHIGAN



National Three tube wonder short wave receivers. A. C. and D. C. models. Price net, completely WIRED with 4 Sets of Coils, \$31.50. Descriptive bulletin on request. Our complete catalog (100 pages) covering all parts for short wave receivers and transmitters as well as service supplies, sent on receipt of ten cents (stamps or coin).

**CHICAGO RADIO APPARATUS COMPANY**  
Est. 1921 415 South Dearborn St., Chicago, Ill.

## \$42<sup>50</sup> Power Paint Sprayer

ONLY \$12<sup>50</sup>

for Complete Outfit  
Act quick—save \$30



This is a real spray outfit for house, auto, furniture, etc. No job too large. One man can spray as much as 5 men with brushes, and do better job. Any auto, track, or gasoline engine furnishes the power, running at idle speed. Simple to operate. Remove 2 spark plugs and insert compression valves. Cannot possibly harm engine. Saves more than its cost on any small job. Covering capacity 1,000 sq. ft. per hour. Ideal for paint, lacquer, deco, varnish, etc. Guaranteed to perform like any \$75 outfit on the market.

Outfit consists of 45 ft. best quality Hose, 2 Auto Compression Valves, et. Paint Container, Full Liquid Pressure Type Gun that sprays 12 in. swath; 2 Spray Tips, round and fan. Gun can be used with any compressor. Send \$2.00 deposit, balance C. O. D. Satisfaction guaranteed or money back. Order Now.

**NATIONAL JOBBING & EXPORT CO.**  
109 W. Lake Street Dept. 104 CHICAGO, ILL.



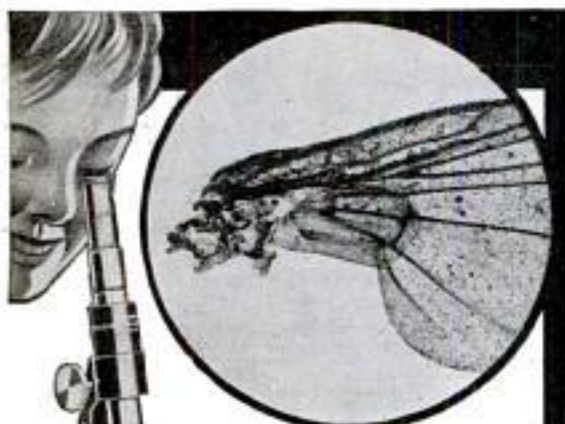

Fly's Wing, 100 Magnifications

OWN THIS  
Fine Microscope  
350 POWER

ONLY  
\$18.50

SEE germs, blood corpuscles, thousands of hidden mysteries. In a drop of water watch animalcules eat, move, split into two separate living beings. Endless instructive entertainment. But be sure yours

is a Wollensak Microscope—fine enough for doctors and laboratories, yet so simple a 10-year-old can use it. Life-time construction. Magnifies 100 to 350 diameters. Only \$18.50, at dealers or from us. 100-power, \$10. Money-back guarantee. Catalog of Microscopes, Telescopes, Binoculars free. Write today.

WOLLENSAK OPTICAL CO., 867 Hudson Ave., Rochester, N. Y.

WOLLENSAK MICROSCOPES  
BINOCULARS • TELESCOPES

## SMOKE WITHOUT ASHES!

Cooler, Sweeter—Not a Cigarette Holder!

Ash Pak prevents falling ashes, flying sparks, burns. Ends nicotine stains. Makes cooler, sweeter smoke. Fits any cigarette. Ideal for motorists, bridge parties. Easily emptied. Made of unbreakable Bakelite, assorted colors. Get introductory offer.

The Norlipp Co., Dept. C-4  
568 W. Congress St., Chicago, Ill.

### Agents

More sold 144 in 2 days, Soreyd, 30 in 10 min. Sell men, women, dealers. Sales guaranteed. Write.

## New Tractors from Old Cars!

DO ALL FARM WORK!

Make powerful tractor out of your old Model "T" or "A" Ford, Chevrolet or other old car with SHAW Tractor Equipment. Low cost! New High Arch Model with 30-in. clearance straddles 1 or 2 rows corn or other crops. Cultivates, plows, seeds, runs belt machinery, etc. Easy to attach. Price Greatly Reduced to meet present conditions. Subject to change. Order quickly. Save! Write Today for FREE literature. Reduced Price. Easy Payment Plan. 10-DAY TRIAL OFFER!

SHAW MFG. CO., Dept. PM4, Galena, Kansas



POCKET SIZE  
**HEATER**  
Boils Water  
For Every Home Use

IMAGINE an electric water heater that slips easily into a man's coat pocket yet so amazingly powerful it boils water almost instantly for cooking—bathing—scrubbing, etc.! Such is the new Super-Lux Double Action Heater recently perfected. Nothing like it ever seen before. Not a mere novelty or toy but a practical, efficient appliance with unlimited usefulness in every home. Write today for full description and introductory offer.

AGENTS—UP TO \$40 IN A DAY!

Unlimited money-making opportunity provided by this new miracle heater. G. Smith (Mo.) made \$41 his first day — C. L. Norman \$195 in 10 days — many others equally amazing. Write for proof of sensational big earnings and generous starting plans.

LUX-VISEL, Inc., Dept. D-60, Elkhart, Ind.



POCKET  
SIZE



GO  
LEVEL RIDING  
in a  
*Chris-Craft*  
Speed • Power  
Comfort for  
**\$795**

Only in Chris-Craft can you experience the joy of LEVEL RIDING. More speed per horsepower! Smoothness and comfort new to motor boating! These can be yours in a smart 15½-foot, 6-passenger, 32-mile runabout of standard Chris-Craft construction throughout, for only \$795 . . . less than the cost of a good outboard motor assembly. There is also an 18-footer at \$1095, and 21, 25 and 27-footers from \$1795 up (F. O. B.). Ask your nearest dealer to take you LEVEL RIDING in one of these . . . the finest boats and greatest values in Chris-Craft's 45 years.

CHRIS-CRAFT CORPORATION  
2304 Detroit Road, Algonac, Michigan

Please send me information about the new LEVEL RIDING Chris-Craft. I am interested in a \_\_\_\_\_-ft. Runabout.

Name \_\_\_\_\_

Street \_\_\_\_\_

City \_\_\_\_\_ State \_\_\_\_\_

(110)



When writing please mention Popular Mechanics

Copyrighted material



# Earn up to \$12.00 a Day in Your Own Business

You can do it filing saws on the Foley Automatic Saw Filer! Start in spare time and build up a fine-paying, steady cash business of your own. V. H. Vander Espt writes, "I filed 21 saws from 8 A. M. to 5:30 P. M. at an average of 80¢ apiece (\$16.80)." Frank Bradek writes, "Cleaned up \$56.00 in three days." It is easy work—no eye-strain—no previous filing experience necessary. The Foley Filer automatically files saws perfectly.

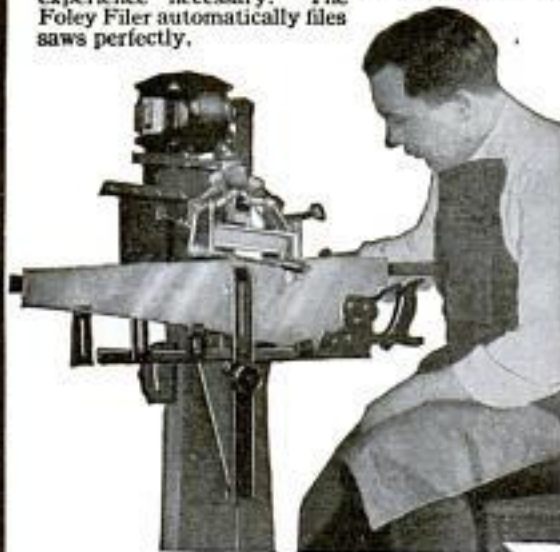

## FOLEY AUTO MATIC SAW FILER

This one machine files and joints all kinds of hand saws, band saws and cross-cut circular saws much better than even the most expert hand filer—every tooth filed exactly uniform in size, height and spacing. Every tooth cuts—that is why saw users like Foley-filed saws best—they cut better, faster, cleaner, truer and stay sharp longer.

## Make Big Profits

FREE PLAN tells you how to start. Easy to get business—one customer brings you more. 96¢ out of every dollar CLEAR PROFIT. J. W. Cremons writes, "I have a Foley Filer and it is a money-maker because it turns out perfect work."

YOU can have your own steady business, too. Small capital needed—pay as you go along. We will help you get started. Send coupon below for FREE PLAN now.

### Foley Manufacturing Co.

4162 Foley Bldg., 11 Main St., N. E., Minneapolis, Minn.

Send me FREE PLAN and tell me how I can start a steady business of my own in spare time filing saws on the Foley Automatic Saw Filer.

NAME.....

ADDRESS.....

CITY.....STATE.....

When writing please mention Popular Mechanics

**FREE 6 FAMOUS SPARK PLUGS**  
worth \$4.50  
To customers for GOOD YEAR  
Goodrich - Firestone and other tires

DEALERS WANTED

### Lowest Prices in History • • 75% Saving

Midland's Immense Buying Power Makes This Possible  
Thousands of motorists all over U. S. A. use and boost our Standard Brand reconstructed Tires. Hard service on roughest roads guaranteed. Our nation-wide success and reputation speaks for itself. FREE for limited time one of the best quality spark plug with every tire shipped. Order 4 tires—get full set 6 spark plugs free. New pop for your car—no extra cost. Be sure to mention make of car, model, year built. ORDER TODAY at these Rock Bottom Prices. Satisfaction Guaranteed.

BALLOON TIRES		REG. CORD TIRES	
Size	Price	Size	Price
28x4.00-21"	\$2.30	30x4.00-21"	\$3.20
28x4.50-21"	2.40	30x4.50-21"	3.25
30x4.00-21"	2.45	30x4.75-20"	3.95
30x4.50-21"	2.45		
30x4.75-21"	2.45		
30x4.95-21"	2.90		
28x4.00-19"	.95		
28x4.50-19"	.95		
28x4.75-19"	.95		
28x4.95-19"	.95		
30x4.00-19"	.95		
30x4.50-19"	.95		
30x4.75-19"	.95		
30x4.95-19"	.95		
30x4.00-18"	1.80		
30x4.50-18"	1.80		
30x4.75-18"	1.80		
30x4.95-18"	1.80		

Send \$1.00 deposit with each tire ordered. Balance C. O. D. If you send cash in full deduct 5 per cent. You are guaranteed a year's service or replacement at half price. Order Today—Save Money. MIDLAND TIRE AND RUBBER COMPANY Dept. 1065 1000-10 W. Sixty-Third Street Chicago



### Catalog No. 30

Illustrating Electrical, Mechanical and Model Makers' Supplies, Small Motors & Gasoline Engines, Motors, Generators, Lathes, Drill Presses, Bench and Band Saws, etc., 16-32 & 64 Watt Dynamo Motors, School Projects, Engine Castings, Motor Parts, etc., Books, Blue Prints, Brass and Steel Tubing, Gears, Pulleys, Hangers, Experimental Material.

Big Copy. Mailed anywhere for 20 cents, 25 cents Canada, refunded first order. LUMMIS ELECTRIC CO. 2822 N. California Ave. Chicago, Ill.



### Build Major "Jumpy" Doolittle's LAIRD Super Solution

3-4" scale. Flies 35 m.p.h. Span 15-1-2". Yellow and green. Complete Kit SF-5, including full-size drawing, and all parts requiring machined work completed, only \$2.50 postfree.

Send 5c for illustrated Jumbo Folder (in color) showing full line of internationally known Cleveland-Designed models—36 in all. Easy to build, realistic, all fly. Send 5c at once for your copy.

Cleveland Model & Supply Co., 1866-P4 West 57th St. Cleveland, Ohio, U. S. A.

**EXTRA STRONG IMPROVED MODEL COPPER BOILER**  
Catalog Free

**SAVE 20% NOW!**  
Most Practical Boiler & Cooker

Made with large 5-inch Improved Cap and Spout. Safe, practical and simple. Nothing to get out of order, most substantial and durable on the market. Will last a lifetime, gives real service and satisfaction.

### Easily Cleaned

Cap removed in seconds; no burning of hands. An ideal low pressure boiler and pasteurizer for home and farm.

Save 20% by ordering direct from factory. No articles of such high quality and utility ever sold at such amazingly low prices. Prices quoted are cash with order or one-fourth cash, balance C. O. D. Send check or money order, prompt shipment made in plain strong box. The only boiler worth having. Large Catalog Free.

HOME MANUFACTURING CO. Dept. 8416 18 E. Kinzie St. Chicago, Illinois



5 Gallon	\$ 6.50
7	8.85
10	11.90
15	14.20
20	18.50
25	22.50
30	27.50



# New Delta Drill Press

## Has Many Unusual Features

THIS useful quality tool should be in every workshop. It is quick and efficient in drilling, boring, grooving, sanding, and mortising. Has many additional uses. Works with metal and composition as well as wood. It is a sturdy, oversize machine built for exacting production work, yet is surprisingly low priced. Incorporates numerous special features such as: Husky Graduated Quill, Perfectly Balanced Ball-bearing Spindle with Sealed Lubrication, Tilting, Swinging Table that levels automatically, and many more.

## Free Catalog!

For complete details send for the FREE 48-page Delta Catalog Today! It shows complete line of improved Motor-Driven Jointers, Circular Saws, Jig Saws, Band Saws, Sanding Units, Woodturning Lathes, Moulding Cutters, Borers, Routers, and Mortisers. All husky, accurate, efficient units—which are now available at astonishingly moderate 1932 price levels!



## 10-Day Trial *Easy* Terms

Send coupon for FREE 1932 Delta Catalog. Shows complete Delta line of motor-driven tools. Many new items. New features. Also details of 10-Day Trial Offer and Easy Payment Plans. Mail the Coupon TODAY for your copy!



### New Drill Press Book!

32-page book—50 illustrations, shows how to use drill press properly—how to sharpen drills—how to perform many special operations. Send only 10c with the coupon at right.

**DELTA SPECIALTY COMPANY** (Division of Delta Mfg. Co.)  
3775 N. Holton Street Dept. A432 Milwaukee, Wisconsin

**DELTA SPECIALTY CO.** (Div. of Delta Mfg. Co.)  
3775 N. Holton St., Dept. A432, Milwaukee, Wis.

Please send me, without obligation, 1932 Delta Catalog. Also send full details of your 10-day Trial Offer and Easy Payment Plans.

Name.....

Address.....

City..... State.....

I enclose 10 cents for 32-page Drill Press Book.

### 6 FT. FLEXIBLE—RIGID RULE

New Low Price

Guaranteed highest quality Swedish Steel. \$1  
Cools in compact case. Postpaid U. S. A.  
for \$1; Two for \$1.60; Six for \$4.00.  
Clip this and order Today!

**EVERLAST ELEC. TOOL CO.**  
150 E. 63rd St. N. Y. City



Books on all subjects are sold by Popular Mechanics Press, 200 East Ontario Street, Chicago, Illinois

## NERVES?

Are You Always Excited? Fatigued? Worried? Gloomy? Pessimistic? Constipation, indigestion, cold sweats, dizzy spells and sex weakness are caused by NERVE EXHAUSTION. Drugs, tonics and medicines cannot help weak, sick nerves! Learn how to regain Vigor, Calmness and Self-Confidence. Send 25c for this amazing book.

RICHARD BLACKSTONE, R-474, FLATIRON BLDG., N. Y. C.

## GIANT TELESCOPE \$1.75

See Miles Away! Distant people and objects seem close. Over 3 ft. long, brass bound. Made in Europe. 10 lbs. of fun. Thousands pleased. **Send No Money!** On arrival pay Postman special price, only \$1.75, plus postage. Two for \$3.25. (Or send price and we pay postage.) Satisfaction guaranteed or money back. Send today. Bargain House, 427 Randolph St., Dept. 10, Chicago

**FREE With Order**  
Strong leatherette Carrying Case and Solar Eye Piece to view the sun.

## \$88 a DAY

"Earned \$88 clear 1st day. Worked 4 1/2 hours," writes W. F. Tesnow. Men earn \$5 to \$18 an hour. We establish honest, dependable men in their own business—mothproofing and furniture rejuvenating service.

### OWN the BUSINESS

No shop required—work done in homes. Rejuvenate, disinfect and clean furniture, auto upholstery, etc. Mothproof upholstery, rugs, furs, clothing, blankets, pianos, closets, auto interiors, etc. (method successful 10 years). Easy to learn. We furnish franchise, electric machines and materials, etc. exclusive store rights. 10 different ways

etc. We help you get first jobs. Many customers waiting to secure business. Many customers waiting—homes, offices, clubs, schools, hotels, theaters. Realized down payment \$40—balance from profits. Income from materials with outfit should return TOTAL investment and several hundred dollars net profit besides. A permanent year-around, highly profitable business for men directed. Territory in two states now ALL sold. Write AT ONCE while your territory is open.  
**HOMESERVICE CO.** CT. 6054  
Racine, Wis.





**All Parts Necessary for Only 10c**

**Runs on No. 6 Dry Battery**

**14-Ac tual Size**

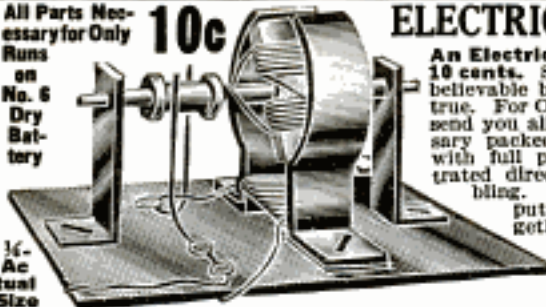

**ELECTRIC MOTOR**

An Electric Motor for Only 10 cents. Sounds almost unbelievable but it is perfectly true. For ONLY 10 cents we send you all the parts necessary packed in a neat box, with full printed and illustrated directions for assembling. No trouble at all putting the parts together. In fact it is FUN. Just follow a few simple instructions and in a few minutes the motor is ready to run.

**AN EDUCATIONAL NOVELTY**

OH BOY! Isn't it speedy. Runs on a No. 6 or similar dry battery. It is an education in itself just putting it together, and you can perform many novel and interesting experiments with it. Remember the price—ONLY 10 cents—nothing more to pay—nothing more to buy.

**JOHNSON SMITH & CO., Dept. B27, RACINE, WIS.**

**BOY AMATEUR ELECTRICIAN 10c**

The HOW and WHY of electricity fully told in simple language that any boy can understand. Scores of plans and instructions for making—dry batteries, dynamos, electric motors, telegraph apparatus, telephones, electric lights, electric door bells, alarms, electric engine, rheostat, mail box alarm, electro-magnets, automatic incandescent flash, electric shocking machine, wireless telegraph apparatus, induction coil, arc light, current reverser, etc., etc. Tells all about electric wiring, static electricity, magnets and magnetism, conductors and insulators, electrostatic induction, electrocopes, electrophorus, condenser, Leyden jar dynamic electricity, the voltaic cell, electro-magnets, electrolysis, rheostat, electrotyping, how to build a radio for a few cents, etc. 64 pages, 100 illustrations. 10c. postpaid. **JOHNSON SMITH & CO., Dept. B27, RACINE, WIS.**

**CIGARETTE ROLLER**

Roll your own and save money. Better and quicker; saves more than half. Use your favorite brand of tobacco. Neat, useful, handy. Pocket size, weighs 14 oz. Made entirely of metal, nickel plated.

**Price 25c. 3 for 65c.**

**IMPORTED CIGARETTE PAPER 5c. per book, 12 books for 50c. post.**



**MIDGET BIBLE**

**GREAT CURIOSITY**

Smallest Bible in the World. Size of a postage stamp—200 Pages. Bound to let you get good luck to the owner. A genuine work of art. Must be seen to be appreciated. Make good money selling them to friends, church societies, etc. **PRICE 15c. each. 3 for 40c. 12 for \$1.35, 100 for \$7.50.** Also obtainable in Leather Binding, with gold edges. **Price 50c each. 3 for \$1.25, \$4.50 per doz. Magnifying Glass for use with Midget Bible 15c**



**STAGE MONEY**

With a bunch of these bills, it is easy for each person of limited means to appear prosperous by flashing a roll of these bills at the proper time and peeling off a genuine bill or two from the outside of the roll, the effect created will be found to be all that can be desired. **Prices, postpaid: 40 Bills 20c, 120 for 50c, or \$3.50 thousand postpaid.**



**Good Luck Ring**

Very striking, quaint and uncommon. Silver finish; skull and crossbones design, two brilliant, flashing gems sparkle out of the eyes. Sold to bring good luck. **Only 25c. post.**



**TRICKS WITH MAGNETISM & ELECTRICITY**

Book contains many unique and novel tricks and experiments with magnetism and electricity, also useful information about lobotomies, magnetism, electricity, etc. **10c. Postpaid.**



**250 Magic Tricks**

An excellent little book containing nearly 300 tricks for parlor or stage that anyone can do. Tricks with cards, coins, handkerchiefs, eggs, bottles, wires, etc. Also Second Sight, Clairvoyance, etc. Fully illustrated. **10c. p.pd.**



**LEARN TO HYPNOTIZE**

Big book over 200 pages tells how. Nearly 100 simple lessons on Hypnotism, Mesmerism, Magnetic Therapeutics, Magnetic Healing, Telepathy, Mind Reading, Spiritualism, etc. Specially prepared for self-instruction. Fully illustrated. **35c. Postpaid.**



**STAR TOY MAKER**

Greatest boys' book written. Tells how to make a Pinhole Camera, a Cannon, model Railroad, a Telephone, Boomerang, Telegraph, Instruments, Rocket, etc. Talking Machine, Microscope, Electric Motor, Electric Door Bell, Water Wheel, Paddle Raft, a pair of Skis, a Dog Sled, Bird House, Rabbit Yard, etc. 64 pages. 150 illustrations. **Price 10c.**



**BOY'S OWN TOYMAKER.** A new book. Tells how to make chemical toys, electrical toys, galvanic toys, mechanical toys, paper toys, cardboard toys, boats, traps, etc. 200 illustrations. **Price 25c. postpaid.**

**BOOK ON BOATS.** How to build fishing, sailing boats. Everything pertaining to boats explained in plain terms so anyone can understand. Illustrated. **10c. p.pd.**

**5-MINUTE HARMONICA COURSE.** A new easy self-teaching method. Teaches how to play, to use the tongue, tremolo, fully illustrated. **Price 15c. postpaid.**

**MONEY MAKING SECRETS.** Golden opportunities for everyone. 64 page copyrighted book chock full of money-making ideas, recipes, formulas, wrinkles, trade secrets, etc. Businessmen that can be started with little or no capital at home in spare time. **10c. postpaid.**

**WONDERFUL X-RAY TUBE**

A wonderful little instrument producing optical illusions both surprising and startling. With it you can see what is apparently the bones of your fingers, the lead in a lead pencil, the interior opening in a pipe stem, and many other similar illusions. **Price 10c. 3 for 25c.**



**Little Wonder Crystal Radio Receiver \$1**

Say what you will about Electrical and Battery Sets, a CRYSTAL set has them all beat for simplicity and clearness of tone. There is absolutely no noise and no distortion—no batteries to buy—no tubes to wear out—no maintenance expense whatsoever. Cost nothing to operate and will last indefinitely. Reception is loud and clear. This Receiver is guaranteed to work equal to the most expensive Crystal Set you can buy. Has a receiving radius of over 25 miles, or under favorable conditions up to 100 miles. Constructed of the finest materials throughout, including super-sensitive crystal, assembled with Ear Phone and Aerial Kit—everything all complete—nothing more to buy. **\$2.95 postpaid.**



**Repeating and Single Shot Air Pistols**

Just what you've always wanted. A powerful high grade Air Pistol, shaped like an Automatic, pocket size. Fires B. B. shot obtainable anywhere. Very powerful yet perfectly safe for boys to handle. Two styles—Single Shot Pistol or Repeater. The Repeater fires 50 shots in one loading. The Single Shot Pistol shoots Air Rifle Darts in addition to B. B. Shot. Well made and durable; all metal parts nickel plated; natural grain wood stocks. Front and rear sights. Weighs about 10 ounces. Better than an air rifle. No license required.

**PRICES: Single Shot Pistol \$2.75, 50 Shot Repeating Pistol \$3.95. Not mailable. Shipped by Express only.**



**BLANK CARTRIDGE PISTOL**

Protection against Burglars, Tramps and Dogs Special Offer

1 Blank Cartridge Pistol  
100 Blank Cartridges  
1 770-page Novelty Catalog **Only \$1.50**

The Lot Shipped by Express Only Cash With Order Only

Well made and effective, modelled on latest type of Revolver; appearance alone is enough to scare a burglar. When loaded it may be as effective as a real revolver without danger to life. It takes standard 22 Cal. Blank Cartridge—obtainable everywhere. Special cash with order offer: 1 Superior quality Blank Cartridge Pistol, 100 Blank Cartridges, and our new 770 page The Latest Catalog of latest novelties; all for **ONLY \$1.50.** Shipped by Express only. Cannot go by parcel post. Extra Blank Cartridges 50c per 100. Special Holder (Cowboy Type) for pistol 50c. No C.O.D. shipments.



**BOYS! THROW YOUR VOICE**

Into a trunk, under the bed or anywhere. Lots of fun fooling the teacher, policeman or friends.

**THE VENTRILO**

a little instrument, fits in the mouth out of sight, used with above for Bird Calls, etc. Anyone can use it. **Never fails.** A 16 page course on Ventriloquism, the Ventrilo and 770 p. novelty catalog, **ALL FOR 10c.**



**MICROSCOPE and FLORSCOPE**

COMBINES ALL THE POWER AND DEFINITION OF THE MORE EXPENSIVE MICROSCOPE

**SURPRISINGLY GREAT MAGNIFYING POWER**

EXAMINE GERMS IN WATER, CHEESE, SUGAR, ETC.

There are few things so interesting and valuable as a Microscope. It enables you to minutely examine mineral animal and vegetable specimens, to test cotton, wool, silk, seeds, water, flour, cheese, milk, and is fast nearly all articles of food. Unwholesome meat can be readily detected and ferments can be closely watched. It is exceedingly interesting to examine the spores of ferns, seeds, sugar, salt, clay, and other crystals, the dust (collected from both and butterfly wings, human hairs, flies and insects, while the animalcules in water are a never-failing source of wonder. Most interesting experiments can be performed with an instrument such as this. Place a small piece of cheese in a box upon the object glass of the Microscope with a pin's head, and you will see beautiful animalcules swimming about with as much freedom as though they were fish in the boundless ocean. It is a truly wonderful sight and an endless source of interest and enjoyment for everybody. The Microscope is made of brass and is 500 times as large, and although small and compact, it will cover a very wide range of microscopic research. **PRICE ONLY 50c. Postpaid.**

**JOHNSON SMITH & CO., Dept. B27, RACINE, WIS.**



**JOHNSON SMITH & CO.**

Dept. B27 RACINE, WIS.

A copy of our 1932 CATALOG mailed on receipt of 10c., or the De Luxe Edition with cloth binding 25c. Bigger and better than ever. Only book of its kind in existence. Nearly 800 pages of all the latest tricks in magic, the newest novelties, puzzles, games, sporting goods, rubber stamps, unusual and interesting books, curiosities in seeds and plants, etc., unobtainable elsewhere. Remit by Coin, Money Order, Check or unused U. S. Postage Stamps, for all articles listed above.





# Turn your spare time into CASH with the new IDEAL LAWNMOWER SHARPENER

## What these men have done, YOU CAN DO!

Walter Wever, Middletown, N. Y., writes: "I have made over \$1,000.00 on my Ideal Lawnmower Sharpener during the past four months." W. T. Moore, Twin Falls, Idaho, writes: "Through the season of about 90 days my Ideal has netted me a profit of \$1,200.00." Ralph L. Lemont, Ocean City, N. J., writes: "My Ideal was the means of making me \$1,500.00 this past season."

## Big Profits in Your Spare Time

C. S. Coburn, North Little Rock, Ark., writes: "With my Ideal Sharpener, working evenings only, I took in \$1,965.20 in 18 months—sufficient to pay for my Ideal and equip my shop with new, modern machinery." W. F. Kendt, Buffalo, N. Y., writes: "I sharpened 994 lawnmowers in one season and the receipts were nearly \$2,100.00—not bad for a side-line." H. Armstrong, Vancouver, B. C., writes: "This year, with business conditions poor, I sharpened 1,000 mowers. The Ideal is a very good machine and I hope 1932 will bring better business to all of us."

## A Permanent Paying Business

S. E. Raup, Harrisburg, Pa., writes: "I started sharpening lawnmowers 5 years ago, as a side line, setting up an Ideal in my basement. Now I am arranging to build a large shop and apartment to take care of my increasing business which employs 2 to 3 men besides myself." Don't lose any time getting into this highly profitable business. The earlier you start, the more business you will do—THIS YEAR.

## No Training Required

You don't have to be a mechanic to operate the Ideal. Its operation is simple and practically automatic after you have placed the lawnmower in position to grind.

## Here Is Your Chance

THE BIG OPPORTUNITY YOU HAVE ALWAYS WANTED—TO MAKE EXTRA MONEY. Send for the new free handsomely illustrated catalog "Turn Your Spare Time Into Cash." It also shows you the best ways to get the mowers to sharpen. Don't wait. Clip the coupon NOW!



# New

The new 1932 model Ideal Lawnmower Sharpener— with direct-connected electric motor and shaft— new variable-feed grinding method— new Reconditioner for "lapping in"— new straight-blade attachment for grinding both faces of straight-blade—the greatest value ever offered.

**A TWO-METHOD Sharpener—a Grinder and a Reconditioner—at Practically the Price of One**

The new 1932 model Ideal Lawnmower Sharpener meets every possible condition—it is the ONLY machine that GRINDS and puts a perfect bevel and cutting edge on the old, dull, thick-bladed, hard-running mowers and also sharpens or reconditions the new, slightly-dull, easy-running kind.

**Sharpens Any Mower in 15 to 20 Minutes**

Just pick up the mower, set it in the Ideal, make a few simple adjustments and proceed to sharpen. In 15 to 20 minutes after you pick up the mower it is ready for the lawn, and you have made \$1.00, \$1.50 or \$2.00, depending on the condition of the mower.

**Special Grinding Wheel Attachment**

For grinding skates, grass shears, sickles, etc. Will add many dollars to your income.

**Uses Little Power**

Operated by  $\frac{1}{2}$  H. P. motor attached to light socket or may be run direct from line shaft.

**Be Your Own Boss**

Work for yourself. Be independent. Hundreds of lawnmowers are waiting to be sharpened. No town too small. Our new, free catalog shows you how to make money from the very start.

**SEND FOR FREE CATALOG**

**THE FATE-ROOT-HEATH CO.,**  
324-360 Bell St., Plymouth, Ohio.

Send me your new free catalog, "Turn Your Spare Time Into Cash."

Name.....

Address.....

City..... State.....







## If it's food I eat it now ..thanks to TUMS

**L**IFE is worth living again for Russ Jones. People used to kid him because he seemed to eat nothing but spinach and invalid dishes. But now, he enjoys his favorite foods without fear of indigestion, sour stomach, heartburn, gas or acidity. He simply carries in his pocket a roll of the new candy-like, antacid mints—Tums. No afternoons or evenings are spoiled for him now on account of upset stomach. He gets real enjoyment from his meals because he can eat his favorite foods without fear of distressing after-effects.

Almost everyone (about 7 out of every 10 Americans) suffers frequent indigestion. Hasty eating, wrong food combinations and nervous strain

are common causes. Many people say they cannot eat the very foods they like best—such as hot biscuits, mince pie, coffee—dressing and gravy—onions and radishes—cabbage—cucumbers—without getting a sour, burning sensation or a nauseating gassy fullness. Excessive smoking very often causes the same troubles.

But now there is automatic, pleasant, almost instant relief. When some favorite food distresses you, simply eat three or four Tums after meals—often one is enough. You'll like Tums. They are so much more agreeable, safe and handy than old-fashioned disagreeable preparations. Carry a roll in pocket or purse. Get a roll at any drug store—only 10c.

**GET 2 ROLLS  
FREE**

Thousands of people are buying Tums in the convenient \$1.00 box containing 12 rolls—thus getting 2 rolls free.



**TUMS ARE ANTACID...NOT A LAXATIVE.** For a laxative, use the safe, dependable Vegetable corrective **NR** (NATURE'S REMEDY). Only 25c.



**P.S. Sweeten the Stomach and You Sweeten the Breath**



# Genuine UNDERWOOD

Guaranteed

Late Model No. 5

**Yours for full 10 Days Trial**

Think of it—over 2 million buyers paid \$102.50 (cash) for this Model No. 5 now offered direct-to-you at way below 1/2 original price—and on easiest terms besides. Positively the greatest bargain ever offered. Accept the special 10 day trial offer and be convinced. See the neat, perfect work it does—compare its bright, shiny locks without risk. *Recognized as the finest, strongest typewriter built.*



**While They Last! Prices Smashed to Rock Bottom**

**Now Only \$44.90 DOWN**

**Save over 1/2 Mfgs. Original Price**



Only by an exceedingly fortunate purchase direct from the manufacturers am I able to offer this amazing low price—less than half (1/2) the manufacturer's original price—and easy terms besides. This is the full-sized late model Underwood with standard universal 4-row keyboard of 84 characters and has all late improvements. Manufactured to sell originally for \$102.50. Fully guaranteed.

**Learn Touch Typewriting FREE**

Learn Touch typewriting. Complete Home Study Course of the Famous Van Sant Touch Typewriting System, fully illustrated, given during this offer. Easily learned. Used in schools, business offices everywhere.



**BRAND NEW CORONA**

**Now Only \$39.90 or On Easy Terms 10 Day Trial**

**Yours for Only \$1.00 DOWN**

Hurry! Only a very limited number of these Brand New Coronas available at this Special Low Price and Easy Terms. Here's your chance to own a wonderful and usually advertised Corona at a real bargain. Use up-to-date improvements and carries our regular New Machine guarantee. Rent on 10-day trial. (If you decide to keep it send only \$1 a month until the special low price of \$42.90 (term price) is paid.)

**Easy Terms—Only 12c a Day**

Think of it—a genuine late model Underwood No. 5 reduced to \$44.90 (cash). Send only \$1 deposit for a 10-day Trial. Then only 12c a day on my easy year-to-pay plan. Use and enjoy your typewriter all the time. Remember this famous No. 5 Underwood all renewed and refinished is without question one of the greatest values ever offered.

**Money Back Guarantee**

Accept my liberal 10-day trial offer. See for yourself the wonderful bargain this famous Underwood really is. Your deposit returned at once if you are not perfectly satisfied. Send now.

**Over 100,000 Satisfied Customers**

**International Typewriter Exchange**  
231 West Monroe St., Chicago, Ill., Dept. 401

Please send the typewriter marked below, F.O.B. Chicago, at the special reduced price for 10-day Trial. I am enclosing \$1.00 deposit on the Underwood No. 5 at \$49.90 (term price); Corona No. 3 at \$42.90 (term price) with the understanding that if I am not perfectly satisfied I can return it Express Collect and get my deposit back. If I keep it I will pay \$3.50 a month on the Underwood or \$3.00 a month on the Corona until I have paid the (term price) in full.

Underwood No. 5       Corona No. 3

Name..... Age....

Address.....

Town..... State.....





Where Turkish tobacco comes from



# Let's all go to Turkey...



In every important tobacco-growing center of Turkey, Chesterfield has its own tobacco buyers.

Eastward ho! Four thousand miles nearer the rising sun—let's go! To the land of mosques and minarets. Let's see this strange, strange country. Let's see the land where the tobacco\* grows in small leaves on slender stalks—to be tenderly picked, leaf by leaf, hung in long fragrant strings, shelter-dried and blanket-cured. Precious stuff!

Let's taste that delicate aromatic flavor—that subtle difference that *makes* a cigarette!

## XANTHI • CAVALLA • SMYRNA • SAMSOON Famous Turkish Tobaccos

\*Turkish tobacco is to cigarettes what seasoning is to food—the "spice," the "sauce."

You can *taste* the Turkish in Chesterfield—there's enough of it, that's why. Four famous kinds of Turkish leaf—Xanthi, Cavalla, Smyrna, Samsoun—go into the

smooth, "spicy" Chesterfield blend. Just one more reason for Chesterfield's *better taste*. Tobaccos from far and near, the best of their several kinds—and the *right* kinds.

That's why Chesterfields are GOOD—they've got to be and they *are*.

Wrapped in No. 300 Du Pont Moisture-Proof Cellophane...  
the Best Made



Chesterfield Radio Program  
Every night (except Sunday), 10:30  
Eastern Time, Columbia Coast-to-  
Coast Network. Popular music beau-  
tifully played and sung.

Finest Turkish and Domestic Tobaccos Blended and Cross-Blended

Copyrighted material