

MARCH

25 CENTS

# POPULAR MECHANICS

## MAGAZINE

WRITTEN SO YOU CAN UNDERSTAND IT

©1931 TRADE MARK, GREAT BRITAIN, NO. 40268

REG. U.S. PAT. OFF.

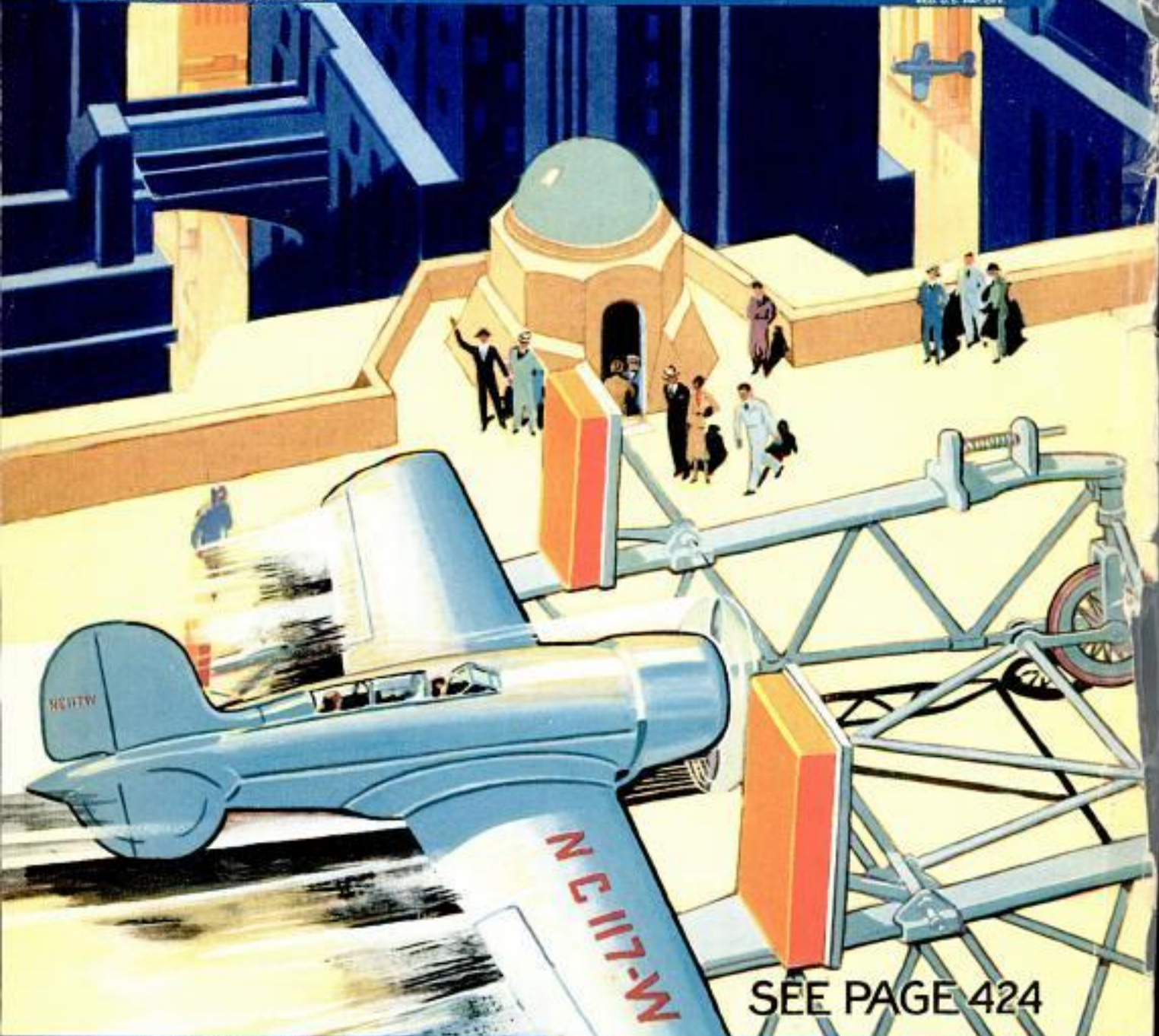

SEE PAGE 424

IN THIS ISSUE

Albert Payson Terhune

Hiram Maxim

Winston Churchill

"Cannonball" Baker



# OPPORTUNITIES *are many*

## for the Radio Trained Man

Don't spend your life slaving away in some dull, hopeless job! Don't be satisfied to work for a mere \$20 or \$30 a week. Let me show you how to get your start in Radio—the fastest-growing, biggest money-making game on earth.

### **JOBS LEADING to SALARIES of \$50 a Week and Up**

Prepare for Jobs as Designer, Inspector and Tester—as Radio Salesman and in Service and Installation Work—as Operator or Manager of a Broadcasting Station—as Wireless Operator on a Ship or Airplane, or in Talking Picture or Sound Work—HUNDREDS of OPPORTUNITIES for a real future in Radio!

## Ten Weeks of Shop Training At Coyne in Chicago

We don't teach by book study. We train you on a great outlay of Radio, Television and Sound equipment—an scores of modern Radio Receivers, huge Broadcasting equipment, the very latest and newest Television apparatus, Talking Picture and Sound Reproduction equipment, Code Practice equipment, etc. You don't need advanced education or previous experience. We give you RIGHT HERE IN THE COYNE SHOPS—the actual practice and experience you'll need for your start in this great field. And because we cut out all useless theory and only give that which is necessary you get a practical training in 10 weeks.

## TELEVISION *and* TALKING PICTURES

And Television is already here! Soon there'll be a demand for THOUSANDS of TELEVISION EXPERTS! The man who learns Television now can have a great future in this great new field. Get in on the ground-floor of this amazing new Radio development! Come to COYNE and learn Television on the very latest, newest Television equipment.

Talking Picture and Public Address Systems offer opportunities to the Trained Radio Man. Here is a great new Radio field just beginning to grow! Prepare NOW for these wonderful opportunities! Learn Radio Sound Work at COYNE on actual TALKING PICTURE and SOUND REPRODUCTION equipment.



### **MANY EARN While Learning**

You get Free Employment Service for Life. And don't let lack of money stop you. Many of our students make all or a good part of their living expenses while going to school and if you should need this help just write to me. Coyne is 32 years old! Coyne Training is tested—proven beyond all doubt. You can find out everything absolutely free. Just mail coupon for my big Free Book.

**H. C. LEWIS, Pres. RADIO DIVISION Founded 1899  
COYNE ELECTRICAL SCHOOL  
500 S. Paulina St., Dept. 32-3H, Chicago, Ill.**

### **All Practical Work at Coyne**

**ALL ACTUAL, PRACTICAL WORK.** You build radio sets, install and service them. You actually operate great Broadcasting equipment. You construct Television Receiving Sets and actually transmit your own Television programs over our modern Television equipment. You work on real Talking Picture machines and Sound equipment. You learn Wireless Operating on actual Code Practice apparatus. We don't waste time on useless theory. We give you the practical training you'll need—in 10 short, pleasant weeks.

### **Mail Coupon Today for All the Facts**

**H. C. LEWIS, President  
Radio Division, Coyne Electrical School  
500 S. Paulina St., Dept. 32-3H, Chicago, Ill.**

Dear Mr. Lewis:  
Send me your Big Free Radio Book, and all details of your Special Offer.

Name .....

Address .....

City.....State.....



# Mystery "TWIN-RAY" Light Tested— Reads Newspaper At 1,000 Feet!

## SEVERE TEST GIVEN NEW SAFETY LIGHT

June 8th: A demonstration of the new Auto Safety Light, designed for safe night driving, was given at the Boston airport on Friday night before an interested gathering of pilots and automobilists. The first test was the ability to read any part of a newspaper at a point of 1,000 feet in front of the light and a foot above the ground, proving that while the ground in front of the light was perfectly illuminated, the rays from the light were at no point above the center of the light itself. Consequently there would be no glare to an on-coming car, showing the light powerful enough to penetrate the lights of the on-coming car and show clearly the road beyond and any obstacles in it.



## Lights Highway Ahead With 67,000 Candle Power Beam

Reporters for the Boston Sunday Post witnessed a demonstration of this light and above is a reprint of their report.

Now—judge for yourself what you can do with a light like this on your automobile—a light that throws a 67,000 candle power beam, for over 1,000 feet—lights up all road signs and curves long before you reach them. Makes the road ahead of you as bright as day yet absolutely can't glare in the eyes of approaching drivers. A road light that literally takes the light

out of the sky—all light on the highway. Fast night driving now safe with this amazing Speedlight—you can drive 50-60—even 70 miles an hour with perfect safety. On a road as brilliantly lit at midnight as at mid-day. Cuts through fog, rain, and darkness. This "twin-ray" road light not only can't glare itself but it cuts through on-coming brights. No wonder it was awarded the grand prize and two gold medals in world competition.

## AGENTS Cleaning Huge Profits

Agents and distributors from coast to coast are making big money equipping passenger cars, busses and trucks with this brand new road light. This is your opportunity to make up to \$10-\$20-\$30 per day. Some agents make even more. Kinney made \$96 in a few hours. Frost made \$150 in one day. Burroughs sold fifty lights to Richmond fire and police departments. Over 20 million cars need

this wonderful light to protect human lives and property against glaring lights, fog, rain and darkness. Hundreds of men have made big fortunes out of makeshift spot lights and painted bulbs that only did half the job. Send the coupon and find out how you can use this great device to build up a crew of your own—and double your earnings—earnings which by themselves will be bigger than you ever saw before. Do it now, before you turn this page.



Cuts Through London Fog and Darkness Like a Knife

Tests in England have proved this. With this light you need have no more fear of fog, rain or darkness. There is no light like it in the world. It is not a spot. It embodies an absolutely new principle in headlighting discovered by a famous light engineer. NOT A PAINTED BULB—But a real scientifically constructed road light with a concentrated 67,000 candle power beam of light on the road for over a thousand feet and no glare. Think of it! Over a fifth of a mile. Put one on your car and see for yourself what you can do with light like this. Send the coupon today for our introductory offer.

### SPEEDLIGHT COMPANY

31 Belmont Ave., Dept. 10-C, Chicago, Illinois

TO GET THIS LIGHT  
**FREE** of Extra  
Cost  
DON'T TURN PAGE—  
MAIL THIS COUPON FIRST



SPEEDLIGHT COMPANY,  
1731 Belmont Avenue,  
Dept. 10-C, Chicago, Illinois.

W This One



PELK-KHF-XZ2F

CITY.....STATE.....

When writing to advertisers please mention Popular Mechanics



# Do Unseen Hand. Keep You Dumb.. When You Ought to Talk.



How often have you wanted to talk, but held back, silent, because you felt unequal to the other people present? How many times have you passed up, or avoided the chance to talk in public—before your business associates, your club or lodge, because of your fear of stage fright? Are you afraid of your own voice—instead of being able to use it as one of the greatest business and social assets in your possession? And yet you might be surprised to hear that many of the most brilliant public speakers we have today felt exactly this way—before they learned how to develop their "hidden knack" of powerful speech—a knack which authorities say seven men out of every ten actually possess. And the chances are that you, too, have in you the power of effective speech—which, if unloosed, would be almost priceless to you in a social or business way. Find out if you have this natural gift—read every word of the message below.

## Discover These Easy Secrets of Effective Speech

**P**ROBABLY you have never pictured yourself being able to sweep a giant audience off its feet—to win the applause of thousands. Yet, the men who are doing such things know that it is all astonishingly easy once you are in possession of the simple rules of effective speech. Before you learn their secrets you may be appalled at the thought of even addressing a small audience. Still it all seems so ridiculously easy when you know how to banish stage fright, and exactly what to do and say to hold an audience of one or a thousand in the palm of your hand.

Yet what a change is brought about when a man learns to dominate others by the power of effective speech! Usually it means a quick increase in earnings. It means social popularity. You yourself know how the men who are interesting talkers seem to attract whomever they wish and name their own friends—men and women alike.

There is no magic, no trick, no mystery about becoming a powerful and convincing speaker—a brilliant, easy, fluent conversationalist. One of America's eminent specialists in effective speech has developed a method that

has already raised thousands from mediocre, narrow ruts to positions of greater prestige and wider influence. This new method is so delightful, simple and easy that by spending minutes a day in the privacy of your own home you cannot fail to make rapid progress.

How you can use this method, how you can banish stage fright, self-consciousness and bashfulness, quickly shaping yourself into an outstanding influential speaker, is told in an interesting book, *How to Work Wonders With Words*. Not men who have millions but the masses of others have sent

**What 20 Minutes a Day Will Show You**  
 How to address business meetings.  
 How to propose and respond to toasts.  
 How to make a political speech.  
 How to tell entertaining stories.  
 How to write better letters.  
 How to enlarge your vocabulary.  
 How to develop self-confidence.  
 How to acquire a winning personality.  
 How to strengthen your will power.  
 How to be the master of any situation.

this book and highly praise it. You receive a copy absolutely free by simply mailing the coupon below. Act now to discover your priceless "hidden knack"—the natural gift within you. Fill out and mail the coupon at once.

### NORTH AMERICAN INSTITUTE

Dept. 1353

3601 Michigan Ave. Chicago, Ill.



**FREE**  
 "How to Work Wonders  
 With Words"  
 Mail Coupon Today

North American Institute,  
 3601 Michigan Ave., Dept. 1353,  
 Chicago, Illinois.

Please send me free and without obligation a copy of your inspiring booklet, *How to Work Wonders With Words*, and full information regarding your course in Effective Speaking.

Name.....  
 Address.....  
 City..... State.....

When writing to advertisers please mention Popular Mechanics



# Popular Mechanics Magazine

200 E. Ontario Street, Chicago, U. S. A.

H. H. WINDSOR, Founder

H. H. WINDSOR, Jr., Editor and Publisher

London: Messageries Hachette,  
3 La Belle Sauvage, Ludgate Hill, E. C. 4

Paris: Hachette & Cie.,  
111 Rue Reaumur

Melbourne: Gordon & Gotch  
309-313 Little Collins St.

Vol. 57

March, 1932

No. 3

## Special Features

Coming—The Silent Air Liner	353
Crystals that Talk and Sing	362
"Bug-Men" Lead Hunt for Black Gold	370
Kindness Can Kill Them	378
Get the Story!	404
Magic for Everybody	434
In a World of Terror	442
Latest Miracle of the Plant Wizards	452
From Europe to New York by Rocket?	458

Advertising—figures dangling on ladder draw crowds	403
Airplanes	
autogiro with engine behind is pushed through air	415
propeller-pitch gauge	451
Animals—dummy "Daniel" shows fate of man in lions' den	402
Archaeology	
first Eskimo mirrors found are made of slate	368
here is the oldest picture of man on horse	368
Army, U. S.—"T-2" Uncle Sam's latest tank	356
Automobiles, Accessories	
car speed recorded in crash by speedometer lock	364
crankcase is kept filled by automatic oiler	438
mirrors on light bulbs eliminate glare	355
Automobiles, Design—auto without an axle gives better ride	377
Automobiles, Repairing—hand tool irons out dents in fenders	439
Automobiles, Trailer—dry-land yacht has all comforts of home	440
Automobiles, Truck	
steel rock-catching shield protects driver	369
thirteen-day non-stop trip tests diesel truck	403
Aviation	
cradle to land wheel-less planes on roofs	424
plane shot over waterfall to make it take air	401
Bacteria—sound waves kill germs	368
Bat—has leaflike nose and "file" for tongue	375
Battleships—the latest in fighting ships and their eyes	376
Boats and Boating	
metal caps driven by foot like a bicycle	439
throttle runs whole boat by one-lever control	416
"Venetian blind" sails add to yacht's speed	353
Books—book printed on paper strip	359
Bridges	
masonry trestle built without forms	357
weights test model bridge for loads and storms	441
Building Construction—metal walls for buildings to lower costs	401
Building Materials—waterproof and stainless material for builders	414
Caisson—giant shell digs own pit in ten minutes	369
Camera—takes three colors all in one "shot"	438
Checks—signature stencil for guards against fraud	355
Cider—is made by the glass in fountain juicer	368
Clocks—clock face six stories tall	375
Crime—perfumed mailbags solved mail thefts	456
Disease—heat applied to rheumatism by short-wave radio	357
Drafting—tape used on drawing board instead of tacks	441
Elevators—moving a city straight up task of	449
Engines, Diesel—auto expert spends half million on	365
File—rubber grips for, protect hands	402
Fires—filmed for future study	412
Flashlight	
handy mounting for service light	479
suspended from neck leaves hands free	424
Furnace, Electric—rocks and wood turn to gas in	360
Greenhouse—that brings plants to buyers	412
Heating and Ventilating—weather factory for home heats or cools air	356
Holder—for watch, cigarets and memorandum pad	377
Household Devices	430
House Moving—house moved across a river with aid of barge	451
Level	
for lines or surfaces	433
that fits your pocket also contains a rule	446
Life—third class of living things would include fungi	402
Locomotives—Stephenson's engine model valued highly	448
Maps	
old map throws new light on Columbus	384
state map on auto radiator	361
Models—yacht dock for model boats	456

[Continued on Page 4]

### ISSUED MONTHLY

### SUBSCRIPTION:

SINGLE COPY, 25 CENTS

In United States and its possessions, Cuba, Mexico, and all countries in the Pan-American Postal Union, per year, postpaid } \$2.50

To all other countries in the Postal Union } 3.00

All subscriptions are discontinued at expiration. Please examine the date printed on your wrapper.

Entered as Second Class Matter Sept. 15, 1903, at the Post Office at Chicago, Illinois, under Act of March 3rd, 1879.

Entered as Second Class Matter at the Post Office Department, Canada.

Published monthly by POPULAR MECHANICS CO.

Copyright, 1932, by Popular Mechanics Co.

Copyright in Australia. Copyright in France

*Stikometer 364*

*light suspended from neck 424*

*Electric eye opener 424*

Copyrighted material



*Ship Rotor  
cycles for  
Annuua 857*  
427  
[4]

[Contents—Continued]

*Prison 1 by 367  
treatment  
43  
Well gravel wall raises capacity*

*Moth Balls - Check Zungis 359*

Moths—electric "bomb" kills moths with chemical fumes 364

Moving Pictures  
how movie mistakes are corrected in advance 446  
portable talking-picture machine 467

Musical Instruments  
miniature pipe organ played by electricity 462  
violin with keys like piano 449

Navy, Italian—cruiser built in record time of less than year 361

Ocean—waves higher in south seas than in northern 465

Paving—road monster lays a mile of paving a day 447

Puzzles 528

Radio  
automatic tuning for radio brings in programs 401  
easy solutions for common radio problems 471  
programs put on film like talking pictures 441

Radio, Aerial—screen antenna for small sets 470

Radio, Apparatus  
light bulb as non-inductive resistor 468  
modern radio test panel for service men 466  
simplified home recording 468

Radio, Batteries—C-bias from batteries 468

Radio, Cabinet  
and humidifier for your den 469  
table cabinet for phono-radio 470

Radio, Coils  
improving hand-wound 467  
spool holder for winding 474

Radio, Construction  
talcum for locating screw holes 467  
tube base as battery connector 474

Radio, Loud Speaker—hinged baffle for dynamic speaker 467

Radio, Panels—new uses for old panels 474

Radio, Receivers—low-cost receiver is all-electric 472

Railroads—box of blocks "spots" cars in big mail terminal 438

Searchlight—"nets" of light on clouds trap air raiders 366

Ships and Shipping—liners guided by sea bottom instead of the stars 439

Skyscraper—bamboo hut the model for first 432

Smuggling—rum-running torpedo caught crossing Detroit river 444

Solder—for welding at home fuses with all metals 367

Stamp, Copying—with stencil has automatic ink feed 415

Stock Market—dial brings quotations to office 433

Tank—built to store steam for rush hours 465

Telephone  
key lock for dial, stops misuse 416  
original Edison phone model is put on exhibition 413

Thermometer—temperature inside and out told on one 414

Tractor  
radio, controlled by key plows field 450  
that digs up trees aids nursery harvest 359

Traffic—stop sign sinks in pavement as auto passes over it 465

Waterfall—lights to color, for display at night 415

Weather—brass brain tells weather by sun's cycles 410

Windows—big vacuum cups raise glass windows into frame 359

Wire—rotation aids wire drawing 451

Wrench—hundred feet long helps end oil fires 464

*Trailer, Camp 497*

Dowel Pins—from meat skewers 507

Drafting—eccentric makes triangle adjustable 508

Drawers—shellac and wax relieve tight 508

Drawing Board—folding, padlocked to wall 495

Faucet—making leather washers for 428

Furnace—clinker guard prevents accidents when cleaning 494

Garage  
doors yoked together open quickly 493  
spring bumper protects rear wall of 503

Grindstone—broken, repaired with flake shellac 506

Heating and Ventilating—thermostat operates fire door 504

Humidifier—water pan in hot-air pipe maintains proper humidity 486

Ladders  
coat hooks on stepladder support work when sawing 508  
rubber mat on top of stepladder holds small tools 478

Lamps—a hall lamp in wrought iron 425

Linoleum—hints on laying 477

Measuring—paper guide for making straight line around cylinder 486

Models—De Witt Clinton train, part III 488

Paints and Painting—holes in bucket rim save paint 482

Phonograph—preserving fiber records 496

Photographs—writing ink for 503

Photography  
films, pinned to float, are kept clean in wash 482  
holder for enlarging paper 508  
photo flash lamp takes underwater views 502

Pictures—making grotesque enlargements of 477

Pool, Water—how to prevent small concrete pools from breakage by freezing 428

Post Holes—scoop for cleaning out 503

Poultry—this warm brooder develops sturdy chicks 481

Reflector—radio horn serves as 487

Saws and Sawing  
caster aids in cutting limber wood 503  
two-blade coping saw makes parallel cuts 482

Scales—improvised balance scale uses coins for weights 496

Seats—playroom seats resemble animals 505

Shelf—swinging, from discarded windshield parts 506

Shoe-Shining Stand—folds into wall 478

Skis—making your own 429

Sleds—build this ice speedster 483

Soldering—platinum deposit on glass provides base for stovepipe—box catches soot when cleaning 487

Tags—shipping, making emergency 507

Tools—rubber bands hold chisel to wrist 494

Weather-vane—caster makes bearing for 493

Window Shade—attaching to roller to prevent tearing 477

Wire—rivet mends resistance wire 494

*Shunt treatment at substitute 867*

AMATEUR MECHANICS

Anvil—detachable anvil made from flatiron 477

Aquarium—siphon for, is self-starting 482

Automobiles, Accessories—booster supplies rich mixture to start cold car 486

Automobiles, Testing—how to determine a faulty coil 496

Automobiles, Trailers—at home on the road in a trailer 497

Bottles  
removing caps and covers with strong cord 494  
shampoo bottle handy for pouring small amount of liquid 482

Camera—testing speed of shutter 504

Chemicals—dissolving crystals and other solid chemicals 478

Cord—short, from cellophane 501

Corn Popper—rotary, fits gas burner 496

Clothes Hamper—for the bathroom 481

Clothesline Posts—telescoping, aid in retaining beauty of lawn 508

Clothing  
cuff on worker's trouser serves as nail nocket 485  
wet clothes kept from freezing to line with paraffin 486

Doors—noise from slamming door reduced with rubber heel 507

SHOPNOTES

Automobiles—"Cannon Ball" Baker tells how to speed up your car 520

Automobiles, Repairing—carbon removed from motor with hydrogen peroxide 518

Bending Machine—portable, for heavy bar stock 519

Calipers—to measure irregular work 525

Cast—plaster, that are unbreakable 527

Corn—tester sprouts seed corn in wet sawdust 517

Dies—rethreading, made from old gears 526

Dowel Rods—quickly pointed on side of emery wheel 513

Engines, Gas—troubles you can cure 515

Gloves, Rubber—inflating, to find small holes 518

Hammer—notched claws improve 526

Ink—stoppers for screw-cap ink tubes 526

Live-Stock Loader—has an adjustable floor 512

Measuring—safety razor holds short section of steel rule 514

Miter Box—worn slots in, repaired with hardwood strips 514

Musical Instruments—removing dents from cornet bell 527

Pinch Bar—fitted with rollers, for moving heavy objects 513

Plastic Wood—inlaying with colored 509

Punch Press—swinging arm to support large work on 514

Saws and Sawing  
pointed saw removes old flooring 527  
teeth on back of saw blade used for cutting nails 513

Screweyes—held on old piston ring 524

Taps—wall rack for, keeps them handy 517

Tool Handles  
ferrules cut from pipe protect small 518  
wooden, sandpaper to prevent getting splinters 527

Vise  
chain-link jig for bending work in 513  
large vise holds smaller one 518

Warning Flag—dirt-filled box holds 526

Window Display—speed reducer for moving 525

*See speedster 485*





## “...and I had no money”

“A MAN can knock along on what he's making until something happens! Then when the emergency comes and the money he *hasn't got* could do so much, the cold realities of life haunt him.

“I know what I am talking about! I'll never forget the time when my child's life was at stake. Not an extra dollar to my name. If it hadn't been for friends. . . .

“But *now* I am able to meet the emergencies of life without depending on my friends. I studied an International Correspondence Schools Course and got the *training* I needed to earn more money.

It was the wisest thing I ever did. I realize it every time I get another promotion!”

Is money one of your problems? Does every unusual situation in your family life frighten you because of the lack of it? Remember this: *It's the trained man today who makes money and saves money.* And thousands of men have acquired this training by spare-time study of I. C. S. Courses. So can you! Don't delay—tomorrow never comes! Mark and mail the coupon—*today!*

### INTERNATIONAL CORRESPONDENCE SCHOOLS “The Universal University” BOX 5586-G, SCRANTON, PENNA.

Without cost or obligation, please send me a copy of your booklet, “Who Wins and Why,” and full particulars about the subject *before* which I have marked X:

#### TECHNICAL AND INDUSTRIAL COURSES

- |  |   |  |  |
|--|---|--|--|
| <input type="checkbox"/> Architect                 | <input type="checkbox"/> Telegraph Engineer                           | <input type="checkbox"/> Aviation Engines                                | <input type="checkbox"/> R. R. Bridge and Building Foreman                   |
| <input type="checkbox"/> Architectural Draftsman   | <input type="checkbox"/> Telephone Work                               | <input type="checkbox"/> Automobile Mechanic                             | <input type="checkbox"/> Air Brakes <input type="checkbox"/> Train Operation |
| <input type="checkbox"/> Building Estimating       | <input type="checkbox"/> Mechanical Engineer                          | <input type="checkbox"/> Plumbing <input type="checkbox"/> Steam Fitting | <input type="checkbox"/> Highway Engineering                                 |
| <input type="checkbox"/> Wood Millworking          | <input type="checkbox"/> Mechanical Draftsman                         | <input type="checkbox"/> Heating <input type="checkbox"/> Ventilation    | <input type="checkbox"/> Chemistry <input type="checkbox"/> Pharmacy         |
| <input type="checkbox"/> Contractor and Builder    | <input type="checkbox"/> Machinist                                    | <input type="checkbox"/> Sheet Metal Worker                              | <input type="checkbox"/> Coal Mining Engineer                                |
| <input type="checkbox"/> Structural Draftsman      | <input type="checkbox"/> Toolmaker                                    | <input type="checkbox"/> Steam Engineer                                  | <input type="checkbox"/> Navigation <input type="checkbox"/> Boilermaker     |
| <input type="checkbox"/> Structural Engineer       | <input type="checkbox"/> Patternmaker                                 | <input type="checkbox"/> Steam Electric Engineer                         | <input type="checkbox"/> Textile Overseer or Supt.                           |
| <input type="checkbox"/> Electric Wiring           | <input type="checkbox"/> Pipefitter <input type="checkbox"/> Tinsmith | <input type="checkbox"/> Civil Engineer                                  | <input type="checkbox"/> Cotton Manufacturing                                |
| <input type="checkbox"/> Electrical Engineer       | <input type="checkbox"/> Bridge Engineer                              | <input type="checkbox"/> Surveying and Mapping                           | <input type="checkbox"/> Woolen Manufacturing                                |
| <input type="checkbox"/> Electric Lighting         | <input type="checkbox"/> Bridge and Building Foreman                  | <input type="checkbox"/> Refrigeration                                   | <input type="checkbox"/> Agriculture <input type="checkbox"/> Fruit Growing  |
| <input type="checkbox"/> Welding, Electric and Gas | <input type="checkbox"/> Gas Engines                                  | <input type="checkbox"/> R. R. Locomotives                               | <input type="checkbox"/> Poultry Farming <input type="checkbox"/> Radio      |
| <input type="checkbox"/> Reading Shop Blueprints   | <input type="checkbox"/> Diesel Engines                               | <input type="checkbox"/> R. R. Section Foreman                           | <input type="checkbox"/> Marine Engineer                                     |

#### BUSINESS TRAINING COURSES

- |  |  |  |  |
|--|--|--|--|
| <input type="checkbox"/> Business Management   | <input type="checkbox"/> Cost Accountant                                   | <input type="checkbox"/> Business Correspondence                             | <input type="checkbox"/> Grade School Subjects |
| <input type="checkbox"/> Office Management     | <input type="checkbox"/> C. P. Accountant                                  | <input type="checkbox"/> Lettering Show Cards <input type="checkbox"/> Signs | <input type="checkbox"/> High School Subjects  |
| <input type="checkbox"/> Industrial Management | <input type="checkbox"/> Bookkeeping                                       | <input type="checkbox"/> Stenography and Typing                              | <input type="checkbox"/> College Preparatory   |
| <input type="checkbox"/> Personnel Management  | <input type="checkbox"/> Secretarial Work                                  | <input type="checkbox"/> Complete Commercial                                 | <input type="checkbox"/> Illustrating          |
| <input type="checkbox"/> Traffic Management    | <input type="checkbox"/> Spanish <input type="checkbox"/> French           | <input type="checkbox"/> Civil Service <input type="checkbox"/> Mail Carrier | <input type="checkbox"/> Cartooning            |
| <input type="checkbox"/> Accountancy           | <input type="checkbox"/> Salesmanship <input type="checkbox"/> Advertising | <input type="checkbox"/> Railway Mail Clerk                                  | <input type="checkbox"/> Lumber Dealer         |

Name.....Age.....Street Address.....

City.....State.....Occupation.....

If you reside in Canada, send this coupon to the International Correspondence Schools Canadian, Limited, Montreal, Canada





## Here's an Amazing New Business THAT PAYS UP TO

# \$1,000 A MONTH

**MEN**, here is a real, red hot money-making opportunity! It's a chance to jump into business for yourself and make more money every week than the average man makes in a month.

Surprising as it may sound, we actually put you in a business, with the first day's profits often running from \$18 to \$55. \$350 to \$600 the first month is not unusual for ambitious men.

### Cut in on the Big Money

All you need is the ambition to make real money. We supply you with complete equipment to make and sell that famous new food specialty—Brown Bobby—a greaseless doughnut baked by electricity!

It's a crispy, flaky, delicious new kind of doughnut cooked without one drop of oil or grease. Easily digested by everyone. More appetizing than old-style doughnuts ever were. Costs less to make. Sells four times as fast. No baker's skill required. Just add water to our prepared "Mix." You can open a shop; rent cheap floor space in a grocery, delicatessen, lunch-counter, drug store, etc. Or start at home—and make up to \$250 your very first week.



"I made \$3,000 in 3 months from my greaseless doughnut business!" — T. Chas. Minch, Fla.

### Start At Once ANYWHERE!

Men and women everywhere are starting in this business daily! YOU cannot afford to delay! Details will gladly be sent without obligations of any sort. Such an amazing money maker may never come your way again. So fill in and send the coupon at once! TODAY!

**FOOD DISPLAY MACHINE CORP.**  
Dept. 33, 500 N. Dearborn St. Chicago, Ill.

Food Display Machine Corp.,  
Dept. 33, 500 N. Dearborn St., Chicago, Ill.

Gentlemen: Please send me the plan by which I can cash in on Brown Bobby, the Greaseless doughnut. It is understood that this obligates me in no way whatever.

NAME.....

ADDRESS.....

CITY.....STATE.....

When writing please mention Popular Mechanics

## BE A RAILWAY TRAFFIC INSPECTOR

Both Railway and Bus—Active Men 19 to 55

TRAFFIC INSPECTION in growing bus line and railway passenger field is a pleasant, unceremonious profession. Interesting, important work, report to important officials; unlimited opportunity. Travel or remain near home.

We train you by our thorough, simple, home-study course in a few weeks and on graduation help place you immediately in a position paying \$120 to \$150 per month up, plus expenses, to start, or refund tuition. Costs little—terms easy.

Write for Free Booklet and record of thirteen years' experience placing men in this profitable work that leads to big opportunities.

Standard Business Training Institute  
Div. 203 Buffalo, N. Y.

## EARN MONEY AT HOME

YOU can make \$15 to \$50 weekly in spare or full time at home coloring photographs. No experience needed. No canvassing. We instruct you by our new simple Photo-Color process and supply you with work. Write for particulars and Free Book to-day.

The IRVING-VANCE COMPANY Ltd.  
356 Hart Building, Toronto, Can.

## MUSIC LESSONS IN YOUR HOME

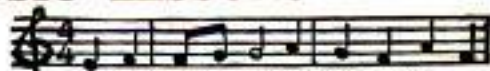

You can play music like this quickly

Write today for our FREE BOOKLET AND DEMONSTRATION LESSON. It tells how to learn to play Piano, Organ, Violin, Mandolin, Guitar, Banjo, etc. Beginners or advanced players. You pay as you learn. Costs you only a few cents a day. Thousands of satisfied students.

AMERICAN SCHOOL of MUSIC, 51 Manhattan Bldg., CHICAGO

## \$100 REWARD

offered by leading magazine for interesting snapshots that you can take. Thousands of other publishers also want your photographs.

Earn \$25 a Week EXTRA

FREE BOOK tells all about this fascinating way to make money with your camera right where you live. Learn Photo-Couriers at home, turn your spare hours into cash. Write today.

UNIVERSAL PHOTOGRAPHERS  
Dept. 106, 10 West 33rd St., New York



**Why STAMMER?**  
I overcame my own stammering. Let me help you. My new, free booklet tells how. You too, can overcome your speech defects and lead a normal, longer and successful life. Write today.  
ROBT. E. CARD, 12688 Woodward Ave., Detroit, Mich.



## GOV'T. POSITIONS SPLENDID SALARIES

MEN - WOMEN

WE HELP YOU GET ONE

Ry. Mail Clerk	Steno Typist
P. O. Laborer	Immigrant Insp
R. F. D. Carrier	Seamstress
Special Agent	Auditor
Customs Inspector	Prohibition Agt.
City Mail Carrier	U. S. Border
Meat Inspector	Patrol
P. O. Clerk	Chauffeur
File Clerk	Watchman
General Clerk	Skilled Laborer
Matron	Postmaster
	Typist

Government Instruction Bureau, Dept. 111, St. Louis, Mo. Send no FREE, particulars "How to Qualify" for positions marked "X". Salaries, Locations, Opportunities, etc. ALL SENT FREE.

Name.....  
Address.....

AGE RANGE 18 to 50



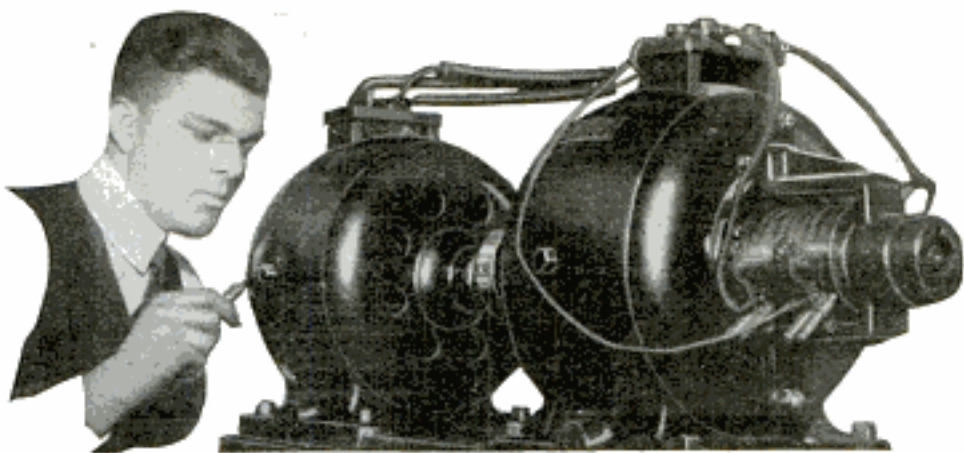

# Amazingly Easy Way to get into ELECTRICITY

Don't spend your life waiting for \$5.00 raises in a dull, hopeless job. Now . . . and forever . . . say good-bye to that uninteresting, low pay job. LET ME SHOW YOU HOW TO PREPARE FOR POSITIONS THAT LEAD TO \$50.00 A WEEK AND UP IN ELECTRICITY—NOT by book study, but by an amazing way to teach RIGHT HERE IN THE COYNE SHOPS IN CHICAGO that makes you a practical trained man in 90 days! Getting into Electricity is far easier than you imagine!

## Learn By Doing In 90 Days

Lack of experience—age, or advanced education bars no one. I don't care if you don't know an armature from an air brake—I don't expect you to! It makes no difference! Don't let lack of money stop you. Most of the men at Coyne have no more money than you have. That's why I have worked out my offers.

### Many Earn While Learning

If you need part-time work to help pay your living expenses and will tell me your problems I may be able to help you as I have thousands of others. Then, in 12 brief weeks, in the great roaring shops of Coyne, I train you as you never dreamed you could be trained . . . on one of the greatest outlays of electrical apparatus ever assembled . . . real dynamos, engines, power plants, autos, switchboards, transmitting stations . . . everything from doorbells to farm power and lighting . . . full-sized . . . in full operation every day!

### TRAINING by Actual Work

No dull books, no baffling charts, no classes, you get individual training . . . all real actual work with only the theory you will need. Building real batteries . . . winding real armatures,



### PREPARE FOR JOBS LIKE THESE

Here are a few of hundreds of positions in the electrical field. Our free employment bureau gives you life-time employment service.

Armature Expert  
Substation Operator  
Auto Electrician  
Inventor  
Maintenance Engineer  
Service Station Owner  
Radio Expert

operating real motors, dynamos and generators, wiring houses, etc. That's a glimpse of how we help to make you a master electrician, and fit you to qualify for jobs leading to the biggest pay.

### Jobs—Pay—Future

"Two weeks after graduation I received a splendid job. The main consideration given my application was that I was a Coyne Trained man," reports Harold Soucy of Illinois. "I wish to thank your Employment Manager for securing this position for me," writes Albert Yagon, "he sent me out to this Company the first day and I was employed there immediately." And I could go on quoting from hundreds of letters of successful Coyne Trained Men. What they have done, you should be able to do!

### Electric Refrigeration

Right now I'm including my big new Electric Refrigeration course at no extra cost.

### Get the Facts

Coyne is your one great chance to get into electricity. Every obstacle is removed. This school is 32 years old—Coyne training is tested—proven beyond all doubt—endorsed by many large electrical concerns. You can find out everything absolutely free. Simply mail the coupon and let me send you the big, free Coyne book of 150 photographs . . . facts . . . jobs . . . salaries . . . opportunities. Tells you how many earn expenses while training and how we assist our graduates in the field. This does not obligate you. So act at once. Just mail coupon.

### Get This FREE Book

**BIG  
PAY  
FACTS**



### Now in Our New Home

This is our new fireproof, modern home wherein is installed thousands of dollars' worth of Electrical equipment of all kinds. Every comfort and convenience has been arranged to make you happy and contented during your training.

**COYNE ELECTRICAL SCHOOL**  
H. C. LEWIS, Pres.      Founded 1899  
500 S. PAULINA ST., Dept. 32-72, CHICAGO, ILL.

H. C. LEWIS, President  
COYNE ELECTRICAL SCHOOL, Dept. 32-72  
500 S. Paulina St., Chicago, Ill.

Dear Mr. Lewis:—Without obligation send me your big free catalog and all details of Free Employment Service and your new Electric Refrigeration course.

Name .....

Address .....

City.....State.....

When writing to advertisers please mention Popular Mechanics





## How I Stepped into a Big-Pay Hotel Job

BY *A. L. Cummin*

*Who in 4 Months, Without Experience,  
Became a Hotel Manager, with a 90%  
Increase in Salary.*

I WAS idly looking over the pages of a magazine. Tired after a hard day at the garage in which I worked, dissatisfied with my salary, the lack of opportunity, long hours and unpleasant surroundings, my attention was drawn to an advertisement 'Hotels Call For Hundreds of Trained Men and Women.' I clipped the coupon and sent for a copy of the Free Book offered.

'Soon the Lewis Schools' book, 'YOUR BIG OPPORTUNITY,' arrived. Here was a profession that offered everything I wanted. Fascinating work amidst rich, luxurious surroundings, daily contact with the best people, more pay and unlimited opportunities. What a contrast to my garage work! I enrolled that evening.

'After completing one-third of the Course, I secured a Clerk's position. In less than FOUR MONTHS I was offered a position as Hotel Manager, with a 90% INCREASE IN SALARY!

'My success is due to the Lewis Hotel Training Schools and the assistance they gave me. I shall never regret the day I clipped the coupon and sent for their literature.'

A. L. Cummin is typical of the thousands of Lewis-Trained men and women who have won quick success in the fascinating hotel, club, restaurant and institutional field—one of America's greatest industries. Our FREE Book, "YOUR BIG OPPORTUNITY," tells how to secure a well-paid position and explains how you are registered FREE of extra cost in the Lewis National Employment Bureau, which covers the country at 70,000 points through special arrangement with Postal Telegraph. A. L. Cummin's story may be YOUR story—if you will make the same decision TODAY that he made a few months ago. Sign the coupon and MAIL IT NOW!

### LEWIS HOTEL TRAINING SCHOOLS

*CLIFFORD LEWIS, President*

ROOM EC-336

Washington, D. C.

- |   |   |  |
|---|---|--|
| <input type="checkbox"/> Manager          | <input type="checkbox"/> Chief Engineer   | <input type="checkbox"/> Accountant      |
| <input type="checkbox"/> Asst. Manager    | <input type="checkbox"/> Cashier          | <input type="checkbox"/> Auditor         |
| <input type="checkbox"/> Supl. of Service | <input type="checkbox"/> Purchasing Agent | <input type="checkbox"/> Sports Director |
| <input type="checkbox"/> Steward          | <input type="checkbox"/> Chief Clerk      | <input type="checkbox"/> Banquet Manager |

LEWIS HOTEL TRAINING SCHOOLS,  
Room EC-336, Washington, D. C.

Please send me FREE of charge and without obligation, details as to how to qualify for the hotel, club, restaurant and institutional field, by spare time study. I am particularly interested in the positions I have checked above.

Name.....  
Address.....  
City..... State.....

When writing please mention Popular Mechanics

## NEW INDUSTRY NEEDS MEN

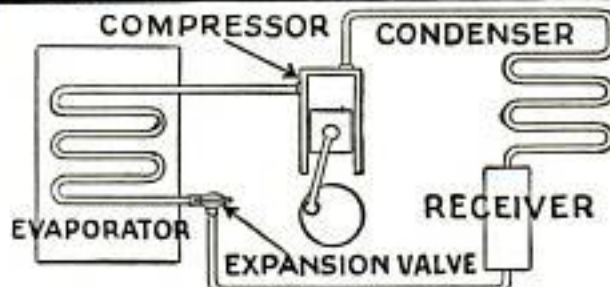

### ELECTRIC REFRIGERATION Calls You!

Newest American Industry needs men for \$200 to \$1,000 a month jobs in production service, installation and sales. Fastest growing, money-making field—backed by General Motors, General Electric, etc. New easy home training qualifies you for big pay job. This training endorsed by Brevet, Kelvinator, Copeland and other large manufacturers.

#### Get Valuable New Book—FREE

Our new illustrated book—'Rich Rewards in Electric Refrigeration'—just off the press, reveals amazing plans to ambitious men. Sent absolutely free, without obligation. Be the first in your locality to get into this new magic industry. Write today!

UTILITIES ENGINEERING INSTITUTE  
404 No. Wells St., Dept. 132, Chicago, Ill.



## Anyone CAN LEARN

No talent or experience necessary. Fascinating work. **Pay big money.** Complete instruction book tells about Alphabets, Colors, How to Sign, Show Cards, Window Board and Wall Signs. Ready made letters, Gilding, Trills of the Trade, also gives 100 Alphabets and Designs. Book bound in flexible imitation leather-gold edges, and four full-bearing Show Card Frames. Sent postpaid \$3.00. (C.O.D.) 15c extra.

Opolis Pub. Co., 57 Ross St., Dept. 28, N. Y. City

### EARN MONEY IMMEDIATELY— WE FURNISH EQUIPMENT TO START!!

## LAW STUDY AT HOME

Be independent. Earn \$3,000 to \$10,000 annually. We train you step by step—furnish all text material, including fourteen-volume Law Library, Degree of LL. B., conferred. Low cost, easy terms. Get our valuable 64-page "Law Guide" and "Evidence" books free. Send for them NOW.

LaSalle Extension University, Dept. 364-L, Chicago

## Learn Photography at HOME

Make money taking pictures. Prepare quickly during spare time. Also earn while you learn. No experience necessary. New easy method. Nothing else like it. Send at once for free book, OPPORTUNITIES IN MODERN PHOTOGRAPHY, and full particulars.

AMERICAN SCHOOL OF PHOTOGRAPHY  
Dept. 1353, 3601 Michigan Avenue Chicago, U. S. A.

## LEARN WATCHMAKING

and become independent. We help you secure a position. Easy to learn. Send for FREE CATALOG.

ST. LOUIS WATCHMAKING SCHOOL Dept. 6, ST. LOUIS, MO.

## WHY NOT spend Spring, Summer and Fall gathering butterflies, insects?

I buy hundreds of kinds for collections. Some worth \$1 to \$7 each. Simple outdoor work with my instructions, pictures, price-list. Send 10 cents (not stamps) for instructions. Proceeds before sending butterflies.

MR. SINCLAIR, DEALER IN INSECTS  
Dept. 6, Box 1424, San Diego, Calif.

## VOICE

### 100% Improvement Guaranteed

We build, strengthen the vocal organs—not with singing lessons—but by fundamentally sound and scientifically correct silent exercises... and absolutely guarantee to improve any singing or speaking voice at least 200%... Write for wonderful voice book—sent free. Learn WHY you can now have the voice you want. No literature sent to anyone under 17 years unless signed by parent.

PERFECT VOICE INSTITUTE, Studio 13-53  
308 No. Michigan Ave., Chicago





# Men who work with their hands make the BEST DRAFTSMEN

## ..and we'll back them with this AMAZING GUARANTEE

We are looking for more ambitious young fellows with factory, building-trade or any other kind of mechanical experience to prepare for and help place in well-paid Drafting positions. Such men, we find, are unusually successful as Draftsmen, because they know how things are done, and that's a priceless asset to the man who makes the blueprint plans. Get in touch with us and we'll tell you how you can cash in on your entire past experience.

### Drafting Is Logically Your Next Move!

Of course you realize the biggest handicap to mechanical work is that you're limited in earning capacity to the output of your two hands, as long as you live. Even the skilled mechanic earning \$30 to \$50 a week has reached his limit. He can never earn more and when he gets old he will earn less. So we don't blame any man for wanting to get away from this futureless outlook. For wanting to get into something where he can use his **head** as well as his hands—where he will be paid for what he **knows**, instead of only for what he **does**...

You know enough about blueprints to understand that PLANS govern every move in factory and construction jobs. The Draftsman who makes them is several jumps ahead of the workman who follows them. And so we want you to know that DRAFTING is a logical, natural PROMOTION from mechanical and building work—better-paid, more interesting—just the kind of work you'd enjoy doing.

**THE AMERICAN SCHOOL**  
Dept. D-347, Drexel Ave. & 58th St.  
CHICAGO, ILLINOIS



**American School**

### 3 GUARANTEES

1. We will get you ready for a good Drafting Job at home, in your spare time.
2. Actual Drafting room practice, prepared by noted Engineers, Architects and Executives.
3. We will help you find a well-paid position as soon as you are ready for it.

We have placed machinists, carpenters, masons, plumbers, railroad men, office clerks, farmers and even laborers in fine Drafting Jobs under this plan. Mail coupon for details of our remarkable offer.

## GET OUR NO-RISK PLAN

The way to a fine Drafting job for you—is easier than you think. It takes no "artistic talent" or advanced education. Thousands of men no smarter than you, with no more education or ability, have learned it quickly and you can, too. With the co-operation of some of the biggest employers and engineers in the U. S., we have worked out a plan to prepare you for Drafting work in your spare time at home—then to help you get a fine position when you're ready for it.



"I have landed a job with the Pacific Tel. and Tel. Co. in Seattle, and I must say that I am greatly indebted to the American School for my success. You have done all that you promised in helping me obtain employment."  
T. C. White,  
Seattle, Wash.

## TEST LESSON FREE

... to prove you can learn at home in your spare time.



**American School,**  
Dept. D-347, Drexel Ave. and 58th St., Chicago.

Please tell us, without cost or obligation, about your training and employment service in line marked X below:

- |   |  |   |
|---|--|---|
| <input type="checkbox"/> Architecture             | <input type="checkbox"/> Accounting              | <input type="checkbox"/> Auto Engineering         |
| <input type="checkbox"/> Contracting and Building | <input type="checkbox"/> Civil Service Positions | <input type="checkbox"/> Highway Engineering      |
| <input type="checkbox"/> Electrical Engineering   | <input type="checkbox"/> Law                     | <input type="checkbox"/> Mechanical Engineering   |
| <input type="checkbox"/> Business Management      | <input type="checkbox"/> Civil Engineering       | <input type="checkbox"/> High School (in 2 years) |

Name.....

St. No.....

City..... State.....

Age..... Occupation.....



## Get This Strong Man's Library!

## Molding Mighty Men

**6 for \$1**

**25¢ Each**

POST PAID

### Each Book a Complete Course

Think of it! A muscle building course showing how to develop a definite part of your body for only 25c or six courses which show you how to develop the entire body for only \$1.00. That's my special offer. I will show you how to mold a mighty arm for a quarter or how to mold a mighty chest, mighty legs, a mighty back or a grip of steel, or I will teach you strong man stunts. Get all of the lessons in this Strong Man's Library for only \$1.00.

I show you how to add inches on your arm, how to put steel cables on your chest, how to get a back of might. I show you how to develop legs of a giant and a grip of steel. The strong man tricks which I reveal will amaze you and your friends. Molding mighty men is the business of George F. Jowett, The Champion of Champions.

#### RUSH COUPON—SPECIAL OFFER

All 6 books are profusely illustrated and will be sent to you by return mail, postpaid. Just slip a dollar bill in an envelope with the coupon below. For any single book, just send a quarter. I will include a free copy of my book titled, "The Thrill of Being Strong." Rush coupon now.

#### JOWETT INSTITUTE OF PHYSICAL CULTURE

422 Poplar Street, Dept. 4Cb, Scranton, Penna.

Dear Mr. Jowett: Your proposition looks good to me. Send, by return prepaid mail, the lessons I am checking below and for which I am enclosing my remittance of \$.....

- All 6 Courses \$1.00  
 Molding a Mighty Arm 25c  
 Molding a Mighty Back 25c  
 Molding a Mighty Grip 25c  
 Molding a Mighty Chest 25c  
 Molding Mighty Legs 25c  
 Strong Man Stunts Made Easy 25c

Name.....

Address.....

When writing to advertisers please mention Popular Mechanics

## Play the Hawaiian Guitar like the Hawaiians!

Only 4 Motions used in playing this fascinating instrument. Our native Hawaiian instructors teach you to master them quickly. Pictures show how. Everything explained clearly.

#### Play in Half Hour

After you get the four easy motions you play harmonious chords with very little practice. No previous musical knowledge needed.

#### Easy Lessons

Even if you don't know one note from another, the 12 graded lessons and clear pictures make it easy to learn quickly. Pay as you play.

**GIVEN**—when you enroll—a sweet toned

#### HAWAIIAN GUITAR, Carrying Case and Playing Outfit—

WRITE AT ONCE for attractive offer and easy terms. You have everything to gain. A postcard will do. ACT!

Value \$18 to \$20 No extras—everything included

**OTHER COURSES** Tenor Banjo, Violin, Viola, Tenor Guitar, Ukulele, Banjo Guitale, Under well known instructors.

**FIRST HAWAIIAN CONSERVATORY OF MUSIC, Inc.** 9th Floor, Woolworth Bldg., Dept. 545 New York, N. Y. Approved as a Correspondence School Under the Laws of the State of New York—Member National Home Study Council

#### Operator No. 38



#### FOLLOW THIS MAN

Secret Service Operator No. 38 is on the job! Naming down dangerous Counterfeit Gang. Falsely finger prints in murdered girl's room.

**Free** The Confidential Report Operator No. 38 made to his chief. Write for it. \$3000 a year and up

YOU can become a Finger Print Operator at home, in your spare time, at small cost. Write for confidential full report and details. Literature will NOT be sent to boys under 17 years of age.

**INSTITUTE OF APPLIED SCIENCE** 1920 Sunnyside Ave. Chicago, Ill. Dept. 13-53



#### Learn Public Speaking

At home—in spare time—20 minutes a day. Overcome "stage-fright," gain self-confidence, increase your salary, through ability to sway others by effective speech. Write now for free booklet, How to Work Wonders With Words.

**NORTH AMERICAN INSTITUTE, Dept. 1353** 3601 Michigan Avenue, Chicago, Illinois

## ENGINEERING and ARCHITECTURE

**INTENSIVE PRACTICAL TECHNICAL COURSES** in Electrical, Mechanical, Structural, Architectural Engineering. Degree in 2 yrs., diploma in 1 yr. Also shorter courses in Electricity, Power Plant, Radio, Television, Electric Refrigerator, Drafting, Welding. Non-essentials eliminated. **LOW TUITION.** Expert instructors. Extensively equipped laboratories. Free lifetime employment for graduates. Part-time work during attendance. 32nd year. Write for catalogue. **FINLAY ENGINEERING COLLEGE** 1001 A Indiana Avenue KANSAS CITY, MO.



## \$60 a Week in AVIATION

Write now for FREE Book that gives all details about this training and a FREE FLIGHT. BIG SAVINGS ON FLYING INSTRUCTIONS. Walter Hinton, Pres.; Aviation Institute of U. S. A., Inc., Suite 601-K, 1115 Connecticut Ave., N. W., Washington, D. C.

## LEARN THE JEWELRY BUSINESS WATCHWORK, JEWELRY AND ENGRAVING

Send for free catalogue  
Bradley Watchmaking School, Dept. P, Peoria, Illinois

### Minstrels

Unique First Parts for complete show with special songs and choruses. Make-up. Catalog free.

T. S. Denison & Co., 623 S. Wabash, Dept. 19 Chicago

## All This for Only 15 Cents

Send only 15c RIGHT NOW and receive The Pathfinder every week by mail for the next 13 consecutive weeks. In these 13 issues you will get 426 pages, with 309 pictures, 906 unusually interesting articles on people and things you want to know about, 1860 picked news items from everywhere, 1560 jokes, squibs and cracks, stories, etc. Newest, snappiest, most entertaining paper in the whole world. The biggest 15c worth YOU ever saw. Send now. Address **Pathfinder, Dept. 74, Washington, D. C.**



# I will train you at home



to fill a  
**BIG PAY**

## Radio Job!

**Here's  
Proof**

If you are earning a penny less than \$50 a week, send for my book of information on the opportunities in Radio. It is free. Clip the coupon NOW. Why be satisfied with \$25, \$30 or \$40 a week for longer than the short time it takes to get ready for Radio?

**Radio's growth opening hundreds of \$50, \$75, \$100 a week jobs every year**

In about ten years Radio has grown from a \$2,000,000 to a \$1,000,000,000 industry. Over 300,000 jobs have been created. Hundreds more are being opened every year by its continued growth. Many men and young men with the right training—the kind of training I give you—are stepping into Radio at two and three times their former salaries.

**You have many jobs to choose from**

Broadcasting stations use engineers, operators, station managers and pay \$1,200 to \$5,000 a year. Manufacturers continually need testers, inspectors, foremen, engineers, service men, buyers, for jobs paying up to \$7,500 a year. Radio Operators on Ships enjoy life, see the world, with board and lodging free, and get good pay besides. Dealers and jobbers employ service men, salesmen, buyers, managers, and pay \$30 to \$100 a week. There are many other opportunities too.

**So many opportunities many N. R. I. men make \$200 to \$1,000 while learning**

The day you enroll with me I'll show you how to do 28 jobs, common in most every neighborhood, for spare time money. Throughout your course I send you information on servicing popular makes of sets; I give you the plans and ideas that are making \$200 to \$1,000 for hundreds of N. R. I. students in their spare time while studying. My course is famous as the course that pays for itself.

**Talking Movies, Television, Aircraft Radio are also included**

Special training in Talking Movies, Television and home Television experiments, Radio's use in Aviation, Servicing and Merchandising Sets, Broadcasting, Commercial and Ship Stations are included. I am so sure that I can train you satisfactorily that I will agree in writing to refund every penny of your tuition if you are not satisfied with my Lessons and Instruction Service upon completing.

**64-page book of information FREE**

Get your copy today. It tells you where Radio's good jobs are, what they pay, tells you about my course, what others who have taken it are doing and making. Find out what Radio offers you, without the slightest obligation. ACT NOW!

**J. E. SMITH, President  
National Radio Institute Dept. 2 CP  
Washington, D. C.**



### Special Free Offer

In addition to my big free book "Rich Rewards in Radio," I'll send you my valuable manual "28 Tested Methods for Making Extra Money." Never before available except to students. Now, for a limited time, it is free to readers of this magazine. How to make a good baffle for cone speakers, how to reduce hum in

externally fed dynamic speakers, how to operate 25 cycle apparatus on 60 cycle current, how to operate 110 v. A. C. receivers on D. C., how to shield sets from local interference are five of the subjects covered. There are 23 others. Get this valuable book by mailing the coupon.



### .. NEW Radio Equipment for Broad Practical Experience Given Without Extra Charge

With this equipment you work out many of the things you read about and are told how to do in your text books. From it you get the valuable experience that tells an expert from a beginner. In a short time you have learned what would take years to learn in the field. You can test the principles used in the 25 best known receiving sets.

**I am doubling and tripling the salaries of many in one year and less Find out about this quick way to**

**BIGGER  
PAY**

**FILL OUT AND MAIL  
THIS COUPON**

**TODAY**

**J. E. SMITH, President  
National Radio Institute, Dept. 2 CP  
Washington, D. C.**

Dear Mr. Smith: I want to take advantage of your Special Offer. Send me your two books "28 Tested Methods for Making Extra Money" and "Rich Rewards in Radio". I understand this does not obligate me and that no salesman will call.

NAME .....  
ADDRESS.....  
CITY..... STATE..... J



**\$100 a week**

"My earnings in Radio are many times greater than I ever expected they would be when I enrolled. They seldom fall under \$100 a week."

**E. F. WINBORNE,  
1207 W. 48th St.,  
Norfolk, Va.**



**Jumped from \$35  
to \$100 a week**

"Before I entered Radio I was making \$35 a week. Last week I earned \$110 servicing and selling Radios. I owe my success to N. R. I."

**J. A. VAUGHN  
3107 S. Grand Boulevard,  
Grand Radio and Appliance Co., St. Louis, Mo.**



**\$500 extra in 6  
months**

"I find I made \$500 from January to May in my spare time. My best week brought me \$107. I should have taken it long ago."

**HOYT MOORE  
R. R. 3, Box 919,  
Indianapolis, Ind.**

**Lifetime Employment Service to all Graduates**

When writing to advertisers please mention Popular Mechanics



## This is FIGHTING Talk



If YOU'RE a quitter you won't read far in this advertisement. If you're not—if you have the courage to face facts—you want to know who is responsible for your not getting ahead faster. It's YOU. The man who won't be licked *can't* be licked. If you're a drifter you'll always wish for success but never do anything about it. The earth is cluttered with that kind.

If you're a fighter you *will* do something about it. You'll get the special training that fits you for advancement, and you'll go on to a bigger job.

In spare time, right at home, you can get the training you need through the home-study courses of the International Correspondence Schools. Thousands of other men have lifted themselves out of the rut and into well-paid, responsible positions by I. C. S. study. Are they better men than you?

The time for action is *this minute*. Find out about this practical educational method that lets you learn while you earn. Check the subjects that interest you in the coupon below and mail it today. It doesn't obligate you in any way to ask for full particulars, but that one simple act may make all the difference between failure and success. *Do it now!*

### INTERNATIONAL CORRESPONDENCE SCHOOLS

"The Universal University"  
Box 5590-G, Scranton, Penna.

Without cost or obligation, please send me a copy of your booklet, "Who Wins and Why," and full particulars about the subject before which I have marked X:

#### TECHNICAL AND INDUSTRIAL COURSES

- |  |  |
|--|--|
| <input type="checkbox"/> Architect   | <input type="checkbox"/> Automobile Mechanic                                 |
| <input type="checkbox"/> Architectural Draftsman                             | <input type="checkbox"/> Plumbing <input type="checkbox"/> Steam Fitting     |
| <input type="checkbox"/> Building Estimating                                 | <input type="checkbox"/> Heating <input type="checkbox"/> Ventilation        |
| <input type="checkbox"/> Wood Millworking                                    | <input type="checkbox"/> Sheet Metal Worker                                  |
| <input type="checkbox"/> Contractor and Builder                              | <input type="checkbox"/> Steam Engineer                                      |
| <input type="checkbox"/> Structural Draftsman                                | <input type="checkbox"/> Steam Electric Engineer                             |
| <input type="checkbox"/> Structural Engineer                                 | <input type="checkbox"/> Civil Engineer                                      |
| <input type="checkbox"/> Electric Wiring                                     | <input type="checkbox"/> Surveying and Mapping                               |
| <input type="checkbox"/> Electrical Engineer                                 | <input type="checkbox"/> Refrigeration                                       |
| <input type="checkbox"/> Electric Lighting                                   | <input type="checkbox"/> R. R. Locomotives                                   |
| <input type="checkbox"/> Welding, Electric and Gas                           | <input type="checkbox"/> R. R. Section Foreman                               |
| <input type="checkbox"/> Reading Shop Blueprints                             | <input type="checkbox"/> R. R. Bridge and Building Foreman                   |
| <input type="checkbox"/> Telegraph Engineer                                  | <input type="checkbox"/> Air Brakes <input type="checkbox"/> Train Operation |
| <input type="checkbox"/> Telephone Work                                      | <input type="checkbox"/> Highway Engineering                                 |
| <input type="checkbox"/> Mechanical Engineer                                 | <input type="checkbox"/> Chemistry <input type="checkbox"/> Pharmacy         |
| <input type="checkbox"/> Mechanical Draftsman                                | <input type="checkbox"/> Coal Mining Engineer                                |
| <input type="checkbox"/> Machinist <input type="checkbox"/> Toolmaker        | <input type="checkbox"/> Navigation <input type="checkbox"/> Boilermaker     |
| <input type="checkbox"/> Patternmaker  | <input type="checkbox"/> Textile Overseer or Supt.                           |
| <input type="checkbox"/> Pipefitter <input type="checkbox"/> Tinsmith        | <input type="checkbox"/> Cotton Manufacturing                                |
| <input type="checkbox"/> Bridge Engineer                                     | <input type="checkbox"/> Woolen Manufacturing                                |
| <input type="checkbox"/> Bridge and Building Foreman                         | <input type="checkbox"/> Agriculture <input type="checkbox"/> Fruit Growing  |
| <input type="checkbox"/> Gas Engines <input type="checkbox"/> Diesel Engines | <input type="checkbox"/> Poultry Farming <input type="checkbox"/> Radio      |
| <input type="checkbox"/> Aviation Engines                                    | <input type="checkbox"/> Marine Engineer                                     |

#### BUSINESS TRAINING COURSES

- |   |  |
|---|--|
| <input type="checkbox"/> Business Management                                  | <input type="checkbox"/> Business Correspondence                             |
| <input type="checkbox"/> Office Management                                    | <input type="checkbox"/> Lettering Show Cards <input type="checkbox"/> Signs |
| <input type="checkbox"/> Industrial Management                                | <input type="checkbox"/> Stenography and Typing                              |
| <input type="checkbox"/> Personnel Management                                 | <input type="checkbox"/> Complete Commercial                                 |
| <input type="checkbox"/> Traffic Management                                   | <input type="checkbox"/> Civil Service <input type="checkbox"/> Mail Carrier |
| <input type="checkbox"/> Accountancy <input type="checkbox"/> Cost Accountant | <input type="checkbox"/> Railway Mail Clerk                                  |
| <input type="checkbox"/> C. P. Accountant                                     | <input type="checkbox"/> Grade School Subjects                               |
| <input type="checkbox"/> Bookkeeping  | <input type="checkbox"/> High School Subjects                                |
| <input type="checkbox"/> Secretarial Work                                     | <input type="checkbox"/> College Preparatory                                 |
| <input type="checkbox"/> Spanish <input type="checkbox"/> French              | <input type="checkbox"/> Illustrating <input type="checkbox"/> Cartooning    |
| <input type="checkbox"/> Salesmanship <input type="checkbox"/> Advertising    | <input type="checkbox"/> Lumber Dealer                                       |

Name.....Age.....

Address.....

City.....State.....

Occupation.....

If you reside in Canada, send this coupon to the International Correspondence Schools Canadian, Limited, Montreal, Canada

When writing please mention Popular Mechanics

## ENGINEERING DEGREE IN 2 YEARS



School of  
Engineering 49th  
year

B. S. Degree in Civil, Electrical, Mechanical, Chemical, Aeronautical Engineering in 2 years. Non-essentials eliminated. Technical training in least time and at lowest cost consistent with thorough preparation.

For ambitious, earnest students. Those who lack high school training may make up work. Courses also in scientific business training. Students from all over the world. Graduates successful. Enter September, January, March, June. Write for catalog.

432 College Ave.

Angola, Ind.

## TRI-STATE COLLEGE

### Wrestling Book Learn at Home **FREE**



Be an expert wrestler. Learn at home by mail. The greatest wrestlers of all, Frank Gotch and Farmer Burns, both world's champions have prepared the most wonderful course of lessons ever written on Scientific Wrestling, Physical Culture, Self Defense and Judo-Jitsu. Be strong, healthy, with an attractive body. Handle and control bizzar and stronger men with ease. Get this Free Prospectus—32 pages—brimming with thrilling information—No Charge—merely send 2c to cover postage. Don't delay. Write Today for your copy. State your age.  
FARMER BURNS SCHOOL, 3373 Courtney Bldg., Omaha, Neb.



## SONG WRITERS

Don't fail to read "Song Requirements of Talking Pictures, Radio and Records" an explanatory, instructive book SENT FREE on request. New writers may mail song-poems for free examination. We revise, compose and arrange music, and secure copyrights, guaranteeing approval.

P. M. Newcomer Associates, 1674 Broadway, New York

## RADIO TELEVISION SOUND REPRODUCTION

World's Newest Big-Pay Big-Future Profession. Thousands of New Positions in an Uncrowded Field for Men who can Qualify. We offer Dependable Training at a Reliable School under High-Class Instructors on Complete Assembly of Up-to-the-Minute Equipment. We teach you right here in our Shops, not by Mail. Also Courses in Electricity, Automobiles and Welding.

COLEMAN ELECTRICAL SCHOOL, 1628-Z Main St., Kansas City, Mo.



### ELECTRIC PANTS PRESSER

Illinois  
Man Makes  
**\$88 in Week**



Pennsylvania agent cleared \$76 in 4 days—Texas live wire started with earnings of \$144. Profits like these easy for you with amazing new invention—just out  
**Pants Pressed in 10 Seconds**  
by ELECTRICITY

Millions waiting for this wonderful RED LION ELECTRIC Trousers Presser. Puts tailor order creases in pants by electricity. As easy to use as a clothes brush. Only presser in the world that will crease pants while being worn. Will last years. Sample free in pocket. Take orders. 100% profits. Experience unnecessary. Write for generous sample offer. **RENT FREE.**

Dept. 8-C

817 Main Street

Cincinnati, Ohio



# LOW PAY.. LONG HOURS.. ROUTINE.. NO FUTURE



Always worrying over money. Always skimping and economizing—going without the comforts and luxuries that every man **DESERVES** for his family and himself.



The Time Clock—a badge of hawk-like supervision and The Rut. A constant reminder that one is "just another name on the payroll."



Human cogs in a great machine. No chance to meet people, travel, or have interesting experiences. A long, slow, tiresome road that leads nowhere.



Always wondering what would happen in case of a "lay-off" or loss of job. No chance to express ability—no chance to get ahead. **COULD** there be a way out?

## I Said "Good-bye" to It All After Reading This Amazing Book— Raised My Pay 700%!



### Where Shall We Send Your Copy—Free?

WHEN a man who has been struggling along at a low-pay job suddenly steps out and commences to earn real money—\$5,000, \$7,500, or \$10,000 a year—he usually gives his friends quite a shock. It's hard for them to believe he is the same man they used to know—but such things happen much more frequently than most people realize. Not only one, but **HUNDREDS** have altered the whole course of their lives after reading the amazing book illustrated at the right.

True, it is only a **book**—just seven ounces of paper and printer's ink—but it contains the most vivid and inspiring message that any ambitious man can read! It reveals facts and secrets that will open almost any man's eyes to things he has never even dreamed of!

#### Remarkable Salary Increases

For example, R. B. Hansen of Akron, Ohio, is just one case. Not long ago he was a foreman in the rubber-curing room of a big factory at a salary of \$160 a month. One day this remarkable volume, "The Key to Master Salesmanship," fell into his hands. And from that day on, Mr. Hansen clearly saw the way to say "good-bye" forever to low pay, long hours, and tiresome routine! Today he has reaped the rewards that this

little volume placed within his reach. His salary runs well into the 5-figure class—actually exceeding \$10,000 a year!

Another man, H. E. Widmer of Mountain View, N. J., got tired of plugging along at a tiny salary and he sent for this book. It wasn't long before he was reporting that salesmanship had raised his pay a total of 600%! L. H. Lundstedt, Chicago, read this free book—and raised himself from a stenographer to the head of a business with 600% increase in earnings. L. Van Houten of Grand Rapids, Michigan, thought that \$50 a week was big money—until N. S. T. A. raised his income to \$900 a month—a pay raise of over 400%!

#### A Few Weeks—Then Bigger Pay

There was nothing "different" about any of these men when they started. None of them had any special advantages—although all of them realized that **SALESMANSHIP** offers bigger rewards than any other profession under the sun. But, like many other men, they subscribed to the foolish belief that successful salesmen are born with some sort of "magic gift." "The Key to Master Salesmanship" showed them that nothing could be farther from the truth! Salesmanship is just like any other profession. It has certain fundamental rules and laws—laws that you can master as easily as you learned the alphabet.

City and traveling sales positions are open in every line all over the country. For years, thousands of leading firms have called

on the N. S. T. A. to supply them with salesmen. Employment service is free to both employers and members, and thousands have secured positions this way.

#### Free to Every Man

See for yourself WHY "The Key to Master Salesmanship" has been the deciding factor in the careers of so many men who are now making \$10,000 a year. Learn for yourself the **REAL TRUTH** about the art of selling! You do not risk one penny or incur the slightest obligation. And since it may mean the turning point of your whole career, it certainly is worth your time to fill out and clip the blank below. Send it now!

#### National Salesmen's Training Association

Dept. C-104, N. S. T. A. Bldg., Chicago, Ill.

National Salesmen's Training Assn.,  
Dept. C-104, N. S. T. A. Bldg.,  
Chicago, Ill.

Without cost or obligation you may send me your free book, "The Key to Master Salesmanship."

Name .....

Address .....

City ..... State .....

Age ..... Occupation .....

When writing to advertisers please mention Popular Mechanics



# NOW FIX ANY MAKE OF AUTO



## SIX BIG AUTO BOOKS ALL SHIPPED FREE

on approval; whether you want to qualify as garage owner, auto repair expert or merely wish to know how to keep your own car 100% efficient, look at these books—they are sent to you for free examination. This brand

new edition has been prepared by a large group of America's greatest automotive engineers. Anybody who can read will understand them, for this great automobile encyclopedia is a veritable gold mine of valuable facts. Take advantage of this offer now; send in the coupon for FREE examination. You don't pay us a penny, you don't obligate yourself to pay anything unless you decide to keep the books. Just tell us you want to see them and the full set of 6 great volumes, just off the press, will be sent to you. Read them, look them over and prove to your own satisfaction that one fact alone, which you will find in them, may save you an expensive repair, or help you to a better job.

**Aviation Motors  
Free Wheeling  
Synchro-Mesh  
Outboard Motors  
Motorcycles  
Tractors  
All Fully Covered**

## Brand New 1932 Edition

Imagine books which are so new that every page is right up to date—wiring diagrams, construction details, service problems—are all right up to the minute. Nowhere else can you get as complete and up-to-date information. Over a million dollars of resources have enabled us to give you the most authoritative books on the subject ever published. Everybody interested in automobiles in any way will welcome these books published by the world's largest publishers of Technical Cyclopedias (est. 1897) with agencies all over the world.



## CAN YOU FIX IT?

Can you take out "play" in differential? Can you kill the "shimmy" in steering? Can you reset TIMING? Can you put your finger on engine trouble without guessing or tinkering? Can you pull the starter off and fix it? Can you adjust and repair transmission, engine, rear axle, bearings?

### These Books Tell How

and tell you how to do any and every auto job right, the first time.

### 6 Big Volumes

Nearly 3,000 pages, over 2,000 illustrations, wiring diagrams, equipment charts, etc. Do Luxe edition with gold-stamped flexible binding. Sent FREE for 10 days' use. If not wanted return express collect. If kept, send only \$2.00 after 10 days, then \$3.00 a month until special advertising price, \$24.80, is paid.

### A Year's Consulting Membership FREE!

Privilege of consulting engineers of million-dollar American Technical Society on any automotive problem for one year without charge, if you mail coupon immediately.

## SEND NO MONEY

American Technical Society, Dept. A-319,  
Drexel Ave., at 58th St.,  
Chicago, Illinois.

I would like to see the brand new 6-volume edition of your automobile books but without any obligation to buy. I will pay the few cents delivery charges only and will examine the books and return them at your expense in 10 days unless I like them, in which case I will send you \$2.00 then and only \$3.00 per month until the special price of only \$24.80 is paid. You are to include (free) consulting membership certificate in the American Technical Society. Send brand new 1932 edition.

Name.....  
Street.....  
City..... State.....  
Employer's Name.....  
Employer's Address.....

The coupon must be filled out in full. If not employed write as a letter explaining your work.

When writing please mention Popular Mechanics

# New York Electrical School

teaches PRACTICAL ELECTRICITY by its own distinctive method of

## "Learn by Doing"

No previous preparation or electrical knowledge is necessary. Every step is guided by expert instructors. Individual attention.

### SPECIAL COURSES IN AUTO MECHANICS AND AUTO ELECTRICITY

Day and evening classes open all year. Start any day.

Write for FREE School Booklet. Visitors Welcome

**New York Electrical School**  
Established 1902 44 West 17th St., N. Y.

## FREE CATALOG OF PRACTICAL BOOKS...

Complete description of Drake books, covering RADIO, AVIATION, ENGINEERING, AUTOMOBILE WORK, BATTERY WORK, ELECTRICITY, BUILDING, SHEET METAL WORK, PAINTING, SIGN MAKING, LETTERING, COMMERCIAL ART, will be sent to you on request.

**Frederick J. Drake & Co.**  
181 N. Michigan Blvd. Chicago

# for MORE PAY learn From An ENGINEER DRAFTING

Practical Home training UNTIL IN POSITION. Salary paid Draftsmen \$50 to \$75 per week and up. I'll train a number of selected students on practical work as Draftsmen, or improve your present job to get a raise. I furnish you all tools and drawing table. Write for FREE PAY-RAISING Drafting Book.

**ENGINEER DOBE, 1951 Lawrence Ave., Div. 13-53 Chicago**

## AVIATION Information FREE

Send us your name and address for full information regarding the Aviation and Airplane business. Find out about the many great opportunities now open and how we prepare you at home, during spare time, to qualify. Our new book "Opportunities in the Airplane Industry" also sent free if you answer at once.

**AMERICAN SCHOOL OF AVIATION**  
Dept. 1353 3601 Michigan Ave. CHICAGO



**SOMETHING DIFFERENT**  
**The EVERLASTING MATCH**  
**MAKE \$25 A DAY UP TO**  
Sells on sight. An everlasting match—a mystery cigar lighter—a scientific marvel. New ignition principle—no flint or friction. Sample and money-making sales plan—25c. Gold, silver or chromium plated sample \$1. Agents—write for proposition.  
**NEW METHOD MANUFACTURING CO.**  
DESK P-3 New Method Bldg. BRADFORD, PA.



# The NEW BRITANNICA will help you increase your usefulness and your enjoyment of life



## COMPACT BOOKCASE

A new compact bookcase, made of mahogany, has been specially designed for the 24 volumes.

**A** PROGRESSIVE education increases your usefulness and your enjoyment of life. And often increases your income.

That is why men and women, young and old, aware of the fact that their schooling has been limited, or that education should continue after college or high school days, try to increase their advantages by studying at home.

Men and women who recognize the need of keeping abreast of the times in science, literature and all varieties of practical and cultural information; parents who hope to move along with their children; those who wish to increase their earning capacity,—indeed all who are anxious to get the most out of life—*can and do* achieve amazing results because of the ease and pleasure with which they can apply themselves to self-directed study in the pages of the Britannica.

*The new 14th Edition offers the material for the home study of almost every subject listed in college curricula.*

## The Incomparable Bargain

**The present prices of the 14th Edition are the lowest regular prices it has been possible to offer.**

Make your purchase now, and you not only save many dollars but you bring into your life something of the immediate rewards of a college education.

Thousands are taking advantage of the new remarkably low prices. Consequently, you cannot afford to delay.

Write for full particulars now—today—about the new low prices and the easy payment plan of

**\$5 down and \$5 a month**

which can bring the Britannica to your home for your immediate use.

### Britannica owners say—

**General J. G. Harbord,**  
*Radio Corporation of America*

"Its usefulness goes beyond the requirements of business and commercial life. It seems to me that no modern American home can afford to be without this valuable reference work in interpreting the day's news and keeping abreast of modern ideas and world affairs."

**R. S. Cabell, Richmond, Va.**

"We are delighted with the books. They are enjoyed by the whole family from 6 years up."

## Great are the rewards of self-education

Naturally, much depends upon the aim and application of those who use the new Britannica. Continued effort and patience are needed to reap the undeniably great rewards of self-education.

These rewards men of affairs fully appreciate. Successful men and women—the trained minds of the world—those who get the most out of life—are among the greatest users of the Britannica. Many have declared that they could not get along without it. And once you have enjoyed its generous services you won't try to get along without it either.

*For the fact remains that opportunity waits for you in the 24 large volumes.* More than 3,500 of the world's highest authorities are here your teachers. In simple and entertaining text they share with you all their special knowledge and experience. And 15,000 pictures and 500 maps and an index simplify and illuminate your reading.



### 62 Page Free Booklet

Fill out the coupon and drop it in the mail. We will send you by return mail a large 62-page booklet free, rich in color plates, maps and sample pages containing a full description of the Britannica. Mail coupon now. No obligation.

## SEND FOR FREE BOOKLET TODAY

**ENCYCLOPAEDIA BRITANNICA, Inc.** P.M. 2-D1  
**342 Madison Avenue, New York City**

Please send me, by return mail, without obligation, your 62-page illustrated booklet with color plates and maps from the new Britannica, together with low price offer, representing a saving of many dollars.

Name.....

Address.....

City.....State.....

## Mail This Coupon Today

When writing to advertisers please mention Popular Mechanics





## A Bigger Job — and You're the Man

Are you hunting a bigger job, or does the bigger job hunt you? Why waste priceless years at routine work, when you can acquire at home in a comparatively few months the specialized knowledge for which big firms pay big money? Thousands of men have greatly increased their incomes by the new home-study business training under the LaSalle Problem Method. Let us show you how you can do just as well or better. The coupon will bring you complete information, together with details of our convenient payment plan; also your free copy of a remarkable book—"Ten Years' Promotion in One." Make your start toward that bigger job today.

— Find Yourself Through LaSalle! —

### LaSalle Extension University

Dept. 364-R Chicago

Please send me full information regarding the course and service I have marked with an X below. Also a copy of "Ten Years' Promotion in One," all without obligation to me.



- |  |   |
|--|---|
| <input type="checkbox"/> Business Management: Training for Official, Managerial, Sales and Departmental Executive positions.   | <input type="checkbox"/> Ry. Station Mgm't                    |
| <input type="checkbox"/> Modern Salesmanship: Training for position as Sales Executive, Salesman, Sales Coach or Trainer, Sales Promotion Manager, Manufacturers' Agent, Solicitor, and all positions in retail, wholesale or specialty selling. | <input type="checkbox"/> Expert Bookkeeping                   |
| <input type="checkbox"/> Higher Accountancy: Training for position as Auditor, Comptroller, Certified Public Accountant, Cost Accountant, etc.   | <input type="checkbox"/> Business English                     |
| <input type="checkbox"/> Traffic Management: Training for position as Railroad or Industrial Traffic Manager, Rate Expert, Freight Solicitor, etc.   | <input type="checkbox"/> Commercial Law                       |
| <input type="checkbox"/> Law: LL. B. Degree.   | <input type="checkbox"/> Credit and Collection Correspondence |
| <input type="checkbox"/> Banking and Finance: Training for executive positions in Banks and Financial Institutions.  | <input type="checkbox"/> Paper Salesman's Training            |
| <input type="checkbox"/> Modern Foremanship: Training for positions in Shop Management, such as that of Superintendent, General Foreman, Foreman, Sub-Foreman, etc.  | <input type="checkbox"/> Railway Accounting                   |
| <input type="checkbox"/> Industrial Management: Training for positions in Works Management, Production Control, Industrial Engineering, etc.   | <input type="checkbox"/> Effective Speaking                   |
| <input type="checkbox"/> Personnel Management: Training in the position of Personnel Manager, Industrial Relations Manager, Employment Manager, and positions relating to Employee Service.  | <input type="checkbox"/> C. P. A. Coaching                    |
| <input type="checkbox"/> Modern Business Correspondence: Training for Sales or Collection Correspondent, Sales Promotion Manager, Mail Sales Manager, Secretary, etc.  | <input type="checkbox"/> Commercial Spanish                   |
| <input type="checkbox"/> Stenography: Training in the new superior machine shorthand, Stenotypy  | <input type="checkbox"/> Stenotypy                            |
|  | <input type="checkbox"/> Telegraphy                           |

Name .....

Present Position .....

Address .....

## Be a DENTICIAN LEARN AT HOME

To make Crowns, Plates, Bridgework, etc., for Dentists. Easy practical way to learn mechanical dentistry at home in spare time. Full equipment of tools and materials included with course FREE. Low tuition. Easy terms. Write for FREE BOOK about this money-making profession and our easy-to-learn homestudy course and special offer.



McCarrie School of Mechanical Dentistry  
316 S. Wabash Avenue Dept. E-494 Chicago, Ill.

## LEARN WATCH REPAIRING



**AT HOME** You can learn by our modern and original system of instruction every part of the Watch Repairing Trade at home as good or better than at a shop. You can earn money while learning and secure a well paying position or start in business after completing our course of instruction. Good watch repairers are always in demand and earn from \$50 to \$75 per week. For particulars apply to the Wisconsin School of Watch Repairing 524 E. Mason St., MILWAUKEE, WIS.

## FREE Radio Handbook

Write today for your copy of the new Radio Association handbook. Shows you easy ways to make money in Radio. Tells you how our members are clearing up \$3.00 an hour spare time. Write for Membership Plus which need not cost you a cent and FREE RADIO HANDBOOK. RADIO TRAINING ASSOCIATION OF AMERICA Dept. PM-3 4513 Ravenswood Ave., Chicago

## Government Positions

Clerk Carriers, Rural Carriers, Railway Mail Clerks, Postmasters, Department Clerks, and many others. Splendid salaries, easy work, vacation with pay. Only common school education required. Examinations often. 44,817 appointed last year. Send for our Civil Service Catalog No. 6. COLUMBIAN CORRESPONDENCE COLLEGE, Washington, D. C.

## ELECTRICITY AT YOUR FINGER ENDS

Have you any electrical question you want answered—**AUDEL'S NEW ELECTRIC LIBRARY** ?

progressive, easy to read and follow—New from cover to cover—6000 pages—9000 illustrations—will answer your questions—pocket size—low cost—send a postal card today for Free Electrical Folder, outlining what every expert electrician wants to know.

THEO. AUDEL & CO., 65 W. 23rd Street, NEW YORK

## Are You BASHFUL ?

Nervous? Easily embarrassed in company? Shy among strangers, afraid of your superiors, fearful of the future, or timid with the opposite sex? These faults are easily overcome when you understand the causes. Send 25 cts. for my amazing book, Money-back guarantee. Richard Blackstone, B-473, Flatiron Bldg., N. Y. C.



New science has added low cost to the convenience of automatic oil heat. Amazing discovery of the Laco Mineral wick does 50% less fuel waste, smoke, soot, grease. Reduces the high cost of heating forever. Dealers Wanted Quick! Think what an opportunity for dealers. Bests fastest because lowest priced, cheapest to operate. Liberal discounts! Exclusive territories. Openings for BIG Jobs. Get full information and sensational low price offer at once! Listed as standard by Underwriters. 26 Models. Price from \$17.50 up. Write today. LACO OIL BURNER CO., 151 Union St., Griswold, Iowa, U. S. A.

When writing to advertisers please mention Popular Mechanics

Copyrighted material



Every  
Good  
Boy  
Deserves  
Fun

**LOOK!**



**Easy as A·B·C  
to learn music this way**

**J**UST see how easy it is! The lines are always E-G-B-D-F. Memorize the sentence, "Every Good Boy Deserves Fun"—and there you are! Whenever a note appears on the first line, you know it is *e*. Whenever a note appears on the second line, you know it is *g*.

And the spaces—just as easy to remember. The four spaces are always F-A-C-E. That spells "face"—simple enough to remember, isn't it? Thus whenever a note appears in the first space, it is *f*. Whenever a note appears the second space, it is *a*.

You have learned something already! Isn't it fun? You'll just love learning music this fascinating way! No long hours of tedious practice. No dull and uninteresting scales. No "tricks" or "secrets"—no theories—you learn to play real music from real notes.

You don't need a private teacher this pleasant way. In your own home, alone, without interruption or embarrassment, you study this fascinating, easy method of playing. Practice as much or as little as you like, to suit your own convenience, and enjoy every minute of it.

**You learn from the start—Previous training unnecessary**

So clear and simple are these fascinating "music lessons" that even a child can understand them. You do not lose a minute with unnecessary details—only the most essential principles are taught. Clear, concise, interesting and attractive—that is

how each lesson is presented to you. And at only a few pennies a day!

#### The surest way to popularity

Don't be just "another one of the guests" at the next party you go to. *Be the center of attraction!* The most popular one at a party is always the person who can entertain—and there is no finer and more enjoyable kind of entertainment than music.

Never before have you had such a chance to become a good player—quickly—without a teacher. And this method does not mean that you will be able merely to read notes and play a simple tune or two—but it means you will become a *capable and efficient player*. Many of our pupils now have positions with professional bands and orchestras.

#### No alibis now for not learning to play your favorite instrument

Like having a phantom teacher at your side every minute, encouraging you, teaching you, smoothing the way so that it becomes so much easier, so much quicker for you to master your favorite musical instrument.

You simply cannot go wrong. First you are told how a thing is done, then by graphic illustrations and diagrams you are shown how, and when you play—you hear it.

Don't be afraid to begin your lessons at once. Over 600,000 people learned to play this modern way—and found it as easy as A-B-C. Forget that old-fashioned idea

that you need special "talent." Just read the list of instruments in the panel, decide which one you want to play, and the U. S. School will do the rest.

#### Send for our free book and demonstration lesson

Our wonderful illustrated Free Book and our Free Demonstration Lesson explain all about this remarkable method. They prove just how anyone can learn to play his favorite instrument by *note* in almost no time and for just a fraction of what old, slow methods cost. The booklet will also tell you all about the amazing new *Automatic Finger Control*.

Act NOW. Clip and mail this coupon today, and the fascinating Free Book and Free Demonstration Lesson will be sent to you at once. No obligation. Instruments supplied when needed, cash or credit. U. S. School of Music, 73 Brunswick Bldg., New York City.

Thirty-fourth Year (Established 1898)

U. S. School of Music,  
73 Brunswick Bldg., New York City

Please send me your free book, "How to Master Music in Your Own Home," with introduction by Dr. Frank Crane, Free Demonstration Lesson and particulars of your easy payment plan. I am interested in the following course:

..... Have you Instr?...

Name.....

Address.....

City.....State.....

#### Choose Your Course

Piano	Violin
Organ	Clarinet
Ukulele	Flute
Cornet	Saxophone
Trombone	Harp
Piccolo	Mandolin
Guitar	Cello
Voice and Speech Culture	
Piano Accordion	
Hawaiian Steel Guitar	
Harmony and Composition	
Sight Singing	
Drums and Traps	
Automatic Finger Control	
Italian and German Accordion	
Banjo (Plectrum, 5-string or Tenor)	
Juniors' Piano Course	

When writing to advertisers please mention Popular Mechanics





## Be Independent! Have Your Own Business

Sharpening lawn mowers by the Foley Electraken System gives you 99c PROFIT out of every dollar you take in. It is the chance of a lifetime for you. Here's exactly the thing you've been looking for, to make a clean-up this summer and have a well established business of your own. *Morse made \$1,520 in five months last year!*

## Foley Electraken Lawn Mower Sharpener

This remarkable machine sharpens all kinds and sizes of lawn mowers with the same method used by leading lawn mower manufacturers. Does a perfect job in from 15 to 20 minutes, sharpening all blades and the cutter bar at the same time. You get \$1.00 to \$2.50 a job—\$3 to \$10 an hour, and most of it CLEAR PROFIT!

## These Men Are Making Money!

Mail This  
Coupon  
NOW!

J. H. Harbeck writes, "Last year I ground 1,289 mowers." R. E. Linkfield says: "I average 15 mowers a day, and people bring them from all over." "Made enough money to pay for the machine and all expenses in three weeks," writes Walter Dambek.

Why don't YOU make BIG MONEY, too? Get started early. FREE PLAN tells you how. Send coupon TODAY!

### FOLEY MANUFACTURING CO.

3072 Foley Bldg., 11 Main St. N. E., Minneapolis, Minn.

Please send me FREE PLAN and tell me how I can make BIG MONEY with the Foley Electraken Lawn Mower Sharpener.

Name.....

Address.....

## "My Father's Rupture Appliance Was Kept by 3,000,000 People AFTER 10 Days Free Trial"—Harold Brooks



C. E. Brooks invented his remarkable "Air-Cushion" Appliance 31 years ago. It brought him safety, comfort and the results he had long desired. Today more than 3 million men, women and children have purchased a Brooks after first trying it at home for 10 days. The trial cost them nothing and the same 10-day Free Trial is yours for the asking. You owe it to yourself to Write Now for Free Trial details, also Free Brochure, both sent in plain, sealed envelope. Act Now!

**BROOKS APPLIANCE CO.**  
C. E. Brooks, Inventor 107-H State Street Marshall, Mich.

## QUIT TOBACCO



No man or woman can escape the harmful effects of tobacco. Don't try to banish unaided the hold tobacco has upon you. Join the thousands of inveterate tobacco users that have found it easy to quit with the aid of the Keeley Treatment.

## KEELEY Treatment For Tobacco Habit Successful For Over 50 Years

Quickly banishes all craving for tobacco. Write today for Free Book telling how to quickly Free yourself from the tobacco habit and our Money Back Guarantee.

Home of the famous Keeley Treatment for Liquor and Drugs. Booklet sent on Request. Correspondence Strictly Confidential.  
**THE KEELEY INSTITUTE, Dept. A-955, Dwight, Illinois**

## Save Your Feet

When all else fails end your suffering with the flexible "no metal"



**Heelner ARCH SUPPORT**  
WRITE FOR FREE BOOKLET

HEELNER ARCH SUPPORT CO. 617 M. E. TAYLOR BUILDING LOUISVILLE KY.

## BUCHSTEIN'S FIBRE LIMB



Send for Catalog Today

is soothing to your stump—strong, cool, neat, light, easy payments. Brace for all deformities. D. BUCHSTEIN CO. 610 3rd Ave., So. MINNEAPOLIS, MINN.



AN EASY WAY TO

## SHAPE your NOSE

Anita Nose Adjuster shapes flesh and cartilage—quickly, safely, painlessly, while you sleep or work. Lasting results. Gold Medal Winner. Doctors praise it. 87,000 users. Write today for **FREE BOOKLET.**

**ANITA INSTITUTE, Dept. 312, 617 Central Ave., E. Orange, N. J. (formerly Newark, N. J.)**

Please send me without any obligation a copy of your FREE BOOK.

Name.....

Home Address.....

City..... State.....

When writing to advertisers please mention Popular Mechanics





**T**HIS is the day of the artist. His skill is sought wherever design and color are important factors in the sale of merchandise.

Furniture, rugs, wall hangings, household utensils, wearing apparel, jewelry, art gifts, lamps, automobiles, — nearly everything sold today depends on design and color to attract the eye of the purchaser. Drawings for advertisements in newspapers, magazines, catalogs, folders, posters, display cards and many other media call for the skill of the modern artist. Consider the number of drawings in this magazine alone! Art is a necessity in modern business. If you like to draw, train this talent of yours and put it to work in a field offering rich reward. You can learn Commercial Art at home in your spare time. Many leading artists have contributed exclusive illustrated lessons to our courses.

Many of our students and graduates now earn \$2500.00 to \$6000.00 a year, some a great deal more.

### Send For Our Free Art Test

It brings out your sense of proportion, design and color. Our instructors will

*When writing to advertisers please mention Popular Mechanics*

# THERE'S MONEY TODAY IN ART

give you frank advice as to your talent and probable chance of success. It costs you nothing. Just fill in the coupon below and we will send you this test together with our book "Your Future," outlining possibilities and showing examples of our students' work.

## FEDERAL SCHOOL OF COMMERCIAL DESIGNING

DEPT. 311-B FEDERAL SCHOOLS BUILDING

Minneapolis, Minn.

— COUPON —  
Federal School of Commercial  
Designing

Dept. 311-B Federal Schools Building  
Minneapolis, Minn.

Please send me free Art Test  
and book "Your Future."



Name.....

Age.....Occupation .....

Address .....



**"That  
coupon  
became  
a  
MARRIAGE LICENSE!"**



"THERE was only one reason we had not already married—money, money! I was desperate, there was no prospect of a raise on my job. The sad truth was, I knew that job was paying the limit. We discussed our situation many times.

"One night Sarah handed me a coupon she had clipped from a magazine and said, 'Mark and sign this, then mail it to the International Correspondence Schools at Scranton. The solution to our problem is more training for you!'

"I did. Today I have a better job because of that coupon. It really became a marriage license, for now we are happily married."

Whatever the incentive, I. C. S. training will help you realize your ambition, just as it has helped thousands of men all over the world to advance to better jobs . . . earn more money. If you have the old fighting spirit, I. C. S. training is a powerful instrument in the battle for success. Spare-time study is not a pastime for quitters. It even takes courage to admit you are not getting ahead! This coupon is a challenge—mark and mail it today!

**INTERNATIONAL CORRESPONDENCE SCHOOLS**

"The Unicursal University"  
Box 5587-G, Scranton, Penna.

Without cost or obligation, please send me a copy of your booklet, "Who Wins and Why," and full particulars about the subject before which I have marked X:

**TECHNICAL AND INDUSTRIAL COURSES**

- |  |  |
|--|--|
| <input type="checkbox"/> Architect   | <input type="checkbox"/> Automobile Mechanics                                |
| <input type="checkbox"/> Architectural Draftsman                             | <input type="checkbox"/> Plumbing <input type="checkbox"/> Steam Fitting     |
| <input type="checkbox"/> Building Estimating                                 | <input type="checkbox"/> Heating <input type="checkbox"/> Ventilation        |
| <input type="checkbox"/> Wood Millworking                                    | <input type="checkbox"/> Sheet Metal Worker                                  |
| <input type="checkbox"/> Contractor and Builder                              | <input type="checkbox"/> Steam Engineer                                      |
| <input type="checkbox"/> Structural Draftsman                                | <input type="checkbox"/> Steam Electric Engineer                             |
| <input type="checkbox"/> Structural Engineer                                 | <input type="checkbox"/> Civil Engineer                                      |
| <input type="checkbox"/> Electric Wiring                                     | <input type="checkbox"/> Surveying and Mapping                               |
| <input type="checkbox"/> Electrical Engineer                                 | <input type="checkbox"/> Refrigeration                                       |
| <input type="checkbox"/> Electric Lighting                                   | <input type="checkbox"/> R. R. Locomotives                                   |
| <input type="checkbox"/> Welding, Electric and Gas                           | <input type="checkbox"/> R. R. Section Foreman                               |
| <input type="checkbox"/> Reading Shop Blueprints                             | <input type="checkbox"/> R. R. Bridge and Building Foreman                   |
| <input type="checkbox"/> Telegraph Engineer                                  | <input type="checkbox"/> Air Brakes <input type="checkbox"/> Train Operation |
| <input type="checkbox"/> Telephone Work                                      | <input type="checkbox"/> Highway Engineering                                 |
| <input type="checkbox"/> Mechanical Engineer                                 | <input type="checkbox"/> Chemistry <input type="checkbox"/> Pharmacy         |
| <input type="checkbox"/> Mechanical Draftsman                                | <input type="checkbox"/> Coal Mining Engineer                                |
| <input type="checkbox"/> Machinist <input type="checkbox"/> Toolmaker        | <input type="checkbox"/> Navigation <input type="checkbox"/> Boilermaker     |
| <input type="checkbox"/> Patternmaker  | <input type="checkbox"/> Textile Overseer or Supt.                           |
| <input type="checkbox"/> Pipefitter <input type="checkbox"/> Tinsmith        | <input type="checkbox"/> Cotton Manufacturing                                |
| <input type="checkbox"/> Bridge Engineer                                     | <input type="checkbox"/> Wooden Manufacturing                                |
| <input type="checkbox"/> Bridge and Building Foreman                         | <input type="checkbox"/> Agriculture <input type="checkbox"/> Fruit Growing  |
| <input type="checkbox"/> Gas Engines <input type="checkbox"/> Diesel Engines | <input type="checkbox"/> Poultry Farming <input type="checkbox"/> Radio      |
| <input type="checkbox"/> Aviation Engines                                    | <input type="checkbox"/> Marine Engineer                                     |

**BUSINESS TRAINING COURSES**

- |   |  |
|---|--|
| <input type="checkbox"/> Business Management                                  | <input type="checkbox"/> Business Correspondence                             |
| <input type="checkbox"/> Office Management                                    | <input type="checkbox"/> Lettering Show Cards <input type="checkbox"/> Signs |
| <input type="checkbox"/> Industrial Management                                | <input type="checkbox"/> Stenography and Typing                              |
| <input type="checkbox"/> Personnel Management                                 | <input type="checkbox"/> Complete Commercial                                 |
| <input type="checkbox"/> Traffic Management                                   | <input type="checkbox"/> Civil Service <input type="checkbox"/> Mail Carrier |
| <input type="checkbox"/> Accountancy <input type="checkbox"/> Cost Accountant | <input type="checkbox"/> Railway Mail Clerk                                  |
| <input type="checkbox"/> C. P. Accountant                                     | <input type="checkbox"/> Grade School Subjects                               |
| <input type="checkbox"/> Bookkeeping  | <input type="checkbox"/> High School Subjects                                |
| <input type="checkbox"/> Secretarial Work                                     | <input type="checkbox"/> College Preparatory                                 |
| <input type="checkbox"/> Spanish <input type="checkbox"/> French              | <input type="checkbox"/> Illustrating <input type="checkbox"/> Cartooning    |
| <input type="checkbox"/> Salesmanship <input type="checkbox"/> Advertising    | <input type="checkbox"/> Lumber Dealer                                       |

Name.....Age.....

Address.....

City.....State.....

Occupation.....

If you reside in Canada, send this coupon to the International Correspondence Schools, Canadian, Limited, Montreal, Canada

**GET REAL EXPERIENCE  
LEARN BY PRACTICAL WORK**

Build your own Electric Refrigerator. Opportunity to establish a good paying business of your own. Manufacturers, Contractors and Apartment owners are confronted with the lack of trained men in this NEWEST industry. Trained men earn unusual big salaries.

**MAKE YOUR START NOW!**

You can learn easily and quickly at home during spare-time; complete instructions furnished, including parts, low cost, easy terms. Investigate at once! Write now—today—for FREE booklet.

**STERLE REFRIGERATION CO., Inc.,**

Suite A, 219 W. Chicago Av.,

CHICAGO, ILL.

**Learn to Dance**

You can learn all the modern dances—the latest Tango steps, the new Fox Trots, dreamy Waltzes, smart Collegiate Steps, and popular Society Steps at home, easily and quickly. New chart method makes dancing as simple as A-B-C. No music or partner required. Don't be a wallflower. Learn to dance. Complete course—285 pages, 54 illustrations, sent on 3 Days' Free Trial. Equals \$20.00 course. Send no money. Pay postage only \$1.50, plus postage upon arrival. Money back if not delighted. Catalog Free.



Franklin Pub. Co., 800 No. Clark St., Dept. 9353, Chicago

**Wireless (Radio)**

and Morse telegraphy taught thoroughly. School, oldest and largest; endorsed by Telegraph, Radio, Railway and Government officials. Unusual opportunities. Expenses low—can earn part. Catalog free.

**DODGE INSTITUTE, Jones St., Valparaiso, Indiana.**

**CONDON'S GIANT  
EVERBEARING TOMATO**



"QUEEN OF THE MARKET." Big Money Maker.

Large, solid fruit; excellent canner. To introduce to you our Northern Grown Live Seeds and Plants, we will mail you 125 seeds of Condon's Giant Everbearing Tomato and our free 1932 Catalog of Seeds, Plants, Shrubs, 192 Page Book tells how and when to plant. Send 2c stamp to cover postage.

Prices Lower Than Ever Before

**CONDON BROS., SEEDSMEN**

Rock River Valley Seed Farms

BOX 123 ROCKFORD, ILLINOIS

**Deaf 20 Years**

But now I hear and will tell any deaf person FREE, who writes me, how I got back my hearing, and relieved head noises by a simple, invisible, inexpensive method which I myself discovered.



Geo. H. Wilson, President  
Wilson Ear Drum Company, Inc.  
1355 Todd Bldg., Louisville, Ky.

Information on any book free. Write Popular Mechanics Press, Chicago, Ill.

**Don't Burn Coal  
use cheap oil**



Do away forever with the drudgery of wood or coal. Save money, time and labor. Most economical and lowest priced Oil Burner on market. Simply sets in fire box of any range, heating stove or furnace. Burns 96% air, 4% cheap oil. Gives three times the heat of coal. Easy to install and operate. Absolutely safe. No noise, dirt or odor. Sold on money-back guarantee.

**30 Days Free Trial Offer**

Try this wonderful burner in your own home at our risk. Special low price to first user in each locality. Write at once for Free book on Home Heating. Agents write for sample offer and protected territory.

International Heating Co., St. Louis, Mo.  
3808 Park Ave., Dept. 403-M

When writing to advertisers please mention Popular Mechanics





## LEARN RADIO-TELEVISION TALKING PICTURES in LOS ANGELES

Come to sunny California where many of the famous Radio Stars make their home—where the great American Television Laboratories are located—and hundreds of trained Sound Engineers and Mechanics are employed in the Talking Picture Studios, Broadcasting Stations and Theatres of Hollywood.

### Railroad Fare Allowed to California

Don't worry about the expense of the trip! For a limited time we are allowing railroad fare to Los Angeles from any point in the United States. This is deducted from your tuition, so the trip costs you nothing extra. Take advantage of this opportunity to visit Los Angeles and Hollywood, and prepare for a good job at the same time. Mail coupon for full details!

#### PRACTICAL SHOP TRAINING

##### At the Oldest Trade School in the West

For over 25 years National has been training men by the practical shop method. Over 20,000 ambitious men from all over America have come to National for their training. You'll find National graduates working in the famous Studios of Hollywood, in Talking Picture Theatres, great Broadcasting Stations, for Radio Manufacturers and Dealers, while many have gone into the Radio business for themselves and are making big money as their own boss. What they have done, you can do! Mail coupon for Big Free Book of Proof!

#### MANY JOBS OPEN

10,000,000 Radio sets to be constantly serviced! 600 Broadcasting Stations employing trained Operators and Mechanics! 10,000 Theatres equipped for sound and the job only half done! Eight stations already sending out regular Television programs! New jobs will be opening up every day—hundreds of golden

#### NATIONAL TELEVISION, TALKING PICTURE and RADIO SCHOOL

Dept. 34E

4006 SO. FIGUEROA ST., LOS ANGELES, CALIF.

opportunities for the trained man. And you can prepare for them in 4 months at National!

#### FREE EMPLOYMENT SERVICE Spare Time Jobs While at School

When you've finished National Training—four months of practical Shop Work in the great National Television, Talking Picture and Radio Shops,—then National's Employment Department will assist you in every possible way to get the job you want. And if you're short of money, National will gladly help you to get a spare time job to pay your living expenses while at school.

#### MAIL COUPON FOR BIG FREE BOOK

Get all the facts! Mail coupon below for our Big Free Book, telling all about National's famous Shop Training and the many jobs opening up in these fascinating fields. No cost or obligation! Just mail the coupon.

National Television, Talking Picture  
and Radio School,  
Dept. 34E, 4006 So. Figueroa St.,  
Los Angeles, California.

Please send me your big new Free Book on  
Television, Talking Pictures and Radio, and full  
details of your Free Railroad Fare offer.

Name.....

Street No.....

City..... State.....

When writing to advertisers please mention Popular Mechanics

Copyrighted material





## Know Electricity as Experts Know It—and Get an Expert's Pay!

Make no mistake about it—there are big jobs in electricity ready for you when you're ready for them. Thousands of men who have the Croft Library know that to be a fact. The Library itself, on a FREE TRIAL BASIS, can prove it to your absolute satisfaction.

## The New Croft Library of Practical Electricity

The Croft Library is a complete electrical educator. It is founded on practice—on 20 years of short-serve experience. Written so that the beginner can easily understand it, yet so sound, so thorough, that it is the daily guide of 39,000 electrical workers and engineers. Croft tells you the things you need to know about motors, generators, armatures, commutators, transformers, circuits, switchboards, distribution systems—electrical machinery of every type—wiring for lights and power—illumination in its every phase—the latest and most improved methods of light use—lamps and lamp fixtures, etc.—how to do a complete job, from estimating it, to completion.

## No money down—easy payments

Fill in and mail the coupon attached and we will send you the entire set of seven volumes for ten days' free examination. We take all the risk—pay all the charges. You assume no obligation—you pay nothing unless you decide to keep the books. Then \$1.50 in ten days and the balance at the rate of \$2.00 a month. Send the coupon NOW and see the books for yourself.

### FREE EXAMINATION COUPON

McGRAW-HILL BOOK CO., 330 W. 42nd St., New York

Send me for ten days' free examination the Croft Library of Practical Electricity. If satisfactory I will send you \$1.50 in 10 days and \$2.00 monthly until the special price of \$19.50 is paid. If not wanted, I will return the books post-paid. (To insure prompt shipment write plainly and fill in all lines)

Name.....

Home Address.....

City and State.....

Position.....

Name of Company..... P.M. 3-32



## High School Course in 2 Years

This simplified, complete High School Course, specially prepared for home study by leading professors, meets all requirements for entrance to college, business, and leading professions.

## 20 Other Courses

Over 200 noted Engineers, Business Men, and Educators helped prepare the special instruction which you need for success. No matter what your inclinations may be, you can't hope to succeed without specialized training. Let us give you the practical training you need.

American School  
Drexel Ave. and 58th St.  
Dept. H-347, Chicago

### Money Back When You Finish If Not Satisfied

American School, Dept. H 347, Drexel Ave. and 58th St., Chicago  
Send me full information on the subject checked and how you will help me win success in that line.

- ....Architect
- ....Building Contractor
- ....Automobile Engineer
- ....Civil Engineer
- ....Structural Engineer
- ....Business Manager
- ....C. P. A. & Auditor
- ....Bookkeeper

- ....Electrical Engineer
- ....General Education
- ....Lawyer
- ....Mach. Shop Practice
- ....Mechanical Engineer
- ....Steam Engineer
- ....Draftsman & Designer
- ....High School Graduate

Name..... Age.....

St. and No.....

Town..... State.....



## FUN!

Learn Taxidermy. It's Fun, and You Can Make Good Money in Your Spare Time. Too.

Learn to mount and preserve all kinds of birds, animals, and fish. Tax skins and make them into rugs and robes. Take COMMON SPECIMENS like rabbits, squirrels, frogs, etc., and make them into ash trays, mirrors, lamps, etc. They sell at sight. Malcolm Greaney made \$25 while learning. Save your troubles and decorate your room. This great new hobby for men and boys will delight you.

**FREE BOOK!** Send AT ONCE—TODAY—for this beautiful new FREE BOOK which tells how you can learn Taxidermy at home. No cost. No obligation. Contains hundreds of fine game pictures. It's FREE! Write for yours TODAY. State your AGE.  
N. W. School of Taxidermy, Dept. 3373, Omaha, Nebr.

Learn to PAINT  
SIGNS and SHOW CARDS

We quickly teach you by mail, or at school, in spare time. Earn more money. Big future, interesting work. Admit and forego school.  
**EARN \$50 TO \$200 WEEKLY**  
Otto Wiseman, Md., home-study graduate, made \$12,000 from his business in one year. John Vassos, N. Y., gets \$25 for a show card. Crawford, R. C., writes: "Earned \$200 while taking course." Write for complete information.  
DETROIT SCHOOL OF LETTERING  
154 Stinson Ave. Est. 1929 Detroit, Mich.



## BE AN OIL EXPERT!

New, easy, practical way to learn at home in spare time. Geology, Drilling Methods, Pipe Line Transportation, Refining and Marketing.  
Write Today! FREE Book!  
PETROLEUM ENGINEERING UNIVERSITY, Dept. 223, FORT WAYNE, IND.



**70 BREEDS** Chickens, geese, turkeys, high quality and most profitable. Fowls, Eggs, Baby Chicks and Incubators at new low prices. America's great plant—since 1893. New large valuable Poultry book and catalog FREE.  
R. F. NEUBERT Co., Box 878. Mankato, Minn.



## SQUAB BOOK FREE

Breed PR Royal squabs, sell rich trade. Raised in 1 month. Sell for double chicken prices. Great cheap. Start now. We ship breeders everywhere on three mos. trial, insuring satisfaction. Established 31 years. Customer writes: "Squabs selling fast, sold all I had last week. Add in large people among." Another: "Have always been successful with chickens, but squabs are 'way ahead of them.' Another: "I am sold on an squab two weeks ahead, getting cially cuts a second. Am also buying squabs of others to fill my own orders. Ship me 150 pairs more. Write: White Kings." Write now for free, big 64-p. book sending four cents stamp for postage; learn how to breed and profit by best sales plan.  
Plymouth Rock Squab Co. 634 H St., Melrose, Mass.



## INCREASE YOUR POULTRY PROFITS!

By proper Breeding, Feeding, Housing, Culling and Marketing AMERICAN POULTRY JOURNAL tells how to do it, and in addition a series of

### COLORED PICTURES

with explanatory text tell and show many things you should know. They are not just colored pictures of birds but pictures of an educational nature, something never before shown by a poultry paper. 12 issues of American Poultry Journal contain about 1000 pages—  
Price 25c a year—5 years \$1.

AMERICAN POULTRY JOURNAL, 14-336 S. Clark St., CHICAGO

## RAISE FOR US FUR RABBITS



**BIG PROFITS** in raising CHINCHILLA and NEW ZEALAND WHITE fur rabbits FOR US on contract backed by eighteen years of service for you by raising an animal that produces 21 young yearly, for which **WE PAY YOU \$1.00 TO \$6.50 EACH** Large illustrated book, catalog and contract—also copy of FUR FARMING magazine, gives complete details all for 10c. Address **STAHL'S OUTDOOR ENTERPRISE CO., Box 1418, Holmes Park, Mo.**



# RADIO has a GOOD PAY JOB for YOU!

TELEVISION  
TALKING PICTURES  
SOUND SYSTEM  
PHOTO CELL WORK



J. Noffsinger



M. L. Ratcliff



E. D. Burns

### \$500 in Spare Time

"Through R. T. I. Training I made \$500 in two months—more time only. You get the credit."  
—J. Noffsinger.

**Enormous Increase**  
"Since finishing your course my pay has increased eleven times. You certainly give your students a break."  
—M. L. Ratcliff.

**In Business for Self**  
"I have built up quite a Radio business for myself and have all the work I can do."  
—E. D. Burns.

### The R. T. I. Advisory Board

Homer Hogan, Manager KYW; Kendall Clough, Chief Engineer, Silver-Marshall; H. P. Manly, Radio Technic Laboratories; Karl E. Hassel, Chief Engineer, Zenith; H. M. Pauley, Service Mgr., Majestic; F. H. Schnell, Chief R. T. I. Staff, and others.

View in R. T. I. Laboratory. Only home-training to give this valuable test.



## Famous Endorsed School Will Train You at Home for One of the Best Paying Positions—Start Now

Why be out of work? Why struggle along on a mere \$20 or \$25 a week no-future job? There is no need for you to do either, because Radio, even in these times, gives employment to hundreds of thousands and ACTUALLY NEEDS MORE AND BETTER TRAINED MEN AT GOOD PAY right now. Over 15 million Radio sets now in use need service. Over 600 Broadcasting stations on the air are still going full time. THOUSANDS OF NEW JOBS, never before existing, have been created by Talking Pictures, Sound Systems, Auto, Police and Aviation Radio, Television and Photo Cell Work. This is all Radio and it means OPPORTUNITIES AND MORE MONEY for trained men. Will you answer the call? If you earn less than \$50 A WEEK, mail the coupon for the free book which gives you all these facts in detail.

### Many Jobs to Choose From

Where only a few hundred men were employed in Radio a few years ago, THOUSANDS ARE EMPLOYED TODAY. Where a few years ago a hundred jobs paid \$50 to \$75 a week, there are thousands of such jobs today. And there will be thousands more for trained men in the next few years to come, because RADIO IS GROWING SO FAST.

### Learn and Earn in Spare Time

Training alone will open these fine, good pay jobs to you! Get ready for one of them now. You can do it easily and in an AMAZINGLY SHORT TIME, with the famous R. T. I. method endorsed by leading Radio firms and engineers. This is the chance of a lifetime, because you will learn under the supervision of the R. T. I. Advisory Board, and will get WITHOUT EXTRA CHARGE special courses in Television, Talks, Sound Systems and Industrial Radio. While you learn you can make EXTRA MONEY in spare time, so your training NEED NOT, SHOULD NOT, COST YOU ONE PENNY.



## Select the Training Endorsed by 18 Leading Radio Manufacturers and be Safe

Because there is a vast need for more and better trained men, many large concerns are co-operating with the R. T. I. in a great training programme. The endorsement by these well known firms is your guide—your assurance—that here you can get the training you need to enter this rich, new field of opportunity and future.

### These Great Concerns Endorse R. T. I. Training

BOSCH  
BRUNSWICK  
BALKEFF  
CROLEY  
CLARION  
D-FOREST  
ECHOPHONE  
FADA  
GREBE  
HOWARD

KENNEDY  
MAJESTIC  
PHILCO  
SILVER-MARSHALL  
STROMBERG-CARLSON  
STEWART-WARNER  
SENTINEL  
ZENITH

### SALARIES PAID IN RADIO

Broadcasting stations use engineers, operators, and maintenance men, and pay \$40 to \$100 a week and up.

Manufacturers, jobbers and dealers employ thousands of men as engineers, foremen, inspectors, testers, service men, salesmen and managers, and pay \$40 to \$150 and \$200 a week.

Sound picture concerns and public address systems use engineers, installation and maintenance experts, etc., and pay \$40 to \$200 a week and up.

Manufacturers of photo-electric cell equipment (Radio's electric eye) use designers, adaptation engineers, installation men and salesmen, at salaries ranging from \$40 to \$200 a week and up.

Steamship companies employ hundreds of Radio operators, give world-wide travel, at salaries of \$85 to \$200 a month and all expenses.

### Salaries Doubled and Tripled

Already hundreds of R. T. I. men have DOUBLED AND TRIPLED their former pay. Why shouldn't you when you are trained? Lack of education or experience is no drawback. We train you the way the industry wants you trained, furnish all the equipment you need in your training, and HELP YOU LOCATE A GOOD JOB when you are trained.

### Send For Free Book—It Explains All

If you are interested in bettering your position—if you want to get into work you will enjoy—where you have a chance to earn the money you need to buy the things you want—ACT NOW! Just mail the coupon below for the free Opportunity Book. It won't obligate you in any way and it might be the turning point in your life.

**Radio and Television Institute, Inc.**  
2130-2150 Lawrence Avenue Chicago

### FREE OPPORTUNITY BOOK COUPON

RADIO AND TELEVISION INSTITUTE,  
Dept. 13, 2130 Lawrence Ave., Chicago.

Please send me a copy of your Opportunity Book and full particulars of your plan for helping men into good pay positions in the Radio field.

NAME.....

ADDRESS.....

CITY.....STATE.....

When writing to advertisers please mention Popular Mechanics

Copyrighted material





## There's Quicker, Bigger MONEY for YOU—in POULTRY

Earn \$2,000 to \$5,000 a Year or Have a Business of Your Own!

Whether you want a job at good pay or a highly profitable business of your own—the Poultry Industry offers you more than any other. There's a shortage of poultry meat and eggs — a shortage of trained poultrymen. I'll train you quickly at home—to fill a good job in Poultry—and our FREE Students' Employment Dept. will help you get one!

### Spare Time or Full Time YOU Can Cash - in Big

No matter where you live—city, town or country—or what you do now, my proved methods will assure your success right from the start. I'll help you make from \$2,000 to \$5,000 a year and UP! And, if you choose to start your own business, I'll show you how to make your tiny investment multiply itself automatically. What I've done for thousands of others—I can do for you.

### FREE Book Shows Way to Big Pay and BIG Profits

Mail coupon below TODAY—for my Big NEW FREE Book, "How to Raise Poultry for Profit." My forty years of experience are yours. The Poultry Industry needs YOU. You need my book. Get it—and get in line for the BIG Money that's waiting for you in POULTRY.



## Mail NOW for FREE Book

NATIONAL POULTRY INSTITUTE, Dept. 411-G  
Washington, D. C., Attn: Harry M. Lamson, Pres.

Dear Mr. Lamson: Send me your FREE Book, "How to Raise Poultry for Profit." I want to know more about my opportunity to make \$2,000 to \$5,000 a year, spare or full time.

Name.....

Address.....

## CHEMISTRY



Complete, practical home-study courses prepared by some of the best-known chemists in this country, including ALLEN ROGERS, B.S., M.S., Ph.D.—Head of Department of Industrial Chemistry, Pratt Institute; L. M. TOLMAN, Ph.D.—Formerly Chief Chemist, Wilson & Co. Now Vice-president, United Chemical and Organic Products Co.; BRADLEY STOUTON, B.S.—Head of the Department of Metallurgy, Lehigh University, and OWEN L. SHINN, Ph.D.—Professor of Applied Chemistry, University of Pennsylvania.

Mail Coupon for Free Booklet

INTERNATIONAL SCHOOL OF CHEMISTRY  
Associated with the International Correspondence Schools  
Box 5591-G, Scranton, Penna.

Without cost or obligation, please send me full details of your home-study course in

- |   |  |
|---|--|
| <input type="checkbox"/> Analytical Chemistry | <input type="checkbox"/> Metallurgical Chemistry |
| <input type="checkbox"/> Chemical Engineering | <input type="checkbox"/> Short Chemistry Course  |
| <input type="checkbox"/> Industrial Chemistry | <input type="checkbox"/> Pharmacy                |

Name.....

Address.....

### AN EDUCATIONAL NOVELTY

Runs on No. 6 DRY BATTERY

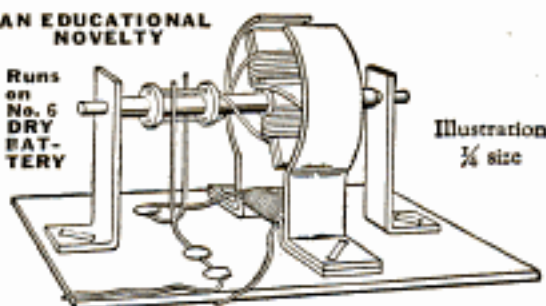

Illustration 1/4 size

Men and Boys build this MOORE ELECTRIC MOTOR

All parts necessary only 10¢ Add 5¢ for postage and packing.

The most popular Educational Toy of a decade. If carefully built it has a speed of over 6000 revolutions per minute. Full directions and instruction sheet "HOW A MOTOR WORKS". You can learn more about a motor in 30 minutes than by hours of study.

Distributed by

JOHNSON SMITH & CO., 826, Racine, Wis.

## DANCE WITH PROFESSIONAL SKILL



Don't be an amateur! Put professional snap into your dancing by this remarkable new scientific method—the Danceograph—complete in 10 easy lessons. Send only \$1.98 for complete course on 5 day trial—money back if not satisfied.

- |                                       |                                 |
|---------------------------------------|---------------------------------|
| <input type="checkbox"/> BALLROOM     | } Mark X for the course desired |
| <input type="checkbox"/> TANGO        |                                 |
| <input type="checkbox"/> TAP and CLOG |                                 |

Danceograph Dance Art, Inc.  
555 Sutter St., San Francisco, California

## ELECTRICAL ENGINEERING

A CONCISE, comprehensive course for men of limited time, complete in one year. Mathematics, engineering drawing, shop-work. Students construct motors, install wiring, test electrical machinery. Buildings fireproof. 38 years' successful experience. Catalog on request.



**BLISS ELECTRICAL SCHOOL**

133 Takoma Ave., Washington, D. C.

## LEARN WATCHMAKING AND ENGRAVING



BY OUR PROFIT-SHARING PLAN  
OUR GRADUATES SUCCEED

One of our own students started in a very small way—now doing over \$30,000 a year. Another in Wisconsin, over \$10,000 the first year. Day or night classes. Call or write for FREE BOOK.

Chicago School of Watchmaking, Dept. 8201, 155 N. Clark St., CHICAGO



"BECOME A LIGHTNING TRICK CARTOONIST"

Send \$1.00 for Laugh Producing Program of 33 Trick Drawings with Instructions. Catalog of Chalk Talk Supplies Free. BALDA ART SERVICE, Dept. 1, Oshkosh, Wis.

## WHY STAMMER?

Don't be a failure. Master perfect speech. Live a healthy, normal and happy life. Send for free book which tells you how.

THE LEWIS INSTITUTE, 12050 Woodward Ave., Detroit, Mich.

## LEARN CARTOONING

AT HOME DURING SPARE TIME

with the course that has trained HUNDREDS of beginners successfully. The Landon Picture Chart Method of teaching ORIGINAL drawing by mail makes cartooning easy to learn. This school is a Member of The National Home Study Council. Write today for sample picture chart to TEST YOUR ABILITY and examples of the work of successful students now earning from \$50 to \$200 and more per week.

Enclose 6¢ in stamps and STATE YOUR AGE.

THE LANDON SCHOOL, 2838 National Bldg., Cleveland, Ohio





# Want a Steady Job?



## Railway Postal Clerks

**\$158 Month First Year**

**Raise to Maximum of \$225 Month**

Many Other U. S. Government Jobs Open to Men and Boys 18 to 45

POST OFFICE CLERKS RURAL MAIL CARRIERS CITY MAIL CARRIERS

PROHIBITION AGENTS

CUSTOMS INSPECTORS

These are steady positions. Strikes, poor business conditions, lockouts or politics do not affect them. U. S. Government employees get their pay for full twelve months every year. There is no such thing as "HARD TIMES" in the U. S. Government Service.

### ALLOWANCE FOR HOTEL EXPENSES

Railway Postal Clerks now get \$1900 the first year regularly, being paid on the first and fifteenth of each month. \$79.16 each pay day. Their pay is increased \$100 and \$150 a year. The maximum is \$2700 a year. \$112.50 each pay day. They get extra allowance for hotel expenses when away from home.

### PAID VACATIONS

Railway Postal Clerks, like all Government employees, are given a yearly vacation of 15 working days (about 18 days). When on runs they usually work 3 days and have 3 days off duty or in the same proportion. During this off duty and vacation, their pay continues just as though they were working. When they grow old, they are retired with a pension. As Railway Postal Clerks are continually traveling, they have an excellent chance to see the country. Many Spring examinations expected.



### CITY MAIL CARRIERS—POST OFFICE CLERKS

Clerks and Carriers get \$1700 the first year regularly and automatically increase \$100 a year to \$2100 with further special increase to \$2300. They also have 15 days' vacation. City residence is unnecessary.

### What Will You Earn 5 Years From Now?

Compare these conditions with your present or your prospective condition, perhaps changing positions frequently, kicking around from post to pillar, no chance in sight for PERMANENT employment; frequently out of a position and the year's average salary very low. DO YOU EARN \$1900 EVERY YEAR? HAVE YOU ANY ASSURANCE THAT A FEW YEARS FROM NOW YOU WILL GET \$2700 OR MORE A YEAR, EVERY YEAR?

FRANKLIN  
INSTITUTE  
Dept. N-174  
ROCHESTER, N. Y.

Rush to me entirely free of charge 32-page book with (1) a full description of the position checked below; (2) a list of U. S. Government jobs now obtainable; (3) tell me how to get the position checked.

- Railway Postal Clerk...(\$1900-\$2700)
- Post Office Clerk.....(\$1700-\$2300)
- City Mail Carrier.....(\$1700-\$2100)
- Rural Mail Carrier.....(\$2100-\$3400)
- General Clerk and File Clerk.....(\$1260-\$2500)
- Inspector of Customs.....(\$2100-\$3300)
- Prohibition Agent.....(\$2300-\$2800)
- Immigrant Inspector.....(\$2100-\$3000)

Name.....

Address.....

Use This Coupon Before You Mislay It—Write or Print Plainly

### Get FREE List of Positions

Fill out the coupon. Tear it off and mail it today—now, at once. DO IT NOW—This investment of two cents for a postage stamp may result in your getting a U. S. Government Job.

When writing to advertisers please mention Popular Mechanics



# DRAFTING

BOOKS SENT FREE!



**For Beginners**  
Written, so you can understand every word, by 22 famous engineers and architects. DeLuxe flexible binding, nearly 2,000 pages, 1546 blue-prints, charts and diagrams; prepares you for a good drafting job in mechanical or architectural lines. Sent for 10 days' free use if you mail coupon immediately.

**5 Volumes Brand New Edition**  
Only 15 minutes a day with these WONDER BOOKS will prepare you for a good drafting job in less than a year. Mechanical and architectural drafting from simple straight lines to important complex plans. A step at a time! Built especially for beginners, for men with only grammar schooling. Drafting room practice, PLUS ENGINEERING, made easy and clear. Includes complete course in blue-print reading.  
**Big Field Big Demand Big Pay**  
Competent draftsmen are urgently needed right now in all building and manufacturing lines at \$50.00 to \$100.00 a week. That's just the beginning—FOR DRAFTSMEN HAVE THE BEST CHANCES FOR ADVANCEMENT. Pleasant, fascinating work, easy to learn and do. Learn quickly with these books—send coupon for a set FREE and see for yourself.  
A year's consulting membership in the American Technical Society now given free to all readers of this famous cyclopedia of drafting. Many say that it is worth more than the cost of the books.



Complete set of drawing instruments if you send for these drafting books NOW. These instruments are made of the finest of German silver, are absolutely accurate and are packed in velvet lined leatherette pocket case. Real \$10 value, but free to you with these books.  
**AMERICAN TECHNICAL SOCIETY**  
Dept. D-319, Drexel at 58th St., Chicago, Ill.

American Technical Society, Dept. D-319, Drexel at 58th St., Chicago, Ill.  
Send for 10 days' free use New 5 volume set of drafting. I will pay the few cents delivery charges. If I wish, I may return books in 10 days and see you nothing but if I decide to keep them I will send \$2.50 after 10 days, then only \$3.50 a month until \$12.50, the special introductory price, is paid. Send Brand New edition and include drawing instruments.  
Name.....  
Address.....  
Employer's Address.....

## New Easy Way to LEARN AUTOS AT HOME!

**Earn Up to \$50 a Week**  
Stop just wishing for a good job with big pay. You'll never get it that way. Let me train you at home, my new, easy "JOB WAY" will let me prepare you for a wonderful future in AUTOS, the World's Biggest Business, where trained men-Auto Experts-get \$40-\$50-a-week.

**Keep Your Job**  
No need to quit your job. You can learn easier, better, quicker and cheaper this new, easy method. Only your spare time needed. I teach you everything you need to know and show you how to make extra, spare time money while training—then help you get a good job or go into business for yourself.

**At Home**  
Clip coupon for my FREE Auto Book. Read how "Job-Way" Training has lifted scores of men—many with very little education and no previous ex-

perience—out of dull, tiresome, poorly paid jobs into the big money class. "Job-Way" is easy—if you're between the ages of 15 and 55 and can understand plain, simple, everyday words, get my book and see what I can do for you.

**Get My Offer**  
Right now, I am including 3 big outfits and also many other features, free of extra cost. Mail coupon for full details.

**B. W. COOKE**  
Directing Engineer  
Motor Institute of America  
Motor Institute Bldg.  
Evanston, Ill.  
Dept. 5163

**B. W. COOKE**  
Directing Engineer  
Motor Institute of America  
Motor Institute Building  
Evanston, Ill.  
Dept. 5163

Send me absolutely FREE your Auto Book giving proof that you can train me for a big pay job—also details of your big offer.

**GET THIS FREE BOOK-MAIL COUPON**

Name.....  
Address.....  
Town..... State.....  
Age..... Occupation.....

When writing please mention Popular Mechanics

## SAVE ON TIRES!

**GOOD YEAR Goodrich Firestone AND OTHER TIRES**  
This big, reliable company leads the field in tire values. Thousands of satisfied motorists all over the U. S. A. use and boost our standard brand tires, reconstructed by the original scientific Midland process. Long, hard service on roughest roads guaranteed  
**—12 MONTH WRITTEN GUARANTY BOND sent with each tire.**

**DEALERS WANTED**

FREE SPARK PLUGS	BALLOON TIRES	Reg. CORD Tires
See offer Below	Size Rim Tire Tubes	Size Tire Tubes
NEW LOW TIRE PRICES	29x4.40-21** \$2.30 \$0.55	30x3 \$2.20 \$0.50
NEW GUARANTEED TUBES	30x4.40-21** 2.40 .55	30x3 1/2 2.25 .55
	30x4.40-21** 2.45 .55	31x4 2.95 .55
	28x4.75-18** 2.45 1.00	32x4 2.95 .55
	22x4.75-20** .50 1.00	32x4 2.95 .55
	22x5.00-19** .95 1.20	32x4 1/2 3.20 1.35
	30x5.00-20** .95 1.20	32x4 3/4 3.20 1.35
	28x5.25-18** .95 1.20	34x4 3.45 1.35
	28x5.25-19** .95 1.25	30x5 3.60 1.60
	30x5.25-20** .95 1.25	32x5 3.60 1.60
	31x5.25-21** 1.10 1.25	All Other Sizes
	28x5.50-18** 1.20 1.30	
	28x5.50-19** 1.20 1.30	
	31x5.00-19** 1.20 1.30	
	31x5.00-20** 1.20 1.30	
	31x5.00-21** 1.20 1.35	
	32x5.00-21** 1.20 1.35	
	32x5.00-22** 3.50 1.45	

Send \$1 Deposit with each tire ordered. Balance C. O. D. If you send cash in full deduct 5%. You are guaranteed a year's service or replacement at 75 price. Order today—save money.

**12-MONTH SERVICE GUARANTEED**

One of the best quality spark plug with each tire ordered. Full Set, 6 spark plugs worth \$4.50 Free with order for 4 tires. Mention make of car, model, year.

**MIDLAND TIRE & RUBBER CO., Dept. 565**  
1000-10 West Sixty-Third Street, Chicago, Illinois

## ELECTRICITY RADIO WELDING TELEVISION AUTOMOBILES

No Finer Training Equipment Anywhere at Any Price. Improved Methods of Practical Instruction. Ele tric Arc and Oxy-Acetylene Welding, Armature Winding, Power Plants, Transformers, Motors, Generators, Batteries, Automobiles, Radio, Television and Sound Reproduction. **PREPARE FOR STEADY WORK AT GOOD PAY.**  
Write for information, Mentioning Course Desired.  
**COLEMAN ELECTRICAL SCHOOL, 1628 Main Street, KANSAS CITY, MO.**



Wonderful, new device, guides your hand; corrects your writing in a few days. Big improvement in three hours. No failures. **Complete outline FREE.** Write C. J. Orment, Dept. 34, St. Louis, Mo.

**DENISON'S PLAYS**  
Musical Comedies, Operettas, Vaudeville Acts, Minstrels, Comedy Songs, Make-up Goods.  
Catalog Free  
**T. S. Denison & Co., 623 S. Wabash, Dept. 9, Chicago**

## MAIL FOR FREE INFORMATION

**BEDFORD YMCA TRADE SCHOOL**  
1115 Bedford Ave., Dept. PM-3a Brooklyn, N. Y.  
Send me without obligation complete information on (check subjects).  
 Caterpillar Tractor Mechanic  
 Aviation Mechanic  
 Flying  
 Welding  
 Auto Mechanic  
 Radio Mechanic and Television  
 Talking Pictures—Double Western Electric Equipment  
 Electrical  
 Machine Shop  
 Starting, Lighting, Ignition  
 Window Dressing  
 Commercial Art  
 Sign Painting  
 Architectural Drafting  
 Mechanical Drafting

Name.....  
Street & No.....  
Town..... State.....



Only \$ **37.50**

COMPLETELY  
ASSEMBLED  
WITH LARGE  
DYNAMIC  
SPEAKER!

Pentode  
Variable-Mu  
and Real  
Automatic  
Volume  
Control

## 11-TUBE Super- Het.

RADIO FANS! What a radio! A powerful new 11-tube super-het at an unbelievably low price. Reception equal to fifteen ordinary tubes—in a perfectly balanced, non-oscillating, non-radiating, super-heterodyne TEN-TUNED circuit with real automatic volume control that holds those powerful locals down to the same volume as the distant stations and counteracts that annoying fading on weak stations. Two Push-pull Pentode power output tubes with twice the power and four times the sensitivity of ordinary 45's—and Multi-Mu tubes, together with a -24 first detector, gives you SIX SCREEN GRIDS. These six screen grids, together with the -27 oscillator, second detector, first A. F., and automatic volume control—the -80 tubes—gives total of ELEVEN TUBES. The use of a band-pass or pre-selector stage, together with Multi-Mu full range tubes, makes this radio actually surpass 10 K. C. selectivity. Absolutely eliminates those noisy singing "birdies" and annoying cross talk. You'll be positively amazed and delighted when you see this sensational new set—hear the beautiful mellow, cathedral tone—know what it means to have that pin-dot selectivity and unequalled sensitivity together with true tone fidelity.

Be convinced—TRY A MIDWEST 30 DAYS BEFORE YOU BUY. Don't send a penny. Mail coupon right now for amazing FREE trial offer and complete details. You'll be surprised.

### ALL-WORLD—ALL-WAVE



Midwest now offers, if desired, ALL-WORLD—ALL-WAVE reception. The new self-powered Midwest Converter with a powerful 9 or 11 tube super-heterodyne brings in short and long wave broadcasts from everywhere—15 to 550 meters.

### Buy Direct--SAVE UP TO 50%

Never before in the history of radio have such powerful sets been offered at Midwest's amazing low prices. Deal direct with the big MIDWEST factory and save the jobber's profit. Your outfit will reach you splendidly packed, rigidly tested with everything in place ready to plug in. No assembling! Entertain yourself for 30 days absolutely FREE—then decide. Save up to 50 per cent in buying direct from factory—insure satisfaction—deal direct with the world's veteran radio builders—MIDWEST. And don't forget—every MIDWEST outfit is backed by an absolute guarantee of satisfaction. You take no risk.

## MIDWEST RADIO CORP.

Dept. 55 (Est. 1920) CINCINNATI, O.

When writing to advertisers please mention Popular Mechanics

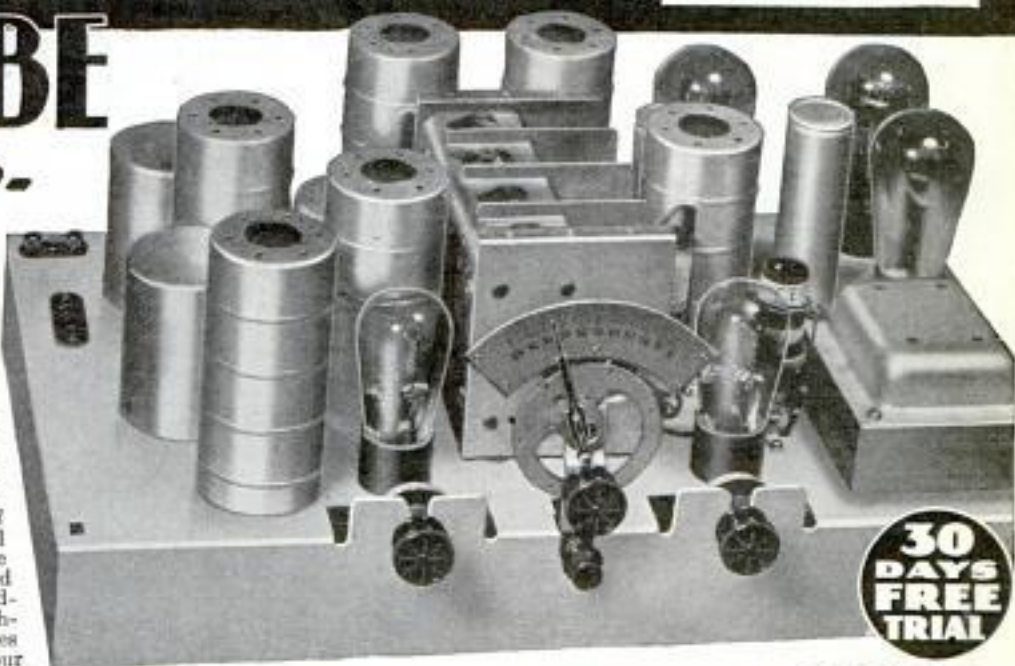

30  
DAYS  
FREE  
TRIAL

### TERMS

as low as  
\$5.00 DOWN

### Read This!

New Zealand User Hears New York  
and Other Stations Eight Thousand Miles Distant

"I would stack my Midwest up against any other make of set on the market. I have a log of 141 stations. 'Midwest gets 'em all over the world.' 36 stations in New Zealand, 34 Austrian, 10 in Japan, 1 in China, 2 in India, 1 in Czechoslovakia and Bratislava, 2 in Honolulu, and a total of 56 stations in the U. S. A., including New York, Cincinnati and Los Angeles. I have received WTIC on two different frequencies . . . also Siam 'Radio Bangkok.' This is a log which would be hard to eclipse by any other set of any power."

FRED W. MORLEY,  
Hawke's Bay, New Zealand.



Complete Line of  
Consoles

The big FREE catalog beautifully illustrates the complete line of gorgeous Midwest Consoles. "Deluxe," Highboy and Lowboy models.

### Mail this Coupon for Complete Details and Big FREE Catalog!

Midwest Radio Corp.,  
Dept. 55  
Cincinnati, Ohio.

Without obligation on my part send me your new 1932 catalog, and complete details of your liberal 30-day free trial offer. This is NOT an order.

Name.....

Address.....

Town..... State.....

Send me SPECIAL USER AGENTS PROPOSITION.

#### USER AGENTS

We pay you BIG MONEY just for showing your radio to friends and neighbors. Easy EXTRA MONEY! Check coupon for details.



## "A correspondence course?"

— YES  
and be sure it's  
**I. C. S.**"



"If a man is going to get ahead these days, he must continually acquire more training — and the only time he can do this is in spare time. And the only way he can do it is by studying a correspondence course.

"But don't start if you haven't the determination to go through with it. Spare-time study is not a business for weaklings. It takes courage — and work! But remember this, completion of a course will pay dividends the rest of your life!

"But don't take any chances. Once I faced the problem you now face — and I enrolled with the International Correspondence Schools. My choice was a wise one. I recommend I. C. S. to you!"

Every day, all over the world, thoughtful employers recommend I. C. S. training to ambitious employees. They have not forgotten what spare-time study did in shaping their careers. And when you mark and mail this coupon, you follow in the path they have blazed. Why not do it — today?

### INTERNATIONAL CORRESPONDENCE SCHOOLS

"The Universal University"

Box 5389-G, Scranton, Penna.

Without cost or obligation, please send me a copy of your booklet, "Who Wins and Why," and full particulars about the subject before which I have marked X:

#### TECHNICAL AND INDUSTRIAL COURSES

- |  |  |
|--|--|
| <input type="checkbox"/> Architect   | <input type="checkbox"/> Automobile Mechanic                                 |
| <input type="checkbox"/> Architectural Draftsman                             | <input type="checkbox"/> Plumbing <input type="checkbox"/> Steam Fitting     |
| <input type="checkbox"/> Building Estimating                                 | <input type="checkbox"/> Heating <input type="checkbox"/> Ventilation        |
| <input type="checkbox"/> Wood Millworking                                    | <input type="checkbox"/> Sheet Metal Worker                                  |
| <input type="checkbox"/> Contractor and Builder                              | <input type="checkbox"/> Steam Engineer                                      |
| <input type="checkbox"/> Structural Draftsman                                | <input type="checkbox"/> Steam Electric Engineer                             |
| <input type="checkbox"/> Structural Engineer                                 | <input type="checkbox"/> Civil Engineer                                      |
| <input type="checkbox"/> Electric Wiring                                     | <input type="checkbox"/> Surveying and Mapping                               |
| <input type="checkbox"/> Electrical Engineer                                 | <input type="checkbox"/> Refrigeration                                       |
| <input type="checkbox"/> Electric Lighting                                   | <input type="checkbox"/> R. R. Locomotives                                   |
| <input type="checkbox"/> Welding, Electric and Gas                           | <input type="checkbox"/> R. R. Section Foreman                               |
| <input type="checkbox"/> Reading Shop Blueprints                             | <input type="checkbox"/> R. R. Bridge and Building Foreman                   |
| <input type="checkbox"/> Telegraph Engineer                                  | <input type="checkbox"/> Air Brakes <input type="checkbox"/> Train Operation |
| <input type="checkbox"/> Telephone Work                                      | <input type="checkbox"/> Highway Engineering                                 |
| <input type="checkbox"/> Mechanical Engineer                                 | <input type="checkbox"/> Chemistry <input type="checkbox"/> Pharmacy         |
| <input type="checkbox"/> Mechanical Draftsman                                | <input type="checkbox"/> Coal Mining Engineer                                |
| <input type="checkbox"/> Machinist <input type="checkbox"/> Toolmaker        | <input type="checkbox"/> Navigation <input type="checkbox"/> Boilermaker     |
| <input type="checkbox"/> Patternmaker  | <input type="checkbox"/> Textile Overseer or Supt.                           |
| <input type="checkbox"/> Pipefitter <input type="checkbox"/> Tinsmith        | <input type="checkbox"/> Cotton Manufacturing                                |
| <input type="checkbox"/> Bridge Engineer                                     | <input type="checkbox"/> Woolen Manufacturing                                |
| <input type="checkbox"/> Bridge and Building Foreman                         | <input type="checkbox"/> Agriculture <input type="checkbox"/> Fruit Growing  |
| <input type="checkbox"/> Gas Engines <input type="checkbox"/> Diesel Engines | <input type="checkbox"/> Poultry Farming <input type="checkbox"/> Radio      |
| <input type="checkbox"/> Aviation Engines                                    | <input type="checkbox"/> Marine Engineer                                     |

#### BUSINESS TRAINING COURSES

- |   |  |
|---|--|
| <input type="checkbox"/> Business Management                                  | <input type="checkbox"/> Business Correspondence                             |
| <input type="checkbox"/> Office Management                                    | <input type="checkbox"/> Lettering Show Cards <input type="checkbox"/> Signs |
| <input type="checkbox"/> Industrial Management                                | <input type="checkbox"/> Stenography and Typing                              |
| <input type="checkbox"/> Personnel Management                                 | <input type="checkbox"/> Complete Commercial                                 |
| <input type="checkbox"/> Traffic Management                                   | <input type="checkbox"/> Civil Service <input type="checkbox"/> Mail Carrier |
| <input type="checkbox"/> Accountancy <input type="checkbox"/> Cost Accountant | <input type="checkbox"/> Railway Mail Clerk                                  |
| <input type="checkbox"/> C. P. Accountant                                     | <input type="checkbox"/> Grade School Subjects                               |
| <input type="checkbox"/> Bookkeeping  | <input type="checkbox"/> High School Subjects                                |
| <input type="checkbox"/> Secretarial Work                                     | <input type="checkbox"/> College Preparatory                                 |
| <input type="checkbox"/> Spanish <input type="checkbox"/> French              | <input type="checkbox"/> Illustrating <input type="checkbox"/> Cartooning    |
| <input type="checkbox"/> Salesmanship <input type="checkbox"/> Advertising    | <input type="checkbox"/> Lumber Dealer                                       |

Name.....Age.....

Address.....

City.....State.....

Occupation.....

If you reside in Canada, send this coupon to the International Correspondence Schools Canadian, Limited, Montreal, Canada

When writing please mention Popular Mechanics

# PYROIL

Brings Greater  
**SAFETY TO  
FLYING**



Say Engineers of  
**CURTISS-WRIGHT  
FLYING SERVICE**

Genuine PYROIL is identified by the winged PYROIL trade-mark and signature of W. V. Kidder, on every label.

"When an engine is protected with PYROIL, should anything happen to the oil supply in flight, this safety factor would enable the pilot to manipulate his ship into a safe landing without danger to his passengers or damage to his motor."

This is the statement of engineers of Curtiss-Wright Flying Service, following a road test of PYROIL, the revolutionary new LUBRICATING PROCESS for automobile, airplane and A.L.L. motors.

PYROIL is simply added to regular oil and gas supply. It "builds lubrication into the metal." Protects where oil fails, does what oil alone cannot do. PYROIL reduces oil and gas consumption—reduces auto—cuts repair bill—free valves—sets rings—reads hard carbon. Temperature. Saves 10 times its cost.

PYROIL'S PATENTED PROTECTED PROCESS CANNOT BE COPIED. Used and recommended by the world's largest industries. Nationally advertised.

**UP TO \$200 WEEKLY  
FOR LIVE DISTRIBUTORS**

PYROIL holds a big money-making future for red-blooded men. Let us show you how to start at once, in protected territory, build a permanent business, rich in daily profits. WRITE AT ONCE.

W. V. KIDDER, President

**PYROIL**  
THE ALL NEW OIL



**PYROIL COMPANY**

532 Pyroil Bldg. La Crosse, Wisconsin



Build Major "Jumbo" Doolittle's  
**LAIRD Super Solution**

3-4" scale. Flies 35 m.p.h. Spans 15-1-2". Yellow and green. Complete Kit SF-5, including full-size drawing, and all parts requiring machined work completed, only \$2.50 postfree.

Send 5c for illustrated Jumbo Folder (in color) showing full line of internationally known Cleveland-Designed models—36 in all. Easy to build, realistic, all fly. Send 5c at once for your copy.

**Cleveland Model & Supply Co.,** 1866-P3 West 57th St. Cleveland, Ohio, U. S. A.



**Do Your PRINTING**

Cards, stationery, circulars, tags, labels, advertising, etc. Save money. Print for others, big profits! easy rules sent. Will do popular Raised Printing like Engraving. Junior Press, \$5.00. Job Presses \$11 up. Power \$149. Write for free catalog. THE KELSEY CO., Y-37, Meriden, Conn.

## A NEW EDITION OF

**NOW READY  
4th Edition**

**Radio Noises  
and their cure**

**62 ARTICLES  
200 Illustrations**

**PRICE 50 Cts.**

Every article complete gives all types of Radio noises and tells how they may be cured. 76 full size pages 8 1/2" x 11". Only book of its kind ever published. Written in question and answer form so everyone can understand it. Send 50c for your copy today (75 cents for Canada and foreign countries).



**Newark Electric Co.** 228 W. Madison St. CHICAGO, ILL.





**New**

**SAVASOLE**  
PAT.  
APPL.  
FOR

**SOLES 4 1/2 CENTS**

Heels <sup>as low as</sup> 1 cent

**New Improved SAVASOLE Pays You \$42 a DAY**

Up to

No more costly shoe repairs. No more wearing worn-out shoes with leaky soles that are harmful to health. This amazing invention—now perfected—saves your money. It's called Savasole, a scientific, plastic, repair set that puts new soles on worn-out shoes. Makes them like new for as low as 4 1/2 cents a sole. Rebuilds run-down heels for as low as 1 cent. New way of applying. Just take a spoonful out of the can and roll it out. Trim it to size. See picture below.

Then it cements on to the old sole and hardens overnight. You have a solid, non-skid, waterproof surface that covers all cuts, holes, cracks.

**Cash In Now On This  
HARD TIMES NECESSITY**

**Now! So Easy!**



**Before**

No muss. Just roll out the plastic Savasole to a thickness of about 1/4 inch. Trim it to the size of your sole. (See picture.)

Then apply cement to Savasole and shoe. Press together firmly and let harden overnight. Wears better than ordinary soles—and can't come off.



This sensational specialty has captured the country and is filling distributors' pockets with gold. Even in hard times it has proved a gold mine for agents! We give you quick, one-minute demonstration that amazes prospects and compels them to order. Sure repeat business. Good territory still open. Rush coupon for Free Sample on leather and new exclusive territory plan.

**It's GUARANTEED!**

Do not confuse Savasole with cheap imitations that spread on with a knife, sometimes drying rough and uneven. Savasole alone is applied in one solid piece and dries thick, smooth and even. And Savasole is the only one that has the Bollman Double-Action Cement process that means Savasole cannot come off. It actually out-wears the uppers. My money back guarantee protects you and your customers.

**AGENT Makes \$135 in a Week**

*Hundreds of Other Letters Like This*

G. C. Miller writes:

"I gave up my former connection where I ranged in earnings from \$115 to \$386 per month. I started out with three gross of Savasole. Since that time, my earnings have netted me over \$135 a week and I am sure that I will soon hit \$200 per week. Savasole has solved my financial problems, and you are the wisest bunch of people to work with I ever saw."

**Mail for FREE SAMPLE**

R. R. Bollman, Pres.  
PERFECT MFG. CO., C-30 Daylight Bldg., Cincinnati, O.

Dear Mr. Bollman: Please send me a Free Sample of Savasole applied to miniature leather sole and tell me how I can make up to \$42 a day. I am not obligated.

Name.....

Address.....

Town.....State.....

Territory preferred.....

**THE PERFECT MFG. CO., C-30 Daylight Bldg., Cincinnati, Ohio**

When writing to advertisers please mention Popular Mechanics



Send *now*  
for my **Free**  
**Book!**



## It tells you, page by page, how to get a steady Government Position

I have shown thousands of fellows like you the way to secure the well-paid, permanent Civil Service jobs they now hold. And the very **FIRST** step they took was to send for my **FREE BOOK**. Get it quick! It tells you exactly what I would, if you came to see me in Rochester. Page by page this book tells you **EVERYTHING** you want to know about getting a Government Position. Here are a few "high spots":

### PAGE 4 tells What Uncle Sam Pays

He's the finest, squarest boss in the world. You don't have to worry all the time about layoffs and being "fired"; **HARD TIMES DO NOT AFFECT THE GOVERNMENT EMPLOYEE**; and he gets an average of \$200 a year more than other workers. Railway Postal Clerks start at \$1,850 a year—can work up to higher paid jobs. My book gives salaries of every branch.

### PAGE 9 tells How You Pick Your Job

Pick the job you want; I'll help you get it. You can work in your home town, travel, or work in Washington, D. C. Uncle Sam has many openings.

### PAGE 12 tells How I Prepare You Quickly

For eight years I was Official Examiner of the Civil Service Commission, so I know just what kind of questions are asked. You can depend upon me to help you to pass **HIGH**, and be offered one of the **FIRST** jobs open.

### PAGE 18 tells About Raises Every Year

You don't have to take the boss's vague promise of a raise—and never get it. You can depend on your increase from Uncle Sam. Read all about this **BIG ADVANTAGE** in my **FREE BOOK**.

### PAGE 18 tells About Vacations with Pay

In some branches you get up to 30 days with pay every year, and up to 30 days' sick leave. See my book for full information on this liberal plan.

### PAGE 10 tells About Civil Service Pensions

Uncle Sam doesn't chuck you out when you're "too old." He retires you on a generous pension. Get my book and read all about this.

### MAIL COUPON TODAY!

If you're an American citizen, 18 to 50, you can quit worrying **FOREVER** about losing your job or being laid off. I mean it! There's a wonderful **PERMANENT** position waiting for you in the Civil Service. You can be a Railway Postal Clerk, Postmaster, Customs Service Man, Post Office Clerk, City Mail Carrier, or get any of the other positions described in my book. Send for it **NOW** and find out how I help you **GET THE JOB YOU WANT!** Get ready **NOW** for the next Railway Postal Clerk Examination. Mail the coupon today!

Arthur R. Patterson, Civil Service Expert  
PATTERSON SCHOOL, 83 Wisner Bldg., Rochester, N. Y.

Arthur R. Patterson, Civil Service Expert  
PATTERSON SCHOOL, 83 Wisner Bldg., Rochester, N. Y.

Send me your big **FREE BOOK** telling how I can secure a position with the U. S. Government paying from \$1,850 to \$3,200 a year, with excellent chances for advancement. This doesn't obligate me in any way.

Name.....  
Address.....  
City.....State.....

## STOP FATAL NIGHT CRASHES



Night driving now safe! A new scientifically constructed spheroidal condenser heavily plated with solid silver—not a painted bulb. Increases light of headlights 50% without glare. Instantly installed. No dimming—no tilting—penetrates fog, rain, mist and snow. Low retail price. Undersells all competition. Big commissions.

**AGENTS UP TO \$50.00 A DAY**

New plan of demonstrating Marvelight rolls agent's sales up to \$50.00 a day. Write for details of free offer today.

**MARVELIGHT CO.** 3228 N. Ashland Ave.  
Dept. 10-C, Chicago

## ASTROLOGY 10 YEAR READING \$1

Your good and adverse periods to 1942. Ten year forecast reading indicating favorable and unfavorable astrological periods in which to court, marry, speculate, invest, travel, change, expand business, obtain promotion, increase income, seek employment. Forecast prepared by expert and arranged in decanates for greater accuracy. Based on recognized scientific Astrology. With this forecast you may plan your affairs with precision, greater assurance of success and happiness. Send birthdate and \$1.00 today for your 10 yr. reading. "LUCKY DAY CHART" FREE. NATIONAL PUBLISHING CO., Desk 829, Hunter, N. Y.

Let us recommend the best books to study on any subject. Popular Mechanics Press, Chicago, Illinois.

## Rupture No Longer Spoils My Fun

"Now that I am rid of my rupture and do not wear a truss, I enjoy dancing again. Many strenuous activities are pleasures, because I am not handicapped in any way. My work is no longer a task—I enjoy it. No one would ever believe I was crippled by rupture."

This is the way people write us after ridding themselves of rupture by using **STUART'S ADHESIF PLAPAO-PADS**.

Stacks of sworn endorsements report success—without delay from work.

Plapao-Pads cling to the body without straps, buckles or springs. Easy to apply—economical and comfortable.

Convince yourself by actually testing Plapao at our expense. Send coupon today.

Test of Factor "PLAPAO"

**FREE!** **ACT SPEEDILY**

MAIL COUPON BELOW TO-DAY

Plapao Laboratories, Inc.  
789 Stuart Bldg., St. Louis, Mo.

Send me **FREE** Trial Plapao and 48-page book on Rupture. No charge for this now or later.

Name.....

Address.....

When writing please mention Popular Mechanics



# Give me your measure and I'll PROVE You Can Have a Body like Mine!

I'll give you PROOF in 7 DAYS that I can turn you, too, into a man of might and muscle. Let me prove that I can put layers of smooth, supple, powerful muscles all over your body.

If you are underweight I'll add the pounds where they are needed and, if you are fat in any spots, I'll show you how to pare down to fighting trim.

And with the big muscles and powerful, evenly-developed body that my method so quickly gives you, I'll also give you through-and-through health—health that digs down into your system and banishes such things as constipation, pimples, skin blotches and the hundred-and-one other conditions that rob you of the good times and the good things of life.

## Here's All You Do!

Just jot down your name and address on the coupon below, mail it to me—and I'll send you, absolutely free, a copy of my new book, "Everlasting Health and Strength." It reveals the secrets that changed me from a 97-pound, flat-chested weakling into a husky fellow who won the title of "The World's Most Perfectly Developed Man" against all comers! And it shows how I can build you into an "Atlas Champion" the same easy way.

I haven't any use for apparatus; I don't dose you or doctor you. **Dynamic-Tension** is all I need. It's the natural, tested method for developing real men inside and out. It distributes added pounds of powerful muscles over your body, gets rid of surplus fat, and gives you the vitality, strength and pep that win you the admiration of every woman and the respect of any man.

NOTE: No other Physical Instructor in the World has ever DARED make such an offer!

*Charles Atlas*

Holder of the title:

"The World's Most Perfectly Developed Man"—won in international contest against ALL strong men willing to compete with him.



Charles Atlas As He Is Today. (Photo taken July 5, 1931.)

## Gamble a 2c Stamp — To Prove I Can Make YOU a New Man!

Gamble a 2c stamp today by mailing the coupon for a free copy of my book, "Everlasting Health and Strength." It tells you all about my special **Dynamic-Tension** method, and what it has done to make big-muscled men out of run-down specimens. It shows you, from actual photos, how I have developed my pupils to the same perfectly balanced proportions of my own physique, by my own secret methods. What my system did for me, and those hundred or others it can do for you too. Don't keep on being only 25 or 50 percent of the man you can be! Find out what I can do for you.

Where shall I send your copy of "Everlasting Health and Strength?" Jot your name and address down on the coupon, and mail it today. CHARLES ATLAS, Dept. 8-11, 133 East 23rd Street, New York City.



CHARLES ATLAS, Dept. 8-R,  
133 East 23rd Street, New York City.

I want the proof that your system of **Dynamic-Tension** will make a New Man of me—give me a healthy, husky body and big muscle development. Send me your free book, "Everlasting Health and Strength."

Name.....  
(Please print or write plainly)

Address.....

City.....State.....

When writing to advertisers please mention Popular Mechanics

Copyrighted material



## ANOTHER VON HOFFMANN MAN SUCCEEDS-

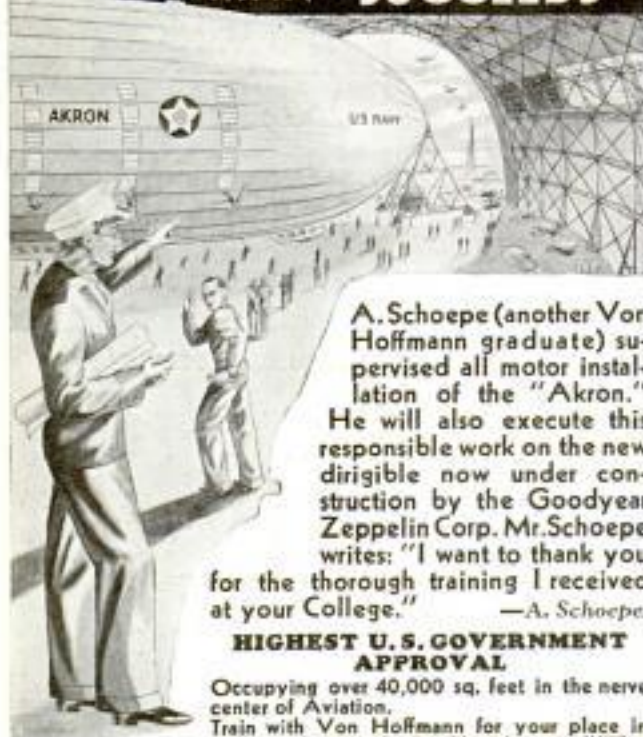

A. Schoepe (another Von Hoffmann graduate) supervised all motor installation of the "Akron."

He will also execute this responsible work on the new dirigible now under construction by the Goodyear Zeppelin Corp. Mr. Schoepe writes: "I want to thank you

for the thorough training I received at your College."

—A. Schoepe.

### HIGHEST U. S. GOVERNMENT APPROVAL

Occupying over 40,000 sq. feet in the nerve center of Aviation.

Train with Von Hoffmann for your place in Aviation. Write for Booklet No. 151 "What

Aviation Offers You." If you are under 17 write for preparatory Course.

**VON HOFFMANN AIR COLLEGE**  
LAMBERT ST. LOUIS AIRPORT ST. LOUIS MO.



## HEATH STILL LEADS

Again Heath demonstrates why it is America's most popular Sport Plane. Performance—Safety—Economy—have always been Heath Qualities and now is added the quality of EASY OWNERSHIP.

Flying is the greatest sport known—why not enjoy it? You can buy your Heath, less motor, for only \$499.00, ready to assemble and cover. Finished parts supplied include welded fuselage, welded tail group, welded ailerons, controls, landing gear, etc. Can be completely assembled at home in a few weeks' time.

Or start from progressive groups of parts. First group, \$15.00, including set of 28 factory made ribs. You don't have to be a mechanic to build your Heath under this system.

Heath Model LN is approved by the United States Department of Commerce, and home assembled Heath LN models are eligible for Federal License, A. T. C. No. 456.

You can fly your Heath anywhere, safely and economically, and you can pay for it as you fly.

Fill out the attached coupon and send it with 15c for descriptive matter and information about our partial payment plan. Special club offers.

## HEATH AIRCRAFT CORP.

DEPT. P-23, NILES, MICH.

HEATH AIRCRAFT CORP., Dept. P-23, Niles, Mich.

Send me more information about the new Heath ( ) fly-away ( ) assembly plan. I am interested in ( ) partial payment plan, ( ) special club offer.

Heath Model LN fly-away . . . \$1074  
K. D. Airplane, less motor . . . \$499  
Heath B-4 Engine . . . \$300

Name . . . . .

ADDRESS . . . . . City . . . . .

## Learn Why You

# STAMMER

...and how quickly you can secure relief

HERE is a 279-page cloth-bound book that gives you a wealth of new facts on Stammering. Clearly written, easy to understand.

**It Tells You:** What Causes Stammering—Why Stammerers are Better and Worse at Times—How Stammering Causes Nervousness—How It Affects Mind, Health—Why It Is Difficult to Talk on the Telephone—Why Some Cases Cannot be Corrected—How to Determine Whether Your Case Can be Corrected—Facts About "Inherited" Stammering.

Based on 31 Years' Experience, this book is the crystallized knowledge of Benjamin N. Bogue, himself a stammerer for nearly 20 years, for 31 years principal of the Bogue Institute for Stammerers, who has met more than 24,000 stammerers and diagnosed 105,000 cases of speech trouble.

If you stammer, you are losing if you don't get this book—"Stammering—Its Cause and Correction." Just send 10 cents, coin or stamps, to cover packing, and this book will come by return mail, postage paid. BENJAMIN N. BOGUE, Dept. 53, 1147 North Illinois Street, Indianapolis, Indiana.

## ASSEMBLE IT YOURSELF WE FURNISH THE PARTS



### YOU SAVE TWO-THIRDS THE COST

We furnish complete plans and boat parts accurately machined and ready for assembly, according to the Welch system of boat building. Send 10c for catalogue showing 27 models.

J. B. Welch, Inc., 3142 N. 31st St., Milwaukee, Wis.



National Three tube wonder short wave receivers. A. C. and D. C. models. Descriptive bulletin on request. Liberal discounts.

Our complete catalog (100 pages) covering all parts for short wave receivers and transmitters as well as service supplies, sent on receipt of ten cents (stamps or coin).

CHICAGO RADIO APPARATUS COMPANY

Est. 1921

415 South Dearborn St., Chicago, Ill.



## SUPER-FILTERMATIC The Modern Indoor Aerial

Can also be used in conjunction with your regular aerial. Thousands of satisfied users, praised by radio experts. Replaces unsightly outside aerials, reduces static and noises. Especially good on distance reception. Helps to separate stations, is absolutely non-corrosive and non-directional. Does not connect in light socket therefore eliminating burn and line noise! Installed in one minute, no tools needed. Will never wear out. Eliminates lightning arrester. Money back guaranteed after 5 day trial. Price only . . . . . \$2.00

Send for information about "SUPER-TONE" tone control, and "FILTERMATIC" Aerial adjusting Coil and Station Separator. Dealers and Service Men write for information, and FREE advertising service. FILTERMATIC MFG. CO. (Dept. B-7), 4438 Franciscan Ave., Philadelphia, Pa.



# Classified Advertisements

## WORLD'S BEST WANT AD MEDIUM

Advertisements in this section, 35 cents per word, each insertion, minimum 10 words, payable in advance  
To be inserted under proper classification in April issue, copy should be in our office February 18th

### ADVERTISING AGENCIES

**GET** into advertising. Learn quickly at home. Experience unnecessary. New easy plan. No text books used. Practical work. Old established school. Send name and address for interesting free booklet. Page-Davis School of Advertising, Dept. 3432, 3501 Michigan, Chicago.

**ADVERTISING:** 24 Words 8 big city Sunday papers—\$10. One inch display, 50 country weeklies—\$5. Copy prepared. Free list, magazines, farm. LeGrand Agency, 24 West 33rd St., New York.

**ADVERTISERS:** Make your advertising pay better. Our service has helped hundreds. Newspaper, magazine rate-book free. Chicago Union Agency, (Est. 1900), 29 West Jackson, Chicago.

**BEFORE** Advertising get our catalog. No charge. 26 years in business. The largest classified agency in the world. Ankrum Advertising Agency, 100 N. LaSalle St., Chicago, Ill.

**FREE—New 1932 Advertisers Rate Guide,** 44 pages. Includes everything. Lowest rates. E. H. Brown Advertising Agency, 140 S. Dearborn, Chicago.

**TIME** Counts in applying for patents. See pages 134 and 135. Clarence A. O'Brien, Registered Patent Attorney, Washington, D. C.

**INCH** Display advertisement 50 magazines year \$24. Wood's Popular Services, Atlantic City, N. J.

**ADVERTISE** in rural weeklies. Lists free. Meyer Agency, 4112 Hartford, St. Louis, Mo.

### FOR ADVERTISERS

**ADVERTISE** in 250 country town newspapers 23 words, \$18. Lists free. All states. Keator, Hartford Bldg., Chicago.

**ADVERTISING:** 20 Words; 48 magazines 60c; three insertions, \$1.25. Inch display, three months \$6.00; year \$24.00. Mailing Bureau, Lawndale, Calif.

**ADVERTISE** 53 Magazines, 3 months, \$6.00 inch. List, special offers, free. Evans King Co., Box 672P, Wilmington, Delaware.

### CIRCULAR MAILERS

**LATIN-AMERICA!** Commercially unexplored by you. 2,000,000 homes anxiously awaiting for your propositions. Exceptional opportunity for introducing new products, personal and household utilities, novelties. Send dime for samples and full information. Agents wanted. English or Spanish circulars (12" or smaller) mailed for \$3.00 thousand; 35c hundred. Rush circulars to-day. Quick! Efficient service guaranteed. Compania Internacional, Box 1518, San Juan, Puerto Rico.

### SALES PROMOTION

**EFFECTIVE** Sales letters—written, revised or analyzed—small fee—by our direct mail specialists. Advertisers Letter Co., 410 So. 19th, Omaha, Nebr.

### INFORMATION

**ANY** information desired 25c coin and up. Fred Klotz, Reading, Pa.

**FOR** information send 25c to "The Informer," 2350 Aqueduct Avenue, Bronx, New York City.

**MODEL** Airplanes, Building and Flying—Joseph S. Ott, America's foremost model builder and designer teaches you how to build ships that fly. Very interesting and fascinating sport. 350 pages, 165 plans. Cloth. Price \$2.50. Purchase of book entitles you to membership in Junior Sky League of America. Postpaid upon receipt of price or C.O.D. anywhere in U. S. A. Popular Mechanics Press, Room 803, 200 E. Ontario St., Chicago.

### AUTOMOBILES

**BUILD** Your own trailer at home spare time. Complete line of parts and body hardware. Also trailers complete \$43.50 up. Locke Pattern Works, Detroit, Mich.

**TIME** Counts in applying for patents. See pages 134 and 135. Clarence A. O'Brien, Registered Patent Attorney, Washington, D. C.

**DIRT** Track Racing. Now you can break into the racing game. How to build racer, contest rules, speed, "rers"—Complete illustrated treatise, postpaid \$1.00. Ray Kuns, Dept. B, Madisonville, Cincinnati, O.

### AUTO SUPPLIES

**BRAKES** Renewed almost indefinitely by an occasional application of Bestolite Brake Dressing. Cures glazing, squeaking, chattering, grabbing and most all other brake ills. Gives you an ideal brake on any kind of lining. A year's supply for a passenger car for \$1.00. Guaranteed results. Brake Products Sales Company, 2907 East First Street, Los Angeles, California.

**GOODYEAR** Tires—at 60% saving. Also Goodrich and Firestone. Rebuilt. All new treads. Guaranteed perfect. Send for price list and descriptions of these amazing values. Atlas Tire and Rubber Co., 6250 South Morgan St., Chicago.

**BARGAINS**—Excellent reprocessed compressors, battery chargers, test benches, car washers. Terms. Trial. Write Ken's Automotive Service, Box M-321, Troy, Ohio.

**CHROMIUM** Plating powder plates iron, steel, brass, copper and nickel, without electricity or machinery. Guaranteed not to tarnish; ½ pint can \$1.50 prepaid. Gunmetal Co., Ave. J, Decatur, Ill.

**RADIATORS**—Guaranteed. All standard makes. Save 40% to 75% buying at wholesale prices. Give models. Write for prices. Independent Radiator Co., 1119 So. Wabash, Chicago.

**CHEVROLET** Six—New book just out details mechanical features, operation, maintenance, and repair of the latest including the new 1932 models Chevrolet cars and trucks. 180 pages, fully illustrated, cloth-bound. Price \$2.00 postpaid upon receipt of price or will be sent by mail C.O.D. anywhere in U. S. A. Popular Mechanics Press, Room 803, 200 E. Ontario St., Chicago.

### AUTOMOBILE SERVICE EQUIPMENT

**SUBSTANTIAL** Savings—reprocessed compressors, battery chargers, test benches, car washers. Terms. Trial. Write Ken's Automotive Service, Box M-322, Troy, Ohio.

**BATTERY** Charging is profitable. Buy our 15 battery capacity charger, \$27.34. Adams-Barr, Columbus, Ohio.

### MOTORCYCLES, BICYCLES AND SUPPLIES

**MOTORCYCLE** Bargains, lowest prices, bargain sheet for stamps, motorcycle accessories, largest line in America, lowest prices. Largest motorcycle mail order house in the United States. Rochester Harley Davidson Corporation, 129 West Main St., Rochester, N. Y.

**SEND** 15c For illustrated used Motorcycle catalog. Large stock. Bargains. Indian parts. Accessories. Indian Motorcycle Sales, Kansas City, Mo.

**LOW** Prices—Special bargains in Harley-Davidsons—14 models. Send 6c stamps for catalog. Knuth's, 2525 Pond du Lac Ave., Milwaukee, Wis.

**HARLEY** Davidson motorcycles and new and used parts. Dustin Cycle, Topeka, Kans.

**REPAIR** With good used parts, save ½ or more, state parts needed, no lists. J. B. Dahl, 3661 Archer Ave., Chicago, Ill.

### AVIATION

**U. S. Air** corps, takes in 700 men each year for free flying training. Gives them over 200 solo hours, special uniforms, transportation and pay. It costs absolutely nothing. Let us tell you: how to get in, information about salary, uniforms, rank, leave, and actual life at the new \$10,000,000 field. Hand postman \$1 and postage for entire information. Flying Intelligence Bureau, 401 J. C. Rives Bldg., Los Angeles.

**MEAD** Gliders lead the field. You can easily build and fly one. Send 10c for our catalog with full particulars, prices of supplies, etc. Mead Gliders, Dept. B, 12 South Market St., Chicago, Ill.

**BE** Sure that the motor you purchase for your light plane will fly it. Heath B-4 and Heath Henderson motors are guaranteed to fly and 7 years of constant performance prove it. For economy and reliability these motors cannot be equalled. Send 10c for large illustrated booklet. Heath Aircraft Corp., Dept. KP-3, Niles, Michigan.

**TIME** Counts in applying for patents. See pages 134 and 135. Clarence A. O'Brien, Registered Patent Attorney, Washington, D. C.

**WACO** Steel fuselage gliders. New, \$150.00. Also power gliders and motors. Send dime for photos. Glider Motors, P. O. Box 1585, Cincinnati, Ohio.

**OFFERING** Heath fuselage, bargain. Lilia, 915 Nineteenth St., Rockford, Ill.

**SPRUCE**—Finished to size for airplanes, gliders, leeboats. Highest quality. Lowest prices. Mail sizes for quotation. Pike-Dial Lumber Co., 2257 Loomis, Chicago.

**METAL** Tipped Henderson propellers, \$9.95; Fords, \$12.50. Hibbs, Ft. Worth, Texas.

**SEND** 5c For bundle of balsa, reeds and price list on supplies. Aero Shop, 3050 Hurbit Ave., Detroit, Mich.

**MODEL** Aircraft—How to build and fly. Model builders and tournament contestants, get the complete official handbook of the Playground and Recreation Association, 300 pages, fully illustrated. Price \$2.25. Sent postpaid upon receipt of price or C. O. D. anywhere in U. S. Popular Mechanics Press, Room 803, 200 E. Ontario St., Chicago.

### BOATS, OUTBOARD MOTORS, ETC.

**PROPELLERS,** Pumps, stuffing boxes, bearings, etc. Wm. H. Baker, Pond St., Quincy, Mass.

**BOAT** Show number The Rudder 35—stock boats illustrated, 1932 engines, building plans 27-foot power boat, designs, cruise stories, beautiful illustrations, subscription (12 months) \$3.00. Send for free catalog boat plans. Rudder, 15 Murray Street, New York.

**BUILD** Your own boat. Save over ¼ and have fun besides. Simplified instructions in Popular Mechanics New Boat Book, just out, are easy to follow. Every 12" of small boat covered, outboard, inboard, sailing and hand-propelled craft. In addition complete information on all phases of boating needed by every boating enthusiast. 269 pages. Fully illustrated. Postpaid upon receipt of price, \$3.00 or will be sent C.O.D. anywhere in U. S. Popular Mechanics Press, Room 807, 200 E. Ontario St., Chicago.

### CARTOONING

**NATIONAL** Cartoon magazine, contests—sales 10c—10c. Cartoon Company, West Springfield, Mass.

**CARTOON** Course—Self-instructive; consisting of 30 lessons illustrated with over 300 drawings. Sent postpaid for \$1.00; outside U.S.A. \$1.25. Scovell Publishing Co., Box 610 Hollywood, Calif.

**SEE** Yourself in cartoon. A knockout comic sketch from your photo \$1.00. State hobby and nickname. Photo returned unframed. Fido Fagin, 46 W. 71st Street, N. Y.

### MANUSCRIPT SERVICE

**HAVE** Your letters reproduced and mailed. Typewriting of all kinds. Manuscripts a specialty. Prices on request. Cecile M. Groom, 215 Bul Building, Des Moines, Iowa.

**USE** Sheets in Figures. Save valuable time. The quickest way of working all problems. Instructions for drilling yourself to be come rapid with figures. Complete, yet simplicity itself. Just write a postal for "Sheets in Figures." Pay postman \$1.25 and postage. Popular Mechanics Press, Room 802, 200 E. Ontario St., Chicago, Ill.



**ARCHERY**

**YOU** Have never seen this ad before nor heard of such low prices on new guns and archery tackle. Send for this free catalog now! Outdoor Amusement Company, Dept. H, Clinton, Mo.

**MAKE** Your Bow and Arrows. We sell materials. Send 25c for working instructions and catalogue. Sidney Archery Co., Sidney, Ohio.

**CHALK TALKS**

**LAUGH** Producing program, \$1.00. Catalog free. Balda, The Cartoonist, Oshkosh, Wis.

**BOOKS AND PERIODICALS**

**HUNDREDS** Unemployed panning gold. Big placer-deposits still untouched. Learn prospecting—placer-mining. \$10 day possible. Copyrighted treatise, with map showing localities, covers everything. Price \$1.00—now 50c. W-S Laboratory, Coeur d'Alene, Idaho.

**MONEY**—Heads and Tails is the story of money throughout the ages. Educational and entertaining. Cloth, \$1 delivered. Southland Publishing Company, Roanoke, Va.

**HANDBOOKS**—Trades, automobiles, electricity, etc. Shorthand, 25c. Marr, B605, Nashville, Tenn.

**CASH** Paid for old books. Want list 25c (silver.) Richard, 349 Summer Street, New Bedford, Mass.

**HYPNOTISM** Easily learned. Lessons guaranteed. Postpaid \$1.10. Smith Pub. Co., Dept. 3, Springfield, Mass.

**GOOD** Books, magazines; stamp brings circulars. Goldenrod Company, Harrisburg, Ill.

**SELL** Books from our catalog. Earn big money. World famous house. Particulars free. Meador Publishing Co., 470-A Atlantic Ave., Boston, Mass.

**NEW** 16th Edition of Dyke's World Famous Auto Encyclopedia—right up-to-date with free wheeling, synchro-mesh, down-draft carburetion, front-wheel drive, etc. The book auto repairmen swear by. 1,329 pages, 4,000 illustrations. Cloth binding \$6.00, flexible Morocco \$7.50. Postpaid upon receipt of price or C.O.D. anywhere in U. S. A. Popular Mechanics Press, Room 803, 240 E. Ontario St., Chicago.

**GAMES, ENTERTAINMENTS AND PLAYS**

**PLAYS,** Operettas, musical comedies and minstrels, comedy and talking songs, black-face skits, vaudeville acts, monologs, dialogues, recitations, juvenile plays and songs, musical readings, entertainments, make-up goods. Catalog free. T. S. Denton & Co., 623 So. Wabash, Dept. 11, Chicago.

**TICKLE-KIT**—"It's a game" for "adults only." Entertain your guests with Tickle-Kit. They'll laugh, they'll scream, they'll blush, but they'll like it. The ice-breaker every hostess has been wishing for. Send \$1.00. Tickle-Kit, Box M. P., Wheaton, Ill.

**MAGIC TRICKS, BOOKS AND JOKER NOVELTIES**

**MAGIC**—Tricks. Books and Supplies. For amateurs as well as the great professionals. Anyone can learn through our instructions. Feature Acts in Mind-Reading, Spiritism, Rope Ties, etc. Large illustrated professional catalog, 20c. Chicago Magic Co., 140 So. Dearborn St., Dept. B, Chicago, Ill.

**DEMON** Tag trick! Defies detection! 50c. Balfar, Box 271, San Francisco.

**SEVEN** Optimagical delusions. Four Magic catalogs 25c. Gilmagic, Meegan Park, Chicago.

**FIVE** Mind-reading stunts, \$1.00. Details free. J. Tillber, Proctor, Vermont.

**TWO** \$1.00 Tricks, catalog, 15c. Lux, Magellan, Mount Morris, Illinois.

**THREE** Interesting card tricks 20c. Specialty Sales, 2611 Indiana, Chicago.

**FREE!** Catalogue of new magic. New pocket trick 50c. Three for \$1.00. Eagle Magic, Minneapolis, Minn.

**CATALOG** 500 Wonders 20c. Brings Magic, 715 North Cicero, Chicago.

**MAGIC** Catalogue, sheet stage money, free. Singer, 555, Hancock, Wisconsin.

**MYSTERIOUS** Jumping peg trick!! 15c complete! Alritero, 1224 Augusta, Racine, Wisconsin.

**ELECTRIC** Fun! 200 stunts, 110 volts, \$1. Kutting Son, Campbell, Calif.

**"1000 WONDERS."** Amaze and mystify! This famous magic book and catalog postpaid 10c. Largest line. Lowest prices. Send today! Lyle Douglas, Station A-5, Dallas, Texas.

**MAGIC** Catalog 20c. Lynn, 105 Beach, Dept. 3, Jersey City, N. J.

**TRICK** Catalogue, Illustrated, 10c. Oaks Magiral, Dept. 548, Oshkosh, Wis.

**LEARN** To hypnotize, instructive book on hypnosis, 10c. Geo. Fenner, 2401 Jefferson, Louisville, Ky.

**SPHINX**, Magicians' magazine, 35c. Catalogue of magic, 10c. Holden Magic, 235 W. 42nd St., N. Y.

**CHALK-TALK** Your way to popularity. Audiences at your feet if you learn how to entertain with a few simple pictures. Little artistic ability needed. "How to Chalk Talk" tells what to say and what to draw. Profusely illustrated. Make money giving chalk talks. Just order on a postal. Pay postman \$1.00 and postage when delivered. Popular Mechanics Press, Room 802, 200 E. Ontario St., Chicago, Ill.

**MINERALS AND GEMS**

**MINERALS,** Gems, rocks, ores, for study or cabinet display. Splendid values. Gem Shop, 15C, Kohrs Block, Helena, Montana.

**RADIO SETS AND SUPPLIES**

**SENSATIONAL** New "Melody King" radio delights everybody. Uses no batteries or tubes yet reception over hundreds of miles has been reported. Ordinary receiving range of 10 to 25 miles easily extended by proper hookup. Ideal bedside radio. Brings endless enjoyment. Rush order now. Price "Melody King" set only \$1.00, postpaid. Prompt shipment. Agent's deal included. Melonite Company, Dept. PM, Fairmount Station, Kansas City, Mo.

**SHORT** Wave, television kits for easy, low cost assembly. Literature, 10c. Federal Radio, Box 911, Cincinnati, Ohio.

**"B"** BATTERY Eliminators for 32 volt systems, \$5.95; "A" eliminators, \$1.50; dynamic speakers, \$6.00. Meek, Rockbridge, Ill.

**TIME** Counts in applying for patents. See pages 134 and 135. Clarence A. O'Brien, Registered Patent Attorney, Washington, D. C.

**GUARANTEED** "Pocket Radio," \$2.00. Catalogue, 10c. Neil Tasker, Shamokin, Pennsylvania.

**STAMP COLLECTING**

**MESOPOTAMIA** Is one of those countries whose stamps are exceedingly hard to obtain. For only 4 years ending 1922 were Mesopotamia stamps issued and all of them catalogue fairly high. We offer number 26, cataloguing 200 with 10 other real good stamps including a 62 year old classic and a dollar value United States, total catalogue value well over \$1.00, for only 10c to approval applicants. Globus Stamp Co., 268 Fourth Ave., New York City.

**BIG Parade**—A packet of more than twenty all different better grade stamps showing exciting scenes and records of nations at war. Includes fire-pot hurler; the storming of a city; hand-to-hand bayonet struggle; bloody battle scenes; troop transport; red cross stamp; dying soldier; victory stamps; etc. Send for this thrilling "Big Parade" packet at once—limited supply. Only 10c to approval applicants. W. A. Rowell, 58 Cornhill, Boston, Mass.

**IMMENSE** Triangle stamp! The largest in the world, an album giant (Spain 1830 Columbus commemorative) included in amazing packet of thirty-four scarce varieties from queer far-off lands; Boli, Kouang-Tsueo, Gwalior, etc. Absolutely no common European varieties to mar the high quality of this wonderful packet. Only 10c (coin) to approval applicants. Vogue Stamp Co., Dept. P3, Post Chester, N. Y.

**SCARCE** Airmail and triangle. Beautiful Uruguay "flying horse" airmail and scarce Guatemala triangle (smallest in the world) are included in our big packet of 60 different stamps from Aloites, Grand Liban, Venezuela, British and French Colonies, etc. All for 5c to approval applicants. Big illustrated lists free with each order. Write today! Mystic Stamp Co., (Dept. 80), Camden, New York.

**ANCHER'S \$\$\$** Outfit—only 12c. Fine triangle stamp, set German stamps (pre-war) value millions dollars, perforation gauge and mm scale, airmail set, interesting stamp smallest republic, newspaper set, packet good stamps Travancore, Malay, Dutch Indies, etc., fine pocket stock book. Entire outfit 12c to approval applicants. Ancher Stamp Company, Rutherford, N. J.

**THE Biggest dollar**—100 foreign including Newfoundland, Persia, etc., for 40c; 1000 mixed U. S. for 50c; 100 different U. S. with Civil and Spanish War revenues and old 1861 cover for 40c; 100 Latin-Americans for 25c; 100 different from 50 countries for 15c. All above with 100 hinges for only \$1.00. Approval selection with each order. New England Stamp Co., Established 1893, 53 Broomfield Street, Boston, Mass.

200 ALL Different good U. S. for \$1.00. New England Stamp Co.

200 STAMPS from 200 countries for \$1.00. New England Stamp Co.

200 ALL Different Asiatic for \$1.00. New England Stamp Co.

200 ALL Different Africa for \$1.00. New England Stamp Co.

10 DIFFERENT Afghanistan for 50c. New England Stamp Co.

APPROVALS To fit Int. Jr. Album. New England Stamp Co.

SEND For new 1923 U. S. price list. New England Stamp Co.

20 DIFFERENT Abyssinia for only 50c. New England Stamp Co.

38 DIFFERENT Persia for only 50c. New England Stamp Co.

TWENTY Stamps, dime with approvals. Broadway's, Box 664, Akron, Ohio.

OUR Grace yard. Remains of collections and approvals, slightly damaged rare stamps. A hand full for a dime. Approvals. Gasper, 1221 California, Cincinnati, Ohio.

**LIBERIA** Snake triangle, two other triangles in our packet 53 different stamps 5c. Croesder Company, Carroll, Baltimore, Md.

**LARGEST** Stamp in the world! Rare China Wild Goose special delivery stamp (value 75c) for only 5c to approval applicants. Supply limited. Positively only one to a customer. Western Philatelists, 6021 Harper, M-33, Chicago.

**RELIABLE** Boys. Sell our dandy approvals. Excellent pay. We trust you. Nice free premium if you write today. References please. Le Roy Stamp Co., B20 W. Jackson Blvd., Chicago.

100 DIFFERENT Foreign stamps from 100 different foreign countries, including Africa, Asia, Australia, Europe, West Indies, etc., for only 20c. Free with each order, our pamphlet telling "How to Make a Stamp Collection Properly," together with our price list of albums, supplies and hundreds of bargains in sets, packets, etc. Queen City Stamp Co., Room 36, 604 Race St., Cincinnati, Ohio.

5 COLUMBUS Shins 5c to approval applicants, 2608 No. 60 St., Omaha, Nebr.

TWO Beautiful Spanish almost 4c. Bargain approvals. Illinois Stamp Co., LaGrange, Ill.

SIAM 15 Var, 10c, 12 Newfoundland 10c. U. S. missions 37c lb, 10 lbs, \$3.00. Foreign missions 75c lb, 10 lbs, \$7.00. Popular Co., 4512 North Racine, Chicago.

1000 DIFFERENT 60c. With approvals. U. S. list free. Hollinbeck, 312 Marquette, Minneapolis.

PAPUA, Zanzibar, Iraq, Johore, Lebanon, Transvaal, etc., in our packet 57 different, 5c with approvals and lists. Monumental Stampco, Arlington-203, Baltimore, Md.

ABYSSINIA Rhinoceros (catalog 47c), also packet Andorra, Oltre Giuba, Epirus, Nigeria, Mozambique, etc., 5c with approvals and lists. Pilgrime Stampco, Mount Washington, Md.

20 BRAZIL 10c; 400 Different 15c; approvals included. Mantle Stamp Company, London, Canada.

ZANZIBAR! Packet queer freakish stamps from Zanzibar, Indore, Algeria, Malay States, Victoria, Goldcoast, Nigeria, British Colonies, Souamericans. Don't delay! Don't wait. This whooping packet free for 5c postage. Gray Stampco, Toronto, Canada.

BEGINNER'S Outfit-Album, 300 stamps, 100 hinges, stamp tongs, watermark detector, prize stamp set, 69c postpaid. Ransom, 1333 Pontiac, Ann Arbor, Mich.

50 FRENCH Colonies, Alaouttes, Gabon, Caledonia, etc., with approvals 6c. Hollinbeck, 312 Marquette, Minneapolis.

FREE! World's smallest stamp! 2c postage, 10 different triangles, 18c. Scott's International Junior Album (cloth bound edition; 21,000 spaces) \$2.95! Approvals sent. Tatham Stampco, West Springfield, Mass.

CANADA Airmail stamp free if you ask for approvals and send 15c for 25 different airmails or 30 different Canada; both packets only 25c. We list 350 countries in our dime packets. Lists free. Special bargains, 500 different, 25c; 1,000 different, 75c; 2,000 different, \$2.50. Victoria Stamp Co., London, 4, Ontario, Canada.



**301 DIFFERENT** 10c to approval applicants only. Free list of bargain packets. Kansas City Stamp Co., Lee Bldg., Kansas City, Mo.

**FIVE** Complete sets South American envelope stamps for a dime to approval applicants. Philatelic Stamp Co., 129 Harvey, Glendale, Calif.

**5 TANSA** Tours 6 cents with approvals. Dorval Co., Gloversville, N. Y.

**WONDERFUL** Packet of 40 stamps from strange countries—Flint, Tasmania, Mozambique, Stam, etc., including smallest stamp 1/4c. (No Europe.) 9 Nyassa triangles 20c. 25 Cuba 10c. Bargain Stamp Co., 2777 West 23 St., New York.

**50 DIFFERENT** Unused, 10c to approval applicants. H. L. Hunter, Box 531, Clemson, S. C.

**35 INCLUDING** United States commemorative, Albania, etc., 5c. Approvals. Deagle, 7763 Logan, Detroit.

**FREE** Useful gift with fifty stamps, 4c postage, with approvals. Trenton Stamp, 788 Beatty, Trenton, N. J.

**SET** Of 14 mint Persia for only 10 cents to approval applicant. Chippewa Stamp, 42 West Chippewa, Buffalo, N. Y.

**SELL** Good U. S. foreign commission. References. The Bing Company, Minneapolis Minn.

**100 DIFFERENT** To approval applicants—5c. American Stamp Company, 816 Chimes Building, Syracuse, N. Y.

**BARGAIN** All large stamps. Newheids—Aphrodis, Nauru—ship, Corea—ornament, Abyssinia—animals, Persia—portraits, Dominica—building, Ruandaurand—landscape, Belgium; other dandies. Entire 10c to approval applicants. Milton, P. O. Box 185, Sta. 8, Los Angeles, Calif.

**100 DIFFERENT** From 100 different countries, 10c. Approval applicants only. Hornell Stamp Company, Hornell, N. Y.

**STAMPS**, 100 All different. Postage 2c. Lists free. P. M. Quaker Stamp Co., Toledo, Ohio.

**FREE**—Attractive French Colonial packet given approval applicants. Lincoln Stamp, Shelbyville, Ill.

**50 DIFF.** United States, including \$2 tax, 10c; 30 Canada 10c. Robert Harnes, Point Place, Toledo, Ohio.

**STAMP** Hunters' Club, friendship, mystery, adventure; trial membership 10c. Edgar Snyder, 3 Churchill Rd., Youngstown, Ohio.

**STAMPS** Sent on approval at 50% discount. 50 all different U. S., 25c; 100 all different \$1.00, mostly old issues and Commemoratives. Fred Herzberg, 297 So. Washington St., Wheaton, Ill.

**NOSSIBE**, Volta, Indore Travancore, Mexico Revolutionary, Mozambique, Reunion and others, catalogue \$1.37. Yours for 5c and request for 50% discount approvals. Pacemco, Box 552M, Glendale, Calif.

**MYSTERY** Packet free with approvals. Melvin Spencer, Lewis Street, Springfield, Illinois.

**FREE**—Sample copy unique weekly stamp paper. Stamp Collector, Mill City, Oregon.

**150 DIFF.** Free; approvals priced 1/2 or less. Jacob Minnich, 3413 W. 90 St., Cleveland, O.

**105 (CHINA, Etc.)** 2c. Album (500 illustrations) 3c. Bullard, 448 Tremont, Boston.

**FREE!** 25 French colonies with approvals, postage 2c. Potomac Stamp Company, 3708 Thirteenth St., Washington, D. C.

**THREE** Spanish Monastery commemoratives. 5c. Approvals. Oak Park Stamp, Oak Park, Ill.

**BE A Sport**. Take a chance, send me a dime and see what I shall send you. If not satisfied, dime refunded. A. E. Anderson, 815 Carroll St., Brooklyn, N. Y.

**FIVE** Spanish Columbus commemoratives, 5c. Approvals. La Grange Stamp, La Grange, Ill.

**WHOLESALE** Stamp lists, samples. Send 2c postage. Hoyt, 275 Middlesex St., Lowell, Mass.

**WONDERFUL** Approvals! Big discounts! Free prizes! Box 114, Minneapolis, Minn.

**75 DIFFERENT** Stamps from 75 different countries, 8c to approval applicants. Barcus, Box 1054, Detroit, Michigan.

**LIBERIA**—Four varieties 2c to approval applicants. William Calkins, Cleveland, O.

**1000 ASSORTED** U. S. stamps, 25c. Auburn Stamp Co., Syracuse, N. Y.

**5 SPAIN** Columbus ships 7c to approval applicants. C. A. Leeson, 266 Shelldrake Blvd., Toronto, 12, Canada.

**FORTY** Different United States and price—12c. 60% approvals. Seidenberg, Baroda, Mich.

**RAROTONGA**, 15 U. S. (air mail, commemoratives, etc.) 10 South America—5c. Hudson Co., Plainfield, N. J.

**WHITE** Russia complete 10c. 9 Nyassa triangles 20c. Both 25c. Webers Stamp Shoppe, 1377 Park, Plainfield, N. J.

**FREE** Packet to approval applicants. Write, Neely, So. Salem, Ohio.

**STOP!**—Look!—5 different complete sets rare old South American envelope stamps, just enclose 10c requesting unusual approvals. Bargain Stamp Service, 1332 South Hope Street, Los Angeles, California.

**UNITED** States stamp album, new, entirely different. Particulars free. Reynolds Stamp Co., Flint, Mich.

**ILLUSTRATED** Album 25c. 500 stamps 25c. United Stamp Co., 691 Bell Street, Akron, Ohio.

**25 DIFFERENT** 5c. Approval applicants. Wilbur Holland, McClellandtown St., Uniontown, Penna.

**WHOLESALE** Catalog for dealers; 4c postage. Grossman, 192 W. 42nd, New York.

**20 SCARCE** West Indies 10c. Request approvals. North, South, Central America only. Bill Bloss, 1173 North Kingsley Drive, Los Angeles, California.

**25 DIFFERENT** African 5c to approval applicants. Knaue, Edwardsville, Illinois.

**SIAM** Air mail free with 112 page stamp album—20 cents. Keystone Stamp Company, Chambersburg, Pa.

**1000 MIXED** United States—25c. Wilcox, 607 Bear St., Syracuse, N. Y.

**1,000 FOREIGN** Stamps 15c to approval applicants. Fulmer, Columbia, Missouri.

**BRITISH** Colonies; 25 diff. given approval applicants sending 2c postage. R. D. Davis, Silver Lake, Ind.

**BONANZO** Packet good foreign and R. C. 55 var. old U. S., 50 var. Canada. 25 var. Newfoundland, and gift of valuable entries—all \$1.40. Wicks' Stamp Company, Brantford, Ont., Canada.

**SCARCE** Belgium airmail, pocket album, commemorative set, 40 scarce stamps from South America and Canada for 5c to approval applicants. Glendale Stamp Co., 1312P Linden, Glendale, Calif.

**BRUNEL**; 3 Varieties 5c to approval applicants. Allison, Angola, Ind.

**FINLAND**, 100 Varieties, \$1.00. Shenita, Box 990P, City Hall Annex, New York.

**REWARDS**—Premiums given actual approval buyers. Purser Pope, Acondale, Ga.

**STAMPS** On approval at half other dealers prices. Riedell, Greensburg, Penna.

**UNITED** States stamps on approval. Haines Stamp Co., 251 Market St., Lowell, Mass.

**BRUNEL** (Native Scenes), gigantic bi-colored Persian airmail, Johore, Tanganyika, French Guinea Provisional, Grenada, Eritrea, Foreign Revenue, Kedah, Orange River Colony, Nyasaland Protectorate, and scarce genuine Baden, all for 5c to introduce our famous approvals! Viking Stamp Co., Sheepshead Bay Station, Brooklyn, N. Y.

**WHOLESALE**—Retail catalogues free upon application. Midland Stamps, Toronto, Canada.

**40% PROFIT** Selling U. S. stamps, write. National Stamp Company, Box 428, Chicago.

**PACKET** Giant stamps (including world's largest, valued 75c) only 10c to approval applicants. Gem Co., 1830 Unionport Road, New York.

**SET** 4 Hongkongs to approval applicants sending 4c postage. Masche, 5805 Seminary Court, Oakland, California.

**FIFTY** Different United States ten cents to applicants for bargain penny approvals. Knodle, 1942 N. Talbott, Indianapolis, Ind.

**FREE**—Thrilling jungland packet! Iraq (Winged Bull), Tunis (Fighting Arab), Liberia (Jungle Village), Congo (Explorer Stanley), many others, also lists, valuable coupons, dandy penny approvals—everything 4c postage. Midwest Stamp, Midwood Station, Brooklyn, N. Y.

**NEWFOUNDLAND** 1932 Catalogue free. Prices average 38%. Scott, Rev. Butler, St. Georges, Newfoundland.

**300 DIFFERENT** Stamps 20c; 500, 35c. Michael, 942 So. 23rd, Bellwood, Ill.

**FIJI**, Brunel, Airmail, Zanzibar, Tanganyika, Mauritius, Kenya, in packet 49 different "hard-to-get" stamps, 6c only to approval applicants. Kenwood Stamp Company, 528 Kenwood, Glenfield, California.

**BICENTENNIAL** Offer—10c! Airmail and six other attractive sets. Three packets, approvals. Deering, 164 Albion, Somerville, Mass.

**EUREKA**. What is it? Write. Ask. Box 1089, Vancouver, Canada.

**COLLECTORS!** Exchange stamps! Members in every country! Over 700 new members joined during 1931! Send stamp for particulars. Monda Ligo Club, Cameron, Montana.

**QUALITY** Stamps on approval 1/4c up. Free premium. Kelgwin Stampco, Vineyard, N. J.

**300 SURPRISE** Mixture (unpicked) \$1.10. Approvals. Stevens Stamps, Walden, N. Y.

**UNITED** States on approvals. Huber, 3551 Penn No. Minneapolis, Minn.

**TRIANGLES**—Eight different triangle stamps including Guatemala (world's smallest), Latvia (air mail), Liberia, Nyassa only 10c to approval applicants. Paul Beeve Stamp Co., Box 49, Astor Station, Boston.

**200 DIFFERENT** Triangle, airmail, etc., 10c. R. H. Carlton, 1211 W. 37 Place, Los Angeles, Calif.

**SAN** Marino set and 50 different stamps, 5c to approval applicants. Malboro Stamp Co., 1630 East Fifth Street, Brooklyn, N. Y.

**ILLUSTRATED** Album holding 3500 stamps to approval applicants 25c. Swan Stamp, 605 Swan, Dunkirk, New York.

**STAMPS** Bought, sold, exchanged. Ritchie, Box 743, Watertown, So. Dak.

**80 STAMPS** From 80 different countries, 10c. Reimers, 29 N. LaSalle, Chicago.

**NYASALAND** Protectorate and 25 other British Colonies 4c to approval applicants. Frank Ewing, Box 693, Cleveland, Ohio.

**100 DIFFERENT** British Colonies including scarce old New Brunswick, Newfoundland Canada commemoratives 25c to approval applicants. Reid Stamp Company, 608 Yonge Street, Toronto.

**1000 MIXED** U. S. 25c, pound U. S. 55c. Weatherly, Lakewood, Ohio.

**200 DIFFERENT** 10c, 25 Japan 10c, 60% discount approvals. Covert Stamp, 39 State, Rochester, N. Y.

**100 DIFF.** 10c; 1000 Mixed 60c; 25 diff. U. S. 25c; 1000 hinges 15c; album 60c. Price list and approvals sent with every order. C. Stegman, 5941 Cole Brilliant Ave., St. Louis, Mo.

**1000 UNIVERSAL** Hinges 10c; lists free. Harvey Temple, Decatur, Indiana.

**FREE!!** 15 Pictorial stamps. Postage 2c. F. Roberts, 901 Fourth, Bay City, Michigan.

**EXCELLENT** Mixture 2000 stamps. Large variety including Africa, Asia, Latin America, etc. Price only \$1.00. Longacre Shop, 160 West 42 St., New York, N. Y.

**80% DISCOUNT** Off Scott's many hard to get nineteenth century stamps. References please. Hubert Cadzise, Garland St., Lynn, Mass.

**33 1/2% CASH** Commission, no investment, selling stamps up to most expensive. Price 50% below Scott. Unsold stamps returnable. References. Lux Stamp Co., 865 Fairmount Place, New York.

**RARE** China Airmail showing airplane flying over Great Wall of China; also Vatican City stamp. Nyassa, Morocco—and 51 other fine stamps. All for 5c with request for approvals. R. G. Howard, 245 Waverly Ave., Newcom.

**SIAM** Five free to approval applicants. Bernard Karsh, Middle River, Maryland.

**PACKET** 62 Different from Alaska, Lebanon, Stam, etc., also watermark detector and rare old Hawaiian stamps—all for only 5c to approval applicants. Highland Stamp Co., Newton Highlands, Mass.

**FREE** 6 Different Luxembourg to approval applicants. E. D. Stamp Co., 3905 Forest Park Ave., Baltimore, Md.

**ILLUSTRATED** United States list, price 50c, large complete. United States price list, 1932, free. Stanley Gibbons, 38P Park Row, N. Y.

**300 DIFFERENT** Stamps 20c; 600 50c; 1,100, \$1; 2,000, \$3. Fred Onken, 630 79th St., Brooklyn, N. Y.

**PENNY** Approvals, 5,000 Sudan, Congo, Nyassa, Liberia, etc. Also 14,000 averaging 1 1/2c. Philatelic Exchange, Huntington, W. Va.

**PAPUA** (Lakatol boat), Zanzibar, Iraq, Johore, Lebanon, Transvaal, etc., in our packet 57 different, 5c with approvals and lists. Monumental Stampco, Arlington-203, Baltimore, Md.

**BEST** One cent approvals in America. P. Hand, 1117 So. 60th St., Philadelphia.

**FREE!** Loose leaf postage stamp album at rate of 8 pages each month given with subscription to monthly journal. Send 2c stamp for prospectus. United Stamp Co., Marquette Bldg., Chicago, Ill.

**150 GOOD** Mixed foreign stamps, 3c. Stanton, East Lyme, Conn.

**24 VARIETIES** Cuban stamps, 10 cents. List of stamps free. Chambers Stamp Co., 111P, Nassau, New York City, N. Y.



**560 DIFFERENT Stamps for 25c.** Big collection including Armenia, Andorra, Finland, Spanish Morocco, Kenya, Liberia, Mexico, Nigeria, Quillman, Syria, Victoria, Vatican City and other hard-to-get countries. Catalog value over \$10.00. Price only 25c to approval applicants. Illustrated lists free. Loma Stamp Company, 4231 42nd St., San Diego, Calif.

**FREE—\$1.00 U. S. postage Lincoln memorial free.** If you write for our 56 page price-list of U. S. and foreign stamps, 2,400 illustrations and fine stamps on approval. Hussenamp Stamp Co., 620-3 Olive St., St. Louis, Mo.

**ONLY 5c.** 33 Different stamps including scarce Latinian triangular airmail stamps, 10 airmail, 12 United States (early issues, commemoratives, etc.) and 10 Canada. Approvals and illustrated price-list sent with each order. Curhan Stamp Company, Gloucester, Mass.

**STAMPS Sent on approval at 70% discount.** Reference required. Emory Renoll, Hanover, Pa.

**FREE Outfit!** 52 stamps, hinges, pocket wallet. Postage 4c. Approvals. United Philatelists, South Berkeley, Calif.

**27 LICHTENSTEIN 4c** To approval applicants. Hagen, Box 129, Sioux Falls, S. Dak.

**BOYS Wanted—Everywhere.** Show our big bargain stamp assortments to friends. We trust you and pay you splendid cash commissions. Fast sellers. Earn money with our new plan. Dandy free premium if you write us at once. LeRoy Stamp Co., B20 W. Jackson Blvd., Chicago, Ill.

**"ALTHOUGH My stock of stamps is adequate to take care of business for years to come, yet results were so far beyond my expectations that with the help I had, I was unable to take care of further new customers." Such are the reports received from advertisers using space under this classification. Your offer should do equally as well. For further information as to rates, closing dates, etc., write M. L. Rund, Manager, Classified Advertising, Popular Mechanics Magazine, 200 E. Ontario St., Chicago, Ill.**

#### RARE COINS

**LARGE Copper cent 20c.** Dromgoole, 329 Blaine, San Antonio, Texas.

**OLD Money wanted.** Do you know that coin collectors pay up to \$100.00 for certain U. S. cents? And high premiums for all rare coins? We buy all kinds. Send 4c for large coin folder. May mean much profit to you. Numismatic Co., Dept. H, Ft. Worth, Tex.

**AMERICAN Half dime Confederate State note.** China Box Emperor, last coin and catalog 25c. George Best, Cedar Rapids, Iowa.

**FINE Foreign coins, before 1800.** 3 large crisp notes and catalog 10c. M. Flagg, Box 283, Cedar Rapids, Iowa.

**WASHINGTON Medallions, three types, 20c each.** Washington celluloid buttons 15c. W. H. C. Co., 4343 Sheridan, Chicago.

**PAPER MONEY—100 Different Confederate, Mexico, etc., 79c!** Stamp and coin approvals sent. Tatham Stampco, West Springfield, Mass.

**25 COINS And bills, 25c.** 100 coins and bills, 75c. Oddehon, Box 981, Kansas City, Mo.

**COIN 100 Years old and my catalog, 10c.** Amer. Lincoln, Bradshaw, Neb.

**COMMEMORATIVE Coins for sale at low prices.** Price list and old coin 10c. Towns Davis, Box 1791, Huntington, W. Va.

**UNITED States, large cent, two-cent bronze, three-cent nickel and bargain list, 25c.** Thirteen dates large cents, \$1.00. George Coffin, Greenwood Mountain, Maine.

**UNITED States white cent and bargain selling price list 10c.** Arty, Box 483, Muskegon, Okla.

**20 DIFFERENT Coins 25c; 68 different, \$1.00.** Bischoff, No. Kansas City, Mo.

**100 FOREIGN Coins \$1.00; 10 white cents 65c; Norse American Commemorative half-dollar octagonal medals \$1.65.** S. Drutz, Box 749, Saranac Lake, N. Y.

**SEND 10c For 5 different coins and catalog or 50c for 25 different.** Trover Coin Co., La Fontaine, Ind.

**GET Profit and pleasure in collecting old coins.** Send 10c for large illustrated coin catalog. You'll be delighted with it. Send for it right now. B. Max Mehl, Numismatist, Mehl Bldg., Dept. P, Fort Worth, Tex. Largest Rare Coin Firm in the U. S.

**CALIFORNIA Gold—Quarter size, 27c; 1/2 size 52c; 3c piece and catalog, 10c.** Norman Shultz, Box 746, Salt Lake, Utah.

**OLD Coins, large fall selling catalog of coins for sale, free to collectors only.** Catalog quoting prices paid for coins, ten cents. William Hestlein, 101A Tremont St., Boston, Mass.

**7 DIFFERENT Coins, 11 bills and catalog, 25c.** Creamer's, 1112 Somerset, Baltimore, Maryland.

**2 COINS, 5 Notes and catalogue 10c.** Lester White, Box 66, West Newton, Mass.

**RARE United States and foreign coins, war medals and decorations.** Selling catalogue, 10c. Alexis Mengelle, Colorado Springs, Colorado.

**\$5 TO \$500 Each paid for old coins.** Many very valuable. Keep all old money. Get posted. Send 10 cents for illustrated coin value book, 48c. Guaranteed prices. We buy and sell. Coin Exchange, Box 6, Le Roy, N. Y.

#### CAMERAS AND PHOTO FINISHING

**BARGAINS—Hundreds of them listed in our new bargain book just off the press.** In cameras for still and motion pictures, lenses and other photographic supplies. All guaranteed and sold on ten days' trial or money back if not satisfied. Write for your copy now. It's free. Central Camera Co., 230 South Wabash Ave., Dept. PM3F, Chicago, Ill.

**MOUNTED Colored enlargements that are different.** 5x7, 25 cents; 8x10, 50 cents. Send negative. Gibson Photo Co., 833 Gravesend Avenue, Brooklyn, N. Y.

**MAKE Money with your camera.** New plan, steady income. Amateurs or professionals, anywhere. You can too. Wells Studios, Cleveland, Ohio.

**LEARN "Transography."** Photograph without films. Guaranteed instructions \$1.00. Sample 10c. Koch's Studio, Fruita, Colo.

**TRIAL Offer.** Developing roll 5c. prints 3c each. Beautiful 10-inch enlargement 25c. Young Photo Service, 405 Bertha St., Albany, N. Y.

**FREE Framed enlargements.** Send roll and 30c for 8 prints and coupons for enlargements. Reprints 3c. Perry Photo Co., Box 58, Perry, Iowa.

**QUARTER Buys three enlargements (same negative.)** Force, 2097 Eye, Washington, D. C.

**MAKE Money in photography.** Learn quickly at home. Spare or full time. New plan. Nothing like it. Experience unnecessary. American School of Photography, Dept. 3431, 3601 Michigan Avenue, Chicago.

**FIRST Film developed, six prints and photo calendar from any negative 30c.** Beautifully mounted 8x10 enlargement 40c. Young Photo Service, 405 Bertha St., Albany, N. Y.

**HAVE You a camera? Write for free sample of our big magazine, showing how to make better pictures and earn money.** American Photography, 110 Camera House, Boston, 17, Mass.

**YOUR Favorite kodak picture enlarged, size 5x7, 10c.** Three for quarter, coin. Send best negative (film) today. Address Danner Photo Lab., 221 Securities Bldg., Des Moines, Iowa.

**SPECIAL Trial offer: Developing any size roll 5 cents; prints 3 cents each.** Beautiful 7 inch enlargement 20 cents. Send for special bargain list. Roanoke Photo Finishing Company, 209 Bell Avenue, Roanoke, Virginia.

**MAKE It yourself—Most instructive book develops resourcefulness in men and boys by teaching them to make useful articles.** 300 different things are described, 480 pages, 823 illustrations. Cloth. Price \$3.00. Sent postpaid upon receipt of price or C.O.D. anywhere in U. S. A. Popular Mechanics Press, Room 803, 200 E. Ontario St., Chicago.

#### MOTION PICTURES AND SOUND EQUIPMENT

**BASS Bargaingram No. 208 is ready.** Send 4c in stamps for the greatest motion picture camera, projector and accessories list in the world. A Riden spring motor drive camera, 3.5 lens for \$22.50. 100 ft. Keystone automatic camera at \$35.00. 100 feet of standard Eastman negative at \$3.00. 400 ft. DeVry motor drive 16mm. projector, \$15.50. Hundreds of bargains, text books and accessories. Send four cents at once for your copy to the camera headquarters, Bass Camera Company, 179 West Madison Street, Chicago, Illinois.

**NEW Merchandise—16 M.M. film—travel, comedy, etc., \$8.00 per 400 ft. with reel and hunder can, with sound disc \$14.40.** Eastman 400 ft. Empty spools 49c. 16 M.M. projector \$3.95, with motor \$10.49. Beaded screen \$1.49. Keystone 100 ft. movie camera \$9.85. DeVry 25 M.M. specials: News-reel camera \$89.50, also model 'E' projector \$149.75. Pathe P23.5 movie camera \$9.85 with case. Pathe DeLuxe projector—special \$16.50. "Our Gang," "Aesop" film 49c. Mogull Bros., 1944J, Boston Road, N. Y. C.

**\$1.70 FOR Original photoplay story.** Our sales department sold unknown author's first story for above amount. We revise copyright and submit to studios stories for talking pictures. Being located in the heart of motion picture industry we know production requirements. Established 1917. Free booklet. Universal Scenario Company, 206 Meyer Bldg., Western and Sierra Vista, Hollywood, Calif.

**TALKIE And movie producers are clamoring for new short story ideas, plots, etc.** Perhaps you can write one that we can shape and sell for you. One writer (V.M.) received \$3,000. New York best market. Write now for free booklet, without obligation—How To Write For the Talkies! Daniel O'Malley Company Inc., Suite P, 1776 Broadway, New York.

**16mm. MOVIE Exchange Plan.** 50 cents to exchange 100 foot film. 30 cents to exchange 50 foot film. Send for large lists of films. Exclusive Movies, 732 S. Wabash, Chicago, Ill.

**500 FEET 90c. odd reels \$1.25, plus postage.** Lists. Hoffman Film Service, 57 Broad, Albany, N. Y.

**16mm. PICTURES, \$3.85.** Keystone Cameras, \$12.50. Titles, Lorenz Pictures, Madison, Indiana.

**DON'T Buy until you get our bargain list.** 16mm and 35mm silent and sound. Jones Hlve. Co., Movie Department, Shamokin, Penna.

**BUY From reputable film dealers.** Honesty, quality. Chicago Film Dealers, 6801-03 So. Carpenter, Chicago.

**16MM MOVIE Cameras and projectors for the home, school, church and business organization.** Literature free. D. F. Elder & Company, Dept. A-3, Chelsea, Mass.

**TIME Counts in applying for patents.** See pages 134 and 135. Clarence A. O'Brien, Registered Patent Attorney, Washington, D. C.

**FILMS 60c 100-Ft. list.** Edgar Film Supply, Woodville, Mass.

**16MM CHAPLIN, Mix, Fairbanks films, 75c each.** Lists. Home Movies, Box 32, Easton, Pa.

**16 AND 35MM Film.** Savarese, Box 493, Hillsdale, New Jersey.

**500 FEET 35MM 95c.** 16MM cheap. Lowell Films, Allentown, Pa.

**16MM FILM Every description sacrificed.** Odd lengths two cents foot. Home projectors \$7.50. Thousand feet 35MM film \$1.00. Eversolor Films, Cincinnati.

**SPECIAL DeVry G 16M millimeter projectors.** List \$88.00. Our price including 100' Chaplin films \$32.50. Factory packed. Brand new. Milton Mendelwager, 192 Ave. B., Bayonne, N. J.

**DE VRY 16M Cameras \$30.00, projectors \$28.00.** Special wholesale price to dealers. 100 foot 16m negative \$4.50. 16m films 2c foot. 35m cameras \$25, projectors \$35, comedies \$4, 35m negative stock 2c foot, kodak \$1. Ray, 820 - 8th Ave., New York.

**FILMS \$1.00, Projectors \$25.00, 10c coin for lists.** Box No. 6, Rosedale, Kansas.

**WORLD'S Greatest "Passion Play" 16 MM. (new) 5 reels.** Rent or purchase. Write Henshaw Film Co., 37 Church Street, Boston, Mass.

#### TRADE AND TECHNICAL SCHOOLS

**BLUE Print reading.** Easy to learn. Write Columbian School, Drexel Building, Philadelphia.

**GUSTAS School trains thoroughly in shoe rebuilding, hat renovating, clothes pressing in short time.** Gustas, 7 W. Division, Chicago.

**LEARN Watch repairing.** Hiles School, 5330 Mission St., San Francisco.

**SHOP Notes for 1932.** Get your copy now. Only a limited edition. Contains all the articles published in the Shop Notes department of Popular Mechanics Magazine during 1931. Send 50 cents. If you want the set of Shop Note books consisting of 7 volumes including the 1932 number and 6 others issued previously we will send them C. O. D. for \$3.50. Popular Mechanics Press, Room 808, 200 E. Ontario St., Chicago.



## TELEGRAPHY

**LEARN** Wireless (Radio) and Morse Telegraphy. School, oldest, largest; endorsed by telegraph, radio and government officials. Expenses low—can earn part. Catalog free. Dodge's Institute, 11 Street, Valparaiso, Ind.

## BUSINESS OPPORTUNITIES

**THE** Plastex industry needs manufacturers on small scale for big production of Art Goods, Novelties, Souvenirs, etc., in Plastex and Marble imitation. Experience unnecessary. 5c material makes \$1 articles. Rubber moulds furnished for speed production. We place orders and buy goods. Small investment brings big returns. Interesting booklet mailed free. Plastex Industries, Dept. A, 1985 Washington Avenue, New York.

**BRAND** New product, just out! Mechanical wall cleaner for homes, banishes house-cleaning drudgery. Big season now on. Simple, easy to use. Cleans wallpaper, painted walls, window shades, etc., like magic. No standing on chairs or dangerous stepladders necessary. Breathtaking demonstration. Whirlwind seller. Low price. Up to 170% profit. Also 47 other fast selling household specialties. Outfit free. Write Kristee Mfg. Co., 1432 Bar St., Akron, Ohio.

**LEARN** Marbleizing; start a business yourself. No expensive machinery needed, with our new process. Dry powder chemical and water, applied to any concrete products, wood, wallboard. Resembles polished marble, all veining, cheaply applied. (See samples.) Make artificial granite perfectly. Also best floors, ever old or new. Novelties, statues, etc. Unlimited uses and markets. Send dime for samples. Cowell Institute, Grayling, Mich.

**CLEAN** Upholstered furniture. Instructions 50c. Lloyd Cleaners, 4th Spring, Seattle, Wash.

**FIFTEEN** Practical money making ideas 50c. Lasco, 329 Republic Building, Seattle, Wash.

**"SCHEMER,"** 32p monthly, prints big \$-getting schemes, business starters, formulas. Subscriber reports \$10,000 from one copy. Another \$25,000 from three. Now, three special copies, only 25c. Patterson, Publisher, Box 719, Alliance, Ohio.

**OPERATE** Chain of vending and amusement machines. Be independent for life. Start small, grow big. P. Goodbody, 1826 East Main Street, Rochester, N. Y.

**START** Business, sharpen Gillette. Probak blades, spare time. Send dime for plan, ten blades for sharpening. F. Karmann, 115 Miller Ave., Muskegon, Mich.

**MONEY** Mailing circulars at home. 10c brings particulars, catalogues, magazines, year. Pennell Standard, Corning, Ky.

**INCORPORATE** Delaware preparatory financing invention, business. Retain perpetual control. Booklet, forms free. Universal Corporators, Dover, Del.

**MAIL** Trade books. Annual mail order dealers' year book, bristful of money making ideas and valuable information. Copy 50c, 4, \$1.75. Fred Hettick, Secretary, Mail Order Dealers' Ass'n., Bismarck, N. Dak.

**THREE** Red stamps bring our priceless literature on profitable home employment. Albert Frelich, M3842 Highland, St. Louis, Mo.

**WHY** Work for others when you can have a business of your own? We will sell you a formula for making fine auto polish, or top dressing, for \$2.00, or \$3.00 for both formulas. This is not a cheap product, but very good. Voero Chemical Co., 3515 Elston Ave., Chicago, Ill.

**SUCCEED** Making, selling your own products, using our guaranteed formulas. List 10c. Timber Products, Box 396, Station A, Champaign, Ill.

**SUCCEED** With your own products. Make-sell them yourself. Formulas, processes, trade-secrets, analytical service. Catalog free. B. Thaxly Co., Washington, D. C.

**SPECIAL** Enterprises—Eye-opening magazine of money-making ideas! Mail order plans! Capital raising tips! Formulas! Stunts! Opportunities! New—different—original! Sample copy and valuable information 10c. Sterling Press, Plainville, Nehr.

**810-855 WEEKLY** Mailing circulars, no canvassing. Samples, instructions 25c. Popperis, 2140 N. Carlisle, Philadelphia.

**BUILD** Your own floor sanding machine; sanding drums sold separate, six, seven, eight inches wide, aluminum construction, knurled clamp rods tighten paper, rubber covered, complete with hollow shaft and bearings. Gha. Box 2582, Boston, Mass.

**OPPORTUNITIES.** Unusual, fascinating, profitable. Particulars free. Economy Sales Co., Manchester, Iowa.

**MAKE** \$75.00 Per week at home, making engravings. We furnish equipment and instructions. Aurora Photo-Engraving School, Aurora, Mo.

**DOLLARS** In "Fixit." Instructions \$1.00. Particulars free. Houglates "Fixit" Service, 1305 N. Elmwood, Pasadena, Calif.

**NEW** Mail-order opportunity. Excellent profits. Address Roland System, Wareham, Mass.

**COMPOSITION** Floor making earns industrious men \$12 and more daily if used as trade. Or make business of it with profits up to \$10,000 yearly. Openings everywhere. Semi-Tile, Box 43, Hollis, N. Y.

**MAILORDER** Men, beginners, oldtimers, 9 wonderful big plans. Get money easily, quickly, steadily. Complete set \$3.00, guaranteed. Sample plan 50c. American Sales, Box 1278P, San Francisco.

**\$100.00 PROFIT** In every town. Clever advertising stunt. Steady employment. Enclose 10c (stamp) for "Profit Plan." Arrow Signs, Hutchinson, Minnesota.

**RAISE** Frogs. "French Frog Farming" tells how. Postpaid \$1.00. Lee Publishers, Monterey, Calif.

**MANUFACTURE**—Sell your own beverages, extracts, soaps, perfumes, candles, etc. Free booklet. Truway Laboratories, 1333 Walton St., Chicago.

**108 MONEY** Making opportunities. Write Jensen, 4907 Race Ave., Chicago.

**TIME** Counts in applying for patents. See pages 134 and 135. Clarence A. O'Brien, Registered Patent Attorney, Washington, D. C.

**EARN** Up to \$25 weekly or more growing mushrooms in your cellar or shed. Illustrated booklet free. American Mushroom Industries, Dept. 845, Toronto, Ont.

**FURNITURE** Refinishing; job painting; handyman shop. Start yours on nearly nothing; mostly all profit. John Breeland, 1439 South Ninth, Philadelphia, Pa.

**BELL** Mail order business at home will bring you many dollars profit. Start spare-time. Complete system explained free. Address Mail Order Success Club, Murfreesboro, Tennessee.

**25 BEAUTY** Formulas \$1.00. Postpaid. Edgar Laboratories, Woodville, Mass.

**CHARTERS;** Delaware; best, cheapest; free forms. Colonial Charter Co., Wilmington, Del.

**EARN** Large income with "chain" of peanut-chewing-gum vending machines. Start small capital. Particulars free. Robbins Corp., DeKalb and Broadway, Brooklyn, N. Y.

**LEARN** The collection business. Good income, quick results. Interesting booklet. "Skillful Collecting" free. National Collectors Assn., Long St., Newark, Ohio.

**START** A mail order business. Dollar saver. Booklet and literature tells how. Dime. Claxton Dawson, Coshucon, Ohio.

**WANTED** Reliable men or women for indoor work. Puffert Enterprises, Douglas, Wash.

**POPCORN** Machines \$15 up. Money makers. Northside Co., 2117 Harding, Des Moines, Iowa.

**"TIMELY** Tips" moneymaking plans! Opportunities! Three sample copies 10c. Elite Magazines, 1821 East 101st, Cleveland, Ohio.

**MIRRORS** Resilvered at home. Costs near 5 cents per square foot, you charge 75 cents. Profitable business plating like new brass, worn-off autoparts, reflectors, tableware, stoves, etc. Outfits furnished. Details free. Sprinkle Plater, 137. Marlon, Ind.

**MAIL** Order business fascinating and profitable. Many earn thousands yearly. Begin small. No canvassing, no personal contact. Inside pointers from 50 years experience. Send quarter for book, also batch of mail order information. R. Breniser, 257 S. 21st, Philadelphia.

**WHOLESALE** Directory 300,000 articles 10c. Other valuable information, Moran Company, Wareham, Massachusetts.

**LEARN** To make men's ties. Quick money for smart people. No canvassing. Pattern and complete instructions. Send \$1.00 to Hty Bitty Tie Shop, 350 Montgomery Street, Portland, Oregon.

**A BUSINESS** of your own making—Sparkling Glass Name and Number plates, Checkboards, signs. Big book and sample free. E. Palmer, 510. Wooster, Ohio.

**MAKE** Your own products. Employ agents yourself. Toilet articles, soap, extracts. We furnish everything. Valuable book free. National Scientific Laboratories, 1950 W. Broad, Richmond, Va.

**FIFTY** Successful mail-order propositions. Address. K. Home, 3949 Metropolitan, Chicago.

**AMATEUR** Cartoonists: Sell your work. Write Smith's Service, PW1194, Wenatchee, Wash.

**SELL** By mail. Books, novelties, bargains! Large profits. Particulars free. B. Eifes, 525 S. Dearborn, Chicago.

**ARTIFICIAL** Marble sanitary flooring, instructions covering wood or cement flooring 1/2 inch thick, fireproof, all colors, low cost. Ornamental casting, concrete plaster papier-mache decorations, garden furniture, statuary, flexible molds, particulars and illustrations free. Chris. Mahler, Elmont, N. Y.

**CHEMICAL** Expert will furnish formulas and trade secrets. All lines. Lists free. W. L. Cummings, Ph. D., 228 Gordon Ave., Syracuse, N. Y.

**BIG** Money at home plating auto parts, reflectors, mirrors, chandeliers; by new method; experience unnecessary. Outfits furnished. Gunmetal Co., Ave. N, Decatur, Ill.

**FREE** Booklet describes 67 plans for making \$20-\$100 weekly in home or office business of your own. Elite Co., 84 Elizabeth St., New York.

**UNUSUAL**—Uncommon specialties always sell best. Make these yourself from Miller's guaranteed formulas. Why work for others when others can be working for you? Latest eye-opening literature brings you many specialty propositions for you an independent business. Miller Chemist, 705-K Chemical Bldg., Tampa, Fla.

**THAXLY** Formulas produce perfect products. All lines. Catalog free. B. Thaxly Co., Washington, D. C.

**MAKE** Artificial marble, colorful glossy tiles, no polishing; rather uncanny. Novelties, tabletops, bookends, floors, whetstones. Hard, inexpensive, fireproof, enamels wood. Secret cement methods. Amazing samples 2c. John A. Pynn, 945 Grande Vista Drive, Los Angeles, Calif.

**MAKE** Poultry Pay. Learn how to produce phenomenal layers by paying more attention to breeding of fowls. James Dryden, authority, tells how in his book. 416 pages. Over 300 illustrations. Price \$2.00. Sent postpaid upon receipt of price or C. O. D. anywhere in U. S. Popular Mechanics Press, Room 308, 200 E. Ontario St., Chicago.

## CHEMISTRY

**BECOME** Trained chemist. Thousands of opportunities—fascinating career. Learn at home. Complete experimental laboratory outfit given. Write for big free book. Chemical Institute, 19 Park Place, Dept. P-332, New York.

**JOIN** The American Amateur Chemists Society. 10,000 word journal and particulars 10c. 323-B, North Sramore, Lansing, Mich.

**HANDBOOK** For chemical experimenters, illustrated 50c. Experiment booklet 15c. 1932 chemical catalogue 10c. General Chemical Co., Reading, Pa.

**CATALOG** listing 2,500 illustrations chemists' supplies, 5,000 chemical, 1,000 scientific books sent for 50c. Laboratory Materials Company, 643 E. 71st St., Chicago, Ill.

## FORMULAS AND TRADE SECRETS

**GUARANTEED** Formulas, recipes, processes. Expert analysis. Catalogue free. Industrial Institute, Dept. 23, 64 West Randolph, Chicago.

**WONDERFUL** Formula. Make and sell your own skin lotion. Big profits. Send 25c silver. William H. Bicket, Dinsdale, Iowa.

**EXTRA** Money making photo frames with wood plastic. Formulas and instructions guaranteed, \$1. Tinker-Wood Works, 1823 Payne Ave., Cleveland, Ohio.

**NEWEST** Tested formulas. Catalog free. This month's special—"Save-a-Sole" formula \$1.00. Grinstead, Chemist, Edwardsville, Illinois.

**EXTRA** Money making photo frames with wood plastic. Formulas and instructions guaranteed, \$1. Tinker-Wood Works, 1823 Payne Ave., Cleveland, Ohio.

**MANUFACTURE.** Ten good formulas 50c. Lasco, 329 Republic Building, Seattle, Wash.

**FIVE** Cleaning formulas 50c. Lloyd Cleaners, 412 Spring, Seattle, Wash.

**SUPERIOR** Formulas—for real business building products. Skilled advice. Expert analysis. Atlantean Research Laboratory, 1501 Euclid, Cleveland.



**ARTIFICIAL Marble.** Formula 50c. All formulas 50c. Catalog free. T. Huffman, Room 101, 1518 Wilson, Chicago.

**SUCCEED** With your own products. Make-sell them yourself. Formulas, processes, trade-secrets, analytical service. Catalog free. B. Thaxly Co., Washington, D. C.

**500 VALUABLE Formulas 25c;** circular free. Harry Teeple, Decatur, Ind.

**FREE Catalogue,** formulas, analysis. Hertstein, Chemist, 206 Prospect, Grand Rapids, Mich.

**LATEST Improved formulas,** \$1.00 each. List free. Persian Laboratories, Bay City, Mich.

**FORMULAS—Our literature** will surprise you. Belfort, 4042 N. Keeler, Chicago.

**FORMULAS:** All beverages, gums, flavors, extracts. Manufacturing everything. Interesting valuable information free. The Formula Co., 5th Ave. and Broad, Seattle, Wash.

**1,000,000 FORMULAS,** Industrial facts, tables, processes, rules, trade secrets, and calculations for all kinds of Trades and Businesses. Book—"Moore's Assistant"—1016 pages. Sent postpaid for \$2.00. Ogilvie Publishing Co., 57 Rose St., Dept. 22, New York.

**FORMULAS All kinds.** Catalog free. Clover Laboratories (P), Park Ridge, Ill.

**FREE Formulas—Free materials** making \$32.00 worth of guaranteed highest class specialty-necessities. Thirty-third unequalled anniversary offers explains all. Miller, Chemist, 1701-G Jetton, Tampa, Fla.

**500 FORMULAS** And big illustrated catalog 25c. Ideal Book Shop, Park Ridge, Ill.

**MAKE Your own products.** Employ agents yourself. Toilet articles, soap, extracts. We furnish everything. Valuable book free. National Scientific Laboratories, 1930W, Broad, Richmond, Va.

**10,000 MONEY-MAKING Formulas.** Tells you how to make and sell almost everything under the sun; cosmetics, mullage, anti-freeze solutions, battery solutions, beverages, cheese, chewing gum, cleaning preparations, extracts, hair preparations, inks, bluing, leather polish, mirrors, perfumes, polishes, typewriter ribbons, carbon paper, washing powders, liquid soap, and hundreds of other profitable articles. Send no money. Just write a postal for "Hensley's 20th Century Book of Formulas." Pay postman postage and \$1. Popular Mechanics Press, 200 E. Ontario St., Room 802, Chicago.

#### AGENTS WANTED

**I START Men** in a grocery business a new easy way. You use my money. Don't need to put up a penny of your own cash for stock. Expansion program now opens up many desirable opportunities also established trade. Hustlers make good money from the start increasing rapidly as they learn the business. Not a "chain" proposition but your own business. Buy on credit. Give credit if you wish. If honest and need more money write at once for application and details to McCannon & Co., Room L-6003, Winona, Minn.

**BIG Money** selling shirts, ties, underwear, dresses, hosiery, raincoats, coveralls, pants, belts, play suits. Sales kit free. Nimrod Co., Dept. 8, 4922-28 Lincoln Ave., Chicago.

**GUARANTEED Hosiery—At lowest market prices.** Men's latest fancy hose—doz. \$1.25-\$1.90, ladies' fashioned hosiery—doz. \$1.90-\$2.90. Catalog free. The Superior Hosiery Company, Dept. 34, New Haven, Conn.

**33% COMMISSION.** 1000 Business cards, three colors, only \$1.50. Including genuine leather case. Outfit free. U. S. Business Card, 480 Canal Street, Dept. CC-14, New York.

**SUCCEED** With your own products. Make-sell them yourself. Formulas, processes, trade-secrets. Analytical service. Catalog free. B. Thaxly Co., Washington, D. C.

**ASTHMA Sufferers** want your demonstration for latest invention for relief. Big profit, no investment. George Erdman, Hudson, N. Y.

**SEND Me** your name and address and I'll mail you absolutely free full details of a successful money-making plan that is bringing others \$10 to \$25 a day. Albert Mills, 1546 Monmouth, Cincinnati, O.

**MAKE Your auto** look like new. Dri-Cleanit removes mud, grease, all one operation. No soap or water used. Cleans car for about 10c. Free sample. Agents wanted. American Accessories Co., Desk D31, Cincinnati, Ohio.

**WANTED—Dealers.** Selling experience unnecessary, but only reliable people need apply. We supply everything—products, sales outfits, sales and service methods that get the most business everywhere. Superior Rawleigh quality, old established business, lowest prices, guarantee of satisfaction or no sale, makes quick sales. 250 farm and home necessities all guaranteed best values. If you are willing to work steady every day for good pay, write for information how to start your own business with our capital. W. T. Rawleigh Co., Dept. C-R-PPM, Freeport, Ill.

**THAXLY Formulas** produce perfect products. All lines. Catalog free. B. Thaxly Co., Washington, D. C.

**GOOD Paying job** open as local representative, old successful manufacturer selling direct to wearer. Sensational values pants, breeches, coveralls, shopcoats. Largest line in field. Belt free with every 3. Big cash commissions. Outfit free. Longwear, Dept. Z3, 489 Broome St., New York.

**REPRESENT Manufacturer** of shirts, ties, hose, underwear. Beat store competition on price and value both. Startling free offers make orders come easy. You earn big money. Cash commissions, free shirt offer, cash bonuses. Write today for giant outfit free! Dept. M30, Albert, 860 Sixth Ave., New York.

**CASH Paid** for butterflies, insects. See Sinclair Display Advertisement on page 12.

**BIG Profits** selling groceries, motor oils, paints, stock minerals. Sample case free. Lovern & Brown, 1602-C So. State, Chicago.

**STRANGE Ironing cord.** Prevents scorching. Saves electricity. Abolishes kinks, snarls. Approved by Good Housekeeping. For telephones also 200% profit. Samples furnished. Neverknot, Dept. 3-A, 4303 Ravenswood, Chicago.

**MEN, Women** wanted to represent manufacturer locally. Earn big money. Pleasant work showing shirts, ties, underwear, hosiery. Guaranteed one year. Amazingly low priced. Sensational merchandising idea gets orders. No experience. Free sales outfit. Dept. J3, Quaker, Broadway and 31st Street, New York.

**AMAZING New metal electric sign.** Automatically flashes electric designs in brilliant, illuminated Neon effect. Sensational sight seller, \$2.95 retail. Dent, 111, Red Lion Co., 215 Fourth Ave., New York.

**300% PROFIT Selling Mystery Gas Lighter.** Retail 25c. Costs you \$1.00 doz. Sample free. Square Deal Mfg., Desk PM-29, Bradford, Pa.

**ELECTRIC Water heater—New.** Heats water instantly. Pocket size—retails \$3.75. Two minute demonstration makes you \$1.95 profit. Lux-Viel, Dept. 37, Elkhart, Ind.

**BUY 900,000 Articles** wholesale. 300 jobbers, manufacturers directory 25c. Arts, B-1611-M, Denver.

**MARVELOUS Chemical cloth,** cleans, polishes all metals instantly without liquid, paste, powder; record-breaking seller to housewives, stores, offices; 300% profit; sample free. Shef. D. Mfg. Co., Weehauken, N. J.

**NEW Principle lifetime stropper** for safety razor blades. Latest out. Costs few cents. No cranking—no effort. Amazing free offer to workers. Park Specialties, 219 Park Place, Brooklyn, N. Y.

**NEW Hemstitcher,** ragmaker, darning, embroidery-guide. Fits any sewing machine. Retail 50c and dollar. Sample dime. Agents, demonstrators wanted everywhere. K. J. Manufacturing, 648 N. Vermont, Los Angeles, California.

**SELL Blades,** notions, novelties, toiletries. Our sensational prices challenge world. Free catalogue. Mills Sales Co., 901 Broadway, New York, or 37 South Wells Street, Chicago.

**\$10 EARNS \$26 Weekly.** Presto sharpener puts keen edge on dullest scissors. Quick demonstration sells it. Day's supply carried in your pocket. Sells 25c. Cost \$1.20 dozen. Gross \$10. Williams Corp., 32 Williams Bldg., Montclair, N. J.

**"BRING Back Beer and Prosperity."** Sell these signs. Sample dime. Hussman, 2240 Blackrock Ave., N. Y.

**SELL Made-to-measure raincoats** for men, women, children from \$3.95 up; big weekly income. Outfit free. Goodgear Rainwear Co., 18 West 22nd St., New York City.

**EARN Big, steady cash,** representing old established manufacturer, selling fine shirts, ties, underwear, hosiery direct to wearer. Free shirt, tie offer. Free besides cash bonuses regularly. No investment required. Expensive sales outfit free. Write today. Dept. L3, Roscliff, 1237 Broadway New York.

**FAST Sellers!** Metallic polishing cloth, new can opener, gas lighters. Other big profit items. New low prices. Superba Company, A103, Baltimore, Md.

**AGENTS Wanted.** To sell Phenoris (a real tooth powder) made by pharmaceutical house 40 years experience. Perhaps your territory is available. Send 10c for sample. Easily sold. R. J. Strassenburgh Co., Rochester, New York.

**AGENTS Sell to housewives.** Cost 2 1/2c, retail 10c. Particulars. Miller Company, 505 East 175 St., Bronx, New York.

**EXPERT Valued** our \$3 genuine Bluffash gem \$900.00. Dazzling brilliancy, flashing rainbow fire assures big, quick profits. Guaranteed 20 years. \$5 sample case free. Mexican Gem Co., Suite PM, Monterey, Calif.

**400% PROFIT Selling signs** used everywhere. Largest selection, wonderful repeat business. \$1.00 worth samples, 25c; 50 signs \$2.00; 100 signs, \$5.00. P. Franklin Co., 3223 Third Ave., N. Y.

**AT Last,** scratch eraser that heals scratches on finest furniture. Rub lightly—scratch disappears. Sells on demonstration. 100% profit. Agents being appointed. Write, Freemans, 696 So. Broadway, Denver, Colo.

**100% PROFIT In new everlasting match lighter.** No flint or friction. What makes it light? No wind can blow it out. Retail 50c. Sample and sales plan 25c. New Method Manufacturing Co., Box PM-3, Bradford, Pa.

**TWO Superior formulas.** Business building products. Special introductory price \$1.00. Expert analysis. Skillful personal guidance in establishing your own business. Atlantic Research Laboratory, 1501 Euclid, Cleveland.

**ELECTRIC Water heaters.** Guaranteed shock proof. Send \$1.25 for agents sample. Free circulars. Arline, 6652 Wentworth, Chicago.

**\$25.00 REWARD** For any corn Great Christopher "Positive" Corn Cure cannot remove; relieves painful bunions; removes warts, moles, callouses; earn \$5-\$8 daily; sample 25c, particulars free. Reliable Specialty Corporation, Buffalo, N. Y.

**NEW, Profitable—Sell auto step mats.** Quality rubber with owner's name molded white. Details free. Ebonite Products, Dept. C-40, 895 Main, Akron, Ohio.

**MAPS—Big profits,** no competition, experience unnecessary. Every office and retailer prospect. New proposition never before offered. Sells itself. Mid-West Map Company, Aurora, Missouri.

**AGENTS Sell** the Dancing Bell Hop, World's greatest clog dancer. Sample \$1. R. Sammelson, 224 Stevens St., New Brunswick, N. J.

**EVEN Poor people** must keep clean. Brushes, brooms, mops sold by the millions. Sell them in your own name. 300 per cent profit. Write for proposition. Wire-Grip Sanitary Brush Corp., 41 E. 11th St., New York.

**GENUINE Gold Leaf Letters** anyone can put on store windows. Guaranteed to never tarnish. Large profits. Enormous demand. Free samples. Write today. Metallic Letter Co., 438-D North Clark, Chicago.

**MANUFACTURER Of plastic leather** wants agents. Resoles shoes—rubbers—8c pair. Thrives on depression. Details and sample. E. W. Parker, Pierce Ave., Salem, Mass.

**MEXICAN Hand made** leather pictures. Most artistic, beautiful, attractive. Novelty work. Great margin of profit. Send 25 cents for \$1.00 worth sample and details. Mexican Art, Apartado 1303, Mexico City.

**ELECTRIC Sign,** new process on glass, any wording; low price. Twinad, 143 West 22nd, New York.

**EVERY Loving mother** wants her baby's first shoes permanently preserved by "Metalizing." Makes beautiful, lasting mementos. Excellent commissions. Williams-Craft Co., Dept. M, Charleston, S. C.

**AGENTS Sell guaranteed AvoidArun** on hose and lingerie. Something women buy. 200% profit. Sample 25c. Western States Distributing Company, 815 South Hill, Los Angeles, California.

**WONDERFUL Opportunity** to make big money with sensational new invention. Sells to housewives, autoists, garages, gas stations, etc. Large profits assured. Steady earnings. See page 55 this magazine, or write Gyro, Dept. CC14, Bloomfield, New Jersey.

**TOILET Soaps,** creams, shampoos. Enormous profit. Williams Mfg. Co., North Bellmore, N. Y.

**NEW Invention!** Fastest-selling household necessity. 25c. Big profits. Gilbert Supplies, 16 East 23rd, New York.



**SELL Hasty-Cake** maker, the greatest staple food discovery in 20 years. Enough in 25¢ package for delicious three-layer cake. Two flavors, devil's food, oriental spice. A fast, sure repeater. Average home uses two cakes per week. Half million packages sold in last month. You can earn up to \$10 per day. No experience needed. We furnish capital, free canvassing license, guarantee 100% satisfaction to everybody concerned. 3000 territories already assigned. Write today for your town. Hasty-Cake, A2367 Archer, Chicago.

**EASY** As pie to sell Christy's polishing cloth. Works like magic. Everybody buys. Big profits. Free sample. Write Christy, 6767 Lakeway, Newark, New York.

**\$20 DAILY** Easy. Auto seat and furniture covers. \$2.25 up. No competition. Free outfit. Quality, 1834 North Ave., Dept. 317, Chicago.

**BLIND** Women's needles, size 3/8, 10c. Wm. Oatesby, Vandalia, Ill.

**GENERAL AGENTS**—New line food flavors, toilet preparations made under your own label. A hit! Write quick. Diversified Products, Box 638, Toledo, Ohio.

**300% PROFIT** in new "20-in-1" kitchen necessity. Retail 25¢. Costs you \$1.00 a dozen. Sample 15¢ to cover cost of mailing. New Method Co., Nu-Method Bldg., Desk PMS-3, Bradford, Pa.

**START** Business yourself? Tested formulas; catalog free. This month's special—"Polmetalshine" polishing cloth formula \$1.00. Grinstead, Chemist, Edwardsville, Illinois.

**PORTRAIT** Men! We finance your sales and arrange for delivery and collections. An absolutely new red-hot proposition that is going over big even in these times. Big commissions! Crew managers investigate. Write or wire at once, territory being closed fast. J. D. Keating, Salesmanager, G-36 E. Randolph, Chicago.

**NEW** Discovery. Washes clothes without rubbing. Cleans everything. Sells 25¢. Profit 17¢. Sample free. Besco, 4315P Irving Park, Chicago.

**"POWDERED** Silk" America's best hand cleanser sells fast to everybody. Removes grease, stains, ground-in dirt. Big profits. Sample free. Adams Manufacturing Co., Dept. A, Boone, Iowa.

**MEN**—Women \$3 to \$6 daily. Selling 25¢ household necessity that repeats. Three to ten sold in every home. Free sample. Write Pure Company, Dept. B-271, 3107 Pine St., St. Louis, Mo.

**BIG** Profit putting our genuine gold leaf sign letters on store windows. Experience unnecessary. Samples. Consolidated, 69-T West VanBuren, Chicago.

**NEW** Changeable sign sells to stores for \$1.00. Agent's profit 300%. Particulars free. National Sign System, St. Louis, Mo.

**MAKE** Your own products. Employ agents yourself. Toilet articles, soap, extracts. We furnish everything. Valuable book free. National Scientific Laboratories, 1950W Broad, Richmond, Va.

**AGENTS** For handkerchief original powdered handsoap. Approved Good-Housekeeping. Everybody customer. Fine opportunity for hustler. Sample free. Solar Products, J-2144 So. Troy, Chicago.

**OUR** Free gift deals with our toilet goods assortments, food products, polishes, etc., get the business. 150 repeaters—100% profits. Also cash prizes to best producers. E. M. Davis, Dept. 260, 560 Randolph, Chicago.

**EARN** Extra money at home. No canvassing. Hetzel, 892 Garden, Hartford, Conn.

**RAZOR** Blades, hollow ground, improved double edge, ten cent packages, carded, easy selling. Sold everywhere. Standard Safety Razor, Pittsburgh, Penna.

**MAKE** Your own products. Employ agents yourself. Toilet articles, soap, extracts. We furnish everything. Valuable book free. National Scientific Laboratories, 1950W Broad, Richmond, Va.

**"ANTI-STEAM"** Keeps windshield clear of steam, frost, rain, snow. Remarkable seller. Exceptional opportunity. Free sample proves this. Walter S. Doe & Co., Kent, Ohio.

**SELL** Stores carded razor blades, etc. Lerrac Products, Albany, N. Y.

**FREE** "Booklet describes money making opportunities," new ideas, original plans, money making secrets and other valuable information. None require peddling or outfits. Elite Co., 84 Elizabeth St., New York.

**ANYONE** Can make signs with the easiest sign letters on the market. Real paint. No brush necessary. Free sample. "Balco," 1045 Washington, Boston, Mass.

**A BUSINESS** Of your own—Making sparkling glass name and number plates, checkerboard signs. Big book and sample free. E. Palmer, 512, Wooster, Ohio.

**AGENTS**—Clever Invention! Inkspoon makes every pen a fountain pen. Past office seller; big profit, demand increasing everywhere. Exclusive territory offered. Sample free. H. Marul Company, Tribune Bldg., New York, N. Y.

**AGENTS** Everywhere making money with our line of kitchen specialties, demanded in all homes. Big earnings possible. Write today for details. P. Seed Filler Co., 353 Broadway, New York.

**MAKE** Your own products. Employ agents yourself. Toilet articles, soap, extracts. We furnish everything. Valuable book free. National Scientific Laboratories, 1950W Broad, Richmond, Va.

**FREE** "Booklet of money making opportunities," new ideas, original plans, money making secrets and other valuable information. None require peddling or outfits. Elite Co., 84 Elizabeth St., New York.

**MIRRORS** Resilvered at home. Costs near 5 cents per square foot, you charge 75 cents. Profitable business plating auto parts, reflectors, tableware, stores, refinishing metalware, etc. Outfits furnished; details free. Write Sprinkle, Plater, 128, Marlon, Ind.

**POLMET** Polishing Cloth removes tarnish from all metals without the use of liquid, paste or powder. Our agents say it sells like "hot cakes." Retail 25¢; sample free. Gale & Co., Inc., 15 Edinboro St., Boston, Mass.

**PHOTO** Medallion men and women, the largest line of photo novelties in the world. Lowest prices, quickest service. Send for catalog showing over 200 money makers. Gibson Photo Jewelry Co., Inc., 833-837 Gravesend Ave., Brooklyn, N. Y.

**PROFITABLE** Home business. Legitimate. No canvassing. Maywood Publishers, P-923 Broadway, New York.

**WOULD** You like to make \$10 to \$15 a day selling our line of toilet preparations? We want agents in every town; men, women, students; whole or part time. Write for free sample outfit offer. Hinds Perfume Co., 515 E. 47th St., Chicago, Ill.

**MAN** in each town to plate auto parts, reflectors, bathroom fixtures, refinish beds, mirrors, chandeliers; by new method. No capital or experience required. Simple plan of manufacturing at home starts you in big money-making business. Outfit furnished. Free particulars and proofs. Gun Metal Co., Ave. H, Decatur, Ill.

**BIG** Money and fast sales. Every owner buys gold initials for his auto. You charge \$1.50; make \$1.45. Ten orders daily easy. Write for particulars and free samples. American Monogram Co., Dept. 40, East Orange, N. J.

**AGENTS:** Stamping names on pocket-key protectors. Sample check with your name and address, 25¢. Stamping outfits, Emblem checks, check-fabs, name plates. Hart Mfg. Co., Desk 2, 303 Degraw St., Brooklyn, N. Y.

**REPLATE** Brass worn-off automobile parts, reflectors, bath room fixtures, worn spoons, forks, etc., with pure silver. Looks like new. Use U-Kan-Plate Polish. Positively no mercury; \$1.00 half pints. Postpaid. Satisfaction guaranteed. Agents wanted. Dept. A, U-Kan-Plate Co., Philadelphia.

**SOMETHING** The housewives want. A signed guarantee to save money and time in cooking. No competition. 400% profit. No license required. Station C, Box 25E, San Diego, Calif.

**AGENTS**—Engraved name plates, signs, number plates, etc., easily sold with large profits. Brett Bros., Winthrop, Mass.

**CALIFORNIA** Perfumed beads, selling like hot cakes. Agents robbing money. Catalog free. Mission Factory, P. 2328W Pico, Los Angeles, Calif.

**THIS** Advertisement may make you thousands of dollars, if you write immediately for my "Eye-Opening" literature describing guaranteed formulas; valuable trade processes, moneymaking information how to easily make the world's best-selling specialties. All lines. Investment small. Profits immense! Start in your home, room or office. Make the good money you're entitled to. Dr. Liscombe Miller, Chemist, Tampa, Fla.

**WE** Start you without a dollar. Soaps, extracts, perfumes, toilet goods. Experience unnecessary. Carnation Co., 641, St. Louis, Mo.

**SELL** Men's neckwear—wonderful proposition. Astor-M, 39 East 28th, N. Y.

**FLAVORING** Extracts—Bottle yourself! Labels furnished. 600% profits! Whirlwind money-makers! Repeaters! Free offer. Thomas Manufacturing Company, Indianapolis, Ind.

**200 TRICKS** You can do—Mystify your friends; have loads of fun. This collection of tricks has been selected by Thurston for the average person. Neither unusual skill nor elaborate apparatus are required. Send for this 200-page illustrated book. Pay postman \$1 plus postage when delivered. If outside U. S. remit when ordering. Popular Mechanics Press, Room 892, 200 E. Ontario St., Chicago.

#### HIGH-GRADE SALESMEN WANTED

**BUILD** A route of satisfied steady repeat customers with the only genuine California grape brick and orange brick. One brick makes one gallon juice, all flavors, (port, sherry, champagne, orange, lemon, etc.) Every home, hospital, physician, grocer, druggist, prospect. Take orders, give service, build up trade, 100% and more profit. Our business was booming during depression year. Beware cheap imitations flooding country since our product received nationwide publicity. Legality twice successfully tested in Federal courts. Vino Sano Co., Dept. 8-228, San Francisco, Calif.

**LOCAL** County manager to service extinguishers now in use and demonstrate new patented device for schools, homes, stores, shops, garages, churches, warehouses, trucks, autos and buses. Our men are earning from \$35 to \$50 weekly on service work alone in addition to profits on sale of new equipment. Lifetime job for men who are reliable and ambitious to build up steady business. Successful men earn from \$3,500 up to \$10,000 a year. Large manufacturer with "A-1" rating. The Fyr-Fyter Co., Dept. 3, Fyr-Fyter Bldg., Dayton, Ohio.

**SELL** 2-Pants suits \$21.95. You can make \$6 an order. Pure wool fabrics. Celanese lining. Fine tailoring. Union label. Guaranteed satisfaction. Many repeats. Sample suit. Big sales outfit free. Write Dept. P.16, MacRae Tailors, 275 Seventh Ave., New York.

**APLENTY** Now and different—Fast selling 5c and 10c merchandise on attractive counter cards. 100% comm. for you and dealers. Advertised by radio. No investment required. Catalog free. (Estab. 1921.) World's Products, 190 Central, Spencer, Ind.

**MANUFACTURER** Wants local representative fine shirts, ties, underwear, hosiery; exceptional values, maker to wearer, large earnings daily. Extra cash bonuses regularly. Free shirt, tie. We start you without investment. Thousands successful. Expensive outfit free. Write Dept. K3, Roselliff, 1237 Broadway, New York.

**BUSINESS** Stationery. Largest line. Highest quality. Quickest delivery. Biggest commissions. Bonuses. Free copyrighted cuts. Experience unnecessary. Outfit free. Wilens, 2130 Gladys, Dept. 537, Chicago.

**\$136.00 COMMISSION** From \$6.95 sale! You can make 3 sales daily. Our salesmen do it. Free kit. Sales Stimulators. Dept. 12H, 4311 Ravenswood, Chicago.

**SALESMEN**—At last! New feature sells punchboards everywhere. Dealers wild with joy—prosperity back again. Profits enormous. Samples free. Puritan Nov., 1467 Jackson Blvd., Chicago.

**\$18 TO \$25 Daily;** biggest selling line of men's suits. Meets present day conditions. Amazing values at \$11.95, \$14.50, \$16.95, \$18.95. Also raincoats, slickers, topcoats and boys' suits. Biggest commission paid in advance. Liberal bonus. Free outfit. State age and selling experience. "Jim" Foster, Inc., Dept. 23, 2250 South Spaulding Ave., Chicago.

**SALESMEN** Represent manufacturer direct to wearer. Sell guaranteed all wool suits, topcoats, \$18.95. You can make \$5.00 an order. Fabrics from America's finest mills. Union tailored. Satisfaction guaranteed. Outfit free. Write your experience. All Wood, Dept. P3, 890 B'way, New York City.

**SALESMEN**—Rubber stamps, accessories. Wonderful sideline. Central Stamp Co., Burlington, Iowa.

**SALESMEN**, Sell Bump-0, only dust mop cleaner on market. Twenty million homes need them. Sund Mop & Broom Cleaner Co., Santa Rosa, California.

**LOCAL** Representative wanted for large manufacturer, maker to wearer fine shirts, ties, hose, underwear below store prices. Sensational free offers bring easy orders. Big cash commissions. Free shirt, tie offer, cash bonuses. Outfit free. Write Dept. 31 29, Albert, 860 Sixth Ave., New York.



**GOOD** Paying job open as local representative, old successful manufacturer selling direct to wearer. Sensational values pants, breeches, coveralls, shopcoats. Largest line in field. Belt free with every 3. Big cash commissions. Outfit free. Longwear, Dept. P3, 489 Broome St., New York.

**I'VE** Placed 5,000 men in good paying jobs, selling shirts, ties, hosiery, underwear, work shirts, suede shirts, etc. I'll give you a marvelous outfit free. Remarkable values get orders and repeats. Big cash commissions and bonuses. Write Dept. H3, Quaker, 1107 Broadway, New York.

**MANUFACTURER** Of plastic leather wants distributors and agents. Business thrives on depression. Will finance responsible parties. E. Parker, Pierce Ave., Salem, Mass.

**WORLD'S** Best razor sharpener (new). Attractive display cards. Quick sales everywhere. Big profits. Repeat protection. Particulars, sample 25c. Burnisharp, 122 South Michigan, Chicago.

**SELL** Carded razor blades, aspirin, violet breath gun, chewing laxative, polishing cloths, shoe laces, handkerchiefs, rubber goods, etc. Large line. Big repeat profits. Attractive displays. Superba Company, 8203, Baltimore, Md.

**MARVELOUS** New changeable price cards; sell all stores. Retteprint, Lakewood, Ohio.

**FLAVORING** Extract sensation. \$1.00 vanilla, \$1.00 lemon, 60c almond, 60c maple, \$3.20 value in attractive sample case 99c. Your profit 50c. Every home uses. Sales easy. Order C.O.D. Crema Folks, St. Paul, Minn.

**AMAZING** Tailoring values pay you up to \$60 weekly. Virgin wool 2 pants suits \$17.50, \$5.00 profit. Union tailored. Leads furnished. Sample suit to producers. \$25.00 outfit free. Williams Bros., 879 Broadway, Dept. W-22-P, New York.

**CAN** You sell \$1.00 worth toiletries for \$1.00, giving ladies hose free with each purchase. Parts Laboratories, 3145 Locust, St. Louis, Mo.

**100% PROFIT** Sell garages, service stations. Zell Company, Box 297, Pleasant Ridge Station, Cincinnati, Ohio.

**SALESMEN!** Twenty-three-year-old progressive calendar and advertising specialty house has need for live salesman with proven sales record on liberal commission basis. Write fully. Klein Advertising Co., Dept. D, Quincy, Ill.

**CANVASSERS**—Crew managers—Add-A-Wiper promises to be the largest selling automobile item of the year. Sells itself on demonstration. On in ten seconds without tools. 100% profit. Send 38 cents for sample and details. Money refunded if sample is returned in ten days. Dept. 3, Add-A-Wiper, 182 So. Portland Ave., Brooklyn, New York.

**BIG** Money selling shirts, ties, underwear, dresses, hosiery, raincoats, coveralls, pants, belts, play suits. Sales kit free. Nimrod Co., Dept. 65, 4922-28 Lincoln Ave., Chicago.

**\$15.00 DAILY** Selling Union Label business stationery, \$2.70 per 1000; cards and blotters 1000 for \$1.50. Free cut service. Big commission. Large profit. National, 168-28 N. Jefferson, Chicago.

**DISTRIBUTORS**, Salesmen, agents—Earn 40% selling our 25c pocket cigarette roller direct or 100% selling dealers. Sample 25c. H. P. Mfg. Co., 2323 Carnegie, Cleveland, Ohio.

**\$3.00 CASH** Every time you sell \$22.50 all-wool, tailored-to-order suit. Amazing values. Greatest money-making opportunity. Beautifully styled garments quickly attract orders. Large swatch samples furnished free. Pioneer Tailoring Co., Congress and Throop, Dept. Q-1117, Chicago.

**SALESMEN**, Trade. New idea. No competition. Perfect eye protector. 100% commission. Exclusive. Sample, particulars 25c. 173 E. Market, Long Beach, Calif.

**IMITATION** Ice cream. Amazing new product. No freezing. Made at home in 2 minutes. Solidifies milk into delicious dessert; 8 dish sample with money-making plan 10c. Tremolett Co., St. Paul, Minn.

**SALESMEN** \$2.98 Old Hickory work shoe. Direct to wearer. Patented non skid soles. Amazing seller. Free sample. Astill Shoe Co., 1050 West Newton, Mass.

**MAKE** \$150.00 per week! New legal salesboard plan. No investment to anyone. Season starting. Act quick! A&J Novelty Co., 161 Washington, Chicago.

**BIG** Profit putting our genuine gold leaf sign letters on store windows. Experience unnecessary. Samples. Consolidated, 69-V West VanBuren, Chicago.

**PREMIUM** Salesmen—Brand new trade stimulator appeals instantly all lines retail business. Just what you always wanted. Big commissions. Well rated company. Outfit free. Salesmanager, 4th Floor, 308 North Michigan, Chicago.

**SALESMEN**—Four \$15.00 sales to stores net you \$48.00 daily. Sayers Systems, Est. 1895, 2891-123 Sheffield Avenue, Chicago, Illinois.

**SALESMEN-DISTRIBUTORS**. New auto tire patch; guaranteed 10,000 miles. Repairs blowouts permanently. Sells garages, gas stations, tire shops. Salesmen's profit 100%. Up to 300% to dealers. Easy seller. Exclusive territory. Economy Rubber, 608 Burkhardt, Dayton, Ohio.

**FREE** Booklet describes 67 plans for making \$29-\$100 weekly in home or office business of your own. Elite Co., 84 Elizabeth St., New York.

**SALESMEN**—Become independent. Own your business; experience unnecessary, selling our \$10,000 accidental death; \$50 accident; \$25 sick weekly benefits—\$10.00 yearly. Other amounts proportionate. Guaranteed steady income from renewals. \$250,000 deposited insurance department. Universal Policy, Dept. A, 716 Lefcourt Bldg., Newark, N. J.

**WONDERFUL** Opportunity. Twenty dollars per day can be earned. Experience unnecessary. Home protection at cost. Ages one to eighty, \$250 to \$1000 at death. Not insurance. You make \$5 for each member secured. Childless, of Virginia, sent in 54 one day. National Aid Society, Myers Building, Springfield, Illinois.

**PENNY** Golfer, new fascinating coin-controlled game. Legal. Exciting. Merchants everywhere buy. Splendid commission. Specialty Mfg., 617 Division, Chicago.

**NEW** Specialty—Sells every business and professional man. Four \$15 sales daily pay \$280 weekly. Feyer cleared \$4920 in three months. Write, F. E. Armstrong, President, Dept. PM, Mobile, Ala.

**SALESMEN!** Be successful. Get the Montgomery sales formula, a valuable aid to selling and other helps from "What a Master Salesman Should Know," by L. L. Montgomery. Price \$2.50. Sent postpaid upon receipt of price or C. O. D. anywhere in U. S. Popular Mechanics Press, Room 803, 200 E. Ontario St., Chicago.

#### HELP WANTED

**AMAZINGLY** Simple spare-time business. Big profits. No risk. Your home is your office. If you want to make real money, here's your chance. Full details free—write quick. Albert Mills, 1567 Monmouth, Cincinnati, O.

**CASH** Paid for butterflies, insects. See Sincclair Display Advertisement on page 12.

**AMAZING** New electric trouser presser good for \$25 daily; puts razor edge in pants in 10 seconds, sells for \$2.50; your commission \$1.00. Sample fits pocket. Munny Mfg. Co., Dept. CSC, 817 Main St., Cincinnati, Ohio.

**AGENTS**—Mosco corn and callous remover will build you a steady repeat business. Send today for pocket-size trial outfit. The Moss Company, 201 Searle Bldg., Rochester, N. Y.

**BOY** Mechanic—Famous library of 4 volumes covers the building of everything a boy might want to make. A great boon to parents and teachers. Actually covers 4000 different articles. Each volume 460 pages, fully illustrated. Cloth. Price \$2.00 or set of 4 vols.—\$7.00 postpaid upon receipt of price or C.O.D. anywhere in the U. S. A. Popular Mechanics Press, Room 803, 200 E. Ontario St., Chicago.

#### EDUCATIONAL AND INSTRUCTION

**GREGG** Shorthand 25c week, guaranteed; sample 10c. Haessler, Norman Road, Newark, N. J.

**GAIN** Word mastery—new system. Speak effectively, write convincingly. Free particulars. Spreen, 5108-W 18th, Cicero, Ill.

**WORK** For "Uncle Sam." Steady, \$107-\$250 month. Men-women, 18-50. Paid vacation. Short hours. Common education usually sufficient. Experience unnecessary. 25 coached free. Full particulars and list positions free. Write today sure. Franklin Institute, Dept. N3, Rochester, N. Y.

**LEARN** Photo-engraving at home by experience. Equipment furnished. Earn while learning. Aurora Photo-Engraving School, Aurora, Mo.

**BECOME** A landscape architect. Uncrowded profession; wonderful opportunity for money-making. Easily mastered by mail. Earn while you learn. Est. 1916. Write for details. American Landscape School, 7 Plymouth Bldg., Des Moines, Ia.

**PHOTOPLAY** Talking picture and magazine stories wanted for revision, development and copyright. Sell on commission. Established 1917. Booklet free. Universal Scenario Company, 408 Meyer Bldg., Western and Sierra Vista, Hollywood, Calif.

**WANTED**, Men-Women, 18-50, qualify for steady Government jobs. Salary range, \$105-\$250 month. No Government experience required. Paid vacations. Common education. Thousands appointed yearly. Write Omment Institute, 191, St. Louis, Mo., immediately.

**U. S. GOVERNMENT** Wants men, \$1,700-\$1,900 and up at start. Railway mail clerk examination coming. Let our expert (former government examiner) prepare you for this and also rural carrier, post office, customs, internal revenue, and other branches. Write today for free booklet. Dept. 8, Patterson School, Rochester, N. Y.

**DON'T** Prepare for any civil service examination without seeing our catalog. Free. Columbia Correspondence College, Washington, D. C.

**SOUND** Motion picture engineers wanted. Learn to operate. Free practical training when course is completed. Easy terms. 50% of tuition payable when employed. 103 North Rowan Ave., Dept. A, Los Angeles, Calif.

**15,000 PROFIT** Making formulas. Following and many others: Accidents and emergencies, agriculture, alloys and amalgams, artist's materials, beverages, cements, glues, pastes, mullages, bleaching, renovating, coloring metals, dyeing glass, heat treatment of metals, household formulas, ice cream, confectionery, chewing gum, lapidary work, exterminating vermin, lubricants, paints, varnishes, photography, condiments, canning formulas, rubber, soap, randles, soldering, toilet preparations, perfumes, waterproofing, fireproofing, writing materials. Just write for "Scientific American Encyclopedia of Formulas." When postman hands you book pay \$5.50 and postal charges. Popular Mechanics Press, Room 803, 200 E. Ontario St., Chicago, Ill.

#### SHORT STORIES

**SHORT** Stories revised, typewritten and marketed. Details free. Hursh Service, Box P-1013, Harrisburg, Penna.

**HISTORAP**—Something New—4000 years of history on a single page. A chart in 8 colors presenting a continuous, re-ordained record of events and characters of history from 2000 B. C. to date. Size 13x53 inches. Price \$1.00. Should be in every school and home. Sent postpaid upon receipt of price or C. O. D. anywhere in U. S. Popular Mechanics Press, Room 803, 200 E. Ontario St., Chicago.

#### TYPEWRITERS AND SUPPLIES

**TYPEWRITERS**—All standard makes. Lowest prices. Catalog free. Northwestern Typewriter Exchange, G-121 N. Francisco Ave., Chicago.

**All TYPEWRITER**, Adding machine ribbons 50c, \$4.75 doz. O-Kar Ribbon Co., Box 147, Burlington, Iowa.

**TYPEWRITERS**—All makes, \$1 to \$32. Guaranteed. Catalog free. Typewriter Works, Ada, Okla.

#### ADDING MACHINES

**NEW** \$4.75 Automatic Adding Machine. Fully guaranteed. Bassett, 1458-D, Hollywood Avenue, Chicago.

#### PRINTING, MULTIGRAPHING AND MIMEOGRAPHING

**250 LETTERHEADS**, 125 Envelopes \$1.00. C.O.D. Abbott Printery, Oswego, Kansas.

**100 EACH**, Quality letterheads, envelopes, cards, \$1.50. Art Printer, 5735 174th Ave., S., Minneapolis.

**200 LETTERHEADS** And 100 envelopes, \$1.00; 200 letterheads, 8 1/2 x 11, 150 envelopes, \$2.00; 250 cards, \$1.00. Hooster Print Shop, Portland, Ind.

**CLASSY** Mimeographing 200—\$1.25; additional hundreds 25c. Letterheads, envelopes \$2.25 thousand. Fields, 1562 Glenmont Road, Cleveland, Ohio.

**2,000 BUSINESS** Cards printed \$1.50. Canterbury Bros., Tannehill St., Pittsburgh, Pa.

**200 SHEETS**, 100 Envelopes, 94c. Applebaum-P, 1238 Brook., New York.

**500 LETTERHEADS**, 250 Envelopes \$2.93. Print anything. Lowest prices. Free cut service. National, Goshen, Indiana.



**SELL** By mail with facsimile typewritten letters: 100 cost \$1.00; 500, \$2.50. Free plan, samples. A-G Service, Fifteen Park Row, New York City.

1000 LETTERHEADS, Envelopes, post-cards, 6x9 circulars, \$2.95; 5,000, \$9.95. 5,000 attractive colored folders, \$11.45. All printing low prices. Samples. Goodprint, Harrisonburg, Va.

200 LETTERHEADS, 6x7, and 100 envelopes \$1.00. 250 letterheads, 8 1/2 x 11, 200 envelopes, \$2.25 postpaid. Samples. Quality Press, Bay City, Michigan.

2000 BUSINESS Cards \$2.00. Postpaid. Agents. Fineprinters, 625 So. Virgil, Los Angeles.

1000 BUSINESS Cards, card case, \$1.50. Miller, Printer, Narberth, Pa.

WE Print stationery, booklets, catalogs, circulars. Samples. Commercial Press, Batavia, Ohio.

LETTERHEADS, Envelopes, 500, \$1.10; 1,000, \$2.00; 5,000, \$8.00, plus postage. Samples. Coyle & Kimballs, Newport, N. Y.

250 BOND Letterheads, envelopes, bill-heads, cards, \$1.35 each. Economic Press, Leonia, N. J.

#### PRINTING OUTFITS AND SUPPLIES

JOB Type and other material dirt cheap. Sentinel, Hoxie, Kansas.

PRINT Your own cards, stationery, circulars, advertising, etc. Save money. Easy rules furnished. Print for others, big profits. Junior press, \$5.90; job presses, \$11; power, \$149. Write for free catalog and full information. Kelsey Co., 8-11, Meriden, Conn.

USED Press bargains. What size do you want? Send stamp for reply. Exchange, D-1, 480 E. Main, Meriden, Conn.

PRINT Your own circulars, envelopes, with home made press costing less than \$1.00. Illustrated instructions 10c. Carl Eduqvist, Odessa, Minn.

PRINTING Outfits—Presses, type supplies, type novelties. Send stamp for catalog. Model Press, York, Penna.

#### GUMMED LABELS

COLORED Stickers pay. Economical, too. Samples. Rex, 6818F Quimby, Cleveland, Ohio.

1,000 PRINTED; Name, business, address 50c. JBS Company, Box 93, Holyoke, Mass.

#### DUPLICATORS AND DEVICES

STENCIL Duplicator—Anyone can make. Particulars free. Grinstead Laboratory, Edwardsville, Illinois.

"EXCELLOGRAPH" Rotary stencil duplicator \$39.00. "Two-Faced" film duplicator \$4.00. Booklet free. Pittsburgh Typewriter Supply, Dept. 601, Pittsburgh, Pa.

#### RUBBER STAMPS

RUBBER Stamps: Name, address, 2 lines 25c, 3 lines 35c. Newman, 120 So. 15th, Lincoln, Nebr.

NAME, Address, 2 lines 25c; 3 lines 35c. Stamp Works, Auburn, Nebr.

#### ELECTRIC CLOCKS

"SPLIT Second" electric clock movement, only \$1.99. You get \$5 to \$10 for it—send dime for "Make Big Money Electrifying Clocks". Kuempel, Guttenberg, Iowa.

#### FOR THE HOME

CHESAPEAKE Bay fish, salted. Not to be compared with the store kind of salted fish. 50c, \$1.00 or \$2.00 for a trial package, postpaid, on a money back guarantee. Hampton Seafood Co., Box 479C, Hampton, Va.

BEST Books for \$1. Formerly \$2.50 to \$5. Get these best sellers you have wanted to read: Abraham Lincoln (The Prairie Years) by Sandburg, Hoodini by Kellogg, Henry the Eighth by Hackett, Napoleon by Lubric, Meet General Grant by Woodward, Omnibus of Crime by Sayres, Vagabond Journey Around the World by Frank, Royal Road to Romance by Halliburton. Postpaid upon receipt of price or C.O.D. by mail anywhere in U. S. Popular Mechanics Press, Room 801, 200 E. Ontario St., Chicago.

#### FOR SMOKERS

HOME Cigarette machine! Illustrated circular. \$3.25 postpaid. Automatic Cigarette Machine Wks., Dept. C-2, 1035 Sheridan, Chicago.

OUTDOOR Sports for everyone—Enjoy them all year round with aid of book published by Popular Mechanics. This veritable encyclopedia not only furnishes hundreds of ideas for new and popular sports for every season of the year, but also gives complete instruction for making the necessary equipment at very small cost. 350 pages and 650 illustrations. Send today as book is full of thrills and excitement for winter sport enthusiasts. Mailed postpaid anywhere for \$2, or will be sent C. O. D. to any address in U. S. Simply pay postman when delivered. Popular Mechanics Press, Room 802, 200 East Ontario St., Chicago.

#### FIELD GLASSES, TELESCOPES AND MICROSCOPES

WONDERFUL Microscopes magnifying 500 times, 75c. B. Valles, 22W 114th, New York.

\$10.00 QUEEN Prismatic telescope, six power, 30 millimeter. Cost \$38.00. Selection binoculars, musical instruments. Buy, sell or exchange. Write your wants. Well's Curiosity Shop, 20 South Second Street, Philadelphia, Pa.

#### DIAMONDS, WATCHES, CLOCKS AND JEWELRY

WATCHES—All makes, \$3 up. Guaranteed. Catalog free. Dee's Exchange, Ada, Okla.

#### RAZORS AND BLADES

ALL Makes razor blades resharpened 1c each. Petter Wetterquist, Rockford, Ill.

SEND Dollar bill for 40 Gillette type razor blades. James Gallo, Box 91, Flushing, N. Y.

HAIRSPPLITTING Edge—Blade lasts years. Quick, simple method. Send only 25c. No added cost. Box 1512, Hollywood, Calif.

SAFETY Razors resharpened; new honing method; excellent results. 25c ea. Double edge 35c. A. Schuster, 434 N. Van Buren, Kirkwood, Mo.

#### WATCH REPAIRING

YOUR Watch cleaned, adjusted—dollar twenty five. Wrist excluded. Strain Honor Bound Service, Brookfield, Mo.

INVENTIONS—Have you conceived one? There is a long, winding road to travel before your vision of rewards can be realized. Send for the new book "Inventions and Patents, Their Development and Promotion" by an eminent authority. It is designed to guide the inventor on his way and help him avoid pitfalls. Will be sent C. O. D. Pay postman \$2.50 plus postage when he hands you the package. Popular Mechanics Press, Room 802, 200 E. Ontario St., Chicago.

#### GUNS, FISHING TACKLE AND SPORTING GOODS

OLYMPIC Games, description, programme, complete 25c. Sport Bureau, 424 E. Broadway, Los Angeles.

HAENEL Air pistols; most powerful made; .177 or .22 caliber (500 pellets free) \$11.75. Genuine Wolsensak (\$1.50) Pocket-escape \$1.00. Free catalog. Hudson Sporting Goods, W-52 Warren Street, New York.

#### ANTIQUES, WAR RELICS AND INDIAN GOODS

INDIAN Relics, coins, curios, Beadwork. Catalog free. Vernon Lemley, Northbranch, Kan.

SEND 5c For fine new list Indian relics, antique firearms. F. E. Ellis, Webster Groves, Missouri.

#### PRECIOUS STONES

(DIAMOND'S Rival) genuine Zircron. Full information 10 cents. Goetz Gem Co., Gallon, Ohio.

MINERALS—Catalog and colored photographs 15c, refunded on first purchase. Scott Lewis, 2500 Beachwood Drive, Hollywood, Calif.

FOSSILS. Leaves, ferns or moss. Clear specimens guaranteed. Two dollars prepaid. Box 91, Glacier, Washington.

5000-YEAR Story of Flying in pictures. A monumental work—complete pictorial history of man's efforts to conquer the air from the earliest times to the present day. 1200 rare prints and photographs with text matter. Originally published in 2 vols. at \$15, reduced to sell while they last at only \$3.75 per set. Sent prepaid upon receipt of price or C.O.D. anywhere in U. S. A. Popular Mechanics Press, Room 803, 200 E. Ontario St., Chicago.

#### MUSIC AND MUSICAL INSTRUMENTS

FORTUNES Being made from songs through talking pictures, radio, phonograph, music publishers. "Hit" writers revise, arrange, compose music to your lyrics. We submit to studios and other markets. Free reading. Send for booklet. Universal Song Service, 625 Meyer Bldg., Hollywood, Calif.

SONGWRITERS—Read "song requirements of talking pictures, radio and records" an explanatory instructive book sent free to aspiring writers of words for songs. We compose, arrange music and secure copyrights. Write today. P.C. Newcomer, Associates, 1674 Broadway, New York.

SONG Poets, write Sequela Songwriters Service, Sherman Branch, Los Angeles, Calif.

SONGWRITERS Service. Lee Arranging Studios, 109 Judson, Syracuse, N. Y.

SONGWRITERS! Poems, music. Astounding proposition. Hibbeler, D1, 2101 Keystone, Chicago.

POEMS Wanted. Work guaranteed. We publish. Great Eastern Song Bureau, Dept. 27, Thomaston, Me.

SUBMIT Your song for publication. Greatwestern Music Company, 442 Plymouth Ct., Chicago.

DUO-Flex reeds for clarinets and saxophones eliminate your reed troubles. Write for circular. Duo-Flex Reeds, 1204 1st Ave., Evansville, Ind.

SYSTEM Complete \$1.00. Address "Mugle Shorthand," Pismo Beach, California.

WRITE Songs. Big money and reputation. Write for information. J. Gordon Pub. Co., 201 N. Hoyne Ave., Chicago.

"MUSIC Composed" to words. Bauer Bros. (formerly of Sousa's Band), Oshkosh, Wis.

SEND Song poems, 50-50 plan. Indiana Song Bureau, (Brookside), Salem, Ind.

COMPOSERS—Verse or music. Brilliant opportunity. Write VanBuren, 2644 McClurg Bldg., Chicago.

#### PATENT ATTORNEYS

PATENT Your invention; Send for free book, "How to Obtain a Patent," and "Record of Invention" blank. Consult us about how to protect your ideas. Victor J. Evans & Co., 601C Victor Bldg., Washington, D. C.

PATENTS Secured. Low cost. Write for book, "How to Get Your Patent" and "Record of Invention Certificate." Personal, skillful service assured. 35 years experience. Preliminary advice free. L. F. Randolph, 302A Victor Building, Washington, D. C.

WORLD'S Largest organization of inventors. Helpful information for inventors. Booklet free. Chartered Institute, 1135 Barriester Building, Washington, D. C.

LACEY'S Patent Sense. Valuable book free. See ad page 138.

TIME Counts in applying for patents. See pages 134 and 135. Clarence A. O'Brien, Registered Patent Attorney, Washington, D. C.

MANUFACTURERS Everywhere seek new inventions to improve their product. Send sketch or model for free opinion as to acceptability. Write W. T. Greene, 952 Barriester Building, Washington, D. C.

INVENTIONS Patented and Exploited. Former patent office examiner; Master patent law. Benj. Webster, Esq., No. 15 East 26 Street, New York.

PATENTS, Booklet free. Highest references. Best results. Promptness assured. Watson E. Coleman, Patent Lawyer, 724 Ninth St., Washington, D. C.

LANCASTER, Alwine & Rommel, Suite 411, 815 - 13th St., N. W., Washington, D. C. "Originators of the Form Evidence of Conception." Before disclosing your invention to anyone send for blank form to be signed and witnessed. Form and patent information bulletin free.

PATENTS Procured; trade marks registered—preliminary advice furnished without charge. Booklet and form for disclosing idea free. Irving L. McCathran, 700A International Bldg., Washington, D. C.



**PATENTS.** Reasonable rates. Write, The Ramsay Company, World Patent Attorneys, 273 Bank St., Ottawa, Canada.

**WHAT To Invent**—Names of manufacturers and wanted inventions sent free on request. Write W. T. Greene, 946 Barrister Building, Washington, D. C.

**"INVENTOR'S Guide,"** valuable information, free. Frank Ledermann, Registered Attorney-Engineer, 1712 Woolworth Bldg., New York.

**INVENTORS:** Send for booklet telling how to patent and sell your inventions at lowest cost. Ralph Burch, Patent Lawyer, 909 F St., Washington, D. C.

**PATENTS.** Send sketch or model for advice. Free book, "How to Obtain a Patent." Established thirty years. Highest references. Prompt service. Reasonable charges. Chandice & Chandice, 908 F Street, Washington, D. C.

**ESTABLISHED 1864.** Milo B. Stevens Company. Free booklet. Patents. Trade marks. Copyrights. Offices. Monadnock Block, Chicago; Barrister Bldg., Washington, D. C.

**PATENTS**—Write for free information, How to Obtain a Patent and Record of Invention—or send drawing or model for examination. Miller & Miller, Patent Attorneys (former Patent Office Examiners), 1400-A Woolworth Building, New York; 673 Earle Building, Washington, D. C.

#### FOR INVENTORS

**GET Help** on your ideas from trained technicians. Write to J. Coleman, 1012 7th Ave., Boulder, Colo.

**PROVE** Priority on your inventions. Don't depend on unsafe procedure to protect you while waiting to apply for patent. Establish irrefutable precedence on your ideas in the meantime with my ironclad "Evidence of Conception" form. Large size 4 for \$1.00, "35c each." Small size 6 for \$1.00, "25c each." Harry Johnston, 1036 Beaubien St., Detroit, Mich.

**HELPFUL** Information for inventors. Booklet free. World's largest organization of inventors, Chartered Institute, 1136 Barrister Building, Washington, D. C.

**IDEAS** Bring fortunes. Patents prepared, filed, \$60.00 up. Canadian patents filed \$35.00 up. Valuable circular free. J. J. O'Brien, Patent Attorney-Engineer, 100 W. 42nd St., New York City.

**FINANCE** Your invention. Sell your patent. Read the inventors own magazine—contains lists of manufacturers and promoters; valuable ideas, information. Saves you time and money. Low advertising and subscription rate. Send for free details now. Sample copy 25c. Inventive Age & Patent Market, Box 14, 718 East 4th St., Brooklyn, N. Y.

**BRASS** Gears and model supplies. Send for catalog. The Pierce Model Works, Tinley Park, Ill.

**TO Inventors:** We are in the market to purchase a good patent, preferably in the automobile accessory line. Will purchase outright or on royalty basis. Purchasing Agent, 241 Front St., New York, N. Y.

**PATENT** Your invention: Send for free book, "How to Obtain a Patent," and "Record of Invention" blank. Consult us about how to protect your ideas. Victor J. Evans & Co., 602C Victor Bldg., Washington, D. C.

**TIME** Counts in applying for patents. See pages 134 and 135. Clarence A. O'Brien, Registered Patent Attorney, Washington, D. C.

**LACEY'S Patent Sense.** Valuable book free. See ad page 138.

**INVENTORS!** Copyright a description or drawing of your invention or patented article in our magazine. This will help secure you direct evidence for priority patent claim. Promoters! Your advertisement will put you in direct touch with the inventor you are seeking. Advance Publishing Company, 405 Lankershim Bldg., 3rd and Spring Sts., Los Angeles, Calif. Established 1911. Sample copy of magazine 10 cents.

**MANUFACTURERS** Everywhere seek new inventions to improve their product. Names of manufacturers and wanted inventions sent free on request. Write W. T. Greene, 944 Barrister Building, Washington, D. C.

**INVENTIONS** Patented and Exploited. Former patent office examiner; Master patent law. Benj. Webster, Esq., No. 15 East 26 Street, New York.

**LOW** Cost manufacturing. Large plant completely equipped for blanking, drawing, stamping and wire forming in any finish. Can save you money on your product. Our figures will convince. Eastern States Products, Box 721, New Haven, Conn.

**INVENTOR'S Universal Educator:** contains 900 mechanical movements; 50 perpetual motions; instruction on procuring and selling patents and selecting an attorney, etc. Suggests new ideas. Price \$1.00 postpaid in U. S. A. Address Dietrich Co., 602B Ourray Bldg., Washington, D. C.

#### PATENTS FOR SALE

**WANTED**—Partner to pay patent fee on valuable inventions and market same. Half interest. Write Earl Coleman, Kiefer, Okla., Box 433.

**FOR** Sale or royalty. Patent seal ring for locking gas and water service cocks, etc.; strong, cheap, practical, cannot be removed without cutting. J. D'Ewart, 92 7th St., San Francisco, Calif.

**FRONT** Or four wheel drive and steer. Works fine. Patent, sale or royalty, or partner to finance more inventions. Erik Kjärp, 747 St. Clair, Pontiac, Mich.

**OUTRIGHT.** Patented, burglar-proof milk bottle holder and locker. Marie Benoit, 3172 Lockwood, Detroit, Michigan.

**TIME** Counts in applying for patents. See pages 134 and 135. Clarence A. O'Brien, Registered Patent Attorney, Washington, D. C.

**SOMETHING** New, fowl and meat carving tray. Cash or royalty. Wm. L. Stonehouse, 5103 Canton Ave., Detroit, Mich.

**INVENTORS**—Cash in on your invention now! Don't delay the sale any longer! Send for a free copy of our specially prepared booklet, "Turn Your Patent into Money," today! It contains helpful information for all inventors. M. L. Rund, Mgr. Classified Advertising, Popular Mechanics Magazine, 200 E. Ontario St., Chicago, Ill.

**MANUFACTURERS** Wanting profitable new inventions, write Chartered Institute American Inventors, 1221 Barrister Building, Washington, D. C.

**PARTNER** For two Canadian patents, sell. Carl Orn, Millet, Alberta, Canada.

**NEW** Invention—"Automatic Milk Cap Lifter." Must sell entire U. S. patent rights. Manufacturing cost 2c, retails 25c. Sold 45,000 to date. Robt. Poulson, Hutchinson, Minn.

**MANUFACTURERS** Looking for new inventions should write W. T. Greene, 949 Barrister Building, Washington, D. C.

#### COPYRIGHTS—TRADE MARKS

**COPYRIGHTS, Trade-Marks.** Protect almost anything! Low charges. Wade Service, 2274-N Brooklyn Station, Cleveland, O.

#### MODELS AND MODEL SUPPLIES

**INVENTORS:** Send us sketch or crude model of your idea. Crescent craftsmen will develop it into a practical working model. 30 years of successful experience and thousands of satisfied clients. Confidential service guaranteed. Bank references furnished. Free illustrated book: "Making Inventions Pay." Crescent Tool Co., Dept. S-3, Cincinnati, Ohio.

**DE WITT** Clinton brass. Kirk Hardware, 128 East 23 St., New York City.

**DE WITT** Locomotive builders. Adent lathe with compound rest \$12.75. Stamp for circular. Adent Tool Company, 1342 Hampton Road, East Cleveland, Ohio.

**BRASS,** Copper, steel, rods, tubes, sheets, bars, screws. For the home mechanic. De Witt Clinton locomotive parts \$4.75 postpaid. National Home Workshop Supply Co., 299-B North Ave., New Rochelle, N. Y.

**SUPPLIES** For model making. De Witt materials, etc. Send for list, Seefeld Co., 57 Seefeld Ave., Bridgeport, Conn.

**TIME** Counts in applying for patents. See pages 134 and 135. Clarence A. O'Brien, Registered Patent Attorney, Washington, D. C.

**30 KINDS** Of engines, castings, blue prints and supplies. Catalogue 10c. Howard, 2417 N. Ashland Ave., Chicago, Ill.

**WE** Make working models for inventors and do experimental work and carry a complete stock of brass gears and model supplies. Send for catalog. The Pierce Model Works, Tinley Park, Ill.

**RAILWAY** Model supplies—Trucks, signals, locomotives, cars. Price list 2c. Crocan Railway Models, Greenwich, Conn.

**WOOD,** Metal, plaster, castings supplied. Send sketches for estimates. Topping Pattern and Model Works, 663 St. Clair Ave., Detroit.

**SHIP-MODELER.** Magazine of the ship model makers' club. Sample copy 20 cents. C. A. Middagh St., Brooklyn, N. Y.

**ACME** Model Works, 200 North Jefferson Street, Chicago, Ill. Working models, mechanical, optical and electrical apparatus. Light manufacturing.

**GASOLINE** Engine, two cycle type,  $\frac{3}{8}$ " x  $\frac{3}{8}$ ". Steam engines, boilers for model boats. Propellers, fittings. Catalog 15c. Anton Bohaboy, 212 Price St., Rahway, New Jersey.

#### MANUFACTURING

**ECONOMICAL** Manufacturing from sheet, bar, wire or tubing. Models, dies, special machinery. Stranberg, 5124 N. Kildare Ave., Chicago.

**MANUFACTURING,** Models, dies, stampings, brasswork, moulds for castings, vulcanizing. Circular free. Baums Metal Specialties, Kansas City, Mo.

**LOW** Cost manufacturing. Large plant completely equipped for blanking, drawing, stamping and wire forming in any finish. Can save you money on your product. Our figures will convince. Eastern States Products, Box 721, New Haven, Conn.

**METAL** Articles developed and manufactured. Model making. Reasonable price and first class workmanship. W. F. Meyers Company, Bedford, Indiana.

**WIRE** Goods made to order. Cooley Mfg. Co., 3240 Carroll Ave., Chicago.

#### SURVEYING INSTRUMENTS

**SAVE** Money by buying our rebuilt transit and levels. All fully guaranteed—sold subject to field test. Cash or easy terms. Write today for list M-63. Warren-Knight Co., (Makers of "Sterling" Surveying Instruments), 136 N. 12th Street, Philadelphia, Pa.

#### WELDING AND SOLDERING

**"SOLDER-PAL"** Sticks plain solder on aluminum. Should be in every garage, radio, electric and fixit shops, also in every workman's tool kit. Don't turn away aluminum repair jobs. Price \$1.00. Money back guarantee. "Solder-Pal" Laboratories, 1626 Lakeshore Ave., Los Angeles, Calif.

**BARGAINS**—Excellent repossessed arc welders, buffers and grinders. Entirely rebuilt—guaranteed. Trial. Terms. Write Ken's Service, Box M-323, Troy, Ohio.

#### MACHINERY, TOOLS AND SUPPLIES

**LAQUER** Spray, trigger control, with air hose, complete, \$2.00. Air Devices Division, 1010 E. Michigan, Indianapolis.

**AMAZING** Prices. Cleveland, Morse, high speed drills; taps, reamers, other standard tools 50-90% off. Lists free. C. Mowrey, 2 Keener Bldg., Elmira, N. Y.

**KELLOGG** Air compressors, excellent condition, \$6.00. Electroplating generators \$8.00. Taylor, 105 East 102nd Street, New York City.

**LATHES**—Practically new 9-inch South Bend and 16-inch South Bend lathes. Both have chucks. Bargains. P. O. Box 171A, Niles, Michigan.

**\$100.00** SCREW Cutting lathes. Inventors, amateurs, schools. Amphion 305-24th St., Milwaukee, Wis.

**9"x3½"** SHEPARD Lathe \$75.00, Kemp-Smith milling machine \$175.00, 16" Smith & Mills crank shaper \$175.00, 14" U. S. sensitive drill press \$48.00, No. 60 Heald cylinder grinder \$350.00, 10" new drill press \$21.00, new automatic air compressor, with tank, motor, etc., \$85.00; battery charging outfit, complete \$100.00. Write for catalog. Terms to suit. Cincinnati Machinery & Supply Co., 27 West 2nd St., Cincinnati, Ohio.

**SUBSTANTIAL** Savings—used arc welders, buffers, grinders, platers, compressors, paint sprays. Entirely rebuilt; guaranteed. Trial and terms. Write Ken's Equipment, Box M-324, Troy, Ohio.

**START** Business of your own, small investment required, doing chromium, nickel, copper, silver plating. This work in big demand. Information free. Electro Platers Supply Co., 28 West Second St., Cincinnati, Ohio.

#### ELECTRICAL EXPERIMENTS

**ELECTRICAL** Experimenters. Salvage bargain—Lot No. 20-549 electrical laboratory experimental kits consisting of—(generator, ringer, receiver, microphones, condensers, induction coil, etc.)—\$13.50 value—special \$2.48 complete. Hundreds experiments, applications. Complete instructions. Lot No. 22—Hand driven A.C. generators \$3.50 value, special 77c each. Catalog, send stamp. Engineering Service Company, 1718 So. 14 St., Lincoln, Nebraska.



## ENGINES, MOTORS AND DYNAMOS

D. C. SMALL Holtzer-Cabot motors—110 volts— $\frac{1}{4}$  and  $\frac{1}{2}$  h.p., 1100 r.p.m.; perfect condition, built for electric piano work; retail value \$27.00; to be sold at \$3.00 each; suitable for any purpose. Kohler Brambach Piano Company, Inc., 609-619 W. 51st St., New York.

1/12 HORSE 110 Volt Universal motors. Double shaft, emery wheel and grooved pulley, mounted, \$2.95.  $\frac{1}{4}$  horse alternating motors \$4.50. Other bargains. Electrical Surplus Company, Dept. 12, 1885 Milwaukee Ave., Chicago.

\$15—GASOLINE Engines:  $\frac{1}{2}$  hp.—Brand new—Magneto—Starter. Guaranteed. Harris Machinery, Minneapolis, Minnesota.

$\frac{1}{4}$  HP, A.C. Motors \$4.50. Motors, generators, converters at equally low prices. Queen City Electric, 1739 Grand Avenue, Chicago.

GOVERNORS For auto engines used for stationary or portable power. No cash down. Cande-Smith Governor Co., 215 North Los Angeles Street, Los Angeles.

TIME Counts in applying for patents. See pages 134 and 135. Clarence A. O'Brien, Registered Patent Attorney, Washington, D. C.

GAS Engine. Portable  $\frac{1}{2}$  h.p. 2 cycle. New. Weight 66 lbs. Complete \$15.00. One Minute Manufacturing Co., Newton, Iowa.

FOR Sale: Slightly used electric motors,  $\frac{1}{4}$  h.p. \$3.00;  $\frac{1}{2}$  h.p. \$4.50. Cash with order. The Maytag Chicago Co., 160 E. Illinois St., Chicago, Ill.

## FARMS AND FARM LANDS

FREE Books on opportunities in Minnesota, North Dakota, Montana, Idaho, Washington, or Oregon. Complete information on climate, crops, location for farm or suburban tract for grain, livestock, dairying, fruit, poultry—a home, independence, plenty of food, clothing, continuous employment. No occupation offers more to industrious capable men. Write E. C. Leedy, Dept. 237, Great Northern Railway, St. Paul, Minn.

1000 FARM Bargains. Nearly 1000 pictures in Strouts big new spring catalog country real estate and money-making farms for sale in many states. Saves you time and money. Just out. Free. Write today. Strout Agency, 255-P Fourth Ave., N. Y. City.

CANADIAN Tax sale lands for a dollar an acre and up; small monthly payments. Farms, timber, hunting and fishing camps, minerals. Limited number of properties. Write at once for free illustrated booklet. Tax Sale Service, Room 613, 72 Queen St., W., Toronto, Canada.

OKARKS—Timbered river lot, cabin; fishing, hunting, trapping, boating, pearling; \$200, \$10 monthly. Hubbard, 216 Grassman Bldg., Kansas City, Kansas.

OWN A farm in Minnesota, Dakota, Montana, Idaho, Washington or Oregon. Crop payment or easy terms. Free literature; mention state. H. W. Byerly, 119 Northern Pacific Railway, St. Paul, Minn.

SELL Your property quickly for cash, no matter where located. Don't pay big commission. Particulars free. Real Estate Salesmen Co., Desk B, Lincoln, Nebr.

## OLD GOLD WANTED

SEND Your discarded gold jewelry, watch cases, crowns, medals, etc., for cash offer. Goods returned promptly if offer is unsatisfactory. Old State Metal Co., Box 51, Shrewsbury, Mass.

## WANTED—MISCELLANEOUS

MAIL Us your discarded jewelry, gold crowns and bridges, watches, diamonds, silver, platinum. Money promptly mailed. Goods returned if offer refused. United States Smelting Works (The Old Reliable) 29 So. State St., Dept. 71, Chicago.

CASH For old gold, broken jewelry, bridge work, crowns, etc. Money mailed immediately. Beebe Co., 510 Central Ave., Cincinnati, Ohio.

## RABBITS

ANGORA Wool rabbits. Big profits. Sunnyside Fur Ranch, Vaughn, Montana.

RABBIT Supplies—America's oldest Rabbit supply house. Free catalog. Desk 11, National Rabbit Supply Company, 1126 North Dearborn Street, Indianapolis, Ind.

RAISE Rex rabbits—Fur like seal. Booklet 10c. Clay Farms, Sharon, Wash.

PEDIGREED New Zealand whites \$1.00 per month of age. Fur Bearers, Inc., Watertown, N. Y.

CHINCHILLAS, Easter Rexes. Prices reasonable. Bucks free. Oakwoods Rabbitry, Amana, Iowa.

RABBITS And supplies. Complete literature, 10c. Albert Fahey, Inc., 115-X, Valley Stream, New York.

SILVER Fox rabbits; Enormous profits. Convenient payments. No references. Details 10c. Hickory-Dehl, Glenheulah, Wis.

RAISE Rex rabbits. We pay \$12.00 each. Information 25c. Eastern Rabbitry, New Freedom, Pa.

STANDARD Rabbit Journal, Milton, Pa. Special year 25c; sample dime.

## DOGS AND PETS

CHOW Chow puppies, broods, champion pedigrees. Ella Helmers, Manning, Iowa.

REGISTERED Alredales. Choice puppies, \$15.00 to \$25.00. Lawrence Gartner, Lexington, Ohio.

SQUIRRELS—Ideal pets. For prices write: Shuler Home, Charleston, S. C.

FOR Sale. Minks, squirrels, raccoons, foxes, ferrets, muskrats, ginseng, rabbits, skunks, wolf pups, opossums. B. Tippman, Caledonia, Minn.

BEAUTIFUL Registered bull pups, \$15. Bulldogs, 501 Rockwood, Dallas, Texas.

## FOR SALE—MISCELLANEOUS

WATCHMAKERS Lathe for sale at a bargain. B. Jaegermann, 5815 Easton Ave., St. Louis, Mo.

UNDERWOOD 5, Standard office machine \$39.95. Checkwriter, duplicator, multi-grapher, Dictaphones, bargain prices. Pruitt, 190 North La Salle, Chicago.

NECKTIES! Hosiery! Shirts! Reasonable prices. Folder free. Guimette's, 81 Holly D20, New Bedford, Mass.

## ROOTS AND HERBS

HERBS And Indian remedies. For all diseases. Send 10c for valuable Herb and Indian Doctor Book. Indian Gardens Co., Centreville, Mich.

JUST Out! Beautifully illustrated 84 page medicine and almanac. Contains over 500 old-fashioned herb medicine recipes and Indian secrets for home use. 10c postpaid. Worth dollars! Botanics, 145 West 112th St., Chicago.

## PERSONAL

YOUR Handwriting is your Handwriting scientifically reveals your character and latent talents. Send \$1 for complete personal, individual analysis by expert graphologist. Benson Tettell, Box 61, Kew Gardens, New York.

SUPPORTO Appliance. Amazing invention that restores confidence. Immediate results guaranteed. Men write for valuable information. Surgical Co., 1906 San Pablo, Oakland, Calif.

TATTOOING Outfits, free catalog. 5 tattoo remover formulas \$1.00. Chicago Tattoo Supply House, 434 So. State, Chicago.

YOUR Handwriting analyzed. Trial reading quarter. Gwyn, Suite 1202, 15 East 44th, New York.

CORNS Cured. Money back guarantee. Send 25c. C. L. Ross, Box 1973, Wilson, N. C.

PALMISTRY Handbook, 125 pages, practical, brief, understandable, describes 1000 markings. Postpaid \$1.00. Chiremant, 1539 West 7th, Los Angeles.

BEAUTIFUL Pen and ink portrait, from your photograph, 50c each. Photograph returned. Fred Schneider, Towaco, New Jersey.

BUNIONS Actually dissolved without pain. Booklet free. Eugene Eaton, D196, Bandon, Oregon.

## MISCELLANEOUS

ANY Name on 100 poker chips \$1.50. Valentine, 11775 Findlay, Detroit, Mich.

PRINTING Process makes distinctive letterheads, cartoons, photos, etc., at home. Samples 10c. Lene, 2245 South 51, Lincoln, Nebr.

SEE Panama Canal for \$1.00. Postpaid book of 78 views, 64 pages, 10x12. Ramey & Company, Box 1875, Cristobal, Canal Zone.

LEARN Yodeling. Sharp, clear expression. New, proved system. Complete \$1.00. McConnell, 444 - 5th Ave. W., Twin Falls, Idaho.

CASH Paid for butterflies, insects. See Sinclair Display Advertisement on page 12.

CASTINGS. Home shop machinery. Assemble, yourself. Blueprints included. Lynn Peltcher, Ocean Beach, Calif.

ASTONISHING Chemist composition; saves 50% gas in your automobile. Formula \$1. Manuel Garcia, Apartado 841, Montevideo, Uruguay.

WEIGHING Balances. Ounce capacity, accuracy 5 milligrams. \$2.85. H. Hammett, Greer, S. C.

INLAYS—Motifs and borders. Beautiful designs. Send for price list. Michael S. Mathes, 459 South Second Ave., Mount Vernon, N. Y.

MITRE Boxes. Various sizes, correct machine made. Write free circular. Box 57, Yankee Specialties, New Rochelle, N. Y.

PENCILS. Your or firm name imprinted free. 12—30c, 48—\$1.00, 144—\$2.88. Cash delivered. Pencil Market, Knoxville, Tenn.

CARTOONISTS, Amateurs—card writers—commercial proposition. No books—no courses. Scott Brown Publicity, Mansfield, Ohio.

TRANSFERRING Liquid—Takes any pictures or print off bills—magazines—funnies, etc. 25c bottle, formula 35c, both 50c. No stamps. Clinch, Brielle, New Jersey.

MIRRORS Resilvered at home costs near 5 cents per square foot; you charge 75 cents. Profitable business plating autographs, reflectors, tableware, stores, refinishing metalware, etc. Outfits furnished. Details free. Write Sprinkle, Plater, 288, Marion, Indiana.

AMATEUR Cartoonists—Earn \$25.00 week, spare time, copying cartoons for advertisers. E.M. Syndicate, Argyle, Wis.

TATTOOING Outfits, supplies. Illustrated list free. "Waters," 965 Putnam, Detroit.

AMATEUR Cartoonist: Sell your work. Write Smith's Service, PX1194, Wenatchee, Wash.

RADIO



## BOTH GIVEN

Powerful 6-Tube Radio Set built under RCA patents or Rego 1 75cm 22 Calibre Rifle. Choice of Belt Action and Take Down Models. Given for selling our famous Uca-Mentho Salve (used for Eczema, Cuts, Colds, etc.) at 25c a box, and receiving according to instructions in catalog. Open receipt of name and address we send you initial 12 boxes of salve and illustrated catalog showing how to get gifts of your choice. Send no money. We gladly treat you.

UCA-MENTHO COMPANY

P.M. 78

CHICAGO

## 22 CAL. RIFLE



GIVEN

## Get Into A Business of Your Own—EARN \$150 to \$300 Monthly



NEW ATTRACTIVE PRICES—TERMS AS LOW AS \$10 MONTHLY Charge batteries in one-third the usual time and at half the cost. Hundreds doing profitable business with HB. Recommended by leading battery manufacturers, approved by U. S. Bureau of Standards. Small space required—start in your home or small corner of a shop. HB Car Washing, Test Benches, Paint Spray, Arc Welding offer same opportunity. No special experience needed to operate. HB shouldn't cost a cent—will pay for itself on EASY MONTHLY PAYMENTS, mean practically no investment and a handsome profit for you.

WRITE NOW for details to HOBART BROTHERS, Box M32, TROY, OHIO

## 30 DAYS TRIAL—Pay Out of Income Terms



## NEW KIND of CAN OPENER Hangs On The Wall



**AGENTS  
30 DAYS'  
FREE TRIAL**

Big money! No experience needed to make \$4 and \$5 an hour. Start operations at 12-15 times. Sales guaranteed. Full territory protection. We supply most novel demonstrating outfit you ever saw. 30-Day introductory FREE TEST OFFER starts you. Mail coupon at once.

**A HIT!** New and needed everywhere! At last comes a Feal Can Opening Machine for the home! This amazing little patented discovery hangs on the wall. Holds the can for you. Opens it automatically at a mere twist of your wrist. No wonder it has already banished dangerous, old-style can openers from thousands of homes wherever it has been introduced!

Approved by Good Housekeeping Institute, this clever little discovery ends fuss, muss and danger. Absolutely nothing else is even remotely like it. For it cuts the top OUT, not merely off. Leaves rim as smooth and slick as a china cup. No scraping or spooning, food pours right out. All danger of infection from deadly "can opener scratches" is forever banished. Guaranteed for 5 years. Inexpensive. No wonder housewives simply go wild at mere sight of this discovery! Liberal advertising offer now gives you a chance to test it in your own home. Simply use coupon at once! Central States Mfg. Co., 4500 Mary Ave., Dept. C-705, St. Louis, Mo.

Central States Mfg. Co.,  
4500 Mary Ave., Dept. C-705, St. Louis, Missouri.

Rush Details of FREE TEST OFFER. Also Agents' money-making plans.

Name .....

Address .....

Town.....State.....

Check here if interested only in one for your home.

Books on all subjects are sold by Popular Mechanics Press, 200 East Ontario Street, Chicago, Illinois

## New Way to Improve YOUR ENGLISH



A command of effective English gives you added advantages and better opportunities. Poor English handicaps you more than you now realize. You can improve your English through Sherwin Cody's 100% self-correcting invention. If you are ever embarrassed by mistakes in grammar, spelling, punctuation, or pronunciation, this new free book, "How You Can Master Good English—in 15 Minutes a Day" will prove a revelation to you. Send for it now. It is free. Address  
**SHERWIN CODY SCHOOL OF ENGLISH**  
53 Searle Building Rochester, N. Y.

**FREE** HELPFUL CATALOGUE OF  
**AVIATION**  
**RADIO**  
**ELECTRICITY**  
**AUTO BOOKS**

Send your name for free catalogue of famous "Willcox" PATENTING books for home use. Practical help for good pay jobs in four best fields. Used by hundreds of schools. Up-to-date Authoritative. Simplified and practical. **WRITE NOW.**

Goodheart-Willcox Co., Inc., Dept. 13, 2009 Michigan Ave., Chicago

When writing to advertisers please mention Popular Mechanics

Play  
**GUITAR**  
Mandolin-Ukulele

this  
**FREE BOOK**

shows the way to Popularity,  
Pleasure, Increased Income.  
Send for your copy now.

**Gibson Inc.**

303 Parsons Street, KALAMAZOO, MICH.

## Don't Envy The Plumber—BE ONE!

**\$11.00—\$16.00 PER DAY** and work EVERY day, is the Plumber's wage.

**LEARN IN 8 to 12 WEEKS** without previous experience.

If you are making less than \$60.00 a week you owe it to yourself to investigate. Get FREE catalog that tells in pictures and words how we teach this trade. Special rates now.

**UNIVERSAL PLUMBING SCHOOL, 2030 Truett Avenue, KANSAS CITY, MO.**

## Rules for Knife-Craft Contest

**\$1,000.00  
IN CASH**

## Plus One Thousand Extra Prizes

(1) Entries may be any kind of model, figure or special carving, requiring skill and ingenuity, made entirely of wood, and with no other tools than a jackknife.

(2) No liquid adhesives such as glue, shellac, cements, etc., may be used.

(3) Carvings or models submitted must not be painted or silvered or gilded, and will remain the property of Popular Mechanics after the contest ends.

(4) Awards will be made as follows for the best or most unique models or designs submitted:

First Prize .....	\$250
Second Prize .....	100
Third Prize .....	75
Fourth Prize .....	50
Fifth Prize .....	25

Also there will be twenty-five \$10 prizes and fifty of \$5 each. In addition, 1,000 special jackknives will be distributed to all winners of cash awards and to those receiving honorable mention.

The contest will close on July 1st, 1932, but models should be submitted as soon as possible. Awards will be made by a competent board of judges, and in case of ties, duplicate prizes will be given. The judges' decision will be final in all cases.

Models, which may be of any size, must be shipped in strong wooden boxes, as Popular Mechanics cannot be responsible for breakage due to improper packing. Employees of Popular Mechanics and members of their families are not eligible for prizes.

When models are sent, be sure to affix tag, giving your name and address, to the model itself. In addition, put name and address on outside wrapper of package.

Address all packages, "KNIFE-CRAFT EDITOR, POPULAR MECHANICS MAGAZINE, 200 EAST ONTARIO STREET, CHICAGO, ILL."





**THIS AMAZING  
INVENTION  
Banishes Dimming  
Yet  
Doubles  
Roadlight!**

*Will You Accept*

**A SET FOR 10-DAY TEST  
IN YOUR OWN HEADLIGHTS?**

**N**O more driving "blind" down any highway at night! No more lives or property endangered because the driver "couldn't see the road!" No need either for expensive spot-lights or make-shift "driving" lights. An astonishing new invention now replaces the old glass "bulbs" in your headlights and makes them throw double the illumination on the road . . . yet ends all need of dimming! No wonder motorists everywhere simply go wild over this discovery that banishes forever the curse of night driving! No wonder, too, that one sale brings dozens of others wherever it is introduced!

### Acts Absolutely Like Magic

This new lighting discovery is called Perfect-O-Lite. It is not merely an improvement over old methods. Not a mere "attachment." No extra wiring or installation. Yet it actually DOES double road illumination. Cuts through the other fellow's light, yet absolutely cannot



Lights Entire Roadway

glare in his eyes. Makes night driving at 40 to 50 miles an hour safe and easy. Makes ruts, animals, children, detour signs, etc., far more visible. The secret of the amazing things this new light does is the kind of "beam" or "ray" that it throws. Instead of ordinary light, this new invention pours a solid beam of double-reflected or "infused" light down the entire roadway. Shows up ditches at the side, as well as distant objects, absolutely clear, without the usual flickering "shadows."

### Limited Introductory Offer

Under an introductory offer you are now invited to be the judge and jury without risking one penny. The coupon brings full details of the invention, offer of a set on FREE TEST and facts about agent's money-making opportunities. Mail the coupon, without obligation, TODAY!

**PERFECT-O-LITE**  
**HACHMEISTER-LIND CO.**  
Dept. C-31 Pittsburgh, Pa.



Ends Dangerous Glare

### FORTUNES FOR AGENTS

Here actually IS that chance for \$8 to \$14 your FIRST hour, \$6,000 to \$10,000 THIS year, with no limit **WHATEVER** for Distributors! Fleet owners buy quantities. Wallace & Tiernan, N. J., trucks just equipped. Other big orders flooding in. Each car equipped is seen by thousands. Davis, Pa., made \$1,400.00 in one week. Sacks, W. Va., made \$207.00 on one order. Start full-time or spare-time. Use coupon for **FREE TEST OFFER** and details of Exclusive Territory, etc. Sales Guaranteed. Act NOW!

Hachmeister-Lind Co., Dept. C-31  
Pittsburgh, Pennsylvania

Rush Free Test Offer also facts  
about money-making opportunities.

Name.....

Address.....

Town..... State.....

When writing to advertisers please mention Popular Mechanics



# Learn Autos

## in Los Angeles

100,000 trained mechanics needed every year in the Auto Trade! 27,000,000 cars to be constantly repaired and serviced. Unlimited job opportunities—and you can prepare for them in 3 months of practical work in the great National Automotive Shops.

### Railroad Fare Allowed

For a limited time only we are making a Special Free Railroad Fare Offer to California. So mail the coupon at once! Take advantage of this opportunity to visit Sunny California and prepare for a good paying job at the same time! Mail coupon for details!

### Free Employment Service

### Spare Time Jobs While at School

National has been training men for the Auto Industry for over 25 years. Let National help place you in a Big Pay Auto Job! Don't worry about money. We will gladly help you to get a part time job to pay your living expenses while at school.

### Mail Coupon for Big Free Book

Get all the facts! Mail coupon below for Big Free Automotive Book. No cost or obligation.

National Automotive School,  
Dept. 34C, 4006 So. Figueroa St.,  
Los Angeles, California.

Please send me your big Free Auto Book and all details of your Free Railroad Fare Offer.

Name.....

Street No.....

City.....

State.....

# SPECIALIZE ON RADIO

...enter the industry of the future with training you get at



Our own broadcast control room!

NO matter what branch of radio interests you... it is offered at RCA Institutes. Here, in four large resident schools at New York, Boston, Philadelphia and Chicago... or through interesting extension courses for home study, you can get the radio knowledge that will help you become successful. These elementary and advanced courses in every branch of practical radio are taught you by men of experience... on equipment that is of the very latest type. New equipment is always being added... and courses revised to meet the new developments of the radio industry's largest research laboratory, with which we are associated.

There are no "cut-and-dried" courses. You can choose one best fitted to your needs. Classes start in the resident schools about every six weeks. You may start an extension course at any time. Mark the field that interests you and mail the coupon. You get our general catalog which describes the schools in detail and full information about the course in which you are most interested.

A Radio Corporation of America Subsidiary



## RCA INSTITUTES, INC.

Dept. PG-3, 45 Varick St., New York

Please send me your General Catalog. I am checking below the phase of radio in which I am interested.

- Microphone Technique     Aviation Radio     Talking Pictures  
 Radio Operating     Broadcast Station or Studio  
 Servicing Home Entertainment Equipment     Television

Name.....

Address.....

Occupation.....

Age.....

# GET STRONG!



## BUILD GIANT MUSCLES WITH THESE 10 SPEEDY DEVELOPERS

### HERE IS WHAT YOU GET

1 10-cable chest expander  
 2 Patented hand grips  
 Wall exercising parts  
 Head Strap  
 Foot Strap  
 Strap  
 Strap  
 Strap  
 Rowing machine attachment  
 Illustrated Course Music clock

Realize your ambition and develop muscles of a superman. GET STRONG! Easily master feats which now seem difficult—or if you want physical culture for your health's sake, this equipment is what you need. With this special offer you save at least half. Take advantage of this unparalleled offer and enjoy the full advantages of a gymnasium at home, in your spare time, at your own convenience at this new low sensationally bargain price. The 10-cable, powerful chest expander adjustable to 300 lbs. resistance and with its many uses, gives you all the advantages of a gymnasium. ENTIRE SATISFACTION GUARANTEED OR MONEY BACK.

### SEND NO MONEY

Send name and address. We send all 10 speedy developers by return mail. Pay postman \$3.49 plus postage.

MUSCLE POWER CO.  
 Dept. P.M.-3—150 Nassau St.,  
 New York, N. Y.

If you live in the Philippines, Canada, Hawaii or other foreign countries, enclose money order for \$4.49.



## Learn ADVERTISING at Home

Greater opportunities now in advertising. Learn easily and quickly in spare time. Practical work. No text books. Old established school. Low tuition—Easy terms. Send for free booklet of interesting information. Page-Davis School of Advertising, Dept. 1353, 3601 Mich. Ave., Chicago

## LEARN MECHANICAL DENTISTRY



### Earn Big Money—Steady Work

Don't waste the best years of your life. Prepare now for prosperity. Learn this money-making business in a few months in Day or Evening sessions. Big Demand. School is highly endorsed. Practical training. Individual instruction. Easy terms. Write NOW for free catalog P and reduced rate. New York School of Mechanical Dentistry, 125 West 131st Street, New York

SEND FOR FREE BOOK



## The Musical Sensation ACCORDEON Played by Music Rolls

The Only Accordion played with Music Rolls. Without any knowledge of Music or Notes you play perfect like an artist in a few minutes. Three Models, No. 1—\$40.00, No. 2—\$55.00, No. 3—\$70.00. With an assortment of twelve Music Rolls free. Every instrument guaranteed for five years.

We also have instruments of each model having been played for a short while in our showrooms or some evenings at RADIO BROADCASTING STATIONS which we offer at a special low price. They are slightly marked but in excellent condition, perfect in tone and mechanical construction. Fully guaranteed like brand new instruments. Model No. 1—\$15.00, No. 2—\$30.00, No. 3—\$30.00. With twelve best selected Music Rolls free. Half of purchase price allowed if returned or exchanged in one year.

The playing of these Accordions offers a very good income and if you are interested, how to make money, we give advice and make arrangements for you. Illustrated folder mailed upon request.

TREASURE SALES COMPANY, 1690 Boston Road, New York, N. Y.





**Buy Direct**  
at New  
**Low Prices**  
Never Before Have  
Fine Watches Been  
Offered at Such  
Low Prices  
Save 30% to 50% by  
Buying NOW

In addition to our NEW LOW PRICE, I will send for your approval one of these Standard Watches, guaranteed for a lifetime of satisfactory service—WITHOUT ONE PENNY DOWN—allow you to wear it 30 days FREE—then sell it to you on easy payments. Write for catalog.

**DIAMOND RINGS**  
Write for our new Diamond Ring and Wrist Watch Catalog, showing marvelous new designs. Think of it—beautiful diamond rings and artistic dependable watches at cut prices. Catalog is sent FREE.  
Ask for our Special Spot Cash Offer. Good for 30 days only.

**SANTA FE WATCH CO.**  
36 Thomas Bldg. Topeka, Kansas



## See How Easy You Can Learn HYPNOTISM TRY FREE 5 DAYS!

SEE for yourself how easy it is to master the great science of Hypnotism—how quickly you can learn to bend people to your will—banish fear, worry and opposition—increase your earnings—and force others to give you the recognition, power, and admiration you deserve. I'll show you how to use this great force to help you master every situation or **The Five Day Trial is FREE!**

In just a few hours I'll teach you the hidden secrets of Hypnotism—the methods used by the great operators—the amazing things you

can accomplish once you understand this mighty power. You can use it to overcome obstacles, achieve your fondest ambitions and become MASTER of yourself, friends and acquaintances—either sex. Now you can quit being just one of the crowd—now you need not be in popular, lonesome or unhappy a minute longer. Through this strange power you can learn how to stand out—dominate—to make your life what you want it to be!

In his startling NEW book, *The Science of Hypnotism*, the world famous hypnotist—Prof. L. E. Young—reveals the most carefully guarded secrets of this fascinating subject. He not only explains the methods of noted hypnotists, step by step—but tells clearly all about the nine stages of Hypnotism. The Hypnotic Mirror, Mental Telegraphy, how to select your subjects, magnetic healing, methods of hypnotism, how to wake the subject, how to make money out of hypnotism!

**Try 5 Days FREE—  
Send No Money**

So confident are we that Prof. Young and his great book will quickly teach you the science of Hypnotism, that we will send you a copy without any cent in advance! Simply clip and mail the coupon below. When the book arrives pay the postman the special low price of \$2.00 plus low cost postage. Then test the powers of Hypnotism 5 days! If not amazed and delighted, return the book and money will be refunded at once.

**FRANKLIN PUBLISHING CO.,**  
Dept. C-70, 800 No. Clark Street, Chicago, Illinois

Franklin Publishing Co., Dept. C-70,  
800 No. Clark St., Chicago, Ill.

Please send me your amazing new book—*The Science of Hypnotism*—by Prof. Young. When book arrives, I'll pay the postman only \$2.00 plus postage. If I am not satisfied after 5 days' trial, I may return the book and you are to refund my money.

Name.....

Street and No.....

City..... State.....

If you are likely to be out when postman calls, send \$2.00 with coupon and we'll pay delivery charges. Customers outside U. S. must send cash with order.

### Mysteries of Hypnotism Revealed

How to Hypnotize at a Glance  
Susceptible Subjects  
How to Hypnotize by Telephone  
How to Give an Entertainment  
How to Make Others Obey You  
Overcoming Bad Habits  
How to Do Dozens of Hypnotic Feats  
Use of Hypnotism in Operations



## LUCKY TIGER A PROVEN GERMICIDE



For a clean, healthy scalp use Lucky Tiger. Destroys germs, and gives to thin, falling hair a new life and lustre. Delicately perfumed; world's largest seller at Druggists, Barbers, Beauty Parlors. **Try It Today!**

## BIG FACTORY SALE



### NEW MODEL Extra Strong Copper Boiler

The best, strongest, heaviest and safest Utility Copper Boiler made. New Improved adjustable cap and spout makes boiler steam-tight by twist of thumb screw. Ideal home cooker, boiler and pasteurizer.

### BIG CUT To Early Buyers

Order Now—Save Money at these New Low Factory Prices. No article of such high quality and utility ever sold at such amazingly low prices. Guaranteed.

### Guaranteed PURE COPPER

Prices quoted are net, cash with order, or send one-fourth, money order or check. Pay balance C. O. D. Ask for Free Catalog. Shipped in plain strong box.

**Home Manufacturing Co.** 26 E. Ninzie St. Dept. 6316  
CHICAGO, ILLINOIS

When writing to advertisers please mention *Popular Mechanics*





## This Revelation Will Startle

# Men Past 40!

**But It May Bring Years of Comfort to Their Lives!**

HAVE you lost much of your strength? Do you suffer from pains in back, legs and feet? Are you forced to get up 2 to 10 times at night? Are you a victim of nervousness, fatigue, dizziness, mental depression, chronic constipation, sciatica, bladder trouble? Many men past 40 often mistake these ailments for symptoms of approaching old age. They undergo prolonged treatments that frequently bring no relief and a life of miserable old age. Because they fail to strike at the real trouble.

### The True Meaning of a Tiny Gland

Science has found that these ailments in men past 40 are often due to Prostate Gland failure. This tiny gland becomes swollen and fails to function. Unless corrected it will likely grow worse. The result is often wretched old age or grave surgery.

### What This Treatment Really Means

Now an American scientist has perfected an amazing drugless home treatment used and endorsed by physicians and sanitarians. It goes directly to the area of the prostate gland, relieving congestion, increasing circulation, toning and stimulating. Many users report relief almost over night. Others say they actually felt 30 years younger in 7 days. Not a drug—medicine—nothing to swallow—massage—diet—violet ray—of exercise. It is a natural method. Any man can use it in the privacy of his own room.

### 200,000 Men Have Found the Answer

They have been shown the secret of new health and strength in keeping this tiny vital prostate gland active at the period in many men's lives when it begins to fail.

**FREE — If You !  
Act Now !**

The results of this new method are so startling that the inventor will let you test it on 7 days' Free Trial. If it doesn't bring immediate relief—if it doesn't make you feel 10 years younger in 7 days—it will cost you nothing. Mail the coupon for details and Free copy of "The Destroyer of Male Health." It tells amazing facts that may prove priceless to you. No obligation.

If you live West of the Rockies address The Electro Thermal Co., 303 Van Nuys Building, Dept. 21-E, Los Angeles, Calif. In Canada, address The Electro Thermal Co., Desk 21-E, 53 Yonge St., Toronto, Can.

W. J. KIRK, President,  
2151 Morris Ave., Steubenville, Ohio.

Send details of Free Trial and Free Copy of "The Destroyer of Male Health." No cost or obligation.

Name.....

Address.....

City.....State.....



# Using Tobacco

Perhaps you've tried to stop using tobacco only to find that the habit has such a hold on you that you gave up trying.

You know, better than anyone else, whether tobacco is hurting you, and if it is, that sooner or later, it will undermine your health. Heart trouble, indigestion, dyspepsia, nervousness, insomnia, poor eyesight—these and many other disorders can often be traced directly to the use of tobacco, according to good medical authority. Besides it is an expensive, utterly useless habit.

## Let Us Help You To Banish The Habit

No matter how firm a grip tobacco has on you—no matter whether you've been smoking cigars, pipe or cigarettes or chewing plug or fine cut for a month or 50 years—Tobacco Redeemer will in most cases remove all craving for tobacco in any form in a very few days. It does its work so quickly that all tobacco "hunger" is gone almost before you know it. The desire for a smoke or chew usually begins to decrease after the very first dose.

Tobacco Redeemer contains no habit-forming drugs of any kind—it is in no sense a tobacco substitute. It does not cause the slightest shock to the nervous system; on the contrary, it often helps to quiet the nerves and make you feel better in every way.

## SEND for PROOF

Get our free booklet. It tells you all about the deadly effects of tobacco and how easy it is now to quit. We will also send you copies of letters from confirmed users telling how this simple, home-treatment freed them absolutely from the habit. Just mail coupon—or a postal will do.



### NEWELL PHARMACAL CO.

Dept. 999 St. Louis, Mo.

Send me without obligation to me in any way, proof that Tobacco Redeemer will positively free me from the Tobacco Habit or my money will be refunded.

Name.....

Street and No.....

Town.....State.....

When writing to advertisers please mention Popular Mechanics



## FOOT PAINS Ended Quick



New discovery stops pain in 5 minutes in feet, legs, and body due to fallen arches, Morton's Toe, Hammer Toe and callouses. No more braces, metal supports, appliances, pads or bandages. Amazing "cushion" method entirely different. Endorsed by physicians. Now you can wear stylish shoes in comfort and ease.

**FREE 14-DAY TRIAL**

Send no money... nothing but name and Address. No obligations... Write TODAY!

Fairyfoot Co., 1223 S. Wabash, Dept. 1190 Chicago, Ill.

## Study LAW AT HOME

Lisken did it! Also thousands of other great lawyers, politicians and business men. YOU, too, can become a lawyer or law trained business man through home study guided by the successful practicing lawyers of our faculty. Write today for free book.

**AMERICAN CORR. SCHOOL of LAW**  
3661 Michigan Ave., Dept. 1353, Chicago

## WANTED: LOCAL MANAGERS

Reliable men to look after our repeat business and also demonstrate new fast-selling popular-priced device. Opportunity for right man to earn \$350 to \$500 monthly. No investment in stock required. Opportunity to become associated with one of the largest and fastest growing concerns of its kind in America. Write for full particulars and records of what others are earning.

**THE FYR-FYTER CO., 90-51 "F. F." Bldg., Dayton, Ohio**



## How to Obtain A Better Looking Nose

Improve your personal appearance

My free book tells you how I guarantee to improve the shape of your nose by remodeling the cartilage and fleshy parts, quickly, safely, and painlessly, or refund your money. The very fine, precise adjustments which only my new patented Model 25 Nose Shaper possesses, make results satisfactory and lasting. Worn night or day. Over 100,000 uses. Send for free book to **M. TRILETY, Pioneer Nose Shaping Specialist** Dept. 288 BINGHAMTON, N. Y.

## No Joke To Be Deaf

—EVERY DEAF PERSON KNOWS THAT

George P. Way made himself hear, after being deaf for

25 years, with Artificial Ear Drums — his own invention. He wore them

day and night. They stopped head

noises and ringing ears. They are

invisible and perfectly comfortable.

No one sees them. Write for his

true story, "How I Got Deaf and

Made Myself Hear." Also booklet

on Deafness. Address

George P. Way, Inc., 729 Holzmann Building, Detroit, Michigan



Artificial Ear Drum

## Rupture Sufferers, Attention!

Investigate the Positive Anchor Truss.

Comfortable and easy to wear. Holds the rupture well.

Recommended by doctors and users.

**YETTA POSITIVE ANCHOR TRUSS CORP.**

L. B. 62 CONNERSVILLE, IND.

## A ROSE that changes

### COLOR with the Weather



This beautiful and ornamental Rose in a miniature flower pot is a chemical novelty.

Tests show it to operate correctly over a number of years. In fair weather the color is blue, when a storm is in the air it changes to a pink, and when lavender it indicates that a change of weather is in progress. It's amazing!

Send 25c to pay for year's subscription to our monthly magazine and 5c extra, or 30c in all, and we will send Everyday Life to your address for one year and the Weather Barometer Rose,

both for 30c. Send 60c and we will send Everyday Life for 2 years and three ROSES. Don't wait. Write — **EVERYDAY LIFE, 918R, 337 W. Madison St., Chicago**

## I. C. S. STUDENT



WINS

**\$5000 PRIZE**

IN 1930 the Standard Sanitary Manufacturing Company of Pittsburgh started a movement for better architectural designs in bathrooms.

Prizes were offered, in two classes, for the best plans and specifications. Architects from all parts of the United States and the world competed. Eminent architects served as judges.

Class A Prize — \$5000 — was won by Edgar Thompson, of Detroit, a draftsman associated with Albert Kahn, Inc., architects and engineers.

After returning from overseas military service, Mr. Thompson, then in his early twenties, enrolled for a course with the International Correspondence Schools. Here is what he says:

"I. C. S. study is the foundation of what little I have thus far done in my line, and I hope with the years to make it more."

Most likely you need a technical foundation for your own native talents. Ambition must follow a framework of training! Spare-time study of I. C. S. Courses has given this training to thousands of men — it will give it to you! Return the coupon — today.

### INTERNATIONAL CORRESPONDENCE SCHOOLS

"The Universal University" Box 5588-G, Scranton, Penna.

Without cost or obligation, please send me a copy of your booklet, "Who Wins and Why," and full particulars about the subject before which I have marked X:

#### TECHNICAL AND INDUSTRIAL COURSES

- |  |  |
|--|--|
| <input type="checkbox"/> Architect   | <input type="checkbox"/> Automobile Mechanic                                 |
| <input type="checkbox"/> Architectural Draftsman                             | <input type="checkbox"/> Plumbing <input type="checkbox"/> Steam Fitting     |
| <input type="checkbox"/> Building Estimating                                 | <input type="checkbox"/> Heating <input type="checkbox"/> Ventilation        |
| <input type="checkbox"/> Wood Millworking                                    | <input type="checkbox"/> Sheet Metal Worker                                  |
| <input type="checkbox"/> Contractor and Builder                              | <input type="checkbox"/> Steam Engineer                                      |
| <input type="checkbox"/> Structural Draftsman                                | <input type="checkbox"/> Steam Electric Engineer                             |
| <input type="checkbox"/> Structural Engineer                                 | <input type="checkbox"/> Civil Engineer                                      |
| <input type="checkbox"/> Electric Wiring                                     | <input type="checkbox"/> Surveying and Mapping                               |
| <input type="checkbox"/> Electrical Engineer                                 | <input type="checkbox"/> Refrigeration                                       |
| <input type="checkbox"/> Electric Lighting                                   | <input type="checkbox"/> R. R. Locomotives                                   |
| <input type="checkbox"/> Welding, Electric and Gas                           | <input type="checkbox"/> R. R. Section Foreman                               |
| <input type="checkbox"/> Reading Shop Blueprints                             | <input type="checkbox"/> R. R. Bridge and Building Foreman                   |
| <input type="checkbox"/> Telegraph Engineer                                  | <input type="checkbox"/> Air Brakes <input type="checkbox"/> Train Operation |
| <input type="checkbox"/> Telephone Work                                      | <input type="checkbox"/> Highway Engineering                                 |
| <input type="checkbox"/> Mechanical Engineer                                 | <input type="checkbox"/> Chemistry <input type="checkbox"/> Pharmacy         |
| <input type="checkbox"/> Mechanical Draftsman                                | <input type="checkbox"/> Coal Mining Engineer                                |
| <input type="checkbox"/> Machinist <input type="checkbox"/> Toolmaker        | <input type="checkbox"/> Navigation <input type="checkbox"/> Boilermaker     |
| <input type="checkbox"/> Patternmaker  | <input type="checkbox"/> Textile Overseer or Supt.                           |
| <input type="checkbox"/> Pipefitter <input type="checkbox"/> Plumber         | <input type="checkbox"/> Cotton Manufacturing                                |
| <input type="checkbox"/> Bridge Engineer                                     | <input type="checkbox"/> Woolen Manufacturing                                |
| <input type="checkbox"/> Bridge and Building Foreman                         | <input type="checkbox"/> Agriculture <input type="checkbox"/> Fruit Growing  |
| <input type="checkbox"/> Gas Engines <input type="checkbox"/> Diesel Engines | <input type="checkbox"/> Poultry Farming <input type="checkbox"/> Radio      |
| <input type="checkbox"/> Aviation Engines                                    | <input type="checkbox"/> Marine Engineer                                     |

#### BUSINESS TRAINING COURSES

- |   |  |
|---|--|
| <input type="checkbox"/> Business Management                                  | <input type="checkbox"/> Business Correspondence                             |
| <input type="checkbox"/> Office Management                                    | <input type="checkbox"/> Lettering Show Cards <input type="checkbox"/> Signs |
| <input type="checkbox"/> Industrial Management                                | <input type="checkbox"/> Stenography and Typing                              |
| <input type="checkbox"/> Personnel Management                                 | <input type="checkbox"/> Complete Commercial                                 |
| <input type="checkbox"/> Traffic Management                                   | <input type="checkbox"/> Civil Service <input type="checkbox"/> Mail Carrier |
| <input type="checkbox"/> Accountancy <input type="checkbox"/> Cost Accountant | <input type="checkbox"/> Railway Mail Clerk                                  |
| <input type="checkbox"/> C. P. Accountant                                     | <input type="checkbox"/> Grade School Subjects                               |
| <input type="checkbox"/> Bookkeeping  | <input type="checkbox"/> High School Subjects                                |
| <input type="checkbox"/> Secretarial Work                                     | <input type="checkbox"/> College Preparatory                                 |
| <input type="checkbox"/> Spanish <input type="checkbox"/> French              | <input type="checkbox"/> Illustrating <input type="checkbox"/> Cartooning    |
| <input type="checkbox"/> Salesmanship <input type="checkbox"/> Advertising    | <input type="checkbox"/> Lumber Dealer                                       |

Name..... Age.....

Address.....

City..... State.....

Occupation.....

If you reside in Canada, send this coupon to the International Correspondence Schools Canadian, Limited, Montreal, Canada

When writing please mention Popular Mechanics





## VIOLETTA

High  
Frequency  
Ray  
RELIEVES  
PAIN  
Quickly and  
Harmlessly

Thousands of men and women suffering from rheumatism, paralysis, neuritis, nervousness, skin diseases, headaches, constipation, sprains, prostate trouble, goitre and many other ailments, even hay fever and asthma, have found quick relief and renewed health and vitality with this marvelous invention. PAINS VANISH ALMOST INSTANTLY. Is it any wonder that VIOLETTA has been called the

### Greatest of Home Remedies

The HIGH FREQUENCY electrical currents produced by VIOLETTA stimulate and normalize the "life processes" of the tissues with which they come in contact and thus relieve pain, eliminate congestion, promote circulation, and restore the functions of sluggish organs. They do this painlessly and harmlessly and so quickly it will surprise you.

OUR FREE Booklet tells how VIOLETTA not only relieves pain but beautifies the hair and stimulates its growth; how it beautifies the complexion better than cosmetics; and how it generates OZONE for the treatment of respiratory ailments. We have been manufacturers of "violet ray" equipment since 1914.



Model  
3112  
\$100  
Ten  
Days  
Trial

Chicago Electric Scientific Mfg. Co. (Successors to Blendon-Dun Co.).

2300 Warren Blvd., Dept. 12-A, Chicago, Ill.

Please send me without cost or obligation your FREE Booklet describing your VIOLETTA High Frequency Ray Equipment.

Name.....  
Address.....  
City..... State.....  
Ailment.....

## Big Money in ART

Learn at home in spare time. Our famous method of "constructive criticism" teaches you quickly. Earn while you learn. Hundreds successful! Make up to \$200 weekly. FREE BOOK. WASHINGTON SCHOOL OF ART Dept. 5-2, 1115 15th St., N. W., Washington, D. C.

## AGENTS! SELL ELECTRIC CLOCKS

BIG POPULAR DEMAND

Brand new LIVE seller! Now sweeping the country. WYLO ELECTRIC CLOCK works automatically from light socket. Tells accurate time ALWAYS. No setting, winding or attention necessary. Absolutely accurate—no ticking. Low popular price. Big commissions for agents and distributors. Beautiful selling outfit furnished. Write for details.

WYLO CORPORATION  
220 Fifth Avenue, Dept. C-15, New York



Sells  
on  
Sight  
for  
\$1.00

Good  
Profits  
for  
Salesmen

## Salesmen make BIG MONEY introducing the NEW *Gits* HANDIBLADE

Over 20,000 Handiblades sold in a few weeks proves its popularity as the greatest sensation in Pocket Knife History.

The construction of Handiblade lasts for years. Its basic principle is entirely new, yet sturdy and positively safe. The 4-in.-one genuine steel blade idea will amaze prospects. Replaceable blade holds a sharp edge. Its rapid adjustment to four different lengths makes quick sales.

Handiblade is absolutely different, speedy one-hand operation, utility handle for perfect grip, beautiful color combinations, has 1,000 uses.

Ideal for thousands of men now competing in the National Whittling Contest.

Handiblade is the knife you read about in February Popular Mechanics.



Send only 60c for demonstration sample. Shipping and post paid. Money refunded if not satisfactory. You will also receive full details of our

big MONEY-MAKING PROPOSITION.  
GITS BROS. MANUFACTURING CO.  
1847 South Kilbourn Ave. Chicago, Ill.

## What Every Mason Wants

We have Masonic books and lodge supplies for Blue Lodge, Chapter, Commandery, Scottish Rite, and Shrine.



Our Rituals Are Used the World Over

Send for free catalog of books and rituals for Masons, Odd Fellows, Knights of Pythias, Knights of Columbus, Elks, etc.

EZRA A. COOK, Publisher, Inc.  
P. O. Box 796, M, Chicago, Ill.

## MINIATURE SHIP FITTINGS

EVERY ARTICLE GUARANTEED PERFECT

Bronze pulley blocks and deadeyes from 1/16", steering wheels, ladders, water barrels, buckets, gratings, cars, etc.

Brass, bells, davits, capstans, belaying pins, searchlights and propellers.

White Metal anchors, cleats, chocks, bitts, ventilators, etc.

White pine life boats from 2" to 4".

We offer authentic ship fittings at the lowest prices obtainable.

Send 5c for complete illustrated catalog No. 8.

Best Model Specialty Company, 341 Madison Ave., New York City, N. Y.

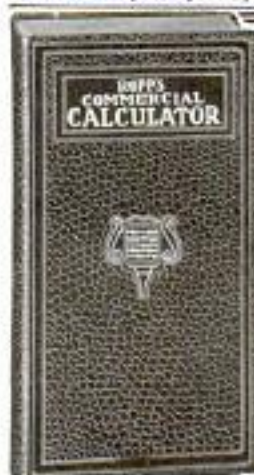

## Mathematics Made Easy by ROPP'S CALCULATOR AND SHORT-CUT ARITHMETIC

Shows the Answer as Quickly as a Watch shows the Time to all Problems likely to occur in the Office, Store, Shop, Bank, Farm, or Factory.

Over 2,000,000 Sold

Explains and simplifies every principle in Arithmetic, Mechanics, and Mensuration.

PRICES POSTPAID

Desk Size, Flexible Keratol Binding.....\$2.00

Pocket Size, Art. Leather Binding.....\$1.00

Pocket Size, Cloth Binding, \$0.50

POPULAR MECHANICS PRESS

Room F3 100 E. Ontario St. CHICAGO



# NEW WAY *to* WASH CARS



**GYRO  
Works  
By  
Water  
Pressure**

The Gyro Brush harnesses the terrific power of water pressure. Water from an ordinary garden hose runs through the handle of the Gyro, and revolves the center brush at a speed of more than 1,000 revolutions per minute. This powerful revolving brush INSTANTLY removes all dirt, mud and the dreaded "traffic film." It cleans cars SPOTLESSLY CLEAN. Yet it is guaranteed never to mar or scratch the finest surface. Can be used on any finish—Duco, lacquer, etc. Soft, velvety outside brush prevents the water from splashing or dripping, and acts as a chamois and cleaner in one. Gyro not only washes, cleans and polishes, but it prolongs and beautifies the car finish as well.

## WASHES-CLEANS-POLISHES *in one operation!*

NOW—A NEW WAY TO WASH CARS. Gyro Turbine Brush—the sensational new invention—*actually makes car washing a pleasure!* Saves time, labor and money. Eliminates chamois, soap, and spray. No more scrubbing and heaving. No more messy, bothersome, hard labor. Gyro cleans cars without hard physical effort in less than 15 minutes easy, pleasant work.

No wonder agents are finding this new device a whirlwind seller. Autoists, garages, gas stations, auto laundries, fleet owners, service stations, etc., buy on sight. More than ever auto owners are saving money and washing their own cars—that's why Gyro agents are steadily increasing their profits.

### A Tremendous Market!

Not only does Gyro wash cars quicker, easier and better, but it is just as convenient for washing down outside walls, windows, screens, porches, etc. Sells to home owners everywhere. Housewives find Gyro an invaluable aid. Strong, binding guarantee of satisfaction protects customers and agents.

## AGENTS!

Here's a real seller. Profits assured by unique demonstration features and scientific selling plans. Exceptionally large earnings reported by agents everywhere. *Big profit margin on every sale.* Only 10 brushes a day will net you \$17.50—\$105.00 clear profit for a six-day week. *Desirable territories still open.*

Write or wire for full details of this splendid money-making opportunity. Full facts and attractive proposition FREE. For fast action mail the coupon below.

**GYRO BRUSH CO., Dept. C-14,  
Bloomfield, N. J.**

Rush special proposition and complete details of your money making opportunity FREE. Also reserve territory for me.

Name.....

P. O. Address.....

Town.....State.....

# 100% PROFIT *for* YOU!

When writing to advertisers please mention Popular Mechanics



1896 J. M. Williams Cochrane  
Newstead, England

## "Venetian Blind" Sails Add to Yacht's Speed

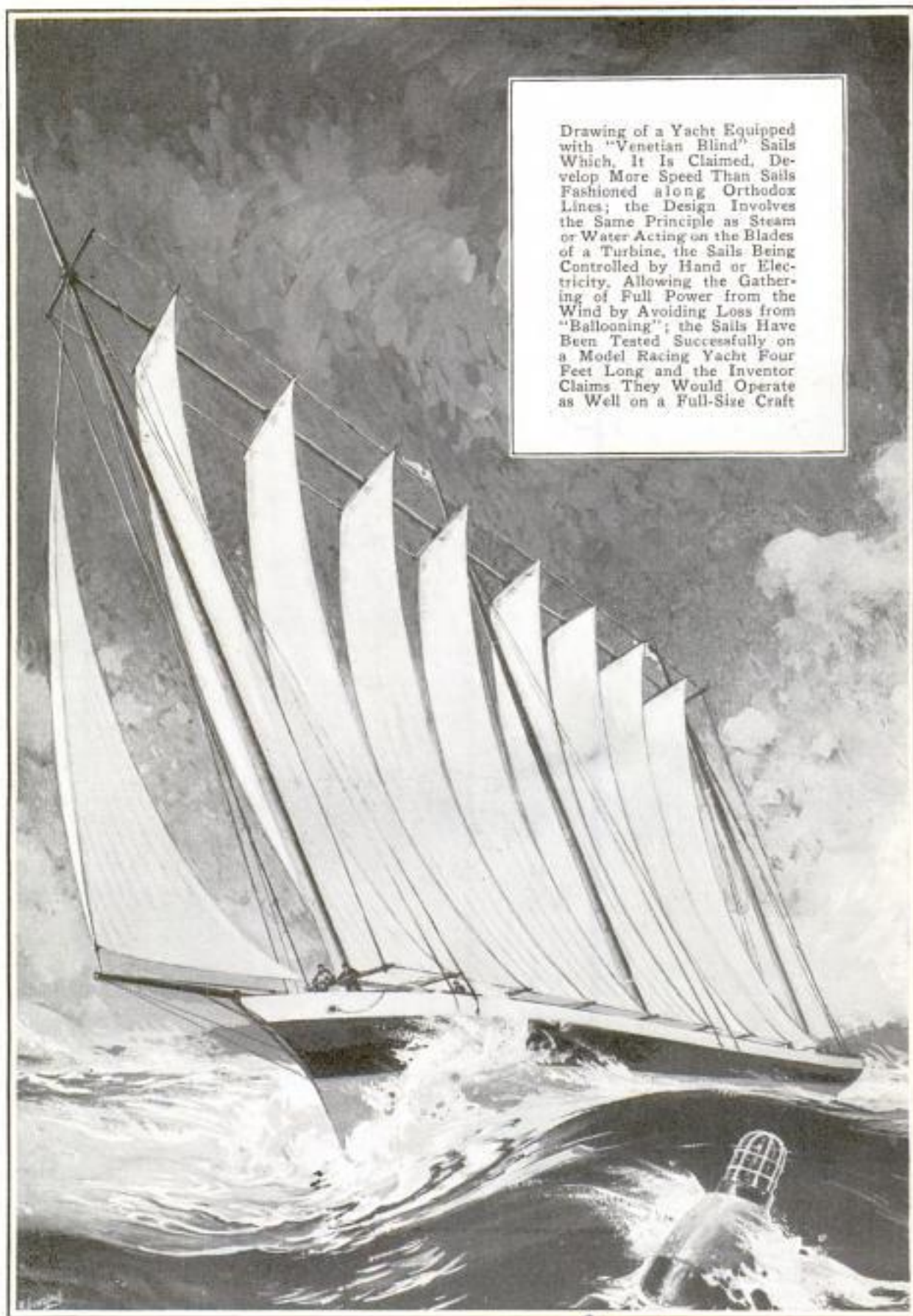

Drawing of a Yacht Equipped with "Venetian Blind" Sails Which, It Is Claimed, Develop More Speed Than Sails Fashioned along Orthodox Lines; the Design Involves the Same Principle as Steam or Water Acting on the Blades of a Turbine, the Sails Being Controlled by Hand or Electricity, Allowing the Gathering of Full Power from the Wind by Avoiding Loss from "Ballooning"; the Sails Have Been Tested Successfully on a Model Racing Yacht Four Feet Long and the Inventor Claims They Would Operate as Well on a Full-Size Craft

Wide World

Copyrighted material



# Popular Mechanics Magazine

REGISTERED IN U. S. PATENT OFFICE

WRITTEN SO YOU CAN UNDERSTAND IT

Vol. 57

MARCH, 1932

No. 3

92543



## COMING-

Steam Multiplane Weighing  
8,000 Pounds, Built in 1894 by  
Sir Hiram Maxim at Cost of  
\$200,000; It Was Wrecked in  
Its First Test

## The Silent Air Liner

By HIRAM MAXIM

(AS TOLD TO JOHN F. COGGSWELL)

16. Edgewood Road,  
Belmont, Mass

**M**OST persons have the idea that the greatest part or all of an airplane's terrific noise comes from the engine exhaust. If this were so, all modern airplanes would be silent now, for, several years ago, I perfected an exhaust silencer that eliminates this noise and sets up no back pressure. The device is inexpensive and weighs only about twenty pounds.

The reason such silencers are not part of the equipment of all planes today, is that this noise constitutes less than a third of the din that comes from an airplane in flight. It is easy to stifle the exhaust noise, but the sounds from other sources have proved exceedingly difficult to silence. To understand the problems in-

olved, it is necessary to consider some of the ways in which sounds are created. Any movement of any body through the air causes a sound. Even a wave of the hand makes a noise, though this is too soft to be heard by the ear. The faster the object moves, the louder the noise.

A golf club makes an audible swish as it is swung on the ball; a whip makes a more pronounced swish, for it can be moved faster. If the movement is faster than the speed of sound in air—1,100 feet a second—the noise becomes very loud. For instance, the lash on the end of a whip concluding a swing at 1,101 feet per second, gives a loud crack; the crack is absent when the movement is but 1,099

No Maxima Silencer copyrighted material  
Harford, Conn



612543

feet per second. Why does an object moved through the air make a sound? Because it compresses the air before it. This compressed air expands back to nor-



mal pressure just as suddenly as it was compressed; the expansion sets up a movement of the atoms of the atmosphere and the impinging of the moving atoms upon the eardrum makes us hear the sound.

We have actually taken photographs of the sound waves created by a rifle bullet flying through the air, a sound that is absolutely distinct from that of the powder explosion. This is possible because light rays passing through a segment of compressed air are refracted and registered upon a fast photographic plate. The pictures were made with an exposure of one-millionth of a second.

Now consider the tip of an airplane's



Hiram Maxim Making First Tests of His Famous Gun Silencer with an Army Rifle

eight-foot propeller, turning at 1,800 revolutions per minute, or thirty a second. The speed of the propeller tip is not faster than sound, but it is amply fast to create a pretty loud noise. Its velocity of 754 feet per second is getting up fairly close to the speed of sound. If the tips traveled faster than sound, no human could stand to be in or near a plane. Naturally, then, the whirling blades create considerable noise; in fact, nearly one-third of the total sound produced by the machine.

Fortunately, it is not necessary to have the propeller turn as fast as 1,800 revolutions a minute during flight; an airplane, once it is off the ground, travels just as swiftly and functions much more efficiently with the propeller's speed cut down considerably. Already, an airplane has been fitted with gears, enabling the pilot to cut down the speed of the blades. This practically eliminates the noise and, at the same time, increases the efficiency of the craft.

The third source of noise is due to flutter, an inherent characteristic of any object moved rapidly through the atmosphere. At first thought, one would imagine that a flag flying in a strong, steady breeze would stand out from the staff motionless. But we know that a flag in moving air always flutters and that flutter sometimes makes quite a noise.

The blades of a propeller move in a veritable super-hurricane, and the passage of the airplane through the air sets up a

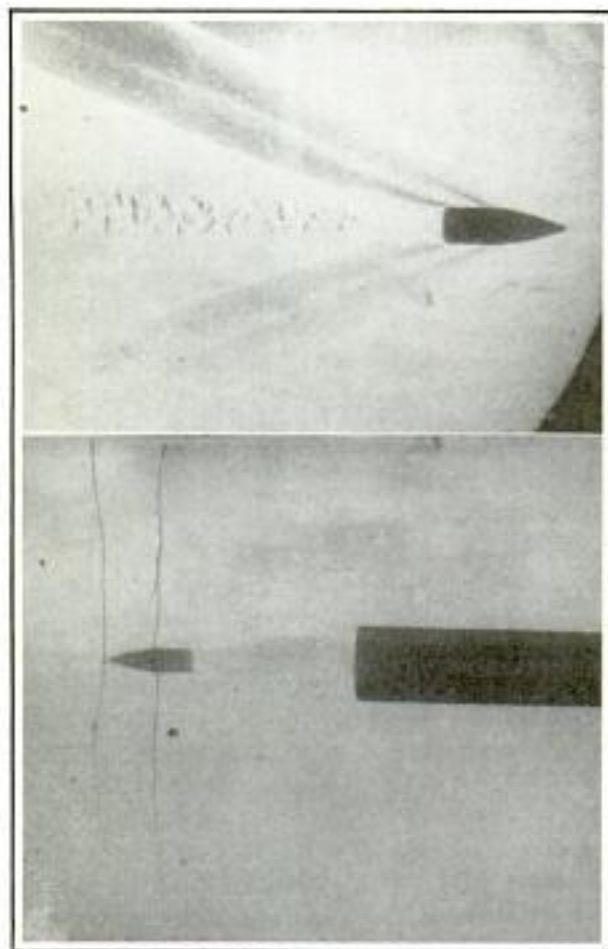

Top, Photo of Sound Waves from Speeding Bullet; Below, Bullet after Passing through Silencer



*u. 2521 d no. Blamey A  
Accord. Treasurer, Res  
Cale. Ind. 355*

continuous flutter in all parts and that makes a lot of noise.

The fact that devices which will eliminate the flutter noises are still on their way through the patent office, makes it impossible to give a detailed description at present. However, it can be stated that the creation of air foils before the propeller and other of the worst-offending parts, has successfully done away with this source of noise. Silencing the exhaust, the propeller blades and the flutter, completes the job, as far as the person outside of the plane is concerned.

However, other things are necessary to make travel in a cabin plane absolutely comfortable. The building of a sound-proof cabin is already an accomplished fact. The walls are lined with sound-absorbing materials, and the windows are double and made of small laminated panes, of three layers—two layers of glass with an intervening layer of celluloid.

Finally, the ventilator silencer, announced a year ago for shutting street noises out of buildings, has been modified for use in plane-cabin ventilators. Two intake ventilator silencers will be installed in the forward end of the cabin and two outlets, of the same construction, toward the stern. That airplane will be soundless to the person on the ground, and in it the passenger will be able to read or carry on a conversation with the same ease as in his own home.

Machine Prints Facsimile of Payee's Signature on Face of Check



*265-4th  
u  
New York*

**SIGNATURE STENCIL FOR CHECK GUARDS AGAINST FRAUD**

By stenciling the payee's signature on the face of bank checks, business houses and banks hope to prevent payroll padding and other forms of fraud. A device for doing this work is an adaptation of stencil and ink rollers. The signature of each employe of a company is obtained upon a stencil sheet. When the payroll checks are drawn, each stencil is fitted upon a check blank bearing the usual printed matter and having a proper space to receive the stenciled name. Then check blank and stencil are passed through a machine so that ink penetrates the stencil and leaves on the check a facsimile of the payee's signature. When the check is cashed, the indorsement can be readily compared with the stenciled signature.

**MIRRORS ON AUTO LIGHT BULBS ELIMINATE GLARE**



Headlight bulbs on automobiles can now be fitted with mirrors which eliminate glare, dimming or tilting, and also make night driving safer, particu-

larly in fog, snow and mist. The device consists of a condensing mirror fastened to the top of the bulb at an angle. By reflection from the lighted bulb filament the efficiency of the bulb is increased. The upper flange of the attachment casts a shadow on the upper sector of the headlight, which eliminates glare.

**PLANT WARNS OF GAS DANGER**

Growing an ordinary tomato plant in your home may be the means of saving your life, for it has been found that this plant is very sensitive to asphyxiating gases. A mere trace of illuminating gas, for instance, is enough to cause the younger leaves to droop. It would be difficult to find a better test for gas leakage which may be imperceptible to humans.

*Marvelite Corp  
3223 W. Hubbard  
Chicago*

*Experiment of Prof. Carl U  
Gale University  
Miss. Harv. Conn*



Holland Furnace Co ) no export business  
 Air Conditioning Div.

356

POPULAR MECHANICS

Holland, Mich (578 branches

#235.00  
 plus connected  
 expense  
 #10,000.00  
 on budget plan



cupying about ten square feet of floor space. Air first passes through a filter which removes much of the dust, then, forced by two fans, it is drawn through swirling water sprays. After its "laundering," the air passes through the furnace casing, where, in winter, it is warmed for the house. If the heating plant is not

New York. Chrysler Bldg.  
 Chicago. Straus Bldg.

Air Conditioner for the Home That Heats or Cools the Flow; at the Right Is Seen a Phantom View of the Apparatus, Showing Details of Operation

**WEATHER FACTORY FOR HOME HEATS OR COOLS AIR**

Air is heated in winter, cooled in summer and washed and circulated at all times by a home "weather factory" now available to the average family. Yearly comfort and health, with marked savings in fuel and economy from dust elimination, are claimed with the apparatus, which can be employed in connection with any type of heating plant. The entire outfit is simple and has few parts to service. It looks like a metal cabinet, oc-

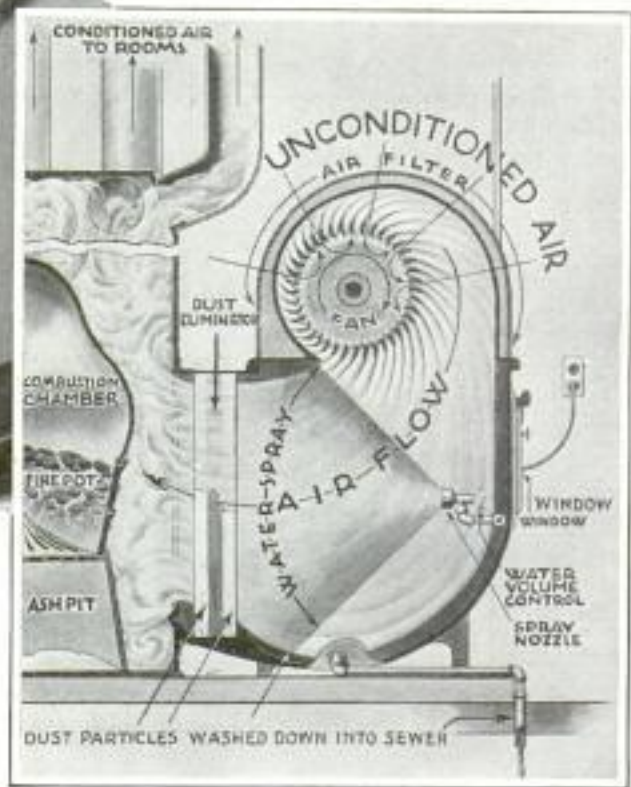

of the warm-air type, the weather factory is installed as an independent auxiliary. Humidity is provided by the adjustable water sprays. In summer, when there is no fire in the furnace, the air is cleaned and cooled by the sprays, and in extremely hot weather refrigerating units can be installed.

**RIGHT FOOD ENDS TOOTH DECAY IN TESTS ON ANIMALS**

For the first time in history, a way to prevent tooth decay has been found. A method effective on animals need only be applied to human beings to end rotting, decaying and infection of teeth. Drs. E. V. McCollum, Henry Klein and H. G. Kruse, after ten years' work, discovered that the quality of the saliva is the im-

portant thing in determining whether teeth will decay and that quality depends upon the chemical composition of the blood. The proper foods will put into the blood those things necessary to keep teeth in healthy condition. A certain proportion of phosphorus will keep the saliva at the right state between acid and alkaline, acting as a buffer solution. In addition, calcium and phosphate are necessary to preserve the enamel. Foods such as milk,

Complete report - Journal  
 American Dental Assoc  
 25/4

Prof. of biochemistry Johns  
 Hopkins School of Hygiene and  
 Public Health, Baltimore Md.

Science Service

12/23/30, Copyrighted material



A 2526

eggs, lean beef, beans and peas are rich in phosphorus. Calcium-rich foods are milk, eggs, watery vegetables, especially spinach, lettuce and cabbage, and some fruits. Vitamin D, the third substance for keeping teeth healthy, is present in fish oils, egg yolk, butter fat and whole milk.

**MASONRY TRESTLE BUILT WITHOUT FORMS**

Built entirely of brick, reinforced with steel rods, a railway trestle, 293 feet long, has been completed in Illinois by two bricklayers, working fourteen days. The bridge has twenty-one piers, each with a flat arch at the center. Steel rods were placed in the mortar joints to give the structure tensile strength, and the piers were reinforced in all directions. Sleepers and tracks were laid immediately after the brickwork was finished and the trestle put to use at once. No special shapes or sizes of brick and no forms were required. Research has shown that the structural strength of reinforced brick is amazing. Beams, twelve feet long, have carried as much as twenty-two tons without breaking, and slabs, eight feet long and only three and three-fourths inches thick, 1,000 pounds per square foot.

*Common Brick Type. Green Smarante Title Bldg. Cleveland Ohio*

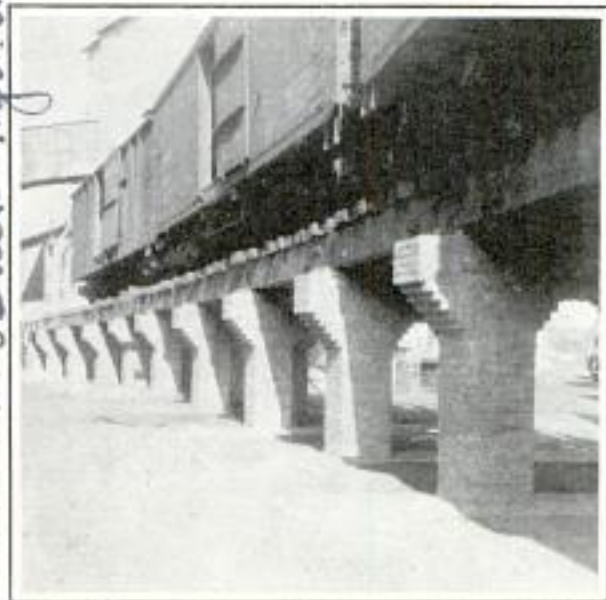

Railway Trestle Built in Fourteen Days of Steel-Reinforced Brick; There Are Twenty-One Piers

*Industrial Track Trestle  
Wedron, Ill.*

Applying the Principle of Short-Wave Radio. This Fever-Producing Machine Is Used in Treating Rheumatism and Similar Ills

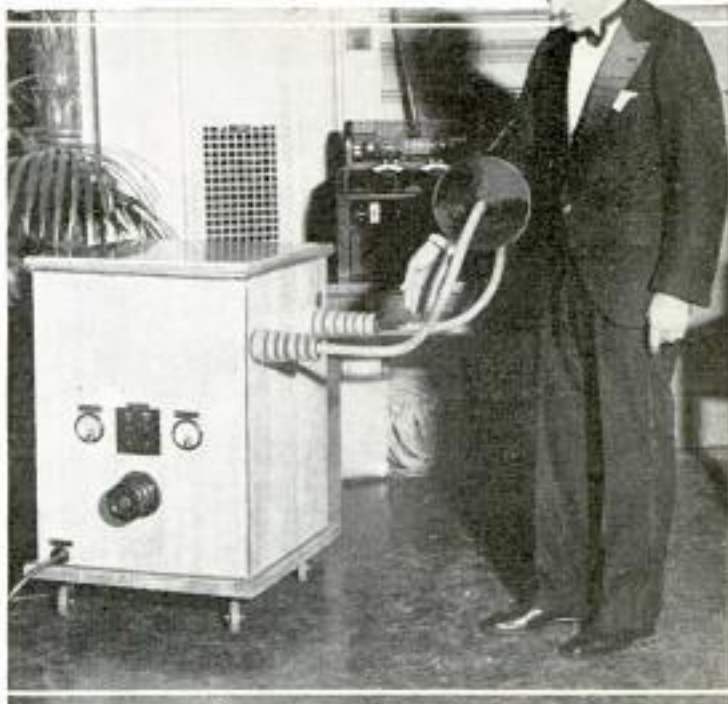

**HEAT APPLIED TO RHEUMATISM BY SHORT-WAVE RADIO**

Treatment of rheumatism and other ill with heat has been advanced by the introduction of a portable electric fever-producing machine constructed on the same principle as the short-wave radio transmitter. The device makes it possible to raise the internal temperature of certain body parts—arm and leg joints for example—without producing a complete fever temperature. Heat ranging from ninety-eight to 105 degrees can be developed by the machine, which was produced by the General Electric company. The greatest heating consistent with the tube output has been obtained from the use of a thirty-meter wave, oscillating ten million times between the plates. The device, called a "radiotherm," has been used in giving more than 500 heat treatments.

**OYSTERS FOR ANEMIA**

Oysters are rich in iron and copper, providing a valuable dietary aid in preventing anemia. The copper is helpful to the fixation of iron in the blood, research workers of the Canadian department of fisheries have found. Some lately found vitamins also are contained in oysters.

*discussed before  
Boehme's Club of New Orleans  
Brooklyn, New York*

*Built by Allen R. Page.*

*Schenectady, N.Y.*

*60 St. James Montague  
London, England*



9 2585

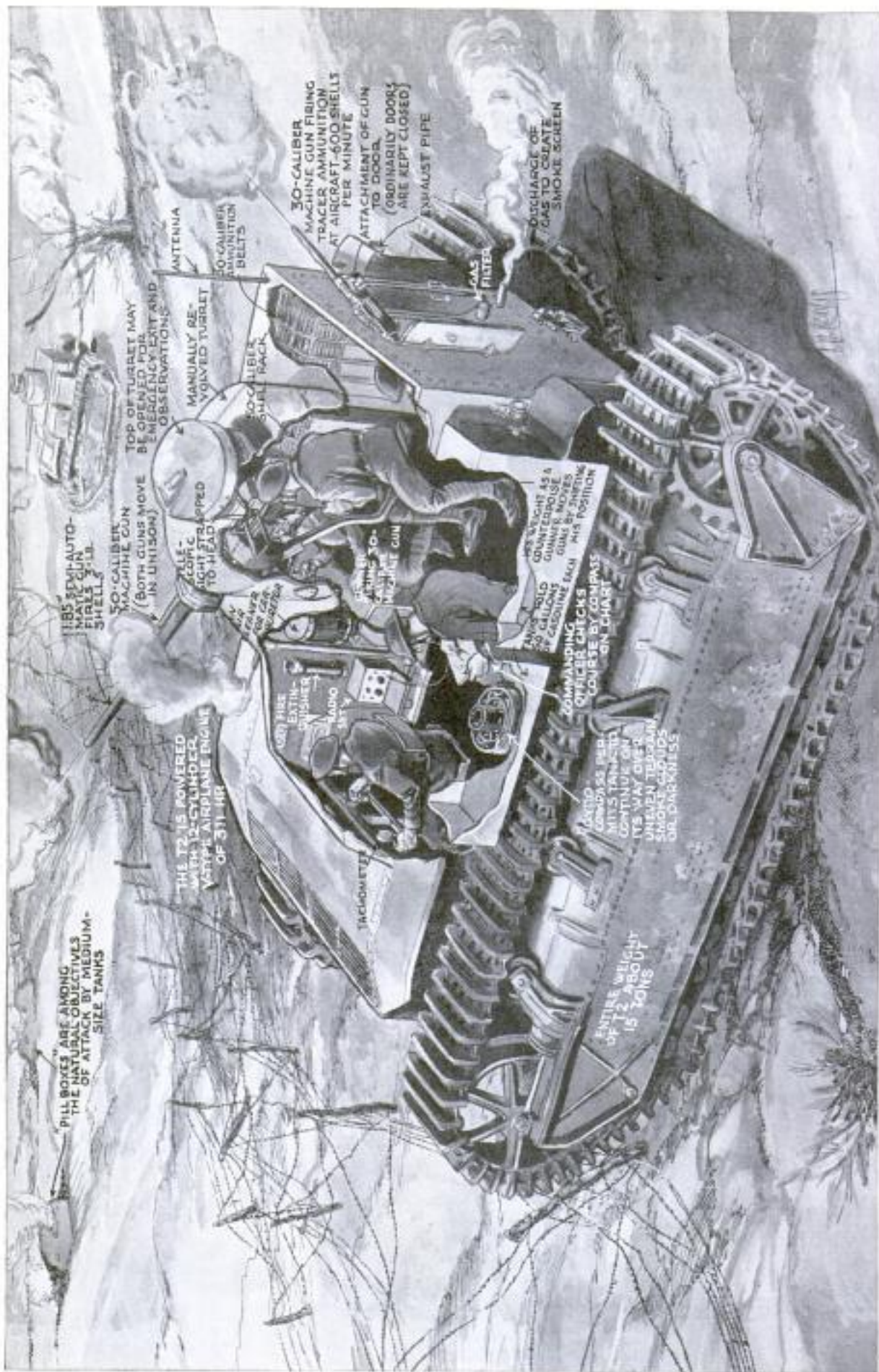

Artist's Drawing of the "T-2," Uncle Sam's Latest Tank; This Mobile Fortress Can Travel Thirty Miles an Hour and Bridge a Trench Seven Feet Wide; Note Various Types of Guns, the Radio, Gyro-Compass and Smoke-Screen Discharge Pipe of This Fifteen-Ton Fighting Machine



U.S. Daily 12/16/31

B-6 Aluminum Company  
of America, Oliver B. Day  
Pittsburgh, Pa

**AUTOS OWNED ON THREE-FIFTHS  
OF AMERICAN FARMS**

Fifty-eight per cent of the farms in the United States own automobiles, according to the census bureau. Figures for April 1, 1930, showed that thirteen and four-tenths per cent of the farms had motor trucks, slightly less than the ratio for tractors. In addition, four and one-tenth per cent of the farms have electric motors for farm work, while fifteen per cent have stationary gas engines. Nebraska has the largest percentage of automobiles, ninety-one and eight-tenths.

**TRACTOR THAT DIGS UP TREES  
AIDS NURSERY HARVEST**

Trees up to twenty feet high are dug by a tractor recently placed on the market. The tractor straddles the row of trees, much like a potato digger, and penetrates the soil to a depth of sixteen inches. Tree stock is left in the ground, heeled and ready for lifting. The blade cuts a swath twenty-four inches wide and is quickly raised or lowered with little effort. The entire machine can be turned in its own length at the row end and an additional advantage is its ability to dig only part of a row of trees if it is desired to leave some.

Tree-Harvesting Tractor at Work in Nursery; Roots Are Cut and the Saplings Left Standing Until Ready to Be Lifted for Delivery



Caterpillar Tractor  
Co. Peoria Ill.

Electric Wheel Co  
Quincy, Ill.

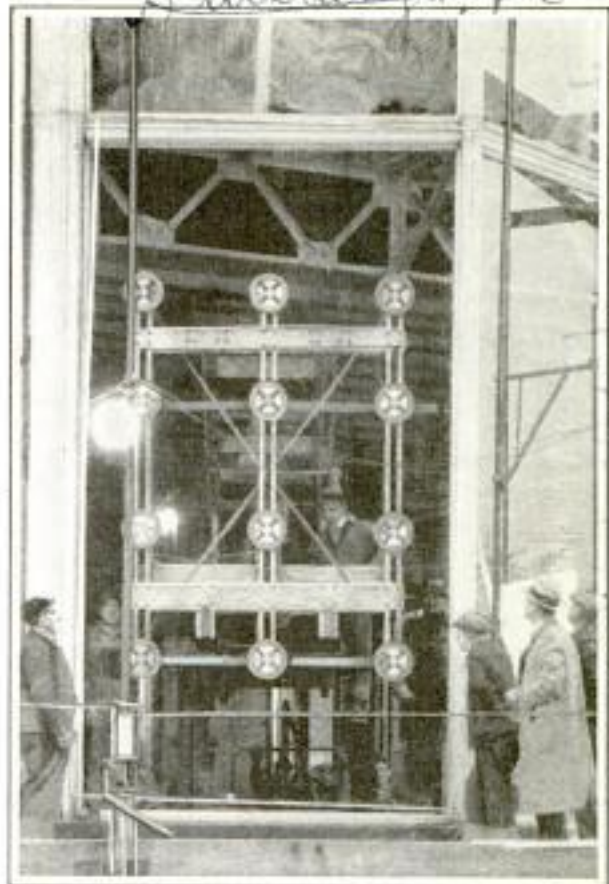

Plate Glass Being Raised into Position by Means of Vacuum Cups Attached to Metal Frame

**BIG VACUUM CUPS RAISE GLASS  
WINDOWS INTO FRAMES**

Large plate-glass windows are being lifted into frames and moved about by the use of big vacuum cups, the principle being the same as is employed in holding a match box to the windshield of a car by a small suction cup. The glass lifter consists of a frame containing twelve vacuum cups, each one foot in diameter. These are set against the glass and a vacuum applied. By means of valve connections, each cup may be placed independent of the others. With such a device it is possible to place large glass windows on tall buildings in removable frames, swinging the glass in for cleaning with the suction lifter.

Moisture balls have been found to check fungi and parasites that kill plants.

Mrs. Freeman  
Weiss and Co.  
Evansville, Pa  
Copyrighted material

And. J. W. Bangs, 121 Newtonville Ave  
Newton, Mass

W. S. Leitch of  
Agriculture



NY Times 12/17/31

W. J. Electrothermic Corp Trenton, N.J.  
Frank J. Cleland, chief mechanical engineer working under  
the direction of Peter Northrup, Director

2535



Controlled Heat, 1,000 Degrees Hotter than That Heretofore Found Practical for Commercial Purposes, Is Shown Being Applied to an Ordinary Electric Furnace

base were turned into vapors which were expelled to burn in the air with the white flame of magnesium flash powder or silicon metal. Iron, which vaporizes at 2,400 degrees, seemed to form a carbide quickly, and as such was kept in the furnace until the heat was close to 3,600 degrees. At that point, a roaring blue and white flame rushed out into the air. In one case, the power was kept on too long and the vapors wrecked the furnace. Even greater heat may be reached.

Q 2547

### COPPER MADE HARD BY ADDITION OF BERYLLIUM

Copper, alloyed with about two per cent of beryllium, has been shown, when heat-treated, to possess the tensile strength and hardness of good steel, while retaining all its particularly

### ROCKS AND WOOD TURN TO GAS IN ELECTRIC FURNACE

Rocks, wood and metals can be converted into vapor by a heating method in which an ordinary electric furnace is used. Heat of 3,600 degrees centigrade has been reached, pushing the limit for controlled heat up 1,000 degrees. While higher temperatures have been reached with furnaces of special design, this method is the first to make such heat commercially practical with a furnace of conventional design. One feature is that while graphite is being vaporized under 3,600 degrees heat inside, the outside of the furnace, three inches away, remains cool. Bits of wood apparently were converted into gas before they even entered the heating chamber. The gas thus formed, even from a small piece of a quarter-inch cube, was almost sufficient to blow the furnace apart. Ordinary rocks of silica or magnesium

necessary qualities as copper. The development of the alloy has followed several years' experimentation to produce sufficient beryllium to make it commercially interesting. About the only source is the ore beryl, from which emeralds and other precious and semiprecious stones are obtained. The cost of beryllium, however, has now been reduced from \$150 to \$50 per pound and the alloy, with a content as high as twelve and a half per cent of beryllium is quoted at \$6.35 per pound. The alloys have very high electrical conductivity, cast with ease and possess great sonority. They are elastic, fatigue-resisting and non-corrosive. For the latter reason they are adaptable to the manufacture of springs in instruments and measuring devices. Included in the long list of prospective uses are valve parts, condenser tubes, propeller shafts, bearings and gears. Principal supplies of the ore are in New England and the far west-

Beryllium Development Corp. Port Huron, Mich



ern states, sometimes as a by-product of mining mica and feldspar. Beryllium is one of the lightest metals known.

**WHEELLESS TIRES  
"FLOAT" OVER  
BUMPS** 22573

Smooth riding over railroad tracks, curbstones, deep ruts and chuck holes is claimed with a new type of auto tire that is fitted directly to an oversize hub instead of a wheel and operates on only twelve pounds of pressure. In cross section the new tire is triangular, like a pyramid with the apex at the bottom, making the base broad and the tread narrow. It is said to contain two and a half times the volume of air of the ordinary "doughnut" type at much lower pressure. As a result of the narrow tread there is no more rubber on the road surface than with the usual balloon type, while the almost straight side walls and broad base are credited with giving

*Streamline Jumbo*  
Only Twelve Pounds of Air Are  
Required for These Tires



the car greater stability, safety in emergencies and easier steering. A "floating" ride is stressed as the principal result.

Chicago. 2247  
Collage Iron

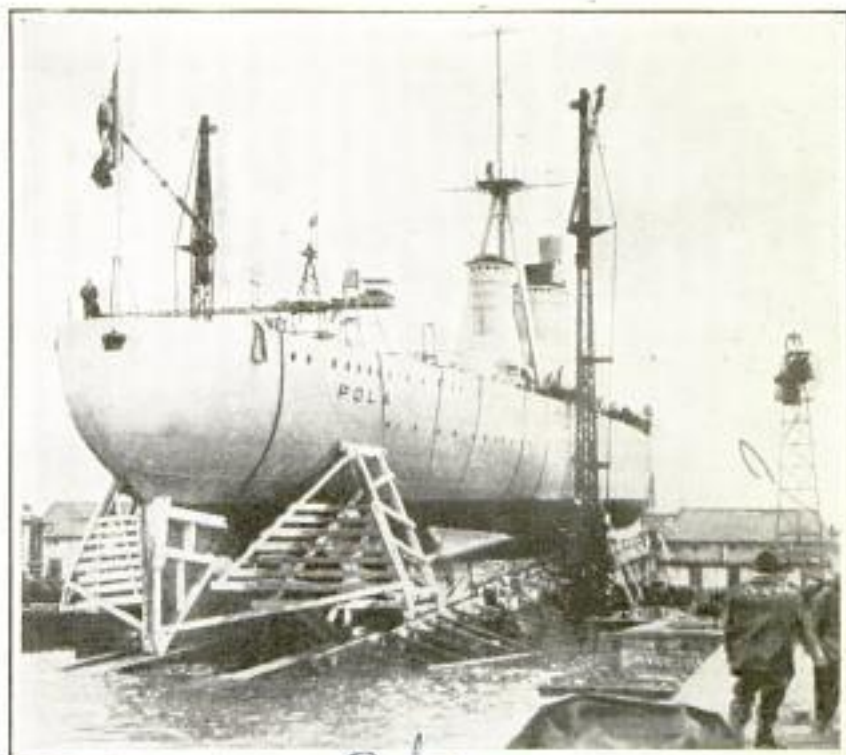

© International News Photo  
Here Is Italy's Latest Cruiser, of the 10,000-Ton Peace-Treaty Type, Just Before Its Launching within a Year After Work Started

**CRUISER BUILT IN RECORD TIME  
OF LESS THAN YEAR**

Marking a record for construction in that class, a 10,000-ton treaty cruiser has been completed and launched by the Italian government. The keel was laid early in 1931 and the vessel was christened and launched shortly before Christmas. King Victor Emmanuel christened the cruiser, naming it the "Pola."

**GOGGLES FOR GLASS BLOWERS  
TO IMPROVE WORK** 2560

Lenses have been designed for goggles worn by glass blowers to eliminate the objectionable yellow glare from incandescent glass. When observing a piece of glass in the flame, the wearer sees only the red glow of the glass, with sharply defined outlines. Under usual conditions, the glass blower must frequently remove the work so as to note the exact shape of the glass. The new lenses are transparent to other light, making it practical to wear the goggles indefinitely, since they do not interfere with normal vision when looking for objects on the workbench. The lenses are pinkish in color, being constructed of special didymium glass.

Burgess. Parr Co. Inc.  
202 E 44th St New York



A2527

# CRYSTALS *that* TALK

3745 - Index for Cleveland, Ohio - see July 19 38-90  
3311 - 25 Perhaps are, Cleveland &



Photo by Fred R. Hill

"CLEAR as a crystal" will be no idle comparison for the voice of your radio or phonograph within a short time, now that a hundred years of study and research with talking crystals have yielded something more practical than a mass of figures and notes.

Radio loud speakers, phonograph pick-ups, microphones and other instruments working on a revolutionary principle are to be placed on the market soon. They will be of the simplest construction imaginable, their working parts being nothing more complicated than a piece of Rochelle-salt crystal.

It remained for the Brush laboratories in Cleveland, headed by Dr. C. Baldwin Sawyer, to convert the Rochelle crystal that had been a scientific curiosity for years into something that can be used by you and almost everyone else.

Crystals of Rochelle salt, grown at the Brush laboratory to huge proportions by

a secret process, possess the peculiar property of giving off electricity when squeezed or caused to vibrate, and of changing their shape when subjected to electrical charges. This property of certain substances to produce or react to electricity is known as the piezo-electric effect.

During the world war, talking crystals were studied in an effort to devise a means of submarine communication at extremely high frequencies, above the range of human ears, so that both surface and undersea ships could talk to each other without enemy ears listening in.

Because Rochelle salt produces the best singing crystal, most of the development work has been done on that substance. These remarkable crystals are grown

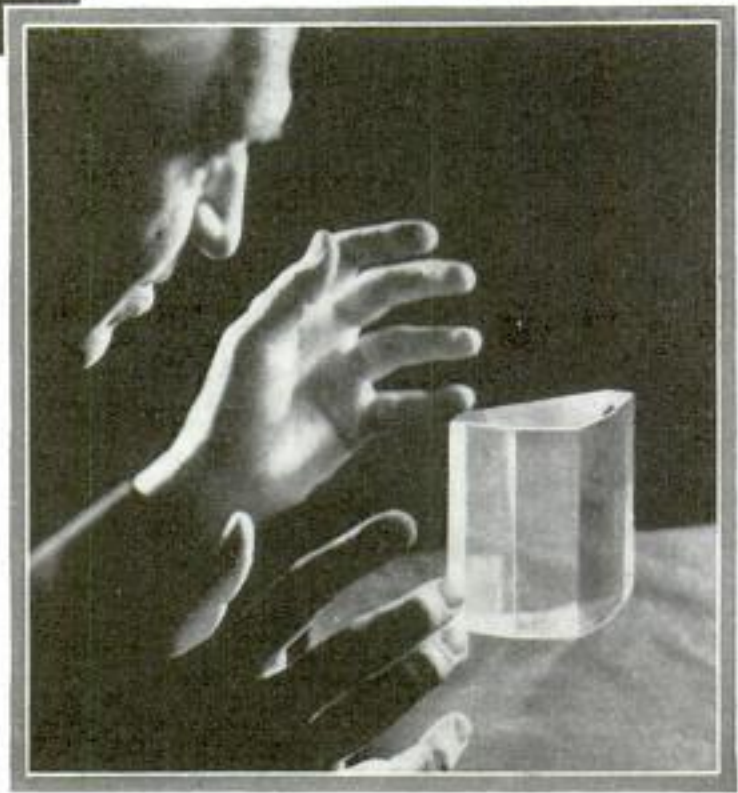

Above, Dr. C. B. Sawyer of Brush Laboratories, Expert Crystallographer; Below, a Specimen of Cut Crystal

from a saturated solution of sodium-potassium tartrate. A Rochelle crystal must be squeezed in a certain way in order to make it act as an electric generator. The electricity is collected by plates of metal foil cemented to opposed surfaces, and to these plates the lead wires are attached.



2 types of loudspeakers  
available 4/4/32

Q 2527

# and SING

A whole crystal is not used in a loud speaker, pick-up or other device. It is cut into plates or other forms, and these smaller pieces are used. If a rectangular plate of crystal is mounted so that one end is rigid while the other is free to move, and if an electric charge is applied to the two large surfaces through their foil covering, the crystal will distort in a certain direction. If the current is vibrating—as that coming from a radio receiver—the crystal will vibrate in unison.

Now, if the free end of the crystal is attached by a small rod of wood or other material to the apex of a speaker cone, and the two tinfoil plates connected to the speaker terminals of a radio-receiving set, the

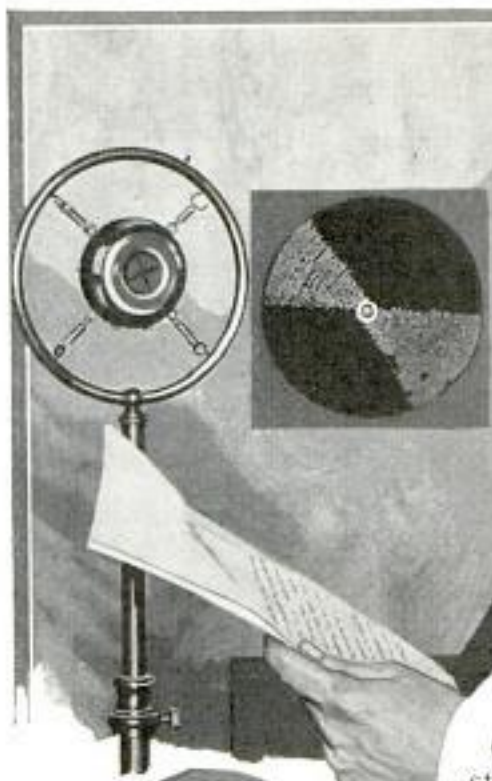

crystal will convert the electrical impulses into sound which is magnified by the cone so that it is heard as music or speech.

One of the most important steps taken by Doctor Sawyer and his associates in the art of making crystals talk was the developing of a high-powered unit. A crystal plate moves in one direction only, when a certain electrical force is applied. Likewise, another plate will behave in the same way. Now, if these two plates are placed with two of their large faces together and arranged so that one will move in one direction and the other in an opposite direction, a unit much stronger than any single plate results. An arm can be attached to the moving end and to a speaker cone. It is this type of unit that is being introduced in the new crystal speakers. The diaphragm movement is as great as one-eighth of an inch for low musical notes.

Many radio speakers do not reproduce notes higher than about 3,500 vibrations a second. Some of the better ones go as high as 6,000. The Rochelle-salt crystal will handle a note of 100,000 cycles just as easily as the thirty-two cycle boom

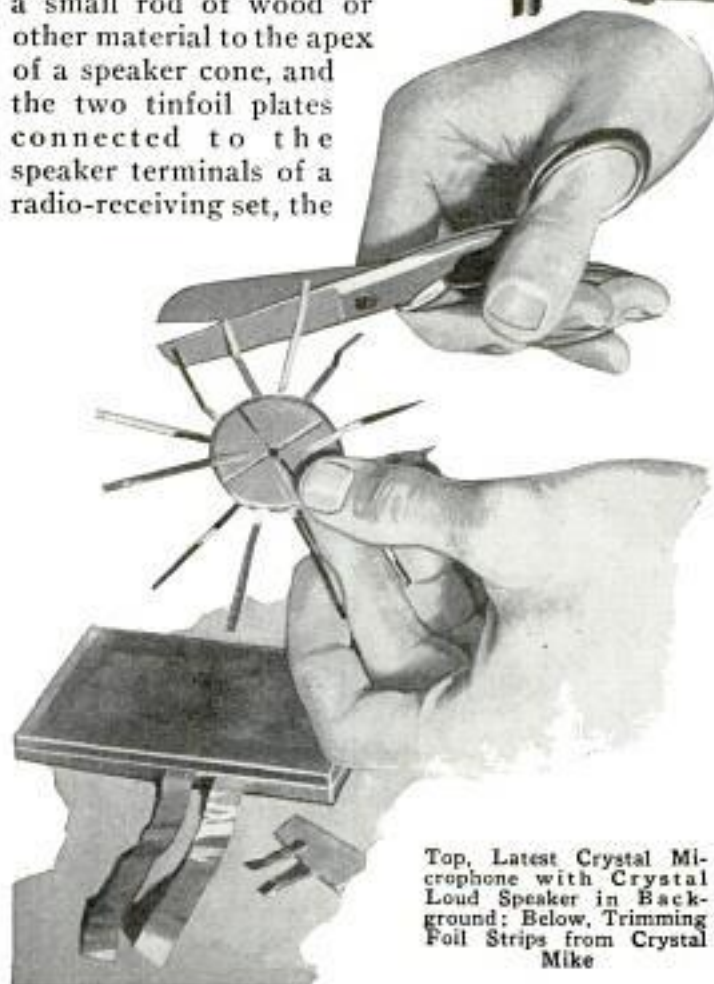

Top, Latest Crystal Microphone with Crystal Loud Speaker in Background; Below, Trimming Foil Strips from Crystal Mike



Emb. A. B. Bruce  
1521 Minger St.  
Houston Tex.

of an organ pipe. In commercial types of crystal speakers, however, the upper limit

Assembling a Crystal Speaker Which Reaches High Frequencies



is not reached, because human ears seldom are responsive much above 20,000 cycles.

Because of the ease with which it reproduces high notes, a form of the piezo-electric speaker has been developed for use in conjunction with dynamics which handle bass notes better than high ones. This auxiliary unit has a cone smaller than the standard crystal speaker. It is likely, therefore, that radio receivers a year or two from now will be equipped with two speakers, to cover the entire music range completely.

This, truly, is a mystic crystal from which an untold number of wonders may be expected to come.

**ELECTRIC "BOMB" KILLS MOTHS WITH CHEMICAL FUMES**

Chemical fumes heated by electricity are used to kill moths in an automatic exterminator now on the market. When placed in a clothes closet, it will kill all moths and larvæ and immunize the garments in twenty-four hours. Two chemicals, naphthalene and paradichlorobenzene, when heated by the electric unit connected to the



Automatic Washer Co.  
Newton, Mass.

nearest wall socket, send out the fumes. Only a single ball is necessary for each closet, it is said.

**RADIO BRINGS DOCTOR'S ADVICE TO PEOPLE OF FAR NORTH**

One Ottawa, Canada, doctor probably covers more territory in treating his patients than any other physician, but he uses the radio instead of an automobile to make his visits. He is Dr. F. S. Parley, an official of the department of health, and all his diagnosing and treatments are accomplished by wireless. Dotted throughout the far north are small settlements of men and women isolated from civilization. When sickness adds to their loneliness, they appeal to the settlement radio station, and their symptoms are wirelessly to Doctor Parley who makes a diagnosis and flashes back a course of treatment. A medical manual, a first-aid kit and a cabinet of staple drugs are standard equipment at every government post. Doctor Parley has a manual identical with those at the posts. He radios the page number, and the patient follows instructions he finds there. When special treatment is required, the drugs are specified by the numbers of the vials containing them.

**CAR SPEED RECORDED IN CRASH BY SPEEDOMETER LOCK**

Speed of an automobile or truck at the moment it collides with another vehicle or object can be recorded automatically by a device which locks the speed indicator under a lateral impact. Called a "strikometer," it is intended to be a silent witness in accidents, a protection to the careful driver. The device is not actuated by the severest horizontal jolting such as might be received by traveling over a rough road or hitting a rut. It is built into speedometers during the process of manufacture and is provided with a seal to be broken only by authorized persons.



B-13

and W. J. Abidine  
1716 1/2 Colorado Blvd.  
Beverly Hills, Calif.



u2564

15830 South Park Blvd,  
Shaker Heights

POPULAR MECHANICS  
*Cleveland Ohio*

# Auto Expert Spends Half Million on Diesel

High speed and high power are obtained by F. B. Stearns, automobile expert, through a new type of Diesel engine which has eight cylinders and sixteen pistons. The engine is shaped like a diamond, or like two "V" eight

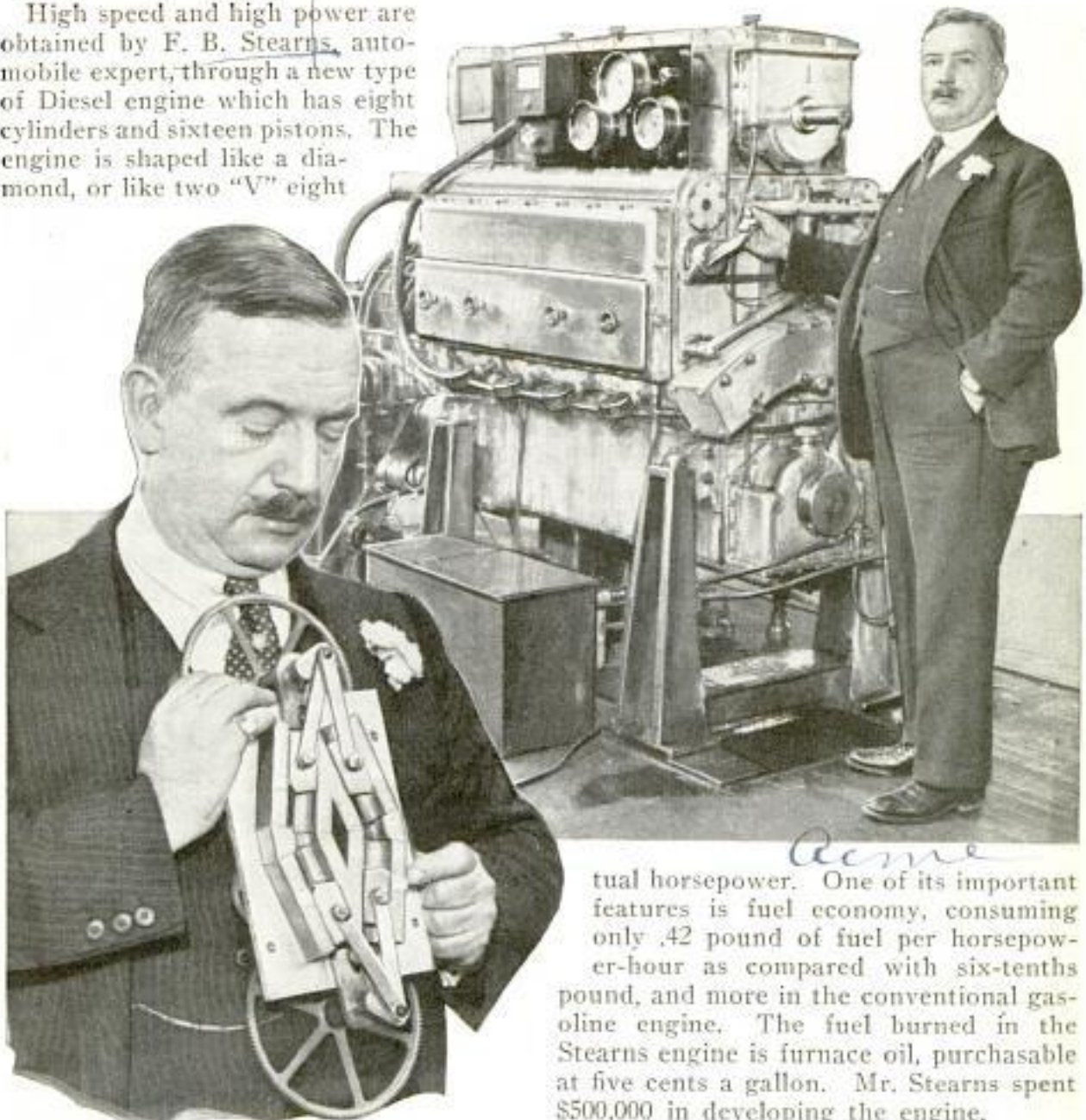

F. B. Stearns and His New Diesel. Above: the Inventor with a Cut-Away Model, Below

engines placed one above the other with the prongs of the vees in the middle. Combustion space is between the two pistons in each cylinder, the pistons being pushed apart on the power stroke. Thus a "cushion" is provided on the compression stroke, making for extreme smoothness. There is a crankshaft at top and bottom, the two being geared together. Except for the two shafts, the entire engine is made of an aluminum alloy and weighs 2,000 pounds. It develops 160 ac-

*acme*  
tual horsepower. One of its important features is fuel economy, consuming only .42 pound of fuel per horsepower-hour as compared with six-tenths pound, and more in the conventional gasoline engine. The fuel burned in the Stearns engine is furnace oil, purchasable at five cents a gallon. Mr. Stearns spent \$500,000 in developing the engine.

## FAST ADDS TO MENTAL ABILITY IN PREPARING FOR TEST

If you want to do your best at examinations, it may pay you to go without food for several days provided you eat just before the test. In experiments at the universities of Chicago and Michigan, volunteers who starved themselves for periods ranging from ten to thirty-three days were found to be physically fit. Steadiness of the hand was improved, while the mental processes were increased if the faster took food shortly before examination.

*Science Service  
12/21/31*

*reported by Mr. La Blaze,  
Copyrighted material  
Kansas State Teachers College  
Publication 1931*



a2553  
366

British Air Ministry  
Lt Col Major Jack Savage  
POPULAR MECHANICS  
London, England

# "Nets" of Light on Clouds Trap Air Raiders



Left, Night Photo of Net of Light Projected against Sky; Above, the Equipment

recent test, a bomber of the latest type flew 12,000 feet above London, blanketed in fog, with its engines muffled so no noise was heard below. Ordinary searchlights scanned the sky in vain, and just as the "enemy" was about to release his flares, indicative of bombs, he was netted in a great square of light, divided into sixteen smaller squares, the beams of which he had not been able to see until he was directly in their path. Etched within one of the smaller squares, the position of which was quickly correlated by the gun pointers below, he was a perfect target.

## HOW FAST YOU LIVE SHOWN BY ELECTRIC METERS

Another difference between the nervous, energetic person and the slow easy-going character has been reported by scientists of the Mayo foundation. They have found that those whose internal fires burn at a rapid rate generate small differences in electrical potential between two points on their arms or legs, while those with low rates show higher readings. The potential differences are extremely minute, of course, usually limited to a few thousandths of a volt. It also was found that the voltage is increased by an emotional storm or a hearty meal.

Science Service 12/25/31 a257

Light of three-billion candlepower projected against the clouds in the shape of a rectangular grid, by means of which enemy planes' positions may be accurately plotted, is a new British invention that threatens to change aerial tactics. In a

Mr Charles Sheard  
Charlotte Purdy  
Copyrighted material  
Roberts & Mann

Cmd. Walker



*Maynard  
M. Metcalf*  
A 25 78  
Alumaweld Co  
710 E. Broadway  
367  
Isle of Wales, Calif

**POPULAR MECHANICS**

**EASY POISON-IVY TREATMENT RELIEVES PAIN QUICKLY**

An easy and simple method for the relief of poison-ivy irritations has been recently described by a Johns Hopkins University scientist. He explains that the poison is in the form of an oil and that the dissolving and removal of the oil before it can be absorbed into the skin is the most effective cure. His method is to prepare a hundred or so pinches of absorbent cotton; fill a saucer with alcohol, of seventy-five per cent or greater strength; dip the cotton into the alcohol and sop up the poisonous oil, throwing each pinch away as soon as used and being careful not to allow the alcohol to dry on the skin. The alcohol should be frequently changed. About fifty applications are usually sufficient for a small patch of poison. The first thirty applications should not be rubbed, merely sopped. After that, it is well to rub with the wet cotton each time. At last, rub vigorously to bring the dissolved poison out of the pores, and to break any small blisters that already may have formed. The more extensive the poison patch, the more swabs will be needed, and the more treatments with relatively varying degrees of pressure are necessary. Fifty swabs are sufficient for a patch the size of a silver dollar.

*Baltimore Md*

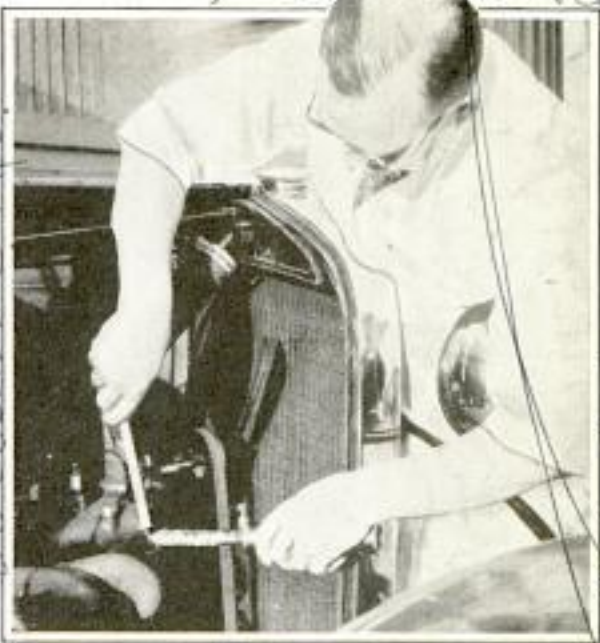

Repairing a Cracked Water Jacket on the Road with New Soldering Material

**SOLDER FOR WELDING IN HOME FUSES WITH ALL METALS**

Home welding is made easier by a new kind of solder now on the market. The product may be fused at a comparatively low temperature, but requires a much higher temperature for re-fusing. Aluminum, copper, pot metal, cast iron, steel, brass and all other metals may be soldered. A chemical reaction causes the metal surface to break down, the metal and solder fusing into a solid piece. Steam pipes can be soldered with this substance to withstand 500 pounds of steam pressure, kitchen utensils can be repaired in the home, and a cracked automobile water jacket can be fixed speedily on the road. An ordinary soldering iron is used.

*May 4, 1926. ad  
241 S. S. Parkway  
Chicago  
Indiana*

**STATE MAP ON AUTO RADIATOR IDENTIFIES YOUR CAR**

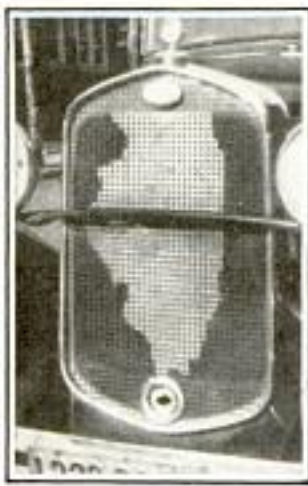

Tourists traveling outside their own state are now employing a radiator map of their home commonwealth to aid other motorists in identifying them. The map is painted on the front of the radiator, red or black being used for the borders and white, or

some other contrasting color, for the map itself. Approaching drivers thus easily identify a car by the radiator where they might have difficulty in observing the license plates.

*Emb. Geo A Harrison  
Valparaiso  
Ind*

*Ill. Com. Tech. High Sch*

**COMMON ELECTRIC LIGHT AIDS IN CURE OF RICKETS**

Babies can be cured of rickets by exposure to electric lights, such as are used for illuminating purposes, recent experiments have shown. Lights used for this purpose are the 115-volt, 500-watt tungsten-filament bulbs incased in frosted glass. The bulbs are placed in oxidized-aluminum reflectors and suspended five feet or more above the patient. Children so treated usually tan, but there are no reports of sunburn. Exposure is for twelve hours a day for about three months.

*Dr. H. J. Eisenberger  
A. J. Horech*

*Wm. Evans Chicago Tribune*







# Caisson Shell Digs Own Pit in Ten Minutes

Four feet in diameter and thirty feet long, a caisson shell recently sunk itself into the earth in ten minutes in building the subpiers for a Chicago bridge. The shells are steel casings and each is sunk by affixing to its bottom rim six jets through which 1,000 gallons of water per minute are forced under pressure of 135 pounds to the inch. The jets have orifices at both the top and bottom, the bottom loosening the earth below and the top forcing it out of the hole, the shell dropping by its own weight. The shell then is filled with concrete and becomes one of the supports for the bridge. It takes about twenty of the big caissons for the Chicago project. The process replaces the old method of digging the caissons by man power, under high air pressures, requiring days and often weeks of time.



Photo, Frank M. Hallenbeck  
Giant Caisson Tube Digging Its Own Pit by Means of Water Jets on a Big Bridge Project in Chicago

*Al Johnson, Construction Co. 528 E. North Water Chicago*

Q2494

## STEEL SHIELD GUARDS DRIVER OF TRUCK FROM ROCK

Trucks being used in the construction of Boulder Dam are equipped with a steel

roof shield, three-eighths of an inch thick. The shield is part of the truck's body and is placed there to protect the driver against possible injury from falling rocks at the gigantic project.



Steel Rock-Catching Shield Protects Driver

## "EYELID CRUTCH" FOR GLASSES HELPS CORRECT SIGHT

Glasses fitted with a "crutch" will help to correct ptosis, a paralysis which causes the upper eyelid to droop or to close completely, resulting in partial or total deprivation of sight. The crutch consists of a half hoop of thin gold wire, fitted to the contour of the patient's eye socket and welded to the nosepiece of the spectacles. Precise fitting to the eye is accomplished after the wire is welded to the glasses. The crutch is adjusted by putting it on over the patient's closed lid and then pulling the lid over the gold arch.

(Sulpho-cyanide of ammonium, dissolved in an equal weight of water, will lower the temperature from sixty to ten degrees Fahrenheit.

*Q2498*  
*Waltham Chemical Works*

*Perfected in clinic Pennsylvania State College under Dr. John C. Neill*

*Herald Tribune 12/9/31*

*Wide World*

*Franklin Institute 23-359 Philadelphia*



-A2424 Cont. Joseph H. Mountain,  
650 Rampart Drive  
Los Angeles, Calif

# "BUG-MEN" Lead Hunt

## Searching for Oil With A Microscope

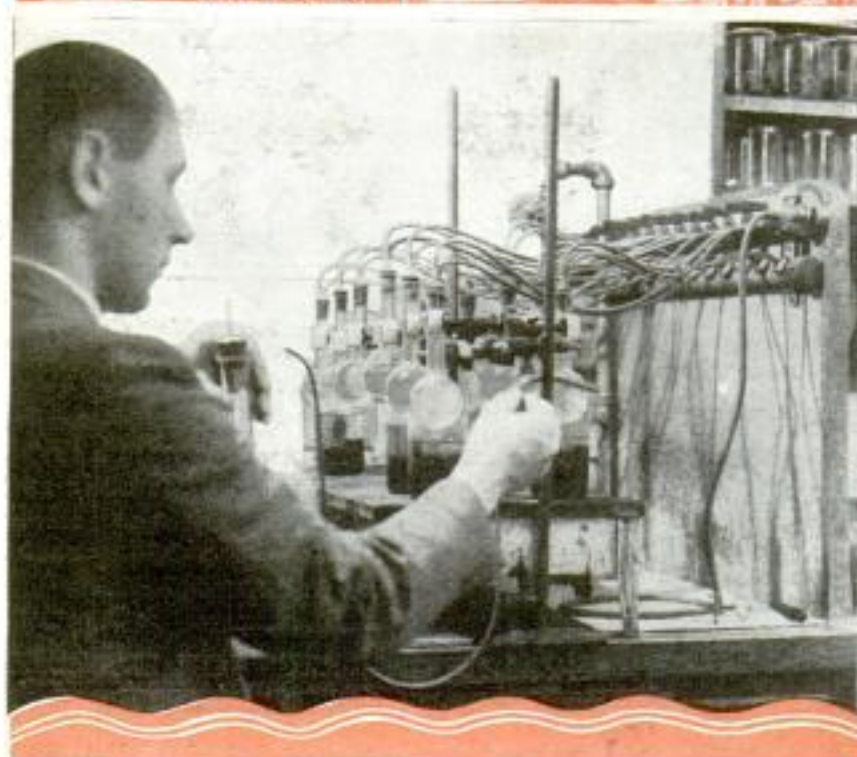

Samples-Containing "Bugs" Being Boiled with Acids to Loosen the Tiny Fossilized Shellfish for Microscopic Examination

**T**INY bugs, dead millions of years, recently led to the discovery of a great California oil field, whose millions of barrels of sticky "black gold" brought sudden wealth to many producers. These tiny fossil bugs are today locating new sands far below the producing levels of nearly dead fields. They infallibly tell drillers when to set casing, when to abandon hopeless drilling projects and when to spend thousands of dollars more to reach their goal.

In years past, several dry wildcat wells were drilled near Venice, Calif., but not until oil men applied the newly developed

science of micro-paleontology to the old samples of shale and sand from these "dusters," was there definite promise of an oil structure.

Locating the oil structure is the greatest problem in prospecting for oil. Level fields or lofty mountains may cover buried hills and valleys. The layers of which the earth's crust is composed have been lifted, twisted, and folded by the earthquakes and convulsions that have occurred since these strata were deposited on ocean beds in long

forgotten ages. When these layers are arranged so that they form a subterranean hill, or anticline, the prospect of oil is favorable.

Although many methods of mapping this underground topography have been devised, the one used by "Duke" Curtice, a Los Angeles oil operator, in the discovery of the Venice field is not only the newest, but perhaps the most effective. Micro-paleontology, or "bug hunting," depends on the fact that in each layer of the ground certain kinds of bugs predominate. These bugs, the fossilized remains of microscopic shellfish, may be identified and

Arthur A. Curtice,  
Bartlett Bldg. 215 W  
7th St. Los Angeles Calif



# for BLACK GOLD

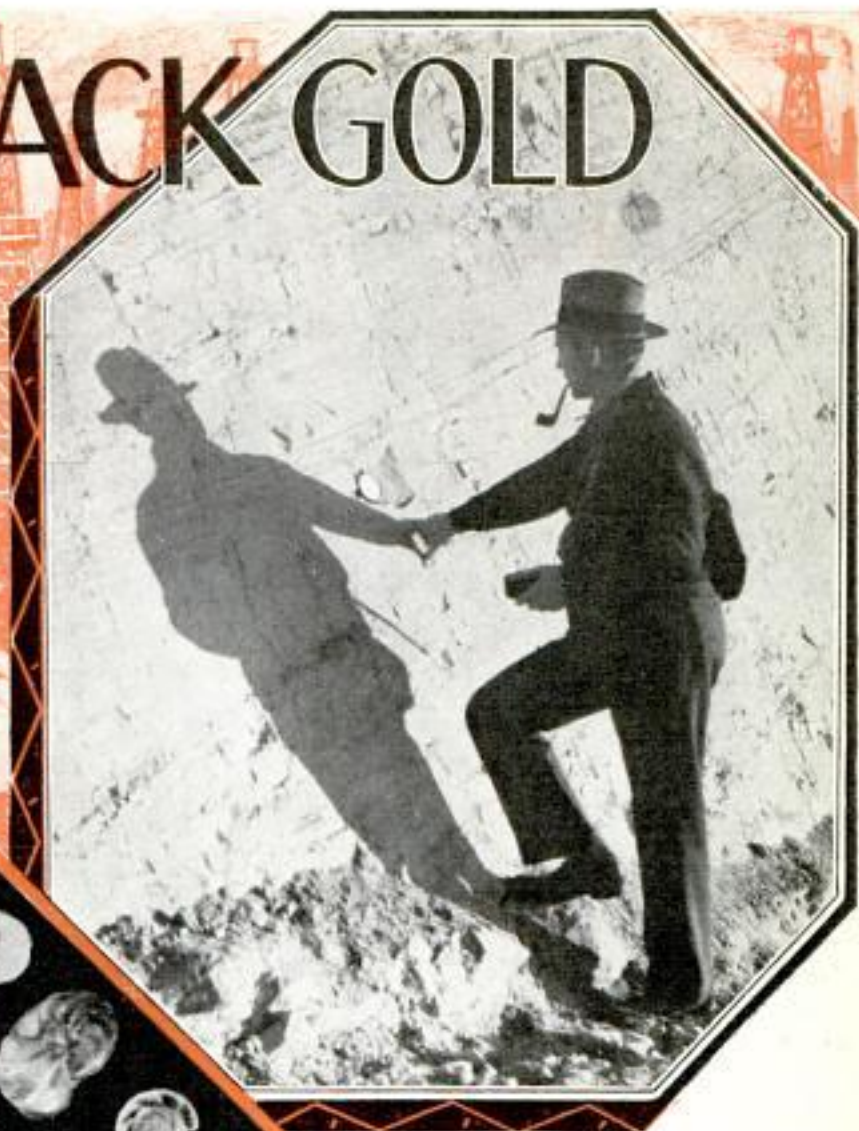

Above, Geologist Studying Walls of Excavation to Find Types of "Bugs" Predominating; Below, Magnified Bugs

their types traced to determine the underground structure.

"We were making a subsurface contour map of the whole Los Angeles basin," said Mr. Curtice, "when it became apparent that there was a strong likelihood of an oil structure on the west side of the basin. Immediately we redoubled our efforts in

this locality. From hundreds of outcrop and well samples, we picked thousands of bugs, examined them under the microscope and classified them. Correlation of the findings from several oil wells, together with what little surface information we could get, gave us a fair, but not a complete, picture of the subsurface conditions.

"On the basis of the information we had, we estimated the location of the structure, leased 850 acres and drilled a test well. Although we went to about 7,000 feet, we did not strike oil. We were 'off the structure.'

"But we were not disappointed," the oil man continued. "During the drilling of the first well, we took a great many core samples. From these we were able to obtain enough information to complete our picture.





Above, "Bugs" and Sand Classified for Reference;  
Right, Microscopic Slides Containing Bugs

"We moved our location exactly one mile west, drilled a well, and brought it in with an initial production of 2,600 barrels."

Micro-paleontology was here the cause of the most phenomenal example of town-lot oil production ever seen in the industry. But many other uses are being found for this new science: locating productive zones, showing depth of new oil sands, determining the geologic age of formations, identifying structure, showing faulting and extending productive area of old fields. In many ways these tiny bugs are leading to riches.

One of the valued services rendered by the "micro man," or paleontologist, to the oil company, is predicting the depth of the oil sand. In the Signal Hill and Dominguez, California, districts a few years ago, this sort of information would have meant success instead of failure, riches instead of poverty for many drillers. Many of the wells drilled in that district were abandoned as dry when later information showed the prospectors' bits were within two or three hundred feet of producing

sand. Thanks to the bug man and his microscope, such a catastrophe cannot happen again.

These subsurface surveyors are able to chart the underground seas of liquid gold with such marvelous accuracy that the companies depend on them for drilling locations, underground geologic structure and a great mass of information necessary to successful operations.

But such confidence has not always been placed in the micro men. One well in the Coalinga, California, district was supposed, from surface indications, to be on the crest of an anticline. If this had been true, they would drill through the thin layer of Pleistocene formation and strike the Pliocene at a shallow depth.

"At 1,500 feet our bugs showed



conclusively that we were still drilling in the Pleistocene, which proved absolutely that we were not on an oil structure. There was no hope that we would ever strike oil," the paleontologist said, "but the operators had no confidence in our results. At a cost of several thousand dollars, they drilled 3,000 feet deeper before they had enough."

Another operator drilling a well in the Los Angeles basin was advised before he spudded in that he was off the structure. The micro men had sufficient evidence



from near-by wells to show that the new location was not over an oil-bearing structure. This operator drilled to a depth of 8,000 feet at a cost of more than \$150,000 before he was convinced that the opinion of the bug men was correct.

The unbelievable accuracy with which this new science can predict the depth of a particular formation is used frequently as an indication of when to set casing. In order to avoid reducing the size of the hole, it is desirable to set the casing as late as possible before drilling into the oil sand. By means of micropaleontology, the depth of the oil sand is often predicted within ten feet.

In the North Belridge field in San Joaquin valley, California, paleontologists were puzzled by the absence of the so-called valvulineria zone which was always encountered a few feet above the producing sand in many other California oil



Core Samples from Wells Containing "Bugs"; Pencil Points to a Fault Shown in a Core



fields. By examination of the bugs taken from the relatively shallow wells of the North Belridge district, the micro-fossil men decided that the valvulineria zone should be considerably deeper than any of the wells.

Since the old shallow wells were producing little oil, a test was made. The Belridge Oil company's No. 15 was drilled to a depth of about 4,850 feet, 3,000 feet deeper than any well in the district. At

this depth presence of characteristic micro-fossils indicated the valvulineria zone. The driller knew that in a few more feet the producing sand would likely be found. Casing was set at 5,000 feet, and the well was drilled into the sand. With a production of several thousand barrels of oil and more than twenty million cubic feet of gas, this well opened an era of unprecedented production. Within a few weeks, somnolent old North Belridge was buzzing with activity. Not only were many of the old shallow wells immediately deepened, but dozens of new wells were started to tap this newly discovered reservoir of liquid wealth.

The Seal Beach, California, field might never have been developed had the services of subsurface men not been available. After carefully surveying the surface geological features of the district, a large oil company obtained land and drilled two or



92424



Above, Paleontologist Hunting for "Bugs": Right, Magnified Varieties of the Tiny Diatoms

of the direct impact was only about one thousandth of a second, the material receiving the shock "felt" it for a period varying from half a second to more than a full second. He also found the shock due to a falling weight is at least six and one-half times that caused by the same weight resting on the material. Movies were made of fifteen models set up in different positions to show the variety of stress distribution. The patterns were filmed from such sources as holes, grooves, notches, sharp curves, scratches and

three wildcat wells. Although the surface indicated the presence of a good structure, the wells, one after the other, proved to be dry holes. Other companies drilled a few wells, on the advice of geologists who depended upon the same surface indications, but these also were "dusters."

Finally, after all the others had become discouraged and had given up their holdings, one company, which had been doing a great deal of micro-fossil research, entered the field. They carefully surveyed the subsurface formations by means of micro-paleontology and found that the old wells were on the wrong side of the fault along which oil was expected. This company drilled on the other side of the fault, brought in a good well and reaped a reward which many times over repaid them for their research.

**MOVIES REVEAL "HURTS" FELT BY MATERIALS WHEN BENT**

Motion pictures have made visible the "hurt" felt by materials when they are bent, punched with a sharp die or subjected to other stresses. The movies are the work of Dr. Max M. Frocht, of the Carnegie Institute of Technology, who has conducted experiments in connection with investigations in stresses and strains in gear action, tool cutting and impact shocks. He found that, while the duration



steep edges. The pictures illustrate the destructive effect of stresses at close intervals, and show that a scratch on a polished surface is of greater potential danger than one on a rough surface. The records were obtained by photographing the patterns caused by the stresses to which transparent blocks of bakelite were submitted. The polarized light caused beautiful patterns to appear at the point of stress. To the civil engineer, the tests suggest the danger of placing a flat-end steel column on a concrete floor, and to the mechanical engineer the similar danger resulting from mounting of machinery on foundations.

Those wishing further information on anything described in the editorial pages can obtain it by addressing Bureau of Information, Popular Mechanics Magazine.

NY Herald Tribune  
12/02/21  
Pittsburgh Pa.







# The Latest in Fighting Ships and Their Eyes

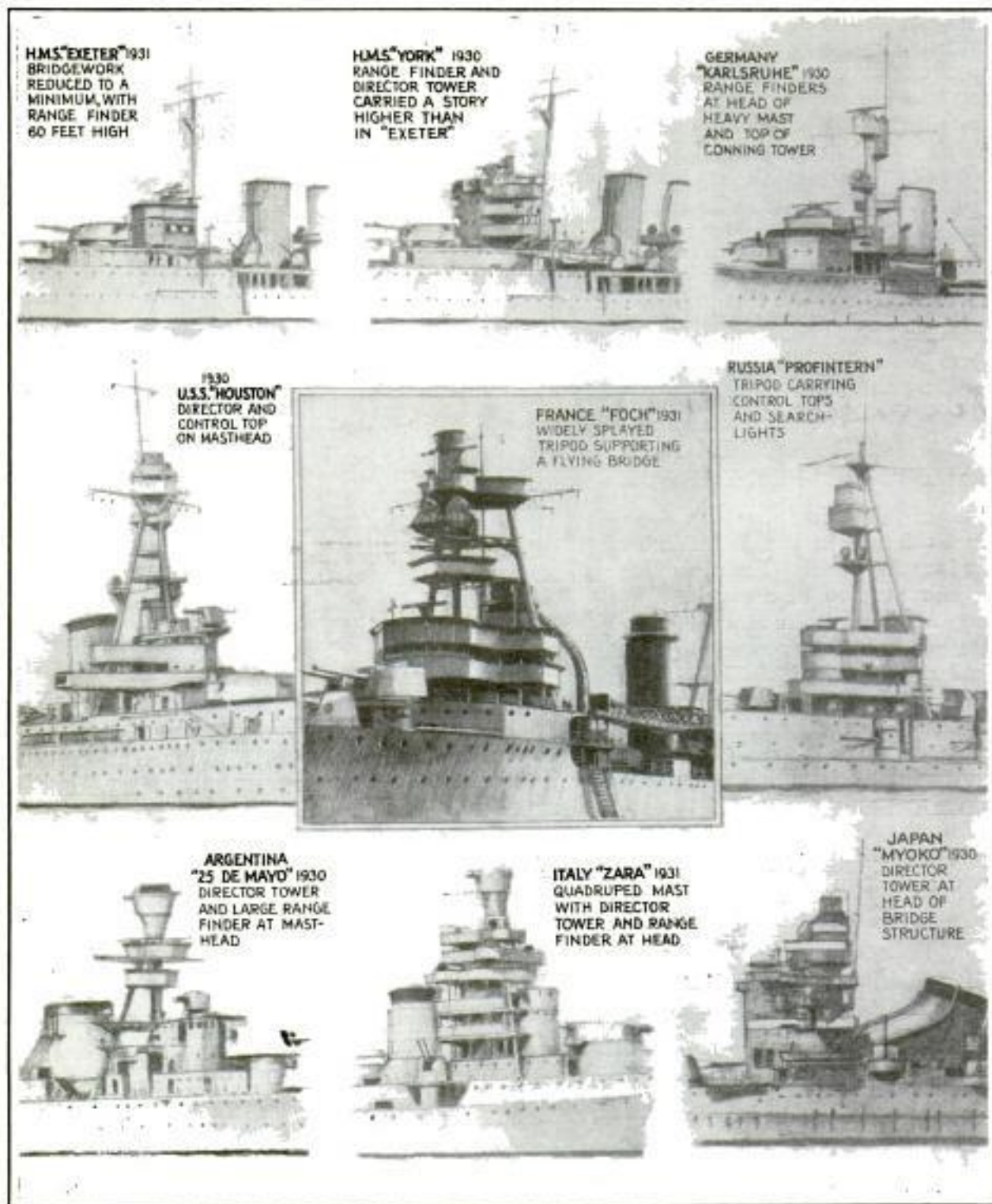

Sketches Showing the Different Types of Mast and the Various Styles of Range Finders Employed on Fighting Ships Today; British Ships Are Reducing Their Bridgework

By OSCAR PARKES

*Esq. Janis Fighting Ships, 12 Han Crescent, London, W. 1*

One of the most remarkable features in the latest British cruisers is the disappearance of the tripod mast and lofty bridgework which has hitherto been re-

garded as essential for the housing of the range finders, control tops and searchlights. While naval constructors of other nations seem to be vying with one another



a2431

er as to who can produce the most formidable-looking structures in the way of combined mast and bridgework, the trend in British design is again toward a minimum of target and top-weight in this direction. Thus, the "York," completed in 1930, has a three-story bridge and pole mast, whereas in the "Exeter," just finished for sea, the bridge is reminiscent of thirty years ago before gunnery control was invented, her main range finder being only some sixty feet above water level. The tripod has grown into a quadruped capped by a huge conical tower and surrounded by tiers of bridges in the Italian "Zara," and even a stage further in the Japanese "Myoko," where the central cone mast is hidden in a pagodalike structure around which range finders and searchlights cluster like blackberries, necessitating a signaling pole being clapped on abaft it to serve its original purpose. The sketches show the various styles of masting adopted in contemporary cruisers, and the range finders can be clearly seen. All except the Russian ship have them mounted in the turrets. "Karlsruhe" has a strong and rigid mast adequate and efficient; "Houston's" mast is an enlarged edition of the earlier British type, while "Foch" bears a gaunt structure at the top of which is a flying bridge.

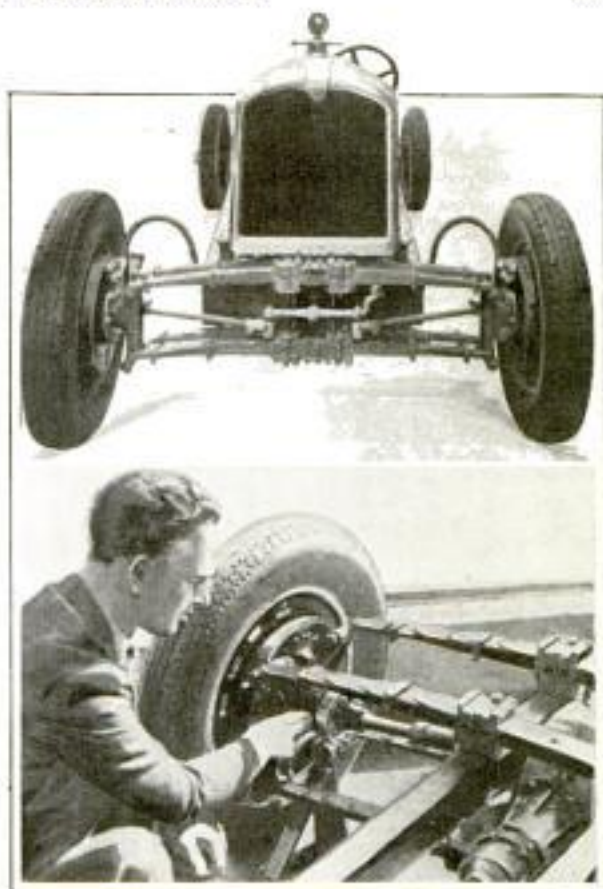

Top, Front Suspension, and, Below, Rear of Auto That Has No Axles

### MOTOR CAR WITHOUT AN AXLE GIVES BETTER RIDE

With its frame suspended between two sets of double transverse springs, both front and rear, an automobile without any axles has made its appearance in California. Unsprung weight, the bugaboo of automobile engineers, is almost entirely eliminated by the novel design and, by mounting the differential directly between the side rails of the frame, the center of gravity has been lowered materially, since it is not necessary to allow clearance between frame and housing to prevent hitting "bottom" when the car goes over rough stretches. Drive is taken from the differential through two universal-jointed shafts. A new form of steering linkage also is incorporated in the design, the tie-rod being double instead of single, and linked to a crank arm, one side of which connects through a drag link with the steering assembly. In tests, the car traveled smoothly over six-by-six-inch timbers laid crosswise of its path at eight to ten-foot intervals, jumped curbs and was able to outrun other cars because it could turn corners at high speeds.

*Wingelins & Eccleston, 3547 N. La Brea Ave. Los Angeles, Calif.  
Mergers*

### HOLDER FOR WATCH, CIGARETS AND MEMORANDUM PAD

As a convenience for the automobile or desk telephone, a holder is now offered with receptacles for a watch, cigars, memorandum pad and pencil. It also contains a removable ash tray, the curved top of which serves as a cigar holder. The combination clamps to the steering column in the car just below the wheel or to the base of any type of desk telephone.

a2454



Holder for Watch, Cigaretts and Memorandum Pad Which Attaches to Auto Wheel or Telephone

*Handy  
Sylvania*

*Kruger Stamping Co  
1902 Jefferson Ave  
Toledo, Ohio*



Owned by Mrs A. A. Bigsfield Barl. Leicester Eng  
 12525  
 Vlasto  
 sham at

Com. Kammene Josef  
 55 W. 42nd  
 New York

# KINDNESS

Borgois



A Winning Team of Russian Wolf Hounds Which Walked Away with Four First Prizes When Exhibited at an English Show

bones to him. As to the sugar—did nobody ever bother to tell you that a dog's digestive organs have no apparatus for handling sweets?"

"I believe in kindness to animals," he returned, stiffly. "My dog has done well today. I am going to reward him."

"You are going to set forward the date of his death," I corrected him, "if you follow out the program you just spoke of. More dogs are killed by ignorant kindness than are killed by motor cars. And heaven knows the cars kill enough of

THE splendid young chow had won every blue ribbon in his various classes; and at last won the purple rosette of the "Winners' Class," which gave him three points toward his championship. His novice owner led him in triumph back to his bench. As they passed the collie benches where I was grooming one of my dogs, I heard the novice declaiming rapturously to his victorious chow:

"Oh, Ming, you were great! As soon as we get home tonight I am going to give you a heaping plate of chicken bones and a whole pound of lump sugar."

Now this was no affair of mine. But I crossed over to the blithering novice and said to him:

"Why not give your great young dog a heaping plateful of strychnia, instead? You'll get the same result more quickly and much less painfully than by feeding chicken

them." Evidently he thought me an intrusive crank. For he turned haughtily away and busied himself with preparing his fine chow for the "Best of Breed Class." I never knew whether the young dog died from that night's gorge of chicken bones or from some later feast of the same kind. But the incident set me thinking. Mistaken kindness has killed and will



Spitz



Here is a remarkable contrast in Kennel Blue Bloods; at the left is a Spitz puppy imported from Russia and of Aristocratic Mien and Family; Above is a Prize-Winning English Bulldog Looking Dignified for the Coaxing Photographer

Owned by Mrs J. L. Pennock Syracuse N.Y.

Diagnoston Son of  
 Rhy. owner W. Clarke  
 Detroit



also Sunnybank Farm R 2525  
Pompey Lakes, N.Y.

# Can KILL Them

By

Albert Payson Terhune

67, Riverside Drive,  
New York

kill many thousand dogs. This kindness may take any one of myriad forms. If it were a matter of cruelty or of neglect, I would see the uselessness of protesting. But when love for an animal leads so often to that animal's death, perhaps a word or two of sanity may save the lives of a few other dogs.



Ayer, Mrs.  
Lewis  
Craigm., Pa.

Laureston Legacy.



the parsley you chew so harmlessly would kill your parrot. The belladonna leaves which your rabbit can nibble in safety would kill you. The unchewed gulps of hard food and the swallowed knuckle bones which don't seem to distress your dog would send you posthaste to the hospital.

In like manner, diet and treatment which are fairly safe for you are sometimes hideously harmful to your dog.

The novice I have spoken of was going to fill his chow's stomach with chicken bones, not knowing that the half-chewed bones of any form of cooked poultry have a tendency to split into many sharp little slivers which soon or late will pierce a dog's throat or stomach or intestines, and kill him. With large dogs, chop bones offer a like, if slightly less peril.

Cake, pastry, candy—these are not bad, in moderation, for a healthy human system. They are ruinously bad for a dog. You like these sweets. You like your dog

Three Blue Bloods of Three Different Breeds; the One at the Top Is Registering Anticipation

In the first place, no dumb creature's physique is in the least like a human's. The things which you enjoy and which do you no especial harm, may be murderous for your pets, and vice versa. For instance,

see June 1932 962  
Copyrighted material



Q2525

*Vols of Heden, owned by Mrs J Wood, shown at Crystal Palace*

and you want to please him. So you dole out sweets to him. It would be less unkind to dole out kicks. They would do

terspersed by romps and races. The seven which are now loose spend much of their time sprawling on the ground near my desk. Yet every few minutes one or another of them gets up and incites his fellows to a tearing gallop or a swim, returning presently for another doze beside the desk. Two minutes of this top-speed hillside galloping or tag-playing does them more good than if I led them along ten miles of sidewalks. They

Below, the Magnificent Head of a Full-Grown and Rather Haughty Mastiff



him less ultimate harm. You give him daily food which seems palatable and healthful to you. So you think he will like it as much as you do. Perhaps he will like it, after you have spoiled his taste for more normal canine food. But it works havoc with him; even as severe dog diet would wreak havoc on your own inner man.

And you do it in the name of kindness, this cruelty. Your dog by nature is 100 per cent a normal, wild animal, plus a perhaps unfortunate ability to adapt himself to his exotic surroundings as a household pet. The nearer you keep him akin to his original wild state the healthier he will be and the longer he will live.

In the wilds, he had plenty of exercise. Not meekly slow ploddings along hard pavements at the end of a leash, but sweeping runs over dirt and turf. Does he get that, and get it daily and in large-sized quantities, in your home? If not, you are shortening his life and undermining his health. No sedate walk on a leash is going to take the place of those wildly ecstatic scampers.

I am writing this article at my outdoor desk, here at Sunnybank. Seven of my ten dogs are loose on the lawn. All ten of them had a two-hour ramble through the forests and over the hills this morning, in-

are hard and lean and of ravenous appetites, and fairly sizzling with high spirits. In brief, they are as near as I can make them, physically, to their wild-dog ancestors of many thousand years ago.

After they pass the age of twelve months, they get but one meal a day; a big meal which duplicates as far as possible the best kind of diet I can imagine the wild dog as having: beef bones to gnaw; meat scraps mixed with greens; an avoidance of starchy foods. Add to this an occasional hard dog biscuit, a dish of milk, some form of roughage. These last items constitute an effort to adjust the eaters to civilized conditions and to adjust civilization's exigencies to them.

I don't claim that I know everything about dogs or about their correct diet. But I do know that my regime has given me a series of gloriously healthy and hardy dogs for a period of something more than forty years, and that the bulk of my dogs live to great ages, as did old "Sunny-



62525

at Angell Memorial Hospital 381  
Boston

bank Lad" who lived and throve until well after his sixteenth birthday.

Then, as to housing your dog: Perhaps you yourself like a very soft bed with plenty of warm covers, and a warm room to sleep in. This is pleasant to you. So you infer it must be a good thing for your dog. It is not.

In the most freezingly inclement winter weather, the wild dog crept into a cave or under a windfall tree where an irregular ruffle of dead leaves formed his bed. He was geared to that kind of sleeping quarters, and he throve therewith. You shut him in a hot and ill-ventilated room, either in a softly bedded

Bandaging the Foot of a Fox Hound That Spent Eight Days in a Trap and Finally Was Rescued by Another Dog; Below, the Smile of a Blue Ribbon Winner



Sleeping on a deep and soft bed in a warm room will eventually sap his health, even if it does not kill him at once.

Here at Sunnybank, every kennel dog has a raised house whose floor is at least fourteen inches from the ground and whose narrow door faces south. On hot summer days, the dogs can burrow in the cool earth beneath these houses. At night, if they will, they can sleep on the floor boards of their houses. The floors are dry and high; and the kennels themselves are tight-built.

In winter a deep coating of prepared cedar shavings covers the kennel floors; that or hay or straw, but preferably the shavings. The bedding is changed before it can get matted or soiled or weather damp. My two house dogs sleep on a thin rug on the floor of a room whose windows are open. As I have told you, they are well and they seem happy.

If you keep a dog in the house, let him have a good-sized roomful of fresh air all night, and let his bed be a not-too-thick rug. Your mistaken ideas of kindness will soften him and make him susceptible to any of several ailments.

In my long-distant childhood, pugs were the most fashionable of all dogs. Not only were thousands of these killed by kindness, but that same mistaken kindness led to the breed's loss of popularity and almost to its extinction. Every magazine picture of a pug represented him as fat and asthmatic and waddling.



Wencha Karen

Shoval Alexandra Palace

basket or else on a downy bed of some other kind. Some of you even put a blanket over him, to keep him warm while he sleeps.

What would be the effect on you if you should dash out into a blizzard while you were still enervated and sweating from a Turkish bath? You would die more quickly and more readily than does your dog when he goes out into the winter air from such a bedroom and bed as you provide for him; but that is only because he is hardier and more adaptable than you are.



02525

*Merald Pearl. Entered at*

382

POPULAR MECHANICS

*Metropolitan and Essex Hwy show at Crystal Palace London*



**A Huge St. Bernard and His Little Playmate; He Represents a Lot of Dog Even for \$5,000, Which Was the Price One Man Offered for Him**

ened by being kept in a heated incubator all night, you could not expect the luckless youngster to have much stamina or figure or brains.

Many more dogs die from overeating than under-eating. Many more dogs die from food that is too rich than from food that is too meager. Many more dogs die from over-coddling than from over-exposure. Remember that. And if you don't believe me, ask your veterinary. Unless he is one of those rare and inexcusable vets who grow rich by prescribing for pampered dogs, he will endorse all I say.

There is no magic, no mystery, in the correct upbringing and treatment of a dog. The whole thing depends on patience and on common sense. With his owner's wholesale use of those two assets, there is no dog that cannot be

Decently treated, a pug is a fine and vigorous and clever and healthy dog, an excellent chum. But seldom, in his prime, did he have decent treatment. He was coddled and cosseted, and put to sleep in a padded and airless basket, and stuffed with more food and richer food than a dog three times his size could have assimilated. Also, his exercise was usually confined to a short and slow daily walk. What happened? He grew as fat as a barrel. He hated to move. He wheezed at every breath, and he rolled in his gait, under an unwieldy mountain of soft flesh.

Cartoonists and comic paper artists began to make fun of the poor little chap. Among them they laughed him out of his once boundless popularity. It was his idiotic owners who should have been laughed at, not the kindness-ruined pug himself.

If your child were deprived of exercise and were stuffed unmercifully with fattening and indigestible food and were soft-

kept healthy and that cannot be made a good canine citizen. Until you make him abnormal by abnormal treatment, your dog will prefer to live in a normal and healthful fashion. Such a dog is the most ideal chum a human can have. But if you kiss and cuddle and fondle him and feed him on masses of indigestible foods and cut off his rightful amount of exercise and soften him by too-luxurious sleeping quarters, you are going to have a worthless dog, and at an early age a dead dog.



When and if your dog falls ill, care for



him at home. Don't try to save a \$3 veterinary bill by giving so-called "home treatment" to a \$300 dog. But don't send him to a hospital unless you have to. Send for the best vet you can find, and follow his prescribed line of treatment. But let that treatment be given at home.

If you yourself are sent to a hospital, you know it is done for your good. Your dog does not know that. All the poor animal knows is that his owner has apparently forsaken him at the very time he most needs that owner's care and companionship. He knows he has been thrust out of the home he loves and has been consigned to strangers. Keep him at home. That is almost half the battle for health recovery. It is worth a thousand times more than all the mistaken kindnesses you lavished on him when he was well.

Here is a simple remedy which I apply at once, the moment one of my dogs seems mopey or off his feed: A huge dose of castor oil. He will hate to take it, and it must be given by force. But, three times out of five—or oftener—it will cure him, if it is given soon enough. Don't be afraid of giving him too much. There is no danger from an overdose.

Don't force a half-sick dog to eat. His instinct is a wiser guide, just then, than is his master. If your dog is sick, keep him by himself in a darkened room, and let

him sleep all he will. See that he has plenty of fresh and cool water within reach and that he is kept out of drafts.

Sick or well, see to it that your dog always has plenty of fresh and cool water close at hand or where he can find it. A dog needs to drink much oftener than does almost any other animal, and he suffers worse from the lack of water, especially in hot weather.

Don't kill him by what you miscall kindness. Give him a square deal. That is all he wants or needs.

And don't forget what I said about patience and common sense.

Those two simple qualities, by the way, are the keystones to more than most of

*Es H Pugilist  
Dinner 1930  
B. Waly  
at Olympia  
Ihoo*

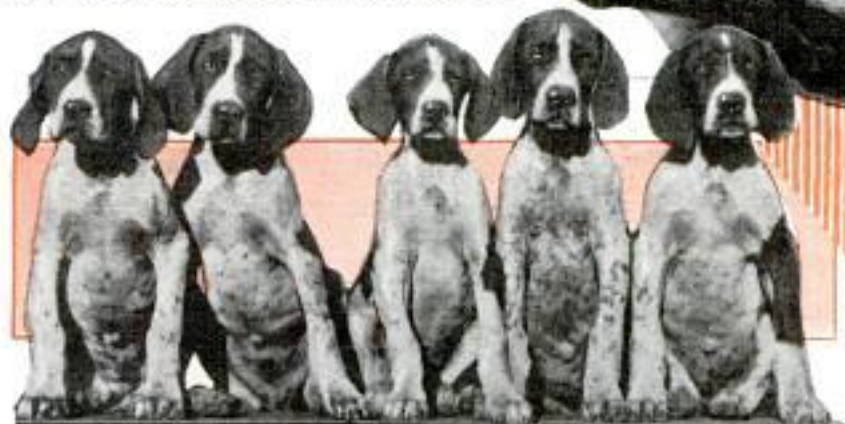

Top, a Winner of Twenty-Three Championships; Left, a Group of Pointer Pups

us realize. Never are they in better use, nor of greater importance, than in the treatment of a dog.

Their application, or the neglect of them, will decide whether your dog is to be a pet or a pest.

*Genl Oland,  
San Marcos, Calif*



12.2436

Mr. Francis Michie  
11 Rue de la guerre, Paris (14)  
France

# Old Map Throws New Light on Columbus

in Collection of Bibliotheque National Paris

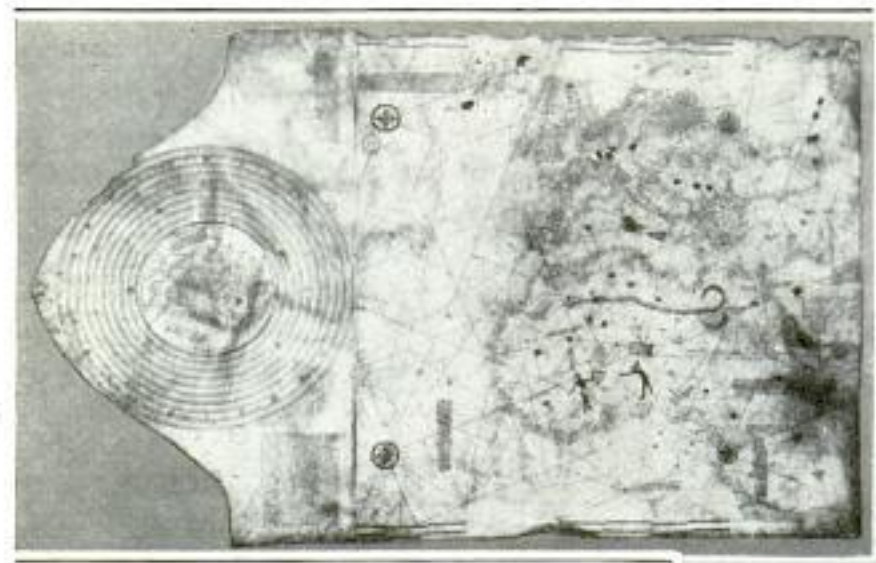

could not meet it. So regular factories for "old" maps came into being. Old paper, which is fairly easy to procure, was used. Upon this was printed, and sometimes even engraved, the reproduction of old and sometimes authentic

Above, Map Made and Used by Christopher Columbus; Right, a Miniature of the "Santa Maria"

In honor of the most noted geographers from forty-six nations gathered for a World Congress at Paris, there was presented the only map in existence of Christopher Columbus. Not only was it his property, but he himself created it and carried it upon his voyages of discovery. In 1480, Columbus was sent by the banking house of Luigi Centurione, of Genoa, to find gold on the shores of the Mediterranean. He failed. He was discharged. He came to his brother at Lisbon who was a mapmaker. Columbus took up the work, and became a partner in the firm. The map is on parchment and is beautifully illustrated and drawn. It is dotted with legends and pictures of animals, and many notes, one of which states: "In the city of Arbis an eclipse of the moon was seen which was noted in Carthage three hours later." Claiming attention, nearly equal to the Columbus map, was a remarkable one by that sturdy old explorer Pere Marquette. This courageous missionary, after much hazardous journeying, made a map of Louisiana in 1673. The land he called Manitounic, giving the country a name after a statue of the Indians' idol called Manitou which he found in a beautiful valley. Interest in maps as indoor decorations has come into fashion. American visitors to France, and Paris in particular, created a demand so great for maps that all the antiquaries in Europe



model at Spanish Ministry of Marine, in Madrid Spain

up the Survey City of Md

maps. With old and yellow paper, dead and faint colors, and China ink slightly rusted, artists have turned out some very creditable imitations. These maps are artistically done, beautiful in texture, and quite as much an adornment for a lamp shade, fire screen or wall piece as the genuine articles.

## DISEASES ARE GIVEN NUMBERS

Easier designation of diseases by numbers instead of names has been adopted by New York hospitals. According to this plan, number 6, signifying the digestive system, and 1, signifying infection, would make 6-1, infection of the digestive system. The manual for numbering will include 10,000 or more conditions.

New York Academy of Medicine  
Copyrighted material

model at Spanish Ministry of Marine, in Madrid Spain

12515

Facot March 207



Developed by  
H. R. Hensel and Co  
Machinists

B. 35  
Cant. John F. Coggeswell  
385

POPULAR MECHANICS  
STEEL STUDY AFFORDS  
GREATER SAFETY  
IN BUILDING

16. Edgemore Road  
Belmont, Mass

Bigger and higher skyscrapers, better bridges, hotels, apartments, elevators and machinery now can be built with even a greater factor of safety than heretofore as the result of new steel research carried out by the Westinghouse Electric and Manufacturing company. What happens to steel of any type when placed under too great a load can be told by a process just completed. Ten years ago, a German physicist discovered flow lines in steel that had been too highly stressed. He found that etching would bring out the lines and make them visible for study. Present-day steel, however, does not contain enough nitrogen to make the etching process a success. Westinghouse research workers have developed a technique of nitriding steel so that the etching will show, thus making it possible to pick out any weak spots that might develop in building before they actually occur.



Dentist's Office Equipped with Movie Projector Which Throws Pictures on Ceiling to Entertain Patients

MOVIES ON CEILING ENTERTAIN DENTIST'S PATIENTS

Patients visiting one Boston dental office are entertained with moving pictures while the dentist works on their teeth. Children compose much of the doctor's practice, and he conceived the idea to attract the children, then found it so popular with grown-ups that he now gives a show for every patient. An inclined base was constructed for the projector which throws pictures on the ceiling. The picture is shifted to the point that will keep the patient's head in the best position for the doctor. Each picture runs for about twenty minutes, the average time a patient is in the chair. It was found that animated cartoons were best to make the patient relax and forget the discomforts. A young victim of infantile paralysis confined to a respiration machine also was entertained for weeks with the movies.

Dr. Lawrence J. Corey  
Boston, Mass

TRACTION TREADS FOR TRUCKS  
FIT OVER TIRES

Trucks equipped with pneumatic tires can be given added traction by attaching iron treads over the rubber. These treads consist of steel plates with ground-gripping edges. The plates are fastened to a chain around the tire, giving a tractor-type of tread.



Steel Plates Attached to Truck Wheels to Give a Traction/Tread to Pneumatic Tires

Hipkins Mfg Co  
Port Deposit Md

ROCK MADE BY PLANTS

Rocks which were formed centuries ago by lime deposits gathered by marine plants have been found in Glacier National Park, Montana. Especially large and abundant specimens of fossil plants have been uncovered, the marine growth belonging to a very ancient part of the world's history. Three new species of plants were found in the latest study of the rocks by two geologists, Dr. and Mrs. Carroll Lane Fenton.

B. 54  
June Service  
1/8/32

Journal of Geology  
Copyrighted Material



*suggest United*

*A 2594  
386*

# POPULAR MECHANICS

*Balloon Co  
125 5th Ave New York*

*Cont. Rositer Snyder  
Lombardford, Conn*



This Vender Made His Balloons into "Cats" by Painting Faces and Tying Up Corners for Ears

## IDEA IS TURNED INTO MONEY BY BALLOON VENDER

How money often is made by the mere process of slightly altering some standard article is exemplified by the recent venture of a balloon vender. He found that the ordinary colored or tinted balloon needed some new feature to help it sell at the county fairs. He painted a cat's face on each balloon and tied up two corners, which, when inflated, looked like ears. The balloons quickly sold out.

## MOTOR GAS EXTRACTS NICKEL AT LOW TEMPERATURE

Carbon monoxide, the deadly gas exhausted from automobiles, now is being used to extract pure nickel from filings, plating or ore as the result of a new process recently developed. The monoxide is passed at comparatively low temperature, about 100 degrees, through the metal source and led to another chamber where it is heated to about 150 degrees. The heating causes it to drop its load of metal which is deposited in the pure state. The gas is then cooled once more, passed again through the nickel ore and again heated. Thus is the cycle continued, the tank accumulating a supply of pure nickel with almost no temperature required. Nickel has an extremely high melting point. Since it is closely related chemically to

*nickel works 3 Co 67 Wall St  
New York  
Great Britain  
part of it returned to nickel*

*Conk Lewis Hurman Roy,  
192 Erie St  
Detroit Mich*

iron, after long experiment it was found the same process would work in refining the more common metal. The iron source, however, must be much hotter than the nickel. The iron, recovered in the form of black powder, is absolutely pure and melts at 1,200 degrees. Its greatest field of usefulness at present is in the form of medicine, which can be taken internally without modification or chemical treatment.

## TWO-IN-ONE LOCK CAN BE FASTENED BY KEY OR COMBINATION

*B2 36*

One lock now being offered is opened either by a key or combination. It can be operated with

a key in the usual manner, or opened by plunging the correct combination. It is declared to be unpickable because pressure on the plungers is eliminated, and the one bolt acts both as a spring when the door is open and as a dead bolt when it is locked, making it impossible to insert flat-sided objects between the door and jamb to displace it. It is easy to install, only two circular holes being required, and is adjustable to any standard door. The lock can be changed from one combination to another in a few minutes, and is not a dial-operated device so it does not have to be worked in any particular order.

When the door is closed, even if unlocked, anyone not knowing the combination will probably lock it if he tries to open the door, because, when any number except a combination number is punched, the combination automatically locks itself. If the key is mislaid or lost, the lock still can be operated with the combination.

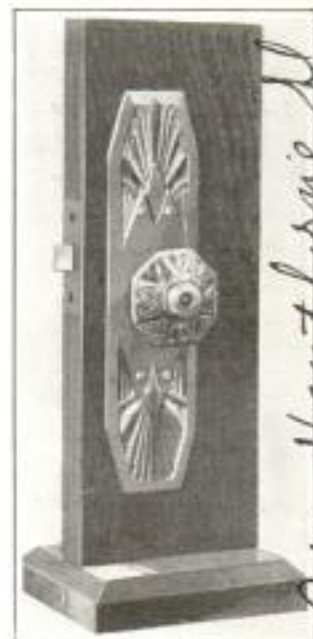

*Hawthorne St  
Leland, Calif  
Lee Fisher  
26 W  
Berkeley*

*Esuyton Lock Co  
716 Chapman Bldg  
Los Angeles, Calif*



## Vacuum Sweeper Recovers Sunken Treasure

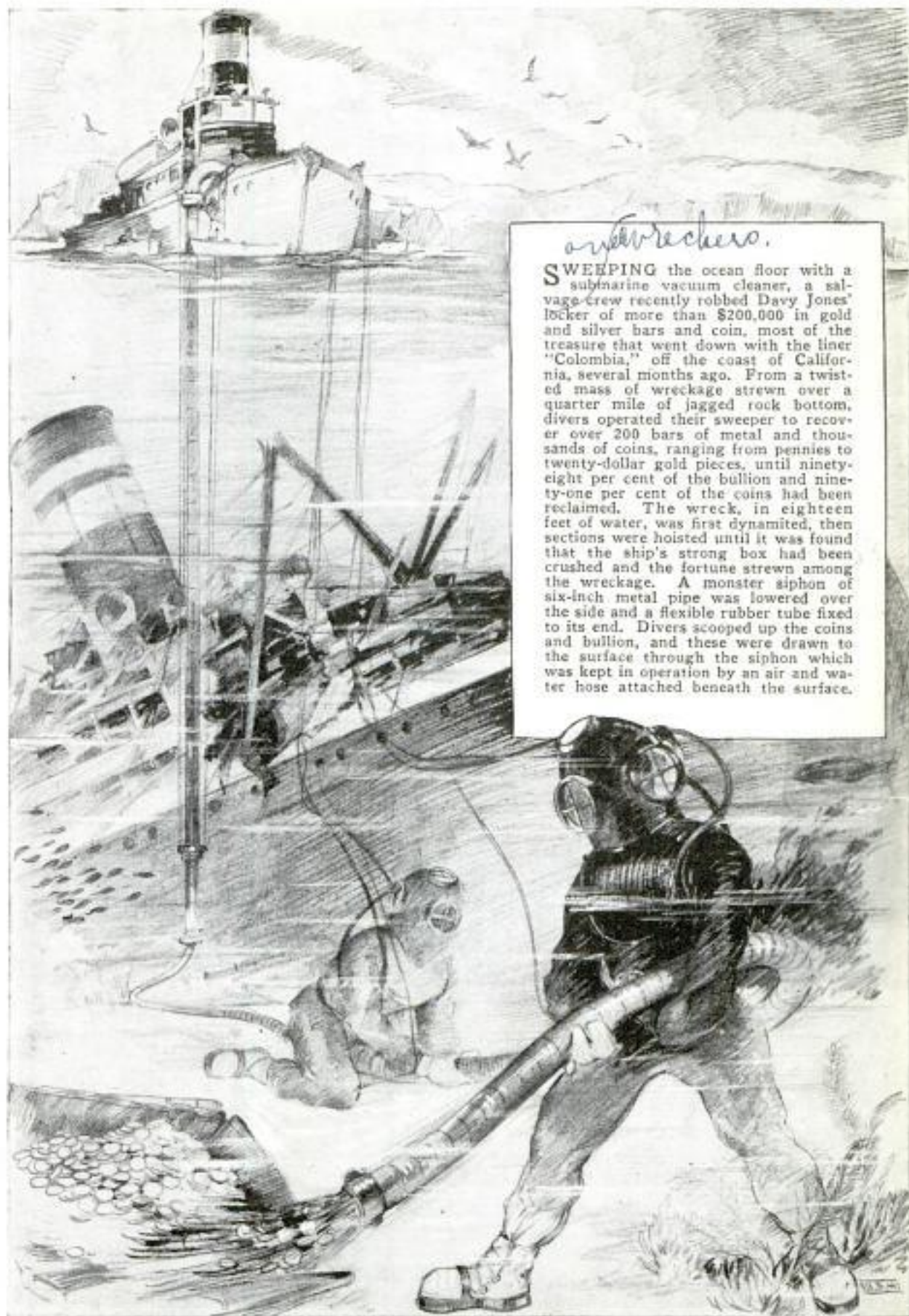

*overrecher.*

**S**WEEPING the ocean floor with a submarine vacuum cleaner, a salvage crew recently robbed Davy Jones' locker of more than \$200,000 in gold and silver bars and coin, most of the treasure that went down with the liner "Colombia," off the coast of California, several months ago. From a twisted mass of wreckage strewn over a quarter mile of jagged rock bottom, divers operated their sweeper to recover over 200 bars of metal and thousands of coins, ranging from pennies to twenty-dollar gold pieces, until ninety-eight per cent of the bullion and ninety-one per cent of the coins had been reclaimed. The wreck, in eighteen feet of water, was first dynamited, then sections were hoisted until it was found that the ship's strong box had been crushed and the fortune strewn among the wreckage. A monster siphon of six-inch metal pipe was lowered over the side and a flexible rubber tube fixed to its end. Divers scooped up the coins and bullion, and these were drawn to the surface through the siphon which was kept in operation by an air and water hose attached beneath the surface.



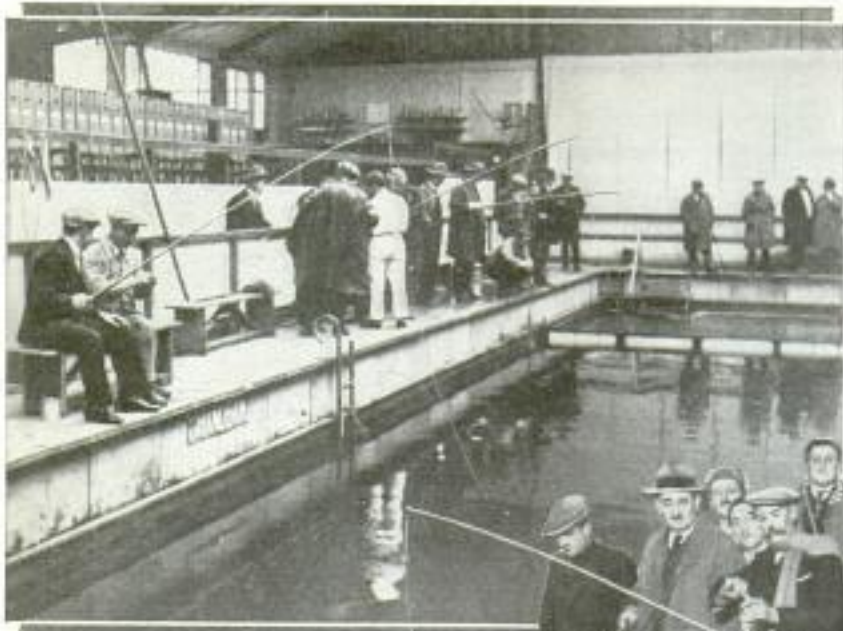

© Keystone View Co.  
Indoor Swimming Pool in Paris—Which Has  
Been Stocked with Game Fish to Attract  
Winter Anglers

### FISH IN SWIMMING POOL FOR WINTER ANGLERS

French anglers who like to pursue their sport in winter, but do not fancy the cold weather, are being attracted to an indoor swimming pool which has been converted into a fish pond. The large pool in Paris has been stocked with hundreds of pounds of fish,



and the angler pays a nominal sum for the privilege of fishing and for rental of rod and tackle. When leaving the pond, he submits his catch to be weighed and pays the market price for the fish. In the summer, the anglers take to the outdoors and the swimming pool is used for its original purpose.

### TELEVISION ON BEAM OF LIGHT SEEN BY ELECTRIC EYE

Utilizing a wavelength of only a few billionths of a meter, television transmitted on a beam of light has been demonstrated successfully at the laboratories of the General Electric company. More distinct television pictures are confidently predicted, and while the work done so far is experimental, those engaged in it foresee the time when television will be broadcast from a powerful arc light mounted on top some tower in each city. The pick-up device is of the usual type, but instead of the impulses being fed into a radio transmitter, they are modulated into high frequencies on a light beam. The beam is projected the length of the laboratory and picked up by a photo-electric cell which transposes the light waves back into electric waves. The impulses then reproduce

the image by means of the ordinary television receiver. In its commercial application, it is expected the light waves will be picked up in each home by means of individual electric eyes instead of the present type of wire antenna. Since the light beam can be broadcast only for relatively short distances, probably ten miles, each community would have its own light-broadcasting system.

### HONEY TURNED INTO CRYSTALS WILL KEEP INDEFINITELY

Honey, converted into crystal form under a new preserving method, will keep indefinitely when canned or placed in glass. The crystal honey is an opaque gray-white butter, does not drip, is not sticky and has a slightly different flavor. Liquid honey, under this process, is heat-

Mr. E. A. W. Anderson

Schenectady, N.Y.

NY James 1/30/32



Discovery of Dr. E. J. Nye  
Canadian Annals

B-33

POPULAR MECHANICS

Cornell University Ithaca NY

ed to about 160 degrees Fahrenheit to kill yeasts and molds. Then it is cooled to seventy-five degrees and five per cent of crystallized honey added. This small dose of crystals is like setting off a pack of fire-crackers. Honey crystals begin to grow everywhere in the liquid and to multiply rapidly. The mixture is brought to fifty-seven degrees, and within forty-eight hours the mass has turned to crystals. Honey naturally will revert to a crystal form, but often requires months or even years before the change is completed.

B-34

THIS AUTOGYRO EQUALS SPEED OF ORDINARY AIRPLANE

All the safety of the autogyro and all the speed of an airplane are incorporated in an autogyro developed recently in England that will go as fast as a conventional type of plane powered by the same kind of motors. Despite its high speed in the air, the craft is able to ascend and descend almost vertically, thus greatly increasing the safety factor. The high-speed autogyro carries two passengers, and its 105-horsepower motor develops a top speed of 118 miles an hour and a cruising speed of 100 miles an hour. An autogyro has been made in this country that exceeds this speed, but it uses about three times the horsepower. The English craft has three rotor blades instead of four and they are of the cantilever type, without external supports. The fuselage is narrow, seating two persons tandem inside the cabin, and the streamlined shape is made possible by using a motor that has its cylinders in line, although they are air-cooled. Small fins are attached to either side of the tail, and a third wheel is fastened beneath the motor cowling to facilitate take-offs.

U.S. Patents owned by Autogyro Co. and Title of Invention



Cierva

acme

Autogyro That Offers Both Speed and Safety; It Cruises at 100 Miles an Hour and Has a 105-Horsepower Motor.

Dr. Juan de la Cierva of Cierva Autogyro Co. England



By Crushing Stone Fences, Material for Paving Rural Roads Was Obtained by One Contractor

OLD FENCES MADE INTO ROADS BY STONE CRUSHER

Abandoned stone fences have been turned into roads by a Maryland engineer using a portable stone crusher. The fences, many of which were built one hundred years ago, are regarded as antiquated by their owners. The engineer took his crusher into rural districts where roads were bad, crushed the stone fences and used the product for paving.

Tulson Edwards 111 W. County Engineer Port Deposit Maryland Cecil County, Md.

THIS BUILDING PAPER EXPANDS AS TEMPERATURE CHANGES

Building paper that stretches is now being used to compensate for the expansion of a structure due to temperature changes or external forces. Paper that is not elastic often is torn by such expansion, thus admitting cold and heat. The resilient paper is an asphalt product which will stretch fifteen per cent before breaking, but goes back to its former length when stress is removed. It is claimed it will stand a pull of forty pounds per linear inch, and a blow of 100 pounds is required to punch a hole one and one-half inches through it. When pulled and twisted, it clings to nails, thus making it virtually water-tight.

B-58

W. G. Herbert Co. North England



A. 2503 Curtis Brown, Ltd., 130 W. 42nd St.  
New York

from The Strand, London, Eng.

# FIFTY YEARS

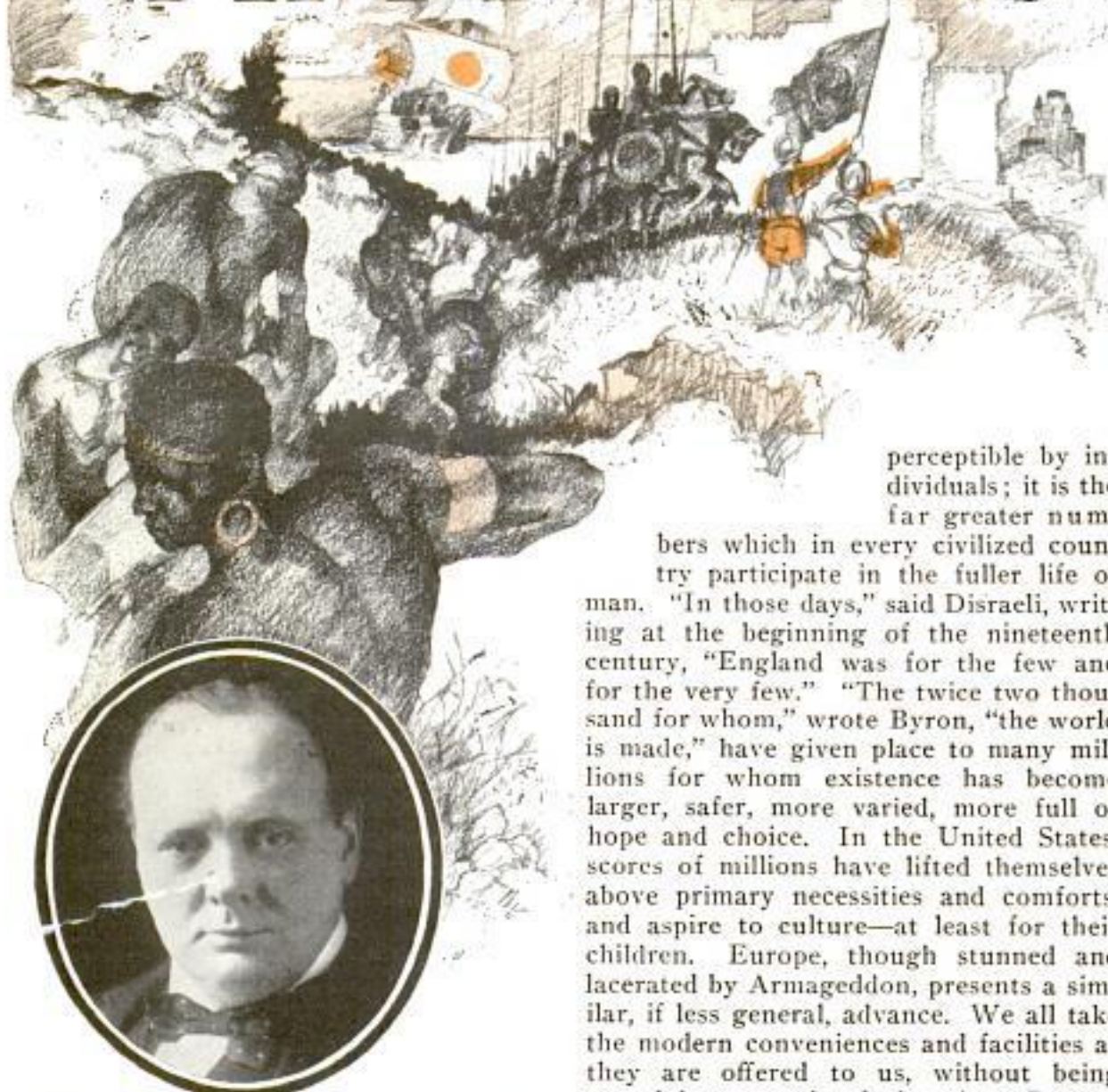

Winston Churchill, Former British Chancellor of the Exchequer

**T**HE great mass of human beings absorbed in the toils, cares and activities of life, are only dimly conscious of the pace at which mankind has begun to travel. We look back one hundred years and see that great changes have taken place. We look back fifty years and see that the speed is constantly quickening. This present century has witnessed an enormous revolution in material things, in scientific appliances, in political institutions, in manners and customs.

The greatest change of all is the least

perceptible by individuals; it is the far greater numbers

which in every civilized country participate in the fuller life of man. "In those days," said Disraeli, writing at the beginning of the nineteenth century, "England was for the few and for the very few." "The twice two thousand for whom," wrote Byron, "the world is made," have given place to many millions for whom existence has become larger, safer, more varied, more full of hope and choice. In the United States, scores of millions have lifted themselves above primary necessities and comforts, and aspire to culture—at least for their children. Europe, though stunned and lacerated by Armageddon, presents a similar, if less general, advance. We all take the modern conveniences and facilities as they are offered to us, without being grateful or consciously happier. But we simply could not live if they were taken away. We assume that progress will be constant.

"This 'ere progress," Mr. Wells makes one of his characters remark, "keeps going on. It's wonderful 'ow it keeps going on." It is also very fortunate; for if it stopped, or were reversed, there would be a catastrophe of unimaginable horror. Mankind has gone too far to go back, and is moving too fast to stop. There are too many people not merely whose comfort, but whose very existence is maintained by processes unknown a century ago, for us to afford even a temporary check, still less



# HENCE

by WINSTON CHURCHILL

*Former British Chancellor of the Exchequer*

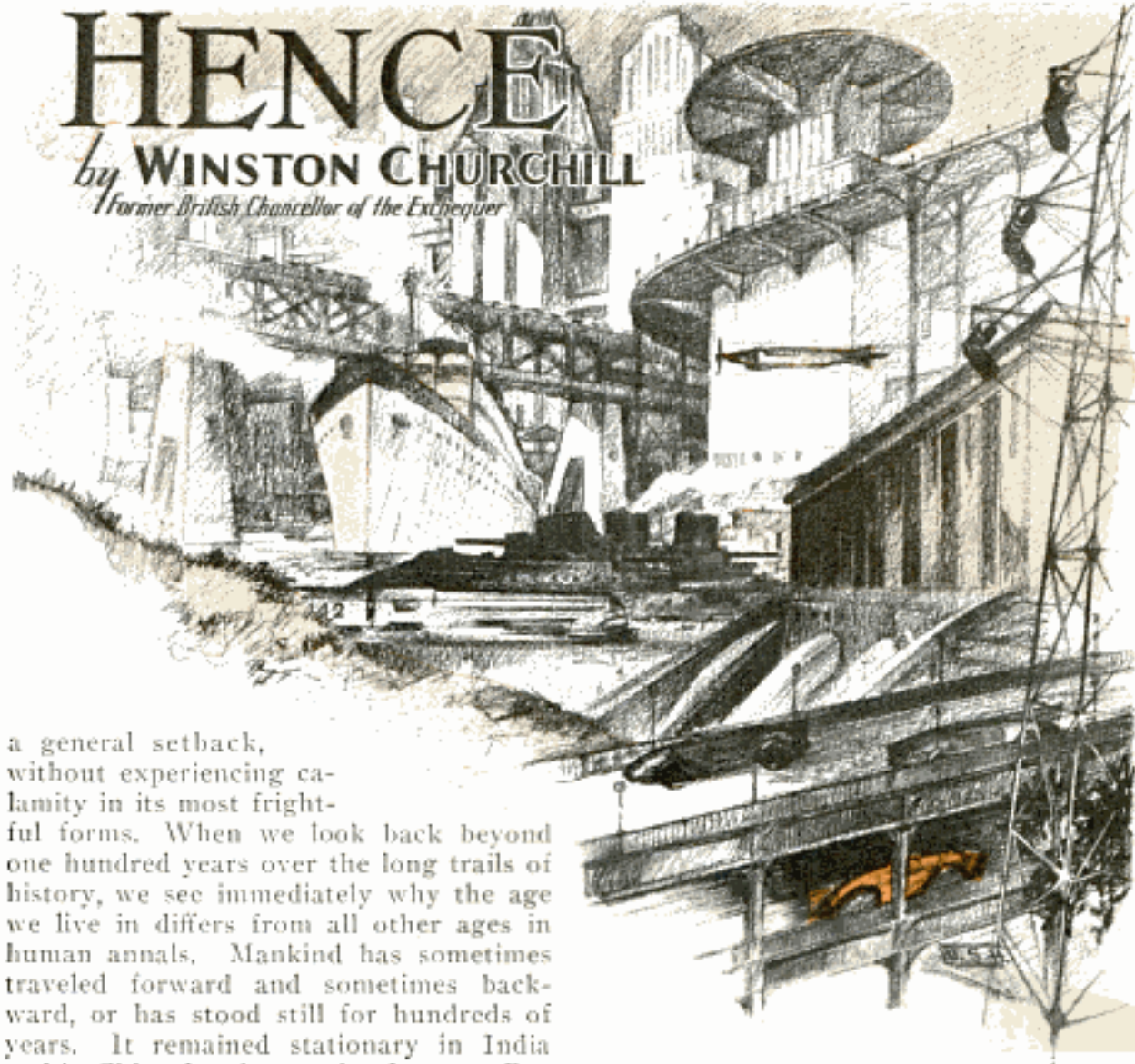

a general setback, without experiencing calamity in its most frightful forms. When we look back beyond one hundred years over the long trails of history, we see immediately why the age we live in differs from all other ages in human annals. Mankind has sometimes traveled forward and sometimes backward, or has stood still for hundreds of years. It remained stationary in India and in China for thousands of years. But now it is moving very fast.

What is it that has produced this new prodigious speed of man? Science is the cause. Her feeble groping fingers lifted here and there, often trampled underfoot, often frozen in isolation, have now become a vast organized, united, class-conscious army marching forward upon all the fronts toward objectives none may measure or define. It is a proud, ambitious army which cares nothing for all the laws that men have made; nothing for their most time-honored customs, or most dearly cherished beliefs, or deepest instincts. It is this power called science which has laid hold of us, conscripted us into its regiments and batteries, set us to work upon its highways and in its arsenals; rewarded us for our services, healed us when we were wounded, trained us when we were young, pensioned us when

we were worn out. None of the generations of men before the last two or three were ever gripped, for good or ill, and handled like this.

Man in the earliest stages lived alone and avoided his neighbors with as much anxiety, and probably as much reason, as he avoided the fierce flesh-eating beasts that shared his forests. With the introduction of domestic animals the advantages of co-operation and division of labor became manifest. In neolithic times, when cereals were produced and agriculture developed, the bleak hungry period, whilst the seeds were germinating beneath the soil, involved some form of capitalism and the recognition of those special rights of landed proprietors the traces of which are still visible in our legislation. Each stage involved new problems, legal, sociological and moral. But progress only



Q2503  
392



cular efforts of all the inhabitants. Later empires, scarcely less imposing but far less stable, rose and fell. In the methods of production and communication, in the modes of getting food and exchanging goods, there was less change between the time of Sargon and the time of Louis XIV, than there has been between the accession of Queen Victoria and the present day. Darius could probably send a message from Susa to Sardis faster than Philip II could transmit an order from Madrid to Brussels. Sir Robert Peel, summoned in 1834 from Rome to form a government in London, took the same time as the Emperor

crawled, and often rested for a thousand years or so.

The two ribbon states in the valleys of the Nile and the Euphrates produced civilizations as full of pomp and circumstance, and more stable than, any the world has ever known. Their autocracies and hierarchies were founded upon the control and distribution of water. The rulers held the people in an efficiency of despotism never equaled till Soviet Russia was born. They had only to cut off or stint the water in the canals to starve or subjugate rebellious provinces. This gave them powers at once as irresistible and capable of intimate regulation as the control of all food supplies gives to the Bolshevik commissars. Safe from internal trouble, they were vulnerable only to external attack.

But in these states man had not learnt to catalyze the forces of nature. The maximum power available was the sum of the mus-



Television May Be Expected to Span Oceans and Continents to Conquer Distance as Radio Has Already Done



Vespasian when he had to hasten to his province of Britain. The bathrooms of the palaces of Minos were superior to those of Versailles. A priest from Thebes would probably have felt more at home at the council of Trent, two thousand years after Thebes had vanished, than Sir Isaac Newton at a modern undergraduate physical society, or George Stephenson in the Institute of Electrical Engineers. The changes have been so sudden and so gigantic, that no period in history can be compared with the last century. The past no longer enables us even dimly to measure the future.

There are two processes which we adopt consciously or unconsciously when we try to prophesy. We can seek a period in the past whose conditions resemble as closely as possible those of our day, and presume that the sequel to that period will, save for some minor alterations, be similar. Secondly, we can survey the general course of development in our immediate past, and endeavor to prolong it into the near future. The first is the method of the historian; the second that of the scientist. Only the second is open to us now, and this only in a partial sphere. By observing all that science has achieved in modern times, and the knowledge and power now in her possession, we can predict with some assurance the inventions and discoveries which will govern our future. We can but guess, peering through a glass darkly, what reactions these discoveries and their applications will produce upon the habits, the outlook and the spirit of men.

The most wonderful of all modern prophecies is found in Tennyson's "Locksley Hall:"

For I dipt into the future, far as  
human eye could see,

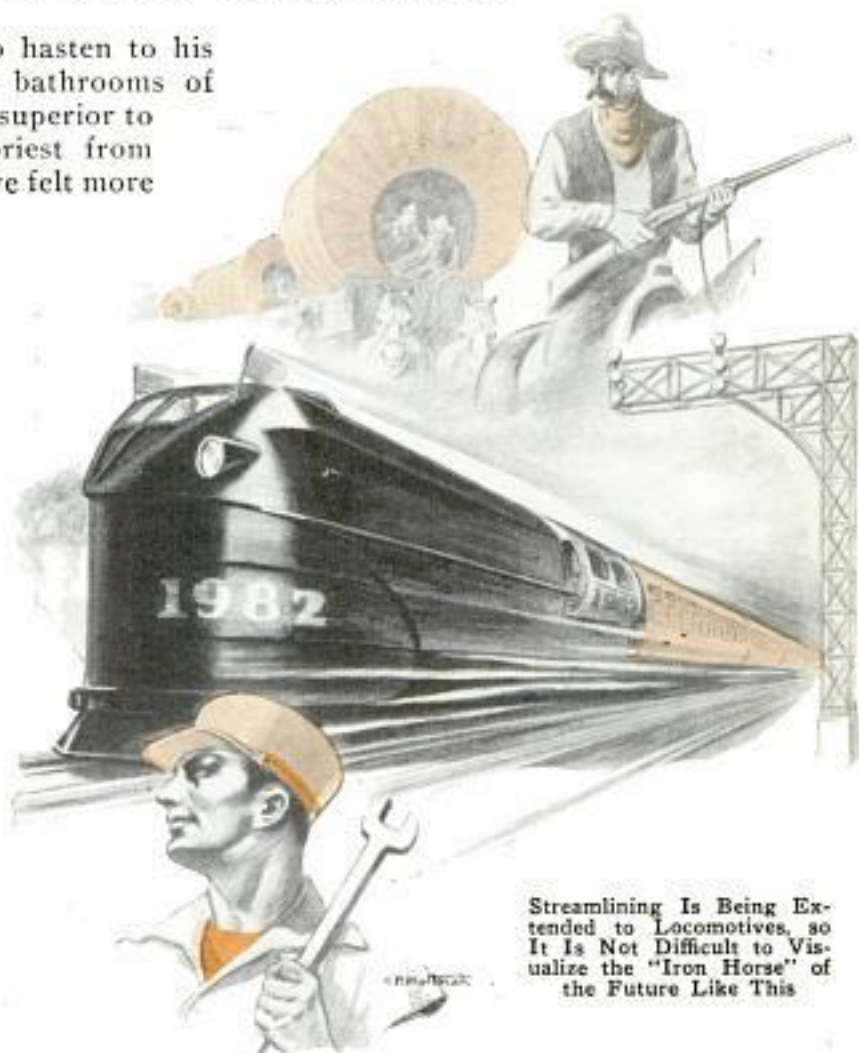

Streamlining Is Being Extended to Locomotives, so It Is Not Difficult to Visualize the "Iron Horse" of the Future Like This

Saw the Vision of the World, and all  
the wonder that would be;

Saw the heavens fill with commerce,  
argosies of magic sails,  
Pilots of the purple twilight, drop-  
ping down with costly bales;

Heard the heavens fill with shouting,  
and there rain'd a ghastly dew  
From the nation's airy navies grap-  
pling in the central blue;

Far along the world-wide whisper  
of the south wind rushing warm,  
With the standards of the peoples  
plunging thro' the thunderstorm;

Till the war-drum throb'd no longer,  
and the battle-flags were furl'd  
In the Parliament of man, the  
federation of the world.

Slowly comes a hungry people, as a  
lion, creeping nigher,  
Glares at one that nods and winks  
behind a slowly-dying fire.





Hidden Cities, and Even a Lost Civilization, May Be Discovered When Exploration of the Ocean Floor Is Made Easy

These six stanzas of prediction, written eighty years ago, have already been fulfilled. The conquest of the air for commerce and war, the world struggle of Armageddon, the League of Nations, the Bolshevik revolution—all divined in their true sequence by the great Victorian, all now already in the history books and stirring the world around us today. We may search the Scriptures in vain for such precise and swiftly vindicated forecasts of the future. Jeremiah and Isaiah dealt in dark and cryptic parables, pointing to remote events and capable of many varied interpretations from time to time. A Judge, a Prophet, a Redeemer would rise to save his chosen people; and from age to age the Jews asked disputing, "Art thou he that should come? or look we for another?" But "Locksley Hall" contains

an exact foretelling in their sequence of stupendous events, which many of those who knew the writer lived to see and endure! The dawn of the Victorian era opened the new period of man, and the genius of the poet cast back the curtains which veiled it.

Whereas, formerly, the utmost power that man could guide and control was a team of horses, or a galley full of slaves, or, possibly, if they could be sufficiently drilled and harnessed, a gang of laborers like the Israelites in Egypt, it is today already possible to control accurately from the bridge of a battle cruiser all the power of hundreds of thousands of men. Or to set off with one finger a mine capable in an instant of destroying the work of thousands of man-years. These changes are due to the substitution of molecular energy for muscular energy, and its direction and control by an elaborate, beautifully perfected apparatus.

These immense new sources of power, and the fact that they can be wielded by a single individual, have made possible novel methods of mining and metallurgy, new modes of transport and undreamed-of machinery. These, in their turn, enable the molecular sources of power to be extended and used more efficiently. They facilitate also the improvement of ancient methods. They substitute the 100,000-kilowatt turbo-generators at Niagara for the mill wheel of our forefathers. Each invention acted and reacted on other inventions, and with ever-growing rapidity that vast structure of technical achievement was raised which separated the civilization of today from all that the past has known.

There is no doubt that this evolution will continue at an increasing rate. We



know enough to be sure that the scientific achievements of the next fifty years will be far greater, more rapid, and more surprising, than those we have already experienced. The slide lathe enabled machines of precision to be made, and the power of steam rushed out upon the world. And through the steam clouds flashed the dazzling lightnings of electricity. But this is only a beginning. High authorities tell us that new sources of power, vastly more important than any we yet know, will surely be discovered. Nuclear energy is incomparably greater than the molecular energy which we use today. The coal a man can get in a day can easily do five hundred times as much work as the man himself. Nuclear energy is at least one million times more powerful still. If the hydrogen atoms in a pound of water could be prevailed upon to combine together and form helium, it would suffice to drive a 1,000-horsepower engine for a

tonator to cause the dynamite to explode. The scientists are looking for this.

The discovery and control of such sources of power would cause changes in human affairs incomparably greater than those produced by the steam engine four

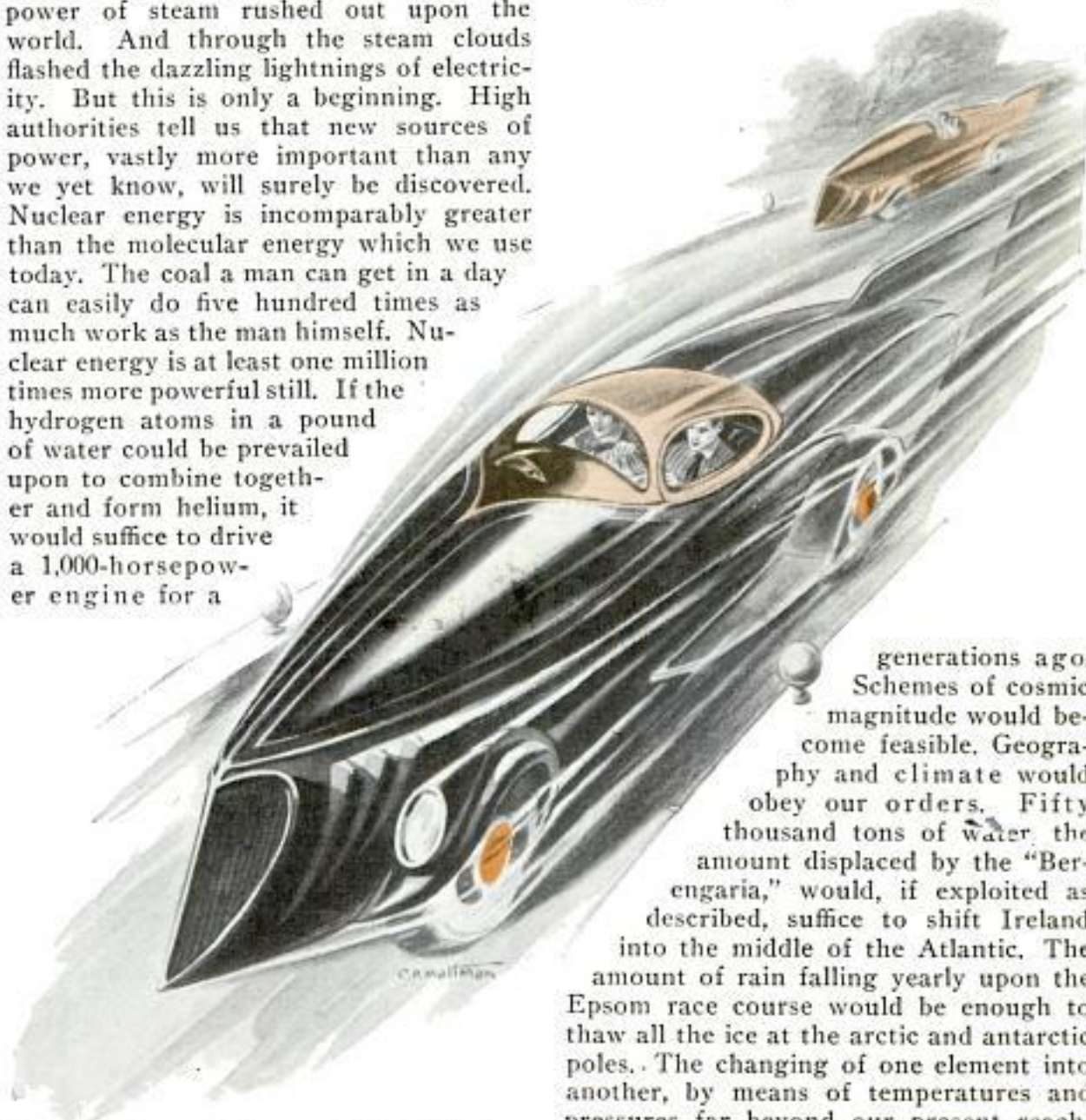

High-Speed Lanes on Highways Will Possibly Come with Further Evolution of Streamlined Cars

whole year. If the electrons—those tiny planets of the atomic systems—were induced to combine with the nuclei in the hydrogen, the horsepower liberated would be one hundred and twenty times greater still. There is no question among scientists that this gigantic source of energy exists. What is lacking is the match to set the bonfire alight, or it may be the de-

generations ago. Schemes of cosmic magnitude would become feasible. Geography and climate would obey our orders. Fifty thousand tons of water, the amount displaced by the "Bergengaria," would, if exploited as described, suffice to shift Ireland into the middle of the Atlantic. The amount of rain falling yearly upon the Epsom race course would be enough to thaw all the ice at the arctic and antarctic poles. The changing of one element into another, by means of temperatures and pressures far beyond our present reach, would transform beyond all description our standards of values. Materials thirty times stronger than the best steel would create engines fit to bridle the new forms of power. Communications and transport by land, water and air would take unimaginable forms if, as is in principle possible, we could make an engine of six hundred horsepower weighing twenty pounds and carrying fuel for a thousand hours in a tank the size of a fountain pen. Wireless





The Metropolis of the Future May Contain Set-Back Structures Like These and Elevated Streets

telephones and television, following naturally upon their present path of development, would enable their owner to connect up to any room similarly equipped and hear and take part in the conversation as well as if he put his head in through the window. The congregation of men in cities would become superfluous. It would rarely be necessary to call in person on any but the most intimate friends; but if so, excessively rapid means of communication would be at hand. There would be no more object in living in the same city with one's neighbor than there is today in living with him in the same house. The cities and the countryside would become indistinguishable. Every home would have its garden and its glade.

Up till recent times, the production of food has been the prime struggle of man. That war is won. There is no doubt that the civilized races can produce or procure all the food they require. Indeed, some of the problems which vex us today are due to the production of wheat by white men having exceeded their own needs, before yellow men, brown men and black men have learned to demand and become able to purchase a diet superior to rice. But food is at present obtained almost entirely from the energy of the sunlight. The radiation from the sun produces from the carbonic acid in the air more or less complicated carbon compounds which serve us in plants and vegetables. We use the latent chemical energy of these to keep our bodies warm, we convert it into muscular effort. We employ it in the complicated processes of digestion to repair and replace the wasted cells of our bodies. Many people, of course, prefer food in what the vegetarians call "the secondhand form," i.e., after it has been digested and converted into meat for us by domestic animals



# POPULAR MECHANICS

kept for this purpose. In all these processes, however, ninety-nine parts of the solar energy are wasted for every part used.

Even without the new sources of power great improvements are probable here. Microbes, which at present convert the nitrogen of the air into the proteins by which animals live, will be fostered and made to work under controlled conditions, just as yeast is now. New strains of microbes will be developed and made to do a great deal of our chemistry for us. With a greater knowledge of what are called hormones, i.e., the chemical messengers in our blood, it will be possible to control growth. We shall escape the absurdity of growing a whole chicken in order to eat the breast or wing, by growing these parts separately under a suitable medium. Synthetic food will, of course, also be used in the future. Nor need the pleasures of the table be banished. That gloomy Utopia of tabloid meals need never be invaded. The new foods will be practically

indistinguishable from the natural products from the outset, and any changes will be so gradual as to escape observation.

If the gigantic sources of power become available, food would be produced without recourse to sunlight. Vast cellars, in which artificial radiation is generated, may replace the cornfields and potato patches of the world. Parks and gardens will cover our pastures and plowed fields. When the time comes, there will be plenty of room for the cities to spread themselves.

But equally startling developments lie already just beyond our fingertips in the breeding of human beings and the shaping of human nature. It used to be said of



Ultraviolet Light May Result in Many Changes in Life Processes Just as It Already Aids in the Treatment of Disease

scientific progress: "You have taught the dog more tricks; but you cannot alter the breed of the dog." But this is no longer true. A few years ago London was surprised by a play called "Rossum's Universal Robots." The production of such beings may well be possible within fifty years. They will not be made, but grown under glass. There seems little doubt that it will be possible to carry out the entire cycle which now leads to the birth of a child, in artificial surroundings. Interference with the mental development of such beings, expert suggestion and treatment in the earlier years, would produce beings specialized to thought or toil.



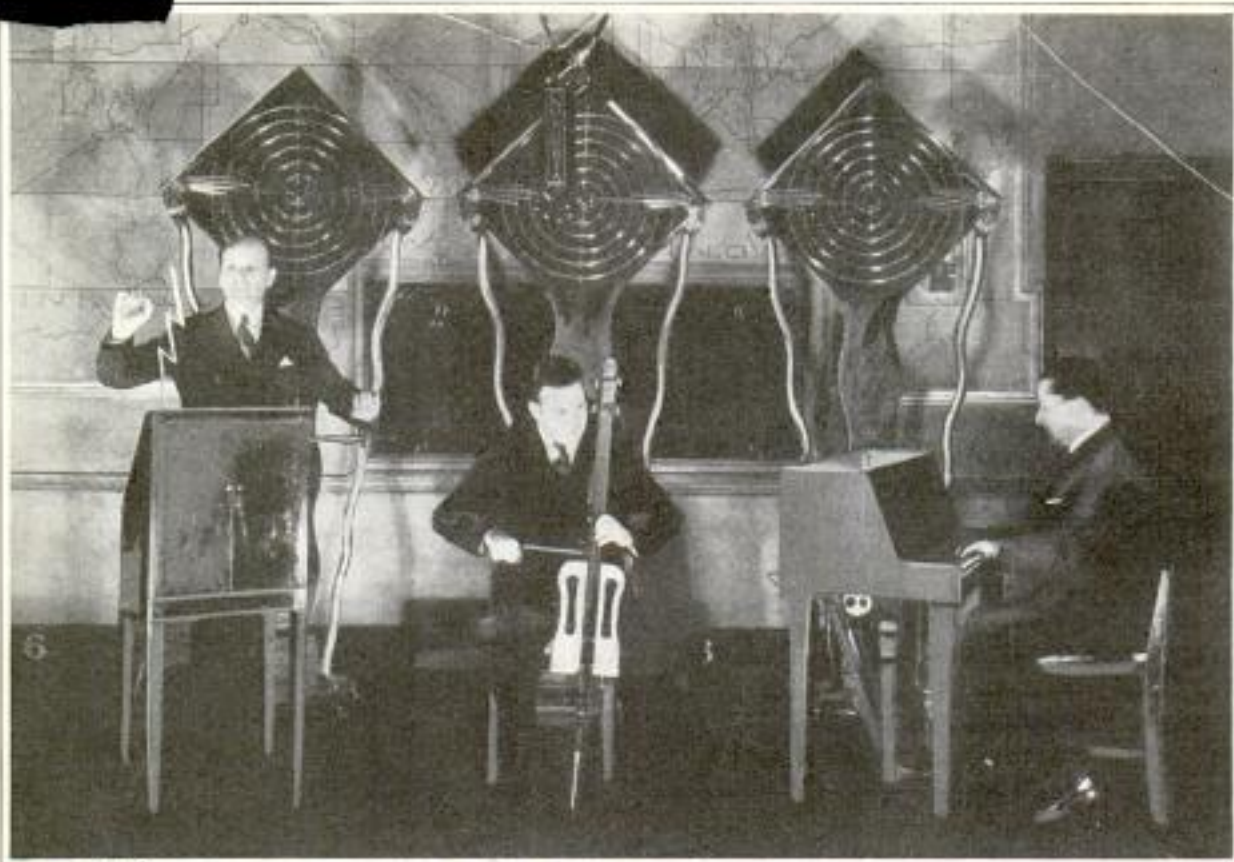

Electric Voice, Cello and Piano in the Studio during a Nation-Wide Broadcast of the Trio; the Music Is Produced Entirely by Electric Vibrations

**ELECTRIC VOICE AND MUSIC ARE PUT ON THE AIR**

Voice, cello and piano, each produced solely by electric vibrations, are being broadcast regularly over the Columbia network. The instruments operate on the principle of the "theremin" and are known as the electro-voice, the electro-cello and the electro-piano.

**DOLLARS IN SCENTS SAVINGS BY CONTROL OF SMELLS**

Chemical experts have discovered that from a standpoint of smell, there are two things that may be done with a manufactured product. An unpleasant odor may be neutralized or a pleasant odor may be added. For instance, in the manufacture of most laundry soaps strong-smelling chemicals are used, but this is usually covered up by adding perfume. In the silk industry many manufacturers use a small quantity of perfume to neutralize the odor of certain oils, gums and other ingredients. By using a little more perfume, any silk manufacturer may give his silk a

pleasant odor of its own. The idea of a scent control in industry is growing. The point has been reached in perfume chemistry where almost any such job may be accomplished without adding materially to the cost of the product. Chemists now analyze an unpleasant odor and find out what substance causes it. That substance is made part of the new odor. For example, some fly sprays, made of kerosene and pyrethrum powder, formerly were scented with five or six per cent oil of wintergreen. Now the chemists know eight or ten different substances that can be used in much smaller quantities. Research by the Dennison Manufacturing company, which makes lamp shades in which gelatin is used, revealed that in damp weather molds were likely to appear, causing black spots on the shades. They added a small percentage of phenol (carbolic acid) as a sterilizer, which settled the difficulty, but did not create an agreeable odor. They then discovered that many of the perfumes used by scent experts are as effective disinfectants as is phenol. They now use perfume materials for sterilizing their

radio wa ac

come

Howard A. Bellavance and C. P. Engle

Cont. Harry K. Hobart, 71, Albemarle Ave. Hempstead, L. I. New York



*Bureau of Chemical Research Dept. of Agriculture*

*A. 2505 Stromberg Motoscapes Co 399 1145 Riverside Parkway Chicago*

shades. In one large hospital, white uniforms and the like are sterilized with aromatic products. Several manufacturers are now adding a trace of odor to silk stockings. One leading auto maker perfumes his upholstery. Statistics show that one man out of every six is color-blind, and it is believed that the percentage of those who are insensible to smell is not any greater. Men like spicy odors, women do not. W. C. Crocker and L. F. Henderson are two government chemists and pioneer perfume experts. At present they are engaged in working on odors that cancel each other. These experts declare that the keenest human sense of smell is negligible as compared with that of insects. The United States government is now buying several thousand pounds of geraniol every year. This has a rose odor, and it attracts Japanese beetles a mile away. When they arrive at the source of the odor they are exterminated. Crocker and Henderson have tentatively divided all odors into four elementary odor sensations: fragrant, acid or sour, burnt and caprylic, which means goatlike.



This Portable Track Makes Car Pull Itself Out of Snow, Mud or Sand.

**AUTO CARRIES ITS OWN TRACK TO PULL IT FROM SNOW**

Snow, mud or sand-bound motorists now can pull out of the impediment by a simple device that is carried right in the car. It consists of a matlike track, with a corrugated surface, that can be laid on the roadway in front of the rear wheels. As soon as the wheels start spinning, the corrugated surface takes up the traction and the car moves away. The track is light and easily stowed in the auto.

**"BREAK-EM-UP" IS THE ORDER TO TRUCK TESTERS** *B. 48*

Loaded with four tons of steel, giant trucks are driven into and out of a pit three feet deep at the proving ground of an English manufacturer. Other strenuous trial spots must be conquered by each truck before it is ready for the market.

Plunging In and Out of Three-Foot Pit Is One Test for Trucks



**STOP GAS FIRES ON BOATS WITH BILGE SOLVENT** *B. 69*

Gasoline and oil in the bilge of a boat constitute a fire hazard in case of a back-fire or short circuit, so one manufacturer has placed on the market a bilge solvent intended to neutralize this inflammable material. A few handfuls of the solvent not only keep the bilge free of grease and oil, but remove the musty, stagnant odor as well. It is effective in all waters, dissolves completely and is harmless, the makers claim.

*Chicago & nationally magazine, Super by C. 10 & n well*

*Scannell Lorries, Ltd Watford, West. Yorks. England*

*Puro Products Co 2602 Payne Ave Cleveland Ohio*



2567

John James, Island of Corfu, Greece!



Testing a Balloon That Can Be Guided and Propelled by the Passenger, Who Manipulates the Gas Bag from His Perch beneath It

### BALLOON CAN BE GUIDED IN AIR AND PROPELLED BY FLYER

Balloonists have always been handicapped because they have been unable to control the gas bag once it was aloft, but a Greek engineer has invented a balloon which can be both guided and propelled by the operator. The flyer sits in a frame suspended beneath the bag from which he manipulates the propulsion mechanism and the steering apparatus.

The United States shipping board, with a fleet of 2,239,153 gross tons in 397 vessels, is the world's largest ship owner.

Bureau of Navigation

### GLASS HOUSES ON BRIDGE OFFER CITY VIEW

Twin pergolas of glass are planned for the two steel towers on top of the Washington Memorial bridge in New York for service as observation towers. The steel framework above the points where the great cables are supported will be glassed in, express elevators installed to carry tourists 635 feet above the water, and sandwich and coffee shops, lounge chairs and radio equipment placed in the area. An open-air promenade will be provided, with the usual telescopes. It is expected that the profit from the towers will add about \$200,000 yearly to the revenue of the port authority, and that the towers will develop rapidly into full-fledged rivals of the Empire State and Chrysler buildings.

M. J. James 12/24/31

### EXPANDER STOPS PISTON SLAP

Piston slap in your automobile engine can be stopped permanently by installation of adjustable

expanders now on the market. The expanders fit any piston up to four inches in diameter and can be installed in all split-skirt-type pistons. Adjustable to take up space wherever wear occurs, the expanders meet a demand for something to end motor noises in used cars. The device presses the sides of the piston against the cylinder wall by means of a nut-and-screw arrangement.



John E. Hodg Co. 152  
1627 N. Franklin  
Chicago

Copyrighted material



James Fox

Mon. Standard 10/31/32

PLANE SHOT OVER WATERFALL TO MAKE IT TAKE AIR <sup>B 30</sup>

One of the most dangerous and thrilling take-offs in the history of aviation was recorded recently by a geologist and his mechanic upon their return from northern Saskatchewan where they had been forced down on a small lake on an exploring trip. A piston was broken, which they repaired as best they could with native copper found on the shore. Attempts to take off, however, were vain, as the crippled engine had not sufficient power. Cruising over the lake, they discovered a 400-foot waterfall at one end. At its base were trees in a rock-studded ravine. Taxiing back to the opposite end, they raced the plane with all the speed it would master over the waterfall. It dropped sickeningly for about half the distance of the fall, then took the air slowly and the explorers were able to return to within a few miles of their base.

AUTOMATIC TUNING FOR RADIO BRINGS IN PROGRAMS <sup>B 7</sup>

Your radio favorites for the entire day can be tuned in when you get up by the use of a program selector attached to the set. With the automatic tuner, any fifteen-minute program can be preselected from one of six stations throughout a twelve-hour period. When the time for any program arrives, the device turns on the set, tuned to the proper station.



Radio-Program Selector Which Can Be Set to Bring in Favorite Programs from Various Stations for a Twelve-Hour Period

Wide World  
No answer maker and  
inventor unknown

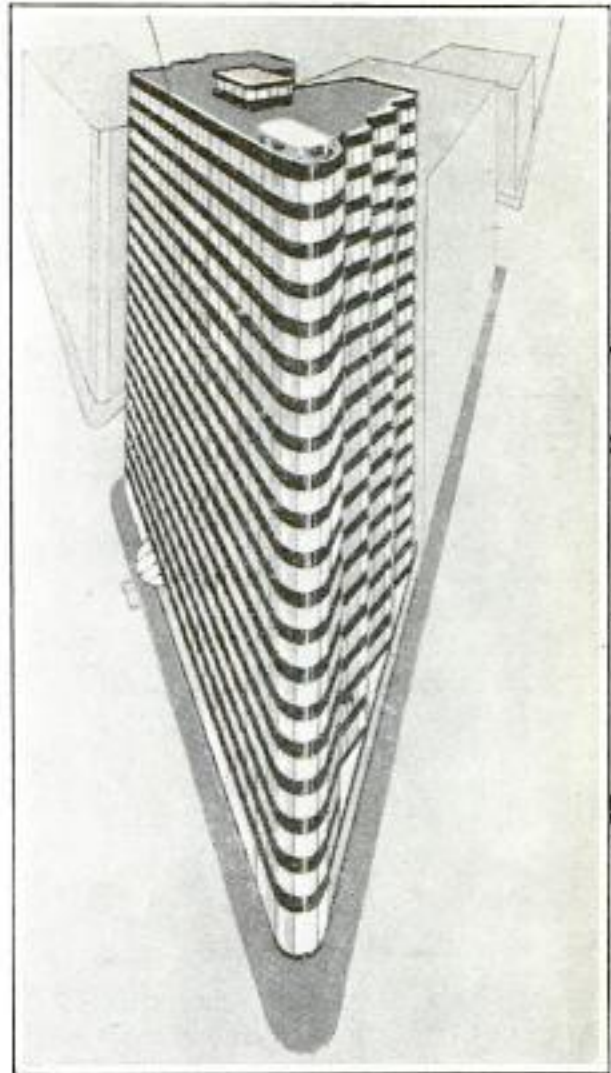

Walls of Metal to Reduce Weight and Cost of Buildings; One Architect Submits Above Drawing

METAL WALLS FOR BUILDINGS TO LOWER COSTS

Metal walls give great strength with small thickness, reducing the weight and cost of buildings. One Chicago firm of architects, which expects to erect six all-metal buildings in 1932, points out that an exterior wall only three inches thick is necessary. The insulation may be of cork, rock wool or other materials, and the interior finish may be applied in the factory directly to the insulation on the inside of each wall slab. An interior wall finish, such as linoleum, can be used, eliminating the necessity of plastering. A three-inch wall of this type will have about one-tenth the weight of a masonry wall and about three times the insulation value. The metal units may be shop fabricated and erected quickly on the job, saving a great deal of labor.

Bowman Bros. Inc. Architects  
952 N. Michigan Ave Chicago



A 2439

A 2573

Clara City down

Lions Attacking a Man-Size Dummy Acting the Part of a Modern Daniel



DUMMY "DANIEL" SHOWS FATE OF MAN IN LION'S DEN

Curious to know what would happen to a modern Daniel in a lion den, a photographer rigged up a man-size dummy on a California lion farm. Then he trained his camera on the dummy as twenty beasts of the jungle were turned loose in the inclosure. The dummy actor lasted about thirty seconds, the first lion taking off the head at one bite, the second snatching an arm, and the rest helping themselves to the shreds that remained.

It is estimated that 557,400,000 incandescent lamps were sold in the United States in 1931.

John Liston, General Electric Review

THIRD CLASS OF LIVING THINGS WOULD INCLUDE FUNGI

Instead of the ordinary division of the world of living things into two sections, animal and vegetable, it should be divided into three classes to include fungi, according to Prof. G. W. Martin, of the State University of Iowa, whose conclusions are based on a study of the slime molds, creatures very low in the scale of life, that have been regarded variously as animals and fungi. He holds that the theory that plants and animals are all descended from a single original cell is not necessarily the case at all, but that it is more probable that life originated from several independent sources, widely separated in both space and time. Thus there would be no necessity for forcing such unlike things as green plants and fungi into each other's company, which is now done mainly because of the idea of a common descent.

FILE RUBBER GRIP PROTECTS HANDS

For protection of the user's hands, a soft-rubber grip that fits over the end of files has been developed. The grip is shaped to fit snugly inside the palm, and makes it easy to hold the file flat and apply the proper pressure, preventing scars on the work. It also serves as a shock absorber if the file is dropped and is available for all file sizes.

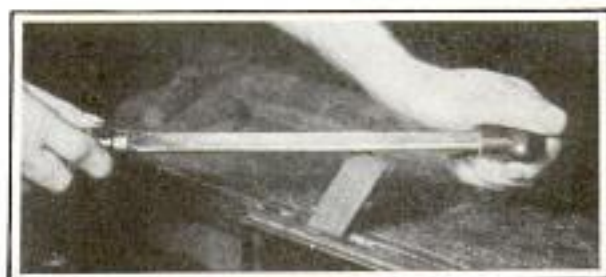

Rubber Grips for Files Enable the User to Do Better Work and Protect His Hands

J. L. Clegg Tool Co.

43. Pearl Buffalo, N.Y.

Scay's Lion Farm, El Monte, Calif.

Clara City down

A 2486

Copyrighted material



B 9

**THIRTEEN-DAY NON-STOP TRIP  
TESTS DIESEL TRUCK**

a2587

Thirteen days without a stop was the test run of a Diesel-engined truck recently. The engine ran continuously fourteen days, while the truck was driven one day less in its non-stop journey, one wheel becoming loose after the first day's run. The truck was driven 10,005 miles without refueling and 13,535 miles without stopping. The total cost at an average speed of forty-three miles per hour was \$75.54, or about one-half cent per mile. The run was staged at the Indianapolis speedway. The two and one-half ton truck, with a total weight of 21,000 pounds, was overloaded at the start, when 908 gallons of fuel were aboard, but the truck averaged ten miles to the gallon of fuel and 1,825 miles per gallon of lubricating oil. The Diesel engine used on the run has no spark plugs and no carburetor. The fuel oil, much the same as that used in the household furnace, is heated and injected into the cylinders in the form of vapor. The heat generated by the compression of pure air in the cylinders ignites the vapor. Otherwise the engine does not differ in its movements from the ordinary gasoline engine. Top speed of the truck is sixty-five miles an hour.

Reported in *Baltimore Herald* 8-10-1914

**WHITE ROSE IS COLORED GRAY  
WITH DYE FOR MOURNING**

B 32

Artificial coloring has been used in producing a gray rose for mourning purposes. White roses treated with an aniline dye, naphthol black B, take on a delicate gray or grayish-black hue without affecting the odor. The dye is worked into the rose by placing the stems in a solution of coloring matter. The same process may be used in darkening and intensifying the colors of flowers in which the natural tint is faint. Life of the flower is unaffected, the roses keeping as well as if they had not been treated. One-eighth ounce of dye dissolved in a pint of water is effective, while the solution may be diluted ten times without losing its strength. The color begins to appear in the rose ten or fifteen minutes later. Carnations grown in sand will absorb dye fed through the roots, but experiments with other flowers have been only partly successful.

Mr. Henry Kraemer

Research material collected by  
Research Dept. Library, Academy of Natural Science



Figures Dangling in Air as Interest-Catchers; Lifelike Appearance Attracted Thousands

**FIGURES DANGLING ON LADDER  
DRAW CROWDS**

Figures dangling from a rope ladder suspended high in the air drew throngs of curious to a department store in Milan, Italy. The figures were extremely lifelike dummies and were placed on the ladder in various acrobatic poses. The ladder, in turn, was suspended from a huge packing case, swung from the building cornice. Thousands of persons were astonished at the display, stopping to discuss it.





# GET

The Cameraman Follows the Explorer and Adventurer to the Far Corners of the World; Here Is Robert Donahue, Newsreel Photographer, Who Went to the North Pole with Admiral Byrd

By E. C. SCHNURMACHER

22 8 69 M

"ZUNI Indians, snowbound and freezing to death in blizzard, north of Gallup, New Mex." Over the teletype, this brief graphic dispatch reaches the news desk of the Universal office in New York. Its receipt galvanizes Samuel Jacobson, newsreel editor, into action.

He glances at pins set in a big map on the wall above him. The nearest pin to Gallup is set in Los Angeles, Calif. That pin represents Leroy A. Mervyn, one of Universal's 500 cameramen. Jacobson picks up the telephone and calls Los Angeles.

"Get the story!" is his terse command. Expense, danger, hardship, and all other obstacles, must be waved aside. The rescue of those Indians must be filmed, and the cameraman must be the first on the spot. A newspaper reporter can reconstruct a story from reports of eyewitnesses, but the greedy lens of the newsreel camera must be an eyewitness itself.

Fifteen minutes after receiving the call, Mervyn is on his way to the Los Angeles airport with his camera. A swift airplane

flies ~~from Los Angeles~~ <sup>from Gallup</sup> Over Albuquerque a bad storm develops that the plane cannot buck. It lands. Within an hour, Mervyn is on his way again in a fast automobile. The storm gets worse. He does not reach Gallup until the following day.

No time to rest. The rescue party has set out three hours before. They cannot average much over a mile an hour breaking trail with their horses and sleds. Eighteen miles—nearly eighteen hours through snow and ice. Mervyn hires a guide, a horse and a sled. Then he starts out after the rescue party. Hours later he catches up to them. Later still, he films the actual rescue of the Indian woodchoppers and nutpickers. His job is half done.

Wearily he retraces his way to Gallup, arriving there before the rescue party. The plane he left at Albuquerque has finally come through, refueled, and is waiting for him. He delivers the precious negative to the pilot and the latter starts winging his way east toward New York.

Then and only then, Mervyn wires the New York office. He has spent three full



# the Story!

They Risk Their  
Lives To Live

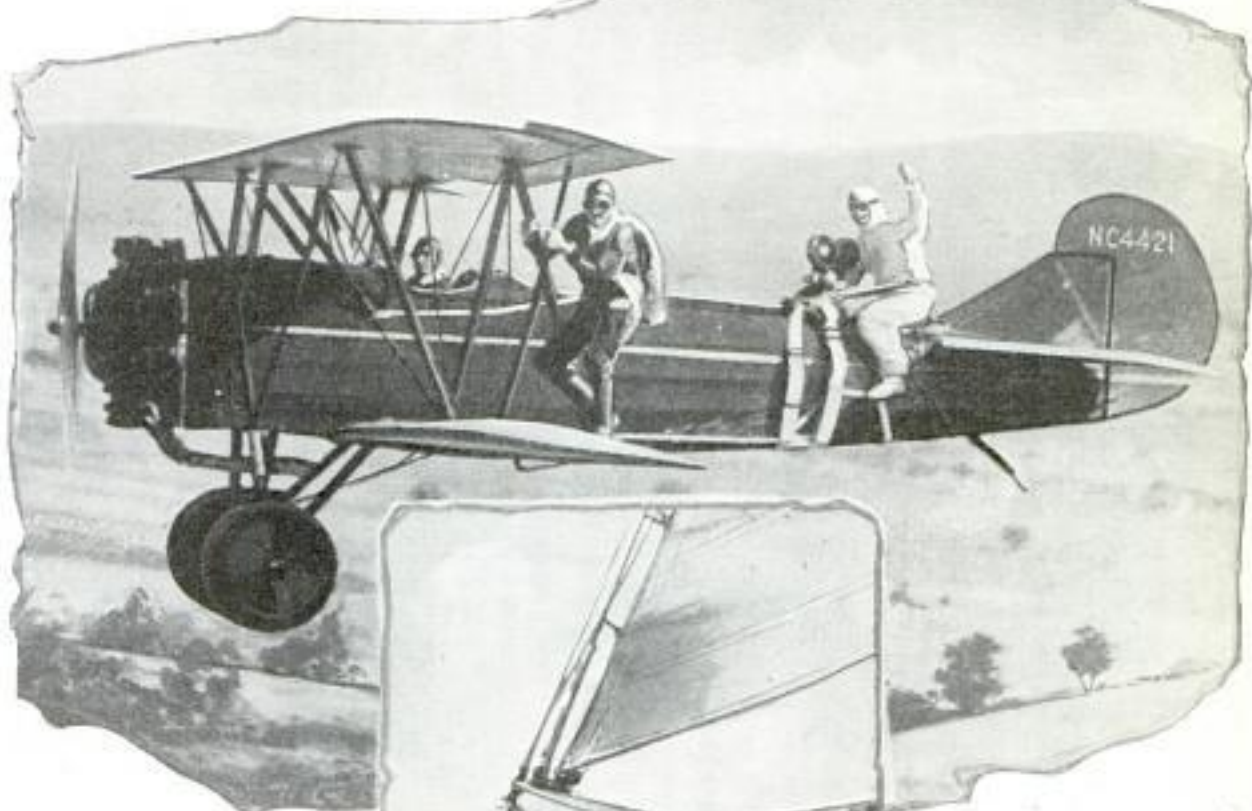

days and nearly \$2,000 making a bit of news-reel which, three days hence, will run for exactly one minute and forty seconds.

A staff car is waiting for the pilot at Newark airport. The film is taken swiftly to the synchronization and developing plant at Camden, N. J. Mr. Jacobson and Graham McNamee, the talking reporter, are there to receive it. The film is quickly developed

and projected. After seeing it once, Mr. McNamee is ready to "put it into sound." With a microphone in front of him, he gives a running description of the action on the screen, carefully timing himself to finish when the picture does.

The master negative is now ready for making hundreds of prints which will be sent all over America and to eighteen foreign coun-

Cameramen Working under Difficulties from  
Aquaplane, Airplane and Yacht



02552



of the newsreel cameramen," said Mr. Howard, "are recruited from the ranks of the newspaper still photographers. In fact, many of the production staff of the Big Four, Pathe, Paramount, Universal and Fox Movietone were formerly newspapermen.

"The other forty per cent grow up from office boys in the newsreel offices. These lads, 'punks' as they are called, carry batteries and equipment on their holidays and spend as much time with the cameramen as they can.

"There are two kinds of newsreel men, the chap who can bring in a first-rate news story and the pictorial specialist. Each is important, and it is virtually impossible to find one man who combines both these qualities."

Universal Newsreel is the only one of the four big newsreel companies that does not have sound units, preferring to synchronize the sound at the laboratory after the picture has been taken. The

unit, which is moved in a fast truck, consists of a sound cameraman, a silent cameraman, a sound man and a contact man.

The sound cameraman and the sound man work together. The sound camera, electrically operated,

tries. At the same time, clips, or cuttings, have been made of the most graphic pictures. These are enlarged and rushed to news-picture syndicates, whose men sell them to the newspapers. A single picture, appearing in one metropolitan daily paper, may cost that newspaper as much as \$300.

It is rarely that a newsreel cameraman gets into print. It is only when some tragedy occurs in which he is killed, that a brief notice appears in the newspapers. Such an event, for example, as when the racing driver, Lee Bible, was killed at Daytona Beach, Fla., and his car, running amuck, killed the cameraman that was filming him.

Where do the newsreel cameramen come from? Percy Howard, newsreel editor for Pathe, and the first newsreel editor to introduce sound news, answers that question.

"About sixty per cent



Top, Modern Sound Camera; Center, Spectacular Stunts, Once Popular, Have Been Discarded for News; Below, Tiger Shark Filmed and Then Caught



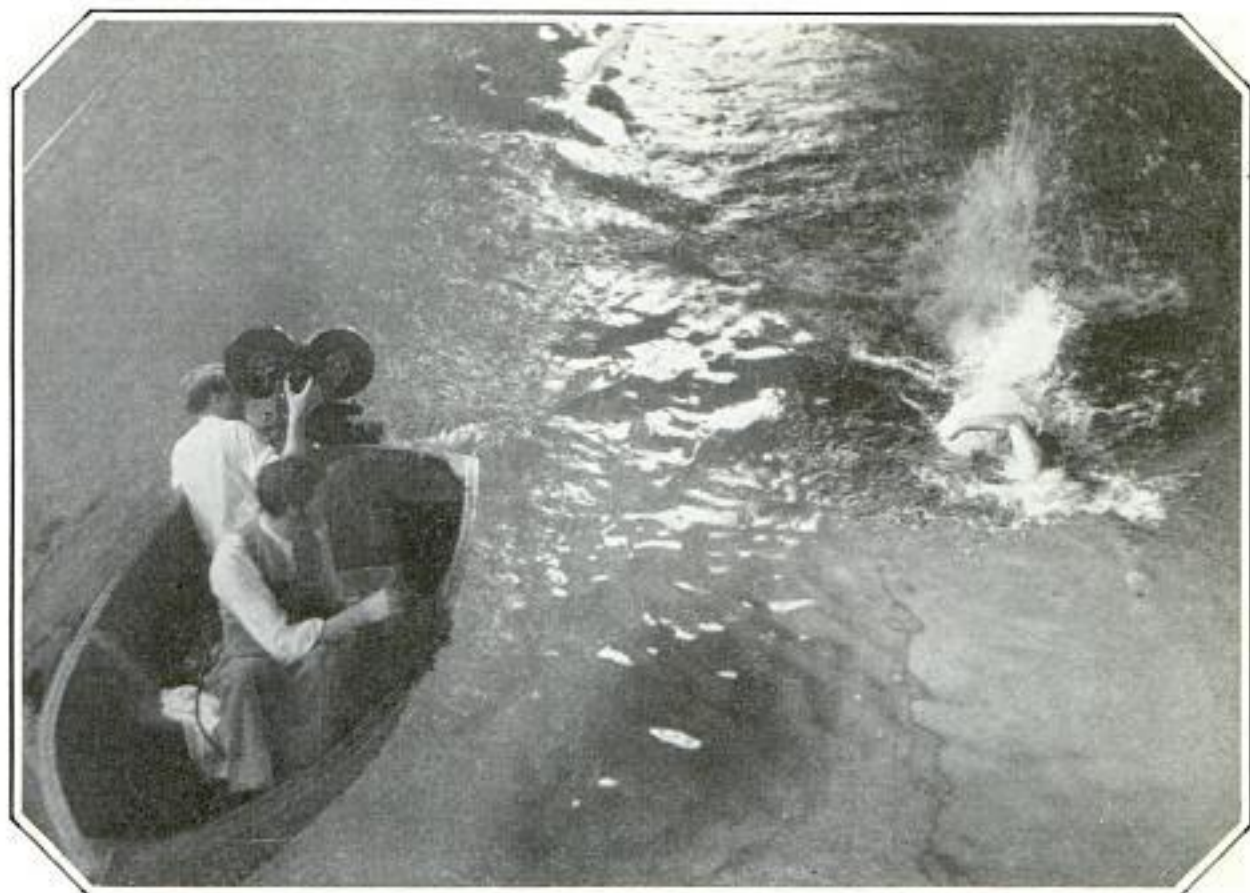

Newsreel Men Using Rowboat in Indoor Swimming Pool to Photograph Helen Madison, Swimming Champion; She Swam for Two Hours and They Got Pictures Lasting Forty Seconds on the Screen

is synchronized with the recording apparatus through a control box operated by the sound man who sets up the mike wherever it is most advantageous.

The sound man is generally recruited from the ranks of the radio engineers. His job is often difficult but seldom so dangerous as the newsreel cameraman's. He has to be ingenious and have a thorough knowledge of the mechanics of sound and acoustics, plus a sixth sense to make the sound plausible. As an example of this, a sound cameraman recently made a picture of a speeding motorboat. While the boat was quite far away from the camera, the newsreel man had no difficulty in "pulling it in" with a telephoto lens on his camera. The sound man could not resort to any such expedient. He solved his problem by engaging another boat which was tied to the dock in front of the microphone, its motor running at racing speed.

The contact man occupies an important function. It is his job to see that things run smoothly, and his duties vary from arranging camera interviews with royalty

to carrying the batteries connected to the sound-recording apparatus. He generally is a cameraman too, and takes his turn with the slow or stop-motion camera to secure additional "angleshots."

When sound was first introduced to newsreels about four years ago with a reel of Lindbergh's take-off for Paris, sound trucks were cumbersome and equipment weighed about 1,000 pounds. Many refinements have been introduced and equipment now weighs considerably less than half of that, and is so portable that it may be taken in airplanes. A sound-camera outfit costs between \$35,000 and \$50,000. A silent newsreel camera costs \$1,000 to \$5,000.

Not only does a newsreel cameraman have to face dangers incidental to the story he is filming, he must also contend with competition. Rival cameramen will go to any lengths to prevent a scoop.

"At all important points, whether here or abroad," said Editor Howard of Pathe, "the newsreel companies maintain tipsters, who phone or wire in when an important story is about to break. At Langley field,



Q2552



Top, Photographers on Way to Cover Mountain-Lion Hunt; Below, Shooting Fight between Police and a Criminal Cornered in New York

Va., for example, it is virtually impossible for a newsreel cameraman to secure a scoop, for in so important a flying center all of the newsreel companies maintain tipsters.

"Once in a while it is possible to 'sew a story up tight.' When Post and Gatty made their epochal round-the-world flight, they had one of our newsreel cameras along. Naturally we had to take every

precaution to see that the film was not stolen at any port of call."

Film is sometimes stolen, hijacked or spoilt. When rival cameramen flew to Murray bay to film the "Bremen" many blows were struck. This situation also has its humorous side. Joe Gibson, Universal cameraman, covers with his silent newsreel camera many stories covered by sound units. When Mr. Gibson starts to grind his camera in slow motion, it emits such a high, whining tone that the sound cameramen have to stop and the noise



The Newsreels Go after Celebrities; Here Is the Prince of Wales before the Camera

will not be recorded in their microphones.

During the war, several newsreel cameramen were killed filming action from the front-line trenches. In peacetime, they take just as many chances. One of the most dangerous exploits of a newsreel cameraman occurred very recently when Pathe filmed a story in which a pouch of mail was taken by a small dirigible from the top of the Empire State building in New York to a ship at sea.

Only a single door on one side of the dirigible could be opened, and it was necessary for the pilot to use that to lower a rope for the mail pouch. To accommodate the cameraman, a large canvas bag was attached to the landing wheel beneath the dirigible and the action was





Photographer Climbing Unfinished Building to Get Picture from the Dome, Shown in Insert

speed record. Pictures were made of the first try. On the following day, while the cameramen were gathered at the hotel waiting for the rain to stop, Bayles announced that he would try again. With their film "in the can," the other cameramen scoffed at the idea of shooting the same story over again in the rain.

That sixth sense pricked Traynham. He was the only cameraman on the spot to shoot the fatal accident, securing a remarkable though harrowing picture. He was so close to the scene that he was sprinkled with flaming gasoline from the wrecked plane and had to roll on the ground to put out the fire in his clothing.

The pictorial-newsreel cameraman has danger to face as well as the news cameraman. He, too, goes to the far places and frequently has to pitch in and help the story along when it gets too much "atmosphere" and too little fiction. One member of a Grantland Rice Sportlight unit in Florida, filming a fishing story of the Everglades, recently jumped into the water and wrestled with an alligator to make the story more interesting.

In another pictorial bit, a number of automobiles of ancient vintage were filmed in a race. In order to make a better picture, a member of the unit, unknown to the contestant, placed a rocket in the exhaust of his car and touched it

off. The look of amazement and consternation on the face of the contestant when the rocket went off made a very entertaining incident of the story.

With the passing of the years, the dangerous work of the newsreel man is taking on historic as well as news importance. Such events as the Dayton flood of 1913, Roosevelt in Africa in 1910, the Irish Free State rebellion in 1923, the Japanese fire and earthquake in 1926, and thousands more, in which the newsreel cameramen played daring parts, are now preserved in newsreel archives which will be available to historians of centuries to come.

As for the newsreel cameraman himself, he is the man behind the camera much preferring to remain in personal obscurity, but scorning every danger to heed the first mandate of the newsreel editor—"GET THE STORY!"



A2531

Wif June 1/3/32

Motorcycle-Mounted Movie Camera That Films All Fires for Study



**FIRE FIGHTING WITH CAMERA HELPS TEACH EFFICIENCY**

Movie cameras mounted on motorcycles now rush to each fire to which apparatus is called in Paris, and the whole conflagration is filmed for future study. Fire-department heads and the firemen themselves study the films later in an effort to locate points of procedure by which the fire could have been more quickly or completely smothered.

**SUN FOUND JUST A WEAKLING COMPARED TO FAR STARS**

As a luminary, the sun that warms and lights the earth has been found a veritable weakling compared with stars 5,000 and 10,000 times as brilliant. Exact brilliancy measurements of 5,000 stars that can be seen with the naked eye have been completed after two and a half years of study by Dr. Gustaf Stromberg of the Mount Wilson observatory. While some of these

stars are found to be so much brighter than the sun as to be almost inconceivable, Doctor Stromberg also found some sixteen times fainter, but still visible. All values are obtained by imagining the stars to be at the same distance from the earth as the sun. In addition to brilliancy measurements, Doctor Stromberg calculated the total amount of heat given off by each star per second and found that if the measurements varied, the star was unstable and likely to explode. Sometimes the "pulsating" star splits in two, thus explaining the double stars that always have been a puzzle.

**GREENHOUSE THAT BRINGS PLANTS TO BUYERS**

Flowers growing in an actual, if miniature, greenhouse now are being taken right where the crowds are and there plucked and sold, by means of a trailer which can be taken by car any-

where there is a road. The greenhouse is fitted with double glass windows and roof and can be connected to any convenient power outlet to operate the heaters or refrigerating units. In addition to flowers, plants, bulbs, seeds, shrubs and novelties, the "super show window" can be employed for the sale of green vegetables. In very cold weather, the salesman can take the customer into the greenhouse.



Super-Showroom for Florists That Takes the Plants to the Customer While Still Growing

*national greenhouse*  
*Wif Co Pana, Ill.*

2 1/2

B-18

Chicago 955 Essex Ave

\$495.00 for Pana

Copyrighted material



**DELPHIC ORACLE'S  
BASE IS FOUND  
IN TEMPLE**

225 70

Identification of a slab of limestone found in the Temple of Apollo as part of the equipment used for the famous Delphic oracle has been made by Dr. Leicester B. Holland. The stone served as a base for the oracle. Its area is divided into two parts. In one section are holes, obviously for the attachment of three legs and central support of a metal tripod. The priestess who breathed the intoxicating vapor and who spoke the inspired messages is known to have been seated upon a tripod. There are two more holes in the slab, on opposite sides of the tripod base. These, Doctor Holland says, may have held rods or may have been openings through which sprang laurel boughs of real or metal foliage which the priestess shook as she prophesied in her frenzy. Straight down through the stone runs a hole through which Doctor Holland believes the inspiring vapor or fumes were made to rise about the priestess' head. While the ancients believed the fumes issued from a hole in the earth, Doctor Holland points out that there is no such hole beneath the temple and is of the opinion that the fumes were artificial. Possibly pine and laurel were used, with hemp seed, to produce a form of intoxication.

Science Service 12/23/31



Some of the Many Instruments on the Panel of a Transport Plane Which Enable the Pilots of These Large Ships to Fly Blind

perform many maneuvers without glancing from his instruments. One of the aids to blind flying tried for transports is the Sperry directional gyro, a navigating instrument to show the compass course of the craft. It does not oscillate in rough air like the magnetic compass. Another gauge is an altimeter with two hands like a clock, one indicating thousands and the other hundreds of feet, giving the flyer a closer check on his actual altitude. The third aid is the Sperry horizon, giving the position of the craft with relation to the actual horizon.

**BLIND FLYING FOR AIR LINERS  
TO SAVE TIME**

225 76

Pilots of large transport planes are now able to fly "blind" with the aid of the same instruments that enable the pilots of smaller ships to stay on their course without exterior visibility. Three such devices have recently been tested for transport ships, each of them playing a part in indicating constantly to the pilot the course of the craft in flight. All were found to operate successfully on the larger planes, thus enabling the flyer of a big plane to

Tested on United Air Lines Pacific Coast Seattle San Diego Airway

**ORIGINAL EDISON PHONE MODEL  
IS PUT ON EXHIBITION**

B 8



An original experimental model of the telephone, designed by the late Thomas A. Edison, was one of the many curiosities placed on exhibition at the eighty-ninth annual meeting of the American Association for the Advancement of Science, held recently at New Orleans. The model consists of a box, a microphone and a call bell, rung by a coil-vibrated clapper.

Used World



*Formica Insulation Co*  
 4614 Spring Grove Ave

POPULAR MECHANICS

22593 *Amelmatall*  
 WATERPROOF AND STAINLESS  
 MATERIAL FOR BUILDERS

a2561  
 414



© International News Photo

Torpedo Powered by a Motor and Used by Liquor Smugglers to Carry Contraband under Water

**RUM-RUNNING TORPEDO CAUGHT CROSSING DETROIT RIVER**

Liquor smugglers operating between Detroit and Canada until recently were employing a submarine conveyer in the form of a torpedo to run the contraband across the Detroit river. This underwater container was powered by a motor and was attached to a cable, a mile long, stretched beneath the water. Twenty cases each half-hour was the capacity of the layout.

*New York Herald Tribune*  
**RUBBER MADE FROM CRUDE OIL AND GROUND SUGARCANE**

Synthetic rubber is being made from crude oil by a company in Mexico which is employing a process developed by a research chemist who for a long time had held the idea that petroleum in its early stages closely resembled rubber. The formula is intended merely to return the oil to its early stages, and to do this ground sugarcane or any other ingredient with a high sugar content is mixed with the petroleum. The compound is refined and fried in the sun, then vulcanized with sulphur. Automobile tires have already been made from this synthetic rubber and tested successfully, and it has been found it can be used for nearly any purpose to which natural rubber is adapted.

*Used by Compania Hulera Mexicana Mexico City*

A laminated material with a fiber base, produced in many different colors, designs and wood grains, has recently been presented for inside or outside finishing and decoration. It is used for the same purpose as marble, structural glass, wood paneling or finish plaster coats. It is supplied in sheets easily cut with ordinary carpenters' tools, and for interior decoration can be cemented directly over concrete or plaster. Several different marble finishes are available for exterior or for baseboards, window sills, table tops, kitchen finishes or artistic effects. The material is washable with any type of cleansing material, even paint remover being unable to change its color. It does not absorb water or oil and is unstained by fruit acids. It withstands temperatures as high as 300 degrees and is not seriously injured by such accidents as cigaret burns. Scratches can be sanded down and the color restored by oiling. One of its most beautiful applications is as wall paneling in the various wood grains available, or in jet or variegated marble for use as exterior fronting.

*Electrical Insulating Co*

*1300 W Washington, Chicago*

*a2459*  
**TEMPERATURE INSIDE AND OUT TOLD ON ONE THERMOMETER**

Temperatures indoors and outside can be read at a glance from the same instrument which has two separate scales. At the top is an ordinary column thermometer to record room temperature. Below is a dial which registers the outside reading by means of a tube from a sensitive element outdoors.

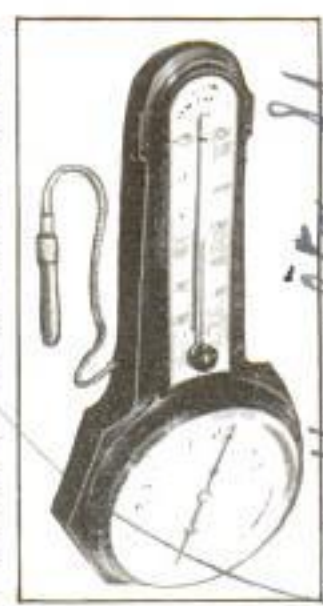

*5111 Hamilton St. St. Louis, Mo.*

The cause of infantile paralysis is an exceedingly minute microbe, roughly only five-hundred-thousandths of an inch in size.

*Dr. Frederick Elerson, Tul. Jim Hospital, Univ. of Calif. Medical School, San Francisco Calif.*

*perfected by Baron Julio Salas*

Copyrighted material



A 2566 Buhl Aircraft

POPULAR MECHANICS

Corp. St. Clair Mich

Cleveland Plain Dealer 11/32

BUSY BRAIN USES MORE SUGAR THAN ARM

B-5  
Buhl Aircraft

More sugar is absorbed from the blood stream by a man's busy brain than by his arm or leg. Tests on more than 300 subjects showed Dr. Abraham Myerson that brains of conscious persons absorbed twice as much sugar as when the same people were unconscious. This discovery is expected to aid in the study of mental and nervous disorders. Doctor Myerson tested the blood as it moved into the brain through an artery and again as it left the brain through the jugular vein, before it could mix with blood from the rest of the body. In a large majority of the tests the jugular vein contained less sugar than did the blood vessel entering the brain. In similar tests, it was found that the brain withdraws more sugar per 100 cubic centimeters of blood than does the arm or leg.



Latest Type of Autogiro Has Two-Place Cockpit in Front, and Engine and Rotor behind the Pilot; Frame Is Triangular

AUTOGIRO WITH ENGINE BEHIND IS PUSHED THROUGH AIR

With engine and "windmill" placed behind the pilot's seat, a two-place autogiro of the pusher type recently was successfully test-flown at St. Clair, Mich. Instead of a closed fuselage, the rear structure of the craft is a triangular open frame, converging at the elevator and rudder surfaces. Placing the driveshaft of the rotor and the framework behind the flyer is expected to give the pilot much better vision.

COPYING STAMP WITH STENCIL HAS AUTOMATIC INK FEED

A 2555

Thousands of copies may be made with a self-inking stamp now on the market without re-inking. No set-up work is required in operating the stamp, which is already inked. A stencil is prepared by typewriting, handwritng or drawing on paper. The stencil is then laid on the face of the stamp, the frame is snapped on and the stamp pressed on paper used for copy work. The ink is fed automatically.



copy stamp  
Patd

price - so accurate

Stencil and Self-Inker Enable This Stamp to Make Thousands of Copies without Re-Inking

The Stencil Stamp Co  
297 Fulton St  
Brooklyn, N.Y.

LIGHTS TO COLOR WATERFALL FOR DISPLAY AT NIGHT

A 2545

Colored lights playing on sixteen waterfalls down the side of a seventy-foot hill will welcome night visitors to a park at Jackson, Mich. In the completed project, cascading water will start at the top of the hill, continuing through a series of falls and pools to the bottom. One-color floodlight will be directed upon the face of all the falls, while from the bottom changing colored light will creep slowly to the top. Three groups of falls will be headed with pools, enlivened by electric fountains with varying sprays of colored water. A model of the illuminated cascades has been constructed by the General Electric company.

General Electric Co  
Schenectady, N.Y.

Prado de Capitan  
outdoor beauty place

Copyrighted material



Science Service  
12/10/31

EDISON WORK REVIVED TO END PHONOGRAPH-NEEDLE SCRATCH

The kind of phonograph recording used by Edison in his original work promises to return to practical use and bring about the most faithful reproductions of music. Halsey A. Frederick, of the Bell Telephone laboratories, has demonstrated new disk records cut by the vertical instead of the lateral method used in ordinary phonographs. The new system of music reproduction is claimed to eliminate needle scratch. The material of the new disk is cellulose acetate, the same substance that is used in making cellophane, rayon and other new products of synthetic chemistry.

Q2539  
THROTTLE RUNS WHOLE BOAT BY ONE-LEVER CONTROL

One small lever controls the entire movement of the gasoline-powered boat or cruiser from full speed ahead to full speed astern, by means of mechanism recently developed that shifts the clutch and reverse gearing by power. The mechanism is composed of two units, the control head installed at the hand of the pilot, and a power assembly installed on or near the engine. Throttle-synchronizing mechanism in the control head is so linked that when the throttle lever is placed in neutral or reverse, the power clutch acts to carry out the operation automatically. The entire mechanism is simple and easily installed, as all heavy rods, hangers, chains, gears, jackshafts and levers are eliminated. Copper tubing is placed between the control head and the power unit, and can be run in any direction and to any necessary distance. The control is furnished in two types, the smaller handling engines up to 200 horsepower and the larger for heavy-duty power units. Finger-tip pressure is sufficient to move the control lever.



Vac Power  
\$125.00 \$135.00  
\$155.00

▲ America's expenditure for education in 1931 was \$3,200,000,000, it is estimated.

Federal Office of Education

Copyrighted material

Weather Variations Are Recorded by This Device Which Figures in Periods or Cycles

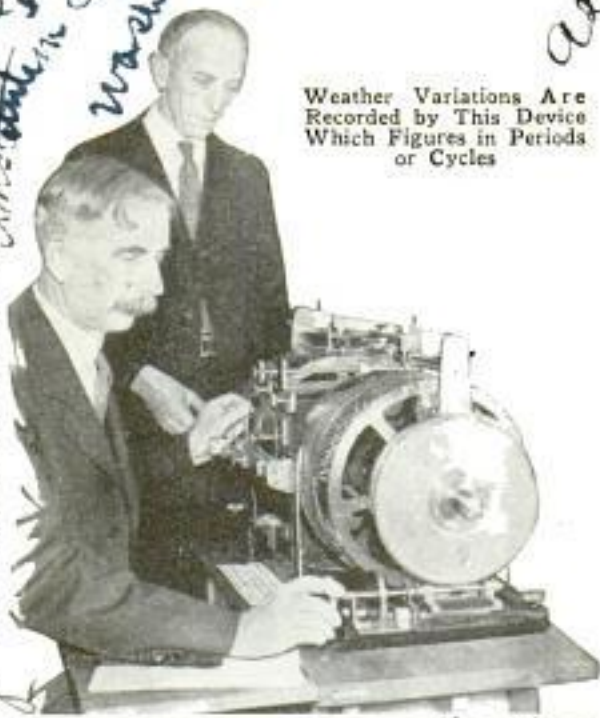

BRASS BRAIN TELLS WEATHER BY SUN'S CYCLES

Long-distance weather forecasting may be made possible by an instrument which reacts to solar radiation. Constructed in a large part of brass, the device is expected to show whether variations of the sun's heat occur in cycles, periods of rise and decline, at regular intervals. The instrument can be operated by anyone without training in mathematics, and works out periods faster than a mathematician with pencil and paper. Should the machine show that the solar variations occur in cycles, weather experts will be enabled to forecast weather for long periods.

KEY LOCK FOR DIAL TELEPHONE STOPS MISUSE



Unauthorized use of dial telephones may be stopped, and toll bills reduced, by a lock now on the market. The lock is a cover which fits over the dial, and when the key is turned, operation of the phone is impossible.

Dr. Charles W. Booth  
Secretary, Smithsonian Institution  
Washington

Protector, Forie Co.  
41 Union Square  
New York

20. Corcoran, Inc.  
155 W. Washington  
Chicago

195 Broadway  
New York

Walcox, Crutenden & Co. Machine Co. Conn.



a 2595 Chance Bros & Co Ltd

POPULAR MECHANICS

417

Durhill Glasgow W.W. Scotland

# Glass Is Spun as Fine as Silk to Save Heat

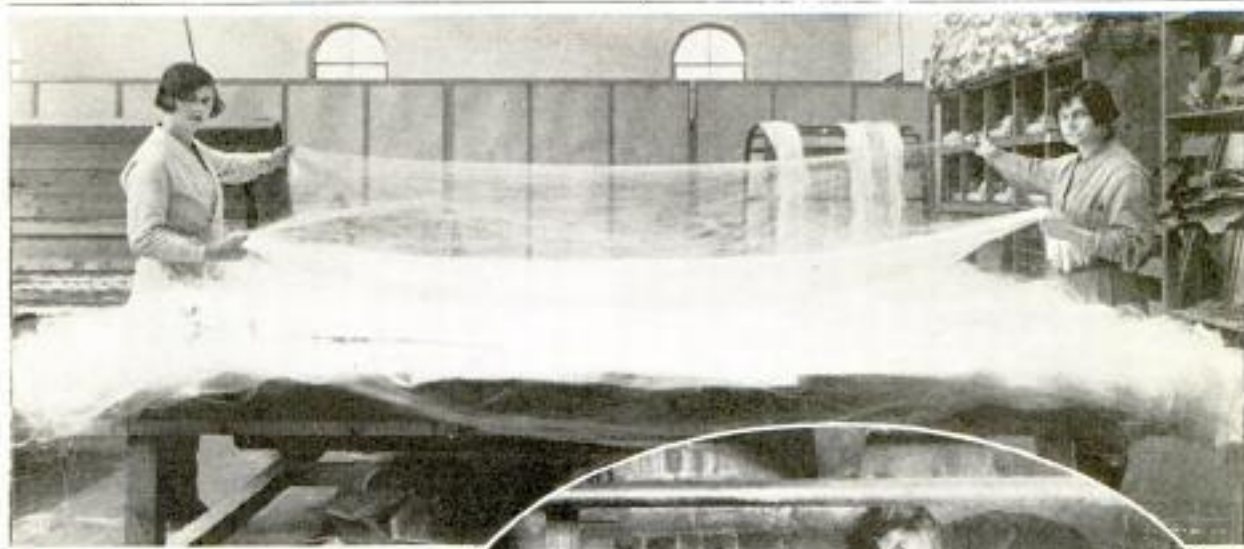

Glass as Fine as Silk Is Good Insulation; Above, Spinning Glass; Below, Pipe Being Wrapped with This Non-Conductor Material



Long threads or fibers of glass, flexible and fine as silk, are now used as heat insulation on pipes, boilers, tanks, turbines, locomotives and marine engines. The fibers are made up loose for internal packing, in sheets and strips for outside wrapping, or in mattress form to be inclosed in wire gauze, netting or asbestos cloth. The glass is unaffected by cold and withstands 900 degrees Fahrenheit without disintegrating.

B23

## FEEDING GERMS IS WORLD'S QUEEREST OCCUPATION

One of the world's strangest and most exacting occupations was brought to light in St. Louis recently when motion pictures of living cancer cells were exhibited before the Radiological Society of North America. The cells are being grown in glass tubes, and the feeding of them is the ticklish part. Three research workers from Columbia and Johns Hopkins universities are the scientists who have succeeded in causing the cells to grow. Although, in man, the presence of cancer is sure death unless checked, the cells themselves are extremely delicate. A single invisible bacterium or mold, floating through

the air of their glass prison while they are being fed, kills them. They are kept in a specially constructed tunnel, lighted by windows. It is big enough to hold a table, on which the cells live in glass receptacles of various shapes. The caretakers sit outside, thrusting their sterilized hands and faces through special openings. They are dressed in sterilized uniforms, and they cannot even speak while their heads are inside. Even the air is washed before it enters the tunnel. The cells are fed through sterilized glass pipettes on special food, known as plasma. They keep on living indefinitely if fed, and each cell has the power to move from place to place by a sort of swimming motion. Along with the cancer cells, healthy human flesh cells are raised artificially in an effort to learn the differences between the malignant and normal cell. Some of the cancer cells are highly sensitive to radiation from X-rays and radium while others are not. Some also can be killed easily with heat.

similar glass - Friederich + 7 1/2 4 1/2 inch stemmocher 2 new York

Can. S. D. Bruce, 1521 Mungell Houston, Tex, as

Washington, Md  
Crocker Cancer Research Institute  
New York City



# ELECTRICITY

Scientists Predict New Era  
of Power Produced Directly  
from Light

By W. W. COBLENTZ

United States Bureau of Standards

Washington, D. C.

## The Power of the Future

**S**OONER or later we shall have to go directly to the sun for our major supply of power. This problem of the direct conversion of sunlight into power will occupy more and more of our attention as time goes on, for eventually it must be solved.—Edison Pettit, Mount Wilson Observatory.

is an old ambition. But not until recent years has the dream come true that light can be transformed directly into electric current. That the phenomenon depends upon the length (frequency) of the light wave, and is not

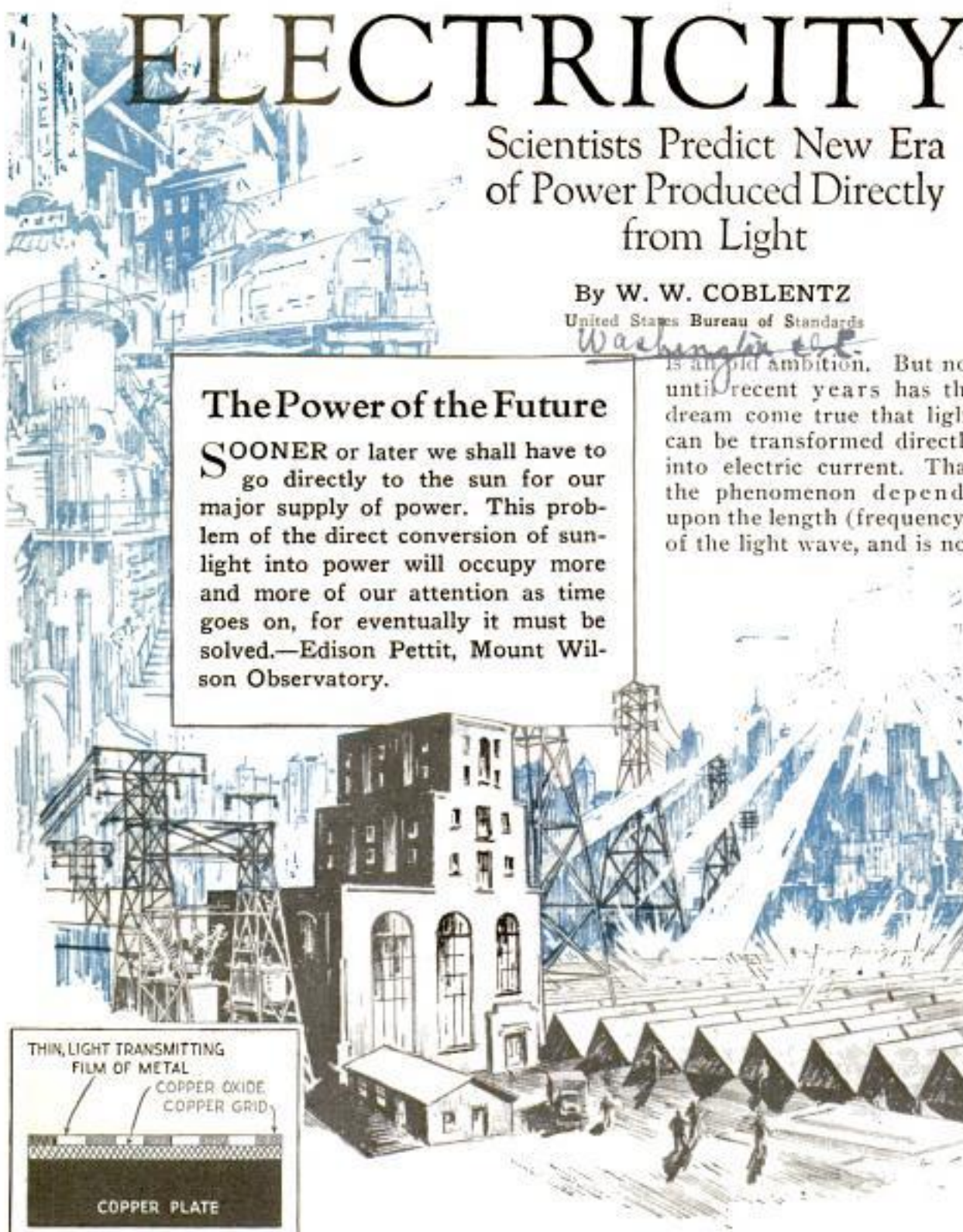

How Light Cells May Be Utilized to Produce Electric Energy from Sun. Something Already Accomplished Experimentally; Insert Shows Construction of Unit

**N**OT all the physical forces have been harnessed. We are now subsisting principally on the application of power generated from coal and oil; sources of power stored up for us ages ago.

The generation of power from sunlight

a photochemical or thermoelectrical reaction appears to be established by the experiments on isolated spots of molybdenite, using measured amounts of radiation of different wavelengths.

The few experimental machines for gen-



# from the SUN

erating electricity from light are inefficient. Nevertheless, discounting the undue publicity given to this device, the generation of electric current by the direct transformation of light waves contains unknown possibilities as great as those of the radio of thirty years ago.

**W**ILL the wheels of commerce and industry one day be spun by electricity taken from the sun? Is mankind on the threshold of a revolutionary source of electrical power—one that will render obsolete the dynamo, release coal, oil and gas from their bondage of servitude?



"Yes," declares Dr. W. W. Coblentz, noted government scientist, who says: "The generation of power from sunlight is an age-old dream of man's; but not until recent years has he succeeded in wresting the secret of accomplishment



Above, Doctor Coblentz Showing How He Transforms Sunlight into Electricity; Left, Model of Solar Furnace Now under Construction

from nature—the transformation of light directly into electric current."

Doctor Coblentz picks up a mysterious little pasteboard box—the familiar circular pill box of the drug store—from which protrude two tiny wires, like insect antennæ. A peep into the box discloses these two wires soldered to a sliver of whitish mineral—molybdenite. Closer inspection through a microscope reveals a tiny particle, not so large as a pinpoint, of some mineral or substance buried in the sliver. He places the top on the pill box and attaches the wires protruding from its side to an ammeter. Then the apparatus is moved into the sun where the light may penetrate through a pin-pricked aperture in the top of the box directly over the tiny mineral crystal buried in the sliver of molybdenite. The needle of the ammeter jumps. He covers the aperture and the needle subsides. Light falling on the "unknown speck" has gen-





German scientist, Dr. Bruno Lange, is our host. He has before him an apparatus that looks somewhat like a dressing table mirror from milady's boudoir. From it leads a wire cord attached to a small motor. Doctor Lange sets his "mirror" in the sun. Immediately the motor begins to purr. Light has been transformed into electric current and the current is running a motor. The accomplishment of the age-old dream is realized. The practical transformation of light into electricity has taken place. The output of energy from this one photo cell is sufficient for use without amplification.

Doctor Lange has not used the hidden crystal found in molybdenite. His light-sensitive cell is a sheet of metal covered with a thin layer of silver selenide over which another layer of transparent metal is laid, a very few molecules in thickness. Light passing through this transparent metal

erated a current of electricity. Or as Doctor Coblentz puts it, "Light has—supposedly, for we do not know exactly how—knocked the electrons out of the crystal particle and they flow in a circuit."

Doctor Coblentz has measured the length of the light waves that do the trick. They are in the visible range, a little beyond the infra-red rays. They are not longer than one micron—the thousandth part of one millimeter.

His experiment is, however, after all only an experiment. It remains yet to produce electric current from sunlight on a grand scale—and more cheaply than it is produced today in plants, hydroelectric and otherwise, if mankind would be benefited. If only we knew what that tiny crystal is hidden in the molybdenite. If we could only isolate it, find it elsewhere in greater surface measure, manufacture it or locate its counterpart, what unknown possibilities for the progress of man would be opened up through the transformation of sunlight into electricity!

Let us leave Doctor Coblentz and America now, for a moment, and go to Germany. We are in the great Kaiser Wilhelm institute in Berlin. A young



© Harris & Ewing  
Above, Dr. Charles G. Abbott, Authority on Solar Radiation;  
Below, Dr. Coblentz and His "Pill Box"

coat generates a current of electricity between the two layers of the "metallic sandwich." The use of silver selenide as a "filler" for the sandwich results in fifty to 150 times more current from the sandwich than can be got from a copper-oxide filler. The photo cells of Doctor Lange are very sensitive, comparing favorably with the sensitivity of the human eye, being but ten per cent less. They are also peculiarly sensitive to color differences.

Doctor Lange has taken out patents at home on his newly developed photo cell and looks forward to its use in the production of electrical energy from sunlight,

see also July 1934-112.



though he believes this will not come hurriedly. First an arrangement of a large number of cells in aggregate must be worked out, but the first hurdle is over.

Practical application of these cells to date consists in transmitting phonograph records and sending signals by them. As a future possibility infra-red telephony over long range looms up. Also automatic control of rollers in steel mills, the red-hot iron giving out sufficient light to work the cells, causing them to automatically change the direction of the rollers.

One of the German liners is now equipped with these cells in a new smoke and fire-control system. Air from over the ship is pumped past them through a tube, and smoke in the passing air causes the cells to set off an alarm.

The cost of installing a sun power-generating plant is estimated at about \$25,000 per kilowatt, while the initial cost of present plants ranges from \$100 to \$300 per kilowatt and up. But it must be remembered, points out Doctor Lange, there is practically no second cost to a sun power-generating plant. A 300,000-kilowatt station, he estimates, would require about one square mile of silver-selenide cells.

Here is a promise of enormously more power than mankind shall ever use and from the source of all energy—the sun. Its possibilities are as great as the application of the expansive power of steam to engines, or of wireless.



Electric Eye in Garage Door Which Actuates Opening Mechanism as Car's Lights Fall on It

CAR LIGHTS OPEN GARAGE DOOR DURING NIGHT HOURS

Headlights from approaching automobiles cause the doors of a garage in Albany, N. Y., to swing open automatically as the beams of light fall on them. The secret involves just another application of the photo-electric cell, or "electric eye." In a tiny window in the door, at about the level of the car lights, a General Electric photo-electric tube is placed behind a protective glass covering. The beams of the car lights strike the light-sensitive surface of the electric eye to actuate a relay which operates a door-opening mechanism. Push-button switches operate the doors during daylight hours. When the door has been opened, it stays open until a closing button is pushed, but once closed, it is ready to open again as soon as a car light strikes the window. The installation makes it unnecessary for drivers arriving at night to wait for someone to open the doors for them, or to get out of the car to operate the push buttons.

EXPANSION RINGS FOR PISTONS CHECK NOISES IN MOTOR

Excessive oil consumption, wristpin noise and piston slap can be checked by expansion rings for automobile engine pistons. These rings, now on the market,



are installed by removing the lower crankcase, but without removing the connecting-rod assembly. By pressing the skirt of the piston against the cylinder wall, the ring restores and maintains the original size of the piston.

Chicago. S. E. Cronin by 2011 S. Michigan Blvd

22589

Reliance Specialty Co. Cabot St at 2nd level Canal Holyoke, Mass

New York Power and Light Corp. Service Building, Albany, N.Y. Schenectady, N.Y.



B. 47

at New York auto show

Washington  
22

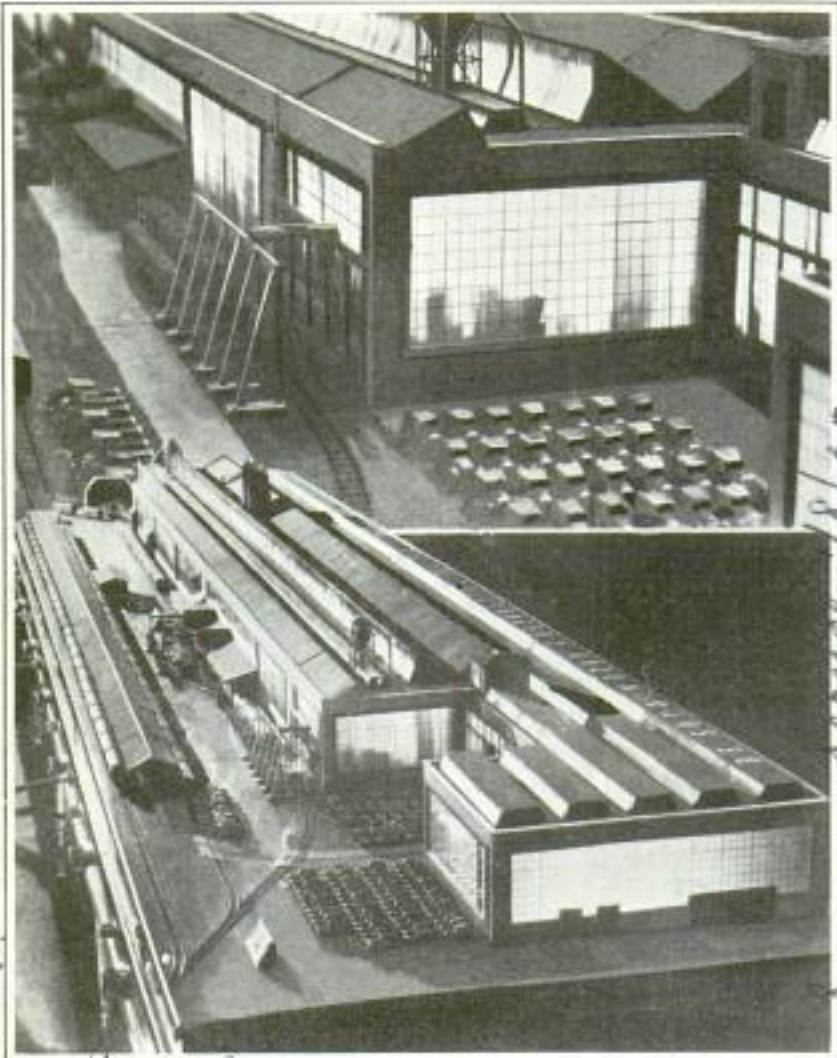

Two Views of a Miniature-Automobile Factory That Assembles Tiny Cars as They Pass through the Plant on Endless Conveyors

**TOY-SIZE AUTO PLANT TURNS OUT FINISHED CARS**

Tiny automobiles are assembled at the rate of 140 an hour in a miniature-automobile factory costing \$25,000 and representing a working model of one of the large car plants. The model is twenty feet long and four feet wide and is complete in every detail, even to railroad tracks and cars bringing in the materials. The assembly operation starts with the frames as they are unloaded from railroad cars at the factory. The frames move on endless conveyors through the plant, various parts of the tiny cars being added as the frame travels along its route until a small but complete auto emerges.

■ New types of plants have been produced recently by using X-rays to speed up the processes of nature.

Botanical Laboratories,  
McGill University  
Montreal, Canada

shut out and animal life would become impossible.

**DISASTER TO EARTH IF AIR GASES CHANGE**

Disaster in many forms would come to the earth if gases in the atmosphere were removed or changed in composition. Dr. W. J. Humphreys, of the U. S. weather bureau, points out that if water vapor, which constitutes only one per cent of the atmosphere, were to be removed, all plants and animals would be killed. There would be winds and dust clouds but never a shower. The small amount of carbon dioxide is essential to plants and if they could not grow, all life would become extinct. Removal of the thin sheet of ozone from its position above the earth would blind every living person, since this ozone shuts out that portion of ultraviolet solar radiation harmful to the eyes. On the other hand, if the ozone were increased, all ultraviolet light would be

**LESS "ACID MOUTH" IS FOUND IN EXCITABLE PERSONS**

Acidic saliva, popularly known as "acid mouth," which attacks the tooth enamel, has been found to be less prevalent in persons of excitable temperament, while calmer personalities are more apt to exhibit its presence, according to a research physician at a Chicago juvenile institution. The report suggests that abnormal acid-base factors may affect not only the temperament of the normal person but also the more serious disturbances of mental disease. The evidence, says the report, shows that serious mental deviations almost invariably exhibit signs of acid-base disturbance, and that lowered acidity is associated with the more active states.

Dr. J. S. ...  
Research 907 Lincoln

the auto factory at Detroit

to me

same same 18 52



B. 31 *Inw. Tallei esudo. Via*

POPULAR MECHANICS

423

*Ruggieri Bonghi 19.9*

# Air Propeller of Disks Has Variable Pitch

*Rome, Italy*

Four rotating disks arranged at equal distances around a hub and set at a variable angle to its plane of rotation, make an effective air propeller as designed by Guido Tallei, Italian inventor. The disks are held in place by fork arms and rotate with the friction of the air. The over-all length between the outer peripheries of the disks is considerably less than the standard type

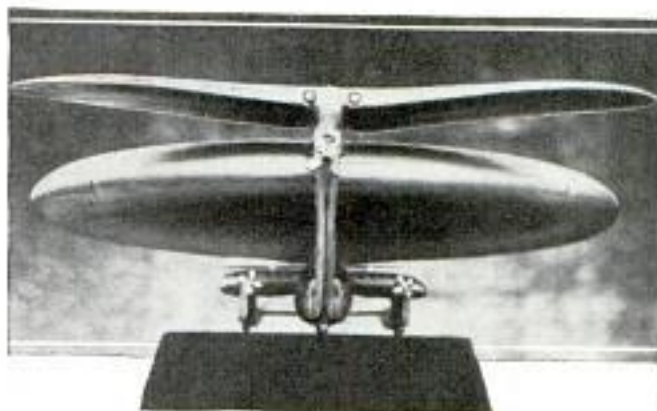
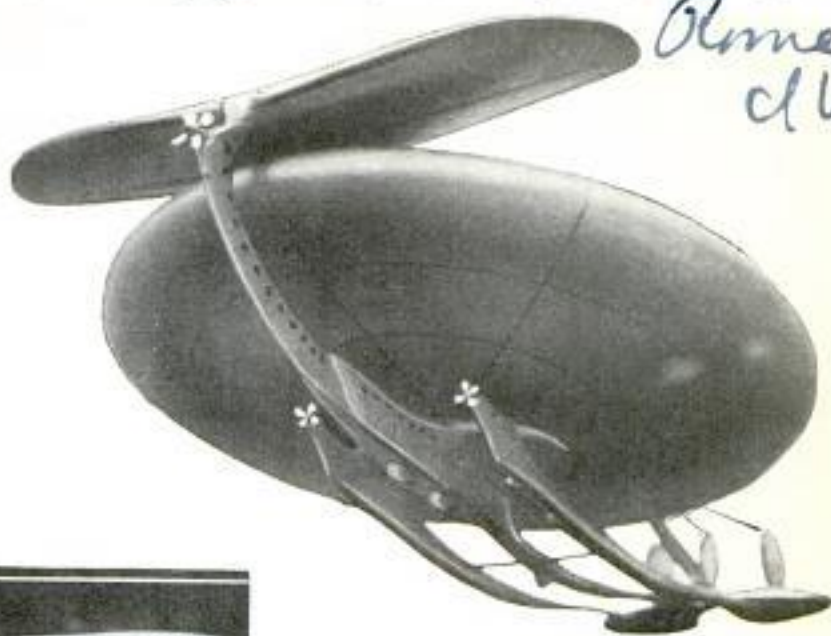

"Diri-Disk" as It Appears in the Air, Top; Working Model of Craft, Above, and Disk Propeller, Right

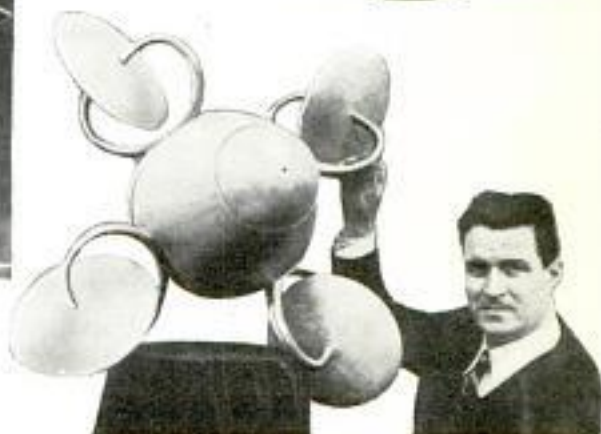

of fixed-pitch propeller. Sig. Tallei has fixed his new propellers to his latest model of the "Rotating Diri-Disk," an amphibian dirigible-gyropter-airplane which he introduced a year or so ago. In addition to the propellers, the latest design of the diri-disk has a fixed elevator projecting above and slightly in front of the round "wing." The diri-disk makes use of a disk-shaped gas bag, turned by airplane engines, which acts as wing surface besides supplying lifting power as a result of its gas content.

## TERNs SHOW "HOMING ABILITY" SUPERIOR TO PIGEONS

Terns or sea swallows have the ability to fly back home from greater distances than the most carefully trained homing pigeon. Experiments by Dr. John B. Watson, working with the Carnegie Institution's marine biological laboratory, show

that the tern, without training, can reach home from distances of at least 1,000 miles, even though the territory over which it flies is completely barren of guiding marks. One bird, released at Cape Hatteras, flew to its nest at Bird Key in the Tortugas islands in the Gulf of Mexico; 1,081 miles by alongshore route. In comparison, the world's record for homing pigeons is 1,010 miles, covered by a bird selected and trained for the purpose. Terns make their way back to nesting grounds in spite of darkness, storm and unknown seas, Doctor Watson found. Not only are they adept at homing, but they never fail to identify their own eggs and chicks, a seemingly impossible task on Bird Key, which is covered with thousands and thousands of similar-looking eggs, as great numbers of the birds gather there for the nesting season.

*Washington, D.C.*

*Sarena Service 1/6/32*



a 2258  
424

Cont. Elm Islandman 55 W. 86 N  
New York

POPULAR MECHANICS  
drawing. S. H. Dean's. 55 W. 42nd  
New York

# Cradle to Land Wheel-Less Planes on Roofs

University Club, 4 W. 54th St., New York

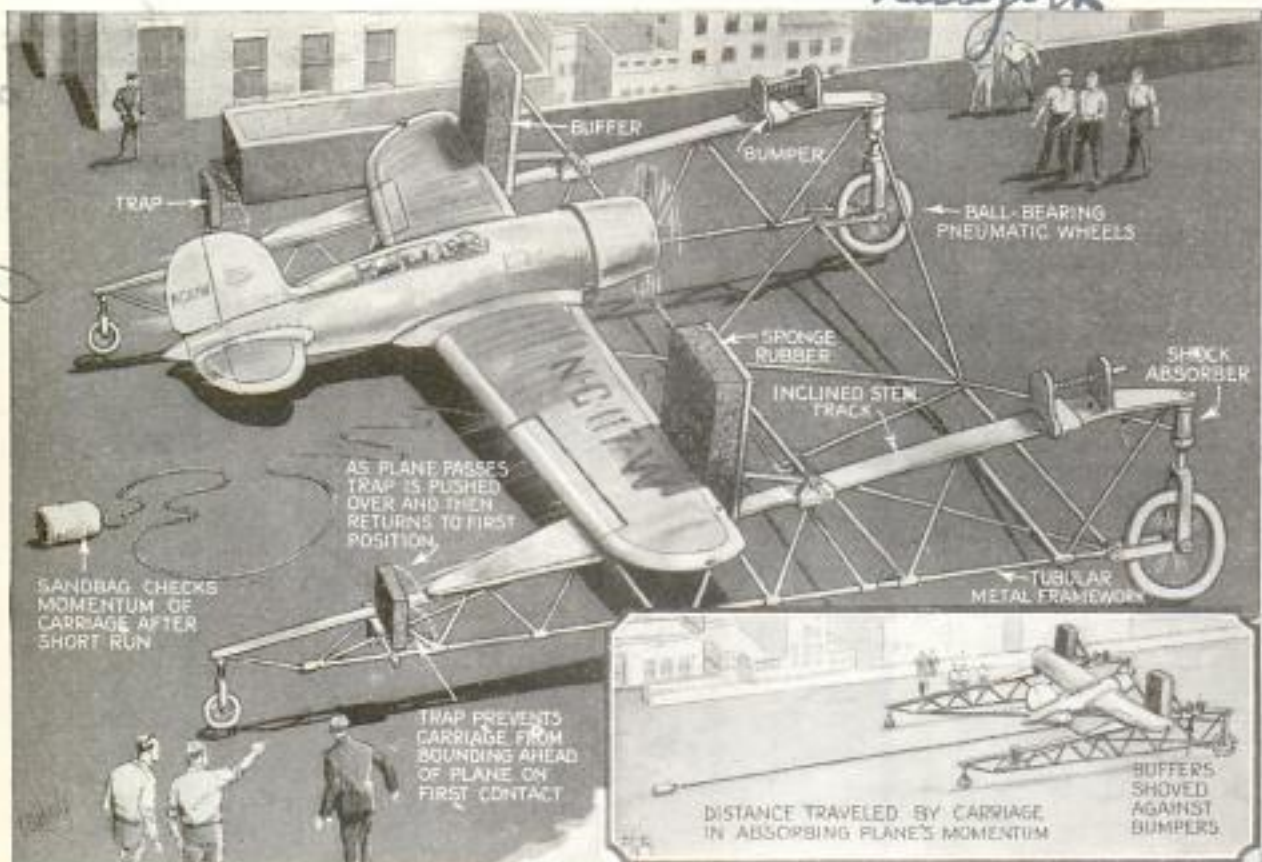

Planes Which Have Dropped Their Landing Gear Can Come to Earth Safely on a "Cradle"; Roof Landings Are Possible, Since the Cradle Stops Any-Size Aircraft after a Short Run

Herndon and Pangborn, first to cross the Pacific ocean in a non-stop flight, gained seventeen miles per hour and added many miles to their cruising range by dropping their landing gear soon after taking off from Japan. But on landing in the state of Washington, the flyers almost lost their lives. To safeguard airplanes minus the proper landing gear, William S. Glennon, a former naval officer, has introduced an airplane "cradle" which exactly reverses the work done by the catapult used on aircraft carriers. Whereas a catapult is a means of accelerating airplane speed, Glennon's cradle can be used on a ship deck, skyscraper roof or landing field to decrease the speed of a wheel-less airplane quickly and gently, so that the passengers may reach earth safely. The cradle can receive planes with or without landing gears. Its general dimensions are twenty by forty feet. It can easily be built to accommodate ships with a large wing spread. The inventor anticipates that all long-distance flyers will hereafter discard

their rolling gear before starting off on a long flight. In civil or military flying, the addition of seventeen to twenty-five miles per hour is a factor worth consideration.

a 2491

## LIGHT SUSPENDED FROM NECK LEAVES HANDS FREE



Strapped to the body and leaving both the wearer's hands free, a light operating from a six-volt battery now is available. It is especially useful to sportsmen and to those who find it necessary to work outdoors at night.

The light is suspended from a strap around the neck and held firmly against the body by another strap that is fastened around the waist.

Spalding & Bros  
211 S. State  
Chicago



Geo. M. Mantor  
 ex-Chief, Seattle Wash.  
 POPULAR MECHANICS  
 fire dept.

B-49

Fire Dept. Aephany  
 2920-1st Ave  
 Seattle, Wash.

**DUST THAT SMOTHERS FLAMES  
 ENDS WATER DAMAGE**

Dust that extinguishes fire instead of starting or encouraging it was demonstrated recently before Portland, Ore., fire officials. The dust is sprinkled in the vicinity of any fire hazard, and, upon being heated, releases carbon-dioxide gas which smothers the flame. It is a substitute for water or other liquids which might damage property with which they come in contact. The dust can be swept up after it dries and be used over again, according to its inventor.



Enlarged Sample of the Work Done on Machine That Types Hebrew or Latin Characters

**ENGLISH AND HEBREW WRITTEN  
 ON SAME TYPEWRITER**

Reversing the Hebrew letters to read from left to right, instead of in the age-old manner from right to left, a St. Louis educator and attorney has invented a typewriter that writes Hebrew and English, linearly or interlinearly, simultaneously or interchangeably. It is the first of its kind ever to work successfully, it is said.

Mr. David Langah  
 1011 1/2 Street

**"IRON MAN" TAMES BAD HORSES  
 FOR CAVALRY SMITH**

46 39 Montgomery Ave

Various western remount stations of the United States cavalry have adopted an ingenious "iron man" to tame horses. Lives of the army blacksmiths long have been menaced by vicious steeds brought in to be shod, so new stock now is placed in a rugged wooden frame and haltered there. A sling operated with a winch and rope cable then lifts the horse until his toes barely touch the floor, in which position the outlaw is practically helpless and much of the fight already taken out of him. A metal clamp attached to a pipe arm is then fastened around the fetlock of the hoof to be shod, and by means of gears controlling the movement of the arm, the foot is raised to the position desired. It needs but a few tussles with the iron man to tame the wildest broncho.

Comb. So. H. H. H. H. H.

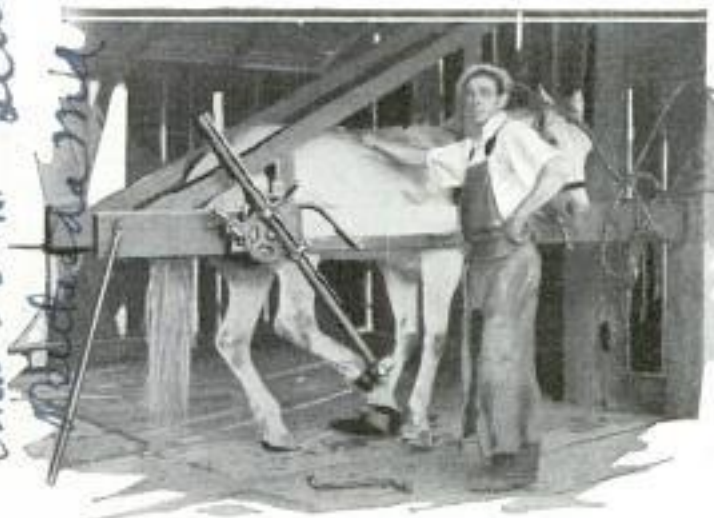

Courtesy U. S. Forest Service  
 The Iron Man That Speedily Convinces the Wildest Outlaw Horse That His Struggles Are in Vain

Used at Army Remount Station

**HOW CLEAR IS LAKE WATER  
 TOLD BY "SUN MACHINE"**

Experiments in the productivity of certain lakes have led to the development of a curious instrument which will show the transparency of the water. Many natural bodies of water have been shown to be as clear and free of chemicals as though the water had been distilled. The apparatus is known familiarly to the investigators as a "sun machine" and consists of a revolving disk containing colored glasses corresponding to the colors of the spectrum. The device is sunk to the depth desired and readings taken on electrical instruments in a boat on the surface. From the amount of energy registered on the surface instrument the amount of transparency is obtained, and from this, the quantity of vegetation, supplying the food of animals, in the water.

Dr. Allen P. Child,  
 46 73, Carnegie Mo  
 City.

University of Wisconsin  
 Madison, Wis.



B. 25 National Theatre Science Service 10/32  
 426 *Supplied by* POPULAR MECHANICS  
 92 *East St*  
*New York*



Complete Portable Sound-Film Projector Designed for Use in Schools as Teaching Aid

### PORTABLE TALKIES FOR SCHOOL SPEED UP EDUCATION

Projection of sound pictures for school and other non-professional purposes is achieved with portable equipment said to be the first ever developed for the purpose. Sound film is used in the projector and the entire equipment is complete, including loud speaker. In a test of visual education, a group of ninety-seven school children were first given a written and oral test of subjects previously studied. They then were shown sound pictures of the same subjects, and the final test showed an average gain of thirty-eight per cent in knowledge. The equipment is not offered as a substitute for the ordinary methods of teaching children, but as a very effective supplementary. The projection and sound apparatus is designed to give results equal to those obtained with the finest theater equipment. While designed primarily for educational purposes, the equipment is equally adaptable for use in hospitals, churches, community centers, industries and on ship board.

### SPEED OF SNAKES IS DELUSION PRODUCED BY FRIGHT

Snakes do not travel at lightning speed, despite popular opinion about their rate of locomotion. This is the conclusion of Dr. Walter Mosauer, zoologist at the University of California, who found that

*Los Angeles, Calif*

under repeated tests the famed blue racer never exceeded a maximum of two and one-half miles an hour, hardly as fast as a person walks. Reports of racing speed, the zoologist believes, are usually the result of mental delusions produced by fright, both of the observer and the snake, and by the winding motion of the reptile. To find just exactly how a snake propels itself, there was research with an X-ray camera, scalpel and stop watch. Devoid of legs, fins or other reasonable propeller mechanism, the snake makes up for the deficiency with an elaborate muscular layout. In general its backbone is connected with its ribs by a host of strap muscles, each attached to at least one vertebra and one rib. Sometimes a rib is connected to a joint sixteen ribs away, sometimes to one near by. These connections permit any kind of wiggle or bend. Nothing is connected at right angles, all forces acting obliquely, and as a result the snake never gets on "dead center." The "side-winder" rattlesnake apparently slides side-wise in two parallel tracks, corresponding in this performance to a two-loop spiral modified by muscular displacement.

### LABEL ON HOOD OF CAR SHOWS THE SIDE FOR OILING

Filling-station attendants know at a glance which side of the hood is to be lifted for oil inspection if the car is equipped with decorative gilt labels conveying this information. The signs are on paper that, when wet, transfers them to the side of the hood. On one panel the sign reads "Oil on the Other Side," while the opposite label reads "Oil on This Side."



Gilded Label for Hood of Car, Which Shows Filling-Station Man the Side to Lift in Checking Oil

*Chas. E. Freund*  
*Valparaiso, Ind*

B. 53

*Copyrighted material*



B-16 Cmt. Lawrence & Andrews  
113 Lafayette Ave  
Hempstead, L.I.  
New York

# Across Atlantic in Seventeen Hours?

## AIR ROTOR SPEED CRAFT

### To Seek Record

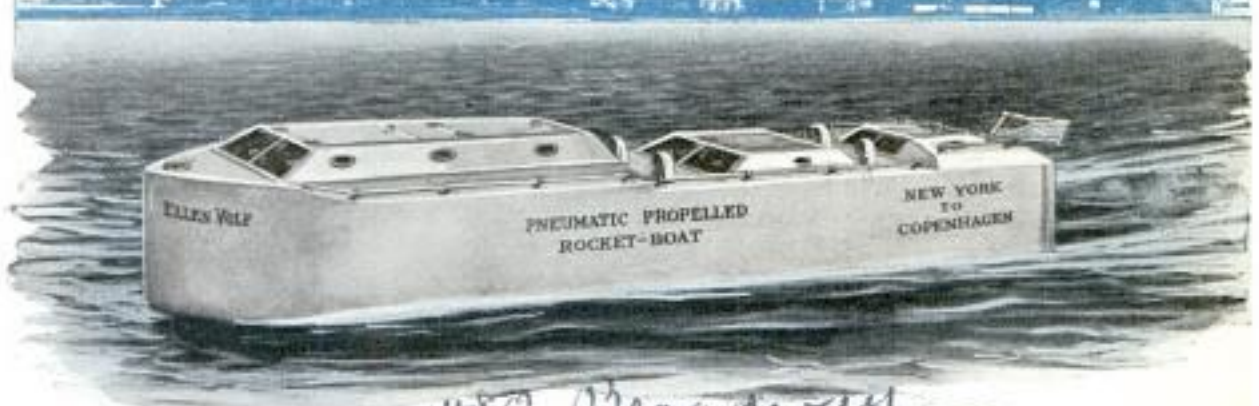

14872 Broadway

© Brown Bros.

SOLO transatlantic flights to establish new time records from the United States to England will not be confined to aviation this spring. Passengers on oceanic liners need not be surprised if they find the steamer lanes usurped by a twenty-foot silver-streak, skimming the surface at more than 100 miles per hour.

Dr. Christian A. Volf, New York inventor, has planned just such a trip to visit his native home in Copenhagen. He will make it in his own revolutionary type of boat, the "Ellen Volf," the first air-driven ship.

In fact, the inventor expects to arrive in England seventeen hours after leaving the United States, departing at two o'clock in the morning and arriving that same night in England.

Tests with the "Aditi" indicated that, while the fastest speed boats in the country now require about 2,000 horsepower to gain a speed of 100 miles per hour, the rotor-propelled ships will require but little over 100 horsepower.

As the name implies, the basic part of the new craft is the rotor. Air is taken in through deck ventilators aft, the openings of which face the direction of the boat. Then it is piped to the forward part, drawn down by two high-speed rotors and expelled through an exhaust pipe beneath them.



Above, the Rotor Ship in a Trial Spin down East River; Below, a View of the Rotors

The rushing air strikes the water with a tremendous force and the boat moves forward. All motion created tends to accelerate movement. This is unlike the conventional type of propeller-driven boat, in which efficiency is lost when the propeller whirls too fast or when the blades create a hole at the stern, causing it to settle and adding to the resistance of water slapping at the prow.

In the rotor boat, the prow is built in bulbous shape, like that of the whale. Movement sets up only one resistance, that of the original contact of prow with the water. There is no other surface offering resistance to motion. It rides an even keel regardless of speed. In effect, it is



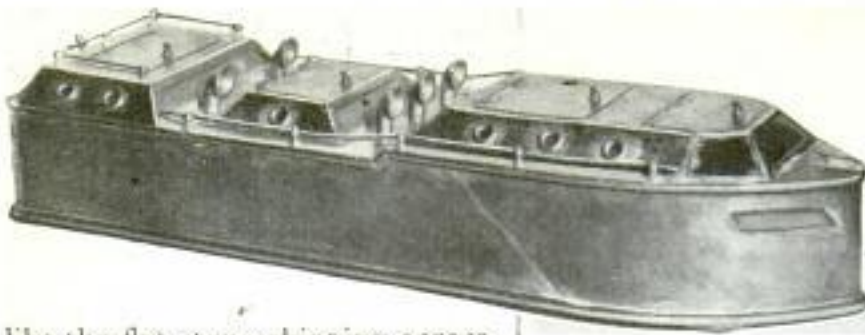

Left, a Model of the New Complete Twenty-Foot Rotor Ship; Below, the First Rotor Speed Boat, "Aditi," as It Appeared in Action

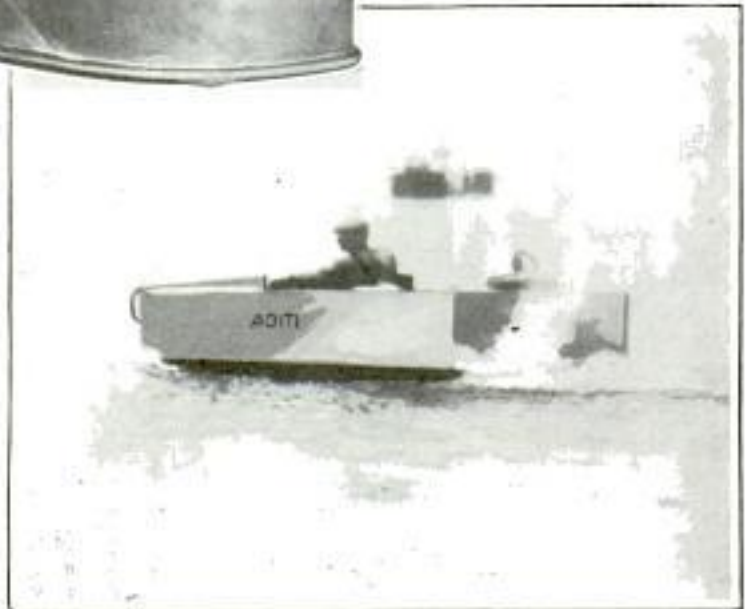

Photos © Brown Bros.

like the flat stone skipping across the water, although the boat does not leave the surface.

"Present efficiency of speed boats from the standpoint of horsepower consumption," says Doctor Volf, "is hardly more than eight per cent. The more speedy they are, the less efficient do they become. In all boating, it is safe to say the average is eighty per cent deficiency in use of energy. What constitutes any other boat's deficiency becomes my efficiency. My boat utilizes more than eighty per cent of the energy.

"In developing the boat rotor, I decided to use air as the force instead of hydraulic force, because water finds its own equilibrium too soon. Use of air eliminated vibration for it had 'give,' its compression taking up the shock. Water striking water would create vibration as it cannot compress. It would leave no force beyond the momentum.

"Speed of the conventional boat is retarded forty per cent because it sinks at the stern, rising at the prow in proportion to its length. Water slapping at the raised prow at top speed adds twenty per cent further retardation. Thus the efficiency of the speed boat is far less than the steamer, for the steamer rides a level keel."

The first of the rotor ships, the "Aditi," had its trials on the Hackensack river, New Jersey. These tests established the practicability of pneumatic-propelled craft. The boat, fourteen feet long and utilizing but one of its six horsepower of energy, moved its ton of weight at one mile per hour.

The keel construction is as revolutionary as the power plant and hull design. There is a tri-sectional keel. One triangular keel is in the center and one each on starboard and port side. The air ex-

hausts are forward, between the keels.

In the ordinary boat, a wave, as it passes, off-balances the gravitation center, causing a rolling motion. In the Volf boat, the wave strikes the side and is tossed back by the outside keel, keeping the boat balanced.

The new twenty-foot craft is all enclosed and is made entirely of duraluminum. While it is much larger than the first boat, it does not weigh as much.

## LONG-RANGE WEATHER IS TOLD 25 1/2 BY ABNORMALITIES

Weather predictions good for a month are being made possible by the fact that abnormal weather in mid-winter or mid-summer often persists over periods of sixty days or more. Forecasts based on this discovery are correct over eighty per cent of the time, in certain cases, Charles D. Reed, of the Des Moines weather bureau, has found. A hot June, for instance, will be followed by a dry July nearly 100 per cent of the time in the Mississippi valley, and a cold January indicates an eighty-per-cent chance that February also will have temperatures below normal.

Des Moines, Iowa



### INDIANS THAT MET COLUMBUS - OBJECTS OF RESEARCH

What tribe of Indians welcomed Columbus to San Salvador has never been known to scientists, but a one-man expedition from the U. S. National museum has set out to identify them, if possible. Herbert W. Krieger will seek remains of the tribe by digging at the location where the discoverer of America first set foot. The common belief is that the tribe which met the explorer was of North American origin, but Mr. Krieger believes it quite possible they were South American, the Arawaks. In previous West Indian explorations he has found all Indian cultures to be South American. The islands nearest Florida remain in doubt, however. Although Columbus left letters and diaries describing the natives he encountered, none of his accounts is sufficiently complete from the ethnologist's view to give a definite clue. Such details as he did give, however, point to the Arawaks, Mr. Krieger believes. The tribe was friendly, and had it been a band of Caribs, there would have been a different story to tell. The fact that they ate cassava bread instead of bread made of maize further bears out his theory of their South American origin.

see Art. 1931. Columbus's frame

Field Glasses Fitted to Headgear Leave Sports Announcer's Hands Free



### "EYES" FOR SPORT BROADCASTS FASTENED TO HELMET

Following the ball is easy for the radio announcer assigned to football, baseball or other games if he wears a new headgear fitted with field glasses. This leaves his hands free for operating his radio.

### FOUR MINERALS NEW TO MAN ARE DISCOVERED IN U. S.

Four minerals hitherto unknown to man have been discovered in the United States. The most important, according to the department of geology of the Smithsonian Institution, is a radioactive substance whose largest constituent is uranium, from which radium is derived. This was found in rocks near Spruce Pine, N. C. The new material, called "Clarkeite," is dark brown to orange brown in color and has a slightly waxy luster. A nearly transparent substance, found in close conjunction with uranium-bearing rocks, but itself not radioactive, is the second new mineral. It is apparently insoluble in water and its principal constituents are vanadium, iron and water. This mineral, named "fervanite," was found in southwestern Colorado and southeastern Utah. The third substance, named "schairerite," is described as a sulfate and fluoride of soda, soluble and occurring only in the form of crystals. It is a brittle mineral, found in the Searles lake region of California. "Krausite," the fourth new mineral, consists of iron, potassium and sulphur. It is found in several forms.

### THREE-WHEELED AUTO SPEEDS EIGHTY-FIVE MILES AN HOUR

Speeds above eighty-five miles an hour are claimed for a small three-wheeled automobile developed by a Long Island engineer. Built of duraluminum, the car has its thirty-four-horsepower motor in the rear. In trial spins, the inventor has attained an eighty-five-mile pace.



Powered with a Small Engine in the Rear. This Three-Wheeled Auto Attains High Speed

Inv. James Martin  
Sardis City, La.  
New York

Discovered by Clarence S. Ross, Geological Survey

Ben Wilson station KFI  
1009 S Hope St  
Los Angeles

B52

B. 85



# MAKING HOME



Powder Atomizer That Speeds the Process of Applying Makeup; Inside the Tassel Is a Bulb Forcing the Powder Out When the Bulb Is Pressed

Ball-Bearing and Rotating Swivel Plug Which Can Be Attached to Cord of Any Electric Appliance and Will Prevent Kinking



Right, Handy Darning Form Which Fits the Foot of a Stocking, Making Easier the Task of Mending

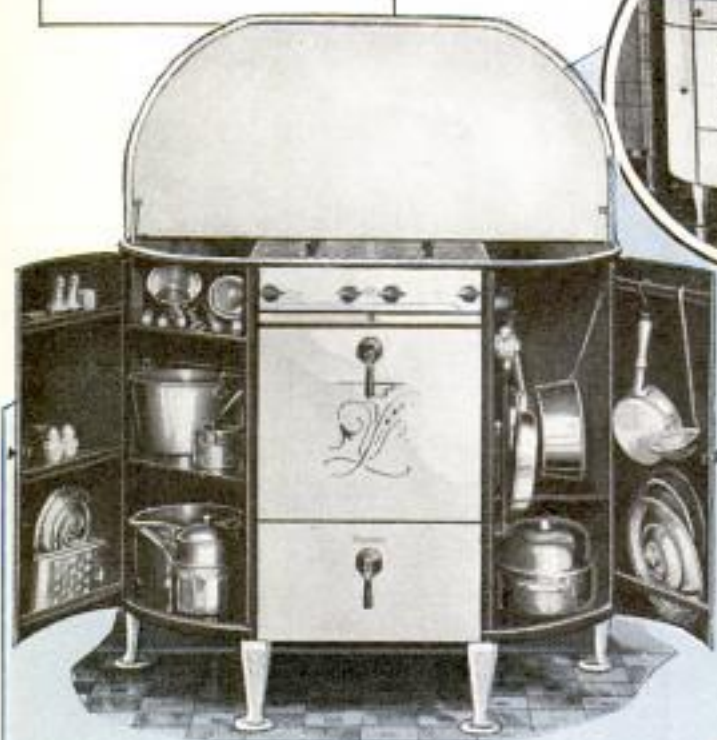

Above, Cabinet Gas Range with Side Compartments That Offer Storing Space for the Largest Pots and Pans; Right, Egg Holder for the Refrigerator; It Is Placed against One of Side Walls





# TASKS A PLEASURE

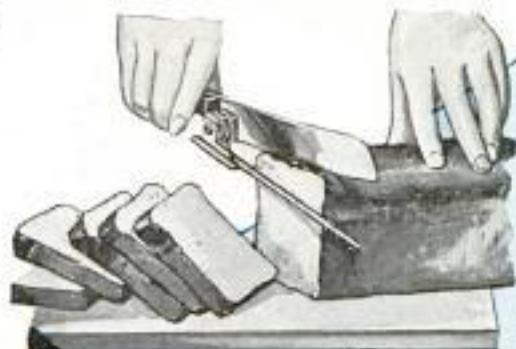

Adjustable Guide That Fits on Bread Knife to Insure Even Slicing; the Attachment Can Also Be Used in Cutting Cabbage or Other Vegetables



Electric Light and Mirror on Adjustable Stand; It Is Particularly Useful for Makeup and Shaving; the Outfit Also Comes on a Bracket for Bathroom Use



Right, Cut-Flower Holder for Dish or Bowl That Permits Graceful Arrangement as Above



Right, Wire Pan Rack for Holding Pot Lids That Attaches to the Wall

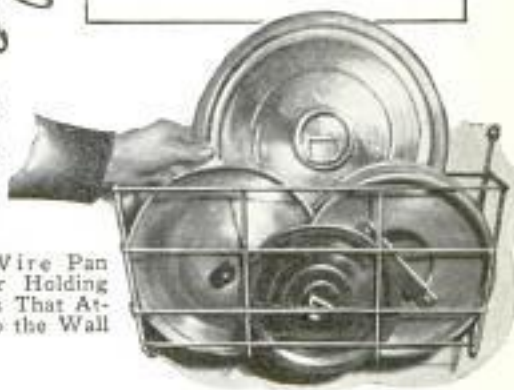

Collapsible Support in a Loose-Leaf Binder, Which Transforms It into a Book Rest When Raised into Position; Binder Hooks Hold Book in Place



Gas Stove, with Cylinder Flue and Plate, Which Saves Fuel



a 24 + 9  
432

Cont. George A. King & Hayes,  
Loeb & Co. J. S. Dearborn  
POPULAR MECHANICS  
Chicago

# Bamboo Hut the Model for First Skyscraper

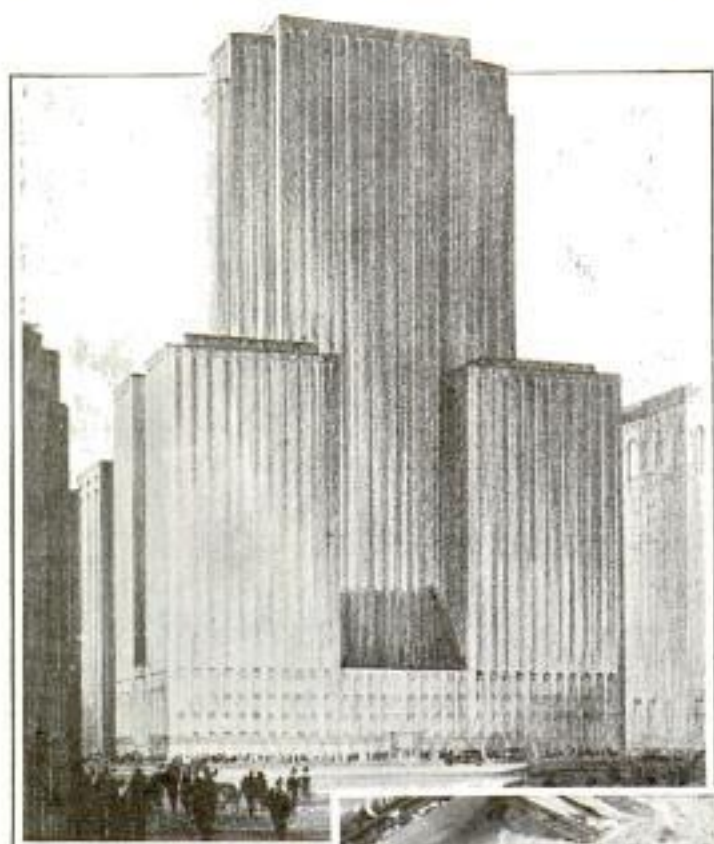

Top, Office Building to Occupy Site of First Skyscraper; Center, Column of First True Skyscraper, and, Below, a View of the Building, Recently Torn Down



The Home Insurance building, a twelve-story structure in Chicago, recently razed to make way for a forty-two story office building, constituted America's first true skyscraper, a committee of architects has decided. In reaching their decision, the architects were forced to define a skyscraper, and they finally agreed that it embodies the principles of skeleton construction in which "a metal frame or cage, composed of girders, beams and columns, supports all internal and external loads and carries all stresses directly to the foundations." The Home Insurance building, erected in 1885, was the first structure in which these principles were fulfilled, for its steel framework support-

ed all the rest of the building. The architect, the late William LeBaron Jenney, got the idea for its construction during a visit to the Philippine islands. He observed that the natives built their huts by making a skeleton of bamboo trees, then introduced a curtain-wall effect by weaving smaller members and leaves with the skeleton sides. Returning to this country, he incorporated the idea of iron columns instead of bamboo in some of the smaller structures he built, then boldly proposed to build a steel frame "towering" ten stories high, and hang the walls on it. There were claims that contraction and expansion of the metal would cause the walls to bulge and the roof to rise, but Jenney went ahead and proved his idea was sound. When

the building was torn down, it was found that the interior of the cast-iron columns had been filled with concrete. Records showed cautious city officials re-





by H. J. Quinn, Jr. 2487

quired the concrete as extra fire protection, much to the chagrin of the salvage man who had purchased the columns on a pound basis, not knowing they were filled with concrete.

**GRAVEL WALL IN YOUR WELL RAISES ITS CAPACITY**

Capacity of a well drilled in sandy strata can be increased by placing a gravel wall at the bottom of the well casing, according to a report before the American Waterworks association. In one case cited, ten wells had been scattered over as many acres in an attempt to obtain an adequate city water supply, all of them producing a total of only 1,200 gallons a minute. With the adoption of gravel walls, one well alone gave twice as much water as all ten had been able to do. By feeding the proper type of rough gravel into the space between the inner and outer well casings, a circular wall will be built up around the metal screen, necessary in sandy soils, about three times the diameter of the screen tube. The wall actually becomes a screen itself and stops the fine sand from clogging the screen grating.

See news Service 12/15/31

Q 251

W. W. 12/15/31

**LEVEL FOR LINES OR SURFACES IS TWO TOOLS IN ONE**

Two tools are combined in a level that checks either lines or surfaces satisfactorily. The instrument weighs only a half ounce, is three and a half inches long and is made of aluminum tubing, hexagonal in shape. Special hooks are placed on the two ends to prevent the level from falling off the line. The fluid is quick-acting and of a contrasting color, making it easy to see. The instrument is designed particularly for all types of carpentry layout work, including lawn grading, is useful in the home for leveling clocks and stoves.

Q 2469

James 12/15/31



Level That Measures Lines or Surfaces and Is So Built It Cannot Fall Off

in window trimming, sign painting and bricklaying, or for laying out golf courses.

Sand's Level & Tool Co  
8631 Erskine Ave  
Detroit, Mich



Dialing the Number of a Stock Will Bring Latest Prices on Private Office Registers Now in Use

**DIAL BRINGS STOCK MARKET FIGURES TO OFFICE**

Stock-market quotations may be received in one's private office direct from the exchange by means of a device called the "teleregister." To get quotations on a certain stock, a dial signal is put through to the exchange and the figures are flashed on a receiver in the broker's office.

**WAY TO TEST WELDED JOINTS IN BUILDING IS SOUGHT**

Q 2504

While a few buildings with welded instead of riveted joints have been constructed, some instrument for testing or inspecting the welded parts on the job must be found if the noisy pneumatic riveter is to be replaced. A building with a thousand welds may have just one defective joint—enough to cause a collapse if great strain and weight were to fall on that joint. The possibility of rapid X-ray inspection of the internal soundness of a weld has been held out by experimenters, but nothing definite has been developed. In recent tests, it was found that good welded joints are better than riveted joints. A riveted joint is no stronger than the steel members to be united, for the riveted metal invariably breaks at the joint. But in a weld the point of union may be made stronger than the plate itself.

Prof Ray C. Brumfield  
Cooper  
New York



Q2023

Carl Sam Brown,  
157 Carlisle St  
Marion Ohio

# MAGIC for

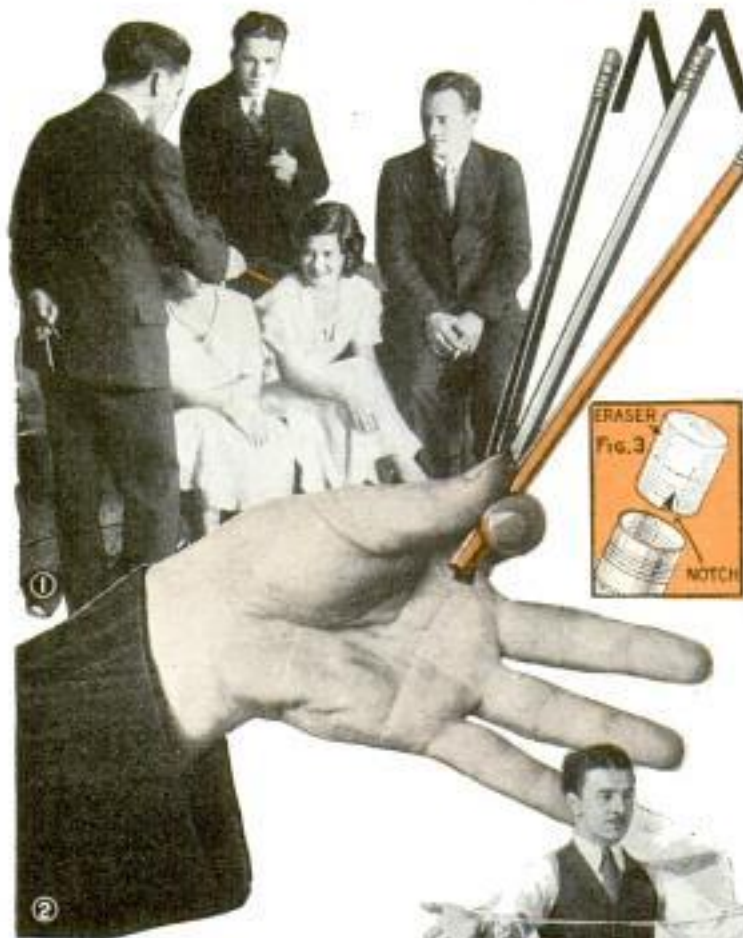

and the ends of this second cord are held by a spectator while the performer retires behind a screen or ducks around a doorway. You count ten, and out bobs our hero again. The knots are still intact, but the performer's vest is turned inside out. Ten seconds behind the screen again, and the vest resumes its normal position.

Behind the screen, you simply push the loop formed by the second cord up over your wrist, as shown in Figs. 6 and 7, so that it can be pulled free. Then you unbutton your vest, and, reaching over your head, you grip the vest at the back of the neck and pull it forward, as in Fig. 8. This will bring it to the front with the cord

HERE we are—three different-ly colored pencils, identical except that one is black, one blue, and the third orange. They go behind the performer's back after being examined by the audience, and he divines each color before bringing the pencil forward.

There really isn't a whole lot of mystery. The eraser tips had been removed and the inside edge of the rubber notched with a pocketknife. One notch indicated the orange pencil; two notches labeled the blue one, and the black was left plain. It was then a simple matter for the performer to secretly pull out the erasers behind his back, feel the markings, put the eraser back, and then make the divination. Smooth working is insured by filing down the small tabs that hold the eraser in place.

Here's another: The performer's wrists are tied with a length of cord, leaving the hands securely tied but some distance apart, as shown in Fig. 4. The knots may be sealed with wax. A second cord is looped over the piece between the wrists,



Above, Naming the Color of Hidden Pencils by Notches Cut in the Eraser Tips; Below, How to Turn Your Vest Inside Out with the Hands Securely Tied



# EVERYBODY

passing through the armholes. Nothing more to do, then, but to turn the vest inside out, as in Fig. 9, put it on, button it and slip the spectator's cord back in position. The return to normal, of course, is simply a reversal of this procedure.

If you like card tricks, try this. The spectator selects a card. He returns it to the deck. The performer immediately hands him the deck with the request that he cut it several times and then deal the cards out on the table, face up, in either two, three or four piles. The performer turns his back; he does not know how many piles the cards are being dealt in. The deal being completed, the spectator is told to pick up



Above, Color Card-Location Trick That Is Quite Boring; Left, Making a Coin "Pass" through a Folded Handkerchief

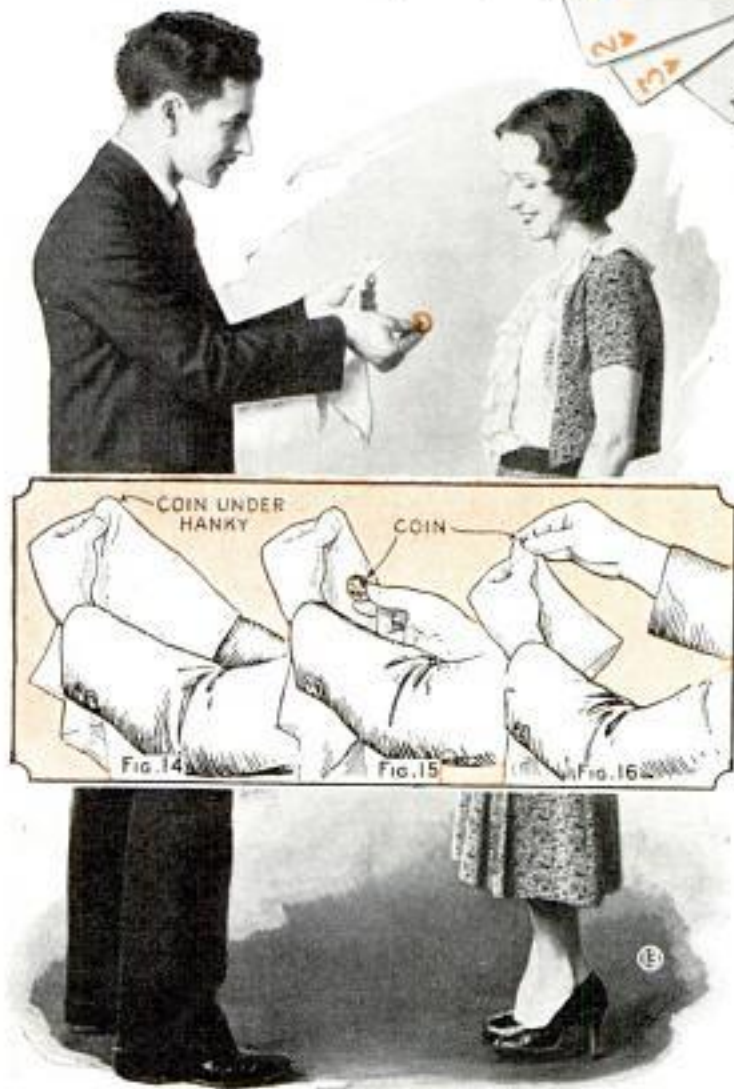

the one packet containing his card and to discard all the others. This packet is cut once or twice. The performer then deals the cards face up on the table. Suddenly he stops and declares that the card he is holding is the selected one—and it is.

The whole thing practically works itself. You need do but two things: First, when the selected card is returned to the deck, casually break the pack so that it will be returned under the eleventh card, as shown in Fig. 12; that is, the selected card will be the twelfth card from the top of the deck. This small number of cards can be easily counted as you fan the deck for a selection. Second, before handing the deck to the spectator, casually note the bottom card and remember it. You can easily tell from the size of the packet handed you whether





Cigaretts Can Be Made to "Pass" from the Pocket of One Person to That of Another if the Pack Is Prepared Beforehand as Shown

the deck was dealt in two, three or four piles. The chosen card will always follow the key card by three, four or six cards. The performer merely divides the number of piles dealt into twelve and he has the number. Thus, if the pack was dealt in two piles, the chosen card will be the sixth card after the key card. If three piles, the chosen card would be the fourth card after the key card, and so on. The key card will always fall in the same pile as the chosen card, and, holding the packet, back up, and dealing the cards face down, the key card will fall first, after which the chosen card will follow third, fourth or sixth depending on the original deal.

For something simple, try the little solid-through-solid effect shown in Fig. 13. You apparently wrap a fifty-cent piece in a handkerchief and then pull it right through the cloth. Fig. 14 shows the start of the deception. The coin is held in the right hand. The left hand takes the handkerchief and drapes it fairly over the coin. The left hand grips the coin through the cloth. The right hand is then brought from under the cloth in a perfectly natural manner to join the left hand in holding the coin from the outside. But instead of bringing the right hand forth empty, the performer takes the fifty-cent piece along, the deception being screened by the cloth and the impression of a coin in the handkerchief. The right hand then twists the coin in the folds of the cloth, and, after a suitable "penetrating" period, the fifty-

cent piece is magically pulled out. How is this? A brand-new pack of cigarets is opened by the performer. He spills the contents of the pack into his hand. A spectator is asked to take a handful and put them in his pocket. The performer counts the cigarets remaining. If there are ten left, the spectator



must have the other ten in his pocket.

The performer then slips his handful of cigarets into his own pocket. A second's pause, and then the wizard commands two cigarets to jump from the spectator's pocket to his own. Counting proves it, the performer having twelve cigarets while the spectator has but eight. Of course, no one is supposed to know that the performer has previously slit open the bottom of the pack and extracted two cigarets.

Here is a very simple formula for magic squares. These squares are arrangements of figures which can be added along any row or diagonally to equal the same total. For example, the one shown in the photo, Fig. 19, totals ninety-nine in every direction. You can easily make a magic square from any number from fifteen to one thousand in a moment. Suppose someone calls out ninety-nine. Subtract nine from this, leaving ninety. Divide this by three, giving you thirty. Then, subtract one. Twenty-nine. Starting with this number and stepping as indicated from 29 to 30, 31, 32, etc., you would fill in the nine squares in the order shown. That's all there is to it. Some numbers will give you a fractional result, but this is simply carried forward in regular rotation.

Try this card location. The performer hands the deck to a spectator. The latter is requested to deal the cards into four



a2023



Above, Illustrating Simple Formula for Making Magic Square for Any Number from Fifteen to 1,000 Almost as Soon as Number Is Called by a Spectator; Sketch Shows How Unbalanced Design of Backs of Cards Makes a Location Trick Easy

heaps face down. The performer turns his back while this is done. Now, the spectator is asked to remove a card from within any pile. He is to remember this card. He is to place it on top any of the piles and assemble the four piles in any order. The performer quickly deals the deck onto the table, one card at a time, and accurately stops at the chosen card.

The trick is based on the fact that many decks have reverse backs, that is, the design is unbalanced so that the card either faces one way or the other. At the start of the trick, the cards are all facing one way. To show the spectator how the

cards are to be dealt, the performer deals out eight cards in regular order to make four piles of two cards each. Two of these piles, four cards, are then picked up and placed on top of the deck, which has, meanwhile, been turned end for end by simply transferring it from one hand to the other. The other two piles are swept together and the pack is dropped over them. Thus, in a seemingly fair manner, you have reversed four cards at the bottom of the deck and four at the top. Now, going through the card selection as outlined above, the deck will return to you with eight reversed cards, assembled in pairs. Dealing out the deck, you pay no



*London Series  
London  
England*

attention to two reversed cards which immediately follow each other, but when you come to the one pair of reversed cards which house an odd card between them, as shown in Fig. 21, you can consider the trick over. For that is the selected card.

**CAMERA TAKES THREE COLORS ALL IN ONE "SHOT"**

As the result of the development of a new color camera that can take all three primary colors in the same exposure, news photographs printed in natural colors on a reel-fed rotary press are appearing in the weekly edition of a London publication. The camera operates much like the ordinary news camera, except that it takes prints in yellow, red and blue on three plates all at the same time. A single print in the natural colors of the original is obtained, from which the process worker is able to obtain much better results than if he were working from three color positives. The print paper is passed through successive cylinders, the finished impression being in full color. By this method, what has long been called the "three-color process" has been adapted to the photo-gravure method with the added advantage of rapid printing on rotary presses.

*Wm. A. ...*

**BOX OF BLOCKS "SPOTS" CARS IN BIG RAIL TERMINAL**

To solve the problem of "spotting" express cars so they can easily be pulled in order onto the main line without tying up

*Q 2461*



Block Board That Enables Terminal Manager to Switch Cars and Make Up Trains in Advance

yard traffic, a terminal manager in New York has designed a box with blocks sliding in grooves representing the track layout. Since cars are assigned to certain positions daily and changes have to be made on short notice, the problem of keeping track of them is exceedingly difficult. They must be placed so they can be pulled in the order of train-departing time. Each block, representing one car, is marked with city destination, train number and time of departure. These can be placed in the grooves in any desired order. Each car also has a diagram for loading so that shipments are placed in position to simplify unloading as the train stops at stations along the line. Trains thus are made up one day in advance on the block board and closely followed when the empty express cars are backed in to the terminal by road engines. Much switching is eliminated.

*West Side Terminal*

*New York Terminal*

**CRANKCASE IS KEPT FILLED BY AUTOMATIC OILER**

Oil is kept at constant level in the crankcase of automobile or other gas engines by an automatic gravity feed now on the market. A float in the system drops with the oil level, opening a valve which lets lubricant flow from the reserve tank into the crankcase until the normal level is restored. The float-control rod then presses a ball on the seat shut-off to stop the flow. Vibration of the engine is neutralized, so far as the oil feed is concerned, by a tension spring pressing on the top side of the float-control rod. The action of the feed-valve may be regulated.

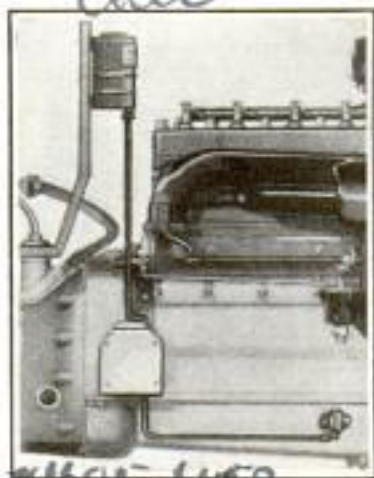

*Q 2435*

*Cont Stanley W. Todd  
230 Park Ave  
New York*

Whenever you find that you wish to know more about any article in this magazine, write our Bureau of Information.

*Mr. H. E. Sigmund  
1009 S. Hope St  
Los Angeles, Calif*

*Copyrighted material*



a 2479

maker. Fred, Quindone  
390 N.E. 79th St  
Miami, Fla

Left this address  
4/19/92



© International News Photos

Here's the Latest Vehicle in Water Sports; Pedals Like Those on a Bicycle Are Connected to a Propeller and the Craft Is Driven by the Operator's Feet; Pontoons Add to Its Safety

### METAL CANOE DRIVEN BY FOOT LIKE A BICYCLE

Propelled by pedaling like a bicycle, metal canoes, or sub-water cycles, have been tested successfully in Florida. The canoes have water-tight pontoons at the side, back and front, are made of aluminum and are said to be unsinkable. A propeller at the back is turned by pedals.

Miami Beach

U2538

### LINERS GUIDED BY SEA BOTTOM INSTEAD OF THE STARS

Transatlantic liners, on the most dangerous part of their course, will use the ocean bottom instead of the stars as a guide. The United States coast and geodetic survey has issued a new chart of the ocean floor around Georges Bank, off the New England coast, and this map will be compared with readings of echo depth finders on ships. So well does this chart describe the hills and valleys beneath the water that the navigator will be able to determine his position by speedy soundings and so keep on the right course. This method of navigating will eliminate much of the danger of crossing the Georges Bank in fog, when ships must be guided between the hills which rise close enough to the surface to ground many vessels. A

Scene scene 12/19/31

large submarine valley, eleven miles long, two and one-half miles wide and 2,000 feet deep, was found in the 1931 survey. The tops of its ridges are 600 feet below the surface, while at its mouth, on the edge of the shelf, the depth drops to 6,000 feet.

### HAND TOOL IRONS OUT FENDERS QUICKLY AND CHEAPLY

U2455

Dents in the body and fenders of an automobile may be ironed out quickly and cheaply with a hand-operated tool now ready for the market. Special training is unnecessary for operation of the device, and a saving in time is claimed by its makers. A length of twenty-four inches enables the tool to reach the center of any door panel on passenger cars.

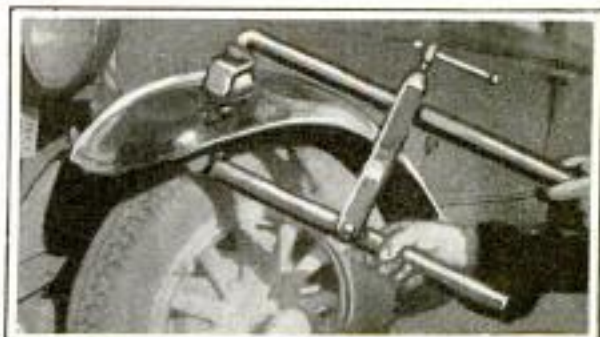

Hand-Operated Fender Tool That Irons Out Wrinkles in Automobile Body

Huron Machine Works  
Huron, Mich.  
Copyrighted material



a 2397  
440

Aerocar Company of Detroit

~~112~~ POPULAR MECHANICS

Chicago

# Dry-Land Yacht Has All Comforts of Home

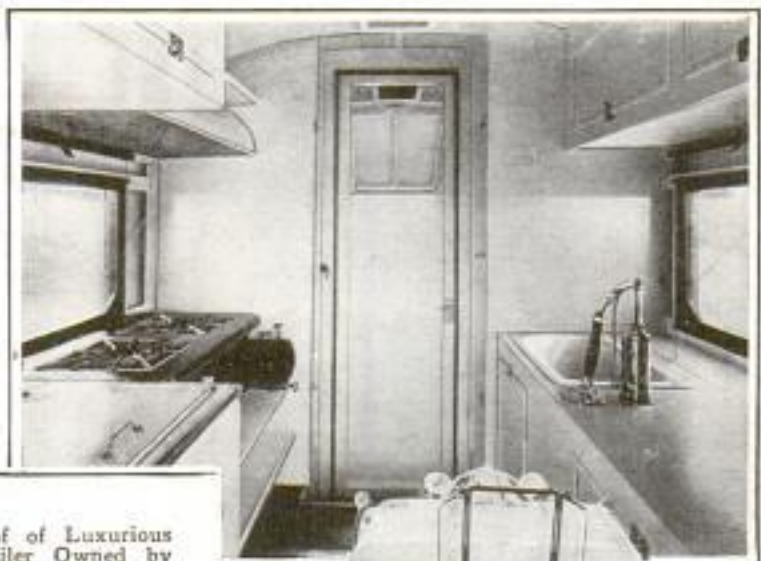

Left, Roof of Luxurious Auto Trailer Owned by Henry L. Doherty, Showing Doors in Top to Form Upper Deck; Right, View of Kitchen and of Roof with Top Laid Back

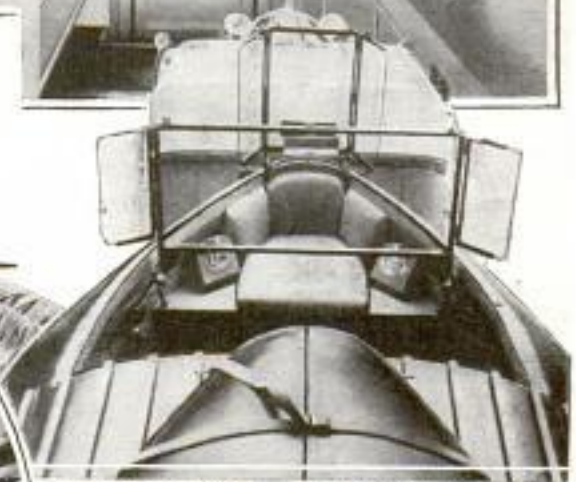

Full-Length View of the Land Yacht Attached as a Trailer to an Auto; in Circle Are Shown the Living Quarters and Pullman-Berth Sleeping Accommodations



Coach only \$1350.00 (shell) 7424 Melville Ave Detroit, Mich for home  
Standard - \$1850.00 (ready)

Chicago agent - H. S. Horton  
Hotel Maryland



J.C. Crowhall M. Sc. Q 2462.

Dept. Glass Technology

Science

POPULAR MECHANICS

J.C. Crowhall, Dept. Glass Technology  
Science Museum, London, England

### ELASTIC ARMOR- PLATE GLASS IS UNBREAKABLE

While it has long been known that the strength of glass can be greatly increased by toughening the surface through rapid cooling, it is only recently that this glass has been produced on a commercial scale. An English manufacturer has termed the product "armor-plate" glass and calls it the strongest glass known today. A plate of this glass, one-quarter of an inch thick, three feet long and one foot wide, supported at the ends, will carry a weight of 336 pounds at its center, deflecting two inches by bending as the weights are applied, but coming back to normal when the load is removed. This glass may be used for the same purposes as present safety glass, which consists of two layers cemented together.

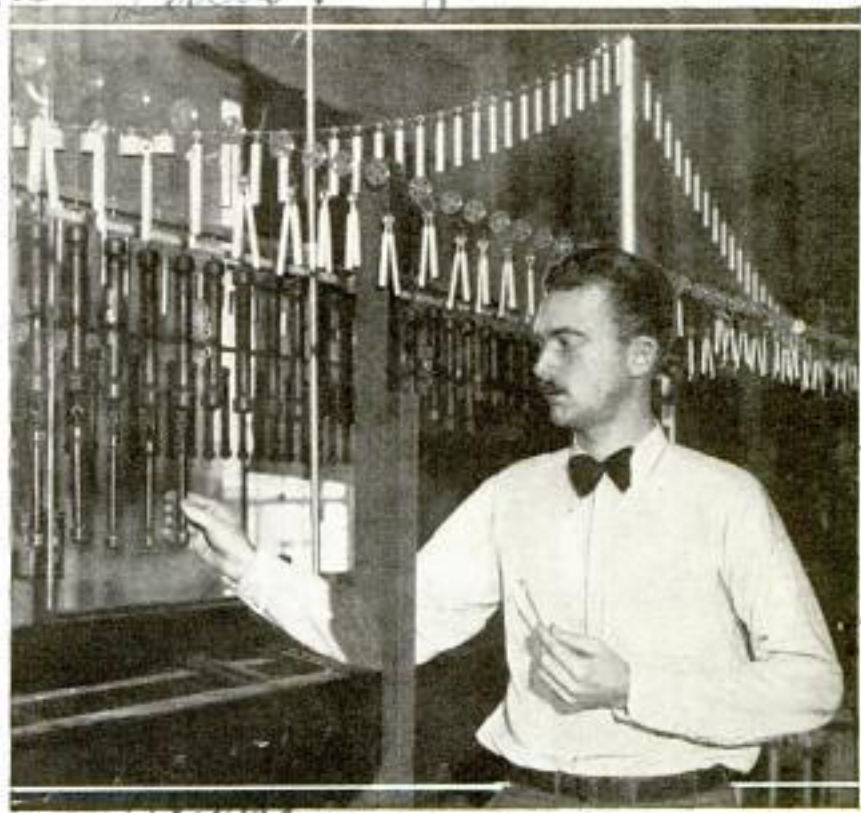

Small Weights Hung on This Bridge Model Reveal the Strain Which May Be Applied Before Collapsing Point Is Reached

### WEIGHTS TEST MODEL BRIDGE FOR LOADS AND STORMS

Strains and stresses of bridges are predetermined at the University of California's laboratory by means of weights which are attached to parts of model bridges. Load and storm tests are conducted on a sixty-foot model, which is subjected to the same strain that a 100-mile gale would impose on an actual bridge built to the same scale.

Philip H. Fletcher, engineer

### TAPE USED ON DRAWING BOARD INSTEAD OF THUMB TACKS

Transparent tape for holding down the drawings of draftsmen is now on the market, offered as a substitute for thumbtacks. It is made of a material similar to cellophane, with one side coated with an adhesive compound which grips both paper and wood surfaces firmly, yet can be stripped from either without leaving a mark. The tape may be used repeatedly.

Q 2460

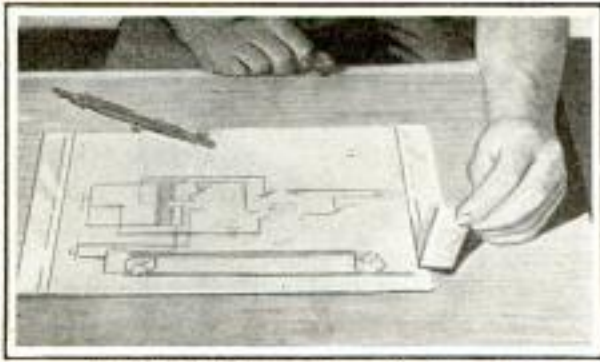

Paper Is Held Firmly on Drawing Board by Tape Instead of Tacks

### RADIO PROGRAMS PUT ON FILM LIKE TALKING PICTURES

Sound on film, the secret of the "talkies," has been adapted to radio broadcasting in Austria. The device is literally a phonograph with films instead of records. The General Electric company in the United States has experimented with the sound film to the point where a program two and one-half hours long may be broadcast without changing records, stopping the film or shifting from one film to another. Austrian broadcasters are using the device to catch American programs coming in late at night. The films are then developed, printed and put on the air ten to fifteen hours later.

Berkeley Calif. Q 2495

Schlegel

Engene Huetzgen  
2425 Sheffield Ave  
Chicago

Christian Science Monitor  
12/1/31

reproduced material



92375

Bruce Museum Bruce Park  
Lancaster, Conn

# In a WORLD

## As a Fly Sees It

Right, Two Beetles Battling to the Death over a Banana, While the "Lady" at the Right Awaits the Result; Below, the Dragon Fly's Smile; Note Its Great Eyes



By P. G. HOWES

**D**ESPITE the news of crime and disaster daily before us, our world is as tame as a pet rabbit compared with another world that lies all about us, a world in which the inhabitants, from birth until death, spend all of their time in one violent, merciless battle against other members of their tribe. This is the world of insects, where life itself is almost always dependent upon the destruction of others. It is a world where fighting, killing, pillaging and cannibalism form the accepted creed of all the successful.

Let us spend a day in this land of blood-thirsty creatures that we may get a true idea of what a tame and simple and well-protected world we human beings really live in. Let us be ordinary flies for the simple reason that we shall be agile and fleet of wing, and thus we shall be able to get about easily, and our compound eyes, made up of hundreds of separate facets, will enable us to observe things thoroughly and at the same time keep us out of the



gravest dangers. We have no more than started upon our journey when a loud droning overhead, like that of a gigantic airplane, comes to our experienced ears. Without looking up, we dart for cover as the sound grows stronger. It is deafening and high-pitched and the great shadow which circles over our hiding place fills us

with terror, for we know that it is only one of hundreds of great carnivorous hawklike flies that are ever mercilessly killing and devouring our kind.

The monster circles about, a great bristly thing with huge eyes and a long poisonous saber protruding from its head. Its eyes penetrate the grassy forest where we are hiding, then suddenly the creature swoops down like lightning, and in another instant it has borne away one of our brothers who was not hidden quite as well as we are.

We come forth cautiously and are about to take off when an enormous yellow fleshy mass shoots out at us through the grass. The mass is covered with a thick



# of TERROR

This Dragonlike Creature Is a Beetle Caught in the Act of Committing Murder; Its Victim Is a Fly That Was Caught Feeding on a Bit of Fruit



layer of entangling mucus which holds whatever comes in contact with it as though it were a powerful magnet.

It is the tongue of a great amphibian monster of our world, a thousand times our bulk. Its horrible tongue engulfs one of us and snaps our unfortunate brother back into a cavernlike mouth as we fly off in wild confusion, thinking only of saving our lives.

After a time we find one another again. We are one less, but that is not so bad considering our world, and after resting and recovering from our fright, the desire for food returns with increasing insistence.

After flying some distance, we spy some soft pears that have fallen upon the ground, a tempting meal for us. Already there are bees and black and white hornets, twenty times our size, feeding there. We will give them a wide berth, for they love to tear off our wings and then mince us into hash for their young ones, but they are partly

drunk now, and if we are on the alert, we may eat at another pear near by.

Other flies are hovering near, and, when they see us approaching, there is a wild rush to be first at the feast. We are outdistanced by the larger flies whose intention it is to keep us away once they have landed upon the prize. Two big bluebottles are the first to arrive and we are close behind, but suddenly there is a stampede for safety and all is panic and commotion.

A gray form, moving with lightning speed darts out from its hiding place beneath the pear. It is long and slim and glistening, its fangs are wide and heavy

and curved like two orange-colored sickles. Rearing up like a dragon, it pounces upon one of the bluebottles. It crushes its head and almost with the same movement spears the other upon its sharp tusks.

It is noon now and food is an absolute necessity. We turn our thoughts to flowers, but there are many traps among the blos-



A Wasp That Is a Terror of the Insect World; It Can Kill Creatures That Are Twice Its Size



92395  
444

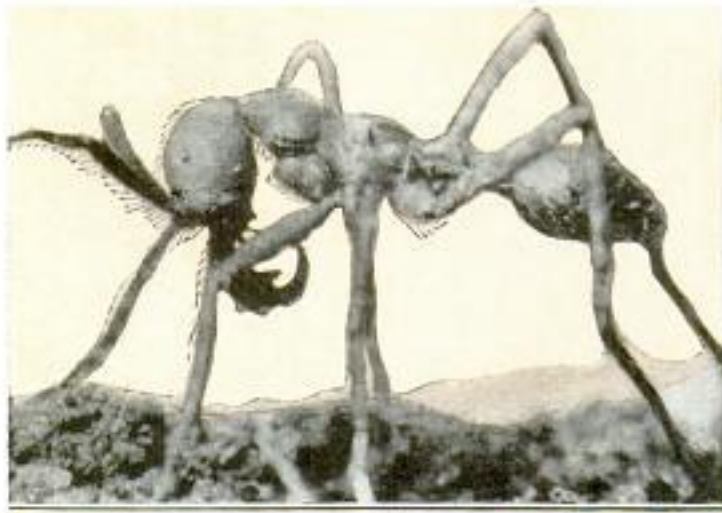

soms. Here the big crablike spiders lie concealed with their bodies perfectly camouflaged to match their surroundings. Even the blossoms themselves are dangerous sometimes. Some contain fluids that trap us, others hold us fast until we die of starvation, while still others are the abodes of parasites which attack us. At length we obtain some nectar from a friendly flower, and as we sit sunning ourselves upon a leaf afterward, we hear a disturbance below. Looking down, we witness three highway robbers at work. One ant is fighting hard for its property, which appears to be a baby ant, but the others are merciless. There is no such thing as law and order or redress in our world, and so the smaller ant is tortured into giving up its burden, but at this instant a gigantic feathered creature swoops down out of the air, and in the twinkling of an eye all four ants and the young one are swallowed.

Hoping for an hour of peace, we fly away across the country to

new scenes, but as we descend to rest partly exhausted, we find that we have come down within sight of a great insect battle in which tens of thousands of warriors are engaged. It is a frightful sight. The whole of antdom appears to be in the seething multitude, as wave after wave of the combatants surge here and there, back and forth across the field of battle. They are linked in twos and threes and fours in desperate hand-to-hand fights, tearing at each others throats and legs and bodies like mad creatures that have lost all control of themselves.

From our perch, aloof and safe from the onslaughts and the strife

below, we see the mandibles of these ant warriors closing in deadly grips about the waists or necks of opponents, and once they close, not even death will open them. No quarter is shown, no instincts of mercy succor the wounded and dying. It is a war to the death without consciousness of why.



Top, Mandibles of Army Ant; Center, Fly Feeding on a Victim; Below, the Toad, a Monster to the Insect World





Above, Dead and Dying Ants after a Battle; Right, Bird Skeleton Cleaned by Army Ants

Being weak-bodied flies, all but defenseless and surrounded by enemies, death and destruction wherever we turn, we are terror-stricken most of the time. Life is hardly worth living in such a world. But our brothers in the tropics fare still worse. Down in the jungles there are many additional dangers and enemies. There are those dreaded army ants that surge through the forests in millions, tearing every living thing to pieces. They respect no other breathing creature.

Q2569

MOON WEAKENS RADIO WAVES

Veteran radio operators, who long have held the theory that a full moon weakens distant signals, are right. In thousands of tests, it was found that reception invariably was at its best when the moon was below the horizon. As soon as it rose, reception fell off fifty per cent. Little difference was noted whether the moon was beclouded or not, whether new or in the last quarter. According to Orestes H. Caldwell, former member of the Federal Radio commission, the moon apparently



has collected a considerable negative electrostatic charge from the electrons poured upon it with the sun's rays. Such a moon, passing over the earth's Heaviside reflecting layer, would induce a charge that would depress and distort the layer, making a sort of bulge. This interferes with the reflection of radio signals.

newspaper Service Bureau, Natural. Hill Publications, 330 W. 42nd St. New York



a2478

Max Rice,  
studio art  
director



Movie Sets First Are Built in Miniature, Then Every Detail Is Checked for Mistakes Before the Real Scene Is Constructed

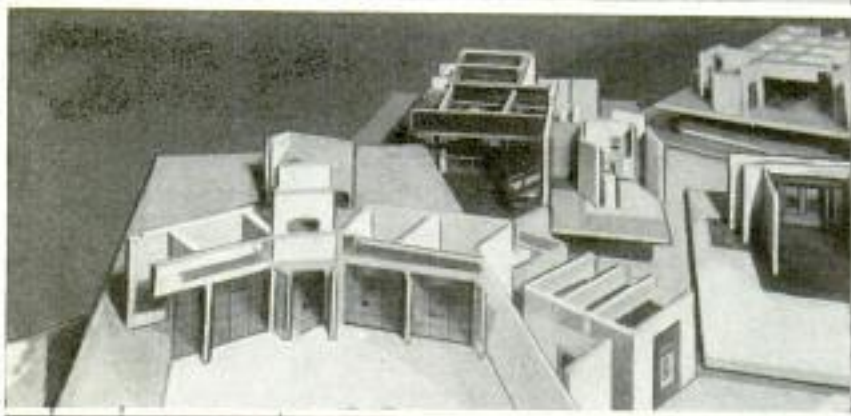

*architectural*  
**HOW MOVIE MISTAKES ARE CORRECTED IN ADVANCE**

One of the greatest time and money-saving pursuits in the motion-picture industry is said to be the practice of constructing models of every "set" in advance of actual production. This permits a thorough study of camera angles, lighting effects, property arrangements, and, in short, corrects many mistakes before they are made. After the models are completed and approved, the full-size set is built, incorporating changes that have been found helpful in the study of the models.

**DANGER OF FROZEN DYNAMITE REDUCED BY RESEARCH**

Frozen dynamite, the substance that has caused so many deaths and injuries in America's mining industry, promises to be eliminated as a result of recent chemical findings. Dynamite has a freezing point of

fifty-six degrees Fahrenheit, twenty-four degrees higher than water. When placed in position, frozen dynamite is likely to be detonated by the friction of handling and tamping, or may burn, rather than explode, throwing off deadly gases. Thawing it is extremely dangerous. For many years the process of making dynamite or explosive jelly has undergone no change. Finally the old principle of lowering the freezing point of water by adding salt was thought of. Further investigation showed that this property of lowering the freezing point was not confined to inorganic salts, but that many organic substances had the same effect. The use of the principle in bringing about a lower freezing point for dynamite came by accident. In munitions research, T.N.T. was developed, leaving a

tarry residue. The dynamite makers decided to try it as a binder for their product. To their surprise, it was found that it lowered the freezing point. Recently ethylene glycol has been produced by the petroleum industry and widely distributed as an automobile anti-freeze.

*a2501*  
**LEVEL THAT FITS YOUR POCKET ALSO CONTAINS A RULE**

Rules and levels are used at the same time so much by woodworkers that a handy pocket tool combining the two is now being offered. It consists of a six-inch rule with a level set in its center, and takes up no more space than any other similar tool.



*a2591*

*Emb. Verell Sprung,  
1729 N. Capital St  
Washington, D.C.*

*The Anderson Level Co  
5715 N. Commercial  
Chicago*



## Road Monster Lays a Mile of Paving a Day

Paving now is mixed, spread and tamped in one continuous operation with the aid of road machinery recently demonstrated in Illinois. The machine is in two sections, each of which can be operated independently of the other. The crushed stone first is spread on the site of the

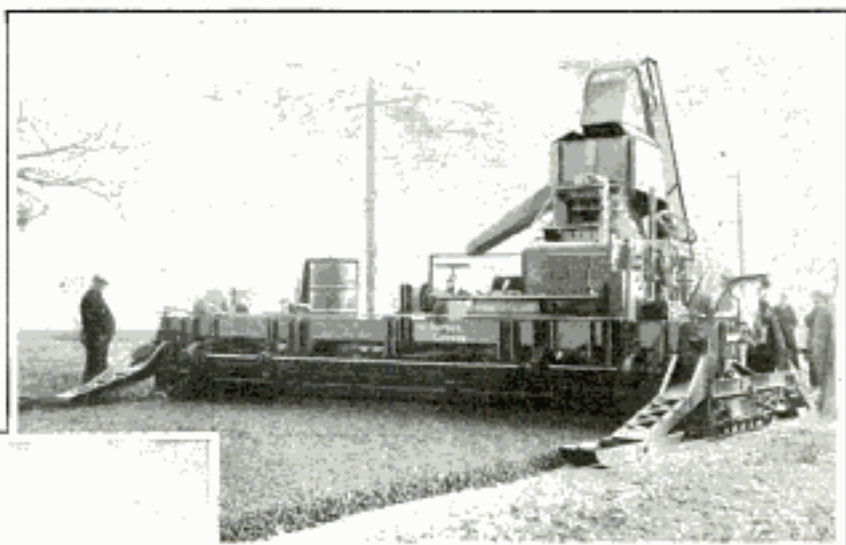

Rear and Front View of Machine That Paves Whole Road Width in One Operation without Forms



new paving by a special truck that measures the quantity needed. The mixing machine then starts at one end, "gobbling"

up the aggregate and mixing it thoroughly with bitumen. From the mixer it is passed to the spreading and tamping machine, which in the Illinois demonstration was connected directly to the mixer. The material is spread to the correct depth and tamped with a force of 6,000 pounds. Special leveling shoes, on the outside edges, iron out uneven spots in the roadbed, and the apparatus automatically lays the material to make a crown in the center. No forms are needed. The machine builds one mile of road a day.

A 2468

### THREE CURRENTS ON ONE WIRE CONTROL HOME DEVICES

Electric water heaters and other home appliances can be turned on and off at specified hours by an extra electrical current sent over the same wires that bring the power to operate them, and controlled by an engineer at his desk in a distant power station. By the same development, announced by the General Electric company, 800 street lights in Springfield, Mass., are being lighted and extinguished from one central point with no extra wiring or hand operation of switches. The currents that do the control work, having different characteristics from that supplying power, travel on the same wire without becoming scrambled. The regular power currents in general use travel at

sixty cycles or 120 alternations per second, while the message-bringing currents have much higher frequencies. Those for controlling water heaters, for instance, use a frequency of 720 cycles. With such a system, electric water heaters can be used at night when power is cheaper. The carrier currents will turn the heaters on when the demand for power is light, the water heated at night being stored for use during the day. The carrier currents are the same form of electrical energy which, superimposed upon high-voltage currents, is sent over high-tension transmission cables for telephone communication. Engineers claim it is technically possible to "crowd" a transmission wire with many carrier currents without mutual interference between them or with the regular service current.

Science Service 12/5/31



Cmt. George H Eckhardt.  
4528 Walnut, Phila  
POPULAR MECHANICS

448

a2421

# Stephenson's Engine Model Valued Highly

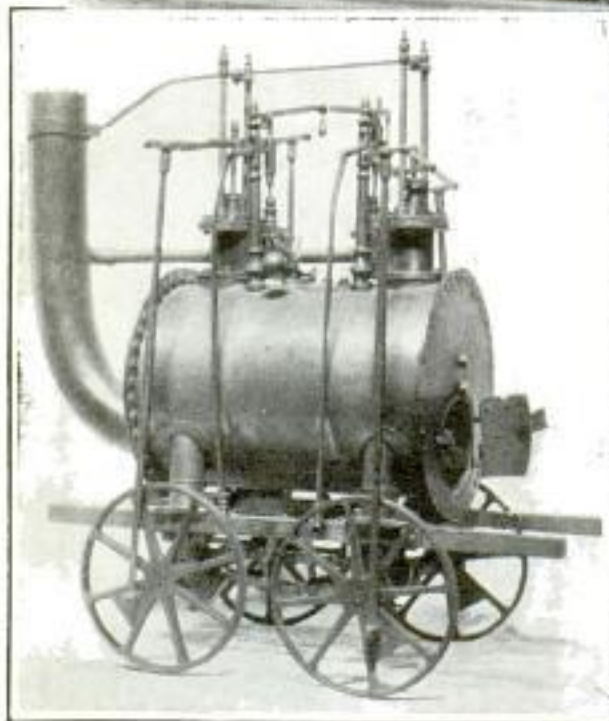
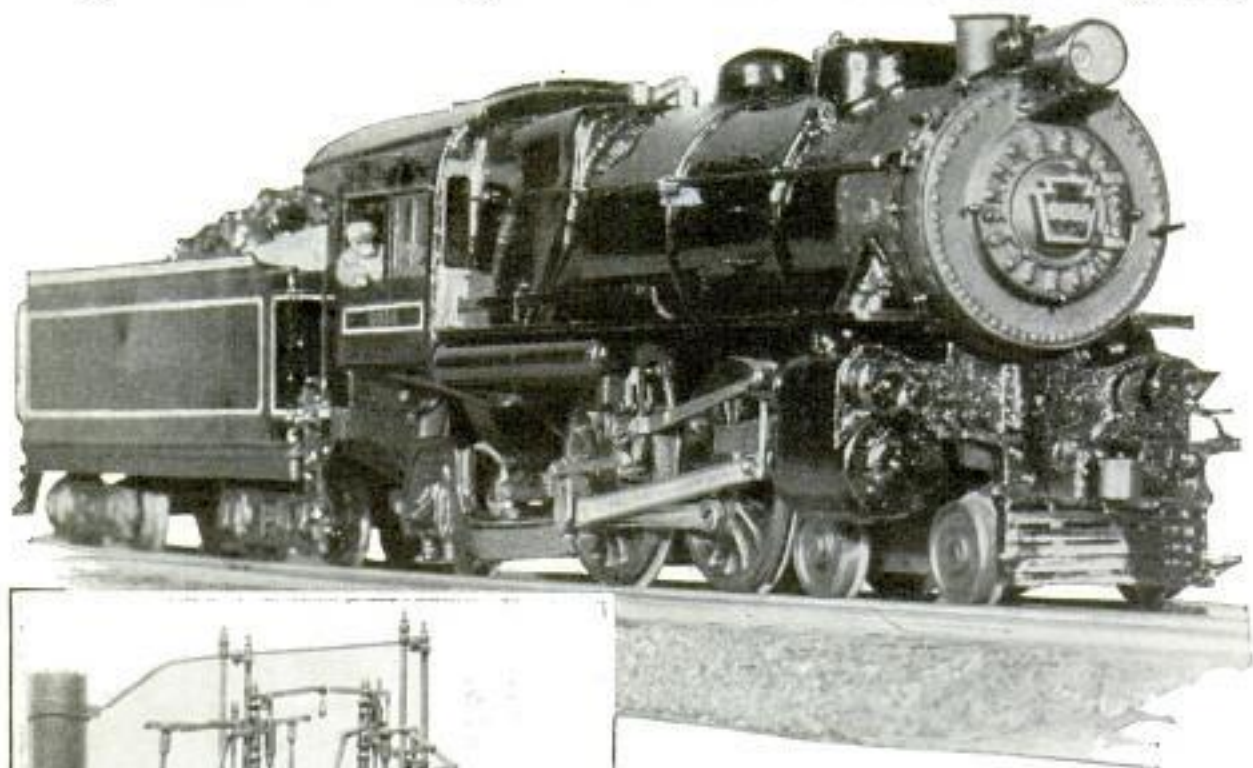

Model of Stephenson's Engine, and at Top, Scale Model of Modern Locomotive

new, and it practically marks the beginning of railroads in America. In striking contrast is a modern engine, a one-fourth-inch scale model.

## LIMIT TO SPEED OF AIRPLANES 2497 SEEN BY EXPERT

Belief that airplanes in the stratosphere would be able to travel at almost limitless speeds and consume little power has been shattered by Prof. Alexander Klemin, of the Guggenheim School of Aeronautics. "Even if the engine power is fully maintained in rarefied air of great altitude, there is a definite limit to the speed at which a plane can fly," he stated. "It is entirely premature at this time to talk of speeds of 1,000 miles per hour. It should, however, be quite possible to double the top speed of the transport plane, and instead of cruising at 150 miles per hour it should be possible to fly at 300 or even 500 miles at 60,000 or 65,000 feet. For such flying, the engine will have to be supercharged with extreme care and the cabin will have to be made air-tight and provided with means for compressing the air and delivering it to the occupants." Two planes along these principles are now being built, one in Germany and one in France.

made by Paul Egolf, 1221 Arch St Phila

made by Paul Egolf, 1221 Arch St Phila

New York University  
Copyrighted material  
New York City



Manufacturers Rev. a 12/17/31

a2519

Christy Bros

a 2490.

Carl. N W Ayer & Sons, Inc

POPULAR MECHANICS

449

Phila

### CIRCUS ELEPHANTS AID IN BUILDING ROAD

When modern equipment bogged in soft spots after several weeks of rain, circus elephants were given the job of helping build a highway between Houston, Tex., and the coast. For the first twelve weeks after the road was started, rain retarded the contractors. Trucks could not be moved through soft places in the right of way, cars on a short railroad spur track could not be switched and other heavy work was handicapped. Then the contractors made arrangements with a circus near by, and the elephants were put on the job, enabling the work to proceed at a rapid rate.

Houston Texas



Elevator Tower Built in Bahia, Brazil, to Transport the City's Population from Lower to Upper Level

### VIOLIN WITH KEYS LIKE PIANO HAS ONLY ONE STRING

Producing the sixteen different notes necessary in playing the average church or popular music, a violin with only one string and with a piano keyboard has been developed. Lacking violinists but having plenty of one-finger piano players, a Sunday-school orchestra leader adapted the piano keyboard to the violin to produce what he calls the "violano."

Spencer in Harris County

a 2498

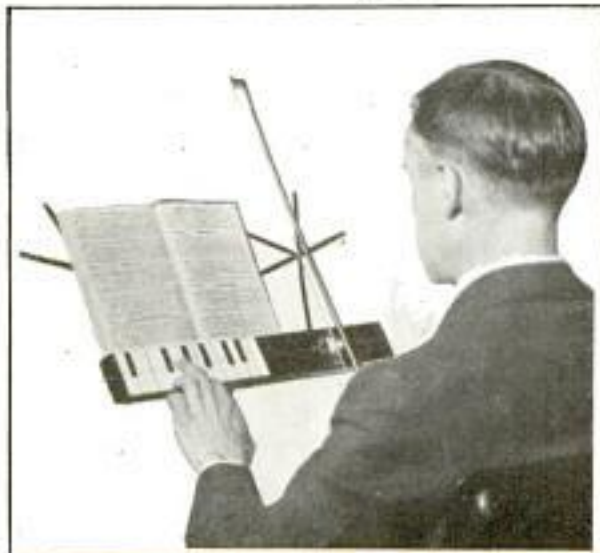

Piano Keys on This Violin Make It Easier to Play; the Instrument Has Only One String

### MOVING A CITY STRAIGHT UP TASK OF ELEVATORS

Giant express elevators carry most of the pedestrian traffic between the upper and lower sections of Bahia, Brazil. The business section of the city borders the bay, while the residential district is on top of a hill 195 feet above. Engineers of the Otis Elevator company were consulted and, at their recommendation, the monumental LaCerde tower was built of reinforced concrete, 240 feet high, and connected with a structure on top of the hill by a bridge. The tower houses two large elevators comparable in size and speed with those in American skyscrapers.

Popular Mechanics Magazine does not publish the name of the maker or seller of any device described in its pages, but this information is kept on file and will be furnished free upon application to our Bureau of Information.

260-11th Ave New York City.

Sole agent. Wm. J. Quenore, 918 Haddon Ave. Camden, N.J.



A 2485  
450

International Harvester Co  
606 S. Michigan Ave  
POPULAR MECHANICS

# Radio Tractor Controlled by Key Plows Field

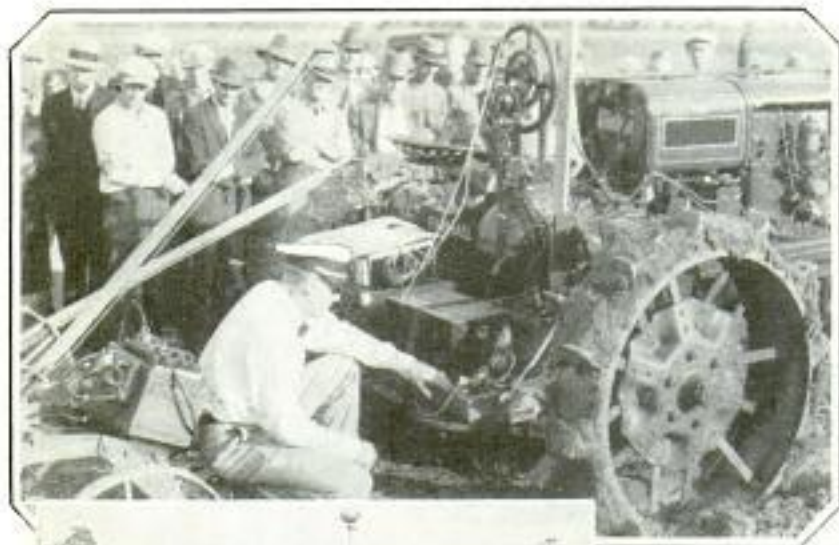

Receiver Attached to Tractor, Top; Plowing Field by Radio, Center, and Sending Apparatus Controlling Tractor's Movement



cussed as feasible. Operation of stationary machinery by radio from the house could be easily accomplished. The apparatus consists of a low-wave broadcasting plant with loop aerial, receiving set and small battery-operated motors for driving the steering wheel, moving the power lift, shifting the gears, and so

The plowing of an entire field by a radio-controlled three-plow tractor was witnessed recently by a crowd in Indiana. A motor truck carried the controlling apparatus in the demonstration, but it was pointed out that it could easily be installed so one operator could drive one tractor and control another by radio from his seat. Possibility of controlling the radio tractor from the farm home without leaving the house also was dis-

on, and selective switch and relays to place the motors in operation. The selective switch has a number of points, and each time the telegraph key is depressed, the radio impulse causes the switch arm to move to one of these. Each controls a separate function of the tractor.

Booklet by J. J. Lynch, Mules City, Mont

## BLACK CARBON AS A WHITENER IS MODERN MIRACLE

Carbon, in its normal state one of the blackest substances, has been known since the fifteenth century to possess peculiar properties of purification. Earlier users, however, knew only of the charcoal form of carbon, made from wood, the most common form, and bone. Boneblack still maintains a position as the key material in the refining of raw sugar. In recent years, materials have been discovered,

known as "activated" carbons, made from vegetable substances and twenty to fifty times more powerful than the charcoals previously known. The activated carbons are made by charring vegetable matter and then removing all hydrocarbons deposited by the process. It is the hydrocarbons that previously limited the activity of the carbon as a purifier. One of the peculiarities of activated carbon is its ability to decolorize almost any solution. It is also used in the manufacture of gas masks, where it likewise acts as a purifier.

Farnall

A 2544

Booklet "Activated Carbon" by C. L. Mantell, Ph.D., Consulting Engineer, coop. Technical Staff, Industrial Chemical Sales Co., 230 Park Ave. New York.



Samuel Beardon,  
Curator of Minerals

POPULAR MECHANICS  
Academy of Natural Science  
OPAL CHIPS FLOATING IN BALL  
MAKE A GIANT "JEWEL" <sup>Q2588</sup>

Opals an inch in diameter would be worth a fortune, but a gem that size can be made from a number of smaller and imperfect opals, or even from opal chips. It has been found that the play of colors in the opal is almost perfectly matched by the refraction of glycerin. Small glass balls, about an inch in diameter, are blown and filled with glycerin containing small opals or chips. When sealed, the small stones send out their beautiful play of colors, aided by the glycerin in which they float. Because of temperature changes and the floating characteristic, the pieces are constantly in motion and present an even more dazzling display than does the actual jewel.

Q2530

HOUSE MOVED ACROSS A RIVER  
WITH AID OF BARGE

Army engineers were faced recently with the job of moving a large frame house across the Delaware river from Fort Mott to Fort Du Pont, and decided it would be easier to float the structure across than to tear it down, move it piecemeal and reconstruct it. The house was loaded onto a large barge, which required twelve hours, then ferried across the stream to its new location, the actual water journey requiring only one and one-half hours.

del



© International News Photo  
Moving a Frame House across a River; the Dwelling Was Loaded on a Barge and Floated

Phela

Q2541



Courtesy C. LaTour, 7806 Ardleigh St.  
Propeller-Pitch Gauge in Use, Above, and Below, a View of the Time and Money Saver

HOURS OF DELAY SAVED PLANE  
BY PROPELLER GAUGE

The pitch of an airplane propeller now can be accurately measured without removing it, and in only a few minutes' time. This is the result of a gauge invented by J. Wesley Smith, of Philadelphia. The operation of checking and adjusting propeller pitch always has been a time waster, usually expensive, and often one which required the propeller to be shipped long distances to have the work done. The gauge in appearance is something like a precision protractor combined with an L-square. It is light in weight, small in size, and easily operated.

Q2506

ROTATION AIDS WIRE DRAWING

Less power is required in wire drawing if the drawplate is rotated, scientists at Manchester University, in England, have discovered. The saving in power is proportional to the speed of rotation. At 3,300 revolutions per minute, the power was reduced one-fourth. No structural differences between the rotated wire and wire drawn in the old way were found.

metal Research Dept.

Eckhardt

Chas. H. Keller Phela  
6227 Academy St  
Bermentown

Technique for All  
12/1931



Q2425 Cmt. Walter E. Burton  
1032 Florida Ave  
Akron, Ohio

# The Latest MIRACLE



*Director of Plant Industry Washington D.C.*

ly independent of seasons, is so easy that almost anyone can do it. The trick lies merely in controlling the length of time during which light falls on the plant.

Many a farmer and flower grower has wondered why a chrysanthemum does not come out with the violets, for instance. Until a short time ago, they concluded that it was a matter of temperature, and perhaps other factors, which they could not very well control.

Then the government scientists took up the problem. Dr. W. W. Garner and other plant experts observed that, when a plant is moved

*Principal Physiological in Charge*

## CAN plants tell time?

Why do some flowers bloom only in the spring?

Can poinsettias that normally display their blossoms only at Christmas time, be made to bloom in the spring?

All these questions have been answered by Uncle Sam's plant wizards who have learned how to juggle vegetables, flowers and fruit so they seem to have lost all seasonal habits.

They have learned how to make spring flowers bloom all summer. They persuade poinsettias to burst forth in June, and ordinary spinach, under their guidance, obligingly produces great, curly leaves until fall.

This process of making plants seeming-

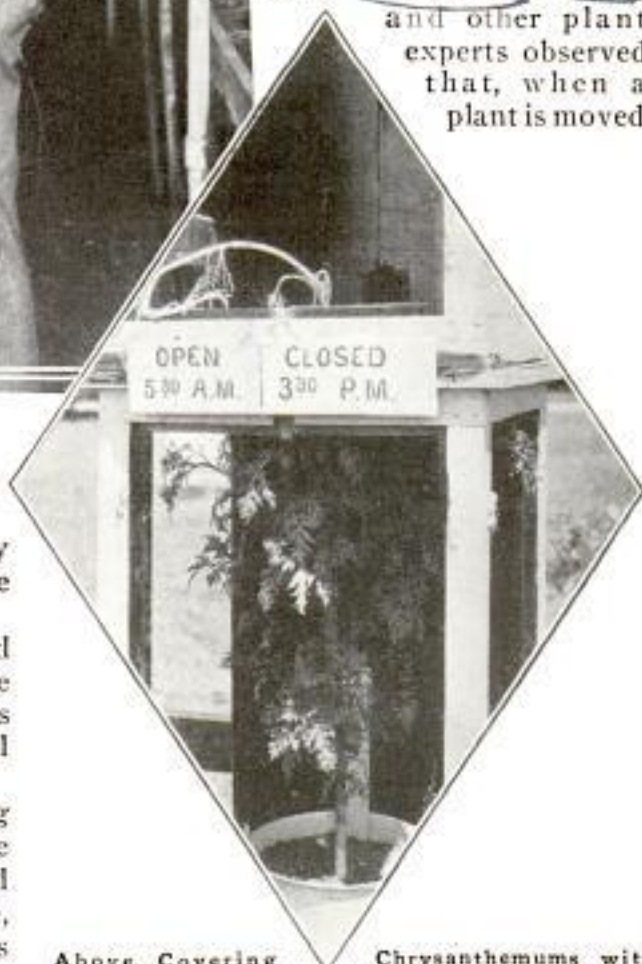

Above, Covering Chrysanthemums with Black Cloth to Induce Them to Blossom Sooner; Right, Drooping Cosmos Plant That Was Kept in Darkness



# of the PLANT Wizards

from one latitude to another, it often changes its habits entirely, blooming during a different part of the year, or exhibiting some other new characteristic.

Experiments soon indicated that the behavior of plants is not entirely a matter of temperature or other seasonal features usually associated with plant growth. The problem of plant behavior was

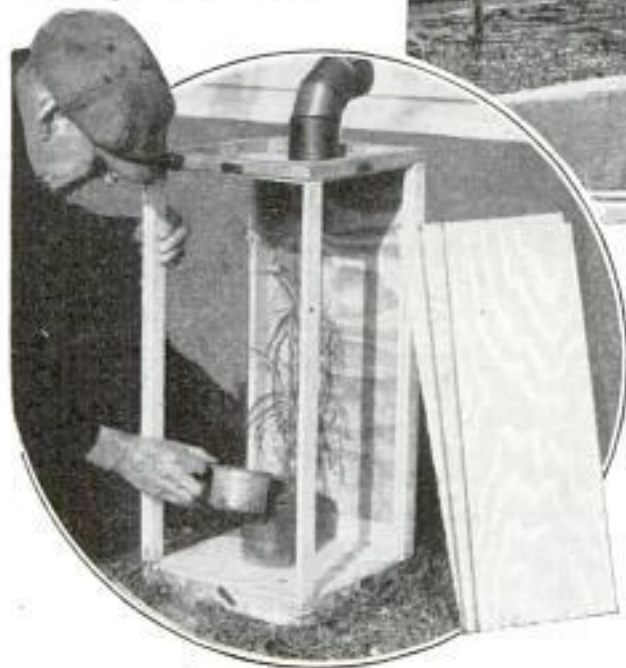

*Dr. J. S. Charleson*  
 Courtesy William Tricker, Inc., *Independence, Ohio*  
 Above, Growing Water Plants under 1,000-Watt Lamp;  
 Left, Box to Force Blooming of Plants

attacked from the standpoint of light duration, with some surprising results. Early experiments were conducted by placing test plants on steel cars which could be run into or out of a light-tight shed. Thus the hours of daylight exposure were regulated.

Soy beans germinated on May 17 and, growing in normal daylight, required 110 days to produce flowers. But they needed only twenty-six days to flower when the daylight ration was cut down to seven hours. By reducing the light period, chrysanthemums were made to flower in summer instead of fall, late dahlias were advanced several weeks, and poinsettias,

usually found in bloom at Christmas, were forced to flower in August. Later, in studying plant response to light, the hours of light exposure were shortened by means of special boxes having removable panels, which could be placed about the growing specimens.

But it is not always to advantage to shorten the duration of natural light. Plants which blossom in midsummer or where days are long during the flowering period, require an increased light diet. This is best attained, at least experimentally, by suspending electric lamps above them and burning these after the daylight period has ended. Fortunately the intensity of light need not be great. Many plants respond nicely to the stimulus from forty-watt lamps. Winter annuals require long days in which to produce flowers or fruit. Plants taken from the field in the fall were placed in a greenhouse and provided with electric illumination from darkness until midnight. In fifty-five to sixty days, they were in full bloom. Control iris plants, not given the additional light diet, did not flower until June.



A 2425  
454

Installation made by Detroit  
Edison Co in Electric  
Greenhouse

POPULAR MECHANICS



Top, Growing Easter Lilies under Artificial Light; Below, Measuring Growth of Lettuce under Lights

Plants can be grouped generally as long-day and short-day varieties. The former are those which produce flowers or fruit as the season advances into summer, with increasing day length. Short-day plants blossom or fruit in early spring or fall,

when daylight hours are fewer. When it is desired to advance the flowering period of short-day plants, the length of summer days can be artificially reduced. Likewise, long-day plants can be made to flower out of season by increasing the light duration. By reducing light duration, growers of spinach have been able to produce plants that remain in the rosette stage indefinitely, like annuals, instead of going to seed. Uncle Sam's experimenters also determined how a plant will grow when one part receives more or less light than another.

By building a box around the top of a cosmos plant, hours of daylight could be reduced, while the bottom portion remained in normal light. In this way, flowering of the top half occurred in midsummer, while the lower half blossomed when October came. Then conditions were reversed, and the lower part flowered in summer, while the upper half waited until the normal time arrived. The upper



and lower thirds then were put on a restricted light diet, while the middle was allowed to grow normally. The top and bottom produced flowers first, while the middle remained inactive until the flowering season came in October. Hence it was concluded that, in some plants at least, the effect of light is strictly localized; and that, when all parts of a plant are subjected to some daylight, the controlling of one section does not affect another appreciably. Experiments when part of a plant is kept in darkness indicate that the effects of light extend to adjacent parts when these

and not in the middle. It is a little early to outline all of the ways in which the knowledge of light duration and its effect on plants can be put to work, but a few

Water Plants Grown under Electric Lights and Chrysanthemums Brought in Earlier by Use of Black Shades

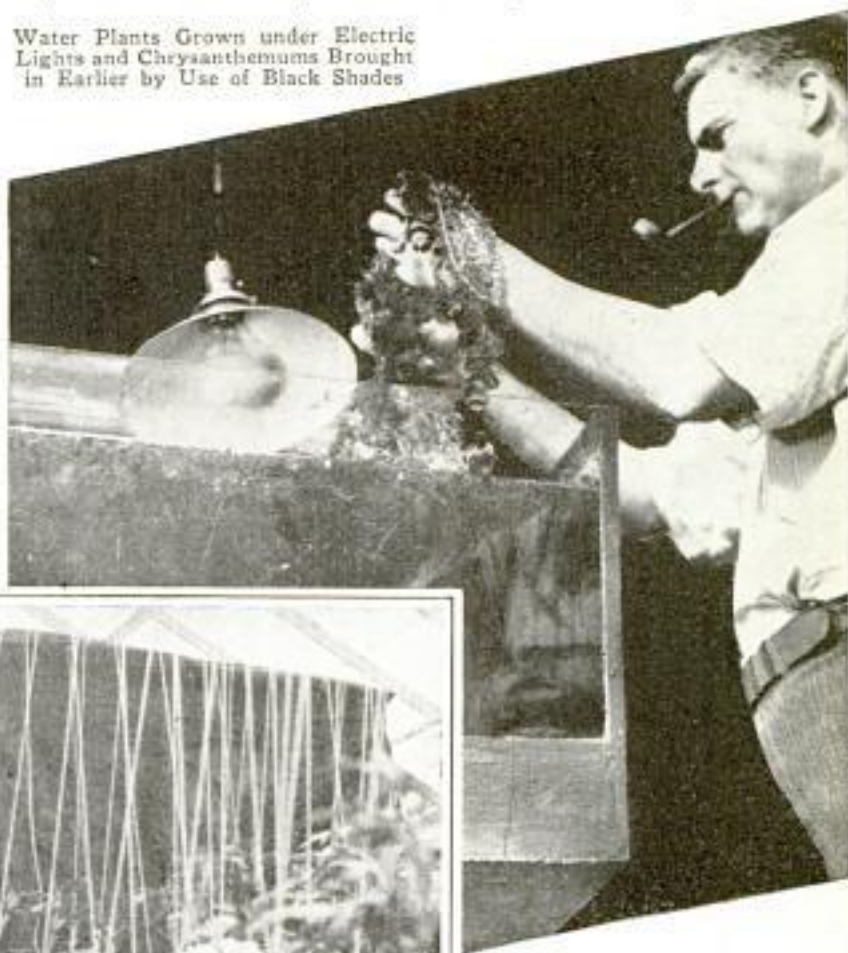

Courtesy Ohio State University

*Prof. Allen Laurie*

are dark, and that continuous darkness itself will not hasten flowering.

The department of agriculture experimenters further found that an increase or decrease of light, to be effective, must be made at the beginning and end of a day,

applications already have been made.

Florists, simply by darkening their greenhouses for a little while each day, can speed up the production of chrysanthemums which otherwise might be late; or by lengthening the day with electric lamps they can delay flowering until Christmas. They can grow violets throughout the entire summer by taking away some of the light.

Now, also, strawberry growers have a means of determining just where a new kind will do best. Specimens are put through tests to find out how many hours of light they require a day, whether they have a rest period, and what effect temperature has on them.



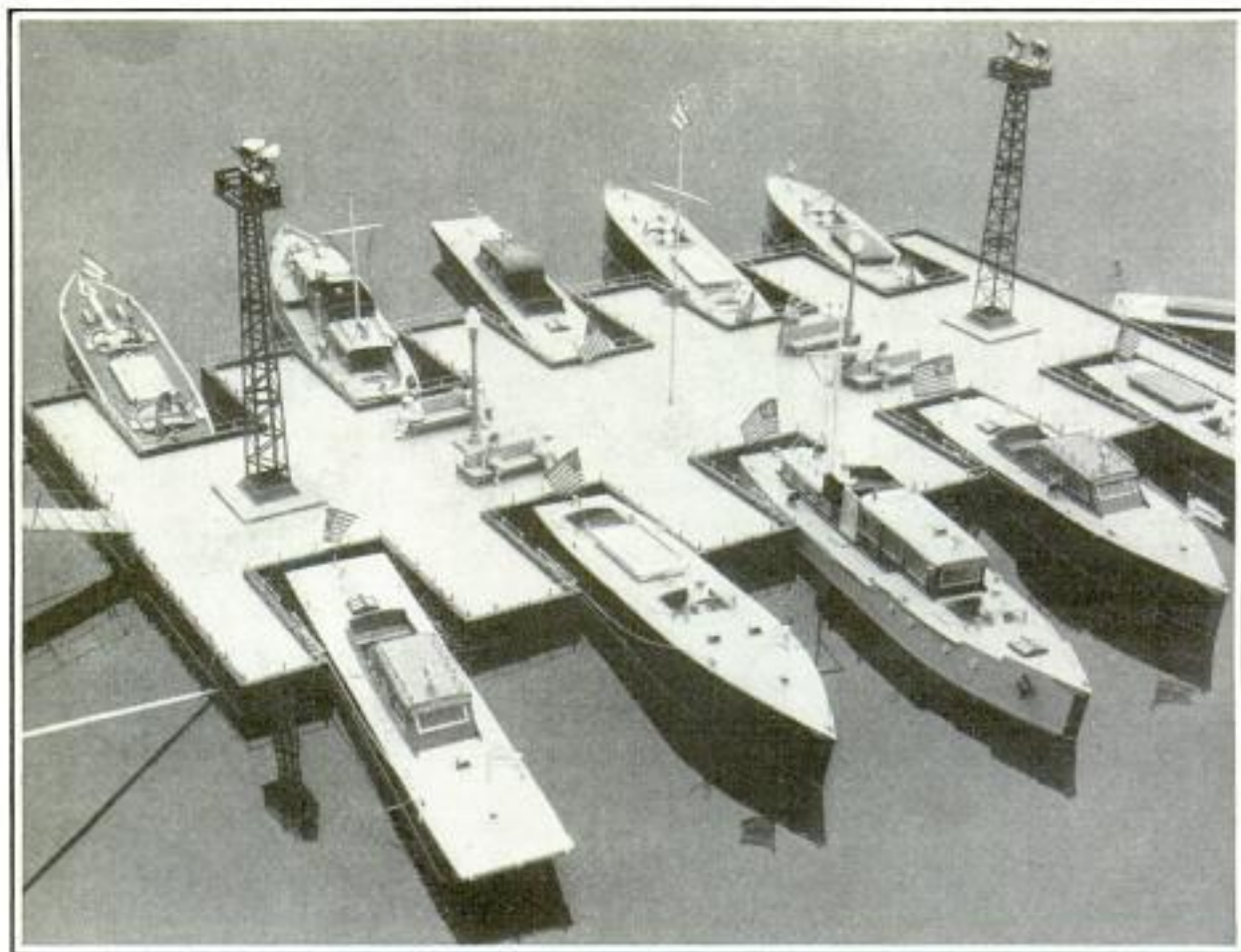

Model Boat Landing Built for a Miniature Speed-Boat Regatta; the Yacht Dock Accommodates Ten Boats, Each Two Feet Long, and Is Complete Even to the Light Towers

**YACHT DOCK FOR MODEL BOATS ACCOMMODATES TEN CRAFT**

Models have been built of nearly everything, and now a miniature boat landing has been constructed in California, complete in every detail, even to light towers and a landing platform. The dock accommodates ten model boats, each two feet long, and was built for a miniature speed-boat regatta in Los Angeles.

**PERFUMES SOLVE MAIL THEFT WHEN PUT IN MUCILAGE**

Perfumed mucilage recently solved a baffling series of mail thefts in the southwest after the robberies had been narrowed down to one of six post offices. Packages and letters had been opened, their contents removed, and resealed. After several months of work, an inspector hit upon the plan of perfuming the mucilage pots of each of the six post offices with a different scent. When the next opened letter was examined, he mois-

tened the flap, sniffed it, and announced that he soon would solve the mystery, as he now knew which of the six offices involved harbored the thief.

**BOOK PRINTED ON PAPER STRIP READ WITH "LORGNETTE"**

Every author can be his own publisher if he uses a printer and reading machine developed by Rear Admiral Bradley A. Fiske which enables a 100,000 word novel to be printed on two strips of paper about as long and wide as an ordinary newspaper column. The cost of such a "book" would be about five cents and it could be sent anywhere in this country for the price of a two-cent stamp. The process of making the book is simple. First, the manuscript is typed on a sheet of paper about two-thirds the width of an ordinary letter head. At the end of each twenty-third line—the average length of a book page—the typist jumps a space and begins the next. The typed script goes to a

*at Echo Park, Los Angeles, Calif.*

*A 258*

*Com. Everett Sprung, 1729  
N. Capitol St. Washington  
D.C.*

*U.S. N. retired  
Hotel Commodore  
New York*



A 2540

E. W. Ruggie  
30 Carroll St  
457  
Trenton, N.J.

photo engraver who reduces it to one twenty-fifth of its size. The author takes the four plates, one for each side of the two strips of paper, to a printer and in a day or so can mail out his book. To peruse the volume, however, requires a reading machine which likewise is inexpensive. It weighs less than four ounces and resembles a lorgnette in size and shape. It has two lenses but a shield can be used to cover one while the reader looks through the other. The machine is held on the nose, and after a page is read, the thumb of the hand holding it turns a screw to bring the next "page" on the strip of paper into view. After reading the first 25,000 words on one side of one of the two strips of paper, the reader reverses the paper and peruses the other side. It is claimed that there is actually less strain in reading through the lens with one eye than in the ordinary manner with both. It is believed the process will make available many technical works which now never see the light of day because of the cost of printing.

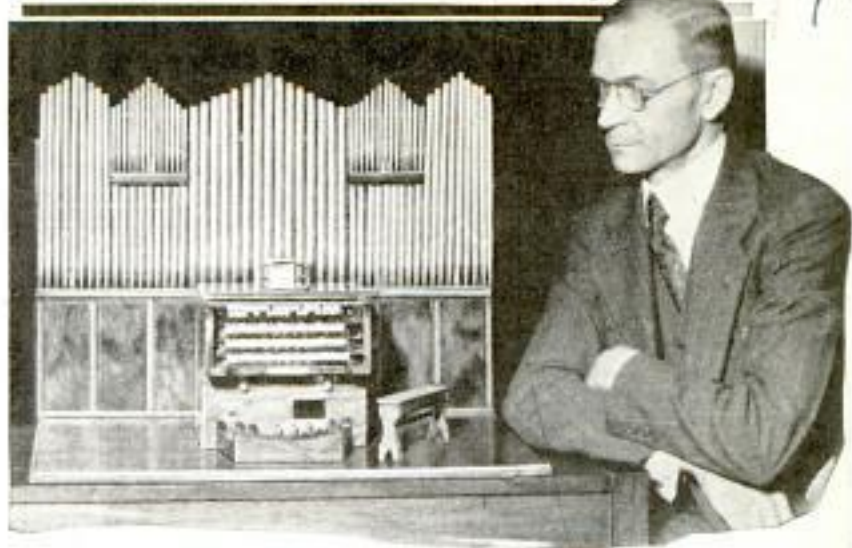

This Midget Organ, Complete in Every Detail, Really Plays; Electricity Operates a Blower Which Causes Reeds to Produce Notes

**MINIATURE PIPE ORGAN PLAYS, BUT BY ELECTRICITY**

Complete in every detail, even to the 108 keys only one-fourth inch wide, a miniature pipe organ which is played by electricity has been constructed. The keys and pedals of the organ are workable, but will not cause the organ to sound because the making of miniature magnets and air valves would be too difficult. The instrument is equipped with a small motor driving a blower which operates on a set of reeds to produce chords of pure organ tones. The pipes are eighteen inches high and twenty-four inches wide, while the console measures seven and three-quarters inches high, seven and three-quarters inches wide and seven and one-half deep. The pipes are bronzed.

Using a Reading Machine to Peruse a "Book" Printed on a Paper Strip



**EVEN SPACING OF CORNSTALKS PRODUCES BIGGER CROP**

If corn is planted in evenly spaced hills, one plant to a hill, the yield will be improved in several respects. Dr. George H. Dungan, of the University of Illinois, has found that this method produces a greater grain yield, greater uniformity of plant size and weight of ear and earlier maturing. Doctor Dungan tried raising the same number of stalks per acre that is customary under the present practice of planting two or more seeds in hills about three feet apart. But instead of bunching the seed, he spaced them evenly and gathered a bigger crop.

Science Service 12/21/19

American Society of Plant Physiologists

yet a market  
6/15/02

Arbans. d.l.



Q2476

*Ex. Timmers, Hillside  
Road, Ewell,  
Surrey, England*

# From EUROPE to NEW YORK

By G. H. DAVIS

(Special correspondent who recently was commissioned by Popular Mechanics to visit the Raketan Flugplatz, the world's first rocket airfield near Berlin, to learn what has been accomplished there.)

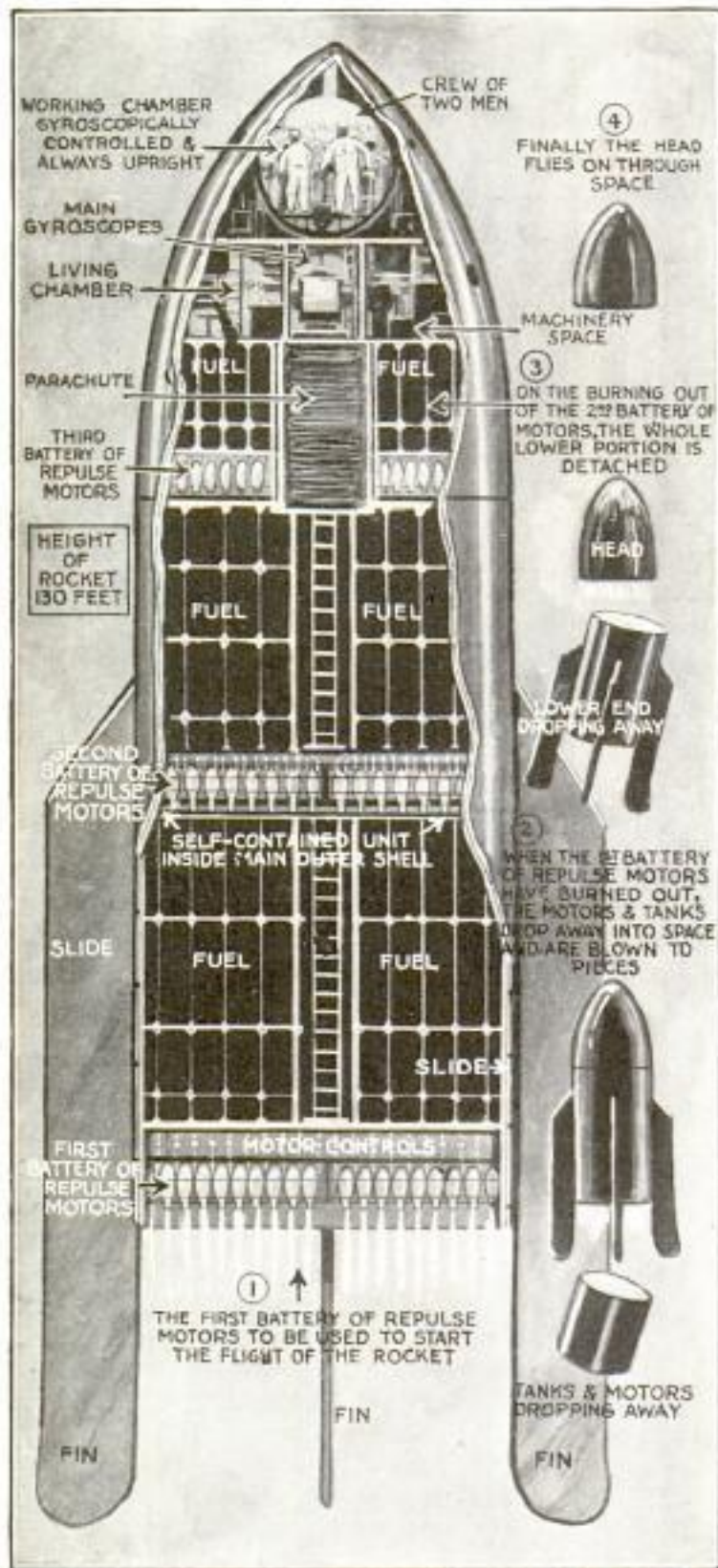

ARE we within measurable distance of a rocket post from Europe to America in which special-type rockets will be able to carry a considerable amount of urgent mail and parcel post from Berlin to New York in about twenty-five minutes?

So much has been said about rockets in the last few years, so many extravagant promises have been made for them, that the enormous technical difficulties in the way of developing these new sources of power for useful ends has often been lost sight of. Along with all this talk, fortunately, experiment and research of the most dramatic kind have been in progress. For two years engineers and experimenters all over the world have been endeavoring to master the innumerable obstacles in the way of success, and now their efforts are beginning to bear fruit.

Only last summer the first conquests were made in the long campaign which may lead to the development of mail and freight-carrying rocket projectiles, rocket-powered passenger lines girdling the world, and perhaps even interplanetary exploration. These are the ultimate dreams of practically every worker in this field, and now for the first time they seem to have been brought within the range of possibilities, from an engineering point of view.

These first steps have consisted principally in finding ways to overcome some of the difficulties in the use of liquid explosive fuels. Ordinary skyrocket-saving rockets, and many experimental rockets, including

Drawing by G. H. Davis  
Drawing Giving Some Idea of What a Rocket Designed to Carry Two Men to the Moon and Back Would Look Like, as Suggested from Data Known at Present



# by **ROCKET**?

*Pendray  
rebel*

Shall We Soon be Sending  
Mail Across Ocean in  
Twenty-Five Minutes?



Left. Testing Small Rocket Motor in Metal Container; Below, Experimental Rocket Motor Developing Fifty Horsepower

cently sent to an altitude of six miles by Reinhold Tiling at Wandergog, Germany, are driven by a variety of gun-powders. This composition, burning at a rapid rate, generates the gas pressure necessary to drive the rocket.

But these fuels are useless in large rockets for several reasons. In the first place, there is no simple way to control the speed of burning. An even more serious objection is that dry fuels have been shown by experiment to be too weak for the needs of long-distance rockets. One of the first rocket engineers to call attention to the fact that these difficulties might be overcome by using liquid fuels was Dr. Robert H. Goddard, the great American rocket experimenter. Almost at the same time Prof. Hermann Oberth in Germany, and Robert Esnault-Pelterie in France, published results of their own researches pointing to the same conclusions.

The fuel of a rocket, whether powder or liquid, must burn with extreme rapidity; so fast that, if it were to depend upon the oxygen of the air for combustion, it would not work at all. Pyrotechnic fuels, such as are used in skyrockets, include chemicals which liberate the necessary oxygen during the heat of the explosion. If we use liquid fuels, such as gasoline, we must supply not only the fuel but

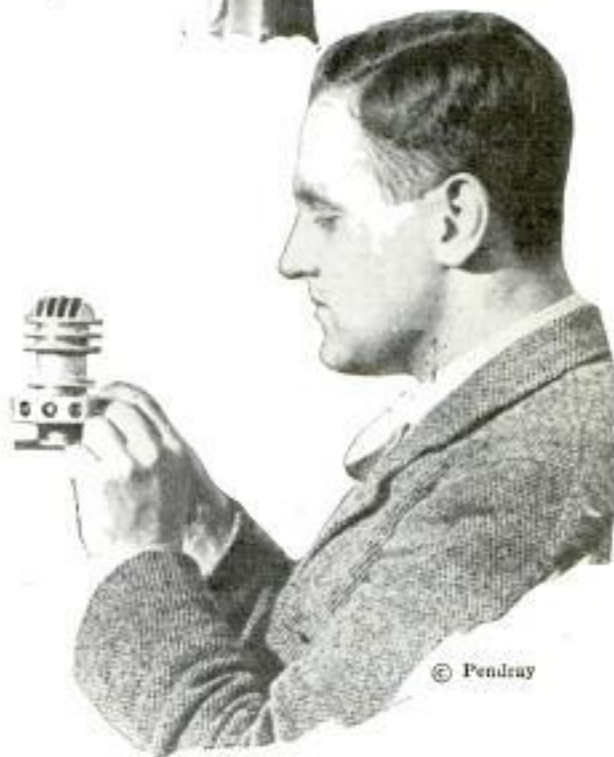

© Pendray

also the necessary oxygen. Thus one of the liquid fuels must always be liquid oxygen, for obviously the best way to carry oxygen in a rocket is to use it in its liquid state. Liquid oxygen is cranky and dangerous stuff, boiling at the frightfully low temperature of  $-182$  degrees centigrade



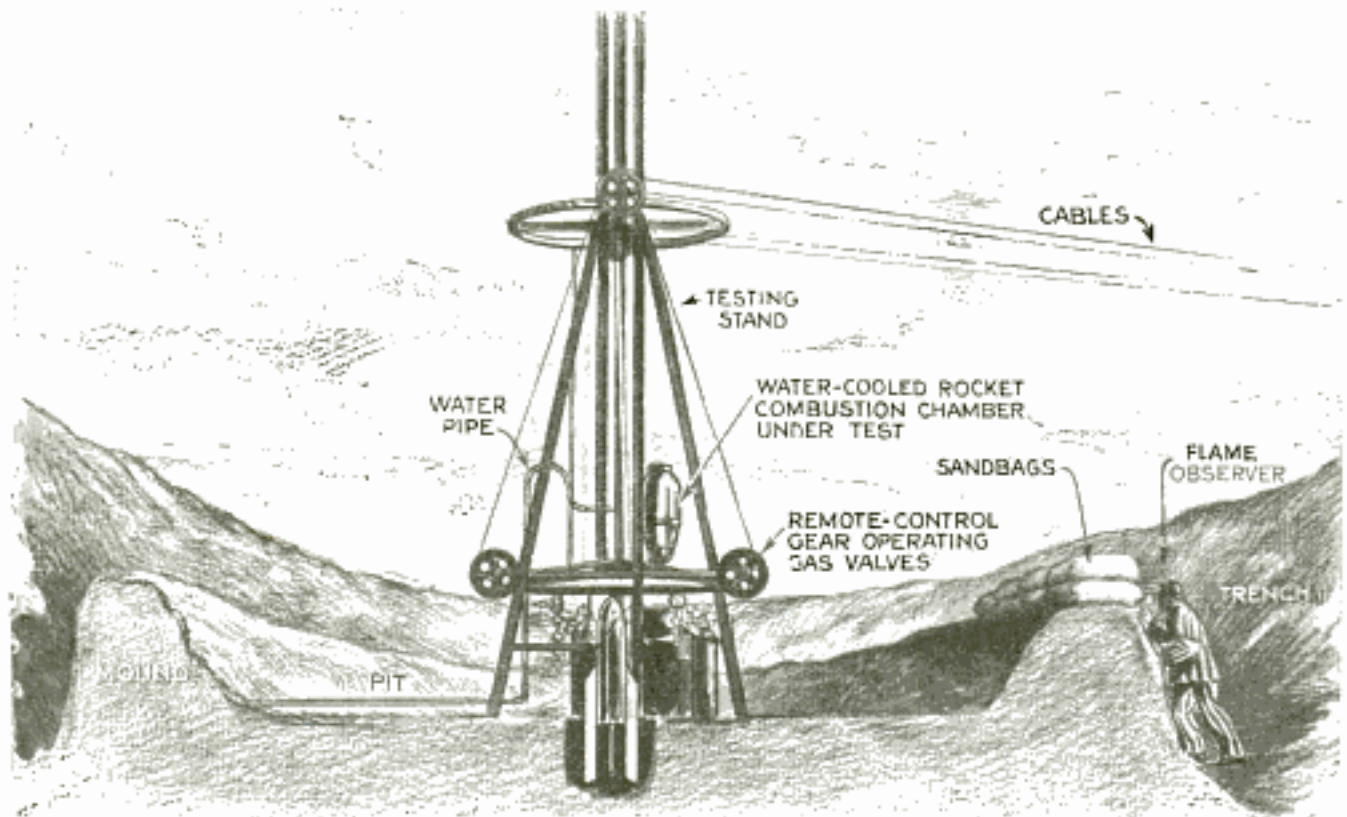

Drawing Indicating the Elaborate Precautions That Must Be Taken to Protect Men and Equipment during Rocket Tests in Germany, Owing to Limited Knowledge of What May Happen

and exploding violently from its own gas pressure if confined in a tank at ordinary room temperatures. Consequently there is a serious problem in the control of this volatile fuel under the conditions present in a rocket, where the temperature in the oxygen tank is about  $-185^{\circ}$  and in the combustion chamber, only a few inches away, that of an oxyacetylene flame.

Another problem is how to get the liquid fuels into the combustion chamber of the rocket against the frightful heat and explosion pressure there. The fuels must, of course, be introduced rapidly and steadily to keep the reaction pressure steady. This calls for some kind of pumping apparatus, yet any type of mechanical pump would add greatly to the weight of the rocket—perhaps so much as to overcome the advantage of liquid fuels over dry fuels.

Finally, the change to liquid fuels brings up innumerable questions relating to the rocket motor itself. What is the best shape? What materials must be used to withstand at the same time high pressure and intense heat? How can the motor be kept cool to prevent melting or bursting?

At what points and in what direction may the fuels be introduced, and in what proportions? Finally, what should be the shape of the nozzle, and how long should it be? These problems are still not completely solved, though engineers are now working on liquid-fuel rockets in at least seven countries.

The first liquid-fuel rocket ever to fly is believed to have been shot by Doctor Goddard near Worcester, Mass., on July 17, 1929. This rocket, burning oxygen and a hydrocarbon fuel, the exact nature of which has never been revealed, made a successful flight and landed by parachute. But its performance has since been so far surpassed by the German rockets that the credit for solving the major problems of fuel pumping and control must apparently be given to the engineers of the Raketen Flugplatz, or rocket-flying field, at Berlin.

This field is the property of the Verein für Raumschiffahrt, or German Interplanetary society. The thousand or more members of this society support the work at the flying field, and six full-time engineers are employed, under the direction of Rudolf Nebel and his assistant, Klaus Reidel.



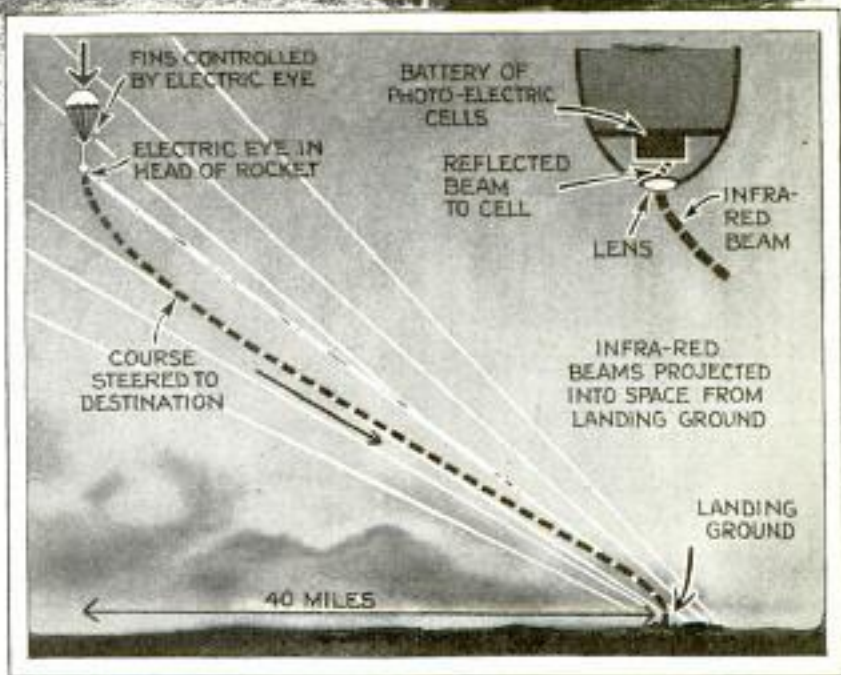
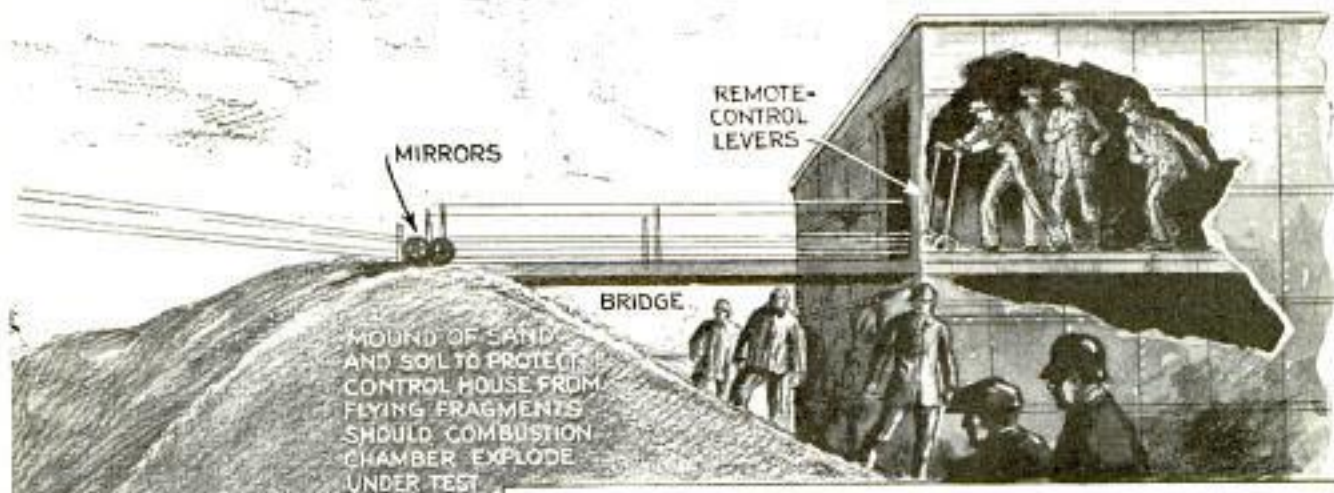

Diagram Showing How It Is Proposed to Use the Electric Eye, or Photo-Electric Cell, to Steer a Rocket to Its Destination

As might have been expected, it was at the Raketten Flugplatz that many of the major advances in harnessing liquid fuels to rockets were made.

It has certainly been demonstrated that liquid-fuel rockets can be built and will fly, and also that the efficiency of the rocket motor, when properly constructed, is very great.

The motor used by the Germans in their experiments is actually only about the size of an egg, and somewhat the same shape, with a nozzle about two and a half inches long. The whole apparatus may be concealed in the hand. Built of duralumin, it weighs somewhat less than half a pound. Yet it will deliver a lift of over thirty pounds, and is capable of hurling a fifteen-pound rocket nearly fifty miles into the air in one minute if sufficient fuel is provided to keep coming going so long.

At the Raketten Flugplatz a rocket, capable of flying for an hour and twenty minutes, is being constructed. The rocket is a... tra-

chute to bring the whole apparatus down safely. This rocket will have three motors, each about eighteen inches in length, and each capable of lifting 180 pounds. It will be possible to build a rocket weighing about a quarter of a ton, which will have an acceleration of about thirty-two feet per second and a range of many miles, depending upon the amount and type of fuel carried.

The next problem to be solved in rocketry is the difficult one of flight control. It is now mechanically possible to build a rocket capable of crossing the ocean, but as yet we have no apparatus which will guarantee that it would land where di-





© Pendray

rected. Some kind of light, efficient and automatic steering device must be invented which will control the rocket in flight and bring it down at the proper point. To date, almost no experimental work has been done on this angle of the problem, because the first task obviously was that of constructing a liquid-fuel rocket which would fly at all.

So far the European engineers have made the greatest strides in solving the rocket problem, but we may confidently expect that the next great advances will be made by Americans. Already experiments are being carried on in the United States in at least four widely separated places. Doctor Goddard is working silently at his laboratory in New Mexico, aided by a fund of \$100,000 made available to him by the late Simon Guggenheim. In San Francisco, another member of the American Interplanetary society, Cleve Shaffer, is building his fourth experimental rocket motor. A third experimenter is Harry W. Bull, of Syracuse, N. Y., who is carrying on his work in the laboratory of the University of Syracuse, and will soon build a rocket to test important theories of his own in relation to flight stability and control. A fourth experimental project is that of the American Interplanetary society, near New York City,

where a rocket is now being built under the direction of Edward Pendray, David Lasser and H. F. Pierce. Dr. H. H. Sheldon, of New York University, is also aiding with this project.

At any one of these four points of experimentation the important idea may be developed which will lead to positive control of rockets in flight. When this has been accomplished, it is only a matter of time until the stratosphere will be explored by rocket projectiles, and until rockets will be flying from city to city and across the ocean, bearing mail, express and even passengers. When these objec-



Above, Copper Lining of a Small Rocket Motor; Below, Pouring Liquid Oxygen into a Test-Stand Tank

tives have been reached, the next step will be the problem of sending a rocket out into space, to the moon or to another planet.

It is well known that to escape earth's gravitational pull a rocket must rise 250 miles of the atmosphere to the stratosphere. To be able to keep a rocket in the air for a period of time...

113 W. 42nd  
New York



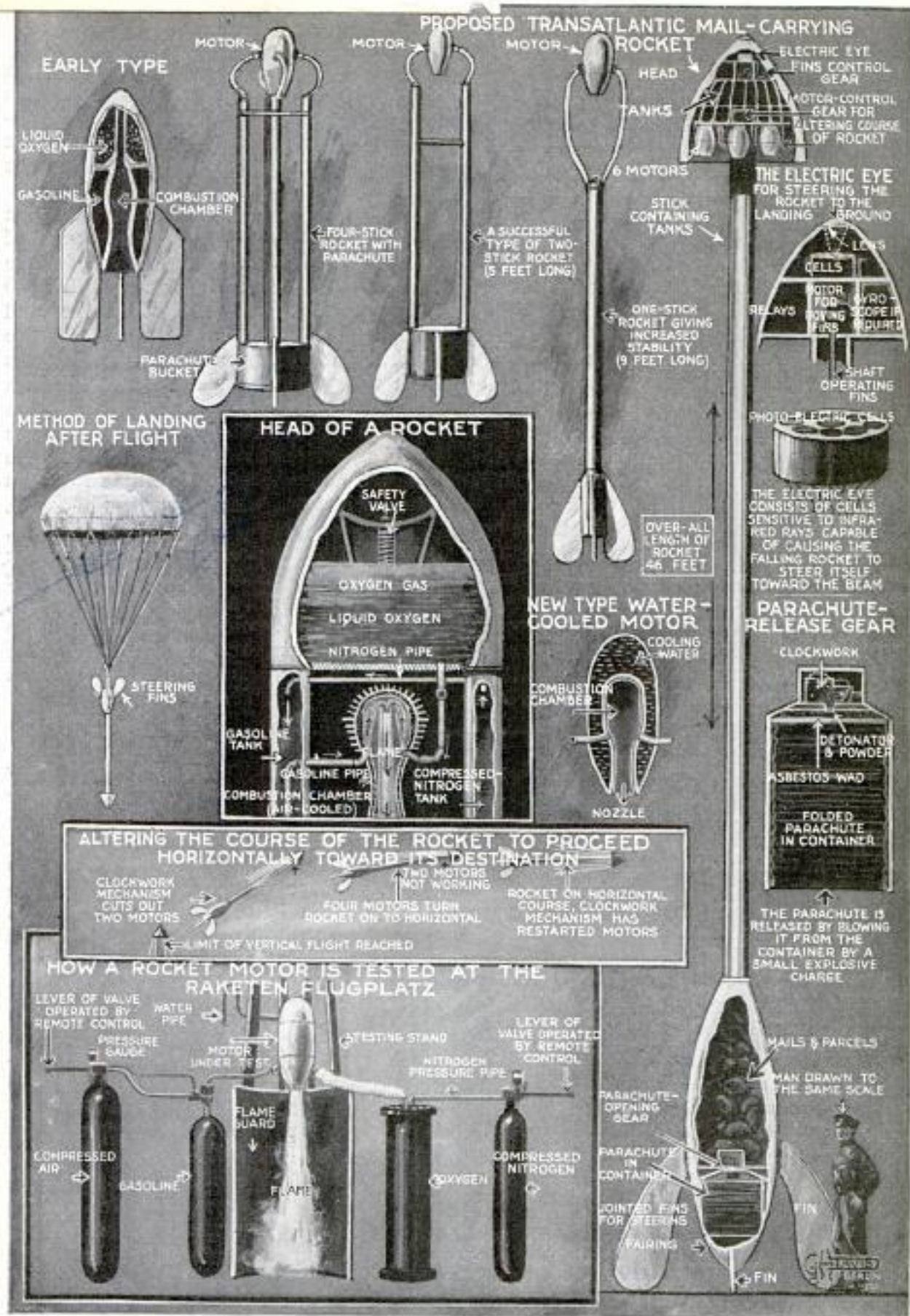

Some of the Earlier Types of Rockets That Have Been Used Successfully as Compared with the Proposed Transatlantic-Mail Rocket; Note Parachute-Release Gear



Q 2476  
464

vehicle would also not only have to lift itself away from the earth, but also have sufficient energy to continue to combat the earth's pull, a pull that continues—with diminishing intensity 'tis true—to infinity. Therefore it will be seen that the propellant must be of enormous power-for-weight to lift the rocket through the atmospheric belt into free space.

It has been figured that a flight across the Atlantic would require a rocket forty-six feet in length, driven by at least half a dozen motors and that it must climb right up through the atmospheric belt to a height of 300 miles. So definite are the scientists in the accuracy of their calculations that they claim there will be not more than a fifty-mile error at the end of the flight; that is, the rocket will be within fifty miles of its destination should it be allowed to fall directly to earth.

But to get over this error efforts are being made to perfect gear for guiding the rocket "home." Scientific people in Berlin have now constructed photo-electric cells sensitive to infra-red rays. Experiments are being made to project the rays to considerable distances and guide the falling rocket to its point of destination by means

of an "electric eye" in the head of the rocket.

To arrest the free fall of the rocket, a special type of parachute has up to the present been found to be the most satisfactory fitment, though vanes somewhat like those of an "Autogiro" airplane have been tested.

It may to us seem inconceivable that man will ever fly, at a speed undreamed of today, vast distance through space, for the moon is a minimum distance of 240,000 miles away, Mars 50,000,000 miles and Venus 26,000,000 miles distant from the earth. But what would our grandparents have thought if someone had told them that man would be flying at 400 miles an hour in 1931 and others talking across the world by wireless telephony, or using the hundred and one other scientific wonders that are just everyday playthings of today.

These people of the rocket science, not only the German enthusiasts at the Raketen Flugplatz, but many men in other parts of the world, are not just dreamers, they are skilled scientists and engineers who are helping forward the progress of the human race, and that is all there is to it.

**WRENCH HUNDRED FEET LONG HELPS END OIL FIRES**

A wrench with a wire-cable handle 100 feet long recently was employed in ex-

tinguishing an oil-well fire in Texas. The outlet pipes around the casing were melted off. Hugh L. Patton, a teamster who has become a fire expert, began operations by placing his special wrench around the "Christmas tree," as the maze of outlet pipes is known, attaching his hundred-foot handle and unscrewing the pipes until the flow was confined to the main outlet. Then he brought into play another of his devices, a nozzle operated by a steam shovel with a long beam. The shovel pushed the nozzle into the pipe that runs into the oil sands, and water under pressure was pumped in. When it reached the oil sands, it displaced the oil in the casing and put out the fire.

B-15

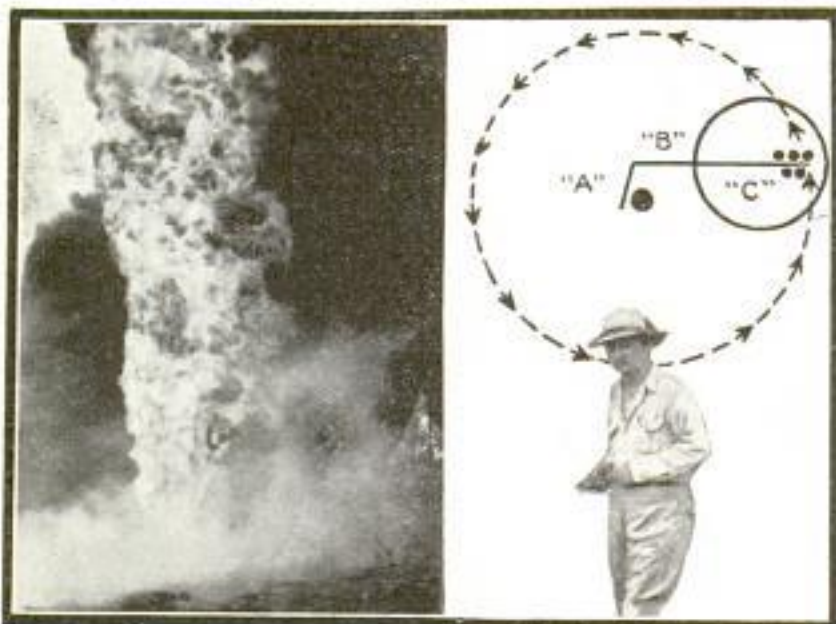

How Men "Walked" Wrench; "A," Well; "B," Handle; Inventor Below

*Inv. Hugh L. Patton, Overton*

Copyright material



*Cont. Esuy Korman, u 2493*  
*% Dr. Ward Machel, 85 Rockrose*  
 POPULAR MECHANICS

**WAVES HIGHER IN SOUTH SEAS THAN IN NORTHERN**

Careful records kept by hydrographic offices of several governments have established the fact that ocean waves seldom reach a height of more than forty feet in the most severe storms. On very rare occasions they have been measured at eighty and ninety feet, tidal proportions. Seas produced by the same degree of wind, however, will rise higher and have crests at greater distances apart in southern latitudes than they will in northern sections. Gales in the north will cause waves from thirty-five to forty feet in height, with crests three to four hundred feet apart, while in the southern hemisphere the gale will cause seas to run between forty and forty-five feet in height, seven hundred feet apart. The reasons given are the nature of the southern storms and the distribution of the land, which is greater in the northern hemisphere. Most northern storms are of cyclonic origin and are quickly beat down by shifting wind, while in the south the wind blows almost constantly from the west. Waves appear much higher to the ocean traveler because of the rolling.

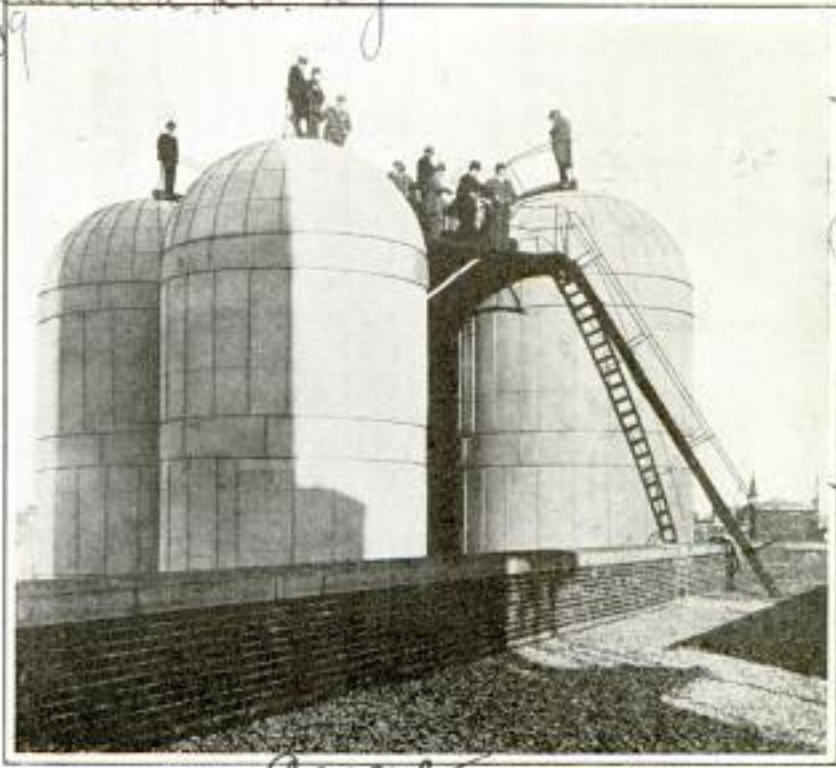

Steel Tanks of Special Design Are Used to Store Up Steam Generated in Slack Periods by Swedish Plants

**TANKS BUILT TO STORE STEAM FOR RUSH HOURS**

Storage tanks for conserving steam have been constructed in Sweden to equalize the load of producing plants. Steam manufactured in slack periods is stored in the reservoirs to carry the heavy burden of rush hours.

**"FOOLS' GOLD" BURNED AS FUEL WHERE COAL IS SCARCE**

Iron pyrites, the glittering metal known as "fools' gold," have been discovered to have potentialities as a heat-producing element. Experiments in South Africa near mines where there is a shortage of fuel have been so successful that the iron sulphide now is to be burned to generate steam. The chemistry of the combustion is simply the formation of iron oxide from iron sulphide, with its accompanying intense heat. The method is particularly effective in districts where copper is mixed with the pyrite, as the copper can be recovered from the ashes. Three hundred tons of pyrite have about the same steam-producing ability as fifteen tons of coal, but the valuable metallic products recovered add to the efficiency.

*Dr. W. Johannes Ruths, Swedish inventor*

**STOP SIGN SINKS IN PAVEMENT AS AUTO PASSES OVER IT**

Disappearing stop signs that sink into the pavement as cars pass over them are being used in California. These warnings are made of cast iron and are fitted into a recess in the road surface. They are balanced by weights beneath the pavement which lift them into view as soon as the wheels have passed.



*Emb. Eckhardt*

*Signal Equipment Co*  
*41 85 Duquesne Ave*  
*Los Angeles, Calif*

*The Buring Magazine*  
*London*  
*Copyrighted material*



# A Modern Radio Test Panel for Service Men

## Easily Assembled from Standard Parts



erating conditions. Practically any receiving tube may be tested, if proper adapters are used. A material list is available. Rectifier and screen-current measurements may be taken; in all screen-grid tests, a short flexible lead is connected from the grid-terminal post to the cap on the tube, and another lead between the grid-clip post and the grid clip in the receiver. Grid-voltage measurements may be taken with the 150 positive range of the grid voltmeter for a screen-grid amplifier tube. This meter should be cut out of the circuit before inserting the plug in any

Every radio-service shop should be equipped with a panel capable of carrying out any test of a receiver that is necessary for its operation. Commercial equipment of this type is often beyond the reach of the small shop, but a comparatively inexpensive set analyzer, with binding posts available for external tests, may be constructed from standard parts. The resistance values are all designed for Weston meters; if other instruments are used, the proper values would have to be obtained from the manufacturers. The bakelite panel is  $\frac{3}{8}$  by 14 by 28 in., and can be bought cut, drilled and engraved if desired. Two shelf brackets hold the panel upright at the rear of the bench, as shown in the lower photo. The two small batteries specified are placed behind the panel, and the leads are identified for convenience according to the color code given at the top of the diagram. When ready for use, as shown in the upper photo, the tubes are removed from the receiver, one at a time, and inserted in either the 4 or 5-prong socket, and the cable plug into the socket in the set. In this manner, the tubes may be accurately tested under op-

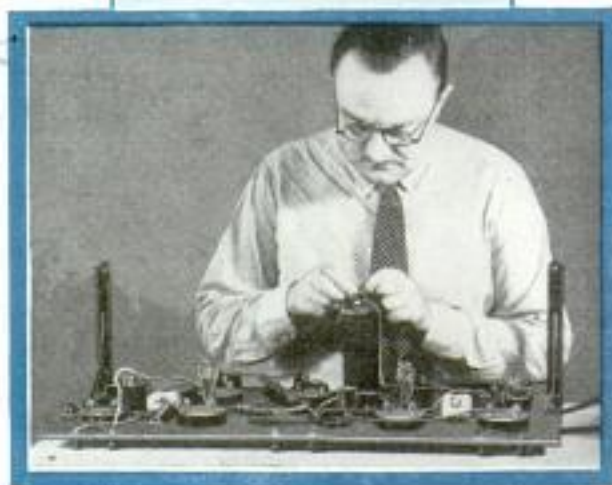
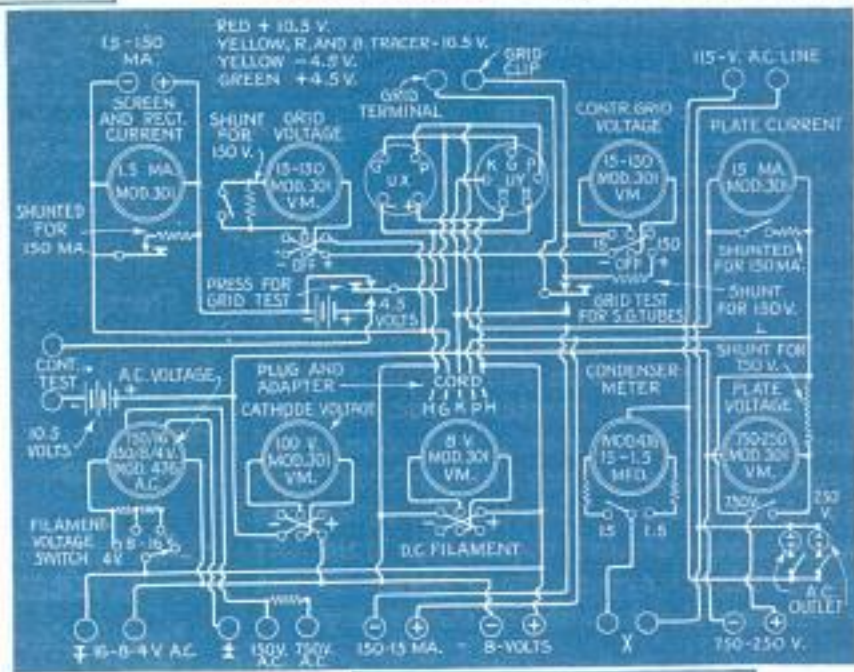



rectifier-tube socket. Other tests that may be made include determinations of control-grid voltage, plate current, a.c. filament voltage, cathode voltage, d.c. filament voltage, condenser and resistance measurements, d.c. plate voltage and continuity tests.

### Improving Hand-Wound Coils

A piece of friction, or adhesive, tape on the thumb and finger will enable the experimenter to wind his coils evenly without the burning and chafing that usually accompanies this operation. This will not only protect the hands but will provide additional friction to keep the wire taut.

### Talking-Picture Machine Is Portable

Talking-pictures for homes, clubs, camps, hotels and churches are now available by means of a small portable talking-movie machine employing 16-millimeter film and playing either standard or 16-in. talking-picture records. A medium-size transparent screen is supplied as a part of the portable equipment, but, if desired, a 7 by 9-ft. screen may be placed 25 ft. from the projector. A 250-watt lamp is used within the projector, and a small a.c. motor drives both it and the phonograph turntable. By means of an automatic device, the film and record are synchronized immediately upon starting the motor. The sound equipment consists of a powerful amplifier employing a screen-grid tube in the first stage, directly coupled to two type-45 power tubes in push-pull. A type-80 full-wave rectifier completes the amplifier unit.

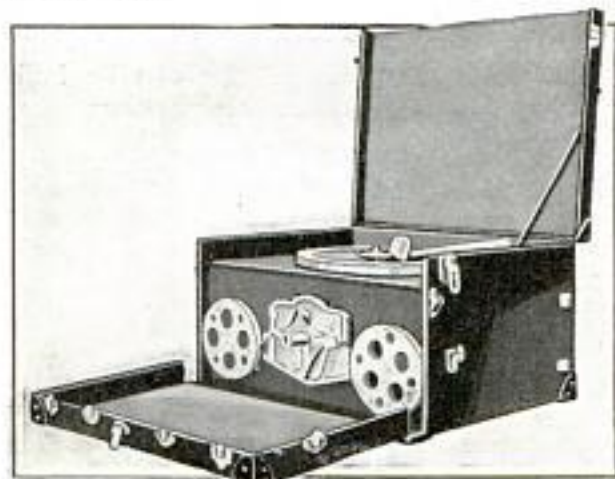

Portable Talking-Movie Machine with Case Opened Ready for Use

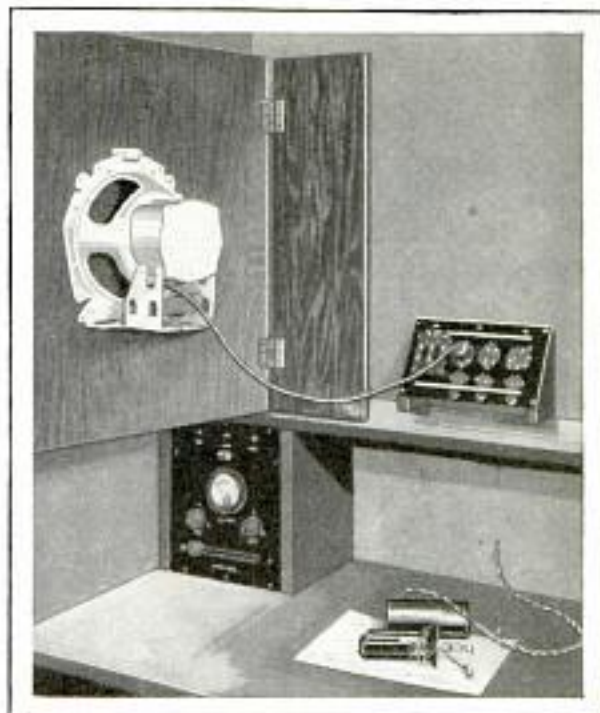

Baffle That Serves Also as Locker Door, and Method of Mounting the Speaker

### Hinged Baffle for Speaker

A swinging baffle for the dynamic speaker, at the experimenter's workbench, may be made to serve double duty as a locker door. Mounted in this manner, the speaker is readily accessible for repairs, adjustments or comparative tests, and takes up very little room. A spring catch, or the usual screen-door hook, may be used to latch the baffle.

### Talcum for Locating Screw Holes

Variable condensers or similar parts with a shaft, or projection, extending through the panel present an awkward problem when mounting-screw holes are to be located for drilling. An easy method of locating them is to drill the hole for the shaft first. The shaft is then inserted so as to bring the frame of the condenser flat against the panel in position for mounting. A little talcum may then be placed in each hole in the frame and a slight tap with the finger will deposit it on the panel. The condenser is then removed and the holes marked with a scribe.

Blueprints covering radio construction articles in past issues can be obtained for 25 cents each; material lists are always available without charge.

Talkiola Corp.  
1600 Broadway  
New York  
Chicago



### Simplified Home Recording

Home recording through midget receivers is now possible with the addition of a phonograph turntable, an electric pick-up arm and a microphone with an input stage or coupling transformer. These receivers

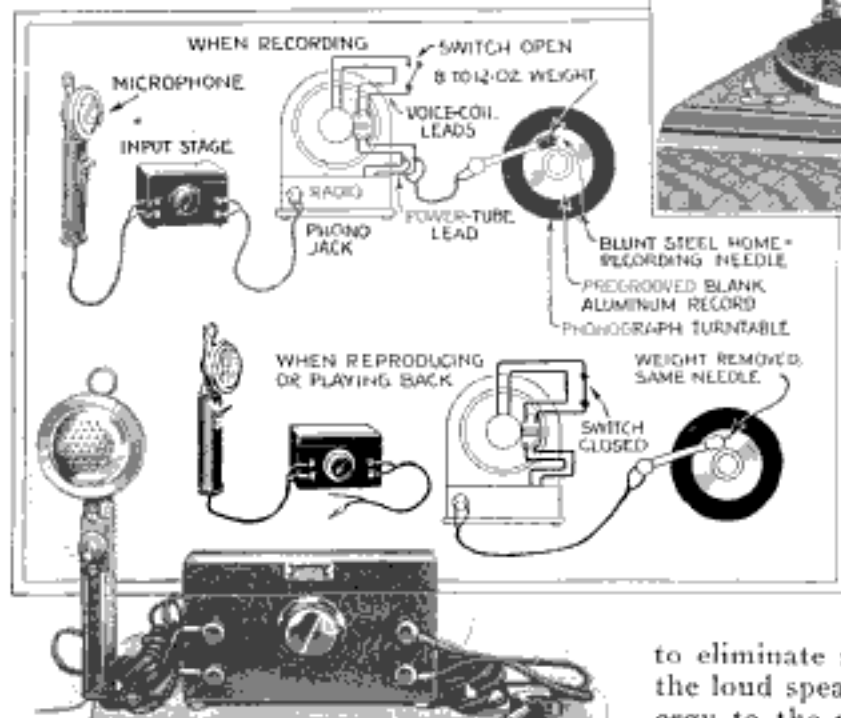

type equipped with a phonograph jack is used. A special home-recording needle, obtainable at any phonograph store, is

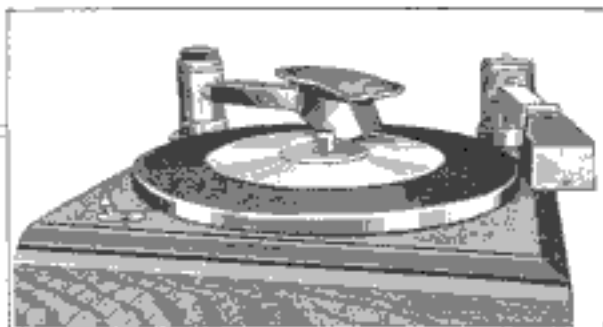

Upper Right, Turntable with Pick-Up Weighted by Small Bag of Sand for Added Pressure on Recording Needle; Lower Left, Hand Microphone and Input Stage

employed when playing records of this type. Therefore, if you receive a record through the mail, do not attempt to play it until you have obtained such a needle. In making records, it is necessary

to eliminate reproduction of the voice by the loud speaker and divert all of this energy to the phonograph pick-up. This is easily done by opening the circuit of the speaker voice coil and connecting the pick-up across the primary of the output transformer, as shown. Note that a single-pole switch is used for opening and closing this circuit.

to eliminate reproduction of the voice by the loud speaker and divert all of this energy to the phonograph pick-up. This is easily done by opening the circuit of the speaker voice coil and connecting the pick-up across the primary of the output transformer, as shown. Note that a single-pole switch is used for opening and closing this circuit.

### C-Bias from Batteries

Battery-operated receivers employing different types of modern power tubes sometimes present a problem to the novice when he desires to install a new set of C-batteries or change the set to use a different power tube, such as the 112-A or 171. The illustration indicates how to obtain practically any bias voltage. Two groups of batteries are shown, and it will be noted that the positive terminals at P<sub>1</sub> and P<sub>2</sub> are common. This positive lead is, of course, connected to

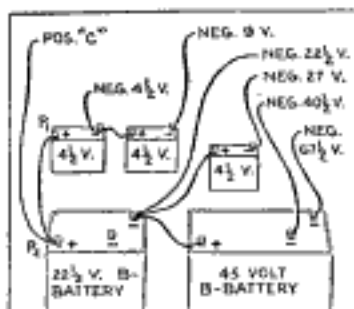

negative A. The desired negative voltages are then tapped off, as shown, according to what tube is used. The instruction sheet supplied with every tube gives a certain value of C-bias voltage for various plate voltages. Best results can be had only by following these instructions.

### Light Bulb as Non-Inductive Resistor

Ordinary light bulbs are commonly used as resistors, but few radio amateurs know that a mazda light bulb makes a fine non-inductive grid suppressor for the transmitting tube. Anyone who has tried to neutralize a transmitter of any power will realize the advantage of using grid suppressors, and a more economical or serviceable resistor can hardly be found.



## A Radio Cabinet and Humidor for Your Den

Where the radio need not be a conspicuous piece of furniture, the cabinet may be designed to serve several purposes. A small homemade a.c. set of the midget type, or a commercial chassis of the same description, together with a small dynamic speaker take up very little room. The cabinet to be described is modernistic in design and may be finished to harmonize with the other furniture. It not only completely houses the receiver but also provides room for a humidor in the lower compartment. Furthermore it is of suitable height to serve as an end table thus making an ideal radio installation for a man's den where space is usually at a premium. The construction is quite simple. The veneered-wood top is hinged to a secondary top in which an 8 by 12-in. service opening is cut for ventilation and easy access to the receiver. Thin felt pads are glued to the corners of the top. The frame of the cabinet is built of  $\frac{3}{4}$ -in. pine where possible, all outside pieces being made of walnut, or mahogany, veneer. The panels are  $\frac{1}{4}$ -in. veneer, the rear one being fitted with a dummy grill, for ventilating purposes. Air space is also provided at the top. The humidor is built to open at the rear. All mortised joints are glued and quarter-round strips are used to support the baseboard for the set. The joints are shown in the back-view sketch of the cabinet, and the screws are inserted so that the heads will not show. The dial arrangement on the front panel will depend on the type of receiver used. The speaker baffle, made of 1-in. close-grained wood, is mounted directly back of the speaker grill. The rear panel for the set and speaker compartments is easily removed by lifting upward and out at the bottom where it is held in slots.

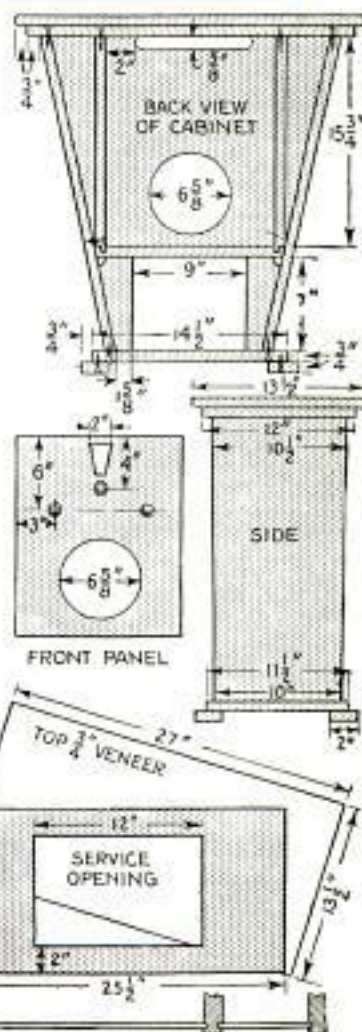
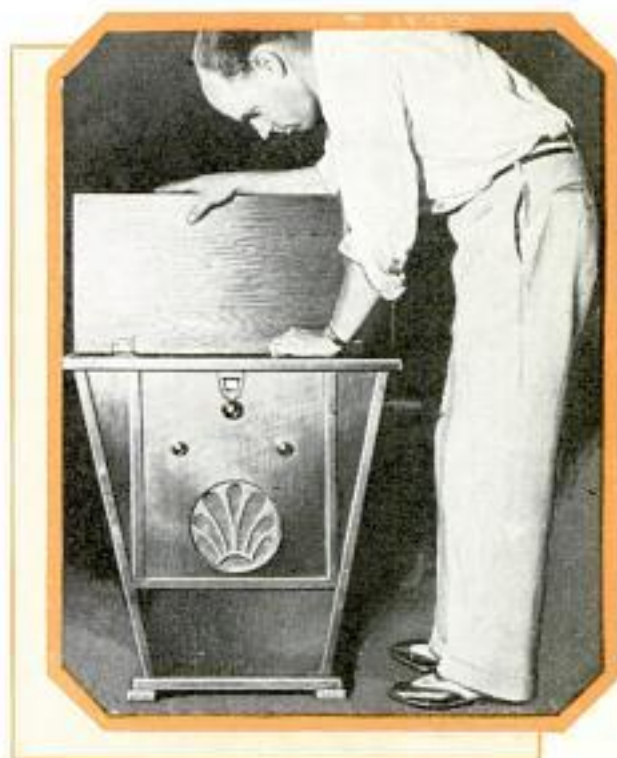

CROSS-SECTION VIEW LOOKING DOWN ON TOP SHOWS PANELS FITTED IN GROOVES

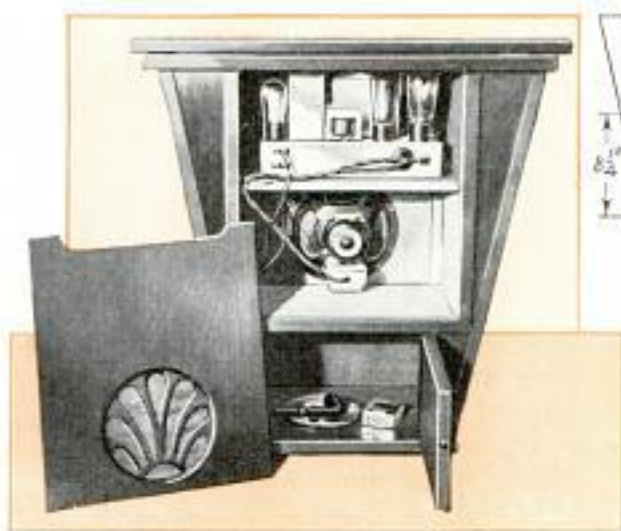





Table Cabinet, with Center Doors Removed, to Show Set Panel and Phonograph Compartment

### Table Cabinet for Phono-Radio

This homemade table cabinet was built to house an a.c. radio set and a phonograph turntable. The cabinet is placed on a library table and is trimmed and finished to match. Two small compartments at each end provide space for records, logs and writing material. The speaker is placed on top of the cabinet. A desk-lamp fixture is mounted on top of the speaker at the front, and a small candelabra lamp, with a reflector, above the phonograph turntable at the right.—L. C. Goodwin, Hornell, N. Y.

### Screen Antenna for Small Sets

Miniature or "mantle type" sets employing screen-grid tubes have sufficient pick-up for locals to operate from a small indoor antenna. Where these sets are placed on a table, copper-screen wire may be tacked to the underside of the table to provide a good antenna. A Fahnestock clip can be soldered to one corner of the screen so that the antenna lead may be quickly fastened or disconnected as desired. Another idea, that makes the in-

stallation really portable, is to cut a piece of bristol board to fit inside the sides and top of the cabinet. When cut to fit, the cardboard is removed and one side is coated with aluminum paint; a Fahnestock clip is then fastened to the painted side with a paper fastener. After the metallic paint is dry the cardboard is replaced in the cabinet and a short piece of flexible wire is used to connect the cardboard antenna to the set binding post.

### New Photo-Cell Operation

Experimenters placing a new photo-cell in operation for the first time are cautioned not to apply full-rated voltage to the cathode at first. It is better to start with a comparatively low value and work up, at the same time observing the performance of the tube closely for any irregularity.

### Handy Mounting for Service Light

A clothespin of the spring-clip variety and a length of busbar wire can be used to mount a flashlight bulb so that it may be clamped in any convenient position. The aluminum shade, Fig. 1, is optional, but is useful for keeping the light out of the operator's eyes. Two short wood screws hold the socket and soldering lug, which forms the bottom contact, as shown in Fig. 2. Flexible rubber-insulated leads are soldered to the screw heads and terminate in small clips that are connected either to the filament supply or to a small flashlight battery.

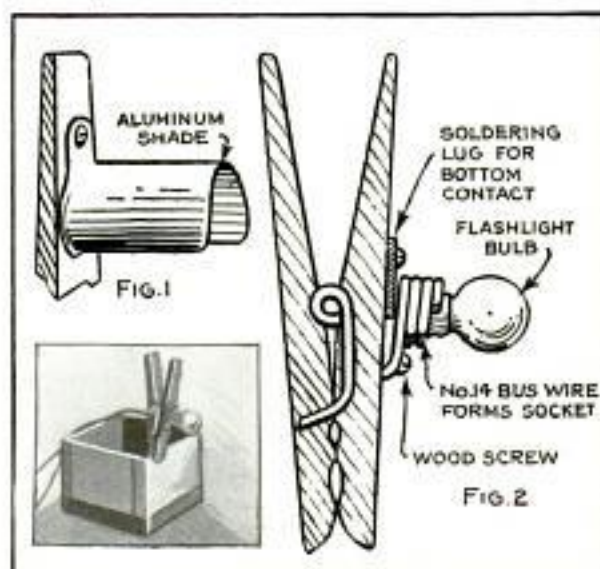



# Easy Solutions for Common Radio Problems

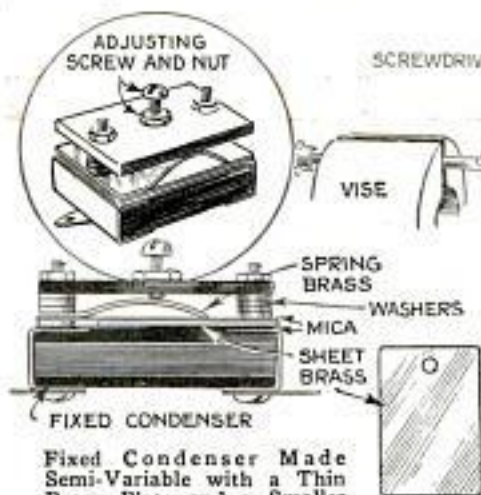

Fixed Condenser Made Semi-Variable with a Thin Brass Plate and a Smaller One of Spring Brass between Mica; Adjusting Screw Is Mounted on Fiber Strip

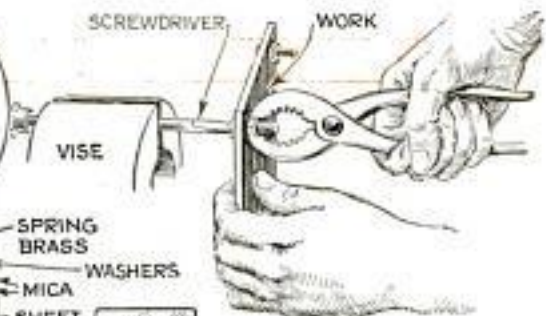

Screwdriver in a Vise Is Equal to Extra Hand When Tightening Hexagon Nuts on Panels

Right, Combination A.C. and D.C. Amateur-Band Receiver Is Supplied with Three Sets of Band-Spreading Coils for the 20, 40 and 80-Meter Bands



Left, Spacers for Zeppelin-Type Antenna Made from 10-In. Lengths of Kiln-Dried Wood and Thoroughly Boiled in Paraffin

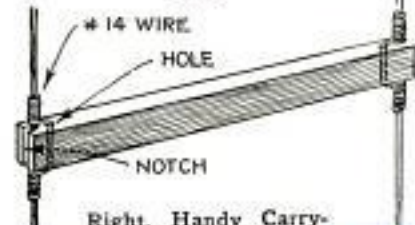

Right, Handy Carrying Strap for Testing Instruments Made from Old Belt; Below, Useful General-Purpose Clips and Jacks for Test Cords Made from Small Spring Clips



Above, Heavy-Duty Resistor That May Be Used as a Variable Load for Testing Batteries, Meters and Other Equipment; Below, Easily Made Shield and Chassis for Small Units

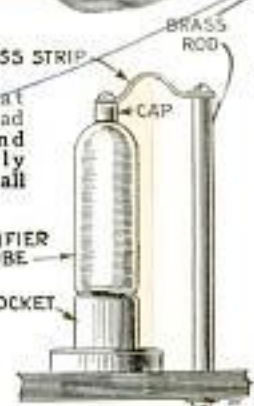
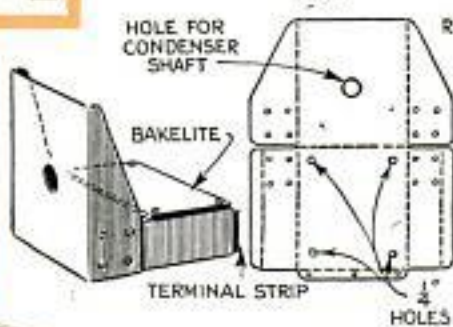

Above, Improved Terminal for Top of High-Voltage Rectifier Tubes; Copper Braid or Thin Brass Strip Holds Cap

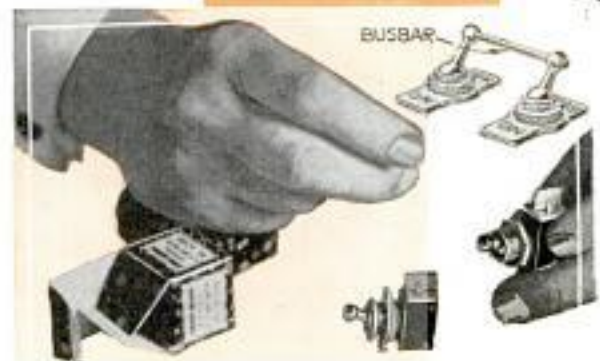

Left, Two or More Tumbler Switches May Be Ganged if Handles Are Insulated from the Circuit; Right, Pin-Jacks Used to Make Convenient Connector for Portable Receiver

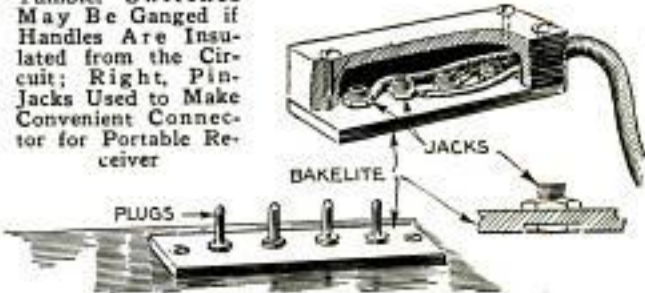

*Notional Company, Inc.  
Malden, Mass.  
Chicago, Ill.  
Clavotal, Ill.  
Cycling Co. & S. N. 6 1/2 St. N.Y.  
9 S. Clinton Chicago, Ill.*





# LOW-COST Is All-Electric

transformer specified. The latter, however, costs very little more and is advised. A suggestion for bringing the cost down would be to dismantle a junked receiver and salvage many of the necessary parts. The average radio shop has such receivers and would gladly part with them for little or nothing. Suitable parts will also be found in the chain stores.

The circuit shown in Fig. 1 is for use with a vario-coupler and a 5-volt filament supply. In this diagram, it will be noted that the filaments of the two type-27 tubes are connected in series to obtain the necessary 2½ volts for their operation. The model shown in the photos was built and tested in Popular Mechanics radio laboratory and employs circuit Fig. 2. In this case a three-circuit tuner is used and the tube filaments are in parallel for a 2½-volt transformer. No difficulty was encountered in separating powerful local stations, and the re-

**N**O batteries or expensive parts are required to build and operate this two-tube a.c. receiver, and the cost will depend on the quality of these parts. The writer has built one of the sets for \$7, exclusive of tubes and phones, by substituting a 10-watt bell-ringing transformer for the filament

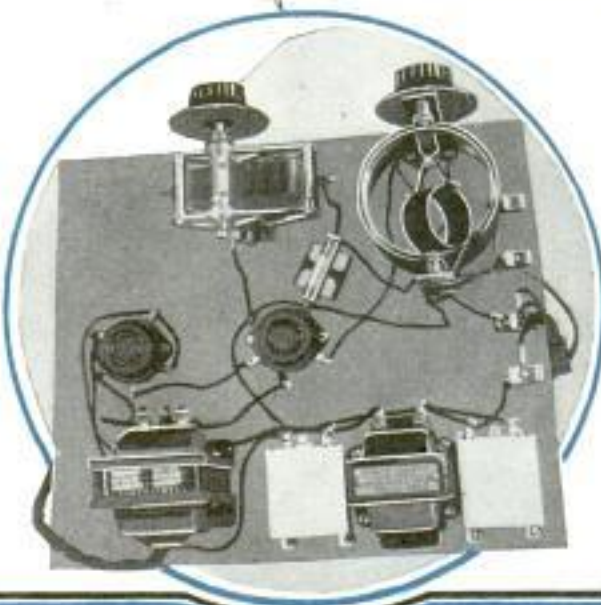

necessary 2½ volts for their operation. The model shown in the photos was built and tested in Popular Mechanics radio laboratory and employs circuit Fig. 2. In this case a three-circuit tuner is used and the tube filaments are in parallel for a 2½-volt transformer. No difficulty was encountered in separating powerful local stations, and the re-

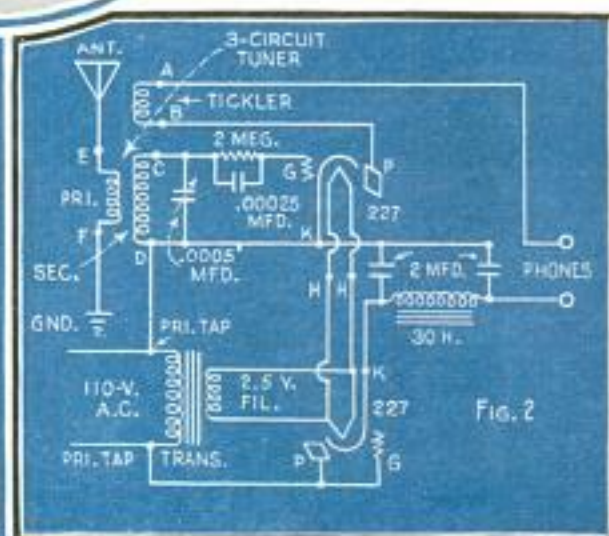
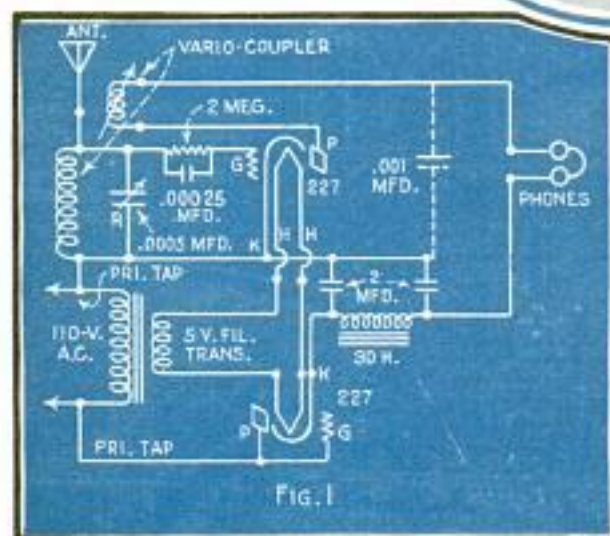



# RECEIVER

By Arthur B. Cooney

sults were very satisfactory. In both circuits one tube has its plate and grid terminals connected at the socket, as it is employed as a rectifier, the other tube being the detector. Unmounted paper filter condensers, or cheap electrolytic ones, of either 2, 4 or 8 mfd. may be used. An old audio transformer with the primary and secondary windings connected in series usually has enough inductance to act as a filter choke. The parts are assembled as shown in the simplified wiring diagram on this page.

If the filament transformer used is housed in a case, it is necessary to remove the case so that the primary taps for the plate supply may be connected as shown. If a vario-coupler is used, as shown in Fig. 1, do not ground the antenna binding post or the house fuse will be blown. If built with the three-circuit tuner, care should also be taken that the light wires do not touch any part of the antenna circuit, or the result will be the same. If the terminals on your three-circuit tuner do not correspond with the lettered sketch, use the same identifying letters and trace out the windings. The large winding is the secondary; the primary has less turns and is located inside the secondary at one end. The rotating coil is the tickler. The grid-leak may be any value from 2 to 5 megohms. Material lists and enlarged diagrams are available.

The set is tuned by slowly rotating the variable condenser and

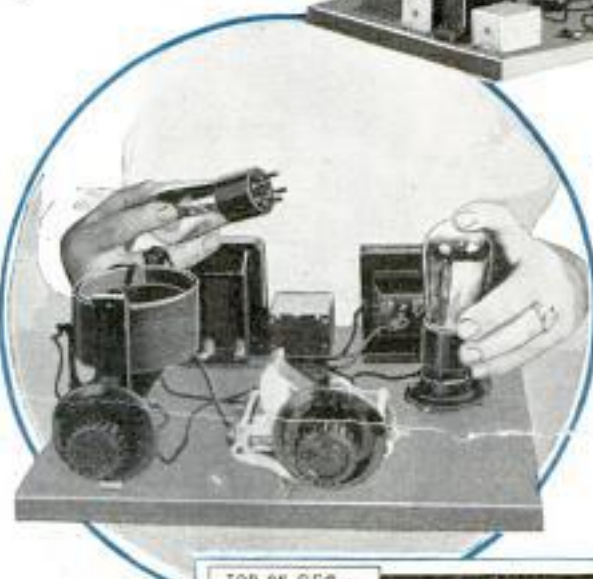

adjusting the movable coil until the station comes in clear and with maximum volume.

An indoor antenna may be used for local stations but an outside type is required for distant reception.

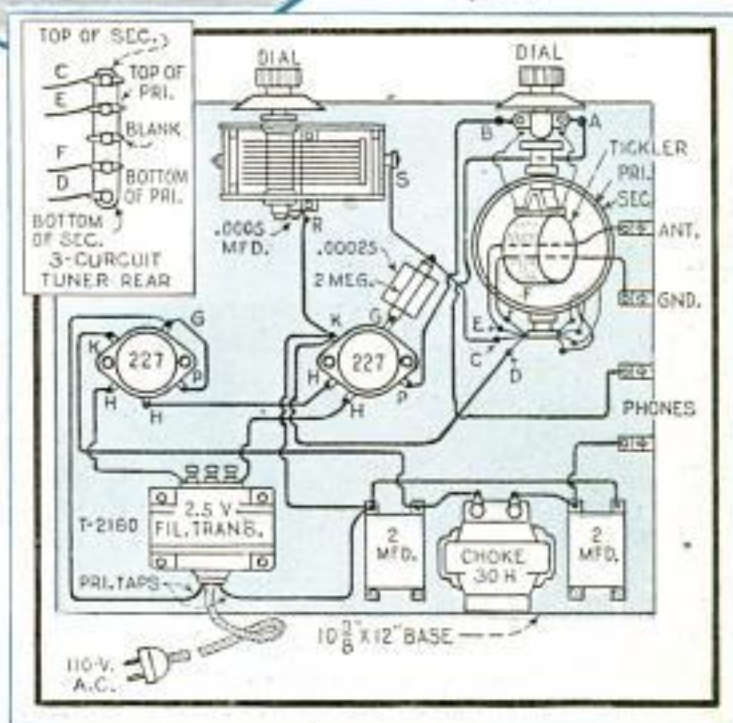



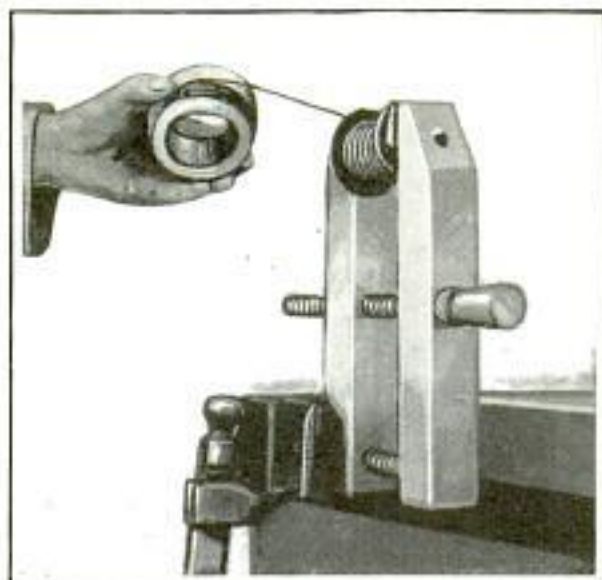

Wooden Hand Clamp Showing Spool in Position

### Spool Holder for Coil Winding

When winding coils, either by hand or in a drill chuck, it is necessary to provide some means for holding the spool of magnet wire. A simple method for bench workers is indicated in the photo. A hole is drilled through both jaws of a wooden hand clamp to take a piece of dowel rod for supporting the spool. The clamp is then placed in a vise and adjusted until the desired tension is secured. If the spool does not turn smoothly, or does not keep the wire taut, two large washers may be inserted between the jaws.

### Inexpensive Ground Connections

Many long-distance broadcast-reception records are made with elaborate grounds, one record holder using as many as fifteen ground connections. A cold-water pipe is usually selected, and, if connected at a point before it reaches the meter, an excellent ground may be obtained. This may be supplemented with earth grounds made by driving iron rods or pipes into damp earth. In dry or sandy localities, it is often quite difficult to obtain a good ground connection. Some experimenters bury old leaky auto radiators and arrange a lead pipe and funnel for adding water to keep the ground damp. Old dry cells may be stripped of their cardboard covering and buried to provide a good ground. The red sealing wax in the top of each cell is broken away so that moisture may be absorbed by the chemical filler. A No.

14 bare copper wire is soldered to the zinc casings, connecting all the cells together, and this lead is continued up to the ground post on the receiver.

### Tube Base as Battery Connector

Circuit terminals for battery leads may be soldered to a four or five-prong tube socket for a separable plug-in connection. The socket is mounted at a convenient point on the rear of the chassis, near the audio end. The cabled leads from the batteries are then soldered to the prongs of an old tube base, to correspond to the socket contacts. This provides a quick means of connecting batteries and set.

### New Uses for Old Panels

Old panel material need not be discarded because of numerous holes left from previous hookups. It may be decorated to cover the unused holes by pasting on small triangles of multi-colored tissue paper. The tissue may be cut into various shapes and sizes. If the design on the tissue is small and complicated, fairly large pieces may be used; otherwise it is best to make the pieces rather small. First remove any grease on the panel and apply the paste to the tissue. Bookbinders' paste will be found best. When completed, the panel should be allowed to dry for several hours, after which a thin coat of clear varnish or shellac may be applied. Small pieces of scrap panel material also can be cut into resistor mountings, insulating bushings and small unit panels for experimental breadboard layouts.



Completed Panel Showing Inlay Effect Obtained with Bits of Colored Tissue

For further information on any radio construction article write to the radio department; this service is free.



Swedish wrought iron  
 Swedish American Steel Corp  
 429 Kent Ave

Brooklyn  
 N.Y.



# AMATEUR MECHANICS

## A HALL LAMP in Wrought Iron

by  
 Keenan  
 H.  
 Ward

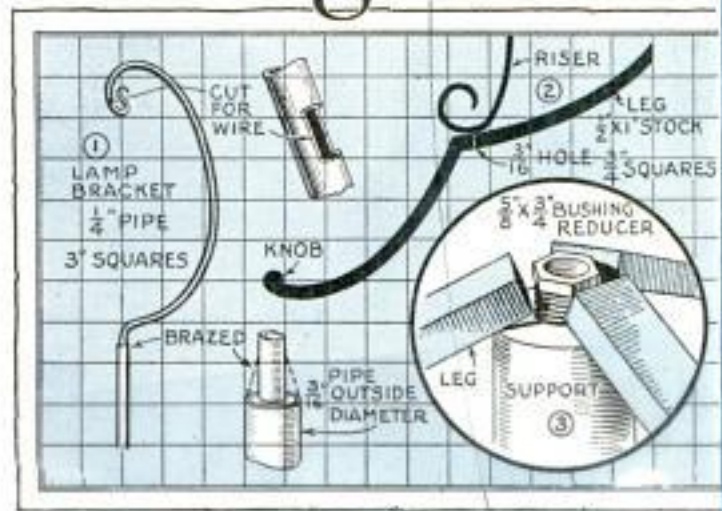

**F**ASHIONED from wrought iron and brass tubing, this attractive hall lamp should appeal to the home craftsman for its simplicity and practicability. With slight changes in the lamp and bracket, it will serve as a reading lamp, but in the form shown it is primarily for use in the hallway or corridor.

The first and most difficult step in the construction has to do with the making of the base. This is formed from three legs, fashioned from 1 by 1/2-in. iron to the shape shown in Fig. 2. The three legs, when finished, are properly spaced around a common bushing reducer, as in Fig. 3, and the assembly is brazed or welded together. Roughness on the work should be filed smooth, and the threads inside the reducer should be cleared of surplus metal by retapping, as shown in Fig. 6. This part of the job may be beyond the facilities of your own shop, but it is a simple and inexpensive matter to have the brazing or forging operations done by a workman equipped for this

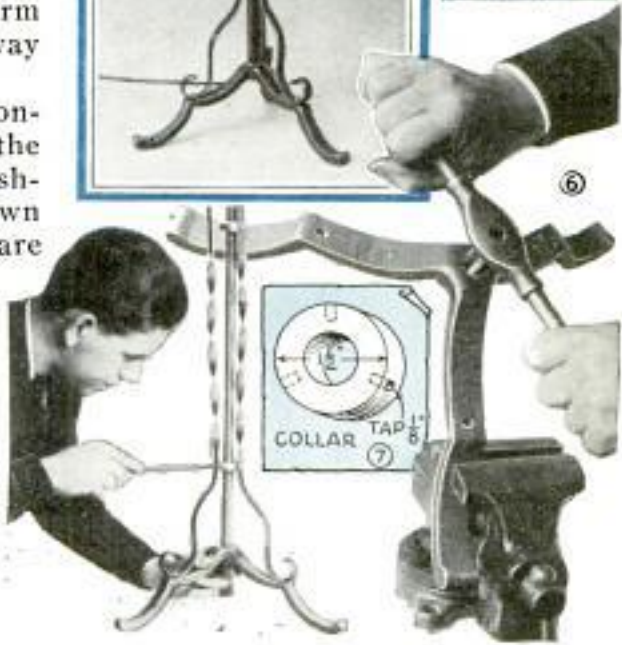



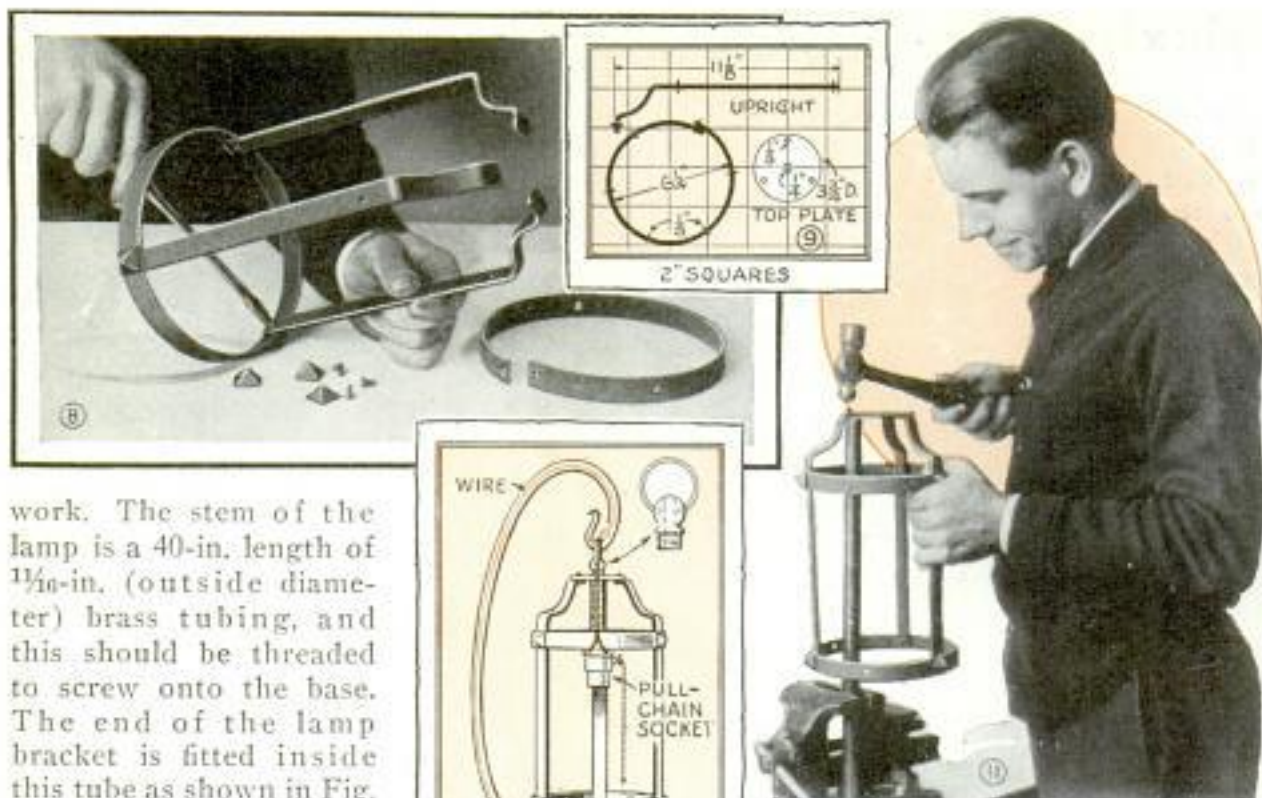

work. The stem of the lamp is a 40-in. length of  $1\frac{1}{16}$ -in. (outside diameter) brass tubing, and this should be threaded to screw onto the base. The end of the lamp bracket is fitted inside this tube as shown in Fig. 1. Notice that the bottom of this is a length of rather heavy pipe, of an exact size to fit snugly within the brass tubing to allow for adjustments in the height of the lamp from the floor. The lamp bracket proper is made from  $\frac{1}{4}$ -in. pipe, the upper end being heated and drawn to a tapering point as shown. A small cut is let into the metal for the lamp cord. Fig. 4 shows the shape for the three risers which are made from  $\frac{5}{8}$ -in. strap stock and drilled so that they can be fitted to the base, the screws being driven into a tapped collar as shown in Fig. 7. Small stove bolts may be used for fastening, or iron heads may be filed from a piece of square stock, as shown in Fig. 5, and tapped to take a  $\frac{1}{8}$ -in. bolt shank. Iron work of any kind usually looks best with a hammered, natural finish. Small ball-peen-hammer marks can be used for the most, with a few indentations made with a planishing hammer. The hammering is best done before the metal is fitted to the desired shape, as any subsequent hammering would only tend to destroy the carefully bent design.

The lantern itself offers scope for a considerable variety of designs, but the one on this page is undoubtedly the easiest to make. Fig. 9 shows the necessary parts.

You will need three uprights, made from  $\frac{5}{8}$  by  $\frac{1}{16}$ -in. brass to the size and shape shown. The two rings are simply overlapped at the ends, the  $\frac{3}{4}$  by  $\frac{1}{16}$ -in. brass stock making the joint fairly compact. For the assembly, pyramid-shaped nuts are used on the bolts, the bolt heads fitting holes countersunk on the inside of the lantern, as shown in Fig. 8. The  $\frac{1}{16}$ -in. brass top plate is riveted in place, as shown in Fig. 11, to complete the unit. Fig. 10 gives the details of the wiring. A standard pull-chain socket is used, and this is fitted to a short length of ornamental brass pipe which ties onto the ring nipple fitting through the top plate. The shade is a 6-in.-diameter colored-glass cylinder which is held in place by three small metal tabs (see Fig. 10).

The iron work preferably should have a natural finish. This is best done by the burning-off process. The parts are coated with linseed-oil varnish which is then burned off over a light fire. This should be repeated about three times to obtain the proper blackness. Then the highlights are brushed out with steel wool and file. Wax is lightly rubbed over the surface to protect the exposed portions. The brass is blackened by brushing with sodium sulphide, 1 oz. in 1 qt. of water.



## Making Grotesque Enlargements of Pictures

Slotted lengthwise to make a sliding fit over the head of a thumbtack, as shown, an ordinary 12-in. rule or similar piece of wood can be used for making distorted enlargements of cartoons and photographs. The slot in the center should extend to  $\frac{1}{8}$  in. from one end and about 1 in. from the other. A hole is then drilled through the latter to receive a pencil. A pointer, cut from thin sheet brass or tin, is fastened to the rule, to serve as a tracing guide as in a pantograph. Push a thumbtack, the head of which fits the slot in the rule, about halfway into a large flat board or table top and place the rule over this. The cartoon or picture to be distorted and a large sheet of white paper are laid to the right of the tack, both being held in place with thumbtacks. Insert the pencil in the hole

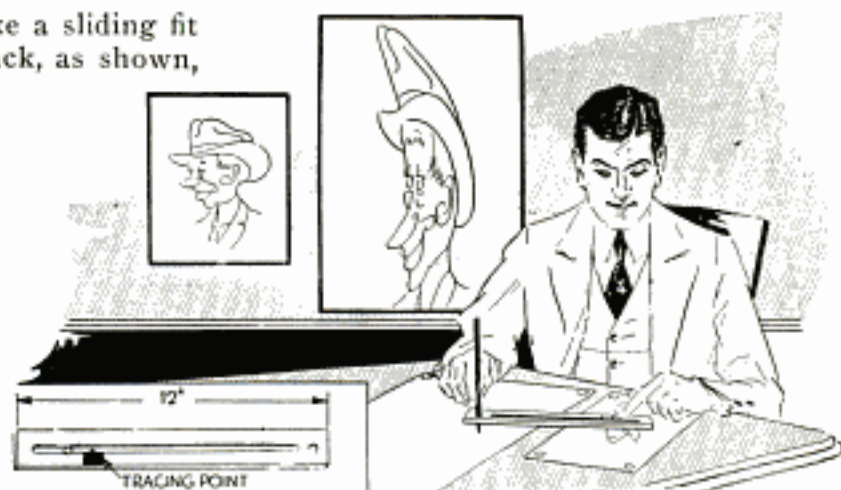

With This Slotted Rule and a Pencil, You Can Make Distorted Enlargements of Cartoons or Photos

in the rule, and follow the outlines of the cartoon with the tracing point, raising the pencil whenever a line is finished. It is not necessary to watch the pencil or the large sheet of paper. When all the lines have been traced, a distorted picture of the original will appear on the large sheet of paper.—H. R. Wallin, Brooklyn, N. Y.

### Detachable Anvil Made from Flatiron

An ordinary flatiron is utilized to make this detachable anvil. The iron is drilled and tapped for two bolts, inserted through countersunk holes drilled in a hardwood base, which in turn is attached to the bench by means of a bolt and wingnut as shown in the detail.—W. C. Wilhite, Hornsby, Ill.

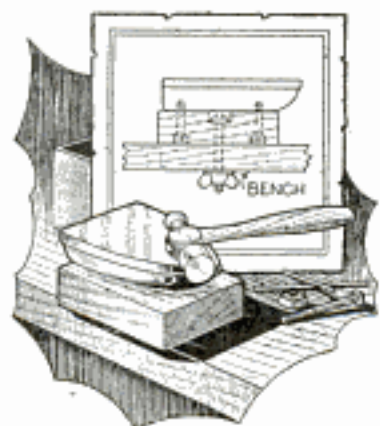

### Hints on Laying Linoleum

Linoleum can be handled much more easily if it is exposed to the sun or artificially warmed to make it pliable before it is put down. In order to prevent buckling, which is caused by expansion when the edge of the linoleum is tacked to the floor, remove the molding along the base-

board, and let the linoleum extend to within  $\frac{1}{8}$  in. of the wall. Then replace the molding and nail it to the baseboard instead of the floor, which allows the edges to be held down without binding. The floor should be surfaced before the linoleum is laid, as a rough floor greatly shortens its life. When it is pieced together, tack down the seam at 3-in. intervals with brass escutcheon nails.

### Attaching Window Shade to Roller to Prevent Tearing

To prevent a window shade from being torn from its roller, cut the end of the shade at two points, forming three equal sections. Fasten the center section to one side of the roller and the two end sections to the other side as shown, tacking the edge down in the usual manner.







Hinged Panel with Folding Footrest Forms Disappearing Shoe-Shining Stand

### Shoe-Shining Stand Folds into Wall

Here is a shoe-shining stand that swings out of the way when not in use. A footrest is hinged on the inside of the panel and is held in position by a folding bracket, etc. Both the rest and the bracket fold down flat against the panel, which is hinged to the baseboard. A shelf for the polish and brush is provided on the inside.

### Dissolving Crystals and Other Solid Chemicals



When making solutions of crystals and solid chemicals, sediment of undissolved matter can be prevented by simply wrapping the crystals in small pieces of cambric or muslin. Small cloth bags are useful for this purpose. Where considerable stirring is necessary, the bag may be dropped in and

agitated by means of a spoon or rod, but if the chemical dissolves easily, the bag can be hung from a short stick laid over the mouth of the bottle.—Jos. M. Creamer, Astoria, N. Y.

agitated by means of a spoon or rod, but if the chemical dissolves easily, the bag can be hung from a short stick laid over the mouth of the bottle.—Jos. M. Creamer, Astoria, N. Y.

### How to Prevent Small Concrete Pools from Breakage by Freezing

If a few small logs or boards are thrown into a small concrete pool, so that they float on top of the water, the freezing of the water will not crack the sides of the pool. The expansion of the ice causes the boards to rise out of the water, thus relieving the pressure against the sides. For small pools, pieces of 2 by 4-in. stock, or even a few lengths of flooring, will do as well as short logs.

### Rubber Mat on Top of Stepladder Holds Small Tools

You will find a small corrugated-rubber mat nailed to the top of a stepladder useful to prevent small tools and parts from falling off. Narrow strips of inner tube can be nailed under the outer edges of the mat, to form a "tray." Such a mat also reduces the risk of slipping when standing on top of the ladder.

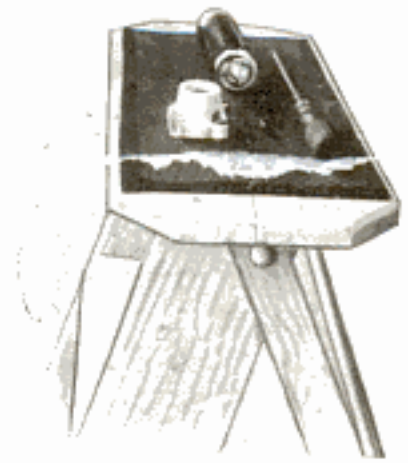

### Making Leather Faucet Washers

Water-faucet washers that are pliable and will last longer than the ordinary kind, can be cut from good belting or harness leather. Then they should be dipped in melted paraffin for two or three minutes to waterproof them, being careful not to burn the leather by having the paraffin too hot. These washers allow the water to be shut off with little pressure on the faucet, thus eliminating the possibility of grooving them, which causes leaks.

☛Woolen blankets will dry quicker if they are hung in a breeze dripping wet.



# MAKING *Your Own* SKIS

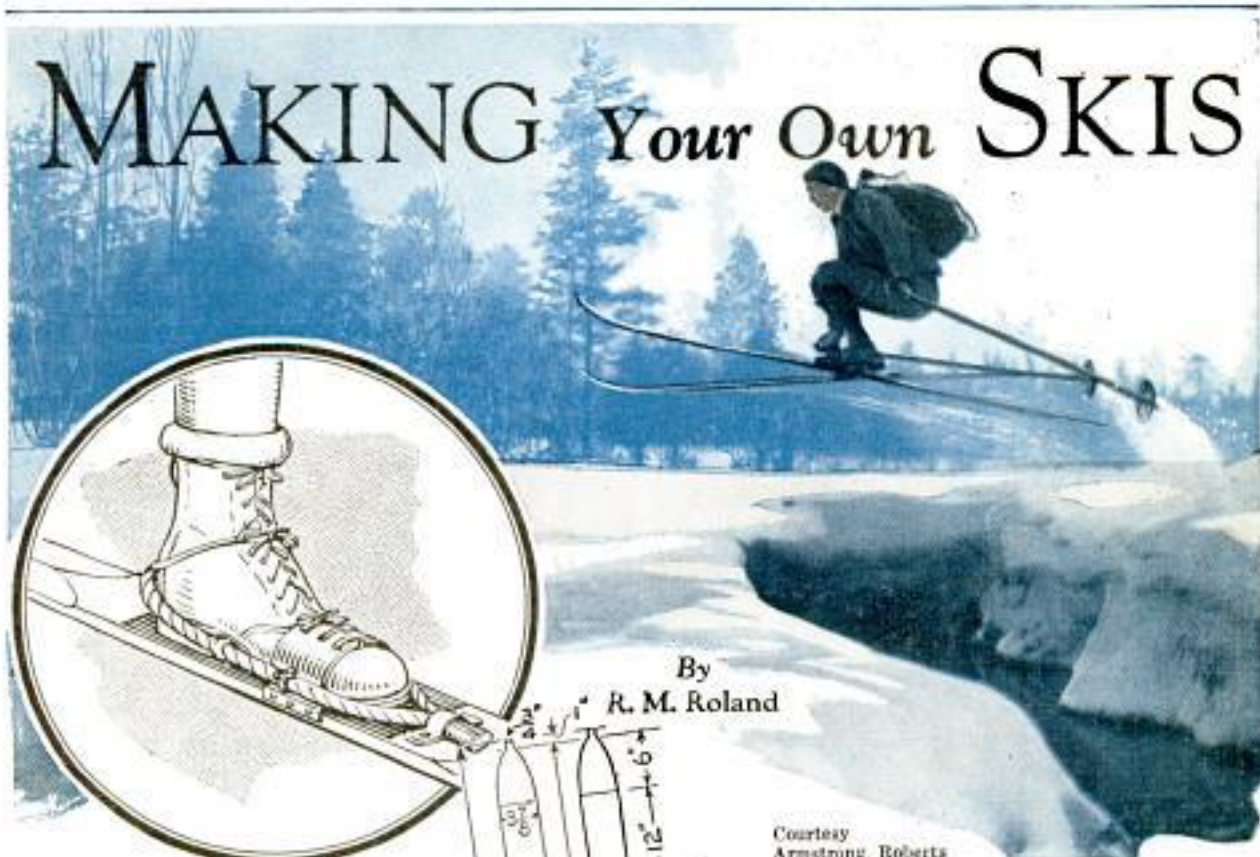

By  
R. M. Roland

Courtesy  
Armstrong Roberts

WITH a little care and patience, it is comparatively easy to make a pair of skis. Get two 8-ft. lengths of select well-seasoned  $1\frac{1}{8}$ -in. ash or hickory. Plane the top down from  $1\frac{1}{8}$  in. at the center to  $\frac{1}{2}$  in. at the rear and  $\frac{3}{8}$  in. at the front, leaving a 12-in. flat section at the center. Then round off the tips as indicated. The underside of each ski is to be grooved, starting 6 in. from the tip and running the entire length of the ski. This can be done on a circular saw, using a

dado head, or by running the saw through the stock several times, setting the ripping fence back about  $\frac{1}{16}$  in. for each successive cut. A single groove should be  $\frac{1}{2}$  in. wide, but if two grooves are used, they should be  $\frac{1}{4}$  in. wide and should be spaced 1 in. apart. The grooves should be  $\frac{7}{16}$  in. deep; a single groove is centered and the two grooves spaced equidistantly from the edges.

After the grooves have been cut, the edges are planed down so that the width is  $3\frac{7}{8}$  in. at the front,  $3\frac{1}{4}$  in. at the center, and

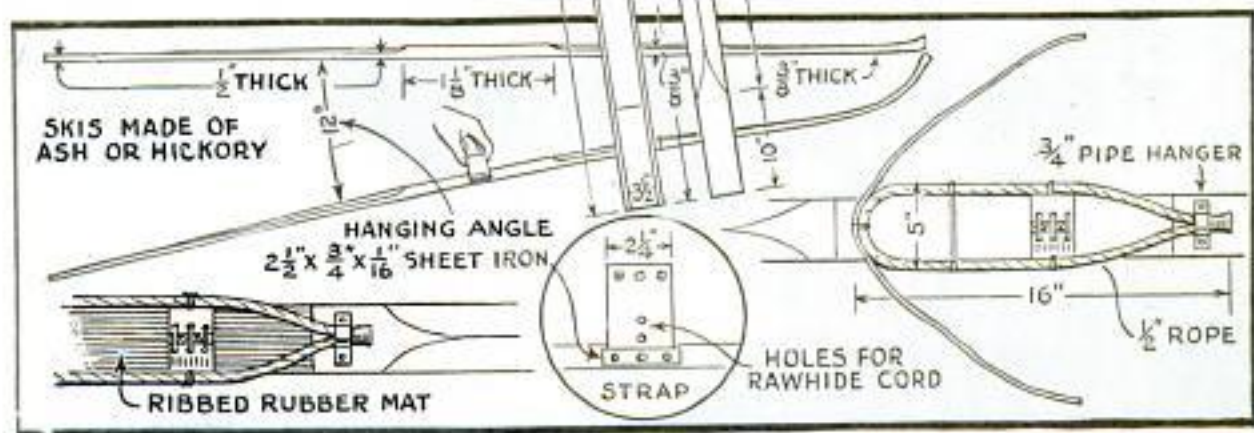





Racing with the Wind down a Long Hill on Skis, Is One of the Most Thrilling Winter Sports

3½ in. at the rear end. Beveling the tops is next, after which the tips are held in boiling water and the skis placed in a bending form as shown on this page. Note that the center of the skis is slightly raised above the ends. Be sure to leave them in the form until thoroughly dry. Also keep them there when not in use, as it is essential that they be kept perfectly flat, for if they are slightly twisted, skiing will be quite difficult.

Next, a pad of corrugated rubber is glued to the flat center portion and a 32-in. length of ½-in. rope, looped to fit your shoe, is fastened to the ski by means of a pipe hanger. The ends of the rope should be wrapped with strong cord or picture wire to prevent them from unraveling. The toe strap is then attached. It consists of two pieces of leather with eyelets

for lacing, and is attached to the edge of the ski by means of two strips of ¼-in. flat iron, drilled to receive screws. A rawhide crosspiece is tied across the rope loop, just in front of the heel, two other lengths of rawhide are tied to the rear end of the loop to come over the instep, and the rope is fastened to the straps with rawhide cord. When the ski is held at the toe strap, it should incline about 12° toward the rear, such balance being accomplished by careful beveling. Also be sure that each ski is well balanced crosswise. After the skis have been finished, they are carefully gone over with a fine grade of sandpaper and then given a coat of shellac or spar varnish, followed with wax, which is brought to a high polish. However, if you desire, the skis may be given a coat of lacquer or paint, possibly in two colors, and then waxed.

You should also have a pair of ski sticks. These can readily be made from 4-ft. lengths of stout bamboo with a small baby-carriage wheel, from which the hub has been removed, securely wired to each stick, about 6 in. from one end. The bottom of

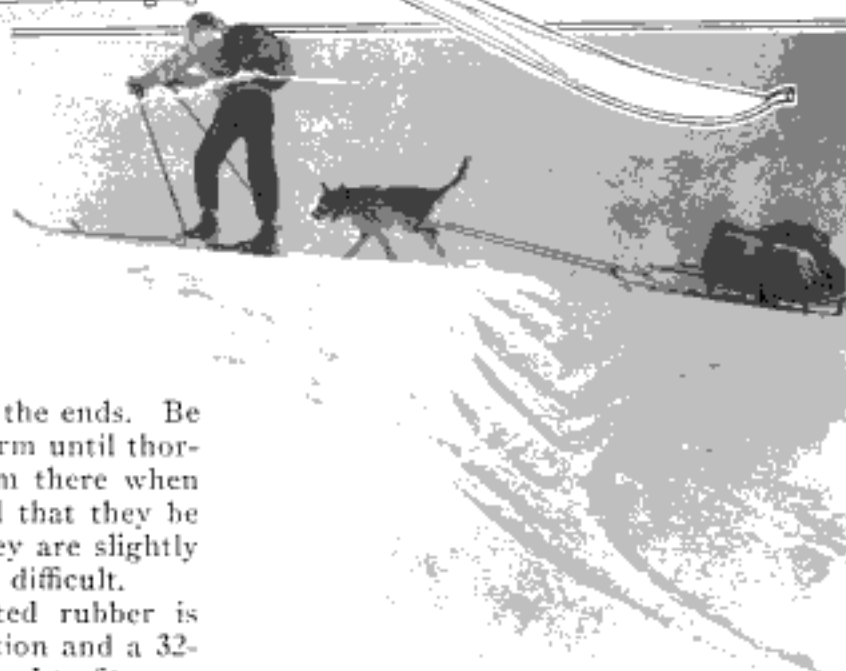

Courtesy Armstrong Roberts

each stick is then provided with an iron spike, imbedded in rosin, while a leather loop to fit your wrist, is attached to the other end, the loop being large enough, so that you can free your hands easily.



# This Warm Brooder Develops Sturdy Chicks

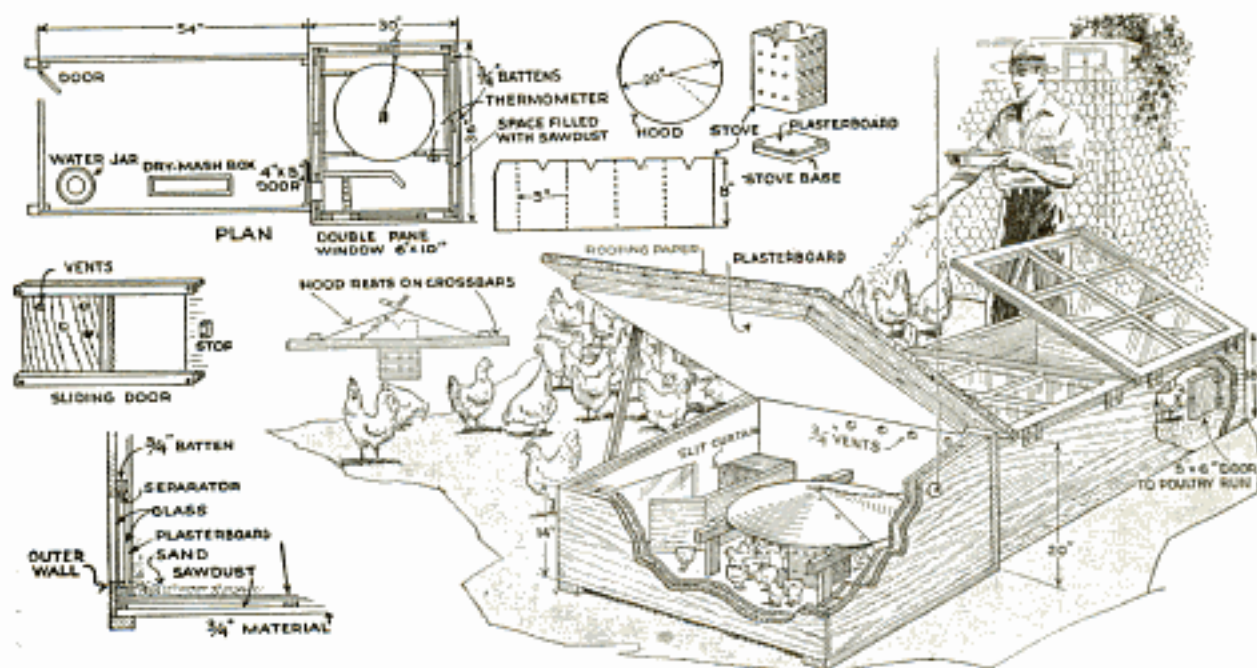

Two years' experience has proved this brooder highly efficient. The double-wall construction provides warmth in the coldest weather. Matched lumber is the best material for the outer walls, although ordinary  $\frac{3}{4}$ -in. boards will serve. Build the inner wall and floor of plasterboard over battens, so there will be a space between them to be filled with dry sawdust. Lay waterproof roofing paper on the floor, which is to be covered with dry, sifted sand. A double-pane window is necessary in cold sections, but in milder climates a single pane will do. Build a wall, about 8 in. high, at the door end to avoid drafts. A piece of flannel, with a number of vertical slits, hung at the doorway, retards the inrush of cold air. No severe draft is possible, however, as all air must come in from the glass-roofed inclosure, which is kept closed on cold nights. The stove and hood are made from light galvanized sheet iron and an electric lamp is placed inside. The hood rests on crossbars and can be lifted for inspection and for changing lamps. The temperature should be maintained at 85 to 90° the first two weeks, and gradually diminished until the chicks are six or eight weeks old. Start with a 60-watt lamp and work down to one of 25 watts. On winter nights, the sliding door, detailed on the left, is closed. This does not prevent circulation as the fresh air comes in through the holes in the door

while the foul air goes out through the vents near the roof. Props should be made to hold up the roof and also the glass frames that form the top of the "sun room," when it is necessary to open either compartment.

## Combination Dresser and Clothes Hamper for Bathroom

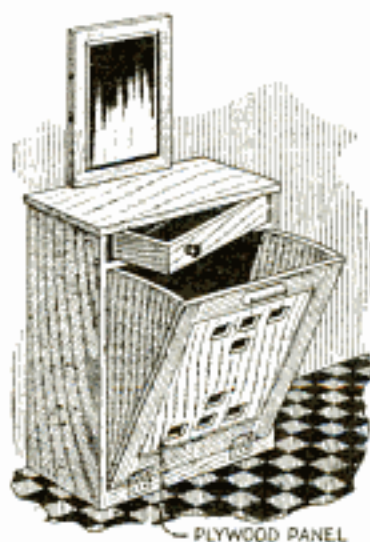

Fitted with a swinging drawer for small articles and a ventilated bin, this clothes hamper takes little space in your bathroom. The drawer is hinged at one corner, while the clothes bin is hinged at the bottom and has a plywood panel in which

small holes are cut for ventilation. With the addition of a mirror above the hamper, it will serve satisfactorily as a dresser.

☛ A piece cut from a canvas tool kit or rubber mat will serve as a blowout patch if you leave the tire partly inflated.





Coping Saw Equipped with Two Blades Assures Equidistant Spacing of Cuts When Sawing Scrolls

### Two-Blade Coping Saw Makes Parallel Cuts

By fitting a coping saw with two blades, two equidistant cuts can be made in one operation, which is especially helpful when cutting scrolls. When using two blades in this way, it will, of course, be necessary to arrange them so that the teeth face the side of the saw frame, in which notches are cut for attachment of the extra blade as shown.

### Films, Pinned to Float, Are Kept Clean in Wash

When washing films without a standard tank, the amateur photographer often experiences difficulty in having particles adhere to them. By pinning the negatives to the edge of a piece of cork or wood,



about 6 by 8 in. in size, they can be floated in a basin as shown without coming in contact with the bottom. Glass-head thumbtacks should be used for

this purpose, as the long heads act as buffers to prevent the negatives from scraping against the sides of the basin.—Charles B. Barr, Stratford, Conn.

Pat. no. 1,764,864  
 by Arthur F. Jungerhülle.  
 Bridgeport, Conn.  
 Shampoo Bottle Handy for Pouring  
 Small Amount of Liquid

If you have ever spilled liquids when trying to pour just a few drops from a bottle, you will appreciate the use of a shampoo or hair-tonic bottle that allows only a few drops to be shaken out at a time. Such a bottle needs no cap to prevent excessive evaporation, and should it be accidentally tipped over, not more than a drop or two of the liquid will be lost.—Warren F. Robinson, New Bedford, Mass.

### Holes in Bucket Rim Save Paint

Punched in the rim of a paint bucket, a number of small holes allow paint to run back into it. If carefully made, the holes will not prevent the lid from properly sealing the can against the entrance of air, which, of course, soon would cause the paint to dry out. Another advantage of this method of draining off the paint that collects on the rim, is that it will not run over on the outside of the bucket.



### Fireproof Container for Valuable Papers Made of Pipe

A fireproof container for valuable papers can be made as follows: Thread both ends of a 15-in. length of 2-in. pipe to take caps. Put a  $\frac{3}{8}$ -in. layer of asbestos inside each cap and seal it with a snug-fitting disk of sheet brass. Then place an equal length of 1-in. brass pipe inside of the iron pipe, concentrically, which is done by inserting three strips of wood between the two pipes. Pack the space between the pipes with asbestos, remove the wooden strips and pack the space left with asbestos. Papers rolled and placed in the inner pipe will be safe from fire when the caps are fitted on tightly.

☛ Tri-sodium phosphate mixed with water makes a good wash for removing paint from the hands.



# Build this Ice Speedster

## PART TWO

WITH the framework, motor mount and skis of the ice speedster finished, the completion of the body becomes comparatively simple. Next comes the application of the side and forward deck coverings. These should be cut from a good grade of plywood or from wood-fiber composition board. The exact shape is easily found by temporarily nailing a slab of the material into place and penciling around it. Galvanized nails will do for the fastenings, as shown in Fig. 20. Note that the right side covering is cut out at the rear to form a wedge-shaped door which affords entrance to the motor, and that a semicircular cut is made about midway for a step. The paint job shown in the pictures can be easily duplicated and is very effective in green and white or blue and white. Galvanized iron, painted to match the wood covering, is used to partly close in the motor.

The woodwork around the cockpit comprises five pieces, two of which, the round-topped seat back and the dash, are probably already in place. The next two to be fitted are the coaming strips, which extend along each side of the opening. These are made from  $\frac{3}{8}$ -in. stock, 4 in. wide. Fig. 21 shows how the forward end of the coaming on either side is cut to allow the wind plate to be screwed into position, as in Fig. 22. This piece, like the

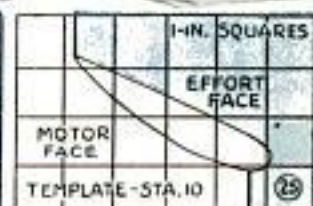
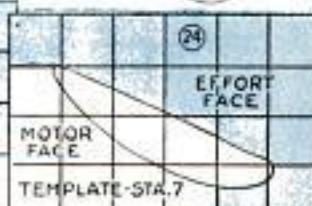
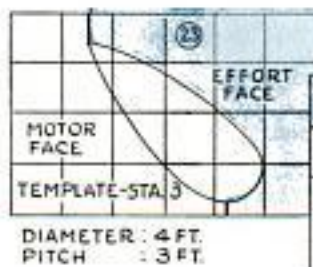
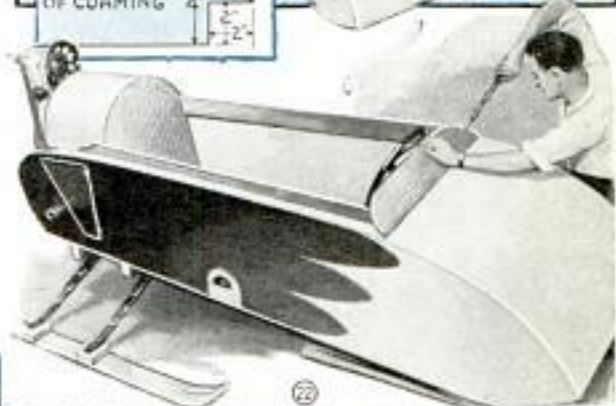

A Speed of 30 Miles on Snow and 60 Miles on Ice Is Attained by This Ice Speedster Which Is Fitted with a 4-Ft. Air Propeller Driven by a Twin-Cylinder Motorcycle Engine



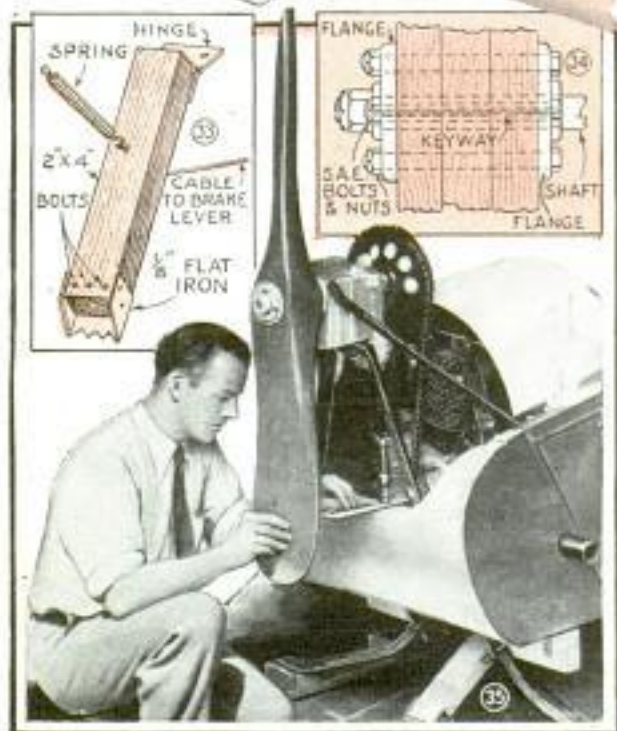
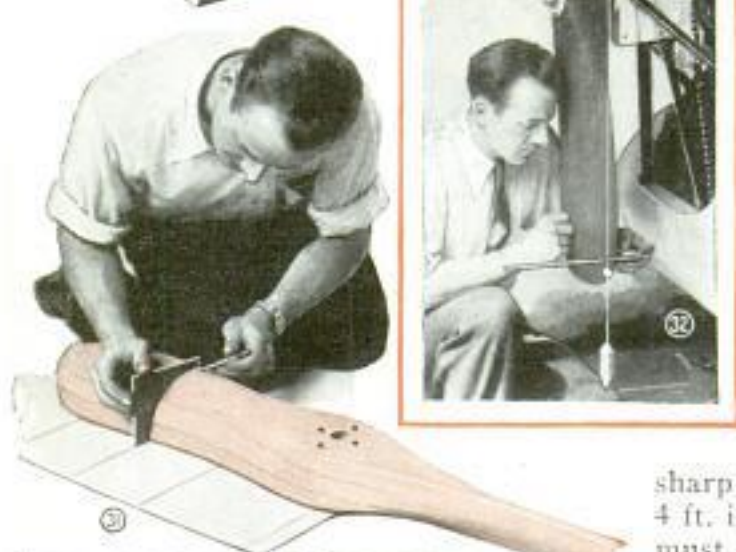
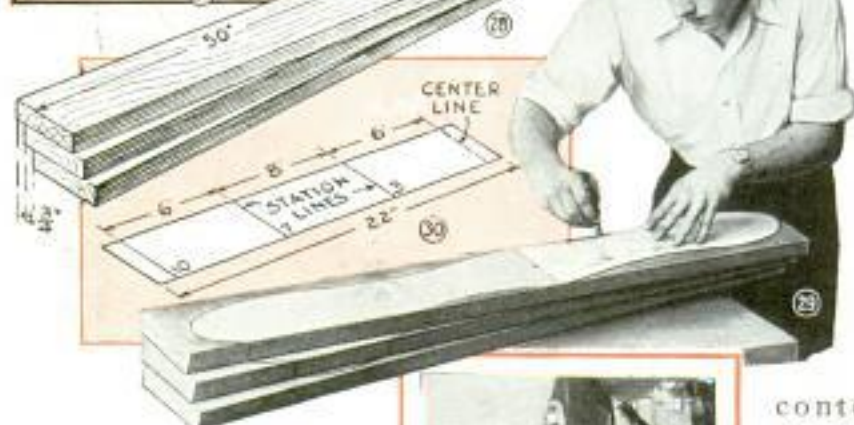
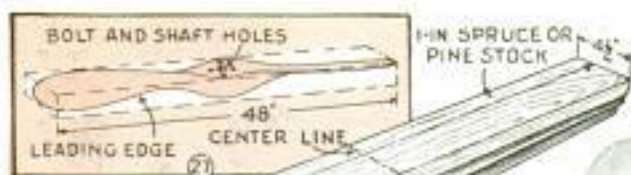

coamings, is from  $\frac{3}{8}$ -in. stock, beveled on the underside to fit the deck, and rounded and curved along the top to show a pleasing contour. Round-head wood screws are used to fasten the woodwork. All raw edges formed by the joining of sides and deck should be finished before painting.

Now for the propeller. While you will undoubtedly get a better product by purchasing it, good results can be obtained with the homemade wheel shown in the illustration. First make cardboard patterns similar to those shown in Figs. 23 to 26 inclusive. These should be carefully laid out full size, and then cut to shape with sharp scissors.

As the propeller is to be 4 ft. in diameter (Fig. 27), the wood used must be at least that length or a few inches over. This is not to be in one solid piece but is built up from three 1-in. pieces, which are glued together with aviation glue as in Fig. 28. Spruce or good white pine is satisfactory and easy to work. Fig. 29 shows how the paper pattern is used in laying out the propeller shape on the wood surface. One-half of the blade is marked at a time, then the pattern is turned over, adjusted to the center lines, and the opposite side penciled in. You will observe that the pattern extends beyond the surface of the uppermost board, thus doing away with some of the hard work of carving. After cutting the slab to shape on a bandsaw, it is advisable to drill the shaft and bolt holes as indicated in Fig. 26. These should be perfectly true, and are best done on a drillpress.

Then comes the carving. Fig. 27 gives an idea of what edges to start on, and the templates can be used as a constant check



as you approach the finished shape. Besides the templates, you will need a length of cardboard with the three station marks and the center line set off on it, as in Fig. 30. This is placed under the propeller, center line at the hub hole (see Fig. 31) as a guide in placing the templates at the proper position.

The method of fastening the propeller to the motor shaft is shown in Fig. 34. A 4½-in. pipe flange is fitted to either side of the hub and held in place with bolts. These should have an S.A.E. standard thread. Each flange is properly cut to take the key, as indicated in the shaft drawing Fig. 9 of Part I. There are three important factors in the propeller construction, two of which are common to all air screws. First of all, the propeller must balance exactly, that is, one side cannot be heavier than the other. The application of stain and hot linseed-oil coats should not be done until the balance is perfect; after that the propeller should be touched up with sandpaper not coarser than the No. 0 grade. The propeller is not set to drive straight ahead but is inclined 2° to the rear to exert a slight upward pull necessary to offset the weight of the motor at the rear. Check with a plumb bob, as in Fig. 32. The 2° inclination of the propeller amounts to about 1 in. when projected the half-length of the blade. Finally, the blade must "track," that is, it should check perfectly to a point set out from the framework at either blade tip, as shown in Fig. 35. In all three factors of balance, angle and track, it is advisable to correct inaccuracies by recarving and shimming at the hub.

A substantial guard, made of pipe or heavy bar iron, should be mounted, as shown in Fig. 36, to prevent danger of injury from the propeller. The parts of the guard are welded together for strength, and suitable braces are used to hold it rigidly in position.

For a brake you will make up the simple arrangement shown in Fig. 33. This is hinged to one of the rear-spring supports and is operated by means of a cable connecting to a rod within convenient reach of the driver. Seating accommodations for the pilot and one passenger are provided by standard folding seats used on all coach-model cars.

Paper Wrapped around Cylinder Serves as Guide for Making Line Square with Its Axis

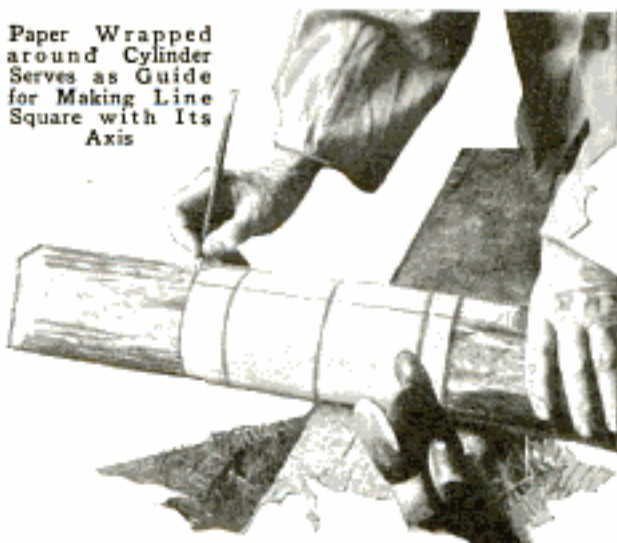

#### Paper Guide for Making Straight Line around Cylinder

For making a straight line around a cylinder, at right angles to its axis, a piece of paper with a straight edge can be used as a guide. Wrap the paper so the overlapping edges form an unbroken line, then follow this around the cylinder with a pencil.—Charles A. King, East Kingston, New Hampshire.

#### Cuff on Worker's Trouser Serves as Nail Pocket

Where a worker must assume a bending position, as when nailing flooring, a 2 or 3-in. cuff turned up on the trouser leg provides a good pocket for the nails as



it keeps them within easy reach. It is, of course, advisable to sew the cuffs in this position permanently, and it will be found convenient to form several narrow pockets instead of two or three wide ones so that the nails will be held vertical

and thus readily can be taken out. The height of the pockets should be less than the length of the nails.





### Water Pan in Hot-Air Pipe Maintains Proper Humidity

In order to maintain the proper humidity in a room that is heated by a hot-air furnace, a water pan can be placed in the pipe behind a wall register and nailed to the floor as indicated. The pan is filled with water by means of a funnel and a length of rubber hose. A similar method can be adapted to a floor register by suspending the pan from the register grating. —Harry C. Jackson, Chicago.

### Clothes Kept from Freezing to Line with Paraffin

Wet clothes hung outside in cold weather often freeze to the line, especially if it is of the woven-cable type, which may result in some of the more delicate garments being torn when removing them. To avoid this, draw a piece of softened paraffin wax back and forth on the line so that it becomes covered with a waterproof film, which will last indefinitely.

### Platinum Deposit on Glass Provides Base for Soldering

By depositing a coat of platinum on glass or porcelain, it can be soldered to metal. Crush dry platinum chloride, 1 gram, to a fine powder, and mix in enough oil of lavender to form a thin paste. Dur-

ing this process, keep the mixture on ice to prevent it from reducing and let it remain there for at least two hours. Then add oil of rosemary to obtain the desired consistency. A good solution is formed by adding enough of this oil to increase the bulk of the paste about ten times. The mixture may be brushed on the glass, or small parts can be dipped into it. After the paste has been applied, heat the glass over a Bunsen flame for a few seconds and the metallic coating will form, the coated parts turning to a bright silver color. The higher the temperature of the glass, the better the coating will adhere. Solder takes readily to this coating and cannot be removed without chipping the glass. When soldering glass to metals, it is necessary to remember that their expansion is unequal, and, therefore, the metal parts should be thin enough to bend and conform to the size of the glass at different temperatures.—H. E. Overacker, Palo Alto, Calif.

### Booster Supplies Rich Mixture to Start Cold Car

Mounted on the intake manifold at its highest point, a booster taken from an old vacuum tank can be used to supply a rich fuel mixture for easier starting of a car during cold weather. A petcock, which holds the booster, is fitted to the intake manifold, and a dash control is provided for operating the cock, which is only opened for starting. The gasoline supply for the booster is taken from the float chamber of the carburetor by means of a

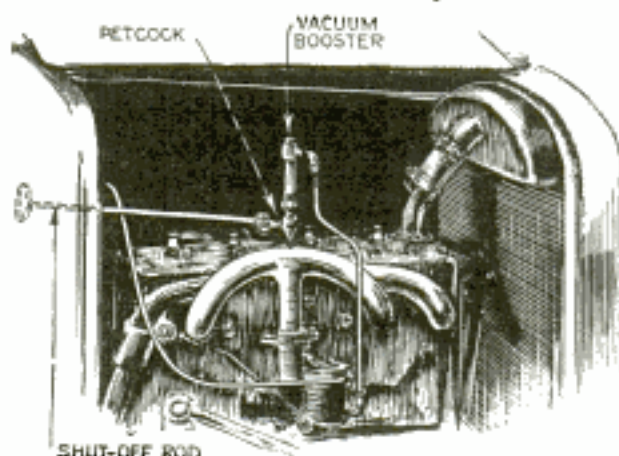

Booster Forces Rich Mixture into Intake Manifold for Starting Car in Cold Weather

copper tubing, attached as shown. Closing the hand throttle and opening the pet-



cock will supply a finely atomized mixture into the manifold when the engine is cranked.—A. H. Vance, Bensenville, Ill.

### How to Make "High-Key" Photos

Any amateur photographer who does his own finishing can make "high-key" prints, that is, without dense shadows. Dilute the regular developing solution with an equal amount of water, and add 1 oz. of hypo fixing bath. First develop a test strip of film that has been given a short exposure. If a suitable image does not appear within 3 or 4 minutes, increase the exposure. If the image becomes too dark and dense, add more hypo until the picture comes up in delicate tones. A developing time of 5 minutes is usually required for such pictures. As the developer loses its strength rapidly, it is a good idea to observe its effect constantly. When made on fairly rough paper, these photos somewhat resemble sketches or etchings.

### Radio Horn Serves as Reflector



An old radio loud speaker of the horn type, now almost obsolete, can be used as a reflector for a wall lamp. After removing the unit, a wooden plug is fitted into the neck of the speaker and an extension cord is run through the plug so that the lamp will be held in the position shown.

### Siphon for Aquarium Is Self-Starting

You can easily make a self-starting siphon for draining your aquarium. Get a glass tee and bend one end as shown. Take a 3-in. length of  $\frac{3}{4}$ -in. glass tubing and fit corks in each end, a  $\frac{1}{16}$ -in. hole being drilled through one cork, while the other is drilled to receive the bent end of the smaller tubing. If desired, a bottle or test tube of suitable size can be used instead of the larger tubing by drilling a  $\frac{1}{16}$ -in. hole in the bottom of it, as shown in the left-hand detail. A length of rub-

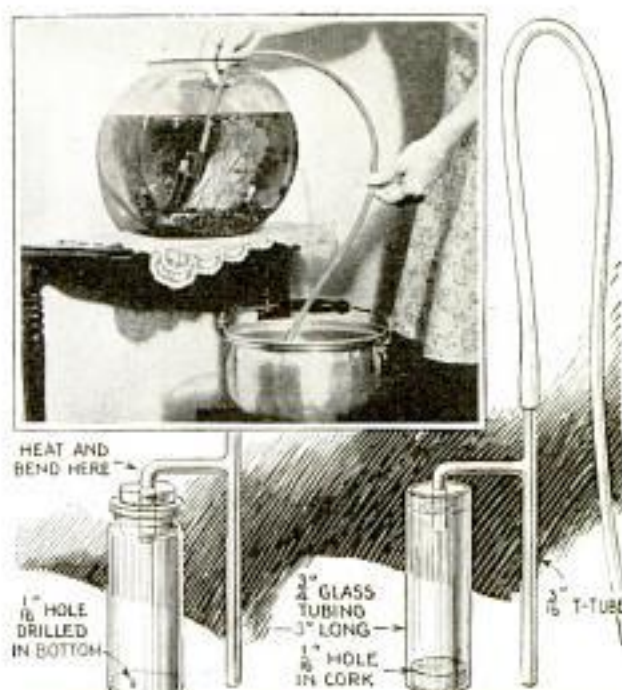

Automatic Siphon Made of Glass Tubing and Rubber Hose Quickly Drains Small Aquarium

ber tubing slipped over the upper end of the glass tee completes the job. The siphon is plunged into the water, which rushes through the small hole at the bottom and displaces the air in the chamber, forcing it up through the rubber tubing. The buoyancy of this air carries the water with it, and when the air is out of the chamber, the water continues to flow in a steady stream.

### Box Catches Soot When Cleaning Stovepipe

By inserting the end of a section of stovepipe into a hole in a cardboard box as shown, you can prevent the soot from being blown around when cleaning the pipe. The box should be tightly closed. By tapping or scraping the inside of the pipe with a stick, the soot will fall into the box.

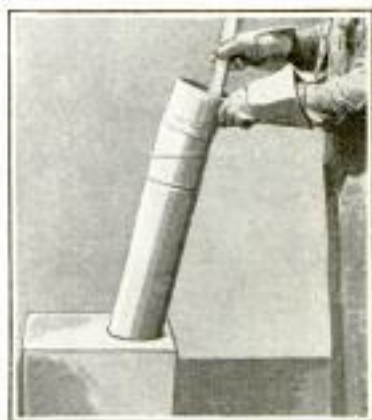

Coloring, added to paint after the final thinning, causes it to be streaky.



# Making the TENDER for the

By Reginald H. Claudius

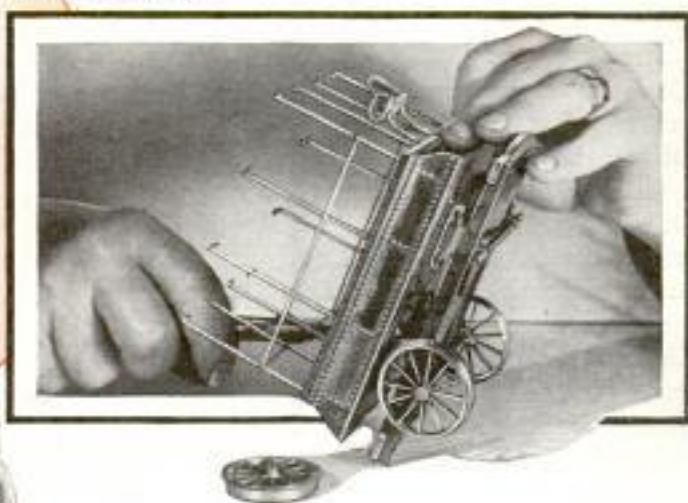

## PART III

**A**FTER completing the locomotive, the tender is a comparatively simple job. First the wheel rims are sawed from  $1\frac{3}{4}$ -in. outside diameter brass tubing with  $\frac{1}{8}$ -in. wall, allowing  $\frac{1}{16}$  in. for finish on each rim. The flange is formed by turning down the tread to  $1\frac{5}{8}$  in. in diameter and  $\frac{3}{32}$  in. width as in Fig. 48, leaving  $\frac{1}{16}$  in. for the flange, the face side of which should meet the tread at a small angle. The top edge is rounded slightly when taking off the final finish cut, and the edges are brought to within  $\frac{1}{64}$  in. of the required finish dimension. The hubs are cut from  $\frac{1}{4}$ -in. brass rod and are rough-faced, allowing approximately  $\frac{1}{32}$  in. on each end for finish. The hubs are not drilled until the wheels are fully assembled.

The wheels are made on a jig cut from  $1\frac{1}{2}$ -in. hard maple or aluminum, about 4 in. square. It is faced in the lathe to leave a center projection  $1\frac{1}{2}$  in. in diameter and  $\frac{1}{8}$  in. high, as in Fig. 48, which is slotted  $\frac{1}{16}$  in. deep for twelve spokes cut from No. 22-gauge brass. Care must be taken to have the slots equally spaced, and

they are sawed to the same depth. It is necessary to select a blade that will cut a slot the same width as the thickness of No. 22-gauge brass, so that the spokes will be held in the proper position when the wheel is assembled for soldering. A  $\frac{1}{4}$ -in. hole is bored in the exact center of the jig to an exact depth of  $\frac{1}{4}$  in. The hub should be a snug fit in the hole to prevent tipping. The spokes are made by cutting a long strip from No. 22-gauge brass to a width of  $\frac{3}{64}$  in. Then the strip is held in the vise and draw-filed to a width of  $\frac{1}{8}$  in. The spokes are cut from the strip to a length slightly greater than that required, and are inserted in the slots with the inner ends bearing tightly against the hub. The outer ends are filed down lightly until the rim will slip snugly over, after which the spokes are soldered to both rim and hub. Excess solder is removed with a fine file, the rim is finished to  $\frac{3}{32}$ -in. width, and the outer end of the hub is faced, leaving the inner end until you are ready to assemble the wheels and axles on the frame.

Four axle boxes are made as shown in Fig. 48. The top plate of each box is of No. 22-gauge brass, and the box proper is filed from  $\frac{3}{16}$ -in. stock, to the shape and size shown. Slight allowances are made for filing to finish dimensions after the box is assembled. For greater accuracy in assembling, the axle box may be held to the plate with a No. 0-80 screw as indicated, the head of the screw being filed



# DE WITT CLINTON *Train*

off after soldering. The boxes are finished by filing lightly, and a No. 36 hole is drilled through the center of each, as indicated. The axles are then turned from  $\frac{1}{8}$ -in. brass rod to the dimensions given in the lower detail of Fig. 48. A slight allowance is made on the shouldered ends to insure a free-running fit in the boxes.

Mahogany is used for the frame, as in Fig. 49, the parts being joined together with No. 0-80 screws and nuts. All holes in the frame are drilled with a No. 52 drill. The three-leaf springs and spring brackets are made as shown. The leaves of the spring are cut from No. 22-gauge brass and are soldered together at the center to hold them in position for drilling a No. 52 hole at the center. Before assembling, the eye at each end of each spring is filed down to a width of  $\frac{3}{32}$  in. so that it will fit the notch in the bracket. The lower spring holster is cut from No. 22-gauge brass to the same size as the axle-box plate, and it is drilled and tapped for three No. 0-80 screws, two of which hold the axle box, and one the spring, as in the upper left-hand detail of Fig. 49. The boxes must be placed on the axles before bolting to the frame, and care must be taken when drawing up the bolts to see that the axles do not bind. Owing to the difficulty of drilling the small holes accurately in the wood, it is possible that one or more

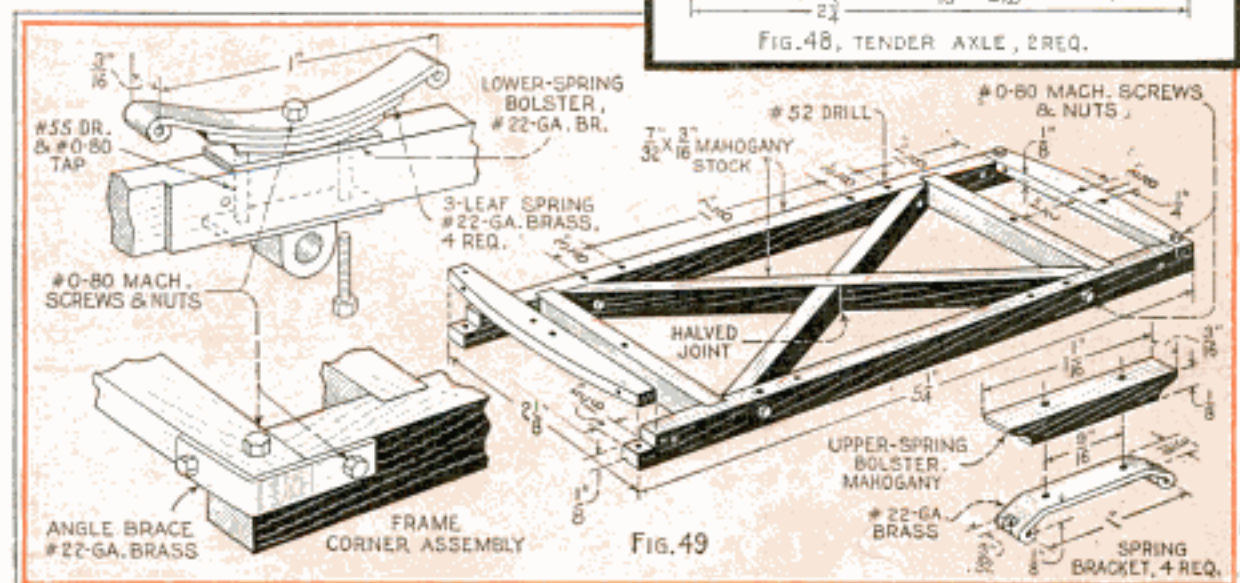
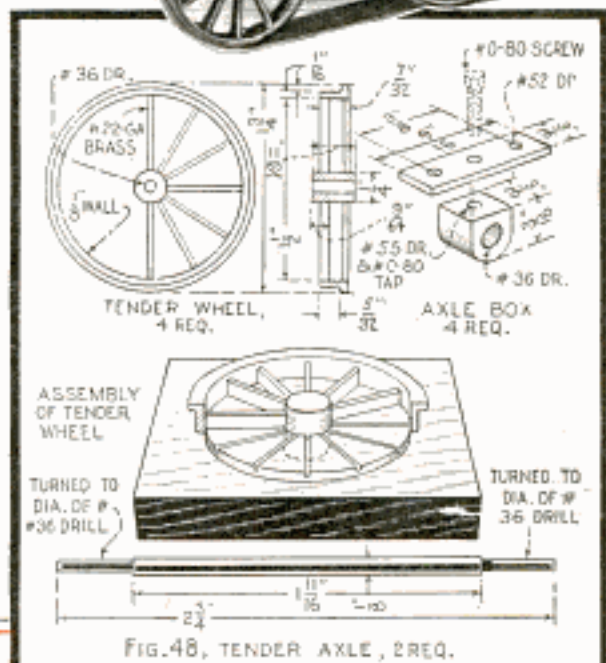







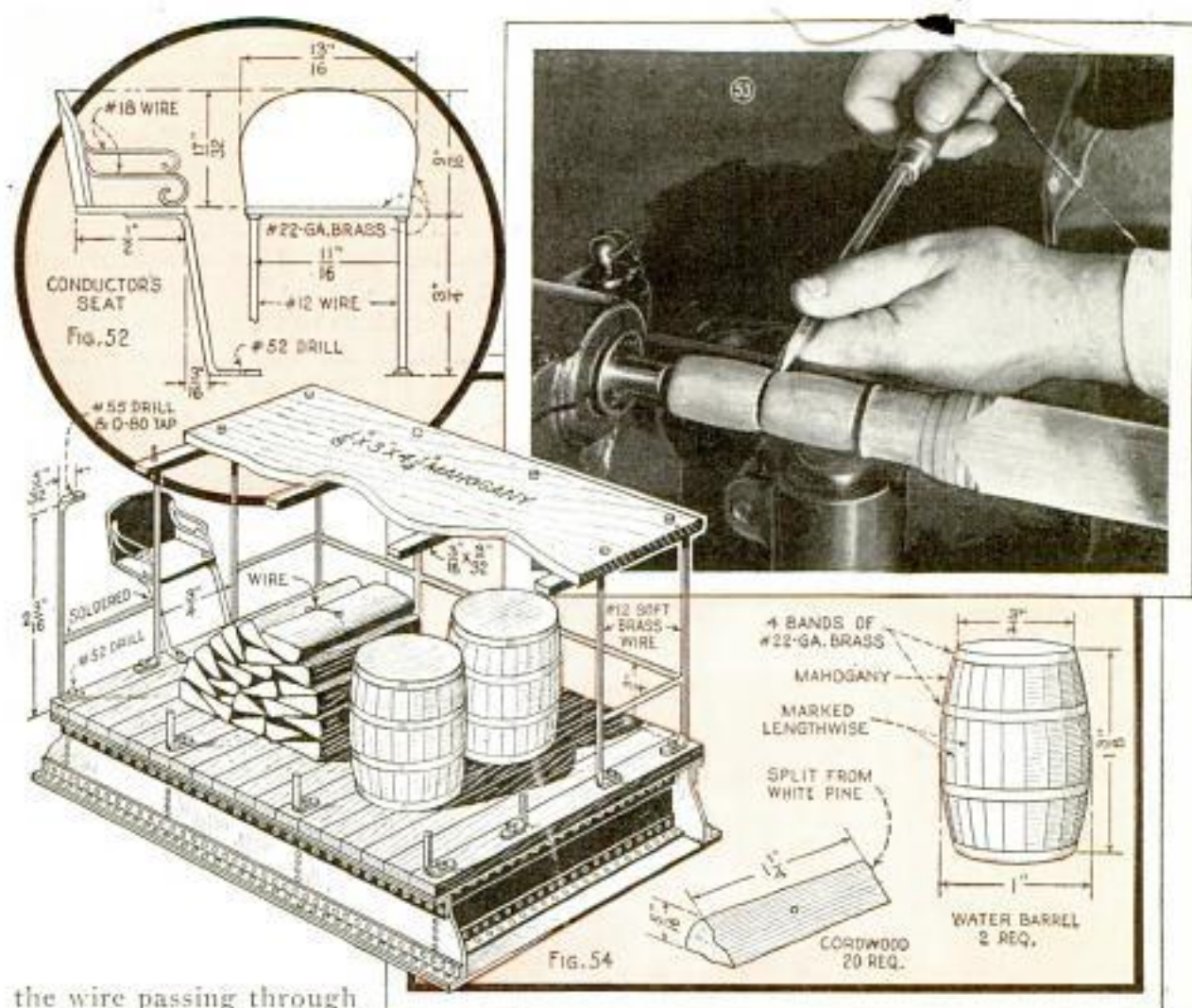

the wire passing through the cordwood, the ends of the wire being bent on the underside of the platform to hold the wood pile in place. The top pieces of wood are arranged so that the wire is as little exposed as possible.

Next, make the stanchions supporting the top from No. 12-gauge wire to the dimensions of Fig. 54, and flatten, drill and tap the ends as indicated. Place the deck in position, then bolt the stanchions or uprights in place with No. 0-80 screws turned into the tapped holes in the top plate of the tank, the screws passing through the deck as in Fig. 54. Solder a railing to the uprights  $\frac{3}{4}$  in. above the deck, leaving the ends open between the two center uprights as shown. Make and attach the conductor's seat as shown in Figs. 52 and 54. Turn two water barrels from mahogany, as in Figs. 53 and 54, and mark the barrels lengthwise with a marking gauge, as in Fig. 55, to represent the staves. Four  $\frac{3}{32}$ -in. bands, cut from No. 22 or 26-gauge brass, are made and fitted

to each barrel as shown. Center a No. 55 hole in the bottom of each barrel, cut the heads from two No. 0-80 screws, and turn these up half the length of the thread in each hole. Then drill two No. 55 holes in the wood platform, insert the projecting end of the screw and turn down each barrel until tight. The holes in the platform are drilled in such a position that the barrels will be located approximately as in Fig. 54. The exact location is of no importance.

The top is supported on crosspieces  $\frac{3}{16}$  by  $\frac{3}{16}$  in. in size, and both top and crosspieces are held by No. 0-80 screws, turned into the tapped holes in the upper ends of the stanchions. The thickness of the top is given as  $\frac{1}{8}$  in. but  $\frac{3}{16}$ -in. material may be used. Bolt the upper bolsters and spring brackets to the bottom of the tank as in Fig. 57, and bolt the two crosspieces in place with No. 0-80 screws, which are turned into the wood through the bolster. Set the tank on the running gear, fit the



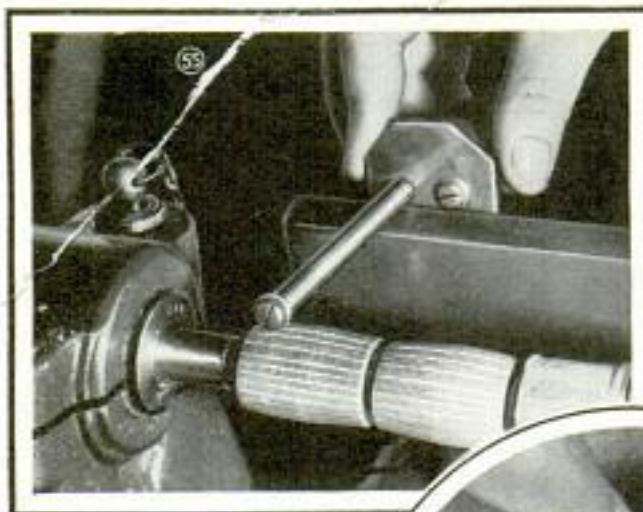

springs to the brackets, run fine wire through the eyes in both spring and bracket, and place a drop of solder on each end of the pins to hold them in place. Level the tank by bending the springs and brackets slightly if necessary. Allow only about  $\frac{1}{16}$ -in. clearance between the bottom of the tender tank and the wheel flange. Make couplings from No. 22-gauge spring brass as in Fig. 58. The eye is simply a short length of No. 18-gauge wire bent to the U-shape approximately  $\frac{3}{16}$  in. high and soldered to the plate which is bolted to the front and rear crossmembers. The No. 0-80 screws holding the plate are turned up from underneath into tapped holes in the plate and the projecting ends of the screws are filed flush. The spring is slotted to fit over the eye thus formed.

Lastly, the wheel hubs are drilled with a No. 36 drill and the wheels are placed on the axles in a trial fit to determine the amount of stock to be removed from the inner face of the hubs, allowing just sufficient clearance between the rim and frame to insure that the gauge is correct. Take the necessary waste off the inner ends of the hubs and sweat the wheels to the axles. In doing this, be very careful to allow sufficient play so that the wheels will turn freely without binding. File the projecting ends of the axles flush with the

hubs. As the wheels are built up on a wooden jig, it is possible that slight inaccuracies may occur in the finished wheel, making it necessary to depart somewhat from the dimensions given in Fig. 48 when fitting the wheels to the axles. The gauge is of the greatest importance and, within reasonable limits, it is permissible to alter the dimensions of the hub to insure the necessary clearance of the rim and the correct gauge.

The next, and probably last, installment of the article covering the construction of the De Witt Clinton train, which is to appear in the April issue of Popular Mechanics, will show the details and assembly of the coaches. After

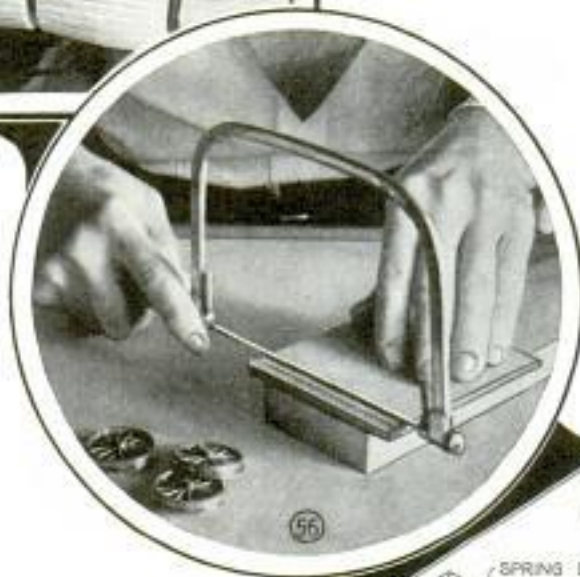

TENDER-TANK  
BOTTOM  
FIG. 57

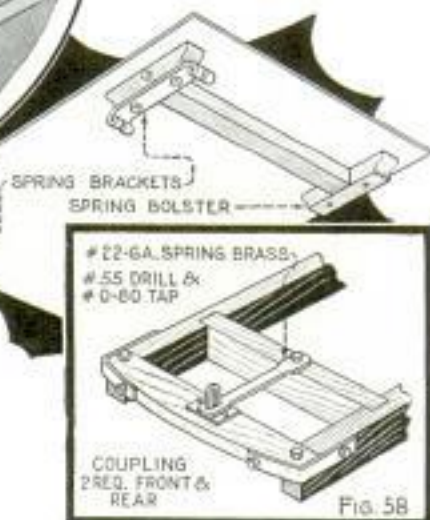

this, full information will be given on the painting and lettering.

#### De Witt Clinton Prize Contest

Prizes totaling \$2,500 in cash and free trips to New York, will be awarded by Popular Mechanics Magazine to those who build the best models of this train. Contest closes Dec. 31, 1932. For more information, write to S. N. Dept., De Witt Clinton Contest, Popular Mechanics Magazine, 200 E. Ontario St., Chicago.

*If you cannot purchase No. 0-80 screws, write to Popular Mechanics, and we will furnish them at cost. Blueprints on the De Witt Clinton model are also available.*



# Garage Doors Yoked Together Open Quickly

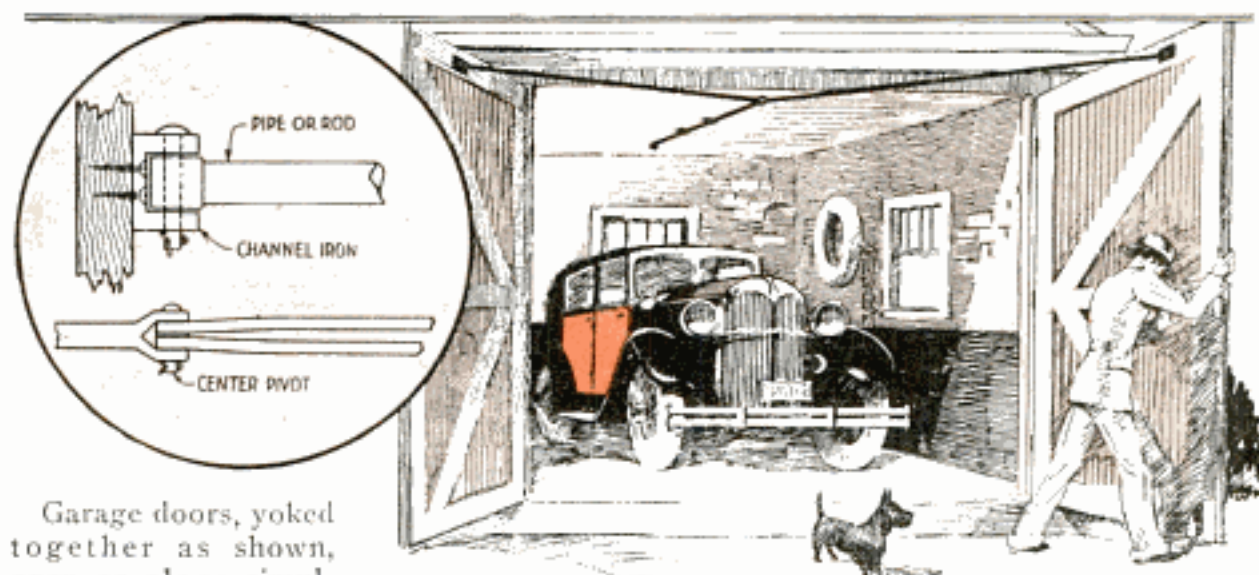

Garage doors, yoked together as shown, open or close simultaneously, saving many steps. Another advantage is that the wind cannot blow one door shut without exerting enough pressure to move both of them, and as it blows against the outside of one and the inside of the other, the pressure is equalized. Two slides are fastened to garage joists, or blocks of wood nailed to the joists, to accommodate a rod or pipe pivoted to two similar lengths which are attached to the top crosspiece of the doors. The slides must allow the rod to move back and forth easily, and a little grease applied at these points helps to reduce friction. The length of the sliding rod depends on the size of the doors and their swing, and also on the length of the cross rods, while the loca-

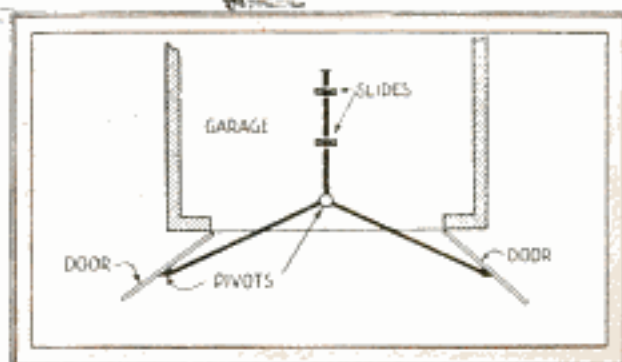

tion and spacing of the slides is determined by the distance that the rod moves back and forth. All three rods are flattened at the ends and pivoted together. Similarly, the cross rods are pivoted to the doors, the pivots being shown on the left-hand detail.—J. E. Hyler, Peoria, Ill.

## Caster Makes Bearing for Windvane

Casters of the ball-bearing type make good bearings for homemade weather-vanes. Remove the roller and attach the vane as shown in the left detail. The ball

bearing has very little friction so that the vane will register the slightest change in the air currents. As it is constantly exposed to all kinds of weather, the bearing should be kept well greased to avoid rust.

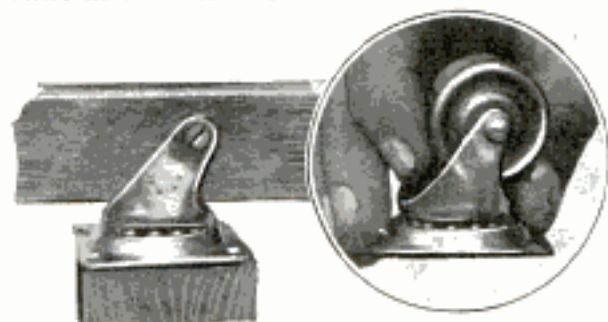

Ball-Bearing Furniture Caster Provides Frictionless Pivot for the Weather-vane

## Rubber Mat in Sink Saves Dishes

To offset the risk of breaking dishes when washing them in the sink, it is a good idea to cover the bottom of the sink with a rubber pad or mat. Old auto mats, which are worn out in spots may be cut to shape and used for this purpose, or corrugated rubber can be purchased in any desired size. A hole is cut through the rubber to fit over the sink drain.



### Metal Guard Prevents Hot Clinkers Burning Shoes and Trousers

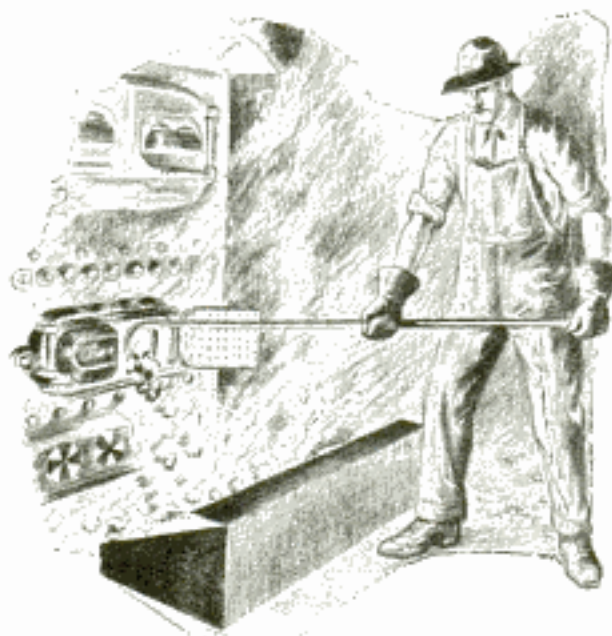

Sheet-Metal Guard Prevents Hot Clinkers from Scattering over Floor When Cleaning Furnace

Firemen and janitors will appreciate this clinker guard. It is a piece of heavy sheet metal shaped as shown, and is placed on the floor in front of the furnace to keep hot clinkers from scattering over the floor when pulled out of the furnace.

### Bottle Caps and Covers Removed with Strong Cord



When you have a bottle cap or tight cover to remove and no opener is at hand, try the following trick: If the bottle is fitted with a screw cap, loop a strong cord around it as shown in the left-hand detail, and pull the cord as indicated. In the case of a crimped cap, loop the cord around the bottle neck just below the edge of the cap and pull up on the cord. The use of a small block placed on the cap will increase the leverage, and

if cord is apt to be cut on the edge of the cap, a length of wire may be substituted. —Paul L. Ambelang, Chicago.

### How to Keep Photographic Solutions

Photographic solutions can be kept for several weeks without losing much of their strength, if they are kept in bottles fitted with air-tight caps or covers. After putting the solution in the bottle, heat it slowly until it is as hot as you can hold in your hand and screw on the cover. Heat expands the air over the solution and forces out some of it. If the bottles are immediately capped securely after heating, they will contain less air, upon cooling, than otherwise, and the solution consequently absorbs less air, with the result that it will last much longer. This method is useful for the amateur who has prints to develop every day or so, but not if only occasional work is done.

### Rubber Bands Hold Chisel to Wrist

To prevent the loss of a chisel when a glancing blow from a hammer knocks it out of the hand, loop two rubber bands together, fasten the end of one band around the shank of the chisel and slip the other band over the wrist as shown. The bands will not interfere with the work.

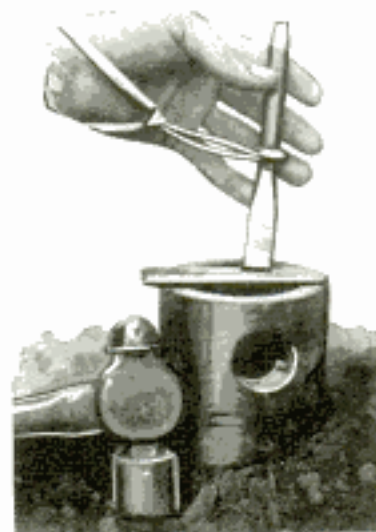

### Rivet Mends Resistance Wire

Broken resistance elements used in electric stoves, toasters and other electrical appliances, can be repaired by fastening the broken ends together with a small brass rivet. Bend the broken ends of the wire to form eyes to fit the rivet, which is peened over to make a tight electrical connection. Such a repair will last longer than the remaining part of the element.



# Folding Drawing Board Padlocked to Wall

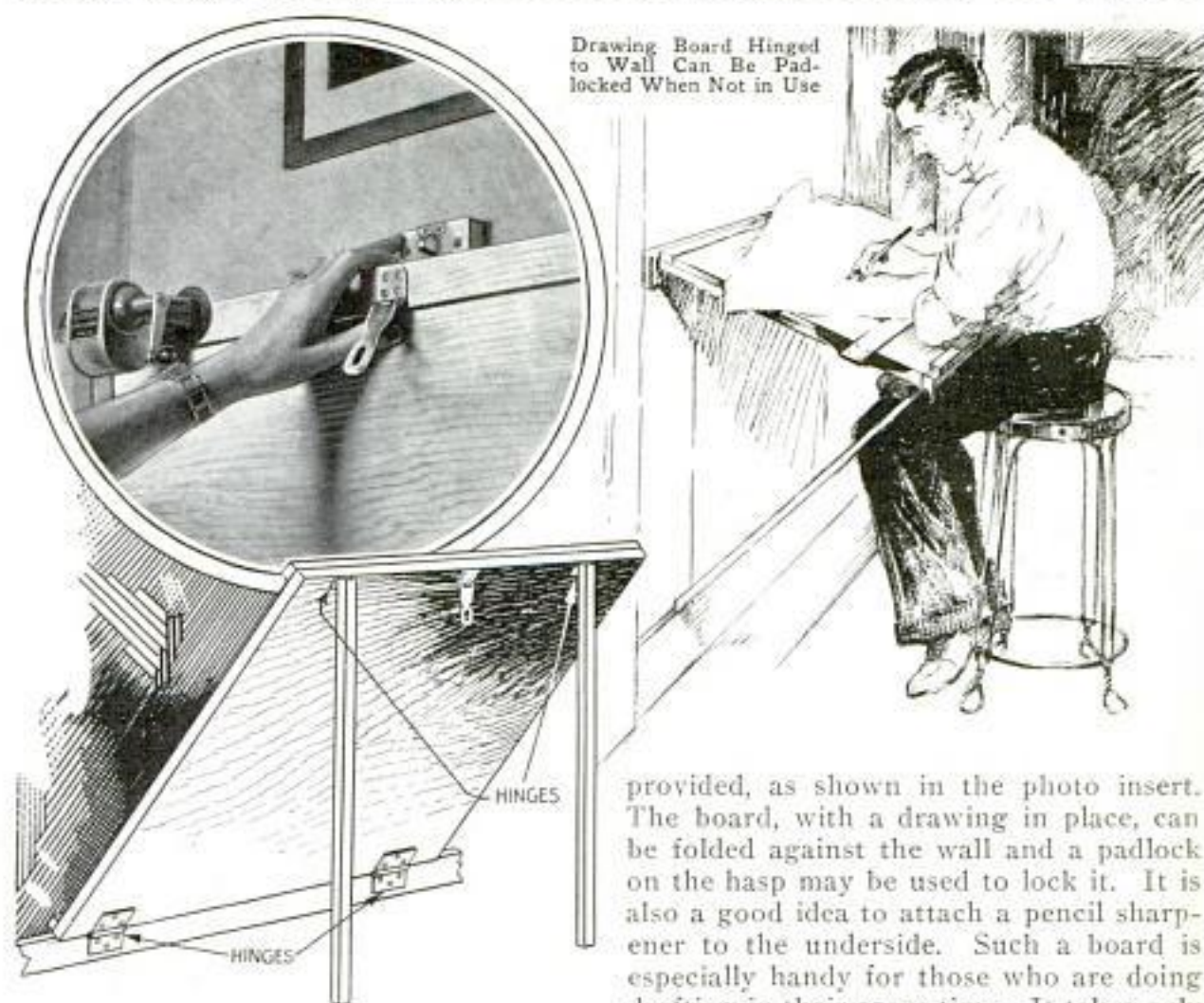

Drawing Board Hinged to Wall Can Be Padlocked When Not in Use

If you have a drawing board that is always in the way, or in some place rather difficult to reach, try mounting it against the wall where it occupies scarcely any space, yet can be dropped down in an instant ready for use. An ideal place for attaching the board is between two windows. Almost any wall space of sufficient size can be used, however. Across the bottom of the board fasten a wooden strip to form a ledge for holding pencils and other instruments, and then attach the top to a cross strip with hinges. At the corners, on the underside, hinge two legs which should be of such length that, when the board is tilted at the proper angle, they will rest against the baseboard or on the floor. Lengths of cord can be used to limit the fall of these legs. For holding the board up against the wall when not in use, a hinge hasp and staple, the latter raised flush with the board on a block, are

provided, as shown in the photo insert. The board, with a drawing in place, can be folded against the wall and a padlock on the hasp may be used to lock it. It is also a good idea to attach a pencil sharpener to the underside. Such a board is especially handy for those who are doing drafting in their spare time. It takes only a few minutes to unlock it and set it up for use.

## Water Penetration through Brick and Mortar

When water penetrates through a brick or masonry wall during a rainstorm, the U. S. bureau of standards has found that the water usually enters through the cracks between the bricks, not through the bricks themselves. This is due either to shrunken mortar or poor workmanship. Experiments have shown that a brick must be highly saturated to transmit water to another material and that, under normal conditions, it is not likely to absorb enough water to wet interior plastering. As a precaution, however, it is a good idea not to plaster directly on the bricks in an 8-in. wall, but to put lath over the bricks, or use metal ties in place of the header bricks.



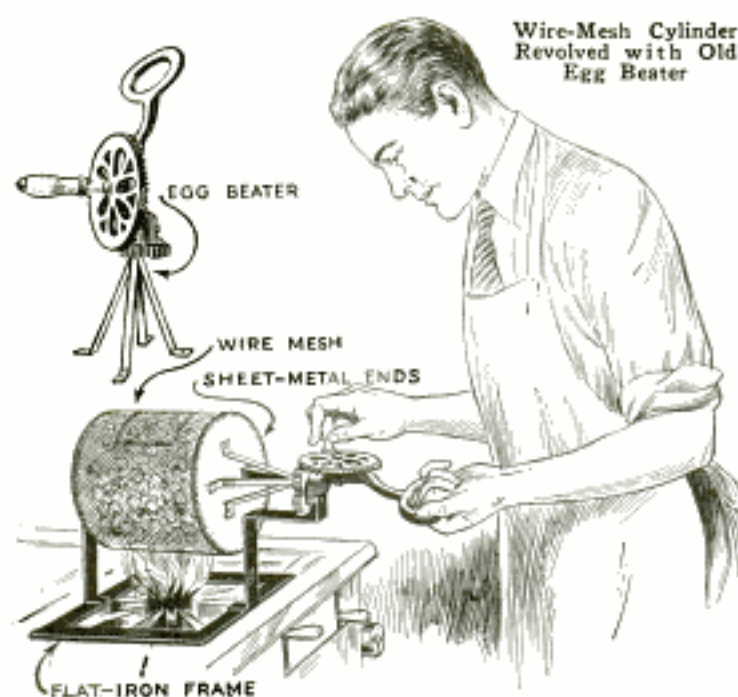

### Rotary Corn Popper Fits Gas Burner

Here is a rotary corn popper that turns the kernels over completely and thus keeps them from being burned, which prevents popping. It consists of a flat-iron frame carrying a cylinder with sheet-metal ends and wire-mesh sides, in which a door is made for putting in and removing the corn. An old egg beater is adapted to drive the cylinder.

### Celluloid for Protection of Paper around Wall Switches

In order to avoid soiling the paper around a switch on a wall, remove the plate, cut a piece of clear celluloid large enough to extend about  $1\frac{1}{2}$  in. beyond the edges of the plate and replace the latter with the celluloid underneath. Celluloid is easily washed and will not hide the design of the paper.

### Preserving Fiber Records

The tendency of new fiber phonograph records to warp can be overcome by cementing them together. This will not damage them, as they are played on one side only. Duco cement is good for this purpose. After the records have been joined in this way, place them on a smooth surface and put a heavy weight on them until the cement has dried.—R. V. Silliman, Minneapolis, Minn.

### How to Determine a Faulty Coil

Faulty coils are sometimes the cause of an elusive miss in a motor which is especially noticeable at slow speeds or on hard pulls. A miss caused by a coil will not always be evident on the same spark plug; sometimes the motor may even stop firing and then immediately pick up again, although it will probably idle fairly well unless the coil is dead. The best way to check a coil is to replace it with a new one and drive the car for a while. If this does not show any improvement, the cause is probably due to the condenser, although the coil itself usually wears out first. A defective coil or condenser may work satisfactorily at times or it may stop functioning entirely, leaving you stranded, perhaps several miles from a garage. Therefore, it is best to replace the defective part as soon as trouble shows.

### Improved Balance Scale Uses Coins for Weights

Made from a wooden mixing spoon, this quickly improvised scale for weighing chemicals is fairly accurate. The balancing center of the spoon is determined and a hole drilled through it at this point for a nail which serves as a pivot, the ends of the nail being stapled to two blocks. A small wooden block under each end of the spoon acts as bumper to prevent the scale from tipping too far. United States coins that are not worn, can be used for weights. A penny weighs 48 gr., or .1 oz.; a nickel, 77.16 gr.; a dime, 38.58 gr.; a quarter, 96.5 gr.; a half dollar, 192.9 gr., and a silver dollar 412.5 grains.





3 blueprints 75 cents

# AT HOME on the



## ROAD in a TRAILER

Tour Pays for Itself  
from SAVINGS MADE  
in RENT

*Here is an ideal touring trailer incorporating almost all home conveniences. Although only five and one-half by eight feet in size, it includes two full-size beds, running water, electric lights and a radio, besides a kitchen, pantry, wardrobe and several storage bins. Two years of continuous service have proved this trailer practical in every detail.*

By A. RUHLAND  
PART I

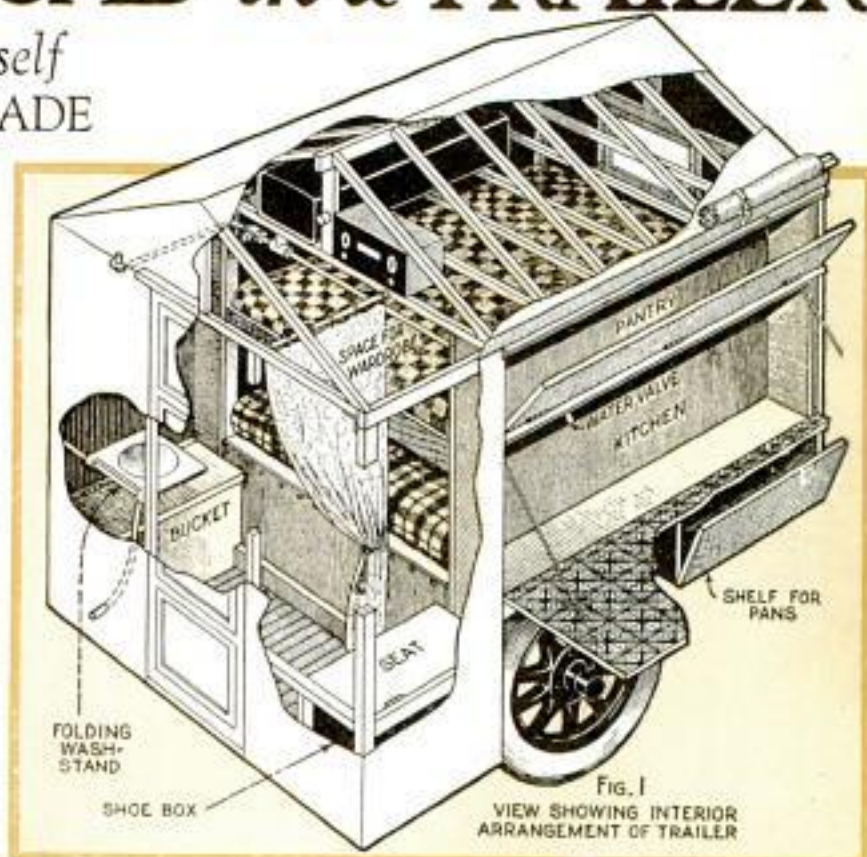

**A**T a cost of about \$90, which includes new tires, this trailer can be built by anyone handy with tools. The total weight is approximately 750 lb., which is distributed so well that, when suitably hooked to a car, it is scarcely noticeable. Furthermore, there is very little additional gasoline consumption.

First get the front end of a light car from an auto wrecking yard. This should include two springs and the frame, which is sawed off about 3 in. from the point

where the springs are attached. A Ford front end cannot be used as it has only one spring. In the illustrated trailer, an Essex front end was used, the axle being underslung. Then get two rails of 2 by 4-in. ash or oak, 6 ft. long, and bolt them to the frame. Hardwood washers, 4 by 4 by 1 in., separate the rails from the frame, in order to allow the spring shackles to work freely, and lock washers are used under all nuts throughout the entire construction. The circular insert in Fig. 2



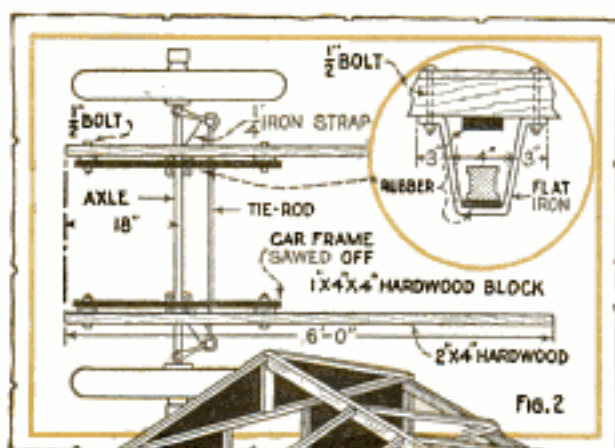

FIG. 2

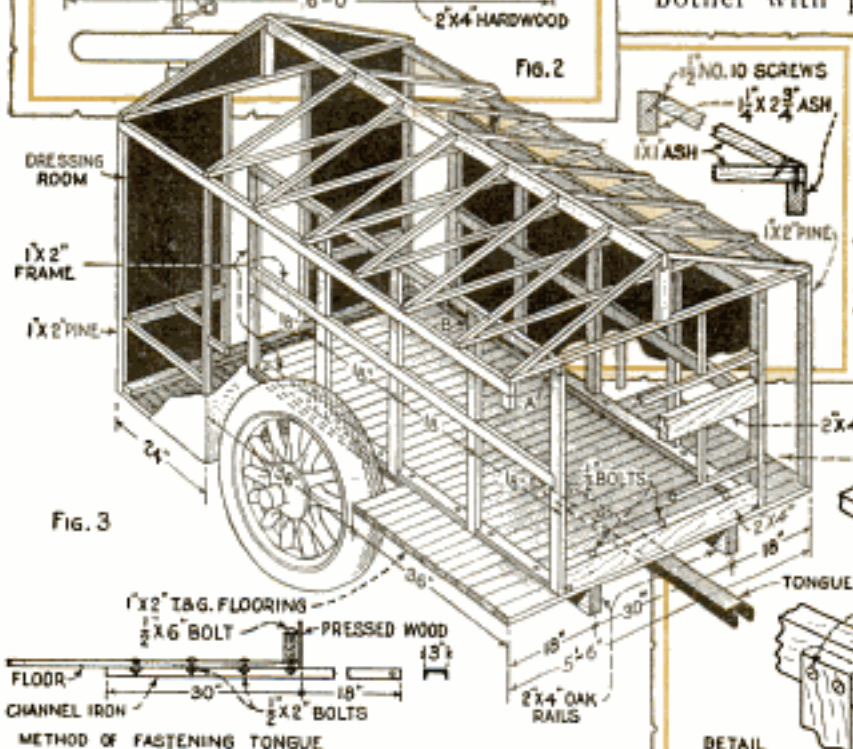
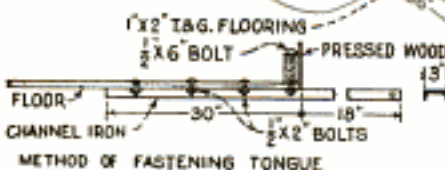

FIG. 3



shows a snubber arrangement, which consists of two lengths of flat iron, bent to a U-shape and bolted to the underside of the rails to pass underneath the axle. Rubber pads are attached to both the rails and to the snubbers. It is also necessary to fasten the wheels rigidly in line parallel to the rails, which is done by means of two  $\frac{1}{4}$ -in. iron straps, bolted to the ends of the tie-rod and to the axle or frame. The rails should project 18 in. beyond the axle, as shown in Fig. 2. Tongue-and-groove pine flooring,  $2\frac{1}{2}$  in. wide, is laid on the rails. The tongues should be painted and the flooring fastened down with  $1\frac{1}{2}$ -in. No. 10 flat-head wood screws.

Next, the framework is erected, first the inner sides, then the roof and finally the outer sides. Use 1 by 2-in. stock, joining the ends as shown in Figs. 3 and 4. The uprights are spaced 18 in. apart, center to center. As soon as the side framing has been made,  $\frac{1}{8}$ -in. pressed wood is screwed on the outside with  $\frac{7}{8}$ -in. No. 6 flat-head

screws. The sides are then screwed onto the floor, with the outer edge exactly 7 in. from the edge of the flooring, which leaves 4 ft. between the sides and places them inside of the wheels. Temporary bracing is used to hold the sides in position until the front piece of pressed wood can be screwed on. This piece extends to the edge of the floor on both sides. Do not bother with putting on the roof trusses or window frames yet, as it is better to do this later. Two 2 by 4-ft. cross-pieces are laid on the floor at both ends and are fastened to the rails beneath with  $\frac{1}{2}$  by 9-in. carriage bolts. The upper

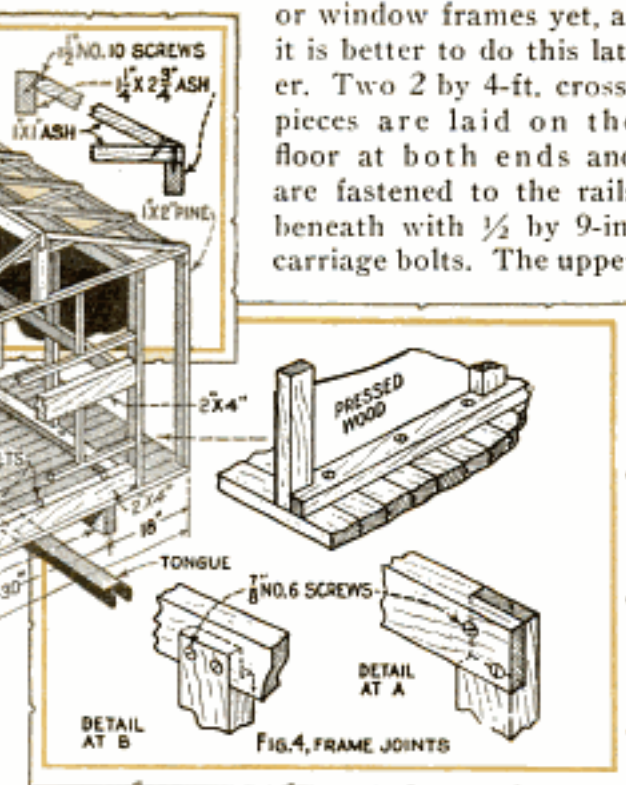
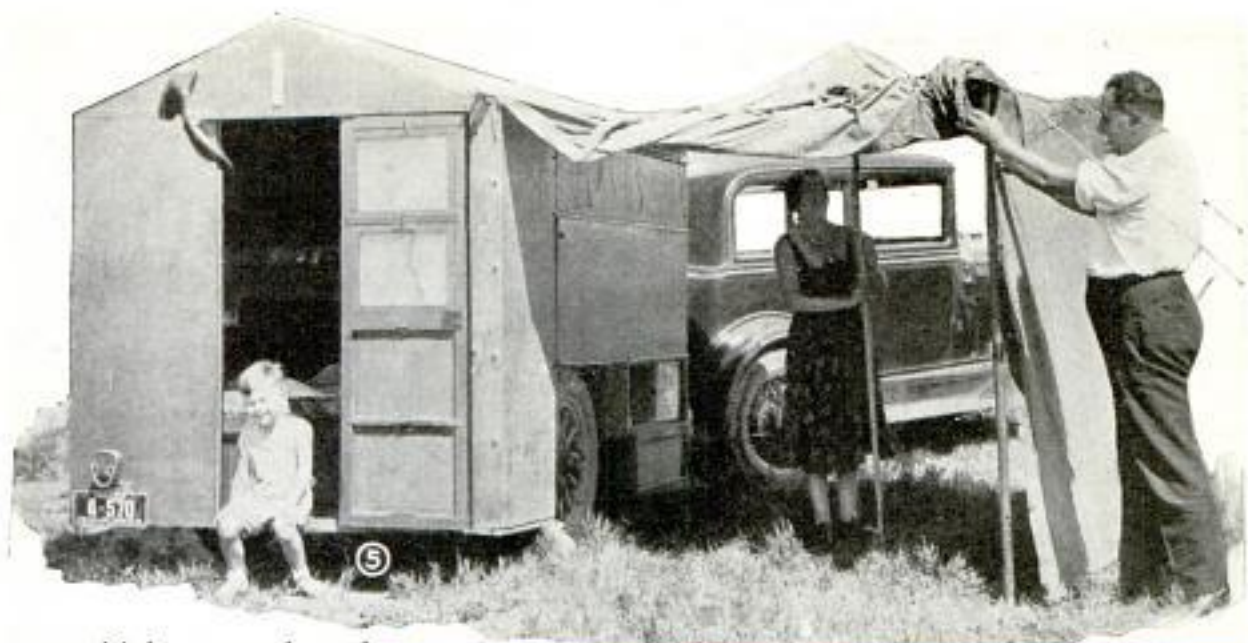

FIG. 4, FRAME JOINTS

bed frame is located about 2 ft. above the lower one. In building the frame to support the upper mattress, apply the bracing crosswise at 6-in. intervals. A piece of pressed wood is screwed onto the underside of this framing to provide a smooth ceiling over the lower bed, and another piece is screwed to the top side to distribute weight evenly.

The roof framing is applied before the dressing room is erected, as the latter is partly suspended from the roof. Details of the roof framing and the method of making the joints are given in Fig. 3. All the trusses should be spaced 1 ft. apart except the last two, which are 2 ft. apart in order to provide more head clearance in the room. Of course, the roof must project 9 in. beyond the sides so that its edge will be in line with the edge of the floor. The ridge of the roof is 14 in. above the sides in order to make the dressing





room high enough and also to provide a storage space. Pressed wood is screwed onto the roof trusses and a cove molding is applied, upside down, on the ridge to prevent leakage, which forms an excellent ridge roll. Triangular pieces of composition board complete the front inclosure.

To construct the dressing room, examine the right-hand detail of Fig. 6. Note that the flooring is screwed to the underside of the 1 by 2-in. crosspieces, one of which is laid flat and the other on edge. The latter is screwed to a piece of  $\frac{5}{16}$ -in. three-ply veneer, 14 in. wide, which is in turn screwed to the 2 by 4-in. crosspiece at the rear. This places the dressing-room floor 10 in. below the lower bed. The framework of the dressing room is then put in place as indicated, after which the sides and back are covered with pressed wood, leaving the center part open for the installation of a door. Angle brackets should be used in attaching the dressing-room frame to the roof and floor, in order to obtain maximum strength at these joints. The shoe box and bucket box can now be built in and provided with hinged tops, after which the water tank can be installed on

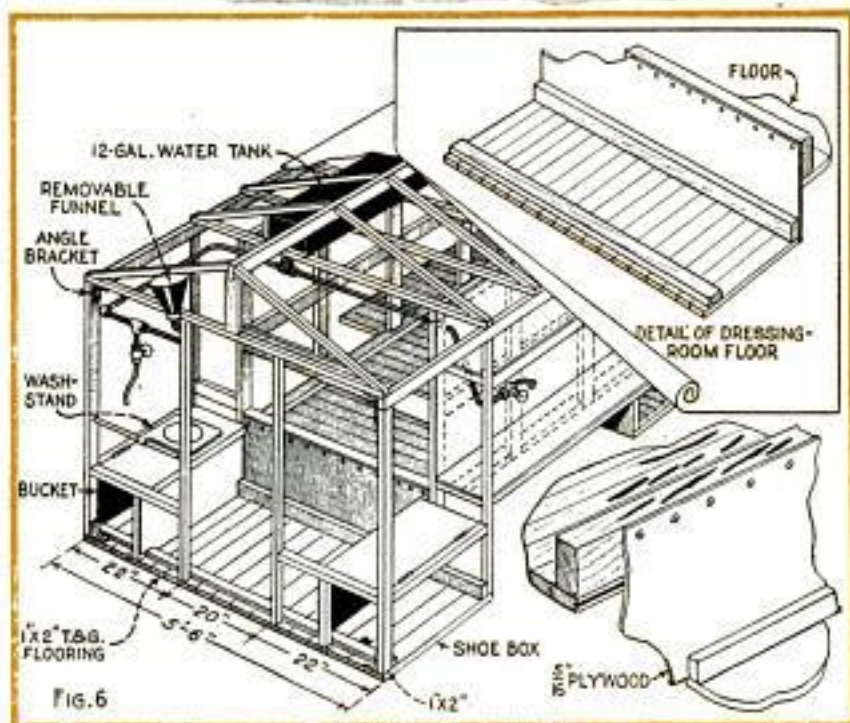

the joists above the upper bed as shown in Fig. 6. For the water pipes, the  $\frac{1}{2}$ -in. size will be found large enough. The water system runs to the folding washstand and also through the right wall to the compartment that is to serve as the kitchen. Ordinary hand valves are screwed onto the end of the pipe at the service points, and a length of hose is added for convenience. Filling of the water tank is done at the rear, the pipe projecting above the level of the tank, and on the outside of the trailer, permitting a funnel to be inserted as indicated in Fig. 6.

Figs. 7 and 8 show how the storage



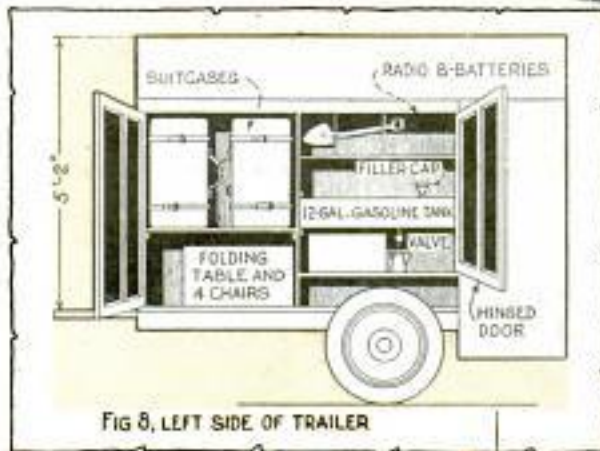

FIG. 8, LEFT SIDE OF TRAILER

space on the left side of the trailer can be utilized. After the partitions have been built, door frames, covered with pressed-wood panels, are hinged on as indicated. You can divide the storage space as you see fit, although the arrangement illustrated has been found highly satisfactory. One compartment holds two suitcases, with sufficient space underneath to store a folding table and four folding camp stools. At the top of the rear compartment, radio B-batteries were installed, extra inner tubes, a shovel and other equipment. A 12-gal. reserve gasoline tank, placed just below this shelf, is handy to keep fuel for the cookstove, and a measure is located near at hand as shown.

If small articles are placed in these com-

partments, rubber bands, cut from old inner tubes, are tacked to the partitions and the articles slipped between to hold them securely without rattling. In the case of larger articles, other arrangements can be improvised. Fig. 9 shows an end view of the trailer and the installation of accessories. The radio aerial consists of a length of phosphor-bronze stranded cable running back and forth on suitable insulators, attached to the underside of the roof trusses. On the right side of the trailer, the kitchen pantry and pan shelves are arranged as shown in Fig. 10.

The kitchen table is built up of 1-in. stock and is hinged horizontally so that it also serves as the side. Lengths of furnace chain are fastened to the table top and to the side of the trailer to hold the table horizontally when open, as shown in Fig.

11, and to take the weight of the table as it has no legs. The inside of the table is covered with oilcloth and as many compartments as are needed are built to hold dishes, groceries and a folding gasoline cookstove. In arranging the kitchen, it is best to plan a definite place for each article, where

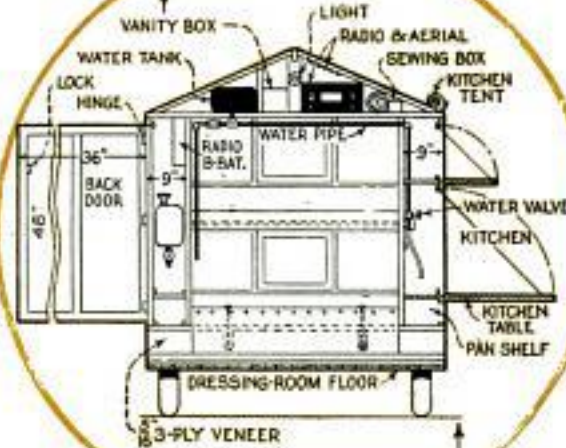

FIG. 9, END VIEW

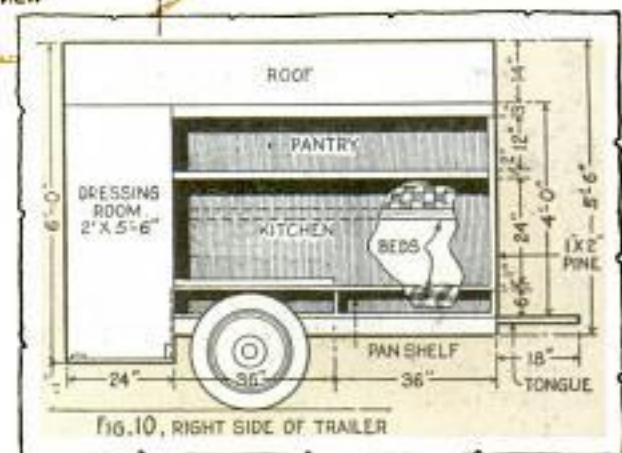

FIG. 10, RIGHT SIDE OF TRAILER



it can be held snugly. The same plan is followed in allotting space for canned goods in the pantry. Notice that there is a water tap on the kitchen side for convenience in washing dishes.

During rainy weather, the open-air kitchen can be quickly inclosed by means of a tent shown in Fig. 5. When not in use, this part of the equipment is rolled up and strapped to the edge of the roof as shown. It is only a moment's work to unroll it and set it up.

The center and corner poles have pins at the ends to fit eyes sewed in the canvas. The tent is, of course, especially made for the purpose and consists of a large tarpaulin, cut and sewed together to form a top and three sides. The edge of the top, which has no sidepiece sewed on, is tacked to the edge of the roof.

In Fig. 13 is given a front view of the trailer, showing the window location, and Fig. 14 shows how the windows are swung open for

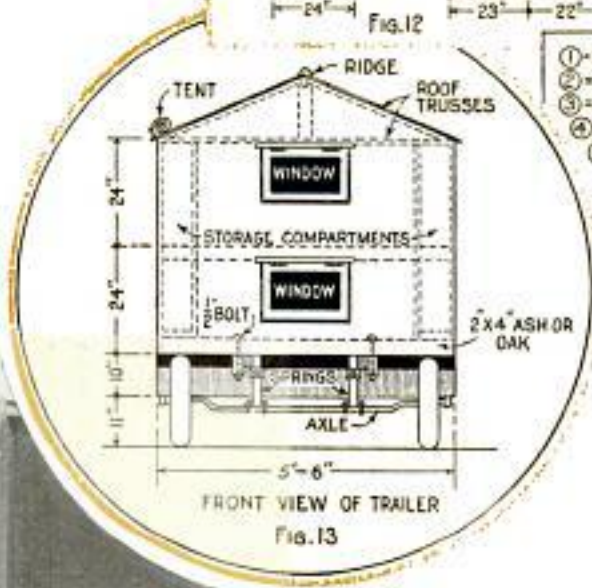
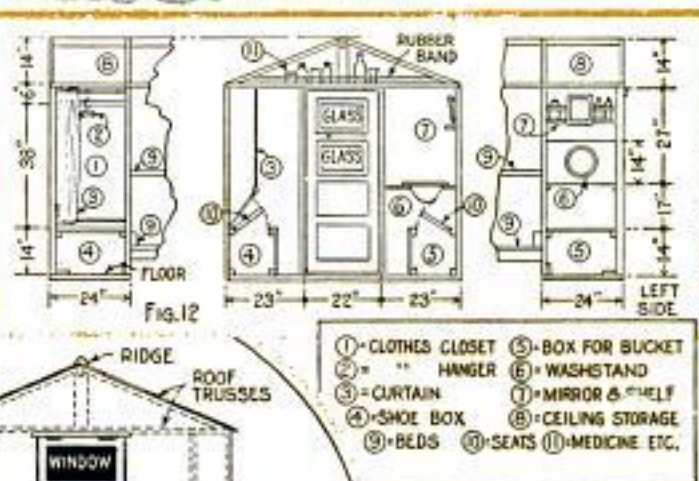

ventilation. The details of their construction and also the construction of the door, trailer tongue, hitch, electrical connections and other parts of the assembly, that have not been covered in this article, will be given in the second installment which will appear in the April issue.

#### Short Cord from Cellophane

When a piece of short cord is needed and none is at hand, improvise one from the cellophane taken from a cigaret package. The cellophane, when twisted, will tie easily and will not be affected by moisture.

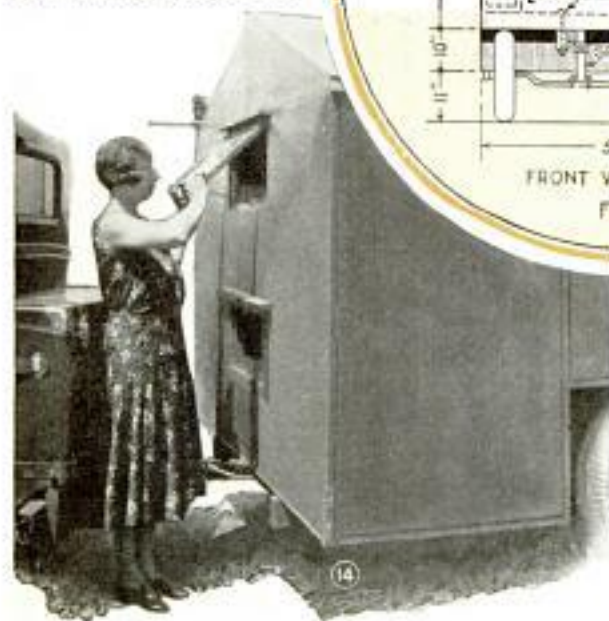



## Photo Flash Lamp Takes Underwater Views



Underwater Photos Successfully Taken with Aid of Photo Flash Lamp and Sheet-Metal Hood on Camera

touched the floor. As surface ripples distort images, a specially made hood, fitting the camera, was lowered under the surface of the water. The hood was made of sheet metal and fitted with a plate-glass window and was submerged until the window was about 3 in. below the surface. The camera was then placed inside of the shield, as shown in the upper photo, so that the lens was even with the water level. The shutter was set for one-fifth of a second, and the lamp flashed during the exposure,

a synchronizing switch being employed to provide perfect coincidence between the opening of the shutter and the flash. The slight blurring of the lines of the swimmer in-

In the past, underwater photographs taken indoors with the aid of a flashlight have been impossible, as the illumination produced by flashpowder set off above the surface of the water scarcely penetrates at all, but is almost all reflected. The taking of such photographs necessitates a high intensity of light beneath the surface, such as can be provided by a submerged photo flash lamp. In the case illustrated, water, 7 ft. deep, in the Cleveland Y. W. C. A. pool was no barrier to the taking of the picture. A single lamp, lowered into the water, flashed its nearly one-half million candlepower of light as the diver, Miss Jean Duncan, swimming instructress,



dicate her own movement. Undoubtedly, this method of taking underwater exposures will prove advantageous for other purposes, such as the photography of aquatic life and vegetation.

### Care of Chromium-Plated Car Parts

Chromium-plated parts and fittings on your car should be treated with care if the bright finish is to be retained. This plating is very thin and depends on a subplate of copper, or copper covered with nickel, for its adhesion. If the chromium-plate is deeply scratched or broken, the metal underneath will soon corrode and cause the chromium to peel off. Owing to the fact that the hardness of chromium

is almost equal to that of a diamond, ordinary polishes have no effect on it except to remove grease and dirt. As the plating is applied extremely thin, it is sometimes porous, which in time will allow enough dampness to reach the underlying metal to cause peeling. To avoid this trouble, it is a good idea to polish frequently with an oiled cloth, especially during rainy weather, in order to keep the plating covered with a thin coat of oil.—Geo. A. Luers, Washington, D. C.



### Caster Aids in Cutting Limber Wood

When ripping or plowing limber wood with a circular saw, a wooden spring clamped to the saw table is often used for holding the material against the fence. If the end of the spring is large enough, drill a hole to receive the shank of a caster so that there will be a rolling, instead of a rubbing contact against the material. In this way, the spring can be set up more firmly without danger of scoring or marking the material.—John E. Hyler, Peoria, Illinois.

### Spring Bumper Protects Rear Wall of Garage

A spring bumper that absorbs shocks caused by driving a car into the rear wall of the garage, consists of a Ford-car front spring bolted to a 3 by 4-in. plank. This assembly is hung on the wall, at the same height above the floor as that of the bumper on the car, by two rods which are fastened to the studs and plank with screweyes, as shown. In order to allow for the flexibility of the spring, a wooden block, sliding in a greased guide, is fastened to each end of it. These guides are nailed to a 2 by 6-in. plank, also nailed to the studs. A short chain, fastened between the two planks at each end, checks the rebound of the spring and prevents tipping of the bumper plank, should one end be hit harder than the other. With such a bumper, damage to the garage wall can usually be avoided.

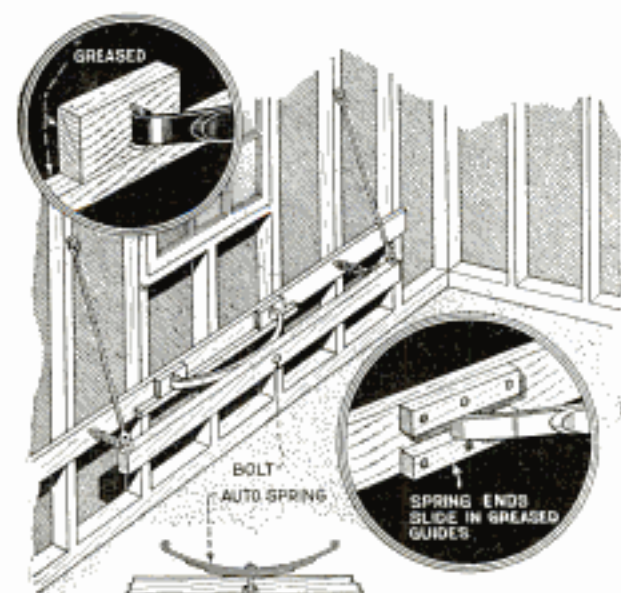

Bumper Fastened to Garage Wall Absorbs Shocks and Prevents Studs from Being Dislodged

Tin-Can Scoop Helps to Clean Dirt from Post Holes



### Scoop for Cleaning Out Post Holes

The illustrated clean-out scoop is for persons who have no post-hole digger, but find it necessary to use a spade for the purpose. The scoop is made by cutting one side from a tin can and nailing it to the end of a broomstick.

### Mixing Water-Color Stencil Paint

To make a water-color stencil paint, mix any dry color pigment in a solution of white dextrin, 4 oz., dissolved into 6 fluid oz. of cold water. When dry, the color may be applied by mixing it with oil or damar varnish. This pigment is also the basis of the many compounds for imitating the graining of various woods. Paint manufacturers grind the pigment in water with or without the binding medium. Final thinning of the ground paste is done with water, 2 parts, and alcohol, 1 part. The addition of denatured alcohol causes quicker setting and prevents the graining from flowing together.

### Writing Ink for Photographs

An ink for use on photographs can be made by mixing potassium iodide, 1 oz.; iodine, 45 gr.; gum arabic, 45 gr., and water, 3 fl. oz. Write on a dark portion of the photograph. The writing will soon bleach and add an extra touch to your pictures.



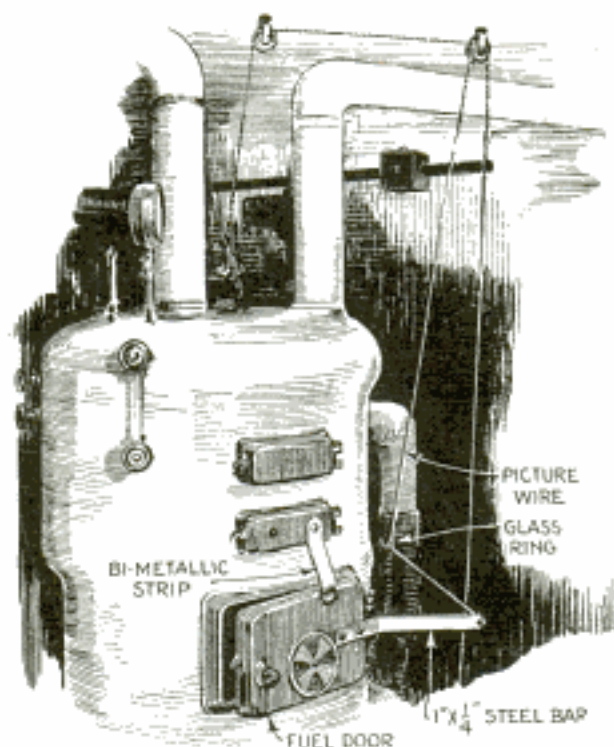

Fire Door, Controlled by Thermostat, Checks Fire and Prevents Overheating in Mild Weather

#### Thermostat Operates Fire Door

During mild weather when the damper and draft controls on a boiler do not check the fire sufficiently to prevent overheating, a thermostat attachment to open or close the fire door will usually solve the problem. First a steel bar is bent and bolted to the door, as shown, and a length of picture wire is fastened to the bar, after which it is run through a glass ring anchored behind the bar and fastened to the arm of the thermostat in such a way that the door is opened by the arm pulling on the wire. A length of flat spring or a bi-metallic strip, bolted to the clean-out door and bent over the fire door as indicated, holds it closed when the thermostat is not

acting on it. The door latch, of course, must be removed in order that the arrangement may work freely.

#### Testing Speed of Camera Shutter

Anyone can test the speed of a camera shutter by the following method: Attach a flashlight to a wooden block and mount it across a lathe faceplate, or a grinder spindle, so that it can be rotated at high speed without vibrating. Use a flashlight of sufficient length to produce a brilliant circle of light from 4 to 6 in. in diameter. For shutter speeds over 1/100 second, rotate the light at 2,000 r.p.m., for 1/25 to 1/50 second, 1,000 r.p.m., and for 1/10 second either 500 or 1,000 r.p.m. Remove the back and lenses from the camera and set it up so that you can see the circle of light produced by the lamp through the shutter from the front. If one eye is held in this position, and the shutter snapped while the lamp is rotating, a sector of light will be retained on the retina of the eye long enough for you to determine at what point of a revolution the lamp was visible. By dividing the fractional part of the circumference that the arc covers by

the revolutions per second, the time that the shutter was open will be found. On large shutters, a more accurate result can be obtained by photographing the sector of light with the camera focused on the lamp. This will produce a line of black on the negative when developed, varying in intensity and width according to the light received at any particular instant. Such a test should be made with the lens wide open. The length of the arc of approximately equal density and width will be the true value.

## \$1,000 in CASH

and one thousand high-grade jackknives for the best examples of whittling done entirely by means of a jackknife.

*Models must be shipped, prepaid, in suitable packages to avoid breakage in transit, with a tag bearing your name and address. Contest closes July 1, 1932. Awards will be made by a competent board of judges and in the event of a tie for any prize offered, a prize identical in all respects with that tied for will be awarded to each tying contestant. A circular containing full details of the whittling contest will be sent upon request.*

Address "Knife-Craft" Editor

POPULAR MECHANICS  
MAGAZINE

200 E. ONTARIO ST., CHICAGO



38989

# These PLAYROOM SEATS Resemble Animals

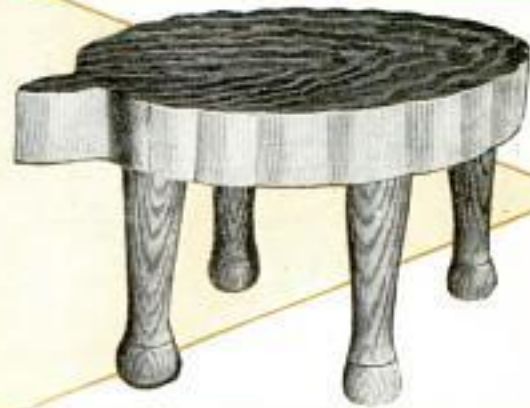

PARTICULARLY suited for children's playrooms, these animal stools can be made with little labor and expense. The parts can be cut out by hand or on a power-driven scrollsaw or bandsaw. Any kind of wood can be used, although a close-grained material, such as white pine or poplar, is preferable. For thickness, 1-in. stock will do, especially if it is hardwood, but  $\frac{1}{4}$  or  $\frac{1}{2}$ -in. stock is much better as it is less likely to crack.

The designs shown in the illustrations include a duck, a rabbit and a turtle, and although the latter is not exactly true to form, because of its long legs, it serves the purpose of a seat better. In making the turtle, holes are drilled in the underside of the body, and the legs, which are turned as indicated, are glued into these holes. The head of both duck and rabbit are attached in a similar manner, a recess being cut to receive the tenon on the neck. As the feet are subjected to considerable strain, it is best to drive in a long wood screw from the top, first drilling and countersinking the top to re-

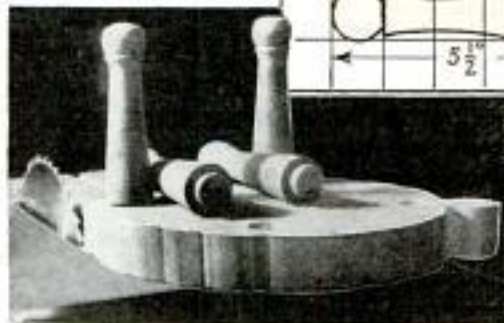
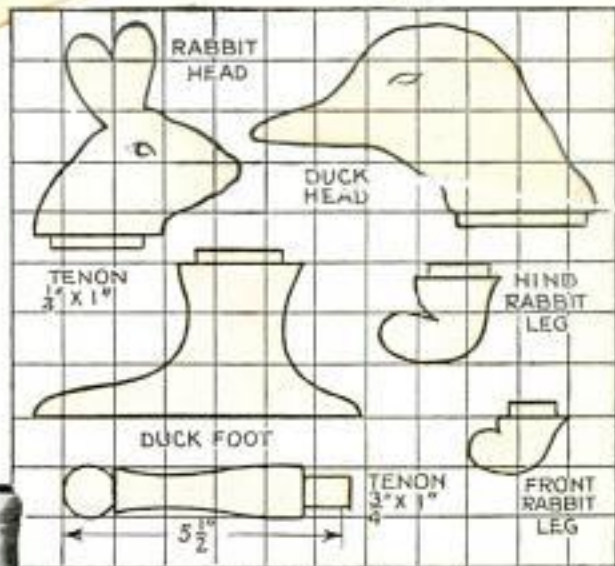

ceive a screw shank, and then drilling a small guide hole in the feet to prevent the screw from splitting the wood. The hole in the top is filled with a wood plug, which is sanded flush with the top. The patterns for all the parts are given in the cross-hatched sections, in which each division represents 1 sq. in. On the duck, the two large feet are set rather far apart so that it will not have any tendency to tip over. Two wings are suggested, but their tips



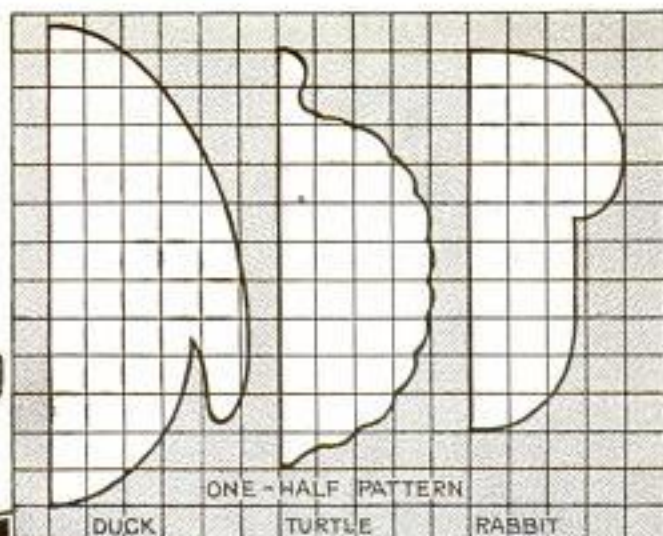

should not extend far or they are likely to break off with rough usage.

In laying out the pattern on the stock, you should remember that narrow portions are likely to break off rather easily if the grain of the wood runs crosswise. For this reason the grain should run lengthwise. Besides the patterns shown here, it is easily possible to design numerous others, sketching and redrawing the figures on paper until a satisfactory shape is obtained, and then tracing them on the stock by means of carbon paper.

For the finish, bright colors are generally considered in keeping with the playroom. Either lacquer or enamel can be used, but before applying it, the work should be thoroughly sanded and given a priming coat of shellac. A two-color job, done in complementary colors, is, of course, preferable to a one-color job, especially if such vital portions of the anatomy as the eyes and mouth are simulated, and the wings are shaded to indicate feathers.

#### Broken Grindstone Can Be Repaired with Flake Shellac

When a piece has been broken out of a grindstone, it can be cemented into place

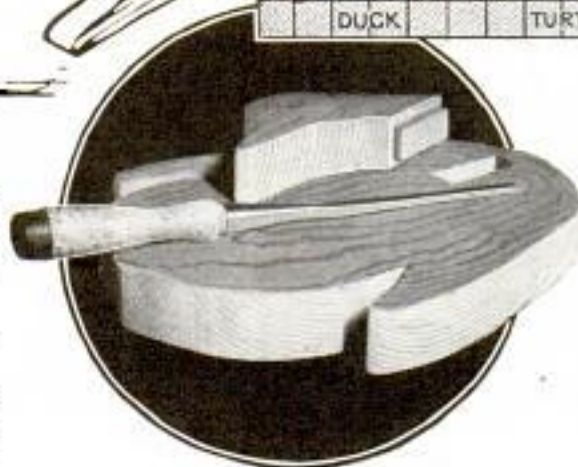

again with flake shellac. First, gradually heat the stone until it is almost too hot to touch. Then melt the shellac and brush it over the broken edges, press the piece and the stone together and allow the work to cool gradually. When properly made, this

repair is waterproof and can be detected only on close inspection. While this is a good repair, it will not, of course, stand so much strain as a perfect stone and therefore the latter should not be rotated as fast as normally.

#### A Swinging Shelf from Discarded Windshield Parts

Made from the arm and bracket of an old windshield, and screwed to a window casing, this swinging shelf is handy for



holding small parts when it is necessary to work on them under good lighting conditions. When not in use, the shelf can be disconnected and

put away. Draftsmen may also find such a swinging tray a handy attachment for their drawing table.



### Noise from Slamming Door Reduced with Rubber Heel

Noise caused by the slamming of a door can be reduced by the use of old rubber heels. Nail one heel to the edge of the door about 3 in. from the top, and another a similar distance from the bottom, fastening them so that they will extend a little beyond the edge of the door. In this way, the rubber strikes the door-stop when closing the door, and deadens the noise from the impact. The heels will last a long time.

### How to Make a Good Wall Size

Wall sizing that will not crack or peel off can be made by dissolving whale-oil soap, 4 oz., fine pumicestone, 4 oz., powdered alum, 3 oz. and sulphate of zinc, 1 oz., in warm water. Pour this solution into 10 lb. of calcimine and run the whole through a 16-mesh screen three or four times in order to remove the lumps and to more thoroughly mix the ingredients. This size becomes very hard when put on the wall. It is necessary, of course, to clean the walls perfectly before applying the size.

### Dowel Pins from Meat Skewers

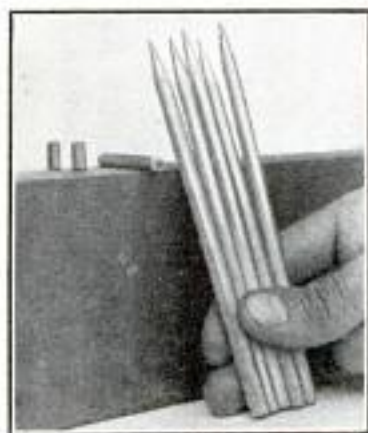

Meat skewers, cut to various lengths, make a good substitute for small dowel pins. These sticks are made in several sizes, and your butcher will supply them.

### Mold and Pattern for Small Castings

Where only one or two small castings in brass or other soft metal are required for models, it is a simple matter to cast them in a plaster-of-paris mold formed with a wax pattern. The wax used for this purpose should have a high melting point. After the pattern has been made, it is attached to a short nail which in turn is



Molds for Small Model Fittings of Brass Made with Plaster Mixture and Wax Patterns

fastened to a metal base with molten wax. As the hole left by this nail is used as an entrance or "sprue" hole for the metal, it should be of a sufficient size to allow the molten metal to flow in easily. A short pipe nipple or tube is placed over the pattern and is filled with a mixture of finely powdered marble dust, 2 parts, and plaster of paris, 1 part, to which water is added to form a rather stiff paste. After the paste has dried, remove the metal base and nail. Then heat the nipple to melt the wax pattern, which will be absorbed by the plaster, leaving a mold of the pattern. Where the work must be duplicated, it is, of course, necessary to make a new mold.

### Making Emergency Shipping Tags

When your supply of shipping tags has become exhausted, substitutes can be improvised from paper clips, cardboard and string. The cardboard is cut to the desired size and the strings are attached to them with small paper clips of the type shown.





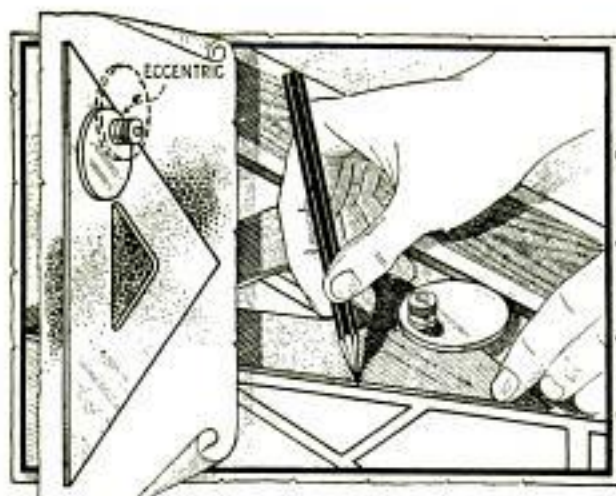

Triangle Fitted with Eccentric Is Useful for Drawing of Screw Threads and Section Linings

### Eccentric Makes Triangle Adjustable

Any 45 or 60° triangle can be made adjustable to various angles by fitting it with an eccentric made of wood, celluloid or hard rubber, which is fastened to the triangle by means of a small countersunk flat-head screw fitted with a knurled nut. When not needed, the eccentric is removed or swung out of the way. If desired, graduations can be cut on the eccentric to indicate the different angles. Such a device will be found useful for drawing screw threads and section linings.

### Ink Eraser Removes Mercury Amalgam from Watches

Gold or silver articles, such as watches and rings, that have become coated with mercury amalgam are easily cleaned by using an ordinary typewriter eraser. This will leave a dull finish which may be left as it is or polished on a buffing wheel.

### Holder for Enlarging Paper

Intended primarily for converting glass-plate holders into cut-film holders, a metal cut film sheath makes a support for bromide paper used either with a vertical or horizontal enlarger. It may be found necessary to bend the edges of the sheath outward slightly before the paper will slide smoothly in the grooves



without bulging. These sheaths can be obtained in most of the standard paper sizes for a few cents.

### Shellac and Wax Relieve Tight Dresser Drawers

Desk and dresser drawers that have a tendency to stick can be made to work by coating the contacting parts with shellac. This should be done in dry weather so that there will be no moisture in the wood to expand it. After the shellac has dried, the surfaces should be given a generous coating of floor wax. The shellac and wax should be applied to both the drawer and the groove in which it runs. This will provide a well-oiled surface for the contacting parts and will also help preventing them from expanding in damp weather.—Forrest L. Bezanson, Arlington, Mass.

### Coat Hooks on Stepladder Support Work When Sawing

Two coat hooks, driven into the legs of a stepladder as shown, form a handy support for sawing small pieces. This



arrangement will take short boards less than 6 in. in width, and will save many trips to a sawhorse or other support.

### Telescoping Clothesline Posts Aid in Retaining Beauty of Lawn

By using telescoping posts for supporting a clothesline, the beauty of a lawn will not be marred by an unsightly arrangement of posts and wire. Each post is made up of one 4-ft. length of 1-in. pipe and one 4-ft. length of 1½-in. pipe, both of which telescope into a 4-ft. length of 2-in. pipe, sunk in concrete below the surface of the lawn. A hole is drilled through each of the two smaller pipes, 10 in. from the lower ends, to take steel pins which support them when they are raised for use. The smaller pipe is capped at the upper end, the cap being drilled to take a ring for use in attaching the clothesline.—Philippe La Fee, Columbus, Ohio.





# INLAYING with Colored Plastic Wood by W. Clyde Sammey



**P**LASTIC wood in colors offers unlimited possibilities of inlaying. Although solid wood may be used as a ground, plywood is best, except in the case of turnings, as the surface veneer can be removed easily and quickly.

The design is first traced or sketched on paper and is then transferred to the wood with carbon paper. The lines on the wood are cut with a very sharp knife and the edge of the part to be inlaid is undercut to hold the inlay. The knife blade should be ground and honed to a long bevel to insure a clean cut, and care must be taken to avoid chipping the edges. After the pattern has been cut, gently lift out the top layer of veneer by prying it up with the knife blade. If the pattern is more than 1 in. wide, it is better



to recess through the second veneer to the core stock, bringing the recess to a depth of approximately  $\frac{3}{32}$  in. Where the pattern is of a regular form, the recessing may be done on a drill-press with a small router bit, as shown on page

511. A guide or jig is first scrollsawed slightly larger than the outline of the pattern and then clamped to the ground with the pattern outline located in the position desired, after which the work is placed on the drill table, and the spindle is lowered and locked so that the bit will cut the required depth. The drill is driven at

the highest speed, and the work must be held firmly on the table when moving it. A small, shallow recess may be filled with the plastic wood in one operation but a recess,



Porter. Cable Hutchinson Corp  
100 Wall St.  
POPULAR MECHANICS  
Syracuse, N.Y.

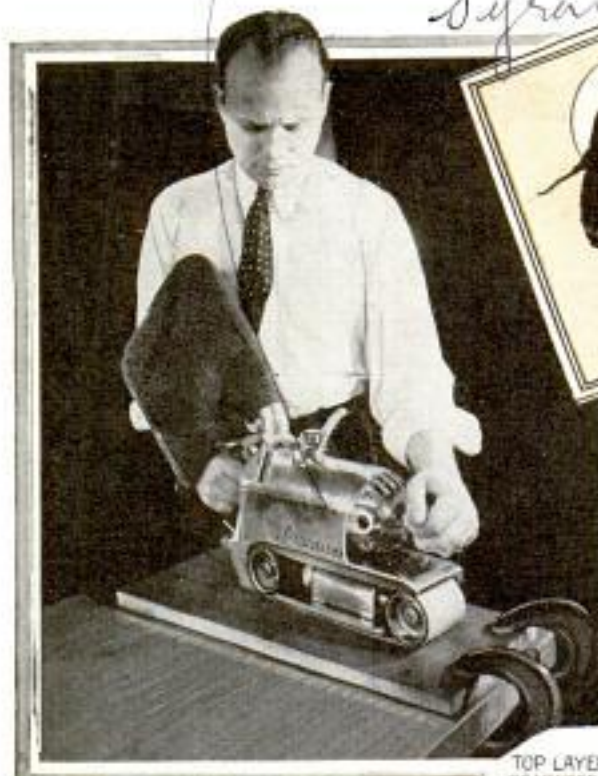

short dowel, fitting the hole, to force the inlay into the recess

To obtain a clear-cut appearance in the inlay, it must be finished very carefully. The excess material cannot be scraped or planed off without damaging the edges and it must be removed by sanding only, which can be done by hand or with a small sanding machine. If the work is sanded

by machine, as in one of the photos, use a No. 1/2 grit belt, and lift the machine off the work at intervals of a few seconds to prevent heating. Also, keep the machine moving while the belt is in contact with the work and be very careful not to cut through the thin face veneer of the plywood ground. When sanding by hand, fasten a long strip of sandpaper to a block. This

gives greater bearing surface and al-

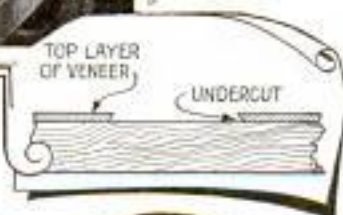
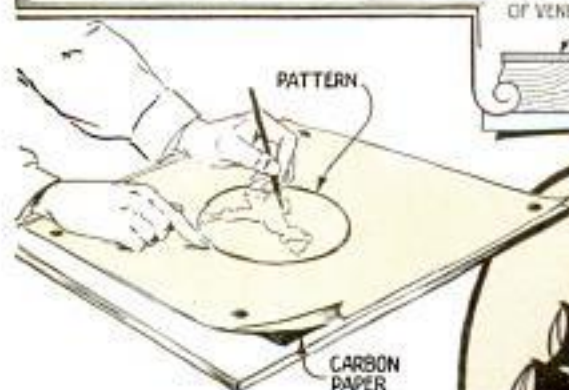

wider than 1 in. and deeper than the thickness of the face veneer, is best filled in two layers, allowing the first to become thoroughly dry before applying the second. Use a thin putty knife for filling the recess with plastic wood and work fast, as the material sets quickly. Build up the inlay slightly above the level of the ground and over the edges to allow for shrinkage while drying, which should take 24 hours. On large patterns, a board clamped over the work, with a sheet of heavy paper between them, will aid in leveling and forcing the material tightly into the recess. After two or three hours, remove the board and tear the paper off gently, then allow it to dry thoroughly before sanding. In filling round holes, press the material into place, let it set slightly, then use a





*Drill press Delta mfg Co  
 Model A 434  
 3775 N. Halsted  
 Milwaukee  
 W.S.*

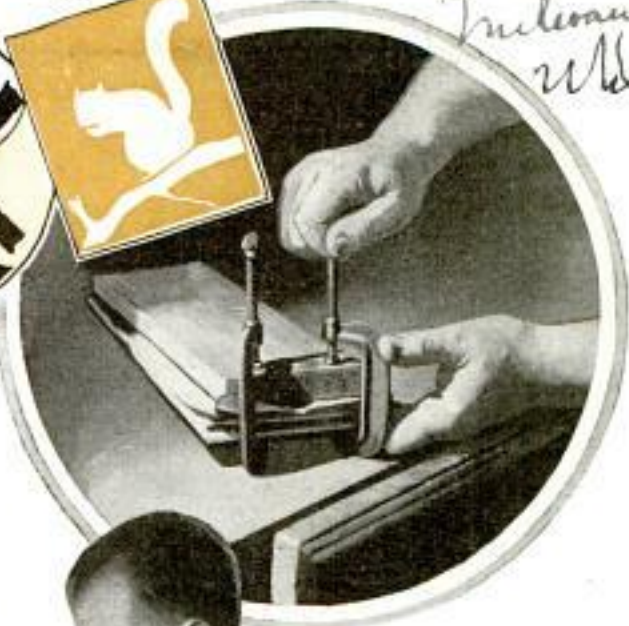
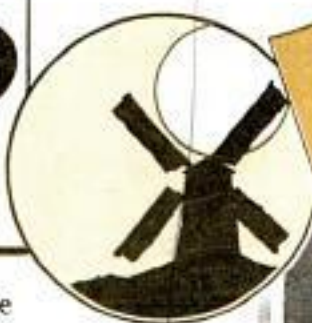

lows sanding without the ends of the block passing over the inlaid surface. In either hand or power sanding, the inlay is not finished flush with the coarse paper. In order that the inlay may be finished smooth and unbroken, it is necessary to use a finer grit, Nos. 0 and 00, to remove the remainder of the material above the level of the groundwork. Any openings, which show up at the edges of the inlay when sanded flush, are filled, allowed to dry and again sanded.

Where two colors are used with the edges meeting, the ground color is applied first. This is allowed to dry thoroughly, the joining edges are cut down square with a sharp knife and then

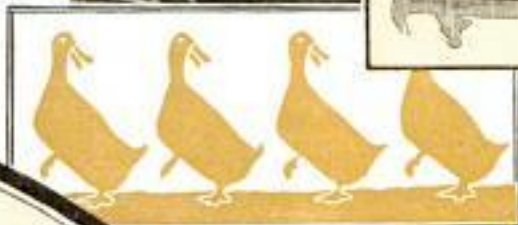

the second color is added. If the inlay is made on a turning, like the inlaid bowl shown in the headpiece, it is applied in the same way as described, allowed to dry, then sanded, taking care not to heat the work. Woodturners' cement or stick shellac may also be used for inlay work. It is melted into the pattern recess with

a soldering iron, and the excess material is sanded off, but shellac cannot be used for the first finish coat over turners' cement as it acts as a

solvent. Where the cement is used, the recess should always be undercut slightly and somewhat deeper than that needed for plastic wood. Either product is obtainable in a variety of colors.

#### Rough-Finishing Plaster Patches

Smooth plaster patches often show through tinting. To overcome this roughen the surface of the patch with a stiff-bristle brush, before the plaster has set completely, giving the patch the same texture as the adjoining plaster.





# Live-Stock Loader Has an Adjustable Floor

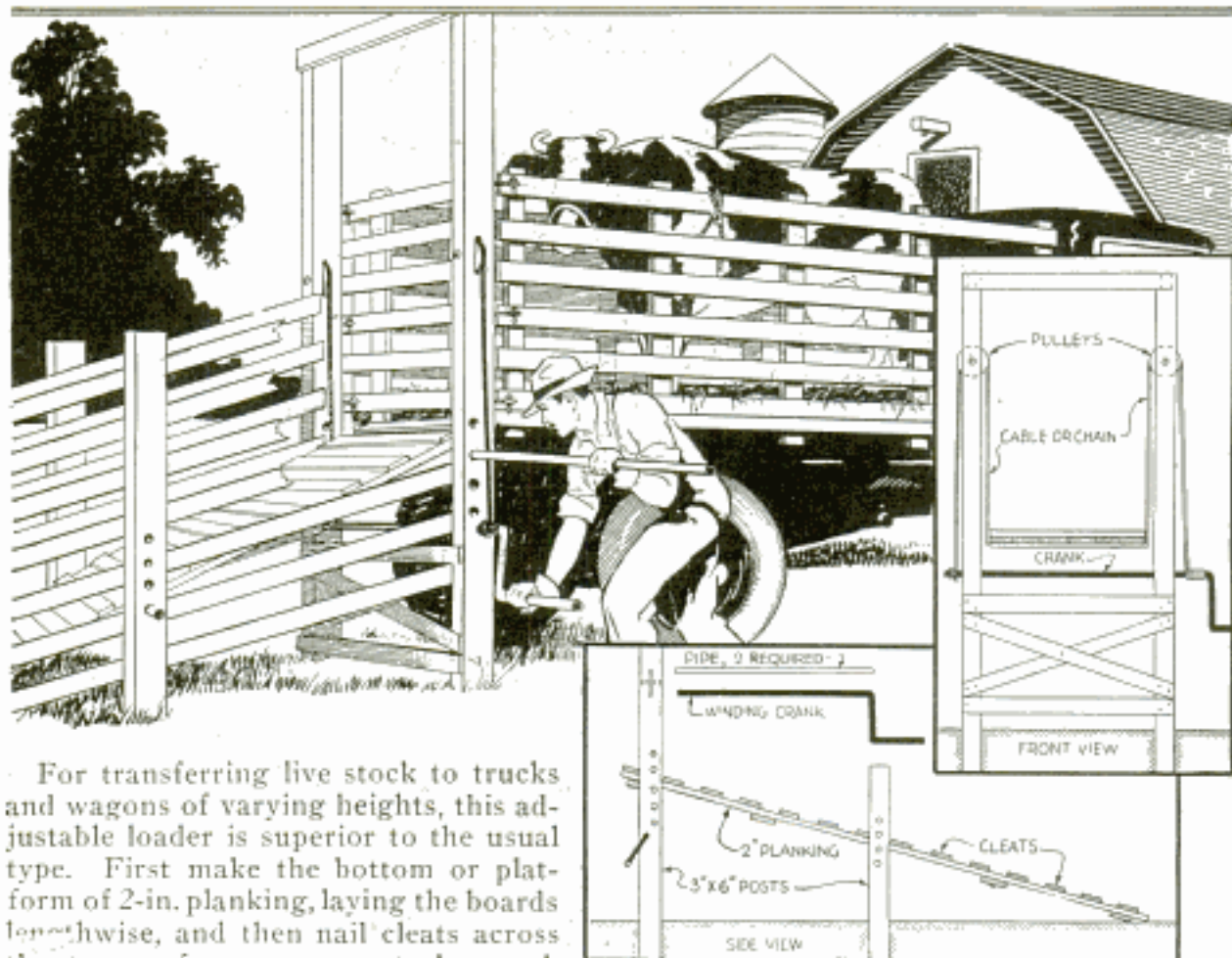

For transferring live stock to trucks and wagons of varying heights, this adjustable loader is superior to the usual type. First make the bottom or platform of 2-in. planking, laying the boards lengthwise, and then nail cleats across the top surface to prevent the stock from slipping. The posts are 3 by 6-in. planks set in concrete, a vertical row of holes being drilled in the front and center posts to receive lengths of heavy pipe, which support the platform at various heights. The two front posts are also drilled to take a winding crank, made of heavy iron rod and bent as shown. Two lengths of wire cable or strong rope, fastened to the platform, are run over two pulleys mounted on the front posts, and

are then wound on the crank. The sides of the loader are nailed to the inside of the support posts in the usual way. It is a good idea to nail a metal or wooden strip vertically over the side boards at each post, to prevent the platform from catching on them when it is raised or lowered. In use, the platform is adjusted to the desired height by turning the crank, and the pipes are then inserted in the proper holes to support it in this position.

## Applying Green Finishes on Brass

Verde and tiffany-green finishes can be easily applied to brass by anyone without special equipment. For the verde finish, dissolve white arsenic, 8 oz., into 1 qt. of warm muriatic acid, and add copper carbonate,  $\frac{1}{2}$  lb. In another vessel, dissolve copper acetate, 2 lb., and ammonium chloride, 2 lb., in 2 gal. of water. Mix these two solutions together in an earthen vessel and apply the mixture to the brass with

a brush. Smaller quantities can be mixed in like proportions. To obtain the tiffany-green finish, immerse the brass in a solution of copper sulphate, 8 oz., ammonium chloride, 4 oz., zinc chloride, 1 oz., acetic acid, 2 oz., and water 1 gal., also mixed in an earthen or porcelain vessel. If the color is not uniform after the first immersion, allow the work to dry and repeat the operation as often as necessary in order to obtain the desired effect.



### Lye Test for Impurities in Sand

When mixing concrete, a fair idea of any impurities in the sand can be obtained as follows: Dissolve lye, 1 heaping teaspoonful, in  $\frac{1}{2}$  pt. of clean water, contained in a glass jar. Pour  $\frac{1}{2}$  pt. of the sand into the water, replace the jar cap and shake vigorously for two minutes. After the mixture has settled for about 24 hours, the water will be clear if the sand is free of impurities. If the water is no darker than apple-cider vinegar, the sand will be suitable for use, but if darker, it should be washed until the test shows it to be sufficiently clean.

### Blueprint Files Resemble Boiler Flues

A sheet-metal contracting firm in Omaha, Nebr., has a file for its blueprints that resembles the flue system of a boiler. Sheet metal was used to form supports for metal tubes, which were left open at the ends. With the tubes marked in alphabetical order, filing and finding blueprints is comparatively easy. This method also keeps the prints nicely rolled and well protected from dust or other damage.

### Teeth on Back of Saw Blade Used for Cutting Nails

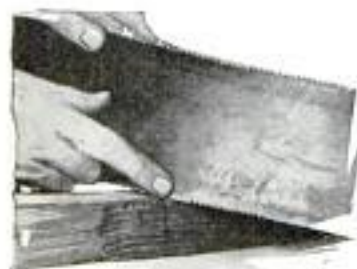

Teeth filed on the back of a saw blade are useful for cutting nails imbedded in old lumber. They should be filed straight across at right angles to the blade and must not be set. When a nail is encountered, it is a simple matter to reverse the blade and cut through it. If desired, the section where the extra teeth are cut, may be hardened.

### Chain-Link Jig for Bending Work in a Vise

Clamped in a vise, one link from a discarded heavy chain is useful for bending strap iron. Two links, similarly clamped with small work between them, will serve as extension jaws, or for filing work without marring the vise jaws.

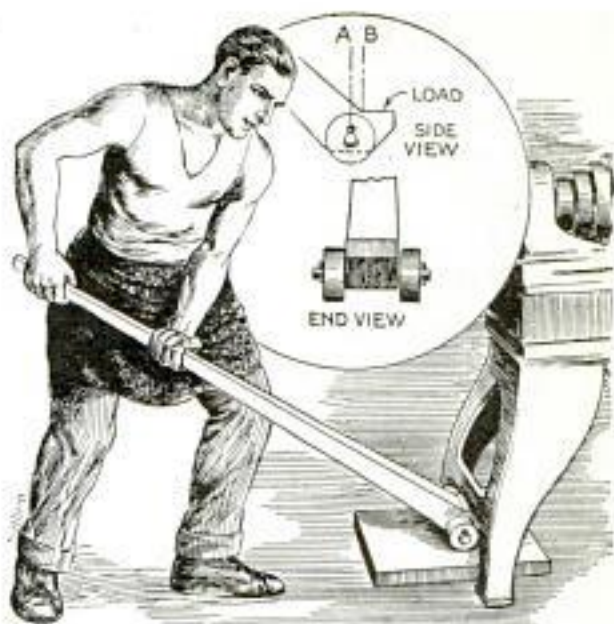

Pinch Bar Fitted with Rollers Is Handy for Moving Heavy Objects in the Shop

### A Roller Pinch Bar for Moving Heavy Objects

Fitted with rollers, this pinch bar is handy for moving heavy objects where crane facilities are not available. It consists of a length of heavy bar iron, shaped as shown in the detail, and fitted with two small iron rollers which turn on a pin inserted through a hole at the end of the bar. In use, the end of the bar is run under the object so that the load comes at B; then, as the handle is lowered, the center line of the load moves to A, or even a little farther.

### Dowel Rod Quickly Pointed on Side of Emery Wheel

Dowel rods can be quickly and neatly pointed by rotating them against the side of an emery wheel. If the wheel is mounted in a lathe, the tool-rest, set at the correct angle, will make a good support for the work. This method is useful when pointing a lot of rods.







Trolley, Run on Swinging Arm, Supports Work at Various Heights on Punch Press

### Swinging Arm to Support Large Work on Punch Press

For work that must be held at variations in height on a punch press, the illustrated swinging arm will be found useful. It is made of pipe and fittings as shown, the arm acting as a trolley for a pulley from which is suspended an iron bar drilled with a number of holes. An S-hook is used in one of the holes in the bar for adjusting the work to the right height for punching.

### Worn Slots in Miter Box Repaired with Hardwood Strips

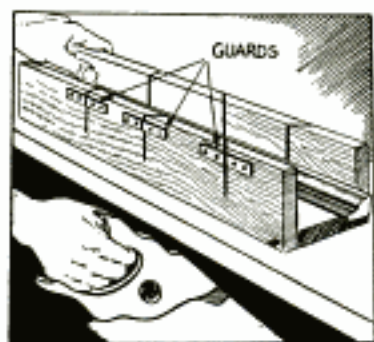

hardwood strips. Screw one of these strips on each side of the slots as shown, so that they serve as guides and hold the saw. When the strips become worn it is an easy matter to replace them.

Slots in a wooden miter box, that have become enlarged from continued use and hence will not cut to correct angles, can be repaired with

### Iron Filings Will Increase Yield and Quality of Fruit Trees

Tests made over a four-year period with cherry trees and grape vines, in the same lot and under similar conditions, have proved that a few handfuls of iron filings buried around the roots of the trees during the fall or winter months will give them greater vitality, resulting in larger yields and better quality of fruit. The filings oxidize under the action of air and moisture and the iron oxide thus formed is absorbed by the roots.—Ralph W. McPherson, Omaha, Nebr.

### Safety Razor Holds Short Section of Steel Rule

Inside measurements that are hard to get without the proper tools can often be taken by using small sections of a steel rule held by means of a safety razor. Cut a steel rule in sections of different lengths and clamp them between the jaws of the razor handle. The handle enables the user to get the small rule into places where it cannot be held by the fingers.



### Using Carbon Tetrachloride in Confined Places

The commanding officer of a submarine recently reported that two men were affected with nausea and vomiting while cleaning the motors with carbon tetrachloride. Because of its non-inflammability, this chemical is excellent for cleaning electrical windings, but will corrode steel parts, and gives off slightly toxic gases. For this reason it should not be used in confined or poorly ventilated places.—Wilton Edgar Matthews, Annapolis, Md.

☞ When dressing aluminum stock, light machine oil applied to a file prevents the file from clogging and tearing the stock.



# GAS-ENGINE TROUBLES

## You Can Cure

By James R. Ward

THE life of a gas engine, as of almost any other machine, depends largely upon lubrication, and this factor is neglected only too often. The oiler should be carefully adjusted to feed just the right amount. An insufficient supply allows excessive friction between moving parts, which results in rapid wear, while an oversupply causes car-

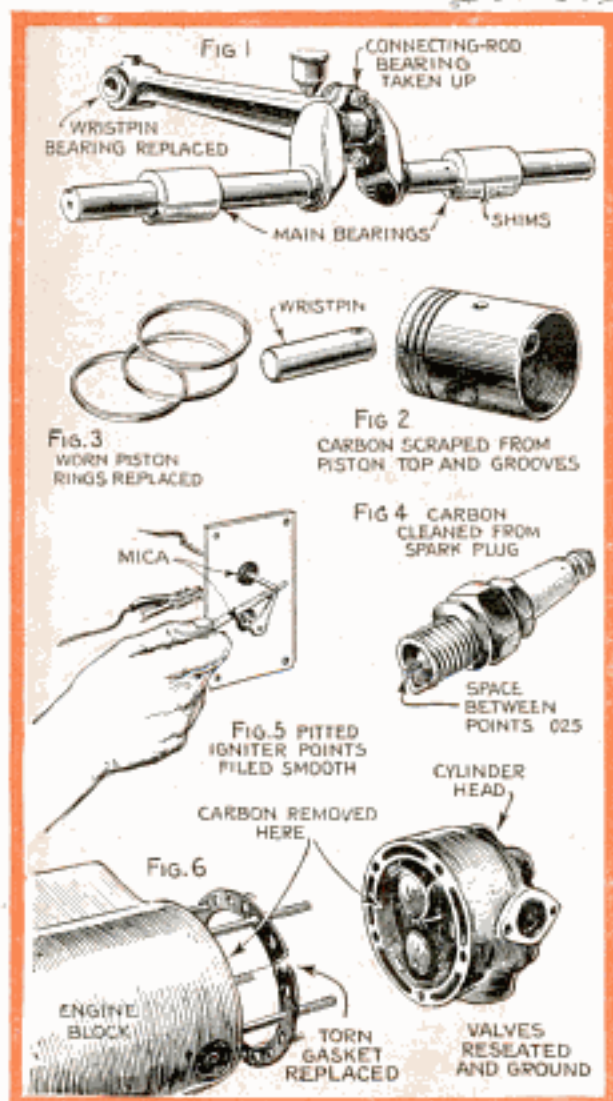
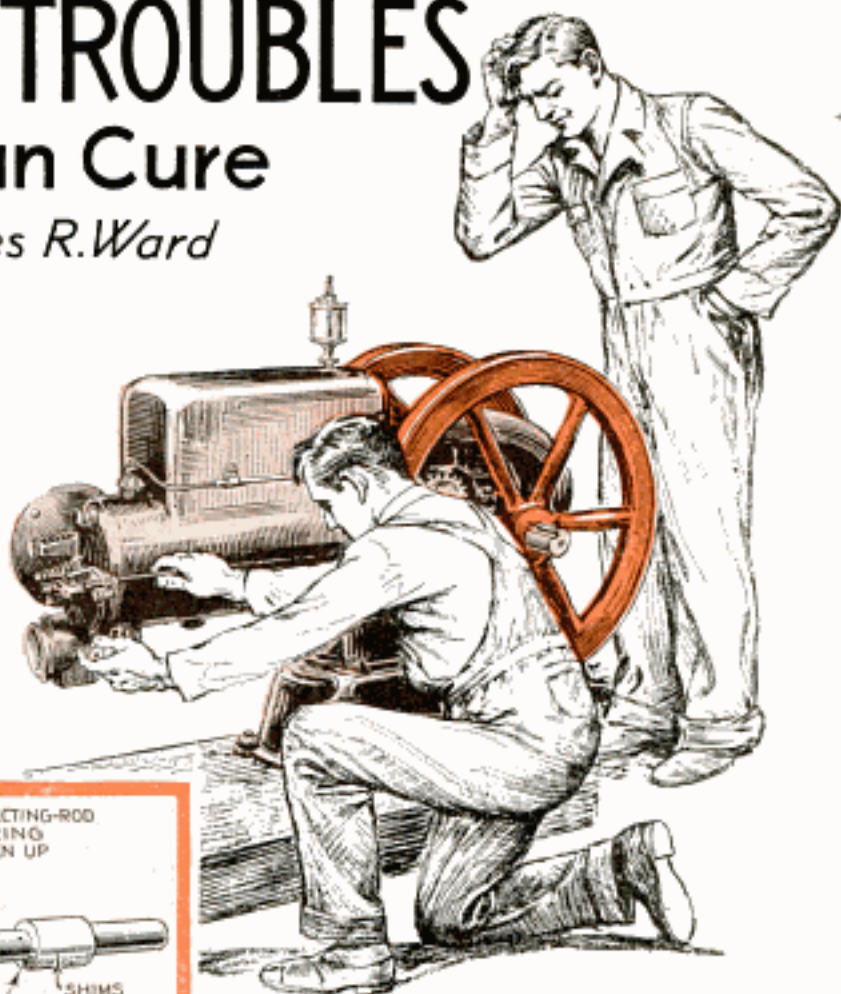

bon deposits. The consistency of the oil should be kept uniform, as nearly as possible, during both cold and warm weather, to assure the correct feeding through the cup. As oil thickens in cold weather, a lighter grade should be used to get the same consistency as a heavier grade has in the summer. The main, wristpin, and connecting-rod bearings, shown in Fig. 1, should be checked at regular intervals for play. The main and connecting-rod bearings can be tightened by removing one or two of the shims, but the wristpin bearing will have to be replaced.

When an engine refuses to start, it is usually due to one of two causes, viz., improper vaporization of gasoline or faulty ignition. If the engine uses a spark plug and a high-tension magneto, remove and clean the plug, and then adjust the points to .025-in. clearance, as in Fig. 4. Place the plug so that the base touches unpainted metal on the engine head, and crank the engine. This should produce a hot spark at the plug points. If there is no spark, check the wiring for loose connec-



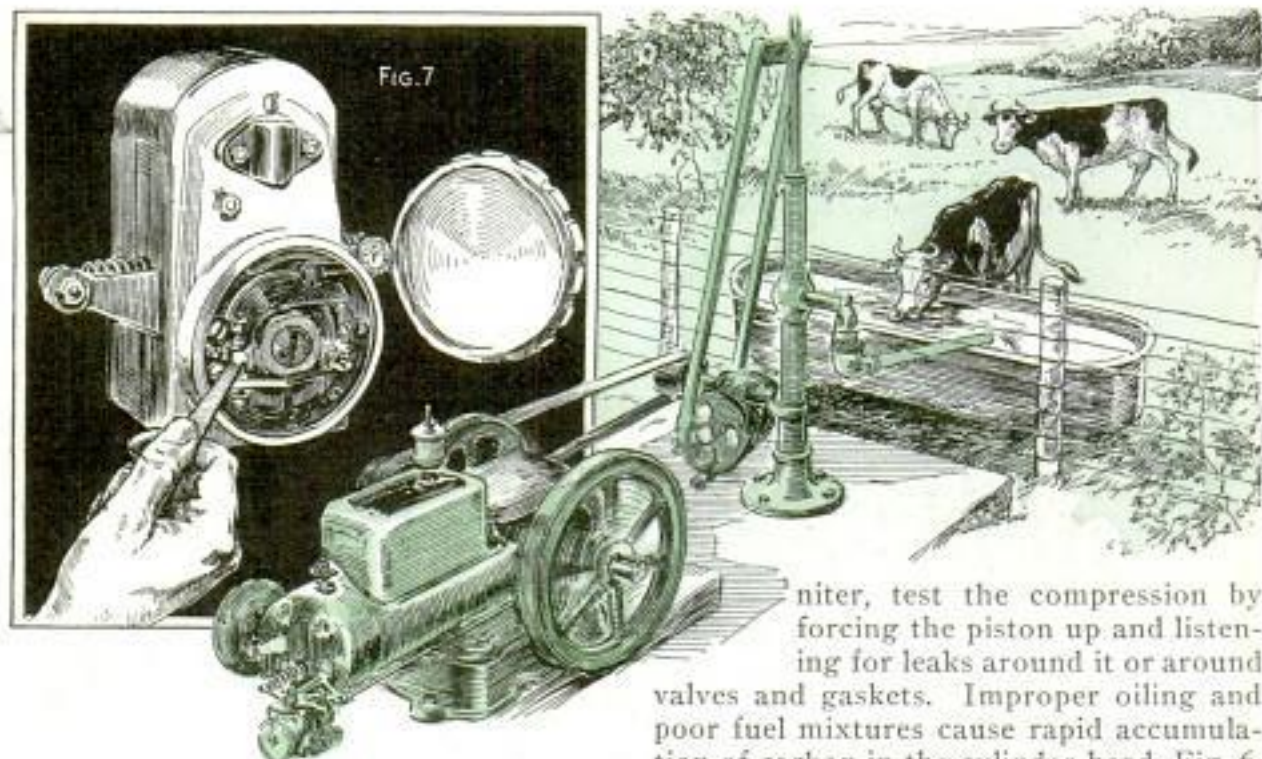

tions and broken insulation. In case the trouble is not found here, the magneto is probably at fault, Fig. 7. Magnetos sometimes become gummed with oil, which interferes with their operation. This condition can be quickly remedied by cleaning the inside with a gasoline-saturated cloth. While you have the cover off, file down the breaker points with a coil file, removing all pits and corrosion, to provide smooth contacting surfaces. For engines having a make-and-break ignition, remove one of the wires from the igniter, and with the switch on, brush the wire across the engine block. This should produce a number of hot sparks. If not, check the batteries and vibrator coil for loose connections, and the wires for broken insulation. Also test the battery with an ammeter. Each dry cell should test over 12 amp. If they test less, they should be replaced, since this amperage is not sufficient to produce a spark hot enough to fire the fuel charge under compression. Next, remove the igniter and see that the points make good contact. In order to produce a hot spark, the entire surface of the points should make a good electrical contact, possible only when they are thoroughly clean and smooth, a condition that can be obtained by occasional filing, as in Fig. 5.

After replacing the spark plug or ig-

niter, test the compression by forcing the piston up and listening for leaks around it or around valves and gaskets. Improper oiling and poor fuel mixtures cause rapid accumulation of carbon in the cylinder head, Fig. 6, and on the piston. This should be scraped off with care, so as not to mar the cylinder wall. The valves should be resealed and ground, and replaced if they are warped. Also, the piston should be removed and the carbon scraped out of the ring grooves. It may be necessary to replace the piston rings, Fig. 3, if the engine has had long service.

Next, check the timing. The spark should appear at the end of the compression stroke. The exhaust valve should open at the end of the power stroke and close at the end of the exhaust stroke. See that the rocker arm opens the exhaust valve wide enough to allow the burnt gases to escape quickly. The stem of the exhaust valve often becomes covered with carbon so that it will not properly open or close. If this is the case, it should be removed. Examine the cam gears and replace all worn parts. As gas engines are subjected to strong vibration, they should be inspected at regular intervals and all loose bolts tightened.

#### Uniform Stain on Black Walnut

Black-walnut wood trimming can be given a uniform stain by using a high-grade paste wood filler, tinted with a little black umber. This assists in producing an even surface on which to apply the finish, whether oil, varnish or wax.



## Tester Sprouts Seed Corn in Wet Sawdust

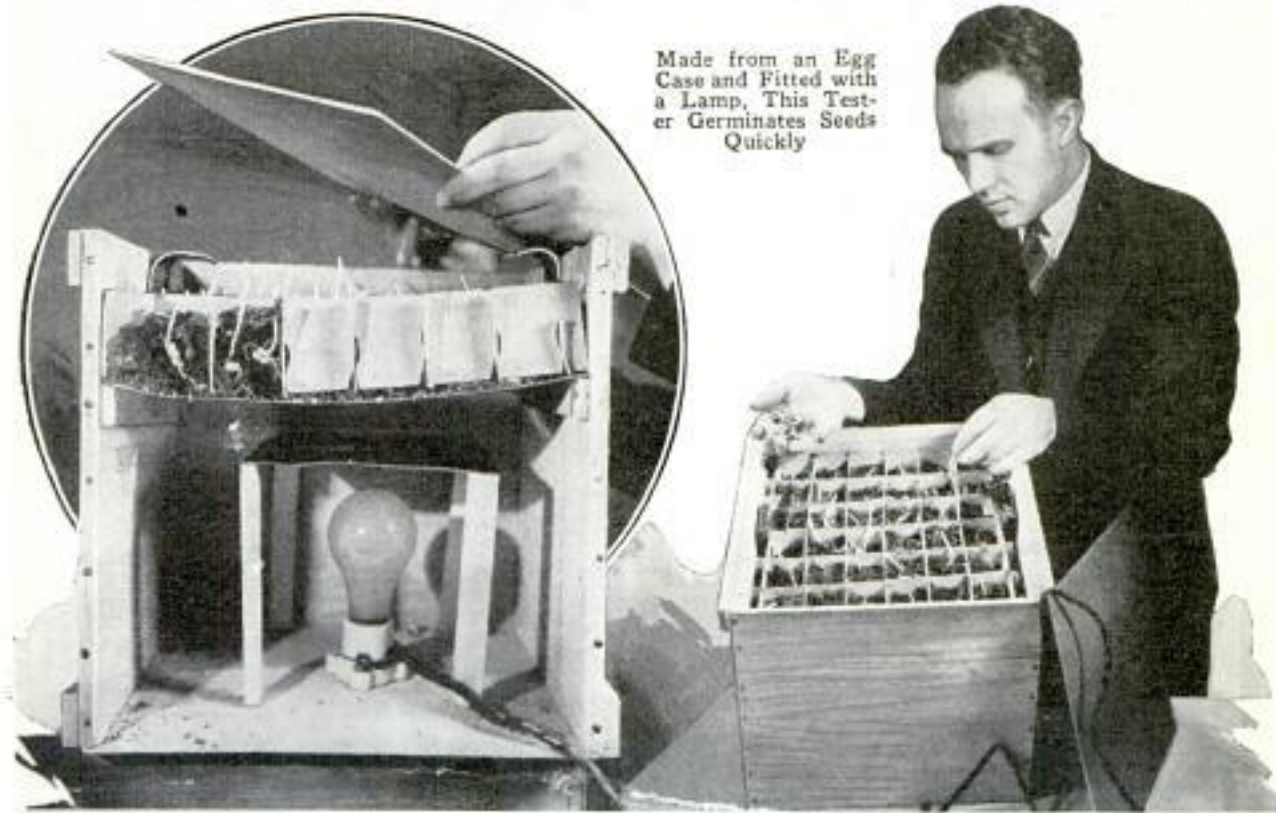

Made from an Egg Case and Fitted with a Lamp, This Tester Germinates Seeds Quickly

Heated by means of an electric or small oil lamp, a good seed tester can quickly be improvised from a 30-doz. egg case cut in half. Cleats are nailed to the sides to hold a piece of sheet metal upon which the egg-case filler is placed. Handles for removing the bottom are made by leaving lugs on the edges and bending these up vertically. The lamp is placed in a receptacle fastened to the bottom, and a small stand to hold a sheet-metal shield is ar-

ranged directly over the lamp to distribute the heat evenly. In use, wet sawdust is placed in the compartments of the filler and the seeds inserted. Take five grains from different parts of each ear and place them in separate sections, laying the ears in rows to correspond with the sections of the tester. Another piece of sheet metal is placed over the tester as wood will warp. Examine frequently and add water as needed.—Floyd Mix, Chicago.

### Wall Rack Holds Taps Orderly

Taps are always handy, and the waste of time in looking for the correct size when they are scattered around or piled in a box, is eliminated if this rack is used. It is simply a wide board set at a slant to the wall above the workbench, with wooden partitions to separate the taps, and a narrow piece nailed along the lower edge to prevent them from sliding out. The size of each tap is marked on this piece for ease in locating the proper one.

☞ To hold valve keys in place while releasing the spring, apply heavy grease to the pin; this will prevent it from slipping.

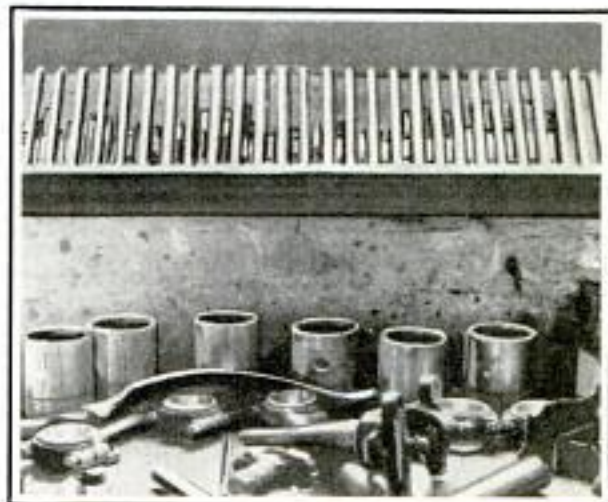

Rack for Taps Keeps Them Handy and Helps in Quickly Selecting Correct Size





Inflating Rubber Gloves over Wooden Disk Helps in Detecting Small Holes

### Inflating Rubber Gloves to Find Small Holes

When rubber gloves are worn by workmen handling acids or doing electrical work, they must be free from small holes. These holes are hard to locate without some means of inflating the glove. A simple device for this purpose consists of a wooden disk, mounted on a suitable stand, with an air connection in the center. The open end of the glove is held against the disk, as shown, by means of a wooden ring, which is kept to the stand tightly with a small C-clamp. In this way the glove can be inflated so that small holes will make themselves apparent.

### Large Vise Holds Smaller One

A small vise can be made handier to use by clamping it to a large bench vise. Twist a  $3\frac{1}{2}$ -in. length of  $\frac{1}{2}$ -in. flat iron as

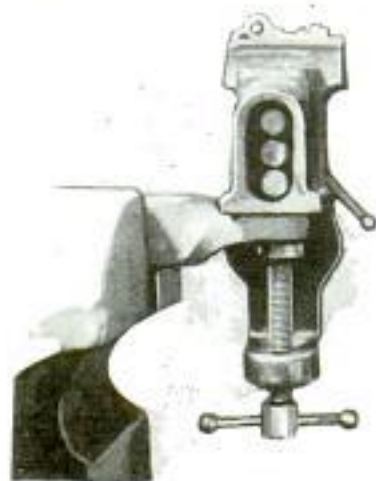

shown. Clamp one end of it in the bench vise and then attach the small vise to the other end. In this way, the latter can be raised to a position that will be most convenient for doing the work.

### Correct Way to File Circular Saw

Few saws are so likely to crack in use as circular cut-off saws, for the reason that they are often incorrectly filed with a square corner at the base of the teeth, the bevel on the face of the teeth being carried their full length. After beveling the front of the teeth, a round file should be used at the base to prevent the formation of square corners, from which the cracks usually start. A cut-off saw will clear the work well if the bevel is filed only halfway down the length of the teeth. —W. L. Brown, Gravette, Ark.

### Ferrules Cut from Pipe Protect Small Tool Handles

Fitted over the end of a wooden tool handle, a  $\frac{3}{4}$ -in. length of pipe will prevent it from being split or "mushroomed" by hammer blows. The end of the handle is turned down in a lathe to fit the ferrule, and the tang end is held in the chuck as indicated.—R. B. Wailes, Bethesda, Maryland.



### Carbon Removed from Car Motor with Hydrogen Peroxide

For a simple and economical method of removing carbon from a motor, detach the rubber tube from the windshield wiper and insert it into a bottle of hydrogen peroxide. Then start the motor. The peroxide is drawn through the windshield-wiper tubing to the intake manifold and then into the cylinders, where the supercharge of oxygen, which is contained in the peroxide, burns out the carbon.

### Applying Paint to Tile

Paint will adhere to tile if the latter has been thoroughly washed and allowed to dry. Then apply a coat of equal parts of wall primer and paint, mixed in the proportion of  $\frac{1}{2}$  gal. of flattening oil to each 25 lb. of heavy-paste white lead.



**Paper Protects Bees in Spring**

Before setting my beehives outside in the early spring, I cover them with black tar paper, which absorbs the heat from the sun and raises the temperature inside the hive. This induces the queen bee to begin laying eggs much earlier than under ordinary conditions, as she will not start until the hive temperature is quite high, and the result will be a greater number of young bees.—P. H. Ashby, South Edmonton, Alberta, Can.

**How to Make Silver Solder**

To braze or silver-solder sheet brass, tubing or pipe, requires so much heat that the work is likely to warp. A hard, malleable solder that flows smoothly and melts at a comparatively low heat, can be made by melting together silver, 1 part, and pure tin, 1½ parts. If you have no soldering block, a small quantity of this mixture can be made by placing the silver in a shallow depression cut in a piece of asbestos board and heating it with a blowpipe. Sprinkle borax on the silver and continue to apply the heat until the mixture melts and forms into a ball. Then drop small pieces of the tin into the molten silver, one at a time, while applying the heat, and sprinkling on more borax until the tin is melted into the silver. After the metal has cooled, turn it over and melt it again from the other side in order to get a uniform mixture, and lay a piece of flat iron on top of it which flattens it out to a convenient shape for use. When cold, remove the metal and wash it in water to remove particles of asbestos, then tap lightly to remove the incrustated borax. Sal ammoniac is a good flux for this solder, which flows readily.

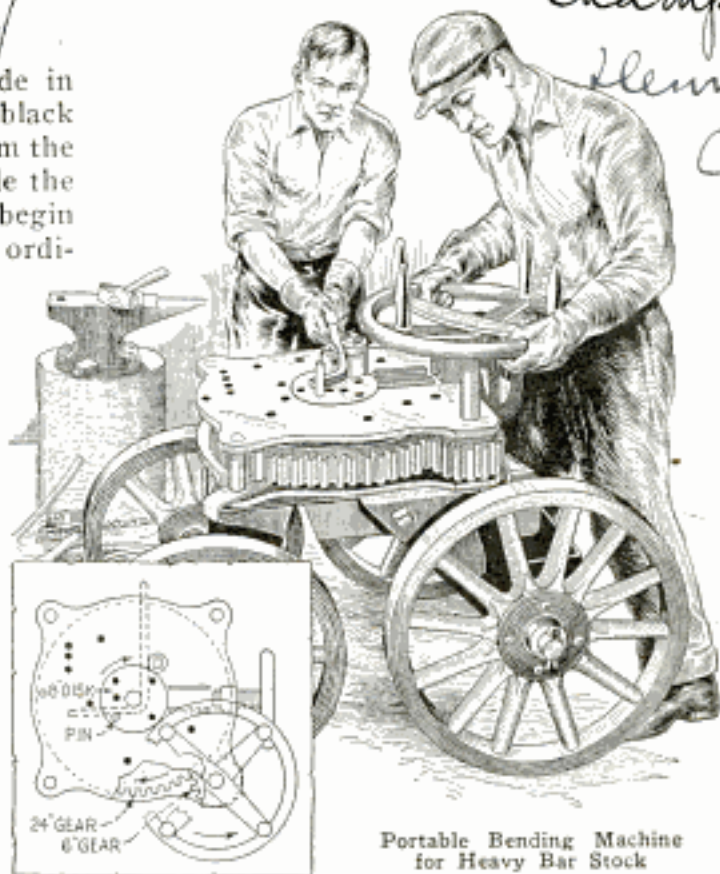

Portable Bending Machine for Heavy Bar Stock

**This Portable Bending Machine Exerts Great Pressure**

Mounted on wheels, this machine is handy for bending heavy bar metal, as considerable leverage can be obtained. The bending is done with a 24-in. gear, meshing into a 6-in. gear, to which is attached a steel shaft and a wheel with handles for applying pressure. The gears are inclosed in a housing made of two ¾-in. steel plates, joined at the corners by bolts. An 8-in. disk in the center of the upper housing is attached concentrically to the large gear and turns with it. In the center of the disk a 1¼-in.-square hole is cut to hold forms, while seven smaller holes are drilled to receive pressure pins. The stationary housing also has holes for pins.

**300 Blueprints for Home Craftsmen**

**IN ORDER** to supply our readers with workable drawings of large size (17 by 22 in.) for convenience in making the projects published in *Popular Mechanics Magazine*, we have prepared blueprints on almost everything that is of interest to the home craftsman. Prices: Single prints, 25 cents; six prints, \$1, postpaid. For more information, and a complete list of all our blueprints kindly write to *Blueprint Dept., Popular Mechanics Magazine, 200 E. Ontario Street, Chicago.*



902 Grayfold Drive  
Cleveland, Ohio



# "CANNON BALL" Speed Up

By "CANNON BALL" BAKER

Champion Record Breaker in Transcontinental Races

**I**F you intend to alter your car to increase its speed, it should be remembered that speed is mainly dependent upon air resistance, rolling resistance and engine power. As an example of air resistance, the maximum speed of a car equipped with regular headlights was found to be 87 miles per hour, but after removing the headlights, an additional 5 miles per hour was possible. In respect to rolling resistance, it was found that, at

speeds above 60 miles per hour, a slight wheel misalignment often reduced the speed five per cent.

In overhauling your car with the pur-

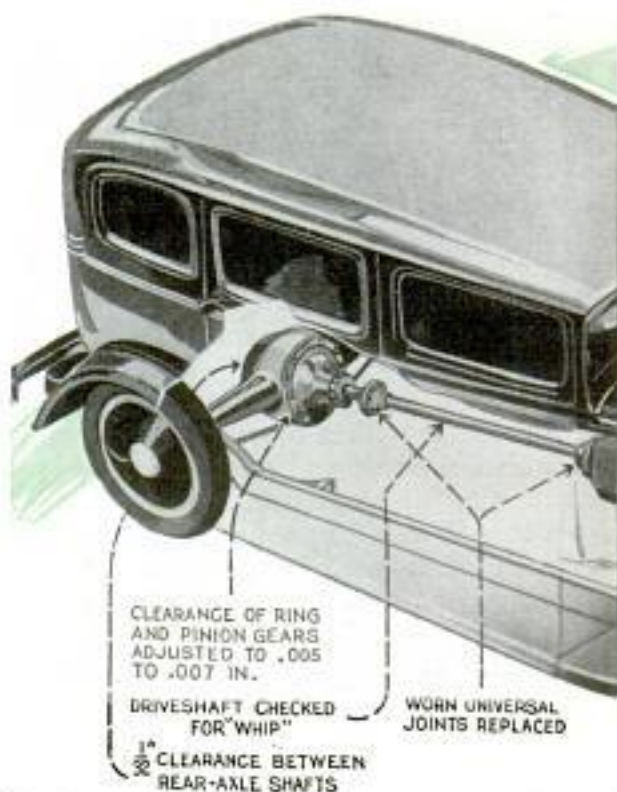

pose of increasing its speed, wheel bearings are first examined. Remove these and wash out the old grease, replacing the rollers and other parts that are chipped or damaged. When replacing the bearings, tighten each adjustment until there is no play in the wheel as the tire is gripped and pushed from side to side. Then back it off about one-third of a turn and see that the setting is securely locked. Wash out all the old grease or oil from the rear-axle housing and differential gears with

Brutal Tests at High Speeds on the Race Track Show Up Imperfections in Design and Result in Constantly Improved Models



# BAKER tells how to your Car

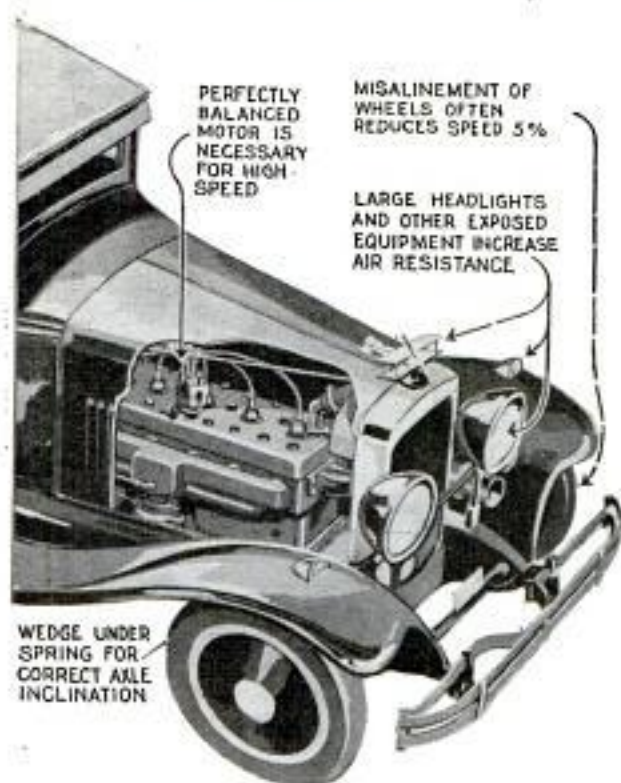

kerosene, and be sure that this is all drained out before reassembling. While the differential is open, check the backlash of the gears. The best way to do this is to take hold of the driveshaft, if construction permits, and shake the pinion, turning the ring gear until you find the point of least backlash, and then adjust for a clearance of from .005 to .007 in. Refill with castor oil up to  $\frac{1}{2}$  in. on the ring gear. Next drain and flush out the transmission with kerosene, allowing it to drain long enough to get all the kerosene out, and refill it with castor oil up to the cen-

ter line of the lowest set of gears. Check the driveshaft for whip and the universal joint for play, as either whip or play will cause considerable vibration at high speeds and may completely destroy the rear-transmission bearing or the pinion bearing—possibly both. A driveshaft can best be checked between centers on a lathe. Likewise, the universal joints should be replaced if noticeable play exists.

Now examine the rear-axle shafts inside the differential housing. The ends of the shafts should not butt together, but should have a  $\frac{1}{32}$ -in. clearance between them. If necessary, grind off the ends to obtain this clearance, which is important because many axles are held by the outer wheel bearings, and the expansion of the shafts, upon heating, may cause them to butt together and ruin the bearings. Also see to it that the rear-axle felt washers do not bind on the shafts.

Most cars are delivered with a gear ratio that gives best all-around performance, and changing will make very little difference in the top speed of the car in most cases, unless it is stripped of fenders, lights, etc. The only way to know just what is right for your car is to try several ratios and note the results.

When running at high speed, all the tires, which must be in perfect condition, should be inflated to 5 lb. higher pressure than is carried for regular running. The wheels should be carefully balanced. Any tendency to settle at one point can be offset by wrapping wire solder around a spoke and taping it in position. All steer-



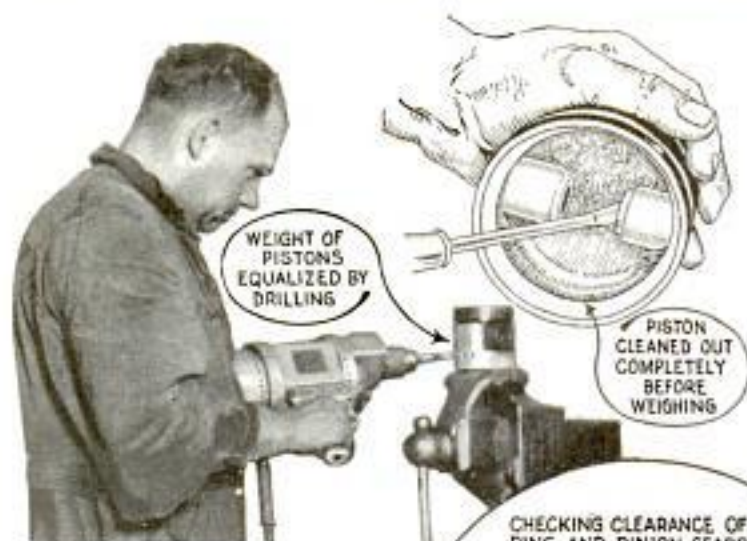

ing connections should be removed, cleaned, lightly lubricated and snugly adjusted. The front wheels should be adjusted so that they are parallel with each other. To measure this, first check to see that there is no wheel wobble and that the tires run true. Then spin one front wheel and, with the hand resting on a support hold a piece of chalk against the center of the tire. This will give a good mark from which to measure. The steering gear should be adjusted so there is no play and no binding. If the car has a tendency to wander from side to side on the road, try increasing the inclination of the front axle by placing tapered shimmy wedges at the rear of the axle where it rests on the spring.

Next comes the engine. The first thing to do is to get all parts in balance, which should be attempted only in a shop equipped for this work. The matter of balance is particularly important if you are working on a low-priced car. The crankshaft, flywheel, clutch and reciprocating parts especially require this attention. To balance the pistons, first clean out all carbon from the ring grooves and from the underside of the piston head and weigh each piston accurately. If one is heavier, carefully scrape a little metal from the inside of the skirt or drill several  $\frac{1}{4}$ -in. holes in it. Continue this work until all pistons are of equal weight. The rods must be balanced in two ways: Let

the small end hang from a string and check the weight of the large end by allowing it to rest on a scale. Variations in weight should be equalized by filing the outer surfaces at the upper half of the large end of the rods that are too heavy. Then weigh the small ends in the same way and correct variations by filing. Make a final check by taking the total weight of each rod to see that they are all exactly the same. See that the piston

pins are an easy push fit and then assemble the pistons and rods. The complete assemblies should correspond in weight within  $\frac{1}{4}$  oz. With the piston rings removed and using the connecting rods as handles, try the pistons in their respective cyl-

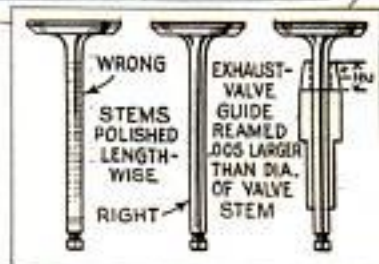
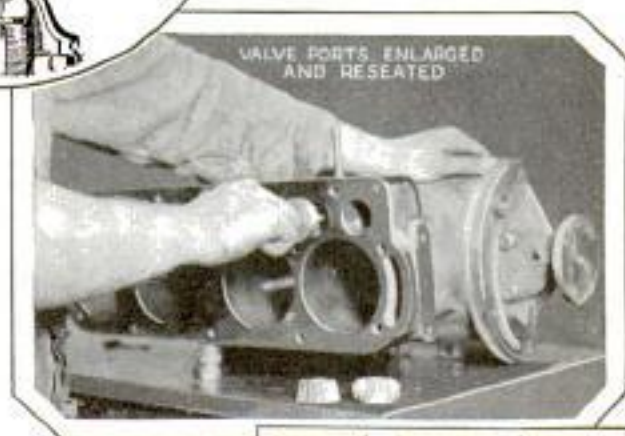

inders. The clearance between the pistons and the cylinder walls should be 50

per cent greater than that recommended by the manufacturers, in order to take care of the abnormal expansion caused by maximum motor speed. This may cause a piston slap when the engine is cold, but it is the only way to prevent sticking at continued high speeds. For solid cast-iron pistons allow .001 in. plus 50 per cent for each inch of cylinder bore or fraction thereof, or .006 in. for a  $3\frac{3}{4}$ -in. bore, which is con-



sidered as being 4 in. When checking with a feeler gauge, there should just be a slight drag on a narrow .006-in. blade. If aluminum pistons of the split-skirt variety are used, the same rule for clearance applies, but if the pistons are of solid-skirt type, the clearance should be doubled, or .002 in. plus the 50 per cent. The piston rings should be filed down until there is .010 to .014-in. clearance between their ends when compressed inside of their respective cylinders. If a piston seems to fit tight in one or two spots, these are dressed down. However, if the pistons are a tight fit all around, they should be honed to fit properly. All main and connecting-rod bearings, on pressure-lubricated engines, should be fitted to have a .003-



PISTON CLEARANCE 50% GREATER THAN USUAL

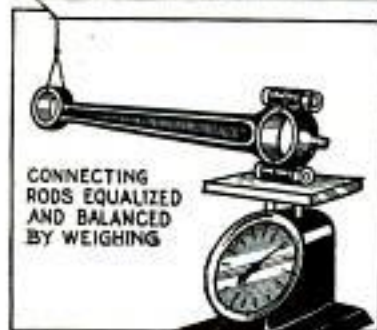

CONNECTING RODS EQUALIZED AND BALANCED BY WEIGHING

The valves and carburetion are now gone over carefully. Remove, clean and face all the valves and ream the valve seats, using a narrowing reamer to make the valve port as large as possible. When finishing with valve-narrowing tools, see that the exhaust valve has a seat  $\frac{3}{16}$  in. wide, and the intake valve a seat  $\frac{1}{16}$  in. wide. When the valves are seated correctly, their heads should be ground off so



CHECKING FOR WHEEL ALIGNMENT AND Wobble

PISTON PIN SHOULD BE AN EASY PUSH FIT

STEERING-WHEEL PLAY SHOULD NOT EXCEED  $\frac{1}{4}$ "

in. clearance. For splash-lubricated engines, a tighter fit is needed, the bearing being perfectly free but not loose.

that there are no sharp edges or burrs, as these become red-hot and cause detonation. Then polish the valve stems with very fine emery cloth. Polish them lengthwise and not across the stem as this causes scratches that will collect carbon and may make the valves stick at high speed. Lap the valves in lightly until the seats show an even gray color all around the contacting surfaces. Valve stems should work entirely free, but not loose, in their guides. When the engine runs at high speed, the head of the exhaust valve becomes hot, causing it to expand at the top of the stem, and therefore the top part of the guide should be reamed .004 to .005 in. larger than the diameter of the valve stem. It is a good idea to install an entire set of new valve springs, as the old ones will probably have lost their tension and strong springs having uniform action are necessary at high speed. When setting the valve clearance, follow the manufacturer's recommendations. If no information on this subject is available, cover the radiator and run the engine until the water boils. Then set the clearance of each valve at .004 in. while the motor is hot and running intermittently. If the car has been run less than 10,000 miles, the camshaft should be removed and the bearing clearances increased 50 per cent. A special racing camshaft will speed up the engine considerably. A racing camshaft



*Essex Engineering Co  
Dayton Ohio  
Jewel Buff Co. Nutwaahetli*



WIRE SOLDER WRAPPED AROUND SPOKE TO BALANCE WHEELS

raises and lowers the valves very quickly and holds them at their maximum opening longer than is possible with a regular shaft.

If the motor does not knock when accelerated, the compression can be raised by having  $\frac{1}{16}$  in. planed from the block or head to reduce the size of the combustion chamber, which should only be done at a well equipped machine shop. If, after trying out the motor, it still does not knock, another thin layer can be removed. The car will then operate well on non-detonating or doped fuel. As the power of an engine depends on the quantity of fuel fed to the cylinders, the inside of the intake manifold should be perfectly smooth. This may be accomplished by sand blasting, or by hand-scraping as far as possible. In mounting the carburetor on the manifold, or the manifold to the motor, be sure that the edge of the gasket does not project into the gas passage. Fitting the motor with a larger carburetor and intake manifold may also be helpful. When tuning up, a larger jet or richer setting will boost the speed, but will reduce the number of miles per gallon. With the higher compression and high speed, it will probably be necessary to use different spark plugs. Practically all spark plugs are now available in various designs ranging from cool

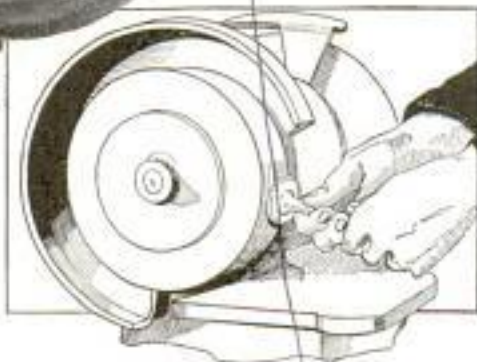

VALVE TOP GROUND SMOOTH

to hot running. By carefully experimenting, you can find a plug that will serve best in your engine the way you drive it. After a lively run of about 10 miles, remove and check the plugs. A light tan on the insulator with a slightly oily film is ideal. A white insulator indicates a hot plug, while a dark insulator means the plug is running too cool. The spark-plug gap should be about .018 in. The ignition points should be cleaned, the springs on the moving points replaced and the points adjusted for a maximum opening of .018 in. This setting is closer than for ordinary running, but it is necessary to give the ignition coil time to build up a charge

at high speed. Using different coils and condensers will sometimes increase the speed a mile or two. Heavier ignition wire should be used, because the increased compression puts a greater strain on the insulation as the voltage for ignition is increased. It is estimated that the fan requires 7 hp. on a large

engine when the car is running 65 miles per hour. If you are running at high speed at all times, it may be possible to disconnect the fan.

In testing out the car, an increase in speed may perhaps also be effected by varying the camshaft timing. Start out with this set according to factory recommendations, and then, when you know just what your car will do, advance the camshaft one tooth. If this results in improvement, try another tooth ahead and repeat until the engine runs at the greatest possible speed.

#### Screweyes Held on Piston Ring

By slipping screweyes, washers and nuts on an old piston ring, any particular size selected can readily be pulled through the opening in it. The ring can be hung on a nail over the workbench.





## Speed Reducer for Moving Window Display

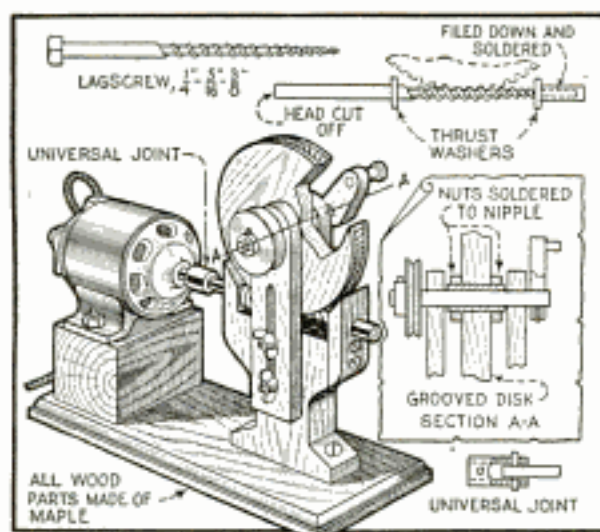

Made from Maple Parts, This Worm Gear Gives Wide Range of Speed for Moving Window Displays

For operating mechanical devices of the small kind that are used in window displays, a speed-reduction gear is often needed. The homemade worm-gear assembly shown was designed for use with a small electric motor of less than  $\frac{1}{8}$  hp., and it enables a wide range of speed. The worm is a lagscrew of any size from  $\frac{1}{4}$  to  $\frac{1}{2}$  in. The driven gear is a grooved maple disk. The use of disks of different sizes gives variety of gear ratios, the same worm being used for all the disks. It is best to turn the disks on a lathe, although they can be cut with a saw and grooved with a round file. After the wooden brackets and the base have been made up, two lagscrews are fitted with thrust washers as shown in the upper detail. Three flutes are cut in the threads of one lagscrew with a three-cornered file to serve the purpose of a tap. It is placed in its respective bracket and the disk is brought to bear down upon it. The shank of the screw can be chucked in a hand drill and turned. It will rotate the disk and cut teeth. When a complete turn of the disk has been made, examine the threads to see that they match at the starting point, and repeat the operation until teeth of substantial depth have been cut. The tap is then replaced with the other lagscrew which serves as a permanent worm, and is hooked up to the driving motor. Graphite and oil are used for lubrication. No bushings are needed on the worm shaft as the



maple itself, with free use of graphite, makes a good bearing. The insert shows the shaft fitted with a pulley and crank. Either can be used as the case requires. Note that the bracket supporting the disk, is slotted to be adjustable over a wide range, which allows the use of different-size disks. The right-hand drawings show the machine put to use for operating window-display signs.

### Calipers to Measure Irregular Work

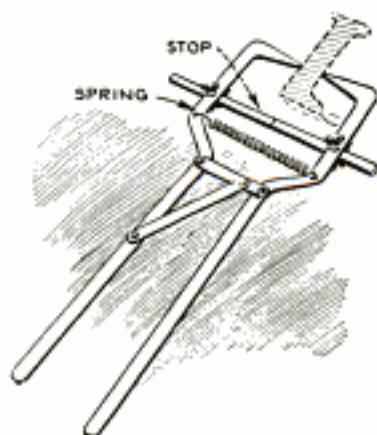

Work that is flanged or of irregular shape, where step-over jaws must be used, is easily calipered with the illustrated tool. The jaws are forged from mild steel and pivoted together by means of a brace rigidly attached to one of them. Two stop rods fitted into slides provide the adjustment, while a small coil spring furnishes the necessary tension on the jaws.



### Rethreading Die Made from Old Gear



Old Gears Bored,  
Threaded and Hard-  
ened Make Good  
Rethreading Dies

As the stock for making rethreading dies, where the diameter of the thread is over 2 in., was hard to get, a machine shop in Washington, D. C., converted a number of discarded auto gears into dies. The steel used in these gears is of high quality and will stand the hardening treatment necessary.

### Preventing Erasure of Lines on Ruled Tracing Cloth

Draftsmen who letter lists and charts on tracing cloth that has been previously ruled, often experience trouble by having the lines obliterated when making an erasure. To overcome this, rule the lines on the glossy side of the cloth and letter the lists and charts on the dull side. Erasures can then be made without injury to the lines.—Jules J. Sickman, Harvey, Ill.

### Notched Claws Improve Hammer



Notches filed in the end of each claw on a hammer enable you to get greater leverage when pulling long nails. If the end of one of the claws

is filed down to a thin edge, it can be used for pulling tacks. The notched claws also provide a good grip when pulling staples. Of course, discretion should be used in applying the claws to nails as they may break if subjected to excessive strain.

### How to Solder with Leadfoil

When using leadfoil to sweat together thin metals, such as sheet brass and copper, thoroughly clean the surfaces to be soldered with sandpaper or emery cloth so they will be slightly roughened in order to assure perfect adherence of the foil. Then apply a coat of flux to the work, sandwich a layer of foil between two layers of tinfoil and place these between the pieces to be soldered. Next, lay the work on a flat surface, on top of the assembly, place a piece of flat iron or steel that has been heated to a red color, and weight the whole down with a heavy stone until cool. The work absorbs the heat and melts the leadfoil.

### Dirt-Filled Box Holds Warning Flag

When it is necessary to erect a warning flag on a hard surface, a cardboard box can be used as an anchor to hold it in an upright position. Fill the box with dirt or sand and stick the flag-staff down in one corner. While this anchor is not lasting, it will save the cost of a metal stand.



### Stoppers for Screw-Cap Ink Tubes

Printers, having an assortment of inks in tubes on which the stoppers often become stuck, will find it an advantage to drill a hole through the top of the cap and use a woodscrew as a stopper. When the ink is needed again it is a simple matter to remove the screw.—Robert A. Foss, Laconia, N. H.



### Solution for Staining Polished Metal to Show Scribed Lines

When laying out work on polished brass or steel, the finely scribed lines and punch marks will be more visible if the work is first stained. A good stain can be made by mixing methyl violet,  $\frac{1}{2}$  oz., and clear shellac, 1 oz., and then adding enough denatured alcohol to make a volume of  $\frac{1}{2}$  pt. When brushed on the polished surface of metal, this stain produces a bright purple color, on which finely scribed lines are easily seen. The stain can be removed with fine emery cloth or steel wool, and will not injure the surface of the work.

### Pointed Saw Removes Old Flooring

For wiremen, plumbers and carpenters the illustrated saw is useful in tearing up old tongue-and-groove flooring and replacing it with as little damage as possible. With a pair of dividers, scribe an arc from the point of a tooth 3 in. from the end of the saw blade to the upper corner. Cut away the portion outside of the line and grind the edge down on an emery wheel being careful not to burn the steel. A second line, inside the first, and at a distance from it equal to the depth of the teeth, is then scribed as a guide for filing the new teeth. A handsaw prepared in this manner will remove the tongue in the flooring without the necessity of drilling a starting hole.—Kenneth B. Manning, Le-moore, Calif.



Rounding End of Handsaw Provides Means of Removing Flooring without Damage to Surrounding Surface

Dents in Musical Instruments Removed by Using Solid-Rubber Ball and Hammer



### Removing Dents from Cornet Bell

With a rubber ball and hammer, I have successfully removed dents from the bell part of cornets and other tubular instruments. I place a solid rubber ball inside against the dent and tap the ball lightly with a hammer and stick. With a little care and patience, the dent can be removed so that it will be almost unnoticeable.—A. H. Waychoff, Phoenix, Ariz.

### Plaster Casts That Are Unbreakable

Casts that are hard and will stand severe casting heats, can be made as follows: Mix powdered borax,  $\frac{1}{4}$  lb., and dry plaster of paris, 1 lb. Then add enough cold water to bring the mixture to a smooth puttylike consistency, after which more plaster is added until the whole becomes very stiff. The borax keeps the plaster from setting during the mixing process and will keep it fairly plastic until long after it has been pressed into a mold. If the mixture becomes too stiff, add water sparingly until it thins out to your requirements. Allow the cast to dry in a warm place from two to eight hours, and it will then have the hardness of granite.

☛ Sandpaper wooden handles on tools to prevent getting splinters in your hands.



A 2412 Cont. Sam Lloyd  
 153 Halsey St.  
 Brooklyn N.Y.

# Can You Solve these Puzzles?

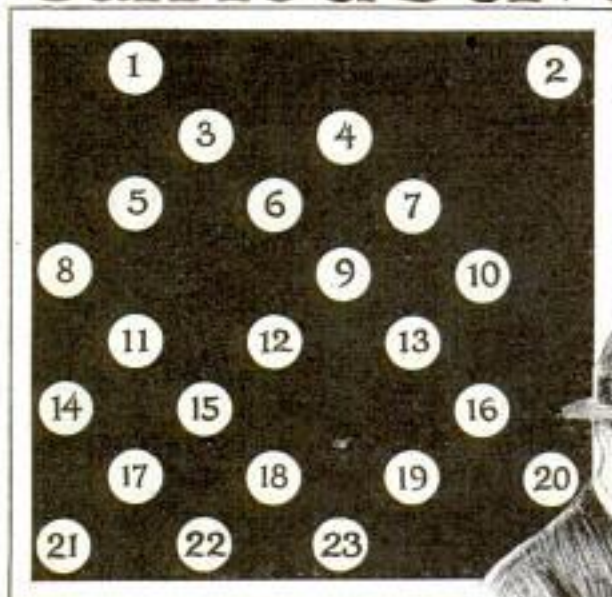

**H**ERE is something different. The twenty-three disks upon our blackboard are in orderly arrangement with respect to being in rows and columns. How many different combinations of three-in-line are to be found upon the board? The line must pass through the centers. For example, 1, 3 and 6 is a combination of three in a straight line; 1, 13, 20 is another and 4, 12, 22 a third.

**F**ARMER Smith worked a field of grain on shares, agreeing to give Jones, the landlord, three-sevenths of the crop. Smith used some wheat, and he and Jones agreed that it was worth \$54, which would be \$10.80 less than the value of the same number of bushels of rye, for they figured

twelve bushels of rye were worth \$5.04 more than six bushels of wheat. Jones preferred rye for his initial share, so Smith's problem is to figure out how many bushels of rye he should give Jones to offset the \$54 worth of wheat he had taken.



## Answers to Last Month's Puzzles

Placing the figure 1 before the five-figure number A on Mrs. Terwilliger's blackboard obviously increases it by 100,000, so it then amounts to A plus 100,000. The figure 1 placed after the number A, its condition after A plus 100,000 has been multiplied by three, is equivalent to multiplying it by 10 and adding 1. Therefore, 3A plus 300,000 equals 10A plus 1 and A is 42,857.

In beginning the fish fight, nine of the little ones, matched three to one against three of

the kings, held them at bay, while the remaining four devilfish dispatched the fourth king in three minutes. The thirteen devils then were able to bring an overwhelming force against each of the remaining three kings. Four devils being able to kill a king in three minutes, thirteen would kill one in twelve-thirteenths of a minute, and would destroy three in two and ten-thirteenths minutes. Thus the battle would last five minutes forty-six and two-thirteenths seconds.



Solution to the Astonishing Button



# Genuine UNDERWOOD

Late Model No. 5  
Yours for full  
10 Days Trial

Think of it—over 2 million buyers paid \$102.50 (cash) for this Model No. 5 now offered direct-to-you at way below 1/2 original price—and on easiest terms besides. Positively the greatest bargain ever offered. Accept the special 10 day trial offer and be convinced. See the neat, perfect work it does—compare its bright, shiny looks without risk. Recognized as the finest, strongest typewriter built.

**While They Last!**  
**Prices Smashed**  
**to Rock Bottom**



Save over 1/2 Mfgs. Original Price

Only by an exceedingly fortunate purchase direct from the manufacturer am I able to offer this amazing low price—less than half (50) the manufacturer's original price—and easy terms besides. This is the full-sized late model Underwood with standard universal 4-row keyboard of 84 characters and has all late improvements. Manufactured to sell originally for \$102.50. Fully guaranteed.

## Learn Touch Typewriting FREE

Learn Touch typewriting. Complete Home Study Course of the Famous Van Sant Touch Typewriting System, fully illustrated, given during this offer. Easily learned. Used in schools, business offices everywhere.



## BRAND NEW CORONA



Now Only  
**\$39.90**  
or  
On Easy  
Terms  
10  
Day  
Trial

Yours for Only \$1.00 DOWN

Hurry! Only a very limited number of these Brand New Coronas available at this Special Low Price and Easy Terms. Here's your chance to own a wonderful nationally advertised Corona at a real bargain. Has up-to-date improvements and carries our regular New Machine guarantee. Sent on 10-day trial. (If you decide to keep it send only \$2 a month until the special low price of \$42.90 (term price) is paid.)

## Easy Terms—Only 10c a Day

Think of it—a genuine late model Underwood No. 5 reduced to \$42.90 (cash). Send only \$1 deposit for a 10-day Trial. Then only 10c a day on my easy year-to-pay plan. Use and enjoy your typewriter all the time. Remember this famous No. 5 Underwood all renewed and refinished is without question one of the greatest values ever offered.

## Money Back Guarantee

Accept my liberal 10-day trial offer. See for yourself the wonderful bargain this famous Underwood really is. Your deposit returned at once if you are not perfectly satisfied. Send now.

Over 100,000  
Satisfied  
Customers

## International Typewriter Exchange

231 West Monroe St., Chicago, Ill., Dept. 301  
Please send the typewriter marked below, F.O.B. Chicago, at the special reduced price for 10-day Trial. I am enclosing \$1.00 deposit on the Underwood No. 5 at \$47.90 (term price); Corona No. 3 at \$42.90 (term price) with the understanding that if I am not perfectly satisfied I can return it Express Collect and get my deposit back. If I keep it I will pay \$3.00 a month until I have paid the (term price) in full.

Underwood No. 5  Corona No. 3

Name..... Age.....

Address.....

Town..... State.....

When writing to advertisers please mention Popular Mechanics

Copyrighted material



**CHANGE SPARK PLUGS EVERY 10,000 MILES FOR BETTER ENGINE PERFORMANCE**

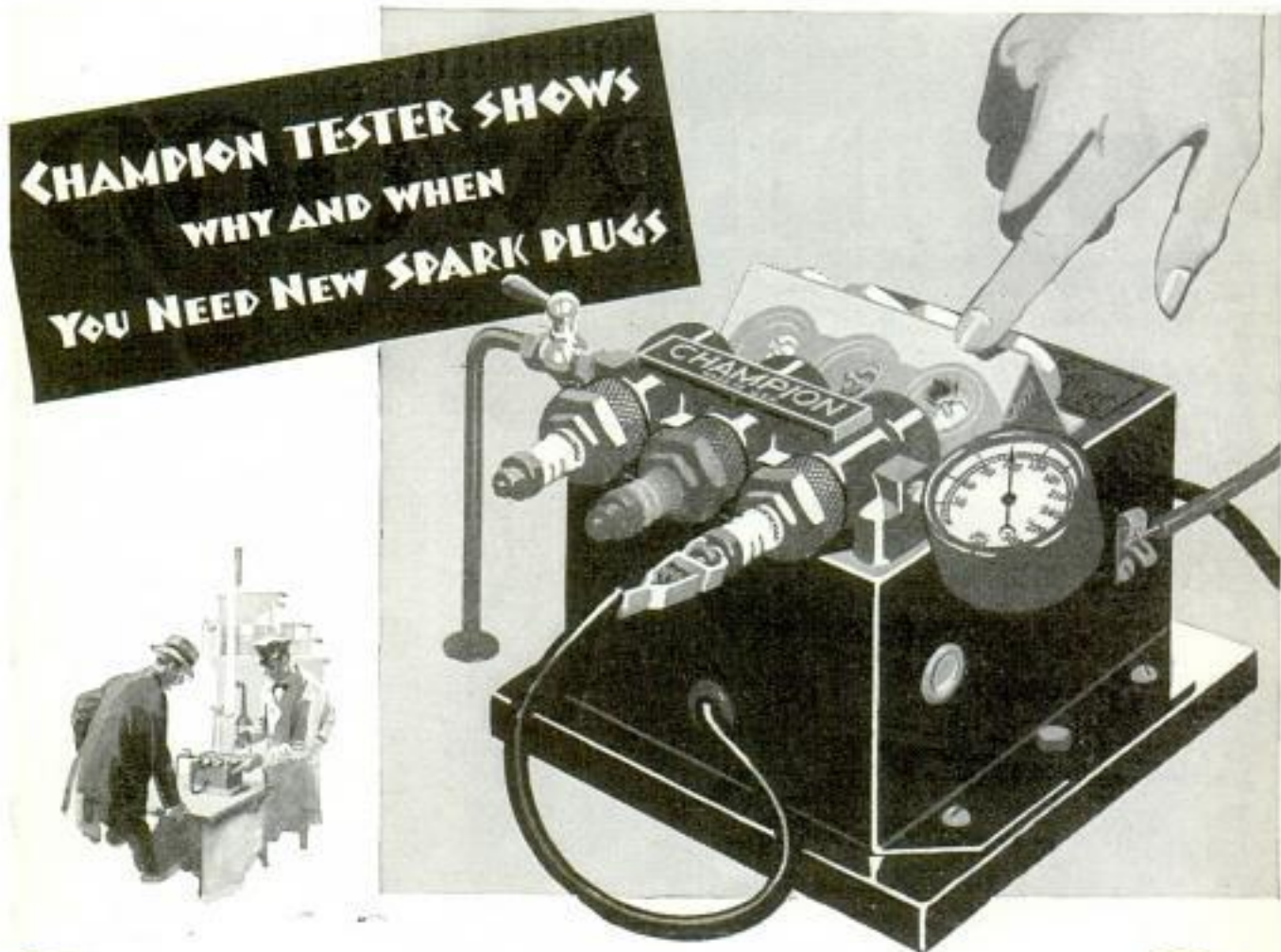

**T**O PROPERLY serve motorists who want to know why and when to change spark plugs, the Champion Spark Plug Tester is now in the hands of dealers everywhere.

You plainly see under compression similar to that in your own engine, the weak, wavering and wasteful spark of your old spark plugs. Then you see, and compare to this the clean, full and intense spark of new Champions—the spark that brings renewed efficiency to every engine.

Let your Champion dealer perform these interesting and conclusive comparative tests for you.

Motorists who regularly install new Champion Spark Plugs every 10,000 miles have learned that they renew engine power, speed, acceleration and economy each time.

Champion Spark Plugs are preferred by the majority of the world's motorists. Their better performance is demonstrated by consistent and unparalleled victories in the major racing events of the world.

CHAMPION SPARK PLUG COMPANY  
TOLEDO, OHIO WINDSOR, ONTARIO



**CHAMPION SPARK PLUGS**

*When writing to advertisers please mention Popular Mechanics*

Copyrighted material



# What is this

## FLOATING POWER?

PATENTED AND FULLY PROTECTED

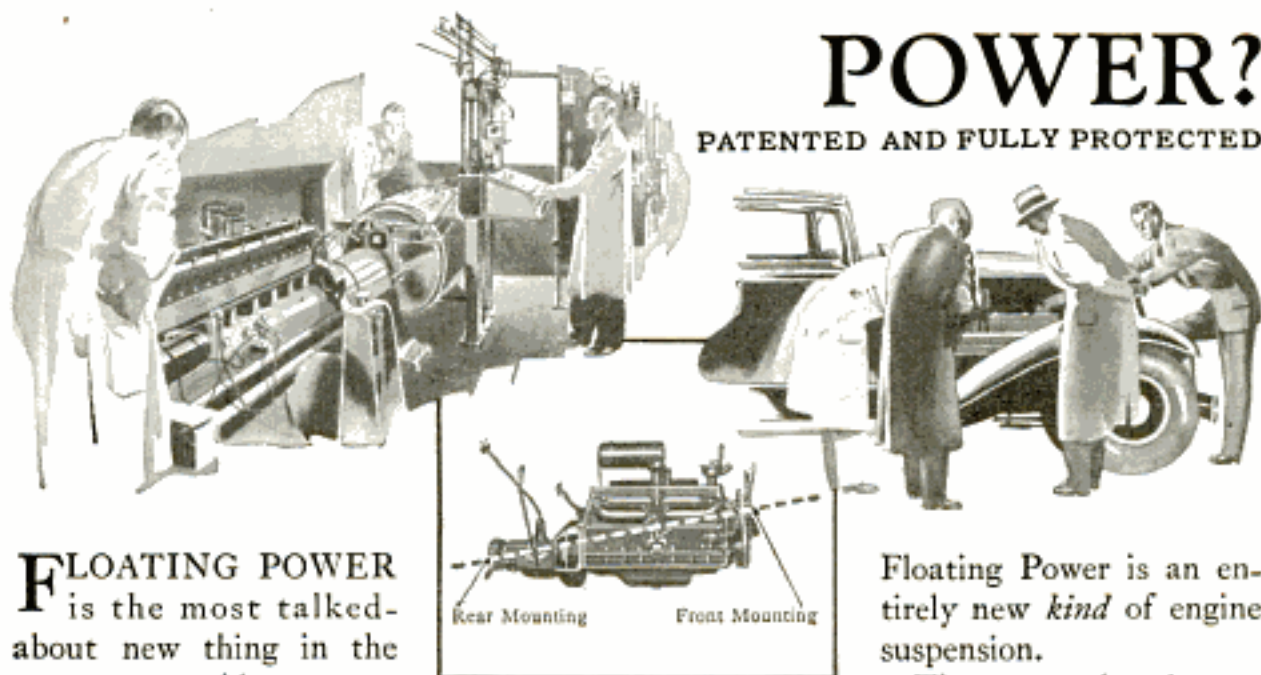

**F**LOATING POWER is the most talked-about new thing in the motor car world.

Everybody is interested—asking questions—asking what it is and what it does.

Floating Power is not just another name for a certain quality of power—it is engineering's final triumph in the long, hard fight against vibration.

Automotive engineers have grappled with vibration for years. Flywheels and crankshafts have been balanced almost to a hair. Pistons and connecting rods have been perfectly matched. Vibration dampeners have been employed. Every known means of securing mechanical precision has been used in efforts to reduce and minimize vibration. Years ago Chrysler Motors engineers developed rubber mountings. Those mountings did much to control and subdue vibration—and they still are used by many manufacturers.

But Chrysler Motors engineers are never satisfied. They kept on working. They kept on endeavoring to wipe out vibration *entirely*. Finally, their efforts led to the discovery of Floating Power.

Floating Power is an entirely new *kind* of engine suspension.

The power plant is supported at two points—front and rear—on mountings of bonded rubber and steel. These mountings are so located as to support the engine in perfect balance.

Power impulses from the engine never reach either the frame or the body—because the impulses are absorbed at their source by the slight movement of the engine in its Floating Power mountings.

The result is an entirely *new kind of performance*.

Floating Power creates a fascinating new "feeling" in motoring—a new smoothness impossible to describe, but noticeable the moment you take the wheel.

Floating Power is patented and used exclusively on the cars of Chrysler Motors—Plymouth, Dodge, De Soto and Chrysler.

Previously there had been nothing like Floating Power—in principle or in results. Drive one of these cars and learn for yourself the wonderful experience of driving at all speeds without feeling *any* vibration.

*When writing to advertisers please mention Popular Mechanics*



## PUT THIS ELECTRIC LIGHT IN PLACE



*Without  
Connecting a Wire!*

ANY ONE can install the Eveready Wallite. It needs no wires or connections! Fix it fast with two screws, or hang it on a nail as a portable light. Ideal for closets, garages, attics, basements, stairways, boats, and workshops.

The Wallite is powered by two of the new, *extra long life* Eveready Flashlight Batteries that have metal tops, instead of the old-fashioned, wax-compound seals. Their *all-armed* construction keeps the power-producing ingredients fresh . . . stores up hours of bright, certain light! (Renewal batteries cost 20 cents a set.) See a Wallite today . . . at all leading stores. Only \$1.55, without batteries.

• • •

The *new* Eveready Pocket Light. Novel mechanism. Convenient size for vest-pocket or hand-bag! Beautiful red and black buffed French enamel finish. Bright, clear light. 85c without batteries.



**EVEREADY**  
WIRELESS-  
ELECTRIC  
LIGHT

NATIONAL CARBON COMPANY, INC.

General Offices: New York, N. Y.

Unit of  and Carbon Corporation

When writing please mention *Popular Mechanics*

## NO CAMP IS COMPLETE WITHOUT A CANOE



A CANOE brings all the beauty of miles of water right to the dock of your camp. There's fishing on the stretch of a lazy lake. There's exploring . . . day-time excursions to secluded spots . . . overnight trips. It's no back-breaking work to go places in an Old Town Canoe. The easy stroke of a paddle takes you there and back — smoothly, quickly, and enjoyably.

Old Town canoeing is *not* an expensive luxury. There are 1932 models lowered to \$63. And Old Towns give years and years of hard use without any expensive up-keep cost. Write for a free catalog showing paddling, sailing, and square-stern types. Also outboard boats, including big, fast, seaworthy, all-wood boats for family use. Row-boats and dinghies. Write today! Old Town Canoe Co., 1343 Middle St., Old Town, Maine.

## "Old Town Canoes"



### "FLYING CLOUD"

Get clean-cut parts and clear blue-prints for 20' model. Readily made in spare hours as hull fully shaped and sanded. Set includes anchor, bell, capstan, dead eyes, wheel, rigging line, etc. Complete for \$11. Postage 5 lbs. White metal figurehead 50c. Send 15c (coins) for beautiful catalog of ships and coaches.

ROY HANCOCK

323 Douglas Ave. Portsmouth, Va.

**To Keep  
GUNS  
LIKE  
NEW**

Every owner of a gun should have Hoppe's Gun Cleaning Pack, to keep away leading, metal fouling and rust. Contains bottle Hoppe's No. 9, Can Lubricating Oil and tube Gun Gresse. All dealers. Send 10c for sample No. 9 and Gun Cleaning Guide.

FRANK A. HOPPE, INC.  
2309 N. 8th St., Philadelphia



## DO YOU

WANT a new business profession of your own, with all the trade you can attend to? Then become a foot correctionist, and in a few weeks earn big income in service fees,—not medical nor chiropody—easy terms for home training, no further capital needed, no goods to buy, no agency. Established 1804. Address Stephenson Laboratory, 1 Back Bay, Boston, Mass.

## MOVIES In Your Home

Our marvelous, practical Movie Machines sell as low as \$5.00 postpaid. Also finest 16 mm. cameras and projectors at factory prices. A complete line of both standard and 16 mm. film available at low prices with exchange service. Write for big, FREE catalogue.



PARAMOUNT MFG. CO.

Dept. G-49  
Boston, Mass.



— USE STARRETT HACKSAWS —

# NO ARGUMENT

Expert tool users have ideas of their own on everything else under the sun. But they don't waste any words about tools. There's no question about it — no more argument than there is about a diameter after you put a Starrett mike on it. Good machinists like Starrett Tools — and the best like them most.

For their accuracy, of course. But more than that — their design, which means easy, rapid work — their workmanship which keeps them on the job for years beyond the life of ordinary tools — their dependability.

Standardize on Starretts for your kit and your work will be better — faster.

Write for a copy of the Starrett Catalog and check it over for the tools you need. Ask for No. 25 AP

**THE L. S. STARRETT CO.**

*World's Greatest Toolmakers*  
*Manufacturers of Hackaws Unexcelled*  
*Steel Tapes—Standard for Accuracy*  
**ATHOL, MASS., U. S. A.**



# Use Starrett Tools





When You

# CAN'T QUIT

Nerves on edge. A head that throbs. You can't stop work, but you *can* stop the pain—in a hurry. Bayer Aspirin will do it every time. Take two or three tablets, a swallow of water, and you're soon comfortable. There's nothing half-way about the action of genuine aspirin. If the box says Bayer, you'll get complete relief.

These tablets should be in every shop, office, and home. Ready to relieve any sudden ache or pain, from a grumbling tooth to lumbago. Don't suffer with neuralgia, neuritis, rheumatism, etc. Don't lose time because of colds or sore throat. Get some Bayer Aspirin and read the *proven* directions for instant relief.

Be sure to ask for Bayer Aspirin it does not affect the heart.

## BAYER ASPIRIN

When writing to advertisers please mention Popular Mechanics

## World's Lowest Priced Quality Homes

Price includes all lumber readi-cut, mill-work, windows, doors, interior woodwork, hardware, roofing, glass, nails, paints, varnish, stains. All material shipped in a sealed box car. We pay freight.



4 to 9 Room Homes

**\$366 to \$2392**  
WE PAY FREIGHT

## Summer Cottages

Buy direct from Mill at Wholesale. Aladdin's famous Read-Cut System saves 18% lumber waste and 30% labor cost.



Summer Cottages

**\$231 to \$1495**  
WE PAY FREIGHT

**Garages** Complete instructions and drawings enable you to build an Aladdin yourself if you are handy with tools.

## FREE Catalog

Address nearest office. No obligation. Ask for Free Catalog No. 451

THE ALADDIN CO.  
Bay City, Mich., Portland, Ore.



Garages

## ALADDIN

**\$92 to \$307**  
WE PAY FREIGHT

World's Oldest and Largest Exclusive Manufacturers of Read-Cut Houses

**INCREASE YOUR BUSINESS** by using the NEW **\$5.85 "Two-Faced"** Film Duplicator to make 100 copies, in 1 to 5 Colors each time. Or the **\$37.05 "Excaligraph"** Rotary Stencil Duplicator to Print Copies of Anything Typed, Panned, Drawn or Traced in numbers up to 3000 each operation, as Price Lists, Hand Bills, Special Sales Announcements, Bulletins, Menus, Quotations, or "what have you?" Write—

**PITTSBURGH TYPEWRITER & SUPPLY CO.**  
Suite 552, 339 Fifth Avenue, Pittsburgh, Pa.

**FREE** Get BB Magic at once. A wonderful shooter's digest—tells how to hold, aim and handle rifles; become a crack shot. The principle of compressed air action that made the Benjamin Single Shot world famous has been applied to 25 shot automatic firing. Learn all about both rifles. **SEND NOW!**

 Benjamin Single Shot now \$4.50 postpaid. Benjamin Automatic 25 shot now \$7.50 postpaid. **WRITE!**  
**BENJAMIN AIR RIFLE CO.**  
 619 N. Broadway, St. Louis, Mo.

**Big 3 ft. Telescope** Five Sections. Brass bound. Powerful Lenses. 10-Mile range. Special Eye Piece for looking at the Sun, included **FREE**. Can be used as a Microscope. Guaranteed. Big value. Postpaid. \$1.75. C. O. D. 15c extra. **Benner & Company, 7-15, Trenton, N.J.**

**GUARANTEED TO FLY 100 Ft. If Built Properly**

A realistic, 1916, r. o. g. model of the fast single-seater British Sopwith Fighter. A steady flyer indoors or out. Set includes aluminum propeller, shaft, rubber band motor, streamlined wheels, nose block, ready-cut struts, etc. Full building and flying directions. No tools needed. Simplified construction—most easily built model on market. Can be built in 2 hrs. and will give more real satisfaction than expensive sets. Mailed in unbreakable container, postpaid in U. S. and Canada, only 50c. Order one **now**.

**THE MIDLAND MODEL WORKS, Dept. S, Chillicothe, Ohio**  
(No stamps. No c. o. d.'s. No returns. Suitable for boys 14 or older.)



# Now you can *SEE* the difference Ethyl makes



ORDINARY GASOLINE is in the cylinder. You see the spark in the picture at the left. In the next the gasoline vapor starts to burn. More—more—more burns. Then suddenly, in the sixth picture—BANG! The remaining gasoline explodes. That is KNOCK. The last picture shows nothing but afterglow. Knock wasted the gasoline that should be working now.



ETHYL GASOLINE starts from the spark in the same way—as shown in the first three pictures. But Ethyl can burn at only one speed: *the right speed*. See how its flame spreads *evenly* from start to finish. It is not all burned until the last picture—delivering its greatest power when the piston is going down—when power counts most in the performance of your car.

**Y**OU could always *feel* the difference with Ethyl Gasoline in your car. Now you can *see* the difference.

By fitting a quartz window in the cylinder head of a modern high-compression motor, engineers took photographs of the actual combustion of motor fuels.

The photographs show that ordinary gasoline burns *unevenly*. They prove that the power of Ethyl Gasoline is delivered with smoothly

increasing pressure that brings out the *best* performance of *any* motor.

Seeing is believing. Look at the pictures above and you will understand why nearly every car manufacturer now offers high compression engines as either standard or optional equipment—to take full advantage of Ethyl and its almost universal distribution.

Stop at the pump that bears the Ethyl emblem. Ethyl Gasoline Corporation, New York City.

© R. G. C. 1932



The quality of Ethyl Gasoline is maintained by laboratory inspection of samples collected daily in all parts of the country. Ethyl fluid contains lead.

# Buy ETHYL GASOLINE

When writing to advertisers please mention *Popular Mechanics*



## TAKE THE GRIEF OUT OF EMERGENCY REPAIRS

A sudden leak in the heating boiler—the hammer handle flies off—water squirts from a dent in the auto radiator—a drawer knob pulls out—screws strip from and loosen the door lock—a water pipe freezes and cracks—one caster won't stay in the table leg—your favorite pail starts to leak—a persistently loose nut puts the vacuum cleaner out of business—etc., etc.

POSSIBILITIES like these are ever present to the householder, but invite no delays, repair bills or expensive new purchases if you have a copy of the Smooth-On Home Repair Book, and a can of Smooth-On No. 1 on the shelf and like to prove yourself equal to the emergency.

Hundreds of repairs similar to the above are made quickly, easily and cheaply with Smooth-On No. 1, which stops leaks of steam, water, gas, oil, gasoline, smoke, etc., anchors loose screws, bolts, nuts, handles, machinery, etc., and holds equally well in metal, masonry, bath room tile, and wood.

Smooth-On No. 1 expands in hardening and when metallized holds as tightly as the metal to which it is attached. Power plant engineers, shop foremen and professional repair men prefer Smooth-On repairs because the simple cold application avoids fire risk and extra labor and a dependable finished job is ready in a hurry.

Mail the coupon for the Smooth-On Repair Book and get Smooth-On No. 1 in 7-ounce or 1 or 5-pound can from any hardware store.



Write for FREE BOOK



## Do it with SMOOTH-ON

SMOOTH-ON MFG. CO., Dept. 37,  
574 Communipaw Ave., Jersey City, N. J.

Please send the free Smooth-On Repair Book.

Name.....

Address.....

3-32.....

When writing please mention Popular Mechanics



Boiler Crack



Radiator Leaks



Cracked Fire Pot



Cracked Ovens



Stove Pipe Leak

## FREE SALE CATALOG

### FACTORY PRICES

### Slashed

Send today for new free Kalamazoo catalog! Stove, Range and Furnace factory prices drastically reduced. Save 1/2 to 1/3 by buying direct from the factory. You'll see values beyond belief—bargains never known before. Kalamazoo quality—famous for 31 years—is rigidly maintained.

#### 200 Styles and Sizes

800,000 satisfied customers! 200 styles and sizes: Beautiful Porcelain Enamel Ranges in sparkling colors. Coal and Wood Ranges, Gas and Combination Gas, Coal and Wood Ranges, Heaters, Furnaces, Household Goods.

#### Only \$5 Down

Easy terms—only \$5.00 down on any Kalamazoo. A year to pay. 30 days trial. 360 days approval test. 24 hour shipments. \$100,000 bank bond guarantee of satisfaction. 5 year guarantee against defects in materials and workmanship. Don't miss this big free bargain catalog. Write today.

KALAMAZOO STOVE CO., Mfrs.  
391 Rochester Ave., Kalamazoo, Mich.



Ranges \$37.50 up



Furnaces \$57.85 up

"A Kalamazoo Direct to You"

## AGENTS! SELLS LIKE WILD FIRE



\$380 monthly selling 10 improved patented Carter Window Washers daily. Cleans, dries, polishes. Eliminates all mudd. Good Housekeeping approval. Restricted territory. Write today. CARTER PRODUCTS CORPORATION 998 Front Ave., Cleveland, O.

## You Can Print

Cards, stationery, circulars, tags, labels, advertising, etc. Make big profits spare or full time. Do Your Own Printing. Save Money. Easy rules sent. Will do popular Raised Printing like Engraving. Junior press \$5.95, job presses \$11 up, power \$149. Send for free catalog. The Kelsey Co., N-37, Meriden, Ct.



Forms to cast Lead Soldiers, Indians, Trappers, Hunters, Wild and Farm Animals. 239 different forms to select from. Every Form guaranteed to cast perfect figures. Send 5c stamp for illustrated catalogue.

HENRY C. SCHIERCKE SPENCER RD. GHENT, N. Y.

**BABY CALCULATOR**  
CHICAGO ILL. U.S.A.

ADDITION  
SUBTRACTION  
MULTIPLICATION  
DIVISION

**VEST POCKET ADDING MACHINE**

Adds, Subtracts, Multiplies, Divides. Does work of \$200 machine. Not a toy. Million dollar capacity. Simple and accurate. Guaranteed 5 years.

**FREE TRIAL** **\$2.50**  
—SEND NO MONEY— Total Cost

Just name and address. We will ship Calculator immediately. On delivery pay postman \$2.50 (plus few cents postage). (If outside U. S. send cash.) 50c additional in Leatherette Case. If not satisfied after 10 days' trial you get your money back. THOUSANDS OF SATISFIED USERS. Write for Agents' Proposition. **BABY CALCULATOR MACHINE CO.** (Mfrs.) P. O. Box 1118, Dept. 31, CHICAGO, ILLINOIS



# new SOUTH BEND JUNIOR 8" BACK GEARED SCREW CUTTING PRECISION LATHE

as low as  
\$ **100**

\$20<sup>00</sup> Down Payment  
\$7<sup>00</sup> a month  
for 12 months

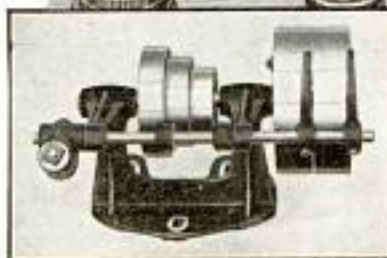
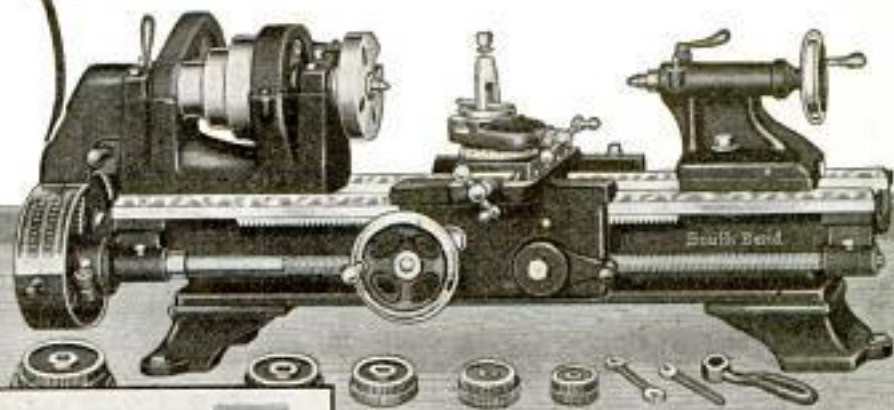

8" x 24" Junior Back Geared Screw Cutting Precision Bench Lathe with Tight and Loose Pulley Countershaft and Equipment, \$100 Net Weight 175 lbs.

f. o. b. factory

## Easy Payment Terms

As low as \$7 per month will put this lathe in any shop in the United States. Other sizes from 9" to 18" swing with bed lengths from 2½ to 14 feet sold on similar easy payment terms. Send for details of easy payment plan, without obligation.



8" x 24" Junior South Bend Back-Geared, Screw Cutting, Precision Bench Lathe, with graduated Compound Rest, Horizontal Drive Unit and Lathe Equipment **\$115.00**

¼ H. P. Non-Reversing Motor, 1800 R. P. M.  
(1-phase 60 cycle A. C. 110 volt) . . . . . \$12.00  
"V" groove pulley for motor . . . . . 1.25  
Knife Switch, enclosed type . . . . . 1.50  
"V" Belt, Motor to Drive Unit . . . . . .75  
Flat Leather Belt, Drive Unit to Lathe Spindle (1" x 72") 1.25  
**TOTAL Price of Lathe and Motor Drive Complete . . . . . \$131.75**

In the tabulation above we itemize motor and motor drive equipment so you can purchase only the parts you need. This applies to any 8" bench lathe with various bed lengths.

## Prices of 8" Junior Lathes with Longer Beds

	Between Centers	Net Weight	With Counter-shaft Drive	With Motor Drive
8" x 24"	6"	175 lbs.	\$115	\$131.75
8" x 30"	12"	190 lbs.	\$120	\$136.75
8" x 36"	18"	205 lbs.	\$125	\$141.75
8" x 42"	24"	220 lbs.	\$130	\$146.75

For lathes with plain rest, deduct \$15 from above prices.

Lathe Builders Exclusively for a Quarter of a Century  
Over 55,000 Lathes in Use

A lathe of the same high quality, accuracy, precision and up-to-date mechanical features which characterize the complete South Bend line. This new 8" Back-Geared Screw Cutting, Precision Bench Lathe can be used for the finest work in tool room and shop — for gauges, small tools, dies, etc. — for auto service, electrical manufacturing, home work shop and laboratory.

Lathe has these important features: ¾" hole in spindle—set-over tailstock—¾" diameter lead screw—power feed to carriage—plain rest (or compound rest optional) for holding tool—cuts screw threads 4 to 40 per inch—takes 1" belt—six spindle speeds—weighs 175 pounds net.

Complete line of attachments for this lathe available at similar attractive prices—including draw-in collet chuck attachment with collets, milling attachment, taper attachment, grinding attachment, thread dial, chucks, tools, accessories, all for precision work.

## Write for new Circular No. 8

describing and illustrating in detail all the features of this new up-to-date bench lathe. Sent free, post-paid, to any address. Fill out and mail coupon below.

## SOUTH BEND LATHE WORKS

603 East Madison Street, South Bend, Indiana, U. S. A.

Gentlemen: Please send circular No. 8, illustrating and describing the New South Bend Junior 8" Lathe.

Name \_\_\_\_\_  
Street \_\_\_\_\_  
City \_\_\_\_\_  
State \_\_\_\_\_



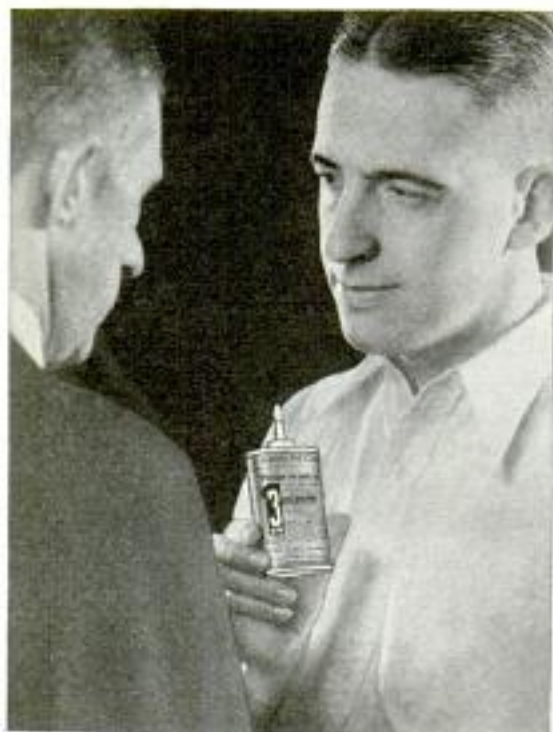

**"It saves me  
MONEY—  
that's why I use it!"**

"You bet I use 3-in-One Oil—on every tool in my shop! What if it does cost a few cents more to buy? I'm saving dollars—not pennies. Why, I haven't had a repair bill in months!"

Blended from three different oils by a special process, 3-in-One does three different things at once to provide full protection for shop equipment. As it lubricates, it also cleans working parts and guards them against rust.

Sold everywhere; in both handy cans and bottles. For free "Dictionary of Uses" write Three-in-One Oil Co., 170 Varick Street, New York, N. Y.

**3-IN-ONE OIL**

CLEANS - LUBRICATES - PROTECTS

ANY VOLTAGE - 110 - 220 - 440 - 550 - ANY VOLTAGE

It's DANGEROUS To Locate

**Burnt-Out Fuses**

And Other Electrical Trouble Except With A

**Test-O-Lite**

Out go your lights; your electric iron doesn't heat; the washing machine stops; the vacuum cleaner doesn't start; the radio goes dead. Why? Something wrong electrically, but where? TEST-O-LITE, with its tiny Neon Lamp locates the trouble INSTANTLY and SAFELY—no shocks, no burns!

TEST-O-LITE tests any voltage from 100 to 550 A. C. or D. C. It is a household necessity and should be in every home where such electrical emergencies are common. Keep one in your fuse box or tool kit.

Electricians find it indispensable for a thousand different uses. They carry one in their pocket like a fountain pen.

Electrical and hardware stores sell TEST-O-LITE. If your dealer does not carry it mail us \$1.50 with your name and address.

Pat. Oct. 21, 1933  
#1,775,552

**L. S. BRACH MFG. CORP.**  
65 Dickenson Street, Newark, N. J.

ANY VOLTAGE - 110 - 220 - 440 - 550 - ANY VOLTAGE

ANY VOLTAGE - 110 - 220 - 440 - 550 - ANY VOLTAGE

**ANY PHOTO ENLARGED**

Size 8x10 inches or smaller if desired. Same price for full length or bust form, groups, landscapes, pet animals, etc., or enlargements of any part of group picture. Safe return of original photo guaranteed.

**47¢**

**SEND NO MONEY** Just mail photo or snapshot (any size) and within a week you will receive your beautiful life-like enlargement, guaranteed fadeless. Pay postman 47¢ plus postage or send 47¢ with order and we pay postage. Big 16x20-inch enlargement sent C. O. D. The plus postage or send 50¢ and we pay postage. Take advantage of this amazing offer now. Send your photos today. Specify size wanted.



STANDARD ART STUDIOS, 908 W. Lake St., Dept. 362-C, Chicago, Ill.

**QUICK CASH**

Sell VEG-E-TONIC. Nothing on earth exactly like it. A fertilizer for lawns, flowers, plants, shrubs, etc. Comes in powder form. Mix with water. Apply with sprinkling can. No bother. No dust. No dirt. Penetrates deeply into soil. Works marvels. Sells right and left. Wonderful proposition for tree surgeons and landscape men. Permanent repeat business. Unlimited field. Write for detailed plan. All FREE for asking.

**McCLAIN BROTHERS COMPANY**  
Dept. P-32, Canton, Ohio

**IT'S NEW**

**MOTORCYCLES**

Direct to you at wholesale prices

Send 50¢ today for the latest Illustrated Bulletin and Confidential Price List of Guaranteed Indians Harleys Hendersons SuperX etc. (Sold on easy terms if desired)

**THE CRANDALL-HICKS COMPANY, 780 Commonwealth Ave., Boston, Mass.** Shipments to all parts of the world

**Let me pay you**

A daily income of quick, cash commissions in advance by representing me in your locality. My prices are sensationally reduced on all-wool, tailored-to-measure suits **Amazing values—\$19.50—24.50—29.50—** make orders easy to take.

100% co-operation, liberal bonus to producers who show my big selling, well known line. No special experience required. Big **FREE** outfit of large swatches puts you in business. Write now. **W. Z. GIBSON, Inc., 500 Throop St., Dept. Q-516, Chicago**

**Lowest Prices in 24 Years**

up to **\$75** A WEEK

When writing to advertisers please mention Popular Mechanics



# Does \$50 Job for 35¢ with amazing new discovery

Water was seeping between the tiles and the sill in the bathroom, running between the floors and settling on the dining room ceiling. He called in an expert who wanted \$50 to make the repairs. Too much! So he bought a can of Plastic Wood for 35¢ and did the job himself—as well as any high-priced expert could! That was two years ago. Since then he hasn't had a bit of trouble. There's no ugly water-stain on the dining room ceiling now.

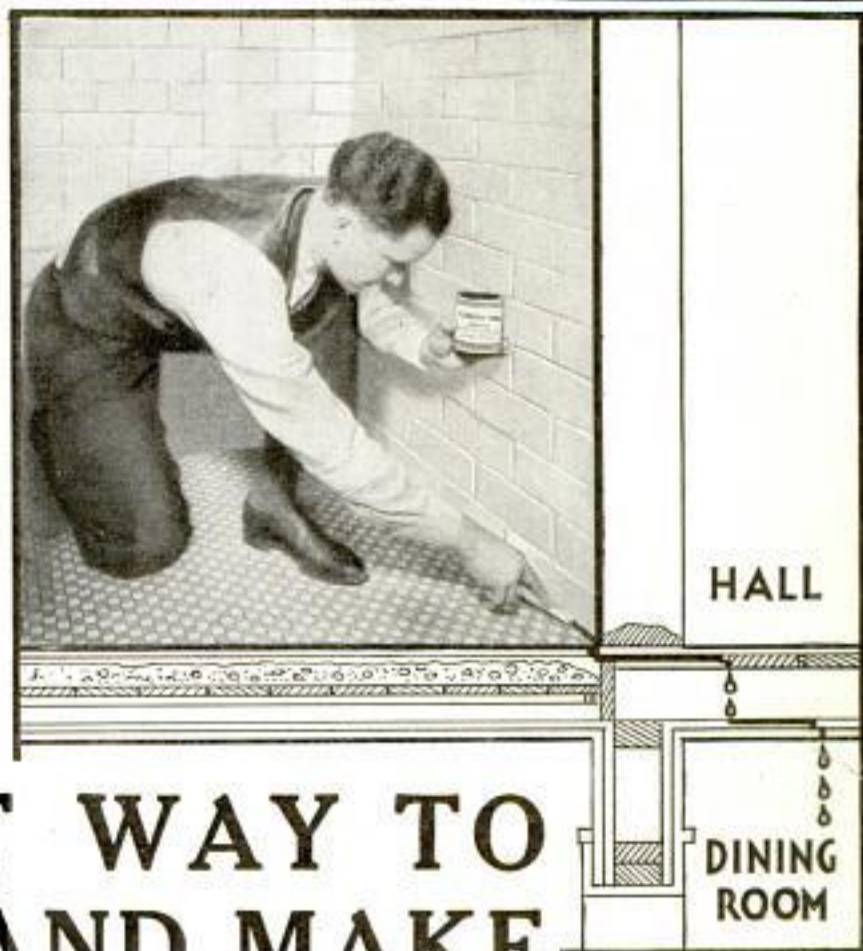

## EASIEST WAY TO REPAIR AND MAKE *a thousand and one things*

Now you can hide nicks, seal cracks, plug up holes—repair a thousand and one things around the house—and make an endless variety of models—with this amazing new discovery that handles just like putty and quickly hardens into wood. Wood that takes and holds nails and screws. Wood that neither cracks nor warps. Wood you can carve, paint or turn in a lathe. Wood that outlives most natural woods.

**THAT'S WHAT YOU CAN DO WITH PLASTIC WOOD.** Even if you're inexperienced you can do expert mending, repairing and modeling with this amazing preparation—easily and quickly. Try it and you'll get the surprise of your life.

*Note:* If you want the best results—refuse to accept counterfeits—the market is flooded with them—insist on the genuine Plastic Wood

which is sold in 9 colors by all paint, hardware and department stores. For the asking we will send you an interesting, profusely illustrated 48-page book which tells in detail the varied uses for Plastic Wood. Mail coupon for it today.

### MAIL FOR FREE BOOK

The A.S. Boyle Co., Dept. PM-3 Cincinnati, O.

Send me—free—Big Book of Uses for Plastic Wood.

Name.....

Street & No.....

City..... State.....

THIS OFFER GOOD IN UNITED STATES ONLY

# PLASTIC WOOD

*sold in 9 colors*

When writing to advertisers please mention Popular Mechanics

Copyrighted material





## STERLING HOME only \$979

### Fire-proof Cellar Ceiling

Rosewood, above, only \$979, double construction, 5 rooms, bath. Freight paid. We cut lumber at mill, saving expensive time of carpenters. Detailed plans enable easy erection—large savings. We will furnish "Steelface" joists for first floor with fire-proof "Gyplap" cellar ceiling, making your home safe against any fire from your cellar. Also—Thermostat Insulation, bronze weather stripping, paint, hardware, 1-panel de luxe doors, etc. 84 low-priced modern, attractive homes for your selection. Build now! Also garages, summer cottages. Send 25 cents today for catalog in color. Estab. 1906, International Mill & Timber Co., 235 Winona Ave., Bay City, Michigan.

STERLING HOMES HAVE STYLE

## NEW SMOKELESS ASH TRAY NEW

ONLY \$1  
POSTAGE  
PREPAID



### EXTINGUISHES FIRE— ELIMINATES SMOKE & ODOR

Something you have always wished for—THE PERFECT ASH TRAY. Does away with bad odors produced by smoldering cigarettes, eliminates fire hazard, prevents finger stains made by putting out lighted cigarette stubs. In fact it does away with all the bad points of smoking.

A marvelous invention—needed in every home or office. Made of finest quality brass, finished in red, green or black enamel with contrasting stripes. Will harmonize perfectly with the furnishings of any room. Height 4½ in., width 4 in.

#### ORDER YOURS TODAY!

This patented tray is offered at the amazingly low price of only \$1.00. Satisfaction Guaranteed or money back. **SEND NO MONEY**—Send name and address and we will mail promptly this beautiful ash tray for which you pay postage \$1.00 plus a few cents collection charges. **PARK SHERMAN, 1620 So. Wabash Ave., Chicago, Ill.**

## SHIP MODEL FITTINGS

Extensive line! Authentic quality fittings! Construction sets for Sailing Ships, Whalers, Steamships, Destroyers, Yacht Boats, Blauplate, model studios. Send 15c for list, illustrated catalogue.

A. J. FISHER, 1002-1 Etowah Ave.

Royal Oak, Mich.

CATALOG 15¢

## \$350 a Week IN OWN BUSINESS

W. F. Tesnow, Berwyn, Ill., earned \$350 his best week. Many others make \$125 to \$200 a week with H-B Rug-Washer. L. A. Eagles took in \$200 his first week in Madison, Wis. C. J. White, Louisville, says: "I \$100 business in 6 days—never a complaint." Harry Hill, Marseilles, Ill., says: "Paid for home with rug-washer. Earned \$80 first day." Frank Diedrich writes: "I started business with one H-B Rug-Washer. Today I own large Milwaukee store with 4 machines." Thousands earning quick, easy profits. Electricity does the work. Finishes rugs like new on customer's floor. Write for booklet.

### EASY TERMS

Inexpensive equipment. No shop necessary. Hundreds of customers in your vicinity and nearby towns—residences, hotels, offices, schools, clubs, theaters. Backed by \$58,000,000 company. Used by U. S. Gov't.

**FREE Book** Send today (no obligation) for booklet illustrating rug-washer and telling how you can earn large profits at prices below other methods; how you can build a permanent year around business; and how you can pay on easy terms. Enjoy a larger income. Write today—NOW.

H-B CO.,

6093 H. B. Bldg.

Racine, Wis.



## BE A WAGON-MAN.. We Furnish the Capital

A great, responsible, successful, 40-year-old company now makes this surprising offer to honest men. Invest no capital! Let us start you in this permanent business that YOU own and control for yourself. **Become the authorized McConnon Dealer and handle the complete McConnon line—no red tape and no division of line.** We finance you. You extend credit to your own friends and customers when you please. Only a certain number of these "no-investment" propositions are open. Each one offers a good living with a chance to put some money in the bank every week. Honest, steady men who write promptly are assured of first consideration. Write today and ask for "no-investment" offer. Address The House of Friendly Service, McConnon & Company, Desk D-6603, Winona, Minn.



### GET THIS Free new No. 23 Edition of our RADIO SERVICE TREATISE. Contains some 75 new hookups, circuit diagrams; over 350 illustrations. POSITIVELY THE GREATEST BOOK EVER PUT OUT.

CONTENTS: VACUUM TUBE TREATISE, with many illustrations; Vacuum Tube Average Characteristic Charts; How to Take Care of Your Tubes; Phonograph Pickups—Connecting Additional Loud Speakers; Fully illustrated with diagrams, Modernizing Old Radio Sets; How to Convert Battery to Power Sets; Voltage Dividers; Selecting and Installing Replacement Parts in Radio Sets. **WRITE TODAY.** Enclose 2 cents for postage. Treatise sent by return mail.

RADIO TRADING COMPANY  
29 West Broadway New York City



Cal. 30-40 Six Shot



Price  
\$975

All the qualities of a high price rifle. In fine used condition, all working parts guaranteed for one year. Send today for our Free Catalogue illustrated catalogue of money saving values; Guns, Ammunition, Cutlery, Sports and Gov't goods.

Deposit required on all orders. Money refunded if not satisfactory.

W. Stokes Kirk, Dept. P. M.-3, 1627 N. 10th St., Phila., Pa.

## Catch Fish!

Eels, Mink, Muskrats with our new folding galvanized **STEEL WIRE TRAP.** Write for our **FREE TRAP OFFER** and Bargain Catalog. \$1 Box of our famous Fish Bait FREE to introduce our traps. **WALTON SUPPLY CO., 3502 JUNIATA AVE., ST. LOUIS, MO.**



## NEW KIND OF WATER HEATER Boils Water Instantly!

**NOW**—in a matter of seconds—you can have boiling water for any purpose—at any hour. Already over half a million homes use Lux, the pioneer direct contact electric heater. For shaving, bathing, washing dishes, hot water bags, this super speed electric device is the most efficient of all water heaters. Introductory offer proves results or costs you nothing. Write Lux-Visel Co., Dept. C-60, Elkhart, Indiana.

\$195.00  
IN 10 DAYS

—is Neuman's profits. Prentice, \$26.25 first day. Mrs. Misener, \$38.75 in 8 hours. Sells on 1-minute demonstration. Needed in millions of homes. Write



# SWIFT as an ARROW

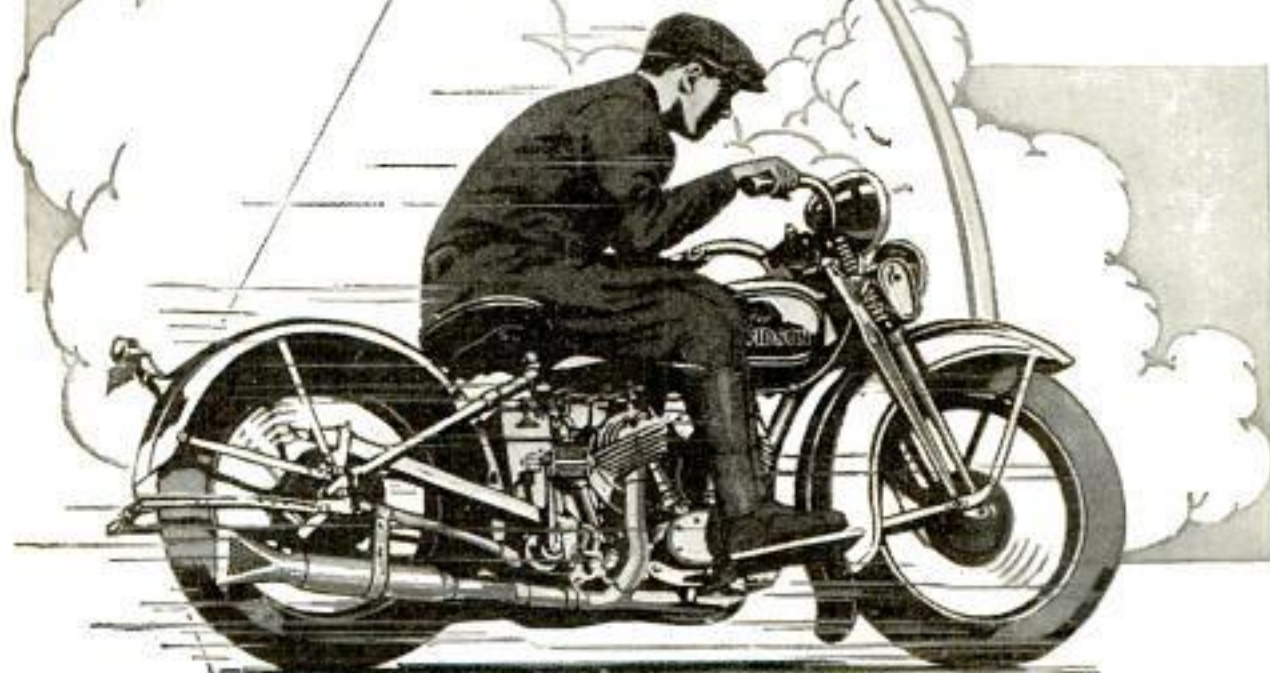

Flashing acceleration of a 1932 Harley-Davidson is like flight of arrow from twanging bowstring—swift, eager, effortless.

The power of its wonderful motor is so smooth, so easily controlled, that miles slip by and hills flatten out before you are really aware of them.

Ride a new Harley-Davidson and see for yourself. No printed words can do justice to its speed and power, its balance, comfort, ruggedness, and economy.

*Your nearby Dealer wants to show you the 1932 Twin and Single. See him soon.*

**New Single \$195 f.o.b.**

Here's the biggest value in Harley-Davidson history—a completely equipped, 3-speed motorcycle for only \$195, at the factory. Seems impossible, but it's true. What a buy!

Ride a  
**HARLEY-DAVIDSON**

## MAIL THIS COUPON

Harley-Davidson Motor Co., Dept. P, Milwaukee, Wis.  
Interested in your motorcycles. Send literature.

Name \_\_\_\_\_

Address \_\_\_\_\_

My age is ( ) 16-19 years, ( ) 20-30 years, ( ) 31 years and up, ( ) under 16 years. Check your age group.

When writing to advertisers please mention Popular Mechanics



## Famous Anachronisms



"Didn't mind it at all,"  
said Jonah. "It was quiet  
and I was *THERE* with a  
**CROSLEY**  
**RADIO**

Vaudeville offers, proposals of marriage and chances to endorse things for the ads came Jonah's way after the whale episode. But Jonah, simple soul, would have none of it. He seemed happy to let things go on as usual. Jonah didn't want publicity. As he put it—"Just forget it. The whale didn't hurt me. I rigged up my automobile radio, the ROAMIO, in the Whale Sedan, and I was *THERE* with a Crosley."

You, too, can be *THERE* with a Crosley when great future events occur.

Tune in **WLW Cincinnati** (700 K.C., 428.3 Meters) every Saturday night at 8:00 E. S. T.

**THE CROSLEY RADIO CORPORATION**

Home of "the Nation's Station"—WLW

Powel Crosley, Jr., President

CINCINNATI

**BOW LEGS?**

THIS GARTER (Pat'd)  
Makes Trousers Hang Straight  
If Legs Bend In or Out

Free Booklet—Plain Sealed Envelope

**THE T. GARTER CO., Dept. E**  
South Bend, Ind.



**MAKE MONEY**  
**SPARE OR PART TIME**

**HOME MANUFACTURING**  
Make Colorcrete Products

**NEW—EASY—FASCINATING**

Many pieces sell for 6 times cost to make. Crockett of Tex. shows a profit of \$1231 as a side-line. Kauble of Iowa \$2000 with only 3 designs, etc., etc. Permanent, charming color **SELLS THEM ON SIGHT.**

**NO EXPERIENCE NECESSARY**

Start this exclusive fast-growing business now. Over 40 designs to select from—more than 30 colors and shades. Equipment \$30 up. Learn more about this great opportunity. Send for **COMPLETE INFORMATION.**

**COLORCRETE INDUSTRIES**  
570 Ottawa Ave., Holland, Mich.



When writing to advertisers please mention Popular Mechanics

**HOT SHOT... NEW ELECTRICAL WIZARD**  
**GOOD FOR \$15 TO \$25 A DAY**

**NEW MOTOR INVENTION** **JUST OUT!**

"HOT SHOT" the instant cold weather starter. Saves gas, oil, and battery. More Power. Pays for self in one week.

**\$1.50**

Complete **GUARANTEED**

**GOLD MINE FOR LIVE AGENTS**  
Townsend had 765 the first five weeks—Hollub ordered one thousand—Caglesold 220 first month. **HOT SHOT** is installed in a few seconds without tools.

**WRITE FOR FREE TRIAL OFFER**  
Dept. F-3, REARDON MFG. CO., Peoria, Ill.

**A. C. Electric Plants**

ONAN A. C. PLANTS furnish the same current as city service—110 volt, 60 cycle, A. C. Operate Radios, Water Systems, Refrigerators, all Household Appliances. Sizes 500 to 1800 Watts Available from stock. No battery used except to start the engine. Ideal for farms, camps and lake homes. Also a complete line of D. C. Models.

**D. W. ONAN & SONS**  
95 Roselton Ave. Minneapolis, Minn.

**\$18.85** Now buys a genuine **MEAD Bicycle**

RANGERS cost a few dollars more. Do not buy until you get our astonishing new prices and terms.

**30 Days' Trial** We ship on approval. If not satisfied after trial return the bicycle at our expense.

**Tires** lamps, wheels, equipment at half usual prices. Write for marvelous new prices and terms.

**Mead CYCLE COMPANY** Write us today for free catalog  
DEPT. L112, CHICAGO

**ARE YOU Suffering from "NERVES"?**

Are you always excited? Fatigued? Worried? Gloomy, Pessimistic? Constipation, indigestion, dizzy spells, sleeplessness and sex weakness are caused by **NERVE EXHAUSTION.** Drugs, tonics and medicines cannot help weak, sick nerves! Send 25 cents for my amazing book. Money-back guarantee. **Richard Blackstone, N-473, Flatiron Bldg., N. Y. C.**

**SOUSA**

Says: "Complete equipment of Conn Instruments enhances the musical value of any band at least 50%." More than 50 years' experience and extensive, patented features make Conn Instruments superior. Easier to play. Perfect in tone.

**WRITE FOR FREE BOOK**  
Ask your Conn dealer to show you the late models. Home trial. Easy payments. Write for free book on your favorite instrument. Mention instrument.

**C. G. CONN, Ltd.**  
Conn Bldg., Elkhart, Ind.

**CONN**  
World's Largest Manufacturers of BAND INSTRUMENTS



# Turn your spare time into CASH with the new IDEAL LAWNMOWER SHARPENER

## What these men have done, YOU CAN DO!

Walter Wever, Middletown N. Y., writes: "I have made over \$1,000.00 on my Ideal Lawnmower Sharpener during the past four months." W. T. Moore, Twin Falls, Idaho, writes: "Through the season of about 90 days my Ideal has netted me a profit of \$1,200.00." Ralph L. Lemont, Ocean City, N. J., writes: "My Ideal was the means of making me \$1,500.00 this past season."

## Big Profits in Your Spare Time

C. S. Coburn, North Little Rock, Ark., writes: "With my Ideal Sharpener, working evenings only, I took in \$1,965.20 in 18 months—sufficient to pay for my Ideal and equip my shop with new, modern machinery." W. F. Kendt, Buffalo, N. Y., writes: "I sharpened 994 lawnmowers in one season and the receipts were nearly \$2,100.00—not bad for a side-line." H. Armstrong, Vancouver, B. C., writes: "This year, with business conditions poor, I sharpened 1,000 mowers. The Ideal is a very good machine and I hope 1932 will bring better business to all of us."

## A Permanent Paying Business

S. E. Raup, Harrisburg, Pa., writes: "I started sharpening lawnmowers 5 years ago, as a side line, setting up an Ideal in my basement. Now I am arranging to build a large shop and apartment to take care of my increasing business which employs 2 to 3 men besides myself." Don't lose any time getting into this highly profitable business. The earlier you start, the more business you will do—THIS YEAR.

## No Training Required

You don't have to be a mechanic to operate the Ideal. Its operation is simple and practically automatic after you have placed the lawnmower in position to grind.

## Here Is Your Chance

THE BIG OPPORTUNITY YOU HAVE ALWAYS WANTED—TO MAKE EXTRA MONEY. Send for the new free handsomely illustrated catalog "Turn Your Spare Time Into Cash." It also shows you the best ways to get the mowers to sharpen. Don't wait. Clip the coupon NOW!



# New

The new 1932 model Ideal Lawnmower Sharpener—with direct-connected electric motor and shelf—new variable-feed grinding method—new Reconditioner for "lapping in"—new straight-blade attachment for grinding both faces of straight-blade—the greatest value ever offered.

## A TWO-METHOD Sharpener—a Grinder and a Reconditioner—at Practically the Price of One

The new 1932 model Ideal Lawnmower Sharpener meets every possible condition—it is the ONLY machine that GRINDS and puts a perfect bevel and cutting edge on the old, dull, thick-bladed, hard-running mowers and also sharpens or reconditions the new, slightly-dull, easy-running kind.

## Sharpens Any Mower in 15 to 20 Minutes

Just pick up the mower, set it in the Ideal, make a few simple adjustments and proceed to sharpen. In 15 to 20 minutes after you pick up the mower it is ready for the lawn, and you have made \$1.00, \$1.50 or \$2.00, depending on the condition of the mower.

## Special Grinding Wheel Attachment

For grinding skates, grass shears, sickles, etc. Will add many dollars to your income.

## Uses Little Power

Operated by  $\frac{1}{4}$  H. P. motor attached to light socket or may be run direct from line shaft.

## Be Your Own Boss

Work for yourself. Be independent. Hundreds of lawnmowers are waiting to be sharpened. No town too small. Our new, free catalog shows you how to make money from the very start.

## SEND FOR FREE CATALOG

THE FATE-ROOT-HEATH CO.,  
324-360 Bell St., Plymouth, Ohio.

Send me your new free catalog, "Turn Your Spare Time Into Cash."

Name .....

Address .....

City ..... State .....



When writing to advertisers please mention Popular Mechanics



# Now! Do Your Own Electric Nickel Plating

COMPLETE  
INTRODUCTORY  
OUTFIT ONLY  
**\$6.50**

Plate with  
Nickel, Brass,  
Copper, Silver,  
Gold, etc.



## A REAL MONEY-MAKING OPPORTUNITY

**NO EXPERIENCE REQUIRED.** Do YOUR OWN Electro Plating in Your Home, Garage, Office, or Place of Business. Electrically Deposit Metal—Nickel, Brass, Copper, Silver, or Gold. You can successfully do all the plating on your Automobile, Electric Fixtures, Faucets, Spoons, Forks, Chandellers, Tools, Coffee Urns, Surgical and Dental Instruments, Utensils, large or small, Iron Stoves, Music Instruments; recondition worn plating or plate New Work; do it instantly without interrupting the service or without removing the parts to be plated with the

## ALADDIN PORTABLE ELECTRO-PLATER

Simple and Economical to operate. Not a toy, but a practical Plating Outfit with which Perfect and Durable Work can be done. Positively Guaranteed to do as we claim. **BE YOUR OWN BOSS!** Build up a Profitable Aladdin Electro-Plating Business of your Own. This offers wonderful **ECONOMY** to users and **BIG MONEY-MAKING** possibilities to **AGENTS**. Thousands in Service since 1924. Write today for **FREE PARTICULARS AND TESTIMONIALS**.

P. J. F. BATENBURG CO. Dept. 280 RACINE, WISCONSIN

—AGENTS—  
WANTED EVERYWHERE



America's Greatest  
Boat Values

## CATALOG FREE!

Canoes  
\$45  
and up



Three models and four lengths. Including non-sinkable sponson canoes.

Row-  
boats  
\$35  
and up



Improved models. Safe and seaworthy. Strong and durable. Easy to row and handle with oars.

Motor  
Boat  
\$65



Thompson's new World-Beater in Motor Boats. 16-ft. TVT Model with full length spray rails. 4-cylinder engine with electric starter installed. Speed 25 to 35 miles per hour. Also 18-ft. mahogany sedan at usual price of a runabout.

Out-  
board  
Motor  
Boats  
\$48  
and up



A complete line of real fast, safe and seaworthy boats for family use. Also fastest racing models. Only Thompson TVT Outboards have full length spray rails. Keep occupants of boat perfectly dry in rough waters.

**CATALOG FREE—SAVE MONEY—PROMPT SHIPMENT!**

(58) Please state the kind of boat you are interested in

—TWO LARGE FACTORIES—

**THOMPSON BROS. BOAT MFG. CO.**  
213 Ann St. [Write to] 113 Elm St.  
PESHIGO, WIS. [Either Place] CORTLAND, N. Y.

PRIZE  
MODEL  
CONTEST

## DE WITT CLINTON

Complete materials for Popular Mechanics Flyer Contest. Wheel rim, best-lined No. 8-80 screws and tapet mahogany brass rod and tubing for driving boxes, cylinders, valve chest, eccentric, etc.

A. J. FISHER, 1002-6 E. Iowa Ave., Royal Oak, Michigan

WRITE  
to  
FREE  
LIST

**\$20 A DAY**  
for AGENTS

Every home, store, factory, etc. buys 12 or more. Agents making \$500 to \$1000 a month selling the new, improved, patented

### 6-in-1 Fuse Plug

Think of it! 6 fuses in 1 plug. "A turn to the right brings back the light." Most necessary invention in years. Approved by Board of Fire Underwriters. Demonstration outfit given. Easy seller. Write at once for proposition. Send 25c for sample fuse plug.

**6-IN-1 FUSE CO.** Dept. 166, Chicago, Ill.



## MOTORCYCLES

Wonderful Bargains

Small Deposit—Liberal Terms  
Indians Harley-Davidson  
Ace and Henderson

W. J. WALKER CO., 1311 Boylston St., Boston, Mass.

## DEAFNESS IS MISERY



Many people with defective hearing and Head Noises enjoy conversation, go to Theatre and Church because they use Leonard Invisible Ear Drums which resemble Tiny Megaphones fitting in the Ear entirely out of sight. No wires, batteries or head piece. They are inexpensive. Write for booklet and sworn statement of the inventor, himself deaf.



A. O. LEONARD, Inc., Suite 699, 70 5th Ave., New York

## STANDARD GARDEN TRACTOR

Plows Seeds Cultivates Mows Hay and Lawns. A Powerful Tractor for Small Farms, Gardeners, Florists, Nurseries, Fruit Growers and Poultrymen. Walk or Ride—High Clearance. Free Catalog. Does Belt Work. **STANDARD ENGINE COMPANY** 3221 Como Ave. Minneapolis, Minn.



## New Model G-V. Rotary Compressor Type Electric Sprayer At Half Price

Ideal outfit for spraying paint, lacquer, varnish, insecticides, etc. High quality—elec. rotary type compressor, 110 vt. Universal Motor, for AC or DC. Encased in aluminum. GUN is full liquid pressure type (do not confuse with ordinary cheap suction type gun) aluminum, light, easy to handle. Outfit includes 5 interchangeable containers in wire basket—15 ft. high quality oil resisting hose; 10 ft. elec. cord with plug-in-2 spray type, fan and round, both adjustable. Reg. price \$39.50. Our price only \$19.75 for complete outfit. Send \$2.00 deposit, bal. C. O. D. plus postage. Satisfaction guaranteed or money back. Order today.



ONLY  
**\$19.75**  
Complete

Regular Price  
**\$39.50**

for This Nationally  
Advertised  
Outfit

**NATIONAL JOBING & EXPORT CO.**

Dept. 103 109 W. Lake St. Chicago



## A New Tractor From Your Old Car

Easy to Build—  
We Tell  
You  
How!

with SHAW Tractor  
Equipment

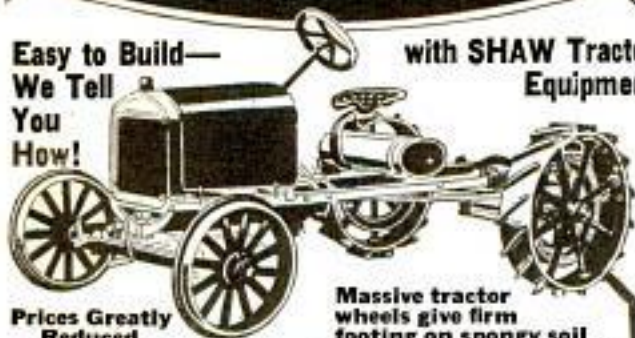

Prices Greatly  
Reduced

Massive tractor  
wheels give firm  
footing on spongy soil

### DOES ALL FARM WORK!

Increase profits—though prices are low—with a tractor. You can make a powerful dependable tractor—at low cost—from your old Model "T" or "A" Ford, Chevrolet and many other old cars—with SHAW Tractor Equipment. Does farm power jobs as well as expensive tractor! Pulls 16-inch plow, or two 12-inch plows, 7-foot disc, 1 or 2-row corn cultivator, large harrow. Also runs feed grinders, concrete mixers, saws and other belt machinery.

New HIGH ARCH Model with 30 in. clearance straddles corn and other crops without touching. Cultivates 1 or 2 rows at a time.

Easy to Attach SHAW Equipment in short time with monkey wrench and screw driver. You needn't be a mechanic. We furnish all parts; easy-to-follow instructions.

Pays for itself in one short season saving time, labor and money. Will draw 5 acres per day.

SHAW MFG. CO.  
Dept. PM3, GALESBURG, KANS.

Write for FREE Book

PRICES Greatly REDUCED to meet present conditions. But subject to change any day. Act quickly! Write for details, Reduced Price, Easy Payment Plan, 10-DAY TRIAL OFFER! FREE LITERATURE—Gives full information on SHAW Tractor Equipment—tells how SHAW Tractorized Car has made more money for hundreds. Photos of SHAW in use.



H & A Shaper

### NEW BALL BEARING SHAPER

EARN EXTRA MONEY AT HOME in your spare hours. This new H & A Ball Bearing Shaper helps you produce finest moulding and shaper work with ease. Best for home or commercial shop. Steady high speed. Reversible. Rotation. Accurate. Priced lower. Portable, electric, built of finest materials. Write for FREE catalog, showing the complete line of H & A equipment, and the New H & A Unit Plan Catalog. Act Now!

HESTON & ANDERSON 603 Park Avenue  
FAIRFIELD, IOWA



### FREE "YANKEE" TOOL BOOK

to Help You Make Things. Photos show ingenious uses, in shop and home, of famous "Yankee" Tools. Write to North Bros. Mfg. Co., Dept. M, Philadelphia, U. S. A.



Free Catalog  
**GERSTNER TOOL CHESTS**  
for Machinists and Toolmakers  
H. GERSTNER & SONS  
403 Columbia Street Dayton, Ohio

## NOW is the best time to ASSEMBLE YOUR BOAT



You'll have more confidence in the boat you build yourself. It's no trick at all—the Brooks Way! Pay yourself the workman's wages and have the fun of assembling a husky, speedy Brooks Knock-Down boat in your spare time. Hours of health and happiness outdoors will be your reward—at a fraction of the usual cost. Our master craftsmen cut and shape the parts. We send them to you plainly marked—with fastenings and complete assembling instructions. Send 10c today for our new illustrated catalog showing 38 distinctive cruiser, runabout, outboard, sail and rowboat designs. Don't delay—spring is just around the corner.

**BROOKS BOAT COMPANY, INC.**  
DEPT. 10-R  
SAGINAW WEST SIDE, MICHIGAN

# Saw-Filing PAYS BIG



Earn \$2 to \$3  
an Hour

Have  
Your  
Own  
Cash  
Business  
and  
Work  
Steadily!

\$10  
Brings  
It to You

### FOLEY AUTO MATIC SAW FILER

Files all kinds of hand saws, cross-cut circular saws and band saws

W. B. Menees reports, "Am using the Foley Automatic Filer with great success. Business is increasing daily due to the satisfactory work turned out." M. S. Gray writes, "I file for the school system here, The Telephone Co., City Water Works, Oil Burner Co., Carpenters Union, lumber yards and many others. Between Aug. 4 and 28 I filed 300 saws for the schools."

**No Canvassing** Our Free Plan tells you how to get started. Many have started in spare time and built up a big-paying permanent cash business. You can do it, too! No experience necessary. Just follow a few simple instructions and the Foley does the rest! Sold on easy payments. Act now!

### FOLEY MFG. CO.

3162 Foley Bldg. 11 Main St. N. E.  
Minneapolis, Minnesota

Please send FREE PLAN on how I can have my own Cash Business with the Foley Automatic Saw Filer.

Name.....

Address.....

Mail  
Coupon  
for  
FREE  
PLAN

When writing please mention Popular Mechanics



## SLEEP TONIGHT



"I'm certainly thankful that we had this bottle of Sloan's in the house tonight."

"I'm twice as thankful! It made that shoulder feel a whole lot better, believe me."

## SORE MUSCLES —stiff joints

After a hard day's work, aching muscles need the comforting warmth of Sloan's. Just pat it on—and pain won't spoil your night's rest. Sloan's restores circulation at once with fresh blood. Congestion is carried away. Pain stops. You don't lose sleep... Get a fresh bottle today at your druggist's. Only 35¢.

# SLOAN'S Liniment

WARMS LIKE  
SUNSHINE



### BUILD DUTCH WINDMILLS

Build and Sell Windmills. Beautifully designed Windmills beautify any garden. Can be easily constructed with our complete set of blue prints (21x24). Drawings mechanically correct to scale, with full instructions. Price 68¢ CRAFTSMAN'S MODEL CO., 475 E. North Ave., Wauwatosa, Wis.



### Build Model Ships of the Better Kind

We can supply construction sets and all sorts of parts, such as semi-finished hulls, blocks, deadeyes, flags, anchors, steering wheels, capstans, heavy leads, guns, blue prints, books, etc., for building real life scale models of the U. S. Destroyer Preston, Flying Cloud Constitution, Spanish Galleon, Viking, Baltimore Clipper, Mississippi steamboat, Bluebird, Mayflower and many others. Also special construction sets for racing sail boats, power boats, model steam engines, boilers, propellers, etc., and fine tools for the model maker. New large 36-page photographically illustrated ship model booklet has just been released. This booklet contains valuable information and hints for building ship models, in addition to prices and full description of the above articles. Many people only slightly interested in models have become greatly enthused upon receiving this booklet. A copy will be sent postpaid upon receipt of 15 cts. (coin preferred).



MODEL SHIP SUPPLY CO., Dept. D, Mineola, N. Y.

FREE! FREE!  
TIRE  
GAUGE

WITH EACH ORDER  
FOR 2 TIRES

MON-TAKE TIRE PRESSURE  
THROUGH SIDE WALL OF TIRE

SAVE  
ON TIRES

12  
MONTHS  
SERVICE  
WARRANTY

New LOW PRICES  
ON GOOD YEAR  
GOODRICH-U.S.-FIRESTONE  
FISK AND OTHER TIRES

LOWEST Prices on Earth!

Thousands of satisfied tire users all over the U.S.A. will vouch for the LONG HARD SERVICE, under average road conditions of our standard brand tires reconstructed by the ORIGINAL SECRET YORK PROCESS. To introduce this genuine tire value to you, this big responsible company offers, ABSOLUTELY FREE a modern tire gauge with each 2 tires ordered—now take pressure through side wall of tire in a jiffy—no fuss—no dirt. OUR 16 YEARS IN BUSINESS makes it possible to offer tires at LOWEST PRICES in history. Guaranteed to give 12 months' service

Don't Delay — Order Today

CORD Tires BALLOON Tires

Size	Tires	Tubes	Size	Tires	Tubes
20x3	2.20	1.00	20x4.40	2.30	1.10
20x4	2.25	1.00	20x4.50	2.40	1.15
20x4 1/2	2.70	1.10	20x4.60	2.45	1.20
21x4	2.95	1.10	20x4.70	2.45	1.20
22x4	2.95	1.10	20x4.75	2.45	1.20
22x4 1/2	2.95	1.10	20x4.80	2.45	1.20
24x4	3.50	1.10	20x5.00	2.55	1.25
24x4 1/2	3.50	1.10	20x5.00	2.55	1.25
24x4 3/4	3.50	1.10	20x5.00	2.55	1.25
24x4 1/2	3.45	1.10	20x5.20	2.95	1.50
26x3	3.40	1.10	21x3.25	3.10	1.50
26x3 1/2	3.40	1.10	20x5.77	3.20	1.40
26x3 3/4	4.45	1.10	20x6.00	3.30	1.40
			21x6.00	3.40	1.40
			20x6.00	3.20	1.40
			20x6.20	3.50	1.60

DEALERS WANTED

Send only \$1.00 deposit with each tire ordered. We ship balance C. O. D. Deduct 6 percent if cash in full accompanies order.

TUBES BRAND NEW — GUARANTEED

Tires failing to give 12 months' service replaced at half price.

YORK TIRE & RUBBER CO., Dept. 909-A  
3855-59 Cottage Grove Ave. Chicago, Ill.

Send for FREE  
BULLETINS

CRESCENT  
WOOD WORKING  
MACHINES



Crescent Wood Working Machines make history for you by turning out work accurately, fast and easily. Portable machines operate from any light socket. Big line of heavy machines for factories, all quality made; moderately priced.

Send for Free Bulletin.

The Crescent Machine Co., 93 Columbia St., Leetonia, O.

## BUILD YOUR OWN AUTOMATIC ELECTRIC REFRIGERATOR

Why pay \$200.00 and upwards? Use your present ice-box. We supply parts. Can be built for only \$34.50. Easily made. No special tools necessary. Operating cost, quality and size of machine same as well known makes. Complete blueprints and instructions—\$1.00. Circular "B" on request.



B. & L. ENGINEERING CO., 706 Bergen Ave., Jersey City, N. J.

**TOBE** Filterette Servicemen Wanted!  
Exclusive territories now open. Get into this profitable business now.

Tobe Deutschmann Corporation Filterette Division  
CANTON, MASS.

# 100 Shaves from EACH Blade

The Master-Hone puts a hair-splitting edge on the duldest razor blade—ANY make—in 5 seconds. Many get 100 shaves per blade. W. P. Walsh, Windsor, Ontario, used same blade daily 8 months. Only honing can give a NEW edge on a blade. This patented, accurately beveled hone of special abrasive makes each blade worth \$2.00 in service. MONEY REFUNDED if not delighted.

YOURS FREE We will send you a Master-Hone with FIRST ORDER of 12 for \$3.00, or send 50¢ for 1 or \$1.00 for 2, POSTPAID. Or, send no money and pay postman plus postal charges. Hurry, send today. These are Agents' prices. Regular retail price \$1.00.

WISCONSIN ABRASIVE CO.  
Dept. 7093, Sta. A, Milwaukee, Wisconsin



Agents

net up to \$30 a day. Mr. Earl Smith made \$99 in 8 hours.

When writing please mention Popular Mechanics



**WITTE NITE-LITE****\$33**  
BRINGS ONE  
TO YOU**CHASE THE  
GLOOM**with *SUNSHINE'S ONLY RIVAL*

**Complete Self-Contained Unit**  
A complete self-contained, self-starting unit with the WITTE electric light engine and generator. Correctly designed by experienced engineers, furnishing either 32 or 110 volts direct to your lamps or through a large dependable battery.

Switch on "Nite-Lite". Do away with the messy, dangerous, open flame oil lamps. Enjoy all the conveniences of city lights and current. Use sweepers, percolators, washing machines, irons and other appliances.

**Send Today For Special Offer**  
Let us place a WITTE "Nite-Lite" with you on such liberal terms that you'll never miss the money. Write today.

Buy DIRECT FROM FACTORY - WORLD'S LOWEST PRICES

210-N Carson St. **WITTE** 1743 Oakland Ave.  
PITTSBURGH, PA. **ENGINE WORKS** KANSAS CITY, MO.

**SEND US 50 CENTS  
Or Ask Your Dealer**For This New,  
Handy, Low-  
Priced Level.Length  
3 1/4"  
Width  
3/8"WEIGHT  
1/2 Oz.For  
**HOME,  
SHOP, FACTORY**

HOME WORK-SHOP and for use on clocks, stoves, lawns, etc. Also appeals to machinists, carpenters, plumbers, masons, etc. Hard drawn aluminum tubing, nickel silver end pieces. Yellow fluid easy to see, quick acting. Order now.

New SAND'S-STEVENS  
No. 555 LINE & SURFACE  
LEVEL. Different, sturdy, COM-  
FACT, accurate. A necessity in every

ALSO LEVELS OF EVERY TYPE. Literature Free.

SAND'S LEVEL &amp; TOOL CO., Detroit, Michigan

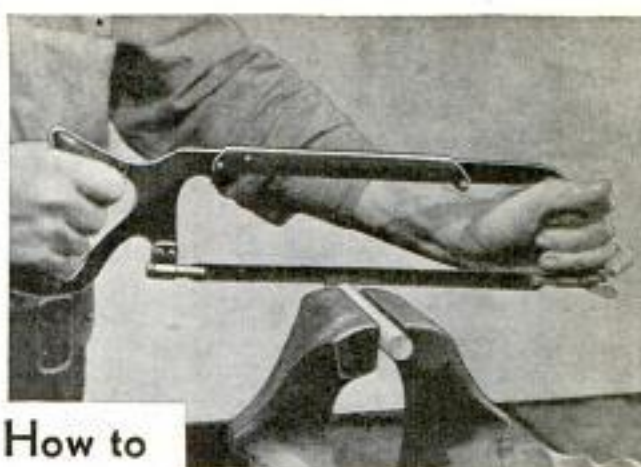

How to

**Cut Metal Easier**

in Home Shops, with Hand or Power Saws

HOME workers who like to make things of metal will find an interesting chapter on the latest methods of metal-cutting, in this new book. Pages 23 to 28 were written by an authority on shop metal work, and they show you how to cut all kinds of metal faster, easier and better.



Atkins Silver Steel metal-cutting band saw and circular saws.



First, he tells how to get the best results with hand hack saws, in cutting pipes, rods, tubes, band or angle iron, thin metals, etc. Next, he takes up metal-cutting with circular saws and shows how speedily many metals and hard compositions may be cut on a saw table.

Then comes a page on how to saw out sheet metal projects with a metal-cutting band saw blade. He tells also, about Bakelite Bonded Wheels, used as circular saws, to cut hard and soft steels, slate, tile, etc. There are hints on grinding metals, and making handy guides for cutting metal on saw tables.

But this is only one of nine sections in the book. Whether your hobby is working with wood or metal, you'll find a wealth of practical instruction! The final chapter gives you helpful facts on the world-famous "Silver Steel" saws and shows the best type for each job of cutting wood or metal. This 40-page book will save your time, improve your work, and increase the fun or profit from your shop. Send coupon and 10 cents for a copy today.

If your dealer does not have the Atkins Saws you want, write us.

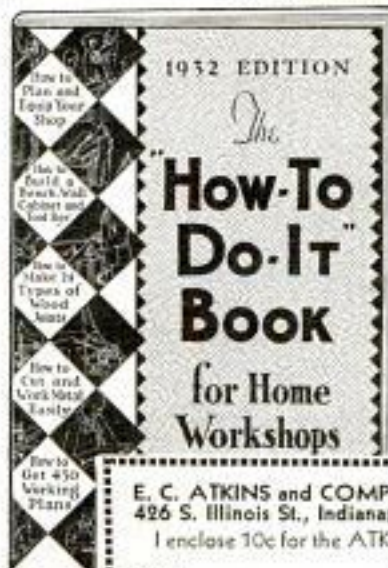

1932 EDITION

**The  
How-To-Do-It  
Book  
for Home  
Workshops**E. C. ATKINS and COMPANY, Est. 1857  
426 S. Illinois St., Indianapolis, Ind.

I enclose 10c for the ATKINS How-to-do-it Book.

Name..... (PRINT)

Street.....

City..... State.....

When writing please mention Popular Mechanics

**Start a Welding & Battery Shop**

Lead Burning Outfits..... \$18.00 up  
Welding Outfits..... 25.00 up  
Bubbling Outfits..... 8.00  
Welding Torches..... 10.50 up  
Cutting Torches..... 30.00 up  
Regulators and Gauges..... 9.50 up  
Combination Welding and  
Cutting Torch..... 16.00  
Welding Supplies — Agents Wanted.  
Superior Oxy-Acetylene Machine Co.  
P. O. Box 285 Hamilton, Ohio

**BURN YOUR NAME ON TOOLS****WITH THE  
ARKOGRAF**

**PROTECT YOUR TOOLS FROM THEFT**  
Write with electricity any name or design on the hardest and finest tools and instruments, or any metal, like writing on paper with pen or pencil. Complete outfit \$3.50 — Found Anywhere. Interesting illustrated circular free. Write today. Agents wanted.  
ARKOGRAF PEN CO., 1171 E. Stark St., Portland, Oregon

**CHROMIUM PLATING POWDER**

PLATES IRON, STEEL, NICKEL, BRASS and COPPER without electricity or machinery. Guaranteed not to tarnish; dispenses with polishing. Half pint can \$1.50, prepaid. Particulars FREE.  
GUNMETAL CO., Ave. T, Decatur, Illinois

**MONEY IN HOME-SHOPS!**

Premier Circular Saw

\$29.90

without  
motor and base

You can make good money with a home-shop equipped with this new and sturdier machine — moderately priced.

The Parks  
Wood-  
working  
Machine  
Co.**PARKS**  
WOODWORKING MACHINESSend  
today  
for  
descrip-  
tive  
circular

Dept. PM-3, 1530 Knowlton St.

Cincinnati, Ohio



# BOYS! ELECTRIC MOTOR 10c

All Parts Necessary Only 10c  
Runs on No. 6 Dry Battery

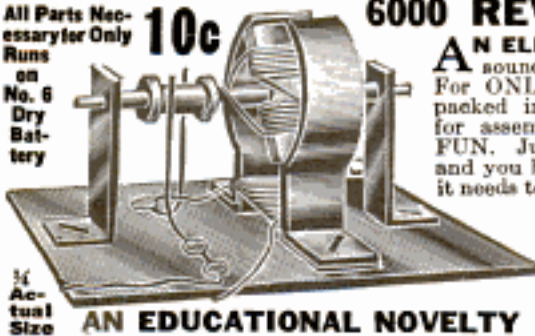

6000 REVOLUTIONS PER MINUTE

**AN ELECTRIC MOTOR FOR ONLY 10 CENTS.** It sounds almost unbelievable but it is perfectly true. For ONLY 10 cents we send you all the parts necessary packed in a neat box, together with full printed and illustrated directions for assembling. No trouble at all putting the parts together, in fact it is FUN. Just follow a few simple instructions—it takes only a few moments—and you have your motor all ready to run. And OH BOY! Isn't it speedy! All it needs to run it is a No. 6 or similar dry battery. As to the fun you will get out of it, you won't have this motor an hour before you have it running and performing many novel and interesting experiments—has more power than you'd think. Besides, assembling the parts is an education in itself for any boy. Send 10c (with 5c extra for postage and packing) in any convenient form—stamps will do—and the motor will be sent you at once. Nothing more to pay—nothing more to buy.

Actual Size

AN EDUCATIONAL NOVELTY

JOHNSON SMITH & CO., Dept. 825, RACINE, WIS.

## The BOY AMATEUR ELECTRICIAN

GREAT BOOK FOR BOYS, STUDENTS—ONLY 10c



The HOW and WHY of electricity fully told in simple language that any boy can understand. Scores of plans and instructions for making—dry batteries, dynamos, electric motors, telegraph apparatus, telephones, electric lights, electric door bells, alarms, electric engine, rheostat, mail box alarm, electro-magnets, automatic incandescent flash, electric shocking machine, wireless telegraph apparatus, induction coil, arc light, current reverser, etc., etc. Tells all about electric wiring, static electricity, magnets and magnetism, conductors and insulators, electrostatic induction, electroscopes, electrolysis, condensers, Leyden jar dynamic electricity, the voltaic cell, electrocution, electroplating, electro-typing, how to build a radio for a few cents, etc. 64 pages, 100 illustrations. 10c. postpaid.

JOHNSON SMITH & CO. Dept. 825 RACINE, WIS.



## THE BUDDY PHONE

**A Real Telephone. Works Indoors or Outdoors. 100 ft. or 1000 ft.**  
Though this is merely a very clever toy, it is quite as serviceable for short distances as the most elaborate apparatus made and it is much less liable to get out of order or to need adjustment; in fact it cannot be rendered inefficient unless roughly handled. No troublesome battery, no intricate "hook-up." Can be put to practical use from one room to another, up or down stairs, around corners, etc. The patented sliding glass transmits and receives the voice perfectly, making it a really practical talking telephone. Set consists of two phones, transmission cord and full instructions. PRICE ONLY 65c per set postpaid. JOHNSON SMITH & CO.

### MIDGET BIBLE

GREAT CURIOSITY Smallest Bible in the World. Size of a postage stamp. 300 Pages. Said to bring good luck to the owner. A genuine work of art. Must be seen to be appreciated. Since good money selling them to friends, church acquaintances, etc. PRICE 15c each. 3 for 40c, 12 for \$1.25, 100 for \$7.50. Also obtainable in Leather Binding, with gold edges. Price \$10c each. 3 for \$1.25, \$4.50 per doz. Magnifying Glass for use with Midget Bible 15c



### SURPRISE MATCHES

More fun than fighting with your wife. Look just like ordinary matches. As the victim tries to light one he gets quite a surprise. Price 10c per box. 3 boxes for 25c, 12 for 75 cents.



### STAR TOY MAKER

Greatest boys' book written. Tells how to make a Pinhole Camera, a Cannon, model Railroad, a Telephone, Boomerang, Telegraph Instrument, Box Kite, Talking Machine, Microscope, Electric Door Bell, Water Wheel, Pencil Hairs, a pair of Skis, a Dog Bed, Bird House, Rabbit Yard, etc. 64 pages. 150 illustrations. PRICE 10c.

**BOYS OWN TOYMAKER.** A new book. Tells how to make chemical toys, electrical toys, galvanic toys, mechanical toys, paper toys, cardboard toys, boats, traps, etc. 200 illustrations. Price 25c postpaid.

### FUN with MAGNETISM

50 novel and unique experiments in MAGNETISM that you can perform with the aid of an ordinary magnet; magnetic chis, fishing and spinning needle, nail and ball cluster, magnetic fish, top, motor, magnetic billiard balls, many other stunts. Also interesting information about lodestone, magnetism, electricity, etc. 10c p.p.

**BOOK ON BOATS.** How to build rowing, sailing boats. Everything pertaining to boats explained in plain terms so anyone can understand. Illustrated. 10c p.p.

**5-MINUTE HARMONICA COURSE.** A new easy self-teaching method. Teaches how to play, to use the tongue, tremolos, fully illustrated. Price 15c postpaid.

**MONEY MAKING SECRETS.** Golden opportunities for everyone. 64 page copyrighted book chock full of money-making ideas, recipes, formulas, wrinkles, trade secrets, etc. Businesses that can be started with little or no capital at home in spare time. 10c postpaid.

**TRICKS & SOCIAL ENTERTAINER.** Contains hundreds of simple tricks, illusions, diversions that anyone can do. Also explains secret of secret sight. Price 25c postpaid.

### WONDERFUL X-RAY TUBE

A wonderful little instrument producing optical illusions both surprising and startling. With it you can see what is appearing in the bones of your fingers, the lead in a lead pencil, the interior opening in a pipe stem, and many other similar illusions. Price 10c, 3 for 25c.



### SERPENT'S EGGS

Box contains 12 eggs. When lit with a match, each one gradually hatches itself into a snake several feet long, which curls and twists about in a most life-like manner. Price per box. 10c postpaid, 3 for 25c



### STAGE MONEY

With a bunch of these bills, it is easy for each person of limited means to appear prosperous by flashing a roll of these bills at the proper time and peeling off a genuine bill or two from the outside of the roll, the effect created will be found to be all that can be desired. Prices, postpaid: 40 Bills 20c, 120 for 50c, or \$3.50 thousand postpaid.



### NOSE FLUTE

The Magic Nose Flute, or Harmonica, is a unique and novel musical instrument that is played with nose and mouth combined. There is just a little knack in playing it which, when once acquired after a little practice, will enable you to produce very sweet music that somewhat resembles a flute. There and once you have mastered all kinds of music with facility and ease.



Post Paid 10c  
It is no fidgeting, and once you have mastered all kinds of music with facility and ease.

JOHNSON SMITH & CO. Dept. 825 RACINE, WIS.

A De Luxe Edition of our 1932 CATALOG mailed on receipt of 25c. Handsome binding. Bigger and better than ever. Only book of its kind in existence. Nearly 800 pages of all the latest tricks in magic, the newest novelties, puzzles, games, sporting goods, rubber stamps, unusual and interesting books, curiosities in seeds and plants, etc. everywhere. Remit by Cash, Money Order, Check or unused U. S. Postage Stamps, for all articles listed above; also on following page.

## LOOK 35c LOOK

**Wonderful instrument.** Greatest thing yet. Nine separate articles in one. Everybody delighted with it. Odd, Curious and Interesting. Lots of pleasure as well as very useful. It is a double Microscope for examining the wonders of nature. It is also an Opera Glass, a Stereoscope, a Burning Lens, a Reading Glass, a Telescope, a Compass, a pocket Mirror, and a Laryngoscope—for examining eye, ear, nose and throat. It is worth all the cost to locate even one painful clinder in the eye. Folds flat and fits the pocket. Something great—you need one. Don't miss it. Sent by mail. Only 35c or 3 for \$1.00.



## PISTOL CIGARETTE CASE

It looks like a deadly weapon, but it is merely a novel Cigarette Case. This clever contrivance has proved itself better than the real thing in many an awkward encounter. Great fun "sticking up" your friends. They squirm and protest it might be loaded. Pull the trigger and the slide flies open disclosing the cigarettes. Well made, light and compact. Weight only 2 ounces.



PRICE POSTPAID 35c

## MICROSCOPE and FLUOROSCOPE

COMBINES ALL THE POWER AND DEFINITION OF THE MORE EXPENSIVE MICROSCOPE SURPRISINGLY GREAT MAGNIFYING POWER EXAMINE GERMS IN WATER, CHEESE, SUGAR, ETC.

There are few things so interesting and valuable as Microscope. It enables you to minutely examine mineral animal and vegetable specimens, to test cotton, wool, silk, seeds, water, flour, cheese, milk, and in fact nearly all articles of food. Unwholesome meat can be readily detected and ferments can be closely watched. It is exceedingly interesting to examine the spores of ferns, seeds, sugar, salt, alum and other crystals, the dust (scalen) from moth and butterfly wings, human hairs, flies and insects, while the animalcules in water are a never-failing source of wonder. Most interesting experiments can be performed with an instrument such as this. Place a small piece of cheese in a box and allow insects to feed on it for a day or two. Then examine a tiny portion of the cheese under the Microscope and you will see little animals, assigned to the size of large beetles; you can count their legs and the joints in them, the talons or claws upon each foot, also the hair or bristles upon their bodies. Or, obtain some stagnant water; deposit a small portion of soap upon the object glass of the Microscope with a pin's head, and you will see beautiful animalcules swimming about with as much freedom as though they were fish in the boundless ocean. It is a truly wonderful sight and an endless source of interest and enjoyment for everybody. The Microscope is made of brass and is capable of magnifying 500 times, and although small and compact, it will cover a very wide range of microscopic research. PRICE ONLY 50c Postpaid. JOHNSON SMITH & CO. Dept. 825 RACINE, WIS.



LATEST CATALOG  
JOHNSON SMITH & CO. RACINE WIS.





# BOYS! BOYS! BOYS! Throw Your Voice

Into a trunk, under the bed, under a table, back of the door, into a desk at school, or anywhere. You get lots of fun fooling the teacher, policemen, peddlers, and surprise and fool all your friends besides.

## THE VENTRILO

is a little instrument that fits in the mouth out of sight. Cannot be detected. It is used in connection with the above, and with the aid of this wonderful DOUBLE

THROAT, or VENTRILO, you can imitate many kinds of birds, animals, etc. Remember you get everything for **ONLY TEN CENTS**—a booklet giving you full instructions how to become a ventriloquist and throw your voice, the Double Throat, or Ventrilo, and our big page catalog of novelties, tricks, puzzles, jokes, books, etc., **ALL SENT POSTPAID TO ANY ADDRESS FOR ONLY 10 cents**



Johnson Smith & Co.  
Dept. 825  
Racine, Wis.

### BLANK CARTRIDGE PISTOL

This well made and effective pistol is modelled on the pattern of the latest type of Revolver, the appearance of which alone is enough to scare a burglar, whilst when loaded, it will probably prove just as effective as a revolver with real bullets without the danger to life. It takes the standard .22 Calibre Blank Cartridges, that are obtainable most everywhere. Special cash with order offer: 1 superior quality Blank Cartridge Pistol, 100 Blank Cartridges, and our new 550-page Deluxe Catalog of latest novelties all for **ONLY \$1.50**. Shipped by express only. Cannot go by parcel post. Extra Blank Cartridges 50c per 100. Remember it is quite harmless, as it will not accommodate loaded cartridges. Special Halutz (Cowboy Type) for pistol 50c. No C. O. D. Shipments.



**Special Offer** 1 Blank Cartridge Pistol, 100 Blank Cartridges, 1 550-page Novelty Catalog **ONLY \$1.50** The lot Shipped by Express Only Cash with Order Only

Johnson Smith & Co.

### MAGICIAN'S BOX OF TRICKS

Apparatus and Directions for a Number of Mysterious Tricks, Enough for an Entire Evening's Entertainment..... **\$1.00**

**ANYONE CAN DO THEM**

It is great fun mystifying your friends. Get the Conjuror's Cabinet, and you will be the cleverest fellow in your district. It contains the apparatus for ten first-class tricks, including THE MAGIC BALL AND VASE TRICK (a wooden ball is placed inside, and upon replacing the lid has disappeared and is found in someone else's pocket); THE HINDOO TRICK CARDS (can be made to change completely no less than five times); DISAPPEARING COIN BOX (a coin, placed in the wooden box, vanishes entirely or changes into a coin of another denomination); THE GLASS GLOBULE TRICK (a coin is dropped into a glass of water and when the water is poured out the coin has vanished and is found somewhere else); THE RIBBON FACTORY FROM THE MOUTH TRICK (a seemingly endless supply of colored paper ribbons come out of your mouth); THE DISAPPEARING HANDKERCHIEF (a handkerchief held in the hand mysteriously vanishes); THE WIZARD'S RING COIN TRICK; THE ENCHANTED BOTTLE (no one but yourself is able to make it lay down); THE GREAT HAT AND DICE TRICK (a large die is placed on top of a hat, disappears, and is found underneath yet no one has touched the hat), and last, but not least, the GREAT PHANTOM CARD TRICK (a card from five leaves nothing). Full instructions are sent for performing each trick. In addition to the above, a number of other feats and illusions are fully explained for which you can easily make or procure the necessary apparatus. Price complete \$1.00 postpaid. JOHNSON SMITH & CO.



**Good Luck Ring**

Very striking, quaint and uncommon. Silver finish, skull and crossbones design, very brilliant, shining glass sparkle out of the eyes. Said to bring good luck. Only 25c post. Johnson Smith & Co.

### Exploding Cigarettes



Box contains 100 cigarettes of excellent quality. They appear to be ordinary, but when each cigarette is smoked, the victim gets a very great surprise as it goes off with a loud BANG! A great crowd's provoker yet entirely harmless. Price 25c box. Johnson Smith & Co.

### The "Little Giant" Typewriter

A First Class Writing Machine For \$1.50



A perfect little typewriter for \$1.50. There are thousands of persons who would like to use a typewriter but whose needs and business do not warrant the expense attached to the purchase and use of a fifty or seventy-five dollar machine. To such persons we confidently recommend our Little Giant. It is strongly made, but simple in construction, so that anyone can quickly learn to operate it, and write as rapidly as they would with pen and ink. The letters of the alphabet most frequently used are so grouped as to enable one to write rapidly, the numerals 1 to 10, and the punctuation marks being together. With this machine you can send your boy and girl typewritten love letters, address envelopes, make out bills, and do almost any kind of work not requiring a large, expensive machine. Price complete \$1.50 by mail postpaid to any address in the world. Johnson Smith & Co.

### U. S. BABY TANK

It goes with real Yankee Pep—by its own power



Most remarkable toy ever invented. By drawing the Tank backward, either with the hand or over the floor or table and then placing it down, it will crawl along, overcoming all obstacles, in the same life-like manner as the larger Tank that proved so deadly in the great war. What makes it go is somewhat of a mystery, for there is no mechanism to wind up as is usually understood with mechanical toys, yet this tank will keep plodding along ten times longer than the ordinary run of toys. It will perform dozens of the most wonderful stunts; 2 1/2 inches long. Price 25c.



### 250 MAGIC TRICKS 10c

For Parlor or Stage

An excellent little book containing nearly 300 Tricks for parlor or stage. Tricks with cards, coins, handkerchiefs, eggs, rings, glasses, flowers, thimbles, spoons, bottles, string. Explains the mystery of the floating head and scores of other amazing feats of magic and illusion. Also includes Shadowgraphy, etc. So simple a child can perform them. Profusely illustrated. **ONLY 10c.**

125 CARD TRICKS and sleight of hand. Contains all the latest and best card tricks as performed by celebrated magicians, with exposure of card tricks used by professional gamblers. Price 25c



### RAPID CIGARETTE MAKER

ROLL YOUR OWN SAVE MONEY

With this AUTOMATIC CIGARETTE MAKER you can make your own cigarettes from your favorite brand of tobacco and save money besides. It takes but a few seconds. Better cigarettes at about one-fourth the cost. Simplicity itself to use. It is neat, useful and handy. Pocket size, weighs but half an ounce. Case is made entirely of metal, nickel plated. Full printed instructions with each Cigarette Maker. Pays for itself in no time at all. **PRICE ONLY 25 CENTS POSTPAID.** 3 for 65 cents; or 1 dozen for \$2.25 postpaid

Send remittance (Postage Stamps accepted) for all articles listed above, also in our other ad on previous page

**JOHNSON SMITH & CO.** Dept. 825 Racine, Wis.



# PATENT

## Protect Your Ideas

### Take the First Step Today

If you have a useful, practical, novel idea for any new article or for an improvement on an old one, you should communicate with a competent Registered Patent Attorney AT ONCE. Every year thousands of applications for patents are filed in the U. S. Patent Office. Frequently two or more applications are made for the same or substantially the same idea (even though the inventors may live in different sections of the country and be entirely unknown to one another). In such a case, the burden of proof rests upon the last application filed. Delays of even a few days in filing the application sometimes mean the loss of a patent. So lose no time. Get in touch with me at once by mailing the coupon on the opposite page.

### Prompt, Careful, Efficient Service

This large, experienced organization devotes its entire time and attention to patent and trade mark cases. Our offices are directly across the street from the U. S. Patent Office. We understand the technicalities of patent law. We know the rules and requirements of the Patent Office. We can proceed in the quickest, safest and best ways in preparing an application for a patent covering your idea. Our success has been built on the strength of careful, efficient, satisfactory service to inventors and trademark owners located in every state in the Union.

### NO CHARGE for Information On How to Proceed

The booklet shown here contains valuable information relating to patent procedure that every inventor should have. And with it I will also send you my "Record of Invention" form on which you can sketch your idea and establish its date before a witness. Such evidence may later prove valuable to you. Simply mail the coupon and I will send you the booklet, and the "Record of Invention" form, together with detailed information on how to proceed and the costs involved. Do this NOW. No need to lose a minute's time. The coupon will bring you complete information entirely without charge or obligation.



My Offices  
Just Across  
Street From  
U.S. Pat. Office



Above is a view of my drafting and specification offices where a large staff of experienced experts is in my constant employ. All drawings and specifications are prepared in my offices.

# NEWS

## Inventors Write for these Free Books

### Strict Secrecy Preserved

All communications, sketches, drawings, etc., are held in strictest confidence in strong, steel, fireproof files, which are accessible only to authorized members of my staff. Feel free to write me fully and frankly. It is probable that I can help you. Highest references. But **FIRST**—clip the coupon and get my free book. Do **THAT** right now.

## Clarence A. O'Brien

Registered Patent Attorney

Member of the Bar of: The Supreme Court of the United States, U. S. Court of Customs and Patent Appeals, U. S. Court of Claims, Court of Appeals, District of Columbia and Supreme Court of the District of Columbia.

Practice confined exclusively to Patents, Trademarks and Copyrights



**Clip this Coupon and Mail it Now!**

CLARENCE A. O'BRIEN, Registered Patent Attorney

70-V Adams Building  
Washington, D. C.

(Or, Suite 1106, Dept. A-21, Woolworth Bldg., New York City)

Please send me your free book, "How to Obtain a Patent," and your "Record of Invention" form without any cost or obligation on my part.

Name.....

Address.....

(Important—Write or print name plainly and address office nearest you)

When writing to advertisers please mention Popular Mechanics



# "How to Obtain a PATE This FREE BOOK Tells You How to Protect Your Invention

**Delays in Patenting Your Idea May Prove Costly  
Get the Facts—Mail Coupon NOW!**

## **Little Ideas May Have Big Commercial Possibilities**

**ACT AT ONCE**—and protect your idea. Remember, to get the benefits of your invention, you not only have to invent it—you have to **PATENT** it. Many men spend years perfecting an invention, only to find that someone else thinking along the same lines has already received a patent on the idea. When we think of all such cases that have come under our personal observation, we cannot urge too strongly that you take steps to protect your idea **IMMEDIATELY**. Delays of only a few days may be vitally important to you. Do not lose all the benefits of your hard work in planning and perfecting your invention.

## **Mail the Coupon for FREE Book Today**

It is of tremendous importance that you file your application for a patent at once. Our free book tells you how to proceed, what you need to know about patents in general and gives you an estimate of our reasonable fees. We also send you a "Record of Invention" blank. Take the first step toward getting your patent now. Mail the coupon at once. If you send along a sketch and description of your invention, we will promptly write you what, in our opinion, ought to be done in order to protect it, and for which service there will be no charge.

## **Highest References—Strictest Secrecy**

### **33 Years of Proven Service**

The members of the firm of Victor J. Evans & Co. are registered Patent Attorneys. Our legal and technical forces include lawyers, registered patent attorneys, patent draftsmen and searchers. Our Patent Office and Federal Court practice is confined to patents and trademarks. We specialize in these two subjects to the exclusion of all others. In our 33 years of patent practice, we have successfully served thousands of inventors to whom we can refer. It is a distinct advantage to an inventor to employ an attorney located in Washington as the U. S. Patent office has no branches.

## **Here's How We Operate**

As soon as the description of your invention comes into our office, it is immediately put in charge of an attorney, who is particularly familiar with the kind of invention you have perfected. Under his close personal supervision, patent searchers and skilled draftsmen work. He personally sees your case through to its conclusion. In short, you have the advantage of highly skilled and experienced service.

*When writing to advertisers please mention Popular Mechanics*



# FREE VALUABLE RECORD OF INVENTION BLANK

Mail the coupon today, and in addition to the free book, we'll send you without charge a "Record of Invention Blank." This form, when properly filled out, may be of value to you as evidence should occasion require it. There is no charge or obligation for this service.

# PATENT

## HOW TO OBTAIN A PATENT



VICTOR J. EVANS & CO.  
REGISTERED PATENT ATTORNEYS  
WASHINGTON, D. C.

**MAIL THIS NOW**

**Record of Invention**

**VICTOR J. EVANS & CO.**

1912

VICTOR BUILDING  
600 C VICTOR BUILDING  
WASHINGTON, D. C.

VICTOR J. EVANS & CO.  
Victor Building, 600 C Victor Bldg. NW  
Washington, D. C.

Date: \_\_\_\_\_

Condition: \_\_\_\_\_

I send you a sketch and description of my invention, which I will accept and that you will file an application for me in your name, the name may be printed, if you.

Your name: \_\_\_\_\_

Address: \_\_\_\_\_

To Whom It May Concern:

Be it known that \_\_\_\_\_ 1912 declared to the invention illustrated and described on this sheet and \_\_\_\_\_ fully understood the contents thereof.

Witness: \_\_\_\_\_

If you need an agent to see that it has your name and address, on the way we will be pleased to do it.

### What the Coupon Brings Mail It Today!

Mail the coupon today and take the first step toward protecting your idea. You will receive the FREE Book, a FREE Record of Invention Blank, and information on our fees. You create no obligation by mailing this coupon. Our service is complete, our fees reasonable, and our terms convenient. Don't waste priceless time; mail the coupon NOW.

## VICTOR J. EVANS & CO.

*Established 1898*

### REGISTERED PATENT ATTORNEYS

**MAIN OFFICE: 600 C Victor Building, Washington, D. C.**

**BRANCH OFFICES:** 1640 C Conway Building, Chicago; 1007 C Woolworth Building, New York; 828 C Fidelity Philadelphia Trust Building, Philadelphia; 514 C Empire Building, Pittsburgh; 1010 C Hobart Building, San Francisco.

Please send me your free book, "How to Obtain a Patent," and your "Record of Invention Blank."

Name.....

Street and No.....

City..... State.....

When writing to advertisers please mention Popular Mechanics



# PATENTS

Booklet Free      Highest References  
Promptness Assured      Best Results

Send drawing or model.

## ALL BUSINESS GIVEN PROMPT AND PROPER ATTENTION

Listed Patent Lawyer in the latest editions of the Rand-McNally Directory of Bankers and Bank-Recommended Attorneys, published by Rand-McNally & Co., Chicago, Ill.; The Baggott & Ryall Directory of Guaranteed Attorneys, published by Legal Directory Corporation, Boston, Mass.; Flugel's Law List, published by Legal Directory Publishing Co., St. Louis, Mo.; American Lawyers Annual, published in Cleveland, Ohio; Bankers Service Legal Directory, published by Bankers Service Co., Boston, Mass.; Eyre's Law List, 9 Park Place, New York City; Walters Legal Directory, Omaha, Nebraska, and the National Directory of Attorneys, Baltimore, Maryland.

**WATSON E. COLEMAN,**  
REGISTERED PATENT LAWYER

Victor Building, 724 Ninth Street, N. W.  
**WASHINGTON, D. C.**



# PATENTS

**COMPLETE SERVICE**

A personal confidential service for serious-minded inventors, having worth-while practical ideas.

Patents—Trade-Marks—Designing and Drafting—Working Models—Automatic Labor-Saving Machinery. Manufacturing (small and large quantities.) Preparation and prosecution of patent applications, trade-marks, etc.

COMPLETE FACILITIES for inventors to develop, perfect, or to patent their inventions. Facilities—10 engineers, draftsmen and patent experts, 50 mechanics and supervisory staff. All or any part of the above service is available. Complete service for those desiring it.

Send for FREE Book

**D. M. HELLER**  
Reg. Patent Attorney  
Consulting Engineer  
31 EAST 17<sup>TH</sup> ST., NEW YORK, N. Y.

# PATENTS

## PROTECT YOUR IDEAS

Write today for FREE BOOKLET, HOW TO OBTAIN A PATENT and RECORD OF INVENTION—or send Drawing or Model of your Invention for Examination.

Promptness Assured with Best Results

## MILLER & MILLER

REGISTERED PATENT ATTORNEYS

Former Members Examining Corps U. S. Patent Office  
Dept. A-1006 Woolworth Bldg. New York  
672 Earle Building Washington, D. C.

## PATENTS—TRADE MARKS

All cases submitted given personal attention by members of the firm. Information and booklet free. Patent Office and Federal Court Practice.

**LANCASTER, ALLWINE & ROMMEL**  
PATENT LAW OFFICES

Suite 412, -815 15th St., N. W. Washington, D. C.

Established 71 Years

## Mason, Fenwick & Lawrence

REGISTERED PATENT ATTORNEYS

Woodward Building Washington, D. C.

Other Offices      Send description and  
New York—Chicago      sketches. Prompt service

## INVENTORS

who derive largest profits know and heed certain simple but vital facts before applying for Patents. Our book *Patent-Sense* gives those facts; sent free. Write LACEY & LACEY, 635 F Street N. W., Dept. 5, Washington, D. C. Estab. 1869.

Information on any book free. Write Popular Mechanics Press, Chicago, Ill.

# PATENTS

## TO THE MAN WITH AN IDEA

Preliminary advice gladly furnished without charge. Booklet of information and form for disclosing idea free on request.

**IRVING L. McCATHRAN, Patent Lawyer**

Formerly with and successor to RICHARD B. OWEN  
750 International Bldg. Washington, D. C.  
41-E Park Row New York City

TRADE-MARKS

# PATENTS SECURED TRADE-MARKS REGISTERED

A PATENT secured for a novel invention may prove to be valuable to you. I have had thirty-five years of experience in the practice of the patent and trademark law. Every case submitted to me will receive prompt personal attention.

Write to me for FREE book HOW TO GET YOUR PATENT and RECORD OF INVENTION CERTIFICATE. All business will be kept strictly confidential. Send me a model or sketch and description of your invention for my free opinion whether it comes within the provisions of the Patent Law. Delays are dangerous.

I ASSIST MY CLIENTS TO SELL THEIR INVENTIONS

**L. F. RANDOLPH, Registered Patent Lawyer, 302 Victor Building, Washington, D. C.**





« «

» »

**"It's a pleasure to work  
with a lathe like Regal"**

To do accurate work and know that it's accurate—that's one of the biggest pleasures of being a mechanic. And it puts more money in the pay envelope, too.

You can do accurate work with a LeBlond Regal Lathe. Alignment tests show that the lathe turns a true diameter within .0005" of the absolute. Thirteen other alignment tests in proportion.

Yet, the LeBlond Regal Lathe sells for a price, in competition with lathes that don't begin to have such features as eight speed selective sliding geared headstock, one piece apron, quick change geared feed, separate lead screw for chasing, and ten others.

Write for 40-page illustrated catalog. Send 25c for a copy of "Running a Regal" which shows how to get the most from a lathe.

The R. K. LeBlond Machine Tool Co.  
No. 111 Regal Division—Cincinnati, Ohio

Five Sizes: 10" to 18"

—\$275.00 to \$947.00 f.o.b. factory.  
Convenient Terms.



## GEARS

In Stock—Immediate Delivery

Gears, speed reducers, sprockets, thrust bearings, flexible couplings, pulleys, etc. A complete line is carried in our Chicago stock. Can also quote on special orders of any kind. Send us your blue prints and inquiries.

Write for Catalog No. 10

CHICAGO GEAR WORKS  
769-773 W. Jackson Blvd., CHICAGO, ILL.

**"YOU CAN BUILD ONE"**

### Ship Model or Coach Model

We furnish all parts, cut, fitted and ready to assemble, detailed instructions and carefully numbered diagrams.

Flying Cloud \$4.00; Constitution \$2.00. Santa Maria, Pequod and other ship and coach models \$4.00.  
Send 2c stamp for coloring. Canadian prices, duty paid, slightly more. 39 King Street, W., Toronto, Canada.

Miniature Ship Models, Inc.  
Dept. RT Perkasie, Pa.



PRICE \$24.50

Complete ready to install—as shown.  
Send Money Order.

## Big Money

Selling and Installing  
OIL BURNERS

in Stoves, Ranges, etc.  
Sells ON SIGHT  
Anyone Can Install  
Lasts a Lifetime

WRITE

OIL KING  
BURNER CO.

P. O. Drawer 1201  
NEW HAVEN, CONN.

FOR  
\$795

a Fast, Powerful  
*Chris-Craft*  
with LEVEL RIDING

Think of it—a full-sized runabout, built as only Chris-Craft builds, with heavy sawed frames and double-planked bottom, seating six in comfort, with flashing acceleration and speeds up to 32 m. p. h.—at a price for which you could not buy a good outboard assembly! Besides the 15½-footer pictured below, Chris-Craft offers an 18-foot runabout at \$1095, and 21, 25 and 27-footers from \$1795 up. Any Chris-Craft dealer will demonstrate the wonderful new LEVEL RIDING principle which has revolutionized motor boat performance. (Prices F.O.B. Algonac.)

CHRIS-CRAFT CORPORATION  
2303 Detroit Road, Algonac, Michigan

Please send me information about the new LEVEL RIDING Chris-Craft. I am interested in a \_\_\_\_-ft. Runabout.

Name \_\_\_\_\_

Street \_\_\_\_\_

City \_\_\_\_\_ State \_\_\_\_\_



(141)

When writing please mention Popular Mechanics



# Tilt the Saw - Not the Table

Has\* time-saving scales on rip fence, tilting arbor and miter guide.

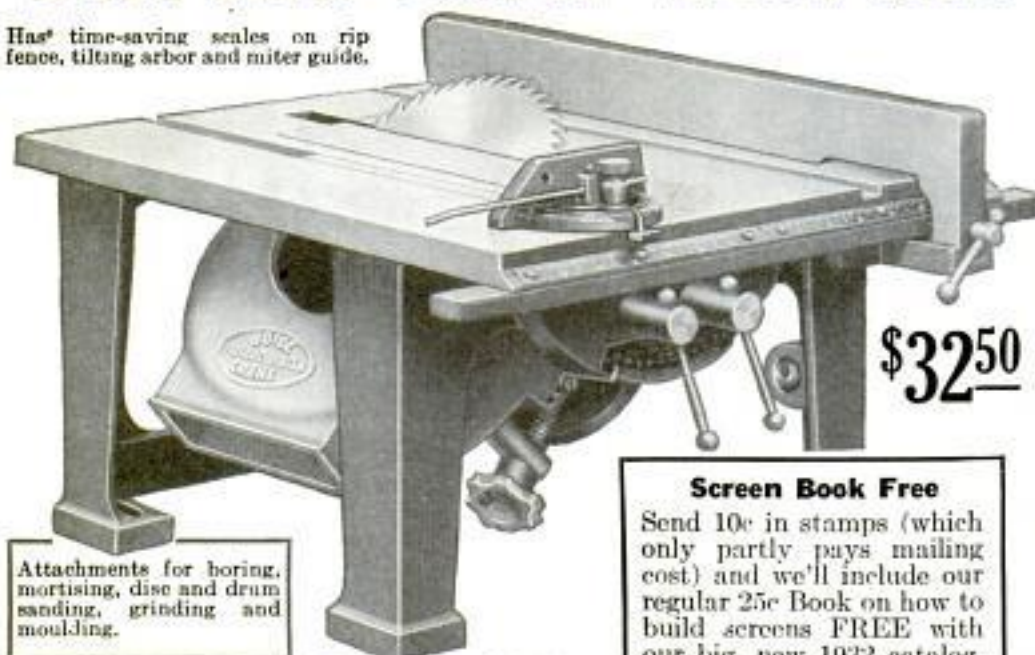

Attachments for boring, mortising, disc and drum sanding, grinding and moulding.

## Ball Bearing Lathe \$29

A marvel of true-running precision. No vibration. 11" swing; 42" center to center. Price \$29. Also 60" center to center in same model. Write about our Junior lathe at \$12.



**W. B. & J. E. Boice Dept. PM-3H Toledo, O.**

No more toboggan-slide tilting tables. This Boice-Crane large, highly polished 15"x17 1/2" table ALWAYS REMAINS LEVEL. All ripping, cross-cutting, darning, bevelling, rabbeting done on flat table. Lumber can't slide down against whirling saw. No binding, no stalling, no wedging. The ARBOR tilts, raises and lowers. No shop complete or up-to-date with out this modern saw. Weighs 80 pounds. Powerful, fast, accurate. Larger table—20"x27 1/2"—if desired. Full details in new catalog—send for it.

**\$3250**

## Shaper \$49



**Buy Now Pay Later** **Use Our E-Z Pay Plan**

Has 17" table cast solid to base. Spindle raises and lowers. High constant speed—7000 R. P. M.—at all loads. Weighs 80 lbs. Electrically reversible motor if desired.

### Screen Book Free

Send 10c in stamps (which only partly pays mailing cost) and we'll include our regular 25c Book on how to build screens FREE with our big, new 1932 catalog. **Be Our Demonstrator**

Your territory may be open. If interested in having a Boice-Crane shop that will pay for itself, write. You demonstrate for liberal commission on sales. We sell and collect. Write for the plan,

## Sport Bodies for Fords At Factory Prices



Make Your Ford into Classy Car

This Model in Grey Prime **\$3850**

Send 10c for catalog showing all models of bodies and other equipment for Ford and Chevrolet. 16-compression heads, underbody parts, 2:1 gears, headlights, fenders. Cut shows body on Model T Ford. Also made for Model T Ford.

**Sport Factories, Dept. B-2, Aurora, Illinois**

## \$50.00 SHIP MODEL for \$4.50 COACH MODEL for \$3.98



We furnish all parts cut to fit; numbered and ready to assemble for the following models: Clipper Ship and Flying Cloud (with electric lights), Santa Maria, Mayflower, La Pinta \$4.00 - Constitution, \$5.98 - SPANISH GALLEON electrically equipped, \$8.98 - COACH MODELS: Geo. Washington, Princeton to Philadelphia, TULLY-HO, Deserose, Overland Western, D. O. L. HOUSES with electric lights \$2.98. Our new Illustrated Catalog FREE on request. All models sent C. O. D. Foreign orders accompanied by check or money order.

C. J. SIERBOWER, Dept. P. M., 3216 Baring St., Phila. Originator of Build Your Own Ship Model

## STRANGE IRONING CORD Pays Immense Profits

**PREVENTS SCORCHING—SAVE ELECTRICITY Cannot Kink or Snarl**



200% Profit! Hudson made \$75.00 in 15-minute sale to large

Company for telephones. We furnish proof. H. M. Hay says, "Out of hundreds of Neverknots left on trial have had only two returns. I sold over 80 to one bank."

### New Kind of Cord Set FREE

Every Neverknot Salesman is given free the beautiful De Luxe Neverknot Cord Set (with only Unbreakable Off'n On Plug of its kind in the World) which automatically coils itself out of the way, prevents scorching and saves electric bills. Every woman buys instantly

for it saves its own cost in electricity. It's brand new and yours free if you work for us. Important! There is only one Neverknot. Write this Company for exclusive territory, special prices and big free offer. **NEVERKNOT CO., Dept. 3-V, 4503 Ravenswood, Chicago**



New Off'n On Unbreakable Plug Saves Electric Bills

## The SCOTT ALL-WAVE

15-550 METER—Superheterodyne

Brings in stations 2,000 to 10,000 miles away with full volume and clarity. Major stations all over U. S. come in like local. Write now for particulars. **THE E. H. SCOTT RADIO LABORATORIES, Inc.** 4450 Ravenswood Avenue Dept. P-3 CHICAGO, ILL.

## AGENTS MAKE UP TO \$20 A DAY WITH A \$3 VALUE TO SELL FOR 98c



**No. 62 Set.** Pen fitted with chromium point, guaranteed not to tarnish, pencil to match. Latest pearl effect colors. Each set in box. Guaranteed for life. Retail for \$3.00.

SAMPLE 50c DOZ. \$5.40

**SPORS IMPTG. CO., 132 Main St., Le Center, Minn.**

When writing please mention Popular Mechanics



# Make This ROWING MACHINE Yourself!

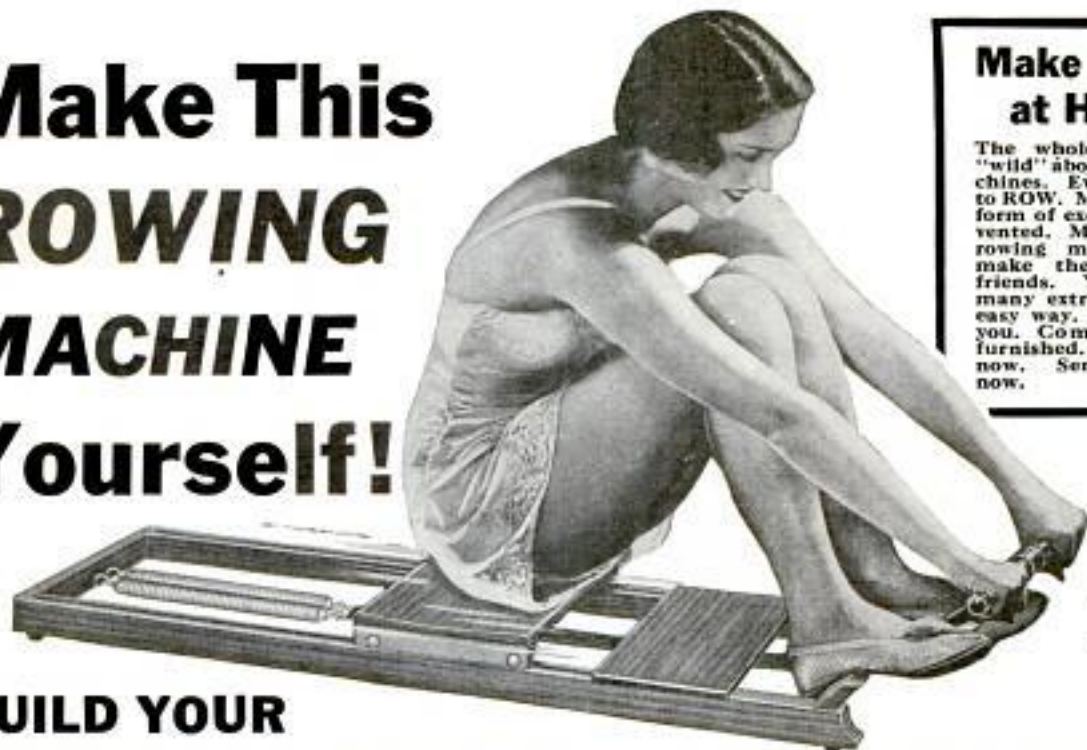

## Make Money at Home!

The whole country is "wild" about rowing machines. Everybody loves to ROW. Most enjoyable form of exercise ever invented. Make your own rowing machine, then make them for your friends. You can earn many extra dollars this easy way. We will help you. Complete plans furnished. Mail coupon now. Send no money now.

Copyright, 1931  
U. S. and  
Foreign Patents  
Pending

## BUILD YOUR HEALTH AND STRENGTH...KEEP SLENDER AND FIT

Now—with a few tools—a few feet of lumber, and the parts and blue prints we furnish, you can build your own Rowing Machine. Hundreds of thousands of Rowing Machines have been purchased at \$12 to \$55 each. Imagine making one for only \$3.98, complete with rolling seat.

No Other Form of Exercise is so pleasant for the entire family. Like having a **Health Club Gymnasium** in your own home. Keep fit and strong. Remove excess fat. Gain strength! You will enjoy rowing because it is more fascinating than a game! All your neighbors and friends will want you to make rowing machines for them too. Make money in your spare time.

## Complete Set of Parts \$**3.98** ...also Blue Prints for Making Frame

### What You Get

1. 4 Specially made rubber wheels, with hard center and soft rim. The same type of rubber wheels used on rowing machines which sell for \$25 to \$55.
2. Set of axles for wheels.
3. Heavy cotton webbing, with fasteners.
4. Set of flexible actuators of our own design. Safe and strong.
5. Lignum Vitae pulley including axle and housing, over which the webbing rolls.
6. All necessary screws, bolts and nuts.
7. Six rubber "feet" on which the machine rests when completed.
8. Complete set of blue prints.
9. License for making, under our Patent Applications.
10. Expert plans for selling to neighbors and friends.

This Rowing Machine is exactly the same as the **Flex-Roll** which we are advertising in all the leading magazines. We furnish all the parts that you need. The frame is easy to make by following our simple blue prints. Any wood can be used. Read list of parts furnished. If you can use a saw, plane, and screw driver you can make this rowing machine in a few hours, at home.

### Send No Money

Just mail coupon. We will send kit of parts and complete blue prints at once. Pay postman only \$3.98 plus postage. Money back if not delighted within a week. You take no risk. Everybody needs exercise daily. Especially the women folks who want to keep slender, and everybody who wants to be strong and healthy! Rowing, on the **Flex-Roll**, with its thrilling rolling seat is a joy ride to wonderful Health, Youth and Slenderness. Make this rowing machine at home for yourself and family, and make them for others, for profit. The whole country is wild about rowing machines! Now is the time to make yours, this easy, inexpensive way. Mail coupon now.  
Steelflex Corp. of America, Dept. 303, 1785 East 11th St., Cleveland, O.

STEELFLEX CORPORATION  
OF AMERICA  
Dept. 303, 1785 East 11th St.,  
Cleveland, O.

Please send me complete set of parts for building the **Flex-Roll** Rowing Machine, including blue prints for making frame. I will pay postman \$3.98 plus postage. You agree to refund my money within one week if I am not delighted.

Name .....

Address .....

City ..... State .....

(Canadian and Foreign Prices on Request)

When writing to advertisers please mention *Popular Mechanics*



## How CASCO Mended A Broken Heart...

"I've used Casco for practically all my gluing work," writes J. A. L. of Louisville, Ky., "from mending wood to BROKEN HEARTS! My little girl dropped her doll... Smashed its head... She was broken-hearted...but CASCO, like a good friend, repaired the doll's head...and so mended a broken heart!"

This actual letter is but one of the many we have received from men who told us how they used their samples of Casco. Send for yours today—and see how useful the strongest glue made CAN BE TO YOU.

### "IT FIXED THE GLASS ON MY WATCH"



"I broke the crystal of my watch and had it replaced with unbreakable crystal, which dropped out twice and was cemented back twice by a jeweler—but dropped out a third time. I then tried CASCO and it has been secure ever since."—P. G. R., New Ulm, Minn.

### "IT SAVED AN EXPENSIVE LINOLEUM FLOOR"



"Two years ago, I had my office floors covered with best inlaid linoleum...and constant washing separated the joints, so that no matter what kind of glue I used they soon separated again after washing. Three months ago I used Casco, weighted the linoleum down over Sunday—now try and separate the joints—water won't!"—Dr. L. P. B., St. Paul, Minn.

Now...TAKE YOUR SAMPLE of **CASCO** WATER PROOF GLUE and do expert gluing jobs on EVERYTHING!

By actual test, Casco is the strongest glue ever made—and yet, it's so simple to use, that you can't go wrong. All you do is mix it in cold water from the tap—and Casco is ready!

Take this large trial package of CASCO—and also our FREE folder of uses, showing you how to do things with Casco you never thought glue could do—cementing linoleum—and gluing almost every kind of material; making waterproof kalsomine; crack filler; etc. Casco is so easy to use, that even if you never glued anything before, you're sure to get perfect results on your first job. Send this COUPON for YOUR FREE SAMPLE.



THE CASEIN MFG. CO. OF AMERICA, INC.  
205 East 42nd Street, New York, N. Y.

P. M. 3-32

Here's my 10c (stamps). Please send trial package of CASCO Glue.

Name.....  
Street.....  
City & State.....  
And here's my dealer's name and address (paint, hardware, or lumber dealer).....

Information on any book free. Write Popular Mechanics Press, Chicago, Ill.

## ROLLER CHAINS AND SPROCKETS



For Machinery of All Types—Farm Implements, Trucks, Motorcycles, Etc.

—Write for Prices—

CHICAGO BALDWIN SUPPLY CO.  
547-549 W. Randolph St. Chicago, Illinois

## ELECTRIC LIGHTS ANYWHERE

### Complete Lite Plant

ready to run. Supplies 300 watts, 110 volt Direct current. Operates 1/2 H. P. motor, flat iron, electrical appliances.

\$99

Fine for Lake Cottage, Camp, Farm, Ranch or Portable Concession.—Wiring complete and ten lights \$12. Also other D. C. and A. C. models. Write D. W. ONAN & SONS 905 Royalston Ave., Minneapolis, Minn.



## AERO WORLDWIDE SHORTWAVE RECEIVER

\$6.45

Listen in DIRECT to London, Paris, Berlin, Buenos Aires and other broadcasting stations throughout the world via short waves. Your ordinary receiver cannot tune in these low wave stations. WORLD-WIDE RECEIVER sets 14 to 550 meters.



**AERO SHORT WAVE CONVERTERS**  
Convert Your Present Set Into a Short Wave Super-Heterodyne  
**A. C. MODEL \$12.50—D. C. MODEL \$11.50**  
**AT LAST! The Perfect Auto Radio... ONLY \$20.00**  
Built by pioneers in the manufacturing of Auto Radios. We guarantee 1,000 miles radius of reception. A masterpiece of Radio engineering. Latest model! 6 Tube Aero Pentode Auto Radio. Price of set only \$20.00. Set complete with tubes, batteries, dynamic speaker, antenna equipment and noise suppressors, \$39.50.



### NEW AERO MIDGET

Using the Latest Type Pentode and Multi-Mu Tubes  
Price \$16.50

We guarantee COAST TO COAST RECEPTION



Wonderful tone quality and selectivity. Full dynamic speaker. Full vision dial. Beautiful walnut cabinet. 5 Tube set \$10.95. Less tubes. Complete set of 5 matched tubes \$4.95 extra.  
SEND FOR COMPLETE CATALOG  
CHAS. HOODWIN COMPANY  
4240 Lincoln Avenue Chicago, Illinois  
Dept. P-2



## "SHIP MODELS ARE CHEAPER! NOW'S THE TIME TO BUILD ONE!"

Three different models \$1.50 for boys from 10 to 60

**ALL PARTS COLORED AND ANTIQUED**  
Build a model of one of history's famous ships. Printed sails, flags, shields and assembling instructions. Sent Parcel Post C.O.D.—We pay postage in U. S.  
Free illustrated pamphlet sent on request

TRU-ART MODELS CO.

Dept. M Perkasie, Penna.

## 30 Days' Trial

On all Mead bicycles. New RANGER models now ready for delivery direct to rider. Many recent improvements. Astonishing new prices and terms.

\$18.95 buys a genuine Mead bicycle. Rangers cost a few dollars more.

Tires, lamps, horns, wheels, parts, equipment, and repairs at half usual price. Established 30 years.

**Mead CYCLE COMPANY**  
DEPT. 112, CHICAGO

Write us today for free catalog



## KINKADEE GARDEN TRACTOR and Power Lawnmower

A Practical, Proven Power Cultivator for Gardeners, Suburbanites, Truckers, Florists, Nurserymen, Fruit Growers and Poultrymen.

Low Prices—Easy Terms  
AMERICAN FARM MACHINE COMPANY  
1050 23rd Ave. SE. Minneapolis, Minn.



Catalog Free

## GIANT TELESCOPE



See Miles Away! Distant people and objects seem close. Over 8 ft. long, brass bound. Made in Europe. 8 lbs. of fun. Thousands pleased.

**Send No Money!** On arrival pay Postman special price, only \$1.75, plus postage. Two for \$3.25. (Or send price and we pay postage.) Satisfaction guaranteed or money back. Send today.  
Bargain House, 427 Randolph St., Dept. 19, Chicago

**FREE With Order**  
Strong leatherette Carrying Case and Solar Eye Piece to view the sun.



**IDEAL Spad Vought Corsair Lockheed Sirius**  
15 in. Size

**BUILD 3 MODELS FOR \$1.65 Postpaid**

Biggest value ever offered. IDEAL 3-in-1 Kit contains everything required to build three 3-Flying Models, including Plans and instructions. Easy to build.  
IDEAL AEROPLANE & SUPPLY CO.  
26 West 19th Street N. Y. City



When writing please mention Popular Mechanics



# New **DELTA** Band Saw WINS WOODWORKERS' APPROVAL



**T**HE new, improved 1932 Delta Band Saw has already passed its workshop tests with flying colors. The absolutely Rigid Frame, Balanced Disc Wheels, Ball Bearing Blade Support, Accurate Tilting Table, Easy Tensioning Device, Large Capacity and Special Guides make this an exceptionally safe, accurate, fast-cutting machine capable of giving years of good service. Woodworkers everywhere are also welcoming the new Delta Band Saw "Sanding Belt"—an unique attachment that eliminates many tedious hand sanding operations. (Pat. App. For.)

## FREE Catalog

Send for your copy TODAY! Everything for the modern woodworker—professional, spare-time, or hobbyist—is illustrated and described in this big 1932 Delta Catalog. A complete line of improved motor-driven jointers, circular saws, jig saws, band saws, wood-turning lathes, drill presses, sanding units, moulding cutters, borers, routers and mortisers—all husky, accurate, efficient units—are now available at astonishingly moderate 1932 price levels.



### DELTA Tools Save Time, Money and Labor

They take all the drudgery out of woodworking. They enable you to turn out *better work* in *less time*. They bring the finest professional cabinet work within the reach of all.

### 10 Day Trial EASY TERMS

Send coupon for FREE 1932 Delta Catalog. Shows complete Delta line of motor-driven tools. Many new items. New features. Also details of 10-Day Trial Offer and Easy Payment Plans. Mail the coupon TODAY for your copy!

### Delta Specialty Company

(Division of Delta Mfg. Co.)

3775 N. Holton Street Dept. A332

MILWAUKEE, WISCONSIN

DELTA SPECIALTY CO. (Div. of Delta Mfg. Co.)  
3775 N. Holton Street, Dept. A332  
Milwaukee, Wisconsin

Please send me, without obligation, 1932 Delta Catalog. Also send full details of your 10-day Trial Offer and Easy Payment Plans.

Name.....

Address.....

City..... State.....

TRADE MARK REG. U.S. PAT. OFF.

# DUBLINUM

PATENTED NOV. 25, 1930

## CLEANING and POLISHING MITTS

KEEPS THE HANDS CLEAN

Furnished in several colors and weights scientifically designed and made to meet all cleaning and polishing requirements. Dublinum Mitts are rubberized and treated so as to "protect the hands" simply apply polish to one side of the mitt and rub on article, then reverse the hand in the mitt, and polish to a brilliant finish with the other side.

Attractively displayed in boxes of one dozen each, samples will be mailed for 25c each. Distributors wanted for exclusive territory.

CONSOLIDATED SALES & MANUFACTURING CORPORATION  
89 STATE STREET, BOSTON, MASS.

### DISTRIBUTORS WANTED

### New Automatic

LEMON, ORANGE, GRAPEFRUIT

# WALL JUICER

AT LAST—the perfect, automatic fruit juicing machine that America needs! Amazing SUPER-JUICER gets all the juice from oranges, lemons, grapefruit, etc. instantly—without work, waste, worry, muss, or bother! Hangs on the wall. Just turn magic crank—fruits juice themselves. Automatically strains seeds, pulp, pits. Surprisingly easy to clean. Parts cannot rust. Guaranteed for 3 years. Yet unbelievably low-priced! Up to 4 profits on every sale! No wonder agents report as high as \$17 in an hour, full and spare time. Write at once for FREE TEST OFFER and unique 4-PROFIT PLAN that guarantees sale for you without risk! Territory going fast—no HURRY!

Agents Free Test Offer

CENTRAL STATES MFG. CO.  
Dept. C-5135, 4500 Mary Avenue, St. Louis, Mo.

When writing to advertisers please mention Popular Mechanics



# 51 MILES ON A GALLON of GASOLINE WINS ECONOMY CONTEST

## 49 MILES Takes 2nd Place Winning Cars Equipped With WHIRLWIND GAS SAVERS

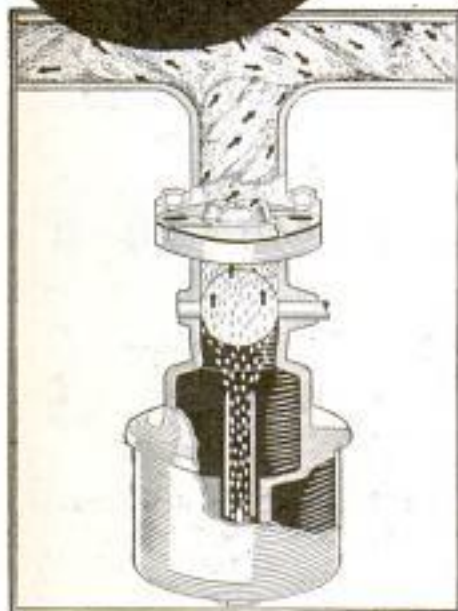

### How Whirlwinds Save Gasoline

The principle of the Whirlwind is to slightly compress the partly vaporized gasoline as it passes thru the raised venturi. Extra air enters from four air inlets at such a tangent as to pick up the unvaporized gasoline particles, whirling them into action. The turbulence created breaks them into a vaporized gas, giving better, smoother power, quicker starting, cutting gasoline waste and carbon formation.

Car owners all over the world are amazed at the results of their tests. "I have more speed, power, and increased mileage," writes Henry Bomberger. "Hills I used to take in second I now make in high." Anton Wetsch: "I wouldn't take the Whirlwind off my car for any money. I am certainly convinced." W. B. Fountain: "My mileage has increased greatly. My car has plenty of pick-up and starts like a whip."

### SALESMEN AND DISTRIBUTORS WANTED To Make Up To \$100 A Week and More

Whirlwind men are making big profits taking care of local business for this fast selling device that car owners cannot afford to be without. Good territory is still open. Free sample offer to workers. Full particulars sent on request. Just check the coupon.

### WHIRLWIND MFG. COMPANY

Dept. 848-A, Station C, Milwaukee, Wis.

Automobile owners who have been worrying about gasoline expense will be interested in an amazing test recently conducted by a Texas Motor Car Company. Twenty-three cars were entered in a mileage economy test, the winning car running 51 miles on a gallon of gas, the second car 49 miles on a gallon. When official test records were published it was found the two winning cars were both equipped with Whirlwind gas savers.

#### "Peak" Contest Mileages

The amazing results obtained in this mileage contest are naturally greater than those obtained in ordinary driving. Careful throttling, most economical speeds—no traffic hold-ups—and no waste of power thru quick stops, help to bring about these "peak" mileages.

#### A Test On Your Car

More power, faster pick-up, less carbon, quicker starting, and increased mileage is what users say in telling of their experience with the Whirlwind. Every motorist owes it to himself to test the Whirlwind to prove the results on his own car.

#### FITS ALL CARS

In just a few minutes the Whirlwind can be installed on any make of car, truck or tractor. It's actually less work than changing your oil or putting water in the battery. No drilling, tapping or changes of any kind necessary. It is guaranteed to work perfectly on any make of car, truck or tractor, large or small, new model or old model. The more you drive the more you save.

#### GUARANTEE

No matter what kind of a car you have or how big a gas eater it is the Whirlwind will save you money. While we do not claim to produce 49 to 51 miles on ordinary driving, we do guarantee that the Whirlwind will save its cost within 30 days or the trial will cost you nothing. We invite you to test it at our risk. You are to be the sole judge.

#### FREE OFFER COUPON

WHIRLWIND MANUFACTURING CO.,  
Dept. 848-A, Station C, Milwaukee, Wis.

Gentlemen: You may send me full particulars of your Whirlwind Carbureting device and tell me how I can get one Free. This does not obligate me in any way whatever.

NAME .....

ADDRESS .....

CITY ..... STATE .....

Check here if you are interested in full or part time salesman position.



Mrs. C. P. Blalock,  
contest winner





## Should she have been frank?

**T**HIS is a case where a woman paid a high price for silence. Like so many other commendable people she kept small irritations to herself.

Little things continually cropped up to mar her happiness. Possibly she should have overlooked them entirely. Certainly it was a grave mistake to harbor bitter thoughts. She allowed petty annoyances to pile up until her patience was almost exhausted. Then her husband grew a bit careless in his appearance—even failed to shave as often or as carefully as he should. She called this the “last straw” and left him.

Is a woman correct in assuming a man is losing respect for her or himself when he

becomes careless about shaving? We think not—discomfort is a more likely reason—although stubble is a handicap in almost every business or social contact. May we suggest today's Gillette blade is the answer in cases like this.

• • •  
This blade is far keener and smoother—invites frequent, close shaving. Once or twice daily use will not irritate the tenderest skin. We urge you to try this remarkable blade on our positive money-back guarantee. If you don't agree every shave is the cleanest and smoothest you have ever enjoyed—return the package to your dealer and he'll refund the purchase price.

# Gillette

RAZORS  BLADES



# "You like them FRESH? So do I!"

**Y**OU don't have to tell the woman who has switched to Camels the benefits of a fresh cigarette.

She knows all about it—that's the reason she stays switched.

She has learned that the fine, fragrant, sun-ripened choice tobaccos in Camels have a perfectly preserved delicate mildness all their own.

She knows by a grateful throat's testimony

what a relief this smooth, cool, slow-burning fresh cigarette means to sensitive membrane.

Camels are fresh in the Camel Humidor Pack because they are *made* fresh, fresh with natural moisture and natural flavors—they are never parched or toasted.

If you don't know what the Reynolds method of scientifically applying heat so as to avoid parching or toasting means to the smoker—switch to Camels for just one day—then leave them—if you can.

R. J. REYNOLDS TOBACCO COMPANY  
Winston-Salem, N. C.

### "Are you Listenin'?"

R. J. REYNOLDS TOBACCO COMPANY'S COAST-TO-COAST RADIO PROGRAMS  
CAMEL QUARTER HOUR, Morton Downey, Tony Wons, and Camel Orchestra, direction Jacques Renard, every night except Sunday, Columbia Broadcasting System | PRINCE ALBERT QUARTER HOUR, Alice Joy, "Old Hunch," and Prince Albert Orchestra, every night except Sunday, National Broadcasting Company Red Network

See radio page of local newspaper for time



● Don't remove the moisture-proof wrapping from your package of Camels after you open it. The Camel Humidor Pack is protection against perfume and powder odors, dust and germs. In offices and homes, even in the dry atmosphere of artificial heat, the Camel Humidor Pack can be depended upon to deliver fresh Camels every time.

© 1932, R. J. Reynolds Tobacco Company

# CAMELS

Made FRESH — Kept FRESH