

JANUARY

N.S.E.  
25 CENTS

# POPULAR MECHANICS

## MAGAZINE

WRITTEN SO YOU CAN UNDERSTAND IT

BLVD. TRADE MARK GREAT BRITAIN No. 60486

REG. U.S. PAT. OFF.



SEE PAGE 16

# This Wonderful VIX Engine Humidifier Invention Will Give Your Auto a Completely New All Around Performance in 30 Minutes

## New Pickup

No matter how quick your pickup may now be—this VIX Humidifier will positively make it quicker. Your engine will flash ahead with the slightest touch of the accelerator pedal. Your car will scoot around others with amazing alertness and complete safety in and out of traffic.

## New Power

This VIX Humidifier improves the power of any engine to approximately the equivalent of another cylinder added. You can fly over hills, in high, that you always chanced gears on before. A scientific humidifying treatment of the engine fuel does it.

## New Speed

This VIX humidifying process gives the engine more speed. Your car will be faster, with lightning-flash acceleration, in passing other cars, and top speed increased several miles per hour. A new top speed for every engine, from a Ford to a Rolls-Royce.

## New Smoothness

Glasslike smoothness—less vibration at both low and high speed—the purr of the engine is made less audible than the swish of engine speed. This VIX invention makes the motor run softer, with quieter valves and tappets, and a cushioned explosion that gives you the utmost in vibrationless driving comfort.

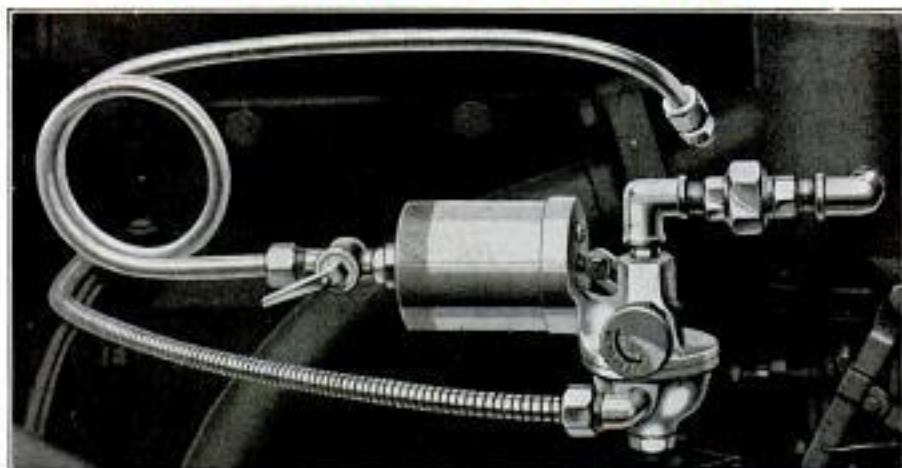
## New Mileage

This is not a joke gas saver. But scientific engine humidification DOES GIVE more mileage. Gains up to 30%, 40%, and 50% are regularly reported. The average gain for all cars is 20% minimum. Humidifying the auto engine effects more perfect combustion, and a NEW mileage is attained.

**Uses Lowest Price Gas with Better Than Highest Price Gas Results**

### An Auto Engine Humidifier

Its Function Is The Same That Makes Autos Run The Wonderful Way They Do In The Cool Damp Evening Air Or In Foggy Or Rainy Weather



### Not A Joke Gas Saver

Nothing Else Like It The World Over—Now Or Ever Before Fits All Autos Any Average Handy Man Can Install In 30 Minutes

**An Engineering Achievement of Outstanding Importance**

PATENTED AND TRADE-MARKED IN 109 NATIONS

## Decarbonizes Engine—Saves Carbon-Caused Repair Bills

When you drive down the road at night, many times you notice a car ahead of you belching red-hot sparks from the exhaust outlet pipe. That's because the moisture from the atmosphere taken into the engine through the carburetor is disintegrating the hard carbon, and it is coming out of the exhaust in red-hot sparks.

This VIX Humidifier invention scientifically sends a constant stream of moisture into the engine, all the time, which completely decarbonizes the engine and keeps it clean, everlastingly.

Ends carbon knocks, stops engine overheating, cures sticky valves, lubricates cylinders, kills carbon monoxide gas, and the expense of frequent valve grinding and spark plug cleaning. Everyone knows the average car owner spends all the way from \$25.00 to \$100.00 a year in engine repairs, due to the bad effects of hard carbon. The VIX saves all carbon-caused repair bills. Fits every auto, truck—is easily attached—works alike, winter and summer—is easily changed from one car to another. Mail coupon below or postal request.

**FREE VIX Mail Now Offer**

WALTER G. CRITCHLOW  
INVENTOR AND MANUFACTURER  
805—Y2 STREET, WHEATON, ILLINOIS, U. S. A.

Please send me without obligation or cost your 10 days' Trial and FREE VIX offer.

Name .....

Address .....

Town ..... State .....

If you wish Salesman's or Distributor's Agency Reservation

Mark X here .....

## Pays Agents Big Quick Cash Profits

Choice Territory available. I want to appoint County, State, Province, National, Salesman and Distributor, and General Agencies to make \$350.00 to \$1,500.00 month, filling the great demand bound to arise for this wonderful invention wherever introduced. One Distributor already made profits of \$4,939.00 in 3-1/2 months. BIG MONEY can be made FITTING Engines with VIX. Startling, stunning, convincing demonstrations make sales EASY. Write quick for all details: full proof, ALL SENT FREE. Mail FREE VIX Offer Coupon TODAY. Or send postal.

## Gives Substantial Mileage Gain Pays For Itself Over and Over Each Year

By a scientific process of mixing humidified air or vapor moisture with engine fuel, this VIX invention brings about more perfect combustion. This better combustion gives a much smoother running engine, with far greater power, vastly quicker acceleration (pickup), and several miles per hour more top speed. Like coal burns better when it is sprinkled with water before thrown into the fire, so does this process of mixing moisture with engine fuel make the fuel burn up more completely. Thus you get more miles per gallon of gas and oil.

Remarkable mileage gains have been reported to us, up to as high as 100%. The average gain for all cars reported to us is 20%. The function of this VIX Humidifier permits the use of lowest priced gas, with better than highest priced gas results. That means a saving of from 3c to 5c a gallon every time you fill your gas tank. The doing away with carbon-caused repair bills. The money saved in cheaper gas, plus mileage gain, pays for this VIX Humidifier invention over and over again every year.

The Inventor and Manufacturer will furnish at his risk, direct from Factory, a suitable VIX Model on trial for you to try out on your own Car.

Fill out and mail the coupon QUICK for full details and FREE VIX offer. Or send postal request. ALL SENT FREE.

**Walter G. Critchlow**

Inventor and Manufacturer

805—Y2 Street, Wheaton, Illinois, U. S. A.

# Genuine

## Amazingly Low Priced for Christmas Shoppers!

# UNDERWOOD

### Late Model No. 5

## 10 Days Trial

Think of it—over 2 million buyers paid \$102.50 (cash) for this Model No. 5 now offered direct-to-you at way below 1/2 original price—and on easiest terms besides. Positively the greatest bargain ever offered. Accept the special 10 day trial offer and be convinced. See the neat, perfect work it does—compare its bright, shiny newness without risk. Recognized as the finest, strongest typewriter built.



### The Ideal Xmas Gift to Yourself or Family

At the exceedingly low price this world-famous Underwood makes a wonderful and practical gift. See easy terms below.

## Save over 1/2 Mfgs. Original Price

Only by an exceedingly fortunate purchase direct from the manufacturer's am I able to offer this amazing low price and just in time for Christmas, too. While they last—less than half (1/2) the manufacturer's original price—and easy terms besides. (Do not confuse this genuine late model Underwood with inferior or frail machines worth only one-half as much.) This is the full-size late model Underwood with Standard universal 4-row keyboard of 84 characters and has all late improvements. Manufactured to sell originally for \$102.50. Fully Guaranteed in writing.

### Easy Terms—Only 10c a Day

Think of it—a genuine late model Underwood No. 5 reduced to \$39.90 (Cash). Send only \$1 deposit for a 10-day Trial. Then only 10c a day on my easy year-to-pay plan. Use and enjoy your typewriter all the time. Remember this famous No. 5 Underwood all renewed and refinished is without question one of the greatest values ever offered at this rock-bottom price. (See column to left for its many outstanding features and improvements.)

### Money Back Guarantee

Accept my liberal 10-day trial offer. See for yourself the wonderful bargain this famous Underwood really is. Your deposit returned at once if you are not perfectly satisfied. Send now.

## International Typewriter Exchange

231 W. Monroe St. Chicago

### Complete Course in Touch Typewriting Given During This Offer Also Office Supply Set

Learn Touch typewriting. Complete Home Study Course of the Famous Van Sant Touch Typewriting System, fully illustrated, given during this offer. Easily learned. Used in schools, business offices everywhere. We also give complete office supply set during this sensational sale.



### LATE MODEL No. 5 UNDERWOOD With Modern Improvements

1. Genuine Underwood No. 5
2. Standard 4-row Keyboard (84 Characters)
3. 2-color Ribbon—Rising Scale
4. Back Spacer
5. Ribbon Reverse
6. Tabulator
7. Automatic Release
8. Shift-Lock Key
9. Lowest Price
10. Easiest Terms
11. 10-Day Trial
12. Fully Guaranteed

This One



XDTQ-F31-3YHQ

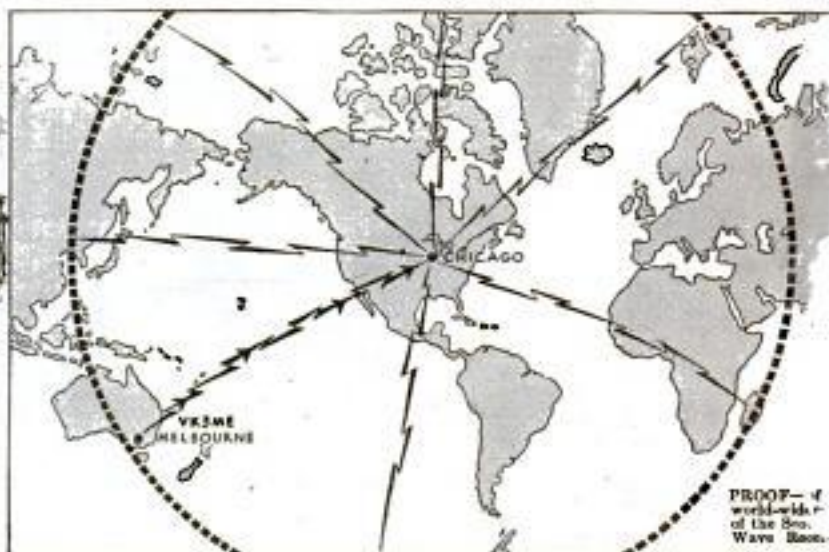
Name.....Age.....

Address.....

Town.....State.....

# 'Round the World Reception Every day, in all seasons

21 weeks, constant reception record from VK3ME proves SCOTT ALL-WAVE capable of tuning in clear 'round the earth regularly—every day, summer and winter.

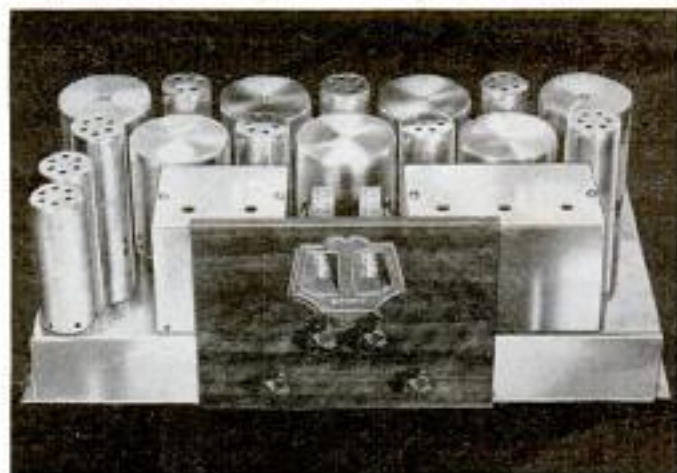


PROOF—of world-wide reception of the Scott All-Wave Receiver.

FOR 21 weeks, a Scott All-Wave Receiver, located in Chicago, has brought in, and recorded on disc, every broadcast from VK3ME, Melbourne, Australia. Each broadcast was received with perfect clarity and full volume—as the disc records decisively prove. Think of it! VK3ME, half way 'round the earth! Not just once in a while. Not just a freak happenstance. As this book goes to press, VK3ME is still being received with perfect regularity, and recorded. With a Scott All-Wave, you could get VK3ME and dozens of other foreign phone stations whenever you choose.

When the distance between Melbourne and Chicago is used as a radius, a circle drawn from Chicago as the center, includes practically the entire world. This establishes the range of the Scott All-Wave Receiver, and steady reception from all points north, south, east and west, at the extremes of the circle. PROVE the world-wide range of this remarkable instrument.

The reason for the greater range of the Scott All-Wave is the far greater amplification obtained in its intermediate stages. A new type of transformer, in which the primary is shielded from its secondary, provides such an enormous increase in gain per stage that the sensitivity of the receiver is more than adequate for world-wide reception, with the tubes operated below the noise level. Short Wave reception that is ordinarily attended with terrific interference,



The Beautiful Chrome Plated Scott All-Wave Chassis

comes in clearly on the Scott All-Wave—and with beautiful, full, round, natural tone. Reception from VK3ME, from G5SW, Chelmsford, England, from 12RO, Rome, and other far off points, invariably has the quality and volume of a local station! Actually, in all truth, the Scott All-Wave gives 'round the world reception every day, in all seasons—between 15 and 550 meters.

## FIVE YEAR GUARANTEE

The Scott is not a flake. It's built in Italy, by experts. Industry stands that men make the usual guarantee made on receiver. The Scott All-Wave is for full reception of the world's radio that falls will be replaced. CHARGE.

### Mail Co Today

Full particulars of All-Wave will be sent upon request to them now. Be sure the receiver is the whole realm any kind of test. The Scott will bring them. Mail it in—mail it.

The E. H. SCOTT RADIO LABORATORIES, Inc.  
(Formerly Scott Transformer Co.)  
4450 Ravenswood Avenue - Dept. P1 - Chicago, Ill.

# The SCOTT ALL-WAVE

## 15-550 METER SUPERHETERODYNE

When writing to advertisers please mention Popular Mechanics

### CLIP—MAIL NOW

THE E.H. SCOTT RADIO LABORATORIES  
4450 Ravenswood Ave., Dept. P1, Chicago

Send me full details of the Scott All-Wave Receiver

Name.....

Street.....

Town..... State.....

# Popular Mechanics Magazine

200 E. Ontario Street, Chicago, U. S. A.

H. H. WINDSOR, Founder

H. H. WINDSOR, Jr., Editor and Publisher

London: Messageries Hachette,  
3 La Belle Sauvage, Ludgate Hill, E. C. 4

Paris: Hachette & Cie.,  
111 Rue Reaumur

Melbourne: Gordon & Gotch  
509-513 Little Collins St.

Vol. 57

January, 1932

No. 1

## Special Features

The Sovereign Ship of the Seas	34
Peace-Time Spies	44
On the Trail of the Forty-Niners	52
Stalking Killer Fish	60
Dinner-Table Magic	67
Midnight with the Battlefleet	82
How Body Stains Betray Criminals	98
House is Heated and Cooled with Gas	103
Fishing Through the Ice	107

Agriculture—Canada grows Chinese crop for export to China	59	Bicycle—trailer is hooked to, for carrying parcels	49
Air—tests show how air conditions affect you	42	Birds—the speed of	72
Airplanes—four transatlantic planes in "flock" at airport	33	Boats and Boating—speedboats race on a curved prairie "track"	77
Airships—helicopter fitted on, for flying straight up	88	Building Construction—sealed joints in brick wall keep out moisture	49
Archaeology—skeletons in motion show how they lived	101	Buttons—history of, reflects march of civilization	88
"apartments" found in caves used by Arizona Indians	43	Cables—gypsum used in fireproofing	113
cemetery of unknown race unearthed in Persia	92	Caves—stalagmite rings count past time in	93
signs of Noah's flood found in Mesopotamian sands	58	Cement—made of magnesium is stone-hard	113
Army, U. S.—big gun on six-wheel truck	119	City—town springs out of desert at Boulder Dam site	91
mystery pursuit plane built for army flyers	66	Coffee—bricks used for fuel	
Art—pieces of, made out of pieces of rubbish	89	Currency—why two-dollar bills have reputation for illuck	02
Automobiles, Accessories—felt oiler for valve stems and guides	71	Deafness—"silent talkies" teach deaf to "hear" with eyes	105
fender guides help steering of low-seated autos	80	Desk—strain on student reduced by posture corrector	51
ignition booster starts car in coldest weather	65	Diamonds—stray, found in U. S. indicate rich field	57
infra-red rays melt ice on windshield	88	Disease—gas-light rays for relief of rheumatism	81
lens in rear window aids traffic driving	76	Eggs—made into caricatures	96
license plate locked to car with keyless screw	64	Electric Motor—ten-cent, built from kit	92
neon turning signal warns drivers behind	41	Elevator—pipe-line, carries hay to silo	90
periscope reflects overhead traffic lights	72	Engine, Gasoline—small, runs on thimbleful of fuel	65
spark lever works starter of small auto	112	Engraving—stylus etches photo on zinc to speed	70
Automobiles, Fuel—corn turned into auto fuel	81	Fire Alarm—beds shaken as, in home for deaf mutes	86
Automobiles, Truck—phone connects the drivers of hundred-ton truck	94	Fire Fighting—air purifier guards fireman from smoke peril	66
Aviation—light in flyer's helmet aids in reading instruments	92	fire extinguished by robot with "electric eye"	87
mountain-top seaplane base established in Alps	87	Fish and Fishing—lure has many spinners like propeller blades	105
robot pilot for big planes	109	Fowls—nesting place of blue goose in Arctic	91
seaplanes are launched on land by catapult	90	Fruit—prune picker improves fruit by eliminating wrinkles	57
Awnings—for porches, which do not flap in the wind	81	Germes—that eat poison	111
Batteries—auto battery operates household appliances with aid of converter	43	Glass—"precious" art glass formed in many colors	80
wedge used instead of bolt on terminal	109	Guns—pistol with triple barrels shoots tear-gas shells	106

Depth sounding gear 10  
Continued on Page 41  
Road signboard, water cooled 82

ISSUED MONTHLY SUBSCRIPTION: *3 mos Aug 17* SINGLE COPY, 25 CENTS

In United States and its possessions, Cuba, Mexico, and all countries in the Pan-American Postal Union, per year, postpaid \$2.50  
To all other countries in the Postal Union *Electrophot 72* 3.00  
All subscriptions are discontinued at expiration. Please examine the date printed on your wrapper.  
Entered as Second Class Matter Sept. 15, 1908, at the Post Office at Chicago, Illinois, under Act of March 3rd, 1879.  
Entered as Second Class Matter at the Post Office Department, Canada.

Published monthly by POPULAR MECHANICS CO. Copyright, 1931, by Popular Mechanics Co. Copyright in Australia. Copyright in France

*Hold from depth sounding 59*  
*Hammer with removable face 86*  
Copyrighted material

*Pipe contains match strikes 5*  
*Pipe paint prevent sweating of*

*Glass cleaning fluid*  
*Chemicals 132*

[4]  
 [Contents—Continued]

*Under turned into bases that 66*

Ice Box—deodorizer prevents contaminated foods	51
Inventions—Washington was inventor of farming tools	96
Keys—made to fit auto locks	71
Lamps	
light of sodium-vapor lamp found most efficient	101
odd-shaped, gathered by collector as hobby	80
Life-Saving—electric life buoy equipped with flare light	59
Models—motor car carved in wood has engine	58
Music—page turner worked by pressure of knee	72
Musical Instruments—violin turned into bass viol by use of electricity	66
New Orleans—millions spent to improve city's 'back-yard'	112
Oxygen—air supply carried on backs of mountain climbers	105
Paints and Painting	
old masters' paint secrets are rediscovered	92
paint fed to brush by tubing helps sign painter	70
pipe paint resists moisture and heat	71
Patents—plant in color help describe new varieties	51
Photography—"electric eye" helps camera by timing exposure	72
Physiology—capillaries heat fingers and toes	80
Pipe Lines—oil or gas line not corroded by electric currents	106
Pipe Organ—in compact case is as portable as piano	94
Pipes—gas main wears four coats to keep out cold	77
Potatoes—seed potatoes shipped in a gas grow faster	91
Poultry—artificial sunlight for hens produces better eggs	76
Projector—for home talkies cuts down distortion	43
Power—mercury-vapor steam plant to supply cheap	42
Power Plant—electric, wind-driven on wheels	50
Psychology—how science has turned fortune teller	95
Puzzles	176
Radio	
gold-leaf "larynx" for, reproduces deep tones	64
practical ideas for the radio experimenter	117
static and fading eliminated by short waves	106
Radio, Apparatus	
amplifier gives old phonograph new voice	114
cash boxes used to house test sets	121
converter for old sets makes superheterodyne	71
hi-power supply for fifty-watt transmitter	122
you can build this vacuum-type voltmeter	115
Radio, Coils—protecting from moisture	121
Radio, Receivers	
an a.c. short-wave receiver for the amateur bands	118
table set has control on top	121
Radio, Reception—Ford coils as interference filters	116
Radio, Repairing—insulating auto-set cable	121
Railroads—electric car is streamlined for high speed	113
Rays, Cosmic—more powerful than waves from sun	109
Roofing—bakelite is used for, in place of heavy tile	87
Safety Devices and Measures—stand for workmen on building exteriors	102
Saws and Sawing—one-man circular tree saw	33
Scale—automatic, fills bags and weighs contents	71
Ship and Shipping	
delicate electric car hears remote fog signals	33
how electricity adds to your comfort at sea	110
'Old Ironsides' rebuilt	74
Skyscraper—gauge on, shows speed of construction	57
Speech—muscle study of stuttering may result in cure	106
Streets—hand sprayer cleans with chemical compound	64
Telephone—phone charge given by robot to any part of the world	91
Theaters—lights on backs of seats in	76
Tools	
pressure nail driver makes picture framing easy	105
removable face on hammer is quickly replaced	86
Toys—toy windmills make living for man with hobby	41
Traffic mirrors aid drivers at three-way crossing	81
Trees—big cypress tree records dawn of history	41
Tunnel—highway built under town	58
Vocabulary—how many words you know told by test	65
Wagons—grease gun for hubs	59
Watches—new alloy changes art of watchmaking	73
Water Drainage—tower with ten bathrooms tests	111
Windmill—saws farmer's wood in primitive fashion	102
Windows—lock secures open, against intruders	111
Scale, bathory, give weight	
AMATEUR MECHANICS	
Airplane, Model—flies like a bird	105
Automobiles, Accessories	
quick-acting glare shield operated by shade roller	125
spare tanks mounted on trunk rack	132
tool kit fits under front seat of coach-type car	146

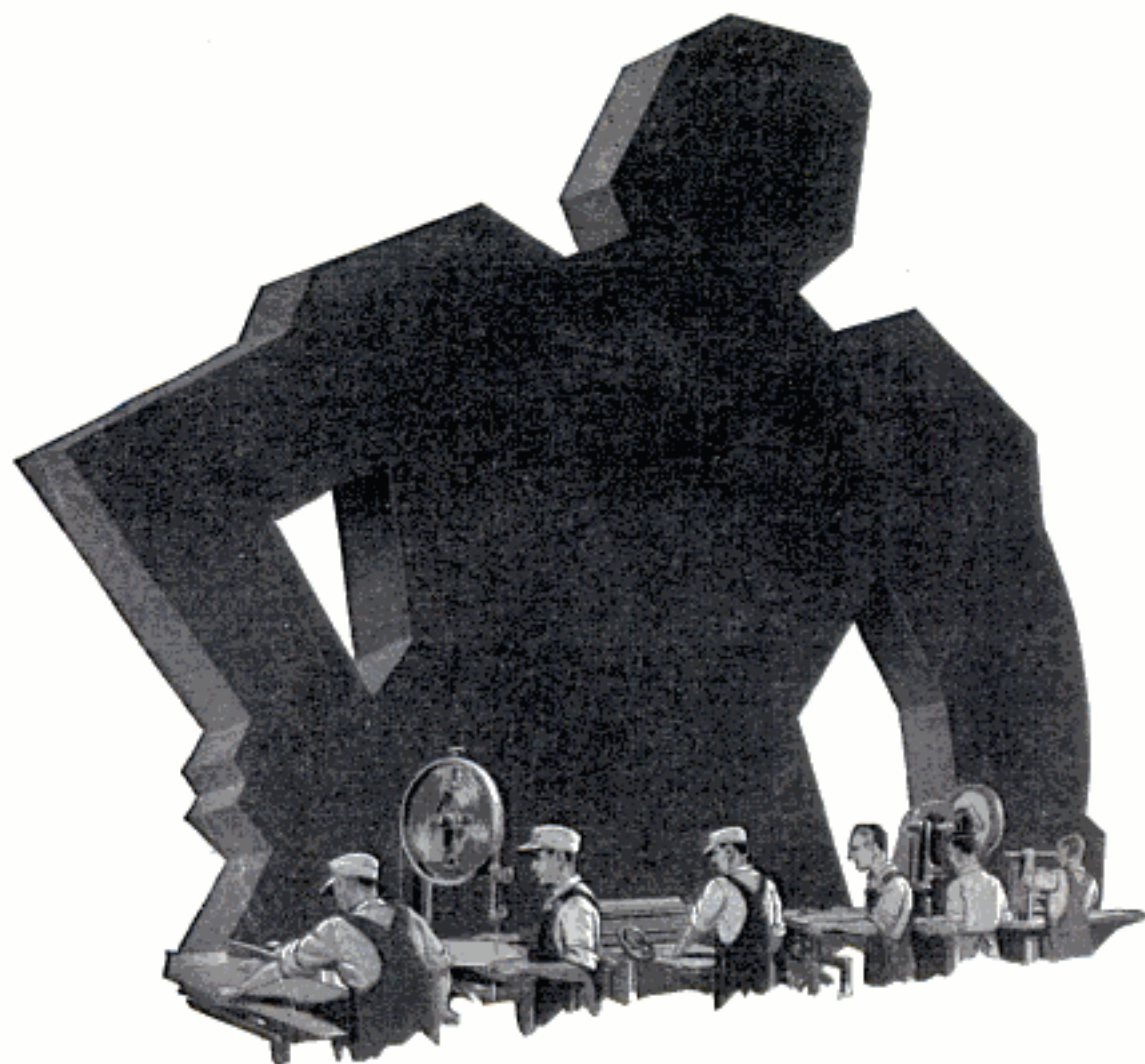
Automobiles, Repairing	
drain hose for radiator prevents spilling	146
how to open clogged grease fittings	128
jack used to straighten axle	135
shock-proof spark plug tester	126
spring hinge pins cure door rattles	145
Automobiles, Tires—vulcanizing long patches on inner tubes	150
Automobiles, Truck—gasoline gauge for tank	156
Bookplates—blueprint your bookplates by photography	131
Boots—easily removed with the bootjack	132
Boxes—cutter for opening cardboard boxes	142
Brushes	
cleaning showcard	129
rubber bumper on floor brush	141
Camera	
operating electrically	128
pistol grip useful in "shooting" pictures	155
Cards (Playing)—metal rack for	142
Christmas Tree—concrete base for large	156
Clothes Hook—fastened to hinge of bathroom door	142
Dogs—dog tonneau carries pet in comfort	127
Drafting—T-square from ruler and cardboard	125
Drill Press—from a vise and electric motor	134
Electric Toaster—sheet asbestos makes more efficient	133
Flour Bin—cupboard, is removable for cleaning	126
Food Cooler—attached to door	130
Heating and Ventilating—removing film from water in boiler	130
Ice Shaver—resembles cheese grater	146
Ice Skates—improvised sharpener for	145
Kitchen Utensils—truing the edges of	132
Leather—it's easy to tool	147
Milk—asbestos cover keeps from freezing	156
Models—DeWitt Clinton train	136
Paints and Painting—cup holds putty on paint bucket	145
Paste—rubber plate scraper used as brush	145
Pencil—holder on finger aids in making check marks	151
Photography—test light for photo flash lamp	134
Roller Skates—move packing cases	151
Roofing—rubber aids when using nails and washers	129
Roofs—to avoid slipping on	145
Shadow Box—yuletide, gives realistic effect	143
Shears—with broken handle can be used in vise	154
Sheet Metal—shaping, without bending machine	144
Skis—sheet-metal brakes prevent backslip	135
Snow Shovel—from an auto hood	128
Sports, Winter	
snowshoeing is real sport	152
thrills in whirling merry-go-round	150
Stool—kitchen, swings under table	126
Toys—toy washing machine	144
Wagon—lifting boxes from running gear	133
Windmill—automatic shut-off for	134

SHOP NOTES

Automobiles, Repairing—brazing cracked blocks and crankcases	165
Bench—fireside bench you can make	163
Drafting—gummed tape holds paper on board	167
Drilling—marking holes on highly finished surfaces	162
Drill Press—vise on table increases efficiency of	172
Electroplating—non-metallic objects	173
Garage—drip pan for	174
Gauge—celluloid protects face of	171
Knife—how to sharpen your blade	160
Lamps—adjustable floor lamp for shop or garage	162
Light Fixtures—ceiling, easily removed for cleaning	172
Luggage—cross-country bag for airplane pilots	166
Measuring	
across large openings with folding rule	160
differential gauge made from combination square and head	161
Metals—three-section bin for metal cuttings	162
Oil Drum—portable truck supports	166
Paints and Painting	
extension handle for brush	161
wall decoration improves your home	168
Pipe Valve—emergency	171
Rope—winder measures	175
Saws and Sawing	
cutting molding on circular saw	157
scabbard for saws	161
screen molding made on small circular saw	166
Show Cards—hydrometer forms raised letters on	167
Stakes—driving brace stakes in wet ground	172
Tape—holder prevents unrolling of	162
Tools—heat-treating small	175

*scale bathory give weight*  
*AMATEUR MECHANICS*  
*105*

*Rheumatism, Gas Light*  
*Sharp 81*  
*Plating nm.*  
*metallic material*  
*173*



**PRESDWOOD . . .**  
REG. TRADEMARK  
*puts speed in industry*

Masonite Presdwood, the all-wood grainless board, grew up with the machine age—with the speed of presses, the whirl of planers, the bite of saws. It thrives on the rushing speed of modern production methods . . . saves precious minutes in every operation . . . never slows up the production line. Works equally well with hand tools. Never splits in nailing close to the edge. Everywhere it's used, Presdwood cuts labor and material costs, eliminates waste and rejects. It's strong, durable, impervious to moisture, easily workable. Comes in lengths up to 12 feet or cut to your specifications. Smooth finish,

rich brown in color; takes any finish—lacquer, enamel, paint, stain or varnish.

A sample of Presdwood sufficiently large for testing will be sent on request. Also the Presdwood booklet telling the story of its manufacture and listing 80 of its uses.

**Masonite**  
**PRESDWOOD**

REG. TRADE MARK  
 STRUCTURAL INSULATION • INSULATING LATH  
 QUARTZBOARD • Customized FLOORING

*"Made in Mississippi"*

**Cut or processed  
 to your order**

The Masonite Corporation is now prepared to supply manufacturers with Presdwood specially processed to meet any particular requirement, or cut to any desired irregular outline or size. Check the coupon or write in for full information describing service required of board.

MASONITE CORPORATION, Dept. L-21 © M.C., 1931  
 111 W. Washington Street, Chicago, Ill.

Please send your free illustrated booklet that describes Masonite Presdwood and its many uses.

Name

Street

City  State

If interested in specially cut Presdwood, check here

*When writing to advertisers please mention Popular Mechanics*

*Railroad track kept free from ice and snow by gas burner*

*Copyrighted material 19*

# Answer This Ad!

## If You Want Quick Success and Big Pay In AUTOS



### Morrison Did!

When Morrison of Parkersburg, West Virginia, wrote for my auto book he was working in a steel mill for low pay. In six short months he doubled his earnings and got into business for himself—even before he finished his "Job-Way" Training. You can have the same book that started Morrison on the road to success. Clip the coupon—and mail it today.

## Earn Up to \$75<sup>00</sup> a Week

Get YOUR share of the \$7,000,000,000 spent every year on auto upkeep. Just think of it—more than 25,000,000 autos in the U. S. No wonder there are so many big pay jobs! Get into this fascinating game, now. Don't put it off another day. Get the facts. Mail coupon for big, FREE auto book. Learn of the countless opportunities in the World's Biggest Business where real jobs and big pay come quick. See how \$40—\$50—\$75 a week is possible for you now. Learn how "Job-Way" Training has brought big money—promotion—shops of their own to scores of men. Find out about my Employment Department—how it helps you get a good job in the auto business.

**3 Working Outfits**  
also included FREE of extra charge if you act quick!

## Learn at Home in Spare Time

"Job-Way" Training is the short cut to Auto Success. No need to quit your present job—no need to leave home—just use your spare time to prepare for a brilliant future—a real job paying up to \$75.00 a week. All you need is common schooling. I don't care if you never touched an auto before, I can train you at home. You should be able to make extra money quick—a few weeks after starting. Men from all walks of life who worked

long, hard hours for low pay are becoming garage owners, foremen and superintendents. If you like autos—if you're between 15 and 55—get the facts now. "Job-Way" Training covers everything about autos—Mechanical and Electrical Work, Starting, Lighting, Ignition, Welding, Vulcanizing, etc.—Everything you need to get in line for a big money job as an Electrical and Mechanical Auto Expert.

It's the trained man who gets the good jobs and "Job-Way" Training is COMPLETE yet so simple, so easy that you get it quick.

## Send Coupon for FREE Auto Book

Get my FREE Auto Book. Learn how "Job-Way" Training has brought success to hundreds. See what it can do for you. Find out how my Employment Department helps you get a good job—about the three big outfits you get. Read my money-back agreement, "Other Special Services" and many other features.

**B. W. Cooke, Directing Engineer**  
**Motor Institute of America**  
Motor Institute Bldg. Dept. 5161  
EVANSTON, ILLINOIS  
(Chicago's Largest Suburb)



**Do It Now!**

Don't delay another day. Clip the coupon before you turn this page. Take the first step to a big-pay auto job. Now.

**B. W. Cooke, Directing Engineer,**  
**MOTOR INSTITUTE OF AMERICA,**  
Motor Institute Bldg., Dept. 5161, Evanston, Ill.

Send me your free auto book. I want to succeed in the auto business. Tell me about "Job-Way" Training—about your Employment Department and your 3 testing and repair outfits offer. No obligation on my part whatever.

Name.....

Address.....

Town..... State.....

Age..... Occupation.....



# NEED MONEY?

—here's a way to get it without  
having to pay it back!

**H**OW does this sound? . . . 25, 50, 75 per cent more than your present salary—possibly even two or three times the amount of money you're getting today—for the rest of your business life.

—not a loan—not an advance—nothing you have to return or pay back, but your own money—your cash to do with as you please.

Is it interesting? All right, here's the way:

Make an investment in the greatest, the surest profit-making possibility you ever heard of—your own self.

Train yourself definitely for the job ahead, or for a larger job somewhere else—build your ability to do more and make more for your employer.

Invest some of your spare time—at home—nights: the money cost compared to the possibilities of increasing your earning power is almost nothing.

Train under the LaSalle Problem Method—learn by doing—that's the interesting—the practical way.

Can you do it—are you fitted? Other men—average men—men from every walk of life and every vocation have increased their ability and their earnings through investing spare evening hours at home.

How would you like to have the experience these men have had? Here are a few striking cases out of thousands from our files who turned bleak futures into cash realities through LaSalle training.

## 250% Increase in Income

For instance, H. F. Lofquist, now a star Seattle salesman for Elliott-Fisher equipment, was working for an oil company—at a small salary and with little chance for promotion. Before completing half his LaSalle training in Higher

Accountancy, his income doubled and now it is 250 per cent larger.

Incidentally, sales contest prizes won by Lofquist have paid for his training several times.

## Doubled His Income

F. V. Tiernan of Washington, D. C., was employed by the Government—with little prospect for advancement. Passing a window in which was exhibited LaSalle training material, he stopped, investigated and enrolled for Modern Salesmanship.

Like Lofquist, his income jumped before he finished the training—and today it is 103 per cent greater than when he enrolled. More important, he sees even better prospects ahead.

## Now Has a Profession—and More Money

E. A. Bachman, now a successful attorney of Chattanooga, Tenn., was a clerk in a retail store—who found in LaSalle training the aid which enabled him to get full value and full reward for his ambition and industry. Against obstacles that would have stopped most men, he studied Law at home nights, passed the bar examination and began to practice.

## The First Step—Get the Facts

There's a coupon below for men who are sincerely interested in themselves. Men who want to get ahead and are willing to invest an evening or so a week for the sake of a permanently increased earning power.

You can't lose anything by sending—the time to act is when you have the urge. All you are doing is investigating—the judging comes after you have all the facts—and can't be done before. Mail the coupon now for full information—sent without cost or obligation.

# LaSalle Extension University

LaSalle Extension University, Dept. 164-R Chicago, Ill.

I would welcome an outline of the LaSalle training plan, together with a copy of "Ten Years' Promotion in One," all without obligation.

- |   |   |   |
|---|---|---|
| <input type="checkbox"/> Business Mgmt.     | <input type="checkbox"/> Industrial Mgmt.   | <input type="checkbox"/> Credit & Collection Correspondence |
| <input type="checkbox"/> Higher Accountancy | <input type="checkbox"/> Mod. Foremanship   | <input type="checkbox"/> Business English                   |
| <input type="checkbox"/> Expert Bookkeeping | <input type="checkbox"/> Personnel Mgmt.    | <input type="checkbox"/> Effective Speaking                 |
| <input type="checkbox"/> C. P. A. Coaching  | <input type="checkbox"/> Ry. Station Mgmt.  | <input type="checkbox"/> Comm. Spanish                      |
| <input type="checkbox"/> Mod. Salesmanship  | <input type="checkbox"/> Business Corres.   | <input type="checkbox"/> Traffic Mgmt.                      |
| <input type="checkbox"/> Law: LL. B. Degree | <input type="checkbox"/> Banking & Finance  |   |
| <input type="checkbox"/> Commercial Law     | <input type="checkbox"/> Railway Accounting |   |

Name.....

Present Position ..... Address.....



The leaders of the next ten years will be determined in the next ten months.

When writing to advertisers please mention Popular Mechanics

Copyrighted material



## New Easy Way to Learn Drawing

How you can earn big money in Commercial Art, Illustrating, Designing, or Cartooning, without being a "genius," and regardless of your present ability.

NEVER was there such a need for artists as today! Business needs thousands. Illustrated catalogs, advertisements, posters, circulars, trademark designs—countless pieces of art work are needed by the busy business world. 48,868 periodicals are published in America—every one of them needs the services of at least two artists for each issue. You can't begin to realize the gigantic amount of art work that must be done—and the demand is increasing daily. Big money is gladly paid—and big money is waiting for anyone with foresight enough to prepare for this pleasant profession. Regardless of your present ability, our easy method of teaching offers an opportunity to earn \$50 to \$200 a week.

### Learn in Spare Time

This new method is like a fascinating game. No matter how little you may know about drawing, no matter whether people tell you, "you have no talent," no matter what your present ability may be—we can train you. The new method simplifies everything—all the red-tape, "art for art's sake" teaching, and superfluous theory is taken out and in its place is put definite, practical instruction so that you may make money in the art game. The course is the work of men who have made practical successes in this field themselves. They know how Success and Progress are made in this Profession, and then guide you along these lines.

### Write for Big Free Book

An interesting and handsomely illustrated booklet, "Art for Pleasure and Profit," has been prepared and will be sent to you without cost if you mail the coupon below. Mail coupon NOW for this attractive free book and full details about our NEW ARTIST'S OUTFIT OFFER. No obligation whatever. Address, Washington School of Art, Dept. 5X, 1115—15th St., N. W., Washington, D. C.

WASHINGTON SCHOOL OF ART,  
Dept. 5-X, 1115—15th St., N. W., Washington, D. C.  
Send me, without obligation, free book, "Art for Pleasure and Profit." Also full particulars of Artist's Outfit Offer.

Name.....

Address.....

## BE A PASSENGER TRAFFIC INSPECTOR

### Both Bus and Railway

ADVANCEMENT rapid. Energetic, dependable men, 19 to 55, needed at once in the well-paid profession of TRAFFIC INSPECTION. Interesting, healthful, outdoor occupation offers opportunity for rapid progress in the transportation field—contact with important executives—travel or remain near home. Many S.B.T.I. graduates write us of their rapid advancement in pay after a few months' work. One man writes: "I received \$100 per month salary and think it was very liberal for a beginner." Another man writes that since he started in three years ago, he has climbed several rungs in the ladder and has acquired an executive position. We train men thoroughly in a few weeks' time by our home-study course, on completion of which we help place them in positions starting at \$120 to \$150 per month up, plus expense, or refund tuition. Thirteen years' experience and success explained in our free booklet. Do not delay making your start!

Standard Business Training Institute  
Div. 201 Buffalo, N. Y.



## LEARN WATCH REPAIRING



You can learn by our modern and original system of instruction every part of the Watch Repairing Trade at home as good or better than at a shop. You can earn money while learning and secure a well paying position or start in business after completing our course of instruction. Good watch repairers are always in demand and earn from \$50 to \$75 per week. For particulars apply to the Wisconsin School of Watch Repairing 524 E. Mason St., MILWAUKEE, WIS.

## UNIVERSITY OF CHICAGO

### HOME-STUDY COURSES

Continue your high-school, college or personal program of education. Teachers, Religious and Social Workers. Men and Women in many vocations are using the 450 courses in 45 different subjects to obtain guidance by experts for cultural and for practical purposes. The courses yield credit. Ask for free booklet.

627 ELLIS HALL THE UNIVERSITY OF CHICAGO CHICAGO, ILL.



## HOT PIANO

Ultra-modern Piano Jazz taught by mail. Note or ear. Easy rapid lessons for adult beginners. Also Self-instruction system for advanced pianists. Learn 358 Bass Styles, 976 Jazz Breaks, hundreds of Trick Endings, Hot Rhythms, Sock, Stomp and Dirt Effects; Symphonic and Wicked Harmony in latest Radio and Record Style. Write for Free Booklet.

WATERMAN PIANO SCHOOL, 1828 W. Adams St., Los Angeles, Calif.



Wonderful, new device, guides your hand; corrects your writing in a few days. Big improvement in three hours. No failures. Complete outline FREE. Write C. J. Osment, Dept. 34, St. Louis, Mo.

### MAIL FOR FREE INFORMATION

BEDFORD  
Y M C A  
TRADE  
SCHOOL

1115 Bedford Ave., Dept. PM-1a  
Brooklyn, N. Y.

Send me without obligation complete information on (check subjects).

- Caterpillar Tractor Mechanic
- Aviation Mechanic
- Flying
- Welding
- Auto Mechanic
- Radio Mechanic and Television
- Electrical

Name.....

Street & No.....

Town..... State.....

# WHY

## J. A. SETHER



### IS CHIEF ENGINEER OF THE HOTEL ST. GEORGE!

The Business Leaders of today are  
the I. C. S. Students of yesterday

HOTEL ST. GEORGE, in Brooklyn, is the largest hotel in Greater New York. It has 2632 rooms and 17 ballrooms.

The power plant in this hotel generates as high as 22,000,000 watt hours of electric current in one day.

The steam plant, which operates this electrical equipment, also operates the ice-making, refrigerating and ventilating systems. Another interesting feature of service is pumping salt water from underground artesian wells, at the rate of 1000 gallons per minute, into an enormous swimming pool, the largest indoor pool in New York City.

J. A. Sether, chief engineer, is in complete charge of these and other engineering operations at Hotel St. George.

"My salary is commensurate with my position, and it is many times what it was when I enrolled with I. C. S. I consider my course the best investment I ever made.

"Two of my four assistants are former I. C. S. students. I recommend I. C. S. Courses to all my ambitious employees."

Do you want to get ahead? Is lack of training the handicap that is holding you back? This coupon will bring the answer to your problem. Mark and mail it—today!

And remember this important fact: *The I. C. S. students of today will be the business leaders of tomorrow.*



"I owe my entire engineering training to the I. C. S. Steam-Electrical Course.

"At the time I enrolled I was only a helper in the engine room, working twelve hours a day, seven days a week, and found it very difficult to pay for my course out of my small wages, but the sacrifice and application to my studies have been repaid hundreds of times over."



*J. A. Sether*

## INTERNATIONAL CORRESPONDENCE SCHOOLS

"The Universal University" BOX 5577-G, SCRANTON, PENNA.

Without cost or obligation, please send me a copy of your booklet, "Who Wins and Why," and full particulars about the subject *before* which I have marked X:

### TECHNICAL AND INDUSTRIAL COURSES

- |  |   |  |  |
|--|---|--|--|
| <input type="checkbox"/> Architect                 | <input type="checkbox"/> Telegraph Engineer                           | <input type="checkbox"/> Aviation Engines                                | <input type="checkbox"/> R. R. Bridge and Building Foreman                   |
| <input type="checkbox"/> Architectural Draftsman   | <input type="checkbox"/> Telephone Work                               | <input type="checkbox"/> Automobiles Mechanic                            | <input type="checkbox"/> Air Brakes <input type="checkbox"/> Train Operation |
| <input type="checkbox"/> Building Estimating       | <input type="checkbox"/> Mechanical Engineer                          | <input type="checkbox"/> Plumbing <input type="checkbox"/> Steam Fitting | <input type="checkbox"/> Highway Engineering                                 |
| <input type="checkbox"/> Wood Millworking          | <input type="checkbox"/> Mechanical Draftsman                         | <input type="checkbox"/> Heating <input type="checkbox"/> Ventilation    | <input type="checkbox"/> Chemistry <input type="checkbox"/> Pharmacy         |
| <input type="checkbox"/> Contractor and Builder    | <input type="checkbox"/> Machinist                                    | <input type="checkbox"/> Sheet Metal Worker                              | <input type="checkbox"/> Coal Mining Engineer                                |
| <input type="checkbox"/> Structural Draftsman      | <input type="checkbox"/> Toolmaker                                    | <input type="checkbox"/> Steam Engineer                                  | <input type="checkbox"/> Navigation <input type="checkbox"/> Boilermaker     |
| <input type="checkbox"/> Structural Engineer       | <input type="checkbox"/> Patternmaker                                 | <input type="checkbox"/> Steam Electric Engineer                         | <input type="checkbox"/> Textile Overseer or Supt.                           |
| <input type="checkbox"/> Electric Wiring           | <input type="checkbox"/> Pipefitter <input type="checkbox"/> Tinsmith | <input type="checkbox"/> Civil Engineer                                  | <input type="checkbox"/> Cotton Manufacturing                                |
| <input type="checkbox"/> Electrical Engineer       | <input type="checkbox"/> Bridge Engineer                              | <input type="checkbox"/> Surveying and Mapping                           | <input type="checkbox"/> Woolen Manufacturing                                |
| <input type="checkbox"/> Electric Lighting         | <input type="checkbox"/> Bridge and Building Foreman                  | <input type="checkbox"/> Refrigeration                                   | <input type="checkbox"/> Agriculture <input type="checkbox"/> Fruit Growing  |
| <input type="checkbox"/> Welding, Electric and Gas | <input type="checkbox"/> Gas Engines                                  | <input type="checkbox"/> R. R. Locomotives                               | <input type="checkbox"/> Poultry Farming <input type="checkbox"/> Radio      |
| <input type="checkbox"/> Reading Shop Blueprints   | <input type="checkbox"/> Diesel Engines                               | <input type="checkbox"/> R. R. Section Foreman                           | <input type="checkbox"/> Marine Engineer                                     |

### BUSINESS TRAINING COURSES

- |  |  |  |  |
|--|--|--|--|
| <input type="checkbox"/> Business Management   | <input type="checkbox"/> Cost Accountant                                   | <input type="checkbox"/> Business Correspondence                             | <input type="checkbox"/> Grade School Subjects |
| <input type="checkbox"/> Office Management     | <input type="checkbox"/> C. P. Accountant                                  | <input type="checkbox"/> Lettering Show Cards <input type="checkbox"/> Signs | <input type="checkbox"/> High School Subjects  |
| <input type="checkbox"/> Industrial Management | <input type="checkbox"/> Bookkeeping                                       | <input type="checkbox"/> Stenography and Typing                              | <input type="checkbox"/> College Preparatory   |
| <input type="checkbox"/> Personnel Management  | <input type="checkbox"/> Secretarial Work                                  | <input type="checkbox"/> Complete Commercial                                 | <input type="checkbox"/> Illustrating          |
| <input type="checkbox"/> Traffic Management    | <input type="checkbox"/> Spanish <input type="checkbox"/> French           | <input type="checkbox"/> Civil Service <input type="checkbox"/> Mail Carrier | <input type="checkbox"/> Cartooning            |
| <input type="checkbox"/> Accountancy           | <input type="checkbox"/> Salesmanship <input type="checkbox"/> Advertising | <input type="checkbox"/> Railway Mail Clerk                                  | <input type="checkbox"/> Lumber Dealer         |

Name..... Age..... Address.....

City..... State..... Occupation.....

If you reside in Canada, send this coupon to the International Correspondence Schools Canadian, Limited, Montreal, Canada



## How I Stepped into a Big-Pay Hotel Job

BY *A. L. Cummin*

*Who in 4 Months, Without Experience,  
Became a Hotel Manager, with a 90%  
Increase in Salary.*

"I WAS idly looking over the pages of a magazine. Tired after a hard day at the garage in which I worked, dissatisfied with my salary, the lack of opportunity, long hours and unpleasant surroundings, my attention was drawn to an advertisement 'Hotels Call For Hundreds of Trained Men and Women.' I clipped the coupon and sent for a copy of the Free Book offered.

"Soon the Lewis Schools' book, 'YOUR BIG OPPORTUNITY,' arrived. Here was a profession that offered everything I wanted. Fascinating work amidst rich, luxurious surroundings, daily contact with the best people, more pay and unlimited opportunities. What a contrast to my garage work! I enrolled that evening.

"After completing one-third of the Course, I secured a Clerk's position. In less than FOUR MONTHS I was offered a position as Hotel Manager, with a 90% INCREASE IN SALARY!

"My success is due to the Lewis Hotel Training Schools and the assistance they gave me. I shall never regret the day I clipped the coupon and sent for their literature."

A. L. Cummin is typical of the thousands of Lewis-Trained men and women who have won quick success in the fascinating hotel, club, restaurant and institutional field—one of America's greatest industries. Our FREE Book, "YOUR BIG OPPORTUNITY," tells how to secure a well-paid position and explains how you are registered FREE of extra cost in the Lewis National Employment Bureau covering the country at 70,000 points through special arrangement with Postal Telegraph. Hundreds of graduates put in touch with positions. A. L. Cummin's story may be YOUR story—if you will make the same decision TODAY that he made a few months ago. Sign the coupon and MAIL IT NOW!

### LEWIS HOTEL TRAINING SCHOOLS

CLIFFORD LEWIS, President

ROOM EA-336 Washington, D. C.

- |   |   |  |
|---|---|--|
| <input type="checkbox"/> Manager          | <input type="checkbox"/> Chief Engineer   | <input type="checkbox"/> Accountant      |
| <input type="checkbox"/> Asst. Manager    | <input type="checkbox"/> Cashier          | <input type="checkbox"/> Auditor         |
| <input type="checkbox"/> Supt. of Service | <input type="checkbox"/> Purchasing Agent | <input type="checkbox"/> Sports Director |
| <input type="checkbox"/> Steward          | <input type="checkbox"/> Chief Clerk      | <input type="checkbox"/> Banquet Manager |

LEWIS HOTEL TRAINING SCHOOLS,  
Room EA-336, Washington, D. C.

Please send me FREE of charge and without obligation, details as to how to qualify for the hotel, club, restaurant and institutional field, by spare time study. I am particularly interested in the positions I have checked above.

Name.....  
Address.....  
City..... State.....

## Play the Hawaiian Guitar like the Hawaiians!

Only 4 Motions used in playing this fascinating instrument. Our native Hawaiian instructors teach you to master them quickly. Pictures show how. Every thing explained clearly.

**Play in Half Hour**  
After you get the four easy motions you play harmonious chords with very little practice. No previous musical knowledge needed.

**Easy Lessons**  
Even if you don't know one note from another, the 62 printed lessons and clear pictures make it easy to learn quickly. Pay as you play.

**GIVEN** when you enroll  
—a sweet toned

**HAWAIIAN GUITAR, Carrying Case and Playing Outfit—Value \$16 to \$20**

WRITE AT ONCE for attractive offer and easy terms. You have everything to gain. A postcard will do. ACT!

No extras—everything included

**COURSES** Tenor Banjo, Violin, Tiple, Tenor Guitar, Ukulele, Banjo Ukelele Order well known instructors.

**FIRST HAWAIIAN CONSERVATORY OF MUSIC, Inc.**  
9th Floor, Woolworth Bldg. Dept. 548 New York, N. Y.  
Approved as a Correspondence School Under the Laws of the State of New York—Member National Home Study Council

## Anyone CAN LEARN

No talent or experience necessary. Fascinating work. Pays big money. Complete instruction book tells about: Alphabets, Colors, How to Mix Paints, Show Cards, Window Board and Wall Signs, Ready made Letters, Gildings, Tricks of the Trade, also gives 100 Alphabets and Designs. Book bound in flexible imitation leather—gold edges, and four ball-bearing Show Card Pans. Sent postpaid \$3.00. (C. O. D. \$1.10 extra.) Ogilvie Pub. Co., 57 Rose St., Dept. 20, N. Y. City

**EARN MONEY IMMEDIATELY—  
WE FURNISH EQUIPMENT TO START!!**

## RADIO TELEVISION SOUND REPRODUCTION

World's Newest Big-Pay Big-Future Profession. Thousands of New Positions in an Uncrowded Field for Men who can Qualify. We offer Dependable Training at a Reliable School under High-Class Instructors on Complete Assembly of Up-to-the-Minute Equipment. We teach you right here in our Shops, not by Mail. Also Courses in Electricity, Automobiles and Welding.

COLEMAN ELECTRICAL SCHOOL, 1628-Z Main St., Kansas City, Mo.

## SONG WRITERS

Don't fail to read "Song Requirements of Talking Pictures, Radio and Records" an explanatory, instructive book SENT FREE on request. New writers may mail song-poems for free examination. We revise, compose and arrange music, and secure copyrights, guaranteeing approval.

P. M. Newcomer Associates, 1574 Broadway, New York

## LEARN WATCHMAKING

and become independent. We help you secure a position. Easy to learn. Send for FREE CATALOG.  
ST. LOUIS WATCHMAKING SCHOOL Dept. 5, ST. LOUIS, MO.

## GOV'T. POSITIONS SPLENDID SALARIES

WE HELP YOU GET ONE

Ry. Mail Clerk	Steno Typist
P. O. Laborer	Immigrant Insp
R. F. D. Carrier	Seamstress
Special Agent	Auditor
Customs Inspector	Prohibition Agt.
City Mail Carrier	U.S. Border
Meat Inspector	Patrol
P. O. Clerk	Chauffeur
File Clerk	Watchman
General Clerk	Skilled Laborer
Matron	Postmaster
	Typist

Age Range 18 to 50

Send me FREE particulars "How to Qualify" for positions marked "X". Salaries, Locations, Opportunities, etc. ALL SENT FREE.

Name.....  
Address.....

# Get Into One Of These BIG PAY FIELDS



Practical work on real  
Electrical machinery



Student working on Television  
transmitter in  
Coyne Radio Shops

## Amazingly Easy Way to Get Into ELECTRICITY

Dissatisfied with your job? Not making enough money? Then let me show you an easy way to get into Electricity, where thousands of Trained Men are drawing down Big Pay envelopes every week. Coyne has been training men for the Electrical Industry since 1899. **12 WEEKS' TRAINING HERE IN MY SHOPS WILL GIVE YOU THE START YOU NEED.**

### PRACTICAL WORK IN THE GREAT COYNE SHOPS

Come to Coyne in Chicago and learn one of these two great Trades the Quick and Practical way —By Actual Work On Actual Equipment. In the Electrical School you are trained on huge motors, generators, switchboards, auto and airplane engines, etc. No useless theory! Remember the average time to complete the Electrical Course

### FREE EMPLOYMENT SERVICE TO STUDENTS

When you complete the course, we'll do all we can to help you find the job you want. We employ three men on a full time basis whose sole job is to help secure positions for our students. And if you are a little short on funds, we'll gladly help you in finding part-time work while at school. Some of our students

### MAIL ONLY THIS COUPON FOR FREE ELECTRICAL BOOK

**H. C. LEWIS, President**  
**COYNE ELECTRICAL SCHOOL, Dept. 12-72**  
500 S. Paulina Street, Chicago, Illinois  
Gentlemen: Please send me your big Free Electrical Book, with 161 illustrations. This does not obligate me in any way.

Name.....  
Address.....  
City..... State.....

## Learn RADIO TELEVISION TALKING PICTURES

Prepare for jobs in Service Work, Broadcasting, Talking Pictures, Wireless Operating, etc. Get in on the ground floor of Television! Radio has grown in a few years from a mere experiment to a BILLION DOLLAR industry. Scores of jobs are open to the Trained Man. **PREPARE FOR THEM NOW BY 10 WEEKS OF ACTUAL SHOP WORK AT COYNE!**

is only 12 weeks. And in the Radio Course the average time is 10 weeks. Here we have complete Radio, Broadcasting, Television and Sound Reproduction equipment. Everything that is necessary to make your training complete, practical and resultful. And, you need no advanced education or previous experience at Coyne.

pay a large part of their living expenses that way. But get all the facts! Select the field you like best and mail one of the two coupons below. Let me send you either my Big Free Electrical Book or my Big Free Radio and Television Book. Mail only one coupon, but be sure to mail it at once!

### MAIL ONLY THIS COUPON FOR FREE RADIO BOOK

**H. C. LEWIS, President**  
**RADIO DIVISION, COYNE ELECTRICAL SCHOOL**  
500 S. Paulina St., Dept. 12-3H Chicago, Ill.  
Gentlemen: Send me your Big Free Radio, Television and Talking Picture Book. This does not obligate me in any way.

Name.....  
Address.....  
City..... State.....

When writing to advertisers please mention Popular Mechanics

# STEAM-ENGINE GIVEN

Here's our special "Little Hercules" Steam Engine. Made by "Weeden," world's leading maker. Fine quality and high finish. Has heavy fly-wheel, pulley-wheel, easy acting piston, and heavy cylinders. Strong boiler and fittings. Has fire box. Runs by alcohol or canned heat. Will run mechanical toys like Erector, Meccano. A big, high quality steam engine—powerful—just what you have been waiting for and you can have it FREE.

## The Magazine of Thrills

The Open Road for Boys magazine has fifty pages crammed with thrilling, breath-taking stories that will hold you spell-bound. Tense stories of high adventure on land, on sea and in the air. Deep mystery. Suspense. "The Inca's Treasure House"—the most thrilling adventure serial in

years, now starting. 12 thrilling issues! Regular subscription price alone \$1.00 a year. We'll send you The Open Road for Boys magazine for a whole year for \$1.00 and this dandy steam engine FREE! Wow! What a bargain.



**\$1**  
*Both together*

## MAIL COUPON TODAY

The Open Road for Boys  
Fire Chief  
130 Newbury Street  
Boston, Mass.

This Offer Good Only  
in the United States

You bet I'll grab that bargain. Here's my \$1.00. Rush the Steam Engine right out to me and put me down for a year's subscription to The Open Road for Boys Magazine.

Name.....

Street.....

City..... State.....

## BIG OPPORTUNITIES in PHOTOGRAPHY



### TO MAKE MORE MONEY

Interesting work, splendid demand everywhere for men and women. No previous experience needed. Expert instructors prepare you for the branch you like best—at home in spare time, or in our great New York studios.

#### Send for FREE Book

It tells all about the varied opportunities. Check which interests you most:

- Motion Picture Photography and Projection.
- Still Photography (Portrait, Commercial, News) and Photo-Finishing. WRITE TODAY.

NEW YORK INSTITUTE OF PHOTOGRAPHY  
Dept. 49 10 West 33rd St. New York, N. Y.

## FREE CATALOG OF PRACTICAL BOOKS...

Complete description of Drake books, covering RADIO, AVIATION, ENGINEERING, AUTOMOBILE WORK, BATTERY WORK, ELECTRICITY, BUILDING, SHEET METAL WORK, PAINTING, SIGN MAKING, LETTERING, COMMERCIAL ART, will be sent to you on request.

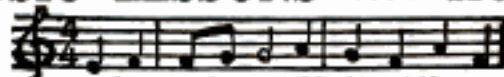
Frederick J. Drake & Co.  
181 N. Michigan Blvd. Chicago

## EARN MONEY AT HOME

YOU can make \$15 to \$50 weekly in spare or full time at home coloring photographs. No experience needed. No canvassing. We instruct you by our new simple Photo-Color process and supply you with work. Write for particulars and Free Book to-day.

The IRVING-VANCE COMPANY Ltd.  
356 Hart Building, Toronto, Can.

## MUSIC LESSONS IN YOUR HOME



You can play music like this quickly

Write today for our FREE BOOKLET AND DEMONSTRATION LESSON. It tells how to learn to play Piano, Organ, Violin, Mandolin, Guitar Banjo, etc. Beginners or advanced players. You pay as you learn. Costs you only a few cents a day. Thousands of satisfied students. AMERICAN SCHOOL OF MUSIC, 51 Manhattan Bldg., CHICAGO

DENISON'S Musical Comedies, Operettas, Vaudeville Acts, Minstrels, Comedy Songs, Make-up Goods.

56  
YEARS  
OF HITS

Catalog Free  
T.S. Denison & Co. 623 S. Wabash, Dept. 9, Chicago

## Stop Slamming Doors EARN UP TO \$15 Daily!



Kant-Slam Door Check is an amazing new invention that closes all doors silently and automatically. Closing speed easily adjusted by turning screw at top of check. Holds doors open when wanted open. Operates on new oil principle. Low priced. Everlasting. Easily installed in 10 minutes. Never needs attention.

A REAL DEMONSTRATOR Furnished Every Agent! You get orders quickly demonstrating actual sample on easy to carry miniature door. Every office, factory, store, institution and public building needs a Kant-Slam for every door. Rush name and address for details of amazing money making opportunity. Demonstrator FREE  
KANT-SLAM DOOR CHECK CO.  
Dept. T-7, Bloomfield, Ind.  
to WORKERS

When writing to advertisers please mention Popular Mechanics

**CHANCE of a LIFETIME  
TO GET INTO . . .**

# ELECTRICITY

**PANICS** have not cut salaries in the fastest-growing, most prosperous of industries. The facts and figures will amaze you. Here is the greatest opportunity open to ambitious men today.

The millions of men employed in **ELECTRICITY** are not worrying about losing their jobs, or cuts in wages. It doesn't matter what conditions are in other lines—we still use electric light and power—we are building and buying more electric refrigerators than ever before—we have not given up riding on electric street cars—or telephoning—or telegraphing.

So if you are looking for a line that has both a permanent future as well as a secure present—we invite you to investigate **ELECTRICITY**—get a list of the positions open—the salaries paid—the industries that depend on Electricity for light, power and automatic controls—the whole astonishing array of facts and figures that will give you a new idea of your chances in the future of Electricity.



E. B. Aikman, Ardmore, Okla.—"Through your employment department I accepted a position with the Oklahoma Gas and Electric Company and it is entirely satisfactory to me."



Amos S. Hamish, Wilkesbarre, Pa.—"In spite of hard times I have secured employment with Edison Electric Company learning to operate. I only realize how deep the electrical game is. I wish to thank you very much."

## Office and Factory Men Under 35— WANTED!

Practically ALL companies in all lines need men with Electrical training. Refrigeration, railroad, automobiles, steel mills, paper plants, mines, road-building, manufacturers in all industries are employing the men we prepare. All you need is a little training in Electrical Engineering principles, which we will give you at home, in your spare time. Whatever experience you have now in office or factory—whatever education—won't be wasted. You can move ahead from where you are now. Depression or prosperity—we can promise to help place you in a satisfactory position under money-back penalty! (Read contract at the right.)

### You Can Save Money If You Investigate Now!

We recommend Electricity above all other lines because electrical light, power and conveniences have become a necessity in everybody's life—in home, office, factory and farm. And its future is as solid as the nation itself.

Right now we are making the most astonishing money-saving offer in our 35 years of existence. Monthly payments sharply reduced to encourage more men under 35 to prepare for the coming expansion of the electrical industries. Savings up to \$47.85 cash. So if you are dissatisfied with your present earnings, or worried about your job—here is your chance to get a better-paying position as well as to make your future safe. Just mail the coupon for complete information.

# The American School

Dept. E-147

Drexel Ave. &amp; 58th St.

Chicago

**SAVE  
UP TO  
\$47.85**

American School

### Read These 4 Guarantees

1. Guarantee of complete, up-to-date training prepared by noted engineers.
2. Guarantee to help you get a job when you're only half way through the course.
3. Guarantee of tuition credit for previous education and experience.
4. Guarantee of money back after you finish if you are not satisfied.



*As Milligan*

**LESSON FREE**—to prove that you can learn quickly and easily at home in your spare time. Also Electrical book of facts, free. Just mail coupon.

AMERICAN SCHOOL, Dept. E-147, Drexel Ave. & 58th St., Chicago, Ill. Please send free money and tell me about your money saving offer in line marked X below.

#### ELECTRICITY

- |   |   |
|---|---|
| <input type="checkbox"/> Architecture           | <input type="checkbox"/> Shop                   |
| <input type="checkbox"/> Building               | <input type="checkbox"/> Superintendent         |
| <input type="checkbox"/> Drafting               | <input type="checkbox"/> High School in 2 years |
| <input type="checkbox"/> Business Management    | <input type="checkbox"/> Structural Steel       |
| <input type="checkbox"/> Accounting             | <input type="checkbox"/> Civil Engineering      |
| <input type="checkbox"/> Mechanical Engineering | <input type="checkbox"/> Auto Engineering       |
|   | <input type="checkbox"/> Highway Engineering    |

Name.....  
St. No.....  
City..... State.....  
Age..... Occupation.....

# More Money



## Be a Trained Radio Expert

If you're earning a penny less than \$50 a week, get my free book of information about the opportunities in Radio. Many trained Radio Experts are needed every year in more than twenty different lines of this new and growing profession. Why go along at \$25 or \$35 or \$45 a week all your life? Study Radio and after only a short time land yourself a REAL job with a REAL future! Be a man who has money in his pocket and in the bank—don't scrimp and scrape for the rest of your days.

## Many Make \$50, \$75 and \$100 a Week

Broadcasting stations use engineers, operators, station managers and pay \$1,200 to \$5,000 a year. Manufacturers continually need testers, inspectors, foremen, engineers, service men, buyers, for jobs paying up to \$7,500 a year. Shipping companies, police departments, commercial land stations, aircraft companies, pay Radio operators well. Dealers and jobbers are always on the lookout for good service men, salesmen, buyers, managers and pay \$30 to \$100 a week for good men. Talking movies pay as much as \$75 to \$200 a week to men with Radio training. There are openings almost everywhere to have a spare-time or full-time Radio business of your own—to be your own boss. Radio offers many other opportunities. My book tells you about them.

## READ WHAT THESE GRADUATES SAY

J. G. Dahlstead, Radio Station KYA, San Francisco, Calif., writes "I had 15 years as a traveling salesman but could see the opportunities in Radio. I made more than \$400 each month. I can't say too much for your school." E. E. Winborne, 1267 W. 48th Street, Norfolk, Va., writes, "My earnings seldom fall under \$100 a week. If your course cost four or five times more I would still consider it a good investment." J. A. Vaughn, Grand Radio & Appliance Co., 3107 S. Grand Blvd., St. Louis, Mo., writes "I had the pleasure of earning \$110 last week servicing and selling sets. I have made as high as \$241 in two weeks. Before I entered Radio I was making \$35 a week.

## SPECIAL FREE OFFER

Act now and receive in addition to my big free book "Rich Rewards in Radio," this Service Manual on D.C., A.C., and Battery operated sets. Only my students could have this book in the past. Now readers of this magazine who mail the coupon will receive it free. Overcoming hum, noises of all kinds, fading signals, broad tuning, howls and oscillations, poor distance reception, distorted or muffled signals, poor Audio and Radio Frequency amplification and other vital information is contained in it. Get a free copy by mailing the coupon below.



Broadcasting Stations offer fascinating jobs paying from \$1,200 to \$5,000 a year.



Radio factories employ thousands. Salaries for well trained men range from \$1,800 to \$5,000 a year.



Spice store set servicing is paying N. H. L. over \$200 to \$1,000 a year in spare time. Earnings begin after studying.



Operating on board ship gives you world-wide travel, board and lodging free and a salary of \$85 to \$150 besides.



When writing to advertisers please mention Popular Mechanics



# for you in Radio

## Learn Quickly, Easily Train at Home in Spare Minutes

Stay home! Hold your job! I'll bring your Radio training to you, and you can learn in your spare time after work. No need to go to a strange city and live for months at big expense. You study in the quiet of your own home. As for this training—it's written just as I would talk—in straight-forward, everyday, understandable language. You'll get it, and you'll get it quickly—in a few months' spare time—because I've made it so clear and interesting! No particular education needed—lots of my successful students didn't finish the grades.

## Many Earn \$10, \$20, \$25 Weekly Right Away "On the Side"

The day you enroll with me I'll show you how to do 28 jobs, common in most every neighborhood, for spare time money. Throughout your course I send you information on servicing popular makes of sets; I give you the plans and ideas that are making \$200 to \$1,000 for hundreds of N.R.I. students in their spare time while studying. My course is famous as the one that pays for itself. G. W. Page, 2210 Eighth Ave. So., Nashville, Tenn., writes: "I picked up \$935 in my spare time while taking your course."

## 64-Page Book Sent Free for the Asking

Get your copy today. It tells you where Radio's good jobs are, what they pay, tells you about my course, what others who have taken it are doing and making. Find out what Radio offers you, without the slightest obligation. **ACT NOW!**

**J. E. Smith, Pres. NATIONAL RADIO INSTITUTE  
Dept. 2AP, Washington, D.C.**

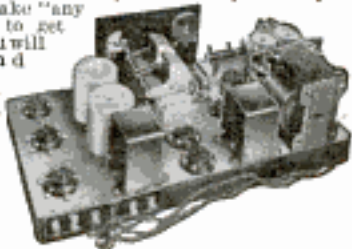
### Your Money Back If Not Satisfied

That is the agreement I make with you. I am so sure that I can satisfy you that I will agree to return every penny of your money if, after completion, you are not satisfied with the Lesson and Instruction Service I give you. Could anything be fairer?



## . . . You Get Extensive Practical Experience with the Outfits I Give You

With me you not only get the theory of Radio—you also get practical Radio experience while learning. You can build over 100 circuits—build and experiment with the circuits used in Atwater-Kent, Majestic, Crosley, Evershield, Stewart-Warner, Philco and many other sets. These experiments include A.C. and screen grid sets, push pull amplification and other late features. When you finish my course you won't need to take "any old job" just to get experience—you will be trained and experienced ready to take a responsible job in the Radio field of your choice—a good job with a real future.



## I Help You Specialize Through My 5 New Advanced Courses

My training not only gives you a thorough knowledge of Radio—all you need to get and hold a good job—but, in addition, you may take any one of my new advanced courses without extra charge. They are:

**TELEVISION  
AIRCRAFT RADIO  
BROADCASTING  
Commercial and Ship Radio Stations  
SOUND PICTURES AND PUBLIC  
ADDRESS SYSTEMS  
ADVANCED RADIO SERVICING AND  
MERCHANDISING**

"Rich Rewards in Radio" gives you an outline of these courses. Get a copy. See for yourself how valuable this new idea in Home Study Training can be to you.

## Clip and mail NOW for FREE INFORMATION

J. E. Smith, President,  
National Radio Institute, Dept. 2AP,  
16th and U Sts., N. W., Washington, D. C.

Dear Mr. Smith: I want to take advantage of your special free offer. Send me your two books "Rich Rewards in Radio" and "Trouble Shooting in D.C., A.C. and Battery Sets." I understand this request does not obligate me and that no salesman will call.

Name .....

Address ..... Age.....

City..... State.....

When writing to advertisers please mention Popular Mechanics

Copyrighted material

# TURN YOUR WORKSHOP INTO MONEY



Now you can put your hobby to work and make it pay big dividends. Blueprints for 300 practical, tested projects make it possible to earn a profit in your spare time. There is always a big demand for novelties, simple toys and home furnishings that you can turn out with little effort using few tools. You will find great pleasure and profit in making some of these articles for your own home, friends and neighbors. Many small businesses have been built-up in this way.

## 300 PRACTICAL-ACCURATE-EASY-TO-READ BLUEPRINTS GIVE YOU WIDE CHOICE

Every project listed has been built and thoroughly tested in Popular Mechanics Model Workshop. Special care has been taken in designing these articles so that all materials needed can be easily and cheaply obtained. By following the blueprints carefully anyone can turn out well-finished articles—all dimensions and necessary details are on every blueprint.

### BOAT BUILDING

- SN 524 and SN 525—12-ft. Sailing Skiff
- SN 571—12-ft. Racing Hydroplane
- SN 633—16-ft. Iceboat
- SN 688 and SN 689—Aero-boat
- SN 707—12-ft. Rowboat

### CRAFT WORK

- SN 530—Waste-paper Baskets
- SN 533—Pirate Tobacco Chest
- SN 540—Hand-wrought Book Ends
- SN 550—Pierced-metal Entrance Lantern
- SN 667—Etched-copper Trays
- SN 677—Miniature Japanese Garden

### ELECTRICAL

- SN 522—Simple Sunshine Arc Lamp
- SN 679—Electric Soldering Iron and Electric Heater

### MACHINES

- SN 560—Vertical Spindle Sander
- SN 579—Belt Sander
- SN 605—Homemade Shaper
- SN 609—10-in. Drum Sander

### PLAYGROUND AND GYMNASIUM

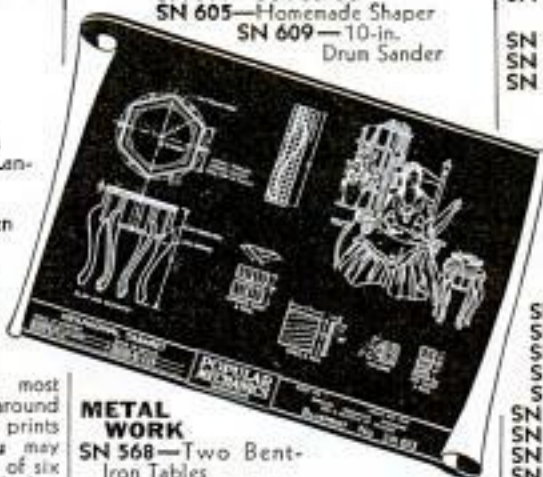
- SN 564—Wobble-Go-Round
- SN 698 and 699—Gymnasium Apparatus

### TOYS

- SN 511—Toy Donkeys That Walk
- SN 514—Flying Dragon Kite
- SN 555—Fighting Saurians Toy
- SN 575—Wedding-Duck Toy
- SN 582—Windmill and Horse Toy
- SN 585—Crazy-Clown Toy
- SN 626—Toy Submarine

### WOODWORK

- SN 500—Revolving Book Stand
- SN 501—Colonial Grandfather Clock
- SN 505—Inlaid Backgammon and Checker Board
- SN 515—Drop-leaf, Pivot-top Table
- SN 518—Electric Banjo Clock
- SN 521—Smoking Stand
- SN 526—Queen Anne Coffee Table
- SN 528—Phyfe Console Table
- SN 529—Lawn Chair
- SN 593—Bric-a-brac Shelves
- SN 598—Bird-house Suggestions
- SN 602 to 604 incl.—Colonial Spinning Wheel
- SN 620—Cabinet Work Bench
- SN 624—Spiral Candlesticks
- SN 639—Lattice Suggestions
- SN 640—Ornamental Wood Fences
- SN 649—Magazine Stand
- SN 650—End Table
- SN 651—Kitchen Wall Case
- SN 652—Priscilla Sewing Cabinet
- SN 661—Child's Rocking Horse
- SN 666—Tea Cart
- SN 676—Folding Drawing Tables
- SN 694—Spanish Radio Bench



### METAL WORK

- SN 568—Two Bent-Iron Tables
- SN 614—Bent-Iron Floor Lamps
- SN 642—Hammered-Copper Letter Box

### MODEL MAKING

- SN 664—27-in. Model Racing Yacht
- SN 709 to 714 incl.—Flying Cloud Ship Model
- SN 717 and 718—Half Moon Ship Model
- SN 719 to 721 incl.—Scale Model of Ford Tri-motored Plane
- SN 729 to 734 incl.—Horizontal Steam Engine and Boiler
- SN 755 and 756—U. S. S. Constitution
- SN 759—Santa Maria

Size of blueprint—17"x22", most convenient for handling around the work bench. Single prints are 25c each but you may order any assortment of six for \$1.00 postpaid. Just list numbers on the coupon and mail with remittance. A sample blueprint sent for coupon and six cents.

POPULAR MECHANICS BLUEPRINT DEPT.  
300 East Ontario St., Chicago, Ill.  
Mail me at once Blueprints Nos. \_\_\_\_\_  
 Sample Blueprint 6c.  
Name \_\_\_\_\_  
Address \_\_\_\_\_  
City \_\_\_\_\_  
State \_\_\_\_\_

\$1.00

Only a Few of Popular Mechanics Blueprints  
Complete List Free on Request

When writing to advertisers please mention Popular Mechanics



National Salesmen's Training Association,  
Dept. A-104, N.S.T.A. Bldg.,  
Chicago, Ill.

Without cost or obligation you may send me your free book, "The Key to Master Salesmanship."

Name.....

Address.....

City..... State.....

Age... Occupation.....

# They Laughed When I Mailed This Coupon

*..But It Brought Me The Book That Showed Me How to Make \$10,000 a Year!*

As I walked up to the mail box, Joe nudged Ed and winked broadly for my benefit.

"Sh!" he hissed in a loud stage-whisper. "This is going to be the big turning point in Frank Parker's life! He's writing for a book that tells how to get into salesmanship. Pretty soon he'll be earning so much that he'll make the rest of us look like pikers!"

Ed sneaked. "Won't it be grand!" he grinned. "Now he can quit punching time-clocks and eating 40-cent lunches." He raised his voice. "Drop me a postal sometime when you get out into the big business and start making \$10,000 a year, will you, Frank?"

They both laughed uproariously. And probably it did seem like a joke to them that a \$30 a week clerk would have the nerve to think he could ever get anywhere or make real money without some special "gift" or "pull."

But they laughed too soon. Just yesterday I sat down and wrote to Ed, who is still at the shop, dragging along at the same old job. "Dear Ed"—I wrote. "You asked me to send you a card when I 'got into big business and started making \$10,000 a year.' Well, here's your card. Yesterday I was promoted to the job of assistant Sales Manager of the Western Metal Works, at a salary that goes with it. I'll lend you my copy of that book on salesmanship you used to think was such a joke."

Only a book! Just seven ounces of paper and printers' ink—but it contains one of the most vivid and inspiring messages that any ambitious man can read. It reveals the real truth about the art of selling, explains the science of selling in simple terms, and tells exactly how the great sales records of nationally-known star salesmen are achieved. And not only that—it outlines a simple plan that will enable almost any man to master scientific salesmanship without spending a moment on the road—without losing a day or a dollar from his present position.

## A Few Weeks—Then Bigger Pay

Reason it out for yourself. Salesmanship offers bigger returns and delivers them quicker than any other line of work under the sun. But many people have subscribed to the foolish notion that a man has to be "born" with some sort of "gift" for salesmanship. Nothing could be farther from the truth. Just like any other profession, salesmanship is governed by certain fundamental rules

and laws—laws which you can master as easily as you learned the alphabet.

Right now an unusual demand for salesmen is being reported. City and traveling sales positions are open in nearly every line all over the country. Last year requests for trained men were received from many firms in all quarters. This employment service is free to both employers and employees, and thousands have secured excellent positions this way.

## Free to Every Man

See for yourself why "The Key to Master Salesmanship" has been the deciding factor in the careers of so many men who are now making \$10,000 a year. See how A. C. Wallahan of Huron, So. Dakota, used this training to become District Manager for his firm at a 400% pay increase. Find out how G. T. Patterson of Stillwater, Okla., left a small-pay job for a position that paid him up to \$550 a month. Learn for yourself the REAL truth about the art of selling! If we were asking \$2 or \$3 a copy you might hesitate. But the book is now FREE. You do not risk one penny nor incur the slightest obligation. And since it may alter your entire future, it certainly is worth your time to fill out and clip the coupon at the top of this page. Why not do it now!

National Salesmen's Training Association

Dept. A-104  
N. S. T. A. Bldg. Chicago, Ill.



Where Shall  
We Send Your  
Copy FREE?

MAIL COUPON ABOVE TODAY

When writing to advertisers please mention Popular Mechanics

# 90 Days the PRACTICAL WAY... then an

Remarkable  
Tuition Offer  
for Short  
Time Only



Complete  
RADIO  
COURSE

# ELECTRICAL JOB

Complete  
AUTOMOTIVE  
ELECTRICAL  
COURSE

## at Big Pay

Railroad Fare Paid to Cleveland

**\$40 to \$100 a Week**

MAIL COUPON TODAY  
For Big, illustrated 48-Page **FREE BOOK**

Not a Correspondence Course—No Books—No Lessons

J. H. McSweeney, Pres.,  
McSweeney Electrical Schools,  
Dept. E-10-1, Cleveland, Ohio

Dear Mac: Without obligation, send me a copy of your  
big book on **ELECTRICITY**, also details of *Special Limited  
Tuition Offer*.

Name.....

Address.....

Town..... State.....

# McSWEENEY

## ELECTRICAL SCHOOLS

Dept. E-10-1 CLEVELAND, OHIO



# DRAFTING

**BOOKS SENT FREE!**

—ON APPROVAL—

**5 Volumes Brand New Edition**

Only 15 minutes a day with these WONDER BOOKS will prepare you for a good drafting job in less than a year. Mechanical and architectural drafting from simple straight lines to important complex plans. A step at a time! Built especially for beginners, for men with only grammar schooling. Drafting room practice, PLUS ENGINEERING, made easy and clear. Includes complete course in blue-print reading.

**Big Field Big Demand Big Pay**

Competent draftsmen are urgently needed right now in all building and manufacturing lines at \$50.00 to \$100.00 a week. That's just the beginning—FOR DRAFTSMEN HAVE THE BEST CHANCES FOR ADVANCEMENT. Pleasant, fascinating work, easy to learn and do. Learn quickly with these books—send coupon for a set FREE and see for yourself.

A year's consulting membership in the American Technical Society now given free to all readers of this famous syndicated series of drafting. Many say that it is worth more than the cost of the books.

Complete set of drawing instruments if you send for these drafting books NOW. These instruments are made of the finest of German silver, are absolutely accurate and are packed in velvet lined leatherette pocket case. Real \$10 value, but free to you with these books.

**AMERICAN TECHNICAL SOCIETY**  
Dept. D-115, Drexel at 58th St., Chicago, Ill.



American Technical Society, Dept. D-115, Drexel at 58th St., Chicago, Ill. Send for 10 days' free use New 5 volume set of drafting. I will pay the few cents delivery charges. If I wish, I may return books in 10 days and owe you nothing but if I decide to keep them I will send \$2.00 after 10 days, then only \$2.00 a month, until \$10.00, the special introductory price, is paid. Send Brand New edition and include drawing instruments.

Name.....  
Address.....  
Employer's.....  
Address.....



**GET THIS** Free new No. 23 Edition of our **RADIO SERVICE TREATISE**. Contains some 75 new booklets, circuit diagrams; over 350 illustrations. **POSITIVELY THE GREAT-EST BOOK EVER PUT OUT.**

CONTENTS: VACUUM TUBE TREATISE, with many illustrations; Vacuum Tube Average Characteristics Chart; How to Take Care of Your Tubes. Phonograph Pick-ups. Connecting Additional Loud Speakers; all fully illustrated with diagrams. Modernizing Old Radio Sets; How to Convert Battery to Power Sets; Vacuum Dividers; Selecting and Installing Replacement Parts in Radio Sets. **WRITE TODAY.** Enclose 2 cents for postage. Treatise sent by return mail.

**RADIO TRADING COMPANY**  
29 West Broadway New York City

## Learn to Dance

You can learn all the modern dances—the latest Tango steps, the new Fox Trots, dreamy Waltzes, smart Collegiate Steps, and popular Society Steps at home, easily and quickly. New chart method makes dancing as simple as A-B-C. No music or partner required. Don't be a wallflower. Learn to dance. Complete course—285 pages, 64 illustrations, sent on 5 Days' Free Trial. Equals \$20.00 course. Send no money. Pay postman only \$1.95, plus postage upon arrival. Money back if not delighted. Catalog Free.



Franklin Pub. Co., 800 No. Clark St., Dept. 9437, Chicago



**WHY NOT** spend Spring, Summer and Fall gathering butterflies, insects? I buy hundreds of kinds for collections. Some worth \$1 to \$7 each. Simple outdoor work with my instructions, pictures, price-list. Send 10 cents (not stamps) for my illustrated Prospectus before sending butterflies.

**MR. SINCLAIR, DEALER IN INSECTS**  
Dept. 6, Box 1424, San Diego, Calif.

## 1000 POULTRY SECRETS

Our famous home-study Poultry Course teaches how to get more eggs, cut feed bills, avoid losses. Methods used by successful Poultry raisers the world over. FREE Book tells all about Course. Write today for your free copy. National Poultry Institute, Dept. 411-E, Washington, D. C.



When writing to advertisers please mention Popular Mechanics



... say these

## Leading Radio Manufacturers

Millions of people have learned that the names below stand for the very highest possible quality in Radio design, manufacture and performance. Now, after a thorough examination and investigation by their engineers, these great companies have put their stamp of approval on R.T.I. Training. They have endorsed this training and recommend it to all men who want to make good in Radio.

- ... .
- BOSCH**—United American Bosch Co.
- BRUNSWICK**—Brunswick Radio Corporation
- BALKEIT**—Balkeit Radio Corporation
- CROSLEY**—Crosley Radio Corporation
- CLARION**—Transformer Corporation of America
- DEFOREST**—DeForest Radio Co.
- FADA**—F. A. D. Andrea, Inc.
- HOWARD**—Howard Radio Co.
- KENNEDY**—Colin B. Kennedy Co.
- MAJESTIC**—Grigsby-Grunow Co.
- PHILCO**—Philadelphia Storage Battery Co.
- SILVER-MARSHALL**—Silver-Marshall, Inc.
- STROMBERG-CARLSON**—Stromberg-Carlson Telephone Mfg. Co.
- SENTINEL**—United Air Cleaner Corporation
- ZENITH**—Zenith Radio Corporation
- R. T. I. Training is also endorsed by these Radio Trades Associations:
- RADIO TRADES ASSOCIATION**—St. Louis, Mo.
- RADIO SERVICE MANAGER'S ASSOCIATION**—New York
- MUSIC AND RADIO TRADES ASSOCIATION**—Salt Lake City, Utah

# An OPPORTUNITY TOO GOOD TO MISS

Ambitious \$20 to \$40 a week men who want to earn \$50 to \$75 a week and more, will be interested in this message.

The great Radio Industry, because of its amazingly rapid growth, is today very much in need of TRAINED men to fill its more responsible jobs. These are the better-paying jobs in Radio... those which give steady work at good pay, as a starter, and early advancement to still better-paying jobs, as a future.

But to qualify for these better jobs men must know Radio as they know their A B C's. They must know the theory of Radio, as well as the practical side, and be able to teach other men some of the things they know. The day of the tinkerer or amateur mechanic in Radio is gone... and gone forever. What the industry wants today... what it is demanding... is TRAINED men. And men now doing Radio work will either have to get their training at once or make way for TRAINED men from the outside.

The Radio Industry urges men to get the training they need, but it has no time or facilities to train them itself. So with the co-operation of leading Radio manufacturers and Trade Associations, the Radio and Television Institute was organized to train them at home... no matter where they live... in their spare time... easily and quickly... and at a cost of only a few cents a day.

The Institute's Course of home-training was planned, written and is actually supervised by an Advisory Board, made up of prominent and highly paid Radio Engineers and Executives, each actively connected with some large Radio concern. That means R.T.I. Trained Men are trained right, because the members of this board, through their Radio connections, know exactly what the industry needs in the way of trained men, and they are pledged to see that every R. T. I. student is trained to meet that need.

Radio service and installation work is just the starting point in R.T.I. Training. It prepares men for the more important positions in Radio and the Sound Picture field, and gets them ready for the new positions being created, or to be created, through new uses of Radio



- Offered in the World's Fastest Growing Business

principles in the amazing new field of Electronics. This feature alone makes R.T.I. the one outstanding home training.

Because it is so practical... so helpful... so thorough and complete... many of the largest and best known Radio Manufacturers... whose names are listed to the left... have unqualifiedly endorsed R.T.I. Training and are recommending it not only to their own men, but to all men who want to make good in Radio.

So if you are ambitious... if you are not progressing as fast as you would like... if you want to get into work where the future is certain... learn what Radio and its sister industries has to offer. Find

out more about this amazingly easy course of home training, and more about the wonderful opportunities for TRAINED men in this... the world's fastest growing industry. Everything is fully explained in the

**RADIO BOOK OF FACTS AND OPPORTUNITIES**

Send today for your copy. The book is free.

### The Electronic Field

"Radio"... as most folks know it today... is only one part of a tremendous and amazing new field called "Electronics". The R. T. I. book of facts tells all about it. Industrial Radio... Television... Talking Pictures... and all the new uses for vacuum tubes and photo-electric cells are included and are fully explained.

**RADIO and TELEVISION INSTITUTE, Dept. 11 2130 Lawrence Ave., Chicago**

Without obligation of any kind please send me a copy of the "Radio Book of Facts and Opportunities." I am interested in your home-training and the opportunities you say exist in the great field of Radio, for "trained" men.

NAME.....

ADDRESS.....

When writing to advertisers please mention Popular Mechanics

## former laborer now earns \$20,000 a year



"Yes, that's all I was — just an ordinary laborer, working for the highway department in my state. I was young and had ambition, it's true, but I had no special training and had left school early because of family reasons. One day I was talking to the superintendent and asked him how a man got ahead in the construction business. He told me that he had taken a Highway Engineering Course with the International Correspondence Schools when he was a young man, and suggested I do the same thing.

"I did. I stuck to my spare-time study and finished it. After that I made real progress.

"Today I am a road contractor in my own right. Last year my net profit was \$20,000. And I give much of the credit to I. C. S."

Does this *true* experience suggest an idea to you? Trained men get ahead today — why not be a trained man? Mark and mail the coupon, today!

### INTERNATIONAL CORRESPONDENCE SCHOOLS "The Universal University" Box 5580-G, Scranton, Penna.

Without cost or obligation, please send me a copy of your booklet, "Who Wins and Why," and full particulars about the subject before which I have marked X:

#### TECHNICAL AND INDUSTRIAL COURSES

- |  |  |
|--|--|
| <input type="checkbox"/> Architect   | <input type="checkbox"/> Automobile Mechanic                                 |
| <input type="checkbox"/> Architectural Draftsman                             | <input type="checkbox"/> Plumbing <input type="checkbox"/> Steam Fitting     |
| <input type="checkbox"/> Building Estimating                                 | <input type="checkbox"/> Heating <input type="checkbox"/> Ventilation        |
| <input type="checkbox"/> Wood Millworking                                    | <input type="checkbox"/> Sheet Metal Worker                                  |
| <input type="checkbox"/> Contractor and Builder                              | <input type="checkbox"/> Steam Engineer                                      |
| <input type="checkbox"/> Structural Draftsman                                | <input type="checkbox"/> Steam Electric Engineer                             |
| <input type="checkbox"/> Structural Engineer                                 | <input type="checkbox"/> Civil Engineer                                      |
| <input type="checkbox"/> Electric Wiring                                     | <input type="checkbox"/> Surveying and Mapping                               |
| <input type="checkbox"/> Electrical Engineer                                 | <input type="checkbox"/> Refrigeration                                       |
| <input type="checkbox"/> Electric Lighting                                   | <input type="checkbox"/> R. R. Locomotives                                   |
| <input type="checkbox"/> Welding, Electric and Gas                           | <input type="checkbox"/> R. R. Section Foreman                               |
| <input type="checkbox"/> Reading Shop Blueprints                             | <input type="checkbox"/> R. R. Bridge and Building Foreman                   |
| <input type="checkbox"/> Telegraph Engineer                                  | <input type="checkbox"/> Air Brakes <input type="checkbox"/> Train Operation |
| <input type="checkbox"/> Telephone Work                                      | <input type="checkbox"/> Highway Engineering                                 |
| <input type="checkbox"/> Mechanical Engineer                                 | <input type="checkbox"/> Chemistry <input type="checkbox"/> Pharmacy         |
| <input type="checkbox"/> Mechanical Draftsman                                | <input type="checkbox"/> Coal Mining Engineer                                |
| <input type="checkbox"/> Machinist <input type="checkbox"/> Toolmaker        | <input type="checkbox"/> Navigation <input type="checkbox"/> Boilermaker     |
| <input type="checkbox"/> Patternmaker  | <input type="checkbox"/> Textile Overseer or Supt.                           |
| <input type="checkbox"/> Pipefitter <input type="checkbox"/> Tinsmith        | <input type="checkbox"/> Cotton Manufacturing                                |
| <input type="checkbox"/> Bridge Engineer                                     | <input type="checkbox"/> Woolen Manufacturing                                |
| <input type="checkbox"/> Bridge and Building Foreman                         | <input type="checkbox"/> Agriculture <input type="checkbox"/> Fruit Growing  |
| <input type="checkbox"/> Gas Engines <input type="checkbox"/> Diesel Engines | <input type="checkbox"/> Poultry Farming <input type="checkbox"/> Radio      |
| <input type="checkbox"/> Aviation Engines                                    | <input type="checkbox"/> Marine Engineer                                     |

#### BUSINESS TRAINING COURSES

- |   |  |
|---|--|
| <input type="checkbox"/> Business Management                                  | <input type="checkbox"/> Business Correspondence                             |
| <input type="checkbox"/> Office Management                                    | <input type="checkbox"/> Lettering Show Cards <input type="checkbox"/> Signs |
| <input type="checkbox"/> Industrial Management                                | <input type="checkbox"/> Stenography and Typing                              |
| <input type="checkbox"/> Personnel Management                                 | <input type="checkbox"/> Complete Commercial                                 |
| <input type="checkbox"/> Traffic Management                                   | <input type="checkbox"/> Civil Service <input type="checkbox"/> Mail Carrier |
| <input type="checkbox"/> Accountancy <input type="checkbox"/> Cost Accountant | <input type="checkbox"/> Railway Mail Clerk                                  |
| <input type="checkbox"/> C. P. Accountant                                     | <input type="checkbox"/> Grade School Subjects                               |
| <input type="checkbox"/> Bookkeeping  | <input type="checkbox"/> High School Subjects                                |
| <input type="checkbox"/> Secretarial Work                                     | <input type="checkbox"/> College Preparatory                                 |
| <input type="checkbox"/> Spanish <input type="checkbox"/> French              | <input type="checkbox"/> Illustrating <input type="checkbox"/> Cartooning    |
| <input type="checkbox"/> Salesmanship <input type="checkbox"/> Advertising    | <input type="checkbox"/> Lumber Dealer                                       |

Name..... Age.....

Address.....

City..... State.....

Occupation.....

If you reside in Canada, send this coupon to the International Correspondence Schools Canadian, Limited, Montreal, Canada

# Electricity!

## Learn in Los Angeles

### Come West at Our Expense!

For a limited time we are making a railroad fare offer from any point in the United States to Los Angeles. Just think of it! A trip to California with your railroad fare allowed.

### Quickly Train for Big Pay Jobs!

Quickly train for Big Pay Jobs in Electricity. Unlimited Lifetime Employment Service. Employers insist on our men instead of green, half-baked electricians who don't know what it's all about. You need good training to earn Big Pay!

### Don't Worry About Money! We'll Help You!

If you are short of money, we'll help you. We help you secure a part time job to earn living expenses while learning.

### It's Easy at National!

Short, condensed training in our Million Dollar Practical "School of Shops"...instruction on the most modern equipment money can buy... with the country's best staff of expert, experienced instructors. No previous experience needed. None too old or too young to learn. Start any time. **WRITE TODAY!** We'll send you the full story about Railroad Fare Offer, Unlimited Employment Service, etc. New Book sent FREE.

# FREE BOOK

**NATIONAL ELECTRICAL SCHOOL**  
Dept. 14-D, 4006 S. Figueroa St., Los Angeles, Calif.

## CARTOON YOUR WAY TO SUCCESS!

DON'T COPY — LEARN TO ORIGINATE!

RAYE BURNS will teach you HOW to CREATE ORIGINAL CARTOONS at home that you can SELL! Course contains 26 lessons and over 600 illustrations. All for Only... **\$ 2.85**

Send name and address for free details.

RAYE BURNS SCHOOL, 836 Lakeview Rd., D-9, Cleveland, Ohio



## Learn Public Speaking

At home—in spare time—20 minutes a day. Overcome "stage-fright," gain self-confidence, increase your salary, through ability to sway others by effective speech. Write now for free booklet, *How to Work Wonders With Words*.

NORTH AMERICAN INSTITUTE, Dept. 1381  
3601 Michigan Avenue, Chicago, Illinois



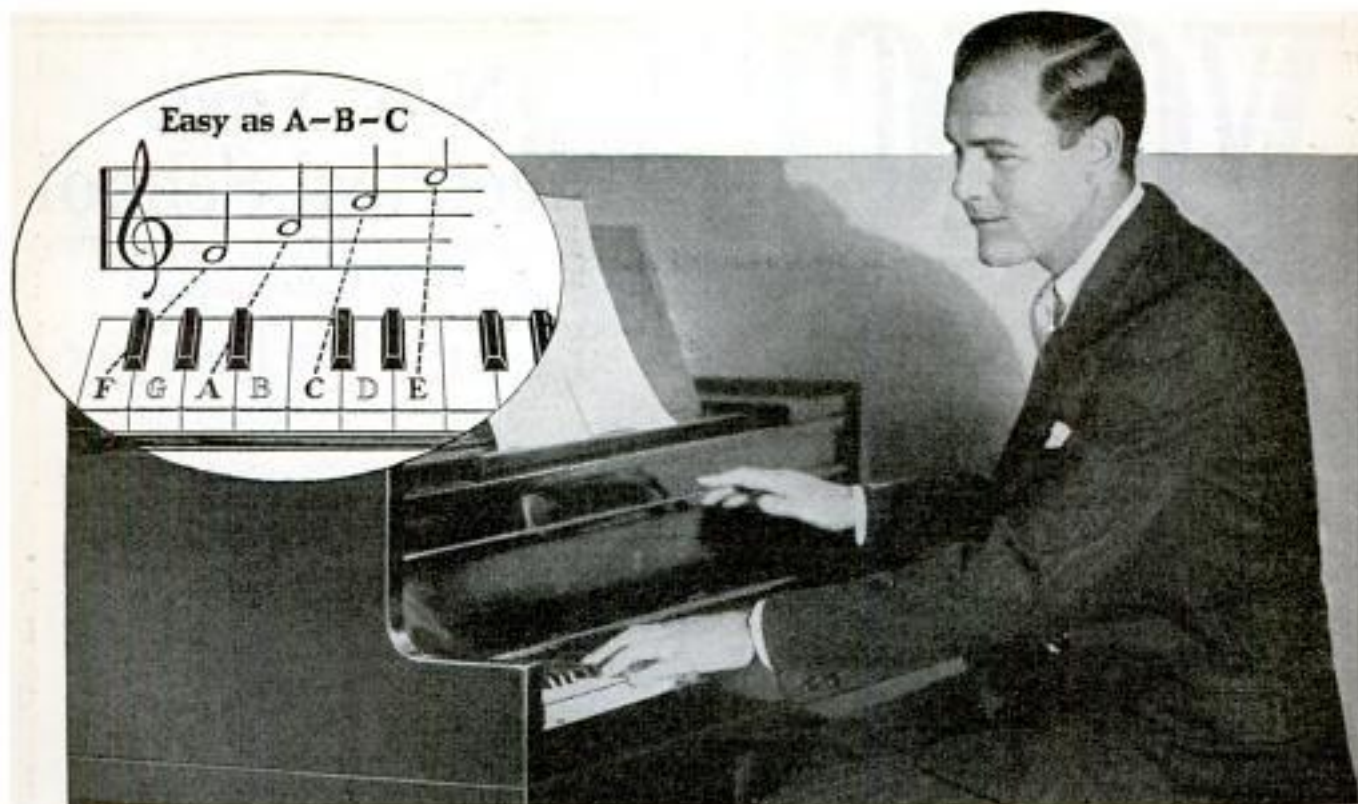
Learn to Write  
Begin Today. Write for my Free Book, "How to Become a Good Penman." It contains specimens and tells how others learned to write in spare time. Your name elegantly written on a card if you enclose stamp for postage. Write today. F. W. TAMBLYN,  
418 Ridge Bldg., Kansas City, U. S. A.

## FREE Radio Handbook

Write today for your copy of the new Radio Association handbook. Shows you easy ways to make money in Radio. Tells you how our members are clearing up \$1.00 an hour spare time. Write for Membership Plan which need not cost you a cent and FREE RADIO HANDBOOK.

RADIO TRAINING ASSOCIATION OF AMERICA  
Dept. PM-1 4513 Ravenswood Ave., Chicago

When writing to advertisers please mention Popular Mechanics



# Too Old to Learn Music?

Hardly. Not after thousands of men and women between the ages of 30 and 50 have enrolled with the famous U. S. School of Music and have learned to play their favorite instruments without the slightest difficulty or waste of time!

**W**HAT has your age got to do with learning music when you now have a method at your disposal that has done away with compulsory practice—tabooed monotonous scales—that has slashed expensive fees—that makes you the boss instead of requiring a personal teacher?

If hundreds of children, scarcely in their "teens," learn to read notes and play a musical instrument with only our printed instructions and illustrated diagrams, think how simple it must be for older people to follow, benefit, and progress rapidly in this home-study manner.

## Always Fascinating

You'll never lose patience. You'll *want* to study—you'll actually look forward to the "next lesson" when you study music the U. S. School way.

And no wonder. You spend a little time each day in your own home hearing your musical dreams come true. There's no personal teacher—no intricate explanations to baffle you—no trust-to-luck tactics. For right with you at all times are our concise print and picture instructions keeping you on the right track—telling you what to play and showing you how to play it. Each new lesson contains a new thrill. For

the entire course from the very beginning to the end is brimful of cheerful, tuneful selections which you eagerly learn to play *by note*.

And, regardless of which instrument you select, the cost of learning will average only a few cents a day.

## Music Will Be An Unfailing Friend

The older you get, the more you need the solace and pleasure that self-made music affords. Anyone can tune in on a radio—play a record or get music out of a player piano. But what empty satisfaction compared to making music *yourself!*

The ability to play offers you a definite escape from monotony—gives you the opportunity to do something real—to meet people—to make friends. And there's nothing like good music to help you forget your troubles.

Every child, too, who can play a musical instrument enjoys an accomplishment that attracts, entertains and holds chums—that replaces bashfulness with confidence and poise—that assures a social and profitable "standby" for their later years.

Think of the satisfaction of being able to play what and when you want. Forget your age. And bear in mind, you don't

have to know one note from another to start your lessons from the U. S. School of Music.

## Write Us First

Are you sincerely interested enough in music to want to find out all about this easy as A-B-C method of learning? Then send at once for our free 64-page booklet, "Music Lessons in Your Own Home," explaining this famous method in detail. With it will be sent a Free Demonstration Lesson, which *proves* how delightfully quick and easy—how *thorough*—this modern method is.

If you really want to learn to play—without a teacher—in one-half the usual time—and at one-third the usual cost—send for the Free Booklet and Free Demonstration Lesson TODAY. No obligation. (Instrument supplied if desired—cash or credit.) U. S. School of Music, 71 Brunswick Bldg., New York City.

Thirty-fourth Year (Established 1898)

U. S. SCHOOL OF MUSIC,  
71 Brunswick Bldg., New York City.

Please send me your free book, "Music Lessons in Your Own Home," with introduction by Dr. Frank Crane, Free Demonstration Lesson, and particulars of your easy payment plan. I am interested in the following course:

Have You  
..... Instrument?.....  
Name.....  
Address.....  
City.....State.....

## PICK YOUR INSTRUMENT

Piano	Violin
Organ	Clarinet
Ukulele	Flute
Cornet	Saxophone
Trombone	Harp
Piccolo	Mandolin
Guitar	Cello
Hawaiian Steel Guitar	
Sight Singing	
Voice and Speech Culture	
Harmony and Composition	
Drums and Traps	
Automatic Finger Control	
Banjo (Plectrum, 5-String or Tenor)	
Piano Accordion	
Italian and German Accordion	
Juniors' Piano Course	

When writing to advertisers please mention Popular Mechanics

# VOICE

**NOW! you can have  
the VOICE you want!**



## 100% Improvement Guaranteed!

We build, strengthen the vocal organ—not with singing lessons—but by fundamentally sound and scientifically correct silent exercises... and absolutely guarantee to improve any singing or speaking voice at least 100%... Write for wonderful voice book—sent free. Learn WHY you can now have the voice you want. No literature sent to anyone under 17 years unless signed by parent.

**Perfect Voice Institute, Studio 13-51  
305 N. Michigan Ave., Chicago**

### Mail Coupon for Free Voice Book

**Perfect Voice Institute, Studio 13-51  
305 N. Michigan Ave., Chicago**

Please send me FREE and without obligation, Prof. Feuchtinger's new book, "Physical Voice Culture." I have checked subject in which I am most interested.

Weak Voice  Singing  Stammering  Speaking

Name

Address

City

State

Age

When writing please mention Popular Mechanics

## New York Electrical School

teaches PRACTICAL ELECTRICITY  
by its own distinctive method of

### "Learn by Doing"

No previous preparation or electrical knowledge is necessary. Every step is guided by expert instructors.

Individual attention.

### SPECIAL COURSES IN AUTO MECHANICS AND AUTO ELECTRICITY

Day and evening classes open all year.  
Start any day.

Write for FREE School Booklet.  
Visitors Welcome

**New York Electrical School**  
Established 1902 44 West 17th St., N. Y.



## Astrology

*Will You Be Lucky in 1932?*

What do the stars foretell for 1932? Would you like to know? Our special 12-page Astrological Reading gives predictions, month by month—with exact days, dates and happenings for 1932 based on your sign of the Zodiac. Consult it before making any change in home or business affairs, signing papers, love, marriage, seeking employment, raises in salary, speculation, travel, friends, enemies, health, accidents, lucky days etc. Send exact birthday with \$1.00 for reading.

Franklin Pub. Co., 800 N. Clark St., Dept. 1351, Chicago



### "BECOME A LIGHTNING TRICK CARTOONIST"

Send \$1.00 for Laugh Producing Program of 28 Trick Drawings with Instructions. Catalog of Chalk Talk Supplies Free. BALDA ART SERVICE, Dept. 1, Oshkosh, Wis.

## NOW at a New Big Saving!

**The New Britannica**

Write for FREE 56-Page Booklet

Encyclopaedia Britannica, Inc., 342 Madison Ave., New York

## Wrestling Book

Learn at  
Home

**FREE**



Be an expert wrestler. Learn at home by mail. The greatest wrestlers of all, Frank Gotch and Farmer Burns, both world's champions have prepared the most wonderful course of lessons ever written on Scientific Wrestling, Physical Culture, Self Defense and Jiu Jitsu. Be strong, healthy, with an attractive body. Handle and control bigger and stronger men with ease. Get this Free Prospectus—32 pages—brimming with thrilling information—No Charge—merely send 2c to cover postage. Don't delay. Write Today for your copy. State your age.  
**FARMER BURNS SCHOOL, 3371 Courtney Bldg., Omaha, Neb.**





# NEW KIND OF AUTO EYES

## Makes Night Driving Safer Than Day!

No more driving "blind" on a crowded highway at night! An astonishing new invention banishes night wrecks and smash-ups. Ends fear of running over children or animals. Mail coupon quick for the manufacturer's introductory Free Test Offer.

**FITS ANY HEADLIGHT—ENDS DANGEROUS DIMMING—DOUBLES ROAD LIGHT!**

**A**T LAST! An amazingly queer yet simple invention lifts the base and curse of night driving from the motoring-world. Actually like magic this altogether new discovery replaces the "bulbs" in automobile headlights with truly amazing results. Road illumination is instantly doubled yet glare is absolutely banished. Ordinary objects in the road, ruts, animals, obstructions, etc., are made clearly visible at least three times as far. Even cuts right through fog, mist, rain and snow. Gives you a solid wall of light 3 feet high, 25 to 30 feet wide. Instead of ordinary "direct" light, this beam is composed entirely of double-reflected or "infused" light. This new kind of beam pours down the highway ahead of you so far that you can actually see to go 70 miles an hour in safety. At a 40 to 50 mile an hour clip, it is positively safer than daylight because all the light is on the road and you see nothing of your surroundings to distract you.

### INEXPENSIVE

Patent rights in this new lighting invention are fully protected. It is not in any sense a new "attachment." There is no wiring or installation. No extra up-keep. In the past, millions of motorists have paid from \$10 to \$25 for so-called spot-lights and driving-lights that at best

are only make-shifts. This new method costs only a fraction as much and actually doubles road illumination with your present headlights! Cuts through the other fellow's light so you can see the road, yet absolutely cannot glare in his eyes. No wonder fleet owners, manufacturers, taxi and bus lines, etc., concerns like Wallace & Tiernan, N. J.; Blue and Gray Bus Lines; Columbus Fire Trucks, etc., are fast turning to this discovery as standard equipment. It's positively needed on every car in America, new or old, right this minute.

### Offered On Introductory Test

Every driver who ever rolled half-blind down the highway at night knows exactly what such an invention means in added speed, nervous energy saved, perhaps fatal accidents banished. To prove as quickly as possible to motorists in every section what this invention will do, the manufacturer now makes a liberal FREE TEST OFFER. Simply mail the coupon for details. No obligation. Send it today.

**HACHMEISTER-LIND CO.**  
Dept. A-30 PITTSBURGH, PA.

## Agent Makes \$1,400 In One Week

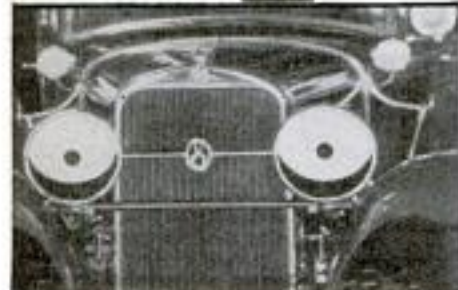
Full-time and spare-time workers. New FREE DEMONSTRATION Plan with SALES GUARANTEED. EXCLUSIVE TERRITORY. Sell in bunches to fleet owners. A real chance for \$8 to \$14 very first hour, \$6,000 to \$10,000 a year. Wehner, Pa., made \$1,125 in 90 days' spare time, Owens, W. Va., made \$500 a month, Davis, of Pa., made \$1,400 in one week. No limit for distributors. Use coupon for full details of money-making proposition. It's red-hot. ACT NOW!

HACHMEISTER-LIND CO.  
Dept. A-30, Pittsburgh, Pa.  
Rush details of your Free Test Offer; also facts about agent's money-making opportunities without obligation.

Name.....

Address.....

Town.....State.....



This new kind of Light even LOOKS entirely different. No wonder every installation brings a dozen more sales.



Lights up entire roadway, including ditches at side. Gives perfect illumination without shadows or flickering.



Banishes Glare Shields, Spot Lights, etc. Floods the road with light, yet absolutely cannot glare.

When writing to advertisers please mention Popular Mechanics



## He Found the Key to \$10,000 a Year!

"Just a bookkeeper"—that's how J. A. Hogg, now Public Accountant at Logan, W. Va., would have classified himself six years ago when he first enrolled with LaSalle for home-study training in Higher Accountancy.

Little he dreamed that within two years—thanks to his specialized training—his yearly income would be \$5,000, and that two years later he would be making better than \$10,000 a year! But read what he writes, under recent date—

"It isn't often that an investment brings money profit of more than 7500 per cent in only six years, yet that's exactly what my enrollment in two LaSalle courses—Higher Accountancy and Law—has meant to me. I estimate it worth more than \$30,000 in cash returns, besides additional returns in personal and business prestige, in self-confidence and all-round larger success.

"Whereas when I first became a LaSalle member I was earning about \$100 a month, today I have my own successful public accounting firm, and have been mayor and police judge of my home town for the past five years, and LaSalle has made all this possible.

"I have enjoyed very much my LaSalle work. Your Problem Method has been a revelation—so much easier and more efficient than the classroom methods of my school days."

### His Opportunity Is Yours— Send for Free Book

Are you ambitious to make a real success in business—to fit yourself for positions paying \$3,000, \$5,000, \$10,000 a year, and even better?

Here, then, is your chance—the same chance that faced J. A. Hogg when he clipped a LaSalle coupon.

Below is the coupon, and it will bring you—free—LaSalle's 64-page book, "Accountancy, the Profession that Pays." You will find it of the greatest help and inspiration.

If you mean what you say when you say that you want to get ahead—fill in, clip and mail the coupon NOW.

— Find Yourself Through LaSalle! —

### LaSalle Extension University

The World's Largest Business  
Training Institution

Dept. 164-HR Chicago

I should be glad to have details of your salary-increasing plan as applied to my advancement in the business field checked below. Also a copy of "Ten Years' Promotion in One," all without obligation.

- |   |   |
|---|---|
| <input type="checkbox"/> Higher Accountancy                   | <input type="checkbox"/> Modern Business Correspondence |
| <input type="checkbox"/> Business Management                  | <input type="checkbox"/> Modern Foremanship             |
| <input type="checkbox"/> Modern Salesmanship                  | <input type="checkbox"/> Expert Bookkeeping             |
| <input type="checkbox"/> Traffic Management                   | <input type="checkbox"/> C. P. A. Coaching              |
| <input type="checkbox"/> Railway Station Mgmt                 | <input type="checkbox"/> Business English               |
| <input type="checkbox"/> Railway Accounting                   | <input type="checkbox"/> Commercial Spanish             |
| <input type="checkbox"/> Law—Degree of LL.B.                  | <input type="checkbox"/> Effective Speaking             |
| <input type="checkbox"/> Commercial Law                       | <input type="checkbox"/> Stenotypy—Stenography          |
| <input type="checkbox"/> Industrial Management                | <input type="checkbox"/> Telegraphy                     |
| <input type="checkbox"/> Banking and Finance                  |   |
| <input type="checkbox"/> Personnel Management                 |   |
| <input type="checkbox"/> Credit and Collection Correspondence |   |



Name.....

Present Position.....

Address.....

## LEARN DRAFTING FROM AN ENGINEER

Established 1900

ALL TOOLS FURNISHED

Practical Home Training  
Until in Position. Salary paid Draftsmen \$50 to \$75 per week and up. Men I have trained earned \$100 per week. I'll train a number of selected students on practical work as draftsmen, or improve your present job to get a raise. More pay and a safer job. Pleasant work. Surer advancement. Keep your job while learning. Write for

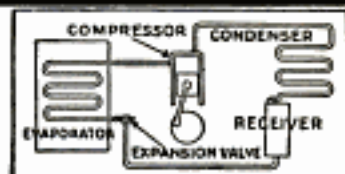
"FREE Pay-Raising Plan."

ENGINEER DOBE, 1951 Lawrence Ave.

Div. 13-51 Chicago, Ill.

## NEW INDUSTRY NEEDS MEN

Electric Refrigeration Calls You!



NEWEST American industry needs plain, practical men for jobs paying up to \$75 and \$100 a week in production, service, installation and sales. Fast-growing, big money field—backed by General Motors, General Electric, etc. New, easy home training fits you quickly in spare time. Endorsed by Servel, Kelvinator and other manufacturers. Free employment service, 2 weeks' actual factory training without extra cost. Low fee, easy terms. Money back agreement.

FREE new book contains full details. Sent without obligation. Write now! UTILITIES ENGINEERING INSTITUTE, Dept. 112, 4483 Sheridan Rd., Chicago, Ill.

**CRIME DETECTION SECRET SERVICE AND FINGER PRINTS**

**SECRET SERVICE BOOK FREE**

For 30 Days Reading  
No Money Down—Actual Crime Cases—  
If You Act Quick!—We will send you this stirring book on Crime Detection, Secret Service and Identification Work for 30 days free reading. Send no money. If you decide to keep it, then send only \$1.00. If not, return it. WHITE TODAY. Not sent to boys under 17 years of age.

T. G. Cooke, Book Dept. 13-51, 1920 Sunnyside Ave., Chicago

## NERVES?

Are You Always Excited? Fatigued? Worried? Gloomy? Pessimistic? Constipation, indigestion, cold sweats, dizzy spells and sex weakness are caused by NERVE EXHAUSTION. Drugs, tonics and medicines cannot help weak, sick nerves! Learn how to regain Vigor, Calmness and Self-Confidence. Send 25c for this amazing book.

RICHARD BLACKSTONE, N-471, FLATIRON BLDG., N. Y. C.

free RADIO CATALOG

10th ANNIVERSARY CATALOG

WHOLESALE RADIO SERVICE CO.

38 Vesey St., Dept. A-11, New York, N. Y.

new 1932 bargains

New 10th Anniversary Catalog just out! 144 pages crammed full of bargains. Everything new in radio at lowest wholesale prices. Replacement parts, tubes, kits, speakers, accessories, Lafayette 7, 8 and 10 tube Super-Heterodynes, etc. Brand new, nationally advertised radio merchandise. Write for this FREE 144 page book today.

When writing to advertisers please mention Popular Mechanics

# Hey! Buddie! Join me working for Uncle Sam!

**I Make \$2700 a Year as Railway Postal Clerk**

"\$2750.00 to be exact. That's \$53 a week. And listen! Here's what makes it so good—I make it every week! The year round! Before I landed this government position I thought I was a lucky boy if I wasn't out of a job at least 6 or 8 weeks a year. Never could keep any savings in the bank. Now I can positively count, in advance, on getting every dollar of my year's pay. And I'm just as sure of my regular raise every year too. No 'pull' or 'boot-licking' needed to get it either!

**No More Worry About Layoffs!**  
"I figure that I'm all through looking for a job. I'm sitting pretty. I sure can plan my future, because my income from Uncle Sam is definite and certain. He's the right boss to have when private business is laying 'em off right and left!

**I Get Vacations and Sick Leave With Pay**  
"15 days' vacation a year and 10 days' sick leave. My pay goes right on. That's a plan that sure makes a hit with us Railway Mail Service boys.

**Patterson's Help Made It a Cinch**  
"I mean Arthur R. Patterson, of Rochester. He helped me get this berth. He used to be one of Uncle Sam's Civil Service Secretary-Examiners (for eight years)—so he knows all the ropes—just the kind of questions you get asked in the exams. He's helped thousands into fine Government positions. He helped me to get a high rating—so I could get appointed in just a short while.

**He'll Help You Too**  
"Listen to me! I don't know you personally—but if you are a U. S. CITIZEN (anywhere between 15 to 50 years old) and want a sure, safe job—with good and regular pay—then I say, 'Write for Arthur R. Patterson's FREE BOOK!' In it he tells just how you can qualify for the very government job you want—Railway Postal Clerk, Post Office Clerk, City Mail Carrier, Rural Carrier, Postmaster, Customs Service, or any other branch you fancy. Write Arthur R. Patterson, Civil Service Expert, 51 Wisner Bldg., Rochester, N. Y. I'll say he is—and his advice won't cost you but two cents. Just mail him the coupon. He'll do the rest."

**Patterson prepared us to win!  
Now you get his FREE BOOK!**



**TELLS OTHERS ABOUT MY HELP**  
"Just a line to let you know that I was appointed a Railway Postal Clerk. Am assigned to the Chief Clerk at Peoria, Ill. I like the work fine. Also, am sending a few names of persons who might take up a course."  
**Michael Reiss, Ramsey, Ill.**



**SPEEDY APPOINTMENT AS POSTAL MAIL CLERK**  
"Received my rating from Commission Nov. 18, in the Railway Mail examination. Four days later, Nov. 22, I received my appointment as clerk. I stood No. 27 on the list in this state. I certainly can recommend your school whenever I have occasion to do so. My advice to any prospective student is to enroll with 'one who knows'."  
**Wm. R. O'Kelly, Fleischmanns, N. Y.**



**ANOTHER QUICK APPOINTMENT**  
"Received my rating from the Railway Mail Clerk exam. I passed and received my blank oath from Peoria to report for work. I could not have done so well without your training."  
**James M. Wright, Chatsworth, Ill.**



**PICK YOUR JOB!**  
**Patterson Helps You Get It . . . . . or You Don't Pay a Cent!**  
**RAILWAY POSTAL CLERK**  
\$1,850 to \$2,700 a year. Extra travel pay.  
**POSTOFFICE CLERK**  
\$1,700 to \$2,100 a year. Special clerks at \$2,200 and \$2,300. Eligible to promotion to higher paid positions.  
**CITY MAIL CARRIER**  
\$1,700 to \$2,100 a year. Promotions to bigger pay.  
**R. F. D. MAIL CARRIER**  
\$1,800 to \$2,600 a year. Fine job for men in rural districts.  
**POSTMASTER**  
\$1,200 to \$2,500 a year.  
**INTERNAL REVENUE AND CUSTOM HOUSE POSITIONS**  
\$1,140, \$1,680 to \$3,000 and up a year. Extra pay for overtime.  
**DEPARTMENTAL CLERKS**  
\$1,440 to \$1,620-\$1,860 a year and up to \$3,000 a year. Work in Washington.

**IMPORTANT — Get Ready NOW for the next Railway Postal Clerk Examination.**

**Arthur R. Patterson, Civil Service Expert, PATTERSON SCHOOL, 51 Wisner Building, Rochester, N. Y.**  
Dear Mr. Patterson:  
Send me your 32-page FREE BOOK telling how I can secure a position with the U. S. Government paying from \$1,850 to \$3,300 a year. This request doesn't obligate me in any way.

NAME.....  
ADDRESS.....  
CITY..... STATE.....

# FIND OUT FREE If You Can Become a Successful DRAFTSMAN



**Get Free Test-Lesson**  
—investigate how  
to get a permanent  
position paying  
**\$40 to \$75 a week**

Men say—the most thrilling and interesting work in the world—is building machinery and railroads, highways and skyscrapers, autos and 1001 other manufactured products—on PAPER, in the drafting room. How would you like to be a Draftsman for an Architect, Contractor, factory, railroad or under Civil Service? Mail coupon for free test-lesson—you'll be surprised at how easy Drafting is to learn right in your home, in spare time.

**You have the ability to become a well-paid Draftsman, if you can meet these simple requirements:**

**1. HAND** Any man in office or factory who can do semi-skilled or skilled work with his hands, such as working to dimensions, or adjusting valves on an auto, or even laying out a business chart—has the necessary skill of hand to become a Draftsman. Drafting is mechanical drawing, with tools, and requires no artistic talent.

**2. BRAIN** If you can add, subtract, multiply and divide, we can teach you the rest of the mathematics you will need in Drafting. You only need grammar schooling, and you must be under 35 years of age.

## Save up to \$40.60

Right now we are making a remarkable offer to ambitious men, that will save you up to \$40.60, depending on your previous education and experience. In addition to preparing you for a well-paid Drafting position, we will undertake to place you when you are ready, or refund your money. Just mail coupon for free test-lesson, drafting book and money-saving offer.

### American School

Drexel Ave. and 58th St., Dept. D-147, Chicago, Ill.

Without the slightest obligation, please send free test-lesson to prove I can learn Drafting at home in spare time, also free Drafting book and your money-saving offer to ambitious men.

Name.....Age.....

St. No.....

City.....State.....

When writing please mention Popular Mechanics

# Learn Autos



## in Los Angeles

**Come West at Our Expense!**

For a limited time we are making a railroad fare offer from any point in the United States to Los Angeles. Just think of it! A trip to California with your railroad fare allowed.

**Quickly Train for Big Pay Jobs!**

Quickly train for Big Pay Jobs in Auto work. Unlimited Lifetime Employment Service. Employers insist on our men instead of green, half-baked mechanics who don't know what it's all about. You need good training to earn Big Pay!

**Don't Worry About Money!  
We'll Help You!**

If you are short of money, we'll help you. We help you secure a part time job to earn living expenses while learning.

**It's Easy at National!**

Short, condensed training in our Million Dollar Practical "School of Shops"... instruction on the most modern equipment money can buy... with the country's best staff of expert, experienced instructors. No previous experience needed. None too old or too young to learn. Start any time. **WRITE TODAY!** We'll send you the full story about Railroad Fare Offer, Unlimited Employment Service, etc. New Book sent FREE.

## FREE BOOK

**NATIONAL AUTOMOTIVE SCHOOL**

Dept. 14-C, 4006 S. Figueroa St., Los Angeles, Calif.

## All This for Only 15 Cents

Send only 15c RIGHT NOW and receive The Pathfinder every week by mail for the next 13 consecutive weeks. In these 13 issues you will get 426 pages, with 300 pictures, 900 unusually interesting articles on people and things you want to know about, 1800 picked news items from everywhere, 2500 jokes, squibs and cracks, stories, etc. Newest, snappiest, most entertaining paper in the whole world. The biggest 15c worth YOU ever saw. Send now. Address **Pathfinder, Dept. 74, Washington, D. C.**



## Minstrels

Unique First Parts for complete show with special songs and choruses. Make-up. Catalog Free.

T. S. Denison & Co., 623 S. Wabash, Dept. 19 Chicago



## Study LAW AT HOME

Like to do it! Also thousands of other great lawyers, politicians and business men. YOU, too, can become a lawyer or law trained business man through home study guided by the successful practicing lawyers of our faculty. Write today for free book.

**AMERICAN CORR. SCHOOL OF LAW**  
3601 Michigan Ave., Dept. 1351, Chicago

# Photography



for **PLEASURE or PROFIT**

A fascinating hobby or a profitable business can now be yours. Prepare quickly at home under the personal guidance of leading experts in the art of photography. No experience necessary. Full or spare time. Many earn while learning. Our thorough studio method also qualifies you to fill a well paying position upon graduation. Send coupon now for FREE booklet, *Opportunities in Modern Photography*.

**AMERICAN SCHOOL OF PHOTOGRAPHY**  
3601 Michigan Avenue Dept. 1351

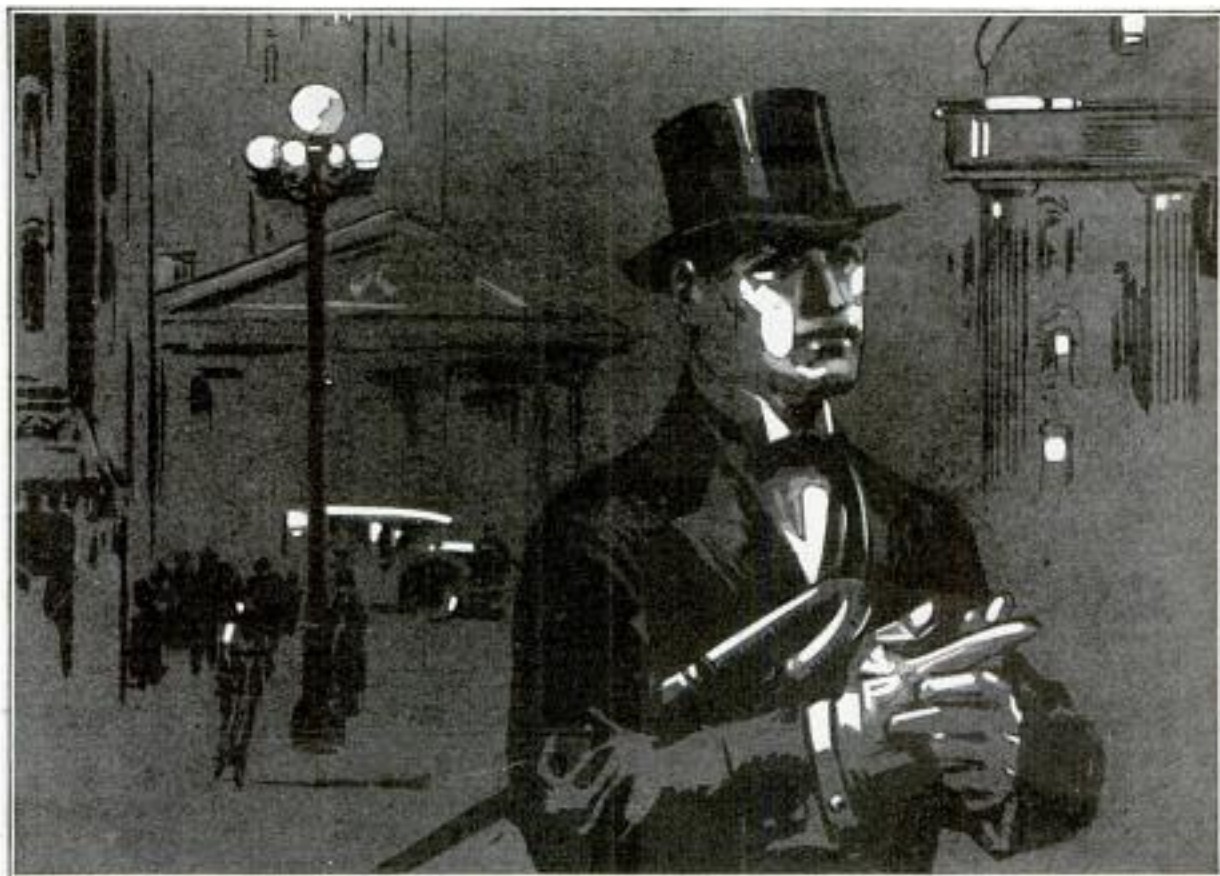
Chicago, Ill.

Send FREE booklet, *Opportunities in Modern Photography*, and full information.

Name.....

Address.....

City.....State.....



# Follow this Man!

*Secret Service Operator 38 Is on the Job*

Follow him through all the excitement of his chase of the counterfeit gang. See how a crafty operator works. Telltale finger prints on the lamp stand in the murdered girl's room! The operator's cigarette case is handled by the unsuspecting gangster, and a great mystery is solved. Better than fiction. It's true, every word of it. No obligation. Just send the coupon.

## **FREE** The Confidential Reports No. 38 Made to His Chief

And the best part of it all is this. It may open your eyes to the great future for YOU as a highly paid Finger Print Expert. More men are needed right now. This school has taken men just like you and trained them for high official positions. This is the kind of work you would like. Days full of excitement. Big salaries. Rewards.

### **Earn \$3000 a Year and Up** *You study at home in spare time*

No advance education is needed. Any man who can read and write, and think can make good. A wonderful book tells all about what others have done. Shows pictures of real crimes and the men who solved them. We'll send you a FREE copy with the free reports. Get our low prices and easy terms. Mail the coupon.

**INSTITUTE OF APPLIED SCIENCE**  
1920 Sunnyside Ave., Dept. 13-51 Chicago, Illinois

#### **INSTITUTE OF APPLIED SCIENCE**

1920 Sunnyside Ave., Dept. 13-51 Chicago, Illinois

Gentlemen:—Without any obligation whatever, send me your new, fully illustrated Free Book on Finger Prints, also FREE Copy of operator No. 38's confidential report. Tell me about your low prices and easy terms. Literature will NOT be sent to boys under 17 years of age.

Name .....

Address .....

Age .....

When writing to advertisers please mention Popular Mechanics

Copyrighted material

"I'll prove in only  
7 days I can make  
**YOU a NEW  
MAN**"

No other  
Physical  
Instructor  
has ever  
**DARED**  
make such  
an Offer

By **CHARLES ATLAS**  
Holder of the Title:  
"The World's Most Per-  
fectly Developed Man"

**YOU** don't  
have to take  
my word—nor that of  
hundreds of my pupils who  
have added inches to their  
 chests, biceps, necks, thighs, and  
 calves. Prove for yourself in just  
 one week that you can, too, actu-  
 ally become a husky, healthy  
 **NEW MAN!**

My *Dynamic-Tension* system  
 does it. That's how I built my-  
 self from a 97-pound weakling to  
 "The World's Most Perfectly De-  
 veloped Man." Let me prove  
 that you can get a big, balanced  
 muscular development in the same  
 easy way.

**Gamble a 2c stamp—Mail Coupon for FREE Book!**

*Dynamic-Tension* is a natural method of developing you, in-  
 side and out—without using any tricky apparatus, any pills,  
 "rays" or unnatural dieting. It goes after such ailments as  
 constipation, pimples, skin blotches, and other conditions that  
 keep you from really enjoying life.

Gamble a 2c stamp today. Mail coupon for a free copy of my  
 new illustrated book, "*Everlasting Health and Strength*." It  
 shows you, from actual photos, how I have developed my pupils  
 to the same perfectly balanced proportions of my own physique.

Put your name and address down on the coupon. Send it to  
 me personally. **CHARLES ATLAS**, Dept. 8-N, 133 East 23rd  
 St., New York City.

**CHARLES ATLAS, Dept. 8-N**  
133 East 23rd Street, New York City

I want the proof that your system of *Dynamic-Tension* will  
 make a New Man of me—give me a healthy, husky body, and  
 big muscle development. Send me your free book, "*Everlasting  
 Health and Strength*."

Name.....  
(Please print or write plainly)

Address.....

City..... State.....

When writing to advertisers please mention Popular Mechanics

**FREE 6 FAMOUS SPARK PLUGS**  
worth \$4.50  
To customers for GOOD YEAR  
Goodrich - Firestone and other tires

DEALERS WANTED

**Lowest Prices in History - - 75% Saving**

Midland's Immense Boring Power Makes This Possible  
Thousands of motorists all over U. S. A. use and boost our Stand-  
ard Brand reconstructed Tires. Hard service on roughest  
roads guaranteed. Our nation-wide success and reputation  
speaks for itself. **FREE** for limited time one The best quality  
spark plug with every tire shipped. Order 4 tires—get full set  
6 spark plugs free. New pep for your car—no extra cost. Be  
sure to mention make of car, model, year built. **ORDER  
TODAY** at these **Rock Bottom Prices**. Satisfaction Guaranteed.

BALLOON TIRES			Reg. CORD Tires		
Size	Rim	Tubes	Size	Tires	Tubes
28x4.40-21**	\$2.30	\$1.10	32x4.00-21**	3.20	\$1.40
28x4.50-20**	2.40	1.15	32x4.20-20**	3.25	1.45
28x4.50-21**	2.45	1.20	32x4.35-20**	3.35	1.50
28x4.75-19**	2.45	1.20			
28x4.95-21**	2.90	1.20			
29x5.00-19**	2.95	1.25			
30x5.00-20**	2.95	1.25			
30x5.15-19**	2.95	1.25			
30x5.35-19**	2.95	1.25			
30x5.55-20**	2.95	1.25			
31x5.25-21**	3.10	1.30			
30x5.50-19**	3.20	1.30			
30x5.77-20**	3.20	1.40			
30x5.90-18**	3.20	1.40			
31x5.90-18**	3.20	1.40			

Send \$1.00 deposit with each tire ordered.  
Balance C. O. D. If you send cash in full de-  
duct 5 per cent. You are guaranteed a year's service or  
replacement at half price. **Order Today—Save Money.**  
**MIDLAND TIRE AND RUBBER COMPANY**  
Dept. 765 1000-10 W. Sixty-Third Street Chicago

## ELECTRICITY

RADIO WELDING  
TELEVISION AUTOMOBILES

No finer Training Equipment Anywhere at Any Price. Improved  
Methods of Practical Instruction. Electric Arc and Oxy-Acetylene  
Welding, Armature Winding, Power Plants, Transformers, Motors,  
Generators, Batteries, Automobiles, Radio, Television and Sound  
Reproduction. **PREPARE FOR STEADY WORK AT GOOD PAY.**

Write for information, Mentioning Course Desired.  
**COLEMAN ELECTRICAL SCHOOL, 1628 Main Street, KANSAS CITY, MO.**

## LEARN WATCHMAKING AND ENGRAVING

BY OUR PROFIT-SHARING PLAN  
**OUR GRADUATES SUCCEED**

One of our Iowa students started in a very small way—now do-  
ing over \$30,000 a year. Another in Wisconsin, over \$10,000 the  
first year. Day or night classes. Call or write for FREE BOOK.

Chicago School of Watchmaking, Dept. 8801, 155 N. Clark St., CHICAGO

## Wireless (Radio)

and Morse telegraphy taught thoroughly. School, oldest and largest  
endorsed by Telegraph, Radio, Railway and Government officials.  
Unusual opportunities. Expenses low—can earn part. Catalog free.  
**DODGE INSTITUTE, Jones St., Valparaiso, Indiana.**

## MAIL FOR FREE INFORMATION

**BEDFORD**

1115 Bedford Ave., Dept. PM-1  
Brooklyn, N. Y.

**YMCA**  
**TRADE**  
**SCHOOL**

- Send me without obligation com-  
plete information on (check subjects).  
 Caterpillar Tractor Mechanic  
 Aviation Mechanic  
 Flying  
 Welding  
 Auto Mechanic  
 Radio Mechanic and Television  
 Talking Pictures—Double  
Western Electric Equipment  
 Electrical  
 Machine Shop  
 Starting, Lighting, Ignition  
 Window Dressing  
 Commercial Art  
 Sign Painting  
 Architectural Drafting  
 Mechanical Drafting

Name.....

Street & No.....

Town..... State.....

# NOW—A Powerful New 11-Tube Super Heterodyne at a Sensationally Low Price!

Save 50%  
up to



**Push-Pull Pentode Power Output Tubes—Multi-Mu Screen Grid Tubes—Real Automatic Volume Control—All the Latest Improvements that Give Amazing New Clarity, Perfect Tone, Split-Hair Selectivity and Sensitivity Never Before Heard Of!**

only  
**\$37.50**  
COMpletely ASSEMBLED  
With Specially Matched Large DYNAMIC SPEAKER

**30 DAYS FREE TRIAL**

## Complete Line of Consoles

Rush the coupon for big, beautiful catalog that illustrates the complete line of MIDWEST console cabinets. All new, all different, all specially designed by MIDWEST master craftsmen. The catalog is FREE—it doesn't cost you a penny. Rush the coupon—NOW!

**Buy Direct from Factory!**  
SAVE UP TO 50%



Never before in the history of radio have such powerful sets been offered at Midwest's amazing low prices. Deal direct with the big MIDWEST factory. Save the jobber's profit. Save the retailer's profit, too! In buying direct from factory you save 50% or more—insure satisfaction—deal direct with the world's veteran radio builders—MIDWEST. And don't forget—every MIDWEST outfit is backed by an absolute guarantee of satisfaction. You take no risk.

**TERMS**  
as low as  
**\$5.00 DOWN**

**MIDWEST RADIO CORP.**

Dept. 32

Est. 1919

CINCINNATI, O.

When writing to advertisers please mention Popular Mechanics

**RADIO FANS!** Just what you've been looking for! A powerful, new 11-tube radio at an unbelievably low price. And what a radio! Two Push-pull pentode power output tubes with twice the power and four times the sensitivity of ordinary 45's—and Multi-Mu tubes, together with a -24 first detector, gives you SIX SCREEN GRIDS. These six screen grids, together with the -27 oscillator, second detector, first A. F., and automatic volume control—the -80 tubes—gives a total of ELEVEN TUBES, with reception equal to fifteen ordinary tubes—in a perfectly balanced, non-oscillating, non-radiating, super-heterodyne TEN-TUNED circuit with real Automatic Volume Control that holds those powerful locals down to the same volume as distant stations and counteracts fading on weak stations. The use of a band-pass or pre-selector stage, together with Multi-Mu tubes, makes this radio actually surpass 10 K. C. selectivity. Absolutely eliminates those noisy singing "birdies" and annoying cross talks. You'll be positively amazed and delighted when you see this sensational new set, hear the beautiful mellow, cathedral tone—know what it means to have pin-dot selectivity and unequalled sensitivity.

Be convinced—TRY IT 30 DAYS BEFORE YOU BUY. Don't send a penny. Mail coupon right now for amazing FREE trial offer and complete details. You'll be surprised.

**Mail this Coupon for Complete Details and Big FREE Catalog!**

Midwest Radio Corp.,  
Dept. 32  
Cincinnati, Ohio.

Without obligation on my part send me your new 1932 catalog, and complete details of your liberal 30-day free trial offer. This is NOT an order.

Name.....

Address.....

Town..... State.....

Send me SPECIAL USER AGENTS PROPOSITION.

### USER AGENTS

We pay you BIG MONEY just for showing your radio to friends and neighbors. Easy EXTRA MONEY! Check coupon for details.

# \$5,000.00 in

## TWO GRAND CASH PRIZE CONTESTS...

### Contest No. 1 \$2500.00

## For Letters Telling About The Best Money-Making Ideas Found In Popular Mechanics

(Contest Ends February 10, 1932)

### PRIZES

\$1,000.00	FIRST PRIZE
500.00	SECOND PRIZE
250.00	THIRD PRIZE
150.00	FOURTH PRIZE
100.00	FIFTH PRIZE
FIFTY	\$10.00 PRIZES

(In case of ties, duplicate prizes will be awarded)

### SAMPLE LETTER

#### How Phillip Scott Found a \$1200.00 Secret in Popular Mechanics



"Some time ago I saw an article in Popular Mechanics which illustrated and fully described some grotesque figures carved out of hardwood that would crack nuts and be useful as well as ornamental. This clever idea appealed to me at once as a real money-maker and as a friend of mine, Phillip Scott, was out of

work, I showed it to him. He read the simple instructions for making these unique dolls and became enthusiastic at once. He got busy making them and has since made over \$1200 in profits by selling them to folks for household use and for gift purposes. He gets lots of orders because he is the only one who makes these figures, and as a result today has money for things he could not otherwise afford. We're both grateful to Popular Mechanics for his sake." . . . (He then states his reasons for thinking this is a good money-making idea.)—R. R. Pierce, Bookkeeper, Peoria, Illinois.

HOW would you like to win \$1,000.00 in real cash—just for writing a few words? This wonderful first prize and fifty-four other big cash awards totaling \$2,500.00 are waiting for readers of Popular Mechanics, in one of the most unique liberal cash prize contests ever conducted.

For many years, Popular Mechanics has been read regularly by thousands upon thousands of thinking men and women in every walk of life. Everyone has found this fascinating magazine a treasure chest of world-wide facts and money-making ideas. A steady parade of strange developments and scientific facts, gathered by our staff of 4346 correspondents from every corner of the globe, has enabled scores of wide-awake folks to turn their time into money.

No doubt you have seen many ideas in Popular Mechanics which struck you as being real money-makers. If so, you can win a big cash prize now by simply writing a short letter of 500 words or less, telling about some idea that you have found in any issue of Popular Mechanics. This may be an idea that you have seen or used yourself or simply an idea that you consider good enough to be used by somebody else.

That's all you have to do to win the \$1,000.00 first prize or one of the many other fine cash awards. What an easy way to win a nice bundle of cash to do with as you please! Remember, you have as good a chance to win as anybody. So follow the simple rules below and mail your letter before the contest ends.

### Simple Rules

1. In 500 words or less, tell about some money-making idea that you have seen in any issue of Popular Mechanics which you have used to make money or which you feel could be used by someone else for profit, and give your reason.
2. Write on one side of the paper only, either typewriter, pen and ink, or pencil.
3. Literary style and grammar will not be considered. Selections will be based on ideas and the reasons for your choice.
4. Send in as many letters as you please. Replies must be post-marked not later than midnight, February 10, 1932.
5. Anyone can enter this contest except employees of Popular Mechanics Magazine or members of their families.
6. Five judges will decide the winners and their decisions will be considered final.
7. Your name, complete address and your occupation must be plainly given at the end of your letter.
8. All answers to this contest must be addressed to Editor, Contest Number One.

**POPULAR MECHANICS Magazine**  
200 East Ontario St. CHICAGO, ILL.

### Nothing to Buy or Sell . . . Now or Ever

When writing to advertisers please mention Popular Mechanics



# Cash Prizes

...110 BIG CASH AWARDS IN ALL

Contest No 2 \$2500.00

**Popular Mechanics Offers  
\$2500.00 For Practical  
Money-Making Ideas  
(Contest Ends February 10, 1932)**

**T**HIS contest is entirely different and separate from Contest No. 1, which is described on the opposite page. Its purpose is to reward thinking folks who send in practical money-making ideas suitable for publication in Popular Mechanics Magazine. Fifty-five big cash prizes, totaling another \$2,500.00, will be given away for the best letters—in addition to the fifty-five cash prizes offered in Contest No. 1.

Think of it! All you have to do to win a handsome cash prize in this unusual contest is to send in a short letter of 500 words or less presenting your money-making idea. It may be an idea that is already helping you or some friend of yours to make extra money. It could be something to do at home, such as canning fruits and preserves or renting rooms to tourists, or it might be something like killing animal pests for bounty.

No matter how small your idea seems to be to you, do not hesitate sending it in at once. It is the simple, practical suggestion that is likely to win the first prize of \$1,000.00. You can enter one or both of these contests and send in as many letters as you wish. Literary style or grammar is not a factor. Awards will be based on the ideas and reasons submitted. So get busy at once and send in your letters. You may be \$1,000.00 richer by next spring if you do!

## Simple Rules

1. In a letter of 500 words or less, state briefly your money-making suggestion. Your idea may be something that you or someone you know is already making money with. Or it may merely be a plan that you believe anyone can use to advantage for profit in full time or spare time.
2. Write on one side of paper only.
3. Literary style and grammar not considered. Selections based only on merits of ideas and reasons submitted.
4. Send in as many letters as you wish. Replies must be post-marked not later than midnight, February 10, 1932.
5. You can enter either or both of these contests. (Anyone is eligible to compete except employees of Popular Mechanics or members of their families.)
6. Winners of prizes in Contest No. 1 are eligible for prizes in Contest No. 2 but no one can win more than one prize in each contest.
7. Five judges will decide the winners and their decisions will be considered final.
8. Your name, complete address and your occupation must be plainly given at the bottom of your letter.
9. Replies to this contest must be addressed to Editor, Contest Number Two.

DO NOT SEND MODELS

**POPULAR MECHANICS Magazine**

200 East Ontario St.

CHICAGO, ILL.

**Nothing to Buy or Sell . . . Now or Ever**

When writing to advertisers please mention Popular Mechanics

## PRIZES

\$1,000.00.....	FIRST PRIZE
500.00.....	SECOND PRIZE
250.00.....	THIRD PRIZE
150.00.....	FOURTH PRIZE
100.00.....	FIFTH PRIZE
FIFTY \$10.00	PRIZES

(In case of ties, duplicate prizes will be awarded)

## SAMPLE LETTER

### How "House-to-House" Gardening Brings Kole \$35 to \$40 a Week

"Early this spring, I was laid off at the garage," writes Walter F. Kole. "Rather than sit around idle, I decided to fix up my back yard which I had never had time to give attention to. Soon I had a beautiful lawn and lovely flowers shooting up. One day while I was sprinkling my garden, my next door neighbor, an old widower who was in ill health, offered me \$25 to fix up his garden and \$5 a week to take care of it after that. You bet I grabbed his offer. That gave me the idea to go after other neighbors and friends who either didn't have the time or weren't physically able to do this work. My plan worked out so well that now I make as high as \$45 a week and enjoy the work very much more than at the garage." (He then states his reason why he thinks this idea a good one for publication in a magazine like Popular Mechanics.) Walter F. Kole, Mechanic, Brooklyn, N. Y.



"A correspondence course?

—YES

and be sure it's

I. C. S."



"If a man is going to get ahead these days, he must continually acquire more training — and the only time he can do this is in spare time. And the only way he can do it is by studying a correspondence course.

"But don't start if you haven't the determination to go through with it. Spare-time study is not a business for weaklings. It takes courage — and work! But remember this, completion of a course will pay dividends the rest of your life!

"But don't take any chances. Once I faced the problem you now face — and I enrolled with the International Correspondence Schools. My choice was a wise one. I recommend I. C. S. to you!"

Every day, all over the world, thoughtful employers recommend I. C. S. training to ambitious employees. They have not forgotten what spare-time study did in shaping their careers. And when you mark and mail this coupon, you follow in the path they have blazed. Why not do it—today?

INTERNATIONAL CORRESPONDENCE SCHOOLS

"The Universal University"

Box 5379-G, Scranton, Penna.

Without cost or obligation, please send me a copy of your booklet, "Who Wins and Why," and full particulars about the subject before which I have marked X:

TECHNICAL AND INDUSTRIAL COURSES

- |  |  |
|--|--|
| <input type="checkbox"/> Architect   | <input type="checkbox"/> Automobile Mechanic                                 |
| <input type="checkbox"/> Architectural Draftsman                             | <input type="checkbox"/> Plumbing <input type="checkbox"/> Steam Fitting     |
| <input type="checkbox"/> Building Estimating                                 | <input type="checkbox"/> Heating <input type="checkbox"/> Ventilation        |
| <input type="checkbox"/> Wood Millworking                                    | <input type="checkbox"/> Sheet Metal Worker                                  |
| <input type="checkbox"/> Contractor and Builder                              | <input type="checkbox"/> Steam Engineer                                      |
| <input type="checkbox"/> Structural Draftsman                                | <input type="checkbox"/> Steam Electric Engineer                             |
| <input type="checkbox"/> Structural Engineer                                 | <input type="checkbox"/> Civil Engineer                                      |
| <input type="checkbox"/> Electric Wiring                                     | <input type="checkbox"/> Surveying and Mapping                               |
| <input type="checkbox"/> Electrical Engineer                                 | <input type="checkbox"/> Refrigeration                                       |
| <input type="checkbox"/> Electric Lighting                                   | <input type="checkbox"/> R. R. Locomotives                                   |
| <input type="checkbox"/> Welding, Electric and Gas                           | <input type="checkbox"/> R. R. Section Foreman                               |
| <input type="checkbox"/> Reading Shop Blueprints                             | <input type="checkbox"/> R. R. Bridge and Building Foreman                   |
| <input type="checkbox"/> Telegraph Engineer                                  | <input type="checkbox"/> Air Brakes <input type="checkbox"/> Train Operation |
| <input type="checkbox"/> Telephone Work                                      | <input type="checkbox"/> Highway Engineering                                 |
| <input type="checkbox"/> Mechanical Engineer                                 | <input type="checkbox"/> Chemistry <input type="checkbox"/> Pharmacy         |
| <input type="checkbox"/> Mechanical Draftsman                                | <input type="checkbox"/> Coal Mining Engineer                                |
| <input type="checkbox"/> Machinist <input type="checkbox"/> Toolmaker        | <input type="checkbox"/> Navigation <input type="checkbox"/> Boilermaker     |
| <input type="checkbox"/> Patternmaker  | <input type="checkbox"/> Textile Overseer or Supt.                           |
| <input type="checkbox"/> Pipefitter <input type="checkbox"/> Tinsmith        | <input type="checkbox"/> Cotton Manufacturing                                |
| <input type="checkbox"/> Bridge Engineer                                     | <input type="checkbox"/> Woolen Manufacturing                                |
| <input type="checkbox"/> Bridge and Building Foreman                         | <input type="checkbox"/> Agriculture <input type="checkbox"/> Fruit Growing  |
| <input type="checkbox"/> Gas Engines <input type="checkbox"/> Diesel Engines | <input type="checkbox"/> Poultry Farming <input type="checkbox"/> Radio      |
| <input type="checkbox"/> Aviation Engines                                    | <input type="checkbox"/> Marine Engineer                                     |

BUSINESS TRAINING COURSES

- |   |  |
|---|--|
| <input type="checkbox"/> Business Management                                  | <input type="checkbox"/> Business Correspondence                             |
| <input type="checkbox"/> Office Management                                    | <input type="checkbox"/> Lettering Show Cards <input type="checkbox"/> Signs |
| <input type="checkbox"/> Industrial Management                                | <input type="checkbox"/> Stenography and Typing                              |
| <input type="checkbox"/> Personnel Management                                 | <input type="checkbox"/> Complete Commercial                                 |
| <input type="checkbox"/> Traffic Management                                   | <input type="checkbox"/> Civil Service <input type="checkbox"/> Mail Carrier |
| <input type="checkbox"/> Accountancy <input type="checkbox"/> Cost Accountant | <input type="checkbox"/> Railway Mail Clerk                                  |
| <input type="checkbox"/> C. P. Accountant                                     | <input type="checkbox"/> Grade School Subjects                               |
| <input type="checkbox"/> Bookkeeping  | <input type="checkbox"/> High School Subjects                                |
| <input type="checkbox"/> Secretarial Work                                     | <input type="checkbox"/> College Preparatory                                 |
| <input type="checkbox"/> Spanish <input type="checkbox"/> French              | <input type="checkbox"/> Illustrating <input type="checkbox"/> Cartooning    |
| <input type="checkbox"/> Salesmanship <input type="checkbox"/> Advertising    | <input type="checkbox"/> Lumber Dealer                                       |

Name.....Age.....

Address.....

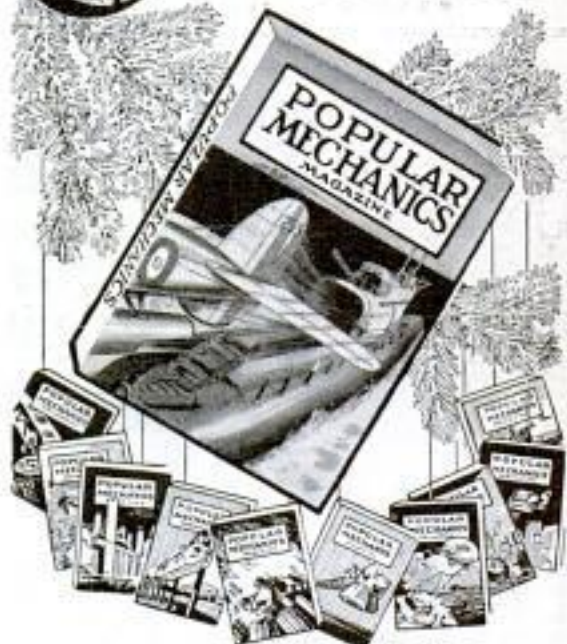
City.....State.....

Occupation.....

If you reside in Canada, send this coupon to the International Correspondence Schools, Canadian, Limited, Montreal, Canada

When writing please mention Popular Mechanics

# Save on Your Christmas Gifts



MAKE three friends happy on Christmas and all the rest of the year—besides saving \$1.50 for yourself. A gift subscription to Popular Mechanics Magazine is a reminder every month for 12 months and can't be beaten as a gift for a man or boy.

Every issue of this entertaining and valuable magazine contains 176 pages and over 400 pictures of fascinating events in every corner of the world. The Romance of Modern Progress is told in pictures and simple language. Radio enthusiasts, home craftsmen and practical shopmen are shown countless "easy-to-make" conveniences that save time, labor and money.

Order three subscriptions, save \$1.50  
Price for one year is \$2.50 but until January 1, 1932, you may order 3 one-year subscriptions for only \$6.00—and an engraved Christmas card will be sent to each subscriber for you.

3— one-year subscriptions \$6.00

1— two-year subscription \$4.00

1— one-year subscription \$2.50

Foreign and Canadian subscriptions 50c a year additional.

Mail your order to:

Xmas Gift Dept., Popular Mechanics Magazine  
200 East Ontario St., Chicago, Ill.

\$ **7.50** for \$ **6.00**

# Want a Steady Job?



## Railway Postal Clerks

**\$158 Month First Year**

**Raise to Maximum of \$225 Month**

*Many Other U. S. Government Jobs Open to Men and Boys 18 to 45*

**POST OFFICE CLERKS RURAL MAIL CARRIERS CITY MAIL CARRIERS  
PROHIBITION AGENTS CUSTOMS INSPECTORS**

These are steady positions. Strikes, poor business conditions, lockouts or politics do not affect them. U. S. Government employees get their pay for full twelve months every year. There is no such thing as "HARD TIMES" in the U. S. Government Service.

### ALLOWANCE FOR HOTEL EXPENSES

Railway Postal Clerks now get \$1900 the first year regularly, being paid on the first and fifteenth of each month. \$79.16 each pay day. Their pay is increased \$100 and \$150 a year. The maximum is \$2700 a year. \$112.50 each pay day. They get extra allowance for hotel expenses when away from home.

### PAID VACATIONS

Railway Postal Clerks, like all Government employees, are given a yearly vacation of 15 working days (about 18 days). When on runs they usually work 3 days and have 3 days off duty or in the same proportion. During this off duty and vacation, their pay continues just as though they were working. When they grow old, they are retired with a pension. As Railway Postal Clerks are continually traveling, they have an excellent chance to see the country. Many Spring examinations expected.



### CITY MAIL CARRIERS—POST OFFICE CLERKS

Clerks and Carriers get \$1700 the first year regularly and automatically increase \$100 a year to \$2100 with further special increase to \$2300. They also have 15 days' vacation. City residence is unnecessary.

### What Will You Earn 5 Years From Now?

Compare these conditions with your present or your prospective condition, perhaps changing positions frequently, kicking around from post to pillar, no chance in sight for PERMANENT employment; frequently out of a position and the year's average salary very low. DO YOU EARN \$1900 EVERY YEAR? HAVE YOU ANY ASSURANCE THAT A FEW YEARS FROM NOW YOU WILL GET \$2700 OR MORE A YEAR, EVERY YEAR?



### Get FREE List of Positions

Fill out the coupon. Tear it off and mail it today—now, at once. DO IT NOW—This investment of two cents for a postage stamp may result in your getting a U. S. Government Job.

FRANKLIN  
INSTITUTE  
Dept. L 174  
ROCHESTER, N. Y.

Rush to me entirely free of charge 32-page book with (1) a full description of the position checked below; (2) a list of U. S. Government jobs now obtainable; (3) tell me how to get the position checked.

- MAIL COUPON TODAY
- Railway Postal Clerk...(\$1900-\$2700)
  - Post Office Clerk.....(\$1700-\$2300)
  - City Mail Carrier.....(\$1700-\$2100)
  - Rural Mail Carrier.....(\$2100-\$3400)
  - General Clerk and File Clerk.....(\$1260-\$2500)
  - Inspector of Customs.....(\$2100-\$3300)
  - Prohibition Agent.....(\$2300-\$2800)
  - Immigrant Inspector.....(\$2100-\$3000)

Name.....

Address.....

Use This Coupon Before You Mislay It—Write or Print Plainly



## Here's an Amazing New Business THAT PAYS UP TO \$1,000 A MONTH

**MEN**, here is a real, red hot money-making opportunity! It's a chance to jump into business for yourself and make more money every week than the average man makes in a month.

Surprising as it may sound, we actually put you in a business, with the first day's profits often running from \$18 to \$55. \$350 to \$600 the first month is not unusual for ambitious men.

### Cut in on the Big Money

All you need is the ambition to make real money. We supply you with complete equipment to make and sell that famous new food specialty—Brown Bobby—a greaseless doughnut baked by electricity!

It's a crispy, flaky, delicious new kind of doughnut cooked without one drop of oil or grease. Easily digested by everyone. More appetizing than old-style doughnuts ever were. Costs less to make. Sells four times as fast. No baker's skill required. Just add water to our prepared "Mix." You can open a shop; rent cheap floor space in a grocery, delicatessen, lunch-counter, drug store, etc. Or start at home—and make up to \$250 your very first week.



"I made \$3,000 in 3 months from my greaseless doughnut business!" — T. Chas. Minch, Fla.

### Start At Once ANYWHERE!

Men and women everywhere are starting in this business daily! YOU cannot afford to delay! Details will gladly be sent without obligations of any sort. Such an amazing money maker may never come your way again. So fill in and send the coupon at once! TODAY!

#### FOOD DISPLAY MACHINE CORP.

Dept. F-31 500 N. Dearborn St. Chicago, Ill.

Food Display Machine Corp.,  
Dept. F-31, 500 N. Dearborn St., Chicago, Ill.

Gentlemen: Please send me the plan by which I can cash in on Brown Bobby, the Greaseless doughnut. It is understood that this obligates me in no way whatever.

NAME.....

ADDRESS.....

CITY.....STATE.....

When writing please mention Popular Mechanics

## TELEVISION WANTS MEN

Wonderful openings for operators, salesmen, service and repair men at big pay. More jobs NOW in Television and Aircraft Radio than there are available trained men. We want ambitious beginners and will train you to step into a good job quick. No matter what your past experience, if you are over 18 years old and want to make \$300 to \$600 a month in this fascinating big pay profession, write today for full particulars.

"SID" NOEL, Pres.

FIRST NATIONAL TELEVISION, INC.  
2101 Fairfax Airport KANSAS CITY, KANSAS

## LEARN THE JEWELRY BUSINESS WATCHWORK, JEWELRY AND ENGRAVING

Send for free catalogue  
Bradley Watchmaking School, Dept. P, Peoria, Illinois

## RAISE FUR RABBITS for US WE CONTRACT FOR ALL YOU RAISE - PAYING UP TO \$6.50 EACH



**BIG PROFITS** in raising CHINCHILLA and NEW ZEALAND WHITE fur rabbits FOR US on contract backed by eighteen years of service **PROFITS** for you by raising an animal that produces 24 young yearly, for which **WE PAY YOU \$1.00 TO \$6.50 EACH**  
Large illustrated book, catalog and contract—also copy of FUR FARMING magazine, gives complete details all for 16c. Address STAHL'S OUTDOOR ENTERPRISE CO., Box 1418, Holmes Park, Mo.

## INCREASE YOUR POULTRY PROFITS!

By proper Breeding, Feeding, Housing, Culling and Marketing AMERICAN POULTRY JOURNAL tells how to do it, and in addition a series of **COLORED PICTURES**

with explanatory text tell and show many things you should know. They are not just colored pictures of birds but pictures of an educational nature, something never before shown by a poultry paper. 12 issues of American Poultry Journal contain about 1000 pages—

Price 25c a year—5 years \$1.  
AMERICAN POULTRY JOURNAL, 14-536 S. Clark St., CHICAGO

## WONDERFUL NEW BOOK FREE

**NATION'S GREAT POULTRY MANUAL:** facts about housing, feeding, diseases. **BERRY'S TESTED CERTIFIED CHICKS GUARANTEED TO LIVE 30 DAYS** or replacement at 1/2 price. **32 VARIETIES, NEW LOW PRICES** chicks, fowls, supplies and equipment. **BERRY'S POULTRY FARM, Box 29, Clarinda, Iowa**

## NEW SQUAB BOOK FREE

Breed PR Royal squabs and make money. Sold by millions at higher prices than chickens. Raised in one month. Send four cents stamps for postage on brand new big 64-p. illustrated free book how to breed and profit by fast sales method. Thirty-first year.  
Plymouth Rock Squab Co., 634 N St., Melrose, Massachusetts

## NEW LOW CHICK PRICES

**48 BEST VARIETIES:** Large, Strong, Vigorous, Quick Maturing, Heavy egg Production. **New Colored Book with NEW LOW PRICES:** chicks, fowls, eggs, supplies etc. Best References, "Fair Play" and "Money-Back" Guarantee. Write for new book.  
GREAT WESTERN HATCHERY Box 52 SALINA, KANSAS

Valuable Poultry BOOK FREE

## 70 BREEDS Chickens, geese, turkeys, ducks, Pure-bred, hardy, high quality and most profitable. Fowls, Eggs, Baby Chicks and incubators at new low prices. America's great plant—since 1893. New large valuable Poultry book and catalog FREE.

R. F. NEUBERT Co., Box 878. Mankato, Minn.

## Save Your Feet

When all else fails end your suffering with the flexible "no metal" **Heefner ARCH SUPPORT**  
WRITE FOR FREE BOOKLET



HEEFNER ARCH SUPPORT CO. 685 M. E. TAYLOR BUILDING LOUISVILLE, KY

# -takes only 8 weeks to get a big job



George Smith owns an agency and repair shop in West Alexandria, Ohio. He makes \$200 a week.

## and Earn \$50 to \$100 a Week as Auto Expert

Learn the auto and tractor business by the McSweeney method, then step out and get a good job at \$50 to \$100 a week or open your own repair shop and make up to \$1,500 a year. Trained men are needed everywhere. Opportunities galore! Eight weeks training fits you to open repair shop or to go with one of the big firms waiting for trained men. Read what George Smith and C. E. Gillespie have done. Hundreds of other McSweeney trained men can tell as interesting facts. Every month McSweeney men who complete their training are taking the place of half-trained and incompetently self-trained men.



C. E. Gillespie has charge of a fleet of tractors for the State Highway Commission, due to McSweeney training.

### Learn in Only 8 Weeks

Simple, thorough, practical shop methods. You learn the "why" of everything you do, then learn to do it right. You do real work with real tools and real equipment. No book studying. Very little schooling necessary. Any man from 16 to 60 can learn. Write today for Big Special Limited Time Tuition Offer, including—

### SPECIAL! R. R. FARE

### Also FREE course in AUTOMOBILE ELECTRICITY to those who enroll soon. Don't delay—write at once for complete details and BIG AUTO BOOK FREE. Mail coupon NOW.

## AVIATION COURSE INCLUDED

AVIATION is paying tremendous incomes to trained men! Now eight weeks' course also includes complete course in Aviation Mechanics. Learn on real airplane engines under experienced instructors. Don't miss this remarkable opportunity. Save by enrolling at once. The sooner you start the sooner you will be ready to earn big pay or get into business for yourself.

### MAIL COUPON FOR FREE BOOK

McSweeney Auto, Tractor and Aviation School, Dept. A-10-1, Cleveland, Ohio.

Without cost or obligation, send me your big FREE book on Autos; also, full details of your big offer including R. R. Fare and New Course in Aviation.

Name.....

Street.....

Town..... State.....

# McSWEENEY SCHOOLS

Auto, Tractor and Aviation Department A-10-1, Cleveland, Ohio

## ELECTRICAL ENGINEERING

A concise, comprehensive course for men of limited time, complete in one year. Mathematics, engineering drawing, shop-work. Students construct motors, install wiring, test electrical machinery. Buildings fireproof. 35 years' successful experience. Catalog on request.

### BLISS ELECTRICAL SCHOOL

131 Yakoma Ave., Washington, D. C.

## TRICKS WITH ELECTRICITY!

How to be a "human dynamo"—make electric lights obey voice—do spirit rapping and fortune telling by electricity—make all kinds electric novelties and devices at home. "Electric Fun", fascinating book telling how to do 200 stunts with ordinary house current (110 volts A.C.) \$1.00 postpaid.

CUTTING & SONS Dept. 105 CAMPBELL, CALIF.

## NOW YOU CAN LEARN THE ORNAMENTAL COLORED CONCRETE TRADE

Learn how to make beautiful one-piece Cement Fireplaces in any color, effect or design at a cost for materials of less than four dollars!

Learn how to make both plaster and cement molds. Learn how to reproduce in colored cement pictures, designs, scrolls, coat-of-arms, etc., from your own molds.

Learn how to reproduce in colored cement the effect of marble, brick, granite, tile, Travertine, Terrazzo, etc. How to make colored cement garden benches, portable garage blocks, etc. How to do all of the above without the use of any machinery whatever! The time to act is NOW—Write for details of personal instruction or home study courses and easy payment plan.

### ORNAMENTAL CONCRETE INSTITUTE

Dept. B 246 Fifth Avenue New York City

Learn ADVERTISING at Home

Greater opportunities now in advertising. Learn easily and quickly in spare time. Practical work. No text books. Old established school. Low tuition—Easy terms. Send for free booklet of interesting information.

Page-Davis School of Advertising Dept. 1351, 3601 Mich. Ave., Chicago



# Men! Extra Money Quick

## Here's An Easy Way!

—to bring you a fine cash income! Without taking any time away from your job. Pleasant easy work at home. Decorate beautiful gift-wares the Fireside way. You can do it—in spare moments. No previous training required. No special ability needed. No tedious study. No memorizing. With the Three Simple Steps sent you by Monsieur Petit the great artist—Director of Fireside Industries, it is just fun! We want men in every community. Be the first!

Dept. 66-A ADRIAN, MICH.

## Begin Right Now!

Thousands are making Fireside decorations—making from hundreds to thousands of dollars and doing their own work besides. We supply you with everything you need. Big Generous Complete Kit WITHOUT EXTRA COST. It's a cinch! Your success is assured.

## FREE!

Fill out and mail coupon at once. Without any obligation it brings you wonderful Fireside Books in colors. Explains everything.

Fireside Industries, Dept. 66-A, Adrian, Mich. Send me your wonderful Free Book in colors. This does not put me under any obligation.

Name.....

Address.....

Fireside Industries

Act Now!

**"I MADE  
\$117.00  
IN 2  
DAYS"**



*Just*  
**TURNING  
THIS MAGIC  
CRANK**

**I**MAGINE a little automatic can opening machine that opens any size or shape can in a couple of seconds—at just the twist of the wrist! Hangs on the wall. Holds the can for you and cuts out the entire top slick, smooth and clean—inside the rim, so that juices can't spill! Food pours out without scraping or spooning. No jagged edges to snag fingers. Banishes dangerous old-style can openers to the scrap heap forever! Sells on sight to women everywhere.

## Million Dollar Can Opener Brings Record Profits!

No wonder Speedo representatives often sell to every house in the block and make up to \$12 in an hour! E. T. Barclay, N. Y., made \$117 cool profit in just two days. J. Williamson, Wis., made \$5 his first hour. Mrs. Spain, Kas., made \$9 her first afternoon. You, too, can make big money in full or spare time. Unique liberal selling plan now brings you this revolutionary Speedo invention and two other great household sellers on **FREE TEST**. Also startling **TRIPLE-PROFITS, GUARANTEED SALES** Plan that starts you **WITHOUT RISK** whatever! **SEND NO MONEY**—simply mail coupon **NOW!** Central States Mfg. Co., Dept. A-705, 4500 Mary Ave., St. Louis, Mo.

## FREE TEST OFFER SIMPLY MAIL COUPON

Central States Mfg. Co., Dept. A-705,  
4500 Mary Ave., St. Louis, Mo.  
Rush full details of your generous **FREE TEST OFFER**.

Name.....

Address.....

City..... State.....

Check here if interested only in one for your home.

When writing please mention *Popular Mechanics*

## OPPORTUNITIES IN Traffic Management

### Become a Traffic Expert

The opportunities in traffic management are limited only by the boundaries of the business world. The trained traffic man is in demand by transportation systems and by industrial organizations.

**Three Detroit Firms  
Pay Their Traffic Managers  
Over \$20,000 a Year**

Prepare for this growing, profitable profession at home in your spare time under supervision of traffic experts. Low cost; easy terms. Thru the LaSalle Problem Method you learn by doing. Valuable 64-page booklet free. Send for it Now.

**LaSalle Extension University, Dept. 164-T, Chicago**



**This Book  
FREE!**

## TRI-STATE COLLEGE

DEGREE IN 2 YEARS



**B. S. DEGREE** in Civil, Electrical, Mechanical, Chemical, Aeronautical Engineering in 2 years. Those who lack high school may make up work. Living costs, tuition low.

412 College Ave., Angola, Ind.

Catalog

## EARN MECHANICAL DENTISTRY

**Earn Big Money—Men Needed Everywhere.** This money-making business easily learned in a few months in day or evening sessions. Practical training. Individual instruction. Easy terms. School is highly endorsed. Write **NOW** for free catalog P and special tool offer. Address **NEW YORK SCHOOL OF MECHANICAL DENTISTRY, 125 W. 31st St., New York**



**80 BREEDS** Chickens, ducks, geese and turkeys. Pure bred tested hardy northern raised Gold Seal stock Fowls, eggs, baby chicks, lowest prices. 50 years experience and my large new Catalog and Breeders' Guide **FREE**.  
**W.A. Weber Co. Box 28, Mankato, Minn.**

**Keds**

At \$1.00, \$1.25, \$1.50  
\$1.75 and up to \$4.00.



United States Rubber Company



## How to Obtain A Better Looking Nose

**Improve your personal appearance**  
My free book tells you how I guarantee to improve the shape of your nose by remodeling the cartilage and fleshy parts, quickly, safely, and painlessly, or refund your money. The very fine, precise adjustments which only my new patented Model 25 Nose Shaper possesses, make results satisfactory and lasting. Worn night or day. Over 100,000 users. Send for free book to **M. TRILETY, Pioneer Nose Shaping Specialist Dept. 288 BINGHAMTON, N. Y.**



## Deaf 20 Years

**But now I hear** and will tell any deaf person **FREE**, who writes me, how I got back my hearing, and relieved head noises by a simple, invisible, inexpensive method which I myself discovered.

Geo. H. Wilson, President  
Wilson Ear Drum Company, Inc.  
1345 Todd Bldg., Louisville, Ky.

## MOLES and WARTS



### REMOVED PERMANENTLY

Rid your face, neck, arms and body of all unightly moles and warts with "ANTI-MOLE." One application does it. Safe—easy to use—painless—leaves no scar. Used successfully by physicians, skin specialists and beauty experts for 28 years. Write for **FREE** booklet on treating all kinds of moles and warts.

Miller Co., 2445 South St., Lincoln, Nebr.

A Blessing in "Hard Times"

# New Soles 9¢ A PAIR

as low as

## FREE SAMPLE SAVASOLE

to Readers of POPULAR MECHANICS

See this amazing discovery that ends costly half sole repairing forever. It's called Savasole—a scientific "plastic leather" that puts new soles on worn out shoes—makes them wear like new—for as low as 9c a pair. Rebuilds run down heels too. Fills in all cuts, holes, cracks, forming a smooth, thick waterproof surface. Agents are cleaning up with this sensational specialty. Mail coupon for Free sample and money-making agents' offer.

Spreads on Soles Like Butter on Bread

**Dries Hard and Smooth Overnight**

No more taking shoes to the repair man. No paying from \$1.00 to \$1.75 for leather soles and heels. Just spread SAVASOLE on the worn out soles with an old knife—as easily as you spread butter on bread. Let it dry overnight. In the morning you have a new wearing surface that is hard, smooth, and durable. Looks like leather. Wears like leather and is absolutely waterproof.

**Pays Agents UP TO 42% A DAY**



"WELCOME"



"JUST WHAT I WANTED"



"WHAT A SELLER"



### SAVASOLE

The Original Perfected "Plastic Leather"



**BEFORE**—Here is an old shoe, worn down, ready to be sent to the shoemaker, who would charge \$1.00 to \$1.75 for a first-class job.



**AFTER**—Here is the same shoe repaired with SAVASOLE. No hammer, nails, or pegs. Just use an old knife. All the cracks and breaks are filled in and covered up with a hard, smooth, waterproof, non-skid surface. SAVASOLE repairs shoes for one-tenth the cost of ordinary heels and soles.

**GUARANTEED!** Do not confuse SAVASOLE with "cheap" imitations. SAVASOLE alone has the special Bollman Double-action Cement Process (patent applied for) that means SAVASOLE CANNOT COME OFF THE SHOE. SAVASOLE outwears the uppers.

My money back guarantee protects you and your customers.

**MONEY-MAKING PROOF \$135 PER WEEK**



I gave up my former connection where I failed in earnings from \$215 to \$386 per month. I started out with three gross of Savasole. Since that time, my earnings have netted me over \$135 per week and I am sure that I will soon hit \$200 per week. Savasole has solved my financial problems, and you see the widest bunch of people to work with I ever saw.

**30 GROSS HIS FIRST MONTH**

I have given Savasole a thorough trial and think it is wonderful. This order complies my requirements for sole distributor. Send me four gross of Savasole at once.



E. L. BURTON

### 1001 Other Uses

On any Leather, Rubber, or Canvas Goods such as: Arctics, Auto Tops, Auto Floor Mats, Beltings, Bicycle Tires, Canvas Shoes, Leather Coats, Cut Filler for tires, Electric Insulation, Galoshes, Garden Hose, Rubber Gloves, Grips for Handles, Linoleum, Overshoes, Raincoats, Rugs on slippery floors, Sporting Goods, Stair Treads.

### MAIL FOR FREE SAMPLE

R. R. Bollman, Pres., Perfect Manufacturing Co. A-30 Daylight Bldg., Cincinnati, Ohio

Dear Mr. Bollman: Please send me FREE sample of SAVASOLE and explain how I can earn up to \$42.00 a DAY. Also send me details. Exclusive Territory Plan. Send everything to me FREE and without obligation.

Name.....

Address.....

Town.....State.....

Territory preferred.....

### PERFECT MANUFACTURING CO.

Manufacturers of SAVASOLE—the Original, Perfected "PLASTIC LEATHER"  
A-30 Daylight Building CINCINNATI, OHIO

When writing to advertisers please mention Popular Mechanics

**NOW**  
**Less than**  
**\$100.00**

**MINERAL WICK**

**LACO AUTOMATIC**

**OIL HEAT**

**At Amazing Low Cost**

**Burns Oil Cheap as Coal**

Listed as Standard by Underwriters Lab., Inc.

**Fits Every Furnace**

Heat for two rooms or twenty stories. For every type of heating system. Hot air, steam, vapor, or hot water. Twenty-six sizes and models. No bricking of firebox or injury to your furnace. Write today for complete information.

**THINK of it!** A fully automatic, guaranteed and proven, oil burner now for less than \$100. (Mass production makes this possible.) On the easiest terms ever offered! No wonder our dealers are swamped with orders. It's making them fortunes almost over night. It ends furnace drudgery, coal, ashes, smoke, and soot. Absolutely quiet and safer than the ordinary kitchen range. Famous LACO REMOVABLE GAS GENERATING CHAMBER with patented Mineral Wick SMASHES FUEL COSTS TO A FRACTION. This porous, sponge-like fireclay, indestructible by special heat treating process, changes oil into gas and

burns it with AIR! Uses every drop of oil! Ends fuel waste up the chimney. Best of all, it burns either oil or gas (natural or manufactured). No soot, smoke, grease. Simple to install. Nearly anyone can do it in only a few hours. Highest quality materials and workmanship. Designed to eliminate service. Attractively finished. Now cheaper to operate than ever because of the amazing low price of oil.

**NEW Model F**

Now ready! New Improved 1932 Model F, the World's Lowest Priced Atomizing Power Oil Burner, at Still Greater PRICE REDUCTIONS. Many outstanding improvements. Packingless pump. Quieter. Radio-proof coil. All Brass Tubing. New Steel Electrodes. Diffuses air and oil instantly under low spiral velocity. Creates intense heat. Noiseless flame. No fuel waste. Burns heavy grade, cheap oils and 24 Models. And A SPECIAL MID-WINTER OFFER IF YOU ACT NOW. Send at once for complete information!



**DEALERS WANTED**

NEW LOW PRICES without any cuts in discounts OFFER YOU THE GREATEST OPPORTUNITY EVER TO MAKE MORE MONEY. No experience required. Only small investment. Some report as high as \$50,000 Annually Clear. SPECIAL OFFER IF YOU ACT RIGHT NOW! Few Openings Left for Large Jobbers. Hurry.

**SPECIAL OFFER**

Right now get our mid-season low price offer—less than \$100 Easy Payment Plan. Write today stating number rooms you want to heat and present type heating system. Do it now and SAVE ON YOUR FUEL BILL!

**LACO OIL BURNER CO.** 150 Union St. Griswold, Iowa

**Does Your English Help or Hurt You?**

Wonderful new way to improve your English. No rules to learn. No hard study. Grammar, spelling, punctuation, and expression, taught in 15 minutes a day—at home. Self-correcting feature makes it fascinating as a game. Write today for free book, "How You Can Master Good English in 15 Minutes a Day." Address



**SHERWIN CODY SCHOOL OF ENGLISH**  
51 Searle Building Rochester, N. Y.

**LEARN TO DRAW**

Cartoons—Comic Strips—Illustrations  
You will be SURPRISED when you learn of the low price of

**THE ACE OF CARTOON COURSES**  
Send your name and address for FREE particulars and sample illustrations.  
**CARL ANDERSON SCHOOL, Madison, Wis.**



**Government Positions**

Clerk Carriers, Rural Carriers, Railway Mail Clerks, Postmasters, Department Clerks, and many others. Splendid salaries, easy work, vacation with pay. Only common school education required. Examinations often. 44,817 appointed last year. Send for our Civil Service Catalog No. 6. **COLUMBIAN CORRESPONDENCE COLLEGE, Washington, D. C.**

**NO JOKE TO BE DEAF**

—EVERY DEAF PERSON KNOWS THAT

George P. Way made himself hear, after being deaf for 25 years, with Artificial Ear Drums—his own invention. He wore them day and night. They stopped head noises and ringing ears. They are invisible and perfectly comfortable. No one sees them. Write for his true story, "How I Got Deaf and Made Myself Hear." Also booklet on Deafness. Address  
George P. Way, Inc., 729 Hoffmann Building, Detroit, Michigan



Artificial Ear Drum

**WHAT EVERY ELECTRICIAN WANTS TO KNOW!**

is easily found in AUDELS NEW ELECTRIC LIBRARY. Electricity made simple as ABC. Up to date trade dope for the expert and ALL electrical workers.

Questions, answers, diagrams, calculations, underwriter's code; design, construction, operation and maintenance of modern electrical machines and appliances FULLY COVERED.

Audels NEW Library is necessary wherever electricity is used. Available at small cost, easy terms. FOUR-MONTH service puts this NEW electric information in your hands for 6c a day.

Write TODAY for Electric Folder and FREE TRIAL Offer.

**Theo. Audel, 65 W. 23rd St., New York**



\$1.50 A Vol.

NAME.....  
ADDRESS..... PM

**QUIT TOBACCO**

No man or woman can escape the harmful effects of tobacco. Don't try to banish unaided the hold tobacco has upon you. Join the thousands of inveterate tobacco users that have found it easy to quit with the aid of the Keeley Treatment.

**KEELEY Treatment For Tobacco Habit Successful For Over 50 Years**

Quickly banishes all craving for tobacco. Write today for Free Book telling how to quickly Free yourself from the tobacco habit and our Money Back Guarantee.

Hope of the famous Keeley Treatment for Limer and Drugs. Booklet Sent on Request. Correspondence Strictly Confidential.  
**THE KEELEY INSTITUTE, Dept. A-953, Dwight, Illinois**





# Classified Advertisements

WORLD'S BEST WANT AD MEDIUM \*

Advertisements in this section, 35 cents per word, each insertion, minimum 10 words, payable in advance  
To be inserted under proper classification in February issue, copy should be in our office December 18th

## ADVERTISING AGENCIES

**ADVERTISE**—Bargain value—24 words in 24 representative Sunday newspapers \$15; Free assistance with your ads, sales letters, literature. Helpful Ad-Guide showing best paying newspapers, magazines, rates, mailing lists, etc., free. Chicago Union Agency, Great Northern Bldg., Chicago.

**ADVERTISING**: 24 Words 8 big city Sunday papers—\$10. One inch display, 50 country weeklies—\$5. Copy prepared. Free list, magazines, farm. LeGrand Agency, 24 West 33rd St., New York.

**SELL** Your product with "sure-fire" sales letters. We write specimens to guide you. \$1; money back if not satisfied. Market advice, free. Give details. GE Agency, 1729 Grandview, Glendale, Calif.

**BEFORE** Advertising get our catalog. No charge. 25 years in business. The largest classified agency in the world. Ankrum Advertising Agency, 100 No. LaSalle St., Chicago, Ill.

**FREE**—New 1931 Advertisers Rate Guide, 44 pages. Includes everything. Lowest rates. E. H. Brown Advertising Agency, 140 S. Dearborn, Chicago.

**ADVERTISE** In rural weeklies. Lists free. Meyer Agency, 4113 Hartford, St. Louis, Mo.

**INCH** Display advertisement 50 magazines year \$24. Wood's Popular Services, Atlantic City, N. J.

**ADVERTISE** In southern negro newspapers! Lists free. R. Strickles, Jr., Staunton, Va.

**TIME** Counts in applying for patents. See pages 124 and 125. Clarence A. O'Brien, Registered Patent Attorney, Washington, D. C.

## FOR ADVERTISERS

**ADVERTISING**: 20 Words; 50 magazines 60c; three insertions, \$1.20. Inch display, three months \$6.00; year \$24.00. Mailing Bureau, Lawndale, Calif.

**ADVERTISE** 53 Magazines, 3 months, \$6.00 inch. List, special offers, free. Evans King Co., Box 672P, Wilmington, Delaware.

**24 WORDS**—70-95 Southeast weeklies, \$3.96. S. Stout, Warm Springs, Ga.

**ADVERTISE** In 50 M.O. papers \$1.00. The Sterling Novelty Co., Blue Island, Ill.

## MAILING LISTS

1,000 **AGENTS**, Salesmen and sales representatives. Guaranteed 100% correct. All 1931 producers. Here is a profitable, live-wire mailing list for your proposition. Price \$6.00 cash. Hutchinson Specialty Co., Hutchinson, Minn.

1,000 **BUYERS** And agents, 60c hundred. Seeley Service, Jennings, La.

## INFORMATION

ANY Information desired 25c coin and up. Fred Klotz, Reading, Pa.

"IF You want to fly" let Alexander Klein, brilliant engineer, teach you. With great skill whole course of training has been simplified and made crystal clear. Remarkable book teaches in most practical and easily understood fashion. Recommended by skilled fliers. Sent C. O. D. anywhere in U. S. Simply pay postman \$2.50 and postage when delivered. Sent postpaid to any address upon receipt of price. Popular Mechanics Press, Room 802, 200 E. Ontario St., Chicago.

## AGENCIES WANTED

**RESPONSIBLE** Business man wants New England agency for good product. Successfully operated own business twenty years. Address Room 843, 100 Boylston St., Boston, Mass.

## TYPING SERVICE

**EXPERT** Typing. Manuscripts typed in duplicate. 25c thousand words. Tabulating, etc., rates on request. Fair Typing Service, 161 W. King Street, York, Penna.

## BATTERIES

**STORAGE "B"** batteries. 24 volt \$1.75; 96 volt \$6.00. F. A. Meek, Rockbridge, Ill.

## AUTOMOBILES

**DIRT** Track Racing. Now you can break into the racing game. How to build racer, contest rules, speed, "revs"—Complete illustrated treatise, postpaid \$1.00. Ray Kuns, Dept. B, Madisonville, Cincinnati, O.

**TIME** Counts in applying for patents. See pages 124 and 125. Clarence A. O'Brien, Registered Patent Attorney, Washington, D. C.

## AUTOMOBILE SUPPLIES

**BARGAINS**—Excellent repossessed compressors, battery chargers, test benches, car washers. Terms. Trial. Write Ken's Automotive Service, Box M.121, Troy, Ohio.

**DE-NEG** Carbon Remover, fifteen years success on market. Pint delivered, United States, \$1.25. De-Neg Chemical Company, Birmingham, Ala.

**CHROMIUM** Plating powder plates iron, steel, brass, copper and nickel, without electricity or machinery. Guaranteed not to tarnish; ½ pint can \$1.50 prepaid. Gunmetal Co., Ave. J, Decatur, Ill.

## AUTOMOBILE SERVICE EQUIPMENT

**SUBSTANTIAL** Savings—repossessed compressors, battery chargers, test benches, car washers. Terms. Trial. Write Ken's Automotive Service, Box M. 122, Troy, Ohio.

## MOTORCYCLES, BICYCLES AND SUPPLIES

**REBUILT** Motorcycles \$25 to \$100 easy. Tires, used tires \$2.50. New Firestone \$5. Engines for motorcycle ice sleds, airplanes, boats \$15 to \$75. Forks \$3, frames \$3, cylinder \$3, saddles \$3, chains \$1.50, handle bars \$3, belts \$5, wheels \$5, side cars \$25. Bicycles \$9.50, airplane wheel \$1.00 was formerly \$2.00. Save you dollar prices. Oldest house in U. S. Send 25c for catalogue. Price Cutter Deninger, Rochester, N. Y.

**MOTORCYCLE** Bargains, lowest prices, bargain sheet for stamp, motorcycle accessories, largest line in America, lowest prices. Largest motorcycle mail order house in the United States. Rochester Harley Davidson Corporation, 129 West Main St., Rochester, N. Y.

**HENDERSON**, Excelsior, Harley, Indian, used parts. Catalogue, wings pin 10c. Baljak, 100 N. 12th, St. Louis, Mo.

**TYPEWRITERS**, Mimeographs, \$1.99-\$34.99. Agents. Radios, motorcycles, Knights, 1506 Locust, St. Louis, Mo.

**SEND 15c** For illustrated used Motorcycle catalog. Large stock. Bargains. Indian parts. Accessories. Indian Motorcycle Sales, Kansas City, Mo.

**LOW Prices**—Special bargains in Harley-Davidsons—14 models. Send 6c stamps for catalog. Knuth's, 2525 Fond du Lac Ave., Milwaukee, Wis.

**REPAIR** With good used parts, save ¼ or more, state parts needed, no lists. J. B. Dahl, 3661 Archer Ave., Chicago, Ill.

## AVIATION

**BE** Sure that the motor you purchase for your light plane will fit it. Heath B-4 and Heath Henderson motors are guaranteed to fly and 7 years of constant performance prove it. For economy and reliability these motors cannot be equalled. Send 10c for large illustrated booklet. Heath Aircraft Corp., Dept. KP-21, Niles, Michigan.

**LIGHTPLANE** Motors, propellers, wheels, conversions, plans, cut prices. All new ideas illustrated. 1932 catalog 10c. Bates Aero Works, 214-Sigel, Chicago.

**NEW** Low prices on propellers and used motors, propellers \$5 up. Used motors \$15 up. Send two cent stamp to Sosenich Bros., Litzitz, Pa.

**SNOW** Sleds. While their last—used airplane fuselages fitted with skis, \$75.00 and up. Can be powered with a motorcycle engine. Enjoy this great winter sport. Converted Henderson engines as low as \$190.00. Propellers \$18.00. Heath Aircraft Corporation, Dept. NP.21, Niles, Michigan.

**SPRUCE**—Finished to size for airplanes, gliders, iceboats. Highest quality. Lowest prices. Mail sizes for quotation. Pike-Dial Lumber Co., 2257 Logan, Chicago.

**FOUR "Aerodrive"** Sled blueprints, \$1. Aircraft supplies, propellers. Ostergaard Aircraft, Dunning, Chicago.

**AUTOMOBILE** Wanted in exchange for flying instruction. Air Activities Airport, West Chicago, Ill.

**PHOTOGRAPHS** Of 156 different types airplanes—foreign, American and historic. 3 for 25c. Send 2c stamp for list. Pilot Plane Photos, Gen. P. O. Box 560M, New York City.

**SHATTERPROOF** Pilot goggles \$1. Large. Cushioned. Hinged. Adjustable. Airc, 1315 So. 12th, Lincoln, Nebr.

**BUILD** Speedy motor driven ice and snow-sleds. Plans, \$1.00. Parts furnished if wanted. Oceana Aeronautical Sales, Hart, Michigan.

**FLYING** Simplified—Just out. Here is a remarkable non-technical book for beginners, prospective or advanced students that teaches in an easily understood manner all you can need to know to master the art of flying. Will save you many dollars when you learn to fly. Pay postman only \$1 and postage when book is delivered at your door C. O. D. Popular Mechanics Press, Room 802, 200 E. Ontario St., Chicago.

**USED** Airplane bargains, \$155 and up. Folder 10c. Federal Equipment Co., Box 911, Cincinnati, Ohio.

**SEND 5c** For bundle of balsam reeds and price list on supplies. Aero Shop, 3850 Harbut Ave., Detroit, Mich.

**SEND** For descriptive list of New, Rebuilt and Used Curtiss OX5 and Hispano Suiza Airplane Engines. Heckman Machine Works, 4026 W. Lake St., Chicago, Illinois

**AIRCRAFT** Directory 50c. Thousands surplus airplanes, motors, parts, supplies. Invaluable. Aerebuilders Service, 1305-15 So. 12th, Lincoln, Nebr.

**TIME** Counts in applying for patents. See pages 124 and 125. Clarence A. O'Brien, Registered Patent Attorney, Washington, D. C.

**AVIATION**—Every person interested in this subject should make full use of the opportunity to learn aerodynamics with Alexander Klein as his instructor, through his timely new book, "Simplified Aerodynamics." Heretofore this subject has been rather difficult for the thousands who need it but Klein's method enables all to master it. Every pilot, mechanic, student needs this book. Pay postman price, \$3.50, and few cents postage when he delivers it. Order from Popular Mechanics Press, Room 802, 200 E. Ontario St., Chicago.

## MODEL AIRPLANES

**CHEAPEST**. Best supplies. Catalog dime. Peru Model Aero Shop, Peru, Ind.

**NEW** Catalogue dime. Miniature Aircraft Corp., 83 Low Terrace, New Brighton, N. Y.

## BOATS AND LAUNCHES

**BOATBUILDING** Plans, designs, cruise stories, fine illustrations in The Rudder, oldest yachting monthly. Subscribe now for 1932 \$3.00, get October, November, December free. Send for new catalog. Rudder, 15 Murray Street, New York.

**PROPELLERS**, Pumps, stuffing boxes, bearings, etc. Wm. H. Baker, Pond St., Quincy, Mass.

## MODEL BOATS

**SEVERAL** Clipper ship models, and model ship fittings for sale. Repairing and rigging models. John Neck, 390 Second St., Brooklyn, N. Y.

## CARTOONING

SEE Yourself in cartoon. Send photo, state hobby, \$1.00. Edw. Stack, 84 First Ave., Pratt City, Alabama.

CARTOONING For profit, illustrated, \$1.00 postpaid. Smith's Service, Wenatchee, Wash.

COMIC Sketch from your photo \$1.00. State hobby. Photo returned unharmed. Teebson, 249 Wheatland St., Rochester, N. Y.

## FOR BOYS

BOYS—Here's a knockout! Get a genuine United States Government trench periscope. Fun for sham battles, dugouts, hunting, etc. Brand new (original cost \$2.00) price 50¢ each; 3 for \$1.00 postpaid. Pearlman Import, A-866 Broadway, New York.

LEARN Typewriting at home. Rational typewriting, brief course by Sorelle (a Gregg publication) enables you to become proficient at typing without the aid of an instructor. 96 pages. Illustrated Cloth. Sent C. O. D. Pay postman price, \$1 and small amount of postage upon delivery. Popular Mechanics Press, Room 802, 200 E. Ontario St., Chicago, Ill.

## ARCHERY

ARCHERY Tackle from the Ozarks where raw material is plentiful and woodcrafters exceptional. Catalog free. Outdoor Amusement Company, Clinton, Mo.

MAKE Your Bow and Arrows. We sell materials. Send 25¢ for working instructions and catalogue. Sidney Archery Co., Sidney, Ohio.

## CHALK TALKS

LAUGH Producing program, \$1.00. Catalog free. Balda, The Cartoonist, Oshkosh, Wis.

## BOOKS AND PERIODICALS

HUNDREDS Unemployed panning gold. Big placer-deposit territories untouched. Learn prospecting—Placer mining. New thorough treatise, with map showing localities; reports of rich strikes, etc. \$1.00, postpaid. W-S Laboratory, Coeur d'Alene, Idaho.

GOOD Books, magazines; dime brings circulars. Goldenrod Company, Harrisburg, Ill.

SELL Books from our catalog. Earn big money. World famous house. Particulars free. Meador Publishing Co., 470-A Atlantic Ave., Boston, Mass.

BOOKKEEPING And accounting self taught. Easily learned. Complete text \$1.00 C.O.D. Accounting Institute, Duluth, Minn.

ANOTHER Inhabited world! Sensational discoveries! Amazing descriptions 10¢. Hughes, South Whittier, Ind.

LEARN The truth. Atheism, Darwinism answered, 15¢. Supplement "debunking" Clarence Darrow, 5¢. Free unemployed. Exponent, 3838 Leclade, St. Louis, Mo.

CARTOONING For profit, illustrated, \$1.00 postpaid. Smith's Service, Wenatchee, Wash.

## PICTURES AND POSTCARDS

ACTION Photos, same as imported. Box 801 Santa Ana, Calif.

## GAMES, ENTERTAINMENTS AND PLAYS

PLAYS, Operettas, musical comedies and minstrels, comedy and talking songs, black-face skits, vaudeville acts, monologs, dialogues, recitations, juvenile plays and songs, musical readings, entertainments, make-up goods. Catalog free. T. S. Denison & Co., 623 So. Wabash, Dept. 11, Chicago.

## MAGIC TRICKS, BOOKS AND JOKER NOVELTIES

MAGIC—Tricks, Books and Supplies. For amateurs as well as the great professionals. Anyone can learn through our instructions. Feature Acts in Mind-Reading, Spiritualism, Rope Ties, etc. Large illustrated professional catalog, 25¢. Chicago Magic Co., 140 So. Dearborn St., Dept. B, Chicago, Ill.

MAGIC Catalog, illustrated, 10¢. Spelzer Specialty Co., Box 6, Brandywine Station, Schenectady, N. Y.

LEARN To hypnotize, instructive book on hypnotism, 10¢. Geo. Fenner, 2401 Jefferson, Louisville, Ky.

SPHINX, Magicians' magazine, 35¢. Catalogue of magic, 10¢. Holden Magic, 235 W. 42nd St., N. Y.

MAGIC Cards, produce startling effects. Complete with instructions 25¢. Davis Co., A-2669 East Allegheny, Phila., Pa.

SEVEN Opticalmagical delusions. Four Magic catalogues 25¢. Gilmagico, Morgan Park, Chicago.

MAGIC Catalog 20¢. Lynn, 105 Beach, Dept. 3, Jersey City, N. J.

## MINERALS AND GEMS

MINERALS, Gems, rocks, ores, for study or cabinet display. Splendid values. Gem Shop, 15C, Kohrs Block, Helena, Montana.

## RADIO SETS AND SUPPLIES

"EXTRAORDINARY Offer." If you own an electric or battery radio set, send for the "Tone Control" and receive your stations clearer, louder, and increase the receiving distance. Complete directions, price \$1.00 postpaid (anywhere). Advancement of Radio, Inc., 259 N. Fremont Ave., Los Angeles, California.

GREAT Fun making simple crystal radios. Crystal with instructions, 25¢. Five, \$1.00. "Melomite" crystal radio set only \$1.00. Melomite Co., Fairmount, Kansas City, Mo.

RADIOS Wholesale \$16.00. List free. "American," 3002 Wesley, Berwyn, Ill.

SHORT-WAVE Transmitter-receiver, complete, two tubes, instructions, etc., \$1.39. Amateur Radio Station, 54 Cohasset Street, Worcester, Massachusetts.

TIME Counts in applying for patents. See pages 124 and 125. Clarence A. O'Brien, Registered Patent Attorney, Washington, D. C.

SHORT Wave, television kits for easy, inexpensive home assembly. Folder 10¢. Federal Radio, Pewaukee, Wisconsin.

GUARANTEED "Pocket Radio," \$2.00. Catalogue, 10¢. Neil Tasker, Shamokin, Pennsylvania.

## EXPORTS AND IMPORTS

THE Uebersee Post, German importing and exporting monthly English journal offers numerous bargains in latest goods. Thousands seeking American outlet. A wonderful opportunity for obtaining any distributing agency. Subscription 1 year \$3.15. Sample copy 60¢. Fred Hettick, Sec'y., Mail Order Dealers Ass'n., Bismarck, North Dakota.

## STAMP COLLECTING

MEN Wanted to introduce a souvenir proposition of foreign stamps to stores, markets, etc. You make \$7.00 on each order which you collect right away. Live wires can get several orders a day. Sample outfit including carrying case, beautiful advertising material, packets, circulars, order book, etc., supplied at cost of \$2.50. This money returned when you get second order. Get started now and make big money. Grossman Stampco, 192 West 42 Street, New York.

A BIG Bargain—All for only 50¢. Stamp album, providing spaces for 2200 stamps with 700 illustrations, packet of 500 different stamps, 500 hinges, and millimeter measure. Free with each order our pamphlet which tells "How To Make A Stamp Collection Properly," and our 80 page price list of albums, supplies and hundreds of bargains in sets and packets. Queen City Stamp & Coin Company, Room 36, 604 Race Street, Cincinnati, Ohio.

THE Biggest Dollar—1000 mixed foreign including Newfoundland, Persia, etc., for 40¢; 1000 mixed U. S. for 40¢; 100 different U. S. with Civil and Spanish War Revenues and old 1861 cover for 44¢; 100 Latin-Americans for 25¢; 100 different from 50 countries for 10¢. All above with 1000 hinges for \$1.00. Approval selection with each order. New England Stamp Co., Established 1892, 53 Bromfield Street, Boston, Mass.

200 ALL Different U. S. for \$1.00. New England Stamp Co.

10 DIFFERENT Afghanistan for 50¢. New England Stamp Co.

SEND For new 1932 U. S. price list. New England Stamp Co.

NEW Issues and airmails on approval. New England Stamp Co.

SEND For U. S. and foreign on approval. New England Stamp Co.

SEND For complete sets on approval. New England Stamp Co.

300 DIFFERENT Fine foreign stamps 25¢. Drexel Stampco, 6057 Drexel, Chicago.

STAMPS Bought, sold, exchanged. Ritchie, Box 743, Watertown, So. Dak.

THE Molly Pitcher stamp of the United States is only 3 years old and yet has increased in catalogue value over 300% over last year's price. That stamp is a classic and will soon catalogue several dollars owing to the small quantity issued. Following our traditional policy of offering stamps of sound investment values, we offer it, together with 25 other stamps of excellent value, for only 10¢ to approval applicants. Globus Stamp Co., 258 Fourth Ave., New York.

BIG Parade—A packet of more than twenty all different better grade stamps showing exciting scenes and records of nations at war. Includes fire-pot hurler; the storming of a city; hand-to-hand bayonet struggle; bloody battle scenes; troop transport; red cross stamp; dying soldier; victory stamps; etc. Send for this thrilling "Big Parade" packet at once—limited supply. Only 10¢ to approval applicants. W. A. Rowell, 58 Cornhill, Boston, Mass.

IMMENSE Triangle stamp! The largest in the world, an album giant (Spain 1930 Columbus commemorative) included in amazing packet of thirty-four scarce varieties from queer far-off lands; Redi, Kouang-Tcheou, Gualior, etc. Absolutely no common European varieties to mar the high quality of this wonderful packet. Only 10¢ (coin) to approval applicants. Vogue Stamp Co., Dept. P2, Port Chester, N. Y.

SCARCE Airmail and triangle. Beautiful Uruguay "flying horse" airmail and scarce Guatemala triangle (smallest in the world) are included in our big packet of 60 different stamps from Abolites, Grand Liban, Venezuela, British and French Colonies, etc. All for 5¢ to approval applicants. Big illustrated lists free with each order. Write today! Mystic Stamp Co., (Dept. 80), Camden, New York.

ANCHER'S \$\$\$ Outfit—only 12¢. Fine triangle stamp, set German stamps (pre-war) value millions dollars, perforation gauge and mm scale, airmail set, interesting stamp smallest republic, newspaper set, packet good stamps Travancore, Malay, Dutch Indies, etc., fine pocket stock book. Entire outfit 12¢ to approval applicants. Ancher Stamp Company, Rutherford, N. J.

CANADA Airmail stamp free if you ask for approvals and send 15¢ for 25 different airmails or 30 different Canada; both packets only 25¢. We list 350 countries in our dime packets. Lists free. Special bargains, 500 different, 25¢; 1,000 different, 75¢; 2,000 different, \$2.50. Victoria Stamp Co., London, 4, Ontario, Canada.

10 PORTUGAL 1928 Commemoratives with approvals 6¢. Co-Operative Stamp Co., 110 Bates St., Paul, Minn.

FINE Penny approvals; write Stearns, 915 Sybil, Ann Arbor, Michigan.

80 STAMPS From 80 different countries, 10¢. Reimers, 30 N. LaSalle, Chicago.

EXCEPTIONAL Offer: Seven different United States airmail and parcel post stamps with perforation gauge and pricelist 10¢. Seidenberg, Baroda, Mich.

1000 DIFFERENT 60¢ With approvals. U. S. list free. Hollinbeck, 312 Marquette, Minneapolis.

SCARCE South American Commemorative set, pocket album, 30 different South and Central American stamps 4¢. Free lists. Glendale Stamp Co., 1342A Linden, Glendale, Calif.

NYASALAND Protectorate and 25 other British Colonies 4¢ to approval applicants. Frank Ewing, Box 493, Cleveland, Ohio.

100 DIFFERENT British Colonies including scarce old New Brunswick, Newfoundland Canada commemoratives 25¢ to approval applicants. Reid Stamp Company, 608 Yonge Street, Toronto.

BRUNEL (Native Scene), gigantic bi-colored Persian airmail, Johore, Tanganyika, French Guiana Provisional, Grenada, Eritrea, Foreign Revenue, Kedah, Orange River Colony, Nyasaland Protectorate, and scarce genuine Baden, all for 5¢ to introduce our famous approvals! Viking Stamp Co., Sheephead Bay Station, Brooklyn, N. Y.

AIRMAILS, Battle scene, volcano, native rulers, locomotive, South American stamps, 45 different including 15 Canada—5¢. If you request approvals. Glendale Stamp Co., 1342P Linden, Glendale, Calif.

UNCHALLENGED 70% Approvals against references. Rosswag, 339 East 86 Street, New York.

SEASONABLE Packet of beautiful and desirable stamps, including scenes, commemoratives and many other odd stamps. An ideal Xmas gift for yourself or others. Only 25¢ each. Order early. Jackson, Box 804, Timmins, Ont., Canada.

11 MINT Cabs including beautiful special delivery—12¢. Walter Brooke, Hoyertown, Pa.

U. S. Mission stamps 40c, foreign 75c lb., 35 Canada 20c, 75 U. S. 50c, 100 Portuguese Colonies 50c. Popular Co., 4512 North Racine, Chicago.

1000 MIXED U. S. 25c, pound U. S. 55c. Weatherly, Lakewood, Ohio.

TANNOU Touva triangle! This scarce triangle and packet Vatican, Andorra, Libia, etc., only 5c with lists and approvals. Seminoles Company, 121-Druid, Baltimore, Md.

FOUR Spanish Catecomb commemoratives 5c. Approvals. Oak Park Stampco, Oak Park, Illinois.

68 PAGE Illustrated album, 1000 stamps, hinges, 20c. Orren Krause, Harbor Beach, Mich.

CANADA 50c Schooner, Newfoundland 1/2c dog, 15c. Approvals. Freedy & Co., 1039 Frances St., London, Canada.

200 DIFFERENT 10c, 25 Japan 10c, 60% discount approvals. Covert Stamp, 39 State, Rochester, N. Y.

LIBERIA Packet 2c to approval applicants. Welsh, Elmers, N. Y.

WONDERFUL Packet of 40 stamps from strange countries—Fiji, Tasmania, Mozambique, Siam, etc., with smallest stamp in the world for 10c. (No Europe.) 9 Nyassa Triangles 20c. Bargain Stamp Co., 277P West 23 St., New York.

FREE: Curious set Azerbaijan to approval applicants. Commemoratives, U. S. British Colonials, Air Mails. Riedell, Greensburg, Pa.

PACKET Beauties—(Montserrat, St. Kitts-Nevis, Borneo, Sarawak, etc.) 10c to approval applicants. Gem Co., 1839 Unionport Road, New York.

SPAIN: 30 Varieties 5c to approval applicants. Allton, Angola, Ind.

27 LICHTENSTEIN 4c to approval applicants. Hagen, Box 129, Sioux Falls, S. Dak.

\$2.73 SURPRISE Packet, only 14c. Hawley, Johnson St., Lynn, Mass.

COMMEMORATIVES, Air mails, United States. Three packets—10c to approval applicants only. Hornell Stamp Company, Hornell, N. Y.

FOREIGN Mixtures. Sample pound, special world wide Christmas assortment, \$3.50. Excellent variety. Quality. Honest value. 1/2 lb. \$2.00. Pade, Woodside, N. Y.

125 DIFFERENT Unused airmails, triangle, Spain ships, etc. 15c to approval applicants. References. Peppenger, 478 South Maple, Akron, Ohio.

GIVEN Approval buyers: Stamp wallet, fongs, premiums. Pope, Avondale, Ga.

5 DIFFERENT Ireland and price lists 2 cents. Joseph Henderson, 547 - 83rd Street, Brooklyn, N. Y.

100 DIFF. 10c; 1000 Mixed 60c; 25 diff. U. S. 25c; 1000 hinges 15c; album 60c. Price list and approvals sent with every order. C. Stegman, 5941 Cote Brilliant Ave., St. Louis, Mo.

NEWFOUNDLAND—Set of 5 Caribou 10c. Better grade approvals to applicants. DeLisle, 762 Harding, San Jose, Calif.

FREE Illustrated catalogue, also 1000 foreign stamps 35c. Empire Stamp Co., 222 Fulton St., New York.

SET Ireland or Spain 3c with approvals. W. M. Quigley, 211 East 49th St. N. Y. C.

112 PAGE Illustrated world stamp album, packet stamps, 100 varieties, booklet "How to Start a Collection, hard-to-get triangle stamp, 25c. Approvals sent with order. George L. Ott, Box 165, Avonmore, Pa.

ALPHABET Travel packet—100 stamps, from 100 countries—outlandish places, people, animals—25c to approval applicants. Ohio Stamp, Box 249, Cleveland, Ohio.

1000 ASSORTED U. S. stamps, 25c. Auburn Stamp Co., Syracuse, N. Y.

LARGEST Stamp in the world! Rare China Wild Goose special delivery stamp (value 15c) for only 5c to approval applicants. Supply limited. Positively only one to a customer. Western Philatelists, 6021 Harper, M18, Chicago.

WORLD Stamp album, 3000 spaces, 1675 illustrations, 25c to approval applicants only. Electra Co., Mayberry, W. Va.

UNITED States and foreign stamps on approval. Reference. Haines Stamp Co., 251 Market St., Lowell, Mass.

SERVILLE Commemorative free. Postage extra. Stanley's Stamps, Herworth Building, Chicago.

FIVE Spanish Columbus commemoratives 5c. Approvals. La Grange Stampco, La Grange, Illinois.

WHOLESALE Catalog for dealers. Illustrated. Postage 5c. Frank Co., 4900 Chalgrave, Baltimore, Md.

ABYSSINIA Rhino. (Catalogs 45c), also packet Andorra, Oltre, Giuba, Epirus, Nigeria, Mozambique, Malay, etc., only 5c with approvals and lists. Pilgrimage Stampco, Mount Washington, Md.

PAPUA (Lakotol boat), Zanzibar, Iraq, Johore, Lebanon, Transvaal, etc., in our packet 57 different, 5c with approvals and lists. Monumental Stampco, Arlington-203, Baltimore, Md.

20 BRAZIL 10c Approvals included. Mantle Stamp Co., London, Canada.

LIBERIA Triangle, two other triangles in our packet 53 different stamps, 5c. Crowder Company, Carroll, Baltimore, Md.

SURPRISE Stamp free to approval applicants. Phil-A-Telic Stamp Co., 120 Harvey Drive, Glendale, Calif.

FREE! Fascinating Azerbaijan picture set (6 values). Lists. Penny approvals, 2c postage. Midwood Stamp Co., Midwood Station, Brooklyn, N. Y.

SOMETHING New. Royal stamp packets in display envelopes prices 5c each; 25 different Norway; 25 different French Colonies; 100 different foreign; 25 different Africa; 20 different Liechtenstein; 25 different Japan; price list free. Arty Stamp Co., Box 483, Mustang, Ohio.

FREE—5 Columbus commemoratives with every order 100 beautiful unused stamps 10c with approvals. Stevens Stamp Co., Walden, N. Y.

IF You like North, South, Central American stamps, approvals, lists, write Bill Bloss, 1173 North Kingsley Drive, Los Angeles, Calif.

EVERYTHING 10c: Assortment of triangles, Abyssinia, Borneo, Nyassa and what not. Offered to approval applicants only. Doscher, Valley Stream, N. Y.

BEAUTIFUL Picture stamps sent free. Paul Cornish, Schenectady, N. Y.

UNPICKED Mission stamps from 75 countries; 5,000. \$2.00; 20,000. \$6.00 and free stamps cataloging amount of order. Garden-spot Stamps, Lancaster, Penna.

TWENTY Liechtenstein free with approval applicants. "Covered Wagon," Conshohocken, Pa.

1000 UNIVERSAL Hinges 10c; lists free. Harvey Teeple, Decatur, Indiana.

MYSTERY Packet free with approvals. Melvin Spencer, Lewis Street, Springfield, Illinois.

RARE Set 4 Persia and 100 different stamps, 5c to approval applicants. 9 Nyassa Triangles 20c. Real Stamp Co., 4222 Gray Ave., Detroit, Michigan.

FREE! 300 Stamps with winter's subscription; 10c. "Stampist," Hyndman, Pa.

TASMANIA Set free. Approvals. Koupal, 622 East 135th Street, New York.

JOIN Stamp hunters' club, membership magazine, bobby bound, 10c. Edgar Snyder, Printer, 3 Churchill, Youngstown, Ohio.

THOUSAND Dollar prize contest. Full particulars, 3c postage. Imperial Stamp Co., Station J, Toronto, Canada.

UNITED States stamps on approval. R. Siegel, Shukert Bldg., Kansas City, Mo.

STAMPS, 100 All different. Postage 2c. Lists free. P. M. Quaker Stamp Co., Toledo, Ohio.

FIFTY Different United States ten cents to applicants for bargain penny approvals. Knodle, 1942 N. Talbot, Indianapolis, Ind.

UNITED States stamps on approval. Huber, 3551 Penn North, Minneapolis, Minn.

300 DIFFERENT Stamps 20c. Michael, 942 So. 23rd, Bellwood, Ill.

PERFORATION Gauge free with approvals! B. C. Stamp Exchange, Rutland, Can.

35 UNITED States different 15c to approval applicants. C. A. Leeson, 266 Sheldrake Blvd., Toronto, 12 Canada.

REQUEST Our quality stamps on approval. Thousands of stamps 1c to 3c each. Dandy premium 2c. Extra large selections require references. Keigwin Stampco, Vineland, N. J.

FREE Beautiful, large Commemorative set to new 1c approval applicants. Amiel, Box 1155, St. Petersburg, Fla.

ABYSSINIA To Zambesia—\$2.00 catalog value. 34 scarce stamps, Abyssinia, Helaz, Spanish Morocco, etc. Only 10c to approval applicants furnishing references. Weaver, Dept. 5, 1451 Broadway, New York.

150 ALL Different de luxe high grade stamps and wholesale catalog 10c. A. McCreery Co., Chatham, Ontario.

50 FRENCH Colonies, Alaouites, Gabon, Caledonia, etc., with approvals 6c. Hollinbeck, 312 Marquette, Minneapolis.

ZANZIBAR! Packet queer freakish stamps from Zanzibar, Indore, Algeria, Malay States, Hyderabad, Goldcoast, Nigeria, British Colonies, Souamericans. Don't delay! Don't wait. This whooping packet free for 5c postage. Gray Stamps, Toronto, Canada.

FREE!! 15 Pictorial stamps. Postage 2c. F. Roberts, 901 Fourth, Bay City, Michigan.

80% DISCOUNT Off Scotts many hard to get nineteenth century stamps. References please. Hubert Codwise, Garland St., Lynn, Mass.

33 1/2 CASH Commission, no investment, selling stamps up to most expensive. Price 50% below Scott. Unsold stamps returnable. References. Lux Stamp Co., 805 Fairmount Place, New York.

CANADIAN Confederation set, 5 varieties, only 10c. Rheume, 8951 Routhier, Montreal, Canada.

REMARKABLE Bargain: Aitutaki, St. Kitts-Nevis, Cehin, Triangle, others; also free gift. 10c to approval applicants. Beacon Stampco, Box 880, Fall River, Mass.

SEVEN Sets! Three packets! 10c. Approvals! Deering, 164 Albion, Somerville, Mass.

RAROTONGA, 15 U. S. (Air mail, commemoratives, etc.) with approvals. 10 South America—5c. Hudson Co., Plainfield, N. J.

SEVENTY Different stamps from seventy different countries, 6c to approval applicants. Barrus, Box 1054, Detroit, Mich.

RARE China Airmail showing airplane flying over Great Wall of China; also Vatican City stamp, Nyassa, Morocco—and 51 other fine stamps. All for 5c with request for approvals. R. G. Howard, 245 Waverly Ave., Newton, Mass.

STAMPS—50 Diff. No European, 10c. Album 50c, 1000 Hinges 15c, 25 diff. U. S., 25c. Price list and approvals sent with every order. C. Stegman, 5941 Cote Brilliant Ave., St. Louis, Mo.

SIAM Five free to approval applicants. Bernard Karch, Middle River, Maryland.

PACKET 52 Different from Alaouites, Lebanon, Siam, etc., also watermark detector and rare old Hawaiian stamp—all for only 5c to approval applicants. Highland Stamp Co., Newton Highlands, Mass.

PACKET Rare diamond shaped stamps 10c to approval applicants. J. Pawliczek, Pine Island, N. Y.

105 (CHINA, Etc.) 2c. Album (500 illustrations) 3c. Bullard, 446 Tremont, Boston.

FREE 6 Different Luxembourg to approval applicants. E. D. Stamp Co., 3903 Forest Park Ave., Baltimore, Md.

FREE. 100 Different stamps to approval applicants. John Cooley, Fishers Island, N. Y.

ILLUSTRATED United States list, price 50c, large complete United States price list, 1932, free. Stanley Gibbons, 38P Park Row, N. Y.

300 DIFFERENT Stamps 20c; 600 50c; 1,100. \$1; 2,000. \$3. Fred Onken, 630 79th St., Brooklyn, N. Y.

PENNY Approvals, 5,000 Sudan, Congo, Nyassa, Liberia, etc. Also 14,000 averaging 1 1/2c. Philatelic Exchange, Huntington, W. Va.

STAMPS, Sent on approval at 50% discount. Fred Herzberg, 207 So. Washington St., Wheaton, Ill.

EXCELLENT Mixture 2000 stamps, Large variety including Africa, Asia, Latin America, etc. Price only \$1.00. Longacre Shop, 106 West 42 St., New York, N. Y.

BEST One cent approvals in America. F. Hand, 1117 So. 60th St., Philadelphia.

EUREKA Mixture. What is it? Write. Ask. Box 1089, Vancouver, Canada.

ATTRACTIVE Approvals, United States, etc. Neamus Stamp Co., 312 East 23rd Street, New York.

50 DIFF. United States, lists and approvals. 12c. Robert Haynes, Point Place, Toledo, Ohio.

FREE Stamp collection—contains Salvador, Turkey, Africa, etc. 2c postage. 10 different triangles 25c, 1000 hinges 7c. Scott's 1932 catalogue, \$1.85. Approvals sent. Tatham Stampco, West Springfield, Mass.

FREE! Loose leaf postage stamp album at rate of 8 pages each month given with subscription to monthly journal. Send 2c stamp for prospectus. United Stamp Co., Marquette Bldg., Chicago Ill.

301 DIFFERENT 10c To approval applicants only. Free list of bargain packets. Kansas City Stamp Co., Lee Bldg., Kansas City, Mo.

150 GOOD Mixed foreign stamps, 3c. Stanton, East Lyme, Conn.

500 DIFFERENT Stamps for 25c. Big collection including Armenia, Andorra, Fiume, Spanish Morocco, Kenya, Liberia, Memel, Nigeria, Quelimane, Syria, Victoria, Vatican City and other hard-to-get countries. Catalog value over \$10.00. Price only 25c to approval applicants. Illustrated lists free. Loma Stamp Company, 4231 42nd St., San Diego, Calif.

FREE—\$1.00 U. S. postage Lincoln memorial free. If you write for our 56 page price-list of U. S. and foreign stamps, 2,000 illustrations and fine stamps on approval. Hussman Stamp Co., 620-3 Olive St., St. Louis, Mo.

24 VARIETIES Cuban stamps, 10 cents. List of stamps free. Chambers Stamp Co., 111P, Nassau, New York City, N. Y.

ONLY 5c. 33 Different stamps including scarce Latvian triangular airmail stamps, 10 airmail, 12 United States (early issues, commemoratives, etc.) and 10 Canada. Approvals and illustrated price-list sent with each order. Curhan Stamp Company, Gloucester, Mass.

WHOLESALE Catalog for dealers; 4c postage. Grossman, 102 W. 42nd, New York.

STAMPS Sent on approval at 70% discount. Reference required. Emory Renold, Hanover, Pa.

FREE Outfit! 52 stamps, hinges, pocket wallet. Postage 4c. Approvals. United Philatelists, South Berkeley, Calif.

BOYS Wanted—Everywhere. Show our big bargain stamp assortments to friends. We trust you and pay you splendid cash commissions. Fast sellers. Earn money with our new plan. Dandy free premium if you write us at once. LeRoy Stamp Co., 129 W. Jackson Blvd., Chicago, Ill.

#### RARE COINS

COMMEMORATIVE Coins for sale at low prices. Price list and old coin 10c. Towns Davis, Box 1791, Huntington, W. Va.

100 FOREIGN Coins \$1.00; 10 white cents 65c; Norse American Commemorative half-dollar octagonal medals \$1.55. S. Druz, Box 749, Saranac Lake, N. Y.

ANCIENT Silver coin; interesting old coin and monthly bulletins, 25c cents. Coin Exchange, 5427 Nottingham, St. Louis.

FINE Foreign copper and nickel coins. 4 crisp notes and catalog 10c. M. Figg, Box 283, Cedar Rapids, Iowa.

ANCIENT Roman coin, 3 large crisp notes and catalog 10c. George Best, Cedar Rapids, Iowa.

BEGINNERS! Free! Foreign coin and bargain lists. Daurer, Box 8252, South Bend, Ind.

Old Money wanted. Will pay \$100.00 for 1894 dime, 8c mint; \$50.00 for 1913 Liberty head nickel (not Buffalo). Big premiums paid for all rare coins. Send 4c for large coin folder. May mean much profit to you. Numismatic Co., Dept. H, Ft. Worth, Tex.

10,000,000 MARK German bill and bargain list 10c. Greenclay, 1626 Washington, Denver, Colo.

SEND 10c For 5 different coins and catalog or 50c for 25 different. Troyer Coin Co., La Fontaine, Ind.

20 DIFFERENT Fine coins, 25c; 68 different, \$1.00. Bishoff, No. Kansas City, Mo.

MANCHU Chinese coin, Emperor Kuang-hsu, 15c; Roman coin, 25c. Rollo Gilmore, 4213 P. Sheridan, Chicago.

WANTED—U. S. currency, \$1 to \$20 national bank notes, etc. C. N. Simmons, Box 680, Santa Fe Springs, Calif.

START Your coin collection now. Write for my monthly purchase plan. Wiseman, Box 665, Huntington, W. Va.

6 COINS 10c, 6 Bills 10c. Oddshon, Box 681, Kansas City, Mo.

CALIF. Gold quarter 27c, half 52c, large cent or \$100 bill 25c. Wylie, 365, Wheaton, Illinois.

PAPER MONEY—100 Different Confederate, Mexico, etc., \$1.00. Stamp and coin approvals sent. Tatham Stampco, West Springfield, Mass.

5 BILLS, 10 Coins—nickel, copper, aluminum, 25c. Paul Summers, Sagerton, Tex.

UNITED States white cent and bargain selling price list 10c. Arcy, Box 483, Muskogee, Okla.

OLD Coins, large fall selling catalog of coins for sale, free to collectors only. Catalog quoting prices paid for coins, ten cents. William Hesslein, 101A Tremont St., Boston, Mass.

UNITED States. Large cent, two-cent bronze, three-cent nickel and bargain list, 25c. Thirteen dates large cents, \$1.00. George Coffin, Greenwood Mountain, Me.

7 DIFFERENT Coins, 11 bills and catalog, 25c. Creamer's, 1112 Somerset, Baltimore, Maryland.

2 COINS, 5 Notes and catalogue 10c. Lester White, Box 66, West Newton, Mass.

RARE United States and foreign coins, war medals and decorations. Selling catalogue, 10c. Alexis Mengelle, Colorado Springs, Colorado.

\$5 TO \$500 Each paid for old coins. Many very valuable. Keep all old money. Get posted. Send 10 cents for illustrated coin value book, 40c. Guaranteed prices. We buy and sell. Coin Exchange, Box 6, Le Roy, N. Y.

GUIDE To the value of all rare United States and early American coins, superbly illustrated. Price 50 cents. Descriptive circular free. Scott Stamp and Coin Co., 1 West 47th St., New York, N. Y.

GET Profit and pleasure in collecting old coins. Send 10c for large illustrated coin catalog. You'll be delighted with it. Send for it right now. B. Max Mehl, Numismatist, Mehl Bldg., Dept. P, Fort Worth, Tex. Largest Rare Coin Firm in the U. S.

CALIFORNIA Gold—Quarter size, 27c; 3/4 size 53c; 3c piece and catalog, 10c. Norman Shultz, Box 746, Salt Lake, Utah.

#### CAMERAS AND PHOTO SUPPLIES

BEAUTIFUL 8x10 Enlargement 50c. Send your best negative now. Bill's Photo Studio, McAdoo, Pa.

DETECTIVE Camera, the famous little "Expo" watch (new) with one roll of film taking 20 pictures \$3.95, view finder \$0.85 extra. Take picture without being seen. Write for our free bargain book listing used bargains such as, 2 1/2x3 1/2 Icarette "C" with Tessar f4.5 lens \$29.50, Eastman kodak 3 1/2x4 1/4 with f5.3 lens \$11.75, 3 1/2x4 1/4 Graflex with Tessar f4.5 lens \$54.50, or a brand new IA Hawkeye roll film with double lens \$8.25. All sold on ten days trial. Central Camera Co., Dept. PM 13E, 230 South Wabash Ave., Chicago, Ill.

YOUR Photographs are worth money. Newspapers and magazines pay good prices for pictures. Our new plan shows you what photographs to take—helps you sell them. Thousands of interesting subjects everywhere. Always a ready market. Free book gives full details. A wide open field for making extra money. Write today. Universal Photographers, Dept. 6, 10 West 33rd St., N. Y. C.

FIRST Film developed, six prints and photo calendar from any negative 20c. Beautifully mounted 8x10 enlargement 40c. Young Photo Service, 405 Bertha St., Albany, N. Y.

YOUR Kodak is worth \$100—\$20 daily, taking photos for news syndicate. Dime brings valuable plan. Capitol Photo Service, Albany, N. Y.

QUARTER Buys 3 enlargements or prints 6x8. Force, 2907 Eye, Wash., D. C.

HAVE You a camera? Write for free sample of our big magazine, showing how to make better pictures and earn money. American Photography, 115 Camera House, Boston, 17, Mass.

YOUR Favorite kodak picture enlarged, size 5x7, 10c. Three for quarter, coin. Send best negative (film) today. Address Darmer Photo Lab., 221 Securities Bldg., Des Moines, Iowa.

SPECIAL Trial offer: Developing any size roll 5 cents; prints 3 cents each. Beautiful 7 inch enlargement 20 cents. Send for special bargain list. Roanoke Photo Finishing Company, 209 Bell Avenue, Roanoke, Virginia.

5x7 ENLARGEMENT—Send negative and 25c. Negatives safely returned. Frey's Photo Finishing, 760 High St., Newark, N. J.

#### MOTION PICTURES AND SOUND EQUIPMENT

JUST Out! Bass will mail postpaid Cine Amateur, Complete Handbook of motion picture photography for the amateur, \$1.00. Voice of the Films, a complete description of the process used in making sound motion pictures just out. Price postpaid, \$1.00. Motion Pictures With Sound by James Cameron, 400 pages crammed with information on all systems, \$5.00 postpaid. Bass Bargaingram No. 267 listing red hot bargains in standard and 16mm. motion picture cameras, projectors and accessories, 4c stamps. Bass Camera Company, Motion Picture Headquarters, 179 West Madison St., Chicago, Illinois.

SEND \$1.00 Deposit and Bass will ship the newest and greatest motion picture camera value, 100 ft. 16 mm. Keystone automatic spring motor drive motion picture camera with fine F:3.5 focusing lens. You pay the postman the balance of \$34.00 for this greatest of all values. Guaranteed, your money refunded if not satisfactory. We include free with shipment a \$6.00 roll of Eastman reversible cine film which is developed free. Send your order at once. Literature free on request. Also Bass Bargaingram No. 207A. Bass Camera Company, 179 W. Madison St., Chicago, Ill.

\$1.250 FOR Original photoplay story. Our sales department sold unknown author's first story for above amount. We revise copyright and submit to studios stories for talking pictures. Being located in the heart of motion picture industry we know production requirements. Established 1917. Free booklet, Universal Scenario Company, 206 Meyer Bldg., Western and Sierra Vista, Hollywood, Calif.

TALKIE And movie producers are clamoring for new short story ideas, plots, etc. Perhaps you can write one that we can shape and sell for you. One writer (V.M.) received \$3,000. New York best market. Write now for free booklet, without obligation—How To Write For the Talkies! Daniel O'Malley Company Inc., Suite P, 1776 Broadway, New York.

SPECIAL DeVry G 16 millimeter projectors. List \$88.00. Our price including 100' Chaplin films \$25.00. Factory packed. Brand new. Milton Mendelwazer, 192 Ave. B., Bayonne, N. J.

400 FEET 35 mm Films full of action \$1.00. J. Brink, 133 Back Bay, Boston, Mass.

TAKE Your own movies with Pathex cameras, special offer \$9.85 complete; electric projector \$6.49, film \$1.49, headed screw \$1.95. Moccull Bros., 1944J Boston Road, New York City.

TIME Counts in applying for patents. See pages 124 and 125. Clarence A. O'Brien, Registered Patent Attorney, Washington, D. C.

WESTERNS \$1.75 reel 500 ft. \$1.00. Jersey Films, 2015 Waterbury, Lakewood, O.

16MM MOVIE Cameras and projectors, for the home, school, church and business organization. Literature free. D. F. Elder & Company, Dept. A1, Chelsea, Mass.

500 FEET 95c. Odd reels \$1.35. Lowell Films, Allentown, Penna.

MOVIE Films—100 feet cartoon comedy \$1.00 postpaid. Home Movies, Box 744, Minneapolis, Minn.

16mm. MOVIE Film, 25 foot lengths. Complete subjects. New film. Animals, comics, serials 75c per subject, three for \$2.00. Ernest M. Reynolds, 165 E. 191st Street, Cleveland, Ohio.

RELIGIOUS Films for 16—35 mm. projectors. Are Film Co., 630 - 9th Ave., N. Y. C.

EXCELLENT Movie films—projectors, cheap. Lists. Robert Schmitt, Collins, O.

FILMS \$1.00—Projectors \$25.00, Box 6, Rosedale, Kansas.

DE VRY 16M Cameras \$35, projectors \$35. Special wholesale price to dealers, 100 foot 16m negative \$4.50, 16m film 2c foot, 35m cameras \$25, projectors \$35, comedies \$4, 35m negative stock 2c foot, kodak \$4. Ray, 820 - 8th Ave., New York.

16mm. FILMS, \$4.75. Home Movies, Box 32, Easton, Pa.

WORLD'S Greatest "Passion Play" 16 MM. (new) 5 reels. Rent or purchase. Write Hemenway Film Co., 37 Church Street, Boston, Mass.

500 FEET 90c. odd reels \$1.25, plus postage. Lists. Hoffman Film Service, 57 Broad, Albany, N. Y.

FILMS 60c 100-Ft. list. Edgar Film Supply, Woodville, Mass.

#### TRADE AND TECHNICAL SCHOOLS

LEARN Watch repairing. Hiles School, 5230 Mission St., San Francisco.

LEARN Blue print reading. State your trade. Carroll Ramsey, Drexel Building, Philadelphia.

GUSTAS School trains thoroughly in shoe rebuilding, hat renovating, clothes pressing in short time. Gustas, 7 W. Division, Chicago.

LANDSCAPING. The Complete Home Landscape, a guide to the planning, construction and planting of the garden and grounds of the average home. 178 pages. Illustrated. Price \$2.50. Send postpaid upon receipt of price or C. O. D. anywhere in U. S. Popular Mechanics Press, Room 808, 200 E. Ontario St., Chicago.

## TELEGRAPHY

**LEARN** Wireless (Radio) and Morse Telegraphy. School, oldest, largest; endorsed by telegraph, radio and government officials. Expenses low—can earn part. Catalog free. Dodge's Institute, H Street, Valparaiso, Ind.

## BUSINESS OPPORTUNITIES

**THE** Plastex industry needs manufacturers on small scale and for big production of Art Goods, Novelties, Souvenirs, etc. in Plastex and Marble imitation. Experience unnecessary. 5c material makes \$1 articles. Rubber moulds furnished for speed production. We place orders and buy goods. Small investment brings big returns. Interesting booklet mailed free. Plastex Industries, Dept. A, 1085 Washington Avenue, New York.

**LIQUID Marble:** made with dry composition powder mixed with water. Costs 5c per gallon. Brushed or sprayed over concrete products, wallboard, wood. Imitates best polished glossy finish. Especially fine for enameling, burial vaults, garden furniture, flower boxes, novelties, statues, building trim, anything imaginable. All colors and veining. Send dime for marbled samples and our exclusive territory plan. Marble Co., Grayling, Mich.

**BETTER** Than a Job. Fascinating opportunities. Particulars, addressed stamped envelope. Economy Sales Co., Dept. P., Manchester, Iowa.

**MAKE** Artificial marble, colorful glossy tiles, no polishing; rather uncanny. Novelties, tabletops, bookends, floors, whetstones. Hard, inexpensive, fireproof, enamels wood. Secret cement methods. Amazing samples 2c. John A. Pynn, 945 Grande Vista Drive, Los Angeles, Calif.

**MAKE** Illuminated signs. No brush skill. Patented process. One order cleared \$500.00. Particulars, Merritt Signs, So. Berkeley, Calif.

**\$5,000.000 CASH** Awards yearly. Contest News gives details monthly. Sample copy free! The Contest News, Station A-7, Toledo, Ohio.

**"HUNDREDS** Panning gold." Look under classification "Books." WEL, Coeur d'Alene, Idaho.

**CLEVER** Advertising stunt—(average town good for \$100.00.) Enormous profits. Steady employment. Originator cleared \$185.00 in two weeks. Here is interesting work. Enclose 50c (stamps) for contract, including "profit plan." (Curiosity seekers—save your postage.) Address—Arrow Signs, Hutchinson, Minnesota.

**LEARN** To make men's ties. Pattern, complete instructions. No canvassing. Send \$1.00. 350 Montgomery Street, Portland, Oregon.

**BEAUTY** Formulas—Ten for \$1.00. Dr. Macenhein, 935 - 49 St., Brooklyn, N. Y.

**BIG** Profits operating your own business by mail. Details free. Green, 15788 Parkside, Detroit, Mich.

**DISTRIBUTOR!** Wholesale-retail business of your own may be started spare time. Complete information and samples. Write today. Tomorrow may be too late. Pays Hand Soap, New Park Avenue, Hartford, Conn.

**"MAIL** Order Selling" magazine. "Opportunity for You" booklet and "Big Twelve Proposition" 10c. Pruitt System-A, Brookfield, Ill.

**BUSINESS** Opportunity for right man. Conduct a profitable business under your name, in your own town. Dignified work and a winner. Write us at once. Diversified Products Company, 1215 Jackson Ave., Toledo, Ohio.

**START** Business. Re-Gloss autos. instructions and sample \$1. Our product, direct selling. Auto Re-Gloss System, Berryville, Ark.

**COMPOSITION** Floor making earns industrious men \$12 and more daily if used as trade. Or make business of it with profits up to \$19,000 yearly. Openings everywhere. Semi-Tile, Box 43, Hollis, N. Y.

**NEW!** French cleaning fluid, guaranteed formula \$1.00. Dr. Magenhein, 935 - 49 St., Brooklyn, N. Y.

**OPPORTUNITIES** Outdoors—Learn how to start building a successful industrial career, beginning in spare time and developing until full time service of yourself and others required raising small animals, birds and plants. Send for reliable instruction book. Price \$2.00. Sent postpaid upon receipt of price or C. O. D. anywhere in U. S. Popular Mechanics Press, Room 808, 200 E. Ontario St., Chicago.

**EARN** Good money making and selling polishing cloths; very plain and easy. Sample with instructions how to make 25c "all-ster." Edward Hower, Rumson, New Jersey.

**YOUR** Name in directory sent to 5,000 firms, 25c. Brings avalanche of mail. Nepeco, Roseland, Fla.

**LEARN** How to make beautiful one piece cement fireplaces in any color effect or design. Cost of materials less than four dollars. Quick profits. See display ad page 35 this issue Popular Mechanics. Ornamental Concrete Institute, 246 Fifth Avenue, New York.

**MANUFACTURER** Wants quality distributors for new Liquid Bakelite Coating. Re-conditions, waterproofs linoleum, auto tops, store fronts, trucks, wood, metal or rubber. 100% profit. Staminite Corporation, New Haven, Conn.

**CHEMICAL** Expert furnishes manufacturing formulas with complete working directions. Reliable individual services. Charges reasonable. Dr. Vanheden, 3836 Lakepark Avenue, Chicago.

**MAKE** Money manufacturing building material Marble, Granite, Fireproof Paint, Flooring, Roofing. No machinery, cheap, big profits; formulas, latest methods. Wm. Lang, Lang Hotel, Portland, Ore.

**EARN** Up to \$25 weekly or more growing mushrooms in your cellar or shed. Illustrated booklet free. American Mushroom Industries, Dept. 749, Toronto, Ont.

**POPCORN** Machines \$15 up. Money makers. Northsides Co., 2117 Harding, Des Moines, Iowa.

**MANUFACTURE** Chipped glass house numbers. Beveridge, 160-22 Locust, Jamaica, N. Y.

**TIME** Counts in applying for patents. See pages 124 and 125. Clarence A. O'Brien, Registered Patent Attorney, Washington, D. C.

**BOOK** 500 Formulas, money-making secrets, directory 300,000 articles wholesale and copy money-making magazine 25c. A. McCreery, Chatham, Ontario.

**SIGNS** and showcards easily painted. If you use Letter Patterns. Write for free samples. John Rahn, G2120 Neva Ave., Chicago.

**"TIMELY** Tips" moneymaking plans! Opportunities! Three sample copies 10c. Elite Magazines, 1821 East 101st, Cleveland, Ohio.

**OPPORTUNITY:** Own your business, pleasant, legitimate, permanent, particulars, 2c stamp. E. B. Spencer Co. 744 Broadway, Newburgh, N. Y.

**MIRRORS** Resilvered at home. Costs near 5 cents per square foot, you charge 75 cents. Profitable business plating like new brass, worn-off autoparts, reflectors, tableware, stoves, etc. Outfits furnished. Details free. Sprinkle, Plater, 127, Marion, Ind.

**MAIL** Order business fascinating and profitable. Many earn thousands yearly. Begin small. No canvassing, nor personal contact. Inside pointers from 30 years experience. Send quarter for book, also batch of mail order information. R. Breniser, 277 S. 21st, Philadelphia.

**WHOLESALE** Directory 300,000 articles 10c. Other valuable information. Moran Company, Wareham, Massachusetts.

**A BUSINESS** Of your own making—Sparkling Glass Name and Number plates, Checkboards, signs. Big book and sample free. E. Palmer, 540, Wooster, Ohio.

**MAKE** Your own products. Employ agents yourself. Toilet articles, soap, extracts. We furnish everything. Valuable book free. National Scientific Laboratories, 1950 W. Broad, Richmond, Va.

**FIFTY** Successful mail-order propositions. Address, K. Home, 3949 Metropolitan, Chicago.

**SUCCEED** With your own products. Make-sell them yourself. Formulas, processes, trade-secrets. Expert analytical service. Catalog free. B. Thaxly Co., Washington, D. C.

**SELL** By mail. Books, novelties, bargains! Large profits. Particulars free. B. Elfrs, 525 S. Dearborn, Chicago.

**ARTIFICIAL** Marble sanitary flooring, instructions covering wood or cement flooring 1/2 inch thick, fireproof, all colors, low cost. Ornamental casting, concrete plaster papier-mache decorations, garden furniture, statuary, flexible molds, particulars and illustrations free. Chris. Mahler, Elmont, N. Y.

**LEARN** The collection business. Good income, quick results. Interesting booklet, "Skillful Collecting" free. National Collectors Assn., Long St., Newark, Ohio.

**AMATEUR** Cartoonists: Sell your work. Write Smith's Service, PW1194, Wenatchee, Wash.

**OPERATE** Chain of vending and amusement machines. Be independent for life. Start small, grow big. P. Goodbody, 1824 East Main Street, Rochester, N. Y.

**CHEMICAL** Expert will furnish formulas and trade secrets. All lines. Lists free. W. L. Cummings, Ph. D., 228 Gordon Ave., Syracuse, N. Y.

**I MADE** \$30 A week home. French breadmaking. 15 years' experience; free booklet tells. Ashbrook 67, Marengo, Ohio.

**BIG** Money at home plating auto parts, reflectors, mirrors, chandeliers; by new method; experience unnecessary. Outfits furnished. Gunmetal Co., Ave. N, Decatur, Ill.

**FREE** Booklet describes 67 plans for making \$20-\$100 weekly in home or office business of your own. Elite Co., 84 Elizabeth St., New York.

**UNUSUAL**—Uncommon specialties always sell best. Make these yourself from Miller's guaranteed formulas. Why work for others when others can be working for you? Latest eye-opening literature brings you many specialty propositions for you an independent business. Miller Chemist, 706-K Chemical Bldg., Tampa, Fla.

**THAXLY** Formulas produce perfect products. All lines. Catalog free. B. Thaxly Co., Washington, D. C.

## FORMULAS AND TRADE SECRETS

**GUARANTEED** Formulas, recipes, processes. Expert analysis. Catalogue free. Industrial Institute, Dept. 201, 64 West Randolph, Chicago.

**CHEMICAL** Analysis, formulae, technical information. Robert Henderson, Laboratory, Madison, Maine.

**FREE** Catalogue, formulas, analysis. Herstein, Chemist, 206 Prospect, Grand Rapids, Mich.

**"SOLSAVER"** Plastic resolcing compound at wholesale. Particulars free. Big sample \$1.00. Geo. Donahoo, Box 693, Hondo, Calif.

**LATEST** Improved formulas, \$1.00 each. List free. Persian Laboratories, Bay City, Mich.

**SUPERIOR** Formula; complete manufacturing information for automobile batteries, particulars free. "Molab," 2453 N. Albany Ave., Chicago.

**CHEMICAL** Aid, processes, plans. Small investment. Analysis \$5.00. Guaranteed formulas. Write Associated Chemists, Indianapolis, Ind.

**FORMULAS**—Our literature will surprise you. Belfort, 4042 N. Keeler, Chicago.

**FORMULAS:** All beverages, syrups, flavors, extracts. Manufacturing everything. Interesting valuable information free. The Formula Co., 5th Ave. and Broad, Seattle, Wash.

**NEWEST** Formulas. Tested, guaranteed. Catalog free. Imperial Laboratories, Edwardsville, Ill.

**1,000,000** FORMULAS, Industrial facts, tables, processes, rules, trade secrets, and calculations for all kinds of Trades and Businesses. Book—"Moore's Assistant"—1016 pages. Sent postpaid for \$2.00. Ogilvie Publishing Co., 57 Rose St., Dept. 22, New York.

**SUCCEED** With your own products. Make-sell them yourself. Formulas, processes, trade-secrets. Expert analytical service. Catalog free. B. Thaxly Co., Washington, D. C.

**FORMULAS** All kinds. Catalog free. Clear Laboratories (P), Park Ridge, Ill.

**FREE** Formulas—Free materials making \$32.00 worth of guaranteed highest class specialty-necessities. Thirty-third unequalled anniversary offers explains all. Miller, Chemist, 1707-G Jetton, Tampa, Fla.

**500** FORMULAS And big illustrated catalog 25c. Ideal Book Shop, Park Ridge, Ill.

**MAKE** Your own products. Employ agents yourself. Toilet articles, soap, extracts. We furnish everything. Valuable book free. National Scientific Laboratories, 1950W, Broad, Richmond, Va.

## CHEMISTRY

**BECOME** Trained chemist. Thousands of opportunities—fascinating career. Learn at home. Complete experimental laboratory outfit given. Write for big free book. Chemical Institute, 19 Park Place, Dept. P132, New York.

**HANDBOOK** For chemical experimenters, illustrated 50c. Experiment booklet 15c. 1932 chemical catalogue 10c. General Chemical Co., Reading, Pa.

**CATALOG** listing 2,500 illustrations chemists' supplies, 5,000 chemical, 1,000 scientific books sent for 50c. Laboratory Materials Company, 643 E. 71st St., Chicago, Ill.

**10,000 MONEY-MAKING Formulas.** Tells you how to make and sell almost everything under the sun; cosmetics, mullage, anti-freeze solutions, battery solutions, beverages, cheese, chewing gum, cleaning preparations, extracts, hair preparations, inks, bluing, leather polish, mirrors, perfumes, polishes, typewriter ribbons, carbon paper, washing powders, liquid soap, and hundreds of other profitable articles. Send no money. Just write a postal for "Hensley's 20th Century Book of Formulas." Pay postman postage and \$4. Popular Mechanics Press, 200 E. Ontario St., Room 802, Chicago.

#### AGENTS WANTED

**I START** Men in a grocery business a new easy way. You use my money. Don't need to put up a penny of your own cash for stock. Expansion program now opens up many desirable opportunities also established trade. Hustlers make good money from the start increasing rapidly as they learn the business. Not a "chain" proposition but your own business. Buy on credit. Give credit if you wish. If honest and need more money write at once for application and details to McCann & Co., Room L-6601, Winona, Minn.

**MEN** Wanted to introduce a souvenir proposition of foreign stamps to stores, markets, etc. You make \$7.00 on each order which you collect right away. Live wires can get several orders a day. Sample outfit including carrying case, beautiful advertising material, packets, circulars, order book, etc., supplied at cost of \$2.50. This money returned when you get second order. Get started now and make big money. Grossman Stamped, 104 West 42nd St., New York.

**GENERAL** Agents and others. New, fast-selling, profitable line of flavors, toiletries, and other specialties—under your own imprint. Our plan wins. Write us at once. Diversified Products Company, 1215 Jackson Ave., Toledo, Ohio.

**WANTED—Agents.** For attractive, quick-selling office and store necessity, selling at \$2.00. Commission 75c. Specialty Sales Co., Cairo, Ill.

**SELL** To stores, carded merchandise, razor blades, aspirin, etc., 45 different items. Metro Specialty Co., 8 West Pearl St., Cincinnati, Ohio.

**NEW** Invention, improved alarm chases robbers, intruders, etc. Simple, effective, safe. Approved by police. Radt-O-Larm Co., 1701 Barr Bldg., Warren, Ohio.

**"POWDERED-SILK"** America's best hand cleanser sells fast to everybody. Removes grease, stains, ground-in dirt. Big profits. Sample free. Adams Manufacturing Co., Dept. A, Boone, Iowa.

**NEW** Rubber goods line. 47 money makers. Rubber runs, cushions, bath mats, raincoats, rubber soles, aprons, baby goods, etc. Big profits, best values. Direct from Akron, the rubber city. Make \$90 weekly. Credit given. Write for catalog and free outfit. Kristee Mfg. Co., 1431 Bar St., Akron, O.

**AGENTS, Mechanics' soap!** Cleans greasy hands immediately. Dozen cans \$1.50. Mechanics Soap Co., 1610 Knapp, St. Louis.

**SELL** Dealers Uncle Jerry's aluminum solder. Your profit over 50%. Box 146, Hamilton, Ohio.

**"ANTI-STEAM"** Keeps windshield clear of steam, frost, rain, snow. Remarkable seller. Exceptional opportunity. Free sample proves this. Walter S. Doe & Co., Kent, Ohio.

**AGENTS** Wanted for coal saving heating appliance easily attached to any hot air or hot water furnace. Write The Campbell-Hausfeld Company, Department Three, Harrison, Ohio.

**PROTEX-ELEC** New liquid insulation keeps motors running in rain, sleet, snow. Just out—no competition. Hustlers coin money. Any motor serviced in two minutes for only 50c. Protex-Elec Co., Dept. 1P, Peoria, Ill.

**AGENTS—Here's** something brand new and good for \$10 profit a day—any day in the week. Prepared doughnut flour—everything ready mixed. Makes delicious doughnuts in a jiffy. Simply add water and fry. Do housewives snap it up? Oh boy! Does a duck take to water? Grab this while it's hot. Albert Mills, 1502 Monmouth, Cincinnati, O.

**MAKE** Your own products. Employ agents yourself. Toilet articles, soap, extracts. We furnish everything. Valuable book free. National Scientific Laboratories, 1950W Broad, Richmond, Va.

**SELL** Hasty-Cake—the greatest staple food invention in 20 years. 25c package makes delicious 3-layer cake, 2 flavors. Devil's food, oriental spice. A fast, sure repeater. Average home uses 2 packages per week. Half million packages sold in last month. You can earn \$10.00-\$20.00 per day easily. No experience needed. We furnish capital, free canvassing license, guarantee 100% satisfaction to everybody concerned. 3,000 territories already assigned. Write today for your town. Hasty-Cake, A-2307 Archer Ave., Chicago.

**AGENTS** For handlick; original powdered handsoap. Approved Good-Housekeeping. Everybody customer. Fine opportunity for hustler. Sample free. Solar Products, J-2144 So. Troy, Chicago.

**\$40-200 A WEEK.** Genuine gold letters for store windows. Easily applied. Free samples. Liberal offer to general agents. Metallic Letter Co., 438-B North Clark, Chicago.

**FORGET** "Hard times." One dollar fetches formula which renews upholstery and rugs. Think. One 2 Three Products, Box 920, Savannah, Georgia.

**SIMPLICITY** in mop wringing. The Christensen oval double cone mop wringer cleans mops, dries mops. H. K. Christensen, Ft. Atkinson, Wis.

**PROPELLOLIGHT** Free to agents. Beautiful automobile ornament. Revolves producing ring of colored light. Write. Propellolight Co., Newtown, Ohio.

**AMAZING** New electric trouser presser good for \$25 daily; puts razor edge in pants in 10 seconds, sells for \$2.50; your commission \$1.00. Sample fits pocket. Mummy Mfg. Co., Dept. C-8A, 817 Main St., Cincinnati, Ohio.

**100-IN-1** Fuse plug; retails 35c. Sample 25c; doz. \$1.50. Industrial Concern, 937 Franklin, Johnstown, Pa.

**FLY** On egg tapemeasure. (See August Popular Mechanics, 255.) Particulars free. Sample 5c. Elgin Toy, Elgin, Ill.

**SELL** Self-threading needles. Over 80% profit. Importer, Dept. M, Myerstown, Pa.

**CHICAGO** Expert valued \$3.00 stone at \$900. Diamond's only guaranteed rival. Greatest spare time side-line article known! Amazing profits. Write quick for sample gem on approval. Mexican Gem Company, Suite PM2, Monterey, Calif.

**MEN, Women—\$12** daily selling raincoats. Andrews, 369 5th Ave., New York.

**BIG** Money selling greatest poultry egg tonic known, positively increases egg yield. Worthington Specialties, Box 11, 2384 Yonge St., Toronto 12, Ont.

**FREE** Catalog. Enormous profits in needle assortments. Cost 1 1/2c to 11c; sell 25c to \$1.00. Dime brings 50c sample. Wright Service, 390 Madison Avenue, Paterson, N. J.

**SELL** Stores carded razor blades, etc. Lorrax Products, Albany, N. Y.

**SELL** Our beautiful changeable letter signs to stores for \$1.25. Send 50c for sample sign. Three signs for \$1.20. Unit Products Co., 3162 South Ashland Ave., Chicago, Illinois.

**PHOTO** Medallions. Send for latest catalogue. Hundreds of our newest designs. Photo novelties. Lowest prices. Quick service. Medallion Novelty Co., Inc., 208 Bowery, New York, N. Y.

**CASH** Paid for butterflies, insects. See Sinclair Display Advertisement on page 18. 50c REPEATER, Cost 6c, Sample dime. Moyes Laboratory, 1262PM Harrison, Paducah, Kentucky.

**AGENTS** And distributors to sell the Hansen Water Power Filter, also the Hansen Hand Filter; thousands now in use satisfactorily; agents make from \$40.00 to \$100.00 a week; write for particulars. Buffalo Marine Malt Company, 399 Hamburg Street, Buffalo, New York.

**BIG** Profits selling groceries, motor oils, paints, stock minerals. Sample case free. Lovern & Browne, 1602-A So. State, Chicago.

**BIG** Money easy, simply showing new Polly Wrench. 10 wrenches in one. Guaranteed fast seller. Sample furnished. Gellman Manufacturing Co., Dept. PM-1, Rock Island, Ill.

**NEW, Profitable—Sell** auto step mats. Quality rubber with owner's name molded white. Details free. Kbonite Products, Dept. A-40, 895 Main, Akron, Ohio.

**DON'T** Choke me! Hot Shot new elec. wizard starts cars without choke; saves gas, oil. Delivers 11,000 volts. \$1.50 seller. Pays for self immediately. Hustlers gold mine. Reardon Mfg., Dept. 1-HS, Peoria, Ill.

**BIG** Profit catalog. Toilet preparations, food products, remedies, household specialties, portraits, frames, medallions, photo-pillows, religious goods. Credit. James Halley Company, Station C1, Chicago.

**AGENTS, \$25** daily and more selling handkerchiefs. Everybody a prospect—Easiest item to sell. (10) handkerchief assorted sample numbers, and wholesale price list \$1. Great City Company, 3 West 17 St., New York.

**ARTICLES** That sell on sight. \$10 day easy. No competition. Anyone can sell them. Write today. National Supply Co., 1611 Great Northern Bldg., Chicago.

**ELECTRIC** Water heater—New. Heats water instantly. Pocket size—retails \$3.75. Two minute demonstration makes you \$1.95 profit. Lux-Visel, Dept. 137, Elkhart, Ind.

**100% PROFIT** in new everlasting match lighter. No flint or friction. What makes it light? No wind can blow it out. Retails 50c. Sample and sales plan 25c. New Method Manufacturing Co., Box PM-1, Bradford, Pa.

**300% PROFIT** in new "20-in-1" kitchen necessity. Retail 25c. Costs you \$1.00 a dozen. Sample 15c to cover cost of mailing. New Method Co., Nu-Method Bldg., Desk P3M-1, Bradford, Pa.

**300% PROFIT** Selling Mystery Gas Lighter. Retails 25c. Costs you \$1.00 doz. Sample free. Square Deal Mfg., Desk PM-27, Bradford, Pa.

**STRANGE** Ironing cord. Prevents scorching. Saves electricity. Abolishes kinks, snarls. Approved by Good Housekeeping. For telephones also 200% profit. Samples furnished. Neverknot, Dept. 1-A, 4502 Ravenswood, Chicago.

**NEW** "Wonderful" No-Plin Clothes Line. Absolutely banishes clothes pins—Instant demonstration, sure sale, big commissions daily, no investment. John Dunn, Hempstead, New York.

**AGENTS—Metaloid** the garage man's friend. Make big money selling repair metal. 100% profit. Send \$1.00 for sample 4 bars, post paid. Metaloid Mfg. Co., 411 Hague Ave., Detroit, Mich.

**DRAFTSMEN—Beam** compass \$1.75. Sell \$3.50. Porter, Rhodes Ave., Hempstead, N. Y.

**JUST** Invented—New washing machine. No motors or moving parts. Automatically cleans entire washing. Fully guaranteed. Retail price \$9.50. Your profit 100%. Protected territory. Preston Manufacturing Company, Dept. W-26, St. Louis, Mo.

**JUST** Invented—New oil burner. Fits in any stove or furnace. Burns clean oil. Fully guaranteed; 100% profit. Free sample and protected territory. International Oil Heating Company, Dept. C-3, St. Louis, Mo.

**200 TO 500% Profit,** making and selling your own products. We supply formulas, concentrates, free labels. Whirlwind sellers. Repeaters. Scheld, Chemist, 535 Dixwell Ave., New Haven, Conn.

**"HOW** To Secure Agents," a specially prepared booklet, tells of one of the most inexpensive methods in which to secure good live producing agents. It is free; write for your copy today! M. L. Rund, Mgr., Classified Advertising, Popular Mechanics Magazine, 290 E. Ontario St., Chicago, Ill.

**BIG** Profit putting our gold sign letters on store windows, without experience. Samples. Consolidated. 69-T West VanBuren, Chicago.

**NO-TANGLE** Ironing cord. Never kinks. Prevents scorching. Saves electricity. For telephones also. Great seller. Good profit. Free offer. Bestever Co., 4315-P Irving Park, Chicago.

**FREE** "Booklet describes money making opportunities," new ideas, original plans, money making secrets and other valuable information. None require peddling or outfit. Elite Co., 84 Elizabeth St., New York.

**ANYONE** Can make signs with the easiest sign letters on the market. Real paint. No brush necessary. Free sample. "Ralco," 1045 Washington, Boston, Mass.

**ONE** Hundred percent profit. Rapid selling auto necessity without competition. Every car owner buys upon demonstration. Exclusive territory. Weithas, 147 Fulton St., New York.

**FREE** Circulars describe how you can make big money in a mail order business at home. Agraph Publishers, 1217P-Avenue U, Brooklyn, N. Y.

**GUARANTEED** Hosiery—Lowest mill prices. Men's latest fancy hose—doz. \$1.40-\$2.80. Ladies' fashioned hosiery—doz. \$2.25-\$3.50. Catalogue free. Superior Knitting Company, Dept. 31, New Haven, Conn.

**BOATMEN** Buy our \$5 boat speedometer on sight. Liberal proposition to agents. Constant Device Works, Jefferson Station, Chicago.

**THOUSANDS** Waiting to buy the Presto Electric Motor Heater—Automobiles start instantly on cold days. Big profits. Easy seller. Write for free sample offer. Metal Specialties Mfg. Co., 3260 Carroll Ave., Chicago, Ill.

**MAKE** Old clocks electric. Big profits. Bestever Co., 4319-P Irving Park, Chicago.

**MAKE** Your own products. Employ agents yourself. Toilet articles, soap, extracts. We furnish everything. Valuable book free. National Scientific Laboratories, 1950W Broad, Richmond, Va.

**A BUSINESS** Of your own—Making sparkling glass name and number plates, checkboard signs. Big book and sample free. E. Palmer, 512, Wooster, Ohio.

**AGENTS**—Clever Invention! Inkspoon makes every pen a fountain pen. Fast office seller; big profit, demand increasing everywhere. Exclusive territory offered. Sample free. H. Marul Company, Tribune Bldg., New York, N. Y.

**AGENTS** Everywhere making money with our line of kitchen specialties, demanded in all homes. Big earnings possible. Write today for details. P. Seed Filter Co., 353 Broadway, New York.

**MAKE** Your own products. Employ agents yourself. Toilet articles, soap, extracts. We furnish everything. Valuable book free. National Scientific Laboratories, 1950W Broad, Richmond, Va.

**FREE** "Booklet of money making opportunities," new ideas, original plans, money making secrets and other valuable information. None require peddling or outfits. Elite Co., 84 Elizabeth St., New York.

**MARVELOUS** Chemical cloth cleans, polishes all metals instantly without liquid, paste, powder; record-breaking seller to housewives, stores, offices; 300% profit. Sample free. Shef D. Mfg. Co., Weehawken, N. J.

**NEW** Changeable sign sells to stores for \$1.50, agents profit 400%. Particulars free. National Sign System, St. Louis, Mo.

**MIRRORS** Reelivered at home. Costs near 5 cents per square foot, you charge 75 cents. Profitable business plating auto-parts, reflectors, tableware, stoves, refinishing metalware, etc. Outfits furnished; details free. Write Sprinkle, Plater, 128, Marion, Ind.

**POLMET** Polishing Cloth removes tarnish from all metals without the use of liquid, paste or powder. Our agents say it sells like "hot cakes." Retail 25c; sample free. Gale & Co., Inc., 15 Edinboro St., Boston, Mass.

**PHOTO** Medallion men and women, the largest line of photo novelties in the world. Lowest prices, quickest service. Send for catalog showing over 200 money makers. Gibson Photo Jewelry Co., Inc., 833-837 Gravesend Ave., Brooklyn, N. Y.

**PROFITABLE** Home business, legitimate. No canvassing. Maywood Publishers, P-923 Broadway, New York.

**WOULD** You like to make \$10 to \$15 a day selling our line of toilet preparations? We want agents in every town; men, women, students; whole or part time. Write for free sample outfit offer. Hindu Perfume Co., 515 E. 47th St., Chicago, Ill.

**MAN** In each town to plate auto parts, reflectors, bathroom fixtures, refinish beds, mirrors, chandeliers; by new method. No capital or experience required. Simple plan of manufacturing at home starts you in big money-making business. Outfit furnished. Free particulars and proofs. Gun Metal Co., Ave. H, Deratur, Ill.

**MAKE** Sell your own products. Formula catalog free. Clover Laboratories, (PM) Park Ridge, Ill.

**BIG** Money and fast sales. Every owner buys gold initials for his auto. You charge \$1.50; make \$1.45. Ten orders daily easy. Write for program and free samples. American Monogram Co., Dept. 40, East Orange, N. J.

**AGENTS:** Stamping names on pocket-key protectors. Sample check with your name and address, 25c. Stamping outfits, Emblem checks, check-fobs, name plates. Hart Mfg. Co., Desk 2, 303 Degraw St., Brooklyn, N. Y.

**REPLATE** Brass worn-off automobile parts, reflectors, bath room fixtures, worn spoons, forks, etc., with pure silver. Looks like new. Use U-Kan-Plate Polish. Postpaid, no mercury; \$1.00 half pint. Postpaid. Satisfaction guaranteed. Agents wanted. Dept. A, U-Kan-Plate Co., Philadelphia.

**SELL** Goodyear raincoats, \$2.95 up. Goodyear Hainwear, 18 West 22nd, New York.

**SOMETHING** The housewives want. A signed guarantee to save money and time in cooking. No competition. 400% profit. No license required. Station C, Box 23E, San Diego, Calif.

**THAXLY** Formulas produce perfect products. All lines. Catalog free. B. Thaxly Co., Washington, D. C.

**AGENTS**—Engraved name plates, signs, number plates etc., easily sold with large profits. Brett Bros., Winthrop, Mass.

**NEW** Line Counter Displays, Aspirin, Flints, Chewing Laxative, Breath Gum, No-tartar, Silktone, etc. Steady Repeats, Over 100% Profit. Superba Co., W5, Baltimore, Md.

**THIS** Advertisement may make you thousands of dollars, if you write immediately for my "Eye-Opening" literature describing guaranteed formulas; valuable trade processes, moneymaking information how to easily make the world's best-selling specialties. All lines. Investment small. Profits immense! Start in your home, room or office. Make the good money you're entitled to. Dr. Liscombe Miller, Chemist, Tampa, Fla.

**WE** Start you without a dollar. Soaps, extracts, perfumes, toilet goods. Experience unnecessary. Carnation Co., 641, St. Louis, Mo.

**FLAVORING** Extracts—Bottle yourself! Labels furnished. 600% profits! Whirlwind money-makers! Repeaters! Free offer. Thomas Manufacturing Company, Indianapolis, Ind.

**CALIFORNIA** Perfumed beads, selling like hot cakes. Agents coining money. Catalog free. Mission Factory, P. 2328W Pico, Los Angeles, Calif.

**SELL** Men's neckwear—wonderful proposition. Aastor-M, 39 East 28th, N. Y.

**SUCCEED** With your own products. Make-sell them yourself. Formulas, processes, trade-secrets. Expert analytical service. Catalog free. B. Thaxly Co., Washington, D. C.

**15,000 PROFIT** Making formulas. Following and many others: Accidents and emergencies, agriculture, alloys and amalgams, artist's materials, beverages, cements, glues, pastes, mullages, bleaching, renovating, coloring metals, dyeing glass, heat treatment of metals, household formulas, ice cream, confectionery, chewing gum, lapidary work, exterminating vermin, lubricants, paints, varnishes, photography, condiments, canning formulas, rubber, soap, candles, soldering, toilet preparations, perfumes, waterproofing, fireproofing, writing materials. Just write for "Scientific American Encyclopedia of Formulas." When postman hands you book pay \$5.50 and postal charges. Popular Mechanics Press, Room 802, 200 E. Ontario St., Chicago, Ill.

#### HIGH-GRADE SALESMEN WANTED

**LOCAL** County manager to service extinguishers now in use and demonstrate new patented device for schools, homes, stores, shops, garages, churches, warehouses, trucks, autos and busses. Our men are earning from \$35 to \$50 weekly on service work alone in addition to profits on sale of new equipment. Lifetime job for men who are reliable and ambitious to build up steady business. Successful men earn from \$3,500 up to \$10,000 a year. Large manufacturer with "A-1" rating. The Fyr-Fyter Co., Dept. 1, Fyr-Fyter Bldg., Dayton, Ohio.

**\$18 TO \$25** Daily; biggest selling line of men's suits. Meets present day conditions. Amazing values at \$11.95, \$14.50, \$16.95, \$18.95. Also raincoats, slickers, topcoats and boys' suits. Biggest commission paid in advance. Liberal bonus. Free outfit. State age and selling experience. "Jim" Foster, Inc., Dept. 21, 2250 South Spaulding Ave., Chicago.

**DON'T** Be a job hunter—Start your own city business on our capital; no hard times, no lay-off, always your own boss; hundreds average \$5,000 annual sales year after year; we supply stocks, equipment on credit; some 225 home necessities, selling experience unnecessary; wonderful opportunity to own pleasant, dignified, profitable business backed by \$17,000,000 world-wide industry; for complete information write Rawleigh Co., Dept. A-U-PPM, Freeport, Ill.

**LARK** Newest type ball sum vender—America's most popular machine—Twenty thousand in use—Salesmen wanted. Sample \$17.50. Lark, 1089 Third St., Oakland, Calif.

**AUTO-MECHANICS** Or auto-electricians wanted to sell standard manuals in spare time. Easy way to earn extra money. Every garage and service station a prospect. Manual price seventeen dollars fifty cents. Liberal commission allowed on each sale. Write for salesman's proposition and special price for sample. Standard Engineering and Publishing Co., 678 Mass. Ave., Cambridge, Mass.

**CONGENIAL** Work calling on banks and business houses—selling filing and mailing supplies. Liberal commission. Write today. Ames Safety Envelope Co., Boston, Mass.

**GRAPE** Bricks, Grape concentrates—Port, sherry, champagne, claret, etc., in solid brick form. One brick makes one gallon juice; legality established twice in Federal courts. Government financing industry. Every home, drug and grocery store, church, hospital, a prospect. State and county rights available. Apply V. S. Co., Dept. 8-224, 393 - 9th St., San Francisco, Calif.

**APLENTY** New—Different—Fast selling 5c-10c merchandise on attractive counter cards. 100% comm. for you and dealers. Advertised over WLW 3 nights weekly. No investment. Catalog free. (Estab. 1921.) World's Products, 180 Central, Spencer, Ind.

**\$100.00 COMMISSION** From \$6.95 sale! You can make 3 sales daily. Our salesmen do it. Free kit. Sales Stimulators, Dept. 10H, 4311 Ravenswood, Chicago.

**SALESMEN**—At last! New feature sells punchboards everywhere. Dealers wild with joy—prosperity back again. Profits enormous. Samples free. Puritan Novelty, 1407 Jackson Blvd., Chicago.

**EVERY** User of the mails needs an envelope sealer. The Kendall seals fifty a minute. Retail \$2.50. Big profit. Good territories. Kendall, Dept. 8, East Jaffrey, N. H.

**SALESMEN**—Experienced coupon, premium men new business stimulator proposition, \$100 weekly commission. Federal Community Service, Inc., 101 Fifth Ave., New York.

**WANTED.** Intelligent well dressed men to place our special collection methods before business and professional men. Unusual opportunity to make from \$5.00 to \$10,000 per year. References appreciated. Creditors Protective Association, Box 447, Plainfield, N. J.

**BUSINESS** Stationery—Largest line—highest quality—quickest delivery; biggest commissions—bonuses—free copyrighted cuts. Experience unnecessary. Outfit free. Wilens, 2130 Gladys, Dept. 515, Chicago.

**SALESMEN:** Wonderful sideline. 40% commission paid daily. Sells all merchants. Large outfit free. Lionel, 312 So. Hamilton, Dept. 522, Chicago.

**FOR** Big income, sell garages, gas stations, marhinitis, R. H. men, amazing safety non-slip shoes. Exp. unnecessary. Sample free. Atlas Shoes, 74, Waltham, Mass.

**DISTRIBUTORS** Earn \$20 to \$30 daily selling stores, agents, public direct. Low-priced, depression-proof, indispensable merchandise to men. 200 to 300% profit. Sells on sight. Exclusive territories. Write for sample. Red Bottom Products Co., 417-C Wilcox Bldg., Los Angeles, Calif.

**REPRESENTATIVES**—Local or traveling—Promote service station advertising campaigns for us. Write National Sales Service, 525 E. College St., Oberlin, Ohio.

**EARN** \$20.00 Daily; establish life income selling for only \$1.50 a year \$1500.00 accident policy. Superior Policy, 11 South LaSalle, Chicago.

**RUN** My oil agency. No investment required. I divide profits 50-50 every week. \$50 to \$200 weekly your share. Products nationally known. My partners made \$187,000 last year taking orders direct from farmers, auto owners, etc., All or spare time. Free selling equipment. Write quick. Central Petroleum Co., 704 Century Bldg., Cleveland, Ohio.

**PREMIUM** Salesmen—Brand new trade stimulator appeals instantly all lines retail business. Just what you always wanted. Big commissions. Well rated company. Outfit free. Salesmanager, 4th Floor, 308 North Michigan, Chicago.

**REPRESENTATIVES.** Enroll men for training on sound motion picture engineering. Guarantee \$40 weekly when approved. Start on commission. 103 North Rowan Ave., Dept. B, Los Angeles, California.

**WELDING** And cutting apparatus salesmen. Make substantial profits distributing welding and cutting tips, apparatus and accessories. Apply by letter only. Tips, Inc., 515 Cathedral St., Baltimore, Md.

**\$5000 SPECIALTY Men**—Collect capacity earnings. Sell Morgan patent, thin-model, indoor-outdoor neon signs. Industry's greatest improvement. Nothing similar. Large production, low prices. Fine commissions, protected territory, competitionless. Demonstrator loan plan. Bank references required. Complete line. Display Products, Ltd., 31st at Oak, Kansas City, Missouri.

**GIVE** Away ladies pure silk stockings or double compact—with wonderful value \$1.00 set toiletries. 100% profit. Paris Laboratories, 3145 Locust, St. Louis, Mo.

**SELLING** Like blazes! 11 piece toilet goods assortment at \$2.00 with self-sharpening shears free to your customers. 100% profit. E. M. Davis, 560 Randolph, Dept. 869, Chicago.

**NEW**, Largest color catalogue, punchboards, vending machines, produces quicker orders, big commissions. Free outfit. Lincoln Sales, 116 So. Wells, Chicago. Dept. D. Established 29 years.

**SALESMEN**—Four \$15.00 sales to stores net you \$48.00 daily. Sayers Systems, Est. 1895, 2801-123 Sheffield Avenue, Chicago, Illinois.

**SALESMEN-DISTRIBUTORS**. New auto tire patch; guaranteed 10,000 miles. Repairs blowouts permanently. Sells garages, gas stations, tire shops. Salesmen's profit 100%. Up to 300% to dealers. Easy seller. Exclusive territory. Economy Rubber, 608 Burkhardt, Dayton, Ohio.

**BIG** Profit putting our gold sign letters on store windows, without experience. Samples. Consolidated, 69-V West VanBuren, Chicago.

**FREE** Booklet describes 67 plans for making \$20-\$100 weekly in home or office business of your own. Elite Co., 84 Elizabeth St., New York.

**NEW** Legal punchboard plan! We furnish everything! No investment for you or your customer! Nothing to sell or carry! 50% profit! Unsuitable merchandise returnable! Full repeat commissions. AJ Novelty Company, 161 Washington, Chicago.

**MEN** To sell batteries with complete line of supplies to garages. Lowest prices. Mickman Battery Co., St. Paul, Minn.

**\$15.00 DAILY** Selling Union Label business and blotter cards, 1000 for \$1.50 including card case. Free cut service. 33% commission advanced. Outfit free. National, 108-28 No. Jefferson, Chicago.

**SALESMEN**—Become independent. Own your business; experience unnecessary. Selling our \$10,000 accidental death; \$50 accident; \$25 sick weekly benefits—\$10.00 yearly. Other amounts proportionate. Guaranteed steady income from renewals. \$250,000 deposited insurance department. Universal Policy, Dept. A, 716 Lefcourt Bldg., Newark, N. J.

**WONDERFUL** Opportunity. Twenty dollars per day can be earned. Experience unnecessary. Home protection at cost. Ages one to eighty. \$250 to \$1000 at death. Not insurance. You make \$5 for each member secured. Childress, of Virginia, sent in 54 one day. National Aid Society, Myers Building, Springfield, Illinois.

**PENNY** Golfer, new fascinating coin-controlled game. Legal. Exciting. Merchants everywhere buy. Splendid commission. Specialty Mfg., 617 Division, Chicago.

**SELL** Egg Cartons! Dandy repeat sale line. Everyone who sells eggs needs cartons—grocers, poultry farms, dairies. Send for information and samples. Pick up these extra commissions. Self-Locking Carton Company, 575 E. Illinois Street, Chicago, Ill.

**NEW** Specialty—Sells every business and professional man. Four \$15 sales daily pay \$280 weekly. Foyer cleared \$4920 in three months. Write, F. E. Armstrong, President, Dept. PM, Mobile, Ala.

**BEST** Books for \$1. All formerly sold for \$2.50 to \$5 each. Select from the following list of guaranteed bargains. All brand new books: Woodcraft by Seton, Book of Letter Writing by Crowther, Etiquette by Eichler, Creative Chemistry by Slosson, Revolt in the Desert by Lawrence, Trader Horn, White Shadows in South Seas by O'Brien, Count Luckner (The Sea Devil) and Outline of History by Wells. Delivered at your door C. O. D. Simply pay postman \$1 each and postage. Popular Mechanics Press, Room 892, 200 E. Ontario St., Chicago.

#### HELP WANTED

**A MAN** With car wanted to deliver famous Zamel Products to steady customers on established route. Routes pay \$27.50 weekly up. Pay begins at once. Write Albert Mills, Route Manager, 1563 Monmouth, Cincinnati, O.

**A RICH** Opportunity—men-women! The offer of a lifetime! We put you in a business of your own which once started, becomes self-sustaining, requiring an investment of less than two dollars. Our plan pays you up to \$25.00 and more cash profits everyday with no selling. Grasp this bonafide opportunity to enjoy complete financial independence, be your own boss. Quick action necessary. Wire or write at once. The Plaque Studios, Inc., 56 E. Randolph, Dept. 27, Chicago, Ill.

**AGENTS**—Moose corn and callous remover will build you a steady repeat business. Send today for pocket-size trial outfit. The Moss Company, 204 Searle Bldg., Rochester, N. Y.

**CASH** Paid for butterflies, insects. See Sinclair Display Advertisement on page 18.

**MAIL** Order house wants ambitious young man each county to mail circulars, appoint agents, fill orders. Experience unnecessary. Part or full time. Good pay. International Laboratories, 162 N. State, Chicago.

**GO** Into business—Make big money. We start you furnishing everything. Experience unnecessary. Federal Pure Food Co., X2307 Archer, Chicago.

**THAT** Concrete Job. Don't be afraid to tackle it. With the instructions found in the new edition of Popular Mechanics Concrete Handbook you can easily make 173 articles of utility and beauty ranging from ordinary steps to garden furniture. This book will be sent for only 98c plus postage C. O. D. Send your order today to Popular Mechanics Press, Room 892, 200 E. Ontario St., Chicago, Ill.

#### EDUCATIONAL AND INSTRUCTION

**SONGWRITERS!** Poems, melodies. Outstanding proposition. Hibbeler, D15X, 2104 Keystone, Chicago.

**FIREMEN**. Brakemen, baggagemen; colored train or sleeping car porters. \$150-\$250 monthly. Experience not necessary. 810 Railway Instruction Bureau, East St. Louis, Ill.

**WANTED**—Men—Women, 18-50, \$105.00 to \$250.00 month. Qualify for U. S. Government life jobs. Steady work. Paid vacations. Common education sufficient. List positions, sample coaching and full particulars—free. Write immediately—today sure. Franklin Institute, Dept. L3, Rochester, N. Y.

**SOUND** Motion picture engineers wanted. Learn to operate. Free practical training course is completed. Easy terms, 50% of tuition payable when employed. 103 North Rowan Ave., Dept. A, Los Angeles, Calif.

**GAIN** Word mastery quickly through our "Popular Vocabulary-Builder." Speak effectively, write convincingly. Increase your language power. Book only 50c. Spruen, 5168-W 18th, Cicero, Ills.

**LEARN** Rapid figuring from "Higher Arithmetic." New low rates. Frederick A. Smith, 4746 Virginia Ave., Chicago.

**WANTED**—Names of men desiring steady outdoor jobs, \$1,700-\$2,400 year; vacation; pleasant, healthful work; patrol parks; protect game. Details free. Write Delmar Institute, A49, Denver, Colo.

**BECOME** A landscape architect. Uncrowded profession; wonderful opportunity for money-making. Easily mastered by mail. Earn while you learn. Est. 1916. Write for details. American Landscape School, 7 Plymouth Bldg., Des Moines, Ia.

**LEARN** Automobiles, electricity, fenders, bodies, welding. Stevinson's, 2008A Main, Kansas City, Mo.

**IMPROVE** Your handwriting. Gaskell's penmanship course gives 20 separate lessons and complete book of instructions, only \$1.00. Quile Publishing Co., Dept. 29, 57 Rose St., New York.

**USE** Shortcuts in Figures. Save valuable time. The quickest ways of working all problems. Instructions for drilling yourself to be come rapid with figures. Complete, yet simplicity itself. Just write a postal for "Shortcuts in Figures." Pay postman \$1.25 and postage. Popular Mechanics Press, Room 892, 200 E. Ontario St., Chicago, Ill.

**FINGER** Print and secret service particulars free. Write, American Institute, 2190 Broadway, N. Y.

**LEARN** Photo-engraving at home by experience. Equipment furnished. Earn while learning. Aurora Photo-Engraving School, Aurora, Mo.

**PHOTOPLAY** Talking picture and magazine stories wanted for revision, development and copyright. Sell on commission. Established 1917. Booklet free. Universal Scenario Company, 405 Meyer Bldg., Western and Sierra Vista, Hollywood, Calif.

**WANTED**. Men-Women, 18-50, qualify for steady Government Jobs. Salary range, \$105-\$250 month. No Government experience required. Paid vacations. Common education. Thousands appointed yearly. Write Orment Institute, 191, St. Louis, Mo., immediately.

**U. S. GOVERNMENT** Wants men, \$1,700-\$1,900 and up at start. Railway mail clerk examination coming. Let our expert (former government examiner) prepare you for this and also rural carrier, post office, customs, internal revenue, and other branches. Write today for free booklet. Dept. 8, Patterson School, Rochester, N. Y.

**DON'T** Prepare for any civil service examination without seeing our catalog. Free. Columbia Correspondence College, Washington, D. C.

**YOU** Need a better grip on mathematics? Ask us to send you a copy of "Mathematics for the Practical Man," only \$1.50. By common sense methods it removes the mystery and difficulties so algebra and calculus are made simple. Assuming your knowledge is limited to arithmetic you quickly and easily gain a working knowledge of algebra, geometry, Trigonometry and calculus. Simply pay postman when he hands you the package. Address Popular Mechanics Press, Room 892, 200 E. Ontario St., Chicago, Ill.

#### SHORT STORIES

**LEARN** To write short stories at home. News writing, the approved foundation training, taught by practical experts. Send for free writing test. Newswriter Associates, 7407A So. Harvard Blvd., Los Angeles.

**SHORT** Stories revised, typewritten and marketed. Details free. Hursh Service, Box P-1013, Harrisburg, Penna.

#### TYPEWRITERS AND SUPPLIES

**TYPEWRITERS**—All standard makes \$10 up. Catalog free. Northwestern Typewriter Exchange, G-121 N. Francisco Ave., Chicago.

**TYPEWRITERS**—All makes, \$6 to \$32. Guaranteed. Catalog free. Typewriter Works, Ada, Okla.

#### ADDING MACHINES

**NEW** \$4.75 Automatic Adding Machine. Fully guaranteed. Bassett, 1458-C, Hollywood Avenue, Chicago.

#### PRINTING, MULTIGRAPHING AND MIMEOGRAPHING

**200 BOND** Letterheads 20-lb. (8½x11), envelopes, cards, statements, \$1.00 each, postpaid. Samples. Roland Company, Wareham, Massachusetts.

**POSTPAID**—1,000 Business cards, \$1.50, 1,000 Hammermill letterheads, 8½x11, \$2.75. Steve Bowen Co., 542 S. Dearborn, Chicago.

**GUMMED** Labels, rubber stamps, circulars, coin mailers, money-getting home business plans. McPherson Popular Print, Middletown, Conn.

**500 HAMMERMILL** Bond noteheads, four lines, postpaid, \$1.00. Printery, 1258 Brook, New York.

**500 BOND** Letterheads, envelopes, billheads, cards, \$1.85 each. Wilson, 2922 Victor, Kansas City, Mo.

**5000 ATTRACTIVE** Envelope folders, \$11.50; envelope slips, \$5.00; 6x9 circulars, \$7.50. Samples. Goodprint, Harrisonburg, Va.

**QUALITY** Printing for less—Letterheads \$3.50, envelopes, business-cards \$2.65, 1932-depression price list. Pound samples dime. Large equipped plant. Webb-Print-Press, Gettysburg, Penna.

**COMPLETE** Set stationery printed, 100 bond letterheads, 100 envelopes, 100 cards, for only \$2. Correct style, high quality, quick service, 6 lines limit. \$1 with order, balance C. O. D., plus postage. Congress Printing Co., 912 N. Wells St., Chicago, Ill.

**1000 BUSINESS** Cards \$1.40, 21 beautiful Xmas cards \$1.00. Bradshaw Specialty Co., Dept. A11, 3214 West Huron Street, Chicago, Ill.

**STATIONERY** 30 Sheets, 25 envelopes, two color monogram, 50c postpaid. Frisco, 3849 Cornell, Des Moines, Iowa.

**CHEMICAL** "Change-a-Kolor" Fluid—Transforms your present one-color printing into dazzling color jobs. Rapidly applied. Investigate! Explanation free. Imperial Laboratories, Edwardsville, Illinois.



**FINE** Printing, mimeographing. Depression prices. Field's, 1562 Glenmont Road, Cleveland, Ohio.

15 **PERSONAL** Christmas cards \$1.00. Applebaum-P, 1258 Brook, New York.

**AGENTS.** Three-color business cards, \$2.95 thousand. Crescent, 1715½ Wood, Dallas, Texas.

1000 **BUSINESS** Cards, card case. \$1.50. Miller, Printer, Narberth, Pa.

200 **LETTERHEADS** And 100 envelopes. \$1.00; 200 letterheads, 8½x11, 150 en. elopes, \$2.00; 250 cards, \$1.00. Hoosier Print Shop, Portland, Ind.

WE Print stationery, booklets, catalogs, circulars. Samples. Commercial Press, Batavia, Ohio.

**LETTERHEADS.** Envelopes, 500, \$1.10; 1,000, \$2.00; \$5,000, \$8.00, plus postage. Samples. Coyle & Kimballs, Newport, N. Y.

250 **BOND** Letterheads, envelopes, billheads, cards, \$1.35 each. Economic Press, Leonia, N. J.

#### PRINTING OUTFITS AND SUPPLIES

**PRINT** Your own circulars, envelopes, with home made press costing less than \$1.00. Illustrated instructions 10c. Carl Edouard, Odessa, Minn.

**BUILD** An 8x10 printing press for \$1.00. Complete instruction only 50 cents. K. Wise, 100 E. Broadway, Red Lion, Pa.

**COMPLETE** Printing outfits, presses, type, ink, paper, supplies. Write for free catalog. Kelsey Co., B-11, Meriden, Conn.

**PRINTING** Outfits—Presses, type supplies, type novelties. Send stamp for catalog. Model Press, York, Penna.

**PREUSED** Printing presses and supplies. Lists 2¢ stamp. Popular Bargains, Richmond, Pa.

#### GUMMED LABELS

**COLORED** Stickers pay! Economical, too. Samples. Harvey Wolf, 6818 F Quimby, Cleveland, Ohio.

1,000 **PRINTED;** Name, business, address 50c. JRS Company, Box 93, Holyoke, Mass.

#### DUPLICATORS AND DEVICES

"**EXCELLOGRAPH**" Rotary stencil duplicator \$39.00. "Two-Faced" film duplicator \$6.00. Booklet free. Pittsburgh Type-writer Supply, Dept. 601, Pittsburgh, Pa.

**STENCIL** Duplicator—Anyone can make. Particulars free. Imperial Laboratories, Edwardsville, Illinois.

#### RUBBER STAMPS

**NAME.** Address, 2 lines 25c; 3 lines 35c. Stamp Works, Auburn, Nebr.

#### FOR SMOKERS

**CUT** Your cigarette cost—Send for factory fresh Green Rivers at \$1.25 per carton, 200 cigarettes, postpaid. Smoke 5 packs. If you don't enjoy milder more tasty natural flavored smoke—return 5 packs and get \$1.25 back. Green River Tobacco Co., Box 981, Owensboro, Kentucky.

**ECONOMIZE.** Roll-your-own. New novel cigarette roller. Perfect cigarettes for one-third cost. Agents 100% profit. Sample 50c. Economy Manufacturing Company, Atlanta, Georgia.

**HOME** Cigarette machine! Illustrated circular, \$3.75 postpaid. Automatic Cigarette Machine Wks., 1935 Sheridan, Chicago.

**WOODTURNING** For amateurs. Excellent new instruction book just published for the amateur and home work shop owner. Contains all the needed information and is well illustrated yet published to sell at the low price of 25 cents postpaid. Send for your copy today. Mail remittance with your order. Popular Mechanics Press, Room 802, 200 E. Ontario St., Chicago.

#### RAZORS AND BLADES

**YOUR** Gillette. Probak blades resharpened, 1c each. Pester Wetterquist, Rockford, Ill.

**WORLD'S** Fastest, simplest razor blade sharpener, only 25c. Satisfaction guaranteed. Chesterfield Sharpener Co., 9523 Calumet, Chicago.

#### ELECTRIC CLOCKS

"**SPLIT** Second" electric clock movement, only \$2.32. You get \$5 to \$10 for it—send dime for "Make Big Money Electrifying Clock." The Kuempel Clocksters, Guttenberg, Iowa.

#### DIAMONDS, WATCHES, CLOCKS AND JEWELRY

**GENUINE** Elgin, Waltham, Balova, Gruen watches, \$4 to \$19. Guaranteed. Catalog free. Dea's Jewelry House, Ada, Okla.

#### FIELD GLASSES, TELESCOPES, ETC.

**BINOCULARS,** Field glasses, telescopes, microscopes. New used. All makes \$1 up. World's largest assortment. DuMaurier Importers, Dept. 201-A, Elmira, N. Y.

\$14.00 **BAUSCH & Lomb** binoculars, six power, leather case. Big selection guns, field glasses, musical instruments. Sell and exchange. Send list. Wed's Curiosity Shop, 26 South Second St., Philadelphia, Pa.

#### GUNS, FISHING TACKLE AND SPORTING GOODS

**FOR** Boxers; good jumping ropes with rubber handles, "unbreakable." Send \$1.50 money order. J. Andrie, 5772 Lenox Ave., Detroit, Mich.

#### PRECIOUS STONES

(**DIAMONDS** Rival) genuine Zircons, deep blue, pale blue, golden brown, and blue white. Sample blue white \$3. Goetz Gem Co., Gallon, Ohio.

#### WATCH REPAIRING

**STRAIN** Honor Bound Service, Brookfield, Missouri, repairs watches for anyone anywhere. No job over three-fifty. Mail yours.

#### ANTIQUES, WAR RELICS AND INDIAN GOODS

**GAS** Masks, souvenir World War, \$2.00. Mailed free. Atlantic, 929 Florida Ave., N. W., Washington, D. C.

**STONE** Age relics, 32 page catalog 5c. Grutzmacher, Mukwonago, Wis.

**INDIAN** Relics, coins, curios, beadwork. Catalog free. Vernon Lemley, Northbranch, Kan.

**SEND** 5c For fine new list Indian relics, antique firearms. F. E. Ellis, Webster Groves, Missouri.

#### MUSIC AND MUSICAL INSTRUMENTS

**FORTUNES** Being made from songs through talking pictures, radio, phonograph, music publishers. "Hit" writers revise, arrange, compose music to your lyrics. We submit to studios and other markets. Free reading. Send for booklet. Universal Song Service, 625 Meyer Bldg., Hollywood, Calif.

**SONGWRITERS**—Read "song requirements of talking pictures, radio and records" an explanatory instructive book sent free to aspiring writers of words for songs. We compose, arrange music and secure copyrights. Write today. P. C. Newcomer, Associates, 1674 Broadway, New York.

**SONGWRITERS** Service, 1727½ Whitley, Hollywood, California. Music composed, songs revised for publication, broadcasting, exploiting. Free particulars.

**SONGWRITERS!** Poems, melodies. Outstanding proposition. Hibbler, D1, 2104 Keystone, Chicago.

**COMPOSERS**—Verse or music. Brilliant opportunity. Write VanBuren, 2588 McClurg Bldg., Chicago.

**DUO-Flex** reeds for clarinets and saxophones eliminate your reed troubles. Write for circular. Duo-Flex Reeds, 1204 1st Ave., Evansville, Ind.

**SONGWRITERS,** Professional plan. Edward Madden, 113 Michaels, Syracuse, N. Y.

**SONGWRITERS**—Free booklet "How To Turn Your Songs Into Gold." Stan Tucker, 320 Wadsworth Ave., New York.

**SYSTEM** Complete \$1.00. Address "Music Shorthand," Pismo Beach, California.

**SONG** Posts, write Sequoia Songwriters Service, Sherman Branch, Los Angeles, Calif.

**POEMS** Wanted. Work guaranteed. We publish. Great Eastern Song Bureau, Dept. 27, Thomaston, Me.

**SONG** Writers. Send for our "Publishing Agreement." McKinley Music Printers, 1501 E. 55th St., Chicago.

**WRITE** Songs. Big money and reputation. Write for information. J. Gordon Pub. Co., 201 N. Hoyne Ave., Chicago.

"**MUSIC** Composed" to words. Bauer Bros. (formerly of Sousa's Band), Oshkosh, Wis.

**SEND** Song poems, 50-50 plan. Indiana Song Bureau. (Brookside), Salem, Ind.

200 **TRICKS** You can do—Mystify your friends; have loads of fun. This collection of tricks has been selected by Thurston for the average person. Neither unusual skill nor elaborate apparatus are required. Send for this 200-page illustrated book. Pay postman \$1 plus postage when delivered. If outside U. S. remit when ordering. Popular Mechanics Press, Room 802, 200 E. Ontario St., Chicago.

#### PATENT ATTORNEYS

**INVENTIONS** Patented and Exploited. Former patent office examiner; Master patent law. Benj. Webster, Esq., No. 15 East 26 Street, New York.

**PATENTS.** Booklet free. Highest references. Best results. Promptness assured. Watson E. Coleman, Patent Lawyer, 724 Ninth St., Washington, D. C.

**LACEY'S** Patent Sense. Valuable book free. See ad page 128.

**TIME** Counts in applying for patents. See pages 124 and 125. Clarence A. O'Brien, Registered Patent Attorney, Washington, D. C.

**PATENT** Your invention: Send for free book, "How to Obtain a Patent," and "Record of Invention" blank. Consult us about how to protect your ideas. Victor J. Evans & Co., 602A Victor Bldg., Washington, D. C.

**LANCASTER,** Allwine & Rommel, Suite 411, 815 - 15th St., N. W., Washington, D. C. "Originators of the Form Evidence of Conception." Before disclosing your invention to anyone send for blank form to be signed and witnessed. Form and patent information bulletin free.

**PATENTS** Procured; trade marks registered—preliminary advice furnished without charge. Booklet and form for disclosing idea free. Irving L. McCathran, 700A International Bldg., Washington, D. C.

**PATENTS.** Reasonable rates. Write. The Ramsey Company, World Patent Attorneys, 273 Bank St., Ottawa, Canada.

**WHAT** To Invent—Names of manufacturers and wanted inventions sent free on request. Write W. T. Greene, 946 Barrister Building, Washington, D. C.

**PATENTS** Secured. Promptness and skill assured. Examination and advice free. Book sent free. Randolph Company, Section-456, Washington, D. C.

"**INVENTOR'S** Guide," valuable information, free. Frank Ledermann, Registered Attorney-Engineer, 1712 Woolworth Bldg., New York.

**MANUFACTURERS** Everywhere seek new inventions to improve their product. Names of manufacturers and wanted inventions sent free on request. Write W. T. Greene, 952 Barrister Building, Washington, D. C.

**INVENTORS:** Send for booklet telling how to patent and sell your inventions at lowest cost. Ralph Burch, Patent Lawyer, 900 F St., Washington, D. C.

**PATENTS.** Send sketch or model for advice. Free book, "How to Obtain a Patent." Established thirty years. Highest references. Prompt service. Reasonable charges. Chandee & Chandee, 908 F Street, Washington, D. C.

**ESTABLISHED** 1864. Milo B. Stevens Company. Free booklet. Patents. Trade marks. Copyrights. Offices. Monadnock Block, Chicago; Barrister Bldg., Washington, D. C.

**PATENTS**—Write for free information. How to Obtain a Patent and Record of Invention—or send drawing or model for examination. Miller & Miller, Patent Attorneys (former Patent Office Examiners), 1006-A Woolworth Building, New York; 678 Earle Building, Washington, D. C.

**SHOP** Notes for 1931. Get your copy now. Only a limited edition. Contains all the articles published in the Shop Notes department of Popular Mechanics Magazine during 1930. Send 50 cents. If you want the set of Shop Note books consisting of 6 volumes including the 1931 number and 5 others issued previously we will send them C. O. D. for \$3.00. Popular Mechanics Press, Room 808, 200 E. Ontario St., Chicago.

#### FOR INVENTORS

**INVENTIONS** Patented and Exploited. Former patent office examiner; Master patent law. Benj. Webster, Esq., No. 15 East 26 Street, New York.

**PATENT** Your invention: Send for free book, "How to Obtain a Patent," and "Record of Invention" blank. Consult us about how to protect your ideas. Victor J. Evans & Co., 601A Victor Bldg., Washington, D. C.

**CONSULTING** Development engineer-patent attorney. Inventions perfected. Valuable engineering and sales plans made. J. J. O'Brien, 154 E 42nd St., New York City.

**TO Inventors:** We are in the market to purchase a good patent, preferably in the automobile accessory line. Will purchase outright or on royalty basis. Purchasing Agent, 241 Front St., New York, N. Y.

**CASH** For practical unpatented or patented invention.—Bailey Smith, Burtonsville, Md.

**LACEY'S Patent Sense.** Valuable—book free. See ad. page 129.

**READ** The inventor's own magazine. Sell your invention. Write to Invention Age & Patent Market, Box B 1577 East 18th Street, Brooklyn, N. Y., for free details.

**TIME** Counts in applying for patents. See pages 124 and 125. Clarence A. O'Brien, Registered Patent Attorney, Washington, D. C.

**INVENTORS Manual.** Not an advertisement. Explains why inventors get defrauded. Instructs correct methods of protecting, estimating worth, and profitably selling inventions. May save you thousands of dollars. Low cost. Send \$1.00 immediately for complete manual or write DuVan International Company, Chamber of Commerce Building, Cincinnati, Ohio.

**NATION** Wide search for best inventions. American Society of Inventors, Crosby Bldg., Buffalo.

**LOW Cost manufacturing.** Large plant completely equipped for blanking, drawing, stamping and wire forming in any finish. Can save you money on your product. Our figures will convince. Eastern States Products, Box 721, New Haven, Conn.

**INVENTOR'S Universal Educator:** contains 900 mechanical movements; 50 perpetual motions; instruction on procuring and selling patents and selecting an attorney, etc. Suggests new ideas. Price \$1.00 postpaid in U. S. A. Address Dietrich Co., 602B Ouray Bldg., Washington, D. C.

**MANUFACTURERS** Now buy inventions. Valuable circular sent free. Fees \$25.00 up to prepare and file patents. Twenty years experience. J. J. O'Brien, Patent Attorney-Engineer, 154 E 42nd St., New York City.

**MANUFACTURERS** Everywhere seek new inventions to improve their product. Names of manufacturers and wanted inventions sent free on request. Write W. T. Greene, 944 Barrister Building, Washington, D. C.

**INVENTIONS—Have you conceived one?** There is a long, winding road to travel before your vision of rewards can be realized. Send for the new book "Inventions and Patents. Their Development and Promotion" by an eminent authority. It is designed to guide the inventor on his way and help him avoid pitfalls. Will be sent C. O. D. Pay postman \$2.50 plus postage when he hands you the package. Popular Mechanics Press, Room 802, 200 E. Ontario St., Chicago.

#### PATENTS FOR SALE

**TIME** Counts in applying for patents. See pages 124 and 125. Clarence A. O'Brien, Registered Patent Attorney, Washington, D. C.

**FOR Sale—State** rights on "Automatic Milk Bottle Cap Lifter." Will sell outright or on royalty. 45,000 sold in Minnesota. Sample 50c. Write quick. Robt. Poulson, Hutchinson, Minnesota.

**OUTRIGHT** Or royalty—Attractive new signal lamp for automobiles. Important safety accessory. Practical. Patent pending. William N. Thrall, Box 262, West Rutland, Vermont.

**FOR Sale** or Royalty. New improved sanitary toilet seat cover. Investigate. Joseph Bilek, 5914 W. Fullerton, Chicago, Ill.

**SELL** Patent commercial specialty costs 10c, retails \$2.50, very novel, sells easily. Minto, 96 Romaine Av., Jersey City, N. J.

**LATEST** Model patent on automatic backstop for motor-driven vehicles. Apply Box 401, O. Bjork, Kamloops, B. C., Canada.

**PATENT** Just allowed. Article holder. Cheap. Useful for any household. Made of wire. Outright or royalty. Rudolf Muhlichen, 314 Park Ave., Hoboken, N. J.

**AUTOMOBILE** Right and left signal. Patent pending. Moving illuminated arrow. Electrically operated. Cheaply manufactured. J. M. Foster, 3rd and Broadway, Dayton, Ohio.

**IMPROVED** Airship, safer faster. H. J. Ross, P. O. Box 61, Farming Dale, N. Y.

**MANUFACTURERS** Looking for new inventions should write W. T. Greene, 939 Barrister Building, Washington, D. C.

**MANUFACTURERS.** Get our complete list of inventions. American Society of Inventors, Crosby Bldg., Buffalo.

**OUTDOOR Sports** for everyone—Enjoy them all year round with aid of great new book just published by Popular Mechanics. This veritable encyclopedia not only furnishes hundreds of ideas for new and popular sports for every season of the year, but also gives complete instruction for making the necessary equipment at very small cost. 350 pages and 650 illustrations. Send today as book is full of thrills and excitement for fall and winter sport enthusiasts. Mailed postpaid anywhere for \$2, or will be sent C. O. D. to any address in U. S. Simply pay postman when delivered. Popular Mechanics Press, Room 802, 200 East Ontario St., Chicago.

#### MODELS AND MODEL SUPPLIES

**FROM** Your rough idea we design and build practical working model at lowest cost. We manufacture and sell, and pay you royalty. Our 25 years experience covers mechanical, electrical, photographic, musical, motion picture, phonograph, radio, etc., and also vending machines, packaging and counting machines, automatic sales machines, scales, games, amusement machines, automatons. Confidential service. Member Cleveland Chamber of Commerce. Write now. Wm. Gent Mfg. Co., 17300 Neff Road, Cleveland, Ohio.

**COPPER, Brass, craftsmans tools, bearings, hangers.** Free circulars. Ask about special offer for beginners in metalcraft. Kirk Hardware Company, Dept. 30, 128 E. 23 St., New York City.

**SHIPMODELER.** Magazine of the ship model makers' club. Sample copy 20 cents. 55A, Middagh St., Brooklyn, N. Y.

**MODELS** Made, experimental work, stampings, tools, dies and light manufacturing. Frostholt Bros., Syracuse, N. Y.

**INVENTORS:** Send us sketch or crude model of your idea. Crescent craftsmen will develop it into a practical working model. 30 years of successful experience and thousands of satisfied clients. Confidential service guaranteed. Bank references furnished. Free illustrated book: "Making Inventions Pay." Crescent Tool Co., Dept. S-1, Cincinnati, Ohio.

**TIME** Counts in applying for patents. See pages 124 and 125. Clarence A. O'Brien, Registered Patent Attorney, Washington, D. C.

**ACME** Model Works, 200 North Jefferson Street, Chicago, Ill. Working models, mechanical, optical and electrical apparatus. Light manufacturing.

**30 KINDS** of engines, castings, blue prints and supplies. Catalogue 10c. Howard, 2417 N. Ashland Ave., Chicago, Ill.

**GASOLINE** Engine, two cycle type, 3/4"x3/8". Steam engines, boilers for model boats. Propellers, fittings. Catalog 15c. Anton Bohaboy, 212 Price St., Rahway, New Jersey.

**WOOD** Turning on the lathe. Both interesting and fascinating. Send for a copy of Milton & Wohlers Course in wood turning. It gives you quickly a complete mastery of this manual art. 340 pages. Cloth. 141 plates. Sent C. O. D. Pay postman price \$1.50 and small amount postage upon delivery. Popular Mechanics Press, Room 802, 200 E. Ontario St., Chicago, Ill.

#### COPYRIGHTS

**COPYRIGHTS** Procured; very low cost. Wade Service, 2274-N, Brooklyn Station, Cleveland, O.

**ELECTRICAL** Trouble shooting on the motor car and airplane. Don't trust to luck or guess work. Learn to make every motion count in testing and repairing. Send for our standard 493-page book for electricians and mechanics. 300 diagrams. Hundreds of practical tests. Pay postman \$4.00 plus postage when delivered. If outside U. S. remit when ordering. Popular Mechanics Press, Room 802, 200 E. Ontario St., Chicago.

#### MANUFACTURING

**MANUFACTURING.** Models, dies, stampings, brasswork, moulds for castings, vulcanizing. Circular free. Baums Metal Specialties, Kansas City, Mo.

**LOW Cost manufacturing.** Large plant completely equipped for blanking, drawing, stamping and wire forming in any finish. Can save you money on your product. Our figures will convince. Eastern States Products, Box 721, New Haven, Conn.

**SPECIAL** Machinery or parts, dies, tools, metal specialties, models, special gears, stock gears and model supplies. Send for catalog. The Pierce Model Works, Tinley Park, Ill.

**METAL** Articles developed and manufactured. Model making. Reasonable price and first class workmanship. W. F. Meyers Company, Bedford, Indiana.

**WIRE** Goods made to order. Cooley Mfg. Co., 3240 Carroll Ave., Chicago.

**SPECIALIZE** Complete manufacture, dies, tools, special machinery and patterns. Models made. Atlas Indicator Works, 821 W. Washington, Chicago, Ill.

#### BLUEPRINTS

**HAVE** Fun, make money, make comic action lawn toy. Send 75c for blueprint. Walter Geddes, Gilmanton, New Hampshire.

**FAMOUS** Bailey Handbook—Prepares you to pass the examination for any grade of license for stationary, marine and Diesel engineers, firemen and boiler inspectors in any state of the Union or any province of Canada. Flexible cover. Handy pocket size. Pay postman \$2.00 plus postage when he hands you the package. Popular Mechanics Press, Room 802, 200 E. Ontario St., Chicago, Ill.

#### SURVEYING INSTRUMENTS

**ALL** Our rebuilt transits and levels are now reduced 20%. All fully guaranteed—sold subject to field test. Cash or easy terms. Write today for list M-61. Warren-Knight Co., (Makers of "Sterling" Surveying Instruments.) 136 N. 12th Street, Philadelphia, Pa.

#### WELDING AND SOLDERING

**BARGAINS—Excellent** reprocessed arc welders, buffers and grinders. Entirely rebuilt—guaranteed. Trial. Terms. Write Ken's Service, Box M-123, Troy, Ohio.

**BUILD** Your own boat. Save over 1/2 and have fun besides. Simplified instructions in Popular Mechanics New Boat Book, just out, are easy to follow. Every type of small boat covered, outboard, inboard, sailing and hand-propelled craft. In addition complete information on all phases of boating needed by every boating enthusiast. 269 pages. Fully illustrated. Postpaid upon receipt of price, \$3.00 or will be sent C. O. D. anywhere in U. S. Popular Mechanics Press, Room 802, 200 E. Ontario St., Chicago.

#### BENDING MACHINES

**THE** Famous Hossfeld "Wrenchless" Universal Iron Bender is the last word in bending machines. Bends metal, cold or hot, into most any conceivable shape, including Eye Bolts and Automobile Spring Eyes. Bends up to 1" bars or 1 1/2" pipe cold. Also bends "Angle Iron." Thousands in use by all classes of trade, from the smallest shops to the largest railway systems. Write for circular and prices. Hossfeld Mfg. Co., Winona, Minn.

#### MACHINE DESIGNING AND DRAFTING

**WORKING** Drawings made for all purposes. P. Rogge, Bonne Terre, Missouri.

#### MACHINERY, TOOLS AND SUPPLIES

9"x3 1/2" SHEPARD Lathe \$75.00. Kemp-smith milling machine \$175.00. 16" Smith & Mills crank shaper \$175.00. 14" U. S. sensitive drill press \$40.00. No. 60 Heald cylinder grinder \$450.00. 10" new drill press \$21.00. new automatic air compressor, with tank, motor, etc., \$85.00; battery charging outfit, complete \$100.00. Write for catalog. Terms to suit. Cincinnati Machinery & Supply Co., 27 West 2nd St., Cincinnati, Ohio.

**KELLOGG** Air compressors, excellent condition, \$6.00. Taylor, 105 East 102nd Street, New York City.

**SUBSTANTIAL** Savings—used are welders, buffers, grinders, platers, compressors, paint sprays. Entirely rebuilt, guaranteed. Trial and terms. Write Ken's Equipment, Box M-124, Troy, Ohio.

**WANTED—Good** used 1/2" electric drill. Roy Vail, Warwick, N. Y.

**START** Business of your own, small investment required, doing chromium, nickel, copper, silver plating. This work in big demand. Information free. Electro Platers Supply Co., 28 West Second St., Cincinnati, Ohio.

**\$100.00** SCREW Cutting lathes. Inventors, amateurs, schools. Amphion 305-24th St., Milwaukee, Wis.

## ENGINES, MOTORS AND DYNAMOS

**GOVERNORS** For auto engines for stationary or portable power. No cash down. Cambee-Smith Governor Co., 215 North Los Angeles Street, Los Angeles.

**8 LIGHT 32 Or 100 volt complete lighting plant \$48.50, new 1/2 hp. gas engine \$10.75, portable lantern and searchlight \$4.00, electric soldering iron \$2.00, 6" bench grinder \$2.25, bargains on electric motors, generators, etc. General Distributing Co., Duluth, Minn.**

**AIR Compressors, paint spray apparatus, electric motors, grinders, drills, saws, air and electric grease guns, new, used, bargains. Write for list, Major Manufacturing, 4334 Boulevard, Union City, N. J.**

**FIFTY 1-12 Horse 110 volt Universal motors, Double shaft, emery wheel and grooved pulley mounted. \$2.95. Other motor and generator bargains. Electrical Surplus Company, Dept. 12, 1885 Milwaukee Ave., Chicago.**

**STEAM Engines—One h. p. \$18.00; 1/2, \$12.00. James Chambliss, Bessemer, Ala.**

**TIME Counts in applying for patents. See pages 124 and 125. Clarence A. O'Brien, Registered Patent Attorney, Washington, D. C.**

**\$15—GASOLINE Engines: 1/4 hp.—Brand new—Magneo—Starter. Guaranteed. Limited number. Harris Machinery, Minneapolis, Minnesota.**

**BRAND New 1/4 hp. 25 cycle motors \$6.50; 1/2 hp. repulsion motors \$14.00; 1/2 hp. dc. \$15.00; 1/4 hp. 32v. \$8.50. Large stock motors, generators, rotary converters, etc., at bargain prices. Queen City Electric, 1736 Grand Avenue, Chicago.**

## FARMS AND FARM LANDS

**CANADIAN Tax sale lands for a dollar an acre and up; small monthly payments. Farms, timber, hunting and fishing camps, minerals. Limited number of properties. Write at once for free illustrated booklet. Tax Sale Service, Room 613, 72 Queen St., W., Toronto, Canada.**

**300 FRUIT Trees, 53 acres; good 7-room, 3-room houses, barn, 300-bird hennerly; \$2700 including team, cattle, 200 poultry, implements, crops; terms; pictures pg. 76 free catalog 1000 bargains. Strout Agency, 255-P Fourth Ave., N. Y. City.**

**FLORIDA Land opening. "Duke" tract now ready. Rich, high land 35 miles south of Jacksonville—R. R., hard roads—center of trucking, fruit, poultry, farming—10 acres for \$320.00. Only \$6.40 down—\$6.40 monthly. No interest—No taxes—Free maps, etc. Durham Lands, Inc., Room 513 - 29 S. La Salle St., Chicago.**

**OZARKS—Timbered river lot, cabin; fishing, hunting, trapping, boating, pearling; \$200, \$10 monthly. Hubbard, 216 Grossman Bldg., Kansas City, Kansas.**

**FREE Books on opportunities in Minnesota, North Dakota, Montana, Idaho, Washington, or Oregon. Complete information on climate, crops, location for farm or suburban tract for grain, livestock, dairying, fruit, poultry—a home, independence, plenty of food, clothing, continuous employment. No occupation offers more to industrious capable men. Write E. C. Leedy, Dept. 237, Great Northern Railway, St. Paul, Minn.**

**OWN A farm in Minnesota, Dakota, Montana, Idaho, Washington or Oregon. Crop payment or easy terms. Free literature; mention state. H. W. Byerly, 119 Northern Pacific Railway, St. Paul, Minn.**

**SELL Your property quickly for cash, no matter where located. Don't pay big commission. Particulars free. Real Estate Salesmen Co., Desk B, Lincoln, Neb.**

## WANTED—MISCELLANEOUS

**MAIL Us your discarded jewelry, gold crowns and bridges, watches, diamonds, silver, platinum. Money promptly mailed. Goods returned if offer refused. United States Smelting Works (The Old Reliable) 39 So. State St., Dept. 71, Chicago.**

**CASH For gold teeth, crowns and bridge-work. H. Bieri, 1104 Holly Ave., Dayton, Ohio.**

**GEMS For old gold! Send us your dental and other old gold for amazingly liberal allowance and free sample. Mexican Diamond Company, Established 1905, Monterey, California.**

**RABBIT Raising assuming large proportions. Learn how produced for food and fur. Send for reliable book by Frank G. Ashbrook, authority in U. S. Dept. of Agriculture. Price \$2.00. Sent postpaid upon receipt of price or C. O. D. anywhere in U. S. Popular Mechanics Press, Room 802, 200 E. Ontario St., Chicago.**

**MAKE Poultry Pay. Learn how to produce phenomenal layers by paying more attention to breeding of fowls. James Dryden, authority, tells how in his book, 416 pages. Over 300 illustrations. Price \$2.00. Sent postpaid upon receipt of price or C. O. D. anywhere in U. S. Popular Mechanics Press, Room 802, 200 E. Ontario St., Chicago.**

## RABBITS

**RAISE Rex rabbits. We pay \$12.00 each. Information 25c. Eastern Rabbitry, New Freedom, Pa.**

**RAISE Big type New Zealand White Chinchillas. Have income every month in year. 10c literature. Pricelist. R. Peters, Blue Springs, Mo.**

**RAISE Rabbits. Demand for meat and fur exceeds supply. Make \$1000.00 to \$3000.00 extra. Complete course of instruction tells how. Descriptive book free. National Rabbit Institute, Dept. 30, Monrovia, California.**

**STANDARD Rabbit Journal, Milton, Pa. Special year 25c; sample dime.**

## MINK

**SPECIAL Pre-season prices on bred female mink. Underwood Minkery, Eyota, Minnesota.**

**BIG Money made raising mink. Free information. Pennell Fur Farm, Dalkena, Wash.**

## POULTRY

**ENORMOUS Profit raising big type English Leghorns. 305-315 trapnest egg record strain. Income \$250.00 month selling eggs. 10c literature. Pricelist. R. Peters, Blue Springs, Mo.**

## CANARIES

**BIRD World—Aviculturists'. Indoor Bird Breeders' magazine, 2 months 25c; yearly \$1.00, 900 World Building, Baltimore, Md.**

## DOGS AND PETS

**ANIMAL World—Oldest pet fancier's journal. Trial year 25c. 900 World Building, Baltimore, Md.**

**AIREDALES, Shepherds, spitz, rat and fox terriers. Males \$6.00, females \$4.00. Berg Kennel, Hendrum, Minn.**

**FOR Sale. Minks, squirrels, raccoons, foxes, ferrets, muskrats, ginseng, rabbits, skunks, wolf pups, opossums. B. Tippman, Caledonia, Minn.**

**BEAUTIFUL Registered bull pups, \$15. Bulldogs, 501 Rockwood, Dallas, Texas.**

**20 CHOICE Select coonhounds thoroughly trained, shipped on free trial. Pictures furnished. Kentucky Coonhound Kennel, Kevil, Ky.**

## FOR SALE—MISCELLANEOUS

**NECKTIES! Hosiery! Shirts! Reasonable prices. Folder free. Quimette's, 81 Holly D20, New Bedford, Mass.**

**WATCHMAKERS Lathes for sale at a bargain. R Jaegermann, 5815 Easton Ave., St. Louis, Mo.**

**UNDERWOOD 5, Standard office machine \$39.95. Checkwriter, duplicator, multi-graph, Dictaphones, bargain prices. Pruitt, 190 North La Salle, Chicago.**

**INKOGRAPH Fountain Penell, self filling, uses any kind of ink. Price \$2.00, \$3.00 and \$5.00. Send money order to Emil Wehnert, 1643 N. Laundale Ave., Chicago, Ill.**

**MIMEOGRAPHS, Kardexes, addressographs, Ediphones. Bought, sold. Office Machine Exchange, 1902 Olive, St. Louis.**

**LET'S Swap! Whatcha got? Whatcha want? Dime trial. Swapper, Sportsman, Williamsport, Pa.**

**FURNITURE Finishing, decoration and patching. Valuable new book, the first in its field, contains practical instruction on doing this work and also treats on materials, tools and processes. 543 pages and 335 illustrations. Delivered to your door C. O. D. Pay postman \$5 and postage. Popular Mechanics Press, Room 802, 200 E. Ontario St., Chicago.**

## ROOTS AND HERBS

**HERBS And Indian remedies. For all diseases. Send 10c for valuable Herb and Indian Doctor Book. Indian Herb Gardens, Centreville, Mich.**

**JUST Out! Beautifully illustrated 64 page medicine man almanac. Contains over 500 old-fashioned herb medicine recipes and Indian secrets for home use. 10c postpaid. Worth dollars! Botanics, 145 West 112th St., Chicago.**

**861 PRACTICAL Ways to Reduce Farm Labor and Expense and Increase Income. One farmer writes he would not part with this information for \$100, if he could not duplicate it. Nothing experimental. These ideas have all been put to test and proven practical. Send today for a copy of our Handbook for Farmers and get ready to put these ideas into operation for your own benefit. Pay postman only 98 cents and the postage when he hands you the package Popular Mechanics Press, Room 802, 200 E. Ontario St., Chicago, Ill.**

## PERSONAL

**ASTROLOGY Will reveal your future. Special 12-page astrological forecast gives predictions—month by month—with exact days, dates and happenings for 1932 based on your sign of the Zodiac. Consult it before making any change in home or business affairs, signing papers, love, marriage, employment, travel, speculation, "lucky days," etc. Know what to expect. Send exact birthdate with \$1.00. Franklin Publishing Company, 800 No. Clark St., Dept. 9351, Chicago.**

**ALL Outdoors. An outing magazine broad as its name implies. Plain and outspoken as the common folks it represents. With a staff of writers any outdoor sports magazine would be proud of; special get acquainted offer 50c for one year, 6 months—25c. Sample copy 10c. Many fine departments, profusely illustrated. Special outdoor photography dept. Monthly. Colored cover. A real up-to-the-minute outdoor sports magazine. Address All Outdoors—P.M.—534, Douglas Bldg., Los Angeles, California.**

**NUMBERSCOPE Revealing your name 12c. Lepina, New Gretna, New Jersey.**

**HANDWRITING Analyzed. Individual readings 25c. Epstein, 308 Nostrand Avenue, Brooklyn, N. Y.**

**GENUINE Horoscope. One dollar. Send birthday and hour. Lerol, Mason City, Iowa.**

**MIND-READING Fortune telling card, 10c. Eisen Co., Bowling Green, Ohio.**

**ASTOUNDING! Astrological reading, character analysis, 12c. Birth date. Darrell, Superior, Nebraska.**

## MISCELLANEOUS

**LEARN Today—Earn tomorrow. Name plates, house numbers, signs. Oneday system. Print signs, pictures, without press, type or machinery. Samples 10c. Straley, 1334 W. Main, Springfield, Ohio.**

**CASH Paid for butterflies, insects. See Serial Display Advertisement on page 18.**

**PROFESSIONAL Locksmithing assured everywhere by patronizing members of National Locksmiths Association. Headquarters: Charles Blinn, Denver.**

**KEYS Made for any lock, seventy-five cents. Send lock or number. C. A. Shadford, Colo. Springs, Colo.**

**THOSE Interested in learning scientific palmistry. Send 10c for specimen chart. Chirouant, 1539 West 7th, Los Angeles, Calif.**

**CASTINGS For home shop wood working machinery. Lynn Fletcher, Ocean Beach, Calif.**

**TATTOOING Outfits, free catalog. Chicago Tattoo Supply House, 434 So. State, Chicago.**

**250 ADVERTISING Pencils for \$7. Price list free. Tuttle Brothers, Hamden, Conn.**

**TATTOOING. Learn with my outfits. Send for circulars, they explain. Sergt. Bonzey, 367 So. Main, Providence, R. I.**

**MIRRORS Resilvered at home costs near 5 cents per square foot; you charge 75 cents. Profitable business plating autoproducts, reflectors, tableware, stoves, refinishing metalware, etc. Outfits furnished. Details free. Write Sprinkle, Plater, 288, Marion, Indiana.**

**TRANSFERRING Liquid—Takes any pictures or print off bills—magazines—funnies, etc. 25c bottle, formula 35c, both 50c. No stamps. Clinch, Brielle, New Jersey.**

**AMATEUR Cartoonists—Earn \$25.00 week, spare time, copying cartoons for advertisers. 3-M Syndicate, Argyle, Wis.**

**TATTOOING Outfits, supplies. Illustrated list free. "Waters," 965 Putnam, Detroit.**

**AMATEUR Cartoonist: Sell your work. Write Smith's Service, PX1194, Wenatchee, Wash.**

# NOW FIX ANY MAKE OF AUTO



## SIX BIG AUTO BOOKS ALL SHIPPED FREE

on approval; whether you want to qualify as garage owner, auto repair expert or merely wish to know how to keep your own car 100% efficient, look at these books—they are sent to you for free examination. This brand

new edition has been prepared by a large group of America's greatest automotive engineers. Anybody who can read will understand them, for this great automobile encyclopedia is a veritable gold mine of valuable facts. Take advantage of this great opportunity now; send in the coupon for FREE examination. You don't pay us a penny, you don't obligate yourself to pay anything unless you decide to keep the books. Just tell us you want to see them and the full set of 6 great volumes, just off the press, will be sent to you. Read them, look them over and prove to your own satisfaction that one fact alone, which you will find in them, may save you an expensive repair, or help you to a better job.

### Aviation Motors

In addition to being a complete encyclopedia of automobile engineering, these books contain over 100 pages on Aviation Motors, and as they are just off the press they bring to you the newest and latest information obtainable. This alone makes these books invaluable to anyone.

## Brand New Edition

Imagine books which are so new that every page is right up to date—wiring diagrams, construction details, service problems—are all right up to the minute. Nowhere else that we know of can you get as complete and up-to-date information. Over a million dollars of resources have enabled us to give you the most up-to-date books on the subject ever published. You will find nearly 20 pages on front wheel drives alone. Everybody interested in automobiles in any way will welcome these books, especially on our no money offer.



## CAN YOU FIX IT?

Can you take out "play" in differential? Can you kill the "shimmy" in steering? Can you reset TIMING? Can you put your finger on engine trouble without guessing or tinkering? Can you pull the starter off and fix it? Can you adjust and repair transmission, engine, rear axle, bearings?

### These Books Tell How

and tell you how to do any and every auto job right, the first time.

### 6 Big Volumes

Nearly 3,000 pages, over 2,000 illustrations, wiring diagrams, equipment charts, etc. De Luxe edition with gold-stamped flexible binding. Sent FREE for 10 days' use. If not wanted return express collect. If kept, send only \$2.00 after 10 days, then \$3.00 a month until special advertising price, \$24.50, is paid.

### A Year's Consulting Membership FREE!

Privilege of consulting engineers of million-dollar American Technical Society on any automotive problem for one year without charge, if you mail coupon immediately.

## SEND NO MONEY

American Technical Society, Dept. A-119,  
Drexel Ave. at 58th St.,  
Chicago, Illinois.

I would like to see the brand new 6-volume edition of your automobile books but without any obligation to buy. I will pay the few cents delivery charges only and will examine the books and return them at your expense in 10 days unless I like them, in which case I will send you \$2.00 then and only \$3.00 per month until the special price of only \$24.50 is paid. You are to include free consulting membership certificate in the American Technical Society. Send brand new edition.

Name .....

Street .....

City ..... State .....

Employer's Name .....

Employer's Address .....

These books will be sent free for examination to anyone sending name and address and that of his employer

## 34 Lesson

# Drawing Course \$2.98

The biggest value you ever saw advertised anywhere . . . . .



Haven't you often wished that you could draw cartoons, illustrate some idea, sketch some pretty face, etc.? You can do all of these things. One of America's most famous Cartoonists and Illustrators has developed a great, simple system for success in all branches of Commercial Art. This system has revolutionized the entire theory of drawing. It means that drawing can be as easy for you as writing—much simpler than learning shorthand, bookkeeping or typewriting. We are now placing this original system for learning Drawing, Art and Cartooning, consisting of 34 lessons with over 500 illustrations, within reach of every one. If you will devote a few hours each week to the Course WE ABSOLUTELY GUARANTEE that you will learn to draw and draw well before you have half finished the Course. If we fail to make this claim good, we will refund every cent paid us. By eliminating a large office force for answering correspondence, expensive catalogs, etc., we are enabled to make a price of \$2.98, the cheapest price ever known for a high-grade, home study course. Learn to draw. It is a big asset, no matter what field you are in.

### Send No Money

Just order the course and on arrival pay postman \$2.98

plus a few cents postage, payment in full for the entire Course and Drawing Outfit. If not entirely satisfied, return within five days and we will Refund Money. Address: LEDEKER SCHOOL OF DRAWING, Dept. 1143-E, Chattanooga, Tenn. Orders from outside the U. S. A. are payable \$3.28 cash with order.

If you order the course at once, we will include a drawing outfit, consisting of artist's pencils, pens, paper, erasers, thumb tacks, etc., enabling you to go to work without any additional cost.

## Don't Envy The Plumber—BE ONE!

\$11.00—\$16.00 PER DAY and work EVERY day, is the Plumber's wage.

LEARN IN 8 to 12 WEEKS without previous experience.

If you are making less than \$60.00 a week you owe it to yourself to investigate. Get FREE estimate that tells in pictures and words how we teach this trade. Special rates now.

UNIVERSAL PLUMBING SCHOOL, 2030 Troost Avenue, KANSAS CITY, MO.

## EARN \$25 WEEKLY—SPARE TIME

Write short stories and news items for magazines and newspapers. Write today for FREE copyright book "How To Write for Pay."

PRESS INSTITUTE 102 ST. LOUIS, MO.

## BE AN OIL EXPERT!

New, easy, practical way to learn at home in spare time. Geology, Drilling Methods, Pipe Line Transportation, Refining and Marketing.

Write Today! FREE Book! PETROLEUM ENGINEERING UNIVERSITY, Dept. 221 FORT WAYNE, IND.



**Why STAMMER?**  
I overcame my own stammering. Let me help you. My new, free booklet tells how. You too, can overcome your speech defects and lead a normal, happy and successful life. Write today! ROBT. E. CARD, 12088 Woodward Ave., Detroit, Mich.

Let us recommend the best books to study on any subject. Popular Mechanics Press, Chicago, Illinois.

## PREVENT FATAL NIGHT CRASHES

And Get In On This BIG PROFIT Opportunity!



An amazing "two-beam" light invented by a famous light engineer now gives drivers complete safety at night. Road is bright as day for 1000 feet—yet secret principle absolutely prevents glare! Kinney of Chicago made \$96 in one day! Big territories—a fat share of 23 million prospects. Write today for full facts about this amazing safety Speedlight and find out about wonderful money-making sales proposition.

SPEEDLIGHT COMPANY

1731 Belmont Ave., Dept. 10-A Chicago, Ill.

67,000 BEAM CANDLE POWER  
ONE FIFTH OF MILE OF LIGHT  
NO GLARE

SPEEDLIGHT BEAM

LOWER BEAM

# WE CHOSE YOU!



Aviation is the most "depression-proof" industry in the World today. . . . .

Von Hoffmann men are invariably given the most responsible positions as Pilots, Linemen, Mechanics, Welders, Etc.

Train with Von Hoffmann for your place in Aviation. Write for Booklet No. 149, "What Aviation Offers You". If you are under 17, write for Preparatory Home Study Course.



Write for Your Copy Today!

**VON HOFFMANN AIR COLLEGE**  
LAMBERT ST. LOUIS AIRPORT - ST. LOUIS MO.

## RADIO BLUEPRINTS

The blueprints below include the best of Popular Mechanics tested circuits. When ordering, simply quote the numbers of blueprints desired and inclose proper amount addressed to Popular Mechanics Magazine, Radio Dept., 200 E. Ontario St., Chicago, Ill. Magazines containing full descriptions of the circuits can be obtained. Send 25 cents for each magazine desired, giving date of publication.

- No. 139, Simple Television Receiver. . . Dec. 1928. . . 25c
- No. 142, Two-Tube Screen-Grid Short-Wave Adapter. . . . . Mar. 1929. . . 25c
- No. 146, Adjustable B-Eliminator. . . Nov. 1929. . . 25c
- No. 151, Beginners Low Power S-W Transmitter. . . . . June 1930. . . 25c
- No. 152, Portable Radio Amplifier for the Deaf. . . . . July 1930. . . 25c
- No. 153, Low Cost Code and Phone Transmitter. . . . . Sept. 1930. . . 25c
- No. 155, Four-Tube D-X Receiver. . . Nov. 1930. . . 25c
- No. 157, Building a Light-Sensitive Relay. . . . . Dec. 1930. . . 25c
- No. 158, High-Power Supply for Amateur Transmitters. . . . . Jan. 1931. . . 25c
- No. 159, Portable S-W Transmitter. . . . . Feb. and March 1931. . . 25c
- No. 160, Building A.C. Midget Receiver. . . . . Mar. and Apr. 1931. . . 25c
- No. 161, Building Auto Receiver for 2-volt Tubes. . . . . Apr. and May 1931. . . 25c
- No. 162, Battery Eliminator for 110-volt D-C. Supply. . . . . June 1931. . . 25c
- No. 163, Two-Tube A. C. Short-Wave Receiver. . . . . June 1931. . . 25c
- No. 165, Pre-Amplifier for Home Recording. . . . . Sept. 1931. . . 25c
- No. 166, Building Stenotube Superheterodyne. . . . . Sept. 1931. . . 25c
- No. 167, Building an A. C. Super Short-Wave Converter. . . . . Oct. 1931. . . 25c
- No. 168, Television Receiver of Advanced Design. . . . . Nov. 1931. . . 25c
- No. 169, Little Giant, Battery Receiver for 2-volt Tubes. . . . . Dec. 1931. . . 25c

Material Lists for any of the above instruments will be mailed free upon application.

## WHAT DOES 1932

# HOLD FOR YOU?



1931 was an unusual year—and most of us are glad it is gone! Our minds are fixed on brighter days.

But don't deceive yourself! A change in conditions will not necessarily mean a change for you. Prosperity is still an individual challenge!

In this period of economic transition, success is not more difficult—it's more exacting! It doesn't come—you go after it through careful training!

You can blame the year, curse your luck, wonder what's wrong—one year is like another if you do not make them different! Don't you know hundreds of men who never knew a "good" year?

1932 is new! You can make it the most profitable year of your life. You can lay the groundwork for a career which will furnish more satisfaction and more money. Indeed, 1932 is a golden opportunity for you!

How can you do it? That's easy! Acquire more training—do your job better, prepare yourself for the next job. But doing it is not so easy. It takes courage, sacrifice and hard work. Quitters should continue wasting their spare time! Thousands of fighters, to get the training they need, are enrolling for International Correspondence Schools Courses. They are going to make 1932 a good year for themselves. So can you! This coupon is a beginning. Mark and mail it—today!

### INTERNATIONAL CORRESPONDENCE SCHOOLS

"The Universal University"

Box 5578-G, Scranton, Penna.

Without cost or obligation, please send me a copy of your booklet, "Who Wins and Why," and full particulars about the subject before which I have marked X:

#### TECHNICAL AND INDUSTRIAL COURSES

- |  |  |
|--|--|
| <input type="checkbox"/> Architect   | <input type="checkbox"/> Automobile Mechanic                                 |
| <input type="checkbox"/> Architectural Draftsman                             | <input type="checkbox"/> Plumbing <input type="checkbox"/> Steam Fitting     |
| <input type="checkbox"/> Building Estimating                                 | <input type="checkbox"/> Heating <input type="checkbox"/> Ventilation        |
| <input type="checkbox"/> Wood Millworking                                    | <input type="checkbox"/> Sheet Metal Worker                                  |
| <input type="checkbox"/> Contractor and Builder                              | <input type="checkbox"/> Steam Engineer                                      |
| <input type="checkbox"/> Structural Draftsman                                | <input type="checkbox"/> Steam Electric Engineer                             |
| <input type="checkbox"/> Structural Engineer                                 | <input type="checkbox"/> Civil Engineer                                      |
| <input type="checkbox"/> Electric Wiring                                     | <input type="checkbox"/> Surveying and Mapping                               |
| <input type="checkbox"/> Electrical Engineer                                 | <input type="checkbox"/> Refrigeration                                       |
| <input type="checkbox"/> Electric Lighting                                   | <input type="checkbox"/> R. R. Locomotives                                   |
| <input type="checkbox"/> Welding, Electric and Gas                           | <input type="checkbox"/> R. R. Section Foreman                               |
| <input type="checkbox"/> Reading Shop Blueprints                             | <input type="checkbox"/> R. R. Bridge and Building Foreman                   |
| <input type="checkbox"/> Telegraph Engineer                                  | <input type="checkbox"/> Air Brakes <input type="checkbox"/> Train Operation |
| <input type="checkbox"/> Telephone Work                                      | <input type="checkbox"/> Highway Engineering                                 |
| <input type="checkbox"/> Mechanical Engineer                                 | <input type="checkbox"/> Chemistry <input type="checkbox"/> Pharmacy         |
| <input type="checkbox"/> Mechanical Draftsman                                | <input type="checkbox"/> Coal Mining Engineer                                |
| <input type="checkbox"/> Machinist <input type="checkbox"/> Toolmaker        | <input type="checkbox"/> Navigation <input type="checkbox"/> Holtermaker     |
| <input type="checkbox"/> Patternmaker  | <input type="checkbox"/> Textile Overseer or Supt.                           |
| <input type="checkbox"/> Pipefitter <input type="checkbox"/> Tinsmith        | <input type="checkbox"/> Cotton Manufacturing                                |
| <input type="checkbox"/> Bridge Engineer                                     | <input type="checkbox"/> Woolen Manufacturing                                |
| <input type="checkbox"/> Bridge and Building Foreman                         | <input type="checkbox"/> Agriculture <input type="checkbox"/> Fruit Growing  |
| <input type="checkbox"/> Gas Engines <input type="checkbox"/> Diesel Engines | <input type="checkbox"/> Poultry Farming <input type="checkbox"/> Radio      |
| <input type="checkbox"/> Aviation Engines                                    | <input type="checkbox"/> Marine Engineer                                     |

#### BUSINESS TRAINING COURSES

- |   |  |
|---|--|
| <input type="checkbox"/> Business Management                                  | <input type="checkbox"/> Business Correspondence                             |
| <input type="checkbox"/> Office Management                                    | <input type="checkbox"/> Lettering Show Cards <input type="checkbox"/> Signs |
| <input type="checkbox"/> Industrial Management                                | <input type="checkbox"/> Stenography and Typing                              |
| <input type="checkbox"/> Personnel Management                                 | <input type="checkbox"/> Complete Commercial                                 |
| <input type="checkbox"/> Traffic Management                                   | <input type="checkbox"/> Civil Service <input type="checkbox"/> Mail Carrier |
| <input type="checkbox"/> Accountancy <input type="checkbox"/> Cost Accountant | <input type="checkbox"/> Railway Mail Clerk                                  |
| <input type="checkbox"/> C. P. Accountant                                     | <input type="checkbox"/> Grade School Subjects                               |
| <input type="checkbox"/> Bookkeeping  | <input type="checkbox"/> High School Subjects                                |
| <input type="checkbox"/> Secretarial Work                                     | <input type="checkbox"/> College Preparatory                                 |
| <input type="checkbox"/> Spanish <input type="checkbox"/> French              | <input type="checkbox"/> Illustrating <input type="checkbox"/> Cartooning    |
| <input type="checkbox"/> Salesmanship <input type="checkbox"/> Advertising    | <input type="checkbox"/> Lumber Dealer                                       |

Name.....Age.....

Address.....

City.....State.....

Occupation.....

If you reside in Canada, send this coupon to the International Correspondence Schools, Canadian, Limited, Montreal, Canada

When writing to advertisers please mention Popular Mechanics



## This Book Free Only To Men Past 40

YEARS OF VITALITY IN THIS  
AMAZING SECRET!

IF you're past 40 this daring free book "The Destroyer of Male Health" will reveal facts about old age that may show you the way to new health and new joy of living.

For example: Did you know that two-thirds of all men past middle age are said to be victims of a seldom mentioned disorder, which if neglected may lead to wretched old age or gravest surgery? If you are a victim of frequent night rising, chronic constipation, severe pains in back, legs and feet, sciatica, mental depression, dizziness, etc., don't lose a minute writing for this free book.

Many men mistake these distressing ailments for approaching old age. But science now reveals that the decline of a tiny gland—called the prostate—is frequently to blame. Now this gland trouble can be quickly reached by a new kind of drugless home treatment. It goes directly to the gland area without drugs, medicines, massage, exercise or violet rays. Any man can safely use it in the privacy of his own room.

Already thousands of prostate gland victims report it quickly cleared up the ailments and restored normal activity. Its results are guaranteed. Either you feel 10 years younger in seven days or the treatment costs you nothing. If you are past 40 you owe it to yourself and family to mail the coupon for your copy of this startling book. Sent free ONLY to men past 40. Address 2149

Morris Ave., W. J. Kirk,  
President, Steubenville, Ohio.

W. J. Kirk, President,  
2149 Morris Ave., Steubenville, Ohio.

Send your Free book "The Destroyer of Male Health" and facts about your trial offer. No obligation to me.

Name .....

Address .....

City ..... State .....

Western address—Dept. 21-C, 303 Van Nuys Bldg., Los Angeles, Calif. Canadian address—Desk 21-C, 53 Yonge St., Toronto, Ont., Canada.

When writing please mention Popular Mechanics

## Books on Many Practical Subjects

Popular Mechanics Press specializes in supplying the outstanding best books on many subjects. As new books of merit appear, we will revise the list accordingly.

<b>ARCHERY</b> Simplified.....\$2.00	<b>INVENTION</b> Popular History of American.....\$1.00
<b>ARCHITECTURAL</b> Design and Lettering...\$2.00	<b>KITES THAT FLY</b> How to Make.....\$1.25
<b>ARMATURE WINDING</b> Excellent new book...\$2.00	<b>LANDSCAPING</b> Practical.....\$2.50
<b>ATLAS</b> New 1930 Census Edition.....\$2.50	<b>LATHE WORK (METAL)</b> and Drilling and Thread Cutting.....\$1.00
<b>AUTO ENCYCLOPEDIA</b> Dyke's. New 16th Edition Covers Latest Improvements.....\$6.00	<b>LETTER WRITING</b> Social and Business Only.....\$1.00
<b>AUTO KINKS</b> for Owners, Repairmen, Tourists (3 vols.).....\$1.50	<b>LETTERING</b> Modernistic.....\$2.00
<b>BIRD HOUSES</b> How to Make.....\$1.00	<b>MACHINIST</b> Complete, Practical...\$3.00
<b>BLUE PRINT READING</b> For Building Trades...\$1.25	<b>MAGIC</b> 200 New Tricks for Amateurs.....\$1.00
<b>BOAT BUILDING</b> New Edition of Popular Mechanics book.....\$3.00	<b>MAKE IT YOURSELF</b> 900 Different Things to Make.....\$3.00
<b>BOY MECHANIC</b> Famous 4 Vol. Library, 4000 Things to Make...\$7.00	<b>MARKETING BY MAIL</b> Science of.....\$2.00
<b>BRIDGE</b> Official Contract.....\$1.00	<b>MATHEMATICS</b> Made Easy for the Practical Man.....\$1.50
<b>BUILT-IN FURNITURE</b> Complete Instructions...\$2.50	<b>MECHANICAL DRAWING</b> Practical Course in...\$1.00
<b>CALCULATOR</b> Mathematical Ropp's...\$1.00	<b>MODEL AIRPLANES</b> Building and Flying...\$2.50
<b>CARBURETORS</b> Excellent book on all makes.....\$2.00	<b>OUTDOOR OPPORTUNITIES</b> for Making a Living...\$2.00
<b>CARPENTRY</b> Hand book of 336 Kinks...\$1.50	<b>OUTDOOR SPORTS</b> for All Year 'Round New Edition.....\$2.00
<b>CHALK TALK</b> How to.....\$1.00	<b>PAINT SHOP PRACTICE</b> New, very complete...\$5.00
<b>COLOR SIMPLIFIED</b> Practical new Book (for Color Users).....\$3.50	<b>PAINTING</b> House (Best Methods)...\$2.00
<b>CONCRETE</b> 173 Ways of Using New Edition (Cloth)...\$1.00	<b>PLUMBING</b> 500 Plain Facts for Every Homeowner...\$1.50
<b>DOGS</b> Training.....\$1.50	<b>POULTRY RAISING</b> for Profit.....\$2.00
<b>ELECTRICITY</b> for Beginners.....\$1.50	<b>PUZZLES</b> Amusing Mathematical...\$1.50
<b>ELECTROPLATING</b> Practical Results Easily Obtained.....\$1.00	<b>RABBITS</b> For Food and Fur.....\$2.00
<b>ENGLISH</b> Self-Improvement in...\$1.50	<b>ROOF FRAMING</b> Made Easy.....\$1.50
<b>ETIQUETTE</b> New 500-Page Book. Only.....\$1.00	<b>SHOP NOTES</b> 7 Vols. of 2000 Valuable Kinks.....\$3.50
<b>FARMER'S BOOK</b> of 861 Kinks and Book for Farmers' Wives...\$1.00	<b>SLIDE RULE</b> How to use.....\$1.75
<b>FLYING</b> Simplified.....\$1.00	<b>STAMP ALBUM (Modern)</b> 12,000 Varieties.....\$1.50
<b>FORMULAS</b> 10,000 Money Making...\$4.00	<b>STEEL SQUARE</b> Pocket Book, Practical...\$1.00
<b>FURNITURE (Mission)</b> Homemade (2 vols.)...\$2.00	<b>STORAGE BATTERIES</b> (New work) Best on subject.....\$3.00
<b>GARDENS</b> 1001 Questions Answered.....\$2.00	<b>TOY MAKING</b> Complete instructions...\$1.50
<b>GLASS</b> Working.....\$1.75	<b>WALL DECORATION</b> (Interior) Newest Methods.....\$4.00
<b>GLIDING</b> A B C of.....\$2.00	<b>WHITTLING</b> The Art of.....\$1.35
<b>HOME MECHANICS</b> 329 Kinks.....50c	<b>WIRING</b> House (New Book)...\$2.50
<b>HOME REPAIRS</b> Practical Book of.....\$2.50	<b>WOOD TURNING</b> Popular.....25c
<b>IGNITION</b> (High Speed) For Garage Mechanics...\$3.50	<b>WOODWORKING SHOP</b> Motor-Driven (3 vols.) \$3.00

## Books sent C. O. D. anywhere in U.S.

Just check the books you want, write your name and address below, and mail the advertisement. It is your order blank. When postman hands you books, pay him the price and few cents postage. If outside the U. S. remit when ordering and include 10 cents per book extra for postage. We have many other books on these and 2,000 other subjects. Catalog free.

Name .....

City ..... State .....

Address .....

Mail to Popular Mechanics Press,  
Room P1—200 East Ontario St., Chicago, Ill.

# SPORTSMEN

## Read This Offer!

Send the COUPON and receive a magnificent Sportsmen's Book telling you how to learn to MOUNT GAME-HEADS, BIRDS and ANIMALS. You can NOW be your own Taxidermist. Our school has over 100,000 graduates throughout the world. You can now learn AT HOME in SPARE TIME.

## Mount Your Own Trophies!

Hunting and Fishing have entered a new era. All true sportsmen now kill fewer specimens, but DOUBLE their interest by mounting their trophies. The secrets of Taxidermy (mounting birds and animals) are now revealed. YOU CAN NOW LEARN TAXIDERMY FOR YOURSELF. Be a Taxidermy artist. Mount birds, animals, game-heads, fishes, tan skins and make beautiful rugs and robes. Easily and quickly learned in your own home. Adorn your home and den with nature's finest ART. If you enjoy hunting—you will enjoy Taxidermy MORE.

## Big Profits

Do you want to MAKE MORE MONEY? Then give your SPARE TIME to Taxidermy. Make \$50 to \$250 a month by mounting for others or selling your mounted specimens, or go into business—open a Taxidermy shop of your own, and earn \$3,000 to \$6,000 a year.

# This Book FREE

Every Sportsman should have this marvelous book. You can right now, while this edition lasts, get a copy Free and prepaid by mailing the coupon NOW. Only limited number free—Send Today. Nothing like it. Just off the press. Contains 48 large pages and cover in brilliant colors. More than 100 photos of splendid game specimens and masterpieces of the National Museum at Washington. Brim full of interest to every sportsman. And think of it, this valuable unique and artistic book can be had now, by Sportsmen for the asking.

## Mail the Coupon!

If you want to preserve your trophies; if you desire to make money from your spare time, if you are a nature lover—send the coupon and receive your copy by return mail. State your AGE.

N. W. School of Taxidermy, 3371 Elwood Bldg., Omaha, Neb.



### N. W. School of Taxidermy

3371 Elwood Bldg., Omaha, Neb.

Send me your free illustrated book "Sportsmen and Their Trophies." Also tell me how I may learn this fascinating art easily and quickly by mail. No obligation.

Name \_\_\_\_\_ Age \_\_\_\_\_

Address \_\_\_\_\_

Play  
GUITAR  
Mandolin—Ukulele

this  
FREE BOOK

shows the way to Popularity,  
Pleasure, Increased Income.  
Send for your copy now.

Gibson Inc.

103 Parsons Street, KALAMAZOO, MICH.

# Learn AVIATION

WHERE LINDBERGH LEARNED!

GREATER DEMAND FOR MECHANICS! Aviation Mechanics becoming more important. 20 Mechanics' jobs for every Pilot's job. GOOD PAY. Quick advancement! But you must have proper training! Get training that assures success at Lincoln—world's best known Aviation School. Lincoln graduates get best jobs—advance quicker—because of superior training. \$250,000 worth of buildings and equipment. \$100,000 airport. Government-licensed instructors. Mechanics' School connected with airplane factory—assuring practical training. Approved by U. S. Dept. of Commerce as Private, Limited Commercial and Transport; both Ground and Flying. Reasonable tuition. FREE Aerial Radio Course with other courses. Part time employment offer to help pay room and board. Also Flying, Welding, Aerial Radio Courses. Write for Catalog, stating age!

LINCOLN AIRPLANE & FLYING SCHOOL, 206A Aircraft Bldg., Lincoln, Neb.

# Make Money Making DO-NUTS!

\$75 a Week  
and More  
in Your Own Business!

Make and sell Ringer's delicious Do-Nuts. Double your money every day! Hundreds of men and women are making more money in a week than they used to in a month!

Everybody likes do-nuts! Ringer's way makes them electrically—greaseless—easy to digest. Cash in now on the demand for these tasty, healthful, delicious do-nuts!

An investment of less than \$60 can make you independent! Investigate! Find out what others are doing! You can do as well. Easy to operate. No experience needed. Work right in your own kitchen. We teach you, furnish all recipes, guide you to success. Write today for free plan.

**RINGER DO-NUT CO.**

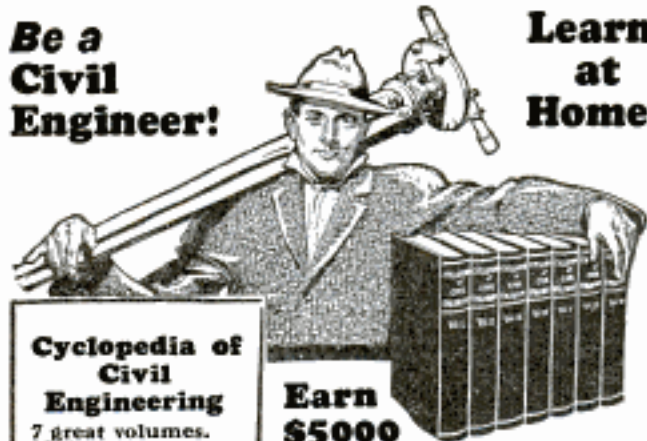
Minneapolis, Minn.  
143 Main St. N. E.

READ  
WHAT  
OWNERS  
SAY:

"RINGER Do-Nuts sell themselves. People who taste them once come back for more."

"Was out of a job—now making over \$75 per week—expect to order more machines soon."

**Be a  
Civil  
Engineer!**



**Learn  
at  
Home!**

**Cyclopedia of  
Civil  
Engineering**

7 great volumes.  
2800 pages.  
1600 illustrations.  
New edition just  
off the press, by  
twelve of America's  
greatest engineers.  
Includes: Surveying,  
bridges, railroads,  
steel structures,  
municipal engineer-  
ing, water supply,  
road building, etc.

Spanish Grain Flexible  
Covers Gold Stamped

**Loaned  
Free!**

To prove you can learn Civil  
Engineering at home in  
your spare time. And be-  
cause no description here  
could do it justice, to let  
you see for yourself the  
scope and simplicity, the  
authority and quality of  
this great home reading  
course. Cost and terms are  
within your reach. Send  
no money—just mail the  
coupon.

**Earn  
\$5000**

**a Year—and Up!**

"CIVIL ENGINEERING" — in plain English  
written so you can understand it, even if you have  
only a limited education. Prepares you for a well-  
paid railroad structural or public works position.  
Covers every branch of Civil Engineering practice.  
At once a reading course for the ambitious student  
and an authoritative reference work for the ex-  
perienced engineer. Borrow a set—free. Look over  
the test questions which help you master each  
subject quickly. Mail the coupon without obliga-  
tion today!

**American Technical Society  
Dept. C-119 Chicago**

American Technical Society,  
Dept. C-119, Chicago

I want to BORROW the CIVIL ENGINEER-  
ING Cyclopedia for 10 days FREE. I will  
gladly pay the few cents express, but I am to  
pay nothing for the loan of the 7 big volumes if  
I return them within 10 days. If I wish to  
keep them I will send you \$2 after the 10 days,  
then \$2 a month until special advertising price  
\$29.50 is paid. Send 1931 Edition.

Name.....

Address.....

(Attach letter stating age, occupation,  
employer's name and address)

**Any  
HIGH SCHOOL  
Subject  
by home-  
study** Or the 4 Year Course  
**IN 2 YEARS**

American School, chartered 1897 as an educa-  
tional institution not for profit

Mail Coupon for Com-  
plete Bulletin. If you  
have taken some high-  
school work, you can get  
full credit for it.

**ENGLISH**  
Business English  
English Literature  
Business Corre-  
spondence  
Composition and  
Rhetoric

**COMMERCIAL**  
Commercial Law  
Typewriting  
Shorthand  
Commercial  
Mathematics  
Bookkeeping  
Economics

**SCIENCE**  
Physiology General  
Physical Geography  
Astronomy  
Physics Chemistry  
Botany Psychology  
**MATHEMATICS**  
Arithmetic  
Algebra Geometry  
Trigonometry  
**DRAWING**  
Mechanical Drawing  
Blue Print Reading  
Freehand Drawing

**A Necessity for Business Success**  
A High School Education is today the MINI-  
MUM REQUIREMENT for success in busi-  
ness. No one can hope to get or keep a "good  
position" without it. And the road to advance-  
ment is forever barred unless you can speak  
and write good English—unless you can "fig-  
ure" costs and estimates, profits and losses—  
unless you have a reasonable familiarity with  
good literature, history, civics and other high-  
school subjects.

**Also for College Entrance**  
In the past 10 years, our graduates have been  
admitted by examination or certificate to 192  
leading Universities, Colleges and Normal  
Schools. Money refunded if you fail to pass en-  
trance requirements for College or Teachers'  
examinations. We use standard texts adopted  
by best resident high schools, plus simplified  
study guides and supplementary instructions.  
Mail coupon for complete bulletin.

**AMERICAN SCHOOL**

Dept. H-147, Draxel Ave. & 58th St., Chicago, Ill.  
Send me full information on the subject checked.  
**4-YEAR HIGH SCHOOL COURSE IN 2 YEARS**  
Architecture Civil Service Positions  
Contracting & Building Law  
Electrical Engineering Law  
Drafting Auto Engineering  
Business Management Highway Engineering  
Accounting Mechanical Engineering

Name.....

Address.....

**JOBS NOW OPEN**



No Education or Experience  
Needed to Learn

**TOOL & DIE MAKING**

**MACHINIST TRADE & DESIGNING  
AUTOMATIC SCREW MACHINES**

Learn these big paying trades  
easily and quickly in our modern shops on finest equip-  
ment. Expert instructors train you on actual work done  
for large manufacturers. No books. No lessons. Day or  
evening instruction. We help place you while learning  
and after graduation. Thousands of Allied trained men  
are now making big pay. You can too. Don't delay.

Write now for FREE catalog. Also Free railroad fare plan.

**ALLIED SCREW MACHINE CO., Inc.**

School of Mechanical Trades

524 W. Monroe St. Chicago, Ill. Dep't. 1023

**WHY  
STAMMER?**  
Don't be a failure.  
Master perfect speech. Live a healthy, nor-  
mal and happy life. Send for free book which tells you how.  
**THE LEWIS INSTITUTE, 12090 Woodward Ave., Detroit, Mich.**

Let us recommend the best books to study  
on any subject. Popular Mechanics Press,  
Chicago, Illinois

Learn to **PAINT  
SIGNS and SHOW CARDS**

We quickly  
teach you by mail, or  
at school, in spare time. Enor-  
mous demand. Big future. Inter-  
esting work. Oldest and foremost school.  
**EARN \$50 TO \$200 WEEKLY**  
Otto Wiegand, M.D., home-study graduate, made  
\$12,000 from his business in one year. John Yasson,  
N. Y., gets \$25 for a show card. Crawford, B. C., writes:  
"Earned \$200 while taking course." Write for complete  
information.

**DETROIT SCHOOL OF LETTERING**  
144 Sherman Ave. Est. 1899 Detroit, Mich.

**COMMON SENSE ABOUT  
RADIO TRAINING**

... facts about  
America's oldest,  
largest radio school  
—RCA Institutes

HERE is what RCA In-  
stitutes offers you:  
More than 22 years experi-  
ence in the instruction of  
practical radio. Association  
with the largest research laboratory in radio. Choice  
of elementary or advanced courses in every branch of  
radio in either *resident* schools — situated in New York,  
Boston, Chicago, Philadelphia . . . or *extension* courses,  
for home study. Free scholarships for outstanding work  
in both resident and extension courses. Splendid instruc-  
tors. The very latest equipment in resident schools . . .  
special home laboratory equipment for extension students.  
The tuition is moderate. Why not investigate the many ad-  
vantages of this school? Mail coupon today for catalog.



**A Radio Corporation of America Subsidiary**

**RCA INSTITUTE, INC.**  
Dept. MP-1, 75 Varick St., New York

Please send me your General Catalog. I am checking below  
the phase of radio in which I am interested.

Aircraft Radio  Talking Pictures  Servicing Home Entertainment Equip.  
 Disc and Film Recording  Broadcast Station or Studio  Television

Name.....  
Address.....  
Occupation..... Age.....





## Now he **DRAW\$** the things he wants

**L**OOK at drawing No. 1 above. Then compare it with No. 2 and note the improvement Federal School training has made in the work of Art Nelson. Before he studied drawing with the Federal Schools, he worked as a surveyor's assistant at \$18.00 a week. Today he has a fine position in the work he enjoys at \$65.00 a week. He says, "The Federal Schools made this possible through their training and co-operation, as I had only average ability before enrolling as a student." Mr. Nelson is just one of many young people making good money because of Federal training.

Opportunities for artists have never been better. Magazines and newspapers buy millions of dollars worth of illustrations every year. If you like to draw, let your talent make your living.

The Federal School of Illustrating has taught hundreds of successful students. That is be-

cause its methods of instructions are right. Over fifty famous artists contribute exclusive lessons and drawings to the Federal Course. They tell you their methods in a clear understandable way. The subjects include illustrating, cartooning, lettering, poster designing, window card illustrating, etc. They are easy to learn the "Federal Way"—at home in your spare time.

### Have Your Drawing Talent Tested

If you like to draw, you may have the free criticism and analysis of your work by sending for our free Vocational Test Chart. We will send with it our free book, "A Road to Bigger Things," which explains illustrating as a profession. Nelson got his start sending for it. This is your opportunity—grasp it. Fill out the coupon now.

## THE FEDERAL SCHOOL of ILLUSTRATING

1132 FEDERAL SCHOOLS BUILDING

MINNEAPOLIS, MINNESOTA

Federal School of Illustrating

1132 Federal Schools Building, Minneapolis, Minnesota

Please send me free book, "A Road To Bigger Things," and Standard Art Test.

Name \_\_\_\_\_

Age \_\_\_\_\_ Occupation \_\_\_\_\_

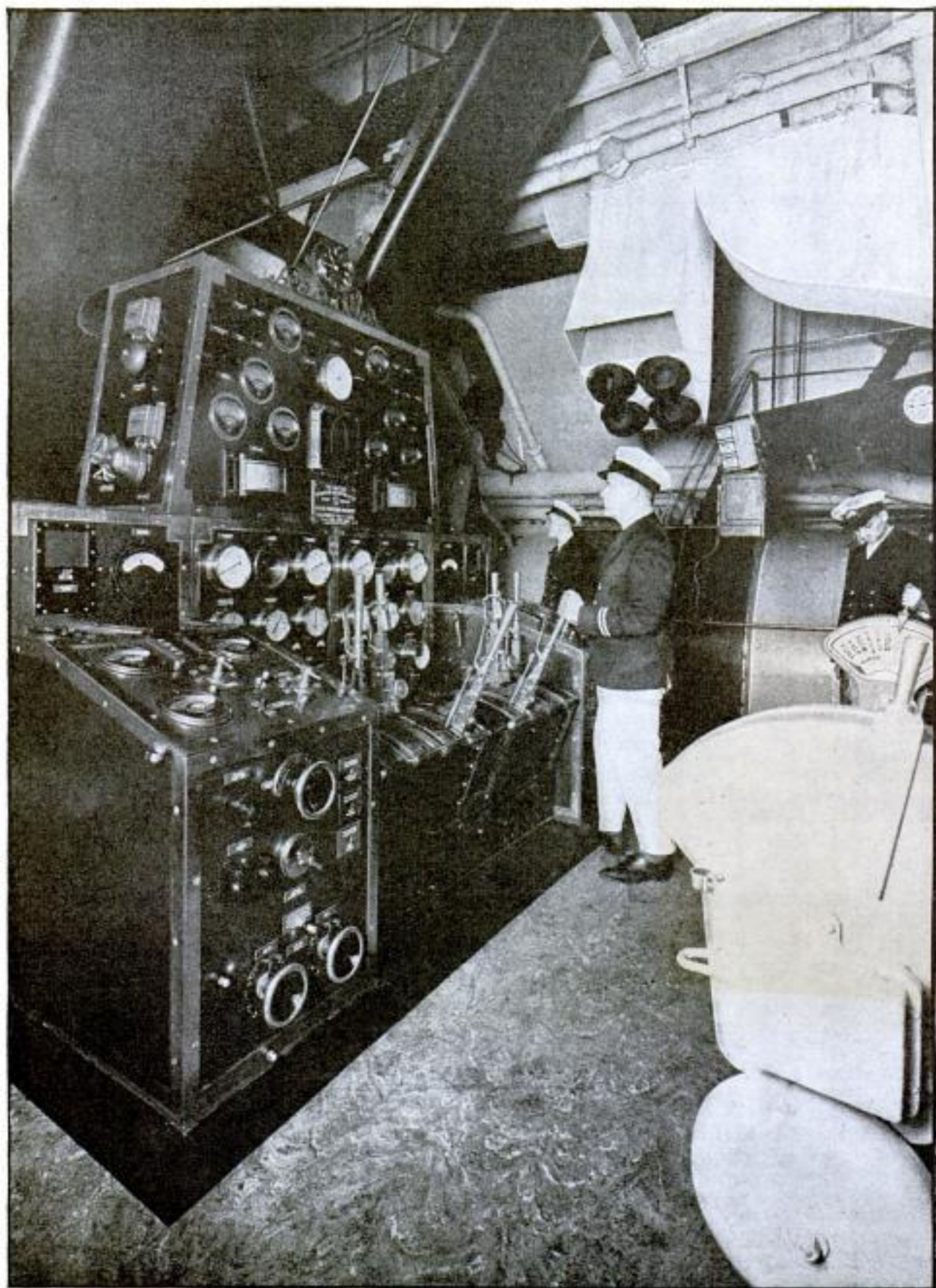
Address \_\_\_\_\_



When writing to advertisers please mention Popular Mechanics

Q2045

## On the Starting Platform of an Electric Liner



Engine-Room Controls of the New "Strathnaver," 28,000 Horsepower, Twenty-Two Knot Addition to British Peninsular and Oriental Fleet

*Built at Naval Construction Works,  
Vickers-Armstrong, Ltd. Barrow-in-Furness  
Copyrighted material  
Eng.*

# Popular Mechanics Magazine

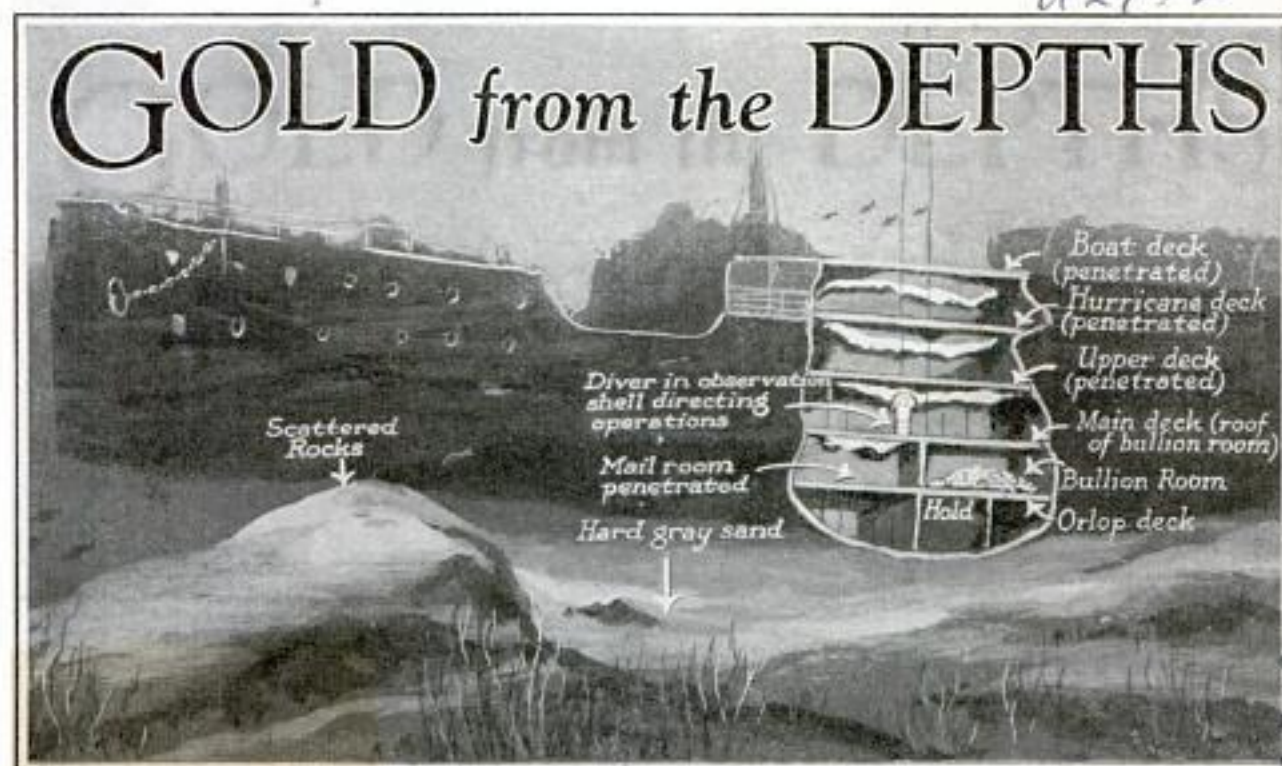
REGISTERED IN U. S. PATENT OFFICE

WRITTEN SO YOU CAN UNDERSTAND IT

Vol. 57

JANUARY, 1932

No. 1



Position of the "Egypt," Nearly 400 Feet beneath Surface, and Diver in Observation Shell Directing Work of Cutting through Vessel to the Bullion Room

AFTER more than two years of effort, aided by every resource of modern science, Italian treasure hunters have reached the \$5,000,000 cargo of gold and silver which sank with the P. & O. liner "Egypt" on May 20, 1922.

Because of the great depth of water, 396 feet, in which the ship sank, ordinary rubber diving suits were useless and many new types of salvage gear became necessary—steel diving suits with flexible arms and legs and an observation chamber, just large enough for one man and fitted with many windows.

In this shell the diver was lowered to the wreck, acting as a kind of underwater foreman. Though unable to work himself, he directed by telephone the lowering and placing of explosive charges and the operation of hooks and "grabs." As the "Egypt" lies on hard sand, practically upright, and as the observation chamber could only be lowered vertically

four decks had to be blown up and torn apart to get to the treasure.

Salvage operations are conducted from a special ship, the "Artiglio II." It is the second attempt to reach the "Egypt's" gold, a previous effort having been suspended because of storms late in 1930. Some of the danger of the enterprise can be seen from the fate of the first salvage vessel, the "Artiglio I." Between the two campaigns the "Artiglio" was sent to demolish the wreck of the American steamer "Florence," which had sunk in 1917.

The "Artiglio I's" task was to explode munitions remaining in the "Florence." The orders were to place explosive charges among the munitions and set them off by means of a two-mile-long electric wire. After the diver had placed the charges, he boarded the "Artiglio," which steamed away to a safe distance. Several times this maneuver was executed, and the explosions were insignificant. The crew,

*Illustrated London News 10/3/31*

*p. 517. 515*

Copyrighted material

501  
 PC 61  
 Nov. 1931  
 me



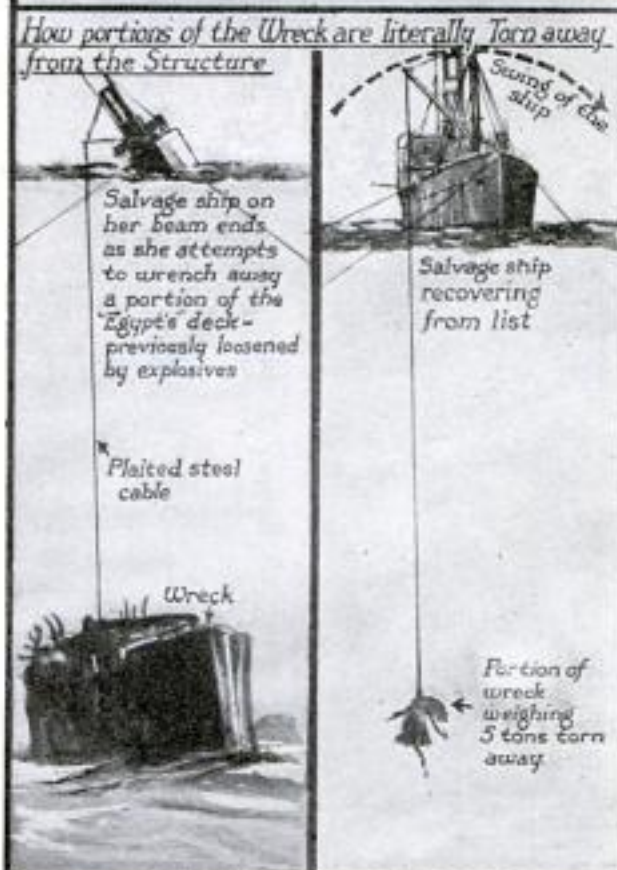
Steel Shell Inside of Which Is a Diver Who Serves as the Eyes for the Salvage Work; the Diver Is Connected by Telephone to the Salvage Ship Nearly 400 Feet Above

eager to return home, persuaded themselves that the munitions buried for thirteen years in the "Florence," no longer were dangerous, and gradually they stopped closer to the wreck, finally at only 1,000 feet from it. Then a terrific explosion annihilated the salvage ship. Of the crew, only seven escaped alive.

The marvelous suits worn by the "Artiglio's" divers, perfected though they are, yet expose them to great perils. These steel suits, beside enabling descent to great depths and staying there for long periods—six hours if necessary—are practically as comfortable as ordinary rubber suits; the diver does not come up exhausted and nearly fainting as with the old-fashioned apparatus; he depends for air not on a hose from the ship, but carries his own supply within the helmet and can renew the oxygen content himself. Nevertheless, the danger of water seeping into the helmet is always present; the glass plate before the eyes of the diver may suddenly break under the great pressure; sometimes, too, it may happen that the diver is imprisoned at the bottom by being entangled with debris.

But such accidents become continuously rarer, and with the new apparatus the diver is able to do much work with comparative ease; the arms of the shell terminate in pincers which he operates with his hands from the inside; he can adjust grab hooks by which big objects are raised from the depths by cranes on board ship; he can even tie a knot in a rope with the pincers.

One of the greatest treasures yet to be brought to the surface is at the bottom of Vigo bay, off the Spanish coast. For three years prior to 1702, Spain had not dared to ship home the products of her Peruvian and Mexican mines. Then she decided at last to risk the venture, confident that she had the protection of the French navy. But the latter was annihilated by a combined English and Dutch fleet, and the commander of the Spanish galleons, rather than giving up the booty to the enemy, ordered his officers to set fire to the ships by their own hands. The English could save only a few, among them the "Toro," which, upon being conveyed to London, yielded gold bars valued at \$1,000,000, while what remains at the bottom is estimated at \$100,000,000.



Photos Courtesy The Illustrated London News  
Diagram Showing Construction of Diving Shell, and, How Wrecked Ship Is Torn Apart

ca 2192  
4



Diver Incased in Steel Shell Rising after Directing Salvage Work to Recover over \$5,000,000 in Gold from the "Egypt." Lying in 396 Feet of Water off Coast of France

2434

my friend Stafford

~~Meridian~~ Meridian

a 223, Cont. E. Carl  
Walton, 9325  
Lauch, St.

### ELECTRIC PENCIL FOR WRITING IN GOLD OR SILVER

Inscriptions in gold or silver on hat bands, luggage, clothing or greeting cards is accomplished with an electric pencil that writes with heat through gold or silver foil. The cord of the device is plugged into a light socket, and a piece of foil is placed on the object to be written on. The writing is then done in the same manner as though tracing a drawing with carbon paper. The heating element is so arranged that the temperature is controlled automatically. The pencil is light and the writing is natural and smooth. Lines can be made thin or broad and they do not smudge or rub off. The foil is furnished with the pencil if desired.

### LATEST V-BLOCKS AND CLAMPS AID MACHINISTS' WORK

Two V-blocks and clamps for unusual work in the machine shop have been placed on the market. One set is designed for flat or round work, and can be used on the sides of the blocks, since the clamps do not project. Stepped construction allows a change from small work to material two inches in diameter. The second set leaves the entire top side of the work accessible, the clamps gripping the work from the sides.



The same manufacturer offers an attachment which converts a vernier height gauge into a depth gauge, measuring over projections or in recesses.

### RAYS GROW TULIP IN DARK

With sturdy green leaves and beautiful red petals, a fine tulip has been grown in complete darkness in London, according to a therapy expert in an address to the London Society of Arts. The flower was irradiated daily by invisible infra-red rays, the same as those employed in a recent American demonstration when an entire audience was photographed in darkness. The rays are those below heat rays.

Dr. W. Beaumont of London



Fully Rigged Boat Models, Less Than Three Inches Long, Made from Old Bottle Corks

### BOAT MODELS MADE OF CORKS FROM DISCARDED BOTTLES

One Los Angeles boy has found an artistic use for corks from old bottles. He makes tiny boat models from the discarded corks, and in a recent exhibit of seventeen such models showed the evolution of sailing ships of all nations from the ancient Egyptian craft down to a full-rigged three-master. All the models are under three inches long, but fully rigged.

### PIPE CONTAINS MATCH STRIKER IN ITS GROOVED BOWL

Pipe smokers always have a handy place to strike matches if they use a pipe with a built-in striker. The bowl is grooved and contains emery sand, the grooves not only improving the appearance but serving also as a place to scratch the smoker's matches.



Blackboards of steel with enamel surface are now being used in schools.

Cincinnati Seating Co. Esplanade

Proctor's Sherman Building

Christina Dagny M... 11/13/31

Indianapolis, Ind.

Longwood Pa.

Edgar Esbridge, Arroyo Seco  
Pebay ground Los Angeles Calif

Chicago, Ill.

1 Kaufman Bros  
1 Bondy. Ave.  
Empire State Bldg. New York

6  
a2198



Liquor-Smuggling Truck with a False Back Cleverly Designed to Appear Like a Load of Lumber to Conceal the Liquor Inside

### COUNTERFEIT LOAD OF LUMBER HIDES LIQUOR IN TRUCK

Among the tricks of liquor smugglers recently uncovered in this country was a clever scheme to make a load of alcohol look like a load of lumber. A false back was built for the truck, this consisting of the ends of planks fastened in an irregular manner to each other to simulate a heavy load of lumber. When a middle section of the fake back was removed, the interior of the truck was exposed, and it was behind the false back that the liquor was carried.

### PLANE THAT FLAPS ITS WINGS TO RISE VERTICALLY

After thirty years of study of bird flight, an Austrian aviation authority has designed a cheap and low-powered airplane having no propeller, but wings that flutter like a humming bird's. The ship, called the "whirring plane," will be able to rise vertically and remain motionless in the air, as well as travel in any direction, the inventor is sure. It is said the plane

*Dr. Dr. Raimund  
Nemjuehr*

will operate with about one-tenth the power now necessary and that it requires neither catapult for launching or air-drome for landing. The wings cannot be moved, but are alterable for pitch and will pulsate rhythmically. Funds have been raised by public subscription for the financing of the first full-sized model, and experts all over the world have predicted its probable success, because of the authoritative work previously done in the field of aviation and meteorology by the inventor.

a2254

### COMBINED RADIO AND FIREPLACE IS MOVABLE

Like any other piece of furniture, a portable electric fireplace that includes a radio in its assembly, can be moved anywhere in the room or house. Natural birch logs and artificial ashes, within which the lights are arranged, give the fireplace all the appearance of the real thing with the advantages of mobility. When the radio is turned on, the music seems to come right from the flames. Tuning controls are located on the side.



Portable Electric Fireplace That Includes a Radio in Its Construction Features

*J. Kraft, 225 Fifth  
Ave New York City*



a 2 30 5

# \$1,000 in Cash Offered to WHITTLERS

HERE is a CONTEST  
for EVERYONE

ONE THOUSAND  
EXTRA PRIZES

By JOHN DRAPER

MAN brought nothing into the world, a great scientist observes, and through long and painful ages he invented a club, an ax of stone, a pebble in a sling, a rubbing of sticks for fire. Then came the sharp edge of a stone—the knife.

And so, from the very dawn of history until the present day, the knife has remained the simplest and one of the greatest of all tools. Whittling is an art older than the memory of man and inseparably linked to his progress.

Early settlers used knives for making everything from furniture to canoes, and in hunting. Lincoln was a constant whittler and carved with his knife models of a boat and a wagon which are still to be seen in Washington. Whitney made his first model of a cotton gin from scraps of wood that he whittled into shape. In fact, the patent office is crowded with innumerable models of world-famous inventions—the products of an idea, a block of wood and a knife.



Here Is the "Junk Man," Serving as an Example of What the Skilled Wood Carver Can Do with His Knife

Whittling is more than aimless cutting up of any chance stick you happen to find. Intelligent planning of the object to be made is just as necessary as in any other

a2205



work, and it may even be advisable to draw or trace a design on the wood you are going to cut, especially in the case of the more elaborate and intricate examples of the work.

Then, the condition of your knife is of considerable importance. Anyone who whittles soon discovers the ease of cutting, the accuracy possible, and the neat clean-cut finish left by a keen razor-edge blade of the best-quality steel. The blade should always be kept in such condition and for this reason a hone and strop are needed.

A word about the kind of wood to use: This depends to some extent on the purpose to which the finished objects are to be put, as well as their design. Straight-grained soft wood, such as cedar, basswood, white or sugar pine and also yellow pine, is generally used. Even balsa wood is excellent material for work having

no slender appendages, and with a sharp knife, this wood is extremely easy to work, although, of course, greater care must be taken in cutting, or the knife may easily slip and spoil your carving.

In the actual work of carving for this contest, no chisels or other knives may be used—only a jackknife. However, this does not mean that you cannot use a saw to cut down the wood to the approximate size and shape desired. A two-blade knife is satisfactory but a three-blade knife is most practical. The large blade can be used for heavy cutting and trimming while the small blades will do the more delicate work. Saber, clip or sheep's-foot blades are preferable for wood carving.

## Rules for Knife-Craft Contest **\$1,000.00 IN CASH** Plus One Thousand Extra Prizes

- (1) Entries may be any kind of model, figure or special carving, requiring skill and ingenuity, made entirely of wood, and with no other tools than a jackknife.
- (2) No liquid adhesives such as glue, shellac, cements, etc., may be used.
- (3) Carvings or models submitted must not be painted or silvered or gilded, and will remain the property of Popular Mechanics after the contest ends.
- (4) Awards will be made as follows for the best or most unique models or designs submitted:

First Prize .....	\$ 250.
Second Prize .....	100.
Third Prize .....	75.
Fourth Prize .....	50.
Fifth Prize .....	25.

Also there will be twenty-five \$10 prizes and fifty of \$5 each. In addition, 1,000 special jackknives will be distributed to all winners of cash awards and to those receiving honorable mention.

The contest will close on July 1st, 1932, but models should be submitted as soon as possible. Awards will be made by a competent board of judges, and in case of ties, duplicate prizes will be given. The judges' decision will be final in all cases.

Models, which may be of any size, must be shipped in strong wooden boxes, as Popular Mechanics cannot be responsible for breakage due to improper packing. Employees of Popular Mechanics and members of their families are not eligible for prizes.

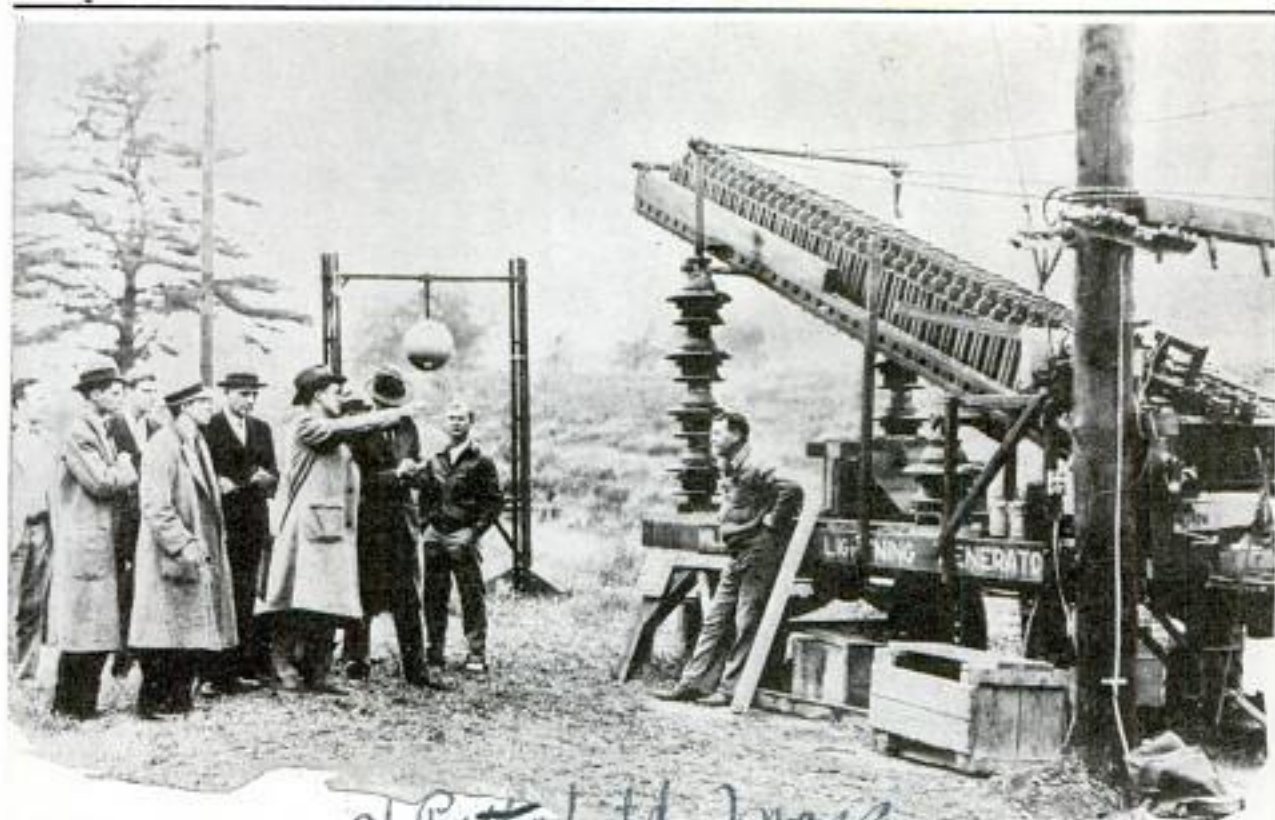
When models are sent, be sure to affix tag, giving your name and address, to the model itself. In addition, put name and address on outside wrapper of package.

Address all packages, "KNIFE-CRAFT EDITOR, POPULAR MECHANICS MAGAZINE, 200 East Ontario Street, Chicago, Ill."

Watch Coming Issues for Other Details

a 22 38

# Man-Made Thunderbolts Hurlled from Truck



Courtesy General Electric Co.

*at Pittsfield, Mass*

Electric Charges of More Than a Million Volts Are Produced by This Portable Generator When Connected to the Ordinary Lighting Circuit; Power Lines Are Tested with the Artificial Thunderbolts

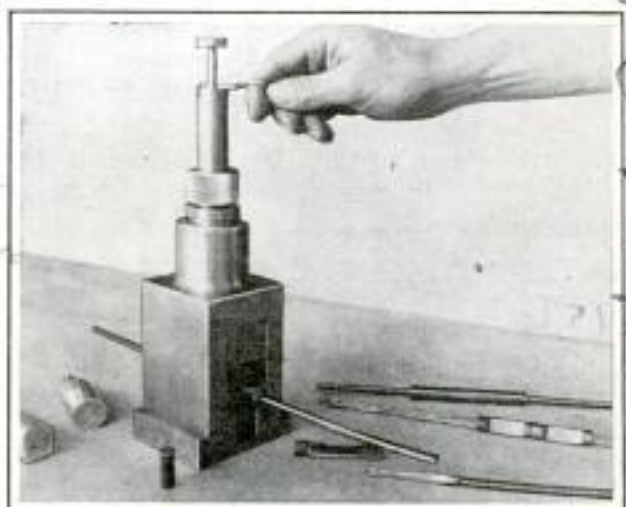
Lightning bolts for testing electric power lines are produced by a portable generator of 1,500,000 volts, mounted on a truck trailer by the General Electric company. The generator, when connected to a 110-volt circuit, such as is used for lighting homes, hurls man-made lightning when and where desired. Power lines are tested with this apparatus to make sure that they are lightning-proof.

a 22 39

## GUNPOWDER USED IN SPLICING COPPER WIRE OR CABLE

Linemen on the job now are using gunpowder in an odd-shaped "gun" for splicing copper wire and cables. The two ends of wire are butted together within a sleeve and inserted between dies. A blank shell with a predetermined charge of powder is placed in a breech, while the firing pin is raised against a strong spring and a stop pin inserted. Pulling out the stop pin discharges the shell and the force of the charge gives a powerful downward thrust to the upper die, stamping the sleeve firmly in place and forcing the wires to

take a shape that locks them within this sleeve. The parts are brought so closely together that electric contact is perfect. The type of gun used looks like some kind of bench tool and weighs only twelve pounds, accommodating four thicknesses with different dies. End eyes can be applied to heavy cables in this manner, using a heavier gun and a greater charge.



Gunpowder Is Used in This Odd-Shaped "Gun," to Furnish Energy for Splicing Copper Wire

*Temple Velocity  
120*

*Equipment, Inc  
Liberty St New York*

*Developed by Robert Temple, Inc.  
14th St. Denver Colo*

Copyrighted material

12197

Marcini Laundry Service  
Co. Ltd. Marcini House  
Strand London W.C.2  
England

See also 1929-936



Bales of Tin and Other Metal Salvaged by Big Magnets from the Waste Thrown Away by Los Angeles Housewives

### TIN-CAN MINE IN CITY'S WASTE YIELDS TONS OF METAL

About 1,000 tons of tin cans and other metal are salvaged each month from the waste of Los Angeles by big magnets, after which the metal is pressed into bales and stacked to form veritable mountains of tin and iron. The salvage process was adopted when a survey disclosed the thousands of tons of metal discarded annually by the housewives of the city, and now provides a profitable business for the company doing this work.

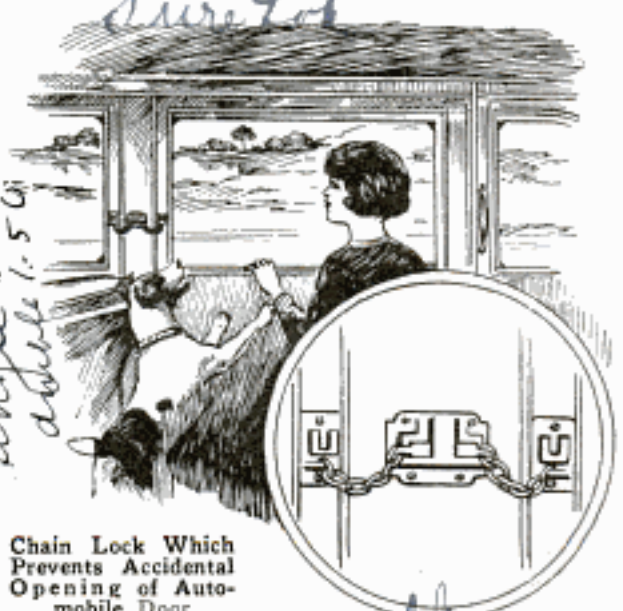
### LATEST DEPTH-SOUNDING GEAR HELPS FISHERMEN

Deep-water fishermen off the coast of England are using a form of depth-sounding gear, particularly adapted to their work, which does away with the old hammer method of echo soundings. With the latest apparatus, soundings are made by high-frequency oscillations which are

noiseless and give a clear sounding record on a dial graduated in fathoms nearly once a second. The captain of a trawler thus will know the depth of water under his keel at any moment, and the apparatus also tells, by the pattern on the dial, whether the bottom is hard or sandy and whether it is undulating or flat. He is warned also of obstructions likely to damage expensive gear, and, having found a good fishing ground, is able by the depth soundings to return to it again. A spot of light is reflected from a mirror and moves along a scale graduated to the speed of sound waves in water. When an echo returns the mirror is "jolted" and this gives a peak of light on the scale to indicate the depth.

### SAFETY LOCKS ON AUTO DOORS PREVENT ACCIDENTS

Chain locks are now available for attachment to automobile doors to prevent the accidental opening of a door if the regular catch is disengaged while the car is in motion. One part of the lock is attached to the door and the other section to the pillar. A metal lug at the end of a chain slips into the toe of a boot-shaped slot to prevent the accidental opening of the door. The lug cannot jar loose.



Chain Lock Which Prevents Accidental Opening of Automobile Door

a 2156  
single 1.00  
double 1.50

McLaughlin Mfg Co  
1000 Fifth Ave  
Columbus, Ohio  
Copyrighted material

A 2156 Cont. Es. H. Davis, Esq.  
 Lymington, Hillside Road,  
 Ewell, Surrey, England

Science Helps Fishing Fleet Increase "Catch"

**ECHOMETER GEAR**  
 FUSE BOX  
 SWITCH BOX  
 4-VOLT BATTERY FOR TUBE FILAMENTS  
 30-VOLT BATTERY  
 INDICATOR FIXED IN WHEELHOUSE

**ECHOMETER IN WHEELHOUSE**  
 HOW THE ECHOMETER INDICATES THE NATURE OF THE SEA BED  
 WATER LINE  
 PROJECTOR RECEIVER  
 HIGH-FREQUENCY WAVES GOING TO THE SEA BED  
 ECHO WAVES RETURNING TO RECEIVER  
 ROUNDED PEAK INDICATED ON SCALE WHEN OVER MUD  
 JAGGED PEAK INDICATED ON SCALE WHEN OVER STONY BOTTOM  
 SHARP PEAK INDICATED ON SCALE WHEN OVER A HARD BOTTOM  
 MUD  
 STONES  
 ROCKS AND HARD SAND

**PROJECTOR AND HULL FITTING**  
 FIXED UPPER (OR INNER) PLATE (RECEIVER)  
 CABLE TO INDICATOR  
 WATER-TIGHT CASING  
 CRYSTAL  
 MOVING PLATE (TRANSMITTER)  
 LOWER PLATING OF SHIP'S HULL  
 WHEN TRANSMISSION IS MADE, VOLTAGE IS APPLIED ACROSS THE PLATES, CAUSING THE LOWER (OR OUTER) PLATE TO VIBRATE, AT HIGH FREQUENCY IMPARTING WAVE MOTION TO THE WATER

**THE DEPTH-INDICATOR DIAL**  
 THE SPOT OF LIGHT IS REFLECTED FROM A MIRROR AND MOVES ALONG THE SCALE CORRESPONDING TO SPEED OF SOUND WAVES IN WATER. WHEN THE ECHO RETURNS THE MIRROR "JOLTS" GIVING A PEAK OF LIGHT ON THE SCALE WHICH INDICATES THE EXACT DEPTH  
 PEAK OF TRANSMISSION  
 SPOT OF LIGHT TRAVERSING DIAL 60 TIMES IN 70 SECONDS  
 PEAK OF RETURN ECHO GIVING DEPTH OF WATER  
 DIAL SCALED IN FATHOMS

**HOW THE SPOT OF LIGHT IS THROWN ON THE INDICATOR DIAL**  
 GONIOGRAPH MIRROR REFLECTS LIGHT TO MOVING MIRROR AND "LENSE" OR SIGNAL AND RECEIVING ECHO  
 MECHANISM MOVING MIRROR AT SPEED OF SOUND WAVES IN WATER  
 INDICATOR DIAL  
 SPOT OF LIGHT TRAVERSING INDICATOR SCALE  
 OPTICAL LANTERN  
 LENS  
 MOVING MIRROR REFLECTS LIGHT TO INDICATOR  
 PRISM

**THE ECHOMETER IN THE WHEELHOUSE OF A TRAWLER**

THE ACCURATE INFORMATION GIVEN BY THE ECHOMETER ALLOWS THE FISHERMEN TO GUARD THEIR GEAR AGAINST DAMAGE BY ROCKS OR OTHER OBSTRUCTIONS  
 DIRECTIONAL WIRELESS  
 ROCKS  
 THE NUMEROUS SOUNDINGS GIVE WARNING OF ROCKS  
 TRAWL WARPS  
 OTTER TRAWL

Marconi Sounding Service Co. Ltd., Marconi House, Strand, London, W.C. 2, Eng.

see p. 10 - Marconi Sounding Service  
 Langens - Chelovsky System

Sold by A. L. Spalding & Bro.  
 211 S. State, Chicago  
 POPULAR MECHANICS  
 518-5th Ave  
 New York

12  
 92255

Mrs. Samm...  
 New York City



Collapsible Umbrella That Folds into a Nine-Inch Length So It Can Be Carried in Handbag

**UMBRELLA CAN BE FOLDED TO FIT IN HANDBAG**

Unexpected showers offer no embarrassment for the woman equipped with a type of collapsible umbrella now being offered. It is of standard size when opened, but is only nine inches long when folded, and hence can be carried in any large handbag, so that the owner is always prepared in case of rain. The fabric is silk and the umbrella may be had in colors to match the user's costume.

**HOW BIG CAN BRIDGE BE MADE ANSWERED BY ENGINEERS**

Suspension bridges are constantly growing larger, and the George Washington bridge in New York, with its 3,500-foot span, will be surpassed by the 4,200-foot span of the Golden Gate bridge at San Francisco. This in turn may be beaten by a 5,000-foot span projected for the Narrows in New York. Such huge structures naturally raise the question of just how long a suspension bridge can be. Civil engineers generally are agreed that 10,000 feet, a little less than two miles, is the economical limit. A longer bridge could be

Helopen...  
 Newport and...

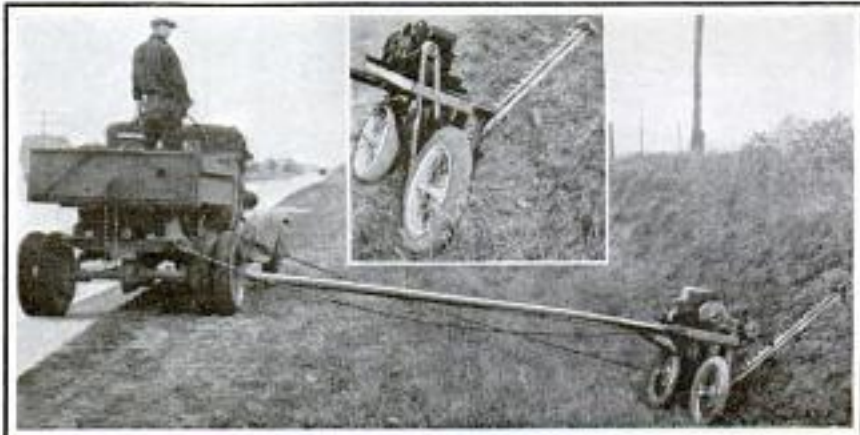
built, but it would not pay for itself because traffic would have to be lightened. Bridges must carry not only a live load but their own dead weight as well, and at about 50,000 feet, cables would snap under the strain of their own weight.

**GUN BORES CHROMIUM-PLATED TO PREVENT RUSTING**

Very thin coatings of chromium-plating are being applied to the interiors of Uncle Sam's large and small-caliber guns to keep them from rusting and give them longer life. Not more than four-tenths of an inch of the metal is used to supply the protective coating for the bores of the small-gun barrels. Chromium also finds employment in the manufacture of both paper and metallic money. Printing plates from which currency and postage stamps are made are coated with chromium, and some dies used in stamping coins are covered with the metal.

**FLEXIBLE WEED-MOWING UNIT OPERATES FROM TRUCK**

Weeds along highways can be mowed cleanly and quickly by a flexible power cutter which is operated from a truck. The cutter consists of a power-driven sickle with cutter bar attached to a steel frame which carries the motor, all mounted on pneumatic-tired wheels in tandem. A telescope pipe permits the sickle unit to be operated near or several feet from the truck, the cutter running in the grass while the truck travels on the highway. A universal coupling unit gives flexibility, the cutter moving up and down freely.



Flexible Weed Cutter Driven by a Small Motor; It Is Operated from a Truck by Means of a Telescoping Pipe Connection

W. Williams...  
 Standards

My James  
 11/8/31

Forw...  
 3100...  
 Minneapolis

22212

Comp. O. H. Green 187  
 Rockaway Parkway,  
 Valley Stream, N.Y. 13

# How Many Parts Has the Modern Airplane?

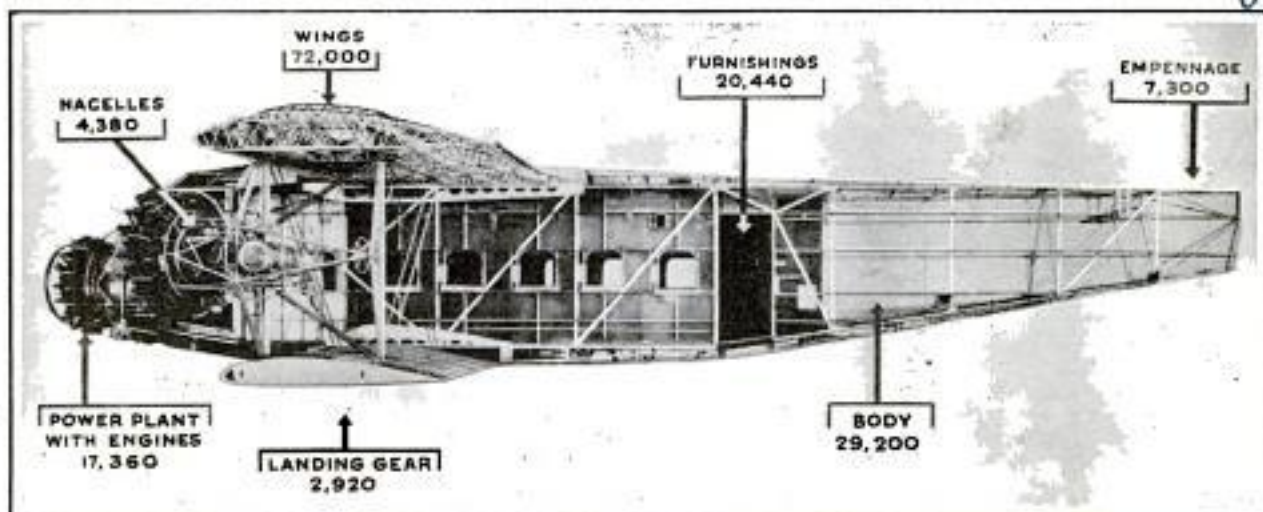


Diagram Showing the Thousands of Parts Making Up a Modern Airplane; Note That the Wings Contain Nearly Half of the Parts That Go into the Entire Ship

Designers of the tri-motored biplane used on the Chicago-San Francisco airline were amazed recently when a list of all the parts used totaled over 153,000. The twelve planes of this line thus have nearly 2,000,000 separate parts. Oddly enough, the wings, which appear simplest, have by far the greater number of parts, or about one-half of the total, exclusive of engines. Many of the pieces, of course, are rivets. The standard parts, such as bolts, rivets, nuts, screws, etc., come to just 85,359. Illustrative of the technical skill required in airplane construction, there are 58,485 parts in this plane that had to be made from original drawings. The plane, without motors, has nearly 140,000 parts, all of which must have one or more inspections, though the rivets are tested in lots, by dipping in a special solution which causes them to turn jet-black if of the required duralumin alloy.

But if aluminum rivets have slipped in by mistake, they are instantly detected by their unchanged silvery color. All metal and wood material is repeatedly tested and examined, as are glue, fittings, dope, etc. Even sewing thread is tested and its strands counted, and fabric wing covering is carefully examined for the slightest defect.

One reason for high prices in aircraft is the considerable engineering required. C. N. Monteith, chief engineer of the large western factory where these transports are built, said recently:

"Our eighteen-passenger airplane is a startling illustration of the long time required to finish a design. After the preliminary design was completed, usually requiring 200 to 1,000 man-hours, a total of 3,970 man-hours was used in determining the sizes of the various pieces in the framework and checking the design of connections. This represents the work of five men for four months.

"The calculation of weights took 2,500 man-hours, or the work of three men for four months. The main job, that of drawing details of all parts, required 17,800 man-hours, or the time of eighteen men for five months. So it is obvious that designing an airplane, particularly a large one like a passenger transport, means work and lots of it."

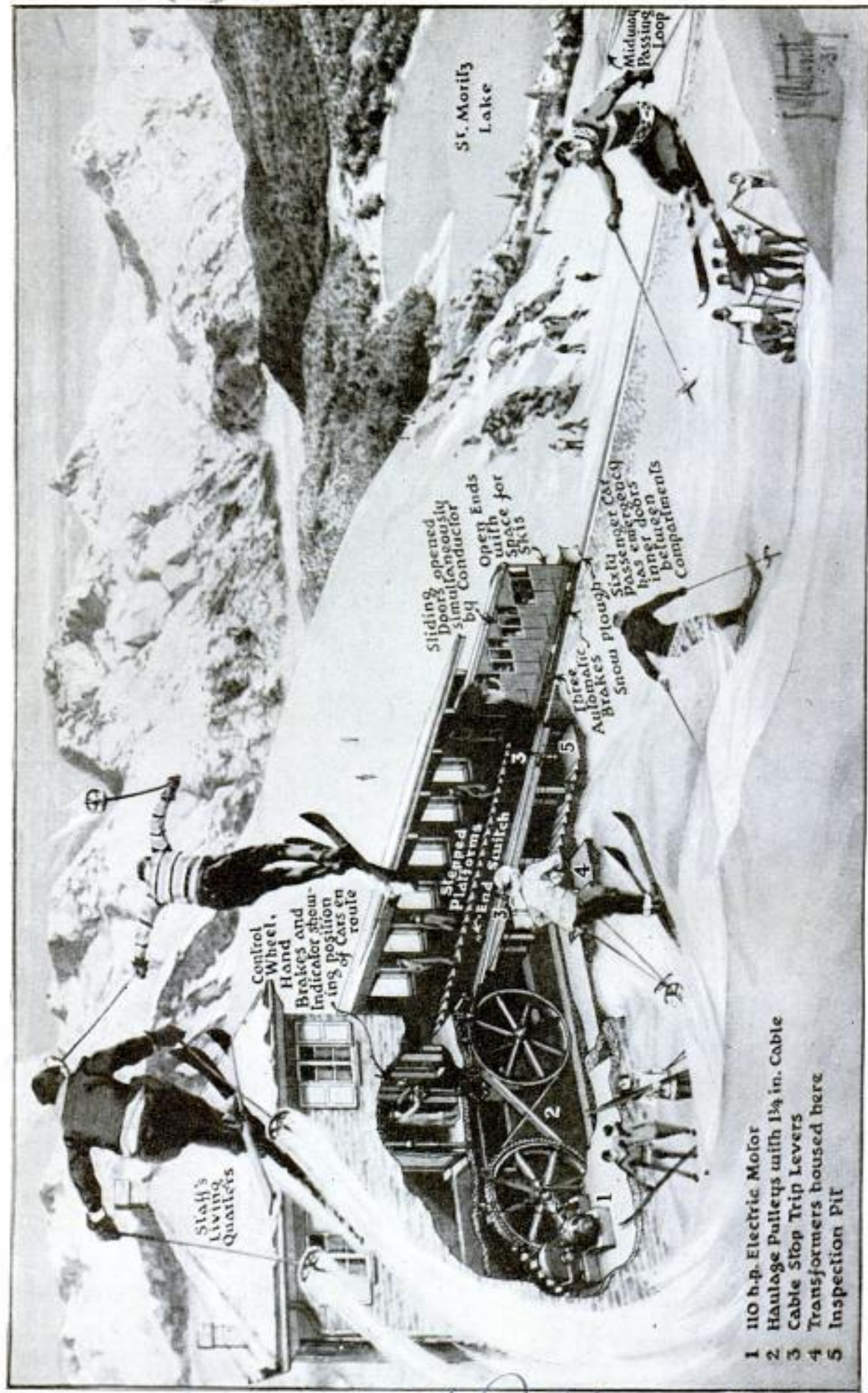
## ONE-AT-A-TIME MATCH HOLDER PREVENTS WASTE



One match at a time is released by an automatic metal holder which is on the market. Pressing down a lever causes one match to drop, the others being held in safety until wanted. This prevents waste of the matches.

Sani. Tray Lid.  
 Precision Metal Workers  
 3100 Carroll Ave Chicago

9797



Cable Railway Hauling Skiers up Mountain at St. Moritz, Switzerland; Ascent Previously Requiring Two Hours Is Made in Fifteen Minutes at Rate of Ten and One-Half Feet a Second; Brake Shoes Grip below as Well as on Sides of Rail to Stop Cars if They Break Away

- 1 110 h.p. Electric Motor
- 2 Haulage Pulleys with 1 1/4 in. Cable
- 3 Cable Stop Trip Levers
- 4 Transformers housed here
- 5 Inspection Pit

54, Ribblesdale Road,  
 Streatham, London S.W. 16  
 Copyrighted material



Bureau of Fisheries.

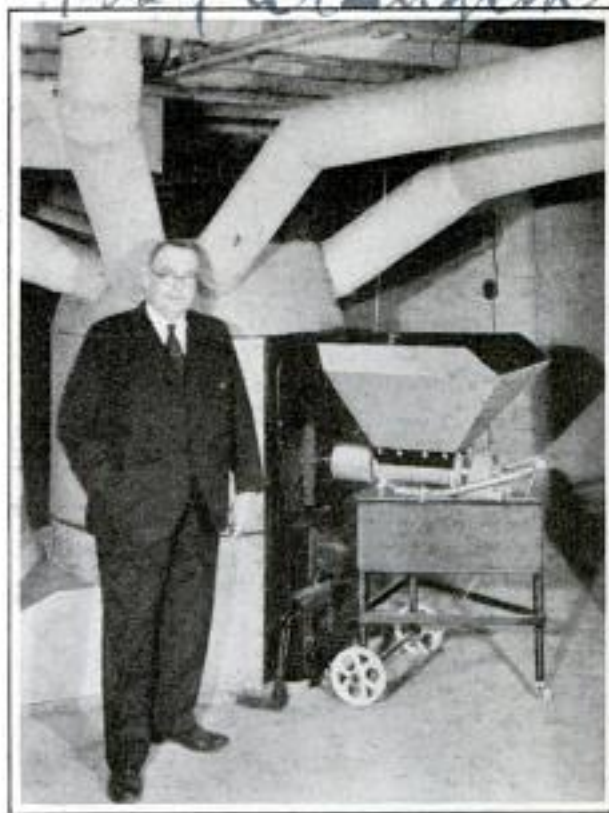
POPULAR MECHANICS

15

A 2250. Crosby  
Radio Corp  
1329 Ardington

**SOIL EROSION THREATENS U. S. WITH BARRENNESS OF CHINA**

Soil erosion threatens to reduce the United States to the conditions in the barren wastes of China, according to Lewis Radcliffe, of the commerce department, after studying the Mississippi, Ohio and Tennessee river districts. Danger of great floods, similar to those which cause the loss of many lives in China each year, increases with deforestation and soil losses. Erosion damages in the United States are estimated at between \$2,000,000,000 and \$4,000,000,000 annually. Mr. Radcliffe points out that rainfall is washing away, in one to seven years, the same quantity of soil which nature takes 400 years to build. Rapidly changing water levels, he says, are caused by the washing of the silt into the rivers. This silt has become so heavy that the slightest obstruction results in rapid accumulations that fill the river bottom. This condition results in increased inability of streams to purify themselves of industrial and municipal wastes, causing pollution and destroying fish. At several points along the Mississippi, organisms found in large quantities in the polluted water have caused disease and the death of bathers.



Automatic Stoker for the Coal Furnace; It Is Operated by a Small Electric Motor

**ELECTRIC STOKER FEEDS COAL TO HOME HEATING PLANT**

Firing the coal furnace in the home has been made easy and clean by the development of an automatic stoker that is electrically controlled. It is of an overfeed type resembling in principle some locomotive stokers, since the fuel is fed into the firebox from the top rather than the bottom, thereby utilizing natural instead of artificial draft. Small-size pocahontas, bituminous coke or anthracite can be used in the stoker, the fuel being fed from a hopper with a capacity of 200 pounds by means of a screw conveyor and pipe that ends at a point directly over the center of the firebox. The conveyor pipe is protected from the intense heat by a larger steel pipe. An automatic switch regulates the flow of fuel, cutting off power and closing drafts as required. Mounted on wheels, the stoker can be moved easily from furnace to coal bin for filling, and in most cases one filling will last twenty-four hours or more, even in the coldest weather. It is operated by a one-sixth-horsepower motor. The price is sufficiently low to enable the average home owner to install the equipment.

**DUAL-RANGE CLIP-ON AMMETER HAS POWER TRANSFORMER**



Power transformer and milli-ammeter are combined in a portable clip-on unit now on the market. The instrument is clipped over a conductor or busbar and the current measurement is read in amperes. The instrument replaces the usual two split-core transformers and portable ammeter necessary to measure various currents. It also has the advantage that the transformer and meter are calibrated as a unit, thus giving a much higher degree of accuracy.

Ferranti, Inc.  
130 W. 42nd St, New York

Press memo 11/2/31 Dept. Commerce  
double range - 0-100 and 0-500  
amp range band  
operatic  
weight 2 lbs. 2 oz.  
price - \$75.00

Cincinnati, Ohio

a 2147  
16

Capt. James H. Miller,  
2024 F. St. N. W.  
Washington, D. C.

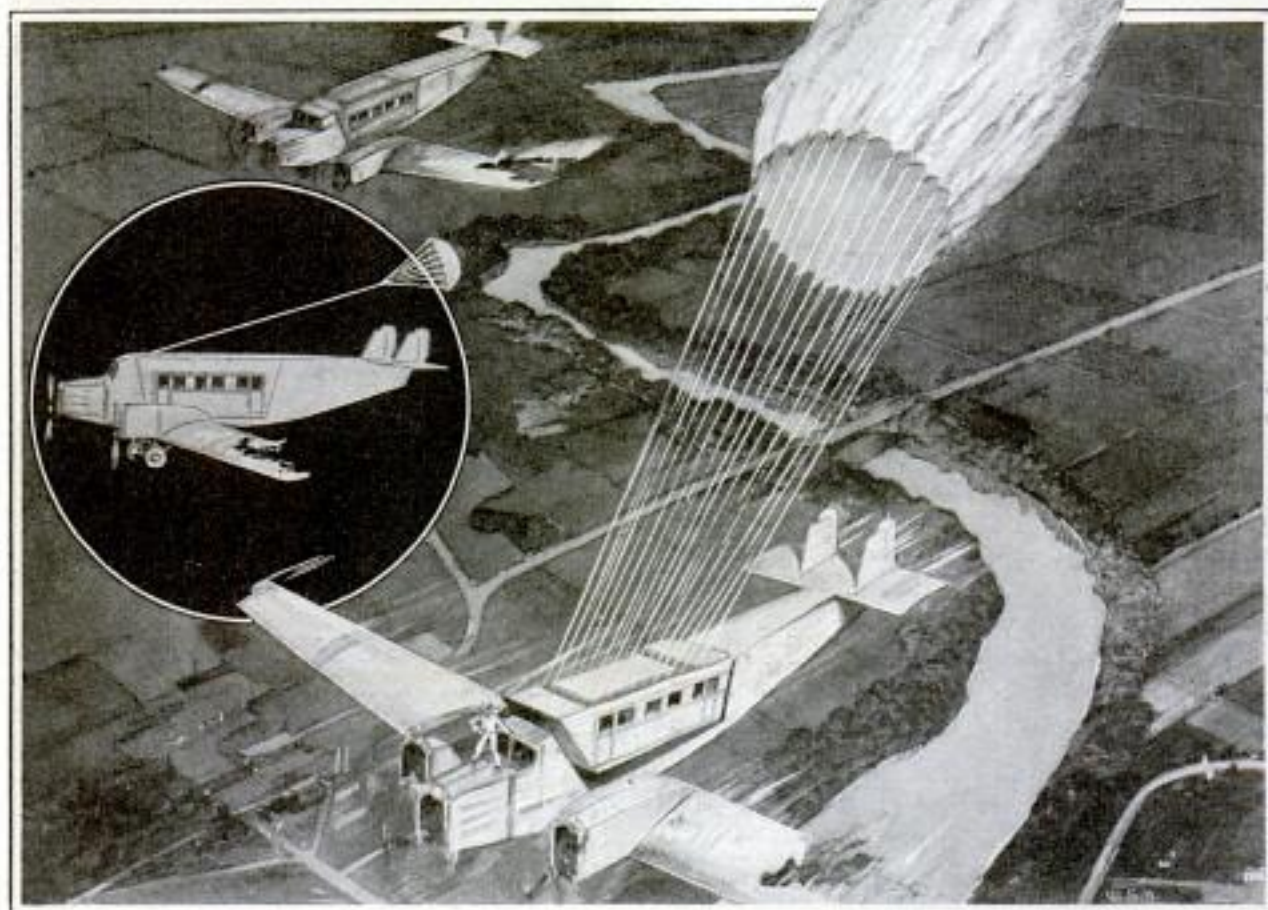
POPULAR MECHANICS

Washington, D. C.

## Huge Chute to Land Cabin of Disabled Plane

When the transport airplane of the future meets with disaster in flight, the pilot may need only to press a lever releasing a parachute to assure the safety of his passengers. This parachute, upon open-

How It Is Planned to Use Giant Parachute to Lift Detachable Cabin from Disabled Plane and Lower Passengers to Earth; Inset Shows Pilot Chute Opening



ing, would lift from the fuselage a detachable cabin and its occupants, then would lower the cabin and passengers to earth, leaving the pilot free to try to land his ship or save his life by jumping with his own parachute. Such is the plan evolved, and recently tested on a miniature scale, by Maj. E. L. Hoffman, parachute expert of the army air corps. The tests were conducted with a small glider carried atop an airplane. The glider contained a detachable compartment to which a parachute was fastened, and in tests up to 3,000 feet and in all sorts of air currents, the chute never failed to open and bring the cabin safely down. A weight of 2,500 pounds has also been lowered by a large parachute such as would be carried by a transport ship, this weight being more than ample to take care of the cabin of a transport ship and ten passengers. An entire

airplane has been lowered by a parachute on various occasions, but thus far no parachute has been designed strong enough to lower with safety a large transport ship filled with passengers. The latest plan, however, calls for lowering only the cabin and passengers, the cabin constituting only a small part of the transport's weight. In case of an accident in the air, the pilot of a ship containing a detachable cabin would first release a small pilot chute located near the tail of the plane. Upon opening, the pilot chute would drag into the air the big master chute, which in turn would automatically free the detachable cabin from the rest of the ship. As the cabin floated to earth, the pilot would be free to try to land his plane, since the cabin would be located at the center of gravity so that its removal would not affect the balance of the ship.

at Wright Field, Dayton, Ohio

Pres. Memo Dept of Commerce 11/3/31

William J. Humphrey,  
Chief, Div. Meteorological  
Physics, U.S. Weather Bureau

a 2249  
Carl Wallin  
93258 17  
Larch St. Anglenwood  
Calif

**TEMPERATURE SEVEN MILES UP IS VIRTUALLY CONSTANT**

It is now known that the atmosphere consists of two major layers, and that the temperature of the top layer remains virtually constant. This fact has a particular significance for such arts as aviation and radio. The general belief in the past was that the atmosphere had no structure and that temperature decreased with height until, at the upper limit of the earth's surrounding envelope, the absolute zero of temperature would be found. This theory has been disproved by recent experiments with small balloons carrying recording instruments, thus establishing the existence of two major layers, the lower known as the troposphere and the upper as the stratosphere. The division between the two occurs a little less than seven miles up, and the temperature steadily decreases with height in the lower layer, but when the stratosphere is reached, the temperature is found to be stationary. The lower layer is extremely complicated in structure while the upper includes dust layers, the auroral base, the Kennelly-Heaviside layer and the ozone layer which determines largely the proportion of ultraviolet radiation reaching the earth.

**PLUG CONTAINS A SAFETY FUSE FOR ELECTRIC APPLIANCES**

As a protection from fire due to defective electric-light cords or connections, a safety plug with a self-contained fuse is now available. It can be attached to the cord of any electric appliance, and in case a fuse does blow out, it is only necessary to pull out the plug, slide off the cover,



Plug Containing a Safety Fuse Which Can Be Inserted into Any Electric-Cord Connection

remove the old fuse with the fingers and replace it with a new one. To change the fuse, the plug must be disconnected.

Brown + Hoffman,  
4724 Franklin Blvd  
Cleveland, Ohio



Five-Foot Goldfish Bowl Made from 100 Pounds of Glass and Pipe with Which It Was Blown

**THREE-STORY GOLDFISH BOWL IS FIVE FEET HIGH**

Standing five feet high and containing about 100 pounds of glass, a three-story goldfish palace was completed recently by a Los Angeles glass blower. The aquarium was made of fine crystal glass and is in three parts, an elongated base, a big bowl of conventional design and another globe surmounting it. The upper globe is closed at the top but there is an opening beneath so that the fish can enter the third story when all three sections are filled.

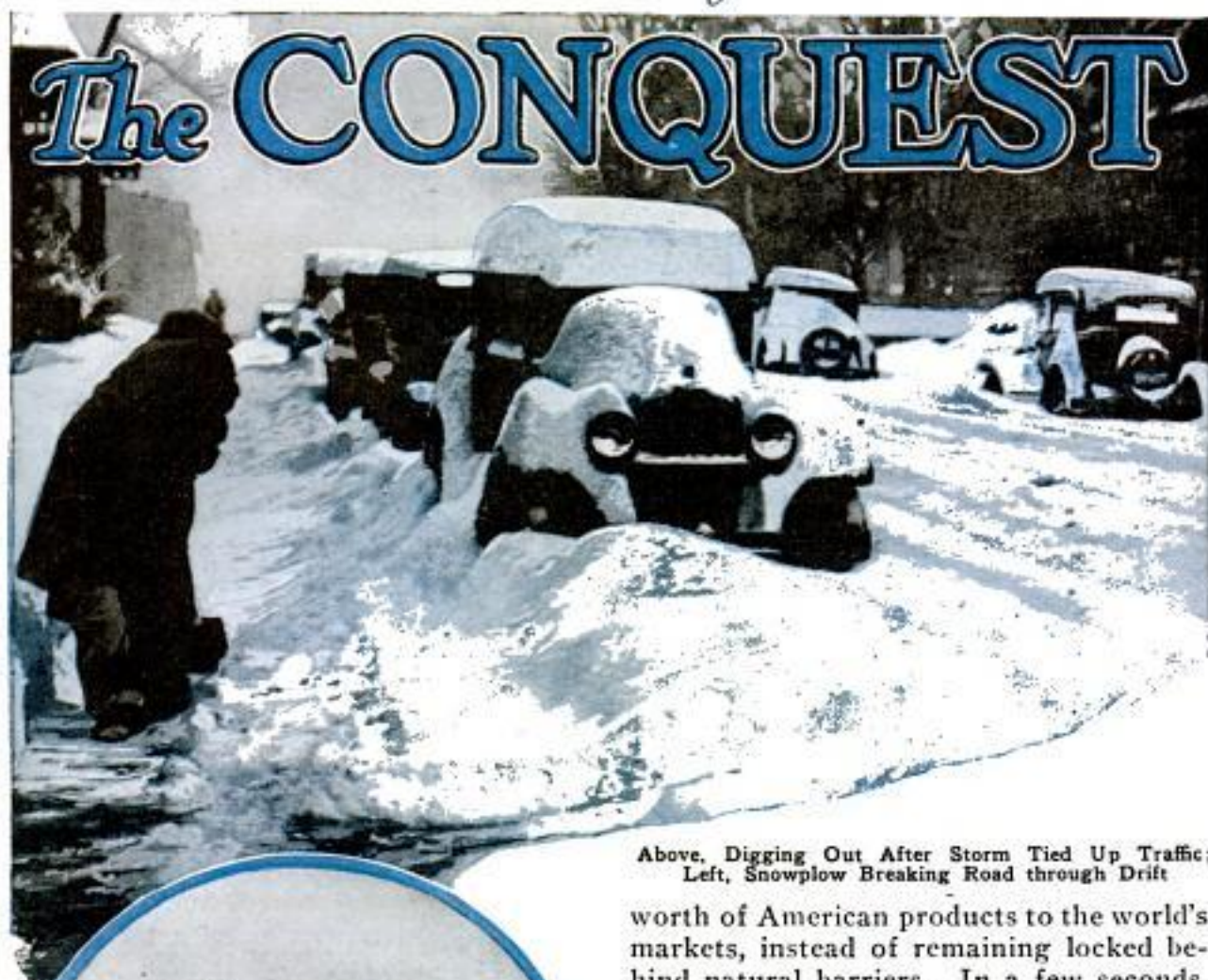
**PING-PONG BALLS IN BOAT HULL PREVENT SUDDEN SINKING**

Buoyancy of racing motorboats has been increased without adding to the weight by placing thousands of ping-pong balls between the hull planking and the aluminum lining fastened to the other side of the ribs. The balls, which are light and noiseless, have been found efficient in keeping a boat from sinking suddenly in case of accidents. Even in a severe crash, hardly more than ten per cent of the balls could be punctured, the remainder keeping the craft afloat long enough for rescue boats to fasten a towing line to the damaged racer.

According to the  
late Sir Henry  
Seagrave

Schultz

a 2300  
Pres. Memo. Dept. of Commerce 11/2/31



Above, Digging Out After Storm Tied Up Traffic;  
Left, Snowplow Breaking Road through Drift



**M**ODERN science, backed by the inventive genius of the mechanical engineer, will prevent a \$10,000,000,000 loss this winter to the 100,000,000 people living in the great American snow belt, as men and machines defeat the "white hell" of winter from hampering progress in thirty-six states of the Union and Canada.

Armed with million-dollar ice breakers, men open northern harbors to ocean greyhounds that speed billions of dollars'

worth of American products to the world's markets, instead of remaining locked behind natural barriers. In a few seconds, the enormous heat developed by thermite is used to melt tons of ice. Giant rotary plows, propelled by power sufficient to operate a large factory, clear thousands of miles of railways, that crack passenger trains may operate on schedule and millions of tons of produce speed from farm to city consumer, the pangs of hunger defeated. Humming mills are served all winter long, as the snow-fighting battalions keep raw material piled up and remove manufactured articles. Fleets of track-laying tractors open 400,000 miles of highways, constructed at a cost of \$7,500,000,000, that 20,000,000 motor cars and trucks of snowland may not remain idle. Many romantic battles are fought that this enormous investment may not remain "frozen" four or five months of the year. Economical and efficient machine methods clear the way at a fraction of the loss in interest charges.

Today men and machines refuse to surrender to the ancient enemy, the snow bogy, master bandit of the northland, wanted "dead or alive," for holding up the

...series of articles on the  
construction of the "DeWitt Clinton" model can be  
obtained from the Jan., Feb., Mar., and Apr., 1932  
issues. The April issue describes the finishing  
of the model and an article on the roadbed and track  
will be published in the May issue. Back copies may  
be secured for 25¢ each from our Subscription Dept.  
Blueprints are also available, a set of six on the  
locomotive at \$1.00, two on the tender 50¢, and two  
on the coaches 50¢ per set. As a convenience to  
readers, we have made arrangements to furnish the  
No. 0-80 hex. head brass machine screws which are  
needed throughout the model. An envelope contain-  
ing 100 nuts and 100 screws will be mailed postpaid  
upon receipt of 75¢. Kindly send remittances to  
"DeWitt Clinton" contest, Popular Mechanics Magazine,  
200 E. Ontario St., Chicago, Ill.

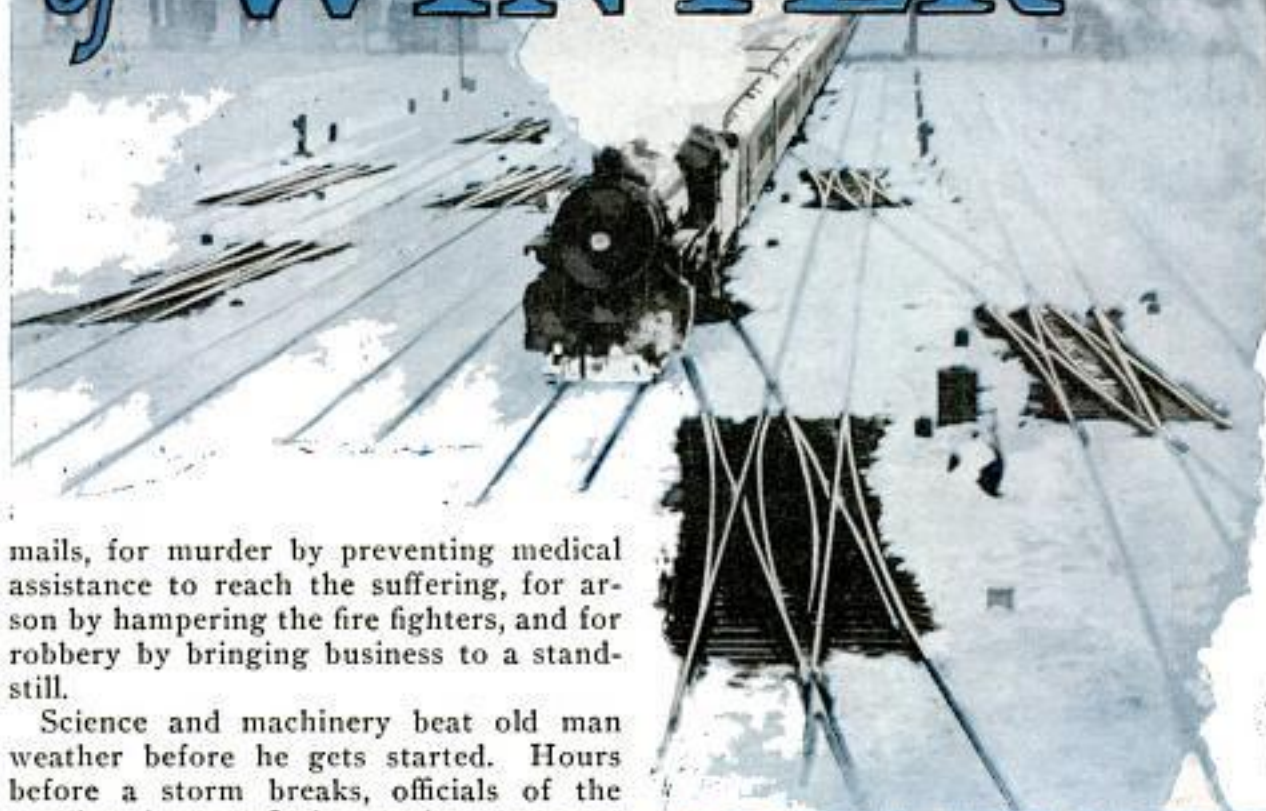
A complete kit of the brass required in  
building the locomotive can be secured by sending  
a remittance of \$4.10 direct to Chas. H. Besly &  
Co., 118 W. Clinton St., Chicago, Ill. They have  
a material list on file and can supply you with  
the necessary sheet brass, tubing, etc. Be sure to  
send sufficient postage for the 8 lb. kit which  
varies according to zones. The taps, #0-80, and  
#1-72, can be secured from the Greenfield Tap &  
Die Co., 611 W. Washington, Chicago for 33¢ each,  
postpaid. or a set of 3, two 0-80 and 1-72 for 93¢,  
postpaid. A set of small drills, Nos. 52, 55, 57,  
48, 44, 42, and 8 are obtainable from the Cleveland  
Twist Drill Co., 9 N. Jefferson, Chicago, for 50¢,  
postpaid. All quotations are subject to change with-  
out notice.

To compete in the prize contest all models  
must be built to the same scale as given, and the  
material and makeup of all parts must be as designated.  
To avoid difficulties, it is also best to follow the  
method of assembly given in the articles.



9460

# of WINTER



mails, for murder by preventing medical assistance to reach the suffering, for arson by hampering the fire fighters, and for robbery by bringing business to a standstill.

Science and machinery beat old man weather before he gets started. Hours before a storm breaks, officials of the weather bureau flash warning messages to keymen located at strategic points all over the northland. By the time the first feathery flakes issue from the clouds, the battalions are on the fighting line.

Down the railway line speeds the giant snowplow, its powerful steel rotors thrust forward by the tremendous weight of 450 tons of machinery, operated by the 6,000-horsepower locomotive, and kept spinning by the 800-horsepower engine. Like a titanic carpenter's bit this augerlike machine cuts a swath through the frozen ice and snow. The sharp flanges eat their way into the solid mass at a speed of ten to fifteen miles an hour. At a cost of \$50,000 one railroad built a rotary-snowplow outfit with machinery housed in steel for protection from the elements. The unit is so massive as to require the combined power of three heavy-duty freight locomotives to propel it through deep snow.

Out in the Rockies, some of the most spectacular snow-fighting campaigns are waged, as it becomes necessary to remove from twenty to thirty-five-foot drifts from the mountain lines. Heavy-duty snowplows, with cutting edges of two-



Above, Switches in Railroad Yards Being Kept Free of Snow and Ice with Gas Burners; Below, Fighting Snow in the Mountains

a460



Clearing Snow from Runway of a Busy Airport; Left, Track-Laying Tractor Bucking Snow in the Sierras

the rotors cut the ice and snow loose, but, as they spin, throw it aside off the right of way.

The heaviest snows in the United States occur in the heart of the Sierra Nevada and Cascade mountains, where between twenty and forty feet fall in a winter. At Summit, Calif., at 7,000 feet above sea level, nearly sixty feet of snow has been recorded in one season, and twenty-five feet within a thirty-day period. The Great Northern railway found it more economical to construct a \$10,000,000 tunnel than to battle the snow with mechanical means.

Using the most scientific methods, motive-power engineers on American and Canadian railroads spend millions to provide uninterrupted traffic for the public. Wet snow is the most difficult to fight, and but a few inches are needed to stop powerful locomotives along the lines.

inch battleship plate, and other mechanical parts of equally heavy proportions, are needed to break a way. Not only do

banked central New York with four and five feet of snow on the level; depressions



were filled to the top, creating a condition which forced 6,000 railroad men to literally excavate hundreds of miles of main and branch lines. These men fought continuously and tirelessly, night and day, for forty to fifty hours. Valiantly the battalion struggled on, seeking to open the four-track main line, on a battle front stretching over three divisions, which threatened to bottle up traffic between the Atlantic and the Mississippi.

So intense and steady was the snowfall of wet, sticky flakes, that men and machines seemed helpless. Just as fast as snow was removed from the tracks, the clouds poured down more. The unceasing bombardment continued unabated hour after hour,



until deep drifts and towering banks were built up beside the railroad. It was soon impossible for the rotary plows to buck the snow, and hand-shoveling crews were put to work.

Generals of the snow-fighting armies were confronted with the titanic task of literally digging a railroad out of the snow. As suddenly as the storm started, it ceased, the thermometer dropping below zero, transforming the wet mass into a solid coat which made the job still more difficult. The icy mantle was cast aside by mobilization of a large force of men, locomotives, and snow-fighting equipment, and carried to a conclusion through perfect teamwork of ev-

Top, Keeping Water Hydrants Open with Steam; Center, Melting Snow with Chemicals; Below, Small Snowplow Keeping Sidewalks Clean

a 460



Here Is the Way a Snow-Blocked Road in South Dakota Looks After the Flakes Have Quit Coming Down; the Highway Is Being Opened by a Tractor and a Rotary Plow

ery department of a great railroad. Opening the snow-bound highways to motor traffic calls for all the genius of the mechanical engineer. The famous Berthoud pass, in Colorado, at an altitude of 11,000 feet, was formerly snow-locked throughout the winter. Powerful heavy-duty track-laying tractors and giant rotary snowplows now open the way. For a distance of two miles on either side of the summit, dynamite is used before the machinery goes into action, throwing blocks of ice far down the mountainside. In one storm, eight tons of high explosives were fired off and a ten-mile section cleared in sixty-five hours. Engineers rate this as one of the most stupendous undertakings of its kind. More than a thousand men, equipped with shovels, toiling many weeks, would have been needed to have accomplished that which machinery achieved in short order.

The Pikes Peak motorway, linking the valley with the summit, 14,000 feet above the sea level, is no longer sealed from October to June. One of the most beautiful scenic drives in the world, this is also one of the nightmares of the snow fighters. The last ten miles are completely snow-blocked, with a coating, the consistency of ice, manfling the twenty to fifty-foot highway, on account of the excessive moisture

which freezes as fast as it falls. The "Battle of Pikes Peak" opens at 10,000 feet and continues right up to the very summit, over grades that are very steep, with a pitch of more than ten feet per 100. Time after time, the powerful tractor outfit charges into deep drifts, bites out a section, backs up, then charges again and again, the rotors throwing snow and ice off the cliff and down into the canyons. From morning till night, the battle rages, the spinning blades surrounded by whirling snow crystals which appear like a Fourth of July pinwheel.

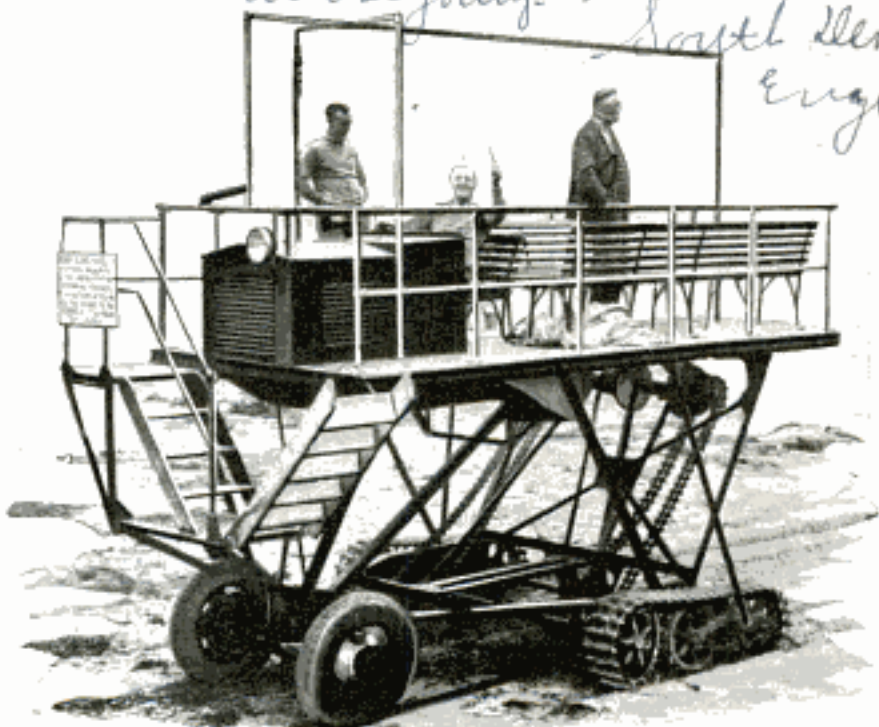
Toiling away one winter day, up near the summit of Pikes Peak, with a fierce blizzard howling from the north, one tractor operator discovered that he could not follow the trail; he could not even see where he was going. Soon he discovered that the heavy outfit, weighing several tons, was far over the edge of the cliff, supported by an icy bank of snow—the only thing that stood between him and destruction. By careful maneuvers he worked the tractor back onto the road, and by a slim margin escaped being dashed several thousand feet down the mountainside.

Winter in the northland is fought by telephone and telegraph linemen, charged with keeping the millions of miles of wire

*A 2167 Operates between  
Borough Island and mainland  
at Bigbury n. Sea  
South Devon  
England.*

up and open to communication. One company spent \$7,500,000 in sixty days to repair damage from sleet which carried down hundreds of miles of wire and broke thousands of poles. A New England sleet storm wrecked 10,000 poles, 20,000 crossarms, 42,000,000 feet of bare copper wire, 8,000,000 feet of insulated wire, and 42,000 glass insulators, the repair costing \$2,500,000.

Linemen who keep the "juice coming" over the vast network of hydro-electric lines are daily confronted with dangers. One power company in Montana, operating 5,000 miles of 50,000 and 100,000-volt lines, maintains log-cabin refuges every few miles through the mountains to house repair crews.



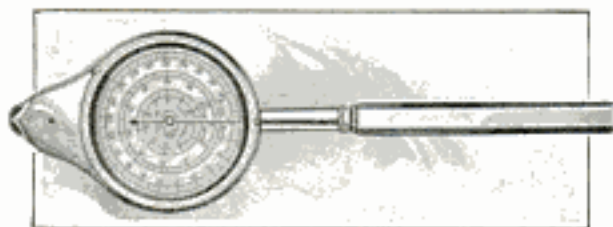
© International News Photo  
At Home on Land or Sea, This Ferry Is Used by Guests at a Hotel off the English Coast

**FERRY WITH TRACTOR WHEELS  
TRAVELS ON LAND OR SEA**

Fitted with tractor wheels, a ferryboat serving hotel guests on an island off the Devonshire, England, coast, travels on land or sea. A chain from the ferry motor to the wheels drives the boat on land.

*A 2208*  
**DISTANCES ON MAP MEASURED  
BY USE OF ROLLER DIAL**

Distances on a chart or map can be determined instantly without any mathematical calculations by the use of a little computation instrument consisting of a dial to which is attached a small wheel. The dial has three readings, so that three different scales may be used with the same instrument. To find the mileage between two points, the wheel is run over the course and the distance is read directly on the dial which has been set to the proper scale. One instrument, for ships,



Dial Which Records Distances between Points on Maps or Charts as It Is Rolled over Them

shows readings in nautical miles, and another, for motorists or surveyors, shows land miles.

**AUTO OF FUTURE TO DEMAND  
BETTER LUBRICANTS** *A 2288*

Automobiles of the future will possess such great speed and acceleration that extreme-pressure lubricants will be needed to keep transmission and differential gears from scoring and breaking down under the strain. This is the opinion of two engineers of the General Motors corporation who point out that even now the generally accepted theory of lubrication does not hold for some parts of the automobile. It is widely believed that in lubrication a film of oil actually prevents rubbing surfaces from coming together, but, the engineers say, this condition does not apply to highly loaded gears which make contact at fast rubbing speeds. Pressures between automobile gear teeth are often as great as 400,000 pounds per square inch, while well-lubricated bearing loads rarely exceed 2,000 pounds.

*crens Service 11/5/37*

*John E. Handr. Assoc.,  
208 Chestnut, Phila*

*H.C. Mougey  
J.A. Almen.*

Book department sells  
Frog Industry \$2.00  
POPULAR MECHANICS

24  
1

# "Frog Farming" in Yard Returns Big Profits

J.A. Esardner, North Hollywood Calif



Electric Lights Attract Insects for Feed at the Frog "Farm" Shown Above; Below, the Operator Holding One of the "Products"

"Frog farming" in back-yard pools has returned big profits to a Californian who stumbled into the business while raising the creatures to supply his own table with that once exclusive European delicacy, frog legs. So great is the demand that frog farming in the United States has grown into a \$2,000,000 industry. In this Californian's yard there are two large pools containing several hundred full-grown frogs and hundreds of

thousand tadpoles. Purchasers pay \$5 a pair for breeders four years old, and \$10 a dozen for one-year old frogs, to be used for eating. An electric light over each pool attracts swarms of insects on which the frogs feed, and in the daytime, bits of liver and fruit replace the electric light as bait. Tiny fish which devour mosquito eggs as rapidly as they are laid, have been placed in the pools, keeping down mosquitoes.

## "FOOL'S GOLD" HAS MANY USES IN FACTORY PROCESSES

Pyrite, which, owing to its yellow color, has so frequently been mistaken for gold as to earn the name of "fool's gold," actually is not the worthless material that the name implies, but has many important commercial uses. It is employed in the manufacture of sulphuric acid and sulphite wood pulp, and in smelters it is used as a fluxing agent to furnish iron for the slag. It also is used to some extent in ra-

dios and jewelry. The largest pyrite deposits are in Spain and Portugal, but it is also found in western United States.

## SALT-WATER RUBBER TO HELP SOLVE WORLD PROBLEM

Development of a synthetic rubber that will fulfill nearly all the requirements of the natural product and at prices practically the same, has been announced by Du Pont. The raw material is acetylene, salt and water. While the product shows,

Dept of Commerce 11/4/21 #10312-227

U.S. Bureau of Mines  
Circular 652 3/6523

Suprenie  
E. I. du Pont de Nemours & Co.

see material Rubber folder - misc. file

a 21 28

25

E. I. du Pont de Nemours Co.,

Wilmington, Del.  
POPULAR MECHANICS

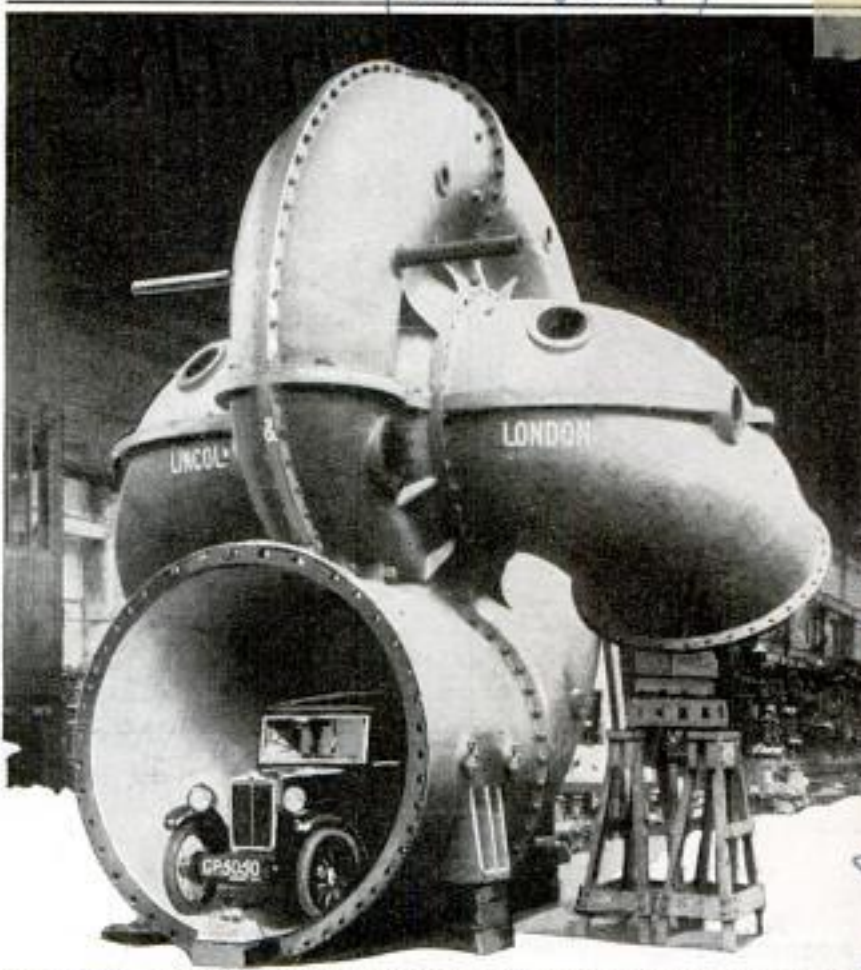
Rubber Chemicals Div. (Cont. Paul)

under X-rays, exactly the same structure as real rubber, there are a few important differences. While it would be usable for automobile tires, for instance, it is not expected it will be employed in this field now, except in case of national emergency. The new rubber is not soluble in gasoline, as is the old, and can be vulcanized by heat alone. A latex, or rubber milk, can be made of the new material which has a much higher impregnating power. The new rubber also resists oil.

a 2 092

**FLUID COLORS DYE ELECTRIC BULBS**

Fluid lamp coloring now is available for tinting electric bulbs to provide indirect-lighting effects in the home at small cost. The lower part of the bulb is dipped in the fluid stain and allowed to dry, the colored bulb giving an amber light that is said to improve illumination for reading, sewing or bridge playing.



Pump with a Capacity of 280,000 Gallons a Minute to Be Used in British Drainage Project; Note Size Compared with Auto

**GIANT PUMP AS BIG AS A HOUSE USED IN DRAINAGE PROJECT**

As large as a two-story house, a giant pump has recently been completed in England for use with two others about the same size in a drainage project in that country. It has a capacity of 280,000 gallons a minute, or more than 400,000,000 gallons a day, and the main pipe is large enough to serve as a garage for an auto.

**CLOTH MADE FROM ALUMINUM IN VARIETY OF COLORS**

Aluminum cloth now is being produced in a variety of colors and designs. It consists of a fabric base coated with aluminum foil and is very pliable. This cloth is expected to find an extensive use in the manufacture of novelty and evening shoes for women, and for handbags, belts, trimmings and other clothing accessories. It has also been suggested for stage settings, shop-window displays and as a substitute for asbestos as insulating material.

bugged Lake Erie states Co. 5802 Hough Ave Cleveland Ohio  
Egyptian Lavender 1/40 Cedar  
naught

England for drainage project  
between Peterborough and the Wash.



Tinting Electric-Light Bulb with a Fluid Stain to Provide Indirect-Lighting Effects

Johnson. Smith Co Wis  
W. W. W.

Quaker Mfg Co.  
Kansas City, Mo

Bernard Abrams Co,  
23 W. 38th St. New York.

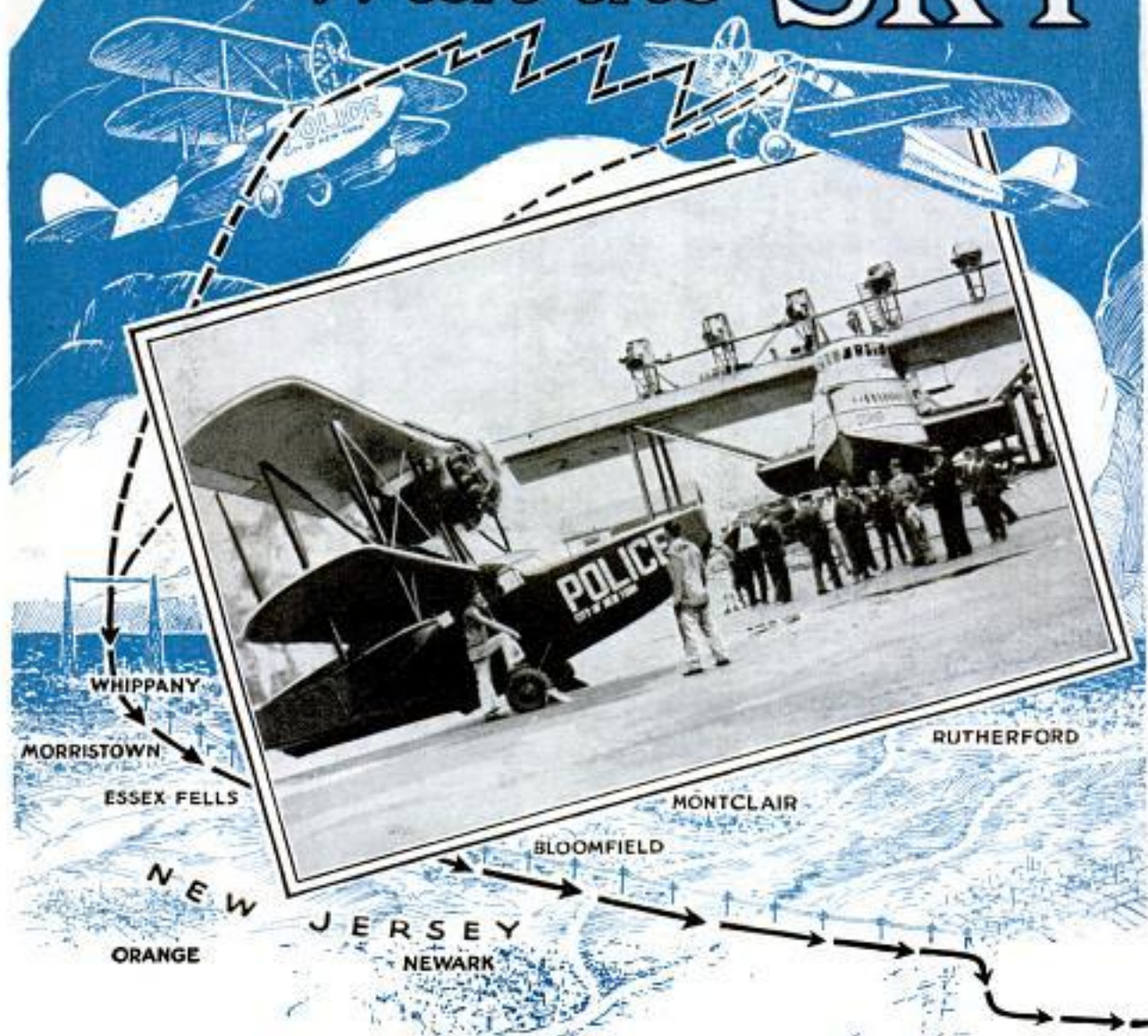
a 22 73

Copyrighted material

Q 2062

Cmt. M. B. Schnafer  
2340 - 63rd St  
Brooklyn NY

# With the SKY



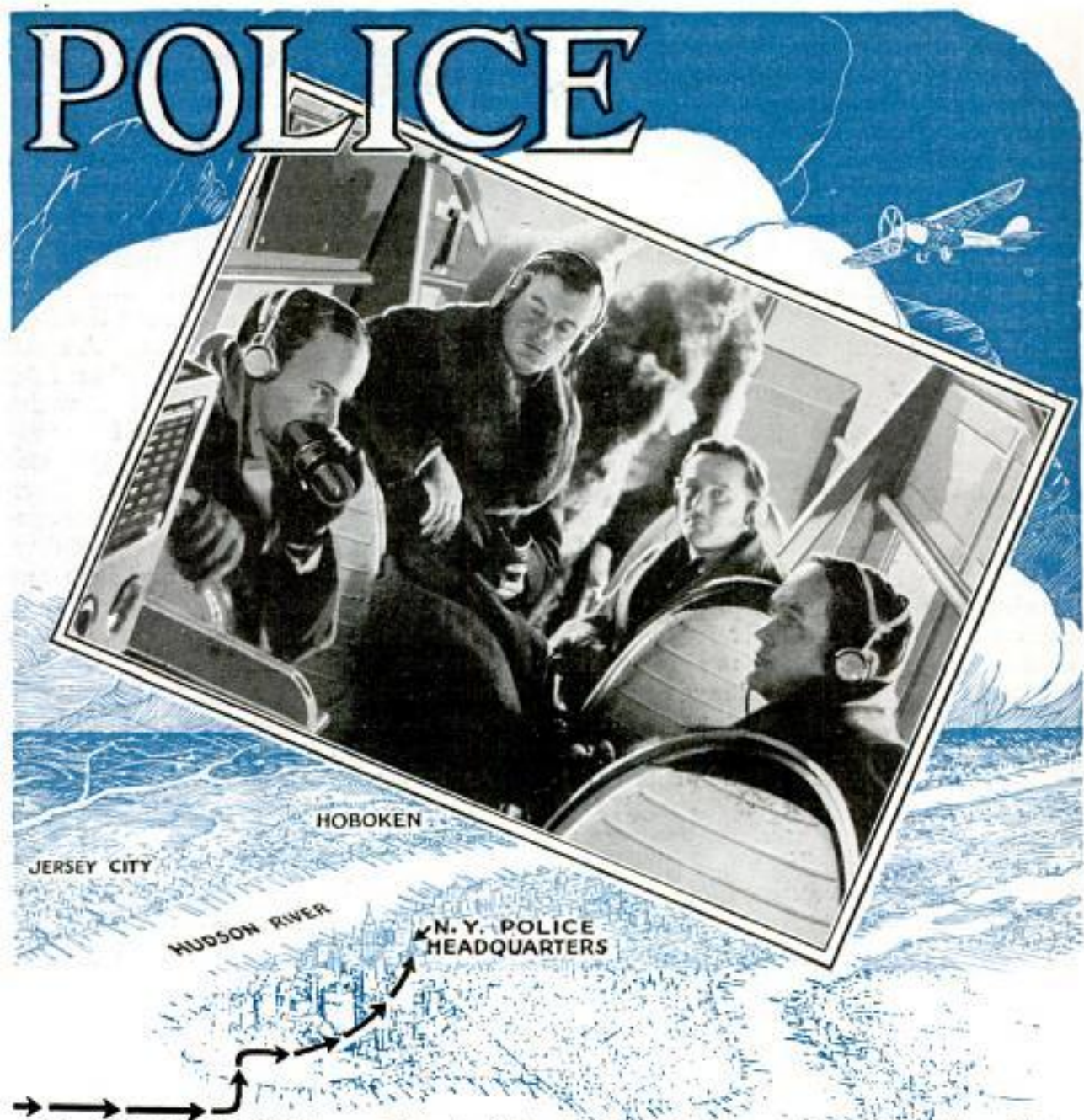
How Radio and Wire Link the Sky Patrol with New York Police Headquarters; Photo Shows Police Airplane beside the Big German Flying Boat, the "DO-X"

COMBINE the worst and the most dangerous elements of crime detection and aviation, and you'll come near to having an idea of what it is to be a member of New York's police air force. But, precarious as are the lives of the aviator and the policeman, individually, not even their combined hazards come up to those of these flying cops. For not only do they know the troubles of both, but they have some more all their own. Escapades and adventure are the meat and drink of these flying guardians of the law. Besides preserving the peace, protecting life and property, preventing crime, enforcing all laws and ordinances, detecting and arrest-

ing all violators of the law, they have a thousand and one other things to do. Chasing thieves, searching for lost flyers, following carrier pigeons, apprehending smugglers, forestalling kidnapers, tracing airplane accidents, saving lives, spotting disaster or tragedy, effecting rescues—these are a few of the big jobs that come their way. Here are a few illustrative adventures.

Word comes that a gangster wanted for murder is escaping to Canada by airplane. "Don't come back without him!" telephones Police Commissioner Mulrooney. Immediately one of the planes is hurried out of the base at North Beach, L. I., bor-

# POLICE



Police Air-Service Officials Communicating by Radio with Police Headquarters from a Patrol Plane; Note the "Muzzle" Type of Microphone Used by Member of the Air Squad

dering on the metropolis. Capt. A. W. Wallander chooses two of his best men and a mechanic for the mission. They jump into their special police aviation clothes while tear bombs, air machine guns and other ammunition are loaded into the plane, and are off.

Scouring the sky for a particular airplane is about as herculean a task as finding a needle in a haystack, especially when the gangster may have picked any route to Canada. But these flying cops know their stuff. A gangster in a hurry to get to Canada will, ninety-nine times out of a hundred, follow the Hudson river. For hours they signal every plane in sight for

inspection. Sunset finds them coming up to a small private plane, apparently in a hurry to get somewhere, perhaps Canada. The number of the plane is identical with that in which the gangster was escaping. Out come the machine guns. The sight of those terrible weapons sends the private plane down. The next day the flying cops are back at headquarters with their man.

Here's another experience taken from the records of the flying police force. They had always viewed suspiciously a social club which seemed to be overfond of pigeons. However, that was the only thing they had against the club—fondness for

92002

pigeons—although they believed it was connected with a liquor-racketeering ring. All means of communication from the club—radio, telephone and mail—were tapped and investigated without results. One day a patrolman got a hunch that the pigeons had something to do with the inside activities of the club. For a week he watched the birds from a near-by roof. Then a police plane was put on the scent. Try keeping your eye on a speck of dust in the air and you'll understand what it is to follow a bird by airplane. That's what the flying police did. They trailed the pigeons to a giant liquor still in the heart of the Catskill mountains. Smashing of the club and the still revealed that an annual business of \$1,000,000 was carried on with the aid of the pigeons.

Another interesting case, from the point of view of the division's efficiency, arose from the loss of a cylinder from an air-cooled motor flying over the city. The heavy fragment of metal plunged through a house top, narrowly missing a woman and causing considerable damage to the building. The identity of the plane was a mystery. Eye witnesses said that it had no identification numbers. The very next morning two police flyers, on regular patrol, sighted a plane camouflaged with shrubbery on Welfare island. It proved

to be the clue to the accident of the day before, and in short order cleared up what the surface police admitted otherwise must have remained a mystery.

Perhaps most frequent of the flying cops' notable deeds is saving persons in danger of drowning. From their high vantage point they can easily detect tragedies in the waters surrounding New York. A capsized canoe, a floating body, a rowboat drifting out to sea are the danger signs. Here's a typical case. A small motorboat suddenly darts out of an inlet and crashes into the side of a yacht. Though several miles away, the flying police have taken in the accident. Quick as a flash they are upon the scene. Then things begin to happen. The police amphibian is put into an almost vertical dive. It swoops down, circles only once and lands within fifteen feet of the scene of the accident. Well trained in the art of life-saving, they waste no time in pulling three drowning persons aboard the plane, giving them treatment and rushing them to the nearest first-aid station.

As for smuggling by airplane, the flying police have helped no little to wipe out the practice, though it is mainly up to the federal government to look after such matters. Until the flying-police system was inaugurated, it was well known that a



Police Planes, Like Any Other Kind, Require Good Mechanics and Frequent Inspections to Keep Them in Condition, and Above Is the Ground Crew of the Police Air Force



A2002



great deal of smuggling was going on through the air. Aliens, valuable foreign goods and jewels and expensive liquors are said to be still stealing their way into this country by airplane from Canada, but little of the traffic is going on in New York. Smugglers have found it isn't a healthy thing to come up against the police air force.

These are outstanding examples of the splendid service rendered by the flying cops. But they have equally important work of a less adventurous and a more technical nature. They are fighting the new menace of modern civilization—the reckless and incompetent flyer. If a plane is noticed flying less than a thousand feet over the metropolis, it is promptly chased, its license number taken and its pilot shunted out of the danger zone over the towering skyscrapers. Any aviator seen stunting or indulging in any kind of acrobatics over the city is handled in the same manner. A violator is liable to imprisonment, fine or both.

Statistics and facts stand behind this good work of the flying cops. Between



Above, Police Amphibian on Water Patrol; Below, Machine Guns and Bombs Used aboard the Flying Police Ships

April 8, 1929, and Sept. 26, of the same year—the date of the organization of the police air force—there were eight airplane crashes in New York City which cost the lives of six persons and resulted in serious injury to twenty-one others. Slightly less than a month after the creation of the aerial police force and before it had begun

Q 2007



Mechanics Servicing One of the Police Planes; This Craft Is Typical of Those Used in Tracking Down Lawbreakers from the Air

was made through the radio station of the Bell Telephone laboratories at Whippany, N. J., about forty miles away. From there the conversation was carried by wire across country and under the Hudson river to police headquarters.

All the men in police air force were taken straight from the uniformed ranks. No professional aviators were imported or outsiders accepted. All the original men of the force were cops in the real sense of the word. Fortunately, several men had flying records either in the army or navy during the world war. The others were sent to Roosevelt and Curtiss fields for training. Arthur N. Chamberlin, an air captain who had made an enviable record for him-

self in the war, was placed at the head of the division. The force has among its members some of the most competent flyers in the United States. Never during its two years of almost perfect record, has any member figured in a serious accident.

to function, there was another fatal crash, when a plane fell into a congested part of the city and killed its pilot. This brought the air-casualty score for 1929 to seven killed and twenty-one injured within the limits of New York City alone. With the sky cops on the job nearly all of 1930, that year passed without a single fatal airplane accident in a congested part of the city.

Another outlet for air police was demonstrated recently when two airplanes, flying high over New York, proved that they could telephone headquarters with ease from the clouds. Now, reporting the pursuit of a criminal from the sky, controlling mobs and traffic tangles, as well as directing the work of fireboats in the harbor, are foreseen as possibilities of the near future.

"What do you see?" asked Police Commissioner Mulrooney, sitting in his office, conversing with officials of the flying force 2,000 feet up. "Miles of waterfront and motor traffic in the streets," replied Capt. A. W. Wallander.

Both planes were equipped with short-wave radio-telephone apparatus, similar to that now used by many of the large air-transport lines. Contact with the ground

### PRACTICE CLUB TELLS GOLFER 222' YARDAGE FOR EACH SHOT

Golfers who like to practice during the winter to keep in form now can obtain a special practice club that automatically records what happens to each ball that is hit. A mechanism in the face of the shaft actuated by the force of the impact between the ball and the club records the



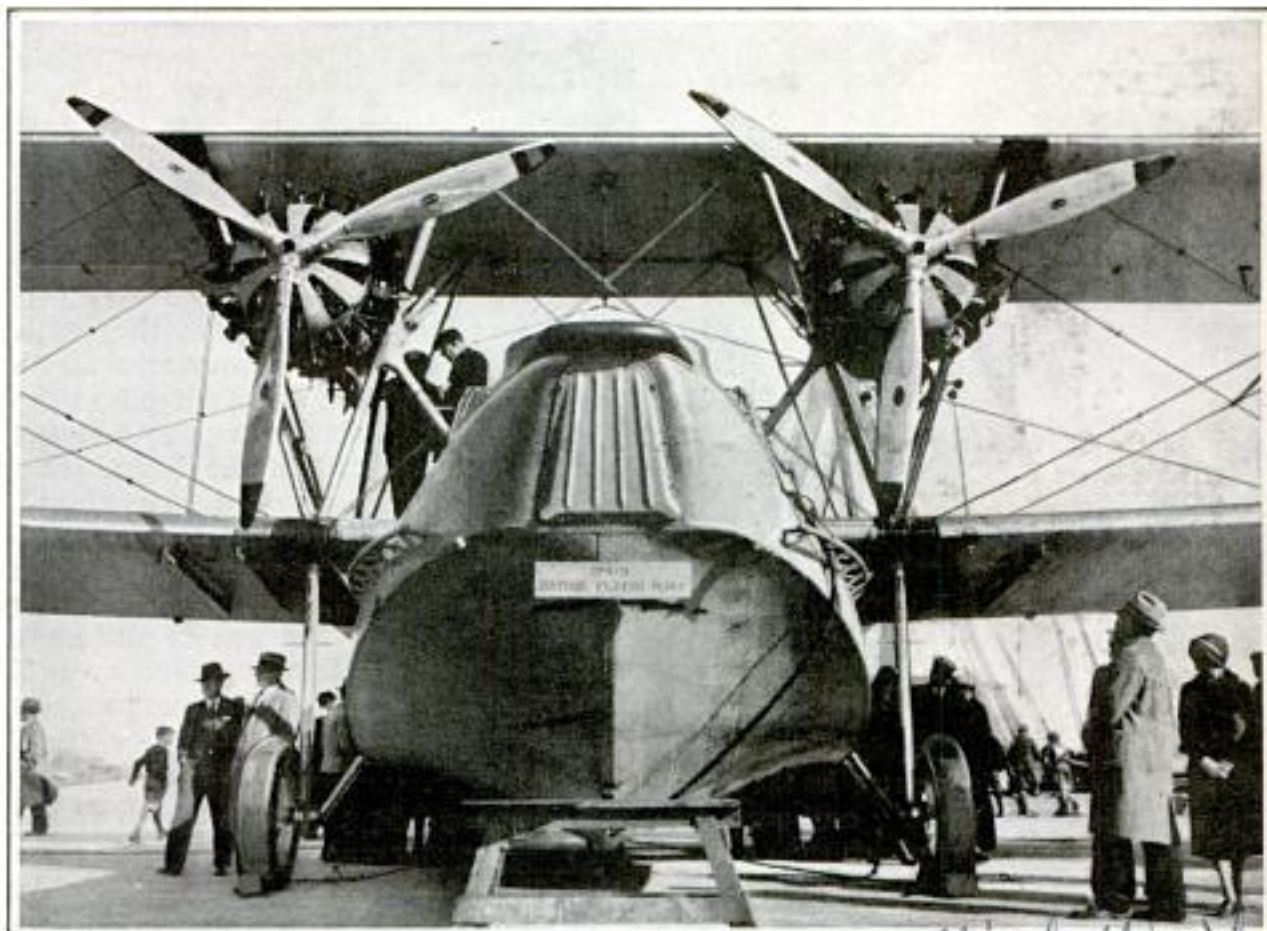
yardage for each shot on a scale. Hooks and slices are also shown by means of the movable driving face, the

player thus being able to observe the yardage that would have resulted from a given effort and also to determine whether the ball would curve to right or left.

*not put on market 12/2/31*  
*J. S. Campbell, Madras, Wash. D. C.*  
*Seattle, Wash.*  
*Wm. Holladay*  
*130 E. 16th St.*  
*Portland Ore.*

2219

XPy-2. Naval Aircraft Station



Twin Motors Carry This Yachtlike Patrol Plane over Land and Sea; Note the Wheels for Dry Landings; the Hull Will Withstand Much Heavier Seas than Ordinary Seaplanes

*Wide World*

**LATEST OF NAVY 'FLYING EYES' IS TWIN-MOTORED PLANE**

Twin motors supply the power for the latest of the navy's "flying eyes." Four patrol flying boats were completed recently at the Philadelphia navy yard. A sturdy, boatlike hull is one of the new craft's features.

supplied for this purpose, the fiery red rays from the tubing are reflected in the lettering to give the illusion that the writing or printing is actually formed of bent glass tubing. An erasing fluid and a cleaning cloth remove any message in an instant, leaving the glass plates ready for a new one.

**WRITE-IT-YOURSELF SIGN SEEN EITHER DAY OR NIGHT**

Neon-light signs on which messages may be written in your own hand in letters of fire, then erased as simply as rubbing the pencil marks from a school slate, are now available for counter and window-display advertising. The sign consists of a base supporting a metal frame in which are inclosed two plain glass panels. Between the panels is a dark mat that causes the glass surfaces to appear black when no lettering is on them. Neon tubing completely encircles the glass inside the frame, and when the blank glass is lettered with a fluid or colored crayons



Neon-Light Sign on Which Messages May Be Written in Letters of Fire and Easily Erased

*made by Stewart Warner Corp of Canada, Ltd. Belleville, Ont. Canada.*

*2219*

*110-120 v 60 cycle ac*

*Write-it-yourself*

*\$10.00 up*

*Stewart Warner Corp. 1828, University Chicago.*

a2173  
32

Play Boy Outboard Motor  
Enterprise II  
Los Angeles, Calif



Electric Outboard Motor Is Silent, Helping the Fisherman; Left, the Motor

### SILENT MOTOR OPERATES ON BATTERY

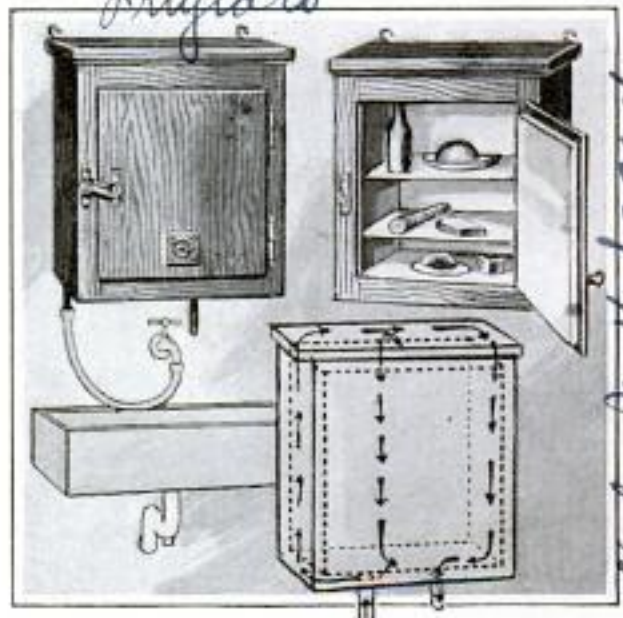
Operating from a storage battery, an electric outboard motor which runs a small boat without noise has been placed on the

market. A snap of the switch starts the motor, which has a speed of about four miles an hour. One twelve-volt or two six-volt batteries provide the power. The motor weighs slightly more than thirty pounds, being constructed of special aluminum alloys which are non-corrosive.

chamber separated by a thin diaphragm. Talking against the diaphragm moves the gas in the second chamber and so causes the flame to flicker. The sending operator swings the reflector to focus on the intended receiver and the receiving operator, who may be ten or fifteen miles away, places the photo-electric cell in the beam, which picks up the variations in light that are too rapid to be detected by the human eye. An electric current, released by the cell according to light-intensity changes, operates an ordinary telephone receiver, cell and receiver being attached to a B-battery.

### WATER COOLS FOOD CUPBOARD WITHOUT AID OF ICE

Food is kept fresh and cool in a cupboard or chest through whose walls water circulates each time the kitchen faucet is turned on. The container is installed above a water tap, a short rubber hose connecting the tap and the inlet pipe of the food cabinet. Then, when the tap is turned, water circulates through the double walls before draining. The water from the food chest is drinkable.



Water, Circulating through Wall Chest When the Faucet Is Turned, Keeps Food Cool

factory 1-12 roll or 26 roll  
19-86 H

230  
Mycopid  
chdals

### LIGHT BEAM TRANSMITS VOICE OVER WIRELESS TELEPHONE

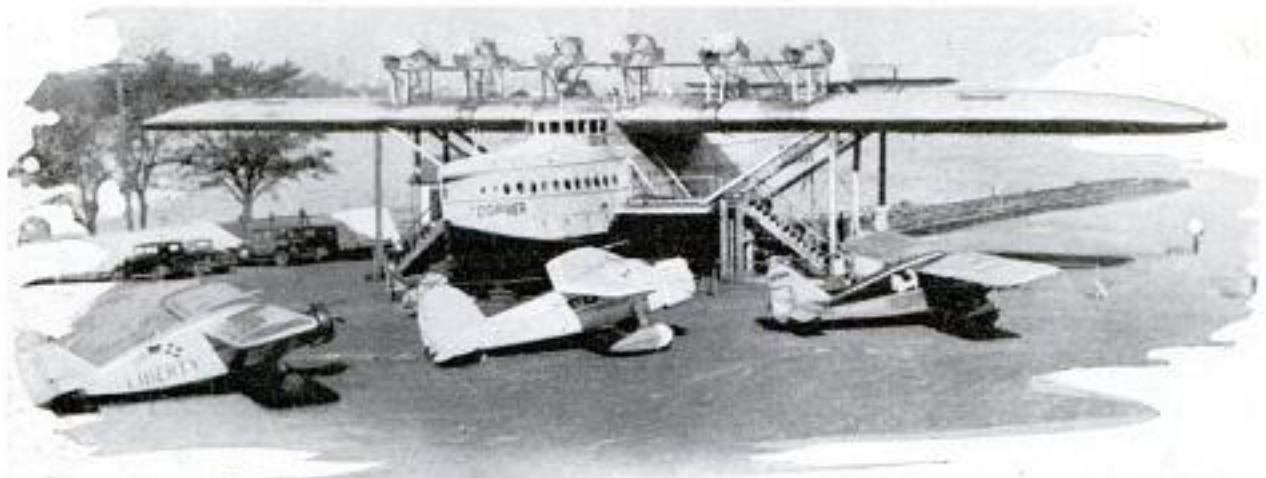
Using a beam of light instead of a wire to transmit the human voice, physicists of the University of Idaho have invented what might be called a light telephone. Since the system enables persons to speak over long distances without stringing wires and without radio-casting messages to everybody equipped to pick them up, it is believed the device may prove useful to the army signal corps and to the forest and ranger service. A sensitive photo-electric cell which detects minute changes in the intensity of light makes possible the receiving device. The sending apparatus consists of a flame fed by acetylene and a reflector to focus the rays on the receiving point or destination of the message. The burner is equipped with a double gas

Christian Science 11/7/31

Italy. No it's present

Mr. Gustaf W. Hammer  
Mrs. Lawrence W. Roskell

Soc. An The Specially  
Trading, is part kept  
Via Ruffini, 9, Milano, 117



© International News  
 These Transatlantic "Birds" Photographed Together Are, Left to Right, the "Liberty" (U. S. to Denmark), the "Winnie Mae" (Round the World), the Giant German "Do-X," and the "Cape Cod" (U. S. to Turkey)

**FOUR TRANSATLANTIC PLANES IN "FLOGK" AT AIRPORT**

Four airplanes of transatlantic fame were assembled recently at the same airport, North Beach, Long Island. There was the giant "Do-X," German craft which flew across the Atlantic to South America and then north to New York; then the "Winnie Mae," in which Post and Gatty circled the globe, and Otto Hillig's "Liberty," which was flown from the United States to Denmark; and the "Cape Cod," flown to Turkey by Poland and Boardman.

out the sounds of ships' whistles and other harbor noises and admit to the sensitive noise meter only the fog signal itself. This would notify a skipper at once that he was within range of a signal.

*a 208 \$*

**ONE-MAN CIRCULAR TREE SAW OPERATED BY HAND LEVER**

Operated by a hand lever, a one-man circular saw for felling large trees has been invented in Germany. The saw is operated from a steel platform, cutting into the tree as the hand lever is moved back and forth.

*a 2160*  
**DELICATE ELECTRIC EAR HEARS REMOTE FOG SIGNALS**

Tests made recently in New York harbor indicate the possibility of replacing human ears with electrical ones in listening for distant fog signals. By means of a microphone and a noise meter, set up on a lighthouse tender, engineers took readings at distances ranging from a few hundred yards to several miles from fog signals on Governor's island and Robbins' reef. The measurements were designed primarily to establish a new method of making the government's regular inspection of the operation of these signals. In addition, electric filters eliminating sound frequencies above 500 cycles were tried, since the fog signals have a much lower frequency. The results indicated that the filter system can be so sharpened as to cut

One-Man Circular Saw Being Operated by Hand Lever; It Is Portable



*Robert photo no info. maker or inventor*

*my presence of impulse 7 Yates and the same high school for that of the same*

*Electrical Research Products, subsidiary Western Electric Co. 50 Church St. N.Y.C.*

a 1895 *Ant. Alex. Glasznan.*  
55 W. 86th Street

# The SOVEREIGN



**A**CROSS the Atlantic speedway with 200,000 horsepower driving her quadruple propellers, England's mysterious supership, the Cunarder "534," will shatter every racing record in greyhound history.

A 73,000-ton colossus, 1,018 feet long, and costing \$30,000,000, the new ship, now under construction on the River Clyde, at Glasgow, is aimed particularly at Germany's supremacy in the transatlantic passenger traffic. Temporarily known as "534," she will vie for the Atlantic blue ribbon, formerly held by other Cunarders, the "Mauretania," the "Lusitania," and the old "Britannia."

"No. 534" is designed for supremacy over anything afloat. In point of size alone, no present ship can compare with her. The "Leviathan" with 59,957 tons, and the "Majestic" with 56,621 tons, are outclassed. "No. 534" will be eighty feet longer than the present blue-ribbon holder, the "Europa," seventeen feet broader, and will displace 23,000 more tons. Her main deck will be 650 feet long; the amidship dining room, between the second and third funnels, will be the largest room ever placed inside a ship; the promenade deck will stretch for 720 uninterrupted feet; her rudder, the largest ever built, weighs 150 tons, and her cubic capacity

see May 1934. 690 - March 1934 - 326

# SHIP of the SEAS



will embrace 7,300,000 cubic feet. Her commodious cabins will care for 5,000 passengers.

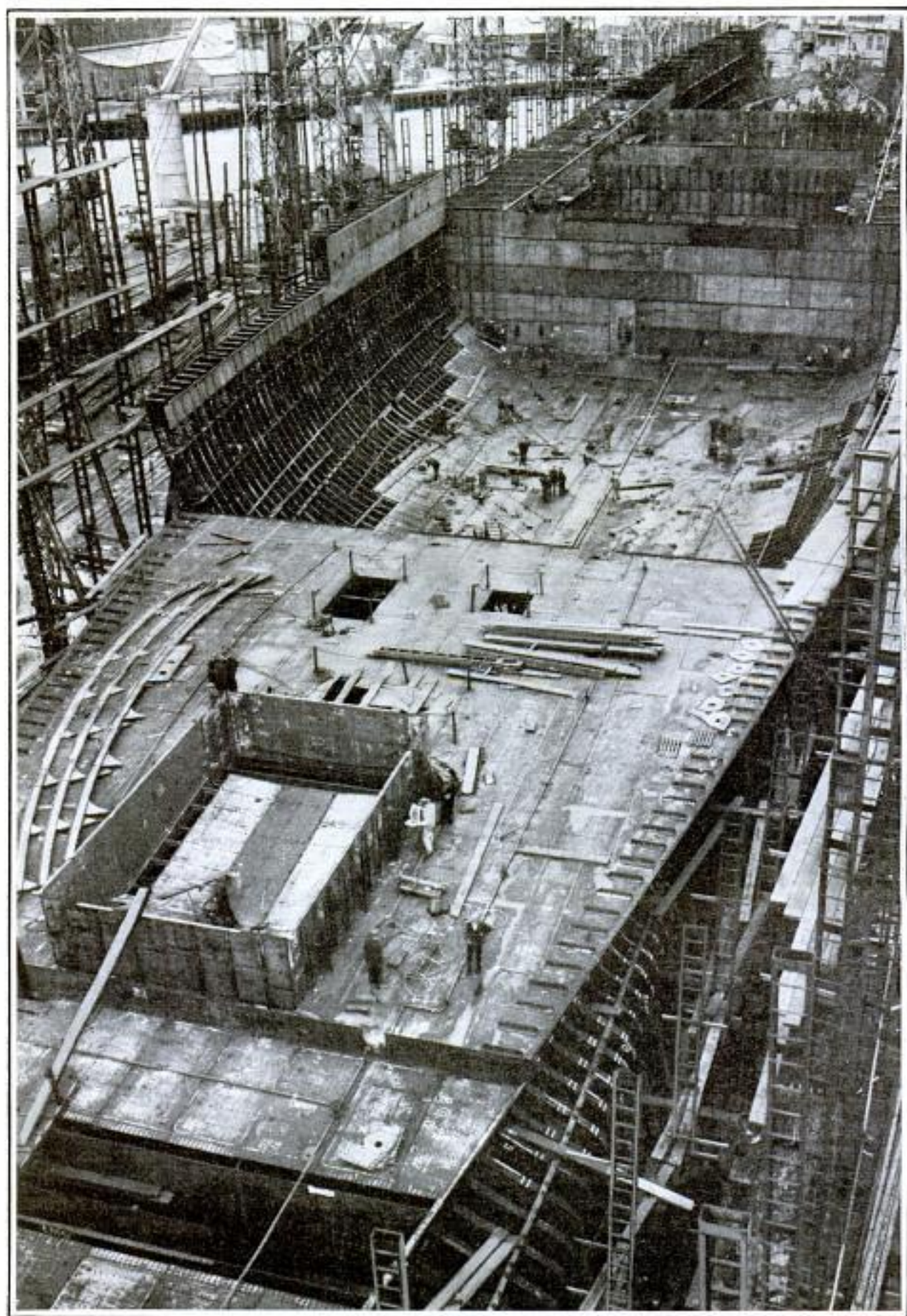
Such staggering dimensions and appointments would avail nothing in the present international rivalry for passengers were it not for the "534's" speed. Five years of study and thousands of tank experiments back this endeavor to wrest the blue ribbon from all possible contenders. The "534's" architects did not design their ship to be abreast of developments in the next five years, but in anticipation of major ship improvements for twenty years to come. Conservatively, it is estimated that "No. 534" will be a four-

day greyhound, and that she will travel thirty-five knots as against the "Europa's" twenty-eight knots.

Simple calculations bring out some startling possibilities in the "534." Her twelve turbines will drive this monster across the ocean at express-train speed. At 40.3 statute miles per hour, she will be able to race across the Atlantic in ninety hours, or six hours less than four days.

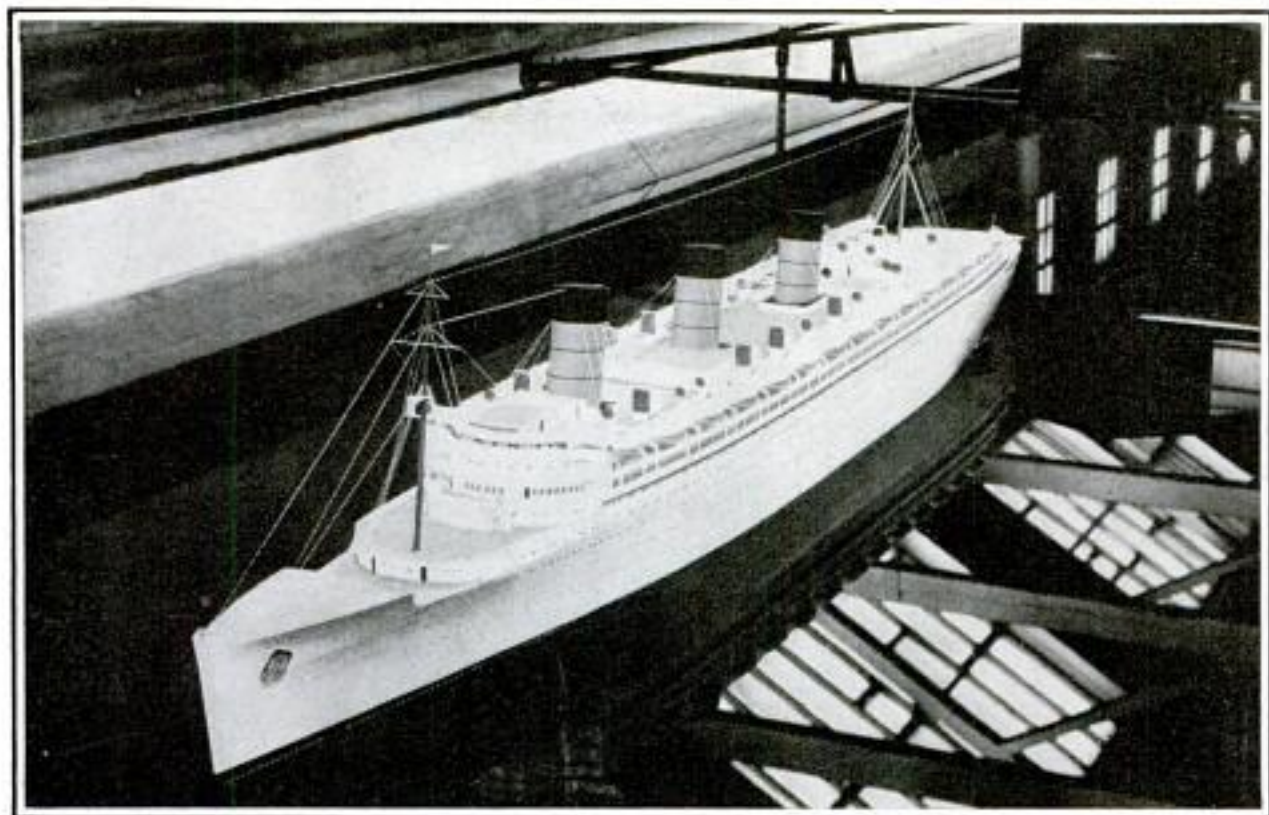
Speed has become more than a convenience to passengers; it is now a rule of economics with shippers and operators. Thus, by increasing speed, the Cunard line can operate a weekly express service with two superships; heretofore three ships

a1895  
36



A View of the Giant 73,000-Ton Cunard Liner Now under Construction on the River Clyde; She Will Cost \$30,000,000 and Her Engines Will Develop 200,000 Horsepower





An Eighteen-Foot Model of the "534"; This Monster of the Deep Will Be 1,018 Feet Long and Is Expected to Be Able to Cross the Atlantic Ocean in Four Days

were necessary to maintain a weekly express service. The company is enabled thereby to carry more passengers per ship and to eliminate the tremendous overhead necessary to operate a third ship.

If the "534" could circumnavigate the globe without refueling, it is within the realm of possibility that she could swim around the earth's equator, 25,000 miles, in 25.9 days, or 620 hours. Thus she becomes a serious competitor to the airship, for the "Graf Zeppelin," in her record-breaking world flight, covered 19,000 miles in twenty-one days and seven hours.

Details of her fittings and appointments are still the secret of the "534's" owners, but they do not hesitate to say that it will cost \$2,500,000 merely to decorate her. On both the port and starboard of the upper deck, fourteen motor lifeboats will be available in case of emergency. Ten miles of carpet will pave the staterooms and vestibules. Ten thousand electric fixtures will be necessary for the lighting and ventilating scheme. The power plant will generate enough current to supply the demands of a city of 100,000. The ship's dining service will need 200,000 pieces of crockery. Tableware, including knives, forks and spoons, etc., will total

100,000 pieces. Her stern frame, weighing 100 tons, is the world's largest casting. In addition to her seven turbo-generators, she will be fitted with 300 electric motors. The world's largest floating garage and a chapel for religious services are special innovations.

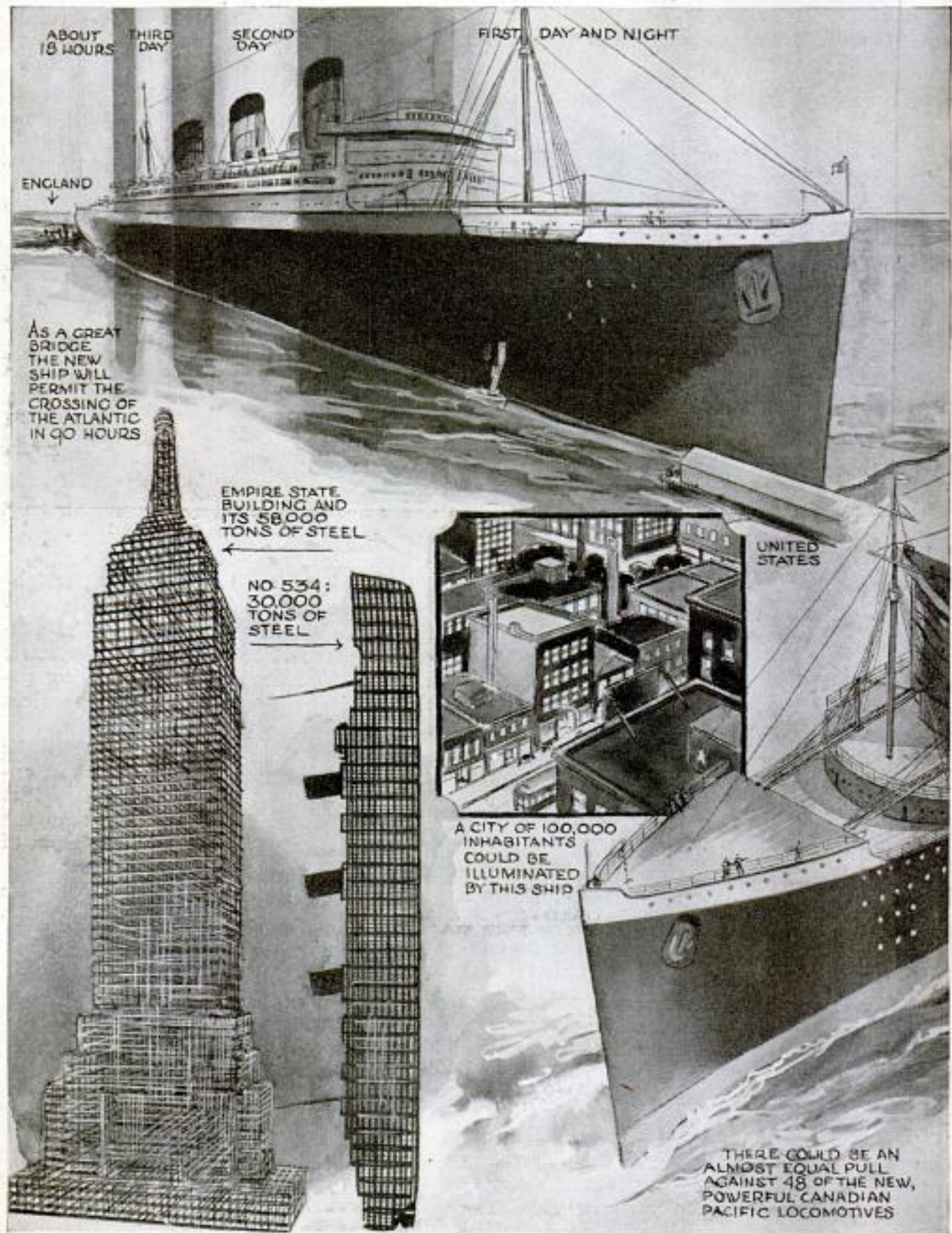
For the first time, a large ship will be equipped with graduated funnels. In exhaustive tank tests, it was discovered that if the forward funnel is higher than the midship and stern funnels, a minimum of smoke and soot will annoy passengers.

To give greater speed and to minimize rolling, the architects have specified bulbous bows, as with the "Bremen" and other recent superships. The "534" is as gracefully streamlined as a racing airplane. Nine decks will rise above the waterline. The width and length of the promenades will surpass those of any other ship.

Modernism will be stressed in both exterior and interior designs, and especially is this true of the four broad stern decks which provide areas sufficient for full-size tennis courts and a miniature golf course. The commodious decks will also have shaded gardens, palm courts and swimming pools. A blaze of green foliage will

a1895  
38

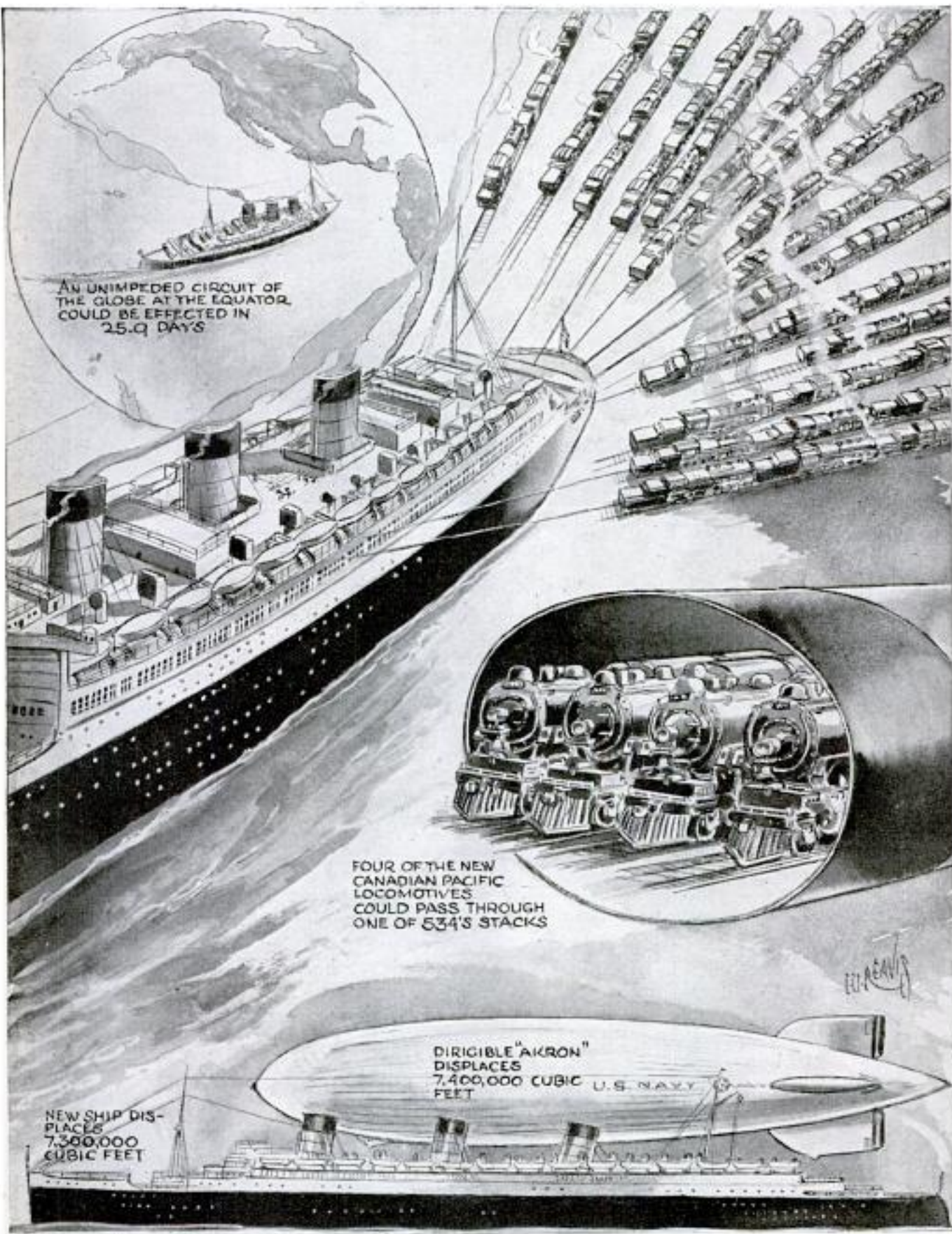
# Thirty-Million-Dollar Super Liner Is Built



Top, Diagram Showing How the World's Largest Liner Will Virtually Form a Bridge across the Atlantic; Below, Comparison of Steel in Empire State Building and in the "534"

9 1895

# To Cross Atlantic Ocean in Ninety Hours



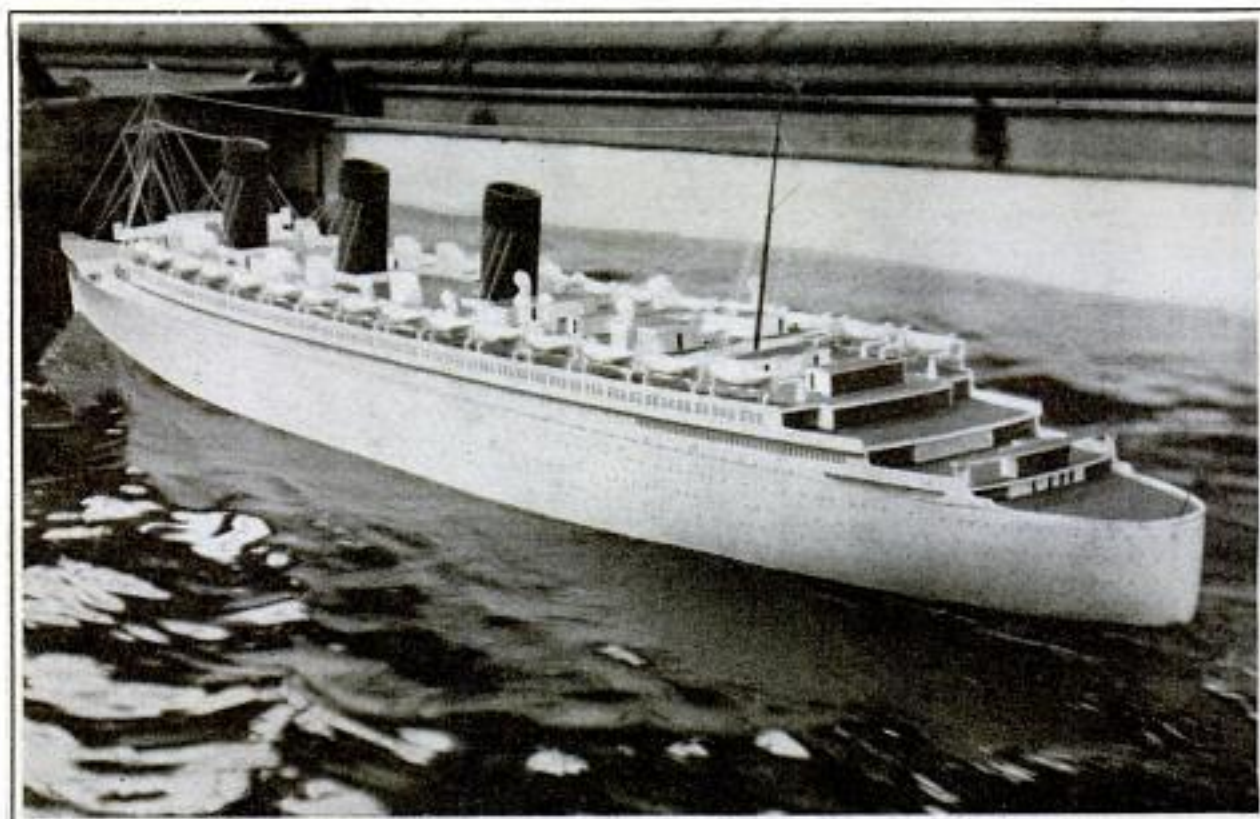
AN UNIMPEDED CIRCUIT OF THE GLOBE AT THE EQUATOR, COULD BE EFFECTED IN 25.9 DAYS

FOUR OF THE NEW CANADIAN PACIFIC LOCOMOTIVES COULD PASS THROUGH ONE OF 534'S STACKS

NEW SHIP DISPLACES 7,300,000 CUBIC FEET

DIRIGIBLE "AKRON" DISPLACES 7,400,000 CUBIC FEET U.S. NAVY

The "534" Will Develop as Much Power as Forty-Eight Locomotives, and Four Engines Could Pass Abreast through a Stack; Below, Displacement of "Akron" and Liner Compared



Stern View of the Model of the World's Biggest Boat; Note the Terraced Arrangement of the Decks; This Boat's Commodious Cabins Will Care for 5,000 Passengers with Ease

relieve the great expanse of white in the superstructure, and in the effort to achieve matchless comfort and luxury, it is planned to stabilize this colossus against the waves. Gyro apparatus, similar to that now being installed in the Lloyd Sabaudo line's "Conte di Savoia," is under consideration for the "534." Stabilizers for a 73,000-ton vessel would cost approximately \$1,500,000 and would have rotors weighing more than 100 tons each.

The reality of a 1,000-foot ship has a far-reaching influence on world shipping. In the first place, very few harbors can accommodate a monster of such size. The port of New York has begun construction of four immense piers to cost \$75,000,000. A new graving dock for the "534" is under construction at Southampton at a cost of \$10,000,000. The "534's" initial cost of \$30,000,000 is but a fraction of the fabulous outlay necessary for her efficient operation. It is safe to say that \$125,000,000 must be spent by all agencies concerned before the "534" earns one cent for her owners.

Launching a 73,000-ton hulk is a major feat in engineering, for as yet shipbuilders have never attempted a 1,000-foot ship. The River Clyde is a tidal stream; there-

fore, the "534" must be launched at high tide. She is being built almost on the very spot where the "Aquitania" was launched in 1914, but that ship was only 868 feet long. Although the "534" will plunge into the stream at an angle, the builders find it necessary to safeguard their creation by widening the River Clyde at a cost of \$400,000.

In selecting geared turbines for the "534," the Cunard engineers profited by the example of the "Bremen" and "Europa"; but the French line has chosen the turbo-electric drive for its 70,000-ton supership now under construction at Saint Nazaire.

About October, 1933, thousands will line the banks of the Clyde as the giant Cunarder slips down the river with her crew of 800 at their posts. Her decks will have standing room for 50,000 people, and her anchors will weigh more than Columbus' flagship.

What her name will be is still unknown. The three most popular ones under consideration are Cunardia, Victoria and Britannia. The last is most popular, for with this great mystery ship, England hopes to prove that she still rules the waves.

An timber lands of  
Lyon Lumber Co  
Livingston Parish La

Canal Band  
Hatcher Re 113 7  
New Orleans La

**BIG CYPRESS TREE  
RECALLS DAWN  
OF HISTORY**

a 2195

A giant cypress, 1,283 years old, was cut recently in Louisiana, and the six huge logs sawed from the great trunk yielded 14,162 feet of lumber. In determining the age of the tree, the rings on the butt were counted. Experts calculated the tree grew one inch for every twenty-eight years of its life. Amazing as the longevity of this cypress may be, it is still more startling to recall the momentous drama that was enacted on the world's stage during its life, for that tree was growing in then unknown Louisiana 700 to 800 years before Columbus discovered America. Contemporary with the first several centuries of this great tree's existence, Alfred the Great, successor to Egbert as king of England, made a treaty with the Danes after their conquests on British soil; the Vikings, most daring seamen of the age, were pushing the prows of their primitive vessels against the ice-bound shores of Greenland, and the crusades fired Europe to war. Meanwhile, this tree grew apace and upon the waters of contiguous bayous Indians paddled birch-bark canoes, seeing not on the horizon the menacing shadows of the French, the Spanish, the English and the American explorers, nor dreaming that the ruthless invasions of these peoples were destined to drive the Red Man, homeless, from his happy hunting ground.



Jim Koerner

Some of the Toy Windmills Which This Man Started Building as a Hobby and Which Now Make a Living for Him

**TOY WINDMILLS MAKE LIVING  
FOR MAN WITH HOBBY**

u 2120

One California man makes a good living by building toy windmills for children. Faced with a breakdown in health, this man moved to a California beach and began looking around for something to occupy his time. He started building the

windmills for near-by children, but the toys became so popular that he soon had a long line of tourists stopping at his door to see the display of toys and garden sticks, and he now sells more than 7,000 of them each month.

a 2094

**NEON TURNING SIGNAL ON AUTO  
WARNS DRIVERS BEHIND**

Warning signals illuminated by neon tubes now are being manufactured to give drivers behind notice that the car ahead will turn left or right at the next corner,



or will slow down or stop. Two semaphore arms are affixed to the rear of the car, hanging in slots when not in use. When a switch is moved on the steering wheel, the right or left arm, or both, come up into position.

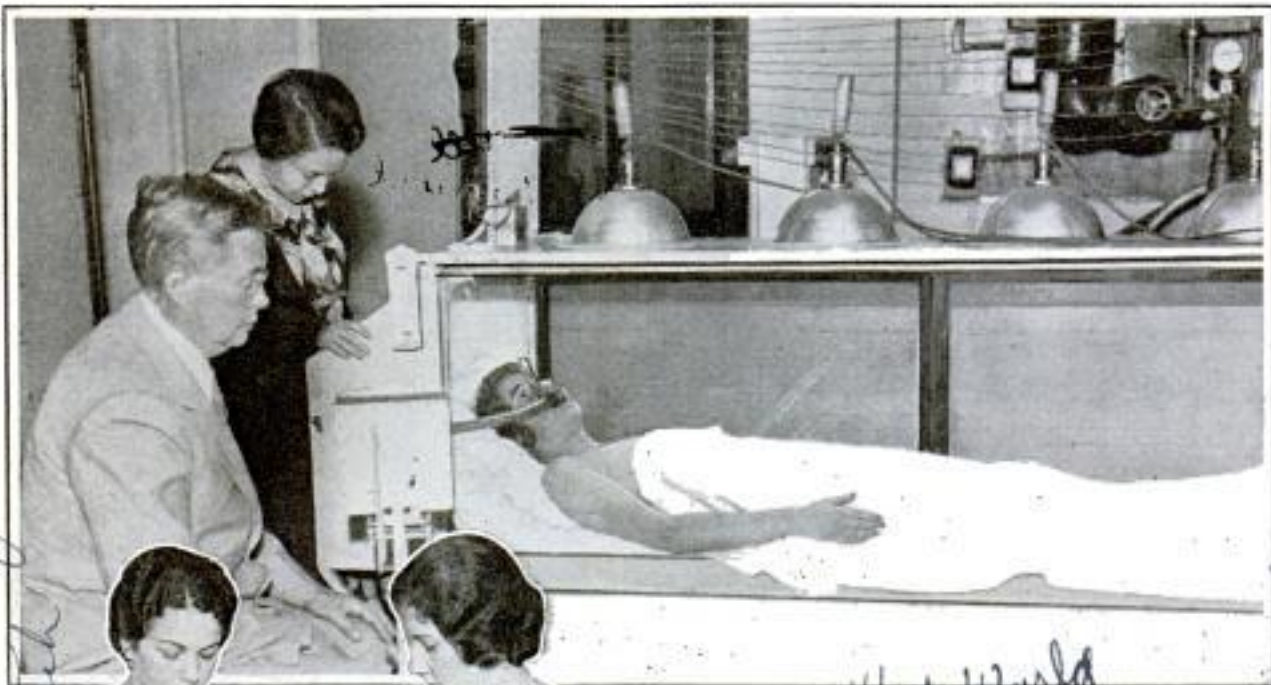
Marvin Hirschaw  
1348 E. 4th Ave Chicago

Jim Koerner,  
Laguna Beach  
Calif

Mr Melas Hanwerk,  
Berlin Germany  
no U S agent

Tests Show How Air Conditions Affect You

Dr. E. Vernon Hill at Physiological  
 Laboratory financed by Holland Furnace  
 Co., Holland Mich



Above, Making Test to Establish Best Air Conditions for Sleep; Below, Subject Taking Dexterity Test

Best temperatures for restful sleep, light work, office work or assembling, and for hard labor, are being studied in a laboratory where subjects perform various tasks under different air conditions. In a dexterity test, for instance, the subject is given marbles, buttons, jacks, dice and corks and asked to place each in certain slots in a box. For this test an even temperature of fifty degrees is maintained in a room, and it has been found that, when in the nude, the subject performs this test in about two and one-half minutes, but when fully clothed a period of from two minutes and fifty seconds to three and one-half minutes is required. The re-

search revealed that the best temperature for sleep is between eighty and eighty-five degrees when the sleeper is in the nude. This is much higher than generally supposed suitable for comfort. In the hard-work test, the subject pedals a bicycle and the energy expended is measured on a dial, the test being made under varying air conditions.

a2137

**MERCURY-VAPOR STEAM PLANT TO SUPPLY CHEAP POWER**

In the plant of the General Electric company at Schenectady, the largest mercury-vapor power installation ever attempted is being constructed, and is expected to have a thermal efficiency of eighty-five per cent as compared with twenty-seven per cent, the highest efficiency ever attained with coal-firing power. This plant will mark the first comprehensive attempt to co-ordinate the steam and electrical requirements of a manufacturer with the production and sale of power on the part of an electric utility. A power company will sell both electric power and steam to the manufacturing concern, the power being obtained from their system and the steam from this plant. To reduce building and structure costs, amounting to between twenty-five and thirty per cent of the total investment

*N.Y. Herald Tribune.*  
 10/18/31 Copyrighted material

A 2070

in steam power plants, the apparatus is being located outdoors. There are two stacks. The mercury vapor from its own boiler, which is served by one of the stacks, flows through the mercury turbine where it generates 20,000 kilowatts of electrical energy. From there, the mercury vapor is brought to the condenser boilers where it produces 300,000 pounds of steam an hour upon condensation. An ordinary steam turbine will produce 6,000 kilowatts of power in addition. One-half of the manufacturing requirements, which are 300,000 pounds of steam an hour at 200 pounds' pressure, will be produced by the mercury boiler. The other half will be furnished by the steam boiler.



Converter Connected to Auto Battery Operates Household Appliances on Six-Volt Power

**AUTO BATTERY CAN COOK MEAL WITH AID OF CONVERTER**

Six-volt power from an ordinary automobile storage battery can be made to operate any household appliance using 110-volt alternating current, by means of a power converter invented by a San Francisco man and called the "dynatropo." Radio sets, coffee percolators, toasters, etc., can be run from the car battery.

**"APARTMENTS" FOUND IN CAVES USED BY ARIZONA INDIANS**

Transient quarters, or "apartments," used by Pueblo Indians of the thirteenth century, have been found in Arizona caves by a representative of the National Museum. Smoke from camp fires still stains the cavern roofs. That the Pueblos did not set up permanent housekeeping within the caves is deduced from the absence of refuse heaps. The time of occupancy is determined by the type of pottery which the people used. The fragments of dishes and jars resemble those of another Pueblo settlement which has been dated by the famous tree-ring calendar evolved for southwestern archaeology.

**PROJECTOR FOR HOME TALKIES CUTS DOWN DISTORTION**

Using a pick-up which reproduces sound on the same principle as that employed in the original recording, a home talking projector, without the usual distortion of sound at the beginning and end of the records, has been placed on the market. A vertical tonearm, which serves to keep the needle in relatively the same position throughout the record, is the means of eliminating distortion. The projector is inclosed in a case which reduces the noise of motor and film movement. During operation, the case is closed and the picture is projected through a slot in front. The turntable is attached to a shaft which protrudes through an opening in the side of the case. A pilot light aids in setting the reproducing needle.



Vertical Tone-arm Reduces Distortion in Home Projector

Wholesale Div. National Theatre Supply Co. 825 Walnut Chicago

approx. 7amps. size 4x4 1/2 amp. \$39.50 Current approx.

see Nov. 1932 San Francisco 801 2607 Arnold 1 Kohler & Charles

Hutch. - Baird Corp. Ltd. San Francisco Calif. (F-F) Hutchings

Vector Animatograph Corp. 4400 1/2 Ave. Haverport, Cal. 40

Neil M. Judd 10/17/31

# PEACE-TIME

"UNDER COVER OF DARKNESS, THE BLANK OIL COMPANY DUMPED THIRTY SACKS OF CEMENT."

SO read a coded message recently received by a Los Angeles oil company, from one of the men of a little known group which forms an espionage system nearly as secretive and almost as determined as any wartime intelligence department. Their operations bordering closely on the illicit, these men find excitement and adventure in a pursuit sanctioned by many of the larger oil companies. Oil scouts, they are called. One to

On the other hand, because the first company to find out that a given piece of ground is oil-bearing is the one to reap the harvest of black gold, every effort is made to obtain information about the progress of a competitor's wildcat well. It is the duty of the oil scout to obtain this information at any cost.

The message above was such a piece of information sent out by one of the almost ever-present scouts. The Blank company thought, by cementing their well at night, they would be able to prevent competitors from knowing they



ten or more are kept busy all the time, by each employer, spying into the secrets of competitors' closely guarded wildcat wells.

Because "wildcatting," or the testing of unproved territory, is one of the most expensive operations of the oil companies, they make every effort to guard their information as closely as possible.



Oil Scout Spying on Progress of Mysterious Wildcat Well, and Below, Checking Soil Far below Surface



# SPIES!

were making a water shut-off, preparatory to bringing in the well.

Getting core samples is the aim of every scout. These are samples of material taken at intervals from the bottom of the well to furnish information about the geological strata through which the well is drilling. Because cores furnish the most conclusive evidence regarding the well, they are highly prized by the scout and closely guarded by the crew.

"Often we can buy our information," said a veteran oil scout. "But sometimes we have to resort to strategy."



Largest and Smallest Core Samples; the Samples Are Sorted in Trays as Shown on Knee



"I worked three weeks trying to scout a well in Culver City, without getting closer than the road, when a friend suggested we try his airplane.

"We took off and flew over the well at a low altitude, but I couldn't see anything more than I could from the ground. But something went wrong over the well, and we landed in a pasture next to it.

"The whole crew of the well rushed out to see what was the matter. We had struck a rock or something when we landed and had broken a wheel. With the help of my partner, the oil-well crew took time enough with the post mortem they held over the ship to let me look through the drilling log of the well, fill my pockets with core samples and make my get-away."

Strategy marks most of the work of the oil scout. Imagine the discomfiture of a driller who found one morning that he

Photos Secretly Taken in Patent Office Are Destroyed by X-Rays, Unknown to Spy, as He Leaves

a 1868



Scout Examining Cores in Sample Storage House; Cross Section of Core Barrel, Right



had not only allowed a scout to get away with core samples, but had actually carried them to the car!

The scout had been trying for two months to get samples from that well. He had obtained bits of information from time to time, but no core samples. He decided on a frontal attack.

At 8:30 one evening he drove rapidly up to the rig, parked and jumped quickly out of his car. Reaching for a notebook and pencil, he stepped confidently up onto the rig floor and started briskly toward the belt house, where he knew the cores were stored. Every movement showed he was in a hurry. The driller followed him.

"Haven't you got a light here, Doc?" asked the scout.

While the obliging driller got a flashlight, the scout filled his pockets with samples grabbed in the dark, so that he would have something no matter when his identity was discovered.

Shortly the driller returned, and held the light while the scout read the tags and selected the samples he wanted to take with him.

"Haven't you got a rig ax or something I can break these up with?" the scout asked the driller. And the unsuspecting driller brought a large hammer with an apologetic, "Ain't got any rig ax. Will

this do?" With every minute increasing his risk of being discovered, this daring scout worked calmly on until he had laid aside all the samples he wanted. Then he loaded the driller's arms full, picked up the rest himself, and together the two men hurried out to the waiting car and dropped the samples into the back.

"See you in the morning, Doc," the scout said, as he drove away with the much-sought samples. "I don't know yet who it was I impersonated," the scout said, "but it must have been somebody who draws some water in that company."

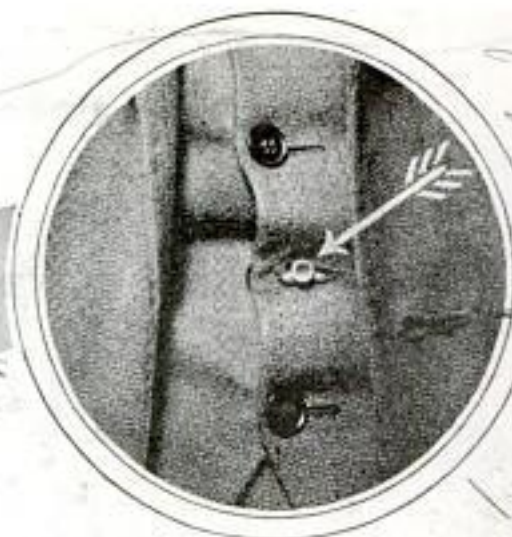
But not always does the scout get away so cleanly. Sometimes quick thinking alone saves him.

A scout was collecting information from a well in California recently, when the driller became suspicious of the scout's questions. The driller, wise in the ways of scouts, said nothing, however, but kept his eye more closely on the oil spy. Finally the driller saw him vanish into the belt house, where the cores were kept.

The driller tipped the wink to one of his helpers, who looked into the belt house. Sure enough, there was the unsuspecting scout breaking off pieces of the cores and putting them into his pockets. The men let the scout get almost to the edge of the derrick floor before someone shouted, "Scout! Throw him in the sump hole!" "When they found I was going to be hard to catch," said the scout, "some-one grabbed the water hose. You know, that's the hose they wash down the derrick floor with. It provides high-pressure water directly from the pumps.

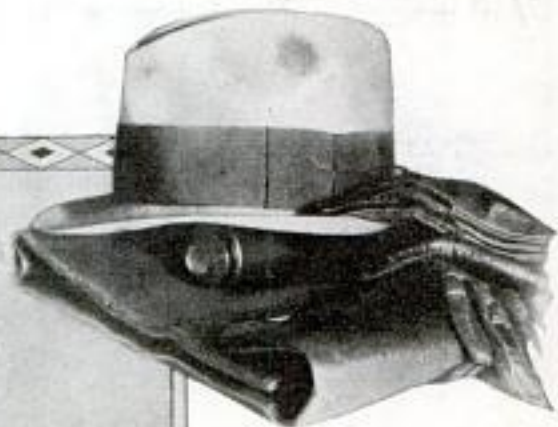
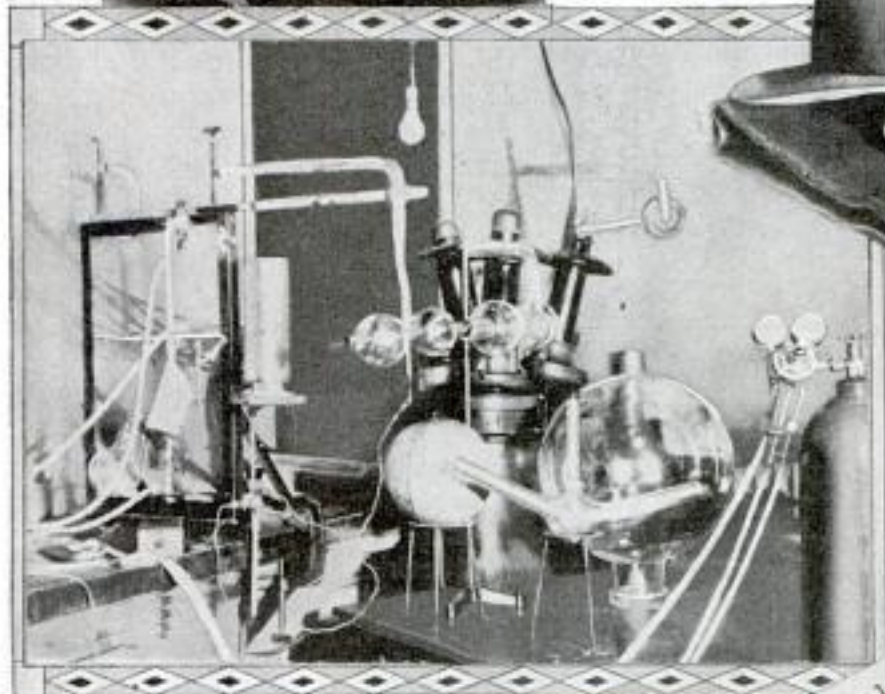
"Just as I thought I was in for a bad beating, somebody came in behind me. I recognized him as the general superintendent of the company whose rig I was on.

"I grabbed the superintendent, thrust him in front of me, holding his arms pinioned tightly to his sides, and backed as quickly as I could to the edge of the derrick. I let loose of the kicking, squirming super—and he was pretty mad, I tell you—jumped off the derrick floor and ran for my car."



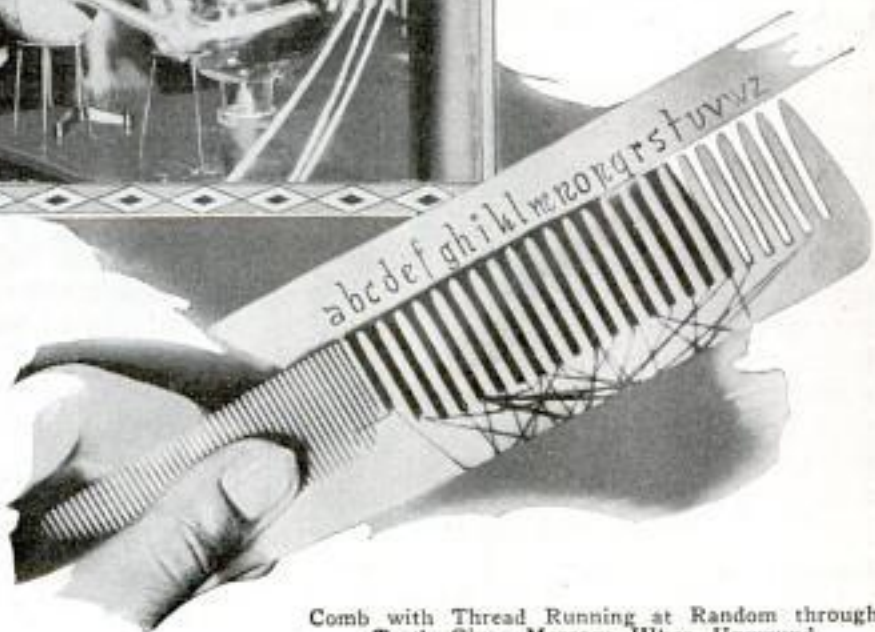
*Suggest watch  
camera. sold by Central  
Camera Co. 230 St. Wash. Chas.*

Detective at Work, Left, Deciphering a Cryptographic Message; Above, Lens of Tiny Camera Projecting through Buttonhole of Spy's Vest



The Picture on the Left Was Taken with a Miniature Camera Such as the One Shown Above, Placed Inconspicuously between Hat and Brief Case; the Apparatus Was One Used in Experiments with Atoms

One oil scout was talking to the men on a well when the mud in the well started overflowing the top of the casing. Instantly all was feverish activity. A couple of men rushed to the mud-mixing pit and started madly shoveling weighting material into the mud. The driller opened up the



Comb with Thread Running at Random through Teeth Gives Message When Unwound



Drying Cores from Well Bottom, at Top; Preparing to Stop a Blowout of Gas, Important News for Scout, Bottom

ran a few yards from the rig and stood staring fascinatedly at that rising drill pipe, while the workmen scurried away like rabbits from the doomed well. I watched the pipe rising slowly, inexorably up out of the hole, conscious of the millions of pounds of gas pressure that was pushing those hundreds of tons of steel up into the air.

"Finally the rising column of pipe started to bend over. More and more it bent and always more was coming up out of the well. I heard a rending crash as wood splintered and guy wires snapped, and the derrick fell. But still the drill pipe came up out of the hole. Hundreds of feet of it. It looped over and writhed on the ground like a great snake. A steel snake eight inches through and seemingly unending!"

A few minutes later, where before had been a mysterious wildcat well, there yawned a gaping crater sixty feet in diameter, with a black geyser in the center shooting a hundred feet in the air, and for weeks throwing mud, rocks and debris hundreds of yards.

"A stand of that drill pipe landed not more than ten feet from me, and a piece of rock went through the top of my car," the scout said. "That was the closest shave I ever had."

"I was passing a well near Long Beach, Calif., about eleven o'clock one cold, foggy night when I noticed quite unusual activity at the well. Several trucks were

pumps to their full capacity in a frenzied effort to load the well enough to hold back the gas pressure.

The scout was getting proof positive that the well was drilling in oil sand because nothing but gas pressure would force the mud over the top of the casing.

"The flow of mud soon subsided," the scout said, "and I was just on the point of leaving to report the gas pressure to my chief, when the mud suddenly shot up several feet into the air. It formed a miniature geyser for a minute or so before it quieted down again. In a short time the well belched forth a great spout of oily mud. This time it was accompanied by an audible 'glug,' and the drill pipe started moving slowly upward. It looked as if it would be a blowout.

"'Run for your lives!' the driller cried, as he hastily shut down the engines. I

a 278 5  
 U.S. Julius S. Madaras Pres. Madaras  
 Rotor Paper Co, 2146

parked near the well, others approaching it, and there were more men around the well than usual.

"I drove on over the brow of the hill and, after parking my car out of sight, walked by a circuitous route back to a vantage point just above the well. In a few minutes, I saw that they were getting ready to cement the well in preparation for bringing it in. From the number of trucks, I could see it was going to be a big job. We didn't think they were anywhere near the oil sand yet, so I couldn't see why they were going to do it.

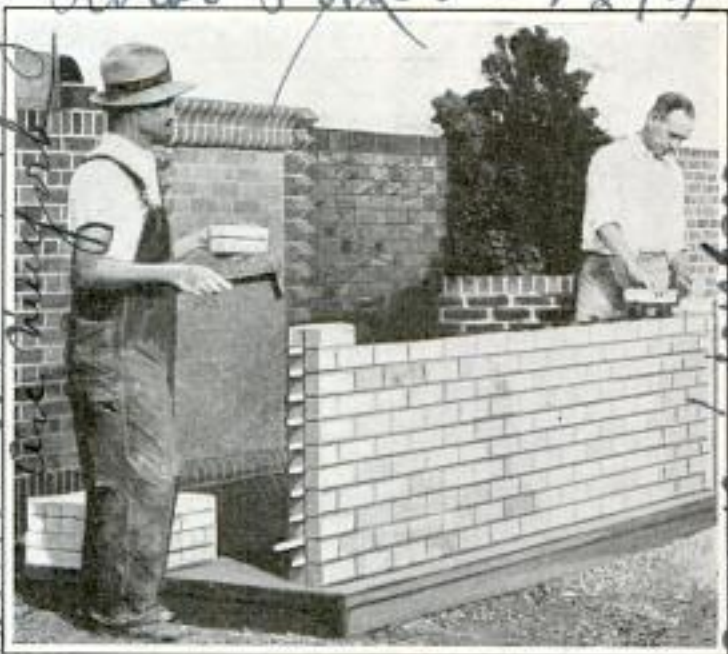
"Wrapping my overcoat around my shoulders, I sat on a rock prepared to make a night of it. About midnight, they started dumping cement. I started checking the sacks as they were dumped. By the time the sun was up, hardly a sign of their nocturnal cement job was left.

"As soon as I thought I could find a place open, I hurried away to rout my chief out of bed by telephone.

"The Blank well cemented in last night," I said, and gave him the details. "I'm going home and get some sleep."

"No, you're not!" the chief said. "You're going back and sit on that same rock and glue your eyes on that rig until I can get another scout down there to relieve you."

"So it goes," he said. "Sometimes hard, sometimes easy; sometimes exciting, sometimes monotonous; but one thing oil scouting always is—interesting."



Joins between Bricks Are Sealed by Inserting Alloy Strips, Like the One in Hand of Workman at the Left

are lighter, have greater strength, are more resistant to fire, have radio shielding qualities, and are air-tight, therefore saving on insulating and heating.

**TRAILER IS HOOKED TO BICYCLE FOR CARRYING PARCELS**

Adaptation of the trailer to the bicycle has been accomplished by construction of a two-wheeled cart which hooks on, yet leaves room enough for easy pivoting and turning of the bicycle. The trailer is built in the form of a parcel container, the covered box being set across two rubber-tired wheels.



Turning and Pivoting Bicycle with Attached Trailer Is Easy, as the Girl Rider Demonstrates

Harvey Wiley Collett, exhibited at the 1927 World's Fair

**SEALED JOINTS IN BRICK WALL KEEP OUT MOISTURE**

Mechanical sealing of mortar joints with strips of non-corrosive alloy is solving the builder's problem of how to make brick buildings water-tight. For many years, moisture has been creeping into great skyscrapers through the mortar joints between the brick, and expensive water-proofing repairs were necessary periodically. But none of these repairs were permanent. By the new process, strips of the alloy are sunk inside as the wall is laid, sealing the joints permanently. In addition to being water-tight, these joints

demanded under auspices of Harvey Wiley Collett, 130 W. 42nd St. New York

Somebody to buy it

Patented Dec. 1, 1914

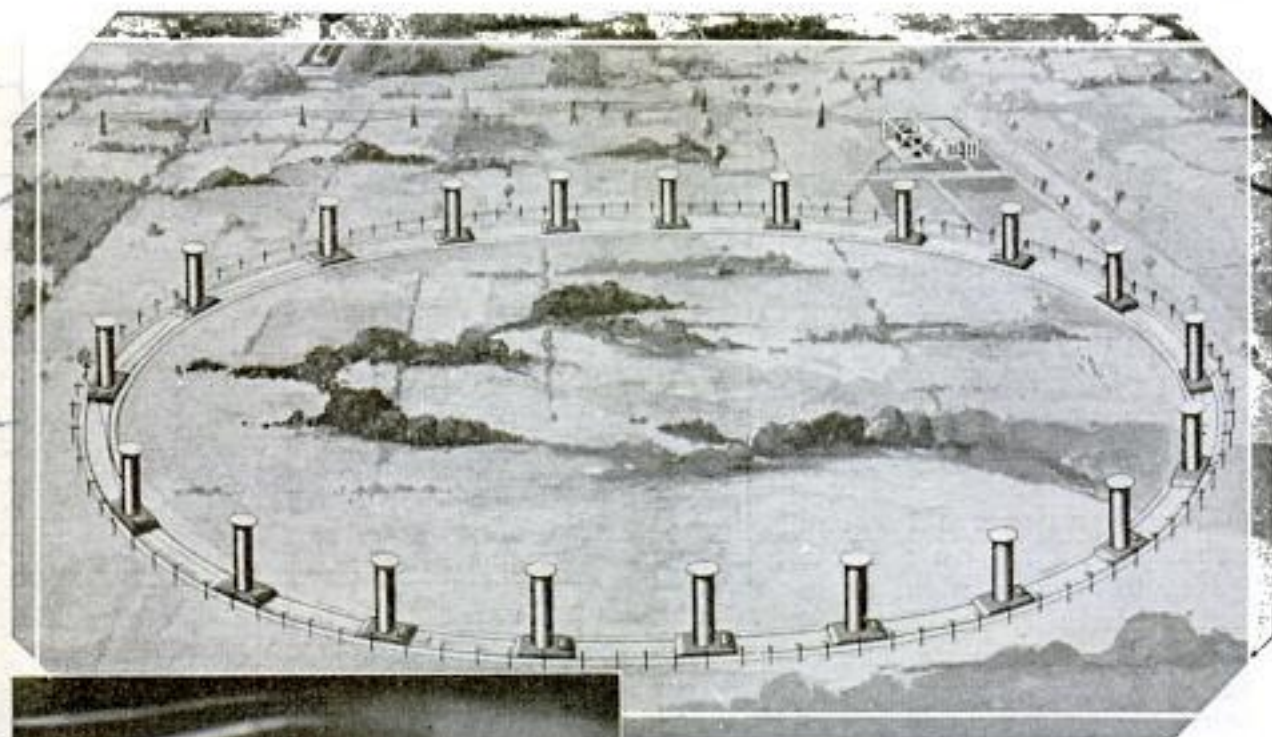
no other data

exhibited in London New York

clw. Julius W. Madaras, Pres  
Madaras Rotor Power Co.

2146 POPULAR MECHANICS

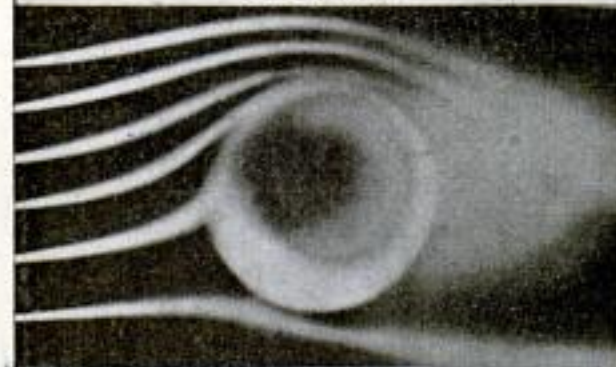
2 19<sup>50</sup> Penobscot Island, Detroit Mich  
Wind-Driven Electric Power Plant on Wheels



Top, Drawing of Wind-Driven Electric Power Plant;  
Left, Diagram Showing How Rotors Are Turned



600 R.P.M.



1200 R.P.M.



2400 R.P.M.

Wind-driven rotors, mounted on flat cars running on a circular track, are seen as a source of cheap electric power. Such an installation is now being built by eastern utility companies. The rotors are comparable to big sails mounted on wheels to which generators are geared like the motors of trolley cars. The streamlined flat cars would be forty feet long and thirty-six feet wide. For a twenty-unit plant, these cars, each carrying an aluminum-sheathed cylinder ninety feet high, with a rotor diameter of 22.2 feet, would run on a circular track 3,000 feet in diameter, the cars being joined by cables, with a distance between cars of 262 feet. It has been estimated one such forty-unit plant could generate 40,000 kilowatts of power. When the wind pushes the cars ahead, they rotate the generators and produce an output of power. A motor which "bleeds" the generator rotates the cylinder, rotation being reversed at the halfway point by vanes which automatically change the direction of whirling. Thus the tractive force of half the cylinders might be exerted toward the west, for example, while the others are pushing east. The cars are propelled by an application of the Magnus effect at right angles to the direction of the wind. The

see Dec. 1931 989

a 2093

Truman

Magnus effect briefly means that if pressure on one side of a cylinder remains normal, or is somewhat increased, while at the same time the pressure on the other side is reduced, the cylinder will tend to move in the direction of the lowered pressure. Normal air pressure is 2,121 pounds per square foot and by reducing the atmospheric pressure on one side of a cylinder of 2,000-feet projected area by only two per cent, a force of nearly 85,000 pounds is created to push the cylinder toward the area of lower pressure. That is what the rotor is said to do. By revolving, it creates a relatively slight difference in pressure on two sides of a cylinder, yet such a pressure is so large in terms of usable energy that it will propel cars joined in a train. The same power might be obtained by mounting giant sails on flat cars but the sails would require a spread so large as to make them impracticable, and a large crew would be needed to manipulate them at each half turn. The cost of the first unit is estimated at \$100,000, but the cost of later ones is expected to be less than half that amount. Owing to unreliability of the wind, such a plant, if used for public-utility purposes, would have to be operated in conjunction with others run by the older methods, but it is claimed that a wind velocity of only six miles an hour would be sufficient to turn the rotors.

Chicago Refrigerator Accessories Co.  
612 N. Michigan Ave.  
Chicago, Ill.

**ICE-BOX DEODORIZER PREVENTS CONTAMINATED FOODS**



Ice-box odors are prevented or neutralized by a refrigerator deodorizer which helps to keep food pure and wholesome by keeping the odor of one article from contaminating others. By using the air purifier, onions, cheese, fish, and other such foods, can be placed in the ice box without fear that their flavor will taint milk and butter. The deodorant is contained in a can with a perforated top and needs no attention.

Block Laboratories,  
612 N. Michigan  
Chicago



How the Posture Corrector Is Installed in Schools beneath Pupils' Seats, Keeping Feet Straight

**STRAIN ON STUDENT REDUCED BY POSTURE CORRECTOR**

Correct posture by school children can be assured by apparatus now on the market. The device consists of a guard attached to the floor under the desk, into which the feet are thrust. There is room for the feet only in a side-by-side position, making it impossible for them to be crossed. It is said by the manufacturers that experiments prove crossing the feet or legs or "slouching" in the seat affects the spinal column. It is also declared that the corrector will relieve unnecessary strain of the leg and body muscles.

**PLANT PATENTS IN COLOR HELP DESCRIBE NEW VARIETIES**

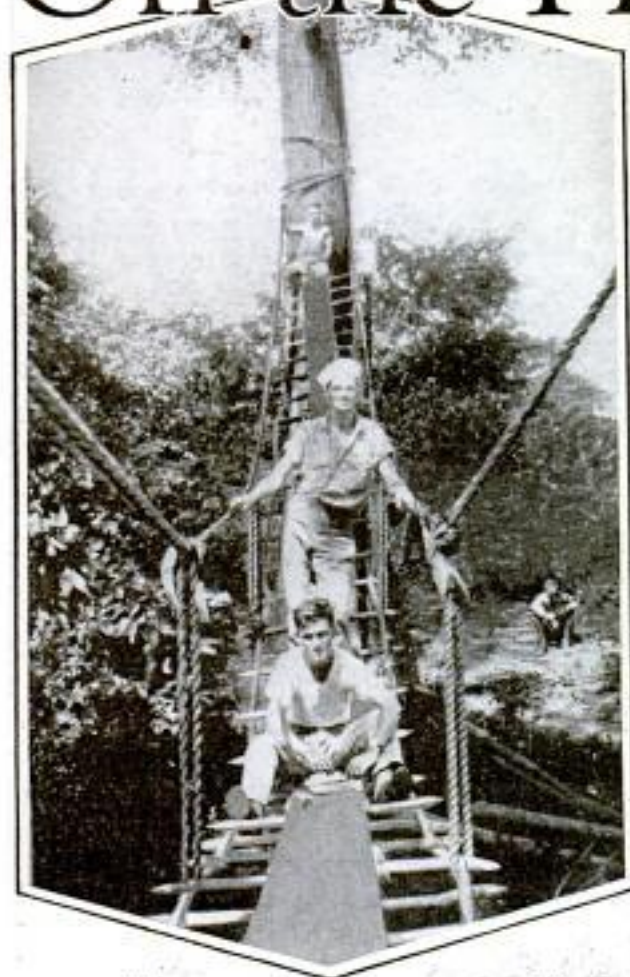
Bright colors are to enliven the monotony of black and white in the files of the patent office. Patents for plants, recently authorized by congress, will be issued in full color whenever the color is a part of the "invention" claimed by the horticulturist who has produced the new plant variety. The first two colored patents were for a white carnation with a delicate touch of yellow and for a rose of a deep pink hue.

Science Service  
Bulletin 10/30/31  
Copyrighted material

correct posture by Co. Rochester, N.Y.  
Letters sold.

a 2097 Cmt. John L Coontz  
714 Jefferson St. N.W.  
Washington D.C.

# On the TRAIL of the



**D**ODGING death at every step through reptile-infested swamps, across treacherous rivers and through almost impenetrable jungles teeming with poisonous insects and plants, 300 men of the army engineering corps, led by Lieut. Col. Dan I. Sultan, have just completed a two years' canal survey across Nicaragua.

The route surveyed was that used by the Forty-niners in their mad rush for California gold. It lies 173 miles across southern Nicaragua, part by river, part by lake and part by jungle.

Colonel Sultan is not sure just what his greatest problem of the survey was; whether it was bringing up supplies, moving equipment or fighting off jungle sickness, disease and accident. He carried with him medical, quartermaster, signal and finance detachments.

"Imagine," says he, "trying to make maps in a country where the rainfall is around 300 inches a year; of 'running a line' in a jungle so thick that you can't see ten feet in any direction; of 'running a



Suspension Bridge across River at Camp Deakne, Top; Sounding the San Juan River Was Accomplished by Hanging onto Ropes Stretched across the Stream



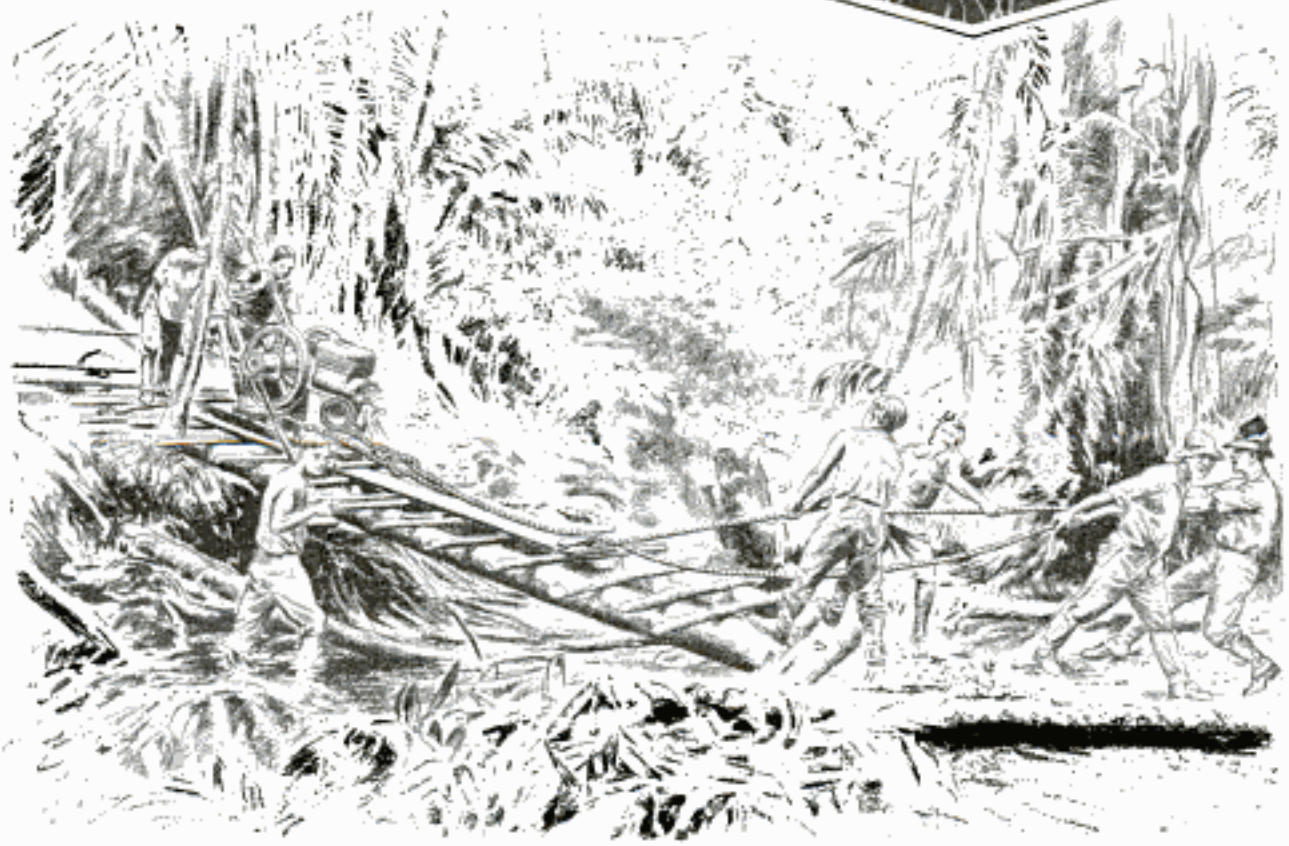
A 2097

# FORTY-NINERS

traverse' across interminable swamps where you often sink to your waist before you secure footing and sometimes to your neck and over your head; of sleeping with billions of mosquitoes, insects of every size, shape and bite by the millions, to say nothing of alligators, snakes, scorpions, vipers and poisonous small reptiles. If you can imagine all this, and men for 'pack mules' for virtually all your equipment, you will have a fair picture of some of the conditions under which the army personnel labored making its survey."

Bringing up supplies for the expedition, small as it was, constituted a major operation.

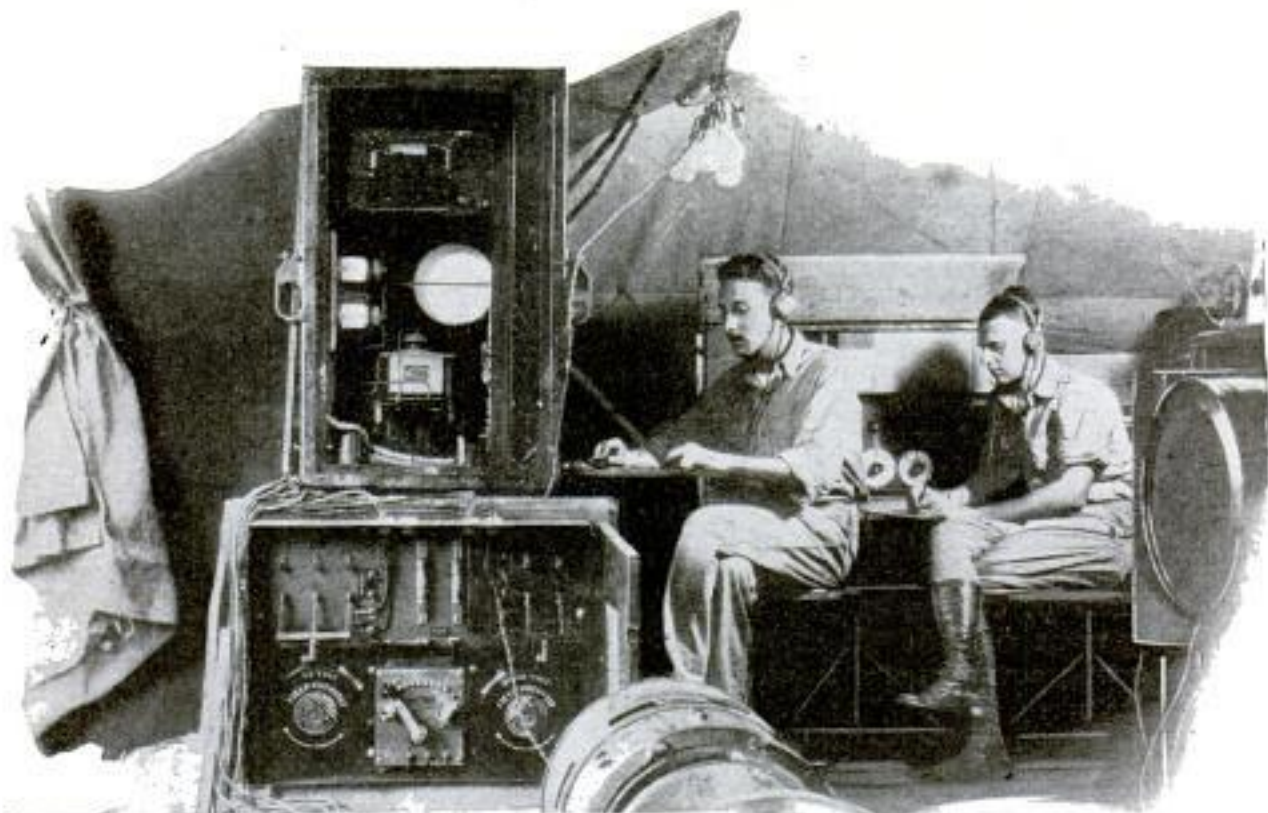
"Take, for instance," says Colonel Sultan, "the young lieutenant just out of West Point who had charge of the supply line from San Carlos to Greytown, the camps scattered along 125 miles of jungle river. No native ration of rice and beans for the American soldier; he must have the good old army ration and plenty of it. To get his supplies down to San Carlos



Box of Cores Obtained at Various Depths during Diamond Drilling of a Hole, Top; at Bottom Is Seen the Accepted Fashion of Moving Equipment through Jungle

For further information write { Col. Sultan  
I. Sultan,

Engineering Corps. U. S. A., Washington, D. C.



Signal Corps Radio Crew in Heart of Jungle, Top; Earth Auger Boring for Lock Site

from Granada, headquarters of the survey, the only transportation means available to the young officer was a sixty-year-old steamer that plied between the two towns once a week. Not so bad; for the steamer was ample for the rations. But the river!

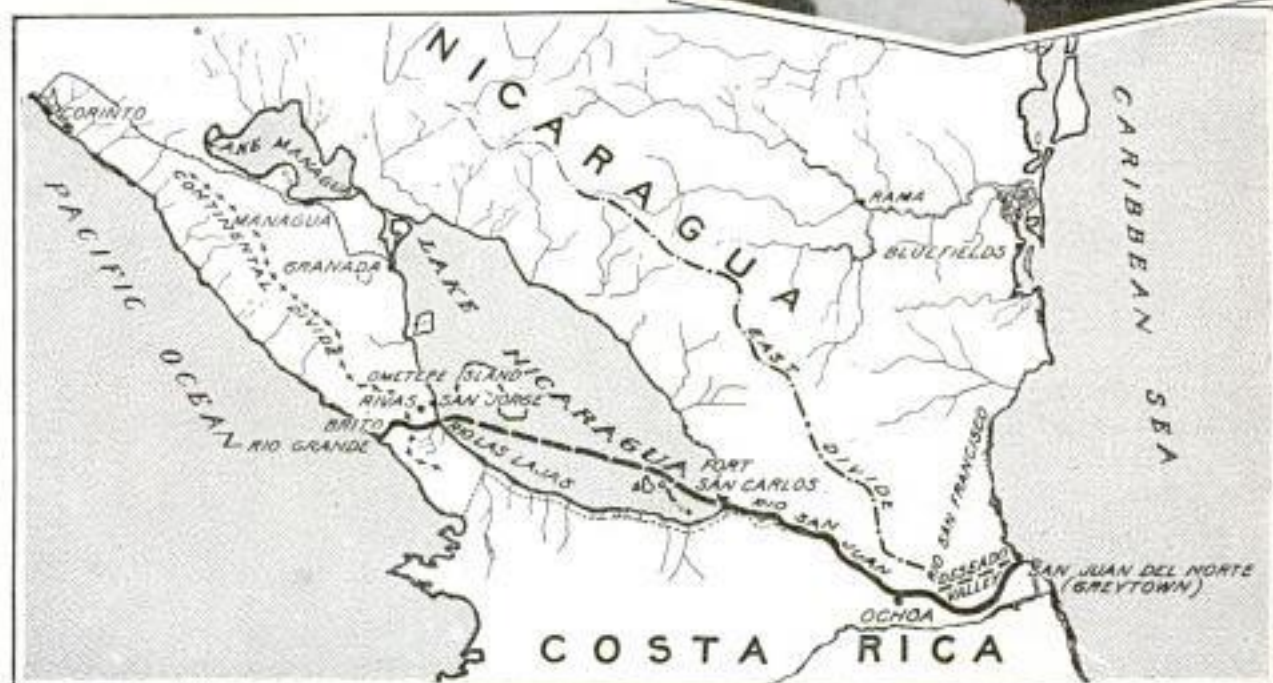
"The upper portion, near San Carlos, gave little trouble; the rest of it—rapids and sandbars. One series of five falls that I recall registers a drop of thirty-five feet with a six-foot drop in one place, in one-third of a mile. Within twenty miles of the mouth, sandbars choke the river, making it impossible to use transportation other than native dug-outs during the dry season. And, for the most part, these have to be dragged by hand through this fiery furnace. The young lieutenant had his troubles and plenty of them.

"Our equipment, drills, motors, radio, maps, instruments, cameras, etc., had to be moved 'man-pack' through the jungle. No roads or trails were there to guide us and each step had to be hewn.

All manner of jungle life teemed about us during these operations; brilliantly plumaged birds flitted through the dim forest aisles with strange, startled cries, and monkeys kept up an incessant chattering, while unknown creatures of every shape and hue stirred noiselessly in the gloomy depths.

"Field hospitals were maintained by the expedition, well equipped and screened. Sanitary regulations were strictly adhered to by the troops, which, coupled with the expert supervision of all medical and sanitary matter by the chief surgeon and his assistants, resulted in excellent health for the entire personnel of the survey."

A canal across Nicaragua is part of an age-old dream, dating from the voyages of Columbus, to find a natural short water passage from the Atlantic to the Pacific and the Far East. Failure to find the passage has led nations—England, France, Spain, Holland and the United States—to seek, from time to time, concessions looking toward a canal route across the narrow portions of the American hemi-



Taking a "Shot" in the Jungle, Top; Surveying under Difficulties on the Rio Nigro, Center, and Route of the Proposed Nicaragua Canal as Surveyed, Bottom



Leisure Time in Surveying Camp, Top, and Checking a Jungle Route on the Map

sphere. One such canal we have already built—the Panama canal.

But figures show today that the Panama canal is operating at from three-fourths to three-fifths of its present operating capacity. What then? It takes from ten to fifteen years to survey, plan and construct a canal. If it should be decided to enlarge the Panama canal it would take about the same length of time.

Uncle Sam, therefore, in sending his engineers into Nicaragua to survey a canal route, is taking time by the forelock. A few years more and it will be urgently

needed. In planning this survey, it was decided to follow the trail used by California gold seekers of '49. These adventurers went down the east coast of America to the mouth of the San Juan river, Nicaragua, thence up the river and across Lake Nicaragua to Granada. This brought them within seventeen miles of the Pacific coast, where, taking boat, they could proceed on their journey to the famed Eldorado.

The canal route surveyed by Colonel Sultan deviates here and there from the tortuous windings of the rivers followed by the Forty-niners. From the Atlantic-Caribbean side, the San Juan is left shortly above its mouth and a cut is made directly across country by way of Deseado valley. Here the river is picked up again and followed to San Carlos at its head on Lake Nicaragua. On the other side of the lake the canal will follow the Las Lajas river to the Rio Grande and the Rio Grande to the Pacific terminus at Brito. The canal will be more than three times as long as the Panama canal and will cost about twice as much. Natural waterways are responsible for this smaller proportional cost.

The expedition spent about eighteen months in mapping the territory through which the canal will run. Six months were spent in foundation drilling on projected lock sites. Colonel Sultan is of the opinion that the locks of the new canal should be larger than those of the Pan-

ama, which are 1,000 by 110 feet. The trend, he points out, favors larger ships.

The canal will shorten the distance to the west coast and Orient by about one day; it will develop commerce for the United States in Central America that the Panama canal cannot develop, and give added security to the United States.

a 2267

### STRAY DIAMONDS FOUND IN U. S. INDICATE RICH FIELD

Stray diamonds found in Michigan, Wisconsin and Illinois gravel deposits are believed to indicate the presence of a great diamond field to the north. Most of the gems are very small, although one weighing 21½ carats has been reported. Glaciers sweeping over the field and moving to the Great Lakes region are believed to have scattered the stones among the gravel in their wake. The search for the hidden field has been in vain, but scientists believe that, if it exists, it probably is located in the wilds of Canada.

a 2157

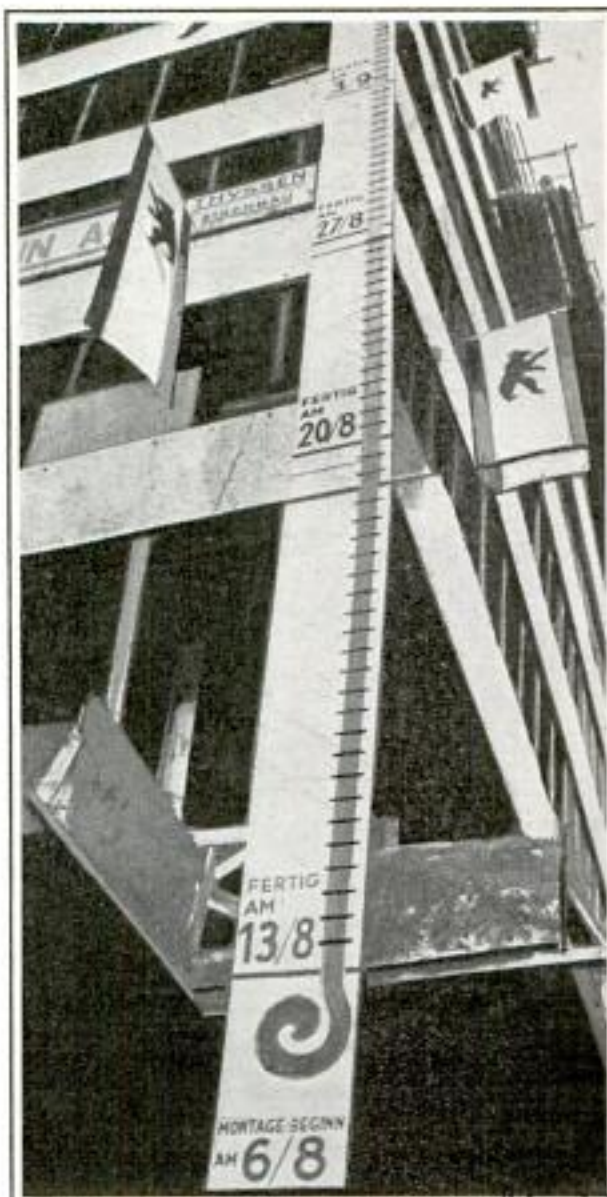
### PRUNE PICKER IMPROVES FRUIT BY ELIMINATING WRINKLES

Prunes without many wrinkles are made possible by a prune picker that resembles a lawn roller except that it is covered with little spikes to pick up the prunes and deposit them in a container at the rear. This eliminates much handling, which is said to cause the wrinkles.



Prune Picker Like Lawn Roller Which Spears the Fruit on Prongs as It Moves

Inv. James J. Liebfried  
Santa Cruz, Calif.



Building "Thermometer" on Skyscraper with Marks Showing How Fast Steel Framework Rose

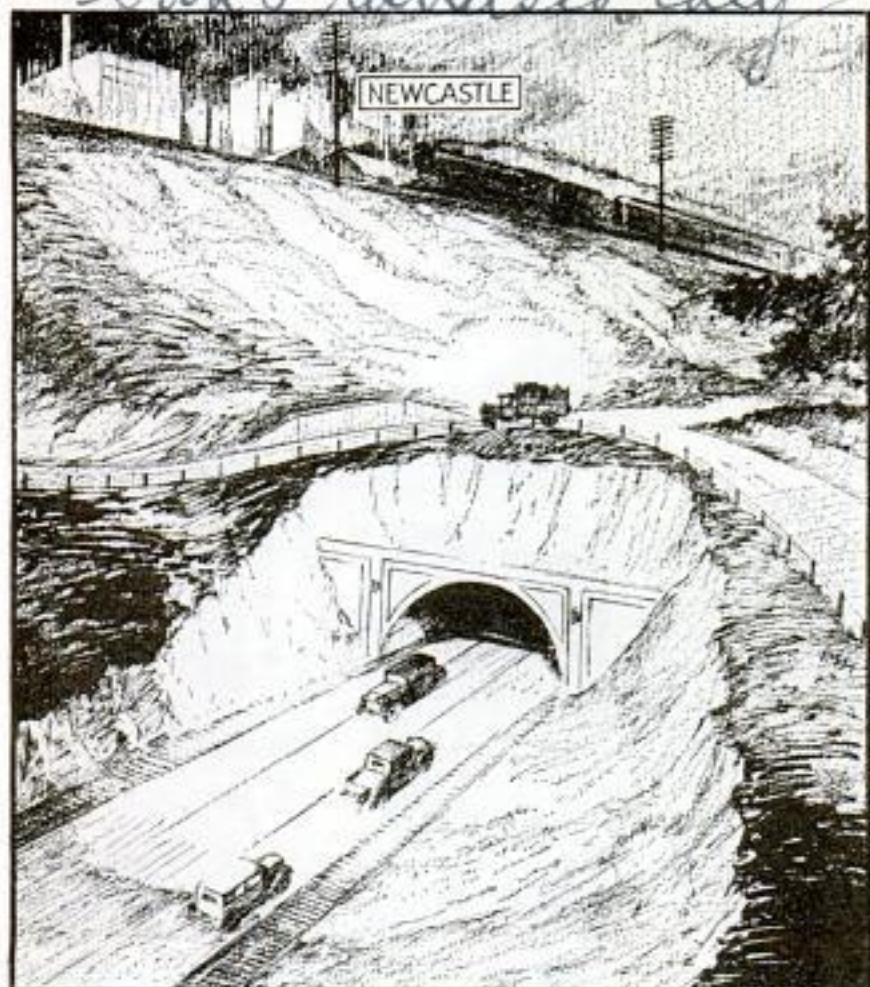
### GAUGE ON SKYSCRAPER SHOWS SPEED OF CONSTRUCTION

To show the speed with which steel workers were erecting the skeleton of a Berlin skyscraper, one contractor built a huge "thermometer" on the side of the structure, adding to the big gauge as the work progressed. At the bottom was recorded the date when work started, and as each story was completed, the date of finishing was placed on the gauge. The large indicator showed that the workmen built at the rate of about one story a week.

Those wishing further information on anything described in the editorial pages can obtain it by addressing Bureau of Information, Popular Mechanics Magazine.

a 2145 Cmt. Mrs Mary Isleson,  
 280 Chronicle Bldg  
 POPULAR MECHANICS  
 San Francisco Calif

58



Highway Tunnel Built under a Mountain Town in California; the Subway Aids in Eliminating Curves and Provides an Easy Grade

### HIGHWAY BUILT UNDER TOWN SOLVES TRAFFIC PROBLEM

To eliminate grades and dangerous curves, the little town of Newcastle, Calif., has a motor-traffic subway in the form of a tunnel built under a portion of the town, which is located on a mountainside. The tunnel also is eighty-six feet under a railroad proceeding along the mountain above the town. Plans for construction of the tunnel necessitated rebuilding the community water and sewer systems, moving several houses and relocating an irrigation canal. Engineers could find no other way to straighten the highway and ease the grades without virtually wiping out the town itself.

### SIGNS OF NOAH'S FLOOD FOUND IN MESOPOTAMIAN SANDS

Silt from the biblical flood of Noah's time has been taken from excavations in Mesopotamia by Dr. C. Leonard Woolley,

of Philadelphia, who claims that all signs indicate the flood was merely local and that it was only the overflow from the Euphrates river. Buildings, cooking utensils and other relics discovered in strata above and below the silt are of identical patterns, Doctor Woolley says, indicating that persons who fled to the hills from the flood later returned and resumed their old manner of living. Assyrian tablets telling the story of the great flood have been found in the same region.

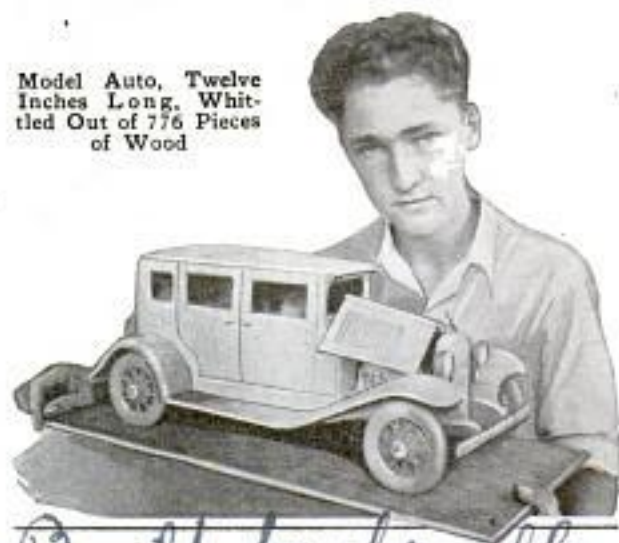
a 2186

### MODEL MOTOR CAR CARVED IN WOOD HAS ENGINE

Built to scale and complete in every detail, even to the tiny engine, a model auto has been carved of sugar pine, birch and balsam by a boy whittler

in California. The hood can be raised to show the engine, while the wheels are movable and delicately fashioned. The whittling occupied 212 hours, and altogether 776 pieces of wood were used. The model is twelve inches long, five and one-half inches high and weighs only four and one-half pounds.

Model Auto, Twelve Inches Long, Whittled Out of 776 Pieces of Wood



a 2251  
 University of Pennsylv.  
 vania, Pa

Built by Drville  
 Crest of Hermosa  
 Beach, Calif

*Am. Rev. Hugh J. O'Neilly  
and Mr. Arthur J. Harriman  
this A 2268 Catholic University  
Department of Biology  
50*

*11/3/31  
same same  
125  
Medan Plant  
125  
Medan Plant*

**FRUIT IS SAVED FROM MOLDING BY DETECTING SKIN CUTS**

Detection of skin scratches in oranges and other fruits susceptible to mold infection has been made possible by a process which will select only whole-skinned fruit for shipping. Mold always spreads through breaks in the peel of fruit, the inventors found by keeping more than 400 sound oranges in a damp, dark cellar for three months without losing one through moldiness, although diseased oranges were kept among them to provide sources of infection. A metallic salt that reacts with the tannin in the tissue just under the fruit skin is used, a microscopic scratch in the peel showing up as a black line, while sound fruit is left unmarked. All fruit is then washed to remove the salt, the sound being kept for shipping and the rest sold for immediate use.

*92179*

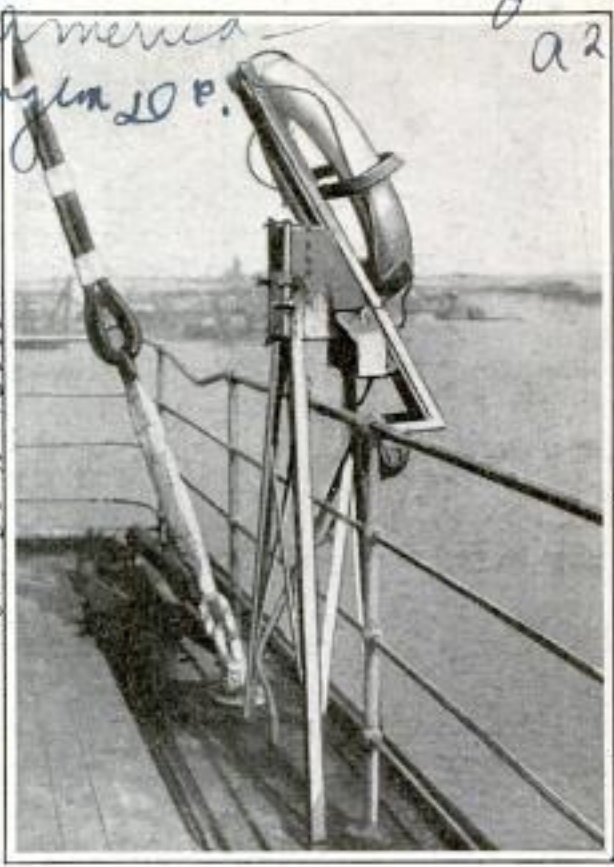
**GREASE GUN FOR WAGON HUBS SAVES REMOVING WHEELS**

Many United States army wagons now are equipped with grease cups on the wheels, so the hubs can be lubricated with a grease gun such as is used for automobiles. The old method of greasing required that the wagon be jacked up and each wheel removed from the hub.



Greasing Army-Wagon Axle with Gun; Until Lately the Wheel Must Be Removed

*Alomite Corp.  
2650 N. Crawford Ave  
Chicago*



Courtesy Chantier de Penhoet  
Electrically Operated Life-Buoy Mounting Throws Buoy into Water at the Touch of a Switch

**ELECTRIC LIFE BUOY EQUIPPED WITH FLARE LIGHT**

One French motor liner is equipped with electric life buoys which are ejected into the sea to the rescue of a drowning person by a touch on a switch controlled by the officer of the watch. The current fires a cartridge on top of the mounting which operates the ejector. A calcium flare attached to the buoy lights on contact with the water to provide illumination for the rescuers.

**CANADA GROWS CHINESE CROP FOR EXPORT TO ORIENT**

Growing Chinese crops on Canadian soil for export to China is becoming a valuable business in Ontario, where ginseng roots bring \$25,000 per acre of 2,000 pounds. The root is used extensively in China where it is credited with medicinal qualities. Cultivation of the herb is fraught with danger of rust and rot, and it requires five or six years after planting for the roots to mature to market size. The name, from the Chinese, means "form of man," to describe the bifurcated root.

*Waterford*

*A 2162*

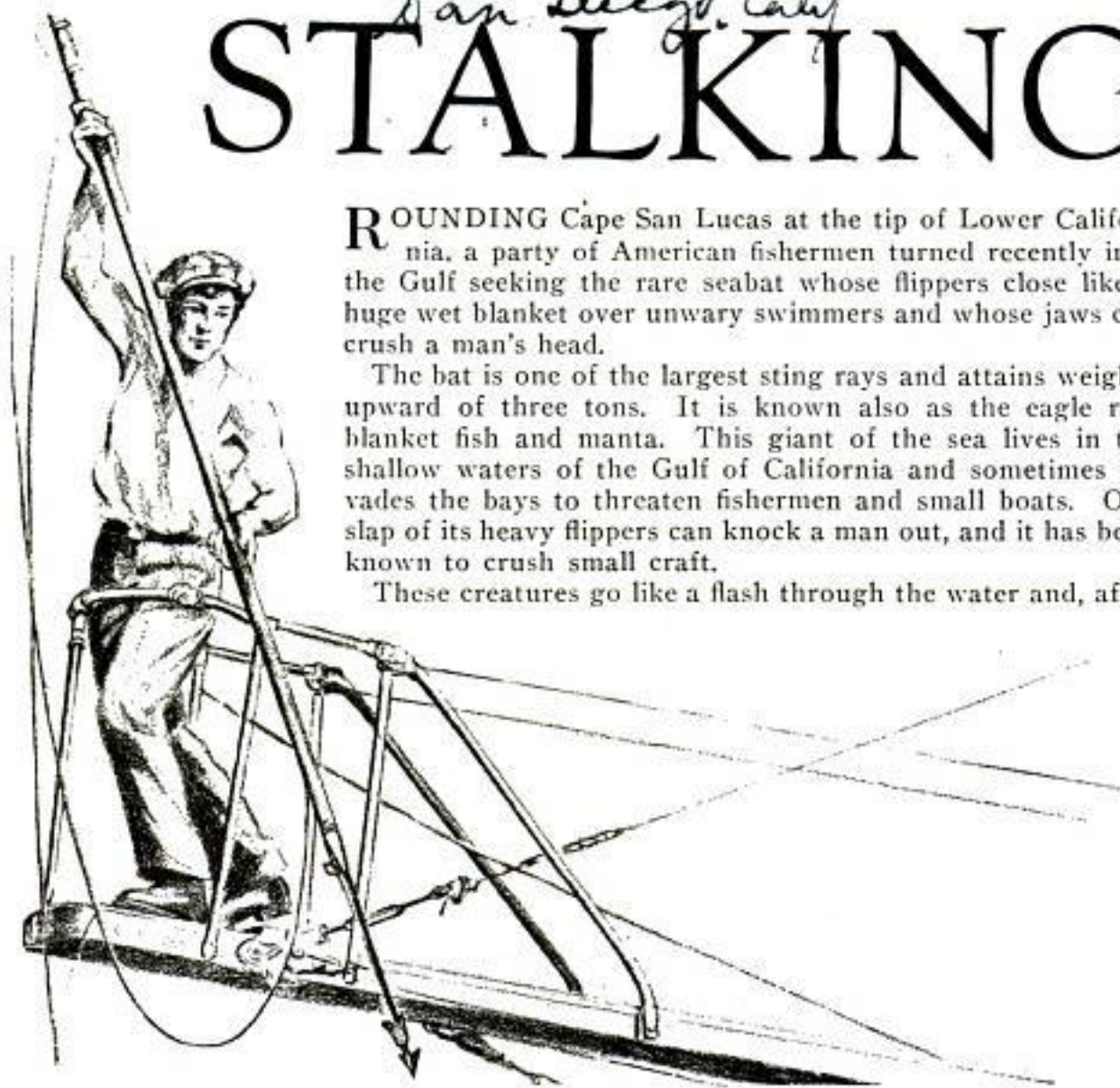
*Colombie*

*A 2262*

*Emt. James Montague  
69 St. Harbour Cove, Poldy.  
870 St. 2 870 St. 2 870 St. 2*

u2096 Capt. Andrew De Borne,  
613 Spreckels Theatre Bldg.  
San Diego, Calif.

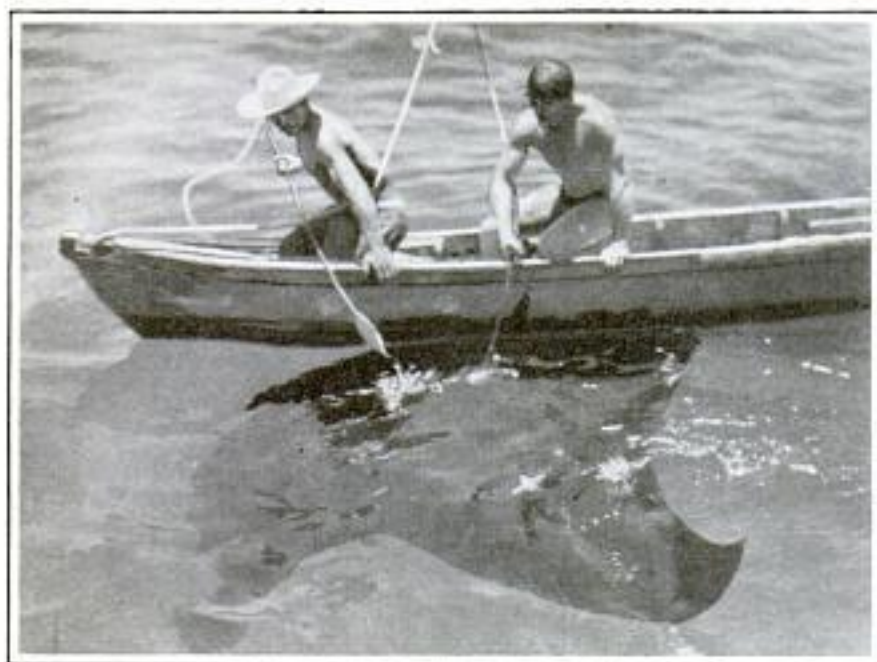
# STALKING



**R**OUNDING Cape San Lucas at the tip of Lower California, a party of American fishermen turned recently into the Gulf seeking the rare seabat whose flippers close like a huge wet blanket over unwary swimmers and whose jaws can crush a man's head.

The bat is one of the largest sting rays and attains weights upward of three tons. It is known also as the eagle ray, blanket fish and manta. This giant of the sea lives in the shallow waters of the Gulf of California and sometimes invades the bays to threaten fishermen and small boats. One slap of its heavy flippers can knock a man out, and it has been known to crush small craft.

These creatures go like a flash through the water and, after



Top, Throwing Spear at Swordfish from Pulpit of Boat; Below, Man-Killing Sting Ray Sunning Itself near the Surface

being speared, have been known to pull boats faster than a hurricane could drive them. Indian pearl divers often sneak up on a seabat, drive a harpoon into its body, then experience the thrill of a wild ride before the giant succumbs to the intense exertion and the barb that has pierced its vitals.

When Harold Austin, with a party of Americans, first saw one of them, it was lying flat on the water with its winglike fins protruding at the extremities.



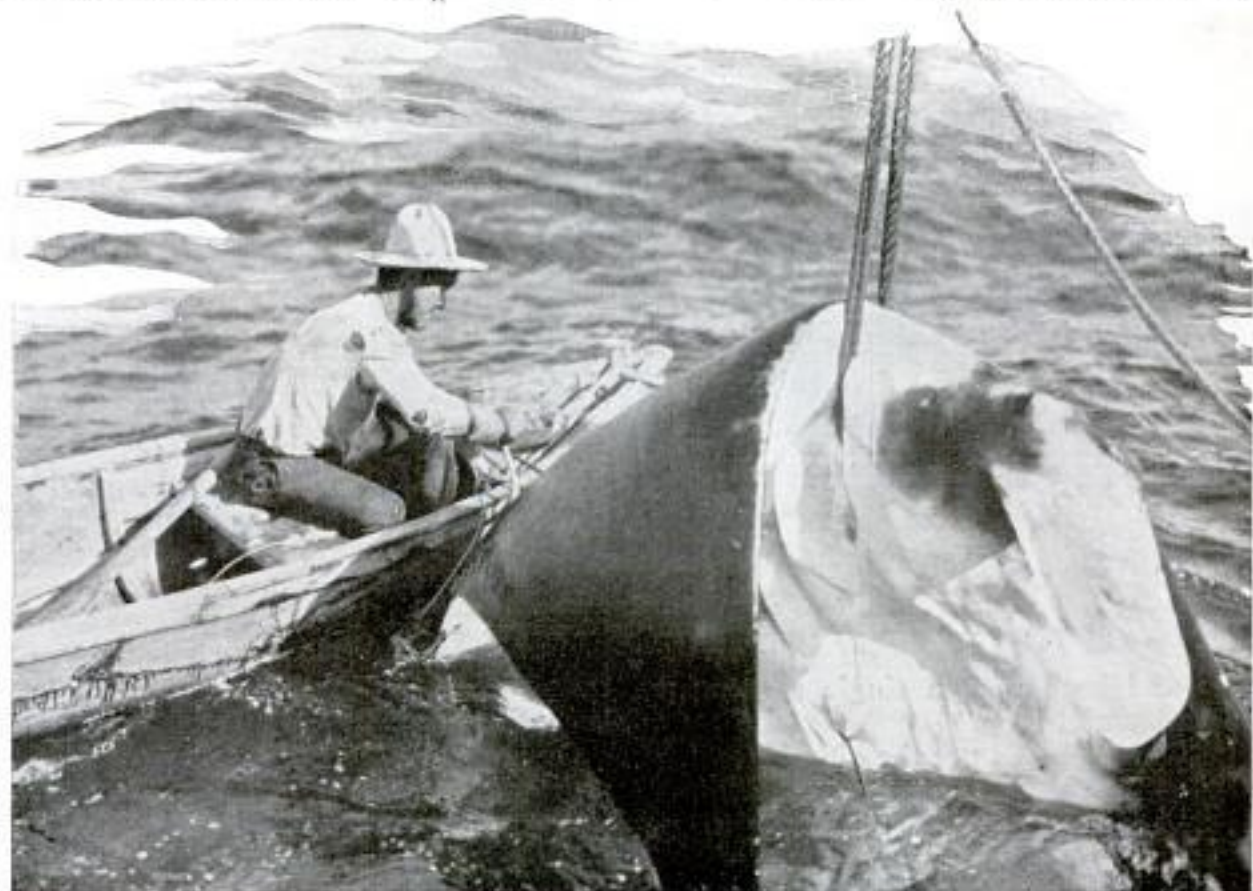
# KILLER FISH

"We persuaded some natives to harpoon one of the giants from a small canoe," he said, "and no man ever witnessed a more thrilling battle. For a moment, the great fish wrapped one of his flippers over the canoe, and only long experience in handling the craft saved them from death. We entered the gulf in a sixty-foot boat designed to ride the surf into the beach and to buck the surf with its stern when putting to sea again. We thought the Indians could get a steadier aim from a boat this size, but after a few trials they flatly refused to cast har-



poons from our craft and returned to their canoes.

"The seabat lies on top of the water to sun itself during the day. Apparently it cannot detect anything approaching from the rear. The Indians paddle silently through the water. One, standing in the prow, suddenly drives the harpoon into the bat's broad, black back, and the bat takes off with a flash. Whatever may happen, the occupants of the canoe evade the jaws which resemble a grinding mill. The bat's strength is so great that it can press a man to its breast, crushing his



Above, Lookout in His Seat at the Top of the Mast, Stalking Swordfish; Below, a Three-Ton Sting Ray Being Hauled aboard a Boat After It Had Been Harpooned

22096

shark fishing. harpoon gun made by  
Vafse's Fabrik. A.B. Huskvarna  
Sweden



Above, Fishermen Holding Aloft a Captured Hammerhead Shark;  
Below, Marlin Swordfish, Much Sought by Sportsmen

© Metro-Goldwyn-Mayer

long catwalks extending over the bow, from which skilled harpooners plunge spears into swordfish. Their meat is a great delicacy.

The sword, a double-edged instrument, is the only weapon of the fish of that name. It has been known to pierce a man's body, but its principal function comes in gathering food. The swordfish swims into a school of fish and as it dashes through, it throws

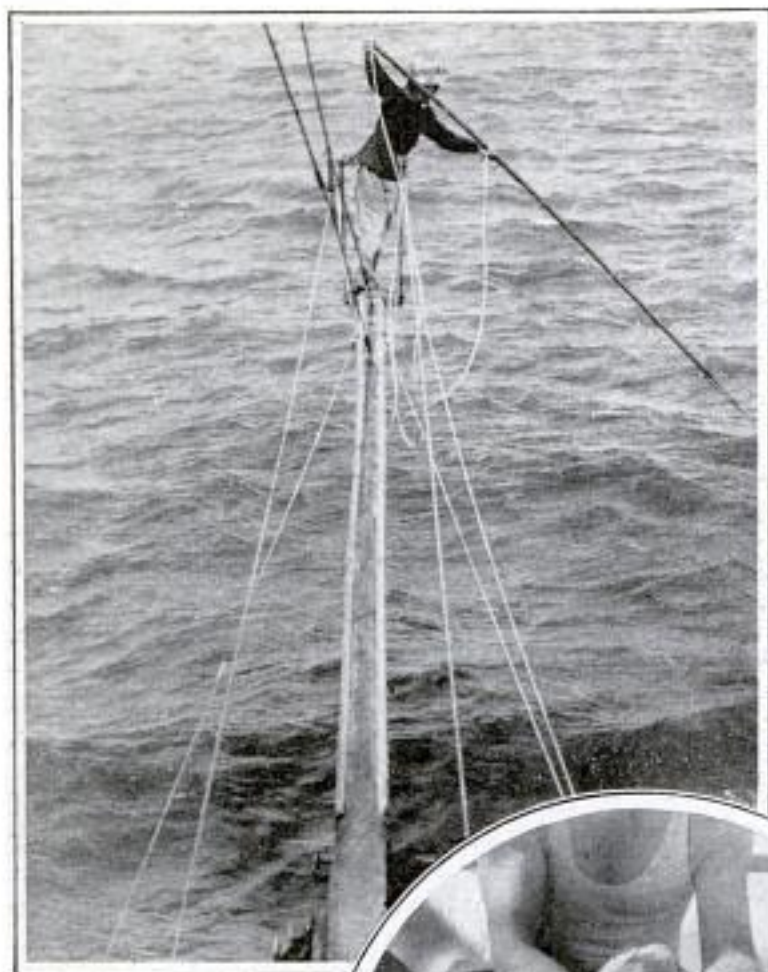
body and head with a single movement of flippers and jaws."

But the seabat is not the only killer fish invading the Pacific off southern California and west Mexico. Sharks, devilfish, swordfish—all these appear frequently. In fact, several boats of the California fishing fleet are equipped with "pulpits"—

the sword about, stunning its prey. Later it returns and picks up its food.

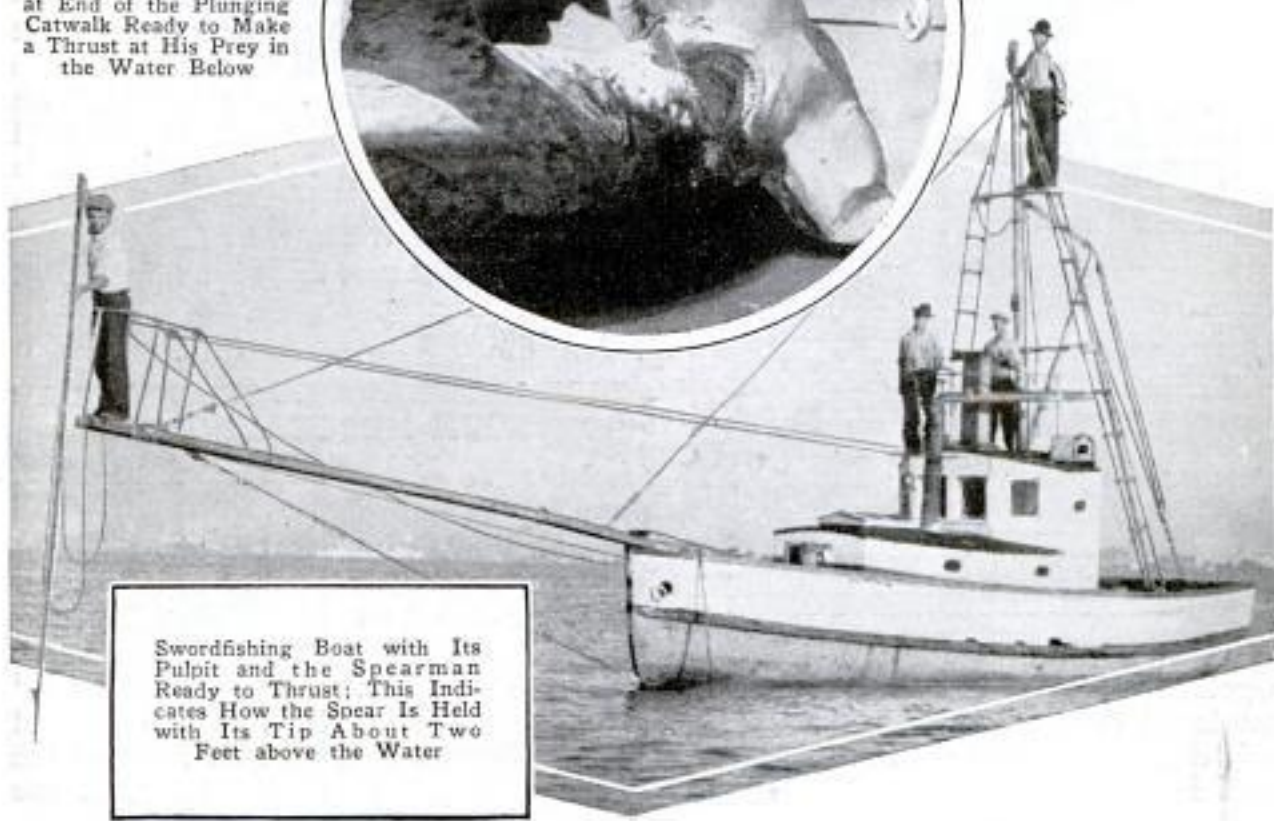
On a calm day, the swordfish play about near the surface, their fins breaking water and flashing phosphorescent warnings to hunters on the kill. Twenty crews of swordfishermen ply out of San Diego in small boats. All hands, including the

42096



Above, Spearman Standing in the Tiny Pulpit at End of the Plunging Catwalk Ready to Make a Thrust at His Prey in the Water Below

Top, a 400-Pound Swordfish Lashed to the Mast after a Terrific Battle; Left, a Fine Specimen of the Hammerheaded-Shark Family



Swordfishing Boat with Its Pulpit and the Spearman Ready to Thrust; This Indicates How the Spear Is Held with Its Tip About Two Feet above the Water

a2096

steersman, become lookouts when they reach the banks from seven to ten miles off shore.

The cry, "Swordfish off the port beam," sends everyone into action. From the chair, the lookout-in-chief pulls a cord which rings a bell alongside the steersman, one bell for port, two for starboard. The helmsman changes his course and follows a pointing finger toward his catch. The spearman goes forward, walking warily out to his pulpit. His eyes scan the surface for the flashing fin. In his

hands he takes an eighteen-foot spear, a thin wooden handle fitted into the socket of a shorter steel spear. A rope connects the spear with gear on deck.

He holds the point of the steel instrument immediately above the water's surface, ready to plunge it into the great fish when his pulpit casts its shadow over its back. If the spear has not reached some vital organ and if the fish is not playing possum—two important ifs—it may ram its sword through the thin planking of the dory.

a213

### HAND SPRAYER CLEANS STREET WITH CHEMICAL COMPOUND



Street cleaners in Berlin use a sprayer outfit to disinfect the streets by shooting a chemical on them. A tank carried on the back of the worker contains the disinfectant, which passes through a tube under pressure.

Chemical-Spray Outfit Used for Disinfecting Streets and Marketplaces in Berlin

### GOLD-LEAF 'LARYNX' FOR RADIO REPRODUCES DEEP TONES

Radio and the talkies may literally have a golden voice as the result of a process developed to stretch gold leaf until it is only one-millionth of an inch thick. The new radio "larynx," created at Purdue University is in the form of a gold-leaf

membrane stretched taut like a drum-head over a steel ring larger in diameter than a silver dollar. Gold leaf as thin has been stretched before, but not so large. A new process of stretching made possible the large-size pick-up which, it is claimed, reproduces the low frequencies, or deep tones, almost without distortion. It can be used both for the pick-up of sound and for loud speaking. Neither fingers nor machines can pull so thin a membrane without tearing. Instead the stretching is the result of the movements of atoms when metals expand in heat and contract in cold. The cold gold leaf is fastened to a sheet of cold aluminum and since the aluminum expands more rapidly than gold in high temperatures, it stretches the gold leaf when the two are heated. The cold ring of steel is laid on the two metals and shellacked to the gold leaf. Then the steel is heated, and this further expands the gold. Finally, in cooling, the steel contracts less than the gold leaf, and hence there is a third period of stretching.

### LICENSE PLATE LOCKED TO CAR WITH KEYLESS SCREW

License plates can be locked to the automobile by a keyless screw lock which has just been placed on the market.



The screw, in the form of two knurled knobs, fastens to a stud on front of the plate, and can be loosened only if the combination is known.

a2260  
Physicist  
Lab

a2078  
West Lafayette, Ind.

by C.K. Stechmann, of  
Vancouver, B.C. Can

C + E Mfg. Co.  
Mail Order Sales Dept.

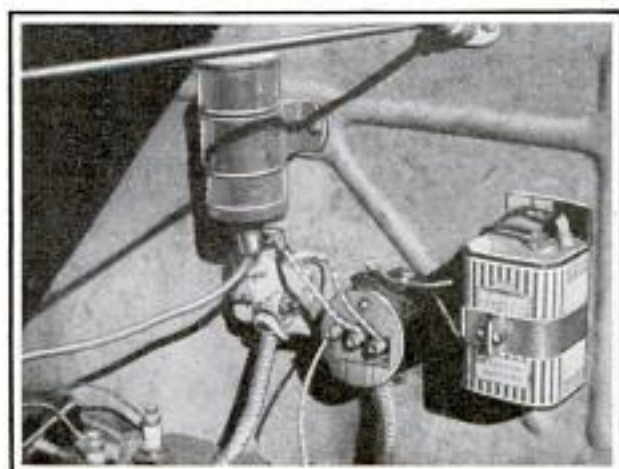
Copyrighted material

**HOW MANY WORDS YOU KNOW  
 TOLD BY TEST** a 2196

Measuring your vocabulary is a simple matter if you enlist the aid of a friend and an unabridged dictionary. Select fifty pages at random from the dictionary and ask the friend to call all the words on them. You attempt to define each word, and the caller keeps your score. The number of pages in the dictionary multiplied by the average number of words per page will represent the approximate number of words listed. From your percentage of known words for the fifty pages, the probable number of words you know out of the entire dictionary can be estimated. Some scholars have a vocabulary of 100,000 words, while most persons use only a few thousand.

**IGNITION BOOSTER STARTS CAR  
 IN COLDEST WEATHER** a 2141

Furnishing an intense spark regardless of the condition of battery, coils or resistor suppressors, an ignition booster for starting the automobile in the coldest weather has been placed on the market. A six-volt dry battery, connected to the booster, is automatically thrown into series with the car's storage battery to supply increased voltage for starting a cold motor. When the foot is removed from the starter pedal, a relay throws out the dry battery, so that there is only a momentary drain. The dry battery lasts six months or more. An average of 28,000 volts is delivered to the spark plugs by the ignition booster, as contrasted to 11,000 with an unaided storage battery.



Voltage for Starting Is Doubled by Auxiliary Dry Battery Connected to Ignition Booster

Burgess Battery Co.  
 Engineering Dept.  
 202 E. 44th St. New York



Little Gas Engine That Weighs Three and One-Half Pounds and Develops One-Twentieth Horsepower

**SMALL GASOLINE ENGINE RUNS  
 ON THIMBLEFUL OF FUEL**

Capable of running for about five minutes on a thimbleful of fuel, a tiny gasoline engine has been constructed by a Detroit mechanic who intends to use it for power in a model motorboat. The little motor is of the one-cylinder, four-cycle type and weighs three and one-half pounds. It develops one-twentieth horsepower and is equipped with the latest innovations, including overhead valves.

**WATER IN GLASS GAUGES RAILS  
 FOR SMOOTHNESS** a 2181

Smoothness and riding qualities of one railroad are tested by maintenance engineers with an ordinary glass of water. The tumbler is filled to within an eighth of an inch of the rim, and is placed on a table or small platform aboard a fast express train. Officials watch the glass every mile of the way and each spill over the edge is recorded and a mark is chalked against the particular section of track where the water slopped over. A much more complicated piece of apparatus records all jolts, sways and swerves.

Benney  
 C. H. X. Sadowski  
 510 The Republican  
 Scranton, Pa.

John Benjamin cannot secure street address

*mines Safety Appliances Co*  
*Bradford Ave. Thomas Bldg.*  
 66 **POPULAR MECHANICS**  
*Pittsburgh, Pa.*

**AIR PURIFIER GUARDS FIREMAN FROM SMOKE PERIL**



Fireman Wearing Air Purifier Which Protects Against Smoke; Also Practical in Water

Air purifiers, which protect the fireman in dense smoke or to a depth of sixteen feet in water, have been supplied to members of the fire department in a western city. The apparatus is self-contained and is designed to supply pure air in the interior of a smoke-filled building or near a flaming oil-well fire. The device also may be worn under water.

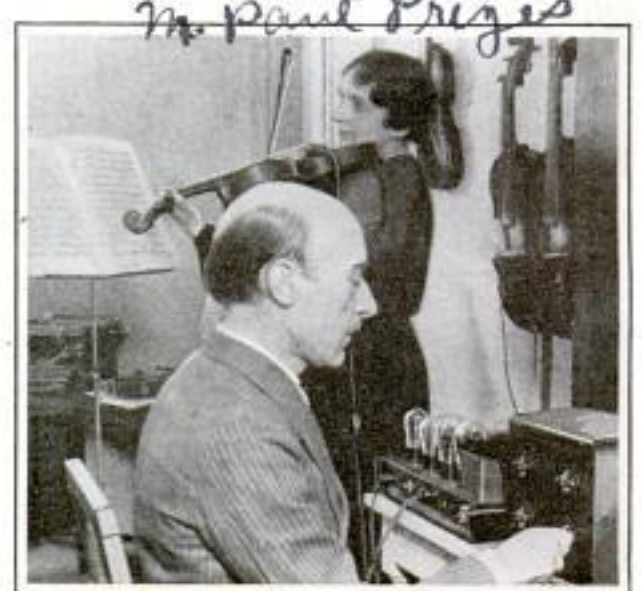
**MYSTERY PURSUIT SHIP BUILT FOR ARMY FLYERS**

What is believed to be not only the most spectacular, but the most advanced fighting airplane in the world, has just been delivered to the United States air service after secret tests covering many months. The "XP900," as it has been designated, is so different from all previous American military planes that it violates all traditions of the air service. In the first place, it is a monoplane, and never before has America used a monoplane for combat military purposes. It is, in addition, the only two-place pursuit plane in the world—carrying the pilot in the forward

cockpit with two machine guns of fifteen and thirty caliber, and a gunner in the rear cockpit, riding backward, who covers a 200-degree arc with a second fifteen-caliber gun. With a speed of 226.42 miles per hour with full load and armament, it is more than forty miles an hour faster than any other pursuit plane ever used by the air service. This super-pursuit ship is a low-wing monoplane, with a full cantilever wing, forty-two feet eight inches in span. It has an over-all length of thirty feet five inches and weighs, fully loaded, 4,350 pounds. The ship is powered with a twelve-cylinder Curtiss supercharged prestone-cooled engine that develops 680 horsepower at 2,450 revolutions per minute. The fuselage is built entirely of duraluminum, the narrow streamline form being obtained by the use of a skeleton of pressed dural rings to which is riveted the outer dural skin. The wing, which is constructed in one unit for the entire span, is nineteen inches thick at the fuselage, tapering to one inch at each tip.

**VIOLIN TURNED INTO BASS VIOL BY USE OF ELECTRICITY**

Application of electricity has turned an ordinary violin into a bass viol. A small device, invented by a Frenchman, is placed on the violin, the electricity is turned on and the violin gives forth the deep tones of the viol when the bow is drawn across the strings.



Electricity, Transmitted by Tubes, Deepens Violin Tones to Those of Bass Viol

*Los Angeles. Mc Case & Co. pipe oxygen breathing apparatus. a2065*

*mines Safety Appliances*  
*hard solder lab*

*World a2053*

*a2154*

*Mr. Paul Prizes*

*Carl Derek White*  
*69 Seward St. Central, Mich*

*no further data*

*Copyrighted material*

91794

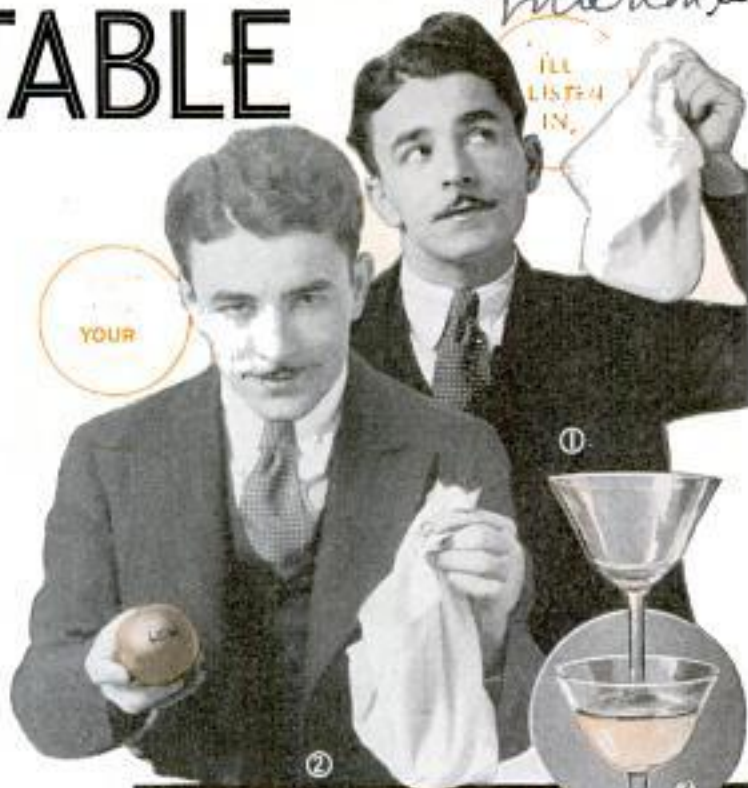
Sam Brown

151 Carhart St  
Marion, Ohio

# DINNER TABLE MAGIC

LET'S start right in. Here's a bowl filled with oranges. Here's a large napkin. The performer offers the fruit bowl to a spectator. The spectator is to take any orange. He is to put his initials on it. While this is being done, the performer picks up two or three of the remaining oranges and drops them into the napkin which he holds by the four corners to form a baglike receptacle. The selected orange is dropped in alongside the other three. The bag is thoroughly shaken. Nevertheless, by merely placing the bag to his ear and "listening in," the performer locates the marked orange and picks it out.

Really, it is a remarkably simple case. You see, the fruit bowl originally held eight oranges. Four of these were minus the little pip on the outside end of the core; the other four were completely furnished with one each of these little buttons. Does it get any clearer? Of course, the



Top, Picking a Marked Orange from a Napkin-Full; Center, a Ciever Trick with Sherbet Glasses; Below, Using a System of Words to Find a Hidden Egg, Orange and Apple



steady hand, and you pour the contents of the lower glass into it. A gentle gurgle, then, as you tilt your head back and imbibe the liquid. It's as simple as all that.

You should like this next little experiment. It has to do with an apple, an egg, an orange and a plate containing exactly twenty-four crackers. If you haven't the crackers, you can use poker chips; and if you haven't the egg, you can substitute something else. At any rate, the performer turns his back or leaves the room, and during his absence, three spectators take possession of the properties, one taking the apple, another the egg, and a third, the orange. These are hidden out of sight. The crackers are still on the table. The performer faces the spectators. He gives one cracker to one of the

spectators, two to another, and three to the third. He makes no mention of the fact, but this automatically labels the parties in the case by numerals 1, 2, and 3. The performer again turns his back or leaves the room. He instructs his audience before leaving, or, while his back is turned, as follows: "I want the person holding the apple to take just as many crackers as I gave him. The person holding the egg will take twice as many crackers as I gave him. The person with

spectator is given a free choice. Then, if he chose a pip, you put three plain oranges in the napkin; if he selected a plain orange, you put two or three pipped oranges in the bag. After that, it is simply a matter of prowling around a bit to relocate the orange the spectator selected.

Here's something: You take two sherbet glasses. You fill one of them with liquid. You place the other glass over it, making the set-up look like Fig. 3. The idea is this: Can you transfer the contents of the lower glass to the upper glass, and then drink it? You may use one hand only, and this must not touch the upper glass. As you will agree after looking at Fig. 4, it's dead easy. You simply take the rim of the upper glass between your teeth and lift the glass from the table. A



Top, Illustrating a Trick with Water Glasses; Below, Some Table-Top Engineering Stunts



the orange will take four times as many."

"All ready?"

"All ready."

Entering the room, the performer quickly notes the number of crackers remaining in the bowl. And then, of course, he tells who has the apple, who has the egg, and who has the orange.

There's really nothing to it. You merely consult the little table shown in Fig. 5. If there is one cracker left, you immediately think of the word "acro." And the order of the vowels, A, E and O (apple, egg and orange) will check with the numbered order of the spectators, 1, 2, and 3. That is, the first person will have the apple; the second, the egg, and the third, the orange. If four crackers were left, the word would be "pergola." And the order would be, egg, orange, apple. And so on—but don't try to figure the reason why!

Consider this: Here's a circle of eight glasses. All of the glasses are standing



Top, "Magnetizing" Two Lumps of Sugar with Butter; Below, a Simple Water-Glass Trick

mouth up. The problem is to start at any glass, count one, two, three, four, turn that glass over, and continue until seven of the glasses are turned over. The rules are simple. You must always count up to four, and then turn the fourth glass over. You can start on any glass, but you cannot start counting on a glass after it has been inverted. The solution is quite simple, merely a matter of going around the circle, counting four, skipping one glass, and then counting four again until the seven glasses are turned over. But invite



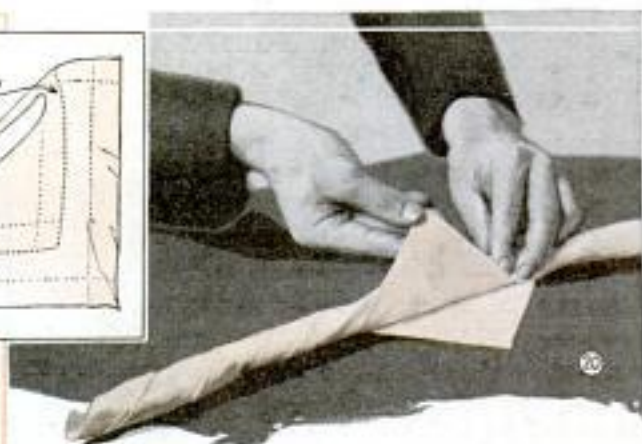
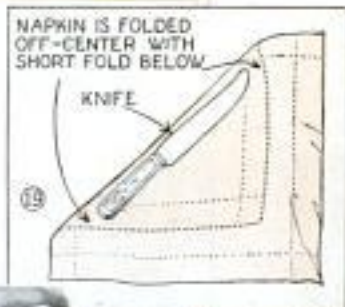
somebody else to do it—and it's not so easy.

Figures 8 to 12 inclusive picture some little stunts in table-top engineering. The four-way bridge in Fig. 9 is quite substantial and will support a plate of the wife's best biscuits. The manner of lifting two knives with one is made clear by Fig. 10.

Four with one is really simpler. Two other knives, six in all, can be lifted by adding the fifth and sixth knives to the arrangement shown in Fig. 11.

Here's one to fuss around with: Get a fair-sized glass and try to pick it up with two fingers, as pictured in Fig. 14. If the glass is the proper size, you will find this rather difficult, the glass constantly slipping away from the spread of the fingers. But if you turn your hand over and spread the two fingers as in Fig. 15, you will find the levitation quite simple.

Did you know that sugar was magnetic? Fact. And if you want two lumps for your coffee, all you have to do is to touch one lump with another and then convey the pair to your cup, as pictured



An Easy Stunt with a Napkin and a Knife That Surprises Even the Performer the First Time

in Fig. 16. Of course, no one is supposed to know that you have dabbed a small pellet of butter on the underside of the "magnetic" lump. And, since you immediately drop the lumps into your cup, no one can ever prove it.

This last little stunt is rather unusual in that you can play it on yourself the

very first time: Take a napkin and fold it diagonally across the center, or rather a little off-center, keeping the short fold underneath, as in Fig. 19. Place a table knife along the folded edge, as shown, and roll the knife inside the napkin. Continue rolling until the two ends come out even as in Fig. 20. Now for the magic. If you were to grip these two outside ends and lift up so that the napkin would unroll, wouldn't you be surprised to find the knife really and truly inside the napkin, as in Fig. 18, and not merely alongside the fold? Well, that's just exactly what happens. But—we would bet a nickel and make money you'll be from Missouri until you try it.

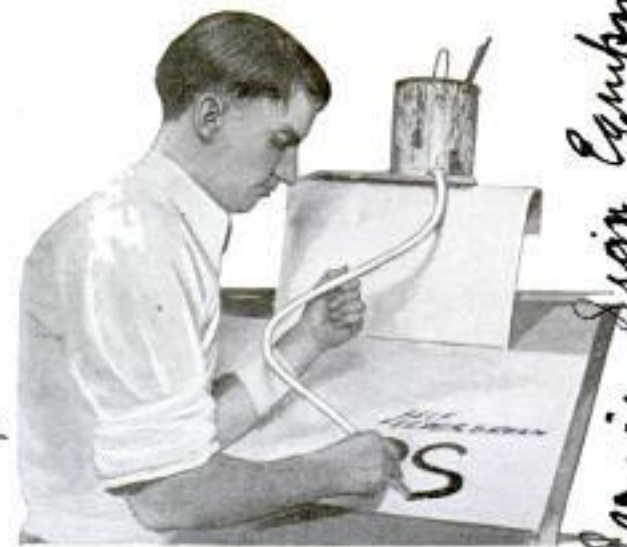
**STYLUS ETCHES PHOTO ON ZINC TO SPEED ENGRAVING**

Photographs are etched on zinc by a steel stylus in an automatic engraver, recently demonstrated, which speeds up engraving work and reduces costs. Lights and shadows on the photo are cast on a photo-electric cell by two small lights. An electrical arrangement causes the lights and shadows in the cell to move the stylus, tracing the photograph on a sheet of zinc. The machine eliminates the necessity of rephotographing pictures on metal to produce an engraving, as well as chemicals and finishing processes.

gravity starts the paint flowing. Shut-off valves are supplied with the tubing to control or adjust the flow, making easy a job where quantity and color combinations are required.

**PAINT FED TO BRUSH BY TUBING HELPS SIGN PAINTER**

Paint, fed to the brush by tubing, saves time for the sign painter. One end of the tubing is placed in the paint pot, the other attached to the brush and the force of



Flow of Paint to the Brush Is Regulated by Valves in the Tubing

*Ans. Walter Hawley leads 9283  
International News Photos  
235 E. 45th St. New York*

*Service Sign Equipment Co.  
214 Washington  
Waukegan, Ill.*

*Becher Brush Co.  
Lithonia, Ga.  
Service Sign Equipment Co.  
214 Washington  
Waukegan, Ill.*

American Electric Steam Co  
 North Ironwood  
 POPULAR MECHANICS  
 New York

Sold by Lee  
 Earl Asquith  
 1494 Merchants

**PIPE PAINT RESISTS MOISTURE  
 HEAT AND DILUTE ACIDS**

Extra protection for pipes used above or under the ground is offered by a form of paint recently developed which is impervious to any degree of heat generated by steam. Moisture has no effect on any surface coated with it, and dilute acids or alkalis do not alter it. When dry, it has been found to be elastic enough to provide for expansion without cracking or checking. While the paint was created primarily for hot pipes, it has been found useful also for boiler fronts, stacks, and gas or water pipes.

General Motors Radio Corp. Dayton Ohio

**CONVERTER FOR OLD RADIO SET  
 MAKES SUPERHETERODYNE**

Superheterodyne reception may be obtained from the old tuned radio-frequency type of receiver by using a converter which has been placed on the market. The converter is built to resemble a smoking stand, with an illuminated dial set into its beveled edge and operated by a small knob. Volume also is controllable. The device is portable and connected to the



receiver by means of a flexible cord. Remote control is provided, in that the operator tunes the converter exactly as he would the old set, without preliminary setting of cams, levers, stops or the like. This makes it possible to operate the set from bridge table, easy chair, bedside, or other positions.

**KEYS MADE TO FIT AUTO LOCKS  
 WHERE CODE IS UNKNOWN**

Keys can be made without code, number or duplicate for ninety per cent of all automobile locks by an easily portable machine now on the market. This precision tool also produces keys for many other locks. Carried in the vest pocket, the machine can be taken to remote jobs.



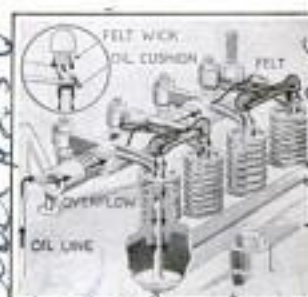
Automatic Scale Which Fills a Bag, Weighs Its Contents and Cuts Off Supply When Full

**AUTOMATIC SCALE FILLS BAGS  
 AND WEIGHS CONTENTS**

To speed up the work of clerks in grocery stores and shops, a scale is now being offered which automatically fills a bag, weighs its contents and cuts off the supply at the proper time as certain levers are manipulated. The supply of material is held in a large container at the top of the machine. In filling bags, levers are set at the poundage desired and to start the scale in operation after a bag has been placed in position. The apparatus speeds up the filling of bags and also eliminates much lifting as it holds up to 150 pounds and weighs the merchandise in lots from one to ten pounds

**FELT OILER FOR VALVE STEMS  
 ADDS TO LIFE OF MOTOR**

Felt oilers for valve stems and guides in the Chevrolet have been placed on the market to eliminate sticking, squawking or warped valves, and to increase the life of the motor. The oilers prevent air being drawn by the intake valves into the combustion chamber by placing a seal of oil between valve stems and guides.



See  
 Mart  
 Chicago  
 La Brea, Texas

Mr. Wm. D. Groves

Kansas City Mo

Out of 1/13/34  
 business.

Modern Supply Co  
 511 Perry  
 Cleveland, Ohio

Felt Oiler Mfg Co  
 B. M. A. Bldg  
 215 Pershing Road

A 2125  
72 Paul

Brush inventions  
No. 1409537 of Mark  
POPULAR MECHANICS  
Chicago

### MUSIC-PAGE TURNER WORKED BY PRESSURE OF KNEE



Music-Page Turner for the Piano Which Is Operated by Pressing a Lever with the Knee

Musicians need no longer interrupt their playing to flip the pages of sheet music, as an automatic page turner has recently been invented. The music turner is intended particularly for attachment to a piano. It consists of a number of wire frames between which the sheets are placed. Pressure of the knee on a lever turns them in order, one at a time.

### "ELECTRIC EYE" HELPS CAMERA BY TIMING EXPOSURE

How much or how little light there may be for the taking of amateur or professional moving pictures now can be measured accurately without guesswork on the part of the photographer. The photoelectric cell, or "electric eye," has been adapted to the purpose, and the apparatus is so small that it can conveniently be carried anywhere.



All that is necessary is to point the

tube at the object to be photographed, and read on the dial the correct setting, in the "f" scale, for the camera diaphragm. The device, known as the "electrophot," is entirely self-contained.

### THE SPEED OF BIRDS

It was once estimated that ducks can fly 180 miles an hour, but the most accurate checks thus far made show that ducks and geese do not ordinarily go more than forty miles an hour, although they are capable of increasing this speed if frightened. They cannot, however, maintain the higher speed for a long period. The fastest bird timed was a duck hawk in California which reached 165 to 180 miles an hour while chasing its prey. Mallards timed in France and England flew from fifty to fifty-eight miles an hour, and a flock at top speed in California, when paced by an airplane, went only fifty-five miles an hour. Pintails chased by a plane flew fifty-five to sixty-five miles an hour, and a canvasback got up to seventy-three miles. Canada geese have been timed at forty-four miles an hour.

### PERISCOPE ON AUTO REFLECTS OVERHEAD TRAFFIC LIGHTS

Overhead traffic lights are brought into the range of vision of the motorist by means of an accessory like a periscope that attaches to the windshield. It consists of two mirrors, one plane and the other convex, which are mounted on a wire support that in turn is attached to a rubber vacuum cup. The mirrors reflect the overhead lights, the convex mirror covering a wide angle so that the lights usually are seen regardless of where the car stops.



Names and addresses of manufacturers of articles described in this magazine will be promptly furnished, free, by our Bureau of Information.

no info as to maker or invention

Biological Survey  
Washington D.C.  
Akron Ohio  
Floude Ave

Sold by Bass  
Camera Co. 1179 W. Madison  
Chicago

Emb. Walter Burton 1032

Bergslore

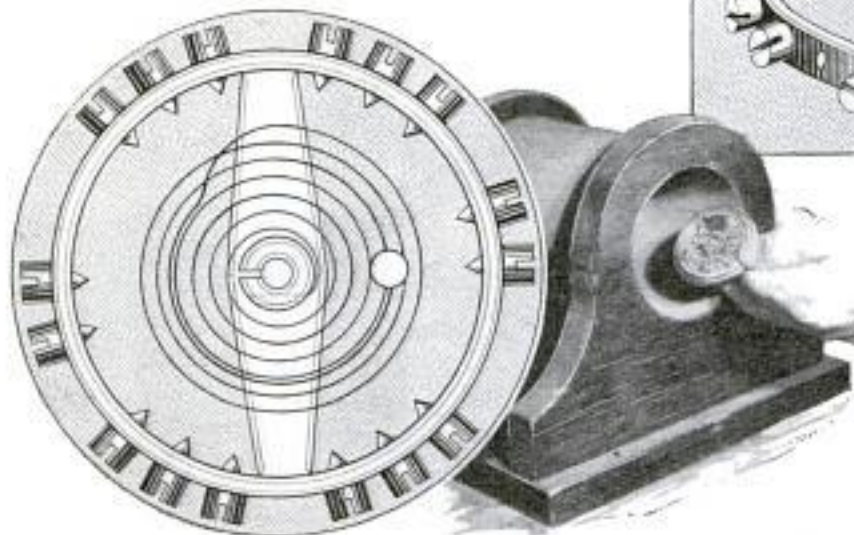
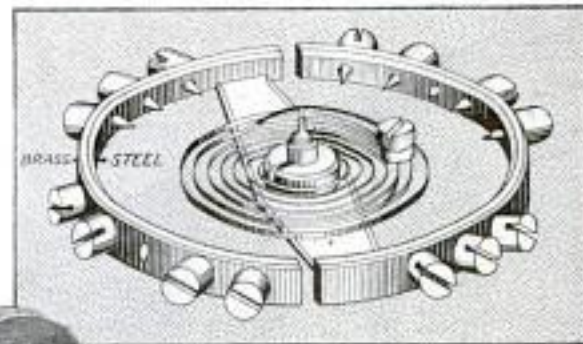
Shuras Rhamstine  
500 E Woodbridge Street, N. Minn.

a2146 *Carl Hayes W. Young*

*913 Virginia Ave  
Lancaster, Pa*

# New Alloy Changes Art of Watchmaking

Do you know that your watch has a tiny thermostat which speeds up or slows down the movement of the hands as the temperature rises or falls? When a man gets "hot under the collar," you can al-



New Solid Balance Wheel for Watch; at Right, Testing Watch; Above, Balance Wheel, Split to Allow for Weather Changes

eter of the wheel, making it easier for the hair-spring to swing it. And this is true also in regard to the effect of decrease in temperature, but in an opposite sense. The balance wheel enlarges, requiring more power to move it at the required speed, when the hair-spring's elasticity is increased. All of which ex-

most see his neck swell, can't you? Just so with most things, metals included. Heat expands. Cold contracts. The hair-spring of your watch, being made of steel, is thus affected by every change of temperature, in length, width and thickness. Of course the expansion is slight, but it is sufficient to change the rate of a watch about one second a day for each degree of variation in temperature, if not automatically counterbalanced in some way. Prior to 1766, these temperature errors were "just too bad" in the opinion of watchmakers. The honor of providing a fairly complete solution of the problem fell to a Frenchman, Pierre Le Roy, who invented the "compensating" balance, a wheel the rim of which is made of two metals, brass and steel. Brass expands about seven-tenths more than steel. It also contracts more. Taking advantage of these facts, watchmakers, since Le Roy showed the way, have been making the balance wheel of these two metals, the brass on the outside. When temperature rises, causing both metals to expand, the brass, expanding more rapidly than the steel, causes the free ends of the rim at the cuts to turn inwardly, toward the center. This virtually decreases the diam-

plains a recent development by one of the country's greatest watchmakers—the first revolutionary change in watch mechanism since before this nation was born—the development of a nickel-steel alloy, called "elinvar" by Dr. Charles Edouard Guillaume, which does away with the need of thermostatic regulation and enables great simplification of the balance wheel. It is no longer necessary to make it of two metals, nor to cut its rim to allow for contraction and expansion. With an elinvar hairspring, a one-piece balance wheel with solid rim is used. This revolutionary change also makes possible the use of a non-magnetic material in the balance wheel. Besides, the new alloy itself is practically unaffected by magnetism.

## a2174 COMPOUND FOR FAST MOLDING MAY BE COLORED EASILY

*Claskon*  
Easy performing and fast curing distinguish a synthetic molding compound which is being produced commercially. It enables rapid low-cost mass fabrication by the molder, and combines bright colors with a hard, lustrous surface. Its mechanical and electrical qualities are said to be excellent.

*Toledo Synthetic Products, Inc. Toledo, Ohio*

*Director of International Bureau Weights & Measures,  
Geneva, Dept. of Science and Art, France  
Iron age  
10/22/31  
Copyright material*

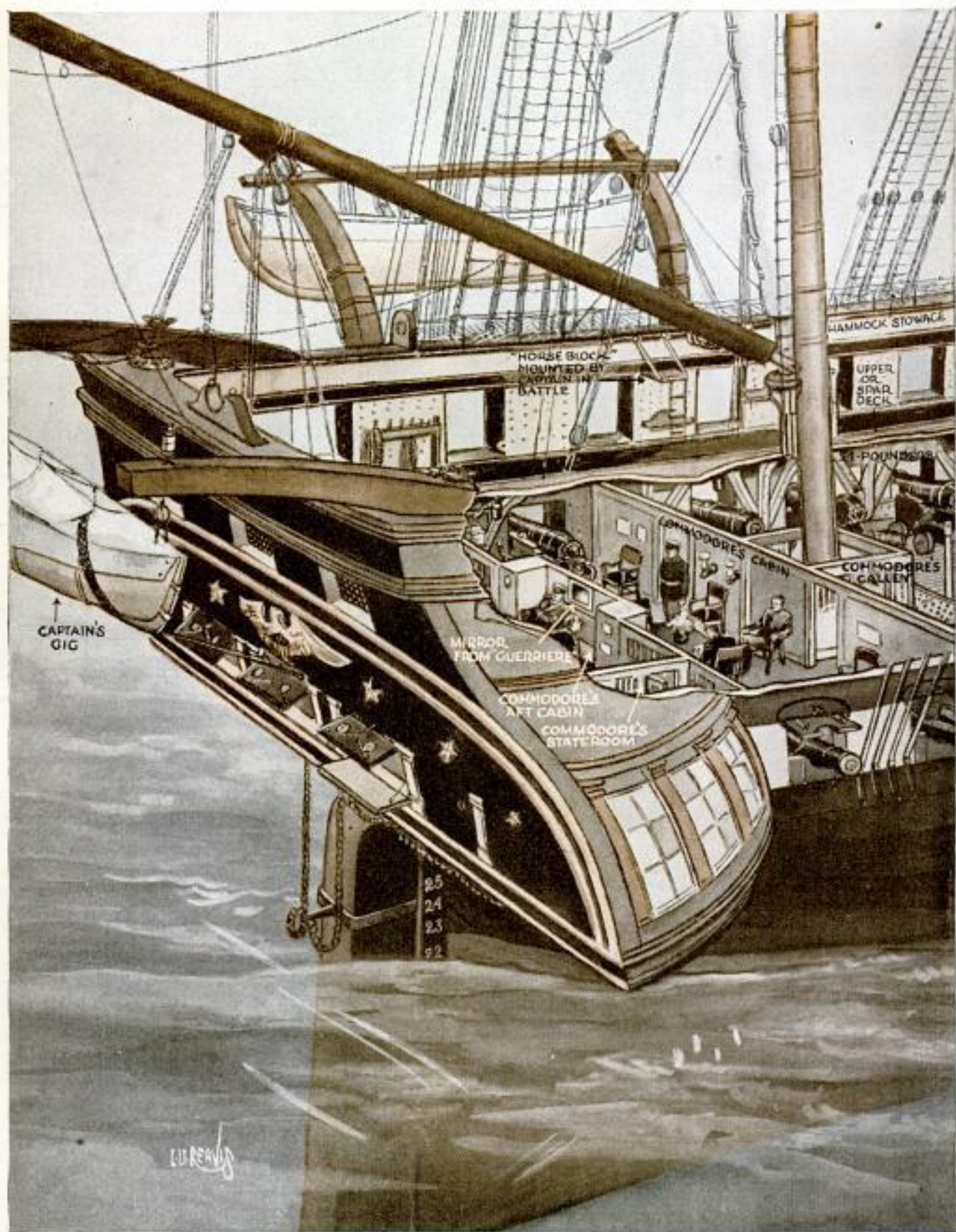
a2010

74

Cmt. Logan H. Pearis, 55 W. 42nd St  
New York

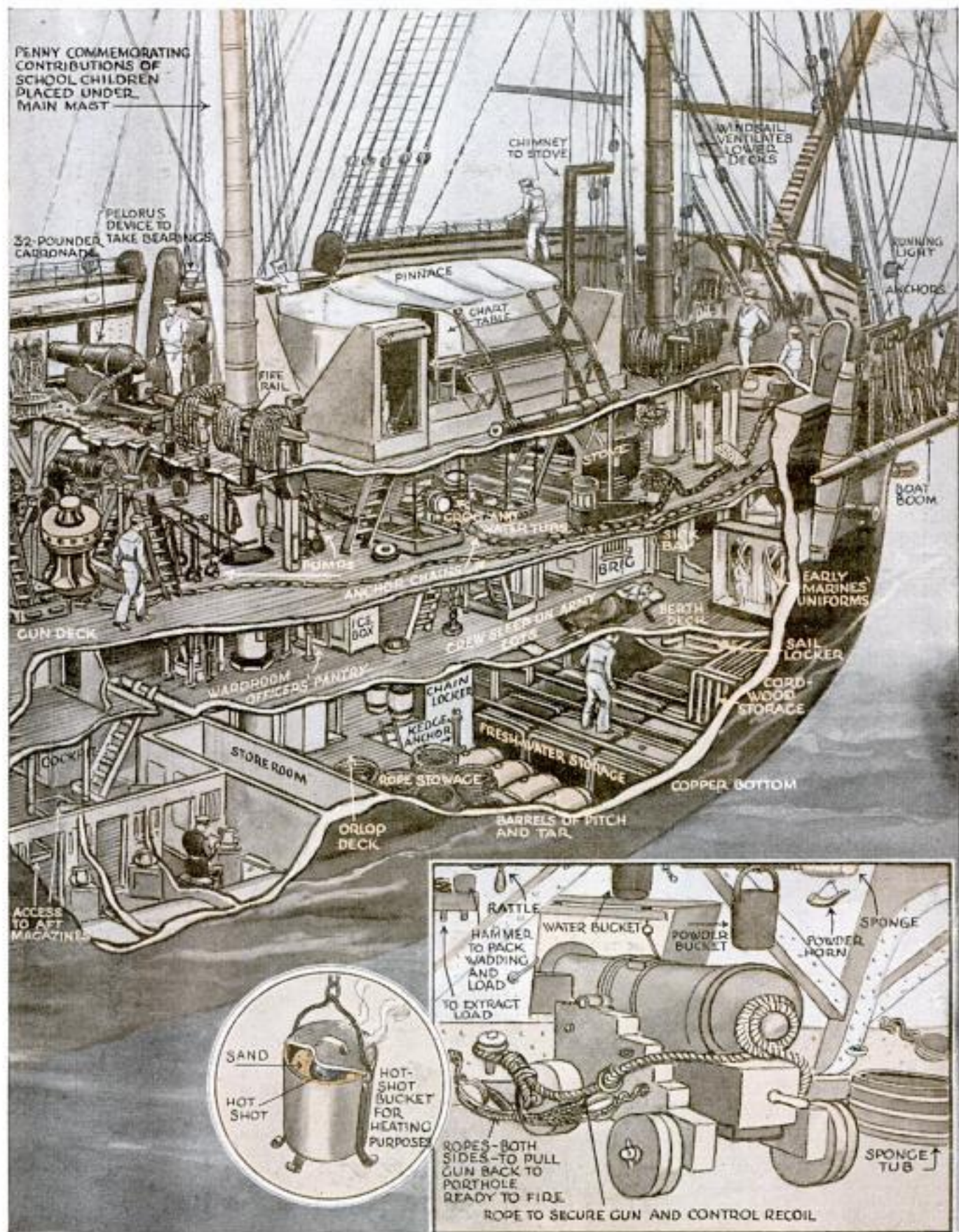
POPULAR MECHANICS

# 'Old Ironsides,' Rebuilt, Recalls Days When...



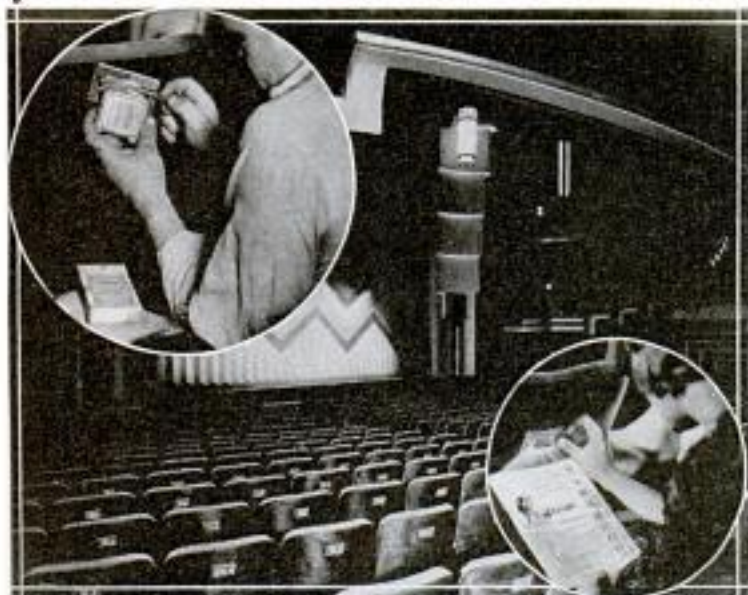
Cutaway Drawing of "Old Ironsides," Showing the Arrangement of Quarters, Equipment and Guns on the Reconditioned Craft; Note Mirror from "Guerriere" in Commodore's Cabin

# Iron Men and Wooden Ships Ruled Waves



Above May Be Seen the Deck Arrangement; a Penny Was Placed on the Mainmast to Commemorate the Contributions of School Children; Below, One of the Guns and Hot-Shot Bucket

a 2046



Lights on Back of Theater Seats Aid Program Reading; Upper Circle, Renewing Battery; Lower Circle, How Light Works

### THEATER SEAT HAS BACK LIGHT FOR READING PROGRAMS

Program lights, installed on the back of each seat, have been placed in one of New York's theaters. By pressing a button, a soft light is projected downward to enable the patron to read his program. The light is sufficiently subdued to cause no annoyance to other patrons, yet is bright enough to make reading easy. Dry-cell batteries supply the current.

### ARTIFICIAL SUNLIGHT FOR HENS PRODUCES BETTER EGGS

Artificial sunshine in the form of ultraviolet light from special electric lamps that emit these rays is pepping up the poultry business. According to data compiled by the General Electric company, the ultraviolet light not only induces the hens to lay more eggs, but improves the quality as well. These rays provide for chickens an ample supply of vitamin D which enables the system to assimilate minerals and build up calcium and phosphorus. Codliver oil has been fed for years as a substitute for natural sunshine in winter, and a few years ago experiments were started with carbon arcs and mercury arcs as a means of providing the needed ultraviolet radiation in winter. Now lamps are being produced for this purpose that are as simple to operate as any electric light used for illuminating purposes, and, in fact, they also serve for

illumination in the poultry house. These lights allow the necessary ultraviolet rays to pass through but stop those likely to be injurious to the eyes. The lamps were found to increase the size and weight of eggs, increase their vitamin D content, decrease the breakage from thin shells, increase the number of eggs laid and the percentage of fertile eggs, eliminate loss of chicks from rickets, increase the rate of growth of small chicks, produce larger and stronger pullets, and eliminate the necessity and inconvenience of feeding codliver oil. During one month, one flock of hens treated with ultraviolet light laid 2,150 eggs, while a second flock, of the

same size but untreated with the light, laid 1,262 eggs. Deducting the cost of current used, this poultryman realized \$8.62 more for the month from the first than from the second flock.

### LENS IN AUTO'S REAR WINDOW AIDS TRAFFIC DRIVING

With the aid of a large lens mounted in the rear window of the automobile, and the conventional mirror mounted on the windshield in front of the driver, operators of automobiles in France now are able to get a sharper and more complete view of the traffic behind them. About five minutes is required to attach the rear lens, and its use is said to be a marked improvement over the normal flat glass window which allows only a partial view.



Lens, Enabling Driver to See Clearly Traffic behind Him, Installed in Rear Window

Carl Carroll Theatre

a 2188

L. C. Portier and J. P. Hutchinson

No lens against mirror

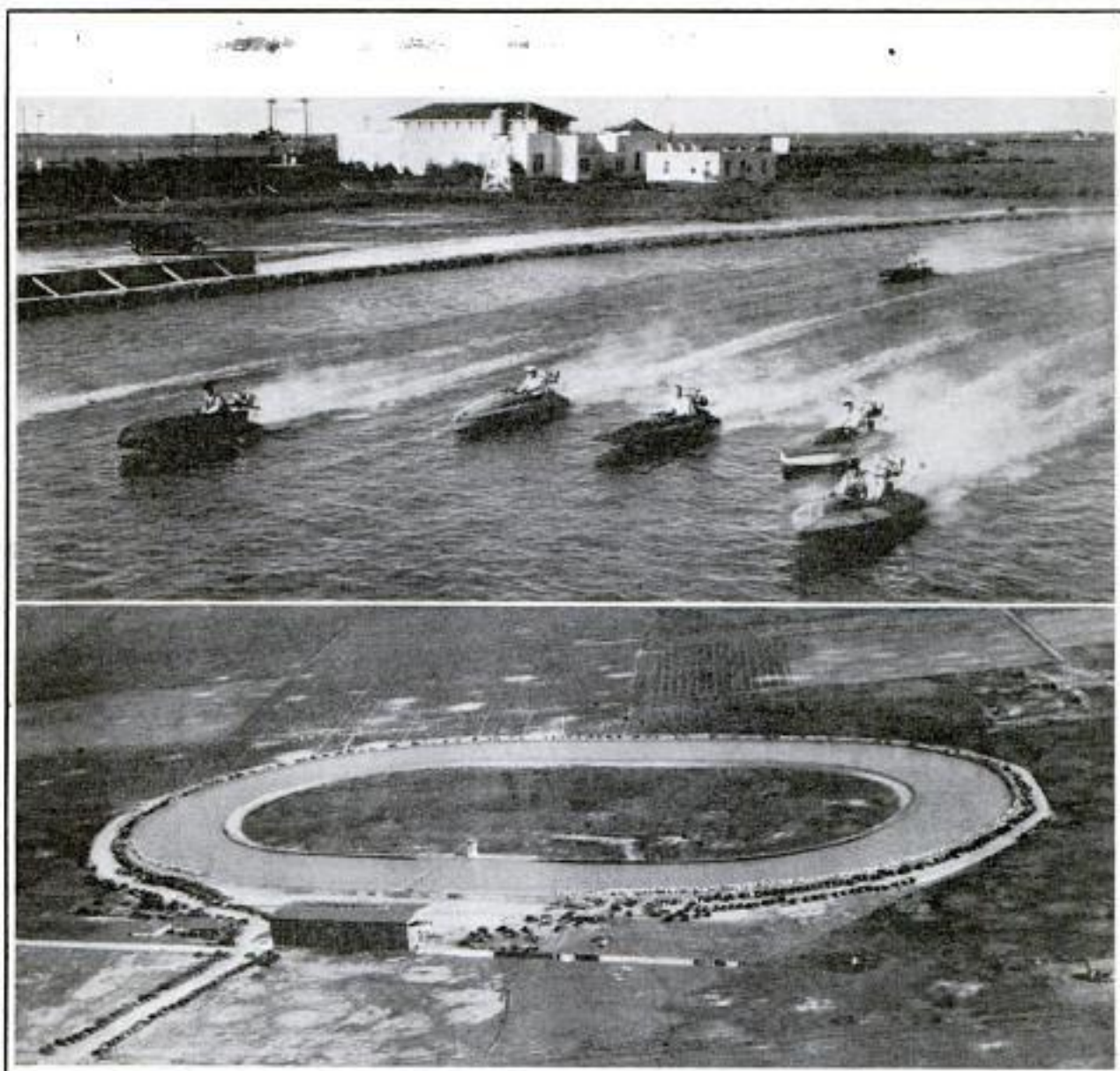
sample, 75 francs plus shipping

Wela Park Engineering Dept

Le Lio 4, Rue des Poissoniers, Neuilly-sur-Seine, France



# Speedboats Race on a Curved Prairie "Track"



Above, Speedboats Racing on a Half-Mile Circular Track Constructed in a Prairie; Below Is an Aerial View of the Circular Waterway Which Is About Five Feet Deep

Thousands of spectators are being attracted to a different sort of speedway in Texas. In a prairie, far from a lake or sea, speedboats are giving thrilling exhibitions on an inland course. The speedway was dug out of the hard-baked clay to a depth of five feet and filled with wa-

*Houston*

ter. It is a half-mile "track" and is wide enough at the turns to accommodate even the largest and fastest of racing craft. A parkway has been provided all around it for motoring spectators, and a grandstand for other watchers fronts the home stretch.

## GAS MAIN WEARS FOUR COATS TO KEEP OUT COLD

a 2150

Gas mains in cold climates require almost as much care as flower bulbs before they are entrusted to the earth. After cleaning off mill scale and dip coating,

such pipe is given a preliminary first coat and then it is primed and covered with an asphalt material. Next it is wrapped with a high grade of insulation, and then an asphalt service coating is applied. The cleaning and wrapping are done entirely by machinery.

*Being laid from Macomb & Cuba, Ill. by Central Ill. Pub. Service*

*Ill. Com. Pub. Utility Corp. 79 W. Wacker Drive*

# New CONVENIENCES



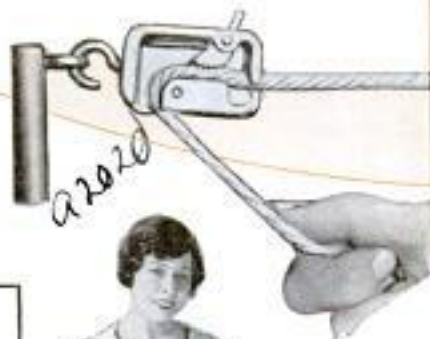
1976



Electric Mixer That Has Attachment for Automatically Regulating the Dripping of Oil in Preparation of Salad Dressing; Above, the Mixer Extracts Juice from Limes as Easily as from Grapefruit; Extractor Is Made of Glass to Eliminate Staining



Saw-Edged Knife, Shown in Use Above, Cuts Thin Slice of Fruit or Soft Vegetable without Breaking the Flesh



92020



Broom Rack, Shown Above Fastened to the Wall, Also Can Be Used as a Dustpan, as Illustrated in Circle; Rack Is Made of Metal and Lasts a Lifetime

92018



92019



Full-Size Folding Bed with Real Springs, Shown at Right Being Prepared for Use on Camping Trip, Weighs Only Sixteen Pounds and Can Be Carried under Seat of Car; Just Above Is the Bed Folded

# for Your HOME

a1988

no  
and  
Saw-e  
Br

Cloth  
O  
A  
M

Full-

Ch  
No

Elec  
Clo  
Kans  
\$35.

Handy

TheS  
C

Kitc  
Swe

Metal

Tic  
Pr

Hand-  
The  
Chic

Br  
Cl



a1982



Cleaning Mattress Is Easy with Handy Vacuum Shown Above, While a Twist of the Wrist Empties the Dustpan; Below Is Kitchenette Grill, Operated by Electricity



a1949

Electric Heater, Set into the Wall. Shown Above, Is Turned On and Off Automatically by Time-Control Clock Just above Wall Grill



a1923

Metal Receptacle, at Left, Helps Keep Kitchen Clean by Catching Wet Scraps; Removable Liner, at Right, Is Easy to Empty

Below, at Right, Hand-Operated Washer Cleans by Action of Water Circulation and Vacuum; the Flower-Shaped Piece Is the Washer, Made of Small Rubber Cups, Each with Perforated Top

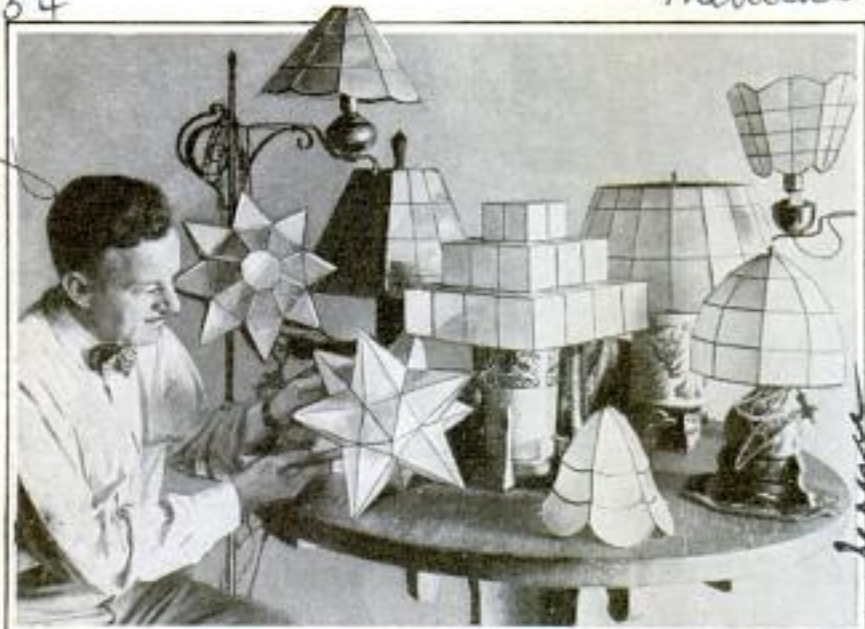


a2021

*Dr Thomas Lewis  
Editor Heart Pulch  
Medical Publication*

*a 2134*

*Charles Melnor, Laguna Beach  
Calif*



Collection of Lamps and Shades of Curious Design, Including Several Made from a Peculiar Form of Iridescent Seashell

**ODD-SHAPED LAMPS GATHERED BY COLLECTOR AS HOBBY**

Curious lamps and shades of odd shapes are collected as a hobby by a California man who has more than 600 pieces of unusual design. Among them are shades shaped like stars and others of a modernistic pattern, including several shell lamps made from a special form of seashell which is split into thin sheets and mounted in lead-lined designs. When illuminated, the latter are unusually iridescent.

**'PRECIOUS' ART GLASS FORMED IN MANY COLORS**

Form and color effects of surprising beauty are produced by a new colored glass exhibited recently in Berlin. Colors are made to flow in the precious glass, mingling indiscriminately with each other



Fish Made of Special Glass in Which Natural Colors Are Reproduced

*Museum for Industrial Art*

and giving the effect of opalescence or luminosity, until, when formed into art objects, they seem almost to reproduce the original colors.

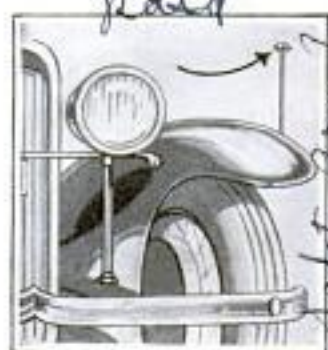
**CAPILLARIES HEAT FINGERS AND TOES**

Special capillaries which act as "heaters" for fingers, toes, ears and similar extremities of the body, have been found. When the extremities are exposed to cold, muscles in these capillaries expand to admit large amounts of warm blood to the cold finger or toe. It has been found that the nerve fibers of these capillaries in the finger tips will produce their heating effect even when the nerve trunks connecting the fibers to the spinal cord and brain have been cut. The special capillaries are direct connecting vessels between the smallest arteries and the smallest veins in the extremities.

*a 2175  
Science Service 10/24/31  
Academy of Science  
Cold*

**FENDER GUIDES HELP STEERING OF LOW-SEATED AUTOS**

Low seats and high cowls of modern car models, in many of which the fenders cannot be seen by the driver without undue strain, now can be fitted with an accessory which unfaillingly points out to the driver just how much clearance he may have in traffic or in entering a garage. The device consists of a slender rod mounted on each front fender, on the top of which is a streamlined ball, made of glass or metal. The rods are chromium-plated, and the ball may be either a solid red color, half red and half white, or chromed metal. They are easily and quickly fitted, and rubber pads in the mounting clamps prevent marring of the fender.



*safety arm*

*Casco Products Corp  
Bridgeport, Conn*

Cont. G. Percival  
to Paul Caplan  
California  
Cape Bros

African Distillers Ltd. A2073  
Verelising  
POPULAR MECHANICS

**CORN TURNED INTO AUTO FUEL  
STARTS NEW INDUSTRY**

Extraction of power alcohol from Indian corn has resulted in the purchase of factory sites near Johannesburg, S. Africa, for the development of this new industry. It is expected the first distillery will cost in the neighborhood of a million dollars, and it is the intention of the company to build ten more plants at various other points in the Union. The alcohol distilled is of such a grade and price as to make it commercially attractive as an automobile fuel.

A2116

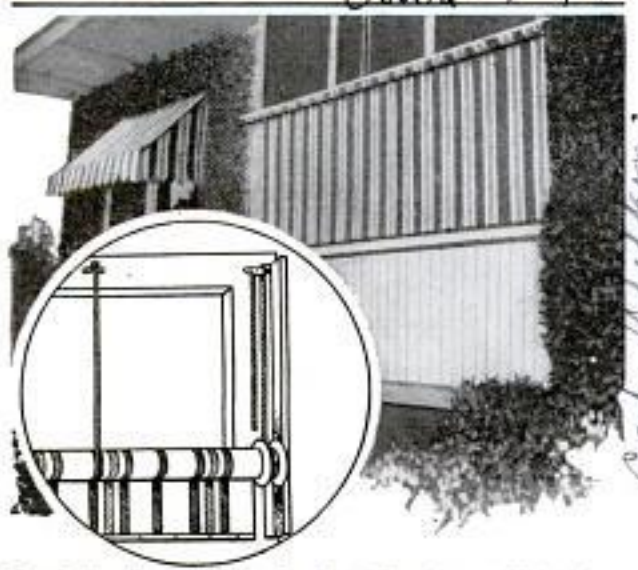
As to sagged knees

**"QUIET AWNINGS" FOR PORCHES  
BUILT TO RESIST WIND**

Awnings for sleeping and service porches that will not flap, bang or break in the wind have been introduced in California. Fourteen-foot sections are operated by a single cord, and instead of being lowered from the top, as is customary, the new awnings are raised on a roller from the bottom. This feature, it is said, gives the advantage of allowing air to enter from the top, while shutting out drafts and rain at the bottom. A special roller is held within shields by springs, the shields protecting the edges of the curtain from catching in the wind. The severest storms do not loosen them, according to the maker, while the strong fabric resists wind and rain like a solid wall. All metal parts are protected against the weather by being rustproofed.

A1974

Patd 12/23/30



Cont. Wilkin

Porch Awnings, Which Do Not Flap in the Wind, Are Raised from the Bottom

uses A Phenix Ideal  
Awning Co. 1430 E Washington  
St. Pasadena, Calif



Reflections of Traffic on Cross Streets Are Flashed to Motorists by Mirrors

**TRAFFIC MIRRORS AID DRIVERS  
AT THREE-WAY CROSSING**

Traffic on two intersecting roads is reflected by mirrors to a driver approaching the crossing on a third road in England. The mirrors are set in a standard in the middle of the intersection, and are so arranged that both of the other two roads are in full view of the approaching driver.

ashford

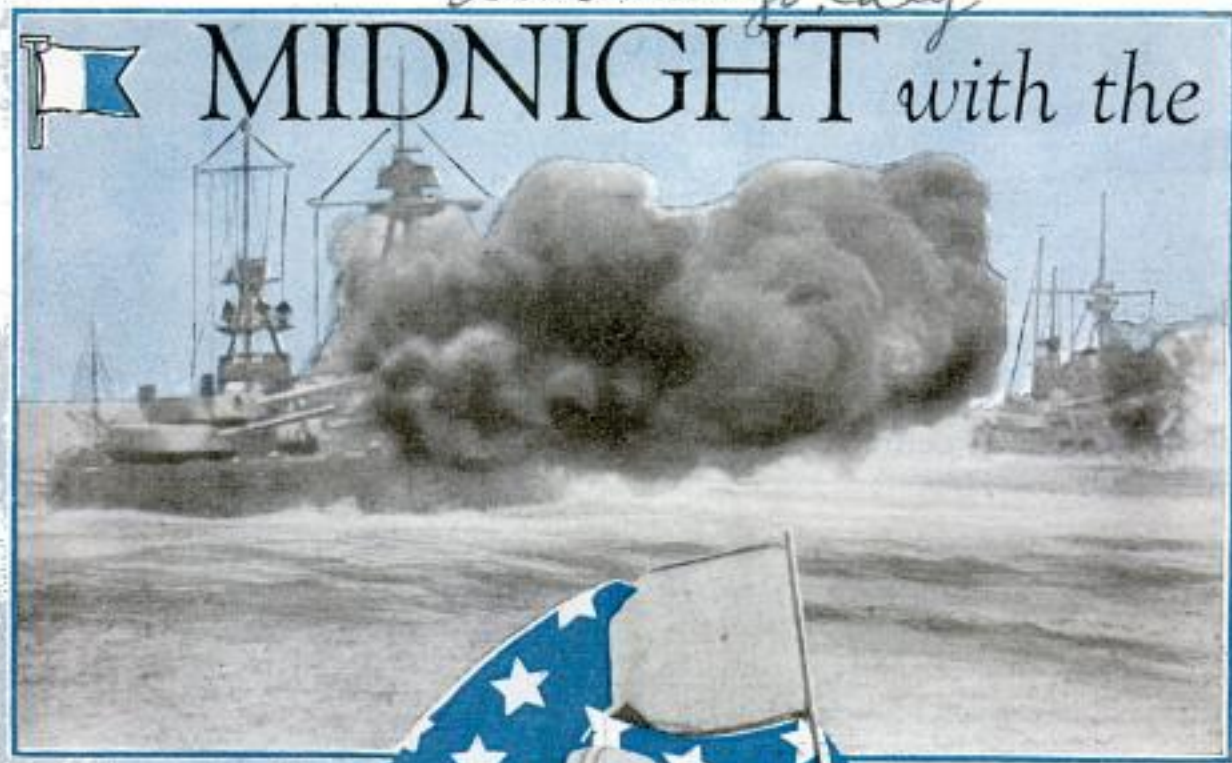
**GAS-LIGHT RAYS FOR RELIEF  
OF RHEUMATISM** A2110

Workers in the research laboratories of a gas-producing company in London have found a new way of healing wounds, relieving rheumatism of the joints and aiding sufferers from surgical tuberculosis, according to Sir Leonard Hill, F. R. S. He explained that coal-gas light produced the long ultraviolet and infra-red rays, considered by radiologists to have curative effects. Swollen joints have been cured by the light and heat reflected by five incandescent gas burners, Sir Leonard said. For sufferers from chronic rheumatism, the curative rays are reflected from a copper bowl and in several cases have effected cures.

Laboratory, Gas  
Light & Coke Co  
London, Eng

A 1962

Cmt Andrew B. Boone,  
613 Spreckels Theatre Bldg  
San Diego, Calif



## MIDNIGHT with the

WHEN the "darken-ship" signal sounds and loud speakers call all hands to battle stations, not so much as a cigaret is permitted to warn the "enemy," somewhere over the horizon, of the battleships' position. In total darkness the powerful column steams ahead toward its expected "battle."

As you peer through the darkness from the bridge of the "West Virginia," flagship during recent night maneuvers off the California coast, you watch the 35,000-ton dreadnaughts maneuver with an accuracy hardly expected of such large ships.

Astern, faintly etched against lowering clouds, the foremasts and yard-arms of the three ships next in column appear, but those beyond have vanished, swallowed in the mist.

Ahead, you see a faint glow on the water immediately astern of the "California." The faint rays of the tiny wake light

would be indistinguishable to an observer on either flank, but it plays an important part in night maneuvers, for it reveals the water line of the ship ahead. The late Rear Admiral Bradley A. Fiske found a way to utilize the light when he invented the stadimeter, a rather complicated mechanism for solving automatically right-angle triangles one side of which is the distance between bridges.

Junior officers constantly check with the stadimeter the range to ships ahead and astern. Calculating the speed of a battleship and its course becomes an exact science, one that must be even more precise in the darkness than under a noon sun. In the proximity of an enemy, this accuracy is even more important.

During night maneuvers battle lookouts lie aloft, searching the sea for any suspicious signs, not only of possible ene-

Two Ships in Battle Line Firing Simultaneously, at Top; Signaling for Take-Off of Planes; Phones Connect with the Bridge

# BATTLEFLEET



Before Catapults Were Developed, the Navy Used Captive Balloons for Observation, Above; Keeping Distance with Stadimeter

my craft but also for unprotected lights among our own ships.

Suddenly word is passed down that a masthead light on some ship in the battle line shines like a star. She was, at the moment, the fourth ship in column, three separated from the "West Virginia." In a few seconds, the light disappears in quick response to dots and dashes flashed from a blinker gun in the hands of an enlisted man who aims the blunderbus directly toward lookouts on the offending ship. This is one of the few weapons on a modern battleship not intended to aid in destroying an enemy. The blinker gun functions like the ordinary rifle. Instead of bullets pouring from its muzzle, however, light waves dance to their objective, and no lookout not in the exact path can see the warning signal.

Everyone hopes during night maneuvers for two things: "victory" and a short "battle." Our battleships are steaming without the protection of cruisers and destroyers. We rely on our own lookouts for observation. Lights were doused at

7:30 and nearly an hour passed before two keen eyes spotted a masthead light on a ship, hull down over the horizon.

"It's a destroyer, sir."

She had thought herself well outside our vision, but the one warning was ample.

"Battle lookouts lay aloft. Sound general quarters, take condition two."

Gradually the distant column moves in closer. Meanwhile the light has disappeared, but now a

series of hulls are faintly etched against the horizon.

"There they are, a whole column," a lookout shouts. Glasses sweep the horizon.

"Open lights one and two." The brilliant beams shoot out. Eight thousand yards away the column suddenly is illuminated, gray ghosts in miniature. Turrets swing to starboard. The enemy is under our guns.

"It isn't pleasant steaming ahead in that light," remarks Capt. C. W. Cole, commanding officer of the "West Virginia." "They can't see ahead."

91762  
84

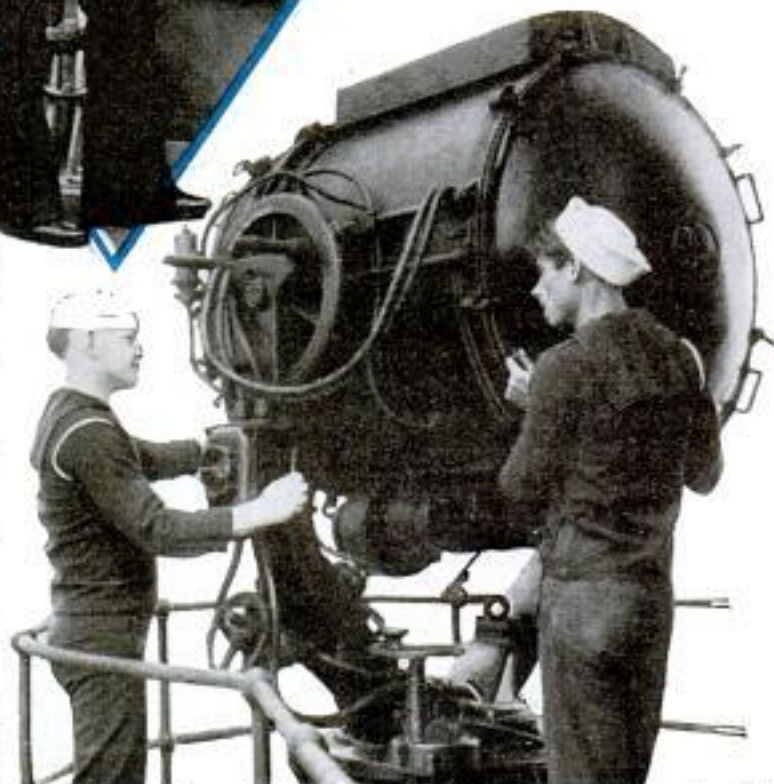
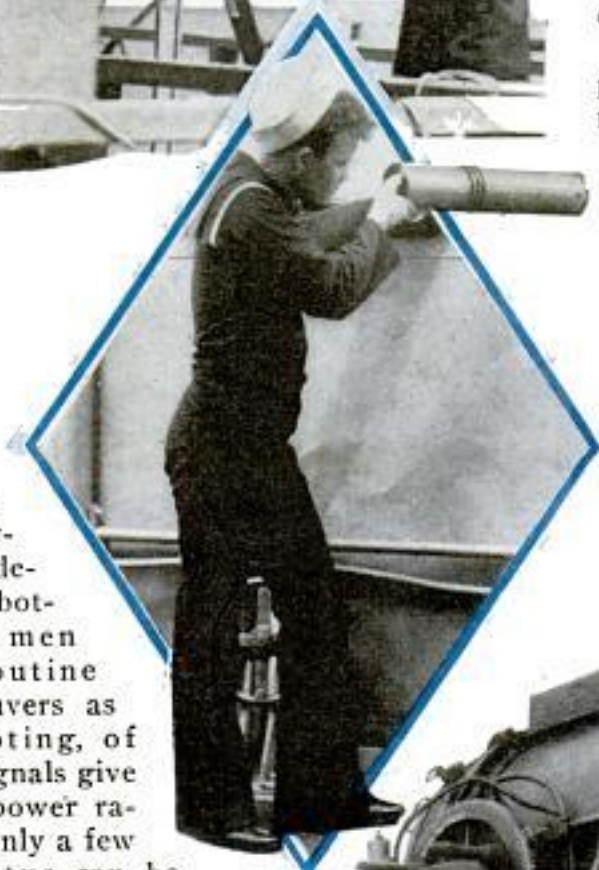


With the opening of the searchlights on all battleships, the battle approaches a close. In a few minutes subcaliber guns, popping up and down the battle line to represent the bigger guns, send the destroyer flotilla to the bottom. Officers and men follow the same routine during night maneuvers as during day, excepting, of course, that visual signals give way largely to low-power radio with a range of only a few miles. This apparatus can be used with impunity, even during an engagement, for no ship removed farther than three or four miles from the transmitter can hear its signals. The searchlights, so powerful that long ago ships' engineers ceased to think of them in terms of candlepower, remain dark until keen eyes fixed to night glasses determine that the enemy has approached rather closely to the battle line.

Modern war tactics require that every known method of attack and defense be kept in readiness for immediate operation both

during the day and at night. Air squadrons from the carriers may rise over the moonless waters. Seaplanes stand ready to be catapulted from the battleships to patrol the battle line, report the enemy's speed and direction and to spot gunfire once the action is joined. Destroyers, deployed ahead or on the flanks in a screen, hinder enemy surface craft.

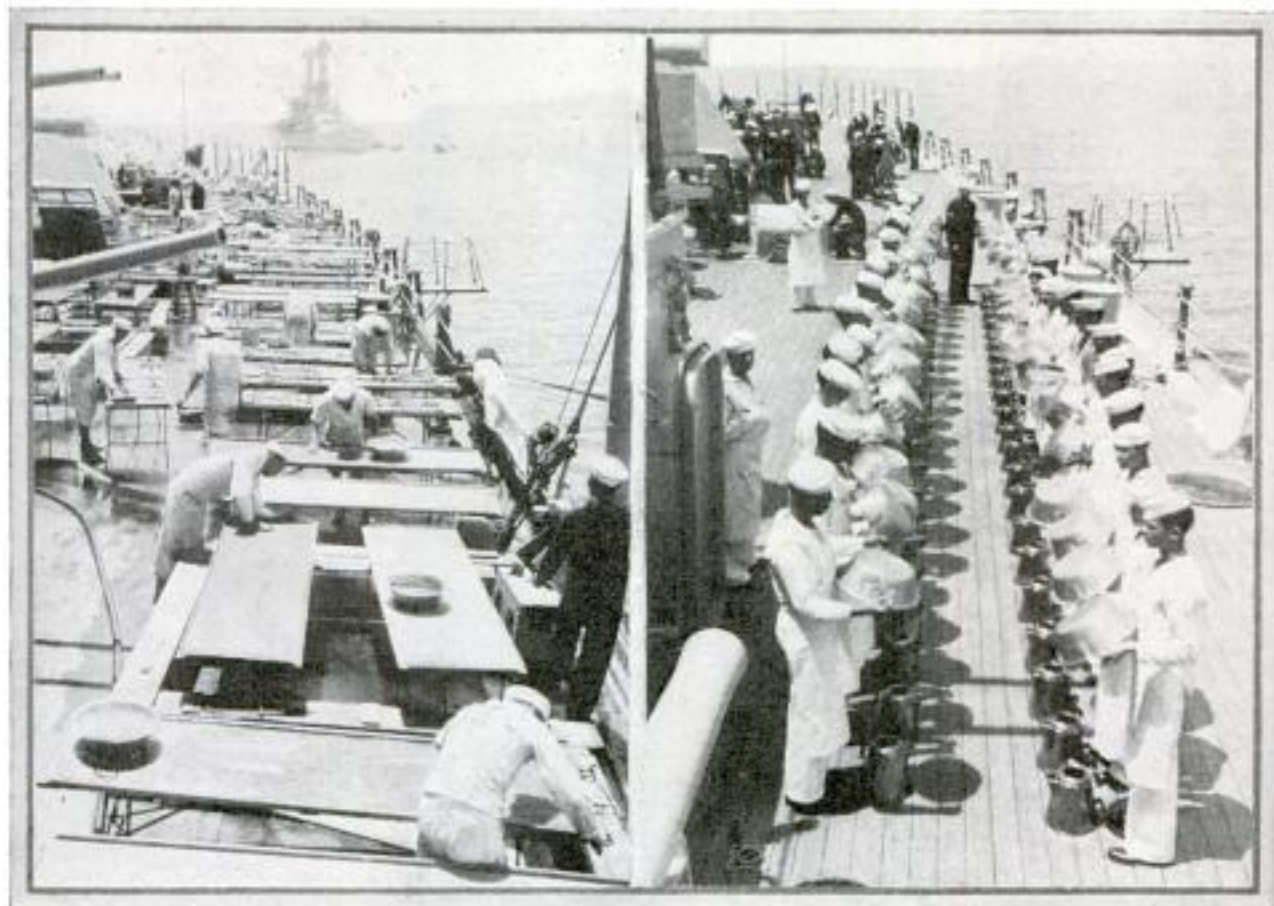
All the battleships' planes are seaplanes, although a few of them are equipped also with wheels which can be lowered for landing aboard a carrier or ashore. Each plane carries a radio by which the pilot reports his observations to his own ship. Two planes are always kept in position on the catapults, with a third lashed



Releasing Balloon for Weather Soundings, Top; Firing Signals with Blinker Gun, Center; One of Giant Searchlights, Below



91762



The Weekly Job of Scrubbing Mess Tables Is Seen in Photo at the Left; Right, Cooks Must Stand Pan and Coffeepot Inspection Each Morning

on a wheeled truck near by, ready to be lifted by a crane onto the afterdeck catapult.

Occasionally the battleship planes fly at night. When ready for a flight, the catapults are swung into the wind. Pilots and observers fasten life preservers over their coats and climb into the cockpits. On deck, a signalman holds two flags, one red and one green. To his head are clamped carphones and a mouthpiece connected with the bridge. Five minutes before the afterdeck plane is to be catapulted, the signalman raises the red flag. An air officer inserts a powder cartridge, resembling a six-inch shell, in the powder chamber, pulls the safety pin and steps away from the apparatus to a position of safety.

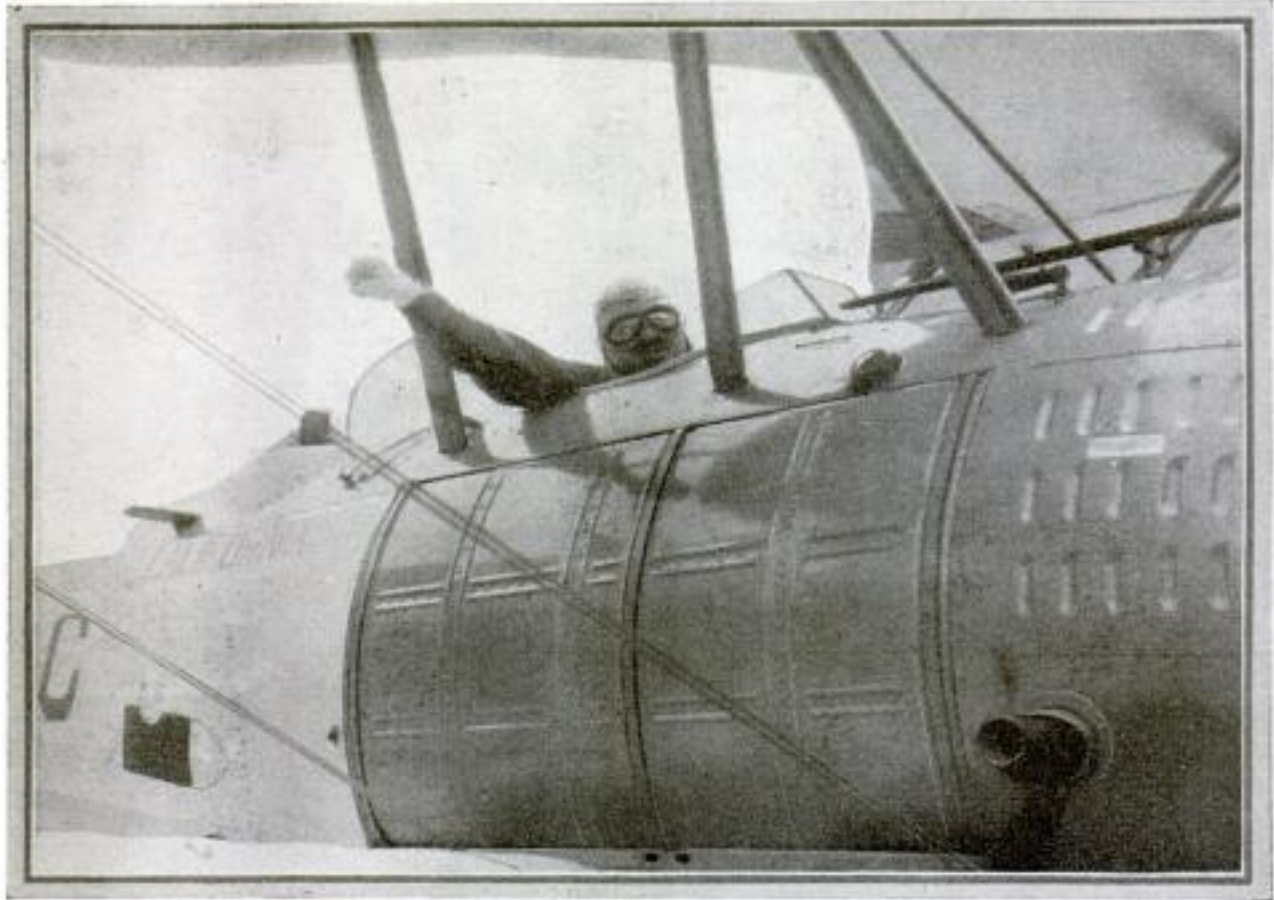
The signalman continues to hold aloft the red flag. Three minutes before launching, the air officer holds up three fingers. The pilot nods. Two fingers... one finger. The pilot "revs" up the 450-horsepower engine. Pilot and observer fix their heads tightly against headrests. Controls are set in neutral and held firmly. The green

flag is now displayed and here comes the order, "launch planes!" The pilot extends one arm and withdraws it. He is ready to be catapulted. The air officer pulls the trigger. S-w-i-s-h... boom! The plane is actually exploded into the air, fired like a big gun, and in less than seventy feet attains flying speed of fifty or more miles an hour. The plane dips over the side of the ship, levels off and soon makes a climbing turn into the sky.

Usually the three planes are catapulted at five-minute intervals. As soon as the first clears the ship, a crew rolls the third up to the crane to be lifted on the catapult. Meantime the signalman has hoisted the red flag as warning to the crew of the second plane. Exactly five minutes after the first has taken to the air, the second plane is shot down the runway and plunges out to sea. The process is repeated for the third.

Officers and men may be called out at any time of night for emergency drill. To sound a general alarm, a bugler steps up to the mouthpiece on the bridge, throws a switch, places the bugle near the

1762



Pilot Extending Arm as a Signal That He Is Ready to Be Catapulted from the Ship; the Plane Is Fired into the Air Like a Big Gun, Quickly Reaching Flying Speed

instrument and blows. In the crews' quarters, down in the torpedo room, back in the steering-motor room, on the after-deck—everywhere—loud speakers boom the call. No one on the ship can fail to hear it.

In the magazine, handling rooms and turrets, where a single spark might bring a burst of flame to snuff out many lives, compressed air expels the gas remaining in the gun barrel before the breech is opened after firing. Powder in bags passes from the magazine to the handling room through revolving drums which always keep the two rooms sealed against each other. Sprinkling systems can douse the handling rooms instantly. A large line leading directly from the pumps can flood a magazine within a few seconds.

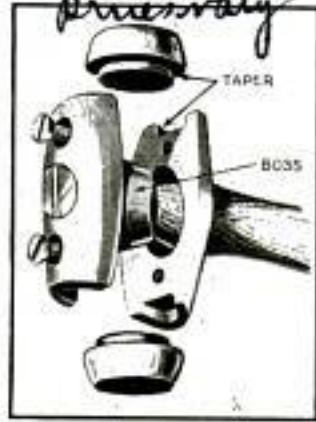
**BEDS SHAKEN AS A FIRE ALARM IN HOME FOR DEAF-MUTES**

To warn sleepers of fire at night, an automatic apparatus has been arranged to shake the mattresses of all beds in a home for deaf-mutes in Germany. The device

is connected to all the beds in the building and is operated from a central control to give a general alarm.

**REMOVABLE FACE ON HAMMER IS QUICKLY REPLACED**

Quick changes of soft faces is possible in a hammer which has been placed on the market to take the place of the old-fashioned lead, copper, brass, fiber and other soft mallets.



The metal head of the hammer is split, the halves held together by two screws. Worn-out faces may be taken from the hammer head, new faces put in, and screws replaced. Or the faces of one material may

be removed and faces intended for some particular operation fitted in less than a minute.

a2109

at Isoerlitz

(Wulms)

Victor Products Corp  
2631 Belmont Ave  
Chicago

Chicago  
228 N. Dearborn  
Chicago

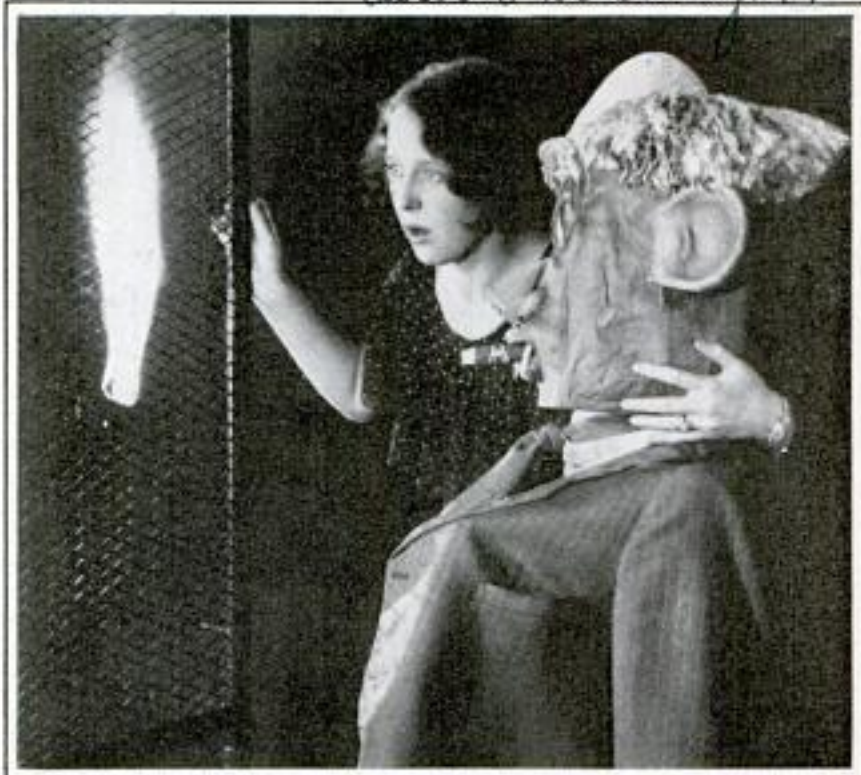
Cont. Q. Percival, 1/2 Port Captain Down  
partly mail under POPULAR MECHANICS  
Mr. P. W. Laidler

Party sent by Rand

A 2081 Westinghouse  
Electric & Mfg Co  
East Pittsburgh, Pa 87

### "STOVES" OF STONE FOUND IN AFRICAN VILLAGE

Archæologists have discovered ruins of an extensive Bantu village in the Union of South Africa, and, for the first time in any southern stone-built hut, have found indisputable evidence of internal hearths. One of those unearthed was carefully built of stone, surrounded by a ring of small stones placed vertically. Other points of interest were carefully leveled courtyards with paved pathways leading to certain huts. The "houses" had been most carefully built, and the weight of some of the huge blocks of stone has raised considerable wonderment among the discoverers as to how they were handled.



Robot Fireman Detects Flames with "Electric Eye," Which Shoots an Extinguishing Fluid through a Dummy Cigar

### FIRES EXTINGUISHED BY ROBOT WITH "ELECTRIC EYE"

Fires are quickly extinguished by a robot equipped with an "electric eye" for detecting smoke and flames and with carbon dioxide for putting out the blaze. The electric eye is an adaptation of the photo-electric cell, operating the extinguisher more quickly than one can call the fire department. The extinguishing substance is shot from a cigar in the mouth of the mechanical fireman in one form of the robot.

92017

### BAKELITE IS USED FOR ROOFING IN PLACE OF HEAVY TILE

Bakelite, which is waterproof and weighs ninety per cent less than tile, cement and concrete materials, is being used for roofing purposes. Light lumber may be used for roof beams, resulting in savings in construction cost.



Weighing One-Tenth of Other Roofing Materials,  
Bakelite Is Used as Waterproof Covering

### MOUNTAIN-TOP SEAPLANE BASE ESTABLISHED IN ALPS

On a mountain in the Alps far from the ocean, the French government has established a seaplane base for this type of fighting ships. This "airdrome" is located on top of a dam 460 feet high, towering above a rocky canyon across the river Drac. From the surface of an expanse of water, three-quarters of a mile wide, above the dam, seaplanes are able to take off, and also to "land" on it. The dam was established primarily to generate electric power, the plane base being a secondary consideration.

Nelson Roofing Co.  
29537 Albany Ave  
Chicago

W. L. Perkins  
Copyrighted material

*Dr. French pilot engineer,*  
88 *Chambers*

*demonstrated at  
Ardmore in Orly*



Helicopter, Controlled from Pilot's Seat, Enables This Dirigible to Fly Straight Up

### HELICOPTER FITTED ON AIRSHIP FOR FLYING STRAIGHT UP

Flying straight up is possible with an airship which combines the principles of the dirigible and the helicopter. Such an aircraft has been demonstrated successfully in France. In addition, the ship is capable of all the evolutions of an ordinary airship, and is readily controlled from the pilot's seat.

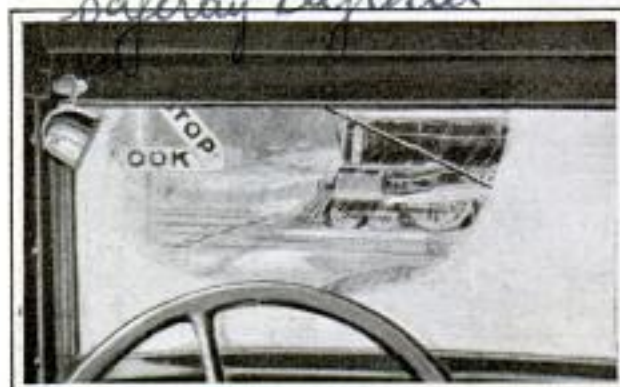
### HISTORY OF BUTTON REFLECTS MARCH OF CIVILIZATION

Buttons, made of such widely diversified materials as nuts, potatoes, hoofs, horns, porcelain, blood, skin, shells, milk, glass, seaweed and metals, are an accurate barometer of civilization's progress. Savages usually fasten their clothes with string. The Greeks and Romans of ancient lore managed nicely merely with a girdle. Buttons first were used on cloth-

ing for ornamental purposes, soon followed by loops for fastening purposes. The buttonhole came last of all. The manufacture of buttons had its beginning in England in the reign of Queen Elizabeth. Brass buttons were made in Philadelphia as early as 1750. Vegetable ivory is one of the most popular materials today. A bath in the Sangamon river of Illinois was the forerunner of the pearl-button industry in 1887. The bather cut his foot and on seeking the cause, found the bottom of the river lined with mussel shells. He had previously been employed as a button worker in Germany and had come to America expressly to find the source of certain shells he had seen in his fatherland, imported from the United States. He inaugurated the present great industry.

### INFRA-RED RAYS MELT ICE ON WINDSHIELD

Infra-red rays, directed upon the windshield by a small lamp, will keep the glass clear of snow and ice, yet will not heat or crack the windshield. Such a lamp, made for both six and twelve-volt battery systems, is now on the market. In action, the rays go through the windshield but are absorbed by the snow or ice, and the melting process begins. The usual windshield wiper does the rest. Under tests at four degrees below zero, the heat-ray lamp proved its effectiveness by keeping the windshield clear of ice at all points reached by the rays.



Rays from Infra-Red Lamp Penetrate the Glass to Melt Snow and Ice

*a 2124*

*Everett Spring,  
17-29 N Capital St.  
Washington D.C.*

*Schwarz  
Electric Co.  
1931 E. Church  
1171 Broadway Wash*

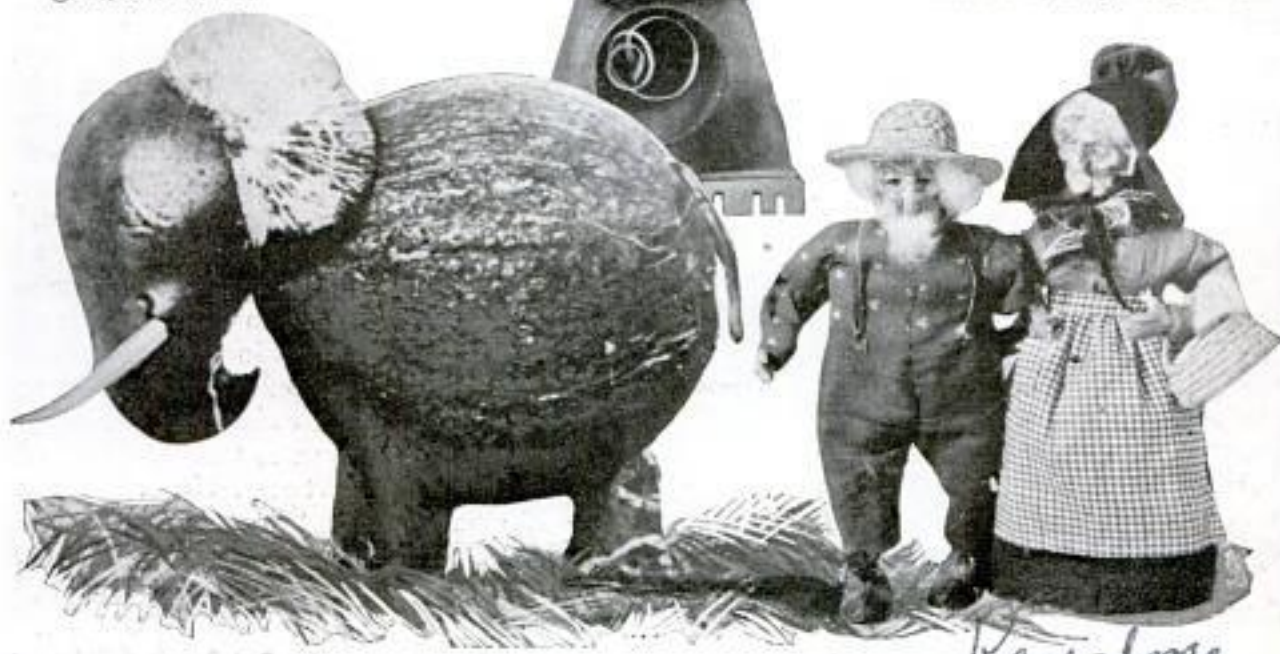
# Pieces of Art Made Out of Pieces of Rubbish



Making Something from Nothing Is Impossible, but Is Approximated by the Objects Pictured on This Page, Representing Pieces of Art and Decorations Made from Rubbish or Ordinary Things Found around the Home; Above Is a Carving Made from a Dried Lichen; Apples, Nuts, Raisins and Cork Compose the Elephant Below Left Photos, Top and Bottom.

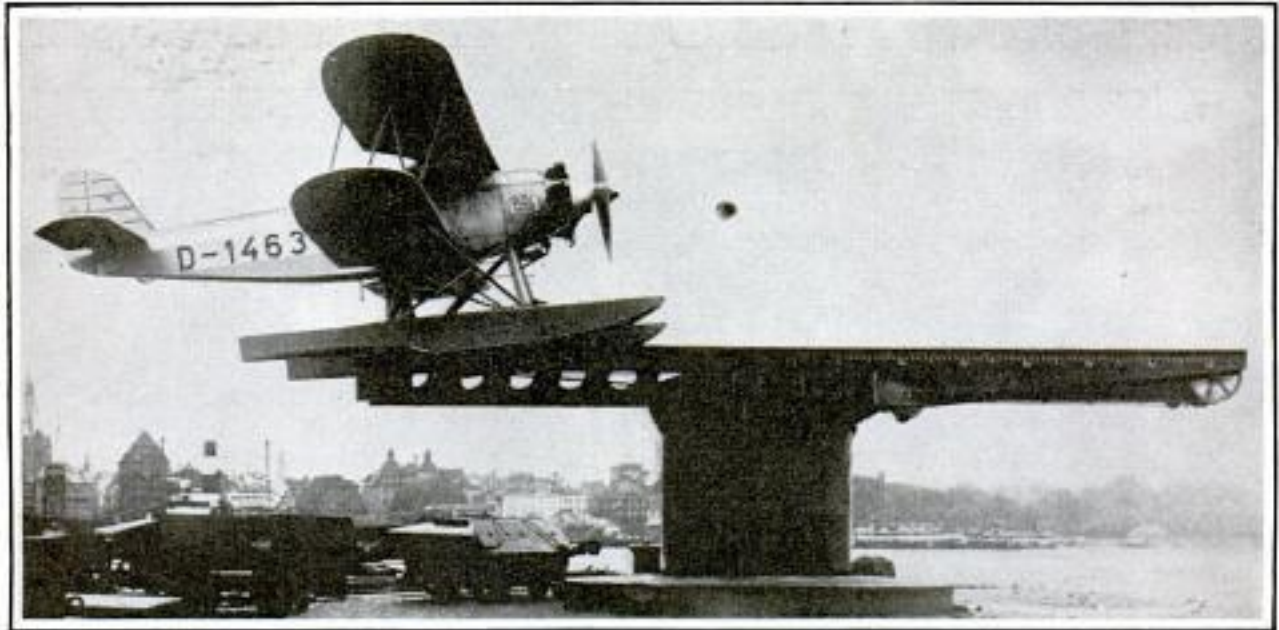
© Keystone View Co.

Above Are Caricatures of Two African Warriors Made of Frog Skin, Carefully Treated, Then Stuffed and Molded; Center, an African Aborigine Made of the Bottom of a Tin Can, a Funnel for a Nose, Watch Springs for Eyes and a Broken Feather Duster for Hair; Below, Are Two Apple Dolls, the Faces Formed of Dried Apples Which Survive Almost Everything Except Mice



*Keystone*

a 2028  
Cmt. Paul



Seaplane, Ready for Launching, Is Shown on Catapult Constructed on Shore at the Harbor in Kiel, Germany; Track at Left Lifts Plane onto Catapult, Which Rises and "Shoots" the Craft

### SEAPLANES ARE LAUNCHED ON LAND BY CATAPULT

German seaplanes are being launched into the air from the harbor at Kiel by a special catapult constructed on the shore of the harbor. The seagoing planes rest on a track at the top of a cylindrical base, the catapult shooting the ships out over the water at flying speed.

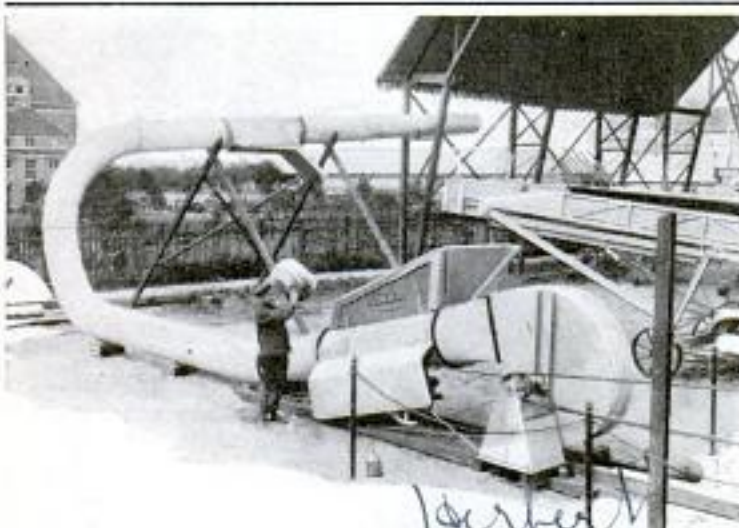
### PIPE-LINE ELEVATOR FOR FARM CARRIES HAY TO SILO

Hay and other farm products may be forced through a steel tube to the silo or barn by hooking up an ordinary farm motor to the carrier pipe. The motor gen-

erates compressed air for the pipe-line elevator, and loose hay and the like are carried swiftly to silo or barn, eliminating haulage and the labor of disposing of the hay after the storage point is reached.

### NUMBER OF PLEASURE YACHTS IN COUNTRY INCREASING

Pleasure boats in the United States are increasing in number, there being 3,582 documented pleasure vessels of 205,272 gross tonnage on June 30, 1931, as compared with 3,315 boats of 188,657 gross tonnage for the previous year. This is an increase of more than eight per cent and is the highest total registered in the history of American yachting. The first sailing yacht to be used for pleasure was the "Una," documented in 1847, and the first steam yacht was the "Wave," built of iron in 1864. The "Half Moon," a naphtha-propelled vessel of nine gross tons, was the first motor yacht, built in 1891. Each of these vessels has long since passed out of existence. Of the pleasure boats now in existence, the largest Diesel type is the "Orion," of 3,015 gross tons, the electric steam yacht "Corsair," now the "Oceanographer," of 2,142 tons, and the schooner yacht "Elena," of 206 gross tons.



Compressed Air Carries Loose Hay, and the Like, through Steel Pipe Line to Silo, Saving Time

no further data ✓

Herbert  
A. J. Tyler, Commissioner  
Commerce Dept. Bureau  
of Navigation

Copyrighted material

42192

Cmt. James B. Lowell,  
212 N. 11th St. Lincoln  
POPULAR MECHANICS

a 2159  
Bell Telephone Co

Will install for display.

91

**SHIPPED IN A GAS SEED POTATOES GROW FASTER**

Seed potatoes shipped from Nebraska to the south are being treated with gas during their journey to hasten growth on arrival. Wide, shallow pans containing ethylene chlorhydrin are placed in the freight cars with the potatoes, and evaporation of the substance forms a gas that penetrates the entire car. Such a treatment causes the potatoes to start growing at once instead of two months later, thus assuring earlier maturity.

Cmt Douglas Sweeney National Museum  
Washington D.C. in with  
retractor School of Agriculture  
Carter Hotel

a 2190

**NESTING PLACE OF BLUE GOOSE IN ARCTIC**

Breeding grounds of the blue goose, which winters on the Gulf of Mexico and provides sport for thousands of hunters, have been found, after years of search, on Baffin island, in Arctic waters. A Canadian naturalist traveled more than 30,000 miles in quest of the nesting haven, finally discovering it on the flat, grassy, and somewhat marshy plains of the island. The naturalist reached the breeding grounds late in May. The blue geese began to arrive early in June and, by the end of the month, thousands were swooping down to begin nest building.



Blue Goose at Nesting Grounds, Found on Arctic Island after Years of Search

J. Dewey Sweeney,  
employed by Canadian  
government



Telephone Map of World, and Control Cabinet Which Gives Phone Rates between Any Two Points When Proper Buttons Are Pressed

**PHONE CHARGE GIVEN BY ROBOT TO ANY PART OF WORLD**

Telephone rates to any part of the world are given instantly by a recently invented mechanism which is a bureau of information in itself. It consists of a large cabinet with control buttons on top and a map of the world with telephone stations indicated on it. Pressing the buttons, representing the cities between which connection is to be made, causes the toll charge to appear instantly.

a 2190

**COFFEE BRICKS USED FOR FUEL**

Inferior coffee in Brazil, that is usually dumped or burned, now is being pressed into bricks and is being tested as fuel for a government-owned railroad in that country. The experiment may result in a means for using low-grade stocks without the expense of laboratories also for alcohol, oil and coffee.

Shown at National Business Show at  
Howard Central Palace by  
Melford Campbell

N.Y. Jamieson  
10/24/31

a 2111

Dr. Erich Schmidt, Field Director, Persian Exc. U of Pa. Museum

at mentions to Lubbers in London

James Service 10/27/21



Flyer's Helmet with a Light in the Visor for Reading Maps; Batteries Are in the Ear Rolls

### LIGHT IN FLYER'S HELMET AIDS IN READING INSTRUMENTS

Inspection of maps or instruments at night is made easy for an aviator by using a helmet equipped with a self-contained electric-lighting unit. The light is in the visor of the helmet, and the batteries are held in the protecting ear rolls. The aviator's hands are left free, as the light is turned and focused when the head is moved.

### OLD MASTERS' PAINT SECRETS ARE REDISCOVERED

By grinding paint ingredients and mixing them with oil in the proper proportions, a Frenchman has rediscovered the secret of the colors used by the old masters. According to a report made to the Academy of Science of Paris, the secret, lost for two centuries, was found after twenty-five years' study of paint composition. One feature of the discovery is that the paint is unusable commercially, as it must be made fresh by the artist and cannot be kept in tubes. The Frenchman's paint is said to have the same transparency and luminosity of that used by many great artists.

My James 10/28/21

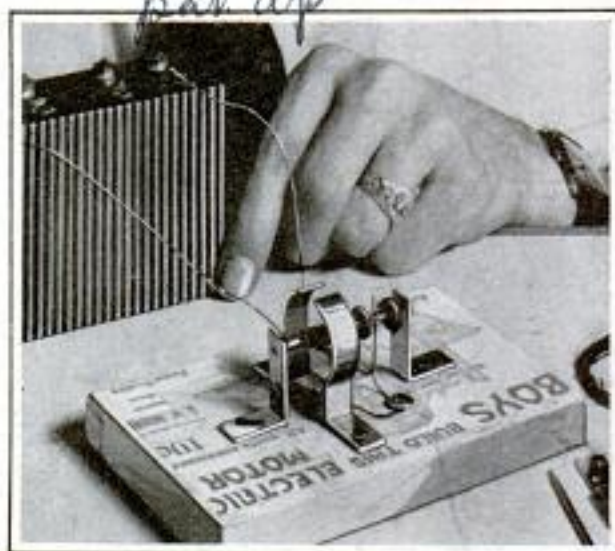
Jacques Maroger, Technical Counsel, Louvre

### CEMETERY OF UNKNOWN RACE UNEARTHED IN PERSIA

Treasured possessions of an unknown race which lived about 4,000 years ago have been found in a great cemetery unearthed in Persia. There were remains of children with their miniature dishes, as well as those of men and women with cups, bowls and pitchers. Many were found with strings of beads on their necks. Translucent and banded alabaster vessels, burnished gray and black pottery, bracelets, anklets and finger rings also were found, while a warrior's grave contained his weapons, a two-pronged spear, dagger, battle ax and helmet. Some of the pottery was taken from the cemetery without a crack or scratch. A little girl's grave yielded, among other things, small figurines carved like cows and sheep.

### TEN-CENT ELECTRIC MOTOR BUILT FROM KIT

How to build the simplest form of electric motor is taught to boys by an inexpensive kit now on the market. The kit contains all parts necessary for a toy motor operated by a single dry cell, and the parts can be assembled in a few minutes with a pocket knife. Every operation in the building of a motor is entered into in assembling this toy, including the winding of the field and armature and the construction of the commutator. Complete directions for building the motor and a simple treatise on how a motor runs are included with each set.



Principle of Electric Motor Is Taught by This Kit Containing Parts for Boys to Assemble

S. W. Moore Co. 44 Fairview Boston, Mass

Copyrighted material



91965

# Stalagmite Rings Count Past Time in Caves

The thousand or so caves in the Guadalupe mountains, New Mexico, have been the abode of man and beast far back into the dim ages. There are no logs whose annual growth rings may be counted to determine time in terms of years. But down in them are stalagmites or stone posts. Water containing dissolved limestone drips from the ceiling and forms this column upon the floor in layers which are not cylindrical, as in a tree, but cone-shaped. By investigation, it has been found that the rings in a stalagmite indicate periods of drouth and rainfall as those in a tree. However, the two have this difference: trees put on rings annually; stalagmites record only seasonable stretches and long periods of drouth. When very little rainfall occurs, almost all the drip in the caves of this region ceases. During this time the stalagmites begin to turn white on the outside. The drouth over, this chalky layer is covered by new depos-



Above, Giant Stalagmite in Carlsbad Cavern; Below, End of a Stalagmite Sawed Off to Show the Rings

© Jay Leek

its. When the stalagmite is sawed in two and the end polished, the dead white layer is seen as a light-colored ring among the darker ones of wetter eras. Thus long drouths and seasonable periods are recorded in the cave stone. Huge stalagmites are indexes of time infinitely greater than any tree can show. The Giant Dome of the Carlsbad Cave, sixteen feet in diameter by sixty feet tall, is perhaps 100,000 years old.

Carl B

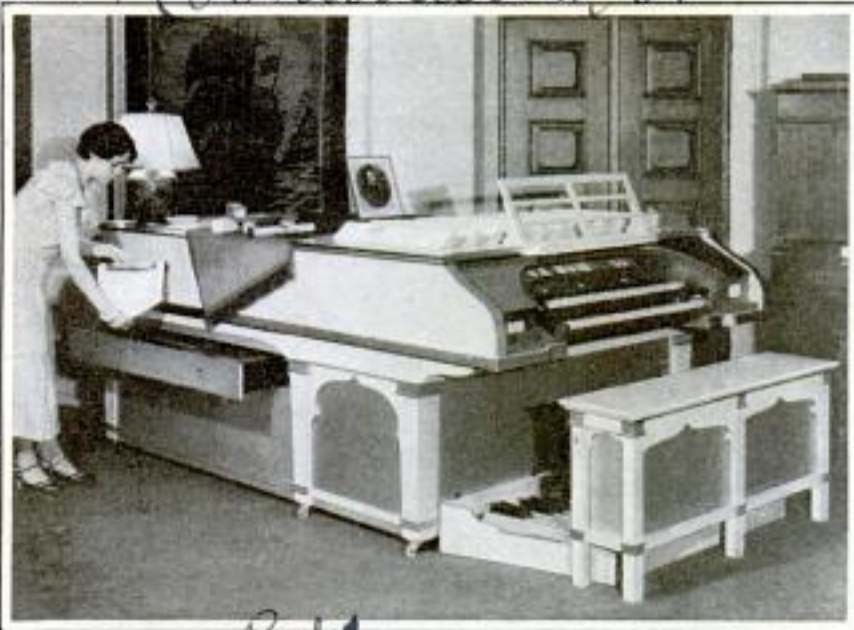
Livingston Carlsbad  
New Mexico

Copyrighted material

Esley Organ Co

94

a 2054 } Brattleboro Vt



Portable and Occupying Little More Space Than a Grand Piano, This Pipe Organ Has All the Tones of a Larger Instrument

**PIPE ORGAN IN COMPACT CASE IS AS PORTABLE AS PIANO**

Music of the pipe organ is brought into the home by an instrument which resembles a grand piano, but produces every tone of an organ by one or by combinations of the 231 pipes. It can also be fitted with an automatic player attachment. An average size living or music room will accommodate the organ without overcrowding. A feature of particular interest to the pianist who is not an organist is the bass accompaniment. This supplies an effect corresponding to that secured on the organ pedal board.

**TOWN SPRINGS OUT OF DESERT AT BOULDER DAM SITE**

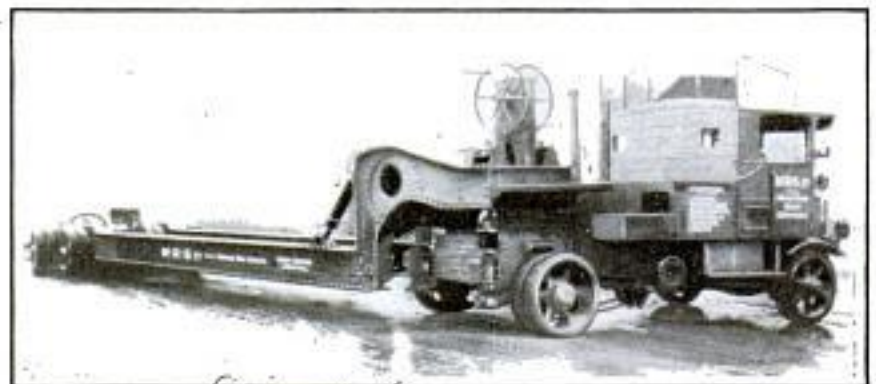
On a site which only a year ago was a desolate wilderness there stands today the town of Boulder City, Nev., a municipality operated by the government under the city-manager plan. The population of 2,000 is made up of workers at Boulder dam and their families, and the town will grow as more men are required. The little city sprang up in a few months, but it is as well ordered today as a town fifty years old.

Pumps bring a supply of water from the Colorado river six miles away, a sewer system has been laid and electric power lines have been run in from California. Street and sidewalk schemes are complete, and city planners arranged the ground with a view to zoning it in such a way that residences and administration buildings are separated. There are all the buildings to be found in any modern town, including a hospital, a town hall, a courtroom and even a jail. Nine deputy United States marshals

constitute the police and a U. S. commissioner presides in court. The fire department is made up of volunteers. All the property is leased by the government and the rents are collected by the manager.

**PHONE CONNECTS THE DRIVERS OF HUNDRED-TON TRUCK**

Telephones are necessary on a truck capable of carrying one hundred tons, because the two drivers, one at front and the other at the rear steering wheel, must have some means of communication. The truck has fourteen wheels and the load is evenly distributed between the axles. There is no danger of the giant vehicle sinking into a soft spot on the road, since provision has been made for lifting the driving wheels of the motive unit clear of the ground so that steel plates can be placed under them.



Turning the Hundred-Ton Truck Is Easy if the Two Drivers Understand Each Other; Phones Connect Front and Rear Driving Seats

Munich

Palo

a 2040

a 2089

Left of interior  
Munich 10/16/31  
Munich 5/200

London Eng

Head measuring device - <sup>and</sup> Burger  
 11950 POPULAR MECHANICS <sup>Villingers</sup> <sup>95</sup>  
 psychological and

# How Science Has Turned Fortune Teller

see May 1931-1939

scientist  
 Berlin  
 Serman

Determining for What Fields of Industry or Art a Subject Is Most Fitted. A Group of German Psychologists and Doctors, Who Have Set Up a School for This Purpose. First Measure the Head; the Photo at the Right Shows an Instrument, Called the "Plastometer," in Operation; Such Means Aid in Finding Strong Points



Low  
 Wiskey

The Electro-Diagnostic Instrument, Invention of One of the School's Scientists, Which Discovers the Peculiarities of Body and Mind and Tells the Character of the Subject



Exercise for Testing the Steadiness of the Hand with Pendulum

Pupils Are Put through Various Rigid Tests Which Aid the Examiner in Computing His Deductions from the Bodily Measurements; After All the Data Have Been Acquired, the Scientists Are Ready to Aid the Subject in Preparing for the Vocation That Most Suits Him; This Is Done by Concentration Exercises and Various Memory Lessons; in the Photo Above, Is Shown the Method of Teaching Foreign Languages; the Words Are Heard on the Record, and the Pupil Is Required to Point Out on the Wall the Pictures Representing Them; a Vocabulary Is Quickly Achieved

Izrahahm Hale, 241 W  
108th St

POPULAR MECHANICS

number

96  
1899  
a



The First Step in Making an Egg Caricature of a Famous Personage, and Some of the Finished and Mounted Eggs

EGGS MADE INTO CARICATURES

One New York artist virtually turns ordinary eggs into golden ones by adding a little paint and gluing on a few pieces of cotton or other material to represent hair. He makes a living by producing egg caricatures of famous persons, painting a likeness of an individual on an egg by using a photograph as a model, then making the egg face more realistic by adding synthetic hair and placing it on a tiny pedestal or base. He sells the so-called "egg-a-toons" at several dollars each.

WASHINGTON WAS INVENTOR OF FARMING TOOLS

Although it is not generally known, George Washington was an inventor as well as a statesman and soldier. Since he was interested in agriculture, he turned his inventive ability to the construction of farm machinery, and the implement in

which he took the most pride was a "barrel plow," or what would be known today as a drill. To speed up his spring planting, Washington made a barrel, or wooden cylinder, mounted on a wheeled plow arranged so that, as the plow moved forward, the barrel turned. In the barrel holes were cut, and through them the seed dropped into tubes that extended to the ground. By regulating the number of holes, the seed could be planted as thickly as desired. A light harrow or drag ran behind the drill to cover the seed, and a cord was attached to the harrow so it could be lifted around at the ends of the rows, the drill being turned by a pair of handles. There also was a leather band around the barrel to regulate the issuance of the seed. He also experimented with what he called a "two-eyed



plow," as differentiated from the duck-billed plow. While president, he inspected a crude form of threshing machine which was operated by two men and threshed two bushels of grain per hour, but this did not impress him. After he had retired from the presidency, however, he set up a threshing machine at Mount Vernon in which he combined some points of several types of machines then in existence, and added some ideas of his own. Concerning his barrel plow, he once wrote to a friend, who wished to borrow it, that the implement worked very well if the land was free from stumps, stones, etc., but not so well on rough ground.

To protect metal airplane propellers of the removable-blade type against centrifugal force, a key that locks the propeller in place has recently been invented.

a 2130

James Hay, Jr. Magazine Pub  
U. S. Commission. Celebration of  
200th Anniversary Washington

Charles H. Hadden  
New York City  
Copyrighted material  
of Iowa

## New Motor Road Climbs Canadian Rockies



Through the Giant Woods on the Cross-Canada Highway: Right, the Road Clings to a Mountain Side High Above the Stream

*Delbert Mountain*  
Climbing the Canadian Rockies through a district as wild as the day it was first seen by explorers, a new motor highway soon will connect the east and west coasts of Canada. The last link in this mountain road is 192 miles long, part of the 750-mile stretch through the Rocky mountains from Vancouver to Calgary. The main United States highways of the Pacific coast connect with this Canadian road, known as the Big Bend highway. Wherever possible, the surveyors led their route along the Columbia river, so now the road lies from 2,000 to 3,000 feet above sea level. At some points, the highway clings to hill-sides high above the river, while at others it crosses roaring streams over bridges constructed of native lumber. The longest of these bridges is built in three sections, each of 95 feet, capable of supporting eighteen tons of live load. Crossing the Bluewater river,



it was necessary to drop in elevation 400 feet along the side hill, and then on the other side to climb 410 feet through wooded slopes.

1950 Frank Isomper, head of  
Criminological Research Lab  
Sheriff's Office  
Los Angeles, Calif.

# How BODY STAINS



package of cigarets lay on the desk. During the interrogation, both men accepted smokes, discarding the butts in the ash tray that had been placed conveniently before them. Then both were permitted to go their ways, each apparently feeling that suspicion had been diverted. One had smoked a half-dozen cigarets during the brief questioning. It was he who was surprised later in the afternoon when two detectives walked into the shop where he was employed, frisked him for a gun and quickly ordered him to "come on in."

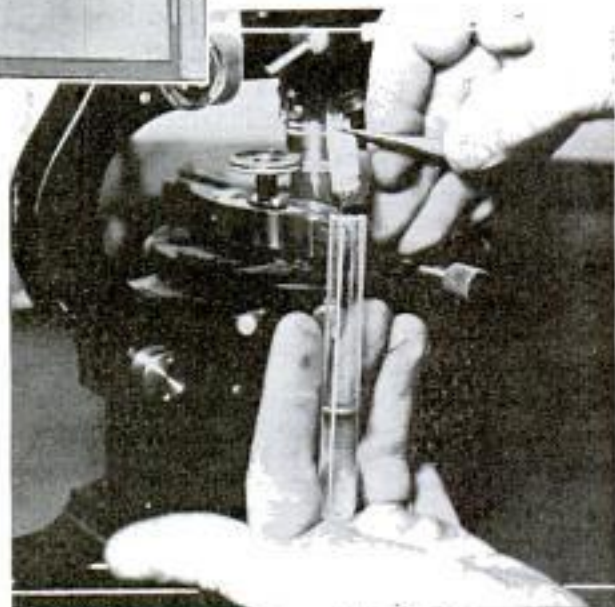
A half-burned cigaret had been his undoing. The dried saliva matched that which had been extracted from a butt found at the scene of the crime. Later a jury found him guilty of murder.

Matching is hardly the word, however. The body secretion which had stained the mouth end of the cig-

**D**EEP in the shadows of an outlying park, a middle-aged man walked toward his home. Suddenly two shots rang out in the darkness. Two flashes, a muffled groan, scurrying feet along the gravel, police sirens, and an ambulance hurrying the victim to the hospital.

But it was too late. The assassin disappeared with no telltale traces. He apparently had used a pistol which ejected no empty shells. The prints of his shoes could not be outlined in the grass, and hundreds of impressions pock-marked the walk.

The murdered man was known to have two enemies, either of whom might have committed the deed. Both appeared the next day in the sheriff's office. As officers questioned first one, then the other, a



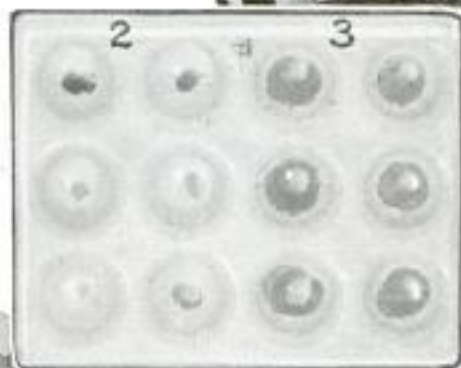
Using Camera and Microscope to Photograph Body Stains, and Classifying Cigaret Butt Blood Serum

cigaretts was classified, just as blood can be classified into one of four general groups.

# Betray CRIMINALS

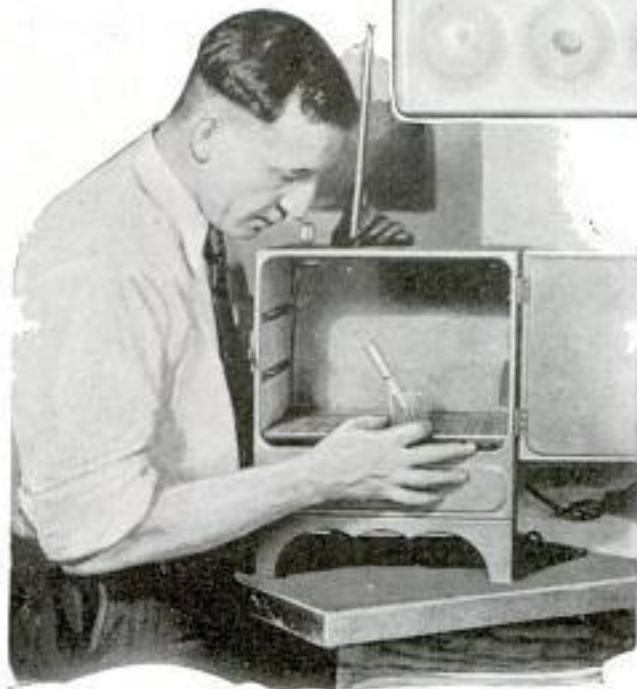
Saliva from the cigaret left on the desk by the first suspect did not fall within the group occupied by the saliva extracted from the cigaret found at the scene of the crime, while that of the second individual did.

Stains from body secretions and excretions are catching criminals in Los Angeles, tripping up suspects confident they have committed the perfect crime. But no such crime has yet been committed, according to Frank Gompert, head of the research laboratory of the sheriff's office, and somewhere along the line every criminal makes a mistake, even though it be only the carelessness of leaving the unburned end of a cigaret ground under foot. As long as 300 days after it has been smoked, the tiny remnant can be placed in a test tube and be made to give up evidence that may send an accused man



to the gallows—or save him, if the chemicals react in his favor. Gompert rolls through his test tubes and baking oven a combined knowledge of bacteriology, chemistry, biology and physics to trace evidence invisible to the naked eye, evidence which in the past would have been tossed

aside as valueless. Classifying chemical deposits from body secretions is the latest development in the scientific detection of criminals. For three decades it has been accepted by the medical world that all human blood falls in one of four classes. Last year Dr. I. Haraguti, of the Nagasaki medical college, Japan, reported he had found that body secretions could be classified. Of equal importance, he found these body stains fall in groups paralleling the blood groups. Therefore, as Gompert has done several times in his Los Angeles laboratory, such secretions as saliva and perspiration can be blood-grouped. Saliva reacts in the same way to a chemical test as does a drop of blood from the same individual.



Top, Obtaining Blood Specimen; Center, Plate Showing Blood Groups; Below, Oven for Incubation

9/18/50  
100



Gompert is adapting this new knowledge to criminal investigations in many cases. He determines first into which blood group a suspect falls. The law in California does not permit police to force an individual to supply a blood sample; here, again, Gompert outwits the suspect by taking a cigar or cigarette butt into his small laboratory and subjecting it to the test devised by Doctor Haraguti.

First, he immerses the remnant in a test tube containing a blood serum. Then he places the tube in a small electric oven and heats it to ninety-two degrees Fahrenheit. At intervals until the dried stump releases the saliva he shakes the tube.

"After making a solution of the cigarette," he explained, "this is mixed with a saline solution of varying strength. When solidifying takes place, we can determine the strength of the blood. So, if we have more than one suspect in a single blood group, each with blood of different strength, we would be able to eliminate those whose blood differed from that re-

vealed by the cigaret butt." This is only one phase of the methods science uses to trick criminals into revealing their probable guilt. Recently Gompert appeared as an expert witness during a murder trial of a young man accused of shooting his sweetheart in an automobile. Gompert testified that he had found evidence the girl might have shot herself. He pursues his investigations impartially, aiding those who deserve help and sending the guilty to prison.

Here, were it not for Gompert's knowledge of acids, an innocent boy might have been executed.

"I found acid stains, left by smokeless powder, on the girl's hand," he said. "What does that prove? That she must have fired the gun. The kick-back from a revolver shot throws the acid on the hand of the person who holds the gun. In order to determine this, I take a paraffin cast of the hand, test it for acid and, if I find any, I know that person fired the weapon. Here, the girl's hand revealed the acids, the boy's did not."

Whenever you



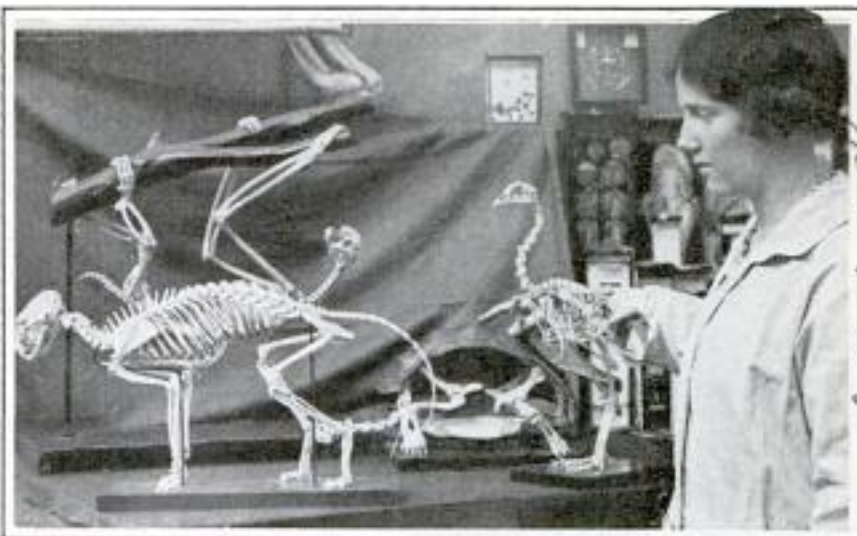
Making Microphoto; Crystals Show Presence of Blood in Shirt, and Examining Blood Sample



touch any object, Gompert explained, you leave on it a residue of saliva or perspiration. No matter whether the object be such a trivial thing as a match or a toothpick, Gompert can detect the residue and classify your blood group and its strength.

One man accused of burglary almost cleared himself, even after Gompert had helped apprehend him by identifying a rubber heel. The thug had made a mistake, however. He took off his shoes before entering the home and suddenly was scared away. In the dark he found only one shoe. The other was brought to Gompert.

"It showed little," Gompert explained. "The rubber heel was worn down, but I found it possible by using acid and the microscope to make out the trade-mark. From that, we traced the type of shoe and found it was of unusual size and make. Through a bit of good fortune, the man was found. But he denied stoutly he had robbed the house. Then I used the perspiration-residue reaction, getting the blood group from the residue in the shoe and testing the man who had been brought in. They coincided, and he confessed."



© Planet News, Ltd.  
Skeletons Which Are Operated Mechanically Help Visitors at a London Exhibition to Understand How Animals Lived

**ANIMAL SKELETONS IN MOTION  
SHOW HOW THEY LIVED**

Mechanical skeletons are used at a London exhibition to show how the animal lived. Among the skeletons set in motion for visitors to the display are those of the lemur, gibbon, fowl and tortoise. The exhibit is regarded as an aid to the student of natural history and kindred subjects.

**BUS IS CONVERTED INTO HOUSE  
FOR USE IN SUMMER A2075**

Addition of a porch to a double-deck motor bus was the last step in the transformation of the vehicle into a summer bungalow for a German family. The "two-story" home is large enough for three or four persons, and it also is provided with numerous windows.



Double-Deck Bus Converted into a Summer Bungalow on a Hillside

**LIGHT OF SODIUM-VAPOR LAMP  
FOUND MOST EFFICIENT**

Light from the sodium-vapor lamp is the most efficient of any produced by artificial devices, according to L. A. Hawkins, electrical engineer. However, it has been found difficult to increase the low operating value of the incandescent lamp, which has a light efficiency of less than two per cent. All the elements which possibly could make good lamp filaments have been tried, Mr. Hawkins says, but none can compete with tungsten. Some were found with higher efficiencies than the latter, but they possessed inherent disadvantages which outweighed their merits.

*Executive Engineer  
General Electric Research  
Laboratory, Schenectady, NY*

*Mechanical Aids to Learning  
Kinesthetic principle of molecule - Sand  
London*

*Berlin*

*Clyde*

a2144 Pittsburgh Pa

Safety Aerial Stand



Aerial Stand for Window Washers and Painters; Note How the Feet Are Strapped to Base

### SAFETY STAND FOR WORKMEN ON BUILDING EXTERIORS

For workmen on the exteriors of tall buildings who must labor while suspended from a block and cable, an aerial stand is available which holds the occupant safely in place. The feet are strapped to the base and the supporting slings are attached to the workman's safety belt. The thimble which fits into the tackle block has a cleat welded to it, so that the occupant may raise or lower himself and make the lead line fast.

### WHY TWO-DOLLAR BILLS HAVE REPUTATION FOR ILL LUCK

Two-dollar bills have the distinction of being the most unpopular form of currency issued. Some dislike them because they are easily confused with other denominations and others believe they are unlucky. For these reasons, they circulate rapidly because nearly all who

chance to get them hurry to pass them along. The treasury has made efforts to get them into circulation but banks seldom order them, and finally they were placed in the pay envelopes of government employes who cannot refuse them. Thousands of the two-spots that come back to the treasury for redemption are minus their "ears," thus testifying to the superstition of those who have handled them, because tearing off the corners is one formula for breaking the bad luck they are said to bring. An attempt once was made to find the origin of the superstition about these bills, and the trail finally led to the Spanish Main. The buccaneers had their pieces-of-eight, but they also had pieces-of-thirteen, which, for some reason, probably connected with the numeral itself, were considered unlucky. This Spanish money, which was current through the southern states, spread the superstition, and one of them equaled \$2 in value. There are less than 26,000,000 two-dollar bills in circulation today against over 488,000,000 one-dollar notes.

### WIND SAWS FARMER'S WOOD IN PRIMITIVE FASHION

Wood is sawed on a farm in Canada by a primitive windmill which has been in operation for many years. When the wind blows, the mill turns a pulley to which the saw is connected.

Lease Peninsule Quebec

Crude Windmill That Is Used for Sawing Wood When the Wind Blows



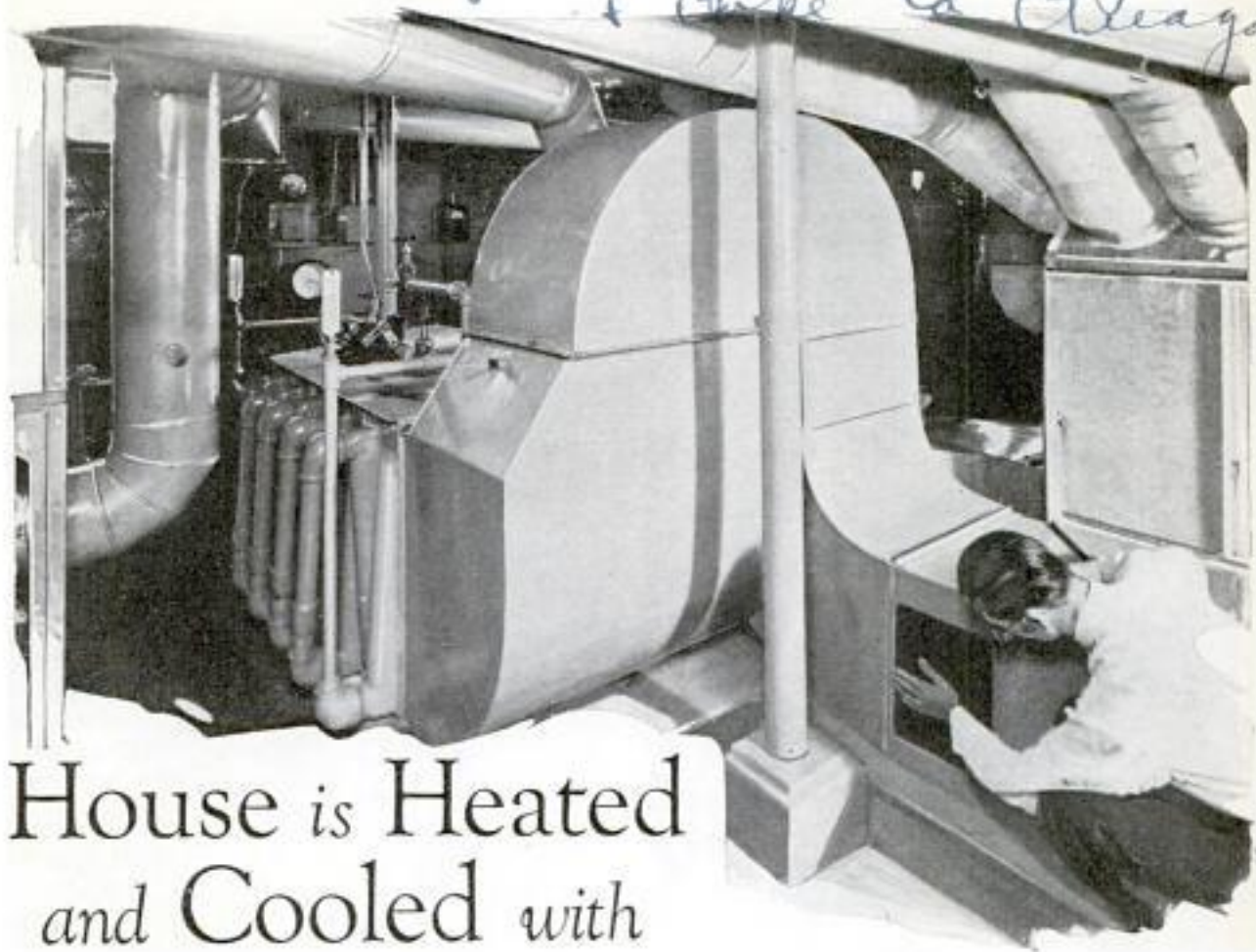
Wide World

Copyrighted material

Everett Spring  
14129 N. Capitol St  
Washington D.C.

a2230

a 1969 J. Is. Cañar, House Heating  
Dept. Peoples Gas Light  
& Coke Co Chicago



## House is Heated and Cooled with ≡ GAS ≡

Part of Gas Cooling Plant for Home, Including Water Pipes to Cool the Air

THE furnace has taken on a year-round job, keeping you warm in winter and cool in summer. In winter you close windows and doors and turn on the heating plant to keep the house warm by heating and moistening the air in it. Now homes are also being kept cool in summer by shutting the windows and starting the furnace. Instead of heating and humidifying the air, however, the cooling system operates by reducing its temperature and removing some of its moisture.

The same warm-air registers that sent a constant stream of heat from the furnace in the basement in winter now reverse the process in summer by carrying a supply of cool, dry air to keep the home always comfortable, regardless of weather conditions outside. During last summer three experimental homes, one in New York, another in Chicago and the third in Dallas, were kept cool by installing this air-conditioning equipment as a part of the warm-air furnace systems us-

ing gas for fuel. The heating plant that keeps the house cool in summer is not the main gas furnace used in winter, but an auxiliary one. The cool air, however, is conveyed to all parts of the house through the regular pipes.

There are two ways to obtain coolness as far as the human body is concerned, one involving lowering the temperature of the air, and the other by lowering the moisture content of the air. In the first case, cooling is caused by the natural flow of heat from the body to the cooler air, and in the second case by the evaporation of moisture from the skin. In the latter instance, the human body actually becomes a form of cooling plant since, when moisture is removed from the air, its ability to evaporate moisture from the skin is increased.

The cooling plant, which operates as a part of the gas-heating installation, combines these two methods. The conditioned air that comes through the furnace pipes

American Gas Association



is cooled by passing it over coils filled with running cold water, and it is also dehumidified by forcing it through beds of silica gel, a substance that has the property of absorbing moisture from anything with which it comes in contact.

Actually, the temperature of the conditioned air may be reduced not more than ten degrees, but the removal of up to thirty per cent of its moisture causes it to appear much cooler.

Cooling and dehumidifying units operate separately, the air passing from one to the other on its way to the furnace pipes. The auxiliary gas furnace is employed to dry out the saturated silica-gel beds after they have absorbed the excess moisture in the air. By means of an electric fan, air is drawn from upstairs or from outside through a filter and passed over the silica-gel beds. There are two of these beds, each being used for an hour. During this period the reactivating gas furnace dries the other bed, after which it is cooled, and, at the end of the hour, the incoming air is automatically switched to the dry silica-gel bed.

Only about ten per cent of the air handled is dehumidified, and this air is then mixed with "raw" air and passed through filters by means of other fans to the cooling system, which looks like an oversize radiator with cold city water flowing constantly through the fins as the air passes over the pipes. Damper arrangements permit drawing any desired part of the air requirements from inside or outside the house, and the entire air content of a building is circulated about ten times an hour. Electrically operated valves and automatic equipment for the furnace insure a system that requires no more attention in summer than a gas furnace in winter.

By means of extensions from floor or wall ventilators, it is possible to deliver the cooled air to any part of a room desired. Careful check on the operating cost of the equipment in one of the air-cooled homes indicated that a house of eight rooms, or even larger, can be thoroughly cooled at a cost of less than



Top, One of Cool-Air Wall Vents; Center, House That Was Cooled; Below, Control Panel

a 2098

twenty cents an hour, this figure covering gas, electricity and water used. All the cooling equipment is made auxiliary to the heating equipment and can be turned off or removed entirely without affecting the efficiency of the heating plant.

As yet the cooling equipment is not in commercial production, but it is estimated that the system, by utilizing the heating-plant pipes, can be produced and installed at a figure well within the means of the owner of an average-size modern home.

*a 2261*  
**"SILENT TALKIES" TEACH DEAF TO "HEAR" WITH EYES**

"Silent talkies" are being made for the deaf and hard of hearing to teach them to "hear" with their eyes. Lip motions and other facial movements, together with body gestures, are emphasized in the silent talkies in order that lip reading and interpretation of other motions may be easier. Ohio State University is experimenting with this form of motion picture with a view to aiding deaf students in their college courses.

*a 2143*  
**PRESSURE NAIL DRIVER MAKES PICTURE FRAMING EASY**



Driving small nails into picture frames is made easy with a tool that squeezes the nails into place. It is operated by placing the base of the tool against the frame and applying pressure to the nail by means of a lever. Besides saving fingers and preventing damaged frames, all nails are driven to

the same depth, and the tool is adjustable for use with frame moldings of many different sizes.

*Walter*  
*77 South*  
*Rochester, N.Y.*  
 Talking scales in England announce the weight vocally when a customer steps on the platform and deposits a coin.



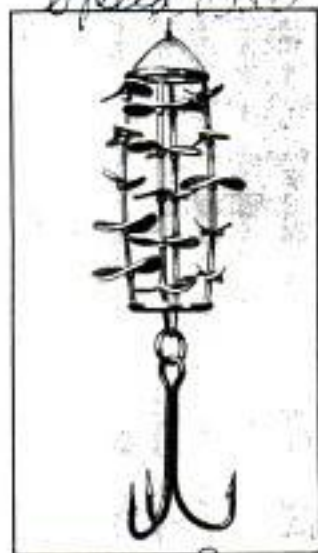
*u 59*  
 Mountain Climber Carrying Air Tanks for His Ascent and Wearing Breathing Mask Connected to Them

**AIR SUPPLY CARRIED ON BACKS OF MOUNTAIN CLIMBERS**

Mountain climbers in the Himalayas who ascend from 20,000 to 30,000 feet above sea level must carry along their own air supply when going into such rarefied atmospheres. Tanks of oxygen are strapped to the backs of the climbers, and connected by breathing tubes to a mask fitted over the mouth and nose. Such equipment slows down the ascent, but is essential if the adventurers are to proceed up to precarious heights where the air is too tenuous.

*a 2163*  
**FISH LURE HAS MANY SPINNERS LIKE PROPELLER BLADES**

Revolving propeller blades have been used with success on fish lures, and one is now produced consisting entirely of spinners. Twenty of these revolving blades are held in a light frame above the hook. It is made in various sizes for casting, trolling or dipping.



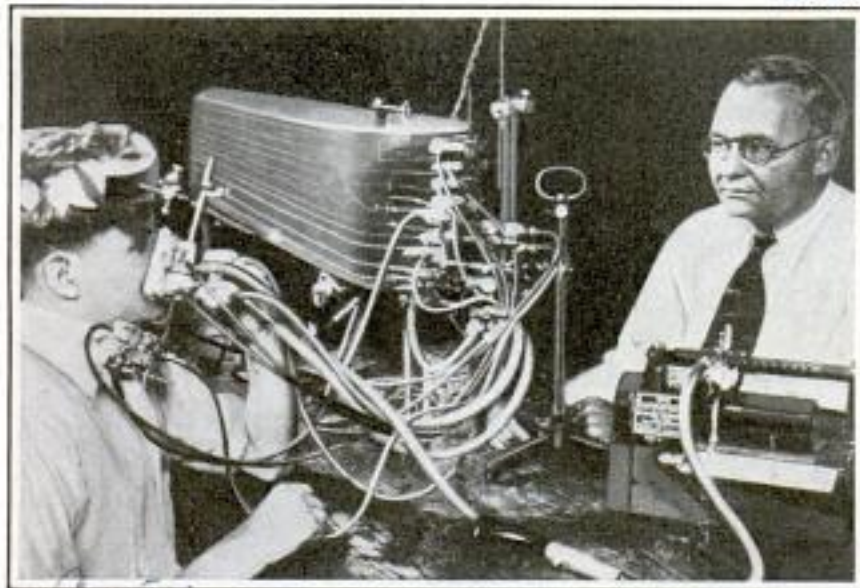
*Walter*  
*77 South*  
*Rochester, N.Y.*

*Carl Bell & Howell*  
*77 South Rochester, N.Y.*

*N.Y. Times 10/31/31*

*Q2242*

*Blair Day K. C. Daniel, School of Speech*



Muscles Used in Speech Are Measured by This Apparatus in Studying the Causes of Stammering and Searching for a Cure

**MUSCLE STUDY OF STUTTERING MAY RESULT IN CURE**

Muscle synchronization and its relation to stuttering are being studied in an attempt to determine the causes of this affliction and to find a cure. Apparatus for measuring the length of sound waves and the movements of speech organs has been installed at the University of Southern California. Tests already conducted have shown that the length of various sounds uttered in the course of conversation average between .05 and .25 second. Just how much greater the sound timing is for people with speech defects will be disclosed by experiment.

*Los Angeles Calif*

**OIL OR GAS LINE NOT CORRODED BY ELECTRIC CURRENTS**

Stray electric currents from street-car tracks may travel along near-by pipe lines and hasten their corrosion, but the currents which follow long oil and gas lines for miles do not speed up rusting and leaking. This is the conclusion of research engineers who made an investigation. It is well known that currents from electric railways often jump to pipe lines and cause heavy damage, but the currents studied in the experiments were those found far from any electric sources. They are known as long-line currents and frequently follow the pipe lines for miles. It is believed they originate in action of the soils on the pipe.

*Stanley and Al L. Rogers, Steel Oil Co, Annet*

*Stanley and Al L. Rogers, Steel Oil Co, Annet, Pittsburgh, Pa.*

**STATIC AND FADING ELIMINATED BY SHORT WAVES**

Complete absence of static disturbances and fading, which are so troublesome in long-wave long-distance reception, is noted in connection with research on the ultra-short beam-wave apparatus, according to Senator Guglielmo Marconi, who has been engaged for some time in such experiments. The very short waves also are economical, using only sixty watts of power.

Senator Marconi also found that the waves will penetrate the brick walls of Italian houses with ease, while American buildings absorb them on account of the amounts of steel and iron used in their construction.

*Rome, Italy*

*Q2132*

**PISTOL WITH TRIPLE BARRELS SHOOTS TEAR-GAS SHELLS**

One of the latest weapons to be placed in the hands of the police is a triple-barreled pistol that shoots tear-gas shells. The barrels of the gun, used in dispersing mobs or resisting a concerted attack, are mounted one atop the other instead of side by side as in a two-barrel gun.



*shown in police chief at M. Petersburg*

Tear-Gas Gun with Three Barrels Instead of One, Thus Tripling Effectiveness of Weapon

*makes unknown*

# FISHING Through the ICE



**P**ULLING 'em through the ice is royal winter sport, entirely different from warm-weather trolling or casting.

Ice fishing now calls millions of followers of Izaak Walton to thrilling adventure all over the snowy empire which stretches across thirty-six states and most of Canada.

A score different kinds of game fish lure sportsmen at a season when the familiar bass, trout, lunge and tuna are not available. Matching wits with whitefish, lake trout, pickerel, perch, dory, tullalie, etc., which tip the scales anywhere from one to six pounds, provides battles which add millions of pounds of food at a season when the supply is not so plentiful.

The equipment for winter fishing varies all the way from nets and spears, used in the remoter districts where game laws are not so strict due to abundance of fish, to the ordinary baited hook, whose lure is the anglerworm, minnow or shiner, a supply of which has been provided the fall before.

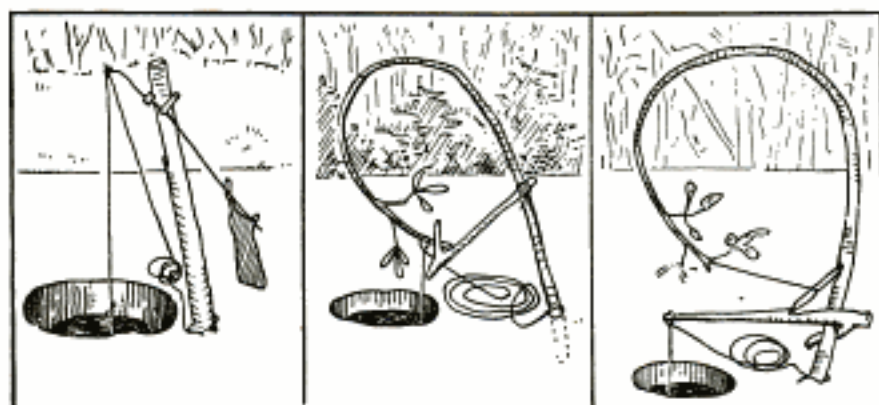
Although the deceptive fly is not used,



Using Hook and Line to Fish through a Hole Cut in the Ice on a Lake in Ontario

nor even the alluring spoon cast into the icy water, ice fishing at most calls for a very simple and inexpensive tip-up, insuring as thrilling a fishing expedition as the high-priced outfit.

In many northern waters, the outfit, aside from line and hook, is homemade. Expertness counts for little; every fisher-



so you can stand in the center and care for each line as the signal flashes a bite. Carefully remove all floating ice from the hole, to insure a clear surface of well-lighted

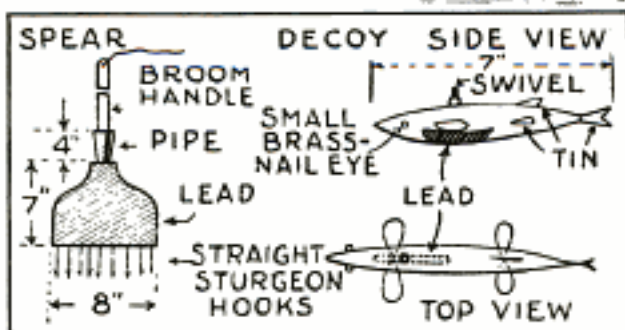
man may enjoy the sport in the open, with an assurance of returning home with a heavy creel. More fish are caught in winter, for the time spent, than in summer, and a wider variety may be captured through the same hole than from any boat.

On such lakes as Champlain, in New York state, where ice fishing is very popular, the only articles needed are two or three dozen strong lines equipped with stout hooks, and attached to each line, through its individual hole in the ice, is the red flag which flashes the signal, "You've got one." The tip-up may consist of a limb of a tree, set into the ice and bent over to carry the lines, or a home-made outfit.

A reel is made out of pine, half an inch thick, two inches wide and sixteen inches long. This is placed across the hole with the line attached, a little slack being allowed to remain on the ice to give the fish play. A limber twig, about two feet long, is stuck into the ice near the hole, and a loop in the line placed over this. Then a piece of red flannel is fastened to the loop to serve as a signal every time the hook is touched.

The best line is ordinary hand line, braided, strong enough to land anything from five to fifteen pounds in weight. The No. 1-0 hook is best for pike or pickerel, and the No. 1 for yellow perch.

The most likely spot to cut the holes is near reed or osier beds, not too far from shore—the same place you would look for pike in open water. Cut six to eight holes in a semicircle about twenty feet across,



Top, Simple Tip-Ups for Ice Fishing; Center, Waiting for a Bite; Below, Spear and Wooden Decoy

water, so Mr. Fish can see the bait. Then the water should be plumbed to get the depth, and the baited hook placed about twelve to fifteen inches from the bottom, where the schools of fish are found in winter, because it is warmer.

In arranging the bait, insert the hook under the skin of the minnow or shiner, directly back of the dorsal or top fin. Be careful not to hook it so near the skin that it can escape, and just as careful not to sever the spine or stomach and kill it. Live bait will attract more fish in winter.

Now make a loop in the line and slip it over the end of the wire tip, which is slightly bent back to retain the loop. The remainder of the line is left rolled up on a piece of stick, to keep it from freezing



A 2071 Sperry Gyroscope Co.  
 40 Flatbush Ave  
 109  
 Extension Brooklyn NY

POPULAR MECHANICS

to the ice, something you will need to watch on a cold day.

Where game laws permit, spearing fish is great sport, and it is easy to land big fighters, weighing as high as fifty pounds. Spears easily can be made in the home workshop. Prepare a mold of one-fourth-inch boards and cut small holes at the bottom to admit prongs which are made from sturgeon hooks. These should not be straightened until they have been heated. When the mold is finished, insert the straightened hooks, and fill the mold with lead. Drill two holes, one-eighth inch in diameter through the pipe handle and insert the nails to make it easy to fasten to the handle, which may be made out of a strong broom handle about four feet long. Drill a hole in the top end of this and insert No. 11 twine, which is one-fourth-inch thick, to assist in regaining the cast spear.

A decoy is used in spearing fish, and greatly assists in attracting them to the lighted hole. The decoy may be whittled out of a piece of soft pine, yellow or white. Cut a slot and pour in some lead to give the decoy proper weight; then drive a staple in the back with a swivel on it so that the decoy will turn in a natural manner. The fins are cut from tin and set in slits cut in side of the decoy. Then put in the eyes and tail, and you are all set to go fishing.

A 2084

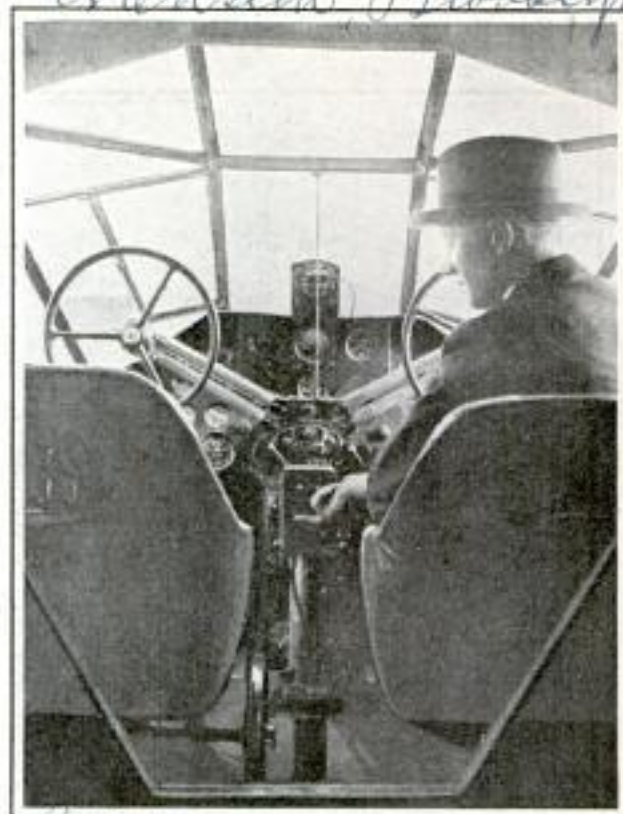
WEDGE USED INSTEAD OF BOLT ON BATTERY TERMINAL

Battery terminals which are wedged to the battery posts instead of bolted have been placed on the market. Bolts, nuts and other threaded devices, which are easily corroded, are eliminated by the wedge, which grips the battery post with its sharp edges, preventing the terminal from slipping up or down.



The terminal and wedge are constructed as a unit. A tight connection is made as the wedge draws the terminal down on the battery with its beads set at an angle.

Corvian Products Co.  
 338 Broadway  
 Denver, Colo



Mechanical Pilot for Planes Is Shown between the Seats; It Has Been Tested Successfully

ROBOT PILOT FOR BIG PLANES IS SUCCESS IN TESTS

Robot pilots may soon be flying passengers on big transport liners from city to city, if tests conducted by gyroscopic engineers receive the approval of the department of commerce. Successful experiments with the device have been conducted for some time by the army and navy air services, and in a recent flight from Baltimore to Newark it was allowed to operate a big eighteen-passenger plane.

COSMIC RAY MORE POWERFUL THAN WAVES FROM SUN

A 2122

Cosmic rays, coming from a point hundreds of millions of miles beyond the sun and visible stars, are more powerful than energy waves from the sun, Prof. Robert A. Millikan says, after recent experiments. The cosmic ray is equal to, if not greater than all other radiant energies combined, one ray having 786,000,000-volt electrons, more power than the average man can imagine. Cosmic rays originate in the building up of atoms from hydrogen at an undetermined point many times the distance of the sun from the earth.

214 Herald Tribune  
 10/15/31

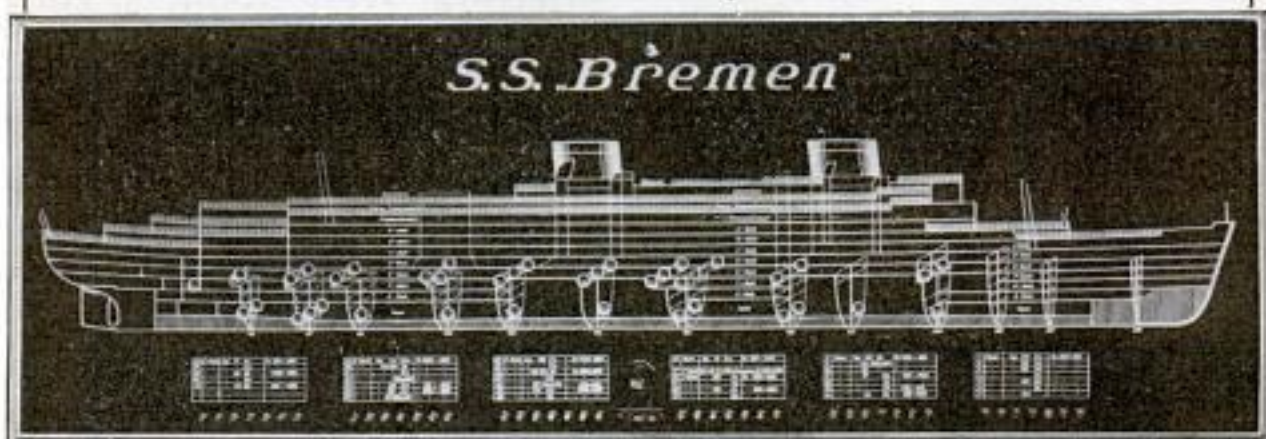
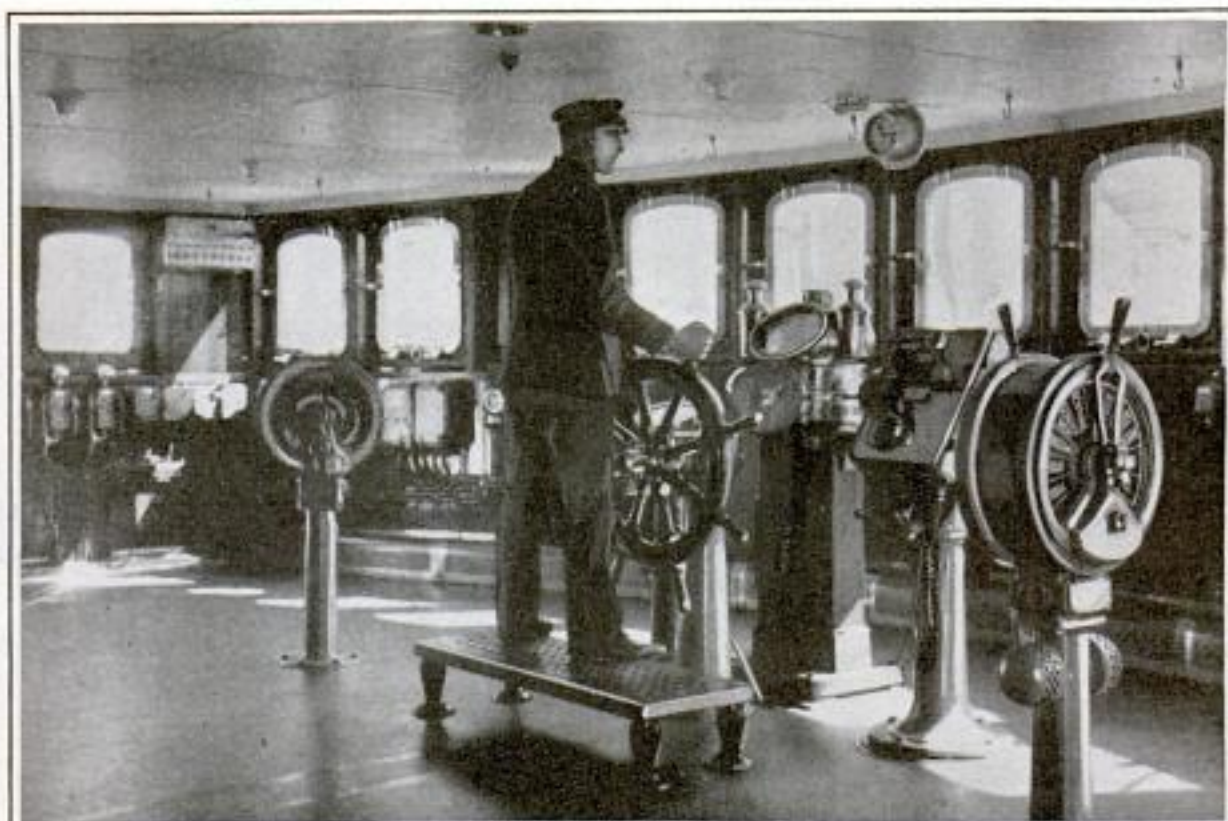
Cmk. Haas J. Rutzbach, Schwarzhof

110

POPULAR MECHANICS

Berlin, Lazkewitz, Germany

a 2 115  
**How Electricity Adds to Your Comfort at Sea**



Above, Control Room of a Modern Ocean Liner, Showing Some of the Many Electrical Instruments That Aid in Navigation; Below, Wiring Diagram of the German Liner "Bremen"

With the tremendous increase in size and speed of Atlantic liners, signaling requirements have changed to such an extent that the old mechanical means have been superseded by gigantic electrical installations. Telephones have replaced speaking tubes, and electricity now operates engine-room telegraphs. With the old type of speaking tube, it was difficult to convey orders at audible intensity over long distances. Moreover, these tubes broke through watertight partitions. Since loud-speaker phones are used, orders are audible at a distance of several yards from

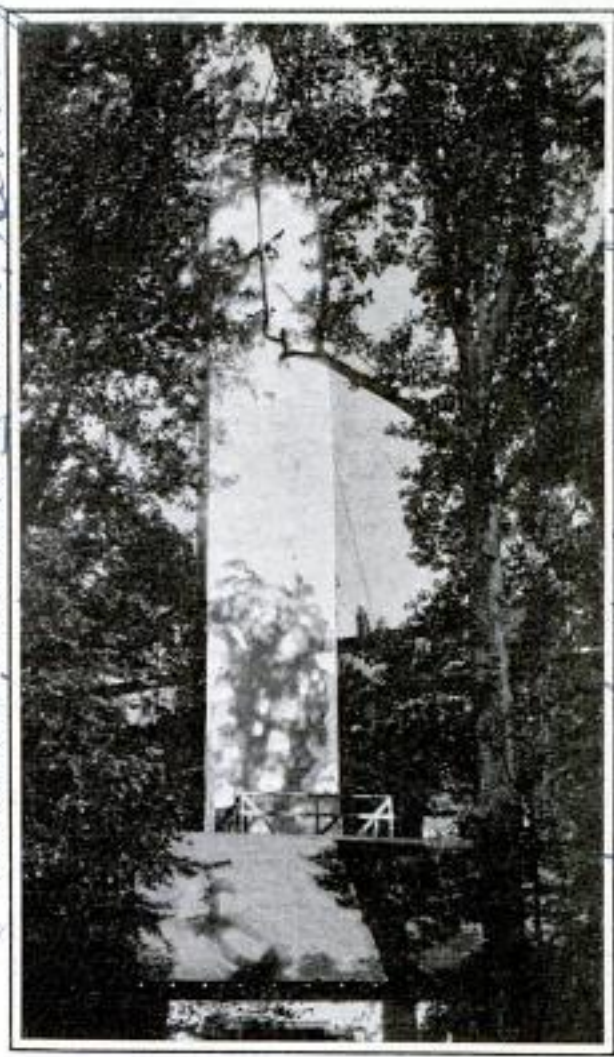
the telephone. Such communication systems are employed with a switchboard, for hand or automatic operation, for intercommunication between different control stations of the ship. In addition to the phones, there are the remote electrical signaling devices, which show, for example, the revolutions of the ship's driving shaft, the speed indicator and water-signaling devices. Bulkhead indicating panels, behind which lamps are mounted, automatically show whether bulkhead doors are closed or not. Fire-signaling systems also add to safety at

*Mr. Thomas & Baker*  
*Pres Carnegie Inst*  
*of Technology, Pittsburgh, Pa*  
 POPULAR MECHANICS

*a 2153*

sea. Telephones and electric clocks in each cabin are nothing extraordinary today. Bell indicators for calling the steward or stewardess have been superseded. At important communication centers, as, for instance, at staircases and elevators, glass-covered tables with route-indicating plans are to be found. Adjacent to these tables are a number of press switches labeled with the names of the most important places in the ship. If a passenger desires to obtain the route to any room shown, he presses the corresponding key and lamps are illuminated beneath the table which indicate the way to be followed.

**TOWER WITH TEN BATHROOMS TESTS WATER DRAINAGE**



This Building, Resembling a Monument, Has Ten Rooms, All Bathrooms, for Drainage Study

Ten stories of bathrooms, constructed in a building only fifteen feet square, are used to test drainage pressure in skyscrapers. Each story has but a single room—a bathroom—reached by an electric elevator. Hydraulic technicians of the bureau of standards will test the drainage for several years, working on the theory that above ten stories, the pressure is about the same in drainage pipes.

**ALUMINUM PLATE ON SHINGLES TESTED FOR ROOFING VALUE**

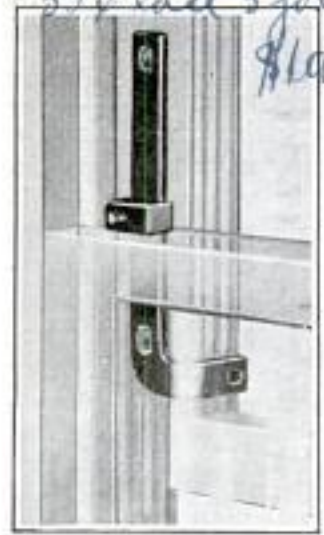
Red-cedar shingles, dipped in hot pitch and covered with aluminum foil, were used for roofing an experiment shed at the University of Washington. The treated shingles are believed to be non-corrosive and fire-resisting.

**GERMS THAT EAT POISON**

Bacteria that eat the poison in illuminating gas and make it safe for breathing have been developed in Germany. The bacteria can live without air and thrive on carbon monoxide, which is the principal poison in illuminating gas. By bubbling the gas through a culture of these germs, the poison is eaten, molecule by molecule, until the gas is safe. The bacteria also produce methane, a good fuel gas, from carbon monoxide and hydrogen by the same process.

**LOCK SECURES OPEN WINDOW AGAINST INTRUDERS**

Windows can be securely fastened to keep out intruders, even when open at either top or bottom, by installing a simple form of burglar-proof lock now being offered. The lock consists of a metal bar, curved at one end and attaches to the upper sash. A metal lug which slides over it can be secured by means of a pin at heights of one, three or six inches. This



permits the window to be opened for ventilation, but the lock cannot be reached from the outside.

*Chicago Eve Post 11/2/27*

*available in Munich - Tube Germany*

*a 225*

*a 2168*

*Webster Small, 718-18th St. N.W., Wash. D.C.*

*Emb. Webster Small, Wash.*

*Emb. Bert Russell, 4338-11th St. S., Seattle, Wash.*

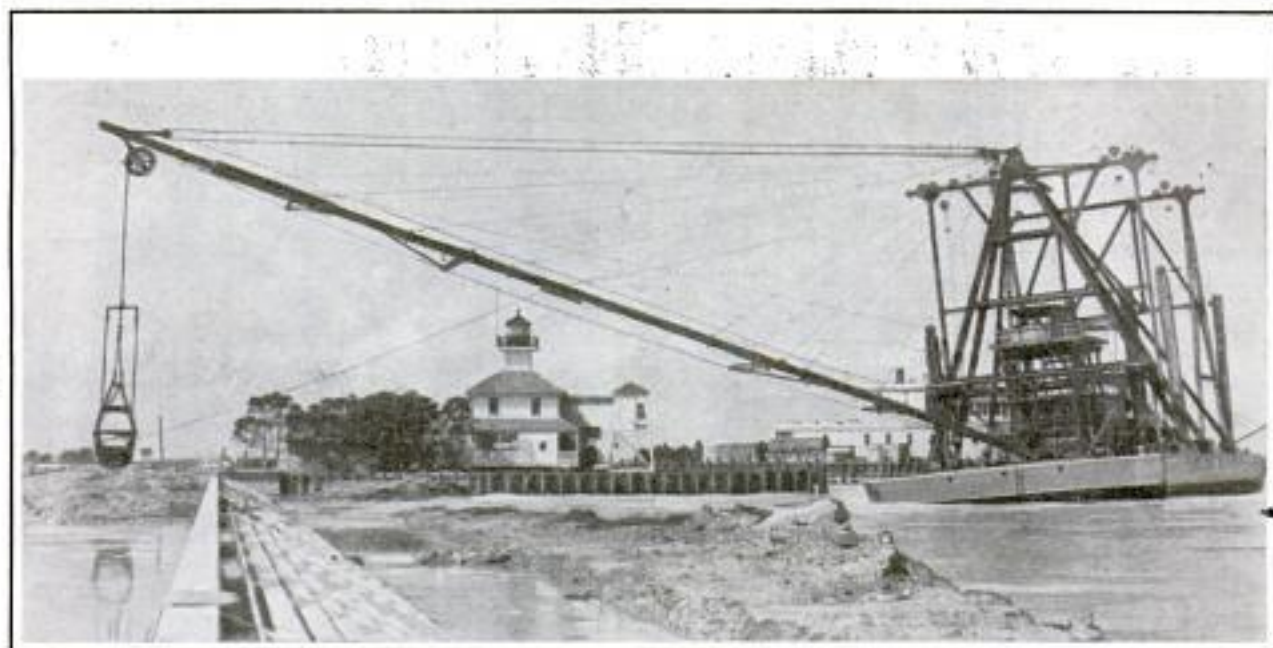
*The Lifetime Corp*  
*B or S S Toledo*  
*Ohio*

a 2180  
112

Carl Harry P. Squires  
2019  
eseneal Taylor M  
POPULAR MECHANICS

New Orleans, La

# Millions Spent to Improve City's 'Back Yard'



End of Development Project along New Orleans' Lakefront, Showing Dredge with 245-Foot Boom Making Last Fill for Seawall; Note the New Lighthouse, atop the Yacht Club, for Lake Vessels

Millions of dollars have been spent to transform New Orleans' "back yard" into a site for bathing beaches, amusement parks, hotels and residences. The city's back yard is along Lake Ponchartrain, where a seawall was constructed to hold the fill for beaches and home sites. One of the largest clam-shell dredges in the world was used on the seawall project, which required the installing of a 245-foot steel boom so the dredge could work from the lake. A canal lighthouse, atop the Southern Yacht club, has been built to guide lake vessels. The seawall cost \$2,000,000, while preparation of beaches, parks and home sites will call for large additional expenditures.

## LIGHTS ON WASHINGTON SHAFT SERVE AS AID TO FLYERS

To eliminate the hazards the Washington monument presents to aviators, twenty floodlights have recently been provided in order to illuminate completely this 555-foot marble obelisk. All the lights will be used only on foggy nights, as tests have shown too much light gives the shaft a rounded appearance, thus reducing visibility. At first, floodlights were considered ineffective, and searchlights, located several hundred feet from the monument,

were tried, but the latter were found to diffuse their rays instead of concentrating them on the shaft. Now floodlights, in groups of five, are placed forty feet from each side of the obelisk. Two searchlights still are used to illuminate the peak because floodlights cannot reach it.

## SPARK LEVER WORKS STARTER OF SMALL AUTOMOBILE

Ford cars can be started by merely retarding the spark through use of a small accessory which eliminates the need of the foot button for this purpose. The spark starter is installed in a few minutes, and is virtually fool-proof, since the car can be started only when the spark is fully retarded. Lever control of the starter stops back-firing, saves time in starting and makes easy a start on a hill or when the motor dies in traffic.



Whenever you find that you wish to know more about any article in this magazine, write our Bureau of Information.

Scene from  
10/2  
Crandall Machine  
works, 2416  
Pedro St Los Angeles, Calif

*Madison Photo and Western Railway*  
*Chem*  
*Sept*  
*Philadelphia*  
*Pa*

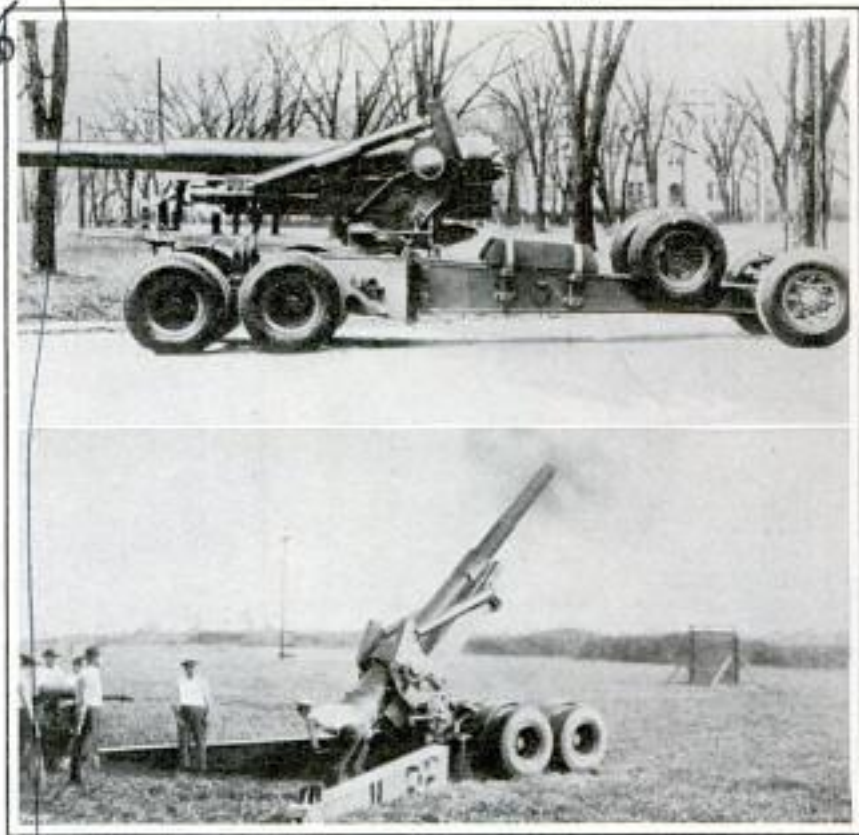
*Philadelphia*  
*Pennsylvania*  
*Pa*

2039

**CEMENT MADE OF MAGNESIUM IS STONE-HARD**

Cement, having a tensile strength of 2,000 pounds per square inch and as hard as granite, has been made by combining magnesium oxide and magnesium chloride in water. The magnesium cement made thus far can be used only for interiors because water causes it to disintegrate. However, it is now possible to produce a magnesium cement that does not absorb moisture from the air, which is something ordinary cement has not yet overcome. The cement is excellent for inside walls and floors, as it sets quickly. It is excellent for insulating wall plaster, and only one coat, from one-quarter to three-eighths of an inch thick, is needed, while, in ordinary wall plastering, three-quarters of an inch is necessary.

2135



© International News Photo

Mounted on Six-Wheeled Truck, This Eight-Inch Howitzer Is Uncle Sam's Fastest Heavy Gun; Below, Howitzer Ready for Firing

**BIG GUN ON SIX-WHEEL TRUCK TO BE WORLD'S FASTEST**

Uncle Sam's latest answer to the world's call for mobile artillery is an eight-inch howitzer, mounted on a six-wheel truck. This big gun is the fastest heavy artillery in the world, its designers say. It is dismounted for firing by dropping part of the truck bed to the ground.

2041

**ELECTRIC CAR IS STREAMLINED FOR HIGH SPEED ON RAILS**

Streamlining of electric railway cars has resulted in the production of a coach which reaches one hundred miles an hour, the highest speed ever attained by a vehicle of that class. The car was built by airplane designers and submitted to wind-tunnel tests. It will be used in regular service on a Pennsylvania line.

between

*Philadelphia and*  
*Harrisburg*



Streamlined Electric Coach Speeds 100 Miles per Hour

*Used by Philadelphia Electric Co*  
*Philadelphia Pa*

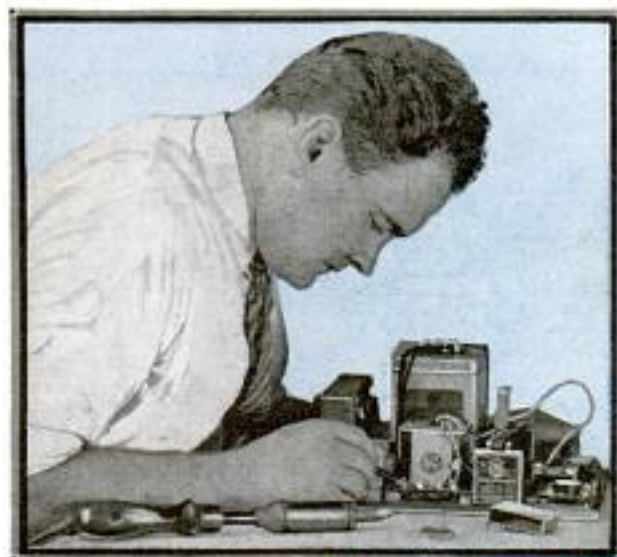
**GYPSON USED IN FIREPROOFING EXPOSED LEAD CABLES**

Lead cables in exposed underground runs may be fireproofed inexpensively by use of a low-grade gypsum mixture. A wooden trough is built to carry the cables, and it is suspended from the beams that support the decking. The gypsum mixture is poured around the separated cables, and has proved effective in guarding lead sheaths and cables against damage in case of cable failure.

2135

*Electrical World*  
*10/17/32*

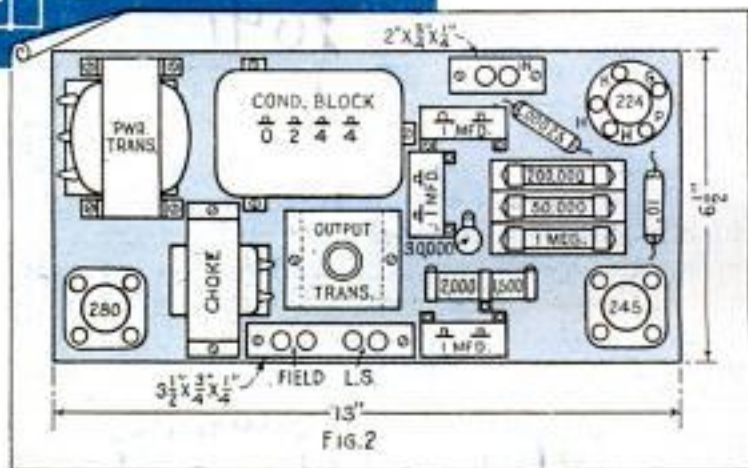
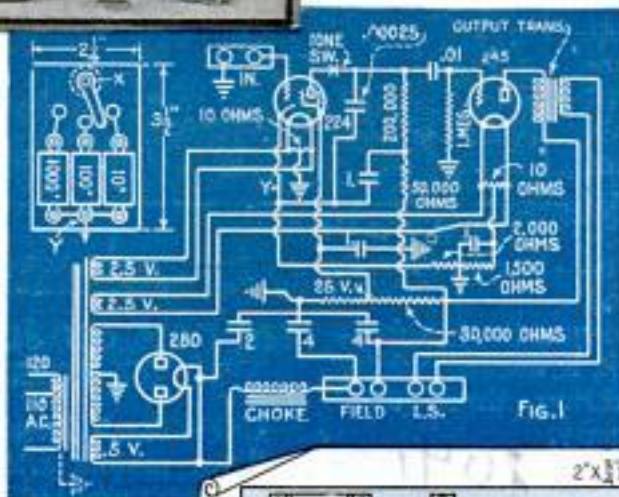
# Amplifier Gives Old Phonograph New Voice



Many good phonographs have been discarded because they will not reproduce modern electrically cut records correctly. Most of these phonographs are incased in good cabinets and the motors are in perfect order. By replacing the reproducer with a pick-up and adding this audio amplifier, these machines can be used to good advantage with modern records. The amplifier takes up very little room and is entirely self-contained. The only connection leading from the cabinet will be that to the 110-volt a.c. supply to a wall socket. Aside from its use as a phonograph amplifier, the unit may also be employed with radio receivers that have inefficient a.f. amplifiers, and with experimental tuners. The schematic diagram, Fig. 1, and layout diagram, Fig. 2, are quite simple. Enlarged copies of these diagrams and additional data and material list are available. The three 1-mfd. by-pass condensers are of the 200-volt test type and are mounted upright to save space. The wood base is  $\frac{1}{2}$  in. thick and is covered with thin sheet

copper for grounding the various parts as they are mounted. It will be noted that the tapped resistor, supplying grid-bias for both amplifier tubes, is grounded at the tap; therefore the two ends should be kept clear of the copper shield. The 30,000-ohm voltage-divider resistor is placed on end and tapped for 25 volts. The total pressure across the resistor is 300 volts. A simple layout for a tone-control panel is given at the upper left in Fig. 1. The leads X and Y connect to those similarly marked in the schematic diagram. The output transformer used will depend on the speaker. The high-

voltage circuit is open at the terminals marked field, which are for the field winding of a dynamic speaker. If the field is supplied otherwise or a magnetic speaker used, the terminals should be shunted by a wire and one choke added.



# YOU CAN BUILD THIS VACUUM-TUBE VOLTMETER

ONE of the most useful and sensitive measuring instruments for the radio experimenter is the vacuum-tube voltmeter. It is quite simple to build and reasonably cheap, consisting merely of a tube, a sensitive microammeter, or milliammeter, and the necessary batteries. These parts are so arranged that the reading of the meter is an indication of the voltage impressed on the input of the vacuum tube.

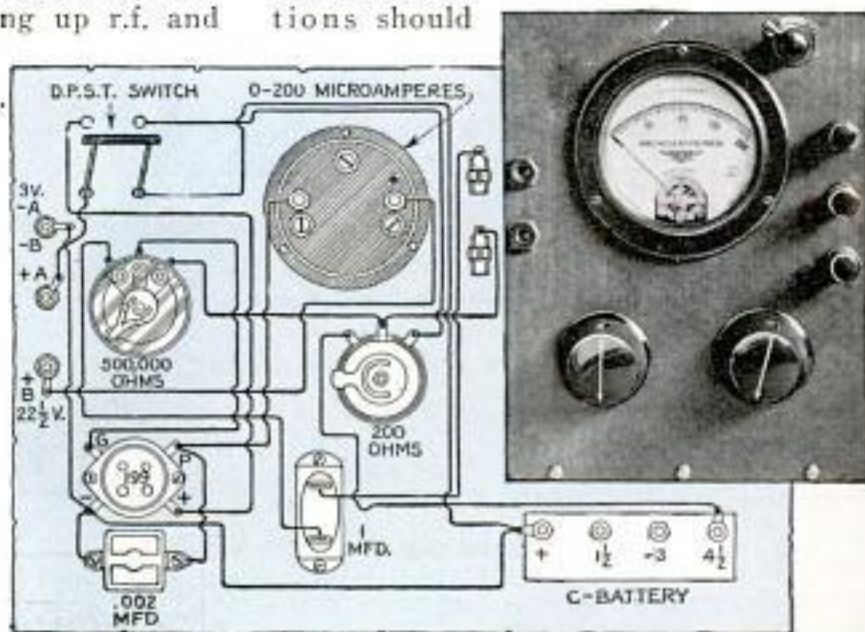
If a d.c. milliammeter is used, the full-scale range should be 0 to 1 milliamp. The 0-to-200 d.c. microammeter shown in the diagrams costs considerably more, but makes a finer instrument, enabling the operator to read minute voltages more accurately. An instrument of this type is not intended for testing the voltages of a B-power supply. It is ideal for measuring the output of a.f. amplifiers, and, when used for this purpose, is connected to the output of the receiver. When used with a constant-signal generator, such as the oscillator described in the April, 1930, issue, the experimenter or service man can easily determine the maximum gain when lining up r.f. and intermediate-frequency stages of radio sets. Other uses are comparing the gain of radio tubes, measuring the comparative selectivity of r. f. tuners and observing the period and percentage of fading.

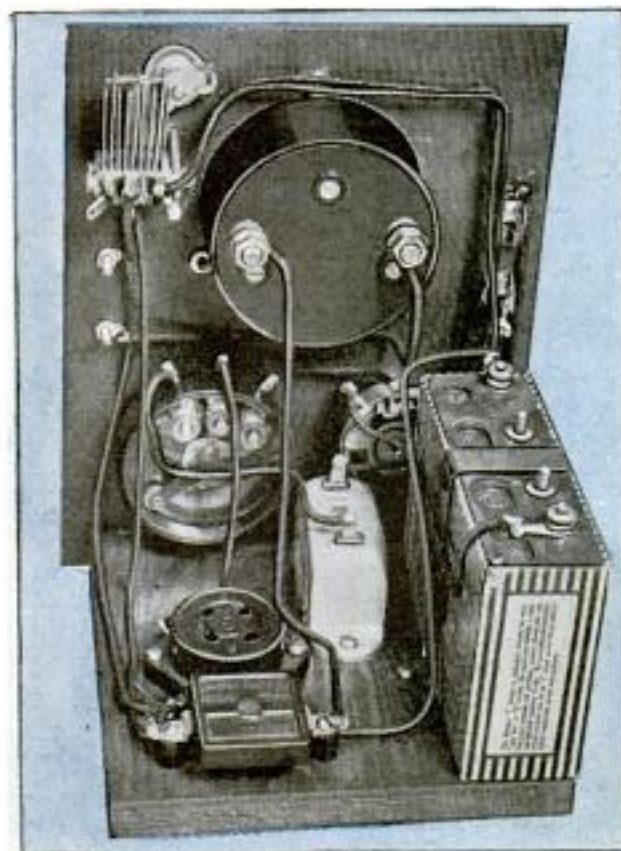
The simplified wiring diagram and front view of the panel are shown on this page. The bakelite panel is  $\frac{1}{8}$  by 6 by  $7\frac{1}{2}$  in., and the wood baseboard  $\frac{1}{2}$  by 6 by  $7\frac{1}{2}$  in. The instrument assembly is clearly shown



in the rear-view photo on page 116. Any type of double-pole single-throw switch may be provided to open the battery circuits when the instrument is not in use.

It will be noted that the  $4\frac{1}{2}$ -volt grid-biasing battery is held in position by means of a narrow strip of thin brass, or copper, ribbon. The .002-mfd. condenser is a small mica type and the 1-mfd. condenser is of the 200-volt by-pass variety. These condensers, together with the tube socket and battery, are mounted directly on the baseboard. The instruments are then assembled on the front panel and wired as shown in the simplified diagram. All connections should





be made with lugs and carefully soldered.

A separate 22½-volt B-battery is used for the plate of the 199 tube, and two No. 6 dry cells, connected in series, supply the filament voltage. Binding posts for these batteries are shown at the right-hand side of the panel in the front-view photo. The negative terminals of these batteries are connected together at the center post, and the two cord-tip jacks on the left side of the panel are for the input leads.

When the vacuum-tube voltmeter is placed in operation, a small plate current will be noted. Now, when connected in the output of an audio amplifier, an alternating potential is impressed on the input terminals of the instrument, and, with the proper bias and filament adjustments, made with the potentiometer and rheostat, there will be an increased reading on the meter. This will be in direct proportion to the amount of a.c. signal strength supplied by the audio amplifier under test. It is then a simple matter to check the gain as the various r.f. and intermediate stages in the set are lined up.

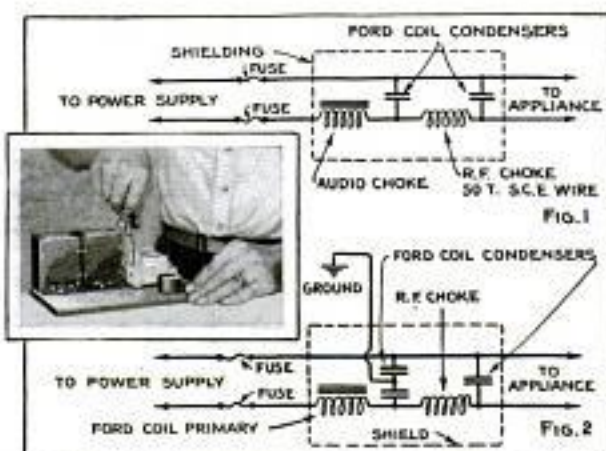
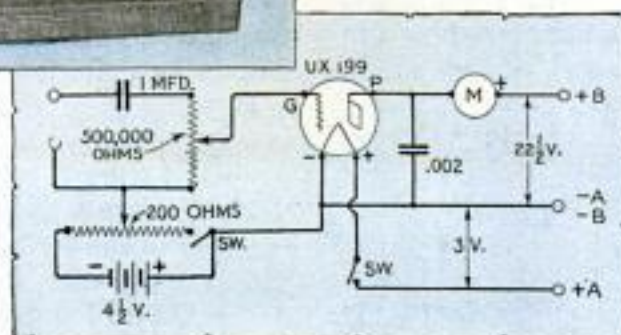
The advantage of a vacuum-tube voltmeter, in comparison with other instruments for similar measurements, is that no power is used in the meter itself when the measurements are taken, that is, it may be used for measuring voltages and currents without taking any power away from the unit under test.

### Ford Coils as Interference Filters

Simple filters that will operate satisfactorily on electrical appliances causing interference with radio programs, can be made from discarded Ford spark coils. Two coils are required for each filter unit. They should be opened carefully and the condensers, located in the side opposite the contact points, removed. The primary winding, complete with the iron core, is then taken from inside the large coil. This core and primary coil are used as an a.f. choke. The r.f. choke is made by

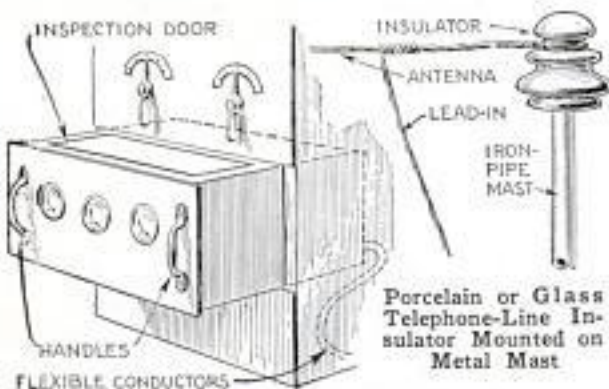
winding 50 turns of No. 18 s.c.e. magnet wire on a porcelain tube of the type commonly used in wiring houses. For general cases of interference, the parts are connected as shown in Fig. 1,

and in extreme cases the circuit shown in Fig. 2 should be followed. Any metal container of suitable size will serve as a shielding can. This container should be connected with the center-tapped condenser to ground. The r.f. end of the filter should be plugged into the appliance and the audio end to the service outlet.





# Practical Ideas for the Radio Experimenter

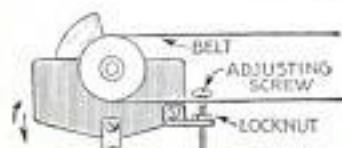


Porcelain or Glass Telephone-Line Insulator Mounted on Metal Mast

Above, Amplifiers or Similar Units May Be Housed in Drawers for Easy Access; Flexible Conductor Cable Permits Withdrawal without Disturbing Connections

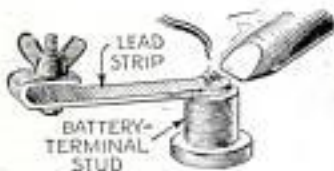


Wheel Acts as Volume Control and Audibility Meter; Left, Filter in Series with Detector Plate Supply Prevents Hum

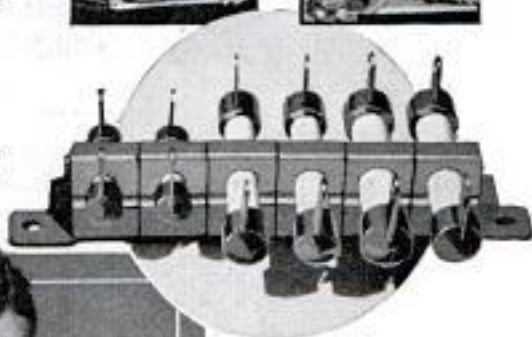


Above, Tension Adjustment for Belt-Driven Ganged Condensers

Below, Thin Piece of Rubber Band between Armature and Pole Pieces Improves Old Phonograph Pick-Up



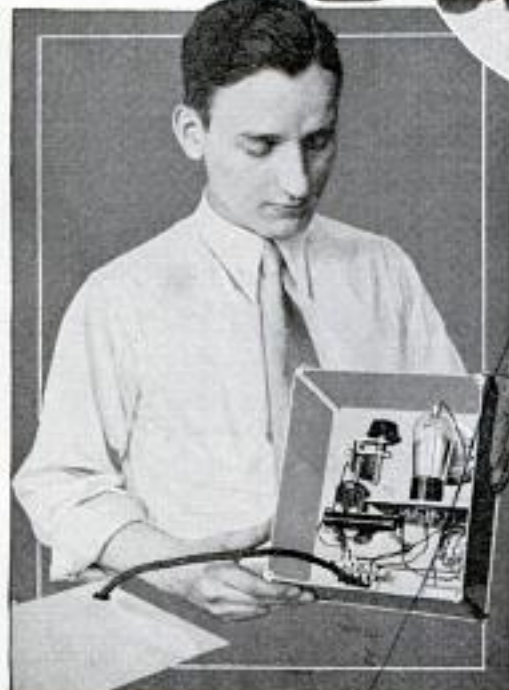
Lead Strips for Battery Terminals Prevent Corrosion



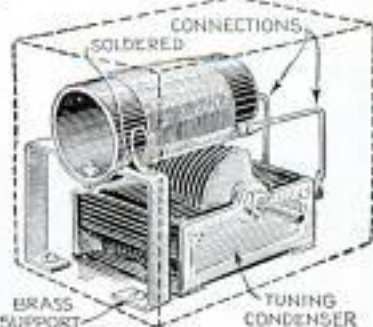
Above, Resistors with Special Center Supports Are Held by Rod through Aligned Holes to Form Ganged Combinations



Above, R. F. Choke Coil for Amateur Transmitter May Be Wound on an Old Tube Base and Mounted as Shown



Left, Slotted Aluminum Corner-Post Stock Simplifies Construction of Metal Cases for Housing Experimental Units



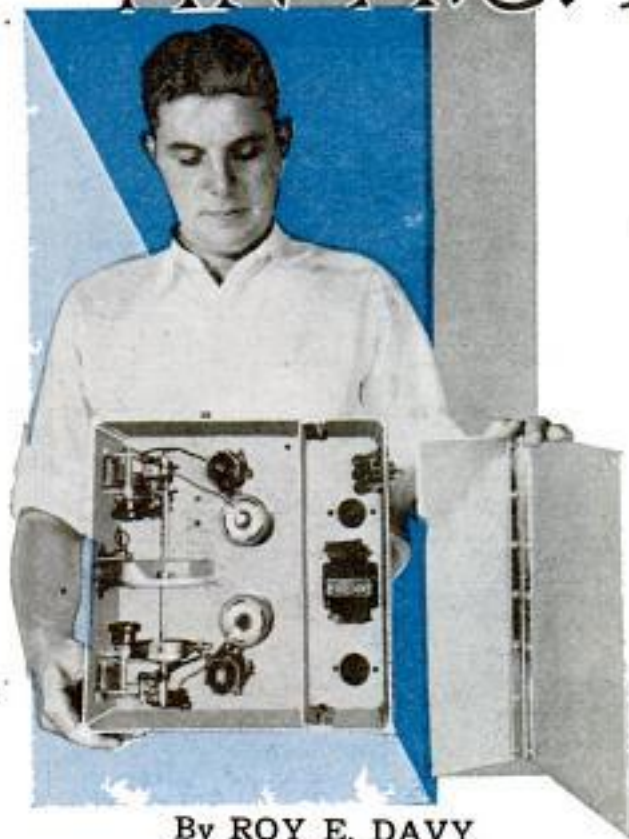
Above, Easier Method of Connecting Coils to Prongs of Tube-Base Forms; Right, Strap-Brass Support Makes Compact Coil Mounting; One Terminal May Be Soldered to It if Strap Is Grounded to Chassis

Short Wave Engineering Laboratories  
 1237 Garvin Ave  
 Chicago

International Resistance Co  
 2006 Chestnut St  
 Phila

*National Radio Club  
61 Sherman St  
Malden Mass*

# AN A.C. AMATEUR- for



By ROY E. DAVY  
PART I

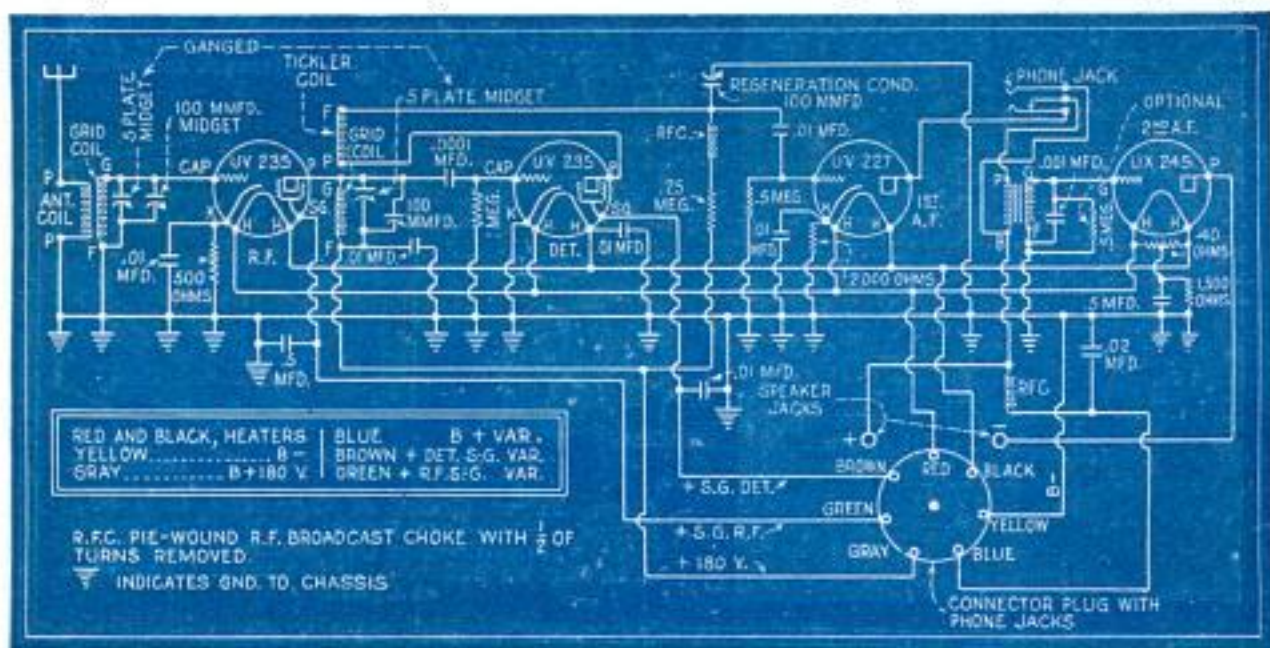
A GOOD a.c. short-wave receiver especially designed for the amateur bands, is not difficult to build, yet not many "hams," or short-wave listeners, own efficient sets.

The receiver to be described has been designed to obtain the best possible results at a cost within the reach of the average amateur. With only 8 or 10 ft.

of receiving antenna, signals are usually too loud for comfort on the first audio stage with headphones; in fact, the writer has operated a speaker very satisfactorily on this stage. Selectivity is extremely good, being about equal to the superheterodyne, without the background noise. Even on the badly congested 80-meter phone band, no difficulty is experienced in pulling in distant phones through locals.

The receiver has several points of superiority over the usual type of short-wave receiver in that it employs single-dial control with a stage of tuned r.f. Smooth regeneration control is obtained over the entire dial, and the efficient r.f. stage and screen-grid detector make the use of a very short indoor antenna possible. The result is much better signal strength in comparison with background noise.

The construction details are so simple that anyone may build this set without difficulty. It is housed in a metal cabinet, the interior view of which is shown on this page. The sub-base is 12 by 12 by 1½ in. deep and projects slightly from the cabinet proper. Fairly heavy copper



# BAND RECEIVER

## Particular Hams

is used for this base, which is easily bent to shape between two pieces of wood clamped in a vise, or the builder can have this done at the local tinshop at very little expense. The remainder of the cabinet is made of either aluminum or craydo, .088 gauge. The four sidepieces are 6 by 11 in. and the partition 6 by 13 in., allowing 1 in. at the ends for right-angle bends. The top piece is 12 by 12 in., and the four aluminum corner posts are 6 in. long and tapped at each end for 6-32 screws.

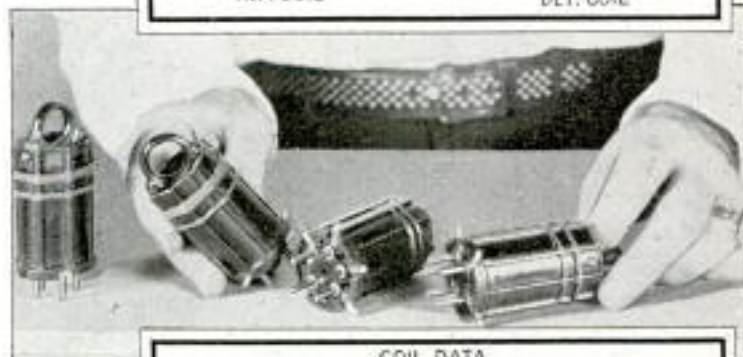
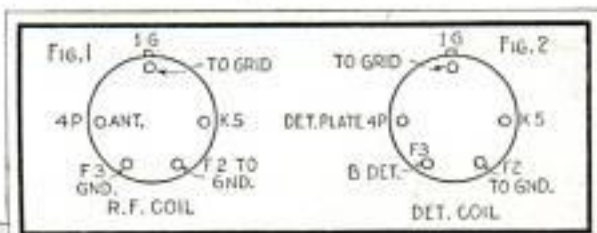
The four sidepieces are first set in the corner posts and placed on the sub-base for marking the holes in the corners. These holes are drilled to clear 6-32 machine screws, and the cover is drilled to match. A 12-in. length of nickelplated piano hinge is placed across the top cover, 4½ in. from the back edge, and the screw-hole positions marked. These holes are drilled and the cover is cut through the center line of the hinge, which may then be mounted. The partition, bent to fit inside the cabinet, is mounted 3 in. from the back. Holes are drilled through the sides of the cabinet and partition flange for machine screws, and the partition is then screwed in place. The sidepieces and back are held firmly in the corner posts by prick-punching the inside of each post. The front panel is not to be fastened, but is left free to slide into place after the tuning dial and condensers have been mounted on it.

The side and back panels are now removed from the base and set aside while the parts are assembled on the base. A flycutter is used to cut the holes for the wafer-type tube sockets, which should be so mounted that all contacts clear the metal base. The coil sockets are of panel-mounting type and are screwed directly on the base. All sockets are of the 5-prong variety, except the one for the 245-tube. The location of the various parts is clearly shown in the

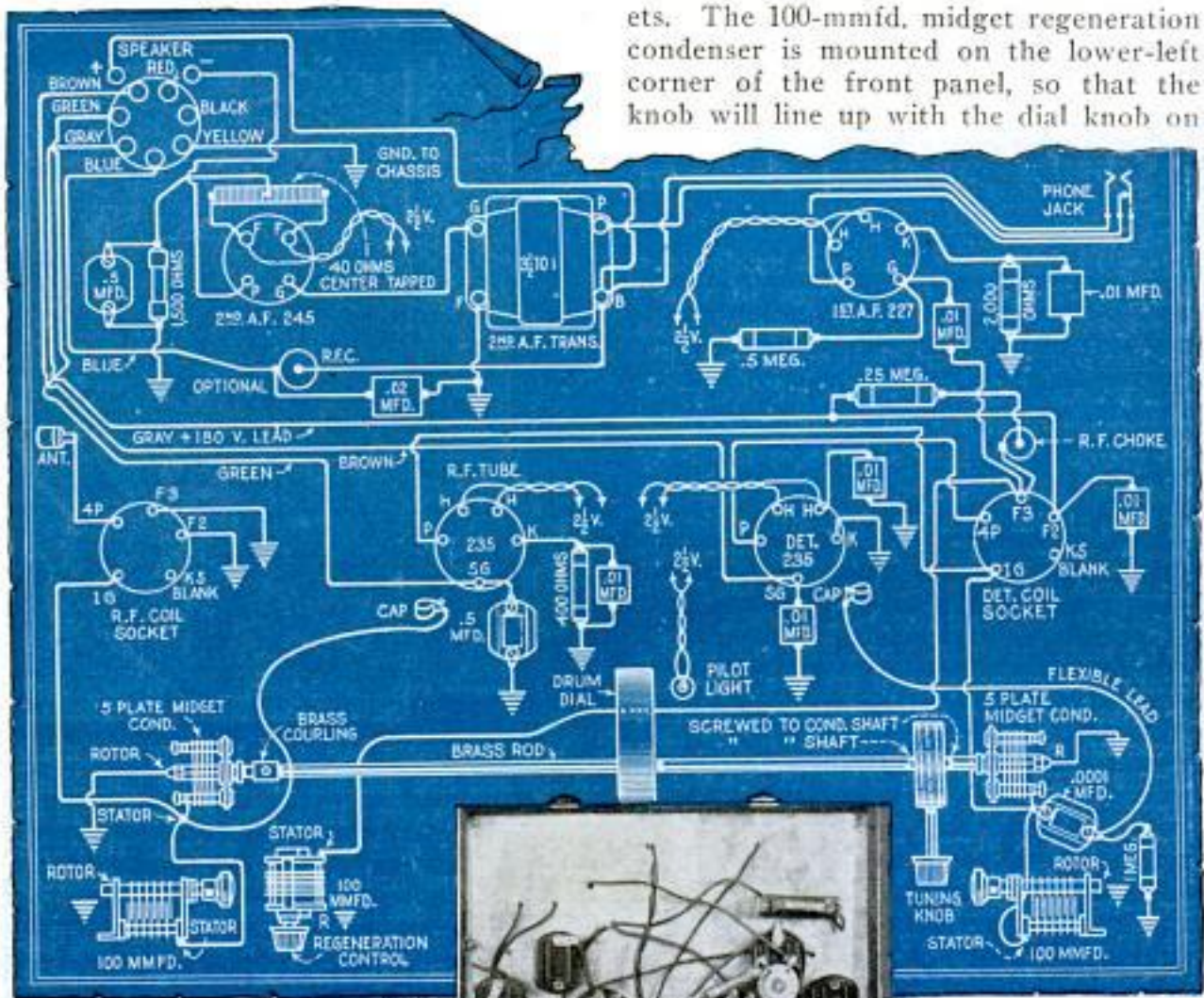


photo on page 118, and the approximate positions are maintained in the simplified diagram on page 120. The screws used to mount the coil sockets extend through the base and hold the .01-mfd. condensers in position on the underside.

The audio transformer is mounted between the 227 and 245-sockets at the rear. The cable plug is also mounted at the left rear corner, and a cut-out is made in

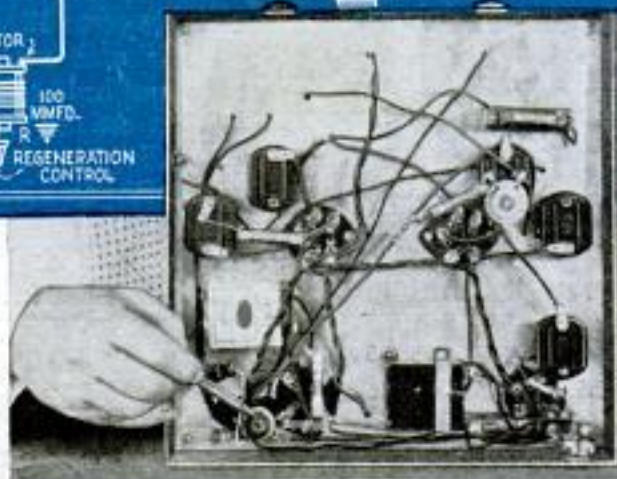


METER	COIL DATA			
	R.F. COILS		DET. COILS	
	TURNS ON GRID COIL	TURNS ON ANT. COIL	TURNS ON GRID COIL	TURNS ON TICKLER
80	23½	5	21	9
40	12½	3½	9½	6½
20	5½	3	4½	5¼



ets. The 100-mmfd. midget regeneration condenser is mounted on the lower-left corner of the front panel, so that the knob will line up with the dial knob on

the back panel to clear this plug. All wiring, except for the variable condensers, may now be done as shown in the simplified diagram.



The next step is to lay out and mount the dial and condensers on the front panel. The two 100-mmfd. midget condensers are mounted on each side of the front panel, with the shafts toward the center, by means of 6-32 screws through the front panel into the tapped holes in the condenser bases. These are the two tank-tuning condensers, shown at the extreme right and left at the bottom in the simplified wiring diagram. The two 5-plate midget tuning condensers are mounted on each end of a 6-in. brass rod, 1/4 in. in diameter. This shaft runs through the dial drum, and the condensers are held to the front panel by means of angle brack-

the right. The cabinet may now be reassembled, and the front panel slid into the slots in the corner posts. The condensers are then wired, running the

ground leads through the base, directly to the ground terminal. All grounds are indicated in the diagram with the usual symbol. Actually the grounded leads on the condenser rotors are all brought directly to a ground binding post mounted directly on the left side of the sub-base at the rear. Do not depend on the panel alone for grounding these rotors. Pull each wire after the connections are soldered to be sure all are tight.

☛ Blueprints covering radio construction articles in past issues can be obtained for 25 cents each; material lists are always available without charge.

*Philadelphia Storage  
Battery Co.  
Antarctic Club  
Phila*

### Protecting Coils from Moisture

Radio-frequency choke coils, and similar units that must be kept dry, may be coated with a good grade of shellac. This may be slow in drying and in no case should it be used with high voltage until it is thoroughly dry. The drying process may be speeded up by suspending the coil in an oven in such a manner that it will not become scorched. Close the oven door but open it frequently to observe the condition of the coil. When it is thoroughly heated, and the smell of alcohol from the shellac is strong, remove the coil and allow it to cool. The heat drives out the alcohol and any moisture present. Dampness will often cause trouble and possible breakdown in radio receivers that have stood in a damp place for any length of time. The set may be quickly dried out by placing a lighted 75-watt bulb inside the cabinet near the chassis and closing the back and top temporarily.

### Cash Boxes Used to House Test Sets

Tool and cash boxes make handy portable containers for tube checkers and set testers. Metal boxes of this type are also suitable for small portable receivers, test oscillators and monitors for short-wave experimenters and transmitting amateurs. They are quite rugged and inexpensive; the bakelite panels are supported by means of four metal brackets.



Test Set in Cash Box; Right, Similar Installation in Tool Box

Table Receiver Showing Ease of Control



Courtesy Paramount Public Corp.

### Table Set Has Controls on Top

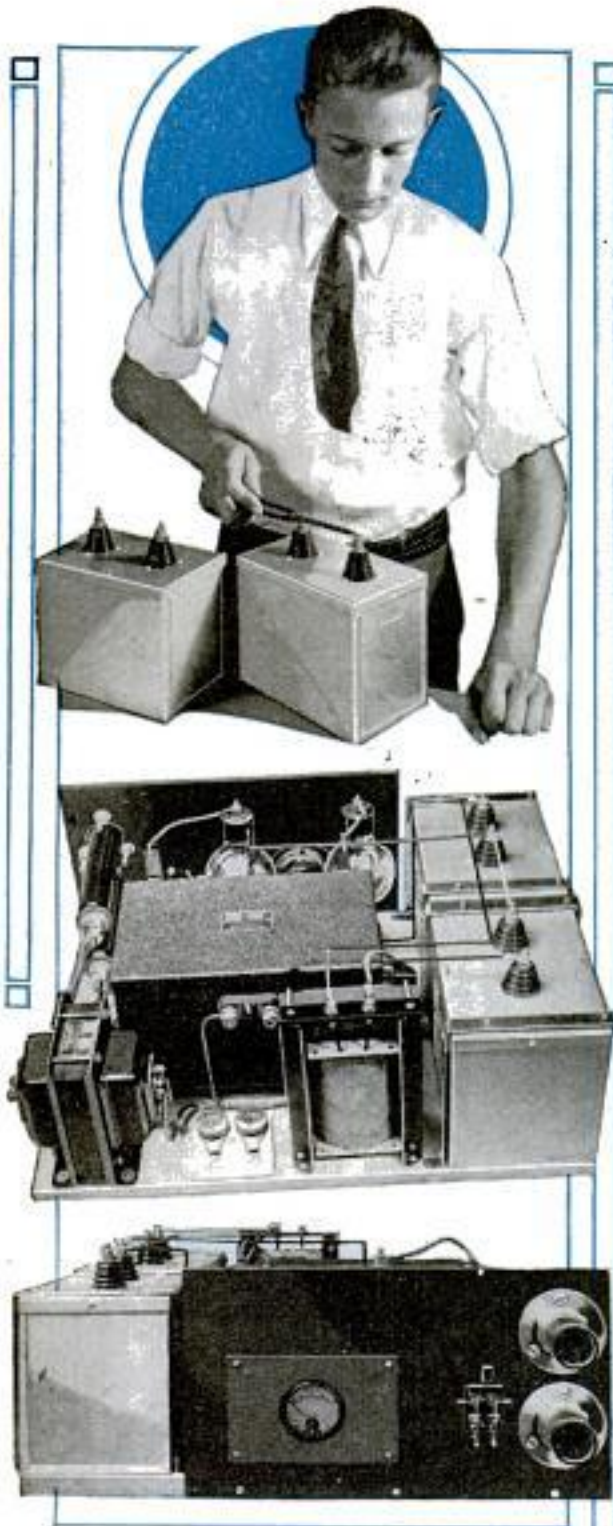
Combining the advantages of a handy utility table and a 7-tube superheterodyne receiver, this set, recently introduced, may be tuned from an armchair. The controls are placed on top within easy reach where the operator may change programs or tone without getting up. The controls are recessed so the top may be used as a table. The circuit employs the new pentode power tube, four 24's, one 27, one 47 and a type-80 full-wave rectifier. An electrodynamic speaker is mounted at one end of the cabinet.

### Insulating Auto-Set Cable

Much trouble with auto receivers can be avoided by the use of suitable protection for the multi-wire cable used to connect the receiver with the battery box. A good method is to slip a length of rubber hose, with a wall about  $\frac{1}{8}$  in. thick, over the cable for its entire length. This precaution costs little and offers protection against acids and moisture. The cable should be clamped under the car securely and all leads should terminate in round-hole lugs where connections are made at the batteries.

☞ For further information on any radio construction article write to the radio department; this service is free.

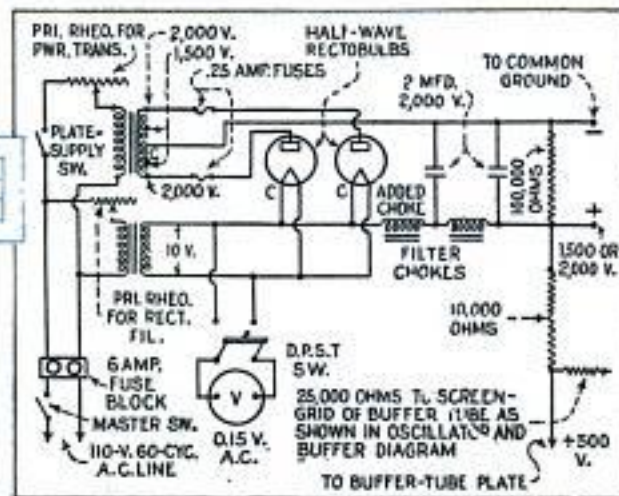
# Hi-Power Supply for Fifty-Watt Transmitter



Many radio amateurs obtain very satisfactory results with odds and ends of power equipment, but, on the other hand, these hit-or-miss methods often result in poor output and interference. A good heavy-duty plate supply is quite necessary, as well as economical in the long

run, since this is one unit that the experimenter will not change when trying out new transmitter hookups. This plate-supply unit, used with the 50-watt CW and phone transmitter, is flexible and may be adapted for any type of transmitter or public-address system employing 50-watt tubes. The complete transmitting unit, shown in the September, 1931, issue, is placed on a sturdy table and the plate-power unit is installed on a shelf below. The parts are assembled on a 20 by 24-in. board. The plate-supply transformer has a 115-volt 60-cycle primary; the secondary supplies 2,000 volts each side of center and is also tapped at 1,500 volts. All terminals are brought out through porcelain bushings. The rectifier filament transformer is a 12-volt type, and the output is reduced to 10 volts by means of a heavy-duty rheostat in series with the primary. A similar rheostat is used in the primary of the power transformer, to reduce the output during preliminary tests. These rheostats, together with an a.c. filament voltmeter, are mounted on a bakelite panel at front, as shown in the lower photo. A 30-henry 300 milliamp. choke was added at the rear, after the center photo was taken, and this choke is indicated in the schematic diagram. The 100,000-ohm bleeder resistor is a safety measure and allows the condenser charge to leak to ground. If this resistor is not used, the charged condensers should be discharged, as shown in the upper photo, before any adjustments are made after the power is off.

(To Be Concluded)





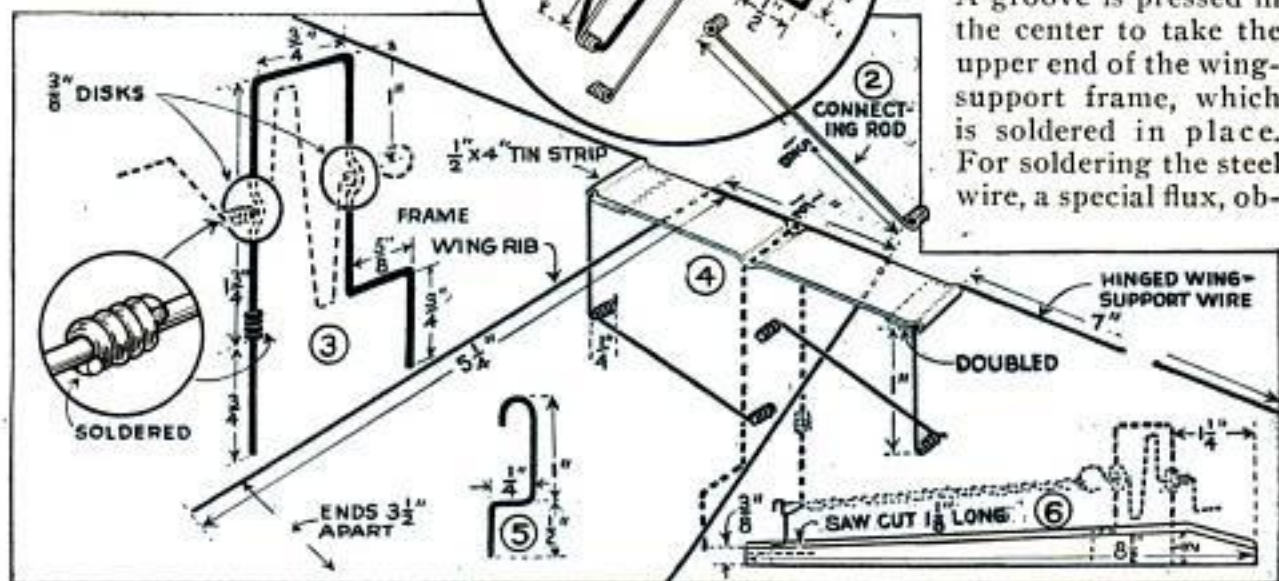
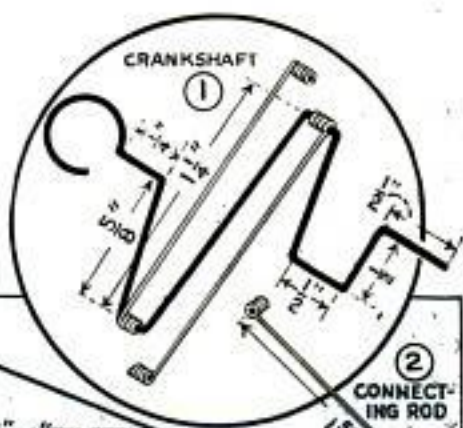
# This Model Airplane *Flies like a Bird*

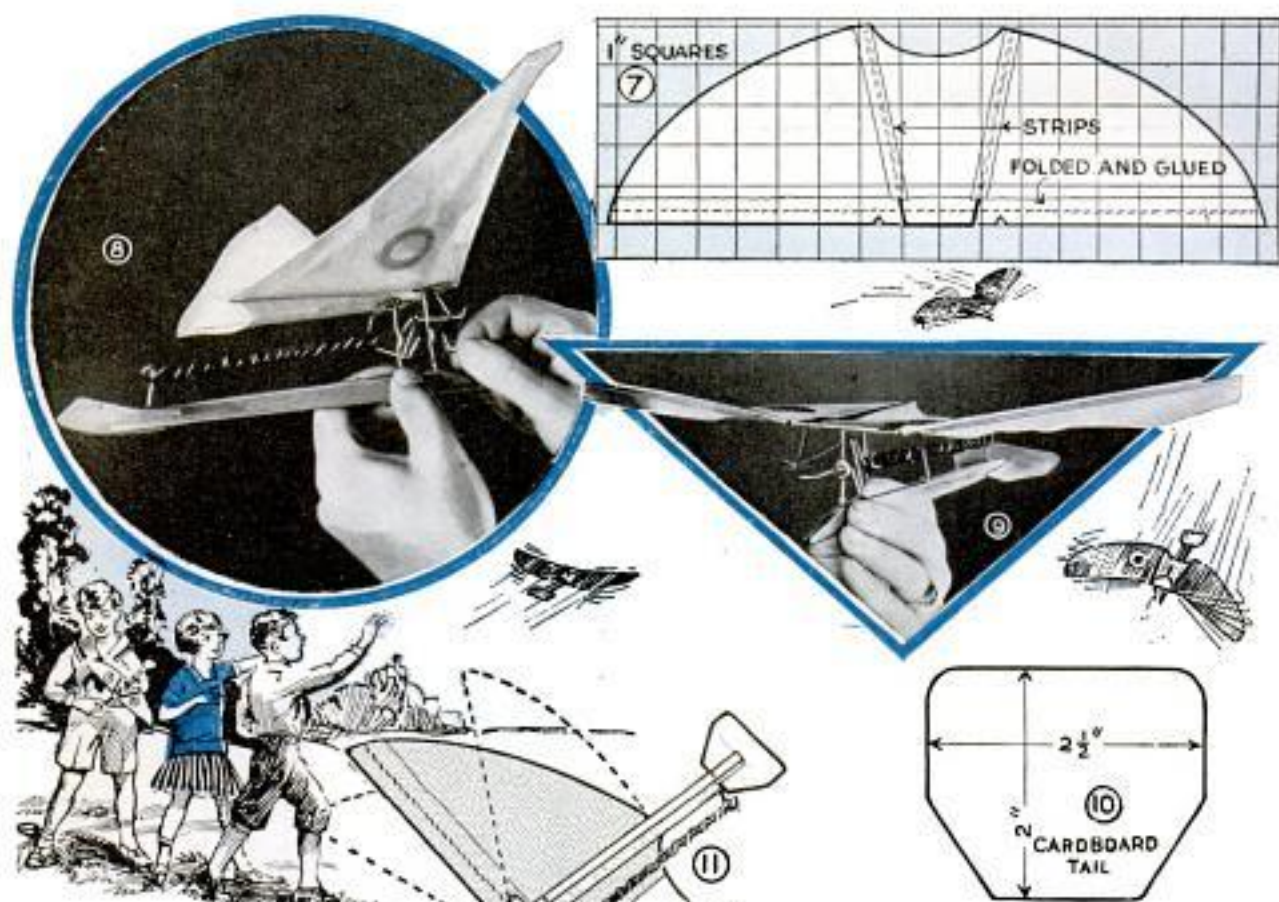
By JAMES B. SLINN

**F**LAPPING its wings in realistic fashion, this little airplane works on an entirely different principle from the usual type of propeller-driven models. In numerous tests outdoors, planes of this kind have flown for distances more than 300 ft.

For the fuselage cut a piece of basswood or soft pine,  $\frac{1}{8}$  by  $\frac{1}{2}$  in. by  $8\frac{1}{2}$  in. Lay it on one edge and drill a  $\frac{3}{16}$ -in. hole  $1\frac{1}{4}$  in. from the front end, another  $1\frac{3}{8}$  in. from the first, and a third 1 in. from the rear end. From the foremost hole taper the top edge down to  $\frac{3}{8}$  in. at the rear, and  $\frac{1}{4}$  in. at the nose, as shown in Fig. 6. Make a  $1\frac{1}{8}$ -in. cut at a slight angle as indicated to accommodate

the tail. The frame that supports the wing and crankshaft, Fig. 3, is constructed from a length of No. 17 gauge tempered steel wire, according to the dimensions given. A wing-support plate, Fig. 4, is made from light-gauge tin, 4 in. by  $\frac{1}{2}$  in. in size. A groove is pressed in the center to take the upper end of the wing-support frame, which is soldered in place. For soldering the steel wire, a special flux, ob-





tainable at almost any hardware store, is needed. The ends of the tin strip are doubled  $\frac{1}{2}$  in. from the end to form hinges for the wing-support wires. Two  $\frac{3}{8}$ -in. tin disks with  $\frac{1}{16}$ -in. holes in the center, Fig. 3, serve as bearings for the combination crankshaft and rubber-band winder, shown in Fig. 1. Be sure that these disks are perfectly flat. For the crankshaft, which must be made accurately, use No. 18 gauge spring steel wire and bend to the size and shape indicated. Then coil the connecting rods, which are made from No. 20 gauge spring steel wire, to the size given in Fig. 2, around the crankshaft. Place the two disks over the crankshaft and solder in place to the main frame, which is bent to permit centering the crankshaft, as indicated by the dotted lines in Fig. 3. Form a bushing for the crankshaft and motor support as shown in the detail accompanying Fig. 3 and solder this in place. A similar bushing on the main frame serves as a stop against the fuselage. The construction of the wing ribs is given in Fig. 4. They are made by bending a length of No. 20 gauge oil-tempered or spring steel

wire to a U-shape,  $1\frac{1}{2}$  in. wide at one end and  $3\frac{1}{2}$  at the other. Note that the wing-support wires are bent in opposite directions. Now attach the main frame to the fuselage and apply a drop of solder to the ends projecting from the underside, to prevent loosening.

The tail is cut from a piece of cardboard,  $2\frac{1}{2}$  by 2 in., as in Fig. 10. Round the back corners neatly and cut the front to  $1\frac{1}{2}$ -in. width at the center. Construct the rear rubber-band support from No. 17 spring steel wire, Fig. 5, insert the lower end through the holes at the rear of the fuselage, and apply a drop of solder to keep it from being pulled out. In making the wings, use a light, tough parchment paper and cut to size as shown in Fig. 7. Turn over the front edge  $\frac{3}{4}$  in. and sew or paste down, leaving an opening large enough to admit the wing-support wires. Also cut notches as indicated in the drawing. Turn the device on its back and fasten the two rear ribs to the wings with  $\frac{1}{2}$ -in. gummed paper tape. Glue the part between the hinges to the



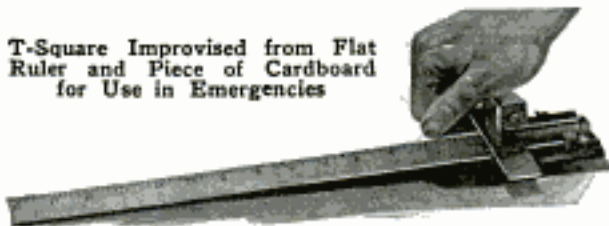
tin plate, and place the wing-support wires in the open hinges, after which the latter are closed. Be careful not to make a joint that will bind. The connecting rod on the right goes to the front crank and that on the left to the rear crank. The attachment and alinement of the connecting rods are highly important; if they are not exactly the same length from center to center of the bearings at the ends, the finished craft will not work properly, if at all. All joints must be free in order to minimize friction. A  $\frac{1}{4}$ -in. strip of rubber band, about 5 in. long when doubled, which may be cut from a discarded inner tube, serves as the motor.

The plane is now ready for trial flight. Hold it in the left hand and wind about 30 turns with the right, as in Fig. 8. When wound up, place the forefinger of the left hand against the back crank, as in Fig. 9. Pointing the model slightly upward, give it a light push and let go quickly. If it has a tendency to climb too steeply, the tail should be bent down just a trifle, and if the plane tends to fly downward, raise the tail sufficiently to correct this fault. Both wings must lift equally to make the plane fly straight. If the right wing support is bent slightly forward at the hinge, the plane will turn toward the right, while if the left wing is forward, the course will be toward the left. The fuselage should be at right angles to the front edge of the wings, and the wing ribs should extend horizontally in line with the fuselage. Several trial flights will probably be necessary before the proper adjustments are obtained.

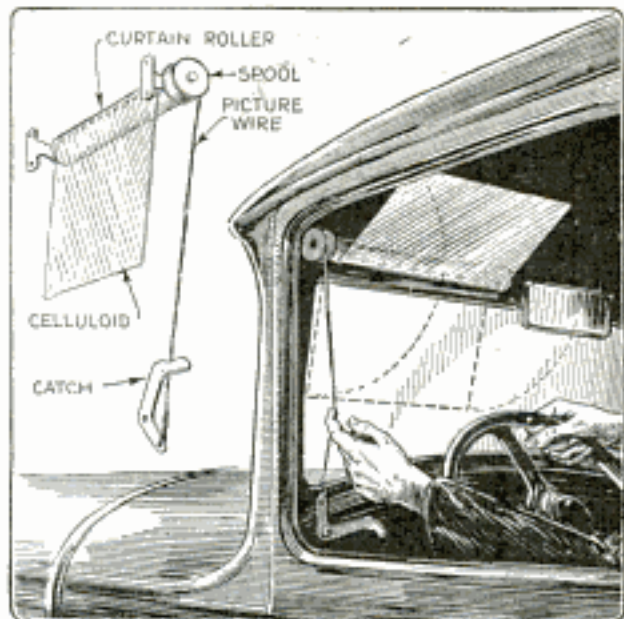
### T-Square Improvised from Ruler and Cardboard

A satisfactory T-square can be improvised by fastening a small piece of card-

T-Square Improvised from Flat Ruler and Piece of Cardboard for Use in Emergencies



board across the end of a ruler. A double piece of cardboard will give the square a better grip, or a soft piece of  $\frac{1}{8}$ -in. wood can be used.



Colored Celluloid Tacked to Shade Roller and Mounted on Windshield Provides Quick-Acting Glare Shield

### Quick-Acting Glare Shield Operated by Shade Roller

Tacked to a section of window-shade roller, a piece of colored celluloid provides a quick-acting glare shield. A small rod is inserted into the end of the roller, opposite the spring end, and fitted with an ordinary spool. The assembly is then mounted on the windshield by means of the regular shade brackets. A length of picture wire is wound around the spool and fastened to a catch mounted on the windshield frame as shown. The spring inside the roller holds the shield against the top when not in use, while a quick pull on the wire immediately drops it. If necessary to hold it in this position for a length of time, lock the catch.

### Salt-Water Bath for Goldfish

To keep goldfish in healthy condition, it is a good idea to give them a salt-water bath once a week. A teaspoonful of salt to a gallon of fresh water is sufficient, allowing the fish to remain in it for about five minutes.

### Cuts in Razor Strop Mended with Glue

Cuts in razor strops can be repaired by applying glue to the edges of the cut. Allow the glue to dry for a few minutes and then carefully press the edges together and wipe off the surplus glue with a damp cloth.



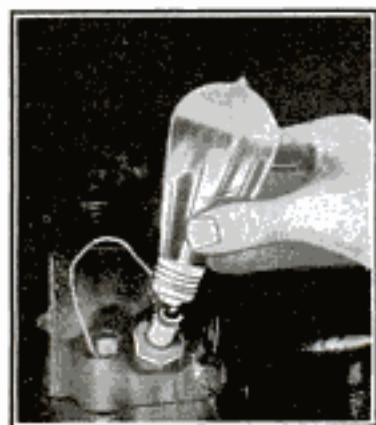
Convenient Kitchen Stool Swings Out of the Way under Table When Not in Use

### Kitchen Stool Swings under Table

Here's a simple one-leg stool that makes a welcome addition to any kitchen. A piece of 2 by 2-in. stock, preferably hardwood, is fitted with a caster at one end and a circular seat at the other. A horizontal arm is screwed to the leg, and a small strap hinge is used for attachment to the table. The dimensions covering the height of the stool and the distance it swings from the table leg vary with individual requirements.

### Shock-Proof Spark-Plug Tester

A burned-out electric lamp and a length of wire provide a spark-plug tester that is shock-proof. The wire is twisted around



the screw end of the lamp and bent so that, when the center contact is placed on the tip of the plug, the end of the wire will come in contact with the motor block.

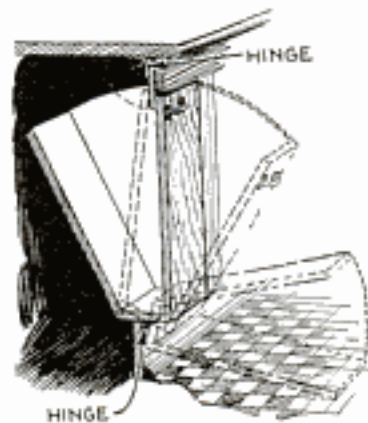
This shorts the plug so the spark will jump between the support wires inside the lamp and can be seen through the glass. By holding the lamp by the glass portion as shown when performing the test, no shock will result.

### Checkers from Phonograph Records

You can easily cut out checkers or poker chips from old phonograph records. Heat the record until it becomes soft enough to bend under its own weight. Then place it on a smooth block and stamp out the chips with a hollow punch or small tin-can lid. If records of different colors are used, a complete two-color set of checkers or chips can be made.—Earl H. Baugh, Naches, Wash.

### Cupboard Flour Bin Is Removable to Permit Cleaning

A flour bin, placed under a bench or table, as shown, can easily be removed for cleaning. A length of 2 by 4-in. stock is nailed to the floor and the bin hinged to it. The two-by-four should be set back slightly to allow room for the feet under the bin when working at the bench. An apron is then nailed to the underside of the bench top to come flush with the bin top. Behind this piece and to the underside of the bench, a piece about 3 in. wide and 5 in. long is hinged to act as a stop when the bin is pulled forward. To allow the bin to come to the floor for cleaning, the stop is held up until the back of the bin clears it.

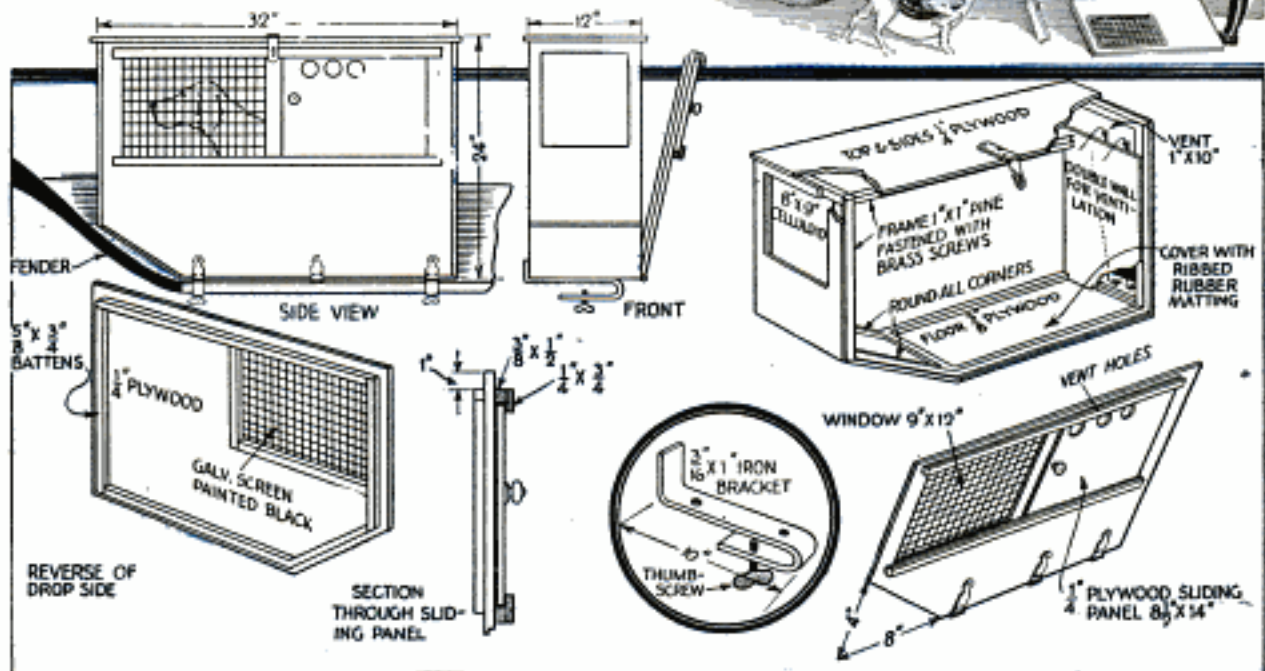
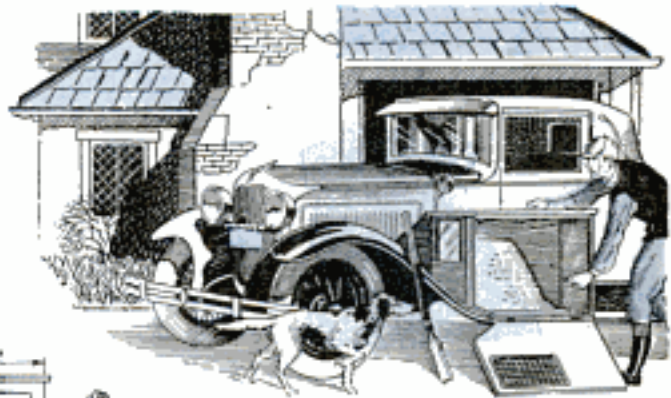


### Clip Prevents Loss of Pocket Comb

Riveted to a pocket comb, an ordinary pencil clip will prevent its loss. A good clip for this purpose can be obtained from a discarded automatic pencil. Pins may be used as rivets, holes being drilled through both the clip and the comb.

# Dog Tonneau Carries Your Pet in Comfort

Here is a light plywood running-board box that will accommodate your dog in comfort. He can see all that is going on, and has plenty of fresh air in fair weather and warmth when it is cold. Moreover, his snug compartment is rainproof. Plywood is used throughout,  $\frac{1}{4}$ -in. stock for the top and sides and  $\frac{3}{8}$ -in. stock for the bottom. The forward lower corner is cut off at an



Box That Fits the Forward End of Auto Running Board Is Provided with Indirect Ventilation and Is Insulated against Heat and Cold, Making Long Trips More Comfortable for the Canine Occupant

angle, permitting the carrier to be set well forward on the running board without interfering with the rear door when opened. At the same time the toe-board gives the dog something to brace his feet against when the car is stopped abruptly. The dimensions given are for an average-size Airedale. In laying out the box, it should be designed for your particular pet. Do not make it any larger than necessary to give him freedom of movement. Cut the plywood to size and assemble with frame members of pine, 1 in. square. At the forward end, a celluloid windshield is set in as shown. The outside rear wall should be cut off to allow a vent opening at the bottom, 1 in. wide, and the inner wall is similarly cut off at the top, providing indirect ventilation so that the dog will not be exposed to a strong draft. The hinged side is reinforced with battens on the inside, and has a window covered with gal-

vanized screen, or chicken wire painted black. A sliding panel is fitted to close this up completely in wet or cold weather, ventilation being provided by three 1-in. holes along the top. Round the corners of the exposed frame members on the inside, and line the entire box as well with heavy building felt or similar material, which serves not only as padding, but also insulates against cold and heat. The carrier should be painted in a color to harmonize with your car, leaving the hasp and hinges untouched. It is best to put these on after the painting. Apply two coats of spar varnish over the paint, and see that all edges of the plywood are well covered to keep out moisture. You'll need to call on the blacksmith for the running-board brackets. These should be substantially made of about  $\frac{3}{16}$  by 1-in. flat iron, with a thumbscrew for clamping them to the running board.



Snow Shovel Made by Nailing Part of Auto Hood to a Wooden Handle

### Snow Shovel from an Auto Hood

Nailed to a suitable stick, the lower half of an auto hood forms a serviceable snow shovel. The hood is removed at the hinge, the handle taken off and the rolled edge flattened out to provide a suitable edge for scraping the snow off the walks.

### How to Open Clogged Grease Fittings on Your Car

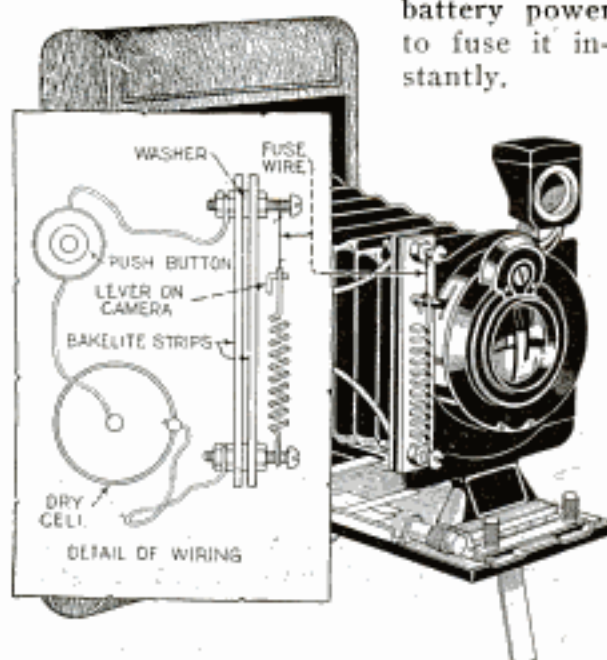
The grease holes in the shackle bolts of my car had become so clogged with rust and dirt that I could not open them with a pressure gun. In this emergency, I took an old 22-caliber long revolver, pulled the bullets out of two cartridges and poured the powder from both into one. Next, with the cylinder removed, I put about  $\frac{1}{4}$  in. of heavy grease in the rear end of the barrel and replaced the cylinder and double-charged cartridge. Then, turning the muzzle up, I poured half a teaspoonful of penetrating oil into the barrel of the revolver. Keeping the muzzle up, I got under the car, pressed the muzzle tight against the grease fitting and pulled the trigger. One shot was enough, as I could

then force grease through the hole with a small hand-pressure gun.—A. E. Granville, La Grange, Ill.

### Operating the Camera Electrically

By using this device, you can operate your camera from a distance of several feet on one dry cell. The operating principle is to melt a small wire causing a spring to actuate the camera shutter. Two strips of bakelite, slightly longer than the front plate of the camera, are spaced by two washers and held together by bolts and nuts. The spacing should be wide enough to allow the strips to grip the front mounting plate of the camera when pushed over the edge. One end of a light coil spring, with sufficient pull to operate the shutter, is attached to the head of the lower bolt, while the other end is bent into a hook and engages the hole in the shutter lever. The device is set by attaching a short  $\frac{1}{2}$ -amp. fuse wire to the hook spring and twisting the other end around the top bolt. The connections to the camera are made by fastening a wire from the dry cell under the nut on the lower bolt, and the wire from the push button under the nut on the top bolt. If the camera is to be operated from a distance greater than 20 ft., you must have more than one dry cell. Regular fuse wire is not necessary; any fine wire will do as long as there is sufficient

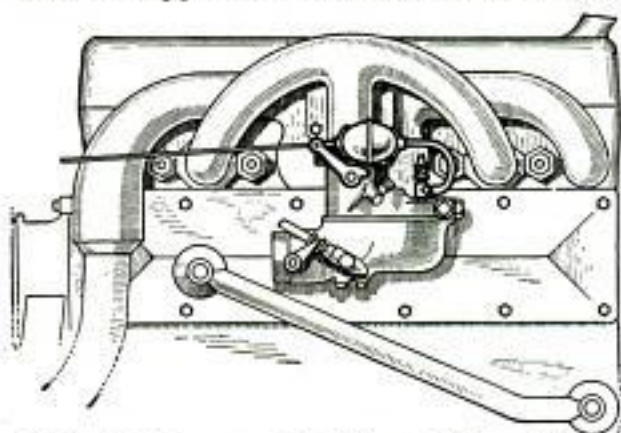
battery power to fuse it instantly.



This Device Operates a Camera from a 20-Ft. Distance with One Dry-Cell Battery

### Accelerating Pump for Ford Car

Acceleration of a model-A Ford car can be improved, especially in cold weather, by the addition of the pump shown. This is simply a syringe or hydrometer bulb that is squeezed by pressure from the throttle, and applies a slight air pressure to the float chamber at the moment the throttle is opened. A bracket for the bulb is mounted on one of the bolts that hold the carburetor to the intake manifold, and a washer is placed between the other end of the bulb and the throttle arm so that, when the throttle is opened, the bulb is compressed and the air forced into the float chamber through a rubber tube provided for this purpose. Drill and tap a hole in the top of the carburetor float chamber for a  $\frac{1}{8}$ -in. pipe nipple, into the top of which is fitted a petcock. Also insert a nipple in the side of the tee to re-



Rubber Bulb Compressed by Throttle Forces Air into Carburetor to Give Supercharger Effect

ceive the rubber tube leading from the bulb, and plug up the regular air vent in the chamber. The petcock provides the accelerating charge adjustment and never should be completely closed.

### Care of Steel Tools in Cold Weather

Steel becomes brittle when exposed to extreme cold and will not stand the same strain as at other times. Therefore tools and equipment of this material should be subjected to less strain to avoid possible breakage or damage in such weather. Inspection of steel equipment should be thorough.—August Jeffers, Bedford, Ind.

☐ Whitewash marks can be removed from woodwork by rubbing it with a cloth to which some paraffin has been applied.



Dried Paint in Small Brushes Removed by Rotating the End on Cake of Soap

### Cleaning Show-Card Brushes

Bristles on show-card brushes, that are continuously used in water color, soon become clogged with particles of dried paint near the ferrule, which ordinary rinsing will not wash out. By dipping the brush in warm water and rotating it against a cake of soap as shown, the dried particles will be forced out. Then the brush is rinsed in clear water and the bristles flattened out to dry.

### Rubber Aids When Using Roofing Nails and Washers

Roofing-nail washers are rather difficult to handle during cold weather. By cutting small squares of rubber from an inner tube and pushing the nail through the washer and then through the rubber, as shown, it is an easy matter to keep the nail and washer together and to start the nail quickly.



Small Squares of Rubber Hold Nails and Roofing Washers Together Until Driven into Place



Box Fitted to Outside of Door with Hinged Panel Provides Convenient Cooler

#### Food Cooler Attached to Door

A box of suitable size, fastened to the outside of a kitchen door, will provide a handy food cooler. Remove the panel in the center of the door and hinge it at one end. The box is fastened to the other side and should fit snugly to prevent the entrance of dust and dirt.—W. S. Beach, Baltimore, Md.

#### Repair for Tears in Raincoats Made of Balloon Cloth

Tears in raincoats made of balloon cloth, can be repaired by cross-stitching the entire length with silk thread, running it through a small piece of cloth placed on the underside to prevent the thread from pulling through. The patch should then be waterproofed with collodion.

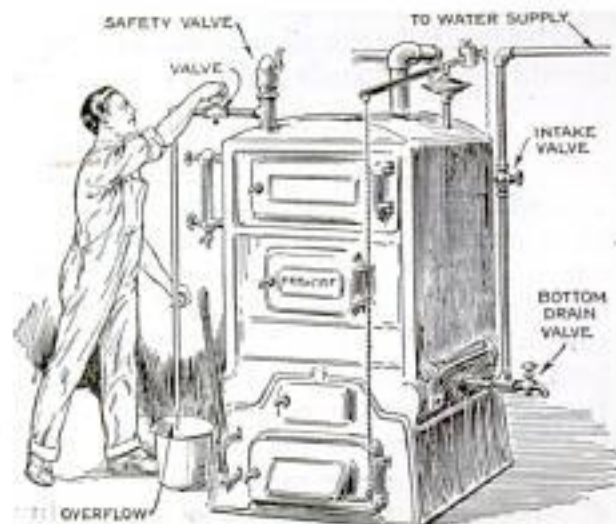
#### Rolling Cutter from Caster Parts

To make a rolling tool for cutting out various curved shapes from cardboard, paper, etc., take a caster and remove the wheel. Then split the latter with a saw. Obtain a piece of steel, about  $\frac{1}{4}$  in. greater in diameter than the roller, and after drilling a hole in it, like that in the roller,

sandwich the steel disk between the two halves of the roller and reassemble. After fitting the caster with a suitable handle and sharpening the disk, you will have a rolling cutter which is easily used and guided. In some cases, a cutter may be desired which will make two parallel cuts at one time. In that case, cut the caster roller in three parts, and sandwich in two cutting disks.—John E. Hyler, Peoria, Ill.

#### Skim Water in Boiler to Increase Efficiency of Heating Plant

Oil, grease or other dirty film on the water in a heating-plant boiler causes "foaming" and retards the generation of steam. To remove the film, install a pipe tee directly below the safety valve and fit it with a valve and overflow pipe, as shown. Fill the boiler with water to a point 1 in. or more above the water gauge and heat it to the boiling point. Then open the intake valve and allow fresh water to trickle into the bottom of the boiler. Open the valve in the drain pipe and allow the water to drain out slowly. If the water is dirty, allow it to run until clean. A satisfactory foaming test of the water in the boiler can be made by removing and boiling a sample. Bubbles created by boiling dirty, oily water are very small and will be more numerous than those obtained in boiling pure water. It will be a good idea to make these tests two or three times each season and especially when installing a new heating plant.—L. H. Burnham, Pittsfield, Mass.



Removing Film from Water in Boiler of Heating Plant Increases Its Efficiency

## Blueprint Your Bookplates by Photography



Here is a simple method of making your own bookplates without the expense of a zinc plate and commercial printing. The idea is to make the drawing of large size, photograph it and run off blueprints from the film. Blueprints require no developing equipment beyond a printing frame which can be purchased for a small sum, or you can make one that will do for this job. At a slightly greater cost, very attractive sepia prints, in velvet finish, can be made from the films. Four representative designs are shown here, ranging from the silhouette to the more elaborate sketch of a house. It is assumed, of course, that if you like the latter, you will incorporate a drawing of your own home. First determine how large a drawing will be required to register about  $3\frac{1}{4}$  in. long on the film. After determining the size of the drawing, lay out the design first in pencil and then ink it in with ruling pens that make broad lines. Two sizes of these pens will be sufficient, one that makes a line about  $\frac{1}{8}$  in. wide for the heavier outlines, and the other for  $\frac{1}{16}$ -in. width for the shading. Solid blacks should be painted in with a brush. Use only black drawing ink on a smooth-finish bristol board of good quality. The designs really are quite easy to make on the large scale required, but if you do not trust your artistic ability, you can at least draw an acceptable silhouette, tracing the outlines from portions of pictures or advertisements. A pantograph, which is not very

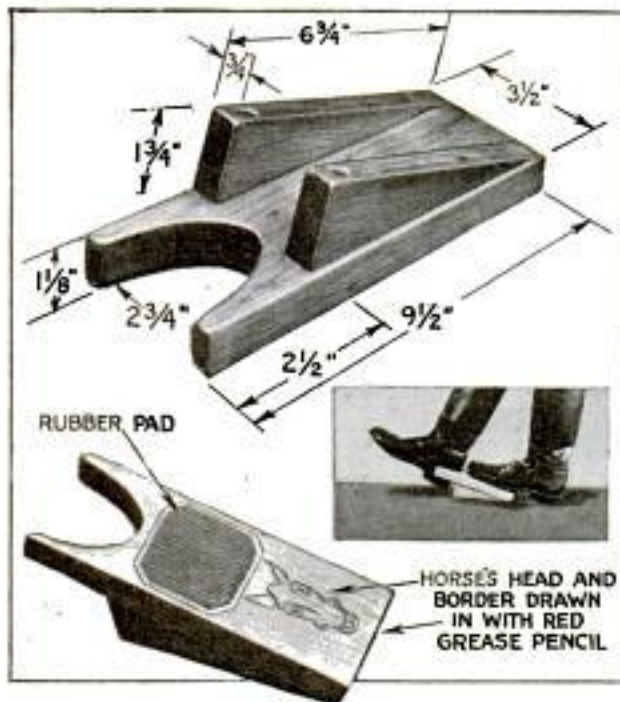
Blueprint or Sepia Bookplates Made by Means of Photography

expensive, will enable you to trace accurately from a photo or drawing on as large a scale as desired. Showcard liquid white will be found practical for touching up the

drawing, painting in white letters on the black background, and in effacing flaws and errors. The camera, of course, should be set as close to the work as is possible with sharp definition, the aperture stopped down and a slow exposure made, preferably in the shade or on an overcast day, so that there will be no glare from the white portions of the paper. If you are not sure of your photography on this type of work, consult some one of experience, and then it will be a good idea to make six exposures, or the entire roll, of the drawing. This will enable you to make six of the blueprints at a time, provided your printing frame is large enough. The blueprint paper is simply soaked in water to fix it. When the print is dry, trim the edges, leaving a  $\frac{1}{4}$ -in. margin, and paste in your books. Rubber cement is most satisfactory for this purpose, as the surplus can be rubbed off with clean fingers.

### Loosening Tight Emergency Brake

It is often rather difficult to release the emergency-brake lever after it has been set tight as is often done when parking. Pressing down firmly on the foot brake at the same time the emergency brake is released, will relieve some of the strain so that it can be loosened with less effort.



Properly Finished and Constructed, This Bootjack Is Useful as Well as Ornamental

### How Boots Are Easily Removed with This Bootjack

Those who wear boots will find a jack a great help in removing them. It is made of maple or other hardwood and consists of a top piece to which two triangular sidepieces are screwed. All edges are slightly planed and the surface is sanded smooth. A rubber pad, tacked or cemented on top for a foot grip, prevents slipping when removing a boot. Any suitable figure can be drawn on the top piece with a colored grease pencil, after which a coat of shellac is applied.

### Truing the Edges of Kitchen Utensils on Lamp Reflector

Pots and pans that have become bent or dented along their edges can be trued up with the use of an auto headlight reflector and a wooden block. Place the utensil over the reflector as shown and press against it, or tap lightly, with the block, which will soon cause the irregular edge to assume its proper curvature.

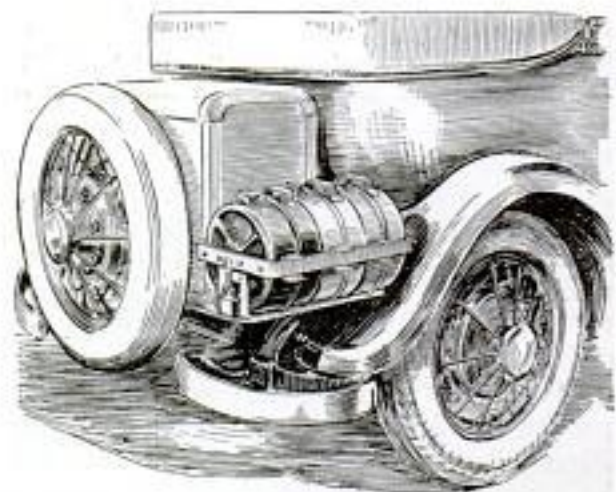


### Glass Cleaned with Chemicals

Glass can be quickly cleaned so that it will sparkle by using carbon tetrachloride, a harmless chemical commonly used for extinguishing fire. A hand spray gun, such as used for spreading liquid insecticide, is handy for applying it. Spray a fine mist on the glass, and immediately wipe it off with a clean cloth. This method will remove the dirt and dust, and leave a pleasing luster.

### Spare Tanks Mounted on Trunk Rack of Auto

Mounting spare tanks that are used for gas, oil and water on the trunk rack keeps them out of the way and fills up space otherwise wasted. The frame holding the tanks is bolted to the trunk rack or frame, depending on the style of the trunk mounting, and is locked in the usual way. When siphoning gas from the spare tank



Spare Tanks Mounted on Trunk Rack Utilize Waste Space and Keep Running Boards Clear

to the auto tank, it is not necessary to remove the former from the rack.—Elmer L. Brown, Folsom City, Calif.

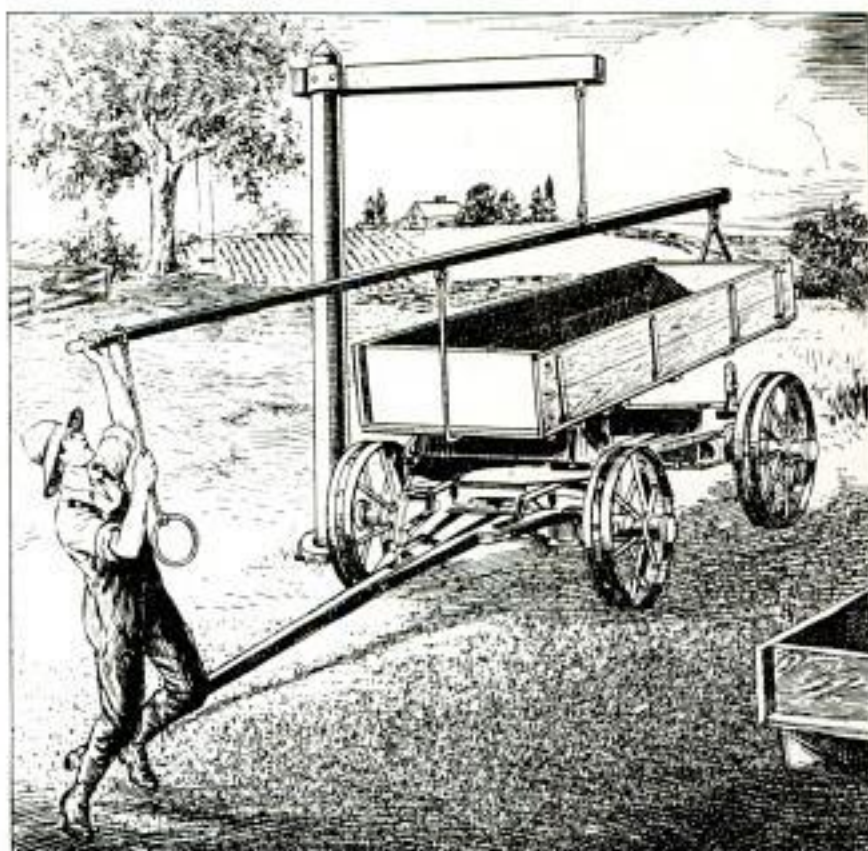
### Recoating Photo Developing Trays Prolongs Their Life

Old photographic developing and fixing trays can be made serviceable for many more years by recoating them with white brushing lacquer. However, hot or alcoholic solutions cannot be used in the trays after recoating, as they will dissolve the lacquer, but for ordinary developing solutions, the method is satisfactory.



## You Can Lift Wagon Boxes Single-Handed

Lifting heavy wagon boxes and racks from the running gear, is a rather difficult task and usually requires two men, but with this simple derrick, one man or a boy can easily do it in a few minutes. A stout post, 10 ft. long, is set in a cement socket, in which it turns easily, and a bracket of 2 by 6-in. lumber is attached and braced at the top so that the horizontal arm extends 6 ft. from the post. From the end of this is suspended a cable supporting a 14-ft. lever, the pivot point being located one-third of the length from the end of the pole. Two strong hooks are suspended from the short end of the lever and one at a point near the center, while a rope and ring are attached to the other end of the pole for convenience in reaching it. In use, the wagon is driven alongside the upright post and this is turned so that the derrick arm comes above the wagon box. The long end of the lever is raised to place the double



Easily Made Hoist That Enables You to Raise a Wagon Box from the Running Gear Single-Handed

hooks under one end of the box, and then pulled down, to engage the third hook at the other end. This places the wagon box in balance so that it can be raised and swung away from the running gear, after which it can be lowered onto a rack. —G. E. Hendrickson, Argyle, Wis.

### Sheet Asbestos Makes Electric Toaster More Efficient

By wiring thin sheets of asbestos to the grillwork on the drop sides of an electric toaster, its efficiency will be considerably



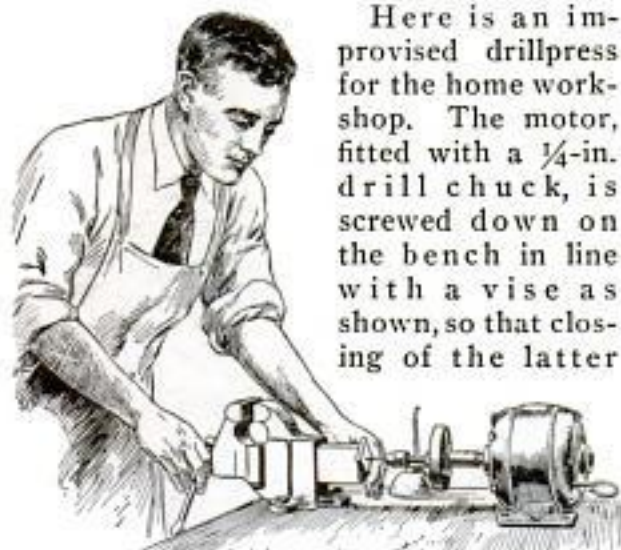
Asbestos Retains Heat and Reduces Electricity Bill

increased. The asbestos will retain the heat given off by the toaster and reduce the amount of current used, but will not interfere with the turning of the bread.

### Waxing Model-Ship Cordage

When ordinary beeswax is applied to model-ship cordage, it tends to leave small flakes on the cord fibers which gives them a roughened appearance, besides catching and holding dust. A good method of applying the wax, is to rub it on the cord in the usual way and then pass the cord quickly over a flame. In this way the wax melts into the fibers, stiffening the cord, and giving it a smooth ship-shape look.

### Drillpress Improved from a Vise and Electric Motor



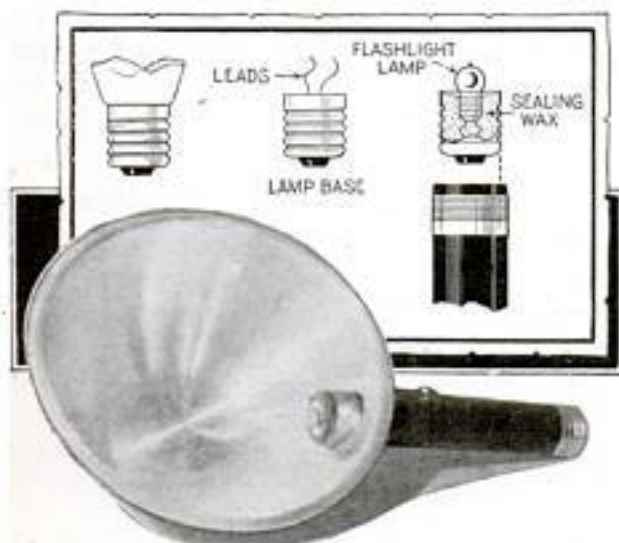
Small Chuck on Electric Motor and a Vise Form Drillpress for Odd Jobs

Here is an improved drillpress for the home workshop. The motor, fitted with a  $\frac{1}{4}$ -in. drill chuck, is screwed down on the bench in line with a vise as shown, so that closing of the latter

pushes the work against the drill. This arrangement is quite satisfactory for odd jobs where the work does not justify the expense of a regular press.

### Test Light for Photo Flash Lamp

Disappointments in having your photo flash lamp fail to work when taking a picture can be prevented by first using a test lamp. It consists of a flashlight lamp mounted on a base from an ordinary burned-out electric or photo flash lamp. After removing the glass close to its base, crush the glass pillar to free the two copper lead wires. Chip off the remaining glass from the inside top edge of the base,



Flashlight Lamp Soldered to Base of Burned-Out Electric Lamp Forms Tester for Photo Flash Lamp

being careful not to rupture the glass piece holding the bottom contact. Connect a small flashlight lamp to the two leads by soldering one wire to the metal base and the other to the bottom contact. Push the lamp down into the base until the top edges of the two bases are even with each other, keeping the leads well spaced, and then flow in melted sealing wax to hold the lamp in place. Before taking a photo, screw the test lamp into the photo flash socket and turn on the light. This checks the battery and the off position of the switch. It is a good idea to wear goggles to protect your eyes while breaking and chipping the glass.

### Automatic Shut-Off for a Windmill

An Indiana farmer has a float in his watering tank that is fastened to a gear arrangement to automatically shut off the windmill when the tank is full and to start it again when the tank is empty. As the water is lowered in the tank, the weight of the float trips a mechanism which allows the wind vane to turn the mill into the wind. An arm is fastened to the plunger which slowly shuts off the mill by means of a pawl-and-ratchet arrangement.—J. C. Allen, West Lafayette, Ind.



### Salt and Cinders Reduce Hazard of Icy Road

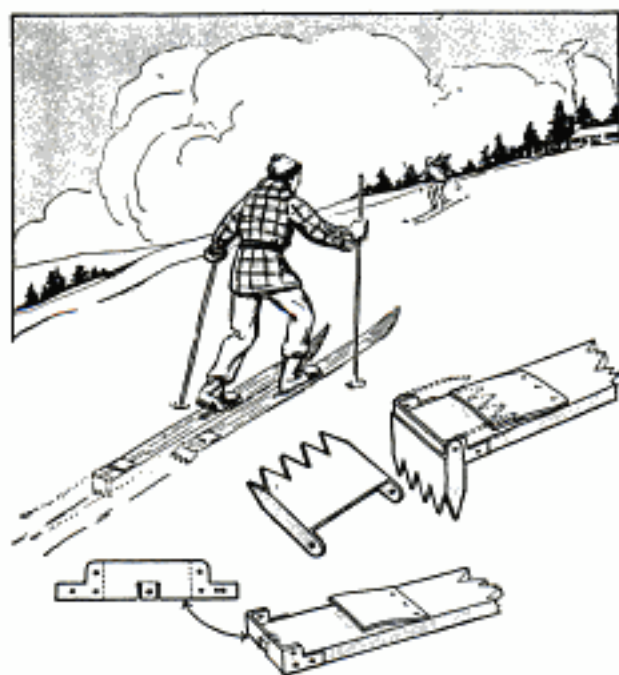
For greater safety in driving over icy and slippery roads, the highway department of Minnesota spread a mixture of salt and sand or cinders over them. When treated in this manner, the sand or cinders become imbedded in the ice and will not blow away.—Allen P. Child, Kansas City, Mo.

### Coloring Antique Ship Lanterns

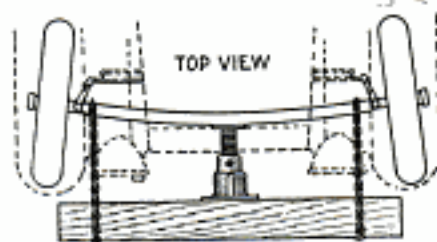
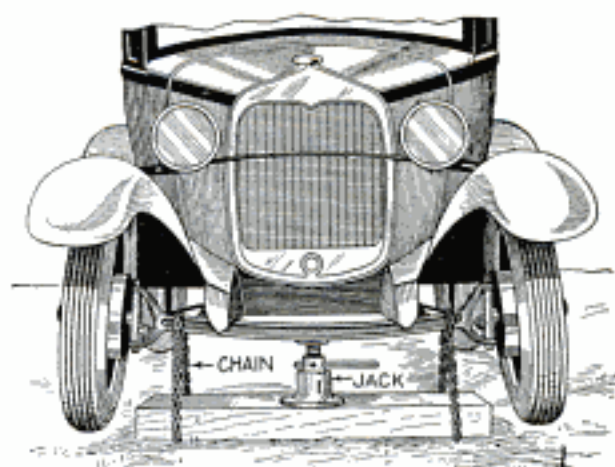
Antique lanterns for model ships can be given a realistic effect as follows: Gouge out the space in the lantern to be occupied by the glass to a depth of about  $\frac{1}{32}$  in. and sand the depression smooth. Then color the depression a dull red. When dry, streak this thinly with a bright yellow color. Next cut a square of transparent celluloid or cellophane to fit the depression. Color this on the inside with a pale blue, and glue the pane in place.

### Ski Brake Prevents Backslip

For skiing uphill, which usually requires use of the herringbone system of climbing, a set of brakes will be found useful. Each brake consists of two parts, cut from  $\frac{1}{16}$ -in. sheet metal as shown. A number of points are cut in one end and two on the sides. The latter are bent back and project above the ski so that the whole brake can be pivoted to the other part. This is fastened to the end of the ski and drilled as shown in the lower detail. The two parts pivot on loosely fitted rivets so the brake will swing back to dig into the snow when the ski slips back, but rides over the surface when going forward. A stiff leather flap is attached to the top of the ski, to hold the brake when it is not needed, as in going downhill.



Attached to Your Skis, These Sheet-Metal Brakes Help You to Climb Hills



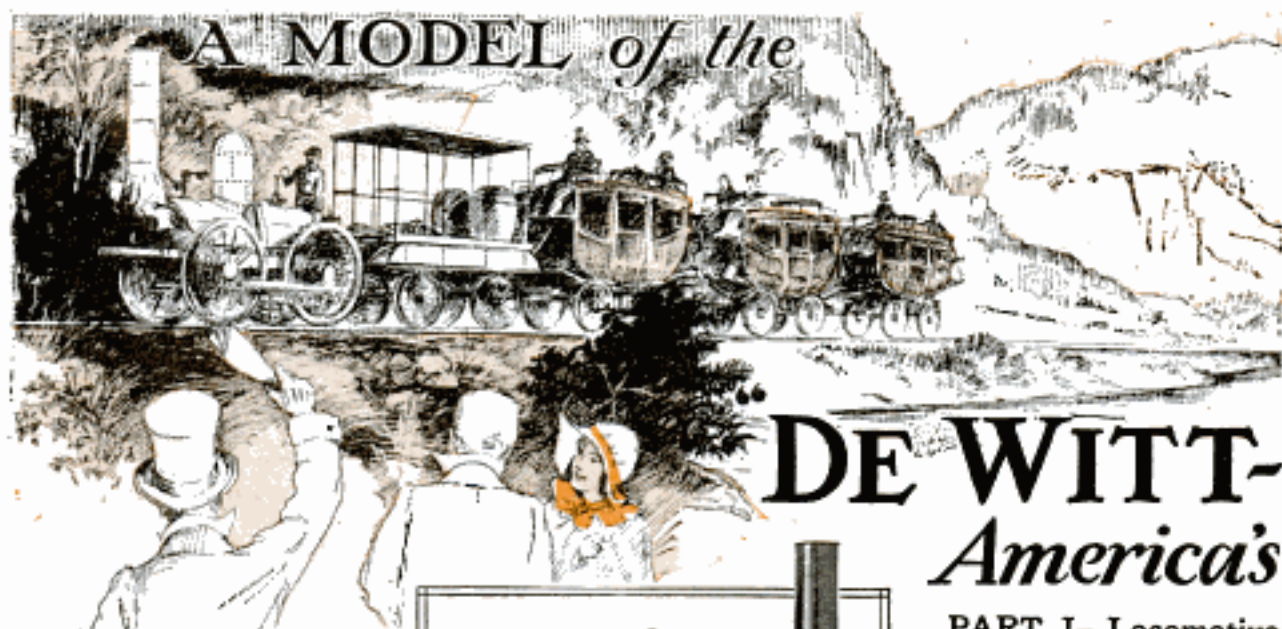
Straightening Bent Axle by Using Jack, Heavy Wooden Beam and Two Lengths of Chain

### Jack Used to Straighten Auto Axle

Bent axles on autos can often be straightened without removing them by using a screw-type jack, two lengths of chain and a heavy wooden beam. The jack is screwed down as far as possible and put between the axle and beam, which is placed either under or in front of the axle, depending upon the position of the bend, and the two are chained together as shown. By running the jack out, the axle will be bent back into its correct position. Considerable time can be saved in cases where it is possible to apply this method.

### Embossed Writing with Ordinary Steel Pen

Embossed writing can be done at small expense with an ordinary steel pen. Thin a good grade of printer's ink with methyl salicylate to a suitable consistency. After the writing has been done and before the ink has dried, cover it with embossing powder of the color desired. Gold, bright silver or copper produces an attractive effect. Hold the paper over an electric heater or other flameless source of heat until the ink just starts to melt; then withdraw the paper quickly. As the ink cools, the writing will become hard and glossy, and will stand out in relief.



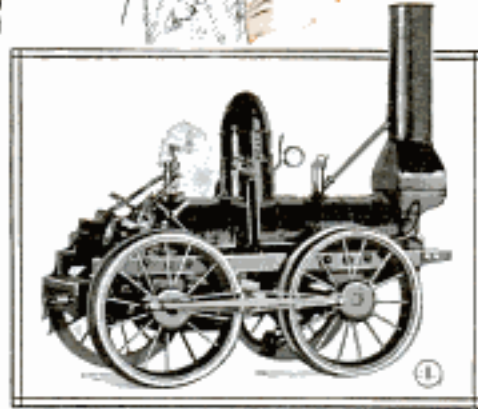
# A MODEL of the

# DE WITT- America's

By REGINALD CLAUDIUS

**O**UTSTANDING in the field of model making in metal, the work on this historic train will give you many hours of keen enjoyment. A small metal-turning lathe and drillpress are needed. Excellence of the product depends on care and accuracy.

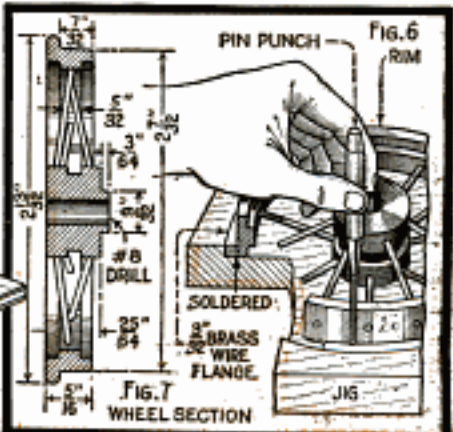
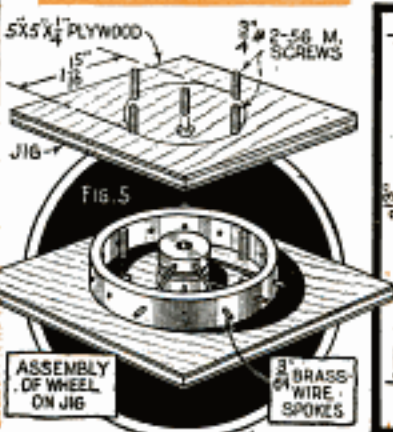
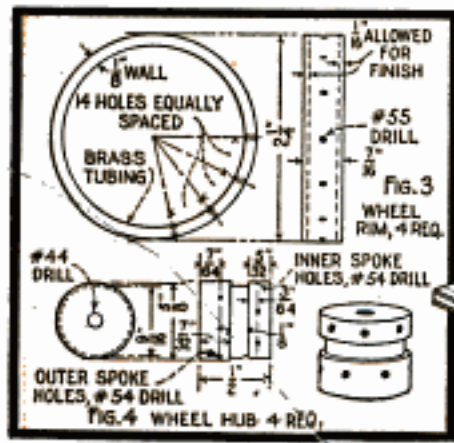
The material required for the four drive-wheels is a 6-in. length of brass tubing of  $\frac{1}{8}$ -in. wall and  $2\frac{1}{4}$ -in. outside diameter; a 6-in. brass rod,  $\frac{5}{8}$ -in. diameter; a 6-ft. length of  $\frac{3}{32}$ -in. medium-tempered brass wire, and the same in  $\frac{3}{64}$ -in. diameter. This leaves excess material which is necessary. File one end of the tubing square for a working face and lay off four  $\frac{7}{16}$ -in. spaces along its length, allowing for the width of a hacksaw



## PART I—Locomotive

cut on each. Locate and scribe center lines on the four spaces. Set the dividers to space off 14 divisions on the center line of each rim. Then prick-punch lightly and place the work in a V-block on the drillpress table and

use a No. 55 drill as in Figs. 2 and 3. Now place the work in the vise and cut off the rim with the hacksaw. To prevent the cut from running, allow the blade to cut through the wall only on one side. Turn the work as the cut progresses, taking care to follow the scribed line. When all rims have been drilled and cut off, tighten them individually on the inside jaws of the lathe chuck and true each edge with a  $\frac{1}{32}$ -in. cut, bringing the width to  $\frac{3}{8}$  in. Later, after the spokes have been added, another cut is taken on



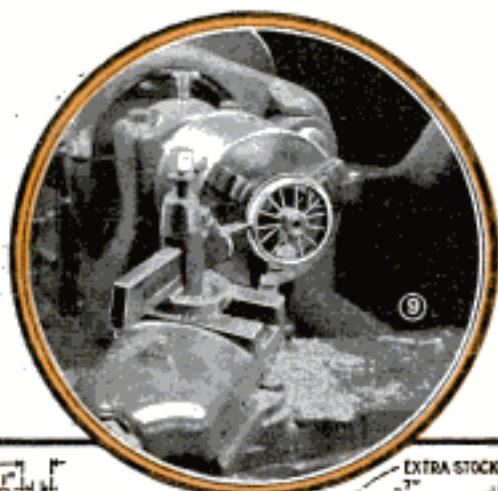


# CLINTON<sup>®</sup> Historic Train

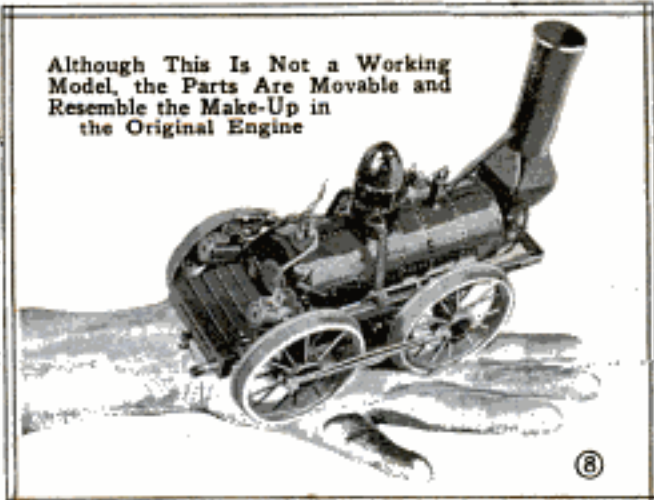
## Drivewheels, Axles, Side Rods and Frame

each edge for finish. For a clean, smooth cut on brass, the cutting tool must be ground and honed with a negative side and back rake and a slightly less front and side clearance than that used for other metals, especially when turning out small parts. Clean the inner and outer faces of the rims with very fine emery cloth so that solder will adhere readily.

Fig. 4 gives dimensions of the hub, laid out on the  $\frac{5}{8}$ -in. rod. First turn in the groove and locate the center line of the staggered spoke holes, following the same method already described for cutting the hubs from the

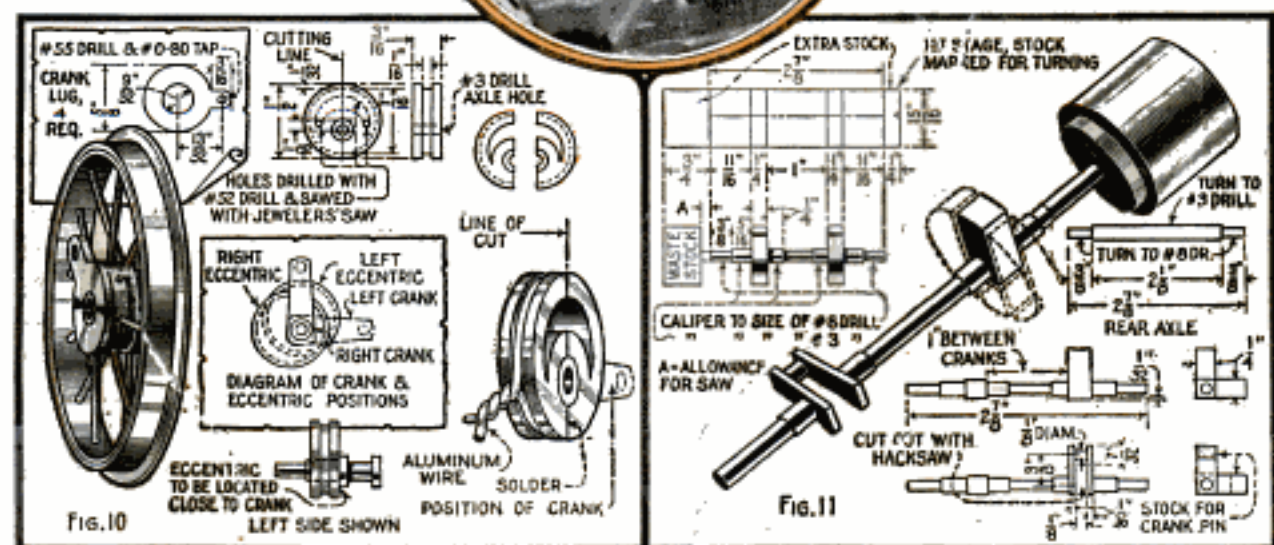


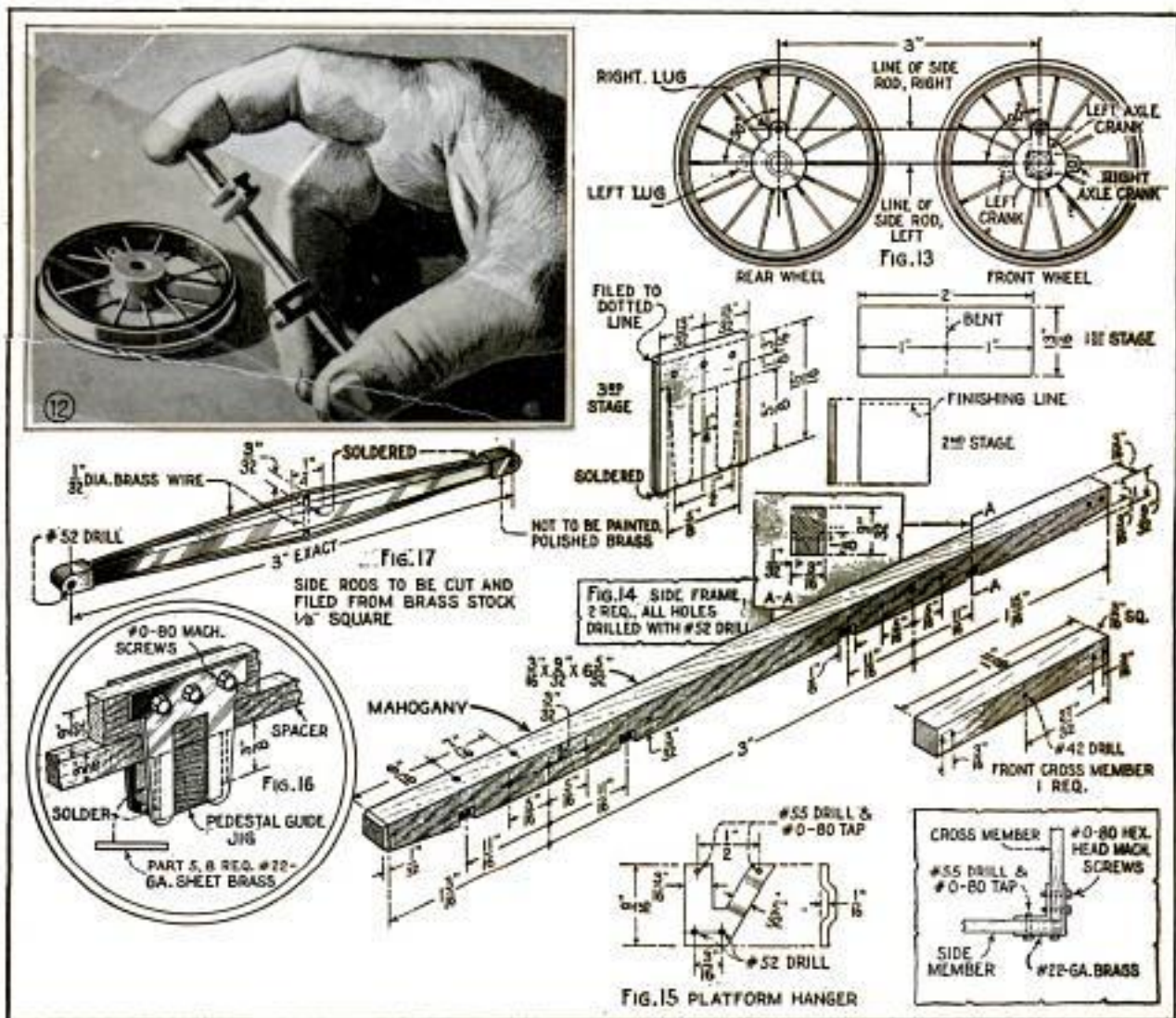
Although This Is Not a Working Model, the Parts Are Movable and Resemble the Make-Up in the Original Engine



rod and allowing for saw cuts. After cutting off the hubs, chuck in the lathe and face both ends with very light cuts. While the hubs are held in the chuck, center a No. 44 hole through each. Set the dividers to space 7 holes on each of the scribed lines, the two sets of holes being staggered. Drill with a No. 54 drill, being careful that the drill does not break through into the center hole. Brighten the hubs with fine emery cloth.

The method of assembling the wheel on a jig is shown in Fig. 5. Place the rim and hub in the position indicated and run down No. 2-56 nuts on the five screws. Then insert the spokes as shown, cutting these from  $\frac{3}{64}$ -in. brass wire. With the spokes in place, flow solder on the hub and outer face of the rim,





using a non-acid liquid flux and wiping off excess solder with a cloth. Remove the work from the jig, mount it to run true on the inside jaws of the chuck and take a very light cut off the rim face to remove all traces of solder. From  $1\frac{3}{8}$ -in. hardwood, cut a block, 5 in. square, and recess one face  $2\frac{13}{32}$  in. in diameter and  $\frac{5}{32}$  in. deep, Fig. 6. Place the wheel in the recess, cut a piece of  $\frac{3}{32}$ -in. brass wire to fit snugly around the periphery of the rim with the ends meeting, and, with a small pin punch, tap the wire into the position shown. Flow just enough solder onto the rim and wire to allow turning down below any irregularities. Chuck the wheel on the inside jaws with the back face against the chuck, as in Fig. 9, and with very light cuts bring the finish dimensions to those indicated in Fig. 7. Before reversing the wheel on the chuck, a  $\frac{3}{64}$ -in. shoulder is turned on the outer end of the hub, leaving a projection exactly

$\frac{1}{32}$  in. in diameter; then center a No. 8 drill through the hub as in Fig. 19. Reverse the wheel and finish the back edges of the hub and rim to the dimensions indicated. Light rabbet cuts on the rim are made to form the web. The crank lugs, Fig. 10, are cut and filed from No. 16 gauge sheet brass to the dimensions indicated, then center-drilled  $\frac{3}{32}$  in. with the lug projection drilled and tapped for No. 0-80 brass machine screws. After the lug has been sweated to the hub, the joints are filed smooth. Be sure to duplicate exactly the tread diameter and width, the hub and the throw of the crank lugs on all four wheels.

Next comes the front crankshaft and the eccentrics, shown in Figs. 10 and 11. Turn the crankshaft from 1-in. round brass, following the dimensions in Fig. 11. Caliper the finish cuts to the drill sizes indicated, make the necessary allowances for the saw cuts, and, as the lathe carriage

must be operated by hand, take very light cuts when the work nears the finish dimension. Quarter the cranks, cut the indicated waste from the disks with a jewelers' saw, and finish the pins to  $\frac{1}{8}$ -in. diameter with a fine, square diemakers' file. The rear axle is simply a  $\frac{1}{4}$ -in. brass rod turned to the dimensions given in Fig. 11. The eccentric body should be turned from  $\frac{1}{2}$ -in. brass rod to the dimensions of Fig. 10; then form the "half-moon" opening and cut the body along the line indicated, with a fine jewelers' blade. Place the halves on the crankshaft inside of the cranks and hold in position with a length of aluminum wire, Fig. 10, then follow the diagram in locating the eccentrics on the shaft in the proper relation to the cranks. Flow solder along the line of the saw cut until the opening is filled, then remove the excess with a fine file. While the  $\frac{1}{2}$ -in. brass rod is in hand, make the driving or axle boxes, shown in the lower right-hand

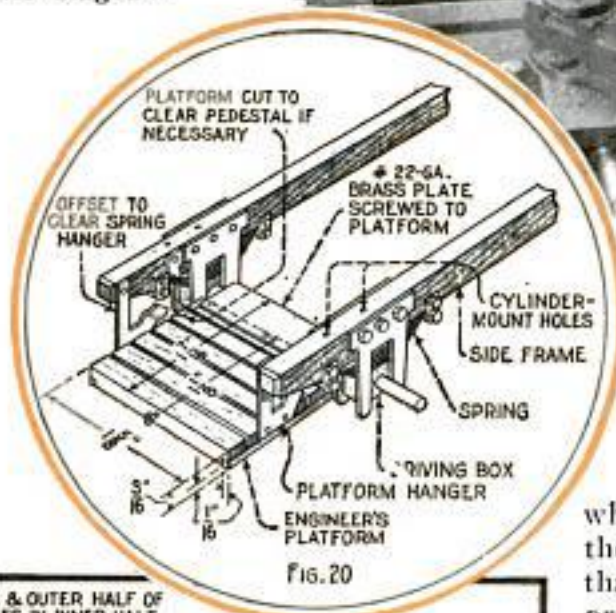
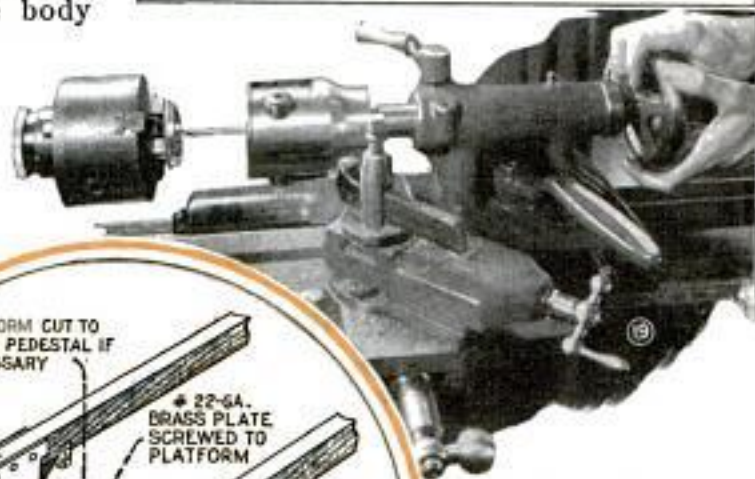
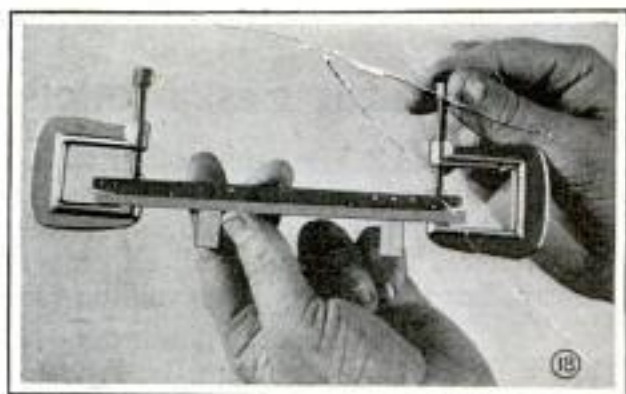


FIG. 20

file. Place the boxes and the front and rear wheels on the axles, then follow Fig. 13 in quartering the cranks and lugs. With the wheels in position, sweat them to the axles. Note that the axles do not project clear through the hubs. The remainder of the hole is to be filled with solder and filed off flush.

In Figs. 14, 15 and 16, the mahogany frame and the brass pedestals are fully dimensioned. Care must be taken to duplicate the pedestals, frame members and platform hangers exactly, to avoid difficulty in the assembly. The pedestals are

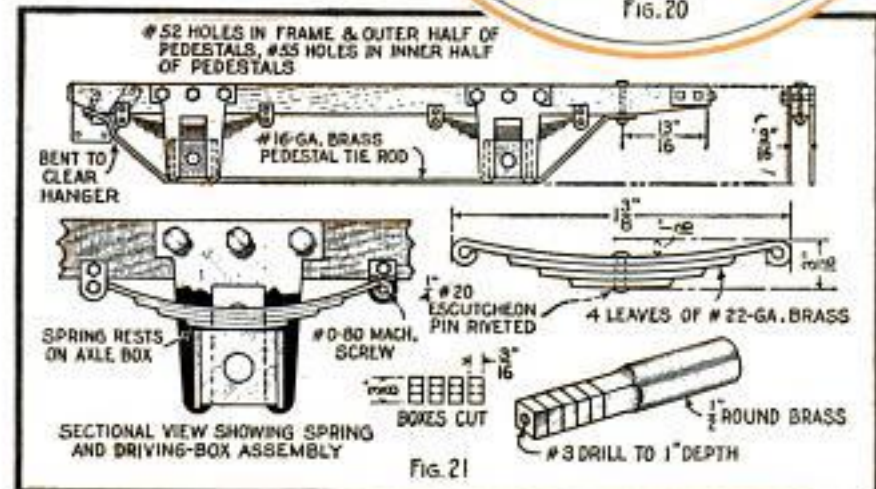


FIG. 21

made from No. 22 gauge sheet brass as in Fig. 14, the two halves of each being formed by bending a single piece along a center line, tacking the lower end with a drop of solder and sawing with a fine jewelers' saw to the form indicated.

made from No. 22 gauge sheet brass as in Fig. 14, the two halves of each being formed by bending a single piece along a center line, tacking the lower end with a drop of solder and sawing with a fine jewelers' saw to the form indicated.

## Cash for Best Models of DeWitt Clinton Train

**P**OPULAR Mechanics offers cash awards for the best models of the DeWitt Clinton train built by anyone in the United States and Canada. The models must be built to the same scale as given in the accompanying and successive articles. When completed, all parts should be duplicated in material and make-up, but the method of assembling may be varied.

*First Prize*, \$1,000 in cash, and a week's visit to New York via the New York Central's Twentieth Century Limited.

*Second Prize*, \$500 in cash, and a week's visit to New York.

*Third Prize*, \$250 in cash, and a week's visit to New York.

In addition, there will be five prizes of \$50 each, and ten of \$25 each for the next best models. In the event of a tie for any prize offered, a prize identical in all respects with that tied for will be awarded to each tying contestant.

Should winners reside in the east, a trip to Chicago may be substituted for the New York trip.

The judges of the contest will be Mr. Claudius, H. H. Windsor, Jr., editor and publisher, and officials of the New York Central Railroad. The date for closing the contest will be announced in the final article.

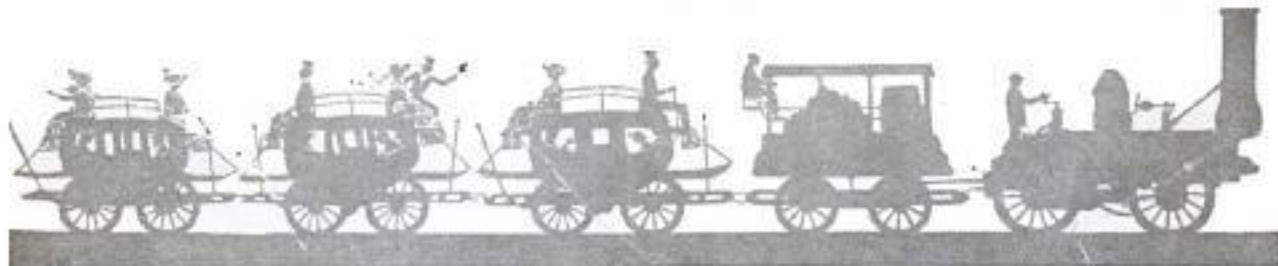
All contestants will be required to submit photographs of their models, and, in case of necessity, the model itself may be requested for inspection by the judges. All models will be returned.

In the latter case, shipping charges will be paid by Popular Mechanics Magazine.

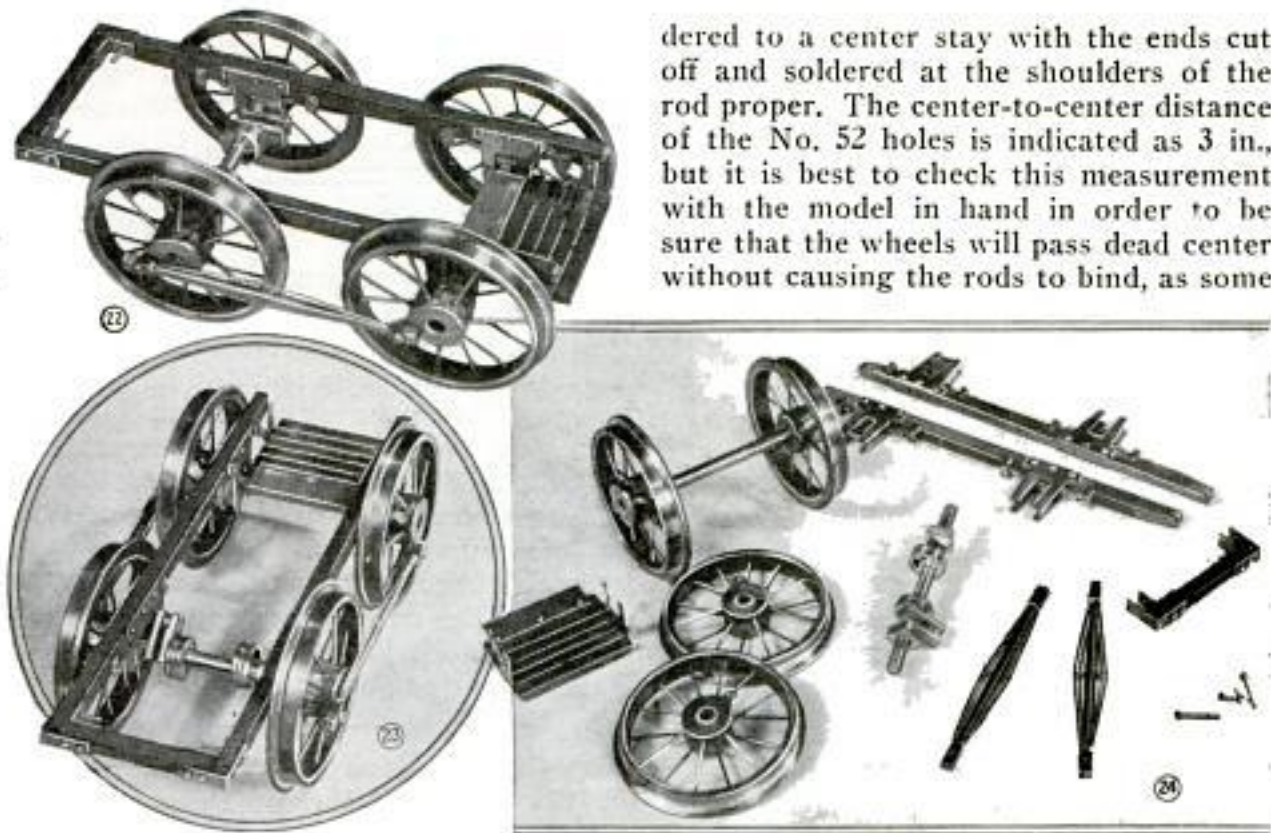
Drill through both halves first with a No. 55 drill, the two outer holes being located  $\frac{3}{16}$  in. from the center hole and  $\frac{1}{8}$  in. from the top edge. Before filing to separate, number the halves for identification. After the eight halves have been made, lay the odd-numbered ones aside and run a No. 52 drill through the holes in the even-numbered halves. Tap the first four halves for No. 0-80 machine screws. Assemble the pedestal halves on the side members of the frame as in Figs. 16 and 18, using a spacer to locate accurately the axle-box guides, part 5, Fig. 16. The guide blocks of the spacer are cut from hardwood to  $\frac{3}{16}$  by  $\frac{3}{8}$  by  $\frac{5}{8}$  in. in size, and are screwed to the spacer bar with a center-

to-center distance of exactly 3 in. The axle-box guides are cut from No. 22 gauge sheet brass,  $\frac{3}{16}$  in. wide and  $\frac{3}{8}$  in. long, and are soldered in position as shown in Fig. 16. The pedestals are removed from the frame to take out the spacer, then re-assembled, and the front crossmember is joined to the side frames with No. 0-80 hexagon-head brass machine screws and angle braces, cut and bent from No. 22 gauge sheet brass.

The engineer's platform is cut from mahogany to the dimensions given in Fig. 20, grooved with saw kerfs to simulate planking and rabbeted  $\frac{1}{16}$  by  $\frac{1}{16}$  in. on the lower edge at each end. The front of the platform is supported by a plate cut from







No. 22 gauge sheet brass, which bears on the rear axle. The hanger is cut from the same material to the shape and size given in Fig. 15, and is fastened to the platform with No. 0-80 hexagon-head screws turned up into the wood, as is also the case with the front supporting plate. The upper holes of each hanger are tapped for a No. 0-80 screw, and the latter is turned up from the outside of the frame through a clearance hole in the wood. Four leaf springs, bearing on the axle boxes, carry the weight of the frame. The method of making these is indicated in Fig. 21. The width of the leaves should be approximately  $\frac{5}{32}$  in., for clearance through the pedestal. The hangers are cut  $\frac{1}{8}$  in. wide,  $\frac{7}{32}$  in. long and the center-to-center distance of the holes is approximately  $\frac{1}{8}$  in. Sixteen holes are required, eight drilled with a No. 52 drill as clearance holes, and eight drilled with a No. 55 drill and tapped for No. 0-80 machine screws, the latter being put through from the outside of the frame. The pedestal tie-rods are cut  $\frac{7}{16}$  in. wide from No. 16 gauge sheet brass, made and fitted as in Fig. 21, but not bolted to the frame as yet, since other fittings to be described later necessitate the removal of this assembly.

The construction of the side rods is shown in Fig. 17, the truss bars being sol-

dered to a center stay with the ends cut off and soldered at the shoulders of the rod proper. The center-to-center distance of the No. 52 holes is indicated as 3 in., but it is best to check this measurement with the model in hand in order to be sure that the wheels will pass dead center without causing the rods to bind, as some

slight discrepancy in fitting will alter this distance. By applying the side rods with No. 0-80 machine screws and setting the frame on the wheels, the locomotive can be assembled to the stage shown in Figs. 22 and 23. The various completed parts so far are shown in Fig. 24.

#### Rubber Bumper on the Floor Brush

A section of old tire casing tacked around the end of a floor brush, provides a bumper for tapping it on the floor in order to remove dust particles, etc., when sweeping large areas. The rubber strip should be about  $1\frac{1}{4}$  in. wide and long enough to reach around the end of the brush as shown in the photo.



Paraffin applied to the edge of a ruler, when using it as a guide to draw inked lines, will prevent the ink from smearing.

### Cutter for Opening Cardboard Boxes

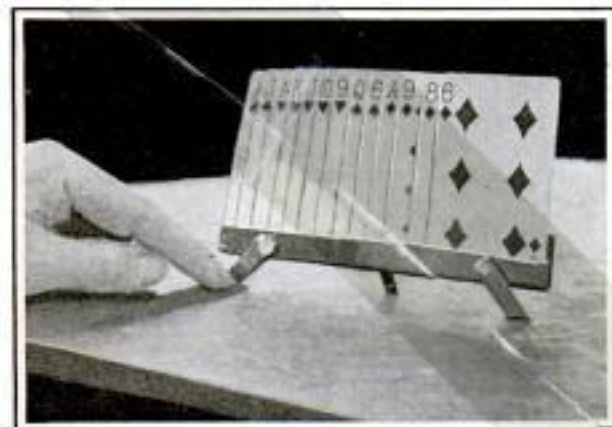
Cardboard Boxes Are Quickly Opened by Running This Cutter along the Edges



Cardboard boxes can easily be opened by cutting the edges with the illustrated tool. It consists of a 2-in. length of light angle iron to serve as a guide, having a  $\frac{3}{4}$ -in. slot cut in the center to admit an old jackknife blade, which is bolted between two short pieces of strap iron, bent and riveted to the guide to serve as a handle. In use, the blade is pushed through the cardboard and pulled around as shown.

### Metal Rack for Playing Cards

Here is a card rack that enables the player to have the cards fully spread out before him without engaging the use of the hands. It is made from two pieces of sheet metal, hinged together at the long



Playing-Card Holder Displays All Cards without Necessity of Using Both Hands

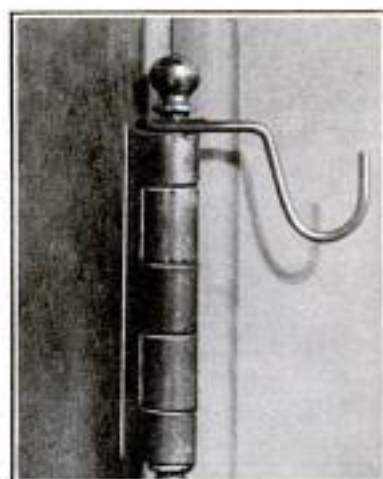
edge. Three short legs are pivoted on so that they can be folded back, permitting the rack to be carried in a pocket.—John Stewart MacClary, Pueblo, Colo.

### Testing Compression of Auto

To make an accurate check of the compression in the individual cylinders of an automobile engine, drive the car upon a smooth incline of a suitable length. Engage it in any gear in which the compression will hold it for a brief period. Then, as the car slowly moves forward against compression, the intervals between "jumps" should be noted. If they are all of the same duration, the compression of the cylinders is equal, but if the time between jumps varies, the compression is not as good as it should be.

### Clothes Hook Fastened to Hinge of Bathroom Door

If it is impossible to install an extra hook in the bathroom without marring the walls, one can be formed from a  $3\frac{1}{2}$ -in. length of wire cut from a metal clothes hanger and fastened to the door hinge. The wire is bent around the hinge pin as shown in the photo.

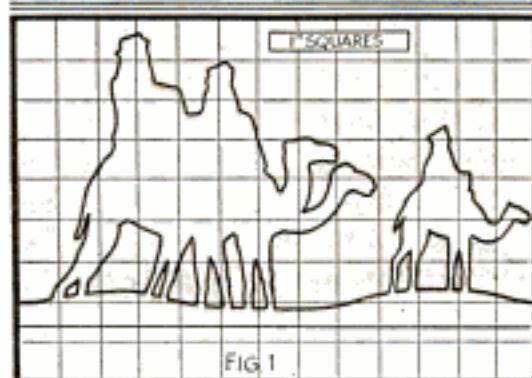


### Salt Thaws Out Pump Quickly

When the hand pump freezes, it can sometimes be thawed out by pouring salt into the top. After a few minutes the ice will be loosened so that the handle can be moved and the pump operated without damage. This method is often as effective as using hot water but takes more time.

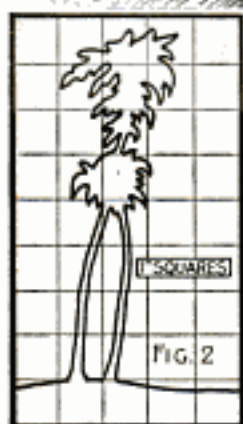
☞ To keep cured meat from getting moldy and "strong," rub it thoroughly with a cloth saturated in vinegar and store it in an unwashed flour sack.

# Yuletide Shadow Box Gives Realistic Effect



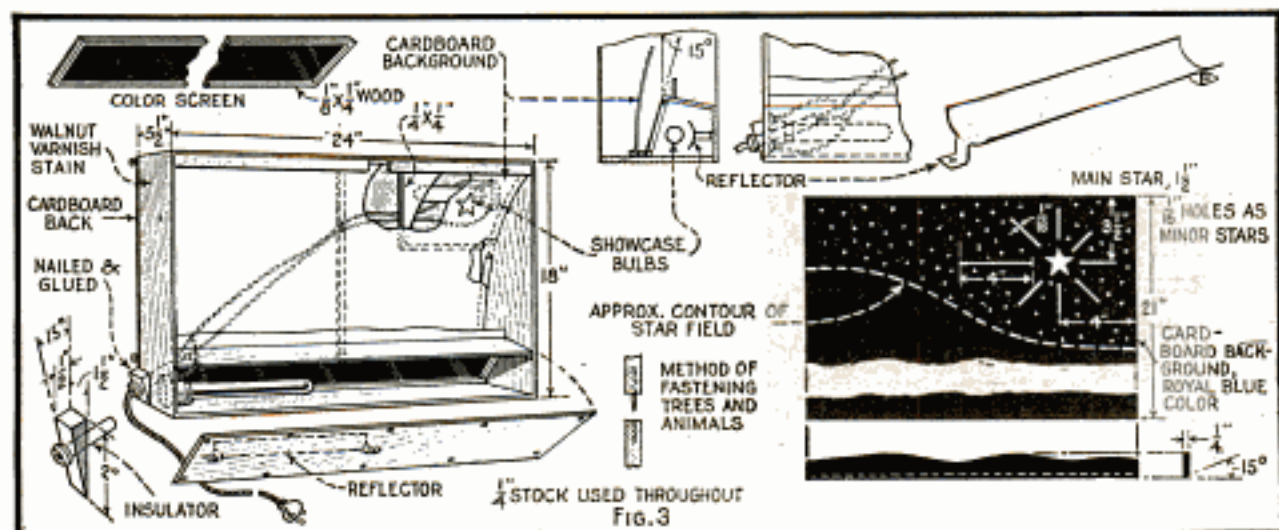
By HAROLD T. BODKIN

**I**NDIRECTLY lighted to obtain a deep blue sky with prominent stars, the realism of an eastern desert scene is closely imitated in this shadow box. It is made of  $\frac{1}{4}$ -in. stock, fitted with two showcase lights, a 20-watt lamp for the upper right, and one of 60 watts for the lower left-hand corner as shown in Fig. 3. Get a piece of bristol board the exact inside length of the box but just a trifle wider so that the top edge will curve toward the front. Small holes are punched through the cardboard, while a large five-point star is cut out on the right side with slots to represent rays. A piece of yellow varnished silk is glued to the back side to cover the star and rays. The outside surface of the board is then given a coat of royal blue water color, after which it is set in place. This should be done with the back of the



box removed so that strips of gummed paper can be used to seal the crack between the paper and the box. A compartment, half the depth of the box and fitted across the bottom, houses the lower lamp, and a blue screen of commercial floodlight screening or blue tissue paper forms

the rear side to throw a blue light on the background. The front side of the compartment holds a reflector made from tin. The wires are brought out through a porcelain tube passed through a wedge-shaped block at an angle to prevent entrance of water in case the box is used outdoors. The tree and camel cut-outs, Figs. 1 and 2, are attached to the sand-dune, which is fastened to the top of the lamp compartment.





Sheet Metal Clamped in Vise Is Bent by Means of Wooden Block and Mallet

### Shaping Sheet Metal without the Use of a Bending Machine

To shape sheet metal without the use of a bending machine, place a suitable length of angle iron on each side of the metal and clamp the assembly in a vise. The sheet metal can then be bent by holding a block of wood against it and striking the latter with a mallet.

### Marble Prevents Scale in Teakettle

Where water has a high mineral content, scale forms in the teakettle. If a clay marble is placed in the kettle when water is boiled, the scale will collect on the marble, leaving the kettle clean. When the marble has "grown" to a good size, it is replaced.

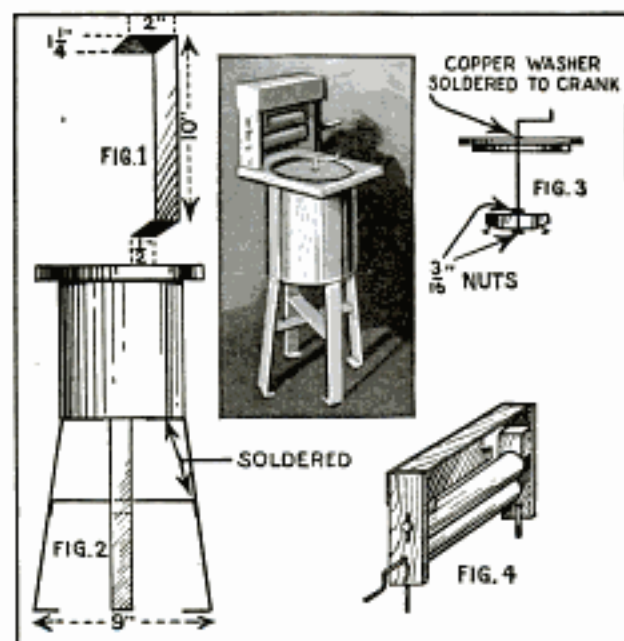
### Faulty Compression Can Be Located with a Mailing Tube

Place one end of a mailing tube in the breather pipe of an auto engine and hold your ear to the other end while someone slowly cranks the engine. There will be a slight hissing sound from all the cylinders even if everything is in order, due to the slow speed of turning, which indicates leakage of compression. After the engine has been turned over a few times, you can readily detect any cylinders that have a noticeably louder hiss than others. At the end of such a hiss, stop cranking, remove the distributor cap and note the

wire to which the arm is pointing, which will be the one connected to the faulty cylinder.

### Toy Washing Machine for Children

Fitted with a wringer, this toy washing machine really cleans small pieces and affords much amusement for the little ones. The tub is a 1-gal. tin can, to the bottom of which are soldered four galvanized-metal legs (Fig. 1), each 10 in. long, spread 9 in. apart at the bottom and crossbraced for rigidity (Fig. 2). The top of the washer is 8 in. square, and is fastened to the can by means of two stove bolts, bent at right angles and inserted through holes punched on opposite sides of the can and through corresponding holes in the top. The lid and dolly are made as one unit, the lid being two circular pieces of wood nailed together and the dolly a circular piece sloped on the bottom and fitted with four evenly spaced brass screws for wash pins (Fig. 3). The lid and dolly are drilled in the center to receive the crank of heavy copper wire, with a copper washer soldered near the handle for a bearing to hold the assembly together, and threaded at the lower end for nuts, which hold the dolly in position. The wringer is made as shown in Fig. 4, the rollers being made of wood,  $1\frac{1}{4}$  in. in diameter, fitted with a crank of the heavy copper wire.



Small Children Can Wash Their Doll Clothes with This Toy Machine

### How to Increase the Magnifying Power of a Microscope

The magnifying power of a compound microscope can be increased by increasing the distance between the lens and the eyepiece. In instruments that have a telescoping tube, all that is necessary to do is to substitute a longer tube of the same inside and outside diameter, which can be made by rolling a large sheet of heavy black paper. For instruments in which the eyepiece cannot be extended, although it may be removed, it is necessary, besides having a long tube for holding the eyepiece, to obtain a short tube fitting snugly into the longer tube in order to couple the long tube to the microscope. Internal reflection of light should be guarded against by blackening the inside of the tube.

### Rubber Plate Scraper Serves the Purpose of Paste Brush



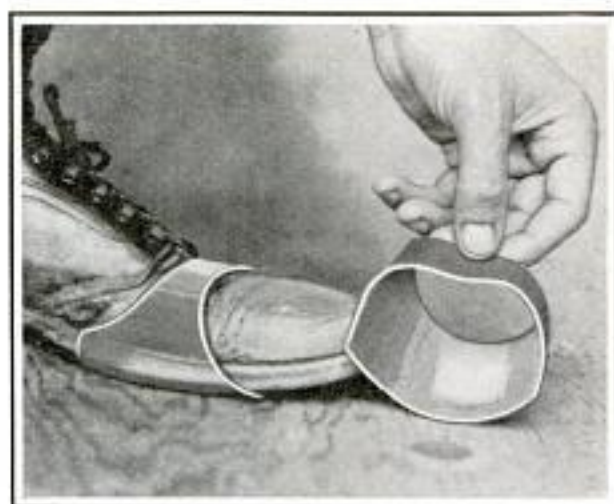
When used in any quantity, paste is hard to spread evenly unless you have the right kind of a brush. A rubber plate scraper will serve the purpose much better than a

brush and can be purchased at most hardware stores. The end of the scraper is easily kept clean as the paste is spread.

### Sprung Hinge Pins Cure Door Rattles

Worn hinge pins are one of the most common causes of car-door rattles. To overcome this trouble, remove each pin, bend it slightly out of line, being careful not to bend it too much, and replace it. The sprung pin holds the hinge slightly off center so that it will be quiet.

☐ Pieces of nut shells can be freed from particles of the meat by dropping them into a basin of water; the meats will float, but the shells will sink.



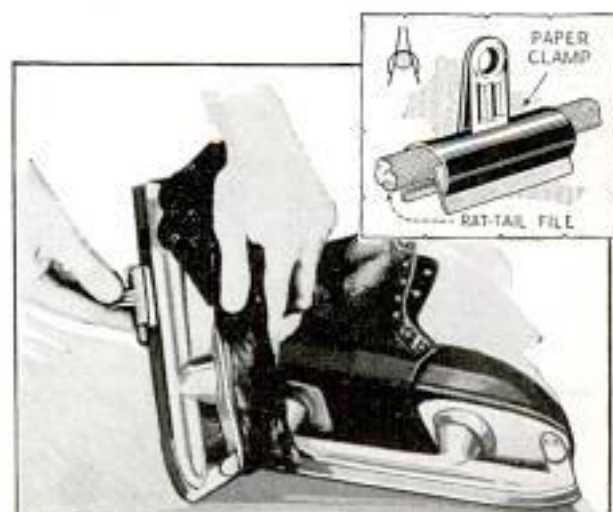
Section of Inner Tube Slipped over Shoes Prevents Slipping on Sloping Roofs

### To Avoid Slipping on Roof

When climbing or walking on sloping roofs, where one is apt to slip, a section of inner tube drawn over the shoe as shown, will greatly reduce the risk of accidents. The sections of the tube are cut narrow on one side, which fits over the top of the shoe, while the wider section, preferably about 3 in., goes under the ball of the foot.

### This Skate Sharpener Is Made from File and Paper Clip

By inserting a piece of rat-tail file between the jaws of a paper clip, you will have a handy sharpener for skates. The jaws of the clip guide the file on the skate runner, and by drawing the sharpener back and forth nicks can be removed and a hollow-ground blade formed.



Easily Carried in a Pocket, This Improved Sharpener Will Be Handy for "Touching Up" Your Skates

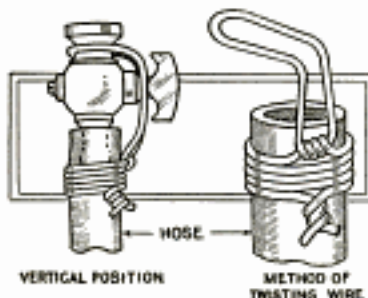


This Kit, Arranged under Front Seat of Coach, Makes Tools Readily Accessible

### Tool Kit That Fits under Front Seat of Coach-Type Car

Fastened under the front seat of a coach-model car, the kit furnished with these cars is in a handy place to get at the tools without disturbing passengers in the rear seat, by merely tipping the front seat forward. The bottom of the seat is usually covered with thin wood and it is only necessary to tack the kit onto it as shown. To prevent the tools from dropping out, attach a canvas cover for the entire kit with snap fasteners.

### Drain Hose for Auto Radiator Prevents Spilling



VERTICAL POSITION

METHOD OF TWISTING WIRE

HORIZONTAL POSITION

To drain a car radiator without spilling the liquid containing anti-freeze solution, a length of rubber hose fitted with a wire hook so that it can be hung on the petcock, will be found use-

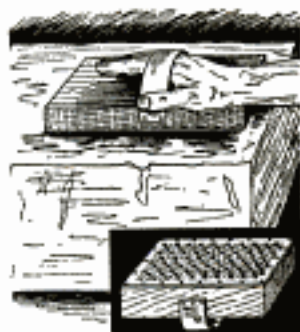
ful. The wire is tightly wrapped around the end of the hose, and a loop is left at the end, which is bent over as indicated so it can be slipped over the cock.

### Filter Shows Density of Shadows When Photographing

Black shadows on finished photographs, caused by bright sunlight, can be detected before taking the photo by looking through a shadow filter. One can be made from ordinary rolled film used in a box or folding camera. For a box camera use the smallest stop, for a folding camera, set the lens at  $f:16$  with a  $\frac{1}{25}$  second exposure. Point the camera at the sky late in the afternoon on a dark day and press the shutter release. The developed film should be a light-gray monotone. Look through it when viewing the scene for a prospective picture, and shadows will look just as they appear in a finished print. The filter is especially good in adjusting the lights for an indoor picture with the use of electric illumination in order that too dense shadows may be avoided. A piece of light-blue celluloid or glass will serve the purpose equally well.

### Ice Shaver Resembles Cheese Grater

Perforated with small holes made by driving a nail through a piece of sheet metal, the illustrated ice shaver is useful in shredding ice for beverages where ice cubes are not desired. The piece of sheet iron is tacked to a wooden block, fitted with a canvas strap for a handle.



### Rubber Tacks Improve Yardstick

When using a yardstick or other rule while wearing gloves or mittens, it will be found a great help to drive small rubber-headed tacks at each end and on both sides. The tacks raise the rule from the surface so that it can be picked up without difficulty.

Leather and tools Wilder & Co. 1038

Crosby, Chicago

W. A. Hall 250 Cleveland

# It's Easy to Tool LEATHER



DECORATIVE leather tooling is so simple that the veriest amateur can do a pleasing job. Although the work can be done with only a nutpick, a small thumb-shaped modeling tool will greatly improve the original job by bringing it into sharper relief, and, as the beginner gains skill, an assortment of homemade stamping dies, punches, and other tools, as shown in Fig. 1, may be added to obtain a variety of pleasing designs.

For a billfold, shown in the center details on



1/4" SQUARES  
FIG. 4

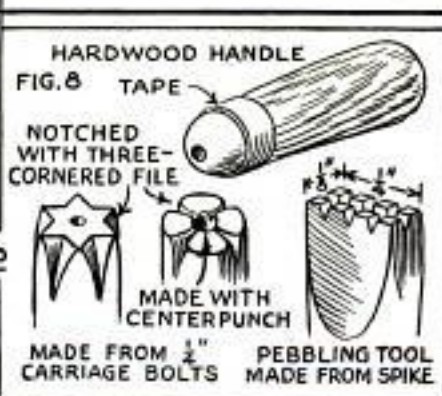
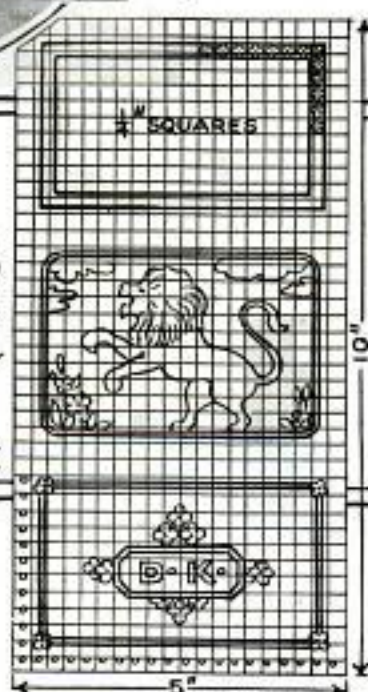
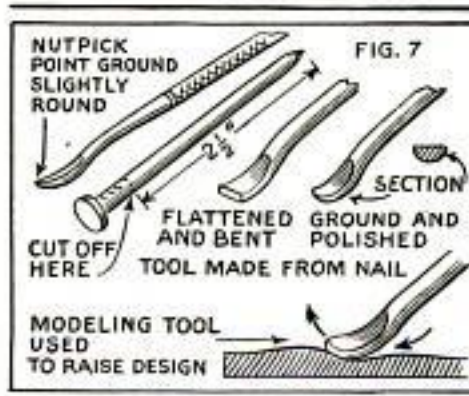


Your Billfold, Purse or Belt Can Be Greatly Improved by Simple Designs Brought into Relief with a Few Homemade Tools

pages 148 and 149, only four tools are required: a nutpick, a modeler, a stamping die for the borders and a leather punch. The most satisfactory material is English tooling calf, which has a velvety surface and retains impressions readily. Ooze calfskin or split cowhide with ooze finish are also suitable.

A test of proper leather is to indent it with the thumb nail. If the impression is retained, the material is suitable. After obtaining the leather, lay out the design shown, or any other of your selection, on a sheet of paper. In choosing design, pick one in which the lines are not too intricate nor too close together. It is best to cut the leather oversize and trim it down after the tooling has been done, as the beginner may pull the piece out of true shape. Besides, a little extra leather permits the use of

Boxm. 9 mags  
Lewis & Co  
Box 1063  
Albany  
N.Y.



thumbtacks or paper clips in tracing, without marring the edges. Get a piece of heavy plate glass, such as part of a windshield, or a slab of smooth slate or polished marble, upon which to lay the work. In tracing the penciled design, you can fasten the work to a smooth board with thumbtacks. Either a hard pencil or a nutpick is suitable for tracing, leaving the design plainly visible on the leather. If the point of the nutpick is sharp and has a tendency to scratch, round it off slightly with a file and smooth with fine emery paper or an oilstone. There should not be the slightest roughness on any of the tools. A modeler can be made by cutting off  $2\frac{1}{2}$  in. from the pointed end of a spike, as in Fig. 7, flattening and bending the end, and then grinding it round, somewhat in the shape of a tiny thumb. Set it in a hardwood handle, Fig. 8, so that the end extends about  $1\frac{1}{4}$  in. While making this tool, you may as well add a pebbling die and a flower stamp, as shown in Fig. 8, as

they will come in handy on subsequent work. The pebbling die is merely the end of a flattened bolt or spike, grooved with a three-cornered file. The flower design is made in a similar manner. Other dies in great variety can be added from time to time, among which a star is often useful.

With the design traced on the leather, deepen the lines with the nutpick as shown in Fig. 2, having first moistened the leather with a wet sponge, and keep it moist but not too wet as you proceed with the work. After the lines have been indented, use the modeler to press down the leather around the main outlines of the design and to work it into relief, as

shown in Fig. 7. Do not attempt this, however, where lines are close together, as in the hairs of the lion's mane, in petals of flowers and leaves, etc. The background

around the figure can either be pebbled with the nutpick or with the pebbling tool. For large surfaces, the latter makes for less heavy work, although the former may perhaps give a more pleasing effect. After the tooling has been completed, cut the piece to finished size, laying it flat on a board and using a sharp, thin knifeblade against a metal rule or straightedge.

For a billfold, cut a plain piece the same size as the tooled piece. Score the tooled piece lightly where it is to be folded, then fold the two pieces along this line, using the hardwood creaser shown in Fig. 10. Note that the inner piece will then extend slightly beyond the outside section; trim the former flush. When this is done, the billfold will fold naturally, without a bulge on the inside piece. With a pair of dividers, or a rule and sharp pen-



cil, lay out centers of the holes for the lacing on the tooled piece. They should not be over  $\frac{1}{4}$  in. apart on centers and  $\frac{1}{8}$  in. from the edge. Use a leather punch of about  $\frac{3}{16}$ -in. diameter, and punch holes in the inner and outer pieces, as well as the card-pocket flats, at the same time so that all holes will register. If you cannot buy thongs cut to suitable size from the shoemaker or leather-supply house, lay a long strip of calfskin on a smooth board, with the grain, and run the knife along the edge of a steel ruler, cutting off strips about  $\frac{3}{16}$  or  $\frac{1}{8}$  in. wide. Splicing can be done by tapering the ends  $\frac{1}{4}$  in. and using leather cement. The lacing is shown



in Fig. 9. At the corners, the thong should be passed through the hole twice.

Embossing a belt is not at all difficult, but requires time and patience. Of course, it can be tooled by the method just described, but the embossing will not be as distinct as when a die is used. Buy a strap of cowhide, ooze finish, about  $1\frac{1}{4}$  in. wide and the required length, with an extra 5-in. length of heavier cowhide to serve as a die. Lay out the flower design, as shown in Fig. 4, on the latter piece and cut it in outline with an incising tool, which is ground from a round file, has a  $30^\circ$  V-shaped edge and leaves a very distinct incision. See Fig. 11. Hold the tool with a firm grip nearly vertical, cutting to about  $\frac{1}{16}$  in. or more in depth. Next lay the belt strap flat on the marble or glass slab, moisten it, place the die over it and pound with a hammer as in Fig. 13. This presses the belt leather down between the incisions of the die, and forces it up along the lines of the design, leaving them in

sharp relief. The die pattern is used successively along the length of the belt until the

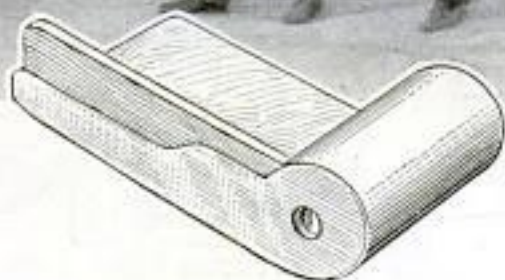
entire piece is embossed as shown in Fig. 5. The petals and leaves can be brought into very prominent relief by using an embossing tool around the edges, as in Figs. 6 and 12. This tool consists of a spike with the end flattened, bent to a curve and then ground to the shape shown. It is worked around borders of the design and tapped with a cowhide-covered stick, as hammer blows would be too sharp for this work. The depressions can be made even deeper by first using the pebbling tool and then smoothing out the marks with the flat-surfaced embossing tool. After the embossing has been completed, a buckle and straps should be sewn on by a cobbler to insure a first-class job. The background of the design can then be darkened with black leather color.

An endless number of useful and attractive objects can be made by the amateur as he gains experience.

## Winter Thrills in Whirling Merry-Go-Round



For a speedy ride on a sled you need go no farther than your backyard, where a whirling merry-go-round, built in a few hours, will give you plenty of exercise in trying to hang on. It consists of a flat-bottom, metal-covered sled attached to the end of a long pole or small tree trunk as shown. The pole is securely fastened to an auto wheel which is pivoted on a sturdy post. The method of fastening the sled to the end of the pole should be carefully noted. As shown in the lower detail, the front end is rolled and circular holes are cut in the sides, centered in the rounded portion. The pole is brought through these holes and serves as a pivot so that the



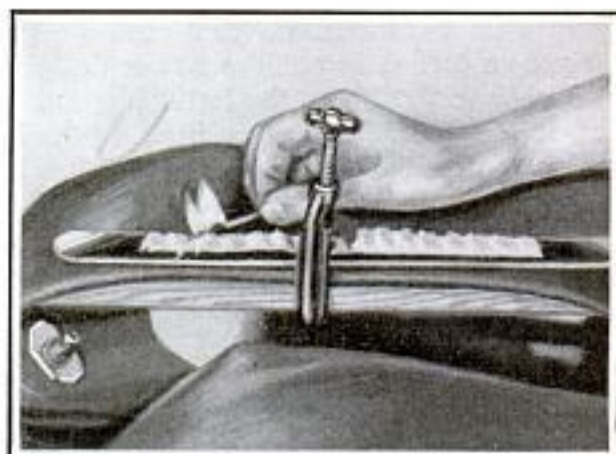
Try to Keep Your Seat on This Whirling Merry-Go-Round, Which Is a Backyard Version of a Speedy Toboggan

sled can ride over an uneven track. A strong chain or rope is used to attach the sled to the pole and prevent it from coming off due to centrifugal force. When thus completed,

the merry-go-round is ready for trial. The motive power is supplied by a number of friends who push the pole around as fast as they can. The rider of the sled will find it takes all of his grip to keep his seat, for, once this is lost, he will be thrown out in the snow beyond the circular track. Properly built, such a thriller provides lots of fun all winter long, and gives those who have only a small lot, a chance to get the thrills of a speedy toboggan.—Floyd Logan, Detroit, Mich.

### Vulcanizing Long Patches on Inner Tubes

Long patches can easily be vulcanized on an inner tube by using a C-clamp, tire iron and a strip of asbestos saturated with gasoline. After cementing the patch to the tube, the tire iron and asbestos strip are placed over the patch, and the assembly clamped firmly to a suitable board with the C-clamp to make an even contact between the metal and the patch. If the iron is curved, put the bellied part over the patch and C-clamps at both ends for good contact.



Inner-Tube Patches Quickly Vulcanized with Tire Iron and Gasoline-Soaked Asbestos Strip

### Storage Batteries Can Be Charged by Direct Current Only

The only method of charging storage batteries properly is to apply direct current at higher voltage than that of the battery. The charging rate is also important, as a battery will last longer when the charging current is relatively low, say from 3 to 5 amp. A "tapering" charge is best, 5 amp. being applied first, and the current reduced to 3 amp. when the hydrometer shows that the charge is nearly completed. "Dope" solutions should be avoided as their addition is injurious to the battery. It should be remembered that a storage battery is not charged by changing the solution but by the application of direct current.

### Pencil Holder on Finger Aids When Making Check Marks

Time can be saved in checking over figures, by soldering a pencil clip to a



thimble with end cut off, and wearing it on the index finger. A short pencil is inserted in the clip and the middle finger is used to turn the sheets.—M. E. Jones, Dallas, Texas.

### Hockey Pucks Made from Old Rubber Heels

Excellent pucks for hockey can be made from rubber heels. Round off the heel to the right size and shape, smooth on an emery wheel, and the puck is ready for use. The usual puck is about 3 in. in diameter and 1 in. thick. Many discarded rubber heels contain sufficient material for making a good puck.

☛ A cement for sticking brass and glass together can be made by boiling a mixture of caustic soda, 1 part; rosin, 3 parts; plaster of paris, 3 parts, and water, 5 parts; when cool it is ready for use.

Shears with a Broken Handle Can Be Used in Vise with Extension Handle of Pipe

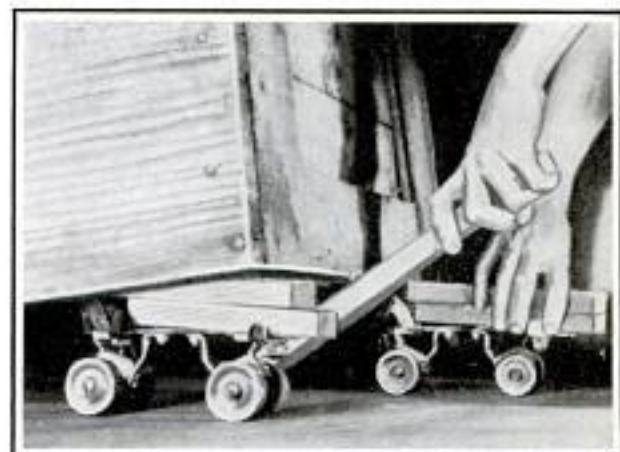


### Broken Shears Used in Vise

Shears that have a broken handle can often be made useful again by the method shown here. The good handle is clamped in a vise and a length of pipe slipped over the broken end. Shears used in this manner have considerable leverage so that heavy sheet metal can be cut with ease.

### Roller Skates Move Packing Cases

Heavy objects, such as packing cases, can easily be shifted around by fastening roller skates under them. Wooden blocks are used to hold the box off the heel guard of the skate, and a short board under the front edge of the box aids in raising it to place the skates in position.

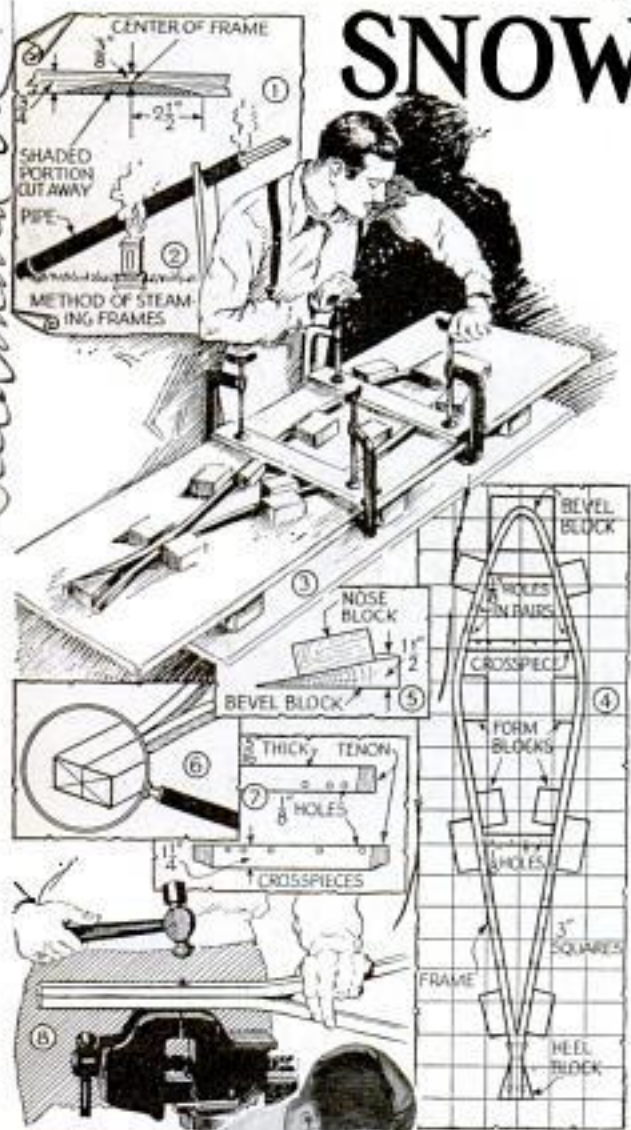


Placed under the Ends of Heavy Objects, Roller Skates Aid in Moving Them

Lumber- { Craftsman Wood Service  
 7355 Lawrence Ave 2727 S  
 Chicago Mary

# SNOWSHOEING IS

Leather. American Race Leather Co Richmond Va

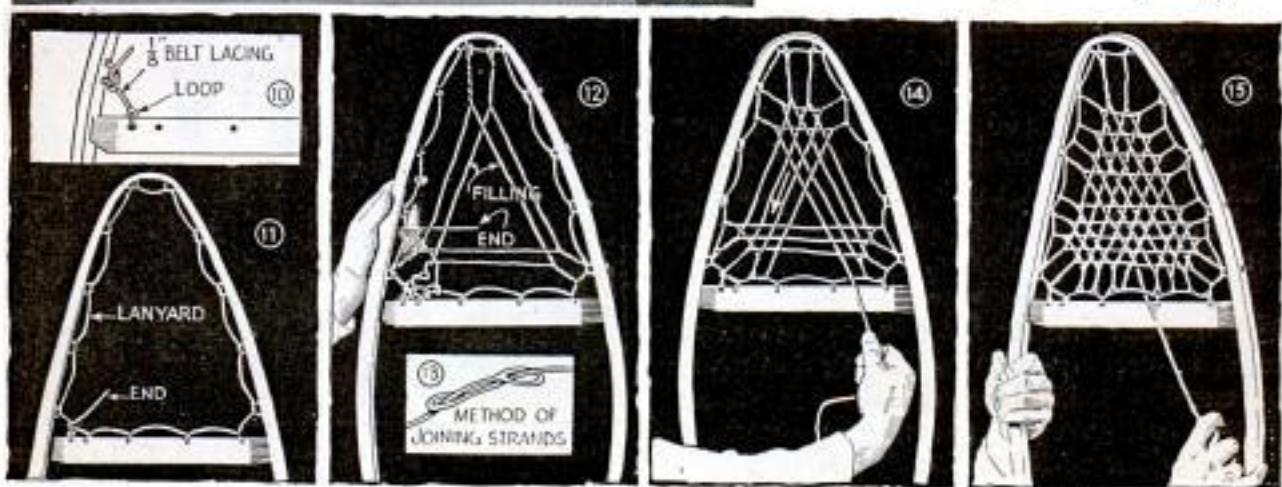


WITH an open stretch of snow-blanketed country and a pair of snowshoes you are sure to find keen enjoyment and good exercise along the trail.

In making the shoes, you will need, first of all, two 10-ft. strips of straight-grained white ash, hickory or birch,  $\frac{7}{8}$  by  $\frac{3}{4}$  in. in size. These must be thoroughly steamed in order that they may be bent to the proper shape. The initial steps in making the frame are shown in Figs. 1 to 4. As the most extreme bend occurs at the toe, the wood at this point should be thinned down to about half thickness, as indicated in Fig. 2. The simplest manner of steaming the frame lumber is to use a 9-ft. length of pipe, heating the water to a boiling temperature with a plumbers' furnace. Fig. 4 gives the necessary details on the shaping of the wood, while Fig. 5 shows how the toe block is mounted on a beveled base piece in order to get an upturn of about  $\frac{1}{4}$  in. Other details of the frame construction are given in Figs. 6 to 9. The two crosspieces are slightly chamfered at either end and fitted into shallow mortises cut into the frame at the proper points, as shown in Figs. 4 and 9.



Weaving the filling comes next. This is started by taking a long strand of  $\frac{1}{8}$ -in. rawhide or belt lacing and looping it through the upper crossbar, as shown in Fig. 10, then crossing to the first pair of holes, tying, and continuing around the toe section, as in Fig. 11. Consulting now Fig. 12, you



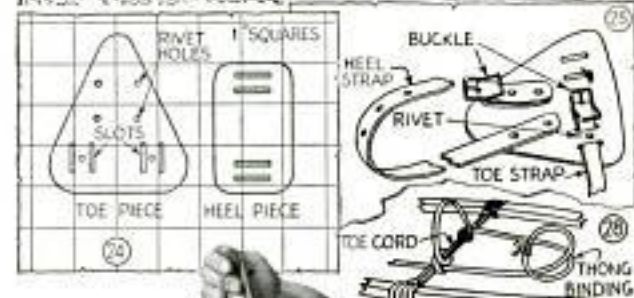
Toe caps, straps  
 E. N. Burwell, Mirror Lake  
 N. D.

# real SPORT

by SAM BROWN

can easily see how the lacing is carried up to the toe, back and across, twisting the filling proper around the lanyard. Progressing from Fig. 12 to Fig. 14 and then to Fig. 15, you can trace the in-and-out intricacies of the lacing. The final up, down and across movement is not shown, as the proper conclusion from Fig. 15 is quite obvious. Naturally, the lacing cannot be put on with a single strand. When it becomes necessary to join two pieces together, use the simple method shown in Fig. 13.

Heavier lacing or rawhide, about  $\frac{3}{8}$  in. wide, must be used for the center filling, but the actual weaving, with the exception of a few differences at the start, is much the same as described and pictured for the toe filling. The start of the operation is shown in Fig. 16; the toe cord is looped around the frame and carried across and back until eight strands are built up, as indicated in Fig. 17. The lacing is looped again and carried over to the opposite side, then up to the crossbar to form the first toe stay, as in Fig. 18. From there on, the operation should be easily apparent from Figs. 19 to 22. Notice that the lacing is looped around the frame instead of being attached to a lanyard as described for the toe. Fig. 22 shows the completion of the center filling, the end of the strand being knotted at the point

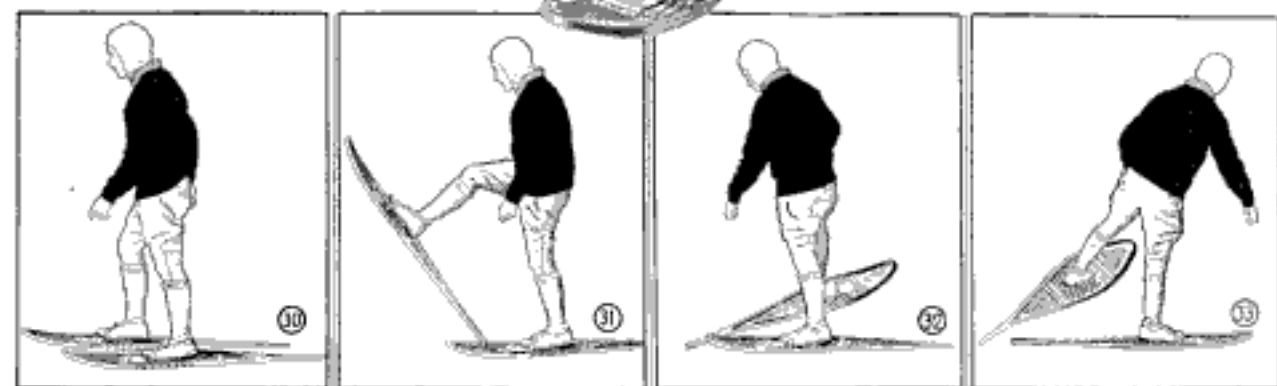


indicated. In order to give additional strength and body to the toe cord and inside toe stays, a length of lacing is looped around the toe cord and carried, by twisting along the cord and up the inside toe stays, to the opposite side of the shoe, as in Fig. 22. Additional lengths of lacing may be looped around the crossbars in order to strengthen the joints, as pictured in Fig. 23, but this is not necessary. Also, the shape of the frame and the exact manner of lacing may be varied to suit individual needs and requirements.

Just as there are hundreds of snowshoe types, so, also, are there scores of methods by which the shoe may be attached to the boot or moccasin. A simple and effective



binding consists of two pieces of pliable leather, shaped as shown in Fig. 24. The triangular toe piece is fitted with straps and buckles, as in Fig. 25, the heel piece being slipped over the heel strap, as can be seen in Figs. 26 and 27. This makes an excellent binding which, once fitted, may be taken off and put on again by simply pushing down on the heel strap. The Indian method of binding is shown in Fig. 28, a long strip of hide or canvas being looped over the toe cord, and carried back around the heel, where it is tied. This binding is more widely used than any other, being preferred by trappers and woodsmen in general, to the more sporty fastening of leather straps and buckles. Either type, however, gives good service.



binding consists of two pieces of pliable leather, shaped as shown in Fig. 24. The triangular toe piece is fitted with straps and buckles, as in Fig. 25, the heel piece being slipped over the heel strap, as can be seen in Figs. 26 and 27. This makes an excellent binding which, once fitted, may be taken off and put on again by simply pushing down on the heel strap. The Indian method of binding is shown in Fig. 28, a long strip of hide or canvas being looped over the toe cord, and carried back around the heel, where it is tied. This binding is more widely used than any other, being preferred by trappers and woodsmen in general, to the more sporty fastening of leather straps and buckles. Either type, however, gives good service.

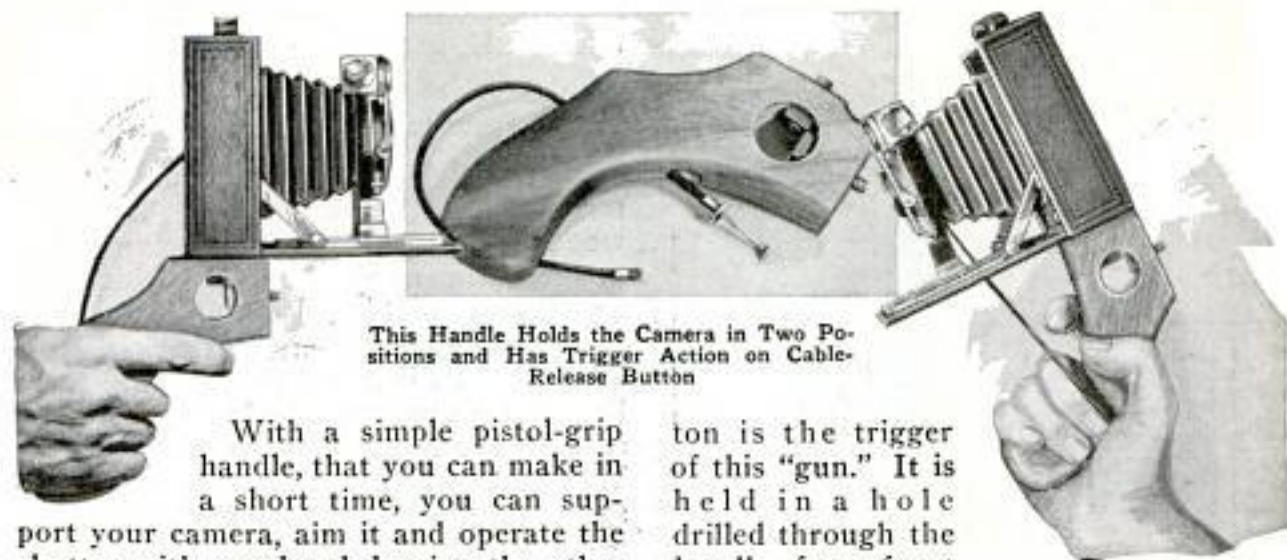
The knack of using the snowshoes can quickly be mastered, provided the binding has been properly fitted so that the toe of the foot has ample freedom to work down

shoe so that it comes to rest on the snow in the opposite direction from that in which you were originally facing (Fig. 32). It is a simple matter then to lift the other foot and complete the movement, as shown in Fig. 33. Properly executed, the turn is performed in a few seconds, and the heel of the shoe barely scrapes the surface of the snow.

Aside from walking and turning, there is very little about snowshoeing that can be learned from reading. To penetrate the brush, make a path, climb a steep grade, and so on, are simply variations of straight walking, which can be acquired only by putting on your webbed sandals and taking the trail.

☛ When driving nails into boards near the end, splitting of the wood can be prevented by cutting off the tapered end of the nails to make them blunt before driving them in.

## Pistol Grip Is Useful in "Shooting" Pictures



This Handle Holds the Camera in Two Positions and Has Trigger Action on Cable-Release Button

With a simple pistol-grip handle, that you can make in a short time, you can support your camera, aim it and operate the shutter with one hand, leaving the other free to manipulate flashlight equipment or do some other job. In addition, the camera can be elevated above crowds or other obstructions. Lay out the handle according to the photo, using some strong wood, such as birch or walnut, at least 1 in. thick. Note that there are two flat surfaces, one at the end where the barrel of a real pistol would be, and the other at right angles to it. A piece of  $\frac{1}{4}$ -in. bolt, having 20 threads per inch, to fit the tripod screw sockets, is driven into the face of each flat surface. Thus the grip can be attached for aiming the camera horizontally or vertically. Cut the handle roughly to shape and carve with a sharp knife or sandpaper smooth until it can be grasped with comfort. Then apply one or more coats of waterproof varnish or lacquer. If you have a revolver or automatic pistol handy, you can use it as a model. There are several ways of fastening the two supporting bolts in place, but the following has been found most satisfactory: Drill a fairly large hole laterally through the handle, near the camera end. Then drill holes to receive the two bolts, at right angles to the large hole and in such position that they intersect it, as shown in the center photo. Countersink the smaller holes on the outside for nuts to hold the bolts in place. Fasten the bolts with a nut on each end, one being placed in the large hole, and adjust the bolts so that when the handle is screwed firmly in place, the camera points in the proper direction. The cable-release but-

ton is the trigger of this "gun." It is held in a hole drilled through the handle, from front to back, and counterbored at the front to receive the enlarged portion of the release where it can be easily manipulated with the thumb. A strap or strong cord may be added to the handle to encircle the wrist so that the camera cannot be dropped accidentally.

### Cup Holds Putty on Paint Bucket

When painting old woodwork, it is often necessary to fill nail holes with putty. A simple method of keeping the putty handy to the worker, is to attach a small can or metal cup to the paintpot with a rubber band cut from an old inner tube. The putty knife can be slipped between the band and the bucket where it, too, will be handy.



Small Cup Clamped to Paint Bucket with Rubber Band Holds Supply of Putty



Concrete Base for Christmas Tree, Flagpole or Sign Has Neat Appearance on Lawn

### A Concrete Base to Hold Large Christmas Trees

A sturdy concrete base for supporting large trees during the Yuletide season can be used at other times for holding temporary advertising signs or a flagpole. A length of pipe is imbedded in the concrete as indicated in the detail. During freezing weather concrete should be heated and after pouring, it should be covered with a heavy layer of straw and tar paper to retain the heat as long as possible.

### Gasoline Gauge for Truck Tank

Owners of trucks, the bodies of which cover the fuel tank so it is difficult to determine its contents, will find the illustrated gauge useful. It is simply a water glass, of the kind used on steam boilers, and is installed by soldering plates, threaded to take the connections, on the tank. The



gauge should have a valve at each end so the gasoline can be shut off in case of leakage or breakage.—Fred H. English, Springfield, Mo.

### How to Make a Flat Paint

When a dull or flat finish is used for interior decoration on either plaster or woodwork, a commercial flattening liquid or turpentine should be mixed with white lead instead of linseed oil. Mix together heavy-paste white lead and flattening liquid or turpentine in equal parts, pouring the liquid into the lead a little at a time and stirring thoroughly before adding more. When turpentine is used, add one tablespoonful of drier for each pint of paint.

### Asbestos Cover Keeps Milk from Freezing

To prevent milk, that has been left on a doorstep, from freezing, make an asbestos jacket as shown and ask the milkman to slip it over the bottle when he delivers the milk. A piece of corrugated sheet asbestos,  $10\frac{1}{4}$  by  $14\frac{1}{4}$  in. in size, is rolled the long way and taped together, and a  $4\frac{1}{2}$ -in. disk of the same material, is similarly taped to one end of the cylinder thus formed. The dead air in the corrugations will keep the milk from freezing for several hours, and will act in a similar manner during warm weather to prevent it from souring.



### Oiling the Shovel Will Prevent Snow from Sticking to It

If you have ever tried to clear a path when the snow is heavy and sticks to the shovel, you will appreciate this idea. By simply rubbing both sides of the shovel with a cloth saturated with kerosene or other oil, the snow, no matter how heavy or sticky, will slide off easily.—Cecil E. Heacox, Auburn, N. Y.





## Cutting MOLDING on your CIRCULAR SAW



by  
*W. Clyde Lamme*

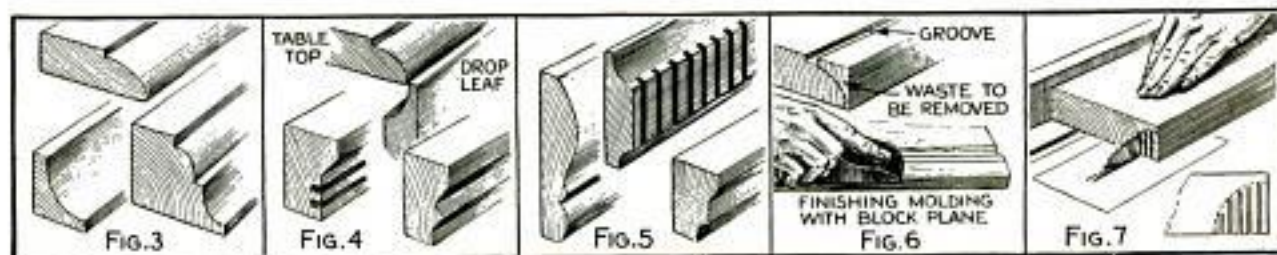


**I**N THE small shop not equipped with a shaper, excellent moldings can be cut on the circular saw, by following the simple tricks described and illustrated in this article. Examples of work produced in this way are shown in Figs. 2 and 8, while suggestions for nine different shapes are given in Figs. 3, 4 and 5. By simply kerfing the edge of the stock on the saw, as shown in Fig. 7, the position and depth of the kerfs depending on the particular design, it becomes an easy matter to remove the waste with a plane or a gouge.

The process of forming ovolo moldings is as follows: First cut a groove approximately  $\frac{1}{8}$  in. deep and centering  $\frac{3}{4}$

in. from the edge of the stock, as shown in the upper detail of Fig. 6. This may be done by setting the table so that the saw blade cuts  $\frac{1}{8}$  in. deep and making the groove in two passes of the stock over the saw, readjusting the ripping fence after the first cut has been taken, so that the second will be adjacent to it so as to make a groove approximately  $\frac{3}{8}$  in. wide. The molding is then finished to the required sectional contour by planing off the waste with a block plane and sanding smooth, as in the lower detail of Fig. 6.

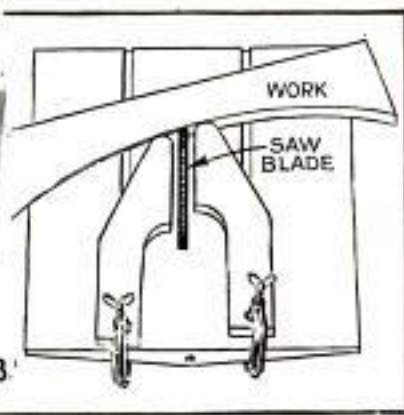
Cove moldings are made by first cutting a series of saw kerfs with the bottom of each just meeting the line of the fin-





Moldings in Almost  
Endless Variety Can  
Be Cut on Your Circular  
Saw by Means  
of Simple Tricks,  
Which Depend on  
Your Own Ingenuity

same procedure is used when forming a molding like the one at the left in Fig. 5. Figs. 1, 17 and 18 show another application of the circular saw in shaping the molding on the edge of a round or oval table top. Note that the guide necessary for this operation is cut to the same curvature as the table top. The guide is clamped to the ripping fence, with its edge placed over the saw blade a distance equal to the width of the blade across the teeth. Then the table is lowered with the work in position, the saw cutting through the guide and into the work the required distance while the latter is revolved slowly until the cut is completed. The accuracy of the finished molding depends on the care with which the stock is band-sawed, as any irregularities will show in the finished



ished contour marked on the end of the stock, as in Fig. 7. Begin with the shallow kerf, adjusting the saw table until the blade just clears the contour mark. Then set the fence to guide the stock and proceed to cut. After all the kerfs have been made, pare off the waste with a gouge, as in Figs. 9 and 10, and finish with a piece of sandpaper wrapped around a piece of round stock as in Fig. 11. Essentially the

work. The waste is then planed off to the required contour and the molding carefully sanded to obtain a smooth finish.

Another useful application of the saw for cutting molding is that shown in Figs. 12 and 13, where it is necessary to shape the edge of curved stock. Two guides are first made as in Fig. 12, and a cleat, fitting the grooves in the saw table, is screwed to the underside of the guide so that,

when put on the table, the curved ends of the guides will be as close to the saw blade as possible. One guide piece is placed slightly ahead of the other with relation to the blade, and both are securely held to the table with C-clamps. Adjust the table so that the saw blade will not cut more than  $\frac{1}{8}$  in. into the edge of the stock. Then pass the work along the ends of the guides, as shown, until the first cut is finished, after which the table is lowered about  $\frac{1}{8}$  in. and a second cut made, and so on, until the molding is of the required shape. The position and diameter of the blade alter the curve and therefore this must be taken into account when cutting.

To produce moldings having a concave face, proceed as indicated in Figs. 14, 15 and 16. A guide is clamped to the table at an angle of about  $30^\circ$  with the blade, and in such a position that the center of the stock will pass directly over the saw arbor. The guide must always be in front of the blade. The table is then adjusted so that the blade will make a cut



FIG. 15

FIG. 14

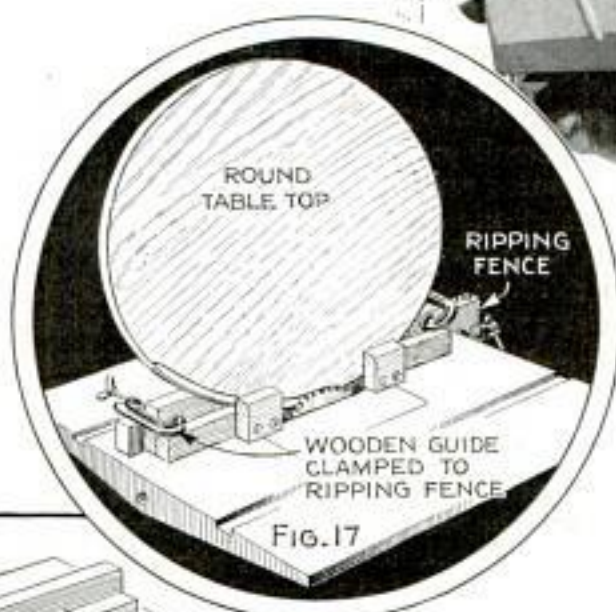


FIG. 17

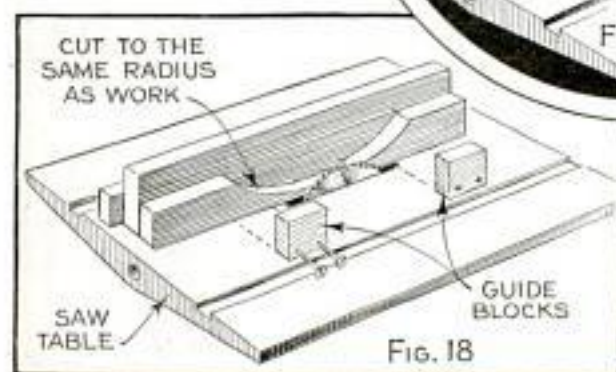


FIG. 18

about  $\frac{1}{16}$  in. deep, and the stock is passed over it as in Fig. 16. The table is lowered about  $\frac{1}{16}$  in. and a second cut made, repeating the process until the molding is finished. The edges may then be planed to the shape shown in Fig. 14, or they may be left square and the stock ripped in half, to form two pieces like that in Fig. 15. Finish all moldings by carefully sanding with progressively finer grades of

paper. In most cases sanding on irregular surfaces should be done with blocks shaped to fit the contour so that the result will be uniform. There are undoubtedly numerous other time and labor-saving tricks and short cuts that can be devised

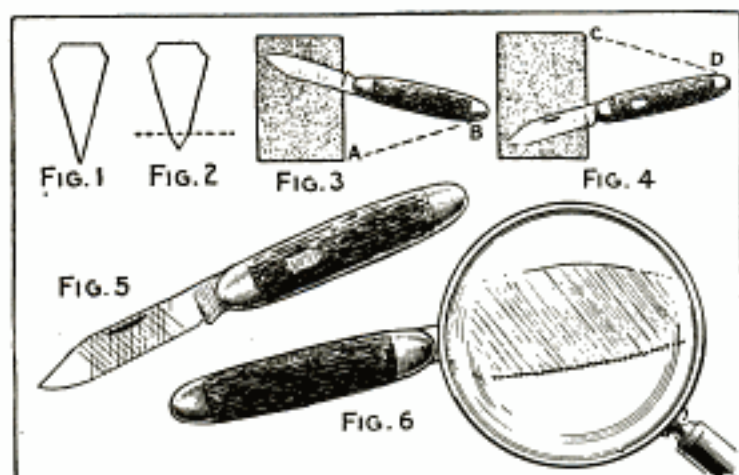
to make moldings of various shapes and designs, depending entirely on the worker's own ingenuity.

#### Lacquer Insulates Pliers

Pliers used on electrical work can be insulated by coating them with lacquer. First thoroughly clean the handles of the pliers and apply a coat of lacquer thinner to them. After the thinner has dried, dip them in the lacquer and allow it to dry. By repeatedly dipping and drying the pliers, an insulation of any thickness can be obtained.

☛ Kerosene is a good cutting fluid or lubricant when working with aluminum.

## How to Sharpen Your Knife Blade Correctly



It's Easy to Whet a Knife Properly if You Get the Correct Bevel and Angle

One of the most important things in sharpening a knife blade is to see that the whetstone is in proper condition. Light oil should always be applied to a stone, and it should be cleaned off thoroughly after using, to prevent the small particles of metal from filling the pores and dulling the stone. In this case, the correct depth of the pores is altered and the stone will not properly edge a knife. Fig. 1 represents the cross section of a factory-beveled blade and Fig. 2 shows the blade after incorrect sharpening. When the edge of such a blade enters squarely into a piece of wood, the sloped sides split the wood. The cutting power of the knife is greatly reduced by a wedge-shaped edge, which is too short and blunt. Jackknives, especially those with only one blade, are required to do all kinds of cutting, and therefore the manufacturer gives the blade a wedge pattern most suitable for use in the toughest material. The correct way of sharpening such a blade is to lay it flat on the stone. Then, if the edge does not stand up, it usually indicates the blade is too thin for the work. In such cases, it is advisable to "dub" the edge. A new blade is thinned by giving it a rotary motion on the stone, and a back-and-forth motion to finish the edge. Care should be taken to whet both sides the same. Take one straight stroke forward, Fig. 4, then reverse the blade and stroke as in Fig. 3. The angle AB in Fig. 3, must be kept equal to CD in Fig. 4, or the abrasions will cross each other as shown in Fig. 5, which puts minute teeth on the

edge with one stroke and wipes them out with the next. Fig. 6 shows a jackknife performing heavy duty, utilizing both its wedge shape and saw teeth. The pitched teeth and diagonal stroke give the saw edge a chance to do its utmost. The basic principle of edging all cutlery is the same. —Ben Parker, Portland, Ore.

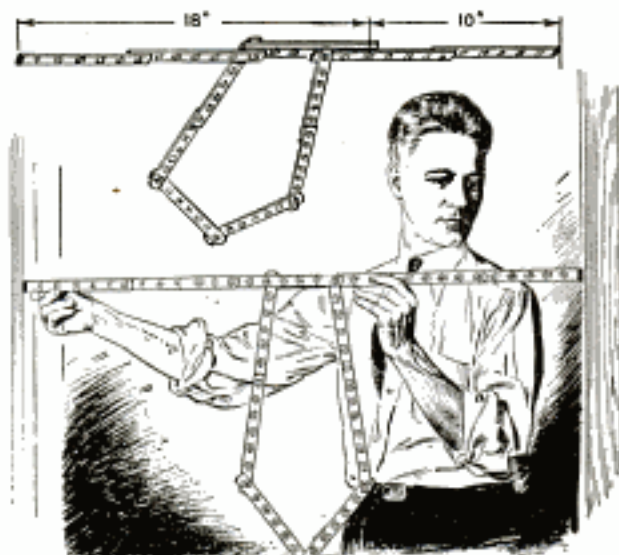
### Lubrication of Bearings

Wherever possible, a lubricant should be fed into a bearing at the point of lowest pressure.

Where the bearing is under the greatest pressure, the continuity of the oil film should not be broken by oil channels or grooves, in order to prevent the escape of oil at these points.

### Measuring across Large Openings with "Zigzag" Rule

Distances across large openings, such as door and window casings, up to 60 in. can be accurately measured with an ordinary 6-ft. folding rule. It is folded as shown so that the two ends, held horizontally, slide past each other. The measurement can then readily be taken by noting just where the graduations on one end come with respect to the 1 or 1½-ft. marks on the other end.



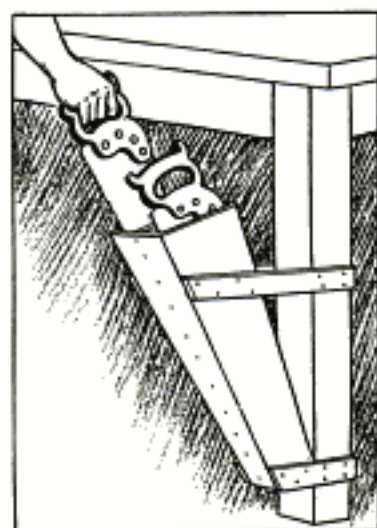
Using a Folding Rule to Measure the Distance across Door or Window Casing

### Rule for Using Crossed Belts

To prevent excessive wear on crossed belts, caused by too abrupt a twist when they run on pulleys that are close together, the following rule is useful: Add the diameters of the pulleys in inches, multiply by two and then by the cube root of the width of the belt in inches. The result is the minimum distance between the shaft centers. This rule applies to high-grade, two-ply leather belting, and is limited to 8-in. belts and pulleys up to 40 in. in diameter. A center distance of 25 ft. will take care of any ordinary combination within these limits. For single-ply belts that are well made, use the same rule. These are more erratic on crossed drives than two-ply belts, owing to the uneven stretch to which they are subjected.—W. F. Schaphorst, Newark, N. J.

### A Scabbard for Your Saws

This scabbard, made of  $\frac{3}{4}$ -in. stock and fastened to a bench leg or other convenient place,



holds your saws out of the way and safe against damage. The sides should be slightly larger than the saw blades while the width of the top and bottom depends on the number of saws to be accommodated. Cleats can be used to hold the scabbard to the bench leg.

### Graduated Pole for Sorting Lumber

Mixed lengths of lumber can be easily sorted and placed in their respective piles by using a small 12-ft. pole which has been marked off in divisions of 4 ft. at one end and 2 ft. at the other. Paint the divisions red and leave the center portion white. This instantly gives you measurements from 2 to 12 ft. The red ends also make the pole easier to locate.



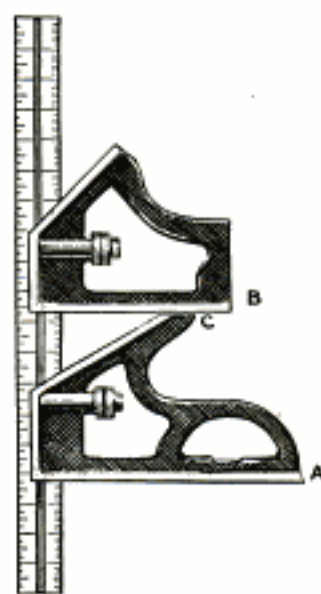
Painters Can Stand Erect When Painting Flat Surfaces by Using This Extension Handle

### Extension Handle for Paintbrush

The discomfort of having to assume a cramped position while painting or oiling flat surfaces, can be relieved by using an extension handle on the brush so the worker can remain erect. Use a strong cord to lash the brush to the handle.

### Differential Gauge Can Be Made from Combination Square and Head

Consisting of a combination square and an extra head, a useful gauge for measuring depths or clearances can be made. Practically all of the angular parts of both heads are cut off as shown. The head A is surface ground at C to be parallel with the base of head B. In use, the deepest or longest measurement is taken, then head B is raised up against head A and locked. In taking the next measurement, head A is moved away from the other, the difference being found by the space between them with the aid of "feelers." As the scale graduations are not used, an inexpensive square and an extra head can be employed.





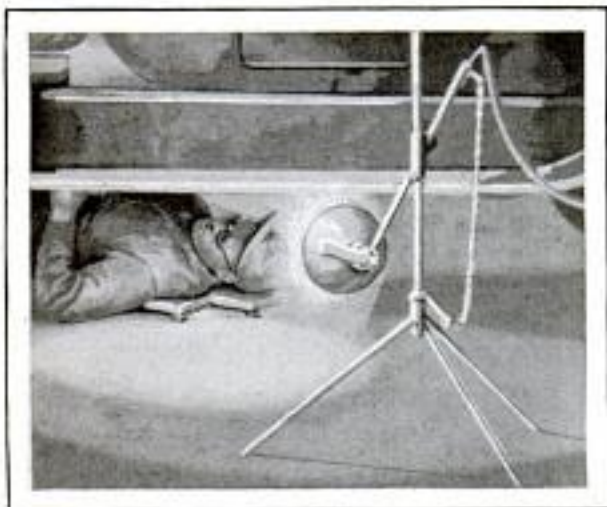
Boxes on Small Truck Placed in Front of Cutting Machine Provide Individual Receptacles for Waste Metal

### Three-Section Bin for Metal Cuttings

Consisting of a number of boxes fastened to a small truck, the illustrated bin for metal cuttings is useful in the shop. The bin is pushed in front of the machine so that the cuttings will drop in the proper compartment.—Max Buchheim, Bridgeport, Conn.

### Adjustable Floor Lamp for the Shop or Garage

Adjustable to any height or angle from the floor to the top of a car, the illustrated floor lamp for the shop is easily constructed by the home mechanic. The upright is a 4-ft. length of  $\frac{1}{2}$ -in. pipe, to which three legs of the same material are brazed or welded at the lower end. A 3-in. length of larger pipe is slipped over the stem and a small nut is welded to the



This Lamp Has a Wide Range of Adjustment, Making It Especially Suitable for Garage Work

lower end for a setscrew, used in adjusting its height. A 20-in. length of  $\frac{1}{2}$ -in. pipe is passed through a metal band welded to the 3-in. piece, and serves as an arm which supports the light. The extension cord passes through the arm, to the end of which is fastened a small chain. This in turn is attached to a cotter key, soldered to the pipe, while the other end of the chain is soldered to a 2-in. washer, which is slipped over the main stem and bent in the middle. When the light is raised, the washer grips the stem and the chain holds the arm in position. A reflector is fitted to the arm.

### Holder Prevents Unrolling of Tape

Here is a holder that prevents tape from unrolling when dropped. Bend a suitable piece of sheet metal to a U-shape and cut two slots close together across the top. Fasten the roll of tape between the ends of the metal with a small bolt, as shown, which may be loosened or tightened to give the correct tension. Then thread the tape through the two slots and the holder is ready for use. Another method is to



smear two lines of shellac, in opposite directions, across the side of the roll.

### Marking Off Holes on Highly Finished Surfaces

In marking off holes to be drilled or cut on a highly finished surface, such as the instrument panel on an automobile, a piece of gummed paper applied first, will prevent scratches or marks on the metal. The measurements can be marked on the paper with a pencil. Be sure to center-punch before drilling. After the job has been finished, the paper is pulled off and the glue removed with a wet cloth.

# A FIRESIDE BENCH

## You Can Make

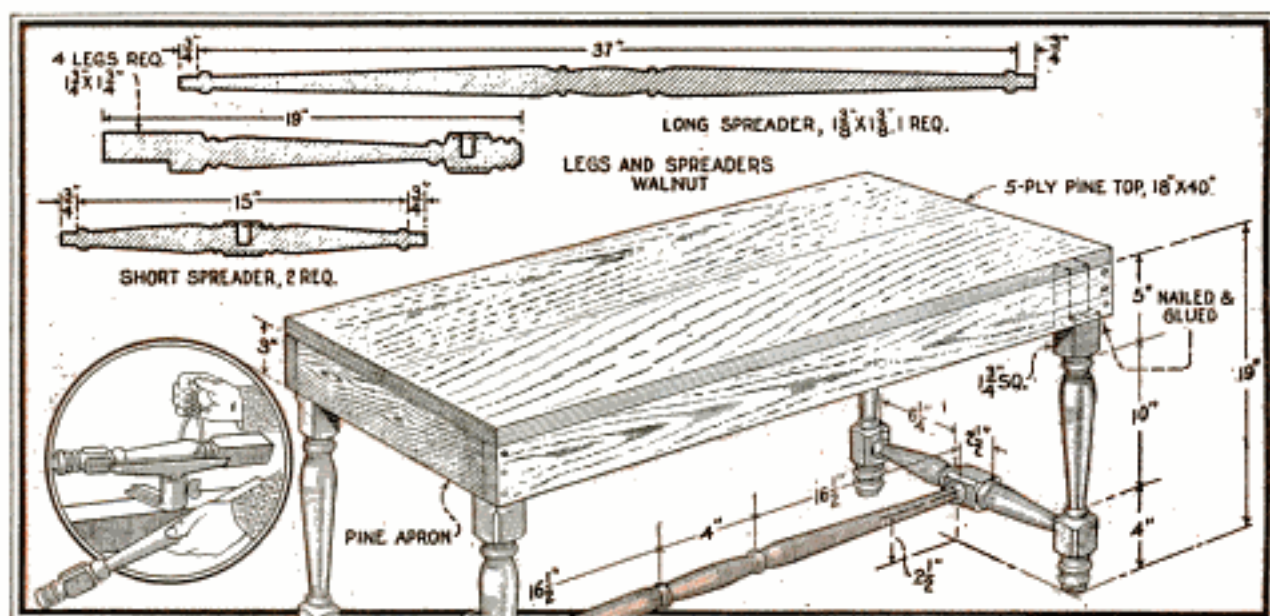
**T**ASTEFUL by virtue of its simple design, this bench will be a pleasing addition to the chimney corner, and its cost depends entirely on the kind of wood used for the legs and spreaders and the grade of tapestry, or other upholstery, selected for the covering.

The bench is 40 in. long, 18 in. wide and 19 in. high, and will seat two persons comfortably. The legs and spreaders should be turned from hardwood, such as walnut, which should be kiln-dried in order to prevent any danger of checking or cracking. For the top, a piece of five-ply veneer will be found best, as it holds its shape and is not liable to sagging or warping, while the side and end aprons are pieces of clear white pine,  $\frac{3}{4}$  in. thick and 3 in. wide. The aprons are cut so that, when assembled, they will come flush with the edge of the top on all four sides. To make assembly of the top easy, drill small holes through the top, about  $\frac{1}{2}$  in. from the edge and at 4-in. intervals. If the holes



are straight, the nails will be driven home without splitting out at the sides. Nails of the ten-penny size are used for this purpose.

The design of the turnings is your own choice. It should be drawn up carefully and transferred to a piece of sheet metal. The part representing the turning is then cut out. By following these templates, it is comparatively easy to match them. Also use a pair of calipers to measure the various diameters. Tenons,  $\frac{3}{4}$  in. long and  $\frac{3}{4}$  in. in diameter, are glued in holes bored to receive them. In each case the mortise-and-tenon joint should be snugly closed with a turned ball driven against the adjoining member. Re-



istry is applied, care being taken to run the pattern square. One side is tacked first to the underside of the apron, and then the other side, following the same procedure for the ends. At the edges, the fabric is doubled so that the tacks will hold securely and the cloth will not tear away. If desired, the underside of the seat may be covered with a piece of black sateen, although this is not essential. In case you find one leg a trifle longer than the others,

this can be remedied by holding it squarely against the face of a sanding disk and dressing down the end smoothly, a little at a time, to avoid any risk of splitting the wood and of removing too much stock, which is likely when using a saw.

#### Chip Breaker for Cutting Tools

When using tungsten-carbide tools, trouble is often experienced in having the chips curl back between the tool and work, thus damaging the tool. To prevent this, make a steel ring to slip loosely over the tool holder directly behind the cutting point. The chip, in curling back, encounters the ring and will break and snap away from the tool instead of directly into it.

cesses,  $\frac{1}{2}$  in. deep, are cut on two adjoining sides of the square end of each leg, as shown in the lower photo on page 163, to fit inside of the corners formed by the apron. The legs are then glued and nailed, or screwed, in place. When nailed from both sides and also from the top, the legs will be held in position securely without weaving.

To preserve the natural finish of the wood as nearly as possible, the use of filler may be omitted, but then it will be necessary to apply one or two extra coats of varnish, each of which is rubbed down smooth.

In covering the bench, about six thicknesses of cotton batting are laid on the top and brought down to the bottom edges of the aprons, after which the tap-



## Brazing Cracked Auto Blocks and Crankcases

When brazing transmission or crankcases and motor blocks, it is often necessary to bridge over a hole. To do this, turn the work so the hole to be filled is at the top. Then take a heavy piece of sheet asbestos and clamp it to the work as in Fig. 1. Other pieces of the asbestos are placed around the break to hold the heat while brazing. Preheat the metal around the break, to prevent too rapid expansion, and fill the hole with molten welding metal, as in Fig. 2. This method makes it easy to fill the hole and still maintain the right wall thickness. It also greatly reduces the time taken to complete the repair. In brazing cracks or holes in the bottom of crankcases, the heat will expand the metal and bow the bolting flanges. As the piece cools, the contraction of the metal is often so great that the surfaces are made convex. To avoid this, place one or two thicknesses of asbestos under the center of the case as in Fig. 3. This "shimming" up lets the bolting surfaces

Asbestos Used When Brazing Cracked Blocks, Crankcases and Gear Housings



bow just enough to come in their correct position when the metal cools, and leaves them practically level.

### Trailer for Transporting Airplanes

Two old auto chassis were welded together end to end to form a trailer large enough to transport two airplanes with the wings removed. A tongue was fitted to the front axle, so that it could readily



Two Auto Chassis Welded Together Form Trailer for Transporting Wrecked and Knock-Down Airplanes

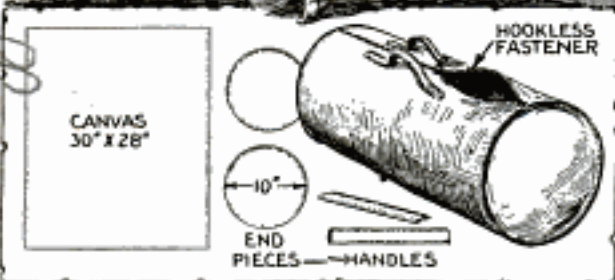
be towed. Truss rods, that can be seen underneath the trailer, were found necessary to provide additional strength and increase the rigidity.

### Hydrogen Peroxide Prevents Pitting of Nickelplating

Trouble sometimes experienced in having nickelplating badly pitted, especially when heavy coats are applied, can be largely prevented by the use of hydrogen peroxide. It should be mixed in the ratio of 25 per cent of peroxide, by volume, to 75 per cent of the nickel bath.

Small tools used around garages and oil stations are less likely to be lost or stolen if enameled a bright color, as they will differ greatly from the usual tools.

**Cross-Country Bag for Airplane Pilots  
Fits Any Luggage Carrier**

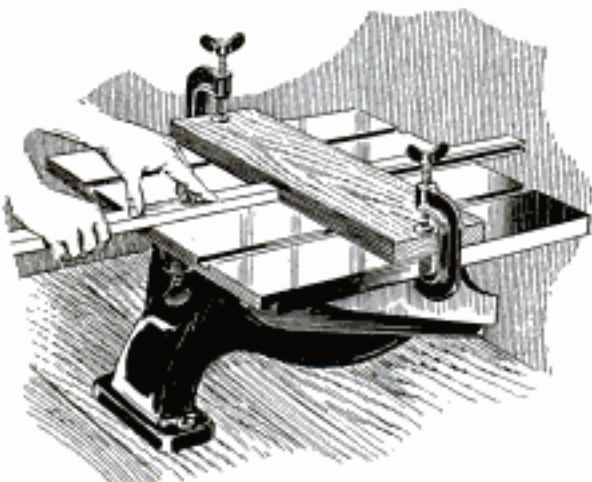


Pilots' Bag Is Made of Waterproof Canvas and Closed with a Hookless Fastener

This type of bag is used in the army air corps because of its compactness, and can be fitted into almost any luggage carrier. The materials required to make it are 1½ yd. of waterproof canvas and a hookless fastener. Two circular pieces of canvas, 10 in. in diameter, are used for the ends and are sewed to a 30 by 28-in. piece. The bag is sewed inside out, and turned. The handles are made of several thicknesses of the same material.

**Screen Molding Made on Small  
Circular Saw**

A molding head fitted with knives of cloverleaf shape, and a short piece of hardwood stock, grooved and clamped to



Screen Molding Made on a Circular Saw by Using a Molding Head and a "Sticker" Board

the saw table, make possible the rapid cutting of screen-frame moldings. A piece of hardwood 1½ in. thick and about 8 in. wide, cut to a length slightly less than the width of the saw table, is grooved ⅜ in. deep and ⅝ in. wide and clamped to the saw table with the groove centering directly over the molding head. The stock to be molded is ripped into strips ⅜ by ⅝ in. in size and the saw table is adjusted to allow the molding knives to cut the full design on the stock, the latter being fed through the grooved "sticker" board as indicated.

**Portable Truck Supports Oil Drum**

Here is a truck for oil drums that can be moved conveniently. Three small wheels are attached to axles on a triangular frame which is made of ½ by 1½-in. flat iron. The drum is held by two semicircular supports of 1 by 1½-in. bar iron, the ends of which are bent over to

Truck for Moving Oil Drums Is Fitted with a Sheet-Metal Tray to Hold Measuring Cans



form uprights, 20 in. or more above the frame, and are also welded to it. Cross-bracing provides rigidity. A sheet-metal tray is hinged to the rear of the frame by two small bolts so it is supported by the axle when in use. When filling large cans, the tray is tipped to a vertical position and the can placed on the floor. A 3-ft. metal handle, attached to the short front axle, is used for pulling the truck.

**Lapped Joints Improve Belts**

When splicing belts, smoother running will be assured if the joints are lapped and cemented together. Pass the belting around the pulleys to determine the

Hookless Fastener Co. Reading, Pa.  
 New Britain, Conn.  
 Lehigh Valley  
 & Erie  
 & Erie

proper length. Pull it tight to allow for the initial stretch, and mark the position of the ends on the uncut portion. Then measure off  $3\frac{1}{2}$  in. more, to provide for the lap, and cut the belt in two. Next clamp one end to a bench with a piece of board, and taper the belt with a sharp plane. The taper should start at the mark and run to a feather edge at the end. Then turn the belt over and repeat the operation on the other end. After both ends are planed so that when they are held against each other the belt will be the same thickness at the joint as it is elsewhere, coat the surfaces with cement and allow to dry. Then spread a fresh coat of cement on one of the ends and clamp both together. If the machine using the belt has bearings on both sides of the pulley, the belt will have to be cemented while in position. Allow the cement to set for one-half hour before using.

#### Hydrometer Forms Raised Letters on Show Cards

By removing the glass float from a storage-battery hydrometer, it can be used to spread the paste for forming raised letters on show cards and display signs. Sift, and thoroughly mix cold-water paint, 2 parts, and flour, 1 part. Then add water until the mixture forms a medium-thick paste. Fill the hydrometer with the paste which can be slowly forced out by squeezing the bulb. After a little practice, a neat job of lettering can be done. If it is desired to have the lettering colored, dissolve ordinary household dyes in water and add to the paste.



Raised Lettering on Show Cards and Display Signs Formed by Squeezing Paste through Hydrometer

#### Gummed Tape Will Hold Drawing Paper on Board

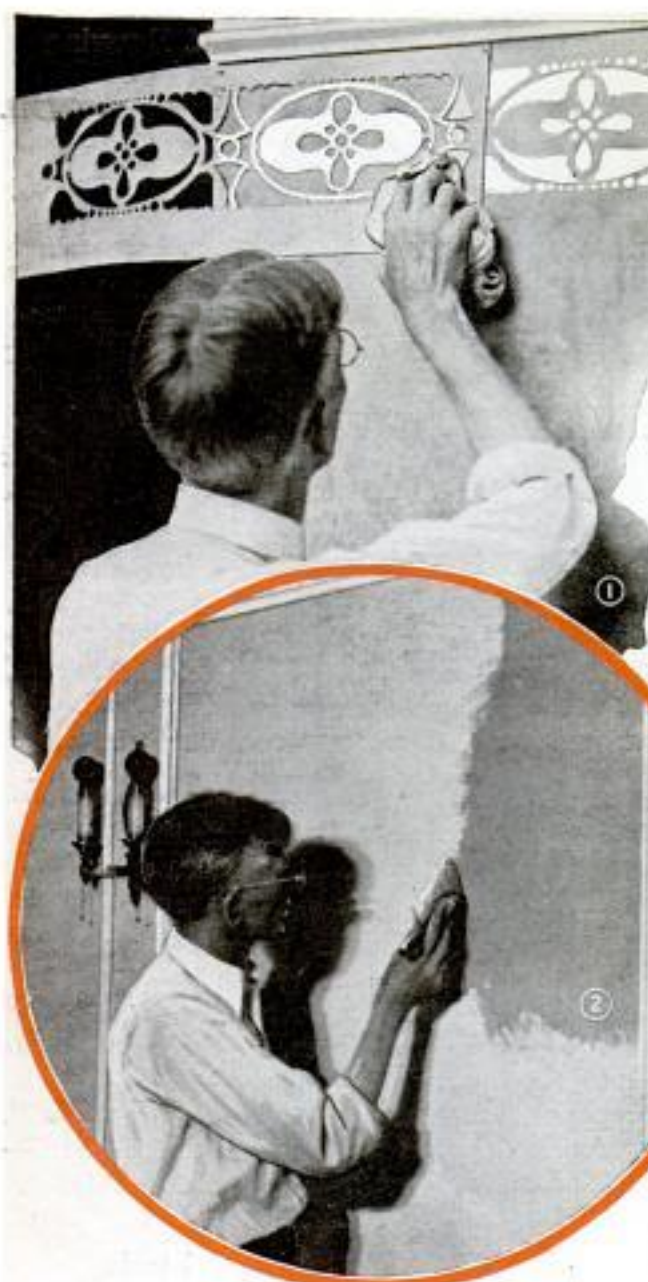
Here Is a Quick Method of Stretching Paper on a Drawing Board with the Use of Gummed Tape



Gluing paper onto a drawing board can easily be done as follows: First sandpaper the board clean, then wet the paper and lay it in place. While it is still wet, cut strips of gummed tape and glue it to the edges of the paper, lapping it over onto the board. Do not stretch or pull the paper, but let it bulge as much as it will. As it dries, it will shrink and flatten.—H. L. Weatherby, Montgomery, Ala.

#### Machining Stainless Steels

Machining of stainless steels should be done at slow speed, taking heavy cuts, with the side rake of the cutting tool at about  $15^\circ$ . The top rake should be greater than that used for ordinary steel, the angle depending on the type of finish desired. The tools should be kept very sharp, and a fine-pitch lead screw used when cutting threads. When centering this steel for drilling, the point of the punch should be ground triangular so that the drill will cut immediately, never allowing it to "ride," which causes hardening. A good lubricant for any operation on this steel is a mixture of 1 lb. of sulphur and 1 gal. of lard oil. In grinding, use fine grits, being careful to remove all pits and spots; otherwise electrolytic action will start at these points.



# WALL Improves

By Berton Elliot.

mixed with a special blending or glazing liquid are generally used for the purpose. Start with the blending liquid and add the oil color, a little at a time, until the mixture is tinted to the desired tone. Two or more harmonizing colors may be used.

They are spread on the wall surface, using a separate brush for each color. In multi-color work, one color should always predominate, the others being used in smaller quantities, here and there, in an irregular manner, but avoiding a spotty effect. Spread the colors, work them in and blend them together with the brush. Only a moderate surface, say from 2 to 4 sq. yd., should be done at a time, so that the mottling can be executed before the paint dries. Special blending or glazing liquids are used for thinning instead of turpentine, as the latter evaporates and allows the paint to dry too quickly. Spaces between doors, from corner to window, etc., should be done from the picture molding down. On a large surface, the edges should be irregular, to make the laps inconspicuous.

After spreading one color in a two-color job, as shown in Fig. 9, leaving uncovered spaces of foundation color here and there, which at once are coated with the second color, the two colors are blended into each other with a piece of clean cloth, crumpled to form a wad, going over the coated surface with a twisting, lifting motion, working the color mixture into scrolls and sweeping twists, blended or clouded effects, as shown in Figs. 6, 10 and 11. If the paint sets too quickly, particularly at the laps, apply a little clear blending or glazing liquid before spreading on the color mixture. Variations of

**I**N painted wall decoration, beautiful designs are applied on a foundation coating of plain color. Distinctive blended and mottled effects, sometimes called cloth-stipple or glaze-color effects, and also known as Tiffany blending, can be done by the average home owner. Proficiency is gained by practicing on sheets of paper or wallboard until first-class results are assured.

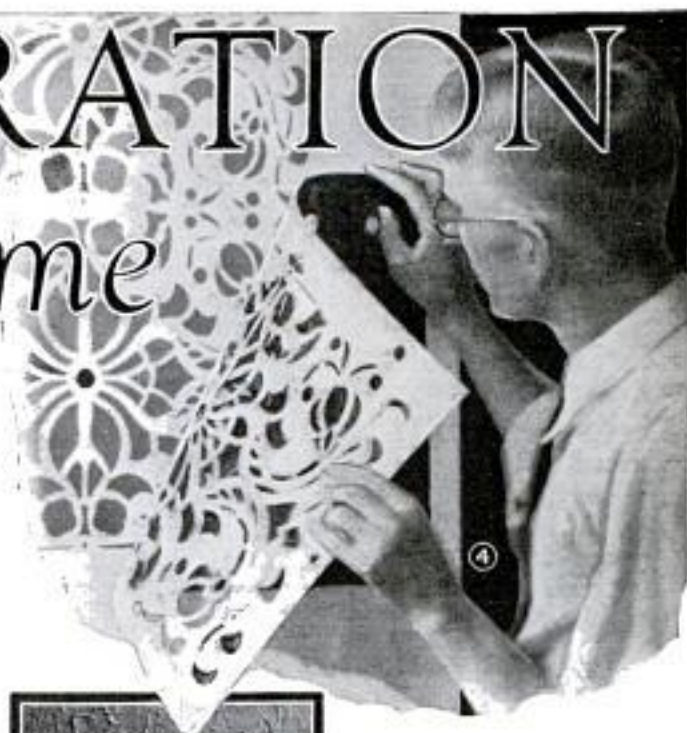
To produce Tiffany effects, brush-coat the walls with a foundation of the desired background color, as in Fig. 2, after a sizing coat has been applied, unless the wall has been previously painted. After the foundation coat has dried thoroughly hard (about 24 hours) the surface is ready for a glaze of semi-transparent color, which is blended and mottled. Oil colors

# DECORATION

## Your Home

texture are also possible through the use of fine or coarse cloth for stippling. As color combinations help determine the success of Tiffany decoration, they should be suited to the size of the room, the purpose for which it is used, whether light or dark, and the furniture and furnishings should also be taken into consideration.

Satin finish, or satin damask finish, often called silk finish, is especially adapted for use in panels only, as its extreme richness and elegance usually makes it out of place for an entire side wall, except in cases where the furnishings are quite elaborate, or the room is somewhat formal in character. This finish is produced by stenciling a suitable all-over design upon an appropriate foundation color or as shown in Fig. 4. In



There Is No Limit to the Varied Artistic Effects Possible in Painted Wall Decoration



selecting the stencil, get one that resembles the patterns found in silk or satin brocade or damask. The changeable effect of silks and satins is further carried out by the use of paint having an eggshell sheen for the foundation coat, and a flat color for the stencil design. The difference in the light-reflecting property of the flat and eggshell paints produces the changeable effect. Such stenciling may be applied over a plain color background or over a Tiffany background, already described.

When the stenciling is applied over a plain color, the eggshell gloss is ordinarily tinted slightly darker and stronger



than the light flat stencil color, as in Fig. 1. When applied over a Tiffany blended background, the blending should be soft and subdued. Decided contrast between stencil and background should be avoided.

The stencil is fastened firmly against the wall, and the color applied through the openings by pouncing with a stencil brush. When the design has been completed, the stencil is moved along to the adjacent area and the procedure repeated, making sure to wipe off the side of the stencil that goes against the wall to avoid smearing. Regular oil colors, sold in tubes or small cans, are used for stenciling, being thinned with turpentine or a special stencil medium. Do not use the paint too thin as it will then run under the edges of the stencil. The brush should be moistened with very little color.

The lace-stencil finish is similar to the satin finish, and the work is practically the same, except that a strip of lace is used as a stencil, as in Fig. 8. The lace is coated with thinned shellac, to stiffen it and make it non-absorbent. A fine pattern in lace should be avoided, as the openings must be large enough to let the bristles of the brush go through to the

foundation coat, which in this case should not be an eggshell gloss, but flat, or practically so. The background may be either plain color or Tiffany blended, the same as with the satin finish.

Wiped-stencil designs over Tiffany finish is a treatment that offers many decorative possibilities. It is especially suited for the inside of panels, for panel borders where relief moldings are not employed, and for stencil borders, as in Fig. 1. In this work the glazing colors are wiped off through the openings, with a cloth, leaving the foundation color showing. In some cases the color is entirely wiped off, leaving the design sharply defined and



clean-cut, while in other cases the outline is left soft and subdued by wiping lightly. Another method sometimes employed is to wipe the design clean, and then apply, through the stencil, one or more of the oil colors (in full strength), originally used in spotting the wall for the Tiffany effect.

Brush stippling is accomplished by simply patting or pouncing the paint just before it has set with a stiff stippling brush, producing a rough texture. Paint to be stippled is mixed thicker than that which is not to be stippled. Ready-mixed wall paint can be stiffened by the addition of whiting so that little points of paint will

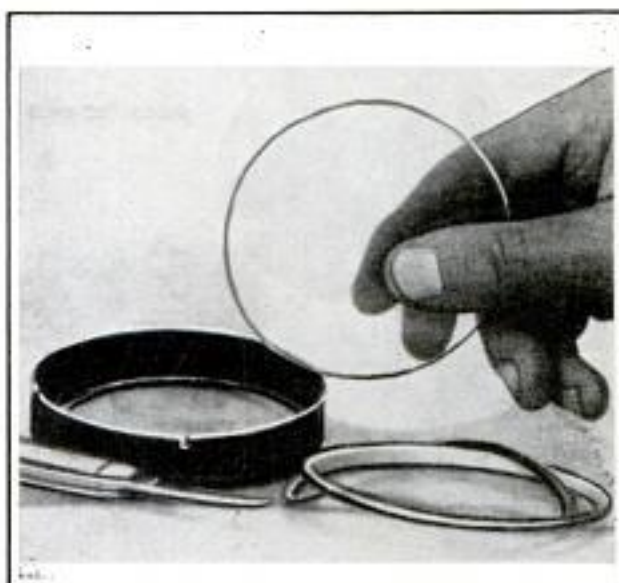
be pulled out as the brush leaves the surface. If the paint is too thin, these points tend to flow together again. Where plain color effects are pebbled, it is the final coat that is stippled, and where Tiffany sponge-figured or glazed effects are pebbled, the stipple treatment is applied to the undercoat.

A variation of the cloth-stippled finish already described, is the crumpled-roll finish, the work being done with an elongated roll of crumpled paper, as in Fig. 7. This is rolled down the wall by turning it over with the fingers, pressing it tightly against the wall to keep it from slipping. Repeat the process for the next strip, allowing the end of the roll to overlap the edge of the previous strip. A new roll should be used as soon as the first becomes ineffective. Any blank spaces may be patted with the end of the roll, and blurs or laps touched up by pressing the roll against the wall.

Walls decorated in Tiffany, sponge-stipple and other treatments are often starched to preserve their beauty. This treatment, which is nothing more or less than brushing a coat of regular laundry starch over the wall surface, protects the finish from dust, dirt, smoky and greasy substances from heating registers, etc. When dirty, the starch coating is washed off, leaving the finish fresh and beautiful. A starch coating should always be stippled or pebbled with a flat wall brush as you go along, to prevent brush marks.

Occasionally, painted walls, in either figured or plain-color effects, may be too bright and shiny, too strong in color, or not just the right shade. A very weak glaze coat, made by tinting some glazing liquid, flattening oil or turpentine, brushed over the surface and immediately wiped off again, will tone down the effect and change its appearance slightly.

Plastic-paint finishes are produced by applying a heavy-bodied plastic paint to the surface, and, before it sets, molding it into relief patterns, fanciful swirls and scrolls, with a knife, spoon or brush, with the fingers, wad of cloth or brush, as shown in Fig. 5. After the paint has dried hard, the surface is smoothed by scraping off all rough projections with a board, or with a coarse grade of sandpaper held on a block.



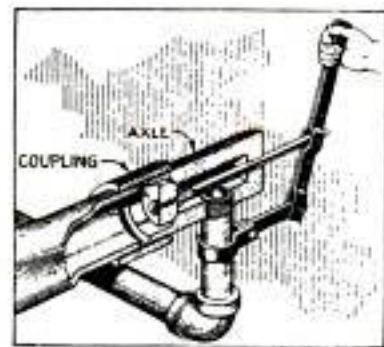
Placed over Gauge Glass, a Celluloid Disk Absorbs Light Blows and Prevents Breakage

### Celluloid Protects Glass Faces of Gauges and Dials

Celluloid placed over the glass face of small gauges and dials helps to prevent breaking the glass. Cut a piece of celluloid from an old auto curtain to fit over the glass and under the ring that usually holds the glass in place. The celluloid, being softer and more flexible than the glass, will absorb light blows or jars.

### An Emergency Pipe Valve

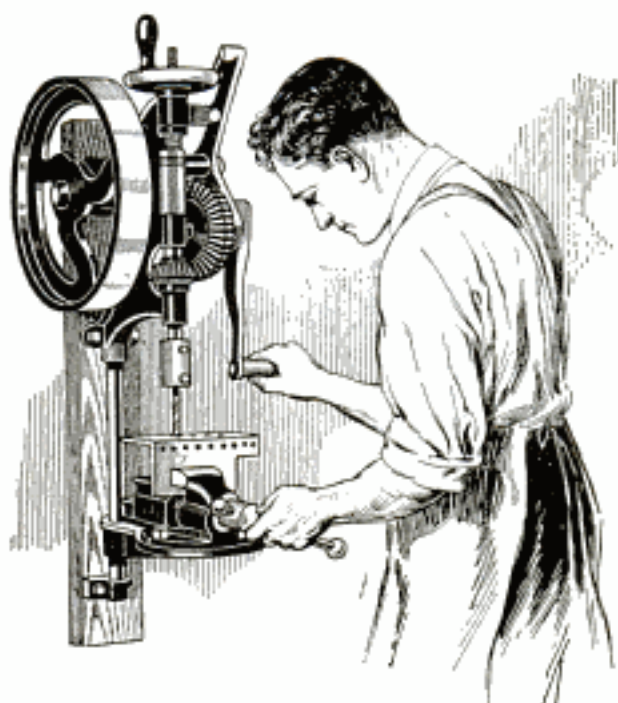
On a construction job, where a large-size pipe valve was needed, one was made as follows: A section was cut from an axle of a railroad car and the center bored out to a size equal to one-half the diameter of the axle and two-thirds of its length. A valve seat was faced off, an outlet cut and



threaded in the side, and the end of the valve body threaded for a coupling, which was screwed to the main pipe. After turning out the valve

to fit the seat, the former was fitted with a leather packing held by copper rivets expanded into holes on the edge and inner face of the valve. A lever was then attached as shown, to open the valve.

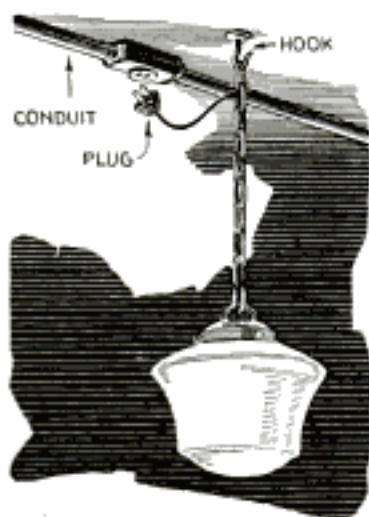
### Vise on Table Increases Efficiency of Drillpress



Vise, Mounted on Drillpress Table, Holds Irregular Work in Rigid Position for Drilling

Bolted to a drillpress table, a small vise will securely hold work of almost any shape, preventing broken drills. A wide range of adjustment can be obtained if the vise is swiveled to the table with one bolt, although it will be made more rigid by using two. If it is necessary to use the table without the vise frequently, the vise can be held on a strap hinge, one end of which is bolted to the underside of the table and the other to the vise, permitting instant removal of the latter.

### Ceiling Light Fixtures Easily Removed for Cleaning



In most stores and shops, the cleaning of ceiling lights and fixtures is often done standing on a stepladder. To promote safety and reduce breakage, a southern corporation devised a

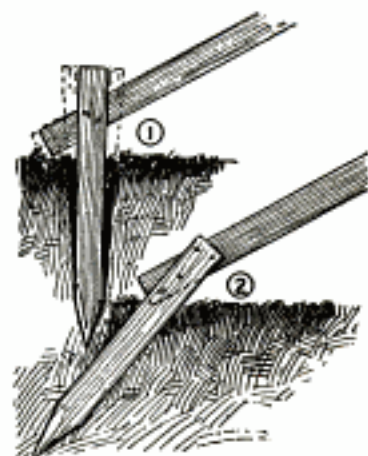
fixture hanger that can be disconnected and removed for cleaning. Instead of being coupled permanently to the wiring system, the fixture chain is hung from a screw hook, and connection to a near-by outlet is with a plug.

### Increasing Working Radius of Hoist

A hoist with a direct-connected motor can be given a wider radius by mounting the frame loosely on a pair of metal skids. The hoist is anchored at the center of the rear end by means of a heavy bolt or clevis arrangement, which allows it to swing toward the right or left. When a load is hooked onto the cable at a new angle, the entire hoist automatically swings into line. A strong wooden block is then inserted against each front corner of the frame to keep it firmly in that position until another change is to be made. The skids should be kept well oiled.

### Driving Brace Stakes in Wet Ground

Brace stakes driven vertically into wet or unfirm ground, as in Fig. 1, soon come loose. If the stakes are driven at an angle toward the brace, as in Fig. 2, the force of the brace drives them deeper into the ground, thus causing the stake to tighten instead of loosen.



### Magnifying Glass Aids in Turning Small Work on Lathe

When turning small and delicate work on a lathe, a more nearly accurate job can be done by using a reading glass to magnify the work. Bend a length of stiff wire around the frame and fasten the glass to the tool post so the bit and work will be magnified.

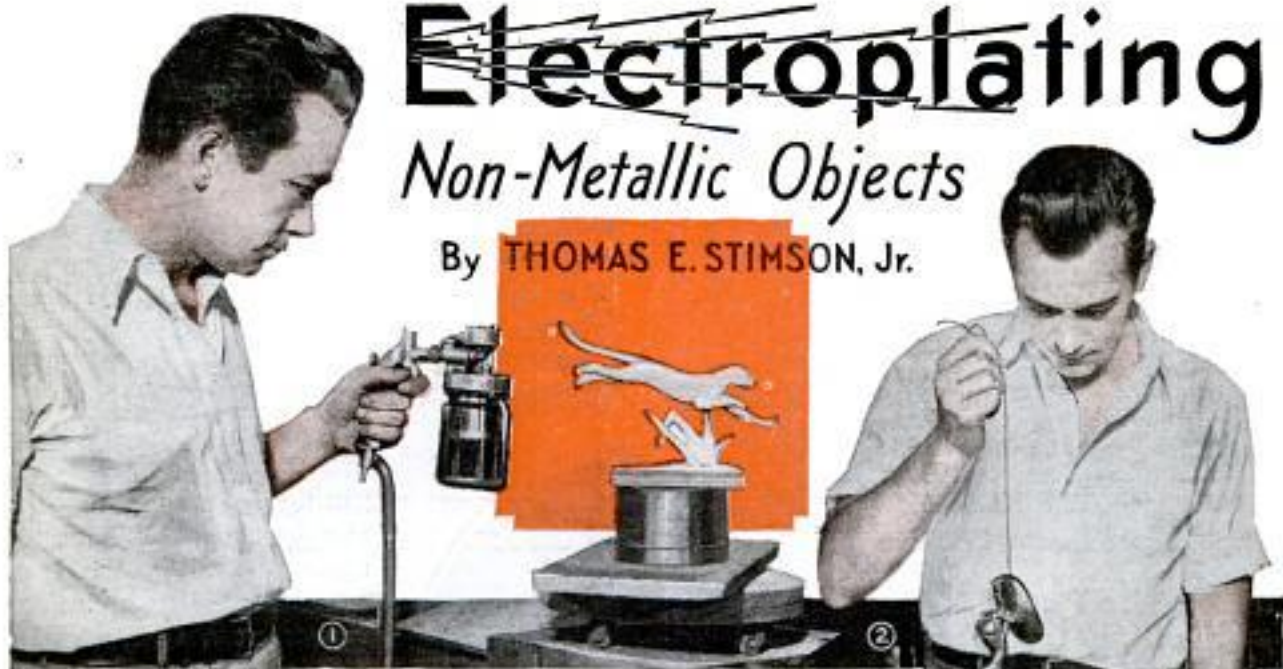
Emergency connecting-rod bearings can be made from pieces of brake lining of the same width as the metal bearings.



# Electroplating

## Non-Metallic Objects

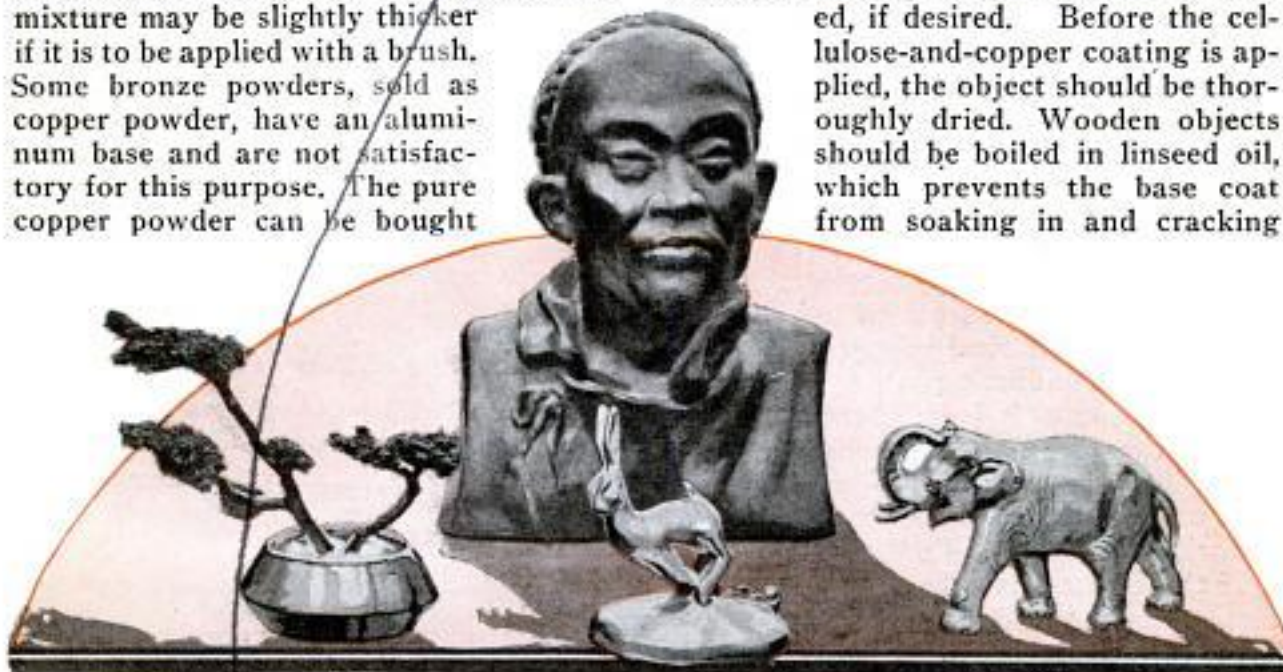
By THOMAS E. STIMSON, Jr.



**T**HERE are innumerable non-metallic objects, such as flowers and fruit, wooden novelties, glass and plaster knick-knacks, leather articles, etc., that can be given a beautiful and lasting finish by electroplating, if they are properly prepared before suspension in the bath.

The most important part of the process consists in giving the object a coating that will conduct electricity. The coating may be either sprayed on or applied with a camel's-hair brush. To 1 pt. of thin, clear cellulose lacquer add 1 oz. of copper powder. Commercial cellulose lacquer is often too thick and should be thinned by adding lacquer thinner until the right consistency for spraying is obtained. The mixture may be slightly thicker if it is to be applied with a brush. Some bronze powders, sold as copper powder, have an aluminum base and are not satisfactory for this purpose. The pure copper powder can be bought

at a chemical house. The mixture should be thoroughly stirred before it is applied so that all the powder is held in suspension. This mixture is a conductor of electricity and does not offer much resistance. When the coating has dried, the object may be plated with a heavy deposit of copper, after which a surface coat of gold or silver can be added, if desired. Before the cellulose-and-copper coating is applied, the object should be thoroughly dried. Wooden objects should be boiled in linseed oil, which prevents the base coat from soaking in and cracking



*Pendleton P. The Chem. and American Cellulose Co.*

*Ermer & Amend 3rd Ave + 18th St. New York*



the wood. Plaster-of-paris objects, which might be affected by the electroplating solution, should be slightly warmed in an oven to remove all moisture and are then dipped in hot wax or paraffin after which the copper lacquer is applied. This waxing treatment should not be given to fruits or flowers, as much of the surface detail would be destroyed.

One electroplater has produced some gleaming chromium drumsticks that are very popular. The sticks are turned out of light basswood, boiled in linseed oil, and painted with the copper-lacquer mixture. They are then given a  $\frac{1}{16}$ -in. layer of copper, a thin coat of nickel, and a final plating of chromium. The sticks are plated slowly to obtain a smooth surface and are buffed between each plating operation. A weight is hung on each stick so that it will sink when placed in the plating bath. When the sticks are finished, they have about the same weight as hickory, and are practically unbreakable.

If the object to be plated has no base to which the electrical connection can be made, the conducting wire should be wrapped around it loosely and the position of the wire should be changed after each plating process, so that any unevenness on the surface, made by contact with the wire, can be buffed off, as in Fig. 4.

If the object has a base, a more satisfactory connection for the first heavy coat can be made by attaching the con-

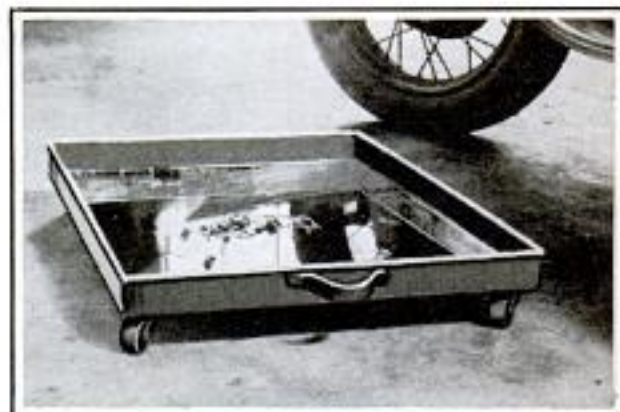
ducting wire to the base with a small amount of heated dental wax. The wax hardens and holds the wire in place firmly so that it can be suspended in the bath as in Figs. 2 and 3. The copper-lacquer mixture should also be painted over the wax and around the wire. This connection can be broken out after the first plating process and the wire wrapped around the article, as already mentioned, for applying the succeeding coats.

An interesting table ornament is made by gluing a few pebbles in the bottom of a small saucer and inserting a branch among them to represent a tree. Small pieces of rubber sponge glued to the branch make realistic clusters of leaves. By dipping the articles in wax and then painting them with the electrically conducting coat, the piece may be finished by plating it

with silver. Those not familiar with electroplating, will find more information on the chemicals used, and their proportions, in the September, 1930, issue of *Popular Mechanics*, page 516.

### Drip Pan for the Garage

To keep oil off the garage floor and prevent loss of small parts when repairing an auto motor, this sheet-metal tray has been found a great convenience. It is 2 in. deep and 30 in. square, with a handle riveted to each end and four casters soldered to the corners.



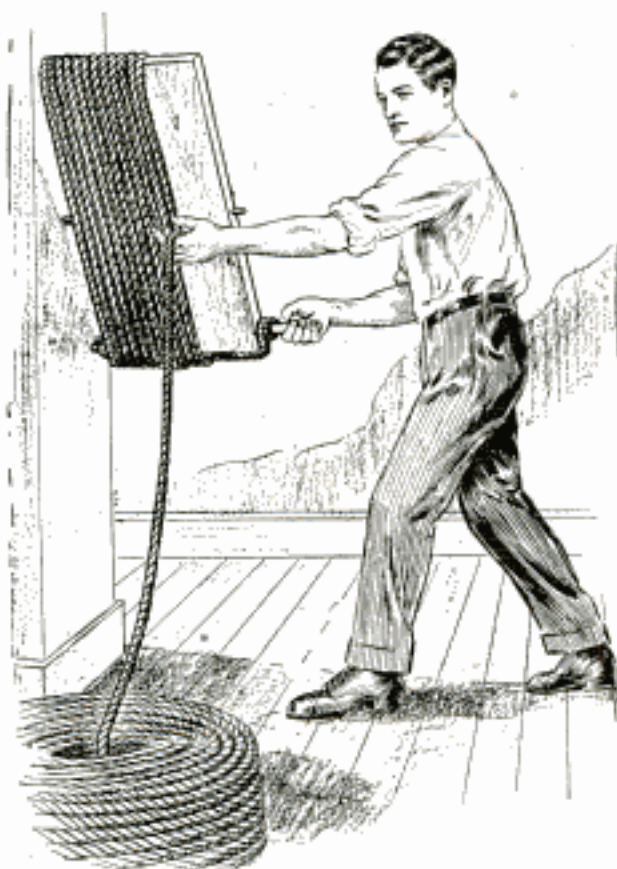
Pan Keeps Oil off Floor When Repairing Auto Motor

### Heat-Treating Small Tools

When hardening sharp-edged tools, it is best to insert the end to be sharpened into the quenching bath first, as the portion first inserted receives the greatest degree of hardening. Carbon steel should be hardened at the lowest temperature possible and on a rising heat. This is an important item in hardening this grade of steel. When using a water quench, the piece will come out bright and clean if the quench is 97 per cent water and 3 per cent sulphuric acid. A good method of annealing small tools is to heat them to a red color and then bury them in dry sand to cool off. A solution for removing the scale from an article after casehardening can be made by dissolving caustic soda, 1 part, into hot water, 10 parts. The article should be allowed to remain in this solution for a few minutes.

### Tests for Lubricating Oil

If you cannot obtain the oil you know is suitable, the samples available may be tested for viscosity by putting a few drops of each on an inclined sheet of clean metal or glass and noting the relative rapidity of their downward flow. That which flows most slowly has the greatest viscosity. For heat resistance and for carbon residue, the oils may be roughly tested by putting a little on a sheet of iron or tin plate and heating gradually over a flame, moving the plate so that it is evenly heated. The oils will become less viscous and will run on the plate. Therefore, two samples compared at the same time, should not be placed too close together. They will gradually vaporize, leaving only a brownish and somewhat thick residue, which should be small in quantity. A good heavy oil will vaporize almost completely, but retain considerable body.



This Winder Saves Time in Coiling and Measuring Rope; Each Revolution Counts for One Yard

### Winder Measures Rope Quickly

In a hardware store, doing a large business in light rope, a device that winds and measures it quickly has been found convenient. The winder consists of a piece of 2 by 12-in. hardwood, 16 in. long, and is pivoted on a long bolt which passes through the center. A handle at one end permits turning the winder. When measuring rope, the end

is brought around the handle, then across the end of the board and once around a pin driven into the opposite edge as shown. A 36-in. length of rope is wound up with each revolution. To remove the rope, unwind it from the handle, slide it off the pin and pull the horizontal length out, which loosens the coil so that it will come off the winder readily.

## 300 Blueprints for Home Craftsmen

**IN ORDER** to supply our readers with workable drawings of large size (17 by 22 in.) for convenience in making the projects published in *Popular Mechanics Magazine*, we have prepared blueprints on almost everything that is of interest to the home craftsman. Prices: Single prints, 25 cents; six prints, \$1, postpaid.

For more information, see page 16 in the advertising section. Address Blueprint Dept., *Popular Mechanics Magazine*, 200 E. Ontario Street, Chicago.

a 1987 Sam Loyd

# Can You Solve *these* Puzzles?



**H**ERE'S one that will take some thought. A monkey weighing five pounds stands holding the end of a rope, passing over a frictionless pulley and attached to a five-pound weight which hangs three feet above the ground. The rope is so light that its weight is negligible. If the monkey climbs six feet up the rope where will the weight be?

**S**OME children find arithmetic a dull subject, but not those in Mrs. Terwilliger's class, for she uses puzzles to dress up her lessons.

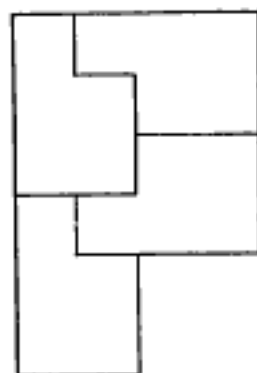
Let us listen to her:

"Now, children, my big A and B stand for two of the ten digits, digits meaning the Arabic numerals 1, 2, 3, 4, 5, 6, 7, 8, 9 and 0. A is a digit and B is a digit and if I were to turn them about, so as to make the number BA, that number would be two more than twice as

much as the number represented by AB." What are the two digits?

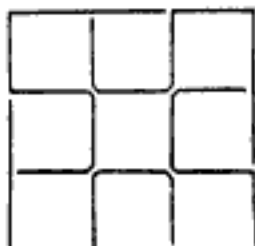
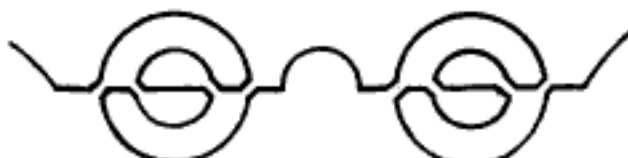
**I**F you weren't able to solve the grocery problem in last month's puzzle page, here's the answer. You remember that the grocerman had an even number of pounds left in a fifty-pound tea chest which he must wrap in five lots.

The amount left in the chest was divisible by five whole numbers only, which corresponded to the five lots. Number 28 is the only one to fulfill the conditions, being divisible by 1, 2, 4, 7 and 14 without remainder.



## Here Are the Answers to Last Month's Diagrams

How the Court Plaster Was Cut into Four Pieces of the Same Size and Shape Is Seen at the Left; Below Is the Solution to "Old Specs," and at the Right the Nine-Cell Square, Drawn in Four Lines



Answers to the monkey and the classroom puzzle will be given in next month's Popular Mechanics

# Here's a new kind of

# FUN!

You Can Model Anything from Dragons and Ships to Picture Frames with

# PLASTIC WOOD

which comes in 9 colors



Now letters are coming in from all sections of the country telling about a new use for Plastic Wood—the preparation that handles like putty and quickly hardens into wood you can carve, paint, and turn in a lathe. There's nothing better for hiding nicks, making repairs and sealing cracks. Everybody knows that! But what's more important, with Plastic Wood you can make a thousand and one useful and decorative things—and have lots of fun doing it! Mirror and picture frames, still-life models, galleons, human studies, book ends, decorative knick-knacks, there's no limit to the things you can make.

## See What an Amateur Made!



You don't have to be an artist to model with Plastic Wood. Men and women, boys and girls who never before worked with their hands are now modeling beautiful things out of Plastic Wood. Many of them are making extra money this way! Try it. You can buy Plastic Wood in 9 colors at any paint, hardware or department store.



You don't have to be an artist to make wonderful things out of Plastic Wood. It's easy to work with.



The 3 models illustrated were selected at random from the photographs of models we have received. They are decorative. They are so cleverly modeled you'd never believe they were made after working hours by a Certified Public Accountant! The old man and the bird in real colors are very lifelike. The vase has all the graceful sweep of line that adorned ancient Grecian vases with such beauty. Try your hand.

## BIG 48-PAGE BOOK FREE

We'll send you free—a 48-page, profusely illustrated book crammed full of facts about Plastic Wood and how to use this amazing preparation.

### MAIL COUPON TODAY

The A. S. BOYLE CO., Dept. 1-PM, Cincinnati, O.

Send me—free—Big Book of Uses for Plastic Wood.

Name.....

Street & No. ....

City..... State.....

THIS OFFER GOOD IN UNITED STATES ONLY

*When writing to advertisers please mention Popular Mechanics*

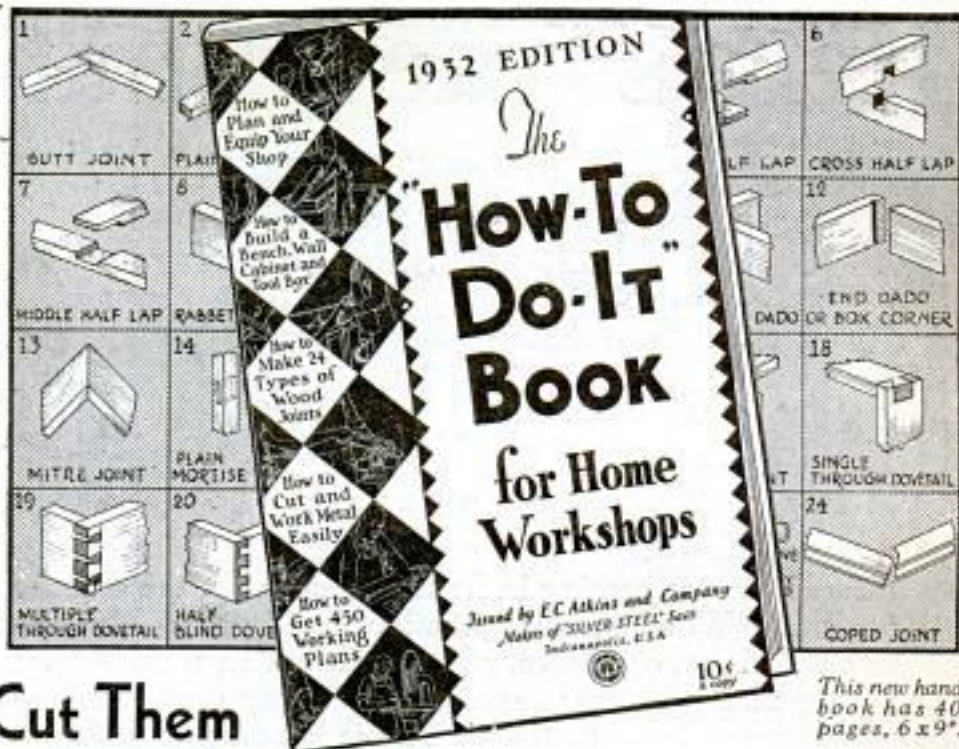
Pages 9-17  
of this Book  
Show You

# 24

TYPES OF

# JOINTS

## and How to Cut Them



This new hand  
book has 40  
pages, 6 x 9".

"Your 1932 How-To-Do-It Handbook is the best one of its kind I've seen. I am now equipping a new workshop and can use lots of the suggestions. I shall need some saws, and you can be sure they will be Atkins," says A.C.S., Pa.

If your dealer does not have the ATKINS saws you want, write us.

E. C.  
ATKINS  
and Company, St.  
426 S. Illinois St.  
INDIANAPOLIS, Ind.

I enclose 10c for the ATKINS 1932 Book for Home Workshops.

Name..... (Print)

St.....

City.....State.....

Dealer.....



ATKINS



SILVER STEEL



S A W S

WITH this new book at your elbow, you'll find it EASY to make perfect-fitting joints of the types used in home shop wood-working.

It's like taking a short course in joinery, to study the nine pages of pictures and step-by-step instructions which a veteran craftsman gives you in this chapter on joints.

First, he explains the uses of 24 common wood joints; then tells you exactly how to make each type—butt, lap, rabbet, dado, mitre, mortise-tenon, dowel, dovetail, matched, coped joints, etc.

Next, he shows you how to use these joints in building a bench, table, tool-box, cabinet, saw-horse and other shop fixtures. Then, comes a feature no other book has—a list of 450 things to make, and where to obtain plans.

That's not all! Other chapters cover . . . laying out a new shop . . . selecting tools and machines . . . choosing woods to work . . . new ways to cut metals . . . grinding and filing . . . and so on!

At the end, are 8 pages of facts on saws—showing types for every job of sawing wood or metal—all made of the world-famous ATKINS "Silver Steel." Send the coupon for this new home-shop handbook.

An ideal Christmas Gift for a boy—this book and a set of tools including an ATKINS Junior Mechanic Hand Saw!

# 100 Shaves

from EACH Blade

The Master-Hone puts a hair-splitting edge on the dulled razor blade—ANY make—in 3 seconds. Many get 100 shaves per blade. W. P. Walsh, Windsor, Ontario, used same blade daily 8 months. Daily honing can give a NEW edge on a blade. This patented, accurately bevelled hone of special abrasive makes each blade worth \$2.00 in service. MONEY REFUNDED if not delighted. We will send you a **YOURS FREE** Master-Hone absolutely free WITH FIRST ORDER of 12 for \$2.00, or send \$0. for 1 or \$1.00 for 3, **POSTPAID**. Or, send no money and pay postman plus postal charges. But send today. These are Agents' prices. Regular retail price \$1.00.

WISCONSIN ABRASIVE CO.  
Dept. 7091, Ste. A, Milwaukee, Wisconsin



Agents

net up to \$30 a day. Mr. Nor sold 40 at noon hour.

When writing please mention Popular Mechanics

### Start a Welding & Battery Shop

Lead Burning Outfits.....\$18.00 up  
Welding Outfits..... 25.00 up  
Soldering Outfits..... 8.00  
Welding Torches..... 10.50 up  
Cutting Torches..... 30.00 up  
Regulators and Gauges..... 9.50 up  
Combination Welding and Cutting Torch..... 16.00  
Welding Supplies—Agents Wanted.  
Superior Oxy-Acetylene Machine Co.  
P. O. Box 285 Hamilton, Ohio



Send for FREE BULLETINS

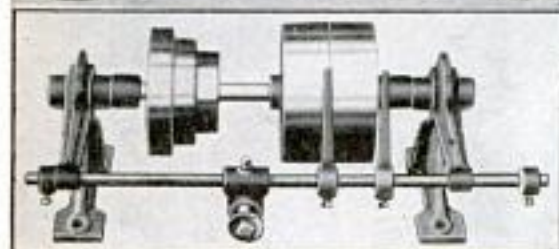
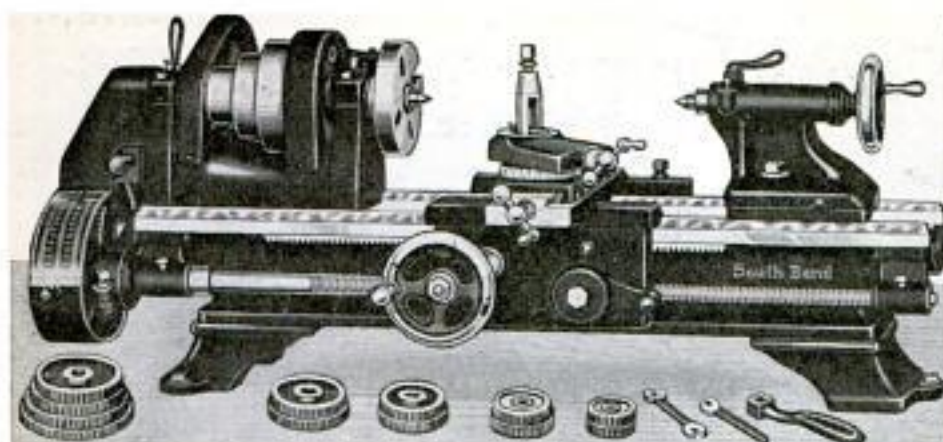
### CRESCENT WOOD WORKING MACHINES



Crescent Wood Working Machines make money for you by turning out work accurately, fast and easily. Portable machines operate from any light socket. Big line of heavy machines for factories, all quality made; moderately priced.

Send for Free Bulletin.

The Crescent Machine Co., 93 Columbia St., Leetonia, O.



8" x 24" Junior Back Geared Screw Cutting Precision Bench Lathe with Tight and Loose Pulley Countershaft and Equipment, \$20.00 down, \$7.00 per month. **\$100**  
Net Weight 175 lbs. l.o.b. factory

Announcing  
The New  
South Bend  
Junior

8"

BACK GEARED  
SCREW CUTTING  
PRECISION LATHE

**\$100 AND UP**

Prices of 8" Lathes with Tight and Loose Pulley Countershaft

	Between Counters	Net Weight	Plain Rest	Compound Rest
8" x 24"	6"	175	\$100.00	\$115.00
8" x 30"	12"	190	105.00	120.00
8" x 36"	18"	205	110.00	125.00
8" x 42"	24"	220	115.00	130.00

**EASY PAYMENT TERMS** as low as \$20 down and \$7 per month for 12 months will place this new precision lathe in any shop in the United States. Write for further details.



8" x 24" Junior Back Geared Screw Cutting Precision Bench Lathe with Simplex Countershaft instead of Tight and Loose Pulley Countershaft with Plain Rest. \$100.00

Prices of 8" Lathes with Individual Motor Drive

	Between Counters	Net Weight	Plain Rest	Compound Rest
8" x 24"	6"	175	\$116.50	\$131.50
8" x 30"	12"	190	121.50	136.50
8" x 36"	18"	205	126.50	141.50
8" x 42"	24"	220	131.50	146.50

In the tabulation below we itemize motor and complete motor drive equipment so that you can purchase only the parts that are needed. This applies to any 8" bench lathe with various bed lengths.

Itemized Prices for Motor Drive Arrangement  
1/4 H.P., 1750 R.P.M., Single Phase, A. C.

Motor	\$12.00
Motor Pulley	1.25
Enclosed Type Knife Switch	1.50
Belting, Motor to Countershaft and Countershaft to Lathe	1.75
<b>Total</b>	<b>\$16.50</b>

The New 8" Back Geared Screw Cutting Precision Bench Lathe illustrated above is announced on the Silver Anniversary of the South Bend Lathe Works, having specialized for 25 years in building lathes exclusively. All the quality, precision, accuracy and up-to-date mechanical features which characterize the complete line of South Bend Lathes are incorporated in this new remarkable lathe.

Recommended and manufactured for auto service, electrical work, tool room work, manufacturing, home work shop, laboratory use and for all classes of fine precision jobs—can be used in the tool room the same as in the small shop as it has the accuracy and precision for gauges, small tools, dies, etc.

Features include back geared headstock—3/4" hole in spindle—set-over tailstock—3/4" diameter lead-screw—power feed to carriage—plain rest for holding tool—cuts screw threads 4 to 40 per inch—takes 1" belt—six spindle speeds—weighs 175 pounds net.

A full line of attachments are available at similar low attractive prices for this lathe including draw-in collet chuck attachment with collets, milling attachment, taper attachment, grinding attachment, thread dial, chucks, tools, accessories, etc., all for precision work.

*Write for new Circular No. 8*

describing and illustrating in detail all the features of this new up-to-date bench lathe. Sent free, post-paid, to any address. Fill out and mail coupon below.

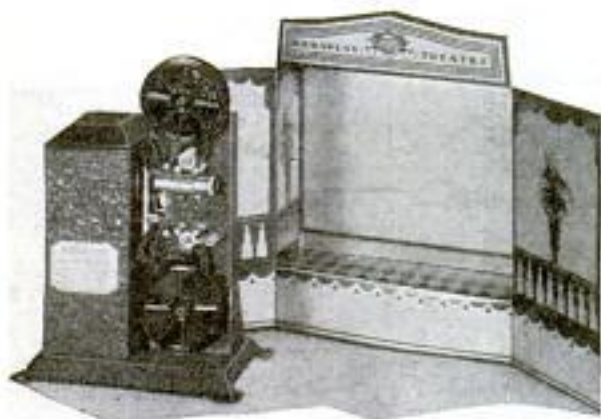
**SOUTH BEND LATHE WORKS**

601 East Madison Street, South Bend, Indiana, U. S. A.

Gentlemen: Please send circular No. 8, illustrating and describing the New South Bend Junior 8" lathe.

Name \_\_\_\_\_  
Street \_\_\_\_\_  
City \_\_\_\_\_  
State \_\_\_\_\_

# For Christmas



## This Toy Movie Projector

Eastman-made

Only <sup>\$</sup>12 complete  
**KODATOY**

Three-blade shutter—many other features usually found only on costly machines. . . . 400-foot extension arms available.

With Kodatoy you can show real movies at home. Lasts and amuses all year round! Kodaplays—special short length movie subjects—cost but 30, 60 and 90 cents each.

Kodatoy projects brilliant, flickerless movies. Powerful condensing and projection lenses—dependable claw pull-down—sprocket threading—three-blade shutter. With extension arms now available, you can run 400-feet of film at one showing. Uses 16 mm. *Safety Film* only.

Complete Kodatoy outfit costs only \$12—hand operated. With motor, \$18.50. Outfit includes projector, miniature theatre with "silvered" screen, and two empty 100-foot metal reels. Universal model for D.C. or A.C. (any cycle) available at only slightly higher prices. See it at Kodak dealers', toy and department stores. **EASTMAN KODAK COMPANY, Rochester, N. Y.** PM-1

## Big \$1 XMAS GIFTS Value 1 SEND FOR CATALOG P.M.

Best value you ever saw. Genuine leather, attractive looking card case, gold corners, holds 5 cards also extra pocket. Masonic or other emblem stamped in gold, FREE. Name and other stamping 35c a line . . . . . \$1  
9 windows . . . \$1.50  
13 windows . . . \$2.00



### SOLID GOLD PINS



Just the right size. Masonic, Chapter, 32nd Degree, Shrine, Grotto, De Molay, etc. . . . . \$1  
Catalog lists hundreds.

### NOVEL CHARM

A most mysterious Masonic watch charm of heavy plated gold. Square and compass show when revolved. Delights owner . \$1



### MASONIC XMAS CARDS

Send one to your friend. 15 specially selected. Beautifully engraved. Also Shrine, Eastern Star & De Molay \$1

Money back if not satisfied

**REDDING MASONIC SUPPLY CO.**

Dept. P.M., 200 Fifth Ave. Est. 1859 New York

"EVERYTHING MASONIC"



### ALL PROGRAMS

Are Good with a FILTERMATIC. For all radios only \$1.00 postpaid. Entirely automatic—no bothersome tuning. Improves tone, reduces static, brings in distant, increases volume, separates stations. Installed in one minute, no tools required, in series with your aerial or across your aerial and ground.

Satisfaction guaranteed or money refunded.

Send check or money order. C. O. D. 25% with order. Money back guaranteed after 5 day trial. Service Men and Dealers Write for Particulars Also Free Advertising Service.

**FILTERMATIC MFG. CO.**

(Dept. B-7) 4458 Frankford Ave. Phila., Pa.

## RADIO BUILDERS

We carry a complete line of radio parts for all Popular Mechanics circuits and replacement parts for all sets.

Send Us Your Order

**NEWARK ELECTRIC CO.**

228 W. Madison St.

CHICAGO, ILL.

## Catch Fish!



Eels, Mink, Muskrats with our new folding galvanized STEEL WIRE TRAP. Write for our FREE TRAP OFFER and Bargain Cat. Inc. \$1 Box of our famous Fish Bait FREE to introduce our traps. **WALTON SUPPLY CO., 3502 JUNIATA AVE., ST. LOUIS, MO.**



Build your own outboard hydroplane motor or sail boat. Use our plans or knock-down frames and machined parts. Many models to select from. Write for new catalog. Please enclose 10c for catalog. **J. B. WELCH, Inc., Dept. B, 3148 No. 31st St., Milwaukee, Wis.**





# Handiest of All

Jack-of-all-trades and *master* of all—that's the combination square. It's a first-class try-square, miter, rule and level; it's also a first-class depth gage, height gage and plumb—the handiest all 'round tool ever made.

On a tool as important as this, you can afford to spread yourself a bit and buy the best—a *genuine*\* Starrett. You can be sure, then, that the blade is really square with the stock—and will stay square. You can be sure of accurate, easy-reading graduations—fine but deep and durable. And you'll get a balance—a *bang*—that only a genuine Starrett Tool can offer you.

Fill in and mail the coupon. It will bring you a copy of the Starrett Catalog No. 25 AP illustrating and pricing the Starrett Combination Squares; showing how to get full use from them; together with over 2500 other Starrett Tools, valuable tables, etc.

\*L. S. Starrett invented the combination square in 1890.

Use  
Starrett  
Hacksaws



# Use Starrett

THE L. S. STARRETT CO., ATHOL, MASS.

Please send me my free copy of Starrett Catalog No. 25 AP

Name \_\_\_\_\_ Address \_\_\_\_\_ City \_\_\_\_\_ State \_\_\_\_\_

# Tools

When writing to advertisers please mention Popular Mechanics

5184

Copyrighted material



**This Is the Way!  
To Make MONEY!**

J. Green averaged \$10 a day the first six days. Andrew Wyman's income increased from \$45 the first week to \$69.13 the sixth week. Henry Morse made \$1520 in 5 months. C. Wanderschied made \$300 in 3 months, just in spare time. Hundreds of other men are making a good living out of this business of sharpening lawn mowers by the Foley Electrakeen System.

## Start Your Own Cash Business at Home Now!

There is no other method for sharpening lawn mowers to compare with the Foley. You can turn out perfect work quickly and easily. Simply put the lawn mower in the machine and turn on the power—the Foley Electrakeen System automatically sharpens ALL blades and cutter bar at once.

## Foley Electrakeen Lawn Mower Sharpener

Uses same system as the leading lawn mower factories. Sharpens all sizes and types of lawn mowers. Costs you only 1c a job and you get \$1.00, \$1.25, \$1.50 each. People would rather have their lawn mowers sharpened the Foley way because they cut better and stay sharp longer.

**Easy to Start** Our Free Plan helps you get business coming your way. Canvassing not necessary. A small investment starts you in a big-paying business. Sold on easy monthly payments if you wish—Spring will soon be here—There will be lots of business for you—Investigate now!

**Send for Complete Information Today**



## Foley Manufacturing Co.

1072 Foley Bldg., 11 Main St., N. E.,  
Minneapolis, Minn.

Tell me how I can start my own Cash Business and Make Big Profits with the Foley Electrakeen Lawn Mower Sharpener.

Name.....

Address.....

City..... State.....

When writing please mention Popular Mechanics

## Thompson BEATS the World on BOATS

THOMPSON  
BOATS

**CATALOG FREE!**



**OUTBOARD MOTOR BOATS**—For Every Purpose and Every Purse—The very fastest and most seaworthy Boats for family use, and a strictly up-to-date line of Step Plane Racing Models. Holders World's Outboard Endurance Record.

Rowboats  
\$48.00  
and up—

Most complete line ever offered, at real money-saving prices.

Canoes  
\$50.00  
and up—

Some all wood, others canvas covered. Light, swift, safe, strong and durable. Many color combinations.



Motor  
Boat  
\$745

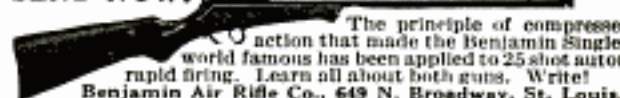
Mahogany Runabout. 16 and 18 ft. Speed 25 to 35 mi. per hr. Complete with 4-cycle motor installed, including electric starter and reverse gear.

**CATALOG FREE—SAVE MONEY—ORDER BY MAIL**  
Please state the kind of boat you are interested in (45)

**THOMPSON BROS. BOAT MFG. CO.**  
213 Ann St. (Write to) 113 Elm St.  
PESHIGO, WIS. (Either Place) CORTLAND, N.Y.

**FREE** Get BB Magic at once. A wonderful shooter's digrest tellshow to hold, aim and handle rifles; helps you guide others in correct knowledge of guns. Gives facts that make crack shots. Gives safety and common sense instruction parents all like.

**SEND NOW!**



The principle of compressed air action that made the Benjamin Single Shot world famous has been applied to 25 shot automatic rapid firing. Learn all about both guns. Write! Benjamin Air Rifle Co., 649 N. Broadway, St. Louis, Mo.



Forms to cast Lead Soldiers, Indians, Trappers, Hunters, Wild and Farm Animals. 239 different forms to select from. Every Form guaranteed to cast perfect figures. Send 5c stamp for illustrated catalogue.

HENRY C. SCHIERCKE SPENCER RD. GHENT, N. Y.

Cal. 30-40 Six Shot



**KRAG CARBINE**

Price

**\$9.75**

All the qualities of a high price rifle. In fine used condition, all working parts guaranteed for one year. Send today for our Free 60-page illustrated catalog of money saving values: Guns, Ammunition, Cutlery, Sports and Gov't goods.

Deposit required on all orders. Money refunded if not satisfactory. W. Stokes Kirk, Dept. P. M. -1, 1627 N. 10th St., Phila., Pa.



## "FLYING CLOUD"

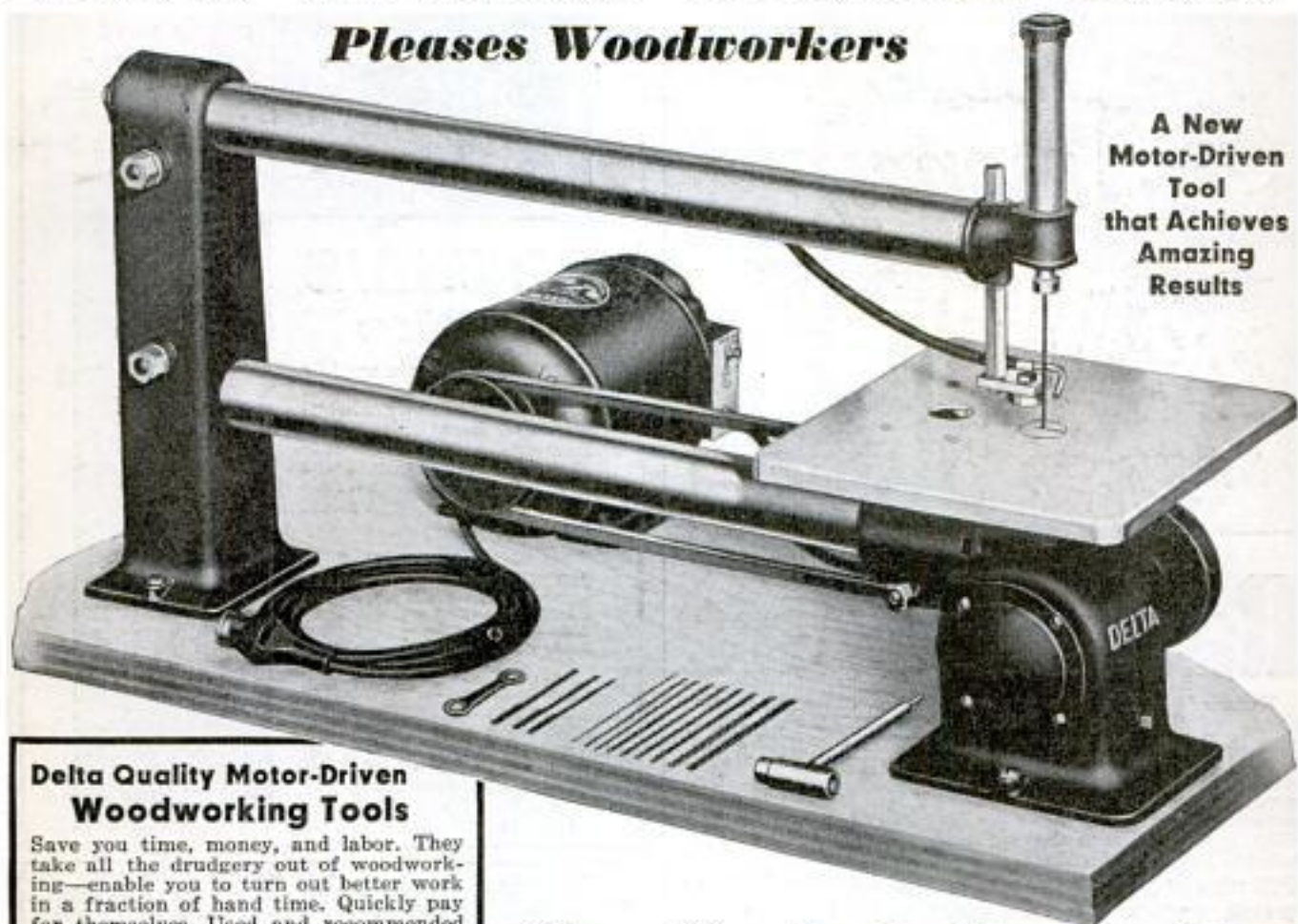
Get clean-cut parts and clear blueprints for 20' model. Readily made in spare hours as hull fully shaped and sanded. Set includes anchor, bell, capstan, dead eyes, wheel, rigging line, etc. Complete for \$11. Postage 5 lbs. White metal figurehead 50c. Send 15c (coins) for beautiful catalog of ships and coaches.

**ROY HANCOCK**

323 Douglas Ave. Portsmouth, Va.

# New "Delta" Scroll Saw

*Pleases Woodworkers*



**A New  
Motor-Driven  
Tool  
that Achieves  
Amazing  
Results**

## Delta Quality Motor-Driven Woodworking Tools

Save you time, money, and labor. They take all the drudgery out of woodworking—enable you to turn out better work in a fraction of hand time. Quickly pay for themselves. Used and recommended by thousands of home workshop owners, carpenters, contractors, farmers, and factories.

### New Delta DRILL PRESS

Large capacity. Ball-bearing spindle. Automatic leveling, accurate tilting table. Many special features. Unusual value.

### New Delta BAND SAW

Smooth running, efficient, safe. Ball-bearings throughout—including the blade guide. Fully guarded in every way. Graduated tilting table. Surprisingly low priced.

### COMBINATION UNIT

Circular Saw, Jointer, Mortiser, all mounted on convenient, portable stand. Each tool can be operated separately or all together. No interference.

### COMPLETE WORKSHOPS

All mounted on bench or convenient stands... available in large variety of combinations, and at prices to fit all needs.

Complete DELTA 1932 Line also includes: Woodturning Lathes, Jointers, Circular Saws, Moulding Cutters and many new accessories.

## Two Tools in One... Has Band Saw Efficiency

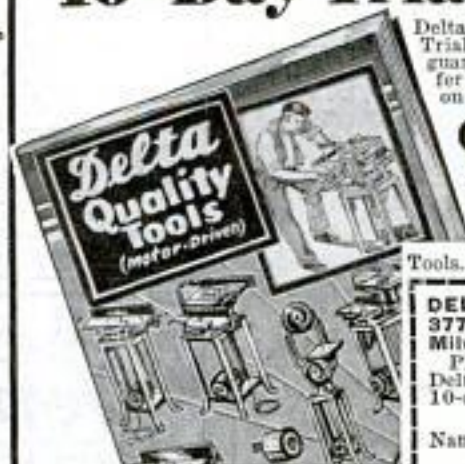
THIS new, moderately-priced tool is radically different from any scroll saw on the market. Runs at full motor speed—1800 strokes per minute—with all springing and twisting eliminated, with perfect balance and absence of vibration! As a result, this remarkable tool produces fine, smooth and accurate work hitherto only possible on a band saw. Has 24-inch throat capacity and it will saw wood 2 inches thick! Works on metal and fibre as well as wood. Has numerous special features. Can be used for filing, sanding, and honing. Send the coupon below for FREE Catalog telling all about this amazing new tool!

## 10-Day Trial—Easy Terms

Delta Tools are always available for a 10-Day Trial without the slightest risk. Satisfaction is guaranteed. For full details of this liberal offer and also of convenient Easy Payment Plans on larger outfits, send coupon below today!

## Catalog FREE!

Send today for this Big Illustrated Book crowded with valuable information for the woodworker—professional, spare-time or hobbyist. Shows the complete 1932 line of Delta Motor-Driven Tools. Send the coupon below—NOW!



**DELTA SPECIALTY CO.**  
(Division of Delta Mfg. Co.)  
3775 N. Holton Street  
Dept. A132 Milwaukee, Wis.

**DELTA SPECIALTY CO. (Div. of Delta Mfg. Co.)**  
3775 N. Holton Street, Dept. A132  
Milwaukee, Wisconsin

Please send me, without obligation, 1932 Delta Catalog. Also send full details of your 10-day Trial Offer and Easy Payment Plans.

Name.....

Address.....

City..... State.....

When writing to advertisers please mention Popular Mechanics

Copyrighted material

# Learn to make more money



## Be a Radio Expert

Hundreds of fine jobs paying \$50, \$60, \$75 a week and plenty of them paying \$100 a week are opening every year in Radio. No wonder. In the short period of a few years Radio has taken its place among the world's greatest industries. Its amazing growth has astounded the world. You can't enjoy the good things of life—a home, an automobile, money in the bank—on \$25, \$35 or \$40 a week. Why be satisfied with that for more than the short time it takes to get ready for Radio.

**I'll show you how to make \$10 to \$25 a week extra on the side while learning**

One month from today you can be making more money. The day you enroll I will show you how to do Radio jobs in your neighborhood. G. W. Page, 2210 8th Ave., S., Nashville, Tenn., made \$935 in his spare time while taking his course.

**I will train you at home in your spare time. You must be satisfied**

Hold your job. Give me only part of your spare time. I'll bring my training to you. I give you eight experimental outfits for extensive practical set servicing experience without extra charge. Further, I will refund every penny of your money if you are not satisfied upon completion with the lessons and instruction service I give you.

**Act NOW. Get "Rich Rewards in Radio"**

This 64-page book points out the money-making opportunities in the different branches of Radio such as broadcasting, operating on board ship which gives you world-wide travel without expense, how to start a spare-time or full-time Radio business of your own. Radio in Aviation, openings with dealers and manufacturers, talking movies, television and many others. Mail the coupon now.

**J. E. SMITH, President,  
Dept. 2A,**

**National Radio Institute, Washington, D. C.**

**Mail this Coupon at Once**

**J. E. Smith, Pres.,  
National Radio Institute, Dept. 2A,  
Washington, D. C.**

Dear Mr. Smith: Send me "Rich Rewards in Radio" explaining your training and Radio's opportunities for bigger success. I understand this does not obligate me and no salesman will call.

Name.....Age.....

Address.....

City.....State.....

When writing please mention Popular Mechanics



**SOUSA SAYS**

"Complete Conn equipment enhances the musical value of any band at least 50%."

## SOUSA'S Choice

and the choice of the world's greatest artists, Conn Band Instruments offer overwhelming advantages to both professionals and amateurs. Easier to play. Magnificent tone. Many exclusive features yet they cost no more.

**Home Trial  
Easy Payments**

Ask your dealer to show you the marvelous new models. Or write us for free book and details of special home trial—easy payment offer. Mention instrument.

**C. G. CONN, Ltd.  
131 Conn Building, Elkhart, Ind.**

**CONN**  
World's Largest  
Manufacturers of  
BAND INSTRUMENTS



## MOVIES In Your Home



Our marvelous, practical Movie Machines sell as low as \$5.00 postpaid. Also finest 16 mm. cameras and projectors at factory prices. A complete line of both standard and 16 mm. film available at low prices with exchange service. Write for big, FREE catalogue.

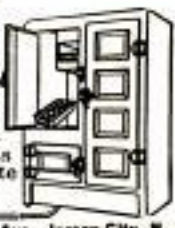
**PARAMOUNT MFG. CO.**

Dept. G-47  
Boston, Mass.

## BUILD YOUR OWN AUTOMATIC ELECTRIC REFRIGERATOR



Why pay \$200.00 and upwards? Use your present ice-box. We supply parts. Can be built for only \$34.50. Easily made. No special tools necessary. Operating cost, quality and size of machine same as well known makes. Complete blue-prints and instructions—\$1.00. Circular "B" on request.



B. & L. ENGINEERING CO., 706 Bergen Ave., Jersey City, N. J.

## CHROMIUM PLATING POWDER

PLATES IRON, STEEL, NICKEL, BRASS AND COPPER without electricity or machinery. Guaranteed not to tarnish; dispenses with polishing. Half pint can \$1.50, prepaid. Particulars FREE. GUNMETAL CO., Ave. T, Decatur, Illinois



**MOULDS**  
For Making Toy Soldiers,  
Indians, Cowboys, Animals, etc.

With one mould you can make many HUNDREDS OF CASTINGS, Whole Armies. Outfits, including material for casting, enamel paints and everything complete \$5.00. Easy enough for any boy to make and great fun for grown-ups. Sport for the whole family. Beware of imitations—insist on "MAKE-A-TOY" Moulds. Write for illustrations of dozens of patterns you can make.

**MAKE-A-TOY COMPANY**  
Dept. E, 1696 Boston Road, New York City

Copyrighted material

# EASY TO MAKE TRACTOR FROM YOUR OLD CAR

## WE TELL YOU HOW!

For Model "T" and "A" Fords, Chevrolets and Many Other Cars



Over view shows new HIGH ARCH which enables tractor to clear tall corn, collecting 1 to 2 rows at one time.



SHAW on Clark Bros. farm, Benton, Ill., pulling two 10-in. plows. Plows 5 to 6 acres per day, depth of 5 or 6 in., on 9 to 11 gal. gasoline.



## DOES ALL FARM WORK

**YOU** have to cut production costs to make money this year. And you surely can cut costs with a tractor! So make a powerful dependable tractor from your old Model "T" or "A" Ford, Chevrolet or other old car—with sturdy **SHAW Tractor Equipment**. The SHAW-Tractorized Car saves you valuable time and costly labor! You'll find it an amazing money-maker!

**Does All Farm Power Work** as well as an expensive tractor. Cultivates 15 to 20 acres per day. Turns about 5 to 10 acres per day with moldboard plow.

Handles 16-in. plow or two 12-in. plows nicely. Easily pulls heavy road drag. Can be used to seed, harrow, furrow, disc, harvest, haul; run log saws, feed grinders, concrete mixers, pumps, and other belt machinery.

**PRICE GREATLY REDUCED**—Costs little to have this tractor now. Price has been greatly reduced to meet present conditions. If you haven't an old car, you can pick up an old Model "T" Ford or Chevrolet for \$5 to \$25; or a Model "A" Ford which has had the body wrecked, very cheaply. Many Model "A" Fords are now being made into SHAW Tractors. SHAW Equipment, bought now for a Model "T" Ford, can be later used on a Model "A." Many attach SHAW Equipment to other make cars.

**SHAW MANUFACTURING CO.**

Dept. PM-1  
Galesburg, Kansas

"I mowed 11 acres of thick, 6 ft. tall oats in 20 hours with my SHAW."—  
H. D. Puffe, Buckley, Wash.

**Pays for Itself**—The SHAW-Tractorized Car is such an unusual time, labor and money-saver, it pays for itself in one short season.

**Anyone Can Attach** SHAW Equipment quickly and easily, using only monkey wrench and screw driver. You don't have to be a mechanic. We furnish all parts, easy-to-follow directions. Can be attached to full-length or sawed-off chassis. Or, you can buy a complete tractorized car from us at low cost.

**Make Tractor Now**—Remember Reduced Price is subject to change any day. So make your tractor now. **SAVE MONEY.** Mail Coupon for full information—TODAY.

### FREE BOOK

Contains complete information about SHAW Tractor Equipment. Explains how simple and economical it is to make tractor from old car. Describes all different models of equipment. Shows 70 actual photos of SHAW Tractors in use by owners. Full of other valuable information. Mail Coupon NOW!



See how this SHAW, owned by Geo. Masentor, Jr., Plainfield, N. J., discs and harrows at the same time.



### SHAW DU-ALL Garden Tractor

Another great time, labor and money-saver! For farms, truck gardens, nurseries, poultry ranches, estates, golf clubs, parks, etc. 1 to 8 ft. harrows, seeds, cultivates, harvests, mows; runs saws, pumps, feed grinders, etc. Briggs & Stratton Engine. Has gear shift: 3 speeds forward, and reverse. Coupon brings details. Reduced Price, Easy Payment Plan, 10-DAY TRIAL OFFER!



Costs 25 to 40 per hour for use.

2 sizes: 1 to 6 h. p.

## MAIL COUPON NOW!

SHAW MFG. CO., Dept. PM-1, Galesburg, Kans.

Gentlemen: Please send me at once the FREE literature checked below. Reduced Price, Easy Payment Plans and 10-DAY TRIAL OFFERS! No obligation on my part. I (am) (am not) interested in becoming your Agent.

Literature on Making Old Car into Tractor

Literature on SHAW DU-ALL Garden Tractor

"Truck Growers' Manual"

Name.....

Address.....

Town.....

State.....

When writing to advertisers please mention Popular Mechanics

## American Flyer Trains



### COMPARE!

## More Fun Features and Costs Less..

Mail coupon for big, colorful, free train book. Plan now to enjoy many years of fun and instructive play. This fascinating book shows you the new electric trains, as low as \$5.50, that *outpull* all others. Full brass trim—*Longest* and *heaviest* freight cars made—fun making automatic signals, stations, tunnels, bridges, etc.

In speed, size, realism in total number of pieces, you get more for your money when you buy an American Flyer. Get the catalog and compare.

**DADS, too, make railroading a hobby**



American Flyer Mfg. Co.,  
2250 S. Halsted St., Chicago.  
Send Free Train Book.

Name.....

Address.....

## American Flyer Trains



## You Can Print

Cards, stationery, circulars, tags, labels, advertising, etc. Make big profits spare or full time. **Do Your Own Printing.** Save Money. Easy rules sent. Will do popular Raised Printing like Engraving. Junior press \$5.00, 100 gross \$11.00, power \$149. Send for free catalog. The Kelsey Co., N-37, Meriden, Ct.

## New LONG AND SHORT WAVE RADIO

Complete with **CABINET,**  
**9 TUBES**  
**DYNAMIC SPEAKER**



only  
**\$79<sup>50</sup>**

Radio listeners are no longer satisfied with local reception. Short wave is the thing. They demand the thrill that come with distance—ships at sea, Australia, Germany, South America. Here is the newest thing in radio. One unit, broadcast band and short wave, in amazingly beautiful cabinet. No coils to change. Four-way switch regulates all. Guaranteed to bring in any station anywhere that can be brought in by any other radio regardless of cost and operated under same conditions. Everything complete for only \$79.50.

**Agents Wanted** This amazing radio sensation will make money for you fast if you write now. No competition at this price. The equal of any radio at any price. Exclusive territory to those who qualify. My company the largest of its kind. Write quick.

**P. H. WILCOX, Secretary** Surrey Court and Fairlawn  
Dept. 4 CHICAGO

When writing please mention Popular Mechanics

**FREE! FREE!**  
TIRE GAUGE

WITH EACH ORDER FOR 2 TIRES

NOW TAKE TIRE PRESSURE THROUGH SIDE WALL OF TIRE

**New LOW PRICES**  
ON GOOD YEAR  
GOODRICH-U.S.-FIRESTONE  
FISK AND OTHER TIRES

**LOWEST Prices on Earth!**

Thousands of satisfied tire users all over the U.S.A. will vouch for the LONG, HARD SERVICE, under severest road conditions of our standard brand tires reconstructed by the ORIGINAL SECRET YORK PROCESS. To introduce this genuine tire value to you, this big responsible company offers, ABSOLUTELY FREE a modern tire gauge with each 2 tires ordered—now take pressure through side wall of tire in a jiffy—no fuss—no dirt. OUR 16 YEARS IN BUSINESS makes it possible to offer tires at **LOWEST PRICES** in history. Guaranteed to give 12 months' service

**Don't Delay — Order Today**

CORD TIRES		BALLON TIRES	
Size	Tires Tubes	Size	Tires Tubes
30x8	\$2.20 \$1.00	28x4.40	\$2.30 \$1.10
30x9	2.25 1.00	28x4.50	2.40 1.15
32x3.50	2.70 1.10	30x4.50	2.45 1.20
31x4	2.95 1.15	30x4.75	2.45 1.20
32x4	2.95 1.15	30x4.75	2.45 1.20
32x4	2.95 1.15	30x4.95	2.90 1.25
34x4	3.50 1.15	30x5.00	2.95 1.25
32x4.50	3.20 1.40	30x5.00	2.95 1.25
32x4.50	3.20 1.40	30x5.00	2.95 1.25
34x4.75	3.45 1.40	30x5.25	2.95 1.25
30x5	3.60 1.75	31x5.25	3.10 1.35
32x5	3.60 1.75	30x5.75	3.20 1.40
30x5	4.45 1.75	30x6.00	3.20 1.40

All Other Sizes  
31x5.00 3.20 1.40  
32x5.00 3.20 1.40  
32x5.25 3.20 1.40  
32x5.50 3.50 1.60

**DEALERS WANTED**

Send only \$1.00 deposit with each tire ordered. We ship balance C. O. D. Deduct 5 percent if cash in full accompanies order.

**TUBES BRAND NEW — GUARANTEED**

Tires failing to give 12 months' service replaced at half price.

**YORK TIRE & RUBBER CO., Dept. 709-A**  
3855-59 Cottage Grove Ave. Chicago, Ill.

## AGENTS! SELLS LIKE WILD FIRE



\$380 monthly selling 10 improved patented Carter Window Washers daily. Cleans, dries, polishes. Eliminates all mud. Good Housekeeping approval. Restricted territory. Write today. CARTER PRODUCTS CORPORATION 995 Front Ave., Cleveland, O.

## GUARANTEED TO FLY 100 Ft. If Built Properly

A realistic, 19-in. r. o. g. model of the fast single-engine British Sopwith fighter. A steady flyer indoors or out. Set includes aluminum propeller, shaft, rubber band motor, streamlined wheels, compass, rudder, ailerons, etc. Full building and flying directions. No tools needed. Simplified construction—most easily built scale model on market. Can be built in 2 hrs. and will give more real satisfaction than expensive sets. Mailed in shatterproof container, postpaid in U. S. and Canada, only 30c. Order one or more now.

THE MIDLAND MODEL WORKS, Dept. 5, Chillicothe, Ohio  
(No stamps. No c. o. d.'s. No returns. Suitable for boys 14 or older.)

## WAX Floors Automatically

Pays Salesmen \$18 to \$39 Daily



Now! At last. End floor drudgery. Amazing new invention waxes floors automatically. Easy as if electrically. Cleans and polishes. No bending or stooping. Representatives are awarded with orders. Sell year round. Unlimited opportunity for the rest men. Send at once for complete information FREE, and New Low Prices. Special Offer to Agents, Dealers, and large jobbers. Write at once!

Sawyer-Weber Tool Mfg. Co.  
Dept. P, 1259 East 12 St. Des Moines, Iowa

**Ahoy Mates**—Learn how to build all steel superdreadnaughts and other ship models that float and run. Booklet free.

**THE MECCANO CO.** 513 Meccano Circle  
New Haven, Conn.

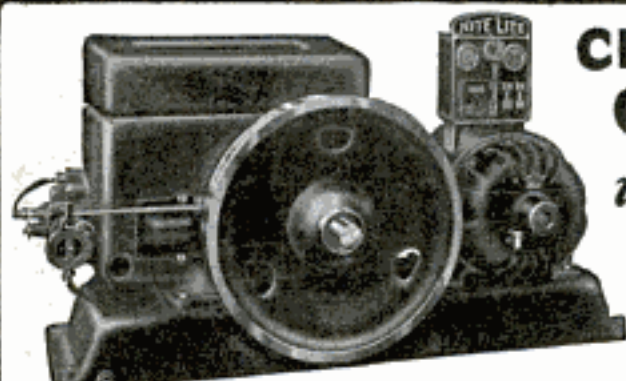
**DO YOU** WANT a new business profession of your own, with all the trade you can attend to? Then become a foot correctionist, and in a few weeks earn big income in service fees,—not medical nor chiropody—easy terms for home training, no further capital needed, no goods to buy, no agency. Established 1894. Address Stephenson Laboratory, 1 Back Bay, Boston, Mass.

**WITTE NITE-LITE****\$33****BRINGS ONE  
TO YOU****BALANCE EASY TERMS****CHASE THE  
GLOOM***with* **SUNSHINE'S ONLY RIVAL**

Switch on "Nite-Lite", let the brilliant glow spread to every corner of your home. Do away with the messy, dangerous, open flame oil lamps. Enjoy all the conveniences of city lights and current. Have an abundance of electric lights—use sweepers, washing machines, percolators, irons and other appliances.

**Send Today For Special Offer**

Let us place a WITTE "Nite-Lite" plant with you on such liberal terms that you'll never miss the money. Send today for further information and special offer.

**Complete Self-Contained Unit**

Here is a complete self-contained, self-starting unit consisting of the WITTE special electric light engine and Robbins & Meyers generator. Correctly designed by experienced engineers and furnishing either 32 or 110 volts D. C., direct to your lamps or through a large dependable battery.

**World's Lowest Prices**

Since 1870

**Buy Direct From Factory**210-L Carson St.  
PITTSBURGH, PA.**WITTE  
ENGINE WORKS**1741 Oakland Ave.  
KANSAS CITY, MO.**PORTABLE GAS ENGINE \$15**

$\frac{3}{4}$  H. P. portable 2 cycle engines with high tension magneto. \$15.00. Adaptable to washing machines and other uses. One Minute Manufacturing Company, Newton, Iowa

**Start the New Year right with a  
GERSTNER TOOL CHEST**

Machinists and Toolmakers, send for Free catalog. H. GERSTNER & SONS Dayton, Ohio  
401 Columbia St.

**DEAFNESS IS MISERY**

Many people with defective hearing and Head Noises enjoy conversation, go to Theatre and Church because they use Leonard Invisible Ear Drums which resemble Tiny Megaphones fitting in the Ear entirely out of sight. No wires, batteries or head piece. They are inexpensive. Write for booklet and sworn statement of the inventor, himself deaf.



A. O. LEONARD, Inc., Suite 699, 70 5th Ave., New York

**FOR PROFIT!**Premier Circular Saw  
**\$29.90**without  
motor and base

Build up a profitable business with home-shop equipped with Parks woodworkers. Many others have done it. Here is your opportunity.

The Parks  
Wood-  
Working  
Machine  
Co.**PARKS**  
WOODWORKING MACHINESSend  
today  
for  
descrip-  
tive  
circular

Dept. PM-1, 1530 Knowlton St.

Cincinnati, Ohio

**New Pocket Screw Driver**

Worth Its Weight in Gold When You Need It  
Fits on the Key Ring  
With Four Different Size Blades  
The Handiest Tool You Ever Saw

**15c** Postpaid

Wonderful Proposition for Agents

Gibson Good Tools, 168 Dartmouth St., Boston, U. S. A.

**AMERICAN METHOD  
Pays Big Profits****\$25.00**  
Per Day

Stop looking for a job. Get into business for yourself. No matter what sort of work you have been doing, you can quickly become independent mending floors using the American Method. Ask about this new and amazingly successful system. No obligation.

AMERICAN FLOOR SURFACING MACHINE CO.  
523 S. St. Clair St. Toledo, Ohio**NOW is the best time to  
ASSEMBLE YOUR BOAT**

YOU don't have to be a carpenter or a boat builder to build a Brooks Boat. Thousands of sportsmen and boating enthusiasts have successfully built

their own boats, using our ready-cut, semi-assembled materials. Brooks Boats are husky and rugged enough for rough camp life—beautiful enough to make your vacation a pleasurable one at the most fashionable summer resort. You can have the fastest, strongest, most attractive boat on the water and save  $\frac{3}{4}$  the builder's cost by assembling a Brooks Boat during your spare hours this winter. Our handsome catalog illustrating 38 cruiser, runabout, outboard, sail and rowboat designs sent anywhere for 10c. Address Dept. P-10.

**BROOKS BOAT COMPANY INC.**  
SAGINAW WEST SIDE, MICHIGAN

# PATENT

## Protect Your Ideas

### Take the First Step Today

If you have a useful, practical, novel idea for any new article or for an improvement on an old one, you should communicate with a competent Registered Patent Attorney AT ONCE. Every year thousands of applications for patents are filed in the U. S. Patent Office. Frequently two or more applications are made for the same or substantially the same idea (even though the inventors may live in different sections of the country and be entirely unknown to one another). In such a case, the burden of proof rests upon the last application filed. Delays of even a few days in filing the application sometimes mean the loss of a patent. So lose no time. Get in touch with me at once by mailing the coupon on the opposite page.

### Prompt, Careful, Efficient Service

This large, experienced organization devotes its entire time and attention to patent and trade mark cases. Our offices are directly across the street from the U. S. Patent Office. We understand the technicalities of patent law. We know the rules and requirements of the Patent Office. We can proceed in the quickest, safest and best ways in preparing an application for a patent covering your idea. Our success has been built on the strength of careful, efficient, satisfactory service to inventors and trademark owners located in every state in the Union.

### NO CHARGE for Information On How to Proceed

The booklet shown here contains valuable information relating to patent procedure that every inventor should have. And with it I will also send you my "Record of Invention" form on which you can sketch your idea and establish its date before a witness. Such evidence may later prove valuable to you. Simply mail the coupon and I will send you the booklet, and the "Record of Invention" form, together with detailed information on how to proceed and the costs involved. Do this NOW. No need to lose a minute's time. The coupon will bring you complete information entirely without charge or obligation.



My Offices  
Just Across  
Street From  
U.S. Pat. Office



Above is a view of my drafting and specification offices where a large staff of experienced experts is in my constant employ. All drawings and specifications are prepared in my offices.

# NEWS

*Inventors*  
*Write for these* **Free**  
**Books**

## Strict Secrecy Preserved

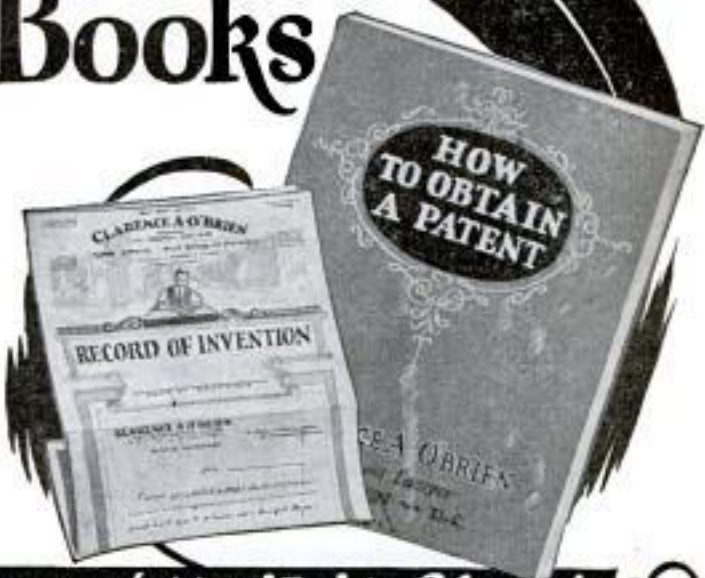
All communications, sketches, drawings, etc., are held in strictest confidence in strong, steel, fireproof files, which are accessible only to authorized members of my staff. Feel free to write me fully and frankly. It is probable that I can help you. Highest references. But **FIRST**—clip the coupon and get my free book. Do **THAT** right now.

## Clarence A. O'Brien

*Registered Patent Attorney*

Member of the Bar of: The Supreme Court of the United States, U. S. Court of Customs and Patent Appeals, U. S. Court of Claims, Court of Appeals, District of Columbia and Supreme Court of the District of Columbia.

Practice confined exclusively to Patents, Trademarks and Copyrights



**Clip this Coupon and Mail it Now!**

**CLARENCE A. O'BRIEN, Registered Patent Attorney**  
70-S Security Savings and Commercial Bank Bldg.  
Washington, D. C.

(Or, Suite 1106, Dept. A-19, Woolworth Bldg., New York City)

Please send me your free book, "How to Obtain a Patent," and your "Record of Invention" form without any cost or obligation on my part.

Name.....

Address.....

(Important—Write or print name plainly and address office nearest you)

When writing to advertisers please mention Popular Mechanics

# PATENTS SECURED TRADE-MARKS REGISTERED

High-class professional service for Inventors and Trade-Mark Users is necessary for PROPER PROTECTION. We Offer you our facilities on Reasonable Terms. If you have an invention send us a model or sketch and description and we will give you our OPINION whether your invention comes within the provisions of the Patent Laws. Our book, "HOW TO GET YOUR PATENT" and Record of Invention Certificate sent on request. DELAYS are DANGEROUS in Patent Matters.

Terms Reasonable.

Best References.

WRITE TODAY

**RANDOLPH & COMPANY, Patent Attorneys**  
301 VICTOR BUILDING, WASHINGTON, D. C.

Name.....

Address.....

## PATENTS

A personal confidential service for serious-minded inventors, having worth-while practical ideas. Patents—Trade Marks—Designing & Drafting Working Models—Automatic Labor-Saving Machinery. Manufacturing (small and large quantities). Preparation and prosecution of patent applications, trade marks, etc. Complete facilities for inventors to develop, perfect or to patent their inventions.



**FACILITIES**—10 engineers, draftsmen and patent experts, 50 mechanics and supervisory staff. All or any part of the above service is available. Complete service for those desiring it. **Send for free book**

**D. M. HELLER**  
Registered Patent Attorney  
Consulting Engineer

31 East 17th St. New York, N. Y.

## PATENTS

### PROTECT YOUR IDEAS

Write today for FREE BOOKLET, HOW TO OBTAIN A PATENT and RECORD OF INVENTION—or send Drawing or Model of your Invention for Examination.

Promptness Assured with Best Results

## MILLER & MILLER

REGISTERED PATENT ATTORNEYS

Former Members Examining Corps U. S. Patent Office  
Dept. A-1006 Woolworth Bldg. New York  
672 Earle Building Washington, D. C.

## PATENTS

### TO THE MAN WITH AN IDEA

Preliminary advice gladly furnished without charge. Booklet of information and form for disclosing idea free on request.

**IRVING L. McCATHRAN, Patent Lawyer**  
Formerly with and successor to RICHARD B. OWEN  
750 International Bldg. Washington, D. C.  
41-E Park Row New York City

TRADE-MARKS

## PATENTS—TRADE MARKS

All cases submitted given personal attention by members of the firm. Information and booklet free. Patent Office and Federal Court Practice.

**LANCASTER, ALLWINE & ROMMEL**  
PATENT LAW OFFICES  
Suite 412, 815 15th St., N. W. Washington, D. C.

## INVENTORS

who derive largest profits know and heed certain simple but vital facts before applying for Patents. Our book *Patent-Sense* gives those facts; sent free. Write LACEY & LACEY, 615 F Street N. W., Dept. 5, Washington, D. C. Estab. 1869.



### BOW LEGS?

THIS GARTER (Pat'd) Makes Trousers Hang Straight If Legs Bend In or Out

Free Booklet—Plain Sealed Envelope  
**THE T. GARTER CO., Dept. E**  
South Bend, Ind.



### BUCHSTEIN'S FIBRE LIMB

is soothing to your stump—strong, cool, neat, light. Easy payments. Grace for all deformities.  
**D. BUCHSTEIN CO.**  
620 3rd Ave., So. MINNEAPOLIS, MINN.

Send for Catalog Today

## PATENTS

Booklet Free Highest References  
Promptness Assured Best Results

Send drawing or model.

### ALL BUSINESS GIVEN PROMPT AND PROPER ATTENTION

Listed Patent Lawyer in the latest editions of the Rand-McNally Directory of Bankers and Bank-Recommended Attorneys, published by Rand-McNally & Co., Chicago, Ill.; The Baggott & Ryall Directory of Guaranteed Attorneys, published by Legal Directory Corporation, Boston, Mass.; Flugel's Law List, published by Legal Directory Publishing Co., St. Louis, Mo.; American Lawyers Annual, published in Cleveland, Ohio; Bankers Service Legal Directory, published by Bankers Service Co., Boston, Mass.; Eyre's Law List, 9 Park Place, New York City; Walters Legal Directory, Omaha, Nebraska, and the National Directory of Attorneys, Baltimore, Maryland.

**WATSON E. COLEMAN,**  
REGISTERED PATENT LAWYER

Victor Building, 724 Ninth Street, N. W.  
**WASHINGTON, D. C.**

When writing to advertisers please mention Popular Mechanics

Copyrighted material

# Delays May Be Costly PATENT Your Idea Now

## Don't lose time - Send for Big FREE BOOK



**FREE VALUABLE RECORD  
OF INVENTION BLANK**

Mail the coupon today, and in addition to the free book, we'll send you without charge a Record of Invention Blank. This form, when properly filled out may be of value to you as evidence should occasion require it. There is no charge or obligation for this service. Mail the coupon NOW.

### Little Ideas May Have Big Commercial Possibilities

**ACT AT ONCE**—and protect your idea. Remember, to get the benefits of your invention, you not only have to invent it—you have to PATENT it. Many men spend years perfecting an invention, only to find that someone else thinking along the same lines has already received a patent on the idea. When we think of all such cases that have come under our personal observation, we cannot urge too strongly that you take steps to protect your idea IMMEDIATELY. Delays of only a few days may be vitally important to you. Do not lose all the benefits of your hard work in planning and perfecting your invention.

### Mail the Coupon for FREE Book Today

It is of tremendous importance that you file your application for a patent at once. Our free book tells you HOW to take the first steps, what you need to know about patents in general and gives you an estimate of our reasonable fees. We also send you a "Record of Invention Blank" FREE. Take the first step toward getting your patent NOW. Mail coupon at once.

### Highest References - Strictest Secrecy

#### 33 Years of Proven Service

Victor J. Evans & Company are registered Patent Attorneys, practicing before the U. S. Patent Office and Federal Courts. We handle only patent and trademark matters, thus giving you the benefit of specialized experience. In our 33 years of practice, we have successfully served thousands of inventors. It is a distinct advantage to an inventor to employ an attorney located in Washington, as the U. S. Patent Office has no branches.

### Here's How We Operate

As soon as the description of your invention comes into our office, it is immediately put in charge of an attorney, who is particularly familiar with the kind of invention you have perfected. Under his close personal supervision, patent searchers and skilled draftsmen work. He personally sees your case through to its conclusion. In short, you have the advantage of highly skilled and experienced service.

### Here's What the Coupon Brings

#### Mail It Now

Mail the coupon today and take the first step toward protecting your idea. You will receive the FREE Book, a FREE Record of Invention Blank, and information on our fees. You create no obligation by mailing this coupon. As soon as we receive the "Record of Invention" (described at the left) we will give our opinion as to whether the invention comes within the Patent Office definition of a "Patentable Invention." Our service is complete, our fees reasonable, and our terms convenient. Don't waste priceless time; mail the coupon NOW.

**MAIL  
THIS  
TODAY**



## VICTOR J. EVANS & CO.

Established 1898

### REGISTERED PATENT ATTORNEYS

MAIN OFFICE, 600A Victor Building, Washington, D. C.

BRANCH OFFICES: 1640 "A" Conway Building, Chicago; 1007 "A" Woolworth Building, New York; 828 "A" Fidelity Philadelphia Trust Building, Philadelphia; 514 "A" Empire Building, Pittsburgh; 1010 "A" Hobart Building, San Francisco.

Please send me your free book, "How to Obtain a Patent," and your "Record of Invention Blank."

Name.....

Street and No.....

City.....State.....

When writing to advertisers please mention Popular Mechanics



## LUMINOUS PAINT

**Make Your Watches, Clocks, Etc., Visible by Night**

The very latest discovery in the scientific world, practically unknown heretofore, is the remarkable LUMINOUS PAINT, which, applied to the surface of any article, emits rays of white light, rendering it perfectly visible in the dark. THE DARKER THE NIGHT, THE MORE BRILLIANT IT SHINES. Quite simple to use. Anyone—you can do it. A little applied to the dial of your watch or clock will enable you to tell the time by night. You can coat the push buttons or switch plates of your electric lights, match boxes, and innumerable other articles; make your own Luminous Candles, Luminous Rosaries, etc. Small bottle, price 25c. Larger size, 50c and \$1 postpaid. JOHNSON SMITH & CO., Dept. 822 RACINE, WIS.

**ONLY 10c Per Pair**



### Fighting Roosters

With very little practice you can make these miniature models of Game Roosters imitate in the most life-like manner the evolutions of a FIERCE COCK-FIGHTING. Endless amusement. Well made, with real feathers.



### GOOD LUCK RING

Very striking, quiet and unobtrusive. Never fails; will ward off crookedness, death, two brilliant, sparkling gemstones, sparkle out of the eyes. Said to bring good luck. Only 25c postpaid.



### Exploding Cigarettes

Box contains ten genuine cigarettes of excellent quality. They appear so real, but when each cigarette is about one-third smoked, the victim gets a very great surprise as it goes off with a loud BANG! A great mischief provoker yet entirely harmless. Price 25c box.

## NOVELTY BADGES



Kissed Permit 10c Garter Inspector 10c Two very novel metal badges, nickel plated, that you can wear, giving you fun out of all proportion to their trifling cost. 10c, each badge, 3 for 25c, or 75c per doz. postpaid anywhere.

## MIDGET BIBLE

**GREAT CURIOSITY** Smallest Bible in the World. Size of a postage stamp. 250 Pages. Said to bring good luck to the owner. A genuine work of art. Must be seen to be appreciated. Make good money selling them to friends, church acquaintances, etc. PRICE 15c each, 3 for 40c, 12 for \$1.25, 100 for \$7.50. Also obtainable in Leather Binding, with gold edges. Price \$5c each, 3 for \$1.25, \$4.50 per doz. Magnifying Glass for use with Midget Bible 15c

## STAGE MONEY

With a bunch of these bills, it is easy for each person of limited means to appear prosperous by flashing a roll of these bills at the proper time and peeling off a genuine bill or two from the outside of the roll, the effect created will be found to be all that can be desired. Prices, postpaid: 40 Bills 25c, 120 for 50c, or 53.50 thousand postpaid.

## NOSE FLUTE

The Magic Nose Flute, or Hummer, is a unique and novel musical instrument that is played with nose and mouth combined. There is just a little knack in playing it which, when once acquired after a little practice, will enable you to produce very sweet music that somewhat resembles a flute. No fingering, cane muzzling, you can play all kinds of music with facility and ease.

## JOHNSON SMITH & CO.

Dept. 822

RACINE, WIS.

A De Luxe Edition of our new CATALOG mailed on receipt of 25c. Handsome binding. Bigger and better than ever. Only book of its kind in existence. Nearly 600 pages of all the latest tricks in magic, the newest novelties, puzzles, games, sporting goods, rubber stamps, unusual and interesting books, curiosities in seeds and plants, etc., procurable elsewhere. Remit by Cash, Money Order, Check or unused U. S., Canadian and Foreign Stamps for all articles listed above.

We also publish a large 750 page catalog of gift goods, diamonds, watches, jewelry, furniture, high grade furniture, etc. Considered the finest catalog ever put out. The art work and color pages are superb and unsurpassable. To eliminate the merely curious we are compelled to ask for a deposit of \$1.00, which is less than one fifth the actual cost of the book. This deposit may be deducted from any subsequent order for merchandise selected from this catalog.

## BLANK CARTRIDGE PISTOL

Protection against Burglars, Thieves, & Dogs' Special Offer

1 Blank Cartridge Pistol  
100 Blank Cartridges  
1 650-page Novelty Catalog  
**ONLY \$1.50**  
The Lot Shipped by Express Only Cash With Order Only



Well made and effective, modelled on latest type of Revolvers; appearance alone is enough to scare a burglar. When loaded it may be as effective as a real revolver without danger to life. It takes standard .22 Cal. Blank Cartridge - obtainable everywhere. Special cash with order offer: 1 Superior quality Blank Cartridge Pistol, 100 Blank Cartridges, and our new 650 page De Luxe Catalog of latest novelties; all for ONLY \$1.50. Shipped by Express only. Cannot go by parcel post. Extra Blank Cartridges 50c per 100. Special Holster (Cowboy Type) for pistol 50c. No C. O. D. shipments.

**THE BUDDY PHONE**

A Real Telephone. Works Indoors or Outdoors. 100 ft. or 1000 ft. Though this is merely a very clever toy, it is quite as serviceable for short distances as the most elaborate apparatus made and it is much less liable to get out of order or to need adjustment; in fact it cannot be rendered inefficient unless roughly handled. No troublesome battery, no intricate "hook-up." Can be put to practical use from one room to another, up or down stairs, around corners, etc. The patented sounding disc transmits and receives the voice perfectly, making it a really practical talking telephone. Set consists of two phones, transmitter cord and full instructions. PRICE ONLY 65c per set postpaid. JOHNSON SMITH & CO.

## LOOK 35c LOOK Wonderful instrument.

Greatest thing yet. Nine separate articles in one. Everybody delighted with it. Odd, Curious and Interesting. Lots of pleasure as well as very useful. It is a double Microscope for examining the wonders of nature. It is also an Opera Glass, a Stereoscope, a Burning Lens, a Reading Glass, a Telescope, a Compass, a pocket Mirror, and a Laryngoscope—for examining eye, ear, nose and throat. It is worth all the cost to locate even one painful cinder in the eye. Folds flat and fits the pocket. Something great—you need one. Don't miss it. Sent by mail. Only 35c or 3 for \$1.00.

## PISTOL CIGARETTE CASE

It looks like a deadly weapon, but it is merely a novel Cigarette Case. This clever contrivance has proved itself better than the real thing in many an awkward encounter. Great fun "sticking up" your friends. They squirm and protest it might be loaded. Pull the trigger and the slide flies open disclosing the cigarettes. Well made, light and compact. Weight only 2 ounces.

PRICE POSTPAID 25c

## DANDY PERISCOPE

A VERY INTERESTING AND AMUSING NOVELTY

SEE WITHOUT BEING SEEN

Look Over the Heads of the Tallest Men in a Crowd. SEE OVER A FENCE, AROUND CORNERS, Etc.

This is the same kind of instrument that the soldiers use in the trenches to watch the enemy without risk of being seen themselves, and every submarine has one to project above the surface of the sea to keep a look-out for other vessels, etc. With it you can gaze over a high wall or see around a corner without being seen yourself, or, if you are in a crowd, you can look right over the heads of the tallest men and watch all the fun. Our illustrations will give you some idea as to the numerous uses to which the Periscope can be put. Every Boy Scout should have one for spying and spying, also who wants some rare amusement. The Dandy Periscope is very strongly made, withstands the roughest handling and the hardest wear, and with ordinary use should last a lifetime. It measures 17 inches long, and a little over two inches wide. The Periscope Tube is handsomely decorated with colored designs to show many of its uses.

Price Postpaid to any Address. \$1.00

JOHNSON SMITH & CO., Dept. 822, RACINE, WIS.





# BOYS! BOYS! BOYS! Throw Your Voice

Into a trunk, under the bed, under a table, back of the door, into a desk at school, or anywhere. You get lots of fun fooling the teacher, policemen, peddlers, and surprise and fool all your friends besides.

## THE VENTRILO

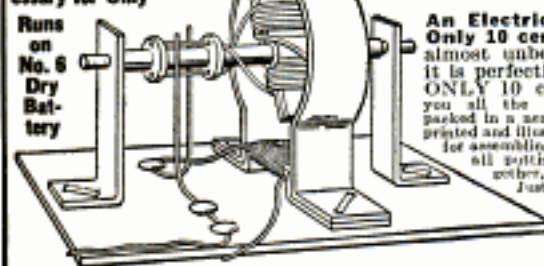
is a little instrument that fits in the mouth out of sight. Cannot be detected. It is used in connection with the above, and with the aid of this wonderful DOUBLE

**THROAT**, or **VENTRILO**, you can imitate many kinds of birds, animals, etc. Remember you get everything for **ONLY TEN CENTS**—a booklet giving you full instructions how to become a ventriloquist and throw your voice, the **Double Throat**, or **Ventrilo**, and our big page catalog of novelties, tricks, puzzles, jokes, books, etc., **ALL SENT POSTPAID TO ANY ADDRESS FOR ONLY 10 cents**



Johnson  
Smith & Co.

All Parts Necessary for Only **10c**



### ELECTRIC MOTOR

An Electric Motor for Only 10 cents. Sounds almost unbelievable but it is perfectly true. For ONLY 10 cents we send you all the parts necessary packed in a neat box, with full printed and illustrated directions for assembling. No trouble at all putting the parts together, in fact it is FUN. Just follow a few simple instructions and in a few minutes the motor is ready to run.

#### AN EDUCATIONAL NOVELTY

OH BOY! Isn't it speedy. Runs on a No. 6 or similar dry battery. It is an education in itself just putting it together, and you can perform many novel and interesting experiments with it. Remember the price—**ONLY 10 cents**—nothing more to pay—nothing more to buy.

### U. S. BABY TANK

25  
Cents

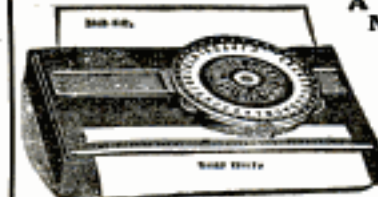


It goes with real Yankee  
Pop—by its own power

Most remarkable toy ever invented. By drawing the Tank backward, either with the hand or over the floor or table and then placing it down, it will crawl along, overcoming all obstacles, in the same life-like manner as the larger Tank that proved so deadly in the great war. What makes it go is somewhat of a mystery, for there is no mechanism to wind up so it is really understood with mechanical toys, yet this tank will keep plodding along ten times longer than the ordinary run of toys. It will perform dozens of the most wonderful stunts, 2 1/4 inches long. Price only 25c prepaid. Stamps accepted. JOHNSON SMITH & CO., Dept. 622 Racine

### The "Little Giant" Typewriter

A First Class Writing  
Machine For \$1.50



A perfect little typewriter for \$1.50. There are thousands of persons who would like to use a typewriter but whose needs and business do not warrant the expense attached to the purchase and use of a fifty or seventy-five dollar machine. To such persons we confidently recommend our Little Giant. It is strongly made, but simple in construction, so that anyone can quickly learn to operate it, and write as rapidly as they would with pen and ink. The letters of the alphabet most frequently used are so grouped as to enable one to write rapidly, the numerals 1 to 10, and the punctuation marks being together. With this machine you can send your best girl typewritten love letters, address envelopes, make out bills, and do almost any kind of work not requiring a large, expensive machine. Price complete \$1.50 by mail postpaid to any address in the world. Stamps accepted.



### RAPID CIGARETTE MAKER

ROLL YOUR OWN SAVE MONEY

With this AUTOMATIC CIGARETTE MAKER you can make your own cigarettes from your favorite brand of tobacco and save money besides. It takes but a few seconds. Better cigarettes at about one fourth the cost. Simplicity itself to use. It is neat, useful and handy. Pocket size, weighs but half an ounce. Case is made entirely of metal, nickel plated. Full printed instructions with each Cigarette Maker. Pays for itself in no time at all. **PRICE ONLY 25 CENTS POSTPAID.** 3 for 65 cents; or 1 dozen for \$2.25 postpaid

Send remittance (Postage Stamps accepted) for all articles listed above, also in our other ad on previous page

JOHNSON SMITH & CO. Dept. 622 Racine, Wis.

### MAGICIAN'S BOX OF TRICKS

Apparatus and Directions for a Number of Mysterious Tricks, Enough for an Entire Evening's Entertainment..... \$1.00

ANYONE CAN DO THEM

It is great fun mystifying your friends. Get this Magician's Cabinet, and you will be the cleverest fellow in your district. It contains the apparatus for ten first-class tricks, including THE MAGIC BALL AND VASE TRICK (a wooden ball is placed inside, and upon replacing the lid has disappeared and is found in someone else's pocket); THE HINDOO TRICK CARDS (can be made to change completely in less than five minutes); DISAPPEARING COIN BOX (a coin, placed in the wooden box, vanishes entirely or changes into a coin of another denomination); THE GLASS GLOBULE TRICK (a coin is dropped into a glass of water and when the water is poured out the coin has vanished and is found somewhere else); THE RIBBON FACTORY FROM THE MOUTH TRICK (a seemingly endless supply of colored paper ribbons comes out of your mouth); THE DISAPPEARING HANDKERCHIEF (handkerchief held in the hand mysteriously vanishes); THE WIZARD'S RING COIN TRICK; the ENCHANTED BOTTLE (no one but yourself is able to make it lay down); the GREAT HAT AND DICE TRICK (a large dice is placed on top of a hat, disappears, and is found underneath yet no one has touched the hat), and last, but not least, the GREAT PHANTOM CARD TRICK, or two from five leaves nothing. Full instructions are sent for performing each trick. In addition to the above, a number of other feats and illusions are fully explained for which you can easily make or procure the necessary apparatus. Price complete \$1.00 postpaid. JOHNSON SMITH & CO.



### RESURRECTION PLANT

Great curiosity. Place in water, plant opens

up and starts to grow in few minutes. Taken out it dries up and goes to sleep until put in water again. PRICE 10c, 3 for 25c. 75c per dozen, postpaid



### MAGIC MADE EASY



### 250 MAGIC TRICKS 10c

For Parlor or Stage

An excellent little book containing nearly 200 Tricks for parlor or stage. Tricks with cards, coins, handkerchiefs, eggs, rings, glasses, flowers, thimbles, spoons, bottles, string. Explains the mystery of the floating load and points of focus of magnets. Also Second Sight, Shadowgraphy, etc. So simple a child can perform them. Profusely illustrated. Sent postpaid for **ONLY 10c., 3 copies for 25c.**

125 CARD TRICKS and sleight of hand. Contains all the latest and best card tricks as performed by celebrated magicians, with exposure of card tricks used by professional gamblers. Price 25c postpaid. JOHNSON SMITH & CO., Dept. 622, Racine, Wis.

## TO STOP LEAKS IN HEATING SYSTEMS

**L**EAKS in steam or hot-water boilers, radiators and pipes in hot air furnaces and ducts, at cracks in ovens and smoke pipes are so easily repaired with Smooth-On No. 1 that you can do as good a job as a professional fixer, and keep practically the whole repair expense in your own pocket.

Smooth-On No. 1 metallizes in hardening, holds in iron, steel, brass or copper and makes a perfect seal against leakage of steam, hot or cold water, hot fumes, gas, gasoline or oil. Engineers in big power plants have used it for 30 years in mending cracks and breaks and in stopping leaks at threaded, flanged and pressed joints.

As an anchoring material, Smooth-On No. 1 also affords a quick, easy, cheap and dependable means of tightening loose handles, resetting stripped screws in metal, masonry or wood, fastening loose casters, loose metal post ends in concrete, etc. Use it on your car to mend a leaky radiator, cracked water jackets, leaky hose, exhaust or heater connections, to fasten loose hub caps, lubricator inlets, loose nuts and stripped wood screws.

Home, car and shop owners find profitable uses for Smooth-On No. 1 every month in the year, and save from 50 cents to

many dollars on every application. By keeping a can of Smooth-On No. 1 in your repair kit and following the simple directions in the Smooth-On Instruction Book, you can make many emergency and routine repairs the instant trouble shows up and almost without cost.

Get Smooth-On No. 1 in 7-oz., 1-lb. or 5-lb. tins at any hardware store or if necessary direct from us.



Boiler Crack



Radiator Leaks



Cracked Fire Pot



Cracked Ovens



Stove Pipe Leak

### HOME & AUTO REPAIRS



WITH  
**SMOOTH-ON**

Write for  
**FREE BOOK**



**Do it with SMOOTH-ON**

SMOOTH-ON MFG. CO., Dept. 37,  
574 Communipaw Ave., Jersey City, N. J.

Please send the free Smooth-On Repair Book.

Name.....

Address.....

1-32.....

When writing please mention Popular Mechanics



**BE A  
WAGON-MAN..**  
*We Furnish the Capital*

A great, responsible, successful, 40-year-old company now makes this surprising offer to honest men. Invest no capital! Let us start you in this permanent business that YOU own and control for yourself. Become the authorized McConnon Dealer and handle the complete McConnon line—no red tape and no division of line. We finance you. You extend credit to your own friends and customers when you please. Only a certain number of these "no-investment" propositions are open. Each one offers a good living with a chance to put some money in the bank every week. Honest, steady men who write promptly are assured of first consideration. Write today and ask for "no-investment" offer. Address The House of Friendly Service, McConnon & Company, Desk D-6601, Winona, Minn.

**INCREASE YOUR BUSINESS** by using the NEW \$5.85 "Two-Faced" Film Duplicator to make 100 copies, in 1 to 5 Colors each time. Or the \$37.05 "Excellograph" Rotary Stencil Duplicator to Print Copies of Anything Typed, Panned, Drawn or Traced in numbers up to 3000 each operation, as Price Lists, Hand Bills, Special Sales Announcements, Bulletins, Menus, Quotations, or "what have you?" Write—

Easy Terms

**PITTSBURGH TYPEWRITER & SUPPLY CO.**  
Suite 552, 339 Fifth Avenue, Pittsburgh, Pa.

**DON'T CHOKE ME  
JUST GIVE ME A HOT SHOT**

HOT SHOT, amazing new electrical wizard starts cars, trucks, tractors without choke. Saves gas, oil. More speed. Sparks BLUE if ignition O.K., —RED if faulty. "\$25 a day easy," says Ben Akeman. "Rush 500" wires Klint. Gold mine for agents. FREE Sample Offer. Act QUICK. REARDON MFG. CO., Dept. F-1, Peoria, Ill.

## BASHFUL?

"Shame on you!" Are you nervous, embarrassed in company of the other sex? Stop being shy of strangers. Conquer the terrible fear of your superiors. Be cheerful and confident of your future! Your faults easily overcome as you can enjoy life to the fullest. Send 25c for this amazing book, RICHARD BLACKSTONE, 8-471, PLATIRON BLDG., N. Y. C.

### FOR FIXIT SHOPS



FREE FOTO GUIDE and Vacuum Cleaner Parts Catalog. Most complete ever published. Lists over 800 items and special tools. 32 pages. Illustrated. Standard material at lowest cost. Valuable source data on obsolete parts. Big help to all repair shops.

### WASHING MACHINE PARTS

Combined washer, vac, and small motor servicing attracts trade and reduces operating expense. We can supply most replacement parts. Uniformity to highest standards guaranteed. Lowest known prices with saving on transportation and trouble. Consolidated orders earn maximum discounts. Instructive catalog free.

**Uron Associated Industries**

1225 W. 6th St.

Cleveland, Ohio

**OTTAWA LOG SAW**  
*only* **39**  
**GREATEST OFFER**  
 EVER MADE  
**Make Money!** Wood is valuable. Saw 15 to 20 cords a day. Does more than 10 men. Ottawa easily operated by man or boy. Falls trees—saws limbs. Use 4-hp. engine for other work. **30 DAYS TRIAL.** Write today for **FREE** book. Shipped from factory or nearest of 4 branch houses.  
**OTTAWA MFG. CO., 1741-W Wood Street, Ottawa, Kansas**

**RUNNING A REGAL**  
 Instructions for the Operation and Maintenance of a LeBlond Regal Geared Engine Lathe



A valuable guide to the beginner. Tells in simple language how to operate any modern geared head engine lathe.

It will tell you how to inspect a lathe, set it in position, describes various units and their purposes, equipment and attachments, the modern gear shift method of changing speeds and feeds, elimination of chatter, tables of measurement, operation chart, and a wealth of information on how to get the best results with this modern precision tool.

This book is backed by 40 years' experience in building lathes for the most progressive industrial shops of the nation. Sells for only twenty-five cents. Mail the coupon.

**The R. K. LeBlond Machine Tool Co.**  
 Cincinnati, Ohio



*Experience the pleasure of making things*

THE R. K. LEBLOND MACHINE TOOL CO.,  
 109 Regal Division, Cincinnati, Ohio.  
 Enclosing 25 cents for copy of "Running a Regal."  
 ( ) Send free illustrated catalog.

Name .....

Address .....

City ....., State .....

When writing please mention Popular Mechanics

## ALUMINUM SOLDER

You can now solder Aluminum, sheet or cast, as easily as tin. Solder Brass, Copper, etc., to Aluminum. Introductory offer \$3.00 size sent postpaid for \$1.50, **MONEY BACK GUARANTEE.** Manufacturers and repairmen demand it! State Distributors Wanted. Pays Big Profits. Write Dept. P-1.

**AMERICAN SOLDERS COMPANY**  
 3534 Sunset Blvd. Los Angeles, Cal.

## BURN YOUR NAME ON TOOLS

**WITH THE ARKOGRAF**  
**PROTECT YOUR TOOLS FROM THEFT**  
 Write with electricity any name or design on the hardest and finest tools and instruments, or any metal, like writing on paper with pen or pencil. **Complete Outfit \$3.50**—Prepaid Airbrush Interlocking illustrated circular free. Write today. Agents wanted.  
**ARKOGRAF PEN CO., 1171 E. Stark St., Portland, Oregon**

## A. C. Electric Plants



ONAN A. C. PLANTS furnish the same current as city service—110 volt, 60 cycle, A. C. Operate Radios, Water Systems, Refrigerators, all Household Appliances.

Sizes 500 to 1800 Watts Available from stock. No battery used except to start the engine. Ideal for farms, camps and lake homes.

Also a complete line of D. C. Models.  
**D. W. ONAN & SONS**  
 93 Royalston Ave. Minneapolis, Minn.

## Earn Extra Income at Home

Now in spare hours at home you can do expert woodworking, make trellis, tables, chairs, book ends, etc. Big demand. New H & A Unit Plan Craftshop gets you started at lowest cost. Five units with one quick change motor. SAVES PRICE OF FOUR MOTORS. Buy one unit at a time or all at once. Easy to learn. Pleasant work. Joiner (illustrated) helps you turn out perfect work—planting, joining, bevelling, rabbeting. Ideal for home or commercial shop. Write today. **NEW FREE Catalog.**



**H & A Joiner** SAVES PRICE OF FOUR MOTORS. Buy one unit at a time or all at once. Easy to learn. Pleasant work. Joiner (illustrated) helps you turn out perfect work—planting, joining, bevelling, rabbeting. Ideal for home or commercial shop. Write today. **NEW FREE Catalog.**  
**HESTON & ANDERSON, 601 Park Avenue, Fairfield, Iowa**

## FREE—This 1932 Pin Catalog



SHOWS HUNDREDS SCHOOL CLASS, PLUS SOCIETY PINS, RINGS, MEDALS, ETC. SHAPED BY 1932 DESIGN. COMPLETE LINE PIN SHOWN, SILVER PLATE 25c EA OR \$3.50 DOZ. STERLING SILVER OR GOLD PLATE 80c EA OR \$5.00 DOZ. 1 OR 2 COLORS ENAMEL AND NAME.



BASTIAN BROS. CO., 18 BASTIAN BLDG., ROCHESTER, N. Y.

## AIR MOTOR—3 cylinder

Complete knock-down kit, Model C, \$1.25  
 Assembled motor \$2.95. Knock-down air tank kit \$1.95. Finished air tank \$4.95. Catalogue and one model plane plan 10 cents. Dealers write for discounts.  
**MODEL AVIATOR PRODUCTS, Dept. 71**  
 3325 Eastwood Avenue CHICAGO



## GEARS

**In Stock—Immediate Delivery**

Gears, speed reducers, sprockets, thrust bearings, stubble couplings, pulleys, etc. A complete line is carried in our Chicago stock. Can also quote on special gears of any kind. Send us your blue prints and inquiries.

Write for Catalog No. 10  
**CHICAGO GEAR WORKS**  
 769-773 W. Jackson Blvd., CHICAGO, ILL.

## New Kind of Fuse Plug "6-in-1"



New, Improved, Patented  
6-in-1 Fuse Plug  
Approved by

**Underwriters' Laboratories**

Amazing invention bringing fortunes to agents. Our men are making money hand over fist selling 6-in-1 Fuse Plugs direct to users and at wholesale. Biggest repeater you ever saw. Every demonstration means a sale.

### Most Necessary Invention in Years

Think of it! Six fuses in one plug! When one fuse blows out, "a turn to the right brings back the light." Necessity in every home, store, factory—in fact, every place that uses electric power. Small towns, large cities, rural communities, farm homes—the market is everywhere.

### FREE Demonstrator

Fascinating demonstration astonishes everyone. Proves necessity of the 6-in-1 Fuse Plug. Outfit given free to agents. **WRITE** at once and start making money. Send 25c for a sample 6-in-1 Fuse Plug and complete proposition.

**6-in-1 Fuse Co., Inc.**  
Dept. 153, 801 W. Madison, Chicago, Ill.

A TURN TO THE RIGHT  
BRINGS BACK THE LIGHT

**\$500  
to \$1000  
a Month**

Actual earnings of many 6-in-1 agents. Orders come thick and fast. You, too, can make big money.

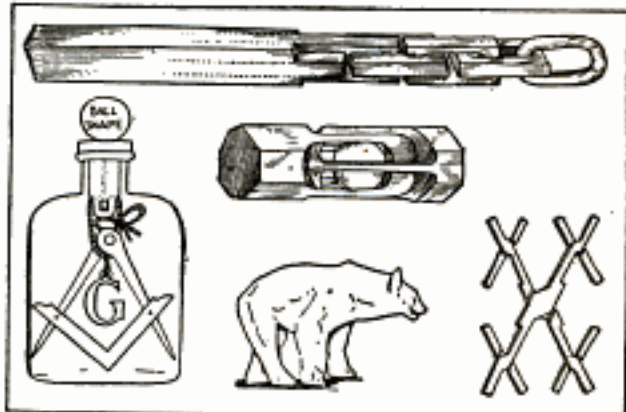
### AGENTS Distributors

Territory still available for exclusive distributors. Small capital starts you. The business pays for itself out of profits. Don't delay!

**ACT NOW!**

## CASH PRIZES for WHITTILING

SEE PAGES 7 AND 8 OF THE EDITORIAL SECTION OF THIS MAGAZINE



Popular Mechanics readers who contemplate entering the whittling contest announced in this issue will be interested in a book, "The Art of Whittling," by Walter A. Faurot. The author's twenty years of collecting ideas and making every queer thing that can be made out of wood with a knife, are embodied in it. The directions cover the making of a great variety of articles including puzzles, chains, cage and ball, interlocked hearts, ring and dumb-bell, etc. Each article is illustrated. It is the only book on the subject. Cloth; 18 Chapters; Size, 5 1/2 x 8 in. Many illustrations.

Price \$1.35 postpaid.

**POPULAR MECHANICS PRESS**  
Room P. 1 200 E. Ontario St., CHICAGO

## MOTORCYCLES



### Wonderful Bargains

Small Deposit—Liberal Terms  
Indians Harley-Davidsons  
Ace and Henderson

Send 10 cents for Bulletin A.  
Motorcycles shipped to all parts of the world

**WALKER-INDIAN CO., 1311 Boylston St., Boston, Mass.**

The Old Reliable Credit Jewelers **LOFTIS** BROS. & CO. 1858 Dept. H-894 30 No. State St. Chicago, Ill.

Send for FREE Catalog  
2,000 Illustrations  
QUALITY CHRISTMAS GIFTS  
GENUINE  
**Diamonds**  
GUARANTEED

Our sparkling blue-white diamonds of amazing beauty, set in artistic Solid 18-k White Gold mountings (except No. 907, which is 14-k Green Gold). Credit Terms: Pay one-tenth down; balance weekly, semi-monthly, or monthly at your convenience.



No. 979  
Waltham Strap Watch—splendid value, 15 jewels, \$35.00. \$3.50 Down; \$3.50 a Mo.

"Miss America"  
No. 962. Dust proof Bolova case, 16 jewels. Watch and bracelet set with 6 synthetic sapphires. \$37.50. \$3.75 Down; \$3.75 a Mo.



No. 962

How to Order—State article desired—name of employer—kind of work you do—how long in position—age—married—where live—how long there. Everything confidential. Send 1st payment. orgoodassent/free.



No. 918  
\$37.50  
\$1.00  
a Week



No. 923  
\$98.50  
\$2.50  
a Wk



No. 907  
\$73.85  
\$1.75  
a Week

Out References: Any Bank or Banker in the U. S. A.

## BUILD YOUR OWN BOAT AT SMALL COST

If you are a boating enthusiast you have long felt the need of a really good book on boating; one that would explain in comprehensive, step-by-step form all the details of boating, boat-building and boat-maintenance.

It is for the amateur builder and small boat owner that



### The New Popular Mechanics BOAT BOOK

is written. Here are boats that are really worth building and so thoroughly explained that any amateur craftsman can build them well. The designs include both inboards and outboards, fast boats, safe boats, sailing boats and hand-propeller craft.

### The One Book Needed By Every Boating Enthusiast

Besides boat building information, there is everything you want to know about the operation, equipment, care, repair and maintenance of boats. This includes seamanship, boating sense, navigation, rules of the road, handling sailing craft, government regulation of motor boats, knots, storm signals, useful boat kinks of various kinds, glossary of terms, tables, etc.

269 Pages (Several in Color)—Profusely Illustrated. Large Size (7 x 10 in.) Cloth, Price \$3.00. Sent postpaid upon receipt of price or by parcel post C. O. D. anywhere in the U. S. A.

**POPULAR MECHANICS PRESS**  
Room P-10 200 E. Ontario St. Chicago, Ill.

When writing please mention Popular Mechanics





**Buy Direct**  
at *New*  
**Low Prices**  
Never Before Have  
Fine Watches Been  
Offered at Such  
Low Prices  
Save 30% to 50% by  
Buying NOW

In addition to our NEW LOW PRICE, I will send for your approval one of these Standard Watches, guaranteed for a lifetime of satisfactory service—WITHOUT ONE PENNY DOWN—allow you to wear it 30 days FREE—then sell it to you on easy payments. Write for catalog.

**DIAMOND RINGS**  
Write for our new Diamond Ring and Wrist Watch Catalog, showing marvelous new designs. Think of it—beautiful diamond rings and artistic dependable watches at cut prices. Catalog is sent FREE.  
Ask for our Special Spot Cash Offer. Good for 30 days only.

**SANTA FE WATCH CO.**  
16 Thomas Bldg. Topeka, Kansas



## Using Tobacco

Perhaps you've tried to stop using tobacco only to find that the habit has such a hold on you that you gave up trying.

You know, better than anyone else, whether tobacco is hurting you, and if it is, that sooner or later, it will undermine your health. Heart trouble, indigestion, dyspepsia, nervousness, insomnia, poor eyesight—these and many other disorders can often be traced directly to the use of tobacco, according to good medical authority. Besides it is an expensive, utterly useless habit.

## Let Us Help You To Banish The Habit

No matter how firm a grip tobacco has on you—no matter whether you've been smoking cigars, pipe or cigarettes or chewing plug or fine cut for a month or 50 years—Tobacco Redeemer will in most cases remove all craving for tobacco in any form in a very few days. It does its work so quickly that all tobacco "hunger" is gone almost before you know it. The desire for a smoke or chew usually begins to decrease after the very first dose.

Tobacco Redeemer contains no habit-forming drugs of any kind—it is in no sense a tobacco substitute. It does not cause the slightest shock to the nervous system; on the contrary, it often helps to quiet the nerves and make you feel better in every way.

### SEND for PROOF

Get our free booklet. It tells you all about the deadly effects of tobacco and how easy it is now to quit. We will also send you copies of letters from confirmed users telling how this simple, home-treatment freed them absolutely from the habit. Just mail coupon—or a postal will do.



### NEWELL PHARMACAL CO.

Dept. 999

St. Louis, Mo.

Send me without obligation to me in any way, proof that Tobacco Redeemer will positively free me from the Tobacco Habit or my money will be refunded.

Name .....

Street and No. ....

Town.....State.....

**BABY CALCULATOR**  
CHICAGO ILL.  
MADE IN U.S.A.

**COMMON**

**ADDITION**  
SUBTRACTION  
MULTIPLICATION  
DIVISION

**VEST POCKET ADDING MACHINE**  
Adds, Subtracts, Multiplies, Divides. Does work of \$200 machine. Not a toy. Million dollar capacity. Simple and accurate. Guaranteed 5 years.

**FREE TRIAL** **\$2.50**  
—SEND NO MONEY— Total Cost

Just name and address. We will ship Calculator immediately. On delivery pay postman \$2.50 (plus few cents postage). (If outside U. S. send cash.) 30c additional in Leatherette Case. If not satisfied after 10 days' trial you get your money back. THOUSANDS OF SATISFIED USERS. Write for Agents' Proposition. **BABY CALCULATOR MACHINE CO.** (Incl.) P. O. Box 1118, Dept. 31, CHICAGO, ILLINOIS

## Don't Burn Coal

~ use cheap oil



Do away forever with the drudgery of wood or coal. Save money, time and labor. Most economical and lowest priced Oil Burner on market. Simply sets in fire box of any range, heating stove or furnace. Burns 96% air, 4% cheap oil. Gives three times the heat of coal. Easy to install and operate. Absolutely safe. No noise, dirt or odor. Sold on money-back guarantee.

### 30 Days Free Trial Offer

Try this wonderful burner in your own home at our risk. Special low price to first user in each locality. Write at once for Free book on Home Heating. Agents write for sample offer and protected territory.

International Heating Co., St. Louis, Mo.  
3838 Park Ave., Dept. 403-J

When writing to advertisers please mention Popular Mechanics

# Hand Reading FREE



**AMAZING! SENSATIONAL!!** You give away blanks for free personal hand readings and sell Skour-Pak, the new steel wool brush. Every housewife wants a Skour-Pak on sight. It cleans and polishes pots, pans, aluminumware and everything else scorable, yet the hands never touch the steel wool. All chance of infection through steel wool getting into the hands is eliminated. Now every Skour-Pak carries a blank good for a personal hand reading. The most sensational selling plan in America—and it is going like wildfire.

Sell both dealers and consumers. Large profits in both. Repeats rapidly. Retail for 15c. Send 10c for sample (including hand reading blanks) or \$1.00 for dozen. Larger discounts for quantity orders. Write now.

**SKOUR-PAK STEEL WOOL CORP.**

1161 East 156th St. Dept. 105 New York City, N. Y.

## A RELIABLE BOAT SPEEDOMETER for Only \$5

An ideal gift. Fits any outboard or runabout. Easily installed in five minutes. No cutting of boat. Sold by Montgomery Ward, and Boat Stores everywhere. If your dealer doesn't stock it order direct, \$5 postpaid anywhere U.S.A. Description Page 933, December Popular Mechanics. Send for bulletin.

CONSTANT DEVICE WORKS, 499 N. Kelmar Avenue, Jefferson Station, Chicago, Illinois

MFRS. OF DEVICES FOR CRUISERS, YACHTS, SAIL BOATS



## AERO WORLDWIDE SHORTWAVE RECEIVER

**\$6.45**

Listen in DIRECT to London, Paris, Berlin, Buenos Aires and other broadcasting stations throughout the world via short waves. Your ordinary receiver cannot tune in these low wave stations. **WORLD-WIDE RECEIVER** gets 14 to 550 meters.



### AERO SHORT WAVE CONVERTERS

Convert Your Present Set Into a Short Wave Super-Heterodyne

**A. C. MODEL \$12.50—D. C. MODEL \$11.50**

**AT LAST! The Perfect Auto Radio . . . ONLY \$20.00**

Built by pioneers in the manufacturing of Auto Radio. We guarantee 1,000 miles radius of reception. A masterpiece of Radio engineering. Latest model 4 Tube Aero Pentode Auto Radio. Price of set only \$20.00. Set complete with tubes, batteries, dynamic speaker, antenna equipment and noise suppressors, \$39.50.



### NEW AERO MIDGET

Using the Latest Type Pentode and Multi-Mu Tubes  
**Price \$16.50**  
Warranted COAST TO COAST RECEPTION



Wonderful tone quality and selectivity. Full dynamic speaker. Full vision dial. Beautiful walnut cabinet. 5 Tube Set \$16.50, less tubes. Complete set of 5 matched tubes \$4.50 extra.

SEND FOR COMPLETE CATALOG  
**CHAS. HOODWIN COMPANY**

Dept. N-2 4240 Lincoln Avenue

Chicago, Illinois

## 450 Miles in a Gallon of Gas!

According to a recent article by the president of the world's largest motor research corporation, there is enough energy in a gallon of gasoline if converted 100% in mechanical energy to run a four cylinder car 450 miles.

### NEW GAS SAVING INVENTION ASTONISHES CAR OWNERS

A marvelous device, already installed on thousands of cars, has accomplished wonders in utilizing a portion of this waste energy and is producing mileage tests that seem unbelievable. Not only does it save gasoline, and reduce carbon formation, but it also creates more power, quicker starting, snappy pick-up and a smoother running motor.



### To Make Up To \$100 A Week And More

To obtain national distribution quickly, men are being appointed everywhere to help supply the tremendous demand. Free samples furnished to workers. Write today for this free sample and big money making offer.

### WHIRLWIND MFG. CO.

Dept. 795-A Station C Milwaukee, Wis.

## REAL NEWS for Aircraft Home Builders

AFTER 23 years of light plane leadership, HEATH again sets the pace with startling new and exclusive Home Builders Offer. Send 15c for catalog and full information.

**HEATH AIRCRAFT CORPORATION**  
Dept. P-21 Niles, Michigan



From detailed plans and hand-cut down sets in your spare time. Suitable for gas or steam power. Send 10 cents for circular.

C. W. BOST  
2216 Wisconsin Avenue  
Milwaukee, Wisconsin

### BUILD 30 SCALE MODEL POWER CRUISER

The man who studies gets ahead. Popular Mechanics Press will advise you what books to read to advance in your trade. 200 East Ontario Street, Chicago, Illinois.

## A PRACTICAL COURSE IN MECHANICAL DRAWING

By WM. F. WILLARD

An ideal book for home study. Each exercise is clinched in the mind of the student by practical application to every day practice. 160 Pages, 157 Drawings. Cloth. Price \$1.00 Postpaid.

POPULAR MECHANICS PRESS 200 E. Ontario St. CHICAGO

## NEW FLEXIBLE SOLE MAKES OLD SHOES NEW-AS

LOW AS

**8¢** Each



Now an amazing new discovery called Luxole cuts shoe resoling cost as low as 8c each! Spreads on with a knife and, overnight, forms a tough, FLEXIBLE, waterproof sole that wears like iron. Distinctive crinkled finish prevents skidding and painful falls. Entirely new—utterly different—not a cement—not a gum—no cork or leather scraps—works like magic! Write at once for details. LUX VISEL INC., Dept. A-3110, Elkhart, Ind.

MAKE UP TO \$25  
IN A DAY!

A REAL hard-earned money maker! From 2 to 6 prospects in every home. Earn up to \$25 in a day easy! Write today for amazing big-money plan.

# Latest Boice-Crane Handisaw

TILTING and RAISING  
ARBOR



Note the graduated scales for rip fence, and tilting saw arbor.

The saw sensation of 1932—a saw that mitres, bevels, dados, grooves and rabbets on a table which stays level and rigid at all

times. Lumber remains flat regardless of operation—no slipping, no wedging, no binding. All kinds of cuts safe, easy and accurate. Highly polished 15" x 17 1/2" table; also a larger model with 20" x 27 1/2" table; cutting capacity 2 3/4" with 9" saw; mortising capacity 1/2"; Boice-Crane quality through and through. Don't buy until you have seen this new saw. A real buy at..... **\$32<sup>50</sup>**

## New Lathe \$29

Ball Bearing headstock. Four speeds. Very heavy bed. Compound slide rest for metal at extra cost. 11" swing; 42" or 60" centers. A lifetime power tool for only \$29.00.

## 4-in. Jointer . . \$12

Long, polished tables; fence tilts two ways—solid, substantial and accurate; balanced steel head; a real machine.



BUY NOW  
PAY LATER

## Send for Big 1932 Boice-Crane Catalog

Just off the press. Largest and most complete book ever printed on Bench woodworking machines, packed with useful information. Many new units. Circular, Band and Jig Saws; Shapers; 4" and 6" Jointers; Lathes for Wood and Metal; motors; books; new low prices. Send 10c (which only pays part of mailing cost) and your copy will be mailed at once.

W. B. & J. E. BOICE « Dept. PM-12 G » Toledo, Ohio

**NOW Make Your Clock Electric \$1.99**

easily with guaranteed "SPLIT SECOND" movement on regulated 110 volt 60 cycle A. C.; finest oilless bearings, simple mounting. No noise, no winding, always accurate. Use your own dial and save. Order today, new low price, postpaid. "Accu- \$3.49" as illustrated, with beautiful big golden 5 1/2-in. dial postpaid. Send dime today for prospectus, "Make Big Money Electrifying Clocks." Kumpel Electric Clocksters, Guttenberg, Iowa

## SAVE ON PAINT SPRAYERS

Complete Outfits and Equipment. Electric or gasoline motor units. Bargain catalog just out. Write today.

NATIONAL JOBBING AND EXPORT CO.

184 N. La Salle St. Dept. 101 Chicago, Ill.

**Let me pay you**

A daily income of quick, cash commissions in advance by representing me in your locality. My prices are sensationally reduced on all-wool, tailored-to-measure suits **Amazing values—\$19.50—24.50—29.50—** make orders easy to take. 100% co-operation, liberal bonus to producers who show my **big selling**, well known line. No special experience required. Big **FREE** outfit of large swatches puts you in business. Write now. **W. Z. GIBSON, Inc.** 500 Throop St., Dept. N-516, Chicago

**up to \$75 A WEEK**

**Lowest Prices in 24 years**

## \$500 SHIP or COACH MODEL \$450



We furnish all parts cut to fit, numbered and ready to assemble for the following Models: Clipper Ship and Flying Cloud (with electric lights), Santa Maria, Mayflower, LaPinta, all \$4.50, Constitution, \$5.98. Beautiful Spanish Galleon fully equipped for electric lighting \$6.98.



**COACH MODELS:** Geo. Washington, London to Bristol, Princeton to Philadelphia, Tally-Ho, Deadwood, Overland Western, Napoleon Coronation Coach, Colonial Coach, Covered Wagon, all \$4.50.

**DOLL HOUSES:** In knockdown form, with electric light, size 15 1/2 x 13 1/2 x 12 1/2, all parts numbered and cut to fit, \$2.95.

All Models sent C. O. D. Foreign orders must be accompanied by U. S. check or money order.

Send two cents postage for our new illustrated Catalog.

C. J. BIERBOWER, Dept. PM, 3216 Baring St., Philadelphia, Pa.

"Originator of build your own ship model"

C. J. BIERBOWER,  
Dept. PM, 3216 Baring St.,  
Philadelphia, Pa.

Please send me the complete parts cut to fit and ready to assemble for Model.....  
I will pay postman \$..... plus few cents postage.

Name.....

Address.....

When writing to advertisers please mention Popular Mechanics

# Rupture No Longer Spoils My Fun

"Now that I am rid of my rupture and do not wear a truss, I enjoy dancing again. Many strenuous activities are pleasures, because I am not handicapped in any way. My work is no longer a task—I enjoy it. No one would ever believe I was crippled by rupture."

This is the way people write us after ridding themselves of rupture by using **STUART'S ADHESIF PLAPAO-PADS.**

Stacks of sworn endorsements report success—without delay from work.

Plapao-Pads cling to the body without straps, buckles or springs. Easy to apply—economical and comfortable.

Convince yourself by actually testing Plapao at our expense. Send coupon today.



Test of Factor "PLAPAO"

**FREE!**

**ACT SPEEDILY**

MAIL COUPON BELOW TO-DAY

Plapao Laboratories, Inc.  
789 Stuart Bldg., St. Louis, Mo.

Send me **FREE** Trial Plapao and 48-page book on Rupture. No charge for this now or later.

Name.....

Address.....

## ANY PHOTO ENLARGED

Size 8x10 inches or smaller if desired. Same price for full length or bust form, groups, landscapes, pet animals, etc., or enlargements of any part of group picture. Safe return of original photo guaranteed.

**47c**

**SEND NO MONEY** Just mail photo or snapshot (any size) and within a week you will receive your beautiful 4x6-like enlargement, guaranteed fadeless. Pay postman 47c plus postage—or send 47c with order and we pay postage. Big 16x20-inch enlargement sent C. O. D. 75c plus postage or send \$6 and we pay postage. Take advantage of this amazing offer now. Send your photos today. Specify size wanted.



STANDARD ART STUDIOS, 908 W. Lake St., Dept. 362-A, Chicago, Ill.

## Makes Radio Static Diminish

A simple amazing device is being offered on trial to users by W. S. Hill, Suite 304, 619 8th Street, Des Moines, Iowa, which diminishes static in radio receiving sets. Not only that, but when static is not bad you increase the volume tremendously, bring in more distant stations, saves on tubes, cuts through powerful local stations, reduces interference, gives every set the equivalent of one more stage of radio reception and greater selectivity. Works on all radios, can be attached without charge by anyone instantly. Mr. Hill wants agents and is willing to send a no-cost sample to you. Write him today.

## Get Into A Business of Your Own—EARN \$150 to \$300 Monthly



### AUTOMATIC AIR SERVICE

Dependable, space saving compressors bring customers to your door. Only \$12 Monthly, 30 Days' Trial.



### PAINT SPRAY PROFITS

Paint autos, houses, furniture. One man does work of 5—highly profitable. Only \$12 Monthly will pay its own way.



### 8-HOUR BATTERY CHARGING

Recommended by leading battery makers. Halves cost, doubles profits. No special experience required.



### 20 MINUTE Car Washer

Big profit washing cars—saves 2-3 hrs., does better job. Savings pay for it. Only \$17 Monthly.

30 Days' Trial, to prove it. Easy Terms. Check items of interest and mail to

**HOBART BROTHERS**  
Box M-12, Troy, Ohio

WRITE TODAY » Only \$16 Monthly — 30 Days Trial to Prove it « NO OBLIGATION

When writing to advertisers please mention Popular Mechanics

**Big Money**  
Selling and Installing  
**OIL BURNERS**  
in Stoves, Ranges, etc.  
**Sells ON SIGHT**  
Anyone Can Install  
Lasts a Lifetime

WRITE  
**OIL KING BURNER CO.**  
P. O. Drawer 1201  
NEW HAVEN, CONN.

**PRICE \$24.50**  
Complete ready to install—as shown.  
Send Money Order.

**Short Waves**  
We have the finest receivers for this work. We can tell you what to buy that will give you the results that you want. Ten years experience with this field. Let us give you recommendations and prices. Bulletins on request.

Established 1921  
Chicago Radio Apparatus Company, Inc., 415 South Dearborn Street  
Chicago, U. S. A., Dept. M-132

**INVENTORS! PATENTEE!**  
Read the inventors' own magazine... the logical market place for inventions...  
Send for Details and Special Subscription Offer "Inventive Age & Patent Market"  
BOX A 1577 EAST 18TH ST. BROOKLYN, N. Y.

**SHIP MODEL FITTINGS**  
Extensive line! Acoustic quality fittings! Construction sets for Sailing Ships, Whalers, Steamships, Destroyers, Yacht! Books, blueprints, model supplies. Send 15c for big, illustrated catalog.  
A. J. FISHER, 1002-1 Etowah Ave. Royal Oak, Mich. **CATALOG 15c**

The man who studies gets ahead. Popular Mechanics Press will advise you what books to read to advance in your trade. 200 East Ontario Street, Chicago, Illinois.

**TODAY'S GREATEST MANUFACTURING OPPORTUNITY**  
**MAKE BRICK FOR LESS THAN \$6.00 per M**  
NEW, LINE-PRODUCTION machine makes 24,000 DUNBRIK per day. Has revolutionized brick-making; astounded the building industry. You make better brick, Common, Tinted, Faced, at less cost.  
Learn why Du Pont Corp. selected DUNBRIK and its wide acceptance where made. Present plants successful beyond anticipation. \$2,000 starts you. Exclusive franchise. Write for full information.  
**W. E. DUNN MFG. CO.**  
600 24th Street, HOLLAND, MICH.

Recessed for Lighter Weight, Stronger Bond, Big Savings in Construction.  
This business warrants \$10,000 to \$30,000 operating companies to each trading area. Capable organizers write for proposition.

# New Soles for 9¢ in 3 Minutes

Here's a wonderful new money-maker for agents. It's SHU-SOLE—the amazing new discovery that puts new soles on old shoes in 3 minutes—at a cost of only 9¢! Huge demand everywhere gives you an opportunity to

## MAKE \$2 AN HOUR

In full time or spare time. Just spread SHU-SOLE over old, worn-out soles with a knife. Fills up holes, cuts and cracks—dries over night—and then wears like new leather. Everybody buys. More men and women needed at once to help handle growing business. No capital or experience needed. Write quick for Outfit Offer.

ALBERT MILLS, Pres., 44 Monmouth Ave., Cincinnati, Ohio

## Build Model Ships of the Better Kind

We can supply construction sets and all sorts of parts, such as semi-finished hulls, blocks, deadeyes, daps, anchors, steering wheels, capstans, figure heads, guns, blue prints, books, etc., for building real life scale models of the U. S. Destroyer Freston, Flying Cloud, Constitution, Spanish Galleon, Viking, Baltimore Clipper, Mississippi steamboat, Bluenose, Mayflower and many others. Also special construction sets for racing sail boats, power boats, model steam engines, boilers, propellers, etc., and fine tools for the model maker. New large 86-page photographically illustrated ship model booklet has just been released. This booklet contains valuable information and hints for building ship models, in addition to prices and full description of the above articles. Many people only slightly interested in models have become greatly enthused upon receiving this booklet. A copy will be sent postpaid upon receipt of 15 cts. (coin preferred).



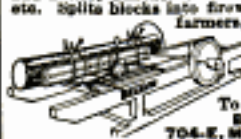
MODEL SHIP SUPPLY CO., Dept. B, Mineola, N. Y.

## ONE-MAN SAW MILL—

Makes lumber, shingles, cross ties, fence posts, laths, fruit and vegetable crates and boxes, dimension blanks for furniture, etc. Splits blocks into firewood. Needed by

**\$39**  
BRINGS IT TO YOU

farmers, timber owners, contractors. Pays for itself in a week, or on one job. Guaranteed. Sold direct from factory. Write today for Special Offer and Free Book "How To Make Lumber." BELSAW MACHINERY CO. 704-E, Wigs. Ex. Bldg., Kansas City, Mo.



## "Little Cut-Up"



The Smallest Little Saw in the World

## AMAZING SPEED AND VERSATILITY

Cuts any wood up to 2 in. thick, 16 in. deep as fast as you can follow line. Inside or outside cuts, straight, curves, angles and intricate scroll work. Cuts fiber, plywood, bakelite, aluminum, brass and other soft metals, leather, paper, etc. Complete with 14 H.P. A.C. 110 V. G. E. Motor, motor to direct connect to any fractional H.P. motor, \$22.50. Extra blades \$1.00. Dealers principal cities. Literature on request or send order and will ship C.O.D. or from our nearest dealer. Manufactured and distributed by

Beebe Bros., 3215 1st Ave. S., Seattle, Wn.

## WANTED: SERVICE MAN

Large manufacturer has number of positions open in various parts of country for middle-aged men to demonstrate and take orders for our new Improved Fire Extinguisher. Want man who is willing to refill and recharge all types of extinguishers along with the regular work. Service work alone should produce earnings of \$35 to \$50 a week in addition to earnings from sale of new equipment. Prospects—Factories, Stores, Garages, Schools, Theatres, Public Institutions, Warehouses, Truck and Bus Owners, Homes, Farmers, etc. If you are looking for an easy salary job don't waste time writing as we are looking for men who are ambitious to earn more than an ordinary salary job will pay. Address:

FYR-FYTER CO., 90-49 Fyr-Fyter Bldg., Dayton, Ohio

## Get your own PATENTS

Inventors have legal right to file their own claims. Our book clearly explains step by step how to prepare all necessary papers. Eliminate chances of theft; avoid delay; deal directly with the Patent Office. Pay government fees only—Legal blanks and book of complete instructions, \$1.00. ("Making Patents Pay", \$1. "How To Get Your Own Copyrights, Trade-Marks, etc.", \$1. Any two books, \$1.75. All three, \$2.50.)

Address: CUTTING & SONS, Dept. 114, Campbell, Calif.

When writing please mention Popular Mechanics

**OWN A CARMELCRISP POP CORN STORE**

MAKE UP TO **\$200** PER WEEK

Here's your chance for independence and quick success. Open a store like this and do a big business at big profits from first day. Charleston store did \$178.45 in one day. Ohio store does \$1200 a month, at gross profit of over \$800.00. Other records still more astonishing! Small town reports sales of \$118.00 in single day! Store in town of only 8,000 does \$200 sales in 5 days. Greatest success in years. Get in while it's new and best.

**Right In Your Town.** Big opportunity waiting in any city, town or village. Best locations available now at lowest rentals. Wonderful time to start.

## Carmelcrisp

### The New Carmel Pop Corn

Most sensational confection in years. Plump, tender, healthful pop corn, coated with delicious, savory carmel candy, prepared according to a secret time tested formula. Crowds attracted by its mouth-watering, appetizing aroma. Jam your store buy and come back for more. Profits start first day and grow bigger daily.

### No Experience Needed

We start you in business. Help you finance if necessary. You need but little money . . . we supply equipment, formula, plans, layouts, help you locate, tell you every step to big success. Should bring cost all back and big profit in few weeks.

## FREE Book of Facts—

### "Golden Kernels of Profit"



Brings you all the facts. Shows how others are making big money . . . and how you can do it. Don't delay getting in this sensational business. Carmelcrisp has taken the country by storm. Act now. Get in on ground floor. Just send name and address. No obligation.

**LONG-EAKINS COMPANY**  
128 High Street, Springfield, Ohio

**Big 3 ft. Telescope** Five Sections. Brass bound. Powerful Lenses. 10-Mile range. Special Eye Piece for looking at the Sun, included FREE. Can be used as a Microscope. Guaranteed. Big value. Postpaid. \$1.75. C. O. D. 15c extra. **Benner & Company, 1-41, Trenton, N.J.**

By mail, 15¢

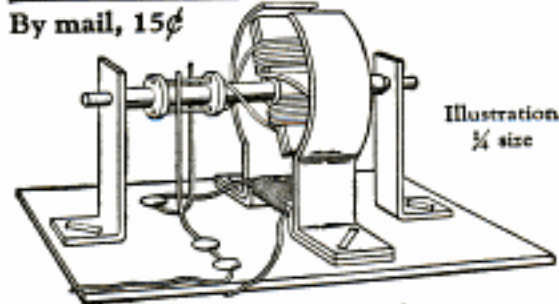


Illustration  
3/4 size

## Men and Boys build this ELECTRIC MOTOR

All parts necessary **10¢** at local chain and other stores

The most popular Educational Toy of a decade. If carefully built it has a speed of over 6000 revolutions per minute. Full directions and instruction sheet "HOW A MOTOR WORKS". You can learn more about a motor in 30 minutes than by hours of study.

Manufactured by

GEORGE W. MOORE, 44 Farnsworth St., Boston, Mass.

## Thoroughbreds

in every line . . . famous for speed, durability, and ease of handling. Get out of doors on

## NORTHLAND SKIS

... it's more fun than hugging the fire. Models for every purpose; prices for every purse. Look for the deerhead trademark.

Write for free booklet, "How to Ski."

Northland Ski Mfg. Co.

World's Largest Ski Mfrs.

95 Merriam Pl.

St. Paul,  
Minn.



## FUN!

Learn Taxidermy. It's Fun, and You Can Make Good Money in Your Spare Time, Too.

Learn to mount and preserve all kinds of birds, animals, and fish. Tan skins and make them into rugs and robes. Take **COMMON SPECIMENS** like rabbits, squirrels, frogs, etc., and make them into ash trays, mirrors, lumps, etc. They sell at sight. Malcolm Greany made \$35 while learning. Save your trophies and decorate your room. This great new hobby for boys will delight you.

**FREE BOOK!** Send **AT ONCE—TODAY**—for this beautiful new **FREE BOOK** which tells how you can learn Taxidermy at home. No cost. No obligation. Contains hundreds of fine game pictures. It's **FREE!** Write for yours **TODAY**. State your **AGE**.

N. W. School of Taxidermy, Dept. 9371, Omaha, Nebr.



## YOU CAN BUILD PASSENGER CARRYING STEAM TRAINS ELECTRIC CASTINGS BLUE PRINTS

No Lathe Needed with Our Finished Castings. Anyone Handy with Tools Can Build Our Scale Built Models. Cost is Small. CATALOG 20 CENTS

Refund on First Order. Coin Preferred.

MODEL RAILWAY SUPPLY CO., 630 POLK ST., PUEBLO, COLO.

The man who studies gets ahead. Popular Mechanics Press will advise you what books to read to advance in your trade. 200 East Ontario Street, Chicago, Illinois

## NOW—Electrify Your Favorite Clock This Low-Cost EASY WAY

Don't part with your favorite clock because it no longer keeps good time. The New Hammond Electric Clock Kit will electrify it simply and permanently—thus adding to the beauty of an old or favorite clock the accuracy of modern electric operation. Anyone can make this installation with just a few common tools and this new kit—which contains every single part necessary for the job, including the mechanism, a free folder of instructions, special adjustable brackets for permanent mounting of the mechanism and 5 differently sized sets of hands, fitting any clock face from 3" to 9 1/4" in diameter. Free repairs on mechanism guaranteed for a year by The Hammond Clock Company.

**SPECIAL PRICE**—Usually sold through stores for \$9.50, this kit is now offered direct to Popular Mechanics Readers for only \$3.95—and you need send no money now! Here's a real Christmas Gift for a handy man!

The Hammond Clock Company P.M. 1-32  
2915 N. Western Ave., Chicago, Ill.

Send me the New Hammond Electric Clock Kit. I'll pay the postman \$3.95 plus a few cents for postage when he delivers it.

Send **FREE** pamphlet "How to Electrify a Clock."

Name.....

Address.....

## Increase Your Earning Power

Apply time and labor-saving kinks to your work. Your efficiency will soon be recognized and you will be in line for advancement.

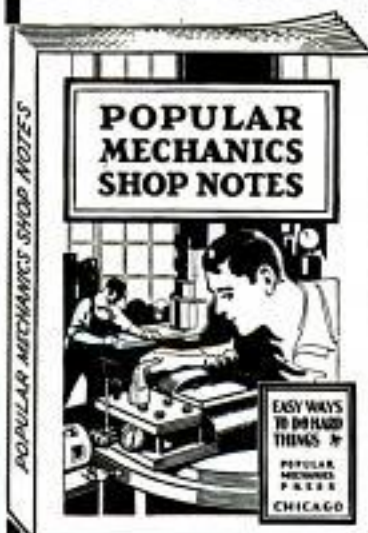
If you do machine shop work of any kind, sheet-metal work, painting, carpentry, auto repairing, farming, concrete work, plumbing, electrical work, welding, building, glass work, general repairing, tool-making, poultry raising, masonry or home repair work, get this

## LIBRARY OF 2600 TIME AND LABOR SAVING IDEAS FOR SHOPMEN AND HANDYMEN

## A NEW VOLUME READY

## SHOP NOTES for 1932

462 Articles  
493 Illustrations  
192 Pages  
Price 50c  
See partial list of contents below



Including the new 1932 issue illustrated above, there are seven volumes in the Shop Notes Library of 2600 easily understood short cuts to every-day jobs. Here are just a few of the subjects taken from the latest issue.

Angle Iron, Uses for Angles, Easy Method of Laying Out

Hand saw Blades, Sharpening

Hand saw, Shortcuts for Bent Iron Work

Clamps for Miter Joints

Drafting Board for Outdoor Sketching

Drum Sander for Workshop

Electric Drill, Portable Electric Feeder for Poultry

Flashlight Photography, Improved

Forge, Homemade Portable

Furnace, Gas-Fired Melting

Furniture Upholstering

Glass, How to Use Properly

Hardware, Hand-wrought

Home Workshop Shaper

Jigsaw, Heavy-Duty

Lathe for Large-Diameter Work

Lathe, Mounting Work on

Lathe Tools, Grinding

Log Cabin Built in Attic

Mirrors, Resilvering

Motoring Problems

Solving Piston Rings, Improved

Method of Fitting Septic Tank for Farm or Cottages

Soldering Iron, Electric

Soldering Iron, Home-made

Gas Stoves, How to Rig

Stereoscopic Photos

With Any Camera

Table Double Capacity of Circular Saw

Table, Drop-Leaf Pivot-Top, Making

Tea Cart, Rubber-Tired

Tools, Hardening and Tempering

Wall Grates, Installing

Water Heater, Instant Electric

Weather-vane, Noiseless

Ball-bearing Wood-Residing

Wood-Residing Unusual Jobs in

Woodworking Ideas

When writing to advertisers please mention Popular Mechanics



## Winter Starting Troubles Eliminated

**Amazing Invention Now Makes It Possible to Keep a Battery Perfectly Charged at All Times—No More Overcharging—No More Undercharging—Easy Starting—Battery Life Is Doubled**

Automobile owners will welcome this new instrument, called "Tel-a-Charge," that instantly tells the condition of your battery—right on the dash. It tells at a glance if the battery is overcharged, undercharged, or if water is needed. These three conditions cause practically all battery troubles. When your battery is low your car may stall anywhere at any time. It is dangerous as well as annoying to have to crank an automobile to get it started. Keep your battery in perfect condition and your car starts easier, runs smoother, has more power, and expensive troubles are eliminated.

### SPECIAL INTRODUCTORY OFFER

Sample with complete instructions sent for \$3.00. Specify car, year, and model. Prepaid if cash is sent with order and this advt. We need men in every locality to aid us in the distribution of "Tel-a-Charge," and are making a proposition so unusual that workers can easily make up to \$100 a week. We are furnishing those who work for us with a free sample for demonstrating purposes. Send TODAY for this big opportunity and free sample offer.

### CLUM MANUFACTURING CO.

Dept. 119 601 W. National Ave. Milwaukee, Wis.



**GIANT TELESCOPE** \$1.75  
5 SECTIONS—3 FT. LONG  
See Miles Away! Distant people and objects seem close. Over 3 ft. long, brass bound. Made in Europe. Bkbs. of fun. Thousands pleased.  
**Send No Money!** On arrival pay Postman special price, only \$1.75, plus postage. Two for \$3.25. (Or send price and we pay postage.) Satisfaction guaranteed or money back. Send today.  
Bargain House, 427 Randolph St., Dept. 17, Chicago



### Bench Lathe

8-inch swing, 24 inches between centers, longer bed if wanted. A husky lathe capable of real work. Also larger and smaller lathes, comutator truing lathes, bench band saws, bench circular saws and drill presses. Money refunded if not satisfactory.

**CENTRAL MANUFACTURING CO., FAIRFIELD, IOWA**

Boeing Biplane  
Travelair Plane  
Army Falcon  
15 in. Size

**BUILD 3 MODELS FOR \$1.65**

Biggest value ever offered; IDEAL 3-in-1 Kit contains everything required to build these 3 Flying Models, including Plans and Instructions. Easy to build.

**IDEAL AEROPLANE & SUPPLY CO.**  
26 West 19th Street N. Y. City

## LUCKY TIGER A PROVEN GERMICIDE



For a clean, healthy scalp use Lucky Tiger. Destroys germs, and gives to thin, falling hair a new life and lustre. Delicately perfumed; world's largest seller at Druggists, Barbers, Beauty Parlors. **Try It Today!**

## Start Your Own Business In Spare Time

**SAWS FILED**  
FOLEY FILER SERVICE



**\$2 to \$3 an Hour**

in this easy, interesting, steady cash business of filing saws by machine. V. H. Vander Espt writes: "I filed 21 saws from 8 A.M. to 5:30 P.M. at an average of 80c apiece (\$16.80)." Frank Brabeck reports, "I cleaned up \$56.00 in 3 days." Hundreds of others have found the road to independence and a big income with the Foley Plan.

**No Canvassing!** Our Free Plan starts you right. Shows how to get saw-filing work from factories, schools, newspapers, printers, electrotypers, carpenters, contractors, etc. No training or experience necessary. No eye strain. It's easy with a

### FOLEY AUTO MATIC SAW FILER

A wonderful machine that files all saws perfectly . . . hand saws, cross cut, circular saws, and band saws . . . twice as fast as expert hand filer . . . makes every tooth of even size, height and spacing so that saws cut better. That's why saw users prefer Foley-filed saws, why it's so easy to start this business.

**Sold on Easy Payments . . .** the Foley soon pays for itself. Send the coupon below for Free Plan. Do it now!

Mail This Coupon NOW!

FOLEY MANUFACTURING CO.,  
1161 Foley Bldg., 11 Main St., N. E.,  
Minneapolis, Minn.

Please send me FREE PLAN on how to start my own saw filing business with the Foley Filer.

Name . . . . .

Address . . . . .

City . . . . . State . . . . .

If you would also like information on the Foley Automatic Key Machine, Check here . . . . .

When writing please mention Popular Mechanics

# World's Lowest Priced Quality Home



## \$483<sup>5</sup> Rooms

Buy direct from Mill at wholesale. Price includes all lumber readi-cut, millwork, windows, doors, interior woodwork, hardware, roofing, glass, nails, paints, varnish and stains. All material shipped in a sealed box car. **We pay freight.** Safe arrival guaranteed. Aladdin's famous Read-Cut System saves 18% lumber waste and 30% labor cost. Complete instructions and drawings enable you to build an Aladdin yourself if you are handy with tools.



### Summer Cottages \$179 and up

### FREE Catalog

Shows many designs in Homes, Summer Cottages, Garages, Filling Stations, Tourist Cottages and Roadside Stores. Overflowing with interest. A revelation to prospective home builders. Send the Coupon today. No obligation.



### Garages \$92 and up

**The ALADDIN CO.** Mail this Coupon

(Address nearest office) Bay City, Mich., or Portland, Ore.  
Send free, without obligation, new Catalog of Homes, Summer Cottages, Garages, etc., No. 286.

Name \_\_\_\_\_

Address \_\_\_\_\_

City \_\_\_\_\_

State \_\_\_\_\_

## Red Top OIL BURNER



Reg. U.S. Pat. Off.  
Copyright - W.S. McKee

**ONLY \$12<sup>50</sup>**  
Buy Direct From Factory  
Red Top is 100% safe.  
Burns No. 1 Fuel Oil. Guaranteed to equal heat of coal. Easily installed. Warranted five years. Furnished complete with Regulator and automatic Safety Valve. Very efficient unit.

**No. 1 BURNER** for Showers, Arcolas, Circulators for Furnaces, Hot Water and Steam Plants, 4-5 rooms, and Hot Water Heaters—120 to 150 gal. tanks, \$18.00.

**No. 2 BURNER** for Furnaces 4-10 rooms, Hot Water and Steam Plants, 5-8 rooms, and Hot Water Heaters—150 to 200 gal. tanks, \$27.50.

**No. 3 BURNER** for Furnaces 6-12 rooms, Hot Water and Steam Plants, 8-12 rooms, and Hot Water Heaters—180 to 250 gal. tanks, \$37.50.

When ordering, specify *flap* diameter above the grate. Prices F. O. B. Chicago. Discount to dealers on 6 to 12 burners at one time.

**RED TOP OIL BURNER MANUFACTURERS**  
6644 Cottage Grove Avenue, Dept. 10, Chicago

# PYROIL

REG. U.S. PAT. OFF.



will build a  
**Lifetime  
BUSINESS  
for YOU**



PYROIL, together with the extensive promotional system behind it which includes national publicity and newspaper advertising, illustrated circulars, literature, posters, cart signs, roadway signs, window transfers and other water-pays men into flourishing businesses of their own! Illustrated here are two of many filling stations now dispensing Pyroil treated gasoline direct from pump!

**REPEAT SALES ENORMOUS**  
Never-failing repeat business in PYROIL'S Big future. One distributor—waiter only 90 days in business—

PYROIL was used by Boardman and Pollock on their world record-breaking flight from New York to Turkey!

begin ordering in carload lots!

### ALL CLAIMS POSITIVELY PROVED

PYROIL provides a new safety and amazing new economies in automobile, truck, tractor, airplane, marine and heavy duty equipment motors. Simply added to oil and gas supply, users testify it minimizes wear, reduces noise and vibration, increases power, seals rings, frees valves, and cures troubles—increases life of lubricating oil, increases mileage, saves many times its cost.

PYROIL is internationally used and tested. It is manufactured under a highly specialized patent protected process. Guaranteed 100% satisfactory. Men of energy, foresight and a sincere desire to establish a permanent business will find in PYROIL, positively one of the greatest opportunities ever offered. Learn what PYROIL will do for YOU! WRITE AT ONCE!

W. V. KIDDER, President  
THE PYROIL COMPANY  
512 Pyroil Bldg.  
La Crosse, Wis.



Genuine PYROIL is identified by the winged Pyroil trademark and signature of W. V. Kidder, both of which appear on every label.

*W. V. Kidder*  
President  
The Pyroil Company



## KINKADE GARDEN TRACTOR and Power Lawnmower

A Practical, Proven Power Cultivator for Gardeners, suburbanites, Truckers, Florists, Nurserymen, Fruit Growers and Poultrymen.

Low Prices—Easy Terms  
AMERICAN FARM MACHINE COMPANY  
1058 33rd Ave. SE. Minneapolis, Minn.



Catalog Free

## THE MOST BEAUTIFUL SHIP MODEL EVER MADE The Barbary Pirate "FELUCCA"

new and now ready. Hull fully shaped and sanded; all parts and accessories supplied cut to fit and ready to assemble.

"You Can Build One" for only \$4.50, and postage

Wonderfully designed and accurately executed, this model, brilliantly colored, is a lasting ornament, and its construction a fascinating pastime. Sent C. O. D. parcel post in U. S. or Canada.

Santa Maria, Mayflower, Covered Wagon or Coach Model \$4.50. Constitution \$6.00, Flying Cloud \$4.00 or a Spraying Wheel \$1.00. Send 2c stamp for catalog.

**MINIATURE SHIP MODELS, INC.**  
90 King St., Toronto Dept. RT, Perkasie, Pa.

**\$3.25 VALUE SELLS FOR \$1**  
OVER 100% PROFIT FOR YOU ON EACH \$1 SALE

**SAMPLE 53c**

D15 deal consisting of a full sized \$1 rayon necktie, \$1.25 fountain pen and \$1 pencil to match. All quality merchandise. No seconds.



**DOZ. 49c EACH DEAL**

**GROSS 47c EACH DEAL**

Spors Importing Co.  
1131 Main St.  
Le Center Minn.



**You Play This Instrument  
On the Day You Get It!**



# Are You *Inside* or *Outside* This Picture? *Something to think about!*

Ralph Smith, Chicago, played the Xylorimba 20 minutes at a wedding; his pay was \$20.

The musical Hallmans, Reading, Pa., average \$65 a week in sparetime.

Sam Herman, celebrated xylophonist—member of "The Eight Victor Artists"—famous for their Victor Records and concert tours—became the player that he is without the aid of a teacher.

If as someone has said, "Life is what we make it," are you entirely satisfied with *your* life? Is your presence demanded at gatherings, parties and dances or are you just "among those present"? Are you having the fun and pleasure that some of the fellows are having? Are you able, when you feel so inclined, to add \$5 to \$25 to your bank roll in exchange for an evening of work that is "play"?

No? Then by all means look into this opportunity! Just imagine! Here is an instrument that makes a "hit" wherever you take it and yet is the easiest of all instruments to play! No teacher—no finger or lip exercises—no tiresome practice. Five minutes after you get your Xylorimba, you can play a simple melody—even if you can't read a note of music right now. In an amazingly short time you are dazzling friends and relatives with snappy dance numbers, dreamy waltzes, rhythmic popular selections.

Xylorimba numbers are *always* popular. That is why they are so much in demand at parties and dances, in radio studios and on the stage. Everyone envies the fellow who plays them. That might just as well be you.

**FIVE DAYS' TRIAL—A YEAR TO PAY—** this, briefly, is the bona fide offer of the world's largest manufacturer of xylophonic instruments. I take this risk because I want you to have the same chance that I have placed hundreds of others on the road to more fun, more friends and profit than they ever had before. Summer and winter, you, as a xylorimbist, are able to create your own music, please your friends, make big extra-time money! *A lifetime of musical joy* in exchange for the determination to investigate!

## **BIG BOOK FREE!**

With these things in mind, I suggest for your own sake that you send in the coupon. By return mail I will forward **WITHOUT COST**, the big Deagan book that tells all about the Deagan line—the money some fellows are making with Deagan instruments—the free easy lessons—the 5-day free trial offer—the wonderful easy payment plan. There is no cost and no obligation. Simply fill in and mail the coupon. There is one way to be sure a thing will be done—that way is to do it **AT ONCE**. *Today* is as good a day as any.

DEAGAN, Inc., Dept. 561, 179 Berens Ave., Chicago  
Fill in without obligation, details of Free Trial  
and easy-payment plan on the Deagan  
coupon.

**START  
TO PLAY  
VERY FIRST  
DAY!**

**NO  
TIRESOME  
PRACTICE**

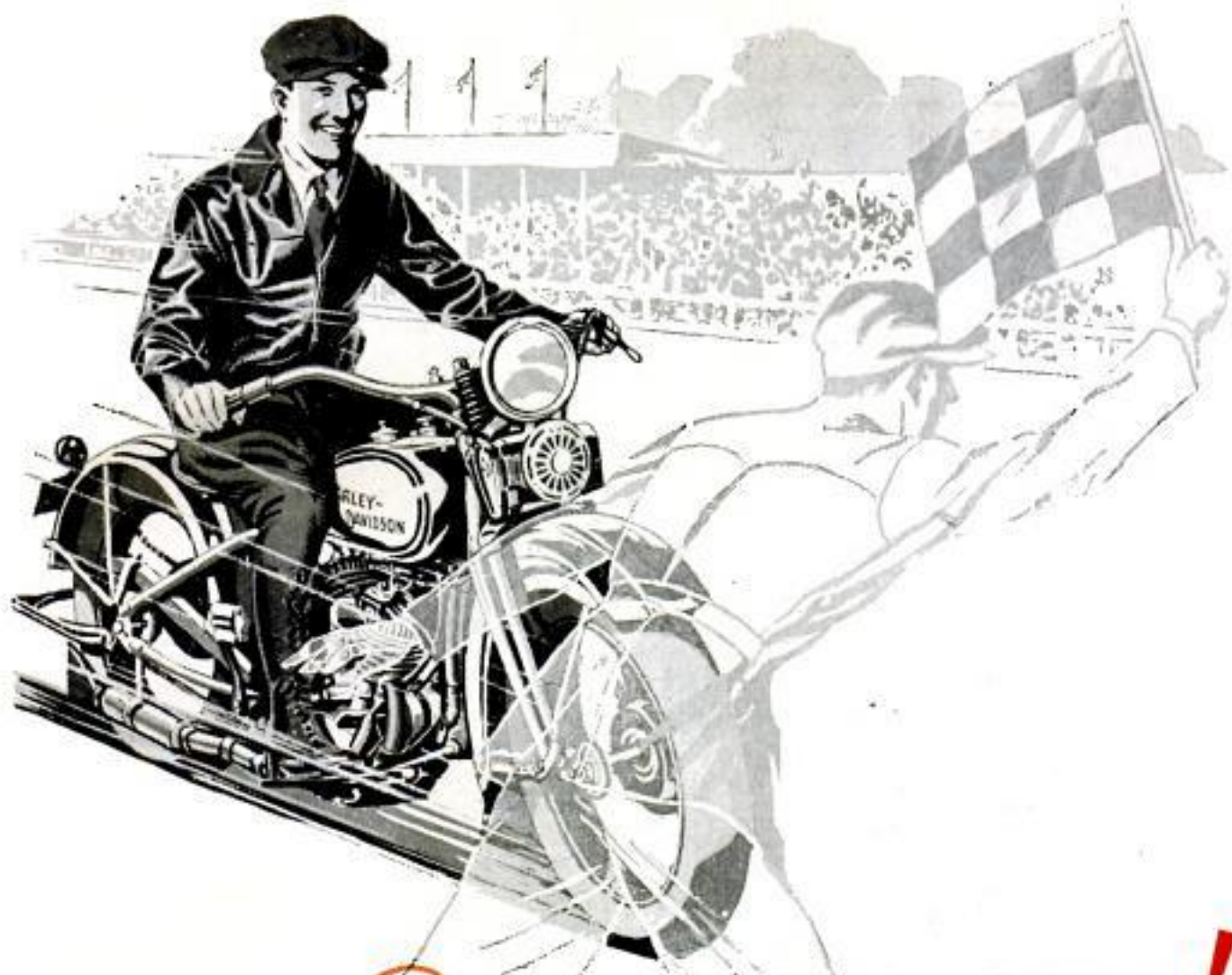
**5 DAYS  
TRIAL  
IN YOUR  
OWN  
HOME**

**FUN,  
PROFIT,  
POPULARITY**

**No  
Teacher**

**A YEAR  
TO PAY**

Copyrighted material



## Ride a **WINNER!**

### Won in 1931 by Harley-Davidson:

**Syracuse Races**—3 National Championships won on Sept. 12th—5-, 10-, and 15-mile races, and the 10-mile open.

**Jack Pine Run**—for American Road Championship—on Sept. 7th. Harley-Davidsons finished first and second—also won both Sidecar Classes—over 466-mile course.

**National Hillclimbs**—5 of the nine National Championships—at Rochester, N. Y., and Oakland, Calif.—won by Harley-Davidsons, as were most hillclimbs in other parts of U. S. A.

**R**IDE the motorcycle that champions choose—the Harley-Davidson, that won most of the national championship races, endurance runs, and hillclimbs in 1931—the champion of champions!

As you flash over the roads in your Harley-Davidson, it's great to realize that this wonderful motorcycle has the dazzling *speed* that won six of the nine National Championship Races run in 1931—the rugged *stamina* that took the Road Championship in the gruelling "Jack Pine Run"—and the amazing *power* that roared over the top, first, in the important hillclimbs of the year.

Look over the 1932 models of this champion motorcycle at your nearest Harley-Davidson Dealer's. Ask him about his easy Pay-As-You-Ride Plan, and *reduced prices*.

Ride a  
**HARLEY-DAVIDSON**

#### MAIL THIS COUPON

HARLEY-DAVIDSON MOTOR COMPANY  
Dept. P, Milwaukee, Wis.  
Interested in your motorcycles.  
Send literature.

Name \_\_\_\_\_

Address \_\_\_\_\_

My age is  16-19 years,  20-30 years,  
 31 years and up,  under 16 years.  
Check your age group.