

NOVEMBER

25 CENTS

POPULAR MECHANICS MAGAZINE

REG'D. TRADE MARK



SEE PAGE 732

1070 TURNS COLD WATER INTO HOT WATER INSTANTLY!



ONLY \$3.95 COMPLETE

SNAP WATER-MATIC on Cold Water faucet, plug into electric socket and zip—Running **HOT Water!** Attaches quick as a wink—NO fuss or plumber bill. \$3.95 pays everything. *Nothing else to buy!* Works instantly AC or DC current. Made of strong

SHOCK-PROOF PORCELAIN

insulated against short circuits and burn-outs; **SAFE!** Gleaming white finish matches your sink; equipped with famous Belden electric plug and cord. **WATER-MATIC** is the original big capacity **HALF-GALLON-A-MINUTE** detachable electric water heater based on a new discovery by America's foremost engineers. Sold under a **POSITIVE GUARANTEE** against breakage or replacement of parts.

1,000 AGENTS NEEDED!

WATER-MATIC is sweeping the country. *Inquiries are pouring in from every section.* We need live men and women as active agents. If you live where homes, stores, offices, garages or farms are wired for electricity, and **WANT TO GET INTO BUSINESS FOR YOURSELF** with one of the fastest selling specialties, **SEND IN THIS COUPON TODAY!**

THIS COUPON IS WORTH \$1.20

WATER-MATIC HEATER CORP.,
1140 Broadway, Dept. 1110. New York, N. Y.

I wish to take advantage of your **SPECIAL AGENT'S OFFER** and enclose **MONEY ORDER** for \$2.75 (Canada \$3.75) for which kindly rush me your Official Agent's Outfit including Complete Sales Information, Order Blanks and One (1) \$3.95 **WATER-MATIC HEATER** (110 Volts AC or DC) ready for immediate use.

Upon receipt of Heater and Data, it is agreed that I am authorized to act as your Official Representative and collect my cash commissions of \$1.20 on every \$3.95 **WATER-MATIC** (110 Volts) and (\$1.75 on every \$5.75) **SUPER WATER-MATIC** (220 Volts) I sell. I promise to send you all orders immediately as received so that you can ship to my customers directly and collect the balance C.O.D. (*Outside of U. S. price is \$1.00 extra on each unit and remittance must accompany order.*)

Name.....
Address.....
City..... State.....

Earn \$30 TO \$40 DAILY

Trade-Mark Reg. U. S. Pat. Off. Pat. App. For.

7 EXCLUSIVE FEATURES

WATER-MATIC differs from anything of its kind. Superior to out-of-date and old-fashioned heaters with 7 amazing improvements.

1. Delivers 1/2 Gallon hot water every minute!
2. Acts instantly, works every time. A.C. or D.C. current
3. Handy and Portable
4. Insulated porcelain, safe for children
5. Will not rust, tarnish or short circuit
6. White-finish matches fine plumbing fixtures
7. **GUARANTEED** against breakage or part replacement.

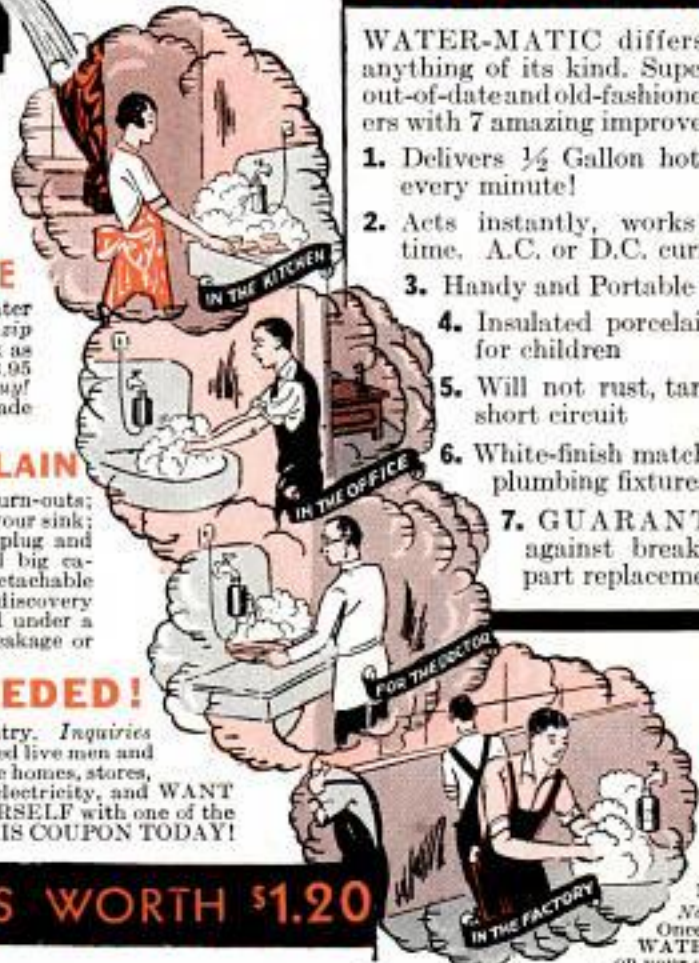

GET INTO BIG MONEY

Why half-starve on a part-time job when you can get into the **BIG MONEY** with **WATER-MATIC!**

No experience needed. Once you see how **WATER-MATIC** works on your own faucet, you become so enthusiastic **NOTHING CAN STOP YOU!**

We show you everything—how to demonstrate, how to close sales, collect your **CASH.** Start in Spare Time—10 Sales, an Evening's Easy Work, nets you **\$12.00 CASH IN HAND.** Full time earnings averaging 25 Sales a Day net you **\$30.00 a Day, \$180.00 a Week, \$780.00 a Month.** More than \$9,000.00 a year! Territory is Going Fast. Tomorrow May Be Too Late.

MAIL THE COUPON AT ONCE

WATER-MATIC

Mystery "TWIN-RAY" Light Tested— Reads Newspaper At 1,000 Feet!

SEVERE TEST GIVEN NEW SAFETY LIGHT

June 8th: A demonstration of the new Auto Safety Light, designed for safe night driving, was given at the Boston airport on Friday night before an interested gathering of pilots and automobilists. The first test was the ability to read any part of a newspaper at a point of 1,000 feet in front of the light and a foot above the ground, proving that while the ground in front of the light was perfectly illuminated, the rays from the light were at no point above the center of the light itself. Consequently there would be no glare in an on-coming car, showing the light powerful enough to penetrate the lights of the on-coming car and show clearly the road beyond and any obstacles in it.

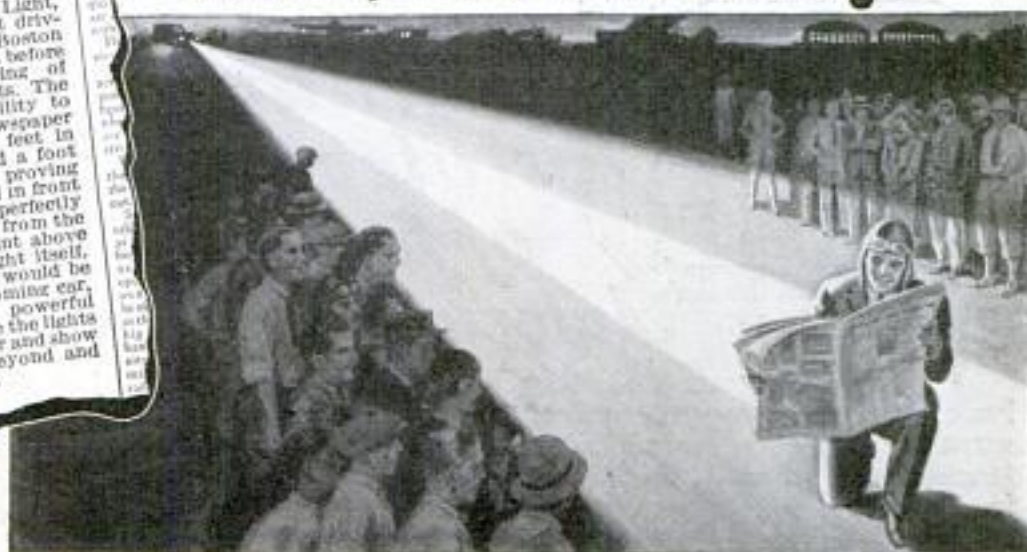

Lights Highway Ahead With 67,000 Candle Power Beam

Reporters for the Boston Sunday Post witnessed a demonstration of this light and above is a reprint of their report.

Now—judge for yourself what you can do with a light like this on your automobile—a light that throws a 67,000 candle power beam for over 1,000 feet—lights up all road signs and curves long before you reach them. Makes the road ahead of you as bright as day yet absolutely can't glare in the eyes of approaching drivers. A road light that literally takes the light

out of the sky—all light on the highway. Fast night driving now safe with this amazing Speedlight—you can drive 50-60—even 70 miles an hour with perfect safety. On a road as brilliantly lighted at midnight as at mid-day. Cuts through fog, rain, and darkness. This "twin-ray" road light not only can't glare itself but it cuts through on-coming brights. No wonder it was awarded the grand prize and two gold medals in world competition.

AGENTS Cleaning Huge Profits

Agents and distributors from coast to coast are making big money equipping passenger cars, busses and trucks with this brand new road light. This is your opportunity to make up to \$10-\$20-\$30 per day. Some agents make even more. Kinney made \$96 in a few hours. Frost made \$150 in one day. Burroughs sold fifty lights to Richmond fire and police departments. Over 20 million cars need

this wonderful light to protect human lives and property against glaring lights, fog, rain and darkness. Hundreds of men have made big fortunes out of makeshift spot lights and painted bulbs that only did half the job. Send the coupon and find out how you can use this great device to build up a crew of your own—and double your earnings—earnings which by themselves will be bigger than you ever saw before. Do it now, before you turn this page.



Cuts Through London Fog and Darkness Like a Knife

Tests in England have proved this. With this light you need have no more fear of fog, rain or darkness. There is no light like it in the world. It is not a spot. It embodies an absolutely new principle in headlighting discovered by a famous light engineer. NOT A PAINTED BULB—but a real scientifically constructed road light with a concentrated 67,000 candle power beam of light on the road for over a thousand feet and no glare. Think of it! Over a fifth of a mile. Put one on your car and see for yourself what you can do with a light like this. Send the coupon today for our introductory offer.

SPEEDLIGHT COMPANY

1731 Belmont Ave., Dept. 10-R, Chicago, Illinois

When writing to advertisers please mention Popular Mechanics

TO GET THIS LIGHT
FREE of Extra
Cost
DON'T TURN PAGE—
MAIL THIS COUPON FIRST



SPEEDLIGHT COMPANY,
1731 Belmont Avenue,
Dept. 10-R, Chicago, Illinois.

Without obligation to me please send me full details of your
Speed

This One

NAME

ADDRESS

CITY



4J5L-8YJ-4D26

450 MILES in a gallon of gas

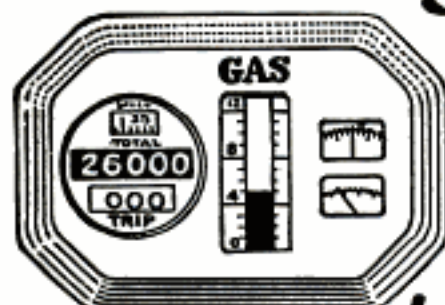

*startling
statement
of famous
Automotive Engineers*

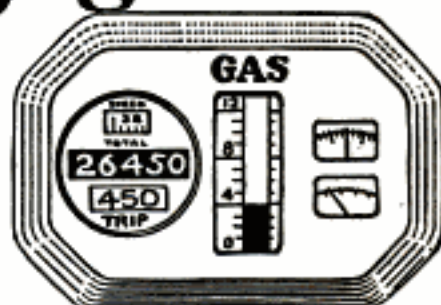

How to increase gasoline mileage has been a problem that Automotive Engineers have been trying for years to solve. Recently a world famous engineer made the statement that the energy produced by burning a gallon of gasoline would run an auto a distance of 450 miles. Other well known authorities go on record as saying that eventually it may be possible to get over four times as much out of gasoline as in the past.

Amazing Whirlwind Device Saving Millions of Gallons of Gas for Auto Owners

The Whirlwind Carbureting device embodies scientific features which conserves part of the gasoline that formerly went to waste.

Letters coming into the office tell of record mileages resulting in amazing gas savings. Low gasoline mileage is reported on practically every make of car. Greater power and smoother running motors are also noticed by users. The cost of the Whirlwind is so little that, basing its gas saving features even on the most modest reports, it would pay for itself almost immediately and then save many, many dollars for its owner by reducing gasoline consumption.

Car owners all over the world are saving money every day with the Whirlwind, besides having better operating motors. Think what this means on your own car. Figure up your savings—enough for a radio—a bank account—added pleasures. Why let the Oil Companies profit by your waste? Find out about this amazing little device that will pay for itself every few weeks in gas saving alone.

FITS ALL CARS

In just a few minutes the Whirlwind can be installed on any make of car, truck or tractor. It's actually less work than changing your oil or putting water in the battery. No drilling, tapping or changes of any kind necessary. It is guaranteed to work perfectly on any make of car, truck or tractor, large or small, new model or old model. The more you drive the more you will save.

SALESMEN and DISTRIBUTORS WANTED To Make Up To \$100.00 a Week and More

Whirlwind men are making big profits supplying this fast-selling device that car owners cannot afford to be without. Good territory is still open. Free sample offer to workers. Full particulars sent on request. Just check the coupon.

WHIRLWIND MANUFACTURING CO.

Dept. 729-A, Station C. Milwaukee, Wis.

GUARANTEE

No matter what kind of a car you have—no matter how big a gas eater it is—the Whirlwind will save you money. We absolutely guarantee that the Whirlwind will more than save its cost in gasoline alone within thirty days, or the trial will cost you nothing. We invite you to test it at our risk and expense. You are to be the sole judge.

FREE OFFER COUPON

WHIRLWIND MANUFACTURING CO.,
Dept. 729-A, Station C, Milwaukee, Wis.

Gentlemen: You may send me full particulars of your Whirlwind Carbureting device and tell me how I can get one free. This does not obligate me in any way whatever.

Name.....

Address.....

City.....State.....

() Check here if you are interested in full or part time salesman position.

When writing to advertisers please mention Popular Mechanics

Popular Mechanics Magazine

200 E. Ontario Street, Chicago, U. S. A.

H. H. WINDSOR, Founder

H. H. WINDSOR, Jr., Editor and Publisher

London: Messageries Hachette,
3 La Belle Sauvage, Ludgate Hill, E. C. 4

Paris: Hachette & Cie.,
111 Rue Reaumur

Melbourne: Gordon & Gotch
509-513 Little Collins St.

Vol. 56

November, 1931

No. 5

Special Features

<u>Harnessing the Earth's Terrific Heat</u>	734
<u>Mayan Mysteries Defy Modern World</u>	738
<u>Adrift Five Days in a Rubber Boat</u>	744
<u>There's Money in Goldfish</u>	783
<u>Chemical Magic</u>	786
<u>Lost Mines Lure Gold Hunters</u>	792
<u>The War on Fur Bootleggers</u>	798
<u>How to Sell an Invention</u>	810

<u>Aerial Ferry—to speed high over a harbor</u>	778
<u>Agriculture</u>	
engine on cultivator lifts water for farm	775
soil chemistry not changed by drouth	797
<u>Airplanes</u>	
forty-seater air liners	809
metal plane that's lighter lifts a heavy load	737
robot pilot guides plane better than human one	733
<u>Airships</u>	
into the arctic wastes with the Graf Zeppelin	753
radio "feeler" tests the air beneath giant dirigible	748
<u>Aquaplane—portable, for slow speeds</u>	785
<u>Automobiles, Accessories</u>	
chain installed in mud without use of jack	779
windshield heated by wires	780
<u>Automobiles, Repairing</u>	
brake lining ground on shoe	809
brush for radiators removes rust and scale	748
<u>Automobiles, Testing—ignition system tested with special engine</u>	749
<u>Boats and Boating—glider boat equipped with an air-plane propeller</u>	765
<u>Building Construction</u>	
houses with copper walls require no painting	767
work with frozen concrete speeds winter building	733
<u>Chairs—chain braces for, eliminate wobbling</u>	782
<u>Chemical Research</u>	
"boys" toys powerful tools for seekers of knowledge	808
"magnetic eye" is detective that hunts elements	810
<u>Currency—millions in cash moved every day</u>	762
<u>Desks—school desk and seat made in one adjustable unit</u>	801
<u>Disease</u>	
radio treatment for brain aided by heat rays	767
typhus carried by rat fleas	721
<u>Diving Bell—with crab claw helps hunt treasure</u>	743
<u>Dogs—injured dog in "wheel chair" is pulled by companion</u>	774
<u>Eggs—eggwhite polishes leather and loosens chewing gum</u>	761
<u>Electric Hammer—takes dents out of auto fenders</u>	761
<u>Electricity—from peanut shell</u>	768
<u>Explosive—new, adds power and speed to bullet</u>	768
<u>Fish and Fishing</u>	
aquarium for native fish	737
fish frightened by shadows and not by noise	736
<u>Fossils</u>	
giant thunder lizard mounted for world to see	775
prehistoric animal's tooth weighs over four pounds	791
<u>Fruit—copperized paper for pears prevents spread of mold</u>	768
<u>Garden Hose—has built-in sprinklers</u>	761
<u>Gate—automatic railroad crossing gate</u>	727
<u>Golf—booth in concrete golf ball for serving players</u>	779
<u>Hoover Dam—"Roman chariots" help build road to</u>	752
<u>Hose—"slip-on" coupling for</u>	749
<u>Household Devices</u>	
ants built first skyscraper eons ago	761
plane kills grasshoppers by poison spray	816
lawnmower—electricity cuts your grass	808
Leggings—snake-proof metal, protect wearer's legs	791
Locomotives—diesel, are sent by ship to Far East	743
Marksmanship—target shooting in reverse shows skill on range	773
Motor Bus—equipped with rubber fenders	775
Museum—coal-age forest exhibited in	779
Music—made with mercury tubes and toy piano	797
<u>Musical Instruments</u>	
piano and harp are combined	781
violin carved out of a steer's horn	765
<u>Navigation—earth globe in cage of wire helps teach</u>	769
<u>Navy, U. S.</u>	
the "me-too" boats and their brood	779
war birds of Asiatic fleet shot from flagship	771
<u>Parachute—opens instantly adding to safety</u>	752
<u>Projector—makes movies of still pictures</u>	769
<u>Psychology</u>	
how smart are you?	728
this will give you answer to speed problem	732

Anglerworm from 70 (Continued on page 4) *Phosphorus talking wire 72*
Call's spread 713

ISSUED MONTHLY SUBSCRIPTION: SINGLE COPY, 25 CENTS

In United States and its possessions, Cuba, Mexico, and all countries in the Pan-American Postal Union, per year, postpaid	\$2.50
To all other countries in the Postal Union	3.00

All subscriptions are discontinued at expiration. Please examine the date printed on your wrapper.
Entered as Second Class Matter Sept. 15, 1902, at the Post Office at Chicago, Illinois, under Act of March 3rd, 1879.
Approved as Second Class Matter at the Post Office Department, Canada.
Published monthly by POPULAR MECHANICS CO. Copyright, 1931, by Popular Mechanics Co. Copyright in Australia. Copyright in France

City Bank member folder
955

automatic gates stop autos at grade crossings 727

Vacuum relay 823

[4]

[Contents—Continued]

varnish quick drying 868

Wm. G. Gilbert
27
for record

Trailer hitch

Radio—practical ideas for the radio experimenter	821
Radio, Aerial	
practical antenna suggestions	823
simplified antenna lead-in	820
Radio, Apparatus	
an electrical hair trigger	823
control box for double-button microphone	818
speech-amplifier unit for amateur phone	822
testing filter condenser paper	823
Radio, Batteries—improving vibrator chargers	823
Radio, Construction—switches shift short-wave coils	819
Radio, Loud Speaker—homemade speaker for car	820
Radio, Television—homemade receiver for advanced design	824
Railroads	
motor railway cars run on rubber tires	774
steam for cooling rail cars	791
Rockets—parachute on rocket motor provides easy landing	733
Roller Coaster—backyard, furnishes big thrill	748
Safety Devices and Measures	
safety suits prevent burns from high voltages	781
traffic light changes shape to aid color-blind driver	775
Salvage—treasure ship raised in hunt for gold	733
Saws and Sawing—speed saw that cuts stone	779
Sculpture	
man and boat carved in sand	808
Washington's face is carved on granite hills	782
Ships and Shipping	
Italian liner "Rex" called fastest on the Atlantic ocean	721
model of Nelson's flagship sails the seas today	790
piloting Mississippi river steamboats	802
Sleep—Indian design to cause sleep aids insomnia victims	785
Statues—made from old newspapers	766
Surf Machine—ocean waves made to order by	817
Telegraphy—words go in Japanese and come out English	780
Tunnels—triple, under hills untangle traffic	747
Vatican City—the scientific miracles of the	722
Wigwam—giant, of concrete makes a novel home	768
Workshop—library installed in film star's home shop	796

AMATEUR MECHANICS

Ashes—vacuum cleaner prevents dust when removing	855
Auto Ramp—steps in, save space on small lots	834
Automobiles, Repairing	
aligning a shifted auto frame	833
graphite and paraffin make windows slide easy	853
Bed Table—folds into small space	847
Birdcage—wire holder for nests	833
Book Markers—rubber bands for loose-leaf	850
Book Stand—revolving, for your library	845
Camera—rubber hose holds detachable legs of tripod	833
Car Dipper—cork and rubber band form handle for	854
Carboy—rockers aid to tilt	850
Clothes Drier—folding, fits stove or furnace register	831
Clothes Hangers—for trousers and sleeveless dresses	854
Depoys—animated, attract ducks	844
Dogs	
sack of hardened cement serves as feeding bowl for training your dog	830
training your dog	840
Drawers—thumbtacks on slides reduce friction	834
Fish Bowl—illuminated stand	834
Flag—pipe cleaner keeps flag straight	839
Flowers	
muslin wicks water	830
salt preserves odor of roses	833
Golf—holder for painting balls	839
House Numbers—built into porch	855
Hunting—pocket lining for carrying small rifle shells	854
Lamps	
brilliancy of two-filament auto lamps doubled	850
medieval wall lantern easily made of copper	835
Letter File—from radio condenser	860
Masks—for Halloween that you can make	856
Matches—simple stunts with, are amusing	859
Motors—auto generator converted into high-speed a.c. motor	848
Musical Instruments	
like ukulele made from tennis racket	844
mandolin pick from razor blade	849
Paints and Painting	
hook for holding paintbrush in bucket	859
"shadow-stenciling" wall borders	832
Pencil Holder—on your belt	859

Photography	
homemade developing reel for movie film	851
mercurochrome tints photographs	844
Poultry—turkeys prevented from flying by stick across wings	853
Projector—projecting sport news on a store window	853
Sandpapering—oval sandpaper mounting helps in rough work	850
Saws and Sawing—avoiding breaks in thin fretwork	855
Scrap Book—made from wrapping paper	838
Scrub Pail—frame with casters for	831
Shoes—rollers aid in shining	839
Show-Card Writing—newspapers aid in practicing	838
Signs—reducing cost of roadside	855
Soldering—light metal uniformly soldered with lead foil	838
Stamp Pad—easily opened by use of tin tab	852
Stovepipe—cleaning horizontal	849
Sweeper—walk, made from discarded lawnmower	860
Target—air-rifle, from tobacco can	832
Tent—wooden block for poles protects floor cloth	860
Tools—wedge screwed to hammer makes nail pulling easier	850
Toys	
sprocket chain for, cut from old movie film	849
this mechanical burro has an amusing gait	843
Tricks—with cards are easy	827
Turnbuckle—converted into small jack	831
Vestibule—storm, quickly erected	832
Warning Flags—held upright by sledge hammer	831
Washing—wire clip on tub or pail holds hose	849
Windows—how to open tight	848
Workbench—door for shelf keeps out dirt	833

SHOP NOTES

Agriculture—ensilage stored in trench saves silo cost	869
Aluminum—how to anneal	871
Automobiles, Repairing	
carbonate of soda cleans radiators	863
heater housings centered on exhaust	863
sand blast cleans spark plugs	876
worn pilot bearing causes noisy second-speed gears	870
Blowtorch—attachment for using tire pump on tank	864
Brazing	
arc-brazing galvanized surfaces	879
enameled ware	878
larger cone tip for	880
Calipers—beeswax aids in caliper flanged work	864
Clamps—for built-up column work	870
Drills—guide prevents jumping of air drill	871
Floors—shop, covering from discarded fabric belting	871
Glass—how to grind and polish ends of tubing	876
Hammer—babbitt, non-slip handle for	878
Ink—glass tubing to erase	869
Insulation—insulating to cut your fuel costs	872
Jacks—small, from capscrews	863
Jointer—table for handling long work on	875
Lathe	
mounting work on a metal-turning	865
steadyrest and "semaphore" gauge speeds up tenon cutting	864
Metals	
pumice paste for lapping soft	868
whiting prevents tin from adhering to brass or copper	880
Motor—on swivel base runs four machines	863
Paints and Painting	
carrying case for paint cans	870
self-sealing shellac-pot cover	878
Planer—surfacing thin stock on a	879
Refrigerator—underground, for the farm	879
Rope	
stretching prevents new rope from twisting	864
tethering, chain link prevents from tangling	876
Saws and Sawing	
miter box for cutting pipe	869
miters cut without miter box	880
this heavy-duty jigsaw has large capacity	861
Seat—shop, made from discarded machine parts	875
Shafts—indicator for testing bent	880
Signs—revolving sign driven by stream	870
Solder—reclaiming silver	878
Soldering—iron for places hard to reach	871
Storage—holders for long round stock	880
Tools—oil keeps chisel edge keen	880
V-Block—wristpins bolted together form handy	871
Wood Inlay—imitation, turned from scrap stock	877

generator into motor 848



Go
Gull
Hone
Ice
Ice
In
Isr
Inv
Mag
Mal
1
'ov

*New in method
style and mode*

MASONITE

Cushioned

FLOORING

OF TEMPERED PRESWOOD

First in this remarkable Masonite family came Structural Insulation and QuartRboard, next Presdwood, then Tempered Presdwood . . . and, now, *Masonite Cushioned Flooring*—both a flooring and a floor covering, new and modern in method, style and mode.

As its name suggests, it has an in-built shock absorber, which eliminates much of the fatigue and discomfort from walking. It is of three-ply construction—outer layers of *durable, wear-resisting* Tempered Presdwood, impervious to moisture and specially toughened by a process similar to that used in tempering steel; an inner layer, or cushion, of QuartRboard to provide resiliency, insulation, and sound absorption.

Masonite Cushioned Flooring is *beautiful*, with endless combinations of design and pattern. It is *economical*, in first cost, in application, in long life, in elimination of floor covering.

Architects, contractors, home and building owners appreciate its practical features, its utility either in new construction or modernizing. Note its distinctive points listed on this page. Also send coupon—today—for folder giving complete facts.

Ten points of superiority

- 1. Appearance**—Smooth, beautiful, grainless squares and borders.
- 2. Durability**—Built to withstand wear; Tempered Presdwood surfaces assure long service.
- 3. Style**—Something entirely new.
- 4. Resiliency**—QuartRboard cushion makes walking easy and restful.
- 5. Grainless**—An all-wood flooring, yet free from splinters.
- 6. Perfect Joints Interlocked**—Tongue-and-groove construction provide smooth, snug fit.
- 7. Easily Laid**—Can be either nailed or cemented.
- 8. Variety of Designs**—No end to patterns—6, 9, 12-inch squares; borders 3, 6, 12 inches wide; 47 inches long.
- 9. Reversible Squares**—Dark on one side; light on other.
- 10. Flooring and Floor Covering**—All in a single unit.

Masonite

Cushioned FLOORING

STRUCTURAL INSULATION · INSULATING LATH
PRESWOOD · QUARTRBOARD

© M. C., 1934
MASONITE CORPORATION, Dept. L-11
111 W. Washington Street, Chicago, Ill.
Please send your free illustrated folder that describes Masonite Cushioned Flooring.

Name _____

Street _____

City _____ State _____

When writing to advertisers please mention Popular Mechanics

BE AN AUTO EXPERT

EARN up to \$5000 A YEAR



Learn Autos
the new easy interesting
JOB-WAY



**From
\$30
a Week
to
\$90
a
Week!**

W. S. Yancy, Perla, Arkansas, was making only \$30 a week when he wrote for my Book. Today he's earning \$90 a week! You can get the same book FREE! Just clip the coupon — and mail it today!

Clip Coupon for Free Auto Book!

Say good-bye to low pay! Get into the Auto Business, where big pay — extra money — raises — come quick! A brilliant future awaits you in the World's Biggest Business.

LEARN AT HOME In Spare Time

If you're earning a cent less than \$50 a week, clip that coupon now. Learn how \$50—\$75—even \$100 a week is now possible for you. See how I train you, right at home, in every branch of Auto Work, quickly and easily. Find out about this Training which boosted Yancy's salary from \$30 a week to \$90 a week!

Experience, Education, Not Necessary!

All you need is common schooling—and it makes no difference if you never touched an auto before. Men from all walks of life who worked long, hard hours for low pay, are now becoming Garage Owners, Foremen and Superintendents. If you like autos, if you're between 15 and 55—get the facts now! "Job-

Way" Training covers everything about Autos — Mechanical and Electrical—everything you need to get in line for a Big Pay Job as an Auto Expert! It's the trained man who gets the good jobs and "Job-Way" is complete Training, yet so simple and so easy that you get it quick.

3 Testing and Repair Outfits also included FREE of extra cost — If You Act At Once!

Right now I am offering an Electrical Experimental Outfit, equipment for a Portable Electric Test Bench, and 381 Auto Wiring Diagram Charts to students. Send coupon now.

Auto Book FREE!

Send for this big new book. Take the first step to a Big Pay Job!



Read My Money-Back Agreement!

Learn about the 14 "Job-Way" Features shown in my big Free Auto Book. Also about my Money-Back Agreement. Be sure to get the book and see how easily you can get in line for a Job paying up to \$100 a week!

MAIL THIS COUPON!

MOTOR INSTITUTE OF AMERICA, B. W. Cooke, Dir. Engineer
Motor Institute Bldg., Dept. 4168, Evanston, Ill.
Send me your FREE Auto Book. Also proof that I can succeed
in the Auto Business. Tell me about "Job-Way" Auto training
—about your Employment Department, and about your 3 Testing and Repair
Outfits and Other Special Services. No obligation on my part whatever.

Name

Address

Town State

Age Occupation

GET FULL PARTICULARS NOW

Find out how greatly EXPERT Service Men and Service Managers are needed in the Auto Business, and how my Employment Department helps you get a good job—raises in pay—and Promotions. Get the details of this money-making Auto Service Training NOW. Send Coupon today!

Address me **B. W. COOKE** Directing
Personally **Engineer**

MOTOR INSTITUTE OF AMERICA

Motor Institute Bldg., Dept. 4168, Evanston, Ill.

Business Demands Accountancy

—because Accountants Command Business

ACCOUNTANTS have been in demand—at far better than average earnings.

But today—more than ever before—the competent accountant finds his services at a tremendous and increasing premium.

In the depression business tightened up the reins and is watching costs—prices—every move—striving to operate on that basis of close control so essential to profits.

Then too, progressive business is building now for the return of prosperity—laying plans for expansion, for new processes, new markets—getting ready for the unparalleled opportunities of the next ten years.

The Home Study Way to Accountancy Success

Thousands upon thousands of men have trained for Accountancy with LaSalle—at night—at home.

Their success—their progress—is a matter of record.

Whether their goal was a C. P. A. degree or advancement in business, our files are full to overflowing with letters reporting income increases so far out of line with the time and cost investment that there is no comparison.

Note, for instance, these four typical cases chosen out of thousands more we might cite: (Names on request.)

F. F. A. was a railroad yard clerk at \$112 a month when he began accountancy training with LaSalle. Five years later, his income was 500% larger and he was a Certified Public Accountant and attorney. F. C. was 22 years of age and general all-around man in an Arkansas lumber yard at \$75 a month. Five months later, his firm made him manager at \$125, and ten months later promoted him to a larger yard at \$250 plus a commission on sales.

O. D. always thought stories about LaSalle training were fairy tales until the training helped him—a clerk at \$75 a month—move up in six months to \$125, and within four years to \$250. Today he is General Auditor of a large national organization—and his income is more than seven times his starting salary.

As an assistant bookkeeper in a great Western bank, C. F. H. looked forward to slow progress. But LaSalle accountancy training speeded up his climb to Assistant Trust Officer and to a salary increase of 400 per cent.

These Men Won Success in Ordinary Times—You Will Profit by Coming Prosperity

Remarkable as is the success of these men—you will have a decided advantage over them—you will be entering accountancy when unusual business conditions work with you for success.

Present conditions and the upturn to prosperity not only call for more capable accountants—but offer unusual opportunities for both quick and permanent success. The accounting student of 1931 will face real opportunity in 1932 and the accounting leaders of 1935-40 will be largely determined in 1931-1932.

—If You Can Qualify

Ask yourself three questions:

1. Are you ambitious?
2. Have you determination?
3. Can you see and grasp an opportunity?

If the answers are "Yes"—you are qualified.

If you have determination; if you are ambitious; if you can take advantage of circumstances—*prove it* by investigating. A two-cent stamp, sixty seconds time, and the coupon below will bring you full information regarding Accountancy training and the opportunities to which such training leads. *Then* you can judge intelligently.

LaSalle Extension University

THE WORLD'S LARGEST BUSINESS TRAINING INSTITUTION

LA SALLE EXTENSION UNIVERSITY, Dept. 1184-88, CHICAGO

Opportunities in Accountancy—Check below and we will send you a free copy of "Accountancy, the Profession that Pays," also information about our new training in Higher Accountancy, all without obligation.

Higher Accountancy

Other LaSalle Opportunities: If more interested in one of the other fields of business indicated below, check that:

- | | | |
|---|--|--|
| <input type="checkbox"/> Business Management | <input type="checkbox"/> Law: LL.B. Degree | <input type="checkbox"/> Business Correspondence |
| <input type="checkbox"/> Expert Bookkeeping | <input type="checkbox"/> Commercial Law | <input type="checkbox"/> Banking and Finance |
| <input type="checkbox"/> C. P. A. Coaching | <input type="checkbox"/> Industrial Management | <input type="checkbox"/> Modern Salesmanship |
| <input type="checkbox"/> Railway Accounting | <input type="checkbox"/> Modern Foremanship | <input type="checkbox"/> Effective Speaking |
| <input type="checkbox"/> Traffic Management | <input type="checkbox"/> Personnel Management | <input type="checkbox"/> Business English |
| <input type="checkbox"/> Railway Station Management | | |

Name.....

Present Position.....

Address.....

When writing to advertisers please mention Popular Mechanics



DON'T RUN AWAY from an Opportunity to attend a professional school in **RADIO AVIATION TELEVISION**

Your success depends on whether you accept money-making opportunities or "run away" from them because of no ambition, negligence or unnecessary thoughts of fear in getting started.

At the Dutton Radio Institute you'll find highly recognized instructors ready to personally assist you in your studies and hundreds of students you'll enjoy knowing.

Unemployment conditions and depressions do not disturb the positions held by men who are professionally trained in Radio and Aviation. The man untrained today cannot find work while thousands of positions are open to the "trained man."

If you want training ability equal to leading colleges write today for catalog giving full information about various courses.

DUTTON RADIO INSTITUTE

Dept. 10, DePaul
University Building
Chicago, Illinois



Dutton Radio Institute:
Please mail me new catalog on Radio and Aviation.

Name

Address

Learn Autos



in Los Angeles

Come West at Our Expense!

For a limited time we are making a railroad fare offer from any point in the United States to Los Angeles. Just think of it! A trip to California with your railroad fare allowed.

Quickly Train for Big Pay Jobs

Quickly train for Big Pay Jobs in Auto work. Unlimited Lifetime Employment Service. Employers insist on our men instead of green, half-baked mechanics who don't know what it's all about. You need good training to earn Big Pay!

Don't Worry About Money! We'll Help You!

If you are short of money, we'll help you. We help you secure a part time job to earn living expenses while learning.

It's Easy at National!

Short, condensed training in our Million Dollar Practical "School of Shops" . . . instruction on the most modern equipment money can buy . . . with the country's best staff of expert, experienced instructors. No previous experience needed. None too old or too young to learn. Start any time. **WRITE TODAY!** We'll send you the full story about Railroad Fare Offer, Unlimited Employment Service, etc. New Book sent FREE.

FREE BOOK

NATIONAL AUTOMOTIVE SCHOOL

Dept. 114-A 4006 So. Figueroa St., Los Angeles, California

Don't Envy The Plumber—BE ONE!

\$11.00—\$16.00 PER DAY and work EVERY day, is the Plumber's wage.

LEARN IN 8 to 12 WEEKS without previous experience.

If you are making less than \$60.00 a week you owe it to yourself to invest. Get FREE catalog that tells in pictures and words how we teach this trade. Special rates now.

UNIVERSAL PLUMBING SCHOOL, 2030 Trest Avenue, KANSAS CITY, MO.

Learn to Dance

You can learn all the modern dances—the latest Tango steps, the new Fox Trots, dreamy Waltzes, smart Collegiate Steps, and popular Society Steps at home, easily and quickly. New chart method makes dancing as simple as A-B-C. No music or partner required. Don't be a wallflower. Learn to dance. Complete course—265 pages, 54 illustrations, sent on 5 Days' Free Trial. Equals \$20.00 course. Send no money. Pay postman only \$1.95, plus postage upon arrival. Money back if not delighted. Catalog Free.



Franklin Pub. Co., 800 No. Clark St., Dept. 9435, Chicago



Why STAMMER?

I overcame my own stammering. Let me help you. My new, free book tells how. You, too, can overcome your speech defects and live a normal, happy and successful life. Write today 4037 E. CARD, 12500 Woodward Ave., Detroit, Mich.

Free Book



"BECOME A LIGHTNING TRICK CARTOONIST"

Send \$1.00 for Laugh Producing Program of 23 Trick Drawings with instructions. Catalog of Chalk Talk Supplies Free. BALDA ART SERVICE, Dept. 1, Oshkosh, Wis.

\$1000 Extra For YOU

Stoneberger makes that in SPARE Time, broadcasting from Station WJBY, Washington, D. C. Hundreds of others playing for Radio, in Orchestras, etc.—BIG PAY FOR YOU!—Free Book tells you all about QUICK, EASY Way to Master popular Hawaiian Guitar. Write for it Today! HAWAIIAN STUDIO 52111, New York Academy of Music, 100 Fifth Ave., New York City

When writing to advertisers please mention Popular Mechanics



"WE SET OUR GOAL AT \$5000 A YEAR"

"SIX YEARS AGO we sat down to figure what we wanted from life—Margaret and I. And to reach the comfortable scale of living we had set our hearts on, we found it would take \$5000 a year! That seemed impossible, it was so much more than I was making, but Margaret had faith that I could do it.

"I enrolled with the International Correspondence Schools and started studying at home. At once I gained a new and wider view of my job—did better work. After four months the boss asked what had happened to me, and I told him. That day I got the first of my promotions.

"We passed the \$5000 mark this year and we're going right on. Thanks to my I. C. S. training, I can give my family an attractive home, a good car, all the comforts they need. It means school and college for the boys, more leisure for Margaret, and vacation trips for all of us. Do you wonder we're boosters for the I. C. S.?"

Is *your* family budget cramped by your salary? In one hour a day of your spare time, the I. C. S. can help you to climb out of the rut and into a bigger, better-paying job. Set your own goal. We can help you reach it. *Today* take the first step.

MAIL THE COUPON FOR FREE BOOKLET

INTERNATIONAL CORRESPONDENCE SCHOOLS, Box 5569-G, Scranton, Penna.

"The Universal University"

Without cost or obligation on my part, please send me a copy of your 48-page booklet, "Who Wins and Why," and tell me how I can qualify for the position, or in the subject, below which I have marked an X:

BUSINESS TRAINING COURSES

- Business Management
- Industrial Management
- Personnel Management
- Traffic Management
- Accounting and C.P.A. Coaching

- Cost Accounting
- Bookkeeping
- Secretarial Work
- Spanish French
- Salesmanship
- Advertising

- Business Correspondence
- Show Card and Sign Lettering
- Stenography and Typing
- English
- Civil Service

- Railway Mail Clerk
- Mail Carrier
- Grade School Subjects
- High School Subjects
- Illustrating Cartooning
- Lumber Dealer

TECHNICAL AND INDUSTRIAL COURSES

- Architect
- Architectural Draftsman
- Building Foreman
- Concrete Builder
- Contractor and Builder
- Structural Draftsman
- Structural Engineer
- Electrical Contractor
- Electric Wiring
- Electric Lighting
- Electric Car Running

- Telegraph Engineer
- Telephone Work
- Mechanical Engineer
- Mechanical Draftsman
- Machine Shop Practice
- Toolmaker
- Patternmaker
- Civil Engineer
- Surveying and Mapping
- Bridge Engineer
- Gas Engine Operating
- Automobile Work

- Aviation Engines
- Plumber and Steam Fitter
- Plumbing Inspector
- Foreman Plumber
- Heating and Ventilation
- Sheet-Metal Worker
- Steam Engineer
- Marine Engineer
- Refrigeration Engineer
- R. R. Positions
- Highway Engineer
- Chemistry

- Pharmacy
- Mining Engineer
- Navigation Assayer
- Iron and Steel Worker
- Textile Overseer or Supt.
- Cotton Manufacturing
- Woolen Manufacturing
- Agriculture
- Fruit Growing
- Poultry Farming
- Mathematics
- Radio

Name..... Street Address.....

City..... State..... Occupation.....

If you reside in Canada, send this coupon to the International Correspondence Schools Canadian, Limited, Montreal, Canada

When writing to advertisers please mention Popular Mechanics

TEST YOUR ART ABILITY FREE



HERE is your opportunity to find out how much talent you have. Our simple, scientific Questionnaire tests your natural sense of design, proportion, color, perspective, etc. It may show you the way to a bigger future—a real career.

Federal Students Are Successful

Many Federal School students are making \$2,000, \$4,000, \$5,000 and \$6,000 yearly. The Federal School is recognized everywhere by employers of artists and by buyers of art work. Big prices are paid for drawings.

Learn Commercial Art at Home

If you like to draw, an almost sure indication of talent, the Federal Course will quickly develop your ability to earn money. Some students earn more than the cost of the course while studying. Many nationally known artists have contributed exclusive, illustrated lessons to the Federal Course. No previous training is needed. You will receive personal, individual criticism on your work.

Send TODAY for Questionnaire!

Just fill out and mail the coupon stating your age and occupation. There is no cost or obligation to you.

Federal School
of Commercial Designing

1111A Federal Schools Bldg., Minneapolis, Minn.

Send me your analysis questionnaire without cost or obligation.

Name.....
Age.....
Address.....

Present Occupation.....

Play the Hawaiian Guitar like the Hawaiians!

Only 4 Motions used in playing this fascinating instrument. Our native Hawaiian instructors teach you to master them quickly. Pictures show how. Every thing explained clearly.

Play in Half Hour

After you get the four easy motions you play harmonious chords with very little practice. No previous musical knowledge needed.

Easy Lessons

Even if you don't know one note from another, the 62 printed lessons and clear pictures make it easy to learn quickly. Pay as you play.

GIVEN—a sweet toned when you enroll

HAWAIIAN GUITAR, Carrying Case and

WRITE AT ONCE for attractive offer and easy terms. You have everything to gain. A postcard will do. ACT!

Playing Outfit—Value \$18 to \$20

No extras—everything included

OTHER COURSES | Tenor Banjo, Violin, Tiple, Tenor Guitar, Ukulele, Banjo Ukulele. Under well known instructors.
FIRST HAWAIIAN CONSERVATORY OF MUSIC, Inc.
9th Floor, Woolworth Bldg., Dept. 548 New York, N. Y.
Approved as a Correspondence School Under the Laws of the State of New York—Member National Home Study Council

Wrestling Book FREE

Learn at Home



Be an expert wrestler. Learn at home by mail. The greatest wrestlers of all, **Frank Gotch and Farmer Burns**, both world's champions have prepared the most wonderful course of lessons ever written on **Scientific Wrestling, Physical Culture, Self Defense and Jiu-Jitsu**. Be strong, healthy, with an attractive body. Handle and control larger and stronger men with ease. Get this **Free Prospectus**—32 pages—brimming with thrilling information—**No Charge**—merely send 2c to cover postage. Don't delay. Write Today for your copy. State your age.
FARMER BURNS SCHOOL, 3378 Courtney Bldg., Omaha, Neb.

STAMMERING

You can be quickly helped if you stammer or stutter

I know, because I relieved myself after stammering for nearly 20 years. The story of my suffering—and relief—has interested thousands, many of whom have permitted me to help them. Full story of my successful efforts told in 279-page book. Sent anywhere for 10 cents. **B. N. BOGUE, 1147 Bogue Building, 1147 North Illinois Street, Indianapolis, Ind.**

\$60 a Week in AVIATION

Is what R. N. Dobbins of New York makes as Aviation instructor. **WALTER HINTON**, first Trans-Atlantic Pilot, trained Dobbins at home, in spare time—and Hinton will train YOU too. Hinton's **EMPLOYMENT DEPARTMENT** got Dobbins his job and can help you **CASH IN** on YOUR training. Prepare for one of the thousands of big pay jobs **ON THE GROUND** or in the air that pay up to \$150 per week and more. Write now for **FREE** Book that gives all details about this training and a **FREE FLIGHT, BIG SAVINGS ON FLYING INSTRUCTION, FREE AIRCRAFT RADIO COURSE**—Walter Hinton, Pres., **Aviation Institute of U.S.A., Inc., Suite 601-F, 1115 Connecticut Ave., N. W., Washington, D. C.**

BE AN OIL EXPERT!

New, easy, practical way to learn at home in spare time. Geology, Drilling Methods, Pipe Line Transportation, Refining and Marketing. Write Today! **FREE** Book!

PETROLEUM ENGINEERING UNIVERSITY, Dept. 220-B, FORT WAYNE, IND.

Anyone CAN LEARN

No talent or experience necessary. Fascinating work. **Pay big money.** Complete instruction book tells about: Alphabets, Colors, How to Mix Paints, Show Cards, Window Boards and Wall Signs, Ready made letters, Gildings, Tricks of the Trade, also gives 100 Alphabets and Designs. Book bound in flexible cloth, leatheroid edges, and four ball bearing Show Card Frames. Best postpaid **\$3.00**. C.O.D. 50c extra. Ogilvie Pub. Co., 57 Ross St., Dept. 20, N. Y. City

EARN MONEY IMMEDIATELY—WE FURNISH EQUIPMENT TO START!!



The Old Way

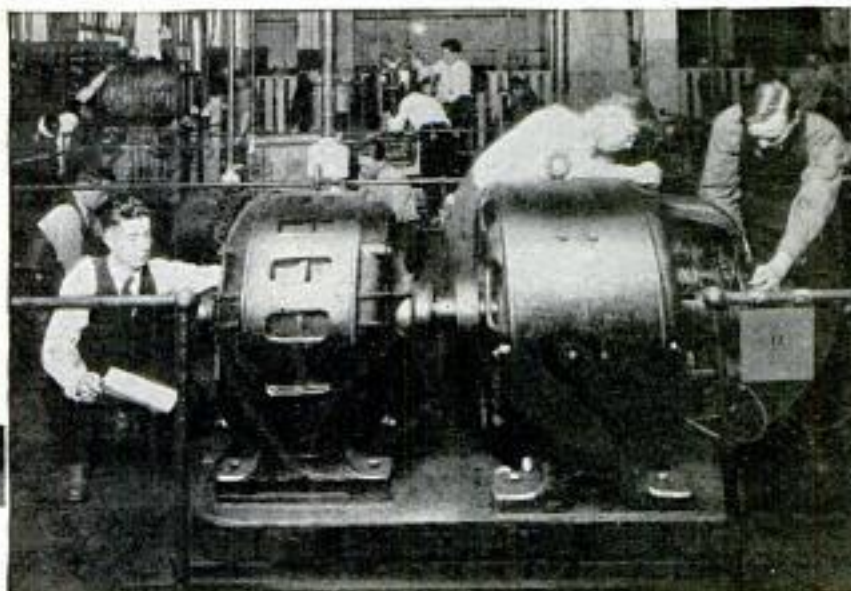

ELECTRICITY Becomes Amazingly Easy When Taught by Actual Shop Work **IN 90 DAYS**

Why work at dull, uninteresting jobs that will never pay you more than \$35, \$40 or perhaps \$50 a week? Make up your mind NOW and become a master of electricity! Train in 12 easy weeks to hold down the kind of a job that pays up to \$60 and more a week, and which creates a constant demand for your services nearly any place in the world!

Practical Shop Training

Electricity, as taught in the Great Shops of Coyne, is surprisingly easy to grasp. That's because we use no books. You learn by doing actual, practical experimenting on big, electrical machinery—finest outlay in the country. You learn BY DOING—and you learn from the ground up. No useless theory!

Not a CORRESPONDENCE School

Experts work right along with you every step of the way. You get personal attention—you are trained by actual shop work on actual electrical machinery. The COYNE WAY gives you real, sound knowledge that fits you to do practical electrical work in all its branches.

Now in Our NEW HOME ...



This is our new, fireproof, modern home wherein is installed thousands of dollars' worth of the newest and most modern Electrical Equipment of all

COYNE ELECTRICAL SCHOOL
H. C. LEWIS, Pres. Established 1899
500 S. Paulina Street Dept. 81-72 Chicago, Ill.

kinds. We now have the largest amount of floor space devoted to the exclusive teaching of practical electricity in the world. Every comfort and convenience has been arranged to make you happy and contented during your training.

NO EXPERIENCE OR ADVANCED EDUCATION NECESSARY

You don't need one day's previous electrical experience or any advanced education to master electricity the Coyne way. Some of our most successful graduates never went farther than the 8th grade.

EARN WHILE YOU LEARN

By special arrangement, our employment department helps students locate part-time work, if they want to earn while they learn. And after graduation we give them the benefit of our FREE EMPLOYMENT Service for Life. Every week we secure many positions for Coyne men.

GET FREE BOOK

Write today for my big book on electricity with over 150 photographs. Learn what great opportunity Coyne Training opens up for you. Also get full details of my Big 3-Special Offer. No obligation. Mail the coupon now.

FREE BOOK Coupon

H. C. LEWIS, President
COYNE ELECTRICAL SCHOOL, Dept. 81-72
500 S. Paulina St., Chicago, Ill.

Please send me your free catalog on Electricity and details of your Employment Service and extra courses. No obligation on my part.

Name

Address

City State

INCLUDED

If You Act Now

1 Battery

course included without one cent of extra cost to you.

2 Aviation

my big new Aviation Electrical course included at no extra charge.

3 Radio Service

course included absolutely without any extra charge.

4 Auto

course, covering truck and tractor electricity.

S E E
COUPON!

**WANT
A
STEADY
GOVERNMENT
JOB?**

\$1260 to \$3400 a Year PICK YOUR JOB Men, Boys—18 to 50

These are steady positions. Strikes, poor business conditions, or politics will not affect them. Government employees get their pay for twelve full months every year.

\$1900 to \$2700 a Year

Railway Postal Clerks get \$1,900 the first year, being paid on the first and fifteenth of each month. \$79.17 each pay day. Their pay is quickly increased, the maximum being \$2,700 a year. \$112.50 each pay day.



Railway Postal Clerks, like all Government employees have a yearly vacation of 15 working days (about 18 days). On runs, they usually work 3 days and have 3 days off duty or in the same proportion. During this off duty and vacation their pay continues just as though they were working. They travel on a pass when on business and see the country. When they grow old, they are retired with a pension.

City Mail Carriers, Post Office Clerks

Clerks and Carriers now commence at \$1,700 a year and automatically increase \$100 a year to \$2,100 and \$2,300. They also have 15 days' paid vacation. City residence is unnecessary.

Customs Immigrant Inspector

Salary \$2,100 to \$3,300. Men 21 to 45. Work connected with examining immigrants and merchandise entering the country from foreign ports.



Is Your Job Steady?

Compare these conditions with your present or your prospective condition, perhaps changing positions frequently, no chance is sight for PERMANENT employment; frequently out of a position and the year's average salary very low. DO YOU GET \$1,900 EVERY YEAR? HAVE YOU ANY ASSURANCE THAT A FEW YEARS FROM NOW YOU WILL GET \$2,100 to \$2,700 A YEAR?

You Can Get Them

Experience is usually unnecessary and political influence is not permitted. Let us show you how.

Get Free List of Positions

Fill out the following coupon. Tear it off and mail it today—now, at once.

This investment of two cents for a postage stamp may result in your getting a government job.

FRANKLIN INSTITUTE, Dept. J-187, Rochester, N. Y.

Rush to me entirely free of charge (1) a full description of the position checked below; (2) Free Copy of 32-page book, "How to Get a U. S. Government Job"; (3) A list of the U. S. Government Jobs now obtainable; (4) Tell me how to get a Government Job.

- Railway Postal Clerk..... (\$1,900-\$2,700)
 Post Office Clerk..... (\$1,700-\$2,300)
 City Mail Carrier..... (\$1,700-\$2,100)
 Rural Mail Carrier..... (\$2,100-\$3,400)
 Government Clerk—File Clerk..... (\$1,260-\$2,500)
 Inspector of Customs..... (\$2,100-\$3,300)
 Prohibition Agent..... (\$2,300-\$2,800)
 Immigrant Inspector..... (\$2,100-\$3,000)

Name.....

Address.....

Use This Coupon Before You Mislay It

Learn AVIATION WHERE LINDBERGH LEARNED!

Best Jobs Go to Lincoln Graduates

Superior training enables Lincoln graduates to get the best Aviation jobs. Our mechanic students learn by factory standards on actual ships, as we are connected with a large aircraft factory. Pilot students learn on 4 distinct types of planes. Radio and welding courses also. \$250,000 worth of buildings and equipment. \$100,000 airport. Government-licensed instructors. Ground and Flying School government approved. Part time employment to help pay cost of room and board while training. Reasonable tuition. Instruction also in Spanish. Write for catalog, stating your age!

LINCOLN AIRPLANE & FLYING SCHOOL
204A Aircraft Bldg. LINCOLN, NEBR.

Professional STAGE TAP DANCING

Learn At Home New Easy Way. Surprise and entertain your friends, win new popularity, earn extra money, develop hidden talent. No music or experience necessary. Business fundamentals and complete Professional Tap Dance included. Pleasant way to reduce. Great muscle builder. For ladies or men. Send only \$1.75 money order for complete course of 17 lessons. Or Send Only \$1.00 and pay postman balance of \$2.00 on delivery (except foreign). Nothing more to pay. Try 5 days. If not delighted, money refunded. Lisleboring exercises given FREE if you ENROLL NOW!

THORNTON DANCE STUDIOS
2751 Milled Ave., Studio Y-50, Chicago, Ill.

LEARN WATCH REPAIRING



You can learn by our modern and original system of instruction every part of the Watch Repairing Trade at home as good or better than at a shop. You can earn money while learning and secure a well paying position or start in business after completing our course of instruction. Good watch repairers are always in demand and earn from \$50 to \$75 per week. For particulars apply to the Wisconsin School of Watch Repairing
524 E. Mason St., MILWAUKEE, WIS.

MUSIC LESSONS IN YOUR HOME



You can play music like this quickly. Write today for our FREE BOOKLET AND DEMONSTRATION LESSON. It tells how to learn to play Piano, Organ, Violin, Mandolin, Guitar, Banjo, etc. Beginners or advanced players. You pay as you learn. Costs you only a few cents a day. Thousands of satisfied students.

AMERICAN SCHOOL of MUSIC, 51 Manhattan Bldg., CHICAGO

AVIATION INFORMATION FREE

Send us your name and address for full information regarding the Aviation and Airplane business. Find out about the many great opportunities now open and how we prepare you at home, during spare time, to qualify. Our new book "Opportunities in the Airplane Industry" also sent free if you answer at once.

AMERICAN SCHOOL OF AVIATION
Dept. 1358 3601 Michigan Ave. CHICAGO

EARN MONEY AT HOME

YOU can make \$15 to \$50 weekly in spare or full time at home coloring photographs. No experience needed. No canvassing. We instruct you by our new simple Photo-Color process and supply you with work. Write for particulars and Free Book to-day.

The IRVING-VANCE COMPANY Ltd.
356 Hart Building, Toronto, Can.

Chance of a Lifetime to Get into

ELECTRICITY

PANICS have not cut salaries in the fastest-growing, most prosperous of industries. The facts and figures will amaze you. Here is the greatest opportunity open to ambitious men today.

The millions of men employed in **ELECTRICITY** are not worrying about losing their jobs, or cuts in wages. It doesn't matter what conditions are in other lines—we still use electric light and power—we are building and buying more electric refrigerators than ever before—we have not given up riding on electric street cars—or telephoning—or telegraphing.

So if you are looking for a line that has both a permanent future as well as a secure present—we invite you to investigate **ELECTRICITY**—get a list of the positions open—the salaries paid—the industries that depend on Electricity for light, power and automatic controls—the whole astonishing array of facts and figures that will give you a new idea of your chances in the future of Electricity.



E. B. Ainsworth, Ardmore, Okla.—Through your employment department I accepted a position with the Oklahoma Gas and Electric Company and it is entirely satisfactory to me.



Anson S. Harshbarger, Wilkes-Barre, Pa.—"In spite of hard times I have secured employment with Edison Electric Company, beginning to operate. I only realize how deep the electrical game is. I wish to thank you very much."

Office and Factory Men Under 35—WANTED!

Practically ALL companies in all lines need men with Electrical training. Refrigeration, railroading, automobiles, steel mills, paper plants, mines, road-building, manufacturers in all industries are employing the men we prepare. All you need is a little training in Electrical Engineering principles, which we will give you at home, in your spare time. Whatever experience you have now in office or factory—whatever education—won't be wasted. You can move ahead from where you are now. Depression or prosperity—we can promise to help place you in a satisfactory position under money-back penalty! (Read contract at the right.)

You Can Save Money If You Investigate Now!

We recommend Electricity above all other lines because electrical light, power and conveniences have become a necessity in everybody's life—in home, office, factory and farm. And its future is as solid as the nation itself.

Right now we are making the most astonishing money-saving offer in our 35 years of existence. Monthly payments sharply reduced to encourage more men under 35 to prepare for the coming expansion of the electrical industries. Savings up to \$48.75 cash. So if you are dissatisfied with your present earnings, or worried about your job—here is your chance to get a better-paying position as well as to make your future safe. Just mail the coupon for complete information.

The American School

Dept. E-847

Drexel Ave. & 58th St.

Chicago

When writing to advertisers please mention Popular Mechanics

Save
UP TO
\$48⁷⁵

American School

Read These 4 Guarantees

1. Guarantee of complete, up-to-date training prepared by noted engineers.
2. Guarantee to help you get a job when you're only half way through the course.
3. Guarantee of tuition credit for previous education and experience.
4. Guarantee of money back after you finish if you are not satisfied.



R. S. Muller

LESSON FREE—to prove that you can learn quickly and easily at home in your spare time. Also Electrical book of facts, free. Just mail coupon.

AMERICAN SCHOOL, Dept. E-847, Drexel Ave. & 58th St., Chicago, Ill. Please send free lesson and tell me about your money saving offer in line marked X below.

ELECTRICITY

- | | |
|---|---|
| <input type="checkbox"/> Architecture | <input type="checkbox"/> Shop |
| <input type="checkbox"/> Building | <input type="checkbox"/> Superintendent |
| <input type="checkbox"/> Drafting | <input type="checkbox"/> High School in 2 years |
| <input type="checkbox"/> Business Management | <input type="checkbox"/> Structural Steel |
| <input type="checkbox"/> Accounting | <input type="checkbox"/> Civil Engineering |
| <input type="checkbox"/> Mechanical Engineering | <input type="checkbox"/> Auto Engineering |
| | <input type="checkbox"/> Highway Engineering |

Name.....

St. No.....

City..... State.....

Age..... Occupation.....

We'll GIVE you
this FOOTBALL
Special Friendship Offer!

Regulation
Size

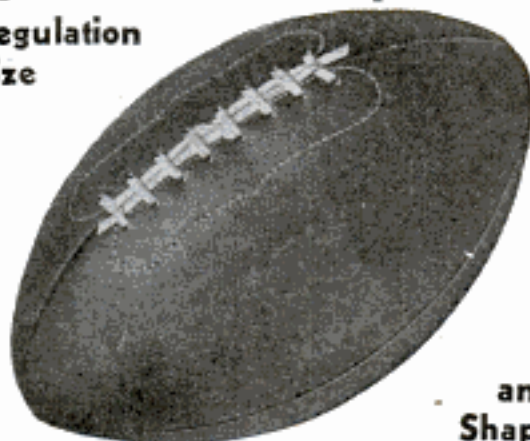

and
Shape

HERE'S a wonderful football. Regulation size and shape. Made of heavy, new material, outwears leather. Stoutly sewn and stitched.

Strongly made, a tough heavy football. Reinforced blind eyelets, heavy, treated lacing. Two-piece, moulded bladder of strong seamless rubber, regulation size, tested for strength.

YOU MAY HAVE IT FREE

of charge on receipt of only \$1.00 for a year's subscription to The Open Road for Boys, a 50-page magazine crammed with air stories, sport stories, school stories, tales of distant jungle lands. Red blooded stories for red blooded boys. Read Special Offer.



Special Offer

Regulation size football, and a one year's subscription to The Open Road for Boys all for \$1.00.

RUSH COUPON

Both for **\$1**

QUARTERBACK,
130 Newbury Street,
Boston, Mass.

Bet your life I'll grab this offer. Here's my \$1.00. Put me down for a year of The Open Road for Boys and rush my football postpaid.

NAME.....

STREET.....

TOWN OR CITY.....STATE.....

Canadian or Foreign Postage 50 cents extra.

BE A PASSENGER TRAFFIC INSPECTOR

Railways and Bus—with Big Opportunity for
Advancement to Executive Positions

S. B. T. I. Trained Traffic Inspectors are in demand by leading transportation companies operating railway and bus lines. For 12 years our trained graduates have been making enviable records.

You travel or remain near home. You work with important officials who have a chance to watch your progress. Many graduates are now important executives in transportation work. Interesting, healthful, outdoor, professional occupation—not a mere job.

Complete our home-study course of perfected instruction in a few weeks. Then we place you in a position paying \$120 to \$150 per month (plus expenses) to start, or refund tuition. Whether or not you are now employed, do not overlook this opportunity. Write today for Free Booklet which gives full details and explains why we can help you to a profitable position with a big future. Low cost—easy terms.

Standard Business Training Institute
Div. 211 Buffalo, N. Y.



BEDFORD YMCA TRADE SCHOOL

Caterpillar Tractor Mechanic
Aviation Mechanic
Flying
Airplane Welding
Airplane Drafting.
Air Navigation
Starting, Lighting, Ignition
Auto Mechanic
Machine Shop. Electric Welding
Oxy-Acetylene Welding
Radio Mechanic. Air Brush
Mechanical, Architectural Drawing
Sign Painting. Show Card Writing
Talking Pictures, Western Electric
Commercial Art. Fine Art
DAY AND EVENING SESSIONS
Write for Catalog 50

Brooklyn Engineering Institute
(Operated by Bedford Y. M. C. A.)
1125 Bedford Avenue, Brooklyn
New York City

TRI-STATE COLLEGE

DEGREE IN 2 YEARS



Catalog

B. S. DEGREE in Civil, Electrical, Mechanical, Chemical, Aeronautical Engineering in 2 years. Those who lack high school may make up work. Living costs, tuition low.

4111 College Ave., Angola, Ind.



Learn Public Speaking

At home—in spare time—20 minutes a day. Overcome "stage-fright," gain self-confidence, increase your salary, through ability to sway others by effective speech. Write now for free booklet, *How to Work Wonders With Words*.
NORTH AMERICAN INSTITUTE, Dept. 1358
3601 Michigan Avenue, Chicago, Illinois

HOT PIANO

Ultra-modern
Piano



Jazz taught by mail. Note or ear. Easy rapid lessons for adult beginners. Also Self-instruction system for advanced pianists. Learn 358 Bass Styles, 976 Jazz Breaks, hundreds of Trick Endings, Hot Rhythms, Sock, Stomp and Dirt Effects; Symphonic and Wicked Harmony in latest Radio and Record Style. Write for Free Booklet.

WATERMAN PIANO SCHOOL, 1826 W. Adams St., Los Angeles, Calif.



Learn to Write
Begin Today. Write for my Free Book, "How to Become a Good Penman." It contains specimens and tells how others learned to write in spare time. Your name elegantly written on a card if you enclose stamp for postage. Write today. F. W. TANBLYN,
418 Ridge Bldg., Kansas City, U. S. A.

NEW ELECTRIC LIBRARY

\$ 1.50 A VOLUME



NEW FROM COVER TO COVER — LATE DATA — HANDY BOOKS — HIGHLY ENDORSED

LATEST INFORMATION

EXPERTS HOME STUDY COURSE

Audels New Electric Library is an entirely new reference Series for engineers, electrical workers, mechanics, maintenance, service men and students. 10 pocket Hand Books, containing 5690 pages—9056 illustrations and diagrams—full information on the latest applications of electricity.

All fully illustrated with test questions, rules, diagrams and calculations—practical ready reference—all up to date.

Highly endorsed—easy to read, understand and own — RED FLEXIBLE COVERS, GOLD EDGES—The complete Library supplied for 50c. a week. Books \$1.50 each and sold separately. No Risk in ordering—Satisfaction Guaranteed—Shipped Free,

PRACTICAL ELECTRICITY IN A HANDY FORM—
Covering: X-Ray, Welding, Ignition, Telephones, Electric Refrigeration, Elevators, Oil Burners, Pumps, Lighting, Signals, Alarms, Illumination, Signs, Talking Pictures, Television, Radio, Railway Signals, Power Stations, Wiring Diagrams for Light and Power, Code, Line and Transmission, Splicing Cables, D. C. and A. C. Systems, Maintenance of Motors and Machines, Troubles, Armature Winding, Experiments, Applications of Electrical Rules and Principles, also hundreds of allied subjects.



PAY 50 CENTS A WEEK

Not a cent to pay until you see the books. No obligation to buy unless you are satisfied. Fill in coupon in pencil. Send now—today—get this new experts standard library.

THEO. AUDEL & CO., 65 W. 23rd ST., N. Y. CITY

FREE EXAMINATION COUPON

Please ship me for one week's free trial "Audels New Electric Library," price \$1.50 a volume. If satisfied, I will mail you 50c. or more each week as payment.

Name.....

Address.....

Occupation.....

Employed by.....

P.M.

When writing to advertisers please mention Popular Mechanics

**YES**

If you accept me to train, can I succeed in drafting?

YES

Is Engineer Dobe's answer to "Do you agree to teach me 'til I'm competent and placed in a permanent position, drawing a good steady salary"?

YES

Do I actually get all drafting tools, drafting table and all supplies without any extra cost?

YES

Do I get help as long as I need it about jobs, extra work, fees and how to make extra money?

YES

FREE PAY RAISING PLAN

ENGINEER DOBE, Div. 13-58
1951 Lawrence Avenue, Chicago

Send me free and postpaid, your book, "My Pay Raising Plan," also Practical Draftsmanship Book and Special Offer on all Drafting Tools and Table furnished to me without extra cost.

Name

Address

City

free
A Valuable Book

You get these tools **FREE** of any extra cost when I train you.

MORE PAY!

Why work all your life for small pay with little chance for a raise or promotion? Let me train you for higher class work and better pay. My Pay-Raising Plan, which I send you free, tells you all about it. It will convince you and show you a way to build a big future for big pay, on clean work leading to salaries of \$60 to \$70, and up to \$100 a week.

I train you at home in actual, practical drafting work. You are put on the same kind of jobs that are assigned to you when you go to work. It isn't hard to do. You don't need talent. If you are interested and can read and write, I make you a good draftsman, if you will work. Dobe trained men are draftsmen and chiefs in big concerns all over the country and many have made good abroad.

ACT NOW!

Mail the coupon below Now. This opportunity does not call for cash. Don't pass it up for lack of ready money. Don't keep yourself down by thinking of your finances at this time. It isn't money I want now. It's men. Mail the coupon.

Electricity!

Learn in Los Angeles

Come West at Our Expense!

For a limited time we are making a railroad fare offer from any point in the United States to Los Angeles. Just think of it! A trip to California with your railroad fare allowed.

Quickly Train for Big Pay Jobs

Quickly train for Big Pay Jobs in Electricity. Unlimited Lifetime Employment Service. Employers insist on our men instead of green, half-baked electricians who don't know what it's all about. You need good training to earn Big Pay!

Don't Worry About Money! We'll Help You!

If you are short of money, we'll help you. We help you secure a part time job to earn living expenses while learning.

It's Easy at National!

Short, condensed training in our Million Dollar Practical "School of Shops" . . . instruction on the most modern equipment money can buy . . . with the country's best staff of expert, experienced instructors. No previous experience needed. None too old or too young to learn. Start any time. **WRITE TODAY!** We'll send you the full story about Railroad Fare Offer, Unlimited Employment Service, etc. New Book sent **FREE**.

FREE BOOK

NATIONAL ELECTRICAL SCHOOL

Depts. 114-E 4006 So. Figueroa St., Los Angeles, California

UNIVERSITY of CHICAGO

HOME-STUDY COURSES

Continue your high-school, college or personal program of education. Teachers, Religious and Social Workers. Men and Women in many vocations are using the 450 courses in 45 different subjects to obtain guidance by experts for cultural and for practical purposes. The courses yield credit. Ask for free booklet.

627 ELLIS HALL THE UNIVERSITY OF CHICAGO CHICAGO, ILL.

1000 POULTRY SECRETS

Our famous home-study Poultry Course teaches how to get more eggs, cut feed bills, avoid losses. Methods used by successful Poultry raisers the world over. FREE Book tells all about Course. Write today for your free copy. National Poultry Institute, Dept. 411-C, Washington, D. C.



GOV'T. POSITIONS

SPLENDID SALARIES

MEN - WOMEN

WE HELP YOU GET ONE

Ry. Mail Clerk	Steno Typist
P. O. Laborer	Immigrant Insp.
R. F. D. Carrier	Seamstress
Special Agent	Auditor
Customs Inspector	Prohibition Agt.
City Mail Carrier	U.S. Border
Meat Inspector	Patrol
P. O. Clerk	Chauffeur
File Clerk	Watchman
General Clerk	Skilled Laborer
Matron	Postmaster
	Typist

Government Instruction Bureau, Dept. 371, St. Louis, Mo. Send me FREE particulars "How to Qualify" for positions marked "X". Salaries, Locations, Opportunities, etc. ALL SENT FREE.

Name.....
Address.....

AGE RANGE 18 to 50



They Told Him Salesmen Were "Born" But Now He Makes \$10,000 a Year ...Thanks to This Little Book

IT was just a little free book that made the difference between Ed Pinkham and the rest of the men in our shop. Nobody ever imagined that Ed would land, even in the \$5,000-a-year class, let alone be making \$10,000 before he was thirty. Ed didn't know himself the abilities he had in him as a money-maker.

But one day, a strange occurrence changed his whole life. During his lunch hour Ed started to read a little book he had brought to work with him.

"It's a book called 'The Key To Master Salesmanship,' Bill," he told me. "It's the most amazing thing I ever read. I never dreamed there was so much in salesmanship. You ought to send for a copy yourself. It's free."

"Huh!" said Luke Jones. "Does that book tell you how to become a salesman?"

"It sure does," replied Ed, enthusiastically.

"Don't waste your time," advised Luke. "You can't learn how to be a salesman. A fellow has to be 'born' that way to be a good salesman."

Ed just smiled at that, but he said nothing. Soon afterward he quit the shop and we forgot about him. And then last night, I met Ed again—driving a snappy new sedan and dressed like a million dollars.

"For Pete's sake," I said, "What are you doing nowadays, Ed?" He smiled. "City Salesmanager for the Steel Castings Company," he told me. "What are you doing?"

"Still at the shop," I replied. "But what I want to know is, how do you come to be salesmanager for Steel Castings? They're one of the biggest firms in the business."

Ed smiled again. "Remember that book on Salesmanship that Luke Jones was kidding me about one day? Well, when I finished my Salesmanship training the Association I took it from gave me a choice of a number of jobs through their Free Employment Department. I got a wonderful job, and I had wonderful training, so I've had a pretty successful time of it. They made me City Salesmanager three months ago at ten thousand dollars a year."

"Good night!" I said. "And Luke and I are still punching the old time clock!"

Ed looked at me seriously. "See here, Bill," he said, "Are you sport enough to risk two cents that you can do as well as I

did? Then spend the two cents to write to the National Salesmen's Training Association tonight and get their free book. Then take their course. When you are qualified, their Free Employment Department will help you get a good sales job. Not only will they help you get the job, but they agree under an iron-clad money-back penalty that you must be satisfied with the training received—or they refund your tuition!"

FREE—TO EVERY MAN

A book—but what a book! Just seven ounces of paper and printers' ink—but it reveals facts and secrets that have led hundreds of men to success beyond their fondest expectations! See for yourself—FREE—why thousands have increased their earning capacities, after reading "The Key To Master Salesmanship." A. L. Galbraith of Detroit, Michigan, went from a bank teller's job to the position of branch manager of a large insurance company, after this book opened his eyes. You can understand how it helped A. A. Fidler of Montgomery, Alabama, to raise his pay 700%. You'll know how it made C. B. Sterling of Boldman, Kentucky, an officer and manager of his Company, raising his pay to ten times what it was. Learn for yourself the REAL TRUTH about salesmanship. You do not risk one penny or incur the slightest obligation. And since it may prove the turning point in your career it is certainly worth your while to fill out and mail the coupon below. Do it now!

NATIONAL SALEMEN'S TRAINING ASSOCIATION,

Dept. S-104, N. S. T. A. Bldg.,
Chicago, Ill.

Now Sent FREE



National Salesmen's Training Association,
Dept. S-104, N. S. T. A. Bldg., Chicago, Ill.

Without cost or obligation please send me my free copy of "The Key To Master Salesmanship," including details of your FREE EMPLOYMENT Service.

Name

Address

City State

Age Occupation



SHOW CARD LETTERING *Learn at Home*

HERE is the very course you need if you want to get a good paying position as a Show Card Letterer or Sign Letterer, or have a business of your own. This course is complete and practical, arranged to meet the needs of the student who studies at home.

H. L. Wood, a clerk, made more than \$700 "on the side" before he had completed his course and also won \$125 in prizes. Harry William Lord writes that he has more than doubled his salary as a result of studying this I. C. S. course in spare time.

There is no doubt that Show Card Lettering and Sign Lettering offer a real opportunity to ambitious men and women. Just mark and mail the coupon and we'll gladly send you a booklet telling all about the I. C. S. course in Show Card Lettering, or any other subject in which you are interested.

INTERNATIONAL CORRESPONDENCE SCHOOLS Box 5570-G, Scranton, Penna.

Without cost or obligation, please send me a copy of your booklet, "Who Wins and Why," and full particulars about the course before which I have marked X in the list below:

- SHOW CARD LETTERING
 ILLUSTRATING CARTOONING
- | | |
|--|---|
| <input type="checkbox"/> Business Management | <input type="checkbox"/> Advertising |
| <input type="checkbox"/> Industrial Management | <input type="checkbox"/> Business Correspondence |
| <input type="checkbox"/> Personnel Management | <input type="checkbox"/> Stenography and Typing |
| <input type="checkbox"/> Traffic Management | <input type="checkbox"/> English <input type="checkbox"/> Civil Service |
| <input type="checkbox"/> Accounting and
C. P. A. Coaching | <input type="checkbox"/> Railway Mail Clerk |
| <input type="checkbox"/> Cost Accounting | <input type="checkbox"/> Mail Carrier |
| <input type="checkbox"/> Bookkeeping | <input type="checkbox"/> Common School Subjects |
| <input type="checkbox"/> Secretarial Work | <input type="checkbox"/> High School Subjects |
| <input type="checkbox"/> Salesmanship | <input type="checkbox"/> Lumber Dealer |
| | <input type="checkbox"/> Spanish <input type="checkbox"/> French |

TECHNICAL AND INDUSTRIAL COURSES

- | | |
|--|---|
| <input type="checkbox"/> Architect | <input type="checkbox"/> Automobile Work |
| <input type="checkbox"/> Architectural Draftsman | <input type="checkbox"/> Airplane Engines |
| <input type="checkbox"/> Building Foreman | <input type="checkbox"/> Plumber and Steam Fitter |
| <input type="checkbox"/> Concrete Builder | <input type="checkbox"/> Plumbing Inspector |
| <input type="checkbox"/> Contractor and Builder | <input type="checkbox"/> Foreman Plumber |
| <input type="checkbox"/> Structural Draftsman | <input type="checkbox"/> Heating and Ventilation |
| <input type="checkbox"/> Structural Engineer | <input type="checkbox"/> Sheet-Metal Worker |
| <input type="checkbox"/> Electrical Engineer | <input type="checkbox"/> Steam Engineer |
| <input type="checkbox"/> Electrical Contractor | <input type="checkbox"/> Marine Engineer |
| <input type="checkbox"/> Electric Wiring | <input type="checkbox"/> Refrigeration Engineer |
| <input type="checkbox"/> Electric Lighting | <input type="checkbox"/> R. R. Positions |
| <input type="checkbox"/> Electric Car Running | <input type="checkbox"/> Highway Engineer |
| <input type="checkbox"/> Telegraph Engineer | <input type="checkbox"/> Mining Engineer |
| <input type="checkbox"/> Telephone Work | <input type="checkbox"/> Pharmacy |
| <input type="checkbox"/> Mechanical Engineer | <input type="checkbox"/> Chemistry |
| <input type="checkbox"/> Mechanical Draftsman | <input type="checkbox"/> Iron and Steel Worker |
| <input type="checkbox"/> Machine Shop Practice | <input type="checkbox"/> Textile Overseer or Supt. |
| <input type="checkbox"/> Toolmaker | <input type="checkbox"/> Navigation <input type="checkbox"/> Assayer |
| <input type="checkbox"/> Patternmaker | <input type="checkbox"/> Cotton Manufacturing |
| <input type="checkbox"/> Civil Engineer | <input type="checkbox"/> Woolen Manufacturing |
| <input type="checkbox"/> Surveying and Mapping | <input type="checkbox"/> Agriculture <input type="checkbox"/> Fruit Growing |
| <input type="checkbox"/> Bridge Engineer | <input type="checkbox"/> Poultry Farming |
| <input type="checkbox"/> Gas Engine Operating | <input type="checkbox"/> Mathematics <input type="checkbox"/> Radio |

Name.....

Address.....

City.....State.....

Occupation.....

If you reside in Canada, send this coupon to the International Correspondence Schools Canadian, Limited, Montreal, Canada

NEW YORK ELECTRICAL SCHOOL

*Opportunities
for All Men!*

Every phase of all branches of Practical Electricity taught by Actual Practice in America's Foremost Institution of Trade Learning.

Special Courses in Automobile Mechanics and Electricity.

Day and evening classes open all year.

Write for *FREE* School Booklet

New York Electrical School
44 W. 17th St., New York City

CARTOON YOUR WAY TO SUCCESS!



DON'T COPY—LEARN TO ORIGINATE!

RAYE BURNS will teach you HOW to CREATE ORIGINAL CARTOONS at home that you can SELL! Course contains 26 lessons and over 600 illustrations. All for Only...

\$2.85

Send name and address for free details.

RAYE BURNS SCHOOL, 336 Lakeview Rd., D-1, Cleveland, Ohio

Learn Photography at HOME

Make money taking pictures. Prepare quickly during spare time. Also learn while you learn. No experience necessary. New easy method. Nothing else like it. Send at once for free book. OPPORTUNITIES IN MODERN PHOTOGRAPHY, and full particulars.

AMERICAN SCHOOL OF PHOTOGRAPHY
Dept. 1358, 3601 Michigan Avenue Chicago, U. S. A.



Wonderful, new device, guides your hand; corrects your writing in a few days. Big improvement in three hours. No failures. Complete outline FREE. Write C. J. Ozment, Dept. 34, St. Louis, Mo.

RADIO TELEVISION SOUND REPRODUCTION

World's Newest Big-Pay Big-Future Profession. Thousands of New Positions in an Uncrowded Field for Men who can Qualify. We offer Dependable Training at a Reliable School under High-Class Instructors on Complete Assembly of Up-to-the-Minute Equipment. We teach you right here in our Shops, not by Mail. Also Courses in Electricity, Automobiles and Welding.

COLEMAN ELECTRICAL SCHOOL, 1628-Z Main St., Kansas City, Mo.

When writing to advertisers please mention Popular Mechanics

THOUSANDS of MEN and WOMEN are Now Buying THE NEW BRITANNICA at a New Big Saving

THE present great reduction from the standard price of the Britannica, announced last month, is attracting unusual interest throughout the country.

We expected, of course, that many who have always wanted the Britannica would take this opportunity of securing it at a great saving. The response, however, to our announcement exceeds even our own expectations.

And it is more than ever clear to us that keen, progressive and prudent people will not neglect this present compelling offer to save money and own the Britannica.

The Incomparable Bargain

The exceedingly low price is possible because we have adventurously faced a temporary condition in the printing, binding and labor fields. It is only because we ordered a printing equal to the largest single printing of the Britannica ever made that considerable savings were realized in the production costs—savings now passed on to you.

At the time of going to press, orders were coming in thick and fast. In a comparatively short time, the printing, we believe, will be entirely sold out. Don't delay, therefore, if you wish to profit by the present low price. We frankly don't know whether business conditions will ever make such a bold reduction possible again.

It isn't surprising that so many people are investing in the Britannica. Its value is traditional, and this completely revised and rewritten 14th Edition represents the most progressive advance in its history.

It is an unrivalled source of practical assistance for the housewife, the business man, the lawyer, the doctor, the minister, the teacher, the child.

Britannica information is needed every day—so today is the time to buy it.

EASY TO OWN

\$5 down

and only \$5 a month

According to our Thrift Plan, only \$5 down is required to bring the set to your home for immediate use. Balance is payable in a few monthly instalments of \$5 or more.

56-page Free Booklet

Fill out the corner coupon, mail it and receive by return mail a large 56-page booklet free, rich with color plates, maps and sample pages. It contains a full description of the Britannica and how you can make it your most useful possession. Send for free booklet today. No obligation.



WHAT OWNERS SAY

"The most for the money of anything I ever bought."

Nathan Abbott
La Jolla, Calif.

"No modern American home can afford to be without this valuable reference work."

General Harbord

"It is the ideal Encyclopaedia for a home with children—indeed, for any home."

Willis A. Sutton
Recent Pres., Nat'l Education Ass'n

WHAT YOU GET

The 24 large volumes carry 35,000,000 words, written by 3,500 authorities. 15,000 pictures, many in full color. 500 maps. 500,000 separate entries in the simplified index.

ENCYCLOPAEDIA BRITANNICA, Inc.
342 Madison Ave., New York City

Please send me, by return mail, without obligation, your 56-page illustrated booklet with color plates and maps from the *New Britannica*, together with low price offer, etc.

1-P.M.-02

Name.....

Address.....

City..... State.....

SEND FOR FREE BOOKLET TODAY

When writing to advertisers please mention Popular Mechanics

WANTED:

\$20 to \$35 a week
men who want to earn
\$50 to \$75 a week...
and more

TODAY—more than any time before in the history of the great Radio Industry—Manufacturers, great Broadcasting Companies, Sound Picture concerns, and others—are on the lookout for men capable of being promoted to their more responsible jobs.

They can get all the men they want for their ordinary work, jobs that pay \$20 to \$35 a week or less, which, of course, is one reason why these jobs don't pay better wages—almost any man can do the work. But for their better-paying jobs—those jobs that pay \$50 to \$75 a week and up, it's different. Here brains, not brawn, are required—knowledge, not guess work, is necessary. Here men capable of some day being promoted to still better-paying jobs are needed.

Radio work is no longer limited to the building and servicing of Radio sets. It now includes such other things as Sound Pictures, Public Address Systems, Radio in Industry, Radio in Aviation, Radio aboard ship, Telephotography, Television, etc.—everything, in fact, that makes use of the vacuum tube or photo-electric cell.

To know Radio is to know the principles of all of these things. And to such men the great Radio Industry offers many wonderful opportunities—steady work at good pay NOW, and an early advancement to still better-paying jobs, as a future. But no ordinary knowledge of Radio will do. To qualify for these better-paying jobs, men must know the theory and practice of Radio as they know their A B C's, and they should be able to teach other men the things they know.

As few men can afford to get their training at some College or University, the Radio and Television Institute, of Chicago, was organized to train such men at home—no matter where they live—in their spare time—easily and quickly—and at a cost of only a few cents a day. The Institute's course of home training is actually supervised by an Advisory Board of outside business men—engineers and executives—each actively connected with some large Radio concern. Which means that—trained the R.T.I. way you can't go wrong.

To the man, then, who is earning \$20 to \$35 a week now—and who would really like to earn \$50 to \$75 a week or more—we say, in all honesty—"we think we can help you."

Write today for particulars and the new Radio Opportunity Book.

RADIO and TELEVISION INSTITUTE,
 Dept. 18. 2130 Lawrence Avenue, Chicago.

Please send me a copy of your Opportunity Book and full particulars of your plan for helping men into good pay positions in the Radio field.

Name.....

Address.....

City..... State.....

What a Beauty!

A Fine-Quality
**MANTEL
 RADIO**

for only
16³⁰
 LESS
 TUBES



5 Tubes
 Two Screen Grid
 Variable Mu
 Pentode Output
 Reia Dynamic
 Speaker
 Loftin-White
 Amplifier
 3 Gang Condenser
 Built-In Antenna
 RCA Licensed
 Loftin-White
 Licensed

30 DAYS TRIAL FREE

The radio buy of the year! A powerful sturdy 5 tube midset, using the new VARIABLE-MU and PENTODE Tubes. Every new development. Look at the list of features. Look at the handsome cabinet pictured above. And the price is only \$16.50—the most remarkable value in radio. Guaranteed by the largest institution of its kind in the country. And you can have 30 days FREE TRIAL in your own home. Write AT ONCE for full particulars.

**FREE
 CATALOG**

Write for new 1932 wholesale Radio Catalog. Everything new in radio at lowest wholesale prices. Guaranteed sets, tubes, speakers, replacement parts, etc.

**NEW 1932
 EDITION**

WHOLESALE RADIO SERVICE CO.
 38 Vesey St., Dept. L-11, New York

"The TRUTH about VOICE"

SENT FREE No Obligation to Buy

If you act quick!—we will send you postpaid—for 30 days free reading—new Voice Book disclosing startling FACTS that may save hundreds of dollars to every man or woman seeking a strong, rich voice for either singing or speaking. 30 days free reading—then send \$1. Otherwise, return it.

Prof. E. Feuchtinger 308 North Michigan Avenue Studio 13-58 Chicago, Ill.



Mould A Mighty Arm

Get a 17-Inch Bicep



**Complete
 Course
 25c**

Get a strong, powerful arm and grip. Within 30 days build your arm from a scrawny piece of skin and bone to huge muscular size. I don't mean just a 17-inch bicep but a 15-inch forearm and an 8-inch wrist. Develop a pair of triceps shaped like a horseshoe and just as strong, and a pair of biceps that will show their double head formation, while your wrist will grow alive and writhe with curly sinew. The guarantee of the strongest armed man in the world stands behind this course. I give you the secrets of strength illustrated and explained as you like it.

Mail your order now and I will include a free copy of "THE THRILL OF BEING STRONG," a 32-page book crowded with muscle building information and life photos of many great strong men. Send 25c with your name and address now.

JOWETT INSTITUTE of PHYSICAL CULTURE
 422 Poplar Street, Dept. 4Ya, Scranton, Pa.

Half a Million People have learned music this easy way

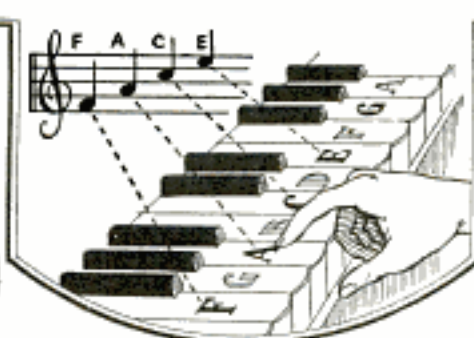

You, too, Can Learn to Play
Your Favorite Instrument
Without a Teacher

Easy as A-B-C

YES, over half a million delighted men and women all over the world have learned music this quick, easy way.

Half a million—what a gigantic orchestra they would make! Some are playing on the stage, others in orchestras, and many thousands are daily enjoying the pleasure and popularity of being able to play some instrument.

Surely this is convincing proof of the success of the new, modern method perfected by the U. S. School of Music! And what these people have done, YOU, too, can do!

Many of this half million didn't know one note from another—others had never touched an instrument—yet in half the usual time they learned to play their favorite instrument. Best of all, they found learning music *amazingly* easy. No monotonous hours of exercises—no tedious scales—no expensive teachers. This simplified method made learning music as easy as A-B-C!

It is like a fascinating game. From the very start you are playing *real* tunes, perfectly, by *note*. You simply can't go wrong, for every step, from

beginning to end, is right before your eyes in print and picture. First you are *told* how to do a thing, then a picture *shows* you how, then you do it yourself and *hear* it. And almost before you know it, you are playing your favorite pieces—jazz, ballads, classics. No private teacher could make it clearer. Little theory—plenty of accomplishment. That's why students of the U. S. School of Music get ahead twice as fast—*three times as fast* as those who study old-fashioned, plodding methods.

WHAT INSTRUMENT FOR YOU?

Piano	Piccolo
Organ	Hawaiian
Violin	Steel
Clarinet	Guitar
Flute	Drums and
Harp	Traps
Coronet	Mandolin
Cello	Sight Singing
Guitar	Trombone
Ukulele	Piano
Saxophone	Accordion
Banjo (Plectrum, 5-String or Tenor)	
Voice and Speech Culture	
Harmony and Composition	
Automatic Finger Control	
Italian and German	
Accordion	
Juniors' Piano Course	

You don't need any special "talent." Many of the half-million who have already become accomplished players never dreamed they possessed musical ability. They only wanted to play some instrument—just like you—and they found they could quickly learn how this easy way. Just a little of your spare time each day is needed—and you enjoy every minute of it. The cost is surprisingly low—averaging only a few cents a day—and the price is the same for whatever instrument you choose. And remember, you are studying right in your own home—without paying big fees to private teachers.

Don't miss any more good times! Learn now to play your favorite instrument and surprise all your friends. Change from a wallflower to the center of attraction. Music is the best thing to offer at a party—musicians are invited everywhere. Enjoy the popularity you have been missing. Get your share of the musician's pleasure and profit! Start now!

Free Booklet and Demonstration Lesson

If you are in earnest about wanting to join the crowd of entertainers and be a "big hit" at any party—if you really do want to play your favorite instrument, to become a performer whose services will be in demand—fill out and mail the convenient coupon asking for our Free Booklet and Free Demonstration Lesson. These explain our wonderful method fully and show you how easily and quickly you can learn to play at little expense. This booklet will also tell you all about the amazing new *Automatic Finger Control*. Instruments are supplied when needed—cash or credit. U. S. School of Music, 711 Brunswick Bldg., New York City.

U. S. SCHOOL OF MUSIC,
711 Brunswick Bldg., New York City.

Please send me your free book, "Music Lessons in Your Own Home," with introduction by Dr. Frank Crane, Free Demonstration Lesson, and particulars of your easy payment plan. I am interested in the following course:

Have you

.....Instrument?.....

Name.....

Address.....

City.....State.....

NOW FIX ANY MAKE OF AUTO



SIX BIG AUTO BOOKS ALL SHIPPED FREE

on approval; whether you want to qualify as garage owner, auto repair expert or merely wish to know how to keep your own car 100% efficient, look at these books—they are sent to you for free examination. This brand

new 1931 edition has been prepared by a large group of America's greatest automotive engineers. Anybody who can read will understand them, for this automobile encyclopedia is a veritable gold mine of valuable facts. Take advantage of this opportunity now; send in the coupon for FREE examination. You don't pay us a penny, you don't obligate yourself to pay anything unless you decide to keep the books. Just tell us you want to see them and the full set of 6 large volumes, just off the press, will be sent to you. Read them, look them over and prove to your own satisfaction that one fact alone, which you will find in them, may save you an expensive repair, or help you to a better job.

Aviation Motors

In addition to being a complete encyclopedia of automobile engineering, these books contain over 100 pages on Aviation Motors, and so they are just off the press they bring to you the newest and latest information obtainable. This alone makes these books available to anyone.

New 1931 Edition

Imagine books which are so new that every page is right up to date—wiring diagrams, construction details, service problems—are all right up to the minute. Nowhere else can you get as complete information. Over a million dollars of resources have enabled us to give you the most modern books on the subject ever published. You will find nearly 20 pages on front wheel drives alone. Everybody interested in automobiles in any way will welcome these books, especially on our no money offer.



CAN YOU FIX IT?

Can you take out "play" in differential? Can you kill the "shimmy" in steering? Can you reset TIMING? Can you put your finger on engine trouble without guessing or tinkering? Can you pull the starter off and fix it? Can you adjust and repair transmission, valves, rear axle, bearings?

These Books Tell How

and tell you how to do any and every auto job right, the first time.

6 Big Volumes

Nearly 3,000 pages, over 2,500 illustrations, wiring diagrams, equipment charts, etc. Do Line edition with gold-stamped flexible binding. Sent FREE for 10 days' use. If not wanted return express collect. If kept, send only \$2.00 after 10 days, then \$2.00 a month until special advertising price, \$24.50, is paid.

A Year's Consulting Membership FREE!

Privilege of consulting engineers of million-dollar American Technical Society on any automotive problem for one year without charge, if you mail coupon immediately.

SEND NO MONEY

American Technical Society, Dept. A-819,
Drexel Ave., at 58th St.,
Chicago, Illinois.

I would like to see the new 6-volume 1931 edition of your automobile books but without any obligation to buy. I will pay the few cents delivery charges only and will examine the books and return them at your expense in 10 days unless I like them, in which case I will send you \$2.00 then and only \$2.00 per month until the special price of only \$24.50 is paid. You are to include free consulting membership certificate in the American Technical Society. Send brand new 1931 edition.

Name.....

Street.....

City..... State.....

Employer's Name.....

Employer's Address.....

These books will be sent free for examination to anyone sending name and address and that of his employer

When writing please mention Popular Mechanics

NEW INDUSTRY NEEDS MEN

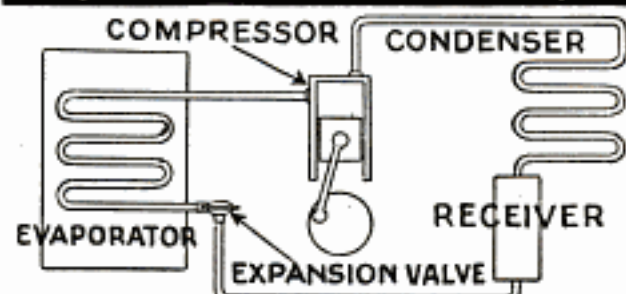

ELECTRIC REFRIGERATION Calls You!

Newest American Industry needs men for \$200 to \$1,000 a month jobs in production service, installation and sales. Fastest growing, money-making field—backed by General Motors, General Electric, etc. New easy home training qualifies you for big pay job. This training endorsed by Servel, Kelvinator, Copeland and other large manufacturers.

Get Valuable New Book—FREE

Our new illustrated book—*Rick Rewards in Electric Refrigeration*—set off the press, reveals amazing plan to ambitious men. Sent absolutely free, without obligation. Be the first in your locality to get into this new money industry. Write today!

UTILITIES ENGINEERING INSTITUTE
4403 Sheridan Road, Dept. 1111, Chicago, Ill.



VOICE

100% Improvement Guaranteed

We build, strengthen the vocal organs—not with singing lessons—but by fundamentally sound and scientifically correct silent exercises... and absolutely guarantee to improve any singing or speaking voice of least 20%... Write for wonderful voice book—sent free. Learn WHY you can now have the voice you want. No literature sent to anyone under 17 years unless signed by parent.

PERFECT VOICE INSTITUTE, Studio 13-58
308 No. Michigan Ave., Chicago



SONG WRITERS

Don't fail to read "Song Requirements of Talking Pictures, Radio and Records" an explanatory, instructive book SENT FREE on request. New writers may mail song-poems for free examination. We revise, compose and arrange music, and secure copyrights, guaranteeing approval.

P. M. Newcomer Associates, 1674 Broadway, New York



SECRET SERVICE BOOK FREE

For 30 Days Reading No Money Down—Actual Crime Cases—If You Act Quick!—We will send you this stirring book on Crime Detection, Secret Service and Identification Work for 30 days free reading. Send no money. If you decide to keep it, then send only \$1.00. If not, return it. WRITE TODAY. Not sent to boys under 17 years of age.

T. G. Cooke, Book Dept. 13-58 1920 Seaside Ave., Chicago

Stop Slamming Doors EARN \$15 Daily!



Kant-Slam Door Check is an amazing new invention that closes all doors silently and automatically. Closing speed easily adjusted by turning screw at top of check. Holds doors open when wanted open. Operates on new oil principle. Low priced. Everlasting. Easily installed in 10 minutes. Never needs attention.

A REAL DEMONSTRATOR FURNISHED Every Agent

You get orders quickly demonstrating actual sample on easy to carry miniature door. Every office, factory, store, institution and public building needs a Kant-Slam for every door. Rush name and address for details of amazing money making opportunity. Demonstrator FREE to WORKERS KANT-SLAM DOOR CHECK CO. Dept. R-7, Bloomfield, Ind.

Opportunities

were never so great for technically trained men!



You Can
Learn
Practical

DRAFTING

At Home By Mail
UNDER EXPERT
COLLEGE INSTRUCTORS

No other calling open to young men of limited schooling, leads so quickly and surely as drafting to big-pay jobs. The field is enormous—world wide. Wake up! Look around you! This is a mechanical and engineering age. Consider our amazing inventions, sky-scrapers, ocean liners, air ships, aeroplanes, automobiles, industrial plants, bridges, dams, power houses, etc. Every-

thing planned or built comes first through the hands of expert draftsmen. What creative work could be more fascinating—a greater inspiration and guide to worthwhile careers? Scores of our noted architects, engineers and builders won their way to fame and leadership with a common school education and a self acquired knowledge of drafting.

\$100 a Week Paid Expert Draftsmen

Let the facts about Chicago TECH successes prove that you, too, can train in spare time. Send the coupon below. Investigate! You'll be amazed when you learn how easily young men have mastered drafting through our practical home-study plan. Nothing difficult about it—the simplest, shortest, step-by-step method you can imagine . . . the result of years of successful experience in teaching by mail and in our resident classes. Read the stories of Chicago TECH successes in our big catalog. Hundreds of our graduates are now engineers, architects, designers, builders, contractors, chief draftsmen, superintendents. Drafting was the ladder on which they climbed to big incomes. Chicago TECH is

famed everywhere for its successful graduates. Don't delay another minute. Send for all the interesting facts at once. Our low cost and easy terms place this training within the reach of every ambitious man. The first small tuition payment brings everything needed to start the course. Draftsman's table, all drawing instruments, tools, etc.—a complete, high-grade outfit is furnished each student free of extra cost.

Send For
Proof Today!

Let the success
of others be your
guide to a big-
pay job.

DRAFTING OUTFIT

furnished FREE
of extra cost

This exceptionally high-grade outfit, a \$25 value, complete in every respect, the same as used by expert draftsmen, is furnished without extra charge. Enrollment includes full equipment. No extras to buy. A small first payment under our easy installment plan brings at once everything needed to begin the course and assure rapid progress.

Big FREE Book on Drafting

Send coupon now for your copy. Tells everything you want to know—what to do and how to do it—to succeed quickly in practical drafting work. Opportunity is calling. This is the big chance you've long wanted. Grasp it today.

Chicago TECHNICAL College

Architecture—Engineering—Drafting—Electricity—Building
We also offer complete resident day and evening classes in above subjects. Founded 1904, our College-Training-At-Home Plan is the result of 27 years' experience in training men both in our Chicago College and at their homes by mail.

Chicago Technical College
Dept. P-204, 118 E. 26th St., Chicago, Ill.

Please send me postpaid, your big Free Book on Drafting, telling about opportunities and your College-Training-At-Home Plan. I have checked below the field in which I am particularly interested.

Architectural Mechanical Electrical
 Structural

Name.....Age.....

Address.....

City.....State.....

Check here if you prefer coming to Chicago to take our short resident day or evening course in Drafting.

When writing to advertisers please mention Popular Mechanics



\$1,000 Reward For the Capture of This Man

CONVICT 6138, escaped from the State Penitentiary; Name, Charles Condray; age 37; Height, 5 feet 8 inches; Weight, 141 pounds; Hair, light brown; Eyes, gray.

Easy enough to identify him from his photograph and this description, you may say — but, Condray took the name of "Brown," dyed his hair, darkened his skin, grew a mustache, put on weight and walked with a stoop.

Yet he was captured and identified so positively that he knew the game was up and returned to the penitentiary without extradition. How was it accomplished? Easy enough for the Finger Print Expert. They are the specialists, the leaders, the cream of operators. Every day's paper tells their wonderful exploits in solving mysterious crimes and convicting dangerous criminals.

More Trained Men Needed

The demand for trained men by governments, states, cities, detective agencies, corporations, and private bureaus is becoming greater every day. Here is a real opportunity for YOU. Can you imagine a more fascinating line of work than this? Often life and death depend on finger print evidence — and big rewards go to the expert. Many experts earn regularly \$3,000 and more per year.

Learn At Home in Spare Time

And now you can learn the secrets of this science at home in your spare time. Any man with common school education and average ability can become a Finger Print Operator in surprisingly short time.

FREE The Confidential Reports No. 38 Made to His Chief!

IF YOU ACT QUICK—We will send you free and with no obligation whatsoever, a copy of the gripping, fascinating, confidential report Secret Service Operator No. 38 made to His Chief. Mail coupon NOW!

Write quickly for fully illustrated free book on Finger Prints which explains this wonderful training in detail. Don't wait. Mail the coupon now. You may never see this announcement again! You assume no obligation. You have everything to gain and nothing to lose. Write at once. Address

Institute of Applied Science
Dept. 13-58 1920 Sunnyside Av., Chicago

INSTITUTE OF APPLIED SCIENCE,
Dept. 13-58 1920 Sunnyside Ave., Chicago

Gentlemen: Without any obligation whatever, send me your new, fully illustrated, FREE book on Finger Prints and the free copy of the Confidential Reports Operator No. 38 made to His Chief. Literature will NOT be sent to boys under 17 years of age.

Name

Address

Age

JOBS NOW OPEN

No Education or Experience
Needed to Learn



TOOL & DIE MAKING MACHINIST TRADE & DESIGNING AUTOMATIC SCREW MACHINES

Learn these big paying trades easily and quickly in our modern shops on finest equipment. Expert instructors train you on actual work done for large manufacturers. No books. No lessons. Day or eve instruction. We help place you while learning and after. Thousands of Allied trained men are now making big pay. You can too. Don't delay. Write now for FREE catalog.

ALLIED SCREW MACHINE CO., Inc.
School of Mechanical Trades

524 W. Monroe St. Chicago, Ill. Dept. 1021

FREE THE Gibson BOOK



Shows you the way to popularity, pleasure, bigger income with an easy playing Gibson banjo, guitar, mandolin or ukulele. If no teacher in your town ask about Reser's Correspondence Course.

Harry Reser, Chief of the Clef Club Kokomo, premier banjo soloist and teacher.

FREE TRIAL; EASY PAYMENTS
on any Gibson. Send for your book now.

Gibson Inc.

1103 PARSONS STREET, KALAMAZOO, MICH.

Government Positions

Clerk Carriers, Rural Carriers, Railway Mail Clerks, Postmasters, Department Clerks, and many others. Splendid salaries, easy work, vacation with pay. Only common school education required. Examinations often. 44,817 appointed last year. Send for our Civil Service Catalog No. 6. **COLUMBIAN CORRESPONDENCE COLLEGE**, Washington, D. C.

ELECTRICAL ENGINEERING

A CONCISE, comprehensive course for men of limited time, complete in one year. Mathematics, engineering drawing, shop-work. Students construct motors, install wiring, test electrical machinery. Buildings fireproof. 35 years' successful experience. Catalog on request.



**BLISS ELECTRICAL
SCHOOL**

121 Takoma Ave., Washington, D. O.

WHY STAMMER?

Don't be a failure. Master perfect speech. Live a healthy, normal and happy life. Send for free book which tells you how. **THE LEWIS INSTITUTE**, 12973 Woodward Ave., Detroit, Mich.

LEARN WATCHMAKING

and become independent. We help you secure a position. Easy to learn. Send for FREE CATALOG.

ST. LOUIS WATCHMAKING SCHOOL Dept. 5. ST. LOUIS, MO.

AVIATION TRAINING



means earning-power in ONE YEAR!

One-year course qualifies for Transport Pilot's license at Parks Air College, world's largest civilian Aviation school, licensed since 1929 by U. S. Dept. of Commerce. Character emphasized, parents endorse Parks standards of training and discipline. Catalogue free.

Parks Air College, Section 11-PM
Parks Airport, East St. Louis, Ill.



BE AN ARTIST

Earn a Big Name and a Fat Income

WHAT would you give to be this artist—earning a big income—enjoying studio life? He has learned the secret of forming simple lines into finished illustrations.

It was only a short time ago that this young artist filled out a coupon like the one below and mailed it to the Federal School of Illustrating. Now he is not only trained in modern art on which magazines are spending millions every year, but he has also had thorough instruction in all branches of illustration. Careful training by Federal Instructors has taught him to turn simple lines into dollars.

More than fifty famous artists—making big incomes themselves—have contributed to the Federal Course, giving you the benefit of their experience in illustrating, cartooning, lettering, poster designing, window card illustrating, etc.

Why drudge at routine work? Opportunities for artists have never been better. Drawing is easy to learn the Federal Home Study way. Earn while you learn, if you wish. Many students find a market for their work after a comparatively short time of study.

Test Your Drawing Talent

If you like to draw, train your talent. Open the way to success and a fine income. Write your name, age and address on the coupon and get our Free Book, "A Road to Bigger Things," illustrated below. With it, you will receive our Free Vocational Art Test to find out your ability. Hundreds of successful artists got their start by sending for these. This is your opportunity—grasp it. **MAIL THE COUPON NOW.**



FEDERAL SCHOOL of ILLUSTRATING

11131 Federal Schools Bldg.
Minneapolis, Minnesota

COUPON

FEDERAL
SCHOOL of
ILLUSTRATING

11131 Federal Schools Bldg.
Minneapolis, Minn.

Please send me free book "A ROAD TO BIGGER THINGS" and Standard Art Test.

Name _____

Age _____ Occupation _____

Address _____

When writing to advertisers please mention Popular Mechanics

THERE'S ROMANCE IN RADIO!

become a part of it .. enter aircraft radio .. broadcast station or studio .. direction finder and radio compass .. disc and film recording .. talking pictures .. servicing of home entertainment equipment .. television



Seek advancement, adventure, excitement in 7 thrilling branches of one of today's fastest growing industries

ARE you looking toward the future? Consider radio. Men who know agree it has in store a tremendous future. Adventure, excitement and advancement are in store for many. But—only those who are qualified will forge ahead with the industry!

Learn any of the 7 thrilling branches of radio listed above. Now you can get this training at RCA Institutes. Four resident schools at New York, Boston, Philadelphia and Chicago offer elementary and advanced courses in practical radio. Courses based on 22 years experience. And, of equal importance, these schools are associated with the largest, most complete research laboratory in the radio industry.

Win Radio Scholarship

If you cannot attend the resident schools, RCA Institute Extension Courses enable you to study at home. Special laboratory equipment furnished. Outstanding graduates of extension courses become eligible for free scholarship at nearest resident school. All tuition costs moderate. Write today for free catalog. The coupon makes it easy.

RCA INSTITUTES, Inc.

RCA Institutes, Inc., Dept. MP-11 75 Varick Street, N. Y.
Gentlemen: Please send me your General Catalog. I am checking below the phase of radio in which I am particularly interested.

- | | |
|---|---|
| <input type="checkbox"/> Aircraft Radio | <input type="checkbox"/> Disc and Film Recording |
| <input type="checkbox"/> Broadcast Station or Studio | <input type="checkbox"/> Servicing Home Entertainment Equipment |
| <input type="checkbox"/> Talking Pictures | <input type="checkbox"/> Television |
| <input type="checkbox"/> Direction Finder and Radio Compass | |

Name _____

Address _____

Occupation _____ Age _____

34 Lesson Drawing Course \$2.98

The biggest value you ever saw advertised anywhere



Haven't you often wished that you could draw cartoons, illustrate some idea, sketch some pretty face, etc.? You can do all of these things. One of America's most famous Cartoonists and Illustrators has developed a great, simple system for success in all branches of Commercial Art. This system has revolutionized the entire theory of drawing. It means that drawing can be as easy for you as writing—much simpler than learning shorthand, bookkeeping or typewriting. We are now placing this original system for learning Drawing, Art and Cartooning, consisting of 34 lessons with over 600 illustrations, within reach of every one. If you will devote a few hours each week to the Course WE ABSOLUTELY GUARANTEE that you will learn to draw and draw well before you have half finished the Course. If we fail to make this claim good, we will refund every cent paid us. By eliminating a large office force for answering correspondence, expensive catalogs, etc., we are enabled to make a price of \$2.98, the cheapest price ever known for a high-grade, home study course. Learn to draw. It is a big asset, no matter what field you are in.

Send No Money

Just order the course and on arrival \$2.98 pay postman

plus a few cents postage, payment in full for the entire Course and Drawing Outfit. If not entirely satisfied, return within five days and we will Refund Money. Address:

LEDERER SCHOOL OF DRAWING, Dept. 1081-Z, Chattanooga, Tenn. Orders from outside the U. S. A. are payable \$3.28 cash with order.

If you order the course at once, we will include a drawing outfit, consisting of artist's pencils, pens, paper, erasers, thumb tacks, etc., enabling you to go to work without any additional cost.



OPPORTUNITIES IN TRAFFIC MANAGEMENT

Conditions point to an unusual demand for trained traffic men, by transportation companies and industrial organizations. Men with scientific traffic training effect big savings for their firms—command big salaries.

Three Detroit Firms Pay Their Traffic Managers Over \$20,000 a Year

Prepare at home in your spare time, under supervision of traffic experts. Low cost; easy terms. "I would not take \$50,000 for my knowledge of traffic management," writes H. E. Stiffler, Traffic Manager, Marion Steam Shovel Co., Marion, Ohio. Send now for 64-page book—**FREE!** LaSalle Extension University, Dept. 1164-T, Chicago

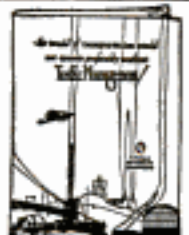

ENGINEERING and ARCHITECTURE

INTENSIVE PRACTICAL TECHNICAL COURSES in Electrical, Mechanical, Structural, Architectural Engineering. Degree in 2 yrs.—diploma in 1 yr. Also shorter courses in Electricity, Power Plant, Radio, Television, Electric Refrigeration, Drafting, Welding. Non-essentials eliminated. **LOW TUITION.** Expert instructors. Extensively equipped laboratories. Free life-time employment for graduates. Part-time work during attendance. 32nd year. Write for catalog. **FINLAY ENGINEERING COLLEGE** 1001 A Indiana Avenue KANSAS CITY, MO.



All This for Only 15 Cents

Send only 15c RIGHT NOW and receive The Pathfinder every week by mail for the next 13 consecutive weeks. In these 13 issues you will get 426 pages, with 300 pictures, 900 unusually interesting articles on people and things you want to know about, 1800 picked news items from everywhere, 2500 jokes, riddles and cracks, stories, etc. Newest, snappiest, most entertaining paper in the whole world. The biggest 15c worth YOU ever saw. Send now. Address **Pathfinder, Dept. 74, Washington, D. C.**

Learn ADVERTISING at Home

Greater opportunities now in advertising. Learn easily and quickly in spare time. Practical work. No text books. Old established school. Low tuition—Easy terms. Send for free booklet of interesting information.

Page-Davis School of Advertising
Dept. 1358, 3601 Mich. Ave., Chicago

LEARN WATCHMAKING AND ENGRAVING

BY OUR PROFIT-SHARING PLAN OUR GRADUATES SUCCEED

One of our Iowa students started in a very small way—now doing over \$20,000 a year. Another in Wisconsin, over \$10,000 the first year. Day or night classes. Call or write for FREE BOOK.

Chicago School of Watchmaking, Dept. 7801, 155 N. Clark St., CHICAGO

When writing to advertisers please mention Popular Mechanics

"Sure..I'll Tell You, Bill, How I Got this Government Job!"

"HAVEN'T seen you for a long time, Bill. I travel around quite a bit now—in this government job.

"How did I get it? Well, I'll tell you, Bill. Right after we got back from France I got a job in a factory. It didn't 'pan out.' They got some kind of new machinery and a lot of us were let out. Boy, I was worried!

"But Uncle Sam has certainly fixed everything okay now. I got \$1,850 a year to start and I'm now earning \$2,700.

I'm All Through Worrying Now!

"Until I got this Railway Mail Clerk job I was always worrying about money. Nowadays I never give a thought to lay-offs or slack times that have other fellows scared. Increases in pay come regularly when you're with the government. Everybody gets the same square deal.

"Every year, Bill, I get 15 days' vacation and 10 days' sick leave with full pay. Mighty few fellows who are not in the government service get a break like that. Best of all, Bill, you don't have to keep worrying about the future all the time, wondering whether some day you're going to be 'living on' your relatives and all that sort of thing. Your retirement pension takes care of you.

Then I Wrote for This FREE BOOKLET

"I suppose I'd be worrying myself sick right now, just as you are doing, if I hadn't happened to get hold of a booklet written by a fellow in Rochester named Arthur R. Patterson. Patterson was a Secretary Examiner of the Civil Service Commission for eight years. It was through the help he gave me that I got such a high rating and got my government job so quickly.

"If you are 'shaky' about your job and wondering what's going to happen to you, I suggest, Bill, that you write to Arthur R. Patterson in Rochester right now. I forget the name of the booklet he'll send you, but it's good sound stuff.

"Well, so long, Bill, we pull out of here in a couple of minutes and I have to get going."

The title of the booklet which this Railway Mail Clerk refers to is "How to Secure a Government Position." If you are a citizen, 18 to 50, this booklet will tell you how to get the government job you want—and a lot of other interesting facts about jobs with the government.



Page 4, for example, tells what Uncle Sam pays. Page 10 tells all about the vacations. Page 12 explains how I prepare you quickly and how, if you don't get the job within a certain time after passing examinations, my help costs you nothing. Page 18 tells about the automatic system of giving you yearly raises.

There is no obligation of any kind in sending for this booklet. My only suggestion is that you get ready NOW for the next Railway Postal Clerk examination! So mail this coupon at once—and get going toward something that stops you from worrying about "hard times" and losing your job. Mail this coupon today. Address A. R. Patterson, Civil Service Expert, PATTERSON SCHOOL, 811 Wisner Building, Rochester, N. Y.

PICK YOUR JOB--I'll Help You Get It!

POST OFFICE CLERK
\$1700 to \$2100 a year
Special Clerks at \$2200 to \$2300

15 days' vacation and 10 days' sick leave every year with full pay. Eligible to promotion to higher paid positions.

INTERNAL REVENUE and CUSTOMS HOUSE POSITIONS
\$1140, \$1680 to \$3000 a year and up

Extra Pay for Overtime POSTMASTER
\$1200 to \$2500 a year
This is a position of great importance.

R. F. D. MAIL CARRIER
\$1800 to \$2300 a year
15 days' vacation and 10 days' sick leave every year with full pay. A fine position for men in rural districts.

RAILWAY POSTAL CLERK
\$1850 to \$2700 a year
Opportunity for travel. 15 days' vacation and 10 days' sick leave with full pay. Paid all the time.

CITY MAIL CARRIER
\$1700 to \$2100 a year
15 days' vacation and 10 days' sick leave every year with full pay. Good chance for rapid promotion to bigger pay.



A. R. Patterson

FREE BOOK

A. R. Patterson,
Civil Service Expert,
PATTERSON SCHOOL,
811 Wisner Building,
Rochester, New York.

Please send me your big free book and tell me how I can secure a position with the U. S. Government paying me \$1,850 to \$3,000 a year, with excellent chance for rapid advancement. This doesn't cost me a penny.

Name.....

Address.....

City.....State.....



When writing to advertisers please mention Popular Mechanics

OIL HEAT

FULLY AUTOMATIC - NOW LESS THAN \$100.00



Cheap As Coal

Now you can actually SAVE MONEY ON FUEL BILLS, yet enjoy carefree, automatic oil heat—at the lowest prices, on the easiest terms ever offered. LACO costs less than ever before—LESS THAN \$100. Operates more economically. The famous Laco Removable Gas Generating Chamber—changes oil into gas—eliminates all fuel waste—gets more heat from every dollar's worth of oil. It's ACTUALLY AS CHEAP AS COAL. Built of finest materials. Simple. Only one moving part. Fits instantly into your present heating system. Only a few hours to install. Seldom needs service. Safe as ordinary kitchen stove.

Clean . . . Automatic . . . Quiet

There's no smoke, soot, grime, or odor. Runs so quietly your guests never hear it. Completely automatic. Easy to install. Room Thermostat and all latest safety features. Attractively finished.

Special Offer

Send at once for our SPECIAL 1931 OFFER, complete information, and low prices—less than \$100. SPECIAL EASY PAYMENT PLAN if you write now. No obligations. Send immediately.

Dealers Wanted

The opportunity of a lifetime to get in on the ground floor. SPECIAL DEALER OFFER now open in rich fields. No experience needed. Small investment. No service work. Dealers report as much as \$5,000 to \$50,000 yearly profits. Write today for SPECIAL FALL OFFER.

Listed as Standard by Underwriters' Laboratories.

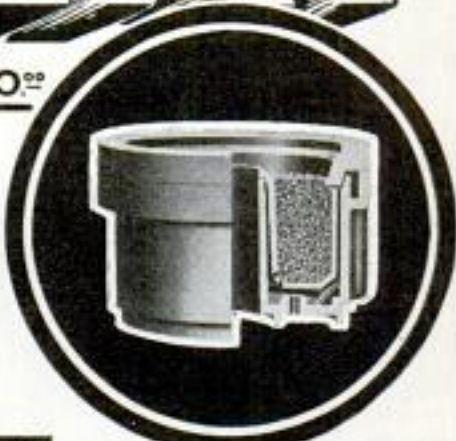

New Removable Gas Generator Chamber

Now burns longer with less attention—slashes fuel costs by eliminating all waste. As oil rises up through hot mineral wick, it is MIXED WITH AIR and turned into hydrocarbon gas. The gas burns in suspension—uses the oil in its original form. That's Why LACO SAVES YOU MONEY ON FUEL BILLS. Now burn either oil or gas (natural or manufactured). Write for complete story of the Laco Mineral Wick and other amazing new features.

26 Sizes and Models

An exact type for every home, including WORLD'S LOWEST PRICED, CHEAPEST TO OPERATE starting power burner—LACO MODEL F for heavy oils and 24 WEST COAST DIESEL OIL. Tell us the number rooms you want to heat and present heating system. Write today and forget your winter heating troubles!

LACO OIL BURNER CO. 149 Union Street
GRISWOLD, IOWA, U. S. A.

CHEMISTRY

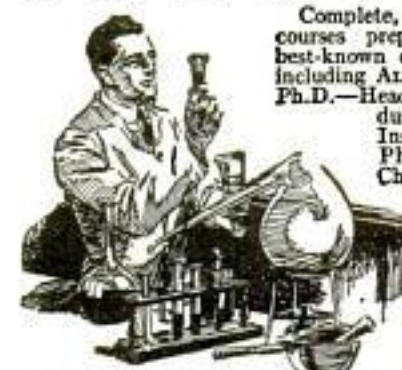

Complete, practical home-study courses prepared by some of the best-known chemists in this country, including ALLEN ROGERS, B.S., M.S., Ph.D.—Head of Department of Industrial Chemistry, Pratt Institute; L. M. TOLMAN, Ph.D.—Formerly Chief Chemist, Wilson & Co. Now Vice-president, United Chemical and Organic Products Co.; BRADLEY STOURGTON, B.S.—Head of the Department of Metallurgy, Lehigh University, and OWEN L. SHINN, Ph.D.—Professor of Applied Chemistry, University of Pennsylvania.

Mail Coupon for Free Booklet

INTERNATIONAL SCHOOL OF CHEMISTRY
Associated with the International Correspondence Schools
Box 5572-G, Scranton, Penna.

Without cost or obligation, please send me full details of your home-study course in

- | | |
|---|--|
| <input type="checkbox"/> Analytical Chemistry | <input type="checkbox"/> Metallurgical Chemistry |
| <input type="checkbox"/> Chemical Engineering | <input type="checkbox"/> Short Chemistry Course |
| <input type="checkbox"/> Industrial Chemistry | <input type="checkbox"/> Pharmacy |

Name.....

Address.....

WELDING ELECTRICITY RADIO AUTOMOBILES

No Finer Training Equipment Anywhere at Any Price. Pipe-Line, Sheet Steel, Structural Steel, Cast Iron, Air-Craft and Commercial Welding; Armature Winding; Power Plants; Switchboards; Transformers; Motors; Generators; Batteries; Radio, Television and Automobiles. LEARN BIG-PAY TRADES AT LOW COST
Write for Information, Mentioning Course Desired.

Coleman Electrical School, 1628 Main St., Kansas City, Mo.



SOMETHING DIFFERENT MYSTERY CIGAR LIGHTER

MAKE \$25 A DAY

Showing this scientific marvel to men. New principle of ignition. What makes it light? No flint or friction. All guaranteed. Sample with sales plan 25c. Sample gold, silver or chromium plated \$1.00. Agents, write for proposition.

NEW METHOD MFG. CO.

Desk P-11, New Method Bldg., Bradford, Pa.

NERVES?

Are You Always Excited? Fatigued? Worried? Gloomy? Pessimistic? Constipation, indigestion, cold events, dizzy spells and bashfulness are caused by NERVE EXHAUSTION. Drugs, tonics and sedatives cannot help weak, sick nerves! Learn how to regain Vigor, Calmness and Self-Confidence. Send 25c for this amazing book.

RICHARD BLACKSTONE, R-4711 PLATIRON BUILDING, N. Y. C.

LEARN CARTOONING

AT HOME DURING SPARE TIME

with the course that has trained HUNDREDS of beginners successfully. The Landon Picture Chart Method of teaching ORIGINAL drawing by mail makes cartooning easy to learn. This school is a Member of The National Home Study Council. Write today for sample picture chart to TEST YOUR ABILITY and examples of the work of successful students now earning from \$50 to \$200 and more per week. Enclose 6c in stamps and STATE YOUR AGE.

THE LANDON SCHOOL, 2838 National Bldg., Cleveland, Ohio

When writing to advertisers please mention Popular Mechanics



Would YOU Gamble 2¢ to Win a Body like Mine?

By CHARLES ATLAS

*Holder of the Title:
"The World's Most Perfectly Developed Man"*

The most you can lose by mailing the coupon is a 2c stamp! The odds are all in your favor that you'll win a magnificent body of tremendous muscular power. *Dynamic-Tension* made my body as you see it here. It has given handsome, powerful bodies to my hundreds of pupils. Let me PROVE within 7 days that it can do the same for YOU! Mail the coupon for my Free Book.

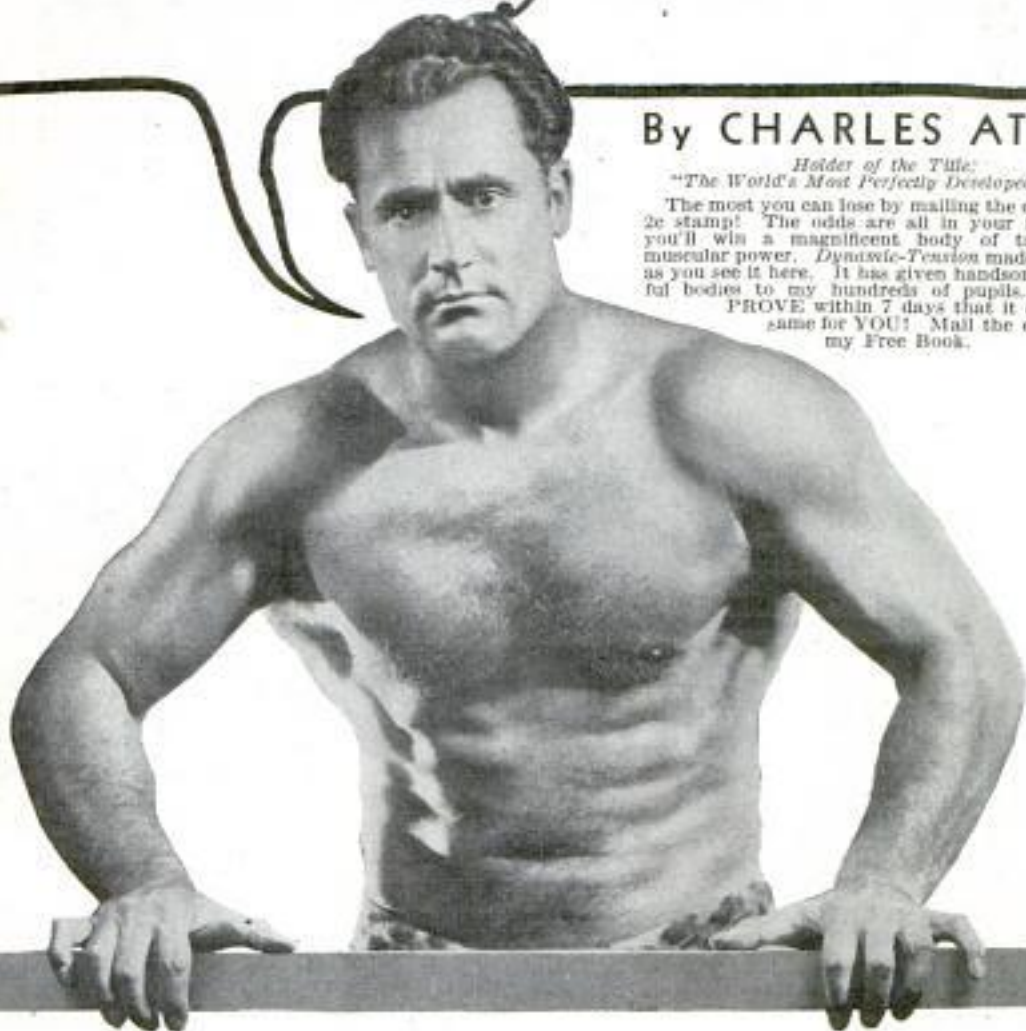

HOW does your body stack up against mine? Will you give me a chance to PROVE that my method, *Dynamic-Tension*, will do for you what it has done for me and hundreds of my pupils?

I'm so sure of what *Dynamic-Tension* can do that I can make you an Offer which other Physical Instructors don't DARE to make. I agree to show you definite results in 7 days, to give you conclusive PROOF within a week that I can transform you, too, into this NEW MAN of mighty energy and strength.

I used to weigh only 97 pounds. I was sick more than half the time. Then I discovered *Dynamic-Tension*. This system changed me from a weakling into the man who was acclaimed

in two international contests as "The World's Most Perfectly Developed Man."

My *Dynamic-Tension* method works hand in hand WITH Nature. There's nothing artificial about it, no pills, special foods, rays, or any tricky apparatus that may strain your heart and other vital organs.

"Everlasting Health and Strength"—FREE

Let me tell you all about it in my free book. You can win a body like mine, as my hundreds of pupils have done —by risking only a 2c stamp to mail the coupon for my free book! Fill in the coupon right now and send it to me personally.
C H A R L E S
A T L A S, Dept. 8-L,
133 East 23rd St.,
New York City.



CHARLES
A T L A S,
Dept. 8-L,
133 East
23rd Street,
New York City.

I want the proof that your system of *Dynamic-Tension* will make a New Man of me—give me a healthy, husky body and big muscle development. Send me your free book, "Everlasting Health and Strength."

Name.....
(Please print or write plainly)

Address.....

City.....

State.....

When writing to advertisers please mention *Popular Mechanics*

ELECTRICITY**PAYS
BIG!**

LEARN IN 90 DAYS ON ACTUAL MACHINERY—NO BOOKS I'LL PAY YOUR R-R FARE TO CLEVELAND

Don't let the world bluff you. Get into electricity—earn \$50.00 to \$150.00 a week—and hold your head as high as the next man. You can do it easily by coming to my famous electrical school. In 12 short weeks you'll pack in many years of practical knowledge. You work shoulder to shoulder with expert instructors on full-sized, moving, whirling motors, generators, batteries,

No Education or Experience Needed

No books to read. No dry lectures to listen to. You learn by doing. I don't care if you can't tell a motor from a horse-and-

buggy now. When you graduate I guarantee that you'll know electricity from "A" to "Z." If you're not satisfied to fill a big-pay job I'll refund every penny of your tuition.

switchboards, telephone and telegraph systems, etc., etc. McSweeney trained men get the biggest paying jobs. Every day I receive requests for graduates.

Satisfaction Guaranteed!

You are the sole judge of McSweeney training. Your tuition will be refunded if, upon graduation, you are not satisfied.



Big Illustrated Book Sent FREE

Today, right now, take the first step out of that low pay rut. Mail the coupon to me for big, illustrated book on ELECTRICITY. Act today. Get my special Railroad Fare offer and Remarkable Tuition offer.

Just Mail Coupon



IT'S EASY THIS WAY

Fascinating, practical shop work in my big school fits you. Not correspondence course.



**RADIO
COURSE
IN-
CLUDED**



J. H. McSweeney, Pres.,
McSweeney Electrical School,
Dept. E-10-11, Cleveland, O.

Dear Sir: Without obligation send me a copy of your big book on ELECTRICITY; also Railroad Fare offer, and details of Employment Service.

Name.....
Address.....
Town..... State.....

McSWEENEY ELECTRICAL SCHOOL

Dept. E-10-11
Cleveland, Ohio

New Kind of Can Opener

"Works Like Magic"

Brings Agents Up To \$8 and \$10 In An Hour!

IMAGINE having a little automatic machine to open cans! Why, to women everywhere, the very idea is revolutionary as well as amazing! No more fuss, muss or bother. And danger absolutely banished! No wonder agents who demonstrate this astonishing invention have made almost incredible sums. E. T. Barclay, N. Y., cleaned up \$117 in a day and a half. Mrs. M. Bridges, Me., made over \$300 in a couple of months spare time. O. C. Gregg, Wyo., made part time profits of \$20 in 3 hours. And why not?

The "Million-Dollar" Can Opener

The wonder-working little machine holds the can for you so you don't need to touch it. Then spins the can quickly around. Next the lid pops up so you can take hold of it. Entire top is cut out slick, smooth and clean. Opens round, square and oval cans. Approved by Good Housekeeping Inst. Guaranteed for five full years. If your present income is less than \$60 a week write quick for details of Territory Reservation, Sales Outfit, and FREE Test Offer.

CENTRAL STATES MANUFACTURING CO.

Dept. P-705, 4500 Mary Ave., ST. LOUIS, MO.

Central States Mfg. Co., Dept. P-705,
4500 Mary Ave., St. Louis, Mo.

Rush your FREE TEST OFFER.

Name.....

Address.....

Town..... State.....

Check here if interested only in one for your home.



NO MORE DANGER

Every woman knows how dangerous the old-style can opener is. Almost daily the newspapers tell of blood-poison, amputations, even death, that sometimes follow the very tiniest "can opener scratches." Now all danger is banished forever. No wonder so many buy on sight!



A Blessing in "Hard Times"

New Soles 9¢

as low as

A PAIR

FREE SAMPLE SAVASOLE

to Readers of POPULAR MECHANICS

See this amazing discovery that ends costly half sole repairing forever. It's called Savasole—a scientific "plastic leather" that puts new soles on worn out shoes—makes them wear like new—for as low as 9c a pair. Rebuilds run down heels too. Fills in all cuts, holes, cracks, forming a smooth, thick waterproof surface. Agents are cleaning up with this sensational speciality. Mail coupon for Free sample and money-making agents' offer.

Spreads on Soles Like
Butter on Bread

Dries Hard and Smooth Overnight

No more taking shoes to the repair man. No paying from \$1.00 to \$1.75 for leather soles and heels. Just spread SAVASOLE on the worn out soles with an old knife—as easily as you spread butter on bread. Let it dry overnight. In the morning you have a new wearing surface that is hard, smooth, and durable. Looks like leather. Wears like leather and is absolutely waterproof.

GUARANTEED! Do not confuse SAVASOLE with "cheap" imitations. SAVASOLE alone has the special Bollman Double-action Cement Process (patent applied for) that means SAVASOLE CANNOT COME OFF THE SHOE. SAVASOLE outwears the uppers.

My money back guarantee protects you and your customers.

MONEY-MAKING PROOF \$135 PER WEEK

I gave up my former occupation where I ranged in earnings from \$115 to \$286 per month. I started out with three gross of Savasole. Since that time, my earnings have netted me over \$135 per week and I am sure that I will soon hit \$200 per week. Savasole has solved my financial problems, and you are the whitest bunch of people to work with. I offer you...

38 GROSS HIS FIRST MONTH

I have given Savasole a thorough trial and think it is wonderful. This order completes my requirements for sole distributor. Send me four gross of Savasole at once. H. L. BURTON

PERFECT MANUFACTURING CO.

SAVASOLE

The Original Perfected
"Plastic Leather"



BEFORE—Here is an old shoe, worn down, ready to be sent to the shoemaker, who would charge \$1.00 to \$1.75 for a first-class job.



AFTER—Here is the same shoe repaired with SAVASOLE. No hammer, nails, or pegs. Just use an old knife. All the cracks and breaks are filled in and covered up with a hard, smooth, waterproof, non-skid surface. SAVASOLE repairs shoes for one-tenth the cost of ordinary heels and soles.

PERFECT MANUFACTURING CO.

Manufacturers of SAVASOLE—the Original, Perfected "PLASTIC LEATHER"
Z-506 Daylight Building CINCINNATI, OHIO

When writing to advertisers please mention Popular Mechanics

Pays Agents ^{UP TO} \$42 ^{A DAY}

Quick Sales and Profits

Every member of the family needs SAVASOLE. It seals the pores of the leather and makes the soles wear as long as the uppers hold together. We show you how to make quick, convincing, dramatic demonstration that amazes customers and compels them to order. Repeat business everywhere. Splendid territories open. Rush coupon now for FREE sample of SAVASOLE. Send no money.

MAIL FOR FREE SAMPLE

R. R. Bollman, Pres., Perfect Manufacturing Co.,
Z-506 Daylight Bldg., Cincinnati, Ohio

Dear Mr. Bollman: Please send me FREE sample of SAVASOLE and explain how I can earn up to \$42.00 a DAY. Also send me details. Exclusive Territory Plan. Send everything to me FREE and without obligation.

Name.....

Address.....

Town..... State.....

Territory preferred.....



The NEW
SPARE
TIME
training
that leads to
BIGGER PAY

DO you want a better position and a higher salary? You can have these if you can do the work. LaSalle experts will show you how, guide you step by step to success and help solve your personal business problems through the time-saving LaSalle Problem Method. Our salary-increasing plan enables you to prepare during your spare hours, without interference with your present duties. Simply mark on the coupon the field in which you desire success, and we will mail you a valuable book describing the opportunities in that field, together with an outline of our salary-increasing plan. Also copy of "Ten Years' Promotion in One." There is no cost or obligation. Find out how the salary-increasing plan starts average men and women on the high road to success and financial independence. Check and mail the coupon NOW.

Find Yourself Through LaSalle!

LaSalle Extension University

Dept. 1164-R Chicago

Please send me full information regarding the up-to-the-minute course and service I have marked with an X below. Also a copy of "Ten Years' Promotion in One" all without obligation to me.



- Business Management:** Training for Official Managerial, Sales and Departmental Executive positions.
- Modern Salesmanship:** Training for position as Sales Executive, Salesman, Sales Trainer, Sales Promotion Manager, Manufacturers' Agent, and all positions in retail, wholesale or specialty selling.
- Higher Accountancy:** Training for position as Auditor, Comptroller, Certified Public Accountant, Cost Accountant, etc.
- Traffic Management:** Training for position as Railroad or Industrial Traffic Manager, Rate Expert, Freight Solicitor, etc.
- Law:** LL. B. Degree.
- Banking and Finance:** Training for executive positions in Banks and Financial Institutions.
- Modern Foremanship:** Training for positions in Shop Management, such as that of Superintendent, General Foreman, Foreman, Sub-Foreman, etc.
- Industrial Management:** Training for Works Management, Production Control, Industrial Engineering, etc.
- Personnel Management:** Training for Personnel Manager, Industrial Relations Manager, Employment Manager, and positions in Employee Service.
- Modern Business Correspondence:** Training for Sales or Collection Correspondent, Sales Promotion Manager, Mail Sales Manager, Secretary, etc.
- Stenography:** Training in the new superior machine shorthand, Stenotypy.
- Railway Station Management**
- Railway Accounting**
- Expert Bookkeeping**
- Business English**
- Commercial Law**
- Credit and Collection Correspondence**
- Paper Salesman's Training**
- Effective Speaking**
- C. P. A. Coaching**
- Commercial Spanish**
- Stenotypy—Stenography**
- Telegraphy**

Name.....Age.....

Present Position.....

Address.....

BIG OPPORTUNITIES in PHOTOGRAPHY



Earn \$1,500 to \$7,000 a year. Opportunities everywhere for trained motion picture, commercial or portrait photographers. Previous experience unnecessary. Train through our Simplified System. We furnish equipment.

GOOD PAY

FASCINATING WORK

YOUR OWN BUSINESS

NATIONWIDE FIELD



Personal Service Bureau helps you start a studio or secure position. Send TODAY for FREE Book on

- Motion Picture Photography or Projection.
 Commercial and Portrait Photography or Photofinishing.

NEW YORK INSTITUTE OF PHOTOGRAPHY, Dept. 49, 10 West 33rd St., New York City

New Invention Boils Water, Instantly!

A remarkable new way to boil water almost instantly has now been made possible by a new kind of electric water heater. Where ordinary boiling makes it necessary to heat the container first, this super-heater dropped into the water heats through direct contact. Indispensable for shaving, washing dishes, hot water bags, baby's bath, etc. Although on the market only a short time, already over half a million homes use and praise it. Costs only a fraction of ordinary water heater prices. Agents are cleaning up small fortunes. Neuman made \$195 in ten days, Prentice \$26.25 his first day. The inventor is opening new territories everywhere and will gladly send sample for test and full details without obligation. Simply write H. A. Visel, Dept. R-60, Elkhart, Indiana.

\$50.00 SHIP MODEL for \$4.50 COACH MODEL for \$4.98



We furnish all parts cut to fit, numbered and ready to assemble for the following models: Clipper Ship and Flying Cloud (with electric light); Santa Maria; Mayflower; La Pinta; \$4.50—Constitution; \$5.98—SPANISH GALLEON (fully equipped for electrical illumination); \$6.98—COACH MODEL; Geo. Washington; Princeton in Philadelphia; TALLY-HO; Deadwood; Overland Western. Our new Illustrated Catalog FREE. All models sent C. O. D. Foreign orders accompanied by check or money order. Illustrated Catalog free on request. C. J. SIERBOWER, Dept. PM3216 Baring St., Phila. Originator of Best of Your Own Ship Model.

EXTRA STRONG IMPROVED MODEL COPPER BOILER

Catalog Free



SAVE 20% NOW! Most Practical Boiler & Cooker

Made with large 6-inch Improved Cap and Spout. Safe, practical and simple. Nothing to get out of order, most substantial and durable on the market. Will last a lifetime, gives real service and satisfaction.

Easily Cleaned

Cap removed in a second; no burning of hands. An ideal low pressure boiler and pressure cooker for home and farm.

Save 20% by ordering direct from factory. No article of such high quality and utility ever sold at a 20% amazingly low price. Prices quoted are cash with order or one-fourth cash, balance C. O. D. Send check or money order; prompt shipment made in plain strong box. The only boiler worth having. Large Catalog Free.

HOME MANUFACTURING CO.

Dept. 7916
18 E. Kinzie St.
Chicago, Illinois

-takes only 8 weeks to get a big job



George Smith owns an agency and repair shop in West Alexandria, Ohio. He makes \$200 a week.

and Earn \$50 to \$100 a Week as Auto Expert

Learn the auto and tractor business by the McSweeney method, then step out and get a good job at \$50 to \$100 a week or open your own repair shop and make up to \$10,000 a year. Trained men are needed everywhere. Opportunities galore! Eight weeks training fits you to open repair shop or to go with one of the big firms waiting for trained men. Read what George Smith and C. E. Gilstrap have done. Hundreds of other McSweeney trained men can tell as interesting facts. Every month McSweeney men who complete their training are taking the place of half-trained and incompetently self-trained men.

Learn in Only 8 Weeks

Simple, thorough, practical shop methods. You learn the "why" of everything you do, then learn to do it right. You do real work with real tools and real equipment. No book studies. Very little schooling necessary. Any man from 16 to 60 can learn. Write today for Big Special Limited Time Tuition Offer, including—

SPECIAL! R. R. FARE PAID!

Also FREE course in AUTOMOBILE ELECTRICITY to those who enroll soon. Don't delay—write at once for complete details and BIG AUTO BOOK FREE. Mail coupon NOW.



C. E. Gilstrap has charge of a fleet of trucks and tractors for the State Highway Commission. Due to McSweeney training.

McSWEENEY SCHOOLS

Auto, Tractor and Aviation Department A-10-11, Cleveland, Ohio



AVIATION COURSE INCLUDED

AVIATION is paying tremendous incomes to trained men! Now eight weeks' course also includes complete course in Aviation Mechanics. Learn on real airplane engines under experienced instructors. Don't miss this remarkable opportunity. Save by enrolling at once. The sooner you start the sooner you will be ready to earn big pay or get into business for yourself.

MAIL COUPON FOR FREE BOOK

McSweeney Auto, Tractor and Aviation School, Dept. A-10-11, Cleveland, Ohio.

Without cost or obligation, send me your big FREE book on Autos; also, full details of your big offer including R. R. Fare and New Course in Aviation.

Name.....
Street.....
Town..... State.....

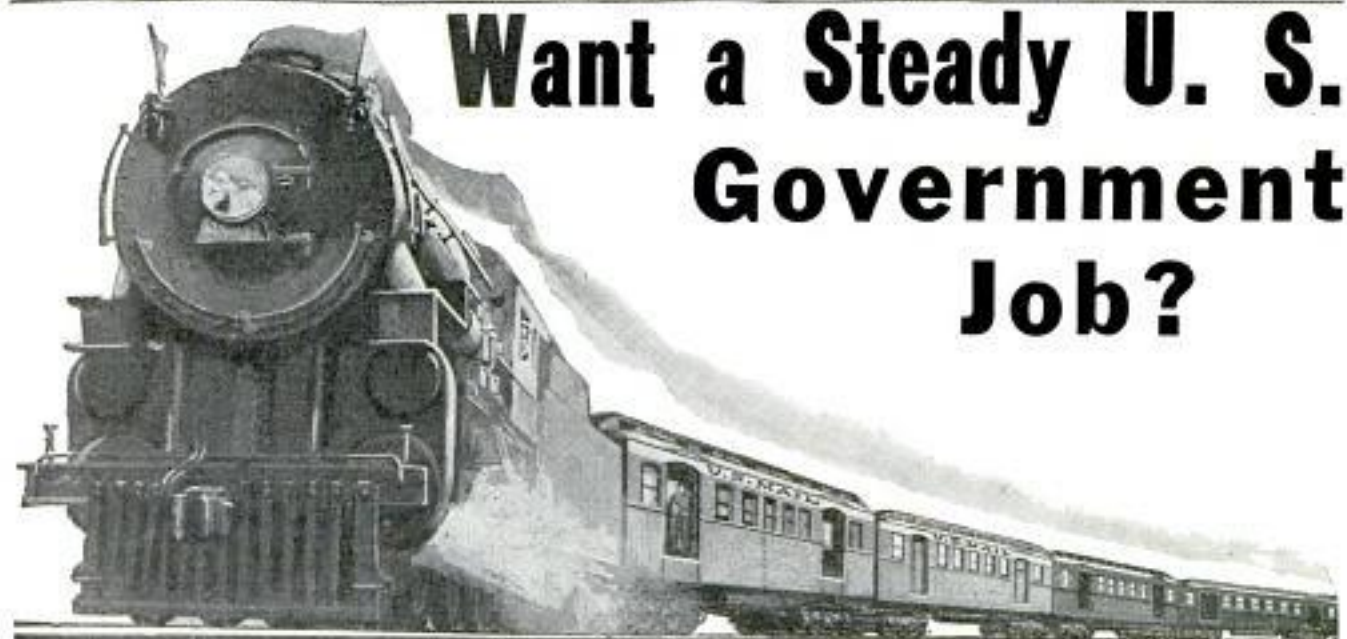

Want a Steady U. S. Government Job?

RAILWAY POSTAL CLERKS

\$1900 to \$2700 a Year

COMMON EDUCATION SUFFICIENT

STEADY JOBS—NO LAYOFFS!

Many other U. S. Government Jobs open to Men—Women 18 to 50. MAIL COUPON—TODAY SURE

Short Hours—Pleasant Work—Rapid Advancement—Permanent Employment—Long Vacation with Pay

FRANKLIN INSTITUTE
Dept. J174
ROCHESTER, N. Y.

Rush to me free of charge: (1) A full description of the position checked below; (2) Free copy of 32-page illustrated book "How to Get a U. S. Government Job"; (3) A list of U. S. Government Jobs now obtainable; (4) Tell me how to get the job checked.

..... Railway Postal Clerk..... (\$1900-\$2700)
..... Post Office Clerk..... (\$1700-\$2300)
..... City Mail Carrier..... (\$1700-\$2100)
..... Rural Mail Carrier..... (\$2100-\$2400)
..... General Clerk—File Clerk..... (\$2100-\$2500)
..... Inspector of Customs..... (\$2100-\$3300)
..... Immigrant Inspector..... (\$2100-\$3000)

Name.....
Address.....



Broadcasting Stations offer fascinating jobs paying from \$1,000 to \$5,000 a year.



Police Departments are finding Radio a great aid in their work. Many good jobs have been made in this new field.



Spare time and servicing is paying N. R. I. men \$200 to a \$1,000 a year. Full time men are making as much as \$50, \$75, \$100 a week.



Talking Movies—an invention made possible only by radio—offers many fine jobs to trained radio men, paying \$75 to \$200 a week.



Television—the coming field of many great opportunities—is covered by my course.

You're Wanted

Take your pick of these fine **Big Pay** Radio Jobs

YOU have seen how the men and young men who got into the automobile, motion picture and other industries when they were started had the first chance at the key jobs—are now the \$5,000, \$10,000 and \$15,000 a year men. Radio offers you the same chance that made men rich in those businesses. Its growth has already made men independent and will make many more wealthy in the future. Its amazing growth can put you ahead too. Don't pass up this opportunity for a good job and future financial independence.

Many Fine \$50 to \$100 a Week Jobs Opening Every Year

Radio needs more trained men badly. Why slave your life away for \$25 to \$40 a week in a no-future job when you can get ready in a short time for Radio where the good jobs pay \$50, \$60, \$75 and \$100 a week? And many of these jobs can quickly lead to \$150 to \$200 a week. Many fine jobs are opening every year for men with the right training—the kind of training I'll give you.

I Am Doubling and Tripling Salaries

Where you find big growth you always find many big opportunities. I am doubling and tripling the salaries of many men every year. After training with me only a short time they are able to make \$1,000 to \$3,000 a year more than they were getting before. Figure out for yourself what an increase like this would mean to you—the many things that mean so much in happiness and comfort that you could buy with an additional \$1,000 to \$3,000 a year.

Many Make \$10 to \$25 a Week Extra Almost at Once

The day you start I'll show you how to do 28 jobs common in most every neighborhood that you can do in your spare time. I'll show you how to repair and service all makes of sets and do many other jobs all through my course. I'll give you the plans and ideas that are making \$200 to \$1,000 for my students while they are taking my course. G. W. Page, 133 Pine Street, McKenzie, Tennessee, writes: "I made \$935 in my spare time while taking your course."

You Have Many Jobs to Choose From

Broadcasting stations use engineers, operators, station managers. Radio manufacturers continually need testers, inspectors, foremen, engineers, service men, buyers and managers. Shipping companies, police departments, commercial land stations, aircraft companies, offer good operators jobs from time to time. There are hundreds of opportunities for you to have a spare time or full time Radio business of your own. I'll show you how to start one with practically no capital. My book tells you of other opportunities. Be sure to get it at once.



\$400 a Month

"I spent fifteen years as traveling salesman and was making good money but could see the opportunities in Radio. Believe me I am not sorry, for I have made more money than ever before. I have made more than \$400 each month and it really was your course that brought me to this. I can't say too much for your school." J. G. Dahistead, Radio Station KYA, San Francisco, Cal.



\$800 in Spare Time

"Money could not pay for what I got out of your course. I did not know a single thing about Radio before I enrolled but I have made \$800 in my spare time although my work keeps me away from home from 6:00 A. M. to 7:00 P. M. Every word I ever read about your course I have found true." Milton I. Leiby, Jr., Topton, Pennsylvania.



Seldom Under \$100 a Week

"My earnings in Radio are many times greater than I ever expected them to be. In November I made \$577, December \$645, January \$465. My earnings seldom fall under \$100 a week. I'll say the N. R. I. course is thorough and complete. You give a man more for his money than anybody else." E. E. Winborne, 1267 W. 48th St., Norfolk, Va.

for a **Big Pay** Radio Job

I will train you **AT HOME** free book gives facts and proof

I Will Train You at Home In Your Spare Time

Hold your job. There is no need for you to leave home. I will train you quickly and inexpensively during your spare time. You don't have to be a high school graduate. My course is written in a clear, interesting style that most anyone can grasp. I'll give you practical experience under my 50-50 method of training—one-half from lesson books and one-half from practical experiments. When you graduate you won't have to take any kind of a job to get experience—you will be trained and experienced ready to take a responsible job in the radio field of your choice.

Television and Talking Movies Included

My course not only gives you a thorough training in Radio—all you need to know to get and hold a good job—but also your choice, without extra charge, of any one of my special advanced courses: (1) Television, (2) Aircraft Radio, (3) Broadcasting, Commercial and Ship Radio Stations, (4) Sound Pictures and Public Address Systems, and (5) Advanced Radio Servicing and Merchandising. You won't be a "one job" man when you finish my course. You'll know how to handle a job in any one of Radio's 20 different branches of opportunity.

SPECIAL FREE OFFER

In addition to my big free book "Rich Rewards in Radio" I'll send you my valuable manual "28 Tested Methods for Making Extra Money." Never before available except to students. Now, for a limited time, it is free to readers of this magazine. How to make a good battle for cone speakers, how to reduce hum in externally fed dynamic speakers, how to operate 25 cycle apparatus on 60 cycle current, how to operate 110 volt A. C. receivers on D. C., how to shield sets from local interference are five of the subjects covered. There are 23 others. Get this valuable book by mailing the coupon now.

ACT QUICKLY!



Lifetime Employment Service to All Graduates

When you finish my course you won't be turned loose to shift for yourself. Then is when I will step in to help you find a job through my Employment Department. This Employment Service is free of extra charge both to you and the employer.

Your Money Back If Not Satisfied

You do not risk a penny when you enroll with me. I will give you an agreement in writing, legal and binding upon the institute, to refund every penny of your money if, upon completing my course, you are not satisfied with my Lessons and Instruction Service. The resources of the N. R. I., Pioneer and Largest Home-Study Radio training organization, stands back of this agreement.

Find Out What Radio Offers You—Get My Book at Once

One copy of my valuable book, "Rich Rewards in Radio," is free to anyone interested in making more money. It tells you where the good jobs are, what they pay, how you can quickly and easily fit yourself to get one. The coupon below will bring you a copy. Send it at once. Your request does not obligate you in any way. Act NOW.

J. E. SMITH, President
NATIONAL RADIO INSTITUTE
Dept. 1MP
Washington, D. C.



I give You **8 Big Outfits** of Radio parts for *Extensive Practical Experiments*

You can build over 100 circuits with the outfits I give you. You learn from actual experience about A. C., Screen Grid circuits, push-pull amplification and the other features in modern sets. You work out with your hands the principles, diagrams and circuits you learn from my lesson books. You get as much practical experience under this unequalled method of home training, in a few months, as the average fellow gets in two to four years in the field.

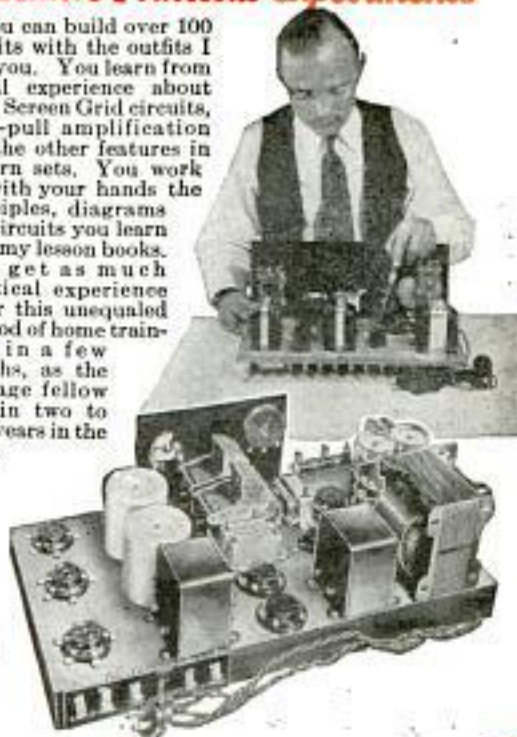

Clip and mail NOW for FREE INFORMATION

J. E. Smith, President,
National Radio Institute, Dept. 1MP,
16th and U Sts., N. W., Washington, D. C.

Dear Mr. Smith:—I want to take advantage of your special offer. Send me your two books, "Rich Rewards in Radio" and "28 Tested Ways for Making Extra Money."

Name.....

Address..... Age.....

City..... State.....

Genuine UNDERWOOD

Below $\frac{1}{2}$ Mfg's. Original PRICE

(Refinished)



Famous Model No. 5

NOW ONLY **\$39.90** DOWN



Think of it—over 2 million buyers paid \$102.50 (cash) for this model No. 5 now offered direct-to-you at way below $\frac{1}{2}$ original price—and on easiest terms besides. Positively the greatest bargain ever offered. Accept the special 10 day trial offer and be convinced. See the neat, perfect work it does—compare its bright, shiny newness without risk. Recognized as the finest, strongest typewriter built.

Easy Terms—only 10c a day

Here is positively the chance of a lifetime to own a World-famous Standard Underwood No. 5 completely refinished like new at the very lowest price and easiest

Learn Touch Typewriting



Learn touch typewriting free! Complete (home study) course of famous Van Sant-System gives with this offer. Fully illustrated—easily learned.

International Typewriter Exch.
231 W. Monroe St., Chicago, Dept. 1101

I enclose \$1 deposit. Send Underwood No. 5 (F.O.B. Chicago) at once for 10 days' trial. If I am not perfectly satisfied I can return it express collect and get my deposit back. If I keep it I will pay \$2 a month until I have paid \$49.90 (cash price in full).

Name.....
Address.....
Town.....State.....

FREE 6 FAMOUS SPARK PLUGS

worth \$4.50

To customers for GOOD YEAR

Goodrich - Firestone and other tires

DEALERS WANTED

Lowest Prices in History - - 75% Saving

Midland's Immense Buying Power Makes This Possible. Thousands of motorists all over U. S. A. use and boast our Standard Brand reconstructed Tires. Hard service on roughest roads guaranteed. Our nation-wide success and reputation speaks for itself. FREE for limited time one 75c best quality spark plug with every tire shipped. Order 4 tires—get full set 6 spark plugs free. New pep for your car—no extra cost. Be sure to mention make of car, model, year built. ORDER TODAY at these Rock Bottom Prices. Satisfaction Guaranteed.

BALLOON TIRES		Reg. CORD TIRES	
Size	Price	Size	Price
28x4.40-21"	\$2.30	30x3.90-21"	\$2.20
28x4.50-21"	2.40	30x4.25-21"	2.25
28x4.75-19"	2.45	30x4.50-21"	2.30
28x4.90-21"	2.50	30x4.75-21"	2.35
29x3.00-19"	2.55	30x5.00-21"	2.40
29x3.00-20"	2.55	30x5.25-21"	2.45
29x3.50-18"	2.65	30x5.50-21"	2.50
29x3.50-19"	2.65	30x5.75-21"	2.55
29x3.50-20"	2.65	30x6.00-21"	2.60
29x3.50-21"	2.65	30x6.25-21"	2.65
29x4.00-19"	2.70	30x6.50-21"	2.70
29x4.00-20"	2.70	30x6.75-21"	2.75
29x4.00-21"	2.70	30x7.00-21"	2.80
29x4.50-19"	2.75	30x7.25-21"	2.85
29x4.50-20"	2.75	30x7.50-21"	2.90
29x4.50-21"	2.75	30x7.75-21"	2.95
29x5.00-19"	2.80	30x8.00-21"	3.00
29x5.00-20"	2.80	30x8.25-21"	3.05
29x5.00-21"	2.80	30x8.50-21"	3.10
29x5.50-19"	2.85	30x8.75-21"	3.15
29x5.50-20"	2.85	30x9.00-21"	3.20
29x5.50-21"	2.85	30x9.25-21"	3.25
29x6.00-19"	2.90	30x9.50-21"	3.30
29x6.00-20"	2.90	30x9.75-21"	3.35
29x6.00-21"	2.90	30x10.00-21"	3.40
29x6.50-19"	2.95	30x10.25-21"	3.45
29x6.50-20"	2.95	30x10.50-21"	3.50
29x6.50-21"	2.95	30x10.75-21"	3.55
29x7.00-19"	3.00	30x11.00-21"	3.60
29x7.00-20"	3.00	30x11.25-21"	3.65
29x7.00-21"	3.00	30x11.50-21"	3.70
29x7.50-19"	3.05	30x11.75-21"	3.75
29x7.50-20"	3.05	30x12.00-21"	3.80
29x7.50-21"	3.05	30x12.25-21"	3.85
29x8.00-19"	3.10	30x12.50-21"	3.90
29x8.00-20"	3.10	30x12.75-21"	3.95
29x8.00-21"	3.10	30x13.00-21"	4.00
29x8.50-19"	3.15	30x13.25-21"	4.05
29x8.50-20"	3.15	30x13.50-21"	4.10
29x8.50-21"	3.15	30x13.75-21"	4.15
29x9.00-19"	3.20	30x14.00-21"	4.20
29x9.00-20"	3.20	30x14.25-21"	4.25
29x9.00-21"	3.20	30x14.50-21"	4.30
29x9.50-19"	3.25	30x14.75-21"	4.35
29x9.50-20"	3.25	30x15.00-21"	4.40
29x9.50-21"	3.25	30x15.25-21"	4.45
29x10.00-19"	3.30	30x15.50-21"	4.50
29x10.00-20"	3.30	30x15.75-21"	4.55
29x10.00-21"	3.30	30x16.00-21"	4.60
29x10.50-19"	3.35	30x16.25-21"	4.65
29x10.50-20"	3.35	30x16.50-21"	4.70
29x10.50-21"	3.35	30x16.75-21"	4.75
29x11.00-19"	3.40	30x17.00-21"	4.80
29x11.00-20"	3.40	30x17.25-21"	4.85
29x11.00-21"	3.40	30x17.50-21"	4.90
29x11.50-19"	3.45	30x17.75-21"	4.95
29x11.50-20"	3.45	30x18.00-21"	5.00
29x11.50-21"	3.45	30x18.25-21"	5.05
29x12.00-19"	3.50	30x18.50-21"	5.10
29x12.00-20"	3.50	30x18.75-21"	5.15
29x12.00-21"	3.50	30x19.00-21"	5.20
29x12.50-19"	3.55	30x19.25-21"	5.25
29x12.50-20"	3.55	30x19.50-21"	5.30
29x12.50-21"	3.55	30x19.75-21"	5.35
29x13.00-19"	3.60	30x20.00-21"	5.40
29x13.00-20"	3.60	30x20.25-21"	5.45
29x13.00-21"	3.60	30x20.50-21"	5.50
29x13.50-19"	3.65	30x20.75-21"	5.55
29x13.50-20"	3.65	30x21.00-21"	5.60
29x13.50-21"	3.65	30x21.25-21"	5.65
29x14.00-19"	3.70	30x21.50-21"	5.70
29x14.00-20"	3.70	30x21.75-21"	5.75
29x14.00-21"	3.70	30x22.00-21"	5.80
29x14.50-19"	3.75	30x22.25-21"	5.85
29x14.50-20"	3.75	30x22.50-21"	5.90
29x14.50-21"	3.75	30x22.75-21"	5.95
29x15.00-19"	3.80	30x23.00-21"	6.00
29x15.00-20"	3.80	30x23.25-21"	6.05
29x15.00-21"	3.80	30x23.50-21"	6.10
29x15.50-19"	3.85	30x23.75-21"	6.15
29x15.50-20"	3.85	30x24.00-21"	6.20
29x15.50-21"	3.85	30x24.25-21"	6.25
29x16.00-19"	3.90	30x24.50-21"	6.30
29x16.00-20"	3.90	30x24.75-21"	6.35
29x16.00-21"	3.90	30x25.00-21"	6.40
29x16.50-19"	3.95	30x25.25-21"	6.45
29x16.50-20"	3.95	30x25.50-21"	6.50
29x16.50-21"	3.95	30x25.75-21"	6.55
29x17.00-19"	4.00	30x26.00-21"	6.60
29x17.00-20"	4.00	30x26.25-21"	6.65
29x17.00-21"	4.00	30x26.50-21"	6.70
29x17.50-19"	4.05	30x26.75-21"	6.75
29x17.50-20"	4.05	30x27.00-21"	6.80
29x17.50-21"	4.05	30x27.25-21"	6.85
29x18.00-19"	4.10	30x27.50-21"	6.90
29x18.00-20"	4.10	30x27.75-21"	6.95
29x18.00-21"	4.10	30x28.00-21"	7.00
29x18.50-19"	4.15	30x28.25-21"	7.05
29x18.50-20"	4.15	30x28.50-21"	7.10
29x18.50-21"	4.15	30x28.75-21"	7.15
29x19.00-19"	4.20	30x29.00-21"	7.20
29x19.00-20"	4.20	30x29.25-21"	7.25
29x19.00-21"	4.20	30x29.50-21"	7.30
29x19.50-19"	4.25	30x29.75-21"	7.35
29x19.50-20"	4.25	30x30.00-21"	7.40
29x19.50-21"	4.25	30x30.25-21"	7.45
29x20.00-19"	4.30	30x30.50-21"	7.50
29x20.00-20"	4.30	30x30.75-21"	7.55
29x20.00-21"	4.30	30x31.00-21"	7.60
29x20.50-19"	4.35	30x31.25-21"	7.65
29x20.50-20"	4.35	30x31.50-21"	7.70
29x20.50-21"	4.35	30x31.75-21"	7.75
29x21.00-19"	4.40	30x32.00-21"	7.80
29x21.00-20"	4.40	30x32.25-21"	7.85
29x21.00-21"	4.40	30x32.50-21"	7.90
29x21.50-19"	4.45	30x32.75-21"	7.95
29x21.50-20"	4.45	30x33.00-21"	8.00
29x21.50-21"	4.45	30x33.25-21"	8.05
29x22.00-19"	4.50	30x33.50-21"	8.10
29x22.00-20"	4.50	30x33.75-21"	8.15
29x22.00-21"	4.50	30x34.00-21"	8.20
29x22.50-19"	4.55	30x34.25-21"	8.25
29x22.50-20"	4.55	30x34.50-21"	8.30
29x22.50-21"	4.55	30x34.75-21"	8.35
29x23.00-19"	4.60	30x35.00-21"	8.40
29x23.00-20"	4.60	30x35.25-21"	8.45
29x23.00-21"	4.60	30x35.50-21"	8.50
29x23.50-19"	4.65	30x35.75-21"	8.55
29x23.50-20"	4.65	30x36.00-21"	8.60
29x23.50-21"	4.65	30x36.25-21"	8.65
29x24.00-19"	4.70	30x36.50-21"	8.70
29x24.00-20"	4.70	30x36.75-21"	8.75
29x24.00-21"	4.70	30x37.00-21"	8.80
29x24.50-19"	4.75	30x37.25-21"	8.85
29x24.50-20"	4.75	30x37.50-21"	8.90
29x24.50-21"	4.75	30x37.75-21"	8.95
29x25.00-19"	4.80	30x38.00-21"	9.00
29x25.00-20"	4.80	30x38.25-21"	9.05
29x25.00-21"	4.80	30x38.50-21"	9.10
29x25.50-19"	4.85	30x38.75-21"	9.15
29x25.50-20"	4.85	30x39.00-21"	9.20
29x25.50-21"	4.85	30x39.25-21"	9.25
29x26.00-19"	4.90	30x39.50-21"	9.30
29x26.00-20"	4.90	30x39.75-21"	9.35
29x26.00-21"	4.90	30x40.00-21"	9.40
29x26.50-19"	4.95	30x40.25-21"	9.45
29x26.50-20"	4.95	30x40.50-21"	9.50
29x26.50-21"	4.95	30x40.75-21"	9.55
29x27.00-19"	5.00	30x41.00-21"	9.60
29x27.00-20"	5.00	30x41.25-21"	9.65
29x27.00-21"	5.00	30x41.50-21"	9.70
29x27.50-19"	5.05	30x41.75-21"	9.75
29x27.50-20"	5.05	30x42.00-21"	9.80
29x27.50-21"	5.05	30x42.25-21"	9.85
29x28.00-19"	5.10	30x42.50-21"	9.90
29x28.00-20"	5.10	30x42.75-21"	9.95
29x28.00-21"	5.10	30x43.00-21"	10.00
29x28.50-19"	5.15	30x43.25-21"	10.05
29x28.50-20"	5.15	30x43.50-21"	10.10
29x28.50-21"	5.15	30x43.75-21"	10.15
29x29.00-19"	5.20	30x44.00-21"	10.20
29x29.00-20"	5.20	30x44.25-21"	10.25
29x29.00-21"	5.20	30x44.50-21"	10.30
29x29.50-19"	5.25	30x44.75-21"	10.35
29x29.50-20"	5.25	30x45.00-21"	10.40
29x29.50-21"	5.25	30x45.25-21"	10.45
29x30.00-19"	5.30	30x45.50-21"	10.50
29x30.00-20"	5.30	30x45.75-21"	10.55
29x30.00-21"	5.30	30x46.00-21"	10.60
29x30.50-19"	5.35	30x46.25-21"	10.65
29x30.50-20"	5.35	30x46.50-21"	10.70
29x30.50-21"	5.35	30x46.75-21"	10.75
29x31.00-19"	5.40	30x47.00-21"	10.80
29x31.00-20"	5.40	30x47.25-21"	10.85
29x31.00-21"	5.40	30x47.50-21"	10.90
29x31.50-19"	5.45	30x47.75-21"	10.95
29x31.50-20"	5.45	30x48.00-21"	11.00
29x31.50-21"	5.45	30x48.25-21"	11.05
29x32.00-19"	5.50	30x48.50-21"	11.10
29x32.00-20"	5.50	30x48.75-21"	11.15
29x32.00-21"	5.50		

SPORTSMEN

Read This Offer!

Send the COUPON and receive a magnificent Sportsmen's Book telling you how to learn to MOUNT GAME-HEADS, BIRDS and ANIMALS. You can NOW be your own Taxidermist. Our school has over 100,000 graduates throughout the world. You can now learn AT HOME in SPARE TIME.

Mount Your Own Trophies!

Hunting and Fishing have entered a new era. All true sportsmen now kill fewer specimens, but DOUBLE their interest by mounting their trophies. The secrets of Taxidermy (mounting birds and animals) are now revealed. YOU CAN NOW LEARN TAXIDERMY FOR YOURSELF. Be a Taxidermy artist. Mount birds, animals, game-heads, fishes, tan skins and make beautiful rugs and robes. Easily and quickly learned in your own home. Adorn your home and den with nature's finest ART. If you enjoy hunting—you will enjoy Taxidermy MORE.

Big Profits Do you want to MAKE MORE MONEY? Then give your SPARE TIME to Taxidermy. Make \$50 to \$250 a month by mounting for others or selling your mounted specimens, or go into business—open a Taxidermy shop of your own, and earn \$3,000 to \$6,000 a year.



This Book FREE

Every Sportsman should have this marvelous book. You can right now, while this edition lasts, get a copy Free and prepaid by mailing the coupon NOW. Only limited number free—Send Today. Nothing like it. Just off the press. Contains 48 large pages and cover in brilliant colors. More than 100 photos of splendid game specimens and masterpieces of the National Museum at Washington. Brim full of interest to every sportsman. And think of it, this valuable unique and artistic book can be had now, by Sportsmen for the asking.



Mail the Coupon!

If you want to preserve your trophies; if you desire to make money from your spare time, if you are a nature lover—send the coupon and receive your copy by return mail. State your AGE.

N.W. School of Taxidermy, 337 8 Elwood Bldg., Omaha, Neb.

N. W. School of Taxidermy

3378 Elwood Bldg., Omaha, Neb.

Send me your free illustrated book "Sportsmen and Their Trophies." Also tell me how I may learn this fascinating art easily and quickly by mail. No obligation.

Name _____ Age _____

Address _____

AN EASY WAY TO SHAPE your NOSE



Anita Nose Adjuster shapes flesh and cartilage—quickly, safely, painlessly, while you sleep or work. Lasting results. Gold Medal Winner. Doctors praise it. 87,000 users. Write today for FREE BOOKLET.

ANITA INSTITUTE, M-12 Anita Bldg., Newark, N. J.

NO JOKE TO BE DEAF

—EVERY DEAF PERSON KNOWS THAT George P. Way made himself hear, after being deaf for 25 years, with Artificial Ear Drums—his own invention. He wore them day and night. They stopped head noises and ringing ears. They are invisible and perfectly comfortable. No one sees them. Write for his true story, "How I Got Deaf and Made Myself Hear." Also booklet on Deafness. Address George P. Way, Inc., 611 Hofmann Building, Detroit, Michigan



Artificial Ear Drum

The man who studies gets ahead. Popular Mechanics Press will advise you what books to read to advance in your trade. 200 East Ontario Street, Chicago, Illinois.

LUCKY TIGER

A PROVEN GERMICIDE



For a clean, healthy scalp use Lucky Tiger. Destroys germs, and gives to thin, falling hair a new life and lustre. Delicately perfumed; world's largest seller at Druggists, Barbers, Beauty Parlors. Try it Today!

When writing please mention Popular Mechanics

TELEVISION WANTS MEN

Wonderful openings for operators, salesmen, service and repair men at big pay. More jobs NOW in Television and Aircraft Radio than there are available trained men. We want ambitious beginners and will train you to step into a good job quick. No matter what your past experience, if you are over 18 years old and want to make \$300 to \$600 a month in this fascinating big pay profession, write today for full particulars.

"SUD" NOEL, Pres.

FIRST NATIONAL TELEVISION, INC.
1111 Fairfax Airport KANSAS CITY, KANSAS

New Way to Improve YOUR ENGLISH

A command of effective English gives you added advantages and better opportunities. Poor English handicaps you more than you now realize. You can improve your English through Sherwin Cody's 100% self-correcting invention. If you are ever embarrassed by mistakes in grammar, spelling, punctuation, or pronunciation, this new free book "How You Can Master Good English—in 15 Minutes a Day" will prove a revelation to you. Send for it now. It is free. Address

SHERWIN CODY SCHOOL OF ENGLISH
511 Searle Building Rochester, N. Y.

EASY-PRACTICAL—
STUDY and SHOP—
ANSWERS GIVEN
MATHEMATICS
STRENGTH of MATERIALS
APPLIED MECHANICS
By DOBE.

This is the EASY SHOP MATHEMATICS you have been looking for. 3 Books in One—it covers also Strength of Materials and Applied Mechanics. All Answers are given and examples worked out, simplified and VERY EASY to understand, EASY for anybody to learn. You can advance faster, easier, better; you can get ahead of others and be a Leader. This book by a practical Engineer contains 375 Working Diagrams, 188 Pages 8½ x 8½ inches, Cloth Binding. PRICE \$2.50 at your Book Store or DOBE ENGINEERING SERVICE, 1953 Lawrence Ave., Chicago

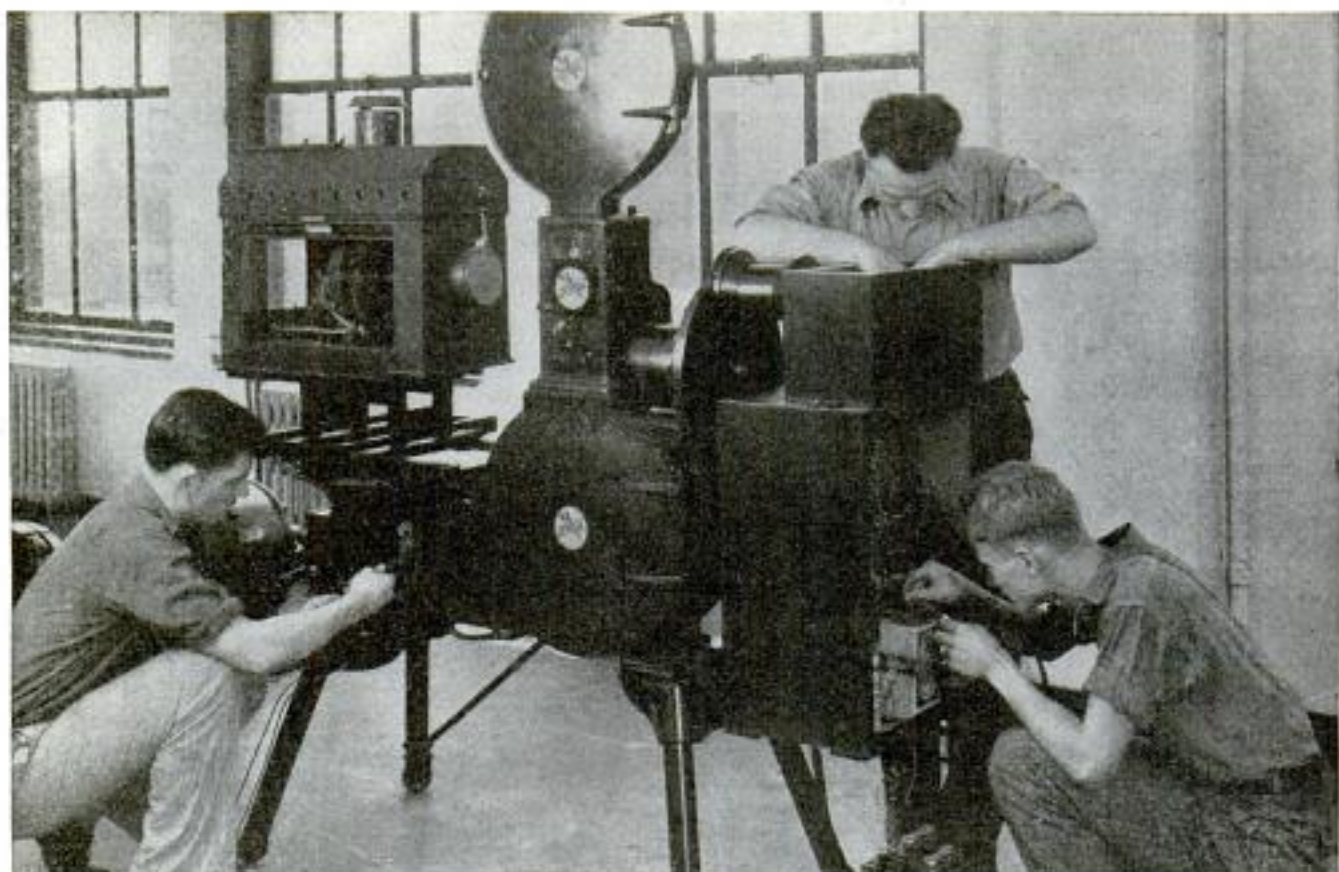

STUDENTS WORKING ON FILM SCANNING MACHINE OF OUR MODERN TELEVISION TRANSMITTER

LEARN RADIO-TELEVISION TALKING PICTURES AT COYNE

TEN WEEKS of SHOP TRAINING on RADIO EQUIPMENT

Dissatisfied with your job? Not making enough money? Then let me show you how to prepare for a real job and how to make real money, in RADIO—one of the fastest growing, biggest money-making trades on earth.

JOBS LEADING TO BIG PAY

Scores of jobs are open—jobs as Designer, Inspector and Tester—as Radio Salesman and in Service and Installation work—as Operator or Manager of a Broadcasting Station—as Wireless Operator on a Ship or Airplane—with Talking Picture Theatres and Manufacturers of Sound Equipment—with Television Laboratories and Studios—fascinating jobs, offering unlimited opportunities to the Trained Man.

PRACTICAL SHOP TRAINING

Come to Coyne in Chicago and prepare for these jobs the QUICK and PRACTICAL

H. C. Lewis, Pres. **Radio Division** **Founded 1899**
COYNE ELECTRICAL SCHOOL
 500 S. Paulina Street, Dept. 81-3H, Chicago, Illinois

way—BY ACTUAL SHOP WORK ON ACTUAL RADIO EQUIPMENT. Some students finish the entire course in 8 weeks. The average time is only 10 weeks. But you can stay as long as you please, at no extra cost to you. No previous experience necessary.

BROADCASTING TELEVISION SOUND EQUIPMENT

In addition to the most modern Radio equipment, we have installed in our shops a complete model Broadcasting Station, with sound proof Studio and modern Transmitter with 1,000 watt tubes—the Jenkins Television transmitter with dozens of home-type Television receiving sets—and a complete Talking Picture installation for both "sound on film" and "sound on disk." We have spared no expense in our effort to make your training as Complete and Practical as possible.

FREE Employment Service TO STUDENTS

After you have finished the course, we will do all we can to help you find the job you want. We employ three men on a full time basis whose sole job is to help our students in finding positions. And should you be a little short of funds, we'll gladly help you in finding part-time work while at school. Some of our students pay a large part of their living expenses in this way.

COYNE is 32 Years Old

Coyne has been located right here in CHICAGO since 1899. COYNE Training is tested—proven by hundreds of successful graduates. You can get all the facts absolutely free. JUST MAIL THE COUPON FOR A FREE COPY OF OUR BIG RADIO AND TELEVISION BOOK.

H. C. LEWIS, President
Radio Division, Coyne Electrical School
 500 S. Paulina St., Dept. 81-3H, Chicago, Ill.
 Send me your Big Free Radio and Television Book.
 This does not obligate me in any way.

Name.....
 Address.....
 City..... State.....

Classified Advertisements

WORLD'S BEST WANT AD MEDIUM

Advertisements in this section, 35 cents per word, each insertion, minimum 10 words, payable in advance
To be inserted under proper classification in December issue, copy should be in our office October 19th.

ADVERTISING AGENCIES

ADVERTISE—Bargain value—24 words in 24 representative Sunday newspapers \$15; Free assistance with your ads, sales letters, literature. Helpful Ad-Guide showing best paying newspapers, magazines, rates, mailing lists, etc., free. Chicago Union Agency, Great Northern Bldg., Chicago.

BEFORE Advertising get our catalog. No charge. 25 years in business. The largest classified agency in the world. Ankrum Advertising Agency, 100 No. LaSalle St., Chicago, Ill.

FREE—New 1931 Advertisers Rate Guide, 44 pages. Includes everything. Lowest rates. E. H. Brown Advertising Agency, 140 S. Dearborn, Chicago.

ADVERTISE in rural weeklies. Lists free. Meyer Agency, 4112 Hartford, St. Louis, Mo.

ADVERTISING: 24 Words 8 big city Sunday papers—\$10. One inch display, 50 country weeklies—\$5. Copy prepared. Free list, magazines, farm. LeGrand Agency, 34 West 33rd St., New York.

INCH Display advertisement 50 magazines per \$24. Wood's Popular Services, Atlantic City, N. J.

TIME Counts in applying for patents. See pages 132 and 133. Clarence A. O'Brien, Registered Patent Attorney, Washington, D. C.

FOR ADVERTISERS

ADVERTISING: 20 Words; 50 magazines 60c; three insertions, \$1.20. Inch display, three months \$6.00; year \$21.00. Mailing Bureau, Laundale, Calif.

ADVERTISE 53 Magazines, 3 months, \$6.00 inch. List, special offers, free. Evans King Co., Box 672P, Wilmington, Delaware.

24 WORDS—70-95 Southeast weeklies, \$3.96. S. Stout, Warm Springs, Ga.

MAILING LISTS

WAUKESHA County, Wisconsin, richest farming community in United States, 1000 farmers, \$5. Hardy Supply Company, Waukesha, Wisconsin.

1000 AIRPLANE Builders and buyers. New. Guaranteed. \$5.00. Aerobuilders Service, 1207-13 So. 12th, Lincoln, Neb.

1,000 AGENTS, Salesmen, \$2.00. M. L. Smith, 93 Coleman Street, Dorchester, Mass.

INFORMATION

ANY Questions, reliable information on business, technical or personal subjects. Ask us anything in the fields of engineering, advertising, patenting, business efficiency, financing, investing, education, travel, personal endeavor. For \$1.00 we will mail you answer covering essential points you need to know. Consolidated Services, 321 Broadway, New York City.

ADVICE, Information any subject, one dollar. National Service Bureau, Box 3563, San Francisco.

ANY Information desired 25c coin and up. Fred Klotz, Reading, Pa.

ADVERTISING WRITERS

POWERFUL Sales letters—circulars written on approval. Hathaway, Rolling Prairie, Ind.

SALES PROMOTION

ADVERTISING—Selling problems solved! Letters, circulars, folders planned and written! Big, positive results! Investigate! Finkel-Advertising, 2270 Ocean Avenue, Brooklyn, N. Y.

AUTOMOBILES

BUILD 18" Electric racing auto. Blue print. Instructions 50c. Joe Bear, Denison, Texas.

TIME Counts in applying for patents. See pages 132 and 133. Clarence A. O'Brien, Registered Patent Attorney, Washington, D. C.

GARAGEMEN, Individuals, learn auto, airplane, tractor, radiator repairing by mail. Write Tri-State Radiator School, 1800 W. Franklin St., Evansville, Ind.

AUTOMOBILE SUPPLIES

REGU Governor for automobile motors used for power plants. Free circulars and full information. Write, mentioning motor. Harlan Maching Co., Dept. 100 Harlan, Ia.

MONEY For mechanics, handy men, installing new sheet remover, 20 minutes work pays a dollar. Send name and get free sample for your car. H. C. Rowell & Co., Hudson, New Hampshire.

BARGAINS—Excellent repossessed compressors, battery chargers, test benches, ear washers. Terms. Trial. Write Ken's Automobile Service, Box M-1111, Troy, Ohio.

STOP Brake rattle—Universal "springs of silence", all brake service stations. Universal Spring Co., Grand Rapids, Mich.

CHROMIUM Plating powder plates iron, steel, brass, copper and nickel, without electricity or machinery. Guaranteed not to tarnish; ½ pint can \$1.50 prepaid. Gunmetal Co., Ave. J, Decatur, Ill.

AUTO SERVICE EQUIPMENT

OWN A Battery Charger and make big profits; buy direct from factory; fully guaranteed; literature free. Adams-Barr Corporation, Columbus, Ohio.

SUBSTANTIAL Savings—repossessed compressors, battery chargers, test benches, ear washers. Terms. Trial. Write Ken's Automobile Service, Box M-1112, Troy, Ohio.

MOTORCYCLES, BICYCLES AND SUPPLIES

REBUILT Motorcycles \$25 to \$100 easy. Tires, used tires \$2.50. New Firestone \$5. Engines for motorcycle ice sleds, airplanes, boats \$15 to \$75. Forks \$3, frames \$3, cylinder \$5, saddles \$3, chains \$1.50, handle bars \$3, belts \$5, wheels \$3, side cars \$25. Bicycles \$9.50, airplane wheel \$1.00 was formerly \$2.00. Save you dollar prices. Oldest house in U. S. Send 25c for catalogue. Price Cutter Deminger, Rochester, N. Y.

MOTORCYCLE Bargains, lowest prices, bargain sheet for stamp, motorcycle accessories, largest line in America, lowest prices. Largest motorcycle mail order house in the United States. Rochester Harley Davidson Corporation, 129 West Main St., Rochester, N. Y.

NEW Clymer Scout bicycles. Lowest prepaid prices in America, \$22 up. Motorcycle \$89. Used motorcycles. Terms. Catalog free. Clymer Motors, D 1-A, Denver, Colorado.

TYPEWRITERS, Motorcycles, radios, \$1.99—\$24.99. Terms. Agents. Knights, 1506 Locust, St. Louis, Mo.

SEND 15c For illustrated used Motorcycle catalog. Large stock. Bargains. Indian parts. Accessories. Indian Motorcycle Sales, Kansas City, Mo.

LOW Prices—Special bargains in Harley-Davidsons—14 models. Send 6c stamps for catalog. Knuth's, 2325 Fond du Lac Ave., Milwaukee, Wis.

REPAIR With good used parts, save ½ or more, state parts needed, no lists. J. B. Dahl, 3661 Archer Ave., Chicago, Ill.

GUARANTEED Reconditioned Harley-Davidsons. All models. Send for bargain list. Ruhl & Artley, 1350 N. Western Ave., Los Angeles, Calif.

AVIATION

LICENSED Plans to build the Crawford Powered Gliders. You must build from approved plans by January first. Here they are, at less than one percent of their actual cost. Boys, get busy this winter and build that licensed airplane, and have real sport next summer. Enclose two dimes for our detailed information. Discount to clubs and trade schools. Crawford Powered Glider Mfr. Seal Beach, California.

WORLD'S Largest bargains in used airplanes. \$160 and up. Folder 10c. Federal Equipment Co., Pesaukee, Wis.

BE Sure that the motor you purchase for your light plane will fit it. Heath B-4 and Heath Henderson motors are guaranteed to fit and 7 years of constant performance prove it. For economy and reliability these motors cannot be equaled. Send 10c for large illustrated booklet. Heath Aircraft Corp., Dept. KP-11, Niles, Michigan.

LIGHTPLANES, Gliders, supplies. Lowest prices. Latest catalog, number 8, dime. Kamm Aircraft Co., 524-12th, Oshkosh, Wis.

MOTORS, Propellers, hubs for lightplanes and iceboats, cheap. Circulars 10c. Storms Aviation, Spartanburg, S. C.

HISPANO-SUIZA 150hp Vee 8 engines, water cooled, block tested \$85.00. Aviation, marine or shop practice use Burns Auto Sales, Dayton, Ohio.

THE 8H Henderson aircraft motor cost only \$225.00 complete. Send ten cents in stamps for new catalog and motor bargain lists. Sensesich Bros., Litzitz, Pa.

SPECIAL Boring propellers for sleds. Send your inquiries to Sensesich Bros., Litzitz, Pa.

SEND For descriptive list of New, Rebuilt and Used Curtiss ON3 and Hispano Suiza Airplane Engines. Heckman Marine Works, 3020 W. Lake St., Chicago, Illinois

24" FLYING Scale model airplanes of U. S. Army "Hawk", "Corsair" or "Falcon." \$1.00 each postpaid. Empire Store, 1195 Haggard Ave., New York.

\$3.00 GLIDER Flying course for 98c. Five books in all. Karl S. Ort, York, Pa.

NEW Waro Gliders, limited stock in original crates, \$150.00 each. Mail deposit at once to: Gliders Motors, P. O. Box 1385, Cincinnati, Ohio.

NEW 2024 Wheels, \$2.00; new tires for same, \$2.00; new tubes, \$0.98; new Zenith altimeters, \$1.00; Johnson strut airspeeds, \$7.50. Write for bargain sheets, Johnson Airplane Supply Company, Dayton, Ohio.

AIRRAFT Directory 50c. Thousands surplus airplanes, motors, parts, supplies. Invaluable. Aerobuilders Service, 1507-15 So. 12th, Lincoln, Neb.

TIME Counts in applying for patents. See pages 132 and 133. Clarence A. O'Brien, Registered Patent Attorney, Washington, D. C.

METAL Tipped Henderson propellers, \$9.95; Ford's, \$12.50. Hibbs, Ft. Worth, Texas.

LEARN To fly where Lindbergh learned at this flying school with highest government approval. Airplane mechanics school connected with aircraft factory. Big opportunity—write today for complete information. Lincoln Flying School, 2002 Aircraft Building, Lincoln, Nebraska.

SEND 5c For bundle of balsam, reeds and price list on supplies. Aero Shop, 3050 Huribut Ave., Detroit, Mich.

MODEL AIRPLANES

LARGEST Assortment of Model Airplanes and Accessories in the world. Send 5c for catalog. Selley, 1377B Gates Avenue, Brooklyn, N. Y.

CHEAPEST, Best supplies. Catalog dime. Peru Model Aero Shop, Peru, Ind.

FREE, Complete plans and instructions for high performance R. O. G., Senter R. O. G. and new eleven minute tractor. If you write for our complete list of lower prices on model airplane supplies. Madison Model Airplanes, Inc., 124 Livingston St., Brooklyn, N. Y.

BOATS, OUTBOARD MOTORS, ETC.

PLANS 12 Foot step racing outboard hydroplane for class C, D, E engines, September Rudder, price 35c. Rudder, 15 Murray Street, New York.

MAKE 12' Rowboat, blueprint, 30c. Weesho-Uro, B75, Detroit, Michigan.

MAKE Rowboats, houseboats, canoes. Address Weesho-Uro, B75, Detroit, Mich.

MAKE 16' Rowboat, Blueprints, 30c. Weesho-Uro, B75, Detroit, Mich.

ICE Boat, sport plane propellers, cheap. Cyril Friesch, Sullivan, Wisconsin.

MAKE Canvas canoe, blueprint, 30c. Weesho-Uro, B75, Detroit, Michigan.

NEW Clymer outboard motors \$95 up. Small gas engines, electric light and water pump plants. Terms. Catalog free. Clymer Motors, D 2-A, Denver, Colorado.

MODEL SHIPS

MODEL Ships made to order, clipper ships a specialty, rigging and repairing models. Orders promptly executed. Prices very moderate. Several clipper models for sale. John Nock, 390 Second St., Brooklyn, N. Y.

BOY SCOUT SUPPLIES

"BOY Scout Knives," \$2.50 value, post-paid, \$1.00. Golden State, Inc., 259 North Fremont Avenue, Los Angeles, California.

CARTOONING

BOOK of 1500 cartoons—Priceless to students, artists. Action, figures, pen lines, shading, etc., \$1.98. Sample page if desired. Summers, 14284 Shaw, E. Cleveland, Ohio.

COMIC Sketch from your photo \$1.00. State hobby. Photo returned unharmed. Tee, 209 Wheatland St., Rochester, N. Y.

FOR BOYS

BOY Agents wanted. Virginia Stamp Company, University, Virginia.

WHEELS—Make your own coaster wagon, four wheels, caps, two axles, blueprint \$2.75. "Ballak," 100 N. 12th, St. Louis, Mo.

ARCHERY

ARCHERY Tackle from the Ozarks where raw material is plentiful and woodcrafters exceptional. Catalog free. Outdoor Amusement Company, Clinton, Mo.

BOOKS AND PERIODICALS

HUNDREDS Unemployed now panning gold. Big placer-deposit territories still untouched. Learn prospecting—placer-mining. New treatise, with map showing localities, covers everything. \$1.00. Circular and reports recent rich strikes for stamp. W-S Laboratory, Coeur d'Alene, Idaho.

HAVE Your wages been cut? Easy to make up the difference. New practical system of poultry raising shows you how you can make \$30.00 or more monthly from your back yard. Complete instructions sent post-paid for \$1.50. Pacific Poultry School, Van Nuys, Calif.

BOOKS, Natural history, travel. Send for my list quick. Walter Webb, Brighton Sta., Rochester, N. Y.

ARE You rich? Successful? 25c brings you the names of four books which, if followed, will positively bring you money, success, prosperity! Address: Chester P. M. Escher, 260 Broadway, New York City.

THOUSANDS Of old magazines. List 10c. O. P. Seeley, Sr., Box 743, Jennings, La.

BOOKLET "Old & Rare Books" tells of 250 books wanted at \$20.00 to \$1,500.00 each. Postpaid 50c. Lester Dudgeon, Cane Valley, Ky.

NOVELTIES, CURIOS, ETC.

HOTTEST Novelty on the market, fast seller at 25-35c each. Can easily be made from material available anywhere at very small cost. Send one dollar for (4) novelties and complete instructions to make them. Forwarded by express, charges collect, shipping weight one pound. Esames No-city Works, 2634 North Ashland Ave., Chicago, Ill.

THIRTEEN Curious love letters, reading two ways, double meaning, thirty different ways to say "I love you" and backseat drivers license, all above, only 25c coin. George Heinemann, 2217 Touhy Ave., Chicago, Ill.

CHALK TALKS

LAUGH Producing program, \$1.00. Catalog free. Balda, The Cartoonist, Oshkosh, Wis.

GAMES, ENTERTAINMENTS AND PLAYS

PLAYS, Operettas, musical comedies and minstrels, comedy and talking songs, black-face skits, vaudeville acts, monologs, dialog, recitations, juvenile plays and songs, musical readings, entertainments, make-up goods. Catalog free. T. S. Denton & Co., 623 So. Washburn, Dept. 11, Chicago.

NUMERAL Golf, A fascinating, educational parlor and lawn game. Price \$1.50. Overland Park Cabinet Works, Overland Park, Kan.

MAGIC TRICKS, BOOKS AND JOKER NOVELTIES

MAGIC—Tricks, Books and Supplies. For amateurs as well as the great professionals. Anyone can learn through our instructions. Feature Arts in Mind-Reading, Spiritualism, Rope Ties, etc. Large illustrated professional catalog, 20c. Chicago Magic Co., 140 So. Dearborn St., Dept. B, Chicago, Ill.

WHOOPEE Cushions and other belly shaking laugh producers, Sample 25c. Price list free. Yorena Company, Box 312, Bayonne, N. J.

MAGIC Catalog 20c. Lynn, 103 Beach, Dept. 3, Jersey City, N. J.

CARD Tricks—baffling, mystifying, entertaining. Perform miracles with our Master Card Trick System. Only 10c, including new, big, magic catalog. Wizard Magic Company, Dept. 15-A, Box 1033, Station "C," Los Angeles, Calif.

TRICK Catalogs, Illustrated, 10c. Oaks Magical, Dept. 548, Oshkosh, Wis.

SEVEN Optical delusions. Four Magic catalogs 15c. Gilmaglio, Morgan Park, Chicago.

RADIO SETS AND SUPPLIES

RADIO Tubes, speakers, pickups, motors, switches, resistances, condenser blocks, power transformers, dial cable, etc. Write for catalog and exceptionally low wholesale prices. Surplus Sales Company, 1941 Boston Road, New York.

BUILD Your own radio-phonograph mailed for 10c. "American," 3692 Wesley, Berwyn, Ill.

TIME Counts in applying for patents. See pages 132 and 133. Clarence A. O'Brien, Registered Patent Attorney, Washington, D. C.

STAMP COLLECTING

HELGOLAND Has the most romantic history. This little island in the North Sea was for centuries bartered around between nations. Finally it was sold by England to Germany and it is now disappearing altogether from the face of the earth, being washed away by the sea. Helgoland issued its last stamp in 1879 and all Helgoland stamps catalogue high, but the old government 50 years ago reprinted a small quantity and these are now very scarce. We offer 2 different ones together with 4 different Georgia, another hard to get country, total catalogue value over \$1.30 for only 10c to approval applicants. Globus Stamp Co., 268 Fourth Ave., New York.

SCARCE Airmail and triangle. Beautiful Uruguay "flying horse" airmail and scarce Guatemala triangle (smallest in the world) are included in our big packet of 60 different stamps from Abscites, Grand Liban, Venezuela, British and French Colonies, etc. All for 5c to approval applicants. Big illustrated lists free with each order. Write today! Mystic Stamp Co., (Dept. 89), Camden, New York.

ANCHER'S \$\$\$ Outfit—only 12c. Fine triangle stamp, set German stamps (new-war) value millions dollars, perforation gauge and name scale, airmail set, interesting stamp smallest reusable, newspaper set, packet good stamps Travancore, Malay, Dutch Indies, etc., fine pocket stock book. Entire outfit 12c to approval applicants. Ancher Stamp Company, Rutherford, N. J.

BIG Parade—A packet of more than twenty all different better grade stamps showing exciting scenes and records of nations at war. Includes fire-pot hurler; the storming of a city; hand-to-hand bayonet struggle; bloody battle scenes; troop transport; red cross stamp; dying soldier; victory stamps; etc. Send for this thrilling "Big Parade" packet at once—limited supply. Only 10c to approval applicants. W. A. Rowell, 58 Cornhill, Boston, Mass.

THE Biggest Dollar—1000 mixed foreign including Newfoundland, Persia, etc., for 40c; 1000 mixed U. S. for 40c; 100 different U. S. with Civil and Spanish War Revenues and old 1861 cover for 45c; 100 Latin-Americans for 25c; 100 different from 50 countries for 10c. All above with 1000 hinges for \$1.00. Approval selection with each order. New England Stamp Co., Established 1893, 53 Bromfield Street, Boston, Mass.

GIANT Triangle stamp! Largest triangle stamp in the world; (Spain, Columbus commemorative.) worth a dime alone, included in packet of twenty-four scarce varieties from queer, far-off lands; Rold, Kouang-Tcheu, Gwalior, etc. Absolutely no common European varieties to mar the high quality of this wonderful packet; amazing value! Only ten cents (coin) to approval applicants. Vogue Stamp Co., Dept. P2, Post Chester, N. Y.

FREE—Set 4 Hongkong to approval applicants who send 4c postage. L. Mascho, 5895 Seminary Court, Oakland, California.

A SNAP—300 Different foreign and 60 different U. S. stamps, including \$1 value, for only 25c. Free, with each order, our pamphlet telling "How To Make A Stamp Collection Properly," together with our price lists of albums, supplies and hundreds of bargains in sets, packet, etc. Queen City Stamp Co., Room 36, 604 Race St., Cincinnati, Ohio.

BELIEVE It or not! You get Montserrat, St. Kitts-Nevis, Borneo, Sarawak and other beauties space does not permit to mention. Everything only 10c to approval applicants. Schoepske, 1307 Keeler Ave., Beloit, Wis.

SPAIN-MADRID Exposition, six big picture stamps 10c. Webers Stamp Shoppe, 1317 Park, Plainfield, N. J.

REUNION, Congo, Tunis, Gabon, etc. 25 varieties unused French Colonies 3c, approvals. Madison Stamp Co., P. O. Box 273, Cleveland, O.

SEVENTY Different stamps from seventy different countries, 6c to approval applicants. Barcus, Box 1074, Detroit, Mich.

WONDERFUL Packet of 40 stamps from strange countries—Fiji, Tasmania, Mozambique, Siam, etc., with smallest stamp in world for 10c. (No Europe.) 25 Newfoundland and Canada 10c. Barcain Stamp Co., 277P West 23 St., New York.

FIFTY Stamps from fifty different countries, 10c. Bleck, 719 No. Lombard, Oak Park, Ill.

RARE China Airmail showing airplane flying over Great Wall of China; also Vatican City stamp, Nyassa, Morocco—and 51 other fine stamps. All for 5c with request for approvals. R. G. Howard, 245 Waverly Ave., Newton, Mass.

FREE Packet stamps to approval applicants. Baker Stamp Co., 341 Tuxedo, Detroit, Mich.

125 DIFFERENT Stamps 8c; 10 sets 75c. Postage extra. Klein, 5343 Dolloff, Cleveland.

AFRICA, Native warriors, river scenes, sphinx, desert scenes. Visit this magic land of romance and adventure. Fine packet of 51 different stamps from Africa, 5c with approvals. Hanson, 1333 Pontiac, Ann Arbor, Mich.

300 DIFFERENT Stamps 12c with approvals. Frank Nagel, 678 Franklin, Denver, Colorado.

ASIA, 25 Beauties 25c. John Starke, 4099 Forest, Norwood, Ohio.

CHINA \$1 & \$2 Stamps only two cents to approval applicants furnishing reference. C. Stuart Williams, Glastonbury, Conn.

STAMPS—50 Diff. No European, 10c. Album 50c, 1000 Hinges 15c, 25 diff. U. S., 25c. Price list and approvals sent with every order. C. Stegman, 5941 Cote Brilliant Ave., St. Louis, Mo.

SIAM Five free to approval applicants, Bernard Karch, Middle River, Maryland.

25 FRENCH Colonies with approvals, 2c. Norman Floyd, Norman, Oklahoma.

FREE Premium to approval applicants, S. Nathanson, 35 Tehama, Brooklyn, N. Y.

100 DIFFERENT British Colonies including old New Brunswick, Newfoundland, Canada commemoratives. Twenty-five cents to approval applicants. Reid Stamp Company, 608 Yonge Street, Toronto.

40 DIFFERENT, United States, 250 foreign including Africa, South America, Asia, British-French Colonies; 25c. World album outfit 25c. Ireland triangle airmail free with approvals. Zieten, 333 Parker Ave., Philadelphia.

REMNANTS Of approval sheets and collections with few slightly damaged higher cataloging stamps, 100 different, 10c to approval applicants. A. W. Lloyd, 8324 Oglesby Ave., Chicago, Ill.

1000 DIFFERENT Europe \$28.86 value, only 1 dollar. Splendid approvals! Josef Wendt, Neumarkt, Ost. Germany.

FREE!!! 100 Different stamps; watermark detector; perforation gauge; 20 different U. S.; Canadian confederation stamp; postage 2c with approvals. Gordon Stamp Company, 292 N. Lakewood Blvd., Detroit, Michigan.

FREE! African airmail with approvals, Monjar, 1543 Knox, Cincinnati, Ohio.

WORLD Album, 2500 spaces, 1675 Illustrations, packet stamps, hinges, Approvals. Electra Co., Mayhew, W. Va.

5 RARE Old stamps 5c. Stamps of Thurn & Taxis, an old German state. Issued 1860. An unusual offer. All unused and guaranteed genuine. Catalog value 43c. Include 2c postage. Cross Stamp Company, 156 Market Street, Newark, N. J.

ABYSSINIA Rhino, (catalogs 4c), and parcel Andorra, Epirus, Oltre Giuba, Niseria, Anatolia, etc., only 5c with approvals and lists. Pilgrim Stamps, Mt. Washington, Md.

AMAZING Offer! Set of Triangles, Monaco, Morocco, Togo, Camerons, also stamps from Angola, Alauites, Cape Verde, Guadeloupe, Congo, Lebanon, Dahomey, Ubangi and other countries including queer six-sided stamp. All for only 10c to approval applicants. Lenott Stamp Company, Department 12, 225 Broadway, New York.

250 DIFFERENT Foreign postage stamps only 10c. Skillman, Titusville, N. J.

SUPERIOR Mixture—1000 foreign stamps \$2.00. Approvals. Albemarle Stamp Co., Bethlehem, Pa.

PERU: 20 Varieties 10c to approval applicants. Allison, Angola, Ind.

TRIANGLE, Animal, and scenery stamps from Nyassa, Malay, etc., free to approval applicants. Earl T. Tyler, Royal Oak, Mich.

1000 DIFFERENT Stamps \$1.00 (money order). Crane, 1038 Page, Toronto, Canada.

YORKTOWN Sesquicentennial commemoratives postmarked Yorktown particulars. Tyndall, 356 Hampton, Va.

SCOTTS 1931 Catalogue \$1.00 with approvals. Neil Grouber, Box 5441, Philadelphia, Pa.

WONDERFUL Approvals! Free prizes! Big discounts! Box 114, Minneapolis, Minn.

PACKET 52 Different from Alauites, Lebanon, Siam, etc., also watermark detector and rare old Hawaiian stamp—all for only 5c to approval applicants. Highland Stamp Co., Newton Highlands, Mass.

PACKET Rare diamond shaped stamps 10c to approval applicants. J. Pawliczek, Pine Island, N. Y.

BARGAINS! 5 Sarawak 10c. Lists free. Sterling, 370 Bucoto, Lexington, Ky.

112 PAGE Illustrated world stamp album, packet 190 stamps, booklet How to Collect Stamps. Premium. A beautiful hard-to-get triangle stamp. 25c to approval applicants. George L. Ott, Box 165, Avonmore, Pa.

200 DIFFERENT Better grade stamps—Airmails, triangles, parcel post, Asia, Africa, South America, many unused for 25c. Wonderful Illustrated catalog free. Walton Stamp Co., 6610 So. Fairfield, Chicago.

200 DIFFERENT Triangle, airmail, etc., 10c. R. H. Carlton, 382 W. So. Temple, Salt Lake City, Utah.

FREE Packet stamps to approval applicants. Albert Anderson, 1232 Liberty, Salem, Ore.

125 FREE 2c Postage. Approvals. La Grange Stamp Co., La Grange, Illinois.

125 FREE To approval applicants. 2c postage. Oak Park Stamp Co., Oak Park, Illinois.

SEND For penny approvals. Stanley's Stamp Store, Hexworth Bldg., Chicago.

WORLD'S Tiniest triangle for official use (scarce Guatemala Quetzal-Bird), also scarce dead country triangle and packet Eritrea, Vatican, Natal, Andorra, etc., only 5c with lists and approvals. Seminole Company, Druid, Baltimore, Md.

PAPUA (Lakute boat), Zanzibar, Iraq, Kenya, Lebanon, Morocco, etc., in wonder packet 60 different, 5c with approvals and lists. Monumental Stamps, Arlington, Baltimore, Md.

WHOLESALE Catalog for dealers. Illustrated. Postage 5c. Frank Co., 5031 Queensberry, Baltimore, Md.

ABOUT 1000 U. S. stamps, 25c. Auburn Stamp Co., Syracuse, N. Y.

U. S. Stamps on approval, reference. Haines Stamp Co., 251 Market St., Lowell, Mass.

FREE! Beautiful set with approvals. Aladdin, 1350 Carroll, St. Paul, Minnesota.

ALBANIAN Set free with approvals. Flechtmann, 4322 N. Richmond, Chicago.

FREE! 15 French Colonies. Postage 2c. R. F. Roberts, 901 Fourth Bay Ctr., Mirb.

ZANZIBAR! Packet queer freakish stamps from Zanzibar, Indore, Algeria, Malay States, Hyderabad, Gold Coast, Nigeria, British Colonials, Southerners. Don't delay! Don't wait. This whooping packet free for 5c postage. Gray Stamps, Toronto, Canada.

APPROVALS Below 6c. Robert Arnold, 77 S. Munn, Easton, New Jersey.

50 STAMPS 50 Different countries 5c, approval applicants. Prall, Somerville, New Jersey.

105 (CHINA, Etc.) 2c. Album (500 Illustrations) 2c. Bullard, 416 Tremont, Boston.

LARGEST Stamp in the world! Rare China Wild Goose special delivery stamp (value 75c) for only 5c to approval applicants. Supply limited. Positively only one to a customer. Western Philatelists, 6021 Harner, M102, Chicago.

50 FRENCH Colonials, 5c. Approvals. Amco, Box 51, Middletown, Ohio.

ALL-NATION Loose-leaf album 60c. Gruda, 4392 27th St., Milwaukee, Wis.

FREE!! Stamp printed on silver paper. Postage 2c. Potomac Stamp Co., 3708-13th Street, Washington, D. C.

1000 ALL Different fine stamps 70c. Approvals. Ramapo Stamp Company, Ramsey, N. J.

FREE Packet with 90% quality approvals. A. V. Pierce, 115 Broadway, Providence, R. I.

FREE 6 Different Luxemburg to approval applicants. E. D. Stamp Co., 3905 Forest Park Ave., Baltimore, Md.

FREE. 100 Different stamps to approval applicants. John Cooley, Fishers Island, N. Y.

MIXED Foreign stamps. Lb. \$1.00. No trash. Stamp Co., 37 Rankin St., Newark, N. J.

RARE Stamps—Free to approval applicants. Stamps sold at large discount. Cut Rate Stamp Co., 244 Avenue C, Bayonne, N. J.

ILLUSTRATED United States list, price 50c, large complete United States price list, 1932, free. Stanley Gibbons, 38P Park Row, N. Y.

300 DIFFERENT Stamps 20c; 600 50c; 1,100, \$1; 2,000, \$3. Fred Onken, 630 79th St., Brooklyn, N. Y.

COMBINATION: Triangle and Hexagon stamps, Monserrat, Famine stamp, Turkistan, and multitude other beauties. All article needed by every collector. Also for to approval applicants. W. H. Taverner Jr., Clark St., Westfield, N. J.

PREMIUM With barbasin approvals. Stamp Shoppe, 1216 Fourth, Bay City, Mich.

35 UNITED States, commemorative: Albania, scarce; etc., 5c. Approvals. Dennis, 7783 Logan, Detroit.

STAMPS, 100 All different, Postage 2c. Lists free. P. M. Quaker Stamp Co., Toledo, Ohio.

PENNY Approvals, 5,000 Sudan, Congo, Nyassa, Liberia, etc. Also 14,000 averaging 1 1/2c. Philatelic Exchange, Huntington, W. Va.

HYVALUE Packet! Pictorial sets, revenues, \$2, \$5 stamps, etc. Only 20c to approval applicants. Joseph Johnson, 61 Brigham, Providence, R. I.

LIBERIA Snake triangle, two other triangles in our packet of 53 different stamps, 5c. Crowder Company, Waverly, Baltimore, Md.

U. S. Dollar due free to approval applicants. References required. Covered Wagon, Conshohocken, Pa.

ANOTHER New England Stamp Company special—200 different U. S. for \$1.00; 500 good mixed foreign for \$1.00; 10 varieties Afghanistan for 50c; 10 Abyssinia, 10 Albania, 5 Tanna Touva for 50c; hinges 10c. All for \$2.00 with our approval. New England Stamp Company, 53 Bromfield St., Boston, Mass.

MYSTERY Stamps—Borneo, Corea, Turkestan, Albania, Hexagon, Ubangi, etc., 10c to approval applicants, catalogue \$1.00. Melvin D. Spencer, 125 N. Lewis St., Springfield, Ill.

STAMPS, Sent on approval at 50% discount. Fred Herzberg, 207 So. Washington St., Wheeling, Ill.

QUALITY Stamps on approval. Thousands of stamps 1c to 3c each. Small selections without reference. Large selections require references. Kelgwin Stamps, Vineland, N. J.

FREE Stamp packet, including Argentine, Brazil, etc. Send postage. H. Buchholz, Norwood, Ohio.

AIR Mails, unused, 30 different 22c; 50 different 48c. F. Buffham, Lake Ave., Racine, Wis.

5 SPAIN Different Columbus Ship 7c. Approval applicants. C. A. Leeson, 266 Sheldrake Blvd., Toronto, 12, Canada.

STOP!—Look!—5 different complete sets rare old South American emerald stamps, just enclose 10c requesting unusual approvals. Bargain Stamp Service, 1332 South Hope Street, Los Angeles, California.

1000 UNITED States and foreign mixed, 25c. Mrs. Shogren, 3932 Southport Ave., Chicago, Ill.

TRIANGLES From Fiume, Austria, Nyassa; Scarce Saxony, etc. Everything only 10c to approval applicants. Parker, 10 Charlotte Road, Marblehead, Mass.

EXCELLENT Mixture 2000 stamps. Large variety including Africa, Asia, Latin America, etc. Price only \$1.00. Longacre Shop, 106 West 42 St., New York, N. Y.

BEST One cent approvals in America. F. Hand, 1117 So. 60th St., Philadelphia.

FREE Packet, wholesale list and approvals. Hoyt, Box No. 597, Lowell, Mass.

SAN Marino set, 60 different stamps, 5c to approval applicants. Malboro Stamp Co., 1630 East Fifth St., Brooklyn, N. Y.

20 BRAZIL—Showing trains, aeroplanes, blacksmith, winged mercury, harvesting, only 10c to approval applicants. Mantle Stamp Company, London, Canada.

TEN French Colonials free with approvals. Dorrall Co., Gloversville, New York.

FREE, Fine British Colonial packet, 2c postage. Lighthouse, Southsea, England.

"ARTISTIC" Packet—Beautiful airmail, Liberia pictorials, animals, War, Victory, Commemoratives, 60 others, 10c, with choice approvals. Rosedale Stamp Company, Box 1733, Winnipeg, Canada.

APPROVAL Selections at 70% discount. Reference. Roswaag, 339 East 86 Street, New York.

100 DIFFERENT For this Ad and 2c to approval applicants. Evanston Stamp Shop, 2412 Noyes, Evanston, Ill.

EUREKA Mixture. What is it? Write. Ask. Box 1089, Vancouver, Canada.

FOREIGN Pound mixtures. List free. Big sample assortment 10c. Pade, Woodside, N. Y.

PACKET Giant stamps (including world's largest, valued 75c); packet beauties. (Montserrat, St. Kitts-Nevis, Borneo, Sarawak, etc.) Either above offers 10c, both 20c, to approval applicants. Gem Co., 1830 Unionport Road, New York.

27 LIECHTENSTEIN 4c To approval applicants. Hagen, Box 129, Sioux Falls, S. Dak.

ATTRACTIVE Approvals, United States, etc. Naemus Stamp Co., 312 East 23rd Street, New York.

80% DISCOUNT Off Scotts many hard to get nineteenth century stamps. Reference please. Hubert Codwise, Garland St., Lynn, Mass.

50 DIFF. United States, lists and approvals, 12c. Robert Haynes, Point Place, Toledo, Ohio.

40 DIFFERENT United States 12c. 60% approval. Seidenberg, Hamda Mich.

FREE Stamp collection—contains Sahrador, Turkey, Africa, etc., 2c postage, 10 different triangles 25c, 1000 hinges 7c. Scott's 1932 catalogue, \$1.85. Approvals sent. Tatham Stamps, West Springfield, Mass.

FREE! Loose leaf postage stamp album at rate of 8 pages each month given with subscription to monthly journal. Send 2c stamp for prospectus. United Stamp Co., Marquette Bldg., Chicago, Ill.

201 DIFFERENT 10c To approval applicants only. Free list of barbasin packets. Kansas City Stamp Co., Lee Bldg., Kansas City, Mo.

UNITED States commemoratives 10 different 4c. Approval buyers. Hudson Co., Plainfield, N. J.

ILLUSTRATED Bulletin. Free to collectors. Reimers, 30 N. La Salle, Chicago.

150 GOOD Mixed foreign stamps, 3c. Stanton, East Lyme, Conn.

BEAUTIFUL Picture stamps sent free. Paul Cornish, Schenectady, N. Y.

500 DIFFERENT Stamps for 25c. Big collection including Armenia, Andorra, Fiume, Spanish Morocco, Kenya, Liberia, Meuse, Nigeria, Quillimane, Serbia, Victoria, Vatican City and other hard-to-get countries. Catalog value over \$10.00. Price only 25c to approval applicants. Illustrated lists free. Loma Stamp Company, 4231 42nd St., San Diego, Calif.

FREE—\$1.00 U. S. postage Lincoln memorial free, if you write for our 56 page price-list of U. S. and foreign stamps. 2,000 Illustrations and fine stamps on approval. Hussenamp Stamp Co., 620-3 Olive St., St. Louis, Mo.

24 VARIETIES Cuban stamps, 10 cents. List of stamps free. Chambers Stamp Co., 111P Nassau, New York City, N. Y.

ONLY 5c. 33 Different stamps including scarce Latvian triangular airmail stamps, 10 airmail, 12 United States (early issues, commemoratives, etc.) and 10 Canada. Approvals and Illustrated price-list sent with each order. Curhan Stamp Company, Gloucester, Mass.

WHOLESALE Catalog for dealers; 4c postage. Grossman, 162 W. 42nd, New York.

STAMPS Sent on approval at 70% discount. Reference required. Emory Benell, Hanover, Pa.

200 DIFFERENT 10c, 25 Japan 10c, 60% discount approvals, Covert Stamp, 39 State, Rochester, N. Y.

PENNY Approvals that satisfy. Nell Gronberg, Box 3441, Philadelphia, Pa.

WHOLESALE Price lists free on application. Midland Stampers, Toronto, Canada.

ABYSSINIA To Zambesia—\$4.00 catalog value. 31 scarce stamps, Abyssinia, Hejaz, Spanish Morocco, etc. Only 10c to approval applicants furnishing references. Weaver, Dept. 5, 1451 Broadway, New York.

BRUNET (Native scene). Tanganyika, Orange River Colony, Kenya, Foreign Revenue, Vatican City, Grenada, Syria, French Guiana (cataloging 25c), Nyasaland Protectorate, and scarce genuine Baden, all for 5c to introduce our famous approvals. Viking Stamp Co., Sheephead Bay Station, Brooklyn, N. Y.

100 DIFFERENT U. S. 30c—50 diff. 15c. Hawkeye Stamp Co., Cedar Rapids, 29, Ia.

BOYS Wanted—Everywhere. Show our big bargain stamp assortments to friends. We trust you and pay you splendid cash commissions. Fast sellers. Earn money with our new plan. Dandy free premium if you write us at once. LeRoy Stamp Co., 120 W. Jackson Blvd., Chicago, Ill.

CANADA Airmail stamp free if you ask for approvals and send 15c for 25 different airmails or 30 different Canada; both packets only 25c. We list 350 countries in our dime packets. Lists free. Special bargains, 500 different, 25c; 1,000 different, 75c; 2,000 different, \$2.50. Victoria Stamp Co., London, 4, Ontario, Canada.

FREE Outfit! 52 stamps, hinges, pocket wallet. Postage 4c. Approvals. United Philatelists, South Berkeley, Calif.

300 DIFFERENT Stamps 15c. Michael, 942 So. 23rd, Bellwood, Ill.

RARE COINS

ROMAN Coin 25c; tiny Trajan's aureus 10c. Bollo Gilmore, 4213 Sheridan, Chicago.

EARLY British historical token, before 1800, two crisp notes and catalog 10c. Geo. Best, Cedar Rapids, Iowa.

THE Collector Magazine for stamp, coin, curio, antique collectors. Year's subscription, 50c. Collector, P-252 Main, Franklin, Minn.

OLD Money wanted. Will pay fifty dollars for nickel of 1913 with Liberty head, two buffalo. We pay cash premiums for all rare coins. Send 4c for large coin folder. May mean much profit to you. Numismatic Co., Dept. H, Ft. Worth, Tex.

AMERICAN White cent, Columbia 25c, two large crisp notes and catalog 10c. M. Fligg, Box 283, Cedar Rapids, Iowa.

HIGHEST Prices paid for old coins, stamps, paper money, Confederate money, relics. Mathews's, Jackson, Georgia.

2c **PIECE**, Mexican, Confederate and 12 Australian bills, 25c. Paul Summers, Safferton, Texas.

UNITED States white cent and bargain selling price list 10c. Arvy, Box 483, Muskogee, Okla.

22 **COINS** And one bill, 25c; 100 coins, \$1.00. Bishoff, North Kansas City, Mo.

20 **DIFFERENT** Coins 25c, 20 different bills 25c. Oddehon, Box 681, Kansas City, Mo.

OLD Coins for sale—Old coin and selling price list 10c. Wiseman, Box 665, Huntington, W. Va.

CALIFORNIA Gold quarter 27c, half 52c, Jackson cent, 1837, 35c. Wylie, Box 265, Wheaton, Ill.

7 **DIFFERENT** Coins, 11 bills and catalog, 25c. Creamer's, 1112 Somerset, Baltimore, Maryland.

2 **COINS**, 5 Notes and catalogue 10c. Lester White, Box 66, West Newton, Mass.

I WANT To buy U. S. currency, \$1, \$2, \$5, \$10 and \$20 bills, National Bank notes series 1863 to 1875, National gold bank notes and early silver certificates. C. N. Simmons, Santa Fe Springs, Calif.

20 **DIFFERENT** Foreign coins 25c. \$100 Confederate note 10c. 10 large copper cents \$1. 5 dates 2c pieces 25c. 10 dates 2c pieces 50c. 10 half dimes 80c. Gold dollar \$2.25. John Zur, Bowie, Maryland.

BARGAINS, 18 Large cents \$1.00; 100 foreign coins \$1.00. Collectors list free. Romanopolis, Springfield, Mass.

RARE United States and foreign coins, war medals and decorations. Selling catalogue, 10c. Alexis Mengelle, Colorado Springs, Colorado.

\$5 To \$500 Each paid for old coins. Many very valuable. Keep all old money. Get posted. Send 10 cents for illustrated coin value book, 42c. Guaranteed prices. We buy and sell. Coin Exchange, Box 6, Le Roy, N. Y.

GUIDE To the value of all rare United States and early American coins, superbly illustrated. Price 50 cents. Descriptive circular free. Scott Stamp and Coin Co., 1 West 47th St., New York, N. Y.

SEND 10c For 5 different coins and catalog or 50c for 25 different. Troyer Coin Co., La Fontaine, Ind.

GET Profit and pleasure in collecting old coins. Send 10c for large illustrated coin catalog. You'll be delighted with it. Send for it right now. B. Max Mehl, Numismatist, Mehl Bldg., Dept. P, Fort Worth, Tex. Largest Rare Coin Firm in the U. S.

CALIFORNIA Gold—Quarter size, 27c; 5/8 size 52c; 5c piece and catalog, 10c. Norman Shultz, Box 746, Salt Lake, Utah.

OLD Coins, large fall selling catalog of coins for sale, free to collectors only. Catalog quoting prices paid for coins, ten cents. William Hessel, 101A Tremont St., Boston, Mass.

UNITED States, large cent, two-cent bronze, three-cent nickel and bargain list, 25c. Thirteen dates large cents, \$1.00. George Coffin, Greenwood Mountain, Me.

CAMERAS

BARGAINS—Slightly used 2 1/2x3 1/2 Carl Zeiss Coranette C Camera with Tessar F-1.5 lens, Compur shutter, \$21.50. "New Complete Handbook of Motion Picture Photography for Amateurs," \$1.00. Send today for our new bargain book listing hundreds of used bargains at great savings. Central Camera Company, 230 South Wabash Ave., Dept. PM111E, Chicago, Ill.

KODAK Films developed 3c roll, prints 3c each. Trial offer. Photo Christmas greeting card from any negative 10c. Beautiful 10-inch enlargement 25c. Young Photo Service, 403 Bertha St., Albany, N. Y.

MAKE Money in photography. Learn quickly at home. Spare or full time. New plan. Nothing like it. Experience unnecessary. American School of Photography, Dept. 2432, 3001 Michigan Ave., Chicago.

HAVE You a camera? Write for free sample of our big magazine, showing how to make better pictures and earn money. American Photography, 116 Camera House, Boston, 17, Mass.

YOUR Favorite kodak picture enlarged, size 5x7, 10c. Three for quarter, coin. Send best negative (film) today. Address Danner Photo Lab., 221 Securities Bldg., Des Moines, Iowa.

SPECIAL Trial offer: Developing any size roll 5 cents; prints 3 cents each. Beautiful 7 inch enlargement 20 cents. Send for special bargain list. Roanoke Photo Finishing Company, 209 Bell Avenue, Roanoke, Virginia.

MOTION PICTURES AND SOUND EQUIPMENT

JUST Out! Bass will mail postpaid Cine Amateur. Complete Handbook of motion picture photography for the amateur, \$1.00. Voice of the Films, a complete description of the process used in making sound motion pictures just out. Price postpaid, \$1.00. Motion Pictures With Sound by James Cameron. 400 pages crammed with information on all systems. \$5.00 postpaid. Bass Bargaingram No. 297 listing red hot bargains in standard and 16mm. motion picture cameras, projectors and accessories. 4c stamps. Bass Camera Company, Motion Picture Headquarters, 179 West Madison St., Chicago, Illinois.

\$1.250 **FOR** Original photoplay story. Our sales department sold unknown author's first story for above amount. We revise copyright and submit to studios stories for talking pictures. Being located in the heart of motion picture industry we know production requirements. Established 1917. Free booklet. Universal Scenario Company, 208 Meyer Bldg., Western and Sierra Vista, Hollywood, Calif.

TALKIE And movie producers are clamoring for new short story ideas, plots, etc. Perhaps you can write one that we can shape and sell for you. One writer (V.M.) received \$5,000. New York best market. Write now for free booklet, without obligation—How To Write For the Talkies! Daniel O'Malley Company Inc., Suite P, 1776 Broadway, New York.

ACME S.V.E. Projector, \$89.50; other bargains. Chicago Film Dealer, 6883 South Carpenter, Chicago.

MOVIE Cameras and projectors. For homes, schools, churches, business organizations. Literature free. D. F. Elder Company, Dept. B, Chelsea, Massachusetts.

BARGAINS in 35mm and 16mm films. Lists. Lowell Films, Allentown, Pa.

DE VRY G 200 Watt bulb, list \$88. Our price including one hundred Chaplin film \$10. Eastman reversible panchromatic 100 foot negative \$4.50. Milton Mendelwager, 192 Ave. B, Bayonne, N. J.

FEATURERS \$10.00, Comedies \$2.25, cartoons \$3.00. No lists. Savarese, Hilldale, New Jersey.

BARGAINS, Machines, Films, Stereopticons, Slides, National Equipment Company, Duluth, Minn.

16 **M.M.** Film 2c foot. New 16 m.m. motor driven projectors \$20.00. 35 m.m. film \$2.00 per 1000 feet. Roadshow Cinema Broker, Box 524, Cincinnati.

WESTERN \$1.75 Reel, 500 ft. \$1.00 Jersey Films, 2945 Waterbury, Lakewood, Ohio.

500 **FERT** Good film, \$1.00 postpaid. Paragon, 126 Winthrop Terrace, Meriden, Conn.

500 **FERT** 35mm Film, perfect condition, 85c postpaid. Easton Films, Galeburg, Ill.

FILMS—Bargain list free. Williams, 317 Gross Ave., Johnstown, Pa.

16 **MM** Films, something entirely different. Catalog ten cents. Spanish American Sales Co., Box 223, New Braunfels, Tex.

SAVE Money. Movie cameras, \$25; projectors, \$35; Pathex camera, \$20; stereopticon, \$25; printing machine, \$75; 35m negative stock, 2 cents foot; 100 foot Eastman 16m negative, \$4.50; kodak \$5. Typewriter, \$16. Cameras and films bought and exchanged. Ray, 266 W. 46th, New York.

ODD Reels \$1.25 plus postage. Bargain lists. Hoffman Film Service, 57 Broad, Albany, N. Y.

WORLD'S Greatest "Passton Play" 16 MM. (new) 5 reels. Rent or purchase. Write Hemenway Film Co., 37 Church Street, Boston, Mass.

COMEDIES, Westerns \$2.50. Power's projector \$75.00. Marshall Films, Rome, Georgia.

TIME Counts in applying for patents. See pages 132 and 133. Clarence A. O'Brien, Registered Patent Attorney, Washington, D. C.

TRADE AND TECHNICAL SCHOOLS

RADIO—Become radio operator, junior radio engineer or radio expert at America's leading radio school. Experience unnecessary. Common education sufficient. Can earn expenses. Excellent opportunities in business and Government service. Preparation for Government examinations. Also extension course by mail for students unable to come to Washington. Free catalogue telling particulars and why Washington is America's best place to learn radio. Loomis Radio College, Strand Building Washington, D. C.

POULTRY Raising is way out of depression. Dodge unemployment, raise poultry for eggs and meat, daily demand for all you raise at good prices. Learn this interesting and profitable business through the most modern and practical home study course yet offered. The nation's foremost poultry breeders take you through every phase of commercial poultry raising. Write today for complete details. Pacific Poultry School, Van Nuys, Calif.

LEARN Automobiles, electricity, fenders, bodies, welding. Stecinson's, 2088A Main, Kansas City, Mo.

GUSTAS School trains thoroughly in shoe rebuilding, hat renovating, clothes pressing in short time. Gustas, 7 W. Division, Chicago.

LEARN Watch repairing. Hiles School, 5330 Mission St., San Francisco.

LEARN Blue print reading. State your trade. Columbian School, Drexel Building, Philadelphia.

TELEGRAPHY

LEARN Wireless (Radio) and Morse Telegraphy. School, oldest, largest; endorsed by telegraph, radio and government officials. Expenses low—can earn part. Catalog free. Dodge's Institute, H Street, Valparaiso, Ind.

BUSINESS OPPORTUNITIES

MIRRORS Resilvered at home. Costs near 5 cents per square foot, you charge 75 cents. Profitable business plating like new brass, worn-off autoparts, reflectors, tableware, stores, etc. Outfits furnished. Details free. Sprinkle, Piater, 127, Marlon, Ind.

BUY Wholesale—Clothing, jewelry, radios, anything. Classified directory, 25c. Direct Sales, Eureka, California.

FREE Formula catalog, latest money makers. Western Chemical, Laton, Oregon.

MAIL Order business for sale—\$190. Box 61-S, Swarthmore, Penna.

MAKE Artificial marble, business, side-line, hobby. Colored glazed tiles, bookends, tabletops, floors, garden furniture. Inexpensive cement compositions. Amazing samples 2c. John A. Paine, 945 Grande Vista Drive, Los Angeles, Calif.

NEW. Big cooperative money possibilities; scientific mass fishing. Blocker, 550 West 144th St., New York.

TRANSFER Pictures and print. Secret process. Formula \$1.00. Clinch, Point Pleasant, New Jersey.

"SCHEMER." Alliance, Ohio, 32p monthly, prints big \$-getters. Subscriber reports \$50,000 from one tip; another \$25,000 from three schemes; another \$10,000 from one formula. Get wise! Year, only \$1.00; 3 months, 25c.

CASH For practical unpatented or patented invention. Raley Smith, Burtons-ville, Md.

LEARN Sign painting with letter patterns, new method, samples free. Clark, Line Ave., Ellwood City, Pa.

\$185.00 PROFIT in two weeks. Clever advertising stunt. (Average town good for \$100.00.) 1,000% profit. Here's another proposition—\$105.00 in four days. (Road signs average \$20.00 each) make 'em with the "Signograph." Do you want steady employment? Enclose three red stamps for "Profit Plan." Robert Poulson, Hutchinson, Minnesota.

\$25.00 WEEKLY in spare time. Get sample and particulars. Staebler, 173 E. 90 St., N. Y.

GRASP This—Your best opportunity to start a small order business on \$1.00 capital. Plans and lots of interesting propositions for 25c (incl.). Tinas Sales Service, 1 Bank Street, Dept. E, East Paterson, New Jersey.

"OPPORTUNITY"—Book interesting money-makers—10c silver. Box 61-N, Swarthmore, Penna.

SUCCEED With Cyanotype and your own letterheads. Lyne, 2245 South 51, Lincoln, Neb.

MAIL Order business fascinating and profitable. Many earn thousands yearly. Begin small. No canvassing, nor personal contact. Inside pointers from 30 years experience. Send quarter for book, also batch of mail order information. R. Bronsler, 257 S. 21st, Philadelphia.

INCORPORATE Your business. Delaware laws. No restrictions. No cash capital required. Cost \$48.00. Includes minute book, stock certificates, seal. Free details. Write Dept. 21, Corporation Fiscal Co., Wilmington, Del.

MEN—Here's a money maker! Learn the secret of our system of Commercial Photography and make \$25.00 up daily. Never before offered the public. Write for particulars. B&B Institute, 8052 So. Park Ave., Chicago.

IODINE Stain remover. Speedy. Safe. 100 stain sample 25c. Formula \$2.00. Ridge Sales, LaPorte, Indiana.

SEVEN Toys. Complete blueprints, 30c. Weesho-Uco, B75, Detroit, Michigan.

MANUFACTURE Chipped glass house numbers. Beveridge, 160-22 Locust, Jamaica, N. Y.

50 WAYS To make money, 25c coin. Free circulars describing opportunities. Fred Lee, 229 Chaffey St., Wetland, Ont., Canada.

WANTED—Men and women to operate cleaning and pressing shops. Big pay. We teach you the business. Write for free circular. Highland Brothers, Orange, Va.

CAPITAL—For copy, the "Promoters' Hand Book," a leaflet on financing; an eye opener for capital seekers. Send \$1.00 to Amster Leonard, East Orange, N. J.

LEARN Today—Earn tomorrow. Name plates, house numbers, signs. Oneday system. 134 W. Main, Springfield, Ohio.

WHOLESALE Directory 300,000 articles 10c. Other valuable information. Moran Company, Wareham, Massachusetts.

A BUSINESS Of your own making—Sparkling Glass Name and Number plates. Checkerboards, signs. Big book and sample free. E. Palmer, 540, Wooster, Ohio.

EARN Large income with "chain" of peanut-chewing gum vending machines. Start small capital. Particulars free. Robbins Corp., DeKalb and Broadway, Brooklyn, N. Y.

FORMULAS: Beverages, syrups, extracts, flavors. Manufacturing everything. Valuable information free. The Formula Co., 5th Ave. and Broad, Seattle, Wash.

FURNITURE Refinishing; job painting; handman shop. Start yours on nearly nothing; mostly all profit. John Braceland, 1439 South Ninth, Philadelphia, Pa.

LEARN Marbleizing with cement; make garden furniture, artificial marble, statues, etc. Inexpensive sanitary floors. Veneer any concrete products, and wood. Enamel walls or anything. Glossy, slinklike hardness. Unlimited uses for this new industry. Dime brings samples. Cowell Institute, Grayling, Mich.

TIME Counts in applying for patents See pages 132 and 133. Clarence A. O'Brien, Registered Patent Attorney, Washington, D. C.

MAKE Your own products. Employ agents yourself. Toilet articles, soap, extracts. We furnish everything. Valuable book free. National Scientific Laboratories, 1950 W. Broad, Richmond, Va.

FIFTY Successful mail-order propositions. Address, K. Home, 3949 Metropolitan, Chicago.

POPCORN Machines \$15 up. Money makers. Northides Co., 1500 Fifth, Des Moines, Iowa.

SUCCEED With your own products. Make-sell them yourself. Formulas, processes, trade-secrets. Expert analytical service. Catalog free. B. Thaxly Co., Washington, D. C.

WE Start you in business, furnishing everything. Men and women, earn \$40 to \$100 weekly operating our original "New System Specialty Candy Factories." Begin home spare time. Unlimited opportunity. Valuable booklet free. W. Hilber Ragsdale, Drawer 4, East Orange, N. J.

THAXLY Formulas produce perfect products. All lines. Catalog free. B. Thaxly Co., Washington, D. C.

SELL By mail. Books, novelties, bargains! Large profits. Particulars free. B. Elfen, 525 S. Dearborn, Chicago.

ARTIFICIAL Marble sanitary flooring. Instructions covering wood or cement flooring 1/2 inch thick, fireproof, all colors, low cost. Ornamental casting, concrete plaster papier-mache decorations, garden furniture, statuary, flexible molds, particulars and illustrations free. Chris. Mahler, Elmont, N. Y.

LEARN The collection business. Good income, quick results. Interesting booklet, "Skillful Collecting" free. National Collectors Assn., Long St., Newark, Ohio.

FREE Book. Start your own little business anywhere, selling novelties by mail. My beginner's outfit contains everything required, novelties, circulars, instructions, etc. Descriptive book free. Hadwell, 33A-74 Cortlandt St., New York.

AMATEUR Cartoonists: Sell your work. Write Smith's Service, PW1191, Wenatchee, Wash.

OPERATE Chain of vending and amusement machines. Be independent for life. Start small, grow big. P. Goodbody, 1826 East Main Street, Rochester, N. Y.

CHEMICAL. Expert will furnish formulas and trade secrets. All lines. Lists free. W. L. Cummings, Ph. D., 228 Gordon Ave., Syracuse, N. Y.

CHARTERS: Delaware; best, cheapest; free forms. Colonial Charter Co., Wilmington, Del.

I MADE \$30 A week home. French breadmaking. 15 years' experience; free booklet tells. Ashbrook 67, Marengo, Ohio.

BIG Money at home plating auto parts, reflectors, mirrors, chandeliers; by new method; experience unnecessary. Outfits furnished. Gunmetal Co., Ave. N, Decatur, Ill.

FREE Booklet describes 67 plans for making \$20-\$100 weekly in home or office business of your own. Elite Co., 84 Elizabeth St., New York.

UNUSUAL—Uncommon specialties always sell best. Make these yourself from Miller's guaranteed formulas. Why work for others when others can be working for you! Latest eye-opening literature brings you many specialty propositions for you an independent business. Miller Chemist, 746-K Chemical Bldg., Tampa, Fla.

CHEMISTRY

CHEMICAL Analysis, formulae, technical information. Robert Henderson, Laboratory, Madison, Maine.

BECOME Trained chemist. Thousands of opportunities—fascinating career. Learn at home. Complete experimental laboratory outfit given. Write for big free book. Chemical Institute, 19 Park Place, Dept. P-1121, New York.

CATALOG listing 2,500 illustrations chemists' supplies, 5,000 chemical, 1,000 scientific books sent for 50c. Laboratory Materials Company, 643 E. 71st St., Chicago, Ill.

CHEMISTRY Makes you money. Colorado Research, 1616 - 9th Ave., Greeley, Colorado.

HANDBOOK For Chemical Experimenters. Illustrated 50c. Experiment booklet 15c. Chemical catalogue 10c. General Chemical Company, Reading, Pa.

FORMULAS AND TRADE SECRETS

NOUVEAUTE: Eau de cologne. Make without the alcohol, simple production, and sending for 2 dollars for complete prescript and samples. Polacek's Perfumes, 5 rue du Texel, Paris 13, emc, France.

ANY Formula: 50c. Wm. Murray, 376 Cumberland St., Brooklyn, N. Y.

GUARANTEED Formulas, recipes, processes, 50c each. Catalogue free. Industrial Institute, Dept. 211, 64 West Randolph, Chicago.

24 FORMULAS, 25c. Real money-makers. Lyco Service, 7717 Atlantic, Bell, Calif.

FREE Formula catalog, describing all lines. Western Chemical, Salem, Oregon.

FORMULA—Make liquid to transfer pictures—print off bills, newspapers, etc., \$1.00. Clinch, Point Pleasant, N. J.

FORMULAS—3c Up. List free. Murel, Box 748, Dayton, Ohio.

WARTS—Easily removed, bottle 25c, formulae \$1.00. Box 293, Neenah, Wis.

3,000 VALUABLE Formulas prepaid \$1.00. National Service, 3644 Tamarrack, Cincinnati, Ohio.

NEWEST Formulas. Tested, guaranteed. Catalog free. Imperial Laboratories, Edwardsville, Ill.

1,000,000 FORMULAS, Industrial facts, tables, processes, rules, trade secrets, and calculations for all kinds of Trades and Businesses. Book—"Moore's Assistant"—1018 pages. Sent postpaid for \$2.00. Ogilvie Publishing Co., 57 Rose St., Dept. 22, New York.

CHEMICAL Assistance, Manufacturing predicable with small capital. Guaranteed formulas. Free consultation. Analysis. Associated Chemists, Indianapolis, Indiana.

FORMULA Encyclopedia \$1.00. List of contents free. J. Belfort, 4042 N. Keeler, Chicago.

FORMULAS: Beverages, syrups, extracts, flavors. Manufacturing everything. Valuable information free. The Formula Co., 5th Ave. and Broad, Seattle, Wash.

SUCCEED With your own products. Make-sell them yourself. Formulas, processes, trade-secrets. Expert analytical service. Catalog free. B. Thaxly Co., Washington, D. C.

FORMULAS All kinds. Catalog free. Cloer Laboratories (P), Park Ridge, Ill.

FREE Formulas—Free materials making \$32.00 worth of guaranteed highest class specialty-necessities. Thirty-third unequalled anniversary offers explains all. Miller, Chemist, 1707-G Jetton, Tampa, Fla.

500 FORMULAS And big illustrated catalog 25c. Ideal Book Shop, Park Ridge, Ill.

MAKE Your own products. Employ agents yourself. Toilet articles, soap, extracts. We furnish everything. Valuable book free. National Scientific Laboratories, 1950W, Broad, Richmond, Va.

AGENTS WANTED

AGENTS! Distributors! Make astounding profits with Servoil—new super motor lubricant that stands up under extreme motor heat and abuse. Has no equal. Greatest motor product ever discovered. Small amount of Servoil added to gasoline and crank case oil stops wear, noise, repairs, saves gas and oil, gives hundreds of miles more life to motor, gasoline and oil. Greatest money-making proposition that ever came your way. Protected territory. Write quick for special offer to agents. Petroleum Products Corporation, P. O. Box 1675, Desk 511, Milwaukee, Wis.

MEN Wanted by world-wide industry—Apply by letter only giving age, experience, references. Industry, reliability, main qualifications. Man selected will become authorized Rawleigh dealer on our capital and taught how to establish \$6,000 annual business in ever 200 farm and home necessities. Man with auto preferred to cover route of steady users. Write immediately. Rawleigh Co., Dept. K-N-PPM, Freeport, Ill.

GENUINE Gold Leaf Letters anyone can put on store windows. Guaranteed to never tarnish. Large profits. Enormous demand. Free samples. Write today. Metallic Letter Co., 438-D North Clark, Chicago.

MAKE Your own products. Employ agents yourself. Toilet articles, soap, extracts. We furnish everything. Valuable book free. National Scientific Laboratories, 1950W Broad, Richmond, Va.

I START men in a grocery business a new easy way. You use my money. Don't need to put up a penny of your own cash for stock. Expansion program now opens up many desirable opportunities also established trade. Hustlers make good money from the start increasing rapidly as they learn the business. Not a "chain" proposition but your own business. Buy on credit. Give credit if you wish. If honest and need more money write at once for application and details to McConnon & Company, Room L-6610, Winona, Minn.

SELL To stores, a complete line of counter cards; fast selling. Metro Specialty Company, 8 W. Pearl Street, Cincinnati, O.

BIG Profits selling groceries, motor oils, paints, stock minerals. Sample case free. Leverin & Browne, 1692-X So. State, Chicago.

NEW Changeable sign sells to stores for \$1.50, agents profit 400%. Particulars free. National Sign System, St. Louis, Mo.

AUTO Mitten dusters. Season's biggest selling hit. Over 200% profit, free sample offer. National Fibre Broom Co., St. Louis, Mo.

NEWEST Thing!—Rubber floor coverings in beautiful colors. Art rugs, comfort foot mats, sponge rubber bath mats, mono-grammed door mats, etc. Attractive. Practical. Economical. Women wild about them. Agents cleaning up! Free outfit. Write quick. Kristee Mfg. Co., 1441 Bar St., Akron, Ohio.

EVERYBODY Needs food! Make up to \$15 a day supplying regular customers. New "easy profits" sales system clinches the orders. Makes selling easy. Write quick for this sensational new plan. Albert Mills, 2250 Monmouth, Cincinnati, O.

MIRRORS Resilvered at home. Costs near 5 cents per square foot, you charge 75 cents. Profitable business plating auto-parts, reflectors, tableware, stores, refinishing metalware, etc. Outfits furnished; details free. Write Sprinkle, Plater, 128, Marion, Ind.

AGENTS—\$6.00 Worth Soap for 60c. Write Earle Mfg. Co., 593 North Eutaw St., Baltimore, Md.

CASH in your pocket every day. Every man needs pants, breeches, coveralls, shop-coats. Longwear's work clothes sell on sight. Belt free with every order for 3. No investment. Complete sales outfit free. Write today. Dept. P11, Longwear, 489 Broome St., New York.

SELL 3A Garage door holders, simple, automatic, quickly installed. Interests garage owners, builders, everybody. Exclusive territory proposition. Knowlson-Stevenson Co., Ann Arbor, Mich.

MYSTERY Hotrod. Heats itself. Replaces water bottle. Electric pads. Free sample offer. Bestover Co., 4317PM, Irving Park, Chicago.

MEN And women, earn five to ten dollars daily. Full or part time. Lowest prices for guaranteed hosiery, lingerie, neckwear. Send for catalogue and full information. Monarch Hosiery Co., 424 Market Street, Philadelphia, Pa.

FREE Formula catalog. Agents' fast demonstrators. Western Chemical, Salem, Oregon.

\$1 REPEAT Seller. Cost you 10c. Moyes Laboratories, 1202PM, Harrison, Paducah, Kentucky.

POLMET Polishing Cloth removes tarnish from all metals without the use of liquid, paste or powder. Our agents say it sells like "hot cakes." Retailers 25c; sample free. Gale & Co., Inc., 15 Edinboro St., Boston, Mass.

GOODYEAR Raincoat free offer—Good-year Co., 2615 Walnut, Dept. 11PM, Kansas City, Mo., offers to send handsome rain-proof coat to one person in each locality who will show and recommend it to friends. If you want one, write today.

PHOTO Medallion men and women, the largest line of photo novelties in the world. Lowest prices, quickest service. Send for catalog showing over 200 money makers. Gibson Photo Jewelry Co., Inc., 833-837 Gravesend Ave., Brooklyn, N. Y.

DAILY Necessity in homes, factories, garages. Quick seller. Fine repeater. Big profits. Exclusive territory. Sample free. Lavendale Products Co., 3209 W. 22nd St., Chicago.

RAZOR Blades, double edge, improved-hollow ground, ten cent packages, carded, easy selling. Sold everywhere. Standard Safety Razor, Pittsburgh, Pa.

PROFITABLE Home business. Legitimate. No canvassing. Maxwood Publishers, P-923 Broadway, New York.

"LIFT-UP" Electric cigar lighter; costs you 69c; retails \$1.50. Demonstrator free. A. Holland Specialty Co., 408 Grant St., Buffalo, N. Y.

NO Dull times selling food! People must eat. Federal distributors make big money; up to \$3,000 yearly or more. No capital or experience needed; unsold goods may be returned. We furnish free sample case, license and free samples for customers—sure repeat orders. Exclusive territory. Ask now. Federal Pure Food Co., A2307 Archer, Chicago.

NEW, Profitable—Sell auto stop mats. Quality rubber with owner's name toolled white. Details free. Ebonite Products, Dept. Y-40, 895 Main, Akron, Ohio.

400% PROFIT Selling signs used everywhere. Largest selection, wonderful repeat business; \$1.00 worth samples, 25c; 50 signs, \$3.00, 100 signs, \$5.00. P. Franklin Co., 3322 Third Ave., N. Y.

SAMPLE \$5 Gem on approval to prove our marvelous Mexican Bio-Flash Gem positively matches finest blue-white diamond side-by-side. Guaranteed 20 years. Sells on sight; enormous profits. Write quick. Mexican Gem Co., Suite PM2, Monterrey, Calif.

SELL Old motor oil for 40c gallon. Particulars for stamp. Ralph Brooks, Arkansas, Wis.

MEXICAN Hand made feather pictures. Most artistic, beautiful, original. Great margin of profit. Details, Mexican Art, Apartado 1593, Mexico City.

\$1.00 PER Hour if you work. 15 fast sellers, including sample case. \$3.50. Stanley Co., 16376 Hamilton, Detroit, Mich.

PAST Seller—Automatic gas lighter, retails 25c. Free sample, Home Supply, 30 Irving Place, New York.

WOULD You like to make \$10 to \$15 a day selling our line of toilet preparations? We want agents in every town; men, women, students; whole or part time. Write for free sample outfit offer. Hindu Perfume Co., 515 E. 47th St., Chicago, Ill.

MAKE Your own products. Employ agents yourself. Toilet articles, soap, extracts. We furnish everything. Valuable book free. National Scientific Laboratories, 1950W Broad, Richmond, Va.

ELECTRIC Water heater—New. Heats water instantly. Pocket size—retails \$3.75. Two minute demonstration makes you \$1.95 profit. Lux-Viel, Dept. 117, Elkhart, Ind.

100% PROFIT in new mystery cigar lighter. No flint or friction. What makes it light? No wind can blow it out. Retailers 50c. Sample and sales plan 25c. New Method Manufacturing Co., Box PM-11, Bradford, Pa.

300% PROFIT Selling Mystery Gas Lighter. Retailers 25c. Costs you \$1.00 doz. Sample free. Square Deal Mfg., Desk PM-23, Bradford, Pa.

SO Good, it's foolish to call this selling. Men must buy shirts, ties, underwear, hosiery, other necessities. Roseliff's powerful year guarantee makes big money for you. Cash bonuses. Free shirt offer. Pin-set outfit free. Write today. Dept. K11, Roseliff, 1237 Broadway, New York.

STRANGE Ironing cord. Prevents scorching. Saves electricity. Abolishes kinks, snarls. Approved by Good Housekeeping. For telephones also. 200% profit. Samples furnished. Neverknot, Dept. 11-A, 4543 Racine, Chicago.

BEAUTIFUL \$1 Box, 21 Christmas cards, sells on sight. 100% profit. Sample box sent on approval. Patterson D-Co., 4111 University, Des Moines, Iowa.

LIQUID Extracts—Tremendous profits. Newport Sunny House, Newport, New York.

DOLLARS in "Fixit" service, depression killer. Particulars. Houkate's "Fixit" Service, 1955 N. El Molino, Pasadena, Calif.

SENSATIONAL Invention. Absolutely new. Indispensable to everybody. Presenting unlimited possibilities. Big profit for agents. Read the Pocket Store editorial description, October issue, page 630. Sells at \$2.50, sample \$1. Specialty Trading Co., Box No. Y, Popular Mechanics, 200 E. Ontario Street, Chicago.

SOMETHING New—Change old clocks to electric. We start you. Clock Converter Co., 1431 Broadway, Detroit, Mich.

BIG Pay giving away shirts, hosiery, underwear. Also Lumberjackets. Smashing free offers win orders. Every man buys. No experience needed. We teach you and supply complete sample equipment free. Write Today. Dept. N25, Albert Shirts, 860 Sixth Ave., New York.

AGENTS Make big money selling quality fountain pen sets. Keystone Pen Company, 467 Willoughby Ave., Brooklyn, N. Y.

300% PROFIT Selling new 20-in-1 kitchen utensil. Retailers 25c. Costs you \$1.00 doz. Sample 15c. Square Deal Mfg. Co., Desk PMM-2, Bradford, Pa.

SELL All latest specialties. Call only where demonstrations are requested. Darwin McFarlin, Delavan, Wisconsin.

IMPORT Your own goods. German export magazine published in English offers numerous bargains latest novelties; opportunity for obtaining profitable agencies. Copy 60c. Square Deal Supply, P-246, Fifth Ave., New York.

CHRISTMAS Card agents. Liberal commission. Special bonus. Beautiful personal greetings. Box assortments. Ten dollar sample book free. Write today. Direct Mail, 1906 Pine, St. Louis, Mo., Dept. B.

FRENCH Perfume counter runs. Write Louisa, 112 Glenbrook, Bethesda, Maryland.

AGENTS—Tremendous profits demonstrating new \$3.00 automatic engine driven tire pump. See Meiser & Company's advertisement page 143 this issue.

GRAPE Bricks, exclusive free territory granted. A brick makes a gallon. Sample brick postpaid \$1.00 with directions. C.F.S. Co., 589 Howard St., San Francisco, Cal.

SOMETHING New—You can't fail. Belts, ties, links, all 3 free, each shirt sale, \$13.50 value for \$3.99. Free kit. Royal Mills, L. I. City, New York.

AGENTS—"Forty Famous Business Plans." How to make and sell forty fast selling necessities \$1.00. Specialty Service, Box 638, Chicago.

AGENTS: Fifty fast sellers. Catalog free. Specialty Supply, Box 638-A, Chicago.

DON'T Choke me! Hot Shot new elec. wizard starts cars without choke; saves gas, oil. Delivers 11,000 volts. \$1.50 seller. Pays for self immediately. Hustlers gold mine. Reardon Mfg., Dept. 11-PM, Peoria, Ill.

300% PROFIT in new "20-in-1" kitchen necessity. Retail 25c. Costs you \$1.00 a dozen. Sample 15c to cover cost of mailing. New Method Co., Nu-Method Bldg., Desk PMM-11, Bradford, Pa.

MAIL Order house wants ambitious man each county to mail circulars, appoint agents, pack and ship merchandise. Experience unnecessary. Part or full time, good pay. International Laboratories, Dept. 9, 201 N. Wells St., Chicago, Illinois.

BIG Money easy. Simply showing New Polly Wrench, 10 wrenches in one. Guaranteed fast seller. Sample furnished. Gellman Manufacturing Co., Dept. 9-G, Rock Island, Ill.

MAKE Sell your own products. Formula catalog free. Clover Laboratories, (PM) Park Ridge, Ill.

HEMSTITCHER, New, different. Agents, demonstrators wanted everywhere. Money making line. Sample 10c, retails fifty and dollar. K. J. Manufacturing, 648 N. Vermont, Los Angeles, Calif.

"MAIL Order Selling" magazine, "Opportunity For You" booklet and "Big Twelve Proposition" 10c. Pruitt System-A, Brookfield, Ill.

MAN in each town to plate auto parts, reflectors, bathroom fixtures, refinish bells, mirrors, chandeliers; by new method. No capital or experience required. Simple plan of manufacturing at home starts you in big money-making business. Outfit furnished. Free particulars and proofs. Gun Metal Co., Ave. H, Decatur, Ill.

GUARANTEED Hosiery—Lowest mill prices. Men's latest fancy hose—doz. \$1.25-\$1.50, ladies' fashioned hosiery—doz. \$2.25-\$3.25. Catalogue free. Superior Knitting Company, Dept. 34, New Haven, Conn.

BIG Money and fast sales. Every owner buys gold initials for his auto. You charge \$1.50; make \$1.45. Ten orders daily easy. Write for particulars and free samples. American Monogram Co., Dept. 40, East Orange, N. J.

AGENTS: Stamping names on pocket-key protectors. Sample check with your name and address, 25c. Stamping outfits, Emblem checks, check-fobs, name plates, Hart Mfg. Co., Desk 2, 393 Degraw St., Brooklyn, N. Y.

MAKE Your own products. Employ agents yourself. Toilet articles, soap, extracts. We furnish everything. Valuable book free. National Scientific Laboratories, 1950W Broad, Richmond, Va.

BIG Proposition; no canvassing. Asco, Box 1081, Washington, D. C.

\$1.75 PROFIT, Each sale. Write Corum Chemical Co., Laurel, Miss.

REPLATE Brass worn-off automobile parts, reflectors, bath room fixtures, worn spoons, forks, etc., with pure silver. Looks like new. Use U-Kan-Plate Polish. Practically no mercury; \$1.00 half pints. Postpaid. Satisfaction guaranteed. Agents wanted. Dept. A, U-Kan-Plate Co., Philadelphia.

300% PROFIT. Whirlwind seller. Sensational Nulustre cloth, cleans, polishes, all metals without liquid, paste, powder. Good Housekeeping tested, approved. Free sample. Shof D Mfg. Co., Weehawken, N. J.

BIG Money selling shirts, ties, underwear, Sox, raincoats, lumberjacks, sweaters, leathersuits, overalls, pants, playsuits. Outfit free. Nimrod Co., Dept. 8, 4922-28 Lincoln Ave., Chicago.

NEW Invention makes any clock electric. Easily attached. Big Profit. Bestever Clock Co., 4319-P Irving Pk., Chicago.

SELL Goodyear raincoats, \$2.95 up. Goodyear Rainwear, 18 West 22nd, New York.

SOMETHING The housewives want. A sized guarantee to save money and time in cooking. No competition. 400% profit. No license required. Station C, Box 25E, San Diego, Calif.

THAXLY Formulas produce perfect products. All lines. Catalog free. B. Thaxly Co., Washington, D. C.

AGENTS For handkerchiefs; original powdered handsoap. Approved Good-Housekeeping. Everybody customer. Fine opportunity for hustler. Sample free. Solar Products, J-2144 So. Troy, Chicago.

SUCCEED With your own products. Make-sell them yourself. Formulas, processes, trade-secrets. Expert analytical service. Catalog free. B. Thaxly Co., Washington, D. C.

AGENTS—Engraved name plates, stems, number plates etc., easily sold with large profits. Breit Bros., Winthrop, Mass.

BIG Money applying gold initials on automobiles. Easiest thing today. No experience needed. \$1.45 profit every \$1.50 job. Free samples. "Balco," X-1043 Washington, Boston, Mass.

NEW Line Counter Displays, Aspirin, Filmit, Chewing Laxative, Breath Gum, Notarar, Silikone, etc. Steady Repeats. Over 100% Profit. Superba Co., W3, Baltimore, Md.

THIS Advertisement may make you thousands of dollars. If you write immediately for my "Eye-Opening" literature describing guaranteed formulas; valuable trade processes, money-making information how to easily make the world's best-selling specialties. All lines. Investment small. Profits immense! Start in your home, room or office. Make the good money you're entitled to. Dr. Liscombe Miller, Chemist, Tampa, Fla.

CHICAGO Expert valued \$3 stone at \$904. The diamond's only guaranteed rival. Greatest spare time, side-line article ever known! Amazing profits. \$5 pocket sample case free. Write quick. Mexican Gem Company, Dept. PM, Monterey, Calif.

FREE "Booklet of money making opportunities." new ideas, original plans, money making secrets and other valuable information. None require peddling or outfits. Elite Co., 81 Elizabeth St., New York.

WE Start you without a dollar. Soaps, extracts, perfumes, toilet goods. Experience unnecessary. Carnation Co., 641, St. Louis, Mo.

FLAVORING Extracts—Bottle yourself! Labels furnished. 600% profits! Whirlwind money-makers! Repeaters! Free offer. Thomas Manufacturing Company, Indianapolis, Ind.

CALIFORNIA Perfumed beads, selling like hot cakes. Agents coining money. Catalog free. Mission Factory, P. 2328W Pico Las Angeles, Calif.

\$60-200 A WEEK. Genuine gold letters for store windows. Easily applied. Free samples. Liberal offer to general agents. Metallic Letter Co., 438-B North Clark, Chicago.

A BUSINESS Of your own—Making sparkling glass name and number plates, checkboard signs. Big book and sample free. E. Palmer, 512, Wooster, Ohio.

SELL Stores 5c carded breathlets, etc. Lorraine Products, Albany, N. Y.

AGENTS—Clever Invention! Inkspoon makes every pen a fountain pen. Fast office seller; big profit, demand increasing everywhere. Exclusive territory offered. Sample free. H. Marul Company, Tribune Bldg., New York, N. Y.

AGENTS Everywhere making money with our line of kitchen specialties, demanded in all homes. Big earnings possible. Write today for details. P. Seed Filter Co., 353 Broadway, New York.

SELL Men's neckwear—wonderful proposition. Astor-M, 39 East 28th, N. Y.

10,000 MONEY-MAKING Formulas. Tells you how to make and sell almost everything under the sun; cosmetics, muckage, anti-freeze solutions, battery solutions, beverages, cheese, chewing gum, cleaning preparations, extracts, hair preparations, inks, bluing, leather polish, mirrors, perfumes, polishes, typewriter ribbons, carbon paper, washing powders, liquid soap, and hundreds of other profitable articles. Send no money. Just write a postal for "Hensley's 28th Century Book of Formulas." Pay postman postage and \$1. Popular Mechanics Press, 200 E. Ontario St., Room 802, Chicago.

HIGH-GRADE SALESMEN WANTED

\$18 To \$25 Daily; blazest selling line of men's suits. Meets present day conditions. Amazing values, at \$11.95, \$14.50, \$16.95, \$18.95. Also raincoats, slickers, topcoats and boys' suits. Biggest commission paid in advance. Liberal bonus. Free outfit. State age and selling experience. "Jim" Foster, Inc., Dept. 211, 2250 South Spaulding Ave., Chicago.

SALESMAN For Hump-O, only dust mop and brush broom cleaner on market, \$2,000-600 homes need them. Sand Mon & Brown Cleaner Co., Santa Rosa, California.

SELLING Like blazes! 11 piece beautiful toilet goods assortment at \$1.75 with 24-inch pearl necklace free to your customer. 100% profit. E. M. Davis Co., 238 North Ave., Dept. 960, Chicago.

NEW Legal punchboard plan! We furnish everything! No investment for you or your customer! Nothing to sell or carry! 50% profit! Unsuitable merchandise returnable! Full commissions on repeats! A3 Novelty Company, 161 Washington, Chicago.

COMIC-Snappy greeting cards. New, unusual. Good with any present line. Quick sales. Big profits. Repeats. \$1 for complete outfit. Satisfaction or money back guaranteed. Pierce Company, 421 Second Avenue Co., Minneapolis, Minn.

SALESMEN: Wonderful sideline, 40% commission paid daily. Sells all merchants. Attractive outfit free. Willens Co., Dept. 509, 2136 Gladys, Chicago.

NEW Different, improved, business stationery line. Biggest commissions—bonuses. Quickest delivery. Free copyrighted cuts. Experience unnecessary. Attractive outfit free. David Lionel Press, 312 So. Hamilton, Dept. 505, Chicago.

GRAPE Bricks, Grape concentrates—Port, sherry, champagne, claret, etc., in solid brick form. One brick makes one gallon juice; legality established twice in Federal courts. Government financing industry. Every home, drug and grocery store, church, hospital, a prospect. State and county rights available. Apply V. S. Co., Dept. 8-217, 395 - 9th St., San Francisco, Calif.

PREMIUM Salesmen—Brand new trade stimulator—appeals instantly all lines retail business. Just what you always wanted. Big commissions. Well rated company. Outfit free. National Advertisers, 308 No. Michigan, Chicago.

APLENTY New—Different—Fast selling 5c-10c merchandise on attractive counter racks. 100% comm. for you and dealers. Advertised over WLW 3 nights weekly. No investment. Catalog free. (Estab. 1921.) World's Products, 170 Central, Spencer, Ind.

\$136.00 COMMISSION From \$6.93 sale! You can make 3 sales daily. Our salesmen do it. Free kit. Sales Stimulators, Dept. 8H, 4311 Havenwood, Chicago.

RUN My oil agency. No investment required. I divide profits 50-50 every week. \$50 to \$200 weekly your share. Products nationally known. My partners made \$187,000 last year taking orders direct from farmers, auto owners, etc. All or spare time. Free selling equipment. Write quick. Central Petroleum Co., 702 Century Bldg., Cleveland, Ohio.

FOR Big income, sell garages, gas stations, marshlands, R. R. men, amazing safety non-slip shoes. Exp. unnecessary. Sample free. Atlas Shoes, 72, Waltham, Mass.

WANTED—County salesman with car, to demonstrate for large Ohio manufacturer. First class job. Fyr-Fyter Co., 2209 Fyr-Fyter Building, Dayton, Ohio.

SALESMEN—At last! New feature sells punchboards everywhere. Dealers wild with joy—prosperity back again. Profits enormous. Samples free. Puritan No. 6ty, 1407 Jackson Blvd., Chicago.

CALL On schools with megaphones and novelties in school colors. Megaphone Novelties, Wade and Demman, Cincinnati, O.

SO Good. It's foolish to call this selling. Men must buy Shirts, Ties, Underwear, Hosiery, other necessities. Rosecliff's powerful rear guarantee makes big money for you. Cash bonuses, Free shirt offer. Finest outfit free. Write today. Dept. L11, Rosecliff, 1237 Broadway, New York.

BIG Pay giving away Shirts, Hosiery, Underwear. Also Lumberjackets. Sunshining free offers win orders. Every man buys. No experience needed. We teach you and supply complete sample equipment free. Write Today. Dept. N26, Albert Shirts, 800 Sixth Ave., New York.

\$25 DAILY Possible selling merchants printing novelties, specialty items at half price. Quick delivery. Union label. 40% commissions advanced. Experience unnecessary. Elaborate outfit free. Northwestern, 625-DB, Jackson, Chicago.

NEW! New! Amazing Pocket Towline, a sensation. Mere handful of steel unwinds into 12 foot towline. Weighs 26 ounces. Tows 15 tons. Occupies no more room than wrench. Handles bulky, costly ropes, cables. Sells on sight. \$20 daily easy. Sell 1 every 5 minutes. Territories going. Details sent free. Pocket Towline Corp., Dept. K13, Rochester, Pa.

SALESMEN—\$72 Worth of soap for \$3. f.o.b. Baltimore. The prettiest packages you ever laid your eyes on. Merchants will pay \$18 a gross. The enormous output enables us to make this attractive offer. Earle Soap Mfg. Co., 393 No. Eutaw St., Baltimore, Md.

PUNCH Board sensation! Free deal brings merchant \$25.50 without cost. Get orders quick. Top commissions in advance—\$2.00 bonus every order. Get free outfit. DePaul Sales, 66-F East Lake, Chicago.

BIG Money steady. High grade coveralls, shopcoats, pants, shirts. Advertising on back. Fast sellers. Great demand. Prospects everywhere. Free outfit. Strong Mfg. Company, 911 West Jackson, Chicago.

SALESMEN. 2 Whirlwind commission items: Coney Cooker and Counter Chef, red hot steamer and sandwich grill, \$22.55 each; \$8 commission; best and cheapest on market; for lunch stands, barbecues, soda fountains, etc. Write quick. Advance Mfg. Co., 1218 S. Kingshighway, St. Louis, Mo.

DRAPERY Hardware salesman wanted for lowest priced ornamental line, also novelty picture line, excellent chain and department store sellers. Write Bar-Hi Artcraft Corp., Middleton, Wis.

ALL Year repeat seller to drug stores everywhere. Samples, information \$5. "H. C. T." Service, 325 1/2 S. Broadway, Rochester, Minn.

ARE You old at forty? See our advertisement on page 144 of this issue. The Electro Thermal Company, 2147 Morris Ave., Steubenville, Ohio.

DISTRIBUTORS And agents—Exclusive territory for Soderlite. See display ad bottom page 143 this issue.

SELL Nothing! \$170 weekly empty handed. \$700,000 punchboard firm announces new plan. No investment for anyone. Season starting. Hurry! K&S Sales, 4320 Ravenswood, Chicago.

BIG Money selling shirts, ties, underwear, Sox, raincoats, lumberjacks, sweaters, leathersuits, overalls, pants, playsuits. Outfit free. Nimrod Co., Dept. 65, 4922-28 Lincoln Ave., Chicago.

NEW Polish for silver, pewter, brass, etc. Big profit, easy sales. Modern Polish Co., Trenton, N. J.

SALESMEN Wanted to call on fish dealers. Snow & Parker, Inc., 41 Fish Pier, Boston, Mass.

SALESMEN—Become independent. Own your business; experience unnecessary, selling our \$10,000 accidental death; \$50 accident; \$25 sick weekly benefits—\$10.00 yearly. Other amounts proportionate. Guaranteed steady income from renewals. \$250,000 deposited insurance department. Universal Policy, Dept. A, 716 Lefcourt Bldg., Newark, N. J.

WONDERFUL Opportunity. Twenty dollars per day can be earned. Experience unnecessary. Home protection at cost. Ages one to eighty. \$250 to \$1000 at death. No insurance. You make \$5 for each member secured. Childless of Virginia, sent in 54 one day. National Aid Society, Myers Building, Springfield, Illinois.

PENNY Gopher, new fascinating coin-controlled game. Legal. Exciting. Merchants everywhere buy. Splendid commission. Specialty Mfg., 617 Division, Chicago.

SELL Egg Cartons! Dandy repeat side line. Everyone who sells eggs needs cartons—grocers, poultry farms, dairies. Send for information and samples. Pick up the extra commissions. Self-Linking Carton Company, 575 E. Illinois Street, Chicago, Ill.

GREAT Sideline for any salesman! Pocket outfit free. New cash customer Building Campaigns for merchants. D&H Premium Co., Dept. 538, 116 So. Wells, Chicago.

NEW Specialty—Sells every business and professional man. Four \$15 sales daily pay \$280 weekly. Foyer cleared \$4920 in three months. Write, F. E. Armstrong, President, Dept. PM, Mobile, Ala.

PUNCHBOARD Salesmen—Most gigantic line ever featured. Vending machines—all kinds. Make as high as \$28.00 on single order. Repeat commissions. Beautiful colored catalog free. Lion Mfg., Dept. 8, 308 W. Erie, Chicago.

NEW, Largest color catalogue, punchboards, vending machines, produces quicker orders, big commissions. Free outfit. Lincoln Sales, 116 So. Wells, Chicago, Dept. D. Established 20 years.

HELP WANTED

IF You want to make money quickly in a pleasant business of your own, send me your name immediately. Wonderful opportunity to make \$15 a day without risking a cent. Particulars free. Albert Mills, 9291 Monmouth, Cincinnati, O.

EARN Up to \$25 weekly or more growing mushrooms in your cellar or shed. Illustrated booklet free. American Mushroom Industries, Dept. 562, Toronto, Ont.

AGENTS—Mosco corn and callous remover will build you a steady repeat business. Send today for pocket-size trial outfit. The Moss Company, 104 Searle Bldg., Rochester, N. Y.

GO into business—Make big money. We start you furnishing everything. Experience unnecessary. Federal Pure Food Co., X3307 Archer, Chicago.

EDUCATIONAL AND INSTRUCTION

MATHEMATICS—Strength of Materials—Applied Mechanics. 3 books in one, with all answers given, examples worked out, simplified and very easy for anybody to learn and understand. You can advance faster, easier, better, you can get ahead of others and be a leader. This book by a practical engineer contains 375 working diagrams, 183 pages, 5½x8½ inches in full cloth binding. Postpaid \$2.50 at your book store or Dobe Engineering Service, 1949 Lawrence Ave., Chicago.

WORK For "Uncle Sam." \$105.00-\$280.00 month. Life jobs. Steady work. Paid vacation. Men-women, 18-50. Many examinations coming. Common education usually sufficient. Experience unnecessary. List positions and full particulars—free. Write today sure. Franklin Institute, Dept. J3, Rochester, N. Y.

LEARN To repair and rewind electric motors. Send for free information. Bandle Bros. Armature Shop, 520 4th St., Waukegan, Ill.

WHAT'S Your future. Develop winning personality, be popular, which promotes friendship and business success. Also business information for personal use. Write for particulars. Business Service, Box 262, West Palm Beach, Fla.

LEARN Bookkeeping at home. I can teach you by mail. Prof. W. F. Grotts, Butler, Illinois.

BECOME A landscape architect. Uncrowded profession; wonderful opportunity for money-making. Easily mastered by mail. Earn while you learn. Est. 1916. Write for details. American Landscape School, 7 Plymouth Bldg., Des Moines, Ia. Iowa.

PHOTOPLAY Talking picture and magazine stories wanted for revision, development and copyright. Sell on commission. Established 1917. Booklet free. Universal Scenario Company, 406 Meyer Bldg., Western and Sierra Vista, Hollywood, Calif.

WANTED, Men-Women, 18-50, qualify for steady Government Jobs. Salary range, \$105-\$250 month. No Government experience required. Paid vacations. Common education. Thousands appointed yearly. Write Ozment Institute, 101, St. Louis, Mo., immediately.

LEARN Photo-Engraving at home by experience. We supply without extra cost all necessary equipment. Make money while learning. Aurora School of Photo-Engraving, Aurora, Missouri.

U. S. GOVERNMENT Wants men, \$1,700-\$1,900 and up at start. Railway mail clerk examination coming. Let our expert (former government examiner) prepare you for this and also rural carrier, post office, customs, internal revenue, and other branches. Write today for free booklet. Dept. 8, Patterson School, Rochester, N. Y.

DON'T Prepare for any civil service examination without seeing our catalog. Free, Columbia Correspondence College, Washington, D. C.

SHORT STORIES

SHORT Stories revised, typewritten and marketed. Details free. Hursh Service, Box P-1913, Harrisburg, Penna.

TYPEWRITERS

TYPEWRITERS—All makes, \$1 to \$32. Fully guaranteed. Catalog free. Typewriter Works, Ada, Okla.

ADDING MACHINES

NEW \$4.75 Automatic Adding Machine. Fully guaranteed. Bassett 1458-B, Hollywood Avenue, Chicago.

PRINTING, MULTIGRAPHING AND MIMEOGRAPHING

5000 ATTRACTIVE Folders, \$11.50; 6x9 circulars, \$7.50; envelope slips, \$5.00. All printing low prices. Samples. Goodprint, Harrisburg, Va.

1000 BUSINESS Cards \$1.75; letterheads, envelopes, statements \$3.25, postpaid. Samples. Dept. PM2, 2311 Lidstone, Houston, Texas.

1000 VELLUM Finish business cards \$1.35. Pitch, 419 E. 113th, Chicago.

QUALITY Printing, mimeographing. Depression prices. Samples, Fields, 1562 Glenmont Road, Cleveland, Ohio.

AGENTS, Three-color business cards, \$2.95 thousand. Crescent, 1715½ Wood, Dallas, Texas.

250 TWO-COLOR Envelopes \$1.25; 5,000 \$9.50. Samples. Rapid Service, Edwardsville, Ill.

200 LETTERHEADS, 100 Envelopes, \$1.00. Prompt service. W-Ine Press, 226 West Ave., South Norwalk, Conn.

COLORED Business cards \$1.00. Samples distinctive printing free. Price, 3435 VanBuren, Chicago.

NAME Cards. Very neat. Send 20c for 2 doz. Pennco Sales Co., Williamsport, Pa.

200 LETTERHEADS 8½x11, Envelopes, cards, blotters, statements, labels, \$1.00 each. Race Printery, Hudson, N. Y.

QUALITY Printing postpaid, unbelievable prices. Battlefield Press, Gettysburg, Pa.

NEW Depression lowestever price!—1000 circulars \$2.00. Big plant. Webb-Print-Press, Gettysburg, Penna.

200 LETTERHEADS, 100 Envelopes, prepaid \$1.00. Abbott Printery, Owego, Kans.

200 LETTERHEADS And 100 envelopes, \$1.00; 200 letterheads, 8½x11, 150 envelopes, \$2.00; 250 cards, \$1.00. Hoosier Print Shop, Portland, Ind.

500 LETTERHEADS, 500 Envelopes \$2.95. Ware, Box 257, Ft. Madison, Ia.

15 PERSONAL Printed Christmas cards —\$1.00. Applebaum-P, 1278 Brook, New York—200 sheets, 100 envelopes, 60c.

WE Print stationery, booklets, catalogs, circulars. Samples. Commercial Press, Batavia, Ohio.

LETTERHEADS, Envelopes, 500, \$1.10; 1,000, \$2.00; \$5,000, \$8.00, plus postage. Samples. Coyle & Kimballs, Newport, N. Y.

250 BOND Letterheads, envelopes, billheads, cards, \$1.35 each. Economic Press, Leonia, N. J.

CHOICE Of letterheads, envelopes, cards, 250, \$1.35; 500, \$2.00. Press, 705 Ridge Road, Hobart, Ind.

200 SHEETS, 100 Envelopes, 90c. T. Vachovetz, Elmsford, N. Y.

1000 BUSINESS Cards, card case, \$1.50. Miller, Printer, Narberth, Pa.

PRINTING OUTFITS AND SUPPLIES

COMPLETE Printing outfits, presses, type, ink, paper, supplies. Write for free catalog. Kelsey Co., B-11, Meriden, Conn.

PRINTING Outfits—Presses, type supplies, type novelties. Send stamp for catalog. Model Press, York, Penna.

MAKE A wooden printing press for \$1.00. Instructions complete only 50 cents. K. Wise, 109 E. Broadway, Red Lion, Pa.

PRESSED Printing presses and supplies. Lists 2c stamp. Popular Bargains, Richland, Pa.

GUNNED LABELS

TRIAL Thousand stickers in color, 60c. 15 words. Harvey Wolf, 6618F Quimby, Cleveland, Ohio.

LABELS: Any kind printed labels. Cake labels, candy wrappers, stickers. Send copy or samples for prices. Old Dominion Label Co., Bridgewater, Virginia.

DUPLICATORS AND DEVICES

"EXCELLOGRAPH" Rotary stencil duplicator \$39.00. "Two-Faced" film duplicator \$6.00. Booklet free. Pittsburgh Typewriter Supply, Dept. 601, Pittsburgh, Pa.

RUBBER STAMPS

NAME, Address, 2 lines 25c; 3 lines 35c. Stamp Works, Auburn, Nebr.

FOR THE HOME

KEEP Your walls clean. Beautiful radiator shields, priced to sell. Write Leader Metal Prod. Co., D-4, St. Louis, Mo.

ELECTRICAL REFRIGERATORS

BUILD Your own automatic electric refrigerator; use present icebox; costs only \$31.50 complete as per our prints. No special tools required; we supply special parts. Complete instructions with blue prints and text \$1.00. B. & L. Engineering Co., 706 Bergen Ave., Jersey City, N. J.

FOR SMOKERS

HOME Cigarette machine! Illustrated circular, \$3.75 postpaid. Automatic Cigarette Machine Wks., 1035 Sheridan, Chicago.

CUT Your cigarette cost—Green Rivers, mildest, tastiest, natural tobacco cigarettes, fresh from factory, \$1.25 carton, 200, postpaid. Order a carton. Smoke 5 packs. If you are not more than pleased, return 5 packs, and we'll refund \$1.25. Green River Tobacco Co., Box 779, Owensboro, Ky.

FOR MECHANICS

CRAFTSMEN: Build bench bandsaw. Simple, cheap, frame or pipe blue prints 90c. Don't miss this. H. Behner, La Grange, Ohio.

AVIATION—Every person interested in this subject should make full use of the opportunity to learn aerodynamics with Alexander Klemm as his instructor, through his timely new book, "Simplified Aerodynamics." Heretofore this subject has been rather difficult for the thousands who need it but Klemm's method enables all to master it. Every pilot, mechanic, student needs this book. Pay postman price, \$3.50, and few cents postage when he delivers it. Order from Popular Mechanics Press, Room 802, 200 E. Ontario St., Chicago.

GUNS, FISHING TACKLE AND SPORTING GOODS

FOR Sale. Firearms—matchlock to cartridge. Also miscellaneous articles. Send 6 cents for list eight. Wanted firearms, marked Patent Arms Mfg. Co., Paterson, N. J. Also large pistols and revolvers with ivory stocks. The Spencers, 111 East Patterson Ave., Columbus, Ohio.

FIELD GLASSES, TELESCOPES AND MICROSCOPES

\$3.00 GOVERNMENT Field glasses, powerful, with carrying case. Large selection binoculars, telescopes, field glasses, microscopes, cameras, lenses, musical instruments, guns, rifles. We buy, sell and exchange. Send free bargain list. Well's Curiosity Shop, 20 South Second Street, Philadelphia, Pa.

WATCH REPAIRING

DEAD Watches brought to life. Have repaired thousands, \$3.50 highest price. Strain, Brookfield, Mo.

RAZORS AND BLADES

YOUR Gillette, Probak blades resharpened, 1c each. Petter Wetterquist, Rockford, Ill.

PRECIOUS STONES

MOST Brilliant gem. Diamond's only rival. Genuine Zircons from Ceylon. Sample gem \$3.00. Goetz Gem Co., Gallon, O.

ANTIQUES, WAR RELICS AND INDIAN GOODS

INDIAN Luck bracelets, 98 cents. Fits anyone. Agents, Strain, Brookfield, Mo.

INDIAN Relics. Sample arrowhead 10c. List free. Kenneth Mayhall, Belmont, Mississippi.

OLD Indian tomahawk 75c; 10 arrowheads, 60c. (Both \$1.00.) Paul Summers, Sagerton, Texas.

FOR Sale: Indian relics, 10 arrows \$1.00, scalping knife 3c, boatstone \$2.75, circular and bird arrow 10c. R. Helke, Pontiac, Ill.

INDIAN Relics, coins, curios. Beadwork. Catalog free. Vernon Linsley, Northbranch, Kan.

SEND 5c For fine new list Indian relics, antique bracelets. F. E. Ellis, Webster Groves, Missouri.

MUSIC AND MUSICAL INSTRUMENTS

FORTUNES Being made from songs through talking pictures, radio, phonograph, music publishers. "Hit" writers revise, arrange, compose music to your lyrics. We submit to studios and other markets. Free reading. Send for booklet. Universal Song Service, 425 Meyer Bldg., Hollywood, Calif.

SONGWRITERS—Read "song requirements of talking pictures, radio and records" an explanatory instructive book sent free to aspiring writers of words for songs. We compose, arrange music and secure copyrights. Write today. P. C. Newcomer, Associates, 1674 Broadway, New York.

COMMERCIAL Music composed to song words. Send 10c for The Song News Magazine. None free. Hasenbain, 130 Nordstr, Bremen, Germany.

SONGWRITERS, Professional plan. Edward Madden, 113 Michaels, Syracuse, N. Y.

SONGWRITERS—Free booklet "How To Turn Your Songs Into Gold." Stan Tucker, 330 Wadsworth Ave., New York.

SYSTEM Complete \$1.00. Address "Music Shorthand," Plume Beach, California.

MELODY For your words, one dollar. Frank Litzig, Nipomo, California.

FOR Sale: Song and piano solo, about 500 copies of each. Will sell cheap, make offer. Wm. Stern, 6331 S. Ada St., Chicago, Ill.

PIKE Song, Virginia West. John Storm, Benwood, W. Va.

SONG Poets, write Sequoia Songwriters Service, Sherman Branch, Los Angeles, Calif.

POEMS Wanted. Work guaranteed. We publish. Great Eastern Song Bureau, Dept. 27, Thomaston, Me.

SONG Writers. Send for our "Publishing Agreement." McKinley Music Printers, 1501 E. 55th St., Chicago.

SONGWRITERS: This pamphlet "How To Get Your Song On The Phonograph Records" sent free! Write Chester A. Escher, Music Publisher, 290 Broadway, New York City.

WRITE Songs. Big money and reputation. Write for information. J. Gordon Pub. Co., 201 N. Hoyne Ave., Chicago.

Duo-Flex reeds for clarinets and saxophones eliminate your reed troubles. Write for circular. Duo-Flex Reeds, 1204 1st Ave., Evansville, Ind.

COMPOSERS—Verse or music. Brilliant opportunity. Write VanBuren, 2536 McClurg Bldg., Chicago.

PUBLISHERS Representative wants ideas, songs, poems, melodies. National Composers' Assn., 827-PM, Kimball Bldg., Chicago.

"MUSIC Composed" to words. Bauer Bros. (formerly of Sousa's Band), Oshkosh, Wis.

SEND Song poems, 50-50 plan. Indiana Song Bureau, (Brookside), Salem, Ind.

CORNETISTS—Trumpetists—Saxophonists—Clarinetists. Get "Free Pointers." Name instrument. Virtuosi School, Buffalo, N. Y.

USE Shortcuts in Figures. Save valuable time. The quickest ways of working all problems. Instructions for drilling yourself to be come rapid with figures. Complete, yet simplicity itself. Just write a postal for "Shortcuts in Figures." Pay postman \$1.25 and postage. Popular Mechanics Press, Room 802, 200 E. Ontario St., Chicago, Ill.

PATENT ATTORNEYS

SELL Before patenting. Safe, practical plan (copyrighted). Saves time, expense. Write Chartered Institute American Inventors, 1136 Barrister Building, Washington, D. C.

PATENTS Secured. Promptness and skill assured. Examination and advice free. Book sent free. Randolph Company, Section 486, Washington, D. C.

PATENTS Procured. Prompt, careful, efficient service. Highest references. Moderate fees. Send sketch or model for actual search and advice. George P. Klausel, Master of Patent Law, 54-K Westory Bldg., Washington, D. C.

LACEY'S Patent Sense. Valuable book free. See ad page 134.

PATENTS Obtained at low cost. Free information. See page 131. Write today. Harry W. Johnson, McGill Bldg., Washington, D. C.

INVENTIONS Patented and Exploited. Former patent office examiner; Master patent law. Benj. Webster, Esq., No. 15 East 26 Street, New York.

MANUFACTURERS Everywhere seek new inventions to improve their product. Names of manufacturers and wanted inventions sent free on request. Write W. T. Greene, 952 Barrister Building, Washington, D. C.

PATENTS Procured for inventors by former member Examining Corps, U. S. Patent Office. Rates reasonable. A. Brostrom, Registered Patent Attorney, 1618 West 13th St., Brooklyn, N. Y.

PATENTS—Write for free information. How to Obtain a Patent and Record of Invention—or send drawing or model for examination. Miller & Miller, Patent Attorneys (former Patent Office Examiners), 1804-A Woolworth Building, New York; 259 McGill Building, Washington, D. C.

TIME Counts in applying for patents. See pages 132 and 133. Clarence A. O'Brien, Registered Patent Attorney, Washington, D. C.

INVENTORS: Send for booklet telling how to patent and sell your inventions at lowest cost. Ralph Burch, Patent Lawyer, 900 P St., Washington, D. C.

PATENTS. Send sketch or model for advice. Free book, "How to Obtain a Patent." Established thirty years. Highest references. Prompt service. Reasonable charges. Chandice & Chandice, 208 F Street, Washington, D. C.

PATENTS Procured: trade marks registered—preliminary advice furnished without charge. Booklet and form for disclosing idea free. Irving L. McLaughlin, 704 International Bldg., Washington, D. C.

PATENTS. Booklet free. Highest references. Best results. Promptness assured. Watson E. Coleman, Patent Lawyer, 724 Ninth St., Washington, D. C.

"INVENTOR'S Guide," valuable information, free. Frank Ledermann, Registered Attorney-Engineer, 1712 Woolworth Bldg., New York.

ESTABLISHED 1864. Milo B. Stevens Company. Free booklet. Patents. Trade marks. Copyrights. Offices. Monadnock Block, Chicago; Barrister Bldg., Washington, D. C.

LANCASTER, Allwine & Rommel, 221 Oquirrh Bldg., Washington, D. C. "Originators of the Form Evidence of Conception." Before disclosing your invention to anyone send for blank form to be signed and witnessed. Form and patent information bulletin free.

FOR INVENTORS

WANTED:—Inventions, patented, unpatented, toys, games. Box 22, Fond du Lac, Wis.

PATENT Your invention: Send for free book, "How to Obtain a Patent," and "Record of Invention" blank. Consult us about how to protect your ideas. See advertisement page 137. Victor J. Evans & Co., 951 Ninth St., N. W., Washington, D. C.

LACEY'S Patent Sense. Valuable book free. See ad page 134.

\$10,000.00 MINIMUM Per year for solution to electrical and mechanical movement problem. Name, address brings details. A. L. Armentrout, Eleven Eighteen East Twelfth Street, Long Beach, California.

MODELS And drawings made, estimates given, inventions perfected, strictly confidential. Hill Machine Wks., 264 Diamond St., San Francisco, Calif.

TO Inventors: We are in the market to purchase a good patent, preferably in the automobile accessory line. Will purchase outright or on royalty basis. Purchasing Agent, 211 Front St., New York, N. Y.

SOUND, Practical inventions, patented, unpatented, in demand. Write Chartered Institute American Inventors, 1135 Barrister Building, Washington, D. C.

BLANKS, Bristol, inventors' supplies. Copyrights procured. Wade Service, 2274-R, Brooklyn Station, Cleveland, O.

INVENTIONS Patented and Exploited. Former patent office examiner; Master patent law. Benj. Webster, Esq., No. 15 East 26 Street, New York.

TIME Counts in applying for patents. See pages 132 and 133. Clarence A. O'Brien, Registered Patent Attorney, Washington, D. C.

HAVE You a good patent or pending application for sale? If so, write American Patents Corporation, 1220 Barrister Building, Washington, D. C.

MANUFACTURERS Will now buy inventions. Send for important circular free. Inventions patented and marketed. Canadian patents filed \$35.00 up. J. J. O'Brien, Patent Attorney, Engineer, 156 E. 42nd, New York City.

LOW Cost manufacturing. Large plant completely equipped for blanking, drawing, stamping and wire forming in any finish. Can save you money on your product. Our figures will convince. Eastern States Products, Box 721, New Haven, Conn.

INVENTOR'S Universal Educator: contains 900 mechanical movements; 50 perpetual motions; instruction on procuring and selling patents and selecting an attorney, etc. Suggests new ideas. Price \$1.00 postpaid in U. S. A. Address Dietrich Co., 692B Oquirrh Bldg., Washington, D. C.

MANUFACTURERS Everywhere seek new inventions to improve their product. Names of manufacturers and wanted inventions sent free on request. Write W. T. Greene, 944 Barrister Building, Washington, D. C.

A BILLION Ideas. This is the title of our remarkable catalog of books along practical lines. Arranged alphabetically by subjects for easy reference. If you have not received it, send for a copy. You will find hundreds of subjects you cannot usually locate in book stores or public libraries. Sent free upon request. Popular Mechanics Press, Room 802, 200 E. Ontario St., Chicago.

PATENTS FOR SALE

RADIATOR Ornament. Unusually attractive. Masterpiece. Best offer accepted. Patent pending. Haller, 1120 Tennessee, Lawrence, Kans.

PATENT For sale: conveyor for cement mixers. Economical, labor-saving. P. A. Davidson, 2160 Dudley Street, Pasadena, Calif.

OUTRIGHT Or royalty—Window lock that is burglar proof. A great improvement over anything that is now in use. Mark Maynard, White Bird, Idaho.

OUTRIGHT, Cash. Canadian patent for pencil sharpener. Russell Harris, Route 6, St. Marys, Ont., Canada.

FOR Sale: Recently patented improved pipe wrench, included adjustment, protected against dirt. Cannot jam. T. Anderson, 6831 Ave. K., Houston, Tex.

LATEST Invention. Portable burglar alarm for doors and windows. So small can carry in pocket. R. W. Nann, Owensboro, Ky.

TIME Counts in applying for patents. See pages 132 and 133. Clarence A. O'Brien, Registered Patent Attorney, Washington, D. C.

MANUFACTURERS. Get our complete list of inventions. American Society of Inventors, Crosby Bldg., Buffalo.

MANUFACTURERS Looking for new inventions should write W. T. Greene, 929 Barrister Building, Washington, D. C.

COASTING Device for automobiles. Patent just allowed. Address the inventor, John M. Denney, Box 276, Deperu, Okla.

FOR Sale:—Thief proof milk bottle container. Patent applied for. J. L. Lowman, U.S.V.H., Chillicothe, Ohio.

WOOLEN Garment stretcher. H. Cook, 1628 Catherine St., Philadelphia, Pa.

INVENTORS—Cash in on your invention now! Don't delay the sale any longer! Send for a free copy of our specially prepared booklet, "Turn Your Patent Into Money," today! It contains helpful information for all inventors. M. L. Bund, Mgr. Classified Advertising, Popular Mechanics Magazine, 200 E. Ontario St., Chicago, Ill.

COPYRIGHTS

COPYRIGHTS Procured; very low cost. Wade Service, 2274-N, Brooklyn Station, Cleveland, O.

MODELS AND MODEL SUPPLIES

FROM Your rough idea we design and build practical working model at lowest cost. We manufacture and sell, and pay you royalty. Our 25 years experience covers mechanical, electrical, photographic, musical, motion picture, phonograph, radio, etc., and also vending machines, packaging and counting machines, automatic sales machines, scales, games, amusement machines, automatons. Confidential service. Member Cleveland Chamber of Commerce. Write now. Wm. Gent Mfg. Co., 17300 Nef Road, Cleveland, Ohio.

POWER Models. Gasoline steam engines. Railway, steamship, boiler fittings, metals. Big catalog 35c. Charles Cole, Ventura, Calif.

INVENTORS: Send us sketch or crude model of your idea. Crescent craftsmen will develop it into a practical working model. 30 years of successful experience and thousands of satisfied clients. Confidential service guaranteed. Bank references furnished. Free illustrated book: "Making Inventions Pay." Crescent Tool Co., Dept. 8-11, Cincinnati, Ohio.

SHIPMODEL Fittings. Lists 5 cents. G. E. Anderson, 301 Parliament St., Toronto.

TIME Counts in applying for patents. See pages 132 and 133. Clarence A. O'Brien, Registered Patent Attorney, Washington, D. C.

MODELS, Tools, dies. General manufacturing. We carry complete stock aluminum, brass rods and sheets any shape. Modern Machine & Pattern Company, Terre Haute, Indiana.

WE Make working models for inventors and do experimental work and carry a complete stock of brass gears and model supplies. Send for catalog. The Pierce Model Works, Tinley Park, Ill.

MODEL Steam engines and boilers for miniature boats, boat and boiler fittings. Catalog 15c. Anton Bobaboy, 212 Price St., Rahway, New Jersey.

SHIPMODELER. Magazine of the ship model makers' club. Sample copy 20 cents. 55A, Middagh St., Brooklyn, N. Y.

BOILERS, Engine castings, practical drawings, supplies for model makers. Catalogue 10c. Howard, 2417 N. Ashland Ave., Chicago, Ill.

PATTERNS, WOOD AND METAL

WILL Make your patterns. Castings any material. Machine work. Models, tools, dies. Modern Machine & Pattern Company, Terre Haute, Indiana.

MANUFACTURING

ESTIMATING Only. Tool, die, and manufacturing costs of metal articles. E. A. Gibbs, 1805 East New York Ave., Brooklyn, N. Y.

EXPERT Metallurgical advice on steel stamping, forming problems. Send sample. Reasonable rates. Metal Service Co., 2122 Griffith Street, Philadelphia, Pa.

SPECIAL Machinery or parts, dies, tools, metal specialties, models, special gears, stock gears and model supplies. Send for catalog. The Pierce Model Works, Tinley Park, Ill.

LOW Cost manufacturing. Large plant completely equipped for blanking, drawing, stamping and wire forming in any finish. Can save you money on your product. Our figures will convince. Eastern States Products, Box 721, New Haven, Conn.

METAL Articles developed and manufactured. Model making. Reasonable price and first class workmanship. W. F. Meyers Company, Bedford, Indiana.

WIRE Goods made to order. Conley Mfg. Co., 3210 Carroll Ave., Chicago.

ECONOMICAL Manufacturing from sheet, bar, wire or tubing. Models, dies, special machinery. Swanberg, 5124 N. Kildare Ave., Chicago.

SPECIALIZE Complete manufacture, dies, tools, special machinery and patterns. Models made. Atlas Indicator Works, 821 W. Washington, Chicago, Ill.

MANUFACTURING. Models, dies, stampings, brasswork, moulds for castings, vulcanizing. Circular free. Baums Metal Specialties, Kansas City, Mo.

CASTINGS

GRAY Iron, malleable iron, brass, bronze, aluminum, white metal castings. Will make necessary patterns. Machine work. Modern Machine & Pattern Company, Terre Haute, Indiana.

BENDING MACHINES

THE Famous Hossfeld "Wrenchless" Universal Iron Bender is the last word in bending machines. Bends metal, cold or hot, into most any conceivable shape, including Eye Bolts and Automobile Spring Eyes. Bends up to 1" bars or 1 1/4" pipe cold. Also bends "Angle Iron." Thousands in use by all classes of trade, from the smallest shops to the largest railway systems. Write for circular and prices. Hossfeld Mfg. Co., Winona, Minn.

BRONZE DIE CASTING MOULDS

DO Your own moulding soft metal ornaments. Send sketches or models for prices. Modern Art Service Company, Terre Haute, Indiana.

BEST Books for \$1. All formerly sold for \$2.50 to \$5 each. Select from the following list of guaranteed bargains. All brand new books: Woodcraft by Seton, Book of Letter Writing by Crowther, Etiquette by Eichler, Creative Chemistry by Blosson, Revolt in the Desert by Lawrence, Trader Horn, White Shadows in South Seas by O'Brien, Count Luckner (The Sea Devil) and Outline of History by Wells. Delivered at your door C. O. D. Simply pay postman \$1 each and postage. Popular Mechanics Press, Room 802, 200 E. Ontario St., Chicago.

WELDING AND SOLDERING

BARGAINS—Excellent repossessed arc welders, buffers and grinders. Entirely rebuilt—guaranteed. Trial. Terms. Write Ken's Service, Box M-1113, Troy, Ohio.

INVENTIONS—Have you conceived one? There is a long, winding road to travel before your vision of rewards can be realized. Send for the new book "Inventions and Patents, Their Development and Promotion" by an eminent authority. It is designed to guide the inventor on his way and help him avoid pitfalls. Will be sent C. O. D. Pay postman \$2.50 plus postage when he hands you the package. Popular Mechanics Press, Room 802, 200 E. Ontario St., Chicago.

MACHINERY, TOOLS & SUPPLIES

13"x4' SIDNEY Lathe, practically new, complete, \$225.00; No. 3 1/2 Fox plain milling machine, \$175.00; No. 60 Heald cylinder grinder, \$500.00; 24" Hender shaper, \$200.00; 10" new drill press, \$21.00; air compressor, complete with tank, motor, etc., \$100.00; battery charging outfit, complete, \$125.00. Write for catalog. Terms to suit. Cincinnati Machinery & Supply Co., 27 West 2nd St., Cincinnati, Ohio.

START Business of your own, small investment required, doing chromium, nickel, copper, silver plating. This work in big demand. Information free. Electro Platers Supply Co., 28 West Second St., Cincinnati, Ohio.

CONCRETE Building block machines and molds. Easy payments. Catalog free. Concrete Machine Co., 5 North Main St., St. Louis, Mo.

KELLOGG Air compressors, excellent condition, \$6.00. Taylor, 165 East 102nd Street, New York City.

SUBSTANTIAL Savings—used arc welders, buffers, grinders, pliers, compressors, paint sprays. Entirely rebuilt, guaranteed. Trial and terms. Write Ken's Equipment, Box M-1114, Troy, Ohio.

\$100.00 SCREW Cutting lathes. Inventors, amateurs, schools. Amphion 305-24th St., Milwaukee, Wis.

LATHES \$3.50 Up. Castings, special parts, tools, dies and model work. Particulars a dime. Irvin Depor, Muncie, Ind.

WELDING And cutting torches, best make cheap. Gemco, Tenth and Carroll, St. Louis, Mo.

MODEL Aircraft—How to build and fly. Model builders and tournament contestants, get the complete official handbook of the Playground and Recreation Association. 200 pages, fully illustrated. Price \$2.25. Sent postpaid upon receipt of price or C. O. D. anywhere in U. S. Popular Mechanics Press, Room 802, 200 E. Ontario St., Chicago.

ENGINES, MOTORS AND DYNAMOS

NEW Clymer electric light plant 110 d.c. Timken bearings, \$160 complete. Water pump unit \$120. Power lawn mower \$150. Small gas engines lowest prices. Terms. Catalog free. Clymer Motors, D 3-A, Denver, Colorado.

DEPENDABLE 8 Light 110 or 32 volt lighting plants with gas engine ready to go \$48.50. New 1/2 hp. gas engines \$10.75. Bargains in electric motors, generators, etc. General Distributing Co., Storage Bldg., Duluth, Minn.

NEW 1/2 Horse motors \$6.50; used \$4.50. New 1/2 horse \$15.00. Air compressors with 1/2 horse alternating motors \$34.75. Steel saw tables with 1/2 horse motors and 12" saws \$21.50. Electrical Surplus Company, Dept. 12, 1885 Milwaukee Ave., Chicago.

STEAM Engines—One h. p. \$18.00; 1/2, \$12.00. James Chambliss, Bessemer, Ala.

AUTO Engines for stationary or portable power. We make necessary attachments. Thirty day trial. No cash down. Candee-Smith Governor Co., 215 North Los Angeles St., Los Angeles.

BRAND New 1/2 Hp. 25 cycle motors \$8.50; 1/2 Hp. 115V. DC \$15.00; 1/4 Hp. 32V. DC \$8.50. Large stock motors, generators, rotary converters, etc., at bargain prices. Queen City Electric, 1736 Grand Avenue, Chicago.

TIME Counts in applying for patents. See pages 132 and 133. Clarence A. O'Brien, Registered Patent Attorney, Washington, D. C.

BUILD Your own boat. Save over 1/2 and have fun besides. Simplified instructions in Popular Mechanics New Boat Book, just out, are easy to follow. Every type of small boat covered, outboard, inboard, sailing and hand-propelled craft. In addition complete information on all phases of boating needed by every boating enthusiast. 269 pages. Fully illustrated. Postpaid upon receipt of price, \$3.00 or will be sent C.O.D. anywhere in U. S. Popular Mechanics Press, Room 802, 200 E. Ontario St., Chicago.

FARMS AND FARM LANDS

120 ACRES \$2000; 6 Cows, horses, hens, sow, machinery, crops; alfalfa land, woven-wire fences, good water, pleasant home, farm bldgs., fruit. Money-maker, only part cash, pg. 103 big catalog 1000 bargains. Free. Strout Agency, 255-P Fourth Ave., N. Y. City.

ATTENTION Colonizers. For sale, 10,000 acres, \$25 per acre, wholesale, one-third cash, liberal release clause, orange, grapefruit, winter garden land, shallow water for irrigation. Owner, Post Office Box 656, Houston, Texas.

LAND Free if planted to bananas. Bananas bear a full crop the second year. \$5.00 monthly will plant a five acre orchard, which should pay \$1,500.00 profit annually. As bananas ripen every day, you get your check every 30 days. A reliable company will cultivate and market your bananas for one-third. For particulars address Jantha Plantation Company, Block No. 10, Pittsburgh, Pa.

OSARKS—Timbered river lot, cabin; fishing, hunting, trapping, boating, pearling; \$200, \$10 monthly. Hubbard, 216 Grossman Bldg., Kansas City, Kansas.

FOR Sale. Quarter central wild hay land in corn, stock belt, fenced. No buildings. Railroad town 3 miles. \$1600 down, \$18 acre. Lock Box 1, Hartford, S. Dak.

FREE Books on opportunities in Minnesota, North Dakota, Montana, Idaho, Washington, or Oregon. Complete information on climate, crops, location for farm or suburban tract for grain, livestock, dairying, fruit, poultry—a home, independence, plenty of food, clothing, continuous employment. No occupation offers more to industrious capable men. Write E. C. Leedy, Dept. 257, Great Northern Railway, St. Paul, Minn.

OWN A farm in Minnesota, Dakota, Montana, Idaho, Washington or Oregon. Crop payment or easy terms. Free literature; mention state. H. W. Ryerly, 119 Northern Pacific Railway, St. Paul, Minn.

SELL Your property quickly for cash, no matter where located. Don't pay big commission. Particulars free. Real Estate Salesmen Co., Desk B, Lincoln, Nebr.

TEN Dollars monthly acquires five acres pecans, tungs, figs, oranges. Guaranteed care. Big returns. Suburban Orchards, Dept. M, Biloxi, Miss.

801 PRACTICAL Ways to Reduce Farm Labor and Expense and Increase Income. One farmer writes he would not part with this information for \$100, if he could not duplicate it. Nothing experimental. These ideas have all been put to test and proven practical. Send today for a copy of our Handbook for Farmers and get ready to put these ideas into operation for your own benefit. Pay postman only 98 cents and the postage when he hands you the package Popular Mechanics Press, Room 802, 200 E. Ontario St., Chicago, Ill.

WANTED—MISCELLANEOUS

MAIL Us your discarded jewelry, gold crowns and bridges, watches, diamonds, silver, platinum. Money promptly mailed. Goods returned if offer refused. United States Smelting Works (The Old Reliable) 39 So. State St., Dept. 71, Chicago.

RABBITS

STANDARD Rabbit Journal, Milton, Pa. Special year 25c; sample dime.

RABBIT Supplies—America's oldest Rabbit supply house. Free catalog. Desk 11, National Rabbit Supply Company, 1126 North Dearborn Street, Indianapolis, Ind.

RABBITRY Supplies. Circular free. Gessner Co., 1123 So. 40, Lincoln, Nebraska.

MINK

START Now raise mink for profit. Quality Quebec-Alaskan reasonable prices. A. Manak & Sons, Fond du Lac, Wisconsin.

RAISE Silky, northern mink. Big profits. Price list free. Full information, fifty cents. Underwood Minkery, Eyota, Minn.

ALASKAN. Kind you want. Very reasonable. Brookside Mink Ranch, Bernardsville, N. J.

BIG Money made raising mink. Free information. Pennell Fur Farm, Dalkona, Wash.

DOGS

THREE Real fox hounds, one hundred dollars; two coonhounds, fifty dollars each—trained. Will deliver the game, not trash. Half cash, balance after thirty days trial. John Young, Clanton, Ala.

IRISH Terriers—boys best pal. Goswyr Kennels, 5435 Hard Road, Columbus, Ohio.

FOR Sale. Minks, squirrels, raccoons, foxes, ferrets, muskrats, ginseng, rabbits, skunks, wolf pups, opossums. B. Tippman, Caledonia, Minn.

BEAUTIFUL Registered bull pups. \$15. Bulldogs, 501 Rockwood, Dallas, Texas.

\$45.00 BUYS A 4-year-old coonhound, guaranteed to please any hunter, on trial. Coonhound Kennel, Kevil, Ky.

I HAVE Some fine shooting dogs well trained and shipped on trial. Write for booklet and descriptive price list. M. J. Turner, Herrick, Ill.

FOR SALE—MISCELLANEOUS

NECKTIES! Hosiery! Shirts! Reasonable prices. Folder free. Quinette's, 81 Holly D20, New Bedford, Mass.

MIMEOGRAPH Machines, Kardexes, addressographs, Ediphones. Bought, sold. Office Machine Exchange, 1902 Olive, St. Louis.

WATCHMAKERS Lathe for sale at a bargain. R. Jaegermann, 5815 Easton Ave., St. Louis, Mo.

UNDERWOOD 5, Standard office machine \$39.95. Checkwriter, duplicator, multi-graph, Dictaphones, bargain prices. Pruitt, 194 North La Salle, Chicago.

ROOTS AND HERBS

HERBS And Indian remedies. For all diseases. Send 10c for valuable Herb and Indian Doctor Book. Indian Herb Co., Centreville, Mich.

PERSONAL

25 LESSONS in hypnotism. \$1.00 postpaid. J. Tibberg, Proctor, Vt.

YOUR Writing tells your hidden talent. Personal report and All Outdoors, the beautiful illustrated, unique western outdoor sports magazine, three months, both for 25c. Your handwriting report made for you. All Outdoors, PM534 Douglas Bldg., Los Angeles, Calif.

BETTER Than a job. Unusual opportunities. Particulars, 2c stamp. Economy Sales Co., Dept. P., Manchester, Iowa.

ARE You old at forty? See our advertisement on page 144 of this issue. The Electro Thermal Company, 2147 Morris Ave., Steubenville, Ohio.

BALDNESS. Bald spots, falling hair? New method, sure results, write today for guarantee. Free particulars. Home Remedy Co., Box 1508, Chicago, Ill.

\$1,000 HEALTH Secret, \$3.00. Booklet 10c. M. Willett, 2508 1st Ave., Richmond, Va.

SUPPORTO Appliance. Amazing invention that restores confidence. Immediate results guaranteed. Men write for valuable information. Surgical Co., 1900 San Pablo, Oakland, Calif.

BUNIONS Painless correction at home by removing the cause, then aiding nature. Liberal offer free. Write Eugene Eaton, D108, Bandon, Oregon.

MISCELLANEOUS

AMATEUR Cartoonists—Earn \$25.00 week, spare time, copying cartoons for advertisers. I-M Syndicate, Argyle, Wis.

YOUR Lists of magazine subscriptions—given cut prices—or send for bargain list of all magazines. Peeter's Publications, 9416a 115th St., Richmond Hill, N. Y.

PENCILS—30c Dozen (wrapped); 4 doz. \$1.00; gross \$2.88. Finest quality 40c dozen (boxed); 2½ doz. \$1.00; gross \$4.00. Print one line inscription wanted. Cash. Prepaid Pencil Market, Knoxville, Tenn.

ELECTRIC Tattooing Machines. Low prices. Wm. Jones, 133 Ward St., Paterson, N. J.

COMPLETE Sets of castings for your home shop. Lathes, table saws, shaft hangers, etc. Assemble them yourself. Exceedingly low priced. Lynn Peltier, Ocean Beach, Calif.

PRINT Signs, pictures, without press, type or machinery. Samples 10c. Straley, 13½ W. Main, Springfield, Ohio.

TATTOOING Outfits, supplies. Illustrated list free. "Waters," 905 Put-nam, Detroit.

AMATEUR Cartoonist: Sell your work. Write Smith's Service, PX1191, Wenatchee, Wash.

HOME Repairs. Every home owner will find this book a mine of suggestions. Its 390 pages are packed with information on how repairs of all kinds can be made and save delay and expense. Fully illustrated. Price \$2.50. Will save its cost 10 times over. Sent postpaid upon receipt of price or C. O. D. anywhere in U. S. Popular Mechanics Press, Room 808, 200 E. Ontario St., Chicago.



NEW KIND OF AUTO EYES

Makes Night Driving Safer than Day!

Astonishing light invention now permits every auto owner to see perfectly at night. Banishes night wrecks and smashups, ends fear of running over children or animals. Coupon Brings **FREE TEST OFFER.**

DOUBLES ROAD LIGHT but ENDS DIMMING

AT LAST! An amazingly queer yet simple invention lifts the curse of night driving from the motoring world. This altogether new discovery called "Perfect-O-Lite," replaces old glass "bulbs" in your automobile headlights with truly amazing results. Road illumination is instantly doubled yet glare is absolutely banished. Ordinary objects in the road, ruts, animals, obstructions, etc., are made clearly visible at least **three** times as far. Instead of ordinary "direct" light, this beam is composed entirely of double-reflected or "infused" light. This new kind of light cuts right through

the other fellow's headlights. Even shoots through fog, mist, rain and snow. There is no wiring or installation. No extra upkeep. Banishes the need for glare shields. No wonder concerns like Wallace & Tiernan, N. J., Columbus Fire Trucks, etc., have already installed Perfect-O-Lite as standard equipment. To prove what this invention will do the manufacturer now offers a set to every motorist on **FREE TEST.** Simply mail the coupon promptly for details.

HACHMEISTER-LIND CO.
Dept. R-30 Pittsburgh, Pa.

Agent Makes \$1,400 in One Week

Full-time and spare time workers. New Free Demonstration Plan with Sales Guaranteed. Exclusive Territory. Sell in bunches to fleet owners. A real chance for \$8 to \$14 first hour; \$6,000 to \$10,000 a year. Wehner of Pennsylvania made \$1,125 in 90 days spare time; Davis of Pennsylvania made \$1,400 one week. No limit for distributors. Use coupon quick!

HACHMEISTER-LIND CO.,
Dept. R-30, Pittsburgh, Pa.

Bring Free Test Offer and money-making facts.

Name.....
Address.....
Town..... State.....



This new kind of Light even LOOKS entirely different.



Gives perfect illumination of entire roadway without shadows or flickering.

When writing to advertisers please mention Popular Mechanics

TAKE THE TIP of Hundreds of successful Men
Send for The R. T. I. FREE OPPORTUNITY BOOK.



**GOOD JOBS
GOOD PAY
GOOD FUTURE
—FOR YOU AND
HUNDREDS OF
OTHER MEN**

IN ELECTRONICS THE NEW FIELD OF RADIO SCIENCE

The new Electronic field needs you! It is the outgrowth of Radio . . . the world's fastest growing industry, and it needs great numbers of TRAINED men in all of its various branches. Never before has there been such wonderful opportunities and such amazing possibilities for real success and a lasting future.

Radio . . . Talking Pictures . . . Television . . . the use of Radio in Industry . . . Public Address Systems . . . Electronic Recording . . . hundreds of other uses of vacuum tubes and photo-electric cells . . . these make up the field of Electronics, which is destined to become the greatest force the world has ever known.

As in every new and fast growing industry, there is sure to be a big demand for men to fill the more responsible jobs. This is especially true in this new field, because only trained men, who understand both the theoretical and practical sides of the work, can be used. Thousands of such men must be trained. Now!

Since few men can afford to attend a University or Technical School to get this training, the Radio and Television Institute, of Chicago, was organized to train them at home . . . no matter where they live . . . easily . . . quickly . . . and at a cost of only a few cents a day, under the supervision of well known engineers. Some of America's largest manufacturers have endorsed the training and are urging men to enroll for it at once.

If you want to make this, the greatest opportunity of all times, your opportunity . . . see what the Electronic field has to offer you. See for yourself how quickly you can be ready for a good pay job, even though you have had no experience of any kind in this work.

It's the chance of a lifetime for ambitious men! Get the facts! Mail the coupon below for the new R. T. I. Opportunity Book. The book is free and sending for it will not obligate you in any way.

MAIL COUPON FOR FREE RADIO OPPORTUNITY BOOK

Radio & Television Institute, Dept. 518
2130 Lawrence Avenue, Chicago

Without obligating me in any way, please send me a copy of the R. T. I. Opportunity Book. I am interested in knowing more about the opportunities in the Electronic field and your course of better training.

NAME.....

ADDRESS.....

CITY..... STATE.....

When writing please mention Popular Mechanics



Industrial Radio



Television



Sound Pictures



Radio Broadcast



Radio Service

Chicago TECH College

FOUNDED 1904

Degree Courses in Engineering Electricity and Architecture. Enter any time. Day and Evening Classes. Many students earn expenses while learning. Free employment service for students and graduates. 27th year. Send for 80 page "Blue Book." Mailed Free. Address the President, Charles W. Morey, B. S., M. E.

CHICAGO TECHNICAL COLLEGE
Dept. P-79, Chicago Tech. Building, 118 E. 26th Street, Chicago, Ill.

Prepare now for increasing opportunities in these fields. Save time here. Special short course (4 months) in Drafting. 1, 2 and 3 year diploma and B. S.

DRAFTING Engineering Electricity Architecture



LEARN TO DRAW

Cartoons---Comic Strips---Illustrations

You will be SURPRISED when you learn of the low price of

THE ACE OF CARTOON COURSES

Send your name and address for FREE particulars and sample illustrations.

CARL ANDERSON SCHOOL, Madison, Wis.

LAW

STUDY AT HOME
Become a lawyer. Legally trained men win high positions and big pay in business and public life. Be independent. Greater opportunities now than ever before. Big corporations are headed by men with legal training. Earn \$5,000 to \$10,000 Annually.
We guide you step by step. You can train at home during spare time. Degree of L.L. B. conferred. LaSalle students found among practicing attorneys of every state. We furnish all text material, including fourteen-volume Law Library, Low cost, easy terms. Get our valuable 64-page "Law Guide" and "Evidence" books FREE. Send for them NOW.
LaSalle Extension University, Dept. 1164-L, Chicago
The World's Largest Business Training Institution

How to Get a Position with the U. S. Government

THOUSANDS of appointments are made yearly. Good salaries—short hours—liberal vacations (as much as 30 days in some branches of the service).

Common school education sufficient as groundwork for most positions. The International School of Civil Service will help you prepare right at home to pass your Civil Service examination with a high mark.

Write for Free Booklet

INTERNATIONAL SCHOOL OF CIVIL SERVICE

Division of the
International Correspondence Schools
Box 5571-G, Scranton, Penna.

Without cost or obligation, please send me full details of your home-study course in the subject checked—

- CIVIL SERVICE
 RAILWAY MAIL CLERK

Name.....

Address.....



AVIATION MECHANICS COURSE

Aviation is growing rapidly. Train to be an Aviation Mechanic. No other industry offers a brighter future, more interesting work or better pay.

Prepare for a good position in Aviation at one of the Curtiss-Wright Aeronautical Universities—leading Aviation Schools in the United States. A new Mechanics' Course provides the best preparation that you can possibly find. The sound, practical experience you obtain in this course applies towards a United States Department of Commerce airplane and engine mechanic's license.

Curtiss-Wright Aeronautical Universities are located at New York, Chicago, Los Angeles, Baltimore, Boston, Pittsburgh and 25 other leading cities. If you are looking for a real opportunity and a chance to make big money, mail this coupon for complete details about the Curtiss-Wright School near your home.

CURTISS-WRIGHT AERONAUTICAL UNIVERSITY

27 WEST 57th ST. NEW YORK, N. Y.

Curtiss-Wright Aeronautical University
27 West 57th Street, New York, N. Y.

Please send me complete details about your new
Aviation Mechanics' Course.

Name.....

Address.....

City.....

State.....

Learn to PAINT SIGNS and SHOW CARDS

We quickly teach you by mail, or at school, in spare time. Enormous demand. Big future. Interesting work. Oldest and foremost school. **EARN \$50 TO \$200 WEEKLY**
Oto Wiegand, Md., business graduate, made \$12,000 from his business in one year. John Yanson, N. Y., gets \$25 for a show card. Crawford, R. C., writes: "Earned \$300 while taking course." Write for complete information.
DETROIT SCHOOL OF LETTERING
154 Stinson Ave. Est. 1899 Detroit, Mich.



1000 Positions Open

HOTEL, club, restaurant and institutional field calling for trained men. Thousands of high-class positions as Manager, Assistant Manager, Steward, Room Clerk, Sports Director and many other important positions paying \$2,000 to \$7,500 a year, open annually. Nearly one billion dollars' worth of **NEW HOTELS, APARTMENT HOTELS, CLUBS AND INSTITUTIONS** being built this year. Lewis trained men start at salaries up to \$2,500 a year, with living often included.

Previous Experience Proved Unnecessary

Qualify for a fascinating, well-paid position—our Personal Coaching Plan adapts the training to your needs in your spare time. Lewis-trained men of both young and mature age winning success. A good grade school education, plus Lewis Specialized Training, qualifies you. Nationwide Employment Service **FREE** of extra charge. All of your training under the personal supervision of Clifford Lewis, who was appointed Managing Consultant by over 300 hotels throughout the United States. Send coupon today for Free Book, "Your Big Opportunity," explaining our Money-Back Agreement, and our Personal Coaching Plan.

FREE BOOK COUPON

Lewis Hotel Training Schools,
Room DT-385, Washington, D. C.

Send me without obligation the Free Book, "Your Big Opportunity," and details of your Personal Coaching Plan.

Name.....

Address.....

City.....

State.....

When writing please mention Popular Mechanics

FREE Radio Handbook

Write today for your copy of the new Radio Association handbook. Shows you easy ways to make money in Radio. Tells you how our members are clearing up \$3.00 an hour spare time. Write for Membership Plan which need not cost you a cent and **FREE RADIO HANDBOOK.**

RADIO TRAINING ASSOCIATION OF AMERICA
Dept. PM-11 4513 Ravenswood Ave., Chicago

LEARN DRAFTING FROM AN ENGINEER

**PERSONAL-PRACTICAL-TRAINING
UNTIL IN POSITION-AT MORE PAY**

Write
To
Day

All Drafting Instruments and tools, also drawing table furnished to you at once for Practical Home Training until in Position. Salary paid Draftsmen \$50 to \$75 per week and up. Men I have trained earned \$100 per week. I'll train a number of selected students on practical work as draftsmen, or improve your present job to get a raise. More pay and a safer job. Short hours on pleasant, clean work. Sure advancement. Keep your present job while learning. Write for "FREE Pay-Raising Plan," and "Draftsmanship" book.

ENGINEER DOBE, 1951 Lawrence Avenue
Established since 1900. Div. 93-98, Chicago, Ill.

ALL
Tools
Given
To You



Here's an Amazing New Business THAT PAYS UP TO \$1,000 A MONTH

MEN, here is a real, red hot money-making opportunity! It's a chance to jump into business for yourself and make more money every week than the average man makes in a month.

Surprising as it may sound, we actually put you in a business, with the first day's profits often running from \$18 to \$55. \$350 to \$600 the first month is not unusual for ambitious men.

Cut in on the Big Money

All you need is the ambition to make real money. We supply you with complete equipment to make and sell that famous new food specialty—Brown Bobby—a greaseless doughnut baked by electricity!

It's a crispy, flaky, delicious new kind of doughnut cooked without one drop of oil or grease. Easily digested by everyone. More appetizing than old-style doughnuts ever were. Costs less to make. Sells four times as fast. No baker's skill required. Just add water to our prepared "Mix." You can open a shop; rent cheap floor space in a grocery, delicatessen, lunch-counter, drug store, etc. Or start at home—and make up to \$250 your very first week.



"I made \$3,000 in 3 months from my greaseless doughnut business!" — T. Chas. Minch, Fla.

Start At Once ANYWHERE!

Men and women everywhere are starting in this business daily! YOU cannot afford to delay! Details will gladly be sent without obligations of any sort. Such an amazing money maker may never come your way again. So fill in and send the coupon at once! **TODAY!**

FOOD DISPLAY MACHINE CORP.
Dept. 3-L 500 N. Dearborn St. Chicago, Ill.

Food Display Machine Corp.,
Dept. 3-L, 500 N. Dearborn St., Chicago, Ill.

Gentlemen: Please send me the plan by which I can cash in on Brown Bobby, the Greaseless doughnut. It is understood that this obligates me in no way whatever.

NAME.....

ADDRESS.....

CITY..... STATE.....

When writing please mention Popular Mechanics

LEARN NOW WHY ACCOUNTANCY Brings Bigger Pay In Better Jobs!



FREE BOOK

Find out today how the new profession of Accountancy is daily increasing the salaries of ambitious men. Thousands of trained accountants are needed, both for public practice and in private firms all over America. Today a new kind of teaching method has surmounted many difficulties which made it hard to learn accountancy quickly. No need to go to school. This "Guided Experience" method trains you quickly at home. Supervised by leading C. P. A.'s. Said by authorities to be "quickest and most thorough method." Training includes C. P. A. coaching without extra charge. Send today for free book "The Modern Way To Learn Accounting" to get complete facts about this amazing big-pay Accountancy field, and this quick easy method of learning. Write to

AMERICAN UNIVERSITY OF COMMERCE
Dept. R-30, 17 W. Elm St., Chicago, Ill.

LEARN MECHANICAL DENTISTRY

Earn Big Money—Steady Work
Don't waste the best years of your life. Prepare now for prosperity. Learn this money-making business in a few months in Day or Evening sessions. Big Demand. School is highly endorsed. Practical training. Individual instruction. Easy terms. **Write NOW for free catalog P and reduced rate.**
New York School of Mechanical Dentistry
125 West 31st Street New York

SEND FOR FREE BOOK
Your Success

Workmen's Compensation Benefits For Injury Arising Out of Employment

This is explained fully in a new book written particularly for employees of all classes. It instructs workers and their families how to obtain these benefits and should be in every household. Write today for this valuable book of practical information. Full price \$1.00. Money back guarantee. **EDUCATOR BOOK COMPANY, P. O. Box 515, Los Angeles, California.**



DRAFTING

BOOKS SENT FREE!
ON APPROVAL

For Beginners
Written, so you can understand every word, by 22 famous engineers and architects. DeLuxe flexible binding, nearly 2,000 pages, 1546 blue-prints, charts and diagrams; prepares you for a good drafting job in mechanical or architectural lines. Sent for 10 days' free use if you mail coupon immediately.

5 Volumes New 1931 Edition
Only 15 minutes a day with these WONDER BOOKS will prepare you for a good drafting job in less than a year. Mechanical and architectural drafting from simple straight lines to important complex plans. A step at a time! Built especially for beginners, for men with only grammar schooling. Drafting 'room practice. PLUS ENGINEERING, made easy and clear. Includes complete course in blue-print reading.

Big Field Big Demand Big Pay
Competent drafters are urgently needed right now in all building and manufacturing lines at \$50.00 to \$100.00 a week. That's just the beginning—FOR DRAFTSMEN HAVE THE BEST CHANCES FOR ADVANCEMENT. Pleasant, fascinating work, easy to learn and do. Learn quickly with these books—send coupon for a set FREE and see for yourself.

A year's constructive membership in the American Technical Society now gives free to all readers of this famous syndicate of drafting. Many say that it is worth more than the cost of the books.



Complete set of drawing instruments if you send for these drafting books NOW. These instruments are made of the finest of German silver, are absolutely accurate and are packed in velvet lined leatherette pocket case. Real \$10 value, but free to you with these books. **AMERICAN TECHNICAL SOCIETY**
Dept. D-819, Drexel at 58th St., Chicago, Ill.

American Technical Society, Dept. D-819, Drexel at 58th St., Chicago, Ill. Send for 10 days' free use New 5 volume set of drafting. I will pay the few cents delivery charges. If I wish, I may return books in 10 days and owe you nothing but if I decide to keep them I will send \$2.00 after 10 days, then only \$3.50 a month, until \$10.00, the special introductory price, is paid. Send 1931 edition and include drawing instruments.

Name.....
Address.....
Employer's.....
Address.....

Now Ready!

THE BOOK THAT THOUSANDS OF MEN HAVE WAITED FOR

RADIO and ELECTRONIC DICTIONARY

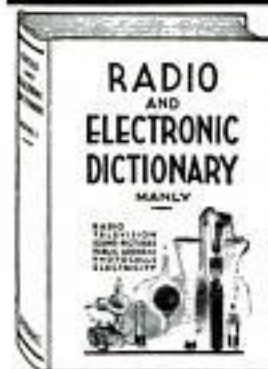

The only book of its kind. Right up-to-the-minute with definitions of the technical words and terms used in all branches of radio, including aviation, navigation and industrial control—photoelectricity and photo-cell applications—sound pictures—public address systems—television—telephotography—electricity and magnetism.

No longer need ambitious men be handicapped because they have no means or facilities for keeping up with the new words and terms used in radio and the electronics field. For now **DRAKE'S RADIO AND ELECTRONIC DICTIONARY**, just published, gives you, at your finger tips, 3,000 practical definitions which you must know to insure your success in radio and its sister industries—the world's fastest growing business. Pentode—variable mu—cross modulation—piezo-electric oscillator—do you know the meaning of these terms? If not—you can—for they are made perfectly clear in this timely book, along with descriptions of hundreds of other new developments and standard definitions. 550 specially made illustrations help to simplify difficult points. Get the **RADIO AND ELECTRONIC DICTIONARY** now—only \$2.50. It's an indispensable handy guide for the beginner and experienced radio man alike. Order it today. Your money back if not pleased.

Size 6 x 9 inches.
260 pages.
550 illustrations.
3800 definitions.

Price Only \$2.50

FREDERICK J. DRAKE and CO.
181 NORTH MICHIGAN AVE...CHICAGO

Drake Books are for sale at all Booksellers



You Can Learn HYPNOTISM ... or No Cost Try FREE 5 Days!

DON'T be unpopular, lonesome, or unhappy a minute longer. Now you can make your life what you want it to be—now you can win admiration, success and big money—through the strange power of hypnotism. I'll show you how to use this great force to help you master every situation or *The Five Day Trial is FREE!*

In just a few hours I'll teach you the hidden secrets of Hypnotism—the methods used by the great operators—the amazing things you can accomplish once you understand this mighty power. You can use it to overcome obstacles, achieve your fondest ambitions and become MASTER of yourself, friends and acquaintances—either sex. See for yourself how Hypnotism can banish fear, worry and opposition—improve your memory—increase your earnings—and force others to give you the good things in life you deserve!

In his startling NEW book, *The Science of Hypnotism*, the world famous hypnotist—Prof. L. E. Young—reveals the most carefully

Mysteries of Hypnotism Revealed

How to Hypnotize at a Glance
Susceptible Subjects
How to Hypnotize by Telephone
How to Give an Entertainment
How to Make Others Obey
You
Overcoming Bad Habits
How to Do Diseases of Hypnotic Feats
Use of Hypnotism in Operations

**Try 5 Days FREE—
Send No Money**

Be confident see what Prof. Young and his great book will quickly teach you the science of hypnotism, that we will send you a copy without one cent in advance! Simply clip and mail the coupon below. When the book arrives pay the postman the special low price of \$2.00 plus low cost postage. Then test the power of Hypnotism 5 days! If not amazed and delighted return the book and money will be refunded at once! Mail the coupon now.

FRANKLIN PUBLISHING CO.
Dept. P-70, 800 N. Clark St., Chicago

Franklin Publishing Co., Dept. P-70,
800 N. Clark St., Chicago, Illinois.

Please send me your amazing new book—*The Science of Hypnotism*—by Prof. Young. When the book arrives I'll pay the postman only \$2.00 plus postage. If I am not satisfied after 5 days' trial, I may return the book and you see to refund my money.

Name.....

Street and No.....

Town..... State.....

If you are likely to be out when postman calls, send \$2.50 with coupon and we'll pay delivery charges. Customers outside U. S. must send cash with order.



High School Course in 2 Years

This simplified, complete High School Course, specially prepared for home study by leading professors, meets all requirements for entrance to college, business, and leading professions.

20 Other Courses

Over 200 noted Engineers, Business Men, and Educators helped prepare the special instruction which you need for success. No matter what your inclinations may be, you can't hope to succeed without specialized training. Let us give you the practical training you need.

American School
Drexel Ave. and 58th Sts
Dept. H-847, Chicago

Money Back When You Finish If Not Satisfied

American School, Dept. H-847, Drexel Ave. and 58th St., Chicago
Send me full information on the subject checked and how you will help me win success in that line.

- Architect
- Building Contractor
- Automobile Engineer
- Civil Engineer
- Structural Engineer
- Business Manager
- C. P. A. & Auditor
- Bookkeeper

- Electrical Engineer
- General Education
- Lawyer
- Mach. Shop Practice
- Mechanical Engineer
- Steam Engineer
- Draftsman & Designer
- High School Graduate

Name..... Age.....

St. and No.....

Town..... State.....

When writing to advertisers please mention *Popular Mechanics*

**Earn \$75 to \$100
a week in
ART**



This way it's easy to learn Art at Home!

Get into the big money! Learn a real profession that puts you head and shoulders above the average. Artists start to earn large salaries almost at once, and the opportunities are unlimited. Our student M. A. Heikilla now has a fine advertising job with one of the country's largest corporations. He earns over \$3600 a year. Harry Hatzenbuchler of Dubuque, Iowa, earns over \$10 a day extra from his drawings.

These men had no previous experience in art. Our famous method of "constructive criticism" by which you receive constant, personal, individual attention turned them into real, professional commercial artists.

The Washington School of Art has been training men to draw for over fifteen years. Our methods are proved. Our course is interesting and easy to master. Simple lessons lead you step by step into the most fascinating profession in the world. We show you how to make good money in your spare time, how to start earning almost with the very first lesson. Our big employment department is at your service. Get the facts about this training—about the rich rewards that an Artist's Life offers you. Send now for our FREE BOOK. MAIL COUPON TODAY!

Free Book shows how

Washington School of Art, Dept. 5-V,
1115 15th St. N. W.,
Washington, D. C.

Please send me your FREE BOOK showing
how I can quickly learn art at home.

Name.....Age.....

Address.....

City.....State.....

FREE!

Big \$300 prize
contest open to
those who act
at once. Send
now for free
book.



\$150 a Week for Roberts

"When I enrolled for your course I knew nothing about commercial art. Now I make signs, showcards, illustrations and cartoons earning from \$60 to \$150 a week, depending on whether I feel like working or not. I cannot thank you enough." P. C. Roberts, Bridge-ton, Me.



Men! Big Opportunity is here in Electric Refrigeration



This new industry is growing by leaps and bounds. Everywhere sales lead all other lines. Look around you; you'll see it's so in your town—everywhere.

Trained Men in Big Demand

Shop mechanics, installers, service men, estimators and sales engineers are needed. These jobs pay \$60 to \$200 per week and lead to rapid advancement.

Easy and Quick to Learn

A few weeks in the finest and best equipped school in the country qualifies you thoroughly; or if you cannot come to Cleveland you can learn by Home Study.

We Help You Secure Position

No matter what your age, education, or past experience is—write for FREE BOOKLET. Find out how we help you get into this growing field. Write at once—NOW—to

THE NATIONAL TECH, 4309 Euclid Ave., CLEVELAND, O.



Does Your ENGLISH Betray You?

How often do you lose your greatest opportunities for more money, and for greater popularity because of mistakes in English, which you make, unknowingly? Can you talk and write your way to a better position with higher pay? Unless you have a perfect guide you may be holding yourself back from whatever business and social advancement you desire. SPEECHCRAFT, perfected by a group of nationally-known educators after 25 years of research and teaching, is your infallible guide. It will make you a master of Correct English, Effective Speech and Letter Writing.

SPEECHCRAFT is NOT a mere set of books. It is fascinating, complete, quick and easy. No tiresome, dull rules to learn. Just 15 minutes a day packed with absorbing study and your English and conversation will be logical, your letters interesting and you will be able to hold and thrill any audience before whom you speak.

SEND FOR THIS FREE BOOK

Write for our new, big book, "The Way to Win With Words." It will be sent without charge to serious-minded men and women who want to get ahead and earn more money. (State age in writing.)

SPEECHCRAFT, INC., Dept. D-10, 25 W. Elm Street, Chicago, Ill.



GET THIS Free new No. 23 Edition of our RADIO SERVICE TREATISE. Contains some 75 new hookups, circuit diagrams; over 350 illustrations. POSITIVELY THE GREAT- EST BOOK EVER PUT OUT.

CONTENTS: VACUUM TUBE TREATISE, with many illustrations; Vacuum Tube Apparatus Characteristics Chart; How to Take Care of Your Tubes. Phonograph Pick-ups. Connecting Additional Loud Speakers; all fully illustrated with diagrams. Modernizing Old Radio Sets; How to Convert Battery to Power Sets; Volume Dividers; Selecting and Installing Replacement Parts in Radio Sets. WRITE TODAY. Enclose 2 cents for postage. Treatise sent by return mail.

RADIO TRADING COMPANY
29 West Broadway New York City

AVIATION

BOYS

Wonderful opportunity in aviation field. Start right by taking our remarkable ten lesson ground course, including membership, class pins, ratings, commission. \$4.50 complete or 50c a lesson. Details free.

Dept. N, National Young Filers League
516 Chimes Building Syracuse, N. Y.

LEARN THE JEWELRY BUSINESS WATCHWORK, JEWELRY AND ENGRAVING

Send for free catalogue

Bradley Watchmaking School, Dept. P, Peoria, Illinois

The man who studies gets ahead. Popular Mechanics Press will advise you what books to read to advance in your trade. 200 East Ontario Street, Chicago, Illinois

Wireless (Radio)

and Morse telegraphy taught thoroughly. School, oldest and largest, endorsed by Telegraph, Radio, Railway and Government officials. Unusual opportunities. Expenses low—can earn part. Catalog free. DODGE INSTITUTE, Jones St., Valparaiso, Indiana.

When writing to advertisers please mention Popular Mechanics



Get out of the rut~ and into the Air

The amazing growth of aviation to a six billion dollar industry within five years' time convinces even the most skeptical that aviation has taken a ranking place in the world of transportation.

The need of today is for men of more advanced training to fill important executive posts — field superintendents, traffic managers, etc.

It is typical of Von Hoffmann to step

VON HOFFMANN AIR COLLEGE

Lambert-St. Louis Municipal Airport
St. Louis, Mo.

ahead and offer training to meet the needs of today. All courses have been extended to give our students thorough training in all the new pre-requisite subjects.

The price of all courses will naturally be advanced, but until *October 15th we offer our new extended courses at old prices.* We urge you, if you are interested in aviation, to get further facts without delay.

VON HOFFMANN AIR COLLEGE 1000-13
342 Lambert-St. Louis Municipal Airport
St. Louis, Mo. MAIL TODAY, "WHAT AVIATION OFFERS YOU."

Name..... Age.....

Address.....

City..... State.....

I am interested in
() FLYING COURSE () MECHANICS COURSE
() WELDING COURSE () HOME STUDY

WOLLENSAK 350 POWER Only \$18.50



Fully
Extended



Showing base
detached
for examining
large objects.

This new microscope is precise enough for thousands of professional men, yet so simple that growing boys and girls use it with ease. Reveals thousands of nature's miracles.

NEW FEATURES

Magnifies 100 to 350 times, in steps of 50 magnifications. Concave mirror gives brilliant illumination above or below object. Rack-and-pinion adjustment aids delicate focusing. Stand tilts for use in any position. Detachable base permits examination of large specimens. Used day or night. Case, mounted object and glass slide included. American mass production assures superior value. Money-back guarantee by American maker.

At Dealers or Direct, Postpaid, \$18.50
Similar Wollensak Microscope, 50 to 110 power..... \$10.00

Complete catalog free.

WOLLENSAK OPTICAL CO.
870 HUDSON AVE., ROCHESTER, N. Y.
Lens problems our specialty



Know Electricity as Experts Know It—and Get an Expert's Pay!

Make no mistake about it—there are big jobs in electricity ready for you when you're ready for them. Thousands of men who have the Croft Library know that to be a fact. The Library itself, on a FREE TRIAL BASIS, can prove it to your absolute satisfaction.

The New Croft Library of Practical Electricity

The Croft Library is a complete electrical educator. It is founded on practice—on 20 years of shirt-sleeve experience—on work as it is actually done. It is jammed from cover to cover with the kind of hard-headed facts you want. Written so that the beginner can easily understand it, yet so sound, so thorough, that it is the daily guide of 40,000 highly paid electrical workers and engineers. Croft tells you the things you need to know about motors, generators, arcatures, commutators, transformers, circuits, switchboards, distribution systems—electrical machinery of every type—wiring for light and power—wiring of finished buildings—underwriters' and residential requirements—illumination in its every phase—the latest and most improved methods of lighting—bumps and lamp effects, etc.—how to do a complete job, from estimating it, to completion.

No money down—easy payments

Fill in and mail the coupon attached and we will send you the entire set of seven volumes for ten days' Free Examination. We take all the risk—pay all the charges. You assume no obligation—you pay nothing unless you decide to keep the books. Then \$1.50 in ten days and the balance at the rate of \$2.00 a month. Send the coupon NOW and see the books for yourself.

FREE EXAMINATION COUPON

McGRAW-HILL BOOK CO., 370 Seventh Ave., New York

Send me for ten days' free examination the Croft Library of Practical Electricity. If satisfactory I will send you \$1.50 in 10 days and \$2.00 monthly until the special price of \$19.50 is paid. If not wanted, I will return the books postpaid. (To insure prompt shipment write plainly and fill in all lines)

Name.....
Home Address.....
City and State.....
Position.....
Name of Company..... P.M. 11-31

When writing to advertisers please mention Popular Mechanics

9/18/28

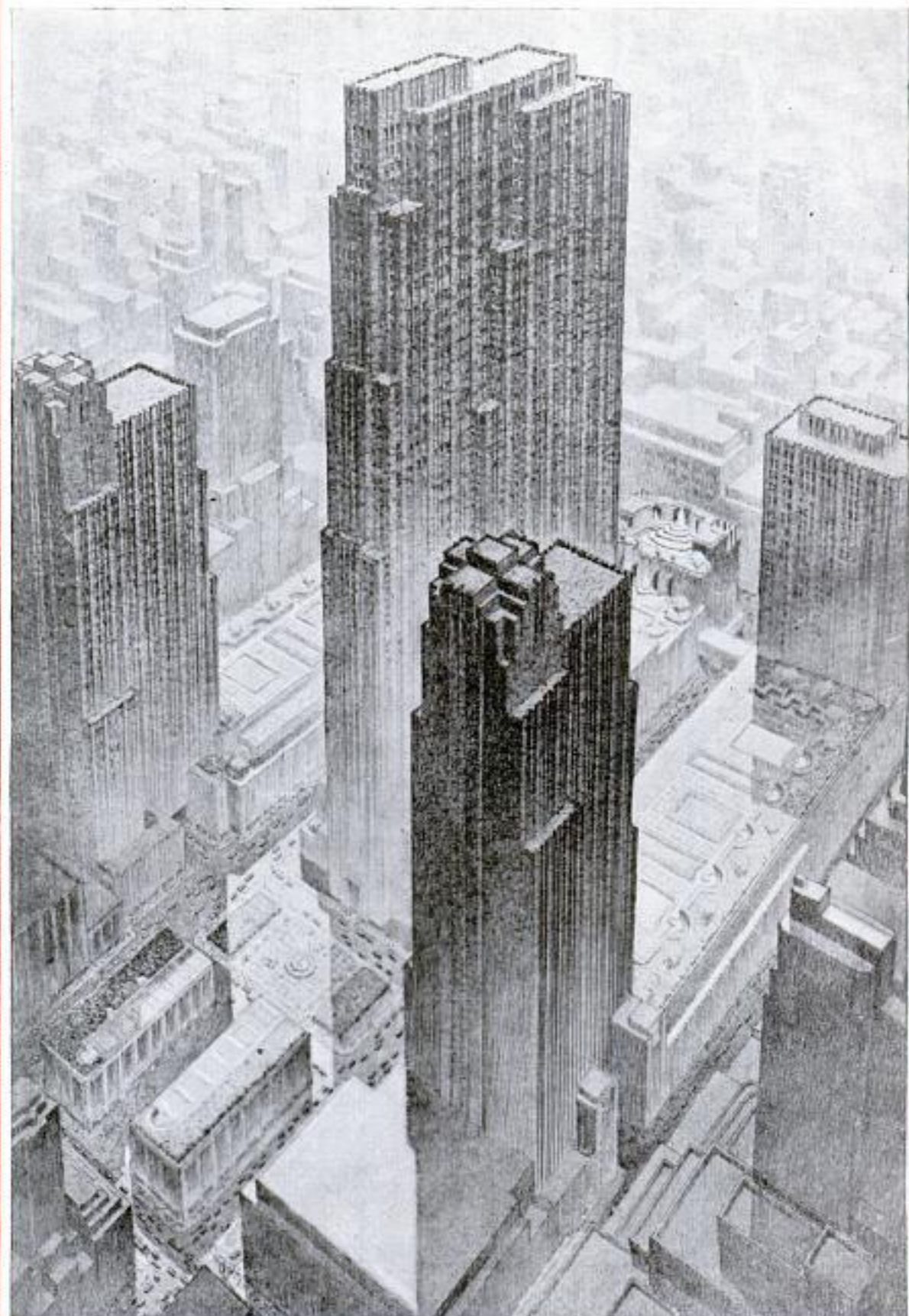

Air View of Radio City As It Will Appear in New York City's Heart When the Ten Buildings, Costing Approximately \$250,000,000, Have Been Completed

Popular Mechanics Magazine

REGISTERED IN U. S. PATENT OFFICE

WRITTEN SO YOU CAN UNDERSTAND IT

Vol. 56

NOVEMBER, 1931

No. 5

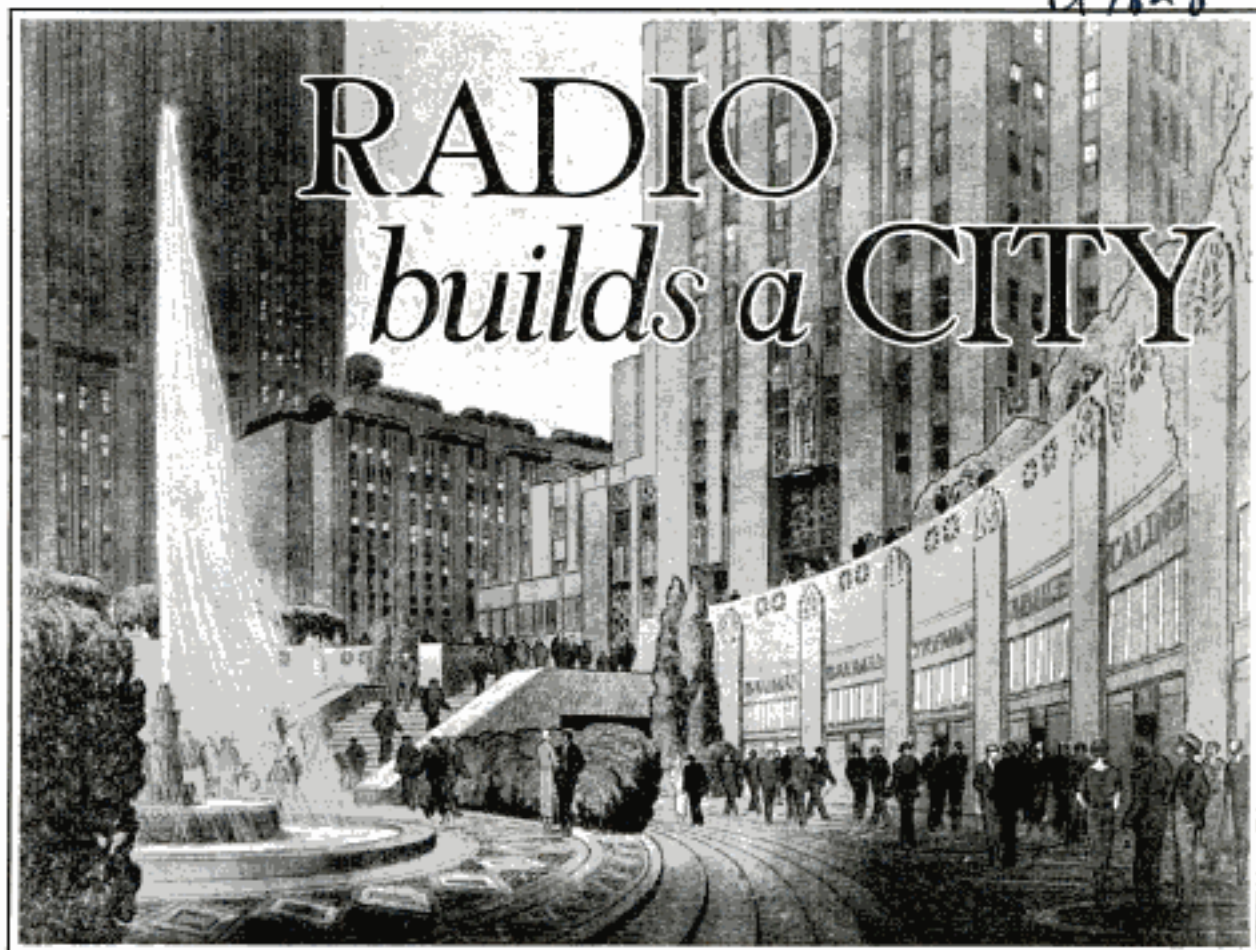

Sunken Plaza of Radio City with View of Entrance to Office Building That Will Be World's Largest in Floor Area; This Ground Costs About \$400 per Square Foot

OLD Babylon might have resembled Radio City if the king's musicians had summoned music out of space, built an indoor theater seating 6,500, or piled up a mountain composed of sixty-six houses, one on top of the other.

Such a miracle crystallizes in the heart of New York. Architects and engineers have revised their original plans and now announce a group of ten buildings to embody a new conception of time, space, art, science and the universe of man.

Thousands labor on this \$250,000,000 project, the largest single construction unit in the history of man, surpassing the fabled tower of ancient Babylon and exceeding all other engineering performances, with the possible exception of the

Panama canal. Listen to the voice of Radio City as it rises triumphantly out of the earth. The whole site reverberates with snarling, biting, clawing, shrieking engines. The metallic staccato of the air drills boring into the igneous rock mingles with the muffled roar of dynamite. Radio City will be anchored to the solid bones of the earth.

The principal building, a sixty-six-story skyscraper, will have no less than 37,952 square feet of roof gardens. The other buildings will have more, aggregating 246,010 square feet of garden space above the street level. Counting 44,000 square feet of garden space in the plaza and around the buildings, there will be, in all, seven acres of landscaping.

Cont. Don Islassman 705
55 W. 86 St. St. Neufel
Copyrighted Material

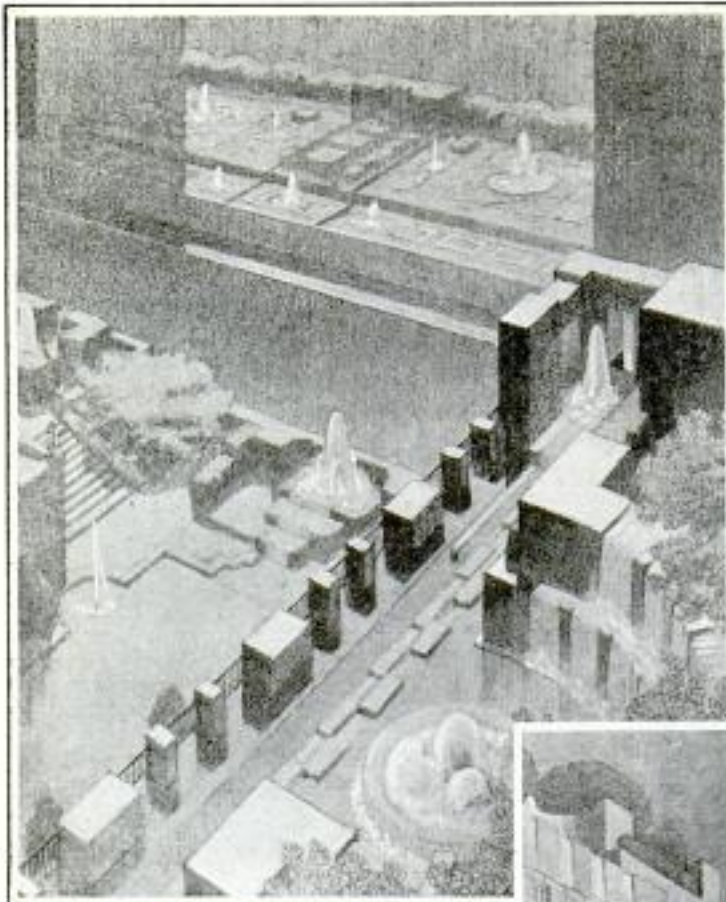

placed, are necessary to fill the 28,000 windows and 10,000 doors in Radio City. If spread out flat, this glass would cover nearly twenty-three acres.

Brick, a material known to the Babylonians, will be used extensively. Thirty million common bricks and 15,000,000 face bricks will be delivered to the site. Another important item consists of about 20,000,000 square feet of hollow tile designed for interior partitions. Five thousand men are necessary to fashion these materials into their proper forms on the building site; 20,000 men are given employment in mines, forests, mills, factories and electrical plants where building sup-

Now the 44,000 square feet of ground space devoted to landscaping represents a major investment. At \$400 per square foot, the Rockefeller interests are contributing \$17,600,000 worth of real estate from which they will derive no direct revenue.

A better understanding of land values may be realized from the carrying charges during construction. Counting the sums paid to lessors, taxes on the investment and lawyers' fees, the rental for this land during its unproductive period of construction runs close to \$6,000,000 per year.

The quantities of materials necessary for the ten structures shatter all previous records in the building industry. The order of 125,000 tons of steel exceeds the quantity used in the Panama canal, the Empire State building or the new Hudson bridge. The price for this one item is about \$15,000,000.

One million square feet of glass, the largest order for building purposes ever



Part of the Roof Terrace, Above, and Garden under Which Broadcasting Studios Will Be Located

plies are produced. The west end of the main building will be bounded by a spacious forum, which will be a connecting link between two great theaters, one the International Music Hall, seating 6,500, and the other a sound-picture theater accommodating 3,500. The forum will be

a 1825

open to theater patrons and will have its own orchestra in addition to special entertainment by the National Broadcasting company.

The third to eleventh floors will contain twenty-four studios of that company. These will be "air-padded," fireproofed and air-conditioned. The large studios will be three stories high. The ground floor will be devoted to shops, arcades and lobbies.

Office space in the entire building will have a uniform depth of twenty-seven feet, made possible by the central location of the elevator shafts and the fact that the building setbacks occur where the elevator shafts end.

The main building will be totally different from all skyscrapers which soar above 600 feet. The size of the building site makes it possible to eliminate the tower construction, which is placed on most high buildings, not because of their peculiar beauty but because city ordinances forbid any other construction.

However, the base is so broad that at the twentieth floor it will have an area of 24,374 square feet which will decrease only to 22,423 square feet at the sixtieth.

TABLE LAMP THAT KILLS FLIES BY ELECTROCUTING THEM

Flying insects are killed by a table lamp that greatly resembles the ordinary electric desk unit. The distinguishing feature is a coil of charged wires encircling it like a shade. Insects flying against it are electrocuted by the electricity with which the wires are charged.



Fire Engine That Extinguishes Flames by Spraying Powder on Them; the Powder, Unlike Water or Other Liquids, Does No Damage to Goods

FIRE ENGINE SPREADS POWDER TO EXTINGUISH FLAMES

Powder, instead of water, is used to extinguish flames by a German fire engine that carries a large supply of this dust which is played on a blaze through large tubes under heavy pressure. The powder smothers the flames and is employed particularly where valuable stocks of goods might be ruined if soaked with water or any other liquid that would be used.

TREADMILL FOR OCEAN WAVES TO HARNESS POWER

To harness the energy of sea waves pound the coast lines of America, experiments now are going forward on a machine of the treadmill type that at first glance looks like the cleated track of a tractor. The cleats are curved paddles on a steel belt, mounted beyond the surf line so that the incoming waves will move them along. The inner surface of the belt is lined with teeth and enmeshed with gears connected to individual shafts, which in turn propel the main power shaft. This shaft operates a battery of air compressors housed above the beach line, and the compressed air runs dynamos. Hydraulic-control apparatus "sets" the paddles in a rigid position only when definite pressure is exerted, while they trail in backwash. The same control keeps the paddles traveling on top of the belt in a position that will provide the least resistance from the wind.



Chicago - a Christmas

145 Valley St. 181813

Herd Electric Park

Mr. Charles Leatey
My Lamin Route
Santa Paula, Calif.

Dressman Supply Co.
2538 W. University St.
St. Louis, Mo

From Le Miroir du Monde
Paris 8/15/31

POPULAR MECHANICS

708

a1764

"Enchanted Isle" Built in Sea on Steel Stilts

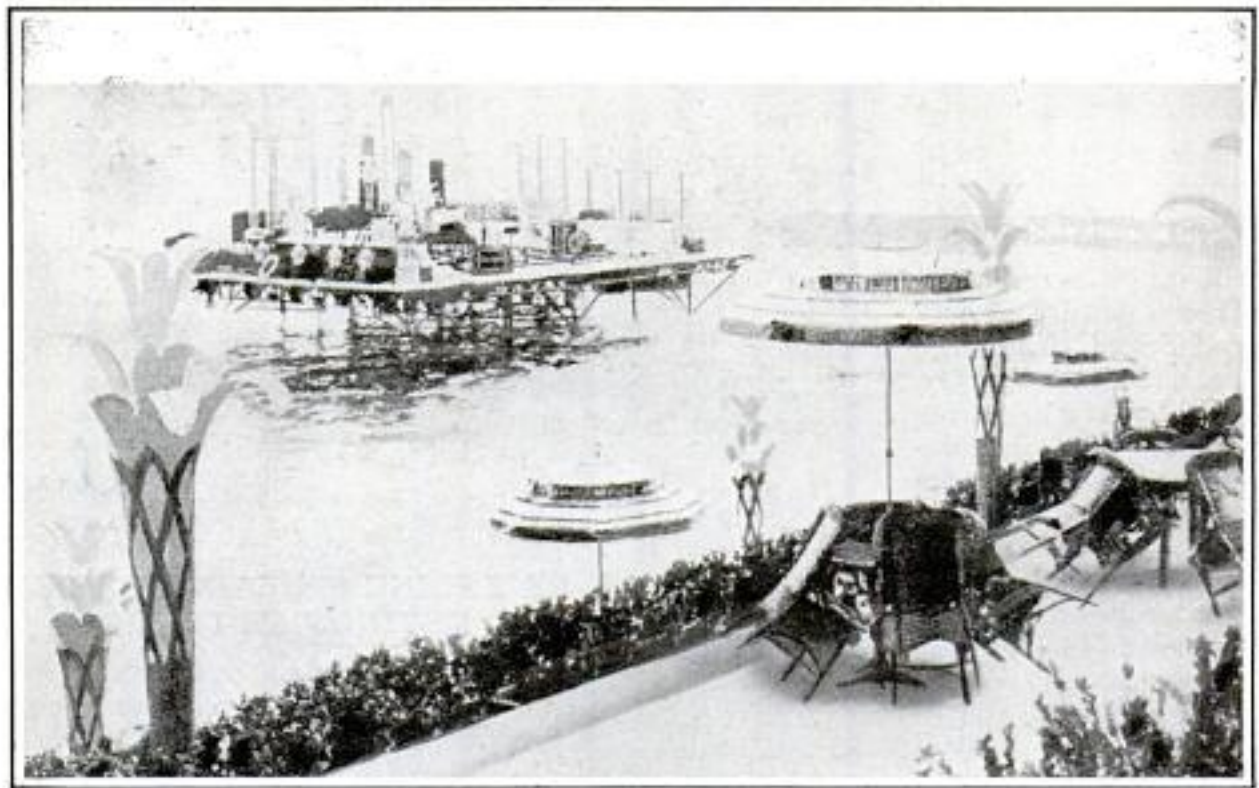

Artificial Island Standing on Stilts off the Shore of Monte Carlo's Beach; the Island Supports a Small Theater, a Lifeguard Station and Several Other Buildings

Anchored off the shore of Monte Carlo's bathing beach is an artificial island that stands on stilts. It is forty by fifty-five feet in dimensions and is known as the "Enchanted Isle." The island is within swimming distance of the shore and is constructed of twenty tons of steel, being raised above tide and waves on braced legs. On the island are a small theater, utility buildings, a lifeguard station and equipment for providing gorgeous illumination by night.

The clasp became loosened and was drawn into his lung, and an ordinary X-ray picture revealed it lodged just above the diaphragm. In such cases a long slender tube usually is inserted into the lung. An electric light attached to the tube's end shows the location of the piece to be extracted, and it is grasped by tiny forceps inserted through the tube and withdrawn. In this instance, however, the tube in which the clasp was lodged, was too small to admit the bronchoscope. The position of the clasp was located with the special X-ray device, then, with the aid of a fluoroscope, the exposed forceps was inserted into the lung tube until the bit of metal had been reached and seized.

BIT OF METAL LODGED IN LUNG REMOVED WITH X-RAY'S AID

After a broken part of his artificial windpipe had been sucked into his lung and lodged in such a manner that it could not be extracted by ordinary methods, the life of a Brooklyn man was saved recently through the use of a special X-ray device and an unusual surgical operation. A year ago the man's voice box, or "Adam's apple," was removed when it became infected, and in its place was installed a metal tube attached by a silver clasp to a permanent fixture in his throat.

POTTED PLANT WATERS ITSELF BY OVERCOMING GRAVITY

Using the dry earth as a pump to draw water upward to the roots, a watering device for potted plants has been developed at Cornell University. They are set in a jacket of tile containing water. If the tile holder were set above the plant to

a1836

pred pass

107 Avenue S, Kings Highway, Brooklyn, NY

by Mr. L. A. Richards
Athaca, N.Y.

Copyrighted material

drip upon the soil, it would not supply enough moisture, but when inclosed next to the soil, it is subjected to the suction due to low pressure, and water is drawn through the tile pores in needed amounts.

91800

PLANE PARTS MADE INTO AUTO DRIVEN BY AIR PROPELLER

One of the popular exhibits at the Cleveland air races was a small automobile built almost entirely of airplane parts and driven by a four-bladed propeller housed in a wire guard at the rear of the car. Power is derived from a four-cylinder air-cooled motorcycle engine converted for use in light racing planes. Four airplane tail wheels with low-pressure tires are mounted on transverse springs and provided with brakes. Steering is accomplished by a wheel, whose shaft operates a crossbar connected to the front axles by rods. The body, which accommodates one passenger, is of sheet steel, and an airplane throttle controls the engine. The propeller is started by a crank engaging in a projection of the shaft, at the rear. Except for the engine, no bolts are employed, welded-steel airplane tubing and rods being used throughout. Without the propeller guard in place, the car made seventy-five miles an hour.

propeller 25 1/2 hp



Small Auto Built of Airplane Parts and Driven by a Propeller Mounted at the Rear

Built by J.C. Canfield Cleveland Ohio no street address Ohio



Air Fanned over Ice and Circulated through the Food Chamber Keeps the Ice Box Several Degrees Cooler

FAN CIRCULATES AIR IN ICE BOX TO COOL FOOD CHAMBER

By circulating air over the ice, a fan now on the market maintains temperatures of forty-five to fifty degrees in any good ice box during the hottest weather. Circulation makes the ice box from eighteen to twenty-five degrees colder than when ice is used alone. The fan will provide the low temperatures as long as ice and electricity are supplied. With the colder air directed into the food chamber, vegetables, etc., are kept fresh.

MYSTERY OF HALIBUT'S ORIGIN IS FINALLY SOLVED

The mysteries of halibut origin, their hatching places and their development to maturity bid fair to be solved by the finding of their larvæ. This discovery may eventually enable the United States and Canada to adopt scientific measures for the conservation of this fish family, the annual Canadian catch of which amounts to more than 30,000,000 pounds.

Announced by John Babcock Chairman Canadian-American

91734
D'ingenerator Wiff Co, 7422 Santa Monica Blvd Hollywood, Calif

Halibut Commission

a 1789
710



Elevated Ferry Made by Lashing Two Boats Together and Building a Superstructure on Which Trains Can Be Run in Sections from the Level of the Bank

OK 4

ELEVATED FERRY TAKES TRAIN IN SECTIONS OVER RIVER

Two boats lashed together and carrying an elevated superstructure provide a ferry for trains over the Dong Hai river

in French Indo-China. There is no bridge over the river and the banks are so high the elevated structure is necessary so the train, which is broken up into sections for the crossing, can be run directly from track level onto the ferry.

FENCE MADE OF ELK ANTLERS SURROUNDS RANGER CABIN

Distinctive in design and said to be as effective as barbed wire, a fence of elks' antlers has been erected around the head-

quarters of a forest ranger at Mammoth Springs, Wyo. It is one of the pastimes of the rangers to collect the antlers shed each fall by the herds of elk, and it required but a short time in the little-hunted area surrounding the ranger's home to gather sufficient to make a highly decorative fence.

a 122



Fence of Antlers around Ranger's Cabin, Said to Be as Effective as Barbed Wire

THIS DRUG MAKES PEOPLE TELL THEIR SECRETS

Small doses of sodium amytal, a drug related closely with luminal, veronal and allonal, commonly used as hypnotics and sedatives, will unlock the most secretive tongue and make the subject actually anxious to discuss his most personal and intimate affairs, according to Dr. Erich Lindemann of the Psychopathic Hospital of Iowa State University. His research on the substance was started some time ago as the result of its effective uses in treating certain mental diseases. Administered in small amounts to mentally diseased subjects and to normal persons at the same time, its most striking effect on

a 1840

amytal
doses
small

at meeting American Psychological Assn

This article killed slower landing speed in next magazine

the normal individuals was their desire to tell about personal matters they ordinarily would keep carefully hidden. They were unable to refuse to answer questions about the most intimate matters. Additional effects on normal subjects were warm emotional attitudes toward others, combined with a sensation of strength, self-confidence and serene contentment.

91845

ANGLEWORM AND MOTH FARMS ODD JOBS

Among the odd jobs of the world, probably one of the most unusual is growing angleworms for the market. One California man makes a living by operating an angleworm farm. He propagates the wrigglers and, when they are fully grown, they are packed in cans and shipped to fishermen. The worms are packed five dozen to the can and they usually survive about ninety-five days. An Iowa youth runs a butterfly farm and has hatcheries, traps and displays for raising more than thirty different species of moths and butterflies. Through a hole in the floor of each caterpillar's home, a branch of its particular food is inserted. Each species must be supplied with its own fresh food, the temperature of the nursery must be watched, and the inmates closely guarded. The insects are sold to collectors, nature teachers and makers of decorative trays.



Traffic Signal for Airport Like Ordinary Stop-and-Go Street Light, and Control Board from Which Airport Lights Are Operated

Web World

land, Brooklyn. A remote-control switchboard in the observation-tower room governs the air-traffic lights and the beacons, floodlights and other illuminating devices.

X-RAY WITHOUT VACUUM TUBE RUNS ON HIGH VOLTAGE

91844

Taking X-ray pictures without using vacuum tubes is the feat of a French physicist whose process has recently been announced. High-voltage electric currents are passed through magnesia, alum, yellow oxide of mercury, or other substances having high electrical resistances and rays of low penetrating power are produced. Medical authorities see promise in the new system as being more convenient in clinical and industrial practice than the conventional tube device.

see form letter #

TRAFFIC TANGLES IN THE AIR AVOIDED BY STOP LIGHTS

91824

Traffic signals, like the stop-and-go lights that govern automobiles, now direct pilots in landing and taking off from Floyd Bennett flying field at Barren Is-

Erving Schlesselman
Cedar Rapids, Iowa
State College
Alhambra

M. L. Rebaud
no address

a 1724

WONDER RAY

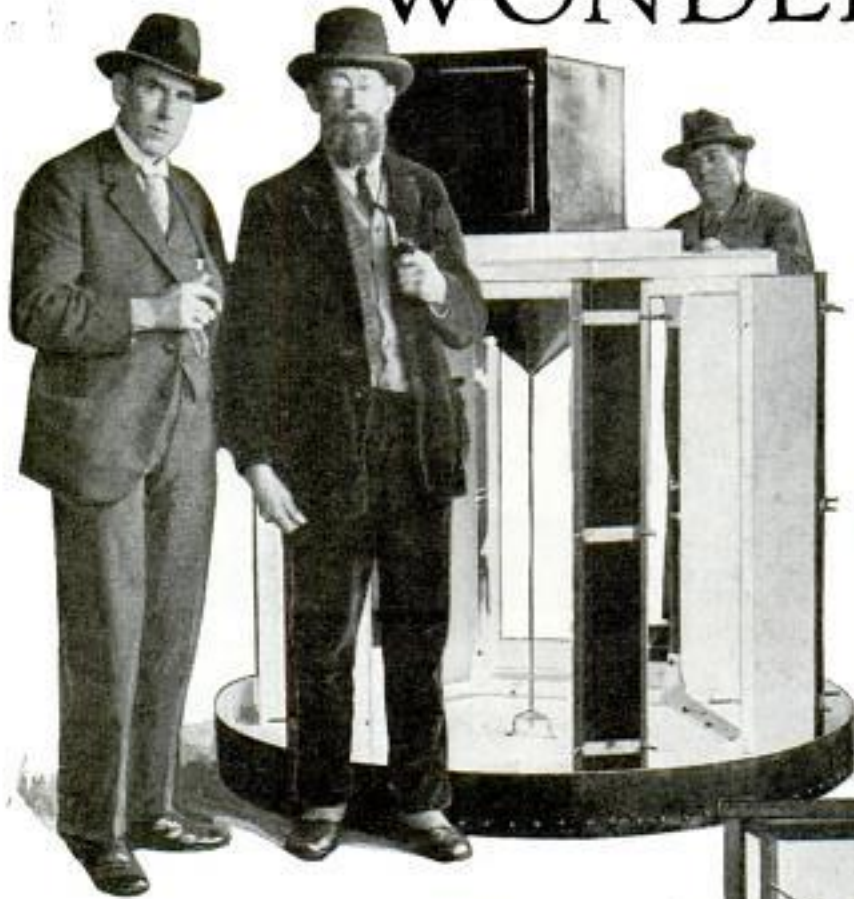

Soest creep past the house on tiptoe after dark, and no cracksman will venture to break into the house of the "wizard," as the inventor is locally regarded.

Day and night, a perpetual humming and vibration in the air indicates that the ray is perpetually at work. This unceasing vibration comes from behind a high hedge and fence where are located an electric generator and radiator, emitting, for a distance of thirty yards all around, waves in whose field no organic matter can decay. These waves, which are not radio or any

By HAROLD T. WILKINS

A DUTCH investigator, working in a quiet country house surrounded by fields and farms close to the village of Soest, Holland, has recently made a discovery which may revolutionize future methods of food preservation and holds striking possibilities for the cold-storage industry.

He has revealed a wave of energy, at present unknown to puzzled scientists and laboratory workers, which will conserve meat, milk, dairy products, eggs, flowers, fruit, fish and vegetables for an indefinite period, and arrest decay where it has once started.

Since the news of the discovery, scientists and newspaper men, business men and industrialists have visited this quiet backwater, which is near the high road along which autos carry visitors to the pretty village of Doorn, where ex-Emperor Wilhelm and his retainers are spending their days in exile, felling trees in the grounds of the royal castle.

The awe-struck folk of the village of

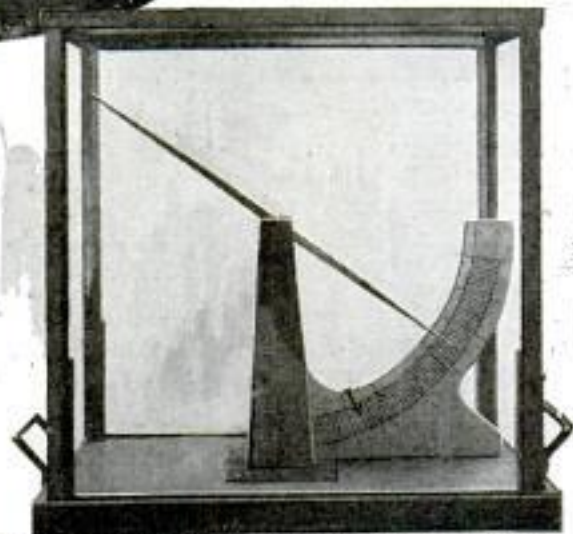

Mixing Chamber of "Life-Wave" Machine, Above, and How Rays Depress Magnetic Needle

waves so far known, travel at a far lower speed than electricity, the Hertzian ray or the light of the sun. Indeed, the speed of transmission of this new ray ranges at from one yard to thirty-one miles an hour. Yet it has electromagnetic properties similar in some respects to those of radio.

Robert Pape, the discoverer of these rays, is a dairy research worker formerly employed by the government of South Africa. His invention takes the form of an apparatus in which moistened and

Life Wave Syndicate
 24, Kolonieweg, Soest, Holland

Q 1724

STOPS FOOD DECAY

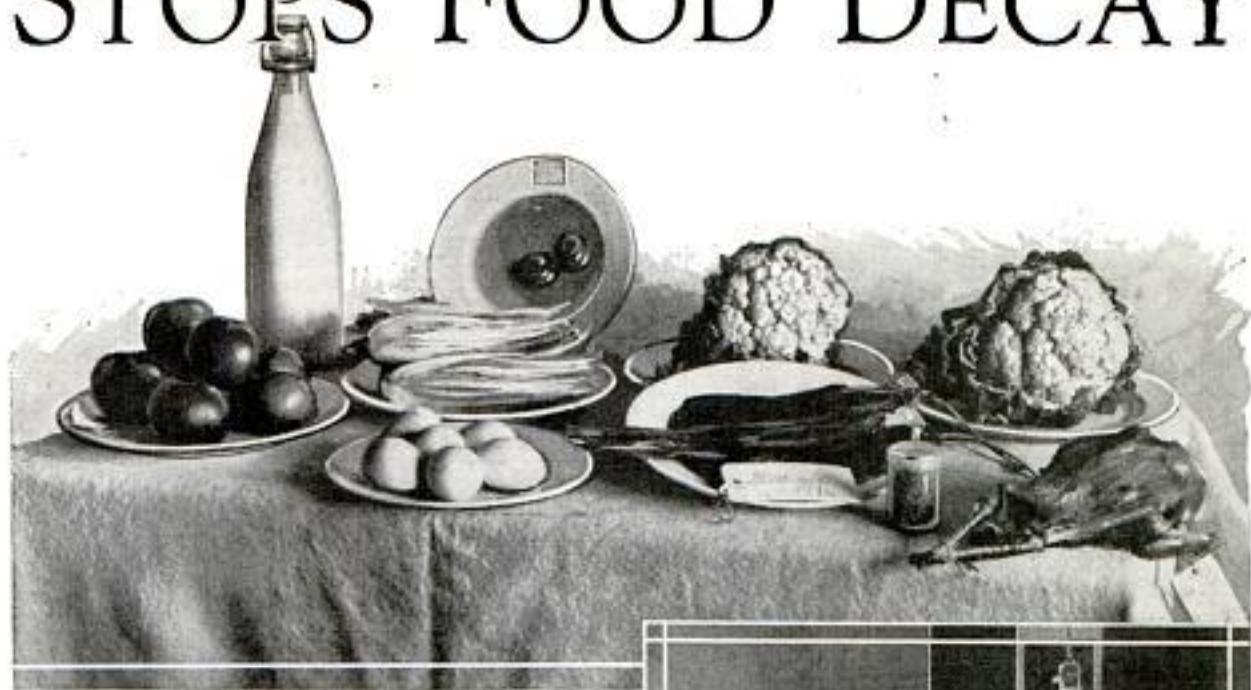

Fresh Foods Kept for Months in Room Adjoining the Machine; Wave Radiator at Right

dry air are combined in a mixing chamber, through which run electrically charged copper wires. The generator radiates short waves of some ten inches. These waves, after about ten days, set up a field of about thirty yards radius, in which no meat, milk, food products, flowers or organic material will decompose or even deteriorate.

"They are not radio waves at all," explained Mr. Pape to a Popular Mechanics representative who chatted with him at Soest. "We do not know what they are, but you can see their effects for yourself. This 'Life Wave,' as I call it, is not shut out by an ordinary lead plate. It will penetrate stone walls, iron, lead, glass and wood, indoors and out, and in any atmosphere or at any temperature. The generator itself is not a bulky machine, and using only about as much electricity as would be needed for an ordinary electric lamp, it will form a field of about 30,000 cubic yards."

He pointed to a large magnetic needle in a frame in the room next door to the generator, on the other side of a thick brick wall. The needle showed a deflection, indicating that some magnetic influence was at work in the room.

Pape also showed me how an ordinary ship's compass needle in the same room



was deflected from the true magnetic north pole by the wave.

"But it is remarkable that a radio receiver is not affected by this wave," he added. "A few days ago, I stood right under and as close up as I could to get to a thirty yards high aerial of the Dutch broadcasting station at Hilversum, which has a power of seventy kilowatts. I held a compass needle there, but it swung only half a degree out of the true magnetic north. Yet that same needle when placed in the range of the life-wave generator was deflected four to five. Now let me

91724
714



while shrimps, to which only four per cent of kitchen salt had been added, showed no ammonia development.

The principal of the infectious-disease department of Wilhelmina hospital at Amsterdam (Dr. D. Herdersche) experimented with dangerous bacteria and

Examining Milk Kept Fresh for Days without Other Means than the Life Rays; Robert Pape, Discoverer of the System
© Vogt & Peets

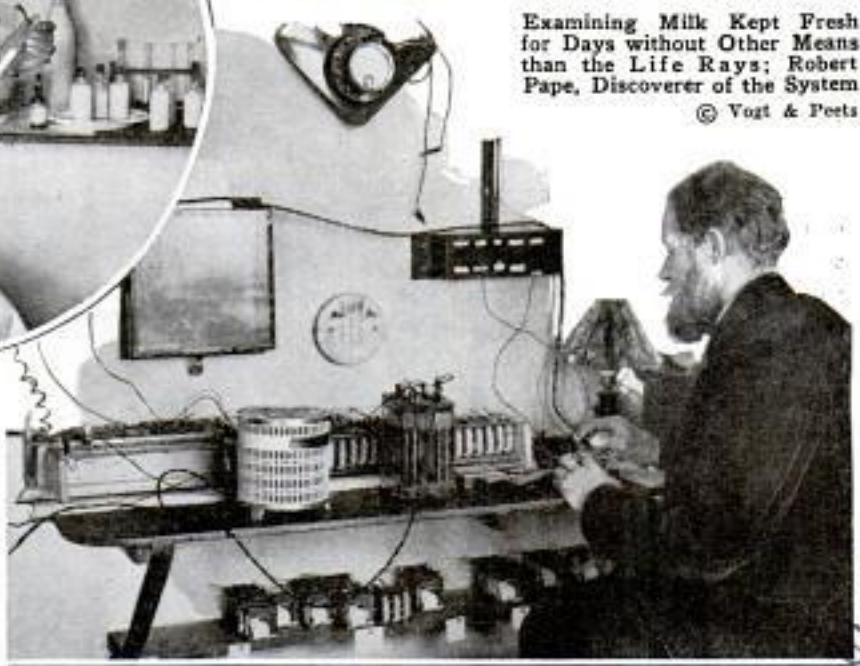

show you how the life wave keeps food products fresh and pure for an indefinite period."

Pape took me upstairs into an attic of the house and showed me food, on plates, quite odorless and undecayed, which had been there for months. There were new potatoes which had been there from June 30, 1930, to August, 1931. They were slightly discolored, but quite fit for cooking and easily to be scraped by the housewife. Yolks of eggs broken on the plates months ago showed no sign of decay and had no odor. He broke the shells of eggs stored in the house at Soest, May 30, 1930, and turned out yolks perfectly yellow and odorless. Steak, hung for many weeks in the house, was dried but quite odorless and fit for consumption.

Dr. A. van Raalte, chief of the Amsterdam meat-inspection service was asked by the Dutch patent council to investigate and report on the use of the waves for conserving food products. For two weeks, he experimented with samples of milk and shrimps, and found that, when kept in the field of the wave machine, they remained fresh and pure much longer than similar samples elsewhere.

"The acid percentage of milk kept in the field of the wave had not increased," says Doctor van Raalte. Fine pears placed in the field maintained all the qualities they had when first placed therein,

found that these pathogenic germs, after they had been placed in the field of the machine from February 7 till February 18, 1931, showed no sign of growth.

ONLY CAUSE OF EXCESSIVE FAT IS TOO MUCH TO EAT

Fat people have been deprived of the conventional alibi, "I gain weight, no matter how little I eat," by recent researches on internal chemistry. The tests showed no abnormality to support the statement, but led instead to the conclusion that the only way to get too fat is to eat and drink too much. The investigation included a careful check on the intake of energy-producing foods, the exchange of energy within the body, and the amount of water absorbed and lost by the fat subjects. Another investigation involved the problem of where the fat comes from and indicated that body fat is built out of fragments of sugars and starches with a possibility that even the proteins, that are supposed to be the dieter's standby, can be split apart to some extent and reassembled into fats.

*Dr. L. H. Newburgh
Univ. of Michigan Hospital
Ann Arbor Mich*

*Dr. William B. Van der...
Amsterdam*

Dr. A. van Raalte

Dr. D. Herdersche

Dr. Pape

*Wm. H. Blachley
Greenville, S.C.*

1919

Hanes Eye-Finishing Co.
POPULAR MECHANICS
LETTERHEAD OF COTTON PAPER
ADDS TO USES OF FABRIC

\$15.00

*George A. Sloan, Pres.
Cotton Textile Institute*

Cotton-fabric letterheads, one of the many uses to which cotton is being put, are fast gaining the favor of big business firms. At the same time, cotton paper is being used for menus in hotels, restaurants and railway dining cars, as well as for radio programs, because of its "crackle-proof" quality. Among other uses are railroad time-tables, book jackets, theater programs, advertising maps, legal documents, children's nursery books and cut-out dolls, calling cards, direct mail advertising material, business and household charts, insurance policies, convention programs, state and municipal license forms and church music. In addition, there is an increasing preference for cotton display posters, which will withstand the elements two to three years—much longer than ordinary paper.

Wm. H. Blachley, Greenville, S.C.



Electric Water Cooler That Kills Germs and "Softens" the Liquid by Precipitation

Water Purifier: 6; 712 W. 6th St. Los Angeles, Calif.

91771
SHOP RESEMBLING HUGE PIANO
HOUSES MUSIC STORE

One Los Angeles music store is advertising its business to the world by its quarters which have been constructed to resemble a huge grand piano. The illusion is made more realistic by real music which issues from a piano just inside the door of the shop.



Music Shop in Los Angeles Which Advertises Its Business by Its Piano-Like Quarters

Scene same 9/1/21

GERMS KILLED BY ELECTRICITY
IN WATER PURIFIER

Killing germs and making the water appreciably softer, an electric purifier has been devised that is almost entirely automatic in its operation. It consists of a five-gallon glass jar with the electric element inserted in the top. When the jar is filled with water, a switch is depressed and the purifier does the rest, shutting itself off automatically when the proper time has elapsed and the correct temperature has been reached. The cost of operation is about one cent per gallon of water.

Purity and Surgery
Dr. R. S. Turner, Medicine and Surgery
Electron College, Berkeley, Calif.

PILLS INSTEAD OF SPINACH
TO SUPPLY VITAMINES

91817
Vitamine-producing material of spinach and carrots, the substance known as carotene, has been isolated and may soon be supplied in a form at which children will not balk, as a powder or a pill, it was announced recently before a meeting of the American Chemical society. A new process has been devised whereby this substance can be produced in a highly concentrated crystalline form at low cost. The pure carotene may also be administered hypodermically when desirable.

Dr. R. S. Turner, Medicine and Surgery
Electron College, Berkeley, Calif.
Henry M. Leicester, Aberdeen College, Aberdeen, Calif.

91785
716

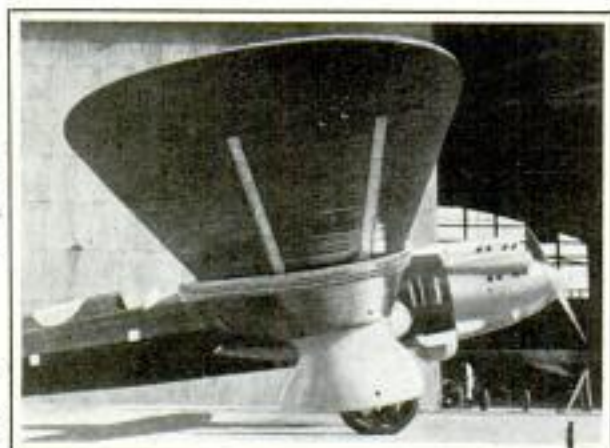

Two Views of Monoplane with Extension Wings; the Outer Sections Can Be Drawn into the Inner Sections When Ship Is in Air

TELESCOPING WINGS ON PLANE ADD TO ITS SPEED

Wings that can be extended from thirty-seven to seventy feet are a feature of a low-wing monoplane which, the inventor claims, will gain increased speed in prolonged flight with the reduced wing area, while retaining the advantage of being able to get off the ground with a heavy load with the wings extended. When in the air, the outer sections of the wings are drawn into the larger inner sections, thus reducing wind resistance. In tests, with wings extended, the craft made 105 miles an hour, and with the shortened wings, its speed was 185 miles an hour.

WASTE OIL MAKES EXPLOSIVE AND REFINES ZINC ORE

New by-products of petroleum, most of them made from "ends" of the oil now wasted, have been developed, and speakers at a recent meeting of the American Chemical Society held out hope that they will aid materially in reducing the troubles with which the petroleum industry is now beset. Improved methods for the refining of toluene, a petroleum constituent and the base of TNT, were described. A new use for methane, or marsh gas, in the recovery of zinc from ore, in which the methane is substituted for the carbon

now essential to the process, was explained. A number of interesting features of the ethyl, or "pure grain," alcohol refined from petroleum were told. Gas from this alcohol, when placed under pressure of 725 pounds at a temperature of 700 degrees, turns into an anti-knock motor fuel, odorless and colorless. When the same gas is given twice the pressure, in the presence of aluminum, copper and nickel catalysts, it becomes a violent explosive, bursting a laboratory bomb set to withstand a pressure of 10,000 pounds per square inch.

91792

AUTOMATIC HITCH FOR TRAILER HAS NO BACKLASH

Instantly attached or detached without the use of tools, nuts or thumb-screws, an automatic coupling

to fasten a trailer to an auto not only allows flexibility but at the same time eliminates rattles and backlash. With the all-steel hitch, the wear is absorbed by a positive locking dog so constructed that any forward thrust causes the coupling to lock tight but still retain its flexibility. A hook for the coupler is attached permanently to the rear of the car, and the coupler can be bolted, riveted or welded to any size or shape of pole. To hitch the trailer, the locking dog is rested on the hook, then pushed down and



Automatic Coupling for a Trailer Which Prevents Backlash and Can Be Attached Instantly

pulled back. In uncoupling, the locking dog is lifted and the process is reversed.

Drain machinery, Paris, France

Petroleum Division meeting 1826

Chicago, Ill. Kimball & Co. 1914 Western

Kansas City Star 9/4/31

The Hagel Mfg. Co
716 E. 12th St.
St. Paul, Minn.

hook only - 756

Web of Glass and Steel Re-Covers Big Hall



Workmen, Engaged in Re-Covering the Grand Palais, Paris, with a Network of Steel and Glass, Look Like Flies Caught in a Giant Spider's Web; the Roof Is 150 Feet High

Heavy wire-reinforced glass, laid in sheets, is used in re-covering the Grand Palais in Paris, where the most important expositions have been held since 1900. The steel supports for the glass roof resemble a huge spiderweb, with workmen clinging to it like flies. The roof is 150 feet above the ground.

"BLIND" PILOTS FLY SIX PLANES IN CLOSE FORMATION

In order to circumvent fog and bad weather, airplane pilots are being trained more and more to fly "blind" when necessary, relying only on their instruments to determine their course and position. Recently army flyers have attempted with considerable success the feat of blind flying in military formation, several ships in usual flight array winging their way through the fog with each pilot directed by his instruments. As a result of such maneuvers, it is possible that, in any future war, fog or poor visibility may be as

much of an advantage in aerial movements as it was a disadvantage during the world war. The experiments were conducted at the army flying school at Kelly field, Texas, where three ships were first sent up in clouds and flown in formation with the aid of instruments, the intervals between clouds giving the pilots an opportunity to recover their position if they lost it. Later the flying was done in thick fog, and finally, when the three-ship formation was mastered, six planes were tried and managed successfully. Army aviators believe now it is entirely feasible to fly even larger units in close formation with the aid of instruments. In the six-ship tests, the last flyer could not see the leader, but was guided somewhat by the outlines of the ship ahead of him at times. In such a flight, the leader relies solely on his instruments, and the rest of the pilots are guided partly by the ship in front and partly by instruments. If forced out of formation, however, they must fly by instruments alone.

at Kelly Field.

N.Y. Times 9/6/31



This article taken and filled

Unloading a White Camel from a Ship to the Dock at San Francisco; the Rope Net Solved the Problem When Other Methods Failed

CAMEL UNLOADED IN ROPE NET FROM DECK OF STEAMER

When "Maida," a white camel, arrived in San Francisco recently from Cairo, Egypt, the crew of the steamer faced the task of landing the immigrant safely. The problem was solved by swinging the animal from the deck of the ship to the dock in a rope net attached to a crane. This camel was brought to America as the mate for "Moses," another white camel now in a San Francisco zoo.

WATER MADE TO HEAT ITSELF AND STORE TIDAL ENERGY

Production of continuous power from the tides has been accomplished at Avonmouth docks, England. When the tide is

low and the storage dock is full, the great head of water drives a turbine, which in turn is connected by a long shaft to a vertical electric generator. Connected to the same shaft is a water brake, turned by the turbine shaft against the flow of the waste water. The friction heats the water to temperatures as high as 388 degrees. This water is stored in an accumulator tank. When the tide rises, and the head is depressed so that the turbine cannot operate, a valve opens and the water turns to steam and runs a steam turbine, connected to a second generator. While the steam pressure falls, the tide is lowering, the pressure head again becomes effective, and the process is repeated.

"STONE" BLOTTER IS RENEWED BY BEING HEATED

A manufactured stone, which blots any ink on any paper, has recently been introduced, cut in a curve like a desk blotter. It weighs just enough to be useful as a paper weight also. It is said the stone blotter absorbs ink instantly, leaves no lint and will not offset. The stone can be renewed by heating it to a red color for a few minutes over a stove burner.

GYPSUM AS A FERTILIZER

Gypsum from Nova Scotia is used in large quantities as a fertilizer and moisture retainer in the peanut-growing districts of Virginia. Large deposits of this mineral are found not only in Nova Scotia but in several other Canadian provinces. In addition to its use in growing peanuts, gypsum is employed, when calcined, for making dental and hard wall plasters.

Canadian Government Bureau of Statistics

new York Warren American Accumulator & Turbo 97

91814 see sheet 96

Deitchbacher

This article on the camel

see also #1812

Q.P. 1/2

material

How Continuous Power Is Produced by Tide

1 AT LOW TIDE THE GREAT PRESSURE HEAD PRODUCED BY THE HEIGHT OF THE WATER IN THE DOCK DRIVES THE WATER TURBINE WHICH IS CONNECTED BY SHAFTING WITH A HEAT GENERATOR AND A VERTICAL ELECTRIC GENERATOR



2 THE HEAT GENERATOR IS SIMILAR TO A TURBINE INTO WHICH WATER FLOWS FROM THE FIXED BLADES ONTO THE BLADES OF THE ROTOR

3 IF THE ROTOR WERE FREE TO REVOLVE, THESE WATER JETS WOULD TEND TO DRIVE IT IN A CLOCKWISE DIRECTION

4 HOWEVER THE ROTOR IS FORCED ROUND ANTI-CLOCKWISE BY THE SHAFT FROM THE WATER TURBINE CAUSING A VORTEX BETWEEN THE BLADES

5 THE FRICTION OF WATER AGAINST WATER GENERATES HEAT AND RAISES THE TEMPERATURE OF THE WATER



6 THE HEATED WATER FROM THE HEAT GENERATOR IS CARRIED TO THE ACCUMULATOR AT A TEMPERATURE UP TO 306° FAHR.

7 WHEN THE TIDE HAS RISEN TO ALMOST THE LEVEL OF THE WATER IN THE DOCK THERE INTERVENES A PERIOD WHEN LACK OF PRESSURE HEAD PLACES THE WATER TURBINE OUT OF ACTION

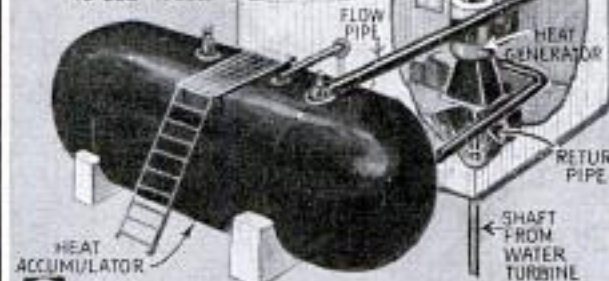

9 THIS DRIVES THE STEAM TURBINE WHICH IN TURN SUPPLIES POWER TO ROTATE THE ELECTRIC GENERATOR No. 2 AND SO CONTINUES TO SUPPLY ELECTRICITY FOR THE PERIOD WHEN THE WATER TURBINE IS OUT OF ACTION

8 AS THE WATER TURBINE GOES OUT OF ACTION THE VALVE OF A STEAM TURBINE IS OPENED AND THE HEAT FROM THE HEAT ACCUMULATOR IS RELEASED IN THE FORM OF HIGH-PRESSURE STEAM

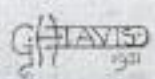
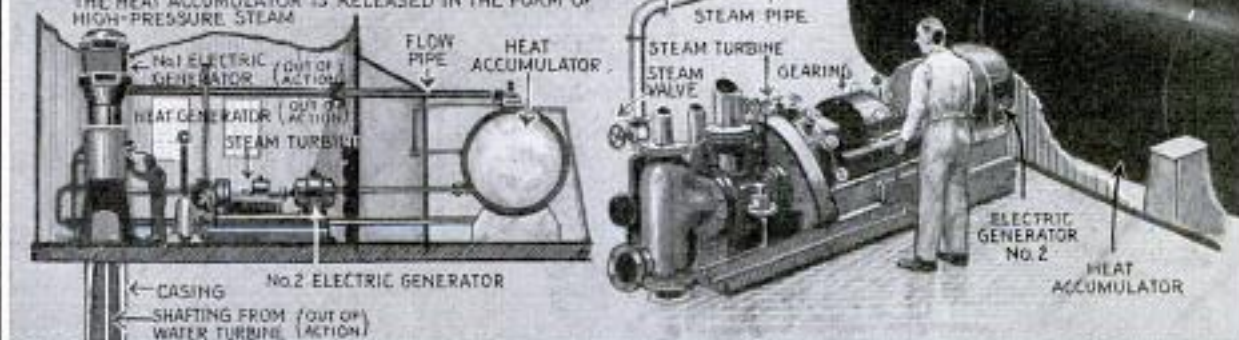

Dr. W. Herbert J. Hoopes Loom

720

POPULAR MECHANICS

a 1998 *designer* *Sanford Mills*
MAN-MADE FUR SAVES ANIMAL
LIFE FROM EXTINCTION
Sanford Maine



Artificial Coonskin Made from the Wool of the Angora Goat by Loom That Took Years to Develop

Conservation of the natural supply of fur-bearing animals is expected to be aided by the development of a realistic man-made fur woven from mohair, the fleece of the Angora goat. A loom has been devised that will handle long and short hairs at the same time, leaving a shaggy, fur-like product. The new material is called "koongora" because of its resemblance to coonskin.

BARE LANDS CAUSE OF FLOODS SHOWN IN CHINA

China's disastrous floods which take a toll of thousands of lives almost annually are caused by irregular and abnormal rainfall descending on arid plains barren of vegetation. This is the explanation vouchsafed by the United States department of agriculture. In some regions of China, a rainfall of one or two inches one month may be followed the next by a deluge of from twelve to twenty inches. The rains in China are always heavier in summer than winter, and, during a normal year at the city of Hankow, the focus of this year's disaster, there is a difference

Science Service
9/4/6

Dept. of Commerce

of forty feet in the river's level for these seasons. Centuries of intense cultivation in China have stripped the land of vegetation because everything grown must be edible. Thus, when the rains fall, there is no spongy green carpet to absorb the waters and they rush to swell the large rivers or their tributaries. As a result, the Yangtze reaches the broad alluvial plains and spreads out over the country in one muddy, death-dealing blanket. Attempts have been made to control this river with wooden dikes, but they have been unsuccessful, although the river itself deposits material along its banks each time it overflows until, in some sections, it is actually higher than the surrounding plains. Masses of Chinese live in this flood plain below the river, to take advantage of the rich soil, and when the flood comes, they often pay with their lives.

a 1965

ACTION OF SHOCK ABSORBERS CONTROLLED BY LEVER

Actions of hydraulic shock absorbers now can be controlled by a lever located on the instrument panel of the automobile, thus enabling the driver to adjust them according to the condition of the roads. The appliance is known as a ride selector, and the control lever can be placed in three positions, making it possible to enjoy the soft resiliency of the car's springs on smooth roads or to bring all four shock absorbers into instant use for rough parts of the highway. Also, body swaying and weaving are reduced by the device, it is claimed.



Lever on Instrument Panel to Control Action of Hydraulic Shock Absorbers, and Diagram Showing How Control Operates

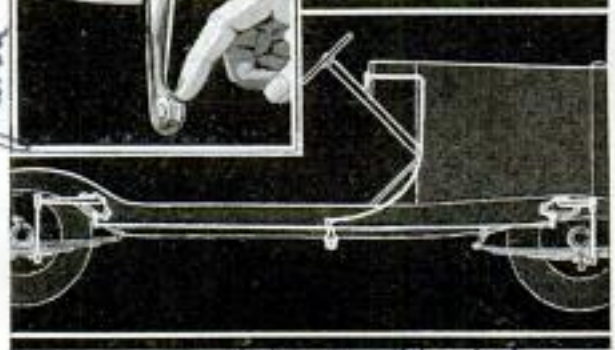

Monroe Auto Equipment Co., Monroe, Mich

Christian Science Monitor 8/19/31

**GREENLAND 'BOWL'
COVERED BY TWO
MILES OF ICE**

Ice in the center of Greenland that is 2,700 meters thick, slightly more than one and two-thirds miles, has been reported by members of the expedition headed by the late Dr. Alfred Wegener. Followers of Wegener consider this as complete proof of his theory of the shifting of continents. They declare that such great thickness is proof that its weight sunk the solid rock until a cross section of Greenland resembles a bowl filled with ice. The opposite process is noted in Scandinavia, which has risen six meters in 600 years and still is gradually rising. Another argument in favor of the Wegener theory is that Greenland moves thirty-six meters every year toward the west and that the American and European continents are believed to be slowly drifting apart.

**CIGARETS EXTINGUISH SELVES
WHEN THROWN AWAY** *a166*

Treating cigarets so they will extinguish themselves in a reasonable time when thrown away has been tried with success as one method of reducing the danger of forest fires. No change in the taste of a cigaret so treated is noticeable, although there is a certain dryness easily counteracted by humidification. Cigarets treated to extinguish themselves were tested by the forestry service and virtually all went out in what was considered a reasonable time after being tossed aside. The chief difficulty in having all cigarettes so treated is that the process would involve some additional expense for the tobacco manufacturer.

NY Times 8/9/31
 Scheduled American airlines carried 417,505 passengers in 1930.



Italian Liner "Rex," as It Appeared When Launched at Genoa; It Has Been Termed the Fastest Vessel on the Atlantic Ocean

**ITALIAN SHIP CALLED FASTEST
ON THE ATLANTIC OCEAN**

Another greyhound of the deep was launched recently, when the Italian liner "Rex" splashed into its element at Genoa. This giant liner of 50,000 tons promises to compete for speed with the big boats of other countries and, at the time of its launching, was hailed by its owners as the fastest vessel on the Atlantic ocean.

**TYPHUS CARRIED BY RAT FLEAS
EXPERIMENTS PROVE** *a1679*

Fleas, long suspected of transmitting endemic typhus fever in this country, have been convicted of the offense by conclusive evidence gathered by workers for the public-health service. The proof was obtained in the course of laboratory tests through inoculating white rats with the typhus virus and then putting fleas on them. Some of these fleas later were emulsified and injected into guinea pigs, which soon showed signs of the disease. Infected fleas were also placed with sound ones, some of which caught the fever.

Dr. W. E. Flyer, A.S.P.
Amreich and L.F.
Badger
Science Service 8/11/31

Q 1528 Cmt. M. B. Schnäpfer,
2018 & 12 St. Bivobly
ny

The Scientific **MIRACLES**



gion in complete harmony. Built during the Middle Ages as the center of the Holy Roman empire, the Vatican City became the cloistered home of the Catholic religion and only in 1928 awoke from its medieval lethargy. Then—three years ago—began the gigantic task of reshaping the state into a modern metropolis.

It is the first state to possess a fleet of helicopters and a unique landing field for them.

An electric railroad,



Pope Pius XI Uses the Most Modern Business Conveniences, Including the Dictaphone; Below, the Gold and Enameled Telephone Presented to Him

WITHIN the ancient walls of the Vatican City today rises one of the greatest scientific centers the world has ever seen. The aura of antiquity still lingers over the Holy City, but only as a fading contrast with machine-age dominance. The sixteenth and twentieth centuries clash frequently within the few acres that comprise this smallest of the world's states. Always the twentieth century wins out, always the old gives way to the new.

Science and religion interlock there in one friendly grasp. There are no concessions or compromises. Religion has taken science under its warm cloak and uses it to spread the Gospel over the face of the earth, aid missionaries everywhere, educate and hold the faithful.

The Vatican City stands today the symbol and embodiment of science and reli-

virtually accident-proof, connects the Vatican City with the outside world.

A sumptuous train, equipped like a modern palace on wheels, stands ready to take the pope where he will.

The 632 citizens—hardly the number of employes in a good-sized department store—have a super water-supply system all their own.

of the VATICAN CITY

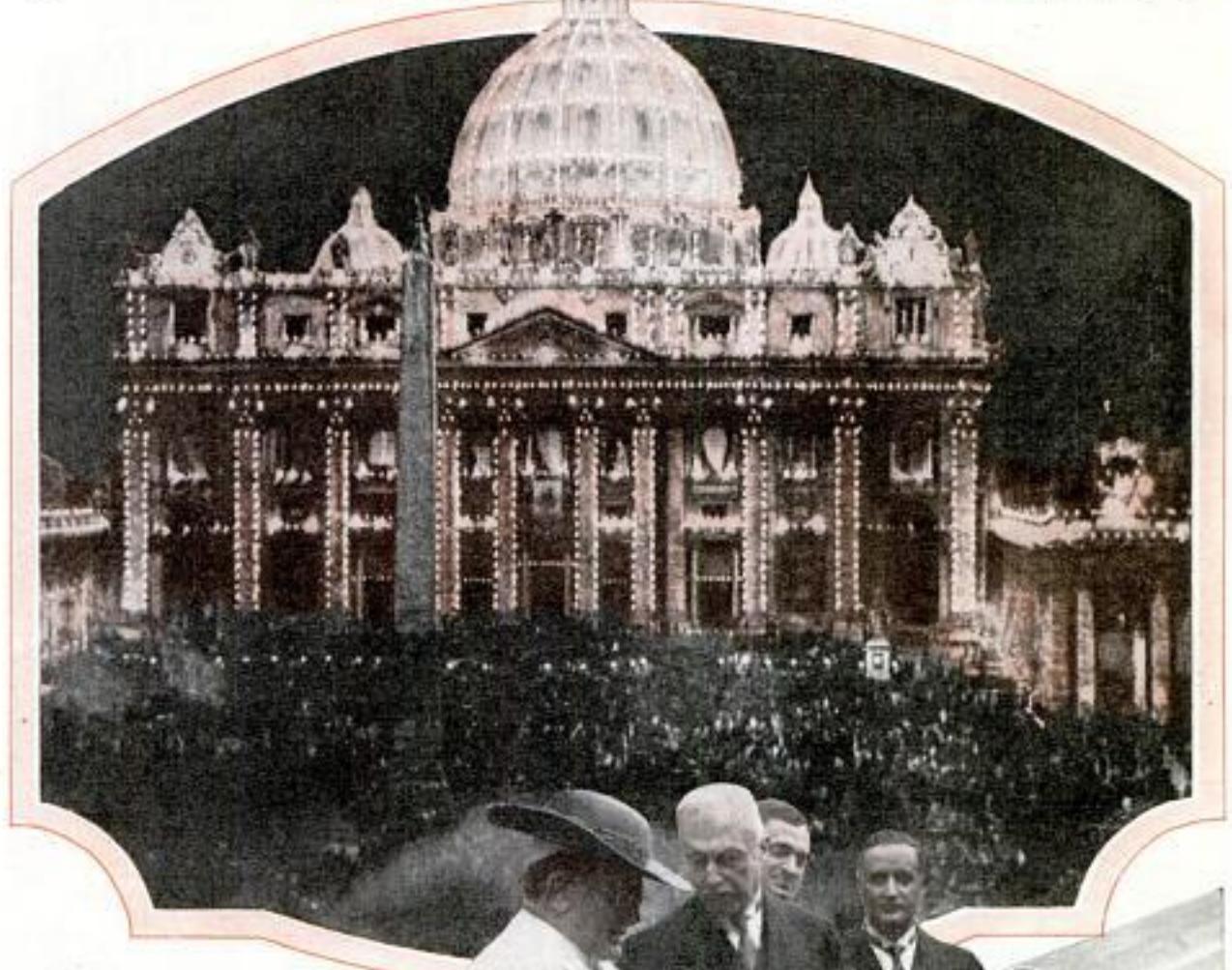

The mightiest radio station and receiving set, built by Senator Marconi himself, can tune in on or send messages to any part of the world.

An automatic telephone system, the last word in service, has direct transatlantic connections.

The Vatican City's telegraph, wireless and postal systems are completely up to date.

A powerful printing plant turns out papers, books and pamphlets at extremely high speed.

One of the most scientifically up-to-date observatories is constantly searching the skies.



St. Peter's Cathedral Beautifully and Brilliantly Illuminated, and, Below, His Holiness Inspects the New Automobile Given Him by the Makers

A splendid example of the pope's eagerness to make the Vatican City a model scientific metropolis occurred recently. In introducing His Holiness just before he made his world-wide radio address on



Official Dedication of the Super-Power Vatican Radio Station; Below, International Telegraph Explained to Officials

The next day the pope ordered the installation of elevators of the type used in the Empire State building.

The railroad station, the tall masts of the wireless station, the strong steel bridge leading to the observatory—all seem to be anachronisms, as the great ancient walls of the city look down upon them. As each twentieth-century structure goes up, as helicopters zoom overhead and electric trains roar below, the ancient walls rumble as if with fear.

Just to the rear of St. Peter's rises the most completely modernized section of the Vatican City. This section, a third of the state, yesterday was a hill. Giant excavators, hissing fire and steam, appeared one day and ate it up. In the center rises the official residence of the governor of the Vatican City, looking very much like a swanky Fifth Avenue building. It lacks nothing in the way of modern conveniences. It contains two luxurious apartments for visiting royalty. These are fitted with duplex bedrooms, kitchenettes and

labor, Mgr. Francis F. Spellman leaned over to the pope and said:

"By the way, you know there are several elevators in the Vatican. The oldest one is a water elevator presented to the pontiffs by the late Emperor Francis Joseph of Austria. It goes at a speed of about one floor per minute. When Mr. Raskob (he was present at the broadcasting ceremonies at the Vatican City) saw it, he remarked that the elevators in the Empire State building do about eighty floors in the time it takes the Vatican elevator to do one."

ultraviolet ray lights. On either side of this imposing structure are other buildings of recent construction, including the wireless station, the school of mosaics, the offices of St. Peter's, the railroad station, the Ethiopic college, the Church of Santa Marta and the law-courts building.

To the right of this section stands one of the world's unique airfields, especially for helicopters. The planes themselves were built by Coridino

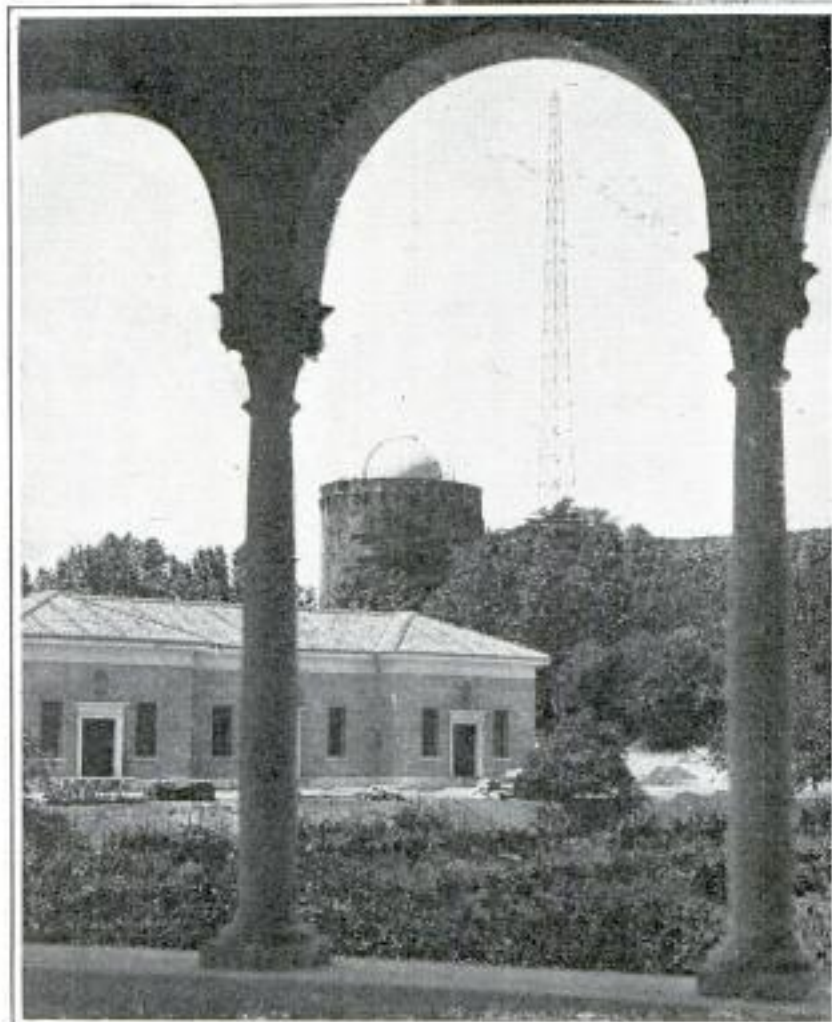

The Pope Making His Second Radio Address, Above, and the Radio Plant in the Vatican Gardens over Which the Message Was Sent to the World

ters is an amusing one. According to the Lateran treaties of 1928 any Vatican City airplanes were not allowed to land in Rome, thus eliminating the possibility of a papal air fleet because of scarcity of land within the Vatican City large enough for an airfield. Just when it appeared that the pope would be obliged to give up all thought of aviation, Signor d'Ascanio's helicopter experiments were successful.

There are 975 telephones for the 632 Vatican citizens. Service to Rome is provided by thirty circuits, through an automatic switchboard, while six trunk lines permit connections with the world. The finest transatlantic radiophone service can be had.

A series of radio, land wire and submarine cable, totaling more than 4,700 miles, connects the Vatican City with the United States. The cost of a call between New York and the Vatican City

d'Ascanio, Italian rival of the Spanish inventor, Juan de la Cierva, under the supervision of Vatican engineers.

The reason the pope ordered helicop-

and submarine cable, totaling more than 4,700 miles, connects the Vatican City with the United States. The cost of a call between New York and the Vatican City

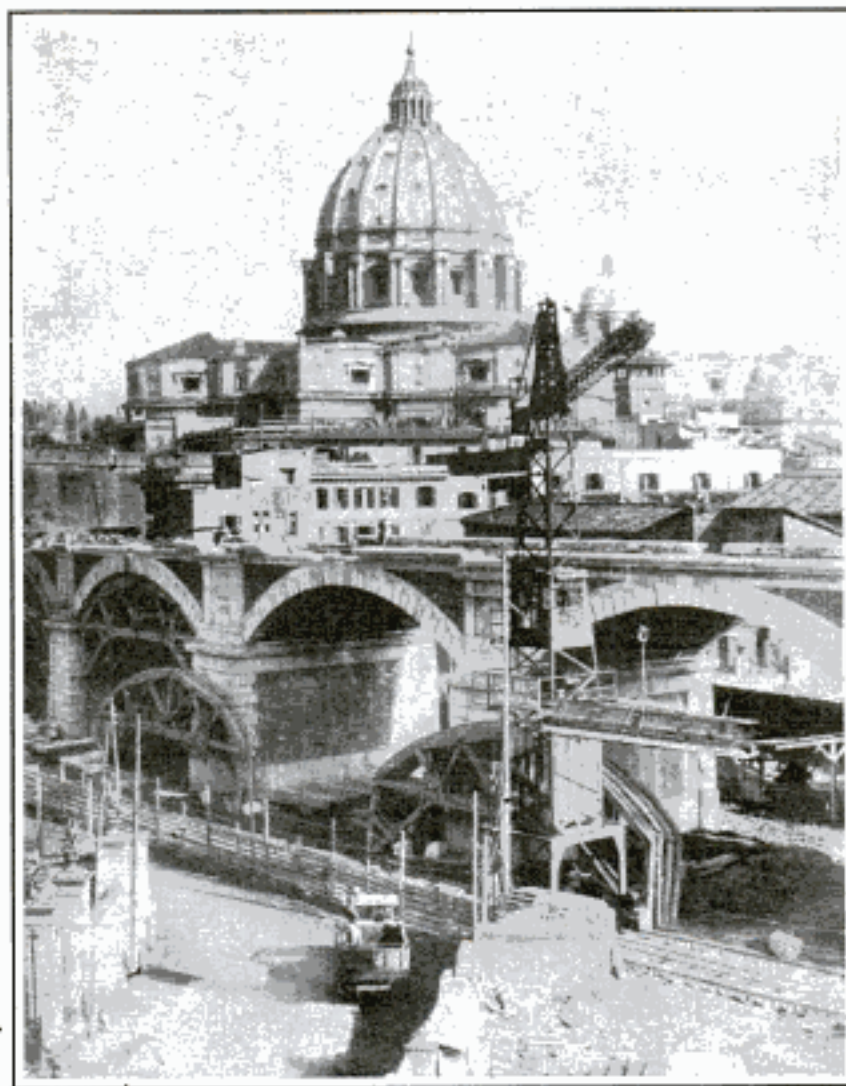

Building the Viaduct for the Railroad Link between Vatican City and the Italian Railway System; St. Peter's in Background

is \$36 for the first three minutes and \$12 for additional minutes.

Telephones are installed everywhere, even on and in the huge ball on the dome of St. Peter's. From the lowly city janitors to the high prelates, all are provided with telephones. A special feature includes a device which registers the number of the telephone making the call.

The phone placed in the pope's workroom is of solid gold with costly enamels of his coat of arms and the symbols of the four Evangelists. This telephone has a special device so that no calls may reach it—"102, Citta del Vaticano"—unless orders are given at the switchboard that they are to go through.

Transportation for many years was one of the city's major problems. During the centuries that the pontiffs remained closed up in the Vatican proper, it was bad enough—very few vehicles were allowed

to enter. With the invention of the steam engine and the automobile matters became worse. Only horse-drawn vehicles were permissible as late as 1928.

The transformation began soon after the present pope's elevation to the chair of St. Peter. On New Year's day of 1928 Pope Pius XI abolished all horse-drawn vehicles, replacing them with motor cars and motor trucks. The magnificent and historic coaches, which once formed the pride of the pontiffs, were moved to the Vatican City museum.

So pleased was the pope with the automobile that he soon announced plans for the building of a railroad viaduct from the heart of the city to the Italian state railway at Rome. Today electric trains, built along accident-proof lines, race to and fro.

Then there is the postal service of which the pope is so proud. Letters mailed to anyone in the Vatican City are delivered within a few minutes by means of a great cable system. But about half the mail received from Italy at the Vatican City post office is held for short postage. The reason is that, as the Vatican City is foreign territory, it costs as much to send a letter from a box in St. Peter's Square, Rome, only a few hundred feet, to the Papal State as it does to dispatch one to any other foreign country.

After a lapse of fifty-nine years, the Papal State has resumed its place among the stamp-issuing countries of the world. By a new process the Vatican City stamps are beyond imitation by counterfeiters. By wetting the stamp, the design will reappear on the back side in a second. If it does not reappear, the stamp is a counterfeit.

The inauguration of the Vatican City's

own coin exchange was a feat that few believed mechanically possible. How could such a tiny state issue its own coins? The cost of the equipment alone would be higher than the value of the coins. The inventive heads of the Vatican evolved, within a few weeks, a machine that turned out 10,000 commemorative sets of nine coins each within a day.

The papal observatory is the result of painstaking researches. With the modernizing of the Vatican City, Pope Pius XI had the observatory renovated according to the plans of the late Father John George Hagen, the only Vatican citizen of American origin. He died in his eighty-fourth year, the oldest astronomer in the world.

The climax of the pope's program to make the Vatican City the most scientific in the world occurred recently with the installation of the giant broadcasting station. With it the pope is able to communicate with stations as far distant as Alaska or Argentina.

In the pontiff's office there is a special microphone that will permit him, whenever he wishes, to broadcast to the world, or to carry on telephonic conversations with papal nuncios, delegates or legates thousands of miles away. Each diplomatic representative has been supplied with a ten-tube short-wave receiver designed by Marconi and his engineers for direct radio communication of instructions from the pope.

TALKING WIRE RECORDS SOUND FOR HOME OR OFFICE

Words and music may be recorded and reproduced by an instrument in which is embodied a "talking wire." A steel wire is used for recording sound which may be played back hundreds of times. In the home, the talking wire is useful for recording voices of the family and friends or to capture favorite radio programs which may be reproduced at leisure. But it is in the office

where the talking wire will be of the most benefit, since it is fast and accurate in dic-



tation. Hand-operated mouthpieces are eliminated, and the transcriber need not use clumsy earphones, merely listening to the dictation being "played back" as one would to a radio or phonograph. Words or phrases may be erased by pushing a button and the corrections inserted during the operation or later. The instrument is easily carried.

AUTOMATIC GATE STOPS AUTOS AT GRADE CROSSINGS

Grade-crossing fatalities are being reduced by an automatic railroad-crossing gate which swings into place as a train approaches. The metal gate with a large stop sign on it is operated by hydraulic power. On approaching a crossing a locomotive makes a contact on the rails which sets the hydraulic pressure in action and the gate swings shut by gravity.

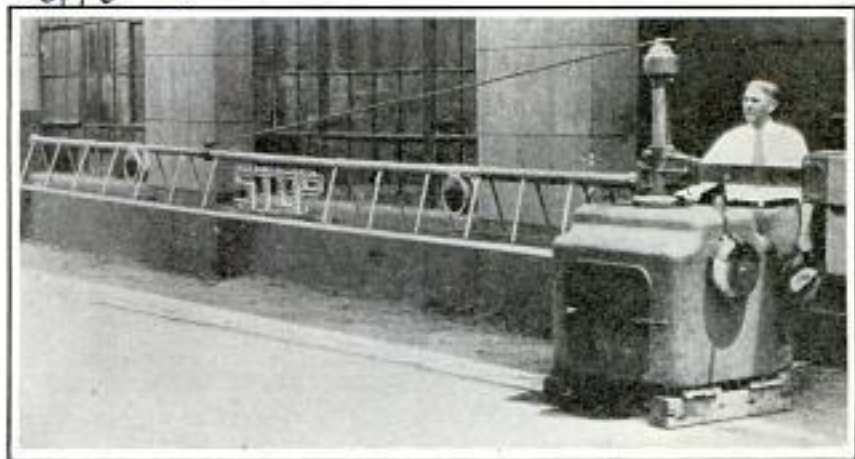

Automatic Railroad Crossing Gate Which Swings into Position as a Train Approaches; It Is Operated by Hydraulic Power

Copyrighted by Inter-Ocean Publishing Co. 270 Broadway, New York City

Tested by Korner Engineering Co. 2026 Santa Fe Ave. Los Angeles, Calif.

Inv. M. H. Wilson. St. Louis, Mo.

Copyrighted material

Magnograph Corp. 621 S. W. 1st St. Los Angeles, Calif.

a1499

How



TEST NO. 1

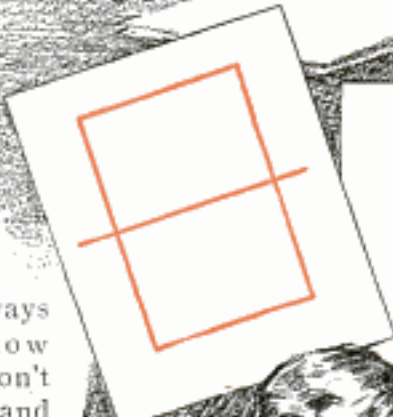

TEST NO. 2



THERE are quick ways of finding out how smart you are. You don't have to wait a lifetime and then, at the end of it, figure out what were your good moves and your mistakes.

The secret of it is that tests are made on the simplest matters of knowledge that everybody has. A test of book learning is absolutely what is not wanted. The purpose is to ascertain the speed and adaptability of the brain-machine.

You may try a psychology test on yourself and give your mind a rating. Below you will find a series of tests arranged by a group of leading psychologists and psychiatrists. The tests are scored for accuracy and speed. You can take a sheet of paper to score yourself, lay your watch on the table and give yourself all the series except Nos. 4, 5 and 6, which are performance tests. A friend can easily give

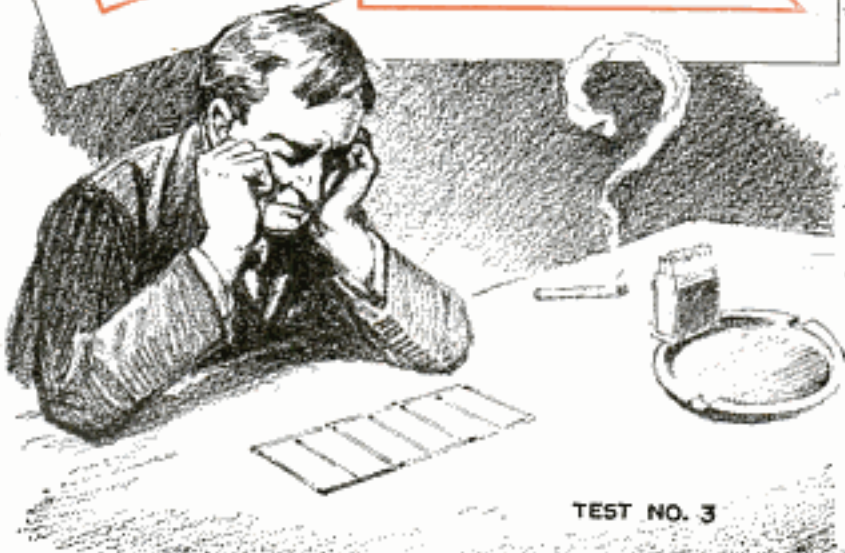

TEST NO. 3

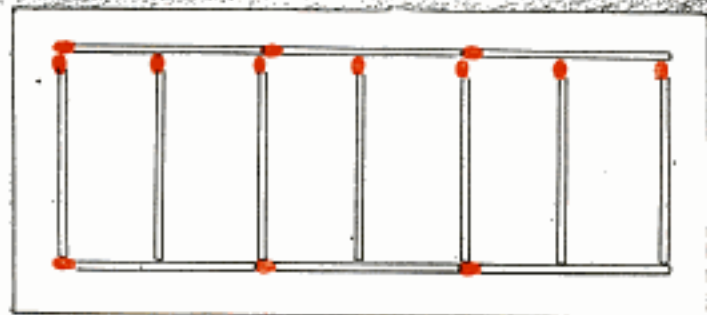

These Illustrations Will Help You Visualize the Problems When They Are Read in the Article

Smart are You

by A. de Ford Pitney

you these at any time to complete the record.

One word—don't read the tests over first and ponder them. They are supposed to be shot at you out of the air. Time yourself closely. Quick reactions are heavily rewarded, just as they are in life.

Each test must be finished

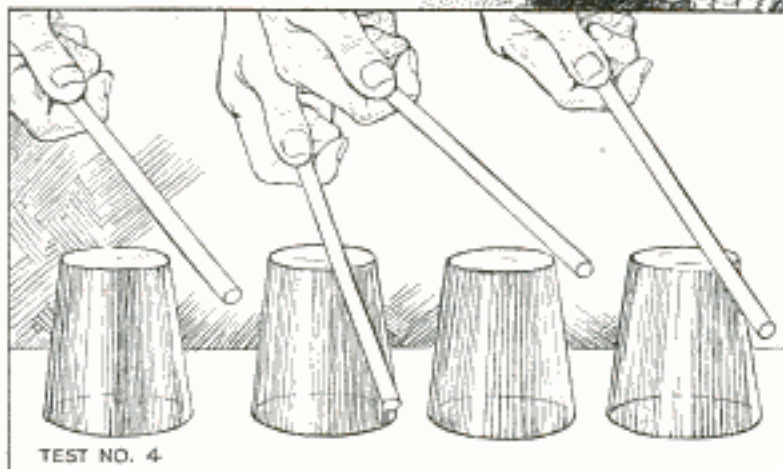

TEST NO. 4

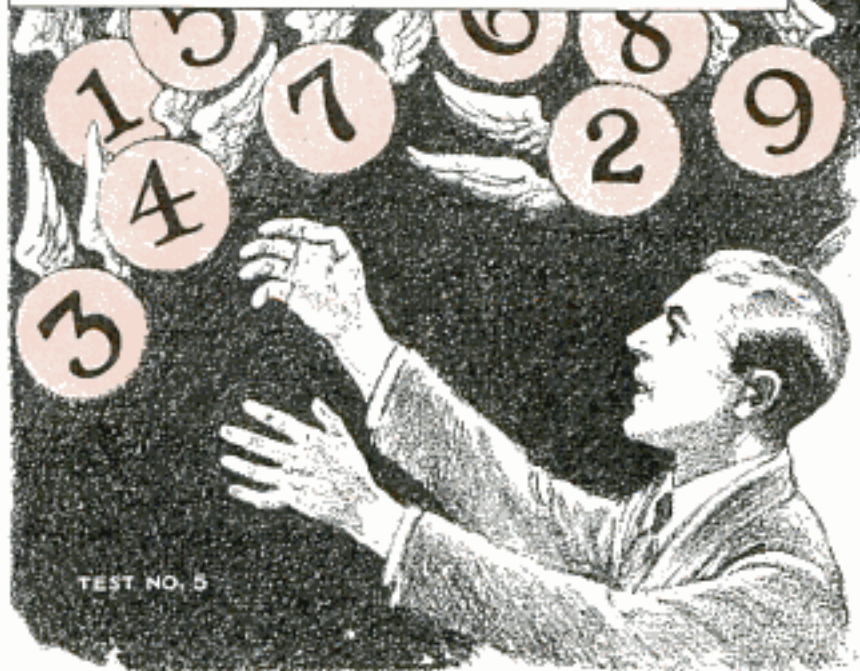

TEST NO. 5

in the time given at the end.

No. 1. Go around the outline shown in the illustration with a pencil in one stroke, without lifting the pencil or going over any part of the outline twice. Score 10; time 1 minute.

No. 2. This outline is a square with the half of another square added. Divide it, without changing the outline, into four parts of exactly the same size and shape. Score 10; time 3 minutes.

Was the Manufacturer Right When He Fired the Watchman? Remember the Picture When You Take Test No. 5; It Will Help

a1449
730

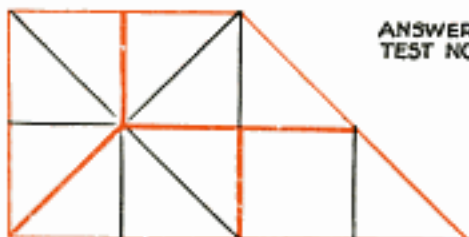

ANSWER TO TEST NO. 2



ANSWER TO TEST NO. 1



ANSWER TO TEST NO. 3

No. 3. Take thirteen matches and make six dog kennels, like those shown, all the same size and shape. Now, take away one match and with twelve matches make six dog kennels again, all the same size and shape. Score 10; time 5 minutes. Increase score by 1 point for each minute under five.

The next three are performance tests of attention and memory. Somebody else will have to give them to you.

No. 4. Set four stout glasses in a row on a table. With a ruler or a short stick the person giving the test will tap the glasses rapidly (at least four taps a second) in irregular sequence, skipping about over the row. Try first four taps and stop; then five taps; then six, and so on. You will sit opposite the person giving the test, and when he stops, you are to take the stick and tap the same glasses he did in the same order. If you make a mistake you can't correct it.

Three tries are allowed after each success and you have three tries to start. If

Don't Use the Same Paper Twice; Take a Fresh Sheet for the Second Cut in Taking This Test

you make four in three tries, you have three tries to make five. If you succeed, you have three to make six, and so on. Score 10 for six; below six, no score; add 2 points to score for each one over six.

No. 5. The examiner will pronounce snappily, but not so rapidly as not to be perfectly clear and distinctly separated, numbers between one and nine in irregular order. He will begin by giving four scattered numbers, then five, then six numbers, and so on.

You will repeat back the numbers in the order given, first forward, then backward. The examiner will note separately the number of digits you can repeat forward and the number you can repeat backward. One try only is allowed. Score 10 for 6 forward and 5 backward; below that no score. Add 1 point to score for each additional number, either forward or backward.

No. 6. The examiner will fold, while you watch him, a sheet of letter paper once crosswise, again crosswise, again crosswise, again crosswise. He will then take a pair of scissors and cut off the top corner on the back of the fold, at the angle where the last two folds were made. You will tell him, before he unfolds the paper, where the holes will appear in the sheet.

The examiner will then fold another sheet in the same way and this time cut a V-shaped notch through the back of the last fold. You will tell him, before he unfolds the sheet, in what position the holes will appear. Score 10; time 5 minutes for each question; 5 points allowed for correct answer to either question. Add 1 point

to score for each minute under 5 for either question.

The next questions estimate reasoning ability.

No. 7. A stranger goes into a clothing store and buys a suit for \$20, giving a check for \$35. The dealer has to get the check cashed by a neighbor to give the change. The customer goes away with the suit. The check is discovered to be no good. The dealer has to refund the \$35 to the man who cashed the check. The cost to the dealer of the suit was \$15. How much did he lose altogether? Score 10; time 2 minutes; no bonus.

No. 8. You have to bring exactly 6 gallons of water from a flowing stream. You have a 7-gallon can and a 4-gallon can to measure the water. Can you do it, and if so, how? Score

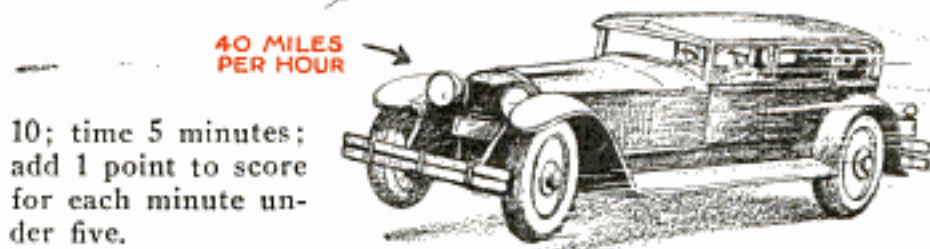
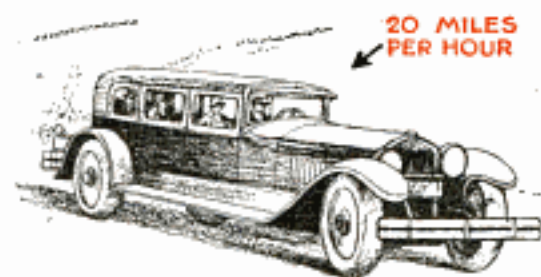
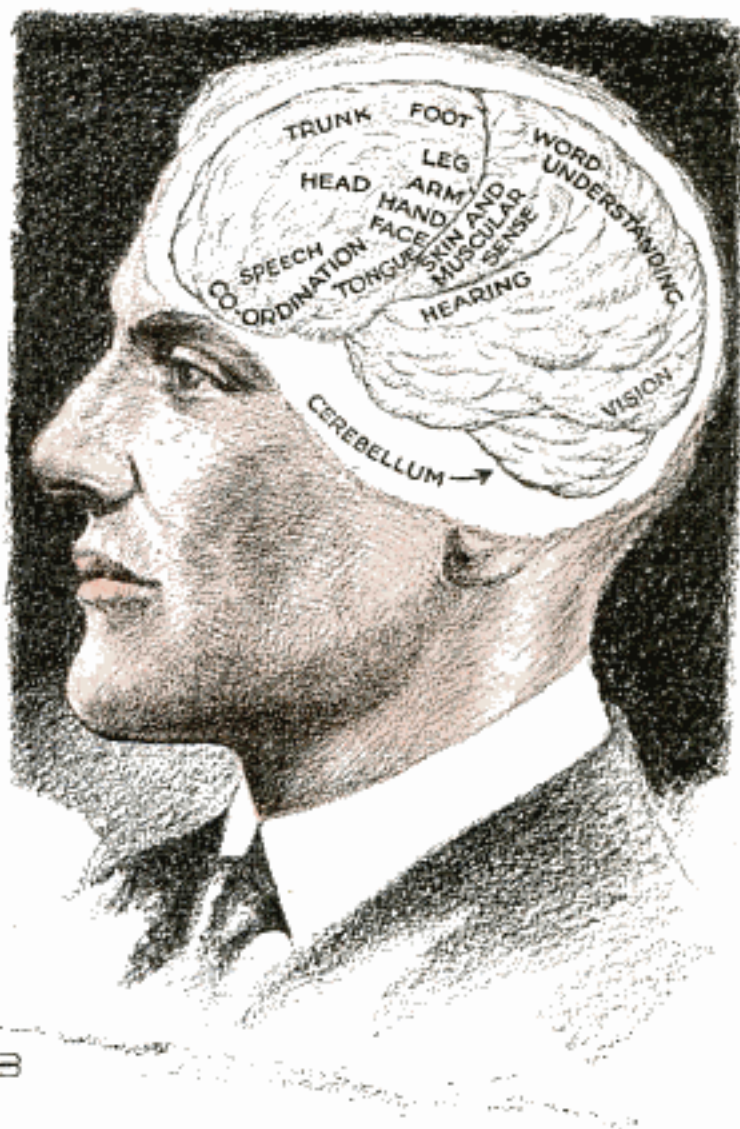

10; time 5 minutes; add 1 point to score for each minute under five.

No. 9. Because of heavy traffic you are able to make only 20 miles an hour on an 80-mile motor trip. But you come back at the rate of 40 miles an hour. What was your average speed? Score 10; time 5 minutes; add 1 point to score for each minute under five.

No. 10. Follow this closely. It is against the rules to repeat. Don't reread.

A midde-west manufacturer decided to make a hurried trip to New York Saturday night. He needed papers from the factory safe. The night watchman came

in, interested in what the boss was doing. When the manufacturer said he was obliged to make a business trip east, the man begged him not to go.

"Don't do it," he urged the manufacturer. "Something bad will happen. Last night I dreamed you took a railroad trip and there was a terrible calamity, a train wreck and an explosion. It was horrible. Please don't go." "Oh, shucks," said the manufacturer, "I've got to go. You are

TEST NO. 9

91449

letting your imagination run away with you. Forget it. Did you have a good time Thursday on your holiday?"

"Yes, sir. But please don't go on the train tonight. I am afraid." The manufacturer went anyhow and came home safely. When he got back he immediately discharged the watchman. Why did he do so? Was he right? Score 10; time 5 minutes; add 1 point to score for each minute under.

If you score 75 in these tests you are well up with the average thinker. The climb above 75 is a hard one. Don't read the answers until you have finished all the tests.

Here they are:

No. 7. He lost the \$15 change given the customer and \$15, the cost of the suit.

No. 8. Fill the 7-gallon can. From the 7-gallon can fill the 4-gallon can, leaving 3 gallons in the 7-gallon can. Empty the 4-gallon can. Pour the 3 gallons from the 7-gallon can into the 4-gallon can. Fill the 7-gallon can. From it fill the 4-gallon can. As it had 3 gallons in it, this will take exactly 1 gallon, leaving the required 6 gallons in the 7-gallon can.

No. 9. You traveled 4 hours out at 20 miles an hour and 2 hours back at 40 miles an hour: Total distance covered, 160 miles; time elapsed, 6 hours; average speed $26\frac{2}{3}$ miles an hour.

No. 10. The night watchman let it slip that he was asleep Friday night, dreaming and having nightmares about things happening to the boss. The employer fired him for being asleep on duty.

THIS WILL GIVE YOU ANSWER TO SPEED PROBLEM

Your brain is a double-acting machine, according to modern psychology. Your brain machine works both in analysis, which is the taking apart of ideas to get at their components, and in synthesis, which is the creation of new combinations from materials most often obtained by analysis. Here is a psychological test which will show to which side your brain inclines, analytical or synthetic? It gives an interesting glimpse of your mental machine at work. Owner of a ninety-mile-an-hour speed boat raced it against a railroad locomotive of the fastest type, tuned to eighty miles an hour. For the trial, the track was cleared 200 miles along a river. A 150-mile-an-hour airplane started at the same time to measure its speed against the boat and locomotive. The boat's performance was disappointing at first. When the locomotive had made eighty miles, the boat was ten miles behind. From then on the boat made its full speed. The airplane flew ahead of the boat five miles and then back five miles over the course until the locomotive was exactly five miles ahead of the boat. After that the plane flew back and forth above them until the boat was abreast of the locomotive, at which time the boat gave up and the race ended. How far did the plane fly? This calculation, involving so many

factors of changing distance between moving objects at different rates of speed, is a test of accurate thinking and close observation. Time yourself on this before you check up your result with the answer, and then try it on your friends and see how quickly they can do it.

THE ANSWER—A thinker of the thorough analytical type might begin by carefully calculating the different trips of the plane above the racers. This type of analytical thinking is one of the most valuable in the world, but it should be applied first to a general survey of every phase. The purely analytical thinker may get his nose too close to the problem. In this case, calculating the plane's separate trips would be a job for an Einstein, but the elapsed time gives an accurate answer instantly. The locomotive and the boat were even at 160 miles. The boat made 70 miles at first while the locomotive made 80, which was an hour's run. Then the boat made its full speed of 90 miles an hour and came even with the locomotive. Ninety plus 70 makes 160, and 80 plus 80 makes 160. That was two hours' run for the locomotive. In two hours the plane, at 150 miles an hour, flew 300 miles.

Those wishing further information on anything described in the editorial pages can obtain it by addressing Bureau of Information, Popular Mechanics Magazine, Chicago.

91738

Cont. A de Ford Pitney Geneva, Ill

TREASURE SHIP RAISED IN HUNT FOR GOLD WORTH MILLIONS ¹⁴⁶

Piece by piece and section by section, a salvage ship is bringing to the surface the twisted masses of plating that formed parts of the liner "Egypt," which went down off the coast of Spain in 1922 with gold bullion worth \$5,000,000 aboard. Divers from the "Artiglio," the salvage vessel, first descend and cut away cabin partitions and other parts of the hurricane deck which then are raised with cables. The "Egypt" went down in 400 feet of water after being rammed by a French cargo steamer. For years plans have been made to recover the fortune in gold.

ROBOT PILOT GUIDES AIRPLANE BETTER THAN HUMAN ONE ^{a1686}

Blind flying through fog, the greatest obstacle to safety in the air, is believed to have been greatly discounted as the result of the completion of a mechanical pilot, recently demonstrated in California. In flights above the Alameda airport, the device not only controlled the plane better than its human occupants could, but it took the ship out of tail spins, put the plane through perfect turns, and controlled speed, altitude and landing glides.



"Robot Pilot" Which Operated Plane Better than Human Could in a Recent Demonstration

Inv. George V. Beeson, San Luis Obispo, Calif.

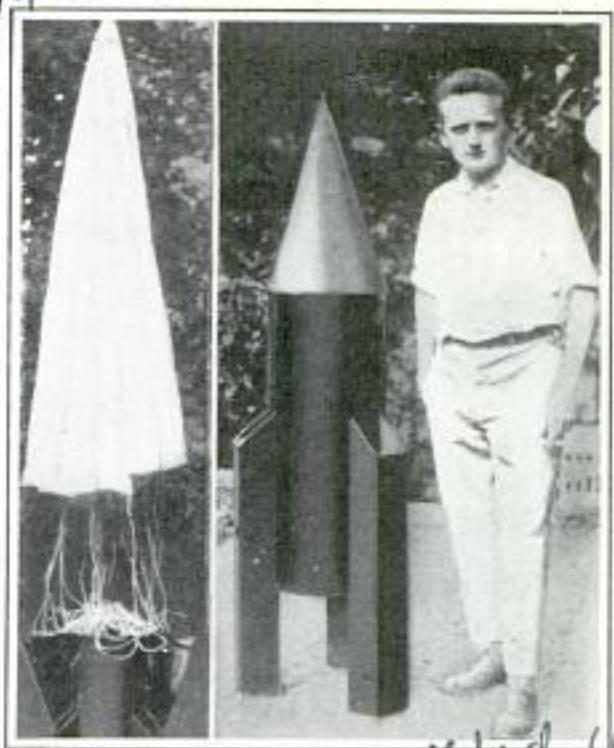

Rocket Motor and Its Inventor on Right, and at Left, How the Parachute Saves It from Damage

PARACHUTE ON ROCKET MOTOR PROVIDES EASY LANDING ^{Belz}

Landing without damage to his rocket motor is provided by Wilhelm Belz in a parachute which opens mechanically when the rocket reaches its greatest height. Belz, who invented the rocket, starts and releases the motor, which mounts high into the sky, then lands gently with the aid of the parachute.

WORK WITH FROZEN CONCRETE SPEEDS WINTER BUILDING ^{a1669}

Winter building operations in Russia are being made possible by one contractor's use of frozen concrete. The work is done in the open air during severe winter weather to force the concrete to freeze before setting. All forms into which this concrete has been poured are protected until spring. As the process of thawing starts, the frozen concrete must be moistened carefully to bring about correct setting of the forms. Although this method ties up the form work for a considerable time, this objection is slight in comparison with the advantages of getting concrete placed during the winter.

There were 13,500,000 radio sets in use in the United States at the end of 1930.

article by A. M. Esenberg engineer, Charkov, U.S.S.R. Copyright material

Wide World
Bernman
Engineering News Record 8/6/31

a 1830 Cont. J. N. Miller,
Park Central Hotel
Washington, D.C.

Harnessing the Earth's

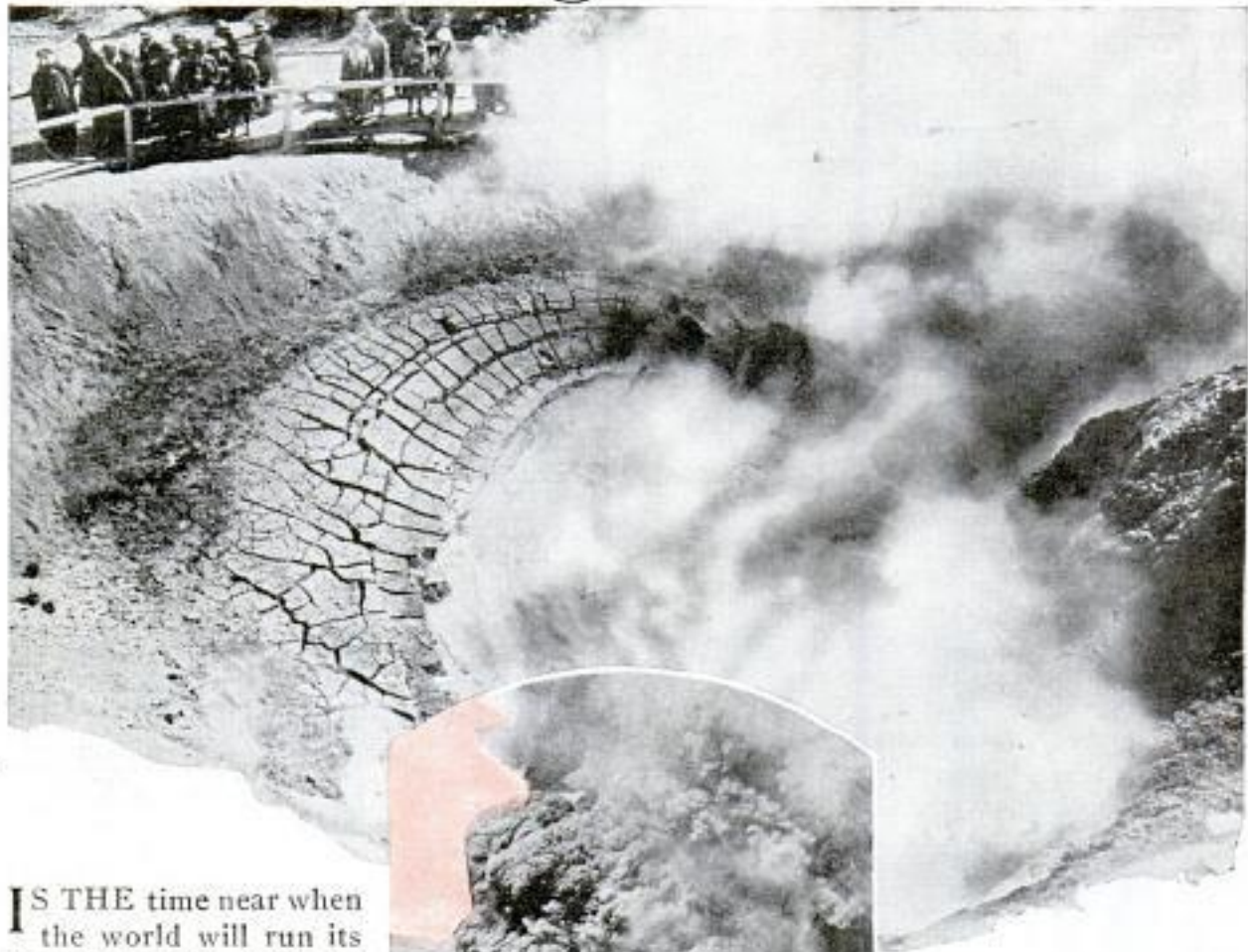

IS THE time near when the world will run its factories and mills by harnessing the terrific heat that lies buried within the earth, and occasionally manifests itself in the form of volcanoes, geysers and hot springs?

Yes, says Sir Charles A. Parsons, distinguished British engineer. Probably the gigantic feat will be accomplished during the next century, he believes.

Sir Charles has just proposed that science try to sink an experimental shaft twelve miles down, an accomplishment that, he says, probably would take eighty-five years and cost more than twenty-



Crater of a Mud Volcano in Yellowstone Park, and Eruption of Hawaiian Volcano

ty-five million dollars. Just to prove the idea is not as fantastic as it may sound, a commercial concern has succeeded in harnessing steam taken from the earth, some 300 feet below the surface, in the region of Steamboat Springs, Calif. The steam furnishes power to run all the engines in an entire factory.

What's the deepest man has ever been able to penetrate into the earth's mysterious interior? About 10,000 feet, or nearly two miles, according to the geological

Terrific Heat

survey, in the oil region of Bakersfield, Calif.

Some scientists insist that the dead line, or limit to which man could travel in person into the earth, is only about three miles, unless some effective way could be found to counteract the terrific heat, estimated at between 600 and 1,000 degrees Fahrenheit. However, already science has gone far in its development of a brand-new refrigeration system which sends cool air a mile and a half down by means of a vast network of pipe systems. This has been tested with pronounced success in the Steamboat Springs project.

How would you go about digging a twelve-mile hole into the earth? Fortunately oil interests have paved the way with their especially devised new oil drills which are approximately eight inches in diameter and are sent down by a cable with a bit attached to the end. Such a system might be utilized, though of course on a substantially larger scale, along with the new refrigeration method.

Aside from the mighty source of power gained by harnessing the earth's heat, what might science learn from digging a twelve-mile shaft such as Sir Charles proposes? Certainly a very great deal, for science knows far less about what's underneath the earth's cover than what's



Photos Copyright, J. E. Harnes
Giant Geysers Evidence the Mysterious Forces That
Enable Tourists to Cook Meals in Natural Ovens

in the heavens and underneath the seas.

However, according to Dr. William Bowie, of the geodetic survey, these facts are pretty well agreed upon:

The earth is like a solid rubber ball

which will yield and change its shape to mighty forces that are exerted upon it. The earth is a globe almost spherical, approximately 8,000 miles in diameter.

a-1330

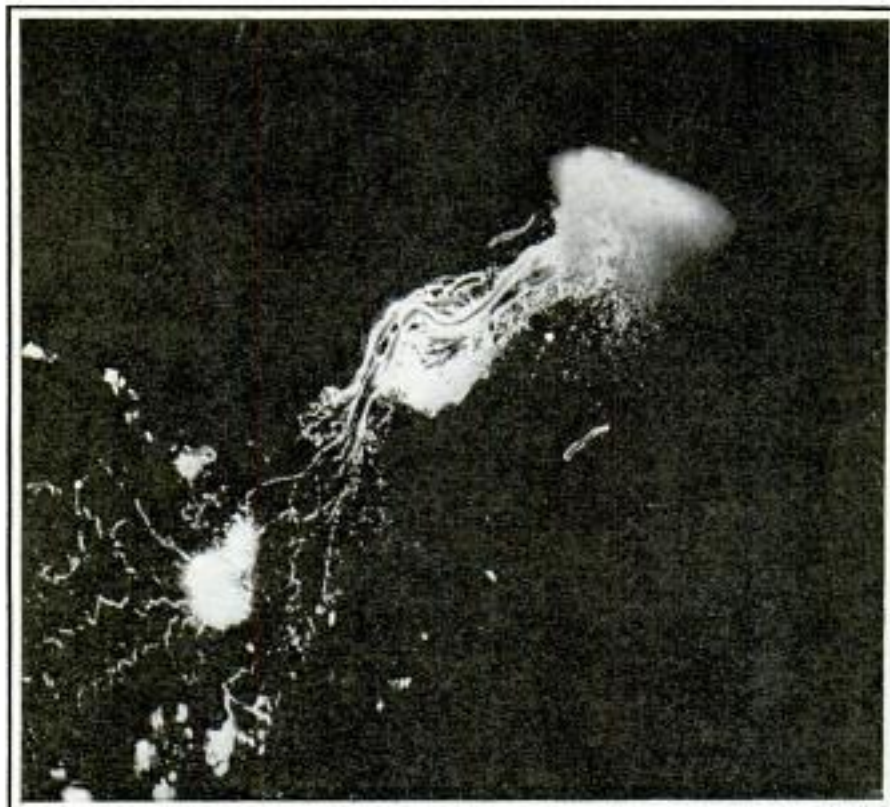

Hotter than Human Imagination Can Realize Is This Lava Fountain Photographed at Night; Exploring the Middle of the Earth by Gravity, at Right

It has been found by engineers, working in different countries, that the outer portion of the earth, to a depth of approximately sixty miles, is composed of solid rock. This rock will break when forces are acting upon it for a long time, provided the forces are of sufficient strength.

The interior of the earth, on the other hand, has been found to be composed of material that will yield like plastic matter to forces that are acting upon it for long periods of time, say tens, hundreds or thousands of years.

This interior material behaves like an elastic structure when forces are acting on it for only a short time. Such forces are the tremors that go out from an earthquake, and the tide-producing forces of the sun and the moon which change phase several times a day.

The outer shell, frequently called the earth's crust, rests on the interior material very much as a raft formed of logs rests upon a body of water. In other words, the tremendous weight of huge blocks of rock upon each other maintains a more or less constant equilibrium.

No one has accounted adequately for

the cause of the many geysers and hot springs. Both are believed to be evidences of minor volcanic activity, since they result only after powerful eruptions have ceased. As for hot springs, the heat of the water is believed to have its origin in subterranean lava.

Experts say lava is a molten mass of rock in which certain minerals, due to the tre-



mendous heat deep down in the earth, have dissolved in other minerals. Lava never attains the exact fluid stage of water, but tends always to be rather stiff, taking solid form when it cools.

Many lavas contain large amounts of water vapor. A striking illustration of this lies in the fact that volcanic eruptions often are accompanied by the condensation of escaping steam which hurls bits of lava to heights of seventeen miles. Dust and ashes from volcanoes have been carried several times around the earth.

Government experts are able to weigh

U.S. Dept of Agriculture 91687

huge blocks of the earth approximately 100 miles square. However, science admits it will have to stay pretty well within the realm of theory regarding the earth's interior, until it finds the necessary capital with which to try out the plan of Sir Charles Parsons.

CHANGE OF COMBS BETTERS FLAVOR OF HONEY 9196

Variance in the color and flavor of honey stored by bees from different flower sources is quite marked, and beekeepers can separate these kinds by changing combs at the right time. If the bees filled one comb before starting another, the honeys could be sorted easily, but many combs are only partly filled, when the source of supply from one flower ceases and the bees begin storing from another. Then the honey can be separated by removing all combs before the bees begin on the new blooms.

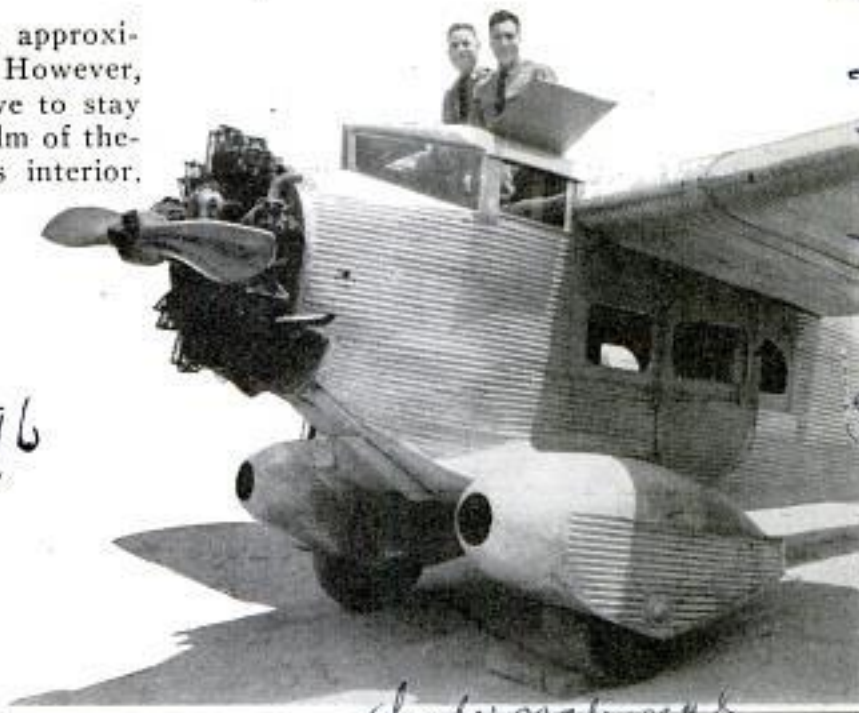

All Metal Plane, Much Lighter than Most of Type, Capable of Carrying Heavier Load; Mexican Army Officials Put It through Its Paces

METAL PLANE THAT'S LIGHTER LIFTS A HEAVY LOAD

Construction of an all-metal monoplane that is from 700 to 1,500 pounds lighter than contemporaries carrying the same load, is announced by an airplane designer in California. Officers of the Mexican army recently put the plane through an official inspection, and as soon as final tests have been completed, a series of transcontinental flights are planned.

FLOUR MADE OUT OF SEAWEED AND BAKED INTO BREAD 91704

Bread made from seaweed is the accomplishment of California bakers. A huge dehydrator has been installed at San Pedro and the kelp is heated to 1,200 degrees, coming out of the vats as flour. One baker declares the innovation is exceedingly popular with his customers.



Dehydrating Plant That Turns Seaweed, or Kelp, into the Finest Flour at Temperature of 1,200 Degrees

Philipp A. Park, Inc. 608 N Dearborn Chicago

AQUARIUM FOR NATIVE FISH 91807

Plans for the new department of commerce building in Washington incorporate space for a large aquarium in the basement where native fish are to be displayed. There will be twenty-four large tanks from six to twelve feet deep and three small floor tanks, all supplied with fresh water from a refrigerating system which will make it possible to exhibit fish found only in the coldest streams. About 2,500 fish are to be obtained from inland streams of the northwest, the Great Lakes, and from Maine to Florida. Blackfish will be brought from Alaska, and a mudcat from the Mississippi.

Carl Everett Spring 1929 2 Capitol Hill Washington D.C.

U.S. Weekly 8/28/21

Crawford motor (Crawford plane) Seal Beach Calif Harvey Crawford

at sea kelp plant

wid world

and at head of...

a1525 Copy George W. Leary
Sparkill, NY

MAYAN Mysteries

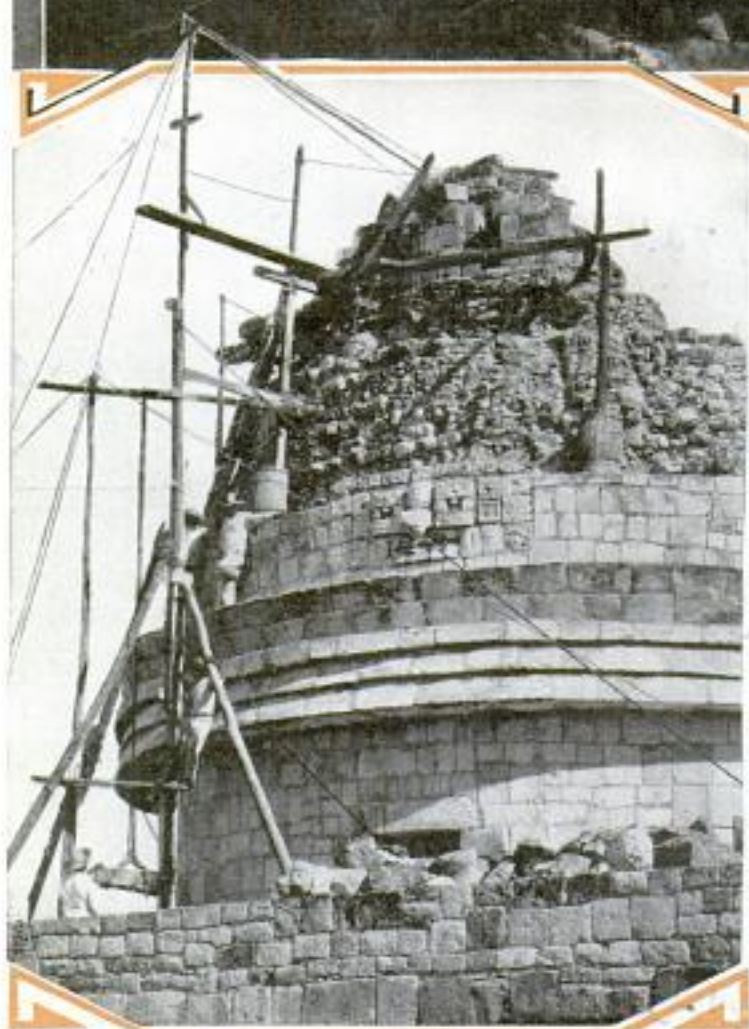
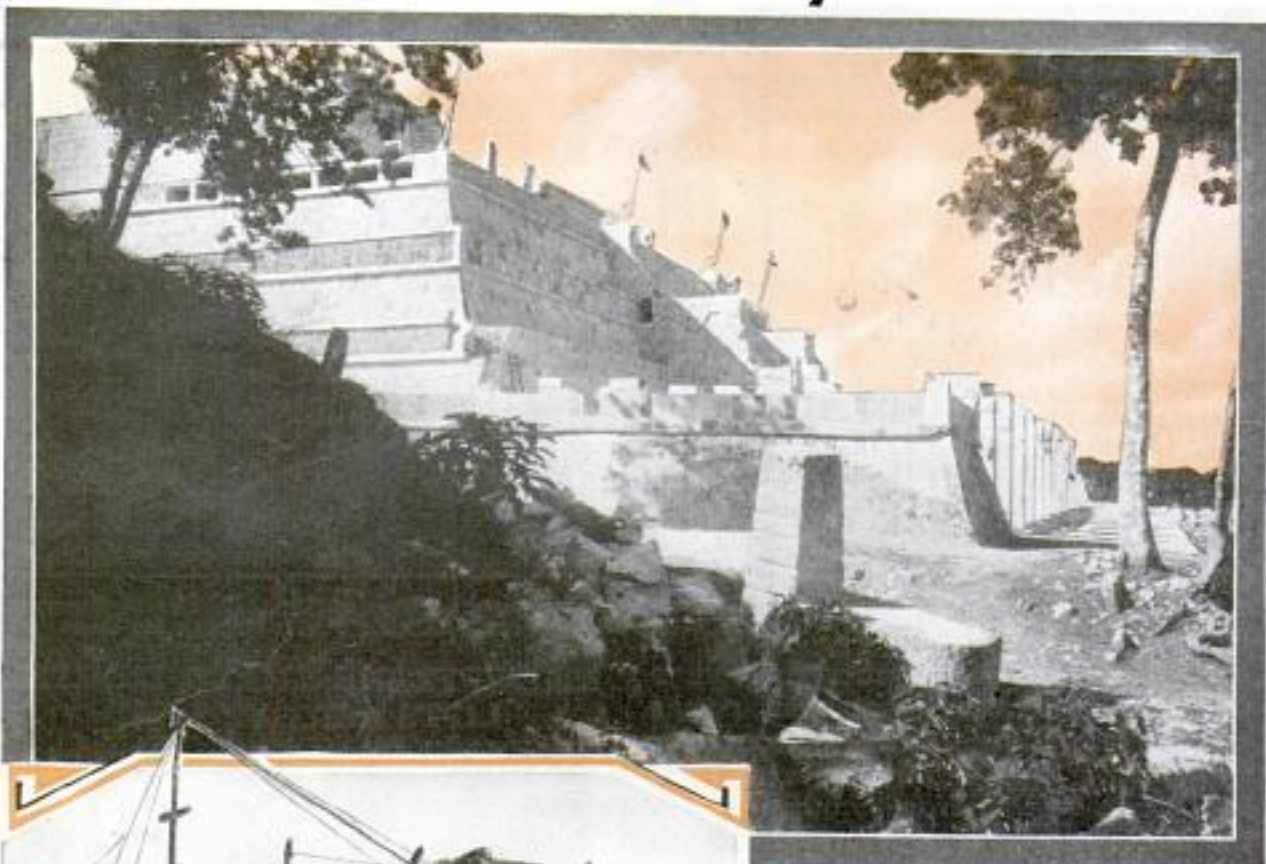

Magnificence Torn from the Jungle's Grasp; the Maya Temple of the Warriors; at Left, Repairing the Ancient Observatory

RECENT digging in Uaxactun, that oldest of all Maya cities, reveals buried structures at levels below that of the great white pyramid and other surface buildings, and points to a much older date for this settlement than the inscriptions show.

Dr. S. G. Morley, the American archaeologist who discovered the ruined city in the thick Guatemala jungle and gave it its name, which means "Eighth Stone," found one monument here with a Maya date carved in hieroglyphs which he reads as equivalent to 68 A. D. It is the oldest dated monument ever to be found in the western hemisphere, and this now abandoned city is our oldest dated settlement.

But Uaxactun must be far older than that monument. The remains beneath the level of the

Photos Courtesy Carnegie Institution

Defy Modern World

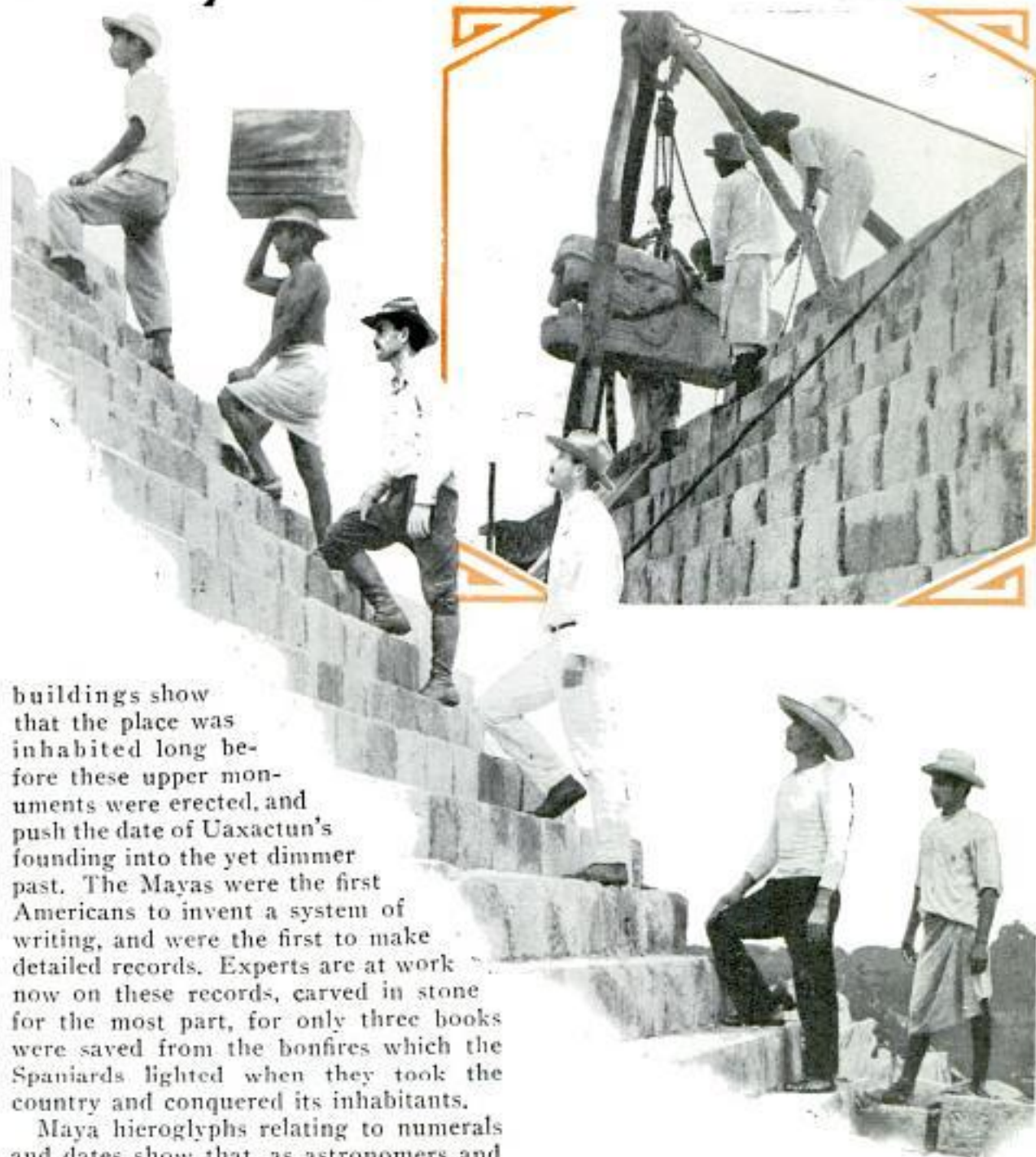

buildings show that the place was inhabited long before these upper monuments were erected, and push the date of Uaxactun's founding into the yet dimmer past. The Mayas were the first Americans to invent a system of writing, and were the first to make detailed records. Experts are at work now on these records, carved in stone for the most part, for only three books were saved from the bonfires which the Spaniards lighted when they took the country and conquered its inhabitants.

Maya hieroglyphs relating to numerals and dates show that, as astronomers and mathematicians, they were far ahead of those of Europe and Asia.

Thus, the Mayas invented the zero and had been using the idea in their computations a thousand years before the zero we use was invented by thinkers in India, later to be brought by Arabs to Europe.

The convenient decimal system of arithmetic, which we use as a matter of course in our everyday figuring, was unknown to

Steep Stairway to Maya "Heaven." Entrance to Temple of Warriors; Top, Replacing Serpent's Head

Julius Cæsar and to all Europe for hundreds of years after him. But over here, in the hot American tropics, there were Maya wise men who could multiply, divide, and do all manner of computations far in advance of the mathematical skill of any other people in the world.

Their main use of this ability, so far as

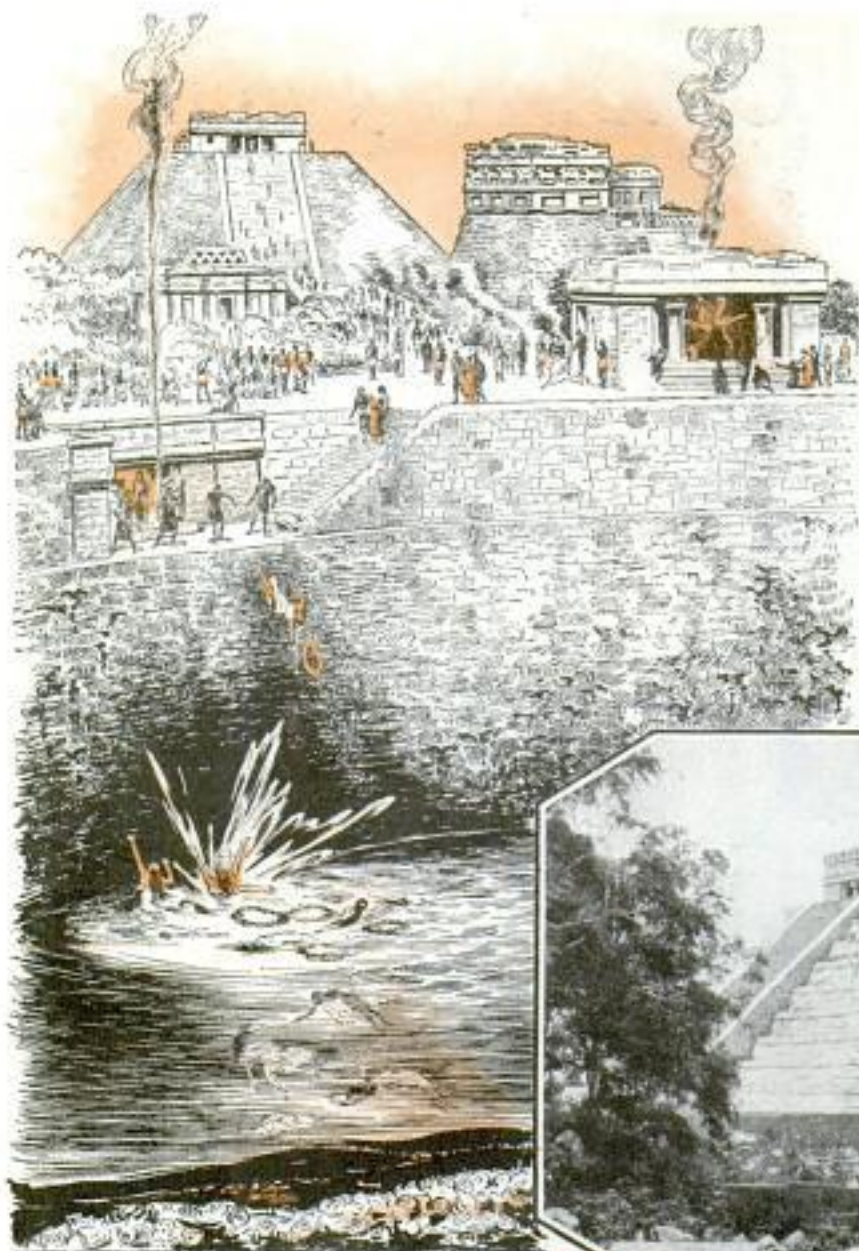

Artist's Conception of the Ceremonies at the Sacred Well of Chichen-Itza; Maidens Were Hurlled into Its 160-Foot Depths as Sacrifices to the Rain God in Times of Drouth

we can learn from the evidence that remains, was in astronomical calculation. The Maya religion seems closely woven with time, and the exact reckoning of the year appears to have been of the utmost importance.

There is a great towering circular structure in Yucatan, in the ancient city of Chichen-Itza, believed to be the remains of a Maya astronomical observatory. It is the finest building of its kind yet discovered in the Maya country, and may be thought of as the great central observatory of the nation. Until recently, this antique hall of science was nothing but a huge pile of tumbled stones, but, thanks

to the work of the Carnegie Institution, its walls have been picked up and replaced, and it is now in a fair state of repair.

You can crawl up the narrow corkscrew stone stairs in the upper section of this massive tower, and find yourself in a tiny room. On two sides, the stones have fallen away and been lost, but on the other the walls still stand, and here you look out through three square holes in the solid masonry.

You can see over the tops of the jungle to the



Airview of the Sacred Well as It Looks Today; Mighty Architecture of the Jungle Folk, Center

far distant horizon, and imagine the keen-eyed astronomer who kept his vigil here in lonely hours, watching the setting of celestial bodies. It has been found that on March 21, the spring equinox, the sun sets in the exact center of the line of sight through the western hole. There is reason to believe that there were similar lookouts in the other walls, and that this upper chamber was indeed the "observers' room."

Certainly the Maya astronomers attained an

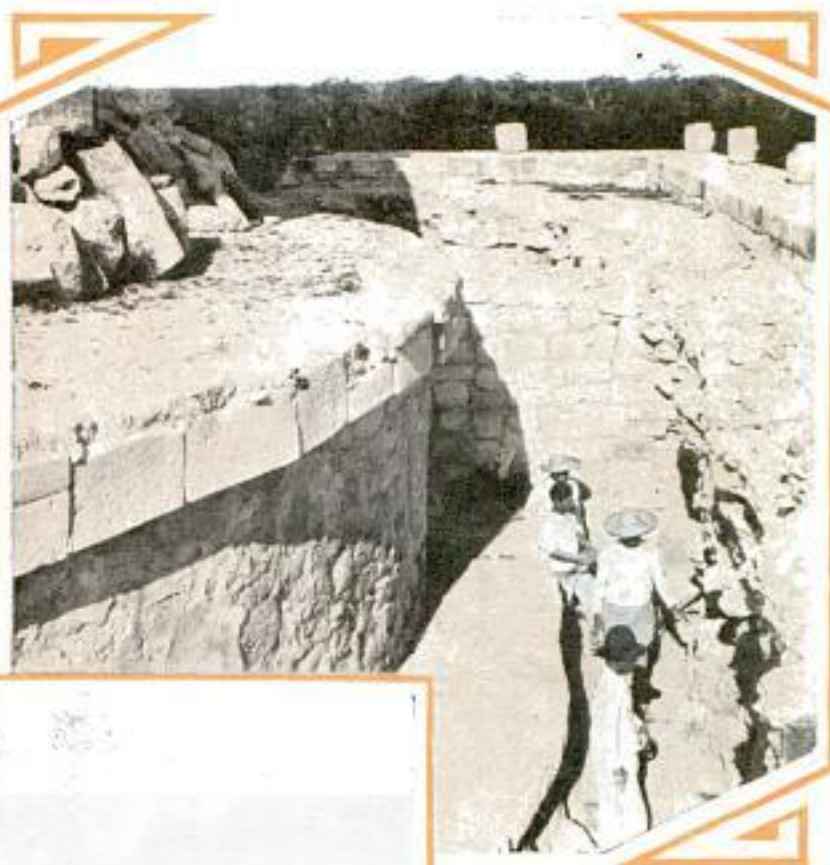

Uncovering the Astronomical Observatory at Chichen-Itza, Above, and How the Walls Were Dug from the Bush and Rebuilt, Below

paving a curiously uniform pattern of stones. They are built in a circular form and are believed to be the base of a sundial used by the native astronomers in their measurement of the hours. The pointer of the dial has not been found.

Nor have any astronomical instruments been discovered in the Maya country, but pictures and sculptures show the method of sighting through a notch and along a point like a gun-sight. A sculptured altar

accuracy in their calendar which was far ahead of any other calendar at the time. Thus, when Columbus sailed on his first voyage of discovery, the European calendar was several days behind the true calendar as measured by the earth's journey around the sun—so much, indeed, that Christmas was slipping into fall and summer was lagging into spring.

On the platform terrace on which the observatory tower stands, there is in the

has been found in the old city of Copan showing a number of seated figures that hold sextant-like objects in their hands; and this has been accepted by some archaeologists as picturing a conference of astronomers. It is possible that instruments like our ship sextants were made of wood which long ago crumbled into dust.

Another scientific mystery is the engineering skill of the Mayas. Some of the stones used in their buildings are of im-



Older Structures Have Been Discovered Beneath Previously Restored Maya Edifices; Note Two Levels in Photo Above; Digging a Temple Out of a Bush-Covered Hill, at Left

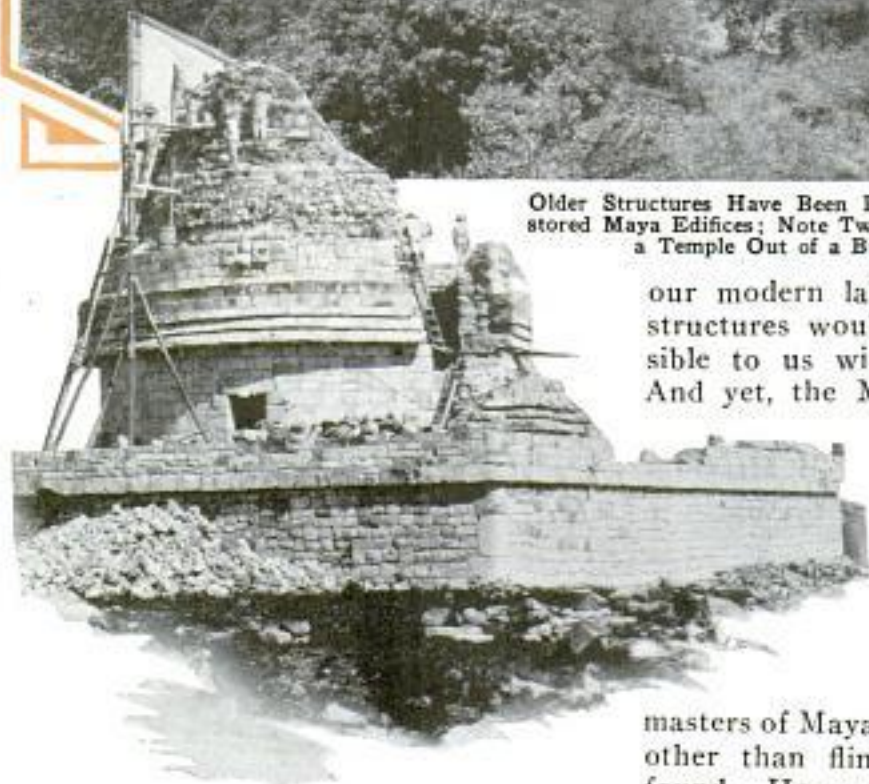

our modern labor. The repair of these structures would seem well-nigh impossible to us without the aid of wheels. And yet, the Mayas got along wonderfully. How? Yucatan limestone is of an amazing hardness. Some of the carved serpent heads that have been lying in the sun and rain for a thousand years still preserve the sculpture that was engraved by the old masters of Mayan art. No sculptor's tools other than flint implements have been found. How were these deep and accurate carvings made?

mense size. Thus, the heads of the feathered serpents that guard the portals of the Tiger Temple in Chichen-Itza are each carved out of a single block which weighs many tons. How the Maya builders were able to raise these huge weights to the top of the temple pyramid, is a riddle.

To see the workers of the Carnegie Institution in Chichen-Itza tugging with a pulley and rope to restore some fallen block to its place in an upper temple, is to realize how indispensable is the wheel in

The Carnegie Institution diggers have recently completed the unearthing of a magnificent temple from a forest-covered mound. In the pyramid or base of this Temple of the Warriors, they discovered the remnants of a buried temple of much older date. Excavating in the floor of this buried temple, they came upon a hidden jar containing a plaque or disk made of 2,500 pieces of turquoise fitted together to form a decorative pattern. It is by far the most beautiful and delicate piece of

A 1720 Isebrüder Sulzer,
Winterthur, Switzerland 743

craftsmanship yet found in the Maya country; and it is also the poser of another riddle.

For it makes us ask where this turquoise came from. There are no turquoise deposits known nearer than New Mexico. Were these blue jewels mined there, carried some hundreds of miles through the jungle to the holy city of the Maya?

There are other objects in Maya land whose presence there it is difficult to explain. Some time ago E. H. Thompson, an American archaeologist, found in the Sacred Well at Chichen-Itza, a number of carved pieces of jade. Where did the jade come from?

9172
DIVING BELL WITH CRAB CLAW HELPS HUNT TREASURE

Steel arms, worked from the inside, will help hunt sunken treasure from a deep sea diving bell just constructed. The bell, made of steel and glass, has oxygen tanks, controls for the compressed-air tanks and for two interchangeable arms which extend in front for handling the treasure or for doing other work.

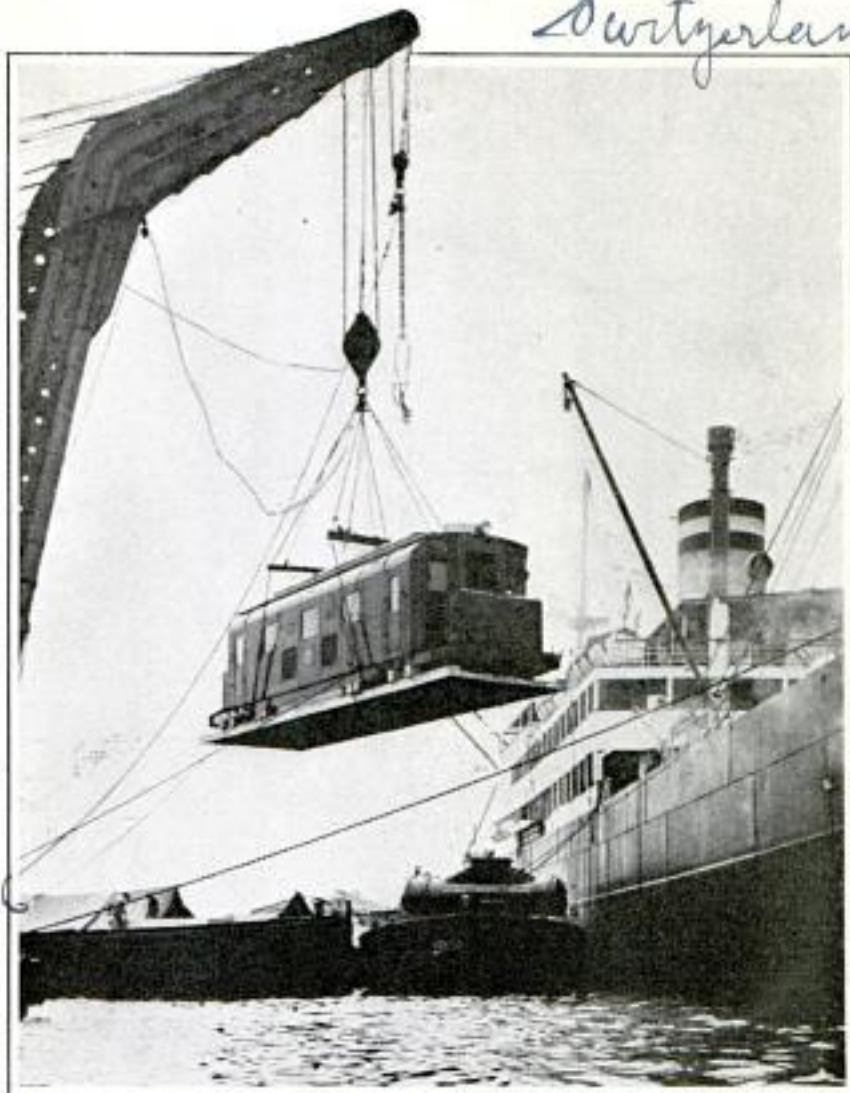

Huge Crane Picks Up a Diesel Locomotive Bodily, Swings It High in the Air and Loads It into Ship's Hold, Bound for the Far East

DIESEL LOCOMOTIVES ARE SENT BY SHIP TO FAR EAST

Dock workers at Genoa recently were startled to see a powerful crane lift bodily a huge Diesel locomotive and swing it into the hold of a steamship anchored in the harbor. It was the sign of further railway progress in the Far East, where it was ordered by the South Manchurian railways for regular freight traffic. The locomotive is equipped with a 750-horsepower four-stroke Diesel engine with two double-axle driving bogies. It is built for standard-gauge track, and at a speed of slightly more than fifteen miles an hour on the level, the engine can haul forty cars of forty-five tons' capacity each.

□ The project of pumping dry the Zuider Zee will be completed in 1952, according to present plans.

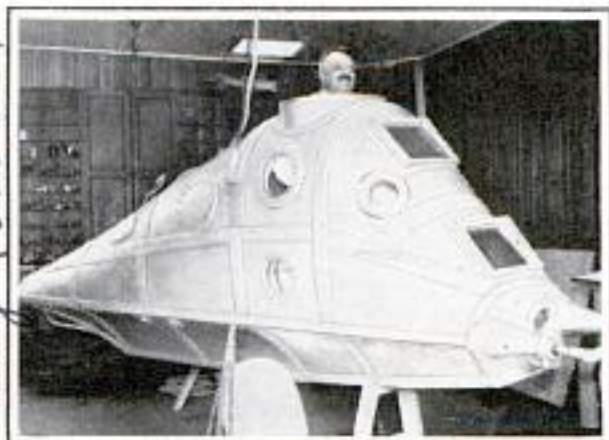

Unique Diving Bell, Fitted with Steel Arms, Which Will Search Sea's Bottom for Treasure

Dr. W. Emil Kulik, no record as of.
Brooklyn, N.Y.

also by Cmdr. Joseph S. Edgerton
c/o Evening Star, Washington

ADRIFT ^{for} Five Days



Flotation Gear Inflated. Above: the Flyer and His Rubber Boat; Note Patches near His Knee

THE story of a naval aviator, forced down in the Pacific ocean, who drifted five days in a little rubber life raft, fighting sharks and dolphin and endangered by a tropical sun that melted the rubber of his cockleshell, will enter navy records as one of the most stirring epics of the men who go down to the sea in airplanes.

For five days he drifted helplessly after his plane had gone down, bearing up under the blow of watching one steamer pass him, unseeing, at close range and a

Flyer Battles Waves and Sharks Under Sun So Hot It Burns Holes in His Frail Craft

flying boat passing overhead, before he finally was picked up by a steamship. During this time, 135 naval vessels and 200 planes were making an intensive search for him.

For five days he was without food, and obtained water by catching it in a silk scarf and permitting the tiny trickle to drip into a canteen top.

Chief aviation pilot Verne W. Harshman, one of the pilots of a navy Curtiss "Hawk" fighter squadron protecting observation planes which were spotting battleship gunfire on a cloudy morning, had been in the air about two hours when the squadron started through a cloud bank.

"We had just got well into a cloud," Harshman said, "when my auxiliary tank of gasoline ran out, the motor cut out and I lost sight of the rest of the squadron.

"I switched to the main tank, and climbed through the clouds, but I did not see anyone."

Coming out beneath the clouds, with only the vacant sea below and the gray

in a Rubber Boat

sky around, Harshman circled, straining his eyes for boats or planes which were not there. He made three careful scouting circuits, but his gasoline supply was getting low, and he made up his mind to land in the open sea while he had power enough to prevent a dead stick landing. He made a good landing and did not hurt the plane or himself. He inflated the flotation gear, compressed air filling two large bags on each side of the fuselage.

He prepared his rubber boat and supplies and, about fourteen hours after his landing, the plane sank, casting him completely adrift.

"Wednesday," Harshman reported, "sharks started bothering me, but I managed to keep them away from the boat by using my oar like a spear and hitting them with it. The spotted dolphin seemed to take a delight in rubbing their sides against the bottom of my boat.

"When the sun came out Friday, it was very hot. I had to pour water on my boat to keep it cool. About noon, I heard a hissing sound and discovered a leak in the forward air chamber. I finally managed to get the leak patched, but had a lively time preparing the rubber to receive this patch while holding the air in at the same time.



The Three Views from Top to Bottom Show How a Rubber Lifeboat Is Unfolded from Its Storage Space in the Naval Seaplane, Inflated with Air and Launched

Described by J. H. Eschsch V. P. Cornel Engine Co



Harshman Floated Five Days, Fighting Sun and Sharks, and Drinking Only Water He Could Catch with His Silk Scarf When It Rained

I found if the sun hit the cement it would melt. I kept the spot wet and covered with a signal flag.

"About 8:30 Saturday night, I sighted the masthead light of a ship. She came fairly close, and when she got to a point I thought the closest, I fired my two remaining Very stars, but these were unnoticed.

"Sunday, the weather cleared. I sighted a plane about 8:00 a. m. He was flying low and too far away to see me. About 12:15 I sighted a ship and began rowing so as to place myself directly ahead of it. As the ship came closer, I waved my red flag. When I was certain they saw me, I took a good big drink of water from my canteen. I was picked up at 12:30 p. m. by the S. S. 'Cerigo' of the Hamburg American line, Capt. Karl Manitius commanding."

Harshman was fed, put to bed, and landed at Buenaventura, Colombia, reporting from there to the naval air station Coco Solo, C. Z.

FLUID SEALED IN PLANE MOTOR MAY ELIMINATE RADIATOR

Aviation engineers have found that they may be able to fill the radiator of an airplane motor and seal the top, never to be faced again with engine-cooling troubles. This, in effect, has been done by research engineers experimenting with a liquid-cooled engine which has no radia-

tor in the ordinary sense of the term. The agent used is ethylene glycol which boils at 385 degrees Fahrenheit, instead of 212 degrees, as water does. Having a higher specific heat, it conducts heat away from the cylinders faster than water. It flows around the cylinders, but instead of passing through coils and fins, it circulates within itself, the hot fluid rising and the cool falling, giving off through the engine casing and external fins the heat absorbed from the walls

With the new medium it will be possible for engineers to build an engine with a radiator only half as large as one that is water-cooled.

FLUSHER FOR AUTO RADIATORS REMOVES RUST AND SCALE

Rust and scale can be removed from automobile radiators with the aid of an automatic flusher for use in garages. This unit consists of a portable tank containing water and a chemical compound, the solution being forced into the cooling system through a heavy hose attached to an electrically driven centrifugal pump. A second hose returns the liquid from the radiator to the tank. In it is a glass tube which enables the operator to observe the condition of the return water.



Automatic Flusher Containing Chemical Compound Which Removes Rust from Auto Radiators

The Marquette Mfg Co 218 N Wabasha St. St. Paul, Minn

91364

Sept 11 - July 1920
Rams as Reptable Car parts 42 miles
and Chemical Corp. 30 2 Lee York

same since 8/1/21
91007

Cornel Engine Corp, Madison Wis

Triple Tunnels Under Hills Untangle Traffic

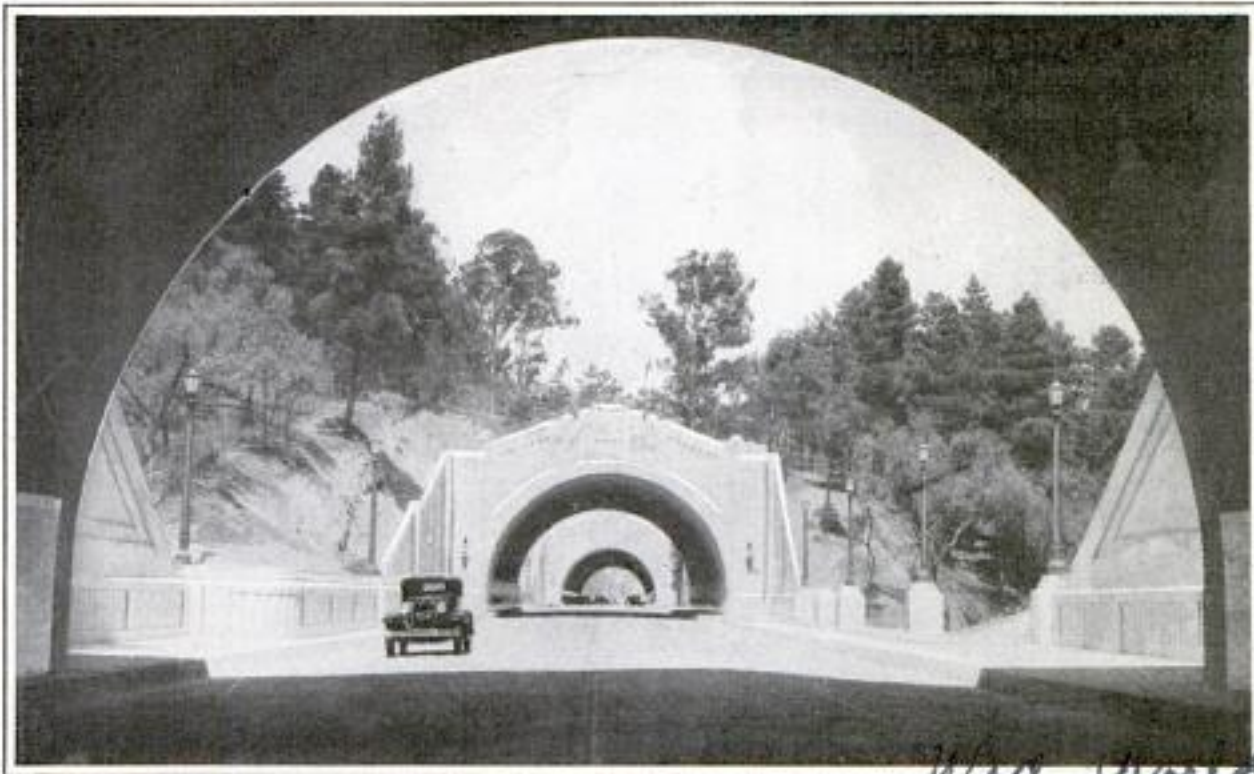

Road near Los Angeles Which Runs through Triple Tunnels; Dug under Three Separate Ridges, They Have Opened a New Outlet from the City and Solved a Major Traffic Problem

Triple tunnels under the scenic ridges of hills rimming Los Angeles are solving the major traffic problems of that city by opening a new outlet to the north. A big burden was taken off other highways entering Los Angeles by this unusual construction of a road running through these tunnels.

SUN'S ENERGY IS DESTRUCTIVE TO MOUNTAINS AND HILLS

In reality the traditionally friendly energy of the sun is the relentless enemy of mountains and hills, seeking to level them and dump them into the sea. Conversely, the dark, upheaving forces of the inner earth, usually considered as destructive, are constantly building up while the sun-born forces are tearing down. This paradox of geology was explained recently by Dr. W. H. Twenhofel, of the University of Wisconsin. Neither the forces from above nor those from below are wholly benevolent to man, he explained. The earth-born forces destroy man and his works with earthquakes and volcanoes and the sun-born ones cause floods, cy-

clones, tornadoes and great waves of the sea. But the former build up while the latter tear down. The most obvious effect of the sun's energy is to make life more pleasant for man, and the most obvious effect of the inner forces is to make life more unpleasant, hence the sun has been considered wholly good and the forces of the inner earth wholly bad. Each is vitally necessary, however, for each sets in motion essential earth activities to make the earth habitable for land life. Throughout the eons of time, the two powers have struggled with the surface of the earth as the stage. So far, the contest has been a draw, otherwise the development of land life would have been interrupted. At times the earth forces have rested, and the sun has reduced the surface of the earth to a featureless plain, while at other times the earth forces rose to great magnitude, and the earth became extremely rugged, only to be leveled again by the sun's energy.

☐ Three-way radio-telephone conversation, between three planes in flight and a ground station, has proved successful.

Madison, Wis

a1929
748

Back-Yard Roller Coaster Furnishes Big Thrill

Building their own roller coaster in back lots, a group of North Philadelphia children recently astonished their guardians and provided themselves with a great



Three Views of the Back-Yard Roller-Coaster; Bottom Shows How Car Was Constructed of Skates

thrill maker. It took a week for them to construct it out of old lumber and a pair of roller skates. A canvas tunnel was built over the lower section of it to provide more realism and add further joy to a ride on the "scenic railway." Sloping ground was selected and the "hills" made steeper by suitable supports.

RADIO "FEELER" TESTS THE AIR BENEATH GIANT DIRIGIBLE

When the "Akron," the navy's giant dirigible, settles toward a landing field obscured by fog or clouds, it does not need to "go it blind," but drops a radio-equipped "feeler" which signals back to an automatically registering apparatus conditions in the air levels below. The instrument was designed originally for sending aloft in sounding balloons to obtain meteorological information at high altitudes. It carries apparatus to measure temperature, air pressure and moisture, and an automatic radio sending outfit whose signals are picked up and recorded on a revolving drum in the dirigible. The sending set is dropped from the ship on a cable to inform navigators whether there is clear air beneath a cloud.

a1929
Ward W. ...
Science Service ...
Russian scientist.
Prof. Mollischanov

91957

Mr. Carl W. Osborne
and Mrs. Blanche
Hatchcock, Buffalo, N.Y.

RINGWORM OF FEET PREVENTED BY WATER PURIFIER

Sodium hypochlorite, a common chemical used in purifying city drinking water, has been found to be effective in preventing the spread of a ringworm infection of the feet, known as "athlete's foot." This infection often develops among people in sports, particularly where common dressing rooms are used, since the spores of the fungi causing the disease are spread rapidly, later causing irritation, cracks and watery blisters. Two Buffalo workers in medical research conducted tests in schools where pans were installed in gymnasiums, the students washing their feet in a weak solution of sodium hypochlorite by wading through these pans as they went to and from gymnasium classes. This treatment checked the spread of the disease effectively, it was found, although the solution is not looked upon as a cure for already established cases. This is the second preventive measure against ringworm of the feet reported recently, other investigators having found that a sodium-thiosulphate solution is helpful.

Science Service 8/21/31

Bushnell Mfg Co. Berkeley, Calif.

"SLIP-ON" COUPLING FOR HOSE SAVES TIME AND WEAR

Making it unnecessary to screw the hose to the faucet or unscrew it when finished, a "slip-on" coupling recently has been placed on the market. It is produced in different sizes and provided with safety catches, so that it is handy not only for home owners but also for gasoline and oil-truck operators, and for use on pipe couplings and air hose. Half the coupling is screwed to the faucet and the other half to the hose, and all that is necessary when



it is desirable to connect the hose is to slip it over the coupling end on the faucet.

91716

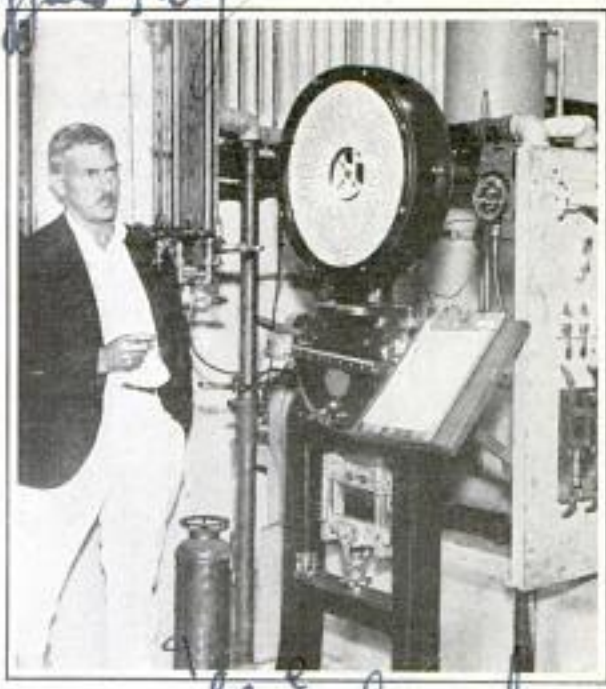

© U. & U. *Is & Israhahm*
Measuring the Efficiency of Various Types of Auto Ignition Systems on a Special Engine

AUTO IGNITION SYSTEM TESTED WITH SPECIAL ENGINE

Peculiarities and characteristics of various types of automobile ignition are being studied by the bureau of standards with a view to finding the kind best suited for easy starting and smooth running. An electro-dynamometer is connected to a special engine and measures the power increase or loss caused by various methods of ignition, a dial registering the horsepower generated by the engine.

CHUTES AND BELTS TO HANDLE MILLION LETTERS AN HOUR

Planned as the largest mail-distributing point in the world, the new post office under construction at Chicago will be equipped with more than twenty miles of conveyor belts, about 450 electric motors for power and thousands of feet of chutes to enable the handling of 1,200,000 letters and hundreds of tons of parcel post and newspapers hourly. Mechanisms will handle the mail in virtually all stages. Incoming mail will be lifted to upper floors and there handled and distributed to chutes leading to predetermined loading places on the main floor. It is calculated that, by 1943, the Chicago office will handle 19,500,000 letters on a peak day.

91806

W. S. Dandy 12/10/31

Instant Sales Co
2926 Telegraph Ave
B. B. ...

Post Office Department
Washington, D. C.

EASIER WAYS



Above, Stove Ventilator Equipped with an Electric Light and Fan to Create a Forced Draft



Above, Rubberlike Flexible Buttons for Washable Garments; They Will Not Break Nor Chip and Do Not Cut the Threads; at Left, Fruit Press That Extracts and Strains the Juice of Oranges or Lemons When Handle Is Pressed, the Pulp Remaining in the Shell of the Fruit; It Has Only Four Parts, All Easily Cleaned



Right, Ice Breaker That Is Operated by a Crank; It Makes Crushed Ice Out of Cubes Taken from the Electric Refrigerator

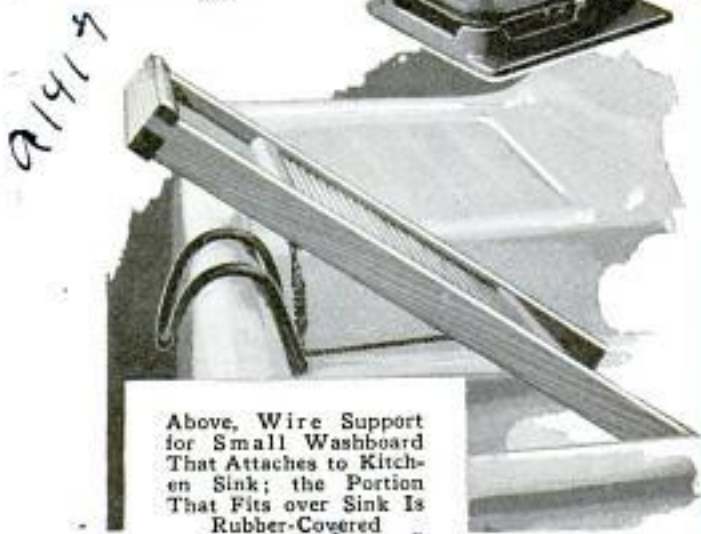

Above, Wire Support for Small Washboard That Attaches to Kitchen Sink; the Portion That Fits over Sink Is Rubber-Covered



Above, Wire Egg Beater and Separator; It Is Handy for Removing Food from Boiling Water, and as a Strainer by Inserting a Piece of Muslin in It

of DOING IT

Right, Electric Heating Coil Mounted on a Circular Support Which Can Be Attached to Guard of Any Electric Fan, Converting It into a Heater or Hot-Air Drier



Below, Clothes Drier That Fits the Top of Any Bathtub; It Contains Twenty-Seven Feet of Rustproof Line and Can Be Folded When Not in Use



Above, Self-Heating Percolator with Stove in Base and Fuel Reservoir in Handle



Electric Insect Killer and Light for the Porch; the Light Provides Illumination and Serves as a Lure for the Insects, and the Charged Wires Electrocute Them



Left, Automatic Heater and Fan That Attaches to Hot-Water Supply Pipe

Right, Vegetable Dicer That Is Operated by Merely Pressing Down the Handle; It Cuts Turnips, Carrots, Potatoes and Other Like Vegetables with Equal Ease

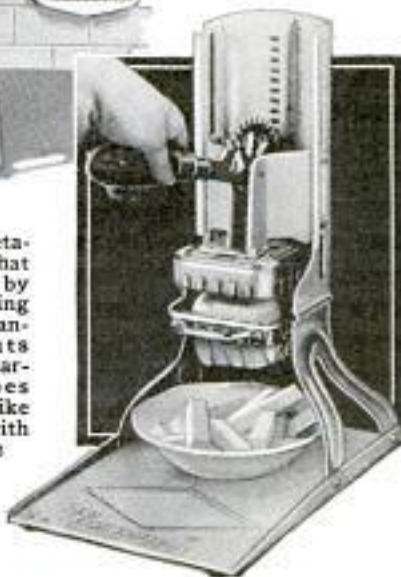

91942

*Mr. Wells A. Baker
Alhambra Calif
Letter rec'd 10/20/31*



Bulbous Parachute Which Opens in the First Ten Feet of Descent; Small Chute Acts as a Shock Absorber

NEW CHUTE OPENS INSTANTLY ADDING TO SAFETY

Instantaneous opening, almost entire elimination of drift and drag, and considerable reduction in size from that of the regulation type—these are some of the advantages claimed for a parachute of a peculiar bulbous construction. A smaller auxiliary chute, halfway down the short shrouds, comes out of the pack first and throws the shrouds out in the proper place, keeping them untangled in the quick opening, which occupies less than the first ten feet of drop. This small chute, which is only five feet in diameter, also acts as a shock absorber in breaking the initial impact and carries its proportion of the load. The large chute is fifteen feet in diameter, has a top panel over which the shrouds run and through the center, holding down the bulging top and creating a higher compression under the chute with a partial vacuum on top. The entire

equipment weighs less than ten pounds, yet supports from fifty to 175 pounds with equal steadiness of action.

"ROMAN CHARIOTS" HELP BUILD ROAD TO HOOVER DAM

91695

Giant vehicles that resemble Roman chariots and others that look like gondolas, with scrapers to match in size and appearance, are building the seven-and-one-half mile stretch of road between Boulder City and the site of Hoover dam. Over this highway supplies for the dam will move. The chariots and gondolas, pulled by tractors, carry as much as seventeen cubic yards of dirt to a load. The wheels are six feet in diameter and eighteen inches wide. This width prevents the vehicles from miring, and the driver of the tractor pulling each can dump the load in a single operation. Scrapers also can be pushed

in front or pulled behind these tractors, and they level the area over which they pass, so that it becomes unnecessary for a crew of shovel men to follow in their wake to do this job.



One of the "Roman Chariots" Used in Making a Road to Hoover Dam; the Wide Wheels Prevent Tipping

21713

Into the ARCTIC WASTES *with the* GRAF ZEPPELIN

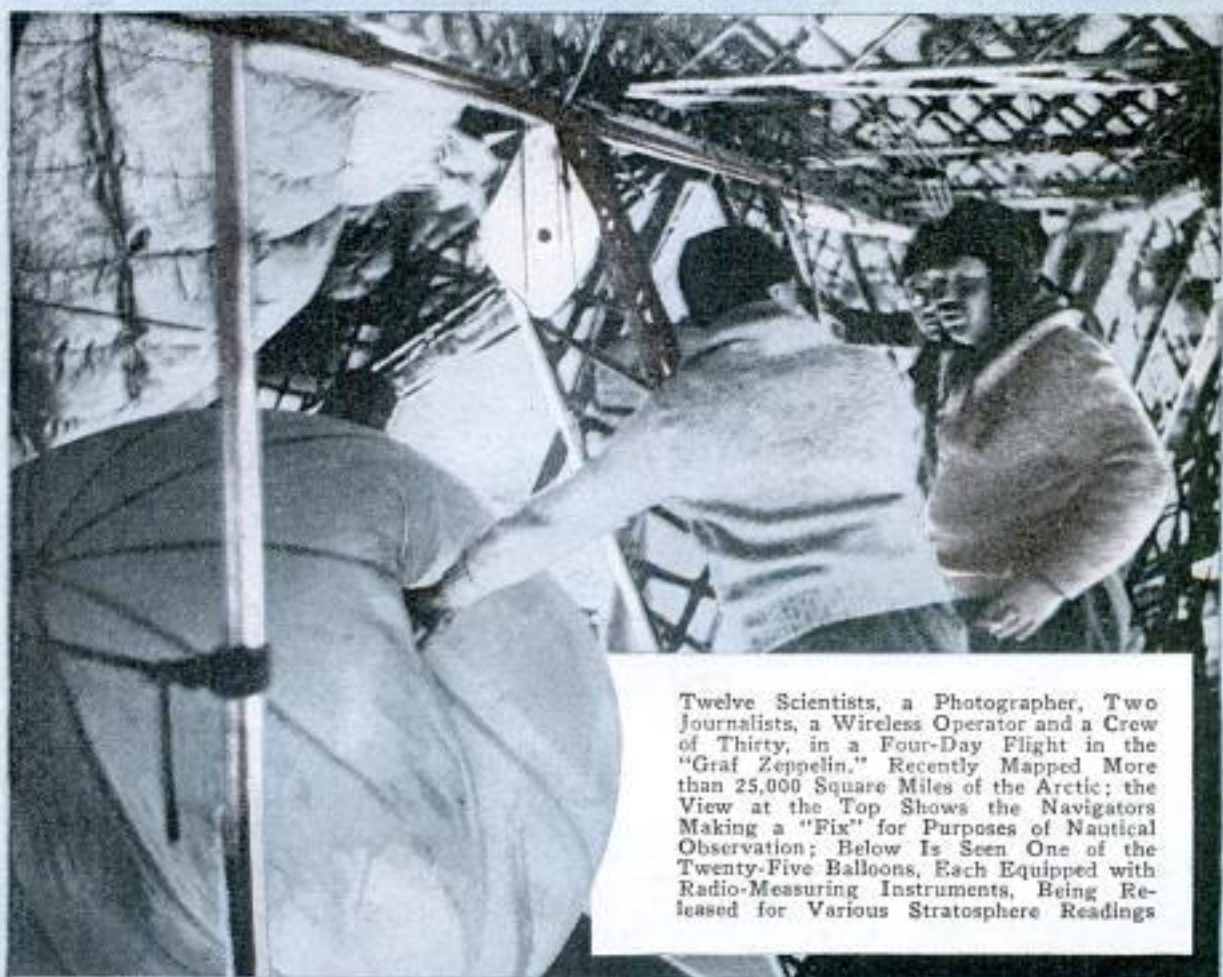

Twelve Scientists, a Photographer, Two Journalists, a Wireless Operator and a Crew of Thirty, in a Four-Day Flight in the "Graf Zeppelin." Recently Mapped More than 25,000 Square Miles of the Arctic; the View at the Top Shows the Navigators Making a "Fix" for Purposes of Nautical Observation; Below Is Seen One of the Twenty-Five Balloons, Each Equipped with Radio-Measuring Instruments, Being Released for Various Stratosphere Readings

Wide World 753

Copyrighted material



Navigation Officer Listens for a Report on Radio Logging, Above; at the Right is a Close-Up of One of the Captive Balloons Going up the Side of the Airship; Below, Officers and Their Scientist Guests Studying the Travel Plan of the Ship in the Social Room; a Rich Reward in Meteorological and Geographical Data Was Reaped, and, Apart from Lack of Water for Washing and the Necessity of Retiring in Sleeping Bags, the Voyage Provided Almost All the Comforts of Home



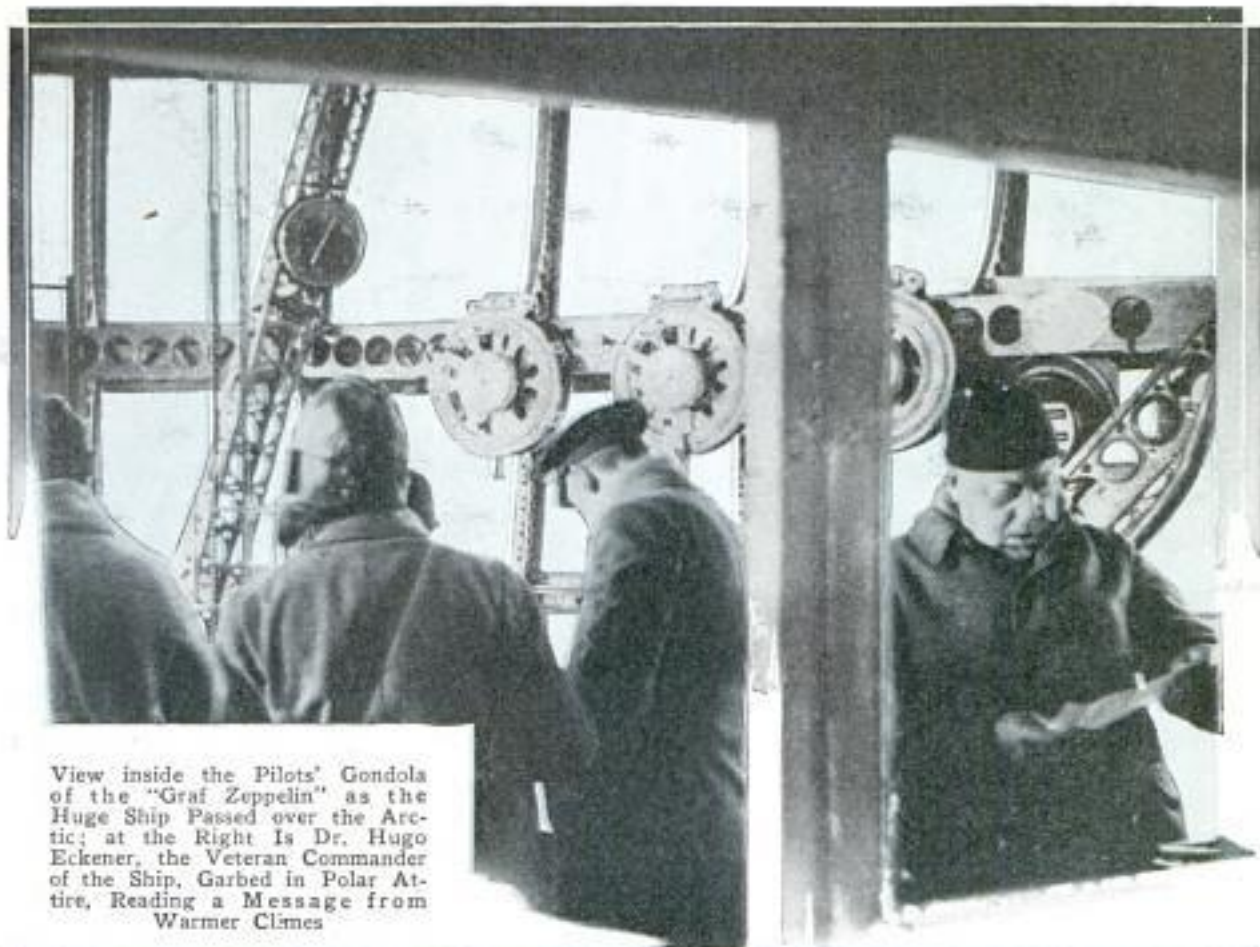

View inside the Pilots' Gondola of the "Graf Zeppelin" as the Huge Ship Passed over the Arctic; at the Right Is Dr. Hugo Eckener, the Veteran Commander of the Ship, Garbed in Polar Attire, Reading a Message from Warmer Climes

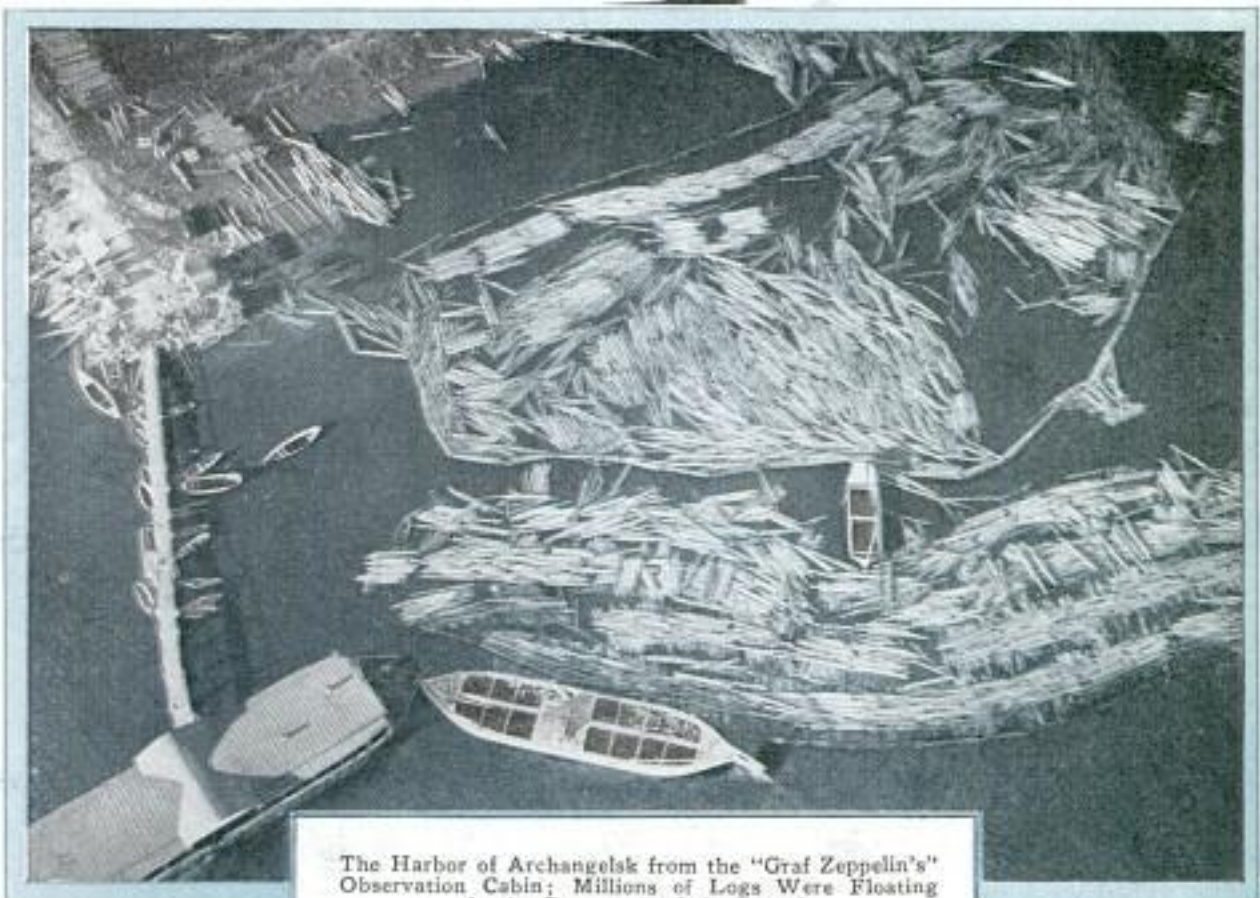

The Harbor of Archangelsk from the "Graf Zeppelin's" Observation Cabin; Millions of Logs Were Floating in the Bay as the Ship Passed

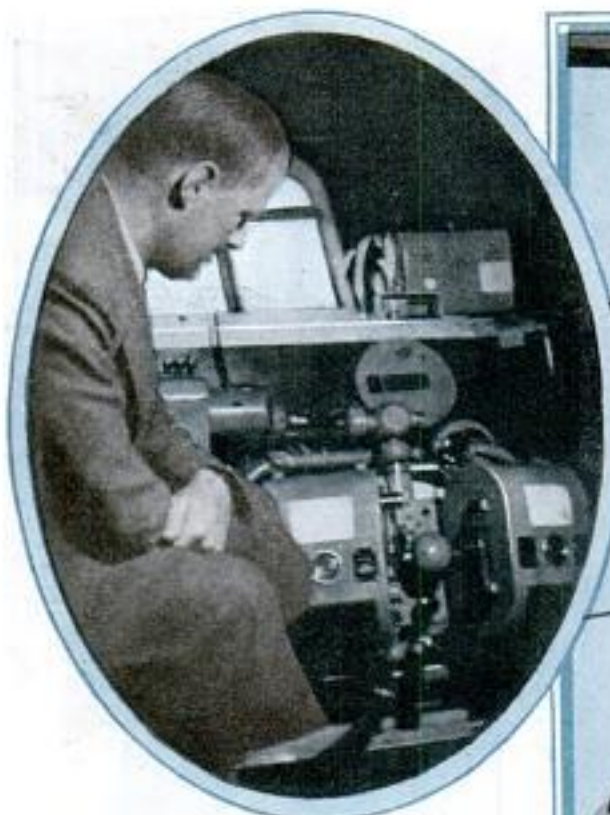

Photogrammetric Apparatus in Operation during the Flight, Above; and Taking Sextant Observations by the Light of the Midnight Sun, Below

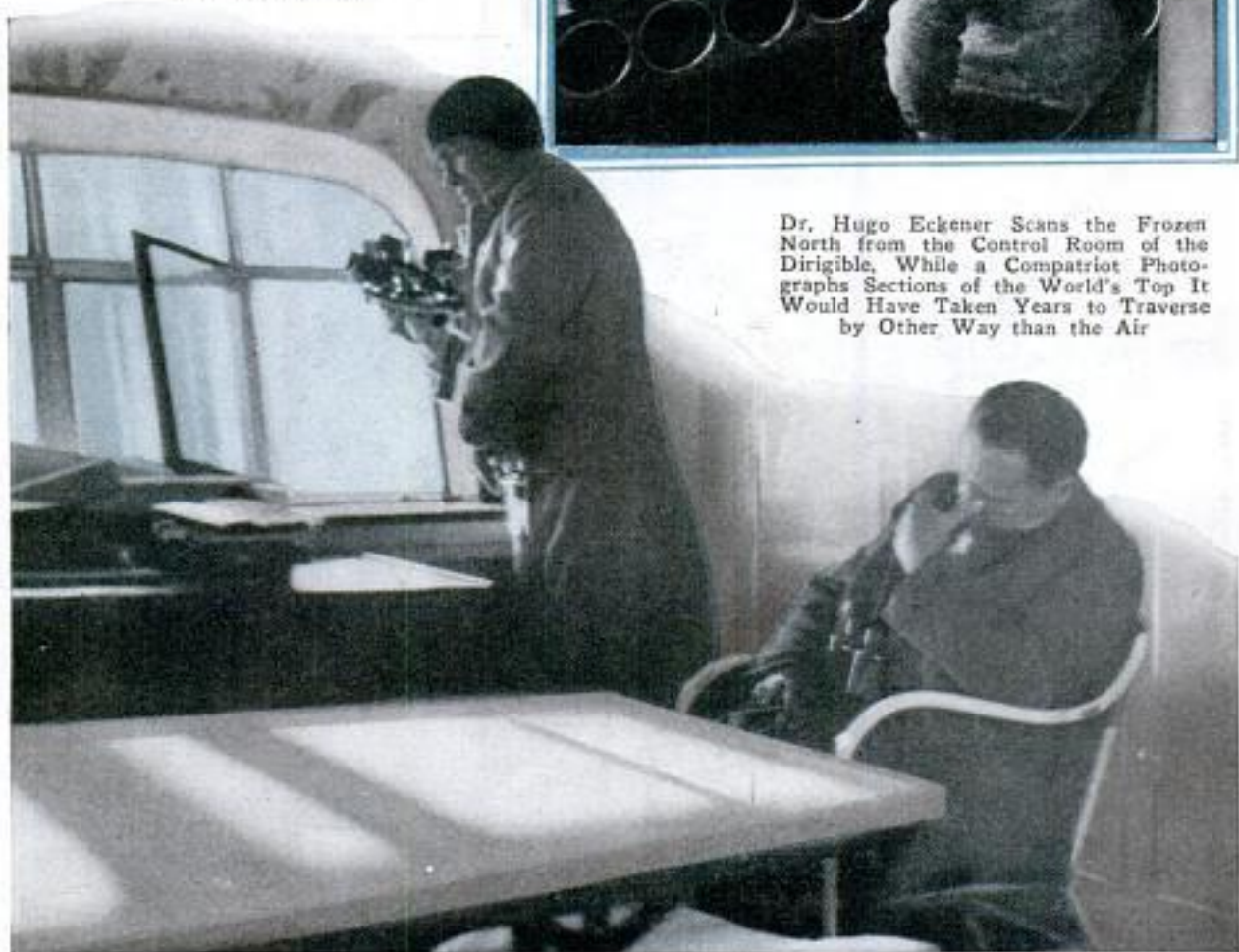

Dr. Hugo Eckener Scans the Frozen North from the Control Room of the Dirigible, While a Compatriot Photographs Sections of the World's Top It Would Have Taken Years to Traverse by Other Way than the Air

91713



The Last Hour on German Soil before the Flight, Above; the "Graf" Is Moored to the Mast in Berlin after a Heavy Rain; Many of the Participants in the Expedition Are Eating in the "Restaurant of the Mooring Mast," Seen in the Left Background; Below, Professor Moltchanoff, One of the Russian Members of the Flight, Is Listening to an Officer's Explanation of a New Sextant, and Two American Members, Lieut. Comm. Edward H. Smith of the Coast Guard, and Lincoln Ellsworth, Sportsman and Explorer.



no further information

Q1713
758



The Above View of the Catwalk of the "Graf Zeppelin" Indicates the Great Size of the Interior and the Crew's and Passengers' Means of Travel from Cabin to Cabin



Professor Samodlovitch, Scientific Director of the Expedition, Is Seen Above, Confering with One of His Associates at Work during the Flight; at the Right, the Arctic's First Aerial Post Office Prepares to Make a Delivery of Mail to the Russian Ice-Breaker "Malygin"; the Post Official of the "Graf" Is Seen Stamping the Last Piece of Mail, Before It Is Sent over the Side for the Ship



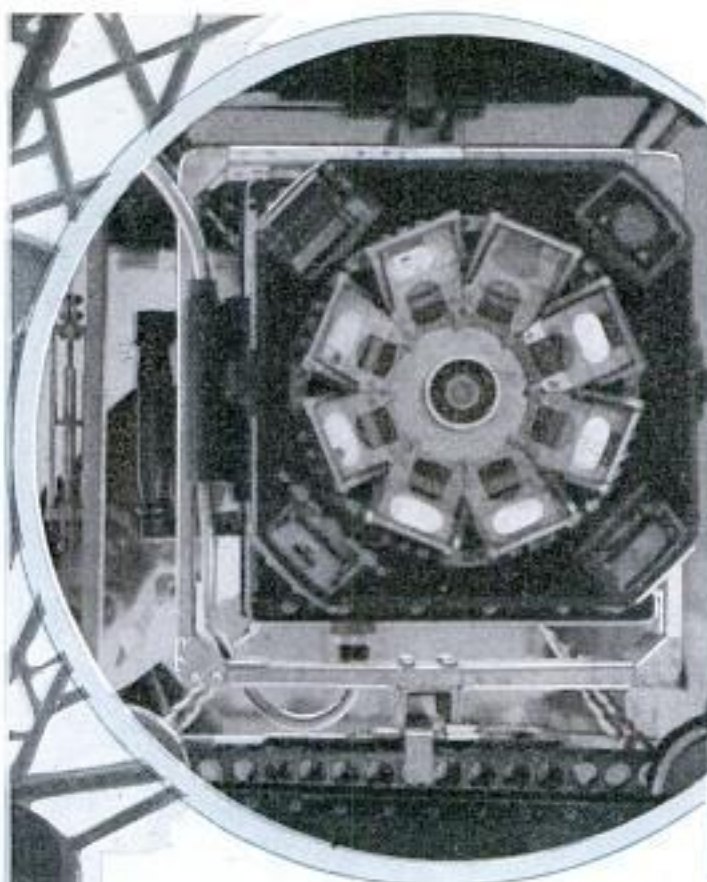

Huge Photogrammetric Camera, Built into the Airship for Taking Vertical Pictures of the Country over Which It Passed, Is Seen Above; at the Right Is Seen Doctor Aschenbrenner with the Geodetic Instruments of Which He Was in Charge; Below Is Reval, Now Known as Tallinn, Esthonia, as It Appeared from the Cabins of the "Graf Zeppelin"

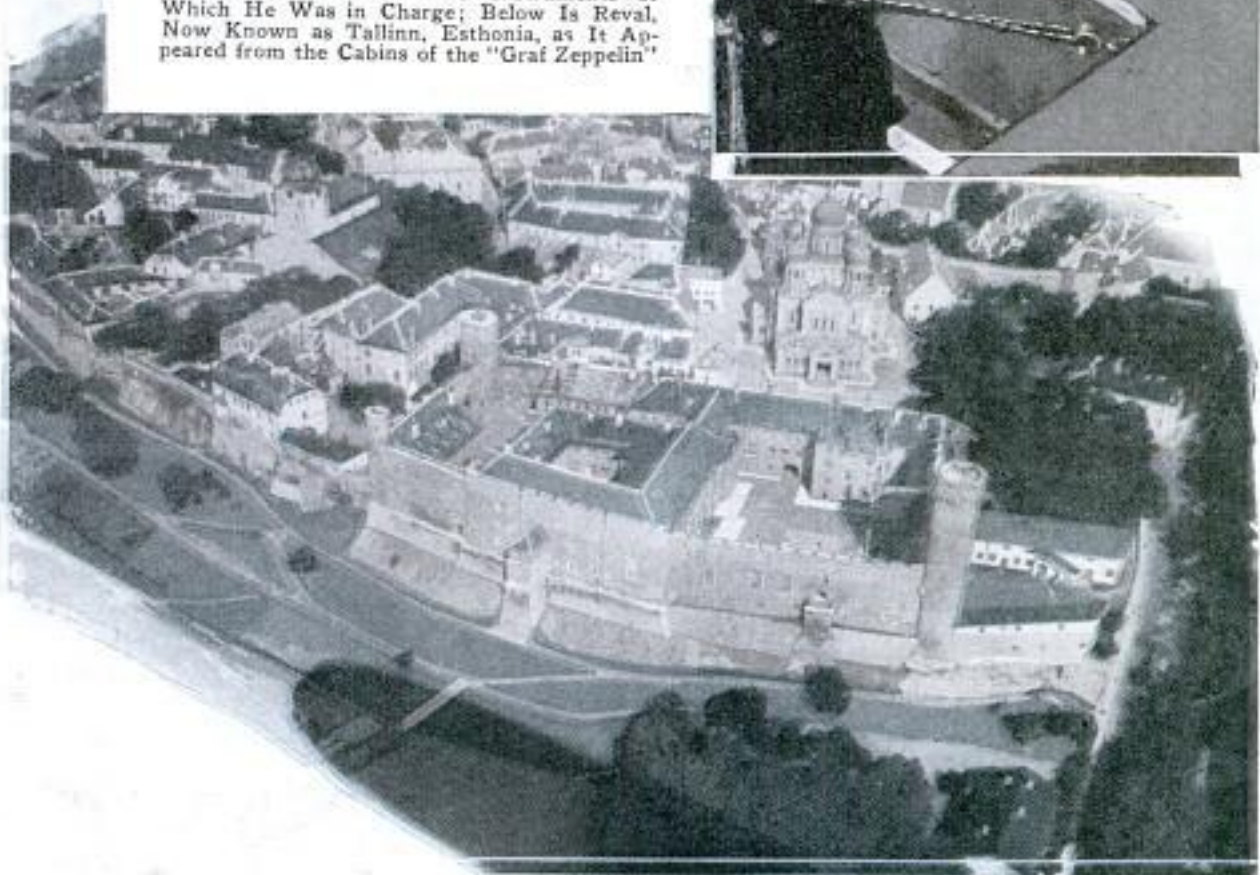
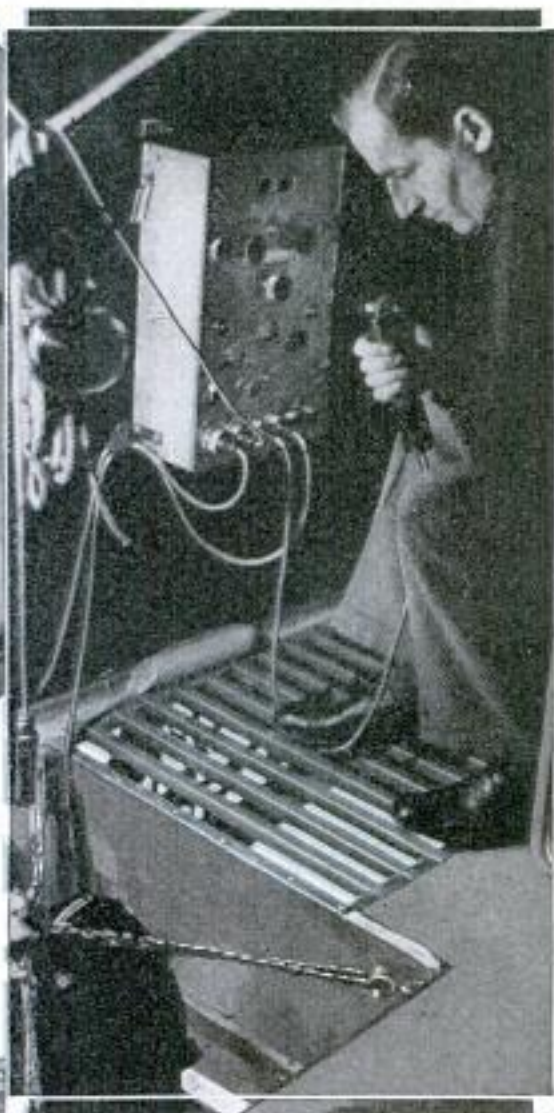

91713



Miles of Hitherto Unmapped and Largely Unphotographed Water, Ice and Land, Constituting Nova-Zembla, Are Seen in the Photograph Above at the Right, Which Also Shows the Forward Gondola of the Dirigible; Above Is Walter Bosshard of Zurich, the News Photographer of the Expedition, in Polar Costume



The Pilot Room of the Dirigible Shortly after Its Take-Off for the 7,000-Mile Trip over the Arctic; Doctor Eckener Can Be Seen at the Extreme Left of the Picture, Scanning the Instruments

Unio. of Nebraska News
8/27/31

POPULAR MECHANICS

Ans. J A
Straley

EGGWHITE POLISHES LEATHER AND LOOSENS CHEWING GUM

Eggs are being used in many ways to make household tasks easier. The whites will remove chewing gum from furniture or even from hair. Leather chairs rubbed with well beaten eggwhites and then polished, shine like new, and the whipped whites make a substitute for cream in salad dressings, while, if stiffly beaten and added to whipped cream, they double the quantity and improve the flavor. When beating eggs separately, a little of the beaten white added to the yolks will cause the latter to thicken more quickly and will not stick to the beater. If fresh-laid eggs are allowed to stand in cold water for ten minutes before boiling, they will peel easily, and it is also claimed that if a knife is dipped into water before cutting hard-boiled eggs, the yolks will not crumble. Cold water has been found best for cleaning soiled egg dishes and for removing egg stains. When only the whites of eggs are to be used in cooking, the yolks can be kept for some time by beating them and adding a little cold water, then placing in the refrigerator.



Electric Hammer That Takes Dents Out of Auto Fenders at Rate of 1,500 Blows a Minute

ELECTRICITY TAKES OUT DENTS WITH PORTABLE HAMMER

Designed especially for metal work, such as fenders, automobile bodies and floors, a portable electric hammer recently was announced that is very light and easily handled. Dents are removed from metal at the rate of about 1,500 blows a minute. A second model is capable of heavier duty. It can be bolted to whatever work in which it may be useful.

Portable Power Hammer Tool Co.
2208 Fairmount Ave. Phila.

HOSE HAS BUILT-IN SPRINKLERS FOR WATERING LAWN

Lawn hose with built-in sprinklers to facilitate the watering of lawn or garden is now on the market. Small sprinkling units, resembling bicycle-tire valve stems, are placed along a length of standard garden hose. The free end of the hose is capped, so that water must pass out through the sprinklers. Thumbscrews enable adjustment of the sprays, and flat metal strips, having a recess for the hose and a hole for the sprinkler, keep the nozzles upright.



ANTS BUILT FIRST SKYSCRAPER EONS AGO EXPERT FINDS

White ants built their "skyscrapers" and were well organized in colonies millions of years before man's advent on the earth, according to Dr. Thomas E. Snyder, entomologist of the department of agriculture. He has found fossilized remains of the ants that show they were in a highly perfected state as far back as the Eocene period, when other animal life dawned. After this, the insects lived through three periods of the age of mammals and then managed to survive the ice age. When the lowest type of man was being developed the white ants were as highly organized as they are today.

Chicago - 316 Taylor

50 H. S. Mangle

Our Bureau of Information is for your benefit. Use it as often as you please.

W. H. Goodrich Co.
Akron, Ohio

U. S. Daily 8/31/31

A 1403 Cont. John L. County,
714 Jefferson St. NW
Washington D.C.

Millions Moved

More than a Million
and a Half in Gold
Coin Being Unloaded
and Placed in Ar-
mored Cars for the
Chase National
Bank from Cuba to
Meet Interest Pay-
ments Due



TO the man in the street, moving millions is a thrilling spectacle of gold piled high in guarded trucks, with officers of the law clearing lanes of progress. But to United States treasury officials, moving millions is just another day's work. Each day sees officials of the government moving untold wealth from the bureau of printing and engraving, where currency and bonds are printed, to the treasury, and from the treasury to banks throughout the country.

How does Uncle Sam guard this money and how is it handled?

The daily replacement of worn-out currency in the United States is around \$10,000,000. This means that around \$10,000,000 in currency finds its way into the treasury each day and a corresponding amount goes out. Tracing the movement of the currency to the source of origin—the bureau of printing and engraving—the daily output of currency at that plant must approximate this figure.

But these figures, huge as they are,

pale into insignificance when it is stated that in December, 1929, alone—the month the stock market broke—over \$1,000,000,000 in currency was shipped out of Washington to the country's banks.

Handling as much as \$3,100,000,000 in a year, Uncle Sam must exercise the greatest precaution and care to safeguard it against thieves of all sorts—gangsters, robbers, inside plants. What are these precautions?

First are impregnable steel chests of great weight, the keys of which never move with them in their eight-ton Gibraltar truck, steel-barred, loop-holed and manned by locked-in guards, armed with rifles, shotguns and machine guns.

Second, the men; the task of guarding

© Keystone

in Cash Every Day!

Uncle Sam's money as it rolls through the streets of Washington is a part of the routine duties of



Above, Steel-Lined Car for the Movement of Treasure in the Wall Street District; Below, Guarding \$2,500,000 in Gold from Japan

the secret service. The very name of this organization defines the manner in which its work is performed. Veiled in mystery, it is known only to exist as a service attached to the treasury to spy out counterfeiters, watch over the president and the treasure of the United States.

You notice an armored truck moving silently under the elms around the Ellipse south of the White House, from the bureau of printing and engraving to the treasury department. You know, perhaps, that it carries the wealth of a Croesus. You know further that guards peer from behind rifle loopholes. But what you do not know, perhaps, is that the eyes of one, two, three, or more, sauntering pedestrians near the great treasury gates

and along the path of the armored car are watching every living, moving thing within the range of their vision. All men of nerve, steel and deadly aim.

And inside those treasury gates no man is permitted. The swiftly, silently moving truck is engulfed by their great maw. Hidden machine guns, gas bombs, electrical devices that can close the treasury in three minutes, locking every soul within, stand by unsuspected as guards

move the treasure chests from the truck cage and along underground passageways to secret vaults.

So perfect, so flawless is the technique of the secret service that a visitor to the treasury department has no knowledge of its existence. Not one penny of the treasure ever has been stolen.

To get an idea of the banknote shipments by Uncle Sam, you take one year, 1922-23. In those twelve months about \$1,500,000,000 in federal-reserve notes left the capital, \$600,000,000 in national banknotes and \$900,000,000 in the three remaining issues, silver certificates, gold notes and greenbacks.

Uncle Sam has, all told, in his hands \$3,696,000,000 in gold. This means that,



Above, Moving \$15,000,000 in Gold from a Liner, and, Below, One of New York's Payroll Cars

in addition to the vast coin store in the vaults at Washington, he has a billion and six hundred-odd millions of dollars worth of gold in the assay office at New York; in San Francisco about a billion; \$600,000,000 at the mint in Philadelphia; \$400,000,000 at Denver, and varying smaller amounts scattered through-

out the nation. There are 525,000,000 silver dollars in existence. In addition to the \$50,000,000 at Washington, the Philadelphia mint has \$230,000,000; San Francisco \$90,000,000; New York \$65,000,000, and federal reserve banks about \$7,000,000.

Elaborate precautionary methods are outlined by the treasury department for banks sending in currency for redemption.

Several months ago, an express guard at Union Station, Washington, was blackjacked and a package of currency destined for the treasury department for redemption was stolen. A few days later the package was found cast away in a Washington alley. It totaled \$800,000 in currency. However, it was worthless. Only half of the bills were there.

Uncle Sam, just to forestall such robberies, in moving millions, instructs banks to slit currency for redemption lengthwise, perforate the halves on a machine and ship half of the total at a time. When the first batch is received by the treasury, the sending bank is notified.

made by Prof. George L. Clark
University of Illinois
 POPULAR MECHANICS
Urbana, Ill.

air 25

**STRONGER COTTON
 POSSIBLE X-RAYS
 DEMONSTRATE**

Better cotton than is being produced anywhere in the world was grown by the Egyptians before the Christian era. This has been revealed by an X-ray study of cloth, taken from Egyptian mummies, at the University of Illinois. In addition to showing that cotton grown centuries ago was better than that produced today, the X-ray analysis also indicated that Texas cotton can be made just as strong as the ancient Egyptian product. The treatment involves softening of the cellulose molecules and alining them under tension. The change in structure is determined by the X-ray pattern. Possibly the Egyptians also treated their cotton.



Glider Boat Equipped with an Airplane Propeller and Driven by 400-Horsepower Motor; It Makes a Speed of Fifty Miles an Hour

**BOAT WITH AN AIR PROPELLER
 RUNS FIFTY MILES AN HOUR**

Fifty miles an hour is the speed attained on trial runs by an odd-looking glider boat, driven by a 400-horsepower motor connected to an airplane propeller, which has been designed for passenger service on the Danube. The first of these boats carries fifteen to twenty passengers with baggage and reduces the time between Vienna and Budapest by seven to ten hours. Larger boats are being built.

**WINDLESS HORN PLAYS MUSIC
 JUST LIKE A VIOLIN**

Carved with a pocketknife, a violin which has an ordinary steer's horn for a sound box produces tones, which its maker says are equal to those of high-priced instruments. The horn-fiddle was made in three months' spare time. It is not placed under the chin like an ordinary violin, but is held against the collarbone when being played. The bow and strings are the only parts which the maker did not produce with his knife.

**ELECTRICITY FINDS NEW TASKS
 ON MODERN LINER**

Of the 105,000 horsepower developed by the engines of the German liner "Bremen," 5,000 are consumed by the many electrical devices for the safety and comfort of passengers. There is a smoke register, for instance, in every room where there may be a fire hazard. This instrument is so sensitive that, if a person steps into the room with a lighted cigaret, a signal is transmitted to a room on the bridge. There are more than a score of telephone loud speakers which replace the old-fashioned speaking tubes, and electricity has also replaced the old-time logs as speed indicators. Electricity likewise shows the engine revolutions, steering position, drives 494 clocks and, from a signal room, water-tight doors can be closed automatically, the electric devices also showing which are closed.



Violin Carved with a Pocketknife out of a Steer's Horn

Wid World
made by Louis Selby

Com. Add. H. H. H. H.
Boys' Club
Phoenix, Ariz.

The Cook Studios
548 E. The Point St. Rox.,
Philadelphia, Pa.

Big Statues Are Made from Old Newspapers

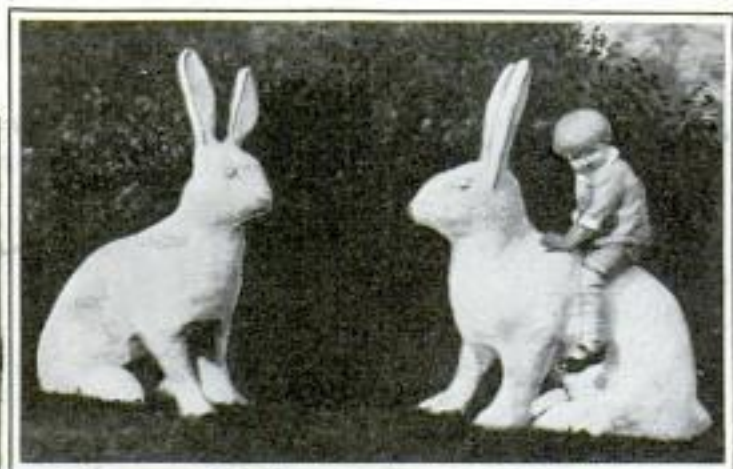

Examples of Large Statue and Other Figures Which Have Been Made from Old Newspapers

Old newspapers are being transformed into huge, bronzelike statues of men and animals that weigh only a few pounds but are very durable. The newspapers are shredded and bleached in a boiling solution of chemicals until the resulting dry pulp resembles gray wool. This pulp is worked into a plaster by mixing it with boiling water and glue as well as alum to prevent shrinkage during drying. The material then can be worked like plaster. The figure to be made is first modeled in clay in full size. A plaster-of-paris cast of the model is made and removed, and the pulp is spread inside with backings

of glue-impregnated paper, openings for working being provided in the cast. When the pulp has dried, the cast is removed and the rough edges on the outer surface are smoothed. In large figures it is also necessary to assemble the head, arms, legs and other parts at this time, as they are made separately. It is also possible to make figures with moving eyes and arms, or a facial expression that changes. In the latter case, the face is made of leather like that used for organ bellows, and the movements are controlled by wires to

Refer enquiries to Mr. Cook, of Cook Studios. We'll give any information that does not interfere with his business.

21740

which small motors are attached. Because of the light weight, little power is required for the desired motions. Paper models also have been made of entire towns since the newspaper pulp is an extremely plastic medium, and hence easy to work with.

Q1539

RADIO TREATMENT FOR BRAIN AIDED BY HEAT RAYS

Treating diseases of the human body with heat applied by ultra-short radio waves has been found beneficial in Germany. The waves, of not more than ten meters' length, penetrate deeper and can be controlled better than the longer rays which formerly were used. By changing the wavelength, a definite organ can be reached. The apparatus is regarded as entirely practical in the treatment of the head. A layer of air does not prevent penetration of the rays, so the electrodes need not be applied directly to the body to get the full effect.

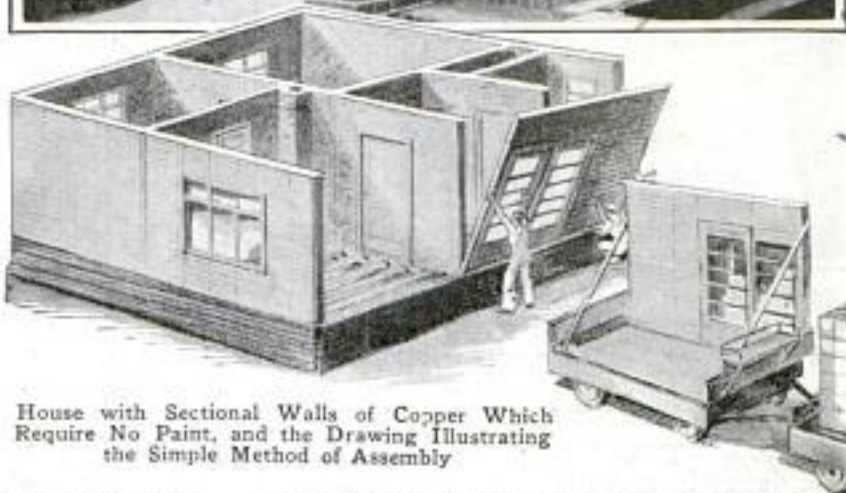

House with Sectional Walls of Copper Which Require No Paint, and the Drawing Illustrating the Simple Method of Assembly

HOUSES WITH COPPER WALLS REQUIRE NO PAINTING

Bungalows with walls of sheet copper are being constructed in Germany since it has been found that this metal offers advantages over steel houses, principally because it is rustproof and requires no protective coat of paint, either inside or outside. The walls are formed of large plates which support a ceiling of beams and have lining of wood as insulating material. In this form, they offer as much protection from heat or cold as a thick brick wall, and experiments have shown the copper houses to be unusually cool in summer and to offer fuel economies in winter as compared with other types. The interior walls are finished in gray, embossed with arabesque patterns and can be washed, so no wall paper is needed. The metal walls are formed ready for assembling, and such a house can be constructed in twenty-four hours. It is easily altered, extended or moved.

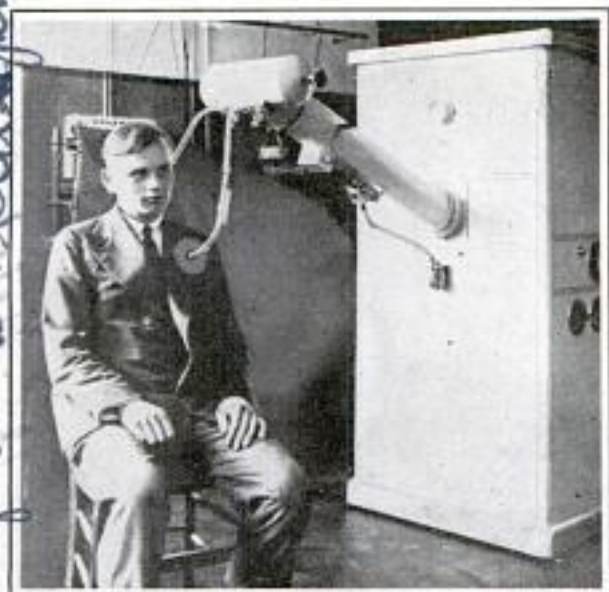

© Press Photo Patient Receiving Heat Treatment from a Radio Apparatus Generating Ultra-Short Waves

Designer Dr. Schickelphahn

Handenbergstr. 43. Berlin. Charlottenburg. Germany. Messingwerke A. S. of

Dr. Prof. Esau
Jena Germany

No A.S. agent known

91696
768

Plant Pathology Bureau
Department of Agriculture
Washington, D.C.



Copperized Paper That Will Prevent Spread of Gray Mold in the Storage of Pears

COPPERIZED PAPER FOR PEARS PREVENTS SPREAD OF MOLD

Spread of gray mold and elimination of nest decay in storage of pears can be prevented by the impregnation of paper wrappers for the fruit with a copper solution. Great savings will be made yearly by covering the pears with this paper.

NEW EXPLOSIVE ADDS POWER AND SPEED TO BULLET

Infantry arms may be placed in the class of light artillery by a new explosive invented by a German engineer which has been found to increase both the speed and consequently the power of a rifle bullet. Using this explosive with an ordinary rifle and soft-nose bullet, tests showed that the projectile could penetrate a steel plate covered with cement at 150 feet. The muzzle velocity developed by the new explosive is about 4,500 feet a second, or about twice that of present military arms. This is expected to enable infantry arms to be used effectively against tanks and light armored artillery. It is said that the recoil is no greater with the new than with ammunition used at present.

Dr. W. Beerlich,
Kiel, Germany

91778
Cml. Add 1 Halsey
Box 4 77
Phoenix
Ariz

PEANUT SHELLS USED AS FUEL TO PRODUCE ELECTRICITY

Electricity from peanut shells is the method proposed for lighting a town in South Africa. The shells are abundant here and are already being used as fuel in the boilers of several factories. Now it is planned to employ them as fuel to produce electric current for a lighting system. The shells, when used as fuel, leave two valuable residues, a fertilizer that is rich in potash salts, and a valuable firm-setting tar.

91769
Spencer James
Potgietersrusk

GIANT WIGWAM OF CONCRETE MAKES A NOVEL HOME

Finding what he considers the ideal location, a hilltop 1,100 feet high, a California orange planter has built on a flat surface, two acres in extent, a huge tepee-shaped house of wood, concrete and steel. The building is sixty feet in diameter at the base and fifty feet high. A third of the circular floor space will be used for dining room, kitchen and storeroom, and the remainder for the living room. A feature of the latter is the fireplace built in the center of the house, with the smoke escaping just as in a regular wigwam. Winding stairs ascend from the living room to a balcony, off which are sleeping rooms, baths and dressing rooms, and another spiral stairway leads from the balcony to an observatory installed on the third floor.

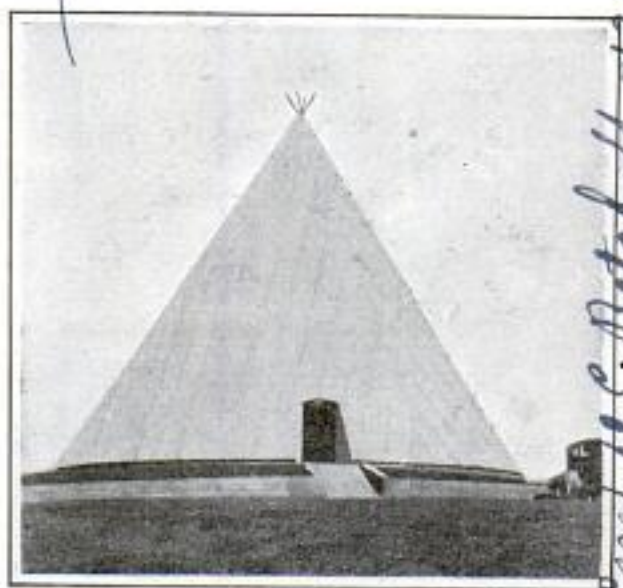

Giant Wigwam of Concrete and Steel Built on a Hilltop Brings Early Days Home to Owner

91720
A. L. Houghtelin,
San Pasquel Valley,
Southern Calif.

91720
Plant Pathology Bureau
Washington, D.C.

A 169.¹ Mrs. Maurice & Morris
 2329 Quincy Ave Quincy Ill
 POPULAR MECHANICS
 Editor Utah 769

"Bent Light" Makes Movies of Still Pictures

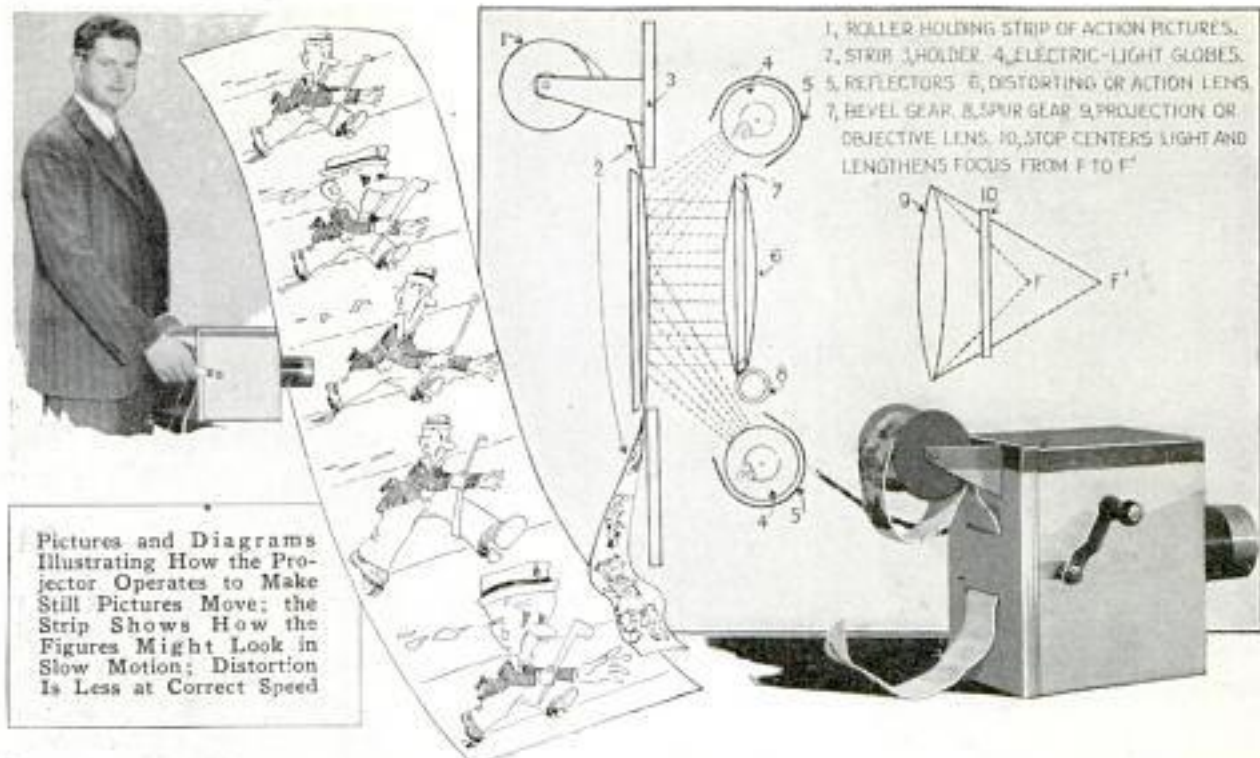

Pictures and Diagrams Illustrating How the Projector Operates to Make Still Pictures Move; the Strip Shows How the Figures Might Look in Slow Motion; Distortion Is Less at Correct Speed

Have you ever stood before a large convex and concave mirror arrangement at an amusement park and laughed at the funny pictures of yourself reflected from the looking glasses? A Utah man did, and it gave him an idea that he has developed into a projector that makes movies out of still pictures. He discovered that if the glass were revolved, the repeated shortening, broadening and lengthening effect of the mirror gave the subject an appearance of motion. The same effect, it was found, was obtainable by placing a revolving power lens between the mirror and the object. It is the latter method that is used in the projector, now being produced as a toy. The lens is turned by a crank, just like a regulation movie projector.

EARTH GLOBE IN CAGE OF WIRE HELPS TEACH NAVIGATION

Hoping to be the first woman flyer to cross the Pacific ocean, Juanita Burns, co-holder of the endurance record for women, has announced she will attempt a flight from Tokio to Seattle, in competition for the \$50,000 in prizes offered for the first pilot to complete such a trip. Her plane, a specially constructed one, now is

being shipped knocked-down to Japan, where it will be assembled, and in the meantime Miss Burns is making an intensive study of the art of navigation under an expert teacher. To make it easier for her to visualize the principles involved, her instructor has mounted a globe at the correct angle and surrounded it by a cage of wires, which are projections of the principal parallels and meridians of the earth.

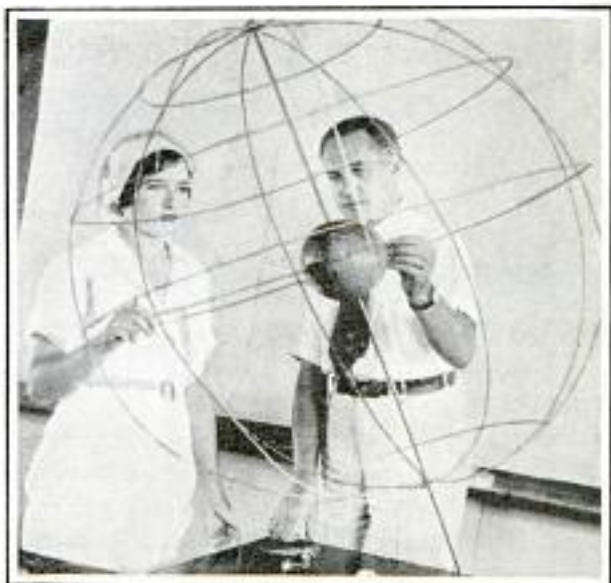

Juanita Burns and Her Instructor Going over Navigation Problems She Will Have to Face

Wide World

a1283 Cmt John Warren Woodley
2589. 29th St NW
Washington, D.C.

The "ME-TOO" Boats

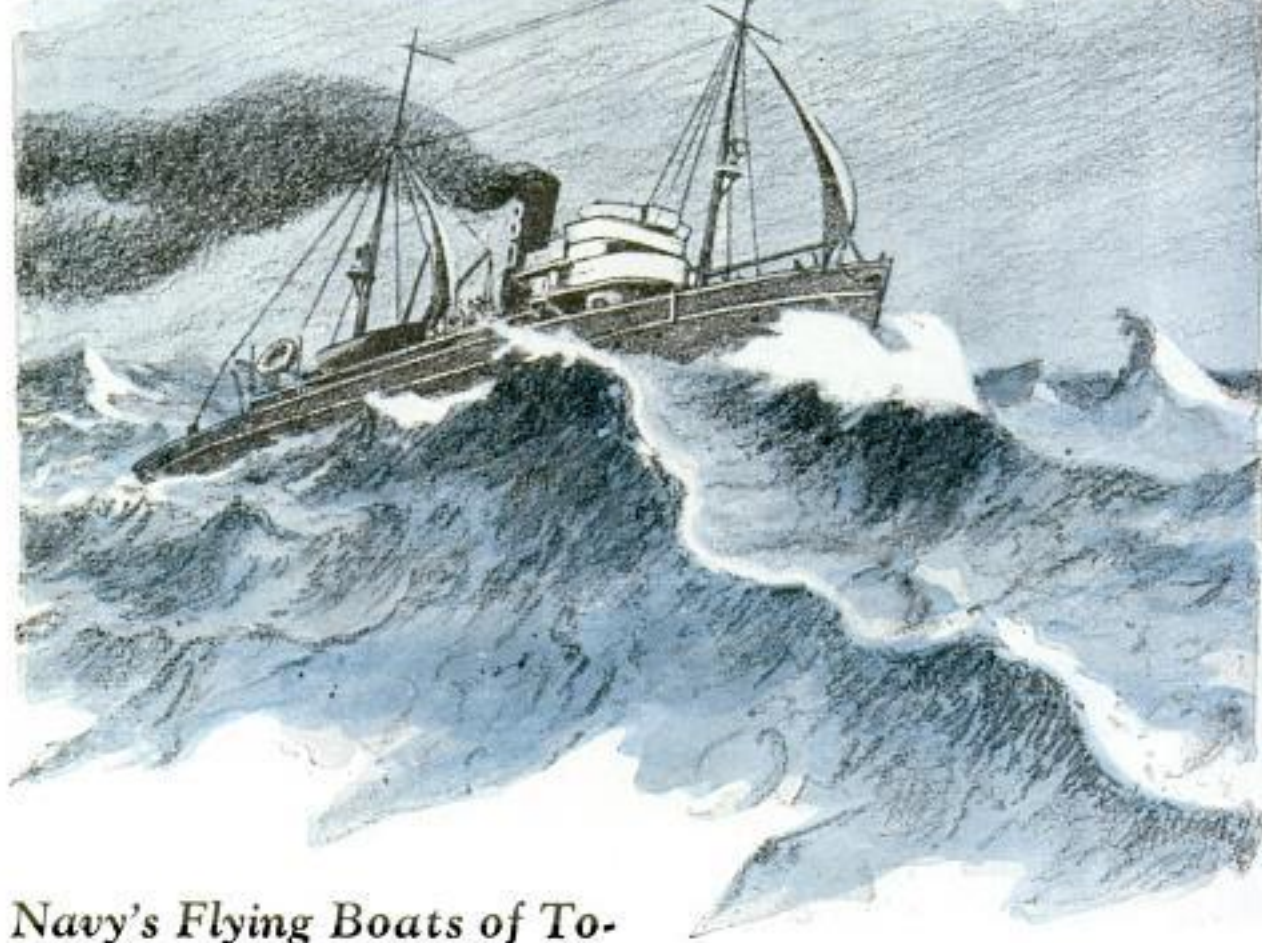

Navy's Flying Boats of Today Carry a Crew of Five Men, are Practically Invulnerable to Attack from the Air and are Able to Stay Aloft for Fifteen Hours

A SQUADRON of six navy patrol planes was under orders to take off at dawn from the southeastern shores of Cuba, their objective the Atlantic terminus of the Panama canal, 700 miles over the wind-swept waters of the Caribbean.

Promptly at the zero hour, engines roaring, the flying boats mounted dripping to the skies and soared southward. Nine hours later, they came to rest on the waters fringing the entrance to the canal and moored to bobbing cylinders anchored along the coastline by their "me-too" tender, a staunch seagoing craft which

had preceded the planes from Cuba. From the tender a purring motor launch had shoved off. As it came alongside each plane, the five men composing the crew of the flying giant heaved their aching bodies into the boat. Soon they were aboard me-too. A shower bath, a change of clothing, a hearty meal, and they stretched out on comfortable bunks in the compartments reserved for them.

The me-too captain sent out his crew of mechanics. They brought the planes astern, one at a time, gassed them from the big tanks, drained and renewed the lubricating oil, towed them back to the buoys. Repairs would wait for the plane-crew mechs. A half day for that, then the me-too would see the planes safely away for the Pacific. The buoys would be picked up, steam raised, and the isthmus crossed. On the Pacific side another me-too would have anchored more bobbing cylinders.

and their BROOD

A "Me-Too" Boat, on the Opposite Page, Riding Weather in the North Sea; in Addition They Were Threatened by Destruction by Mines; Plane Needing Only Minor Repairs after Drifting Nine Days, at Right; Ready to Take-Off, Below

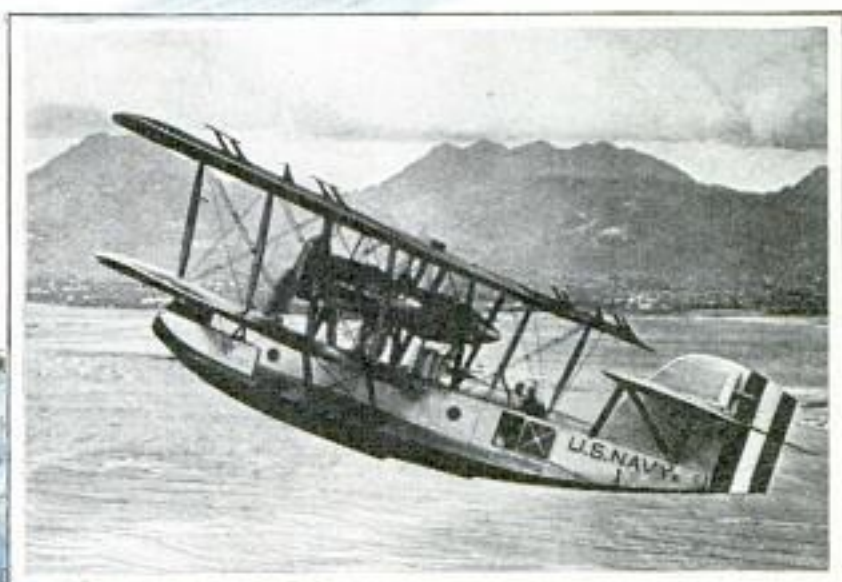

patrol-plane squadrons. In the past they have been minesweepers, and all of them served in the North Sea, clearing that area after the world war of the menacing mine barrage that so effectively forbade the passage toward the

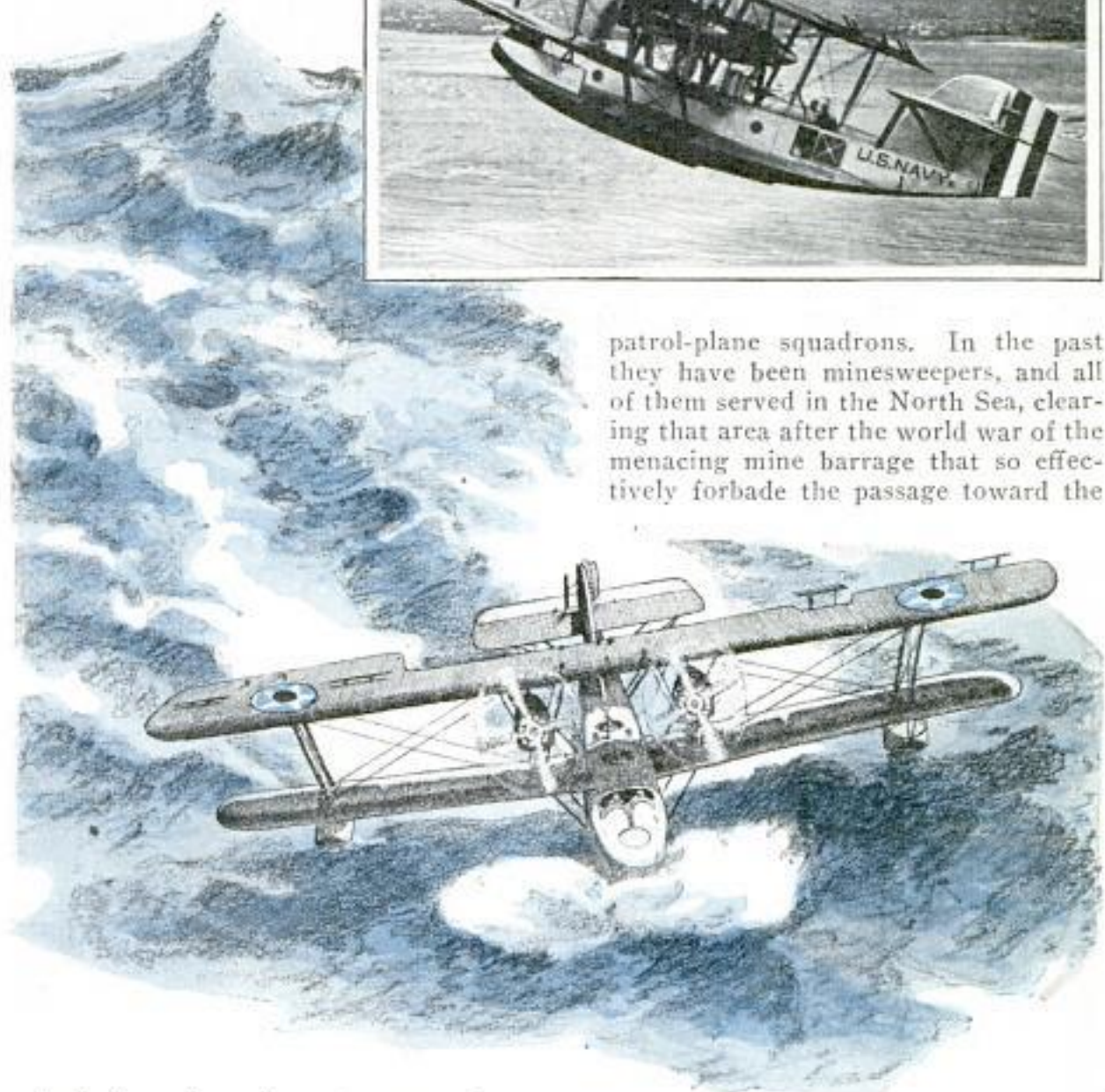

And thus, throughout the year, whenever the navy's patrol planes are ordered on over-water flights, there always are included schedules for the ever-moving, efficient craft which are known, because they are always on hand, as me-too boats.

There are seven of those tenders for the

close of 1918 of the German fleet. In appearance, these tenders resemble gray ocean tugs. A crew of five officers and fifty-seven men is aboard, and they are seamen all, as well as mechanics. When

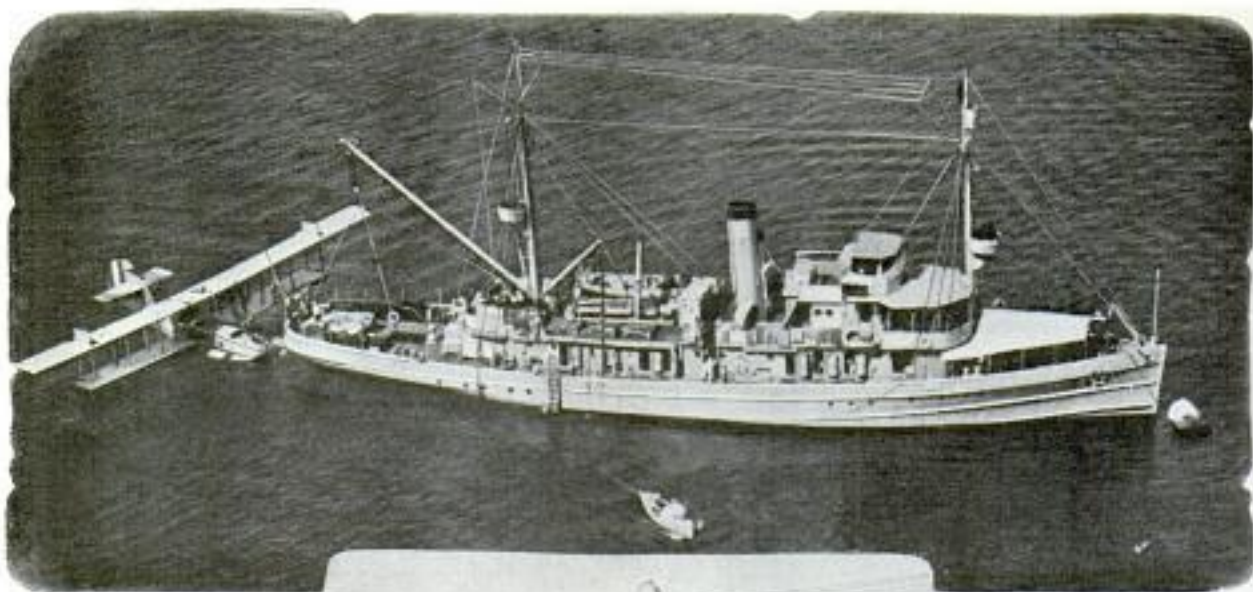

wind conditions are favorable, this crew is not above making sail. In 1925, when the fleet was en route to Honolulu, the commander-in-chief ordered a fleet speed of fifteen knots. The me-too boats could make but fourteen with their oil-burning boilers, but they hoisted sail and were ready in port for their flying brood when the fleet steamed into anchorage.

Recently, the navy has removed all minesweeping gear from the me-too boats and installed additional fuel and oil tanks. They have been equipped, as well, with heavier lifting gear, an extra seaplane cradle and more spacious quarters for plane personnel. The minesweepers which have undergone these alterations are the "Sandpiper" and "Teal," attached to the flying-boat squadrons operating in the Atlantic; the "Gannet," serving the west-coast patrol planes; the "Swan," operating from the fleet air base at the Canal Zone; the "Pelican," tending the patrol planes at the fleet air base, Honolulu, and the "Avocet" and "Heron," attached to the aircraft squadrons of the Asiatic fleet.

In sum, these seven me-too boats tend



a brood of 186 planes—thirty-one squadrons, comprising the mobile, long-distance patrol arm of the U. S. fleet. The evolution of the flying boat or patrol type of seaplane has progressed remark-



"Sandpiper" Refueling a Visitor, Top, Taking Planes Aboard, Center, and Scouting Plane with Two 500-Horsepower Engines

ably in our navy, and the additional facilities recently installed on board their surface tenders indicate another permanent advance toward more efficient operation.

Today, the navy has developed patrol planes to a point where they are the envy of all nations. The original flying boat of

a1383

a1405

world-war days was a mediocre two-passenger machine. These "HS-1" planes, however, performed valuable services along the shores of France and Italy. Toward the close of the war, the navy developed the "NC"-type, one of which, in 1919, made the first transatlantic flight. Thereafter, the navy concentrated its efforts on a "PN," or patrol-navy type, one of the earlier classes of this patrol plane, a "PN-9" under Commander Rogers, making the historic flight from San Francisco to the vicinity of the Hawaiian islands. Today's navy flying boats are seaworthy, habitable with a crew of five, practically invulnerable, by virtue of their armament, to attack from the air, possessed of powerful radio equipment, and capable of fifteen hours in the air at a cruising speed of eighty knots.

As an example, one of the squadrons, attached to the scouting force operating in the Atlantic, cruised during the period from January to April, 1931, a total distance of 95,640 nautical miles. The six planes of this squadron left Hampton Roads in January for winter maneuvers in tropical waters. The planes flew to Guantanamo bay, Cuba, thence, in February, across the Caribbean to Panama and up the west coast of Central America.

There, basing on the me-too boats, they participated successfully in a fleet war problem, scouting 25,000 square miles of ocean daily, discovering and bombing "enemy" ships. Their radio reports were intercepted in Washington.

On their return trip to Guantanamo bay, the planes of this squadron took an active part in air-concentration exercises in the Caribbean and then, in April, returned to Hampton Roads.

a1646

**CLUE TO AMERICA'S FIRST MEN
UNEARTHED IN ALASKA**

Skeletons of humans believed to have been among the first inhabitants of North America have been unearthed on Kodiak island, off southern Alaska, by Dr. Ales Hrdlicka, of the national museum at Washington. The skeletons support Doctor Hrdlicka's belief that the first settlers of this continent came to Alaska from Siberia by Bering straits, moving from island to island in canoes, then south.

Chicago Herald and Examiner

**TARGET SHOOTING IN REVERSE
SHOWS SKILL ON RANGE**



Expert Marksman Who Shoots in Reverse and Aims Rifle with His Head Upside Down

Capt. George Ash, of the Canadian police, has been engaged to give instructions and demonstration in rifle and pistol marksmanship to military units ordered to Salisbury Plain, England, for target practice. One of Ash's most spectacular stunts is to demonstrate sharpshooting by holding the rifle backward between his legs and sighting over the barrel with his head upside down.

**GASOLINE MADE FROM WASTE
BY "ELECTRONIC BARRAGE"**

a1749

Discovered in the laboratory of the University of Minnesota, a new source of gasoline that seems to promise economical production has been announced. In research done for the American Petroleum Institute, the scientist has extracted gasoline, petroleum oils and other allied products from methane gas, which in modern processes of refining is mostly wasted. Methane, commonly known as marsh gas, has a very low carbon content, and the cost of producing gasoline from it is at present prohibitive commercially. Those conducting the research, however, feel confident further tests with propane, ethylene and butane, other gases wasted in refining and having higher carbon contents, will produce fuel and lubricants from waste at attractive prices.

*New York Herald Tribune
8/23/31*

*Dr. E. A. Schuttge
under direction of
Dr. E. Lind*

91612
774

at Saint Ann's, France
POPULAR MECHANICS

Motor Railway Cars Run on Rubber Tires

Michelin Tires Co
uses and vehicle

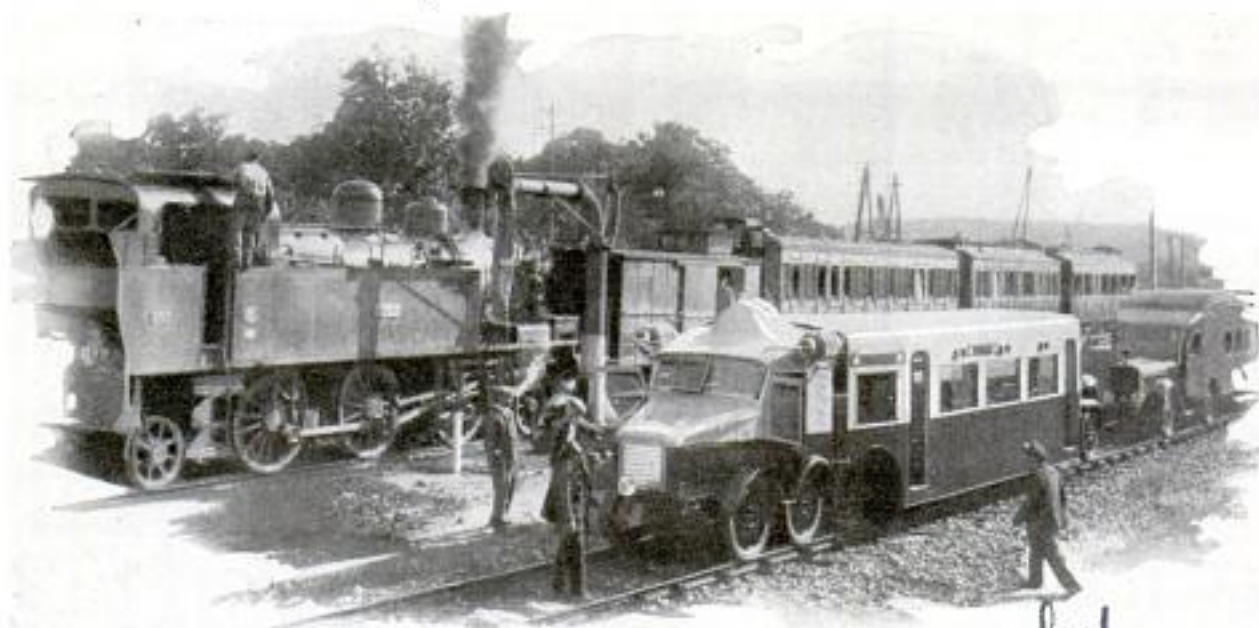

Comfort for Passengers and Plenty of Speed Are Combined in the Motor-Driven Railway Coach Which Is Equipped with Rubber Tires; Note How Much Smaller the Coach Is Than the Old Equipment

Rubber pneumatic tires have replaced steel wheels on railroad motor cars now in service on a French line, resulting in greater riding comfort. The motor cars are smaller than the old type coach drawn by steam locomotive, but run on the regulation track.

much repair work on planes. Somewhere between the two types is the ideal flyer, and of those selected after mental tests, seventy per cent made good.

9173 WAY TO TELL A GOOD AVIATOR BEFORE TRAINING FOUND

Personality, as shown by psychological examinations, is an index to whether or not a student will make a good aviator, according to authorities of the navy medical corps. Bookworms and "grinds" were found not to do so well as a group at the naval air station at Pensacola, where it was shown that the "poor mixer" and also the individual who is overly serious were likely to give too much consideration to the possibility of danger and accident. On the other hand, the mentally dull and self-satisfied student progresses rapidly with his training because he lives only in the present and either does not know when he is in trouble in the air or would not admit it if told. The second type, however, was found to be the careless flyer who is apt to have crashes, collisions in the air and cause

91681 INJURED DOG IN "WHEEL CHAIR" IS PULLED BY COMPANION

Despite an almost hopeless injury to its back, a Boston terrier is slowly learning to walk again with the help of an improvised "wheel chair" and the aid of another dog. The chair consists of a metal frame in which the injured animal is suspended by means of braces, both rear legs being rendered useless as the result of an accident. The dog is able to get around in this harness with reasonable ease and the occasional help of another dog which has been trained to tow its injured friend.

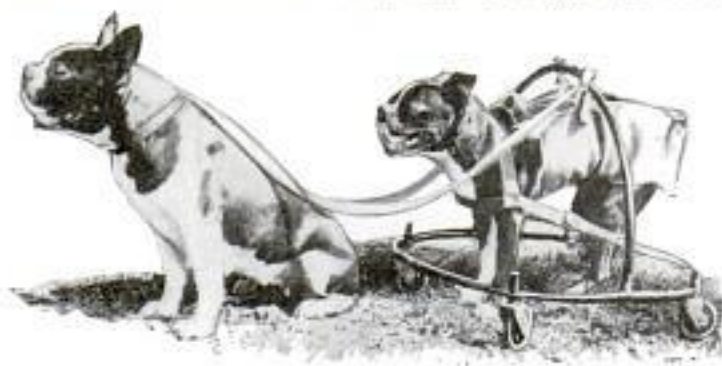

Teaching His Injured Pal How to Walk Again Is Just a Game for This Dog

Science Service 8/18/31

Leut. P. L. De Loney
U.S. Navy Medical Corps
in Medical Bulletin

Judge W. W. Knight a 1680 and George
 Bungle 775

POPULAR MECHANICS

ENGINE ON CULTIVATOR LIFTS WATER FOR FARM a 1710

With power supplied by a motor garden cultivator and the water supply a well ten feet deep, an irrigation system on a farm near Brookings, S. D., this summer resulted in crops that developed much faster than others on the same farm which received only the normal moisture. The owner dug the well himself and found that it had a capacity of about three barrels a minute. The maximum capacity of the cultivator engine and pump is about four barrels, but, at normal operating speed, the three-inch pipe, with a total length of about 500 feet, was kept full without running the well dry. a 1665

TRAFFIC LIGHT CHANGES SHAPE TO AID COLOR-BLIND DRIVER

Traffic signals which change shape in addition to colors are helping color-blind drivers in one large American city. Instead of having three round lights, as is customary, the green light is oblong and placed vertically, the amber light is diamond-shaped, while the red light is also



oblong but placed horizontally. Many persons are helpless in traffic, being unable to distinguish red from green. One man in each hundred is color-blind, while in women, the percentage of color blindness is somewhat lower.

GAME FISH WITH "MORE FIGHT" DEVELOPED BY HATCHERY a 1709

Crossbreeding brown trout with Atlantic salmon, the fish-culture division of the Canadian government has developed a fish larger than the usual brown trout but with the fighting gameness of both parents. It is said the fish is a better fighter than any now found, even in most of the unfished waters, and it is expected the government will stock streams throughout the Dominion for sport fishing at an early date.

Com. James Montagnes
 6081 Harbour. Comm. Bldg
 Toronto, & Ont. Can.



All Jokes about Rubber Fenders Are Stopped by This Bus Equipped with Semi-Flexible Mudguards

RUBBER FENDERS PROTECT BUS IN MUD OR ACCIDENTS

Motor coaches in one American city are equipped with stiff, semi-flexible rubber fenders. The wheels of the busses are in recesses under the floor, but the fenders extend four or five inches from the sides, serving as mudguards and as protection for the paint if the bus should be side-swiped by another vehicle.

BLUE OF THE SKY IS CAUSED BY SUN'S ELECTRICITY a 1718

Electrons streaming from the sun probably produce the blue color of the sky, Dr. Willi M. Cohn says after laboratory experiments with cathode rays. A stream of electrons, which is the cathode ray, was allowed to meet larger electrically charged particles of matter, known to scientists as ions, which are formed either from a piece of radioactive metal, such as thorium, or from a gas. A blue light appeared where the electrons and the ions came together. This light resembles the sky's color closely. Doctor Cohn points out that the sun's electrons and the ions from gases in the air would produce a similar light when the electrons strike the earth's layer of atmosphere.

University of Berlin

Copyrighted material

Com. George R. Harrison
 219 Bay St. Council Bluffs
 Iowa

Dr. Charles Adkin
 Baltimore, Md.

Used in Iowa Coaches, made by F. aged at Kent, Ohio.

James pernce
 8/17/31

Giant Thunder Lizard That Shook the Earth

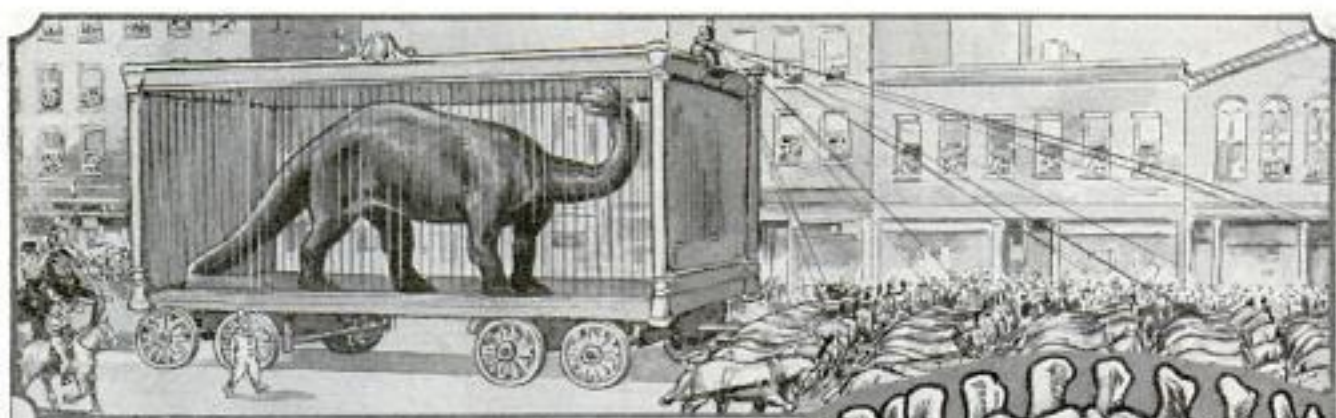

A CIRCUS THAT COULD EXHIBIT THIS ANIMAL IN A PARADE MUST PROVIDE A CAGE AT LEAST 65 FEET IN LENGTH AND 80 HORSES TO PULL IT



LONG TAIL USED AS COUNTERPOISE

FOR 100,000 YEARS THE DINOSAURS-TO WHICH FAMILY THE BRONTOSAURUS BELONGS-DOMINATED THE WORLD

CONTINUATION OF TAIL RECONSTRUCTED

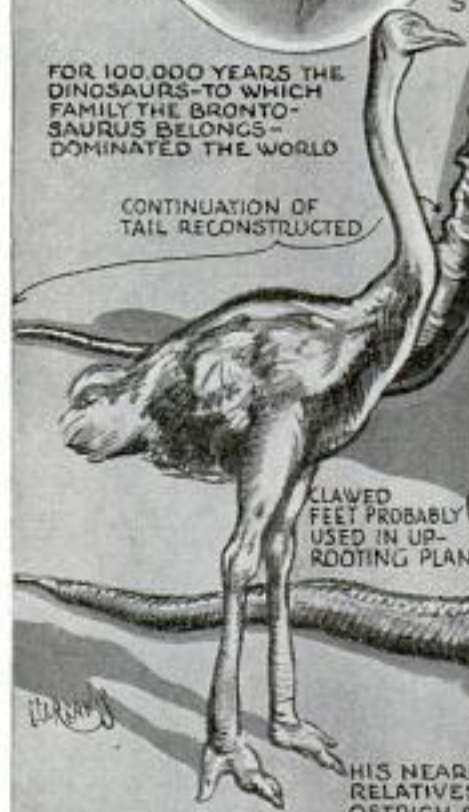

CLAWED FEET PROBABLY USED IN UP-ROOTING PLANTS

HIS NEAREST LIVING RELATIVES ARE THE OSTRICH AND CROCODILE

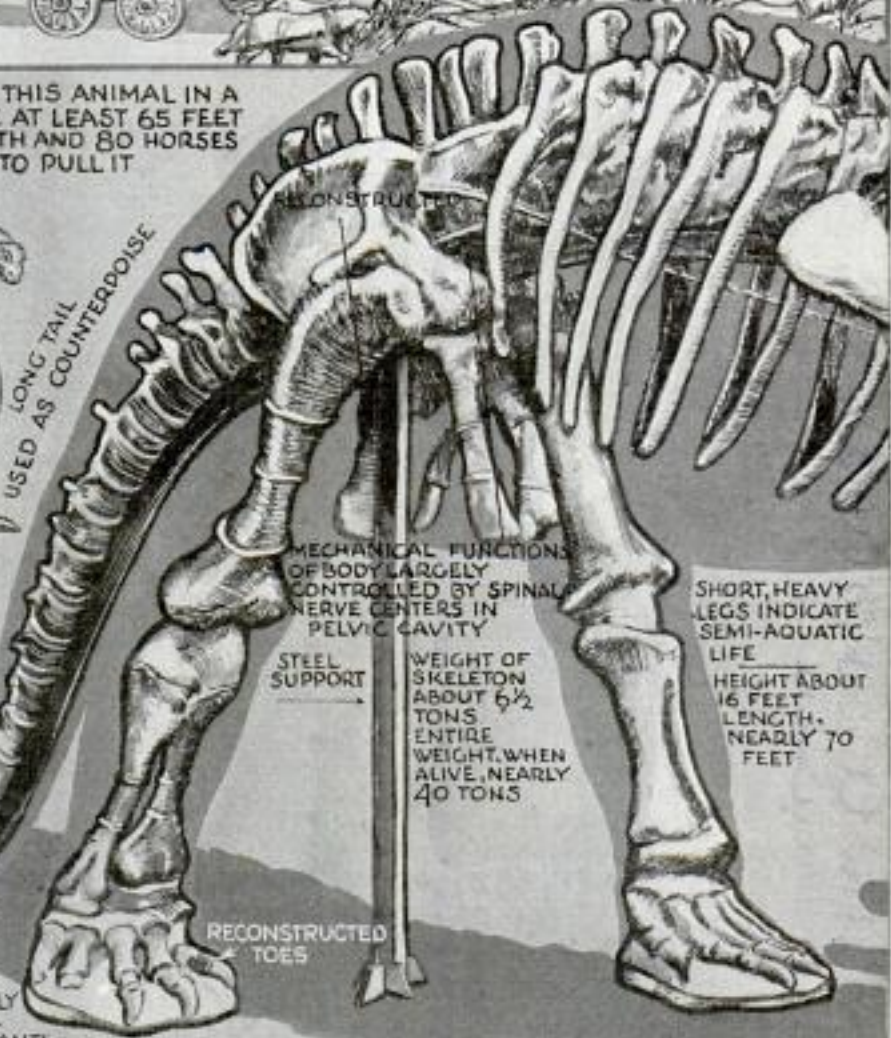

MECHANICAL FUNCTIONS OF BODY LARGELY CONTROLLED BY SPINAL NERVE CENTERS IN PELVIC CAVITY

STEEL SUPPORT

WEIGHT OF SKELETON ABOUT 6 1/2 TONS
 ENTIRE WEIGHT, WHEN ALIVE, NEARLY 40 TONS

SHORT, HEAVY LEGS INDICATE SEMI-AQUATIC LIFE

HEIGHT ABOUT 16 FEET
 LENGTH, NEARLY 70 FEET

RECONSTRUCTED TOES

Brontosaurus Excelsus, or Thunder Lizard, Which Roamed the Earth Millions of Years Ago; the Bones Were Collected in 1881 in Wyoming and Partly Mounted in 1901 for Yale's Exhibition

a1609

Aerial Ferry to Speed High Over a Harbor

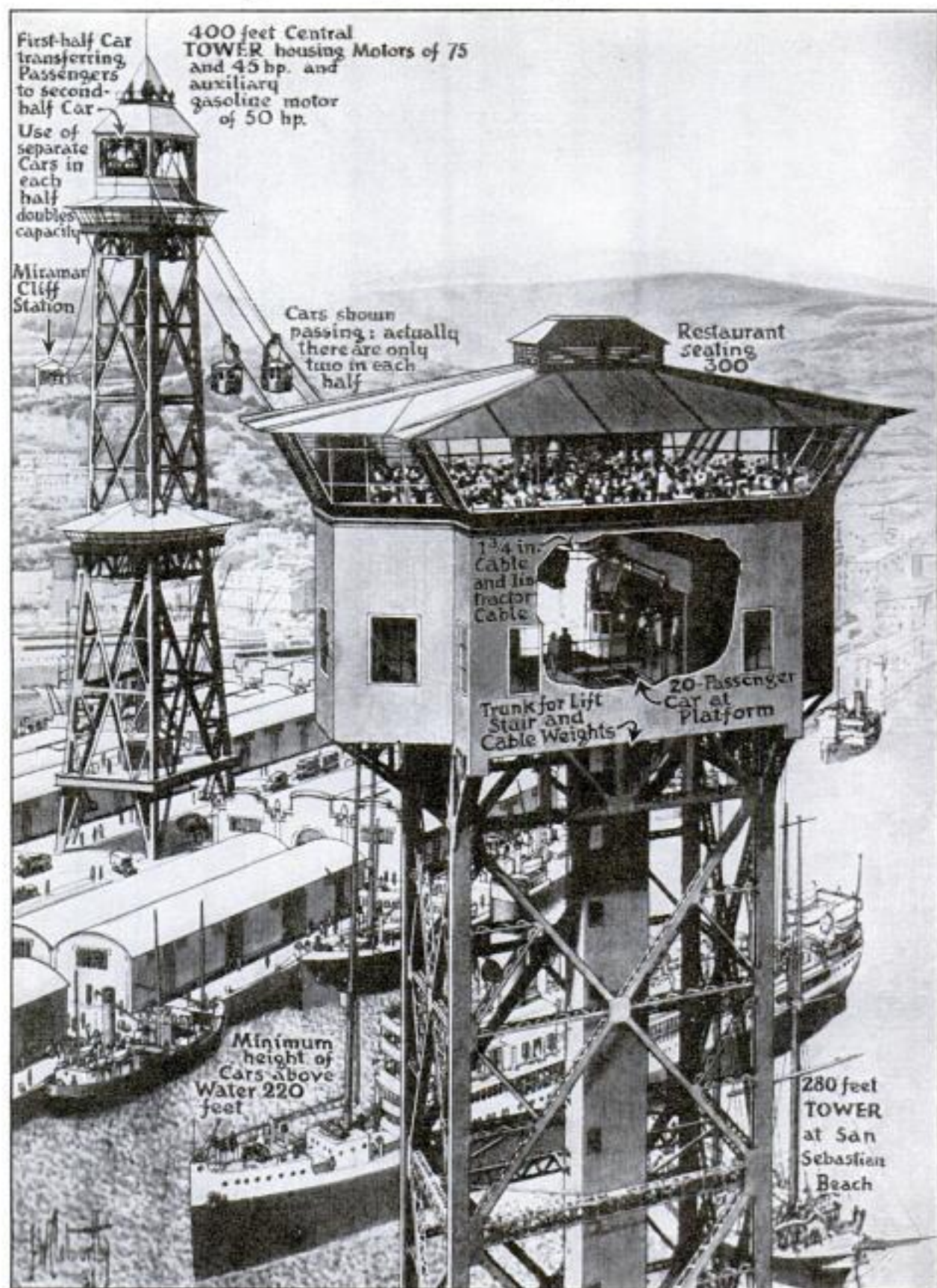

Air Tramway That Will Link the Cliff Section of Barcelona with the Water Front and San Sebastian Beach, a Favorite Resort on Which the Tower in the Foreground Stands

© S. W. Clatworthy

54, Chibblesdale Road,
 Streatham, London
 S.W. 16. Eng.

Copyrighted material

a 793 a1708 C. J. Isoric, Isoric's Place, Mt. Vernon, Ill. 779

COAL-AGE FOREST EXHIBITED IN MUSEUM

Visitors to the Field Museum in Chicago now can step backward in time some 250,000,000 years and see the earth as it looked in the coal age. Museum workers, after years of careful study, have restored a luxurious carboniferous forest with its gigantic and peculiar trees and plants just as they appeared in the past. Not only the trees and plants which were destined to turn into coal are seen, but also the primitive animal life of the period, including dragonflies with a wing spread of more than two feet and cockroaches nearly four inches long. These things have been restored in natural size and lifelike aspect after a scientific study of fossil specimens of the plants and insects, found for the most part in the vicinity of Mazon, Ill., and after careful measurements had indicated the group which each fossil represented.

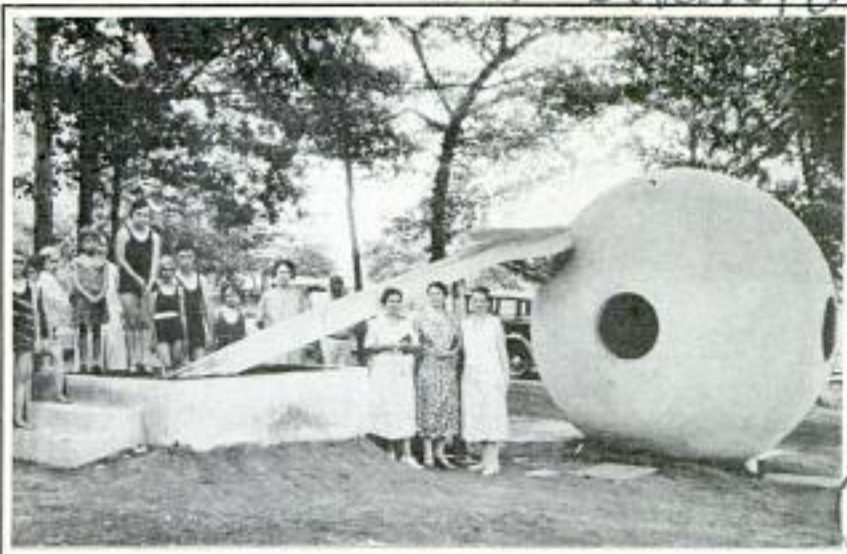

Huge Hollow Golf Ball of Concrete Which Serves as a Refreshment Stand and Supply Booth for Players on a Miniature Course

Constructed by owner

BOOTH IN CONCRETE GOLF BALL FOR SERVING PLAYERS

Constructed of concrete, a huge hollow golf ball serves as a refreshment and supply booth for players on one miniature course. The ball, ten feet in diameter, is equipped with electrical refrigeration and lighting and contains a soda fountain, cash register, golf clubs and balls, and other equipment. The course is so arranged that the player sinks his putt on the eighteenth hole, and the ball rolls into one of several compartments inside the concrete ball, bringing him a prize.

SPEED SAW THAT CUTS STONE IS EASILY PORTABLE

Marble, tile, stone, slate and similar building materials are not too hard for cutting with an electric handsaw now on the market. An abrasive disk is used in this operation, but the saw, which runs at high speed, also can be used for regular work with saw blades. The implement is easily portable.

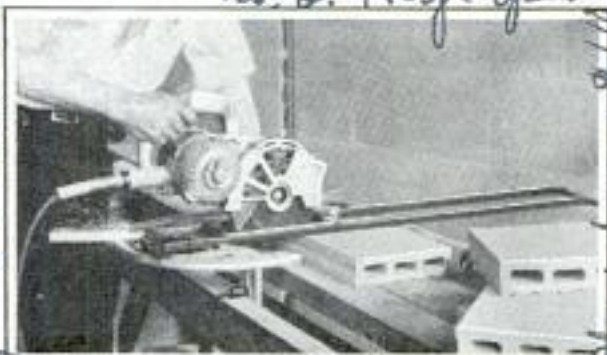

Electric Handsaw with an Abrasive Disk Which Cuts Marble and Similar Building Materials

AUTO CHAIN INSTALLED IN MUD WITHOUT USE OF JACK

Automobile chains now can be installed in the mud or snow after the car has stalled without the use of a jack by employing an appliance which attaches to the chains. The chain is slipped over the top of the wheel and down as far as conditions will allow. The chain appliance, resembling a double pair of ice tongs with curved points, then is attached to the mud chain, inside and outside the wheel and the loose ends are looped over an end of one of the hooks. The appliance is then pulled tight, after which the chain is held in position and the car can be run until a convenient place is found to fit the chains in the regular way.

An automatic sunshine dispenser emits ultra violet rays when a coin is deposited.

cheap. portable electric machine, 134 S. Calygonia

no. 2. High Speed

chain saw

Wapak. d no. 7522 made in Pittsburgh Pa.

*176 7
Berland
Berland
Alma. reb
The Alma Hospital
Alma
Alma*

Q1402
780

Words Go in Japanese and Come Out English



Clock Face in Japanese Characters, and Operator Translating Message into English

Repeated demands for the correct time by her fellow countrymen who do not speak English resulted in the translation of clock numerals into Japanese by a girl employe of a telegraph office which handles messages between the United States and the Orient. The clock is unusual because it carries twelve numerals while Japanese clocks have only six. For transmission to Japan, the operator takes messages in Japanese and send them into the main office in English on a teletype machine. The message crosses the Pacific in this language and is translated back on reaching Japan.

GULF STREAM GETTING WIDER AND PUSHING ARCTIC BACK

Evidence that the Gulf Stream has increased in extent to an unusual degree this year was uncovered by investigators aboard the U. S. patrol boat "General Green," which has returned from four

months of exploration in the north. Cold arctic waters had receded much farther than usual, it was found, and but very few icebergs were seen. Encroachment of the stream was found on both the eastern and western slopes of the Newfoundland banks, and temperature at one point was higher last year.

ROCKET BOMB TO CHASE PLANE IN ATTACK

Invention of a bomb propelled by rockets, launched by sound vibrations from an enemy plane and guided through the air by similar vibrations, is announced in San Diego. The inventor foresees such bombs placed in launching cages whenever there is danger of aerial attack. The bomb, once in the air, would be guided by "electric ears," causing it to twist and turn and follow the aircraft, but at higher speed than the plane. A simple contact detonator would explode the bomb the second it touched its quarry in the air.

WINDSHIELD HEATED BY WIRES MELTS SLEET AND SNOW

Fine wires, imbedded in a windshield of special plate glass, are connected to the car's battery and thereby heated so that they melt snow and sleet, and the wiper has nothing but water to remove, even in the coldest storms. In addition to this safety feature, the glass is of a non-shatterable kind that does not endanger car occupants with flying fragments.

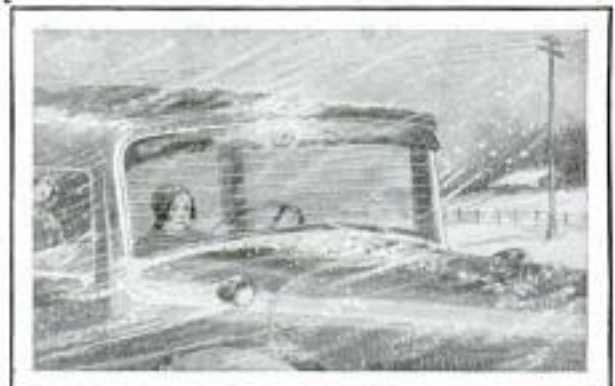

Wires inside Windshield Heat the Glass and Keep It Clear in Snow or Sleet Storms

Christian Science Monitor
8/17/31

Proter Islands Co.
220 Sixth Ave.
New York

San Francisco Examiner 8/16/31

Q1402

Research Laboratories,
RCA Victor Co.

233 Broadway, New York

781
91659

EARTH MOANS LIKE AN ANIMAL AND IS HEARD ON PHONE

That the earth has a distinctive moan or wail of its own, not produced by leaking power currents or other explainable causes, recently was demonstrated when Mother Earth's cries were heard on the telephone. In experiments with military field telephones, in which the return current runs through the ground and spreads out in circles, it was thought possible this spreading circuit could be tapped by stakes driven into the ground. This was done, and a powerful amplifier connected to the tapped circuit. Conversations were heard easily enough, but a peculiar moan and wail also was present. Many additional observations were made at various points, and all explainable phenomena were ruled out as the result of them.

Cmd Echhardt

91682

PIANO AND HARP ARE COMBINED IN COLLAPSIBLE INSTRUMENT

Combining a collapsible piano and a harp into one musical instrument, a Los Angeles inventor has made what he calls a "golden harp." When assembled, it looks like a small piano with an aluminum body. By simply attaching a soundboard and removing the keyboard, the instrument is converted into a harp.



"Golden Harp" Looking Like a Small Piano and Combining Tones of Both; It Is Collapsible



Courtesy Union Gas & Electric Co. Operating High-Voltage Switches While Protected from the Flash by Leather Suits

Cincinnati Ohio

SAFETY SUITS PREVENT BURNS FROM HIGH VOLTAGES

Safety suits of white chrome leather instead of asbestos compounds have been adopted by an electric power company for high-voltage switchboard operators. The suits are simple in design and require but two fasteners. A hood is an integral part of the costume and is fitted with a "skirt" to protect the wearer's face from burns and also to prevent him from inhaling flame. The helmet has a glass eyepiece mounted in the leather. At extremely high voltages, the greatest element of danger lies in the flash of fire during short circuits or other troubles, rather than in the mere handling of the current, and it for such emergencies that the suits have been developed.

The Popular Mechanics' Bureau of Information offers its free service to all readers of this magazine. Names and addresses of manufacturers, and dealers in articles described, and any other details in our possession, will be promptly furnished.

*Dr. Charles W. Presley,
1133 Hyperion
Los Angeles, Calif.*

U.S. Daily
8/18/31

a 1698



George Washington's Face on a Hillside; Note Space at Right of the Head Where a Brief History of the Nation Will Be Inscribed

WASHINGTON'S FACE IS CARVED ON GRANITE HILLS

George Washington's face, carved into solid granite 300 feet high in the Black Hills of South Dakota, is taking form under the direction of Gutzon Borglum, the sculptor, as a lasting memorial. Images of Jefferson and Lincoln also will be carved on the rock, a task which will take about five years.

SPEED OF PLANES INCREASED GREATLY IN THREE YEARS

Trends toward greater speed for airplanes were marked in the last three years, according to the department of commerce aeronautics bureau. The average high speeds of airplanes approved from 1927 to 1930 showed a steady increase between the approximate limits of 101 and 137 miles per hour, but, from the third quarter of 1928 to the end of 1930, there was

Auto Topics 8/8/31

never a time when the average top speed dropped below 117 miles an hour. At the same time it was noted that average landing speed followed exactly the same trend.

a 1730

COTTON COVERING FOR CURING OF CONCRETE

Instead of covering concrete with burlap in the first twenty-four hours of the curing process, a number of contractors have reported the use of cotton fabric with excellent results. The cost is said not to be higher and the curing equally good if not better, because the cotton holds more moisture than the coarser burlap. An estimate, based on the reports of the government as to the amount of concrete construction by states and counties, indicates that more than 100,000 bales of cotton would be consumed, while, if its use were extended to cities and other political subdivisions, more than 300,000 bales could be taken out of the market each year.

Article by John W. Hornsby, 6/24/31
See 20

CHAIN BRACES FOR CHAIR LEGS ELIMINATE WABBLING

Chairs or beds that wobble because glue or screws give way, can be quickly repaired by the use of a chain brace the pull of which is placed on the outside corner of each leg by means of angle-head bolts. From each leg a section of chain extends to a turnbuckle through which equal pressure can be exerted on all the legs so that the piece of furniture will be tightened permanently.

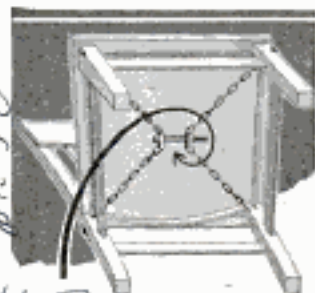

The Wittliff Furniture
Co. 12810 Superior
Ave. Cleveland Ohio

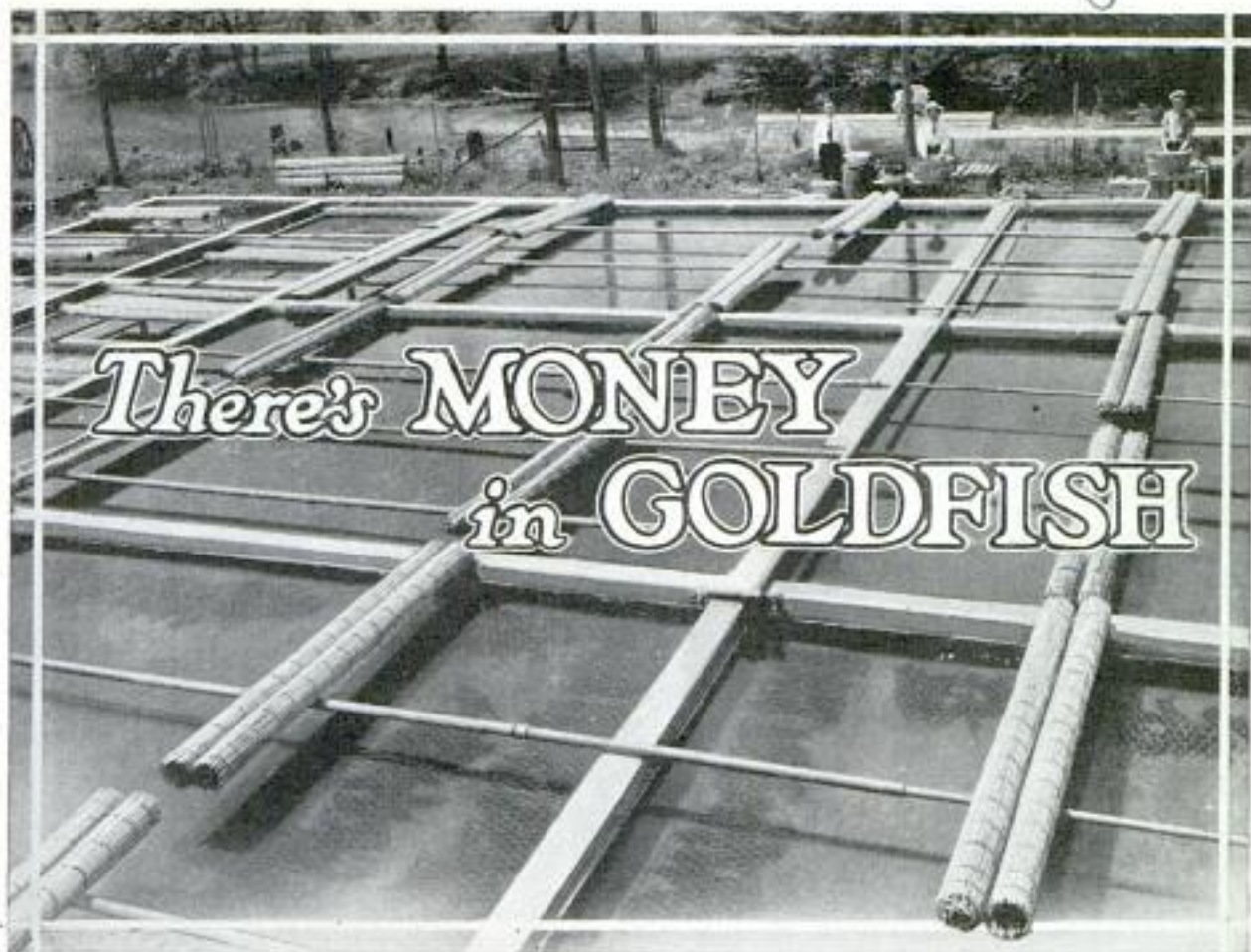

There's MONEY
in GOLDFISH

Breeding and Hatching Pools Where Fancy Goldfish Are Raised; Water Is Piped into These Pools Where Millions of Bright-Hued Fish Are Grown for the Market Each Year

THE saying "poor fish" cannot be applied to the 5,000,000 inhabitants of Kaicha Matsunaga's sixty-acre hatchery on the banks of the Karitan river, near North Branch, N. J., for these pedigreed pets lay eggs that hatch into the fancy goldfish destined to luxuriate in America's most sumptuous garden pools and fish bowls.

Matsunaga and his partner, Masakichi Kashiwa, created both the supply and demand for fancy goldfish in this country. Ten years ago, perfect specimens of lionheads and orandas were hardly seen outside of aquaria. But these enterprising Japanese have made such breeds available to all wishing to invest from \$5 to \$150.

Lionheads top the market in the fancy goldfish trade. They range from two inches up to about seven inches in length, are roundish in body, and stub-nosed and short-tailed. The head is a brilliant red, which seems self-luminous under water. It is a clumsy swimmer, wriggling comically when retreating from danger.

In Japan, fish fanciers take great pride in their lionheads, and among the specimens exhibited at the annual show, the prize winner may command the fabulous price of \$1,000. The value of prize goldfish is determined, first, by the perfection of shape, which includes its swimming form; secondly, by the specimen's development, and last by the shape and development of the head. The head is the most important factor to consider.

Matsunaga also has sold orandas for \$150, but this variety differs from the lionhead in many respects. They have long lacy fins and tails, and swim with the utmost grace. They range in color from reddish gold to creamy white.

Ten years ago, Matsunaga relates, he was an importer and exporter in Japan, more interested in his hobby of raising goldfish than in business. Soon the hobby took complete possession of him and he gave up his business to stake a small fortune to import 4,000 fancy goldfish, including fantails, nymphs, shubunkins, to-

matsunaga's

*Japanese Goldfish
Hatchery Co. Inc.
North Branch N.J.*



Above, Feeding Cooked Oatmeal to Goldfish; Left, Collecting Valuable Specimens from the Pools

in the world. Forty-five acres of the property are under water. The fish swim in 400 rectangular pools arranged in series, each pool measuring sixty by eighty feet. It requires fifteen to twenty men to carry on the work. The company deals with more than 1,000 goldfish wholesalers, who supply individuals with practically all the fancy goldfish bought in this country.

While generally looked upon as a very sensitive creature, the fancy goldfish does not mind ice-cold water. Indeed, it prefers a low to a high temperature. Matsunaga reports that in winter the pools are covered with eight inches of ice, but he does not know of a fish which has suffered from cold. A hole in the ice suffices to replenish the oxygen in the water. Food is also lowered through a hole.

The feeding of 5,000,000 goldfish involves the full-time labor of seven men. The diet consists of two items, cooked oatmeal, and a species of bug, called the daphnia, which is fed alive. The bugs are grown on the grounds, but the oatmeal comes from the grain markets.

The oatmeal flakes are mixed with water and cooked until the water boils and

escapes, calicoes, veil-tail telescope calicoes, orandas and lionheads. Then he approached a steamship company with an amazing proposition: to transport these fragile, sensitive creatures from Japan to New York, halfway around the globe. Only 500 survived the voyage.

Later Matsunaga selected a place on the Raritan river, where the stream is only thirty feet wide, and unpolluted by city refuse. He dug ponds, pumped water from the stream and started a circulation system through a series of galvanized-iron pipes. Out of the original 500 specimens, he already has raised about 20,000,000 fancy goldfish, of which you may see specimens almost anywhere in America.

Today he has the largest breeding place for fancy goldfish in this country, if not

*a 1745 The Speed Aquaplane Co
785
New York, Staten
Island, N.Y.*

the batter reaches a thick consistency. In all respects, save for seasoning, it resembles the oatmeal eaten by us for breakfast.

Winter feeding eases the attendants' work considerably. The fish are fed only twice a week, and then on reduced rations of about five tons per week. Only breeders and left-overs are boarded during the winter, since most of the spawn is sold during the summer and fall. In all, the winter population rarely exceeds 1,500,000.

In early spring the torpid fish grow active, and during May and June they are occupied in breeding. This, of course, is their most important function and they are aided in every possible way by their attendants. The bottom of the concrete pool is covered with a special variety of water fern and covered with a chicken-wire netting. This composes the "nest." Almost as soon as laid, the eggs are transferred by attendants to a hatching pool, for goldfish have a way of eating their eggs. And that accounts, says Matsunaga, for their inability to breed abundantly in natural watercourses.

laminated panel board

**AQUAPLANE FOR SLOW SPEEDS
FOLDS UP FOR CARRYING**



Portable Aquaplane Which Is Light in Weight and Folds Up so It Can Be Carried Easily

Buoyancy sufficient to keep a 200-pound rider afloat at slow speeds is one advantage of a portable aquaplane which is made in two pieces for easy carrying. The two parts are clamped together with turnbuckle bolts, while the aquaplane comes strapped together with a carrying handle and a kit containing four turnbuckles and a tightening tool. The buoyancy is obtained by the hollow construction of both parts of the plane, while there is an upward flare at the bow which keeps it from ducking, and splashing the rider.

**INDIAN DESIGN TO CAUSE SLEEP
AIDS INSOMNIA VICTIMS**

By following the black line in a peculiar Indian design, insomnia sufferers cannot keep from going to sleep, some of them say. Tests by persons afflicted by wakefulness show that the design, which was

a 1744



Indian Design Which Insomnia Sufferers Say Induces Sleep; They Follow the Black Lines

drawn by ancient Indians as an insomnia remedy, is hard to follow three times without falling asleep.

no further info

**HIGH-SPEED CAMERAS PICTURE
ESCAPING AUTO BANDITS**

High-speed cameras have been used with success recently in Scotland Yard in obtaining picture evidence that has resulted in the arrest of escaping automobile bandits. In one instance, a police car equipped with such a camera obtained a picture of a speeding auto, occupied by bandits who had robbed a jewelry store, which showed enough of the driver and of the car to make identification possible. In another case, a flashlight was used with a high-speed camera to make a picture of riders in a stolen automobile. This picture likewise resulted in arrests.

a 1770

Flying Jure

pend

Carl Wilkins

91204

Carl Legel don Benja Owens Jr
42. Le Roy M
Akron Ohio
CHEMICAL

Reprinted by Sam Brown



PLAIN CARDBOARD



are! If desired, you can use a handkerchief instead of the cardboard, stretching this on a frame or placing it on a table or chair while you produce the Hand of Blood.

IN India, there once lived a yogi or holy man. He denied himself all worldly pleasures and devoted his life to the poor. He had no name. He spoke no language. The only sign which marked his journeys throughout the country was the imprint of a human hand—the "Hand of Blood."



--AND THEN--



SODIUM SALICYLATE SOLUTION

CARDBOARD



THE HAND OF BLOOD

You don't believe it? Consider. Examine this sheet of cardboard. Witness that I wash my hands to remove any trace of grime or dirt. Now, look! It's the red hand, the hand of blood as performed years ago by that holy man of India.

All of which, of course, is a "lotta applesauce"—merely the colorful "patter" which accompanies this excellent bit of chemical magic. To prepare for the trick, you paint or spray a square of corrugated cardboard with a solution of sodium salicylate. The water into which you dip your hand is a solution of iron-ammonium sulphate. That's all there is to it.

You exhibit a square of cardboard which looks exactly like any other square of cardboard; then, you plunge your hand in the chemical solution which looks exactly like water; then, you press your hand on the cardboard. And there you

Perhaps the most pleasing of all tricks depending upon chemistry or chemical reaction is the familiar water-to-wine effect in which a glass of water is made to change into wine and then back to water again. The change has a score of variations. Three of the most popular color combinations—water to wine to water; water to ink to water, and water to sherry to water—are pictured at the top of the opposite page. All three feature simple chemicals which can be obtained inexpensively at any drug store.

Let's start with the water to wine. You will need three glasses. The first of these contains the original water, in which has been dissolved a half teaspoonful of sodi-

MAGIC

um carbonate. The second glass holds a few drops of phenolphthalein solution. The third glass houses a few drops



water and in it dissolve a little iron-ammonium sulphate. Put a few drops of tannic-acid solution in the second, and a few drops of strong oxalic-acid solution in the third. If you pour from the first glass into the second, the liquid will assume the color of black ink; if you pour this ink-colored fluid into the third glass, it will change back to the color of water. The non-chalant gesture, in this case, is to dump the final

of tartaric acid dissolved. Now for the magic. By pouring the water from the first glass into the second glass, you will get a beautiful shade of red; by pouring this red mixture into the third glass, you will get clear water again. Both changes are instantaneous. The water at the conclusion of the effect is perfectly clear and may be imbibed with more or less freedom.

Three glasses again. Fill the first with

mix into the kitchen sink since it would be rather destructive even to a magician's stomach.

Once more three glasses. Put plain water in the first; a few drops of tincture of iodine in the second, and a few drops of sodium sulphite or hypo solution in the third. That's your water-to-sherry-to-water. But don't drink it.

The power of fire is strong, yet it can-

a1204



not burn a lump of tablet sugar. That is, unless you happen to be a magician. In that case, you would casually rub some cigaret or cigar ash on the sugar, as shown in the photograph, thus giving it sufficient timber to flare up quite readily.

Here's an "egg-citing" one: You exhibit two tall glasses, both filled with water. A spectator selects two eggs from a dish and writes "sink" on one egg and "suspend" on the other. And that's what they do. The performer mutters the magical words, and the two eggs sink or swim according to the legend. The real secret, of course, is that eggs can hear as well as human beings and will do almost anything you tell them. Then, too, may be the fact that one of the glasses is half-filled with a strong solution of salt water has something to do with it. In preparing this glass, half-fill it with salt water made by dissolving as much salt as possible in boiling water. Then, fill the glass to the brim with clear water, pouring the fresh water slowly down the edge of the tumbler, as shown in the picture.

Did you ever bounce a soap bubble? Take a piece of square laundry or Castile soap and dissolve a one-inch section into a pint of hot water. Add one-half tea-

spoonful of gum arabic and one teaspoonful of glycerine. Then, add another pint of water—cold this time in order to cool the mixture. Bubbles blown with this solution will bounce on wool or on a soft felt hat. Not just once either, but fifteen, twenty or thirty times. And how that glycerine makes them sparkle! An odd little conceit is to blow one full of cigaret or cigar smoke. When it finally goes "boom," you have a dead imitation of a bursting gas bomb. And, if you want a real boom, blow a few with a pipe containing a wad of gasoline-soaked cotton, and touch them off with a match.



THE FLOATING EGG



FRESH WATER

SALT WATER



"Old Man Water" and "Old Man Fire" had an argument. And O. M. W. drew a line. And he dared O. M. F. to cross it. Old Man Fire flared up. He rushed forward. But—lo and behold!—he cowered back as he approached the magic line. He couldn't cross it. You do it with a piece of paper. You draw a light pencil line across it, about halfway. You dip one end of the paper into a strong solution of household washing soda, holding it so that the penciled line is just above the surface of the fluid. You let the paper dry. You erase the penciled line, but not so thoroughly that you cannot locate it again. When doing the trick, you redraw the line and apply the match.

Of course, it is the unprepared half of the paper that burns and this must be held downward in presenting the effect.

Take a piece of fairly coarse paper and rub it with ferric ammonium sulphate in dry form. If you draw or paint on this paper with a solution of tannic acid, the picture will turn out black although you are apparently drawing with clear water. Magical enough as this is, the "piece de resistance" comes when the performer rubs a dry blot-

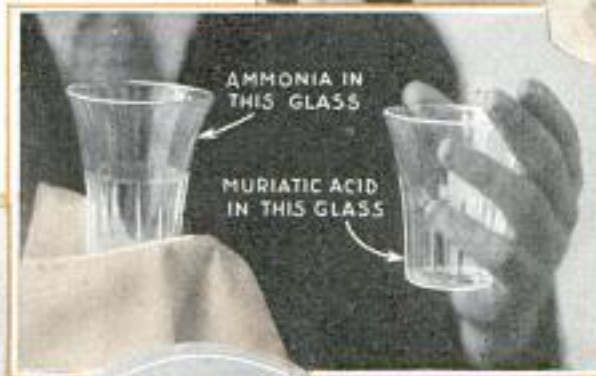

former exhibits two glasses which he covers with a handkerchief. Standing a few feet away, he puffs a cigaret and wafts the smoke toward them. After a



minute or so of this, he removes the cloth and shows the glasses to be filled with smoke which billows out when the two tumblers are separated. The "how" is absurdly simple. You will need two clean glass tumblers. Into one of these put a few drops of muriatic acid, and give the glass a rotary motion so that the liquid will cover the bottom. Into the second glass put a few drops of strong liquid ammonia and give this glass a rotary



ter over the picture and causes it to vanish entirely. Oxalic-acid solution does the latter part of the trick, the blotter being soaked and dried a number of times in and out of this fluid until it is thoroughly impregnated with the magic ink remover.

Would you like some trick matches? Paint a ring about one-half inch below the head of an ordinary safety match with sodium silicate or water glass. Let it dry. When the match is struck, it will flare up beautifully but go out at the exact moment it is needed. Again, dip the whole head in the water glass solution. When the match is struck, it will sputter fiercely and give up a great cloud of smoke, but nary a sign of a light.

Here's another smoky one: The per-

former exhibits two glasses which he covers with a handkerchief. Standing a few feet away, he puffs a cigaret and wafts the smoke toward them. After a minute or so of this, he removes the cloth and shows the glasses to be filled with smoke which billows out when the two tumblers are separated. The "how" is absurdly simple. You will need two clean glass tumblers. Into one of these put a few drops of muriatic acid, and give the glass a rotary motion so that the liquid will cover the bottom. Into the second glass put a few drops of strong liquid ammonia and give this glass a rotary motion also. And the trick is finished. As the gases form dense smoke at short range, keep them apart until they are to be covered with the handkerchief.

MOVIE FLOORS TO SLOPE UP? .

Floors in movie theaters should slope up instead of down, a theater architect declared recently before the Society of Motion Picture Engineers. He argued that the audience would have a better line of vision and would not have to tilt the head back to see the upper part of the screen.

Ben Schlanger

91750

Science Service
12/22/21

a 1591
790

Cont. Christopher Spang
c/o Air Press Agency
66 57, Fleet St London
E.C.4
Eng



Model of Admiral Nelson's Historic Flagship "Victory," Launched Recently; It Participated in a British Naval-Week Celebration

MODEL OF NELSON'S FLAGSHIP SAILS THE SEAS TODAY

Admiral Nelson's flagship "Victory" again sails the seas in model form. The model of the famous vessel recently was launched at Portsmouth and later participated in a British naval-week celebration.

MAN'S SPEED LIMIT ATTAINED AT SIX MILES A MINUTE?

Has the virtual limit of man's speed been reached? Aeronautical experts in Europe are asking this question after seeing the racers produced by England for the 1931 Schneider trophy race. The last ounce of speed has been wrung out of these frail structures of steel and alumi-

num, the two Supermarine planes, which will travel over six miles a minute. Huge superchargers pack over 2,000 horsepower into the twelve-cylinder engines whose maximum vertical dimension is less than three feet. Wings have been reduced until they will not sustain the aircraft at under 100 miles an hour. The cockpit is so cramped that the pilot must be measured for it, pontoons are reduced in size until they only just float the aircraft when at rest, and are used both as radiators and fuel tanks. Every projecting rivet is streamlined to reduce air resistance, yet the magic figure of 400 miles an hour is, experts believe, still out of reach. And the factor which is putting it out of reach is not a matter of engine power or aerodynamic design but simply the problem of getting rid of surplus heat. The British racers are virtually flying radiators. In order to dissipate the heat, fuselage,

wings, tail and float covering all possess double, corrugated skins. Between the skins, the hot water and oil circulate, to be cooled by a 360-mile-an-hour draft. In these racers engine power is almost entirely used in overcoming the friction of the air over the streamlined surfaces of the airplane. If any more engine power is added, more area must be provided to get rid of the excess heat, so the extra engine power will be wasted. If, on the other hand, the skin friction of the airplane is reduced by lessening the surface area, the engine power will have to be stepped down, or the engine will overheat. In order to get more power, with reduced air resistance, the Italians have designed aircraft with two engines, one behind the other. It is feared, however, that this

Supermarine

Kansas City June 8/13/31

O. A. Zimmerman
Chief Engineer
Kansas City Bridge Co
POPULAR MECHANICS

a1707

avenue offers but little promise and that the difficulty of getting rid of the excess heat still remains.

PREHISTORIC ANIMAL'S TOOTH WEIGHS OVER FOUR POUNDS

a1690

Modern machinery, digging eighty-seven feet beneath the bed of the Ohio river, near Evansville, Ind., unearthed a prehistoric monster's tooth weighing four and one-half pounds. The tooth, which was found in what engineers call "cemented gravel," is nearly seven inches long and four inches thick. Experts classified the tooth as having belonged to a mastodon, a giant elephant which roamed the earth thousands of years ago.

pat. app

FATIGUE MEASURED BY METER AS YOU STAND ON IT

a1688

Whether you are tired or not, and, if so, how tired, is told by the "wobble meter," recently tested on passengers landing at a Washington airport. It resembles a "health scale" in form and tells the degree of fatigue by measuring the shifting of weight from one foot to the other when the person wobbles.



Measuring the Degree of Fatigue of a Woman Passenger Just Landed at an Airport

and by Mr. H. A. Mrs.



Snake-Proof Leggings of Light Metal. Made Like Hip Boots, for Travelers in Infested Areas

SNAKE-PROOF METAL LEGGINGS PROTECT WEARER'S LEGS

Snake-proof leggings, made of light metal, provide protection for the wearer's legs on hunting or fishing trips in reptile-infested regions. The leggings reach higher than the average snake can strike. So light is the metal, the leggings weigh less than if made of leather or rubber.

and Maston O'Rowe Mulberry, Fla

STEAM FOR COOLING RAIL CARS MAKES TASK AUTOMATIC

a1751

Steam and water are the only agents used in an almost entirely automatic cooling system demonstrated recently before railroad and Pullman officials. Depending on the well-established principles that water absorbs much heat in the process of evaporation and that the temperature at which evaporation will occur can be lowered greatly by reducing the air pressure above the water, the procedure is to inject steam into a tank of water so as to create a vacuum above it. Evaporation reduces the temperature to forty degrees, and it is run through coils over which air is drawn and blown into the car.

Science Service. 8/22/31

a 1491 Comb. Thomas & Stinson
Jr. 145 S Spring St
Los Angeles Calif

LOST MINES *Lure*

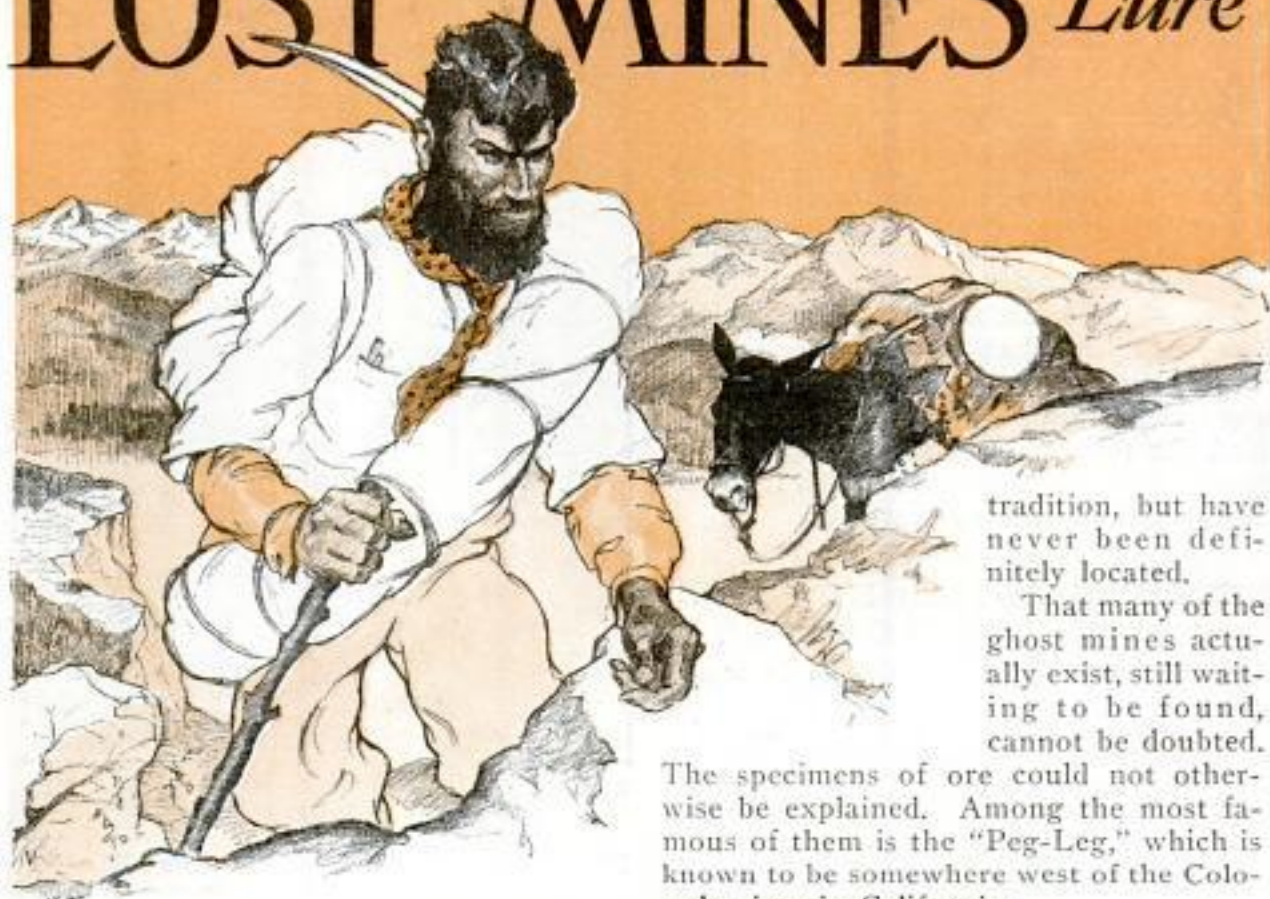

tradition, but have never been definitely located.

That many of the ghost mines actually exist, still waiting to be found, cannot be doubted.

The specimens of ore could not otherwise be explained. Among the most famous of them is the "Peg-Leg," which is known to be somewhere west of the Colorado river in California.

"Peg-Leg" Smith found the mine first. During the early days of the gold rush he wandered into the little desert town of Mojave with \$10,000 worth of black nuggets in his saddle bags. He picked them up, he said, on the top of two black buttes standing by themselves in a hilly region near the Colorado. Nuggets and chunks of pure gold covered the tops of the two hills, he said. But neither Smith nor any of

THE proverbial pot of gold at the foot of the rainbow has not as many seekers as the ghost mines that abound in legend of the southwest and in northern Mexico. For scores of years men have persisted in the search for the fabulous riches that are recorded in history and

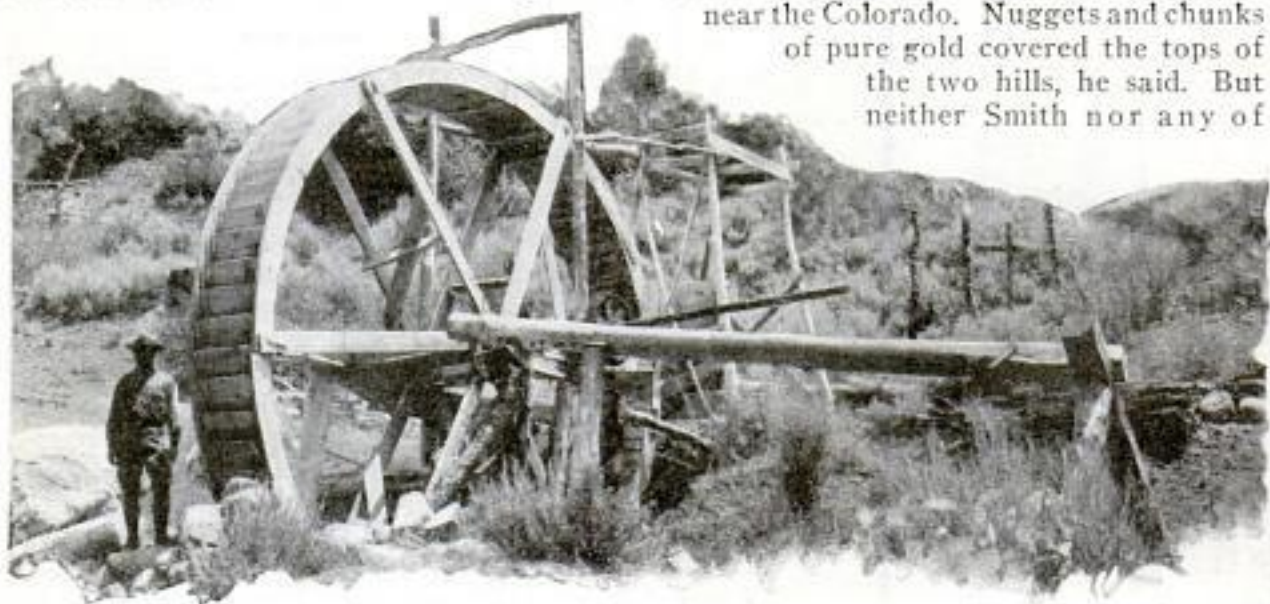

Overshot Water Wheel at a Desert Oasis Used to Operate an Arrastra, a Primitive Milling Contrivance Designed by the Early Spaniards for Crushing Ore

© Fernie Always

Rec March 1935 - 392

a 1491

GOLD HUNTERS

the men who accompanied him on his return could find those buttes.

Another mine from which peculiar specimens have been taken is "White's cement mine." It is probably hidden away in the hills of northern New Mexico. White, an old prospector, arrived in Horse Head Gulch in Colorado in 1858 with specimens of a hard white clay containing free gold that as-



On a 25-acre site...
 Heat Thwarts Search For Lost Gold Hunter
 Indian Legend Also Helps to Shield His Secret: Dead, Arizona Fears.
 Phoenix, Ariz., June 27.—(AP)—
 Searching for...
 knowledge of a...
 combined today in defeat-
 ing the effects of those hunting in
 Arizona comes for A. Toak, 80.

sayed \$15,000 to the ton. The entire camp was stirred by the discovery, and White was forced to promise to reveal its location. He led the camp on a wild-goose chase for weeks, escaping a few hours before he expected to



Typical Prospecting Outfit, Top; the Desert Claims an Adventurer, Center, and Death Valley Scotty, Below

come upon the mine. Half the expedition perished in the search that followed. Three years later, White appeared in Salt Lake City with more of the white ore. Then he disappeared forever.

In spite of all the wealth that has been taken out of the Panamint mountains, the Funeral range, and the other hills that surround the awful region in California called Death Valley, some of the richest mines in the area are yet to be located. Among these are the Gunsight and possibly the Breyfogle, the first being a mountain of silver and the second a ledge of gold ore. Some believe that part of the wealth ac-

a 1491



the Spaniards worked in central Texas. Only a few of the diggings, admittedly the poorest, have been found. The Guadalupe mountains on the Texas-New Mexico border are said to conceal another storehouse of gold. The Spaniards abandoned the mine during the Indian uprising of 1860 and left no traces of their work behind. Although many have looked for the secret



of the Guadalupe, only one man ever found it. This man was "Old Ben" Sublett. For many years before his death, Sublett made trips into the Guadalupe, bringing back each time a load of metal. Untold riches, he said, were in a cave on the floor of a small canyon. The gold is still there.

Men are still searching for Yuma's gold in the mines of Arizona, in the Lost Nigger in Texas, the Mina Perdida, the Lost Padre, and others.



Front and Back of the Map, Showing Way to the Lost Breyfogle Mine; Typical Gold Hunter of the Fraser River, and Prospecting Outfit Leaving Oasis

Library Installed in Film Star's Home Shop



Two Views of a Home Workshop That Contains, Among Other Things, a Shop Reference Library

Collection of a shop library will help home mechanics, says Rod La Rocque, motion-picture actor, who operates his own workshop at his Hollywood residence. The actor says books and magazines have helped him, and points out that the best place for books on shop practice is right where the illustrated setups can be demonstrated. Mr. La Rocque's shop is fully equipped with a motor-driven lathe, an electric grinding wheel, a drill press, bandsaw, circular saw, jointer, anvil, machinist's vise and a complete assortment of tools. He advises amateur

mechanics to buy only good tools. Every phase of shop work is enjoyable to the actor, who says that he built most of the furniture for his summer home, that he is interested in model making, silver chasing, oxyacetylene welding, and builds all his cameras, telescopes and microscopes. To him, the real thrills of the home workshop lie in the problems involved in setups and in working to close tolerances and limits, such as turning camera parts with precision in the lathe.

FISH FRIGHTENED BY SHADOWS AND NOT BY NOISE

Contrary to popular belief, noises do not disturb fish, and anglers do not need to keep quiet while fishing. This is the conclusion reached by Henry W. Fowler, curator of fishes and reptiles of the Academy of Natural Sciences, Philadelphia, who has decided that shadows, particularly moving shadows on the water, frighten the finny creatures instead of noises. Oil-burning trawlers have reported poor catches when great volumes of smoke leave the funnels and cast a shadow over the water. Most people who make much noise while fishing also move about considerably and Mr. Fowler believes that their shadows, rather than the sounds, account for poor luck with such anglers.

Eckhardt

Interviewed by John H. Sheehan of South Bend Lathe Works, 426 E. Madison St. South Bend, Ind. 91715

Cherry - 541 W. W. Working 91768

91719.

91643

MUSIC MADE WITH MERCURY TUBES AND TOY PIANO

Controlled entirely by a tiny piano, a radio "organ" recently was demonstrated by the General Electric company in a Schenectady theater. The organ producer box was fitted with eight Thyatron tubes, each of which was tuned to produce a particular tone in the octave. One of the peculiar characteristics of the Thyatron or mercury tube is that direct current is put into the tube and alternating current comes out. Frequencies can be made to vary widely, according to the resistances used in the circuit. In the toy piano-organ, the eight tubes are made to produce eight different frequencies. Half tones and additional octaves could easily be added, using one tube for each tone. Each of the Thyatron tubes is kept continuously in operation, and the keyboard of the toy piano is connected to the plate, or output, circuit of the tubes. When a key is depressed, the current from that tube flows into the amplifier. Any combination of tones or chords may be played at the same time.

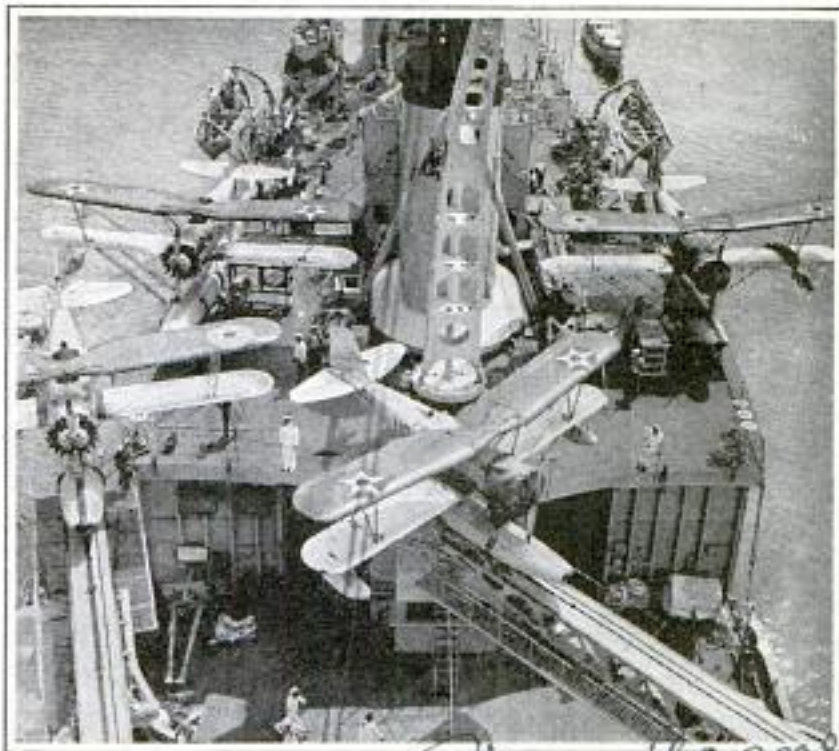

Scout Planes on the Deck of the "Houston," the Flagship of the Asiatic Fleet; Four Catapults Launch These War Birds

WAR BIRDS OF ASIATIC FLEET SHOT FROM FLAGSHIP

Navy scout planes are shot from the flagship of the Asiatic fleet whenever necessary to keep Admiral Charles B. McVay, the fleet commander, in touch with conditions in war-torn China. Four catapults keep their noses pointed out over the water from the U. S. S. "Houston," the admiral's new flagship.

SOIL CHEMISTRY NOT CHANGED BY LAST YEAR'S DROUTH

Farmers who believe that last year's drouth affected the chemistry of the soil in such a way as to improve this year's crops are mistaken. Officials of the weather bureau attribute abnormal crop growth this year to contemporary weather conditions, and not to improvement of the soil. The past summer was warm, and rainfall in the Atlantic seaboard and eastern states was heavy, conditions which promoted rapid development of all vegetable life there. The fact that disproves the theory of soil change is that, while the eastern and southern states had well developed crops, those of the corn belt and the west, where abnormal dryness prevailed this year, again were below the average.

J. B. Kincer

service done 12/12/18



Radio Organ Controlled by a Tiny Piano, the Tones Being Produced by Thyatron Tubes

a 1474 Carl Ls. H. Slacy
4639 Montgomery Ave
Bellesda Md

The WAR on FUR



Beaver Is King of Fur Animals and Poachers Have Extended Operations as Far as the Arctic Circle

from the game commission of Alaska.

A custom cutter intercepted the "Star." Passengers and crew—even the ship cat—were held on board until the federal raiders unearthed what they sought, a cache of \$20,000 in beaver pelts traveling under the alias of dried fish and packed in special cases for that purpose. The shipment of 1,105 pelts was trapped by poachers during the closed season and sent to the United States via the underground smuggling route.

Several weeks later, port policemen at Seattle, through a tip from the game wardens, stopped another coastal steamer from Alaska. The quest was a long one. The usual hiding places were bare of booty. It was only after fittings and fixtures were dismantled and partitions removed that secret compartments were disclosed between decks where \$10,000 worth of illegal beaver pelts were found and confiscated.

When the gas steamer "Ruby" was inspected by custom officials in northwest-

"SEARCH S. S. 'Star,' arriving tomorrow, and confiscate contraband beaver skins," ran a radio message received by the custom office at Seattle, Wash.,

BOOTLEGGERS



Catching Live Beaver with a Net; Wolves Are Most Profitable to the Bounty Hunters

ern waters not so long ago, 100 beaver skins were brought to light concealed by expert fingers behind a false bulkhead.

And now that the guardians of Pacific coast ports are on the watch for smuggled furs until entry by boat is almost prohibitive, pelt poachers are taking to the air. Organized gangs, in communication by radio with the underworld, charter airplanes operated by unscrupulous pilots and run the contraband to the mainland where they are shipped to dealers in St. Louis and New York.

It is not even necessary to go to Oregon, Washington or Alaska to find poachers. They ply their trade within one night's ride of Chicago in northern Wisconsin and the upper peninsula of Michigan. Game gangsters there trap beaver persistently. They maintain central storage depots near the state lines. When they accumulate enough pelts, several truck loads start rolling by night, headed for St. Louis.

The business of fur hijacking prospers



in most of the states where mink, otter and beaver, as well as marten pelts, make robbing the poachers profitable.

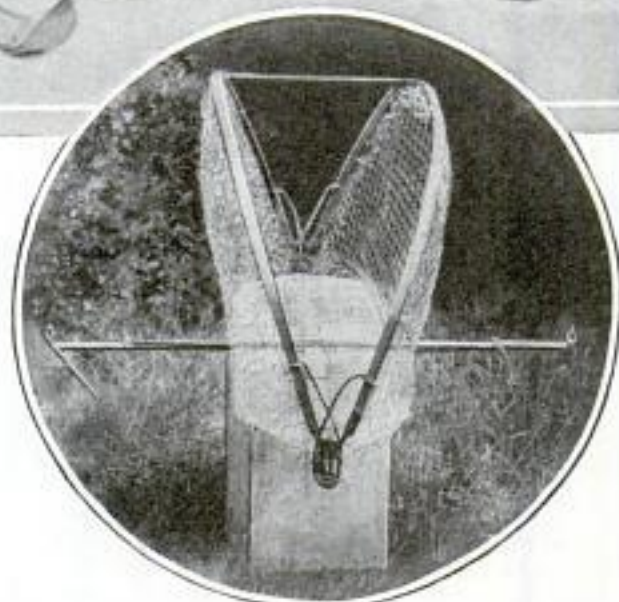

Wisconsin Pays for Wolves and Thousands from Other States Are "Bootlegged"; Poacher's Beaver Trap

The majority of states now protect beaver against legal trapping. This protection, however, is not ironclad. A loophole has been left, providing that the state game commissions can issue special permits authorizing the trapping of beaver on land where they are doing damage. Unscrupulous trappers locate beaver dams and then urge landowners to procure certificates from the state giving them authority to snare the beaver and to market their pelts.

The bounty bootlegger, who now operates in every state where attractive bounties are paid for the extermination of predatory animals and "vermin," is nothing more than a glorified poacher. His trade returns a good income unless he overdoes it and arouses the suspicions of county clerks and game wardens. Here is how the bounty bootlegger fleeces the county officials.

Several counties in Washington pay a \$5 bounty on bobcats. A gang of migratory crooks that specialized in bounty bootlegging began operations recently in Washington. They imported the carcasses of ocelots, small animals abundant in the southwest which resemble

bobcats, and presented them to the clerks in the different counties where bobcat bounties were paid. One trapper brought in 129 bobcats, collected \$645 and disappeared. The county clerk consulted a government hunter in that vicinity about the prevalence of bobcats in his territory. The hunter replied that he had not seen half a dozen bobcats in twelve months. That led to the abandonment of the bobcat bounty system.

Kansas paid about \$200,000 to a gang of bounty moonshiners who dealt exclusively in coyote bounties paying \$1 apiece. The gangsters had a contract with two

disreputable fur firms to supply them with coyote scalps for which they pay twenty-five cents each.

Pennsylvania is now a center of organized bounty bootlegging. That state pays \$15 on wildcats, \$4 on gray foxes and \$1 on weasels. There is no means of identification as to the origin of the scalps. Pennsylvania disburses fortunes in bounties for Maryland, West Virginia, New York, Virginia and Ohio predators smuggled into the state. Weasels come in even from Kansas and Nebraska.

Wisconsin pays a bounty of \$30 on adult female wolves, while Minnesota allows but \$15 and Michigan pays no bounties. Some of the Wisconsin counties bordering the Michigan and Minnesota lines pay bounties on from 500 to 600 wolves annually. South Dakota pays \$25 for each adult wolf killed between May 31 and August 31, while North Dakota pays only \$3.

AIRPLANE DROPS FOOD "BOMBS" TO PARTY OF PROSPECTORS

One party of prospectors in an isolated part of Alaska that is almost inaccessible is being kept supplied with provisions by an airplane that regularly "bombs" the party with food. The supplies are made up in containers shaped like bombs, and the ship flies above the camp, releasing the food bombs just as a war plane releases the destructive ones.



Airplane Carrying "Bombs" of Food and Supplies Which Were Dropped to a Party of Alaskan Prospectors



SCHOOL DESK AND SEAT MADE IN ONE ADJUSTABLE UNIT

School desks and seats are being combined into single movable units constructed on metal-pipe frames that give a modernistic touch. Both the desks and seats are adjustable to the size and needs of the users. The seat is on a swivel, and the desk lids lift and remain in any desired position, making it possible to transform the desk top from a sloping to a flat surface. There is also a disappearing reading easel. The seat back is made of two slats, the lower one having a limited pivot action, which automatically adjusts itself to the position of the occupant. If necessary, the book box in the desk may be replaced by a special box which accommodates a portable typewriter, the latter being hidden when the desk top is down.

☐ About 3,000 stars are visible to the naked eye, and about 1,500,000,000,000 through the best telescopes.

A 1053 *Com. Esarnett L Eshew,*
4581 Capriwald Ave
Chicago

MEMORY MASTERS -



ulated in your mind that you can requisition it at a moment's notice to aid you in negotiating any difficult piece of river—this is merely all in the day's work for the steamboat pilot.

Take any good pilot, blindfold him, and put him at some chance place on the Mississippi shore. Then remove the bandage from his eyes. The chances are he will cock his weather eye at the sun, glance casually along the shore, and tell you the exact location you have brought him to, such as Jones' Woodyard, Williams' Plantation, Bradford Landing or some other point. He can, if he is so minded, tell you

IMAGINE the task of "learning" the location of every tree, light and landmark along a 1,000-mile stretch of treacherous and ever-changing river, varying in width from a half to three or four miles, and you will appreciate what sort of a memory is required by a Mississippi river pilot.

To keep thoroughly "up" on the river, informed of its many changes, to know the snaky course of its channel so well you have a nodding acquaintance with every old tree, stump and wood yard on the shore, to be familiar with all the bends, reaches, sandbars, crossings, islands and towheads; and then to keep this information so perfectly tab-



Capt. Louis Migaud, Oldest Active Pilot on the Mississippi, Above, and Three Veterans, Captain Cooley, Owner, Pilot Migaud, and Mate Cotton

How Mississippi Pilots Whip Ol' Man River in Never-Ending Battle

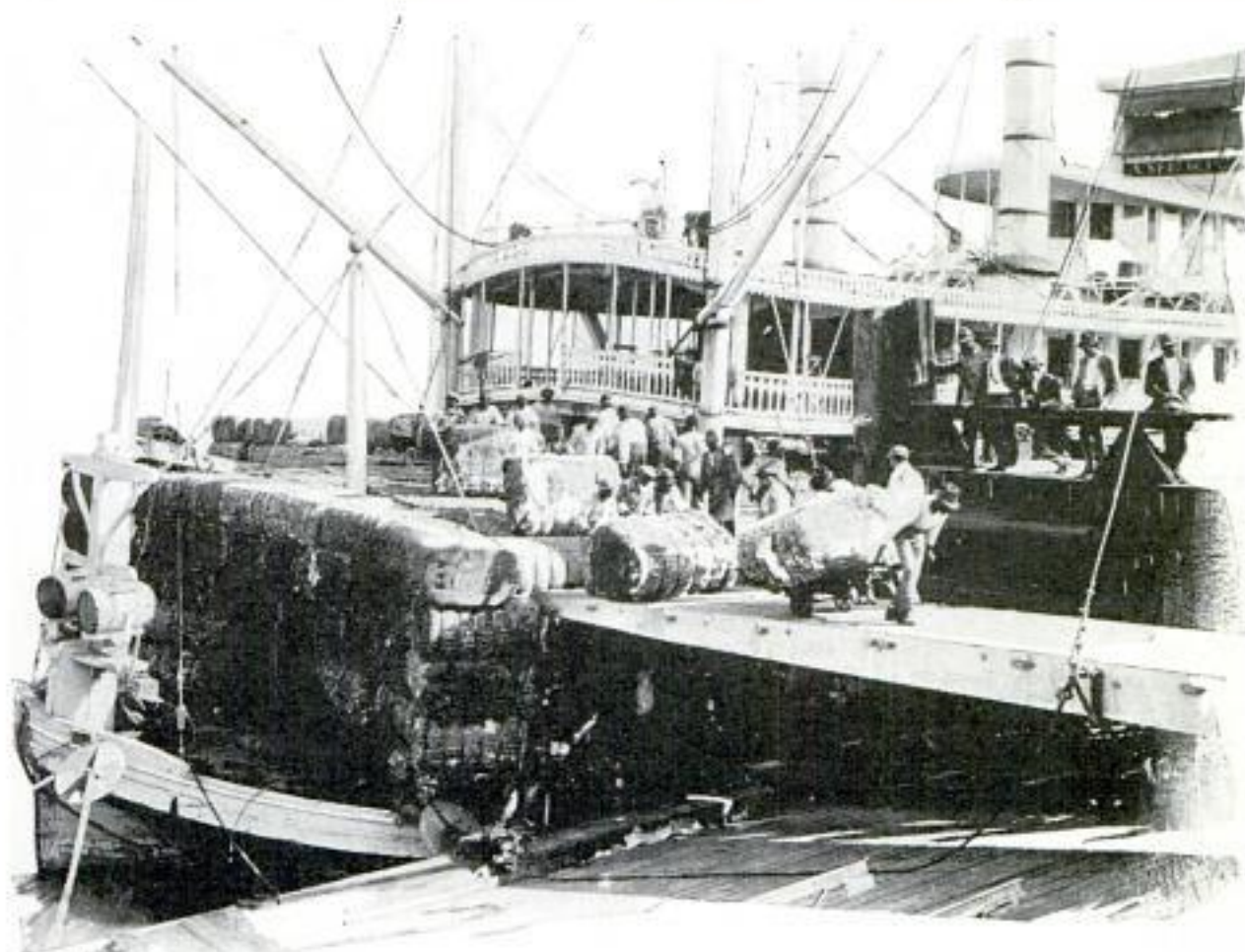

The "America," Big Stern-Wheel Cotton Carrier, Unloading a Cargo at New Orleans; the "America" Is Owned by Captain Cooley and Piloted by Captain Migaud

exactly how far he is from every other point on the river. He can tell you the exact depth of water in the channel at this time, and at this time a year or a month or a week ago, and numerous other items of more or less apparent irrelevance.

But to the pilot all this information is extremely relevant, and he keeps it pigeonholed in that master memory of his. For the average man, learning a ten-mile piece of river in detail would be a gigantic task. Yet the run of a pilot varies from fifty to a thousand or more miles, and he has to know every foot of river in that run.

Pilots share their knowledge with one another. The pilot who is the freshest from a certain run can of course give the latest condition of the river and tell the channel changes that have taken place

within the last few days. He keeps a detailed report, and after each trip this knowledge is frequently made public so that other pilots may have the benefit of it.

Capt. Louis Calvin Migaud is the oldest active Mississippi pilot. Although not far this side of eighty, he is still clear of eye, steady of hand and his memory is still "posted" on the condition of the channel. For sixty years he has been standing his watch at the wheels of steamboats out of New Orleans.

He got his license in 1872, and since that time he has piloted so many steamboats that he cannot recall them all. He was on one of the largest of all the old-time Mississippi packets, the beautiful "Grand Republic," with her capacity of 500 passengers and 8,000 bales of cotton. He was on the "John W. Cannon" with

her lovely cabin, whose owner was also owner of the famous "Robert E. Lee" of race fame. And today he is at the wheel of the "Ouachita," a sturdy stern-wheeler.

"I'll never forget the look of the river at the time of that crevasse in 1889," he said recently while waiting to begin his weekly run. "I've seen the old Mississippi in all her different humors. And this one was the worst. The levee broke, up the river, at Bonnet Carre. And a deluge of water, as big as the river itself in ordinary times, was pouring through a wide gap in the levee and piling up over the farmlands and driving people out of their homes. I was piloting the 'St. James' up from New Orleans.

"You never saw a crevasse, did you? Well, if you had you'd never want to see another. And the noise it makes!—sounds sorter like you pulled the plug out of ten thousand bathtubs at once.

"I was bringing the 'St. James' along close to the bank opposite the crevasse when I saw smoke rising upstream. I picked up my glasses and looked, and it was the 'Katy.' She was one of the biggest boats on the river—finest cotton carrier you ever saw. She was booming toward us, fighting the current over near the side of the river where the hole in the levee was—too near it!

"Just then I heard the door behind me open. It was our captain.

"'Louis,' he says to me, 'there comes the 'Katy,' and do you know who she's

got on board? Jeff Davis himself.'" (You know, after the Civil War, Mr. Davis lived at his plantation, Briarfield, on the Mississippi.)

"As we looked, we saw the current catch the 'Katy' and swing her round, nose in to the crevasse. That big boat (she was about 350 feet long) bobbed around on the current like a chip. Then she went whirlin' away right into the crevasse, clean out of the river and over the fields hidden under the flood.

"Captain," I said, "I'm mighty glad I ain't pilot on that boat."

"'Well, Louis,' says Cap, as quiet as you please, 'we're going right out after her.'

"And we went after her too! Right spank out of the river and through the crevasse. A man couldn't do much steering in that water. A pilot just had to call his nerve into play, and go ahead. I reckon our passengers thought we were headed for perdition when they saw the old 'St. James' turn her bow out of the channel. But—well, anyway, we got Mr. Davis and every other passenger off the 'Katy' and came on down to New Orleans." Davis died a few weeks later.

Such an incident in the life of a Mississippi pilot was no unusual thing during the American steamboat era. A pilot accepted such things as a matter of course. Each trip he made was an adventure and contained new features and experiences he had not encountered before. Boys

The "Robert E. Lee," Veteran Side-Wheeler of the Big River, at the New Orleans Wharf, Where She Has Unloaded Much of the Cotton Seen in the Foreground

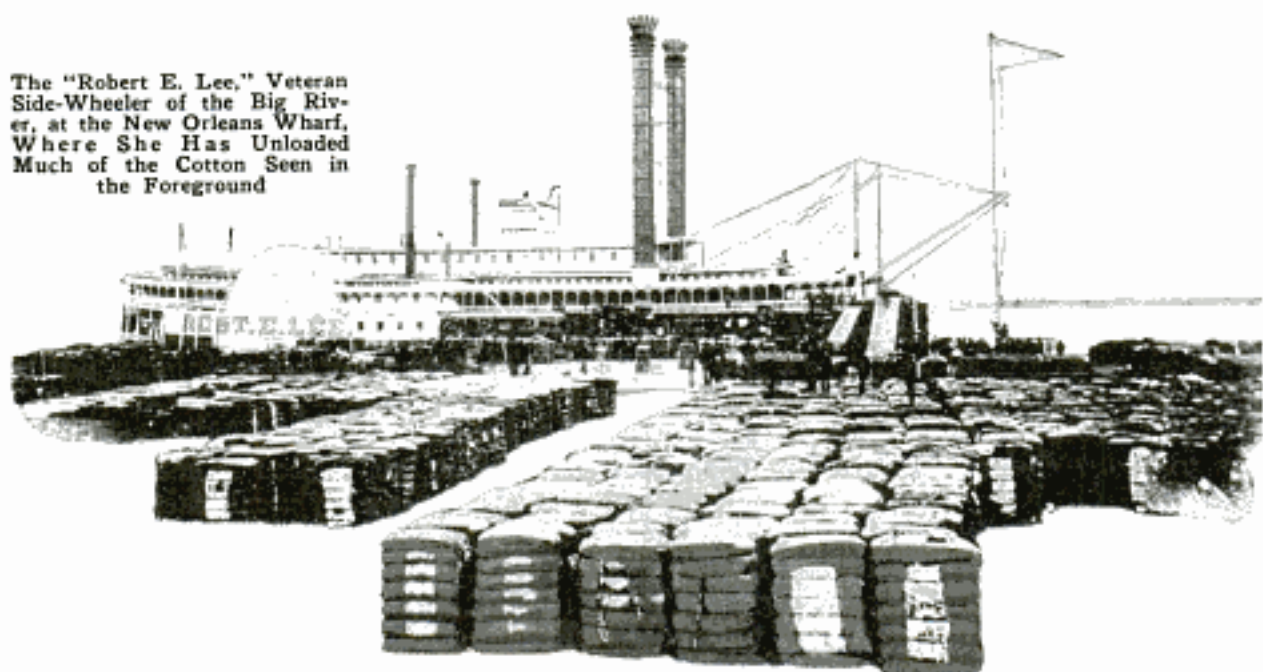



Beautiful Cabin of the Huge Steamboat "Grand Republic"; the Lacelike Ornamentation Is Hand-Carved Woodwork; She Was One of the Most Palatial Boats on the River

growing up at the towns and farms along the Mississippi came to admire and venerate the silent pilot before the wheel in the little glass-enclosed pilothouse on top of the topmast deck. By apparently casual movements of his hands, the pilot controlled the big steamboat and took orders from no one but the captain, and not always from him.

Piloting looked easy. A pilot loafed from one side of the wheel to the other, talking and apparently paying no attention to what he was doing. One boy who cherished an ambition to be a pilot wrote about it afterward and said he thought all a pilot had to do was to keep the boat in the river, and that wasn't much of a job because the river was more than a mile wide. But before long this boy found out different. He found that piloting is the most particular and highly specialized of all professions. Back of that casual confidence the pilot assumed, were days, months and years of wearing work, of training and developing certain qualities of character and personality so as to be able to assume full control of the movement of a great steamer with thousands

of tons of valuable freight and hundreds of lives.

The actual process of steering a boat is not particularly complicated. There is a tall pole rising from the bow of the boat called the jackstaff and another at the stern called the verge staff. The pilot sights along the jackstaff, "aiming" the boat at a certain shore mark ahead, and then sights behind over the verge staff, setting her stern on some other mark. That is known as "setting a boat in her marks," and that is where the thousands of government lights along the Mississippi—one in the head and one in the foot of every bend—are of invaluable assistance. Memorizing the lights is also one of the big jobs.

Piloting on the Mississippi system is different from other piloting. To steer a steamer over an ocean, a bay or a lake where there is plenty of water in the channel and where the charted lanes are always the same, is a big task. But to steer a boat through a channel that twists like a million snakes, that has innumerable shoals, sandbars and mud banks which in dry weather make it hard going for a

steamboat, is an infinitely more difficult task. Such is the Mississippi channel.

Add to this the fact that the Mississippi's channel is never the same.

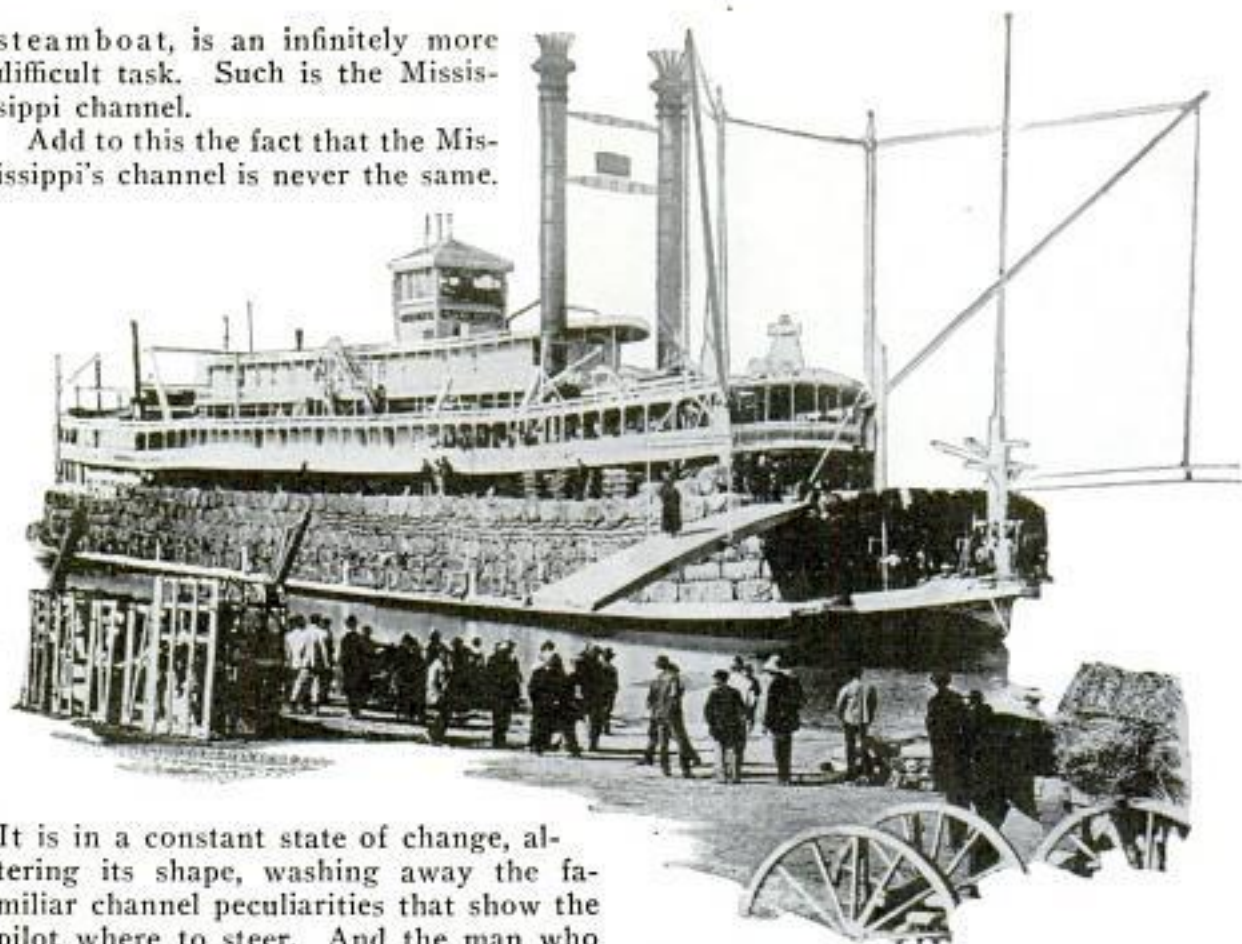

The Steamboat "Natchez" Sidling in to a Landing and Preparing to Unload Her Cotton Cargo

It is in a constant state of change, altering its shape, washing away the familiar channel peculiarities that show the pilot where to steer. And the man who can negotiate that channel, day after day, week in and week out, becomes a marvel of accomplishment. Yet that is what Pilot Migaud, and hundreds of other old-time pilots, had to do.

When a pilot speaks of "learning the river," he means that literally. He does not mean merely learning the general direction in which it flows, the cities and

towns and landings along its banks. He does not mean merely learning the thousands of government lights along the shores. Learning the river means all that, and means infinitely more as well. A pilot has to know the channel as a man knows his own front hall at home.

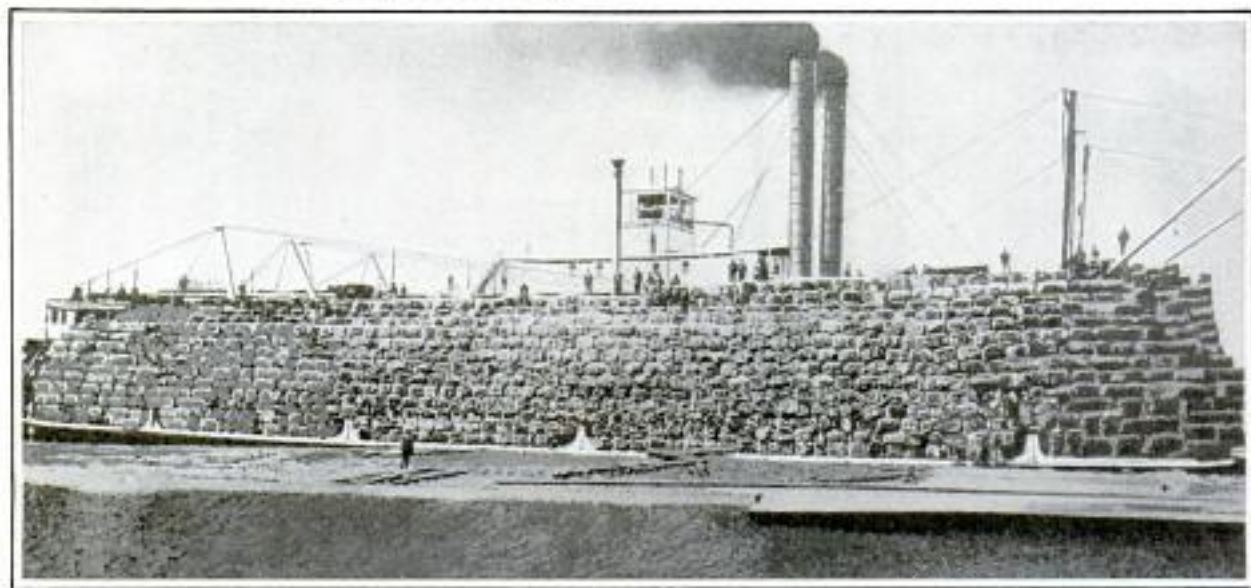

A Mighty Load of Cotton on a Mighty Stern-Wheeler, the "Henry Frank"; This Load of 9,226 Bales Is Said to Be the Largest Ever Carried by a Steamer on the Mississippi

AT General Electric Co
1811 Mela Park 807
Engineering Dept
CARD TABLE CONTAINS LIGHTS
THAT FOLD WITH LEGS

"Piloting a steamboat isn't what it used to be," resumed Pilot Migaud turning to the wheel of the "Ouachita," "In some respects it is harder. These young pilots on the rivers today are engaged in a different sort of steamboating. They are towing freight in barges, and doing a good business too. The river's coming back because there's so much freight to be pushed up and down between the cities of the north and New Orleans. Piloting a single steamboat is a mighty different thing from piloting a steamboat with a dozen barges sticking out in front of you, which is the kind of piloting that is being done on the rivers now. This new piloting is much harder. But then the government aids the pilot today, where it did not aid him in the old days. It keeps lights burning on all the river for him to steer by. It keeps the channels dredged out clean and removes the snags from the river. Also there is the new mechanical steering gear which relieves the pilot of the manual labor of turning a rudder. I remember how hard it was for me to turn the twelve-foot wheel of the old 'Grand Republic.' They all help make the work a little easier.

"But you take my word for it, as long as a man is a pilot on the Mississippi, he's got to be a marvel for memory. He's got to know the river. All the new appliances in the world won't do that work for him."

91847

THE MAN WHO "TAKES IT EASY" MAY DO THE MOST WORK

Those who can "take it easy" while they work may get the most accomplished, it was indicated in a report before a recent meeting of the American Psychological association. The report was delivered by Dr. G. L. Freeman, of Yale, who has studied the relationship between muscular tension and mental effort. He found that in very simple tasks, such as moving a finger back and forth, the output increased in proportion to the muscular tension, while with more complicated tasks, such tension often was a hindrance. When subjects competed for money prizes, both muscular tension and output were affected. Discouragement lowered both and over-encouragement increased tension but decreased accuracy.

Scene Service 9/5/31



Cleveland Ohio



Miss D. G. Connell Jr. and A. B. McHart

Collapsible Card Table Equipped with Electric Lights That Fold Under Like the Legs

Electric-light fixtures are contained in a folding card table, the use of which makes it unnecessary to rearrange lights when the table is set up in a room. Two diagonally opposite legs of the table carry the lights, which are placed on small sections of nickelplated pipe with thumb-screw joints for adjustment. The lamps are shaded by trough reflectors and are located below eye level so that the table is illuminated but the light source is invisible. Ash trays also form part of the equipment, and there is a receptacle for a cigaret lighter. The entire outfit can be folded, the light supports turning underneath like the legs.

NEW POSTAGE STAMP RECALLS BATTLE OF YORKTOWN 91818.

To commemorate the one-hundred-fiftieth anniversary of the battle of Yorktown, the post office department has issued a new two-cent stamp which is rectangular with a red background and a central design in black. The stamp bears the portraits of Rochambeau, Washington and De Grasse, and also the word "Yorktown" and the dates 1781 and 1931, along with its denomination.

Information Service

Dr. C. J. Driscoll
Western Iowa
POPULAR MECHANICS

Science Service 8/21/31

808
a1721

ELECTRICITY CUTS YOUR GRASS IN HOME LAWNMOWER

\$75.00

Electric Lawnmower That First
Combs the Lawn, Then Cuts the
Grass as It Is Pushed Along



patent

Electricity applied to the lawnmower now cuts grass for the tired business man, just as it helps the housewife using the vacuum cleaner. The mower is operated with alternating current and cord connection to a motor of one-eighth horsepower capacity. The lawn is first combed, like a barber combs his patron's hair before cutting it, by seventeen teeth protruding two inches in front of the machine. Then four revolving blades cut the grass. The blades are adjustable and covered by a protecting metal disk. A switch on the handle turns the current on and off.

BOYS' TOYS POWERFUL TOOLS FOR SEEKERS OF KNOWLEDGE

a1803

Small boys who hold burning glasses in the sun until a smoking hole appears in a piece of paper are using one of the newest tools of chemical research. The same principle, intensified by concave-mirror arrangements, is being employed to raise materials of which analysis is desired to intense heats, almost like that of

the sun's surface itself. Examples of similar nature were described at a recent meeting of the American Chemical Society. A bit of boyhood play, that of whirling a bucket of water without spilling a drop, has resulted in the development of ultra-centrifuges, building up forces as much as a thousand times that of gravity. The new molecular-beam method of analysis is reminiscent of the child's love of a fireplace or furnace in the back lot. Material to be investigated is placed in a furnace with a narrow slit in the wall, tormenting it with heat until the molecules come flying out as gas and then turning magnetic or other forces on them to see how they react as they rush by. Differences in nature of the substance under analysis are shown by differences in behavior.

a1671

MAN AND BOAT CARVED IN SAND SHOW SCULPTOR'S SKILL

Using only sand as a medium, realistic figures and scenes are being sculptured on Pacific coast beaches where many persons are becoming adept at this form of art and amusement. One of the unusual pieces of sand carving shows a dozing fisherman and his dog in an upright position in a boat on a lake of sand. Both the boat and figures are made entirely of sand, and a realistic touch is given by waves emanating from the fish line, indicating that the sleeping fisherman has a nibble.



This Dozing Fisherman, His Dog and the Boat Itself, All Have
Been Sculptured from Sand on a Bathing Beach

Herbert Taylor
Long Beach, Calif.

91743

Randley - Page, Ltd., 72

POPULAR MECHANICS

809

Victoria London, S.W. England

The First of the New Forty-Seater Air Liners



Drawing Room of a Forty-Passenger Plane Used by a British Airways Company; There Is Also a Bar, a Salon for Smoking, a Chart Room and Wireless Cabin and Pilot's Compartment

Air travelers will find real comfort for the first time in the forty-seater planes constructed for use on regular routes of an English airways company. Aft of the pilot's seat is a chart room and wireless operator's cabin. Behind that is a drawing room with spacious armchairs to accommodate eighteen travelers. A door from this compartment leads to a large bar and behind this is a smoking salon to seat twenty passengers.

Imperial

is then pushed into the hole to be mended. The flame of a match suffices to start the solder to melt.

BRAKE LINING GROUND ON SHOE TO MAKE PERFECT FIT

91759

Because of the scant clearance between brake shoe and drum in four-wheel construction, it is often necessary that the lining be machined on the shoe. To

SOLDER GENERATES OWN HEAT FOR MAKING REPAIRS

91820

Solder which generates its own heat, doing away with the need for a soldering iron, is now available for mending all kinds of metals and metalware. It is in the form of a stick or pencil and contains all the acid and flux necessary so that nothing else is required to make repairs. The pencil is held over a flame for a few seconds until the end begins to melt, which it continues to do by reason of the heat generated in the stick itself. The end



meet this need, a grinder is now available somewhat like the conventional bench grinder, but fitted with a rubber drum covered by a removable sleeve of emery cloth. When the emery is worn, a new sleeve is put on

the drum. Rests on the machine hold the shoe firmly while being ground.

Metal Products Co
1979 E 55th St.
Cleveland, Ohio
1810131

Albertson & Co. Inc.
St. Louis City
Mo.

Copyrighted material

A 1546-1911 Cont. Arnold H. Kneen,
187 Rockaway Parkway, Valley Stream
ny
How to SELL an



vention. "I have made money," he explained, "through the introduction and sale of my products as a manufacturer, not as an inventor."

Sounds discouraging to inventors without funds! But remember that Edison is a true pioneer in untrodden fields. The pioneer in most lines, if he remains one, may be poorly repaid. California miners of '49 went on to richer



Photos © Keystone View Co.

fields—and companies that worked over the gravel they left took out several billion dollars!

Why do some inventors fail to put over valuable ideas, while others, with far less useful patents, amass great fortunes?

Successful inventors all seem to have business sense. They foresee the uses of their inventions, even before they are perfected. They are able to sell the idea to friends, even strangers, and to hold their interest, often receiving financial aid from them. A great inventor must also be a great salesman, if he wants his discovery to be understood and welcomed in his own time.

Edison for many years has entrusted the business side of his inventions to others. Industries he founded pay out over a billion a year in wages alone. The best business sense is hired to direct them and to fight off "pirates."

But young Tom Edison had to raise

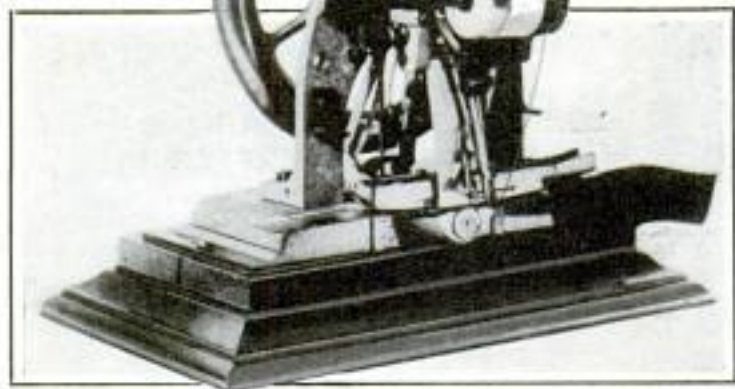

Method of Protecting Battleships from Torpedoes, an Example of What Not to Invent; Below, Howe's First Sewing Machine

"WHY are you not the richest man in the world?" was the question recently put to Thomas A. Edison. It was a logical query, for Edison may well be called the master inventor of all time. He has laid the basis for industries valued at many billion dollars.

Edison replied that, while he has taken out some 1,200 patents, the cost of his labors and that of fighting for his claims has exceeded all the profits from his in-

INVENTION

capital in the beginning. No one realized that this experimenter was destined to be one of the outstanding figures in human history, changing the whole current of civilization with his electric light, phonograph, motion pictures, storage batteries, and other epochal inventions.

In his early years, Edison raised the money on which to live and experiment, by a unique plan of "inventing to order." He undertook for a given sum to develop devices that people needed, and he rarely failed.

This plan, of course, put



© W. K. I. Dickson

Form No. 114
WEEK ENDING SEPT. 17 1912

No. 1
NAME.

THOMAS A. EDISON.

DAY	MORNING	NOON	NOON	NIGHT	EXTRA	EXTRA	TOTAL
	IN	OUT	IN	OUT	1	2	
		12:58	3:25	6:21	8:11		
		11:29	1:40	7:02	8:03	12:29	
9-45	1:03	2:10	6:34	7:58			
	1:13	2:01	6:10	7:54	10:14		
8-30	2:20	1:49	7:30	8:51			
	1:23	1:52	6:14	7:42			
	1:02	1:50	6:18	7:58			
TOTAL TIME <u>112 HR. 6 MIN.</u>							
DATE.....							
TOTAL WAGES FOR WEEK \$.....							

The Tremendous Industry of Edison Is Shown in His Work Sheet—112 Hours of Labor in a Week!

him on his mettle, for only a man with rare confidence and resourcefulness would undertake to invent something without knowing whether he could solve the problem or not. He succeeded so many times, however, that his prestige grew rapidly.

Variations of inventing to order are often found today. Many concerns hire designers, and sometimes men with ideas but no mechanical skill hire firms to perfect their models and inventions. Sometimes an inventor enlists the aid of a man with funds, or a man with merely an idea may obtain the services of a trustworthy inventor and go "fifty-fifty" with him on the profits.

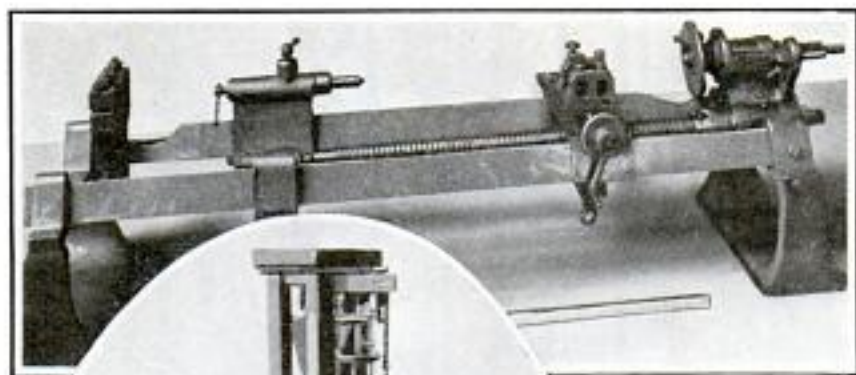

© British Crown

© Keystone View Co.

Maudslay's Original Screw-Cutting Lathe, Above, and a Sewing Machine from France That Predated Howe's

The teletypesetter, a remarkable device whereby a single typesetter may operate a thousand linotype machines by wire in any number of cities, began as the idea of Frank E. Gannett, publisher of Rochester, N. Y. Although he was told that he was seeking to do the impossible—how many inventors are told that!—he kept the idea alive until he met an inventor familiar with all phases of printing.

Charles F. Burgess was a college professor when he decided to invent and build dry batteries, having found one day that he could not buy what he wanted for a laboratory experiment.

"I called in three of my best students," he related years later, "and told them I thought a new dry cell could be built and sold, making profits that could be used in developing other items."

What an idea—a college professor and his students going into business to make

money for further research! Most of us would have predicted early and total failure. But the four men raised \$9,000 between them, and today the company does an annual business of over \$5,000,000.

Armstrong was a student, with the college man's chronic need of capital, when he worked out his notable feed-back circuit that brought radio to millions of homes. His father not only declined to finance his experiments, but ordered him to spend his time on something more useful.

When George Westinghouse patented his first invention—a mechanical car replacer, devised after George had stood for two hours and watched a train crew replacing derailed cars—his father declined to aid him. But George had friends who helped him start on one of the most remarkable careers the world has seen. Westinghouse combined mechanical genius with business acumen—a combination that scarcely ever fails to bring wealth and fame.

Similar to Edison's career is that of another widely known creator of new things, who can sell as well as invent. As a lad of ten years he flouted general advice, like Edison, by choosing invention as his life-work. He set a high position as one of his goals—he would be no less than chief engineer to Thomas A. Edison himself.

Miller Reese Hutchison got the job. Holding it for nine years is proof enough of his mechanical and technical skill plus resourcefulness. But Hutchison had already developed another and rarer talent, among inventors—the ability to convert his patents into money. Over \$400,000,000 worth of products invented by Hutchison have been marketed.

"I decided that to be a successful inventor I would have to be a technical man," said Doctor Hutchison. "I had to know how to use the technical advice of others. So I enrolled for an electrical and mechanical engineering course. Summers I spent in machine shops, foundries and factories of all kinds. There was plenty to learn about machines and mate-

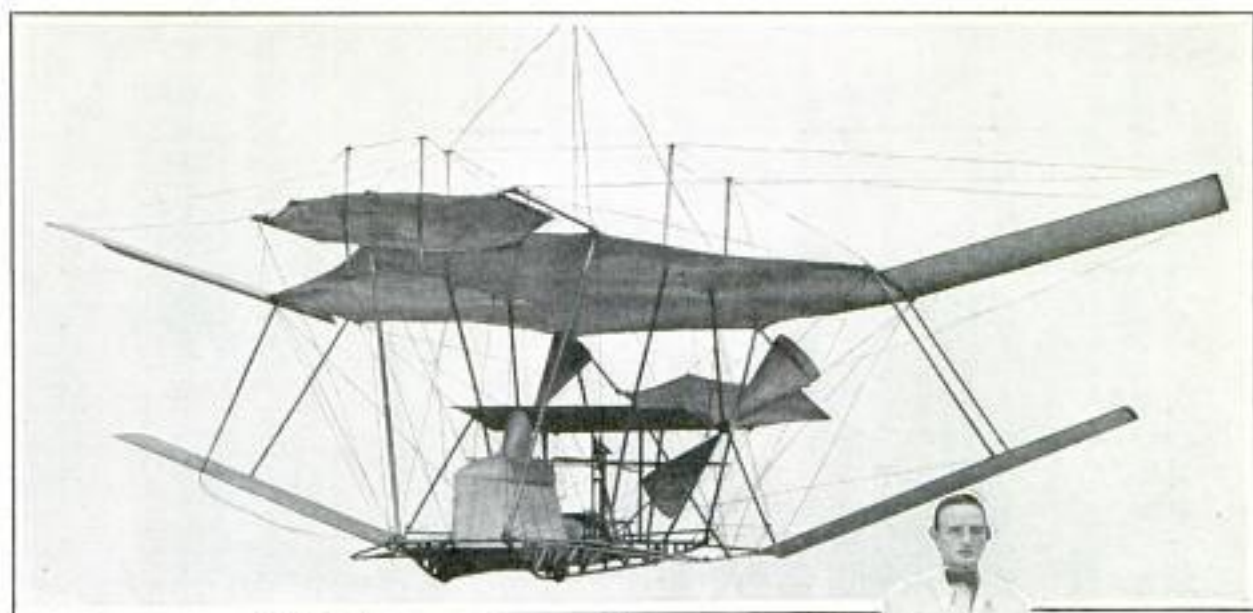

© British Crown

Model of Maxim's Flying Machine, 1894, and at Right, Stockholm Students Who Solved an Abstruse Scientific Problem and Made a Fortune

rials and processes, even in those days.

"Before I started to college, my father, in the wholesale and export grain business, gave me a year's wonderful education in his field. I learned how to look at things through a financier's eyes. It became clear that even when I had invented, patented and produced some needed thing, someone would have to be paid—and paid well—to put it on the market and induce people to buy it. I had a friend who was a deaf-mute. Some such incident starts most inventions. I determined that I would enable my friend to hear, feeling certain that, when I had succeeded, there would be tens of thousands of partly deaf who would be glad to pay for a mechanical ear."

Starting work in an old summer cottage on Mobile Bay, he quickly discovered that he knew nothing about the complex structure of the ear. Yet he was trying to solve a problem on which perhaps thousands had failed. He had to succeed in this, his first invention.

He enrolled for a year's course in medicine. Part of his laboratory work included dissecting dozens of ears. That was the only way to learn what he needed

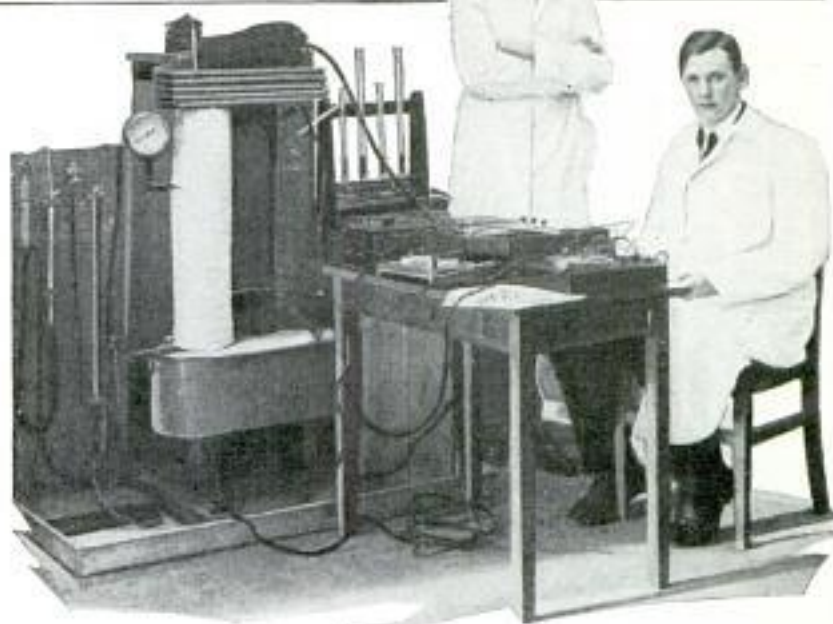

to know. He was back at work on his invention, delving deeply into the intricate problem, when the Spanish-American war interrupted his work. After it was over, he again tackled the problem of a mechanical ear. His acousticon was the first device of its kind to bring hearing to the deaf. An amazing number of them are in use today.

"On most of my inventions I had a partner who had a fifty-fifty break and a free hand on the business end," he continued. "But this scheme does not always get results. Sometimes I have had to invent some sales strategy. Thus, when I had invented and perfected my auto horn, I had to sell it to the public.

"My horn put life into absent-minded pedestrians. I knew it would save many

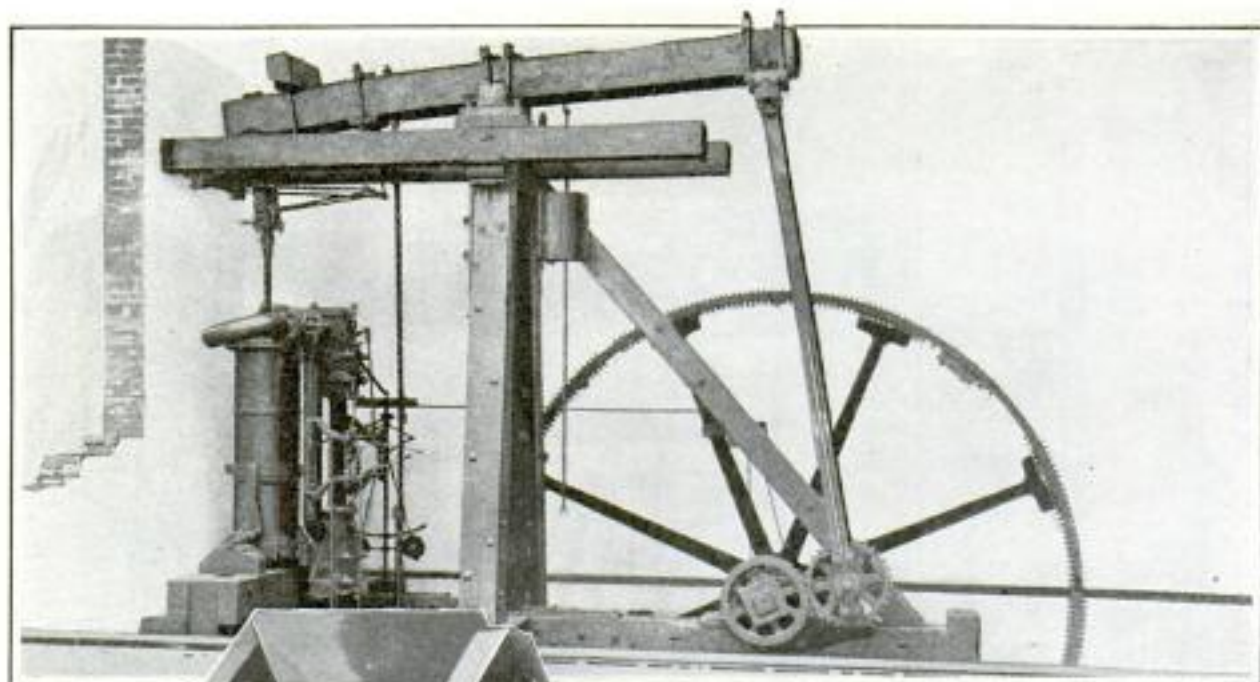

Boulton and Watt Rotative Beam Engine, 1788, and, at Left, Whitney's Cotton Gin

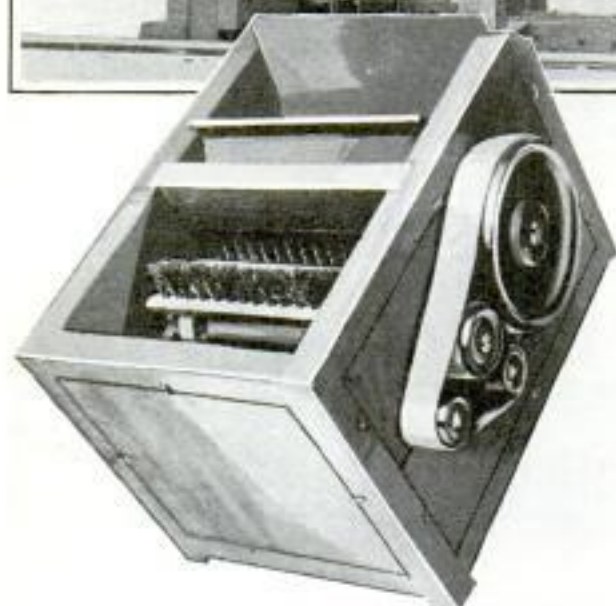

Photos © British Crown,

lives, as cars began to get more numerous and faster. But when I turned over all manufacturing and sales rights to a company, which sold none at all in nine months, I decided that selling those horns was up to me if I wanted to make any money. So I obtained the selling agency for New York, New Jersey and Pennsylvania.

"Some auto races were about to take place. When the cars were on the line awaiting the signal, their explosive exhaust deafened the drivers, so that they could not hear the starter's gun. Nor could they be called back after a false start without wasting time.

"I offered to stop these delays by providing a horn the drivers could not fail to hear. The race committee allowed me to set up a dozen of my horns, at my own

expense, in front of the grandstand. You could hear them for miles. As spectators came in for the race, I had a boy hand them a folder describing the horn.

"Before the end of the first race, we had sold 500. Nor were they sold for a song, either. The bulb horn then sold for \$3.50. Mine cost \$35. With methods like this I sold over 5,000 in thirty days.

"I had previously invented another electric horn, not so good but cheaper to operate, and far better than the bulb. Though I had patented this cheap horn, I let others infringe without a word. I was trying to wean auto owners away from the bulb, now really dangerous.

"One day Chief Croker, head of the New York fire department, asked me to install one of my horns on each piece of fire apparatus. I declined, explaining that such a device, if it happened to get out of order, might be unable to warn people on a dash to a fire, and thus someone might get killed.

"I suggested that one of the new hand-driven sirens would be much better. The men, with nothing else to do, could grind out a whale of a noise with one of them. Probably the chief wondered why I was boosting a rival. But I had a scheme.

"The chief installed a siren. Traffic scattered before him—he had a clear street for blocks. He had them put on all fire apparatus, and the men got a great

91799 Bendix Automatic Corp. 815
 105 W. Adams Chicago
**AUTOMATIC CLUTCH FOR AUTOS
 OPERATED BY ACCELERATOR**

kick out of grinding out a shrieking whine on the way to and from a fire.

"But the chief quickly realized that it would be useless if other drivers were using it. An ordinance was passed, limiting its use to fire engines, police patrols and ambulances. Soon my competitor was doing a land-office business, selling sirens for these uses all over the country. I claimed no commissions on that business. But there his market stopped, while I had all the millions of motor cars for my horn.

"The money received from the horn helped finance other inventions. Most of them I have sold outright or on royalty, often helping to commercialize them. I always work on things for which there is a crying need."

**SUBMARINES SINK OLD CLIPPER
 TO MAKE A MOVIE**

Forty miles off the coast of San Diego, three submarines recently opened fire on the old three-masted clipper "Bohemia," and sent this famous ship to its grave. In spite of terrific explosions which shot smoke more than 1,000 feet in the air and tore away the stern of the vessel, the stanch boat remained afloat for more than twenty minutes after the submarines had done their work. The Yankee clipper was sunk during the making of a moving picture, the spectacle being filmed as the boat went down, stern foremost.



Blowing Up a Yankee Clipper during the Making of a Movie; Three Submarines Fired on the Old Boat

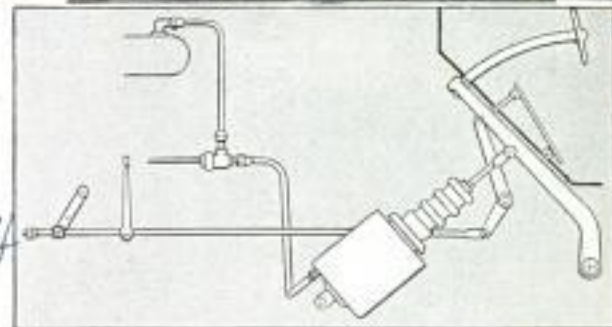

Automatic Clutch Control Which Disengages When the Foot Is Lifted from Accelerator

Automobile drivers need no longer touch the clutch pedal in starting, stopping or shifting gears. A clutch control is being produced which disengages the clutch when the driver lifts his foot from the accelerator, and engages it again when the accelerator is depressed. The system operates by means of a vacuum created in the intake manifold by engine suction when the accelerator is released. This vacuum draws a piston, which actuates mechanism that pulls down the pedal and disengages the clutch. The vacuum is dissipated when the accelerator is pressed down, opening the throttle. The device fits cars having a foot throttle, and gives the sensation and advantages of free wheeling, while at the same time providing easier driving and more efficient clutch operation. The driver can return to conventional control by merely moving the hand throttle to the point where it starts to push down the foot throttle, thus complying with the law in states demanding complete driver control.

*Ord. Chev. 19.50
 other cars higher*

9 17 61 Cont. Robert McIsaac
Amaha Bee news
POPULAR MECHANICS
Amaha helr

Plane Kills Grasshoppers by Poison Spray

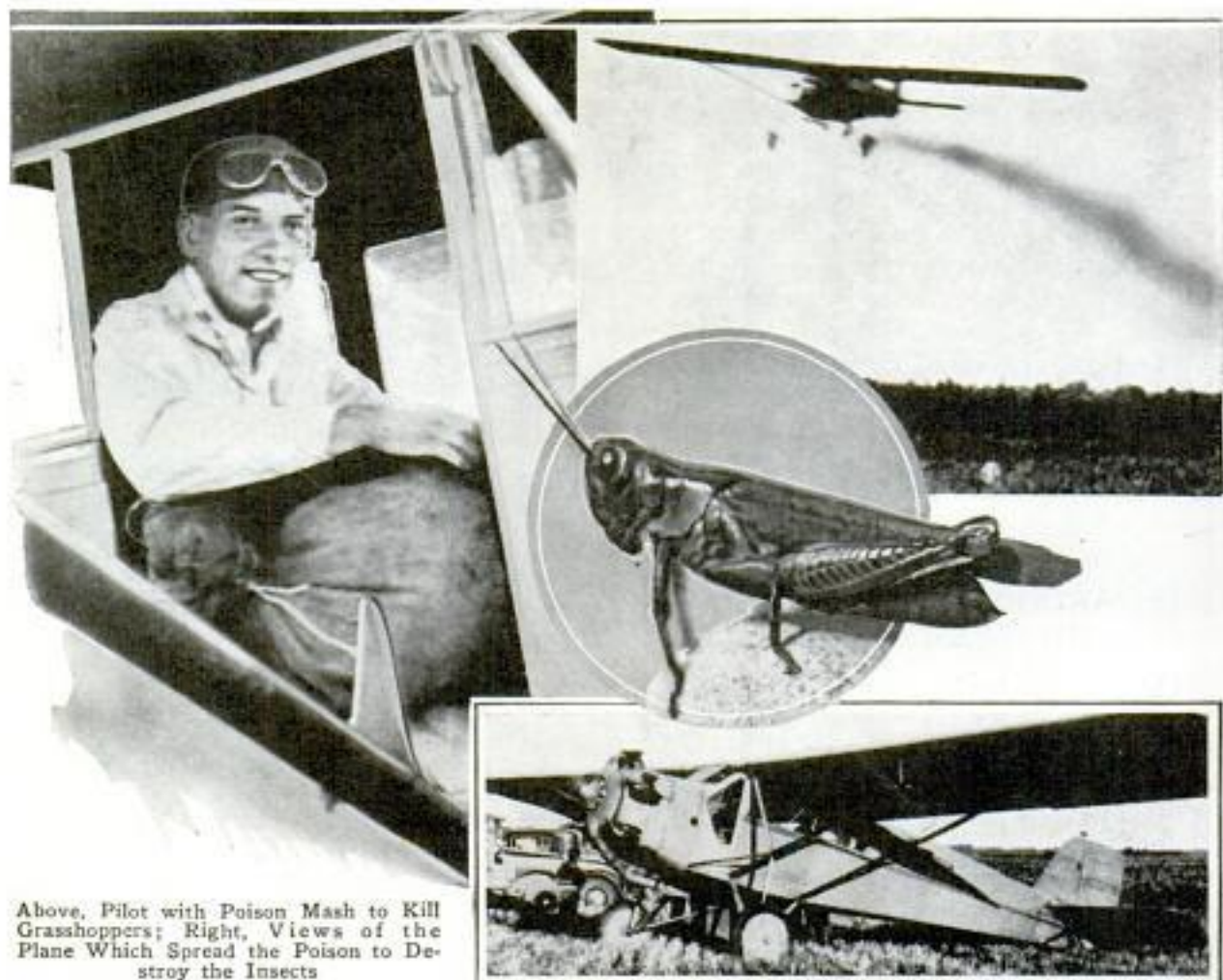

Above, Pilot with Poison Mash to Kill Grasshoppers; Right, Views of the Plane Which Spread the Poison to Destroy the Insects

Grasshoppers were fought with airplanes in Iowa when horses, tractors and automobiles all proved too slow to cope with the menace. When the hoppers invaded western Iowa, the state hired an airplane to exterminate them, and the ship helped curb the insects along highways, drainage ditches and roadside weed patches. The farmers fought the pests with poison bran mash in their fields, and

the airplane used the same material in killing them. The craft carried 400 pounds of the mash aloft at a trip and, with this load, sprinkled an area about fifty feet wide and more than a mile long. One county after another was sprayed with the poison, which killed the insects in one to five days. The mash was mixed with water and molasses until it was heavy enough to fall in the desired area.

"MAGNETIC EYE" IS DETECTIVE THAT HUNTS ELEMENTS

Combining the speed of light with magnetism to detect elements in solutions as infinitesimal as one part in 100 billion, the "magnetic eye" recently was described before a meeting of the American Chemical Society. It was discovered by the method's originator that every one of the ninety-two elements that constitute the

earth reacts differently to this combination of light and magnetism. Substances to be sought, such as gold in sea water are placed in a liquid. The liquid is put in a magnetic field and light passed through. While the light is practically extinguished by the elements in the magnetized liquid, each element takes a different fraction of time to do its job of extinguishing, thus revealing its presence and also the quantity.

a 1805

Discovered by the Fred Allison, Dept of Physics, Alabama Polytechnic Institute Auburn, Ala

Chicago post 9/1/31

91582

LAKE MAY CONTAIN CAPTAIN KIDD'S TREASURE

Preparations are being made to drain a deep lake on Haute Isle, in the Bay of Fundy, in the belief that its waters conceal fabulous wealth in gold and gems hidden by Captain Kidd, world-famed as a pirate. A marble slab recently was found near the lake on which was gouged a chart of the body of water and, among other things, an inscription reading: "R. Kidd. Five fathoms east and two fathoms deep." The inscription is said to tally with the location of the treasure given by a member of Captain Kidd's crew. Several years ago the island was searched but no treasure was found. The latest venture involves draining the water from the lake which is two miles long and 300 feet deep in places. This island is not the only one in the area believed to hold treasure. Oak island, near by, is at present the scene of another search for the pirate's wealth and the Island of Manan, eight miles from the Maine coast, also is supposed to hold more of Captain Kidd's treasure. This treasure has been sought from the West Indies north to the Gulf of St. Lawrence, always without success.



Drawing of Surf Machine to Provide Artificial Ocean Waves for Swimming Pools; the Big Roller Is Operated by an Electric Motor

OCEAN WAVES MADE TO ORDER BY SURF MACHINE

Artificial ocean waves are provided for tanks, swimming pools, lakes and rivers by a patented surf machine run by an electric motor. The motor is on top of a chute from which a large roller is manipulated in the water. The size of the waves depends on the speed at which the roller is operated. It is claimed the artificial waves create no undertow, and the surf machine requires little space since it is less than three feet high. Swimmers are protected from the roller by a mesh fence in front of it. The surf machine can be constructed to fit the dimensions of any pool and the cost of operation is not high, since little power is required to run the roller.

Eighty-six women hold licenses as amateur radio operators in the United States and Alaska.

COPPER BUSHING ON WASHERS STOPS FAUCET LEAKS

Faucet washers fitted with copper bushings in the center are now available as one means of stopping dripping faucets. The bushing keeps the washer from splitting and the pressure of the screw is against the bushing and not the washer, thus assuring longer life. When the screw is tightened, the washer turns against the bushing, and dripping is prevented because the washer turns with the faucet.

Homer Goodwin Mfg Co
2888 W. 19 St
Cleveland, Ohio

Amos C. W. Keller, 165 7th Bldg
A. F. Siferle, 1475 Virginia U. Portland Ore

Control Box for Double-Button Microphone



THE microphone is perhaps the instrument least understood and most abused by the radio experimenter. For the current supply, batteries should be used. Best results cannot be obtained by alternating current from any source. Dry cells will last a long time in microphone use, owing to the very low current consumption. Current from a 6-volt storage battery may also be used, provided a suitable arrangement, such as a potentiometer or voltage divider is employed to reduce the voltage applied to the microphone. For best results never use more than 3 volts or a current of over 10 amp. per button; the less current used, the better for the delicate contact surfaces.

For long life and consistent service a means of checking button current is absolutely necessary. A milliammeter, connected in series with each button, therefore is highly desirable in the control box to be described, and jacks are installed in the circuit so that either side can be checked by the same meter.

The box for the control unit should be

large enough to house it without crowding the parts. A metal stage shield can may be used or a wooden box lined with sheet copper as shown in the photo. In this case, a bakelite front panel was used which was shielded on the underside with a sheet of metal having cut-outs to clear the various binding posts and jacks. The leads from the milliammeter are brought out with flexible cord through the end of the box and terminate in an ordinary phone plug. This enables shifting of the meter from one circuit jack to the other.

The binding posts at the top are for the battery of four ordinary dry cells connected in series. The three binding posts at the right, as shown in the diagram, are connected directly to the microphone.

The posts on the left are connected to the input of the microphone transformer, which is usually housed in the transmitter as in the case of the speech amplifier described on page 822 of this issue.

The input terminals

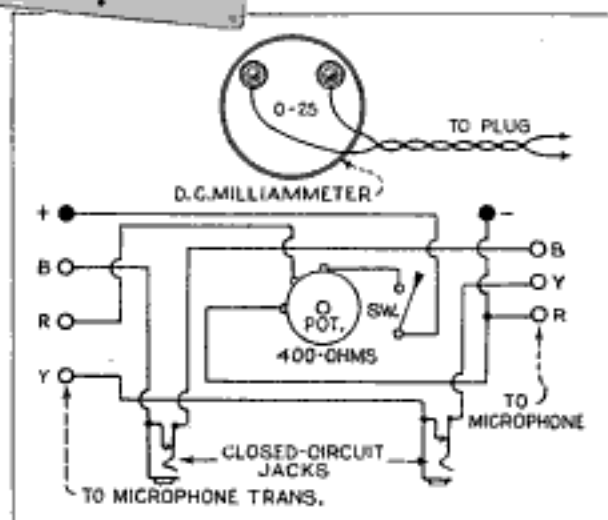

of the microphone transformer are numbered 1, 2 and 3, the center point 2 being connected to the lever of the potentiometer in the control box. Shielded cable should be used if the control box is to be placed any distance from the speech amplifier. To simplify the connections, the leads in this cable are colored red, yellow

and blue, the letters at the binding posts on the control box indicating these colors. Red is the center or negative side, and at the microphone this terminal is grounded to the case.

It will be found desirable to use a combination potentiometer and battery switch as this unit will prevent the possibility of closing the switch with the potentiometer full on, and also breaks the circuit when the potentiometer is in the off-position.

All microphones should be mounted in an upright position, and it is highly important that they be protected from mechanical

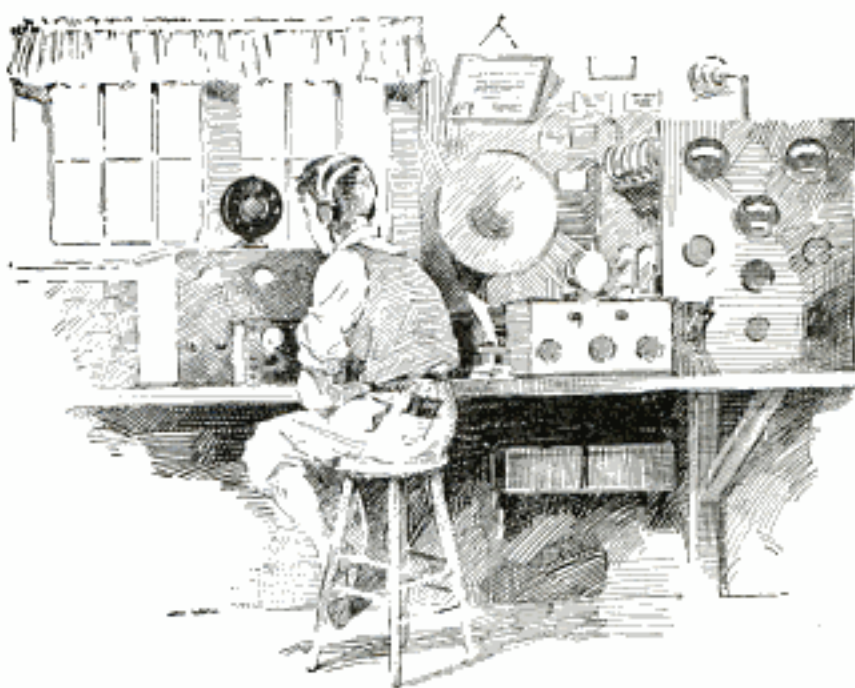

vibration. Small coil springs or rubber bands are used for this purpose.

Switches Shift Short-Wave Coils

Two four-point inductance switches may be used to replace the group of plug-in coils in a short-wave receiver if the coils are connected as shown in Fig. 1. This tuning unit covers the short-wave bands from 15 to 200 meters. Four coils are used of which only one is in the circuit at a time thereby eliminating dead-end losses. The coils are wound as shown in Fig. 2 on thin bakelite or cardboard tubing, according to the chart below. The values shown are for a tuning condenser with a maximum capacity of .00014 mfd. and a type 201-A detector tube. If a screen-grid tube is employed

as a detector, one to five turns should be added to the grid windings, and after the set is in operation, a turn at a time should be removed until the tuning range is correct. The turns on the 20 and 40-meter grid coils are spaced slightly, but the same coils for the 80 and 160-meter bands are close-wound. The ticklers are wound $\frac{1}{8}$ in. from the grid coils without spacing. The leads are soldered to terminal lugs mounted on the coil forms with short machine screws. The coils are mounted on a 4 by 4-in. bakelite panel by means of short metal angle brackets with the grid ends up and the switches are mounted on another panel of the same size, supported by brass posts 3 in. long.

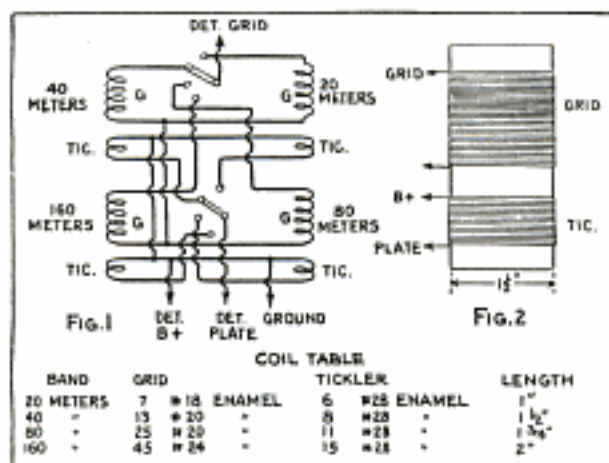

Brackets from Old Condenser Plates

Brass plates from discarded variable condensers may be cut up into angle brackets of various sizes and other metal parts for radio sets. As these plates are lacquered, they should be sandpapered or filed before being employed for electrical contacts.

☞ For further information on any radio construction article write to the radio department; this service is free.

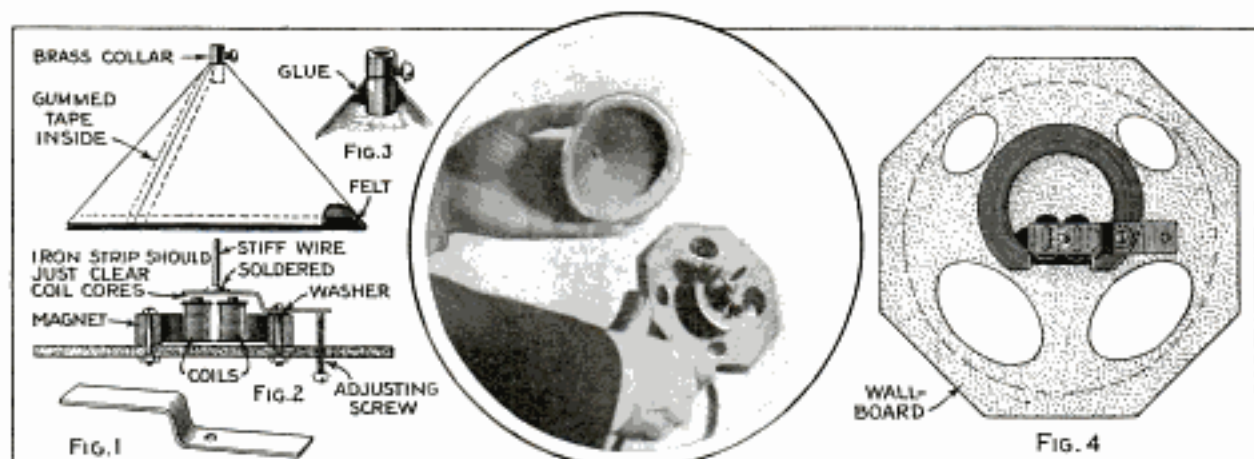

Construction Details of Homemade Cone Speaker Suitable for Installation in Car; Photo Shows the Completed Speaker with the Cone Removed

Homemade Speaker for Car

An inexpensive speaker, suitable for use in an auto radio installation, may be made from odds and ends usually found in the radio experimenter's junk box. The speaker unit is obtained from an old headphone and the cone is made from heavy paper; a disk 6 in. in diameter being required. The paper is cut and lapped to form a cone the apex of which should extend about 1 in. above the top of the coils for best results. A strip of iron, $\frac{1}{8}$ in. thick, $\frac{1}{2}$ in. wide and 3 in. long, is bent, as shown in Fig. 1, to fit above the coils as in Fig. 2. A piece of stiff wire, at least 2 in. long, is securely soldered to the iron strip in an upright position. The tip of the cone is cut off to take the brass col-

lar which is held in position with heavy glue, as shown in Fig. 3. This collar is made from a short brass rod, drilled lengthwise to take the upright wire, and a hole is drilled and tapped in the side for the setscrew. The narrow strip of felt around the bottom of the cone is to cushion it from the base. This baseboard is cut from a 6-in. square of wallboard with cutouts as shown in Fig. 4. A small hole is drilled in this board for the adjusting screw. The leads from the receiver unit may run through one of the larger holes. The cone is placed over the unit with the upright wire through the collar. The wire is then cut even with the top of the collar, and the setscrew is fastened so that it holds the cone snugly against the base.

Simplified Antenna Lead-In

Drilling window glass, to bring in the lead wire from the antenna, is tedious, and there is always the risk of breaking the glass. The same efficient insulation and results may be obtained, however, by cementing two brass or aluminum plates, about 2 in. square, one on either side of an upper corner of the window glass as shown. This may be done with collodion or other colorless cement. If aluminum plates are used they must be

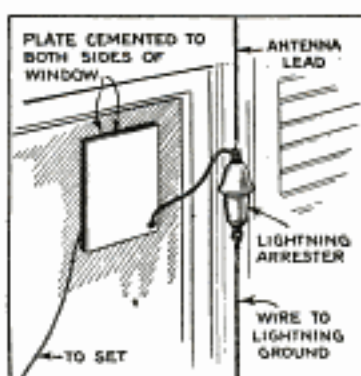

drilled for machine-screw terminals as this metal is difficult to solder. These plates act as an antenna series condenser, coupling the antenna to the receiver. Owing to the condenser action, a longer antenna may be used if desired without lowering the efficiency of the receiver.

Temporary Receiver Installation

Any modern receiver can be operated temporarily by connecting a wire from the antenna post to a radiator or water pipe. It is not necessary, however, to provide any connection to the ground post.

Blueprints covering radio construction articles in past issues can be obtained for 25 cents each; material lists are always available without charge.

Practical Ideas for the Radio Experimenter



Insulated Terminal Support and Choke-Coil Mounting for Type-852 Transmitting Tubes

Screen-Grid Tube Shields Should Be Provided with Several Ventilating Holes at Top and Bottom, as Shown Below, to Admit an Updraft of Air for Cooling the Tube; the Control-Grid Lead Is Also Shielded in This Assembly

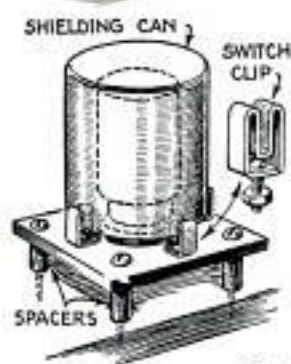
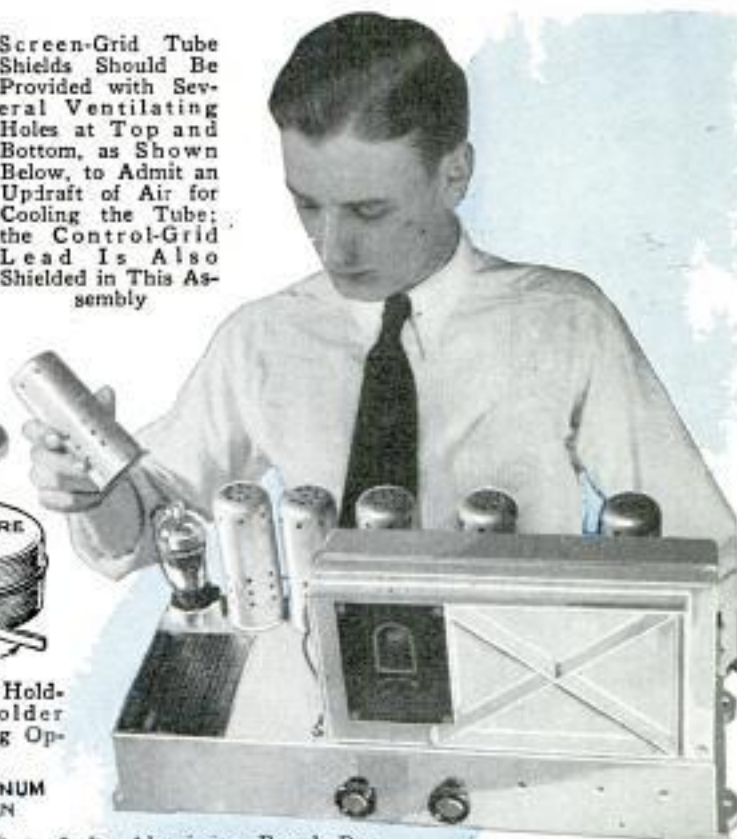

Handy Method for Holding Flat Strip Solder during the Soldering Operation

Above, Clips from Old Knife Switch Make Quick-Detachable Mounting for Plug-In Coil Shields; the Elevated Base Is Handy for Bread-board Layouts

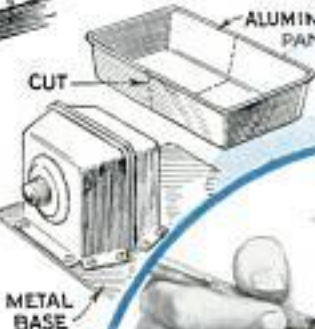

Left, Aluminum Bread Pan Cut to Make Shield for Short-Wave Receiver



Handy Soldering-Iron Holder for the Experimenter



Above, Tips for Plug-In Coils; Right, Well Soldered Connections Important in Multi-Range Voltmeter Assembly



General Utility Switch of Tumbler Type Mounted Directly on Dry Cell

note 9/18/25
9/18/26



Left, Aluminum Spreaders for Cage Antenna; Right, Hookup Wire with Woven Metal Shield



Belden Mfg. Co. Western An Chicago
2 300 A

Charles F. Jacobs.
279 Park Place
Brooklyn, N.Y.

Lead in spools 2 1/8"
5 1/4" ana 7" diameters
10.00 per doz
6.00 " 1 doz

Lubliner Condenser Co
4377 Bronx Blvd
New York

Practical Antenna Suggestions

The current received by your outdoor antenna, regardless of its type, travels on the surface, and so stranded enameled wire is desirable. If plain copper wire is used, make sure that the surface is bright and clean. If badly tarnished it should be replaced. It has been found that merely wiping the insulators free from soot greatly increases the strength of distant signals. Carbon tetrachloride, a common household cleaner, will quickly remove all grease, soot and dirt. It is important that all joints in an antenna system be carefully soldered. One wire, from 50 to 100 ft. long, depending on the type of receiver, is all that is required. This should be elevated at least 30 ft. above the ground for best results; also it should be remembered that the length of the lead-in wire is figured in the overall length of the antenna.—J. B. Bayley, Jersey City, N. J.



Listening for Metallic Specks Imbedded in Condenser Insulating Paper

Testing Filter Condenser Paper

The long strips of paper tissue that go into the making of filter and by-pass condensers must be free from metallic or foreign particles. These troublesome specks are usually too small to be detected by the naked eye, and, if not located, will result in a defective condenser. The simple listening-in method, indicated in the photo, has been found effective. The condenser paper is unwound and rewound and passed between two brass contact rollers in circuit with a direct-current source and a pair of headphones. The operator slowly turns the winding crank and listens for the clicks caused by metallic or conducting specks.

Chicago 330 S Wells

An Electrical Hair Trigger

The slightest mechanical or electromagnetic influence controls powerful electric current by means of this small vacuum contact. It is claimed to eliminate most of the complicated and costly apparatus heretofore required for operating electrical equipment by delicate means. Properly applied, especially in conjunction with simplified light-sensitive cells, this relay has many possibilities for the experimenter. The accompanying diagram shows the operating details. It is rated to handle 6 amp. at 220 volts, or 1,320 watts, on continuous load.

Chicago 111 W Monroe

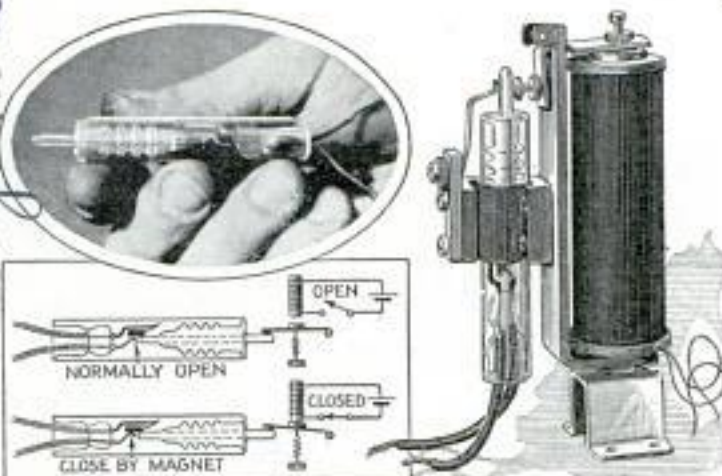

Photo Indicates Comparative Size of the Vacuum Contact; Right, Mounted for Operation by Standard Telephone Relay

Improving Vibrator Chargers

An old vibrator battery charger, that had been in service for a period of years, was greatly improved from the standpoint of efficiency and interference in the following manner: A new set of points and armature were obtained from the factory at small cost. These were substituted for the old parts, and the armature was moved 1/8 in. nearer the pole of the actuating magnet and adjusted in the usual manner. After this change, the charger was more stable, and sparking at the points was practically eliminated. A small filter in the power line will take care of any remaining interference that may be picked up by the receiver.

Burgess Battery Co
295 Madison Ave
New York

Home Made TELEVISION Advanced

By C. A. BRIGGS



TO SEE the artist you are hearing on the broadcast program is now quite common in several metropolitan localities. This does not necessarily mean that television has arrived in its complete and final form, but experimenters, living in or near these cities, are obtaining some very good results. Some are making their own scanning devices but the average experimenter is confining his efforts to the design and construction of a suitable short-wave receiver for television signals. Such a receiver is quite different from the usual short-wave type, and the one to be described contains

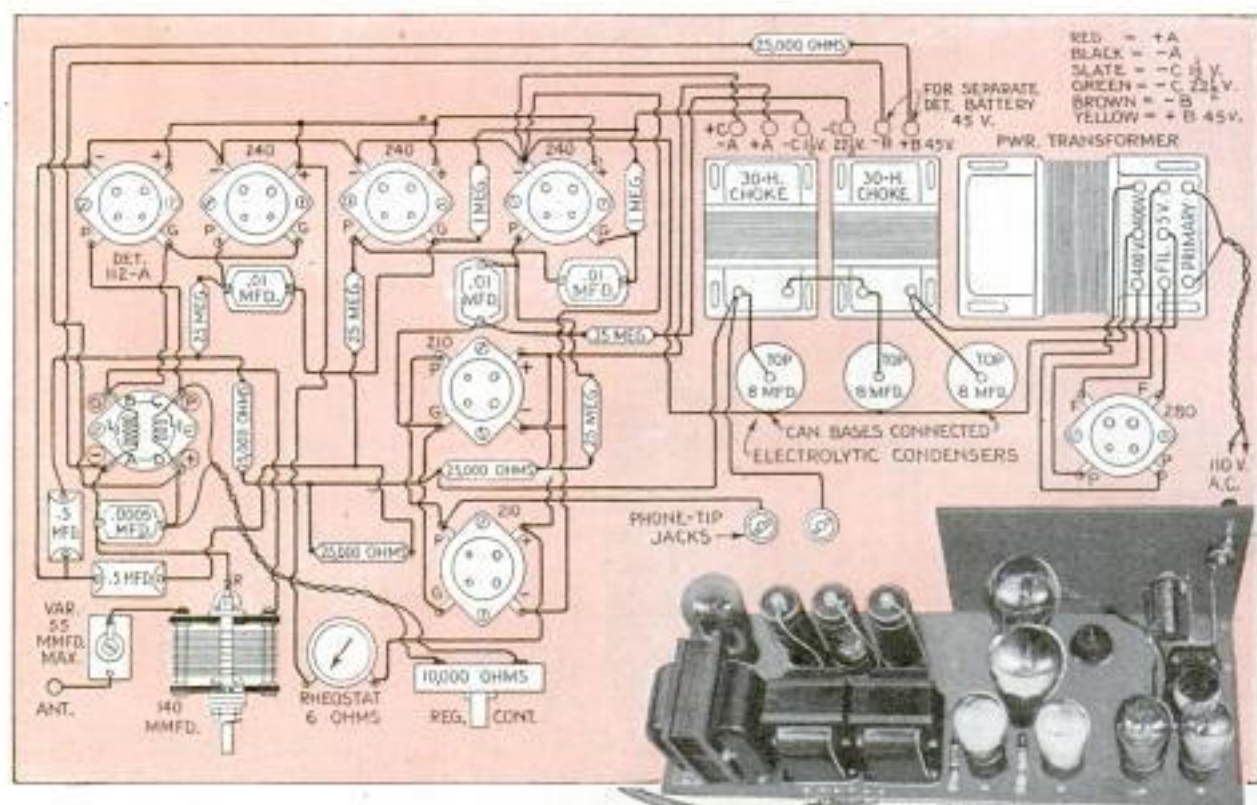

Above, Portable Television Transmitting Scanner for Picking Up Living Subjects; Below, Simplified Wiring Diagram and Photo of the Completed Receiver

RECEIVER of Design

several new and interesting features.

Two tubes divide the action of the ordinary detector, and it will be noted that the grids of these two tubes are tied together. The plate supply from the separate B-battery does not pass through any transformer circuit in reaching the tickler coil or plate of the first tube. The second tube has its plate supply connected through the resistance element for the audio or television output. This power supply is built into the receiver and consists of the usual full-wave rectifier and an efficient filter system employing electrolytic condensers. The audio tubes in the first and second stages are of the "high-mu" type best suited for resistance-coupling, and the last stage consists of two type-10 tubes in parallel.

The filament supply is obtained from a 6-volt storage battery, the full voltage being applied to the filaments of the last two tubes. The filament supply for the other tubes in the set is regulated by means of the 6-ohm rheostat. The switch for the 6-volt battery and the 110-volt a.c. supply are mounted directly on the experimenter's bench.

The simplified wiring diagram is given on page 824, each instrument being shown in its relative position as viewed from the front. All of the wiring, with the exception of the leads to the tuning condenser and regeneration control, are under the subpanel. The photo at the lower right gives



a rear view of the completed instrument with the tubes in position.

This typical experimenter's layout is not intended for a cabinet installation, although the panel arrangement may be altered as desired.

The bakelite subpanel is $\frac{3}{16}$ by 7 by 19 in. and is supported by means of three subpanel brackets, as shown in the un-

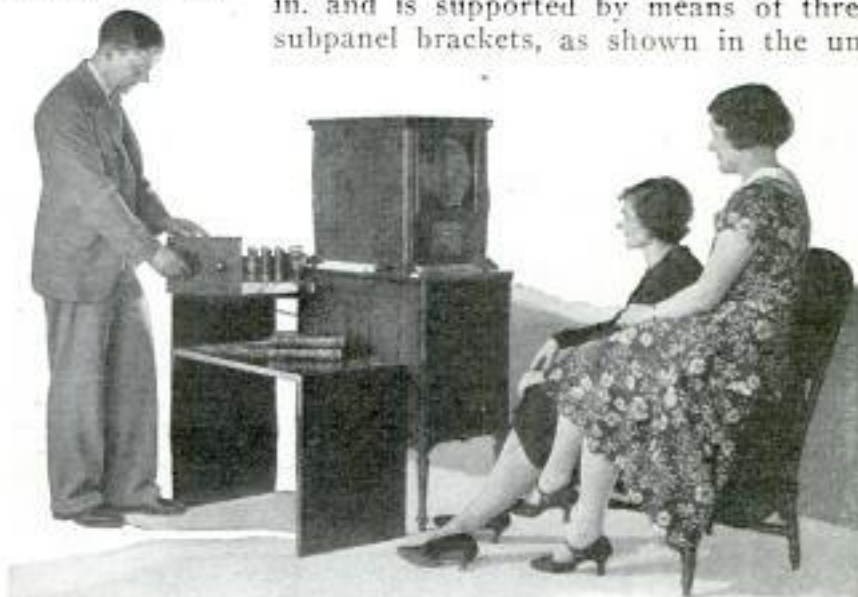

Above, Studio Group for Sight and Sound Program; Below, Receiving the Television Signals in the Home

AMATEUR MECHANICS



TRICKS *with Cards* are EASY

YOU can make your own trick-card decks—decks that tumble in a beautiful cascade from hand to hand; that enable you to divine any card selected, and that change color, etc. For the divination trick, take 26 cards from the deck of 52 and cut a small piece from the upper left-hand corner of each, as shown in Figs. 1 and 4. Now, place the unprepared cards on top of the cut cards. Divide the pack in half and give the unprepared cards to a spectator who selects one and places it anywhere in the half deck you are holding, care being taken not to let him see the cut portions. Then bring the deck to your forehead, as in Fig. 8, and, by looking through the cut portion of the pack, you can easily sight the selected card and call its name.

A "self-shifting" deck is one that enables the performer to mechanically move any selected card to the top or bottom of the deck, although, to all appearances, the selected card is placed in the center of the pack. To make such a deck, get two decks exactly alike. From one select 26 cards over a wide range. These must be cut short by trimming down about $\frac{1}{4}$ in. with a paper cutter, fitted with a block to serve as a guide, as in Fig. 6. If a paper cutter is not available, use a sharp pen-

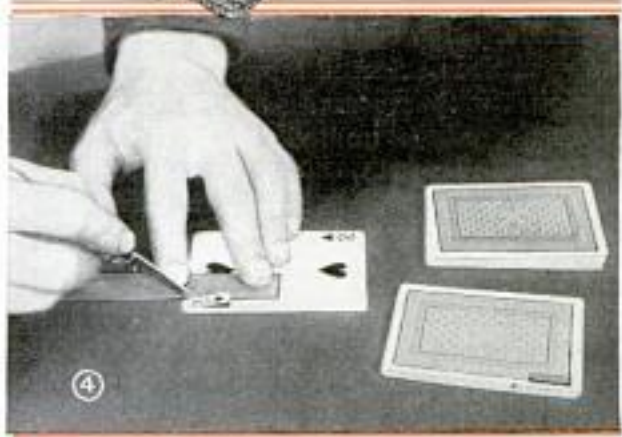
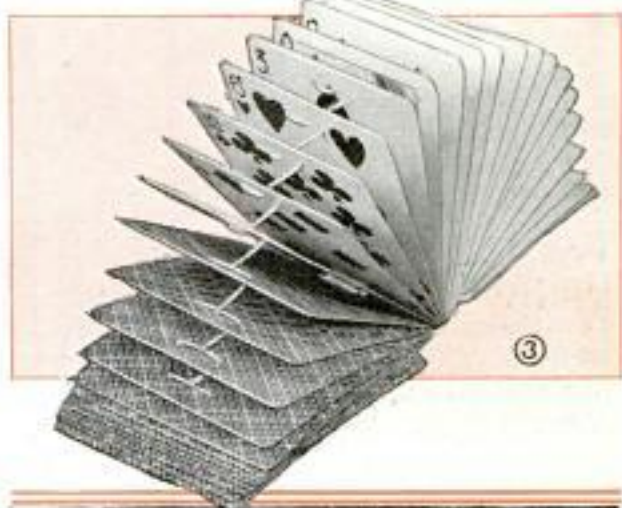

knife and a straightedge, rounding the two corners of each card with a pair of small scissors to conform to the uncut



corners. Now, from the unused deck of cards, select duplicates of the cards just prepared. Assemble both sets as follows: Lay an uncut card, face up, on the table and on top of this place the duplicate prepared card. Continue this procedure throughout the deck. Riffle the deck, with the cards face down, as shown in Fig. 5, and request a spectator to insert his finger into the deck as you riffle. He does this and then removes the card thus selected from the pack. Although the performer has not seen the card selected, he immediately calls out its color and denomination! The secret is simple. Because of the short cards, the deck will fall in pairs when it is riffled, only the long cards being caught by the finger. In reality only 26 cards are shown. Behind each of these cards, which the spectator sees, are the duplicate short cards. When the spectator divides the pack with his finger, the performer simply cuts the pack at this point, placing the upper package on the bottom, and thereby bringing the duplicate of the selected card to the bottom of the deck. After



that, it is a simple matter to sight the card.

And now for the popular color-changing deck. In this, the performer exhibits the cards by riffling the deck, showing that the cards are all different. The backs are blue. And then the backs of the cards are suddenly red, while the pack is composed wholly of black cards! Such a deck is made up from two decks, one blue-backed deck and the other red-backed. From the blue deck, select 17 cards with black faces. These cards should be cut short as described for the self-shifting pack. From the red-backed deck, also select 17 cards with red faces. Now, paste these two sets of cards together at the lower edges, in pairs, a blue-backed card and a red-backed card, both cards face down as shown in Fig. 10. The top card

in each of the 17 sets is the blue-backed, black-faced short card. Now, make up a set of 17 cards—red backs and black faces. Arrange the deck as follows: Place one of the double cards, face down, on the table. On top of this place

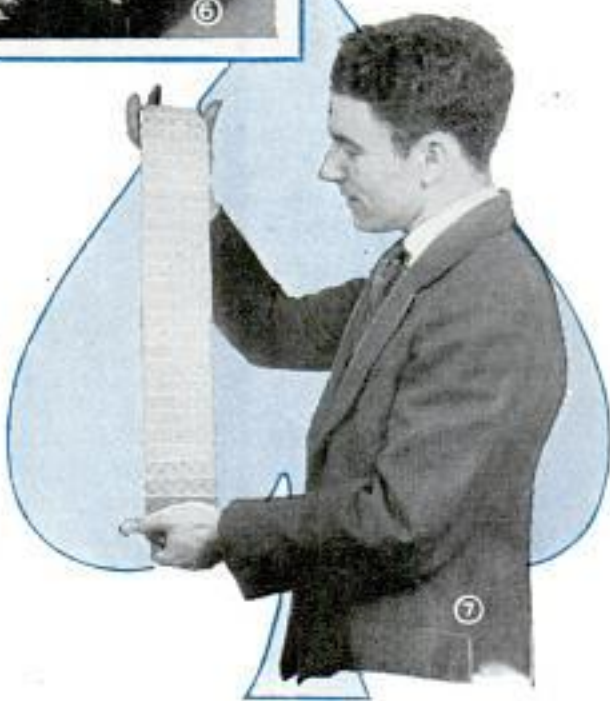

one of the single cards. Then follow with another double card, next a single, and so

on until the pack of 51 cards has been completed. The pasted ends of the double cards should all face the same way. The top card of the deck should have no face; it is double-backed, red on one side, blue on the other, made by pasting a red and a blue card face to face. Start the trick

"string" as in Figs. 2 and 7. Take about 32 cards, and, with a safety pin and one card ruled as a guide, punch six holes in each card, as shown in Fig. 9—three holes in each end of the card, about $\frac{1}{4}$ in. apart, and approximately $\frac{3}{8}$ in. from the edge.



with the blue side of the double card turned up. Riffle the cards loosely from the face to the back, and both red and black cards will appear. Now, riffling in the same manner, from the face of the deck to the back, but turning the deck so that the spectators can see the back of the deck, you can show all the backs to be blue. Then fan the deck, and the spectators will be surprised to see only black cards. While the deck is fanned, and under cover of the spread-out cards, secretly turn over the double card so that the red-backed side is outward. Now, by either riffling the cards from the pasted end or by fanning the deck as before, you can show all of the backs of the cards to be red.

Next comes a deck which you can

Then take a fairly large needle and thread it with a single 5-ft. length of strong white linen thread, the end of which is knotted. The six holes in each card are designated by numbers 1, 2 and 3 at one end and 4, 5 and 6 at the other, 4 being directly under 1, 5 under 2, and so on. Holding the first card face up, push the needle through hole 3. Bring the needle back through hole 1, and then push it through hole 2. Pick up the next card. Push the needle through hole 3 again, back through 1, and then through 2. Thread the whole pack of 32 cards in this manner, leaving about $\frac{1}{2}$ in. of thread between each card. Thread the holes marked 4, 5 and 6 in a similar manner. The ends of the thread will be exposed on both the top and bot-

tom of the deck, and to cover this up, two additional cards should be used, one being pasted to either end. The completed



For the Color-Changing Deck, Cards Are Glued Together Near the Edges

deck, when placed on the table will appear as shown in Fig. 3. By holding the deck in your right hand, cards facing the palm of the hand, you can shower them down to your left hand, 2 ft. below. Again, you can spread the cards neatly along your left arm, and by simply dropping the arm cause all of the cards to neatly cascade into your left hand. Be sure to make these trick decks with the same-pattern back so that you can secretly substitute one deck for the other.

Jack Removes Parked Car from Tight Places

The next time you find your car parked in a tight place between other autos that are locked and cannot be pushed, try this method of getting it out: Take the jack and raise the front end as high as possible, then push it toward the center of the street until it falls off the jack. Repeat this until the front end is clear of the car ahead.

Box Fitted with Casters Makes Movable Storage Chest

Almost any wooden box of good size and sound construction can be fitted with casters at the corners and covered with cretonne, or other material, to make an attractive and easily movable storage chest for the attic. By fitting the box with a hinged and padded lid similarly it will serve both as a window seat and a storage chest.

Screen Wire Helps Prevent Roof Fires

The risk of roof fires can be reduced considerably by the use of a frame covered with $\frac{1}{2}$ -in.-mesh wire screen, on a frame about 16 in. square. Stretch the wire over it, leaving one side open so that it can be inverted over the chimney, and securely fastened.

Sack of Hardened Cement Serves as Dog's Bowl

If you have part of a sack of cement left over from a small job and it becomes set or hardened, you can use it as a feeding bowl for the dog or other pet. Chisel out the center of the lump and you will have a receptacle that cannot be easily upset or broken.—Floyd Mix, Chicago.

Muslin Wicks Water Flowers

Plants can be watered by means of 1 or 2-in. muslin wicks, a suitable weight holding one end in a bucket of water while the other end is pegged near the roots of the plants with toothpicks. The bucket should be set on a box so that its bottom will be higher than the flowerpots. The strips should not touch each other as this would cause the water to go to a few of the plants, leaving the others dry. A saucer is placed under each pot to catch surplus moisture. A bucketful of water will supply the plants with sufficient moisture for several days.—George Pommer, Jr., South Minneapolis, Minn.



Muslin Wicks Can Be Used to Water Your Plants While You Are on Vacation

Tests for the Purity of Linseed Oil

Pure linseed oil should have a light yellow color. A greenish color indicates that it has been made of unripe seed, and if placed on the tongue, will have a bland taste, turning to bitter. The presence of either rosin or mineral oil gives it a nauseating taste. When rubbed briskly between the palms, it should have an odor of flaxseed. If rosin was used as an adulterant, a faint odor of this will be present, and the same holds true if oil was added. A good test is to place a drop of linseed oil on a piece of black japanned tin; if any mineral oil is present it can be detected by a bluish iridescence when held in a strong light, sometimes extending in a ring beyond the drop. Pure linseed oil will not congeal until its temperature drops to 18° below zero F. The presence of adulterants can thus be detected, as rosin freezes at 7° F., and rapeseed oil at 25° F. Another test is to fill a glass bottle with the oil to a depth of about 2 in., adding 3 or 4 drops of sulphuric acid. Then shake the bottle. If the mixture becomes dark brown and siruplike in a few minutes, the oil is pure.

Warning Flag Held Upright by Sledge Hammer

Red warning flags, used in road-construction work, are sometimes rather difficult to keep in upright position when fastened to pipes. Tie the flag stick to a sledge hammer and to the pipe as shown, and the weight of the hammer will keep the flag upright.

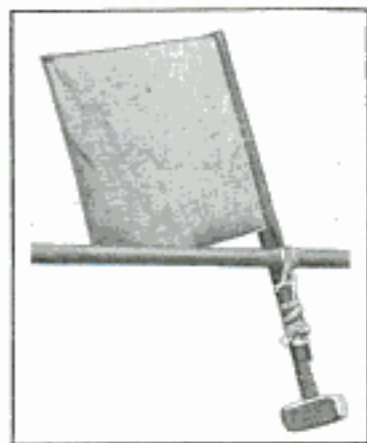

Frame with Casters for Your Scrub Pail

Pushing a scrub pail around with the end of the mop handle is better than carrying it. To do this, make a wooden frame for the bucket and fit it with three casters evenly spaced around the bottom.

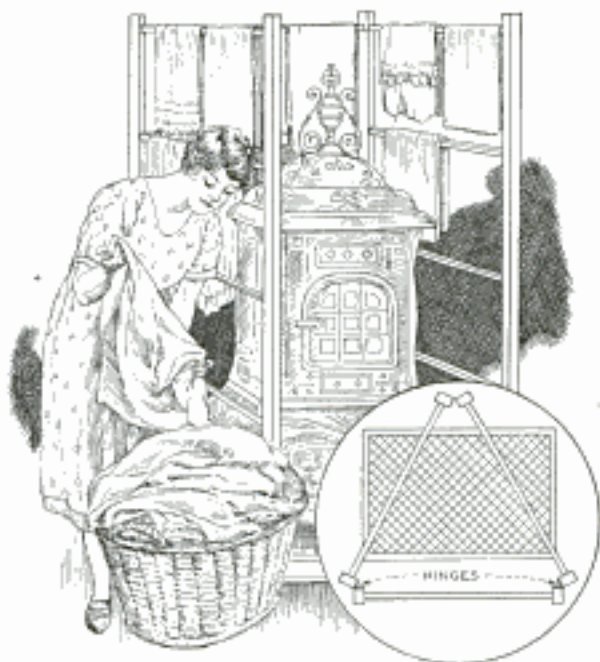

By Using a Folding Rack Your Clothes Can Be Quickly Dried Indoors as Shown Here

Folding Clothes Drier Fits Stove or Furnace Register

Clothes can be dried around a stove or over a furnace register by using a sectional rack. The sections consist of $\frac{1}{2}$ by $\frac{3}{4}$ by 36-in. crosspieces nailed to 1 by 1-in. uprights, 72 in. long. By hinging them together, the rack can be quickly set up, and when folded, occupies little space.—Homer I. Jones, Freeport, Ill.

Turnbuckle Converted into Small Jack

Contractors, farmers and auto repairmen will find this jack and puller useful in their work. The tools can be made from large turnbuckles, such as those used on bridges, which can be obtained at junk yards or iron-supply houses. One is fitted with hooks bent on each end for use with a chain, while the other has holes drilled in the shanks for pins. Pieces of pipe of varying lengths can be slipped over the ends so that you can handle it easily in any position with little effort.

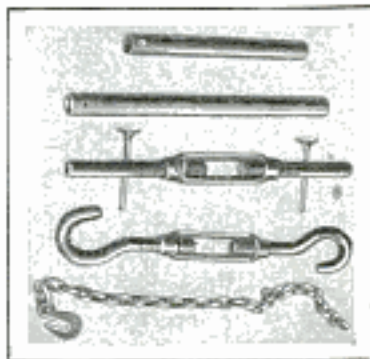

Collapsible Storm Vestibule Quickly Erected

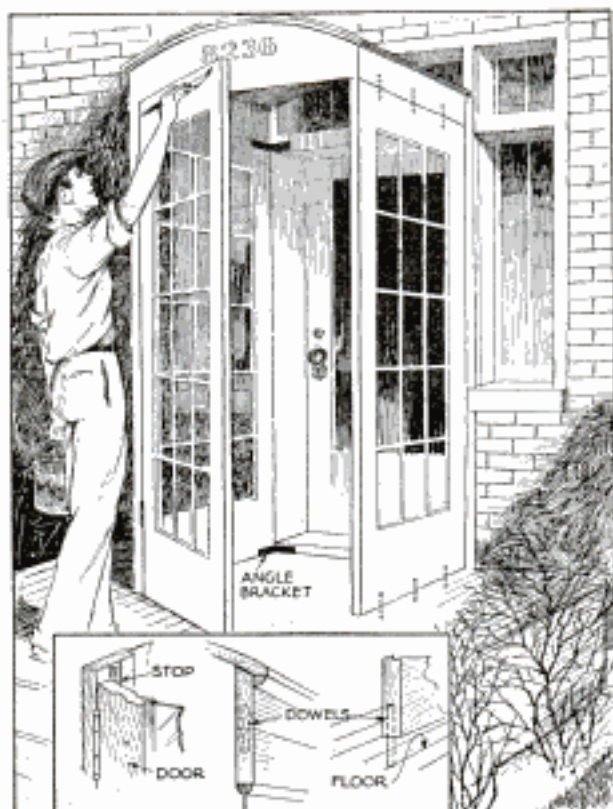

This Collapsible Storm Vestibule Consisting of Four Parts Can Be Assembled Quickly.

Here is a storm vestibule consisting of two large sash, a glazed door and a top, which can be assembled or taken down in a few moments. Dowels are used to hold the sides to the floor and top, as indicated, while angle brackets, attached to the inside edges of the sash and to the door frame of the house, give the inclosure sufficient rigidity. The door is fastened to one of the sash by means of loose-pin hinges which can be quickly taken apart when the door is removed. Suitable latch and door handles should, of course, be provided, and, if desired, an additional hook on the inside.

"Shadow-Stenciling" Wall Borders Gives a Pleasing Effect

"Shadowing" the border on stenciled work adds to the beauty of the work and is very easy to produce. Mix the stencil glaze or paint a trifle heavier than, and about twice as dark as, the finished color is to be. Place the stencil on the wall or object to be decorated and paint it in the usual way, after which the stencil is

moved with both hands to a position about $\frac{1}{8}$ in. lower and toward the right, or $\frac{1}{8}$ in. higher and toward the left. While holding the stencil firmly, wipe out most of the color which shows through the openings. The effect is a darker line or shadow on one side of the design. With a little practice, you will be able to obtain surprisingly fine results.

Using Heavier Tubing for Auto Windshield Wiper

Rubber tubing that is regularly supplied for windshield wipers usually deteriorates in a short time, especially in warm climates. A length of hose such as is used on your tire pump, will last almost indefinitely and costs only a few cents more than the windshield-wiper hose. If it is too large to make a snug fit on the connections, first apply adhesive tape.

Air-Rifle Target from Tobacco Can

In order to discourage haphazard air-rifle practice by his boys, a Wisconsin father made a hinged target from an ordinary tobacco can. It was mounted on top of a post by nailing the cover onto the back of the post so that a shot from the rifle would tip the can over. To reset the target, a length of twine was run from the position of the firing line to a stout wire bent and hinged to the post by means of a nail on each side. The hook on the end of the wire prevents it from dropping back too far, and a pull on the string resets the target.

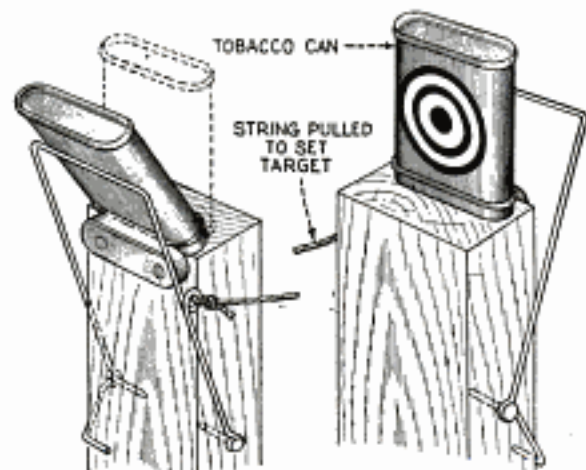

A Target That Can Be Reset with a String Aids in Discouraging Haphazard Air-Rifle Practice

Rubber Hose Holds Detachable Legs of Tripod

Camera tripods that have detachable legs, often drop off when moving the camera for a different view. This can be avoided by pushing 1-in. lengths of rubber hose, of the proper diameter, between the legs at the upper ends. This serves as a wedge and keeps them tightly in position, while the natural friction of the rubber makes it hold securely.—Melvin Kennard, Gasport, N. Y.

Alining a Shifted Auto Frame

Side members of auto frames that have been shifted out of their proper alinement, can often be forced back by placing a jack diagonally across the frame as shown in the illustration, blocks being used if necessary. A string is stretched along the side of the car parallel to the wheels. The frame is then

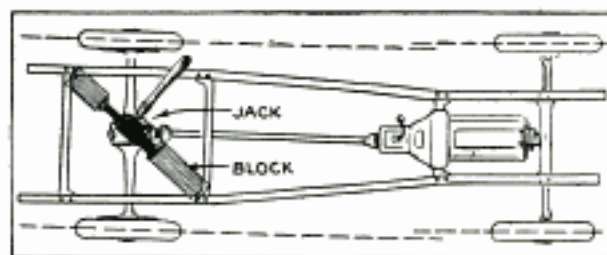

Auto Jack and Two Blocks of Wood Can Be Used to Aline Shifted Auto Frames

forced back until the wheels line up perfectly, a slight additional pressure being applied to compensate for the spring of the frame.

Salt Preserves Odor of Roses

Odor in roses and other aromatic plants can be preserved by using salt, which will force the juice out of the petals. Take 1 lb. salt and 1 lb. of rose petals or other plants and rub them together until the mass is reduced to a paste, after which it is tightly corked in a bottle and set in a cool place until used. This method will preserve the odor for several months.—Delmar S. Whited, Kansas City, Mo.

Paint strained several times after mixing will cover more surface.

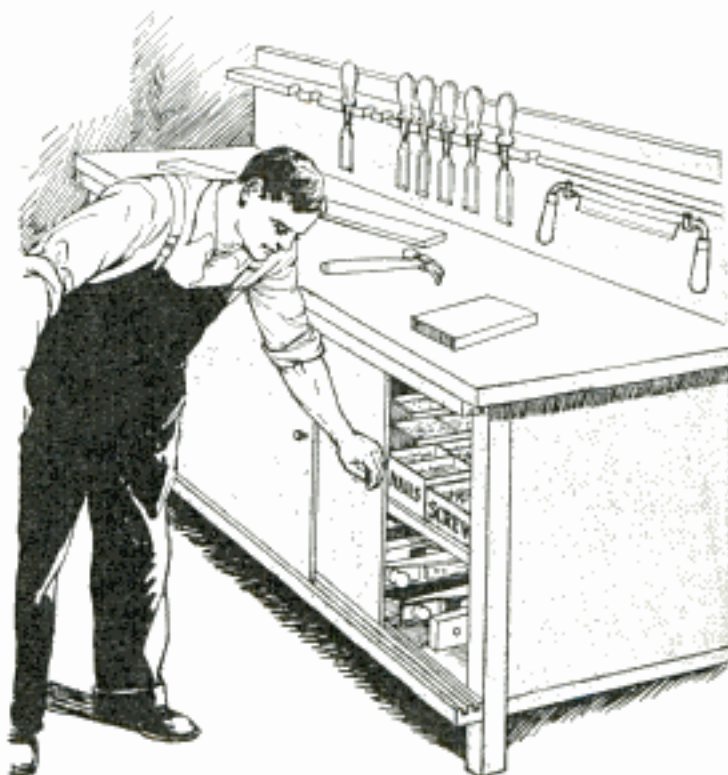

Sliding Doors Fitted to the Front of Your Workbench Will Provide a Clean Storage Place for Tools

Door for Workbench Shelf Keeps Out Dirt

Sliding doors fitted to the front of a workshop bench will keep dirt, shavings, etc., out of the boxes and tools stored on the shelf underneath, and will also make the bench look neater. The doors may be either plain or paneled, and are arranged to slide in grooves cut in two lengths of 2-in. stock, one at the top and the other at the bottom of the bench.—Anthony Siers, Jr., St. Paul, Minn.

A Wire Holder for Bird Nests

It is a simple matter to make nest holders for your birdcage from steel wire. A hook, shown in the detail, is first bent in the middle of the length of wire to hook over a perch, after which the wire is bent to fit around the nest. The ends are shaped to form clips which slip over the cage bars and will not come



loose until pinched together.—Earl B. Forrester, Arlington, Mass.

Steps in Auto Ramp Save Space on Small Lots



Steps May Be Combined with an Auto Ramp on a Sloping Lawn Without Sacrificing Space

Combining steps with an auto ramp, a property owner, who had an unusually small lot, accomplished quite a saving of his lawn, as the combined steps and drive did not occupy more space than ordinarily used for the drive alone. Properly landscaped, the small strip of lawn that would have been used for steps, greatly improved the appearance of the home.

An Illuminated Fish-Bowl Stand

Your fish bowl will be given a beautiful lighting effect when set on illuminated stand made as follows: Take a can large enough to hold a low-wattage electric lamp and cut a hole in the bottom for the light socket. Drill small holes around the side of the can



just below the top, for ventilation. Then cut a hole through the top of the stand, a little larger than the can, and tack the latter in place so the ventilating holes will come just below the underside of the top. Next, cut a circular recess in the top of the stand for a

piece of glass the same diameter as the bottom of the fish bowl. The recess should be deep enough to allow the glass to come flush with the top of the table. If there are no shells inside of the bowl, but a castle is used, the light appears to come from it, giving the bowl and fish a pleasing radiance.

How to Make Antique Sails for Model Ships

On models of ancient ships it is desirable to color the sails to produce the appearance of age. A good method of doing this is to dip the sailcloth, after it is cut to shape and sewed, in a khaki-colored solution made of hot water and a good commercial dye, which can be purchased at any drug store. After the sails have dried, mix a thin solution of turpentine and raw umber and apply this to the sails with a cheap atomizer. One or two applications of the spray should be sufficient, but more can be given if desired.—Harold Bodkin, Chicago.

Thumbtacks on Drawer Slides Reduce Friction

Drawers will slide easier if thumbtacks are driven into the slides as shown in the drawing. If the drawer fits too tight to permit the insertion of the tack, cut a little of the wood



edge of the slides to provide space for the tack head. When the drawer is large and binds by jamming against the sides, drive a couple of tacks in the upright guide as indicated.—G. Stuckey, Alexandria, La.

Wallpaper Roller Made from Caster

With an ordinary bottle, of the proper size to fit the hand, and a caster, you can make a roller for wallpaper. Fill the bottle with a plastic substance that will harden, such as plastic wood, and insert the caster shank into it while soft. This roller can also be used for applying adhesive tape.

MEDIEVAL

Wall Lantern *easily made of copper*

BY JOHN STEINKE



MEDIEVAL in design, this wall lamp uses electricity for illumination, and is appropriate in a hallway, porch or as an outside door light, while a pair of them over or beside a fireplace, add to the attractiveness of any room.

While the glass is the last thing put into the lamp, the dimensions of the latter are partly determined by the curvature of the glass, and it should therefore be obtained before the work is begun. The lantern shown in Fig. 3 was built to accommodate the glass obtained from a brown bottle having an outside diameter of 6 in. A variation from this size is permissible as the dimensions of the copper work can be changed to suit.

To cut the bottle, a narrow strip of metal, preferably copper, is tightly wrapped around it, seaming the ends. Run a hot tinned soldering copper with acid and solder around the strip, and the bottle will crack. After an attempt or two, you should have a glass cylinder which can easily be cut in half with a common glass cutter and the sharp, ragged edges can be smoothed with a file. The pattern of the back is first laid out full size on paper, following Fig. 9 and ruling off the paper in 1-in. and $\frac{1}{2}$ -in.

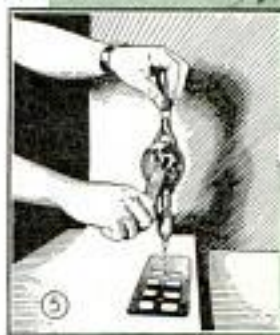

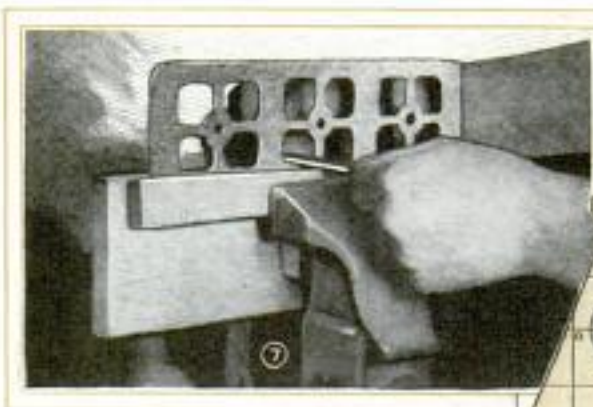

squares. Also draw out the full-sized pattern for the other pieces as in Figs. 1 and 2. A piece of sheet copper, 12 by 24 in. in size, will be sufficient. The lamp illustrated was made from 32-oz. copper. This may seem a little heavy but works and hammers nicely. You may use 24-oz. copper, but the 16-oz. size is too light. The next step is to trace the drawings on the copper, using carbon paper for this purpose. Retrace the carbon lines on the copper with pencil so they will not smear off, after which tin snips are used to cut the metal, as shown in Fig. 6. There are some sharp inside curves which will have to be cut as close as possible and then finished with a half-round file, as in Fig. 7. The design on the front bottom piece is drilled for inserting a metal coping-saw blade, as shown in Figs. 4 and 5. Jewelers' saw blades will also do the job and save some filing, but are finer and more likely to break. Use steady, even strokes and lean the saw forward a little. Also cut out the ventilation holes on the top cone piece and the hole on the back piece to pull the wire through. This is large enough so the wire can be pushed through it when wiring to the house.

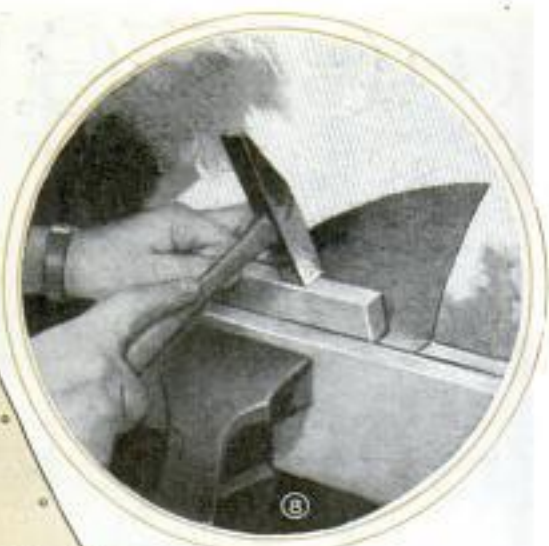
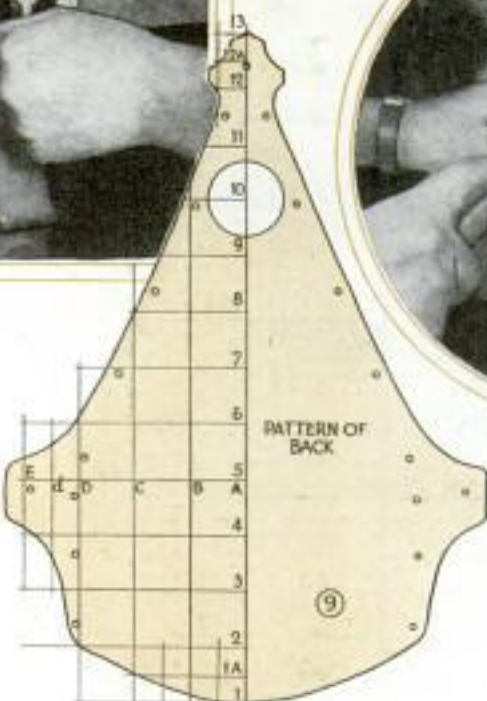

After the design has been cut, you are ready to hammer both pieces of the front. Small ball-peen-hammer marks are better in this case than the larger planishing marks. On the bottom piece, avoid hitting the edges, and on the top piece, work from the center toward the edges. The metal will be stretched sufficiently on the latter piece so that it will overlap the bottom piece, although the measurements are the same. As hammering will curl and harden the metal, it will be necessary to straighten it out to anneal it, which can be done by heating the copper to a dull red and plunging it into water. Then use a mallet or a rawhide hammer to straighten and stiffen it. Transfer the dots from the drawing to the work



by means of a scratch awl, to provide a point to start a $\frac{1}{32}$ -in. drill. The bending is done over the edge of a bench, after it is nearly formed into a cone, the smaller end of which is hammered to shape with a mallet. To bend the edges of the cone, clamp it in a vise between boards and hit a piece of flat stock with a hammer as shown in Fig. 8. Straps are soldered on

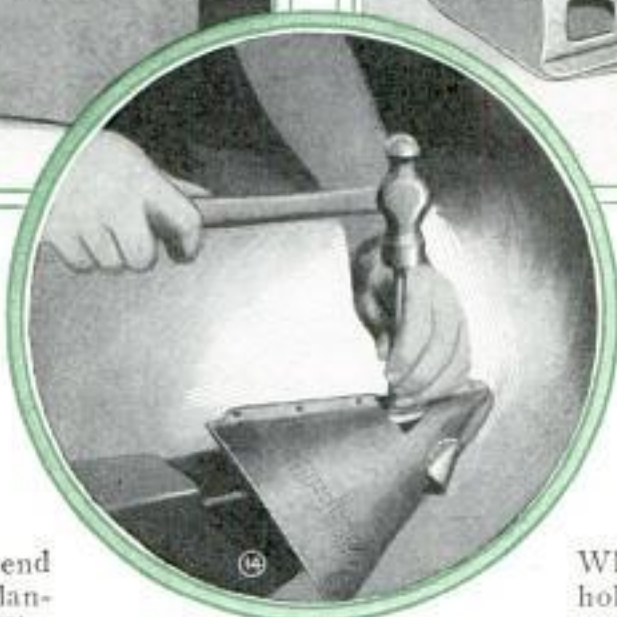
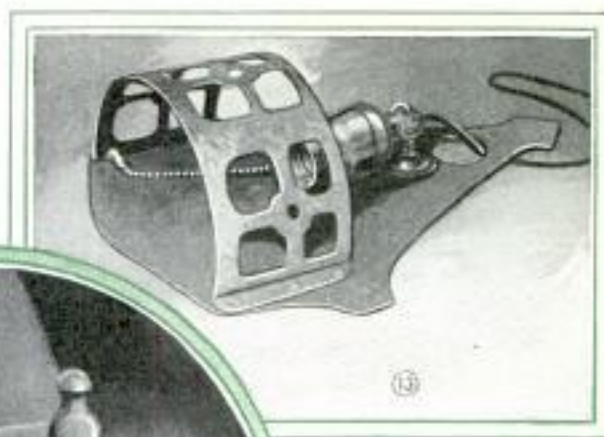
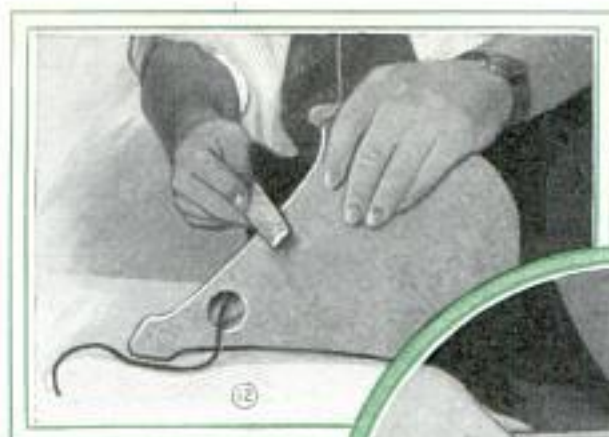

the bottom piece, as in Fig. 10, to hold the glass in place. The straps can be formed into a half circle over a piece of pipe. Now take the back piece you have cut and hammer it on the lower end with a broad-faced planishing hammer, as in Fig. 11, or with the slightly beveled face on the big end of a ball-peen hammer. The purpose of using a broad hammer is to vary the marks and to suggest the reflecting surface used in old-time candelabras.

The lamp is now nearly ready for assembling. You can either drill the holes for the rivets or use a solid punch, as in Fig. 14. Drive it into either the end grain of a hardwood block or a lead cake. It is quicker than drilling and serves the purpose just as well. Use copper rivets, drawing them up with a regular rivet set. After you have drawn up a rivet, hammer it down with a ball-peen. This produces marks on the rivet in keeping with the rest of the job. With the bottom piece in place, attach the socket and wire it before the top cone is riveted on. Use a pull-chain socket attached with an angle fitting, as in Fig. 13. Put the ventilating hoods on the top cone before riveting it on the back. These will have to be ham-

mered to shape, as they are too small to be bent with the fingers. Be sure to hammer mark them before bending. Fit the top cone, with hoods attached, to the back piece.

When fitted, mark the holes on the back piece and rivet together. To provide a means of hanging the lamp on the wall, square caps are used at the corners. These are made by cutting a piece of copper, $\frac{3}{8}$ in. square, with a small cold chisel, and soldering to 8-32 brass machine screws.

Finish by filing down the rough edges as in Fig. 12. The copper can be darkened in keeping with the design by using a solution of sodium sulphide, about 1 oz. to 1 qt. of water, applying it with a brush or rag. Keep this off your hands; it will

not hurt them, but the black stain will remain for weeks. An easy way to get sodium sulphide is to buy one of the redeveloping tubes used in making sepia prints. Use the part of the tube marked redeveloper. After you have darkened the copper, take fine sand or emery paper and polish the high spots. Polish the bottom part of the back piece thoroughly to act as a reflector. Now go over the job with plain beeswax, heating the metal slightly when applying the wax.

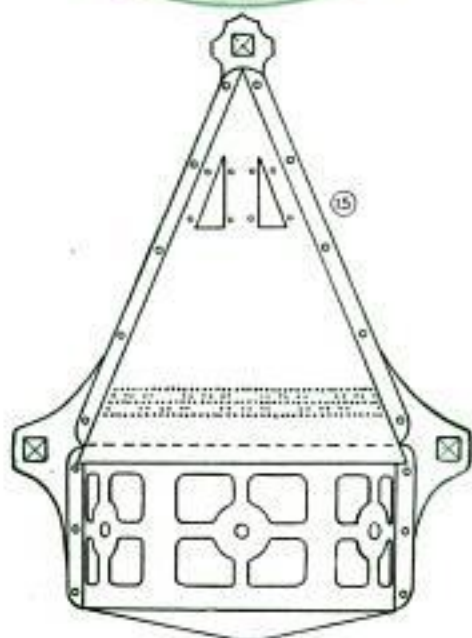

A Scrap Book Made from Wrapping Paper

There are frequent occasions when a scrap book or cheap photo album is de-

paper and cut them all to the required size. Each sheet should be about $\frac{1}{2}$ in. longer than the book, to allow for folding and gluing. The method of assembly con-



sired. Besides, children find great delight in pasting up pictures cut from magazines and newspapers. One method of making such a scrap book is shown in the photo and drawing. Get a number of sheets of rather heavy brown wrapping

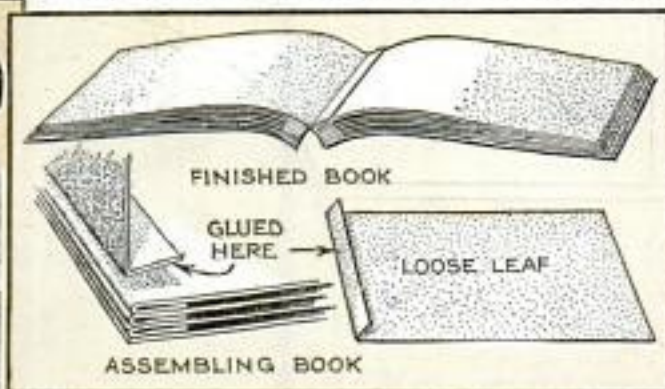

sists in gluing the folded edge of one sheet to the one directly underneath, until a book of the required number of sheets has been built up. If you like to add covers, the use of rather heavy cardboard is preferable. It will be found a good idea to punch holes through the doubled edge of the assembled book, and also through the covers, after which they are laced together. In case you have a hand punch, each sheet may be perforated before gluing, care being taken to get all the holes in line.

Sponge Prevents Marring of Auto Wheels by Wire Brush

On some brushes used for washing the wheels of autos, the wire core extends beyond the bristles and mars the finish. Such trouble can be eliminated by wrapping a piece of sponge around the bared end of the brush and fastening it with a length of copper wire. This idea also helps to prolong the life of kitchen brushes when bristles have worn off at the end. —Darwin Harris, Grand Rapids, Mich.

Light Metal Uniformly Soldered with Lead Foil

Where uniformity is required in sweating a joint of light sheet metal, lead foil can be used. Clean the metal and apply a coating of soldering flux. Then cut a piece of foil to fit the joint, lay it over the flux between the metal pieces and clamp

them together. Heat the metal sufficiently to melt the foil and a strong joint will be the result.

Newspapers Aid in Practicing Show-Card Writing

Beginners in show-card writing will find a newspaper an inexpensive sheet for



Using Newspaper in Practicing Show-Card Writing

practicing. The column lines serve as a guide for the height of the letters, while the lines of type will show whether the letters are being made straight.

Packing for Hose Connections

When the packing in water-hose connections has worn out, a satisfactory substitute can be made by cutting $\frac{1}{8}$ -in. washers from a piece of hose of the same size. The washers should be cut smooth and of the same thickness all around so that they will fit tight in the connection.

Curry Comb Used to Scale Fish

An ordinary curry comb, which can be bought for a few cents from any hardware store, can be used for removing the scales from fish. The comb should be thoroughly washed and sterilized in boiling water before using it for this purpose. —Carol McArdle, Webster Groves, Mo.

Rollers Aid in Shining Shoes

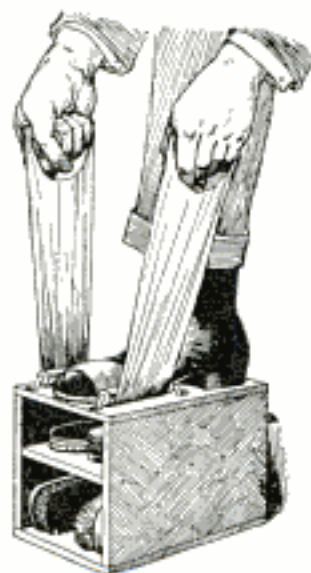

Rollers fitted on suitable shafts, and fastened to a box as shown, will provide an easy means of polishing your own shoes. Place your foot between the rollers and thread the cloth under them and over the toe of the shoe. If holes are cut near the ends of the cloth for hand-holds it can be gripped easily.

Paraffin Protects Vacuum Bottle

To prevent a glass vacuum bottle from breaking in its case, chip up some paraffin and melt it inside so that the bottle will be about one-quarter full. Do not pour in melted paraffin. The hardened paraffin will prevent vibration more effectively than the metal springs usually provided for the purpose. The top cap is replaced before the paraffin hardens.

Holder for Painting Golf Balls

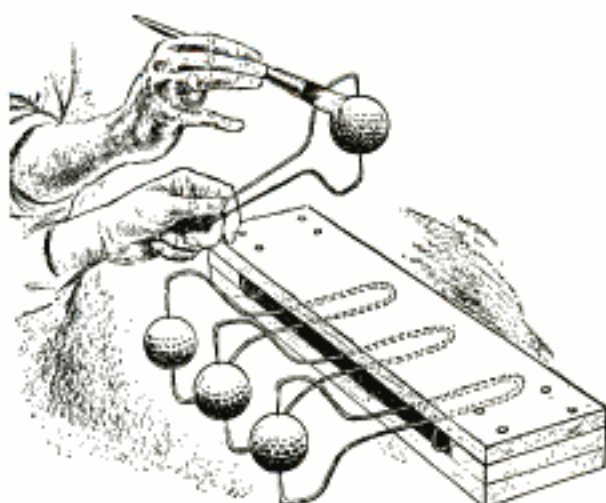

Repainted Golf Balls Are Free from Blotches and Paint Drops When Using This Holder

Pointed at each end and bent to the shape shown, a length of fairly heavy galvanized wire makes a holder for painting golf balls that will not leave a dried drop of paint or a blotch on them. In use, the ball is held between the points and dipped into the paint, after which it is placed in a wooden holder to dry. This consists of two boards nailed to a separator at each end, small grooves being cut in the inner side of both pieces to hold the wire in the position shown. As the paint drains off the ball, it runs down the wire.

Pipe Cleaner Keeps Flag Straight

Small starched flags that are commonly used in cluster decorations are often rather difficult to handle as they have a tendency to roll back when unfurled. This trouble can be eliminated by wrapping one end of a white cotton-covered pipe cleaner around the flag staff and bending the other end around the outer edge. If the cleaner is laid along one of the white stripes, it can hardly be seen.



☞Olive oil of high quality is distinguished by its decided straw color.



Training

THERE is no doubt that every dog should be taught a few things beyond the basic law of cleanliness. Training the dog to lie down is simply

a matter of pressing him into that position, as shown in Fig. 1, while you voice the command. The action must be repeated until the dog learns to associate the command with the required action.

If your dog jumps up on other people, soiling clean clothes with his dirty paws, try the simple remedy pictured in Fig. 2. Every time he jumps up unbidden, step on his toes and give the command "down." A smart dog will then quickly appreciate the advantages of remaining on all fours. Training the dog to heel is very important, especially if you live in a small town where jaunts without a lead are permissible, but where traffic is dangerous, and the dog is not safe unless directly at your heels. To train him to take this position on command, walk him along with a short leash attached to his collar. Carry an old tennis racket in your hand. If he shows a tendency to come up too close, rap him gently on the nose with the racket. If he attempts to hang back too far, use the simple force collar shown in Fig. 4. This will not injure his coat nor harm him physically, yet it will always result in his coming along to escape the irritation provided by the blunt metal points.

In training a dog for draft purposes, the force collar is valuable as it will correct any tendency to hang back. A gentle tug



Three of the Most Desirable Things a Dog Should Know and Can Be Easily Taught Are to Lie Down When Told, Keep Off Your Clothes or Those of Your Guests, and Follow at Your Heels When Out for a Stroll, Especially Where Traffic Is Dangerous

Training Dogs for Draft Purposes Has Great Value for the Youngsters



Your Dog

on the collar lead accompanied with the command "giddap" will soon convey the big idea to the dog. Since the average dog is more or less anxious to please, the rest is easy. Naturally enough, training is made less difficult if the proper equipment is used. A fair idea of dogcart construction can be obtained by studying Figs. 6 to 9 inclusive. For a harness, the simplified arrangement shown in Fig. 10 will give good results. Additional loops are provided at points A, to take the cart shaft on either side, while the reins are attached to a ring at point B.

Tricks can be taught by following a similar practice. The dog must be shown what is wanted. Of his own accord and with very little training, he will invariably jump through your arms, as in Fig. 11. To have him jump through a ring in the same manner requires much patience. It is useless to hold the ring high in the air and expect the dog to know what he must do on the command of "jump." Rather, the ring must be passed repeatedly over the dog, as in Fig. 12, and then a short jump must be mastered, the dog being pushed through. Once the dog gets the idea, the height of the jump is limited only by his activity. For this trick, best results are obtained by using a large hoop at first.

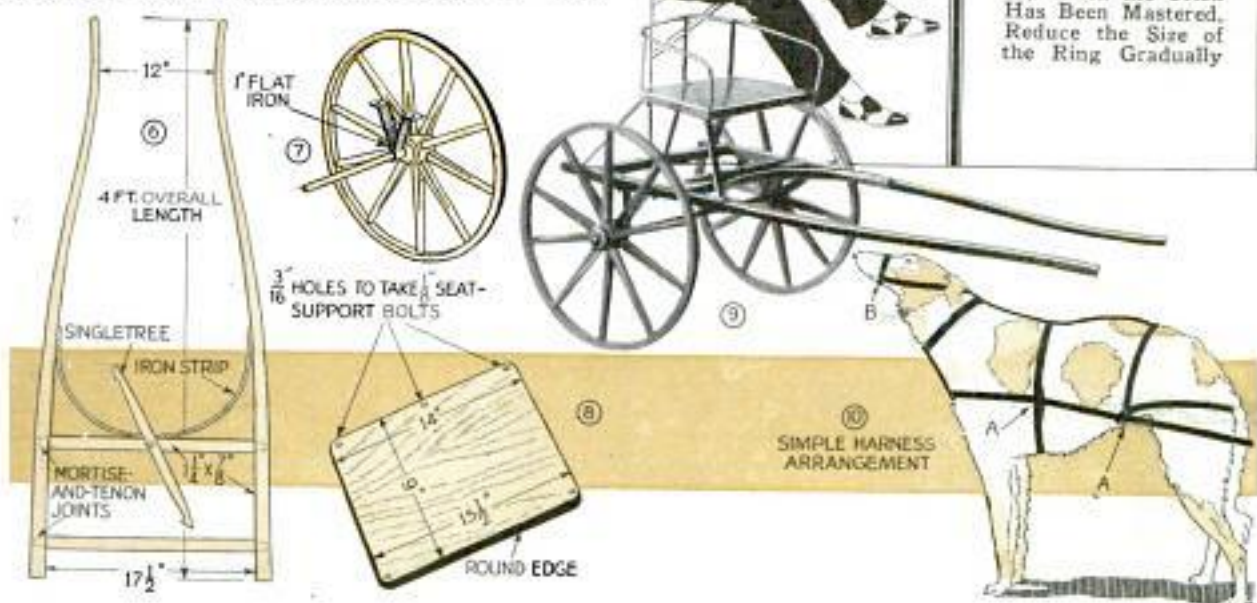



After the dog has become acquainted with the action, a smaller ring can be substituted. It has been demonstrated that a full-grown German police dog can pass through a 9-in. opening.

Other simple tricks, which every dog is taught to perform, are usually accomplished by kindness and petting. He will shake hands, sit up, ask for something, play dead, and do a dozen other tricks with very little prompting. Training the dog to retrieve is usually featured as a simple trick, yet it has a practical side in hunting, life saving, and many other fields. All in all, there is no more featured stunt in dog performance. It may be a person in a burning building, a newspaper in the village post office or simply a rubber ball or a stick, but the act of "fetching" is always the same. Often the dog will fetch on his own initiative, but even here training is necessary in order to bring home to

the dog the association between certain commands and certain actions.



The usual procedure is to use a stick or a corncob. Present this to the dog, commanding "fetch" sharply. When he takes the stick, release your hand and command him to "hold it." After a brief while, command "give up" and take away the stick. These three actions are shown in Figs. 14, 15, and 16. If the dog is inattentive, use the force collar. After a brief period of training, the dog will return the stick under almost any circumstances. If the dog has the bad habit of running after

autos, just fasten a short stick to a strap on his collar, as in Fig. 18. The stick, banging against his legs as he runs, will soon cure him of chasing. Then there's the dog that persists in scratching the finish off your car, etc.; the cure is the simple harness shown in Fig. 19, which prevents him from stretching his legs out to the position necessary for exercising this habit.

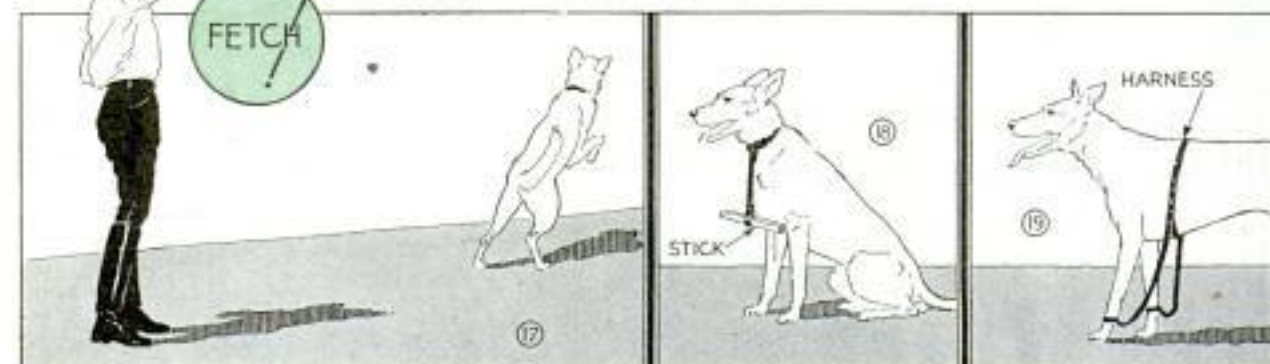

This Mechanical Burro Has an Amusing Gait

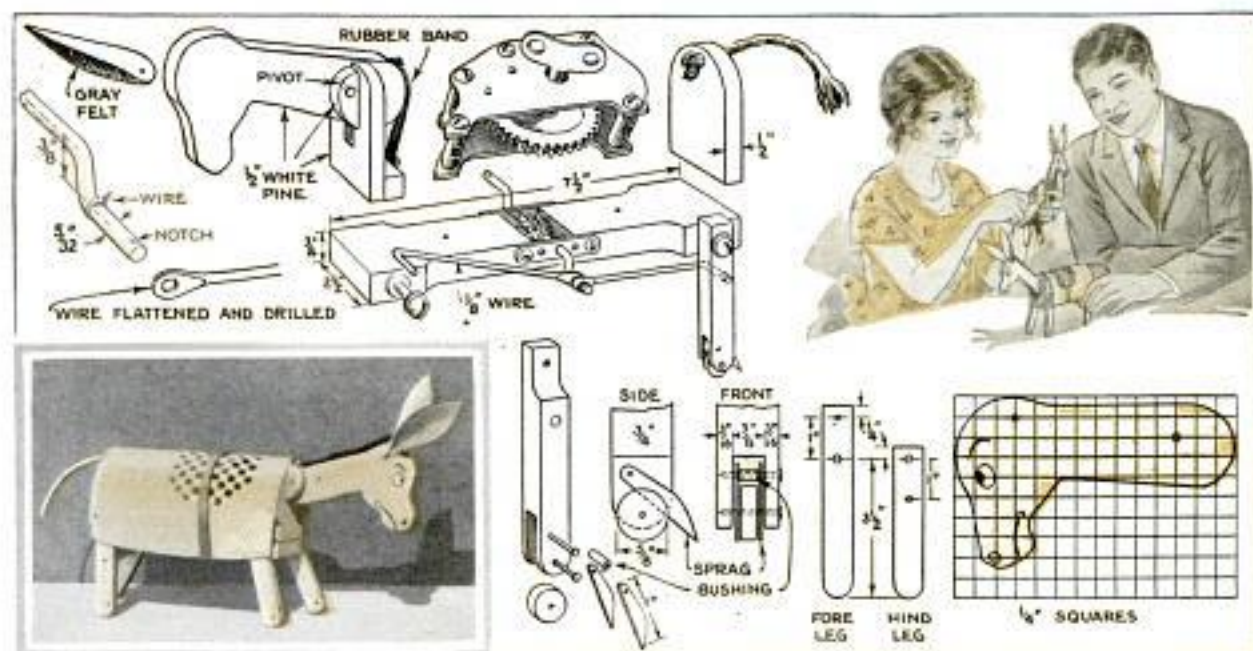

THOUGH it does not carry ribbons for looks at a county fair, this donkey, when wound up, certainly does ramble as if bound for the feed box after a six-day fast. A motor, such as was used in early cylinder-type phonographs, is obtained. Strip off all unnecessary parts to reduce the weight, and then pick up a pinion gear that will mesh with the large gear on the drum containing the spring. The pinion is carried on a $\frac{5}{32}$ -in. shaft with a crank formed at each end. The cranks have a $\frac{3}{8}$ -in. throw, and instead of being set opposite one another, they are 90 degrees apart. The reason for this is so that the legs will move forward successively. The pinion should be set in place before the crank is bent. For connecting rods to operate the legs, galvanized fencing wire, about $\frac{1}{8}$ in. in diameter, is used. Flatten one end and drill it to fit the crank without excessive play. The other end is bent to a right angle and inserted in a hole at the top of the leg. To hold the ends of the rods on the crank, notch the latter with a file and bind two turns of soft wire tightly around it. Bearings for the crankshaft are simply short perforated plates. Be careful in lining up this shaft so that the pinion meshes freely with the motor gear, without danger of the teeth "riding" under load while in motion. The fore and hindlegs are $\frac{3}{4}$ in.

square and are swung on round-head wood screws which must be a close but free fit. Washers should be placed on both sides of the leg. The foot mechanism consists of a small hardwood roller, to allow the leg to move forward without friction, and a sheet-metal sprag, or ratchet, to prevent it from slipping backward. If you have no facilities for making the rollers, take the wheels from small lead autos sold in ten-cent stores, using two to each foot. There are two sprags on each foot, and they are separated with a spacer made of tubing. The roller axle prevents their falling too far forward. Rollers and sprags must operate freely, but without too much play. Test the mechanism before building the body. The connecting rods should be the proper length to give each leg just as much movement back of the perpendicular as ahead of it, in other words, a perfect pendulum swing. The legs should not have too long a stroke: about $2\frac{1}{2}$ in. at the bottom of the roller is enough. The head is swung on a fulcrum and held erect by a rubber band inside the body. A piece of ignition cord, with the covering frayed at the end, makes a first-class tail, while the ears may be cut from gray felt. A piece of pasteboard is cut to serve as the back and is tacked or screwed in place. A saddle and band can be made of colored paper.

Musical Instrument Like Ukulele Made from Tennis Racket

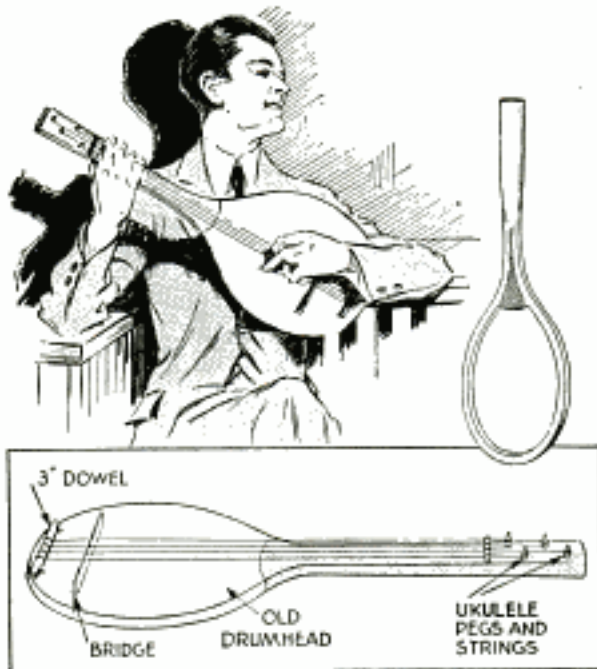

Old Tennis Racket Fitted with Drum Head and Strings Gives Tone Similar to Ukulele

A musical instrument that has a tone similar to that of a ukulele can be made from an old tennis racket and a drum head. Remove the strings from the racket and sandpaper the frame smooth. Soak a drum head in water, stretch it tightly over the racket and tack it to the edges with upholstering tacks. Dress down the top side of the handle even with the drum head or sounding board, and round off the underside. Fasten ukulele strings to pegs fitted in holes drilled through the end of the handle and tie the other end of the strings to a 3-in. dowel rod which has been slotted at both ends. To form the tailpiece, take a discarded gut string from the racket, knot both ends and slip them in the slots, after which the string is slipped over the head of an upholstering tack driven into the end of the racket. The bridge is made from a suitable piece of thin stock.

Mercurochrome Tints Photographs

An amateur photographer has successfully tinted photos different shades of pink with mercurochrome, which can be obtained at any drug store. Dissolve 2 dr. of the mercurochrome in 16 oz. of ordinary developing solution and treat the negative in the usual way. Deeper or

lighter shades of pink can be obtained by adding more or less of the mercurochrome. For pictures already finished, add mercurochrome to water and let the photo soak in this solution until the desired shade has been obtained.

How to Make Glossy Paint

Paint that will have a glossy finish can be made as follows: Mix equal parts of white lead in soft-paste form and linseed oil. Then add $\frac{1}{4}$ pt. of turpentine to each gallon of paint. If heavy-paste white lead is used, it will be necessary to use more linseed oil, stirring in a little at a time. When used as a priming coat, add enough linseed oil to give the desired thickness.

Animated Decoys Attract Ducks

Here is a decoy that has a lifelike head motion highly effective in attracting wild ducks. All the parts are cut from 1-in. wood. The tail is nailed between the wings, which in turn are nailed to a float or base of light wood. The head is cut to shape and pivoted between the wings as shown in the right-hand detail. A length of heavy galvanized wire, having a piece of tin fastened to one end, is suspended from the headpiece through a hole in the base. This serves as an agitator to move the head. A guide for the agitator is made by bending a loop in a length of wire which is fastened to the base. When the decoy is placed on the water, the ripples cause the float to move up and down, while the agitator remains motionless, resulting in movement of the head.

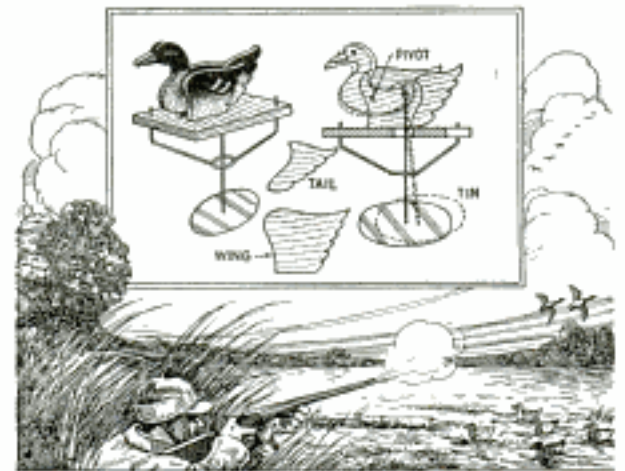

Ripples on Water Move Head of This Decoy Up and Down in Lifelike Manner

A Revolving Book Stand for Your Library

By R. O. BUCK

MAHOGANY and walnut are the best woods for making this revolving book stand, although maple and even pine can be used with good results. A woodturning lathe is needed to make the pedestal, while the feet can be cut out on a bandsaw. If these machines are not available, you can have the piece turned for you and do the curved sawing by hand. A piece of $\frac{3}{4}$ -in. stock, having an attractive grain, should be selected for the top, and another piece of the same size is used for the bottom. Square up and smooth these two pieces and round the corners to a $\frac{1}{2}$ -in. radius, as indicated in the upper detail of Fig. 1. The book partitions are carried on inner top and bottom liners, $\frac{1}{4}$ in. thick. Fig. 3 shows such a liner, and the dotted lines indicate how the partition pieces are arranged on it. As only the edges of these liners show, they may be made of

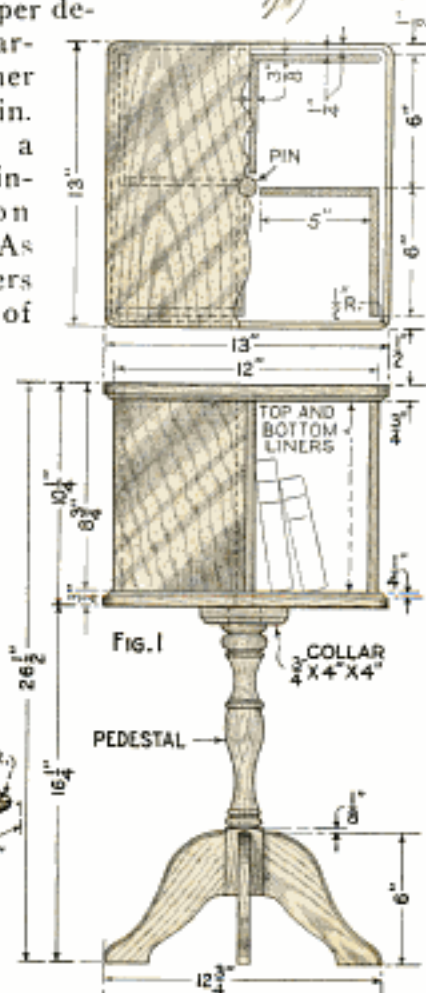
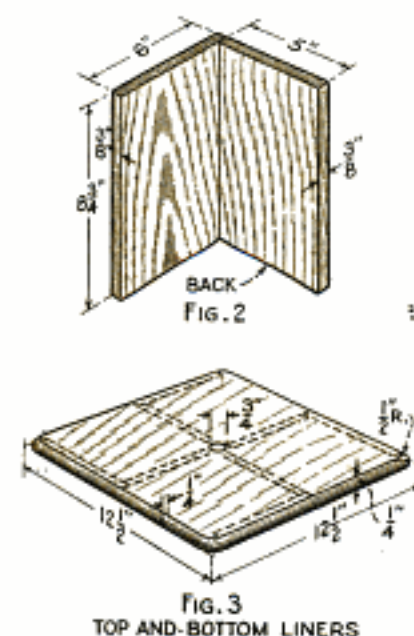
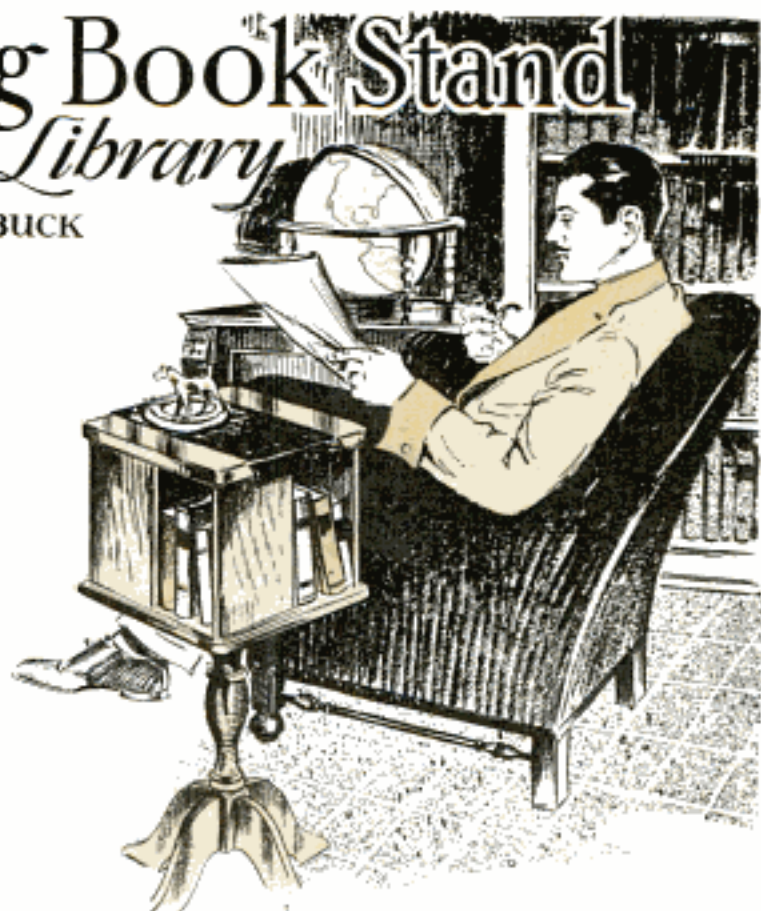

less choice stock than that desired on the exterior. They are simply two $12\frac{1}{2}$ -in. square pieces with the edges planed to a quarter-round and the corners rounded as indicated. Drill a $\frac{3}{4}$ -in. hole through the center of each.

The partition pieces, of which there are eight, are assembled in pairs as shown in Fig. 2. Care must be taken to get all pairs exactly the same size when finished. The table holds sixteen books of average size, four to each partition, allowance being made for some variation in height so that books as high as $8\frac{3}{4}$ in. can be housed. The method of assembling the cabinet part of the table is simple. Nails and glue are used to fasten the partitions between the liners. The next step is to fit the top and bottom. Before this is done, a $\frac{3}{4}$ -in. hole should be bored entirely through the bottom and half-

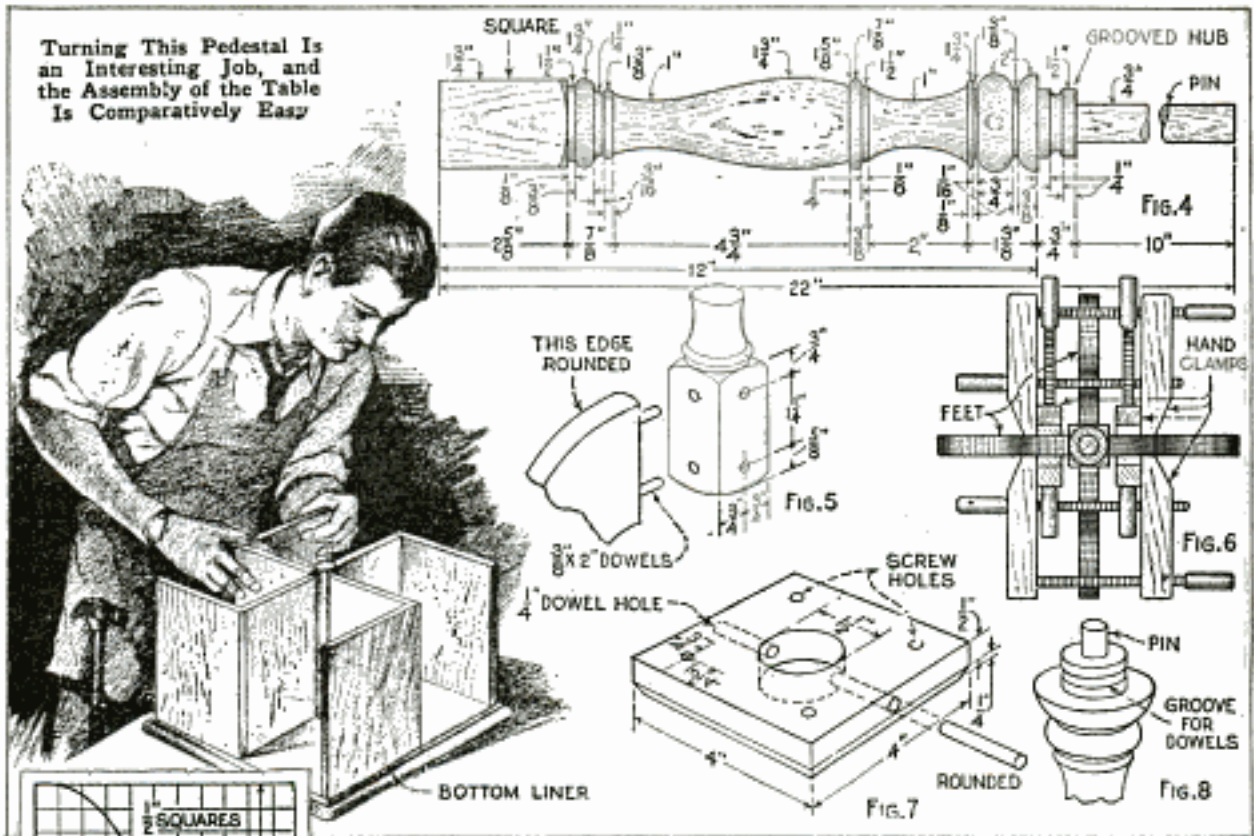

way through the top, care being taken to prevent the point of the bit from coming through the top surface. After this

has been done, the pieces are assembled with glue and clamped firmly together.

The turned pedestal, with complete dimensions, is shown in Fig. 4. Notice that the largest diameter of the squared part is only $1\frac{3}{4}$ in., while the rounded part is a full 2 in. After squaring up the stock and before it has been turned, the squared portion should be sawed and planed to size. The grooved hub and shaft, which form the upper part of the turning, carry the cabinet assembly on a pivot so that it can be revolved readily. In order to prevent the top from being lifted off, when the table is picked up, a square collar is screwed onto the bottom of the cabinet. The collar not only gives the shaft greater bearing surface but is provided with holes through which dowels are driven to travel in the grooves on the hub. The dimensions and construction of this piece are clearly shown in Fig. 7, while the detail of the hub is given in Fig. 8. Note

the groove in which the two dowels ride. The ends of these dowels should be rounded so that friction will be reduced to a minimum.

Fig. 9 gives the pattern of the feet. Lay out $\frac{1}{2}$ -in. squares on a piece of heavy cardboard to copy the pattern, after which it may be transferred to the stock. The grain of the wood should run lengthwise. Finish all edges with a plane and use a file and sandpaper as required. Fig. 5 shows the method of fastening the legs to the square part of the pedestal piece with a $\frac{3}{8}$ by $1\frac{1}{2}$ -in. dowel. The spacing of the holes is also shown. Care must be taken to bore these holes true and square so that the legs will fit well. After the dowel joints have been completed, glue up the four legs and tie with a rope, or better still put a pair of handscrews on the legs, as indicated in Fig. 6, and then clamp these together with another pair.

The table may be stained and varnished, or a very effective antique effect can be obtained by the use of water stain and filler if an open-grained wood is used, followed by repeated applications of a paste made of genuine beeswax cut with turpentine and applied just as you would ordinary furniture wax.

Plywood Bed Table Folds into Small Space

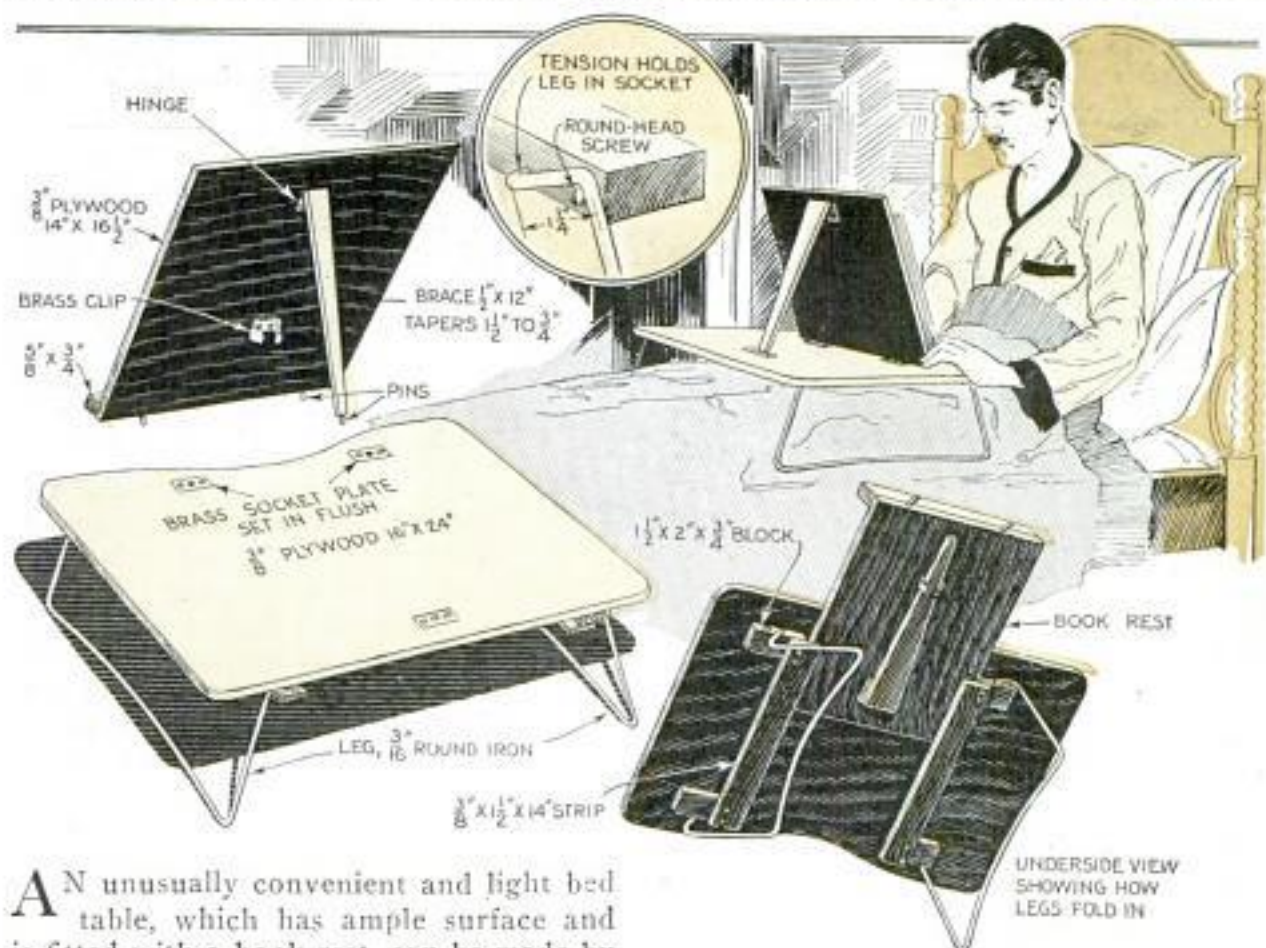

AN unusually convenient and light bed table, which has ample surface and is fitted with a book rest, can be made by following the accompanying drawing. When not in use, the table can be folded up and stored in a space about 2 in. wide. Plywood, about $\frac{3}{8}$ in. thick, is used for the table top and book rest. In cutting this to shape, use a fairly fine-toothed saw so that the wood will not split at the edges. First cut the table top, round off the edges, and set in the brass socket plates, which are to receive the pins of the book rest. Use a plate not over $\frac{1}{16}$ in. thick and chisel out a neat recess so that the plate will lie flush with the surface. Plates are attached with short brass screws, about $\frac{1}{2}$ in. long, the projecting ends being filed off on the underside. Next install the blocks for the legs and the strips which support the book rest when slid under the top, as shown in the underside view. Use brass screws where practicable but finishing nails elsewhere, and glue all joints. Bend the legs to shape from $\frac{3}{16}$ in. iron bar, about 29 in. long. The upper ends of the legs are set in holes drilled in the supporting blocks, and a second right-angle bend permits the leg

to spring up over a round screw head when the table is in use. The upper ends of the legs should be bent in to give sufficient tension to hold them in their sockets. The plywood book rest is 14 by 16 $\frac{1}{2}$ in., with a $\frac{5}{8}$ by $\frac{3}{4}$ -in. strip across the bottom and a hinged leg in back, held in place by a spring clip. Sandpaper the entire job well, stain it walnut and apply two coats of shellac or varnish.

Quick Method of Sewing on Buttons

A quick method of sewing buttons on heavy clothing is to insert a piece of fine radio wire through the eyes of the button into the cloth and twist the ends together on the other side, after which the ends are bent over sharply to prevent catching in the clothes. This will make a neat job and will hold securely.

☛ A lost dog is more likely to be recovered if you have your telephone number stamped on its collar plate.

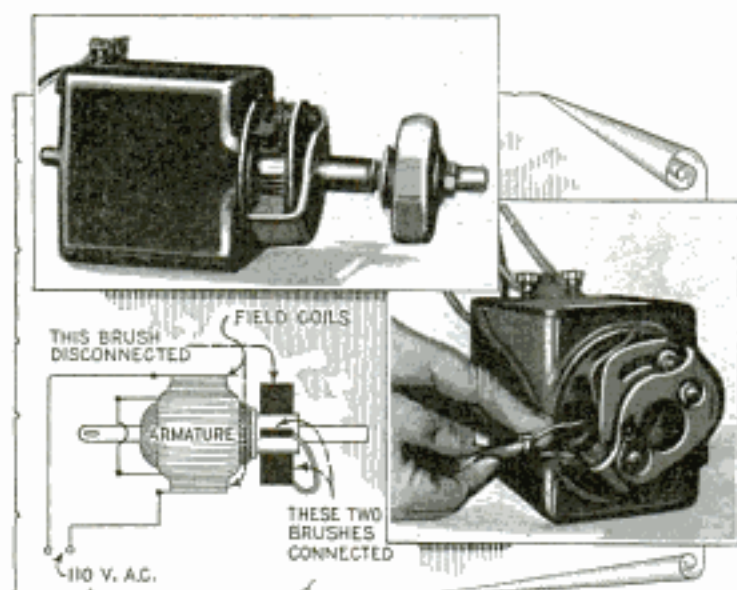

Anyone Can Easily Make This Electric Motor from an Old Auto Generator

Auto Generator Converted into High-Speed A. C. Motor

An old 6-volt auto generator of the three-brush type can be converted into a high-speed motor that will develop from $\frac{1}{8}$ to $\frac{3}{8}$ hp. at a speed of 3,000 to 5,000 r.p.m. Remove the armature and disconnect the three field leads from the brushes. The one that goes to one of the terminals of the generator output is taken off that terminal. Then connect the two remaining wires together and insulate the joint. Connect the field coils of the generator to the 110-volt a.c. line and make sure the field is continuous, which can be determined by holding a screwdriver near the magnetic poles. If the winding is continuous, the screwdriver will be attracted toward them. Next replace the armature and assemble the generator. Connect the movable or third brush to one of the other two and then turn the current on again. If the motor does not run, disconnect it and connect it to the opposite one, which should allow the motor to run. Adjust the movable brush back and forth until the motor runs at its highest speed. On some generators the whole brush assembly is movable. In such cases, move the assembly instead of one brush. It may be necessary to mount the movable brush on an independent support to locate it at the best point. After adjustment, the brushes should be replaced with those of the carbon type, as these have very little

resistance. Some generators have only one terminal, the other being grounded to the frame. In this case, the grounded wire is removed and fastened to an insulated terminal by drilling a hole through the generator case and inserting an insulated binding post. If the motor has a tendency to heat up at high speeds, it can be cooled by mounting a small fan on the armature shaft.

Pipe with Fittings Removes Brush from Boiler Flue

If a cleaning brush breaks off in the boiler flues, here is a way of removing it without taking out a flue. Get a pipe cap that will fit inside of it rather snugly and use reducers to make it fit on the end of a length of pipe somewhat smaller than the diameter of the flue. Insert this assembly into the end of the flue and push the cap up against the brush. By tapping the end of the rod with a hammer, the brush can be driven out at the opposite end. A tee screwed onto the end of the pipe will prevent it from being battered in any way by the hammer.—Henry E. G. Ditzen, Davenport, Ia.

How to Open Tight Windows

Tight windows are often weakened or the glass broken by pounding the upper sash member. To avoid this, get a suitable length of wood and a block. Place one end of the stick under the sash han-

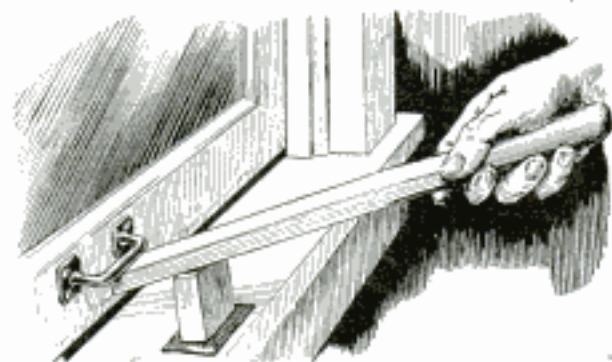

Window Sashes That Are Stuck Can Be Readily Opened with a Wooden Pry Bar

dle and use it as a pry bar with the block as a leverage point.

Worn Universal Joints Cause Rumble in Cars

Worn bushings in the universal joints of a car tend to throw the driveshaft out of balance, which may be noticeable at low speeds, but causes it to "whip" at higher speeds. This sets up a vibration in the body of the car which manifests itself by a disagreeable rumble, especially in closed cars. The wear in the joints can be tested by lifting the end of the shaft vertically or pushing it sideways. If either of these movements is possible, the wear is probably sufficient to cause vibration. The exact amount of whip in open driveshafts can be determined by jacking up both rear wheels and racing the motor in high gear, but on shafts inclosed in torsion tubes it will be necessary to remove the shaft and test it in a lathe.—A. H. Vance, Bensenville, Ill.

Wire Clip on Tub or Pail Holds Hose

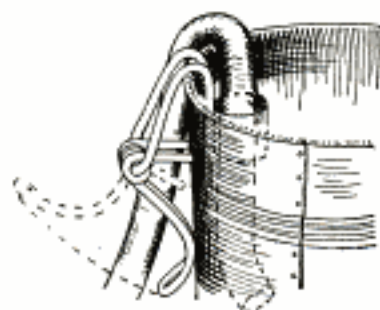

Women who do their washing alone will find this clip useful in holding the end of the water hose over the edge of the tub. It consists of a short piece of sheet metal bent to fit over the end of the hose and soldered to a spring clamp of heavy wire.

It consists of a short piece of sheet metal bent to fit over the end of the hose and soldered to a spring clamp of heavy wire.

Cement for Setting Linoleum

A good cement for setting linoleum and cork-composition flooring can be prepared as follows: Dissolve 2 oz. of para rubber in 1 gal. of gasoline, and add this solution to a mixture of gum shellac, 32 lb., commercial denatured alcohol, 7½ gal. when cut, and 120 lb. of English whiting. A smaller quantity of the same proportions can, of course, be prepared in case you do not need so much. To even up a floor before laying the linoleum, trowel on a mixture of Venetian red, 10 lb.; whiting, 32 lb.; dry white lead, 16 lb.; zinc oxide, 16 lb.; raw linseed oil, 1½ gal.; Japan drier, 3 pt., and turpentine, 3 qt.

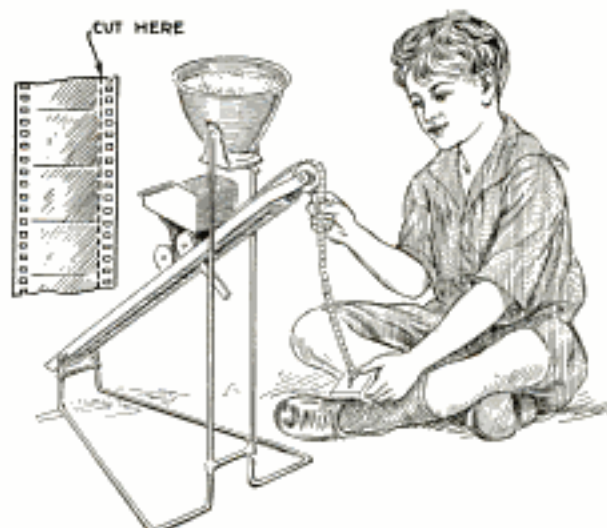

Small Toys and Model Machinery Driven by Sprocket Chain Cut from Old Movie Film

Sprocket Chain for Toys Cut from Old Movie Film

By cutting off the perforated strip of a movie film, sprocket chains can be made for driving small toys and model machinery. The sprocket wheels from a discarded camera or projector can be used on the toy, or, the star wheel from an alarm clock, the one that actuates the bell striker, will serve the purpose. If a stronger chain is needed, cement two strips of the film together with cement or acetone.—George W. Crooks, Norristown, Pa.

Cleaning Horizontal Stovepipe

Horizontal stovepipe can be cleaned without taking it down, if fitted with a T-joint instead of an elbow. A sheet-metal cap should be fitted over the lower opening of the tee to prevent the soot from falling on the floor. When cleaning the pipe push the soot to the tee with a swab, remove the cap and catch the soot in a pan.—J. J. Brindos, International Falls, Minnesota.

Mandolin Pick from Razor Blade

An old safety-razor blade can be made into a serviceable mandolin pick. In order to do this it is necessary to grind the edges down on a fine emery wheel to the shape shown. If desired, the pick can be covered with a piece of thin felt.





Carboys Fitted with Rockers Can Easily Be Tipped to Fill Small Containers

Rockers Aid to Tilt Carboy

Carboys are easier to handle for pouring out the contents if equipped with the rockers shown. These are cut out of 1-in. material and attached to the carboy frame, nailing or screwing the latter to the rockers. Where acids are handled this method insures greater safety.—J. H. Garety, Charleston, S. C.

Wedge Screwed to Claw Hammer Makes Nail Pulling Easier

Screwed to the end of a claw hammer an aluminum wedge will greatly aid in pulling nails.

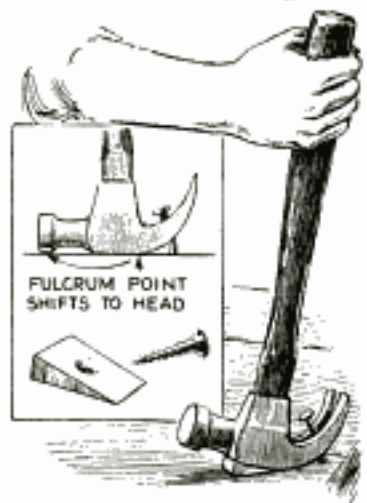

Other metal can be used for this purpose but makes the head heavier. Drill and countersink a hole in the center of the wedge for a flat-head wood screw which holds the wedge in place as shown.

☛ When counting or handling sheets of paper, moisten the finger tips with glycerin; this will aid in quickly separating the sheets.

Brilliancy of Two-Filament Auto Lamps Doubled

An automobile mechanic, having several calls to replace single-contact bulbs of 21 cp. in headlights with brighter ones, changes the ordinary double-contact bulb into a single-contact by soldering a contact across the two leads of a double-contact bulb, having two filaments of 21 cp. each, such as is used in headlights which have a high and low beam of light, both filaments are made to light at the same time, thus providing a bulb of 42 cp. with a single-contact base.

Diluted Lubricating Oil Readily Mixes with Gasoline

When it is desirable to add lubricating oil to gasoline for use in a motor, dilute the oil with a liberal amount of the gas. It will then readily mix with the gasoline in the tank. If the oil is added to the tank without thoroughly mixing, it will settle to the bottom, or will be drawn into the carburetor in sufficient quantity to stop the motor.

Rubber Bands for Loose-Leaf Book Markers

To make your loose-leaf file handier to open at certain pages it is a good idea to use rubber bands as markers. These can be conveniently slipped over the lower ring between the pages and allowed to project outside of the covers as indicated.



Oval Sandpaper Mounting Helps in Sanding Rough Work

When sandpapering metal having a rough surface, an oval mounting for the paper will be found a great aid. The mounting can be made from an ordinary pint jar. First wrap felt around the jar and then the sandpaper over this. The felt provides a flexible base for the paper so that any low spots will be cleaned as well as the remainder of the surface.

Homemade Developing Reel for Movie Film

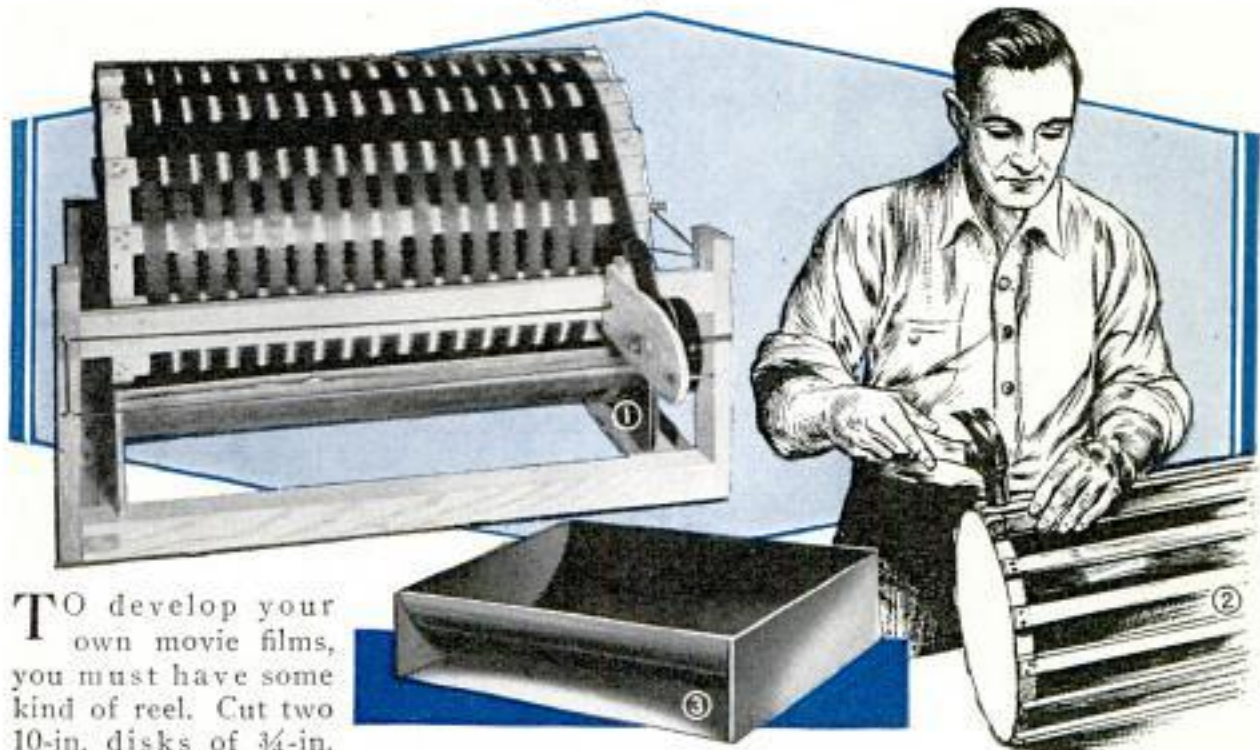

TO develop your own movie films, you must have some kind of reel. Cut two 10-in. disks of $\frac{3}{4}$ -in. wood and 16 strips, each $\frac{1}{4}$ by $\frac{3}{4}$ by 18 in. Before assembling, saturate these pieces with hot paraffin to render them waterproof. Through the center of each disk bore a hole to receive a $\frac{3}{16}$ -in. bolt and then fasten the reel together with 1-in. brass escutcheon pins or nails. The frame that holds the reel is shown in Fig. 4. It is built of 1 by 1-in. stock, and consists of a 13 by 21-in. rectangle fitted with two 8-in. uprights, one in the center of each end. At the upper end of each upright, cut a slot, 1 in. long and wide enough to receive a center bolt of the reel. One of these bolts should project about 2 in. beyond the outside of the upright, and the head should be

removed as in Fig. 5. The spacing device consists of a film guide mounted so that it moves along a horizontal wood bar as the reel rotates. A strong cord, running through screweyes and looped once around the projecting bolt, is the means of moving the guide. For a 16-in. reel, the outside diameter of the projecting bolt about which the cord is looped, should be $\frac{1}{4}$ in. You can use a $\frac{3}{16}$ -in. bolt with a piece of thin rubber tubing slipped over it to obtain the necessary friction. At

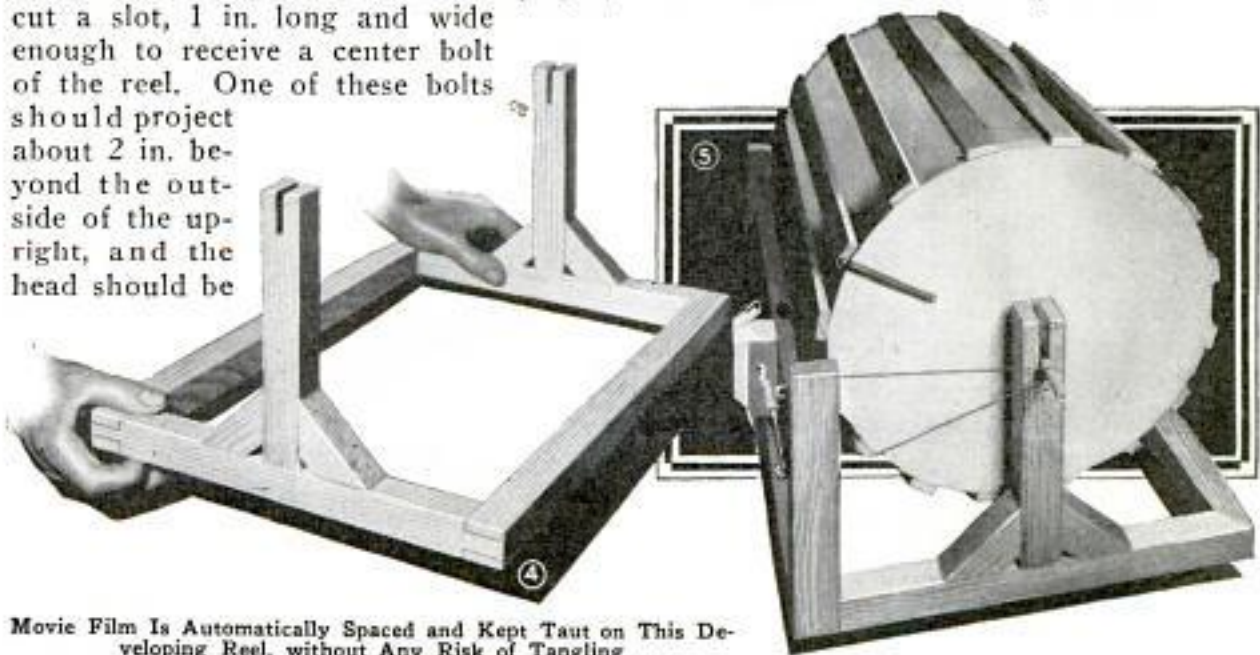

Movie Film Is Automatically Spaced and Kept Taut on This Developing Reel, without Any Risk of Tangling

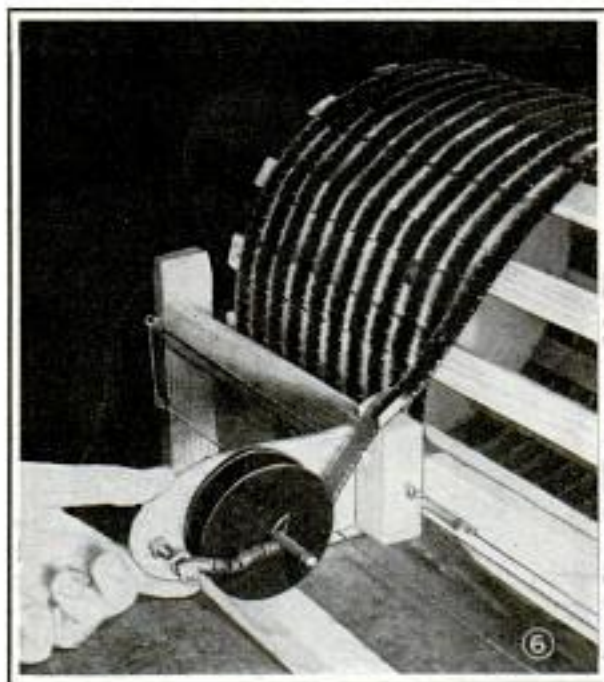

one end of the cord, where it meets the guide, a small coil spring with a hook on the free end, is attached. The guide itself consists of a wood block fitted with a U-shaped piece of sheet metal to keep it on the horizontal bar. A film groove, made of thin sheet brass or other metal, is attached to the top of the block, while a spool holder, consisting of a wood arm and a pin over which the spool is slipped, is also fastened to the block. The spool should turn with a drag, so that the film will remain taut. A piece of spring metal bearing against the side of the spool will give this drag.

Build the tank for holding the developing and fixing solutions of sheet metal, and paint with a waterproof solution on the inside surfaces. The tank is made in the form of a cylindrical section with rectangular ends, as in Fig. 3. The two ends measure $12\frac{1}{4}$ by 4 in. each, and the piece forming the curved part is 15 by 19 in. In use, attach the film spool to the holder so that the sensitized side of the film will be on the outside of the reel. Unhook the spring at one end of the guide cord and move the guide to the extreme left of the reel. Make one complete loop with the cord about the projecting bolt, in such direction that, when the reel is turned with its upper surface moving away from the film guide bar, the guide will travel toward the opposite end. Pull out the paper leader strip of the film until you reach

the film end and fasten this to one of the reel strips with a good thumbtack or two. Then turn the reel until all of the film has been wound up, and fasten the other end in the same way. Do not let the reel move back so that the film is loosened, or you will have a tangle.

Two strips on the reel should be mounted diametrically opposite each other on springs, so that there will be a slight outward pressure on the film to keep it taut. After the reel has been wound, unhook the guide cord and remove it from the reel bolt, lift the reel out of the frame, put the tank of developer in position, replace the reel and turn it slowly until development is complete. Empty the developer, rinse the film with clear water, and then introduce the fixing bath into the tank, turning the reel until the film is fixed. Wash thoroughly and dry, after which you can wind the film on a spool. There is so much turning to do that you may find a small motor a handy accessory, though not a necessity.

Stamp Pad Easily Opened by Use of Tin Tab

Soldered to the bottom part of a stamp pad a tin tab will aid in opening it. By holding a finger of one hand on the tab, the lid can be easily raised with the other. This also provides a means for moving

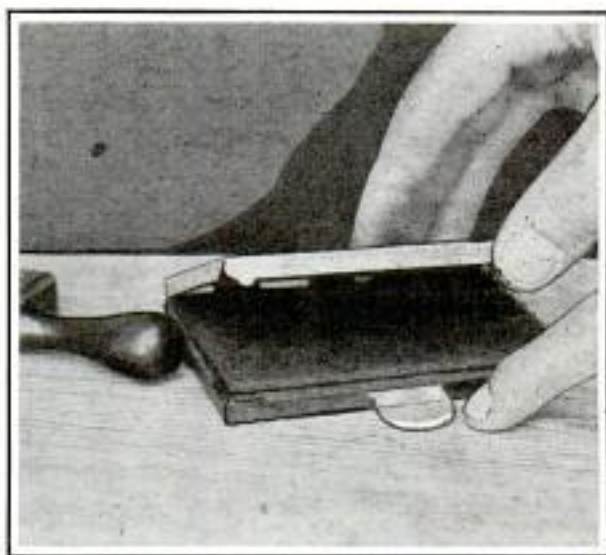

Tin Tab on Stamp Pad Provides Means for Handling Without Getting Ink on Hands

the pad around on the desk without getting the fingers in contact with the ink.

Projecting Sport News on a Store Window

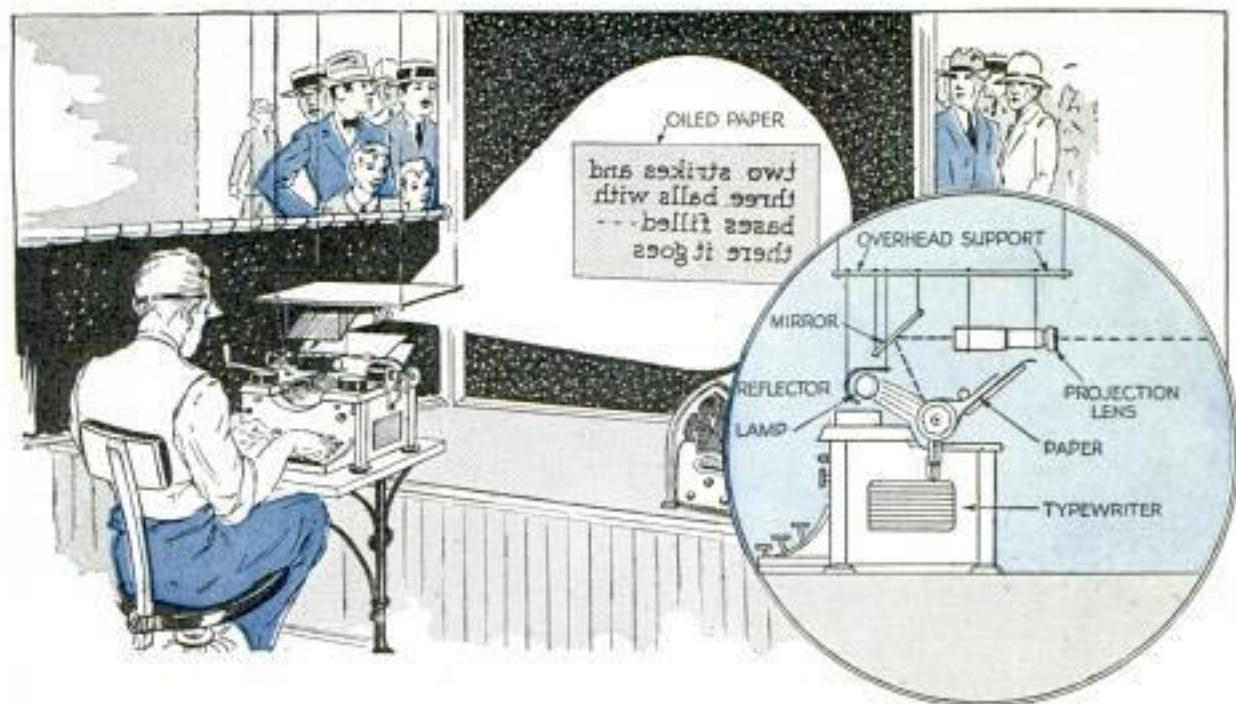

Here is a simple device that will project typewritten news of sporting events on a store window where it can be viewed from the outside. A movie-projector lamp and reflector, the projecting lens and a small mirror are supported by wire, as indicated. Do not attach these parts to the typewriter or its support, as the vibration will blur the projected image. The lamp and reflector are placed in front and slightly above the paper in the typewriter so the words are reflected into the mirror, suspended above the lamp and directly be-

hind the projector, which throws the image onto a piece of solid paper pasted on the inside of the window. If the projector is of the type that makes an inverted image, it will be necessary to use two mirrors instead of one to have the image right side up. It will, of course, be backward when viewed from the inside of the window. If the outline shown in the detail is carefully followed, no difficulty, other than a few minor adjustments, should be experienced in setting up the device.—R. F. Hall, San Antonio, Tex.

Turkeys Prevented from Flying by Stick Across Wings



Fastened across a turkey's back as shown in the illustration, a length of light wood will prevent it from flying over the fence. The stick should be about as long as the width of the turkey's body. Two

small holes, drilled near each end, permit attachment of pieces of cloth with which the stick is tied to the wings.—J. Clark Cullom, Hyannis, Nebr.

Graphite and Paraffin to Make Auto Windows Slide Easy

When car windows are hard to raise or lower, a preparation of graphite and paraffin will make them work easily. Mix, by weight, equal parts of melted paraffin and powdered graphite and form the mixture into a stick by pouring it into a tube made by wrapping paper around a lead pencil. When hardened, rub the stick over the felt window channels, and you will find a decided improvement.



Simple Methods of Improving Wire Clothes Hangers for Holding Trousers and Sleeveless Dresses

Improved Hangers for Trousers and Sleeveless Dresses

By slightly bending up the ends of a wire clothes hanger, women's sleeveless dresses can be kept from slipping off. Trousers can also be held better by placing them between two hangers and slipping rubber bands over the ends.

Cork and Rubber Band Form Handle for Can Dipper

When using tin cans to dip acids or hot fluids, it is advisable to have some kind of a handle.



Here is one easily made. First, take a good-sized cork, place it against the side of the can near the top, and then stretch a section of inner tube around both can and cork.

When decorating candles with sealing wax, dissolve it in alcohol and apply with a brush.

Hints on Greasing Your Car

Keeping the steering connections and shackle bolts on the car well lubricated is a rather difficult task if they are not fitted for a pressure system. Fasten a piece of black cloth around each connection so that it completely covers it. This will keep out dirt and sand, and by keeping the cloth saturated with oil, the joint will be well lubricated. If the connections are equipped for a pressure system and have become worn, allowing the grease to work out in hot weather, the use of a special grease for universal joints, commonly called "splicer grease," will aid in preventing the trouble.

Pocket Lining for Carrying Small Rifle Shells

Those who use a small rifle for hunting or target practice and must carry several boxes of shells, will find this rubber pocket liner useful in protecting the clothes from being soiled by the grease with which these shells are coated.

Cut a section from an inner tube, of suitable size to fit the pocket, and close one end by tacking a thin board between the edges.



Freezing Water with Metals

Water can be frozen with a combination of metals mixed with liquid metallic mercury. Melt and thoroughly stir together tin, 59 parts; lead, 103½ parts, and bismuth, 183 parts. This molten mixture is poured into molds resembling solder bars and allowed to cool, after which it is either powdered or reduced to fine filings. The powdered metal is then stirred into 108 parts, by weight, of liquid metallic mercury. A thermometer placed into this mixture will rapidly sink from room temperature to 3.2° F., and a test tube of water immersed in it will freeze at once.

Avoiding Breaks in Thin Fretwork

When making fretwork overlays, the design is often ruined by small pieces of the wood splitting off, caused by vibration and pressure of the saw. To prevent this, thin a mixture of glue to a watery consistency and apply it to the underside of the work. Then lay a sheet of thin tissue paper over the glue and allow it to dry. This will hold the pieces together and prevent them from breaking while the work is being completed. The paper is removed by gently steaming it.

Reducing Cost of Roadside Signs

Two hotel owners in neighboring cities used an ingenious method to split the costs of erecting several sign boards on a main highway between the two cities. One hotel advertised on one side of each board, this being visible to motorists going in the direction where this hotel was located, while the opposite side of the board was used for advertising the second hotel to traffic going in the other direction.

House Number Built into Porch

The question where to place the house number is answered by the novel method shown here. The numbers are cut from wood and set in the arch of the front-porch roof, adding an ornamental touch. In this particular case it was found that by slightly dropping the top of the window shade in the middle section of the French doors directly behind the number, the light from within the house illuminated it at night.



House Numbers under Arch of Front Porch Are Ornamental and Can Be Seen at Night



Dusty Task of Removing Ashes from Furnace Made Less Dusty with Aid of Vacuum Cleaner

Vacuum Cleaner Prevents Dust When Removing Ashes

Set over an ash can as shown, a vacuum cleaner will quickly absorb dust arising from the can when removing ashes from a furnace. Place a chair near the ash receptacle and set the cleaner on the chair so that the nozzle hangs over the edge as indicated. If care is taken in handling the ashes, almost no dust will result.

Heat Removes Old Patches from Inner Tubes

When repairing inner tubes, it is often necessary to remove an old patch, which is a rather difficult job to do unless it is heated. By placing it against a hot surface, such as a stove, the manifold of the car, or even a 100-watt electric lamp, the patch can be readily pulled off.

Caster Serves as Tightener for Round Belting

An effective tightener for round belting can be formed by cutting a groove in the roller of a caster and mounting it so it will run true on the belt and have sufficient tension to take up the slack. The method of mounting depends on the conveniences at hand.



HALLOWEEN

that you

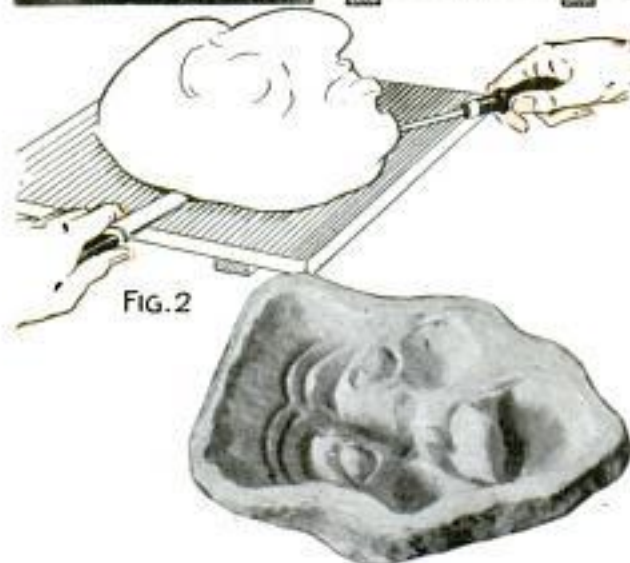
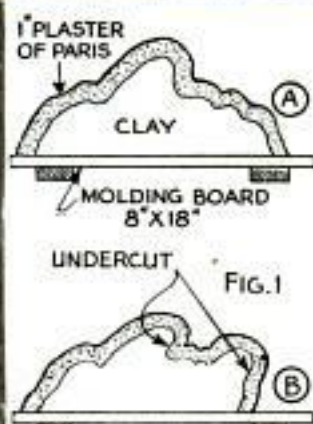
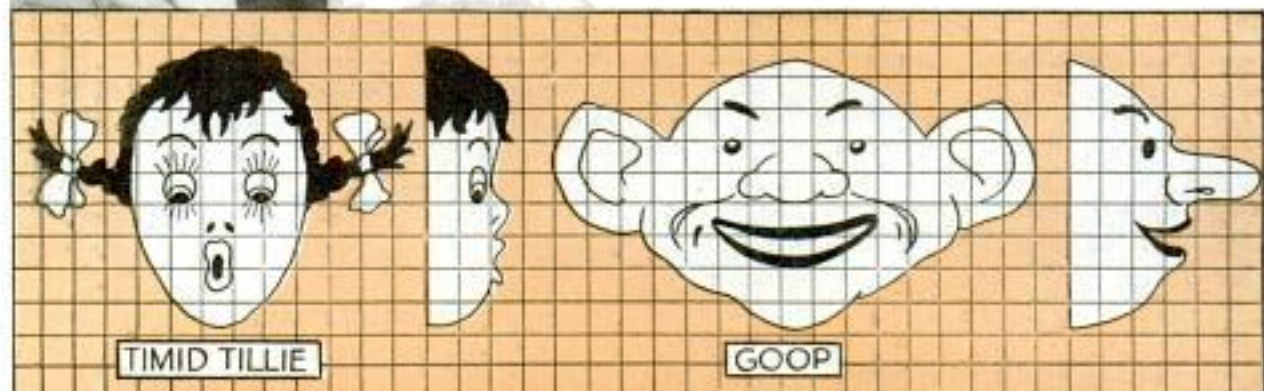

THERE'S lots of fun in making masks for Halloween or parties, as almost any type of face, and, with practice, even caricatures of your friends, can be reproduced. Those shown here were made without any previous experience.

First a clay model of the face is made as shown in the photo, Fig. 1. This is covered with plaster of paris to form a mold. When the mold has set, it is removed from the clay, and the mask is then built up in it with successive layers of tissue paper, thread and mucilage.

Fig. 1 shows cross sections of two types of molds. The easier type is illustrated in detail A. This one can be lifted off the mold intact. Detail B shows an undercut design; that is, the nose and chin overhang so that the plaster must be carefully broken to get the clay out. Although more difficult than the first, it can be successfully made with a little practice. The mold should be made rather thin at the points where it is to be broken, say about $\frac{1}{4}$ in., so that it will crack off readily. After the clay has been removed, the broken pieces are put together again and covered with another layer of fresh plaster of paris.

In preparing the clay model allow it to

MASKS *can make*

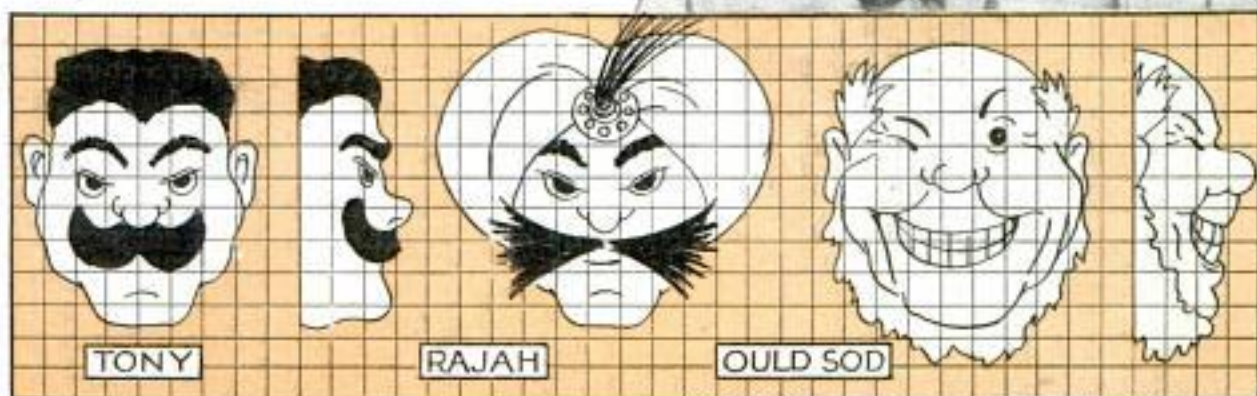

set long enough to become fairly dry on the surface, but not so dry that it cracks. Then rub ordinary machine oil over the exposed surface to prevent the plaster from sticking. Press the plaster down well into the hollows, so there will be as few air pockets as possible, and let it set until hard, after which it is removed with a knife, as shown in Fig. 2. Air pockets and flaws are filled with plaster as in Fig. 3. When the plaster has hardened thoroughly, apply three coats of shellac, allowing each to dry, and then rub oil over the entire inside surface wiping the excess out of the hollows. Cut up light paper toweling, or absorbent tissue paper, into triangles about 4 in. on a side. Paper cut this shape will not wrinkle as quickly as square pieces. Lay them in the mold so that they overlap each other, covering the entire surface, and press them down with a wet sponge or paintbrush. Squeeze out all air bubbles. When moistened, the paper will cling to the mold. Continue with about two more layers of tissue paper, or one layer of paper toweling. Next cover the paper with mucilage and lay threads over the surface in crisscross fashion, after which another layer of paper is applied, beginning at the nose and working



FIG. 3

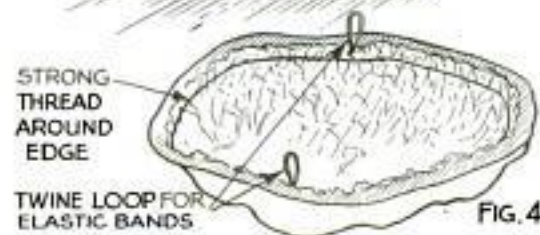

FIG. 4





Above, with Suitable Costumes, Grotesque Figures Can Be Produced; Below, Three Different Masks Built Up in the Same Mold

toward the rim. If the mucilage soaks through, add still another layer and apply more mucilage over that. At this point, twine loops should be placed at the sides to permit attachment of an elastic band, and a stout thread is laid around the edge to prevent tearing. Cover with about four more overlapping layers of paper and mucilage. The final layer of paper should absorb the remaining mucilage to the extent of being moist but not too sticky. Press out all remaining air bubbles, and see that the paper is worked well down into the tip of the nose and other hollows. The mold should then be set up in front

of an electric heater, or in the sunlight. When dry enough to crackle when tapped, begin pulling it away from the mold, very carefully and a little at a time, so that the newly exposed outside surface of the mask will have a chance to dry out before pulling off more. Here and there it may stick to the mold, and should be cut away with a thin, sharp knife. In this way the entire mask can be withdrawn from the mold intact—or with but a few torn places. Even though it is pretty badly torn on the outside layers, don't be discouraged, because these can be pasted down smooth with mucilage. Press out all wrinkles and allow to dry thoroughly before covering inside and out with shellac, which makes the mask waterproof to a certain extent, and prevents softening of the mucilage from moisture or breath. With a sharp knife or manicuring scissors, cut out the pupils of the eyes, the nostrils and the mouth, and proceed to paint the mask. A good flesh tint can be obtained by mixing a little red and orange in white brushing lacquer. For the eyebrows and lashes, use oil colors in brown or black; eyeballs white and lips red. The nostrils should be rimmed with red.

Several types of masks can be made from one mold by altering the mouth and nose. Putty is used to fill up parts of the mold, as this can be readily removed for another alteration. Wigs are very effective, but to save time and labor, hair can be imitated in the formation of the mask and painting this portion to suit. For "Timid Tille," untwisted strands of rope were used, braided into pigtails and tied with ribbons. The pigtails were reinforced with stiff wire. In the squared illustration, other types are shown as suggestive of the many possibilities.

Easy Method of Removing Paint

Waterglass, a common chemical often used for preserving eggs, is a cheap and effective agent for removing paint from furniture. It is applied with a brush and allowed to stand for about ten minutes, after which the paint can easily be removed with an ordinary scrubbing brush.

Simple Stunts with Matches Are Amusing



You Can Make Pencil Marks on Matches Disappear at Will, and, with a Few Moments' Practice, Astonish Your Friends as an Accomplished Sleight-of-Hand Performer

Relighting a match by simply holding it under a lighted one, as in Fig. 1, seems strange. Tear two matches from a paper pad and light both. Blow one out and immediately hold the smoking end under the other, taking a light hold of the latter with the fingers. If quickly done, the flame from the lighted match will jump as indicated by the arrow and will relight the lower one. The second trick is even better. Tear off two more matches and mark one side of each with a pencil or with ink, as in Fig. 2. The object of this trick is to make the pencil marks disappear, after showing your audience that the matches are apparently marked on both sides. Hold them side by side, between the thumb and finger as shown in Fig. 3, with the marked sides in view

and the heads up. Then turn the hand so that the heads are down as in Fig. 5, and, while doing this, twist the matches over, as in Fig. 4. The result is that the marked sides of the matches will still be seen, and, if the twisting is done quickly, it will seem that both sides of the matches are marked. Repeat the movement a few times to strengthen this impression. Then pass the other hand over the matches to hide them, and twist but do not turn the hand, which brings the unmarked side in view. Evidently you have caused the marks to disappear at will. As the effect of such tricks cannot be adequately described, try them, and you will be surprised at the audience's appreciation of your sleight-of-hand performance.—D. S. Hawkins, Youngstown, Ohio.

Hook for Holding Paintbrush in Bucket



With the use of this holder it is not necessary to wipe out surplus paint from the brush every time you want to lay it down. Get a length of heavy galvanized-iron wire and bend it as shown, to fit the narrow part of the brush handle and the edge of the bucket.

Keeping Dirt Out of Auto Brakes While Washing

Mud and grit driven into the brakes of a car by a high-pressure stream of water are often the cause of screeching, cut brake lining and grooved drums. To prevent this, set the brakes while washing

the car, thus expanding the bands against the drums. If the outside bands are connected to the foot or service brake, it can be held down with a suitable stick placed against the pedal and braced against the front seat or other convenient place.

Pencil Holder on Your Belt

Here is a pencil holder attached to your belt with snap fasteners that is useful when no coat is worn. A two-pencil fitting can be purchased from a stationery store for a few cents, and the pin, with which it is usually provided, is removed. Snap fasteners are then attached to each end of the holder and to the belt.—Noble D. Gilkerson, Kansas City, Mo.

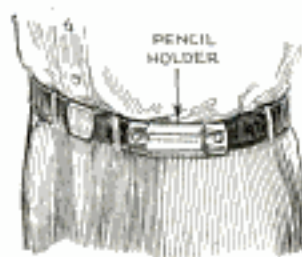

Esillepue. Rogers - Pyatt B
99 John H
neufak



Lawns, Sidewalks
and Cement Floors
Can Be Quickly
Cleaned with This
Revolving Sweeper

Revolving Walk Sweeper Made from Discarded Lawnmower

A revolving-brush sweeper for cement floors and sidewalks can be improvised by fastening brushes to the blades of a discarded lawnmower. The stationary cutting blade and roller are removed and a grass catcher attached close to the blades to gather the dirt. The implement will also be of use for sweeping lawns.

Kerosene Cleans Drain Pipes

Drain pipes can be made clean and kept so by using kerosene and soapsuds. A practical way is to do this each wash day. Pour the kerosene down the drain and after about 15 minutes follow with a bucketful of boiling soapsuds. The kerosene will loosen the grease and dirt and the hot soapsuds will wash them out.

Wooden Block for Tent Poles Protects Floor Cloth



To protect the floor cloth of a tent from being punctured by the center pole or by the legs of heavy objects, such as chairs and cots, a wooden

block with cleats nailed on it to prevent the pole from slipping off, is easy to carry along with the tent equipment. The block should be about 8 in. square, or smaller, depending on the weight and size of the object it is to support.

An Elastic, Quick-Drying Varnish

A varnish superior to ordinary shellac in that it dries more quickly, is clear and elastic and therefore more durable, is made as follows: Manila copal, 4 oz.; flake shellac, 3 oz.; sandarac, 1 oz. These gums, which are obtainable at any paint store, are coarsely powdered and placed in a bottle with washed sand, 1 oz., and denatured alcohol, 40 oz., by volume. The alcohol dissolves the gums while the sand prevents them from sticking together. The bottle is loosely corked with a paraffin-coated cork and set away, shaking the mixture at intervals. After a few days, the mixture is poured out, taking care not to stir up the sediment in the bottom of the bottle.

Letter File from Radio Condenser

Provided with a suitable base, the rotor-plate assembly of an old radio condenser will serve the purpose of a letter file. Drill

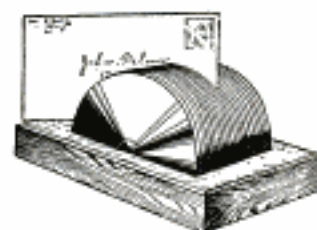

and tap a small hole in the bottom of the condenser for a screw which holds it to a wooden base as shown.

Striping with a Mechanical Pencil

By using an ordinary mechanical lead pencil, a man in Warwick, Mass., was able to do a neat job of striping on the body of his car. He removed the lead and the top from the pencil and screwed the thin piece of metal down on the inside to close the small hole in the end. Then by filling the barrel with enamel and pulling the thin metal piece back he was able to adjust the flow. In this manner he could make a narrow stripe or draw the outlines for a wider stripe, which was then filled in with a brush.

SHOP NOTES



This HEAVY-DUTY JIGSAW has Large Capacity

By M. C. SMOCK, JR.

CUTTING 1-in. stock with ease, and capable of handling large pieces of work, this wooden jigsaw, which is a homemade product, will prove a great help in your workshop. The total cost is about \$5, exclusive of the $\frac{1}{4}$ -hp. motor used to drive it.

Set on two cleats or battens, the base for the jigsaw proper and that for the motor are laid side by side, as shown in the front view, where dimensions of these pieces are given. Flat-head wood screws, $2\frac{1}{2}$ in. long, are used to fasten these parts together. The bearing-support blocks should be of oak. These are

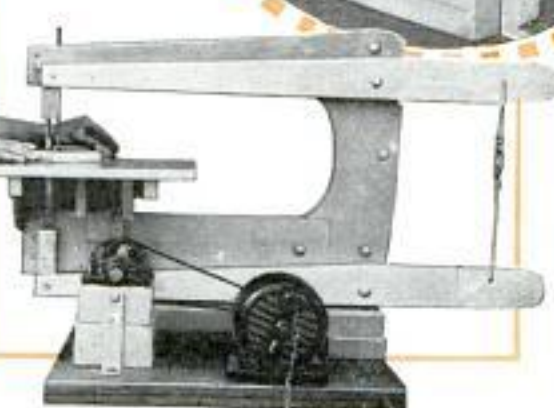
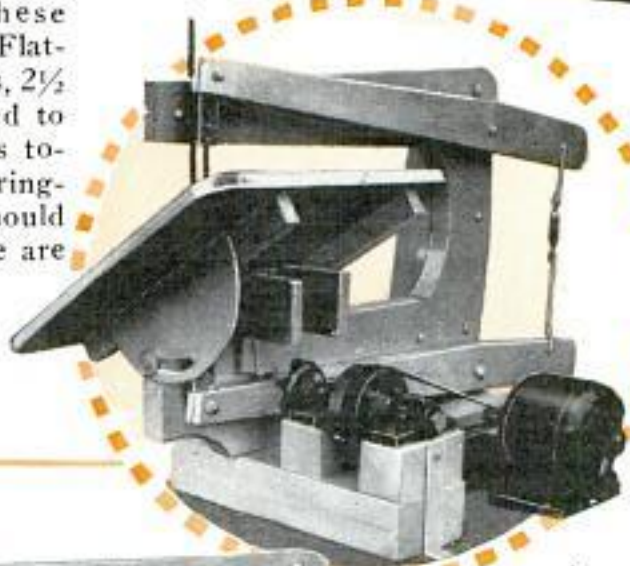
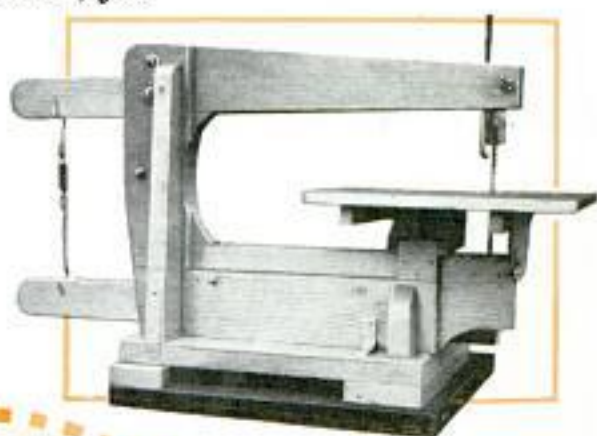

attached to the base with two bolts through each block, the heads and nuts being countersunk. For the main frame, three pieces of hardwood are preferable, screwed and bolted together securely. A 1-in. batten is screwed along the lower edge of the bottom member of the frame,

and a similar piece is attached vertically to the back member. Place the assembled frame on the base with the right side 6 in. from the left side of the base, and nail temporarily from underneath so that you can drive in $3\frac{1}{2}$ -in. screws. Then cut and attach the two braces shown in the front view. Angle braces may also be added for further

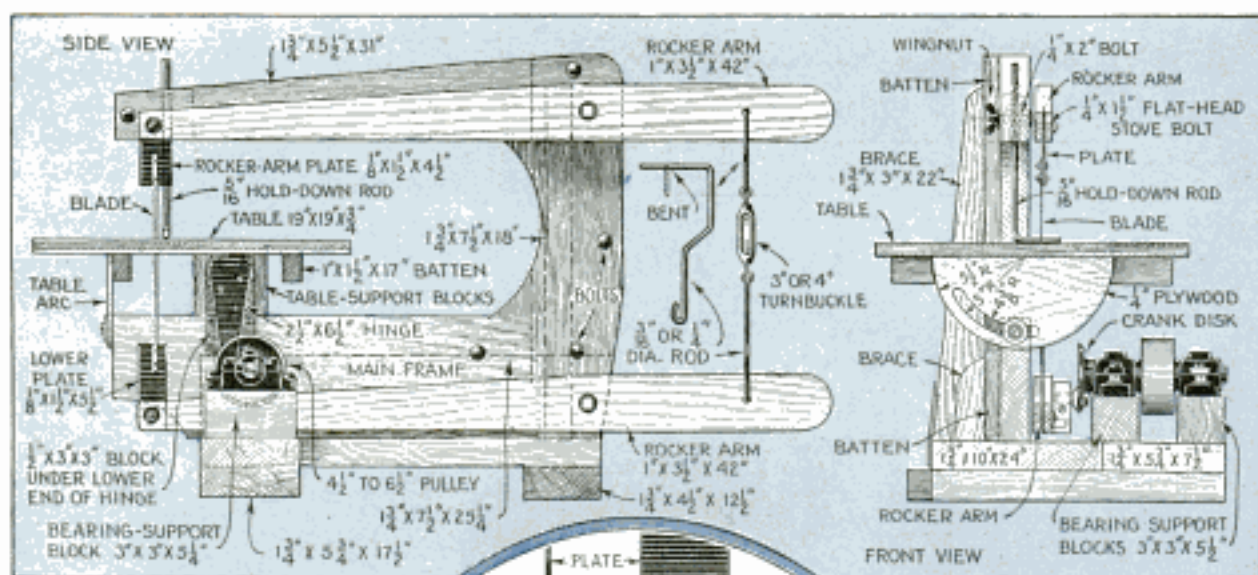

support. For the table-support block use a 3 by 3 by 5-in. piece of oak, cutting out a 2 by 2¼-in. piece at the bottom to fit over the lower member of the frame. Two table-support blocks are screwed to the sides of this piece, one end of all three being cut off at a 45° angle as indicated. The lower part of the center block is screwed to the lower frame member, while the other pieces rest on the frame. A strap hinge is fastened to the underside of the table and to the side of the center block, permitting the table to be tilted 45°. There will just be enough space under the lower end of the hinge for a ½ by 3 by 3-in. block, cut at an angle to allow sufficient clearance for the lower rocker arm. The plywood table is reinforced with two battens. The front batten carries the table arc, which is made of ¼-in. plywood and has a slot cut to the dimensions shown with a coping saw. A round-head wood screw, slipped through a washer, is driven through the slot of the table arc and into the lower frame member, to hold the table at any desired inclination.

The drawing clearly shows the dimensions and assembly of the rocker arms, which are adjusted to get the correct blade tension by means of a turnbuckle

attached to suitable rods, bent to fit holes at the ends of the rocker arms. A slot is cut at the front end for ⅛-in. plates, and these may be fitted with short ½-in. rods slotted to receive pin-end saw blades. This method of holding the blades may, however, be varied. The writer found lengths of

old ⅜-in. bandsaw blades durable and cheap. These were bolted directly to the rocker-arm plates without the slotted holder.

To drill the ends of the blade, the temper must first be drawn, which is done by heating to a bright red and allowing to cool slowly. A hold-down rod runs up through a vertical hole in the upper frame member and is held in any position by means of a bolt and wingnut, shown in the front view. The pitman, or connecting rod, is shown in the detail, this being slipped on pins on the lower rocker arm and on the crank disk. The latter is keyed to a shaft, which also holds a flat-face pulley, the shaft being held in two split bearings and belted to the motor.

Ⓞ A small amount of glue applied to the end of the tape used in winding electric motors will prevent it from unrolling if dropped to the floor.

Motor on Swivel Base Runs Four Machines

Mounted on a swivel base, an electric motor can be used to run four machines direct, and thus eliminate the need of a countershaft. The machines can be arranged on a square-top table, which saves considerable space. The base on which the motor is mounted has a lock pin at one corner which fits in any one of four holes drilled in the table, holding the motor from turning. Washers and a nut, fitting the bolt on which the motor pivots, are used to hold it solid. One belt is sufficient, as the machines can be arranged so that the belt will be taut, and a step pulley is used to permit variation of speed as required.—M. C. Smock, Jr., Indianapolis, Ind.

These Machines Can Be Run from a Motor Pivoted in the Center, Eliminating the Need of a Countershaft

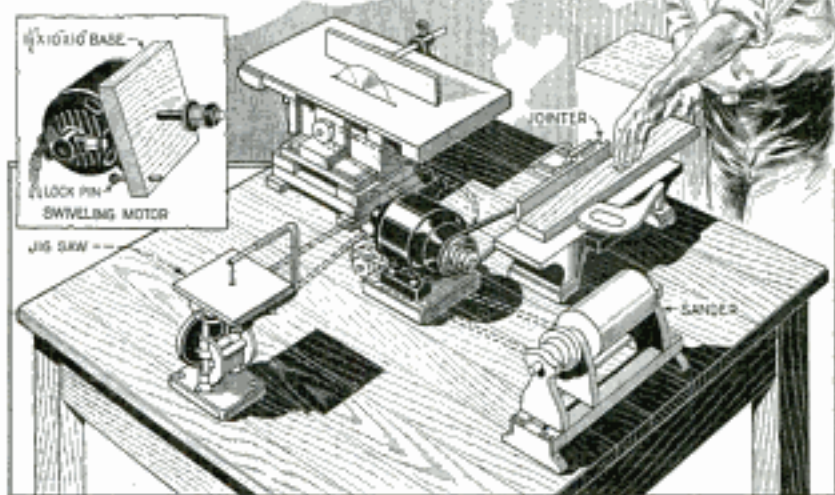

Heater Housings Centered on Auto Exhaust

Heater housings around auto exhaust pipes that become loose and rattle can be securely centered in the following manner: Drill three holes in the housing for stove bolts, and also corresponding holes in a length of strap iron. Clamp the latter around the housing and insert the bolts as shown, holding them in place with two locknuts on each bolt. The bolts are driven in the same distance, centering the housing and stopping the rattling.



Carbonate of Soda Cleans Radiators

Efficiency of radiators can be maintained and a saving in fuel made, if they are kept free of sediment and other deposits from water. This is especially true in localities where the water supply has a high mineral content. Dissolve 2 lb. carbonate of soda to every gallon of water used, and fill the entire circulating

system with it, allowing it to remain overnight. Flush the system the following morning by running water through it under pressure until the water comes out clear. The soda will reduce the deposit to a powder so that it will be carried out with the water. One should make sure, however, there is no soda left in the system before using it again.

Small Jacks from Capscrews

Small jacks for use around the shop can be made from a capscrew nut and a steel ball. The nut is run down on the bolt a distance about two-thirds of its width, and the ball, which should be about one-third larger than the hole, placed on the nut as shown. This assembly is then put under the work with a washer between it and the ball. By running the nut up, the work will be raised. While the range of movement of such a jack is limited, it can be increased by keeping a number of capscrews of different lengths on hand.—Henry Simon, Santa Ana, Calif.





Blowtorch Tank Fitted with Valve Stem Quickly Filled with Tire Pump

Attachment for Using Tire Pump on Blowtorch Tank

By fitting a blowtorch with a valve stem from an old inner tube, a tire pump can be used to force air into it. Take a pipe cap, of suitable size to fit the hole in the blowtorch tank, and solder the valve stem into a hole drilled through the cap. This provides a quick and efficient method of supplying pressure in the tank when the pump provided for that purpose has worn out.—H. L. Weatherby, Montgomery, Ala.

Steadyrest and "Semaphore" Gauge Speeds Up Tenon Cutting

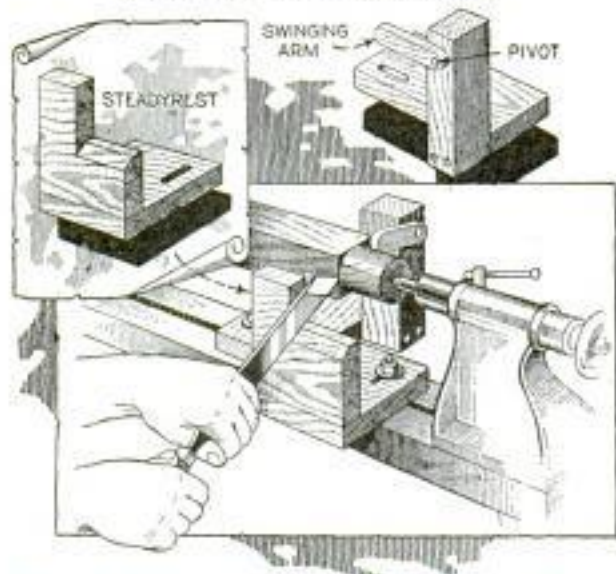

Tenons Quickly and Accurately Cut with the Use of This Steadyrest and "Semaphore" Gauge

When a number of tenons are to be cut, the use of a combined steadyrest and "semaphore" gauge will speed up the work. The attachment is made of wood, as shown in the upper details, and is clamped to the lathe bed with bolts. In use, the tool is held flat against the rest to cut the tenon, after which it is held as shown to cut the shoulder off squarely. The pivoted arm on the gauge rests on the tenon, and is adjusted so that it will drop to a vertical position when the tenon is turned to the required size.—Wm. J. Edmonds, Rutland, Vt.

Beeswax Aids in Calipering Flanged Work

When calipering flanged work, rub a little beeswax or paraffin on the calipers as shown. This will provide a base for the divider markings and will not mar the calipers, as does the usual method of

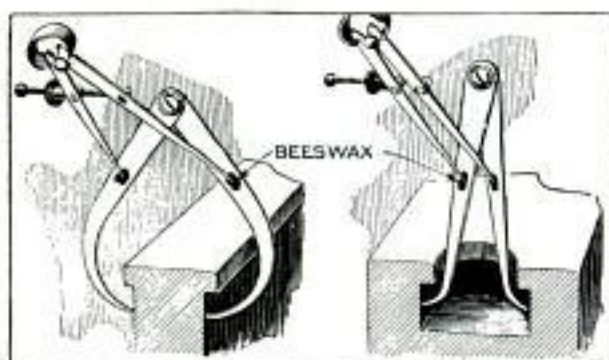

Beeswax Forms Base for Divider Markings on Calipers When Used on Flanged Work

scratching the markings on them. The beeswax will stick to the calipers so markings made with the dividers will be accurate, and can easily be removed when the job is finished.—W. C. Wilhite, Hornsby, Illinois.

Stretching Prevents New Ropes from Twisting

When first used, a new rope has a tendency to twist and tangle. To overcome this, soak it in water for two or three hours before using. After taking it out of the water, tie one end to a tree and hitch a team of horses onto the other end and give it a thorough stretching. Then fasten it in this position and allow it to dry.—Adolph Rieter, Marinette, Wis.

MOUNTING Work

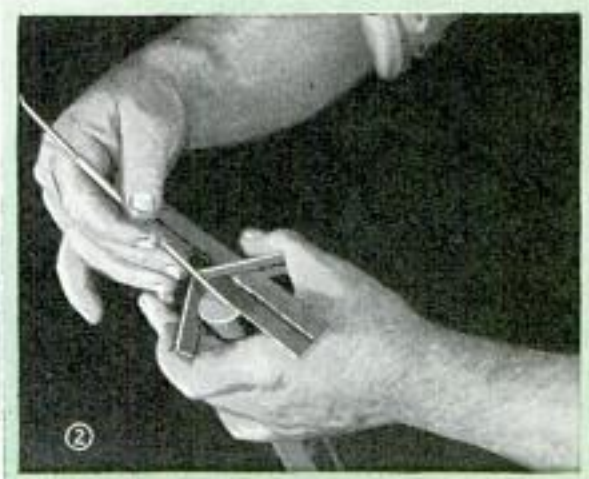
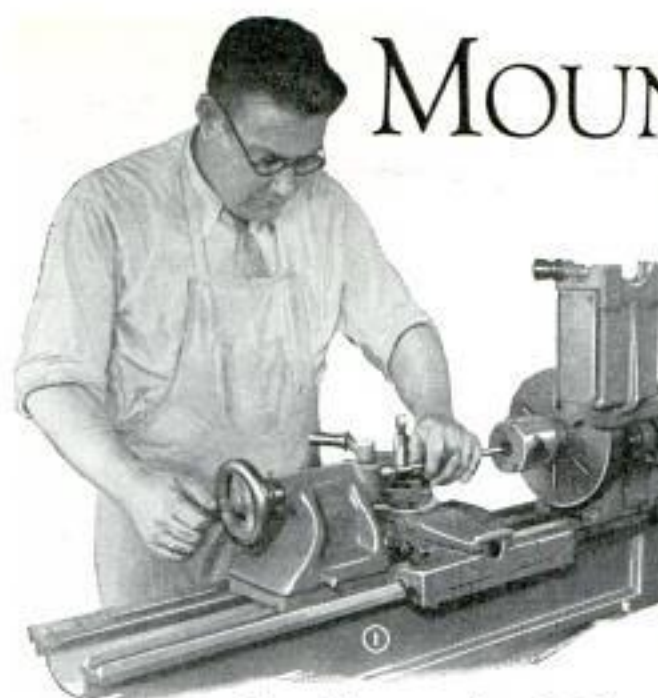

on a Metal-Turning LATHE

By W. CLYDE LAMMEY

IN USING a metal-turning lathe, the first operation is that of accurately centering the work, several methods of which are shown in Figs. 1 to 6. In Fig. 6, the work is laid on a surface plate, the dividers being set to the radius of the work, and right-angle center lines are marked as shown with one leg of the dividers bearing on the plate. If the ends of the work are rubbed with chalk, the lines can be more easily seen. Another method, shown in Fig. 2, makes use of the center head, the blade of the tool being automatically centered on the work. Right-angle center lines are laid



off along the blade with a scribe.

Next, the centers must be accurately checked with a punch. This is done by hand, as in Fig. 5, the point of the punch being located exactly at the intersection of the scribed center lines. One sharp blow with the hammer will suffice to set the punch. If the punch mark turns up slightly off center, it can be moved in the proper direction by inclining the punch and repeating the operation. Another quick means of locating and punching the centers is the use of the bell center punch, as in Fig. 4. Several countersinks are shown in Fig. 3. The first, known as the combination drill and

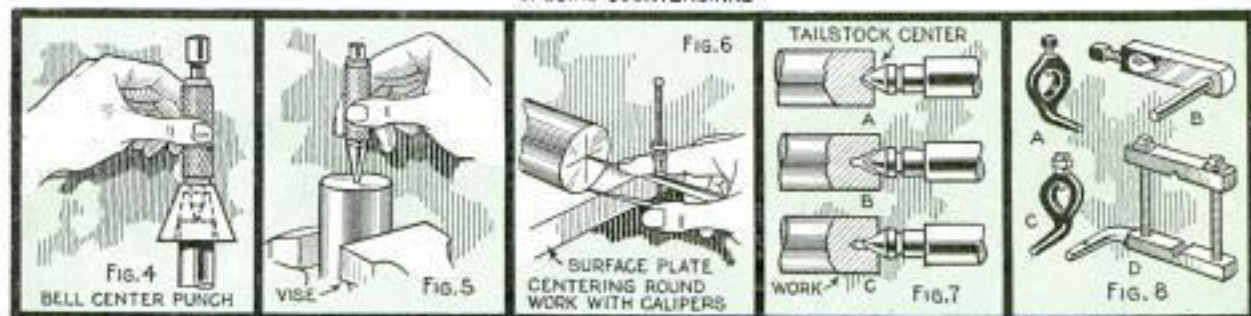

Before Turning on a Metal-Cutting Lathe, the Operator Should Know All the Tricks of Accurately Centering, Countersinking and Mounting the Work, as Success Greatly Depends on These Steps

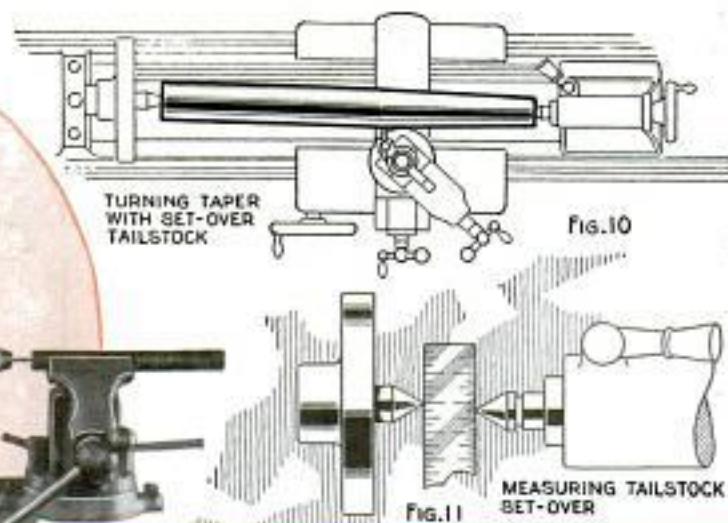

countersink, is most universally used, as it drills and countersinks the center in one operation, while the three tools A, B and C require the drilling of a small pilot hole as a separate operation. The tool C is especially effective on softer metals, such as aluminum. With care, very accurate countersinking may be done with a breast drill, as in Fig. 9, although it is better to do this on the lathe, as shown in Figs. 1 and 14. A drill chuck, fitted with a tapered arbor, is set in the headstock spindle, and the work is mounted with one end supported by the tailstock center. The tool post is removed from the carriage, and a dog is clamped at the center of the work, the tail resting on the carriage to prevent the work from turning. Apply a few drops of lard oil to the drill point when countersinking steel. On ordinary work the error in centering should never be greater than $\frac{1}{4}$ in., and this is, of course, not permissible where the work must be finished within close limits, or where the rough size is close to the required finished dimension.

Further, it is of the greatest importance that the work be countersunk to the proper depth, as shown in detail C of Fig. 7, and in Fig. 12, while details A and B of Fig. 7 show the result of countersinking too deeply or shallowly, both of which

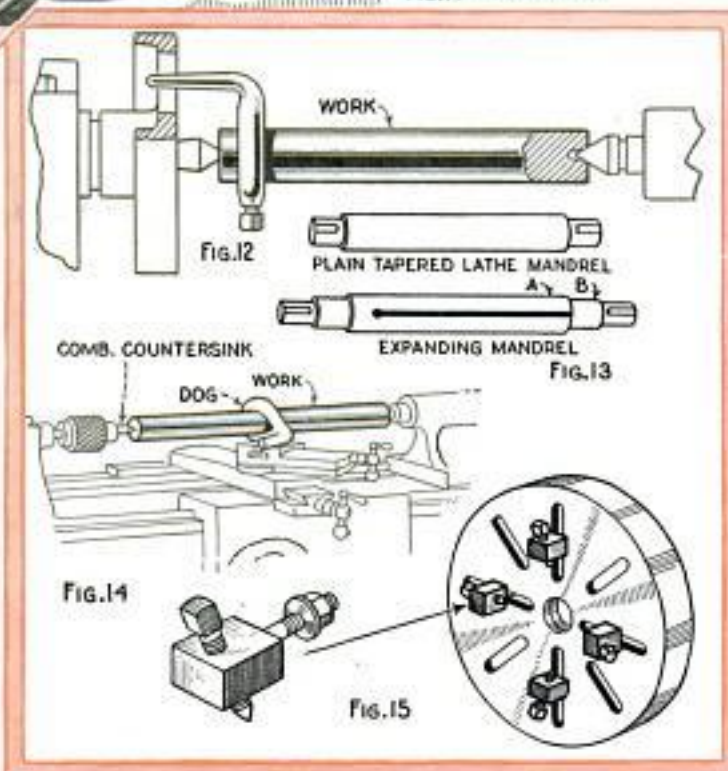

cause undue wear on the lathe centers.

The work is then mounted between centers and is driven by a dog, a few of which are shown in Fig. 8. Of these A is the most commonly used; type B is a variation of the same dog used for driving work of small diameter, while type C is fitted with a cap, covering the exposed head of the setscrew, to reduce danger of injury. Fig. 8, D, shows a dog used for driving square or rectangular work. When mounting the work, make sure that the setscrew is tight and that the tail of the dog does not ride on the bottom of the faceplate slot; also be careful not to draw the tailstock quill up so tightly that the work will bind, for considerable heat is

generated by turning and causes the work to expand slightly lengthwise.

Flat work in the square, rectangular or round, and more particularly work of irregular shape, is generally clamped or bolted to a large faceplate. Where a chuck is not available, the four faceplate dogs shown in Fig. 15 may be turned from square stock. When bolted in the faceplate slots as shown, they can be used for holding a variety of work. Cylindrical work, such as a bushing, which requires to be machined all over, is usually bored or reamed in a chuck and then finished on a mandrel mounted between centers and driven by a dog. Two types of mandrels are shown in Fig. 13. The first is a plain tapered one, while the second is of the expanding type, differing from the former in that it is fitted with a loose internally tapered and slotted sleeve. Detail A of Fig. 18 shows a piece of work mounted on a tapered mandrel, while detail B shows an eccentric mounted on a special mandrel with two pairs of center holes, one pair for concentric and the other for eccentric machining. Before driving the work in place on the mandrel, coat the surface of the latter with light machine oil to prevent the parts from seizing.

Turning a taper on work between centers is done by means of the set-over tailstock as in Fig. 10, practically all lathes being provided with this adjustment. The method of gauging the degree of set-over is shown in Fig. 11, while the common rule for calculating the set-over on work to be tapered its entire length is as follows: Subtract the diameter of the small end from that of the large end and divide the difference by 2; the quotient will be the set-over. Where it is necessary to work to an exact taper per foot, divide the total length of the stock in inches by 12; multiply this quo-

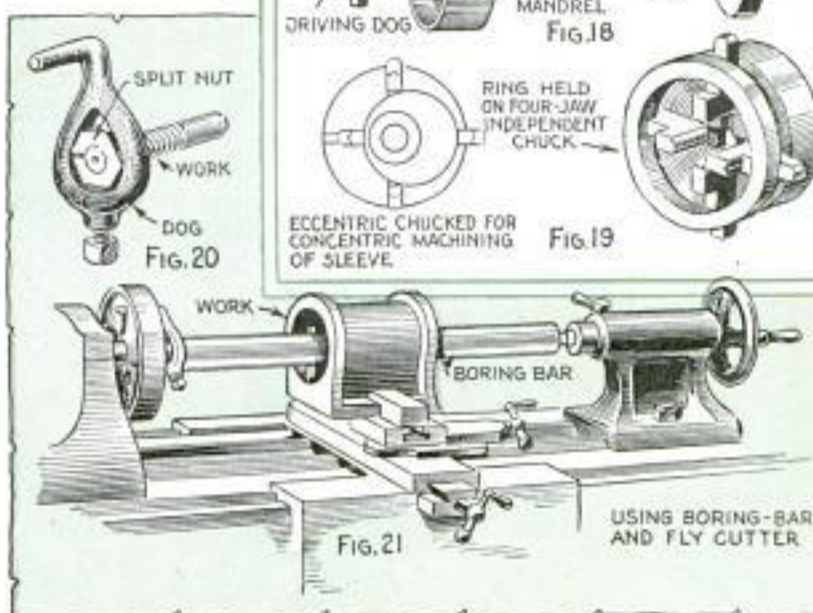
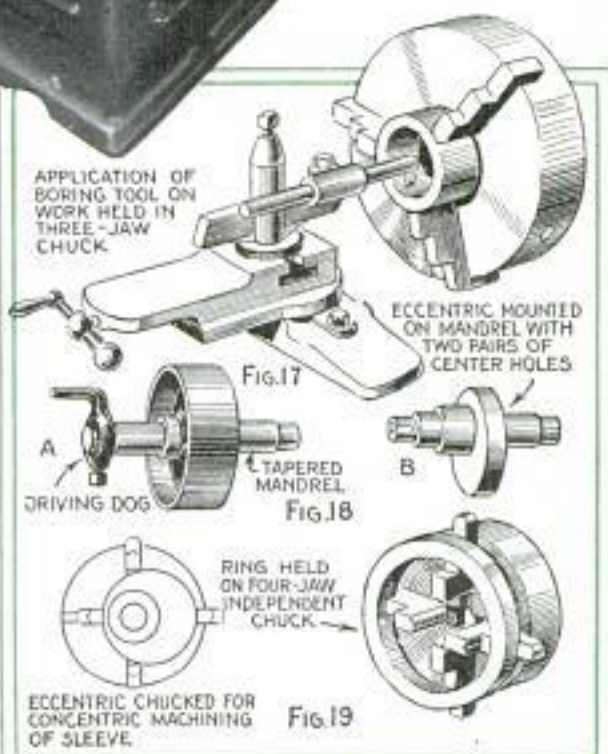
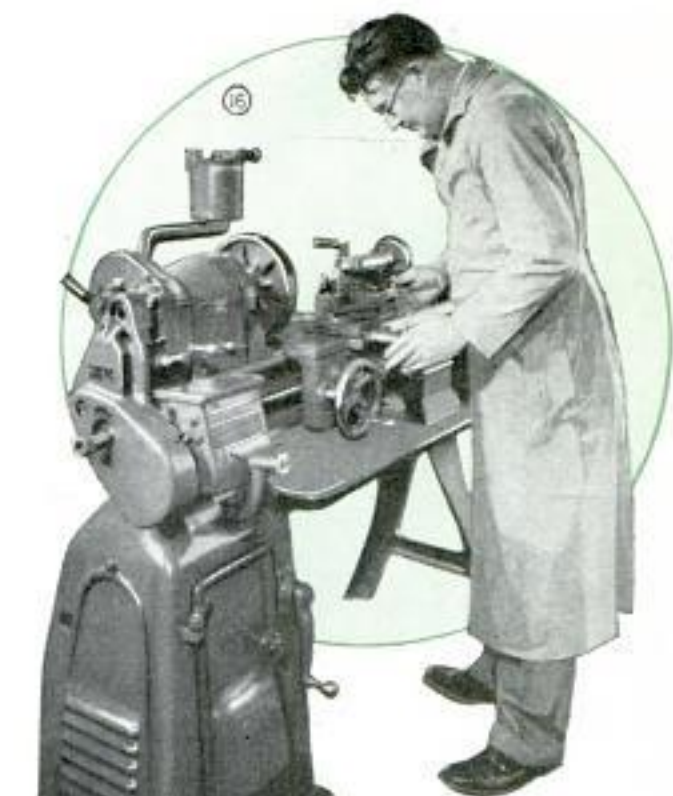



tient by one-half the amount of taper required, and the result will be the set-over.

If the lathe is to be used for a variety of machining operations, a chuck is indispensable, and where the shop affords only one, this should be of the four-jaw independent type, being more universal in adjustment than the self-centering chuck. Fig. 19 shows two typical examples of work mounted in a four-jaw chuck. The first is a method of chucking a large ring and the second a method of holding an eccentric off center for the purpose of machining the sleeve. Unless center-testing devices are at hand, it is necessary to center the work by trial, using the lathe tool as an index. On round work, the circles on the chuck face will aid in centering. The high place on the revolving work can be marked with chalk, and any inaccuracy may be corrected by slacking one or two jaws and tightening the one or the two opposite, to bring the work to the correct position. Be sure to remove the chuck wrench before starting the lathe. In centering some types of work, the tailstock may be used as in Fig. 23, the center of the work hav-



ing been located and checked with the punch. The tailstock center is then run up to the center of the work, to hold it in place while the chuck jaws are tightened. When the thickness of the work is less than the width of the chuck jaws, it is necessary to use a backing piece cut from hardwood of such thickness that, when placed behind the work, the edge of the latter will clear the chuck jaws as in Fig. 22.

When chucking work for external machining, it must frequently be mounted for internal

boring operations. Two examples are shown in Figs. 17 and 21. In the first, the boring tool is held in the tool post vertically, while the second shows a boring bar and fly cutter mounted between centers for boring work clamped to the tool-post saddle, care being taken to get it aligned properly to obtain a true bore. The fly cutter is made adjustable

transversely with the bar, and the latter is mounted between lathe centers and driven by a dog as in Fig. 21.

Another problem the lathe operator often encounters is that of machining a piece of round work, one end of which has been threaded. Fig. 20 shows how this is done by means of a split nut turned up on the threaded end of the work with the driving dog clamped on the nut. The latter holds the work securely and prevents damage to the threaded end.

Pumice Paste for Lapping Soft Metals

When lapping soft metals, such as copper and aluminum, mix equal parts of pumice powder and machine oil to use as a lapping compound. This compound will give a smooth job and will not dig into the surface, as is sometimes the case when emery flour is used.

Ensilage Stored in Trench Saves Silo Cost

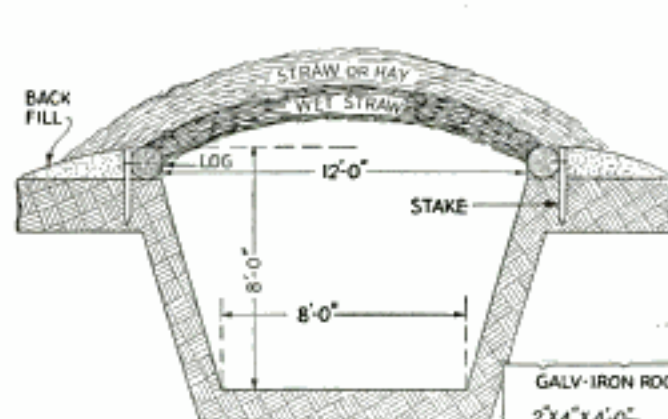

EXPERIMENTS conducted by the Nebraska agricultural department show that ensilage stored in a trench silo suffers very little spoilage, and that the silo can be constructed at small cost. Although the illustration shows the trench lined with bricks covered with cement plaster, or with a concrete wall, such construction is not necessary the first year, if the ground is moderately firm and will not cave in. The trench should be dug on fairly level ground that is well drained, both ends being sloped for ease of driving in and out, or it can be dug in a hillside, leaving only one end open. The size of the trench depends on the amount of ensilage to be stored, but it should not be too wide, as this may cause more spoilage. A trench, 40 ft. long with a 20-ft. slope at each end, 8 ft. deep, 12 ft. wide at the top and 8 ft. at the bottom, held 80 tons of ensilage, which was packed by driving a light tractor over it while filling.

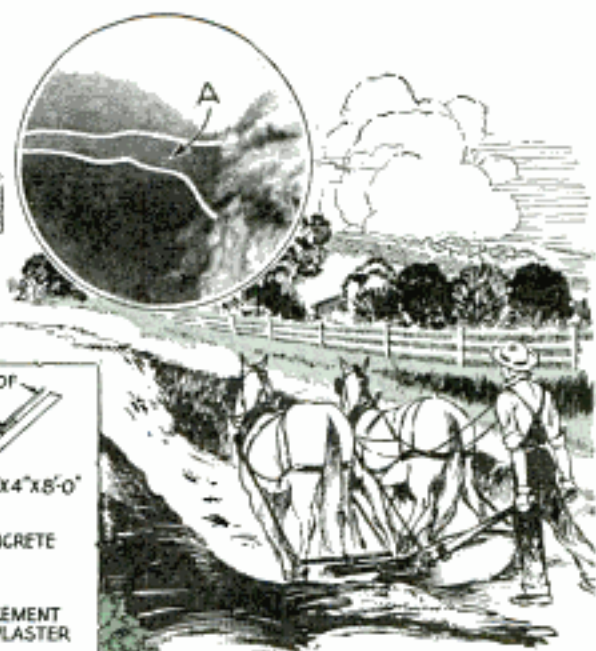
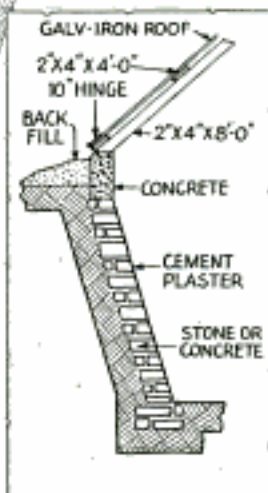

This is equivalent to two tons of ensilage for each foot in length of the trench proper, and six-tenths of a ton for each foot of slope at the ends. After the ensilage

has settled level with the top of the ground, place logs along the edge of the trench and make a backfill of dirt as shown in the left-hand detail. Then spread a 14-in. layer of wet straw over the top and cover this with dry hay or straw. The amount of spoilage is indicated at A in the circular inset. This layer varies from 4 in. at the center to 18 in. at the sides, or about 7 per cent of the total amount of ensilage, which is considerably less than the percentage of spoilage in a concrete or wooden silo of the usual type.

Miter Box for Cutting Pipe



Accurate miter cuts can readily be made in pipe, and metal or wooden rods, by using the illustrated box. It consists of a length of angle iron, of suitable width, hav-

ing miter cuts made in it with a hacksaw. In use, it is clamped to the pipe with a large C-clamp. This is a simple method of doing a job that would otherwise require careful measurement and sawing.

Glass Tubing to Erase Ink

Draftsmen will find a piece of freshly broken glass tubing serviceable as an ink eraser. Hold the tube almost perpendicular to the paper or tracing cloth, and use the sharp edge of the broken portion to scrape off the ink.



Painters Who Have a Number of Small Jobs Requiring Different Paints Will Find This Carrying Case Handy

Carrying Case for Paint Cans

Here is a carrying case that will be appreciated by the painter who has a number of small jobs to do. It is made from an ordinary dry goods box which, in this case, was 10 by 12 by 19 in. in size. It is fitted with a shelf of $\frac{3}{4}$ -in. stock while two $\frac{3}{4}$ by 1-in. cleats nailed on the bottom serve as feet. Strips $\frac{1}{4}$ by $1\frac{1}{4}$ in. in size are nailed across the edges of the shelf and bottom to prevent the cans from falling out. The bottom shelf is divided into two parts by a $\frac{3}{4}$ by 3-in. partition, one side of which may be used for cans and the other for brushes. A suitable handle is also provided by nailing two $\frac{3}{4}$ by 1-in. cleats to the ends of the box vertically and attaching a $\frac{3}{4}$ by $1\frac{1}{2}$ -in. cross-piece.—M. C. Smack, Jr., Indianapolis, Indiana.

Worn Pilot Bearing Causes Noisy Second-Speed Gears

The main driving gear in most automobile transmissions is fitted with a bearing within the gear itself, which supports the end of the main shaft. This bearing is subject to considerable wear if much driving is done in second speed, and allows the gears to run slightly out of mesh, which results in noise and excessive wear

on the teeth. The remedy for this condition is to replace the bearing.

Clamps for Built-Up Column Work

Built-up column work is rather difficult to handle without suitable clamps. The clamp shown in Fig. 1 is to be used in connection with a C-clamp and is not adjustable. It consists of a heavy-gauge tin or light sheet-metal band, about 2 in. wide and 5 in. longer than the circumference of the column. Two blocks of hardwood are cut, with the grain, to the shape shown in Fig. 2, and fastened to each end of the band. In use, the band is slipped around the column and drawn up tight with the C-clamp. Another type, shown in Fig. 3, is adjustable and consists of a 6-in. piece of $\frac{1}{2}$ -in. bar iron and a suitable length of No. 0000 wire-coil chain. The iron is drilled at one end to receive a $\frac{3}{8}$ -in. eyebolt, 6 in. long, while the other end is slotted to receive one end of the chain. It is then bent to the shape shown and assembled. In use, run the nut out to the end of the eyebolt, place the clamp around the work and fasten the chain in the slot. Then tighten it by running up the nut. It is a good idea to place heavy paper under the clamp to prevent marring the work.

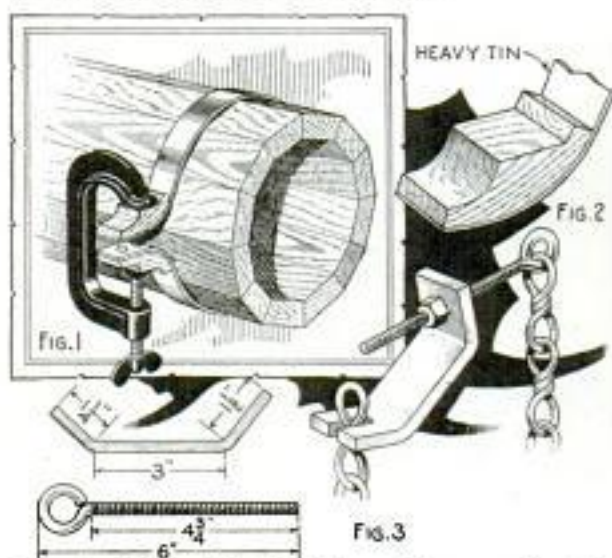

Built-Up Column Work of Large Diameters Can Be Held Firmly with These Clamps

How to Anneal Aluminum

For raising wire edging, forming, or to get elasticity on sheet aluminum, use an acetylene flame without oxygen. This will deposit a dense film of carbon or soot on the part where annealing is to be done. Then add oxygen to the flame until it is neutral, burn the carbon off with a rapidly swinging motion of the torch and with the flame approximately $\frac{1}{2}$ in. from the work. Care should be taken not to hold the flame on the metal after the carbon has disappeared, as such a heat may burn it. This method will be found more satisfactory and thorough than heating with flame and testing with a soft pine stick for charred marks.

A Soldering Iron for Places Hard to Reach

When you have light soldering work to do in places difficult to reach with an ordinary iron, make this one. It consists of a suitable length of copper wire, one end being pointed and tinned and the other wrapped with asbestos paper and fitted into a wooden handle. The purpose of the



paper is to prevent the wire from burning the handle. In use, the wire is heated and kept hot by holding a flame from a Bunsen burner against it, as near the work as possible.

The heat will travel down the wire and keep the point hot.

Shop-Floor Covering from Discarded Fabric Belting

By covering the greasy spots on shop floors with discarded fabric belting, slipping on them and consequent accidents will be reduced. Even though oil continues to drip on the belting, it will not become slippery. It is cut into suitable lengths and laid on the floor where it is tacked down. On a concrete floor, it should be thoroughly cleaned and the belting made fast with linoleum cement.



Guide Aids in Starting Air Drill on a Smooth Surface without Slipping or Jumping

Guide Prevents Jumping of Air Drill

When starting an air drill on a smooth surface, the tendency to slip and jump can be prevented with a guide into which the end of the drill is slipped. Two projecting arms on the guide enable the worker to hold it down securely with his feet. As many air-drill operators attempt to hold the tool between their feet, such a guide will help to avoid accidents.

Wristpins Bolted Together Form Handy V-Block

An emergency V-block can be made from two wristpins held together by a small bolt through the holes in the center. If there are no holes, the pins may be welded or brazed together. As the pins are very hard, they will stand abuse and are as good for faceplate work as for the bed of a drill press.

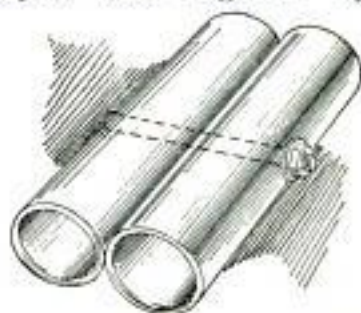

Insulating to Cut

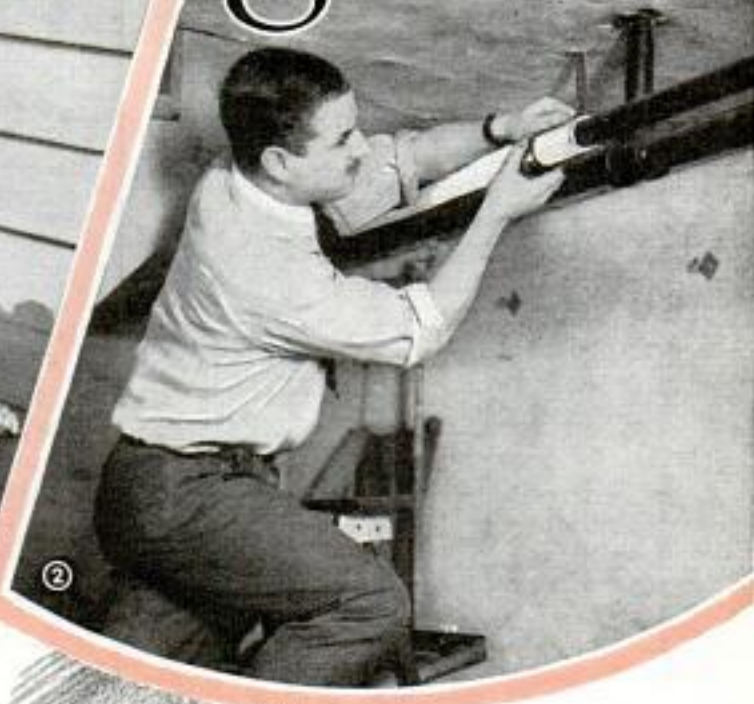

H EAT escapes from your home both by wind action and conduction. Wind striking the exposed sides of the house drives cold air through the cracks and crevices around the doors and windows. The entrance of this cold air crowds a like quantity of warm air out the opposite or sheltered sides of the house through similar exits. Heat is also lost by conduction through the building materials which form the walls and windows. Wood is a poorer conductor than stone, brick or concrete, and a dead-air space

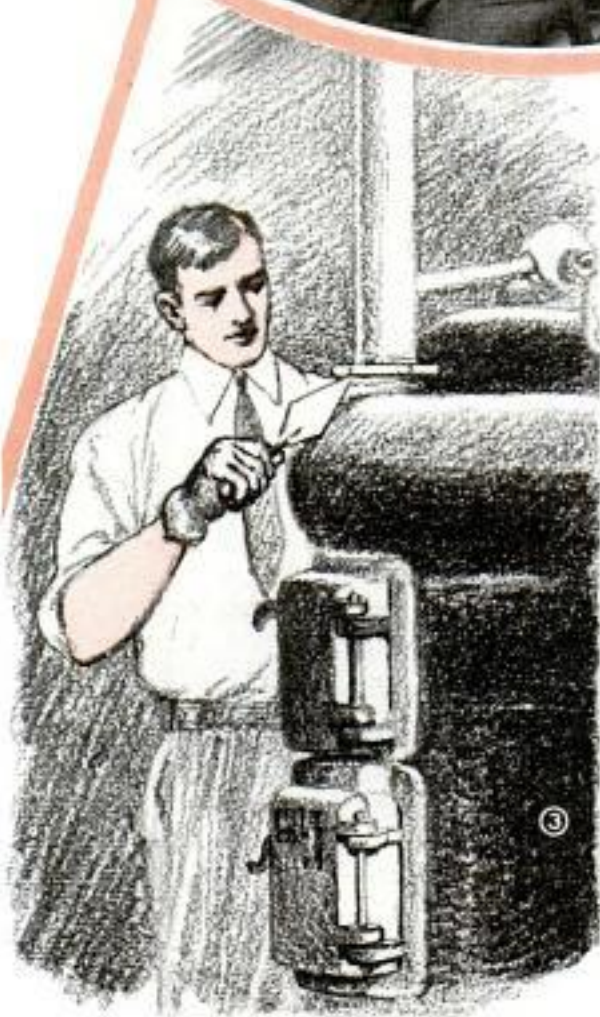

Ground Asbestos, Moistened to Form a Stiff Paste Is Troweled on the Boiler and Covered with Cheesecloth

ranks as the poorest known conductor. Experiments prove that the thicker the material, the less is the heat lost in a given period. Efficient and relatively inexpensive insulation materials are now available, but they should never be substituted for structural materials as they lack strength for such service.

You can prevent heat losses through the ceiling by placing a 4-in. layer of fibrous insulation, such as mineral wool, hair felt, granulated cork, or the like, directly above the plaster and between the

As Much as Three-Tenths of Heat Losses from the Average Home Can Be Stopped by Using Storm Sash on All Windows, Sealing the Sash with Felt, and Screwing Them On Tightly

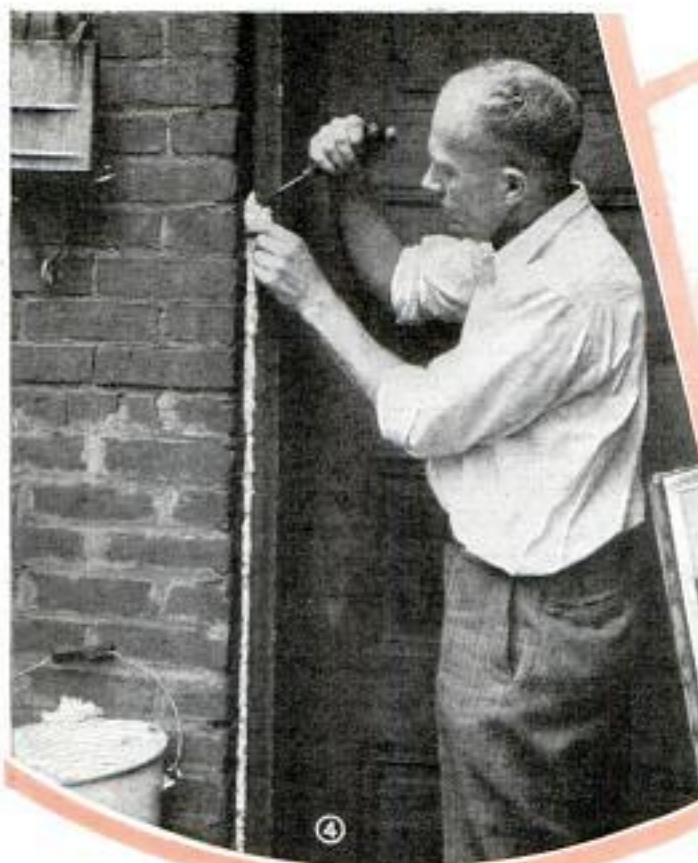

Your Fuel Cost

joists or the top-floor ceiling. A wooden rake with a flat face makes an effective tool to spread this insulation, the width of the rake being slightly less than the distance between the joists. The roof must be leak-proof, as wet insulation is worse than none, and the roof should therefore be inspected and repaired before the insulation is applied. Where it is impractical to use fibrous material, insulation board, which can be nailed to the inside face

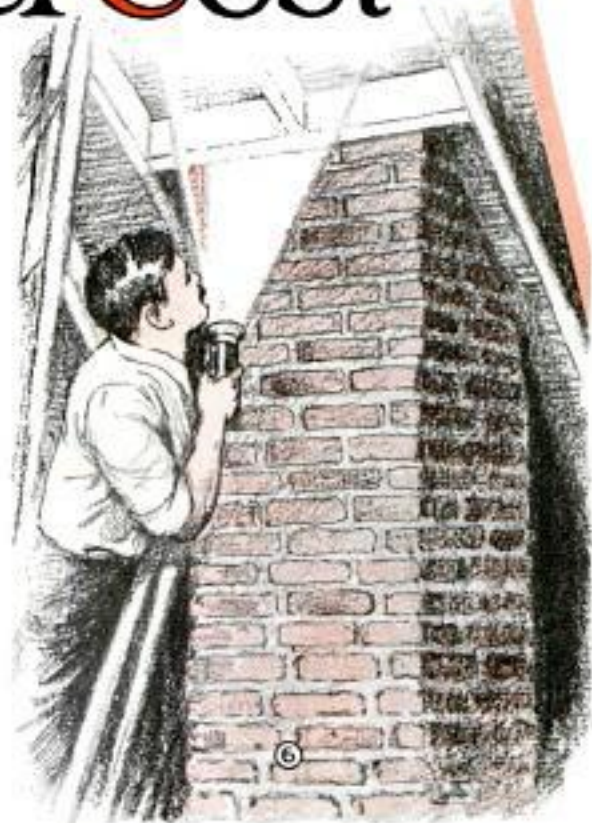

Leaky Roofs Allow Moisture to Soak into Insulation, Which Then Becomes Ineffectual for Its Purpose

of the roof rafters, is advisable. It is usually impractical to attempt to insulate the walls of an old house because of the expense involved, but the average owner can plug the major outlets of warm-air leakage by calking the cracks in the window and door frames with mastic, as shown in Fig. 4. Entrance of cold air between the door and its casing can be greatly reduced by applying stripping as in Fig. 7, while space under a door should be closed as in Fig. 8. In houses



of frame construction, this process may necessitate the temporary removal of facing boards, while in brick, stone or stucco dwellings, the spaces between the walls and the window and door frames must be plugged. Also caulk the crack around the bottom board or skirting which overlaps the foundation, as in Fig. 1, to prevent flue action.

The use of tight-fitting storm sash, sealed with felt strips, as shown in Fig. 5, and drawn up with screws, is one of the most efficient ways to prevent heat loss and improve humidity. If you cannot af-

ford to equip all your windows with storm sash, at least provide them on the north and west exposures and, if possible, on the east frontage also. It is possible to stop approximately three-tenths of the ordinary heat loss in this manner, while condensation and ice formation—the major foes of successful humidification—are prevented by double panes of glass with the supplementary dead-air space.

The importance of vagrant basement heat is seldom appreciated. This seeps readily throughout the average house, which mostly is rather porous. To gain the maximum benefit from this heat, the basement windows must be equipped with tight storm sash. In cases of exposed frame houses, it is good practice to bank the outside basement walls with brush, straw, stable manure and other natural insulation. Under such conditions, it is inadvisable to insulate the hot-water or steam pipes in the basement. If, on the other hand, too much heat is retained in the basement, it is a good idea to cover the pipes as in Fig. 2, in order to prevent excessive loss of heat from them. Similarly, the boiler should be covered with ground asbestos moistened to form a stiff paste, as in

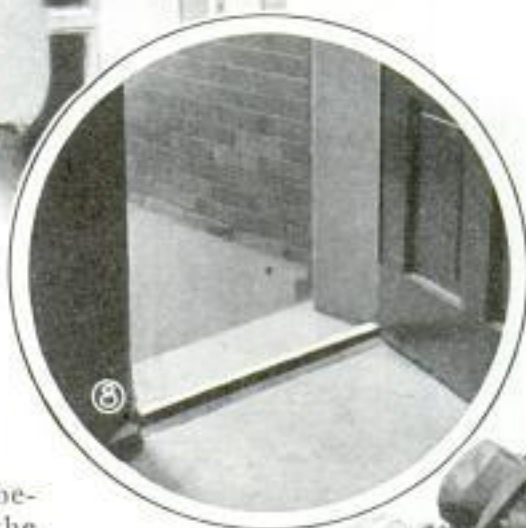

Top and Center, Applying Weatherstrip to Keep Out Draft; Bottom, Workman Repairing Roof before Insulating the Second-Floor Ceiling

Fig. 3, and apply cloth on top of the asbestos.

Low, thin cast-iron radiators, located under windows, heat a room more comfortably and more economically than high-column or tubular radiators, similarly placed. The use of a properly designed shield on a tubular radiator effects a gain in steam economy and more satisfactory air conditions than if a similar but uninclosed radiator is used. Locating radiators near the ceiling is poor practice as the heat does not circulate as well. Oil paint should be used exclusively in painting radiators, as it has no material effect on heat transmission, but heat transmission is about one-eleventh less where the radiators are covered with a bronze or galvanized coating. It has been found, also, that the use of storm doors caused a gain in steam economy as high as 21 per cent, in addition to improving room temperature, while the use of both storm doors and storm sash resulted in a gain of almost one-third in steam economy. In the case of the average householder, this saving depends on the ratio of window and door area to exposed wall area and on the air-tightness of the storm door and sash. Curtains and shades, which screen your rooms against sunlight and afford privacy at night, also increase comfort during the winter by shielding the occupants of the house from radiation of cold from the glass.

Table for Handling Long Work on Small Jointer

Long work can be handled on a small jointer by using extension tables at the ends and a rest to hold the work vertically. The jointer is mounted on two lengths of 2 by 6-in. stock, which must be perfectly straight. The table is then adjusted to make the desired cut, and another table is added at each end by mounting $\frac{3}{4}$ -in. stock, ripped to the same width, on crosspieces as shown. Test all surfaces

With Wooden Extension Tables and a Work Rest, You Can Handle Long, Wide Jobs on a Small Jointer

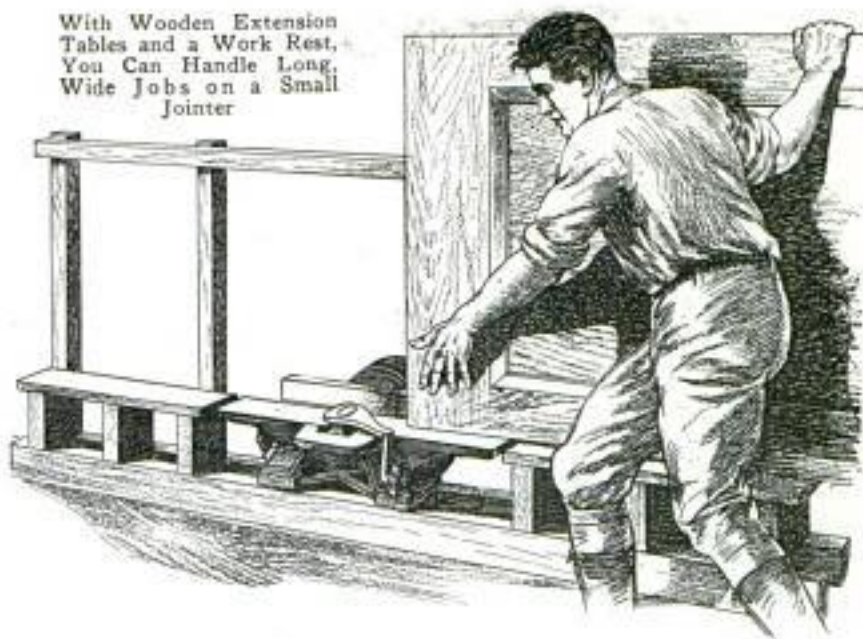

with a straightedge to get the extension tables exactly the same height and width as the jointer tables. Nail four upright pieces to one of the 2 by 6-in. base pieces. Nail a guide rail of 2 by 2-in. stock across the uprights at the top to be in line with the jointer fence. If the tables and guide rail have been accurately lined, no trouble should be experienced in making a cut the full length of work such as doors and window sash.

Shop Seat Made from Discarded Machine Parts

Parts from discarded farm machinery were used to make the shop seat shown here. It consists of a disk blade, a seat and two lengths of pipe. The blade was



used as a base and was welded to a suitable length of pipe. The seat was welded to another length of pipe that would slip easily into the first. A collar and setscrew permit tightening the seat at any height that may be desired.

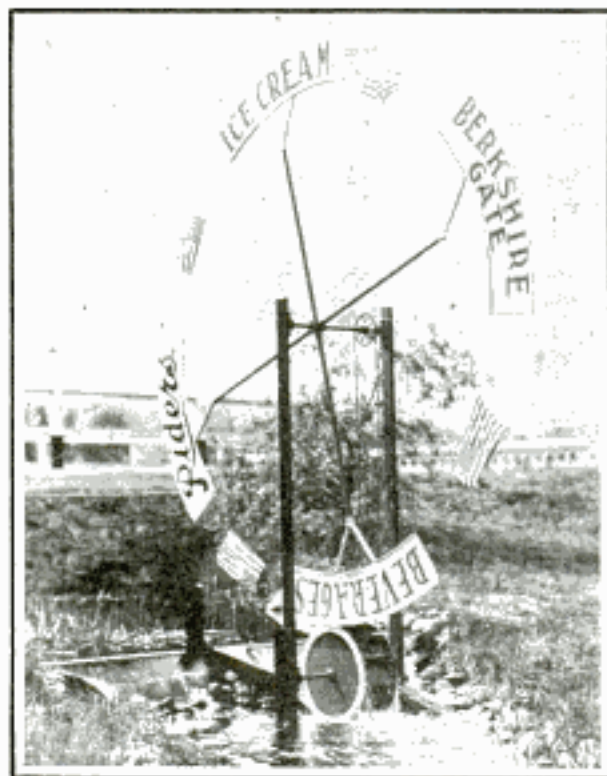

This Sign Will Bring Your Advertising to the Attention of the Public at Small Cost

Revolving Sign Driven by Stream

Here is a revolving sign that costs nothing to operate and attracts considerable attention. It is operated by a water wheel which drives a shaft supported on two uprights. Lengths of pipe attached to the center of the shaft and at right angles to it hold a circular sign as indicated. A small chain runs over sprocket wheels attached to both the sign and wheel shafts. Care should be taken to make the sign sufficiently strong and not too large as a high wind might tear away the mechanism. As little power is required, this sign can be operated by a very small stream.—H. R. Snyder, Guilford, Conn.

How to Grind and Polish Ends of Glass Tubing

Ends of glass tubing can be ground plane and perpendicular to the axis of the tube as follows: Chuck a block of soft brass in the lathe and face off the end. Mount the tube in a wooden frame in the lathe, with the free end held in a padded pipe center and the other end pressed against the brass block. Run the lathe at slow speed and use fine grinding compound mixed with water as an abrasive.

The polishing can be begun with crocus, continued with a hard-rubber lap, and finished with a pitch lap and rouge.

Chain Link Prevents Tethering Rope from Tangling

When staking an animal out to pasture, a chain link will be found a good means of connecting the rope to the stake. Have the stake made with a large head, and drive it through a link that is just small enough not to slip over the head. Then tie the tethering rope into the link. As the animal walks around the stake, the link will turn on it, preventing the rope from being wound around the stake.

Sand Blast Cleans Spark Plugs

Operated by compressed air, obtainable at any gas station, this spark-plug cleaner will be useful to the car owner as well as the garage mechanic. In the lid of an ordinary cigar box, drill a hole near one end and insert a tire valve stem. Directly under this, drill a hole in the bottom to fit the threaded end of the standard plug and also drill a $\frac{1}{2}$ -in. hole at the other end, this one being used as an air vent and covered with fine cloth or fine screen wire. To operate the cleaner, put a handful of fine, sharp sand in the box, insert the plug as shown and press the lid down tight, holding the box in a vertical position with the air vent on top. Press the nozzle of the air hose over the valve stem

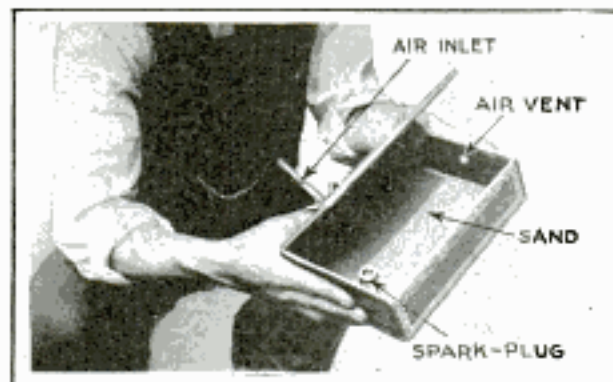

Spark Plugs Are Thoroughly Cleaned with This Sand-Blast Cleaner in Two or Three Minutes

so that the air will drive the sand into the plug, thoroughly and quickly cleaning it.

Be sure to oil the surface of work to be knurled.

Imitation WOOD INLAY

Turned from Scrap Stock



BEAUTIFULLY finished and highly attractive, these imitation lamps, hat stands, and other turnings, cost practically nothing, as scrap stock can be used in making them. The trick lies in gluing alternate layers of dark and light-colored wood on a core and then turning down the resulting block to expose the different woods. All you need is the wood, some glue and varnish, plus a small lathe and a couple of chisels and clamps. First make a core 1 in. square and from 6 to 15 in. long, depending on the design and shape of the lamp base desired. Then drill a $\frac{3}{8}$ -in. hole through the center for the lamp cord. For the longer designs, it is better to split the core and groove out the insides of both pieces with a gouge or a dado head, then glue them together again. The core should be of dark wood, such as mahogany, walnut or cherry. When it is cut to size and planed smooth, add the first layer of wood, which should be light-colored. Prepare four pieces of this wood, $\frac{1}{4}$ in. thick and of suitable dimensions to cover each side of the core. First glue pieces on opposite sides. Clamp the assembly and allow to dry. When thoroughly dry, true up the edges with a plane and glue pieces on the other two sides. Plenty of pressure should be applied in clamping, or an uneven contact is likely to result and there will be gaps or open joints between the different woods after the block has been

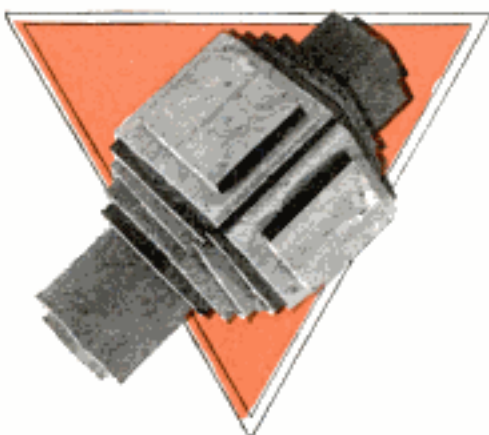

turned. The second layer is applied in the same way, using a dark wood of the same thickness. Continue using alternate layers of light and dark wood until the desired thickness is obtained, as shown in the lower detail.

The base of the lamp can be made in "sandwich" form by gluing three or four layers of different wood on each other. The base is glued onto the bottom of the block so that both can be turned at the same time. A groove should also be cut in the base to receive the lamp cord. When the turning is finished, apply a wood filler. Then follow with three or four coats of varnish, sandpapering between successive coats. The final coat is rubbed with pumice or powdered rottenstone and rubbing oil. A coat of wax gives a very rich luster. The result is a handsome imitation inlay lamp that is difficult to distinguish from genuine inlay work. In addition to lamps, such articles as darning eggs, hat sets and smoking stands, in fact any article of wood that is turned, can be made by this method.

Another method of imitation wood inlay is shown on page 878. Pieces of light and dark wood are selected and planed smooth and to the same thickness as a great deal of the finished effect depends upon this. The pieces of dark and light

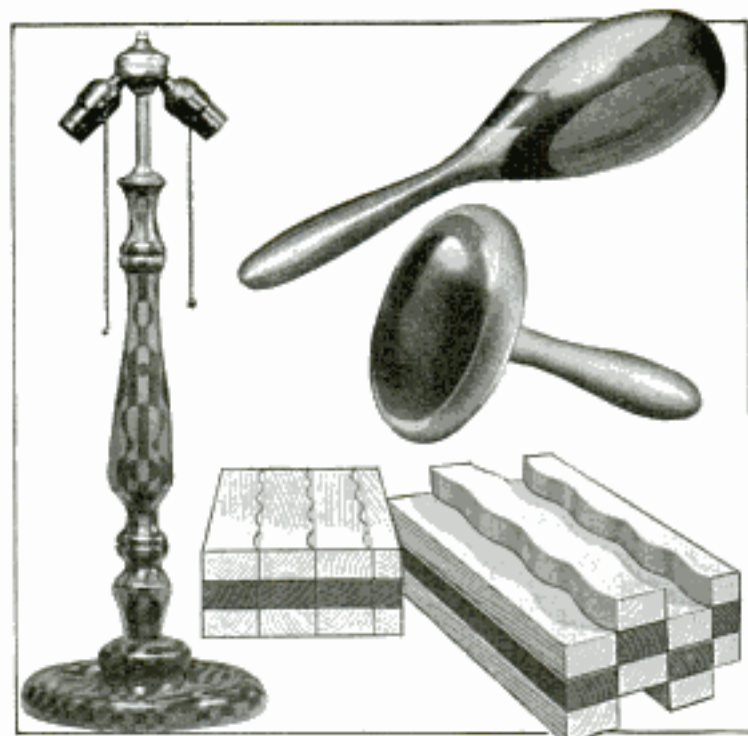

Glued Up Strips of Dark and Light Wood, Checkerboard-Fashion, When Turned, Produce Odd Designs

wood are glued together and placed between clamps to harden. After the pieces have dried, they are run through a band-saw. Any series of wavy lines may be cut along their length and need not be regular in order to bring out the finished effect. After finishing all the sawing, the alternate vertical rows are moved up the thickness of one board and the pieces again glued. When dry, the protruding pieces are cut off, and the piece is ready for the lathe. It should be remembered that one row more than the thickness of the finished block of wood is required because the rows are moved up and then cut off. By carefully following the two methods described, beautiful effects in imitation wood inlay can be produced, and skill in turning depends on practice.

A Non-Slip Handle for Your Babbitt Hammer



When using a babbitt hammer with greasy hands, the chances of having it slip out of your grasp can be greatly reduced by knurling the handle. Do this for

about one-half its length, then flatten it slightly as shown—A. Mathieu, Chicago.

Reclaiming Silver Solder

Silver solder, that is generally used for soldering fuel and oil lines on aircraft engines, can be reclaimed and used again by cleaning off the grease and melting it out of the joints. When melted in a puddle a small rod is plunged into it and the solder will adhere to it. When cool, it can be applied to small jobs under flame, using the rod to make a raking motion where the bonding is needed.

Brazing Enameled Ware

Enameled cooking utensils, of iron or steel, can be brazed when in need of repair. No flux is necessary, as the enamel will serve this purpose. The brazed portion can be tinned when used for cooking. Many otherwise useless articles can be reclaimed in this manner for a few cents.—Hallie P. Davidson, Great Lakes, Ill.

Self-Sealing Shellac-Pot Cover

Covered with an old hydrometer bulb, the contents of a shellac pot can be kept in good condition.

A pot with a wide mouth is fitted to a wooden base by drilling a hole partly through the latter and cementing the pot to the base with shellac. A hole is cut through the center of the bulb to receive a handle.



Surfacing Thin Stock on a Planer

Thin boards can be surfaced on a large planer by laying a piece of heavier stock over them. The heavier piece affords a rigid support so that there is no spring or vibration to throw the boards into the cutters unevenly.

An Underground Refrigerator for the Farm

Underground refrigerators, easily made and efficient, are being used on farms in certain parts of the country as a substitute for the usual method of cutting ice from ponds and storing it in ice houses. Under the floor of a small building, set aside for the purpose, a pit, 8 ft. square and 9½ ft. deep, is dug. The sides are boarded up with cheap lumber, leaving a 12-in. space between the earth and the boards to be filled with sawdust. The bottom of the pit is covered with a 1½-ft. layer of coarse gravel to insure effective drainage. The floor of the ice house should be made of two thicknesses of lumber, with a layer of heavy paper between. The windows are boarded up during the summer so that the inside of the ice house will be kept as cool as possible. During freezing weather, water is run into the pit, a few gallons at a time, and allowed to form ice, the building being left open to admit the cold. This process is repeated until a solid cake of ice, 8 ft. square and over 6 ft. thick, has been formed. The floor is then replaced and the house tightly closed. In many sections of the country such a cake of ice will last throughout the summer, providing a cold-storage compartment for milk and other products. A suitable lift is built to fit into the ice chamber, and a block and tackle are used to raise and lower the lift, which is necessary when it carries an extra heavy load, such as two or three milk cans. The floor of the lift consists of a number of wooden strips, spaced apart to permit circulation of air so that the heat of the load will not be transmitted directly to the ice. Also notice that the parts of the lift are assembled with strap iron to increase its strength.

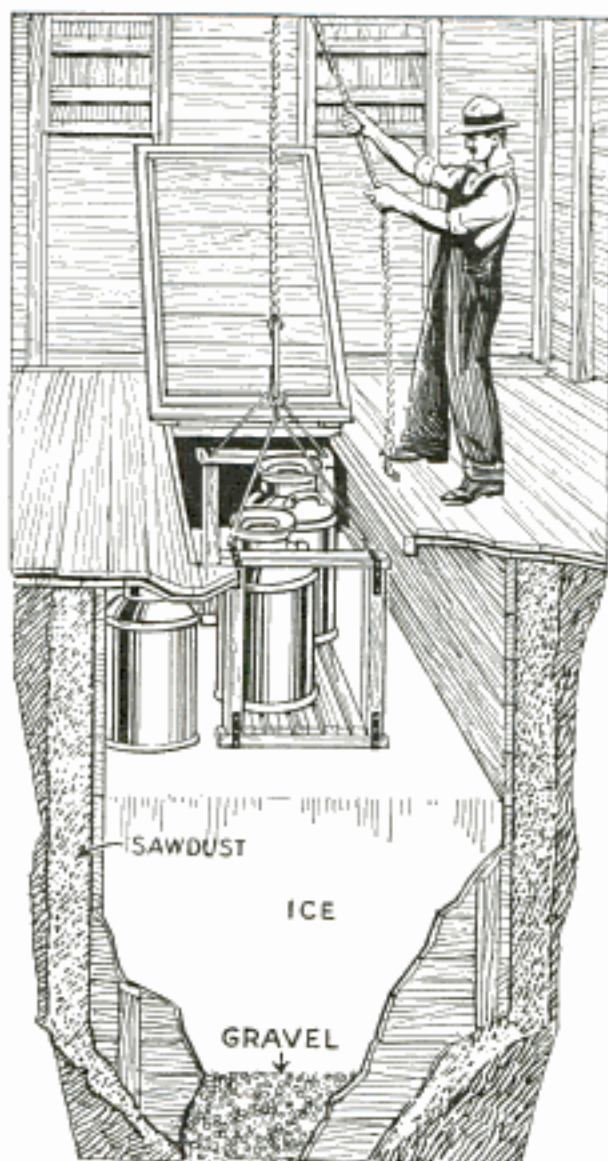

Large Cake of Ice Frozen in Underground Box During Winter, Provides Refrigeration All Summer

The trapdoor should fit snugly to prevent air from getting into the pit unnecessarily, and like the flooring, it is made up of two thicknesses of lumber with heavy paper insulation between.

Arc-Brazing Galvanized Surfaces

It is comparatively simple to braze zinc and galvanized surfaces with an electric arc. To do this, copper, which will melt in the arc, is used instead of brass. It will mix with enough of the zinc to form an adherent alloy similar to bronze. As a current of only 45 volts is needed, a transformer must be used if the voltage of the

current supply is over 45. One wire from the transformer is connected to the work and the other to the carbon. A length of large-size copper wire is then held against the work so the arc is from the wire to the carbon. Flux must be used.

☛ Separate links of worn-out chain placed in a tumbling barrel will aid in polishing or smoothing a product.

Indicator for Testing Bent Shafts

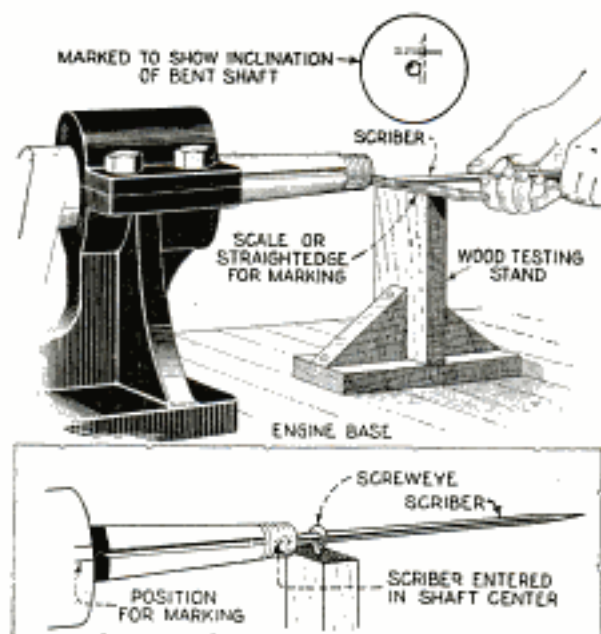

Bent Shafts Straightened without Dismantling by Means of a Jack and Improved Test Indicator

The degree of bend in a shaft can be determined without dismantling it by using this tool. A wooden upright is made to the approximate height of the center of the shaft. A scale or straightedge is placed on top of the upright and used as a steady rest for a scriber, with which lines are scratched in the end of the shaft at right angles to each other to show the direction of bend as in the upper detail. The shaft is then straightened by exerting pressure against it with a jack. Other tests are made until the shaft is as nearly straight as possible. For a more accurate test, a screw-eye is driven into the top of the upright, the scriber passed through it and inserted into the center at the end of the shaft, as shown in the lower detail. The free end then acts as an indicator.

Miters Cut without Miter Box

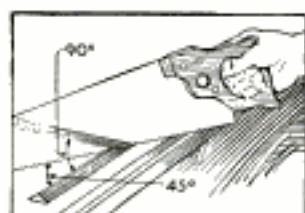

When cutting miters, much time can be saved by "shadow-sawing." A saw having a bright blade is placed on the work in the approximate position where the miter is to be cut. Then the saw is moved until the reflection of the work on the blade forms a right angle with the real work, as shown. After a little practice

you will be surprised with the accurate results obtained in this way.—Roy Beach, Placerville, Calif.

Larger Cone Tip for Brazing

When a white smoke issues from the added material in brazing, its quality is being injured. A larger tip than is ordinarily used should be employed for this work with a neutral flame. When the desired heat is reached, the flame should be held 2 or 3 in. away from the work and the bonding material melted within the envelope, but not directly under the white cone. The flame may be moved closer or farther away from the work to get a good job. The envelope should be maintained in a protective position at all times where brazing is in progress.

Holders for Long Round Stock

For long round stock, the holders shown will be of considerable utility to keep them piled neatly. Lengths of bar iron, with the ends bent at right angles, are placed on each layer of the stock to hold the next layer in place. Besides being neat, the piles cannot roll down and cause injury to workers.

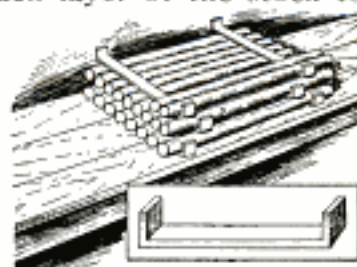

Whiting Prevents Tin from Adhering to Brass or Copper

When dip-tinning brass and copper parts, a mixture of whiting and water, applied to the surfaces not to be tinned, will prevent the tin from adhering to them. This mixture should be allowed to dry before dipping. It will not burn off or injure the tin in the pot.—V. C. Darby, Cedar Rapids, Iowa.

Oil Keeps the Chisel Edge Keen

A cold chisel, used for cutting mild or cold-rolled steel, will stay sharp longer if it is occasionally dipped in oil. A heavy-bodied machine or lard oil has been found best for this purpose.

The three types of men that buy "Yankee" bit braces



"YANKEE"
Chuck will not
loosen

FIRST, the tool lover—mechanic or handyman, who appreciates finish and precision in toolmaking, and takes pride in ownership of fine tools.

Next, the thrifty customer who is careful to put his money into long-run values—insisting that *best* is cheapest in the end.

Then, the ambitious worker who sets up new standards of speed, accuracy, quality, and hunts out the most efficient tools to be had.

And there is a *fourth*, who may be any one of the three: The man who thought he did not need another bit brace—until he saw the "YANKEE," at his tool dealer's.



"YANKEE"
Ratchet Shifter



With Shifter down tool is set for right-hand ratchet. With Shifter up for left-hand ratchet.



Visible, quick, positive and easy-acting. Ratchet Shifter

Famous
"Yankee"
Ratchet

Bronze encased. Dust and moisture proof.

New
"Yankee"
Chuck

Patented, quick-centering. Ball-bearing. Holds any bit: round, square, taper.

"YANKEE"
Brace No. 2100

NOW

*Chromium Plated
Over Nickel
Always Like New
No Extra Charge*

Two-jaw chuck. Holds $\frac{1}{2}$ " round; $\frac{5}{8}$ " square (across corners). Four sizes: 8-, 10-, 12-, 14-inch. Price, 10-inch sweep, \$8.20.

"YANKEE" Bit
Extension No. 2150

Bit held in socket. No jaws! Nothing to break or jam. Bit can't loosen in work; can't pull out of socket. Fits any brace. Follows through. 15', 18', 21', 24'. \$2.25 to \$2.40.



-----"YANKEE" on the tool you buy means utmost in quality, efficiency and durability.-----

North Bros. Mfg. Co., Lehigh Avenue, Philadelphia, U. S. A.

You may send book showing *action pictures* of famous "Yankee" Ratchet tools; such as Ratchet Screw-drivers, Spiral Ratchet Screw-drivers, Ratchet Push Drills, Ratchet Push Braces, Ratchet Breast and Hand Drills, Ratchet Chain and Bench Drills, Ratchet Tap Wrenches, Etc.

Name.....

Address..... (pm)

When writing to advertisers please mention *Popular Mechanics*



New 1932 Delta Motor-Driven Units

THIS SEASON Delta announces new "Quality" Motor-Driven Tools of extraordinary interest to those who work with wood for hobby, spare-time earnings, or production work. The entire Delta line has been greatly enlarged and now includes new tools of almost sensational performance finally perfected after years of careful development and testing. *While new low 1932 prices prevail throughout, the high Delta standards of workmanship, efficient design, and quality materials have been everywhere rigidly maintained.* Delta still offers the most machine value per dollar. Delta quality still pays in the end! Send coupon on next page for FREE catalog giving full details on complete Delta line.



New Delta DRILL PRESS

Large capacity. Ball-bearing spindle. Automatic leveling, accurate tilting table. Many special features—an unusual value.

New Delta BAND SAW

Smooth running—Efficient—Safe. Ball-bearings throughout, including the blade guide. Fully guarded in every way. Graduated tilting table. Surprisingly low priced.

Both Drill Press and Band Saw can be mounted on convenient, portable Delta Stands.

Complete DELTA 1932 Line

Includes
Woodturning Lathes
Drill Presses
Complete Handi-Shop
Jointers
Circular Saws
Band Saws
Mortiser and Router
Moulding Cutter
Scroll Saws
Many New Accessories

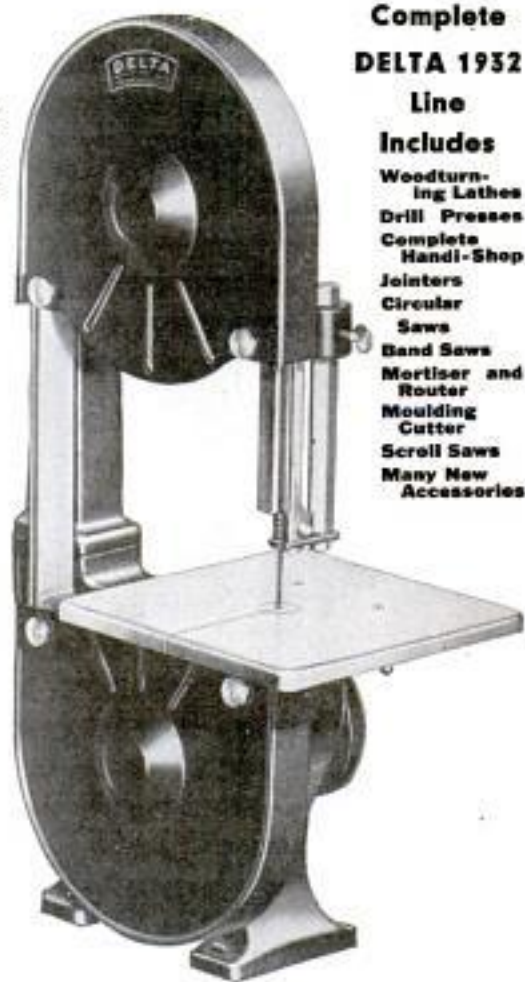

Complete Delta COMBINATION SHOPS

Here illustrated is the Delta "De Luxe" Combination Shop—a complete woodworking shop that includes 4-speed lathe, band saw, circular saw and jointer—all mounted on bench and convenient, portable Delta stands. Delta Motor-Driven Tools are available in a large variety of combinations and prices to fit all needs.

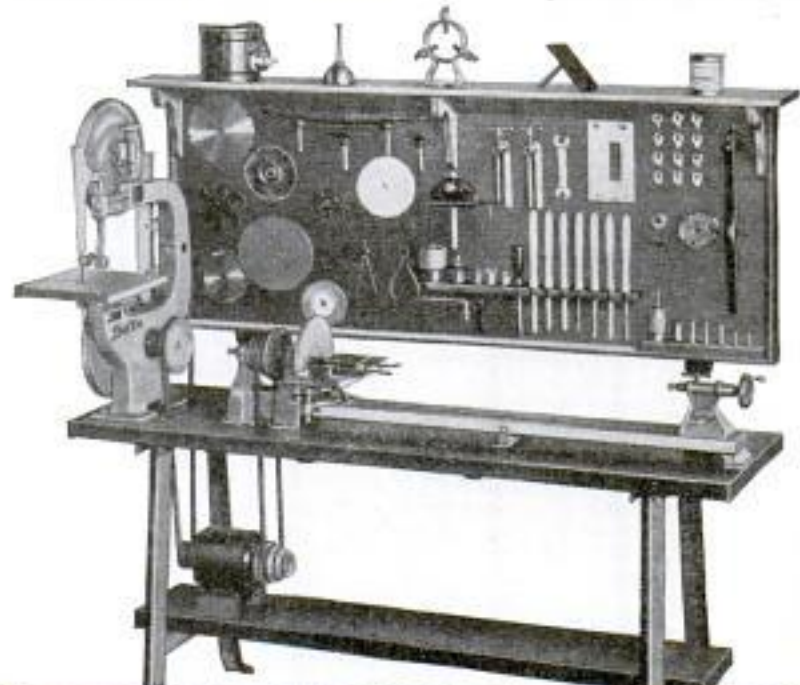

DELTA SPECIALTY CO. (Division of Delta Mfg. Co.)
3775 N. Holton Street, Dept. A-1131, MILWAUKEE, WISCONSIN

See Next Page for Coupon →

New Fields Open for Woodworkers

Delta Quality Motor-Driven Tools save time, money and labor. They take all the drudgery out of woodworking. They enable you to turn out better work in less time. They bring the finest professional cabinet work within the reach of all. Their compactness and practicability, their convenience and low prices, make these motor-driven tools ideal for both production work and home craftsmanship.

Thousands of Delta users report that Delta machines quickly pay for themselves. Delta equipment is being used today in home workshops, in farm shops, in factories for production work, by contractors and carpenters—in all fields where popular-priced but efficient woodworking tools are needed.

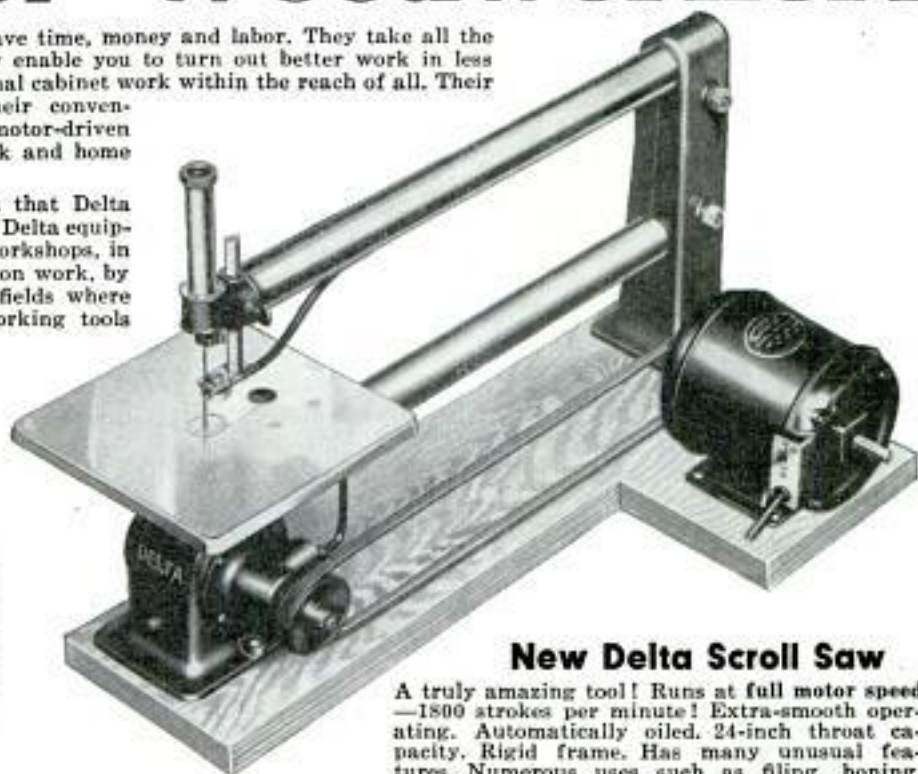

New Delta Scroll Saw

A truly amazing tool! Runs at full motor speed—1800 strokes per minute! Extra-smooth operating. Automatically oiled. 24-inch throat capacity. Rigid frame. Has many unusual features. Numerous uses such as filing, honing, sanding, etc. Sets new standards in scroll-saw performance. Investigate!

TEN-DAY TRIAL EASY TERMS

Because Delta Tools are efficient and practical under actual working conditions, they are always available for a 10-Day Trial without the slightest risk. Satisfaction is guaranteed. For full details of this liberal offer, and also of convenient Easy Payment Plans, send the coupon below TODAY!

Send for FREE Catalog

Everything for the modern woodworker—professional, spare-time, or hobbyist—is illustrated and described in this big 1932 Delta Catalog. Send Coupon now for your copy.



Boring, Routing, and Mortising Attachment. Makes child's play out of difficult mortising operations.

Jointer and Circular Saw

Combination Unit. Each tool can be operated separately or both together. No interference. Furnished with or without motor.

DELTA SPECIALTY COMPANY
(Division of Delta Mfg. Co.)
3775 North Holton Street, Dept. A-1131,
Milwaukee, Wisconsin

Please send me, without obligation, 1932 Delta Catalog. Also send full details of your 10-Day Trial Offer and Easy Payment Plans.

Name

Address

City State

DELTA SPECIALTY CO. (Division of Delta Mfg. Co.)
3775 N. Holton Street, Dept. A-1131, MILWAUKEE, WISCONSIN

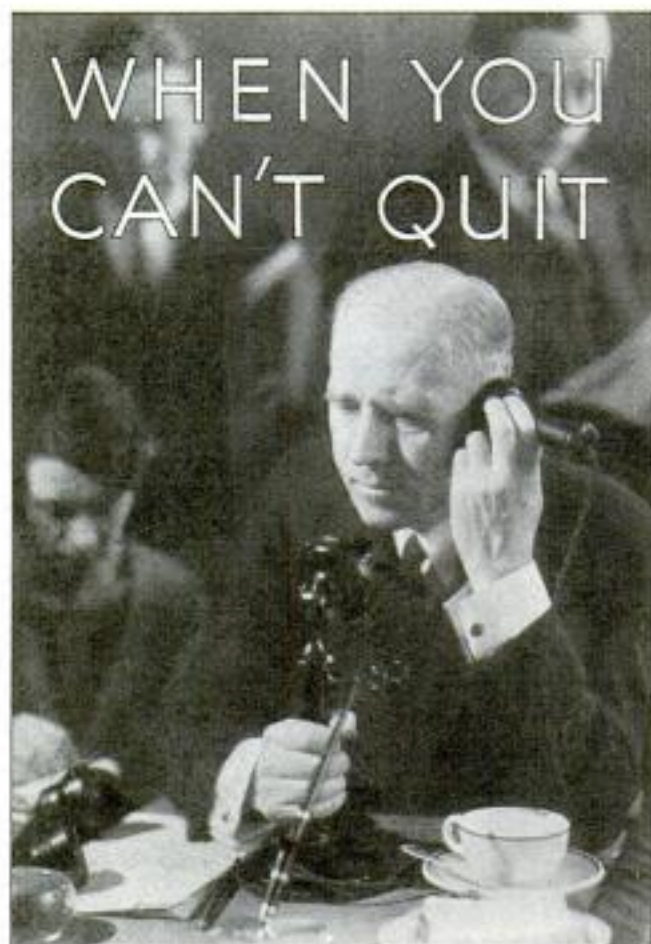

FATIGUE is the signal to rest; obey it if you can. When you can't, keep cool and carry-on in *comfort*.

Bayer Aspirin means freedom from those pains that nag at nerves and wear you down. One tablet will block that threatening headache while it is still just a threat. Take two or three tablets when you've caught a cold, and that's usually the end of it.

Carry Bayer Aspirin when you travel. Have some at home and keep some at the office. Like an efficient secretary, it often "saves the day," spares you many an uncomfortable, unproductive hour. It is harmless, so keep it handy, keep it in mind, use it freely. No man of affairs can afford to ignore the score and more of practical, *proven* uses the directions explain. From a grumbling tooth to the rheumatic pains that seem to bend the bones, Bayer Aspirin is ready with its immediate relief—and always works. Neuralgia. Neuritis. Rheumatism. Any nagging, needless pain.

Get the genuine tablets, stamped with the Bayer cross, for they are of perfect purity and do not affect the heart.

BAYER ASPIRIN

When writing to advertisers please mention *Popular Mechanics*

BRUISES? SPRAINS?

Ease Pain—Sleep!



SON: *That bruise feels better already, Dad.*
DAD: *Good! You'll sleep now and the swelling will be gone tomorrow.*

The pain in a bruise or sprain gets worse at night, keeping you awake. Congested blood causes this pain—pressing on the sore spot... Pat on Sloan's Liniment. Fresh blood flows at once, carrying away congestion. Healing white cells rebuild injured tissue. Sharp pain quickly stops. Swelling goes down. It's easy to sleep... Get a fresh bottle of Sloan's from your druggist today. Only 35¢.

SLOAN'S Liniment



Warms Like
Sunshine

INCREASE YOUR BUSINESS by using the NEW **\$5.85 "Two-Faced"** Film Duplicator to make 100 copies, in 1 to 5 Colors each time. Or the **\$37.05 "Excelligraph"** Rotary Stencil Duplicator to Print Copies of Anything Typed, Penned, Drawn or Traced in numbers up to 3000 each operation, as Price Lists, Hand Bills, Special Sales Announcements, Bulletins, Menus, Quotations, or "what have you?" Write—

PITTSBURGH TYPEWRITER & SUPPLY CO.
Suite 552 339 Fifth Avenue Pittsburgh, Pa.

ELECTRIC PANTS PRESSER

Illinois Man Makes \$88 in Week

Pennsylvania agent cleared \$76 in 4 days. Texas live wire started with earnings of \$144. Profits like these easy for you with amazing new invention—just out **Pants Pressed in 10 Seconds** by **ELECTRICITY**

Millions waiting for this wonderful **RED LION ELECTRIC Trousers Presser**. Pats razor edge crosses in pants by electricity. As easy to use as a clothes brush. Only presser in the world that will cross pants while being worn. Will last years. Sample fits in pocket. Take orders. 100% profits. Experience unnecessary. Write for generous sample offer. **SENT FREE.**

MUNNY MFG. CO.
Dept. 811 817 Main Street Cincinnati, Ohio

JUDGE A HACKSAW BY ITS TEETH

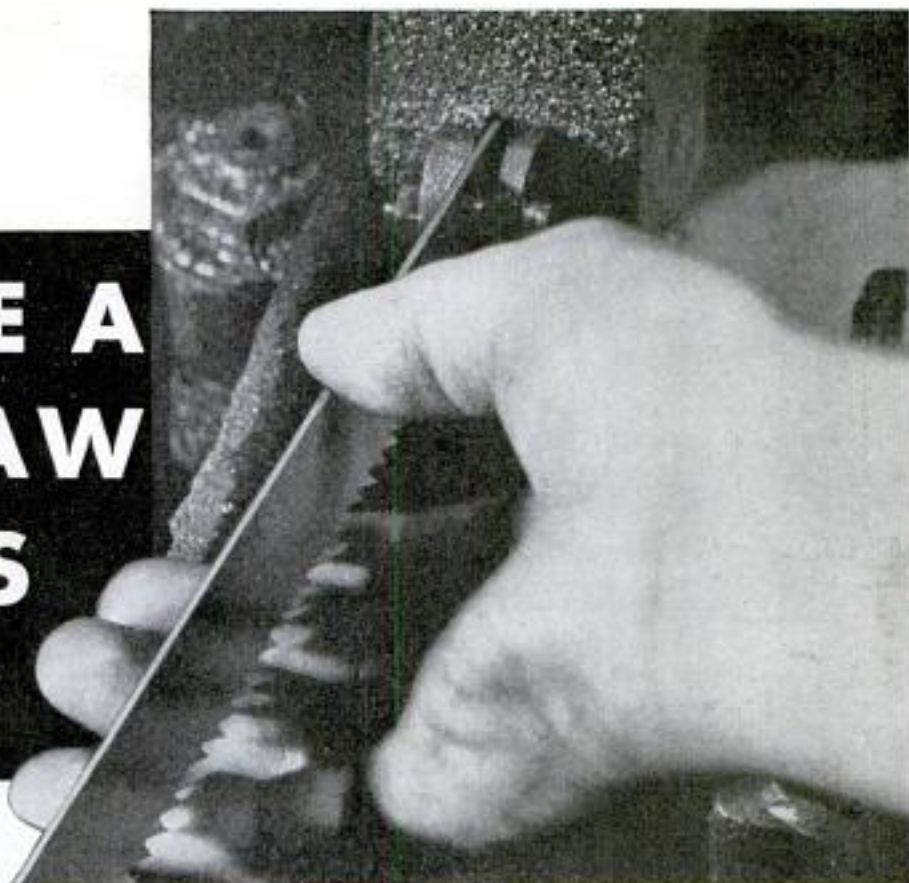

Feel the teeth of a Starrett Hacksaw Blade. You'll find them sound and sharp—still good for plenty of fast, clean cuts—long after the teeth have parted company with an ordinary blade.

It's the steel that does it. The steel . . . and the design . . . and the heat-treating. Starrett blades come fairly by their everlasting toughness and their everlasting bite.

The country's master saw-makers put the value into them. You take it out—in more cuts, faster cuts and easier cuts.

There are three different types of Starrett Hacksaw Blades—the High Speed Steel, for extra fast and extra heavy service—the Tungsten, for every-day service—and the Semi-Flex, for blade twisting, chattering cuts in thin metal.

Get the Starrett blades you need from your jobber or hardware store. Try them. Feel their teeth after you've gotten your money's worth out of them—and keep right on cutting. Write for the Starrett Catalog No. 25 "AP" describing all the Starrett Hacksaw Blades and Frames, and over 2500 Starrett Tools. No charge; glad to send it.

THE L. S. STARRETT CO.
World's Greatest Toolmakers
Manufacturers of Hacksaws Unexcelled
Steel Tapes—Standard for Accuracy
Athol, Mass., U. S. A.



For Machine Shops

—use the Starrett High Speed Steel Blades for more cuts, faster and cheaper. They cost more and they're worth plenty more.

For Home Workshops

—use the Starrett Tungsten Blades for regular jobs and keep an extra Starrett Semi-Flex on hand for the meanest ones. This is Starrett Frame No. 150—mighty handy.

For Auto Service

—nothing in the world like the Starrett Semi-Flex for jobs like this. Vibration or twisting can't hurt it. Sheet metal workers and plumbers like it, too.

For Aircraft Service

—use the Starrett High-Speed Blades; they make short work of any kind of tubing. This is the Starrett Frame No. 153 with the pistol grip. Now send for that Starrett Catalog No. 25 "AP."

Use Starrett Hacksaws

When writing to advertisers please mention Popular Mechanics

5060

PICTURE OF A MAN MAKING HIS OWN CRACK FILLER!



MIX up your own home brew crack filler if you want to. But why take the time and trouble when you can buy Savogran Crack Filler—it's patented—and know you've got a material that's *right*.

Savogran Crack Filler plugs cracks and holes in wood, plaster, metal, stone, so they stay plugged! *Will not shrink! It stays put!* Great for patching up mistakes when you're building furniture, toys, etc. Saws, cuts, smooths—and a coat of paint hides the repair for good. Wonderful for inlays (can be colored), model building, fixing loose casters, mending furniture, and hundreds of repair jobs.

Get a big 1-lb. can today at your paint or hardware store—only 30c. Better still, get a 5-lb. can (\$1.25) or a 35-lb. steel pail (\$7.70), to be sure of having some on hand. And if you do any painting or heavy cleaning, ask for a can of Painters' Savogran, the safe, powerful cleaner that saves hard work.

One Pound Can FREE!

Write today for your free copy of folder C-3, listing over 100 uses for Savogran Crack Filler. Think of a practical new use, write and tell us about it, giving directions, and you will receive a 1-lb. can of Savogran Crack Filler *Free*.



SAVOGRAN CO., DEPT. M-11 INDIA WHARF, BOSTON

SAVOGRAN CRACK FILLER

WILL NOT SHRINK!

DO YOU WANT a new business profession of your own, with all the trade you can attend to? Then become a foot correctionist, and in a few weeks earn big income in service fees,—not medical nor chiropody—easy terms for home training, no further capital needed, no goods to buy, no agency. Established 1894. Address Stephenson Laboratory, 1 Back Bay, Boston, Mass.

When writing to advertisers please mention Popular Mechanics

New
HAMILTON
Bolt-Action Rifle
\$3⁵⁰

A **REMARKABLE** gun at a sensationally low price! A genuine bolt-action rifle with many unusual features. Built like a real sharpshooter's gun—sturdy, accurate and dependable. Easy to load! Quick to get into action! Safe to handle! A gun that any boy or man would be proud to own!

Many Unusual Features!

A new safety feature prevents it from being discharged by an accidental blow on the bolt or cocking device. Automatically adjusts cartridge in firing chamber. Automatically ejects fired cartridge. Barrel is accurately rifled and absolutely true. Shoots short or long .22 rim fire cartridges. Blue-black gun barrel with rustproof bronze lining, guaranteed not to pit—easily cleaned with soap and water. Front knife sight, adjustable Buckhorn rear sight—easy to aim. Walnut finish, pistol-grip stock. Length, 35 inches. It's the next thing to a repeater, yet you can get it for practically one-third the price—only \$3.50 (Ricky Meun-tain and West Coast States, \$3.75).

Free Circular of 4 Hamilton Rifles

Single shot rifles as low as \$2.85. Repeating rifles, \$3.50. Sold by hardware and sporting goods stores—or mailed postpaid if your dealer cannot supply you. Write today for FREE circular.

C. J. HAMILTON & SON

6311 Hamilton St., Plymouth, Mich.

**WRITE
for
FREE
CIRCULAR**

**6 FUSES
in ONE PLUG**

**Agents & Distributors
Making Big Money**

A necessity everywhere. A "turn to the right brings back the light." Safe, economical, dependable. **6-in-1 Fuse Plug**. Most useful invention in years. Many of our distributors in exclusive territory making \$500 to \$1000 a month. Easy to demonstrate. Easy to Sell. Profits begin right away. Write at once for proposition. Send 25c for sample and working instructions.

6-in-1 Fuse Co., 801 W. Madison St., Dept. 116 Chicago

I HELP YOU!

Complete Instructions, Patterns, Woods, Parts.

I ALSO REPAIR!

If your Violin needs fixing, get my Prices.

C. C. FRASER, BOX 14, STA. C, GRAND RAPIDS, MICH.

DEAFNESS IS MISERY

Many people with defective hearing and Head Noises enjoy conversation, go to Theatre and Church because they use Leonard Invisible Ear Drums which resemble Tiny Megaphones fitting in the Ear entirely out of sight. No wires, batteries or head piece. They are inexpensive. Write for booklet and sworn statement of the inventor, himself deaf.

A. O. LEONARD, Inc., Suite 899, 70 5th Ave., New York

FREE—This 1932 Pin Catalog

SHOWS HUNDREDS SCHOOL CLASS CLUB SOCIETY PINS, RINGS, MEDALS, ETC. SHIPPY 1932 DESIGNER. COMPLETE LINE PIN SHOWN SILVER PLATE 35c EA OR \$3.50 DOZ. STERLING SILVER OR GOLD PLATE 90c EA OR \$5.00 DOZ 1 OR 2 COLORS ENAMEL AND NAME.

BASTIAN BROS. CO., 18 BASTIAN BLDG. ROCHESTER N.Y.

HELPER'S
#3193

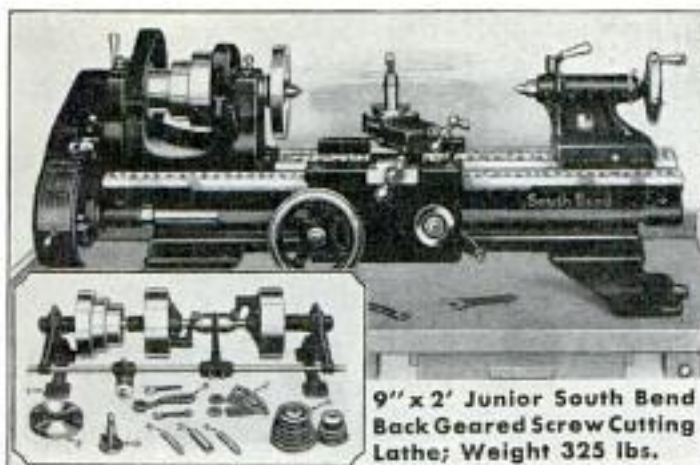

9" x 2' Junior South Bend Back Geared Screw Cutting Lathe; Weight 325 lbs.

\$150 ONLY \$30 DOWN
AND \$10.50 PER MONTH
FOR 12 MONTHS

f. o. b. South Bend with Countershaft and Equipment

9" x 2' JUNIOR

Also made in 2½' to 4½' bed lengths. Practical for precision work in manufacturing and machine shop and adapted to automobile service work on valves, bushings, commutators and pistons. Used by U. S. Government, state, municipal departments and leading industries.

\$230 ONLY \$46 DOWN
AND \$16.10 PER MONTH
FOR 12 MONTHS

f. o. b. South Bend with Countershaft and Equipment

11" x 3' JUNIOR

An ideal lathe for manufacturing and automobile repairs, handling same work as 9" Junior Lathe above; in addition does work on differential cases, connecting rods, universal joints, etc. Also available with silent chain motor drive, underneath belt motor drive, bench or floor leg type in bed lengths from 3½' to 5½'.



11" x 3' New Model Junior South Bend Back Geared Screw Cutting Lathe; Weight 430 lbs.

\$308 ONLY \$61.60 DOWN
AND \$21.56 PER MONTH
FOR 12 MONTHS

f. o. b. South Bend with Countershaft and Equipment

13" x 4' JUNIOR

Practical for manufacturing, machine shop, and automobile service work including all work handled by 9" and 11" sizes above, also brake drum truing on Fords, Chevrolets and other light cars.

EASY PAYMENTS ON ALL SIZES AND TYPES

Send for new catalog No. 92, illustrating, describing and pricing new Junior Series South Bend Lathes, also 96 other sizes and types, with details of easy payment plan. Free. Postpaid, on request.

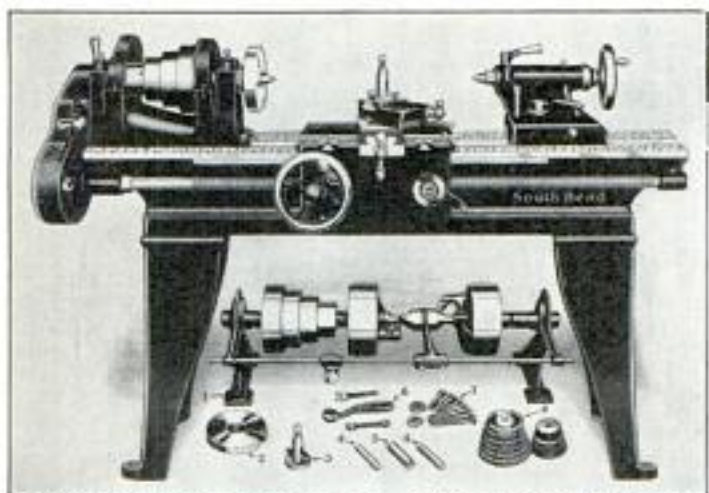

13" x 4' New Model Junior South Bend Back Geared Screw Cutting Lathe. Weight 980 lbs.

SOUTH BEND LATHE WORKS

641 E. Madison St., South Bend, Ind.

Lathe Builders for 25 Years — 55,000 South Bend Lathes in Use

SOUTH BEND LATHE WORKS

641 E. Madison St., South Bend, Indiana, U. S. A.

Please send me your catalog No. 92, on the new Junior Series Lathes; [] details of Easy Payment Plan.

Name _____

Street _____

City _____

State _____

When writing to advertisers please mention Popular Mechanics

WET CELLARS MADE DRY from the Inside!

DAMP musty cellars are unsanitary, a danger to health and a poor place to store valuable material.

Where water or moisture seeps in through cracks or porous spots in the floor or walls, you can make and keep your cellar dry and sweet—a fit place to work, free from odor, mold and rust—by filling the cracks and coating the moist surface with Smooth-On No. 7.

This is the one practical waterproofing that you can apply yourself, easily, from the inside, to wet or dry surface and with every assurance of thorough watertightness, even in the wettest seasons.

Excellent also for patching concrete floors, waterproofing garage, stable and washroom floors, brick walls, cisterns, septic tanks, water troughs, fountains, fish ponds, swimming pools, manure pits, etc.



About 25 pounds of Smooth-On No. 7 are required for each 100 square feet of surface covered, and no experience is necessary. Complete instructions on the package.

Sold in 5-pound cans and 25, 50 and 100-pound kegs.



HOME and AUTO REPAIRS



WITH
SMOOTH-ON

Write for
FREE BOOK

SMOOTH-ON MFG. CO., Dept. 37,
574 Communipaw Ave., Jersey City, N. J.
Please send the free Smooth-On Repair Book.

Name.....
Address.....

**Return this coupon for
FREE copy of Booklet**

11-31

BIGGEST SAVINGS IN YEARS

NEW—FREE!
**Kalamazoo
Catalog of
FACTORY PRICES**

Write now for this new KALAMAZOO-DIRECT-TO-YOU Catalog, quoting you factory prices at sensational reductions. Make your selections direct from factory stock. 200 styles and sizes. Kalamazoo prices are lower, far lower than ever, but Kalamazoo quality, famous for 31 years, is rigidly maintained.

Ranges as low as \$37.50
Don't miss the new Coal and Wood Ranges, new Combination Gas and Coal Ranges—new colors, new improvements. Also Gas Stoves, Oil Stoves, Household Goods.

Heaters as low as \$24.15
Pages of colored pictures and descriptions of heat circulators. New low prices on furnaces (pipe or direct heat).



Furnaces as low as \$57.85
Kalamazoo gives you 30 days Free Trial. Every Kalamazoo carries a 5 year guarantee bond on material and workmanship—\$100,000 bank bond guarantee of satisfaction. 24 hour shipments. Only \$5 down on any stove, range or furnace, regardless of size or price. A year to pay. 300,000 satisfied customers. Write today for this wonderful new book.

KALAMAZOO STOVE CO., Mfrs.
391 Rochester Ave., Kalamazoo, Mich.

**"A Kalamazoo
Direct to You"**

AGENTS 500% PROFIT GENUINE GOLD LEAF LETTERS

S guaranteed to never tarnish. Anyone can put them on stores and office windows. Enormous demand, large profits. Paul Clark says: Smallest day \$28.70, R. L. Reel made \$920 in two months. Write today for free sample and liberal offer to general agents.
METALLIC LETTER CO. 433-B N. Clark St., CHICAGO

BUILD YOUR OWN AUTOMATIC ELECTRIC REFRIGERATOR

Why pay \$200.00 and upwards? Use your present ice-box. We supply parts. Can be built for only \$34.50. Easily made. No special tools necessary. Operating cost, quality and size of machine same as well known makes. Complete blue-prints and instructions—\$1.00. Circular "A" on request.

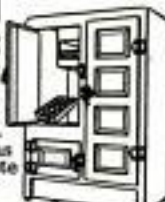

B. & L. ENGINEERING CO., 706 Bergen Ave., Jersey City, N. J.

Cal. 30-48 Six Shot

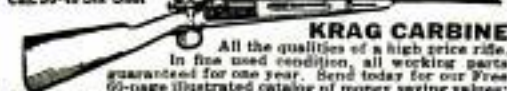

KRAG CARBINE

Price
\$9.75

All the qualities of a high price rifle. In fine used condition, all working parts guaranteed for one year. Send today for our Free 60-page illustrated catalog of money saving values; Guns, Ammunition, Cutlery, Sports and Gov't goods. Deposit required on all orders. Money refunded if not satisfactory.

W. Stokes Kirk, Dept. P. M.-11, 1627 N. 10th St., Phila., Pa.



"FLYING CLOUD"

Get clean-cut parts and clear blue-prints for 20' model. Readily made in spare hours as hull fully shaped and sanded. Set includes anchor, bell, capstan, dead eyes, wheel, rigging line, etc. Complete for \$11. Postage 5 lbs. White metal figurehead 50c. Send 15c (coins) for beautiful catalog of ships and coaches.

ROY HANCOCK

323 Douglas Ave. Portsmouth, Va.

When writing to advertisers please mention Popular Mechanics



THE SIGN
OF A GOOD
ENGINE

Established 1870

2 to 12 H. P.

ON WOOD
SKIDS OR
IRON BASE

**EVERY MODERN IMPROVEMENT
IS BUILT INTO WITTE**

ENCLOSED
SELF-OILING
ROLLER BEARING

ENGINES

Sold on
30 Days
TRIAL
and
EASY
TERMS

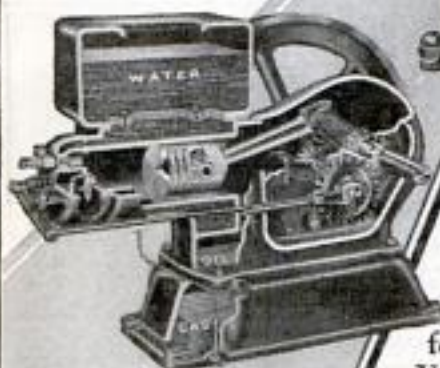
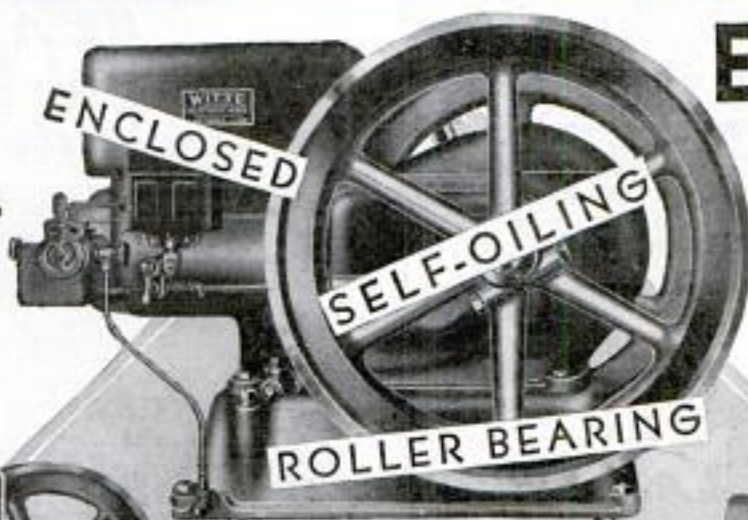

Cutaway views showing important features of this self-contained power plant.



Note center line construction cross bored at right angles for perfect balance. As strong above the line as below it.

World's Finest Engines

The sensation of the engine industry and the supreme achievement of the great WITTE organization. Has all the features you have always wanted in YOUR stationary engine. ENCLOSED like the finest automobile motor, no sand, dirt or grit can get in. SELF-OILING and runs 60 hours on one filling of the crank case—no oil or grease cups to fill and regulate, positive lubrication of all driving parts, mechanically measured. TIMKEN TAPERED ROLLER BEARINGS put snap and pep into the smooth flowing power—saves fuel and oil. There is no other engine like it.



This view shows improved oiling system. Separately enclosed gears, self-oiling.



Maximum to to minimum speed indicator

Compare the Quality—Consider the Value

When you buy an engine you are making a lifetime investment for either profit or more comfort and you want the best to be had and with every modern feature and convenience that advanced engineering and experience has made possible. You want an engine which not only meets every requirement of today but one that will meet your every need for years to come. Get all the facts about these remarkable engines, compare the quality—consider the value. Once you do this your choice will fall on a WITTE, with its great dependability, long life and matchless economy of operation.

Order Direct From Factory — Big FREE Catalog

1932 ENGINES AT 1914 PRICES

210-A Carson St.
PITTSBURGH, PA.

WITTE ENGINE WORKS

1748 Oakland Ave.
KANSAS CITY, MO.

FREE! Our Christmas Gift to YOU

With Each Purchase as Explained in Our SPECIAL OFFER now Ready to mail YOU - Write for Your Copy at Once!

OFFER EXPIRES DEC. 25TH

Your Choice

**DIAMOND RING
ELECTRIC CLOCK
TRAY OF SILVER**
26 Pieces ~ *Free!*

Most Sensational Offer

Ever Made in America.
Lowest Prices ~ Lowest
Terms and in Addition
a Valuable Gift FREE!

To celebrate our 37th year in the Watch and Diamond Business, with a daringness which amazes, we make the most remarkable offer we have ever proposed. In addition to giving you wonderful opportunities to buy jewelry at such splendid values and on credit, we give you absolutely FREE your choice of the FREE gifts listed above.

We Sell Nationally Advertised Watches, Diamonds and Silverware on payments at advertised cash prices.

Think of it. We offer you watches, diamonds, and silverware on credit at nationally advertised cash prices. Now there remains no reason why you should not enjoy a diamond, watch, or any other article of jewelry while you pay for it.

\$3.50 a Month makes it easy for you to own a Valuable Watch or Diamond

Every joy of the ownership and wearing of fine jewelry may be yours for as little as \$3.50 a month. We have removed every obstacle from the path of ownership of fine diamonds and watches. Take advantage of this offer before it is withdrawn.

Write for Catalogue and Beautiful Circular illustrating Free Gifts

SANTA FE WATCH COMPANY
Dept. B-6, Thomas Bldg. Topeka, Kansas

SANTA FE WATCH CO.,
Dept. B-6, Thomas Bldg., Topeka, Kansas.

Please send me the catalog I have checked,

- Railroad and Dress Pocket Watches.....
Ladies' and Men's Wrist Watches.....
Ladies' and Men's Diamond Rings.....
Christmas Circular Illustrating Free Gift.....

NAME.....

ADDRESS.....



**BE A
WAGON-MAN..**
We Furnish the Capital

A great, responsible, successful, 40-year-old company now makes this surprising offer to honest men. Invest no capital! Let us start you in this permanent business that YOU own and control for yourself. Become the authorized McConnon Dealer and handle the complete McConnon line—no red tape and no division of line. We finance you. You extend credit to your own friends and customers when you please. Only a certain number of these "no-investment" propositions are open. Each one offers a good living with a chance to put some money in the bank every week. Honest, steady men who write promptly are assured of first consideration. Write today and ask for "no-investment" offer. Address The House of Friendly Service, McConnon & Company, Desk D-6611, Winona, Minn.

New Discovery/ SAVES OLD TIRES

Pays up to \$20 a Day!
Distributors to

Here's an astonishing new automobile Tire Patch, so tough we guarantee it for 10,000 Miles! Applied in three minutes, and instantly repairs blowouts, rim-ruts, etc. Sells like "hotcakes" to Garage, Filling Stations, etc. Dealers make over 300%. Wonderful repeat business. Distributors with Care Write Quick for Sensational No-Risk offer!
ECONOMY RUBBER PRODUCTS CO., 608 Burkhardt Ave., Dayton, Ohio

Build a CLOCK for Pleasure or PROFIT!

FREE BOOK

of Clock Making, Money Making Ideas. Gives details, prices of tools, parts. Write NOW for copy!

Shows How YOU Can Make Fine Clocks Right at Home

—for yourself, or to sell at Big Profits. We furnish instructions, parts. Works \$1.50 up to others with chains, all prices. Make case or assemble parts. Cash-in on demand for Mason, Bangs, Dressmaker's Clock. Ask about new low-priced Electric Clock and Special Blue Print Offer. FREE Catalog.

AMERICAN CHIME CLOCK COMPANY
1670-S Ruffner St. Philadelphia, Pa.

FREE Get BB Magic at once. A wonderful shooter's digest—tells how to hold, aim and handle rifles; helps you guide others in correct knowledge of guns. Gives facts that make crack shots. Gives safety and common sense instruction parents all like.

SEND NOW!

The principle of compressed air action that made the Benjamin Single Shot world famous has been applied to 25 shot automatic rapid firing. Learn all about both guns. Write!
Benjamin Air Rifle Co., 649 N. Broadway, St. Louis, Mo.

You Can Print

Cards, stationery, circulars, tags, labels, advertising, etc. Make big profits spare or full time. Do Your Own Printing. Save Money. Easy rules sent. Will do popular Raised Printing like Engraving. Junior press \$5.50, job press \$11 up, power \$149. Send for free catalog. The Kelsey Co., N-37, Meriden, Ct.

AGENTS AND SIGN MEN

Earn up to \$100 Weekly, and over, Putting up OUR GENUINE GOLD LEAF SIGN LETTERS

R

—on store and office windows, board signs, trucks and glass signs. We also make to order script signs and business emblems singly or by the thousands. A permanent business. No capital or experience required. Big demand in every City. Samples and Literature Free.

CONSOLIDATED SIGN LETTER CO. 71-X W. Van Buren CHICAGO, ILLINOIS

30 of the 1,000 Uses for PLASTIC WOOD

- | | | |
|----------------------------|-------------------------------|----------------------------------|
| Repairs furniture | Repairs towel racks | Seals cracks in stucco |
| Repairs gouges | Fine for modeling | Repairs wood rot |
| Repairs chipped veneers | Seals drainboard cracks | For sealing window frames |
| Seals cracks | Seals holes around pipes | Strengthens rungs and joints |
| Repairs breaks | Seals cracks in shelving | Fills cracks between floorboards |
| Secures loose drawer pulls | Repairs broken balusters | Repairs loose tool handles |
| Secures loose castors | Repairs linoleum | Rectifies mistakes in carpentry |
| Repairs broken toys | Repairs baseboard cracks | For cabinet-making |
| Re-seals built-in tubs | Seals floor cracks | |
| Secures loose tiles | Repairs concrete floor cracks | |
| Repairs bathroom fixtures | Fills old screw holes | |

FREE! A can of— Simply tell us 5 Other Uses for this amazing preparation



Without a doubt PLASTIC WOOD is the greatest discovery of the century. There's nothing like it!

This marvelous new preparation that handles like putty and quickly hardens into wood—water-proof, weather-proof wood you can carve, paint, or turn in a lathe—has a thousand and one uses. In repairing breaks, in covering up signs of wear and tear, in modeling, it always does an expert job.

Here you'll see 30 of the most common uses for PLASTIC WOOD. Name just 5 more. Write them down on the coupon below. Then mail us the coupon and we'll send you a regular size can of PLASTIC

WOOD—absolutely free. Also we will send you a big, profusely illustrated 48-page book crammed full of interesting facts concerning this new preparation that comes in cans and tubes. PLASTIC WOOD is sold in 9 colors by all paint, hardware and department stores.

FILL IN AND MAIL FOR FREE CAN

The A. S. BOYLE CO., Dept. 11-PM
Cincinnati, Ohio

Here are 5 more uses for PLASTIC WOOD. Please send me—free—a regular size can of this new kind of wood.

- 1
- 2
- 3
- 4
- 5

Name

Street & No.

City State

Many Industrial Uses... Spec.

Tensile Strength	1500 lbs. per sq. inch
Crushing point	3000 to 4000 lbs. per sq. inch
Weight per Cubic Foot	30 lbs.
Absorption, Fresh Water	30%
Absorption, Oil	33%
Hold upon small screws (White Pine at 100)	143%
Combustibility, inception (charring)	400° to 500° F.

When writing to advertisers please mention Popular Mechanics

BELLO FOR DULL BLADES

Wonder-working machine—10 days' free trial

Bello, the Hollow Grinder, grinds a new edge for every shave, changing all blades of Probak and Gillette type to hollow ground concave.

A hundred years ahead of any stropper.

Price \$3.75. Pays for itself two to three times a year on blade cost alone.



E. S. PETERSON, *Durant dealer at Portland, Me., has used one blade for more than 500 shaves.*

TO THE NEW
A sensation in America

You have given your wife every modern device to ease her domestic burdens. If she has not alleviated your one great grief, "shaving torture," by giving you a Bello for a birthday or Christmas gift, get one for yourself.

Dr. R. J. Dice, Okla.: "One blade over a year."
A. W. Stubbs, Iowa: "350 shaves, one blade."

If you cannot secure Bello locally, send us \$3.75 (your money back if not satisfied), or we will forward on 10 days' trial if you attach this ad to your letterhead and check here

FREE — A generous size 35c tube of Bello Bubbles, the new Danish shaving cream, absolutely free, if you send cash with order.

BELLO SALES PLAN

F. A. Ward of Montpelier, N. D., a town of 176 people, has sold over 500 to date. If interested in selling Bello, check here and pin this advertisement to your letter.

THE "BELLO" CORPORATION
Desk 1211, Bello Bldg., Gardner, Mass.

Name _____

Address _____

FROM THE OLD WORLD
6 solid years of European success.

AGENTS: \$6 A DAY



Here's a wonderful chance to make \$6 a day taking orders for No-Frost—the amazing new preparation that keeps rain, snow, frost, mist and steam off auto windshields, show windows, mirrors, etc. A sensation everywhere. No hunting for prospects. Auto owners, bus drivers, store-keepers, housewives buy on sight. Big profits. Steady repeat business.

\$110 PROFIT A WEEK

No-Frost is only one of our 350 profitable Household Necessities in big demand everywhere. With this fast-selling line, Korenblit made \$110 a week. Hall made \$24 first day—Mrs. Hackett, \$33 in 7 hours. This shows the unusual possibilities. No capital or experience needed. Earnings start at once. Write quick for Profit-Sharing Offer.

AMERICAN PRODUCTS CO.
7994 Monmouth Ave., Cincinnati, Ohio



EVERY
AUTO OWNER
A PROSPECT



Popularity

comes quickly when you learn to play a band instrument. For quick advancement and greater musical success start on an easy-playing Conn. The choice of Sogno and the world's greatest artists. Many exclusive improvements at no added cost!

FREE TRIAL, EASY PAYMENTS
Write for details and free book. Mention instrument. C. G. CONN, Ltd.
1131 Conn Building Elkhart, Indiana

FREE TRIAL



Forms to cast Lead Soldiers, Indians, Trappers, Hunters, Wild and Farm Animals. 239 different forms to select from. Every Form guaranteed to cast perfect figures. Send 5c stamp for illustrated catalogue.

HENRY C. SCHIERCKE SPENCER RD. GHENT, N. Y.



SHIP MODEL FITTINGS

Extensive line of quality fittings and construction sets for Sailing Ships, Whalers, Steamships, Destroyers and Yachts. Books, blue prints and model supplies. Send 15c for illustrated catalog.

A. J. FISHER, 1002 Elsworth Ave. (Dept. M) Royal Oak, Mich.

Christmas Card Box Assortments

\$10-\$25 DAILY Cost You 50 cents You Sell for \$1.00 **EXPERIENCE UNNECESSARY**

Agents make up to \$2,500 before Xmas in spare time. Men and women, young and old, equally successful. Inquire exchange, engravings, etc. These listings. Please send stamps. Ten boxes easily sold every hour. Send 5c coin cash for box and details.

GAINSBOROUGH CARD CO. Inc., 327 Washington St., Dept. 204 Buffalo, N. Y.
REFERENCE: LIBRARY BANK OF BUFFALO

Catch Fish!

Eels, Mink, Muskrats with our new folding galvanized STEEL WIRE TRAP. Write for our FREE TRAP OFFER and Bargain Catalog. \$1 Box of our famous Fish Bait FREE to introduce our traps. WALTON SUPPLY CO., 3502 JUNIATA AVE., ST. LOUIS, MO.

BASHFUL?

"Shame on you!" Are you nervous, embarrassed in company of the other sex? Stop being shy of strangers. Conquer the terrible fear of your superiors. Be cheerful and confident of your future! Your faults easily overcome as you can enjoy life to the fullest. Send 25c for this amazing book. RICHARD BLACKSTONE, B-4711 Flatiron Bldg., N. Y.

Now! Do Your Own Electric Nickel Plating

COMPLETE INTRODUCTORY OUTFIT ONLY \$6.50

A REAL MONEY-MAKING OPPORTUNITY

NO EXPERIENCE REQUIRED. Do YOUR OWN Electro Plating in Your Home, Garage, Office, or Place of Business. Electrically Deposit Metal—Nickel, Brass, Copper, Silver, or Gold. You can Successfully do all the plating on your Automobile, Electric Fixtures, Faucets, Spoons, Forks, Chandeliers, Tools, Coffee Urns, Surgical and Dental Instruments, Utensils, large or small, Iron Stoves, Music Instruments; recondition worn plating or plate New Work; do it instantly without interrupting the Service or without removing the parts to be plated with the

ALADDIN PORTABLE ELECTRO-PLATER

Simple and Economical to operate. Not a toy, but a practical Plating Outfit with which Perfect and Durable Work can be done. Positively Guaranteed to do as we claim. BE YOUR OWN BOSS! Build up a Profitable Aladdin Electro-Plating Business of your Own. This offers wonderful ECONOMY to users and BIG MONEY-MAKING possibilities to AGENTS. Thousands in Service since 1924. Write today for FREE PARTICULARS AND TESTIMONIALS.

P. J. F. BATENBURG CO. Dept. 257 RACINE, WISCONSIN —AGENTS— WANTED EVERYWHERE



Plate with
Nickel, Brass,
Copper, Silver,
Gold, etc.

See the
Nickel
Flow



Only \$195
at Factory



Lowest-priced motorcycle ever offered by Harley-Davidson. A swift, sturdy Single, fully equipped—complete electrical system, 3-speed transmission, front and rear brakes, all conveniences. Easy to handle—costs almost nothing to run. Ask your Dealer.

BREEZE down an Autumn road, free as the red leaves that swirl along with you. Open up the eager motor of your Harley-Davidson—feel the thrill of its power, the surge of its silent speed. What a motorcycle!

Have you seen the 1932 models? They are better performers than ever—handsomer, more comfortable, better equipped—yet the prices are much lower.

Your dealer wants to show you these new Harley-Davidsons—and tell you about his Pay-As-You-Ride Plan. Why not look him up today?

Mail the coupon for Free Literature.

Ride a
HARLEY-DAVIDSON

Harley-Davidson Motor Company
Dept. P., Milwaukee, Wis.

Interested in your motorcycles. Send Literature.

Name _____

Address _____

My age is 16-19 years, 20-30 years, 31 years and up, under 16 years.

Check your age group.

When writing to advertisers please mention *Popular Mechanics*

HEAT ON THE SPOT FROM TUBES

**STERNO
CANNED
HEAT**



... NOW
TUBED FOR
THE HANDY
MAN ...

SQUEEZE a little STERNO under article to be heated, or on bent wire. Light. Instant heat guided by your hand for melting solder, glue; for mending, etc. Many uses for Sterno in Tubes in FREE booklet... at home, camp, in shop. Let Sterno help you. Large tube costs only 10¢. Use coupon.

STERNO CORPORATION PM-11
9 East 37th Street, New York

Send me your free booklet.
I enclose 10¢ for full-sized tube.

Name _____

Address _____

FOR FIXIT SHOPS



FREE FOTO GUIDE and Vacuum Cleaner Parts Catalog. Most complete ever published. Lists over 800 items and special tools. 28 pages. Illustrated. Standard material at lowest cost. Valuable source data on obsolete parts. Big help to all repair shops.

WASHING MACHINE PARTS

Combined washer, vac, and small motor servicing attracts trade and reduces operating expense. We can supply most replacement parts. Uniformity to highest standards guaranteed. Lowest known prices with saving on transportation and trouble. Consolidated orders earn maximum discounts. Instructive catalog free.

Uron Associated Industries

1302 Engineers Bldg. Cleveland, Ohio

MOTORCYCLES

Pay As Low As \$2.00 per Week
Hendersons, Harley-Davidsons, Indians
Slightly used and rebuilt. Hundreds to select from. **Send 10c for list today.**

MYEROW BROS. CO., 15 Berkeley St., Boston, Mass., U. S. A.

Keds At \$1.00, \$1.25, \$1.50
\$1.75 and up to \$4.00. **United States Rubber Company**

"Boye" Razor Blade Cushion

Makes Any Good Blade
SHAVE BETTER
Prevents Cracked Blades

See editorial page 609, October issue, describing this article. If your dealer cannot as yet supply you, send 10c in stamps or coin to

THE BOYE NEEDLE COMPANY, 4343 RAVENSWOOD AVENUE, CHICAGO, ILLINOIS



FREE! FREE! TIRE GAUGE

New LOW PRICES ON GOOD YEAR GOODRICH-U.S.-FIRESTONE FISK AND OTHER TIRES

LOWEST Prices on Earth!
Thousands of satisfied tire users all over the U. S. A. will testify for the LONG, HARD SERVICE, under severest road conditions of our standard brand tires reconstructed by the ORIGINAL SECRECY YORK PROCESS. To introduce this genuine tire value to you, this big responsible company offers, ABSOLUTELY FREE a modern tire gauge with each 2 tires ordered—now take pressure through side wall of tire in a JIFFY—no fuss—no dirt. OUR 16 YEARS IN BUSINESS makes it possible to offer tires at **LOWEST PRICES** in history. **Guaranteed to give 12 months' service**

Don't Delay — Order Today

Size	Tires Tubes	Size	Tires Tubes
30x2	\$2.20 1.95	30x4.40	\$2.30 1.10
30x2 1/2	2.25 1.00	30x4.50	2.40 1.15
30x3	2.30 1.05	30x4.60	2.45 1.20
30x3 1/2	2.35 1.10	30x4.75	2.45 1.20
30x4	2.40 1.15	30x4.85	2.45 1.20
30x4 1/2	2.45 1.20	30x4.95	2.45 1.20
30x5	2.50 1.25	30x5.00	2.45 1.20
30x5 1/2	2.55 1.30	30x5.10	2.45 1.20
30x6	2.60 1.35	30x5.20	2.45 1.20
30x6 1/2	2.65 1.40	30x5.30	2.45 1.20
30x7	2.70 1.45	30x5.40	2.45 1.20
30x7 1/2	2.75 1.50	30x5.50	2.45 1.20
30x8	2.80 1.55	30x5.60	2.45 1.20
30x8 1/2	2.85 1.60	30x5.70	2.45 1.20
30x9	2.90 1.65	30x5.80	2.45 1.20
30x9 1/2	2.95 1.70	30x5.90	2.45 1.20
30x10	3.00 1.75	30x6.00	2.45 1.20
30x10 1/2	3.05 1.80	30x6.10	2.45 1.20
30x11	3.10 1.85	30x6.20	2.45 1.20

12 MONTHS SERVICE

DEALERS WANTED
Send only \$1.00 deposit with each tire ordered. We ship balance C. O. D. Deduct 5 percent if cash in full accompanies order.

TUBES BRAND NEW — GUARANTEED
Tires failing to give 12 months' service replaced at half price.

YORK TIRE & RUBBER CO., Dept. 509-A
3855-59 Cottage Grove Ave. Chicago, Ill.

Only 8 Sales a Day Nets You \$116 a Week

Profits on larger size run higher. Unusual earning opportunity for ambitious men. No experience necessary; we teach. Part or full time.

FUGO World's Simplest Fire Extinguisher

Automatic and instantaneous action. Within reach of every home, shop, store, theatre, garage, car owner, etc. Even smallest place needs two or more. Exclusive territory to producers. You get your pay every day. Write for full details.

The National Formetal Co.
6535 Metta Ave. Cleveland, O.

Big 3 ft. Telescope Five Sections. Brass bound. Powerful Lenses. 10-Mile range. Special Eye Piece for looking at the Sun, included FREE. Can be used as a Microscope. Guaranteed. Big value. Postpaid. \$1.75. C. O. D. 15c extra. **Banner & Company, 1-49, Trenton, N. J.**

\$20 A DAY!

Sensational new invention. Increases strength of headlights 15%. No glare. Penetrates fog and rain. Sells for \$1.50 a pair. Every motorist buys on sight. Guaranteed. Agents earn more than \$20.00 per day. Send for exclusive territory offer. Now—today. Only a few territories open.

SIKO SALES, INC.
69 Union St., Dept. A, Newton Centre, Mass.

SIKO NON-GLARE

BUCHSTEIN'S FIBRE LIMB

Is nothing to your stump—strong, elastic, neat, light. Easy to put on. Easy to take off. For all deformities.

G. BUCHSTEIN CO.
810 3rd Ave. So. MINNEAPOLIS, MINN.

Send for Catalog Today

Greatest Improvement in Shaving

Your Razor Will Shave
Smoother and Closer
Without Any Irritation

Eliminates vibration, thus giving safety razor blades the same smooth effect as a barber's straight razor.



**"There!..
that's more like it!"**

Yes... you really can *bear* the difference after your radio connections have been soldered with Kester. Because Kester Radio Solder has a *plastic rosin flux*. The flux is non-corrosive and a non-conductor. Dust and moisture will not collect on connections that have been soldered with Kester Radio Solder, and as a result, electrical leakage is prevented—and of course, that aids receptivity.

Kester Radio Solder carries its flux *inside itself*. You merely apply heat, and the correct amount of flux flows to the job. Even if you've never soldered before, Kester will assure a perfect job.

Try Kester at our expense. Or buy the handy package from your radio store or other dealers. Kester Solder Company, 4201-04 Wrightwood Avenue, Chicago, Illinois. Incorporated 1899.

FREE SAMPLE! Write for it NOW

KESTER
RADIO SOLDER

RADIO BUILDERS

We carry a complete line of radio parts for all Popular Mechanics circuits and replacement parts for all sets.

Send Us Your Order

NEWARK ELECTRIC CO.

228 W. Madison St.

CHICAGO, ILL.

\$BIG MONEY\$

QUICK, EASY SELLING RADIANT HEATER

"Made \$100 in a day" says Spangler. "Cleared \$23.50 in a day" says Maloney. Yes, too, make Big Money selling Sunshine Radiant Heater! Gives clean, healthful Gas Heat—wherever you live. Makes and burns own gas. No piping. No installation. No dirt, smoke, gases. Easily carried anywhere. Below zero is not too cold for Sunshine. It is bringing cheery comfort to thousands of homes now. Every home, store, etc., a good prospect. Now low prices make easy sales. Your profit is not cut.

15-Days Trial—Try FREE—Start— Sunshine in your own home 15 days. Know why it sells easily! Write Quick!

Sunshine Products Co., 333 Factory Bld. Kansas City, Mo.



No stock to buy

Complete Heating Unit in itself

GAS HEAT Anywhere—1 1/2¢ PER HOUR

You Collect Your Profits in Advance!

"Best proposition I ever had."
—C. C. Jark, Ore.

"Had no experience, made big money."
—D. Slice, Idaho.

SAVE MONEY

this MODERN way



OUR GREAT, new Fall and Winter Catalog—The Thrift Book of a Nation—is ready for you. It so well expresses the new standard of values, and offers the new high quality merchandise at present in demand, that we would like you to have it. We know that the real value of the goods presented in it is greatly in excess of the prices asked, and that you will make substantial savings on every purchase. From The Thrift Book of a Nation with its 1100 pages, offering 48,000 articles, you may select everything you need in the quiet of your own home. Ordering by mail is most convenient. Try it once, if you would learn the truly modern, and money saving way of shopping.

Ask for your copy of this book today.
Just fill in and mail the coupon to our mail order store nearest you.

SEARS, ROEBUCK and CO.

CHICAGO, PHILADELPHIA, BOSTON, MINNEAPOLIS,
KANSAS CITY, ATLANTA, MEMPHIS, DALLAS,
LOS ANGELES, SEATTLE

(Mail Coupon to Store Nearest You)

Send me your Latest General Catalog.

80P64

Name _____

Postoffice _____ State _____

Rural Route _____ Box No. _____

(Please give both Route and Box Number if on a Rural Route)

Street Address _____

When writing to advertisers please mention Popular Mechanics

Copyrighted material

Big Money in Do-Nuts



READ WHAT OWNERS SAY:

"Ringer Do-Nuts sell themselves. People who taste them once come back for more."

"My little boy sold 31 dozen in less than one hour."

"Was out of a job—now making over \$75 per week—expect to order more machines soon."

"I have done very well and am well satisfied."

**GET INTO YOUR OWN BUSINESS—
BE INDEPENDENT!**

Make more in a week than many men in a month, with the easy-to-operate Ringer Electric Do-Nut Machine!

Earn profits of 100% and more, making delicious greaseless do-nuts. It's easy! Men and women all over the U. S. are making money in this different business. They're independent. They're happy.

Everybody likes delicious greaseless do-nuts, baked by electricity. No fat or oil to spoil digestion. They're tasty, healthful, and sell like wild-fire!

An investment of less than \$60 plus a willingness to work can make you independent. Investigate now! No experience needed. Do the work right in your kitchen. We teach you, furnish all formulas, guide you to success. Write or wire today for free plan.

RINGER DO-NUT CO.

132 Main St. N. E.
Minneapolis, Minnesota

200 SHEETS — 100 ENVELOPES

On high-grade white bond paper Your name and address neatly printed on each and sent postpaid promptly for ONE DOLLAR.

CAPITOL STATY. CO., Box L285, East Williston, N. Y.

\$1

STRANGE IRONING CORD Pays Immense Profits

**PREVENTS SCORCHING—SAVES ELECTRICITY
CANNOT KINK OR SNARL**



200% Profit! Hudson made \$75.00 in 15-minute sale to large Company for telephones. We furnish proof.

H. M. Hay says "Out of hundreds of Neverknots left on trial have had only two returns. I sold over 80 to one bank."

NEW KIND OF CORD SET FREE

Every Neverknot Salesman is given free the beautiful De Luxe Neverknot Cord Set (with only Unbreakable Switch Plug of its kind in the World) which automatically coils itself out of the way, prevents scorching and saves electric bills. Every woman buys instantly for it, saves its own cost in electricity. It's brand new and yours free if you work for us.



New Off'n On Plug Saves Electric Bills

Important! There is only one Neverknot. Write this company for exclusive territory, special prices and big free offer.
NEVERKNOT CO., Dept. 11-V, 4503 Ravenswood, Chicago

Who doesn't want new business?

HERE IT IS...

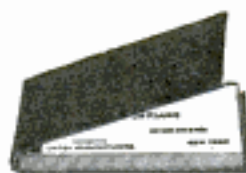

A new business card — in a brand new Case (the Wiggins Compact Binder Case) — both truly representative of

you, your firm, your business, your desire to serve.

A Wiggins-designed-and-engraved Card, the kind used by foremost American business-getters for more than seventy years—all neatly, cleanly and firmly held with tissues bound between cards in the most compact, efficient Card Case you've ever carried.

We're sure you'll be interested in sample tab of Wiggins Cards—together with description and prices of the new Compact Binder Case. They come promptly when you write us.

**The JOHN B. WIGGINS
Company**

1167 FULLERTON AVE. · CHICAGO

Boys—have fun with chemistry—25¢



Get CHEMCRAFT Junior and surprise your friends with magic chemical tricks; make ink; dye cloth; test water and soil; write secret letters with invisible ink; pour blue, brown and black liquids from a pitcher of water. All these and more chemical stunts can be done with Chemcraft Junior. It's the best box of fun you ever had; shows you useful things to do. Get yours now.

**CHEMICAL SURPRISE
Free to Boys!**

Send us the name and address of the store that sells toys where you live and we will send you a fine chemical surprise.

The Porter Chemical Company
411 Washington St., Hagerstown, Md.

GIANT TELESCOPE \$1.75

See Miles Away! Distant people and objects seem close. Over 3 ft. long, brass bound. Made in Europe. 8 lbs. of fun. Thousands pleased.

Send No Money! On arrival pay Postman special price, only \$1.75, plus postage. Two for \$3.25. (Or send price and we pay postage.) Satisfaction guaranteed or money back. Send today.
Bargain House, 427 Randolph St., Dept. 15, Chicago

FREE With Order
Strong leatherette Carrying Case and Solar Eye Piece to view the sun.

Get Into A Business of Your Own — EARN \$150 to \$300 Monthly



AUTOMATIC AIR SERVICE

Dependable, space-saving compressors bring customers to your door. Only \$12 Monthly. 30 Days' Trial.



PAINT SPRAY PROFITS

Paint autos, houses, furniture. One man does work of 3—highly profitable. Only \$12 Monthly, will pay its own way.



8-HOUR BATTERY CHARGING

Recommended by leading battery makers. Halves cost, doubles profits. No special experience required.



20 MINUTE Car Washer

Big profits washing cars—saves 2/3 time, does better job. \$12 Monthly. Only \$17 Monthly.

30 Days' Trial, to prove it. Easy Terms. Check items of interest and mail to

HOBART BROTHERS
Box M-111, Troy, Ohio

WRITE TODAY » Only \$16 Monthly — 30 Days Trial to Prove it « OBLIGATION

Save on Your Christmas Gifts



MAKE three friends happy on Christmas and all the rest of the year—besides saving \$1.50 for yourself. A gift subscription to Popular Mechanics Magazine is a reminder every month for 12 months and can't be beaten as a gift for a man or boy.

Every issue of this entertaining and valuable magazine contains 176 pages and over 400 pictures of fascinating events in every corner of the world. The Romance of Modern Progress is told in pictures and simple language. Radio enthusiasts, home craftsmen and practical shopmen are shown countless "easy-to-make" conveniences that save time, labor and money.

Order three subscriptions, save \$1.50
Price for one year is \$2.50 but until January 1, 1932, you may order 3 one-year subscriptions for only \$6.00—and an engraved Christmas card will be sent to each subscriber for you.

- 3—one-year subscriptions \$6.00
- 1—two-year subscription \$4.00
- 1—one-year subscription \$2.50

Foreign and Canadian subscriptions 50c a year additional.

Mail your order to:

Xmas Gift Dept., Popular Mechanics Magazine
200 East Ontario St., Chicago, Ill.

\$ 7.50 for \$ 6.00



NOW WE STEP ON THE GAS!

The Regal Lathe is made in five sizes, 10" to 18". Prices range from \$275.00 to \$947.00, f. o. b. factory.

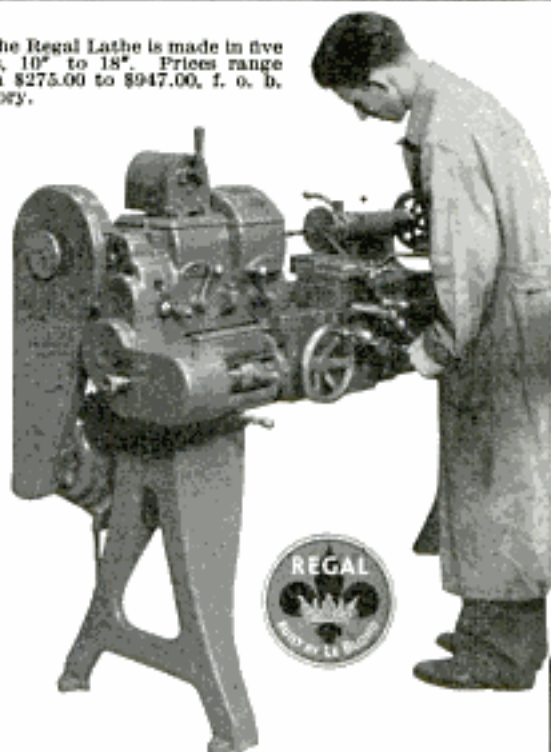

We used to drive a horse and buggy—but we have almost forgotten that day.

It's just as true in machine tools, for either the amateur or the professional. The gear-driven and gear-shift lathe makes other types look like the "Gay Nineties." It's good-by, horse and buggy days, we are stepping on the gas.

Note the distinctive features of the Regal lathe shown here—it's the counterpart of LeBlond heavy duty lathes.

EIGHT-SPEED SELECTIVE SLIDING GEARED HEADSTOCK with convenient controls, quick change of speeds, with perfect safety to the operator.

ONE-PIECE APRON, in which all studs and gears are rigidly supported. Positive clutch control by means of a convenient trip lever. Simple and safe construction.

QUICK CHANGE GEARED FEED, with the drive through the feed rod. A lead screw is provided for chasing.

COMPACT, CONVENIENT BUILT-IN MOTOR DRIVE with enclosed vee belt drive—another safety feature.

Mail the coupon for descriptive literature.

The R. K. LeBlond Machine Tool Co.
Cincinnati, Ohio

THE R. K. LEBLOND MACHINE TOOL CO.,
107 Regal Division, Cincinnati, Ohio.

Send descriptive literature of the Regal Lathe.

Name.....

Address.....

City..... State.....

When writing please mention Popular Mechanics

LUMINOUS PAINT

Make Your Watches, Clocks, Etc., Visible by Night

The very latest discovery in the scientific world, particularly noticeable in watches, clocks, etc., is the remarkable LUMINOUS PAINT, which, applied to the surface of any article, emits rays of white light, rendering it perfectly visible in the dark. THE DARKER THE NIGHT, THE MORE BRILLIANT IT SHINES. None so simple to use. As you see you can do it. A little applied to the dial of your watch or clock will enable you to tell the time by night. You can coat the points, buttons or switch levers of your electric lights, match boxes, and innumerable other articles; make your own Luminous Cigarettes, Luminous Rosettes, etc. Small bottle, price 25c. Larger sizes, 50c and \$1 postpaid. JOHNSON SMITH & CO. Dept. 820 RACINE, WIS.



CIGARETTE MAKER

Roll your own and save money. Better and quicker; saves more than half. Use your favorite brand of tobacco. Neat, useful, handy. Pocket size, weighs 1/2 oz. Made entirely of metal. Nickel plated. 25c, 3 for 65c.



Explosion Cigarettes

Box contains ten cigarettes of excellent quality. They appear so real, but when each cigarette is about one-third smoked, the victim gets a very great surprise as it goes off with a loud BANG! A great worth getter for you. Price 25c per box. 10c per cigarette.

GOOD LUCK RING

Very striking, assist and unconscious. Silver finish; skull and crossbones design; two brilliant, flashing gems sparkle out of the eyes. Said to bring good luck. Only 25c per set.

NOVELTY BADGES



Kissing Permit 10c. Garter Inspector 20c. Two very novel metal badges, nickel plated, that you can wear, bring you free out of all proportion to their trifling cost. 10c, each badge, 3 for 25c, or 75c per doz. postpaid anywhere.

MIDGET BIBLE

GREAT CURIOSITY Headed Bible in the World. One of a postage stamp—200 Pages. Said to bring good luck to the owner. A genuine work of art. Must be seen to be appreciated. Make good money selling them 5c. 10c, 20c, 30c, 40c, 50c, 60c, 75c, 1.00, 1.25, 1.50, 2.00, 2.50, 3.00, 4.00, 5.00, 6.00, 7.00, 8.00, 9.00, 10.00, 11.00, 12.00, 13.00, 14.00, 15.00, 16.00, 17.00, 18.00, 19.00, 20.00, 21.00, 22.00, 23.00, 24.00, 25.00, 26.00, 27.00, 28.00, 29.00, 30.00, 31.00, 32.00, 33.00, 34.00, 35.00, 36.00, 37.00, 38.00, 39.00, 40.00, 41.00, 42.00, 43.00, 44.00, 45.00, 46.00, 47.00, 48.00, 49.00, 50.00, 51.00, 52.00, 53.00, 54.00, 55.00, 56.00, 57.00, 58.00, 59.00, 60.00, 61.00, 62.00, 63.00, 64.00, 65.00, 66.00, 67.00, 68.00, 69.00, 70.00, 71.00, 72.00, 73.00, 74.00, 75.00, 76.00, 77.00, 78.00, 79.00, 80.00, 81.00, 82.00, 83.00, 84.00, 85.00, 86.00, 87.00, 88.00, 89.00, 90.00, 91.00, 92.00, 93.00, 94.00, 95.00, 96.00, 97.00, 98.00, 99.00, 100.00. Price 50c each, 3 for \$1.25, \$4.50 per doz. Magnifying Glass for use with Midget Bible 15c.

LEARN TO DANCE without a teacher. Book gives instructions in old and new dances: Fox-Trot, Tango, One Step, Quadrille, etc., explained and illustrated. 25c postpaid.

STAGE MONEY

With a touch of these bills, it is easy for each person of limited means to appear prosperous by flashing a roll of these bills at the proper time and peeling on a genuine bill or two from the outside of the roll, the effect created will be found to be all that can be desired. Prices, postpaid: 48 Bills 20c, 120 for 50c, or \$3.50 thousand postpaid.

NOSE FLUTE

The Magic Nose Flute, or Noisemaker, is a unique and novel musical instrument that is played with nose and mouth combined. There is just a little knack in playing it which, when once acquired after a little practice, will enable you to produce very sweet music that somewhat resembles a flute. There is no gagging, and once you have mastered it you can play all kinds of music with facility and ease. When played as an accompaniment to a piano or the effect is as charming as it is surprising. Post Paid 10c.

SURPRISE MATCHES

More fun than fighting with your wife. Look just like ordinary matches. As the victim tries to light one he gets quite a surprise. Price 15c per box, 3 boxes for 25c, 12 for 75 cents.

STAR TOY MAKER

Greatest boys' book written. Tells how to make a Pinhole Camera, a Game, model Railroad, a Telephone, Boom-rang, Telegraph Instrument, Hoax Kite, Talking Machine, Microscope, Elc. or V. Motor, Electric Door Bell, Water Wheel, Paddle Raft, a pair of Skis, a Dog Shed, Bird House, Rabbit Yard, etc. 64 pages. 50 illustrations. PRICE 10c.

BOY'S OWN TOYMAKER. A new book. Tells how to make chemical toys, electrical toys, galvanic toys, mechanical toys, paper toys, cardboard toys, kites, traps, etc. 200 illustrations. Price 25c postpaid.

AMATEUR ELECTRICIAN. All about electricity in simple language. How to make batteries, dynamos, motors, telephones, bells, electric coils, incandescent lights, etc. Price 10c postpaid.

MONEY MAKING SECRETS. Golden opportunity for everyone. 64 page copyrighted book chock full of money-making ideas, recipes, formulas, wrinkles, trade secrets, etc. Discovers that can be started with little or no capital at home in spare time. 10c postpaid.

ROPE SPLICING. How to make different knots, hitches, splices, 32 pages. 100 illustrations. 20c postpaid.

25 CARD TRICKS and sleight of hand. Contains all the best and best card tricks as performed by celebrated magicians, with exposure of card tricks used by professional gamblers. Price 25c postpaid.

MAGIC FOR AMATEUR MAGICIAN. Comparing with cards, etc., experiments in magnetism, electricity, etc. 25c.

MELER'S BOOK OF MAGIC. Magic and its systems. Numerous simple magic tricks explained and illustrated. 100 pages. 25c.

TRICKS & SOCIAL ENTERTAINER. Contains hundreds of simple tricks, illusions, diversions that anyone can do. Also explains secret of second sight. Price 25c postpaid.

63 OLD TIME SONGS. All old time favorites, sentimental, patriotic, sacred, etc., with words and full music. Price 25c postpaid.

WONDERFUL X-RAY TUBE

A wonderful little instrument producing optical illusions both surprising and startling. With it you can see what is apparently the bones of your fingers, the lead in a lead pencil, the interior opening in a pine stem, and many other similar illusions. Price 10c, 3 for 25c.

SERPENT'S EGGS

Box contains 12 eggs. When lit with a match, each one gradually hatches itself into a snake several feet long, which coils and twists about in a most life-like manner. Price per box, 10c postpaid, 3 for 25c.

BLANK CARTRIDGE PISTOL

Protection against Burglars, Tramps, & Dogs. Special Offer 1 Blank Cartridge Pistol 100 Blank Cartridges 1 600-page Novelty Catalog **ONLY \$1.50**



Well made and effective, modified on latest type of revolver; appearance alone is enough to scare a burglar. When loaded it may be as effective as a real revolver without danger to life. It takes standard .22 Cal. Blank Cartridges—obtainable everywhere. Special cash with order offers 1 Superior quality Blank Cartridge Pistol, 100 Blank Cartridges, and our new 550 page De Luxe Catalog of latest novelties; all for ONLY \$1.50. Shipped by Express only. Cannot be by parcel post. Extra Blank Cartridges 50c per 100, special 1000 for \$1.75 per 100 postpaid. No U.S. D. shipments.

The Lot Shipped by Express Only Cash With Order Only

Combination Thrift Vault and Savings Bank

HAS REAL THREE NUMBER COMBINATION LOCK KEYLESS—CANNOT BE PICKED

Your power and valuables will be perfectly safe in this new Combination Thrift Vault and Savings Bank, because it has a real combination lock just like the regular Safes and Vaults. The lock requires three numbers to open it. There are over 54,000 different combinations. The lock is pick-proof. It cannot be opened by "biting" for the combination because it operates silently like the lock on a safe or vault. It is keyless in every sense of the word. No key is required. Once you learn the combination it can be opened in a moment or two. It takes care of any size, currency, etc., or you can use it for storing jewelry and other valuable articles, and it keeps your private correspondence, etc., from prying eyes. Colors and patterns can be placed in the bank through the slot at the top, but the larger articles will penetrate opening the bank by means of the combination. PRICE with secret instructions for opening, \$1.50 postpaid.



LOOK 35c LOOK Wonderful Instrument.

Greatest thing yet. Nine separate articles in one. Everybody delighted with it. Odd, Curious and interesting. Lots of pleasure as well as very useful. It is a double Microscope for examining the wonders of nature. It is also an Opera Glass, a Telescope, a Compass, a pocket Mirror, and a Laryngoscope for examining eye, ear, nose and throat. It is worth all the cost to locate even one painful cluder in the eye. Folds flat and fits the pocket. Something great—you need one. Don't miss it. Sent by mail. Only 35c or 3 for \$1.00.



PISTOL CIGARETTE CASE

It looks like a deadly weapon, but it is merely a novel Cigarette Case. This clever contrivance has proved itself better than the real thing in many an awkward encounter. Great fun "sticking up" your friends. They squirm and protest it might be loaded. Pull the trigger and the slide flies open disclosing the cigarettes. Well made, light and compact. Weight only 2 ounces. Price Postpaid 25c.



Send at once and have all the fun before anybody has one.

GYROSCOPE TOP

Spins in any position. Defies law of gravitation.



The Gyroscope Top is a popular scientific toy that defies the law of gravitation. The illustrations above show a very few of the ways of spinning it. It can be thrown and caught, rotating rapidly all the time. It will travel about a fast string or wire. You can suspend it from a loop of string, still spinning vigorously. It will spin on the point of a pin, and will revolve in a dozen different ways on the pedestal. An effective feat can be performed by spinning the top at a high speed and quickly placing it into the square cardboard packing box. Put on the lid and then set the box on one of its corners. The bar will spin around for quite a while, preventing a very curious spectacle. It is a most instructive novelty, always interesting for the many amusements. It is most instructive novelty, always interesting for the many amusements. It is most instructive novelty, always interesting for the many amusements. It is most instructive novelty, always interesting for the many amusements. Price 35c.

LATEST CATALOG
JOHNSON SMITH & CO.
RACINE, WIS.

JOHNSON SMITH & CO.
Dept. 820 RACINE, WIS.
A De Luxe Edition of our new CATALOG mailed on receipt of 25c. Handsome binding. Bigger and better than ever. Only one of its kind in existence. Nearly 600 pages of all the latest tricks in magic, the newest novelties, puzzles, games, sporting goods, rubber stamps, unusual and interesting books, curiosities in seeds and plants, etc., unobtainable elsewhere. Remit by Cash, Money Order, Check or unencd U. S. Currency and Foreign Stamps for all articles listed above. See next page also.

BOYS! BOYS! BOYS!
THROW YOUR VOICE



Into a trunk, under the bed, under a table, back of the door, into a desk at school, or anywhere. You get lots of fun fooling the teacher, policemen, peddlers, and surprise and fool all your friends besides.



The Ventrilo

is a like instrument that fits in the mouth out of sight. Cannot be detected. It is used in connection with the above, and with the aid of this wonderful **DOUBLE THROAT**, or **VENTRILLO**, you can imitate many kinds of birds, animals, etc. Remember you get everything for **ONLY TEN CENTS**—a booklet giving you full instructions how to become a ventriloquist and throw your voice, the **Double Throat**, or **Ventrilo**, and our big catalog of novelties, tricks, puzzles, masks, books, etc.

All Sent Postpaid to Any Address for Only **10c**

INVISIBLE INK Rubber Chewing Gum

The most confidential messages can be written with this ink for the writing makes no mark. Cannot be seen unless you know the secret. Invaluable for many reasons. Keep your posts and other private memorandums away from prying eyes. Great fun for playing practical jokes.



It is just like a regular package of chewing gum and looks as real that it fools everybody. Of course no one suspects it is not genuine until they start to chew it. There's a world of fun in this rubber chewing gum—5 sticks to the package. Price, 10c Pkg.; 3 for 25c. Only 15c a Bottle; 3 for 40c.

Rubber Tacks Box 10c Rubber Cigarettes, Price per Box, 20c
Rubber Cigs., Price Box, 10c Rubber Matches, Price per Pkg. 10c

U. S. BABY TANK



25 Cents
this tank will keep plodding along ten times longer than the ordinary tank of toys. It will perform dozens of the most wonderful stunts! 2 1/4 inches long. Price only 25c postpaid. Stamps accepted.

It goes with real Yankee Peg—by its own power
Most remarkable toy ever invented. By drawing the tank backward, either with the hand or over the floor or table and then placing it down, it will crawl along, overcoming all obstacles, in the same life-like manner as the larger tank that proved so deadly in the great war. What makes it go is somewhat of a mystery, for there is no mechanism to wind up as is usually understood with mechanical toys, yet it will perform dozens of the most wonderful stunts! 2 1/4 inches long. Price only 25c postpaid. Stamps accepted. JOHNSON SMITH & CO.

\$1.50 ROLMONICA



A Mouth Organ that Plays with a Music Roll
Any One Can Play It Without Practice
A Wide Selection of Rolls to Choose From
A Veritable Pocket Size Jazz-Band!

Rolmonica is an auto-matic harmonica, that plays a music roll just like a player piano. It is a whole brass band all in one—the best imitation of the musical world in the last few years. Anyone can play it, for all you have to do is insert a roll, and turn the handle while you blow. That is all there is to it. Nothing could be simpler. Any child who can do these two simple things can play the Rolmonica. It is a veritable pocket size Jazz-Band, combining the principles of the harmonica and the player piano. It is an instrument of a thousand melodies, it plays the popular airs of the past, as well as the latest Broadway hits. There are hundreds of rolls to select from, such as My Blue Heaven, Home Sweet Home, American Old Time Joe, Annie Laurie, Ballerina, Swanee River, Humoresque, Wild Irish Rose, Route O'Grady, Among My Swains, Love's Old Sweet Song, Dixie, Mighty Lak' a Rose, Aloha Oe, Ramona, Juanita, Rose Marie, Onward Christian Soldiers, Billy of My Dreams, Carolina Moon, I Saw Duke & Go Boom, Weary River, Over There, Ma Charlie, Long Way to Tipperary, Make Believe, Desert Song, La Paloma, Sweet Adeline, I've Got a Feeling, Pagan Love Song, When My Dream Come True, Parade of Wooden Soldiers, Land of Sleepy Water, Turkey in Straw, Hail the Gang's All Here, and hundreds of others. An unending source of amusement. You can delight your friends for hours and play tunes after tunes simply by changing rolls. Small in size, fitting your pocket, yet mighty in its fascinating, intoxicating tone power. Not a toy, but a genuine musical instrument and the life of any party. One Roll free with each Rolmonica. Extra Rolls added each month. PRICE with 1 Roll \$1.50; Extra Rolls 10c each, all postpaid. Send remittance (Postage Stamps accepted) for all articles listed above, also in our other ad on previous page.

THE DANDY PERISCOPE

Very Interesting and Amusing Novelty

SEE WITHOUT BEING SEEN



Look Over the Heads of the Tallest Men in a Crowd.

See Over a Fence, Around Corners, Etc.

LOTS OF FUN AND AMUSEMENT

Strongly Made. Equipped with Mirrors, Sight-Finder and Eye-Piece.

THIS is the same kind of instrument that the soldiers use in the trenches to watch the enemy without risk of being seen themselves, and every submarine has one to peep above the surface of the sea to keep a look-out for other vessels, etc. With it you can gaze over a high wall or see around a corner without being seen yourself, or, if you are in a crowd, you can look right over the heads of the tallest men and watch all the fun. Our illustrations will give you some idea as to the numerous uses to which the Periscope can be put. Every Boy Scout should have one for spying and anyone else who wants some real amusement. The Dandy Periscope is very strongly made, will stand the roughest handling and the hardest wear, and with ordinary use should last a lifetime. It measures 17 inches long, and a little over two inches wide. The Periscope Tube is handsomely decorated with colored designs to show many of its uses, and each Periscope comes complete in box.

Price Postpaid to any Address. **\$1.00**

MAGICIAN'S BOX OF TRICKS

Apparatus and Directions for a Number of Mysterious Tricks, Enough for an Entire Evening's Entertainment. **\$1.00**

ANYONE CAN DO THEM

It is great fun mystifying your friends. Get this Conjuror's Cabinet, and you will be the cleverest fellow in your district. It contains the apparatus for ten first-class tricks, including THE MAGIC BALL AND VASE TRICK in wooden ball is placed inside, and upon replacing the lid has disappeared and is found in someone else's pocket; THE HINDOO TRICK CARDS can be made to change constantly as long as you direct; DISAPPEARING COIN BOX a coin, placed in the wooden box, vanishes entirely or changes into a coin of another denomination; THE GLASS GLOBULE TRICK (a coin is dropped into a glass of water and when the water is poured out the coin has vanished and is found somewhere else); THE RIBBON FACTORY FROM THE MOUTH TRICK is amazingly and supplies of colored paper ribbons come out of your mouth; THE DISAPPEARING HANDKERCHIEF is handkerchief laid in the hand mysteriously vanishes; THE WIZARD'S RING COIN TRICK; THE ENCHANTED BOTTLE (no one but yourself is able to make it lay down); THE GREAT HAT AND DICE TRICK (a large die is placed on top of a hat, disappears, and is found underneath yet no one has touched the hat, and last, but not least, THE GREAT PHANTOM CARD TRICK, as two from five leaves nothing. Full instructions are sent for performing each trick. In addition to the above, a number of other tests and illusions are fully explained for which you can easily procure the necessary apparatus. Price complete \$1.00 postpaid. JOHNSON SMITH & CO.



RESURRECTION PLANT

Great curiosity. Place in water, plant opens up and starts to grow in few minutes. Taken out it dries up and goes to sleep until put in water again. PRICE 10c, 3 for 25c, 75c per dozen, postpaid.



MAGIC MADE EASY 250 MAGIC TRICKS 10c
An excellent little book containing 250 Parlor Tricks, tricks with cards, coins, a handkerchief, eggs, rings, glasses, etc. So simple that a child can perform them. Pretty fancy illus. Sent postpaid to any address for only 10c, 3 copies for 25c.

MISSING AGAIN I'M STILL CONSCIOUS Comical Motto Rings
Lots of harmless fun and amusement wearing these rings. Made in platinum finish (to resemble platinum), with wording on enameloid, as illustrated. Price only 25c Postpaid.

The "Little Giant" Typewriter



A First Class Writing Machine For \$1.50
A perfect little typewriter for \$1.50. There are thousands of persons who would like to see a typewriter but whose needs and business do not warrant the expense attached to the purchase and use of a fifty or seventy-five dollar machine. To such persons we confidently recommend our Little Giant. It is strongly made, but simple in construction, so that anyone can quickly learn to operate it, and write as rapidly as they would with pen and ink. The letters of the alphabet most frequently used are so grouped as to enable the presentation marks being together. With this machine you can send your best girl typewritten love letters, address envelopes, make out bills, and do almost any kind of work not requiring a large, expensive machine. With each typewriter we send a tube of ink and full printed instructions for using the machine. Price complete \$1.50 by mail postpaid to any address in the world. Stamps accepted.

most frequently used are so grouped as to enable the presentation marks being together. With this machine you can send your best girl typewritten love letters, address envelopes, make out bills, and do almost any kind of work not requiring a large, expensive machine. With each typewriter we send a tube of ink and full printed instructions for using the machine. Price complete \$1.50 by mail postpaid to any address in the world. Stamps accepted.

JOHNSON SMITH & CO. Dept. 820 Racine, Wis.

PATENT

Protect Your Ideas

Take the First Step Today

If you have a useful, practical, novel idea for any new article or for an improvement on an old one, you should communicate with a competent Registered Patent Attorney AT ONCE. Every year thousands of applications for patents are filed in the U. S. Patent Office. Frequently two or more applications are made for the same or substantially the same idea (even though the inventors may live in different sections of the country and be entirely unknown to one another). In such a case, the burden of proof rests upon the last application filed. Delays of even a few days in filing the application sometimes mean the loss of a patent. So lose no time. Get in touch with me at once by mailing the coupon on the opposite page.

Prompt, Careful, Efficient Service

This large, experienced organization devotes its entire time and attention to patent and trade mark cases. Our offices are directly across the street from the U. S. Patent Office. We understand the technicalities of patent law. We know the rules and requirements of the Patent Office. We can proceed in the quickest, safest and best ways in preparing an application for a patent covering your idea. Our success has been built on the strength of careful, efficient, satisfactory service to inventors and trademark owners located in every state in the Union.

NO CHARGE for Information On How to Proceed

The booklet shown here contains valuable information relating to patent procedure that every inventor should have. And with it I will also send you my "Record of Invention" form on which you can sketch your idea and establish its date before a witness. Such evidence may later prove valuable to you. Simply mail the coupon and I will send you the booklet, and the "Record of Invention" form, together with detailed information on how to proceed and the costs involved. Do this NOW. No need to lose a minute's time. The coupon will bring you complete information entirely without charge or obligation.

My Offices
Just Across
Street From
U.S. Pat. Office



Above is a view of my drafting and specification offices where a large staff of experienced experts is in my constant employ. All drawings and specifications are prepared in my offices.

NEWS

Inventors
Write for these Free
Books

Strict Secrecy Preserved

All communications, sketches, drawings, etc., are held in strictest confidence in strong, steel, fireproof files, which are accessible only to authorized members of my staff. Feel free to write me fully and frankly. It is probable that I can help you. Highest references. But **FIRST**—clip the coupon and get my free book. Do **THAT** right now.

Clarence A. O'Brien

Registered Patent Attorney

Member of the Bar of: The Supreme Court of the United States, U. S. Court of Customs and Patent Appeals, U. S. Court of Claims, Court of Appeals, District of Columbia and Supreme Court of the District of Columbia.

Practice confined exclusively to Patents, Trademarks and Copyrights

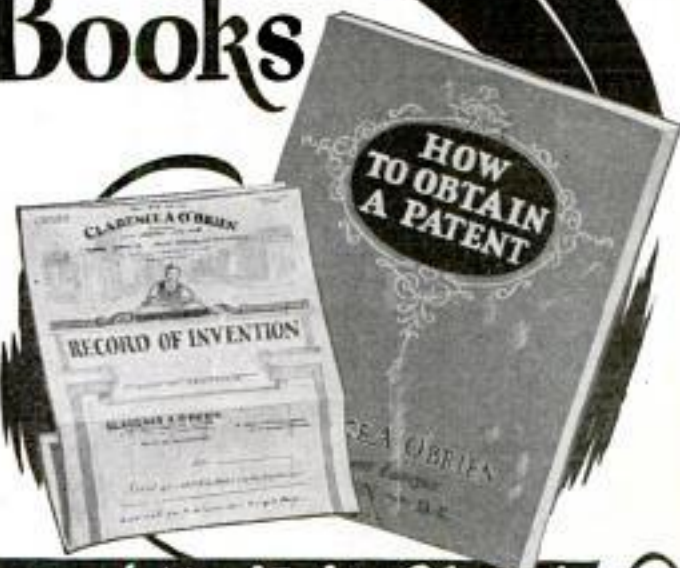

Clip this Coupon and Mail it Now!

CLARENCE A. O'BRIEN, Registered Patent Attorney
70-P Security Savings and Commercial Bank Bldg.
Washington, D. C.

(Or, Suite 1106, Dept. A-70, Woolworth Bldg., New York City)

Please send me your free book, "How to Obtain a Patent," and your "Record of Invention" form without any cost or obligation on my part.

Name.....

Address.....

(Important—Write or print name plainly and address office nearest you)

When writing to advertisers please mention Popular Mechanics

PATENTS SECURED TRADE-MARKS REGISTERED

High-class professional service for Inventors and Trade-Mark Users is necessary for PROPER PROTECTION. We Offer you our facilities on Reasonable Terms. If you have an invention send us a model or sketch and description and we will give you our OPINION whether your invention comes within the provisions of the Patent Laws. Our book, "HOW TO GET YOUR PATENT" and Record of Invention Certificate sent on request. DELAYS are DANGEROUS in Patent Matters.

Terms Reasonable.

Best References.

WRITE TODAY

RANDOLPH & COMPANY, Patent Attorneys

301 VICTOR BUILDING, WASHINGTON, D. C.

Name.....

Address.....

PATENTS

PROTECT YOUR IDEAS

Write today for FREE BOOKLET, HOW TO OBTAIN A PATENT and RECORD OF INVENTION—or send Drawing or Model of your Invention for Examination.

Promptness Assured with Best Results

MILLER & MILLER
REGISTERED PATENT ATTORNEYS

Former Members Examining Corps U. S. Patent Office

Dept. A-1006 Woolworth Bldg. New York
255 McGill Building Washington, D. C.

Win \$250 Cash, Plus Royalty FOR A METAL TOY IDEA

For every accepted new mechanical toy idea, \$250 plus royalties, will be paid by a large 80 year old manufacturing concern.

Offer open to every man, woman, boy or girl in the United States. The toy (or toy set) should sell for \$1 or less and will be made of sheet metal. A pencil sketch or rough model is all that is necessary. Send your entry marked "METAL TOY CONTEST" to Popular Mechanics Magazine, 200 E. Ontario St., Chicago—who have investigated the reliability of this offer. All entries promptly acknowledged.

INVENTORS

who derive largest profits know and heed certain simple but vital facts before applying for Patents.

Our book *Patent-Sense* gives those facts; sent free. Write LACEY & LACEY, 635 F Street N. W., Dept. 5, Washington, D. C. Estab. 1863.

TRADE
MARKS

PATENTS

COPY-
RIGHTS

BEST RESULTS. LOWEST FEES. PARTIAL PAYMENT PLAN

Write today for free information—No obligation, sending sketches and description of invention.

HARRY W. JOHNSON

Registered Patent and Trade Mark Attorney

FORMERLY MEMBER EXAMINING CORPS U. S. PATENT OFFICE
Member of the Bar; Supreme Court of the District of Columbia, The Court of Appeals of the District of Columbia, and the U. S. Court of Customs and Patent Appeals.

219 MCGILL BUILDING, WASHINGTON, D. C.

PATENTS

TO THE MAN WITH AN IDEA

Preliminary advice gladly furnished without charge. Booklet of information and form for disclosing idea free on request.

IRVING L. McCATHRAN, Patent Lawyer

Formerly with and successor to RICHARD S. OWEN

750 International Bldg. Washington, D. C.

41-E Park Row New York City

TRADE-MARKS

PATENTS—TRADE MARKS

All cases submitted given personal attention by members of the firm. Information and booklet free. Patent Office & Federal Court Practice.

LANCASTER, ALLWINE & ROMMEL

PATENT LAW OFFICES

480 Ouray Bldg. Washington, D. C.



GEARS

In Stock—Immediate Delivery

Gears, speed reducers, sprockets, thrust bearings, bevel couplings, pulleys, etc. A complete line is carried in our Chicago stock. Can also quote on special gears of any kind. Send us your blue prints and inquiries.

Write for Catalog No. 10

CHICAGO GEAR WORKS

769-773 W. Jackson Blvd., CHICAGO, ILL.

PATENTS

Booklet Free

Highest References

Promptness Assured

Best Results

Send drawing or model.

ALL BUSINESS GIVEN PROMPT AND PROPER ATTENTION

Listed Patent Lawyer in the latest editions of the Rand-McNally Directory of Bankers and Bank-Recommended Attorneys, published by Rand-McNally & Co., Chicago, Ill.; The Baggott & Ryall Directory of Guaranteed Attorneys, published by Legal Directory Corporation, Boston, Mass.; Flugel's Law List, published by Legal Directory Publishing Co., St. Louis, Mo.; American Lawyers Annual, published in Cleveland, Ohio; Bankers Service Legal Directory, published by Bankers Service Co., Boston, Mass.; Eyre's Law List, 9 Park Place, New York City; Walters Legal Directory, Omaha, Nebraska, and the National Directory of Attorneys, Baltimore, Maryland.

WATSON E. COLEMAN,
REGISTERED PATENT LAWYER

Victor Building, 724 Ninth Street, N. W.
WASHINGTON, D. C.

Send for **FREE BOOK** "How to Obtain a **PATENT**"

Delays may cost you thousands in profits from your invention. "Little ideas may have big commercial possibilities,"—protect them by Patents.

Our new **FREE BOOK**, "How to Obtain a Patent," gives you complete information on how to obtain the exclusive right to your invention and to the profits that may arise from it.

The advisability of immediately applying for a patent on your invention is obvious. Frequently men in widely separated parts of the country work on the same idea at the same time. The first to get his application on file has many advantages over the other party.

We'll send you a "Record of Invention" blank FREE

The first step to take is to secure one of our Record of Invention blanks (for which there is no charge), make a sketch of your invention on it, and have it filled in, dated and witnessed. It can then be used as proof of conception, when necessary. By following the instructions on the blank you may be saved much trouble and expense in securing a patent on your invention.

Established 1898

For over 33 years our staff of experienced attorneys has been serving inventors before the Patent Office and the federal courts. This long record of service, plus the testimonials of thousands of inventors, assures you the kind of patent service you desire.

Strictest Secrecy Preserved

Our offices in various cities are ready to give you personal service. Our Washington office, in close proximity to the Patent Office, does much to hasten the preparation and prosecution of patent applications. Send for the Free Book and the Record of Invention blank **NOW**. As soon as we receive the Record of Invention, one of our attorneys, selected for his knowledge along certain lines of patent work, will take charge of your case. Mail the coupon now—show "diligence" in getting your application on file—it may mean much to you later on.

MAIL COUPON NOW

VICTOR J. EVANS & CO.

Registered Patent Attorneys

Chicago Office
1640-42 Conway Bldg.

Philadelphia Office
Fidelity Phila. Trust Bldg.

San Francisco Office, 1010 Hobart Bldg.

New York Office
1007 Woolworth Bldg.

Pittsburgh Office
514 Empire Bldg.

MAIN OFFICE: 950 Ninth Street, N. W., Washington, D. C.
Please send me your free book, "How to Obtain a Patent," and your "Record of Invention" blank at once.

Name

Street & No.

City State

When writing to advertisers please mention Popular Mechanics



VICTOR J. EVANS & CO.

VICTOR BUILDING
724-722 9TH ST., N.W.

U. S. PATENT OFFICE

What do you
KNOW about
the oil you use?



You *know* you have good equipment in your shop, for you bought the best. And when you use 3-in-One Oil, you'll *know* your equipment is getting the best of care.

Three-in-One is especially blended from *animal, mineral and vegetable* oils to do three jobs at one time. As it *lubricates it cleans and prevents rust*. No plain mineral oil can ever do as much to keep hand and machine tools in working trim.

Handy cans and bottles; all good stores. Send for sample and "Dictionary of Uses."



THREE-IN-ONE OIL CO., DEPARTMENT A-117
170 Varick Street, New York
260 Second Ave., Ville St. Pierre, Montreal, Que.

3-IN-ONE OIL
CLEANS - OILS - PROTECTS

When writing please mention Popular Mechanics



**IT'S NEW
COSTS LESS
SELLS FASTER**

\$16⁰⁰ Daily Easy

Some Profit! If you book only a score orders. The amazing new "Vaughan's Safety Roll Sr." is the only up-to-date stationary Can Opener attachable to both wall and table. Lasts forever. Opens all sizes and shapes of cans with standard rims. Cuts tops out and in a jiffy. Simple and easy to handle—a child can operate it.

30 Million Homes

Need this marvelous new invention. Salesmen coin big money daily in simple 3-minute demonstration. Amazingly generous profits make Vaughan's Safety Roll Sr. the one sure all-year around seller and money maker. Write quick for Free Sample Offer and sure-fire big money plan.

AGENTS NATIONAL DISTRIBUTING CO.

549 W. Randolph St. Dept. 1-H Chicago, Ill.

THREAD CUTTING LATHE



8" Swing; 18" between Centers



Lever controlled reversible Feed permits cutting right or left threads. **\$55**

A real Lathe. Price as shown
12" BAND SAW, ROLLER GUIDES, TABLE TILTS, \$30
A powerful, practical Saw. Write today for catalog on other Machines.
ROSSBACHER MACHINE CO.
1516 Fernwood Avenue Toledo, Ohio

OTTAWA LOG SAW



only \$39
PUTS THREE OTTAWA TO WORK FOR YOU
GREATEST OFFER EVER MADE
Make Money! Wood is valuable. Saw 15 to 20 cords a day. Does more than 10 men. Ottawa easily operated by man or boy. Falls trees—saws limbs. Use 4-hp. engine for other work. 30 DAYS TRIAL. Write today for FREE book. Shipped from factory or nearest of 4 branch houses.
OTTAWA MFG. CO., 1741 -W Wood Street, Ottawa, Kansas

FREE TOOL BOOK

The entirely new Disston Saw, Tool and File Manual tells how to choose, use, and care for tools, file and set saws, etc. Sent free.

Henry Disston & Sons, Inc., Dept. M. Philadelphia. Canadian Factory, Toronto

Brown & Sharpe Tools

"World's Standard of Accuracy"



Send for Catalog No. 31 describing 2300 Precision Tools. Brown & Sharpe Mfg. Co., Providence, R. I., U. S. A.



MOULDS
For Making Toy Soldiers,
Indians, Cowboys, Animals, etc.

With one mould you can make many HUNDREDS OF CASTINGS. Whole Armies. Outfits, including material for casting, enamel paints and everything complete \$5.00. Easy enough for any boy to make and great fun for grown-ups. Sport for the whole family. Beware of imitations—insist on "MAKE-A-TOY" Moulds. Write for illustrations of dozens of patterns you can make.

MAKE-A-TOY COMPANY

Dept. E, 1696 Boston Road, New York City

SOLDER LIKE A PROFESSIONAL
with the
ESICO Junior
(Reg. U. S. Pat. Off.)

MAKES SOLDERING EASY!

Anyone handy with tools can do a good job in jig time with this "little wizard" of soldering irons. Thousands in use by professional mechanics. Plugs in on any current; heats quickly and stays hot! Highest grade nickel-chrome heating element; dark mahogany anti-heat handle; replaceable forged copper tip. Wt. 16 ozs., length 12 3/4 in., 6 ft. flexible cord.

If your dealer can't supply you send us money order or registered letter. We pay parcel post.

The Highest Quality Iron Ever Offered at the Price

Electric Soldering Iron Co., Inc., 137 West 17th St., New York, N. Y.

BUY GOOD EQUIPMENT!

Don't make the mistake of buying toy machines for your home shop — buy a Parks Smooth-all Planer, a real heavy duty machine.

Send today for circular

The Parks Woodworking Machine Co.
Dept. PM-11
1530 Knowlton Street
Cincinnati, Ohio

Smooth-all—4 in. Bench Planer

PARKS
WOODWORKING MACHINES

BURN YOUR NAME ON TOOLS
WITH THE
ARKOGRAF

PROTECT YOUR TOOLS FROM THEFT

Write with electricity any name or design on the hardest and finest tools and instruments, or any metal, like writing on paper with pen or pencil.

Complete Outfit \$3.50—Frosted Keyhole Interesting Illustrated circular free. Write today. Agents wanted.

ARKOGRAF PEN CO., 1771 E. Stark St., Portland, Oregon

QUALITY TOOL CHESTS
at right prices

Every GERSTNER Chest built for long service. The choice of Machinists and Toolmakers

Free Catalog.

Gerstner & Sons

455 Columbia St. Dayton, Ohio

BE A MASTER CRAFTSMAN

Earn extra money at home with H & A portable electric wood-working equipment. Make trellis, benches, book ends, seats, etc. Inexpensive way to start. Big Market. Good Profits. No. 2 Bench Lathe illustrated. Handles heaviest jobs—yet absolutely safe. Plugs in nearest light socket. Accurate, powerful, dependable. Used in hundreds of commercial shops. Portable. Electric. Priced Low. Write today for complete information, FREE CATALOG, and low prices. Also ask about new H & A Unit Plan Costless. Special offer for dealers and large jobbers.

H & A WOOD LATHE

HESTON & ANDERSON, 611 Stone St., Fairfield, Iowa

New Tractors from Old Fords

Do All Farm Work! Easy to Build—We tell you how

Make powerful tractor out of your Model "T" or "A" Ford, or Chevrolet with SHAW Tractor Equipment. Low cost! New HIGH ARCH Model with 30 inches clearance straddles 1 or 2 rows of corn and other crops. Cultivates, plows, seeds, discs, etc. Runs belt machinery. Easy to attach. **SPECIAL LOW INTRODUCTORY PRICE!** Write for FREE literature!

SHAW MFG. CO., 4511 Center St., Galesburg, Kans.

When writing to advertisers please mention Popular Mechanics



Shows
How to

Plan a Workshop and Equip It in Three Easy Stages!

YOU'LL get a great thrill fitting up your home workshop with the aid of this new ATKINS How-To-Do-It Book. It shows floor plans of a typical shop, and how to equip it in three easy stages.

First, it tells the best location for a shop, the space you need, how to get good light and air, and where to put electrical outlets. Then, it shows the work-bench, tool racks, supply shelves, saw horses, etc., arranged in a handy shop for the beginner.

The second plan adds larger fixtures to equip the shop for a more experienced worker. And the final stage shows the workshop completely fitted up, for using modern tools and machines in cutting or working wood and metal.

Shop-planning is only one of many subjects in this new book. It has a wealth of time-and-money-saving information! Tells HOW to select tools . . . choose woods for shop work . . . make 24 types of wood joints . . . build your own bench and shop fixtures . . . cut and work metals easier . . . where to get job plans for 450 shop projects . . . and so on!

The final chapter shows you 50 popular saws for home shops—all made of the world-famous ATKINS Silver Steel, to cut faster, run easier, stay sharp longer and far outlast ordinary saws.

This book has 40 pages brimful of useful information, for amateur or expert. Just send 10c with coupon below!



If your dealer does not have the ATKINS Saw you want, write us and we will see you are supplied promptly.

ATKINS SILVER STEEL SAWS

E. C. Atkins and Company, 426 S. Illinois St., Indianapolis, Ind.
I enclose 10c for the ATKINS 1932 Home Workshop Book.

Name..... PRINT

Street.....

City..... State.....

My dealer is..... 11

AMAZING World Wide Aero Short Wave Receiver

Only **\$6.45** Listen in direct to
London, Paris, Berlin, Buenos Aires

A new radio thrill for you. Span the world with this set. Enjoy unique foreign programs from strange lands. Hear broadcasting stations from all over the world, via short waves. Your ordinary receiver cannot tune in these low-wave stations. World-wide receiver gets 14 to 550 meter stations with surprising clarity. Price of set, including 6 coils, \$6.45; price in foreign countries, \$7.75, postpaid.



ASTOUNDING AUTO RADIO BARGAIN

\$20.00

This is the latest model 6 Tube Aero Pentode Auto Radio. Due to use of the latest Pentode tubes, this set is equal in performance to many 8 tube receiving sets. The circuit used is one which will be embodied in most of the expensive 1932 model auto radios. Complete set can be clamped on steering post of your car or can be operated by remote control from dashboard. Price of set only \$20.00. Set complete with tubes, batteries, dynamic speaker, antenna equipment and noise suppressors. \$39.50.



Send for Latest Catalog of Parts and Equipment

CHAS. HOODWIN CO., Dept. L-2, 4240 Lincoln Ave., Chicago, Illinois

AERO SHORT WAVE CONVERTER Only \$12.50

Convert your AC or DC radio set into a short wave Superheterodyne. With this converter on your regular set you will be able to tune in short wave stations from many different parts of the world. The Aero Converter contains its own filament supply. B voltage can easily be obtained from your regular set, or you may use a single 45-volt B battery. No plug-in coils. Single tuning dial. Very easy to tune. No whistles or squeals. Uses 2 UX227 tubes, one as oscillator and one as mixer. Price, AC model, less tubes, ready for operation, \$12.50. DC model for battery-operated sets, \$11.50. 2 matched UX227 tubes at 75c each, \$1.50; one 45-volt battery \$1.45.



NEW AERO MIDGET USING THE LATEST TYPE PENTODE AND MULTI-MU TUBES

Price \$16.50. Here is a midget radio that everyone can afford that has performance, distance and tone qualities like the larger and much more expensive sets. Wonderful tone quality and selectivity. Full dynamic speaker. Full vision dial. Beautiful walnut finish cabinet. This is a 5 tube set and sells for \$16.50. Price of complete set of 5 tubes is \$4.50.



BOW LEGS?

THIS GARTER (Pat'd) Makes Trousers Hang Straight If Legs Bend In or Out

Free Booklet—Plain Sealed Envelope
THE T. GARTER CO., Dept. E
South Bend, Ind.

Information on any book free. Write Popular Mechanics Press, Chicago, Ill.

NEW CLASS EMBLEMS

Ring, sterling silver, 1 or 2 letters in center, H5, JH, GS or SS beside shield—36 or more, \$1.25 ea., 1 to 12, \$1.75. Silver plated pin with guard, any numerals, any letters, 75c; 12 or more, 65c ea. 56-page catalog shows 550 designs—pins (30c up), rings, emblems, jeweled pins, athletic awards, etc., at special prices. Write for free copy NOW.

METAL ARTS CO., FACTORY 44 ROCHESTER, N. Y.

EST. 1895

10 MONTHS TO PAY
Send only \$1 and this fine, guaranteed Bulova "Lafayette" watch comes to you postage prepaid—no C. O. D. to pay on arrival.

10 DAYS' FREE TRIAL
After examination and 10 Days' Free Trial day balance in 10 equal monthly payments.

SATISFACTION GUARANTEED
All transactions strictly confidential. You take no risk. Satisfaction absolutely guaranteed or money back. No interest—no extras—no red tape.

IT'S A BULOVA 15 JEWEL

\$29.75
F P 5

SEND FOR CATALOGUE—FREE! Shows special values in genuine diamonds \$25. to \$1,000. and standard watches \$12.50 up.

Nationally advertised; fully guaranteed 15-jewel Bulova watch. Engraved sturdy case. "dust-tite" protector; radium dial and hands; latest style open link bracelet. \$2.88 a Month.

ROYAL DIAMOND & WATCH CO.

ADDRESS DEPT. 11-Y
170 BROADWAY, NEW YORK

PANTS MATCHED

Don't Throw Away That Coat and Vest!

Save \$15 or more! Let us match your coat and vest with new trousers tailored to your measure. Save the price of a new suit. Over 100,000 patterns. Mail sample of suit, or your vest which will be returned with FREE SAMPLE for your approval.

Match Pants Co. 20 W. JACKSON BLVD.
Dept. A-14 CHICAGO

LOOK! NEW AND NOVEL. LOOK!
MODELS OF FOREIGN CARTS AND WAGONS



COSTA RICA SUGAR CANE CART
(Including Ox and Load of Cane)
14½ Inches long by 5½ Inches High.

Parts cut to fit and ready to put together. Makes Model exactly as Illustrated. Pay postman \$1.25 on delivery, plus postage and a few cents for C. O. D. charges. Other Models in Preparation. Send for Circulars.

INTERNATIONAL MODELS
Box 4008, Station B Philadelphia, Pa., U. S. A.

\$500.00 REWARD**To Anyone**

who can prove that this plate, which is holding a 25-pound weight, is not cemented with Peerless Waterproof Cement, or that this illustration is not an actual demonstration in daily use.

Peerless Cement is 100 times stronger than glue; waterproof, heatproof, coldproof, acidproof. Free from every fault and weakness of other cements and glues.

Vastly superior in mending, patching and repairing anything.



SEND 25c for a full size bottle of Peerless Waterproof Cement and also ask for our liberal "Get Acquainted" Sales Offer. NO FREE SAMPLES.

PEERLESS WATERPROOF CEMENT CO.
2741 Dodier St. St. Louis, Mo.

1000 Uses

Peerless Waterproof Cement repairs dishes, furniture, radios, airplanes, auto tops, boats, tents, etc.

Use it on any material—cloth, leather, wood, china, glass, fibre, iron or any kind of metal, etc.

AGENTS WANTED

Make big money all year 'round selling Peerless Cement to every home, store, garage, shop, factory, etc., spare or full time—excellent side line. Repeat orders sure.

Satisfaction guaranteed or money refunded. Big profit on each sale. Write or wire today for full details and special "Get Acquainted" Offer.

**MAYHEW**

flexible
RIGID

the newest...
greatest of all

STEEL RULES

- Revolutionary in Principle
- Lower in Price

As rigid as a yardstick, as flexible as twine—this most compact of rules measures straight out, around corners or curves with equal ease. Has so few parts—nothing can get out of order. Gives accurate, direct inside and outside measurements of back and front side of any object. Weighs only about 3 ounces—fits in vest pocket.

See That Tip!

Mayhew's Patented Self-Adjusting Hook Tip—the only precision tip on steel rules—permits accurate reading of entire first inch. Hole at end of tape for scribing arc of radius, making inner measurements, etc.

Nickel Plated Case
Rust-Proof Throughout

Can also be furnished in gold or silver at slight additional cost.

\$2.00

Your Favorite Hardware Store Has Them. If Not, Write Us Direct.

Made in 4 and 6 foot lengths.
B-48". Each.....\$2.00
B-72". Each.....\$2.50



MAYHEW STEEL PRODUCTS, Inc., Dept. 11-PM, Shelburne Falls, Mass. Enclosed find \$..... for B-..... * Mayhew Steel Rule, to be sent me prepaid with Money Back Guarantee.

Name.....

Address.....

City.....

Dealer's Name.....

Copyrighted material

The IDEAL Falcon The IDEAL Travelair The IDEAL Boeing

Build These 3 Popular Models

Get the New IDEAL for the Cost of One! 3-in-1 Kit containing everything required to build these three popular flying Models; all parts, fittings, materials and Full Size Plans and Instructions for each Model. Full fuselage Models, 15 in. Size. Biggest value ever offered; easy to build; wonderful flyers.

All Materials and Plans for 3 Models
\$1.65 Postpaid

Catalogue Model Airplanes and Supplies—6c

IDEAL AEROPLANE AND SUPPLY COMPANY, Inc.,
26 West 19th Street, New York City

SALE Electric

VACUUM CLEANERS

Completely renewed and re-finished—Have N. Order today. State whether you want Furka, Paster or Apex. Send no money. Inspect before you pay expressman. \$10.95, F. O. B. Detroit. Choice grade of Hoover, Pioneer Duster, Royal, \$15.95. 100-120 Yds. any current. New attachments for all cleaners (\$10 to \$12.50 value) \$3.95. AGENTS, some good territory open.

\$10.95

2 YRS GUARANTEE

ReNew Mfg. Co., Dept. B, (Factory) 2262 Gratiot Avenue, Detroit, Mich.

Sell Christmas Cards!

Expensive gifts may not be in demand, but holiday greetings will be mailed by practically everyone. Make money and build a business of your own in spare time taking orders for Demaree Christmas cards. Write early for this remarkable line.

Demaree Stationery Co., 908 Walnut, Kansas City, Mo.

BUILD for PLEASURE or PROFIT

\$25 to \$50 a day making furniture, lamps, storm sash, toys, novelties, built-in cabinets, alterations, repairs, etc.

The Electric Carpenter

New model with 14" Fold-Over Band Saw includes also 8" Rip Saw, 8" Cross Cut Saw, 6" Jointer, 36" Lathe, Reversible Shaper, 1/2" Hollow Chisel Mortiser, and Sander.

Whit, making great occupations.

AMERICAN FLOOR SURFACING MACHINE COMPANY

524 S. St. Clair St. Toledo, Ohio



NOW-A Powerful New 11-Tube Super Heterodyne

\$37.50
COMPLETELY ASSEMBLED WITH LARGE DYNAMIC SPEAKER.



Pentode Tubes
Variable-Mu
Automatic Volume Control

30 DAYS FREE TRIAL

AGAIN—One of America's most famous and oldest radio manufacturers offers the Radio sensation of the year! A powerful, new, 11-tube Super-Heterodyne at the amazingly low price of \$37.50—and combining all the new 1932 features—Pentode Tubes, Variable Mu Tubes, Real Automatic Volume Control, Balanced Unit, Super-Heterodyne Circuit, etc. This is just one of the startling radio bargains from the great selection illustrated in the big FREE, 1932 Midwest Catalog. At our risk, entertain yourself for 30 full days absolutely FREE, then decide. Compare Midwest Radios with the costliest sets on the market. Convince yourself. We guarantee you 100% satisfaction. Midwest can make this daring offer, only because of the excellent quality, and proven performance of these new and longer distance radios. If you're looking for a powerful, 11-tube, Screen Grid, Super-Heterodyne, with all the new features—pin-dot selectivity, and amazing new sensitivity—mail coupon immediately for FREE trial offer, and beautiful new 1932 catalog.



Complete Line of Consoles

The big FREE catalog beautifully illustrates the complete line of gorgeous Midwest Consoles. "Deluxe," Highboy and Lowboy models.

Deal Direct with Factory—Save Up to 50%—Terms as Low as \$5.00 Down

Direct to customer selling makes the surprisingly low Midwest prices possible. Know what it means to have one of the latest and most powerful radios on the market—with all the new 1932 improvements in tone, clarity, selectivity—at about half what you would pay in retail stores.

Absolute guarantee of satisfaction protects you and eliminates all risk. And don't forget—you try any set you select for 30 full days ABSOLUTELY FREE. You must be delighted. Mail coupon for beautiful new FREE catalog and complete details of FREE TRIAL, easy payment plan. You'll be amazed.

MIDWEST RADIO CORP. DEPT. 18 CINCINNATI, OHIO

Mail this Coupon for Complete Details and Big FREE Catalog!

Midwest Radio Corp.,
Dept. 18
Cincinnati, Ohio.

Without obligation on my part send me your new 1932 catalog, and complete details of your liberal 30-day free trial offer. This is NOT an order.

Name.....

Address.....

Town..... State.....

Send me SPECIAL USER AGENTS PROPOSITION.

USER AGENTS
We pay you BIG MONEY just for showing your radio to friends and neighbors. Easy EXTRA MONEY! Check coupon for details.

When writing please mention Popular Mechanics

SMALL CAN OPENER PROVES BIG SELLER

10 SECOND DEMONSTRATION PAYS AGENTS UP TO \$3 AN HOUR

Now! A Pocket Size Can Opener that does the job as well as any \$2 can opener. One hand cuts out entire top of can with lightning speed, leaving edge clean as a whistle.

TAKING COUNTRY BY STORM



Housewives wild about this time and labor-saving device. Economical—lasts indefinitely. No home can be without it. Brings efficiency into the kitchen. Endorsed by thousands.

OVER 100% PROFIT

Quickest seller on market today. Never sold in chain stores. Popularly priced to sell on sight. Easy to carry full day's supply in your pockets—Write today!

IDEAL UTENSIL CO., Dept. 50
10 S. LaSalle St. Chicago, Ill.



Build Model Ships OF THE BETTER KIND

We can supply construction sets, flags, steering wheels, guns, capstans, anchors, blue prints, books, etc., for building models of the U. S. Destroyer Preston, Flying Cloud, Constitution, Spanish Galleon, Mississippi Steamboat, Sovereign of the Seas, Bluenose, Mayflower, Viking, Baltimore clipper and many others. Also special construction sets for racing sail boats, power boats, model steam engines, propellers, etc., and fine tools for the model maker. Our large 56 page photographically illustrated ship model booklet contains valuable information and hints for building ship models, in addition to prices, and full description of the above articles. Many people only slightly interested in models, have become greatly enthused upon receiving this booklet. A copy will be mailed postpaid upon receipt of 15c (coin preferred).

MODEL SHIP SUPPLY COMPANY

Dept. M, Mineola, N. Y.



ALUMINUM SOLDER

You can now solder Aluminum, sheet or cast, as easily as tin. Solder brass, copper, etc., to Aluminum. Introductory offer, \$1.50 size sent post paid for \$1.00. Money Back Guarantee. Manufacturers and repairmen demand it. State Distributors wanted. Pays Big Profits. Write Dept. F. 11.

AMERICAN SOLDERS COMPANY
3534 Sunset Blvd. Los Angeles, Calif.

MOVIES In Your Home

Our marvelous, practical Movie Machines sell as low as \$5.00 postpaid. Also finest 16 mm. cameras and projectors at factory prices. A complete line of both standard and 16 mm. film available at low prices with exchange service.

Write for big, FREE catalogue.
PARAMOUNT MFG. CO. Dept. G-45 Boston, Mass.

Books on all subjects are sold by Popular Mechanics Press, 200 East Ontario Street, Chicago, Illinois



How to Obtain A Better Looking Nose

Improve your personal appearance
My free book tells you how I guarantee to improve the shape of your nose by remodeling the cartilage and fleshy parts, quickly, safely, and painlessly, or refund your money. The very fine, precise adjustments which only my new patented Model 25 Nose Shaper possesses, make results satisfactory and lasting. Work night or day. Over 100,000 users. Send for free book to M. TRILETY, Pioneer Nose Shaping Specialist Dept. 288 BINGHAMTON, N. Y.

The Old Reliable Credit Jewelers

LOFTIS

BROS. & CO. F258

Dept. F-514
30 No. State St.
Chicago, Ill.

Send for FREE Catalog
2,000 Illustrations

QUALITY CHRISTMAS GIFTS
GENUINE **Diamonds** GUARANTEED

Our sparkling blue-white stones of amazing beauty, set in artistic Solid 18-k White Gold mountings (except No. 907, which is 14-k Green Gold). **Credit Terms:** Pay one-tenth down; balance weekly, semi-monthly, or monthly at your convenience.

No. 918
\$37.50
\$1.00 a Week

No. 923
\$98.50
\$2.50 a Wk

No. 907
\$73.85
\$1.75 a Week

No. 979
Waltham Strap Watch—selenoid valve, 15 Jewels, \$35.00. \$3.50 Down; \$3.50 a Mo.

No. 962
"Miss America"—No. 962. Dust proof. Balova case. 15 jewels. Watch and bracelet set with 6 synthetic sapphires. \$37.50. \$3.75 Down; \$3.75 a Mo.

How to Order—State article desired—name of employer—kind of work you do—how long in position—age—married—where born—how long there. **Always keep confidential.** Send last payment. orgoodsent@vva.com

Our References: Any Bank or Banker in the U. S. A.

Genuine **BRAND NEW CORONA**
Model No. 3
at **NEW LOW PRICES**

ONLY \$39.90 on Easy Terms
Small Carrying Charge

ONLY 10c a day

Yours for Only \$1.00 DOWN

Hurry! If you want to be in on the biggest "BUY" in Portables. Only a very limited number of these Brand New Coronas available at this **Special Low Price and Easy Terms.** Don't wait. Here's your chance to get a wonderful nationally advertised Corona at a real bargain. Has up-to-date improvements and carries our regular New Machine iron-clad guarantee. Remember this exceptional offer good only while supply lasts.

Sent on 10 Days' Trial
Send for your 10 days' trial of this new Corona Now. Try it the entire time at our risk. See for yourself the neat, smooth, perfect work it does. Note how easy and quiet it runs. Learn the joy and convenience of writing on a portable. Write all your personal and business correspondence during our generous trial—without obligation to buy. Compare its many improved features—its neat, compact and sturdy design; its superior workmanship, and its bright sparkling finish with other machines costing much more.

Iron-Clad Guarantee
Act At Once—only \$1 brings this shiny new Corona for full 10 days' trial—Write all the personal and business letters you want. If you decide to keep it send only \$3 a month until the special low price of \$42.90 (term price) is paid.

FREE Carrying Case
Beautiful Leatheroid carrying case with nickel trimming is included Free with each Corona while limited quantity lasts. If you have ever wanted a wonderful portable—here's your chance. Don't wait until it's too late. Send the coupon NOW. **LIMITED OFFER**—At this Bargain Price and unheard of easy terms—10c a day—these wonderful New Coronas will go in a hurry. Remember the Corona comes to you fully complete—book of instructions and all—nothing extra to buy. Send at once!

International Typewriter Exchange (Corona Division)
231 W. Monroe St., Chicago Dept. C-1115

Send the Corona F.O.B. Chicago for 10 days' trial at the special low price offered. I enclose \$1.00 deposit with the understanding that if I am not perfectly satisfied I may return it Express Collect and get my deposit back. If I decide to keep it, I will send \$3.00 a month until I have paid \$42.90 (term price) in full.

Name.....Age.....
Address.....
Town.....State.....

Build your own outboard hydroplane motor or sail boat. Use our plans or knock-down frames and machined parts. Many models to select from. Write for new catalog. Please enclose 10c for catalog.

J. B. WELCH, Inc., Dept. B, 3148 No. 31st St., Milwaukee, Wis.

Deaf 20 Years
But now I hear and will tell any deaf person FREE, who writes me, how I got back my hearing, and relieved head noises by a simple, invisible, inexpensive method which I myself discovered.

Geo. H. Wilson, President
Wilson Ear Drum Company, Inc.
1015 Todd Bldg., Louisville, Ky.

MOLES and WARTS
REMOVED PERMANENTLY
Rid your face, neck, arms and body of all unsightly moles and warts with "ANTI-MOLE." One application does it. Safe—easy to use—painless—leaves no scar. Used successfully by physicians, skin specialists and beauty experts for 28 years. Write for FREE booklet on treating all kinds of moles and warts.
Miller Co., 2445 South St., Lincoln, Nebr.

QUIT TOBACCO

No man or woman can escape the harmful effects of tobacco. Don't try to banish unaided the hold tobacco has upon you. Join the thousands of inveterate tobacco users that have found it easy to quit with the aid of the Keeley Treatment.

KEELEY Treatment For Tobacco Habit
Successful For Over 50 Years

Quickly banishes all craving for tobacco. Write today for Free Book telling how to quickly Free yourself from the tobacco habit and our Money Back Guarantee.

Home of the famous Keeley Treatment for Liquor and Drugs.
Booklet sent on Request. Correspondence Strictly Confidential.

THE KEELEY INSTITUTE, Dept. A-551, Dwight, Illinois



Rupture Secret Out



**5000
Packages
Free...**

*No Dope
No Ox-Harness
Exciting Discovery!*

PONDEROUS plasters, cruel springs, leather harness, upholstered pads, iron bars, are not in this picture. Instead, an enlightened invention, exclusively patented, for up-to-the-minute people who want results. It's new. You can be clean with it. Don't know you have it on. Ruptures have been reduced in three weeks by its help. Not merely a "truss" but a strengthening treatment.

More Than a Million Sold

Of the underlying exclusively patented invention, more than a million have been sold by us, to the best people all over the world. Thousands of letters on file. A beautiful book, profusely illustrated, printed on coated paper in two colors will be sent with an educational sample of material free, in sealed parcel, to ruptured people. Learn about this coolest and cleanest and wisest of all systems right now. It takes but a minute to send the coupon. Tomorrow means never.

Sent On Trial (With a Forfeit)

Not only sent on liberal trial to prove its high efficiency and merit, but a forfeit goes with it which is yours if the pleasant help is not all we claim. Rupture eats up nerve force, undermines health and makes people old before their time. Get a free package while they last.

New Science Institute
2190 Clay Street
Steubenville, Ohio

When writing please mention Popular Mechanics

Send This Coupon Before Too Late—
New Science Institute
2190 Clay Street, Steubenville, Ohio
Send the free packet containing the sample of material, the book, "Why Do Thousands Insist on Remaining Ruptured, Cringed," and other valuable information, also your "Forfeit Trial Offer." I am to be under no obligation. I am ruptured.
Name.....
Address.....
City.....
State.....
Please write plainly or print address, the packet is valuable and we want it to reach you early.

Polox Fluid Solder



**POLOX
SAMPLE CASE**
Put Together With
Polox Fluid Solder
POLOX MFG. CO.
Merriam Falls

Made from Nails, Toothpicks, Copper, Leather, etc. Hinges and Fastener applied with "POLOX." Write for Circular.

POLOX MFG. CO.,

MERRIAM, KANS.

AGENTS! SELLS LIKE WILD FIRE



\$380 monthly selling 10 improved patented Carter Window Washers daily. Cleans, dries, polishes. Eliminates all muss. Good Housekeeping approval. Restricted territory. Write today.
CARTER PRODUCTS CORPORATION 998 Front Ave., Cleveland, O.

Ahoy Mates—Learn how to build all steel superdreadnaughts and other ship models that float and run. Booklet free.
THE MECCANO CO. 511 Meccano Circle
New Haven, Conn.

Rupture No Longer Spoils My Fun

"Now that I am rid of my rupture and do not wear a truss, I enjoy dancing again. Many strenuous activities are pleasures, because I am not handicapped in any way. My work is no longer a task—I enjoy it. No one would ever believe I was crippled by rupture."



This is the way people write us after ridding themselves of rupture by using **STUART'S ADHESIF PLAPAO-PADS.**

Stacks of sworn endorsements report success—without delay from work.

Plapao-Pads cling to the body without straps, buckles or springs. Easy to apply—economical and comfortable.

Convince yourself by actually testing Plapao at our expense. Send coupon today.

Test of Factor "PLAPAO"

FREE! **ACT SPEEDILY**

MAIL COUPON BELOW TO-DAY

Plapao Laboratories, Inc.
789 Stuart Bldg., St. Louis, Mo.

Send me FREE Trial Plapao and 48-page book on Rupture. No charge for this now or later.

Name.....

Address.....

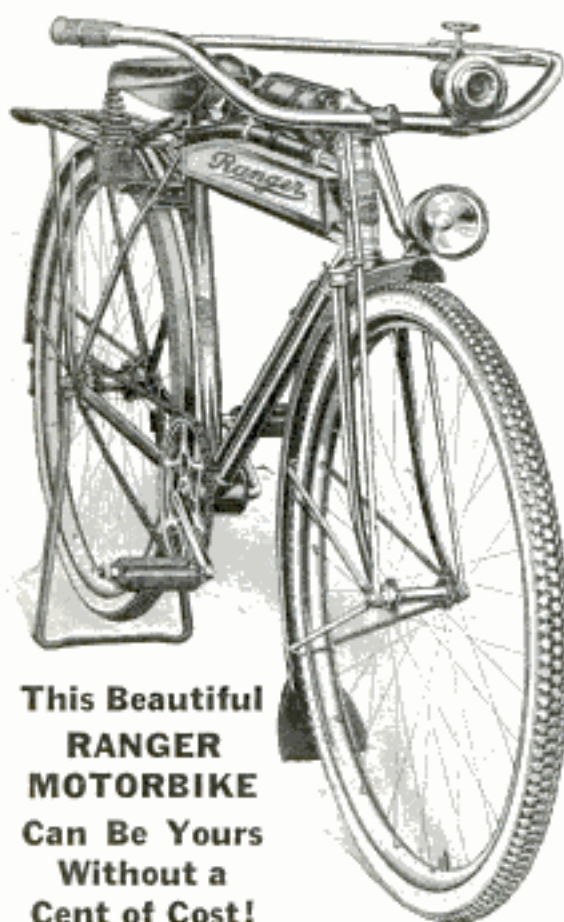

This Beautiful
RANGER
MOTORBIKE
Can Be Yours
Without a
Cent of Cost!

WIN THIS BIKE

IT CAN BE YOURS WITHOUT COST

A RANGER MOTORBIKE—the finest bicycle you ever saw! Made by the Mead Cycle Company. Fully equipped with horn, headlight, rear wheel stand, coaster brake, and other outstanding features. Enameled in beautiful colors. Built for speed, easy running, and long wear. And just think! This bike can be YOURS—without a cent of cost.

MAIL THE COUPON TODAY

Join the Crowell Club and deliver three of America's best known magazines to regular customers. No experience necessary; we show you how to win dozens of dandy prizes and earn your own spending money—in your spare time. ACT NOW! MAIL THE COUPON AT ONCE!

MR. JIM THAYER, Department 228
The Crowell Publishing Co.,
Springfield, Ohio.

Dear Mr. Thayer: I want to earn MONEY and PRIZES. Please start me off as a salesman.

MY NAME.....

ADDRESS.....

CITY..... STATE.....

"Little Cut-Up"



"THE SMALLEST LITTLE SAW IN THE WORLD"

THE SAFE ELECTRIC SAW

Complete with 1-4 H.P.A.C. 110 V. G.E. Motor. Ball bearing drive to Heavy Guide Tension System. 1725 strokes per min. No sliding parts. Cuts 2x4 wood 2 in. thick, 10 in. deep. Inside or outside cuts as fast as you can follow a line. Cuts fibre, plywood, bakelite, aluminum, brass and other soft metals. Thousands in use in home shops, factories, schools, etc. Price, with 4 blades, \$39 f.o.b. U. S. Dealers' points. On brass substitute (without Motor) in direct shipment to any fractional H.P. motor, \$22.50. Extra blades \$1 doz. Dealers preferred cities. Literature on request or send order and will ship C.O.D. or from our nearest dealer. Manufactured and distributed by

Beebe Bros., 3215 1st Ave. S., Seattle, Wn.

ONE-MAN SAW MILL

Makes lumber, shingles, cross ties, fence posts, laths, fruit and vegetable crates and boxes, dimension blanks for furniture, etc. Splits blocks into firewood. Needed by

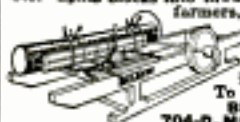

farmers, timber owners, contractors. Pays for itself in a week, or on one job. Guaranteed. Sold direct from factory. Write today for Special Offer and Free Book "How To Make Lumber."
BELSAW MACHINERY CO.
704-D, N. W. 1st St., Kansas City, Mo.

39
BRINGS IT TO YOU

FASTEST SELLING \$1 DEAL EVER OFFERED

Sell famous Paris Toiletries. Make 100% Profit and give away Pure Silk Hose, Pearl Necklaces, and other Valuable Premiums. Full Details FREE! WRITE NOW!
PARIS LABORATORIES, 3147 Locust Blvd., Dept. 9111, ST. LOUIS, MO.

New AUTOMATIC ENGINE DRIVEN TIRE PUMP



\$3
POST
PAID

Here is an amazing device that makes it possible for auto owners to carry an air station in the pocket of their car. This Automatic Tire Pump operates from one cylinder of the engine and pumps up tires perfectly. Nothing but pure air gets into the tires.

12 ft. of hose—Guaranteed 2 years.
Free Sample and Big Profit Offer to Agents

Men are wanted everywhere to introduce this Automatic Tire Pump. "Eagleair" makes a fine demonstration, attracting crowds. Buyers always like it and sell it for you to friends. Don't let someone beat you to it. Order today. Read about "Eagleair" on page 640, April Popular Mechanics Magazine.

G. H. MEISER & CO.
327 E. Marquette Rd., Dept. 1, Chicago, Illinois

CHROMIUM PLATING POWDER

PLATES IRON, STEEL, NICKEL, BRASS and COPPER without electricity or machinery. Guaranteed not to tarnish; dispenses with polishing. Half pint can \$1.50, prepaid. Particulars FREE.
GUNMETAL CO., Ave. T, Decatur, Illinois

Soderite

THE NEW and THE ORIGINAL METALLIC FLOWING SOLDER

No Heat
No Flux

is used on metals of every kind—wood, glass, leather, celluloid, aluminum, hard rubber—one metal to another or to wood or glass—tanks, pipes, radiators, engine heads and blocks, auto tops—models—patterns—boiler rooms—plumbers—garages—homes, hotels, office buildings. This picture together with writeup appear on page 975, June Popular Mechanics.

WRITE for FREE PARTICULARS

AGENTS	DEALERS	REPAIRMEN
Wanted everywhere. 100% profit, quick sales, protected territory	Everyone who enters your store or shop needs SODERITE	Everyday you can make many extra dollars with SODERITE

Send \$1.50 for Large Can Worth 50 Times Its Price

Check— Agents, Dealers, Repairmen

Fluid Solder Products Co.
1446 S. Wabash Ave., Chicago, Ill.

Name.....

Address.....



FREE

The Road to Understanding For Men Past 40



W. J. KIRK

WHY is 40 the "dread age" for many men? What is the "intimate" disorder that often robs them of vitality, health, joy of living? This daring free book answers these vital questions. Mail coupon for Free Copy.

WHY are many men past 40 suddenly afflicted with a dangerous ailment, that if neglected, may lead to wretched old age or perhaps grave surgery? The Free book answers this and other questions every man past 40 should know.

WHY do so many middle aged men suffer backache, leg and foot pains, sciatica, bladder trouble, night rising, chronic constipation and other so-called old-age ailments? Find the answer in the Free book.

HOW can one again frequently know the joy of living, get swift, lasting relief and feel 10 years younger in 7 days? Meet the reason, and learn how an amazing new, drugless treatment is used and endorsed by prominent specialists.



The Truth About Prostate Gland Trouble

Many men mistake these dangerous and distressing ailments for approaching old age and live lives of misery, when by simply re-stimulating a tiny gland—called the prostate—they might be enjoying vim and health. Already 100,000 men have tested the merits of a new drugless method of gland stimulation perfected by a scientist with offices in Ohio, California and England. Now many physicians, specialists, hospitals and sanitariums use and endorse it, for prostate gland failure. It is not a medicine, drug, massage, diet, exercise or violet ray. Its relief is not only usually quick—but lasting. Many users say it cleared up their distressing symptoms and made them feel 10 years younger in 7 days. Now it will be sent to you on a guarantee that if it doesn't do the same for you, pay nothing. If you want to know the joy of living, mail the coupon for your Free copy of "The Destroyer of Male Health."

W. J. KIRK, President

2147 Morris Ave. STEUBENVILLE, OHIO

If you live West of the Rockies, address The Electro-Thermal Co., 303 Van Nuys Building, Dept. 21-A, Los Angeles, Calif. In Canada, address The Electro-Thermal Co., Desk 21-A, 53 Yonge St., Toronto, Can.

W. J. KIRK, President,
2147 Morris Ave., Steubenville, Ohio.

Send free copy of your daring book, "The Destroyer of Male Health." Also facts about your Free Trial.

Name.....
Address.....
City..... State.....



Using Tobacco

Perhaps you've tried to stop using tobacco only to find that the habit has such a hold on you that you gave up trying.

You know, better than anyone else, whether tobacco is hurting you, and if it is, that sooner or later, it will undermine your health. Heart trouble, indigestion, dyspepsia, nervousness, insomnia, poor eyesight—these and many other disorders can often be traced directly to the use of tobacco, according to good medical authority. Besides it is an expensive, utterly useless habit.

Let Us Help You To Banish The Habit

No matter how firm a grip tobacco has on you—no matter whether you've been smoking cigars, pipe or cigarettes or chewing plug or fine cut for a month or 50 years—Tobacco Redeemer will in most cases remove all craving for tobacco in any form in a very few days. It does its work so quickly that all tobacco "hunger" is gone almost before you know it. The desire for a smoke or chew usually begins to decrease after the very first dose.

Tobacco Redeemer contains no habit-forming drugs of any kind—it is in no sense a tobacco substitute. It does not cause the slightest shock to the nervous system; on the contrary, it often helps to quiet the nerves and make you feel better in every way.

SEND for PROOF

Get our free booklet. It tells you all about the deadly effects of tobacco and how easy it is now to quit. We will also send you copies of letters from confirmed users telling how this simple, home-treatment freed them absolutely from the habit. Just mail coupon—or a postal will do.



NEWELL PHARMACAL CO.

Dept. 999 St. Louis, Mo.

Send me without obligation to me in any way, proof that Tobacco Redeemer will positively free me from the Tobacco Habit or my money will be refunded.

Name.....

Street and No.....

Town..... State.....

When writing to advertisers please mention Popular Mechanics

YOUR MESSAGE
HERE

ELECTRIC Neon-Red FLASHER SIGN

The NEW WIL-O-LITE ELECTRIC FLASHER SIGN, CHANGEABLE for every line of business, opens tremendous field for salesmen of ability. Only MEN WHO CAN SELL A LEGITIMATE PRODUCT are wanted. A good paying HIGH GRADE job. Glowing NEON-RED messages at a fraction of the price of other electric signs. Polychrome frame in Gold, Antique Bronze or Silver. Never needs repairs. CHOICE OF 265 STOCK PANELS. Size 25 1/2 in. long, 7 1/2 in. high. (Patented base Size No.) F. O. B. Chicago. Order your WIL-O-LITE today. Catalog of WIL-O-LITE Signs and Message Panels sent on request.

WIL-O-LITE, Inc., 125 W. Austin Ave., Chicago, Ill.

WIL-O-LITE DISTRIBUTOR OPPORTUNITY
In certain territories, on the entire WIL-O-LITE line, for men or firms qualifying.

TEAR GAS

PROTECTION for Stores, Warehouses, Houses, Summer Camps, Automobiles, Trucks, Garages, Filling Stations, Etc.
New automatic electrically controlled Tear Gas Devices give SAFE and SURE Protection against Burglary, Theft and Holdup at small cost. Easily and quickly installed anywhere. Property MUST be protected this year. Business is booming now. High grade ambitious financially responsible men can make exceptional earnings with this complete protection line. No competition. Exclusive territory. Quick sales. Splendid profit margin. Write today for details.
E. R. & S. CO. 64 E. Lake St. Dept. 122 Chicago

INCREASE YOUR POULTRY PROFITS!
By proper Breeding, Feeding, Housing, Culling and Marketing AMERICAN POULTRY JOURNAL tells how to do it, and in addition a series of **COLORED PICTURES** with explanatory text tell and show many things you should know. They are not just colored pictures of birds but pictures of an educational nature, something never before shown by a poultry paper. 12 issues of American Poultry Journal contain about 1000 pages—
Price 25c a year—5 years \$1.
AMERICAN POULTRY JOURNAL, 14-536 S. Clark St., CHICAGO

RAISE CHINCHILLA AND NEW ZEALAND WHITE FUR RABBITS Make Big Money
We Supply Stock and CONTRACT for ALL YOU RAISE paying up to \$6.50 each. Large illustrated book, catalog and contract, also copy of Fur Farming Magazine, all for 10c. **STAHLE'S**
OUTDOOR ENTERPRISE CO., Box 141A, Holmes Park, Missouri

NEW SQUAB BOOK FREE
Breed PR Royal squabs and make money. Sold by millions at higher prices than chickens. Raised in one month. Send four cents stamps for postage on brand new big 64-p. illustrated free book how to breed and profit by fast sales method. Thirty-first year.
Plymouth Rock Squab Co., 634 N St., Melrose, Massachusetts

PYROIL-IZE Your Car!
A few ounces of PYROIL LIQUEFIED GRAPHITE—the new lubricating sensation—added to your gas and oil, stops wear, ends carbon and overheating. Reduces noise, increases power and mileage, increases life of oil. 100% GUARANTEED. Write for "THE STORY OF PYROIL."
W. V. Kidder, Pres.
THE PYROIL COMPANY
38 LaFollette Ave. LaCrosse, Wis.



Hundreds of Big Pay Jobs Open Every Year in Radio

Get one of the many fine jobs that are opening every year in broadcasting stations, commercial land stations, talking movies, radio factories, jobbers, dealers, aircraft radio, or on board ship which gives world-wide travel with good salary and expenses paid. Why stick to a no-future job when you can get ready in a short time for Radio, where the good jobs pay as much as \$50 to \$100 a week?

Jumped From \$35 to \$100 a Week
"Before I entered Radio I was making \$35 a week. Last week I earned \$110 servicing and selling Radios. I owe my success to N. R. I. You started me on the right foot." J. A. Vaughn, 3161 S. Grand Boulevard, St. Louis, Mo.
W. Page, 133 Pine St. McKendee, Tenn., made \$945 in spare time while taking his course. This course is world famous as the one that pays for itself.

I Will Train You at Home in Spare Time for Radio-Television-Talking Movies
Hold your job. Give me part of your spare time. I've trained hundreds of fellows at home to make more money in Radio than they were getting before. High school or college education not necessary. Many successful graduates didn't even finish the grades. Latest developments including Television-Talking Movies—Aircraft Radio—Advanced Radio Servicing and Merchandising, and many other subjects.

Find Out What Radio Offers You Get My 64-page FREE Book of Facts
See for yourself what good money other N. R. I. men are making. "Rich Rewards in Radio" points out where the good jobs are, what they pay, how to get one. A copy of my money-back agreement comes with it. Lifetime Employment Service to graduates and other features also explained. Get a copy. Mail the coupon. Do it NOW!
J. E. SMITH, President, National Radio Institute, Dept. 1-MQ Washington, D. C.

Mail for FREE information **Do it TODAY**

J. E. SMITH, President
National Radio Institute, Dept. 1-MQ
Washington, D. C.

Dear Mr. Smith: Without obligating me, send your 64-page book, "Rich Rewards in Radio," which points out the opportunities in Radio and how you train men at home to become Radio Experts. I understand no agent will call.

NAME.....
ADDRESS.....AGE.....
CITY.....STATE.....

When writing please mention Popular Mechanics

CROSLLEYNew Pentode Output
Variable Mu**SUPERHETERODYNE****\$36³⁶-**Complete With
Tubes

The Crosley

NOW your Crosley dealer is ready to show and demonstrate the new Crosley **LITLFELLA**—a 5-tube table model SUPERHETERODYNE radio receiver incorporating big set features yet housed in an exquisite and convenient cabinet of choice veneers 17 inches high and priced sensationally low. Pentode output, variable Mu tube, full floating moving coil dynamic speaker, continuous (stepless) static and tone control, combined volume control and on-off switch, illuminated dial with vernier drive—such features as these make the Crosley LITLFELLA the greatest of all radio values. Only \$36.36 complete.

Crosley also offers a series of 8-tube Push-Pull Pentode Output, Variable Mu SUPERHETERODYNE models ranging from The PLAYBOY, a beautiful compact table model at only \$49.75, complete with tubes, up to a magnificent grandfather electric clock and radio at only \$95.00, complete with tubes. Send for circular E-11.

(Western prices slightly higher.)

The Crosley Radio Corporation
POWEL CROSLLEY, Jr., President
Home of "the Nation's Station"—WLW
CINCINNATI

YOU'RE THERE WITH A CROSLLEY

**CROSLLEY
RADIO**

MONEY SELLING GENUINE NEON
Changeable Letter **SIGNS!**
Men earning high as \$30 daily
Milwaukee Neon Sign Co., Dept. 1, 722 Lakeview Ave.,
MILWAUKEE

BABY CALCULATOR
CIRCULARS & SAMPLES FREE

VEST POCKET ADDING MACHINE
Add, Subtract, Multiply, Divide. Does work of \$100 machine. Not a toy. Million dollar capacity. Simple and accurate. Guaranteed 5 years.

FREE TRIAL **\$2.50**
—SEND NO MONEY— Total Cost

Just name and address. We will ship Calculator immediately. On delivery pay postage \$2.50 (plus few cents postage). (If outside U. S. send cash.) 10% additional in Leatherette Case. If not satisfied after 10 days' trial you get your money back. **THOUSANDS OF SATISFIED USERS.** Write for Agent's Proposition. **BABY CALCULATOR MACHINE CO., (INC.) P. O. Box 1115, Dept. 31, CHICAGO, ILLINOIS**

**NEW BATTERY METER
PREVENTS
CAR
TROUBLES**

Amazing Invention Now Makes It Possible to Keep a Battery Perfectly Charged at All Times—No More Overcharging—No More Undercharging—No More Dry Batteries—Battery Life is Doubled

Automobile owners will welcome this new instrument, called "Tel-a-Charge," that instantly tells the condition of your battery—right on the dash. It tells at a glance if the battery is overcharged, undercharged, or if water is needed. These three conditions cause practically all battery troubles. When your battery is low your car may stall anywhere at any time. It is dangerous as well as annoying to have to crank an automobile to get it started. Keep your battery in perfect condition and your car starts easier, runs smoother, has more power, and expensive troubles are eliminated.

FREE SAMPLE AND BIG MONEY MAKING OFFER TO AGENTS

We need men in every locality to aid us in the distribution of "Tel-a-Charge," and are making a proposition so unusual that workers can easily make up to \$100 a week. We are furnishing those who work for us with a free sample for demonstrating purposes. Send **TODAY** for this big opportunity and free sample offer.

CLUM MANUFACTURING CO.

Dept. 118 601 W. National Ave. Milwaukee, Wis.

**A 30-MILE RUNABOUT
for \$109**

When you build a Brooks boat you know what goes into it. We furnish materials cut to shape with complete assembling instructions. You have the fun of constructing your own boat in your leisure time. No faulty pieces hidden by paint. Instead you have a seaworthy, rugged, husky hull at two-thirds the builder's cost. Brooks Boats have been built by amateurs for over 30 years. Thousands have assembled their own Brooks boats. Send 10c for catalog, illustrating 38 designs and complete line boat accessories.

Dept. 10 L

**BROOKS BOAT
COMPANY, INC.**

Saginaw West Side

Michigan

Send for **FREE
BULLETINS****CRESCENT
WOOD WORKING
MACHINES**

Crescent Wood Working Machines make money for you by turning out work accurately, fast and easily. Portable machines operate from any light socket. Big line of heavy machines for factories, all quality made moderately priced.

Send for Free Bulletin.

The Crescent Machine Co., 93 Columbia St., Leontonia, O.

**"EXTRA
SPECIAL"****Sale WINCHESTER Latest Light Weight T. D. \$24⁹⁵**

that embodies the simple dependable action of the Winchester. In a light weight (about 6½ lbs.); 24 inch tapering barrel; selected walnut stocks; take-down models; sporting rear sight; Lyman gold bead front sight; capacity 5 shots. Brand new, shipped in original factory sealed box. Either caliber at "EXTRA SPECIAL" price—\$24.95. Write for NEW Illustrated Catalog "W" - Shotguns, Rifles, Binoculars, etc.

HUDSON SPORTING GOODS CO., W52 Warren St., NEW YORK

HEATH WINS AGAIN!

At Cleveland—as in each of the past five National Air Races—Heath planes won first place in all races for which they were eligible.



THIS old story merely proves again, in a dramatic and impressive way, that Heath builds light aircraft that fly and fly fast. And the world's altitude record, brought back from France in July, proves that Heath planes have "upget."

You can buy a Heath ready to fly for \$1,074—or build it yourself easily at home from a special kit for \$269—or assemble it from factory built parts for \$549—all on easy terms.

Write today for full details enclosing 15c

HEATH AIRCRAFT CORPORATION

Dept. P-11, Niles, Michigan

A. C. Electric Plants



ONAN A. C. PLANTS furnish the same current as city service—110 volt, 60 cycle, A. C. Operate Radios, Water Systems, Refrigerators, all Household Appliances.

Sizes 500 to 1800 Watts

Available from stock. No battery used except to start the engine. Ideal for farms, camps and lake homes.

Also a complete line of D. C. Models.

D. W. ONAN & SONS

91 Royalston Ave. Minneapolis, Minn.

Start a Welding & Battery Shop

Lead Burning Outfits..... \$18.00 up
Welding Outfits..... 25.00 up
Soldering Outfits..... 8.00
Welding Torches..... 10.50 up
Cutting Torches..... 30.00 up
Regulators and Gauges..... 9.50 up
Combination Welding and Cutting Torch..... 16.00

Welding Supplies — Agents Wanted.
Superior Oxy-Acetylene Machine Co.
P. O. Box 285 Hamilton, Ohio

AGENTS Some Seller at
Looks Like \$5.00 Worth **\$2.00**
Gives You \$1.00 Profit!



This Is What Gets the Coin

You should see our Lucky 11 Package. Our representatives introduce our products with a first sale of beautiful combination sets of Toilet Articles, Soaps, etc. with valuable premium with each sale at half store prices. No fancy talk—they sell on sight. Make twenty to thirty sales a day with \$1.00 profit on each.

Easy to Average \$100 a Week

Could you ask more while introducing line establishing a permanent business for yourself? 200 Quality Products—100% Profit. Write today for illustrated circulars explaining our unique plans. **Act NOW.**

E. M. DAVIS CO., Dept. 5623, CHICAGO

Free!



this LIONEL RAILROAD PLANNING BOOK AND CATALOG

You will get the same keen pleasure and enjoyment out of reading it that Bob Butterfield and his grandson did.

Bob Butterfield, famous engineer of the 20th Century Limited, pictured above, thinks Lionel Trains are the greatest trains ever made for boys. He and scores of other railroad engineers say that Lionel Trains and accessories are real, true to life, accurate copies of actual railroad trains and equipment.

Ask Dad to give you a Lionel Train for Christmas! There is no fun in the world to compare with Lionel Railroading.

See Lionel Trains demonstrated at your local store and write today for the FREE 52-page, full color, 1931 Lionel Railroad Planning Book and Catalog. Lionel Trains are priced as low as \$5.95.

LIONEL ELECTRIC TRAINS

"The trains that railroad men buy for their boys"

LIONEL CORP., Dept. C, 15 E. 26 St., N. Y. City
Please send me FREE the new 1931 Lionel Railroad Planning Book and Catalog.

Name

Address

Age

When writing please mention Popular Mechanics

New Machines—New Low Prices Again Boice-Crane Leads



4 INCH JOINTER \$12

This is new—never before offered—a 4" solid, substantial, rigid jointer for only \$12! 16" polished tables, 2-way tilting fence. All steel safety head. Accurate.

UNIVERSAL HANDISAW

\$28



This is a new low price on our old reliable saw table.

Here comes the parade! The procession of new Boice-Crane Power Tools has started. New designs, new ideas. Just a few shown here. Don't buy until you have seen the entire line—have seen the new **LOW PRICES!** Get your name on our mailing list—get ready for the surprise of your life—never have you seen such high quality at such low prices. Anybody can now afford quality power tools.



NEW LATHE \$28

Here's another addition to the Boice-Crane line. Ball bearing—4 speed—11" x 36"—the very last word in up-to-date lathe design. A wonder at \$28.

7' X 30' LATHES \$12⁰⁰ | **7' X 36' LATHES \$17⁵⁰**

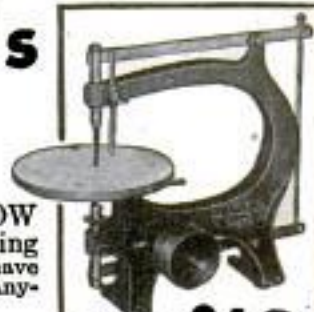

10 Inch \$12 JIG SAW

Boice-Crane quality thru and thru. Solid, true-running and a bear for tough jobs. A real buy at \$12.

Send 10c for Catalog

Ten cents, coin or stamps, helps pay postage on big 52-page catalog and supplement. If you already have catalog "D" just send for supplement of new tools. Supplement is free.

W. B. & J. E. BOICE, Dept. PM-10G, TOLEDO, OHIO

Let us recommend the best books to study on any subject. Popular Mechanics Press, Chicago, Illinois.

The man who studies gets ahead. Popular Mechanics Press will advise you what books to read to advance in your trade. 200 East Ontario Street, Chicago, Illinois.

AT LAST—A TUBE THAT CAN'T be PUNCTURED

Guaranteed Leakproof

Amazing new Waber Tube positively banishes all leaks, punctures. Specially treated (non-liquid) filler, sealed inside tube wall instantly prevents air escape. Seals permanently. Cannot deteriorate.

TESTED—PROVEN

Built for high speed, greater comfort and triple wear. Conforms with U.S. Bureau of Standards—exact specifications for every tire.

SPECIAL LOW PRICES ORDER AT ONCE

Size	Price
4.50-21 (30x4.50)	\$3.50
4.75-19 (28x4.75)	3.80
5.00-20 (28x5.00)	4.50
5.25-20 (30x5.25)	5.10
5.50-18 (26x5.50)	5.25
6.00-18 (26x6.00)	6.50

AGENTS!
Make over 100% Profit.
Big Demand—No competition.
Write at once.



Drive an 8-penny nail into any Waber Tube. If it leaks we'll refund your money!

RUBBER PRODUCTS CORP., 3500 S. Michigan Ave. Dept. 11, Chicago



DOUBLE YOUR INCOME

Make Colorcrete Products

NEW. EASY. FASCINATING
Many pieces sell for 10 times cost to make. Crockett (above) of Texas shows a profit of \$1231 as a side-line. Kauble of Iowa \$2000 with only three designs, etc., etc.
Permanent, charming color SELLS THEM ON SIGHT.

HOME MANUFACTURING

Start this exclusive fast-growing business now. No previous experience necessary. Equipment as low as \$30.
Learn all about this great opportunity today by sending for **FREE 32-page BOOK.**

COLORCRETE INDUSTRIES
570 Ottawa Ave. HOLLAND, MICH.



Now Make Clocks Electric \$2.49



movement on regulated 110 volt 60 cycle A. C. finest alloy bearings, simple mechanism. No noise, no winding, always accurate. Use your own dial and case. Order today, only \$2.49 postpaid. "Accurate" illustrated, with beautiful big golden 5 1/2" dial postpaid, \$3.95. Order NOW! Send dime today for prospectus, "Make Big Money Electrifying Clocks."

Kuempel Clocksters Guttenberg, Iowa

\$90⁰⁰ WEEKLY Easily Made

Lowest prices in years for our all wool tailored-to-measure suits. Finely made. Show our samples and make big cash profits daily plus liberal bonus. Orders come easy, quick. No experience required. Latest styles, beautiful fabrics. Big **FREE** sales outfit of nearly 150 swatches.

Write Today
PIONEER TAILORING COMPANY
921-1116 Congress & Throop Sts., Chicago



\$500% \$1150
PROFIT PER ORDER Including Bonus

AGENTS MAKE UP TO \$15 A DAY No. 8 FOUNTAIN PEN GUARANTEED FOR LIFE HAS ADJUSTABLE INK FEED AND RUBBER SPONGE

which makes it write better and sell faster than any other on the market. A trial order will convince you. Money Back If Not Pleased. Retail for \$1.25, can be sold for 75c and still make over 100% profit. Doz. \$2.90

Sample Only **39¢**



SPORS IMPT. CO., 931 Main Street, LE CENTER, MINN.

When writing to advertisers please mention Popular Mechanics

EMPLOYMENT

Advice from the Head of a Great American Industry

"You can be sure, if you are a normal person, that there is a place for you," says Charles M. Schwab in his introduction to the valuable two-volume guide to employment "The Right Job." "The first step," continues Mr. Schwab, "is to decide exactly what one has, and in what kind of work it can be used to best advantage."

Then "The Right Job" starts right in to help solve this problem of getting a job.

How To Connect With That Job!

You have Mr. Schwab's assurance that there is a place for you (and who could know better?); you need not worry about that! What you do need to consider, in these times, is how to connect with that job! Or, if you are an employer, how you can get just the man you need for what you can afford to pay.

In one place the text of these two handy guides points out that if you would only take as much trouble in finding a job that fits you, as in getting your coat fitted, you would never be out of a job!

It's easy to use a little science in getting a job. Don't waste time applying where dozens are standing in line; don't write empy letters by the hundreds; don't insert characterless advertisements in papers—

How To Sell Yourself

The idea is, to analyze yourself to see just what you have to sell; make a list of the most likely places that could use what you have,

then go at it hammer and tong to sell yourself, just as if you were a salesman with a quota to make.

Does it sound difficult? It isn't if you have an instructor and guide to help you such as is found in "The Right Job."

Are you blonde or brunette? Narrow headed or medium headed? Mental or motive? Feminine nose or masculine nose?—You are told what general lines of work to consider.

Is your hand flexible? rigid? spatulate? psychic? conical?—



the elimination process clears your path a little further.

Subjects Covered

And so on through the 21 fascinating chapters of the first volume and the 37 chapters of the second volume. Here are a few of the subjects covered:—

Handicaps and how to overcome them—Where to look for a job—How to apply in person or by mail—the job higher up—studying human nature—self-analysis of character—jobs for those who can handle women—types for personal service—jobs for the ambitious and un-ambitious—jobs for leaders and drivers.

Hundreds Have Profited

Every man out of a job; every man who thinks he doesn't exactly fit his job; every man working for advancement; every employer of mental and manual labor should have this great work.

Hundreds have profited by the new ideas, practical helps, wise advice, shrewd analysis and the dozens of actual examples set forth in these books. This is the EMPLOYMENT book of the day that one of the greatest employers of labor of all kinds thought so well of that he added to it by writing his introduction.

FREE TRIAL

Here is the practical book that is needed as no other guide and reference work is needed in these times. You are to judge for yourself before finally accepting it. Get these volumes in your hands for a few days, read and study them over, examine the dozens of portraits, sketches, tables and diagrams, then decide for yourself whether or not you think this work is going to be worth real money to you—right away and in the years to come.

Don't delay! The Right Job is waiting for you today—this minute. This coupon brings you the help that clears the path of obstacles. Fill in, detach, mail it TODAY!

Don't Grope Any Longer!

Use a Little Science and Get the Things Out of Life That Are Coming To You

You don't select your automobile blindfolded, or your house or your wife—yet many go to work on a job (on which one's very living depends) without a moment's consideration. Possibly you are a \$10,000 man in a \$2500 job! It only takes a little science and analysis to get out of the rut and get up where you belong. Thousands have done it successfully with the aid of these valuable guides. You owe it to yourself to at least try this scientific method.

FREE TRIAL

Look the "Right Job," two volumes over free. No obligation. Pay only if you feel confident that these guides are a good investment.

Send me "The Right Job" (2 volumes, each 300 pages, fully illustrated, cloth bound) for free trial. After 5 days' examination I will either return the books or send you the purchase price of \$2.95.

REVIEW OF REVIEWS CORPORATION, 55 Fifth Ave., New York, N. Y.

Name.....
Address.....
City.....
State.....

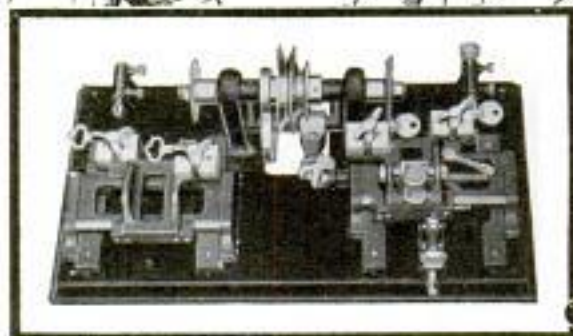

Everybody uses keys . . . every day. Many thousands of keys are replaced or duplicated every day . . . for homes, offices, factories, garages, automobiles, luggage, desks, etc. There's good money in the key business and it's all cash and steady the year 'round. Now it's easy for you to get into this profitable business . . . with a

FOLEY AUTO-MATIC KEY MACHINE

This perfected NEW machine is a marvel of simplicity, accuracy and speed in cutting all kinds of keys . . . cylinder keys, flat keys, bit (house) keys, automobile keys. So easy to operate that a boy can do the work perfectly. Experienced locksmiths declare it superior to anything they have ever seen. Its patented features assure a smooth, finished, perfect-fitting key in one operation, in 12 to 20 seconds.

Start in Spare Time, make \$2 to \$6 a day to start while you are building up a permanent good-paying business.

The Foley Key Machine is made in several models to fit every need and sold on easy payments if you wish. A small investment starts you in this money-making business.

**Fill Out and Mail
Coupon Today**



FOLEY MANUFACTURING CO.

219 Foley Bldg., 11 Main St., N. E., Minneapolis, Minn.

Please send complete information about the Foley Automatic Key Machine.

Name.....

Address.....

If you would also like information on the Foley Automatic Saw Filer, check here.....

When writing please mention Popular Mechanics

DON'T CHOKE ME JUST GIVE ME A HOT SHOT

Amazing electrical invention starts car, truck or tractor motor without choke. Saves plenty gas, oil. More speed. HOT SHOT sparks BLUE if ignition O. K. — RED if faulty. Draws big crowds. Sells on sight. 25,000,000 prospects. 100% profit at \$1.50. Gold mine for agents. "\$25 a day easy," says Akeman. "Rush 500 HOT SHOTS," says Klint. "Send 200 more," says Berg-Williams. "We want exclusive." "Never saw anything to beat it." "My first winner." Selling like wildfire. Your best bet part time—full time. **FREE Sample Offer. Act QUICK.**

Reardon Mfg. Co., Dept. F-11, Peoria, Ill.



Electric Portable Sprayer



Startling offer. Famous spraying outfit. Includes GV full liquid pressure, adjustable, non-clogging \$30 gun having 10" swath at 12 to 20 lbs. pressure. Ideal for spraying paint, varnish, enamel, lacquer, etc., the power way. Saves time, labor and does better work. Big opportunity to make extra money with it. Has Kellogg air cooled compressor. This \$78.50 outfit—now only \$37.50.

Reg. Price \$78.50
our price **\$37.50**

Complete with Spray Gun, Fan and Round Spray Tip, 1/2 H. P., 110 V., 50 Cycle, A. C. Motor, Air Filter Tank, Pop-off Valve, Connectors and 20 ft. Hose. Send \$5.00 deposit. Balance C. O. D. Money back if not satisfactory. Send for circular on larger and smaller spraying outfits now selling at very low prices.

SPECIAL OFFER
Quincy Compressor 1 1/2 H.P.
\$19.50 Value for \$12.50



Steel base.
3 steel wheels. Wt. 70 lbs.

NATIONAL JOBBING AND EXPORT CO.
184 N. La Salle St. Dept. 15 Chicago, Ill.

Here is Cash for You— Build the CONSTITUTION

"Old Ironsides" is now being exhibited by the Government. The price of a nicely constructed model is usually \$100.00. If you build one from our set you have a wonderful profit. We furnish all parts cut to fit and ready to put together; full instructions and carefully numbered diagrams; hull fully shaped and sanded—price \$6.00.

Models for Santa Maria, Mayflower, La Pinta, Coach or Covered Wagon \$4.50; Flying Cloud \$4.00. Send 2c stamp for beautifully illustrated catalog.

Canadian Branch
90 King St., W. Toronto

Miniature Ship Models
Dept. RT, Perkasie, Pa.

Improved Up-To-Date 8" Bench Saw INVALUABLE TO HOME AND SHOP

This design embodies five exclusive features: (1) An Automatic Lifting Device, controlled by a conveniently located hand wheel; (2) Table can be tilted to any angle up to 45°; (3) The saw blade is completely enclosed and guarded beneath the table; (4) An opening is provided at the bottom of the saw enclosure for attaching a bag to collect the sawdust; (5) A hardened and ground shaft is used for mounting the saw.



Saws lumber up to 2 1/4 inches thick. This husky Bench Saw can now be purchased for **\$16.95** only. Motor and base extra.

Compare it with any saw double the price. Order at once. Guaranteed to satisfy or money refunded.

UP-TO-DATE MACHINE WORKS
Dept. 110, 2911 S. Wabash Ave. CHICAGO, ILL.

Hotter than Coal and no dirt



**A New
Invention**

Do away forever with the drudgery of wood and coal. The most simple and economical invention on the market is now giving perfect satisfaction to enthusiastic users everywhere. This new invention is a new type of oil burner that takes the place of wood or coal and automatically and silently changes cheap oil into one of the quickest and hottest fires known.

Burns 96% Air and 4% Cheap Oil

The International Oil Burner fits in the fire box of your present range, stove, or furnace. It can be installed in a few minutes by anyone. No holes to be bored, no damage to your heating plant. There is nothing complicated about the International Oil Burner. It gives you all the heat you want—when you want it. Starts instantly with a match. No soot, smoke, or odor. Costs less than coal.

Costs Only a Few Dollars

International Oil Burners heat just as well as burners costing \$400 or \$500. Simply turn 1 valve and you have all the heat you want. Cleaner and better for heating or cooking. Approved by the National Underwriters' Laboratories and engineers everywhere. Over 150,000 have been sold.

30 Days' FREE TRIAL Offer

Try this wonderful automatic oil burner right in your own home at our risk. Act quickly and get our special low introductory price. Sold under absolute money-back guarantee. Write at once for free booklet on home heating and our free burner offer.



Double Blue Flame Burner for cook stoves, ranges, and parlor circulators. Burns with beautiful clean blue flame.



All-Electric Power Burner designed for larger houses, apartments, etc.

AGENTS—DEALERS— DISTRIBUTORS

Our free burner offer starts you in business. Big money to be made. Demand is enormous. We also want spare or full time workers immediately. If \$500 a month and more interests you, write or wire us for protected territory offer.

INTERNATIONAL OIL HEATING CO.

3800-10 Park Ave., Dept. 403-N, St. Louis, Mo.

CLIP THIS COUPON

International Oil Heating Co.,
3800-10 Park Ave., St. Louis, Mo.
Dept. 403-N

Send your free booklet and free details on home heating for stove.....furnace.....
Also free burner offer.

Date.....

Name.....

Address.....

City and State.....

Check if interested in making money as an International representative with protected territory.

When writing to advertisers please mention Popular Mechanics

Deaf-Dumb-Blind Yet "He" STOPS Auto Thieves

What in the world IS this uncanny new discovery that so instantly terrifies auto thieves? Thieves fear it worse than poison. Its terrible power literally "petrifies" them. They cannot even remove a thing. Now your car can be absolutely safe, anywhere you leave it. Don't confuse this queer new invention with anything you ever saw. It is not a bell. Not a lock. Not an explosion. Not an electrical shocker. Not a poison gas. Yet the deadly fear it puts into thieves throws them into a panic. It works automatically the instant anyone even touches your car. Cannot injure innocent persons. Recommended by police and insurance companies. No bigger than your hand. Costs only one penny a year to operate. Almost never wears out. The cheapest, surest theft insurance you can buy. And that's not all. Excites and amuses everybody. Have lots of fun with your friends.

Mysterious New Invention Offers Agents Up To \$40 a Day

So startling, so absolutely new, so peculiar is this strange discovery that agents who have already taken it on are smashing daily profit records. The greatest crowd gatherer you ever saw. The minute you demonstrate this clever invention people are bewildered. They want to know how it "stiffens," "hypnotizes," "shell shocks" thieves. The need for this scientific protection is so great—the big profit possibilities are so almost unlimited and easy—that now we will actually pay you just to demonstrate this amazing thief chaser. You don't need to sell a single one to make this money. Just stand on the street by your car and make it perform its magic wonders that set your audience agog and bring quick profits. No use wasting your time any longer with "piker" propositions. \$40, \$50, \$75 a day is not too much to expect, is it? If we did not feel sure that you could make as much money as other men with this uncanny new discovery we certainly would not be willing to offer you pay just for demonstrating it. The protection it gives—its utter queerness—its strange power to put fear into thieves—and the fun it gives motorists make it the easiest, fastest selling, biggest money-making opportunity for you in many years.

We Pay You Just To Show It To Motorists

The market is so tremendous—orders are pouring in so fast—that we can afford to do almost unheard of things for our local distributors. Not only will we pay you just for testing it, but we will actually send you a Free Sample offer for your own car so that your car and accessories will be protected and to start you demonstrating it. Yet that's not all. We actually offer to pay you cash for merely testing it on your car. Now we have territories for 1,600 more county distributors and 100 district managers on this generous pay plan. With our nation-wide advertising plans ready to start at once, distributors should be literally flooded with orders. We have worked out a new plan so that you don't have to do any selling or demonstrating to car owners to make big money.



FREE SAMPLE OFFER

Rush the coupon for your Free Sample offer—offer to pay for demonstrating and plan that gets you big money without doing any selling or demonstrating to car owners. Send no money. Just coupon. This is not an order. Nothing will be sent C. O. D. This Sample Offer is yours free of all cost. Just mail coupon now.

Allied Industries, Inc.,
5311 Garver Bldg., Des Moines, Iowa.

I accept your generous Free Sample offer of your amazing new "thief hypnotizer" with understanding that this offer costs me nothing now or ever. Nothing will be sent C. O. D. and I am not obliged in any way to buy anything or to become your distributor. You also offer to actually pay me for just testing it on my own car. Please send details of your offer of pay for demonstrating it, and also your plan that offers me big money even without demonstrating or selling to car owners. If I become your local distributor you agree to give me exclusive territory.

Name.....

Address.....

City..... State.....

Start to Play Very First Day

This Year Give Yourself
Lifelong Fun
Profit and
Popularity



PARENTS!

What greater gift can you confer on your children this year than lifelong fun and entertainment?

Love of music means love of home, an appreciation of the finer things in life. Here is a chance to give your boy or girl that love without the tedious practice that most instruments require. The Xylorimba is easy to play. No teacher is needed. Practice is actually a joy.

Remember, the Xylorimba is the guaranteed product of a company established nearly half a century ago—a company that stands back of every promise it makes.

THINK of the best Christmas gift you have ever received. Multiply the pleasure it gave you by ten, and still you have only an idea of the joy you can give yourself this Christmas if you act at once.

Start to Play the Very First Day!

Haven't you, like millions of others, envied the fellows who "bring down the house" with snappy xylophone or xylorimba numbers? Haven't you longed to create your own music, to be looked up to wherever you go, to be able to make real money in spare time? If you have, this ad spells O-p-p-o-r-t-u-n-i-t-y. The xylorimba—wonderful for home, in demand at dances and gatherings—is nevertheless the easiest of all instruments to play. In fact, on the very day you get yours you play simple melodies, even if you can't read a note of music right now. In a few weeks you astonish your friends and family. All your life you have the joy that comes to those who can entertain.

Plays 20 Minutes; Gets \$20!

Ralph Smith, Chicago, played twenty minutes at wedding; his "pay" was \$20. Harry Breuer, New York, has made thousands of friends thru his xylophone selections on the radio.

L. E. Hallman, Reading, Pa., writes: "Made \$300 in 5 weeks—spare time."

And now J. C. Deagan, Inc., (world's largest manufacturer of xylophonic instruments) has made it so easy to own a xylorimba that nothing stands in your way. Sizes and styles to fit every age and pocketbook. A five-day free trial that eliminates risk. Free, easy lessons that make teacher unnecessary—and, best of all, such easy payments that they are hardly noticed.

Will You Investigate?

Everyone wants to be popular. Everyone wants to make extra money. Everyone wants to be center of attraction at gatherings. But these advantages don't come by themselves. Opportunities must be seized. This is your opportunity—will you pass it up without investigation? The accompanying coupon will bring our big FREE book to your door. It tells all about the Deagan line, the free trial, the easy payments. Remember, no cost or obligation! Simply fill in and mail the coupon—but do it before it slips your mind. Today is as good a day as any. Do it NOW!

YOUR
MAGIC
KEY

to Popularity

Send for
BIG FREE
Book!

Mail
Now!

Please send me full details on the Free Trial offer and easy payment plan of the Deagan Xylorimba.

J. C. DEAGAN, Inc.,
Dept. 4458, 1770 Berceau Avenue, Chicago

Name _____
Address _____
City _____ State _____

"It so happens I don't smoke..."

BUT I've noticed recently that more of my girl friends are smoking CHESTERFIELD, and I asked why.

"One of them said that CHESTERFIELDS really are milder and taste better—that there is nothing strong or sharp or bitter about them.

"Another one spoke up and said that she too liked the taste of CHESTERFIELDS; but that she was especially pleased with the package—so neat and attractive. Chesterfields—she added—are *made* right—properly filled—and burn evenly; and she thought possibly they were using a better cigarette paper.

"Still another one agreed with all we'd said. She'd been smoking CHESTERFIELDS for a long, long time, and had always liked them; but she also liked the way they were advertised. The advertising seemed to her to be the truth, and it wasn't always knocking somebody or something!"



© 1931, LIGGETT & MYERS TOBACCO CO.
