

OCTOBER

N.S.E.
25 CENTS

POPULAR MECHANICS

MAGAZINE

WRITTEN SO YOU CAN UNDERSTAND IT

REGD. TRADE MARK, USE AT BRISBANE, NO. 40489

REG. U.S. PAT. OFF.



SEE PAGE 532

Copyrighted material



Three Chicago food experts invent a delightful new food that is revolutionizing the doughnut business.

Here's an Amazing New Business

That Pays \$1,000 a Month Up to....

Here is a surprising new opportunity. Now you can immediately become the owner of a big business that is paying others from \$75 up to \$250 a week. There is no "Red Tape"—no delay. Wherever you live there are quick, easy profits waiting for you to grab them. Just mail the coupon for full details.

Individual Plans to Fit Every Need

FULL TIME

You can start a Brown Bobby shop with floor space as little as 6 by 6 feet. Sell retail and wholesale.

Thos. Minch, Fla., made \$3,000 his first 3 months.

PART TIME

Invest a few dollars in this new business and get someone else to run it for you. A few hours of your time each week can easily bring you \$50 up to \$150 a week extra cash.

SPARE TIME

Start at home. Make money like Mrs. Nelson, Ill., who sold 90 dozen Brown Bobbys at retail in one week, then went out to triple her profits through wholesale business.

MEN, this is absolutely new! A real red-hot money-making opportunity! Something every red-blooded man has always longed for. It's a chance to jump into business for yourself and make more money every week than the average man makes in a month!

Surprising, yes, almost incredible as it may sound, we actually start you in a **proven business!** The first day's profits often run from \$18 to \$55—and a business of \$350 to \$600 the first month is not exceptional for ambitious men or women.

A Sensational Big-Money Plan

There is just one thing you need to make a "go" of this business, and that is the ambition to make real money. We give you all the plans, advice and help needed to make a big success right from the jump. We supply you with the equipment to make an amazing new food—a **greaseless** doughnut baked by electricity! You sell to homes, bakeries, delicatessens, groceries, restaurants, etc., at a profit of 150% to 600%! No wonder the dollars simply pour in!

A New Food Secret

The **greaseless** doughnut is altogether novel and unique. It's a crispy, flaky, delicious new kind of doughnut cooked without one drop of oil or grease. Easily digested by everyone. More appetizing than old-style doughnuts ever were. Yet costs you less to make. This new business is copyrighted under the trade name "BROWN BOBBY," so there is no competition.

Everyone likes doughnuts. Millions of old-style doughnuts are sold every day. Now you can bake and sell the perfect doughnut—the toothsome **BROWN BOBBY greaseless** doughnut that sells four times as fast as any other.

Start at Once—Anywhere

In this limited space I am able to suggest only the bare possibilities. The details are even more sensational than the facts given here can indicate. I am looking for sincere, ambitious, wide-awake men. I offer such men a plan that is a real eye-opener. The first week's profits usually amount to more than your entire investment. After that it is up to you entirely whether you will make \$300 or \$1,000 a month clear profit.

Men and women start in this business daily. You do not obligate yourself in any way by mailing the attached coupon. So get the details of this amazing new idea at once. Decide for independence! Fill out and mail the coupon today—**now—THIS MINUTE!**

FOOD DISPLAY MACHINE CORP.
Dept. 3-K, 500-510 N. Dearborn St., Chicago, Ill.

**Food Display Machine Corp., Dept. 3-K,
500-510 N. Dearborn St., Chicago, Ill.**

Rush me details of your plan for a "Brown Bobby" business of my own.

Name.....

Address.....

City.....State.....

FOOD DISPLAY MACHINE CORP.
Dept. 3-K, 500-510 N. Dearborn St., Chicago, Ill.

Inventor Takes Light From Sky



Lights Road Ahead With 67,000 Candle Power Beam

A MAZING discovery of new automobile road light literally takes light out of the sky—imagine a light that throws a 67,000 candle power beam for over one-fifth of a mile—yet absolutely **NO GLARE** in the eyes of approaching drivers. A light that makes your road as bright as day. Fast night driving now safe. This "twin-ray" road light not only cannot glare itself, but it cuts through on-coming brights.

An item in the Kansas City Star says, "At a demonstration at the Kansas City Airport a newspaper was read at a distance of more than 1,000 feet in front of the light. The ground in front of the light for this distance was well illuminated but the rays were not projected higher than eighteen inches above the ground." No wonder it was awarded the grand prize and two gold medals in world competition.

AGENTS Cleaning Huge Profits



**67,000 BEAM CANDLE POWER
ONE FIFTH OF MILE OF LIGHT
NO GLARE**

SPEEDLIGHT BEAM

LOWER BEAM

Agents and distributors from coast to coast are making big money equipping passenger cars, busses, and trucks with this brand new road light. This is your opportunity to make up to \$10—\$20—\$30 per day. Some agents make even more. Kinney made \$96 in a few hours. Frost made \$150 in one day. Burroughs sold fifty lights to Richmond Fire and Police Departments. Over 26,000,000 cars need this wonderful light to protect human lives and property against dangers of glaring lights, fog, rain, and darkness.

NOT A PAINTED BULB

But a real scientifically constructed road light with a concentrated 67,000 candle power beam of light on the road for over a thousand feet and no glare. Cuts through fog and darkness like a knife. There is no light like it in the world. It is not a spot, it embodies an absolutely new principle in headlighting. Discovered by a famous light engineer. So judge for yourself what

you can do with a light like this. Send the coupon today for our introductory offer. Speedlight Company, 1731 Belmont Ave., Dept. 10-P, Chicago, Illinois.

TO GET THIS LIGHT

FREE OF EXTRA COST

**DON'T TURN PAGE
MAIL THIS COUPON FIRST**



Speedlight Company,
1731 Belmont Avenue,
Dept. 10-P, Chicago, Illinois.

Without obligation to me please send me full details of your Speedlight and your wonderful introductory offer.

This One

Name

Address

City



DPEE-EZR-YJ2Y

State

When writing to advertisers please mention Popular Mechanics

THE TELEPHONE HAS LIVING IDEALS



THE Bell System is chiefly people. There is four billion dollars' worth of telephone buildings and equipment but what makes these dead things live is the organization, the skill and the ideals of the people who operate this vast plant.

The System's ideals of service are reflected through the employees in 24 regional operating companies. Each company is adapted to the needs of its particular area. Each takes advantage of the improvements developed by the 5000 members of the Bell Laboratories staff. Each avails itself of the production economies of Western Electric, which manufactures equipment of the highest quality for the whole System. Each makes use of the general and technical staff

work done by American Telephone and Telegraph.

The spirit of the people comprising this organization is also shown in the attitude of the System toward its business. Its policy is to pay a reasonable dividend to stockholders; to use all other earnings to improve and widen the service. There are more than 600,000 American Telephone and Telegraph Company stockholders . . . and no one person owns so much as one per cent of the stock.

The ideals of the Bell System are working in your interest every time you use the telephone. Through them, you get better and better service and constantly growing value for your money.

★ AMERICAN TELEPHONE AND TELEGRAPH COMPANY ★



When writing to advertisers please mention *Popular Mechanics*

Popular Mechanics Magazine

200 E. Ontario Street, Chicago, U. S. A.

H. H. WINDSOR, Founder

H. H. WINDSOR, Jr., Editor and Publisher

London: Messageries Hachette,
3 La Belle Sauvage, Ludgate Hill, E. C. 4

Paris: Hachette & Cie.,
111 Rue Reaumur

Melbourne: Gordon & Gotch
509-513 Little Collins St.

ISSUED MONTHLY

SUBSCRIPTION:

SINGLE COPY, 25 CENTS

In United States and its possessions, Canada, Cuba, Mexico, and all countries in the Pan-American Postal Union, per year, postpaid } \$2.50

To all other countries in the Postal Union 3.00

All subscriptions are discontinued at expiration. Please examine the date printed on your wrapper.

Entered as Second Class Matter Sept. 15, 1908, at the Post Office at Chicago, Illinois, under Act of March 3rd, 1879.

Entered as Second Class Matter at the Post Office Department, Canada.

Published monthly by POPULAR MECHANICS CO.

Copyright, 1931, by Popular Mechanics Co.

Copyright in Australia. Copyright in France

Vol. 56

Contents for October, 1931

No. 4

Special Features

<u>Mystery Men of the Sea</u>	547
<u>Only Dummies—but they Hit Back Hard</u>	552
<u>The Glories of Kings Restored with American Gold</u>	562
<u>With the Pipe Line Dispatcher</u>	569
<u>Brain Teasers That Will Test Your Skill</u>	573
<u>Hams to the Rescue</u>	578
<u>With Death as a Spectator They Pry Apart Bombs</u>	595
<u>Hide-and-Seek with the Mallards</u>	600
<u>Flyers of the Sea</u>	626
<u>I Turn a Barn into a Home</u>	634
Adventure—it's a long way across the Atlantic	586
Aerial Car—rises two miles on Alpine tramway	546
Air—ionization of, influences health of animals	599
Airplanes	
gauge speed of birds by flying with them	568
hover plane and air camera join newspaper staff	632
student pilots use plane with "clipped" wings	594
Airport—turntable for amphibian planes at small	561
Animals—dentist goes into lion's den and treats bad tooth	605
Archæology—stenographer, world's first, found in Egypt	584
Archery—modern archer outdoes William Tell's feat	625
Army, U. S.—machine gun on motorcycle for cavalry	546
Automobile Railway—has turntable to speed operations	608
Automobiles, Accessories	
costs quickly counted on automatic record	605
trunk, collapsing fits on luggage rack	557
Automobiles, Driving—tour on canvas shows driver's mistakes	632
Automobiles, Racing—movie shutters on eyes to aid race drivers	560
Averages—law of, you can't lose if you follow the	610
Aviation	
air sickness out of fashion so malady wanes	591
pilot flies in thunder cloud and finds terrific wind	638
Bathing Cap—suction cups on, keep out water	641
Bicycle—sturdy sidecar easily attached to	560
Birds—homing pigeons are new oil-well scouts	642
Blindness—city noises hinder blind in learning to walk	630
Boats and Boating—thirty-pound boat of metal carries quarter ton	629
Bridges—on rockers give heat elbow room	590
Camera—cards copied by, making two per second	571
Card—merry-go-round keeps stock fit	551
Clock—works five centuries, rests and starts again	583
Coal—jumps of, trade-marked	597
Cotton—new uses for, seen with larger crops	551
Crime	
bandit car shot with dye gun easily traced	576
burglar-proof window bars slide with sash	583
Earthquake—may be forecast by tilt of earth's crust	545
Electric Clock— aids business while it tells time	551
Electric Lamps—"torture" wheel for	550
Electricity—electric brain solves hardest problems	545
Engine—steam, made of glass runs as child's toy	577
Exploration—flying explorers to search the "Lost World"	542
Eyes—save, war on glare aided by meter	585
Feet—educating of toes like fingers saves one step in six	631
Fires, Forest—aircraft guard for forests protects against	593
Fish and Fishing—automatic "thumb" for reel prevents backlashing	572
Floodlighting—tower lights up speedway for auto racing	549
Fuel—tar, car runs on	584
Game—shortage of wild life blamed on sunspots	629
Gas—preventing poison from, taught in school	589
Germs—new discovery on	545
Glass—see out but not in with	593
Guns—made of elastic steel to shoot deadly shell	559
Heater—portable, uses a variety of fuels	638
Household Devices	606
Insects	
electric "chair" for, hauled through fields	641
grasshopper traps on autos help harvest chicken feed	631
Iron	
contracts at high heat as atoms shift places	550
has qualities of copper after being purified	608
Ladder—weighs four ounces holds up quarter ton	577
Lizard—has frill on neck to frighten enemies	597
Mail—"electric eye" at railway terminal to route	561
Metals—tin masterpiece proves worker's skill	591

Henry Bell 527
see reading machine 634
589

[Continued on Page 4]

cards copied by camera 571
Card
Cocos Island 536

Museum American holidays
 history's peculiar [4] 2

[Contents—Continued]

Music horns & color
 504
 Telephone 534

Motorcycle ride for children 599

Milk—production affected by changes in weather 591
 Mirror—see yourself like others do in right-angle 643
 Motorcycle—race started by rollers under wheels 592
 Musical Instrument—on a stick sounds like violin 572
 Navy, U. S.
 builds secret plane to seek speed record 641
 drydock gate like big boat is over thirty feet high 643
 parachutes made of cotton meet tests of 546
 whistling on cruiser all by one man 585
 Oil Wells—romance in world quest for black gold 558
 Radio—practical ideas for the radio experimenter 648
 Radio, Aerials—antenna sticks like adhesive tape 650
 Radio Apparatus
 meter indicates effective phone output 653
 R. F. amplifier for the amateur transmitter 654
 Radio Application—radio snaps storm pictures to help weatherman 598
 Radio Broadcasting—portable short-wave sender aids sports 594
 Radio Construction—building a heavy-duty filter choke 651
 Radio Receivers—home movies combined with radio and phonograph 653
 Radio Reception
 column of light aids in tuning 650
 short-wave converter 644
 Radio, Television—pilots soon to see weather by radio eye 639
 Railroads
 auto pumps ice-cooled air into sleeping cars 571
 engine given shower baths by automatic washer 631
 Ropes—buckle for fastening, replaces unhandy knots 591
 Safety Devices and Measures
 railway bumper stops auto when train is coming 641
 track workers are guarded by reflectors 629
 Science—how much work man can do shown by body tests 597
 Sculpture
 figures of real wild west 582
 soap, made easier with half-carved bars 567
 Shower—set up on the lawn keeps everybody cool 608
 Skyscraper
 is lightning rod for New York buildings 568
 looking down upon tower gives modernistic view 638
 Soapbubble—makes balloon of amazing strength 640
 Sports—Horse Racing—track in bay to be built on island 630
 Stilts—height of, adjustable to size of user 559
 Stove—pocket, warms hands 630
 Swimming—boat worn around neck, helps in 583
 Swimming Pool—built into the ocean 633
 Telephone—transatlantic 621
 Toys—tiny sidcar motorcycle carries two children 599
 Tractor—electric guide takes operators' job 561
 Traffic—flying police order by radio to ground 575
 Trees—hydraulic drill saves trees 560
 Typewriter
 ribbon inker insures clear copy 576
 spring keys like shock absorber 539
 Valve Seats—locked in place with cement 643
 Vending Machines—sell ice in suburbs 589
 Water Softener—cuts fuel costs for coffee urn 592
 Wood Carving—six statues cut at one time 557

Lamps—bases, from glazed tile 671
 Mail—folder, improvised, covers both package and letter 679
 Measuring Instruments—self-measuring container 678
 Memorandum Envelope—fastened to cover 674
 Neckties—wrinkles removed from, with clothes hanger 660
 Pans—cooking, can be tilted with angle-iron wedge 670
 Photographs—removed from ferrotype plates by heat 668
 Photography
 clip holds films while developing 674
 night, tricks of 675
 Rabbits—pet, contented in this pen 674
 Rack—curtain rod, on closet door for holding shoes 669
 Refrigerator—removal of drip pan simplified with truck 658
 Rugs—frame, adjustable for making hooked 678
 Screen—frame, notches in, provide exit for flies 684
 Spectacles—cap-visor snap holds 679
 Stepladder—wheeled, saves time 673
 Telephone Stand—neat, fits any corner 661
 Toys
 cart, four-wheeled made from packing boxes 677
 miniature faucet for doll house 658
 Typewriter Desk—window fastener holds drop lid of 673
 Water Heater—blowtorch substituted for gas in 662
 Window Shades—two, allow fresh air and privacy 658

SHOP NOTES

Agricultural Implements—sickle blades, removing 687
 Agriculture
 drag, efficiency of, increased with chains 704
 drying out cribbed corn prevents spoilage 692
 Babbitting—a bearing box 704
 Barrel—hoops, durable from old sprocket chain 694
 Cart, Milk Can—old lawnmower serves as 690
 Ceiling—clamp to handle, boards single-handed 694
 Clamp, Plumbers—holds many sizes of pipe 703
 Clocks, Electric—cases for 690
 Coppering Solution—for oily steel 699
 Drilling—dowel holes, guide for bit when 696
 Drill Press—fluting on a 688
 Electrical Appliances—connectors for electricians' testing equipment 695
 Electric Fans—washer stops oil leakage on 696
 Electric Light—extension fastens on cap 699
 Fence—woven-wire, stretched with tractor 687
 File—made from hacksaw blades is non-clogging 704
 Forge—homemade, is portable 685
 Gauge, Center—improvised to mark work accurately 704
 Gears
 lapping in, compound for 693
 split, making for model and experimental machines 703
 Hammer—spur on, provides grip when shingling roof 696
 Lathe
 steady rest prevents vibration of long work on 696
 tapping attachment for, or drill press 698
 Lettering—celluloid triangles with nail polish 689
 Measuring—tape, held in position with pencil clip 688
 Paintbrushes—paper prevents colors on, from mixing 692
 Photography
 corner in studio for baby pictures 700
 portable darkroom develops photos anywhere 692
 Plane—coarse file used as, for edging boards 695
 Poultry—house, sunlight reaches entire floor in 689
 Press—for cleaning oily waste 692
 Printing—roller from typewriter platen 695
 River Banks—barrier of auto frames prevents erosion of 700
 Sandpaper—file for different grades of 703
 Saws and Sawing—saw table, heavy stock rolled on, with dowel rods 689
 Seed Sampler—tubular, removes seed from center of sack 694
 Shaper—home workshop, how to set up and use a 701
 Studs—extension brazed to sheared, helps remove them 695
 Tongs, Blacksmiths—adapted to all sizes of work 704
 Tool—carving, made from drill rod 690
 Welding
 pipe joints easily with holder 693
 torch tip, steel wool cleans 696
 Wood Turning—clamp nails hold work together for split 693
 Workbench—self-adjusting bench stop 688
 Workshop
 emery wheel, dressing tool for 689
 home, safety switch for 704

AMATEUR MECHANICS

Automobiles, Accessories
 baggage ropes, eyebolts in hinges provide anchorage for 657
 toolbox built under truck body 673
 Automobiles, Repairing
 electric wires, quill toothpicks insulate shorted 658
 skid-chain links made from nails 668
 valve-tappets, loose, located with your fingers 670
 Automobiles, Truck—starting, incline aids in 674
 Automobiles, Wheels—sledge-hammer blows quickly remove rear 684
 Bank—small wooden, to save your dimes 657
 Billiards—table for home and apartment 663
 Bird—attractive 680
 Blackboard—sash cord serves as heading to hold 658
 Box—wheeled storage, for toys rolls under bed 662
 Camera—mounting spectacles on 677
 Culverts—strong road, from steel oil drums 668
 Dart-Throwing—with an "Atlas" 659
 Door Spring—out of sight 662
 Doorstop—worked by turning knob 679
 Drafting—thumbtack puller made from film spool 684
 Games—portable stake bed for playing game of horse-shoes 670

Case

Handwritten scribbles and numbers at the bottom of the page.



Masonite will keep your home warm this winter

Outdoors, it will be cold this winter—of that you may be sure. But the temperature indoors will depend on whether or not you protect your home with Masonite Structural Insulation.

Masonite does its job well. Keeps heat where it belongs: inside in winter, outside in summer. It's a structural material, too: replaces other materials; converts waste attic and basement space into cheerful, useful rooms.

Build Masonite into walls as sheathing, into roofs and ceilings as insulation,

into floors as insulation and sound deadener. That's the practical thing to do—in new building or remodeling. Cuts fuel bills a third or more. Assures continuing value for your property. Enhances the comfort and healthfulness of your home.

For a perfect, crack-resistive plaster base, use Masonite Insulating Lath.

We'll gladly send you the free Masonite booklet, telling the story of its manufacture. Or ask your architect, contractor or lumber dealer for information.

Masonite

STRUCTURAL INSULATION
INSULATING LATH • PRESWOOD • QUARTBOARD

"Make it out of Presdwood" —endless uses for this grainless board

Trunks, toys, furniture, truck bodies, incubators, and many, many other articles are better and more economically made with Presdwood. Cuts time and cost in production. Easy to work with—doesn't crack, chip, split, splinter or warp. Home mechanics praise it, too. Check the coupon and send for free Presdwood booklet.

MASONITE CORPORATION, Dept. L-10 © M. C., 1931
111 W. Washington Street, Chicago, Ill.
Please send me, free, the story of Masonite.

Name.....

Street.....

City..... State.....

If interested in Masonite Presdwood, check here.

When writing to advertisers please mention Popular Mechanics

"Hard times" didn't touch these men*

They had LaSalle Job Insurance

WE'VE been going through one of those periods when men outnumber available jobs.

Lots of fellows riding along on the crest of the wave, thinking things would last forever, have found out differently.

But wherever an individual has had something worth while to offer—so called "hard times" haven't touched him. Many men have increased their earnings—bettered their positions when other fellows found themselves on the street.

And it hasn't been luck—or chance—or circumstance.

The trained man—like the rock in a storm—isn't affected by times or conditions.

Listen to these facts:

"When most of our old men were laid off, I was promoted"

For instance, there was our Industrial Management student in a Middle West aircraft plant who found that his training and his use of it in his daily work paid quickly. He writes, "During these bad times when most of our old men were laid off, I was promoted. Now whenever I meet one of the old gang and he asks me about my 'pull,' I simply show him my LaSalle membership card."

And our Higher Accountancy member in Philadelphia who, employed as a temporary man by one of the nation's outstanding firms of accountants, did so well that a month later his job was made permanent. In telling us of it, he adds, "This I consider quite a boost for LaSalle training, since the firm was letting other men go."

Another man cashed in on his training even more quickly, for, broke and unable to get a job, he enrolled for our

Traffic Management course and then went to the employment department of the largest firm in his Southern city, told them he was enrolled with us and wanted work in their shipping department. He was given the job over a long line of applicants—largely, as they told him, because he was studying with LaSalle.

His LaSalle button won the job and at a bigger salary than he expected!

A LaSalle lapel button turned the trick for another Accountancy member. It showed the employer that he had successfully completed six months training with us. That carries weight and our student got the job—over 100 other applicants—at a salary higher than he had expected!

One company—a national leader in its line—after watching five of its major executives come up from lesser jobs and twenty-eight of its rank and file increase their efficiency with the aid of LaSalle training, has worked out with LaSalle a cooperative plan under which fifty-three of its most promising employees in shop and office and salesforce are training for executive positions—and their opinion after this thorough testing is best evidenced by the words of the president, "As I see it, LaSalle training makes a man worth

more not only to himself but to the firm he works for."

"If we've got a man that ambitious—"

There's no magic, nothing mysterious about this advantage enjoyed by our members. It's just plain common sense.

Alert employers know that it takes ambition and perseverance to study in the hours which others give to rest or pleasure—and they prefer men with those same qualities, especially when those men also have the added efficiency of the trained man.

One executive expressed this attitude forcefully when we told him that a minor employe in his warehouse was studying with us. "If we've got a man who is that ambitious down there, we'll bring him up here and give him a real job."

And another nationally known manager sums up the almost universal feeling of employers, "When we find a man with sufficient faith in himself to spend his own time, energy and money to complete a home study course, we consider him as being in that group from whom our future leaders will be drawn."

You can have this same job insurance

The remarkable thing about this LaSalle job insurance is that it is available to every normal, ambitious adult—and in nearly every major business field—at low cost and on easy terms. If you are really in earnest about protecting yourself in the present and making ready for even larger success when prosperity returns, this outstanding twentieth century development in building business success is at your service. And your first step is simple—

Send the coupon for full and free information.

The booklets which that coupon will bring may be priceless to you—if you read and act on the facts contained in them.

Fill out and mail the coupon now. "Later" means never.

*Names and Addresses gladly given on request.

LaSalle Extension University

THE WORLD'S LARGEST BUSINESS TRAINING INSTITUTION

----- Find Yourself Through LaSalle! -----

LA SALLE EXTENSION UNIVERSITY Dept. 1064-R CHICAGO Michigan Ave. at Forty-first

Please tell me about LaSalle job insurance in the field I have checked below:

- | | | |
|---|--|--|
| <input type="checkbox"/> Business Management | <input type="checkbox"/> Modern Salesmanship | <input type="checkbox"/> Railway Accounting |
| <input type="checkbox"/> Higher Accountancy | <input type="checkbox"/> Paper Salesman's Training | <input type="checkbox"/> Credit and Collection |
| <input type="checkbox"/> Expert Bookkeeping | <input type="checkbox"/> Law: LL.B. Degree | <input type="checkbox"/> Correspondence |
| <input type="checkbox"/> C. P. A. Coaching | <input type="checkbox"/> Commercial Law | <input type="checkbox"/> Business English |
| <input type="checkbox"/> Modern Business Corres. | <input type="checkbox"/> Industrial Management | <input type="checkbox"/> Effective Speaking |
| <input type="checkbox"/> Traffic Management | <input type="checkbox"/> Modern Foremanship | <input type="checkbox"/> Commercial Spanish |
| <input type="checkbox"/> Railway Station Management | <input type="checkbox"/> Personnel Management | <input type="checkbox"/> Telegraphy—Railway and Commercial |
| | <input type="checkbox"/> Banking and Finance | |

Name

Present Position

Address

When writing to advertisers please mention Popular Mechanics



I will train you at home

to fill a

BIG PAY

Radio Job!

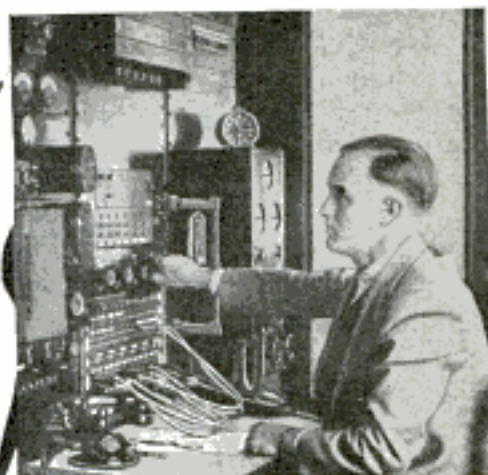

I will give you my new 8 OUTFITS of RADIO PARTS for practical Home Experiments

You can build over 100 circuits with these outfits. You build and experiment with the circuits used by Crosley, Atwater Kent, Eveready, Majestic, Zenith, and other popular sets. You learn how these sets work, why they work, how to make them work. This makes learning at home easy, fascinating, practical.

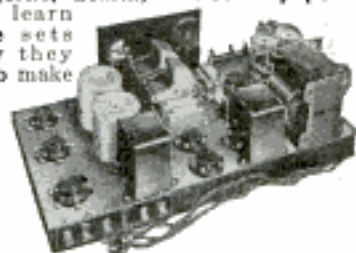

I am doubling and tripling the salaries of many in one year and less Find out about this quick way to

BIGGER PAY

FILL OUT AND MAIL THIS COUPON

TODAY

J. E. Smith, President
NATIONAL RADIO INSTITUTE,
Dept. 1KP, Washington, D. C.

Dear Mr. Smith: Send me your free book. I understand this request does not obligate me and that no salesman will call.

Name.....

Address.....

City..... State.....

Have you a friend or a pal whom you know to be interested in radio? Do him a favor. Write his name and address below. No obligation on his part and we won't mention your name unless you request it.

Name.....

Address.....

City..... State.....

If you are earning a penny less than \$50 a week, send for my book of information on the opportunities in Radio. It is free. Clip the coupon NOW. Why be satisfied with \$25, \$30 or \$40 a week for longer than the short time it takes to get ready for Radio?

Radio's growth opening hundreds of \$50, \$75, \$100 a week jobs every year

In about ten years Radio has grown from a \$2,000,000 to a \$1,000,000,000 industry. Over 300,000 jobs have been created. Hundreds more are being opened every year by its continued growth. Many men and young men with the right training—the kind of training I give you—are stepping into Radio at two and three times their former salaries.

You have many jobs to choose from

Broadcasting stations use engineers, operators, station managers and pay \$1,200 to \$5,000 a year. Manufacturers continually need testers, inspectors, foremen, engineers, service men, buyers, for jobs paying up to \$7,500 a year. Shipping companies use hundreds of Radio operators, give them world-wide travel with board and lodging free and a salary of \$80 to \$150 a month. Dealers and jobbers employ service men, salesmen, buyers, managers, and pay \$30 to \$100 a week. There are many other opportunities too.

So many opportunities many N. R. I. men make \$200 to \$1,000 while learning

The day you enroll with me I'll show you how to do 28 jobs, common in most every neighborhood, for spare time money. Throughout your course I send you information on servicing popular makes of sets; I give you the plans and ideas that are making \$200 to \$1,000 for hundreds of N. R. I. students in their spare time while studying. My course is famous as the course that pays for itself.

Talking Movies, Television, Aircraft Radio are also included

Special training in Talking Movies, Television and home Television experiments, Radio's use in Aviation, Servicing and Merchandising Sets, Broadcasting, Commercial and Ship Stations are included. I am so sure that I can train you satisfactorily that I will agree in writing to refund every penny of your tuition if you are not satisfied with my Lessons and Instruction Service upon completing.

64-page book of information FREE

Get your copy today. It tells you where Radio's good jobs are, what they pay, tells you about my course, what others who have taken it are doing and making. Find out what Radio offers you, without the slightest obligation. ACT NOW!

**J. E. SMITH, President
National Radio Institute, Dept. 1 KP,
Washington, D. C.**

Here's Proof



\$100 a week

"My earnings in Radio are many times greater than I ever expected they would be when I called. They seldom are under \$100 a week."
E. E. WINBORNE,
1267 W. 48th St.,
Norfolk, Va.



Jumped from \$35 to \$100 a week

"Before I entered Radio I was making \$35 a week. Last week I earned \$110 servicing and selling Radios. I owe my success to N. R. I."

J. A. VAUGHN
4075 S. Grand Boulevard,
St. Louis, Mo.



\$500 extra in 6 months

"I find I made \$500 from January to May in my spare time. My best week brought me \$107. I should have taken it long ago."

HOYT MOORE
R. R. 3, Box 919,
Indianapolis, Ind.

Lifetime Employment Service to all Graduates

When writing to advertisers please mention Popular Mechanics

Auto Service Men and Auto Dealers!

Here's a new Opportunity!



M. I. A. "JOB-WAY" TRAINING Is the Only Answer

M. I. A. Training has been successful for over ten years. Through this Training—complete, practical, up-to-date—thousands of men have become Expert Auto Service Men—making good money, holding good jobs. When you enroll for this training, you do not have to leave your job or your home. Your training is brought right to you—on the job, and in your home. You earn while you learn and you give up no time from income producing hours. And "Job-Way" training sticks. It never gets away. Every M. I. A. Trained Service man can do two to three times the number of jobs per day that the ordinary "mechanic" can do. And he does them correctly—every time!

Low Cost—Start Now

The Cost of M. I. A. "Job-Way" training is very low. A small deposit—so little the student never misses it—will start him. The payments are easy. Anyone can make them without scrimping. Get started, now.

FACTS FREE

Simply clip the coupon. It will bring all the details—complete information on M. I. A. Training; exactly what it is—how it is studied—how it is applied—why every man who completes it, never has to worry about his income and his progress—and why every dealer who urges his service men to enroll for M. I. A. training speeds up his business to an almost unbelievable degree. Clip the coupon. Mail it now.

Motor Institute of America
Motor Institute Building
Dept. 41-67 Evanston, Ill.

Good Pay for Service Men—and more Profit for Auto Dealers Who Meet the New Situation In the RIGHT WAY!

The auto business has changed. Now Motor Cars and Trucks are finely engineered pieces of machinery—designed and built to meet a demand for performance unthought of 10 years ago. And the service requirements of these cars are just as different as the service needs of 10 years ago. A new type of dealer service is demanded. A new type of service man is needed. The Dealer, and the service man who recognizes the difference between yesterday and today in the auto business, has an immediate, golden future ahead of him.

The New DEALER SERVICE

The car dealer, regardless of what car he sells, must be able to give expert service on all makes of cars. His shop must be so manned that any repair job on any car can be done just as the factory would do that job. The dealer who offers such service will make service profits and car SALES that will exceed even his greatest ambitions.

The New SERVICE MAN

Today, and in the future, the Service Man can't be just a "mechanic"—just a "fixer." He must understand automobiles; be able to repair or adjust all service troubles, quickly and efficiently. He must work with his head more than with his hands. Such service men get paid for what they know, even more than for what they do. They're invaluable. They never have to look for work.

Jobs seek them. They get big pay, and hold the better jobs.



CLIP COUPON TODAY

Motor Institute of America, Dept. 41-67,
Motor Institute Building, Evanston, Ill.
Send me all the facts on M. I. A. training.
 (If you are a dealer or shop owner, check here.)

Name.....

Street.....

Town..... State.....

Age..... Position.....

When writing to advertisers please mention Popular Mechanics



TO MEN WHO WANT TO MAKE **more money**

You don't "get" raises these days—you earn them!

THESE are strenuous times in which we are living. Competition is keen . . . the demands for efficiency are constantly increasing.

The day is gone when you can "hit the boss" for a raise and get it "on your nerve."

You get raises these days on your ability — and your training!

Today a man must think about himself — and his future. Remember this: If you're just getting by, you're falling behind. Tomorrow your present job may be only a memory. The way to be sure of the future is to be sure of yourself!

Men are realizing this — a new era in the utilization of spare time to acquire specialized training is here! Men who a few years

ago thought they were "sitting on top of the world" today are coming to International Correspondence Schools for additional training. Still more are enrolling because they see the handwriting on the wall. They want to make more money.

Do you want to make more money? If you do, we challenge you to mark and mail this coupon! It has been the beginning of success for men all over the world.

But don't bother if you're a quitter! It takes fight and hard work to get ahead these days—and weak-kneed, spineless men have no more chance of helping themselves by spare-time study than they have of getting a raise tomorrow!

If you have the old fight, if you're willing to risk a two-cent stamp on yourself—mark and mail this coupon *today!*

INTERNATIONAL CORRESPONDENCE SCHOOLS

"The Universal University"

BOX 5565-G, SCRANTON, PENNA.

Without cost or obligation, please send me a copy of your booklet, "Who Wins and Why," and full particulars about the subject before which I have marked X:

TECHNICAL AND INDUSTRIAL COURSES

- | | | | |
|--|--|--|--|
| <input type="checkbox"/> Architect | <input type="checkbox"/> Telegraph Engineer | <input type="checkbox"/> Automobile Mechanic | <input type="checkbox"/> R. R. Bridge and Building Foreman |
| <input type="checkbox"/> Architectural Draftsman | <input type="checkbox"/> Telephone Work | <input type="checkbox"/> Plumbing <input type="checkbox"/> Steam Fitting | <input type="checkbox"/> Air Brakes <input type="checkbox"/> Train Operation |
| <input type="checkbox"/> Building Estimating | <input type="checkbox"/> Mechanical Engineer | <input type="checkbox"/> Heating <input type="checkbox"/> Ventilation | <input type="checkbox"/> Chemistry <input type="checkbox"/> Pharmacy |
| <input type="checkbox"/> Wood Millworking | <input type="checkbox"/> Mechanical Draftsman | <input type="checkbox"/> Sheet Metal Worker | <input type="checkbox"/> Coal Mining Engineer |
| <input type="checkbox"/> Contractor and Builder | <input type="checkbox"/> Machinist | <input type="checkbox"/> Steam Engineer | <input type="checkbox"/> Navigation <input type="checkbox"/> Boilermaker |
| <input type="checkbox"/> Structural Draftsman | <input type="checkbox"/> Toolmaker | <input type="checkbox"/> Steam Electric Engineer | <input type="checkbox"/> Textile Overseer or Supt. |
| <input type="checkbox"/> Structural Engineer | <input type="checkbox"/> Patternmaker | <input type="checkbox"/> Civil Engineer | <input type="checkbox"/> Cotton Manufacturing |
| <input type="checkbox"/> Electric Wiring | <input type="checkbox"/> Pipefitter <input type="checkbox"/> Tinsmith | <input type="checkbox"/> Surveying and Mapping | <input type="checkbox"/> Woolen Manufacturing |
| <input type="checkbox"/> Electrical Engineer | <input type="checkbox"/> Bridge Engineer | <input type="checkbox"/> Refrigeration | <input type="checkbox"/> Agriculture <input type="checkbox"/> Fruit Growing |
| <input type="checkbox"/> Electric Lighting | <input type="checkbox"/> Bridge and Building Foreman | <input type="checkbox"/> R. R. Locomotives | <input type="checkbox"/> Poultry Farming <input type="checkbox"/> Radio |
| <input type="checkbox"/> Welding, Electric and Gas | <input type="checkbox"/> Gas Engines <input type="checkbox"/> Diesel Engines | <input type="checkbox"/> R. R. Section Foreman | <input type="checkbox"/> Marine Engineer |
| <input type="checkbox"/> Reading Shop Blueprints | <input type="checkbox"/> Aviation Engines | <input type="checkbox"/> Highway Engineering | |

BUSINESS TRAINING COURSES

- | | | | |
|---|--|--|--|
| <input type="checkbox"/> Business Management | <input type="checkbox"/> C. P. Accountant | <input type="checkbox"/> Lettering Show Cards <input type="checkbox"/> Signs | <input type="checkbox"/> Grade School Subjects |
| <input type="checkbox"/> Office Management | <input type="checkbox"/> Bookkeeping | <input type="checkbox"/> Stenography and Typing | <input type="checkbox"/> High School Subjects |
| <input type="checkbox"/> Industrial Management | <input type="checkbox"/> Secretarial Work | <input type="checkbox"/> Complete Commercial | <input type="checkbox"/> College Preparatory |
| <input type="checkbox"/> Personnel Management | <input type="checkbox"/> Spanish <input type="checkbox"/> French | <input type="checkbox"/> Civil Service | <input type="checkbox"/> Illustrating |
| <input type="checkbox"/> Traffic Management | <input type="checkbox"/> Salesmanship <input type="checkbox"/> Advertising | <input type="checkbox"/> Mail Carrier | <input type="checkbox"/> Cartooning |
| <input type="checkbox"/> Accountancy <input type="checkbox"/> Cost Accountant | <input type="checkbox"/> Business Correspondence | <input type="checkbox"/> Railway Mail Clerk | <input type="checkbox"/> Lumber Dealer |

Name..... Age..... Address.....

City..... State..... Occupation.....

If you reside in Canada, send this coupon to the International Correspondence Schools Canadian, Limited, Montreal, Canada

When writing to advertisers please mention Popular Mechanics

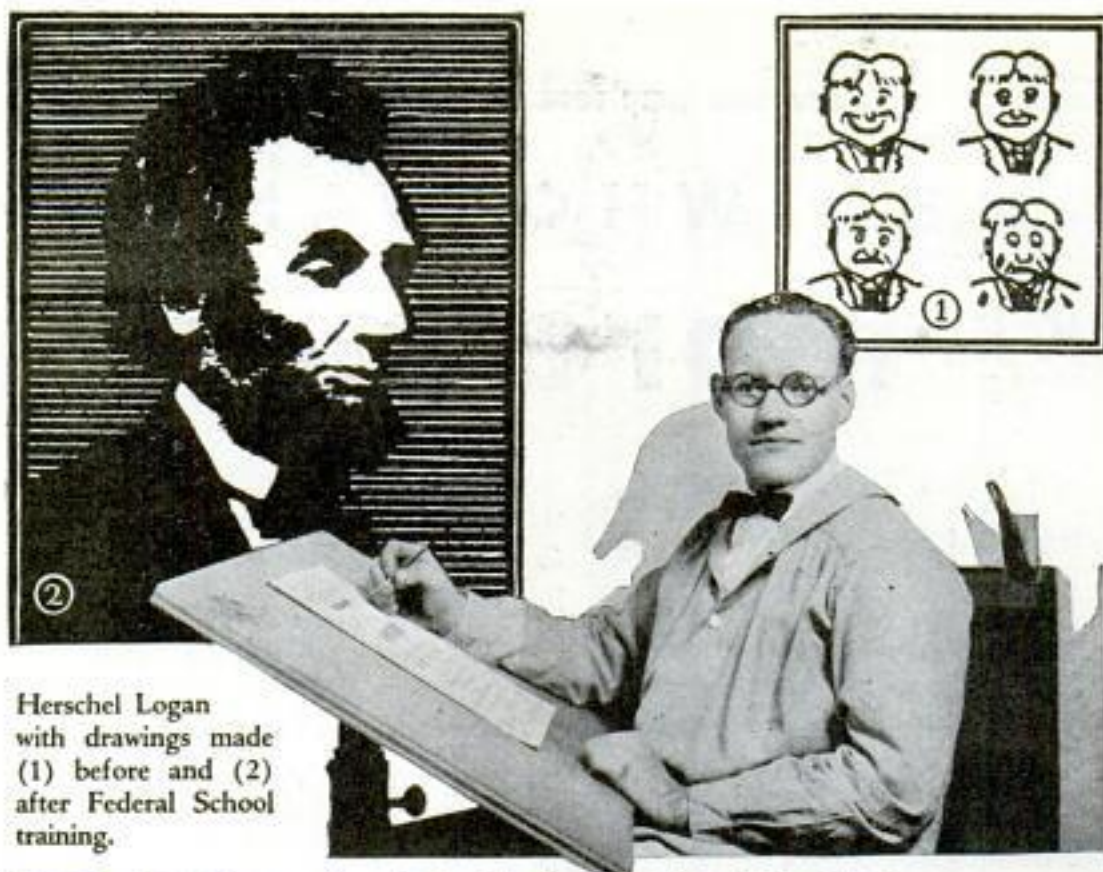

Herschel Logan with drawings made (1) before and (2) after Federal School training.

DRAWING turns INK to GOLD

HERSHEL LOGAN wanted to make money. He liked to draw, but his work (an example of which is shown in No. 1, the small crudely drawn heads above) was not good enough to sell. Seeing an advertisement of the Federal Schools, he filled out a coupon like the one at the bottom of this page. Now compare his recent work, No. 2, with the crude ink scratchings he did before he enrolled in the Federal Course. The drawing of Lincoln shows that Logan understands the proper application of ink. You can see for yourself how the Federal Course has "steadied" his hand. This is the type of drawing that is simple, strong, masterful and pays big money to the man who can do it. Mr. Logan is just one of the hundreds of young people making good money because of Federal Training.

Publishers buy millions of dollars worth of illustrations like Logan's every year. If you like to draw let your talent make your fortune.

Fifty famous artists contribute exclusive lessons and drawings especially prepared for the Federal Course. It's easy to learn the "Federal Way." Study at home in your spare time.

Test Your Drawing Talent

Many people have a talent for art and do not realize it. It is well proven by Logan's first work compared with his drawing of Lincoln. Do you like to draw? A liking for drawing usually indicates talent which can be developed. Our Standard Vocational Art Test will tell you just how much ability you have. Send for it, it's free. We will enclose with it our illustrated booklet, "A Road to Bigger Things," which explains illustrating as a profession, tells about famous artists who have helped build up the Federal Course and shows the remarkable work of students. You'll want both the booklet and the test chart.

Fill out the coupon now.

FEDERAL SCHOOL OF ILLUSTRATING

10131 FEDERAL SCHOOLS BUILDING

MINNEAPOLIS, MINNESOTA

FEDERAL SCHOOL OF ILLUSTRATING,
10131 Federal Schools Bldg., Minneapolis, Minn.

Please send your free book, "A Road to Bigger Things," together with your Standard Vocational Art Test.

Name.....

Age..... Occupation.....

Address.....



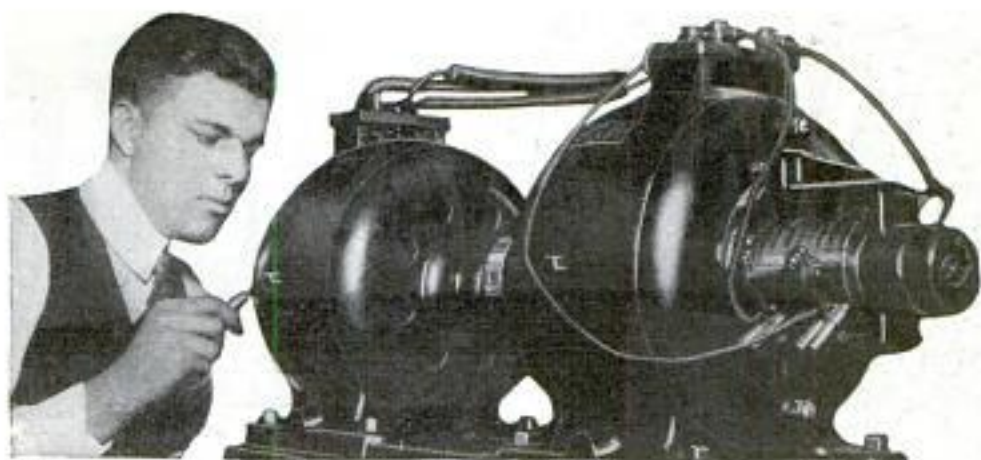

Amazingly Easy Way to get into ELECTRICITY

Don't spend your life waiting for \$5 raises in a dull, hopeless job. Let me show you how to prepare for a real job and how to make real money—in ELECTRICITY, the live, money-making field. Getting into Electricity is far easier than you imagine!

12 Weeks of Practical Shop Training

Come to Coyne in Chicago and learn Electricity the quick and practical way—by actual shop work on actual machinery and equipment. No useless theory! The average time to complete the course is only 12 weeks. You work on real dynamos, switchboards, armatures, auto and airplane engines, transmitting stations, etc.—everything from door bells to power plants—in full operation every day! No previous experience necessary.

FREE Employment Service to Students

When you graduate, we'll do all we can to help you get the job you want. We employ three men on a full time basis whose sole job is to help secure positions for our students. Also we'll help you to earn while learning. Some of our



PREPARE FOR JOBS LIKE THESE

Here are a few of the splendid positions open to Trained Electrical Men:

Power Plant Operator	\$47 to \$60 a week
Maintenance Engineer	\$250 to \$600 a month
Armature Winding	\$45 to \$75 a week
Auto Ignition	\$45 to \$65 a week
Contractor - Dealer	\$3,000 to \$10,000 a year
Motor Inspector	\$250 to \$300 a month
Electric Lighting	\$45 to \$70 a week
Signal Engineering	\$50 to \$75 a week



NOW IN OUR NEW HOME

This is our new fireproof, modern home wherein is installed thousands of dollars' worth of Electrical equipment of all kinds. Every comfort and convenience has been arranged to make you happy and contented during your training.

students pay a large part of their living expenses through part-time work we get them.

COYNE Is 32 YEARS OLD

Thirty-two years is a long time. No school or business could continue that long unless it were rendering real service and getting real results. Yet Coyne has been located right here in Chicago since 1899. Coyne Training is tested—proven by hundreds of successful graduates.

What Graduates Say About Coyne

"One week after graduating, I started my electrical job," writes Leland Hinds of Indiana. "After graduating I was home only two days when appointed Engineer in a light plant in South Dakota," writes George

Bagley, of Canada. "Two weeks after graduating I received a splendid job. The main consideration given my application was that I was a Coyne Trained man," reports Harold Soucy of Illinois. "I wish to thank your Employment Manager for securing this position for me," writes Albert Yagon, "he sent me out to this Company the first day and I was employed there immediately." And I could go on quoting from hundreds of letters of successful Coyne Trained Men. What they have done, you should be able to do!

Get The Facts

But get all the facts! You can find out everything absolutely free. JUST MAIL THE COUPON BELOW FOR A FREE COPY OF OUR BIG ELECTRICAL BOOK, telling all about jobs . . . salaries . . . opportunities. This does not obligate you. JUST MAIL THE COUPON!

COYNE ELECTRICAL SCHOOL
H. C. LEWIS, President
500 S. Paulina Street, Dept. 71-72 Chicago, Ill.

Mr. H. C. LEWIS, President
Coyne Electrical School, Dept. 71-72
500 S. Paulina Street, Chicago, Illinois

Dear Mr. Lewis:
Without obligation send me your big free catalog and all details of Free Employment Service and how I can "earn while learning."

Name.....

Address.....

City..... State.....

NEW WAY *to* WASH CARS



**GY-RO
Works
By
Water
Pressure**

WASHES-CLEANS-POLISHES
in one operation!

NOW—a new way to wash cars! No more fuss or bother. Gone forever is the old-fashioned scrubbing! Chamois, soap and spray are discarded as obsolete. Gy-ro Brush—the sensational new invention—actually makes car washing a pleasure! And, in addition, it saves time, labor and money for car-owners, garages, service stations, fleet operators and home-owners. Simply attach a Gy-ro Brush to an ordinary garden hose. Make no other preparations; don't even remove your coat. Turn on the water. Then brush the car with Gy-ro. Don't splash or spray. Just brush down the car as casually as though you were whisking away a fly!

Many Uses!

Gy-ro washes cars clean in less than half the usual time. In 15 minutes the car will be spotlessly clean. And, surprisingly, Gy-ro is just as handy for washing down walls, saving expensive painting jobs; for cleaning windows, screens, etc. It is an invaluable aid for every housewife.

AGENTS!

Get All the Facts!

Gy-ro pays 100% profit to agents! Unique demonstration features and scientific selling plans make selling a positive cinch. The brush sells itself at \$3.75. Even if you sell only 10 brushes a day you make a **DAILY PROFIT OF \$17.50—\$105.00 profit for a six-day week.** No competition from retail stores or mail order houses. **RESERVE YOUR TERRITORY NOW.** Get started **MAKING MONEY** today. We'll send you all the facts **ABSOLUTELY FREE.** Mail the coupon—**NOW.**

Everyone knows the terrific power of **WATER PRESSURE!** The Gy-ro Brush harnesses that power. Simply attach the brush to an ordinary garden hose. As soon as the water is turned on a steady, powerful stream revolves the center brush at a speed of 1000 revolutions per minute. This powerful revolving brush instantly removes all dirt, mud and traffic film. It cleans cars spotlessly clean. Yet it is guaranteed never to mar or scratch the finest surface. Can be used on any finish—Duco, lacquer, etc. Soft, velvety outside brush prevents the water from splashing or dripping, and acts as a chamois and cleaner in one. In fact, Gy-ro not only washes, cleans and polishes, but it prolongs and beautifies the car surface as well.

100% PROFIT
for
YOU!

GY-RO BRUSH CO.,
Dept. K-14, Bloomfield, N. J.

Without obligation rush full details of your splendid money making opportunity and new selling plans. Also reserve territory for me.

Name.....

Address.....

Town.....State.....

When writing to advertisers please mention Popular Mechanics

Chance of a Lifetime to Get into

ELECTRICITY

PANICS have not cut salaries in the fastest-growing, most prosperous of industries. The facts and figures will amaze you. Here is the greatest opportunity open to ambitious men today.

The millions of men employed in **ELECTRICITY** are not worrying about losing their jobs, or cuts in wages. It doesn't matter what conditions are in other lines—we still use electric light and power—we are building and buying more electric refrigerators than ever before—we have not given up riding on electric street cars—or telephoning—or telegraphing.

So if you are looking for a line that has both a permanent future as well as a secure present—we invite you to investigate **ELECTRICITY**—get a list of the positions open—the salaries paid—the industries that depend on Electricity for light, power and automatic controls—the whole astonishing array of facts and figures that will give you a new idea of your chances in the future of Electricity.



E. B. Ashman, Ardmore, Okla.—"Through your employment department I accepted a position with the Oklahoma Gas and Electric Company and it is entirely satisfactory to me."



Amos S. Harzish, Wilkes-Barre, Pa.—"In spite of hard times I have accepted employment with Edison Electric Company, learning to operate. I only realize how deep the electrical game is. I wish to thank you very much."

Office and Factory Men Under 35—WANTED!

Practically ALL companies in all lines need men with Electrical training. Refrigeration, railroading, automobiles, steel mills, paper plants, mines, road-building, manufacturers in all industries are employing the men we prepare. All you need is a little training in Electrical Engineering principles, which we will give you at home, in your spare time. Whatever experience you have now in office or factory—whatever education—won't be wasted. You can move ahead from where you are now. Depression or prosperity—we can promise to help place you in a satisfactory position under money-back penalty! (Read contract at the right).

You Can Save Money If You Investigate Now!

We recommend Electricity above all other lines because electrical light, power and conveniences have become a necessity in everybody's life—in home, office, factory and farm. And its future is as solid as the nation itself.

Right now we are making the most astonishing money-saving offer in our 35 years of existence. Monthly payments sharply reduced to encourage more men under 35 to prepare for the coming expansion of the electrical industries. Savings up to \$48.75 cash. So if you are dissatisfied with your present earnings, or worried about your job—here is your chance to get a better-paying position as well as to make your future safe. Just mail the coupon for complete information.

LESSON FREE—to prove that you can learn quickly and easily at home in your spare time. Also Electrical book of facts, free. Just mail coupon.

Save UP TO \$48.75

Read here for Guarantees

American School

Read These 4 Guarantees

1. Guarantee of complete, up-to-date training prepared by noted engineers.
2. Guarantee to help you get a job when you're only half way through the course.
3. Guarantee of tuition credit for previous education and experience.
4. Guarantee of money back after you finish if you are not satisfied.

R. S. Milleys, President

AMERICAN SCHOOL, Dept. E-747, Drexel Ave. & 58th St., Chicago, Ill. Please send free lesson and tell me about your money saving offer in line marked X below.

- ELECTRICITY**
- | | |
|---|---|
| <input type="checkbox"/> Architecture | <input type="checkbox"/> Shop |
| <input type="checkbox"/> Building | <input type="checkbox"/> Superintendent |
| <input type="checkbox"/> Drafting | <input type="checkbox"/> High School in 2 years |
| <input type="checkbox"/> Business Management | <input type="checkbox"/> Structural Steel |
| <input type="checkbox"/> Accounting | <input type="checkbox"/> Civil Engineering |
| <input type="checkbox"/> Mechanical Engineering | <input type="checkbox"/> Auto Engineering |
| | <input type="checkbox"/> Highway Engineering |

Name.....
St. No.....
City..... State.....
Age..... Occupation.....

The American School

Dept. E-747

Drexel Ave. & 58th St.

Chicago

When writing to advertisers please mention Popular Mechanics

...The Britannica at

AN UNUSUAL

An unprecedented reduction from the standard price of the Britannica is now publicly announced.

Why reduction is possible

This reduction is possible because long before the regular fall printing went to press, a careful study was made of a plan to meet the business conditions of this unusual year boldly and successfully.

How money is saved

After weeks of investigation and thorough planning, it was found that the manufacturers could make substantial economies in the cost of paper, binding material, printing and over-

What Britannica Owners Tell You

It would be quite impossible to have even a casual familiarity with the things daily discussed were it not for the existence of the Britannica.

Frank B. Jewett,
American Telephone & Telegraph Co.

The new Britannica meets, in an amazingly satisfactory way, the need which the specialist in every branch of science feels for accurate, digested and synthesized information.

Raymond Pearl,
Johns Hopkins University.

From my examination of the new Britannica I should say it is the ideal encyclopaedia for a home with children—indeed, for any home.

Willis A. Sutton,
Recently President, Nat'l Education Ass'n.

The Encyclopaedia Britannica is comprehensive and authoritative. Nothing has been left undone to make it thorough and complete. It is worthy of the great tradition associated with its name.

Charles Evans Hughes,
Chief Justice of the U. S. Supreme Court.

What You Get

Many people may not realize that the 24 large and beautifully bound volumes carry 35,000,000 words written by 3,500 authorities and are richly illustrated with 15,000 pictures, many in full color, and with 500 maps—the whole, indexed with 500,000 separate entries, is easily and agreeably read.

You can get the full details of the new low price if you

When writing to advertisers please mention Popular Mechanics

the New Big Saving

ANNOUNCEMENT

head, *provided* we ordered a printing equal to the largest single printing ever made by the Britannica.

Who makes the saving?

Day and night since early summer, giant presses have been turning out thousands of volumes and we have now completed a printing equal to the biggest single impression of the new Britannica ever made. And the resulting economies are passed on to you. *You pay less, because we printed more.*

Get the particulars now

We believe that many thousands of keen, progressive and prudent people who have always wanted the Britannica will now buy it. We believe that this printing—large as it is—will be sold out in a comparatively short time; but we frankly do not know whether business conditions will ever make it possible to duplicate this unusually low price again. You can't afford to delay.

\$5 down and \$5 a month

Our Thrift Plan favors the pocketbook. Only \$5 down is required to bring the set to your home for immediate use. The balance is payable in a few monthly instalments of \$5 or more, as you wish.

Send for 56-Page Booklet

Now is the time to get full details about new low prices. Fill out coupon, send it to us, and *receive* by return mail, the large, beautiful, 56-page booklet, rich with color plates, maps, sample pages. It contains a full description of the Britannica and how you can make it your most useful possession.



1 P. M.-B1
ENCYCLOPAEDIA BRITANNICA, INC.
 342 Madison Avenue • New York City

Please send me, without obligation, 56-page illustrated booklet with color plates and maps from the new Britannica together with low price offer, etc.

Name.....

Address.....

City..... State.....

send for new free booklet today

When writing to advertisers please mention Popular Mechanics

Copyrighted material

ELECTRICITY

PAYS BIG!

LEARN IN 90 DAYS ON ACTUAL MACHINERY—NO BOOKS I'LL PAY YOUR R-R FARE TO CLEVELAND

Don't let the world bluff you. Get into electricity—earn \$50.00 to \$150.00 a week—and hold your head as high as the next man. You can do it easily by coming to my famous electrical school. In 12 short weeks you'll pack in many years of practical knowledge. You work shoulder to shoulder with expert instructors on full-sized, moving, whirling motors, generators, batteries, switchboards, telephone and telegraph systems, etc., etc. McSweeney trained men get the biggest paying jobs. Every day I receive requests for graduates.

No Education or Experience Needed

No books to read. No dry lectures to listen to. You learn by doing. I don't care if you can't tell a motor from a horse-and-

buggy now. When you graduate I guarantee that you'll know electricity from "A" to "Z." If you're not fitted to fill a big-pay job I'll refund every penny of your tuition.

switchboards, telephone and telegraph systems, etc., etc. McSweeney trained men get the biggest paying jobs. Every day I receive requests for graduates.

Satisfaction Guaranteed!

You are the sole judge of McSweeney training. Your tuition will be refunded if, upon graduation, you are not satisfied.

Big Illustrated Book Sent FREE

Today, right now, take the first step out of that low pay rut. Mail the coupon to me for big, illustrated book on ELECTRICITY. Act today. Get my special Railroad Fare offer and Remarkable Tuition offer.

Just Mail Coupon



IT'S EASY THIS WAY

Fascinating, practical shop work in my big school fits you. Not correspondence course.



RADIO COURSE INCLUDED



McSWEENY ELECTRICAL SCHOOL

Dept. E-10-10

Cleveland, Ohio

J. H. McSweeney, Pres.,
McSweeney Electrical School,
Dept. E-10-10, Cleveland, O.
Dear Sir: Without obligation send me a copy of your big book on ELECTRICITY, also Railroad Fare offer, and details of Employment Service.
Name.....
Address.....
Town..... State.....

WANT A STEADY JOB?

TRAVEL FOR "UNCLE SAM"



MANY OTHER U. S. GOVERNMENT POSITIONS STEADY WORK

MEN—BOYS 18 TO 50

Short Hours Pleasant Work
Rapid Advancement Permanent Employment
Long Vacation with Pay

Mail Coupon Now. Act at Once.

DO IT TODAY. TOMORROW YOU MAY FORGET.

FRANKLIN INSTITUTE, Dept. H187, Rochester, N. Y.

Rush to me entirely free of charge: 32 page book, with list of U. S. Gov't Jobs obtainable and particulars telling how to get the job here checked.

Railway Postal Clerk	(\$1900-\$2700)
Post Office Clerk	(\$1700-\$2300)
City Mail Carrier	(\$1700-\$2100)
Rural Mail Carrier	(\$2100-\$3400)
Prohibition Agent	(\$2300-\$2800)
Inspector of Customs	(\$2100-\$3300)
Immigrant Inspector	(\$2100-\$3000)

Name.....

Address.....

When writing to advertisers please mention Popular Mechanics



National Salesmen's Training
Association.
Dept. R-104, N.S.T.A. Bldg.,
Chicago, Ill.

Without cost or obligation you may
send me your free book, "The Key to
Master Salesmanship."

Name

Address

City State

Age Occupation

They Laughed When I Mailed This Coupon

*.. But It Brought Me The Book That Showed Me
How to Make \$10,000 a Year!*

As I walked up to the mail box, Joe nudged Ed and winked broadly for my benefit.

"Sh!" he hissed in a loud stage-whisper. "This is going to be the big turning point in Frank Parker's life! He's writing for a book that tells how to get into salesmanship. Pretty soon he'll be earning so much that he'll make the rest of us look like pikers!"

Ed snickered. "Won't it be grand!" he grinned. "Now he can quit punching time-clocks and eating 40-cent lunches." He raised his voice. "Drop me a postal sometime when you get out into the big business and start making \$10,000 a year, will you, Frank?"

They both laughed uproariously. And probably it *did* seem like a joke to them that a \$30 a week clerk would have the nerve to think he could ever get anywhere or make real money without some special "gift" or "pull."

But they laughed too soon. Just yesterday I sat down and wrote to Ed, who is still at the shop, dragging along at the same old job.

"Dear Ed"—I wrote. "You asked me to send you a card when I 'got into big business and started making \$10,000 a year.' Well, here's your card. Yesterday I was promoted to the job of assistant Sales Manager of the Western Metal Works, at a salary that goes with it. I'll loan you my copy of that book on salesmanship you used to think was such a joke."

Only a book! Just seven ounces of paper and printers' ink—but it contains one of the most vivid and inspiring messages that any ambitious man can read. It reveals the real truth about the art of selling, explains the science of selling in simple terms, and tells exactly how the great sales records of nationally-known star-salesmen are achieved. And not only that—it outlines a simple plan that will enable almost any man to master scientific salesmanship without spending a moment on the road—without losing a day or a dollar from his present position.

A Few Weeks—Then Bigger Pay

Reason it out for yourself. Salesmanship offers bigger returns and delivers them quicker than any other line of work under the sun. But many people have subscribed to the foolish notion that a man has to be "born" with some sort of "gift" for salesmanship. Nothing could be farther from the truth. Just like any other profession, salesmanship is governed by certain fundamental rules

and laws—laws which you can master as easily as you learned the alphabet.

Right now an unusual demand for salesmen is being reported. City and traveling sales positions are open in nearly every line all over the country. Last year requests for trained men were received from many firms in all quarters. This employment service is free to both employers and employees, and thousands have secured excellent positions this way.

Free to Every Man

See for yourself why "The Key to Master Salesmanship" has been the deciding factor in the careers of so many men who are now making \$10,000 a year. See how A. C. Wallahan of Huron, So. Dakota, used this training to become District Manager for his firm at a 400% pay increase! Find out how G. T. Patterson of Stillwater, Okla., left a small-pay job for a position that paid him up to \$550 a month. Learn for yourself the REAL truth about the art of selling! If we were asking \$2 or \$3 a copy you might hesitate. But the book is now FREE. You do not risk one penny nor incur the slightest obligation. And since it may alter your entire future, it certainly is worth your time to fill out and clip the coupon at the top of this page. Why not do it now!

National Salesmen's Training Association

Dept. R-104
N. S. T. A. Bldg. Chicago, Ill.



Where Shall
We Send Your
Copy FREE?

MAIL COUPON ABOVE TODAY

When writing to advertisers please mention Popular Mechanics

Do You Make these Mistakes in ENGLISH?

MANY persons say "Did you hear from him today?" They should say "Have you heard from him today?" Some spell calendar "calender" or "calander." Still others say "between you and I" instead of "between you and me." It is astonishing how often "who" is used for "whom," and how frequently the simplest words are mispronounced. Few know whether to spell certain words with one or two "c's" or "m's" or "r's," or with "ie" or "ei." Most persons use only common words—colorless, flat, ordinary. Their speech and their letters are lifeless, monotonous, humdrum.



Sherwin Cody

Wonderful New Invention

For many years Mr. Cody studied the problem of creating instinctive habits of using good English. After countless experiments he finally invented a simple method by which you can acquire a better command of the English language in only 15 minutes a day.

Under old methods rules are memorized, but correct habits are not formed. Finally the rules themselves are forgotten. The new Sherwin Cody method provides for the formation of correct habits by calling to your attention constantly only the mistakes you make—and then showing you the right way without asking you to memorize any rules.

One of the wonderful things about Mr. Cody's course is the speed with which these habit-forming practice drills can be carried out. You can write the answers to fifty questions in 15 minutes and correct your work in 5 minutes more. The drudgery and work of copying have been ended by Mr. Cody! You concentrate always on your own mistakes until it becomes "second nature" to speak and write correctly.

FREE—Booklet on English

A new booklet explaining Mr. Cody's remarkable method is ready. If you are ever embarrassed by mistakes in grammar, spelling, punctuation, pronunciation, or if you can not instantly command the exact words with which to express your ideas, this new free booklet, "How You Can Master Good English in 15 Minutes a Day," will prove a revelation to you. Send the coupon or a letter or postal card for it now. SHERWIN CODY SCHOOL OF ENGLISH, 510 Searle Building, Rochester, N. Y.

SHERWIN CODY SCHOOL OF ENGLISH

510 Searle Building, Rochester, N. Y.

Please send me your free booklet, "How You Can Master Good English in 15 Minutes a Day."

Name.....

Address.....

This valuable booklet can not be sent to children

Electricity!

Learn in Los Angeles

NATIONAL Opens Its Doors to You!

Right in the heart of America's most interesting place to live and learn... National... the approved trade school of the West... invites you to Los Angeles! Come West, enjoy life, learn a profitable trade in a land of prosperity, progress, sunshine and happiness. Unlimited Employment Service absolutely FREE to students and graduates.

Your Railroad Fare Allowed for a Limited Time!

Everyone dreams of coming to California. National will pay your railroad fare from any point in the United States. Never again another opportunity like this! Investigate this great offer at once!

Don't Worry About Enough Money! We'll Help You!

If you are short of money, we help you secure part time jobs to earn your living expenses while learning.

Write Today About the Greatest Offer Ever Made!

This great Million Dollar Institution is equipped with the best money can buy the finest faculty of electrical experts in the country opens its doors to you. No age limit... no previous experience required, start any time. Send at once for NEW Book with full details!

FREE BOOK

NATIONAL ELECTRICAL SCHOOL

Dept. 104-E, 4006 So. Figueroa St., Los Angeles, Cal.

HOT PIANO

Ultra-modern Piano

Jazz taught by mail. Note or ear. Easy rapid lessons for adult beginners. Also Self-instruction system for advanced pianists. Learn 358 Bass Styles, 976 Jazz Breaks, hundreds of Trick Endings, Hot Rhythms, Sock, Stomp and Dirt Effects; Symphonic and Wicked Harmony in latest Radio and Record Style. Write for Free Booklet.

WATERMAN PIANO SCHOOL, 1828 W. Adams St., Los Angeles, Calif.

LEARN MECHANICAL DENTISTRY

SEND FOR FREE BOOK

Earn Big Money—Steady Work

Don't waste the best years of your life. Prepare now for prosperity. Learn this money-making business in a few months in Day or Evening sessions. Big Demand. School is highly endorsed. Practical training. Individual instruction. Easy terms. Write NOW for free catalog P and reduced rate. New York School of Mechanical Dentistry 125 West 31st Street New York

YOUR SUCCESS

GOV'T. POSITIONS

SPLENDID SALARIES

WE HELP YOU GET ONE

Ry. Mail Clerk	Steno Typist
P. O. Laborer	Immigrant Insp.
R. F. D. Carrier	Seamstress
Special Agent	Auditor
Customs Inspector	Prohibition Agt.
City Mail Carrier	U.S. Border
Meat Inspector	Patrol
P. O. Clerk	Chauffeur
File Clerk	Watchman
General Clerk	Skilled Laborer
Matron	Postmaster
	Typist

Men - Women

Age Range 18 to 50

Orients Instruction Bureau, Dept. 111, St. Louis, Mo. Send me FREE particulars "How to Qualify" for positions marked "X" Salaries, Locations, Opportunities, etc. ALL SENT FREE.

Name.....

Address.....

Nothing to be "scared" of in learning music this easy way

No private teacher
No compulsory practice
No dry-as-dust theory
No expensive fees
No cost for music
No "guess work"

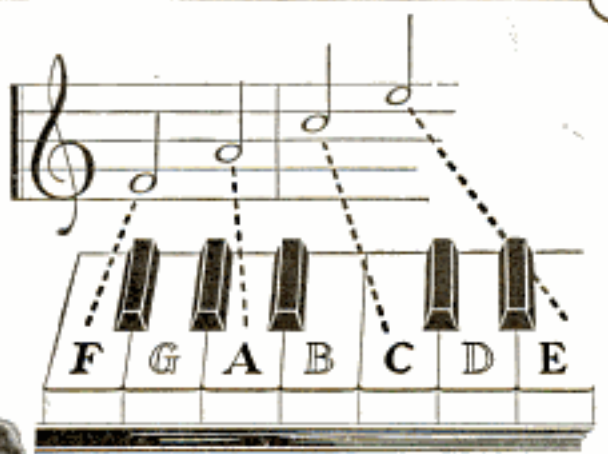

THE days when music lessons were nothing but a hodge-podge of confusing theory, difficult finger gymnastics, expensive fees and slow progress are over and done with.

For old prejudices against home-study lessons have been dispelled. Ancient propaganda about the need of special talent and the necessity of "coming from a musical family" has been definitely dissipated. The U. S. School of Music has taken all the bad taste out of music lessons and made them more like a game than a study.

Now you don't have to know a thing about notes or the make-up of your favorite instrument to start your musical career. You never see a personal teacher—you arrange your own practice periods. You spend less than half what the average private teacher would charge for your lessons—and nothing extra for your music.

Nevertheless in a few short months you are able to play acceptably all types of modern and classic music. This would sound almost incredible were it not for the fact that over 600,000 people have already learned to play their favorite instruments the U. S. School of Music way.

Easy as A-B-C

What a thrill to spend a little time each day in the privacy of your home seeing and hearing your musical dreams come true. No intricate explanations to baffle you. No trust-to-luck tactics. Guess work



is eliminated. For right with you at all times are our simplified print and picture instructions keeping you on the right track—telling you what to play and showing you how to play it—when to play soft or loud, fast or slow—taking you over a delightful short cut to musical accomplishment. There's real enjoyment in tackling each new lesson. For the entire course from the very beginning to the end is brimful of cheerful, tuneful selections which you eagerly learn to play by note.

Pick Your Instrument

Piano	Violin
Organ	Clarinet
Ukulele	Flute
Cornet	Saxophone
Trombone	Harp
Piccolo	Mandolin
Guitar	Cello
Hawaiian Steel Guitar	
Sight Singing	
Voice and Speech Culture	
Harmony and Composition	
Drums and Traps	
Automatic Finger Control	
Banjo (Plectrum, 5-String or Tenor)	
Piano Accordion	
Italian and German Accordion	
Juniors' Piano Course	

New friends— better times

Imagine how jolly it would be at one of your house parties, for instance, to have your friends gather around and sing to your playing—to see them roll up the rugs and dance as you syncopate the hits of the day. You'll find yourself in the spotlight . . . popular everywhere.

And when you're feeling out of sorts, how quickly you get back in the right mood as you play to your heart's content. How proud, too, your family will be as you render their favorites. Think of your-

self, your folks, your friends. Think of the wonderful satisfaction in being able to play what and whenever you are so inclined.

Bear in mind no matter which instrument you select—the cost of learning in each case will average the same—just a few cents a day!

Get Proof—Free!

Don't let a lot of false impressions and silly bagaboos delay your start toward musical good times. If you really want to learn to play—if social popularity and increased income appeal to you—then reserve your decision until we send you a Free Demonstration Lesson and a copy of our free illustrated book which describes in detail the famous U. S. School print-and-picture method. Then it's entirely up to you. You're the judge and jury. No obligation involved, of course.

When writing, kindly mention your favorite instrument. Forget that old-fashioned idea that you need talent to learn music and fill in and mail the coupon now. Instruments supplied when needed, cash or credit. U. S. SCHOOL OF MUSIC, 710 Brunswick Bldg., New York City.

U. S. SCHOOL OF MUSIC,
710 Brunswick Bldg., New York City

Please send me your free book, "Music Lessons in Your Own Home," with introduction by Dr. Frank Crane, Free Demonstration Lesson, and particulars of your easy payment plan. I am interested in the following course:

Have You
Instrument?

Name

Address

City State

When writing to advertisers please mention Popular Mechanics

FORMER CARPENTER



now making **\$15,000**
a year

"I was a carpenter, working hard every day but not making any progress. The future looked pretty desperate to me. I had a family growing up, responsibilities were increasing.

"I didn't have much education but I did have ambition! And that ambition was to be more than an ordinary carpenter. So one day, after some careful thinking on my part, I enrolled for the International Correspondence Schools course in Architecture. I studied it and finished it. I got a better job right away. Today I am a successful architect, making over \$15,000 a year, and when I look back, I realize that I. C. S. coupon I marked changed my whole life."

This is an I. C. S. true story which should interest you if you are not getting ahead . . . if you need more money and don't know how you are going to make it. This is an age in which the trained man has the advantage. You can be a trained man! I. C. S. can help you, just as they have helped thousands of other men who faced the same problems.

Mark and mail the coupon — today!

INTERNATIONAL CORRESPONDENCE SCHOOLS "The Universal University"

Box 5567-G, Scranton, Penna.

Without cost or obligation, please send me a copy of your booklet, "Who Wins and Why," and full particulars about the subject before which I have marked X:

TECHNICAL AND INDUSTRIAL COURSES

- | | |
|--|--|
| <input type="checkbox"/> Architect | <input type="checkbox"/> Automobile Mechanic |
| <input type="checkbox"/> Architectural Draftsman | <input type="checkbox"/> Plumbing <input type="checkbox"/> Steam Fitting |
| <input type="checkbox"/> Building Estimating | <input type="checkbox"/> Heating <input type="checkbox"/> Ventilation |
| <input type="checkbox"/> Wood Millworking | <input type="checkbox"/> Sheet Metal Worker |
| <input type="checkbox"/> Contractor and Builder | <input type="checkbox"/> Steam Engineer |
| <input type="checkbox"/> Structural Draftsman | <input type="checkbox"/> Steam Electric Engineer |
| <input type="checkbox"/> Structural Engineer | <input type="checkbox"/> Civil Engineer |
| <input type="checkbox"/> Electric Wiring | <input type="checkbox"/> Surveying and Mapping |
| <input type="checkbox"/> Electrical Engineer | <input type="checkbox"/> Refrigeration |
| <input type="checkbox"/> Electric Lighting | <input type="checkbox"/> R. R. Locomotives |
| <input type="checkbox"/> Welding, Electric and Gas | <input type="checkbox"/> R. R. Section Foreman |
| <input type="checkbox"/> Reading Shop Blueprints | <input type="checkbox"/> R. R. Bridge and Building Foreman |
| <input type="checkbox"/> Telegraph Engineer | <input type="checkbox"/> Air Brakes <input type="checkbox"/> Train Operation |
| <input type="checkbox"/> Telephone Work | <input type="checkbox"/> Highway Engineering |
| <input type="checkbox"/> Mechanical Engineer | <input type="checkbox"/> Chemistry <input type="checkbox"/> Pharmacy |
| <input type="checkbox"/> Mechanical Draftsman | <input type="checkbox"/> Coal Mining Engineer |
| <input type="checkbox"/> Machinist <input type="checkbox"/> Toolmaker | <input type="checkbox"/> Navigation <input type="checkbox"/> Boilermaker |
| <input type="checkbox"/> Patternmaker | <input type="checkbox"/> Textile Overseer or Supt. |
| <input type="checkbox"/> Pipefitter <input type="checkbox"/> Tinsmith | <input type="checkbox"/> Cotton Manufacturing |
| <input type="checkbox"/> Bridge Engineer | <input type="checkbox"/> Woolen Manufacturing |
| <input type="checkbox"/> Bridge and Building Foreman | <input type="checkbox"/> Agriculture <input type="checkbox"/> Fruit Growing |
| <input type="checkbox"/> Gas Engines <input type="checkbox"/> Diesel Engines | <input type="checkbox"/> Poultry Farming <input type="checkbox"/> Radio |
| <input type="checkbox"/> Aviation Engines | <input type="checkbox"/> Marine Engineer |

BUSINESS TRAINING COURSES

- | | |
|---|--|
| <input type="checkbox"/> Business Management | <input type="checkbox"/> Business Correspondence |
| <input type="checkbox"/> Office Management | <input type="checkbox"/> Lettering Show Cards <input type="checkbox"/> Signs |
| <input type="checkbox"/> Industrial Management | <input type="checkbox"/> Stenography and Typing |
| <input type="checkbox"/> Personnel Management | <input type="checkbox"/> Complete Commercial |
| <input type="checkbox"/> Traffic Management | <input type="checkbox"/> Civil Service <input type="checkbox"/> Mail Carrier |
| <input type="checkbox"/> Accountancy <input type="checkbox"/> Cost Accountant | <input type="checkbox"/> Railway Mail Clerk |
| <input type="checkbox"/> C. P. Accountant | <input type="checkbox"/> Grade School Subjects |
| <input type="checkbox"/> Bookkeeping | <input type="checkbox"/> High School Subjects |
| <input type="checkbox"/> Secretarial Work | <input type="checkbox"/> College Preparatory |
| <input type="checkbox"/> Spanish <input type="checkbox"/> French | <input type="checkbox"/> Illustrating <input type="checkbox"/> Cartooning |
| <input type="checkbox"/> Salesmanship <input type="checkbox"/> Advertising | <input type="checkbox"/> Lumber Dealer |

Name.....Age.....

Address.....

City.....State.....

Occupation.....

If you reside in Canada, send this coupon to the International Correspondence Schools Canadian, Limited, Montreal, Canada



"He's Young For Such a Big Job!"

But This New Accountancy Training Gave Him Ability Beyond Most Older Men!

TODAY thousands of ambitious men, young and older, are outstripping others through mastery of a new and vitally important profession. That profession is accountancy. And now a group of leading accountants and accountancy teachers have devised a training method which authorities say is "the clearest and most thorough." Employs University training methods, yet teaches you right in your own home. Prepares not only for executive accounting positions, but for Cost Accounting jobs, Auditing, Federal Income Tax and Certified Public Accountancy. Includes complete C.P.A. coaching free. Write today and find out about opportunities in business for accountants—positions paying \$3,000 to \$12,000 a year, and the field of public accountancy—earnings literally unlimited. New book "The Modern Way To Learn Accounting," explains new "Guided Experience" Method completely. Send for your free copy today.

THE AMERICAN UNIVERSITY OF COMMERCE
Dept. P-30, 17 West Elm St. CHICAGO, ILL.

EARN MONEY AT HOME

YOU can make \$15 to \$50 weekly in spare or full time at home coloring photographs. No experience needed. No canvassing. We instruct you by our new simple Photo-Color process and supply you with work. Write for particulars and Free Book to-day.

The IRVING-VANCE COMPANY Ltd.
356 Hart Building, Toronto, Can.

ELECTRICAL ENGINEERING

A concise, comprehensive course for men of limited time, complete in one year. Mathematics, engineering drawing, shop-work. Students construct motors, install wiring, test electrical machinery. Buildings fireproof. 38 years' successful experience. Catalog on request.



BLISS ELECTRICAL SCHOOL

120 Takoma Ave., Washington, D. C.

Learn Watchwork, Jewelrywork and Engraving A fine trade commanding a good salary, and your services always in demand. Address **Horological**, Dept. P, Bradley Institute, PEORIA, ILLINOIS, for our latest catalog.

STAMMERING

You can be quickly helped if

you stammer or stutter

I KNOW, because I relieved myself after stammering for nearly 20 years. The story of my suffering—and relief—has interested thousands, many of whom have permitted me to help them. Full story of my successful efforts told in 279-page book. Sent anywhere for 10 cents. B. N. BOGUE, 11146 Bogue Building, 1147 North Illinois Street, Indianapolis, Ind.

When writing to advertisers please mention Popular Mechanics

Speed Course in Drafting

... for the man
who wants to go
far and must
make every
minute
count!

These are times of thrilling speed . . . speed born of intensive specialization. Automobiles must make 75 miles and up an hour . . . airplanes must rush the delivery of mails . . . ships must cross the Atlantic in 5 days . . . the world must be encircled in a few weeks instead of many months! Specialized draftsmen made these marvelous accomplishments possible.

Success is no longer a goal demanding years of grinding preparation. The opportunities for specialization have changed the old order of things. The speed-way to success today is by way of intensive, direct-line procedure—first, fundamentals—then an air-line route—a non-stop flight, with all side trips eliminated.

Chicago TECH'S improved, elective speed-course in DRAFTING is designed to meet this modern need. It divides drafting into its four specific branches; thus offering choice of specialization—the shortest route to any of its highest paid fields. In drafting as in other leading professions, the high posts, the big rewards, are not won by the jack-of-all-trades. Draftsmen who reach the \$5,000 and \$10,000 jobs still young enough to enjoy success, are all masters of some one of its four big specialized branches.

Do It in
Spare Time

College
Training
at home—
a new elec-
tive plan —
that cuts time
and cost to a
fraction of that
required if you go
away to school.



Architectural—mechanical—electrical—structural—each branch of Drafting is world-wide in its scope—each one unlimited in opportunities. Many specialized draftsmen have won fame and fortune as inventors, builders, architects, technicians and designers. This highly-selective method of training in draftsmanship is distinctive with Chicago TECH. It accounts for the swift, outstanding success of Chicago-Tech-Trained men.

The Quick Way to a Good Job

Chicago Tech's Speed Course in Drafting provides training of college-grade—shortened and simplified to assure swift, thorough specialization for those who must learn in spare time at home. This home-study course has produced hundreds of big successes . . . engineers, architects, designers, builders, con-

tractors, chief draftsmen, superintendents. Send for the Chicago Tech catalog. Learn how you, too, can become a college-trained specialized draftsman right in your own home—with maximum speed and amazingly little expense. Our free employment service helps you to a good position

as soon as ready. \$100 a week and up paid experts. Send coupon now for big, free book on drafting and how to qualify. Low cost, easy terms—complete drafting outfit included without extra charge.

\$25 Drafting
Outfit
Free of Extra Cost

No other high-pay field is easier to get into with a common school education. Opportunities never so great for drafting specialists. All our great inventors, builders, engineers and architects owe their fame and fortune to a knowledge of drafting.

CHICAGO TECHNICAL COLLEGE

Dept. N-204, 118 E. 26th St.
CHICAGO, ILL.

We also offer resident day and evening courses in Architecture, Engineering, Drafting, Electricity, Building. Our Home-Study Speed Course in Drafting is the result of 27 years experience in training men both in our Chicago school and at home by mail.



Chicago Technical College,
Dept. N-204, 118 E. 26th St.,
Chicago Ill.

Please send me your big free book on Draftsmen's Opportunities; also full information about your College Home-Study Speed Course in Drafting.

Name.....

Address.....

City.....State.....

Age.....Occupation.....

Check here if you prefer coming to Chicago to take our short resident day or evening course in drafting.

When writing to advertisers please mention Popular Mechanics

Copyrighted material.

BIG FUN-BIG MONEY



Learn to MOUNT BIRDS AND ANIMALS

Be a TAXIDERMIST

Learn this **WONDERFUL** new, fascinating and **PROFITABLE** art at home by mail. This old famous school, with over 100,000 students **GUARANTEES** success. Thousands of Popular Mechanics readers have already enrolled. Mount and preserve **GAME ANIMALS AND BIRDS** like life. Mount common and domestic animals in highly amusing and human-like groups. The actual squirrels shown above, **MOUNTED AND DRESSED** up, cost but a few cents for materials, but sold for \$40 for a window display. Rabbits, frogs, mice, cats, pigs, sparrows, pigeons—**ALL** can be mounted in funny and interesting groups, imitating human situations. Great fun, tremendously fascinating, extremely profitable.

Quickly Learned by Mail

Men, women, boys, all learn easily and quickly, at home **BY MAIL**, from our remarkably clear course of 40 lessons. Begin **ACTUAL WORK** with the first lesson. You become a **TAXIDERMIST**—**ARTIST**, well known and popular. You learn an art of vast interest, and one that will turn spare time to big profits.

Hunters—Anglers!

Preserve your trophies. Save your fine specimens. Have your own **MUSEUM**. Also mount for others and sell your spare specimens at fancy prices. Every **SPORTSMAN** and Nature Lover **MUST** know taxidermy, or lose half the pleasure and profits of the sport. Taxidermy is sweeping the country. **INVESTIGATE!** Send right **NOW** for our fine **FREE BOOK**.

A Business of Your Own

Do you want or **NEED** to **MAKE MORE MONEY?** Here is your **OPPORTUNITY**. Make \$50 to \$200 a month from **SPARE TIME**. Or open a **TAXIDERMIST SHOP**. Have a life-long business of your own, one that is high grade and that can earn for you \$4,000 to \$8,000 a year. All sportsmen want their **TROPHIES MOUNTED**. Business will quickly come, and grow fast. Look into this great **PLEASURE AND PROFIT ART TODAY**. By all means write for our interesting, new,

FREE BOOK: 48 pages, dozens of pictures of mounted game specimens, and full particulars about our lessons and how **YOU** can become an **EXPERT TAXIDERMIST**, at home in **SPARE TIME**. Send the **COUPON RIGHT NOW—TODAY**. **State AGE.**

Send Coupon Today!

FREE BOOK COUPON

**NORTHWESTERN SCHOOL OF TAXIDERMISTRY,
3377 Elwood Building, Omaha, Nebraska**

Gentlemen: Please send at once, your free 48-page book on Taxidermy without any obligation on my part. Tell me how I can learn Scientific Taxidermy at home.

Name

Age

Address



NEW YORK ELECTRICAL SCHOOL

Opportunities for All Men!

Every phase of all branches of Practical Electricity taught by Actual Practice in America's Foremost Institution of Trade Learning.

Special Courses in Automobile Mechanics and Electricity.

Day and evening classes open all year.

Write for **FREE** School Booklet

**New York Electrical School
44 W. 17th St., New York City**

MUSIC LESSONS IN YOUR HOME



You can play music like this quickly

Write today for our **FREE BOOKLET AND DEMONSTRATION LESSON**. It tells how to learn to play Piano, Organ, Violin, Mandolin, Guitar, Banjo, etc. Beginners or advanced players. You pay as you learn. Costs you only a few cents a day. Thousands of satisfied students. **AMERICAN SCHOOL OF MUSIC, 51 Manhattan Bldg., CHICAGO**

Learn to Dance

You can learn all the modern dances—the latest Tango steps, the new Fox Trots, dreamy Waltzes, smart Collegiate Steps, and popular Society Steps at home, easily and quickly. New chart method makes dancing as simple as A-B-C. No music or partner required. Don't be a wallflower. Learn to dance. Complete course—233 pages, 34 illustrations, sent on 5 days' Free Trial. Equals \$20.00 course. Send no money. Pay postage only \$1.98, plus postage upon arrival. Money back if not delighted. Catalog Free.



Franklin Pub. Co., 800 No. Clark St., Dept. 9434, Chicago



Wonderful, new device, guides your hand; corrects your writing in a few days. Big improvement in three hours. No failures. Complete outline **FREE**. Write C. J. Osment, Dept. 34, St. Louis, Mo.

LEARN WATCH REPAIRING



You can learn by our modern and original system of instruction every part of the **Watch Repairing Trade** at home as good or better than at a shop. You can earn money while learning and secure a well paying position or start in business after completing our course of instruction. Good watch repairers are always in demand and earn from \$20 to \$75 per week. For particulars apply to the **Wisconsin School of Watch Repairing** 524 E. Mason St., MILWAUKEE, WIS.

When writing to advertisers please mention Popular Mechanics



THERE'S MONEY TODAY IN ART

THIS is the day of the artist. His skill is sought wherever design and color are important factors in the sale of merchandise.

Furniture, rugs, wall hangings, household utensils, wearing apparel, jewelry, art gifts, lamps, automobiles, — nearly everything sold today depends on design and color to attract the eye of the purchaser. Drawings for advertisements in newspapers, magazines, catalogs, folders, posters, display cards and many other media call for the skill of the modern artist. Consider the number of drawings in this magazine alone! Art is a necessity in modern business.

If you like to draw, train this talent of yours and put it to work in a field offering rich reward. You can learn Commercial Art at home in your spare time. Many leading artists have contributed exclusive illustrated lessons to our courses.

Many of our students and graduates now earn \$2500.00 to \$6000.00 a year, some a great deal more.

Send For Our Free Art Test

It brings out your sense of proportion, design and color. Our instructors will

When writing to advertisers please mention Popular Mechanics

give you frank advice as to your talent and probable chance of success. It costs you nothing. Just fill in the coupon below and we will send you this test together with our book "Your Future," outlining possibilities and showing examples of our students' work.

**FEDERAL SCHOOL OF
COMMERCIAL DESIGNING**
DEPT. 1011-A FEDERAL SCHOOLS BUILDING

Minneapolis, Minn.

COUPON

Federal School of Commercial
Designing

Dept. 1011-A Federal Schools Bldg.
Minneapolis, Minn.

Please send me free Art Test
and book "Your Future."



Name.....

Age.....Occupation

Address



You Can
Lead Men
in business through
LAW
STUDY AT HOME

Look around you—the law-trained man is a leader. Not only does a knowledge of law give you the key to the right move in business but it makes you a leader of men instead of a follower. The whole intricate structure of business is based on law. Everywhere, you find law-trained men filling the high executive positions. Go to school at home—study law nights—follow in the footsteps of great men. You can do it if you will.

**What Does \$10,000.00 a Year
Require of You?**

Answer that question yourself in light of these facts. "In looking over the field," writes a prominent Eastern manufacturer, "I find that nearly all the positions commanding a salary of \$10,000.00 or more are filled by men who have studied law." Many great corporations, for instance the C. & N. W. Ry. Co., International Paper Co., Standard Oil of New Jersey, Packard Motor Co., Anaconda Copper Mining Co., Mutual Life Insurance Co., are headed by men of legal training. Whether you're in a large or small company or your own business, you need a practical knowledge of law.

Fit yourself at home—in spare time. LaSalle will guide you step by step. Full law course leading to LL. B. or shorter business law training. All text material including fourteen volume Law Library. Cost low. Terms easy. Write today for our valuable 64-page book "Law Training for Leadership"—free. Act now.

-----Find Yourself Through LaSalle-----
LaSalle Extension University
The World's Largest Business Training Institution

Dept. 1064-LR Chicago
I would welcome your salary-increasing plan, together with copy of "Law Training for Leadership," all without obligation.

Law: Degree of LL.B.

Other LaSalle Opportunities:

If more interested in one of the fields indicated below, check and mail now.

- | | |
|--|--|
| <input type="checkbox"/> Business Management | <input type="checkbox"/> Personnel Management |
| <input type="checkbox"/> Modern Salesmanship | <input type="checkbox"/> Expert Bookkeeping |
| <input type="checkbox"/> Higher Accountancy | <input type="checkbox"/> Business Correspondence |
| <input type="checkbox"/> Traffic Management | <input type="checkbox"/> C. P. A. Coaching |
| <input type="checkbox"/> Railway Station Mgmt. | <input type="checkbox"/> Business English |
| <input type="checkbox"/> Banking and Finance | <input type="checkbox"/> Commercial Spanish |
| <input type="checkbox"/> Commercial Law | <input type="checkbox"/> Railway Accounting |
| <input type="checkbox"/> Industrial Management | |
| <input type="checkbox"/> Modern Foremanship | |



Name

Present Position

Address

Learn Autos



in Los Angeles

Come West at Our Expense!

For a limited time we are making a railroad fare offer from any point in the United States to Los Angeles. Just think of it! A Trip to California with travelling expenses allowed!

Spend a Few Short Weeks Learning Autos!

Quickly train for Big Pay Jobs in the Auto Game. Unlimited Lifetime Employment Service. Employers insist on our men instead of green, half-baked mechanics who don't know what it's all about. That's why you don't find National Trained Men walking the streets for jobs.

Don't Worry About Money! We'll Help You!

If you are low on cash, we'll help you. We help you secure a part-time job to earn living expenses while learning.

It's Easy at National!

Short, condensed training in our Million Dollar Practical "School of Shops"...instruction on the most modern equipment money can buy...with the country's best staff of expert, experienced master mechanic instructors. No dry lectures or text books. Straight practical work on real jobs. No previous experience needed. None too old or too young to learn. Start any time.

WRITE TODAY! We'll send you the full story about Railroad Fare Offer, Unlimited Employment Service. New Book sent FREE.

FREE BOOK

NATIONAL AUTOMOTIVE SCHOOL

Dept. 104-A, 4006 So. Figueroa St., Los Angeles, California

CARTOON YOUR WAY TO SUCCESS!

DON'T COPY—LEARN TO ORIGINATE!

RAYE BURNS will teach you HOW to CREATE ORIGINAL CARTOONS at home that you can SELL! Course contains 26 lessons and over 600 illustrations. All for Only...

\$2.85

Send name and address for free details.

RAYE BURNS SCHOOL, 826 Lakeview Rd., S-4, Cleveland, Ohio

WELDING ELECTRICITY RADIO AUTOMOBILES

No Finer Training Equipment Anywhere at Any Price. Pipe-Line, Sheet Steel, Structural Steel, Cast Iron, Air-Craft and Commercial Welding; Armature Winding; Power Plants; Switchboards; Transformers; Motors; Generators; Batteries; Radio, Television and Automobiles. **LEARN BIG-PAY TRADES AT LOW COST**

Write for Information, Mentioning Course Desired.

Coleman Electrical School, 1623 Main St., Kansas City, Mo.



Learn to Write

Begin Today. Write for my Free Book, "How to Become a Good Penman." It contains specimens and tells how others learned to write in spare time. Your name elegantly written on a card if you enclose stamp for postage. Write today. F. W. TAMBLYN, 418 Ridge Bldg., Kansas City, U. S. A.

1000 POULTRY SECRETS

Our famous home-study Poultry Course teaches how to get more eggs, cut feed bills, avoid losses. Methods used by successful Poultry raisers the world over. FREE Book tells all about Course. Write today for your free copy. National Poultry Institute, Dept. 411-B, Washington, D. C.



When writing to advertisers please mention Popular Mechanics

\$75 a Week for Dobbins!

My graduate R. N. Dobbins, got a job immediately after finishing my course. Now he's earning \$75 a week as Chief Instructor at a big Aviation School in New York!

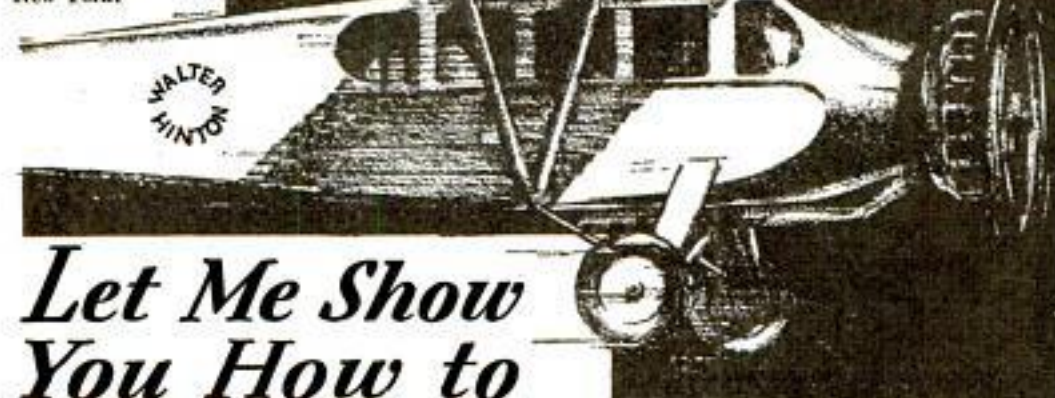

Let Me Show You How to

EARN \$60 to \$100 a Week and UP in AVIATION!

My up-to-date home study Course gives you the ground work you need to *get and keep a real job* in this fascinating, fast growing industry. Scores of my graduates, who didn't know a thing about Aviation a few months ago, are holding down fine jobs right now—in the air and on the ground. *Over forty different types of jobs to choose from*, once you have this necessary training. Get the facts about my practical training, FREE Employment Service and Money-Back Agreement NOW!

**I Teach You QUICKLY—
at home in your spare time**

You don't need to give up your present job—don't need to leave home, to get your training in Aviation. I've made it easy for you. I've put my own fifteen years of experience—backed by over 400,000 miles of flying—five years of instructing in the Navy—all into my thorough, quickly mastered home study Course.

No Previous Experience Needed

You don't even need a high school education—don't have to know anything about planes or engines to learn the ground work of Aviation with my course. Everything is clearly explained—illustrated by hundreds of pictures, drawings and charts—made as simple and easy as possible. You get all the information you need to pass the Government's written examinations for Mechanic's or Pilot's Licenses, in a few short months. If you want to learn to fly, I can save you many times the cost of my Course on your flying time at good airports all over the country.

**There's No Time to Lose—
Get My FREE Book Now!**

Aviation is growing by leaps and bounds—while many other industries are slumping. Don't wait and let the other fellows get ahead of you. Think about your own future. Let me prepare you for a job paying \$60 to \$100 a week or more—in Aviation. Get the FACTS. Mail the handy coupon on the right, today—right now—while you're thinking about it. I'll send you my big new FREE Book—packed with interesting facts about your opportunities in Aviation. Mail coupon NOW.

WALTER HINTON, Pres.
Aviation Institute of U. S. A., Inc.
1115 Connecticut Avenue Washington, D. C.

Get on
**AVIATION'S
PAYROLL!**



Walter Hinton

First to fly the Atlantic; first to fly to South America; first to explore the upper regions of the Amazon by plane. Flying Instructor in Navy for five years. Now giving ambitious men practical groundwork training in Aviation at home. If you are 18 or over, mail the coupon below for your copy of his big new FREE Book today.

I'll Help You Get a Job

My nation-wide Employment Department is at your service—the minute you are qualified to accept a job in Aviation. We are constantly in touch with scores of airports, plane factories, etc., that want trained men for good jobs paying from \$40 to \$100 a week. No extra charge to graduates for this extra service. Free Book tells all about how I help my graduates get the kind of jobs they want! Mail the coupon now.

**FREE Air-
plane Ride**

Right now I'm making an offer of a free air-plane ride to all of my students. Write me at once and I'll send you complete information. Act now—to get in on this fine offer—while it is still open!



Mail for my big **FREE**
BOOK on AVIATION NOW!

Walter Hinton, President,
Aviation Institute of U. S. A., Inc.,
1115 Connecticut Avenue, Washington, D. C.

691-E

Please send me a Free copy of your book, "Wings of Opportunity," telling all about my opportunities in Aviation, how you will train me at home and help me get a job.

Name.....

PRINT CLEARLY

Address.....

Age.....
(Must be 18 or over.)

City..... State.....

When writing to advertisers please mention Popular Mechanics



Follow this Man

Secret Service Operator 38 is on the job

FOLLOW him through all the excitement of his chase of the counterfeit gang. See how a crafty operator works. Telltale finger prints on the lamp stand in the murdered girl's room! The operator's cigarette case is handled by the unsuspecting gangster, and a great mystery is solved. Better than fiction. It's true, every word of it. No obligation. Just send the coupon and get—

FREE!

The Confidential Reports No. 38 Made to His Chief

And the best part of it all is this. It may open your eyes to the great future for YOU as a highly paid Finger Print Expert. More men are needed right now. This school has taken men just like you and trained them for high official positions. This is the kind of work you would like. Days full of excitement. Big salaries. Rewards.

Can you meet this test?

Can you read and write? Are you ambitious? Would you give 30 minutes a day of your spare time preparing yourself for this profession? Answer "yes" and I'll show you how to attain all this. Send the coupon and I'll also send the Free Reports.

INSTITUTE OF APPLIED SCIENCE
1920 Sunnyside Ave., Dept. 13-57 Chicago, Illinois

Institute of Applied Science
1920 Sunnyside Ave., Dept. 13-57 Chicago, Illinois

Gentlemen:—Without any obligation whatever, send me the Reports of Operator No. 38, also your illustrated Free Book on Finger Prints and your low prices and Easy Terms Offer. Literature will NOT be sent to boys under 17 years of age.

Name _____

Address _____

Age _____

When writing to advertisers please mention Popular Mechanics

Play a Gibson GUITAR

Nick Lucas

MAKE everyone love you as they love Lucas, his Guitar and singing. Learn to play your own accompaniment on a Guitar, Banjo, Mandolin or Ukulele. Be popular among your friends.

FREE TRIAL EASY PAYMENTS

this **FREE BOOK**

Gives Valuable Facts—Send for it Now!

Gibson Inc.

1003 Parsons St., Kalamazoo, Mich.

TRI-STATE COLLEGE

DEGREE IN 2 YEARS



Catalog

B. S. DEGREE in Civil, Electrical, Mechanical, Chemical, Aeronautical Engineering in 2 years. Those who lack high school may make up work. Living costs, tuition low.

4101 College Ave., Angola, Ind.

Don't Envy The Plumber—BE ONE!

\$11.00—\$16.00 PER DAY and work EVERY day, in the Plumber's wage.

LEARN IN 8 to 12 WEEKS without previous experience.

If you are making less than \$60.00 a week you own it to yourself to investigate. Get FREE catalog that tells in pictures and words how we teach this trade. Special rates now.

UNIVERSAL PLUMBING SCHOOL, 2030 Trent Avenue, KANSAS CITY, MO.

LEARN WATCHMAKING AND ENGRAVING

BY OUR PROFIT-SHARING PLAN OUR GRADUATES SUCCEED

One of our best students started in a very small way—now doing over \$30,000 a year. Another in Wisconsin, over \$10,000 the first year. Day or night classes. Call or write for FREE BOOK.

Chicago School of Watchmaking, Dept. 7701, 155 N. Clark St., CHICAGO

Wireless (Radio)

and Morse telegraphy taught thoroughly. School, oldest and largest; endorsed by Telegraph, Radio, Railway and Government officials. Unusual opportunities. Expenses low—can earn part. Catalog free.

DODGE INSTITUTE, Jones St., Valparaiso, Indiana.

"BECOME A LIGHTNING TRICK CARTOONIST"

Send \$1.00 for Laugh Producing Program of 20 Trick Drawings with Instructions. Catalog of Chalk Talk Supplies Free.

BALDA ART SERVICE, Dept. 1, Oshkosh, Wis.

All This for Only 15 Cents

Send only 15c RIGHT NOW and receive The Pathfinder every week by mail for the next 13 consecutive weeks. In these 13 issues you will get 426 pages, with 300 pictures, 900 unusually interesting articles on people and things you want to know about, 1800 picked news items from everywhere, 2500 jokes, squibs and cracks, stories, etc. Newest, snappiest, most entertaining paper in the whole world. The biggest 15c worth YOU ever saw. Send now. Address **Pathfinder, Dept. 74, Washington, D. C.**

1000 Hotel Positions Open!



Hotel, Restaurant, Club and Institutional field calling for trained men. Thousands of well-paid positions open annually. Nationwide opportunities for trained men to qualify as Manager, Assistant Manager, Steward, Room Clerk, Purchasing Agent, Sports Director and for many other important positions, paying from \$2,000 to \$7,500 a year, with living often included. Nearly one billion dollars' worth of new hotels, apartment hotels, clubs, restaurants and institutions being built this year will need almost 100,000 trained men and women.

TRAIN IN YOUR SPARE TIME AT HOME

Qualify in your spare time through our Personal Coaching Plan, which adapts the training to your needs. I put hundreds of graduates in touch with positions. All over the United States, Lewis graduates are making good. Hotels start you at salaries up to \$2,500 a year. If you want a steady, permanent position, with quick advancement, fascinating work, good pay, fine living, luxurious surroundings—you can find it in the hotel field.

PREVIOUS EXPERIENCE PROVED UNNECESSARY

All of your training under the personal supervision of Clifford Lewis, former U. S. Government Hotel and Restaurant Expert, who was appointed Managing Consultant by over 300 hotels throughout the United States.

Through Lewis Training, Frederick Schoombs became Steward of a resort hotel and John R. Dobson was appointed Assistant Manager of the largest apartment house in the state. Absolutely inexperienced in hotel work before taking the

Lewis Course, Hal Van Doren was appointed Manager of a Washington Hotel, after he received his diploma from the Lewis Schools.

Opportunity Coupon

Lewis Hotel Training Schools,
Room DS-310, Washington, D. C.

Send me without obligation the FREE BOOK, "Your Big Opportunity," with details about Registration in the Lewis National Employment Bureau.

NAME.....

ADDRESS.....

CITY.....STATE.....

FREE BOOK GIVES FULL DETAILS

No matter what your present occupation—there are opportunities for you in the well-paid hotel, club, restaurant and institutional field. Many students have obtained splendid hotel positions paying as high as \$2,500 a year, even before they had finished the course.

My Free Book, "Your Big Opportunity", tells how to secure a well-paid position and explains how you are registered free of extra charge in our National Employment Bureau, which covers the country at 70,000 points through special arrangement with Postal Telegraph. Send for it today—NOW—before you forget.

LEWIS HOTEL TRAINING SCHOOLS

ROOM DS-310

CLIFFORD LEWIS, Pres.

WASHINGTON, D. C.

The Original and Only School of Its Kind in the World



"I had to make more money—for her"

"THREE weeks after I met Ann we were engaged. It was when we began talking about rents and furniture and such things that I woke up.

"I'd been drifting along in a routine office job for years. I knew I didn't deserve a raise. And yet I had to make more money—a lot of it—and quick. It was Ann herself who suggested the International Correspondence Schools. She believed in me so thoroughly that she made me believe in myself, and I started studying the I. C. S. course in Accounting in my spare time.

"That was a year and a half ago. We've been married six months and I just got my third promotion. I'm head of the cost accounting department now. My I. C. S. course was the finest investment I ever made."

Are you one of the thousands of young men who need a bigger salary and a better job? In an hour a day of your spare time you can secure the training that will bring you advancement. Without cost, without obligation, find out what the I. C. S. can do for you. Mark and mail this coupon now!

INTERNATIONAL CORRESPONDENCE SCHOOLS
"The Universal University"
Box 5568-G, Scranton, Penna.

Without cost or obligation, please send me a copy of your booklet, "Who Wins and Why," and full particulars about the subject before which I have marked X:

TECHNICAL AND INDUSTRIAL COURSES

- | | |
|--|--|
| <input type="checkbox"/> Architect | <input type="checkbox"/> Automobile Mechanic |
| <input type="checkbox"/> Architectural Draftsman | <input type="checkbox"/> Plumbing <input type="checkbox"/> Steam Fitting |
| <input type="checkbox"/> Building Estimating | <input type="checkbox"/> Heating <input type="checkbox"/> Ventilation |
| <input type="checkbox"/> Wood Millworking | <input type="checkbox"/> Sheet Metal Worker |
| <input type="checkbox"/> Contractor and Builder | <input type="checkbox"/> Steam Engineer |
| <input type="checkbox"/> Structural Draftsman | <input type="checkbox"/> Steam Electric Engineer |
| <input type="checkbox"/> Structural Engineer | <input type="checkbox"/> Civil Engineer |
| <input type="checkbox"/> Electric Wiring | <input type="checkbox"/> Surveying and Mapping |
| <input type="checkbox"/> Electrical Engineer | <input type="checkbox"/> Refrigeration |
| <input type="checkbox"/> Electric Lighting | <input type="checkbox"/> R. R. Locomotives |
| <input type="checkbox"/> Welding, Electric and Gas | <input type="checkbox"/> R. R. Section Foreman |
| <input type="checkbox"/> Reading Shop Blueprints | <input type="checkbox"/> R. R. Bridge and Building Foreman |
| <input type="checkbox"/> Telegraph Engineer | <input type="checkbox"/> Air Brakes <input type="checkbox"/> Train Operation |
| <input type="checkbox"/> Telephone Work | <input type="checkbox"/> Highway Engineering |
| <input type="checkbox"/> Mechanical Engineer | <input type="checkbox"/> Chemistry <input type="checkbox"/> Pharmacy |
| <input type="checkbox"/> Mechanical Draftsman | <input type="checkbox"/> Coal Mining Engineer |
| <input type="checkbox"/> Machinist <input type="checkbox"/> Toolmaker | <input type="checkbox"/> Navigation <input type="checkbox"/> Boilermaker |
| <input type="checkbox"/> Patternmaker | <input type="checkbox"/> Textile Overseer or Supt. |
| <input type="checkbox"/> Pipefitter <input type="checkbox"/> Tinsmith | <input type="checkbox"/> Cotton Manufacturing |
| <input type="checkbox"/> Bridge Engineer | <input type="checkbox"/> Woolen Manufacturing |
| <input type="checkbox"/> Bridge and Building Foreman | <input type="checkbox"/> Agriculture <input type="checkbox"/> Fruit Growing |
| <input type="checkbox"/> Gas Engines <input type="checkbox"/> Diesel Engines | <input type="checkbox"/> Poultry Farming <input type="checkbox"/> Radio |
| <input type="checkbox"/> Aviation Engines | <input type="checkbox"/> Marine Engineer |

BUSINESS TRAINING COURSES

- | | |
|---|--|
| <input type="checkbox"/> Business Management | <input type="checkbox"/> Business Correspondence |
| <input type="checkbox"/> Office Management | <input type="checkbox"/> Lettering Show Cards <input type="checkbox"/> Signs |
| <input type="checkbox"/> Industrial Management | <input type="checkbox"/> Stenography and Typing |
| <input type="checkbox"/> Personnel Management | <input type="checkbox"/> Complete Commercial |
| <input type="checkbox"/> Traffic Management | <input type="checkbox"/> Civil Service <input type="checkbox"/> Mail Carrier |
| <input type="checkbox"/> Accountancy <input type="checkbox"/> Cost Accountant | <input type="checkbox"/> Railway Mail Clerk |
| <input type="checkbox"/> C. P. Accountant | <input type="checkbox"/> Grade School Subjects |
| <input type="checkbox"/> Bookkeeping | <input type="checkbox"/> High School Subjects |
| <input type="checkbox"/> Secretarial Work | <input type="checkbox"/> College Preparatory |
| <input type="checkbox"/> Spanish <input type="checkbox"/> French | <input type="checkbox"/> Illustrating <input type="checkbox"/> Cartooning |
| <input type="checkbox"/> Salesmanship <input type="checkbox"/> Advertising | <input type="checkbox"/> Lumber Dealer |

Name..... Age.....

Address.....

City..... State.....

Occupation.....

If you reside in Canada, send this coupon to the International Correspondence Schools Canadian, Limited, Montreal, Canada

NEW INDUSTRY NEEDS MEN

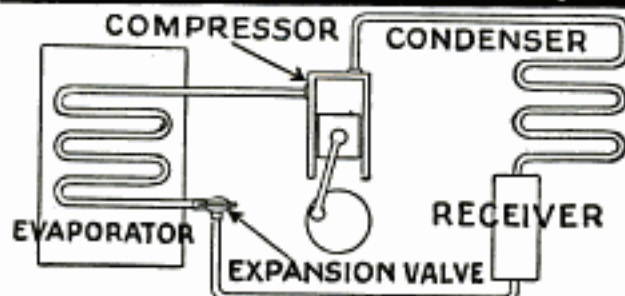

ELECTRIC REFRIGERATION Calls You!

Newest American industry needs men for \$200 to \$1,000 a month jobs in production service, installation and sales. Fastest growing, money-making field—backed by General Motors, General Electric, etc. New easy home training qualifies you for big pay job. This training endorsed by Servel, Kelvinator, Copeland and other large manufacturers.

Get Valuable New Book—FREE

Our new illustrated book—*Rich Rewards in Electric Refrigeration*—just off the press, reveals amazing plan to ambitious men. Sent absolutely free, without obligation. Be the first in your locality to get into this new magic industry. Write today!



UTILITIES ENGINEERING INSTITUTE
4403 Sheridan Road, Dept. 1101, Chicago, Ill.

OPPORTUNITIES IN TRAFFIC MANAGEMENT

Conditions point to an unusual demand for trained traffic men, by transportation companies and industrial organizations. Men with scientific traffic training effect big savings for their firms—command big salaries.

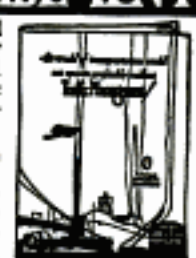

Three Detroit Firms Pay Their Traffic Managers Over \$20,000 a Year

Prepare at home in your spare time, under supervision of traffic experts. Low cost; easy terms. "I would not take \$50,000 for my knowledge of traffic management," writes H. E. Steifler, Traffic Manager, Marion Steam Shovel Co., Marion, Ohio. Send now for 64-page book—

FREE!
LaSalle Extension University, Dept. 1064-T, Chicago

RADIO TELEVISION SOUND REPRODUCTION

World's Newest Big-Pay Big-Future Profession. Thousands of New Positions in an Uncrowded Field for Men who can Qualify. We offer Dependable Training at a Reliable School under High-Class Instructors on Complete Assembly of Up-to-the-Minute Equipment. We teach you right here in our Shops, not by Mail. Also Courses in Electricity, Automobiles and Welding.

COLEMAN ELECTRICAL SCHOOL, 1628-Z Main St., Kansas City, Mo.



Learn Public Speaking

At home—in spare time—20 minutes a day. Overcome "stage-fright," gain self-confidence, increase your salary, through ability to sway others by affecting speech. Write now for free booklet, *How to Work Wonders With Words*.

**NORTH AMERICAN INSTITUTE, Dept. 1357
3601 Michigan Avenue, Chicago, Illinois**

WHY STAMMER?

Don't be a failure. Master perfect speech. Live a healthy, normal and happy life. Send for free book which tells you how.

THE LEWIS INSTITUTE, 12972 Woodward Ave., Detroit, Mich.

\$1000 Extra For YOU

Stoneberger makes that in SPARE Time, broadcasting from Station WJMV, Washington, D. C. Hundreds of others playing for Radio, in Orchestras, etc.—BIG PAY FOR YOU!—Free Book tells you all about QUICK, EASY Way to Master popular Hawaiian Guitar. Write for it Today! HAWAIIAN STUDIO 52101, New York Academy of Music, 100 Fifth Ave., New York City

Hey! Buddie! Join me working for Uncle Sam!

I Make \$2700 a Year as Railway Postal Clerk

"\$2750.00 to be exact. That's \$53 a week. And listen! Here's what makes it so good.—I make it every week! The year round! Before I landed this government position I thought I was a lucky boy if I wasn't out of a job at least 6 or 8 weeks a year. Never could keep any savings in the bank. Now I can positively count, in advance, on getting every dollar of my year's pay. And I'm just as sure of my regular raise every year too. No 'pull' or 'boot-licking' needed to get it either!

No More Worry About Layoffs!

"I figure that I'm all through looking for a job. I'm sitting pretty. I sure can plan my future, because my income from Uncle Sam is definite and certain. He's the right boss to have when private business is laying 'em off right and left!

I Get Vacations and Sick Leave With Pay

"15 days' vacation a year and 10 days' sick leave. My pay goes right on. That's a plan that sure makes a hit with us Railway Mail Service boys.

Patterson's Help Made It a Cinch

"I mean Arthur R. Patterson, of Rochester. He helped me get this berth. He used to be one of Uncle Sam's Civil Service Secretary-Examiners (for eight years)—so he knows all the ropes —just the kind of questions you get asked in the exams. He's helped thousands into fine Government positions. He helped me to get a high rating—so I could get appointed in just a short while.

He'll Help You Too

"Listen to me! I don't know you personally—but if you are a U. S. CITIZEN (anywhere between 18 to 50 years old) and want a sure, safe job—with good and regular pay—then I say, 'Write for Arthur R. Patterson's FREE BOOK!' In it he tells just how you can qualify for the very government job you want— Railway Postal Clerk (like me), Post Office Clerk, City Mail Carrier, Rural Carrier, Postmaster, Customs Service, or any other branch you fancy. Write Arthur R. Patterson, 'Civil Service Expert.' I'll say he is—and his advice won't cost you but two cents. Just mail him the coupon. He'll do the rest."

ARTHUR R. PATTERSON,
Civil Service Expert,
810 Wisner Bldg.,
Rochester, N. Y.



PICK YOUR JOB!

- Patterson Helps You Get It or You Don't Pay a Cent!**
- RAILWAY POSTAL CLERK**
\$1,850 to \$2,700 a year. Extra travel pay.
 - POSTOFFICE CLERK**
\$1,700 to \$2,100 a year. Special clerks at \$2,200 and \$2,300. Eligible to promotion to higher paid positions.
 - CITY MAIL CARRIER**
\$1,700 to \$2,100 a year. Promotions to bigger pay.
 - R. F. D. MAIL CARRIER**
\$1,800 to \$2,600 a year. Fine job for men in rural districts.
 - POSTMASTER**
\$1,200 to \$2,500 a year.
 - INTERNAL REVENUE AND CUSTOM HOUSE POSITIONS**
\$1,140, \$1,680 to \$3,000 and up a year. Extra pay for overtime.
 - DEPARTMENTAL CLERKS**
\$1,440 to \$1,620-\$1,860 a year and up to \$3,000 a year. Work in Washington.

**Patterson prepared us to win—
Now you get his FREE BOOK!**



IMPORTANT — Get Ready NOW for the next Railway Postal Clerk Examination.



TELLS OTHERS ABOUT MY HELP
"Just a line to let you know that I was appointed a Railway Postal Clerk. Am assigned to the Chief Clerk at Peoria, Ill. I like the work fine. Also, am sending a few names of people who might take up a course."
Michael Reiss, Ramsey, III.



SPEEDY APPOINTMENT AS POSTAL MAIL CLERK
"Received my rating from Commission Nov. 18, in the Railway Mail examination. Four days later, Nov. 22, I received my appointment as clerk. I stood No. 27 on the list in this state. I certainly can recommend your school whenever I have occasion to do so. My advice to any prospective student is to enroll with 'one who knows!'"
Wm. R. O'Kelly, Fleischmanns, N. Y.



ANOTHER QUICK APPOINTMENT
"Received my rating from the Railway Mail Clerk exam. I passed and received my blank cash from Peoria to report for work. I could not have done so well without your training!"
James M. Wright, Chatsworth, Ill.

**Arthur R. Patterson, Civil Service Expert,
PATTERSON SCHOOL,
810 Wisner Building, Rochester, N. Y.**

Dear Mr. Patterson:

Send me your 32-page FREE BOOK telling how I can secure a position with the U. S. Government paying from \$1,850 to \$3,300 a year. This request doesn't obligate me in any way.

NAME.....

ADDRESS.....

CITY.....STATE.....

When writing to advertisers please mention Popular Mechanics



DON'T RUN AWAY from an Opportunity to attend a professional school in **RADIO AVIATION TELEVISION**

Your success depends on whether you accept money-making opportunities or "run away" from them because of no ambition, negligence or unnecessary thoughts of fear in getting started.

At the Dutton Radio Institute you'll find highly recognized instructors ready to personally assist you in your studies and hundreds of students you'll enjoy knowing.

Unemployment conditions and depressions do not disturb the positions held by men who are professionally trained in Radio and Aviation. The man untrained today cannot find work while thousands of positions are open to the "trained man."

If you want training ability equal to leading colleges write today for catalog giving full information about various courses.

DUTTON RADIO INSTITUTE



Dept. 9, DePaul
University Building
Chicago, Illinois

Dutton Radio Institute:

Please mail me new catalog on Radio and Aviation.

Name

Address

Play the Hawaiian Guitar like the Hawaiians!

Only 4 Motions used in playing this fascinating instrument. Our native Hawaiian instructors teach you to master them quickly. Pictures show how. Everything explained clearly.

Play in Half Hour

After you get the four easy motions you play harmonious chords with very little practice. No previous musical knowledge needed.

Easy Lessons

Even if you don't know one note from another, the 52 printed lessons and clear pictures make it easy to learn quickly. Pay as you play.

GIVEN when you enroll
—a sweet toned

HAWAIIAN GUITAR, Carrying Case and Playing Outfit—

WRITE AT ONCE for attractive offer and easy terms. You have everything to gain. A postcard will do. ACT!

Value \$18 to \$26
No extras—everything included

OTHER COURSES] Tenor Bass, Violin, Tiple, Tenor Guitar, Ukulele, Banjo Ukulele Under well known instructors.

FIRST HAWAIIAN CONSERVATORY OF MUSIC, Inc.
9th Floor, Woolworth Bldg. Dept. 548 New York, N. Y.
Approved as a Correspondence School Under the Laws of the State of New York—Member National Home Study Council

BEDFORD YMCA TRADE SCHOOL

Caterpillar Tractor Mechanic
Aviation Mechanic
Flying
Airplane Welding
Airplane Drafting
Air Navigation
Starting, Lighting, Ignition
Auto Mechanic
Machine Shop, Electric Welding
Oxy-Acetylene Welding
Radio Mechanic, Air Brush
Mechanical, Architectural Drawing
Sign Painting, Show Card Writing
Talking Pictures, Western Electric
Commercial Art, Fine Art
DAY and EVENING SESSIONS
Write for Catalog 50

Brooklyn Engineering Institute
(Operated by Bedford Y. M. C. A.)
1125 Bedford Avenue, Brooklyn
New York City

ENGINEERING ELECTRICAL · MECHANICAL · STRUCTURAL and ARCHITECTURE

INTENSIVE PRACTICAL TECHNICAL COURSES. Degrees in 2 years. Diploma in 1 year. Special short courses 6 Weeks to 4 Months in Electricity, Radio, Power Plant, Electric Refrigeration, Airplane Winding, Wiring, Testing, Drafting, Welding. **LOW TUITION.** Expert instructors. Extensively equipped laboratories. Free life-time employment service for graduates. Part-time work while attending. Write for new free illustrated catalog giving all facts. 30th year.

FINLAY ENGINEERING COLLEGE
1001 A Indiana Avenue Kansas City, Missouri



SONG WRITERS

Don't fail to read "Song Requirements of Talking Pictures, Radio and Records" an explanatory, instructive book **SENT FREE** on request. New writers may mail song-poems for free examination. We revise, compose and arrange music, and secure copyrights, guaranteeing approval.

P. M. Newcomer Associates, 1574 Broadway, New York

LAW HIGH-GRADE INSTRUCTION BY CORRESPONDENCE

College, Post Grad. and Bar Ex. Rev. Courses. Law has attracted more keen, brainy men than any other calling. Send today for catalog. Low cost, easy terms. Standard tuition. Degrees.
Chicago School of Law Dept. 201, Resner Block CHICAGO, ILL.

Learn Photography at HOME

Make money taking pictures. Prepare quickly during spare time. Also earn while you learn. No experience necessary. New easy method. Nothing else like it. Send at once for free book, OPPORTUNITIES IN MODERN PHOTOGRAPHY, and full particulars.

AMERICAN SCHOOL OF PHOTOGRAPHY
Dept. 1357, 3601 Michigan Avenue Chicago, U. S. A.

Give me your measure and I'll PROVE You Can Have a Body like Mine!

I'LL give you PROOF in 7 DAYS that I can turn you, too, into a man of might and muscle. Let me prove that I can put layers of smooth, supple, powerful muscles all over your body.

If you are underweight I'll add the pounds where they are needed and, if you are fat in any spots, I'll show you how to pare down to fighting trim.

And with the big muscles and powerful, evenly-developed body that my method so quickly gives you, I'll also give you through-and-through health—health that digs down into your system and banishes such things as constipation, pimples, skin blotches and the hundred-and-one other ailments that rob you of the good times and the good things of life.

Here's All You Do!

Just jot down your name and address on the coupon below, mail it to me—and I'll send you, absolutely free, a copy of my new book, "Everlasting Health and Strength." It reveals the secrets that changed me from a 97-pound, flat-chested weakling into a husky fellow who won the title of "The World's Most Perfectly Developed Man" against all comers! And it shows how I can build you into an "Atlas Champion" the same easy way.

I haven't any use for apparatus; I don't dose you or doctor you. **Dynamic-Tension** is all I need. It's the natural, tested method for developing real men inside and out. It distributes added pounds of powerful muscles over your body, gets rid of ailments and surplus fat, and gives you the vitality, strength and pep that win you the admiration of every woman and the respect of any man.

NOTE: No other Physical Instructor in the World has ever DARED make such an offer!

Charles Atlas

Holder of the title:

"The World's Most Perfectly Developed Man"—won in international contest against ALL strong men willing to compete with him.



Charles Atlas' As He Is Today. (Photo taken July 5, 1931.)

Gamble a 2c Stamp — To Prove I Can Make YOU a New Man!

Gamble a 2c stamp today by mailing the coupon for a free copy of my book, "Everlasting Health and Strength." It tells you all about my special **Dynamic-Tension** method, and what it has done to make big-muscled men out of run-down specimens. It shows you, from actual photos, how I have developed my pupils to the same perfectly balanced proportions of my own physique, by my own secret methods. What my system did for me, and those hundred of others it can do for you too. Don't keep on being only 25 or 30 percent of the man you can be! Find out what I can do for you.

Where shall I send your copy of "Everlasting Health and Strength"? Jot your name and address down on the coupon, and mail it today. CHARLES ATLAS, Dept. 8-K, 133 East 23rd Street, New York City.



CHARLES ATLAS, Dept. 8-K,
133 East 23rd Street, New York City.

I want the proof that your system of **Dynamic-Tension** will make a New Man of me—give me a healthy, husky body and big muscle development. Send me your free book, "Everlasting Health and Strength."

Name.....
(Please print or write plainly)

Address.....

City..... State.....

When writing to advertisers please mention Popular Mechanics

Copyrighted material

U.S. GOVERNMENT JOBS

\$1260 to \$3400 a Year PICK YOUR JOB Men, Boys—18 to 50

These are steady positions. Strikes, poor business conditions, or politics will not affect them. Government employees get their pay for twelve full months every year.

\$1900 to \$1700 a Year

Railway Postal Clerks get \$1,900 the first year, being paid on the first and fifteenth of each month. \$79.17 each pay day. Their pay is quickly increased, the maximum being \$2,700 a year. \$112.50 each pay day.



Railway Postal Clerks, like all Government employees have a yearly vacation of 15 working days (about 18 days). On runs, they usually work 3 days and have 3 days off duty or in the same proportion. During this off duty and vacation their pay continues just as though they were working. They travel on a pass when on business and see the country. When they grow old, they are retired with a pension.

City Mail Carriers, Post Office Clerks

Clerks and Carriers now commence at \$1,700 a year and automatically increase \$100 a year to \$2,100 and \$2,300. They also have 15 days' paid vacation. City residence is unnecessary.

Customs Immigrant Inspector

Salary \$2,100 to \$3,300. Men 21 to 45. Work connected with examining immigrants and merchandise entering the country from foreign ports.



Is Your Job Steady?

Compare these conditions with your present or past prospective condition, perhaps changing positions frequently, no chance in sight for PERMANENT employment; frequently out of a position and the year's average salary very low. DO YOU GET \$1,900 EVERY YEAR? HAVE YOU ANY ASSURANCE THAT A FEW YEARS FROM NOW YOU WILL GET \$2,300 to \$2,700 A YEAR?

You Can Get Them

Experience is usually unnecessary and political influence is not permitted. Let us show you how.

Get Free List of Positions

Fill out the following coupon. Tear it off and mail it today—now, at once.

This investment of two cents for a postage stamp may result in your getting a government job.

FRANKLIN INSTITUTE, Dept. H-174, Rochester, N. Y.

Rush to me entirely free of charge (1) a full description of the position checked below; (2) Free Copy of 32-page book, "How to Get a U. S. Government Job"; (3) A list of the U. S. Government Jobs now obtainable; (4) Tell me how to get a Government Job.

- | | |
|--|-------------------|
| <input type="checkbox"/> Railway Postal Clerk | (\$1,900-\$2,700) |
| <input type="checkbox"/> Post Office Clerk | (\$1,700-\$2,300) |
| <input type="checkbox"/> City Mail Carrier | (\$1,700-\$2,100) |
| <input type="checkbox"/> Rural Mail Carrier | (\$2,100-\$3,400) |
| <input type="checkbox"/> Government Clerk—File Clerk | (\$1,260-\$2,500) |
| <input type="checkbox"/> Inspector of Customs | (\$2,100-\$3,300) |
| <input type="checkbox"/> Prohibition Agent | (\$2,300-\$2,800) |
| <input type="checkbox"/> Immigrant Inspector | (\$2,100-\$3,000) |

Name.....

Address.....

Use This Coupon Before You Mislay It

You can sell automobiles!

A-2

You can sell automobiles after a few weeks home study of the "Chrysler Motors" course in successful automobile selling. Course proved by automobile executives, dealers and salesmen everywhere. Now available at one-third the cost you would ordinarily pay. Get into this fascinating, big-pay business. Write TODAY for details.

Sales Educational Dept.
CHRYSLER CORPORATION
Detroit, Michigan

Men! Big Opportunity is here in Electric Refrigeration



You learn by actual work on Household, Commercial and Industrial Machines.

Eight weeks in the finest and best equipped school in the country qualifies you, or if you cannot come to Cleveland, our Home Study Course affords complete instruction, everything made clear and easily understood. No matter what your age, education, or past experience is—write for FREE BOOKLET. Find out for yourself about this hot growing field and how we help you get into it. Write at once—NOW—to

THE NATIONAL TECH, 4300 Euclid Ave., CLEVELAND, O.

FREE Radio Handbook

Write today for your copy of the new Radio Association handbook. Shows you easy ways to make money in Radio. Tells you how our members are clearing up \$3.00 an hour spare time. Write for Membership Plan which need not cost you a cent and FREE RADIO HANDBOOK.
RADIO TRAINING ASSOCIATION OF AMERICA
Dept. PM-10 4513 Ravenswood Ave., Chicago

No Wind
Can
Blow
it
Out



SOMETHING DIFFERENT MYSTERY CIGAR LIGHTER

MAKE \$25 A DAY

Showing this scientific marvel to men. New principle of ignition. What makes it light! No flint or friction. All guaranteed. Sample with sales plan 25c. Sample gold, silver or chromium plated \$1.00. Agents, write for proposition.

NEW METHOD MFG. CO.

Desk P-10, New Method Bldg., Bradford, Pa.

NERVES?

Are You Always Excited? Fatigued? Worried? Gloomy? Pessimistic? Constipation, indigestion, cold

nerve, dizzy spells and headaches are caused by NERVE EXHAUSTION. Drugs, tonics and medicines never help fresh, sick nerves! Learn how to regain Vigor, Galvanism and Self-Confidence. Send 25c for this amazing book.

RICHARD BLACKSTONE, N-4710 FLATIRON BUILDING, N. Y. C.

"The TRUTH about VOICE"

SENT FREE No Obligation to Buy if you act quick!—we will send you postpaid—free 30 days free reading—new Voice Book disclosing STARTLING FACTS that may save hundreds of dollars to every man or woman seeking a strong, rich voice for either singing or speaking.

30 days free reading—then send \$1. Otherwise, return it.

Prof. E. Feuchtinger 308 North Michigan Avenue Studio 13-57 Chicago, Ill.



When writing to advertisers please mention Popular Mechanics

A Blessing in "Hard Times"

New Soles 9¢ A PAIR

as low as

FREE SAMPLE SAVASOLE

to Readers of POPULAR MECHANICS

See this amazing discovery that ends costly half sole repairing forever. It's called Savasole—a scientific "plastic leather" that puts new soles on worn out shoes—makes them wear like new—for as low as 9¢ a pair. Rebuilds run down heels too. Fills in all cuts, holes, cracks, forming a smooth, thick waterproof surface. Agents are cleaning up with this sensational specialty. Mail coupon for Free sample and money-making agents' offer.

Spreads on Soles Like Butter on Bread

Dries Hard and Smooth Overnight

No more taking shoes to the repair man. No paying from \$1.00 to \$1.75 for leather soles and heels. Just spread SAVASOLE on the worn out soles with an old knife—as easily as you spread butter on bread. Let it dry overnight. In the morning you have a new wearing surface that is hard, smooth, and durable. Looks like leather. Wears like leather and is absolutely waterproof.

GUARANTEED! Do not confuse SAVASOLE with "cheap" imitations. SAVASOLE alone has the special Bollman Double-action Cement Process (patent applied for) that means SAVASOLE CANNOT COME OFF THE SHOE. SAVASOLE outwears the uppers.

My money back guarantee protects you and your customers.

MONEY-MAKING PROOF \$135 PER WEEK



I gave up my former connection where I ranged in earnings from \$325 to \$386 per month. I started out with three gross of Savasole. Since that time, my earnings have netted me over \$135 per week and I am sure that I will soon hit \$200 per week. Savasole has solved my financial problems, and you see the whitest bunch of people to work with I ever saw.

G. C. MILLER

38 GROSS HIS FIRST MONTH

I have given Savasole a thorough trial and think it is wonderful. This order completes my requirements for sole distributor. Send me four gross of Savasole at once.

H. L. BURTON



Quick Sales and Profits

Every member of the family needs SAVASOLE. It seals the pores of the leather and makes the soles wear as long as the uppers hold together. We show you how to make quick, convincing, dramatic demonstration that amazes customers and compels them to order. Repeat business everywhere. Splendid territories open. Rush coupon now for FREE sample of SAVASOLE. Send no money.

MAIL FOR FREE SAMPLE

R. R. Bollman, Pres., Perfect Manufacturing Co. Y-506 Daylight Bldg., Cincinnati, Ohio

Dear Mr. Bollman: Please send me FREE sample of SAVASOLE and explain how I can earn up to \$42.00 a DAY. Also send me details. Exclusive Territory Plan. Send everything to me FREE and without obligation.

Name.....

Address.....

Town.....State.....

Territory preferred.....



"WELCOME"



"JUST WHAT I WANTED"



"WHAT A SELLER"



SAVASOLE

The Original Perfected "Plastic Leather"



BEFORE—Here is an old shoe, worn down, ready to be sent to the shoemaker, who would charge \$1.00 to \$1.75 for a first-class job.



AFTER—Here is the same shoe repaired with SAVASOLE. No hammer, nails, or pegs. Just use an old knife. All the cracks and breaks are filled in and covered up with a hard, smooth, waterproof, non-skid surface. SAVASOLE repairs shoes for one-tenth the cost of ordinary heels and soles.

PERFECT MANUFACTURING CO.

Manufacturers of SAVASOLE—the Original, Perfected "PLASTIC LEATHER"
Y-506 Daylight Building CINCINNATI, OHIO

BIG PAY JOBS

open

for the Radio Trained Man

Scores of jobs are open to the Trained Man—jobs as Designer, Inspector and Tester—as Radio Salesman and in Service and Installation work—as Operator, Mechanic or Manager of a Broadcasting station—as Wireless Operator on a Ship or Airplane—jobs with Talking Picture Theatres and Manufacturers of Sound Equipment—with Television Laboratories and Studios—fascinating jobs, offering unlimited opportunities to the Trained Man!

Ten Weeks of Shop Training

Come to Coyne in Chicago and prepare for these jobs the QUICK and PRACTICAL way—BY ACTUAL SHOP WORK ON ACTUAL RADIO EQUIPMENT. Some students finish the entire course in 8 weeks. The average time is only 10 weeks. But you can stay as long as you please, AT NO EXTRA COST TO YOU. No previous experience necessary.

TELEVISION *and* TALKING PICTURES

In addition to the most modern Radio equipment, we have installed in our shops a complete model Broadcasting Station, with sound-proof Studio and modern Transmitter with 1,000 watt tubes—the Jenkins Television Transmitter with dozens of home-type Television receiving sets

—and a complete Talking Picture installation for both “sound on film” and “sound on disk.” We have spared no expense in our effort to make your training as COMPLETE and PRACTICAL as possible.

FREE Employment Service to Students

After you have finished the course, we will do all we can to help you find the job you want. We employ three men on a full time basis whose sole job is to help our students in finding positions. And should you be a little short of funds, we'll gladly help you in finding part-time work while at school. Some of our students pay a large part of their living expenses in this way.



COYNE IS 32 YEARS OLD

Coyne has been located right here in Chicago since 1899. Coyne Training is tested—proven by hundreds of successful graduates. You can get all the facts—FREE. JUST MAIL THE COUPON FOR A FREE COPY OF OUR BIG RADIO AND TELEVISION BOOK, telling all about jobs... salaries... opportunities. This does not obligate you. JUST MAIL THE COUPON!

H. C. Lewis, Pres. **RADIO DIVISION** Founded 1899
COYNE ELECTRICAL SCHOOL
 500 S. Paulina St. Dept. 71-3H Chicago, Ill.

H. C. LEWIS, President
 Radio Division, Coyne Electrical School
 500 S. Paulina St., Dept. 71-3H, Chicago, Ill.

Send me your Big Free Radio, Television and Talking Picture Book. This does not obligate me in any way.

Name

Address

City.....State.....

When writing to advertisers please mention Popular Mechanics

Classified Advertisements

WORLD'S BEST WANT AD MEDIUM

Advertisements in this section, 35 cents per word, each insertion, minimum 10 words, payable in advance
To be inserted under proper classification in November issue, copy should be in our office September 18th.

ADVERTISING AGENCIES

ADVERTISE—Bargain value—24 words in 24 representative Sunday newspapers \$15; Free assistance with your ads, sales letters, literature. Helpful Ad-Guide showing best paying newspapers, magazines, rates, mailing lists, etc., free. Chicago Union Agency, Great Northern Bldg., Chicago.

BEFORE Advertising get our catalog. No charge. 25 years in business. The largest classified agency in the world. Ankrum Advertising Agency, 100 No. LaSalle St., Chicago, Ill.

FREE—New 1931 Advertisers Rate Guide, 44 pages, includes everything. Lowest rates. E. H. Brown Advertising Agency, 140 S. Dearborn, Chicago.

ADVERTISE in trust weeklies. Lists free. Meyer Agency, 4112 Hartford, St. Louis, Mo.

ADVERTISING: 24 Words 8 big city Sunday papers—\$10. One inch display, 50 country weeklies—\$5. Copy prepared. Free list, magazines, farm. LeGrand Agency, 31 West 33rd St., New York.

ADVERTISE in best paying papers. Write for our lists which contain most circulation per dollar spent. Franklin Advertising, 100 Boylston Street, Boston, Mass.

INCH Display advertisement 50 magazines year \$24. Wood's Popular Services, Atlantic City, N. J.

TIME Counts in applying for patents. See pages 132 and 133. Clarence A. O'Brien, Registered Patent Attorney, Washington, D. C.

FOR ADVERTISERS

ADVERTISING: 20 Words; 50 magazines 60¢; three insertions, \$1.20. Inch display, three months \$6.00; year \$24.00. Mailing Bureau, Lardale, Calif.

ADVERTISE 53 Magazines, 3 months, \$6.00 Inch. List, special offers, free. Evans King Co., Box 672P, Wilmington, Delaware.

INCH Display (forty words) three times in Mailman, \$1.00. 110,000 International circulation. P. M. Argus, Culver City, California.

CUTS, Cartoons, photos, Lists, 10c, 20c. Meyer-GPO, Bx471, New York.

MAILING SERVICE

CIRCULARS Mailed 20c 100. Photocolor Mailing Service, 1080 Elmhurst, Detroit, Michigan.

BRANCH OFFICE SERVICE

NEW York mailing office. Address \$1.00 monthly. Steamship Agency, 2305 Broadway.

MAILING LISTS

1,000 **AGENTS**, Salesmen, \$2.00. M. L. Smith, 93 Coleman Street, Dorchester, Mass.

INFORMATION

CONFIDENTIAL Information. All subjects, \$1.00. International Bureau, 605 Garrick, Chicago.

AUTOMOBILES

GARAGEMEN, Individuals, learn auto, airplane, tractor, radiator repairing by mail. Write Tri-State Radiator School, 1800 W. Franklin St., Evansville, Ind.

DIRT Track Racing. Now you can break into the racing game. How to build rarer, contest rules, speed, "tricks"—Complete illustrated treatise, postpaid \$1.00. Ray Kums, Dept. B, Madisonville, Cincinnati, O.

TIME Counts in applying for patents. See pages 132 and 133. Clarence A. O'Brien, Registered Patent Attorney, Washington, D. C.

AUTO SUPPLIES

A SCIENTIFIC Product every automobile owner should have. Guarantees a clean and efficient cooling system at all times. Season opportune. Retail \$1.00. Agents wanted. Good commission. Seric Products Co., 2021-B VanHuren St., Chicago.

AUTOMOBILE Greaser—Knees relieve the hands. Genuinely practical and self-repairing. Guaranteed faultless. Sample \$1.00. 1115 Office Street, Los Angeles, California.

WIZZARD All metal mender metals leak in cracked water jackets, crank cases, hot water and steam radiators, milk cans, pails, anything metal. Sample bar 35 cts. regulation size \$1.00. Postpaid. Davgar Mfg. Co., 65 Broadway, Newburgh, N. Y.

RADIATORS—Guaranteed. All standard makes. Save 40% to 75% buying at wholesale prices. Give models. Write for prices. Independent Radiator Co., 1119 So. Wabash, Chicago.

FORD And Chevrolet owners. New free wheeling device. Catalog free. Agents wanted. Clymer Motors, D 3, Denver, Colo.

BARGAINS—Excellent repossessed compressors, battery chargers, test benches, car washers. Terms. Trial. Write Ken's Automotive Service, Box M-1011, Troy, O.

NEW Auto parts 25-50%. Motors, rear-ends, radiators, wheels, generators, carburetors, brakelining 50%. Used parts 50-80% off. Brightman, 2065 Main, Hartford, Conn.

STOP Brake rattle—Universal "springs of silence", all brake service stations. Universal Spring Co., Grand Rapids, Mich.

CHROMIUM Plating powder plates iron, steel, brass, copper and nickel, without electricity or machinery. Guaranteed not to tarnish; ½ pint can \$1.50 prepaid. Gunmetal Co., Ave. J, Deatur, Ill.

TRAILER Hitch 4 wheel—all steel, best on market. Write for price and circulars. Agents wanted. Hagstrom Model & Tool Wks., Kansas City, Mo.

AUTO SERVICE EQUIPMENT

OWN A Battery Charger and make big profits; buy direct from factory; fully guaranteed; literature free. Adams-Barr Corporation, Columbus, Ohio.

SUBSTANTIAL Savings—repossessed compressors, battery chargers, test benches, car washers, Terms. Trial. Write Ken's Automotive Service, Box M-1012, Troy, Ohio.

MOTORCYCLES, BICYCLES AND SUPPLIES

REBUILT Motorcycles \$25 to \$100 easy. Tires, used tires \$2.50. New Firestone \$5. Engines for motorcycle free sleds, airplanes, boats \$15 to \$75. Forks \$3, frames \$3, cylinder \$3, saddles \$3, chains \$1.50, handle bars \$3, belts \$5, wheels \$3, side cars \$25. Bicycles \$9.50, airplane wheel \$1.00 was formerly \$2.00. Save you dollar prices. Oldest house in U. S. Send 25c for catalogue. Price Cutter Dentinger, Rochester, N. Y.

MOTORCYCLE Parts. Tower Cycle Co., Pine Lawn, Mo.

CLYMER Moto-bike \$89. Bicycle motors \$55. Used motorcycles, outboard motors. Terms. Catalog free. Clymer Motors, D 1, Denver, Colo.

TYPEWRITERS, Motorcycles, radios, \$1.99—\$24.99. Terms. Agents. Knights, 1512 Locust, St. Louis, Mo.

MOTORCYCLE Bargains, lowest prices, bargain sheet for stamp, motorcycle accessories, largest line in America, lowest prices. Largest motorcycle mail order house in the United States. Rochester Harley Davidson Corporation, 129 West Main St., Rochester, N. Y.

NEW Harley-Davidson motorcycles \$210.00. Used \$50.00. New and used parts, Dustin Cycle, Topeka, Kansas.

LOW Prices—Special bargains in Harley-Davidsons—14 models. Send 6c stamp for catalog. Knuth's, 2525 Fond du Lac Ave., Milwaukee, Wis.

REPAIR With good used parts, save ¼ or more, state parts needed, no lists. J. B. Dahl, 3661 Archer Ave., Chicago, Ill.

SEND 15c For illustrated used Motorcycle catalog. Large stock. Bargains. Indian parts, Accessories, Indian Motorcycle Sales, Kansas City, Mo.

GUARANTEED Reconditioned Harley-Davidsons. All models. Send for bargain list. Ruhle & Artley, 1350 N. Western Ave., Los Angeles, Calif.

AVIATION

BE Sure that the motor you purchase for your light plane will fly it. Heath B-4 and Heath Henderson motors are guaranteed to fly and 7 years of constant performance prove it. For economy and reliability these motors cannot be equalled. Send 10c for large illustrated booklet. Heath Aircraft Corp., Dept. KP-10, Niles, Michigan.

PHOTOGRAPHS Of 111 different aeroplanes. Size 4x5 inches. Price 4 for 25c. Send 2c stamp for complete list. Pilot-Plane Photos, General P. O. Box 360, New York.

FOR Sale—Airplanes. Curtiss Jenny 90 H.P., 2-place \$395; American Eagle 3-place \$505; 130 H.P. Clerget motor \$45; new catalog aviation, glider supplies ready. Logan Aircraft, Cleveland, Ohio.

CONVERSION Parts for using war surplus OX5 propellers on auto motors. Send 10c for circulars. Heine Motor Works, Orwigsburg, Pa.

NEW 26x1 Wheels, \$2.00; new tires for same, \$2.00; new tubes, \$0.98; new Zenith 24imeters, \$1.00; Johnson strut airspeeds, \$7.50. Write for bargain sheets. Johnson Airplane Supply Company, Dayton, Ohio.

AIRCRAFT Directory 50c. Thousands surplus airplanes, motors, parts, supplies. Invaluable. Aerobuilders Service, 1305-15 So. 12th, Lincoln, Neb.

TIME Counts in applying for patents. See pages 132 and 133. Clarence A. O'Brien, Registered Patent Attorney, Washington, D. C.

METAL Tipped Henderson propellers, \$9.95; Ford's, \$12.50. Hibbs, Ft. Worth, Texas.

LEARN To fly where Lindbergh learned at this flying school with highest government approval. Airplane mechanics school connected with aircraft factory. Big opportunity—write today for complete information. Lincoln Flying School, 2002 Aircraft Building, Lincoln, Nebraska.

SEND For descriptive list of New, Rebuilt and Used Curtiss OX5 and Hispano Sulza Airplane Engines. Heckman Machine Works, 4026 W. Lake St., Chicago, Illinois.

SEND 5c For bundle of balsa, reeds and price list on supplies. Aero Shop, 3050 Hurbit Ave., Detroit, Mich.

MODEL AIRPLANES

MOTOR And rubber driven scale model airplanes, model gasoline, steam and air motors, Catalogue free. Miniature Aircraft Corp., 83 Low Terrace, New Brighton, N. Y.

24" FLYING U. S. Navy "Corsair" model airplane \$1.00 postpaid. Empire State, 1191 Harrod Ave., New York.

BOATS, OUTBOARD MOTORS, ETC.

PLANS 12 Foot stem raving outboard hydroplane for class C, D, E engine, September Rudder, price 35c. Rudder, 15 Murray Street, New York.

NEW Clymer Outboard Motors, Motorboats, Small gas engines. Terms. Catalog free. Clymer Motors, D 2, Denver, Colo.

PROPELLERS, Pumps, stuffing boxes, bearings, etc. Wm. H. Baker, Pond St., Quincy, Mass.

MODEL SHIPS

MODEL Ships made to order, clipper ships a specialty, rigging and repairing models. Orders promptly executed. Prices very moderate. Several clipper models for sale. John Nock, 290 Second St., Brooklyn, N. Y.

MANUSCRIPT SERVICE

MANUSCRIPTS Typed and revised by experienced English teacher. Terms on request. Kate L. Preusch, 816d, Louisiana.

CARTOONING

YOUR Cartoons drawn, 50c. Send photo. A.P. Studio, 1902 Curly St. St. Joseph, Mo.

BOOKS AND PERIODICALS

HYPNOTISM Lessons. Formerly correspondence course. \$1.40. Box 1385, St. Louis, Mo.

HOME Studies—200 subjects; stenography. 2c. Mar. B 605, Nashville, Tenn.

HYPNOTISM Easily learned. Lessons guaranteed. Postpaid \$1.10. Smith Pub. Co., Dept. 3, Springfield, Mass.

ASTROLOGY Books—25c to \$3.00; free descriptive list. Bullock, Box 1250, Providence, R. I.

GAMES, ENTERTAINMENTS AND PLAYS

PLAYS, Operettas, musical comedies and minstrels, roudy and talking songs, black-face skits, vaudeville acts, monologues, dialogues, recitations, juvenile plays and songs, musical readings, entertainments, make-up goods. Catalog free. T. S. Denison & Co., 623 So. Wabash, Dept. 11, Chicago.

CHALK TALKS

LAUGH Producing program. \$1.00. Catalog free. Balda, The Cartoonist, Oshkosh, Wis.

MAGIC TRICKS, BOOKS AND JOKER NOVELTIES

MAGIC—Tricks, Books and Supplies. For amateurs as well as the great professionals. Anyone can learn through our instructions. Feature Acts in Mind-Reading, Spiritualism, Rope Ties, etc. Large illustrated professional catalog, 20c. Chicago Magic Co., 110 So. Dearborn St., Dept. B, Chicago, Ill.

10 SLEIGHT Of hand card tricks, magic catalogs 25c. Stinger, 2538-N Halsted, Chicago.

PILE Of fun, lots of fun, twenty-five cents. Peoria Novelty Co., 602B So. Adams Street, Peoria, Ill.

SAMPLES, 10c, 20c, 50c. Meyer, Books—GPO, Box 471, New York.

MEXICAN Jumping Beans! Four, 15c; ten, 25c (coin.) Meyer, Box 94, Newman, Georgia.

MAGIC Catalog 20c. Lynn, 105 Beach, Dept. 3, Jersey City, N. J.

TRICK Catalogue, illustrated, 10c. Oaks Magical, Dept. 518, Oshkosh, Wis.

SEVEN Ontimagical delusions. Four Magic catalogs 15c. Gilman, Morgan Park, Chicago.

ELECTRIC Fun! 200 stunts, 110 volts. \$1. Ketting Sons, Campbell, Calif.

RADIO SETS AND SUPPLIES

BUILD Your own radio phonograph. Catalog free. "American," 3602 Wesley, Berwyn, Ill.

WORLD Wide reception of foreign stations on your regular set with short wave conversion. Booklet 10c. Federal Radio & Telegraph Co., Pewaukee, Wis.

TIME Counts in applying for patents. See pages 132 and 133. Clarence A. O'Brien, Registered Patent Attorney, Washington, D. C.

STAMP COLLECTING

CURACAO. That little tropical island in the West Indies has so few people that stamps are used very seldom. For that reason not a single stamp of Curacao catalogues 2c, they all catalogue more and the obsolete stamps increase in value rapidly on account of the great demand for them the world over. We are fortunate enough to obtain a small quantity of Curacao No. 50, obsolete since 1915 and we offer a superb used copy of same together with 100 more all different stamps of a total catalogue value well over \$3.00 for only 10c to approval applicants. Globus Stamp Co., 268 Fourth Ave., New York.

CARIBBEAN Islands—Also early United States, Uganda, Lourenzmarques, Congo's, Salvador, Monte Carlo, Prince Islands, Canada, Uhangl—"Countries collectors haven't got"—Free for 5c postage. Hurry!! For yours, now!! Empire Stamp Company, Toronto, Canada.

BIG Parade—A packet of more than twenty all different better grade stamps showing exciting scenes and records of nations at war. Includes fire-pot burner; the storming of a city; hand-to-hand bayonet struggle; bloody battle scenes; troop transport; red cross stamp; dying soldier; victory stamps; etc. Send for this thrilling "Big Parade" packet at once—limited supply. Only 10c to approval applicants. W. A. Howell, 58 Cornhill, Boston, Mass.

THE Biggest Dollar—1000 mixed foreign including Newfoundland, Persia, etc., for 10c; 1000 mixed U. S. for 40c; 100 different U. S. with Civil and Spanish War Reminiscences and old 1861 cover for 28c; 100 Latin-Americans for 25c; 100 different from 50 countries for 10c. All above with 1000 hinges for \$1.00. Approval selection with each order. New England Stamp Co., Established 1893, 53 Bromfield Street, Boston, Mass.

A BIG Bargain—All for only 50c. Stamp album, providing spaces for 2200 stamps with 700 illustrations, packet of 500 different stamps, 500 hinges, and millimeter measure. Free with each order our pamphlet which tells "How To Make A Stamp Collection Properly," and our 80 page price list of albums, supplies and hundreds of bargains in sets and packets. Queen City Stamp & Coin Company, Room 50, 604 Race Street, Cincinnati, Ohio.

FREE—Set 4 Hongkong to approval applicants who send to postage. L. Mascho, 2805 Seminary Court, Oakland, California.

GIANT Triangle stamp! Largest triangle stamp in the world; (Spain, Columbus commemorative) worth a dime alone. Included in packet of twenty-four scarce varieties from queer, far-off lands; Bodi, Kouang-Tcheou, Gualior, etc. Absolutely no common European varieties to mar the high quality of this wonderful packet; amazing value! Only ten cents (coin) to approval applicants. Vogue Stamp Co., Dept. P2, Port Chester, N. Y.

WORLD'S Finest triangle (rare Guatemala Quetzal-Bird), also scarce dead country triangle and big packet Eritrea, Vatican, Borneo, Natal, etc., for 5c with lists and approvals. Seminole Company, Druid, Baltimore, Md.

WHOLESALE Catalog for dealers. Illustrated. Postage 5c. Frank Co., 5031 Queensberry, Baltimore, Md.

PAPUA (Lakatoi boat), Zanzibar, Mesopotamia, Kenya, Uganda, Lebanon, Congo, Morocco, Sudan, etc., in wonder packet 60 different, 5c with approvals and lists. Monumental Stamps, Arlington, Baltimore, Md.

FREE Surprise packet, unpriced mixture 500 U. S., 35c. Drexel Stamp Shop, 3726 Drexel, Chicago.

CORRESPOND With people in 97 countries. International Correspondence Bureau, Two Rivers, Wisconsin, \$2.00 year.

SEVENTY Different stamps from seventy different countries, 9c to approval applicants. Barrus, Box 1034, Detroit.

25 DIFFERENT French Colonies to approval applicants, 2c. Norman Floyd, Norman, Ohio.

AFRICAN Airmail free with approvals. Monjar, 1533 Knox, Cincinnati, Ohio.

SAN Marino set, 60 different stamps, 5c to approval applicants. Malboro Stamp Co., 1020 East Fifth St., Brooklyn, N. Y.

MAGIC Packet. Fine stamps cataloging up to \$1.00 each. Also triangles, Sarawak, Uhangl, Iceland, etc. All for 10c to approval applicants. Baritan, Box 285, New Brunswick, N. J.

FREE Packet, wholesale list and approvals. Hoyt, Box No. 597, Lowell, Mass.

25 SCANDINAVIAN Stamps cataloging over \$2.00, 10c to approval applicants. Hasselbaum, Times Plaza Station, Brooklyn, N. Y.

FREE 25 French Colonies with approvals, postage 2c. Potomac Stamp Co., 3708-13th St., N. W., Washington, D. C.

LIBERIA Packet, 2c to approval applicants. Welsh, Elmhurst, New York.

20 BRAZIL—Showing trains, aeroplanes, blacksmith, winged mercury, harvesting, only 10c to approval applicants. Mastie Stamp Company, London, Canada.

PREMIUM To approval applicants, A. Motzer, 1022 Liberty, Cincinnati, Ohio.

BARGAINS—Less than half catalogue. Wonderful packet of 40 stamps from strange countries—Fiji, Tasmania, Mozambique, Siam, etc., with smallest stamp in world for 10c. (No Europe.) Hundreds of bargains. Bargain Stamp Co., 277P West 23d St., New York.

FOREIGN Mission 75c, United States 40c D., 50 Africa 25c, 25 Batum \$1.50. Popular Co., 4512 North Racine, Chicago.

TEN French Colonials free with approvals. Dorval Co., Gloversville, New York.

FREE—Big 100 page illustrated album to approval applicants who enclose ten cents postage. Tom Rogers, 2806 Caroline, Houston, Texas.

PENNY Approvals—Send references. Stampateria, 3816 Lafayette Ave., St. Louis, Mo.

FREE Commemorative airmail in big packet, including ships, birds, maps, animals, and scenic stamps. 5c to approval applicants. Chinook Stamps, 2512 Franklin, Bellingham, Wash.

FREE, Fine British Colonial packet, 2c postage. Lightbown, Southsea, England.

"ARTISTIC" Packet—Beautiful airmail, Liberia pictorials, animals, War, Victory, Commemorative, 60 others, 10c, with choice approvals. Rosedale Stamp Company, Box 1733, Winnipeg, Canada.

"HOBBIES" Is a beautiful, illustrated magazine for collectors of stamps, coins, Indian relics, fire arms, books, autographs, and scores of interesting hobbies. Sample copy 10c. Year subscription \$1.00. 2806 So. Michigan, Chicago.

1000 ASSORTED U. S. stamps, 25c. Auburn Stamp Co., Syracuse, N. Y.

APPROVAL Selections at 75% discount. References. Rosswag, 339 East 86 Street, New York.

125 FREE 2c Postage, Approvals. La Grange Stamp Co., La Grange, Illinois.

100 DIFFERENT For this Ad and 2c to approval applicants. Evanston Stamp Shop, 2112 Noyes, Evanston, Ill.

101 UNITED States, all postage \$1.25, approval selections, want lists filled. Catalogue free. Moroni, 121 West 42nd Street, New York City.

LARGEST Stamp in the world! Rare China Wild Goose special delivery stamp (value 75c) for only 5c to approval applicants. Supply limited. Positively only one to a customer. Western Philatelists, 6021 Harner, Montreal, Quebec, Canada.

EUREKA Mixture. What is it? Write. Ask. Box 1089, Vancouver, Canada.

FOREIGN Pound mixtures. List free. Big sample assortment 10c. Pade, Woodside, N. Y.

PACKET Giant stamps (including world's largest, valued 75c); packet beauties, (Montserrat, St. Kitts-Nevis, Borneo, Sarawak, etc.) Either above offers 10c, both 20c, to approval applicants. Gem Co., 1839 Unionport Road, New York.

FREE 100 Different stamps with approvals, Postage 2 cents. Badger Stamp Co., Milwaukee, Wis.

27 LIECHTENSTEIN 4c To approval applicants. Hagen, Box 129, Sioux Falls, S. Dak.

FREE Stamps to approval applicants mailing expenses 4c. 100 different good U. S. 50c. Lincoln Stamp & Coin Co., 109 N. Dearborn Street, Chicago.

1,000 FOREIGN Stamps 17c to approval applicants. Fulmen, Columbia, Missouri.

AUTUAKI, Ascension, Brunel, Nauru, New Guinea, Rarotonga, Penrhyn, Tonga, Mint British Colony Pictorials, 15c to approvals. Marvel Stamp Co., 1476 Broadway, New York.

U. S. Stamps on approval. References. James Randall, 1920 Warren Ave., Chicago.

ATTRACTIVE Approvals, United States, etc. Neemus Stamp Co., 312 East 23rd Street, New York.

120 DIFFERENT, Including United States Commemoratives, to approval applicants sending 4 cents. Tricity Stamps, Rock Island, Ill.

80% DISCOUNT Off Scotts many hard to get nineteenth century stamps. References please. Hubert Codwise, Garland St., Lynn, Mass.

COLLECTORS! For exchanging stamps, illustrated postcards with 2600 collectors. Ask American booklet 102, Registre Echangeistes, 51 Passage Bureau, Paris, France.

50 DIFF. United States, lists and approvals, 12c. Robert Haynes, Point Place, Toledo, Ohio.

POP'S Penny 'provals please. "Pop" Morrison, 32 Magnolia, Albany, N. Y.

125 FREE To approval applicants, 2c postage. Oak Park Stamp Co., Oak Park, Illinois.

100 DIFFERENT Stamps free to all asking for approvals. Postage 2 cents. Christensen, Milwaukee, Wis.

30 FRENCH Colonies, Alsouites, Gabon, Caledonia, etc., with approvals 5c. Hollinbeck, 312 Marquette, Minneapolis.

BARGAIN Packet, 60 different Argentine, Brazil, Chile, Peru, etc., with bargain lists 5c. H. Burdhol, Norwood, Ohio.

40 DIFFERENT United States 12c. 60% approvals. Seidenberg, Baroda, Mich.

FREE! 300 Stamps with three months' subscription, 10c. "Stampist," No. 496, Romney, W. Va.

FREE—25 Different old U. S. if you send 4c postage and ask for approvals. Anchor Stamp, 424 Hicks Bldg., San Antonio, Tex.

TWENTY Different lots 10c. Fascinating selection. Consolidated Stamp, Newton, Mass.

FREE Stamp collection—contains Salvador, Turkey, Africa, etc., 2c postage. 10 different triangles 25c. 1000 hinges 7c. Scott's 1932 catalogue, \$1.85. Approvals sent. Tatham Stamps, West Springfield, Mass.

DANDY Packet! 5 faraway Zanzibar 10c. Stamp bargains. Sterling, 370 Bucoto, Lexington, Ky.

3 ROMANIA Airmail, 1 Guatemala triangular, 1 Spain Pope stamp, big bargain lists all for 10c. 50 different Greece 25c. Marks Stamp Company, Toronto, Canada.

FREE! 15 French Colonies. Postage 2c. R. F. Roberts, 901 Fourth, Bay City, Mich.

FREE!!! 100 Different stamps; watermark detector; perforation gauge; 20 different U. S.; Canadian Confederation stamp; with approvals; postage 2c. Gordon Stamp Company, 292 N. Lakewood Boulevard, Detroit, Michigan.

ZANZIBAR 3 Different 5c. Abyssinia 3 different 6c. Liberia 4 different 6c. Ireland 10 different 10c. These prices are to approval applicants only. Frank Ewing, Box 693, Cleveland, Ohio.

5 SPAIN Columbus ships 7c to approval applicants. C. A. Leeson, 266 Sheildrake Blvd., Toronto 12, Canada.

PACKET Such beauties as Aitutaki, Niue, Togo, Paracuar, Usanda, etc., and useful souvenir, 10c to approval applicants, G. Carlson, 3925 S. Broadway, Los Angeles, Calif.

AFGHANISTAN, Diegosuarez, three triangles, 1000 hinges, etc., 10c. Approvals. Immsun, 3918-17th Avenue, Brooklyn, N. Y.

ZANZIBAR Included in 261 different for 10c; only with approvals. Clark Hallister, 3223 North Seeley, Chicago, Ill.

4 WESTERN, 4 South Australia, 5c with approvals. Allison, Anzola, Ind.

WORLD Album, over 3000 spares, 1675 illustrations, packet of stamps and hinges 25c to approval applicants. Electra Co., Marberry, W. Va.

CUBA Lindbergh Airport 10c; 2 Japan Census 5c; Egypt Special Delivery (approval) 30c. Haney, Sharonville, Ohio.

FREE! Loose leaf postage stamp album at rate of 8 pages each month given with subscription to monthly journal. Send 2c stamp for prospectus. United Stamp Co., Marquette Bldg., Chicago, Ill.

261 DIFFERENT 10c to approval applicants only. Free list of bargain packets. Kansas City Stamp Co., Lee Bldg., Kansas City, Mo.

FREE—Packet 52 different from Alsouites, Lebanon, Quelinans, etc.; also watermark detector and rare old Hawaiian stamp—all free to approval applicants enclosing 4c postage. Highland Stamp Co., Newton Highlands, Mass.

SCARCE Airmail and triangle, Beautiful Uruguay "flying horse" airmail and scarce Guatemala triangle (smallest in the world) are included in our big packet of 60 different stamps from Alsouites, Grand Liban, Venezuela, British and French Colonies, etc. All for 5c to approval applicants. Big illustrated lists free with each order. Write today! Mystic Stamp Co., (Dept. 86), Camden, New York.

ANCHER'S \$\$\$ Outfit—only 12c. Fine triangle stamp, set German stamps (new) value millions dollars, perforation gauge and mm scale, airmail set, interesting stamp smallest republic, newspaper set, packet good stamps Trancore, Malay, Dutch Indies, etc., fine pocket stock book. Entire outfit 12c to approval applicants. Ancher Stamp Company, Rutherford, N. J.

EXCELLENT Mixture 2000 stamps, Large variety including Africa, Asia, Latin America, etc. Price only \$1.00. Longacre Shop, 106 West 42 St., New York, N. Y.

BEST One cent approvals in America. F. Hand, 1117 So. 60th St., Philadelphia.

1000 MIXED U. S., old and new, 25c. Weatherly, Lakewood, Ohio.

WHOLESALE Price lists free on application. Midland Stamps, Toronto, Canada.

ABYSSINIA To Zanzibar—\$4.00 catalog value. 34 scarce stamps, Abyssinia, Hejaz, Spanish Morocco, etc. Only 10c to approval applicants furnishing references. Weaver, Dept. 5, 1451 Broadway, New York.

BRUNEI (Native scene), Tanganyika, Orange River Colony, Kenya, Foreign Revenue, Vatican City, Grenada, Syria, French Guinea (cataloging 25c), Nyasaland Protectorate, and scarce genuine Baden, all for 5c to introduce our famous approvals. Viking Stamp Co., Sheephead Bay Station, Brooklyn, N. Y.

FREE—Different Luxemburg to approval applicants. E. D. Stamp Co., 3905 Forest Park Ave., Baltimore, Md.

100 DIFFERENT U. S. 30c—50 diff. 15c. Hawkeye Stamp Co., Cedar Rapids, Ia.

BOYS Wanted—Everywhere. Show our big bargain stamp assortments to friends. We trust you and pay you splendid cash commissions. Fast sellers. Earn money with our new plan. Dandy free premium if you write us at once. LeRoy Stamp Co., B20 W. Jackson Blvd., Chicago, Ill.

CANADA Airmail stamp free if you ask for approvals and send 15c for 25 different airmails or 30 different Canada; both packets only 25c. We list 350 countries in our dime packets. Lists free. Special bargains, 500 different, 25c; 1,000 different, 5c; 2,000 different, \$2.50. Victoria Stamp Co., London, 4, Ontario, Canada.

FREE Outfit! 52 stamps, hinges, pocket wallet. Postage 4c. Approvals. United Philatelists, South Berkeley, Calif.

300 DIFFERENT Stamps 15c. Michael, 942 So. 23rd, Bellwood, Ill.

SELLING Quality stamps on approvals 4c up. Dandy free premium. Collections and job lots bought. Keigwin Stamp Co., Vineland, N. J.

UNITED States commemoratives 10 different 4c. Approval buyers. Hudson Co. Plainfield, N. J.

105 CHINA, Etc., 2c. Album (500 illustrations) 2c. Bullard, 446 Tremont, Boston.

ILLUSTRATED Bulletin. Free to collectors. Reimera, 39 N. La Salle, Chicago.

150 GOOD Mixed foreign stamps, 2c. Stanton, East Lyme, Conn.

ILLUSTRATED United States list, price 50c. Large complete United States price list, 1931, free. Stanley Gibbons, 38P Park Row, N. Y.

300 DIFFERENT Stamps 20c; 600 50c; 1,100 \$1; 2,000, \$3. Fred Onken, 639 79th St., Brooklyn, N. Y.

BEAUTIFUL Picture stamps sent free. Paul Cornish, Schenectady, N. Y.

STAMPS. Sent on approval at 50% discount. Fred Herzberg, 438 Maple Ave., Elmhurst, Ill.

96-PAGE Illustrated Stamp Album and 100 different stamps—25c to approval applicants. Ohio Stamp Co., Box 249, Cleveland, Ohio.

500 DIFFERENT Stamps for 25c. Big collection including Armenia, Andora, Flume, Spanish Morocco, Kenya, Liberia, Mamel, Nigeria, Quelinans, Syria, Victoria, Vatican City and other hard-to-get countries. Catalog value over \$10.00. Price only 25c to approval applicants. Illustrated lists free. Loma Stamp Company, 4231 42nd St., San Diego, Calif.

FREE—\$1.00 U. S. postage Lincoln memorial free, if you write for our 56 page price-list of U. S. and foreign stamps, 2,000 illustrations and fine stamps on approval. Hussman Stamp Co., 620-3 Olive St., St. Louis, Mo.

24 VARIETIES Cuban stamps, 10 cents. List of stamps free. Chambers Stamp Co., 111P, Nassau, New York City, N. Y.

ONLY 5c. 33 Different stamps including scarce Latvian triangular airmail stamps, 10 airmail, 12 United States (early issues, commemoratives, etc.) and 10 Canada. Approvals and illustrated price-list sent with each order. Curban Stamp Company, Gloucester, Mass.

WHOLESALE Catalog for dealers; 4c postage. Grossman, 102 W. 42nd, New York.

STAMPS Sent on approval at 70% discount. Reference required. Emory Renoll, Hanover, Pa.

200 DIFFERENT 10c. 25 Japan 10c. 60% discount approvals. Covert Stamp, 39 State, Rochester, N. Y.

PENNY Approval that satisfy. Neil Gumberg, Box 5441, Philadelphia, Pa.

RARE COINS

COINS—Lithuania, Ceylon, Romania, Nicaragua, Mexico, 50 cts. Rollo Gilmore, 4243 Sheridan, Chicago.

HIGHEST Price paid for American coin listed, buying and selling list and ancient coin 10c. Geo. Best, Cedar Rapids, Iowa.

AMERICAN 2c Bronze fine foreign coin crisp dollar note and catalog 10c. M. Figg, Box 283, Cedar Rapids, Iowa.

SPECIAL Prices on United States Commemorative half dollars in uncirculated condition; Columbian 69c; Lexington \$1.17; Stone Mountain 87c; Bennington \$1.19; old coin and bargain price list 10c. Arty, Box 483, Muskogee, Okla.

OLD Money wanted—Will pay \$100.00 for 1894 dime, S. Mint, \$50.00 for 1913 Liberty head nickel (not Buffalo). Big premiums paid for all rare coins. Send 4c for large coin folder. May mean much profit to you. Numismatic Co., Dept. H., Ft. Worth, Tex.

FIRST Issue U. S. \$1 greenback, 1862, new and crisp \$3. Fifteen different dates Canada cents \$1. Fifteen varieties Canada bank tokens \$1. 25c and 50c notes, new and crisp \$1. John Zug, Bowie, Maryland.

2 COINS, 5 Notes and catalogues 10c. Lester White, Box 66, West Newton, Mass.

40 OLD Coins, all different, \$1.00; Lexington half-dollar unc. \$1.90; Pilgrim half-dollar unc. \$1.00; Vermont half-dollar unc. \$1.00. Claud Denney, Box 1825, Dallas, Texas.

22 COINS, 25c; 100 Coins, \$1.00. Bishoff, No. Kansas City, Mo.

50,000 COINS, Medals, papermoney. Lists free. Naxx, 8P South 18th, Philadelphia, Pa.

RARE United States and foreign coins, war medals and decorations. Selling catalogue, 10c. Alexis Mengelle, Colorado Springs, Colorado.

20 COINS 25c. 100 Coins \$1.00. Oddehon, Box 681, Kansas City, Mo.

7 DIFFERENT Coins, 5 bills and catalog, 20c. Creamer's, 1112 Somerset, Baltimore, Maryland.

GUIDE To the value of all rare United States and early American coins, superbly illustrated. Price 50 cents. Descriptive circular free. Scott Stamp and Coin Co., 1 West 47th St., New York, N. Y.

\$5 To \$500 Each paid for old coins. Many very valuable. Keep all old money. Get posted. Send 10 cents for illustrated coin value book, 40c. Guaranteed prices. We buy and sell. Coin Exchange, Box 6, Le Roy, N. Y.

SEND 10c For 5 different coins and catalog or 50c for 25 different. Troyer Coin Co., La Fontaine, Ind.

GET Profit and pleasure in collecting old coins. Send 10c for large illustrated coin catalog. You'll be delighted with it. Send for it right now. B. Max Mehl, Numismatist, Mehl Bldg., Dept. P, Fort Worth, Tex. Largest Rare Coin Firm in the U. S.

CALIFORNIA Gold—Quarter size, 27c; \$3/4 size 53c; 3c piece and catalog, 10c. Norman Shultz, Box 746, Salt Lake, Utah.

OLD Coins, large fall selling catalog of coins for sale, free to collectors only. Catalog quoting prices paid for coins, ten cents. William Hesselin, 101A Tremont St., Boston, Mass.

UNITED States. Large cent, two-cent bronze, three-cent nickel and bargain list, 25c. Thirteen dates large cents, \$1.00. George Coffin, Greenwood Mountain, Me.

FOR BOYS

WHEELS—Make your own coaster wagon, four wheels, caps, two axles, blueprint \$2.75. "Ballak," 100 N. 12th, St. Louis, Mo.

CAMERAS AND PHOTO SUPPLIES

FREE—Our new bargain book—Something you ought to have. From cover to cover it is loaded with "real boys" in foreign and domestic. Still and movie cameras, accessories of all kinds and optical goods. Every item guaranteed and sold on ten days' trial. Money refunded if not satisfied. Send for it today. Central Camera Co., Dept. 30A, 230 S. Wabash Ave., Chicago, Ill.

KODAK Films developed 5c roll, prints 3c each. Trial offer. Photo Christmas greeting card from any negative 10c. Beautiful 10-inch enlargement 25c. Young Photo Service, 405 Bertha St., Albany, N. Y.

WANTED Graflex or view camera, state condition, price. Falk, 2 West 33d, New York.

MAKE Money in photography. Learn quickly at home. Spare or full time. New plan. Nothing like it. Experience unnecessary. American School of Photography, Dept. 3432, 3601 Michigan Ave., Chicago.

HAVE You a camera? Write for free sample of our big magazine, showing how to make better pictures and earn money. American Photography, 116 Camera House, Boston, 17, Mass.

ANY 6 Exposure film finished 38c, cash with order. Established 30 years. Center of North America. Pierre S. Dak.

JUST Published—"Photo Coloring and Tinting"—Newest and most complete instruction book on water coloring. \$1.00 at dealers or direct from us. Descriptive booklet showing specimen pages 10c. Hampton Company, 102 Ellison, Rochester, N. Y.

YOUR Favorite kodak picture enlarged, size 3x7, 10c. Three for quarter, coin. Send best negative (film) today. Address Darmer Photo Lab., 221 Securities Bldg., Des Moines, Iowa.

SPECIAL Trial offer: Developing any size roll 5 cents; prints 3 cents each. Beautiful 7 inch enlargement 20 cents. Send for special bargain list. Roanoke Photo Finishing Company, 299 Bell Avenue, Roanoke, Virginia.

MOTION PICTURES AND SOUND EQUIPMENT

JUST Out! Bass will mail postpaid Cine Amateur. Complete Handbook of motion picture photography for the amateur, \$1.00. Voice of the Films, a complete description of the process used in making sound motion pictures just out. Price postpaid, \$1.00. Motion Pictures With Sound by James Cameron. 400 pages crammed with information on all systems. \$5.00 postpaid. Bass Bargaingram No. 207 listing red hot bargains in standard and 16mm. motion picture cameras, projectors and accessories. 4c stamps. Bass Camera Company, Motion Picture Headquarters, 179 West Madison St., Chicago, Illinois.

\$1.25 FOR Original photoplay story. Our sales department sold unknown author's first story for above amount. We revise copyright and submit to studios stories for talking pictures. Being located in the heart of motion picture industry we know production requirements. Established 1917. Free booklet. Universal Scenario Company, 296 Meyer Bldg., Western and Sierra Vista, Hollywood, Calif.

TALKIE And movie producers are clamoring for new short story ideas, plots, etc. Perhaps you can write one that we can shape and sell for you. One writer (V.M.) received \$3,000. New York best market. Write now for free booklet, without obligation—How To Write For the Talkies! Daniel O'Malley Company Inc., Suite P, 1776 Broadway, New York.

SAVE Money. Movie cameras, \$25; projectors, \$35; Pathex camera, \$29; stereopticon, \$25; printing machine, \$75; 35mm negative stock, 2 cents foot; 100 foot Eastman 16mm negative, \$4.50; kodak \$5. Typewriter, \$18. Cameras and films bought and exchanged. Ray, 206 W. 44th, New York.

MOVIES! Interesting literature free. D. F. Elder Company, Dept. A, Chelsea, Massachusetts.

AT Sacrifice—16mm film comedy and cartoon two cents foot. Thousand foot reels 35mm film \$2.00. 16mm and 35mm projectors for home use, silent or talkie. Theatre Equipment Co., Box 524, Cincinnati.

BARGAINS In film and projectors. Clyde D. King, 1842 W. Fiftyfifth St., Chicago, Ill.

ODD Reels \$1.25 plus postage. Bargain Hts. Hoffman Film Service, 57 Broad, Albany, N. Y.

SPECIAL Spring camera, motor driven projector, film for camera and projector all for fifty dollars. Brand new list price \$114. Limited supply. Milton Mendelwager, 192 Ave. B, Bayonne, N. J.

WORLD'S Greatest "Passion Play" 16 MM. (new) 5 reels. Rent or purchase. Write Hemenway Film Co., 37 Church Street, Boston, Mass.

COMEDIES. Westerns \$2.50. Power's projector \$75.00. Marshall Films, Rome, Georgia.

TIME Counts in applying for patents. See pages 132 and 133. Clarence A. O'Brien, Registered Patent Attorney, Washington, D. C.

TRADE AND TECHNICAL SCHOOLS

GUSIAS School trains thoroughly in shoe rebuilding, hat renovating, clothes pressing in short time. Gusias, 7 W. Division, Chicago.

LEARN Watch repairing. Hiles School, 5330 Mission St., San Francisco.

LEARN Blue print reading. State your trade. Columbian School, Drexel Building, Philadelphia.

A TRADE. \$1.50 Hourly. Instructions \$1.00. Trade Institute, Vandalia, Missouri.

TELEGRAPHY

LEARN Wireless (Radio) and Morse Telegraphy. School, oldest, largest; endorsed by telegraph, radio and government officials. Expenses low—can earn part. Catalog free. Dodge's Institute, H Street, Valparaiso, Ind.

BUSINESS OPPORTUNITIES

SAFE. Safe but sure fire money maker for you in your community. Particulars free, and samples of product if you mean business. Proved, time and again, it gets the big money with little effort, because it supplies a human need that must be met. You manufacture, then sell easily, six different ways. The item is a food product—new, different, superior, delicious, easy to make and highly profitable. You get something exclusive. Write quickly, if you are a live one—for this can't wait! H. L. Singleton, Box 432, Texas City, Texas.

AMERICA'S Newest food sensation bringing "fortunes" to men and women everywhere. \$50 a week spare time—\$5000 a year full time easily possible. Openings in every territory. No canvassing. No experience needed. We furnish everything. You operate at home. Write or wire quick for Free Book. Food Display Machine Corp., 500 N. Dearborn St., Dept. C-310, Chicago, Ill.

BUILD A business of your own by mail, spare time. Folder free. Nagel, 1329 Olive, Indianapolis, Ind.

BIG Money easily made. Start your own business during home spare time. Free literature describes dozens of home opportunities. Southern Sales, Box P-774, Fort Worth, Texas.

WANTED—Men and women to operate cleaning and pressing shops. Big pay. We teach you the business. Write for free circular. Highland Brothers, Orange, Va.

LEARN To correct automobile shimmy, hard steering, tire scuffing. Capable men in demand everywhere. Complete course offered at cost (\$2) by gauge manufacturer. Send quick. Bear School, Rock Island, Ill.

FIFTY Vital questions and answers for mail order success with money making plans and formulas 10 cents. Southern Sales, Box 774P, Fort Worth, Texas.

SIGNS And showcards easily painted. If you use Letter Patterns. Write for free samples. John Bahr, G2120 Neva Ave., Chicago.

MAKE Artificial stone, inside or outside decoration. Samples fifty cents. Decorator, Box 165, Valley Center, Kansas.

RECLAIM Auto oil. Make your equipment. About \$50. Complete instructions and drawings \$1. Reclaimer, 2618 Maple, Wichita, Kansas.

CAPITAL—For copy, the "Promoters' Hand Book," a leaflet on financing; an eye opener for capital seekers. Send \$1.00 to Amster Leonard, East Orange, N. J.

TURN Wheat into cash. A permanent profitable business. Write Tricolum Machinery Co., 712 Wade St., Cincinnati, O.

YOUR Kodak is worth \$10—\$20 daily, taking photos for news syndicate. Dime brings valuable plan. Capitol Photo Service, Albany, N. Y.

PHOTOGRAPHY Beckons! Two-cent stamp brings illuminating information concerning photographic field of limitless opportunity. Simple but exceedingly fascinating. John Lirar, 2127 Cuvier, Berwyn, Ill.

LEARN Today—Earn tomorrow. Name plates, house numbers, signs. Omeday system, 15 1/2 W. Main, Springfield, Ohio.

"SCHEMER." 32p Monthly, prints big \$-getting schemes, opportunities, ideas, formulas. Subscriber reports \$16,000 from one copy; another \$25,000 from three. Try your luck! Three copies only 25c. Lewis Patterson, Pub., Alliance, Ohio.

WHOLESALE Directory 300,000 articles 10c. Other valuable information. Moran Company, Wareham, Massachusetts.

SPECTACULAR New amusement ride, suitable Chicago, 1933. Nothing like it anywhere. Birtley A. Ball, Hoodsport, Washington.

A BUSINESS Of your own making—Sparkling Glass Name and Number plates. Checkerboards, signs. Big book and sample free. E. Palmer, 549, Wooster, Ohio.

EARN Large income with "chain" of peanut-chewing gum vending machines. Start small capital. Particulars free. Robbins Corp., DeKalb and Broadway, Brooklyn, N. Y.

MEN Unemployed—Get this! Clever advertising stunt. (Average town good for \$100.00, 1,000% profit. (Here's steady employment) a legitimate proposition. Contract, including details (book form)—\$1.00 prepaid. Robert Paulsen, Hutchinson, Minn.

ARE You old at forty? See our advertisement on page 48 of this issue. The Electro Thermal Company, 2146 Morris Ave., Steubenville, Ohio.

FORMULAS: Beverages, syrups, extracts, flavors. Manufacturing everything. Valuable information free. The Formula Co., 5th Ave. and Broad, Seattle, Wash.

START Home business, making artificial marble, colorful glazed tiles, novelties, tablecloths, floors, garden furniture. Interesting. Cement compositions. Amazing samples 10c. John A. Pynn, 945 Grande Vista Drive, Los Angeles, Calif.

DISTRIBUTORS Wanted—Amazing secret formula Magic Mist sprays windshields, windows clean instantly; absolutely new \$1 seller; repeat sales; colored guns furnished. Exclusive territory. Write quick. Magic Mist, Dept. 10PMD, 1054 E. 75th Place, Chicago.

AMBITIOUS People. Make real money. Plans, sample 25 cts. Refunded on first order. Theora, 419 Kwing St., Fremont, O.

START Your own business buying old gold silver, etc., from the originator and not from those who have copied our literature word for word. F. Polcer, Box 81-A, Cicero, Ill.

BIG Profits. Manufacture—sell your own beverages, candies, extracts, perfumes, soaps, etc., at home. Free booklet. Truway Laboratories, 1333-A Walton, Chicago.

FURNITURE Refinishing; job painting; handyman shop. Start yours on nearly nothing; mostly all profit. John Braetland, 1439 South Ninth, Philadelphia, Pa.

GO Into business in your own home. Send \$1.00 for formula and sales plan. Money-back guarantee. Business Builders, 710 No. Broadway, Milwaukee.

BUSINESS Corporations organized. Delaware laws. Many advantages. Low cost. Write for free forms. Dept. 21, Corporation Fiscal Co., Wilmington, Del.

SELL Products profitably nationally; secure \$1,200 sales promotion without cost. Details \$1. Manthey, 2159 East 24th Street, Oakland, Calif.

LEARN Marbleizing with cement; make garden furniture, artificial marble, statues, etc. Inexpensive sanitary floors. Veneer any concrete products, and wood. Enamel walls or anything. Glossy, flintlike hardness. Unlimited uses for this new industry. Dime brings samples. Cowell Institute, Grayling, Mich.

\$7.50 PUTS You in business for yourself. Make up to \$50.00 daily. Write Elde Mfg. Co., 106 E. Seeboth, Milwaukee, Wis.

TIME Counts in applying for patents. See pages 132 and 133. Clarence A. O'Brien, Registered Patent Attorney, Washington, D. C.

MAKE Your own products. Employ agents yourself. Toilet articles, soap, extracts. We furnish everything. Valuable book free. National Scientific Laboratories, 1950 W. Broad, Richmond, Va.

FIFTY Successful mail-order propositions. Address, K. Home, 3949 Metropolitan, Chicago.

GOLDEN Mail order business. New, original. We show you everything. A. Golden Co., 318 West 51, New York.

START Big money business at home. Liquid window wash, formula, instructions, \$1.00. Di Lemme, 928 Stebbins Ave., N. Y. C.

AMATEUR Cartoonists: Sell your work. Write Smith's Service, PW1194, Wenatchee, Wash.

\$105.00 PROFIT In four days—(Road signs average \$20.00 each.) Make 'em with the "Signograph." Profit plan—4c. Address Arrow Signs, Hutchinson, Minnesota.

INDEPENDENT Business—men earn big pay traveling by automobile carrying our portable electric block leveling machine and re-leveling butchers chopping blocks. Heath Company, 210 Lafayette St., New York.

DOLLARS in "Fixit" service, spare or full time. Small capital. Experience unnecessary. Complete copyrighted 43 lesson instruction course. \$1.00. Particulars free. Houkate's "Fixit" Service, 1395 N. El-Molino, Pasadena, California.

POPCORN Machines \$15 up. Money makers. Northsides Co., 1396 Fifth, Des Moines, Iowa.

MIRRORS Resilvered at Home. Costs Near 5 cents per square foot; you charge 75 cents. Profitable business plating like new brass, worn-out autoparts, reflectors, tableware, stoves, etc. Outfits furnished. Details Free. Sprinkle, Plater, 127, Marion, Ind.

250,000 ARTICLES Wholesale. Directory 10c. W-Patterson Co., 4111 University, Des Moines, Iowa.

SUCCEED With your own products. Make-sell them yourself. Formulas, processes, trade-secrets. Expert analytical service. Catalog free. B. Thaxly Co., Washington, D. C.

WE Start you in business, furnishing everything. Men and women, earn \$40 to \$100 weekly operating our original "New System Specialty Candy Factories." Begin home spare time. Unlimited opportunity. Valuable booklet free. W. Hillier Bagdale, Drawer 4, East Orange, N. J.

THAXLY Formulas produce perfect products. All lines. Catalog free. B. Thaxly Co., Washington, D. C.

SELL By mail. Books, novelties, bargains! Large profits. Particulars free. B. Effco, 525 S. Dearborn, Chicago.

ARTIFICIAL Marble sanitary flooring, instructions covering wood or cement flooring 1/2 inch thick, fireproof, all colors, low cost. Ornamental casting, concrete plaster papier-mache decorations, garden furniture, statuary, flexible molds, particulars and illustrations free. Chris. Mahler, Elmont, N. Y.

LEARN The collection business. Good income, quick results. Interesting booklet, "Skillful Collecting" free. National Collectors Assn., Long St., Newark, Ohio.

FREE Book. Start your own little business anywhere, selling novelties by mail. My beginner's outfit contains everything required, novelties, circulars, instructions, etc. Descriptive book free. Hadwell, 33A-74 Cortlandt St., New York.

OPERATE Chain of vending and amusement machines. Be independent for life. Start small, grow big. P. Goodbody, 1826 East Main Street, Rochester, N. Y.

CHEMICAL Expert will furnish formulas and trade secrets. All lines. Lists free. W. L. Cummings, Ph. D., 228 Gordon Ave., Syracuse, N. Y.

CHARTERS: Delaware; best, cheapest; free forms. Colonial Charter Co., Wilmington, Del.

I MADE \$30 A week home. French breadmaking. 15 years' experience; free booklet tells. Ashbrook 67, Marengo, Ohio.

BIG Money at home plating auto parts, reflectors, mirrors, chandeliers; by new method; experience unnecessary. Outfits furnished. Gunmetal Co., Ave. N. Decatur, Ill.

FREE Booklet describes 67 plans for making \$20-\$100 weekly in home or office business of your own. Elite Co., 84 Elizabeth St., New York.

UNUSUAL—Uncommon specialties always sell best. Make these yourself from Miller's guaranteed formulas. Why work for others when others can be working for you? Latest eye-opening literature brings you many specialty propositions for you an independent business. Miller Chemist, 706-K Chemical Bldg., Tampa, Fla.

CHEMISTRY

CHEMICAL Experimenters—Send for our lists of chemicals and apparatus. Vines-Linkenbaker, Hinton, W. Va.

BECOME Trained chemist. Thousands of opportunities—fascinating career. Learn at home. Complete experimental laboratory outfit given. Write for big free book. Chemical Institute, 19 Park Place, Dept. P-1021, New York.

HANDBOOK For chemical experimenters, 50c. Booklet of experiments, 15c. Chemical catalogue, 5c. General Chemical Co., Reading, Pa.

FORMULAS AND TRADE SECRETS

ARTIFICIAL Marble. Formula 50c. All formulas 50c. Catalog free. T. Huffman, 1518 Wilson, Chicago.

FUN And money manufacturing photo frames, novelties, with new plastic. Guaranteed formula and plans. \$1. Tinker-Wood Works, 1823 Payne Ave., Cleveland, Ohio.

IODINE Stain Remover. Fast. Harmless. Sample 25c. Formula \$2.00. Ridge Sales, LaPorte, Indiana.

1,000,000 FORMULAS, Industrial facts, tables, processes, rules, trade secrets, and calculations for all kinds of Trades and Businesses. Book—"Moore's Assistant"—1616 pages. Sent postpaid for \$2.00. Ogilvie Publishing Co., 37 Rose St., Dept. 22, New York.

GUARANTEED Formulas, recipes, processes, 50c each. Catalogue free. Industrial Institute, Dept. 210, 64 West Randolph, Chicago.

ANT Killer. Old English formula. Harmless exterminator. Send 25c coin. Arthur, 166 Ridgewood Ave., New Haven, Conn.

FREE Formula catalog describing all lines. Western Chemical, Salem, Oregon.

RECLAIM Used motor oil, gallon 2c. Easy process. Guaranteed. No machinery. Send stamp. Ralph Brooks, Arkansas, Wis.

FORMULAS, Chemical analysis, catalogue free. Hartstein, Chemist, 206 North Prospect, Grand Rapids, Mich.

SUCCESSFUL Formulas for all products. Lists free. Ideal Formula Service, Box 891, Toledo, Ohio.

CHEMICAL Assistance. Manufacturing profitable with small capital. Guaranteed formulas. Free consultation. Analysis. Associated Chemists, Indianapolis, Indiana.

ARTIFICIAL Ice making formula, 50c. (Machinery unnecessary.) Nell Tasker, Shamokin, Pa.

FORMULA Encyclopedia \$1.00. List of contents free. J. Belfort, 4042 N. Keeler, Chicago.

FORMULAS: Beverages, syrups, extracts, flavors. Manufacturing everything. Valuable information free. The Formula Co., 5th Ave. and Broad, Seattle, Wash.

SUCCEED With your own products. Make-sell them yourself. Formulas, processes, trade-secrets. Expert analytical service. Catalog free. B. Thaxly Co., Washington, D. C.

FORMULAS All kinds. Catalog free. Clover Laboratories (P), Park Ridge, Ill.

FREE Formulas—Free materials making \$32.00 worth of guaranteed highest class specialty-necessities. Thirty-third unequalled anniversary offers explains all. Miller, Chemist, 1707-G Jetton, Tampa, Fla.

500 FORMULAS And big illustrated catalog 25c. Ideal Book Shop, Park Ridge, Ill.

MAKE Your own products. Employ agents yourself. Toilet articles, soap, extracts. We furnish everything. Valuable book free. National Scientific Laboratories, 1950W, Broad, Richmond, Va.

AGENTS WANTED

\$2 to \$4 Per hour easily made. Nothing ever sold compares with the sale of Christmas Greeting Cards in box assortments. Our 1931 assortment beats all our former triumphs, contains 21 exquisite cards and folders, dainty water colors, steel engravings, embossing, glistening gold metallic effects, tipped-off illustrations, parchment and deckled-edge folders, each with tissue lined envelope. Sells for \$1. Costs you 50c—shipping charges paid. Write for particulars and free samples. Waltham Art Publishers, 7 Water St., Dept. 99, Boston, Mass.

I START men in a grocery business a new easy way. You use my money. Don't need to put up a penny of your own cash for stock. Expansion program now opens up many desirable opportunities also established trade. Hustlers make good money from the start increasing rapidly as they learn the business. Not a "chain" proposition but your own business. Buy on credit. Give credit if you wish. If honest and need more money write at once for application and details to McCannan & Company, Room L-6611, Winona, Minn.

GENUINE Gold Leaf Letters anyone can put on store windows. Guaranteed to never tarnish. Large profits. Enormous demand. Free samples. Write today. Metallic Letter Co., 435-D North Clark, Chicago.

BIG Pay and a great future selling world famous Public Service shirts, ties, hosiery, underwear, work shirts, etc. Cash commissions paid in advance. Also liberal cash and merchandise bonus, also promotions to district manager positions paying up to \$7,000 yearly. We furnish everything free, and supply sales help. Write immediately for complete scientific selling outfit free. Public Service Mills, Inc., Dept. 2110, West New York, New Jersey. Canadian agents write: 119 Dundas St., London, Ontario, Canada.

CASH in your pocket every day. Every man needs pants, breeches, coveralls, shop-coats. Longwear's Work Clothes sell on sight. Belt free with every order for 3. No investment. Complete sales outfit free. Write today, Dept. P10, Longwear, 489 Broomfield St., New York.

START Right now with a prosperous house and a big-paying line. Wonderful opportunity to make \$15 profit a day and get a new Ford sedan besides. Investigate today sure. Albert Mills, 9283 Monmouth, Cincinnati, O.

FIFTY Dollars weekly selling Veltex guaranteed cosmetics, soft drinks, food products. One dollar brings 8 samples. Veltex Company, Birmingham, Ala.

HEMSTITCHER, New, different. Agents, demonstrators wanted everywhere. Money making line. Sample 10c, retails fifty and dollar. K. J. Manufacturing, 648 N. Vermont, Los Angeles, Calif.

SENSATIONAL Seller—Every man buys on 10-second demonstration; magnetic sharpener makes one razor blade give 6 months' shaves; 100% profit. Good income easy; free sample offer. Monroe Company, 119 West 23rd, Dept. F-10, New York.

GIVE Away three-strand pearl necklaces with famous Paris cosmetic sets at special \$1.00 price. Over 100% profit. Paris Laboratories, 3145 Locust, St. Louis, Mo.

BIG Profit Catalog. Toilet preparations, food products, remedies, household specialties, portraits, frames, medallions, Christmas cards. Credit. James Bailey Company, Station C10, Chicago.

MEN And Women represent famous hosiery and lingerie line. Undersell stores! Experience unnecessary! Liberal advance commissions. Free outfit! Adams Co., 611-K Washington St., Boston, Mass.

EXCEPTIONAL Profits, selling household necessities, remedies, toiletries. Write: Berthel, 212 Lincoln Avenue, New York.

LATEST Household invention. New rubber squeegee mop. Sensation everywhere. Ends stooping, scrubbing and wringing. Amazes women. Cleans and dries floor with same easy motion. Needed in every home, store, factory. Low priced. 100% profit. Also 47 other fast selling specialties. Free outfit. Write quick. Kristof Mfg. Co., 1440 Bar St., Akron, Ohio.

NEW Automatic Washer. Cleanses and sterilizes clothes quickly. No rubbing. No electricity. Fast seller! Price \$7.50. Automatic selling plan! Agents reap big repeat profits! Write Storm Royalty Co., 2601 Enright, St. Louis, Mo.

300% PROFIT Selling new 20-in-1 kitchen utensil. Retail 25c. Costs you \$1.00 doz. Sample 15c. Square Deal Mfg. Co., Desk PMM-1, Bradford, Pa.

BIG Profits Selling Groceries, Motor Oil, Paint, Stock Minerals. Sample Case free. Loverin & Browne, 1602-V So. State St., Chicago.

MAKE Up to \$2.00 every hour. Sell every home wonderful preparation. Mends hosiery and clothing without sewing. Send for free sample of work. Queen City Products, Dept. PM-10, Cincinnati, Ohio.

THE Christensen dirt removing oval double cone mop wringer. Price \$2.20. H. K. Christensen, Mfg., Ft. Atkinson, Wis.

80c PROFIT On \$1.00 sales. Cleaner for autos, furniture, metal and glass. Your name on labels. Exclusive territory. Free sample. Write Minute Kleen Laboratories, Dept. E, Evansville, Ind.

48 YEARS Makers of agents goods. Jones Mfg. Co., 243A2 Franklin St., Boston, Mass. Try us.

MAKE Your own products. Employ agents yourself. Toilet articles, soap, extracts. We furnish everything. Valuable book free. National Scientific Laboratories, 1950W Broad, Richmond, Va.

NEW Pat'd rear view mirror. Perfectly clear vision by day. No glare and better vision at night. Distributors wanted. MacNichol & Co., Inc., 3510 Perkins Ave., Cleveland, Ohio.

300% PROFIT Selling Mystery Gas Lighter. Retail 25c. Costs you \$1.00 dot. Sample free. Square Deal Mfg., Desk PM-24, Bradford, Pa.

NO Canvassing. \$50 weekly possible—home work. Free folder tells how. Southern Sales, Box M-774, Fort Worth, Texas.

REAL Money for you selling Celeco Coconut Oil Shampoo. Leaves hair soft and fluffy. Quality product. Attractive price. Big repeater. Generous sample for dime. Celeco, 4203 Waverly, Detroit.

JUST Out! Selling like wildfire! Auto Mud Guards for rear fenders. Car owners buy on sight. Proteto Co., Merchandise Mart, P. O. 3322, Chicago.

AGENTS—Sell our beautiful Christmas card assortments, gift wrappings. Wonderful line. Big profits. Write Nickel's Greeting Card Co., 119 North Seventh Street, St. Louis, Missouri.

"MAIL Order Selling" magazine, "Opportunity For You" booklet and "Big Twelve Proposition" 10c. Prutt System-A, Brookfield, Ill.

DISTRIBUTOR For patented, six-way non-split ash receiver; sells on sight; low cost; big profits; write for sample and territory wanted. Universal Units, Inc., 5713 Euclid Ave., Cleveland, Ohio.

SELL Christmas cards. Box assortments or personal cards. Unusual values. Large profits. Easy to sell. Howard P. Ellis, 15 Wildwood Ave., Pittman, N. J.

NEW, Profitable—Sell auto step mats. Quality rubber with owner's name molded white. Details free. Ebonite Products, Dept. X-40, 895 Main, Akron, Ohio.

CALIFORNIA Perfumed mission beads. Agents east of Mississippi order from Eastern headquarters Kulier Mfg. Co., 31-22 Northern Blvd., Long Island City, New York.

BIG Profits selling novel smokers set. Henry Ledlin, 4105 Washington St. N. E., Minneapolis, Minnesota.

MANUFACTURE Food flavoring, coloring, 600% profit! Whirlwind money-maker! Repeaters! Free labels. Bowen's, 218 N. 16th Street, Omaha, Neb.

BUY 900,000 Articles wholesale—300 jobbers, manufacturers—Directory 25c. Arts, B-1611-BM, Denver.

1000 BEAUTIFUL Gold window letters for 25c. Any size, color, design. Make 'em yourself. Complete manufacturing equipment made at home for \$2.00. Send dollar bill for details of press, printer, cutter, formulas, sketches, plans, blueprints. Information worth a fortune. Atlas Sign Works, 610 W. Michigan, Milwaukee, Wis.

EASY Money! Sell 25 card \$1. Christmas assortment, 100% profit. Also personal greetings. Experience unnecessary. Write for samples. American Cards, Dept. T-2, Lancaster, Pa.

STRANGE Ironing cord. Prevents scorching. Saves electricity. Abolishes kinks, snarls. Approved by Good Housekeeping. For telephones also. 200% profit. Samples furnished. Neverknot, Dept. 19-A, 4503 Ravenswood, Chicago.

FIVE placed 5,000 men in good paying jobs, selling shirts, ties, underwear, hosiery, workshirts, lumberjackets, etc. I'll give you a marvelous outfit free. Remarkable values get orders and repeats. Big cash commissions and bonuses. Write Dept. H19, Quaker, 1107 Broadway, New York.

AMAZING New electric trouser presser good for \$25 daily; puts razor edge in pants in 10 seconds, sells for \$2.50; your commission \$1.00. Sample fits pocket. Munny Mfg. Co., Dept. C-810, 817 Main St., Cincinnati, Ohio.

FREE Formula catalog, agents fast demonstrators. Western Chemical, Salem, Oreg.

MAN in each town to plate auto parts, reflectors, bathroom fixtures, refinish beds, mirrors, chandeliers; by new method. No capital or experience required. Simple plan of manufacturing at home starts you in big money-making business. Outfit furnished. Free particulars and proofs. Gun Metal Co., Ave. H, Desatur, Ill.

FREE Catalogue 50 best sellers, 5000% profit. Cost 5c to 6c. Retail up to \$1. Paty Needles, West Somerville, Mass.

GUARANTEED Hosiery—Lowest mill prices. Men's latest fancy hose—doz. \$1.25-\$1.50, ladies' fashioned hosiery—doz. \$2.25-\$3.25. Catalogue free. Superior Knitting Company, Dept. 34, New Haven, Conn.

ELECTRIC Water heater—New. Heats water instantly. Pocket size—retails \$3.75. Two minute demonstration makes you \$1.50 profit. Lux-Visol, Dept. 107, Elkhart, Ind.

AMAZING Elec. sensation brings agents up to \$15 in a day. 30 million prospects; wonderful demonstrator; \$1.50 seller. Write quick. Beardon Mfg. Dept. 10-PM, Peoria, Ill.

BIG Money and fast sales. Every owner buys gold initials for his auto. You charge \$1.50; make \$1.45. Ten orders daily easy. Write for particulars and free samples. American Monogram Co., Dept. 49, East Orange, N. J.

AGENTS: Stamping names on pocket-key protectors. Sample check with your name and address, 25c. Stamping outfits, Emblem checks, check-fobs, name plates. Hart Mfg. Co., Desk 2, 303 Degraw St., Brooklyn, N. Y.

MAKE Your own products. Employ agents yourself. Toilet articles, soap, extracts. We furnish everything. Valuable book free. National Scientific Laboratories, 1950W Broad, Richmond, Va.

100% PROFIT in new mystery cigar lighter. No snot or friction. What makes it light? No wind can blow it out. Retail 50c. Sample and sales plan 25c. New Method Manufacturing Co., Box PM-10, Bradford, Pa.

BIG Pay giving away shirts, hosiery, underwear. Also Lumberjackets. Smashing free offers win orders. Every man buys. No experience needed. We teach you and supply complete sample equipment free. Write Today, Dept. 025, Albert Shirts, 800 Sixth Ave., New York.

SO Good, it's foolish to call this selling. Men must buy shirts, ties, underwear, hosiery, other necessities. Roscliff's powerful year guarantee makes big money for you. Cash bonuses. Free shirt offer. Finest outfit free. Write today. Dept. K10, Roscliff, 1257 Broadway, New York.

300% PROFIT in new "20-in-1" kitchen necessity. Retail 25c. Costs you \$1.00 a dozen. \$10.00 a gross. Sample 15c to cover cost of mailing. New Method Co., Nu-Method Bldg., Desk PMM-10, Bradford, Pa.

BIG Proposition; no canvassing. Asso. Box 1681, Washington, D. C.

AGENTS—Distributors—Amazing secret formula Magic Mist. Sprays windshields, windows clean instantly; absolutely new \$1 seller; repeat sales; colored guns furnished. Exclusive territory. Write quick. Magic Mist Co., Dept. 10P34A, 1034 E. 75th Place, Chicago.

RAZOR Blades, double edge, improved—Hollow ground, ten cent packages, carded, easy selling. Sold everywhere. Standard Safety Razor, Pittsborough, Pa.

MAKE Up to \$5 an hour opening boxes. Write quick. Charles Lockwood, 612 N. Michigan, Dept. M-1, Chicago.

CASH in \$7.50 to \$12.00 a day with fast selling 25c household specialty. No experience or talking necessary. Self-selling envelope does selling for you. Write for free sample and particulars. A Masterlite, 110 E. 23rd St., New York.

FREE Cost to workers and big money weekly selling made to order raincoats. Lowest prices. Cash commissions advanced. Outfit free. Amazon, 1515-G Milwaukee, Chicago.

SELL Christmas cards. Unusual designs at prices that get the order. Prices begin at \$2.75 for 25 cards. Also two deluxe assortments. Sample book free. Southern Greetings, Dept. P, 161 Spring Street, N. W. Atlanta, Ga.

300% PROFIT, whirlwind seller. Sensational Nalustro cloth, cleans, polishes, all metals without liquid, paste, powder. Good Housekeeping tested, approved. Free sample. Shef D Mfg. Co., Weehauken, N. J.

REPLATE Brass worn-off automobile parts, reflectors, bath room fixtures, worn spoons, forks, etc., with pure silver. Looks like new. Use U-Kan-Plate Polish. Positively no mercury; \$1.00 half pints. Postpaid. Satisfaction guaranteed. Agents wanted. Dept. A, U-Kan-Plate Co., Philadelphia.

SELL Christmas cards (names engraved free.) New easy sales-method and samples 50 cents. Harold Smith Studio, Ellenville, N. Y.

BIG Money selling shirts, ties, underwear, Sox, raincoats, lumberjackets, sweaters, leathersuits, overalls, pants, play suits. Outfit free. Nimrod Co., Dept. 8, 4922-28 Lincoln Ave., Chicago.

FREE—One new rippie cloth necktie with each shirt. Sell 4 shirts for \$5. Improved non-ringing and pershrunk collar; also made to measure shirts; liberal commission. Menzin Shirt Co., 208 Greene St., New York.

NEW Invention makes any clock electric. Easily attached. Big Profit. Bestever Clock Co., 4319-P Irving Pk., Chicago.

"POLOX," The original, trademarked "Fluid Solder," repairs radiators, gasoline lines, tanks, furniture, dishes, etc. See article page 183 August issue Popular Mechanics. Secure agency genuine article. Polox Mfg. Co., Merriam, Kansas.

SELL Goodyear raincoats, \$2.95 up. Goodyear Rainwear, 18 West 22nd, New York.

SELL Personal Christmas cards. Names embossed in gold. Lowest prices, highest commissions. Samples free. Also box assortments. H. Dunbar Co., New Brunswick, N. J.

POLMET Polishing Cloth Removes Tarnish from all metals without the use of liquid, paste or powder. Our agents say it sells like "hot cakes." Retail 25c; sample free. Gale & Co., Inc., 15 Edinboro St., Boston, Mass.

250,000 ARTICLES Wholesale—Directory 10c. W-Patterson, 4111 University, Des Moines, Iowa.

SOMETHING The housewives want. A sized guarantee to save money and time in cooking. No competition. 400% profit. No license required. Station C, Box 25E, San Diego, Calif.

MIRRORS Resilvered at Home. Costs near 5 cents per square foot, you charge 15 cents. Profitable business plating autoparts, reflectors, tableware, stores, refinishing jewelry, etc. Outfits furnished, details free. Write, Sprinkle, Plater, 128, Marion, Ind.

SIGN Salesmen let us tell you about a New Changeable Sign that sells for \$1.50 and gives you 400% profit. National Sign System, St. Louis, Mo.

THAXLY Formulas produce perfect products. All lines. Catalog free. B. Thaxly Co., Washington, D. C.

AGENTS For handiwork: original powdered handsoap. Approved Good-Housekeeping. Everybody customer. Fine opportunity for hustler. Sample free. Solar Products, J-2144 So. Troy, Chicago.

SUCCEED With your own products. Make-sell them yourself. Formulas, processes, trade-secrets. Expert analytical service. Catalog free. B. Thaxly Co., Washington, D. C.

AGENTS—Engraved name plates, signs, number plates etc., easily sold with large profits. Bret Bros., Winthrop, Mass.

NO Dull times selling food! People must eat. Federal distributors make big money; up to \$3,000 yearly or more. No capital or experience needed; unsold goods may be returned. We furnish free sample case, license and free samples for customers—sure repeat orders. Exclusive territory. Ask now. Federal Pure Food Co., A2307 Archer, Chicago.

OUR Luminous crucifix and new luminous St. Theresa statue shine brilliantly in the dark. Sell on first demonstration. Write for prices. W. G. Hannan Co., 2543 So. State, Chicago.

BIG Money applying gold initials on automobiles. Easiest thing today. No experience needed. \$1.45 profit every \$1.50 job. Free samples. "Raleo," X-1043 Washington, Boston, Mass.

NEW Line Counter Displays, Aspirin, Films, Chewing Laxative, Breath Gum, Nostril, Silkstone, etc. Steady Repeat. Over 100% Profit. Superba Co., W5, Baltimore, Md.

THIS Advertisement may make you thousands of dollars, if you write immediately for my "Eye-Opening" literature describing guaranteed formulas; valuable trade processes, moneymaking information how to easily make the world's best-selling specialties. All lines. Investment small. Profits immense! Start in your home, room or office. Make the good money you're entitled to. Dr. Liscombe Miller, Chemist, Tampa, Fla.

CHICAGO Expert valued \$3 stone at \$900. The diamond's only guaranteed rival. Greatest spare time, side-line article ever known! Amazing profits. \$5 pocket sample case free. Write quick. Mexican Gem Company, Dept. PM, Monterey, Calif.

FREE "Booklet of money making opportunities." New ideas, original plans, money making secrets and other valuable information. None require peddling or outfits. Elite Co., 84 Elizabeth St., New York.

MAKE Your own products. Employ agents yourself. Toilet articles, soap, extracts. We furnish everything. Valuable book free. National Scientific Laboratories, 1950W Broad, Richmond, Va.

NEW! Men's leather belt has patented buckle that s-t-r-e-t-c-h-e-s. Real comfort. Sells on sight. Big commissions. Write Flexible Buckle Belt Co., FF-20 E. Jackson, Chicago.

We start you without a dollar. Soaps, extracts, perfumes, toilet goods. Experience unnecessary. Carnation Co., 641, St. Louis, Mo.

FLAVORING Extracts—Bottle yourself! Labels furnished. 600% profits! Whirlwind money-makers! Repeaters! Free offer. Thomas Manufacturing Company, Indianapolis, Ind.

CALIFORNIA Perfumed beads, selling like hot cakes. Agents coming money. Catalog free. Mission Factory, P. 2328W Pico, Los Angeles, Calif.

\$50-200 A WEEK. Genuine gold letters for store windows. Easily applied. Free samples. Liberal offer to general agents. Metallic Letter Co., 438-B North Clark, Chicago.

PHOTO Medallion men and women, the largest line of photo novelties in the world. Lowest prices, quickest service. Send for catalog showing over 200 money makers. Gibson Photo Jewelry Co., Inc., 833-837 Grassland Ave., Brooklyn, N. Y.

A BUSINESS of your own—Making sparkling glass name and number plates, checkboard signs. Big book and sample free. E. Palmer, 512, Wooster, Ohio.

SELL Stores 5c carded breathlets, etc. Lorrac Products, Albany, N. Y.

AMAZING Electric water heater. Pays big profits. Heats water instantly. Pocket size. Sells fast at \$2.95. Write quick. Besterer Co., 4317P, Irving Park, Chicago.

AGENTS—Clever! Invention! Inkspoon makes every pen a fountain pen. Fast office seller; big profit, demand increasing everywhere. Exclusive territory offered. Sample free. H. Marul Company, Tribune Bldg., New York, N. Y.

AGENTS Everywhere making money with our line of kitchen specialties, demanded in all homes. Big earnings possible. Write today for details. P. Seed Filter Co., 333 Broadway, New York.

SELL Men's neckwear—wonderful proposition. Astor-M, 39 East 28th, N. Y.

HIGH-GRADE SALESMEN WANTED

STOP Working For Small Pay—Start your own business on our capital; pays better than most occupations; hundreds average \$6,000 annual sales year after year; some established 30 years; many have acquired wealth, homes, farms, cars; we supply stocks, equipment, on credit; some 200 home and farm necessities; nearly 50 million sold 1930; selling experience unnecessary; wonderful opportunity to our pleasant, dignified, profitable business backed by \$17,000,000 world-wide industry; first send for complete information—then decide. Rawleigh Co., Dept. J-N-PPM, Freeport, Ill.

I'LL Pay you \$68 commission every week for taking just 2 orders a day for my sensational value made-to-measure suits. Fine woolens. Superb tailoring. Amazing money-making plans pay big money even to beginners. If you speak English, rush name for details sent free. W. Z. Gibson, Inc., 500 Throon, Dept. K-517, Chicago.

NEW! Men's leather belt has patented buckle that s-t-r-e-t-c-h-e-s. Real comfort. Sells on sight. Big commissions. Write Flexible Buckle Belt Co., FF-20 E. Jackson, Chicago.

BUSINESS Cards, high grade, \$1.50 per M. Card case free. Splendid side line or full time. Liberal commission to salesman. Southern Card Concern, Box 2633, C. H. Station, New Orleans, La.

SELL Nothing! \$170 weekly empty handed. \$500,000 punchboard firm announces new plan. No investment for anyone. Season starting. Hurry! K&S Sales, 4326 Ravenswood, Chicago.

ADVERTISING Novelty salesmen for new advertising specialty. Liberal commissions in advance. Gits Co., 3421-M Chicago Ave., Chicago.

SALESMEN—Depression is a stranger to our men. Dealers demand Metaloid. Steady repeater. Big profits. Grace, Box 553, Port Huron, Mich.

SO Good. It's foolish to call this selling. Men must buy Shirts, Ties, Underwear, Hosiery, other necessities. Roseliff's powerful year guarantee makes big money for you. Cash bonuses. Free shirt offer. Finest outfit free. Write today. Dept. L10, Roseliff, 1237 Broadway, New York.

SELL—Business getting serious idea to filling stations, druggists, grocers. Brings hundreds of customers. Helps business wonderfully. The new idea sells instantly. Good salesmen earn \$25 daily. Territory free. Here's your opportunity. Write Better Business Service, Dept. 2, Arkansas City, Kansas, for free booklet.

DISTRIBUTORS Wanted: Model-A Ford owners for distributors of fast-selling accessories. Protected territory. Big profits. American Supply Co., Quincy, Ill.

ACTIVE Man part or full time to look orders for complete line of nursery products. Cash weekly, no investment, colored outfit supplied. Exclusive territory. Write, Fairview Nurseries, Geneva, N. Y.

WANTED—County salesman with car, to demonstrate for large Ohio manufacturer. First class job. Fyr-Fyter Co., 2200 Fyr-Fyter Building, Dayton, Ohio.

100% PROFIT Selling patented article to golfers. Representatives cashing in on this new specialty. Write for circular and details. National Automatic Machines Co., St. Paul, Minn.

NEW, Different, Improved, business stationery line. Biggest commissions—bonuses, quickest delivery. Free copyrighted cuts. Experience unnecessary. Large outfit free. Willens Co., Dept. 385, 2129 Gladys Ave., Chicago.

SALESMEN—Wonderful sideline. 40% commission paid daily. Sells all merchants. Pocket outfit free. David Lionel Press, 312 So. Hamilton, Dept. 232, Chicago.

BRAND New—Sure fire trade stimulator. Every retailer buys. \$70-\$200 weekly in advance. Well rated company. Write today for free pocket outfit. Salesmanager, 4th Floor, 308 No. Michigan, Chicago.

STATE And district sales managers wanted for high grade mechanical product of universal usage. Investment required. Address reply to Chemunhealth Holding Corporation, 500 Lincoln Bld., Marion, Ind.

NEW Punchboard plan! We furnish everything! No investment for you or your customer! Nothing to sell or carry! 50% profit! Unsuitable merchandise returnable! Full commissions on repeats! AJ Novelty Co., 101-P, Washington, Chicago.

A Money-Maker!!! Grape Concentrates—Port, sherry, champagne, claret, etc., in solid brick form. One brick makes one gallon juice; legality established twice in Federal courts. Government financing industry. Every home, drug and grocery store, church, hospital, a prospect. 100% profit for salesman; no investment. State and county rights available. Apply: V. S. Co., Dept. S-211, 385 - 9th St., San Francisco, Calif.

BIG Money selling shirts, ties, underwear, socks, raincoats, lumberjackets, sweaters, leathereats, overalls, pants, playsuits. Outfit free. Nimrod Co., Dept. 65, 4922-28 Lincoln Ave., Chicago.

NEW, Practical household necessity, big commission, sample postpaid 50c. Viking Company, 406 S. Main, Los Angeles, Calif.

AGENCY Organizers for Solderite, the new and original metallic flowing solder; needs no heat or acid; tanks, pipes, radiators, dishes, furniture, jewelry. See article page 975, June Popular Mechanics. Fluid Solder Products, 1446 S. Wabash, Chicago.

AMAZING Secret formula. Magic Mist sprays windshields, windows clean instantly; absolutely new \$1 seller; repeat sales; colored guns furnished. Exclusive territory for salesmen distributors. Magic Mist Co., Dept. 10PMS, 1654 E. 75th Place, Chicago.

SPENTACULARLY Demonstrated poultry necessity. Every hour good. Sablin Mfg. Co., Pinehurst, Wash.

NEW Polish for silver, pewter, brass, etc. Big profit, easy sales. Modern Polish Co., Trenton, N. J.

PERMANENT Income assured for limited number high-class men immediately being employed. Exclusive territory. Patents just issued eliminate competition. Large line. Retail prices \$12.50 up. 40% commission. Repeat sales. Old established business. Meezan Neon Specialties, Inc., 21st and Oak, Kansas City, Mo.

ONE \$6.75 order daily means \$100 weekly on our guaranteed money back sales promotion deals. Free kit. Sales Stimulators, Dept. 15-H, 311 Madison, Chicago.

NEW And plenty different—Fast selling 5c-10c merchandise on attractive counter cards. 100% commission for you and dealers. Advertised by radio. No capital required. Catalog free. World's Products (Estab. 1921), 165 Central, Spencer, Ind.

SALESMEN Wanted to call on fish dealers. Snow & Parker, Inc., 41 Fish Pier, Boston, Mass.

SALESMEN—Become independent. Own your business; experience unnecessary, selling our \$10,000 accidental death; \$30 accident; \$25 sick weekly benefits—\$10.00 yearly. Other amounts proportionate. Guaranteed steady income from renewals. \$250,000 deposited insurance department. Universal Policy, Dept. A, 716 Lefcourt Bldg., Newark, N. J.

MAKE Money every day; establish agency selling men's All Wool Suits, Topcoats, Overcoats, below \$20.00. Pays you \$4.00 cash every order. Beautiful selection, easy to sell. Expensive outfit, sales help free. Write experience. All Wool Clothes, Dept. P10, 890 Broadway, New York.

BIG Pay giving away Shirts, Hosiery, Underwear. Also Lumberjackets. Smashing free offers win orders. Every man buys. No experience needed. We teach you and supply complete sample equipment free. Write Today. Dept. 029, Albert Shirts, 809 Sixth Ave., New York.

I'VE Placed 5,000 men in good paying jobs selling Shirts, Ties, Underwear, Hosiery, Workshirts, Lumberjackets, etc. I'll give you a marvelous outfit free. Remarkable values get orders and repeats. Big cash commissions and bonuses. Write Dept. J10, Quaker, 1107 Broadway, New York.

JUST Put our chewing gum outfit in your pocket. Make daily expenses. Sell to stores. Popular flavors; outfit furnished. Helmet Corp., Dept. 332, Cincinnati, O.

\$18 To \$25 Daily; biggest selling line of men's suits. Meets present day conditions. Amazing values at \$11.95, \$14.50, \$16.95, \$18.95. Also raincoats, slickers, topcoats and boys' suits. Biggest commission paid in advance. Liberal bonus. Free outfit. State age and selling experience. "Jim" Foster, Inc., Dept. 210, 2250 South Spaulding Ave., Chicago.

EVERY User of the mails needs an envelope sealer. The Kendall seals fifty minute. Retail \$2.50. Big profit. Good territories available. Kendall Sealer Company, Dept. 6, Berkeley, Calif.

SALESMEN—At last! New feature sells punchboards everywhere. Dealers wild with joy—prosperity back again. Profits enormous. Samples free. Puritan Co., 1467 Jackson Blvd., Chicago.

RECORD Breaking profits selling stores amazing new business stimulator. Low cost. Unusual features. Retailers buy on sight—repeat often. Commissions in advance. Outfit free. General Premium, 65-F, East Lake, Chicago.

SALESMEN Wanted, male or female. Good pay, pleasant work. Flag Printing Co., Deshler, Ohio.

\$25 DAILY Possible selling merchants printing, novelties, specialty items at half price. Quick delivery. Union label. 40% commissions advanced. Experience unnecessary. Elaborate outfit free. Northwestern, 625-D Jackson, Chicago.

\$100 AND More steadily every week. Call on merchants with newest, fastest selling line of counter display cards in colors. Immense repeats. No investment. Drexel Co., Dept. 7101, Elgin, Ill.

PART-TIME Salesmen making \$10 day, full time \$35. Box 58, Station 8, New York.

WE Want to hear from salesmen who can sell shotguns, rifles and accessories to sportsmen, rifle and revolver clubs direct. A. F. Stoeger, 509 Fifth Ave., New York.

GET Something that really sells. Auto seat covers \$1.95. Write today. Colorzone Company, Des Moines, Iowa.

SALESMEN—40% Commission daily. Save merchants 50%. Sell everywhere. Outfit free. Obell, 320 Locust, Des Moines, Iowa.

WONDERFUL Opportunity. Twenty dollars per day can be earned. Experience unnecessary. Home protection at cost. Ages one to eighty. \$250 to \$1000 at death. Not insurance. You make \$5 for each member secured. Childress, of Virginia, sent in 54 one day. National Aid Society, Myers Building, Springfield, Illinois.

MEN To sell Batteries with complete line of supplies to garages. Lowest prices. Mickman Battery Co., St. Paul, Minn.

PENNY Golfer, new fascinating coin-controlled game. Legal. Exciting. Merchants everywhere buy. Splendid commission. Specialty Mfg., 617 Division, Chicago.

SELL Egg Cartons! Dandy repeat slide line. Everyone who sells eggs needs cartons—grocers, poultry farms, dairies. Send for information and samples. Pick up these extra commissions. Self-Locking Carton Company, 575 E. Illinois Street, Chicago, Ill.

80% PROFIT On \$1.00 sales. Cleaner for autos, furniture, metal and glass. Your name on labels. Exclusive territory. Free sample. Write Minute Klean Laboratories, Dept. E. Evansville, Ind.

GREAT Sidekick for any salesman! Pocket outfit free. New cash customer Building Campaigns for merchants. D&H Premium Co., Dept. 538, 116 So. Wells, Chicago.

NEW Specialty—Sells every business and professional man. Four \$15 sales daily pay \$250 weekly. Foyer cleared \$1920 in three months. Write, F. E. Armstrong, President, Dept. PM, Mobile, Ala.

\$15.00 WEEKLY Job—Salesmen-Distributors! Outstanding opportunity, amazing new tire patch guaranteed 10,000 miles. Big profits, steady repeats. Protected territory as factory distributor. Write to Economy Rubber Products Co., 698 Burkhardt, Darton, Ohio.

PUNCHBOARD Salesmen—Most gigantic line ever featured. Vending machines—all kinds. Make as high as \$28.00 on single order. Repeat commissions. Beautiful colored catalog free. Lion Mfg., Dept. 8, 305 W. Erie, Chicago.

NEW, Largest color catalogue, punchboards, vending machines, produces quicker orders, big commissions. Free outfit. Lincoln Sales, 116 So. Wells, Chicago. Dept. D. Established 20 years.

15,000 PROFIT Making formulas, Following and many others: Accidents and emergencies, agriculture, alloys and amalgams, artist's materials, beverages, cements, glues, pastes, mucilages, bleaching, renovating, coloring metals, drying glass, heat treatment of metals, household formulas, ice cream, confectionery, chewing gum, lapidary work, exterminating vermin, lubricants, paints, varnishes, photography, condiments, canning formulas, rubber, soap, randles, soldering, toilet preparations, perfumes, waterproofing, fireproofing, writing materials. Just write for "Scientific American Encyclopedia of Formulas." When postman hands you book pay \$5.50 and postal charges. Popular Mechanics Press, Room 802, 200 E. Ontario St., Chicago, Ill.

HELP WANTED

HERE'S The money you need now! Wonderful opportunity to make \$71 profit a week. Brand new plan. Hundreds cashing in. Write quick, Albert Mills, 9289 Monmouth, Cincinnati, O.

MEN With or without car to operate branch offices everywhere and manage crews. Sales force secured by us through advertising in your local papers. House to house selling campaign. Good pay, experience unnecessary. Year round work. Bloch, Manager, 1100 Chatham Court, Chicago.

AMAZING New invention brings up to \$40 every week from grateful housewives. Sensational kitchen tool has five different uses. Sells on sight every home. Write for free sample offer, Tyler Mfg. Co., Dept. C-510, Muncie, Ind.

MEN—Establish routes for new peanut. Good pay. Sunshine Products Co., 2814 Hampshire Rd., Cleveland, Ohio.

"IF You want to fly" let Alexander Klemm, brilliant engineer, teach you. With great skill whole course of training has been simplified and made crystal clear. Remarkable book teaches in most practical and easily understood fashion. Recommended by skilled flyers. Sent C. O. D. anywhere in U. S. Simply pay postman \$2.50 and postage when delivered. Sent postpaid to any address upon receipt of price. Popular Mechanics Press, Room 802, 200 E. Ontario St., Chicago.

AGENTS—Moose corn and callous remover will build you a steady repeat business. Send today for pocket-size trial outfit. The Moss Company, 101 Searle Bldg., Rochester, N. Y.

GO into business—Make big money. We start you furnishing everything. Experience unnecessary. Federal Pure Food Co., X2367 Archer, Chicago.

AVIATION—Every person interested in this subject should make full use of the opportunity to learn aerodynamics with Alexander Klemm as his instructor, through his timely new book, "Simplified Aerodynamics." Heretofore this subject has been rather difficult for the thousands who need it. Klemm's method enables all to master it. Every pilot, mechanic, student needs it. Book. Pay postman price, \$3.50, and few cents postage when he delivers it. Order from Popular Mechanics Press, Room 802, 200 E. Ontario St., Chicago.

EDUCATIONAL AND INSTRUCTION

LEARN Welding, all types. Big opportunity trade—lowest tuition—finest equipment. National Welders, Kansas City, Kas.

CIVIL Service, complete course by J. Calley covers first, second and third grade examinations. Cloth bound, 234 pages, postpaid \$2.00. Carl Edquist, Odessa, Minn.

MAKE Gold clubs at home. We furnish material, instructions and buy clubs. Ralph Conrad, Aurora, Missouri.

BEGINNERS instructed for Florida hotel positions. Lee Institute, 144 Pearl, Somerville, Mass.

TYPEWRITING, Bookkeeping courses \$2.95 each; both \$4.95. Business Institute, Vandalla, Missouri.

10,000 MONEY-MAKING Formulas. Tells you how to make and sell almost everything under the sun; cosmetics, mucilage, antiseptic solutions, battery solutions, beverages, cheese, chewing gum, cleaning preparations, extracts, hair preparations, inks, bluing, leather polish, mirrors, perfumes, polishes, typewriter ribbons, carbon paper, washing powders, liquid soap, and hundreds of other profitable articles. Send no money. Just write a postal for "Hentley's 20th Century Book of Formulas." Pay postman postage and \$4. Popular Mechanics Press, 200 E. Ontario St., Room 802, Chicago.

U. S. Government steady jobs, \$105-\$250 month. Men—women, 18 to 50. Paid summer vacation. Short hours. Common education usually sufficient. Experience usually unnecessary. 25 coached free. Full particulars and list positions free. Write today sure. Franklin Institute, Dept. H3, Rochester, N. Y.

BEST Books for \$1. All formerly sold for \$2.50 to \$5 each. Select from the following list of guaranteed bargains. All brand new books: Woodcraft by Seton, Book of Letter Writing by Crowther, Ediquette by Eichler, Creative Chemistry by Slosson. Result in the Desert by Lawrence. Trader Horn, White Shadows in South Seas by O'Brien, Count Luckner (The Sea Devil) and Outline of History by Wells. Delivered at your door C. O. D. Simply pay postman \$1 each and postage. Popular Mechanics Press, Room 802, 200 E. Ontario St., Chicago.

BECOME A landscape architect. Unprecedented profession; wonderful opportunity for money-making. Easily mastered by mail. Earn while you learn. Est. 1916. Write for details. American Landscape School, 7 Plymouth Bldg., Des Moines, Ia.

YOU Need a better grip on mathematics? Ask us to send you a copy of "Mathematics for the Practical Man," only \$1.50. By common sense methods it removes the mystery and difficulties so algebra and calculus are made simple. Assuming your knowledge is limited to arithmetic you quickly and easily gain a working knowledge of algebra, geometry, Trigonometry and calculus. Simply pay postman when he hands you the package. Address Popular Mechanics Press, Room 802, 200 E. Ontario St., Chicago, Ill.

LEARN Weather forecasting! Booklet 25c. Merrill Jackson, 6545 S. Union, Chicago.

ADVANCED instruction course in Television. One complete book, \$3.75. Radio, Pacific Building, San Francisco, Calif.

BOOKKEEPING And accounting easily learned. Complete course \$1.00. Satisfaction guaranteed. Accounting Institute, Duluth, Minn.

LEARN Watchmaking at home, complete course, \$4.75. U. S. School of Watchmaking, 1167 N. Mayfield, Chicago, Ill.

PHOTOPLAY Talking picture and magazine stories wanted for revision, development and copyright. Sell on commission. Established 1917. Booklet free. Universal Scenario Company, 405 Meyer Bldg., Western and Sierra Vista, Hollywood, Calif.

DOUBLE Entry bookkeeping 60 hours with 8 keys guaranteed. (Diplomas.) International Bookkeeping Inst., 8 Springfield, Mo.

WANTED, Men-Women, 18-50, qualify for steady Government Jobs. Salary range, \$105-\$250 month. No Government experience required. Paid vacations. Common education. Thousands appointed yearly. Write Oxnent Institute, 101, St. Louis, Mo., immediately.

LEARN Photo-Engraving at home by experience. We supply without extra cost all necessary equipment. Make money while learning. Aurora School of Photo-Engraving, Aurora, Missouri.

DON'T Prepare for any civil service examination without seeing our catalog. Free. Columbia Correspondence College, Washington, D. C.

U. S. GOVERNMENT Wants men, \$1,700-\$1,900 and up at start. Railway mail clerk examination coming. Let our expert (former government examiner) prepare you for this and also rural carrier, post office, customs, internal revenue, and other branches. Write today for free booklet. Dept. 8, Patterson School, Rochester, N. Y.

TRADE AND TECHNICAL SCHOOLS

RADIO—Become radio operator, junior radio engineer or radio expert at America's leading radio school. Experience unnecessary. Common education sufficient. Can earn expenses. Excellent opportunities in business and Government service. Preparation for Government examinations. Also extension course by mail for students unable to come to Washington. Free catalogue telling particulars and why Washington is America's best place to learn radio. Loomis Radio College, Strand Building Washington, D. C.

SHORT STORIES

SHORT Stories revised, typewritten and marketed. Details free. Hursh Service, Box P-1013, Harrisburg, Penna.

BEFORE You submit that manuscript! Los Angeles professional will edit all kinds for \$2 a thousand words. Marketing suggestions. Send cash and stamps for return. Address Editorial Aid, Box 1103, San Pedro, California.

TYPEWRITERS AND SUPPLIES

TYPEWRITERS—All makes, \$4 to \$32. Fully guaranteed. Catalog free. Typewriter Works, Ada, Okla.

TYPEWRITERS—All standard makes \$10 up. Catalog free. Northwestern Typewriter Exchange, 121 N. Francisco Ave., Chicago.

ADDING MACHINES

NEW \$4.75 Automatic Adding Machine. Fully guaranteed. Bassett 1458-B, Hollywood Avenue, Chicago.

PRINTING, MULTIGRAPHING AND MIMEOGRAPHING

CYANOTYPE Your own distinctive letterheads with photograph for business or hobby. No special equipment. Complete instructions 75c, with chemical \$1.00, prepaid. J. Lloyd Lyne, 2245 South 51, Lincoln, Nebraska.

200 BLOTTER Business cards \$1.00. Kenneth Nickel, Printer, York, Penna.

200 LETTERHEADS, 100 Envelopes, prepaid \$1.00. Abbott Printery, Oswego, Kans.

200 LETTERHEADS And 100 envelopes, \$1.00; 200 letterheads, 8 1/2 x 11, 150 envelopes, \$2.00; 250 cards, \$1.00. Hoosier Print Shop, Portland, Ind.

BUSINESS Cards 1000—\$1.45. Free samples. Box 38, Station 8, New York.

500 LETTERHEADS, 500 Envelopes \$2.95. Ware, Box 357, Ft. Madison, Ia.

QUALITY Printing prepaid for less. Special—500 bond letterheads with envelopes \$3.75. New depression price list. Pound samples for dime. Premium. Big new plant. Webb-Print Press, Gettysburg, Penna.

5000 CATCHY 3 1/2 x 6 Folders, \$11.50. Circulars, stationery, postcards. All printing. Low prices. Samples. Goodprint, Harrisonburg, Va.

15 PERSONAL Printed Christmas cards—\$1.00. Applebaum-P, 1258 Brock, New York—200 sheets, 100 envelopes, 60c.

CHOICE Of letterheads, envelopes, cards, 250, \$1.35; 500, \$2.00. Press, 705 Ridge Road, Hobart, Ind.

WE Print stationery, booklets, catalogs, circulars. Samples. Commercial Press, Batavia, Ohio.

GUARANTEED Lowest printing prices. Blair, Box 260, Bowling Green, Ky.

IMITATION Typewritten letters. Low prices. Samples. Standard Company, St. Charles, Illinois.

LETTERHEADS, Envelopes, 500, \$1.10; 1,000, \$2.00; \$5,000, \$8.00, plus postage. Samples. Coyle & Kimballs, Newport, N. Y.

250 BOND Letterheads, envelopes, bill-
heads, cards, \$1.35 each. Economic Press,
Leonia, N. J.

1000 BUSINESS Cards \$2.75 postpaid.
Samples. Miller, Printer, Narberth, Pa.

PRINTING OUTFITS AND SUPPLIES

COMPLETE Printing outfits, presses,
type, ink, paper, supplies. Write for free
catalog. Kelsey Co., R-11, Meriden, Conn.

PRINTING OUTFITS—Presses, type supplies,
type nozzles. Send stamp for catalog.
Medel Press, York, Penna.

GUMMED LABELS

LABELS: Any kind printed labels. Cake
labels, candy wrappers, stickers. Send copy
or samples for prices. Old Dominion Label
Co., Bridgewater, Virginia.

1000 GUMMED Labels with your name,
address, business 50c each. Carl Edquist,
Odessa, Minn.

TRIAL Thousand three color stickers,
\$1.00, 15 words. Harvey Wolf, 6018F
Quincy, Cleveland, Ohio.

1,000 PRINTED: Name, business, address
50c. JBS Company, Box 93, Holyoke, Mass.

DUPLICATORS AND DEVICES

"EXCELLOGRAPH" Rotary stencil du-
plicator \$39.00. "Two-Faced" film dupli-
cator \$6.00. Booklet free. Pittsburgh Type-
writer Supply, Dept. 601, Pittsburgh, Pa.

RUBBER STAMPS

NAME, Address, 2 lines 25c; 3 lines
55c. Stamp Works, Auburn, Nebr.

FOR MEN

WHOLESALE Novelty, books, everybody
likes. Samples 10c. Photo-Art, Southamp-
ton, Mass.

SIDELINE—Cartoon books. Samples 10c.
20c. Meyer G P O. Box 471, New York.

WOOD Turning on the lathe. Both in-
teresting and fascinating. Send for a copy
of Milton & Wehlers Course in wood turn-
ing. It gives you quickly a complete mastery
of this manual art. 340 pages. Cloth. 141
plates. Sent C. O. D. Pay postman price
\$1.50 and small amount postage upon de-
livery. Popular Mechanics Press, Room 802,
200 E. Ontario St., Chicago, Ill.

FOR THE HOME

KEEP Your walls clean. Beautiful ra-
diator shields, priced to sell. Catalog free.
Write Leader Metal Prod. Co., D-4, St.
Louis, Mo.

THAT Concrete Job. Don't be afraid to
tackle it. With the instructions found in
the new edition of Popular Mechanics Con-
crete Handbook you can easily make 173
articles of utility and beauty ranging from
ordinary steps to garden furniture. This
book will be sent for only 98c plus postage
C. O. D. Send your order today to Popular
Mechanics Press, Room 802, 200 E. Ontario
St., Chicago, Ill.

ELECTRICAL REFRIGERATORS

BUILD Your own automatic electric re-
frigerator! use present inbox; costs only
\$34.50 complete as per our prints. No spe-
cial tools required; we supply special parts.
Complete instructions with blue prints and
text \$1.00. B & L Engineering Co., 706
Bergen Ave., Jersey City, N. J.

FOR SMOKERS

CUT Your cigarette cost—Green Rivers,
mildest, tastiest, natural tobacco cigarettes,
fresh from factory, \$1.25 carton, 200, post-
paid. Order a carton, Smoke 5 packs. If
you are not more than pleased, return 5
packs, and we'll refund \$1.25. Green River
Tobacco Co., Box 778, Owensboro, Ky.

A BILLION Ideas. This is the title of
our remarkable catalog of books along prac-
tical lines. Arranged alphabetically by sub-
jects for easy reference. If you have not
received it, send for a copy. You will find
hundreds of subjects you cannot usually
locate in book stores or public libraries.
Sent free upon request. Popular Mechanics
Press, Room 802, 200 E. Ontario St., Chi-
cago.

ANTIQUES, WAR RELICS AND INDIAN GOODS

ANTIQUES, Firearms, Indian relics,
daggers, swords. Lists free. Nagy, 8 South
18th, Philadelphia, (P) Pa.

INDIAN Relics, coins, curios, beadwork.
Catalog free. Vernon Lemley, Northbranch,
Kan.

10,000 INDIAN Relics—Birdarrow and
circular 10c. P. Heike, Pontiac, Ill.

SEND 3c For fine new list Indian relics,
antique firearms. F. E. Ellis, Webster
Groves, Missouri.

BOYS! Vacation fun galore. Every
Boy's Book of Handicraft, Sports and
Amusements. Just the thing for ideas and
suggestions for all outdoor stunts and rainy
days indoors. Big 706-page book full of
pictures, too. Sent postpaid upon receipt
of price \$2.75 or C.O.D. anywhere in U. S.
Popular Mechanics Press, Room 807, 200
E. Ontario St., Chicago.

FIELD GLASSES, TELESCOPES AND MICROSCOPES

\$5.00 GOVERNMENT Field glasses, pow-
erful, with carrying case. Large selection
binoculars, telescopes, field glasses, micro-
scopes, cameras, lenses, musical instruments,
guns, rifles. We buy, sell and exchange.
Send free bargain list. Well's Curiosity
Shop, 20 South Second Street, Philadelphia,
Pa.

EIGHT Mile binoculars. Only \$7.50.
Literature. Tarres, 3129 Natrona, Phila-
delphia.

TELESCOPE Wanted—Good 2nd hand in-
strument, 3-inch objective or over. Please
give particulars and selling price. Will
pay cash. Hamilton Mace, Peru, Ill.

RAZORS AND BLADES

YOUR Gillette, Probak blade, resharpen-
ed, 1c each. Petter Wetterquist, Rock-
ford, Ill.

PRECIOUS STONES

MOST Brilliant gem. Diamond's only
rival. Genuine Zircons from Ceylon. Sam-
ple gem \$3.00. Goetz Gem Co., Gallon, O.

MUSIC AND MUSICAL INSTRUMENTS

FORTUNES Being made from songs
through talking pictures, radio, phonograph,
music publishers. "Hit" writers revise, ar-
range, compose music to your lyrics. We
submit to studios and other markets. Free
reading. Send for booklet. Universal
Song Service, 625 Meyer Bldg., Hollywood,
Calif.

SONGWRITERS—Read "song require-
ments of talking pictures, radio and re-
cords" an explanatory instructive book sent
free to aspiring writers of words for songs.
We compose, arrange music and secure copy-
rights. Write today. P.C. Neumann,
Associates, 1674 Broadway, New York.

COMMERCIAL Music composed to song
words. Send 10c for The Song News Maga-
zine. None free. Hasenbein, 199 Nordstr.
Bremen, Germany.

MUSIC Composed—Autographed. Eddie
Applegate, 1309 First Ave., Asbury Park,
N. J.

COMPOSERS—Verse or music. Brilliant
opportunity. Write VanBuren, 2513 Mc-
Clurg Bldg., Chicago.

SONGWRITERS: Free examination of
song-poems or complete songs. Aid in prepa-
ration and marketing. Unsuitable returned
immediately. Chester A. Escher, Music
Publisher, 125 W. 45th St., New York City.

LYRICS Arranged, piano score, orches-
tration. \$10.00. Lee, 109 Judson, Syracuse,
N. Y.

SONG Poets, write Sequoia Songwriters
Service, Sherman Branch, Los Angeles,
Calif.

POEMS Wanted. Work guaranteed. We
publish. Great Eastern Song Bureau, Dept.
27, Thomaston, Me.

SONG Writers. Send for our "Publish-
ing Agreement." McKinley Music Printers,
1501 E. 5th St., Chicago.

WRITE Songs. Big money and reputa-
tion. Write for information. J. Gordon
Pub. Co., 201 N. Hoyne Ave., Chicago.

DUO-Flex reeds for clarinets and saxo-
phones eliminate your reed troubles. Write
for circular, Duo-Flex Reeds, 1204 1st Ave.,
Evansville, Ind.

"MUSIC Composed" to words. Bauer
Bros. (formerly of Sousa's Band), Oshkosh,
Wis.

SEND Song poems, 50-50 plan. Indiana
Song Bureau, (Brookside), Salem, Ind.

CORNETISTS—Trumpeters—Saxophonists
—Clarinetists. Get "Free Pointers." Name
instrument. Virtuos School, Buffalo, N. Y.

USE Shortcuts in Figures. Save valuable
time. The quickest ways of working all
problems. Instructions for drilling yourself
to be come rapid with figures. Complete, yet
simply itself. Just write a postal for
"Shortcuts in Figures." Pay postman \$1.25
and postage. Popular Mechanics Press, Room
802, 200 E. Ontario St., Chicago, Ill.

COPYRIGHTS

COPYRIGHTS Procured. Reasonable.
Free particulars. Wade Service, 2274-N
Brooklyn Station, Cleveland, O.

RADIO—Very latest information neces-
sary for proper operation, maintenance and
service in Modern Radio Practice including
Short Wave Receivers. New 224-page radio
man's guide now available at only \$1.00.
Sent postpaid upon receipt of price or
C.O.D. anywhere in U. S. Popular Me-
chanics Press, Room 807, 200 E. Ontario
St., Chicago.

PATENT ATTORNEYS

SELLING Before patenting. Safe, prac-
tical, copyrighted plan. Saves time, ex-
pense. Write Chartered Institute American
Inventors, 1139 Barrister Building, Wash-
ington, D. C.

INVENTIONS Patented and Exploited.
Former patent office examiner; Master pat-
ent law. Bend, Webster, Esq., No. 15 East
26 Street, New York.

MANUFACTURERS Everywhere seek new
inventions to improve their product. Names
of manufacturers and wanted inventions sent
free on request. Write W. T. Greene, 952
Barrister Building, Washington, D. C.

PATENTS Procured for inventors by for-
mer member Examining Corps, U. S. Patent
Office. Bates reasonable. A. Bostrom,
Registered Patent Attorney, 1618 West 13th
St., Brooklyn, N. Y.

PATENTS Procured. Prompt, careful ef-
ficient service. Highest references. Moderate
fees. Send sketch or model for actual search
and advice. George P. Kimmel, Master of
Patent Law, 54-J Westory Bldg., Wash-
ington, D. C.

PATENTS—Write for free information,
How to Obtain a Patent and Record of In-
vention—or send drawing or model for ex-
amination. Miller & Miller, Patent At-
torneys (former Patent Office Examiners),
1000-A Woolworth Building, New York;
239 McGill Building, Washington, D. C.

LACEY'S Patent Sense. Valuable book
free. See ad page 126.

TIME Counts in applying for patents. See
pages 132 and 133. Clarence A. O'Brien,
Registered Patent Attorney, Washington,
D. C.

PATENTS—Write for our free book, "How
to Obtain a Patent" and Record of Invention
Blank. Send model or sketch of invention
for inspection and instructions free. Terms
reasonable. See advertisement on pages
124 and 125. Victor J. Evans & Co., 934
Ninth, Washington, D. C.

PATENTS Obtained at low cost. Free
information. See page 126. Write today.
Harry W. Johnson, McGill Bldg., Wash-
ington, D. C.

INVENTORS: Send for booklet telling
how to patent and sell your inventions at
lowest cost. Ralph Burch, Patent Lawyer,
900 F St., Washington, D. C.

PATENTS. Send sketch or model for
advice. Free book, "How to Obtain a Pat-
ent." Established thirty years. Highest
references. Prompt service. Reasonable
charges. Chandee & Chandee, 908 F Street,
Washington, D. C.

INVENTORS—Write for our Guide Book,
"How to Get Your Patent," and Evidence of
Invention Blank. Send model or sketch of
your invention for our prompt examination
and instructions free. Randolph & Co.,
Dept. 430, Washington, D. C.

PATENTS Procured: trade marks regis-
tered—preliminary advice furnished without
charge. Booklet and form for disclosing
idea free. Irving L. McCathran, 704 Inter-
national Bldg., Washington, D. C.

PATENTS. Booklet free. Highest refer-
ences. Best results. Promptness assured.
Watson E. Coleman, Patent Lawyer, 124
Ninth St., Washington, D. C.

"INVENTOR'S Guide," valuable information, free. Frank Ledermann, Registered Attorney-Engineer, 1712 Woolworth Bldg., New York.

ESTABLISHED 1864. Milo B. Stevens Company. Free booklet, Patents. Trade marks. Copyrights. Offices. Menard Block, Chicago; Barrister Bldg., Washington, D. C.

LANCASTER, Allwiss & Rommel, 221 Ouray Bldg., Washington, D. C. "Originators of the Form Evidence of Conception." Before disclosing your invention to anyone send for blank form to be signed and witnessed. Form and patent information bulletin free.

FOR INVENTORS

WE Are equipped to finance, manufacture and market limited number of new devices and articles on royalty basis. If you have a new invention, we will be glad to consider its possibilities. Send complete description and diagrams. Include postage if material is to be returned. Robert Boniel, 1742 N. Prospect Ave., Milwaukee, Wis.

INVENTIONS Suitable for restaurants or confectioneries. Have factory and sales force. Will buy or on royalty basis. Other inventions given consideration. The Aircraft Mfg. Co., Dayton, Ohio.

NATIONAL Inventors Congress New Inventions Exposition, October 19th to 24th, Hotel Leamington, Oakland, Calif. Patents bought, sold and exchanged.

WANTED, Inventions, patented or unpatented, toys, games. Box 22, Fond du Lac, Wis.

LARGE Manufacturer wants complete or undeveloped ideas for inventions. 5,000 house-to-house agents waiting for new product to sell for \$8.00 or less. We will pay \$100 for any ideas used. Magic Damask Company, 831 Englewood Bldg., Cincinnati, Ohio. \$5,000 in bonds back of this offer.

INVENTIONS Patented and Exploited. Former patent office examiner; Master patent law. Benj. Webster, Esq., No. 15 East 26 Street, New York.

TIME Counts in applying for patents. See pages 132 and 133. Clarence A. O'Brien, Registered Patent Attorney, Washington, D. C.

LACEY'S Patent Sense. Valuable book free. See ad page 136.

INVENTIONS—Write for free book "How to Obtain a Patent" and Record of Invention Blank. Send model or sketch of invention for inspection and instructions free. Terms reasonable. See advertisement on pages 134 and 135. Victor J. Evans & Co., 157 Ninth, Washington, D. C.

SOUND, Practical inventions, patented, unpatented, now wanted. Write Chartered Institute American Inventors, 1135 Barrister Building, Washington, D. C.

HAVE You a good patent or pending application for sale? If so, write American Patents Corporation, 1220 Barrister Building, Washington, D. C.

MANUFACTURERS Will now buy inventions. Send for important circular free. Inventions patented and marketed. Canadian patents filed \$35.00 up. J. J. O'Brien, Patent Attorney, Engineer, 156 E. 42nd, New York City.

LOW Cost manufacturing. Large plant completely equipped for blanking, drawing, stamping and wire forming in any finish. Can save you money on your product. Our figures will convince. Eastern States Products, Box 721, New Haven, Conn.

NATION Wide search for best inventions. American Society of Inventors, Crosby Bldg., Buffalo.

INVENTOR'S Universal Educator: contains 900 mechanical movements; 50 perpetual motions; instruction on procuring and selling patents and selecting an attorney, etc. Suggests new ideas. Price \$1.00 postpaid in U. S. A. Address Dietrich Co., 662B Ouray Bldg., Washington, D. C.

MANUFACTURERS Everywhere seek new inventions to improve their product. Names of manufacturers and wanted inventions sent free on request. Write W. T. Greene, 944 Barrister Building, Washington, D. C.

ELECTRICAL Trouble shooting on the motor car and airplane. Don't trust to luck or guess work. Learn to make every motion count in testing and repairing. Send for our standard 493-page book for electricians and mechanics. 300 diagrams. Hundreds of practical tests. Pay postman \$4.00 plus postage when delivered. If outside U. S. remit when ordering. Popular Mechanics Press, Room 802, 200 E. Ontario St., Chicago.

PATENTS FOR SALE

FOR Sale—Harmless, fast selling toy. Baron Denniston, Oak Bluffs, Mass.

LONG Needed tool is invented, patented, and invention is for sale. Works by hand or power in closely confined places, on wood, metal, and composition manufacturing and repairing. A. A. Childs, Orleans, Mass.

FOR Sale, outright or royalty, burglar proof window lock and locking device for window screens, useful to hardware manufacturers, market for millions. Patents pending. Jos. T. Daulick, Jr., 199 Claremont Ave., Jersey City, N. J.

SOMETHING New. Railway railjoint, without fishplates, bolts or screws, simple construction, saves labor. Outright or royalty. Best offer accepted. Pat. in U. S. A. and Canada. Rob. Geese, 272 West Dominick St., Rome, N. Y.

NEW Form of umbrella; wish to sell patent right for America. Address Jean Crescentino, Sion, Switzerland.

OUTRIGHT. Apparatus for viewing small articles, has electric lighting and magnifying unit, is compact and portable. J. A. Bell, 802 E. 26th St., Norfolk, Va.

OUTRIGHT—Aluminum flexible fire escape ladder. Patented. Address Joseph L. Small, Winnisquam, New Hampshire.

BOAT Propelling unit. Eliminates tow boat. M. L. Louvier, 1038 Houston Avenue, Port Arthur, Texas.

MUST Sell patent No. 1740334, on "Mechanical Mouth." Breaks in smokers' pipes as sold. L. Churchill, 22nd St., Oshkosh, Wis.

CASH Or royalty—Crushed for breaking up solid matter mixed with any liquid entering a pump. John Ness, Hotel Albert, 722 W. 3rd St., Los Angeles, Calif.

MICROMILLIMETER Gauge. Patent pending. Simple, practical. Best offer gets it. Write G. H. Styrnell, Box 194, Bay Shore, L. I., N. Y.

SWEATER Stretcher. Adjustable sizes. H. Cook, 1623 Catharine St., Philadelphia, Pa.

TIME Counts in applying for patents. See pages 132 and 133. Clarence A. O'Brien, Registered Patent Attorney, Washington, D. C.

MANUFACTURERS. Get our complete list of inventions. American Society of Inventors, Crosby Bldg., Buffalo.

MANUFACTURERS Looking for new inventions should write W. T. Greene, 939 Barrister Building, Washington, D. C.

INVENTORS—Cash in on your invention now! Don't delay the sale any longer! Send for a free copy of our specially prepared booklet, "Turn Your Patent Into Money," today! It contains helpful information for all inventors. M. L. Rund, Mgr. Classified Advertising. Popular Mechanics Magazine, 200 E. Ontario St., Chicago, Ill.

MECHANICAL AND ELECTRICAL ENGINEERS

ELECTRICAL And mechanical movement problem. Fortune for solution. Name, address brings details. A. L. Armentrout, Eleron Eighteen East Twelfth Street, Long Beach, California.

MODELS AND MODEL SUPPLIES

INVENTORS: Send us sketch or crude model of your idea. Crescent craftsmen will develop it into a practical working model. 30 years of successful experience and thousands of satisfied clients. Confidential service guaranteed. Bank references furnished. Free illustrated book: "Making Inventions Pay." Crescent Tool Co., Dept. S-10, Cincinnati, Ohio.

MODEL Builders handy book of die cast products, pulleys, gears, saw arbors, grinding arbors, driver equipment. Mail 10c in coin for book. A. A. Lohler, 2512 West Monroe St., Chicago, Ill.

BOILERS, Engine castings, practical drawings, tools and supplies for model making. Stamp for reply. Howard, 2417 N. Ashland Ave., Chicago, Ill.

WHALING Barque Lagoda scale plans complete \$6. C. C. Walker, 83 Winthrop St., Taunton, Mass.

SHIPMODEL Fittings, Lists 5 cents. G. E. Anderson, 301 Parliament St., Toronto.

WHEELS Supplied for stage coaches models. Charles Schneider, Whitehall, Mich., Box One.

TIME Counts in applying for patents. See pages 132 and 133. Clarence A. O'Brien, Registered Patent Attorney, Washington, D. C.

MODELS, Tools, dies. General manufacturing. We carry complete stock aluminum, brass rods and sheets any shape. Modern Machine & Pattern Company, Terre Haute, Indiana.

WE Make working models for inventors and do experimental work and carry a complete stock of brass gears and model supplies. Send for catalog. The Pierce Model Works, Tinley Park, Ill.

MODEL Steam engines and boilers for miniature boats, boat and boiler fittings. Catalog 15c. Anton Bohaboy, 212 Price St., Rahway, New Jersey.

SHIP And yacht model fittings. Send fifteen cents for illustrated catalog No. 7. A. J. Fisher, 1002 Etowah Ave., Royal Oak, Michigan.

WOODTURNING For amateurs. Excellent new instruction book just published for the amateur and home work shop owner. Contains all the needed information and is well illustrated yet published to sell at the low price of 25 cents postpaid. Send for your copy today. Mail remittance with your order. Popular Mechanics Press, Room 802, 200 E. Ontario St., Chicago.

PATTERNS, WOOD AND METAL

WILL Make your patterns. Castings any material. Machine work. Models, tools, dies. Modern Machine & Pattern Company, Terre Haute, Indiana.

MANUFACTURING

MANUFACTURING. Models, dies, stampings, brasswork, moulds for castings, vulcanizing. Circular free. Baums Metal Specialties, Kansas City, Mo.

SPECIAL Machinery or parts, dies, tools, metal specialties, models, special gears, stock gears and model supplies. Send for catalog. The Pierce Model Works, Tinley Park, Ill.

LOW Cost manufacturing. Large plant completely equipped for blanking, drawing, stamping and wire forming in any finish. Can save you money on your product. Our figures will convince. Eastern States Products, Box 721, New Haven, Conn.

METAL Articles developed and manufactured. Model making. Reasonable price and first class workmanship. W. F. Meyers Company, Bedford, Indiana.

WIRE Goods made to order. Cooler Mfg. Co., 3210 Carroll Ave., Chicago.

ECONOMICAL Manufacturing from sheet, bar, wire or tubing. Models, dies, special machinery. Swanberg, 5124 N. Kildare Ave., Chicago.

SPECIALIZE Complete manufacture, dies, tools, special machinery and patterns. Models made. Atlas Indicator Works, 821 W. Washington, Chicago, Ill.

REFRIGERATING Machine, homemade. Inexpensive to build. Gives better service than ice. This and 528 other practical articles in our book "Home Mechanics." Just ask for this and "Handbook for Women," containing 294 valuable household helps and pay postman 98 cents and postage for the two books. Popular Mechanics Press, Room 802, 200 E. Ontario St., Chicago, Ill.

CASTINGS

GRAY Iron, malleable iron, brass, bronze, aluminum, white metal castings. Will make necessary patterns. Machine work. Modern Machine & Pattern Company, Terre Haute, Indiana.

BENDING MACHINES

THE Famous Hossfeld "Wrenchless" Universal Iron Bender is the last word in bending machines. Bends metal, cold or hot, into most any conceivable shape, including Eye Bolts and Automobile Spring Eyes. Bends up to 1" bars or 1½" pipe cold. Also bends "Angle Iron." Thousands in use by all classes of trade, from the smallest shops to the largest railway systems. Write for circular and prices. Hossfeld Mfg. Co., Winona, Minn.

BRONZE DIE CASTING MOULDS

DO Your own moulding soft metal ornaments. Send sketches or models for prices. Modern Art Service Company, Terre Haute, Indiana.

SURVEYING INSTRUMENTS

SAVE Money by buying our rebuilt transits and levels. All fully guaranteed—sold subject to field test. Cash or easy terms. Write today for list. Warren-Knight Co., M-510, (Makers of "Sterling" Surveying Instruments), 136 N. 12th St., Phila., Pa.

WELDING AND SOLDERING

BARGAINS—Excellent reprocessed arc welders, buffers and grinders. Entirely rebuilt—guaranteed. Trial. Terms. Write Ken's Service, Box M-1013, Troy, Ohio.

ALUMINUM Soldering Flux. Used by ordinary process with tin alloy. Also for copper, white metal, etc. Package \$1.00 addressed c.o.d. General Solder Manufacturing, 453 St-Joseph Street, Quebec City, Canada.

MACHINERY, TOOLS & SUPPLIES

13"x1' **SIDNEY** Lathe, practically new, complete, \$225.00; No. 3 1/2 Fox plain milling machine, \$175.00; No. 60 Heald cylinder grinder, \$500.00; 24" Hendey shaper, \$200.00; 10" new drill press, \$21.00; air compressor, complete with tank, motor, etc., \$100.00; battery charging outfit, complete, \$125.00. Write for catalog. Terms to suit. Cincinnati Machinery & Supply Co., 27 West 2nd St., Cincinnati, Ohio.

STARY Business of your own, small investment required, doing chromium, nickel, copper, silver plating. This work in big demand. Information free. Electro Platers Supply Co., 28 West Second St., Cincinnati, Ohio.

CONCRETE Building block machines and molds. Easy payments. Catalog free. Concrete Machine Co., 5 North Main St., St. Louis, Mo.

KELLOGG Air compressors, excellent condition, \$6.00. Taylor, 105 East 102nd Street, New York City.

HOMEURAPTSMEN: Used machinery, bought, sold. Educational Service, Dept. 4, Wales, Wisconsin.

BENCH Saw \$7.50. Wood turning lathe \$6.25. Write for bulletins. Hilet Co., Orange, N. J.

SUBSTANTIAL Savings—used arc welders, buffers, grinders, platers, compressors, paint sprays. Entirely rebuilt, guaranteed. Trial and terms. Write Ken's Equipment, Box M-1014, Troy, Ohio.

NEW 12" Bandsaw direct from manufacturer \$17.50. Write Kayco Machine Co., 3974 Parker Place, Cincinnati, O.

ENGINES, MOTORS AND DYNAMOS

AUTO Engines for stationary or portable power. We make necessary attachments. Thirty day trial. No cash down. Candee-Smith Governor Co., 215 North Los Angeles St., Los Angeles.

DEPENDABLE Light plants, 8 light, 32 or 110 volt, ready to go, with gas engine, \$36.50. Can be used for battery charging. Also new 1/2 HP. gas engines \$10.75. Bargains in electric motors, generators, etc. General Distributing Co., Storage Bldg., Duluth, Minn.

BRAND New 1/4 Hp. 25 cycle motors \$6.50; 1/2 Hp. 115V. DC \$15.00; 3/4 Hp. 32V. DC \$8.50. Large stock motors, generators, rotary converters, etc., at bargain prices. Queen City Electric, 1736 Grand Avenue, Chicago.

GASOLINE Engines: New 3/4 hp., four cycle, foot starting, mazetas, \$72.00. Harris Machinery, Minneapolis, Minnesota.

20 NEW Air compressors with 1/2 horse motors \$25.00. New 1/4 horse 1750 speed alternating motors \$6.50. Used \$4.50. New 1/2 horse 3450 speed alternating \$16.50. 1-horse same, \$25.00. Electrical Surplus Company, Dept. 12, 1885 Milwaukee Ave., Chicago.

TIME Counts in applying for patents. See pages 132 and 133. Clarence A. O'Brien, Registered Patent Attorney, Washington, D. C.

FARMS AND FARM LANDS

LAND Free if planted to bananas. Bananas bear a full crop the second year. \$5.00 monthly will plant a five acre orchard, which should pay \$1,500.00 profit annually. As bananas ripen every day, you get your check every 90 days. A reliable company will cultivate and market your bananas for one-third. For particulars address Jantha Plantation Company, Block No. 10, Pittsburgh, Pa.

FREE! Strouts Big Fall Catalog, 1000 farm bargains, Pg. 21 shows 35 acres on river, near city; good 8-room house, 40x50 barn, garage, fruit. Only \$1100 with cows, horse, tools; see picture. Write today. Strout Agency, 255-P Fourth Ave., N. Y. City.

FREE Books on opportunities in Minnesota, North Dakota, Montana, Idaho, Washington, or Oregon. Complete information on climate, crops, location for farm or suburban tract for grain, livestock, dairying, fruit, poultry—a home, independence, plenty of food, clothing, continuous employment. No occupation offers more to industrious capable men. Write E. C. Leeds, Dept. 257, Great Northern Railway, St. Paul, Minn.

OWN A farm in Minnesota, Dakota, Montana, Idaho, Washington or Oregon. Crop payment or easy terms. Free literature; mention state. H. W. Byerly, 119 Northern Pacific Railway, St. Paul, Minn.

GET Good land cheap on terms, fine neighborhood, grow certified potatoes, become independent. Mich. Acresage Co., P-681, 32 No. State St., Chicago.

SELL Your property quickly for cash, no matter where located. Don't pay big commission. Particulars free. Real Estate Salesmen Co., Desk B, Lincoln, Neb.

TEN Dollars monthly acquires five acres pecans, tangeres, figs, oranges. Guaranteed rare. Big returns. Suburban Orchards, Dept. M, Biloxi, Miss.

OZARKS—20 Acres, timbered, \$100. \$5 monthly. Poultry, hogs, fruit; fishing, hunting, trapping. Hubbard, 216 Grossman Bldg., Kansas City, Kansas.

RABBITS

RABBITRY Supplies. Circular free. Gessner Co., 4123 So. 40, Lincoln, Nebraska.

EARN Money raising rabbits. Get facts, Comrad Ranch, 852 Englewood, Denver, Colorado.

RAISE Rex rabbits. We pay \$10.00 each. Information 25c. Eastern Rabbitry, New Freedom, Pa.

48 PAGE Rabbit book 25c. Pedigreed, healthy, prolific New Zealand whites, 3 1/2 to 6 lbs. each, \$5.00 pair. Satisfaction guaranteed. United Sales Co., Dividing Creek, N. J.

RABBITS And supplies. Complete literature, 5c. Albert Facey, Inc., 115-X Valley Stream, New York.

MINK

ALASKAN. Kind you want. Very reasonable. Brookside Mink Ranch, Bernardville, N. J.

BIG Money made raising mink. Free information. Pennell Fur Farm, Dalkena, Wash.

DOGS

FOX, Deer,coon hounds; 25 years a shipper. Stephens Kennels, Marshall, Ark.

I HAVE Some fine shooting dogs well trained and shipped on trial. Write for booklet and descriptive price list. M. L. Turner, Herrick, Ill.

BEAUTIFUL Registered bull pups, \$15. Bulldogs, 501 Rockwood, Dallas, Texas.

HUNDRED Combsounds, foxhounds, rabbit-hounds, blueticks, redbones, blacktans. Supply catalog. Beckennels, A-51, Herrick, Illinois.

OTHER BREEDS

POULTRY, Puppies, pigeons, rabbits. List, stamp. H. Kiewiet, Route 4, Kalamazoo, Michigan.

WANTED—MISCELLANEOUS

MAIL Us your discarded jewelry, gold crowns and bridges, watches, diamonds, silver, platinum. Money promptly mailed. Goods returned if offer refused. United States Smelting Works (The Old Reliable) 39 So. State St., Dept. 71 Chicago.

FOR SALE—MISCELLANEOUS

NUMBERING Machines, automatic. Special low price. Midwest, Box 161, Springfield, Illinois.

MIMEOGRAPHs, Kardexes, addressographs, Ediphones. Bought, sold. Office Machine Exchange, 1902 Olive, St. Louis.

WATCHMAKERS Lathe for sale at a bargain. R. Jaegermann, 5815 Easton Ave., St. Louis, Mo.

UNDERWOOD 5. Standard office machine \$39.95. Checkwriter, duplicator, multi-graph, Dictaphones, bargain prices. Pruitt, 190 North La Salle, Chicago.

PERSONAL

SUPPORTO Appliance. Amazing invention that restores confidence. Immediate results guaranteed. Men write for valuable information. Surgical Co., 1906 San Pablo, Oakland, Calif.

ARE You old at forty? See our advertisement on page 48 of this issue. The Electro Thermal Company, 2146 Morris Ave., Steubenville, Ohio.

YOUR Portrait drawn. Real character study of yourself. Send 2c stamp. Fulton Studio, Box 600, Cleveland, Ohio.

XMAS Cards and envelopes 24, \$1.00, 25 with your name \$2.00. Box 1383, St. Louis, Mo.

QUIT Tobacco, formula and directions \$1.00. Health Institute, Vandalia, Mo.

BUNIONS Painless correction at home by removing the cause, then aiding nature. Liberal offer free. Write Eugene Eaton, 1105, Bandon, Oregon.

JOIN The Leals—Send 7 two cent stamps for four good songs, words and music and other literature. Leals of Science, Hazers-town, Md.

LIVING Pictures, moving, breathing, thrilling. 15c; two for 25c. Order yours now. Economy Sales Co., Dept. P., Manchester, Iowa.

"WHAT To Eat To Reduce," 20c postpaid. Edmond Hearn, 126 West 94th, New York.

TWO Great health secrets, increase your vigor, vitality, ambition, generate body electricity, no diet or strenuous exercise. Full instructions \$1.00. Auckland Press, Box 251 K, Dayton, Ohio.

HIGH Blood pressure inexpensively relieved. Send address. Thomas Stokes, Mowhawk, Fla.

BIBLE Mysteries explained by reader of its symbolism. Any question scientifically answered, \$1. Effie Brown, Dunsmuir, Calif.

ROOTS AND HERBS

GINSENG, Golden Seal, Lady Slipper roots, 25 for \$1.00 or \$2.00 per 100. Fall planting best. Leonard Guttormson, Lanesboro, Minn.

HERBS And Indian remedies. For all diseases. Send 10c for valuable Herb and Indian Doctor Book. Indian Herb Co., Centerville, Mich.

MISCELLANEOUS

SILK Neckties! Newest patterns, 3, \$1.55. Free folder. Oulmette's, 81 Holly D26, New Bedford, Mass.

TATTOOING Outfits, supplies. Free list. Chicago Tattoo Supply House, 434 So. State, Chicago.

COMPLETE Sets of castings for your home shop. Lathes, table saws, shaft hangers, etc. Assemble them yourself. Exceedingly low priced. Lynn Peicher, Ocean Beach, Calif.

PRINT Signs, pictures, without press, type or machinery. Samples 10c. Straley, 1314 W. Main, Springfield, Ohio.

200 TRICKS You can do—Mystify your friends; have loads of fun. This collection of tricks has been selected by Thurston for the average person. Neither unusual skill nor elaborate apparatus are required. Send for this 200-page illustrated book. Pay postman \$1 plus postage when delivered. If outside U. S. remit when ordering. Popular Mechanics Press, Room 802, 200 E. Ontario St., Chicago.

ELECTRIC Tattooing Machines. Low prices. Wm. Jones, 133 Ward St., Paterson, N. J.

TATTOOING Outfits, supplies. Remover, \$5.00. Miller, V431 Main, Norfolk, Va.

HOMEOPATHIC And biochemic preparations sent postpaid to all parts of the world. Booklets free. Halsey Bros. Co., 5547 Ravenswood Ave., Chicago. Established 1855.

TATTOOING Outfits, supplies. Illustrated list free. "Waters," 965 Putnam, Detroit.

AMATEUR Cartoonists—Earn \$25.00 week, spare time, copying cartoons for advertisers. S-M Syndicate, Argyle, Wis.

AMATEUR Cartoonist: Sell your work. Write Smith's Service, P.X1194, Wenatchee, Wash.

OIL HEAT

**NEW
LOW
PRICES**

LISTED AS STANDARD BY
UNDERWRITERS LABORATORIES

Amazing Features Startle Heating Industry as LACO Burns Oil or Gas. Avalanche of Orders Swamp Dealers. Profits Range from \$5,000 to \$50,000 Yearly!

HERE'S the greatest announcement in years. A chance for fortunes to be made almost over night! This famous engineer who amazed the heating industry when he discovered a revolutionary new way to burn oil by turning it into gas—THE LACO MINERAL WICK—again has thrown a bombshell into the industry! Just a few strokes and presto—LACO BURNS EITHER OIL OR GAS! With one great sweep it costs the price of AUTOMATIC HEAT TO A FRACTION of former coal! opens up the greatest market in the world for dealers, salaried men, and jobbers. 26 sizes and models for every home owner and renter—millions of them—factories, apartments, sky-scrapers, bungalows—all can enjoy luxurious, warm, clean, convenient automatic oil or gas heat! Fits instantly into present heating plant. NO COAL OR ASHES! NO SMOKE OR SOOT! AT LOWEST PRICES IN THE HISTORY OF AUTOMATIC HEAT. LACO smashes fuel costs. Burns either oil or gas as cheap as coal. With none of the bother. No wonder dealers report \$5,000 to \$50,000 annual profits. Orders simply here swamp them since we announced the new low prices, and startling new features. Install your Laco now. Just write and tell us type of heating system you have and number of rooms you want to heat.

SPECIAL OFFER FOR DEALERS

If you act right now, we'll make you a special offer—the same offer that has made thousands of dollars for others. Low investment, Big Field and Profits. No service required. Don't wait. Read right now. Get the complete facts. Hurry. It won't cost you a cent! Special opening for large jobbers.

SENSATIONAL DISCOVERY!

There's a new remarkable Mineral Wick—oil burners use also especially best treated and indestructible—it turns oil into hydro-carbon gas. Burns as cheap as coal—without waste. Burns ordinary gas, too—manufactured or natural—more than 25% more efficient than ordinary burners. THINK WHAT THIS SAVES YOU IN FUEL COSTS. Other new LACO FEATURES include new air and oil control valves, wider range and increased heating capacity, without extra oil consumption, new removable wick chamber that burns longer with less attention, new flame control, and many others. Write today for complete information and how you can enjoy the comforts of automatic oil heat at smoking low cost.

LACO OIL BURNER COMPANY

DEPT. 148, GRISWOLD, IOWA One of the World's Largest Makers of Oil Burners U. S. A.

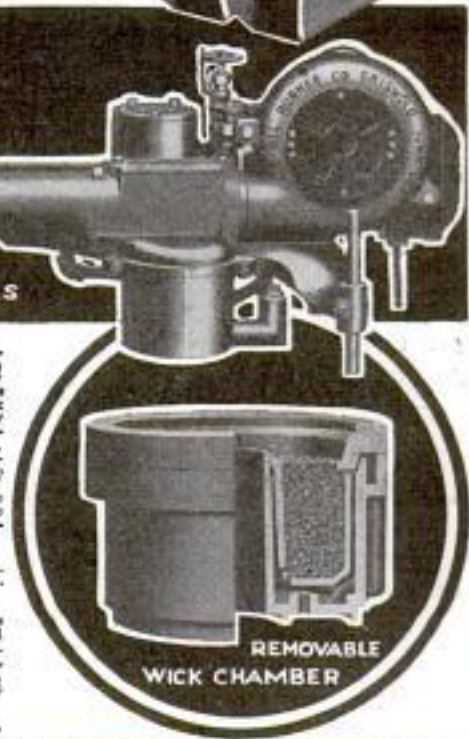

REMOVABLE
WICK CHAMBER

Cal. 30-40 Six Shot



KRAG CARBINE

Price
\$9.75

All the qualities of a high price rifle. In fine used condition, all working parts guaranteed for one year. Send today for our Free 60-page illustrated catalog of money saving values; Guns, Ammunition, Cutlery, Sports and Gov't goods. Deposit required on all orders. Money refunded if not satisfactory. W. Stokes Kirk, Dept. P. M.-10, 1627 N. 10th St., Phila., Pa.

CRIME DETECTION SECRET SERVICE AND FINGER PRINTS

SECRET SERVICE BOOK FREE

For 30 Days Reading
No Money Down—Actual Crime Cases—
If You Act Quick!—We will send you this stirring book on Crime Detection, Secret Service and Identification. Work for 30 days free reading. Spend no money. If you decide to keep it, then send only \$1.00. If not, return it. WRITE TODAY. Not sent to boys under 17 years of age.

T. G. Cooke, Book Dept. 13-57 1920 Sunnyside Ave., Chicago

SAVE ON TIRES

LOOK! TIRES NEW LOW PRICES Why Pay More?
GOODRICH · GOOD YEAR · U.S. Firestone and OTHER TIRES

Lowest Prices on Earth!
Thousands of satisfied tire users all over the U.S.A. Our 16 years of business speaks for itself. This big responsible company will supply you with reconstructed standard make tires at lowest prices in history—Guaranteed to give 12 months' service

Don't Delay—Order Today

CORD TIRES			BALLOON TIRES		
Size	Tires	Tubes	Size	Tires	Tubes
30x3 1/2	\$2.20	\$1.00	28x4.40	\$2.30	\$1.10
30x3 3/4	2.25	1.00	28x4.50	2.40	1.15
31x3 1/2	2.70	1.15	28x4.50	2.45	1.20
31x3 3/4	2.95	1.15	28x4.75	2.45	1.20
32x4	2.95	1.15	28x4.75	2.45	1.20
32x4	2.95	1.15	30x4.35	2.90	1.25
34x4	3.50	1.15	28x5.00	2.95	1.25
32x4 1/2	3.20	1.45	30x5.00	2.95	1.25
32x4 3/4	3.40	1.45	28x5.25	2.95	1.25
34x4 1/2	3.45	1.45	30x5.25	2.95	1.25
30x3 1/2	3.60	1.70	31x5.25	3.10	1.50
30x3 3/4	3.60	1.70	30x5.77	3.20	1.40
30x3 1/2	4.45	1.70	30x5.00	3.20	1.40
			31x5.00	3.20	1.40
			32x5.00	3.20	1.40
			32x5.00	3.20	1.45
			32x5.25	3.50	1.45

All Other Sizes DEALERS WANTED

Send only \$1.00 deposit with each tire ordered. We ship balance C.O.D. Deduct 5 percent if cash in full accompanies order. Tires failing to give 12 months service will be replaced at half price.
YORK TIRE & RUBBER CO., Dept. 409-A 3855-59 Cottage Grove Ave. Chicago, Ill.

DO YOU WANT a new business profession of your own, with all the trade you can attend to? Then become a foot correctionist, and in a few weeks earn big income in service fees, not medical nor chiropody—easy terms for home training, no further capital needed, no goods to buy, no agency. Established 1894. Address Stephenson Laboratory, 1 Back Bay, Boston, Mass.

BE AN OIL EXPERT!
New, easy, practical way to learn at home in spare time. Geology, Drilling Methods, Pipe Line Transportation, Refining and Marketing. Write Today! FREE Book!
PETROLEUM ENGINEERING UNIVERSITY, Dept. 220-A, FORT WAYNE, IND.

How to get the **VOCABULARY** you want WITHOUT using a **DICTIONARY**
Special Offer—55 Course Only \$ 1
A complete, amazingly simplified and practical \$5.00 Course (exactly as given in our Resident School) to increase and broaden your vocabulary. Results immediate. Year 3 restores your fluency. Mailed postpaid, for \$1. NAGARA SCHOOL, Inc., 210 B.L.E. Bldg., Cleveland, O.

Why STAMMER?

I overcome my own stammering. Let me help you. My new, free book tells how. You, too, can overcome your speech defects and live a normal, happy and successful life. Write today.

ROST, E. CARD, 12993 Woodward Ave., Detroit, Mich.

Free Book

When writing please mention Popular Mechanics

Learn AVIATION

WHERE LINDBERGH LEARNED!

**Guarantee Yourself
One of Best Jobs!**

Lincoln-trained mechanics and pilots get the best positions. Superior training is the reason! Lincoln mechanic students get practical training with factory standards on real planes; we are connected with a large aircraft factory. Pilot students learn on 4 distinct types of ships. Also welding and radio courses. **Ground and Flying School government approved.** \$250,000 worth of buildings and equipment. \$100,000 airport. Government-licensed instructors. Reasonable tuition. Part time employment to help pay cost of room and board while training. We also teach in Spanish. Write for catalog, stating your age!

LINCOLN AIRPLANE & FLYING SCHOOL
203A Aircraft Bldg. Lincoln, Nebr.



**\$100 to \$500 A WEEK IS EARNED BY
CARTOONISTS TODAY**

Do you like to draw? Send \$1.00 for our self-instructive course in cartooning consisting of 30 lessons illustrated, with over 300 drawings. Outside U. S. A. \$1.20.

SCOVELL ART STUDIOS, Box 610, Hollywood, Calif.

RADIO NEEDS BETTER MEN!

Can you qualify? Men who will occupy positions of leadership in 1935 in Radio are fitting themselves NOW! By study. By training. By laboratory experience. You have time! Each week you waste 43 hours. Precious hours... that can insure you a better job... bigger pay. Write today, RCA Institutes, Inc., Dept. MPO, 75 Varick St., N. Y. C., giving age, occupation, and branch of radio you prefer.

LEARN WATCHMAKING

and become independent. We help you secure a position.

Easy to learn. Send for FREE CATALOG.

ST. LOUIS WATCHMAKING SCHOOL Dept. S. ST. LOUIS, MO.

Information on any book free. Write Popular Mechanics Press, Chicago, Ill.

NEW 16th EDITION DYKE'S WORLD FAMOUS AUTO BOOK

RIGHT UP TO DATE WITH

Free Wheeling
Synchro Mesh Trans-
missions
Down Draft Carburetion
Ignition Synchronizing

Front Drive
Electrolock Ignition
Switch
Oil Viscosity Tables
16-Cylinder and Other
New Engines

DON'T think of "Dykes" as just one book on Autos. With its 1,339 Pages, 4,400 Illustrations and 15,000 lines of Index it comprises a Complete Automotive Library the equivalent of which in separate volumes would cost you over \$20. If you make your living in any branch of automobile work you need the new "Dyke" covering all the latest engineering improvements and refinements of construction.

PRICE
Cloth—\$6.00
Flexible Morocco—\$7.50

Postpaid upon receipt of price or C.O.D. anywhere in U. S.

**POPULAR MECHANICS
PRESS**
Room P-10
200 E. Ontario St.
CHICAGO



Want Friends, Money Popularity? GET INTO AVIATION

Fun, thrills, action, popularity and plenty of money—that's what awaits you young live-wires who get into Aviation now. Experts predict the greatest boom that Aviation has ever known. And they are getting ready for it. Take a tip from the biggest men in the business. Start your aviation training today and be ready to ride the crest of tomorrow's wave of prosperity.

Learn Quickly at Home

Just give me one hour a day. That's all I want. In a few short months you'll be trained in Aviation—ready to take your place in the most fascinating of all professions. Your choice of 40 high-pay ground jobs will be open to you. Then it's only a short step to your flying license. I will arrange for your flying instructors at special reduced rates either in Dayton or near your home. Don't miss this chance. If you've got red blood in your veins—if you crave life, action, excitement, adventure, popularity and if you want more money—write for Free Book that tells all about my Tuition and Employment Offer. No cost or obligation. Do this now.

Major Robt. L. Rockwell
The Dayton School of Aviation
Desk 101 Dayton, Ohio



NOW FREE Big 36-page book—scores of photographs—fascinating reading.
WRITE TODAY

MORE PAY

That's what you want above everything else—more money to spend. Then pleasant work in a business that will last and get better.

ALL TOOLS FURNISHED

LEARN DRAFTING FROM AN ENGINEER

WRITE FOR FREE PAY-RAISING PLAN

I train you right at home for the great profession of drafting. I can prove that men I have trained have earned more than \$100 per week. They have made good on great big jobs because I gave them just the kind of work they had to do when they started on their first job. It was easy for them. They learned drafting from an engineer. Let me train you just like that.

Write for "My Pay-Raising Plan."

Engineer Dobe, 1951 Lawrence Ave., Div. 13-57, Chicago
Send me free and postpaid, your book, "My Pay-Raising Plan" also Practical Draftsmanship Book and Special Offer on all Drafting Tools and Table furnished to me without extra cost.

Name _____
Address _____
City _____ Age _____



This Revelation Will Startle Men Past 40!

But It May Bring Years of Comfort to Their Lives!

HAVE you lost much of your strength? Do you suffer from pains in back, legs and feet? Are you forced to get up 2 to 10 times at night? Are you a victim of nervousness, fatigue, dizziness, mental depression, chronic constipation, sciatica, bladder trouble? Many men past 40 often mistake these ailments for symptoms of approaching old age. They undergo prolonged treatments that frequently bring no relief and a life of miserable old age. Because they fail to strike at the real trouble.

The True Meaning of a Tiny Gland

Science has found that these ailments in men past 40 are often due to Prostate Gland failure. This tiny gland becomes swollen and fails to function. Unless corrected it will likely grow worse. The result is often wretched old age or grave surgery.

What This Treatment Really Means

Now an American scientist has perfected an amazing drugless home treatment used and endorsed by physicians and sanitarians. It goes directly to the area of the prostate gland, relieving congestion, increasing circulation, toning and stimulating. Many users report relief almost over night. Others say they actually felt 10 years younger in 7 days. Not a drug—medicine—nothing to swallow—massage—diet—violet ray—or exercise. It is a natural method. Any man can use it in the privacy of his own room.

200,000 Men Have Found the Answer

They have been shown the secret of new health and strength in keeping this tiny vital prostate gland active at the period in many men's lives when it begins to fail.

FREE— If You
Act Now!

The results of this new method are so startling that the inventor will let you test it on 7 days' Free Trial. If it doesn't bring immediate relief—if it doesn't make you feel 10 years younger in 7 days—it will cost you nothing. Mail the coupon for details and Free copy of "The Destroyer of Male Health." It tells amazing facts that may prove priceless to you. No obligation.



If you live West of the Rockies address The Electro Thermal Co., 303 Van Nuys Building, Dept. 21-Z, Los Angeles, Calif. In Canada, address The Electro Thermal Co., Desk 21-Z, 53 Yonge St., Toronto, Can.

W. J. KIRK, President,
2146 Morris Ave., Steubenville, Ohio.

Send details of Free Trial and Free Copy of "The Destroyer of Male Health." No cost or obligation.

Name.....

Address.....

City.....State.....

When writing to advertisers please mention Popular Mechanics

DeForest Makes Deaf Hear! Famous Inventor Sends Marvelous Device With Miniature Earpiece on Ten Days' FREE Trial

Hard of hearing people throughout the world will be delighted to know that Dr. Lee DeForest, the famous inventor of Radio and the Talking Pictures, has developed a marvelous hearing device with a small earpiece only one inch in size and moderately priced.

It is more powerful than any other electrical hearing device yet produced and is entirely free from the harsh squeaking noises of other devices.

We have arranged to allow every earnest hard of hearing person to try the wonderful new universal DeForest audiphone at home, on Ten Day Trial. Free of all cost or obligation or deposit.

If you are hard of hearing, do not delay—write today for your free trial, which we know will delight and amaze you. Address Mr. Charles H. Lehman, President, Hearing Devices Company, Inc., 2417 Times Building, New York.

QUIT TOBACCO

No man or woman can escape the harmful effects of tobacco. Don't try to banish unaided the hold tobacco has upon you. Join the thousands of inveterate tobacco users that have found it easy to quit with the aid of the Keeley Treatment.

KEELEY Treatment For
Tobacco Habit
Successful For
Over 50 Years

Quickly banishes all craving for tobacco. Write today for Free Book telling how to quickly free yourself from the tobacco habit and our Money Back Guarantee.

Home of the famous Keeley Treatment for Liquor and Drugs.
Booklet Sent on Request. Correspondence Strictly Confidential.
THE KEELEY INSTITUTE, Dept. A-950, Dwight, Illinois

Save Your Feet

When all else fails end your suffering with the flexible "no metal" Heelner ARCH SUPPORT



HEEFNER ARCH SUPPORT CO. 683 M. E. TAYLOR BUILDING LOUISVILLE, KY.

LUCKY TIGER

FOR HAIR AND SCALP!



A single application stops that miserable itching. A single bottle corrects scalp irritations. A Proven Germicide, delicately perfumed, safe for adults and children. World's largest seller at Druggists, Barber's, Beauty Parlors.

GUARANTEED

Information on any book free. Write Popular Mechanics Press, Chicago, Ill.



AN EASY WAY TO

SHAPE your NOSE

Anita Nose Adjuster shapes flesh and cartilage—quickly, safely, painlessly, while you sleep or work. Lasting results. Gold Medal Winner. Doctors praise it. 87,000 users. Write today for **FREE BOOKLET.**

ANITA INSTITUTE, L-12 Anita Bldg., Newark, N. J.



AVIATION MECHANICS COURSE

Aviation is growing rapidly. Train to be an Aviation Mechanic. No other industry offers a brighter future, more interesting work or better pay.

Prepare for a good position in Aviation at one of the Curtiss-Wright Aeronautical Universities—leading Aviation Schools in the United States. A new Mechanics' Course provides the best preparation that you can possibly find. The sound, practical experience you obtain in this course applies towards a United States Department of Commerce airplane and engine mechanic's license.

Curtiss-Wright Aeronautical Universities are located at New York, Chicago, Los Angeles, Baltimore, Boston, Pittsburgh and 25 other leading cities. If you are looking for a real opportunity and a chance to make big money, mail this coupon for complete details about the Curtiss-Wright School near your home.

CURTISS-WRIGHT AERONAUTICAL UNIVERSITY

27 WEST 57th ST. NEW YORK, N. Y.

Curtiss-Wright Aeronautical University
27 West 57th Street, New York, N. Y.

Please send me complete details about your new
Aviation Mechanics' Course.

Name.....

Address.....

City.....

State.....

Government Positions

Clerk Carriers, Rural Carriers, Railway Mail Clerks, Postmasters, Department Clerks, and many others. Splendid salaries, easy work, vacation with pay. Only common school education required. Examinations often. 44,817 appointed last year. Send for our Civil Service Catalog No. 6. **COLUMBIAN CORRESPONDENCE COLLEGE, Washington, D. C.**

NO JOKE TO BE DEAF

—EVERY DEAF PERSON KNOWS THAT



George P. Way made himself hear, after being deaf for 25 years, with Artificial Ear Drums—his own invention. He wore them day and night. They stopped head noises and ringing ears. They are invisible and perfectly comfortable. No one sees them. Write for his true story, "How I Got Deaf and Made Myself Hear." Also booklet on Deafness. Address



Artificial
Ear Drum

George P. Way, Inc., 610 Hofmann Building, Detroit, Michigan

Stop Slamming Doors EARN UP TO \$15 Daily!



Kant-Slam Door Check is an amazing new invention that closes all doors silently and automatically. Closing speed easily adjusted by turning screw at top of check. Holds doors open when wanted open. Operates on new oil principle. Low priced. Everlasting. Easily installed in 10 minutes. Never needs attention.

A REAL DEMONSTRATOR FURNISHED EVERY AGENT

You get orders quickly demonstrating actual sample on easy to carry miniature door. Every office, factory, store, institution and public building needs a Kant-Slam for every door. Rich name and address for details of amazing money making opportunity. **DEMONSTRATOR FREE TO WORKERS** **KANT-SLAM DOOR CHECK CO.** Dept. P-7, Bloomfield, Ind.

JOBS NOW OPEN



No Education or Experience
Needed to Learn

TOOL & DIE MAKING MACHINIST TRADE & DESIGNING AUTOMATIC SCREW MACHINES

Learn these big pay trades easily and quickly in our modern shops on finest equipment. Expert instructors train you on actual work done for large manufacturers. No books. No lessons. Day or eve instruction. We help place you while learning and after. Thousands of Allied trained men are now making big pay. You can too. Don't delay. Write now for FREE catalog and free railroad fare plan.

ALLIED SCREW MACHINE CO., Inc.

School of Mechanical Trades

524 W. Monroe St. Chicago, Ill. Dept. 1020

BE A RAILWAY TRAFFIC INSPECTOR



RAILWAY AND BUS Earn Up to \$250 Per Month

ACTIVE MEN—19 to 55—needed in this profitable, permanent profession. S. B. T. I. graduates are in demand as Railway and Bus Passenger Traffic Inspectors. Excellent opportunities for promotion—meet high officials—travel or remain near home.

On completion of a few weeks' spare-time home-study course, we place you in a position paying from \$120 to \$150 per month, plus expenses, to start, or refund your tuition. Advance with experience to \$175, \$200, \$250 per month, plus expenses. Many graduates have gone on to important executive positions in this big field of Transportation.

Free Booklet shows how to make your future a certainty. Write today.

Standard Business Training Institute
DIV. 210 BUFFALO, N. Y.

**Be a
Civil
Engineer!**

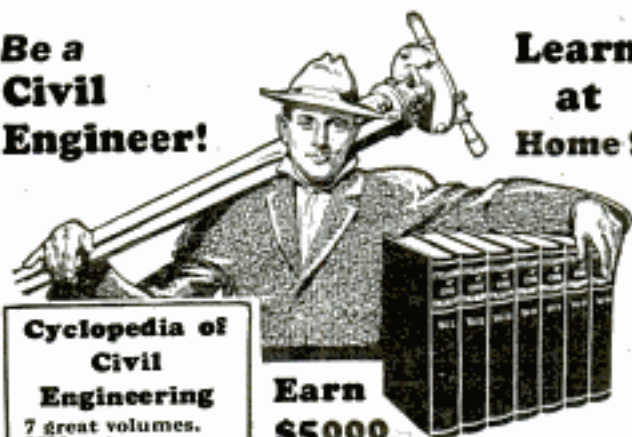

**Learn
at
Home!**

**Cyclopedia of
Civil
Engineering**

7 great volumes.
2000 pages.
1600 illustrations.
New edition just
off the press, by
twelve of America's
greatest engineers.
Includes: Surveying,
bridges, railroads,
steel structures, mu-
nicipal engineering,
water supply, road
building, etc.

Spanish 'Grain Flexible
Covers Gold Stamped

**Loaned
Free!**

To prove you can learn Civil Engineering at home in your spare time. And because no description here could do it justice, to let you see for yourself the scope and simplicity, the thoroughness and quality of this great home reading course. Cut and terms are within your reach. Send no money—just mail the coupon.

**Earn
\$5000**

a Year—and Up!

"CIVIL ENGINEERING"—a plain English written so you can understand it, even if you have only a limited education. Prepares you for a well-paid railroad structural or public works position. Covers every branch of Civil Engineering practice. At once a reading course for the ambitious student and an authoritative reference work for the experienced engineer. Borrow a set—free. Look over the best questions which help you master each subject quickly. Mail the coupon without obligation today!

**American Technical Society
Dept. C-719 Chicago**

American Technical Society,
Dept. C-719, Chicago.

I want to BORROW the CIVIL ENGINEERING Cyclopedia for 10 days FREE. I will gladly pay the few cents express, but I am to pay nothing for the loan of the 7 big volumes if I return them within 10 days. If I wish to keep them I will send you \$7 after the 10 days, then \$2 a month until special advertising price \$29.95 is paid. Send 1931 Edition.

Name.....

Address.....

(Attach letter stating age, occupation,
employer's name and address)



DRAFTING

BOOKS SENT FREE!

ON APPROVAL

5 Volumes New 1931 Edition

Only 15 minutes a day with these WONDER BOOKS will prepare you for a good drafting job in less than a year. Mechanical and architectural drafting from simple straight lines to important complex plans. A step at a time! Built especially for beginners, for men with only grammar schooling. Drafting room practice, PLUS ENGINEERING, made easy and clear. Includes complete course in blue-print reading.

Big Field Big Demand Big Pay

Competent draftsmen are urgently needed right now in all building and manufacturing lines at \$50.00 to \$100.00 a week. That's just the beginning—FOR DRAFTSMEN HAVE THE BEST CHANCES FOR ADVANCEMENT. Pleasant, fascinating work, easy to learn and do. Learn quickly with these books—send coupon for a set FREE and see for yourself.

A year's continuing membership in the American Technical Society now gives free to all readers of this famous cyclopedia of drafting. Many say that it is worth more than the cost of the books.

Complete set of drawing instruments if you send for these drafting books NOW. These instruments are made of the finest of German silver, are absolutely accurate and are packed in velvet lined leatherette pocket case. Real \$10 value, but free to you with these books.

**AMERICAN TECHNICAL SOCIETY
Dept. D-719, Drexel at 58th St., Chicago, Ill.**

American Technical Society, Dept. D-719, Drexel at 58th St., Chicago, Ill. Send for 10 days' free use New 5 volume set of drafting. I will pay the few cents delivery charge. If I wish, I may return books in 10 days and owe you nothing but if I decide to keep them I will send \$2.00 after 10 days, then only \$3.00 a month until \$19.50, the special introductory price, is paid. Send 1931 edition and include drawing instruments.

Name.....
Address.....
Employer.....
Address.....

When writing to advertisers please mention Popular Mechanics

Learn SIGN and SHOW-CARD WRITING
In spare time, few hours weekly



FREE
"Book of Facts"
—
Write For It

Fascinating profession. Big opportunity in this fast-growing trade. Earn while you learn the sign arts. No talent or experience required. Be your own boss or obtain a good position. Learn show cards, posters, bulletins, signs, advertising layouts and allied subjects. We teach by mail or at our school. Quick results—easy to learn.

EARN \$50 TO \$200 WEEKLY

Otto C. Wiegand, Md., home-study graduate, made \$12,000 from his business in one year. Many successful graduates. Oldest and foremost school. Don't delay. Write for complete information.

DETROIT SCHOOL OF LETTERING

153 Stimson Ave. Est. 1899 DETROIT, MICH

Wrestling Book FREE

Learn at Home



Be an expert wrestler. Learn at home by mail. The greatest world's champions have prepared the most wonderful course of lessons ever written on Scientific Wrestling, Physical Culture, Self Defense and Jiu-Jitsu. Be strong, healthy, with an attractive body. Handle and control bigger and stronger men with ease. Get this Free Prospectus—32 pages—brimming with thrilling information—No Charge—merely send \$2 to cover postage. Don't delay. Write Today for your copy. State your age.

FARMER BURNS SCHOOL, 3277 Courtney Bldg., Omaha, Neb.

UNIVERSITY of CHICAGO

HOME-STUDY COURSES

Continue your high-school, college or personal program of education. Teachers, Religious and Social Workers. Men and Women in many vocations are using the 450 courses in 45 different subjects to obtain guidance by experts for cultural and for practical purposes. The courses yield credit. Ask for free booklet.

627 ELLIS HALL THE UNIVERSITY OF CHICAGO CHICAGO, ILL.

TELEVISION WANTS MEN

Wonderful openings for operators, salesmen, service and repair men at big pay. More jobs NOW in Television and Aircraft Radio than there are available trained men. We want ambitious beginners and will train you to step into a good job quick. No matter what your past experience, if you are over 18 years old and want to make \$300 to \$600 a month in this fascinating big pay profession, write today for full particulars.

"SID" NOEL, Pres.

FIRST NATIONAL TELEVISION, INC.
1110 Fairfax Airport KANSAS CITY, KANSAS

Learn ADVERTISING at Home

Greater opportunities now in advertising. Learn easily and quickly in spare time. Practical work. No text books. Old established school. Low tuition—Easy terms. Send for free booklet of interesting information.

Page-Davis School of Advertising
Dept. 1357, 3401 Mich. Ave., Chicago



Deaf 20 Years



But now I hear and will tell any deaf person FREE, who writes me, how I got back my hearing, and relieved head noises by a simple, invisible, inexpensive method which I myself discovered.

Geo. H. Wilson, President
Wilson Ear Drum Company, Inc.
885 Todd Bldg., Louisville, Ky.

DANGEROUS DIMMING ENDED..

≡≡≡ Road Light Doubled! ≡≡≡



Crowds swarm about new invention at Auto Shows and learn how science has at last banished motorist's worst and greatest problem. Read details below.

AMAZING INVENTION FITS ANY HEADLIGHT...

Revolutionizes Night Driving!

At last! Night driving suddenly becomes actually SAFER than day! At one sweep, a tiny, inexpensive invention banishes glare yet doubles road illumination! Cuts through every light on the road! Fits any car. Use coupon QUICK for liberal FREE TEST OFFER!

It is a well-known fact that motor car manufacturers have solved every big problem except one. As soon as the sun goes down at night, the highways of America break forth into a constant, rushing stream of "dimming and damning." Speed is cut down one-third to one-half. Every Monday morning finds the highways littered with broken glass, wrecks, cars in the ditch, overturned, shattered against telephone posts. Every man who ever groped dizzily down the highway in traffic at night knows the horrible sensation of being half-blinded by cars on his left, unable to see the ditch on his right, his own lights seeming dim and shadowy and practically worthless. Now, in a twinkling, this curse of night driving is lifted completely and *inexpensively* from the shoulders of the entire motoring world!

FITS ANY HEADLIGHT

This new lighting discovery is called Perfect-O-Lite. It is a little invention that replaces the "bulbs" in your automobile headlights. No extra wiring or installation. Yet actually DOES double road illumination. Banishes need for Glare Shields. Cuts through the other fellow's light, yet absolutely cannot glare in his eyes. Makes rats, animals, children, detour signs, etc., visible at least three times as far. Makes night driving at 40 to 50 miles an hour safe and easy.

The secret of this new light is in the kind of "beams" or "ray" that it throws. Instead of ordinary light, this new invention throws a solid beam of double-reflected or "infused"

light down the entire roadway. Shows up ditches at the side, as well as distant objects, absolutely clear, without the usual flickering "shadows." Space here limits further discussion of the facts.

MAKE YOUR OWN TEST FREE

Under an introductory offer you are now invited to be the judge and jury without risking one penny. The coupon brings full details of the invention, offer of a set on FREE TEST and facts about agent's money-making opportunities. Mail the coupon, without obligation, TODAY!

AGENTS: Davis Made \$1,400 in 1 Week

This new invention unquestionably opens up one of the most amazing money-making opportunities ever presented. Here actually IS that chance for \$8 to \$14 in your FIRST hour, \$6,000 to \$10,000 THIS year, with no limit **WHATEVER** for Distributors! Fleet owners buy quantities. Wallace & Terman, N.J., trucks just equipped. Other big orders flooding in. A real self-advertiser; each car equipped is seen by thousands. Davis, Pa., made \$1,400 in one week. Start full-time or spare-time. Use coupon for FREE TEST OFFER and details of Exclusive Territory, etc.

HACHMEISTER-LIND CO.

Dept. P-30

Pittsburgh, Pa.



Perfect-O-Lite even looks absolutely unique and entirely different. Every sale brings dozens more. It's the greatest "self-advertiser" ever known.



Lights entire roadway, including ditch. Absolutely no glare to on-coming car. Unique double-reflected, "infused" light beam cuts through every light on the road. No flickering "shadows." Even lights distant objects with daylight clearness.

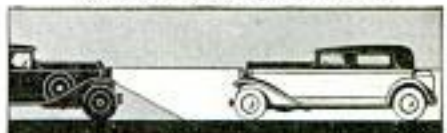

Throws all light on roadway. Shoots through fog, mist, rain and snow, like magic!

Hachmeister-Lind Co., Dept. P-30,
Pittsburgh, Pa.

Book details of your Free Test Offer, also send facts about agent's money-making opportunities, without obligation.

Name.....

Address.....

Town.....State.....

When writing to advertisers please mention Popular Mechanics

Copyrighted material

Chock-full!

Speedy Cruiser
New Design

**"ROAMER"—A
Outboard**

to Build

Starting

POPULAR MECHANICS BOAT BOOK

POPULAR MECHANICS PRESS

POPULAR MECHANICS PRESS

**BUILD YOUR OWN BOAT
AT SMALL COST**

Whatever type of boat you want; whether it be a speedy outboard cruiser, a racing hydroplane, a serviceable outboard runabout, snappy inboard runabout, sailing boat, flat-bottom rowboat for outboard motor, round-bottom rowboat or canoe, the new

**POPULAR MECHANICS BOAT BOOK
SHOWS YOU EXACTLY HOW TO
CONSTRUCT IT**

The need for easily understood directions for the amateur builder of small craft has been met by actually building these boats and photographing every vital step in the construction. Thus you are shown everything just as it is done; nothing being left to guesswork. The designs used in the new Boat Book are of the very latest, up-to-the-minute craft.

**THE ONE BOOK NEEDED
BY EVERY BOATING ENTHUSIAST**

**269 PAGES
(Several in Color)**

**PROFUSELY
ILLUSTRATED**

**LARGE SIZE
7x10 INCHES**

CLOTH—PRICE \$3

Gives you in addition to boat building information, everything you need to know about the operation, equipment, care, repair and maintenance of boats. This includes navigation, pilot rules, handling sailing craft, government regulation of motor boats, knots, storm signals, useful boat kinks of various kinds, glossary of boating terms, tables, etc.

Sent postpaid upon receipt of price or by parcel post C. O. D. anywhere in the U. S. A.

POPULAR MECHANICS PRESS—ROOM P10—200 E. ONTARIO ST., CHICAGO

Be The Man Behind The Camera

**BIG PAY
FASCINATING
WORK**

SPLENDID salaries are paid motion picture cameramen and "still" photographers. Qualify now for this fascinating profession. Play a major part in the production of the great movies that thrill the country or in making photographs for advertisers, magazines and newspapers.



Find Out About YOUR Opportunity in Any Branch of Photography, Projection or Photo-Finishing

Now, you can master every phase of motion picture or "still" photography—short newsreels, great feature pictures, advertising photographs, portraiture or photo-finishing. Our Simplified Plan trains you for a high-salaried position—makes you competent to take every kind of "still" or motion picture.

SEND FOR BIG FREE BOOK

Write today for your copy of our FREE book, which gives full particulars about the ever-growing field of photography—tells how you can qualify through our Simplified Plan as motion picture photographer or projectionist, "still" photographer or photo-finisher, or to open a business of your own.



N. Y. Institute of Photography,
Dept. 49, 10 West 33rd St.,
New York, N. Y.

Without cost or obligation send me a copy of your FREE Book and details about:

() Motion Picture Photography and Projection
() "Still" Photography and Photo-finishing

Name.....

Address.....

City..... State.....

YOUR SUCCESS COUPON

RADIO—TELEVISION

World's finest **TALKING PICTURES**

home training. Prepares for best paying positions in this fast growing business. Training endorsed by leading Radio Manufacturers, dealers and distributors. Many fine opportunities open for men with this training. Laboratory and Consulting Service included. Write for FREE "Opportunity Book."

Radio & Television Institute 2132 Lawrence Ave.
Dept. 1-7, CHICAGO

MOLES and WARTS

REMOVED PERMANENTLY

Rid your face, neck, arms and body of all unsightly moles and warts with "ANTI-MOLE." One application does it. Safe—easy to use—painless—leaves no scar. Used successfully by physicians, skin specialists and beauty experts for 28 years. Write for FREE booklet on treating all kinds of moles and warts.

Miller Co., 2445 South St., Lincoln, Nebr.



"You'll Never Make Good —You Are A Weaking"

You can't hold on to a job in this active world if you are unfit physically for life's tasks and trials. You won't succeed anywhere at anything if dieting, diseases, aching ailments, or weakness depress and worry you—making a mental wreck of you. Men will despise you. Women will shun you. But don't be discouraged—there's a way out of your sorry plight. Let me tell you how my course is.

STRONGFORTISM MAKES YOU MANLY

Through my system of Strongfortism, I build your body up to the symmetrical proportions Nature intended you to possess. You will gain in vigor; your muscular power will increase in flexibility and strength; your nervous system will be fortified to renew its energy.

Just be frank and above board. Tell me your troubles.

Send for My Free Book

Mail This Coupon —
Mr. Lionel Strongfort, Strongfort Institute, Dept. 140,
Newark, N. J. — Please send me immediately free my copy of your book, "Promotion and Conservation of Health, Strength and Mental Energy," in which I am interested.

My ailment is.....

Name.....

Age..... Occupation.....

Street.....

City..... State.....



STRONGFORT
Mus. Builder

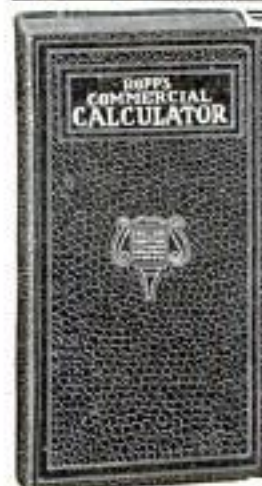

Mathematics Made Easy by ROPP'S CALCULATOR AND SHORT-CUT ARITHMETIC

Shows the Answer as Quickly as a Watch shows the Time to all Problems likely to occur in the Office, Store, Shop, Bank, Farm, or Factory.

Over 2,000,000 Sold

Explains and simplifies every principle in Arithmetic, Mechanics, and Mensuration.

PRICES POSTPAID

Desk Size, Flexible Keratol Binding..... \$2.00

Pocket Size, Art Leather Binding..... \$1.00

Pocket Size, Cloth Binding..... \$0.50

POPULAR MECHANICS PRESS

Room F10 200 E. Ontario St. CHICAGO

**"I MADE
\$117.00
IN 2
DAYS"**



Just
**TURNING
THIS MAGIC
CRANK**

IMAGINE a little automatic can opening machine that opens any size or shape can in a couple of seconds—at just the twist of the wrist! Hangs on the wall. Holds the can for you and cuts out the entire top slick, smooth and clean—inside the rim, so that juices can't spill! Food pours out without scraping or spooning. No jagged edges to snag fingers. Banishes dangerous old-style can openers to the scrap heap forever! Sells on sight to women everywhere.

Million Dollar Can Opener Brings Record Profits!

No wonder Speedo representatives often sell to every house in the block and make up to \$12 in an hour! E. T. Barclay, N. Y., made \$117 cool profit in just two days. J. Williamson, Wis., made \$5 his first hour. Mrs. Spain, Kas., made \$9 her first afternoon. You, too, can make big money in full or spare time. Unique liberal selling plan now brings you this revolutionary Speedo invention and two other great household sellers on FREE TEST. Also startling TRIPLE-PROFITS, GUARANTEED SALES Plan that starts you WITHOUT RISK whatever! SEND NO MONEY—simply mail coupon NOW! Central States Mfg. Co., Dept. M-705, 4500 Mary Ave., St. Louis, Mo.

FREE TEST OFFER SIMPLY MAIL COUPON

Central States Mfg. Co., Dept. M-705,
4500 Mary Ave., St. Louis, Mo.

Rush full details of your generous FREE TEST OFFER.

Name

Address

City State

Check here if interested only in one for own home.

When writing please mention Popular Mechanics

Books on Many Practical Subjects

Popular Mechanics Press specializes in supplying the outstanding best books on many subjects. As new books of merit appear, we will revise the list accordingly.

ARCHERY Simplified.....\$2.00	KITES THAT FLY How to Make.....\$1.25
ARCHITECTURAL Design and Lettering...\$2.00	LANDSCAPING Practical.....\$2.50
ARMATURE WINDING Excellent new book...\$2.00	LATHE WORK (METAL) and Drilling and Thread Cutting.....\$1.00
ATLAS New 1930 Census Edition.....\$2.50	LETTER WRITING Social and Business Only.....\$1.00
AUTO ENCYCLOPEDIA Dyke's. (Covers New Model A Ford).....\$6.00	LETTERING Modernistic.....\$2.00
BIRD HOUSES How to Make.....\$1.00	MACHINIST Complete, Practical...\$3.00
BLUE PRINT READING For Building Trades...\$1.25	MAGIC 200 New Tricks for Am- ateurs.....\$1.00
BOAT BUILDING New Edition of Popular Mechanics book.....\$3.00	MAKE IT YOURSELF 900 Different Things to Make.....\$3.00
BOY MECHANIC Famous 4 Vol. Library, 4000 Things to Make...\$7.00	MARKETING BY MAIL Science of.....\$2.00
BUILT-IN FURNITURE Complete Instructions...\$2.50	MATHEMATICS Made Easy for the Prac- tical Man.....\$1.50
CALCULATOR Mathematical Ropp's...\$1.00	MECHANICAL DRAWING Practical Course in...\$1.00
CARBURETORS Excellent book on all makes.....\$2.00	MODEL AIRCRAFT Building and Flying...\$2.25
CARPENTRY Hand book of 336 Kinks...\$1.50	OUTDOOR OPPOR- TUNITIES for Making a Living...\$2.00
CHALK TALK How to.....\$1.00	OUTDOOR SPORTS for All Year 'Round New Edition.....\$2.00
COLOR SIMPLIFIED Practical new Book (for Color Users).....\$3.50	PAINT SHOP PRACTICE New, very complete...\$5.00
CONCRETE 173 Ways of Using New Edition (Cloth)...\$1.00	PAINTING House (Best Methods)...\$2.00
CONTRACT BRIDGE at Sight.....\$1.00	PLUMBING 500 Plain Facts for Every Homeowner...\$1.50
DOGS Care and Raising.....\$2.00	POULTRY RAISING for Profit.....\$2.00
ELECTRICITY for Beginners.....\$1.50	PUZZLES Amusing Mathematical...\$1.50
ELECTROPLATING Practical Results Easily Obtained.....\$1.00	RABBITS For Food and Fur....\$2.00
ENGLISH Self-Improvement in...\$1.60	ROOF FRAMING Made Easy.....\$1.50
ETIQUETTE New 560-Page Book, Only.....\$1.00	SHOP NOTES 6 Vols. of 2200 Valu- able Kinks.....\$2.98
FARMER'S BOOK of 861 Kinks and Book for Farmers' Wives...\$1.00	SLIDE RULE How to use.....\$1.75
FLYING Simplified.....\$1.00	SPEECH and a Story for Every Occasion.....\$2.00
FORMULAS 10,000 Money Making...\$4.00	STAMP ALBUM (Modern) 12,000 Varieties.....\$1.50
FURNITURE (Mission) Homemade (3 vols.)...\$3.00	STEEL SQUARE Pocket Book, Practical...\$1.00
GARDENS 1001 Questions An- swered.....\$2.00	STORAGE BATTERIES (New work) Best on subject.....\$3.00
GLASS Working.....\$1.75	TOY MAKING (Complete Instructions)...\$1.50
GLIDING A B C of.....\$2.00	WALL DECORATION (Interior) Newest Methods.....\$4.00
HOME REPAIRS Practical Book of.....\$2.50	WHITTLING The Art of.....\$1.35
IGNITION (High Speed) For Garage Mechanics...\$3.50	WIRING House (New Book)...\$2.50
INVENTION Pop lar History of American.....\$1.00	WOOD TURNING (LATHE) Practical Course in...\$1.50
JOINT WIPING (New Edition).....\$1.00	WOODWORKING SHOP Modern Motor-Driven...\$1.00

Books sent C. O. D. anywhere in U.S.

Just check the books you want, write your name and address below, and mail the advertisement. It is your order blank. When postman hands you books, pay him the price and few cents postage. If outside the U. S. remit when ordering and include 10 cents per book extra for postage. We have many other books on these and 2,000 other subjects. Catalog free.

Name

City

Address

Mail to Popular Mechanics Press,
Room F10—200 East Ontario St., Chicago, Ill.

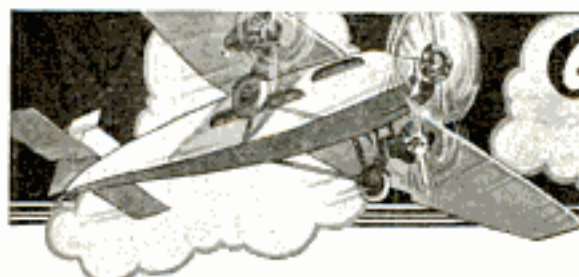

Get out of the rut~ and into the Air

Look about you and you'll see the country at large using airplanes with no more excitement or jittering of the nerves than we endure when climbing into a motor car. Aviation has in ten short years become a \$500,000,000 industry.

The sober selection of Aviation as a lifetime vocation is good business. The world is turning from wheels to wings. The real opportunity is just five years ahead. Learn aviation NOW—where the leaders learned, at the Von Hoffmann Air College where you get the most thorough of any course in the Principles of Flight, the Theory of Flight, Principles of Construction, Materials of Construction, Engine Instruments, Flying Instruments, Maintenance and Repair of Motors, Aero Dynamics, Aerology, Aerostats—ALL ABOUT AVIATION.

Von Hoffmann Air College training open only to students 17 years or older. If you are under 17, send for information on our Home Study Preparatory Course

VON HOFFMANN AIR COLLEGE

Lambert-St. Louis Municipal Airport,
Saint Louis - - - - - Missouri

VON HOFFMANN AIR COLLEGE 1000-13
342 Lambert-St. Louis Municipal Airport
St. Louis, Mo. MAIL TODAY, "WHAT AVIATION
OFFERS YOU."

Name..... Age.....

Address.....

City..... State.....

I am interested in

() FLYING COURSE () MECHANICS COURSE
() WELDING COURSE () HOME STUDY

HAENEL Super Air Pistols

Made by the Greatest Gun Factory in Europe.

Most powerful made. Ideal for target, rats, vermin and small game; no license required. Rifled accurate, hard shooting. 10 1/2" over all; wt. 2 1/4 lbs. Ammunition costs a trifle. Anyone would be proud to own a Haenel. Guaranteed.

.177 and .22 Cal.: [500 lead pellets FREE]—\$11.75
Pellets: per 1000, .177 Cal., \$1.50; .22 Cal., \$2.50.
Write for new catalog "W"—Guns, Rifles, etc.

HUDSON SPORTING GOODS CO., W-52 Warren St., N. Y. C.

\$11.75

Anyone CAN LEARN

No talent or experience necessary. Fascinating work. Pays big money. Complete instruction book tells about Alphabets, Colors, How to Mix Paints, Show Cards, Window Board and Wall Signs, Ready made letters, Gilding, Tricks of the Trade, also gives 100 Alphabets and Designs. Book bound in leather with leather-edged edges, and four full bearing Show Card Press. Sent postpaid \$3.00. (C. O. D.) 10c extra.

Signs Pub. Co., 57 Ross St., Dept. 20, N. Y. City

**EARN MONEY IMMEDIATELY—
WE FURNISH EQUIPMENT TO START!!**

\$3

The Science of Wrestling and the Art of Jiu Jitsu

By EARLE LIEDERMAN
An amazing exposition of this great art—224 pages, fully illustrated. Regular price \$5. Order now and save \$2. Sent on receipt of \$3, or C. O. D.
Address EARLE LIEDERMAN, 305 Broadway, N. Y.

FREE CATALOG OF PRACTICAL BOOKS

for Practical Men, covering the subjects of RADIO, AVIATION, ENGINEERING, AUTOMOBILE WORK, BATTERY WORK, ELECTRICITY, BUILDING, SHEET METAL WORK, PAINTING, SIGN MAKING, LETTERING, COMMERCIAL ART, will be sent to you on request.

FREDERICK J. DRAKE & CO.
181 N. Michigan Blvd. Chicago



High School Course in 2 Years

This simplified, complete High School Course, specially prepared for home study by leading professors, meets all requirements for entrance to college, business, and leading professions.

20 Other Courses

Over 200 noted Engineers, Business Men, and Educators helped prepare the special instruction which you need for success. No matter what your inclinations may be, you can't hope to succeed without specialized training. Let us give you the practical training you need.

American School
Drexel Ave. and 58th St.
Dept. H-747, Chicago

Money Back When You Finish If Not Satisfied

American School, Dept. H 747, Drexel Ave. and 58th St., Chicago
Send me full information on the subject checked and how you will help me win success in that line.

- Architect
- Building Contractor
- Automobile Engineer
- Civil Engineer
- Structural Engineer
- Business Manager
- C. P. A. & Auditor
- Bookkeeper
- Electrical Engineer
- General Education
- Lawyer
- Mach. Shop Practice
- Mechanical Engineer
- Steam Engineer
- Draftsman & Designer
- High School Graduate

Name..... Age.....

St. and No.....

Town..... State.....



GET THE STRENGTH OF AN OARSMAN

A Gym at Home to Make You Strong

Get strong! Enjoy the thrill which giant strength gives to the varsity oarsman. He must be "there" to stand the strain and endure the greatest and most terrific strength test put to any athlete. If you want massive shoulders—a mighty chest—arms like iron—a powerful back—legs like pillars of steel and an all around perfect athlete's body, stop dreaming. Wake up! The invention of the Vig-Row is the answer to your dream. The Vig-Row was created and built by a man who built his own body from a weakling to that of a champion—the Vig-Row offers body-building principles never revealed to the public before because it is the only machine of its kind built by a man who understands muscle building. The Vig-Row is the perfect device for keeping fit and getting strong. Be sure to investigate the VIG-ROW! You will agree that it is the greatest and most perfect rowing machine ever marketed, regardless of price. Its many features and beauty will amaze you—our slogan is "FACTS FIRST"—then the sale—send no money—write now for additional free information.

Examine VIG-ROW First

Some don't permit the entire story about the Vig-Row. It has too many real features. There are too many reasons why you should select the Vig-Row. We don't ask you to purchase from this advertisement—we do ask that you write for our large photographic circular so you can see and realize the difference yourself. Write for free facts now. Don't buy now, from us or anyone else—compare—examine—test—don't buy a rat in the bag—write us now and get the wonderful complete Vig-Row story that brings you the reason why you will be proud to own a Vig-Row.

Exclusive VIG-ROW Features

- 1 Inclined frame for true rowing motion.
- 2 Rubber wheels, oil-less bearings.
- 3 Arch supporting foot rest.
- 4 Rolling, form-fitting aluminum seat.
- 5 Polished hardwood frame.
- 6 Fastenly adjustable progressive exercise, nibbled steel springs.
- 7 Platform for standing exercises.
- 8 Aluminum front.
- 9 Double rollers.
- 10 Ventilated handles.

FREE Instructions

We don't think it enough to just sell you the finest rowing machine in the world and trust to luck that you will use it and get strong. No! We furnish a course of instructions without extra cost, that are complete in every detail. Shows how to develop every part of the body with the Vig-Row—Prepared and written by a master of Physical Culture—and it's yours free, if you write at once.

\$11⁸⁵

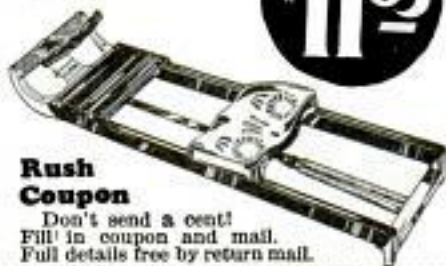

Rush Coupon

Don't send a cent! Fill in coupon and mail. Full details free by return mail.

AMERICAN ATHLETIC APPLIANCE CO.,
239 Broadway, Dept. 1810, New York.

Please send absolutely free and without obligation full details about your wonderful Vig-Row rowing machine. Also reserve one of those free instruction courses. I have checked plan of purchase that interests me, if I decide to purchase a Vig-Row.

Cash Price. Installment Plan.

Name..... Age.....

Street.....

City..... State.....

When writing please mention Popular Mechanics

What a Beauty!

A Fine-Quality
**MANTEL
RADIO**

for only
16⁵⁰
LESS TUBES



5 Tubes
Two Screen Grid
Variable Mu
Pentode Output
Rola Dynamic
Speaker
Loftin-White
Amplifier
3 Gang Condenser
Built-in Antenna
RCA Licensed
Loftin-White
Licensed

30 DAYS TRIAL FREE

FREE CATALOG

Write for new 1932 wholesale Radio Catalog. Everything new in radio at lowest wholesale prices. Unrated sets, tubes, speakers, replacement parts, etc.

NEW 1932 EDITION

The radio buy of the year! A powerful sturdy 5 tube midget, using the new VARIABLE-MU and PENTODE Tubes. Every new development. Look at the list of features. Look at the handsome cabinet pictured above. And the price is only \$16.50—the most remarkable value in radio. Guaranteed by the largest institution of its kind in the country. And you can have 30 days FREE TRIAL in your own home. Write AT ONCE for full particulars.

WHOLESALE RADIO SERVICE CO.
38 Vesey St., Dept. K-11, New York

RADIO BLUEPRINTS

The blueprints below include the best of Popular Mechanics tested circuits. When ordering, simply quote the numbers of blueprints desired and inclose proper amount addressed to Popular Mechanics Magazine, Radio Dept., 200 E. Ontario St., Chicago, Ill. Magazines containing full descriptions of the circuits can be obtained. Send 25 cents for each magazine desired, giving date of publication.

- No. 139, Simple Television Receiver... Dec. 1928... 25c
- No. 140, Power Amplifier and B-Supply for Television..... Jan. 1929... 25c
- No. 142, Two-Tube Screen-Grid Short-Wave Adapter..... Mar. 1929... 25c
- No. 145, One-tube S-G Set for Beginners Nov. 1929... 25c
- No. 146, Adjustable B-Eliminator... Nov. 1929... 25c
- No. 148, Adding Audio Stages to S. G. Receiver..... Dec. 1929... 25c
- No. 151, Beginners Low Power S-W Transmitter..... June 1930... 25c
- No. 152, Portable Radio Amplifier for the Deaf..... July 1930... 25c
- No. 153, Low Cost Code and Phone Transmitter..... Sept. 1930... 25c
- No. 154, A. C. Screen-Grid DX Tuner Oct. 1930... 25c
- No. 155, Four-Tube D-X Receiver... Nov. 1930... 25c
- No. 157, Building a Light-Sensitive Relay..... Dec. 1930... 25c
- No. 158, High-Power Supply for Amateur Transmitters..... Jan. 1931... 25c
- No. 159, Portable S-W Transmitter..... Feb. and March 1931... 25c
- No. 160, Building A. C. Midget Receiver..... Mar. and Apr. 1931... 25c
- No. 161, Building Auto Receiver for 2-volt Tubes.... Apr. and May 1931... 25c
- No. 162, Battery Eliminator for 110-volt D-C. Supply..... June 1931... 25c
- No. 163, Two-Tube A. C. Short-Wave Receiver..... June 1931... 25c
- No. 165, Pre-Amplifier for Home Recording..... Sept. 1931... 25c
- No. 166, Building Stenotube Superheterodyne..... Sept. 1931... 25c

Material Lists for any of the above instruments will be mailed free upon application.

Increase Your Earning Power

Apply time and labor-saving kinks to your work. Your efficiency will soon be recognized and you will be in line for advancement.

If you do machine shop work of any kind, sheet-metal work, painting, carpentry, auto repairing, farming, concrete work, plumbing, electrical work, welding, building, glass work, general repairing, tool-making, poultry raising, masonry or home repair work, get this

LIBRARY OF 2200 TIME AND LABOR SAVING IDEAS FOR SHOPMEN AND HANDYMEN

RECENTLY PUBLISHED

SHOP NOTES

for

1931

192 Pages

464 Illustrations

Price 50c

See partial list of contents below



Including the new 1931 issue illustrated above, there are six volumes in the Shop Notes Library of 2200 easily understood short cuts to every-day jobs. Here are just a few of the subjects taken from the latest issue.

Auto Driving, Winter Hints	Growler for Amateurs Repair	Poultry Ranch for City Lot
Auto Trucks, Handy, for Paint Shop	Router for Garage or Workshop	Roading and Fining, Ornamental
Boys—Lobby Signs, Making	How to Paint with Broad-ax 8x8 Square Logs	Saws, Circular, Repairing
Box Bender Reduces Labor	Inlays, Simple Joiner in the Home Shop	Sawyer Vertical, Made from Buffalo Head
Branch, Portable, for Mechanics, Saves Time	Kitchen Steel, Metal, How to Make	Silver Solder, Use of
Blower for Lowering Fuel Cost	Laboratory Stand	Shaper for Home Shop
Book Ends, Hand Wrought, Making	Makes Workshop Tool	Spice and Line Savers for the Shop
Carbide Leg, Cutting the	Lamp, Star, for Home	Spiral Turnings, How to Make
Drawing Instruments, Homemade	Lantern Illuminates House Numbers	Stairway, Homemade
Fireproof, Portable, How to Build	Machining Chips, Vacuum Cleaner	Disappearing Table, Small Drums, Making
Furniture, Drawer Pulls for	Machining Tools, Making Several with One Electric Motor	Twist, Turning with Portable Router
Gauge Glass, How to Install	Milling Machines Made from Blower	Water Heater for Sunny Climes
Grinding, Surface, on Drill Press	Pipe Repair, Emergency	Workbench, Handy, for Model Airplane Building
	Plating Tricks Made Easy	

Each volume contains approximately 370 articles and 400 illustrations and has 192 or more pages. This unrivaled library of shop helps may be secured for a limited time only. After the present supply of books is exhausted the offer must be withdrawn.

COUPON

POPULAR MECHANICS PRESS,
200 E. Ontario St., Room P10, Chicago, Ill.

Send me, as per your offer, the following books. I will pay postman price and small amount of postage. My money will be refunded if I am not satisfied. (Check what you want.)

- 1931 Shop Notes and Lathe Handbook, both for 95c.
 Shop Notes Library (6 vols.) \$2.95.

Name.....

Street and No.....

City..... State.....

FREE FOR 5 DAYS!

Franklin Publishing Co., Dept. M-70
800 N. Clark St., Chicago, Illinois

Please send me your amazing book—*The Science of Hypnotism*—by Prof. Young. When the book arrives, I'll pay the postman only \$2.00 plus postage. If I am not satisfied after 5 days' trial, I may return the book and you are to refund my money.

NAME.....

STREET AND NO.....

TOWN.....STATE.....

If you are likely to be out when postman calls, send \$2.00 with coupon and we'll pay delivery charges. Customers outside U. S. must send cash with order.

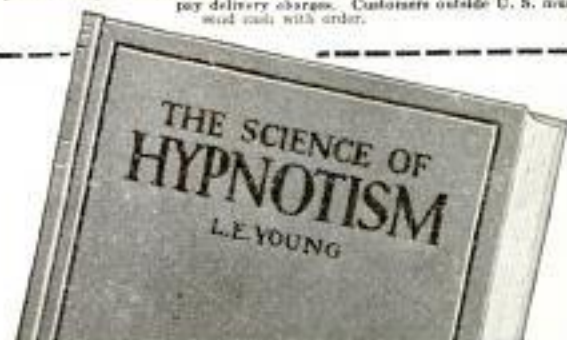

I'll Make You a Master of HYPNOTISM ..OR YOU PAY NOTHING

Don't be unpopular, lonesome, or unhappy a minute longer. Now you can make your life what you want it to be—now you can win admiration, success and big money—through the strange power of hypnotism. I'll show you how to use this great force to help you master every situation or **The Five Day Trial Is FREE!**

In just a few hours I'll teach you the hidden secrets of Hypnotism—the methods used by the great operators—the amazing things you can accomplish once you understand this mighty power. You can use it to overcome obstacles, achieve your fondest ambitions and become MASTER of yourself, friends and acquaintances—either sex. See for yourself how Hypnotism can banish fear, worry and opposition—improve your memory—increase your earnings—and force others to give you the good things in life you deserve!

In this startling book, *The Science Of Hypnotism*, the world famous hypnotist—Prof. L. E. Young—reveals the most carefully guarded secrets of his fascinating subject. He not only explains the methods of noted hypnotists, step by step—but tells clearly all about the nine stages of hypnotism, the Hypnotic Mirror, Mental Telepathy, how to select your subjects, how to make money out of hypnotism!

SECRETS OF HYPNOTISM

How to Hypnotize at a Glance

Susceptible Subjects

How to Hypnotize by Telephone

How to Give an Entertainment

How to Make Others Obey You

Overcoming Bad Habits

How to Do Dozens of Hypnotic Feats

Use of Hypnotism in Operations

Try 5 Days FREE—
Send No Money

So confident are we that Prof. Young and his great book will quickly teach you the science of hypnotism, that we will send you a copy without one cent in advance! Simply clip and mail the coupon below. When the book arrives pay the postman the special low price of \$2.00 plus few cents postage. Then test the powers of Hypnotism 5 days! If not amazed and delighted return the book and money will be refunded at once. Mail the coupon now.

FRANKLIN PUBLISHING CO.
Dept. M-70, 800 N. Clark St., Chicago

MAIL COUPON ABOVE



Stop! Using Tobacco

Perhaps you've tried to stop using tobacco only to find that the habit has such a hold on you that you gave up trying.

You know, better than anyone else, whether tobacco is hurting you, and if it is, that sooner or later, it will undermine your health. Heart trouble, indigestion, dyspepsia, nervousness, insomnia, poor eyesight—these and many other disorders can often be traced directly to the use of tobacco, according to good medical authority. Besides it is an expensive, utterly useless habit.

Let Us Help You To Banish The Habit

No matter how firm a grip tobacco has on you—no matter whether you've been smoking cigars, pipe or cigarettes or chewing plug or fine cut for a month or 50 years—Tobacco Redeemer will in most cases remove all craving for tobacco in any form in a very few days. It does its work so quickly that all tobacco "hunger" is gone almost before you know it. The desire for a smoke or chew usually begins to decrease after the very first dose.

Tobacco Redeemer contains no habit-forming drugs of any kind—it is in no sense a tobacco substitute. It does not cause the slightest shock to the nervous system; on the contrary, it often helps to quiet the nerves and make you feel better in every way.

SEND for PROOF

Get our free booklet. It tells you all about the deadly effects of tobacco and how easy it is now to quit. We will also send you copies of letters from confirmed users telling how this simple, home-treatment freed them absolutely from the habit. Just mail coupon—or a postal will do.



NEWELL PHARMACAL CO.

Dept. 999

St. Louis, Mo.

Send me without obligation to me in any way, proof that Tobacco Redeemer will positively free me from the Tobacco Habit or my money will be refunded.

Name

Street and No.

Town.....State.....

BOYS! Here's Fun Galore



Zip! Here they come! Around a turn and down the home stretch to cross the finish line with a last furious burst of speed!

You want things that will "GO"—things you can race with—scooters, pushmobiles, small autos with motorcycle engines, wind wagons, etc.—Whether on spinning wheels or glistening runners—fast ice yachts, skis, toboggans, bobsleds, motor driven sleds and snow speedsters.

You air-minded boys enjoy gliders and model airplanes. Turn your back yard into a regular amusement park with all these thrillers—ferris wheels, roller coasters, merry-go-round swings, etc.

How fascinating to imitate the big engineers and make small water wheels, pile drivers, aerial cableways and other things that "work."

When at camp or on the water you need plenty of ideas for new ways of having fun. Here are dozens such as water bicycles, push boats, water coasting toboggans, water games, etc.

On rainy days and other times when working in your home shop you have the hardest time finding interesting things to make. Here are any number such as electric locomotives, motion picture cameras, wood turning lathes, etc.

All in this great

Boy Mechanic Library

YES—ACTUALLY

4000 Worth While Things to Make and Do

Don't envy the other boys on account of the things they have. Be the boy in your neighborhood to make the others wonder where you get all your ideas.

Get the thrill of having "Made It Yourself." Everything is pictured out and made easy. Don't try to get along without these books. Send for them right away.

The complete library of 4 volumes, each book 7x10x1½ inches and with 460 Pages.

Price \$7.00

or single volumes at \$2 each. Each volume complete in itself.

Books are numbered: 1, 2, 3 and 4. State the ones you want when ordering. Sent postpaid when remittance is sent with your order, or will be sent C. O. D. anywhere in the U. S. Pay postman price plus extra postage for this service.

POPULAR MECHANICS PRESS
200 E. Ontario St. Room P 10 Chicago, Ill.

-takes only 8 weeks to get a big job



George Smith owns an agency and repair shop in West Alexandria, Ohio. He makes \$200 a week.

and Earn \$50 to \$100 a Week as Auto Expert

Learn the auto and tractor business by the McSweeney method, then step out and get a good job at \$50 to \$100 a week or open your own repair shop and make up to \$10,000 a year. Trained men are needed everywhere. Opportunities galore! Eight weeks training fits you to open repair shop or to go with one of the big firms wanting trained men. Read what George Smith and C. E. Gillespie have done. Hundreds of other McSweeney trained men can tell an interesting story. Every month McSweeney men who complete their training are taking the place of half-trained and incompletely self-trained men.

Money Back Guarantee

If, after completing my training, you are not satisfied, if you are not qualified to accept a big-pay job, your tuition will be refunded.

Learn on Real Machines



C. E. Gillespie has charge of a fleet of trucks and tractors for the State Highway Commission, due to McSweeney training.

Learn in Only 8 Weeks

Simple, thorough, practical shop methods. You learn the "why" of everything you do, then learn to do it right. You do real work with real tools and equipment. No book studying. Very little schooling necessary. Any man from 16 to 40 can learn. Write today for Big Special Limited Time Tuition Offer, including—

SPECIAL! R. R. FARE

Also FREE course in AUTOMOBILE ELECTRICITY to those who enroll soon. Don't delay—write at once for complete details and BIG AUTO BOOK FREE. Mail coupon NOW.

AVIATION COURSE INCLUDED

AVIATION is paying tremendous incomes to trained men! Now eight weeks' course also includes complete course in Aviation Mechanics. Learn on real airplane engines under experienced instructors. Don't miss this remarkable opportunity. Save by enrolling at once. The sooner you start the sooner you will be ready to earn big pay or get into business for yourself.

MAIL COUPON FOR FREE BOOK

McSweeney Auto, Tractor and Aviation School,
Dept. A-10-10, Cleveland, Ohio.

Without cost or obligation, send me your big FREE book on Autos; also, full details of your big offer including R. R. Fare and New Course in Aviation.

Name.....

Street.....

Town..... State.....

McSWEENEY SCHOOLS

Auto, Tractor and Aviation Department A-10-10, Cleveland, Ohio

Book FREE

FREE LESSON Home Art Craft

GOOD MONEY FOR SPARE TIME

A new easy way. Art novelties in big demand. Get free lesson and quickly learn to decorate Gifts, Bridge Prizes, Toys, etc. No experience necessary. Anyone can succeed with simple "3-step" method and you earn as you learn. Everything furnished including supply of Novelties for you to decorate and Homocrafters Outfit.

NO CANVASSING

Just sit at home and make up to \$50 a week spare time or full. Write today for big illustrated book and FIRST LESSON FREE. Absolutely not one cent to pay. Lesson is free. Openings in every locality. Write quick.

FIRESIDE INDUSTRIES
Dept. 66-P, ADRIAN, MICH.

Does Your SPEECH Betray You?

How often do you lose your greatest opportunities for more money, and for greater popularity because of mistakes in English, which you make, unknowingly? Can you talk and write your way to a better position with higher pay? Unless you have a perfect guide you may be holding yourself back from whatever business and social advancement you desire.

SPEECHCRAFT, perfected by a group of nationally-known educators after 25 years of research and teaching, is your infallible Speech and Letter Writing.

SEND FOR THIS BIG FREE BOOK

SPEECHCRAFT is NOT a mere set of books. It is fascinating, complete, quick and easy. No tiresome, dull rules to learn. Just 15 minutes a day packed with absorbing study and your English and conversation will be faultless, your letters interesting and you will be able to hold and thrill any audience before whom you speak.

FREE! Write for our new, big book, "The Way to Win With Words." It will be sent without charge to serious-minded men who want to get ahead and earn more money. (State age in writing.)

SPEECHCRAFT, INC., Dept. C-10, 25 W. Elm Street, Chicago, Ill.



20 Years of Shirt Sleeve Practice in ELECTRICITY

Make no mistake about it—there are big jobs in electricity ready for you when you're ready for them. Thousands of men who have the Croft Library know that to be a fact. The Library itself, on a FREE TRIAL BASIS, can prove it to your absolute satisfaction.

The New Croft Library of Practical Electricity

The Croft Library is a complete electrical educator. It is founded on practice—on 20 years of shirt-sleeve experience—on work as it is actually done. It is jammed from cover to cover with the kind of hard-headed facts you want. Written so that the beginner can easily understand it, yet so sound, so thorough, that it is the daily guide of 40,000 highly paid electrical workers and engineers. Croft tells you the things you need to know about motors, generators, transformers, condensers, transformers, circuits, switchboards, distribution systems—electrical machinery of every type—wiring for light and power—wiring of finished buildings—underwriters' and municipal requirements—illumination in its every phase—the latest and most improved methods of lighting—lamps and lamp effects, etc.—how to do a complete job, from estimating it, to completion.

No money down—easy payments

Fill in and mail the coupon attached and we will send you the entire set of seven volumes for ten days' Free Examination. We take all the risk—pay all the charges. You assume no obligation—you pay nothing unless you decide to keep the books. Then \$1.50 in ten days and the balance at the rate of \$2.00 a month. Read the coupon NOW and see the books for yourself.

FREE EXAMINATION COUPON

McGraw-Hill Book Co., 370 Seventh Ave., New York

Send me for ten days' free examination the Croft Library of Practical Electricity. If satisfactory I will send you \$1.50 in 10 days and \$2.00 monthly until the special price of \$19.50 is paid. If not wanted, I will return the books post-paid. (To insure prompt shipment write plainly and fill in all lines)

Name.....

Home Address.....

City and State.....

Position.....

Name of Company..... P.M. 10-31

When writing please mention Popular Mechanics

Rupture No Longer Spoils My Fun

"Now that I am rid of my rupture and do not wear a truss, I enjoy dancing again. Many strenuous activities are pleasures, because I am not handicapped in any way. My work is no longer a task—I enjoy it. No one would ever believe I was crippled by rupture."

This is the way people write us after ridding themselves of rupture by using **STUART'S ADHESIF PLAPAO-PADS.**

Stacks of sworn endorsements report success—without delay from work.

Plapao-Pads cling to the body without straps, buckles or springs. Easy to apply—economical and comfortable.

Convince yourself by actually testing Plapao at our expense. Send coupon today.

Test of Factor "PLAPAO"

FREE!

ACT SPEEDILY

MAIL COUPON BELOW TO-DAY

Plapao Laboratories, Inc.
789 Stuart Bldg., St. Louis, Mo.

Send me FREE Trial Plapao and 48-page book on Rupture. No charge for this now or later.

Name

Address

The man who studies gets ahead. Popular Mechanics Press will advise you what books to read to advance in your trade. 200 East Ontario Street, Chicago, Illinois.

Chicago TECH College

SAVE TIME WHILE LEARNING HERE IN CENTER OF INDUSTRY

Learn DRAFTING in 4 Months—at Chicago Tech.

Evening Classes. Many students earn expenses while learning. Free employment service for students and graduates. Send for 80 page "Blue Book." Mailed Free. Address the President, Charles W. Morey, B. S., M. E.

CHICAGO TECHNICAL COLLEGE
Dept. N-79, Chicago Tech. Building, 118 E. 25th Street, Chicago, Ill.

Prepare now. Increasing opportunities for Draftsmen. This 27 year old established school offers special short Drafting Course. Complete in 4 months. Also 1, 2 and 3 year diploma and B. S. Degree Courses in Engineering, Electricity and Architecture. High School subjects taught. Enter any time. Day and



ELECTRIC Neon-Red FLASHER SIGN

The NEW WIL-O-LITE ELECTRIC FLASHER SIGN, CHANGEABLE for every line of business, opens tremendous field for salesmen of ability. Only MEN WHO CAN SELL A LEGITIMATE PRODUCT are wanted. A good paying HIGH GRADE job. Glowing NEON-RED messages at a fraction of the price of other electric signs. Polychrome frame in Gold, Antique Bronze or Silver. Never needs repairs. CHOICE OF 265 STOCK PANELS. Size 20 1/2 in. long, 7 1/2 in. high. (Pedestal base Size \$6.) F.O.B. Chicago. Order your WIL-O-LITE today. Catalog of WIL-O-LITE Signs and Message Panels sent on request.

WIL-O-LITE, Inc., 125 W. Austin Ave., Chicago, Ill.

WIL-O-LITE DISTRIBUTOR OPPORTUNITY
In certain territories, on the entire WIL-O-LITE line, for men or firms qualifying.

REAL ESTATE EDUCATOR

A most comprehensive yet concise arrangement of useful facts about buying, selling, leasing and sub-letting of Real Estate, contracting, for erection or repairs, mortgaging, transferring, insuring, etc. New revised edition. 288 pp. Price \$2.00, postpaid. POPULAR MECHANICS PRESS, 200 E. Ontario St., CHICAGO

A NEW HOUSE WIRING MANUAL

PRACTICAL — PLAINLY WRITTEN

BY J. G. WOLBER AND O. K. ROSE
Cass Technical H. S., Detroit, Mich.

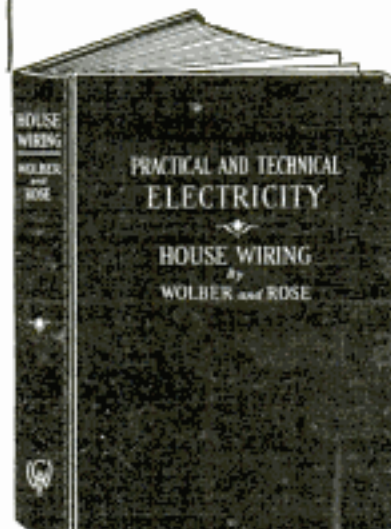

This book is the result of the author's fifteen years of industrial experience and of teaching. The material accumulated during this period of time has been worked over and over until in the author's opinion it was ready for publication.

320 Pages
662 Illustrations
Size 7 1/2 x 5 1/4 inches
Flexible Binding
Price \$2.50 Postpaid
Will be sent C. O. D. anywhere in U. S. or possessions.

POPULAR MECHANICS PRESS
Room P 10
200 E. Ontario St., Chicago

LEARN CARTOONING

AT HOME DURING SPARE TIME

with the course that has trained HUNDREDS of beginners successfully. The Landon Picture Chart Method of teaching ORIGINAL drawing by mail makes cartooning easy to learn. This school is a Member of The National Home Study Council. Write today for sample picture chart to TEST YOUR ABILITY and examples of the work of successful students now earning from \$50 to \$200 and more per week.

Enclose 6c in stamps and STATE YOUR AGE.

THE LANDON SCHOOL, 2838 National Bldg., Cleveland, Ohio





Now It's FUN

To Reduce-Keep Fit-Gain Strength

... in 5 Minutes a Day-at Home!

Re-Creates The "Zone of Youth"
 The true "Zone of Youth" is in the abdominal and hip region. Sagging muscles, protruding stomach, flabby hips are signs of oncoming age, the result of having "let oneself go." But five minutes a day with the Steelflex Health Rowboat quickly Re-Creates the "ZONE OF YOUTH" and KEEPS it youthful.

Copyright 1931
 Patents Pending
 In U. S. A. and
 Foreign Countries

Try it 10 Days on Approval-Send No Money Now!

EVERYONE realizes the value of DAILY exercise. Heretofore, it has been bothersome, took too much time; too much like work! But, wouldn't you like to recover the FITNESS and FIGURE OF YOUTH—if it were actually FUN to do so? Wouldn't you be GLAD to get rid of that PROTRUDING WAISTLINE and EXCESS FAT around hips, arms, legs, neck and shoulders IF YOU COULD REALLY ENJOY DOING IT? Wouldn't you like to restore natural ELASTICITY to sagging, flabby muscles—to generate NEW HEALTH, NEW STRENGTH,

NEW STAMINA in your Chest, Back, Arms, Legs, Stomach, Liver, Kidneys, and Bowels—IF DOING SO... in only 5 minutes a day... WERE AS FASCINATING AS PLAY?

Here—at last—is a new invention that takes the WORK out of WORKOUT—a light, compact, Home Exercising Machine that makes HEALTH BUILDING AND REDUCING a delight instead of a drudge. Priced within reach of every one—only \$9.85. Try it 10 days in your own home. Send no money now—just coupon below!

Adjustable To Fit Any Size Person

Strong Enough To Stand Any "Pull"



STEELFLEX HEALTH ROWBOAT

THIS amazing invention provides the NECESSARY INCENTIVE to reduce, build strength, maintain health, by making it a PLEASURE to take a daily FIVE-MINUTE WORKOUT!

The Steelflex Health Rowboat provides NOT ONLY the scientific rowing stroke but also a COMPENSATING AUTOMATIC "PULL-BACK" utilizing the well-known principle of resistance, endorsed by leading authorities.

Although NEW, thousands of STEELFLEX have already been purchased. A N. Y. Physi-

cian writes: "It reduces abdomen, strengthens muscles of back and abdominal walls." A business man writes, "Reduced 13 lbs. in 2 months." Others say: "Reduced waist-line 3 inches in 1 month." "5 minutes with Steelflex equal to 1 hour's exercise of other type." (Names on request.)

No matter what part you wish to reduce or strengthen—no matter how busy you are—here is an inexpensive, ENJOYABLE way to regain or maintain the HEALTH and FIGURE you desire. You must TRY Steelflex to appreciate it. Try it in the morning—see how it makes you "feel like a youngster." Try it just before bedtime, see how it brings sound sleep. Try it 10 days—if it isn't MUCH MORE than we claim, RETURN IT—your money will be refunded at once!

We will send Steelflex by express, collect on delivery, with understanding that your money will be refunded at once, upon your request. It must "sell itself" to you and your family. Mail coupon NOW to The Steelflex Corporation of America, Dept. 3010, 1783 E. 11th St., Cleveland, Ohio

ONLY \$9.85 COMPLETE Plus Small Delivery Charge

ROWFLEX Health Glider

Same as Steelflex Health Rowboat, but has silent ROLLING SEAT. Provides the racing-shell stroke, with full leg and hip action, complete massaging of the abdominal and thigh region.





Rolling seat brings every muscle into play. If Rowflex Health Glider is desired, place X in square in coupon. Price \$11.85 at factory.

Send no money—Just this coupon

THE STEELFLEX CORP. OF AMERICA
 Dept. 3010, 1783 E. 11th St., Cleveland, O.

Send me Rowing Machine checked below, with instructions for use. I will deposit price, plus delivery charges, with Express Company, with distinct understanding that my money is to be returned promptly should I decide to return machine within 10 days after receiving it.

Steelflex Health Rowboat—\$9.85
 Rowflex Health Glider with Rolling Seat—\$11.85

Name.....
 Address.....
 City..... State.....



These Six BIG AUTO Books Including Aviation Motors

The greatest money makers that any man interested in automobile construction and repairs ever owned. Brimful of fascinating facts, designed to help anyone understand every detail of modern automobile construction. They become invaluable to you whether you own a garage, work for someone else, or are only interested in knowing how to keep your own car 100% efficient. These 6 big automobile books are published by the American Technical Society with over a million dollars of resources, enabling us to get the co-operation of the largest automobile manufacturing concerns who have supplied data sheets, specifications and the results of their own service experience. They are unquestionably the finest automobile books ever published and include over 120 pages on Aviation Motors.

SEND NO MONEY

Just send the coupon and we ship immediately. On delivery deposit only \$2, plus the few cents delivery charges. Then keep the books for full 10 days before you decide whether or not you want them. Jiffy Index gets facts at your finger tips instantly. If you decide to keep them send \$3 in 30 days and \$1 a month until the special low price of only \$24.50 is paid. There is nothing more to pay and no other obligation of any kind.

Note: If you prefer, enclose \$2 with the coupon, and the books will be sent to you with the same guarantee of an immediate refund.

Over 2500 Pages
3000 Charts and
Illustrations
Flexible Covers
Fine Paper
Jiffy Index

AMERICAN TECHNICAL SOCIETY,
Dept. A-719, Drexel at 38th St., Chicago

Send the new 6 volume 1931 edition of your auto books. I will deposit \$2.00 with the postman, which is to be returned to me immediately if I return the books. If I keep them I will pay \$3.00 in 30 days and \$3.00 a month until the special offer price of only \$24.50 is paid. You are to include free membership in the American Technical Society.

Name.....
Address.....
City..... State.....

We Will Train You in a Few Months



Day and Night Schools
in Chicago, Detroit,
Cleveland, Boston, Phila.

No Books—No Classes
Experts Earn Up To
\$125 a Week as Me-
chanical Dentists

We teach you to make rubber plates, crowns, bridge work, metal base dentures, etc., for dentists. After graduating you are ready for a job or can open your own laboratory. We assist you.

Big Demand for Men

Thousands of dentists everywhere send work to mechanical dentists. We train you quickly in day or night school for this unovercrowded field. No mechanical experience necessary.

Work your way thru school. We help you find a job to meet your expenses while taking our training.

FREE BOOK Send at once for interesting free book telling all about this thriving profession. Also details of our liberal offers. Write today!

McCARRIE SCHOOL OF MECHANICAL DENTISTRY—
1338 S. Michigan Ave., Dept. 491, Chicago.

Without cost or obligation, send me your illustrated book on Mechanical Dentistry, and complete information as to my opportunities in dental laboratory work.

Name.....
Address.....



34 Lesson Drawing Course \$2.98

The biggest value you ever saw advertised anywhere



Haven't you often wished that you could draw cartoons, illustrate some idea, sketch some pretty face, etc.? You can do all of these things. One of America's most famous Cartoonists and Illustrators has developed a great, simple system for success in all branches of Commercial Art. This system has revolutionized the entire theory of drawing. It means that drawing can be as easy for you as writing—much simpler than learning shorthand, bookkeeping or typewriting. We are now placing this original system for learning Drawing, Art and Cartooning, consisting of 34 lessons with over 500 illustrations, within reach of every one. If you will devote a few hours each week to the Course WE ABSOLUTELY GUARANTEE that you will learn to draw and draw well before you have half finished the Course. If we fail to make this claim good, we will refund every cent paid us. By eliminating a large office force for answering correspondence, expensive catalogs, etc., we are enabled to make a price of \$2.98, the cheapest price ever known for a high-grade, home study course. Learn to draw. It is a big asset, no matter what field you are in.

Send No Money

Just order the course and on arrival \$2.98 pay postman

plus a few cents postage, payment in full for the entire Course and Drawing Outfit. If not entirely satisfied, return within five days and we will Refund Money. Address:

LEDERER SCHOOL OF DRAWING, Dept. 1932-W, Chattanooga, Tenn. Orders from outside the U. S. A. are payable \$3.28 cash with order.

If you order the course at once, we will include a drawing outfit, consisting of artists' pencils, pens, paper, erasers, thumb tacks, etc., enabling you to go to work without any additional cost.

DRAFTING!

LESSON FREE!



You'll be surprised how easy to learn, how interesting Drafting is—how quickly you can get ready for well-paid positions with Architects, Contractors, and in big manufacturing plants.

\$40 TO \$75 A WEEK—AND MORE!

We help you get a beginner's job when only half way through this course. And when you finish, we guarantee to help you find a position, satisfactory to you in salary, or money refunded. Amazing offer right now to select and factory men, between 20 and 25 years old. Ask for free lesson and Drafting book today.

AMERICAN SCHOOL, Dept. D-747 Chicago
Drexel Ave. & 58th St.

NEW SQUAB BOOK FREE

Breed PR Royal squabs and make money. Sold by millions at higher prices than chickens. Raised in one month. Send four cents stamps for postage on brand new big 60-p. illustrated free book how to breed and profit by fast sales method. Hurry—first year.

Plymouth Rock Squab Co., 634 N St., Melrose, Massachusetts

NEW CLASS EMBLEMS

Ring, sterling silver, 1 or 2 letters in center, HS, JH, GS or SS beside shield—36 or more, \$1.25 ea., 1 to 12, \$1.75
Silver plated pin with guard, any numeral, any letters, 75c; 12 or more, 65c ea.
56-page catalog shows 550 designs—pins (30c up), rings, emblems, jeweled pins, athletic awards, etc., at special prices. Write for free copy NOW.

METAL ARTS CO., FACTORY 46 ROCHESTER, N. Y.

NEW SHOE SOLES for 10c

New, soft pliable waterproof soles may now be yours for only 10c. Spreads on with a knife like butter and hardens over night. Agents desirous of making up to \$25 daily write for no-cost sample offer.

Universal Laboratories, Inc., Dept. 6299, Des Moines, Iowa
Let us recommend the best books to study on any subject. Popular Mechanics Press, Chicago, Illinois.

BUILD for PLEASURE or PROFIT

\$25 to \$50 a day making furniture, lamps, storm sash, toys, novelties, built-in cabinets, alterations, repairs, etc.

The Electric Carpenter

New model with 14" Fold-Over Band Saw includes also 8" Rip Saw, 8" Cross Cut Saw, 6" Jointer, 36" Lathe, Reversible Shaper, 3/4" Hollow Chisel Mortiser, and Sander.

Write, starting present occupation.
AMERICAN FLOOR SURFACING MACHINE COMPANY
524 S. St. Clair St., Toledo, Ohio



O This One Unique Floor Machine Scrubs

Scrapes

Takes off the old dingy shellac or varnish and sandpapers the wood to select smoothness.



Polishes

Waxes the floor and then polishes it. Result is far superior to handwork and you use much less wax.



Here's the way to clean tile, cement or marble floors. Fast. Efficient. No back-breaking drudgery. No splashing.



COSTS but a **FRACTION** of what a contractor would charge for doing over your **FLOORS . . .** so amazingly **SIMPLE** you operate it **YOURSELF**

The electrical way of doing over floors. Plug into an electric light socket like a vacuum cleaner. You don't even push or pull — you merely guide the machine.

YOU'D be surprised how beautiful your floors *could* be. They may look dingy and disreputable now, but how they'll gleam and glisten when done over the *electrical* way.

Instead of pulling rugs over the ugly worn spots, as you may be doing now, you'll be so proud of the lovely finish that you'll hate to cover up a single inch.

Can't you picture how much better your furniture will look . . . and your draperies . . . and rugs!

Can't you just hear your friends asking whether you've had a *new* floor put down?

How amazed they'll be when you tell them that you actually did over your old floor *yourself* . . . that the marvelous improvement was entirely due to *your own* efforts!

Yet that's just what you *can* tell them. The Ponsell Electric Floor machine enables you to scrape, sandpaper, wax and polish your old floors without bringing a single workman into your home.

Too good to be true? Not a bit of it. That's only *one* of the advantages. In addition, you save money because the machine costs but a fraction of what a contractor would charge you to do over your floors.

Then, too, the machine refinishes your floors in such a way that they are no trouble at all to keep looking beautiful all the time.

It's astonishing how quickly and easily floors can be done over with the aid of electricity. The *hard*-work YOU do; the *hard* work you leave to the machine.

You plug into a socket just as you would with a vacuum cleaner. In a few minutes you are running the Ponsell like an expert and your floors are on the way to a vast improvement.

Good-by, Drudgery!

When floors are done over by ordinary methods they have to be refinished every few years; and is no easy task, as you well know, to keep them looking presentable from day to day.

But when you do them over the Electric way, you never have to refinish them again and, what's more, the machine takes care of them for you forever after.

A few minutes' polishing each week, an occasional rewaxing (operations which the Ponsell makes absurdly easy), and your floors become the constant envy and admiration of your friends.

For Your Business Too: Thousands of leading firms keep their floors spick and span with the Ponsell. Far cheaper than hand labor. Write for information. See coupon below.

TEAR OFF . . . FILL IN . . . MAIL TODAY

Ponsell Floor Machine Co.
220-30 West 19th Street,
Dept. PM1031, New York City

Please mail me information regarding your Electric Floor Machine. I am interested in (business) floors.
(residence)

Name.....

Address.....

City.....State.....

PM1031

When writing to advertisers please mention Popular Mechanics

Copyrighted material

a1701

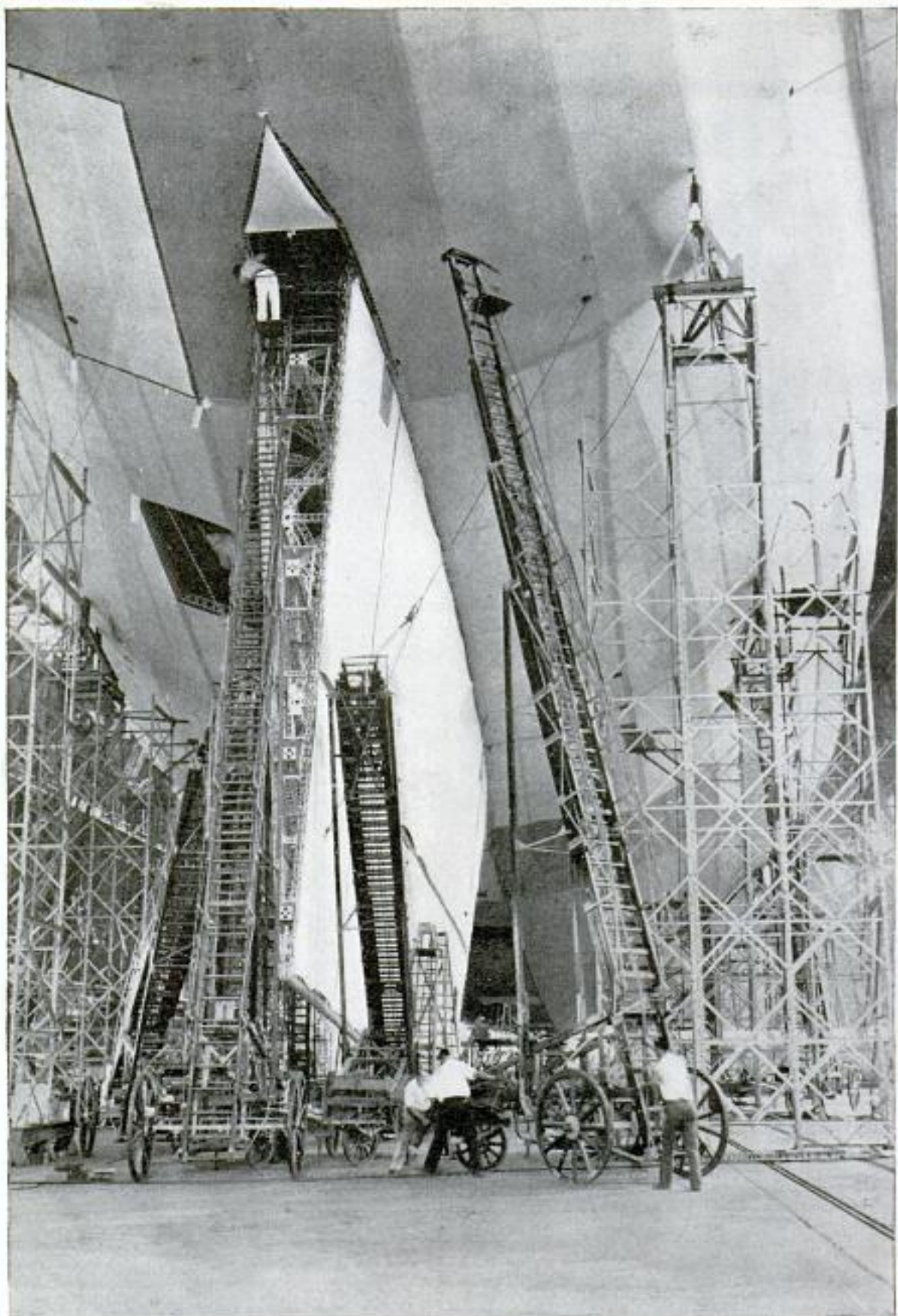

Workmen Put the Finishing Touches on the Lower Fin Which Contains the Auxiliary Control Cabin of the Navy's New Giant of the Air, the "Akron"

Wide World

Popular Mechanics Magazine

REGISTERED IN U. S. PATENT OFFICE

WRITTEN SO YOU CAN UNDERSTAND IT

Vol. 56

OCTOBER, 1931

No. 4

a1694

BLACK MAGIC

Lights the WATERS

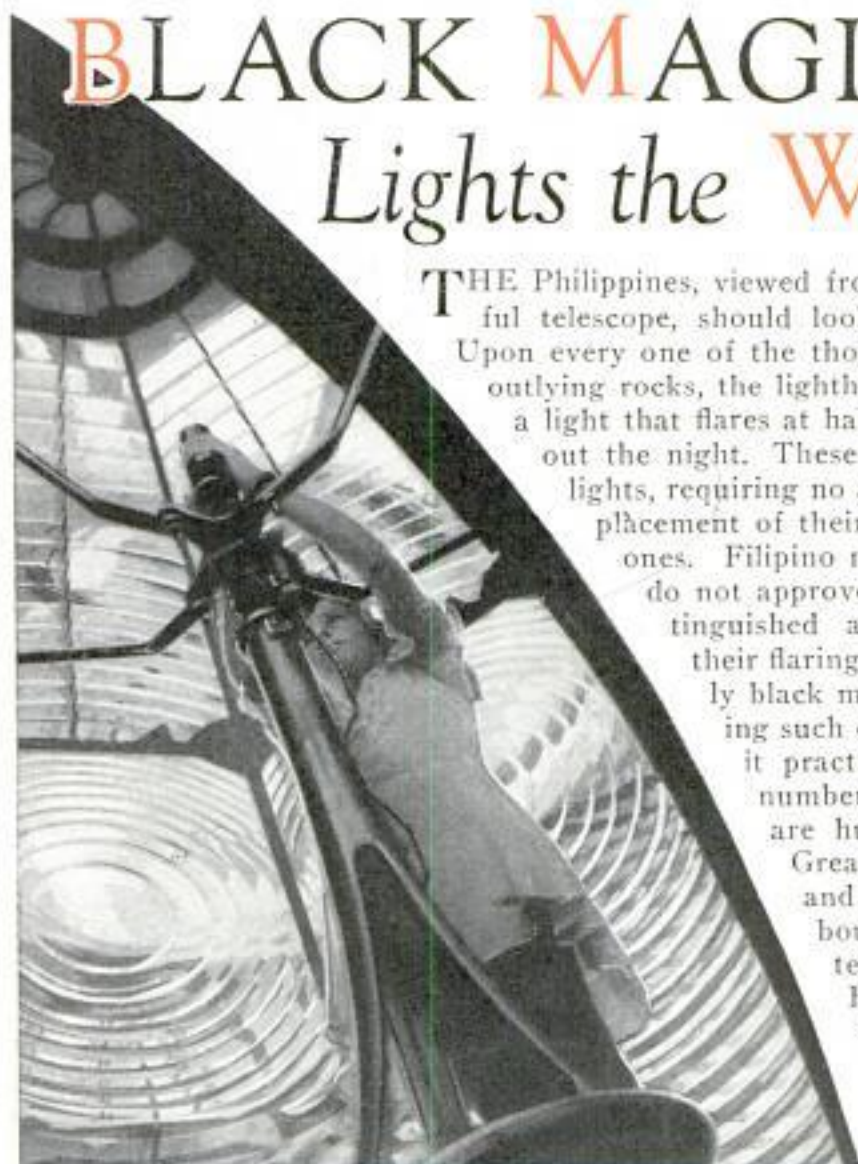

Million-Candlepower Lighthouse, the Lens of Which Is Five Feet in Diameter and Seven Feet High, Made of Cut-Glass Prisms, Highly Polished

THE Philippines, viewed from the moon with a powerful telescope, should look like a swarm of fireflies. Upon every one of the thousands of small islands and outlying rocks, the lighthouse service has established a light that flares at half-minute intervals throughout the night. These are automatic "keeperless" lights, requiring no attention save occasional replacement of their acetylene tanks with fresh ones. Filipino natives of semi-savage tribes do not approve of these lights, which, extinguished at daybreak and resuming their flaring at nightfall, are so obviously black magic. The cost of maintaining such outfits is so small as to make it practicable to establish them in numbers almost infinite. There are hundreds of them along the Great Lakes and the Gulf coast and in Atlantic and Pacific harbors. They dot Alaskan waters. Three, off the coast of Honduras, are visited only once in six months. The "magic" depends upon a very simple contrivance. A tiny pilot light burns day and night. A vertical bar is painted black. Set around it are three small-

er vertical bars, goldplated. A glass bell serves as a cover. When daylight falls upon the device, the black bar, absorbing warmth, expands, its length slightly increasing, while the three small bars, reflecting the light, are unaffected.

By this means is developed a certain amount of energy, enough to actuate a valve which stops an outflow of acetylene gas from a tank. Thus, in early morning, the flares are discontinued, but at nightfall the black bar cools and shrinks in length, causing the valve to open and liberate the gas.

One of the weirdest of sailors' superstitions has to do with so-called "shouting rocks," from which during storms the outcries of drowned and long-dead mariners are supposed to be heard.

Capt. Aerie Bache,
1823 2 St.

Washington, D.C.



There are today a number of shouting rocks along our coasts, with mechanical voices that are audible at distances of several miles, emitted from giant megaphones. They are human voices, originally recorded on phonograph disks, but amplified to stentorian bellows. "Danger!" they yell.

"Keep off the rocks!" They are turned on when fog prevails. But the real magic of this kind is performed by radiophone. It may be on a rocky promontory that the requisite apparatus is set up. The captain picks up his wireless telephone and listens, to hear a voice shouting. "Point Judith light!" Point Judith is near Newport. Every five seconds the cry is repeated, the mechanism on shore being a phonograph which, run by a motor, yells into a transmitter.

A mighty megaphonic voice was established a few years ago at Falkner's island, off the Connecticut shore. It was provided with eight enormous horns, each of them seventeen feet long and seven feet in diameter at the mouth. The apparatus

was installed on a circular platform, on which it rotated, the great horns crying out to all points of the compass with a sound reach of twenty miles. The tremendous vociferation, at intervals of fifteen seconds, was uttered by each megaphone in its turn, with a different combination of long and short howls for each compass point, thus giving to mariners accurate data on directions.

The newest bell buoys have a magic all their own, being wonderful noise makers. They employ a drum, which, as it rises and falls on the waves, turns several wheels. To each wheel a tongue is attached, engaging with a ratchet in such a way as to strike a bell every time the drum goes down or up. Thus the buoy mechanism is operated by the waves.

The magic of the intermittent light has been extended to the bell buoys of newest type. They give warnings near dangerous shoals and along harbor channels, or, when fog blankets them, send sound to replace danger light.



Compressed-Air Foghorns of a Lightship, Top; Sun Valve, Center; and a "Keeperless" Lighthouse

Big Dirigible Is Steered Easily by Propellers

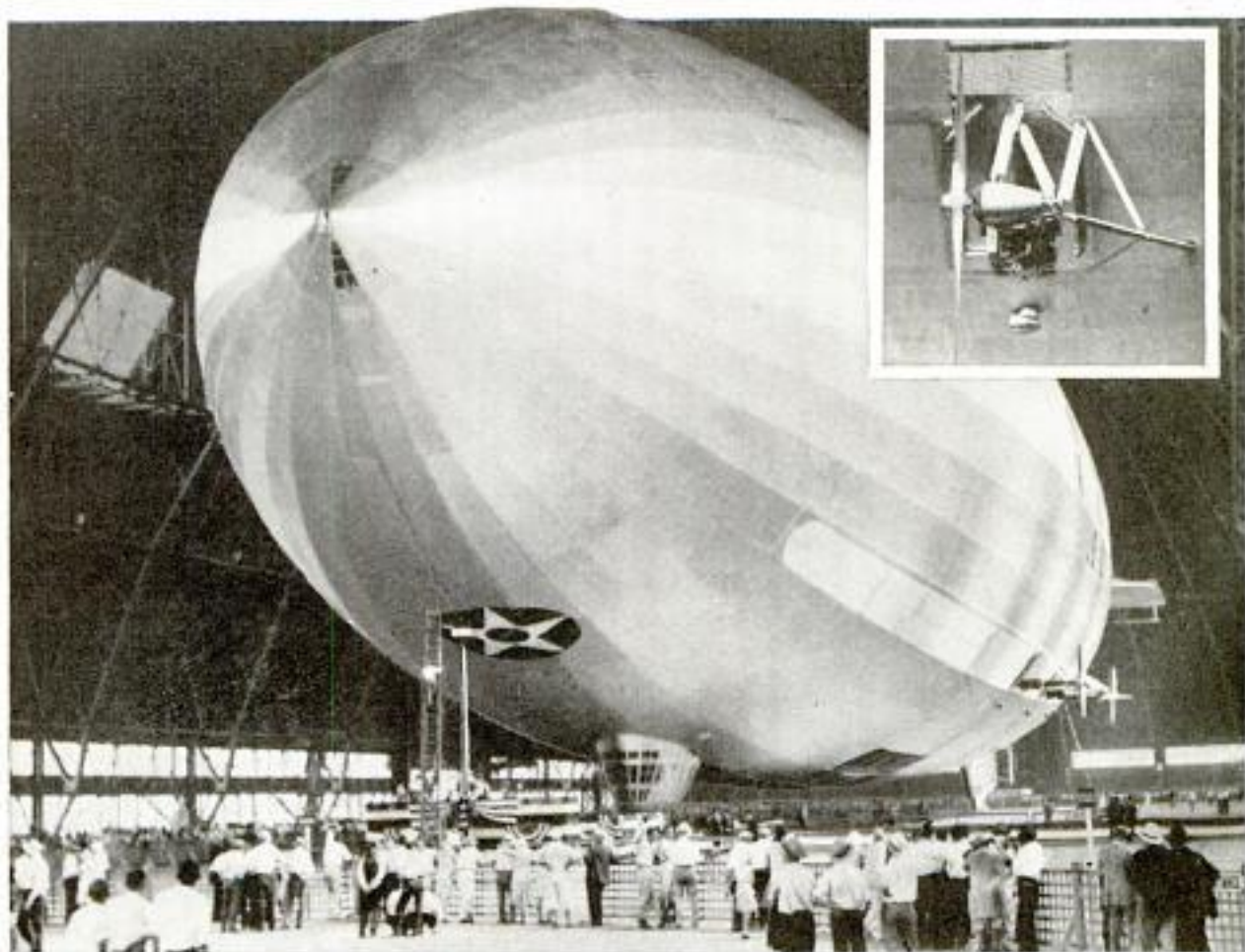

International

The Giant Dirigible "Akron" as It Appeared When Christened by Mrs. Herbert Hoover; Inset Shows Details of the Movable Propellers, by Which the Ship Climbs, Descends and Steers

Despite its huge proportions, the "Akron," the world's largest dirigible, is maneuvered with as much ease as a much smaller craft. This is due in part to its five movable propellers. By changing the position of these screws at will, the pilot of America's queen of the air is able to alter its direction almost the moment the propellers are moved. Some idea of the size of the great ship is obtained from the head-on view, taken as the dirigible rested in its hangar at Akron where it was constructed.

INSECT-PROOF TIMBER ADVISED FOR USE IN BUILDINGS

Spraying of timbers or woodwork with poisons intended to rid buildings of termites, or white ants, is of no real value, according to the department of agricul-

ture. The only effective remedy known, experiments have shown, is the provision of termite-proof materials for foundations. The danger of collapse of a building from termite damage to timbers, however, has been exaggerated, and the department claims such danger constitutes a negligible risk, although it is true that, where termites have infested a building for many years, some of the timbers may become so weakened as to require replacement. Radical reconstruction of the foundation is the only permanent cure for buildings infested with termites, and spraying or removal of bad timbers can, at best, be only a temporary remedy. Foundation walls of concrete and stone with all openings filled with mortar, and mechanical barriers, such as metal shields, used where necessary, protect woodwork against the ants.

91679

U.S. Daily 8/12/31

91590
 "Gulls of War" Are Launched from New Sub



sea. The plane is packed inside the boat when it submerges and can be launched off the deck within six minutes after the vessel comes to the surface. The submarine contains a water-tight hangar on the deck in which the plane rests when the boat submerges. The amphibian is equipped with folding wings in order to fit the hangar. On the deck of the vessel is a catapult from which the bird of war is launched at a speed of fifty miles an hour. When the submarine rises, the hangar is opened and the plane is moved onto the catapult, which is ready to operate as soon as the engine is started and the wings are opened, both these operations proceeding simultaneously. The new

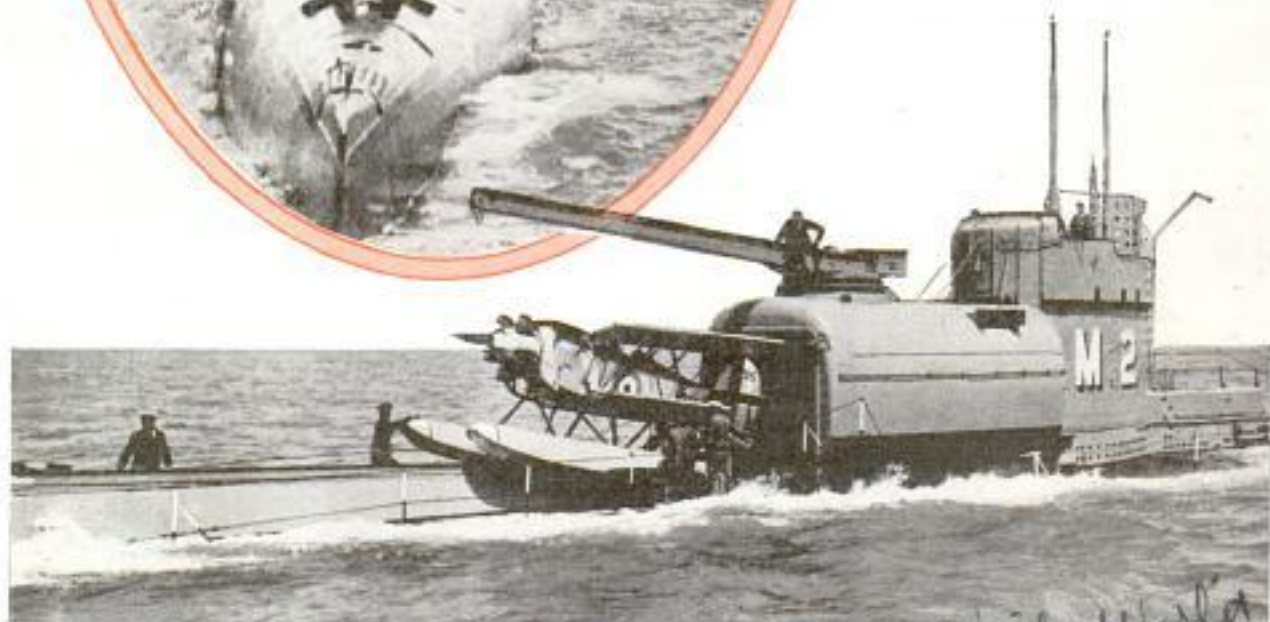

Two Views of a British Submarine Which Carries an Amphibian Airplane in a Hangar on Deck; the Plane Has Folding Wings and Is Launched from a Catapult at Fifty Miles an Hour

One British submarine is equipped to serve as mother ship for an amphibian airplane, thus combining in one unit the eyes of the navy above and beneath the

submarine was a feature of the navy-week celebration recently held at Portsmouth and was the center of interest to the crowds that watched the pageant.

Television News Service, 70 Brookline
Mass
a-1654

Hollis Baird,
Chief Engineer, Short Wave
and Televisual

a1505
POPULAR MECHANICS
20 Brookline Ave
Boston, Mass

533

STATIC SHOWS AS BLACK SNOWSTORM BY TELEVISION

Radio listeners who have wrestled with the problem of eliminating static from their sets find the same pest awaiting them in visible form when they install a television receiver. Static manifests itself on the television screen in the form of a black snowstorm and the black snow usually falls in summer since the television set, like the radio receiver, suffers more from static in summer than in winter. In television the noise of static is translated into dark spots instead of ear-splitting crashes and these appear in a form resembling black snowflakes. Radio engineers believe television will eventually solve the static problem as has been done in broadcasting audible programs, by increasing the power and improving transmission, pickup and reception apparatus.



Easy Crossing of Streams Is Only One Advantage of These Boat-like Rafts Which German Water Sportsmen Are Using

Emb. Laco F. Paul
Chgo. 1409, 537 St. Dearborn
Chicago

ONE-MAN RAFT BOAT IS DRIVEN BY TWO-BLADED OARS

One-man raft boats, propelled with two-bladed oars, are used in the latest water sport in Europe. The boats are made of two stringers ten feet long, joined by convenient crosspieces and braces. A man soon becomes expert in handling this inexpensive craft, which is non-sinkable and almost impossible to capsize.

ELECTRIC LIGHT INSIDE PURSE FLASHES AS BAG OPENS

Rummaging inside a handbag for some small article and finding it by the sense of feeling alone is no longer necessary. A bag is now being offered that is equipped with a small electric light. The light flashes on when the purse is opened.



Handbag with an Electric Light Inside That Flashes On When the Purse Is Opened to Reveal Its Contents to the Owner

CAPACITY OF PHONOGRAPH DISK DOUBLED BY NEW PROCESS

Twice as much music as formerly can be recorded on a phonograph disk by employing a recently developed material for it. The records are made of durium, a synthetic resin which is very tough and at the same time flexible. The improvement, which permits the playing of an entire selection of concert music from one record, is effected by reducing the thickness of the walls between the needle grooves. A special fiberboard is coated with the durium and on this the recording is made. The disk can stand much abuse and, because of its durability, the needle grooves are placed very close together, with twice as many channels to the inch as in ordinary records. Such records also wear longer than the latter.

Photographers cannot locate maker

Durium Products Corp
460 W. 34th St
New York

a 1586 Edward B. Patterson
 534 Engineering Dept. R.P.A.
 POPULAR MECHANICS
 Victor Co. Inc. Camden, N.J.
Radio Music Turns to Color in Your Home



watts of acoustic power, changes occurring in accordance with rapid fluctuations of the input, and this is the secret of telecolor. The music is picked up through a microphone in a theater, or a radio or phonograph in the home, and after amplification, passes through a series of filters, each picking out certain tones. The filters in turn are each connected through a thyratron tube to the respective colors representing the mood of that pitch. The colors are arranged to fit the types of music, red, for instance, representing warm or exciting melodies; blue, cold, tranquil or serene; and green the neutral, peaceful, soothing strains. Since it is possible to match every color by mixing lights of red, green and blue, these three are used, with white lights, to permit degrees of saturation. The music

Reprinted in Proceedings of Radio Engineers Institute of Radio Engineers 34 W. 39th St. New York, N.Y.
 Ant. Eckhardt

Color has invaded the field of radio, making it possible for the listener to receive the music over the air and have it interpreted in terms of color in his home. Telecolor, the apparatus which automatically produces color by means of music, and synchronizes the colors to the music, is a far cry from the color organs that produce lighting effects from a series of switches operated by a keyboard, for it operates just as automatically as the radio which brings in the sound. Through the use of thyratron tubes, thousands of watts of light may be controlled by a few micro-



Cabinet Containing Apparatus Which Interprets Radio Music in Terms of Color in the Home, and an Example of Color Music

thus controls these colors, which are thrown on a screen in the home or used to flood the interior of a theater, and it is even possible to extend the light play to the control of water in fountains, the flow following the mood of the music. The color is not transmitted by radio, but op-

u 1649

the Andreev Lezhava

erates from the sound carried by the wave whether the sound emanates from a radio, phonograph or other instrument. Through the changing of connections, lighting combinations can be altered, enabling musicians to write music and work with the device as with an orchestra.

FUTURE CAR SPEED SET AT SEVENTY FIVE MILES

Seventy-five miles an hour will be the normal road speed of automobiles in five or ten years, automotive engineers predict.

The increased speed will be accompanied by revolutionary changes in design and construction looking to greater safety. These changes will not be toward larger and more powerful engines, but rather toward streamlining. Even removal of front lamps will increase speed.

BOOK THAT WEIGHS TWO TONS IS TWELVE FEET LONG

Germany boasts a book that weighs two and one-half tons and which is more than twelve and one-half feet long and about four feet wide. It is known as the German prince atlas and has covers of veneered wood. The huge volume recently underwent a restoration process to remove the ravages wrought by time.

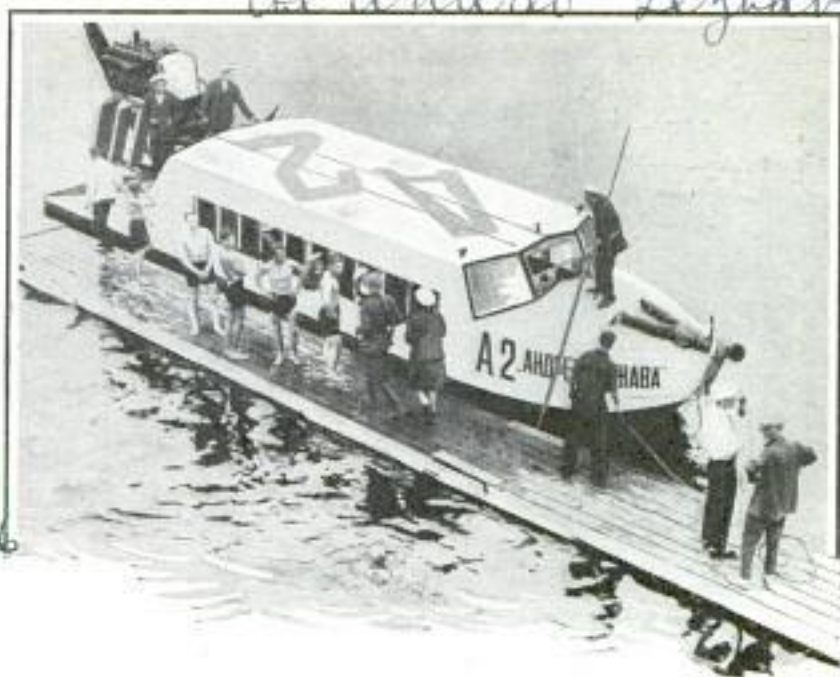

Motorboat Powered with an Engine at the Rear, Which Operates an Air Propeller; Note the High Cabin and Streamline Design

AIR PROPELLER ON MOTORBOAT INCREASES ITS SPEED

Driven by a powerful motored propeller, a large motorboat attracted much attention in Russia recently when it competed in a race with other craft of the water-propeller type. The boat is of streamline design with a high cabin and engine and propeller mounted at the rear.

LARGEST LIVING THING IS TREE IN SEQUOIA NATIONAL PARK

After precise measurements of the big trees of California, a committee of engineers has decided that the General Sherman sequoia in Sequoia National Park is the largest living thing on earth, with the General Grant tree a close second. More than 1,000 measurements and calculations were necessary to determine that the General Sherman redwood was champion. It has a volume of 600,120 board feet, a height of 272.4 feet, a circumference at the ground of eighty-eight feet, and one limb alone has a diameter of over six feet. If made into lumber, it would provide 30,000,000,000 matches or forty five-room houses and a train of thirty cars would be needed to transport its trunk. The General Grant tree contains only nine-tenths of the volume of the champion, but it is larger around the base and higher.

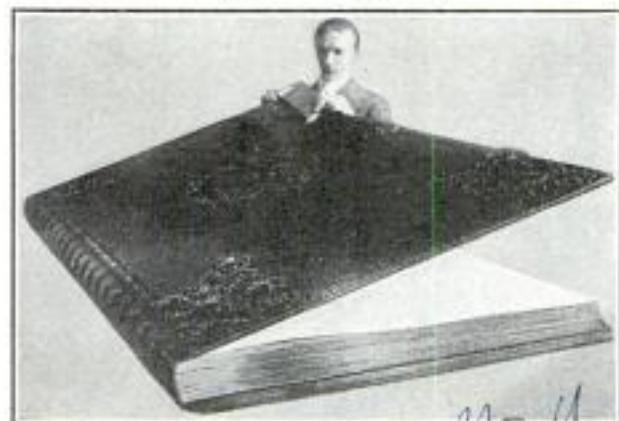

German Atlas Which Weighs Two and a Half Tons and Is Twelve and One-Half Feet Long

u 1651
8/6/31
u 165
u 1645
u 1664

represent California State and District Chambers of Commerce

91409
 For information on Pacific Coast salvaging expeditions.
 Cmt. Leonard H. Helano.
 Sweetland Bldg
 Portland Ore

BURIED

From the Depths
 of the Sea
 to Cocos Island
 Hoards of Hidden
 Gold Lure
 the Adventurous
 and Ingenious
 to the Search



Diving Bell That Can Move over the Ocean Floor, Equipped with Armlike Crane; Shore of Cocos Island at Right

LIFTING power of an eighteen-foot tide is being utilized to raise the steamship "Islander" which sank Aug. 15, 1901, in Stevens Passage, nine miles from Juneau, Alaska, with three millions in gold dust and nuggets aboard.

A heavy barge with a series of winches along the sides is being anchored above the sunken ship and lines let down to be secured around the hulk. The salvagers expect to repeat the proc-

ess of taking up the slack in the lines at each low tide and move toward the beach as the tide rises. This is expected to take between three and four months, according to Frank Curtis, head of the project.

A novel diving apparatus, recently invented by E. H. and C. H. Wiley, is making possible operations at the

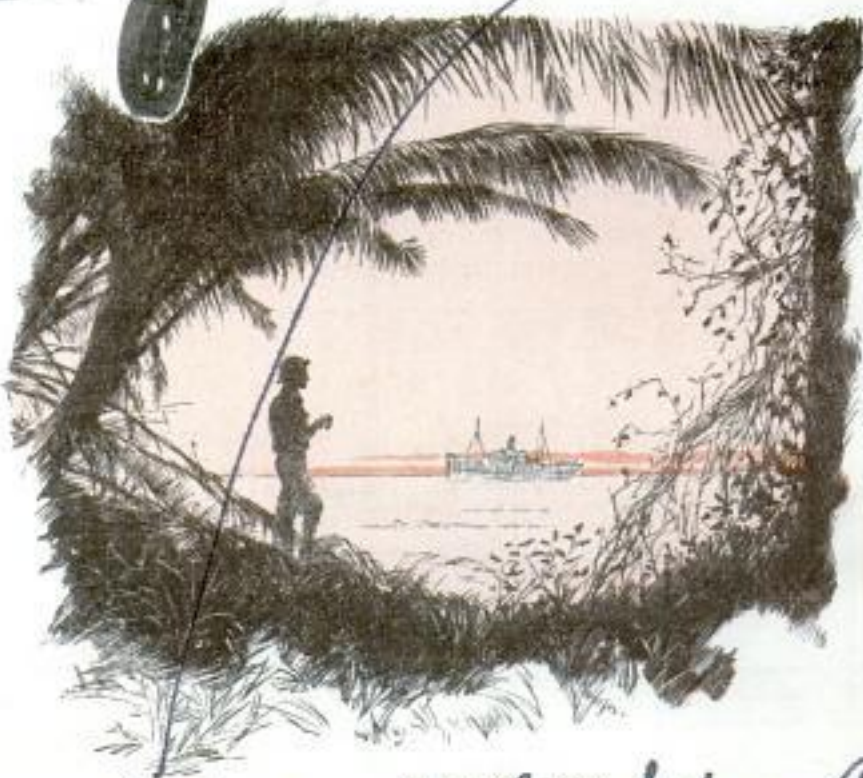

Courtesy Wm. Beebe

to Curtis, Wiley Salvage Corp
 Republic Bldg, Seattle Wash

Q1409

TREASURE!

high-tide depth of 365 feet. This apparatus has tractor treads for moving about on the sea floor and a crablike claw grappling arm—both operated by the occupant. It is propelled by electricity, and its occupant can work under water for twelve hours if necessary. In a previous expedition, headed by the inventors of this novel submarine bell late in 1930, much of the "Islander's" superstructure was removed and considerable work was accomplished before lack of funds and a storm forced their withdrawal.

A feature of this bell is that the operator breathes under normal pressure. No air is forced into the bell, but is circulated by ordinary pumping. How agile the crab claw has proved itself is shown in the dishes

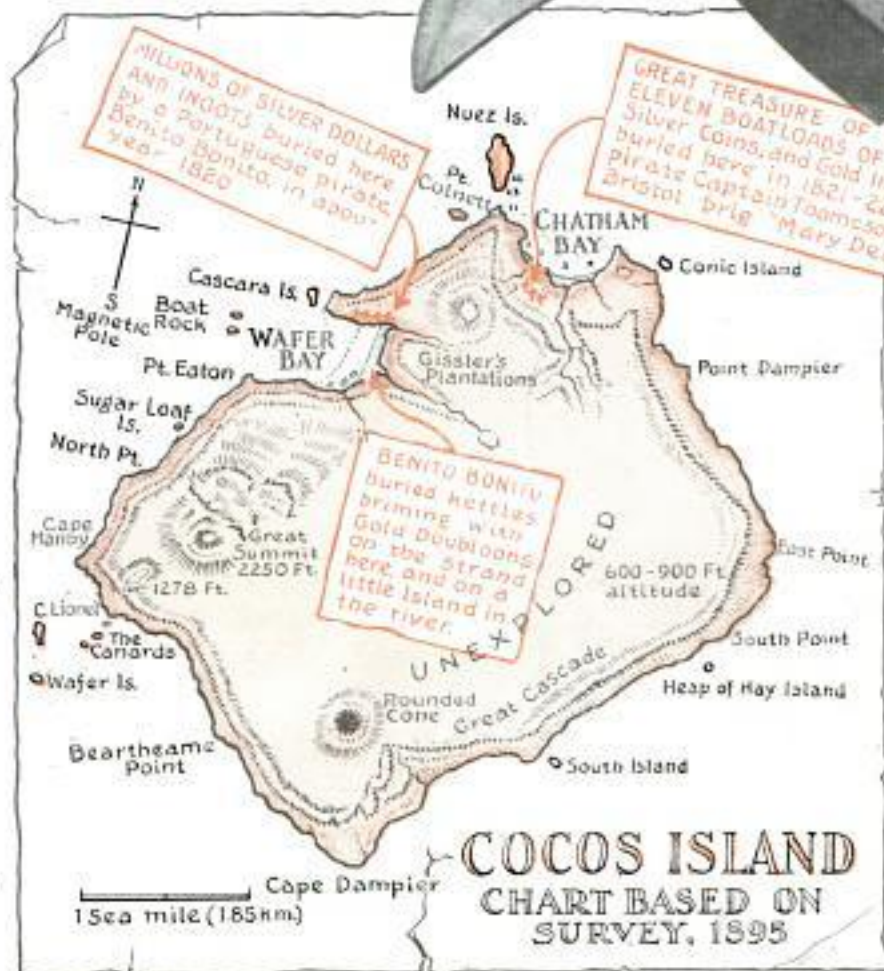

Wife of the Inventor of the Bell, and Bones of a Miner Who Went Down on the "Islander"; Old Treasure Map, Left

and bottles which the operator picked out of the ship's pantry in the 1930 expedition. The bell has withstood pressure at a depth of 900 feet.

The "Islander" has been the subject for conversation among contractors and salvage men of the Pacific coast for many years. Seventy-two lives of the 145 persons aboard were lost when the ill-fated ship struck an iceberg and went down in five

a1409

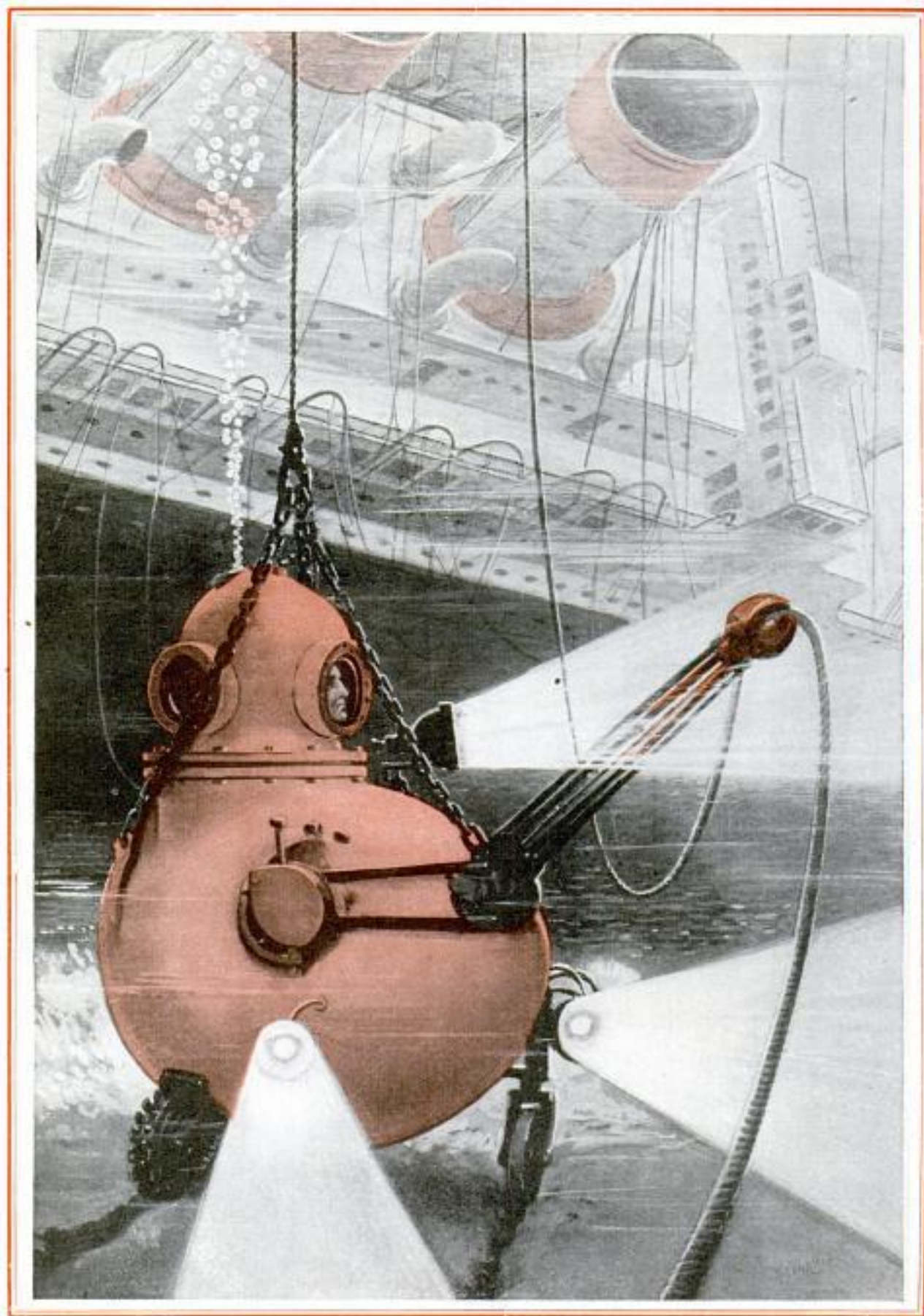

The Mobile Submarine Diving Bell, Built to Travel under Its Own Electric Power, Supplied by Cable, Equipped with Lights and a Crane, to Be Used in Searching the Treasure Ship "Islander"

a 1409

minutes more than twenty-nine years ago. The gold was being shipped at the time of the gold-rush excitement in Alaska and the Klondike territory.

While this treasure hunt is going forward, attention is also being devoted to new expeditions seeking to recover the pirate gold believed to be buried on Cocos island. This little desert island, hardly more than six miles square, 550 miles southwest of the Panama canal, and a rendezvous of buccanniers and pirates since the days of Wafer, Davis and Dampier, and probably of much earlier English and Spanish adventurers, still draws men and women of many different types.

An ex-British admiral, an English lord, hard-headed

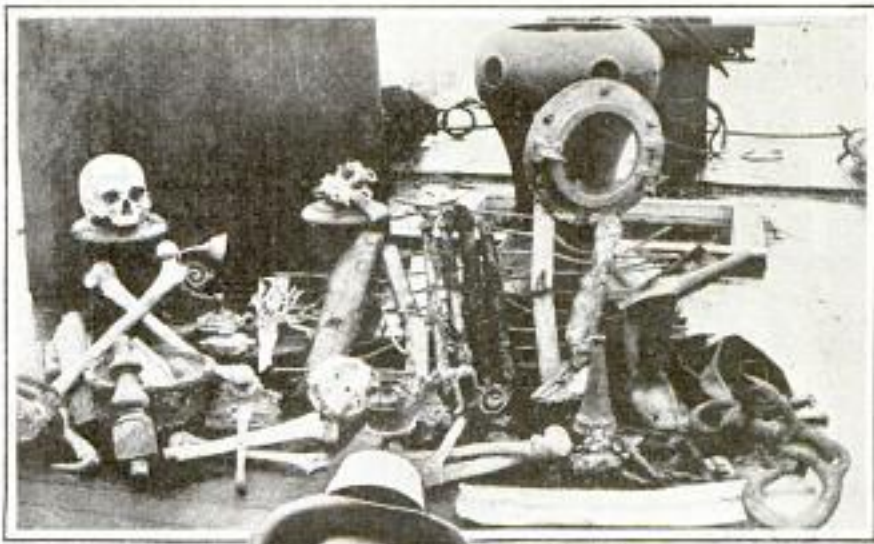

© Oratory
Reconnoitering Divers brought This Up from the "Islander": at Left, the Ship's Bell, and Below, Frank and Roy Curtis, Leaders of the Expedition, Inspecting the Winches



New York and Frisco business men and financiers, scores of newspaper men, runaway seamen, shellback skippers, tramp-steamer captains, women of Newfoundland and the sturdy New England states, and a famous racing motorist, all have sought the stolen hoards hidden on this lone island, which is the verdant top of an extinct volcano in mid-Pacific.

"One needs to go out to Cocos with a well-equipped, thoroughly seaworthy boat, accompanied by a few friends who are determined to put their backs into it," says Sir Malcolm Campbell, in his book "My Greatest Adventure", "and aided either by a strong, able-bodied crew or a gang of native workmen who can stand the heat."

Well known American scientists who in recent years have looked for the treasure include William Beebe, the oceanographer. Like so many others before and since, he tells a tale of dense tropical vegetation, sharks in the bays, landslides and impenetrable jungle.



W.C. London Eng. has no definite info. sold in U.S. by Frederick A. Stokes + Co. New York

Chapters in Welles Book, *Pirate Treasure*.

Published by Thornton, Butterworth & Co. Ltd. 15 Bedford St. London

Cannalocate
maker

Dr. A. A. Kinard
Memphis, Texas

a166

1658

Dr. A. A. Kinard
Hall Quality Products Co
Memphis, Tenn.



Player Ready to Make a Shot on Outdoor Billiard Course; Note the Trigger Cue

BILLIARDS PLAYED IN OPEN AIR WITH TRIGGER CUES

Billiards has been moved outdoors where it is being played on a course as large as a dance floor but shaped like the conventional table. The balls are as large as oranges and are shot with cues that are operated with triggers and resemble small machine guns. The players stand on the big "table" and aim their cues.

CACTUS THAT HARBORS SNAKES KILLED BY COCHINEAL BUGS

Cochineal bugs have been imported into India for the purpose of destroying cactus clumps that harbor dangerous snakes. The insects can kill a cactus plant in about two months, after which the bugs breed rapidly. Cactus and cochineal both are native to America, and at one time the Aztecs raised cochineal on cactus for dyes. Later some European countries imported cactus for similar purposes, but in some cases with disastrous results. In both Australia and South Africa, it infested great grazing areas because its natural enemies were not present. One of these enemies is the cochineal bug. The insects breed about a generation a month and, on hatching, the "crawlers" wander over the plant until they find a favorable spot where they sink their tiny trunks into the cuticle of the plant and stay. It is believed the insects introduce a virus or bacterial disease into the plant. By killing the clumps of cactus in India, the bugs fight poisonous snakes as well.

COOLING JACKET FOR MILK CAN IS INFLATED WITH WATER

Evaporation of water from a burlap jacket keeps contents of a milk can cool, adding to the convenience of shipping perishable products that do not require extremely low temperatures, especially cream. The jacket fits snugly over the can. Because of the freedom permitted in handling the cans and to encourage their use, railways in the southwest have agreed to return the jackets to their points of origin without cost.

SLOW-MOTION BICYCLE KEEPS SHIP'S PASSENGERS FIT

Deck bicycles recently have been added to the gymnasium equipment of one steamship line as an aid in keeping the passengers fit by making available a healthful form of exercise on shipboard. These bicycles are not stationary affairs but can be ridden around the deck with safety. The chain attached to the drive sprocket, actuated, as on an ordinary wheel, by the pedals, is not geared to the rear wheel but to small auxiliary wheels, one at each side of the rear wheel. Although the same amount of energy is necessary to operate the vehicle as is required to pedal an ordinary bicycle, the deck wheel is propelled very slowly.



Courtesy Hamburg American Line
Bicycles for Use on Shipboard; the Auxiliary Wheels Slow Down Speed of the Vehicles

9/16/01

a163

c/o

Science Service
mail report 8/12/01

39 Broadway
New York

Copyrighted material

91706

at Langley Field, Va

Mr. Shasta

Bombing a Ship Tests Skill of Army Pilots

Scoring but two direct hits out of a series of bombs, army planes recently were forced to leave the completion of destruction of a derelict transport ship to the coast guard. Bad weather caused the tests to be postponed at the outset. One result of the tests, however, was the obtaining of some excellent photographs from the air, showing the target far below, tiny in the distance, the bomb on its way shortly after being released, and a second which shows the explosions as the bombs struck the water.

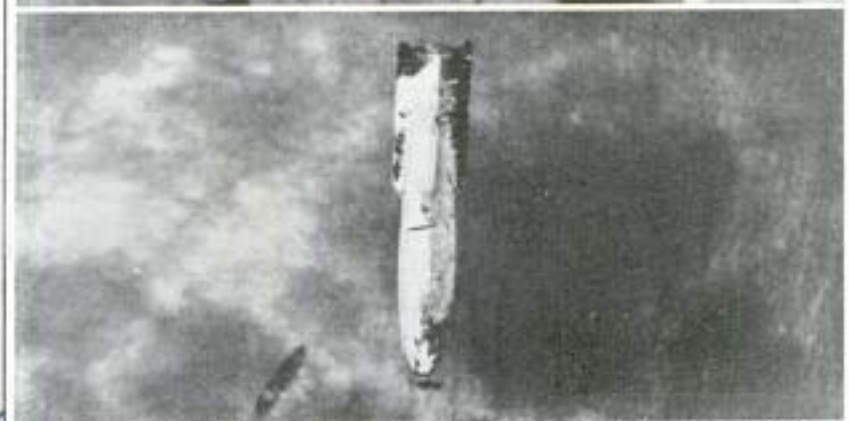

Top to Bottom with Hand on Lever Ready to Release a Bomb; Missile in Mid-Air, and Exploding Bombs near Target

TEETH ARE INDEX TO BRAINS NEW THEORY

While brains grow, teeth rest, and man pays with weak and crooked teeth for a better brain. This is the view of Dr. G. Elliot Smith, professor of anatomy at a British college. During the first seven years of a child's life, he explained, there is a remarkable mental growth and a pause in dental development. For another fifteen years or so, he is sluggish in dental affairs because he is busy adjusting his complicated cerebral apparatus to life's needs, the delay in teeth and jaw development being due to these changes. But while brains are responsible for ugly teeth in man, they have given him a beautiful chin, his distinguishing mark in the animal kingdom. Doctor Smith believes that the part of the chin that does not bear teeth develops while the rest is held up and the salient chin, therefore, is an index of mental development. He does not say, however,

that persons with the most prominent chins or the most outstanding teeth have the greatest brains. He also says there is no justification for the common belief that the smallness or absence of the third molar indicates that man eventually will lose that tooth. Apes, monkeys and the earliest man of which there is any record also had small third molars. Apart from changes resulting from racial mixtures, no developments are taking place to indicate such a radical alteration in human jaws or teeth, and nothing is to be expected, he declares.

King's College - Sumner Service

A 1468

Capt. Logan H. Keane, 55 W. 42nd
New York

Flying Explorers to Search the "Lost World"

Expectation to Venezuela.
Panama

UNTIL THE COUNTRY IS MORE FULLY EXPLORED, LANDINGS, AT FIRST, WILL BE MADE ON WATER.



16 SCIENTISTS, WITH NATIVE HELPERS, ARE TO EXPLORE VAST REGION OF 40,000 SQUARE MILES IN VENEZUELA, WITH THE AID OF AIRPLANES



A THIRD WHEEL TO LESSEN LANDING SHOCKS



BARTERING WITH INDIANS WHO HAVE NEVER SEEN WHITE MEN



STRANGE GEOLOGICAL FORMATIONS TO BE STUDIED

GERRO DUIDA, 7600 FEET, PREVIOUSLY SURVEYED

HITHERTO UNKNOWN SPECIES OF PLANTS MAY BE FOUND



Sixteen Explorers of the American Museum of Natural History Plan to Start Soon to Study the "Lost World" Region of Venezuela; Mountains and Forests Have Made It Impassable

Columbus Ave. & 77th New York

a1468

for Cannibal Plants and Prehistoric Beasts

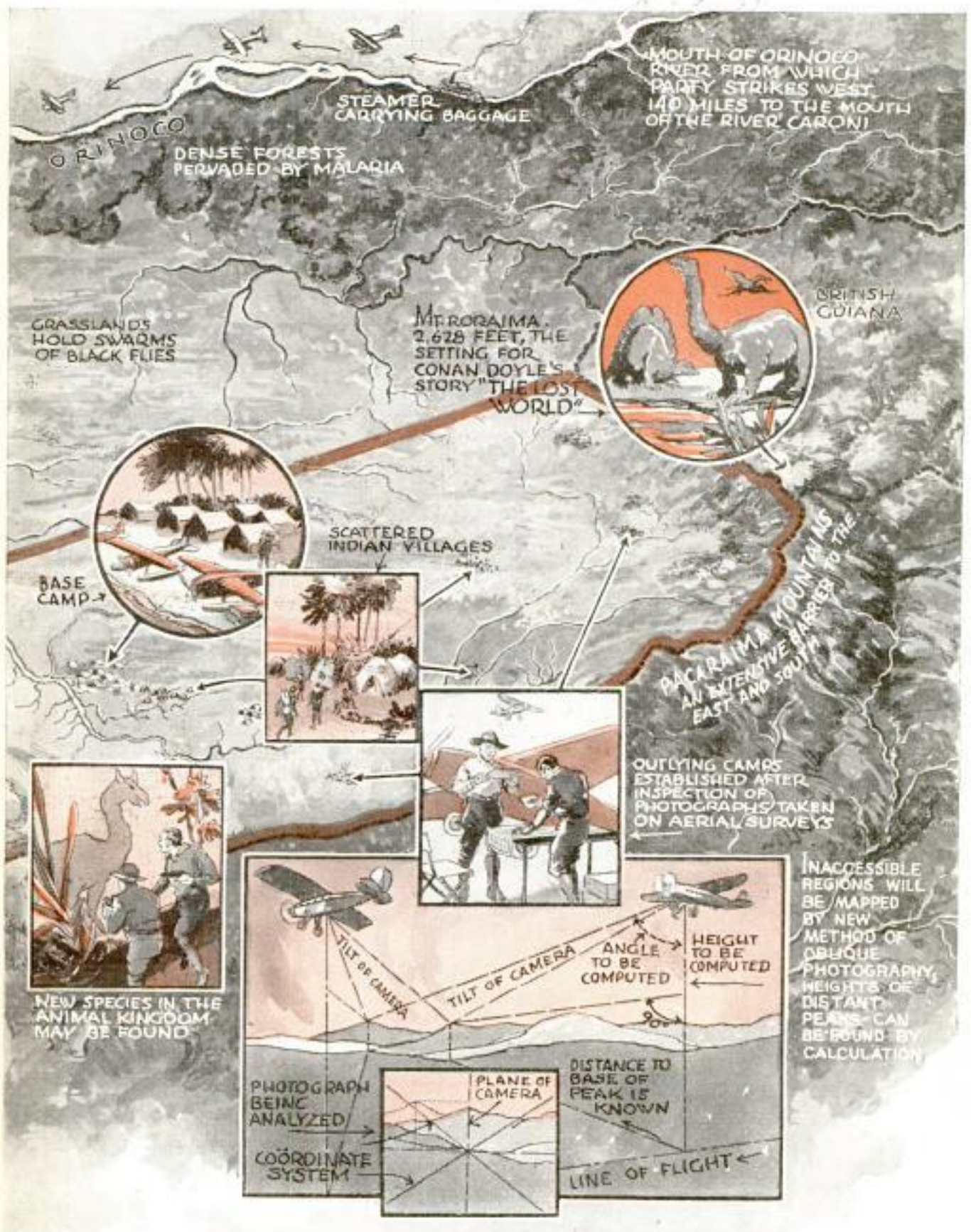

Surveys from the Air Will Be Made of the Country, Most of Which Has Never Been Seen by White Men; Entirely New Plant and Animal Life Is Expected to Be Encountered

J. & J. Welding Co

Developed in General Electric Co. Laboratory

544

POPULAR MECHANICS

a 1619 Vancouver
FREE WHEELING FOR SCOOTER WITH COASTER PEDAL

under direction of John Bellamy Taylor
ceedingly short light waves are focused on the distant receiver by a concave mirror mounted on a tripod. This receiver picks up the single narrow beam, and the electrical vibrations are turned into music or words. The narrow beam can be seen by observers at the receiving end, but cannot be intercepted except by an object interposed in the line of sight. Static does not interfere with this medium of communication, which holds possibilities of secret, direct communication between ships in harbor, within sight of each other, or between ship and shore.



Free-Wheeling Scooter with Pedal Operating a Ratchet Device Which Permits Coasting

Free wheeling, the principle which allows an automobile to coast when the foot is removed from the accelerator, is imitated in a scooter for children which contains a pedal operating a ratchet device to permit coasting. Downward pushes on the pedal supply the motive power, each push sending the wheels forward three feet. Steering from an upright lever is applied to the two rear wheels and a small brake is installed just behind the front wheel.

NEON LIGHT RAYS CARRY SOUND ON NARROW BEAM

a 1658
Light waves from a powerful neon tube are used to transmit sound on a straight line in experiments which seek to perfect a directional "narrow-casting" form of communication. The term narrow-casting refers to the narrow beam on which the sound travels, as compared with the broad beam employed in radio communication. Beams from the neon tube are actuated by electrical vibrations generated by microphone, phonograph and radio receiver, then transformed into ex-

New York Times 8/6/31

FOUR-IN-ONE FRUIT IS FOUND IN SECTION OF ECUADOR

Combining the characteristics of an orange, peach, lime and tomato, a four-in-one fruit that is almost a salad in itself has been found in one small area of Ecuador by a research worker for the Academy of Natural Sciences of Philadelphia. This fruit was found in its wild state on a ranch near Banos. It is like an orange in shape and size, but has a thinner skin covered with a heavy peachlike fuzz. Its juicy pulp is filled with seeds like a tomato, while the skin is green with red veins, and the pulp is a vivid green. The fruit is edible and the juice forms the base for a refreshing drink, which already has found favor in the cafes of Quito.

a 1657
W. Judson Corey

Christian Science Monitor 8/6/31

PLIERS TO REMOVE INSULATION HAVE MILLED HANDLES

Removing the heavy insulation from outside wire is made a simple task with a pair of pliers having a milled surface on the inside of the handles, just back of the joint. With this tool it is easy to remove insulation from wire without damaging the wire itself, and in addition the method will be found much safer than doing the job with a knife and quicker than trying to do it with ordinary pliers.



Forged Steel Products Co., New York

copyrighted material

Electric Brain Solves the Hardest Problems

Mathematical problems are turned into a beam of light and the beam analyzed to find the answer in a new type of calculating machine developed by Dr. Truman S. Gray. Two photo-electric cells are used in the machine, which is called the "integraph," and solutions of extremely intricate problems are reached with amazing rapidity and accuracy. The photo-electric cells scrutinize a beam of light that varies in intensity according to the problem. Screens cut in the shape of graphs, which represent the problem, modify the light beam. Then the modified



Left, "Electric Brain" Which Solves Hardest Problems; Above, Dr. Truman S. Gray, the Inventor, Gets Answer in the Form of a Graph



the answer, which might require several days to reach by usual methods. The flow of the Ohio and Susquehanna rivers was

beam is compared with, or measured by, a beam of known quantity, resulting in

one of the studies to which the integraph was applied.

GERMS LIKE JEKYLL AND HYDE ARE BROUGHT TO LIGHT

Certainty that some germs have been living a double life and playing Dr. Jekyll and Mr. Hyde to the bewilderment of bacteriologists and physicians has been demonstrated by Dr. Arnold I. Kendall, of Northwestern University. Invisible, filterable bacteria have been grown into a visible form for microscopic study by Doctor Kendall, who points out that possibly the life of a germ resembles that of a butterfly, with the caterpillar, cocoon and butterfly stages. Bacteriologists now believe that one disease may be caused by the germ in its invisible form and an entirely different disease by the germ in the form studied under the microscope. Use of Doctor Kendall's discovery may be an

aid in finding a cure for diseases hitherto believed incurable.

EARTHQUAKE MAY BE FORECAST BY TILT OF EARTH'S CRUST

If records can be made of the gradual tilt in the earth's crust before an earthquake, seismologists will advance another step in their efforts to forecast earthquakes, the Rev. Joseph Lynch, of Fordham University, says. That there is such a tilt already has been determined, and only a record of this is necessary to enable science to warn inhabitants in the zone where the quake is forming. In Germany, artificial quakes are created by explosives. By measurements obtained from recording instruments, the mineral content of the earth may be determined.

7/28/31

Chicago Daily News

Ivanston, Ill.

Chicago Herald Examiner
 Copyrighted material
 7/28/31

9/15/68
 Fordham University
 New York City

a 1237

New York Wire Cloth
Co., 342 Madison
Ave New York



Aerial Tramway Which Carries Passengers into the Alps: It Makes an Ascent of Almost Two Miles

AERIAL CAR RISES TWO MILES ON ALPINE TRAMWAY

Starting from Vienna, an aerial tramway carries passengers on a two-hour ride into the Alps, the trip offering one of the most unusual journeys devised by man. Passengers in the aerial conveyance are carried to a height of 9,675 feet, or almost two miles, before they reach their destination.

PARACHUTES MADE OF COTTON MEET NAVY'S TESTS

Parachutes made of domestic cotton cloth have proved equal or superior to those of silk in strength and tear-resistance trials by the navy department. The cloth was woven in the bureau of standards mill and meets all requirements with respect to air permeability and weighs only slightly more than silk. The tests indicate that cotton parachutes closely approach those of silk in rate of descent,

opening time, strength, and ability to function after being stored in the pack for sixty days.

ALUMINUM CLOTH MAKES RUSTPROOF SCREEN

91523 Aldred

Aluminum wire, closely woven to form a cloth for screening windows and doors, is on the market, offered as a rustproof material. It resists rain, wind, sun, salt water and corrosive fumes, eliminating the usual streaking of screens after exposure to the weather. A double wire reinforcement at the edge gives extra strength at the nailing line, where most tears occur in other screen wire. The aluminum cloth is easy to stretch, cut and nail, and requires no painting after years of use.

MACHINE GUN ON MOTOR CYCLE FOR CAVALRY

91508

Cavalry troopers of the United States army are discarding their horses in favor of motorcycles, some of which now carry sub-machine guns mounted on the front. This step in mechanizing the cavalry increases its range of operations and effectiveness many times as compared with the horse era.



Motorcycle with a Sub-Machine Gun Mounted in Front Now Used by United States Cavalry

Christian Science Monitor

7/20/31

and National Advisory

Committee for Sermonettes

3841

Room 604 Old Washington, D.C.

at Fort Lister Va.

A 1329 Cnt. Sec. J. Paul, Co. 1409
537 S. Dearborn, Chicago.

Mystery Men *of the* Sea

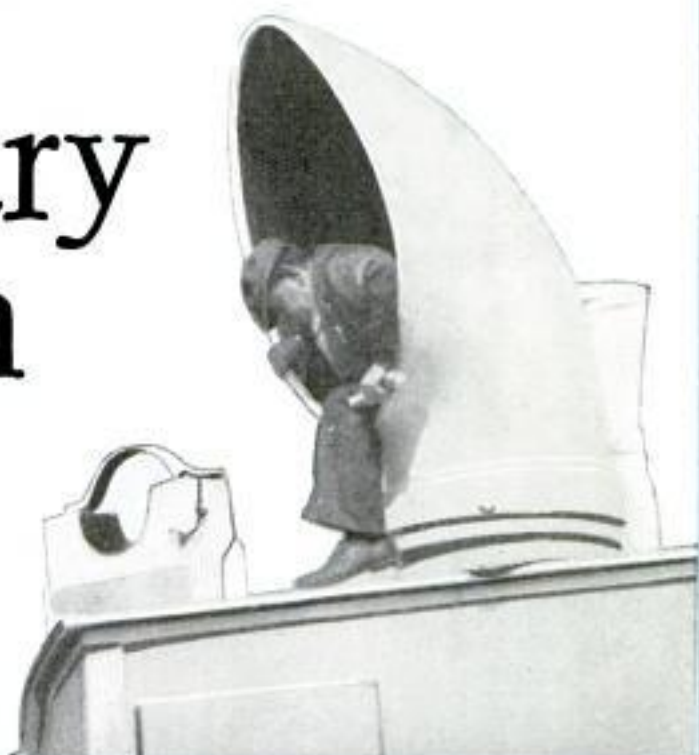

"I'D RATHER search six square blocks of houses than one lone freighter." It was Inspector Mike Russo of the custom service speaking. Dressed in denim overalls, with a face none too clean and a disreputable cap over one eye, he was well cast for the part he was to play, that of a long-shoreman.

Only the slight bulge over the hip concealing a pistol, or a little plumpness where a badge was pinned inside the shirt marked him and his aides as the mystery men of the service, a highly trained special smuggling squad, thoroughly conversant with the traits of international smugglers of dope, Chinamen and liquor.

Methodically they go over a ship with the proverbial fine-tooth comb. And searching a ship is a tedious job with hundreds of seemingly inaccessible places to which the smugglers resort.

They are a fine body of men, these undercover men, taking all sorts of personal risks. Bullets



Searching Ship's Funnels for Narcotics, and Pacing the East River Beat in a Custom Boat on Patrol



of Chinamen who were smuggled into New York.

From \$500 to \$1,000 was the price paid to the smuggling ring to bring them in. The story of the ring's operation, as told by Inspector Russo, may lead to charges of murder as well as smuggling. In many cases, it was said, the smugglers, employed as seamen, dropped some of their human cargo into the sea when capture seemed imminent.

The smugglers of aliens, like the rum runners, have their hijackers. A ring smuggling in one group of hatchet men was hijacked five times with loss of life, before agents of a rival ring succeeded in getting them aboard a ship.

Where, on board a ship, may a Chinaman be concealed? "In any number of places," says Inspector Russo, "ranging from the engine pit right on up to a ventilator on the top deck. And sometimes we don't get 'em out alive either. Starvation, suffocation and the sudden shifting of cargo all take their toll.



Disguised as Stevedores, the Inspector and a Guard Look Over a Lighter, Above, and a Typical Custom Boat on the Hunt for Stowaways and Contraband, Below

are the least of the hazards they face; pneumonia and pleurisy the greatest. A man must have a constitution of iron to search a hot engine room and go out on deck immediately afterward to search a cold hatchway.

Recently these men were instrumental in exposing a ring of smugglers whose activities extended as far south as Buenos Aires. The story of that hunt is a story

"One of the most ingenious smugglers I have caught had made quite a good thing of importing Chinamen in his stateroom. He hollowed out a bulkhead, placed a couch against it and thus provided a fine receptacle for a stowaway. He brought in one each trip until we got wise to him."

Most of the smugglers are found among members of a foreign ship's crew, scarcely ever among the officers. Either a

a1358

smuggler ships as a sea-
man or he may be ap-
proached by a member
of an international ring
after having honorably
served aboard a ship for
years.

The licensed "junkies"
of the harbor, too, occa-
sionally take a hand in
running contraband
ashore. Beneath their
piles of old rope ends
and junk, purchased or
stolen from a near-by
ship, they may conceal
priceless contraband.

There is, however, just
one method of smug-
gling that occasionally
baffles the custom men.
They admit it and soon
expect to have a solution
to the problem. Re-
sourceful smugglers
sometimes lower a heavy
tank from the stern of
the boat, burying it in
the muddy river bottom
while the vessel is being
searched, and leaving, as
the only clue, an inno-
cent-looking line, which
can haul the contraband
ashore again when the coast is found clear.

The secret has been revealed, however,
and the mystery men are now paying
close attention to all such innocent-look-
ing lines.

**ROSE THAT BLOOMS ALL YEAR
GETS FIRST PLANT PATENT**

Exclusive rights to reproduce, use or
sell an ever-blooming rose for seventeen
years have been assigned to a New Jersey
nursery under the first plant patent grant-
ed at Washington since passage of the
act in 1930. The patent covers a "climb-
ing or trailing rose, the 'new dawn,'" and
the patentable feature is its ever-bloom-
ing character. The flower is described as
being identical with the Dr. Van Fleet
climbing rose, except that instead of
blooming only once a year, it blossoms
successively in the same manner as the
ever-blooming tea roses.

Patented by Henry H. Rosenberg, assigned to Louis C. Schubert



Tower of Light That Illuminates a Speedway Bowl at Los Angeles, Making It Possible to Hold Automobile Races at Night

Wired World
Asco

**TOWER LIGHTS UP SPEEDWAY
FOR AUTO RACING**

Huge bulbs, fastened atop a tower in
the infield of a Los Angeles speedway and
casting a flood of light over the area five-
eighths of a mile around, recently were
turned on, and a crowd saw thirty-five
race drivers line up for a contest at night.
It was one of the most spectacular races
ever run, with the cars roaring around
the oval at speeds greater than ninety
miles an hour in the ghostly glare of mil-
lions of candlepower. The system is a de-
velopment of lighting for night baseball.

Popular Mechanics Magazine does not
publish the name of the maker or seller of
any device described in its pages, but this
information is kept on file and will be fur-
nished free upon application to our Bu-
reau of Information.

Somerset Rose
Nursery, New Brunswick
N.J.

Lamp Development Laboratory
 General Electric Co. 91548
 Cleveland Ohio

Dr. Francis M. Walters
 Jr. Director, Bureau of
 POPULAR MECHANICS
 Metallurgical Research

550

91566



"Torture Wheel" through Which a Percentage of Each Type of Bulbs Made Must Pass Unscathed

"TORTURE WHEEL" FOR LAMPS MAKES THEM BETTER

Putting all its predecessors to shame, a new form of testing apparatus has been developed by the General Electric company through which lamp bulbs must pass before they are declared fit for sale. Known as the "gravity impact tester," it might more properly be termed the "chamber of torture." A percentage of lamps of each new type turned out at the factory are put through the machine and subjected to a total of eighty falls from successively higher points. The apparatus is in the shape of a large wheel with shelves built in at graduated distances from the wheel's surface. As the wheel revolves, the bulb being tested falls from one shelf to another, each fall being greater than the preceding one. It is the culmination of a series of tests designed to find in the bulbs any weaknesses or faults which might become apparent as the result of shocks received in transportation.

IRON CONTRACTS AT HIGH HEAT AS ATOMS SHIFT PLACES

Iron expands under heat up to 1,650 degrees Fahrenheit, then it contracts, decreasing in length about two parts in a thousand. If the temperature is increased still more, the iron expands regularly, though at a different rate. When the hot iron is cooled, the process is reversed, the decrease of contraction taking place until the iron has cooled to 1,650 degrees. Then it expands suddenly, but on further cooling, continues to contract. Rearrangement of the iron atoms at this one point in the heat range is the explanation given by metallurgists after studying the strange process by X-ray.

91478

OYSTERS HANGING FROM RAFTS GROW FASTER

Oysters grow much faster and in far greater quantities under a patented process, known as the shellfish-setting apparatus, which is being employed on the California coast after long tests in Japan. The method revolutionizes orthodox practices, which call for raising the oyster on the bed of inlets. Under the Japanese method, the oyster is suspended on specially prepared ropes hanging from a floating raft. The raft may be towed from place to place, to take full advantage of weather and tide.

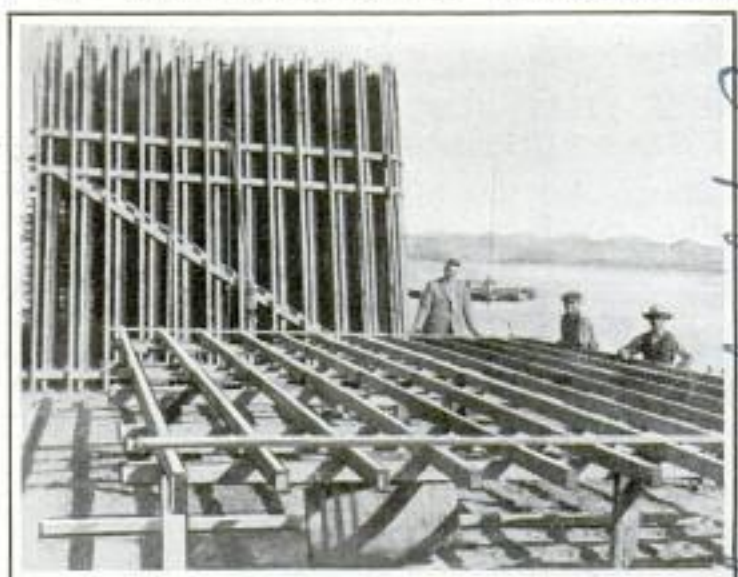

Rafts from Which Young Oysters Will Be Suspended on Ropes under a Patented Method of Shellfish Raising

West Coast Oyster Farms, Ltd.

Copyrighted material

California Monterey Bay Alhambra, Calif.

91544

Charles F. Michael
Pres. Ohio Locomotive
Crane Co., Bucyrus, Ohio

POPULAR MECHANICS

Merry-Go-Round for Cattle Keeps Stock Fit

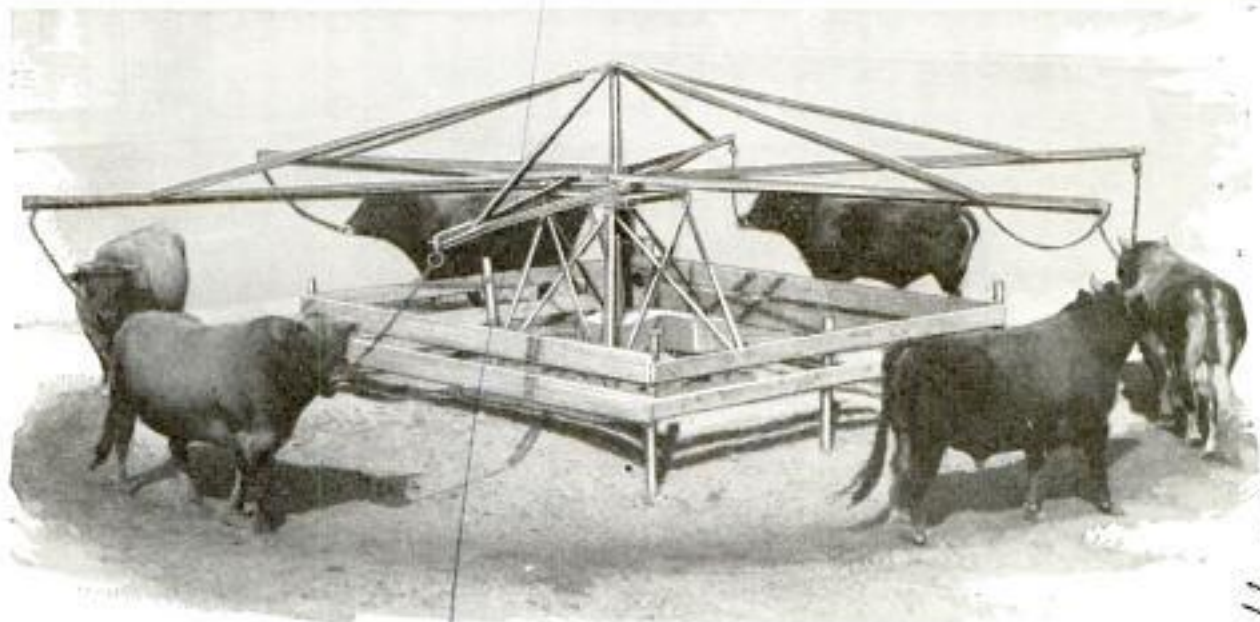

Motor-Driven Merry-Go-Round for Exercising Cattle; the Steel Arms of the Exerciser Lead Half a Dozen Animals at a Time, and the Stock Seem to Enjoy the Experience

Pedigreed stock of one eastern cattle fancier have their own exercising machine in the form of a merry-go-round to keep them fit. After the owner had found that hiring men to lead costly cattle around a paddock was both expensive and dangerous, he solved the problem by making an electric motor-driven merry-go-round, the steel arms of which lead half a dozen animals at a time around in a circle. The blooded stock seem to enjoy the experience, once they become used to it.

be obtained from good soil. This would be mown mechanically, baled, and either ginned in the mass or put directly through the chemical processes for extraction of the cellulose, both from the lint and the plant. Oil in the seeds is recovered chemically.

ELECTRIC CLOCK AIDS BUSINESS WHILE IT TELLS TIME



For the store, bank or office, an electric clock is being offered that talks business while it tells time. Below the face is a space in which may be inserted half a dozen cards in colors, each bearing an advertising message. These cards are

changed automatically at the rate of one each ten seconds by the same impulses that operate the clock. Cards can be replaced without difficulty, and a reflector to give a spotlight effect to the card space can also be obtained. The clock has an eleven-inch dial.

W. S. Lockery, Chemical Laboratories

Chapel Hill, N.C.
Electric Ad. Clock Co. Durham, N.C.
509 W. Jackson St.

NEW USES FOR COTTON SEEN WITH LARGER CROPS

Increased production of cotton plants for the extraction of cellulose, used in making rayon and paper, is being sought at a number of experimental farm stations. Several types of cultivation are being tested to find the one which will produce plants with the most cellulose. It has been found already that, if the plant yield per acre can be increased to about twice the amount produced under customary methods, cotton could in all probability compete successfully with wood pulp as a source of rayon. Experimenters believe that a gross yield of 5,000 pounds of cotton plants per acre can

experiment made by Chapel Hill, N.C.
Prof. J. S. Cameron
1897

91206+

Cont. Dr. Es. Thackwell -
4649 Beverly Blvd
Los Angeles, Calif

Only Dummies - but



"LET'S go!"
 At this command from their coach, Glenn S. (Pop) Warner, veteran football mentor, eleven members of the Stanford University, California, varsity squad snap into it.
 Forming the familiar huddle, a small circle with heads close together as in an Indian powwow, they get the directions for their next play. The huddle over, the players spread out into position, with a line of six men.
 "Ready! Three, five, one, seven, one."
 From center to backfield the ball is passed; the line plunges forward; the backfield shifts and charges forward. But no team opposes them. Instead,

Athletes Developing Shoulders on Charging Sled; Below, Tires on the Field Teach Dodging

they Hit Back HARD



the ends, tackles and guards smash full-force into heavy dummies which are attached by strong springs to a unique scrimmage apparatus which their inventive coach has designed and built. This mechanical equipment, which is not patented, is a cleverly arranged imitation of an imaginary defense. It hits back hard at the players. It gives them a defensive team to attack. It was invented, Pop Warner explains, to serve the same useful purpose as a defensive team. One set of this apparatus has six dummies in the line and one has seven, to provide facilities for practice with either formation. Its use saves an entire team from scrimmage, and it is a decided asset in analyzing plays.

From his position atop a small wooden platform, six feet in height, this dean of coaches calls out to the squad down in front of him: "Come on—get your think-tanks on! You backs were not close enough to the line!" To a line player: "And you didn't come around far enough." To another: "Don't you know you are a guard? Now the same play again!"

Then follows another huddle, lineup, calling of signals, and charge through and around the imaginary team. And those dummies hit back



Swinging Charging Apparatus to Develop Timing

hard, thanks to Warner's inventiveness in arranging them on hooks with a heavy spring at the bottom.

To develop strength and alertness, Warner has invented a charging apparatus. That's what he calls it, but the players refer to it as the "crack-in-the-jaw machine." A round steel bar, about fifteen feet in length, is set up on steel posts. From this bar are suspended four sets of two boards. These planks, a foot in width and about eight feet long, are clamped together at the top, but spread a couple of feet apart at the bottom. Here they are heavily padded and covered with canvas. They swing back and forth. The idea is that four players charge the planks from one side and four from the opposite side at a given signal. Those who are a moment late are likely to get the full force of the padded plank as it is pushed toward them by their opponents. Additional training on this charging apparatus involves crouching on hands and feet (but not knees) and pushing with the shoulder, while, on the opposite side, a fellow player is also pushing.

Warner has also invented a charging sled. This is a plank, heavily padded at the base and hung from a wooden framework, which is built on a base that gives it the name of "sled." The player rushes at this and strikes the plank with the shoulder and gets useful training without risk of injuring some other member of the squad. To speed up this training, Warner revealed that he has recently developed a charging sled which seven men can use at once.

This aids in comparisons, too. Linemen use the sled to develop shoulders and legs and ability to charge, and backfield men use it for leg exercise.

One of the handicaps coaches meet in trying to show a large group of men some detail of play is that they must crowd too close to the squad on the field, if they are to get a clear view of what is going on. This problem puzzled Warner a while, and so he invented a portable grandstand. This is moved readily about on rollers to any point on the field.

To aid in teaching the backfield men how to develop a sidestep, Pop Warner has old automobile tires strewn around flat on the ground, and the men must speed through them as they carry the ball. As they are placed without any order, the backfield man must think fast as he shifts from left to right in running.

One of the problems of a coach during a game is to see that the players do not drink water when they "sponge off" the face and head during time out. To keep fit, they are forbidden to eat or drink during a game. One day recently there appeared on the training field at Stanford an odd-looking rubber-tired water wagon. This is a tank on wheels with six short hose having nozzles at the end. Now six players at a time can spray the head and face and yet cannot drink the water because the stream is adjusted to issue as a fine shower.

A tackling dummy which Warner uses, though he did not invent it himself, is a mechanical apparatus mounted on a steel post. The



Canvas-Covered Dummies Are Pounded around the Field to Teach the Prospective Athletes the Best Method of Making Holes in the Enemies' Lines of Defense



dummy is suspended by a rope at the end of a long steel arm. Claude E. (Tiny) Thornhill, an All-American tackle in 1916, now line coach at Stanford, puts them through the jumps with this mechanical tackling apparatus. By means of a long handlebar, he can cause the dummy to move about at will while the lineman is sprinting toward it.

Bernard F. Oakes, coach at the University of Nebraska, is another inventor of machines to save time and reduce wasted gridiron energy. The modern tendency in football is to curtail scrimmage sessions and to shorten all practice periods. That makes it necessary to introduce speed and efficiency into coaching methods.

Two years ago, Oakes developed his first invention, a football charging machine, which is now employed by several universities. It is used for teaching the fundamentals of defensive line play. This machine consists of three padded bumpers which represent three opposing linemen. The two outside bumpers each represent the shoulder or sides of two charging offensive linemen, and the center bumper, the head and shoulders of the middle offensive lineman. Defensive

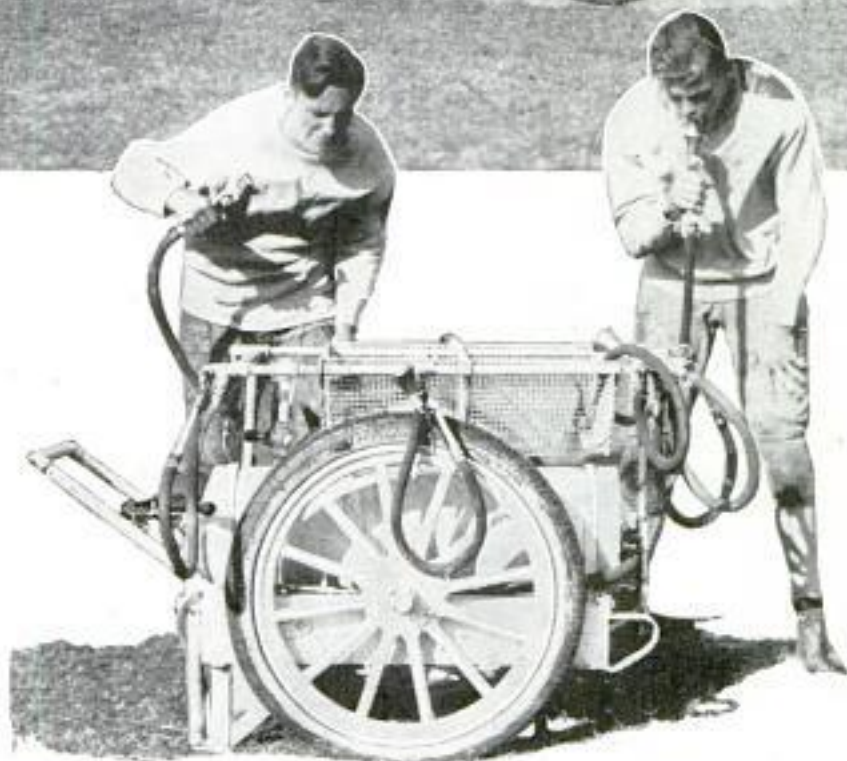

"Mechanical Defense" That Can Present Almost Any Problem to the Players the Operator Wills; Below, the Shower Wagon

players work against this machine to develop the knack of charging through the opposing line, using their hands and developing co-ordination and quick action.

Oakes' latest invention was first used in the 1930 football practices and is employed principally in teaching the fundamentals of offensive play. It consists of scrimmage dummies which are anchored to wooden bases by "back springs." These springs cause the dummies, after they have been hit from any direction, to rebound to an upright position like a roly-poly.

They are used in practicing blocking and in perfecting the timing of plays. The dummies can be arranged to resemble the style of play expected of opposing line-



The Charging Machine in Action, Above; One-Man Sled in the Center, and Below, the "Crack-in-the-Jaw" Machine

men. If the team is preparing to play a game with opponents who use a six-man line, the dummies are arranged accordingly, and the linemen can practice blocking out the linemen of the defensive team.

Coaches also use four dummies to represent the four backfield men, but these are not fastened to any base and can be knocked down. The scrimmage dummies on the line will not be knocked down. They exhibit the same tenacity to get up

and go as is expected of players on a rival team.

Scrimmage dummies can also be changed to meet individual types of play of the opposing linemen. They can be placed to represent the style of play of a smashing end, a waiting end or one that comes straight across, or to represent various styles of tackle, guard and center playing.

A number of coaches have used stationary padded posts in dummy scrimmage. Oakes' scrimmage dummies are superior to them because they can be moved about for various styles of play, and linemen can hit them with any degree of fury without risking injury.

Scrimmage dummies are effective savers of time because they do away with the old kind in which second and third team players take the parts of opposing linemen. By using these dummies, coaches can run two or three teams through the plays consecutively.

The old-fashioned tackling dummy is still used by all football coaches in teaching fundamentals, and the charging sled is in general use by most line coaches.

a 1497

But they do not produce the realistic effect of Oakes' inventions because they will not recoil after being hit. Oakes' machines are like robot football players which react to any charge much in the same way as real players.

Coach Oakes is a firm believer in the value of machines in coaching football players, particularly in line play. He believes machines save time, reduce injuries, and, in some instances, are more effective than actual scrimmage, although he admits some scrimmage is necessary.

a 1490

COLLAPSING AUTO TRUNK FITS ON LUGGAGE RACK OR RUNNING BOARD

Protection for baggage from dust and rain at moderate cost is afforded by a collapsible fabric trunk that can be fitted to any luggage rack or on the running board of the automobile. It can be adjusted to the size of the baggage and is made of double-texture fabric with rubber center, fitted to a steel frame. The top fits over the cover and is tightened with strap fasteners. The carrier can be obtained with a rack provided with hooks to which it is attached, or it can be fitted to any standard rack or on the running board by means of a special base for this purpose. When not in use, it is folded.

Kennedy Parkers List 15.50



Collapsible Fabric Trunk That Fits Any Luggage Rack or Rests on the Auto Running Board

*Kennedy Mfg Co
Van Wert, Ohio*

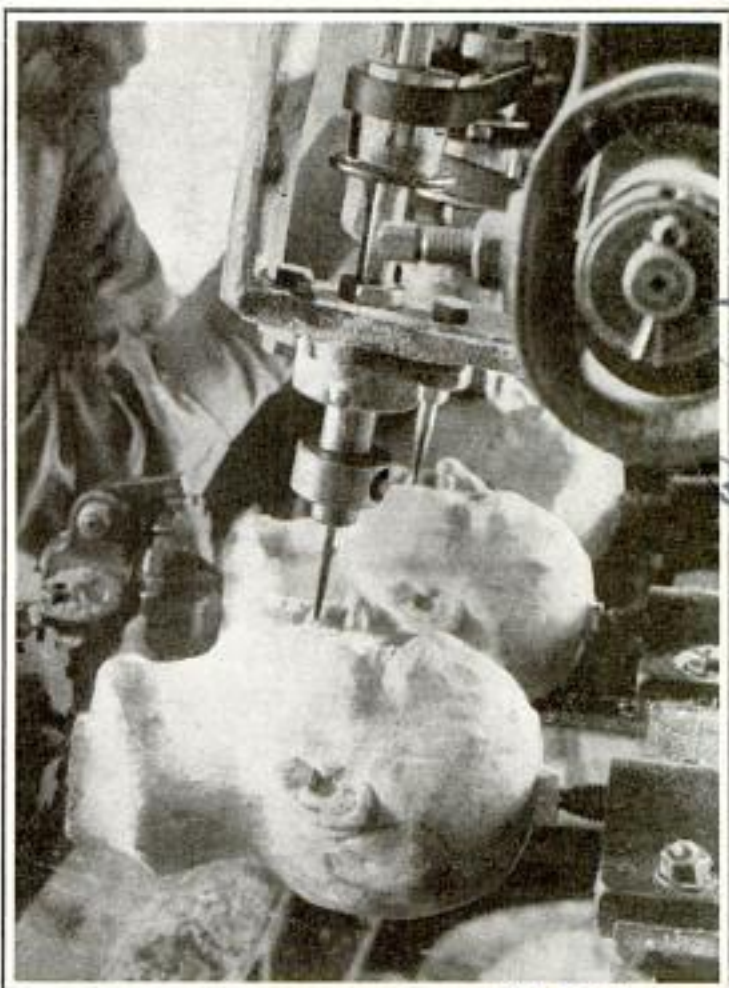

Using an Automatic Wood-Carving Machine to Turn Out Statuettes, Six at a Time, from One Original

SIX STATUES CUT AT ONE TIME BY MULTIPLE WOOD CARVER

Wooden statuettes now can be turned out, six at a time, from an original pattern through the use of an automatic wood-carving machine invented in Germany. After the original model has been made, it is placed in the cradle of the carver, the tools are adjusted to the six blocks of wood and the machine does the rest, cutting six noses or six ears at once.

SEA WHIRLPOOL REPELS SHIPS BY SPINNING OUTWARD

Strong enough to repel a ship, a whirlpool that spins from the center outward has been found 150 miles east of Cape Cod in the Atlantic. Capt. William E. Parker reported that he failed on several attempts to force one of the coast and geodetic survey vessels through the whirlpool, the force of the water throwing him off his course.

*Wenzel & Co
Berlin
Germany*

a 1564

*New York Times
Copyrighted material
7/22/01*

*circulation
9/10/05*

a 1171

Romance in World Quest for Black Gold

Native Burmese Who Is Digging and Operating His Own Oil Well; Below, Deep Well in Central India, and Camels Carrying Parts of Rig across Desert

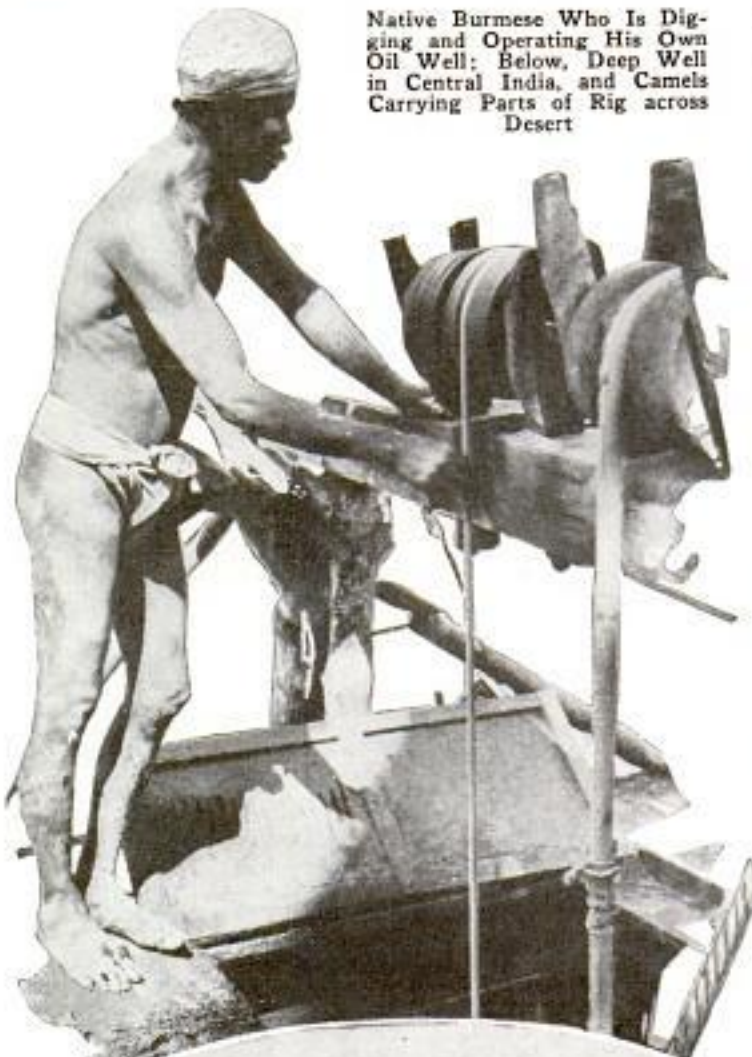

that try the experience of the oldest drillers, but they usually have a trick to overcome any kind of trouble, even in out of the way places of the world. In sinking the holes, the casing may buckle and have to be pulled up or a defective section taken out and re-run. Sometimes it is even necessary to drill up a piece of steel casing to get past it when it cannot be pulled from the hole. American crews have drilled in Lake Maracaibo, Venezuela, where piers, barges and tugs were part of the required equipment. They have gone into the wilds of Borneo forests; worked on burning deserts in India, drilled in Santo Domingo; explored the Holy Lands of Palestine and completed wells in Peru, Ecuador, Mexico, Algeria, Canada, Portuguese East Africa, Rumania, Russia, Persia, and many other places in the far corners of the world. Turning a tropical wilderness into a modern oil camp is an expensive proposition. Derricks of almost every conceivable size and construction are used. Transpor-



The search for oil is world-wide. Conditions of the oil market may delay or slow up some operations, but still the drilling goes on in a never-ending exploration for hidden pools. Difficulties arise

tation into a wilderness or across a desert or swamp land is a laborious matter. In a Borneo forest, a primitive three-pole derrick was used with an American-made diamond-bit core-drilling outfit. The

Cent. Wilbur H. Rose
3608 Indarosa St.
POPULAR MECHANICS
2 Paso, Texas

Q 1456

smokestack of a boiler on a drilling outfit in India was blown away by a tropical hurricane. There was none to be secured within hundreds of miles of the location. The driller glanced at some steel oil barrels and quickly started some workmen knocking the tops and bottoms out of them. Then the barrels were welded together and a very efficient smokestack made with only a day's delay. When the difficulties of sinking a hole have been overcome and the well approaches the desired depth—then comes the climax. The well may be a duster—as dry as a dust storm on a Kansas prairie. Granite and salt water are two of the most dreaded finishes to a well. Granite means that all efforts are futile. But when a new field is discovered that is a heavy producer, the rewards are so great that all discouragements are forgotten.



Stilts with Footrests That Run in Slots and Are Adjustable to Size of User

Stephenson Mfg Co
2308 South Grand

SHOOT WITH BOTH EYES OPEN IS ORDER TO SOLDIERS

Training regulations now in force in the army teach the pistol or revolver marksman to shoot with both eyes open, instead of closing one eye and aiming with the other. The rule was promulgated to enable a soldier to see an enemy approaching from his left while he is in the act of firing. The method also is of value to mounted men who must keep their horses under control while they shoot.

SPRING KEYS FOR TYPEWRITER LIKE SHOCK ABSORBERS

Spring keys which are resilient to the finger touch and at the same time add impetus to the type bar, recently were placed on the market as a typewriting comfort feature. The keys are made to fit over the pads on any standard machine. A coil spring inside the key absorbs the jars and gives a reactive pressure on the type. The letter is inlaid so that it will always remain clear and bright.



HEIGHT OF STILTS ADJUSTABLE TO SIZE OF THE USER

Stilts that are adjustable in height to the size of the boy using them have footrests which run in slots. The rests are held in position by a wingnut and screw so that they can be raised or lowered.

GUNS MADE OF ELASTIC STEEL TO SHOOT DEADLY SHELL

"Enormously destructive" shells, secretly developed by armament experts, will be used in the British navy's guns constructed of elastic steel. These shells hold the secret of the sinking of the old battleship "Emperor of India" in naval target practice. The guns are made of a steel alloy called nickel-chrome-molybdenum, which is so elastic that it is possible to make guns with much longer barrels, increasing the speed at which the shell travels. Weight is saved by this alloy, an important point in the construction of fighting vessels under international treaty limitations.

Naval Ordnance

Speed Key Mfg Co
2308 South Grand
Chicago, Ill
542 S. Dearborn

Q 1594

Q 1497

Q 1558

10/15/16

1214 2082 640

*Ans. H. B. Crum,
H. B. Crum Co,
South Milwaukee
Wis*

**MOVIE SHUTTERS ON THE EYES
TO AID RACE DRIVERS**

Motion-picture shutters are used in a device designed to "slow up" the rapidly flashing impressions passed before a race driver's eyes and brain at high speeds. The device is worn like a cap, with glasses resembling field glasses in front of the eyes, and at the back and above the head, a small motor, which drives the shutter, cutting off the excess number of impressions. The shutter allows the light to come through the opening only twenty-one per cent of the time, thus limiting the number of pictures the eye, and from it the brain, receives, until the brain is able to comprehend all it gets and has a distinct picture of each one. The invention was a result of race drivers' complaints that, when the speed got over 200 miles an hour, the track became a blur and they could not drive faster because they could not see to control the car.

**STURDY SIDECAR FOR BICYCLE
IS EASILY ATTACHED**

Space for an extra passenger, or for luggage, is provided with a sidecar for bicycles which is both light and sturdy. It is equipped with adjustable clamps and fits any standard bicycle. The body can be obtained in the form of a seat for one passenger or a box for carrying packages in making deliveries.



Bicycle with Light but Sturdy Sidecar for Carrying Extra Passenger or Luggage

560
1484



Water Pressure from Long Nozzle Is Digging a Hole to Water Roots of Trees

**HYDRAULIC DRILL SAVES TREES
BY DIGGING WATER HOLES**

Watering of trees during a drouth is made easier through application of the hydraulic-drill principle. A two-foot nozzle, connected by fire hose to the nearest water plug, bores itself into the earth through action of the water, and is left there ten or twelve minutes, depending on dryness of the soil. Four or five such holes, about ten feet from the trunk, will water roots of the tree quickly and more efficiently than by sprinkling the earth around the tree. The flow of the water is regulated by a hand-operated valve on the nozzle.

Canada in 1930 ranked second among the countries as a producer of gold, being exceeded only by the Union of South Africa.

*used in Dayton, Ohio
Cmt. Charles J. Bauer
P. 1005
Dayton Ohio*

Parascope

91253

*The Pal. Car Co
Cedar Rapids
Iowa*

\$25.00 per set

*From Canada Week
Boy Week*

*Leisure Corp
Cedar Rapids
Iowa*

Wilmington - Catalina Air Base



Electrically Operated Turntable for Amphibian Airplanes at a Beach Airport on Catalina Island; the Beach Is Too Small for the Planes to Be Turned without Its Use

TURNTABLE AT SMALL AIRPORT FOR AMPHIBIAN PLANES

To solve the problem presented by a landing field too small for an amphibian airplane to turn around, a turntable, similar in principle to those used for locomotives, has been installed at the beach airport on Catalina island, off the coast of southern California. The airport is located in a narrow canyon that opens out to sea. Amphibians from the mainland alight on the water, taxi inshore to a forty-foot concrete ramp that extends 120 feet out to sea, then wheels are lowered and the ship runs up the incline and onto the turntable, which is twenty-five feet in diameter and electrically operated. This enables the ship to be moved about within a space represented by its own wing-spread, where otherwise a field of several hundred square yards would be required.

91593

"ELECTRIC EYE" TO ROUTE MAIL AT RAILWAY TERMINAL

Sacks of mail will be correctly routed at railway terminals by equipment using the photo-electric relay, or "electric eye." Each sack is loaded with mail for one city, then placed in a tray container which travels on an automatic conveyor of the overhead monorail type. The containers are made up into "trains" pulled along at about five miles an hour by a motor-driven

carrier, as many as fifty containers making up the train. The train has for its destination a number of railway mail cars, each going to a different city. As the train goes by, the mail sacks are automatically sorted and dropped on the loading platform near the proper car. From each mail car is projected a beam of light at an angle different from that of all other cars. The photo-electric relay on each mail-sack container is set at the angle corresponding to that projected from the railway car to which the mail is going, and when the container reaches that point, the mail sacks are dropped. The relay tubes are set at the dispatching platform after the mail sacks are loaded and the destination tags inspected.

ELECTRIC GUIDE FOR TRACTORS TAKES OPERATOR'S JOB

Operators of farm tractors are about to lose their jobs to an electric guide. The farmer makes the first furrow, and the guide wheel does the rest. One man can keep several tractors in operation at the same time, because he has nothing more to do than servicing the machine.

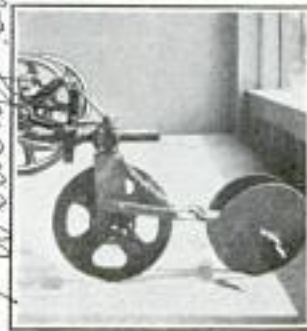

Overholt, Avaloni
and Alma Catalina Island, Calif.
Box 1289 Catalina Island, Calif.

1530

General Electric and
Cleveland Electric Tramway
div. Cleveland Crane & Eng. Co.

C. D. Cox
Cox, Julia
Copyrighted material
Jera

a1370

Cont. St. Francis Dechê.
11. Rue Laquerre
Paris, 14^e France

The Glories of Kings

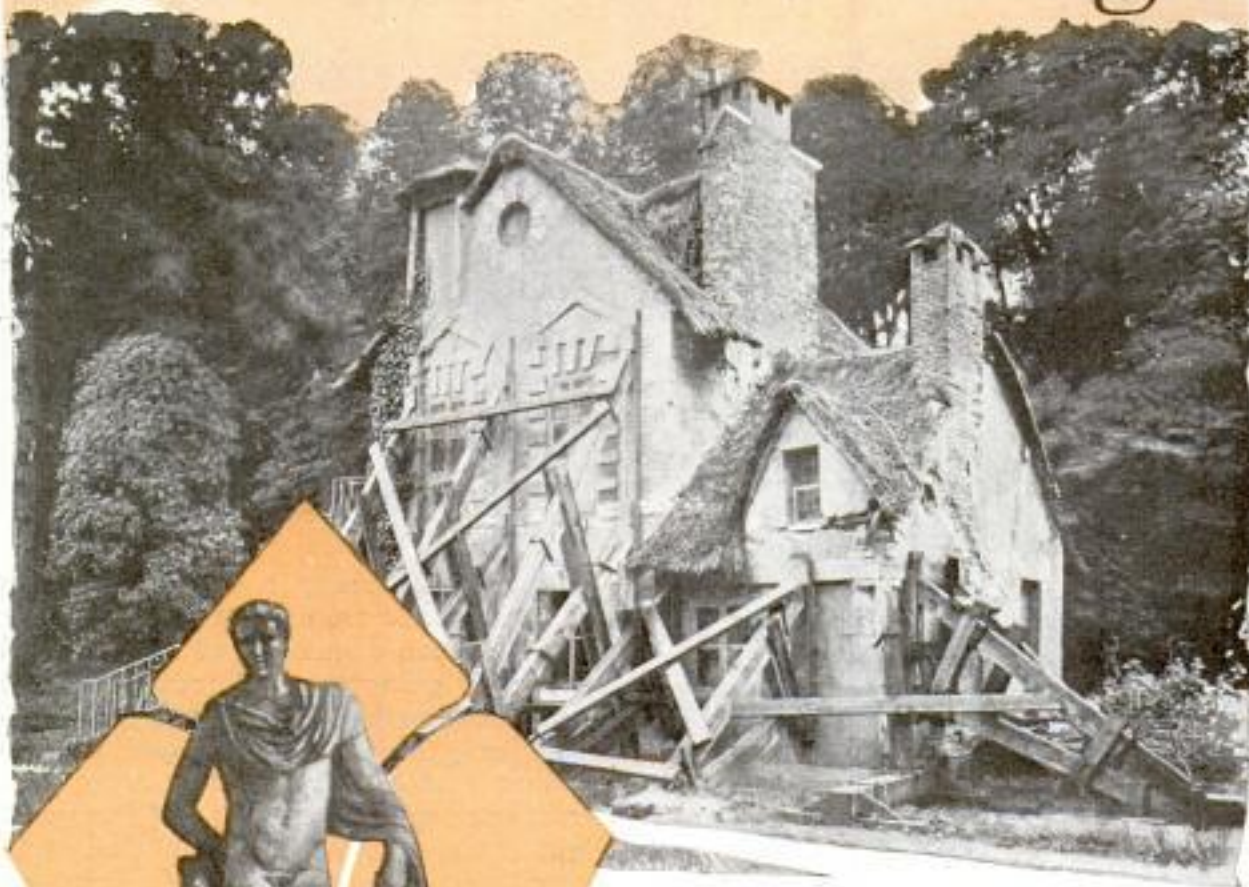

House in Marie-Antoinette's Playground Being Repaired; Below, Cleaning Statues by Steam Process

VERSAILLES and Fontainebleau, magnificent palaces of so many of France's famous rulers, have been saved from ruin, restored to their original beauty, and made secure against the elements and decay for centuries to come, at a cost of millions of francs.

This work is chiefly due to the generosity of John D. Rockefeller, Jr., whose donation to augment the French state funds has made possible a rapid renewal of the splendor of a bygone age.

Through the work, the palace of Versailles, the two Trianons, the hamlet of Marie-Antoinette, her milkhouse and her theater, and most of the grounds are made once more practically as they were in the romantic days after their completion. Fontainebleau, even older, and linked with such great figures as Louis XIII and Napoleon Bonaparte, the only great castle of the period completely furnished today, also has been saved through the American donation.

In the days when the palaces of Fon-



Restored *with* American GOLD

tainebleau and Versailles were erected, men had not mastered the art of building waterproof flat roofs. The entire roof of Versailles was a ruin, and the interior was being destroyed by rain.

In all, thirteen roofs of the palace at Versailles have been entirely replaced. The original roofs had been built in the time of Louis XIV, in 1661, of lead and slate, laid over a wooden structure which had rotted in some places and been badly worm-eaten in others. The first step in the repairs was to erect a structure over all the surface to be covered. This was called an "umbrella," made of heavy timbers and covered with corrugated iron. This protection was high enough so the workmen could operate underneath. Lead and copper replaced the slate on all flat surfaces. The lead was laid in large sheets

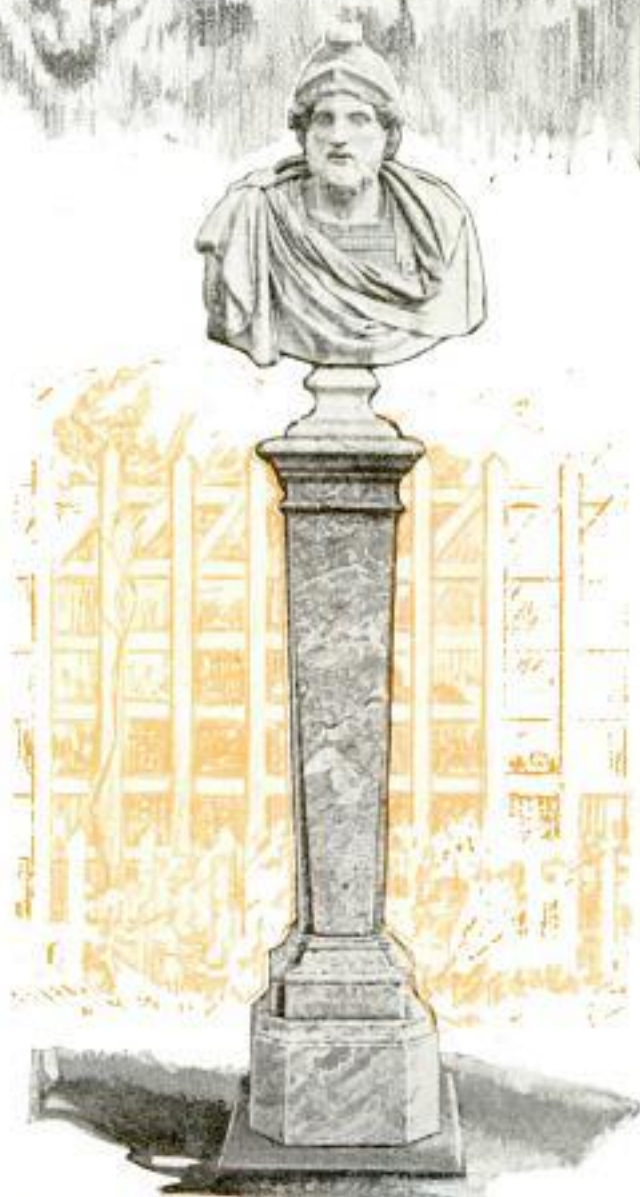

Basin of Neptune at Versailles, Above; and Bust of Hannibal, Below, after Cleaning

91370

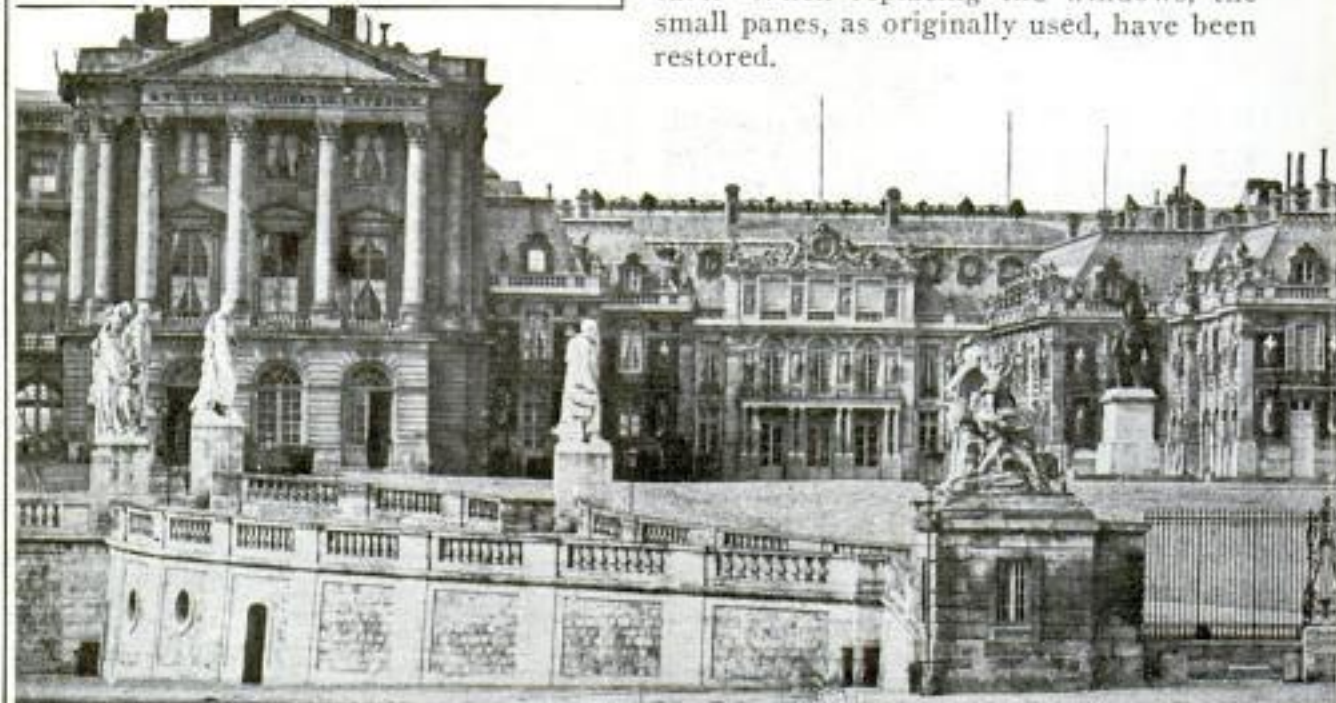
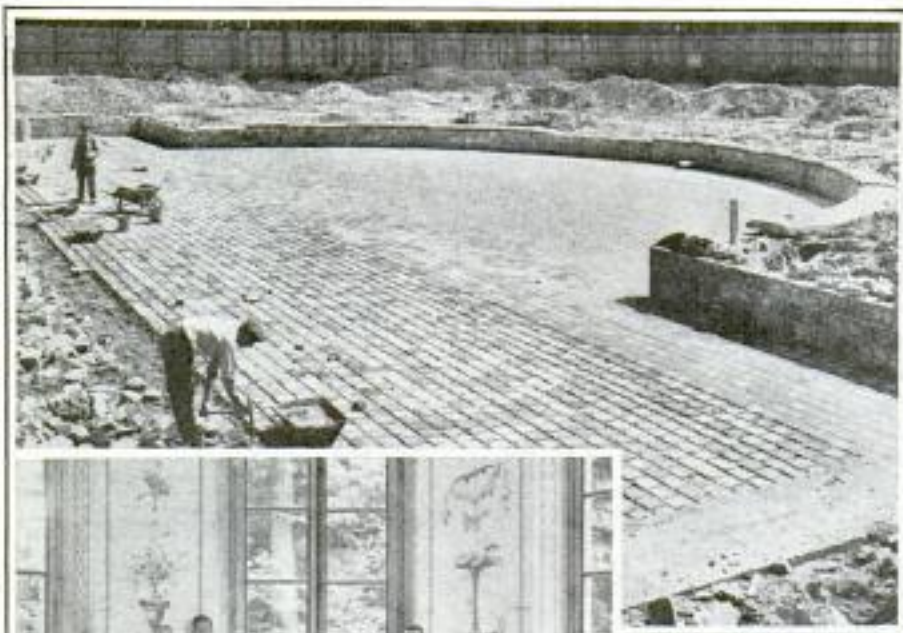

with overlapping seams welded together to form a perfect whole. On the steep slopes slates were again laid to retain the general aspect.

Over the chapel the usual umbrella was constructed. The old roof was removed and the rotted oaken beams were put in iron casings. These casings were extended in such a way that the timbers no longer rested upon the ceiling, but

were lengthened sufficiently to rest on the columns supporting the walls. A light double ceiling of hollow bricks was then constructed over the original one, after which the roof was rebuilt. It is absolutely waterproof, and in this way it is estimated the delicate paintings of the ceiling are protected for centuries to come.

Another important work was the repairing of all the doors and windows. At some previous time, the costly little panes had been changed to large ones, out of keeping and harmony with the architecture. When replacing the windows, the small panes, as originally used, have been restored.

Reclaiming the Basin of the Plat Fond, at Top, a Most Important Feature of the Restoration; Center, New Floor in the Music Room, and Below, the Versailles Court of Honor

91370 / applied by Thomas and
Tarrison, Paris, France
POPULAR MECHANICS 565
66. Rue de la Cordaune

One of the finest things achieved at Versailles is the replacing of the alley of trees which for a distance of nearly a mile reached away on either side of the roadway leading from the Great Trianon. Originally all these trees were perfectly matched. But with the passing of time some had died, until the alley had lost all its original grandeur.

Due to a recent discovery called the "Roxor process," it has been found that not only can statuary and other fine stone work be cleaned, but it can be so treated as to bring back and preserve the original brilliance in varicolored marble. So, not only were some 300 statues treated to a scientific steam bath, but also the faces and columns of the two Trianons.

An even more expensive undertaking was the repairing of seven of the principal basins, of which there are a score at Versailles. Built originally with a bottom of clay, this had ceased to be watertight, and the basins could no longer be kept filled. Furthermore the central figures which served as waterspouts, and were made of lead on an iron framework, were all in a state of collapse. The iron was replaced by bronze, and the figures not only restored to their original form, but with renewed activity as waterspouts. The stone work of the basins was entirely done over, and the bottom covered with

reinforced concrete to make it watertight.

The two Trianons, built in the times of Louis XIV and XV, had been left unrepaired for many years. The roofs were replaced, and the court was repaved ac-

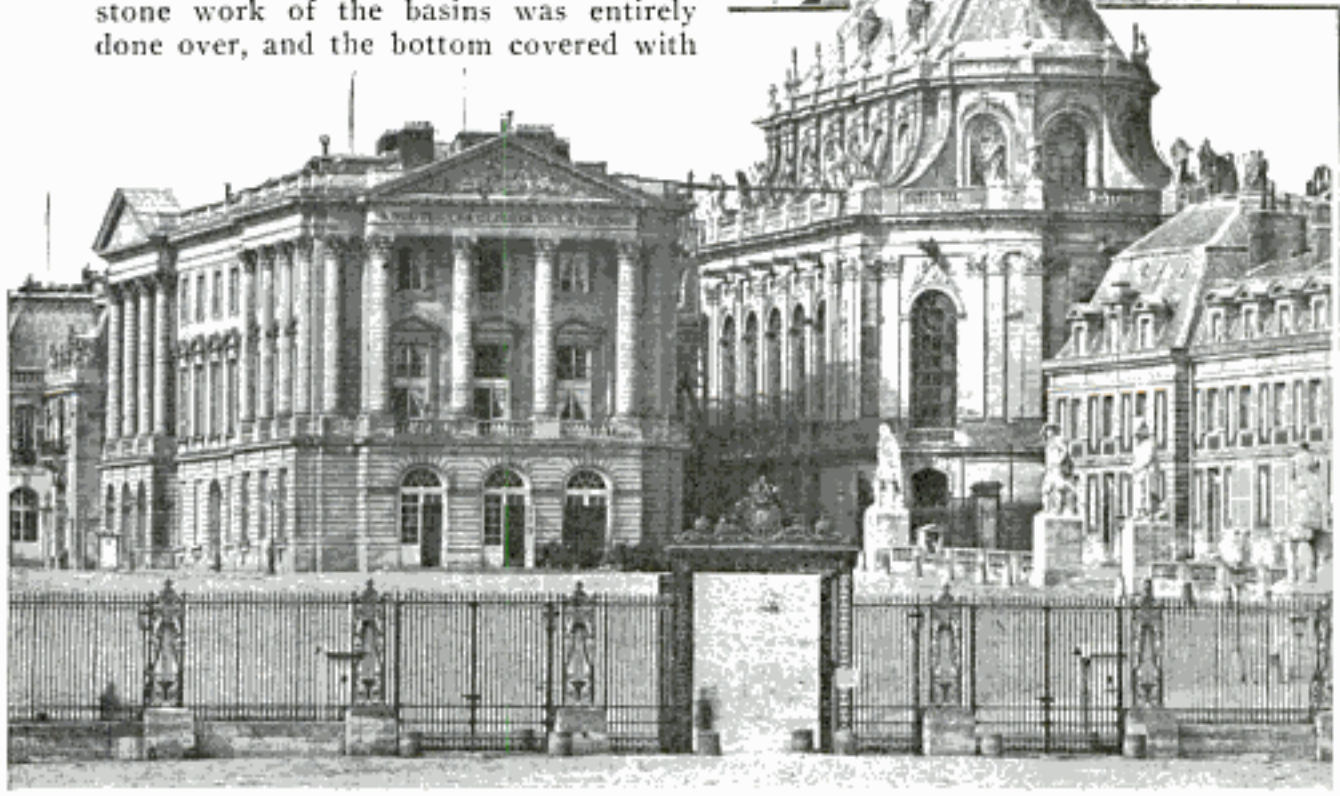
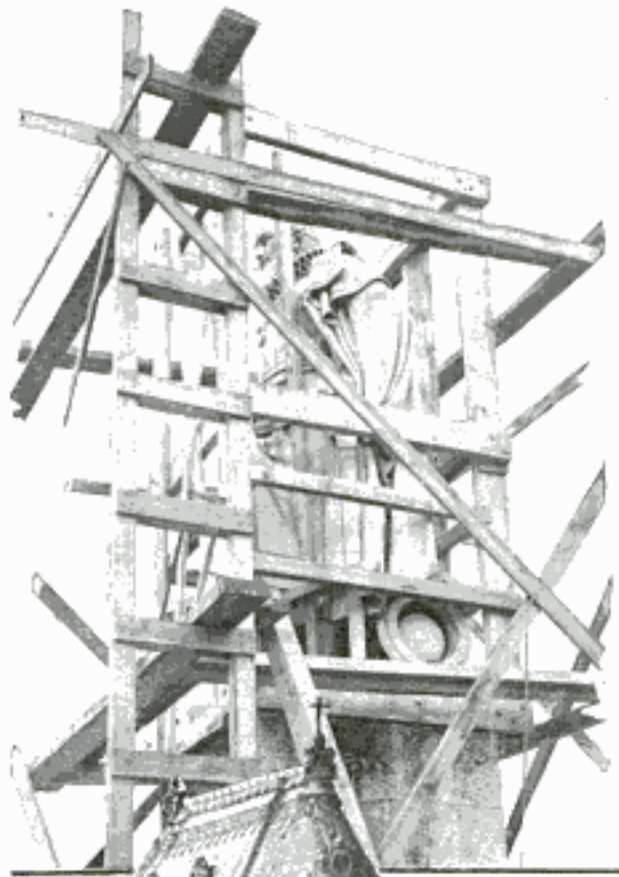

Statue of Sully, Above, One of Fifteen in the Court of Honor Shown Below; All Were Placed in Gigantic Crates and Removed to Restore Ancient Artistry

91390



A very ingenious system of aeration was constructed. The basis of this was putting on the ground a thick layer of coke. Then some low concrete sills were built, partitioned in squares. A floor of concrete was then laid, over which the marble mosaic was reconstructed.

Of all the work, perhaps that which will most appeal to the visitor of the future is the reconstruction of the tiny theater of Marie-Antoinette. Here is the most perfect little auditorium with a balcony in all the world; not only this, but a theater equipped with a stage of a depth and mechanism surprisingly large and ingenious, and still working perfectly today. To anyone familiar with the operating of everything behind the scenes, this theater of the tragic queen

According to the plans of Mansard, which were found in the archives of the palace. The grillwork was also repaired and the level of the garden, which had been destroyed, was restored. In the park, the queen's music room was also the object of a thorough overhauling, bringing out an interesting discovery and a method to overcome the failure of the first builders. This charming circular building, supported by fluted columns with French windows between, was in a state of dilapidation. The floor, which had been originally an excellent mosaic of marble, was eaten by dampness and many of the marble pieces were broken or missing. The whole floor was taken up and the principal source of the mischief discovered in the lack of foundation for the building.

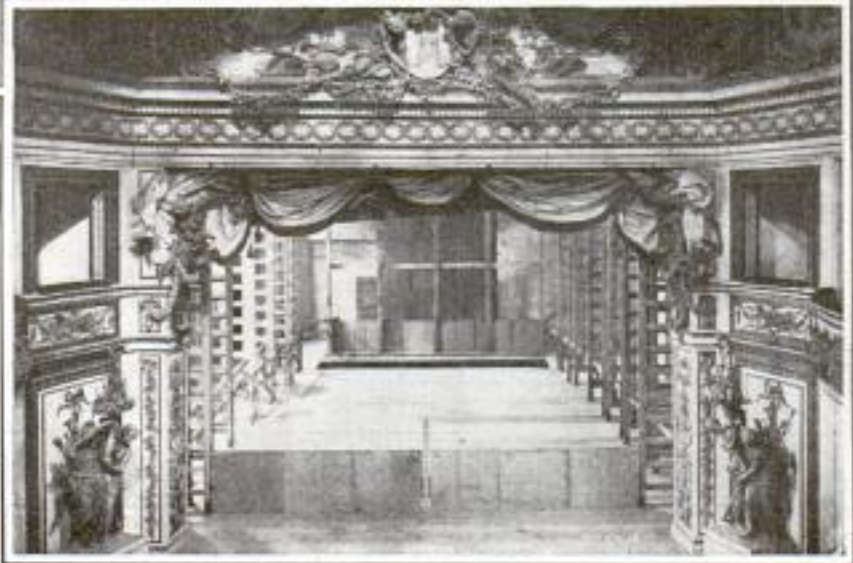
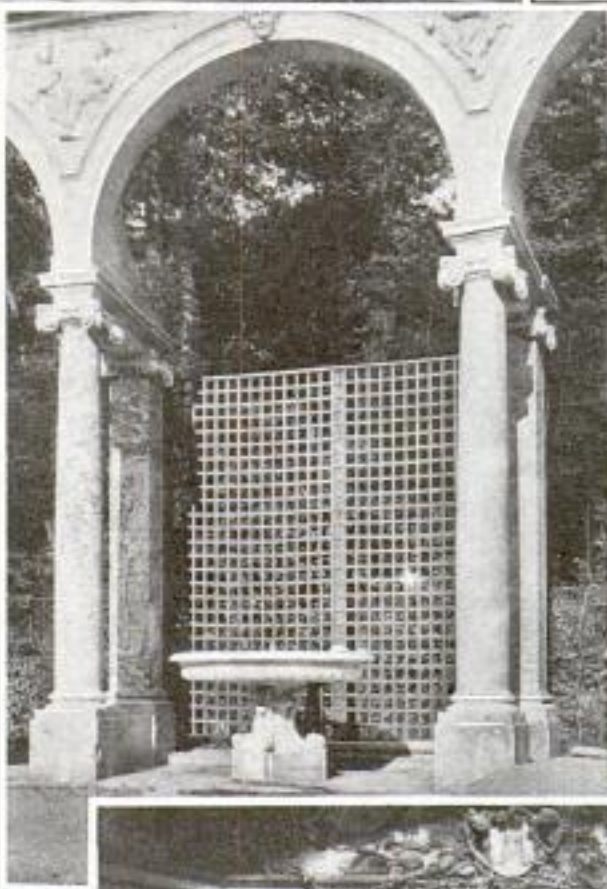

Flyloft of Theater, Restored Lattice and Theater Interior

a1390

a1352

a1352

is a veritable revelation. Few know anything about the theater as it has never been regularly open to visitors.

It was built at the whim of Marie-Antoinette. Here she tried to relieve her boredom by producing little plays with the assistance of some of her court. In the auditorium the king sat with a very few invited guests. When the work started, a piece of the original curtain still hung in place, and the decorations of papier-mache were almost entirely intact and still retained their deep blue and gold coloring. The stage is slightly larger than the auditorium with a height of seventy feet. The beams in the flyloft, the blocks and pulleys are the original ones and in perfect working condition. The upper part of the flyloft had a series of twenty-one wooden drums, which operated the numerous drops. A new floor in the auditorium, a new floor for the stage, a little fixing of the mechanism, and the theater will now operate as in the time of the queen.

The hamlet, the playground of Marie-Antoinette, also has been made to live again. Each of the little houses which formed the village has been repaired. The queen's milkhouse, which had best escaped the ravages of time, and is practically as it was when she played at being a dairy maid, is to be operated again. The interior of this charming little place is lined with white marble. In the center of the room is a large rectangular table of marble upon which butter could be worked. The floor also is of marble.

For a great many years architects have known that the chief factor in the destruction of stone work and buildings was the ravages of dampness. For half a lifetime a Belgian inventor, by the name of Knapen, had been seeking a solution, which he finally succeeded in having taken up about the time the work at Versailles commenced. This solution was a system of aeration of the stone, which consists of cutting a small aperture into the stone, triangular in shape. A pipe, about fifteen inches in length and one and one-half inches in diameter, is inserted at a downward angle. Over the opening is placed a triangular grillwork, through which the air penetrates while the dampness drains out.



Soap Sculpture Is Simplified with These Bars, in Which the Figures Appear Partly Carved

SOAP SCULPTURE MADE EASIER WITH HALF-CARVED BARS

Soap sculpture for school children, and others interested in this pastime, is greatly simplified with soap bars in which the figures of animals and other objects appear partly carved in the bars themselves. Beginners are furnished with bars in which most of the carving is done, and they simply cut away the excess soap to leave exposed the completed figure. As they become more skillful, bars are supplied with less of the figures completed, thus requiring more carving. All the tools needed are a knife and a fine-tooth comb for making hair lines. The figures last indefinitely, and the soap chips may be heated and made into bases for the figures or tied into pieces of muslin to make washcloth and soap combinations.

☐ The Popular Mechanics Bureau of Information offers its free service to all readers of this magazine. Names and addresses of manufacturers and dealers in articles described, and any other details in our possession, will be promptly furnished.

*Joy Craft Soap Co., Rochester, N.Y.
41.00 per 1/2 doz. 3 lbs. soap*

91485

SKYSCRAPER IS LIGHTNING ROD FOR NEW YORK BUILDINGS

Hundreds of New York buildings are protected from lightning today by the Empire State building, world's tallest skyscraper, which acts as a huge lightning rod to guard near-by structures. In addition, the Empire State building has nothing to fear from the bolts, because it is well grounded by its extensive steel work. Proof that this huge structure guards near skyscrapers from lightning was obtained in recent experiments in the laboratories of the General Electric com-

pany where a model of the skyscraper and of other buildings was constructed. Bolts of man-made lightning of 5,000,000 volts were shot repeatedly at the miniature skyline, and each time the pinnacle of the Empire State model was struck, but no damage was done, as it was grounded just like the real structure. The area of protection is cone-shaped, such as would be included by a line drawn from the top of the building to a radius of about two and one-half times the building height for clouds a mile high. The protected area would be reduced should the storm cloud be exceptionally low. For low buildings the protected radius may be four times the height of the structures and thus, while taller buildings protect a greater area, their efficiency is relatively less because they are closer to the clouds.

Schenectady, NY

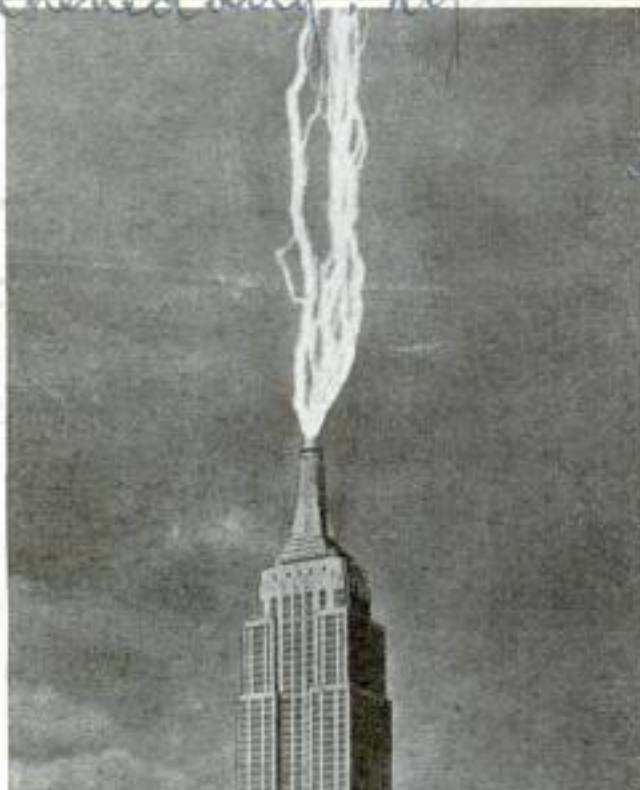

PLANES GAUGE SPEED OF BIRDS BY FLYING WITH THEM

Airplanes have been used successfully to measure the speed of flying birds by the simple expedient of chasing them, and watching the reading of the air-speed indicator when birds and ship are flying at about the same rate. By this method, the flight of a flock of geese was shown to be at the rate of from fifty-two to fifty-six miles an hour, while wild ducks made forty-six miles an hour. Teal are extremely fast, their speed being recorded at about seventy miles an hour. Some birds cannot be timed accurately since they make so many turns to escape.

91487

*Discovery July, 1931
W. H. Seld*

Frank R. W. Nichols



Model of Empire State Building as It Was Struck by Bolt of Man-Made Lightning to Prove That It Protects Near-By Buildings, Also Represented by Models, without Being Injured Itself

*A 1967 Carl Thomas & Starns, Jr.
145 S Spring St. Los Angeles
Calif*

With the Pipe Line Dispatcher

WEAIVING back and forth across the United States and touching nearly every center of population, nearly 100,000 miles of pipe lines carrying petroleum and its products are in use at present.

Oil flowing out of the ground in Texas is delivered underground to New York. Oil from Oklahoma may be pumped direct to Ontario, or may be diverted

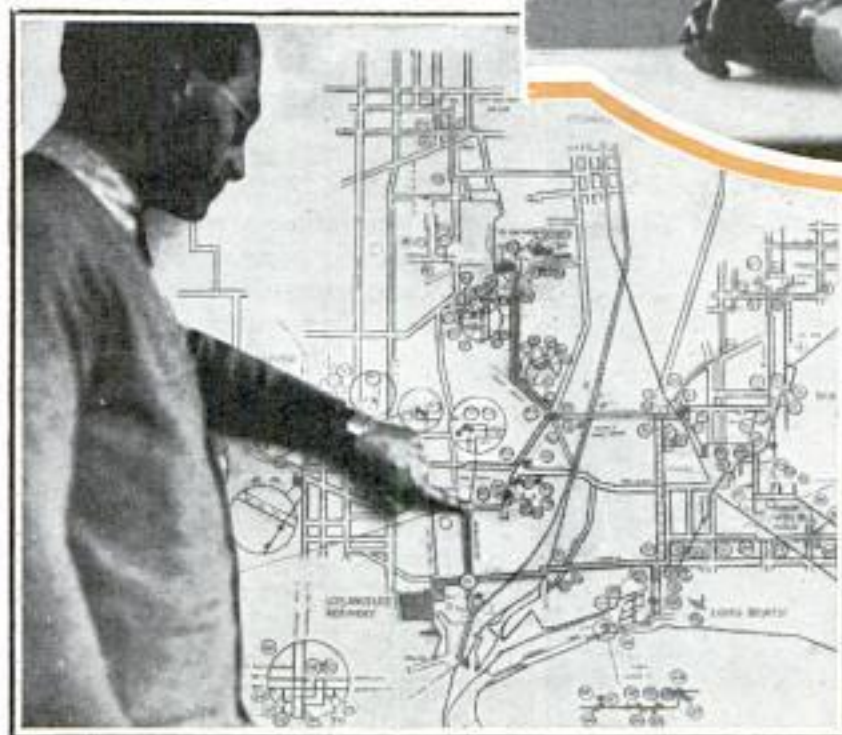
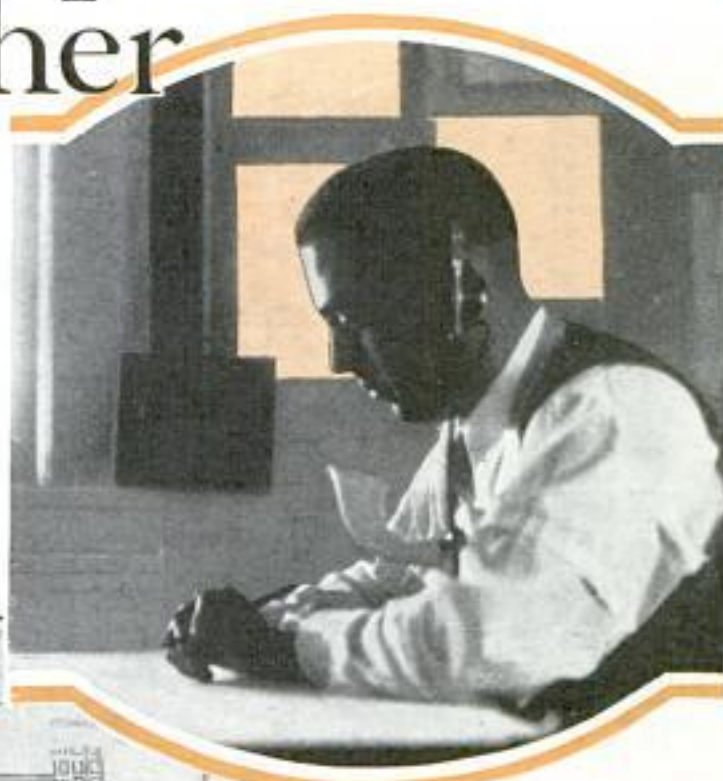

Dispatcher's Board, Ten Feet Square, Which Reflects Operations by One Company on All Its Lines in a Single City Area

from the main trunk line to supply a refinery near Chicago. In areas where fields, refineries, storage tanks, and delivering facilities are in close juxtaposition, each oil company has a complex short-haul pipe system. Oil is pumped from the fields to refineries or storage tanks, from tanks to refineries and return, and from tanks and refineries to ship-loading and truck-loading terminals.

house. He plans the routing of each shipment of oil and is responsible for all its movements. Dispatchers' orders go out to cover the opening or shutting of the valves and the operation of the pumps. Mistakes in this work may mean contamination of the oil, loss of time and possibly broken pipes.

Always get one valve open before you close one, is an old pipe-line rule that is

Dispatcher Whose Office Never Closes; Often a Thousand Phone Calls Are Handled in Twenty-Four Hours

Like the railroad companies, the oil companies have built lines, feeder lines, storage tanks and switching yards. Movement of the oil is handled like railroad traffic, through central dispatching offices.

At each central office, a dispatcher is on duty every hour of the day and night. An intricate telephone network connects him with every outlet valve and pump

21467
570

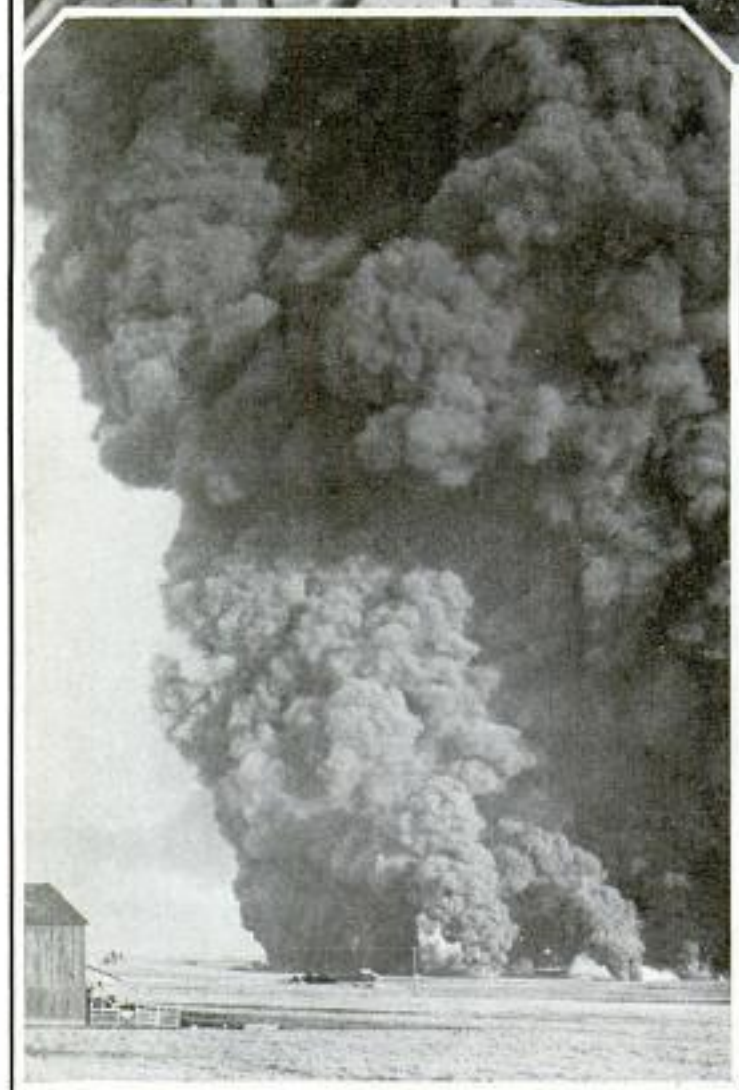
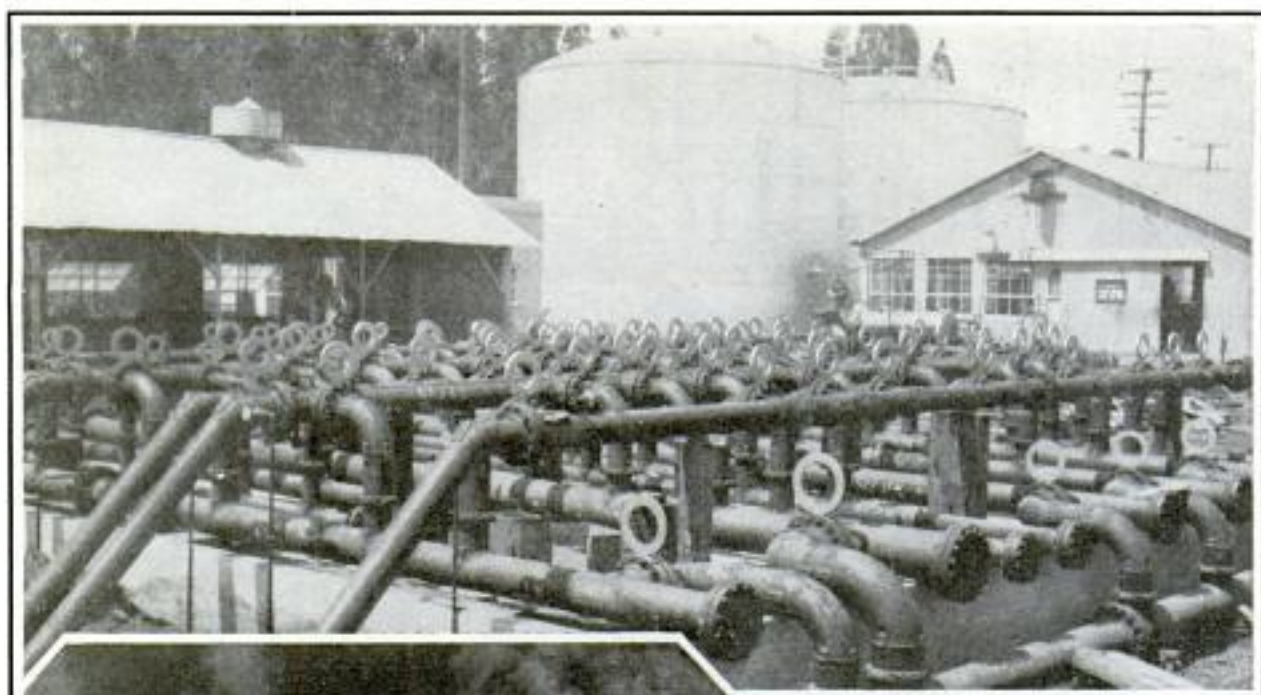

Pipe Line Switchyard, Above; in Fires the Dispatcher Must Route the Oil Away from the Hot Area

executed. The hour and minute at which each order is performed is recorded.

As a final precaution, the gauges at each terminal are checked every hour. If the gauge at the receiving end shows more barrels per hour than does the intake gauge, oil is pouring into the line through some forgotten valve. If the receiving gauge shows fewer barrels than are being pumped, then oil is being lost through an open valve or leak.

In long cross-country lines, efforts are made to confine shipments to the same grade of oil, due to the large amounts that remain in the pipe after a shipment is completed. In one 800-mile gasoline line, more than 10,000,000 gallons of gasoline are held within the pipe.

In the shorter, more intricate underground systems, batches of different grades of oil are pumped in succession. The small amount of contaminated oil between each batch is usually pumped out with the shipment of the lowest grade, or is diverted into storage tanks for return to a refinery.

impressed upon new workers. All orders are repeated back to the dispatcher, and he is notified when the orders have been

Most high-grade crudes flow freely through the lines at ordinary temperatures, but some of the heavier grades

dmw
572

Mr. Herman Fecher,
Hollywood, Calif.
POPULAR MECHANICS

**MUSIC INSTRUMENT ON A STICK
SOUNDS LIKE A VIOLIN**

a1541



Single-Stringed Musical Instrument That Is Fingered Like a Piano and Played Like Violin

Tones an octave higher or lower than the violin are produced on a single-stringed musical instrument that somewhat resembles the one-stringed Japanese instruments. It is called a "vio" and consists of a five-foot mahogany stick to which is attached a small oblong sounding box open at the back. The metal string stretches from the top of the pole to the bottom, being supported on the box by a bridge. Fingering is much the same as for the piano, white and black keys being indicated on a tape beneath the string. A bow is used to play the vio, the sound being produced by drawing it across the side of the string and the upper edge of the box simultaneously. The tone resembles that of the violin but is not so penetrating.

**MECHANICAL AUTO-SPEED CURB
SOUGHT FOR WILD DRIVER**

a1578

Mechanical limitation of auto speeds by state laws ordering installation of governors on all motor vehicles is forecast by Robbins B. Stoeckel, Connecticut com-

H. H. Clarky 7/25/27

missioner of motor vehicles. This will be the result, he says, of automotive operators' failure to govern their own speeds to conform to driving conditions. The recording speedometer is another suggestion of the commission, who pointed out that this device will keep a record of an auto's speed for varying periods or distances. Should such a device be required by states, with an accompanying sealing apparatus to keep owners from tampering with it, there would be a perfect record for investigation of speed and for a suppression of high speeds where such were indulged in to unreasonable limits. The one difficulty about the recording speedometer is that it is impossible to determine the traffic conditions under which the auto is driven at high speed. Several states already have considered installation of governors on commercial motor vehicles, but such legislation has been discarded on account of imperfections in the governing devices.

**AUTOMATIC "THUMB" FOR REEL
PREVENTS BACKLASHING**

1504

A simple means of preventing backlash of the line on a fishing reel is found in a spring which clamps on the rod and, passing under the reel, directly engages the line and holds it snugly, acting as an automatic "thumb." The tension of the spring may be changed, and the whole assembly can be attached to different-sized rods and reels, as it is supplied in an adjustable form. In addition to preventing backlash, the thumb also serves to hold the reel more firmly on the rod. No injury is done to the line through operation of the apparatus.

are being sold 4/27/27

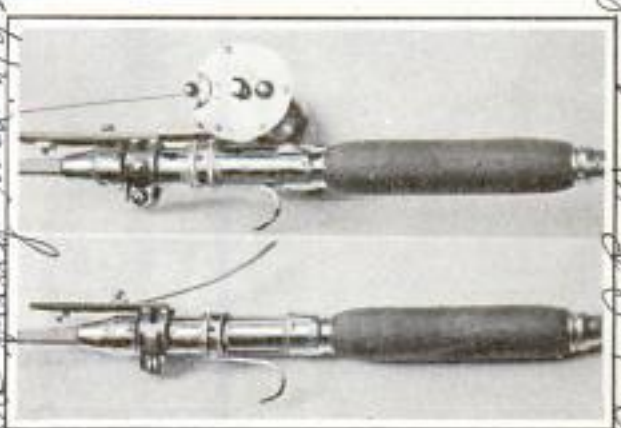

Automatic "Thumb" for Fishing Reel Which Prevents Backlashing of the Line

W. E. Fritts and
E. W. Hedeen, Sheldon, Conn.
Copyrighted material
of own

Emb. C. P. Woods, Sheldon, Conn.

a1211

Cont. Es. H. - Lacey

46 39

Madisonary Ave
Bellemead Ind

Brain Teasers

that will test
your skill

BRAIN teasers, those puzzles that look so impossible, but most of which are so simple if you find the hidden "catch," have risen to a position of importance in courses at a southern university.

Prof. R. D. Doner, of Alabama Polytechnic Institute, is using a great many of the old and new brain teasers as a diversion and as the first step toward interesting his students in higher mathematics.

One of his favorites is the ancient puzzle known as the "Tower of Hanoi," said to have started with Brahma. In its original form it consisted of three towers, on one of which was placed sixty-four disks of gold, with diameters varying large to small from bottom to top. The task Brahma is said to have set his followers was to move the disks to one of the other towers, without ever placing one upon another of lesser diameter. It could be done, but it would require 18,446,744,073,709,551,615 separate moves.



Working the "Tower of Hanoi," One of the Oldest and Most Intricate Puzzles Known, Originating in the Far East

Can You Solve This One?

ON a train the names of the fireman, the brakeman and the engineer are Smith, Jones and Davis, but not respectively. On the same train there are three passengers with the identical names, Mr. Smith, Mr. Jones and Mr. Davis.

1. Mr. Davis lives in Detroit.
2. The brakeman lives half way between Detroit and Chicago.
3. Mr. Jones earns exactly \$2,000 a year.
4. Smith beats the fireman at billiards.
5. The brakeman's nearest neighbor, one of the passengers, earns exactly three times as much as the brakeman does.
6. The passenger with the same name as the brakeman lives in Chicago.

What is the name of the engineer?

The answer will be found on Page 575

Doctor Doner's version of this teaser, however, consists of only seven disks and three spikes, and requires considerably less time to complete than the original.

Another puzzle which will test your prowess consists of a number of small rings fastened to a metal bar and a wire handle in such a way that the rings at one end of the puzzle can be removed from or replaced on the handle. Only a single ring can be removed or replaced at a time and the normal order of the rings cannot be changed. A ring can be removed only when the one next to it in the direction of the closed wire end of the handle is in proper position and the other rings at that part of the handle are removed. To solve the trick and get the

see from letter file for explanations

a 1211
574

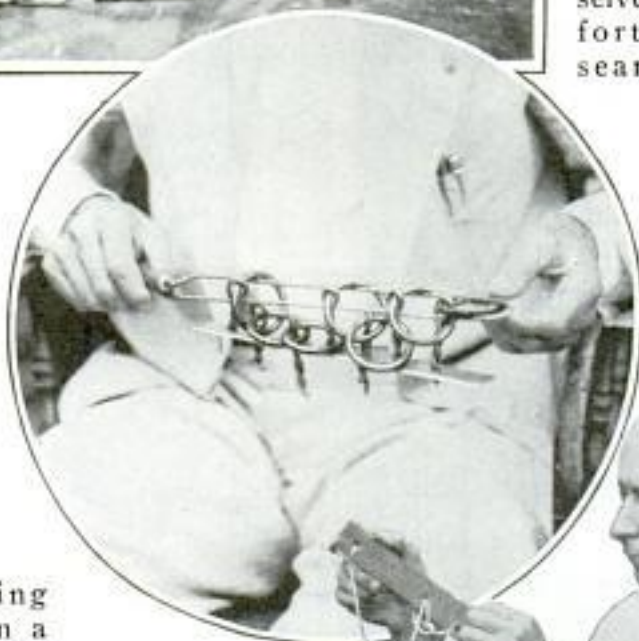
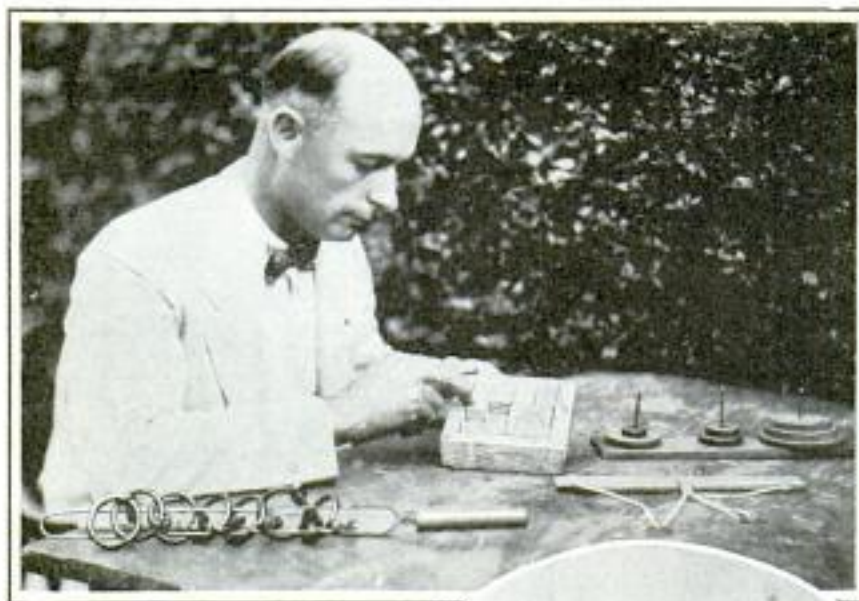

rings off the handle or to remove the handle from the rings is really the sum or product of a geometric series which involves 127 moves or "steps."

What is called the "fifteen" trick is another mathematical puzzle which tests your skill in maneuvering numbered blocks in a shallow box of limited dimensions in such manner that a blank may negotiate the circuit of the receptacle occupying all positions in the container in regular sequence. To start with, the box, which is large enough for sixteen cubical blocks, contains only fifteen. These blocks are shifted about in such manner that the blank in succession appears at every possible position in the box.

Another problem is that of the numbered squares which was originated in India before Christianity. The test in this game is to arrange the magic squares in such alinement that the sum of the numbers in every row, column and diagonal will be alike. History records that this trick, which features fun with figures,

was used during the ancient age of superstition as a charm against the plague.

The famous Josephus problem is a puzzle of human decimation by the law of chance. The ancient accounts claim that Josephus once saved himself from death by his knowledge of such arithmetic riddles. Josephus and thirty-nine others concealed themselves in a cave in an effort to evade Roman searchers who sought their lives. All except Josephus and one other man were so disheartened that they resolved to kill themselves. Josephus suggested

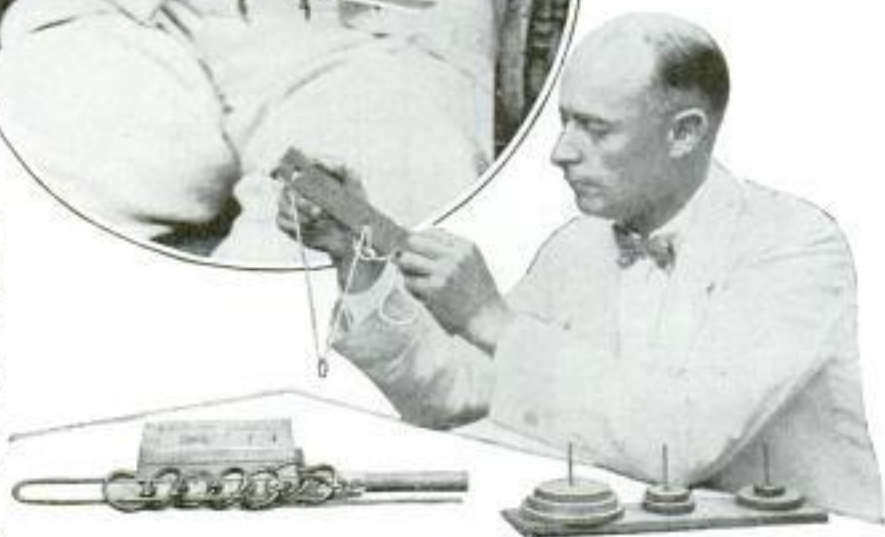

Doctor Doner Studies the Method of Solving the "Fifteen Game," at Top; the Chinese Rings, Center, and the "String and Rings" Puzzle

that the men form a circle and numbering from a given point every third person named should be killed. This was done but Josephus and his one supporter who selected the thirty-first and the sixteenth positions in the circle escaped.

The records show that such necromancers of numbers as Alcuin, di Burgo, Tartaglia and Cardun were prominent among the oriental pathfinders who were the first to appreciate the importance of arithmetical recreations both from the

a-211

a 1429

general amusement and educational standpoints. According to an English authority, these forebears of the pastimes which specialize in fun with figures were the sources of a great variety of trick or catch problems. One of these freak questions follows:

Three highwaymen stole a vase containing twenty-four ounces of balsam from its owner. During their escape, they stole three glass jars from another householder. On arriving at a place of safety, they sought to divide the balsam equally. They then discovered that their stolen containers were unequal in size. One held five, another eleven and the third thirteen ounces of balsam. How could the robbers divide their booty into equal parts?

Old records laud Zeno as one of those who delighted in unraveling such number mysteries. Zeno was he who claimed that fleet Achilles would never overtake a tortoise, given 1,000 yards' start, although his ordinary running speed was ten times as fast as the gait of the tortoise.

Note: The brakeman's name is Jones; the fireman's, Davis, and the engineer's, Smith.



Photo by General Photographic Agency
Interior of Plane Used by London Traffic Police; Crowded Derby Day
Roads May Be Seen to the Pilot's Left

Cont. H. J. Wilkins
Columbian, Boston
Roged
with me...

FIREWORKS TRICK U. S. VOLCANO INTO SYNTHETIC ERUPTION

Tons of fireworks planted in the crater of Mount Lassen, California, were exploded at the opening of Mount Lassen Volcanic National Park, sending that old volcano into an awe-inspiring eruption such as had not been seen since its outburst in 1914. The fireworks were arranged with fuses connected to a control board. At this keyboard a man stood, controlling, for the first time in history, the synthetic eruption of a real volcano.

a 1574

FLYING POLICE ORDER TRAFFIC BY RADIO TO GROUND

Airplanes recently were employed by London police to help them regulate the huge volume of traffic, both motor and pedestrian, on the roads leading out of London and Home county towns to Epsom Downs, the scene of the great English Derby. When a pilot spotted a traffic block, he radioed the news to the patrol below, and orders were telephoned to foot and mounted police to divert the flow from that particular point.

□ We want all our readers to write us freely and often whenever they wish additional information on articles published in this magazine. Address Bureau of Information, Popular Mechanics, Chicago.

Chicago Herald Examiner
7/26/31

576

91514

Bandit Car Shot with Dye Gun Easily Traced



A pistol that shoots a small celluloid shell full of a red dye has been recently devised for the use of police in chasing bandit cars or hit-and-run drivers. When the shell strikes the back or side of the fleeing car, it splashes red paint, making the car easy to trace. The projecting mechanism is a powerful spring, which will shoot the shell more than 900 feet. It is designed particularly for use in downtown areas of cities or other crowded districts where it is highly dangerous to fire on fleeing cars.

Shooting at a Bandit Car with the Dye Gun, Above, and the Distinctive Mark Left by the Shell When It Hits, Below

marks were standard American fifty-yard pistol targets. Firing thirty rounds of ammunition and thirty arrows, and allowing the archers a handicap of seventy-five points out of a possible 300, the police team scored sixty-three more points than their opponents.

PISTOL BETTER THAN THE BOW IN ACCURACY TRIALS

That the pistol is more accurate than the bow, a question long a favorite argument, recently was determined in Los Angeles when members of the crack police pistol team defeated a picked quartet from the Ambassador archery club. The

RIBBON INKER ON TYPEWRITER INSURES CLEAR COPY

Life is added to typewriter ribbons by the use of an automatic inker that insures clear copy after the ordinary ribbon has lost its usefulness. The inker can be attached to any typewriter and is started by moving a lever when the ribbon begins to show wear. Inking takes place while typing is being done, and



the attachment is available for the black half of red ribbons, or there is a model designed to ink both sides.

the attachment is available for the black half of red ribbons, or there is a model designed to ink both sides.

91515

San Francisco Examiner July 19, 1931

Corniac Products Co. 604 Mission St. San Francisco, Calif.

John B. ... 7/28/31

91572

BATTERY A FOURTH-MILE LONG TO RUN PHONE EXCHANGE

al 641

Because dynamos are too noisy, big telephone exchanges are forced to supply the electricity that carries the message over the wires from storage batteries. The bigger the exchange and the more traffic it handles, the bigger must be the battery. Next year the Farm street, Mayfair, exchange in London will have 30,000 automatically operated lines, and a battery of gigantic proportions now is being constructed for it. One hundred and fifty men are employed at the factory on this one battery, which, it is estimated, will take six months to build. Each cell will be nine feet long and the whole battery of 300 will be approximately a quarter of a mile in length. It will weigh more than 400 tons, and 4,000 gallons of dilute sulphuric acid will be needed for the electrolyte. Its capacity will be 13,000 ampere hours, enough to supply the current for a five-tube radio set from now until 1957, without recharging.



no info. 12/23/31

STEAM ENGINE MADE OF GLASS RUNS AS CHILD'S TOY

91588

Pieces of glass tubing—374 pieces of them—were used in constructing a model steam engine by a California glass blower as a birthday present for his grandson. The engine, generating one-twentieth horsepower, is three feet long, twenty-two inches high, and its power comes from steam produced by a small alcohol lamp. It took the designer eleven months to complete the model, which engineering enthusiasts say is a marvel, considering the material used.

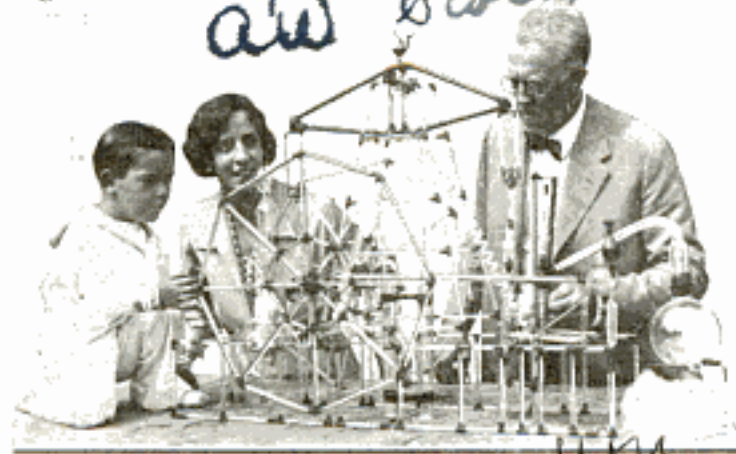

All-Glass Steam Engine, Made for Boy, at Left, by His Grandfather, at Right, Actually Runs

Long Beach Calif

Four-Ounce Aluminum Ladder, Held by the Young Lady, Can Support a Weight of 500 Pounds

Wide World

LADDER WEIGHS FOUR OUNCES HOLDS UP QUARTER TON

Four ounces of aluminum, made in the form of a ladder, supported a quarter-ton weight at an English exhibition. The ladder is the lightest weight for its capacity of any ever exhibited in Great Britain, and attracted wide attention.

Chemical Plant

FUNGUS THAT CAUSES TREE ROT FOUND

U 1637

Eight years of search for the fungus which causes brown heart rot in California redwood trees has been successful. The fungus was found by a research worker at the University of California, and laboratory tests have definitely proved that it was the organism sought. It also was determined that the organism gains a foothold on the trees through trunk scars caused by fire.

Berkeley, Calif

Prof. Emanuel Fritz, Division of Forestry

91363 Cuth James Montagnes
608 Harbour Cove Bldg
Toronto 2, Ont
Canada

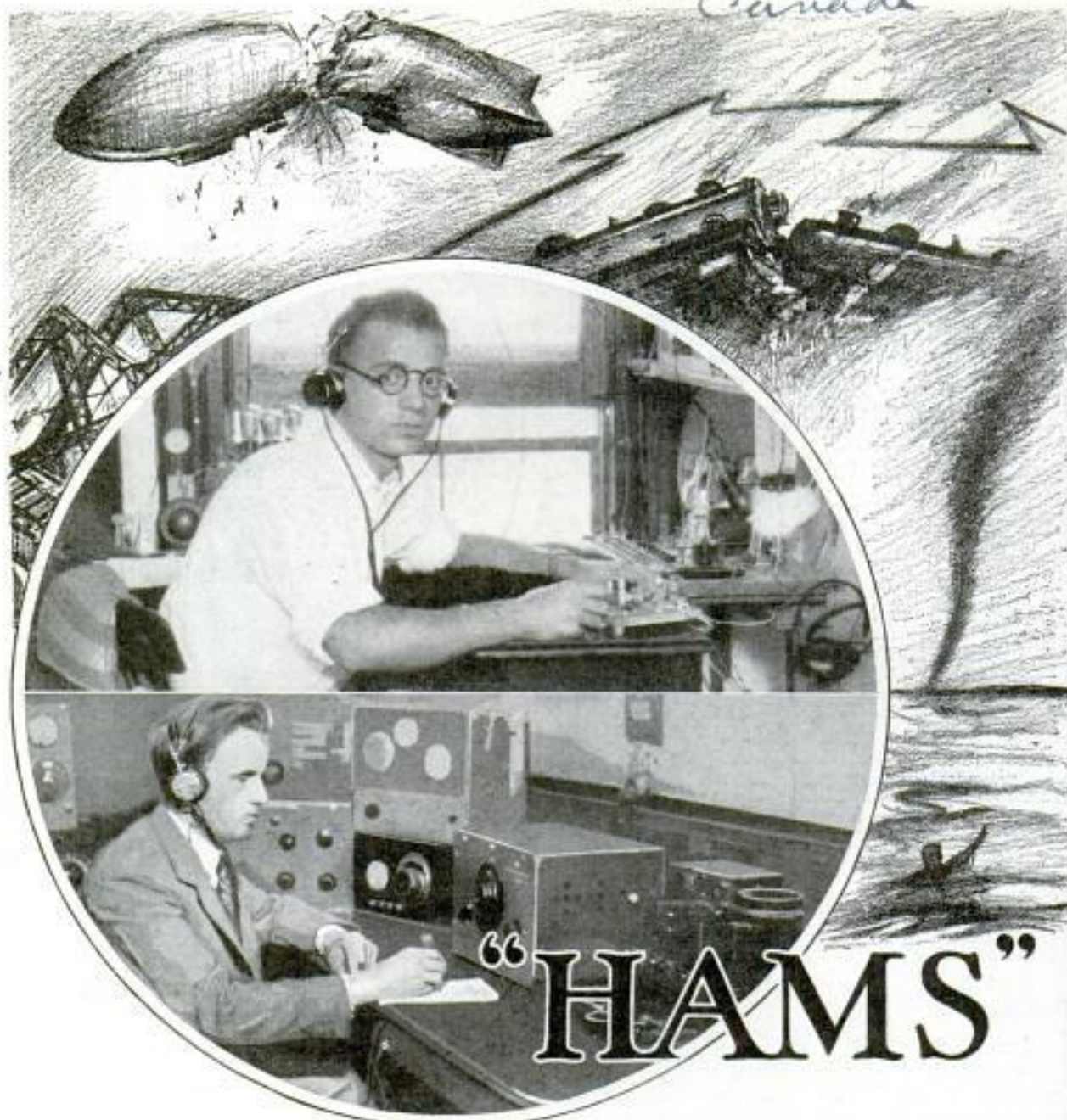

"HAMS"

"Ham" 2APD, Above, and the Owner of VE1AL, Below; Both Operators Have Served Long Hours at Their Sets in Crises, Such as Those Shown, When Other Communications Failed

A SNOW and sleet storm strikes North Dakota and Nebraska, interrupting all communication channels, clogging highways and railroads. Telegraph and telephone wires come down with the weight of the frozen sleet and ice, covering them like thick ropes. Poles snap under the weight of the white-coated wires. Trains are blocked and there is no way of reaching the outside world. Even power has failed in some places.

At each point, radio amateurs learn of the communication break, and drop all other work to try to bring the isolated towns and railway points into contact

with regions where the storm has not played havoc with the wires. Railway dispatchers and telephone officials have called on these chaps for aid.

With batteries in place of power lines, with all thought of sleep put aside, the radio amateurs of North Dakota and Nebraska set to work. Within a few hours they have communication going full blast via their stations. Railway officials outside the states affected learn the extent of the trouble and urgent telegrams are cleared by radio. Repaired power lines first are run to the amateur stations so that better communication can be estab-

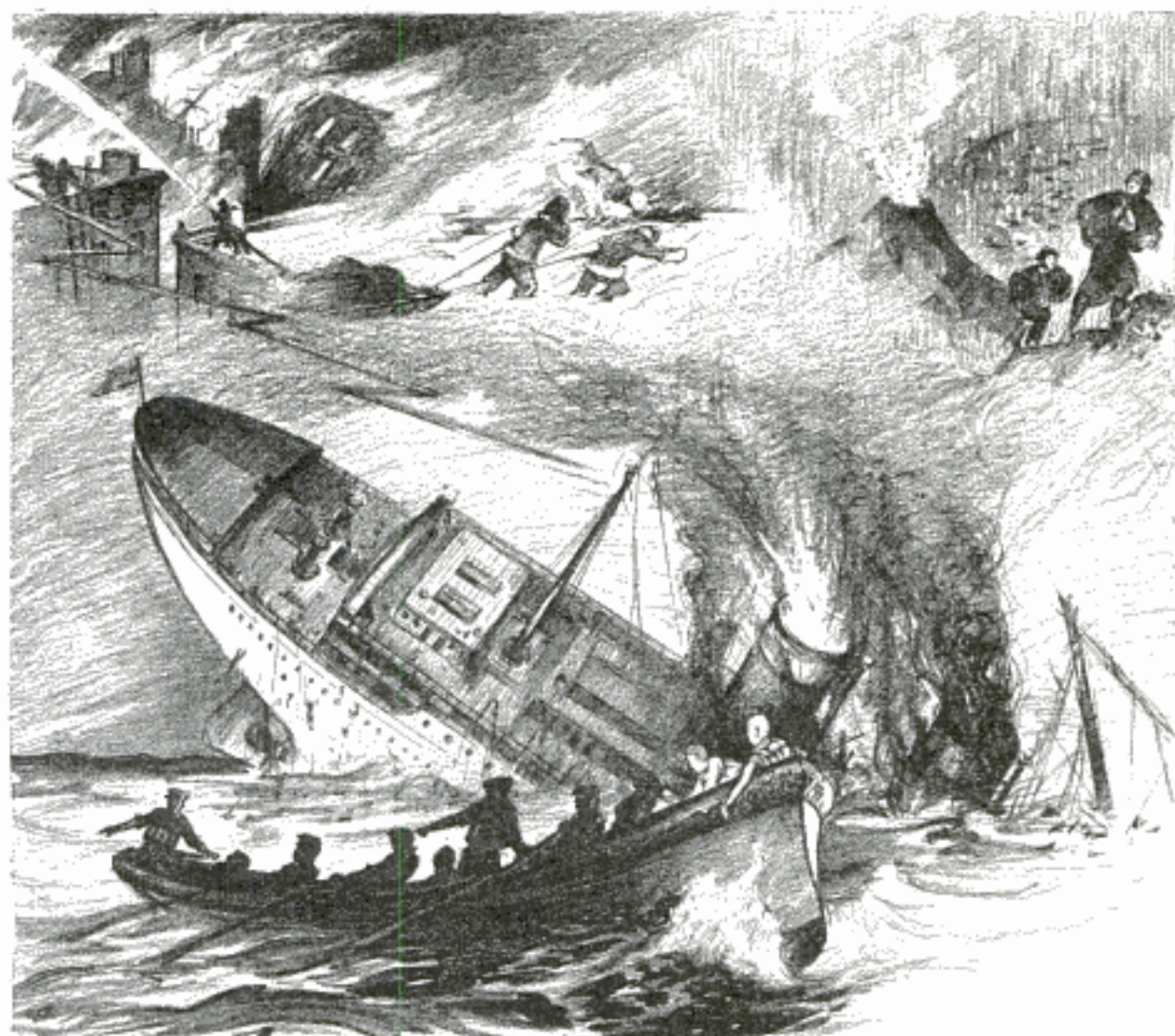

to the RESCUE

lished. Telegraph linemen are soon repairing wires, but five days elapse before the whole structure is functioning again. During that time low-powered amateur transmitting and receiving equipment, for the most part homemade, has successfully bridged the gap.

In New Zealand an earthquake wrecks two resort towns, cutting off all communication. The first call for help comes when, in a radio test room in Wellington, a faint message from the stricken areas is picked up, requesting doctors, nurses and food. The message comes from an amateur station, set up among the ruins of the operator's home. His regular equipment smashed with the caving in of the roof of his house, the operator has res-

cued what parts he could, scoured the ruins of several battery shops and picked up a number of batteries which he took home. Here he has set to work, built a small transmitter and receiver, powered with the rescued batteries, and sent his request for help. His is the only link between the earthquake-shattered towns and the outside world.

These are two recent cases where amateur radio operators have come to the rescue. In the United States, there have been more than twenty disasters within the last ten years in which radio as a hobby has come to the aid of large marooned communities. A vast system of emergency stations has been built up by radio amateurs, so they can come to the aid of

71363

POPULAR MECHANICS



communication when the usual channels no longer function.

There are 20,000 radio amateurs in the United States alone and another thousand

stations in as many cities and towns and rural communities, and within twenty-four hours, 481 of these messages had been countersigned and delivered to the local Red Cross officials to whom they were addressed.

To belong to any of the networks for emergency communication work requires high standards. These all co-operate with the American Radio Relay league, the national transmitting amateurs' organization.

These various networks which can be quickly summoned for emergency use,

in Canada. Throughout the world there are several thousand more. All operate radio transmitters for experimental purposes on short-wave bands. With these transmitters they can reach to all parts of the world either by using the Morse code or by telephony. Telegraphy is the more common form of operation, requiring less power to cover longer distances than telephony. Scheduled contacts are often kept between a number of stations to study conditions and improve operating technique. From such contacts have come the national emergency networks in the United States, co-operating with the army, navy, Red Cross, railroads and communication companies.

The army network of amateur radio stations recently handled a Red Cross message to show the speed with which these volunteer radio experimenters can come to the aid in emergency. A seventy-six-word message was dispatched from Washington, picked up by 494 amateur

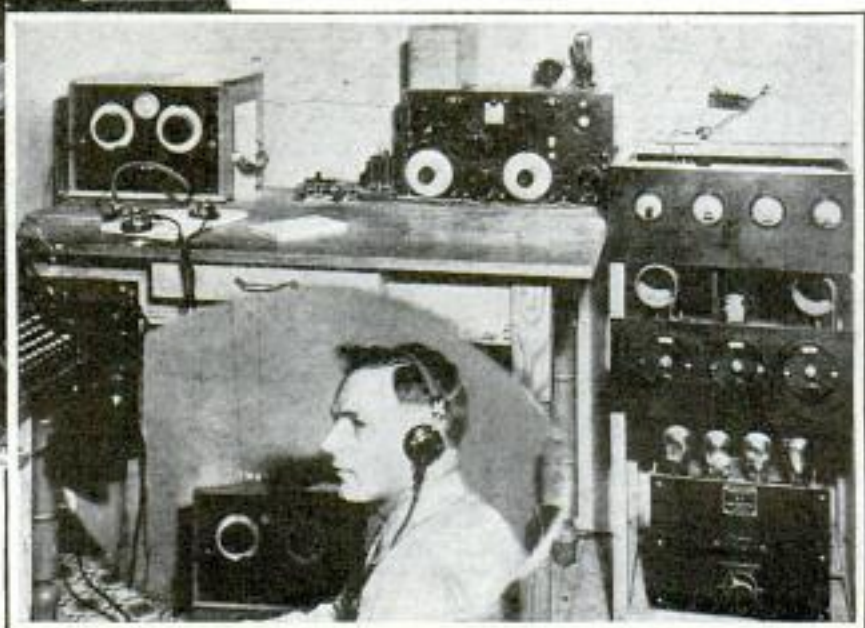

Operator of W9DHO, Above, Who Has Come to the Rescue Many Times When Snow Brought Chaos in Nebraska; Typical Traffic-Handling Station

comprise men and women, young and old, from all walks of life.

Not all emergency communication by amateur stations is connected with storms, floods, earthquakes and similar natural disturbances, though the outstanding work has been done in this field of emergency communication. Radio amateurs played their parts in the New England and Mississippi floods and the Florida hurricanes.

When a boy scout camp on Catalina island was quarantined against infantile paralysis, amateur radio became the only means of communication. Neither mails nor telegraph communication were possible. The short-wave amateur station at the camp made contact with an amateur station at Pasadena, kept the parents and friends of over 100 boys and leaders in-



The Equipment That Brought Much of the News When the "Viking" Exploded off Newfoundland; at Right, Elaborate Antenna of Midwest Station

formed as to conditions, summoned medical aid and food.

The first authentic information that the wreck of the sealing vessel "Viking" off Newfoundland had been caused by an explosion of dynamite, came from an amateur operator at Boston. Contact had been established by another Massachusetts amateur with an amateur near the scene of the wreck when the news of the disaster became known. Three Massachusetts stations supplied most of the news and forwarded most of the instructions for the rescue of the sailors.

An amateur in New London, Conn., one night heard the Detroit river lighthouse radiophone calling the United States coast-guard base at Cresenton, Mich. It was a call for help, and the amateur listened, for here was adventure. To his surprise, the call was repeated a number of times, and from the context of the message the coast-guard station appeared not to answer. Finally in desperation the lighthouse sent out a broadcast asking all stations listening to notify the coast guard that a doctor and patrol boat were urgently needed at the isolated light-

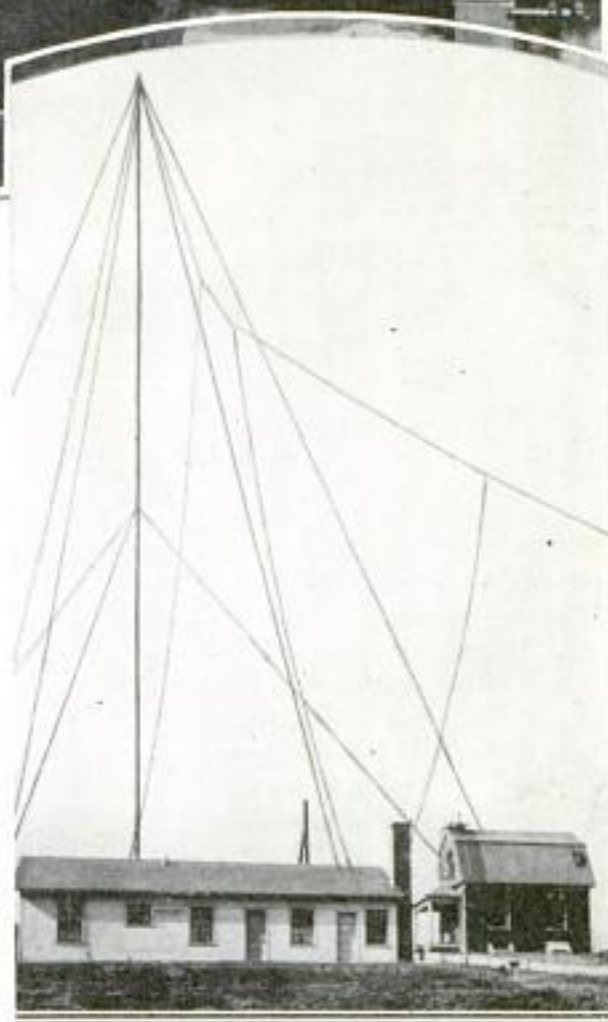

house. New London is a long way from the Detroit river lighthouse, and the amateur telephoned the local coast guard, but they could not pick up the message on their receiver. The Buffalo coast-guard base was notified, and help was sent to the lighthouse.

a1614

Chas. E. Es. Muddick
Mountain View
Calif



Group of Western Figures Sculptured by a Montana Youth Who Has Selected Pioneer History of the "Wild" Days as His Motif

FIGURES OF REAL WILD WEST SCULPTURED IN MINIATURE

Realistic miniature sculptures depicting the fast disappearing life of the old west, turned out by a youth not yet twenty years old, are amazing western art lovers. The youth is Earl Heika of Great Falls, Mont., who is said to be the only living sculptor of note giving representation to this period of the nation's history. In a recent group displayed at a fashionable hotel were shown miniatures of cowboys, prospectors, wranglers, pack trains, broncho-busters and covered wagons.

SUNSHINE LAMP FOR CANARIES KEEPS THEM HEALTHIER

Individual "suns" for canaries have been developed by a bird-loving engineer for General Electric, to provide them artificially with the sunshine they obtain naturally in their normal climate. The developer of these individual sun lamps began by equipping his bird cages with ultraviolet lights. The birds seemed to enjoy the radiation, singing and hopping near the lamp. Breeding cages equipped with the lamps showed a greater percentage of hatchable eggs and prevented rickets. The lamps used several hours a day in

each cage will supply two birds with sufficient light to maintain their health.

a1620

AIR TRIMS TREES AS QUICKLY AS THIRTY MEN

Compressed air operates a pruning machine which will do the work of thirty experts in an orchard and of six of the fastest workmen in the vineyard. The pruner, weighing only four pounds, is built of aluminum with a brass barrel, except for a steel hook and knife. The steel hook is placed over the limb to be cut. The button is pressed to release the compressed air, and the knife is thrown forward,

cutting the limb. When the air is shut off, a steel spring draws the knife back to its original position. The pruner is connected with a compressed-air tank on a wagon, on which also is a small engine for compressing the air. An extension pole, reaching fifty feet, eliminates ladders and the time of climbing.



Faster Pruning Is Possible with This Compressed-Air Knife; the Pruner Does the Work of Thirty Men

a1631

J.C. Porter, Jela Park
Eng. Dept. Cleveland, Ohio

J.A. But.

7/18/31

a1596 dnd Herr
Hubold,

Germany

a1642

CLOCK WORKS FIVE CENTURIES RESTS AND STARTS AGAIN

Five centuries of ticking, followed by forty-five years of silence and now at work again—that is the life of the Salisbury cathedral clock, built in 1386, when Richard the Second was king of England. The clock ticked away faithfully until 1884, when a new one was installed and the old one forgotten. But now the old timepiece has been cleaned, adjusted and set to work again. Every part of the clock was handmade from wrought iron. Like many early clocks, it has no face. It strikes the hours, but does not show them on a dial. The oldest clock in England is that in Peterborough cathedral, which was built 611 years ago. This clock has no dial and has to be wound up daily by means of a wooden wheel. An eighty-pound hammer strikes the hours. The Prague clock, built in 1490, was one of the most remarkable in the world. At the hour, two doors opened and the twelve Apostles issued and bowed. Then came the figure of Christ, raising its hands in blessing and then withdrawing. The figure of Death seized the bell rope. A merchant displayed his money bags, a priest held up a mirror to show that all was vanity, and a cock crowed. Then Death pulled the rope and the hour struck.



Propellers Worked by Hand Push This Swimmer Backward or Forward; Note How "Boat" Is Worn

BOAT WORN AROUND THE NECK HELPS IN SWIMMING

Tiny propellers, turned by two handles on a boat-shaped apparatus worn around the neck, provide a new means of propulsion through the water. A swimmer puts his head through the marine neck-band, made of aluminum, and by simply floating and turning the handles, propels himself forward or backward.

BURGLAR-PROOF WINDOW BARS SLIDE WITH THE SASH

Open windows are made safe from burglars by an attachment which fits into the lower part of the frame and extends through the sill. It consists of metal rods that raise into place with the lower sash, but slide down grooves into the sill when the window is lowered. In the case of children, the attachment also prevents falls from open windows. The rods cannot be raised out of the sill, due to a lock that holds them in place, while a plunger prevents the upper sash from being lowered.



STRONGER AND LIGHTER "LEAD" MADE INTO WATER PIPES

Water mains of a new ternary-lead alloy, discovered by a British organization, are being laid in Manchester, England. That the new metal will largely take the place of lead as now used in water piping is a belief freely held. The ternary-lead pipe weighs thirty-three per cent less than lead, has eighty-four per cent more tensile strength and its resistance to vibration, the cause of most water-pipe troubles, is 217 per cent greater than that of the pure metal. The alloy is composed of lead, tin and cadmium and it is said approximately 1,500 pounds of it will give the same footage as a ton of ordinary lead.

The Thomas & Mermet Co. Metal Buildings

British Nonferrous Metals Research Organization

Compressed Air
Morg. Aug. 1931

a 149 4

Carl. ls H. Eckhardt,
4528 Walnut St

584

POPULAR MECHANICS

White

World's First Stenographer Found in Egypt

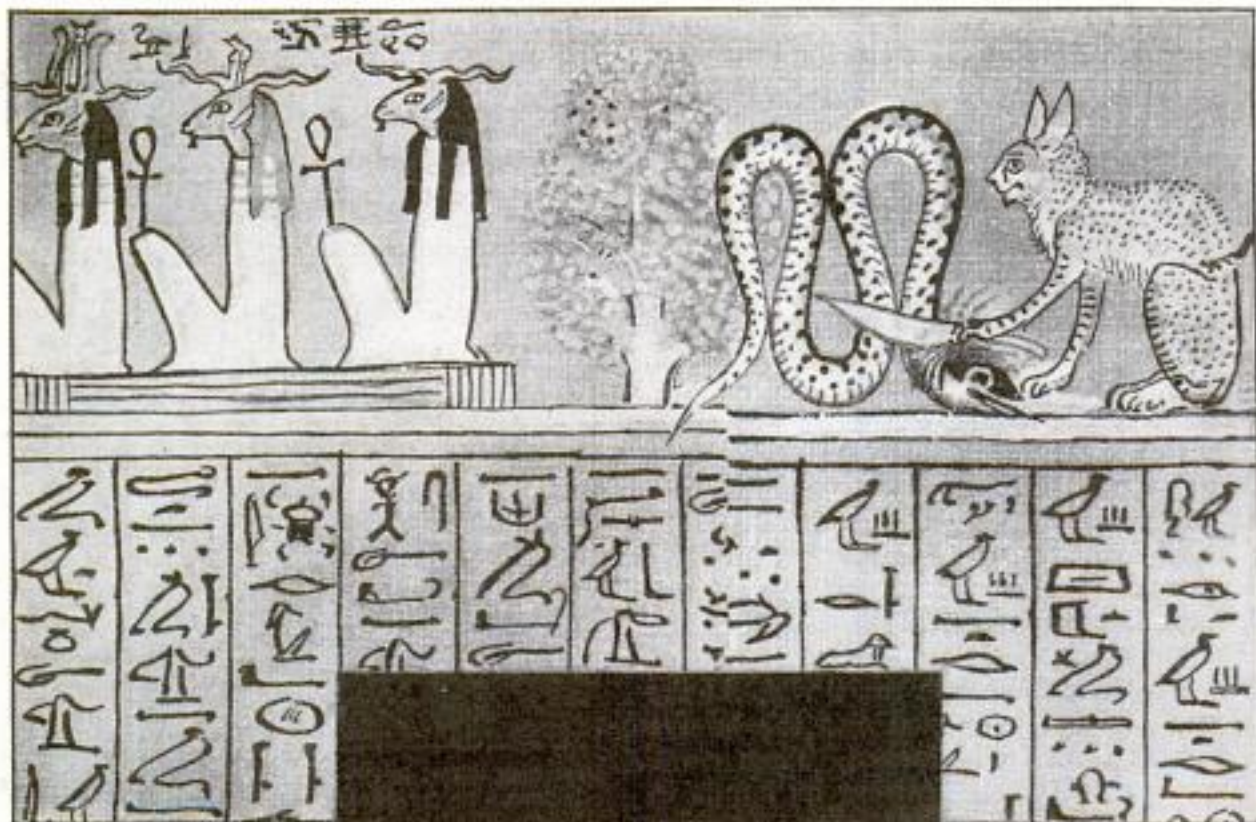

In the University of Pennsylvania museum is a statue of a man who was probably the world's first public stenographer. The figure is that of an Egyptian who lived some 3,500 years ago and prospered at his work to such an extent that he had a statue of himself erected at his tomb. The stone carving represents the man at work with his papyrus sheets, and it has been found that these early stenographers actually had developed a system of shorthand for taking down dictation which they later transcribed on the papyri that have come down through the ages as a record of the civilization of the times. Some of the ancient stenogra-



Statue of an Egyptian Who Was Probably the First Stenographer, and Samples of His Work

pher's work consisted of allegorical pictures such as the sacred cat of night cutting off the head of the serpent of day, it being believed that the serpent grew another one during the darkness of the night.

12/27/20
albs
CAR RUNS ON TAR FUEL

Completion of a coal-tar oil product that is said to be a satisfactory substitute for gasoline in internal combustion

engines has been announced in Ireland. It is claimed about 500,000 gallons of the fuel can be produced yearly and that the cost of production will be considerably less than the present price of gasoline in Great Britain. In a test with the new

Reported by Consul Leonard M. Green at Belfast
Copyrighted material

Dept of Commerce memo 12/27/20

Belfast Ireland 9/15/30
 Esas Works.

fuel a Belfast bus ran twelve miles to the gallon compared with eight with ordinary gasoline. No loss of power was reported, nor was carbon monoxide present in the engine gases. It also is said the new fuel eliminates engine knocking to a great degree and reduces danger from fire. Its use, however, necessitates some changes in the engine design and the car must be run fifty to a hundred yards on gasoline or benzol before switching to the new fuel.

**WHISTLING ON CRUISER
 ALL BY ONE MAN**

Whistling is one of the things that a sailor gives up when he joins the navy. Aboard a battleship one man, and only one, does all the whistling there is to do. The boatswain whistles for the entire crew, and even he is not permitted to do it except on the official pipe. When he blows this whistle it is a signal to the crew translating an order from an officer to do something or stop doing it.



The Boatswain, the Only Man on a Battleship Allowed to Whistle, and His Official Pipe

Thomas J. Malley
 Steubenville Ohio
 U.S.S. Pillsburgh



Doctor Demonstrating "Glarometer" on Another Doctor in Meeting Where Glare Was Blamed for Many Eye Troubles

**WAR ON GLARE TO SAVE EYES
 AIDED BY METER**

Glare, which optometrists declare responsible for many eye ailments, is the enemy hunted with an apparatus designed by Chicago doctors and exhibited at a recent meeting of specialists at Los Angeles. The device is known as the "glarometer" and tests and measures the effect of natural and artificial glare on the eye by submitting the orb to varying degrees of discomfort and measuring the reaction.

**GIANT PACIFIC SUNFISH CAUGHT
 IN THE ATLANTIC OCEAN**

Weighing more than 1,900 pounds, a huge Pacific ocean sunfish was recently caught by commercial fishermen off the coast of New Jersey. It was a struggle for fourteen men to drag the monster from the power-drawn nets into the boat. Officials of the Smithsonian Institution, who arrived to mount and skin the curious creature, said its natural habitat was the central Pacific, and it undoubtedly had made its way around Cape Horn in what they estimated as at least a two-year journey.

CA rifle cartridge developing high gas pressure is used in Germany for starting airplane motors.

Wagner unknugen.
 Illustrierte Technik
 Nr. 22. 1930

Willingly Mendeleev
 Mr. Shepard
 part eradicate eye of institute
 Mr. Ber.
 Bayhead Fisheries
 Montolony

PG 3 1/2 La Baffle
 Chicago

Capt. Franz Romer
55 W 86 St., New York

It's a Long Way Across

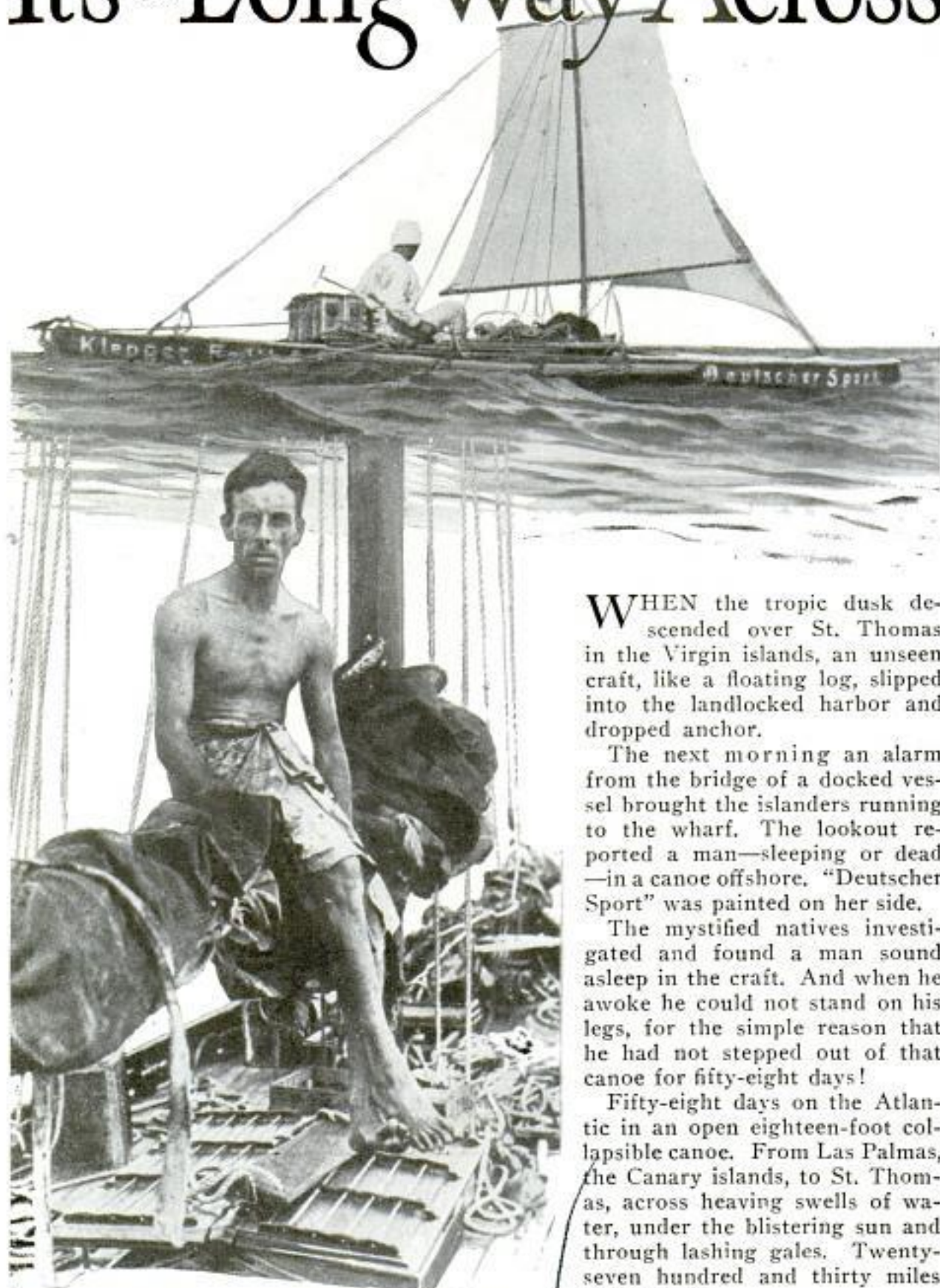

WHEN the tropic dusk descended over St. Thomas in the Virgin islands, an unseen craft, like a floating log, slipped into the landlocked harbor and dropped anchor.

The next morning an alarm from the bridge of a docked vessel brought the islanders running to the wharf. The lookout reported a man—sleeping or dead—in a canoe offshore. "Deutscher Sport" was painted on her side.

The mystified natives investigated and found a man sound asleep in the craft. And when he awoke he could not stand on his legs, for the simple reason that he had not stepped out of that canoe for fifty-eight days!

Fifty-eight days on the Atlantic in an open eighteen-foot collapsible canoe. From Las Palmas, the Canary islands, to St. Thomas, across heaving swells of water, under the blistering sun and through lashing gales. Twenty-seven hundred and thirty miles in a canoe!

The adventurer's name was

*Kleppel Canoe
Germany*

Top, Capt. Franz Romer Who Disappeared on Lone Voyage to U. S.; Below, Alain Gerbault Who Sailed around World Alone



the Atlantic

Capt. Franz Romer, age 29, a German aviator and sailor. He had designed and built the "Deutscher Sport," eighteen feet long, eighteen inches deep and only thirty-six inches in the beam. Her frame was covered with rubberized fabric. He could roll up his transatlantic vessel and tuck it under his arm.

When it had cleared Lisbon, Spain, the "Deutscher Sport" was loaded almost to the gunwales. Her skipper had surrounded himself with food and supplies. Gradually he ate his way into the boat so that he could move his legs freely. He taught his canoe how to pilot herself by fastening the sail to the rudder.

Week after week he drove her on. At night he covered his head with a rubberized helmet and buttoned a cape around his throat. He breathed through a respirator.

He carried fifty-five gallons of water and 500 pounds of food. The sun scorched his hands and face. Salt spray ate into his skin. The sharks butted against the hull. Eight steamers thought he was



Top, Gerbault Aboard His Boat, the "Firecrest"; Below, Sloop in Which Two Brothers Traveled 11,000 Miles

9-14-91

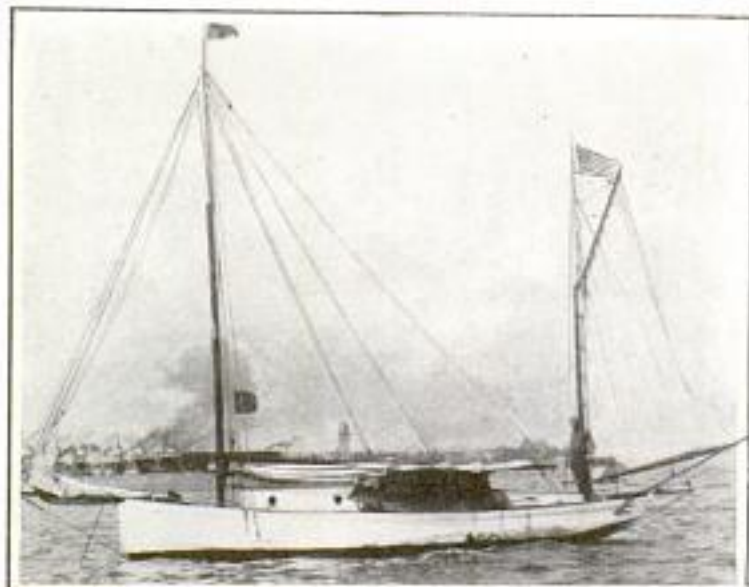

ary, 1905, 221 days on the water at a speed of two knots per hour.

Of all the sixty odd small craft which have made the transatlantic passage, none is more famous than the "Firecrest," which also circumnavigated the globe under the command of her lone owner, Alain Gerbault, a Frenchman.

Gerbault tested his craft in Mediterranean waters. Then he steered for Gibraltar, thence to the open sea.

First, the mainsail began to rip, then the gaff topsail failed to hold. To cap matters, the water went bad. Next the salt beef became unfit to eat. His throat swelled up so that he could not swallow solid food.

A clap of thunder brought on rain for drinking water. Then came the high water. He leaped into the rigging as a battering wave submerged the cutter. The mast groaned, as if she would rip open the deck planks.

But they stuck, the ship and her master.

adrift and stopped to pick him up. Ha! Not Romer. He was comfortable.

On the fifty-eighth day he sighted the Virgin islands, where he rested before starting for Porto Rico.

"Swim?" Captain Romer said to inquirers, "I can't. What good would that do me?" He cleared San Juan after missing the weather bureau's warning of a forthcoming hurricane. Somewhere between Porto Rico and Santo Domingo the sea claimed him and his canoe.

Captain Romer's adventure ranks among the most daring, but there is an actual record of a life-raft, the "America," consisting of four iron cylinders, crossing the Atlantic, from Southampton to New York, in fifty-two days.

Captain Brudel, of Aalesund, Norway, crossed the North Atlantic in an all-metal boat, eighteen feet long, equipped with a hollow steel mast. He started in June, 1904, and finished in Janu-



Top, Boat in Which Harry Pidgeon, in Center, Covered 35,000 Miles; Below, Captain Romer and His Collapsible Boat

a 1495 Die Woche
Pg 779
June 20, 1931

Gerbault forfeited his harpoon while trying to spear a fish. His food supply was running low. Day and night the fog blinded him off Nantucket. At length he spied the shore and headed through Long Island sound for New York.

SLOT MACHINES SELL ICE IN SUBURBS

a 1518

Coin-in-the-slot boxes that dispense twenty-five-pound packages of natural ice cubes, neatly packaged in wrapping paper, stand on the street intersection in busy suburbs of Los Angeles. The boxes are eight feet wide and twelve high and hold 195 packages of ice. A nickel and a dime are inserted in the coin box, a button is pressed, and in seven seconds the folding doors at the lower left of the box open, and a package of ice pops out. The ice itself is cut and sealed without being touched by hands, and the container is serviced from a refrigerator truck.

found write Maxwell Zigler, 3500 W 36th St Los Angeles, Calif
Central Ice and Cold Storage Co



Coin-in-the-Slot Machine That Vends Cube Ice in Packages of Twenty-Five Pounds

Central Ice Cold Storage
Co. Los Angeles, Calif
3500 W 36th St



Courtesy Die Woche
Methods of Resuscitating Poison-Gas Victims Are Taught by Using Dummies; Note the Masks Worn by Students in a Factory School in Germany

PREVENTING POISON FROM GAS IS TAUGHT IN SCHOOL

Use of gas masks and the dangers of gas poisoning are taught in a school operated by a German manufacturer in connection with his gas-mask factory. Doctors, sanitary inspectors, firemen and others of similar occupations take part in the courses, while a woman's organization is seeking to enlarge the scope of the school by making the instruction available to the public. Another objective is construction of gas-tight refuges for the public in case of gas attacks from the air.

OIL MADE FROM BY-PRODUCTS AND REFINERY REFUSE

a 1622

Development of a synthetic motor oil from a base of paraffin wax has been demonstrated by the Standard Oil company of Indiana. Paraffin long has been a "refuse" by-product in the distillation of the crude oil to obtain gasoline, kerosene and the heavier lubricants in which asphaltic bodies, petroleum wax and jelly are left behind. To obtain an ideal lubricant it was found necessary to break up or polymerize the oil, rather than solely to distill it. The new synthetic oils can be made in any viscosity, are of a pale straw color and are said to be highly resistant to oxidation and sludging.

N.Y. James
8/21/31

910 S. Michigan
Chicago

at Aramienburg near Berlin Germany

Booth Engineering Co. Ltd. 15 Park Road New York

91550 Cont. Norman J. Anderson
912 Bush St.

590

POPULAR MECHANICS

San Diego, Calif.

Bridges on Rockers Give Heat Elbow Room

Bridges rock themselves contentedly. If they weren't allowed to rock they would destroy themselves! Heat is the cause of this necessity. Heat demands that it be given lodging room in a steel structure during the day. The demand is

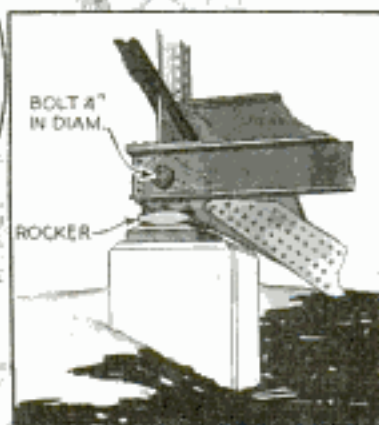
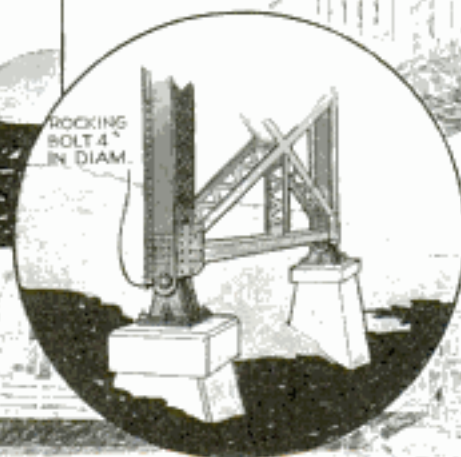
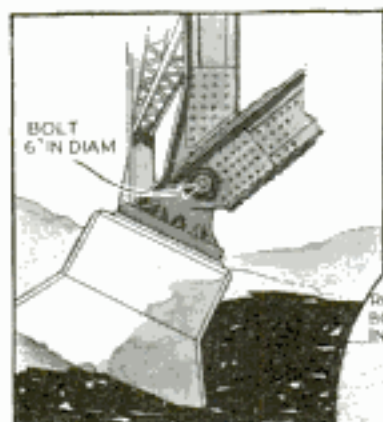

Inset Photographs Demonstrate Three Different Ways to Mount Bridges on Rockers; Each Is Applied to Particular Formations of the Earth at the Point the Bridge Is Built

for an increase of only .00009 of an inch for each foot of steel that is increased in temperature one degree. What would happen if the engineers ignored this demand? In a structure with a span of 650 feet, a change of about sixty degrees would expand it approximately three and one-fourth inches. Heat upon entering would demand three and one-fourth inches in which to stretch, and if the bridge were not free to rock, tremendous stresses would develop that would crush the concrete abutments or crumple the steel girders. Locating the bridge ends, the foundations, centering the rockers, and providing extra pivots throughout the structure call for field work of the most exacting nature. Even the expansion of the measuring tape is taken into account by reading a thermometer when the tape is read. One reading might be

wrong, so four readings are taken of the same distance. Think of the care exercised in designing a bridge of thousands of pieces. Then you can imagine the satisfaction of the men responsible when the last section of the arc is hoisted into place and the rivet holes line up perfectly. One engineer watched the opposite ends of a bridge he had designed approach each other, then sailed for Europe. But the final section was several inches too large. The delay of building a new central section was impossible, as the contract was about to expire. The contractors cabled the engineer. What should they do? The reply came back, "That bridge is designed to fit! Put ice on it!" Tons of ice were placed, and slowly the heat left and the two halves contracted. The central section slid into place. They had made the bridge rock itself.

**AIR SICKNESS "OUT OF FASHION"
SO THE MALADY WANES**

al640

Air sickness in America is passing, according to surveys by pilots, co-pilots and air-line attaches. Most students of the subject have agreed that the biggest reason for the decline is the increasing travel by airways, with consequent decrease in nervousness on the part of passengers. Air travel has now become so common that air sickness has gone out of style. Most authorities agree that there exists no sound physical reason for air sickness, except in "bumpy" weather, as the motion of the airplane is quite different from that of a ship, since the latter rolls and tosses continuously from the time it leaves one port until it arrives at another. In the air, on the other hand, there is none of this rolling, except when the air is upset by storms. It long has been held by air-line operators that air sickness is caused about ninety per cent from nervousness and ten per cent from motion of the plane. It also is believed that better ventilation of ships is partly responsible for the change.

**BUCKLE FOR FASTENING ROPES
REPLACES UNHANDY KNOTS.**

Tiresome and unhandy knotting of ropes is eliminated by a simple rope buckle now on the market! The buckle is made of six-gauge special steel wire. Open prongs in which the rope end is placed are closed with a hammer, taking only a few seconds to make a tie rope which is handy for tourists and farmers.



Complete ventilation of airplane cabins is being provided by slip-stream suction.

George Johnston Ltd.
173 Shaftsbury Ave.
London W.C.2. Eng.

With Snips and Soldering Iron, a Sheet-Metal Worker in Twelve Hours Evolved This Example of Modernistic Art—a Twelve-Foot Man Astride His Tin Horse



**TIN MASTERPIECE AS A SIGN
PROVES WORKER'S SKILL**

Just to show his skill with snips and soldering iron, a sheet-metal worker of Long Beach, Calif., constructed a tin statue of a modernistic man on a horse. The twelve-foot figure was put together in only twelve hours, then placed in front of the artist's shop to attract attention to his working ability.

**MILK PRODUCTION IS AFFECTED
BY CHANGES IN WEATHER**

Changes in temperature have a definite effect upon the milk production of cows. This was shown by recent experiments at the University of California, where it was found that both the quality and quantity of milk given by Jersey cows were affected as the temperature rose. Two cows were kept in a room with temperature carefully regulated for forty-five days, and the milk production fell off as much as thirty per cent in five days as the temperature was raised.

Densen of animal husbandry
Berkeley
Calif

William A. Fi...
Long Beach, Calif.

San Francisco Exam. 8/2/31

Used on Short Bus plane

and only 6.5
al1585
al636
al637
al638
al639
al640
al641
al642
al643
al644
al645
al646
al647
al648
al649
al650
al651
al652
al653
al654
al655
al656
al657
al658
al659
al660
al661
al662
al663
al664
al665
al666
al667
al668
al669
al670
al671
al672
al673
al674
al675
al676
al677
al678
al679
al680
al681
al682
al683
al684
al685
al686
al687
al688
al689
al690
al691
al692
al693
al694
al695
al696
al697
al698
al699
al700

Perfect Rainbow Jesse William Moore, du Mond, and Harry Kerkpatrick
Pasadena Calif

COFFEE-URN WATER SOFTENER CUTS FUEL COSTS



Water Softener Helps to Reduce Costs of Operating Coffee Urn by Removing Minerals

All lime is removed from water used in coffee urns by a water softener now on the market. Considerable saving on operating and maintenance costs is claimed. The accumulation of lime on the interior of urns, say the makers of the softener, causes increasing fuel expense, scoring of valves and faucets, burning out of bottoms and decreased capacity, which results in inaccurate water-gauge measurements. The softener operates on a principle of simple chemical reaction, with common table salt used as the medium of regeneration.

HOW ELECTRONS MOVE IS SHOWN BY X-RAY

Recent completion of a prism spectograph and experiments with it have proved the effects of an X-ray on the electrons within

an atom. Two scientists of the California Institute of Technology say the device which they made has established that there is electronic motion within the atom, the X-ray acting on the electrons like a billiard ball rolled violently into the midst of other billiard balls. The theory was conceived several years ago and the fifty-crystal prism spectograph, with every prism fixed on a single line in the spectrum, was constructed to determine its truth. It was assumed that X-ray waves are scattered by electrons, and that as the scattering angle is increased, a broader line would be cast by the X-ray spectrum, a narrow angle resulting in a narrower line. The instrument, the scientists declare, has proved both theories. It is so delicately adjusted that the spectrum cast by the fifty prisms can be so superimposed that all the lines fall exactly on the same place on a photographic plate. This was necessary in order to make the delicate measurements and calculations essential to proof of the theory.

91600

MOTORCYCLE RACE IS STARTED BY ROLLERS UNDER WHEELS

British motorcycle racers are getting away on even terms by using automatic starters. Each starter consists of a frame supporting two rollers on which the rear wheel of the motorcycle is placed. This enables the machine to be started, the drive wheel revolving on the rollers until the signal to start is given when the wheels are pushed off the tracks simultaneously and the racers get away neck and neck.



Rollers under Rear Wheels Used as Automatic Starters to Enable Motorcycle Racers to Get Away Together

at Wembley Sladden
Copyrighted material

The Bastian Plumbing Co. Chicago
240 E. Adams

91638

91515 American Glass Co. Pittsburgh Pa

POPULAR MECHANICS

593

Ultra Violet Ray

You Can See Out but Not In with This Glass

ve
du
pro
rou
wi
u ar
app
less
illu
light

Schroeder Paint
5914-12-15
Leitch
Mich



Showing How Glass Is Translucent from Inside and Opaque, Reflecting Images Like a Mirror, from the Outside

Schroeder Paint & Glass Co.
5914 - 12 - 15
Leitch
Detroit, Mich.

Glass that is opaque from the outside recently was demonstrated in the windows and windshield of an automobile. Passengers and driver can see perfectly from the inside of the car, but the appearance from the outside is that of a mirror. The only difference from ordinary glass from the inside is a slight bluish tinge. The glass also permits the passage of ultraviolet rays.

AIRCRAFT GUARD FOR FORESTS PROTECTS AGAINST FIRE

Airplanes are being employed by the United States forest service to guard against the danger of fire in Michigan forests. Two planes are on duty, patrolling

four national forests in the state, while other planes of the company holding the patrol contract are subject to call when visibility is so poor that fire towers are useless or when fires are so extensive that present methods of observation are ineffective. Aircraft are being used to fight mosquitoes in New Jersey, scouts being placed on duty to locate bodies of water and marshland areas where the pests breed. The planes carry maps showing all natural bodies of water, and when an uncharted body of water is located, the plane descends to within 300 feet to inspect. In early tests, a plane scouted 220,000 acres of marshland in six flying hours, a task at which forty men on the ground would be kept busy a week.

U.S. Daily 7/25/31

A.B. C. Airline Corp. Lansing Mich

PORTABLE SHORT-WAVE SENDER
 AIDS SPORTS BROADCASTS



Portable Radio Transmitter and Receiver Which Allows Golf Broadcasts Stroke by Stroke

A complete radio plant that you can carry around on your back has been developed by engineers of the National Broadcasting company and received its initial try-out in broadcasting the American open golf championship tournament. It is built in two units, the transmitter being carried by a helper, and the receiver mounted on a pole which also serves as the antenna.

WATER RUNS ENGINE CHEAPLY
 AND WITH MORE POWER

Operating without boilers or condensers, an engine which runs on water instead of steam is being offered for experimental commercial use in England. Expansion of water operates the engine, the water being heated rapidly in one cylinder and cooled in the other to cause a movement against pistons connected to the same shaft. Cheapness of operation and production of more power in less space than ordinary steam and gas engines are two

claims of the inventor. Only a small quantity of water is needed. The mechanism is simple, and the working parts need be opened for inspection only once in four years. It loses less heat than other engines and its outside shell is cool to the touch. The engine has no exhaust, the water being used over and over. All bearings are cold and lubricated by the water itself. For an engine of this type with a rating of 100 horsepower or over, the indicated efficiency as measured by three different engineers was twenty-seven per cent. In comparison, a steam engine of the same class was rated at only eight per cent, and a gas engine at fourteen and seven-tenths per cent. The engineers said the efficiency of the water engine would increase with the size. The weight and cost of this engine are about the same as those of a steam engine, but the inventor says, the liquid engine locomotive can give the same power at half the coal consumption and none whatever of water.

PLANE WITH "CLIPPED" WINGS
 TRAINS STUDENT PILOTS

Fledgling flyers at one New York airport learn the rudiments of handling an airplane without leaving the ground by practicing in a small ship with stubby wings and powered with a two-cylinder motorcycle engine. This trainer can be taxied about the field and lifts its tail as though about to take off, but has neither the power nor the wing spread to leave the ground. The student pilot cannot even "nose over," because there is a safety wheel and frame in front to prevent such an accident.



Plane with Stubby Wings and a Small Motor for Training Students; Note Safety Wheel in Front

Science News Letter
 9/25/28

Dr. J. J. Malone, at North Beach
 Engineer Newcastle Long Island
 on June, England

91542
 91580
 Curtis
 Comb. of Hand 349
 Newcastle, N.Y.

91281 Cmt. Charles W. Person,
452 Webster Ave.

With DEATH as a
THEY PRY
apart
BOMBS

SPECTATOR
New Rochelle, N.Y.

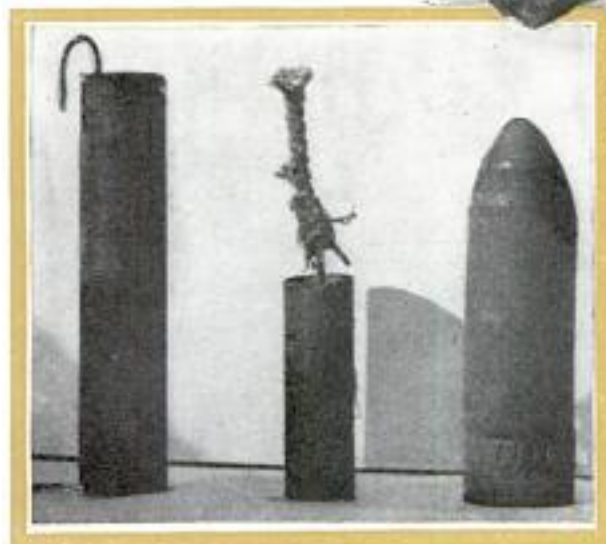

© P. A.

Taking Apart an Infernal Machine; at Left, Typical Pipe Bombs Containing Nitroglycerin and Concrete

cial duty of the bomb expert. Bombs are his business. He knows them all, and he doesn't care how large and dangerous they are or how diminutive and innocent, for they all go the same way.

When you ask one of these experts what would happen if one of the packages of death should blow up, he'll probably say nonchalantly:

"You'll be able to tell when it happened by my watch!"

Every unexploded bomb is carefully examined for characteristics which are expected to reveal the identity of the maker. No two bombs are exactly identical, but the expert can tell at a glance if they are the handiwork of a novice or of a master workman. Most bombs are of dynamite—simply constructed affairs, consisting of two or more sticks of surface-blasting gelatine tied firmly together.

A study of 145 bombs revealed that eighty per cent of them were made by the same group of persons.

Occasionally, however, the police come

LITTLE Negroes who used to sit on safety valves on the Mississippi river steamboats had an easy time compared with the members of metropolitan police forces who are specialists on the disintegration of bombs.

These experts are indispensable to the police in running down makers of bombs and infernal machines. The bravest officer may prove himself absolutely fearless snuffing out a fuse leading to a bomb, but when it comes to handling the bomb and examining its makeup for possible clues, he may wish himself elsewhere.

The responsibility of dealing with bombs in an intimate manner is the spe-



© P. A.

A Huge Police Seizure of Bombs, Guns and Ammunition; Pipe and "Pineapple" Bombs Made Up the Greater Part of the Infernal Collection



upon an infernal machine which is as cleverly designed as it is dangerous. The expert delegated to report on the workmanship of such devices is literally taking death in his hands. The only way to ascertain the mechanism and constituents of an infernal machine is to dig, scratch and pry apart what some fiend has put together to destroy. One wrong move means another star on the board.

Few persons engaged in this work ever

escape uninjured. The dean of them all is the late Owen Eagan, of New York, who was inspector of infernal machines. In his twenty-one years of uninterrupted duty, he furnished clues that ran down the makers and placers of 7,000 bombs. Only once in that long period of service did a bomb explode in his hand. That one was a cunningly contrived instrument of death.

Eagan was called to the apartments of Judge Otto Rosalsky, in New York. On the judge's library table lay a neat package wrapped in yellow paper, about five inches square and three and a half inches high. It looked like a box of candy and was handed to one of the maids of the house by a young man who made no comment. The judge was about to open it, when his better judgment told him not to.

After Eagan had looked at the box intently and had pressed his face close to it to smell it and listen for any mechanism that might be at work, he cut the string and unwrapped the paper. Within, there was a box of white pasteboard.

With caution he lifted the cover and noticed that it resisted a little. This sticking of the cover on so frail a box aroused his suspicion.

"It acts like a real one," he said. "You'd better get out."

Leaning backward with his face partly turned away, he stretched out his arm and gingerly lifted the cover. Little by little he raised it until he could slide it off.

The opened box revealed a piece of iron pipe an inch in diameter with an elbow in it. On each side of it was a small dry battery, connected by wires with a fulminating cap. Lying on top of the apparatus was a small package done up in tissue paper.

On the underside of the cover, near the center, was glued a small piece of cork, apparently a buffer. Another buffer was glued to one of the corners of the cover.

Carefully picking up the small package of powder, he laid it on the table. Then he took out a jackknife and cutting down one edge of the box, he started to cut down the edge of the other side. Instantly there was a blinding flash and explosion. He lost the index finger of his left hand and four fingers of his right hand were rendered permanently numb. Particles of steel were imbedded in his right cheek and eyelid, and he carried them to his death.

LIZARD HAS FRILL ON ITS NECK TO FRIGHTEN ENEMIES

When angered, a rare Queenland lizard opens out a large capelike frill from its neck and distends its jaws. The frill is a foot wide and is draped over the lizard's shoulders like an Elizabethan cape when the reptile is aroused. At rest, the lizard looks like any other.

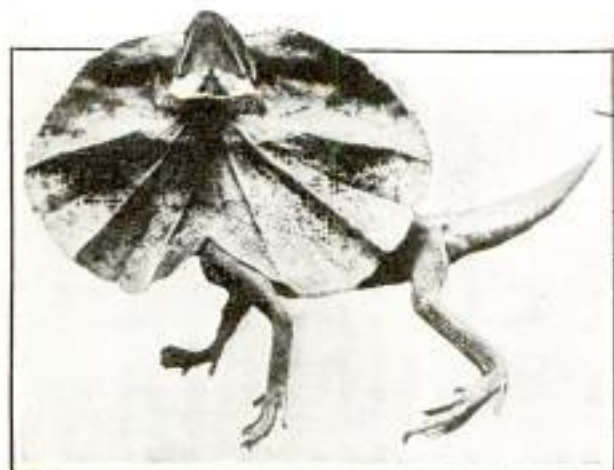

Frilled Lizard Shown with Cape Spread and Mouth Opened Wide to Terrify Enemies

HOW MUCH WORK MAN CAN DO IS SHOWN BY BODY TESTS

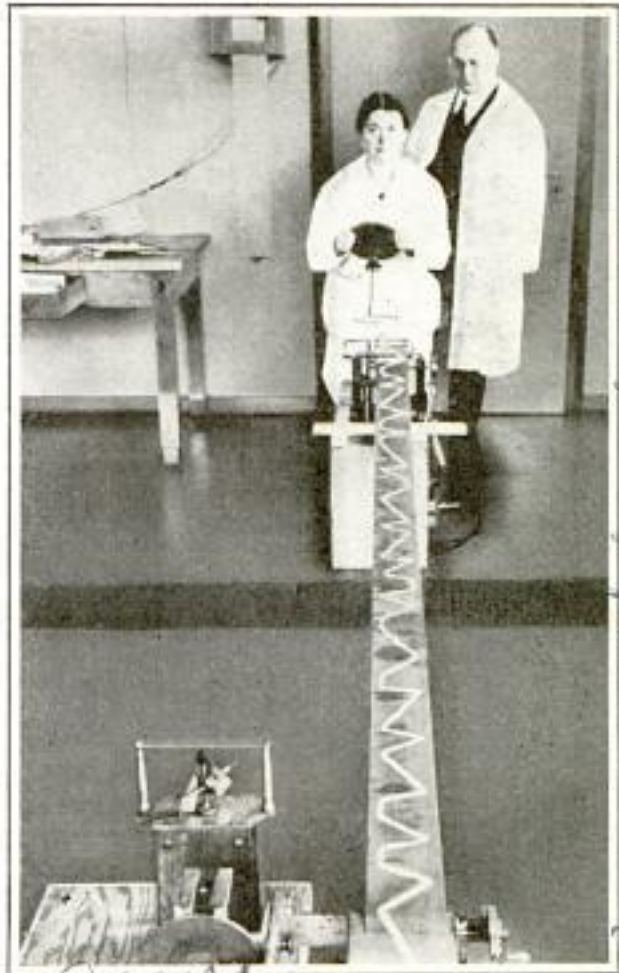

Woman Turns Wheel to Follow White Lines on Laboratory Equipment Which Tests Body's Reactions

Conditions under which the body of man will give the maximum output of work while expending the minimum of energy are determined by experiments being conducted in Germany. The tests also are to show how fatigue can be staved off to the extreme limit.

LUMPS OF COAL TRADE-MARKED

In order to standardize its product, one coal company is giving each lump of coal a distinctive marking. The coal from the mine is passed along a trough conveyor, coming in contact with metal arms placed perpendicularly across the width of the conveyor. At the end of each arm is a shoe which rides over the lump of coal. As long as the shoe is in contact with the lump, the valve to a pressure gun is open and the lump receives a neat band of bright paint.

pressure type spray

at Kaiser Wilhelm Institute of Medicine for investigation of Psychology of Work. Kurt Lewin

91596

The De Vries Co Toledo, Ohio

Science Service from Coal Age

D

Copyrighted material

RADIO SNAPS STORM PICTURES TO HELP WEATHERMAN

91479

Film records of distant thunderstorms are taken at stations in England and Scot-

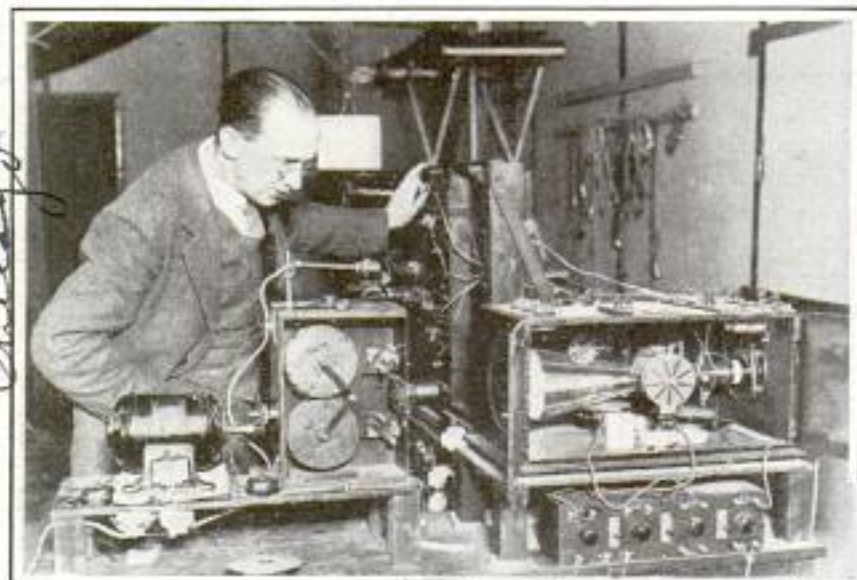

"Pictures" of Storms Are Taken with Machine Above; Right, Picture Projected onto Map to Locate Storm

land with an apparatus which combines the principles of radio and motion pictures. A radio direction finder picks up the disturbance and the resulting sparks are filmed. This "picture" of the storm, together with the one made at another station, is projected onto a map of the world, and the storm is located at the intersection of the direction lines.

LOW-VOLTAGE ELECTRIC SHOCK IS EXTREMELY DANGEROUS

Electric shock of even such low voltage as that found in house circuits is extremely dangerous and may cause death. Heretofore, when people died from shocks supposedly from low-voltage lines, it was thought that the voltage had suddenly become greater. A recent report to the American Medical association, however, advances the explanation that electricity under the pressure of a very low potential affects the heart, causing a tremor or wavering. Instead of all the muscle fibers

contracting together, they each do so separately without co-ordination. When the current passes through one part of the heart this "fibrillation" occurs without interfering with circulation, but when it passes through another part, the circulation stops at once and death usually follows. When the human skin is dry, it is a good non-conductor, but when it is wet, or even moist from perspiration, it is believed it allows enough current to pass to have this effect on the heart. A slight cut or bruise also lowers the skin's resistance.



Household power lines customarily are grounded on one side and contact between the other side and any part of the body becomes dangerous when the skin is wet enough to conduct. Pipes, radiators, sinks and conduits in which power wires run usually are well grounded, and this, together with the fibrillation theory, explains the numerous cases of fatal electric shocks to persons touching electric appliances while in the bathtub, for instance. It also may be dangerous to touch electric lamps with wet hands, especially when there are cuts and abrasions of the skin. Another danger spot is the chain-pull switch, and a safe practice is to attach a piece of silk ribbon to the chain, particularly in the bathroom, kitchen and cellar.

Horatio B. Williams
New York City

Mr. George F. Paul
539 S. Dearborn
Chicago

9155

General Electric C. Schenckel

Albany Service Bldg (a1547)
New York Pier and

Article in 'Isletia'

no further data.

Light Corp
**ELECTRIC "EYE" WATCHES SUN
AND LIGHTS UP STREETS**

When darkness approaches, a tiny electric "eye" automatically turns on street lights in nine circuits of the system at Albany, N. Y. Regardless of the hour, a certain degree of darkness acts on the photo-electric cell, operating a relay which in turn supplies power to throw a switch turning on the lights. During the period of darkness, contact is maintained and the lights remain on, but as soon as daylight reappears, the contact is broken and the switch opens, turning off the lights. The eye is turned to the north so it sees only the average light and thus avoids direct sunlight. Time-delay relays are included in the equipment to prevent instantaneous operation in response to passage of a cloud over the sun, a flash of lightning at night or a person walking in front of the unit, but once the contactor has been actuated, it will remain and not flutter at the critical light intensity. The only factors governing the control unit are light and darkness.

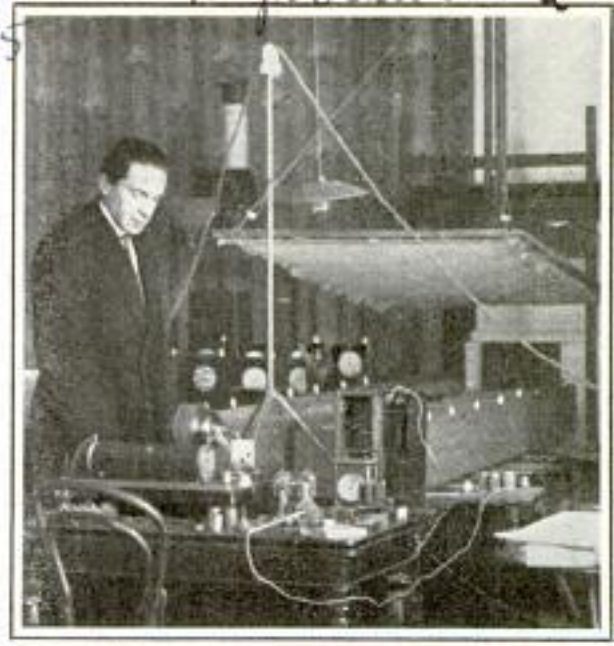

© Press-Clippe
Apparatus That Produces Artificial Ionization of Air
Which Has Been Found to Affect Health

**IONIZATION OF AIR INFLUENCES
HEALTH OF ANIMALS**

Artificial ionization of the air has been found to have a definite effect on the health and well-being of animals. Prof. A. L. Chizhevsky, European scientist, recently summarized the results of ten years of experiments with ionized air on organisms. He said he had established that positive ionization in certain doses produces unfavorable physiological effects, while negative ionization resulted in contrary effects, animals subjected to the latter form growing more rapidly and showing extraordinary virility. Ionized air has been used in the treatment of humans suffering with lung diseases with favorable results, and in general it has been found that negatively ionized air is stimulating and helps to defeat disease. Ionization of air also is being applied to agriculture, and chickens have been found to thrive better and grow faster under its influence.

cannot locate

a1326
**TINY SIDECAR MOTORCYCLE
CARRIES TWO CHILDREN**

One of the latest and most popular vehicles for children in Europe is a tiny motorcycle that is equipped with a sidecar to provide room for an extra passenger. Youthful riders on these racers stage exciting speed contests.



Tiny Motorless Cycles, Equipped with Sidecar, Are Used by German Children in Thrilling Races. Three Wheels Give the Machines Stability

☛The United States imports most of its sunflower seed and oil from Russia, Ukraine and Rumania.

*Carl Hess, J. Paul, R. 1409
537 N Dearborn Chicago*

9997

Truena Square
Chicago

Hide-and-Seek

By BOB BECKER

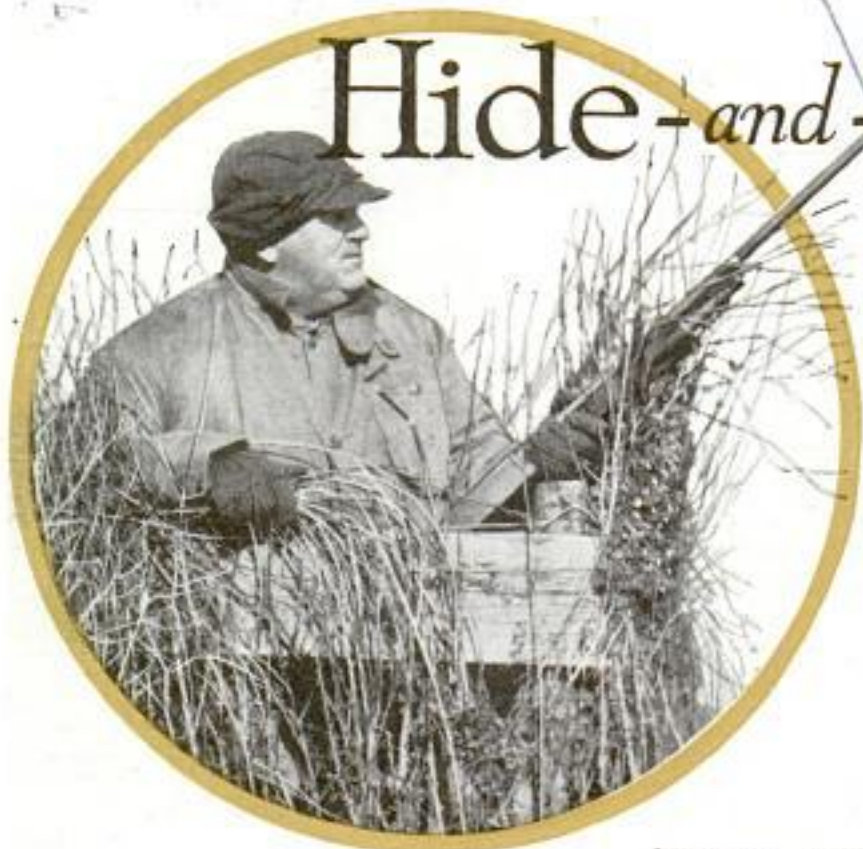

NOW that autumn is here and countless hordes of waterfowl are winging their way southward for the winter, more than 7,000,000 hunters are thinking of shotguns and a hide-and-seek game with the ducks and geese.

The hide-and-seek part of this sport is found in the fact that the waterfowl hunter must take up the art of making blinds or hideouts, learn how to secrete himself

in marsh, slough or on the edge of pond or lake, and then wait out the crafty mallard, canvasback and bluebill as well as the highly prized geese.

Many and ingenious are the stunts used by the hunters to hide themselves so that waterfowl may be lured within range of a scattergun. On dozens of shooting expeditions that have ranged from Brazilian marshes in the south to tidewater flats in Alaska, I have seen some new wrinkle in the way of blinds on nearly every trip.

Here are some practical blinds which nearly any hunter can duplicate. Because of varying topographical conditions in the United States, it is only natural that there

Goose Shooting Often Means Long Waits. Sometimes Hours without a Shot. So Take Along a Portable Radio and, in Cold Weather, an Oil Heater; the Radio Will While Away the Hours of Inaction and the Stove Will Improve the Temper; a Hand That Is Stiff from Cold May Mean a Poor Shot



A Willow, Wire and Frame Blind, a Common Type for Timber Shooting, Above, in Circle; Below, Getting World's Series Results after a Successful Day with the Honkers

with the MALLARDS

*Simplest Blinds Get the Most Birds
and the Trick of Building a
Shelter Lies in the Choice of Nat-
ural Cover That Will Help*

should be scores of different types of blinds in use. The duck hunter on the Mississippi river needs an entirely different kind of blind and decoy from the snow-goose hunter in a Louisiana marsh. In making a blind, it is a wise thing always to take advantage of what natural cover there is. In fact, in some states it is against the law to build a duck blind very far beyond such vegetation. And when building a hide-out in which you are going to wait for the birds, the direction of the wind must be taken into account. Ducks and geese come in against the wind. Therefore, on a given pond or lake, I make two blinds, one for a northwest or west wind and another for an east or southeast wind. The simplest

shelter that can be made on the bank of a shallow pond or slough, where mallards, pintails and teal are found, utilizes the natural rushes, cattails or tall weeds and grass. You do not even need wire to make such a shelter unless you expect to use it many times. Last fall I picked out a stand of smartweed at the edge of a shallow pond and had excellent teal shooting from this crude hideout which also hid my retriever. The main thing is to sit still when birds are circling. Just a little cover will suffice if the hunter will avoid squirming around when they are near.

If your cover is thin, the addition of a few branches, weeds or bundles of grass will help. However, watch this point when you are shooting from behind a thin blind; don't let the birds circle too much, or they may spot you.

To obtain more comfort, especially in

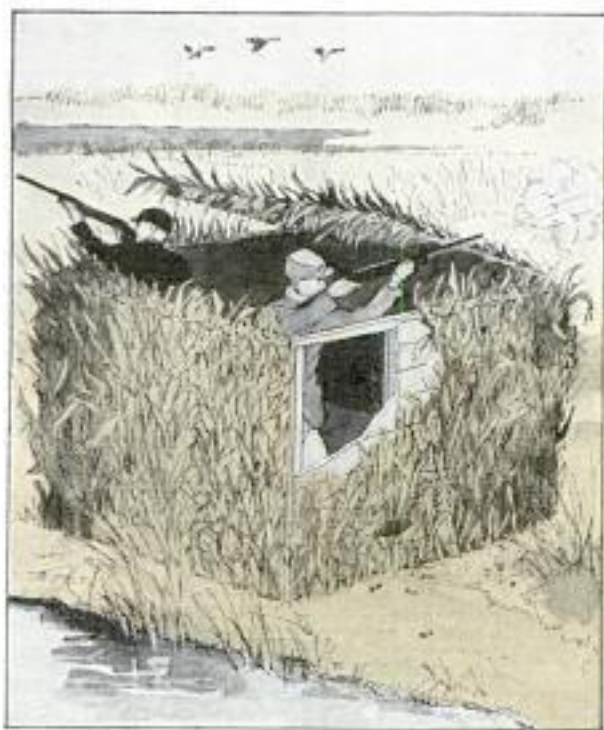

Permanent Blind of Wood with Grass or Cornstalks Threaded through Wire Loops to Cover It



boat, I have been forced to rig up a blind whenever a shoot was desired, because the flood water had covered all the good blinds.

Before you start out to make this blind, get pieces of ordinary wire (hay wire will do) and tack them to the side of the boat, either to the gunwale or flush with the deck. Bulge the wire

cold, windy or rainy weather, the sportsman can go one step further by making blinds of wood and covering them with bundles of grass and vegetation. These should be constructed in sections which hook together, and set up among tall wild sunflowers and weeds growing on the bank of a pond. A roof, covered with waterproof material, can be placed over these, so that you can sit back in the blind and keep out of the rain. In front there is sufficient opening between the roof top and the lower part of the blind to permit you to watch the sky for birds.

Rows of wire tacked on the blind, with open loops of this wire sticking out, make it possible to attach small bundles of weeds and grass to the top and sides, thus making the hideout effective. All weeds and grass around it should be left untouched. A small door at the side provides entrance. These blinds are not expensive, fit into the vegetation nicely and are worth their weight in gold when the weather is uncomfortable.

It's surprising how easy it is to make a serviceable blind out of almost nothing, providing the hunter will use his head in placing it and sit still when birds are working. For example, in high water when it is necessary to use a little duck



Mallard Decoy Silhouettes Cut Out of Wood for Ice Shooting Late in Season, Above; Making a Blind in Ice with Grass and Wire, Below

so that it stands out in a small loop every few inches. These loops are to hold cover. When you have located a good shooting spot where ducks are working, throw out your decoys and then cut big bundles of vegetation growing at the edge of the water. Get plenty and pile it in the boat.

Now you are ready to shove your duck boat into the weeds near your decoys. As soon as you are located, thread this cut grass into the wire loops around your boat until you have a complete ring around you. Cover the decks with the same material.

But don't let this cover stand too high above the boat. It will not look natural. If you sit down on the bottom of the boat, keep quiet when ducks are working, and shoot from a sitting position; you can get plenty of birds. If they are fairly shy, I toss some of the grass across the boat, too, so they cannot get a good look

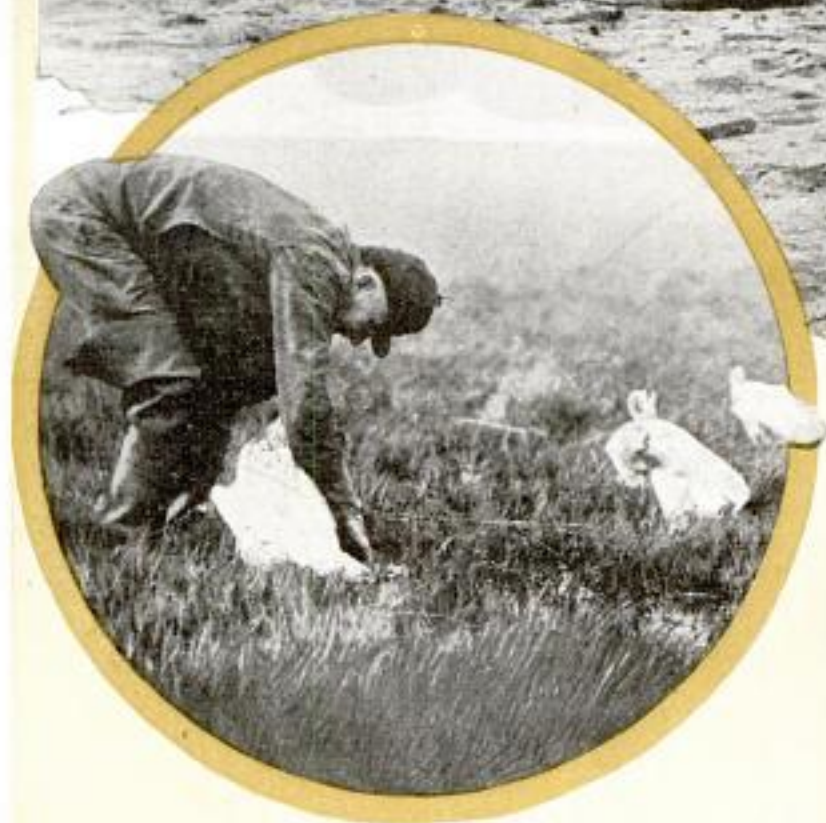

In Circle: "I Was Hunting a Country Where Snow Geese Were Found; When It Came Time to Put Out Decoys, I Noticed the Guide Had Few Blocks and Fewer Live Birds, but He Had Lots of Newspapers; with These He Made Decoys in Just a Few Minutes; the Articles Required Were Papers, Short Sticks and Plenty of String; Ramming a Stick into the Soft Marsh so It Stood Upright About a Foot, He Tied a Sheet of Paper to It; Then He Pulled It Out and Staked Two Corners of the Paper; the Finished Decoy Looked Silly, but It Worked; Snow Geese Came to Them Perfectly."



Action in a Goose Pit on a Bar, at Top; a Pulley on a Stake, About Twenty Feet Out in the Water, Lets You String Live Decoys from Your Hideout without Getting Wet



Natural Color, Above; Below, a Little Camouflage Is Enough if You Sit Still While Birds Work

at the open length of it. If the hunting is in low buck brush at the edge of the timber, cut large bundles of willow branches and arrange them the same way. I have made them even without wire.

One of the most comfortable blinds for timber shooting, where the water is so deep that you must use a boat to get to the hideout and also to retrieve your birds, is the "floater" with a boat compartment. Three big logs form the base of the blind, which should be placed in a clump of willows or trees so that it blends into the background.

A floor is nailed across two of the logs in front and then willow branches, small

dead twigs, and other similar material, are nailed to the blind to make enough cover to hide behind. A long comfortable seat and back also can be placed in it. Immediately behind the seat, leave an opening large enough for your duck boat so it can be slid into the blind and hidden from the birds.

An adaptation of this type of brush blind (a permanent blind) is that which is constructed over a framework of chicken wire and is long and narrow, just wide enough for a duck boat.

The blind is the length of the standard boat. The framework is set up in two parts. Both the front and back sections are as wide as the boat at the base and slope toward the middle so that just enough of an opening is left at the top for the hunter to stand up and shoot. You run your boat into this and then squat on a shell box. Both front and back are covered with branches, if you are in timber, or with grass if in a fairly open marsh.

a1517

Last fall, when cold weather had put ice on a broad shallow marsh covered with smartweed where I was hunting, the birds were working to a couple of open holes in this area. My partner took his duck boat, a push pole, some chicken wire, two live hen-mallard decoys and a duck caller, and walked to the middle of the slough. There was no blind there.

He found a muskrat house near a pool which had been kept open by the birds. This gave him an idea. Leaving his boat, he cut bundles of smartweed, assembled the material at the muskrat house, which was built around a log. Sitting on the log, he placed his chicken wire around him, threaded the weeds into it, set out his decoys, leaned against the rat house and started his duck caller. By keeping perfectly still, he killed his limit in one hour and twenty minutes in spite of the fact that at no time was he completely hidden from view.



Even Lions Object to Aching Teeth. So a Dentist and His Assistant Are Treating "Jimmy," a Movie Lion

Weds World

at Selig Park Zoo

DENTIST GOES INTO LION'S DEN AND TREATS BAD TOOTH

When "Jimmy," one of the movie lions, developed a toothache, he raised a rumpus. His feline companions joined in the uproar. Finally it was necessary to call the dentist.

RADIO ROBOT STEERS WARSHIP DOING WORK OF SIXTY MEN

Manned entirely by radio, a crewless navy destroyer was put through maneuvers at high speed off the Pacific coast recently to demonstrate the practicability of running a fighting ship without a man aboard. Among other things, the vessel made a 180-degree turn, no easy trick even for a well-trained crew. The destroyer run by a radio robot was the decommissioned U. S. S. "Stoddert," a 195-foot vessel of 1,500 tons, and everything from its whistle to its rudder was controlled by radio from the bridge of another destroyer following in its wake. The control panel consisted of a little box containing eight keys, resembling those of a typewriter, and by manipulating these keys, one sailor was able to do the work of a crew of sixty men. Part of the time the vessel was making twenty-six knots or about thirty miles an hour.

a1593

U.S.S. Stoddert

*U.S.S. Stoddert
Copyrighted material
Tribune 7/25/32*

AUTO COSTS QUICKLY COUNTED ON AUTOMATIC RECORD

Cost of operating an automobile can be computed quickly by the use of an automatic bookkeeper, which can be attached to steering post. The device turns down out of the way when not in use. An automatic light illuminates the record as the driver writes.

a1512



Automatic Bookkeeper for Computing Costs of Auto Operation Attached to Steering Post

The Auto-Knight Co. 64 E. Lake, Suite 1104, Chicago

*The Auto-Knight Co.
64 E. Lake, Suite 1104, Chicago*

NEW CONVENIENCES

a1406



Above, Cordless Electric Flatiron That Allows More Freedom in Operation; the Cord Is Attached to the Stand Instead of the Iron, and the Latter Is Heated as It Rests on the Stand

a1405



Above, Automatic Non-Electric Fruit-Juice Extractor; the Reamer Turns When the Fruit Is Pressed onto It; Right, a Handy Rack for Holding a Book or Newspaper in Position for Reading



Above, Bread-Slicing Board to Make Lengthwise Cuts for Ribbon Sandwiches; It Can Also Be Used for Cutting Vegetables



Above, Knife Sharpener That Puts Edge on Blade as It Is Drawn through the Slot



Left, Colored-Enamel Wall-Switch Plate in Hues to Match Walls

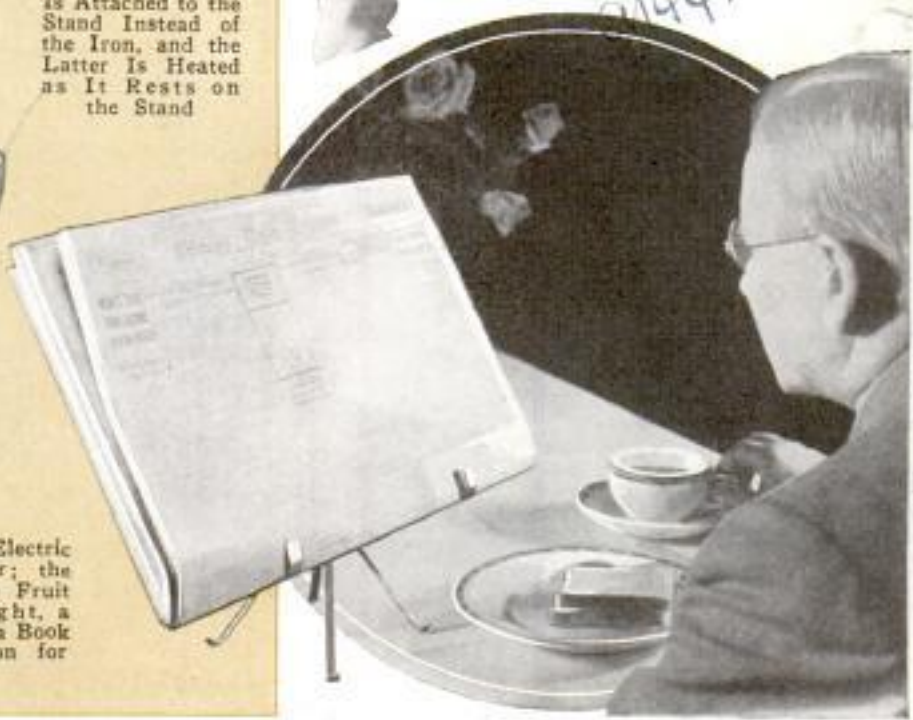

914 48

for YOUR HOME



Above, Manicure Set in Tube Like Fountain Pen; It Consists of Cuticle Stick, File and Brush

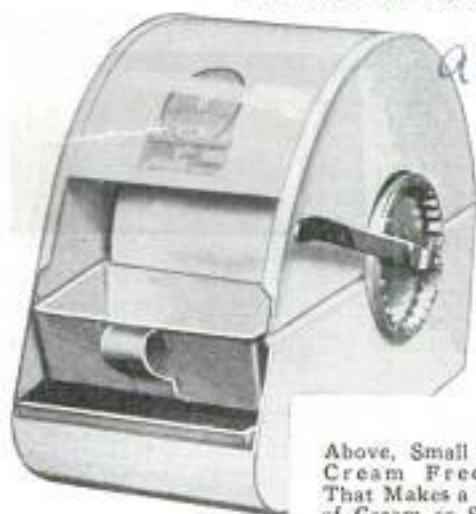

Above, Small Ice-Cream Freezer That Makes a Pint of Cream or Sherbet in About One Minute



Above, Portable Two-Legged Folding Writing Table That Rests on the Floor and on the Lap



Above, Ice Tray That Is Easily Emptied; the Ice Is Frozen in Triangles, and the Tray Section Is Flexible; Below, Portable Reclining Back Rest for the Beach; Right, Ready for Carrying

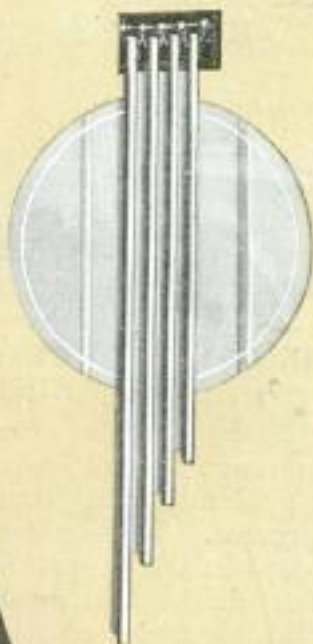

Above, Electric Chimes to Replace Doorbell in Announcing Callers; the Chimes Sound in Different Sequence Each Time

Abraham Straus

608

420 Fulton

POPULAR

MECHANICS

91424

Brooklyn, N.Y.

Mrs. Donald E. Pallejo
and Mrs. A. T. T. T.

Science Bulletin 390

Science

Woods

Bretton

new

W. H.

Mt. Washington



Shower Which Can Be Set Up on Lawn; Note How Hose Is Plugged In at Base

SHOWER SET UP ON THE LAWN KEEPS EVERYBODY COOL

Cooling showers may be enjoyed every hot day by using a lawn shower which comes in three sections, sets up in your front yard and comes apart for easy carrying. The lawn hose is attached at the base, through which small stakes are hammered for steadying.

IRON HAS QUALITIES OF COPPER AFTER BEING PURIFIED

Many qualities of copper are found in iron purified by a German process. There are two steps in the process, the first driving out most of the impurities and leaving the iron in a finely powdered form, and the second changing this powder into solid form by heating to 1,200 degrees Centigrade, twelve times as hot as boiling

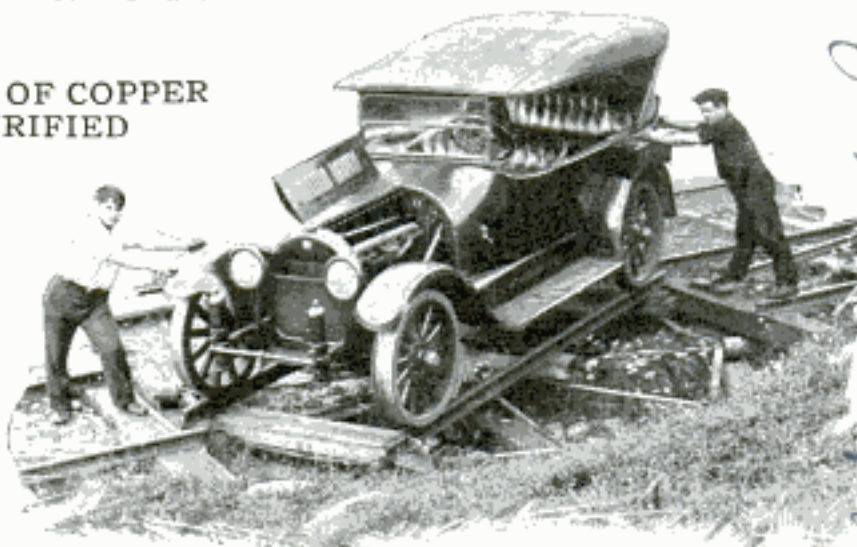

Turntable on Automobile Railway Enables Operators to Turn the "Train" Around Easily; One Man Can Do It Although Two Are Shown

WHITE LETTERS HARD TO READ BECAUSE OF EYE'S HABITS

White letters on a black background result in a delay to the reader of about ten per cent, psychologists of the University of Minnesota have learned as the result of lengthy research. It also was found that black type can be read at a fifteen per cent greater distance than the same size and form of white lettering. At a distance, words in white type appeared merely as a blur, it was reported. The explanation given is that the human eye and mind have been trained over long periods of time to associate dark spaces with objects and light areas with the intervening spaces.

AUTO RAILWAY HAS TURNTABLE TO SPEED OPERATIONS

Operations of a gasoline railway in New England are speeded up by a turntable set into the special track on which an automobile runs. The railway, connecting a New Hampshire town with the station at the base of Mt. Washington, is built across fields and through woods on a direct line between its terminals. It was established for the benefit of engineers of the Mt. Washington cog railway. The table can be operated easily by one man and turns the auto around quickly.

Science Series 539-C

German patents owned by I. G. Farbenindustrie AG, Ludwigshafen am Rhein, Germany.

Floodlights Lure Crowds to Father of Waters



Brilliantly Lighted Mississippi River Excursion Boats Which Continue to Attract Pleasure Seekers When Most Amusements Find Their Attractions Short-Lived

Wide World

Excursion boats on the Mississippi are still crowded and report excellent business, although many other amusements have been complaining of poor attendance. The lure of the "Father of Waters," heightened by floodlights, is given credit for the phenomenon.

SANDSTORM CREATED AT WILL IN AUTOMOBILE FACTORY

In a Detroit automobile plant a curious-looking shed has been installed, inside of which sandstorms are created. Automobiles are driven into the shed and there are subjected to terrific sandblasts, simulating the actual conditions of a desert storm. The purpose of the test is to determine the efficiency of the car's apparatus for purifying the air before it enters the carburetor.

MEMORIAL PREPARED TO LAST TEN THOUSAND YEARS

Names of the 1923 earthquake victims will be preserved 10,000 years in Japan. A superior quality of white Japanese paper, bearing the victims' names in Chinese ink, was selected by scientists. Then the paper was rolled and placed in containers made of the choicest Brazilian quartz crystals. Three bands of monel metal

were inserted to insure uniformity of packing, two of the bands being covered with asbestos and the third with specially sterilized silk. Then the containers were closed with quartz lids fused on, and placed in water for the air to be evacuated. The vacuum was filled with argon gas, which has highly preservative qualities, so that interior pressure equaled atmospheric pressure. Then the containers were covered with asbestos braiding, taped with asbestos and placed in containers made of a compound of carbon and silicon, which is absolutely fireproof.

RAZOR BLADE SHOCK ABSORBER ELIMINATES VIBRATION

Safety razors now can be fitted with rubber composition cushions which act as shock absorbers for the blades. These cushions can be applied to any razor using a double-edged blade. The shock absorber slips over the prongs of the top of the razor after the blade has been placed in position, and the maker claims the resilient cushion keeps the blade from cracking and also stops vibration of the wafer blade.



a1604

Chrysler Corp. 341 MacEachernell Blvd

*under direction of
Mr. Yamaki of
John Deere Co*

*The Boye Needle Co
4343 Ravenswood
Chicago*

01339. Cont. John F. Cogswell
16. Edgewood Road
Belmont Mass

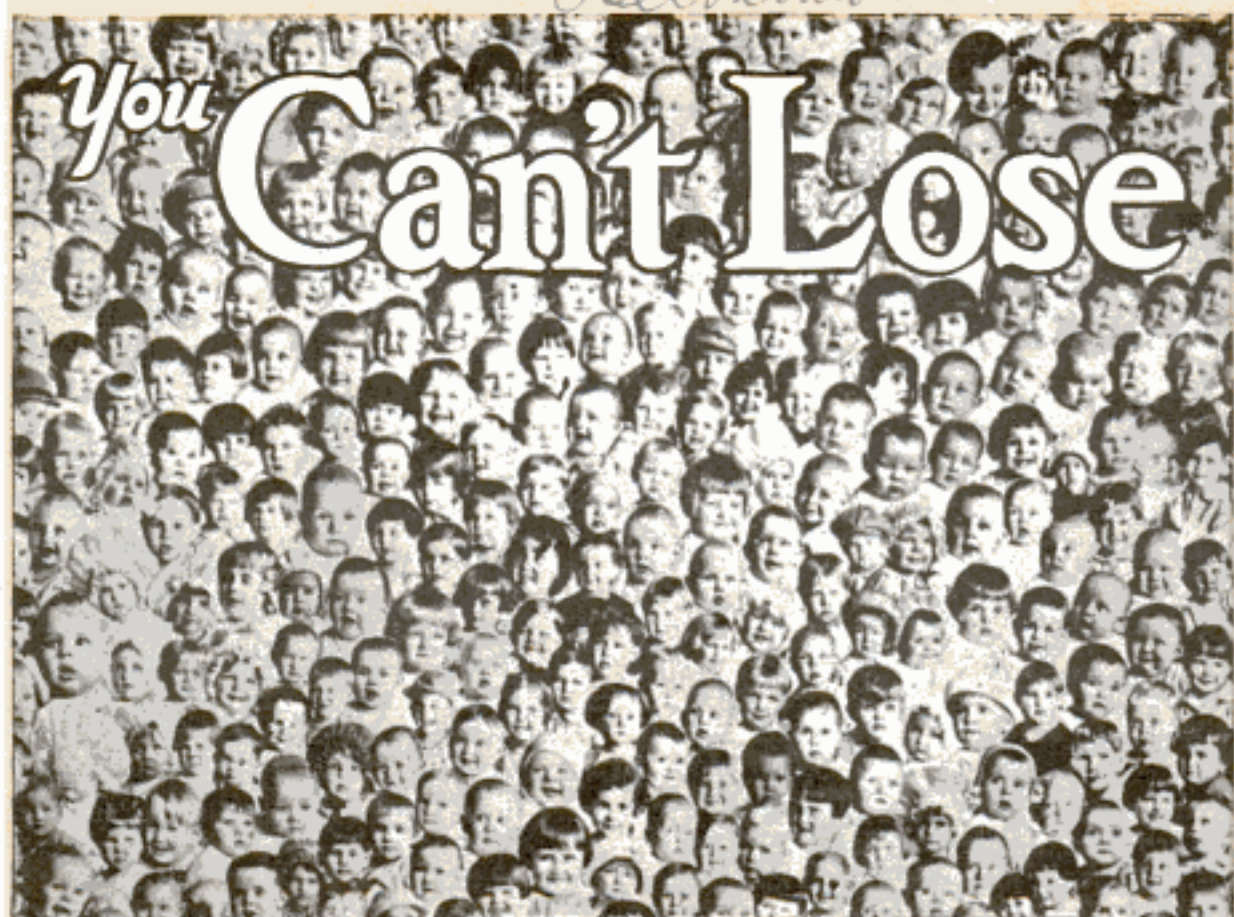

Group of Babies in Kansas, the Most Healthful State;
They'll Live to About Sixty

"YOU can tour Europe for \$10.50 per day," the head of a tourist agency told prospective customers. "Simply decide how many days you wish to spend and multiply that number by \$10.50. Make your own schedule; route yourself as you desire. Visit ten or a hundred cities and we will pay your every expense."

Experienced tour men claimed the plan would result in great loss; that travel in certain countries was much higher than in others; that no two trips figured the same per-diem price; that short stops and long jumps would be ruinous to the plan. At the end of the season, it was found that profits were within three-fourths of one per cent of the profit that had always been made on tours of this class and that it was in favor of the company—you just can't go wrong by relying upon the law of averages.

A business on Fifth avenue, New York, between Forty-second and Forty-fifth streets, will enjoy better trade on the west side of the thoroughfare if it caters to women, but if it caters to men, it will

Do You Know

THAT *it is four times as dangerous to take a bath as to mount a ladder?*

THAT *an air traveler is seventeen times as likely to die of heart disease as a crash?*

THAT *a girl baby born in Kansas will live eight years longer than a boy born in New York?*

THAT *Wednesday is the best day in the week to get out a crowd of business men?*

THAT *only one man in a thousand will ask for a hat size 6½?*

It's the Law of Averages!

a1339

if you Follow this LAW

do better on the east side. A rainstorm in the morning decreases department-store business for the day, but rainfall in the afternoon after a bright morning results in an increase.

If you drive a car in Detroit, it will probably be twenty-five years before you injure a person, but in Boston you are lucky if you keep out of such an accident more than twelve years.

Summer or winter, twenty-four per cent



Wheel of Fortune, Above, and Roulette Tables Thrown Wide Open in Reno, Nev., at Left; the House Can't Lose

Observation of a large number of cases of any kind is necessary to work out true averages. Individual peculiarities and tastes average up and are lost sight of in a big mass of people; the larger the crowd, the more definitely can it be predicted what an average person in it will do.

The more times an operation is repeated, the more likely to occur is

more people walk on the shady side of the street than on the sunny side. One man out of every 124 passing a cigar store will enter and make a purchase.

any rare condition contingent upon that operation.

Practically all gambling games are founded on the law of averages. Success-

21339
612

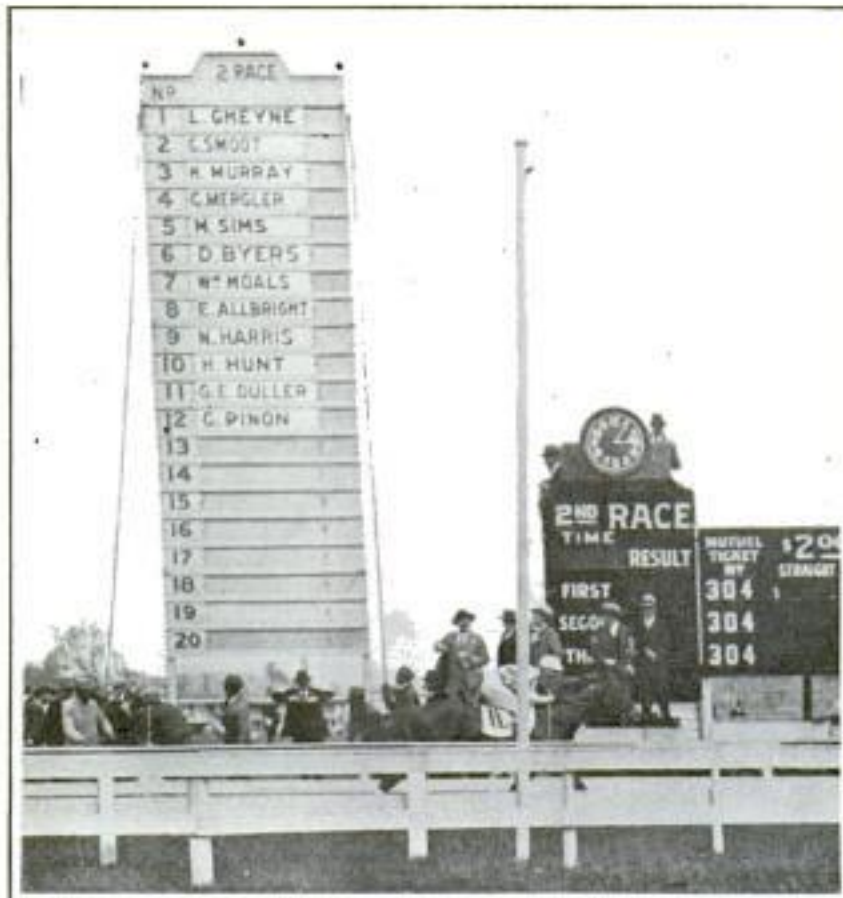

seventy-fourth birthday.

An old automobile is much more likely to be stolen than a new one; the driver grows more careless as the machine falls in value. More automobile accidents occur on Sunday than on any other day of the week. More people are killed and injured by motorists between seven and eight in the evening than during any other hour. Three times as many men as women are killed in automobile accidents, but in numbers injured the sexes run nearly even.

The probabilities are that no man can live long enough to be killed when a passenger on either a

ful bookmakers at race tracks figure the chances of each horse to win and lay their odds to show a profit, no matter which horse comes in ahead. The odds against any single number winning any time the ball is twirled on a Monte Carlo roulette wheel are thirty-seven to one. A winner on a single number at roulette receives thirty-six times the amount of his stake. There being thirty-six numbers and a zero on the wheel, odds of thirty-seven to thirty-six favor the casino. That doesn't seem like a very large margin for the house, but it is plenty to keep them well ahead of the game every year.

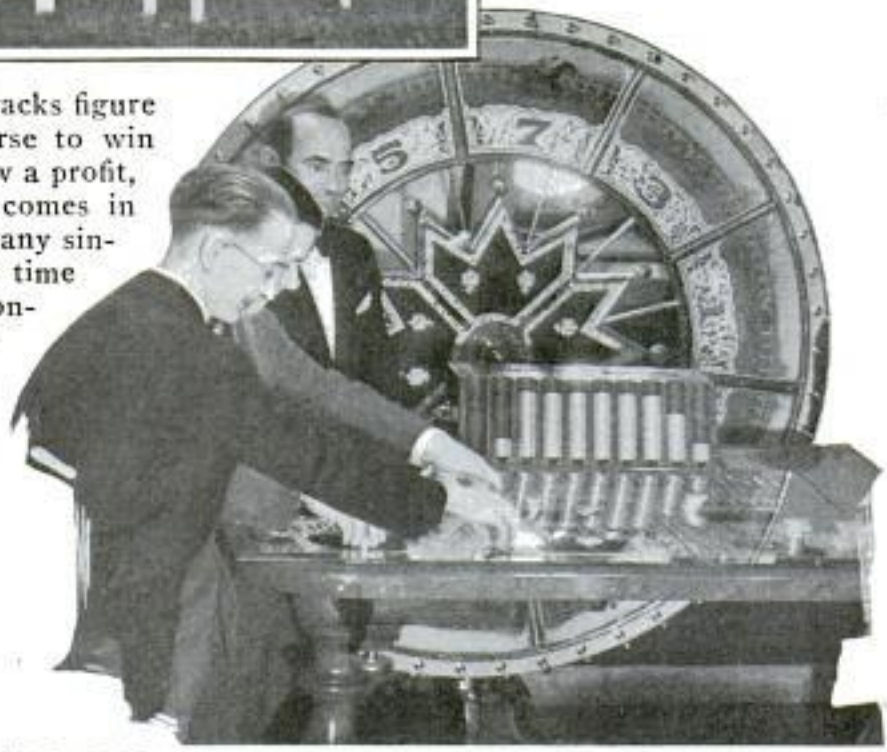

Pimlico's Famous Horse Track, Above, and Wheels of Chance on a Gambling Ship, Outside the Three-Mile Limit, off California

The longer we have lived, the greater our additional age is likely to be. A boy ten years old may be expected to live until he is 59, but those who actually survive to age 20, will probably reach 66, and the average man of 60 lives to reach his

regular airplane line or on a railroad train. He might achieve it in the case of airplane travel, but he'd have to put in most of his time in the air and cover a distance of 3,500,000 miles.

The law of averages is potent in taking

1545

the gamble out of mercantile pursuits. A nation-wide chain of cigar stores selects locations by an actual count of the number of men passing the site. Knowing within a fraction of a cent what the average purchase will amount to, they can tell without likelihood of error how much the store will be worth to them.

As soon as the morning post comes in, a big western mail-order house can tell immediately whether to gear up for a big day's business or a light one. They simply weigh the mail. A large department store will do a greater business if located close to other stores of the same class, but the reverse is true of small stores.

So close to average do the wishes of restaurant customers run, that many a chef is able to prepare exactly enough of each item on the menu.

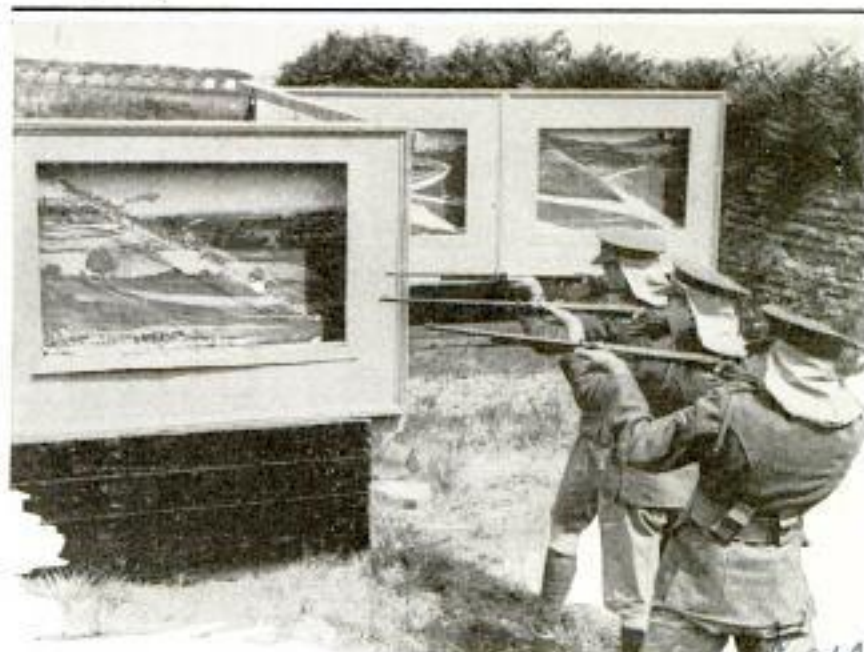

Outdoor Shooting Gallery with Frames Containing Scenic Backgrounds to Add Realism; Targets Move Along the Edges of Frames

COUNTRY SCENES ADD REALISM TO SHOOTING GALLERY

One English shooting gallery that is set up outdoors has added a touch of realism by installing painted country scenes in large frames as a background for tiny rabbits and other mechanical targets. The little animals move across a frame in front of the rural scenes, and the patrons blaze away at the targets in a natural setting.

at Besley, England

DISPENSER FREES BOTH HANDS OF ICE-CREAM SALESMAN

Freeing both hands of the counter-man, an ice-cream-cone tray has been devised that can be set down on a wooden holder while the salesman is filling other orders. The tray is made with a hole in the center and comes with a wooden peg either with portable base or one that can be easily attached to the top of the ice-cream cabinet. The hole fits snugly over the wooden peg of the holder, allowing the tray to be set down.



OIL TAKES COAL FROM WASTE IN MINE EXPERIMENTS

Cleaning of coal by an oil process is yielding good results in several experimental plants in the eastern states. Sulphur content is reduced to one-half per cent, engineers say, and ash to about five per cent, under the process, which produces a fuel of high quality. Mine refuse is made to yield a large amount of coal under this treatment. The secret of the process lies in the fact that oil has a peculiar affinity for coal, but none for ash and other waste. The coal or mine refuse is first crushed and mixed with water, then pumped into an agitator and mixed with oil. Oil envelops each particle of coal, which sinks to the bottom of the container, while the water carries off the ash. As a general rule the oil amounts to about fifteen per cent of the finished fuel.

a 1607

[A committee of scientists has estimated the age of the earth as at least 2,000,000,000 years.]

National Research Council
Trent Process Corp.
17 Battery Place
New York

Tron - David G. 608
much as a
brand of
blat

Key stone

a 984

Cml Lem J. L. L. L.
55 W. 86 St N
New York

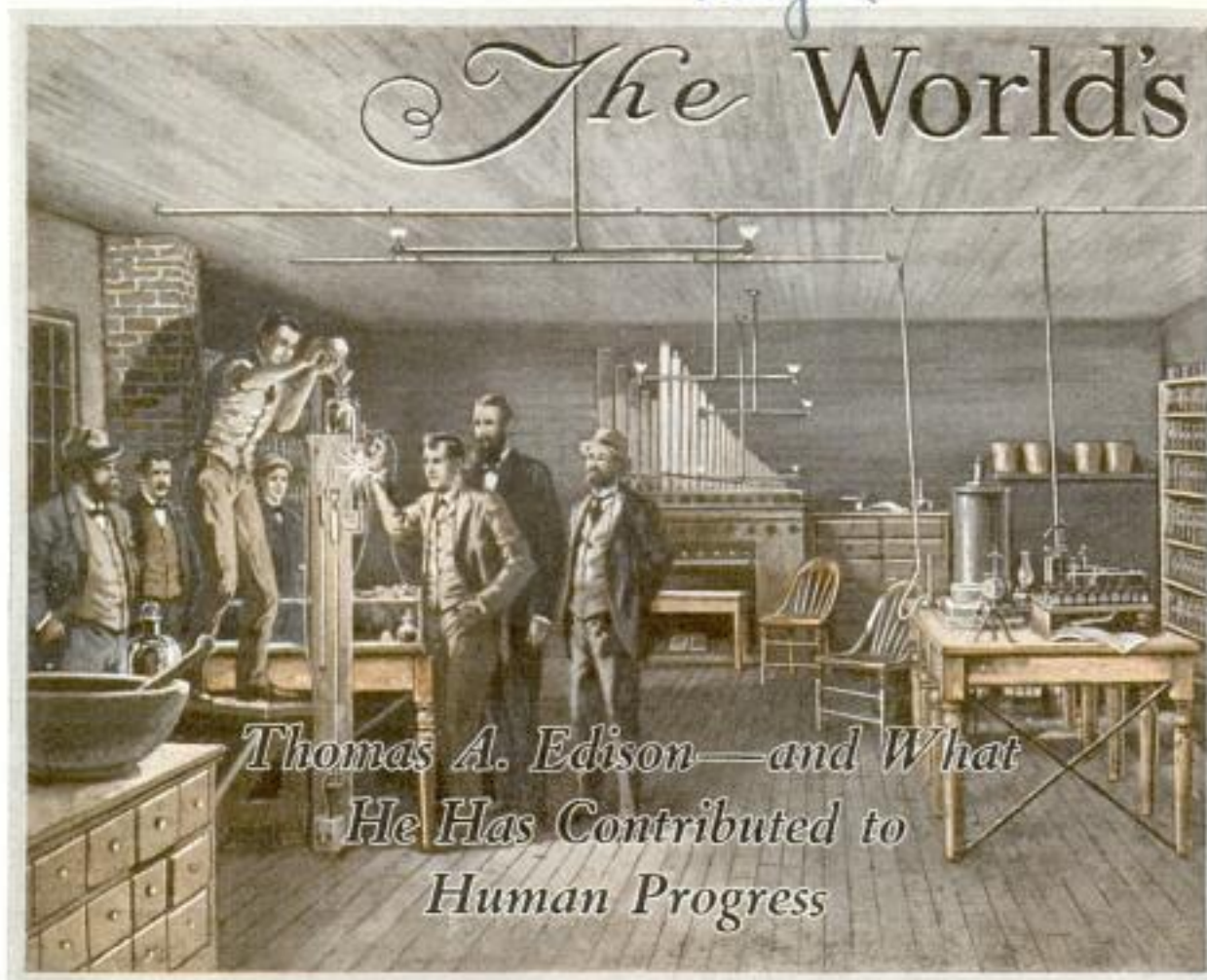

*Thomas A. Edison—and What
He Has Contributed to
Human Progress*

Birth of the Incandescent Lamp in 1879 at Edison's Laboratory in Menlo Park; Edison Is Standing beside the Apparatus, Which Burned Successfully for Forty Hours

WE may sit at home, bathed in colored lights and listen to gifted voices, to deathless music. Or we may project animated figures on a screen and hear their voices from a horn. Or a bell rings; answering, we may hear a voice from another continent.

All these conveniences, within arm's reach in the modern home, bear the stamp of one man's brain—Thomas Alva Edison's. No king, no explorer, no militarist accelerated practical culture more than Edison. Indeed, he ranks with the five men whose lives have most influenced the career of the human race.

Aside from his name, his influence and example, he has created a fabulous fortune in gold and material out of no more material substance than the stuff that ideas are born of. Other men barter, buy and exchange, but they do not add to the world's wealth. Out of sheer common sense and persevering search, Edison presented mankind with an inheritance valued

at more than \$35,235,000,000. The prodigious total tends by contrast to make paupers of millionaires. The sum bears comparison with all the ransoms ever offered for kings, with all the bribes involved in political corruptions, with all the gold mined from the earth in the last century. Yet he has remained humble.

"Well," he says, "if worse comes to worse, I've got a good trade. I can always make \$75 a month as an expert telegraph operator and I can live on that."

Edison was born at Milan, Ohio, on Feb. 11, 1847, the son of Samuel Edison, a mechanic. His close observation led him to ask many questions. He listened solemnly to the answers and then proceeded to investigate matters for himself. His boyhood escapades are still recounted by the citizens of Milan as part of the town's folklore. He was almost smothered once beneath a pile of wheat.

A playmate, aiming an ax at a skate strap, cut the tip off Thomas' finger. And

Greatest Inventor

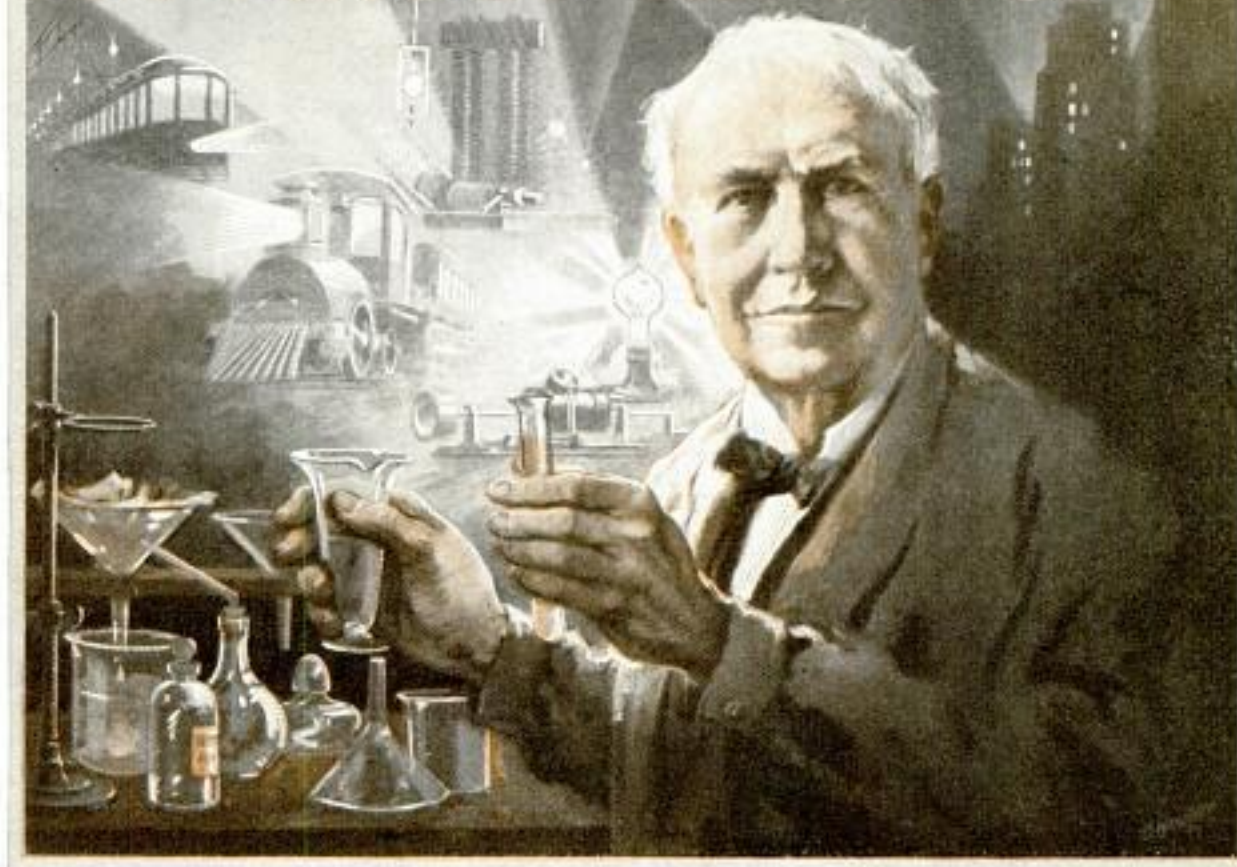

once the inquisitive youngster set fire to a barn, for which offense he received a public whipping.

When his family moved to Port Huron, Mich., Thomas attended a school for three months. That constituted all the formal education he ever received. Thenceforth he was on his own. Before the age of twelve, he had read Gibbon's "Decline and Fall of the Roman Empire" and Hume's "History of England."

Young Edison made the cellar his first laboratory. In order to keep others from tampering with his bottled chemicals, he pasted poison labels on them. All his pocket money went to buying more chemicals from the drug shops.

At length he convinced his parents that they ought to let him apply for the news concession on the Grand Trunk railway in order to increase his stock of chemicals. In one of the baggage-car compartments, Edison was allowed to set up a rolling laboratory, in which he kept jars, bottles, test tubes and every chemical

compound he could afford to buy. In the same baggage car he set up a printing press and published "The Weekly Herald," sold at three cents a copy, and with a circulation of 400 per month.

The rolling laboratory and printing plant flourished until one day the car lurched and caused a stick of phosphorus to ignite and set fire to the car. The conductor rushed in, lost his temper and threw the young inventor off the train after cuffing his ears. Edison grew deaf from the unkind blow of this conductor.

From news vending Edison drifted into telegraphy. He worked in railroad and commercial telegraph offices, acquiring a facility in receiving and sending that is still talked about by veteran Morsemen. His dots and dashes came with such lightning rapidity that the best keymen would have to ask him to repeat. From Cincinnati, Louisville and Indianapolis he went to Boston and took over the high-speed press wire.

It was here that his mind began to bear

a 784

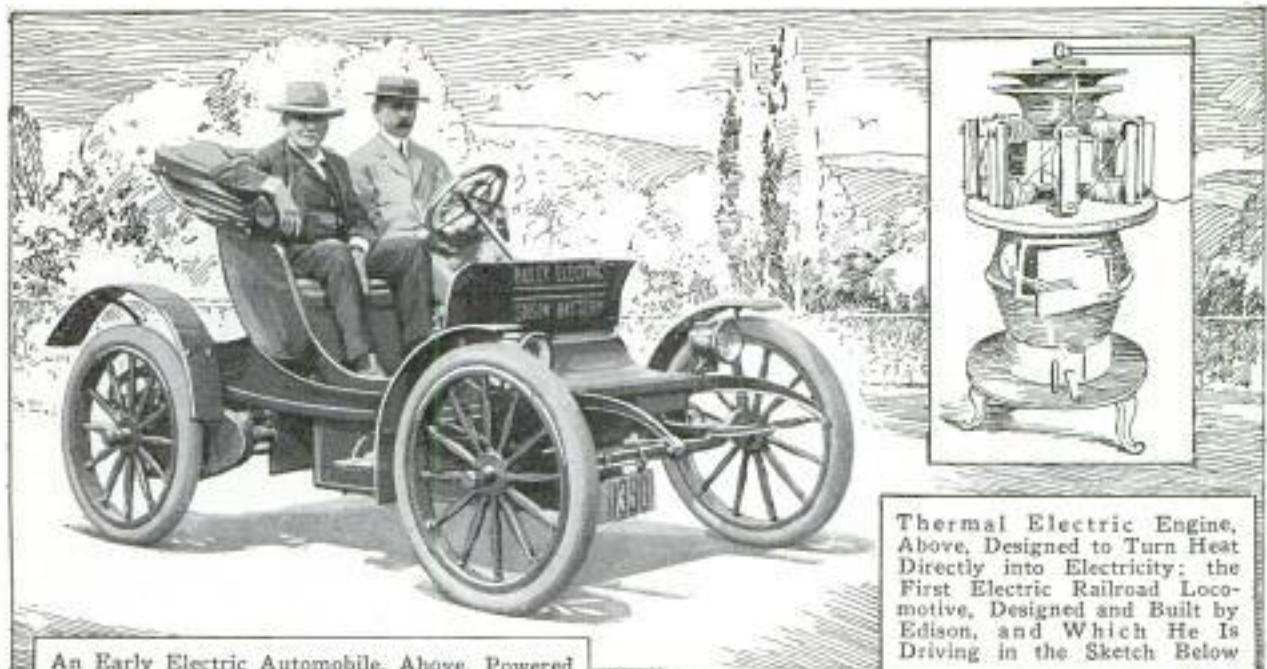

Thermal Electric Engine, Above, Designed to Turn Heat Directly into Electricity; the First Electric Railroad Locomotive, Designed and Built by Edison, and Which He Is Driving in the Sketch Below

An Early Electric Automobile, Above, Powered with an Edison Alkaline Storage Battery, with the Inventor in the Seat; the Battery Made Use of an Alkali, Rather Than an Acid Solution, and Much Work Was Done on It during the War for Submarine Purposes. Seeking to Obviate the Danger of Chlorine Gas from Salt-Water Contact with Acid; Below, a Replica of Edison's First Electric Sewing Machine

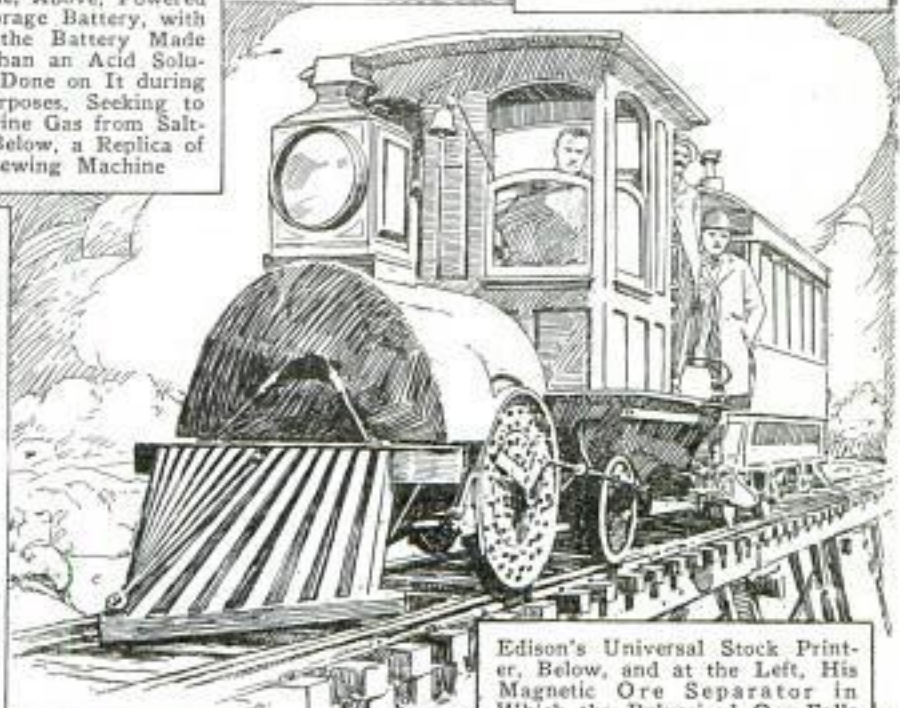

Edison's Universal Stock Printer, Below, and at the Left, His Magnetic Ore Separator in Which the Pulverized Ore Falls upon a Moving Magnetic Apron, the Iron Then Falling into Buckets While the Tailings Are Blown Off by an Exhaust Fan

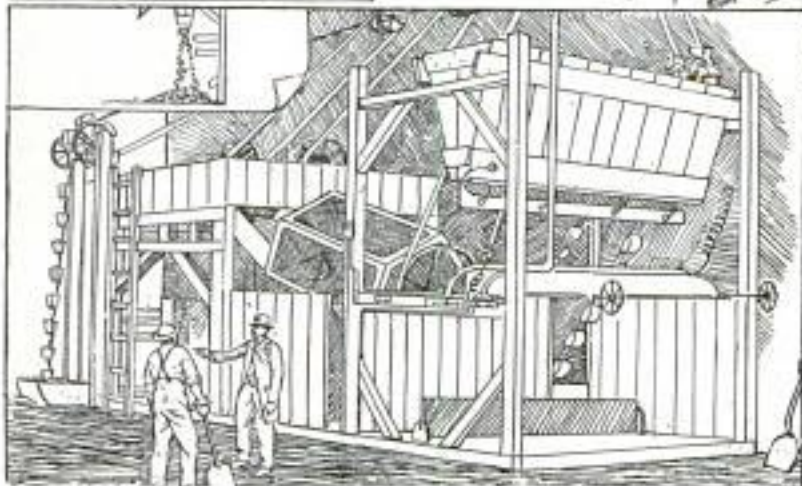

Six of Edison's Inventions That Changed the Course of the World; the Thermal Electric Engine, the Model of Which Is Built around a Stove, Is the Only One He Never Developed

Edison's Greatest Achievements

- 1868 Made his first patented invention, an electrical vote recorder.
- 1872 Completed many inventions, including duplex, quadruplex, sextuplex and multiplex telegraph systems.
- 1875 Discovered previously unknown and unique electric phenomenon, which he called "Ethereic Force," the foundation of radio.
- 1876 Invented the carbon telephone transmitter.
- 1877 Invented the phonograph.
- 1879 Invented incandescent electric lamp.
- 1879 Invented radical improvements in dynamos, making them suitable for light, heat and power.
- 1882 Invented and installed first life-sized electric railway.
- 1882 September 4. Commenced operation of first commercial central station in New York City for distribution of electric current for light, power and heat.
- 1883 Discovered a previously unknown phenomenon known as the "Edison effect." This covers the principle of the radio tube.
- 1881 Invented system of wireless telegraphy (by induction) to and from trains in motion.
- 1900 This period covers the work resulting in the invention of the Edison alkaline storage battery.
- 1905 Made many important inventions relating to the production of Portland cement.
- 1912 Introduced the Kinetophone or talking motion picture. He foreshadowed the production of this combined device in 1887.
- 1923 After the war he filed applications for many patents. Altogether he controls about 1,150 patents. Much of his time is devoted to investigating rubber growing.

York Herald stormed into the newsroom and accusingly laid a copy of that day's paper on the city editor's desk.

"How," demanded Connery, the managing editor, "did that stuff get into the paper, Mr. Orr? You've made a laughing stock of the Herald.

"Lights strung on wires, indeed! What will the owner say?"

"He'll probably say," Orr replied calmly, "that it is the biggest newspaper beat in a long time."

"But don't you know," continued Connery, "that it has been absolutely demonstrated that that kind of light is against the laws of nature?"

The Herald's article aroused such public interest that the railroad ran special trains to Menlo Park, where incredulous visitors saw the strange glow lamps strung on wires between gaunt leafless trees.

Later Edison worked out the whole

system of incandescent electric lighting from a central station. He developed a new type of high-speed dynamo which greatly increased the quantity of his output. The first commercial electric-lighting system in the United States was opened in New York, and it proved highly successful.

At no time in his career has his famous laboratory been idle. The germs of inventions sprang from his mind in a never-ending stream and he kept scores of trained assistants busy with detail work. In rapid succession he invented the carbon transmitter for the telephone and the magnetic ore separator. In 1882, he built the first electric railroad line and a locomotive to run on it. Between 1900 and 1910 he entered the Portland cement industry. He invented the "long kiln," introduced the "poured" house, and perfected the alkaline storage battery.

In 1912 he introduced the "kineto-

a 784.

phone," a talking-movie system, of which he said: "The synchronization of sight and sound is an old idea of mine that has finally been realized. In one way or another it has been in mind for more than thirty years. Back in the late 70's when I invented the phonograph, it was stirring, and in 1887, when I was able to perfect the motion-picture camera, that idea of combining sight and sound persisted.

"The problem of actual synchronization was the least difficult of my tasks. The hardest job



Kinetoscope Record of Carmencita's Dance, Made in 1887; at Left, the First Incandescent Lamp



was to make a phonographic recorder which would be sensitive to sound a considerable distance away, and which would not show within range of the lens. You get some idea of the difference when I make this comparison: If you estimate the volume of sound at a distance of one foot from the recorder at 100, you find that at a distance of two feet it diminishes to 25."

In his long life Edison has hardly known illness. He has a hardihood that survived excruciating labor. One of his

chief assistants once begged the inventor to tell him how he acquired such uncanny powers of endurance. In a humorous vein, Edison replied that he ate Welsh rarebit for breakfast every morning. The assistant, following his employer's example, soon found that the diet made little difference to his own stamina.

Edison's constitution, which allowed him to work from eighteen to twenty hours a day over long periods, is a marvel to science. He has allowed himself few vacations and rarely indulges in outdoor sports. But observers noticed that in his daily habits he maintains a rigid discipline. He works with steadfast concentration and remarkable patience.

a1549
620

New York Times
7/19/30
POPULAR MECHANICS

Lloyd Mosely - Sons, 110
Chapel Field Works
Andover, Manchester
Eng. No. 11 agent for
pipe and the car engine is allowed to idle.

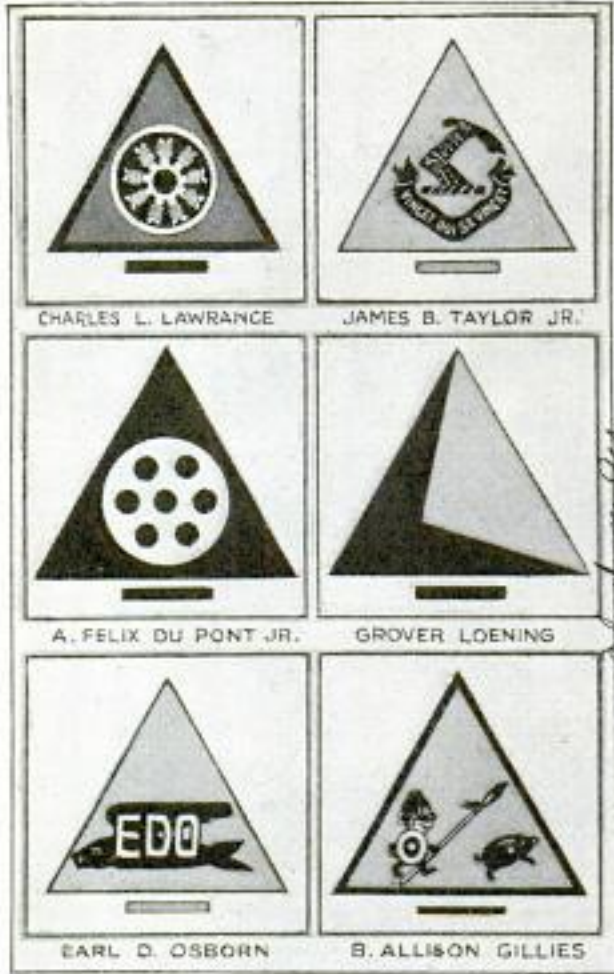

Examples of Insignia for Amateur Air Pilots, All in the Form of a Triangle and Bar

INSIGNIA FOR AMATEUR PILOTS LIKE THOSE FOR YACHTS

Amateur air pilots, affiliated with country clubs devoted to aviation, are being encouraged to select insignia to identify their planes somewhat after the manner of yachting registry. Instead of the conventional pennant of the yachtsman, however, the pilots select designs to decorate their planes. The same general outline, an equilateral triangle and bar, is employed for all, but inside the triangle any desired figure may be used, so long as it has not been registered previously.

VACUUM CLEANER FOR THE CAR ATTACHES TO EXHAUST

For the service station or car owner, a motorless vacuum cleaner has been developed that operates by creating a vacuum from the expulsion of gases. An aluminum attachment at the end of the cleaner hose is fastened to the exhaust

As the gases pass through this device a suction is created at the inlet hole on the side where the hose is connected. The dust and dirt is collected by a nozzle, drawn through the hose and expelled into the air at the rear of the car.

CUSHION WITH TWO AIR TUBES IS MORE COMFORTABLE

Two air tubes are built into a patented cushion to give greater comfort, one tube running around the edge being inflated harder than the rest of the cushion as a support for the legs under the knees. The main or inner tube is blown up to a less degree, giving low-pressure air suspension which absorbs shocks with rebound and eliminates vibration.

BINOCULARS FIT LIKE GLASSES LEAVING BOTH HANDS FREE

Sports enthusiasts who are accustomed to using binoculars to watch the progress of distant races and other events now can obtain the instruments set in frames like those used for spectacles. The frames fit the head snugly to hold the binoculars in place, leaving both hands free, and have adjustable temples and nose pieces, the latter containing ventilating apertures, while each lens of the binoculars has an individual focus and a fine micrometer adjustment to insure good vision.



Small Binoculars Set in an Adjustable Frame so They Fit the Head Like Glasses

Baso Camera Co.
179 W Madison
Chicago

Hand - 6.95 medium 7.95
Universal 9.45
a1651

Eaton Products, Inc.
Cleveland Ohio
6575 Carnegie

Patent Registered

Patent of Seat

Copyrighted material

21394 American Telephone & Telegraph Co. 195 Broadway New York

VOICES across the SEA



Speaking from Steamship 10,000 Miles to His Home Town. Above, and Below, Overseas Telephone Connections of American Telephone and Telegraph and Associated Companies

OUT in California, a salesman was so zealous for orders that he discussed business with a customer who spoke on the day following, and to whose question the salesman gave his reply on the day before—all of which does not seem to make sense, but is quite intelligible when you realize that the two were using the transatlantic telephone.

The conversation took place at 4:00 p. m., San Francisco time, which was 11:30 the following morning in Rotterdam, where the customer was located.

Only a little more than four years ago the transatlantic telephone service was

opened between New York and London. Now the interconnection of telephones extends three-quarters of the way around the globe and from the Arctic circle to the fortieth parallel, south. By the simple process of taking down the telephone receiver, anyone in the United States, Cuba, virtually all of Canada, and in the principal cities of Mexico, can speak to subscribers in practically all parts of western Europe and Scandinavia. The northern part of Africa also can be reached by telephone, and in the southern hemisphere, Argentina, Chile and Uruguay, and eastern Australia and Java.

a1394



Schematic Drawing of Radio Channels Linking Bell Phones with Those of Europe, South America and Australia

While to the telephone user the process seems simple enough, in reality the combination of wire lines and radio circuits is complex and wonderful. The voice of a telephone subscriber anywhere in North America travels over land lines to long-distance headquarters in New York City. Here it is carried to a transoceanic switchboard, handled by trained men. From this switchboard, the voice travels through the control room to the radio station at Rocky Point, if the call is for Europe, thence to London. Or if the call is for South America, the voice is sent to Buenos Aires. The long-distance headquarters exchange is also connected with radio-receiving stations at two other points through which the replying voice is carried from London and Buenos Aires, respectively. From the London trunk exchange, calls are conveyed by land wire and submarine cable to points in Europe, or to the stations establishing the radio circuits to Australia and Java. Buenos Aires is the switching point for Argentina, Uruguay and Chile.

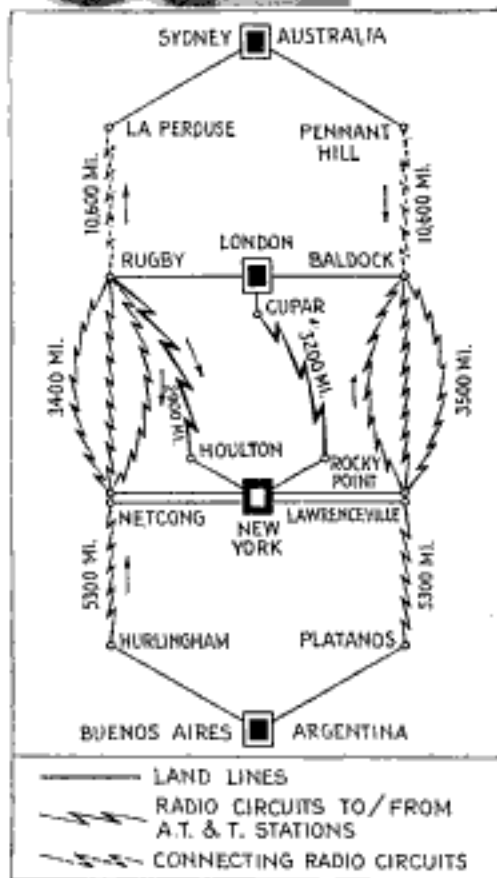

While speed is often a factor in business between continents, the great usefulness of the transoceanic telephone lies not so much in the time element as in the way the telephone enables business men to talk man to man, to explain and to agree upon terms and conditions.

The fact that over the telephone details can be definitely settled made the transoceanic telephone particularly useful to brokers during times of heavy trading and rapid fluctuations in the stock market.

One of the most enthusiastic devotees of the transoceanic telephone is William C. Durant. It is said his longest conversation was from Berlin for an hour and fifteen minutes. His weekly bill for telephone calls sometimes runs into thousands of dollars.

An eastern corporation used the transoceanic telephone for settling a difficult question over machinery con-



U. S.-Mexico Line and "Empress of Britain," Receiver

a 1610 adv. + Mrs. Edwin E. Morrow, 11715 Chrysothria Ave

tracted for with a firm in Glasgow. A change had to be made in the dimensions. A piece of machinery, already in fabrication, was scheduled for shipment from Glasgow November 15, and when it was discovered the change must be made, it was the middle of October. Delay would cost several thousand dollars a day.

"Why not try the telephone?" was a suggestion.

The company's engineers were standing ready, and within five minutes had explained exactly the situation, the heads of the firm in Scotland had confirmed their understanding, and the matter was settled.

Step by step the telephone is extending its scope throughout the world. Through control of the Constantinople telephone company by the international telephone and telegraph system, the way is opened for telephone communication between Europe and Asia, by means of cable under the Bosphorus. Ship-to-shore service of the American Telephone and Telegraph company links all telephones in North America with the steamships "Leviathan," "Majestic," "Olympic," "Homeric," "Empress of Britain" and "Belgenland." The overseas service is constantly being extended.



Cooking of "Hot Dogs" Is Easy with This Equipment Which Sends Electricity through the Meat

ELECTRICITY COOKS "HOT DOGS" LAID ON METAL CONTACTS

Electrical current, flowing from one contact point to another, is being used to cook "hot dogs." The dog is placed on two metal contact points, which are connected to the electric-light socket, the electricity is turned on, and the current thoroughly cooks the dog as it travels from one contact to the other.

Edwin E. Morrow, Ave 11715 Chrysothria Ave Detroit, Mich

ANY BOTTLE MADE INTO SIPHON BY ATTACHMENT FOR CAP

Any metal-capped bottle containing a carbonated beverage can be converted into a siphon by a small attachment that fits the cap itself.



The device consists of a metal cylinder with a threaded tip which is screwed through the metal cap. The bottle is then shaken vigorously to release the gas and when the container is tipped and a button at the top of the device pressed, the stream spouts from an opening at the side. There is a metal ball at the top of the tube which prevents fizzing when the bottle is upright and the button is pressed. When the bottle is tipped, however, the ball rolls away by gravity.

MYSTERY CANAL ON SEA FLOOR MAY YIELD QUAKE SECRETS

Secrets of earthquakes will be sought by the United States navy in a survey of Bartlett "deep," a mysterious "canal" on the bottom of the Caribbean sea. The canal or trench is approximately 1,000 miles long and two miles deep. Careful charting of the trench, and of other parts of the Caribbean, says Dr. William Bowie of the coast and geodetic survey, will help reveal the cause of earthquakes in that region. Sonic depth finders will be used in charting the canal, soundings being taken by measuring the time required for an echo to travel from the surface to the bottom and back again.

The Siphonette Co. 912 W. Pico, Los Angeles, Calif.

Kansas City Star 8/4/37

a1633

at Padilla Bay

POPULAR MECHANICS

Model of Plane That Looks Like an Army Tank; It Operates on a Mechanical Vacuum Principle



PLANE LIKE FLYING ARMY TANK TESTED IN MODEL FORM

Resembling an army tank in appearance, an airplane that the inventor says can rise or descend vertically and hover motionless in the air, was demonstrated recently in this country in model form. The flying tank is motivated by two propellers and operates on a mechanical vacuum principle. The maker of the ship says that he has already flown a model of his plane at his home in Newfoundland.

ODD TYPE OF STONE-AGE TOOLS FOUND IN SOUTH AFRICA

New types of stone-bladed tools that were used by prehistoric men and women thousands of years ago have been found in South Africa near the mouth of the Kogha river. The implements are of a kind hitherto unrecorded in scientific data and appear to represent a distinct stage in stone-age industry. Some of them are long, bladelike shapes, others are scrapers, gravers and points, but the most characteristic specimen is like a giant crescent and is shaped like a quarter of an orange with the flat surfaces forming the cutting edges. Previously a single specimen of the crescent-shaped tool had been found, but it had not been considered as associated with any type of stone-age culture.

OYSTERS GROWN FROM SEED REAPED EACH YEAR

Planting seed oysters from Japan about the first of each year, a company operating on Puget sound has adopted the sow-and-reap method of oyster culture so common to agriculture. Fifty million oysters now are growing in the company's beds and each fall's crop will be replaced by planting the following spring. Care will be taken not to allow the oysters to attain their full growth, but they will be gathered when at the right size.

"SODA-MIXER" WATCH CLEANER OPERATED BY MOTOR

Watches can now be thoroughly cleaned in less than three minutes with the aid of a tiny washing machine that somewhat resembles a soda-fountain mixer both in appearance and operation. The timepiece is taken apart and the dissembled parts are placed in two wire-lined containers which telescope to form a cylinder. After the top is placed on the cylinder, the assembled cleaner with the watch parts inside is attached to the spindle of a small electric motor. The cleaning compartment has hooded openings through which a cleaning solution is forced when the cylinder is dipped in it and started spinning by the motor. The solution is picked up at the top and bottom of the cylinder and diffused to all parts, then forced out through side vents. The actual cleaning operation takes only a minute and a half.

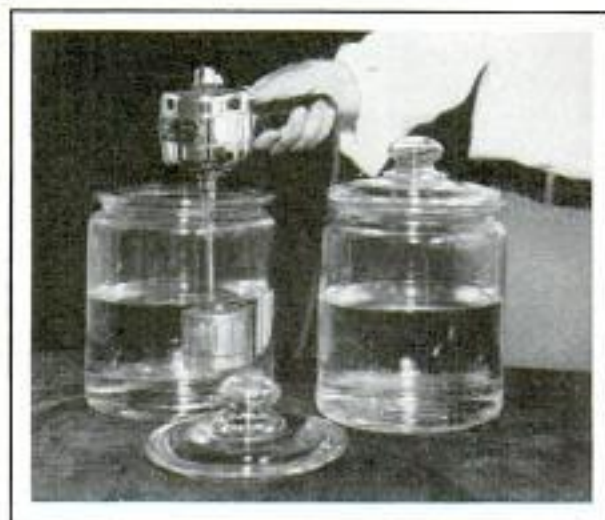

Mechanical Watch Cleaner Like Soda-Fountain Mixer; Watch Parts Are in Cylinder in Jar

Dr. Thomas Blaney of Newfoundland

Scene Service 9/6/31

a1629

a1648

Scene Service 9/6/31

Reported to Royal Society of South Africa

Dr. H. C. Jaquier and Hans Adkins Fresno, Calif

MODERN ARCHER OUTDOES WILLIAM TELL'S FEAT *21516*

William Tell's famous trick of shooting an arrow into an apple on top of his son's head wasn't so difficult. A modern archer, Chester Seay of Los Angeles, does that one at fifty feet, with the arrow piercing an apple balanced on his girl assistant's head. Another of Seay's trick shots is the bursting of a toy balloon held between his assistant's teeth at a distance of fifty yards. In a demonstration of this trick, it took four shots to burst the balloon, but not a freckle on the nose of his assistant, Carroll De Witt, was disturbed. At fifty feet, Seay can knock the ashes off a cigaret with an arrow, split an arrow



Right Through the Apple Goes an Arrow from Modern Archer's Bow, at Right; Above, Bursting Toy Balloon

on a knife blade and other fancy shots. Seay, who is captain of the Los Angeles Archery club, is regarded as one of the foremost archers in the world and is outstanding for his trick shots.

MOTION PICTURES TEST VISION BY REVEALING EYESTRAIN *91608*

Motion pictures provide a good test of vision, as many people have discovered after suffering from eyestrain resulting from an evening at the movie theater. More effort is demanded from the eyes at the motion-picture show, as a person

Wide World
who needs glasses for distance and who goes without them because he suffers no discomfort, will find the trouble asserting itself uncomfortably upon frequent visits to the movies. This is particularly characteristic of middle-aged people who wear glasses only for reading. Screens and seats in theaters rarely are handled in any manner other than to allow a person occupying a seat at least 20 feet in front of the screen to sit through a program without undue visual exertion. The motion-picture shows have done much to reduce eyestrain by proper elevation and angling of the screen, partial lighting of the theater to eliminate harmful effects of the sharp contrast between the darkened surroundings and a bright screen, and by attempting to arrange seats correctly.

☛ To lessen the hazard of forest fires, Michigan conservation officials are urging that all automobiles be equipped with ash trays.

*Hand Levinson
Henrieville, Va.*

91292

FLYERS of

How Germany Is Training Pilots of Giant Seaplanes Able to Cross the Atlantic

"SAFETY for the passengers" is the motto of a school for German seaplane pilots on the Baltic. Daily and nightly lessons and flights aim to bring air travel to the acme of perfection and safety. All kinds of nautical maneuvers with flying boats and seaplanes are practiced, such as towing the planes by tugs or other craft and the transfer of passengers to ships.

A seaworthy patrol boat, with steam up, lies always ready at the landing pier. Pilot, radioman and mechanics make up its crew. Wireless links the boat, planes and land station together. A radio direction finder locates seaplanes in distress or forced to alight on the

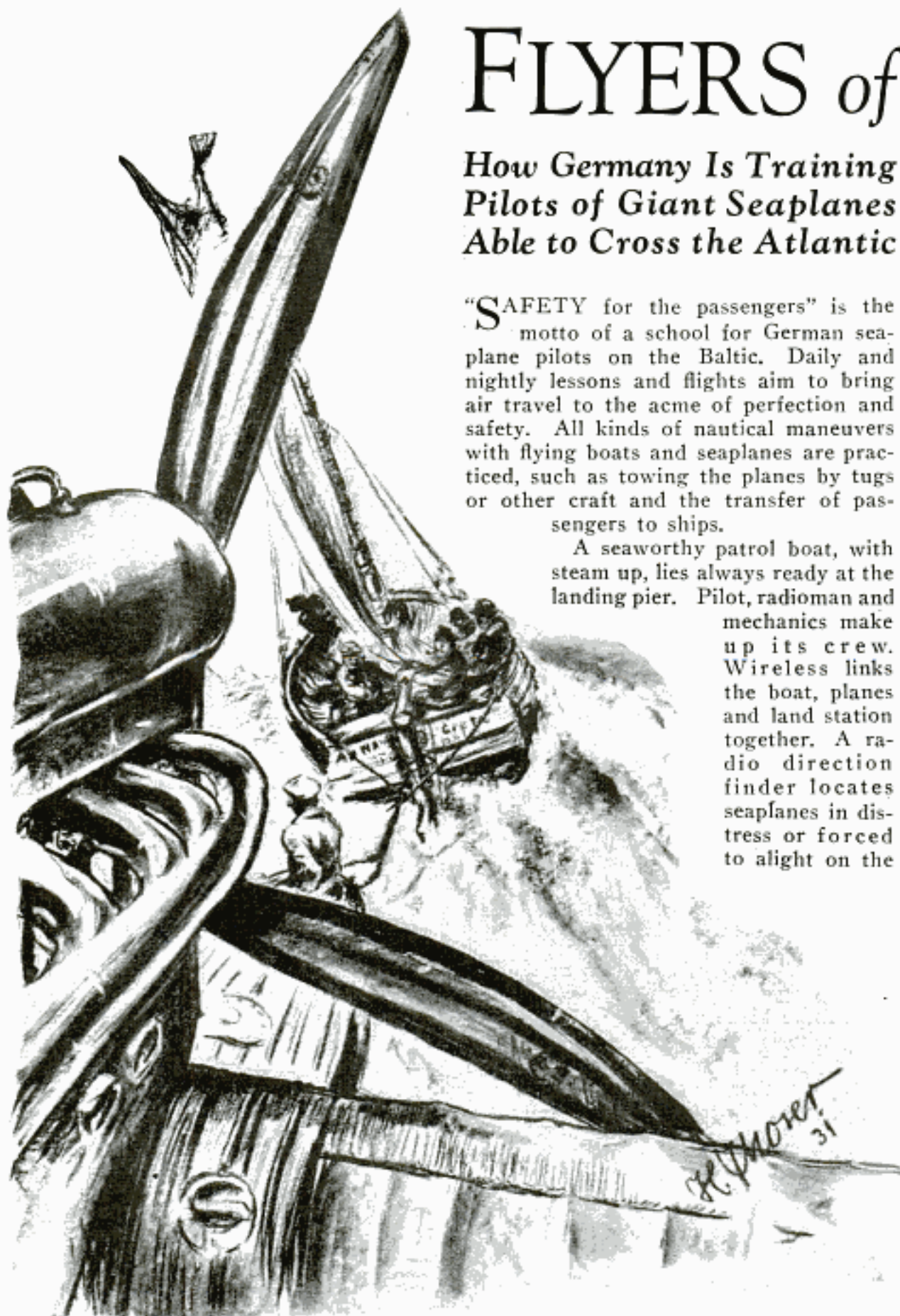

When a Flying Boat Encounters Trouble in the Air, It Lands at Sea, Signals Its Position, and in This Case, Is Towed In by a Fishing Smack

the SEA

water by motor trouble.

You board the patrol boat and, in leaving, pass a floating dock, large enough to accommodate the giant "DO-X," and the forty-five foot runway of a catapult which shoots planes into the sky by air pressure.

High above rumbles the agile "New York," a new craft, which in a few days will accompany the express liner "Bremen" on its transatlantic voyage and save twenty-four to twenty-eight hours by bringing mail from ship to land. With the roar of its 560-hp. motor mingle the lesser voices from the engines of the "Dornier Wal" and the



A Chain of Free Lights Anchored to a Buoy Shows Wind Direction and Marks the Channel: Below, Covered Cockpit for Blind Flying

Junkers "W-33" in a symphony of rhythm and power. They fly ahead of you over the sea, where practice is to begin. The command is taken by the leader of the seaplane division himself.

"Man overboard!"—a life ring flies into the water—he who represents the accident victim must be pulled in—the patrol boat lies to, carefully, lest the ring be caught in the backwash. The life preserver must be lifted by hand, according to rule, not by boathooks.

A collapsible rubber boat—every seaplane carries one of them—is let down upon the water. Very light and taking little space, it is the logical life-saver of these craft. In a few seconds a compressed-air bottle, mounted on it, inflates the hollow rim. Two men with paddles board it and row toward the "Dornier Wal" to be taken aboard.

Some distance away, swimming on the water, the "W-33" comes into view. You



Passengers Are Taken from Plane to Patrol Boat in Collapsible Rubber Boats; at Left, Fitting a Sea Anchor

proceed toward the plane which has radioed motor trouble. On its pontoons stand two of the crew, radioman and mechanic. The pilot turns the plane so that current and wind will not drive it and the sea anchor apart.

The helmsman maneuvers to keep the stern before the nose of the plane. A line, thrown from your boat and caught by the men on the pontoons, is tied to a hook on the plane's struts—and so the craft is taken in tow.

The successful maneuver portrays the

saving of passengers and crew in a real accident. Not only steamers and motor-boats are able to tow a plane, but any fishing cutter, which happened to come on the scene, could do it. One of the plane's crew would simply board the cutter, by means of the rubber boat, and direct the work from there.

Far out on the sea, the patrol ship encounters the "Dornier Wal." Slender and tapering like a fish, it floats on the rocking waves. Its front motor is turned off. The rescue crew stands in the stern ready to throw the towline to the "Wal." The passengers now can be brought safely aboard, and the plane towed to port.

In the night, the same routine is repeated. The patrol boat runs out, its bright searchlight beam scanning the sea. The seaplanes lie in darkness moored to buoys. One of them, the "Wal," is at sea, and it is the object to locate it. Al-

1911 West
New York

a1390

ready a radio message and the searchlight have indicated the direction, and the giant bird soon is seen swimming on the water. Lights define its contour. Between the struts stand the radioman and mechanic signaling. The towline already has reached its goal. The "Wal" is towed back to port.

The whole maneuver takes only a short time. Then the practice is resumed—again the light beam searches sky and sea, until, between scurrying clouds, is discovered a Junkers "W-33" on night practice for preparation on an air-mail line.

Through fog and clouds, this mail plane finds its way by blind flying. All year blind-flying practice goes on for the benefit of student pilots.



Glass Reflectors on a Belt Protect Street-Car Conductors and Track Workers from Autos at Night

TRACK WORKERS ARE GUARDED BY REFLECTORS

Glass reflectors set into a safety belt worn over the shoulders and around the waist, guard street-car conductors and track workers from motorists at night. Fourteen pieces of glass in each belt reflect automobile lights, enabling drivers to see the wearer.

Dr. Walter Pearson
General Traffic Engineering Company
and
Cuthill Belts Street Car

THIRTY-POUND BOAT OF METAL CARRIES QUARTER TON

Capable of carrying 500 pounds and a twin-cylinder engine, a boat built of duralumin has been constructed that weighs only thirty pounds. In addition to its extreme lightness, the craft is constructed with two compartments hinged together, so that it can be transported knocked down with the forward half folded over the aft section. It is claimed by the builder that the boat is thirteen per cent stronger than a steel craft of the same size.

a1462

Thirty-Pound Boat That Carries a Quarter Ton and Can Be Transported with Forward Half Folded over the Aft Section



see June 1931 - 928 - June 1933
Dr. Frank E. Omer
2907 Waverly Drive
Los Angeles, Calif

SHORTAGE OF WILD LIFE BLAMED ON SUNSPOTS

Ultraviolet radiation from the sun is the reason for the ten-year cycle of shortage among birds and mammals, according to the theory of Prof. William Rowan, of the University of Alberta, pronounced at a recent meeting of the Canadian biological conference. In connection with the ruffled grouse it was found that more than thirty parasites and diseases threaten their existence at all times, and that their decennial decrease is largely caused by lack of ultraviolet radiation, thus allowing the disease more complete sway. It was argued that the changes in ultraviolet intensities are caused by sunspots.

Ed Amaha
nhr.

a1579

New York Times
Copyright Material
7/25/31

91527
630

Cmt. Ralph Perry, Miami Beach
Jockey Club, Box 887

POPULAR MECHANICS *Miami Fla*

Racetrack in Bay to Be Built on an Island

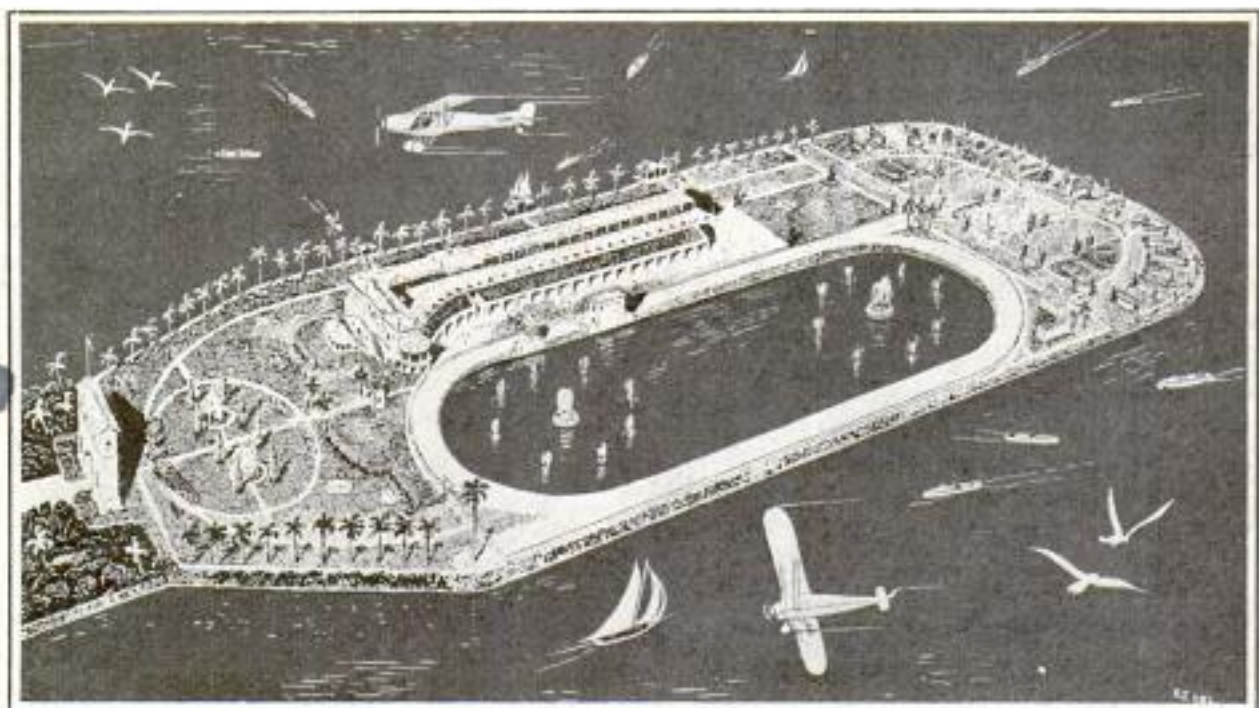

Aerial Drawing of Proposed Racetrack Which Will Be Built around a Lake on a Man-Made Island in Florida; Special Provision Is Made for Airplanes and Boats to Land Passengers

Thoroughbred horses will race around a thirty-two-acre lake on a man-made island constructed as a site for a racing plant at Miami Beach, Fla. The island will be 4,600 feet long and 2,000 feet wide, sufficiently large to accommodate track, club buildings, stables and dormitories, and a park. The lake will be in the center of the track. Speedboats and airplanes will be used to reach the track, with docks and landing fields provided.

The stove is started by merely bringing the mantle in contact with a lighted match for a few seconds and screwing on the cover. The heated mantle draws the gasoline from the wick as fuel, and the stove burns without flame or odor for several hours. It is extinguished by reversing the tube containing the wick, thus cutting off the air, and the heat can be controlled by wrapping the warmer in a cloth, thus reducing the amount of air penetrating through the perforated cover. It can be used on cold days to keep the hands warm, and is likewise employed in bed as a foot or chest warmer.

POCKET STOVE WARMS HANDS WITHOUT FLAME OR ODOR

So small that it fits easily in a coat pocket or handbag, a gasoline stove no larger than an ordinary flashlight supplies a constant source of heat that is easily controlled. It consists of a cylinder with a ventilated top which contains the mantle or heating element. Inside is a tube containing a wick which is saturated with gasoline.



CITY NOISES HINDER THE BLIND IN LEARNING TO WALK

City din often prevents blind persons from walking straight, and children born blind many times must be removed from the city before they can learn to walk, it has been discovered as the result of a survey in New York. The noise of the city drowns the sound of the blind man's footsteps by which he ordinarily is guided, it was said. The average blind person also listens for the footfalls of others to avoid collisions, which consequently are more numerous in the city.

91581
The Specialty Trading Co.
Milano 117 (Italy)
reg. Ruffini 9.

12/2/8
City Health
Commissioner

at Lemar, Calif. a 1543

GRASSHOPPER TRAPS ON AUTOS HELP HARVEST CHICKEN FEED

Farmers in certain grasshopper-infested regions have devised a means of turning the destructive pests into chicken feed. Troughs are placed in front of their automobiles as they are driven through the grain fields. The troughs are partly full of water, into which the insects fall. Later, they are poured into sacks to dry, and this winter will be fed to the chickens. One farmer gathered thirty bushels of grasshoppers to the acre by this method.

EDUCATING OF TOES LIKE FINGERS SAVES ONE STEP IN SIX

Children in the boys' and girls' agricultural clubs all over America are being taught how to use their toes through the extension service of the department of agriculture. To prevent fallen arches, it is of especial importance to develop the muscles in the big toes, it has been found. The children also are taught to walk straight, with the sides of the big toes in a straight-ahead line, as the Indian walks. Attention is called to the fact that straight walking saves one step in six.

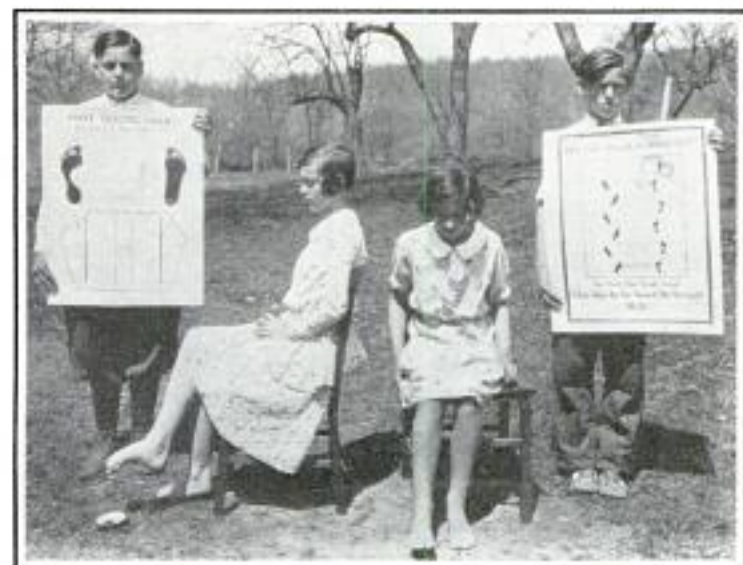

Boys and Girls Learning to Pick Up Objects with Their Toes to Prevent Fallen Arches and Other Defects

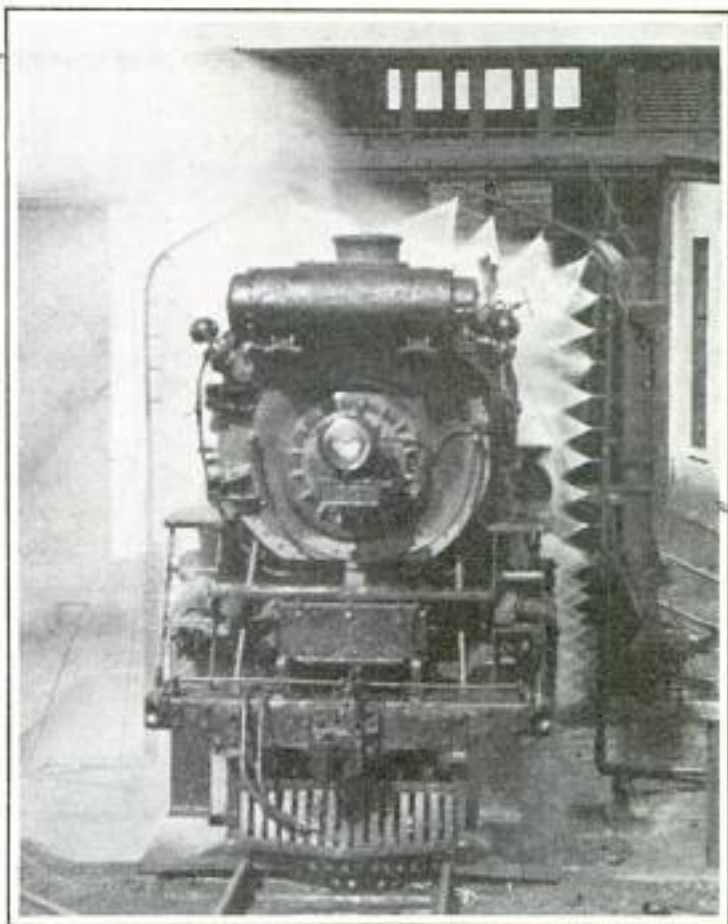

Courtesy N. Y., N. H. & H. R. R. Locomotive Receiving a Shower Bath after a Run; This Washer Cleans an Engine in Less Than a Minute

ENGINES GIVEN SHOWER BATHS BY AUTOMATIC WASHER

Locomotives must be cleaned thoroughly after every run but instead of turning a hose on them, one eastern railroad has installed an automatic shower bath for its engines. The washer consists of a series of spray nozzles arranged at the side and over the track so that an engine passing through the shower will be thoroughly cleaned. A hot cleaning solution is sprayed on the locomotive at high pressure to remove grease and grime, the nozzles swinging into position as the engine approaches the washer. Less than a minute is required to run an engine through the shower. In addition to improving the appearance of the locomotives, the clean condition will add to safety, as the washer enables inspectors to note defects more easily.

Hartford, New Haven and Albany

Installed in Cedar Hill engine house

*7/31/31
New York Times*

a 1616

a 1583

Science Service
8/1/31

11/57/1



Long-Distance Aerial Camera Mounted in an Auto-Gyro Which Will "Cover" News Events from the Air for a Detroit Newspaper

engines, from which carbon monoxide is expelled through the heating system. The warning devices will be set off by the gas in control and engine rooms, the heating system will be cut off, and the air which otherwise circulates through it will be discharged outside the ship. Thus the trouble can be investigated and the leak found without danger to those aboard.

156
"TOUR" ON CANVAS SHOWS DRIVER'S MISTAKES

Mistakes in driving are revealed by a "trip" on a painted landscape while the driver is seated in an auto body in a laboratory. An Iowa State College professor, attempting to find why some drivers get "tangled up" in traffic while others go through easily and safely, designed the equipment to test reactions to all driving conditions. The driver, seated in the laboratory auto equipped with standard controls, looks at a miniature landscape painted on canvas which revolves toward the driver on two rollers. On the road is a toy car which is guided by the steering apparatus of the car in which the driver is seated. A meter, attached to the test car, records the mistakes of the driver while on his trip.

HOVER PLANE AND AIR CAMERA JOIN NEWSPAPER STAFF

With a huge aerial camera mounted in the front cockpit, a three-place auto-gyro has been added to the facilities of the staff of the Detroit News. The plane was selected because of its ability to land and take off in small and restricted areas, to fly at slow speed once in the air, as is oftentimes necessary in news photography, and because it can "hover" over selected spots for short periods. The plane will descend vertically at parachute speed

lege professor, attempting to find why some drivers get "tangled up" in traffic while others go through easily and safely, designed the equipment to test reactions to all driving conditions. The driver, seated in the laboratory auto equipped with standard controls, looks at a miniature landscape painted on canvas which revolves toward the driver on two rollers. On the road is a toy car which is guided by the steering apparatus of the car in which the driver is seated. A meter, attached to the test car, records the mistakes of the driver while on his trip.

with many safety appliances
DEADLY GAS TO SOUND OWN WARNING

Danger of carbon monoxide poisoning from the first heating plant ever installed on an airship will be eliminated on the "Akron." The escaping gas will flash a light and ring a buzzer when the concentration reaches as much as one-hundredth of one per cent. Heat for making the airship comfortable will be furnished by the



"Automatic Landscape" That Reveals Mistakes in Driving to Students in College Laboratory

Naval Bureau of Med. and Surg. and C.E. Carle, Chem. Engr. Bureau of Investigation

Developed by Dr. Joel White, Flight Surgeon

Mr. Alvin A. Lawler Associate Prof. Psychology

Safe Swimming Pool Is Built into the Ocean

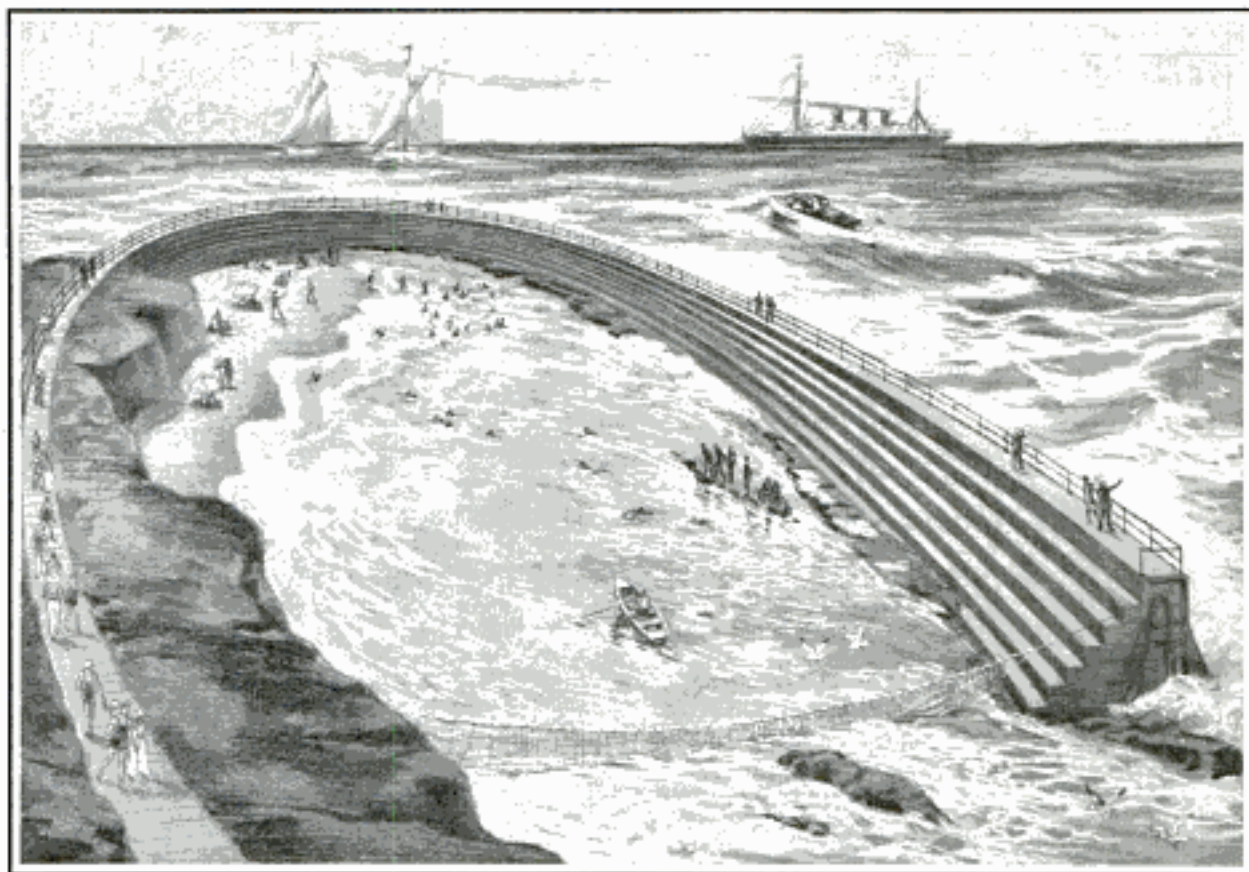

Breakwater Built into the Ocean Furnishes a Beach, Pool, Diving Platforms from the Rocks, Grandstand for the Spectators and a Promenade

Building a breakwater on dangerous rocks, engineers at LaJolla, Calif., have constructed a safe swimming cove in the ocean. The formerly hazardous rocks now provide excellent diving platforms. The inner side of the breakwater is stepped like the downstream side of a single-arc dam, so that it forms a grandstand for the spectators. A floating line prevents swimmers being swept out to sea, and a small beach provides a safe place for the youngsters.

EROSION RUINED MAYAN EMPIRE EVIDENCE INDICATES

Because the face of the land in which they lived began to change insidiously, the Mayas of prehistoric America temporarily lost their grip on civilization, and their first empire fell. This is the view of Dr. C. Wythe Cooke of the U. S. geological survey, who has returned from a study of the region. He found the hills today to be forested with big trees and a little underbrush while the lowlands are a tan-

gled mass of twisted trees covered with vines and flooded in the rainy season. This indicates that at one time the plains were lakes the year round, affording plenty of water and good transportation, both of which are inadequate today. Doctor Cooke suggests that possibly the transition from lake to lowland took place during the time of the Mayan empire, the heavy black soil being washed away until the land was abandoned and reverted to the jungle. The erosion of the soil would have been accelerated by the Mayas themselves, who cut down forests to grow corn for their large population. If the geography of the region in Mayan days had been the same as now, all provisions and merchandise must have been transported on the backs of men and human burden bearers would have had a hard time traveling over the low plains, but if the lowlands were lakes, travel would have been easy. The calamitous change of the lakes into plains also may have brought disease to the Mayas, thus hastening the fall of their civilization.

Science Service 7/29/51

a 1432

I turn a Barn

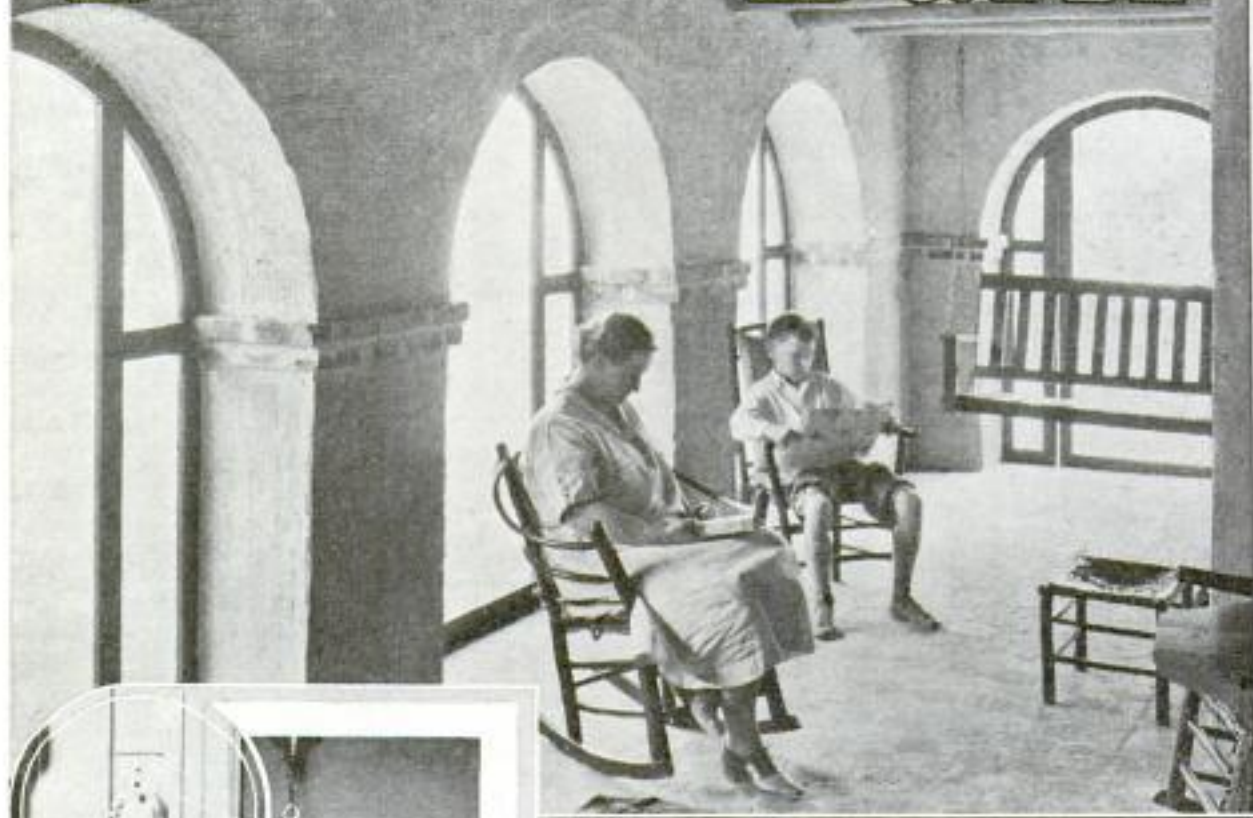

Porch of the House at Left; Hall and Stair Lights Should Be Controlled from Two Points

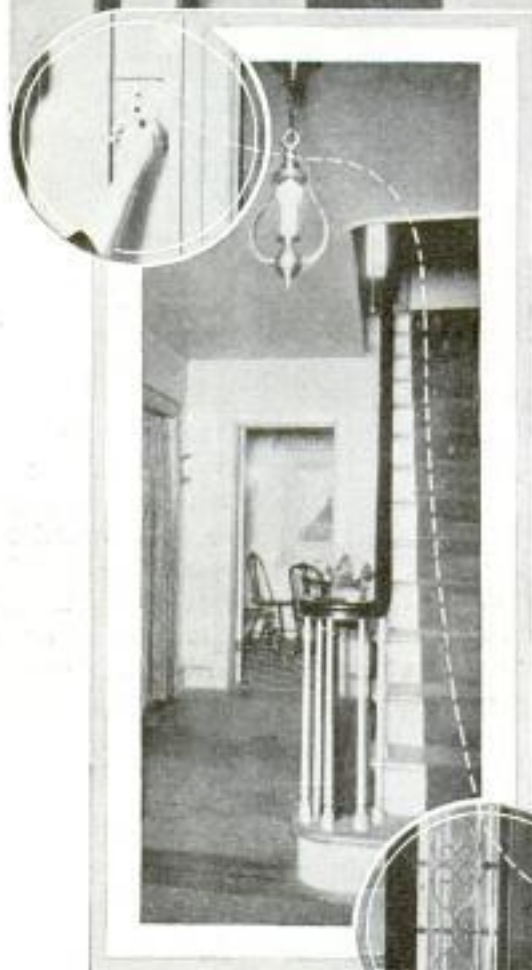

Architect Tells How to Remodel and Judge the Value of a House

By WILLIAM D. BRINCKLOE

312 Stewart Bldg. Boston ma

THIS is the story of how I turned an old frame barn into a home for myself.

The building was the usual two-story frame type. The hayloft was floored with wide boards in fair condition.

Everything, in fact, was in good condition. Here is illustrated the first rule of remodeling, which is:

Never try to remodel something that is not worth remodeling; be sure the old building is in good shape with sound timbers. Don't try to use the old material over.

Except for one section of wall, I did

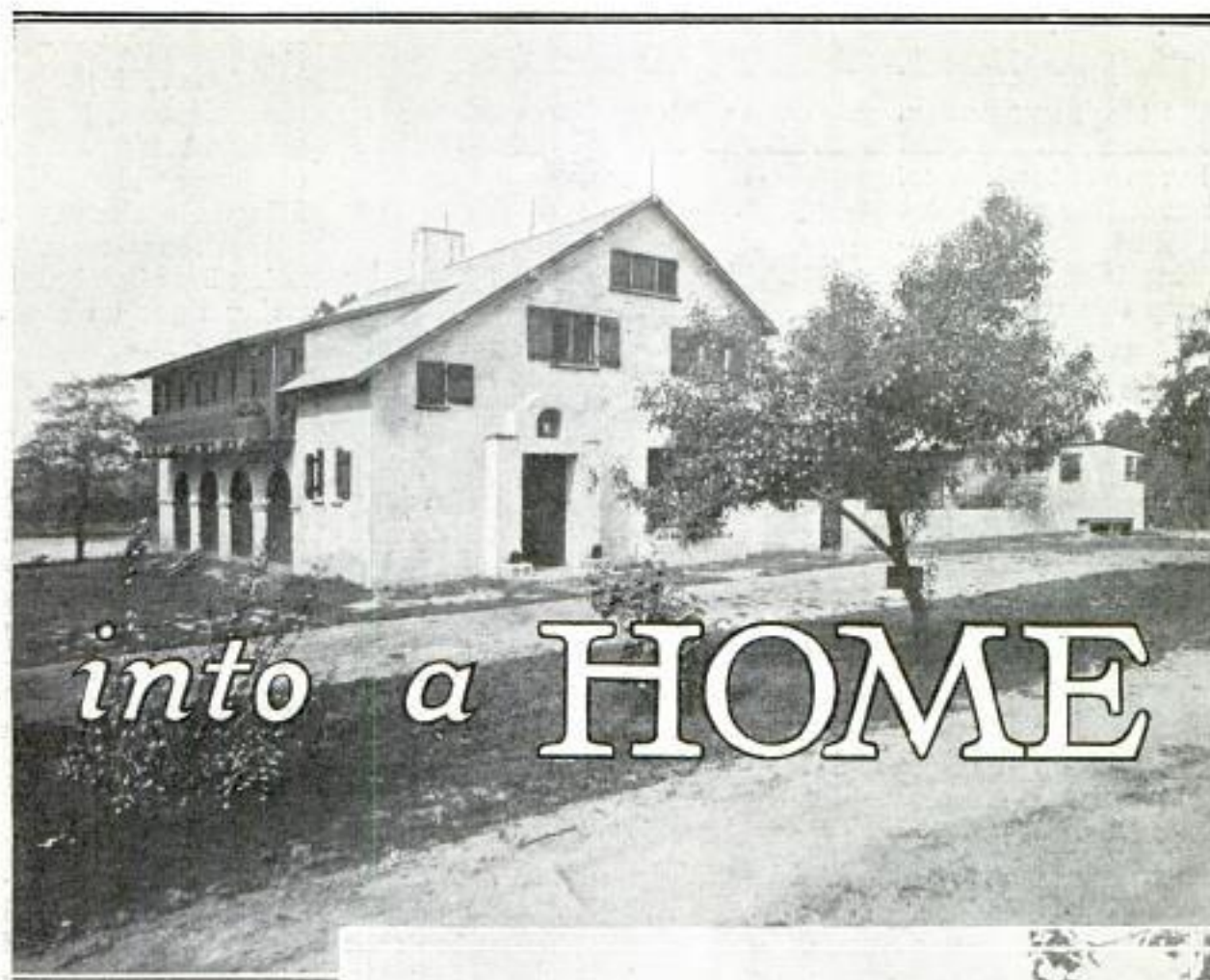

into a HOME

not tear out a single bit of the old exterior shell. The barn was a little too wide for a well-proportioned living room, so I ran up a new partition, leaving the space beyond this for a vestibule, and the remainder was thrown into the porch. At one end I worked in a dining room and stairway with a new kitchen built on the outside. A porch was constructed along the left side, with a clothes closet to continue it. Illustrating rule three: If rooms are too small, tear down some partitions and throw two or more rooms together, and then, if necessary, build on new rooms.

Upstairs I did no tearing out whatever; there was ample space in the old haymow

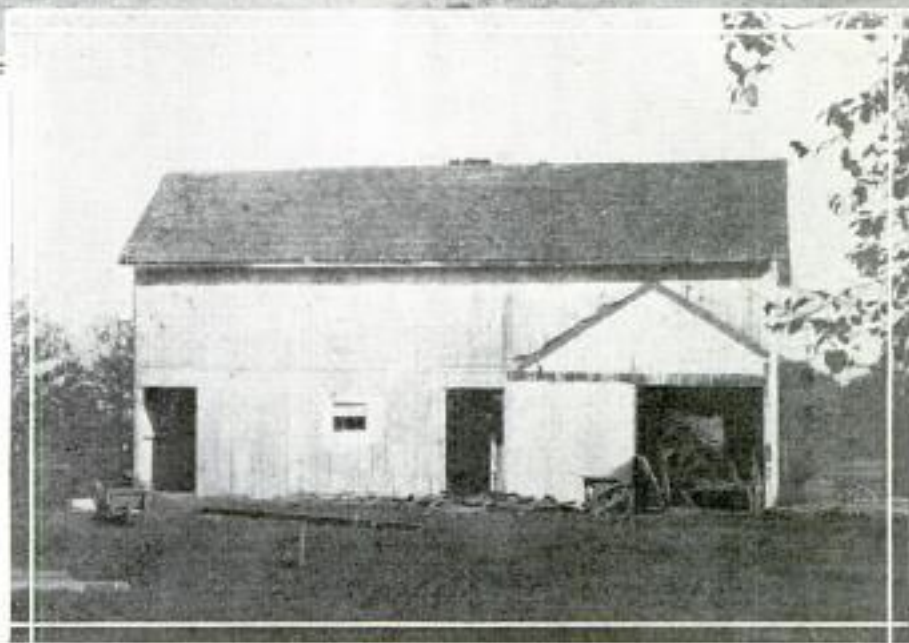

The Finished House, Above, and the Barn from Which It Was Constructed, and Almost All of Which Was Used, Below

for three bedrooms and stairway. The bathroom was built over the new kitchen and the sleeping porch, and two closets were worked in over the downstairs porch and clothes closet.

I built my new roof by carrying the original roof line down over the closet

91432
636

POPULAR MECHANICS

with no change nor break whatever. Over the sleeping porch, however, this would have been too low, so, above that part, I cut in a new roof of somewhat lesser pitch. To keep this roof section

and dry. In the various rooms, I left all the old posts, beams, girders, braces, and so on, just as they were, filling in between them with sheets of insulating board and plastering right on these

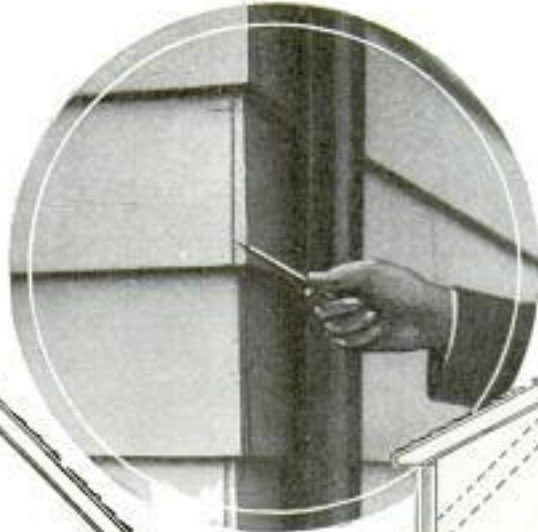

Example of Poor Construction to Save Labor; the Joints Should Be Mitered, Above; the Right and Wrong Way to Raise the Roof to Add a Room in the Attic

from being entirely too flat. I built the floor of the sleeping porch about two feet lower than the old second floor, with three steps down to it. No one ever would suspect from the roof lines that this section was added years after the original roof was built, thus illustrating rule four: The new work should harmonize in design, in proportion and in materials with the old. If a stranger passes by and says "that's a remodeled house," the job is a failure.

I covered the old barn, as well as the new frame additions, with cement stucco on metal lath. As a general rule, it's a good plan to stucco any remodeled building; it makes new and old work look alike, gives a solid, substantial effect, and renders the old portions weather-tight and warm.

Inside the house, I covered the first-story floor with three inches of concrete, poured right down on the earth. Over this, in some of the rooms, I laid floor tile; in others, composition flooring; in still others, I merely finished off the concrete with a smooth top dressing. My friends prophesied all sorts of disaster; The floors would be cold, damp, and altogether undesirable. But their croakings came to nothing: the floors were warm

sheets. Many owners of one-story cottages would like to add a bedroom and bath in the attic by taking off the roof and rebuilding it higher. There is an easier way to achieve the desired effect.

Saw through the rafters near the eaves, and lift them up as if they were hinged at the ridge pole—the whole thing, shingles and all. Then, build in a low frame wall along the front, with windows, preferably of the Dutch dormer type, tucked in it. The principal thing to avoid in this sort of remodeling, is to swing the roof up too far. If this is done, so the windows will be on top of the old roof section, the roof will look top-heavy, and will not have sufficient pitch to keep the rain from running back under the shingles. Instead, set the windows much lower and cut away the old roof in front of them.

A great many prefer to buy a house rather than build or remodel one. There are five elements of value you should consider in your choice of a house: location, appearance, floor plan, structural features and mechanical installations. The most important of these, and the most difficult for the persons not trained in carpentry, is that of structural design.

Before entering a house, I always devote plenty of time to examination of the

materials and workmanship on the outside.

Start with the foundation walls and keep a careful lookout for vertical cracks which may indicate a settlement of the structure. If the concrete is uneven, has holes in it, and has corners broken, not enough cement has been used or the concrete has been



Additions Often Are "Stuck" on, Above; If the Gable End Exactly Matches the Old, the Effect Is Pleasing, Below

carelessly placed in the forms. The sills of all windows should drain outward. Areaways under windows should have a drainage outlet for rain water and snow.

Measure through a cellar window to check the wall thickness. Eight inches should be considered the minimum for concrete, and twelve inches for brick, hollow tile, or concrete blocks. Examine the joint between the top of the wall and the sill to see that there are no air spaces.

If the side walls are stuccoed, look for any sign of cracking or of mortar spalling off. Vertical cracks in masonry due to settling of the foundation are most likely to develop around window and door openings.

Exposed brickwork should be built of hard, well-burned brick which in themselves are durable. The mortar joints should be filled, not simply closed up at the outer edge of the brick.

The only sure way to tell how good the

draft is in a chimney, is to build a fire and see how it burns.

The basement floor should be dry; look for water stains along the angles between floor and walls. All holes where pipes come through the foundation wall should be cemented.

Overhead you will see a row of floor beams. These should be spaced evenly, usually every sixteen inches, and be bridged about every eight

feet of their length with crossbraces cut to fit snugly. Look carefully at any joists which have been cut to permit piping.

Evidence of the use of unseasoned lumber in the construction of a house will be plaster cracks, gaps between the bottom of the baseboard and the finished floor, uneven floors, creaking stairs, sticking doors and the opening of mitered joints.

Go upstairs and, as you walk over the floor, notice if it squeaks, or if it seems to deflect or spring under your weight. Neither of these things should happen.

In a new house you should never be able to detect the outline of the wood lath through the plaster.

Inspect as much of the roof surface as possible. No matter what type of covering is used, be sure that flashing of rust-proof material is fitted around the chimney, at vent pipes and skylights, and along the "valleys"—the channels formed at the intersection.

a 1498

Chicago post 8/3/22



Modernistic View of Bankers Trust Building in New York, Obtained by Aiming Camera at It from Top of Another Skyscraper

LOOKING DOWN UPON TOWER GIVES MODERNISTIC VIEW

From the top of a near-by skyscraper, a photographer recently made an unusual picture of the Bankers Trust building in New York. The pyramidlike roof of the structure towering above Wall street presents a modernistic effect when viewed from above, the impression being enhanced by the perspective of straight lines afforded by other buildings.

PILOT FLIES IN THUNDER CLOUD AND FINDS TERRIFIC WIND

To satisfy his curiosity, a pilot making weather tests above the Cleveland airport recently flew his airplane into a thunder cloud to find what was inside. The interior, he quickly discovered, represented anything but ideal flying weather. Describing his experiences, he said tremen-

Ralph C. Wensinger
Cleveland, O

dous air forces gripped his ship and shot it upward at 1,400 feet a minute, pushed it sidewise at nearly seventy miles an hour and released the plane as it reached the top of the cloud. The pilot, flying blind, attempted to dive until his air speed indicator showed 165 miles an hour, but still the ship rose with the air current. A little later, he picked another smaller cloud, and found it even worse, the updraft carrying him to the mushroom top of the cloud where the ascent stopped so suddenly that he was almost catapulted out of the plane.

PORTABLE HEATER USES A VARIETY OF FUELS

a 1595

Gas, electricity, kerosene and other fuels can be used in a portable water heater now on the market. Heat is applied to a water chamber of

copper, and when the water gets hot, it passes up a feed pipe into a reserve tank. From there it flows into a tubular radiator core, through which are passing air currents propelled by a fan. The hot water heats the air currents which are circulated about the room, providing warmth of the desired degree. This process of heating the air also cools the water, which returns to the copper chamber through another pipe. There are no boilers, and the operating cost is low. The heater can be carried with ease.



Emato Mfg Co. Willmar, Minn

Emato Mfg Co
Willmar, Minn
Copyrighted material

9 15 35

Pilots Soon to See Weather by "Radio Eye"

Cml.iland B. Hampton, 509 Madison Ave New York

*Hampton
509
Madison Ave New York*

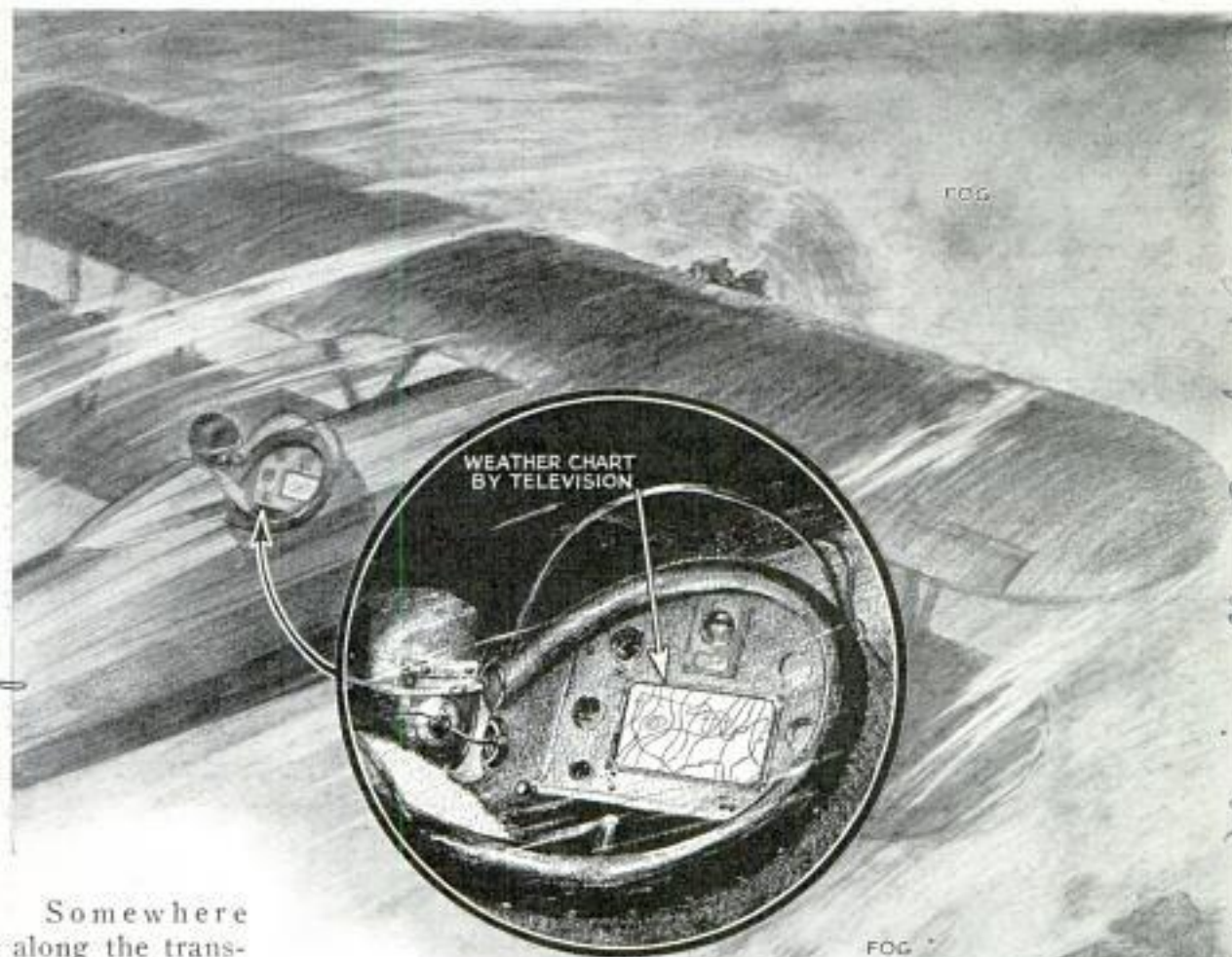

Somewhere along the transcontinental air lines, a great passenger-laden plane is flying above a low-hanging fog. The pilot turns a button on the little radio set beside him and speaks a brief message to the ground. And the answer comes back, not only to his ears but to his eyes. Television brings him an actual weather map—a map that, as it appears on the screen set in his instrument board after its invisible journey, gives him storms, wind, temperature and all other weather data of the area he is approaching. That is a coming possibility in airplane radio communication according to Dr. Gerhard Fisher, research engineer for Western Air Express; a development already being worked out in connection with the highly sensitive and compact receiving set he has just perfected. With the growth of the airline network over the country, came the development of chains of radio stations on the ground, but still a transcontinental plane on its long jour-



ney had to carry on its communication in a hop-skip-and-jump fashion; losing one ground station, picking up another, losing that, reaching out for the next one. With the average receiving set, even the type built especially for airplanes, 200

*head of Radio Laboratories Inc
Los Angeles, Calif*

miles was the limit for voice communication. Experts could and did make sets powerful and sensitive enough to talk and hear more than 200 miles, but they weighed too much to be practical in a plane. So Doctor Fisher set himself the problem of cutting down weight. On an actual test in a plane, his voice traveled more than 700 miles over mountains, des-

erts, farmlands and cities. A little dot in the sky talked with another little dot, while both were racing along at 125 miles an hour. The new receiving set is a six-tube short-wave affair, with every ounce of unnecessary weight eliminated. Instead of operating on the regular electrical equipment of the plane, the set uses its own small but powerful battery.

SOAPBUBBLE MAKES BALLOON OF AMAZING STRENGTH

91584 To determine the tensile strength of a soapbubble and its ascensional power when blown up with hot air, the bureau of standards recently carried out a number of experiments, one of which was to attach an aluminum-wired ring to a huge soapbubble and, with a cat cut from cardboard attached to the ring, make an as-

ension. The wire ring was attached by first soaping it and then pushing it against the bottom of the bubble, where it clung. It was found that the bubble, in comparison with its filmy thickness, has an amazing tensile strength, particularly if glycerine is added to the soap solution. It is so strong that even gasoline vapor may be exploded inside it without it bursting, the bubble merely expanding from the explosion.

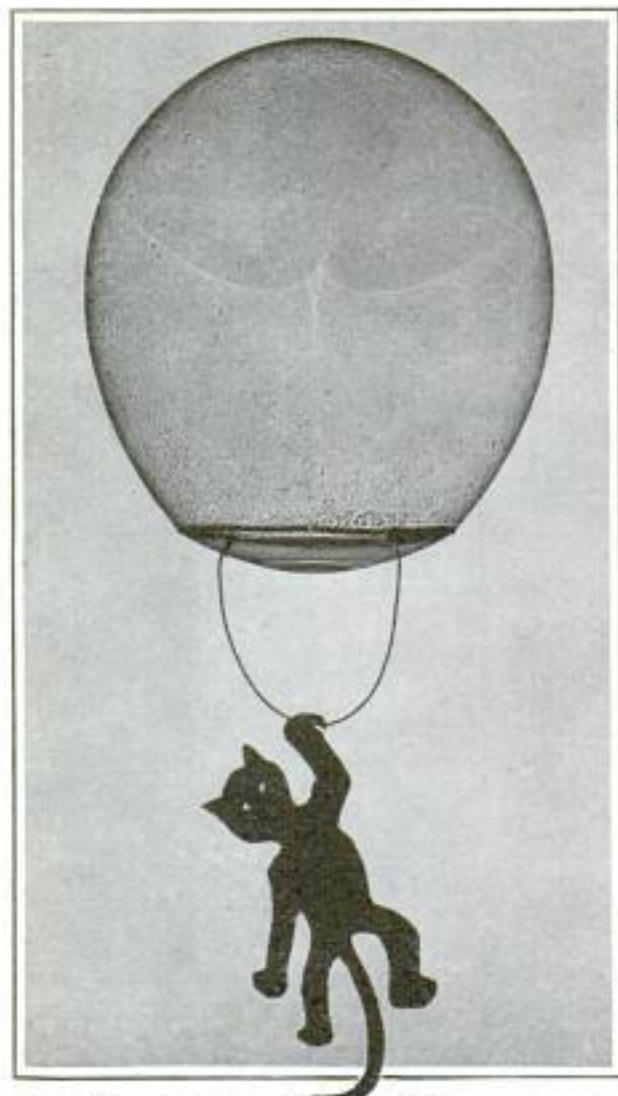

Black Cat, Cut Out of Cardboard, Takes a Ride on a Soapbubble Balloon

PROPER CARE OF YOUR WATCH ADDS TO ITS ACCURACY

91602 Proper care of your watch, such as regular winding and correct handling and carrying, will add greatly to its accuracy. The winding, which should be done at the same time every day, must be made steadily and not too rapidly, and its conclusion should be approached carefully to avoid injury to the spring or winding mechanism. The United States bureau of standards points out that an hour's delay in winding may cause considerable variation in the rate of movement. The watch also varies according to temperature and amount of jar. For instance, a watch carried in the upper coat pocket generally is at a lower temperature and is more frequently disturbed, as well as being held in various positions more irregularly, than in other pockets. This causes loss or gain in time. In a large pocket the watch is apt to turn to the right or left by various amounts, giving irregular rates of movement unless some method of holding it upright is adopted. Perhaps the best method is to keep the watch in a chamois or kid watch bag, such as may be obtained from jewelers, in correct size to fit the watch. The friction of the bag prevents it from turning, while the bag protects the watch and keeps it clean.

Circular # 392

NAVY BUILDS SECRET PLANE TO SEEK SPEED RECORD

World speed supremacy in the air is the objective of engineers who are constructing an airplane engine in secrecy for the United States navy to enter in the 1933 Schneider-cup races. The engine is expected to carry a plane faster than the 375-mile an hour ship Great Britain is entering in this year's race. All details of the new motor are being closely guarded. Great Britain won the 1929 title with an average speed of 328.06 miles an hour. The United States has not won since 1925. The races are held every other year.

21488

RAILWAY BUMPER STOPS AUTO WHEN TRAIN IS COMING

Automobiles are blocked off railroad tracks by a crossing guard which is operated automatically by an approaching train. A model, approved by railway and safety engineers, presents the guard as a steel platform which tilts as it rises from the road on either side of the tracks. The side facing oncoming traffic really is a bumper, equipped with shock-absorbing springs, built to stop an automobile traveling twenty-five miles an hour without serious damage to car or occupants. Autos going at a greater speed also will be halted, with far less damage than if struck by the train. By tilting the guard from the inside, a car already on the crossing can drive off the tracks, thus eliminating the hazard of being trapped by the train.



Rubber Bathing Cap Fitted with Suction Cups around Inside of Rim to Keep Out Water

SUCTION CUPS ON BATHING CAP KEEP OUT THE WATER

Rubber bathing caps with suction cups inside the rim cling to the head of the wearer and keep out water, sand and dirt. The caps have three parallel rows of tiny cups about the edges which, when moistened, adhere firmly to the skin. The headgear is held in place with a band.

ELECTRIC "CHAIR" FOR INSECTS HAULED THROUGH FIELDS

One Nebraska farmer this year saved his crops when they were menaced by grasshoppers by building a portable electric "chair" which killed them by the bushel as it was hauled through the fields by a tractor. The insect destroyer consisted of a system of wires running parallel on a wooden frame and connected to a battery with step-up coils to increase the voltage. The wire frame was mounted on the front of an automobile or tractor.

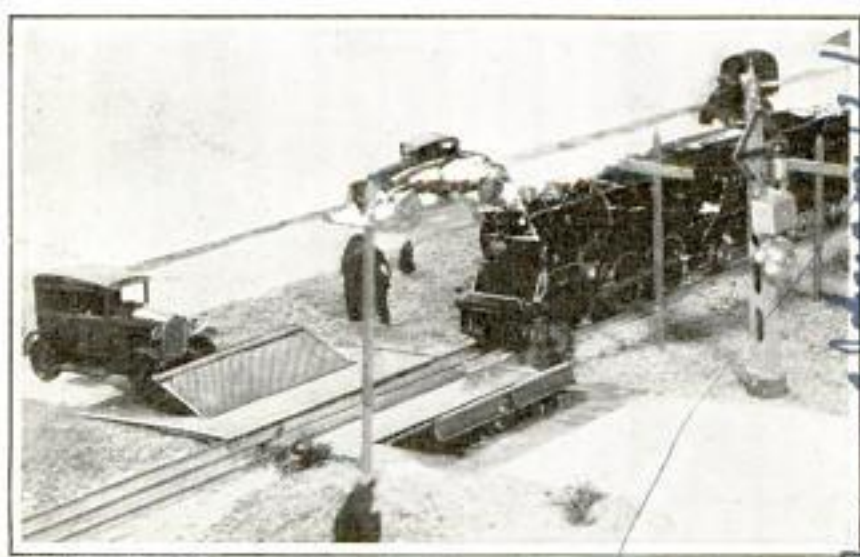

Steel Barrier or Bumper Shown Rising from the Roadway to Stop an Automobile About to Cross the Tracks in Front of a Train

Inv. - William H. Profer, man in
Tulsa, Okla

nebr. copy of material given

Handwritten notes:
Hawland
Chicago, 428 W. Washington
Caulber Co 1720 Broadway New York City

Handwritten notes:
Central Ave
Nebraska City, Nebr

a1389
642

Com. Paul W. Slamm,
Box 1242,
San Antonio, Tex.

POPULAR MECHANICS

Homing Pigeons Are New Oil-Well Scouts



Pigeons Carrying Messages Are Being Released by Oil-Well Workers in Picture at Right; Above, Message Being Received at Operator's Headquarters

Homing pigeons are being used by an oil producer in Texas to carry reports of progress from oil wells in new or "wild-cat" territory to headquarters. The producer, when he introduced the pigeon messenger to the oil fields, was drilling a well 100 miles from his offices, in a district almost impenetrable to autoists. The nearest telephone was twenty-four miles away over a road that was bad in wet weather. In spite of this situation, it was essential that daily reports from the drillers reach the producer. So he pressed the pigeons into service. Each day the drill foreman writes out his reports, attaches them to the metal tube on a pigeon's leg and re-

leases the bird. Within two hours, the pigeon reaches his home loft, near the company's offices.

FEWER FLYERS HAVE TO JUMP INTO CATERPILLAR CLUB

a1477

Only thirty-four new members were added to the Caterpillar Club the first six months of 1931, as compared with sixty-five in the same period of 1930. This organization, composed entirely of involuntary members—those who have had to jump from airplanes to save their lives—has twelve members who have had to jump twice. Among these is Lieut. "Jimmy" Doolittle, who became a member of



the club during the Cleveland air races in 1929. He "took" his "second degree" June 23, 1930, when the fabric tore loose from his wings at a speed of 235 miles an hour. The "monarch" of the club still is Col. Charles A. Lindbergh, who has four emergency jumps to his credit.

Art Corps News Letter
6/12/31

Product Perry H.C. Usage

91506

CAR DETECTS BAD RAILS AS IT RUNS OVER TRACK

Defective rails that track walkers are unable to spot are located and marked by a self-propelled railway car that detects faulty places as it moves along. This mechanical safety patrolman moves over the track at about six miles an hour and operates on the principle that an electric current flowing through a rail must pass around any break in the metal. The car records this electrical deviation and marks the bad spot with a streak of paint. The human eye can see breaks or cracks extending to the surface but the detector car finds faults within the steel itself.

Science Dept 5370
7/18/32

VALVE SEATS LOCKED IN PLACE WITH CEMENT

Valve seats that can be permanently locked in position are being supplied for gas and gasoline engines as replacements for those that have been worn, cracked or burned. After the old seat has been cut out, a recess is bored in the block casting just large enough to receive the valve-seat ring. In the recess and near the bottom, a circular groove is cut in the wall to coincide with the groove in the valve-seat ring and form a mold for iron cement. The ring contains a number of small holes about the groove, each fitted with a sliding steel pin. The cement is used in the plastic state and is placed in the recess and groove in the block and in the groove in the ring before it is driven in, the surplus being squeezed out to leave a circular cement core into which the steel pins are driven to seal, level and lock the valve seat in place. The cement has about the same degree of expansion and contraction as cast iron and eventually becomes as hard as the iron itself.

91540

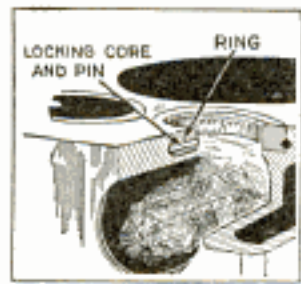

the surplus being squeezed out to leave a circular cement core into which the steel pins are driven to seal, level and lock the valve seat in place. The cement has about the same degree of expansion and contraction as cast iron and eventually becomes as hard as the iron itself.

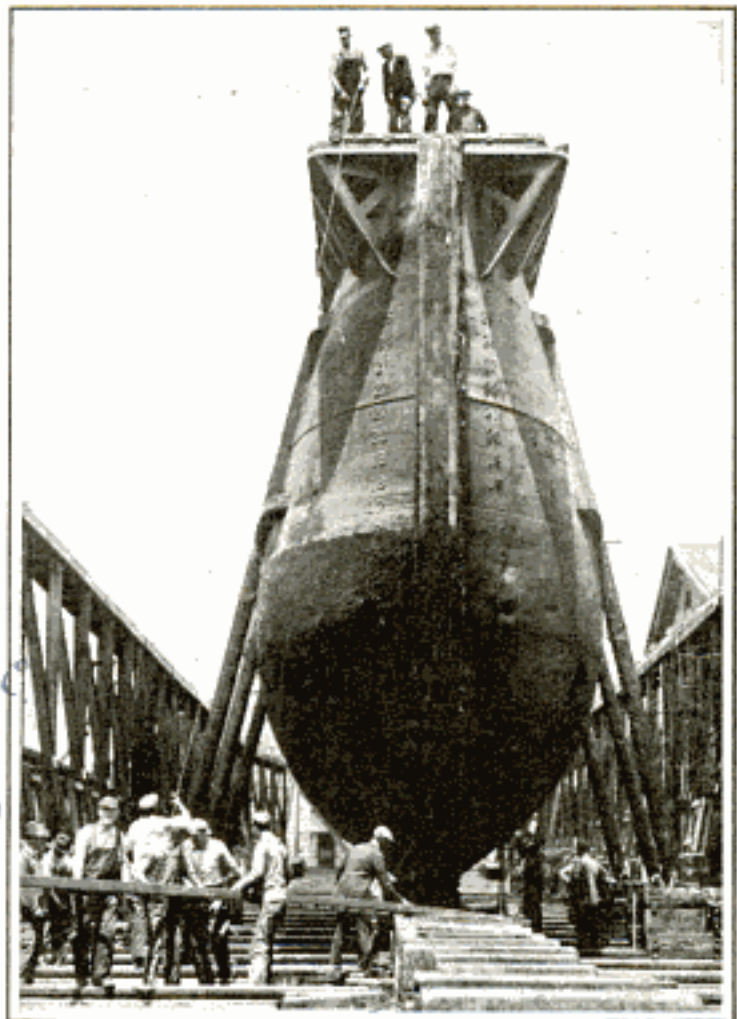

Gate to a Drydock in Boston Navy Yard as It Looked When Placed on the Marine Railway for Repairs

DRYDOCK GATE LIKE BIG BOAT IS OVER THIRTY FEET HIGH

Visitors to the Boston navy yard recently observed a huge structure that might easily have been mistaken for the hull of a big ship or a giant rocket standing on end. Instead, it proved to be the gate to a drydock which was placed on the marine railway for repairs. It towered some thirty feet above the runway.

SEE YOURSELF LIKE OTHERS DO IN RIGHT-ANGLE MIRROR

Seeing yourself as others see you is possible now by looking directly into a mirror invented by Prof. Elihu Thomson. This mirror, which has twin glasses set at right angles, reflects a double reverse image, or exactly as the person appears to others. Print held before the ordinary mirror reads backward.

91560

Wm. L. Free & Smith
Smith Machine Works
Box 261, Santa Paula, Calif

Lynn,
Copyrighted material



box spans oceans and continents. The efficiency of the superheterodyne circuit, especially for short waves, is established and this converter makes a short-wave super out of the modern receiver. The converter supplies the oscillator and first detector, and the broadcast receiver the intermediate-frequency amplifier, second detector and audio amplifier.

Excellent selectivity is obtained with this arrangement, although the selectivity depends somewhat on the same quality in the broadcast receiver. The modern broadcast set provides 10 to 20-kc. station spacing, and this band-pass effect allows needle-sharp tuning with the converter. Fairly broad-tuning receivers will give even greater se-

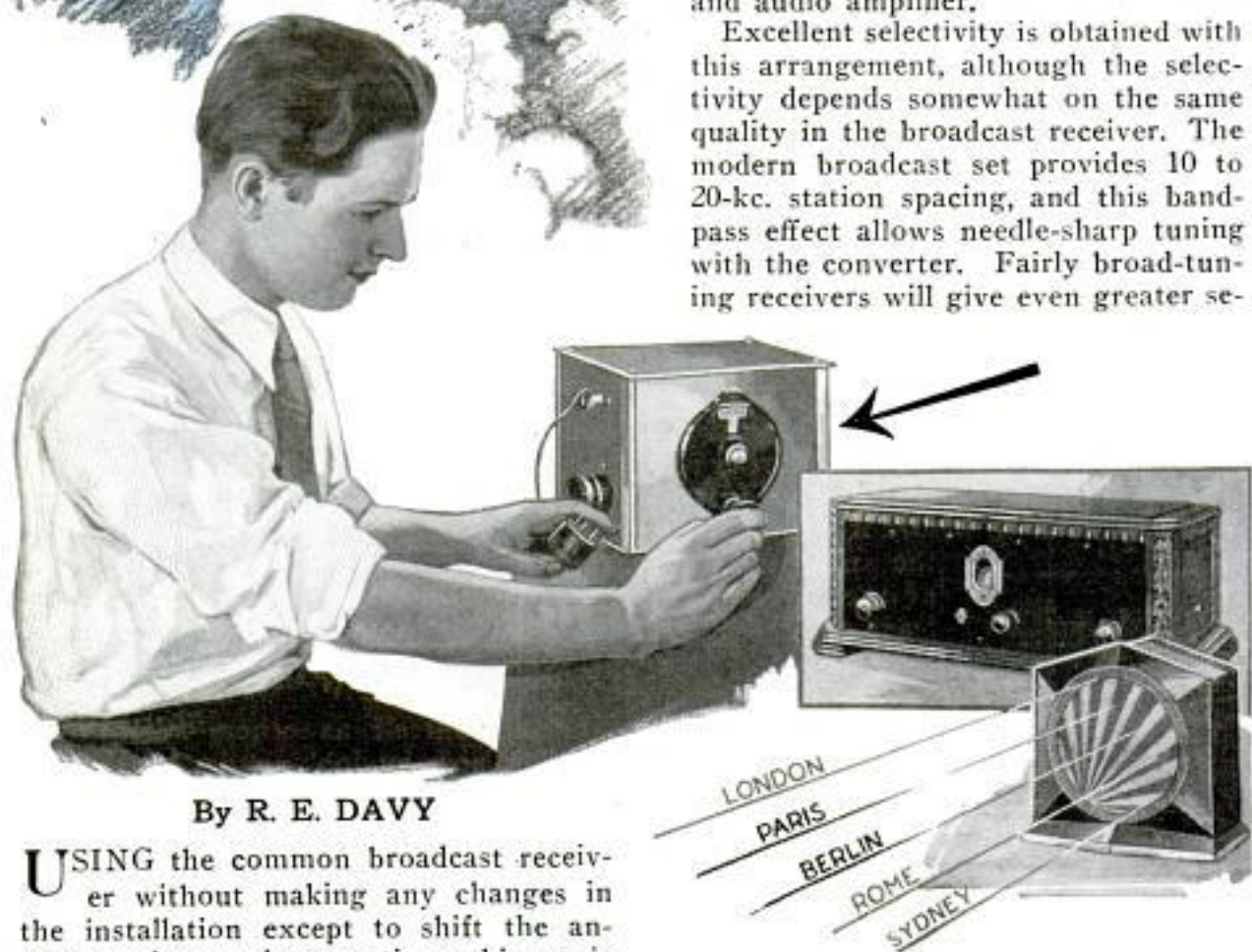

By R. E. DAVY

USING the common broadcast receiver without making any changes in the installation except to shift the antenna and ground connections, this magic

WORLD TO YOU

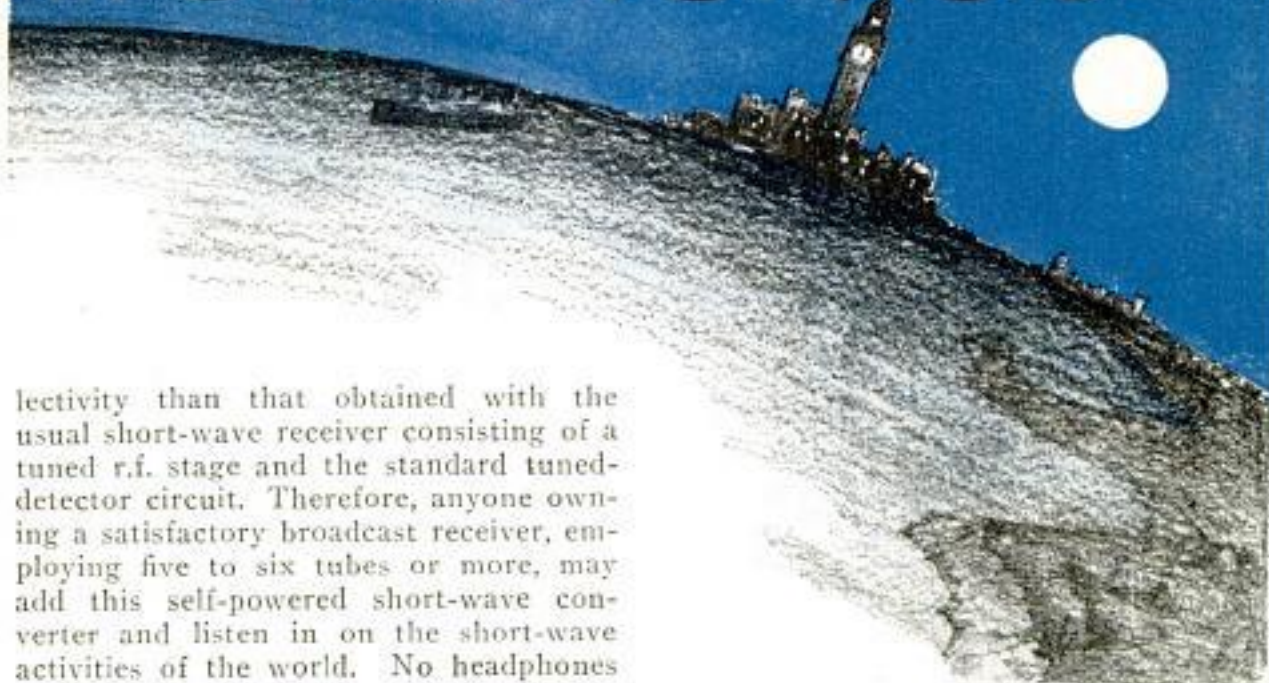

lectivity than that obtained with the usual short-wave receiver consisting of a tuned r.f. stage and the standard tuned-detector circuit. Therefore, anyone owning a satisfactory broadcast receiver, employing five to six tubes or more, may add this self-powered short-wave converter and listen in on the short-wave activities of the world. No headphones are required.

The super short-wave converter has another advantage in that, when receiving modulated signals, extremely fine tuning may be obtained by adjusting the controls on the broadcast receiver.

Owing to the small size of the converter and the simple connections, it may be tucked under the arm and tried out on your friends' receivers with a minimum of trouble as shown in the upper photo on page 647. To make the connections, merely remove the antenna and ground leads from the receiver and connect them to the corresponding posts on the converter. A second antenna post on the converter is then connected to the antenna post on the receiver with a short lead, and the power supply to the converter is plugged into a convenient 110-volt a.c.

outlet. When plugged into a lamp socket, no other external switch is necessary, but, when plugged into a service outlet, a snap switch in series with the power-supply lead, near the converter, will be found convenient.

Tuning is extremely simple. The broadcast receiver is turned on and the volume control turned full on. Tune to a point on the broadcast set where no stations are heard, which is usually found at the extreme top or bottom of the dial. Now slowly rotate the dial on the converter until a short-wave station is heard. The signal volume may then be regulated with the volume control on the set. Try different dial settings on the broadcast set for best reception, bearing in mind that each

What IT WILL Do

HERE are some of the things this short-wave converter will bring in on the loud speaker of your present set:

The chimes of "Big Ben" in London and programs direct from all parts of Europe.

Mexico, Cuba and Australia are easily within your reach.

Liners talking at sea, explorers in distant lands, airplanes and time signals.

It will open a new radio world of romance and adventure to you.

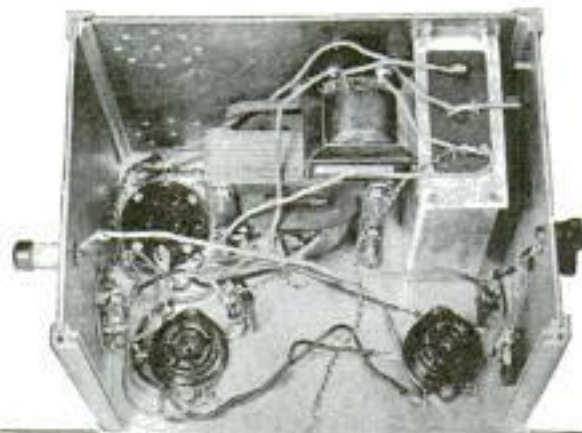
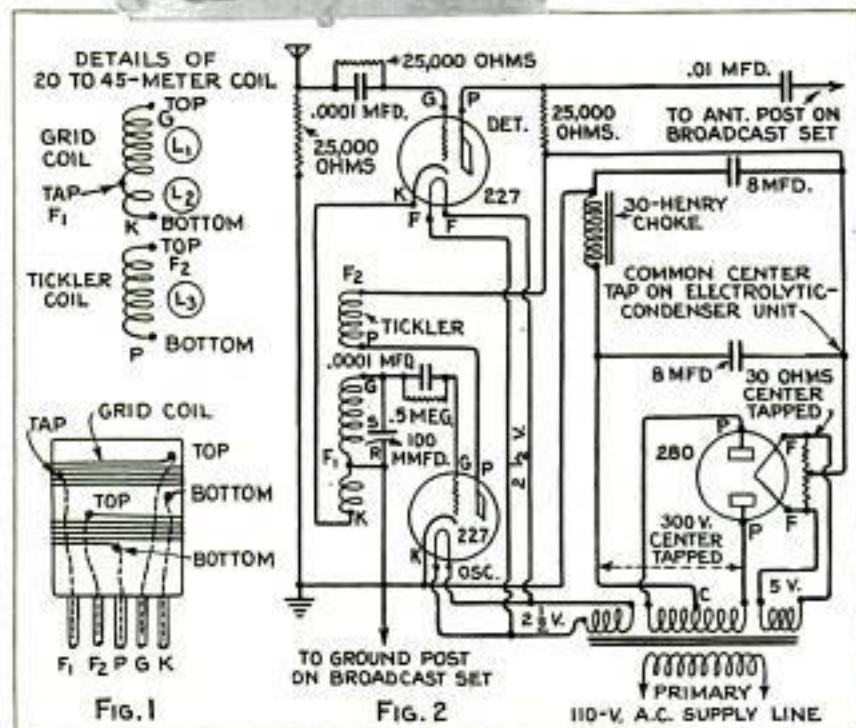

plate supply, is housed in a non-magnetic can, $5\frac{1}{2}$ in. deep, $7\frac{3}{8}$ in. long and 6 in. high. This can is made up in the usual stage-shield manner, employing four slotted corner posts to hold the sides, while the top and bottom plates overlap. Machine screws in the corner posts at top and bottom hold the assembly together. This construction is clearly shown in the photos. The top and bottom plates are 6 by 8 in., the sides 6 by $5\frac{1}{2}$ in., and the front and back panels, 6 by $7\frac{1}{2}$ in. All these panels are cut from .088 gauge eraydo or aluminum stock, and the aluminum corner posts are 6 in. long.

Looking at the assembled can from the rear, a hole is drilled just above center to take an insulating grommet through which the power-supply cord is to be passed. A series of small ventilating holes are drilled near the right edge, at top and bottom. Viewing the can from the front, the left-side panel is drilled to take



change of the dial on the broadcast receiver also changes the intermediate-frequency, thereby causing a change in the dial reading of the converter. However, when the best setting on the broadcast receiver has been found, short-wave stations can be logged on the converter and will be found at the same dial reading each time.

When using the converter with a broadcast superheterodyne receiver employing an antenna choke coil, the antenna lead from the converter should be connected directly to the plate of the first r.f. tube in the receiver. When used with superheterodyne sets without the r.f. choke, the antenna connection is made to the first detector plate. These exceptions refer to superheterodyne receivers only.

Now for the construction details. The converter, including its own filament and

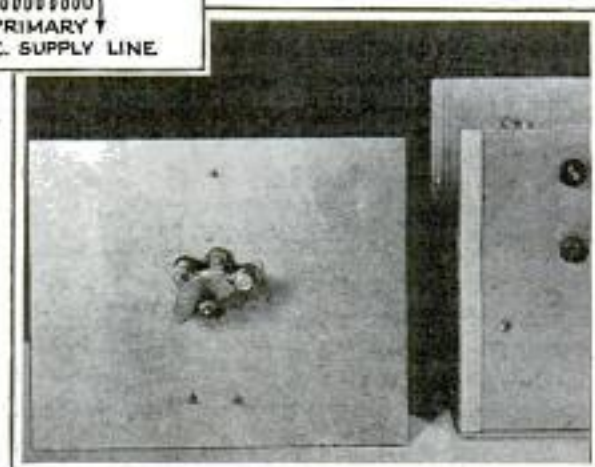

the single insulated antenna binding post, and a cut-out is made for the five-contact socket for the plug-in coils. This side view is given in the lower photo on page 647. An insulated binding post for the antenna lead from the receiver and a binding post grounded to the can, for the ground lead that formerly went to the receiver, are mounted on the right-hand

Practical Ideas

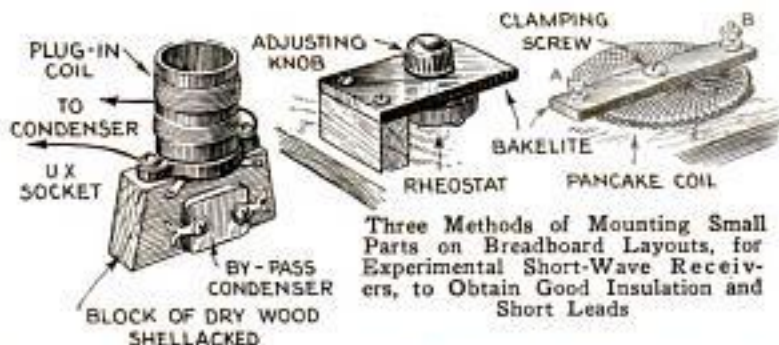

Three Methods of Mounting Small Parts on Breadboard Layouts, for Experimental Short-Wave Receivers, to Obtain Good Insulation and Short Leads



Left, Short-Wave Coils May Be Strengthened by Means of Three or Four Celluloid Strips Fastened with Collodion before Removing Coil from Form



Right, Added Strip-Brass Contact Cuts Out All Resistance When Full Current Is Required

Small Double-Pole-Single-Throw Switches Mounted on Transmitter Panel to Shift Multi-Range Voltmeter for Different Circuit Readings

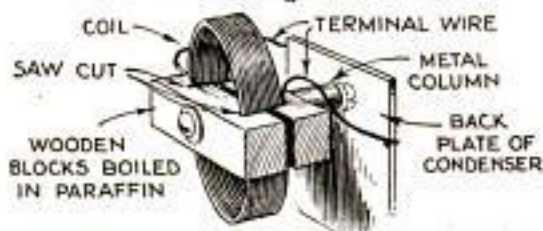

Cathode Prong Clipped from 227 for Neutralizing, for 226-Clip Filament Prong

This Rugged Support for Wave-Trap Inductance May Be Quickly Adapted to Any Coil and Will Hold It Firmly without Affecting Its Efficiency

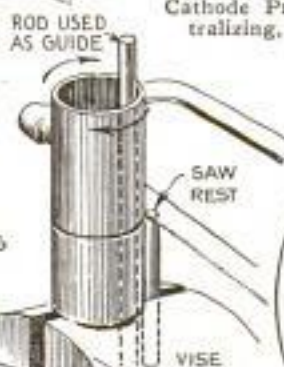
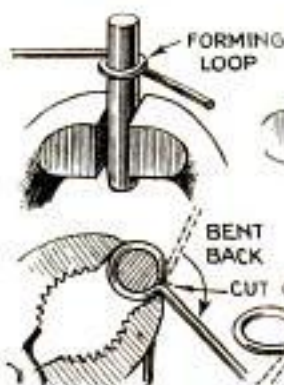

Above, Saw Rest and Guide for Cutting through Bakelite Tubing Squarely

Left, Quick Method of Forming Heavy Copper Wire into Neat Terminal Loops; Above, Y-Type Spring-Suspended Socket for Panel Mounting Is Provided with Drilling Template

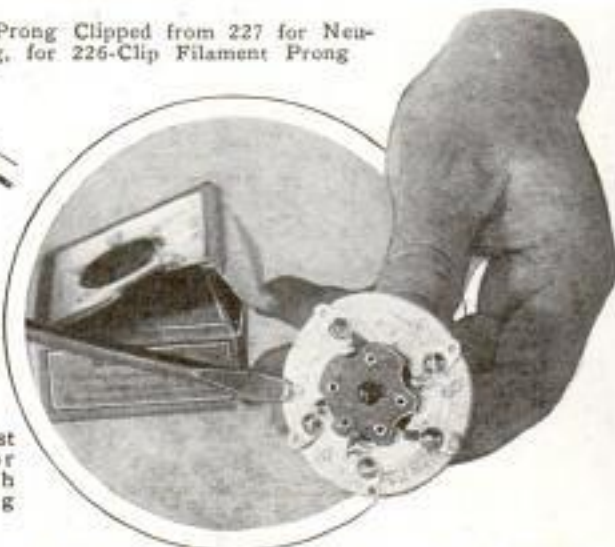

Benjamin Elec. Co.
Chicago, Ill.
 Copyrighted material

*Western Electrical
Instrument Co
618 Wabinghousen
Newark
N.J.*

for the Radio Experimenter

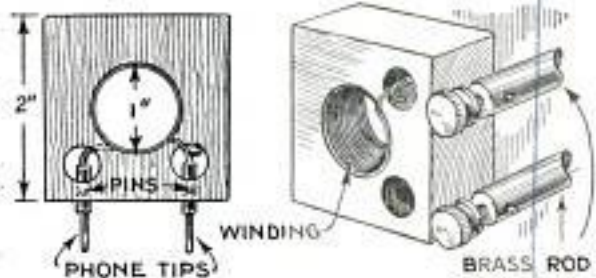

Fragile Short-Wave Coils Inserted in Wood Blocks, Boiled in Paraffin, Are Easily Mounted as Shown

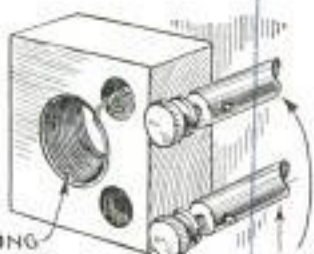

BRASS ROD FASTENED TO TUNING CONDENSER

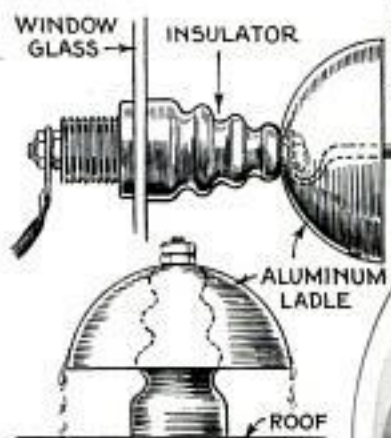

Portable Output Meter Handy for Checking Receivers and Public-Address Systems

Above, Aluminum Ladle Used as a "Corona-Shield" on Amateur Transmitter Line Insulator; Lower Sketch Shows Same Idea for Rain Shield

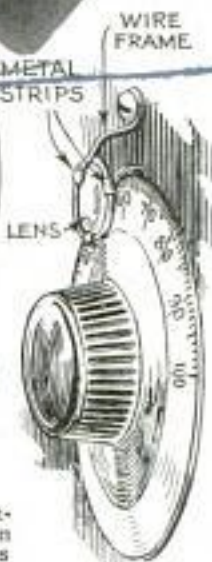
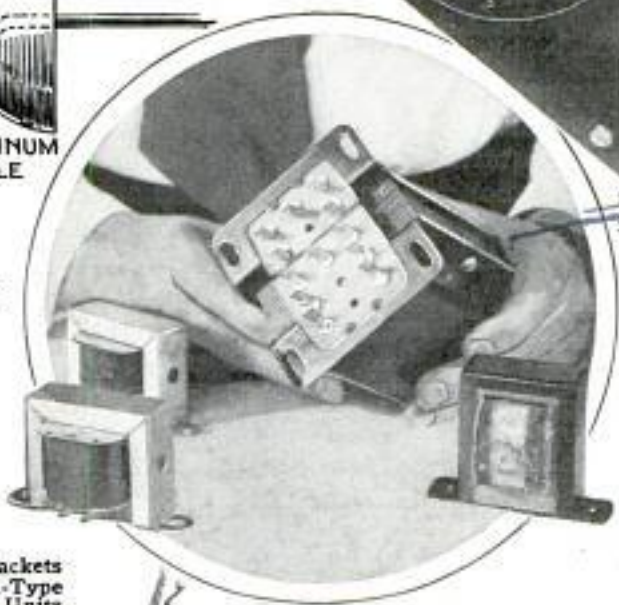

Right, Small Lens Mounted in Wire Frame Aids in Reading Precision Dials on Testing Apparatus

Below, Handy Spring-Clip Brackets for Mounting Large Vitrified-Type Resistors in Amateur Power Units

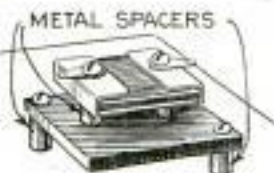
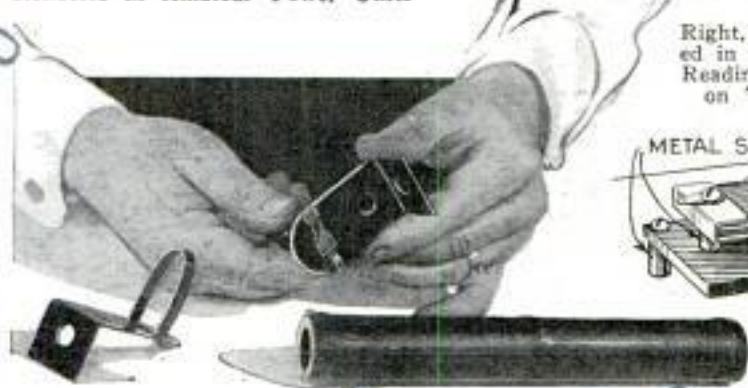

Left, Homemade Mounting Bracket for Fixed Condensers or Other Parts That Must Be Well Insulated from the Metal Chassis; the Base Is Made from Scrap Bakelite Supported above the Chassis by Short Pieces of Brass Tubing through Which Machine Screws Are Inserted

*Replacement Chokes and
Transformers
Chicago
2626 W. Washington Blvd. Chicago*

Chi. 530 Jackson

*Ward Leonard Co
South and Pearl
Mt. Vernon N.Y.*



The illuminated method of visual tuning is similar to the meter system recently introduced, where the dial is rotated for the greatest swing of a needle. In this case, a column of brilliant light rises, in a gas-filled tube, to its maximum height when the station is accurately tuned in and then gradually diminishes as the station is passed. The

tube is inserted in a bayonet socket which is mounted directly above the tuning dial. Extraneous noises, such as static or other electrical disturbances, do not influence the light column. Thus the speaker can be cut out with a switch while tuning across the dial, so that no signals are heard until the desired station is located.

Uses for Old Condensers

Variable condensers salvaged from obsolete receivers are useful additions to the experimenter's junk box. They may be altered to fit into experimental hook-ups where the builder does not care to go to the expense of new condensers until after test. For short-wave receivers many of these old broadcast condensers may be torn down and made over for lowered capacity. Stator plates need not be removed; for the average short-wave receiver, remove all the rotary plates, except two or three, in such a manner that the remaining plates are evenly spaced. The discarded plates may be cut up and used to make small angles, connecting strips and other radio hardware. These plates may have been coated with lac-

quer, and this must be removed before making soldered connections. The brass columns may be used for supporting coils or as shafts for vernier condensers.—R. J. Plaisted, Brecksville, Ohio.

Magnetic Speaker as Microphone

A magnetic cone speaker may be used as a microphone for home broadcasting, on a receiver that is equipped with a phonograph pickup, by merely connecting it in place of the latter. The voice is amplified by audio stages of the receiver and issues from the speaker in the set at greatly increased volume. The speaker used as a microphone should be placed at some distance from the reproducing speaker.—Leo J. Sands, Everett, Wash.

Antenna Sticks like Adhesive Tape

This handy antenna is rolled up like ordinary friction tape with the clip that fits under the set binding post attached to the end as shown. It consists of a 50-ft. strip of metal foil backed with rubber adhesive. To install, the clip is fastened to the set, the antenna is unrolled with one hand and pressed against the wall, or baseboard, with the other. It is extended until the particular set in use shows the proper selectivity and may then be terminated. It is claimed, that the entire 50 ft. is not required, owing to the high capacity and inductance of the antenna.



For further information on any radio construction article write to the radio department; this service is free.

Sampson Industries Inc.
 4225 Olive St.
 St. Louis, Mo

605 W. Washington

605 W. Washington

Building a Heavy-Duty Filter Choke

By S. H. BURNS

MANY filter chokes with inductances ranging from 20 to 30 henrys have this value only when carrying comparatively little current. A good heavy-duty choke must carry and filter at least 80 or 90 milliamperes in the power-supply unit of a modern radio receiver.

The choke to be described, which can be built by any experimenter at small cost, has a 30-henry inductance when it is carrying 100 milliamperes. Various filter circuits require different choke arrangements, and these variations have been provided for in the construction details.

The coil is wound with many turns of enameled wire on a form, or spool, that will hold it in shape while being wound and assembled. A wooden block for this purpose is detailed in Fig. 1 and is 2 by 1 by 1½ in., the 1-in. dimension being made a little full to give ample room for the laminated core. A ¼-in. hole is drilled through the length of this block. The center portion of the bobbin, or spool, may be made

in Fig. 3. A cut-out is made at the center, and the corners are slotted to fold back on the dotted lines. These pieces are slipped over the form at each end with the flaps toward the inside. The flaps are then glued in place with the outer edges parallel

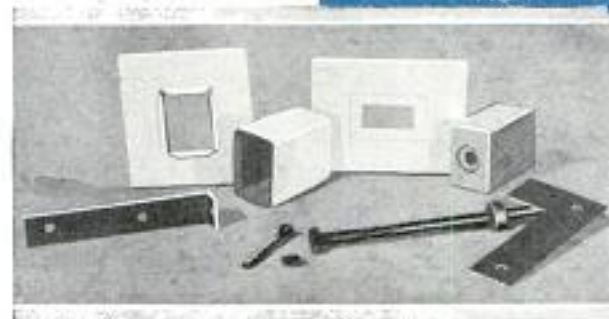
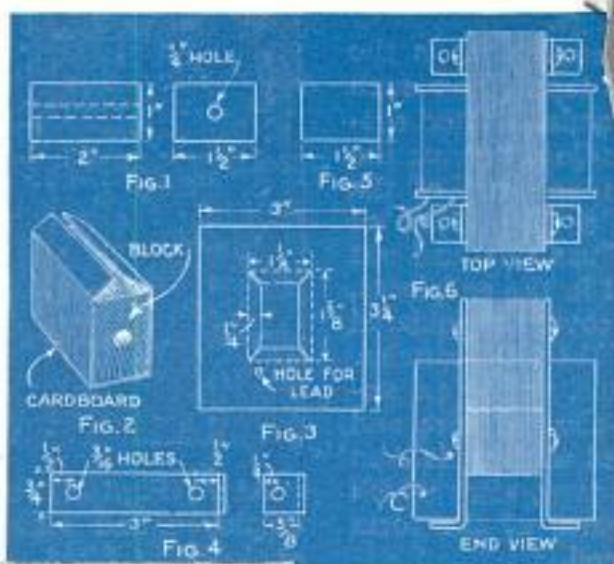

from a piece of cardboard, 2 in. wide. The joint should be along the center of the 1-in. edge and must be a butt joint as shown in Fig. 2.

The ends of the bobbin are cut from two pieces of 3/16-in. cardboard as detailed

to the ends of the wood block, and a layer of tape is wound over the surface of the bobbin.

Two pieces of cigar-box wood, 3 by 3¼ in., are used to strengthen the cardboard ends while the coil is being wound. A ¼-in. hole is drilled in the center of each of these pieces. To assemble the bobbin for winding, a ¼-in. machine screw, 3½ in. long, is required. This is inserted through the wood endpieces and the block. Large nuts hold the assembly together so that the bobbin cannot rotate on the screw.

A coil winder with a turn counter should be used, but if this is not available, a hand drill clamped in a vise will do. In this case, the gear ratio of the drill is determined. For example, if one turn of the handle revolves the chuck four times, only one-fourth as many turns of the handle

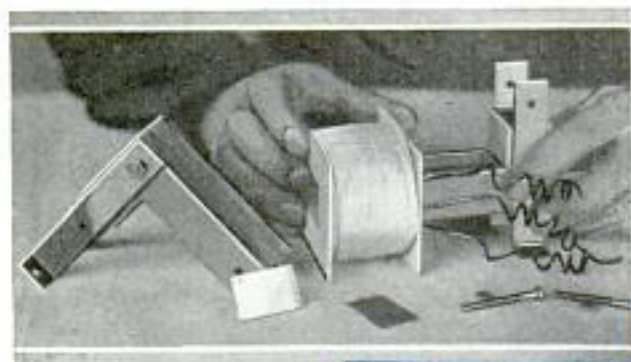

are needed to wind the coil as there are turns on the coil. It is made up of 7,400 turns of No. 30 enameled-copper magnet wire. The turns are wound evenly in layers, thin sheets of insulating waxed paper being placed between adjacent windings.

The first coil to be considered is the 30-henry choke without taps. Two such chokes are used in standard filter systems. To start the winding, remove the enamel insulation from one end of the wire and solder to it a 12-in. lead of rubber-covered wire. Pass this lead out through the hole drilled in the endpieces, as shown in Fig. 3, and cover the soldered joint with tape. When the total number of turns have been made, solder on another length of rubber-covered wire and bring it out. The finished winding is then covered with a layer of tape, after which the screw and wood parts of the form are removed from the coil.

Before taking up the details of the core, other types of coils will be described. The coil for a center-tapped choke is practically the same as the one described with the exception of the center tap. This tap is soldered to the 3,700th turn, and is brought out through a hole in the coil end in the same manner as the lead at the start of the coil. The method of joining the lead without cutting the wire is shown in the upper photo on page 651.

For a choke-input filter, the tap is so located that the first section of the coil will have an inductance of about 6 henrys, and is soldered to the 2,600th turn.

The core is made up of thin steel lam-

inations, which are available, in the shape shown in Fig. 7, already punched and ready for assembly. Four straps of $\frac{1}{16}$ -in. brass or aluminum, as detailed in Fig. 4, are needed for assembling the core. About 210 laminations are required, and these are divided into two equal piles.

When assembling the core, an air gap of .022 in. is maintained at each joint. Fiber strips, cut as shown in Fig. 5, are used, and two are required for each core. One pile of the laminations is inserted in the coil and the other butted together with the fiber separators in place, after which the straps and machine screws are used to hold the assembly together as shown in Fig. 6.

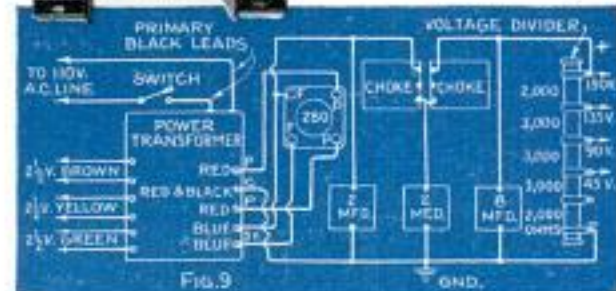
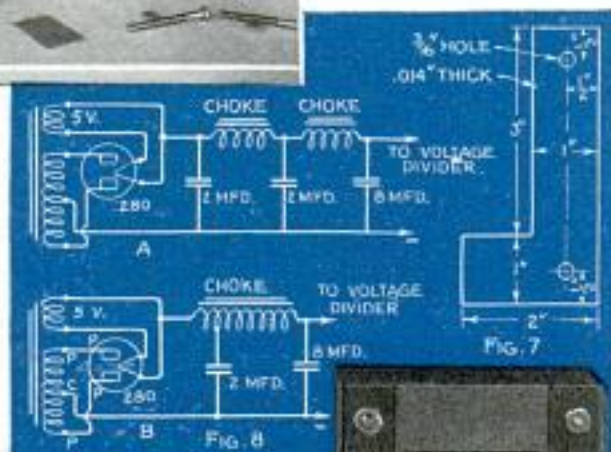

At A, Fig. 8, two straight chokes are employed, and B gives the circuit for the choke-input filter. Fig. 9 shows two of the straight chokes used in a complete power unit employing the homemade power transformer described in the May, 1931, issue, diagrams of which are available.

The filter condensers shown in the diagrams should be capable of continuous operation on 400-volt direct current.

Quieting a Noisy Volume Control

Crackling sounds, which occur when the volume control is adjusted, may be eliminated by applying a little machine oil to the resistor winding. This can be done with a brush or strip of paper.

*Sparks, Wallington
Jackson, Mich 653*

New MU-Tube Is Variable

Designed for more uniform performance, and for the simplification of modern receiver circuits, the new variable MU screen-grid tube is coming into general use. It permits stronger signals to be fed into the r.f. amplifier without causing "cross talk." Hence the ratio of the desired signal to the noise level is raised, eliminating hissing common in sets employing several pre-selector stages. One of the most important advantages of using this tube is that it eliminates the need for various controlling devices heretofore employed to compensate for the difference between distant and local signals. In a set employing the new tubes, there is no need for the antenna and ground shunting potentiometer, the local-distance switch, the double pre-selector and other compensating means.

Meter Indicates Effective Phone Output

Amateurs operating radiophones may now read the percentage of modulation directly, keeping a continuous check on the effectiveness of the station output. The model-558 Weston meter used is a rectifier type with the scale calibrated in percentage of full modulation of the transmitter. The complete unit consists of the meter and an external shunt box with four binding posts. Two of the latter are connected in the plate circuit of the modulated tube, and the other two to the instrument, which may be placed at any convenient location.

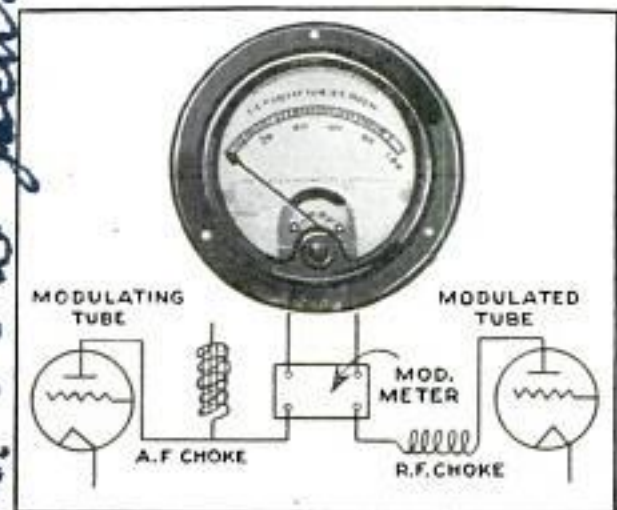

Modulation Meter, and Diagram Showing Its Position in the Radiophone Circuit



Home Talkie and Radio Installation Showing Film Reels and Screen in Position

Home Movies Combined with Radio and Phonograph

All in one compact unit, this radio and home-talkie installation provides about all anyone could expect in the way of entertainment with the exception of television. Either the phonograph or radio may be used without the pictures, or the pictures may be shown in combination with either radio or sound effects. A turntable is so arranged that it can be operated at 33 revolutions per minute, which is the speed used for talking pictures, or 78 r.p.m., the speed for phonograph records. The threading of the 16-millimeter film is simple, and can be done by anyone after a few minutes of instruction. Quickly placed in operation, it is recommended for schools, clubs, children's camps, etc.

Blueprints covering radio construction articles in past issues can be obtained for 25 cents each; material lists are always available without charge.

Chi. 53 W Jackson Blvd

*Weston Electrical Instrument Co
618 Frelinghuysen Ave Newark, N.J.*

R. F. Amplifier for the Amateur Transmitter

One or more stages of amplification are necessary for the maximum power output of a crystal-controlled oscillator. The modulated

type of .00033-mfd. capacity. The tank coil consists of 15 turns, of the above dimensions, wound in the same direction. It is mounted on porcelain stand-off insulators on the panel directly behind the plate milliammeter. The r.f. choke coil in the high-voltage lead consists of 100 turns of No. 30 s.c.e. wire wound on a bakelite tube 1 in. in diameter. The other r.f. choke may be an S-M 277 or similar type. The bakelite front panel is $\frac{1}{4}$ by $17\frac{1}{8}$ by $11\frac{1}{2}$ in. The .0001-mfd. neutralizing condenser, not shown in the photo, is mounted on porcelain stand-off insulators in an upside-down position on the underside of the speech amplifier unit above. It is placed directly behind the 503-A tube.

The leads in the tank circuit should be as short and direct as possible. They are made with heavy copper braid and terminate in spring clips for adjusting the coil turns. The small fuse in the lead to the milliammeter is mounted on the stand-off insulator at the right.

(To Be Continued)



r.f. amplifier, to be added to the output of the buffer stage in the unit described in the September issue, is quite simple. It is tuned to the same crystal frequency in the 80-meter band and may be doubled to 40 meters as desired. This 503-A r.f. amplifier, added to the oscillator and buffer stage, makes an ideal 50-watt short-wave transmitter when keyed in the center-tap lead of its filament supply. The separate antenna-tuning condenser and coupling coil are shown in the upper photo. Only one 1.5-amp. thermocoupled antenna ammeter is required, but two may be used if desired; the capacity of the antenna-tuning condenser is .00045 mfd. The coupling-coil inside diameter is $3\frac{1}{4}$ in. and consists of 9 turns of $\frac{1}{4}$ -in. copper tubing. It is mounted on a hinged, bakelite bracket to be fastened to the transmitter frame near the tank coil. The adjustable 12-in. bracket permits simple coupling and easy clip-lead alterations. The r.f. tank condenser is a heavy-duty

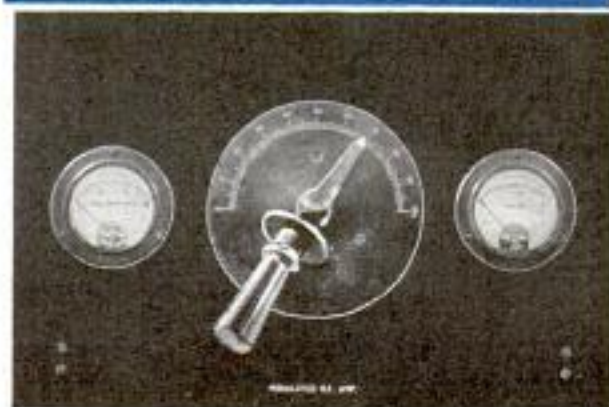
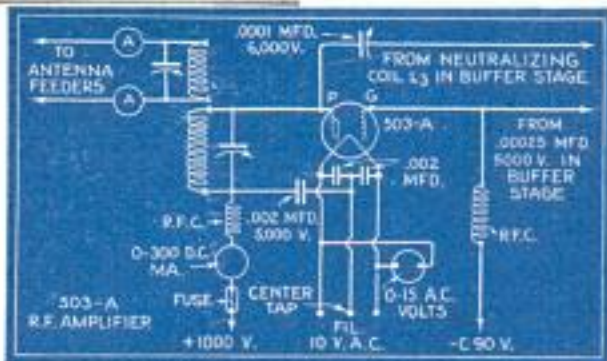



AMATEUR MECHANICS

Fun with PAPER PUZZLES

ONE of the best of all paper brain-teasers is the bell puzzle. Cut an oblong piece of stiff paper or cardboard, fold it in the center, and cut a bell as shown in Fig. 1. Cut two pieces of paper to rectangular shape, each having a slot in the center. The opening in the smaller one should be too narrow for the bell to be passed through. You can easily gather the relative sizes of the various pieces from the details. Take the large rectangular piece and bend it over lightly in half, without creasing the paper, and then slip the small rectangle over the lower projecting arm. Next, open up the folded bell and slip it over the lower part, after which the small rectangle is slipped over the end of the prong and onto the bell. When the assembly is straightened out it appears as in the top photo. If the folding of the original bend has been carefully done,



Try to Unfasten the Bell: It's Easy When You Have Learned How

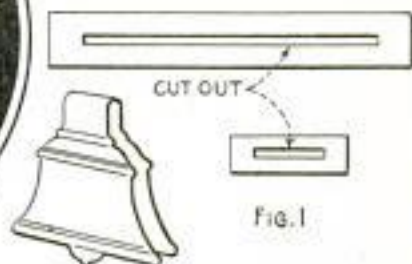
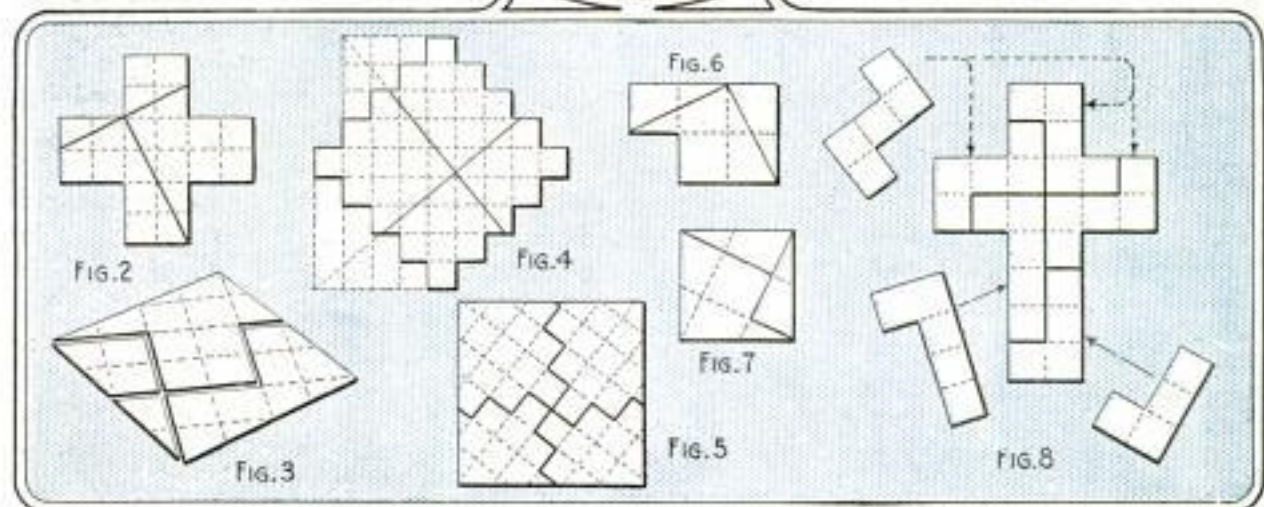

Fig. 1



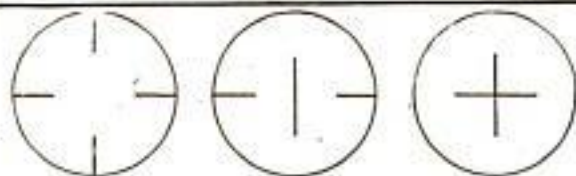

FIG. 9 SHORT CUTS = $\frac{1}{4}$ DIA., LONG CUTS = $\frac{1}{2}$ DIA.

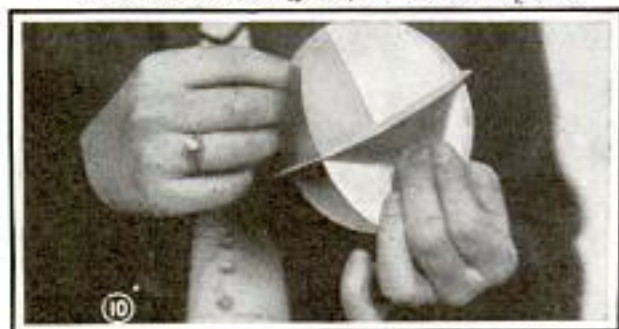

FIG. 11

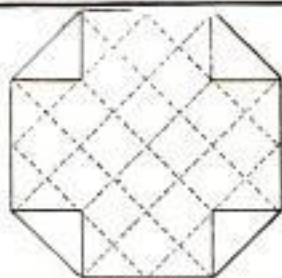

FIG. 12



FIG. 13



FIG. 14

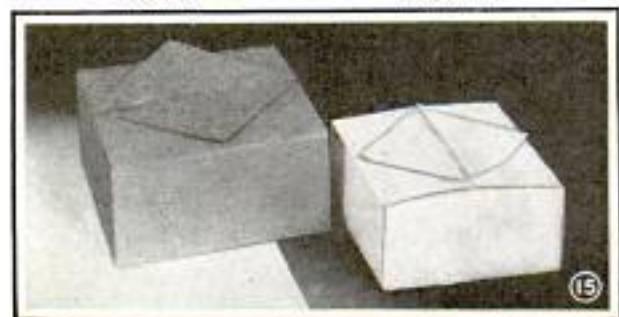

no trace of a crease will be visible, and it will seem impossible to remove the ball from the crosspiece without tearing or bending it. The way of doing this is, of course, merely a reversal of assembling it.

The procedure in the construction of cut-outs, pictured in Figs. 2 to 8, is the same; the paper must be ruled to the proper shape, squared and cut out carefully. A soft eraser should be used to remove pencil marks. Request the spectator to divide the figure with two straight cuts so that the resulting sections can be placed together to form a square as in Fig. 3. Another tricky puzzle of this type is the "crisscross" puzzle, Fig. 4. Here, too, the paper must be divided into four pieces with two straight cuts so that the parts can be joined to form a square as in Fig. 5. The "House-and-Ell" puzzle, shown in Figs. 6 and 7, must also be placed together to form a square. Fig. 8 shows a Latin cross, which is cut out as indicated. In this case, the idea is to form a cross from three L-shaped and two other duplicate pieces cut out exactly as shown.

A clever little paper trick is the "Puff Ball," and you'll scratch your head in assembling it even after you are acquainted with the "how." Cut three circular pieces of stiff paper, about 3 in. in diameter, and make slits with a sharp knife or razor blade as indicated in Fig. 9. Lightly fold the two sides of the left-hand piece together and pass the upper half of this disk through the center cut of the second piece. After getting the paper through the slit, open up the fold, and you will find yourself with the two circular pieces joined at right angles. Then fold the four top halves of these two pieces and pass them through the cross cut in the remaining disk. This can best be managed by holding the folded ends lightly between the four fingers of the right hand, using the left hand to spread open the cuts of the remaining disk. After getting the pieces through the cut, they should be straightened up, so as to form a ball as shown in Fig. 10. The puzzle, of course, is to take the ball apart. And a still bigger job, after the ball has been worked apart without tearing any of the disks, is to put it back together again.

Another puzzle, which is based on the

same interlocking principle, is the "Puzzle Box." To make this, take a piece of paper 8 in. square and fold it diagonally from corner to corner each way. Then fold each corner to the center, as shown in Fig. 11. Open up the paper and fold each corner to the crease just made, as shown in Fig. 12; also make other folds as indicated by the dotted lines. Now cut out the shaded triangular portions as in Fig. 13, and also make slits in the paper as indicated by the heavy lines, forming a piece as in Fig. 14. All that remains to be done is to bring one corner over to the opposite corner, folding the sides of the former lightly so that they can be pushed through the slit in the latter. The fold is opened up after being pushed through the cut, and a similar operation is performed on the two other corners. This will give a neat little puzzle box like those shown in Fig. 15. The idea is to get the box open without tearing it.

A Small Wooden Bank to Save Your Dimes

Two wooden blocks, with $1\frac{1}{2}$ -in. holes drilled in the center and glued together, form a small coin bank that cannot be opened without destroying it. The holes are drilled to a depth of $\frac{3}{4}$ in. in each block, and a groove of suitable size is cut in one block for a slot. Four pins with the heads removed are driven at an angle into the blocks under the slot so that the coins cannot be shaken out. If desired, the bank can, of course, be made larger than the one shown here.

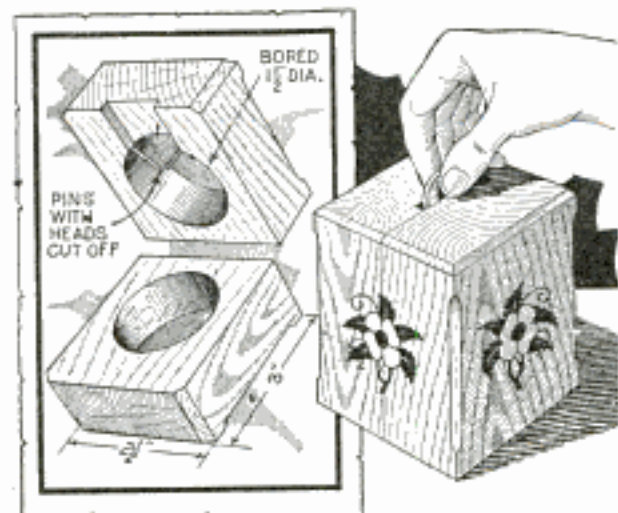

This Wooden Coin Bank Is Glued Shut and Cannot Be Opened without Breaking It

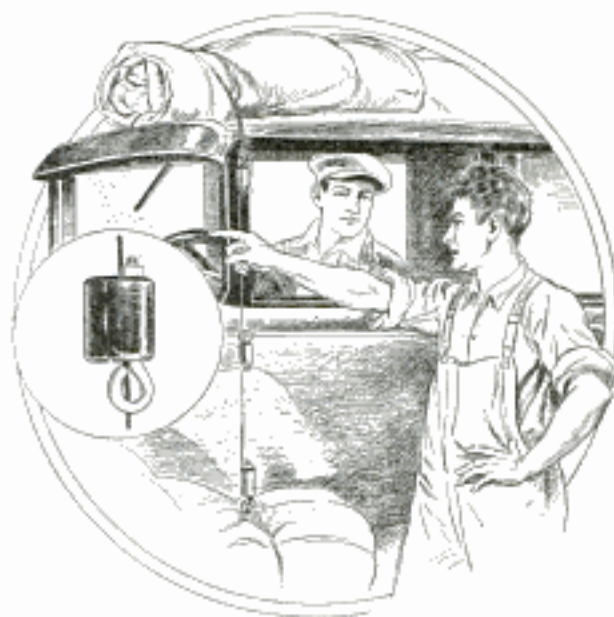

Baggage Held on Car by Means of Eyebolt Anchors Which Replace the Hinge Pins

Eyebolts in Car Hinges Provide Anchorage for Baggage Ropes

By removing the pins in the door hinges of your car and replacing them with eyebolts of the proper size, an anchor for fastening baggage ropes can be provided. The upper hinges serve for baggage on the roof of the car, while ropes holding baggage on the running boards can be tied to the lower hinges.

Golf Tee Replaces Button on Cable Release of Camera

When the steel button on the cable release of my camera broke off, I replaced it with the head of a celluloid golf tee. It was cut off about $\frac{1}{8}$ in. from the head and a hole drilled in it to take the cable. The wire was roughened and cemented in place with ambroid cement, or, if desired, a cement of celluloid dissolved in acetone and alcohol with shellac added may be used.—H. C. Roberts, Urbana, Ill.

Estimating Weight of a Fish

If there are no scales at hand, the weight of a fish can be determined fairly accurately by measuring it. To do this, square its greatest girth in inches, multiply the result by its length, then divide by 800, and you will have its weight in pounds. The more symmetrical the fish is, the more accurate the estimate will be.—E. G. Thostenson, Ellensburg, Wash.

Removal of Refrigerator Drip Pan Simplified with a Truck

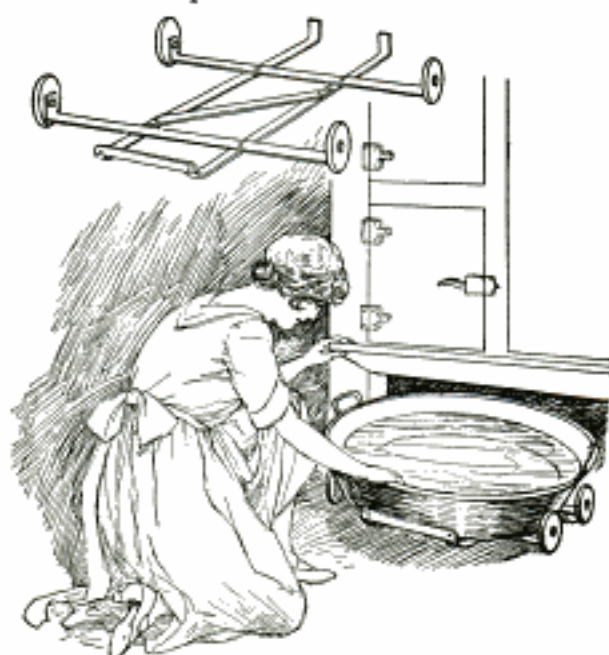

Refrigerator Drip Pans Easily Removed When Kept on This Truck, Made of Strap Iron

A drip pan can easily be removed from underneath the refrigerator by the use of a small truck, the dimensions of which depend on the type of pan used. The frame consists of two lengths of flat iron with holes drilled at each end for bolts which serve as axles for small wheels. Two similar pieces of flat iron are then bent at right angles at one end, and a suitable length of angle iron is riveted across the other ends, which prevents the pan from sliding off. These pieces are then riveted to the crosspieces and braced with a short length of iron attached diagonally.

Miniature Faucet for the Doll House

Here is a miniature faucet for a doll house, such as the one described in the February, 1931, issue of Popular Mechanics, where running water was installed.

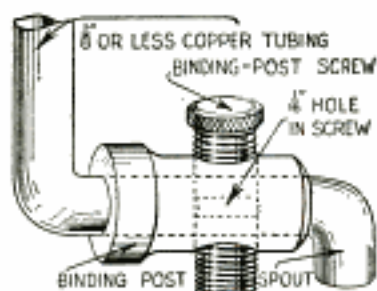

The faucet is made from a radio binding post and a length of copper tubing, bent at right angles at the end. Drill the binding post lengthwise to receive the tubing tightly. The hole on the side of the binding post

is continued through the tubing and then the latter is sweated in place. Tap the hole to receive the knurled screw previously fitted at the end, making a tight fit, after which a $\frac{1}{16}$ -in. hole is drilled through the screw.

is continued through the tubing and then the latter is sweated in place. Tap the hole to receive the knurled screw previously fitted at the end, making a tight fit, after which a $\frac{1}{16}$ -in. hole is drilled through the screw.

Two Window Shades Allow Fresh Air and Privacy

In order to have fresh air, light and privacy at the same time, the use of two shades on the same window has proved satisfactory. One short shade is attached to the top of the lower sash and drawn down to the window sill, while the window is lowered from the top and the regular shade drawn to cover the open part.

Quill Toothpicks Insulate Shorted Electric Wires

Short circuits of the horn wires in the steering column of an auto, caused by oil destroying the rubber insulation, can be repaired with a quill toothpick when it is not desirable or possible to use friction tape. The toothpick is split its entire length and slipped over the wire where the insulation is broken, after which it is rolled tight and slipped into the hole where the wire comes through, or it may be held firmly about the wire by wrapping a piece of twine around it. This repair will be satisfactory until the wire can be replaced.—Paul Leo, Elizabeth, N. J.

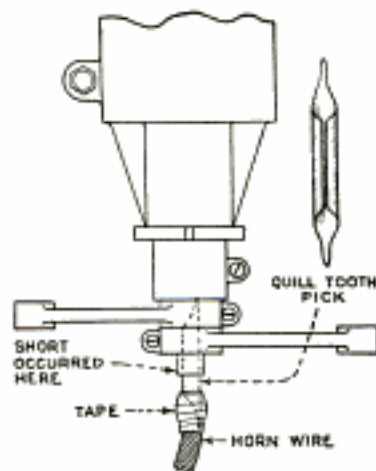

An Inexpensive Scarfpin

A scarfpin that will add to the appearance of your tie can be made from a needle and a common pearl bead. Simply run the eye end of a long needle through the hole in the bead and wedge it in tightly. Fill the top of the hole with a little white soap.

Dart-Throwing with an "ATLATL"

SCATTERED here and there, a hundred years ago, certain Indian tribes used the "atlatl" instead of the bow. Although not as popular as a bow, in the hands of one familiar with its use it was a genuine weapon, sending arrows as far and as accurately. It is an easy matter to make one, and with some practice anyone can send an arrow several hundred feet with surprising accuracy.

The atlatl—pronounced "at-rattle"—consists of a single stick with a notch at one end for the heel of the arrow. In use, you grasp the other end of the arrow between the thumb and forefinger, as in Fig. 11. The whip is then snapped forward quickly, straight over the shoulder, as a pitcher throws a fast, straight ball. The end of the whip describes an arc, equal to that made by the arm plus the whip length, with amazing quickness, and

other type of notch, you may make one from a small piece of tin cut to the shape indicated in Fig. 4, which is bent and fastened to the end of the whip with small brads. A third type of notch, which is also satisfactory, is made of three small nails or screws, driven into the top side of the whip's small end, as shown in Fig. 3. The heads are cut off after the screws are set, to allow the arrow to slip out easily without catching. The two last-mentioned types will permit the use of a

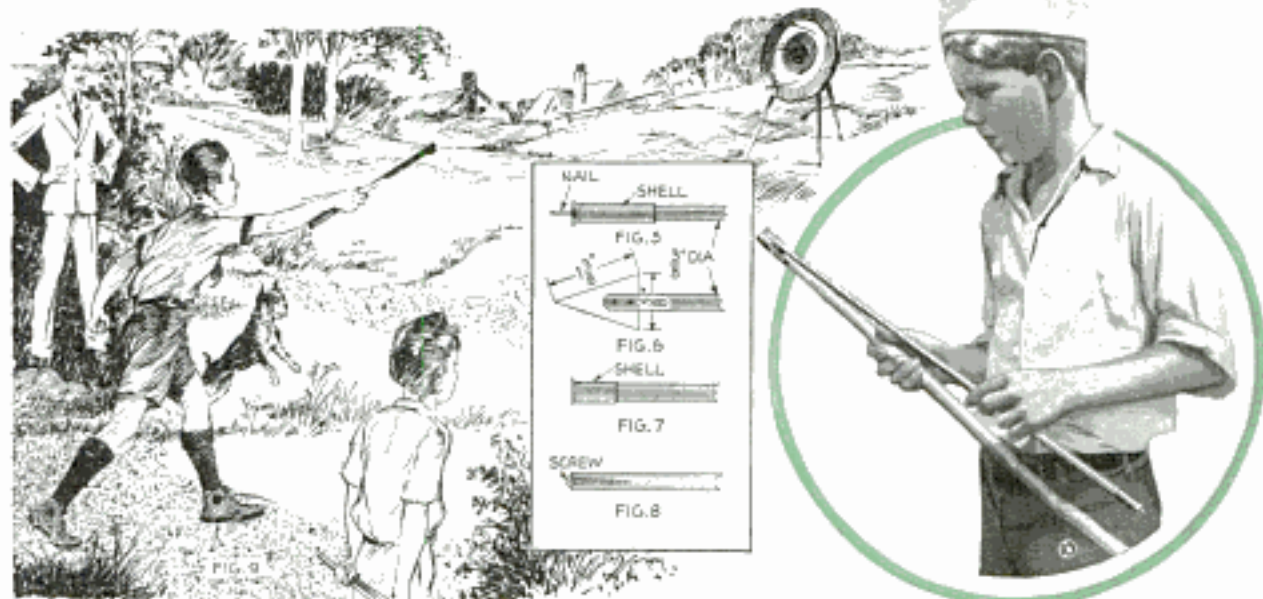
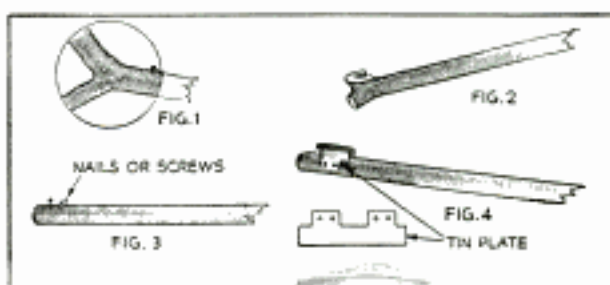

sends the arrow on its course. Get a sapling with a straight length of about 26 in. and a fork at the end as in Fig. 1. The diameter at one end may be $\frac{5}{8}$ in. and at the other $\frac{1}{2}$ in. The knob formed by the branches at the smaller end should be large enough to permit cutting out a strong notch.

Sharpen the knife point and proceed to make the notch as shown in Fig. 2. This must be slightly broader than the width of an arrow heel and about $\frac{3}{8}$ in. long and $\frac{3}{8}$ in. deep. Should you prefer an-

smaller whip, and there is no need for a stick with the enlarged end formed by the fork. Almost any round, straight and springy stick will serve with the tin or nail notches. As a rule, the whip should be at least 4 in. longer than the arrow.

Any straight-grained stick will do for the arrow. If it is of hickory or other tough wood, there will be less risk of breakage. It is not essential that the weight of this arrow is kept down, for you will find, with experience, that heavy shafts can be sent about as far as lighter

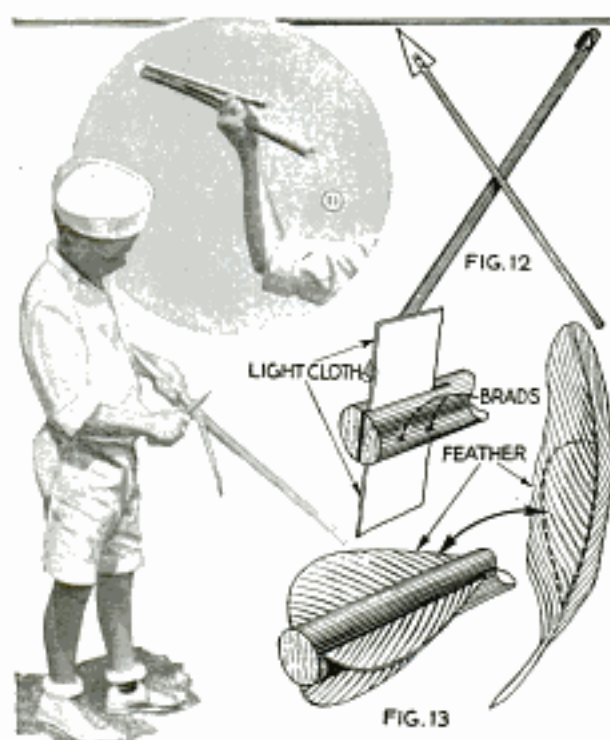

ones. Saw them out about $\frac{3}{8}$ in. square, remove the corners with a plane or sharp knife, then sandpaper down until round or apparently so. Dowel rod can also be used for this purpose. Provide a slight taper between the shaft ends. The larger end should be a tight fit for a 30:30 shell. Cut off the reduced front end, set the shell on a block of soft wood, center a punch over the primer inside and drive it out. If a point is desired, put a six-penny finishing-nail head inside, and drop in some solder. Hold the shell and nail vertically in a flame to melt the solder, then withdraw carefully and let it harden. This not only adds weight to the head, but holds the nail rigid. Now cut off all but $\frac{1}{2}$ in. of the protruding nail and sharpen it. This is an excellent type of head, as it will stick into any wooden target or back-stop.

If you wish a blunt head, leave the empty brass shell as it is, as shown in Fig. 7. An empty .38-caliber shell will also do nicely. Another type of blunt head is made by boring a small hole into the arrow head and driving in a round-head screw as shown in Fig. 8. A real hunting arrow head is made by sawing into the head for 1 in. and inserting a thin piece of triangular steel held with two small rivets, as in Fig. 6. No matter how well made the arrow is, it needs a "rudder" at the rear. The best type is made from

three feather segments, Fig. 13. To save time, however, you may simply split the end of the arrow and, holding the halves apart with a knife blade, insert a 1 by 2-in. piece of thin cloth. Then put a little glue in the split and withdraw the knife.

The atlatl is now ready for use. Raise it over and back of the shoulder, just as you would to crack a whip. Brace yourself by placing one foot toward the front, then snap the whip forward, straight over. A side movement will cause the arrow to wobble at first resulting in loss of speed and distance. Continue shooting until you can send the arrow on a straight flight and then practice until you gain accuracy.

Cold-Cream Tissue Polishes Car

Due to its special texture, sheets of absorbent cold-cream tissue have been successfully used for giving a glossy polish to autos after washing. The tissue is folded into a pad and used in the ordinary manner. It removes any excess polish and has been found superior to cheese-cloth and other fabrics. As the tissue is used, it crumbles away, and it is therefore only necessary to add new sheets to an old pad for continuous polishing.

Wrinkles Removed from Neckties with Clothes Hanger

By stretching neckties over a wire clothes hanger, bent to the shape shown, wrinkles can be removed. Insert the wire into the wide end of the tie and slightly dampen the cloth. By having such a holder for each tie, you can keep them neat at all times.—K. F. Keith, Chicago.

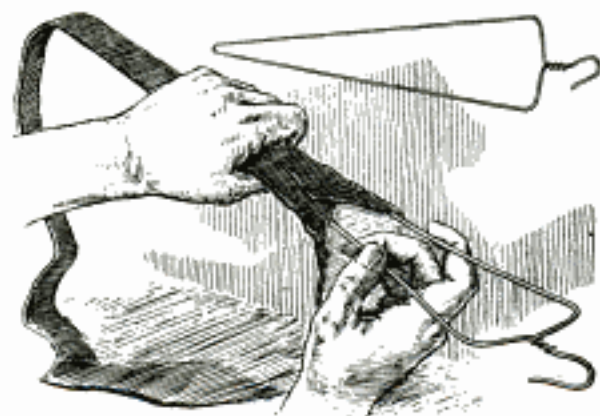

Your Neckties Will Always Look Neat If Stretched over These Wire Holders

This Neat Telephone Stand Fits Any Corner

With the exception of a scrollsaw, no special tools are required to make this corner phone stand, the entire job being completed with a hammer, saw and plane. Plywood panels in open filigree are a feature, and the sections are offset, with a light in the top one, the phone in the next below, and the phone catalog and other items in larger compartments below. The panel concealing the phone swings to the left so that the instrument

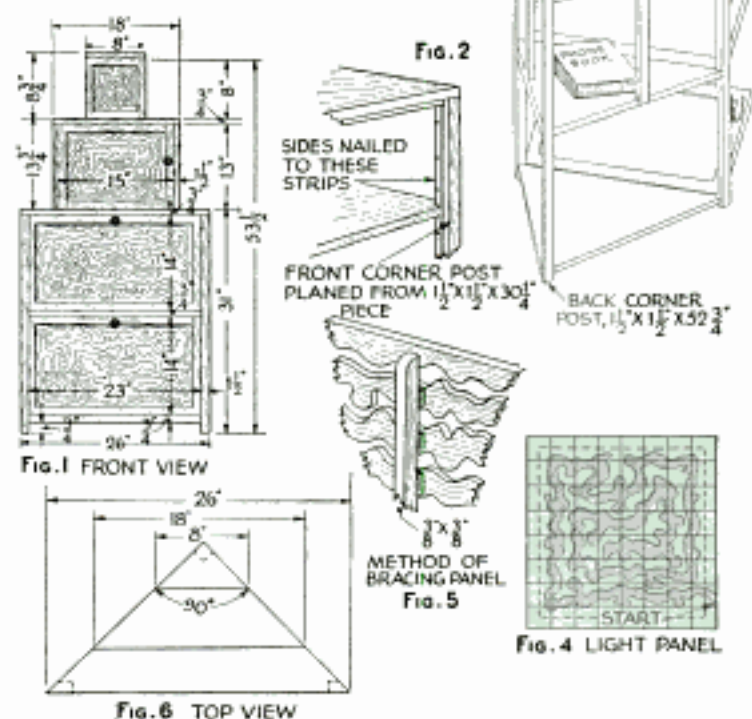

can be drawn out conveniently with the right hand. The plan, Fig. 6, is simply a right-angled triangle with a 26-in. base, the phone compartment being 18 in. across the front and the light compartment 8 in. wide. Fig. 2 shows a perspective of the framework construction from the rear. The three corner posts are of $1\frac{1}{2}$ by $1\frac{1}{2}$ -in. stock. The selection of the wood is a matter of individual taste. Philippine mahogany, maple, birch, and even white pine, are suitable if the job is to be stained. If painted, any kind of easily worked wood, such as poplar, will be satisfactory. Install the tops and shelves, as indicated, allowing for the back panels so that the stand will fit close to the wall. There should be an opening beneath the light to illuminate the phone.

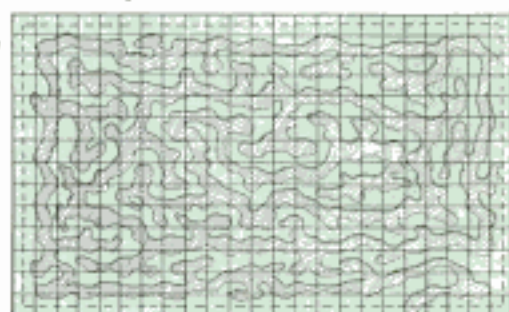

Fig. 3 LOWER PANELS START

Use $\frac{1}{4}$ -in. plywood for the panels. Intricate as the pattern seems in the squared layouts, Fig. 3, it can be cut out entirely without stopping the saw. Note that the cut in each case begins at the edge and winds around toward the middle, where it starts back again and follows the original cut with

a $\frac{1}{2}$ -in. space between them. The filigree is then braced with a strip across the back, as in Fig. 5, and installed in the frame, which is to be hinged to the stand. The two lower panels drop forward and are held horizontally by chains.

Glass Push Pins Aid in Painting Board on Both Sides

When it is desired to paint or lacquer a board on both sides, instead of doing one side and allowing it to dry before touching the other, drive in glass push pins at each corner after painting one side. The board can then be turned upside down to rest on the tacks while the other side and edges are painted.—B. L. Gilbert, Chicago.

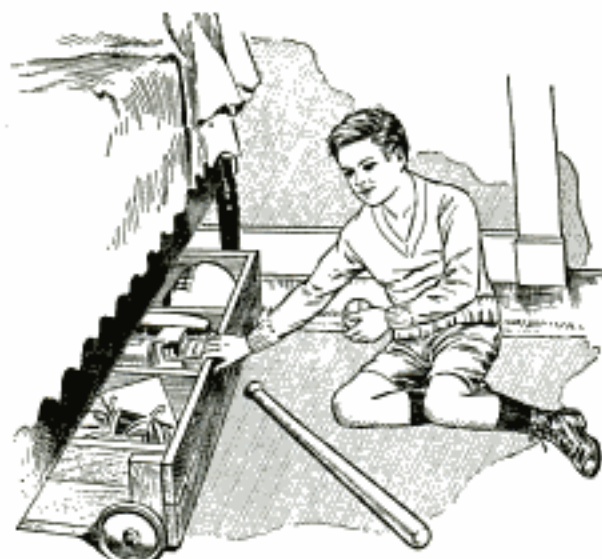

Keeping Toys or Tools in a Wheeled Box Which Rolls under the Bed

Wheeled Storage Box for Toys Rolls under Bed

In homes and apartments where space is limited, this box will be found convenient for keeping toys, as it can be rolled under the bed. It is made of 1-in. stock to any suitable size. Four cart wheels are fastened near the corners, using carriage bolts for axles, so that there will be a clearance of 1 in. between the box and the floor.

This Door Spring Is Out of Sight

Made from a screen-door spring and a piece of rawhide, this door closer is invisible, and especially useful for cabinet doors, although the same idea can be applied to larger doors as shown. The time for installing these closers is when

the house is being built or remodeled, as the work necessitates the removal of plaster and lath. One end of the spring is fastened to the wall stud, while the other is attached to the length of rawhide, which is run

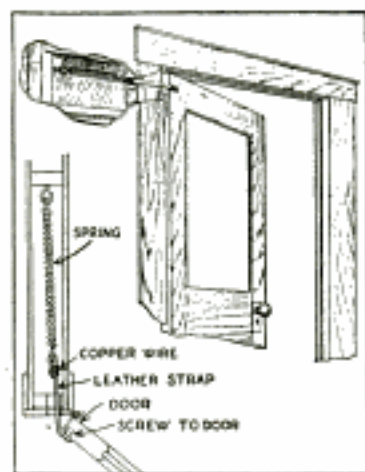

through a hole cut in the door casing and fastened to the edge of the door. The

rawhide prevents noise that would be made by other means of attachment and has long life, needing no oil or attention.—Deane B. Caldwell, Hollywood, Calif.

How Large Drawing Can Be Removed from Drafting Board

In removing large drawings pasted to a drafting board, it often happens that the sheet tears because the paper is stretched too tight. To avoid this, place the drafting board on the floor and set a brick or other suitable support under one side, raising it a couple of inches off the floor. Slit all four corners and also the two ends of the sheet with a razor blade. Pressure applied to the board, causing it to bend down slightly, takes the tension off the paper, so it is easy to remove it by making two more slits on the sides.

Blowtorch Substituted for Gas in Water Heater

In homes where there is no gas supply, a gas-burning water heater can be used to advantage if a blowtorch is installed to provide heat. Remove the gas burner and insert a piece of sheet metal to serve as a flame deflector so that the heat will be more evenly distributed to the coils. Cut a hole in the side of the heater to receive the nozzle of the torch which stands on a shelf bolted to the frame. A large tank of water can be heated with this arrangement in about ten minutes. A 1-qt. torch will burn for about one hour.—Robert J. Bailie, Long Island City, N. Y.

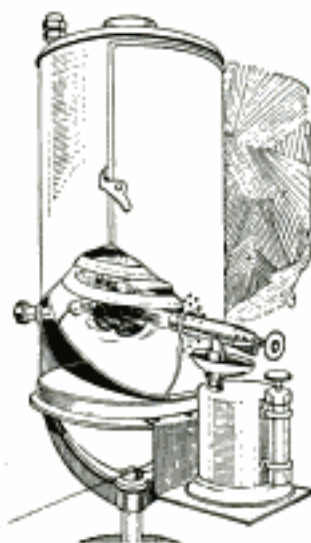

Solution Prevents Rust on Mail Box

Outdoor mail boxes will not rust if coated with a solution made by dissolving enough celluloid in amyl acetate to form a sirup. Apply it with a brush and completely cover the box inside and out.

Brunswick-Balke-Collender Co
623 S. Wabash, Chicago
National Billiard Supply Co
2020 Canal St

A BILLIARD TABLE

for HOME and APARTMENT

by R. O. Buck



FOR the home or apartment, where space is rather limited, a small billiard table that fits on the dining-room table and may be set in a closet when not in use, can be made in your home workshop.

As the entire frame of the table is covered with an inexpensive grade of imitation leather, it is unnecessary to use lumber that will take a fine finish. The stock for the frame should be sound, well-seasoned material, and the pieces should be planed true. Fig. 2 gives the dimensions of these pieces, and Fig. 4 shows where the grooves for housing the bed are located. Ordinary butt joints are used at the corners and are fastened with two 1 $\frac{3}{4}$ -in. No. 10 wood screws at each corner. Be sure not to nail or glue the corners at first, as it is necessary to take the frame apart later. A shallow groove is cut around the outside of the frame pieces so that the imitation leather covering can be pressed into it to form a sunken band, which will relieve the plainness of the flat surface. However, this feature is purely ornamental, and may therefore be omitted without affecting the playing qualities of the table. The location and size of this groove and the spacing of the screws are shown in Fig. 3. The bed of the table is made of wood

fiberboard or wallboard. The former is preferable, owing to its hard surface and the fact that it is less likely to warp, but the cost is greater. Whether wall or fiberboard is used, it is necessary to do some reinforcing on the underside of the table to give it greater rigidity. Fig. 6 shows the framework of the table assembled with the trusses in place, while Fig. 5 gives the sizes of the latter. They should be screwed into place but not glued as it is necessary to nail them to the bed before the latter is covered with felt.

After determining the size of the pockets as given in Fig. 2, make cardboard patterns of these. The corner pockets are round but the center ones are oval. Lay the cardboard pattern on top of the frame and mark around it to establish the line on which the cut for the pocket is to be made. The frame should be taken apart and the opening for the pocket is cut away on a bandsaw, as shown in Fig. 12,

Blueprint 671-673-75 ans

and the latter glued and screwed together permanently. Similarly, glue and screws should be used to fasten the trusses in place. The felt covering for the pockets is cut into triangular tabs which are stretched and glued to the underside of the board, as shown in Fig. 9, thus covering and finishing up the edges of the board where the pocket holes have been sawed out. The leatherette covering for the frame should be applied next. Cut strips of the material $4\frac{1}{2}$ in. wide and as long as the side of the table. If the material isn't long enough to do this, make the joint come at the middle. Start the leatherette just above the groove on the inside face of the frame and stretch it over the top across the face and around under the bottom edge, where it is fastened with tacks. Glue is spread over the entire surface to be covered. At the pockets, the material should be cut away and shaped to fit over the curved edge by fashioning triangular tabs as shown in



SURFACE COATED WITH GLUE
FIG. 8

TRUSS PIECES

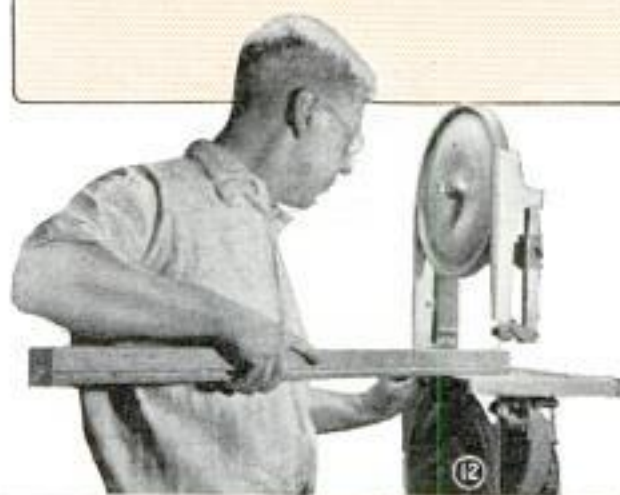
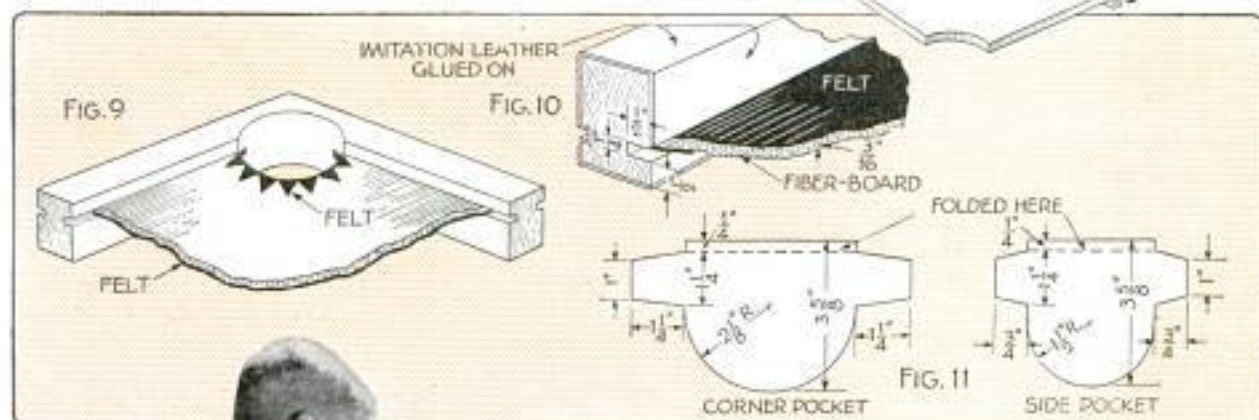

Figs. 13 and 14. While the glue is still fresh, a smooth, blunt instrument, such as the end of a table knife, should be run over the leather along the shallow groove to press the material into it. Fig. 11 gives the dimensions for the pocket trim. These

pieces may be made of the same material as the frame covering, or tan-colored Spanish leather can be used if you wish to make the table a bit more attractive. Fig. 20 shows how the pocket trim is fastened at the top with $\frac{3}{8}$ -in. brass escutcheon pins. The sides of the trim extend under the cushion strips.

In order to give greater rigidity and stiffness to the frame, both an angle iron and diagonal brace are used at each corner as in Fig. 15. The diagonal brace also acts as a support for the pocket rings, a circular saw kerf, shown in Fig. 16, being cut for this purpose. This detail also shows the dimensions of the braces. Fig. 18 shows how the tabs of felt around the pockets can be neatly covered with leath-

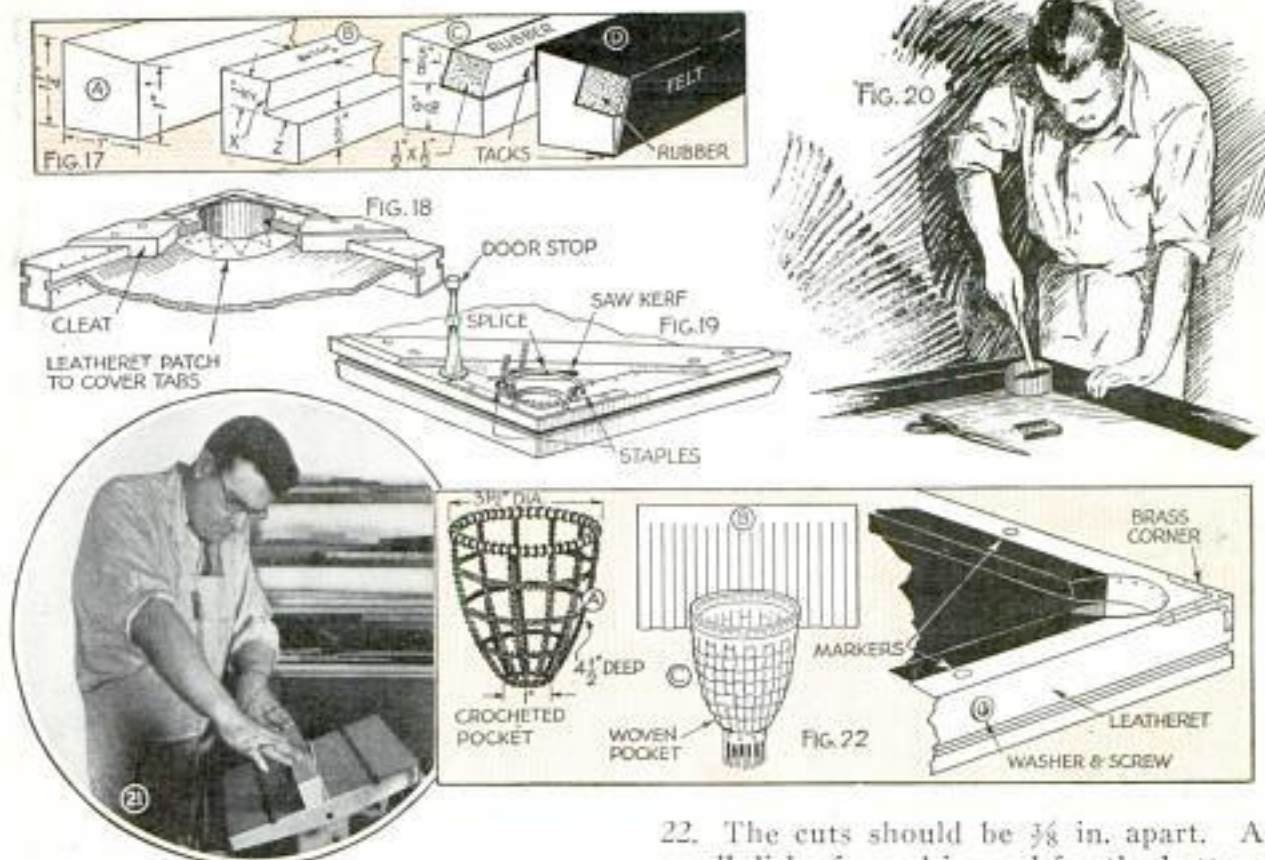

ten-cent store. Of course, folding legs, similar to those used on card and sewing tables, might be used to advantage but are likely to be less rigid, which greatly affects accuracy in playing. Best of all would be a sturdy table in a spare room in the basement or attic where it could be fastened in place permanently and leveled.

The pockets on most small tables are made of strong twine crocheted into two rings, $3\frac{1}{2}$ and 1 in. in diameter respectively. The rings can be bent up readily from soft wire of about $\frac{1}{16}$ -in. diameter. The joint is soldered or simply fastened with a ferrule made of gummed paper, as the pocket can be so placed that the joint will come inside of the saw cut on the diagonal brace which supports the outer edge. This is shown in Fig. 19. Small staples are used to fasten the pockets in place. Of course, the pocket is crocheted right on the rings but was omitted from this drawing for the sake of clarity. Fig. 22 gives the sizes and number of rows of crocheted loops required if a fairly heavy and stiff fishing line is used. The larger tables are equipped with leather pockets and you may want to make this type. A piece of soft leather is cut to within $\frac{1}{2}$ in. from the end, as shown in detail B of Fig.

22. The cuts should be $\frac{3}{8}$ in. apart. A small disk of wood is used for the bottom to which the leather strips are tacked as shown at C. Strips of leather of the same width are woven in "May-basket" fashion to finish the pocket. The ends of the strips are sewed together and the pocket is then sewed to the ring. The location of the head and foot spots and also the head-spot line or string line is shown in Fig. 2. These are simply spots or lines made on the felt with a soft pencil. They should be about $\frac{1}{4}$ in. in diameter and must be located exactly as indicated. If a cover is made for the billiard table of the same kind of leatherette as was used to cover the frame, it will keep the table in better shape and protect the felt.

The playing equipment, which must be purchased, consists of one white cue ball, $1\frac{1}{16}$ in. in diameter; 15 colored balls, $1\frac{1}{16}$ in. in diameter; one triangle of the proper size for the balls; two or more maple cues, 42 in. long, and some chalk.

The approximate cost of the playing equipment is about \$4.75 and this added to the cost of the material for making the table makes the total cost approximately \$12. Although not rigid enough to meet the requirements of the expert player, it provides plenty of entertainment for the average home fan.

Strong Road Culverts from Steel Oil Drums



Discarded Oil Drums with the Ends Removed Were Used by a Tourist-Camp Owner to Make a Culvert over the Grader Ditch between His Camp and the Highway

Discarded oil drums can be utilized for making serviceable road culverts. The ends are cut off and the drums placed in the ditch to be bridged as shown. The removed ends are then bent to the curvature of the sides and laid over the joints to prevent seepage from carrying sand into the culvert, after it has been covered with dirt in the usual way.—Elton Sterrett, Longview, Tex.

Beads Restrung with Catgut

A broken violin E-string of catgut is an excellent substitute for silk thread in restringing beads. It has the advantage of being elastic and will last indefinitely. The gut should be cut diagonally so as to form a joint for easy threading. When finished, wet the end of the gut, tie a knot and cut off the free ends close to the clasp.—K. F. Keith, Chicago.

Skid-Chain Links Made from Nails

Repair links for auto skid chains can be made from sixteen-penny nails, and will probably outlast the life of the chain. They are made by bending the nail to the shape shown, which can be done with two pairs of pliers. The head is cut off, and the link is ready for



use. It is a good idea to make a number of these links at your leisure and carry them in the car for emergency use.

Sash Cord Serves as Beading to Hold Blackboard

When making a blackboard for the children, I had not the time or tools to cut a rabbet in the frame to hold the slate in place. As a substitute method, I nailed the frame to the wall, inserted the slate and then tacked a length of sash cord around the inside edge of the frame, as shown, to keep the slate from falling out.—E. Buckley, Philadelphia, Pa.

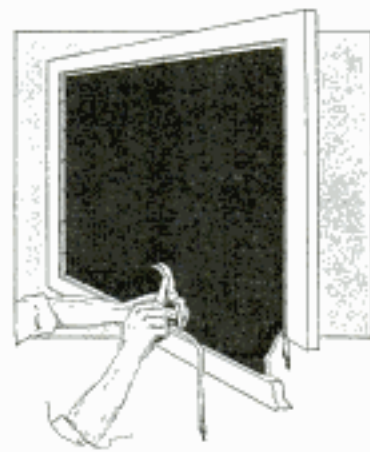

Photos Removed from Ferrotypes Plates by Heat

Photographs that seem dry enough to peel easily from ferrotypes tins sometimes stick and will be ruined if force is used. By holding a burning match under the tin at the point where the print sticks, it can easily be peeled off. The tins should be polished with a solution of benzine and paraffin before using them again.

Removing Bag Increased Suction of Vacuum Cleaner

When using a vacuum duster to clean the upholstery of a car, a much more thorough job can be done if the bag is removed, because this reduces the resistance and increases the suction. Drive the car outdoors and work on the windward side so that the dust will be blown out of the car. If there is a puddle of water close to the car, direct the exhausted dust against the water which will absorb most of it.—C. E. Packer, Highland Park, Mich.

How to Produce Colored Flames in the Fireplace

Many metals and their salts impart colors to a flame when burned, and are prepared by mixing the salts with equal parts of powdered charcoal. The powder may be held a few inches above the fire in a teaspoon or it may be sifted into the cracks of the logs before placing them on the fire. Another method is to make a heavy paste by mixing the powders with rosin, wax, gilsonite, or similar substances, and put the paste into small holes drilled in the firewood. This is one of the best methods as the coloring agent is more slowly liberated and the coloring consequently lasts longer. Potassium salts give a lilac tint; calcium salts a brick color; strontium salts, crimson; barium salts, green; copper salts, blue, and zinc salts greenish-blue. Chlorides of certain metals are best adapted for working into the firewood, as they produce the color at comparative low flame temperatures. By using different coloring agents in the same log, beautiful variations can be arranged.



Rack on Inside of Closet Door Keeps Shoes in a Convenient Place

Curtain-Rod Rack on Closet Door for Holding Shoes

This rack, on the inside of a closet door, will keep your shoes where they are easy to get at and off the floor where they may be stepped on. Curtain rods of suitable length are attached to the door and the shoes slipped between them as indicated. An extra rod may be used to hold stockings.

Money for YOUR Ideas

EVERYBODY is an inventor because everybody has at some time or other thought of a time, labor or money-saving short-cut which would help others if they only knew about it.

Such ideas, trivial though they may seem to you, are interesting and helpful to others, and so we are offering three special awards each month for ideas that will help the autoist, the home craftsman and the shop worker.

All ideas used will be paid for at our regular rates and, in addition, there will be three prizes of \$25 each for the best ideas submitted.

Send your ideas to the Shop Notes editor, with a small sketch or photograph to make them clear, if necessary.

Soap Lubricates Door Latches

To keep the door latches of your car well lubricated, yet prevent them from soiling clothing, wipe off any dirty oil thoroughly and rub white soap on the wearing surfaces. This serves as an excellent lubricant and does not soil the clothes.

*Spray Red Arrow -
McCormick & Co. Inc.*

*McCormick
Bldg. Baltimore, Md*

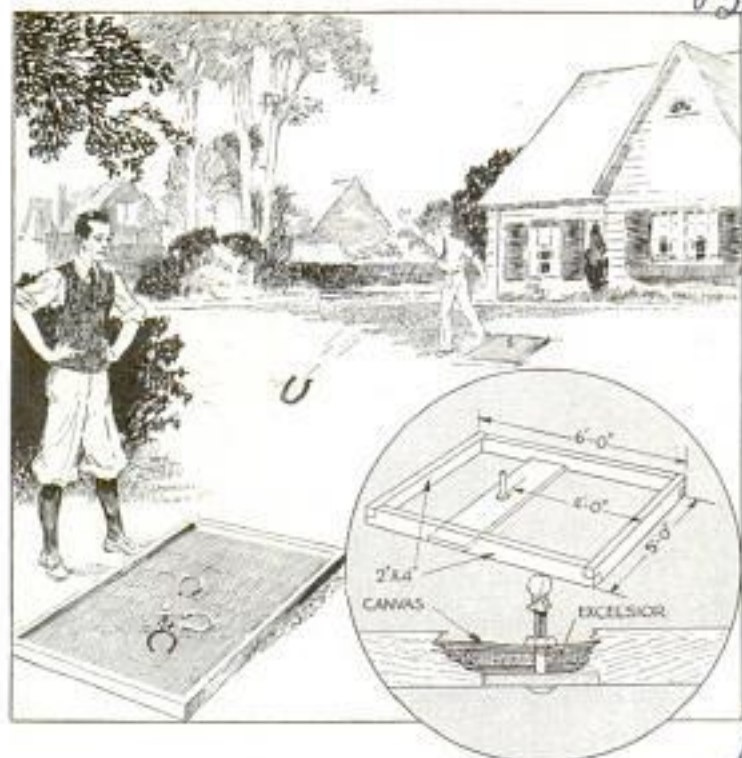

Horseshoe Can Be Played In or Outdoors without Damaging Floors or Lawns with This Stake Bed

A Portable Stake Bed for Playing Game of Horseshoes

You can play horseshoes almost any place with this portable stake bed, without damaging the floors or lawns. Make a wooden frame of 2 by 4-in. stock, as shown in the detail, and securely fasten a bolt, of suitable length for the stake, in a hole drilled in the center of a 1-in. crosspiece. Nail several layers of burlap or canvas across the bottom of the frame and fill in the space between adjacent pieces with excelsior, rags or even sand, to make a strong mat. It should be well tufted by sewing it with small wire to keep the contents intact.—James Francis Goodman, Stockbridge, Mich.

Loose Valve Tappets Located with Your Fingers

Adjusting nuts on valve tappets sometimes loosen and cause a clicking noise which is difficult to locate. The tappet causing the trouble can usually be detected by feeling each one in turn with the forefinger, being careful not to get the end of the finger between the end of the tappet and the valve stem. The actual click of the tappet should synchronize with its movement as felt by the fin-

The amount of clearance of extremely loose tappets can be determined by feeling the actual closing of the gap between the end of the valve stem and the tappet. To be positive that you have located the right one, wedge the end of a screwdriver between the valve spring and the adjusting screw, which should completely eliminate the noise.

Mosquitoes Controlled by Extract of Pyrethrum

A new form of "ammunition" for fighting mosquitoes has been developed by the New Jersey agricultural experiment station. It is a kerosene extract of pyrethrum, emulsified with soap and water. One gallon of the mixture should be diluted with 10 to 15 gal. of water before using it.

It can be safely applied to waters where mosquitoes breed without danger to fowls or water flowers. Unlike oil, it does not discolor the water, and can be used on golf courses and similar places without killing the grass.

Cooking Pans Can Be Tilted with Angle-Iron Wedge

Fitted with a handle, an ordinary piece of angle iron makes a handy kitchen utensil for tilting pans on the stove, especially when it is necessary to drain cooked foods. A 15-in. length of $\frac{3}{4}$ -in. angle iron will be most satisfactory for this purpose, and a wooden handle can be purchased at any hardware store. The latter is riveted to the iron at a slight an-



Cooking Utensils Can Be Tipped and Held in Position with This Angle-Iron Tilter

gle, as shown.—C. B. Barr, Stratford, Connecticut.

Beautiful Lamp Bases from Glazed Tile



By EDWIN M. LOVE

SPANISH tiles of neat design are readily obtainable, and together with plain tiles in various colors, narrow border strips, quarter-rounds and returns, can be combined to form highly attractive lamp bases.

For a square base of the kind shown in Fig. 4, a wooden core is needed. This is made from four pieces of 1-in. pine, cut $3\frac{1}{4}$ by $8\frac{1}{2}$ in., and nailed together to form a column, as in the detail below Fig. 2. Nail a 1-in. bulkhead $1\frac{1}{4}$ in. from the upper end, and bore a 1-in. hole through the center to allow the passage of electric wires. Stud the outside of the column with shingle nails, leaving the heads projecting $\frac{1}{4}$ in. as anchors for the mortar used to hold the tiles. Four 6-in. tiles are mitered together for the base. If possible, get these all alike or else choose harmonizing designs and colors. To miter the joining edges, clamp the tiles in a vise and chip off the edges with a cold chisel, starting close to the back corners to avoid breaking them. When the "feel" of the material is obtained, fairly large chips can be knocked off. Smooth the rough spots and work up close to the glazed surface by grinding on an emery wheel, as in Fig. 8. Before cementing, soak the tiles in water until

bubbles no longer appear, as otherwise they will dry out the mortar and pull loose. For the same reason wet the wooden core. This will also minimize swelling of the wood and help prevent cracks in the plastered top. Tack a short board over the top of the core and wooden blocks, $2\frac{1}{2}$ in. wide, around the column and on the board. Invert this assembly as in Fig. 1, plaster the nails, coat the tiles with mortar, and stand them against the core, resting them on the $2\frac{1}{2}$ -in. blocks. As the tiles are slightly irregular, exact squareness will be impossible, but they should be brought nearly true with a try-square. Bind them together with a stout cord, leaving the corner joints open $\frac{3}{8}$ in. This clearance, as well as the proper distance from the core, can be maintained by driving wooden wedges where opening-up is necessary. Fill open spaces between the tiles and the core with thin cement poured from a can, as in Fig. 3. Then build up a base of mortar, $\frac{3}{4}$ in. thick, mixing the cement stiff enough to allow it to be easily molded. Keep it back from the face of the tiles $\frac{1}{4}$ in. and model it quarter-round. To provide space for the wires, plaster in a paper tube. Lay a wet cloth over the base, so that it will remain moist while setting.

The standard above the base is made of four quarter-round pieces, 6 in. long, assembled in a cylinder with strips of $\frac{1}{2}$ by $\frac{1}{2}$ -in. border tiles, sandwiched between



the quarter-rounds. When the base has hardened sufficiently to bear weight, remove the four blocks and the false base, and set the standard on the bulkhead in the core. Center it, and fill around with fairly stiff mortar. If the core is dry, wet it, and build up, allowing about $\frac{1}{4}$ in. for final plastering. Build up a $\frac{1}{2}$ -in. layer on top of the core around the standard and scrape the modeled part fairly true with the corner of a wooden block, as shown in Fig. 2. Patching plaster is used for finishing. Mix it dry with sufficient pigment to give the light-blue tone of the tiles. Then mix with water and apply. After it has set for several hours, the surface can be finished by scraping with a wooden block. The bottom of the base is finished in the same way.

A double-socket fixture, about $6\frac{1}{2}$ in. high, is good for this base. As the flange cannot be screwed or bolted to the tile, it is necessary to fasten the fixture with a copper wire doubled and passed through from top to bottom. Fix a six-penny nail in the loop, and pull the wire ends out at the top of the fixture until stopped by the nail against the underside of the core bulkhead. Twist the ends of the wire over a shingle nail laid crosswise in the fixture, between the socket outlets, until the wires are fairly tight, and cut off the ends. Then drive short wooden wedges under the flange until the fixture is held rigidly. Fill the space between the flange

them. Set a paper tube in the center, fill around it with mortar and press the flat strips in so that they are $\frac{1}{16}$ in. behind

and the standard with plaster. Now thread the wire through the base and one socket top, and split the silk covering for $2\frac{1}{2}$ in., allowing the two wires to separate. Then tie the knot pictured in Fig. 5, which also shows dimensions of the lamp. This knot prevents the wire from being drawn from the socket cap and relieves the binding screws from strain. Then connect the wire to one socket and run short leads to the other. The wire frame for the shade is

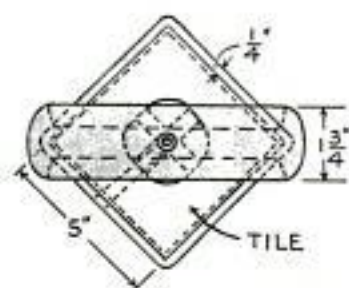
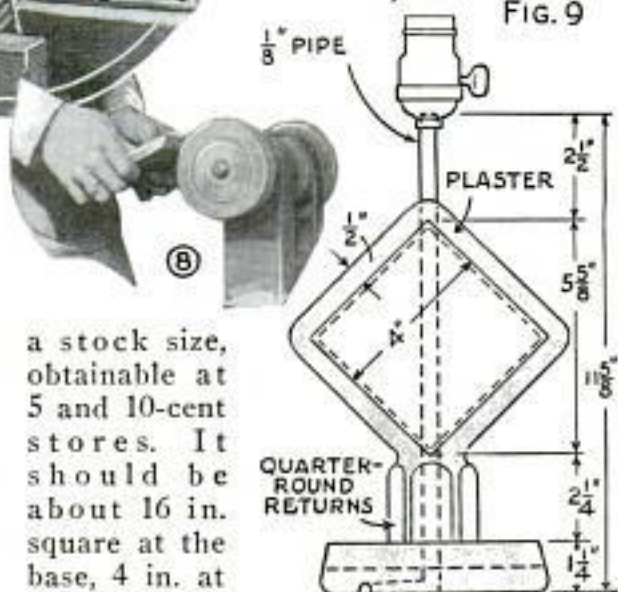

FIG. 9



a stock size, obtainable at 5 and 10-cent stores. It should be about 16 in. square at the base, 4 in. at top and $10\frac{3}{4}$ in. high, or corresponding proportions.

Fig. 6 illustrates a smaller design. Select two 4-in. square tiles, and plaster them together to make an outside thickness of $1\frac{3}{4}$ in., having a paper tube inserted diagonally to leave room for a pipe or tube to take the wires. Tie these together with twine until the cement sets, as in Fig. 7, remove the twine, and add a $\frac{1}{4}$ -in. layer of cement to the edges. While this is setting, drill a 1-in. hole in the center of a 5-in. square tile. Begin by chipping the glaze at the center with the corner of a narrow cold chisel, and gradually widen out to the desired diameter. If the tile is cupped downward, rest it on a 2-in. square block, to lessen the chance of

breaking it. When a rough hole has been chipped to size, put the tile to soak while the pipe is being cemented into the body tiles. Clamp this assembly in a vise, and build up the short column as shown. This column is made of four pieces of black quarter-round returns, cut to a length of $2\frac{1}{4}$ in. Chip the glaze with a cold chisel, tapping lightly, and then break off with heavier blows. Grind the bases even. Bind the pieces together with $\frac{5}{16}$ -in. strips of wood in the joints, slip them over the pipe and support them on a couple of wooden blocks at the proper distance from the body tiles. Fill the interior with cement, adding several nails above to extend to the height of the pipe. After setting up, put the base in place and build up a layer of cement on its underside, $\frac{1}{4}$ in. thick, leaving a groove for the wire, and laying several nails crosswise for additional reinforcement. Mix dry burnt umber with cement in equal parts for plastering the body-tile edges, the base and filling the joints of the column tiles. A hexagonal shade, measuring about $7\frac{1}{2}$ in. high, 4 in. across the top and 9 in. at the bottom, is suitable for this base. If cracks appear in the cement after a few days, peck the exposed parts with a nail point and give a thin coat of plaster, not neglecting to wet the old plaster before applying the new.

Toolbox Built under Truck Body



Built between the frame members at the rear and underneath the body, a wood or metal box on the truck will keep your tools accessible at all times. The box should be fitted with a hinged door, and if provided with a good lock, will be theft-proof. To avoid constant rattling of the tools, pad the box by placing a heavy piece of cloth, doubled, on the bottom, and stuff some rags over the tools.

☛ To drive nails into plaster without breaking or chipping it, first heat them.



Equipped with Casters, This Stepladder Can Be Moved About without Getting Off

Wheeled Stepladder Saves Time

When painting or cleaning ceilings, a wheeled stepladder will save much time in shifting it about. Large casters are the most practical for this purpose and can be purchased with braces for attaching them to the ladder legs. They are easily removed when it is desired to have the ladder stationary.

Window Fastener Holds Drop Lid of Typewriter Desk

Attached to the typewriter desk as shown, an ordinary window-sash fastener will hold the lid securely. The movable latch is attached to the side of the desk, where it is easily accessible, while the catch is fastened to the drop lid. The wedging action of this device holds the typewriter rigid.



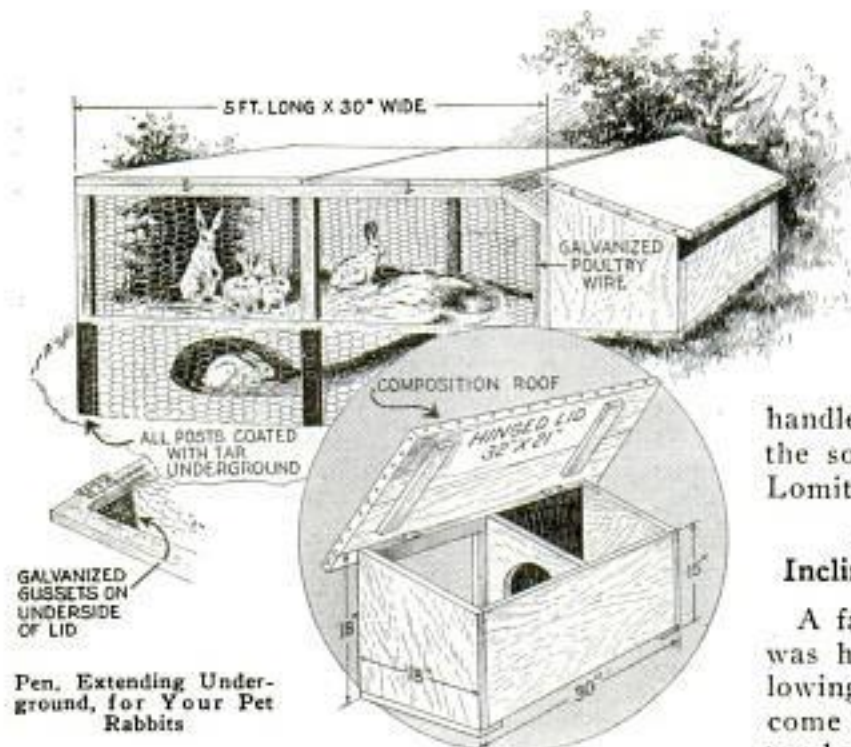

Pen, Extending Underground, for Your Pet Rabbits

Your Pet Rabbits Will Be Contented in This Pen

Pet rabbits are more contented if allowed to burrow, and this pen, which is set 1 ft. into the ground, will allow them to do so without letting them escape. The pen is 5 ft. long and 30 in. wide and will house four or five rabbits comfortably, but can be built larger if desired. The frame, which is strengthened at the corners with galvanized gussets, is covered on three sides and the bottom with 1-in.-mesh galvanized poultry wire. Two lids are provided, being merely frames covered with the wire and hinged to the pen. When completed, the part of the frame that is to be underground is covered with tar to prevent it from decaying. Then a trench, about 1 ft. deep, is dug and the pen set in it. The house at one end of the pen is fitted with a nesting compartment and a hinged lid.

Clip Holds Films While Developing

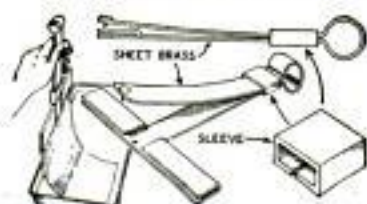

This clip is a great aid for holding negatives while developing them. It is made of light spring sheet brass, cut and bent to the shape shown. The point of a brass

pin is soldered to one end, while a hole is drilled in the other to take the pin when the clip is closed, a brass sleeve being used for this purpose. The clip is fastened to the negative while it is dry, and is not removed until it has been developed and dried, serving as a

handle to keep the fingers out of the solutions.—Harold I. Calkins, Lomita, Calif.

pin is soldered to one end, while a hole is drilled in the other to take the pin when the clip is closed, a brass sleeve being used for this purpose. The clip is fastened to the negative while it is dry, and is not removed until it has been developed and dried, serving as a handle to keep the fingers out of the solutions.—Harold I. Calkins, Lomita, Calif.

Incline Aids in Starting Truck

A farmer, who had a truck that was hard to start, found the following method effective to overcome the trouble. The floor of the truck shed was raised by filling in dirt until it was high at the back and formed a fairly steep incline. When the truck was stored at night, it was backed into the shed and the brakes set. It was then a simple matter to start it by putting it in gear and releasing the clutch and brakes. After the truck had coasted down the incline, the clutch was engaged and the truck immediately started.

Memo Envelope Fastened to Cover

Memos that are written on small sheets of paper can be kept in a book where they are not likely to slip out, if the following method of holding them is used: Cut one end from an ordinary envelope and paste it on the inside of the cover, with the opening toward the back or top. Place the memos inside of this improvised pocket, and they will be there when you look for them the next time.—C. Edward Packer, Highland Park, Mich.



☐ A set of two blueprints, SN-7 and SN-8, on "Aero-Boat" can be obtained for 50 cents and a material list will be sent free.

TRICKS of Night Photography



WITH the use of the films and plates now on the market night photography is a new and thrilling field, heretofore little exploited by the amateur. It is possible to make successful snapshots inside of theaters, along city streets at night, and wherever else there is artificial light of good intensity, without the need of expensive equipment.

Amateur cameras are available with lenses operating at a speed of $f:4.5$, and these will do nicely for night photography. It is possible to make night pictures with slower lenses when light conditions are particularly favorable, and when movement is not great. As most artificial light is rich in red and yellow

rays, it is necessary to use panchromatic films or plates. Cut film, plates and motion-picture film of this sort are sensitive to all colors of the spectrum, whereas ordinary emulsions depend on violet and blue light for

most of their speed. A supersensitive panchromatic film, several times as fast as that formerly provided, is available in cut-film form and in motion-picture film. Plates also are procurable. To make theater pictures, load your camera with this

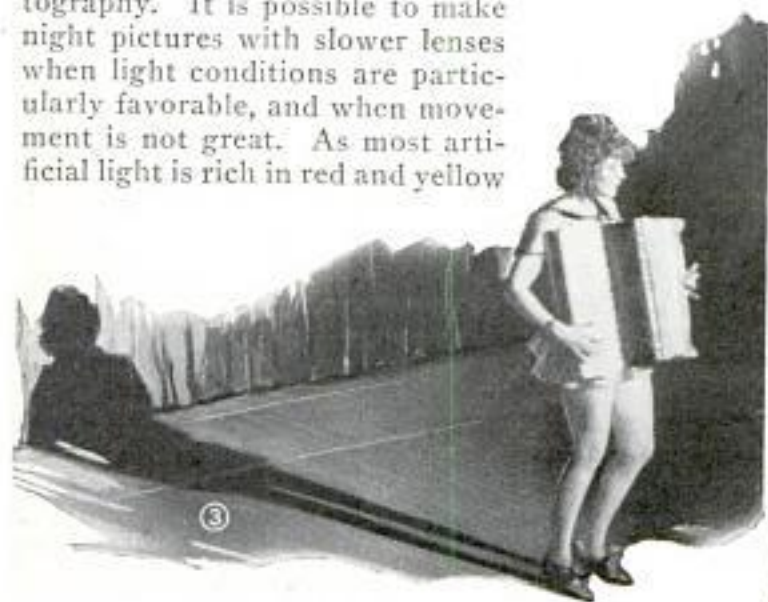

With the Use of the Fast Films and Plates Now on the Market Night Photography Is a New and Thrilling Field, Heretofore Little Exploited by the Amateur



supersensitive film, set the lens at its widest opening, adjust the shutter to $\frac{1}{25}$ or $\frac{1}{20}$ second, and make the exposure when the light is at its maximum intensity. There are periods when actors are practically motionless and when the spot light and all stage lights are

on. Sometimes you can shoot at $\frac{1}{10}$ second and get away with it. One of the best places from which to photograph stage scenes is a box on the first-balcony level. Outdoors, beneath theater canopies, in amusement parks and wherever else the light is fair, you can obtain interesting snapshots. Shutter speed should be as low as practicable, because it is better to overexpose than to underexpose. Where there are people moving about, as in streets, always place yourself so that your subjects are moving either toward or away from the camera to minimize movement. Such a shot is shown in Fig. 5, where the exposure was $\frac{1}{10}$ second at f:4.5 lens stop.

Sometimes even the supersensitive panchromatic films obtainable at photograp-



ic dealers are not as speedy as they might be. By a simple chemical trick, you can step up the sensitivity as much as two or three times in the following way: Mix one part of 28-per-cent ammonia solution in 25 parts of water, preferably distilled. Bathe the panchromatic film or plate in this for about 45 seconds. Then place the film, without rinsing it, in the draft of an electric fan. The quicker the sensitive emulsion is dried, the better. Film thus treated has still greater speed, but will retain this, in normal temperature, for only a few days, and should therefore be used at once.

However, it can be stored, if necessary, in a refrigerator where it will retain its vigor longer. Of course, all of the hypersensitizing operations must be carried on in absolute darkness. Likewise, developing is done in the dark, without the aid of even a special green panchromatic safe light, until development is almost complete. Films and plates hyper-

sensitized with ammonia are useful for purposes other than night snapshots. In making flashlight or flashbulb pictures of some objects where the illumination at best is only fair, such as a large crowd of people or a building, you will find this "pepped-up" film of great value. A window display can also be photographed.

The photos shown here were made according to the methods just described. Fig. 1 was made with a reflecting camera, using ammonia-treated film and making the exposure at $\frac{1}{25}$ second at f:2.5. Figs. 2 and 3 were made with supersensitive panchromatic film, $\frac{1}{25}$ second at f:4.5, the film being untreated. Fig. 4 was taken at $\frac{1}{25}$ second at f:2.5 lens stop, while Fig. 6 was taken $\frac{1}{10}$ second at f:4.5. In both cases the film was ammonia-treated.

Father Made His Carts from Packing Boxes

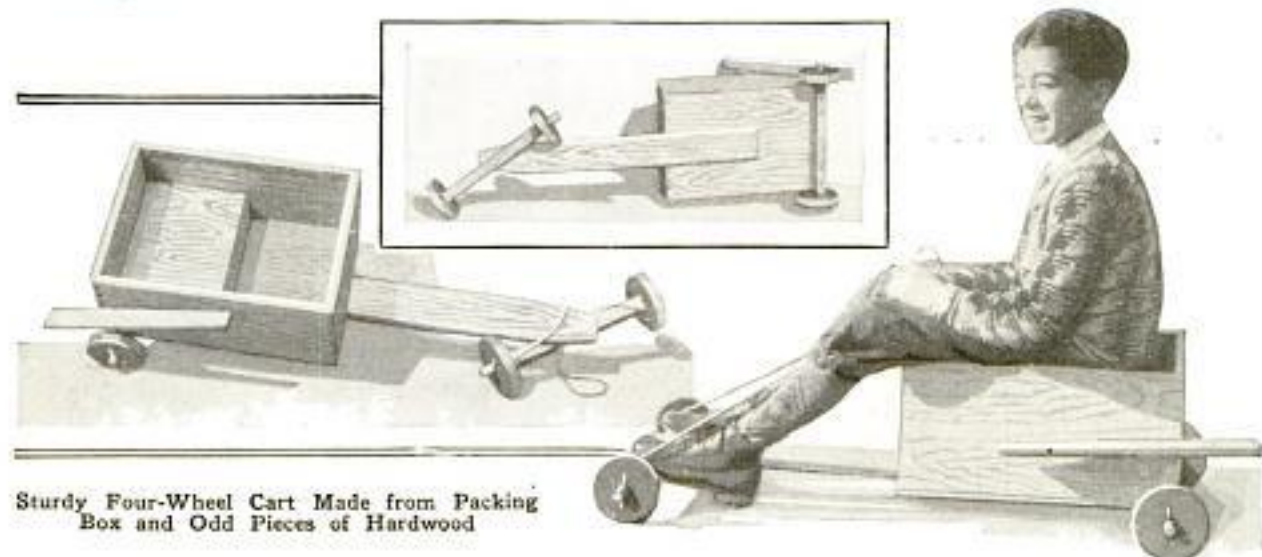

Sturdy Four-Wheel Cart Made from Packing Box and Odd Pieces of Hardwood

No boy need be without a cart, for the kind father used to make cost only a few cents, and perhaps you can build one for nothing. Ask your grocer for two strong wooden boxes, one about 2 ft. long and 18 in. wide, and the other almost any size, as it is to be knocked apart and the pieces used. When you knock the sides off, don't use a hammer on the wood directly, but take a stout stick, hold it against the side and then tap on the stick. This will prevent splitting up the wood. The unbroken box is nailed to a 3 or 4-ft. board, using a sufficient number of nails to prevent it from coming off. These should be driven down through the box and board and clinched on the other side. The axles are made from 2 by 24-in. pieces of hardwood, such as oak or maple, the latter being preferable. The ends of the axles are rounded for $1\frac{1}{2}$ in. and the diameter of the rounded portions should be $\frac{3}{4}$ in., leaving a sharp shoulder on the square part. This should be done on a lathe for accurate results, and while at the lathe, the wheels can be turned down, hardwood also being advisable for this purpose. They should be about 5 in. in diameter, and $\frac{3}{4}$ -in. holes are bored exactly in the center. Drill a hole through the center of the front axle and another through the end of the board for a $\frac{1}{4}$ -in. bolt. Then attach it, slipping a large washer between the board and axle. The rear axle is bolted to the bottom of the box. The wheels are then attached and small holes are drilled through the ends

for cotter pins to keep the wheels on, washers being used between the wheels and pins. A little cup grease should be applied to the axles to make the cart run smoothly. If you can't get someone to turn down the wheels on a lathe, use a fretsaw and cut them down to the right size, scribing a circle of 5-in. radius and sawing straight across the wood on the line. A length of rope is tied to the ends of the front axle near the wheels, and a wooden brake lever is pivoted to the box so that it can be pushed against one of the rear wheels. A seat inside will also be handy.—C. H. Adler, Corona, L. I.

Mounting Spectacles on Camera

A cameraman in Montreal, Can., has solved the problem of hunting for his spectacles when focusing his camera for



a quick "shot." He attaches them to the sides of the focusing hood on his Graflex as shown in the photo. This method has made it possible to obtain many good pictures that had to be taken on the "spur of the moment," and would otherwise have been lost.

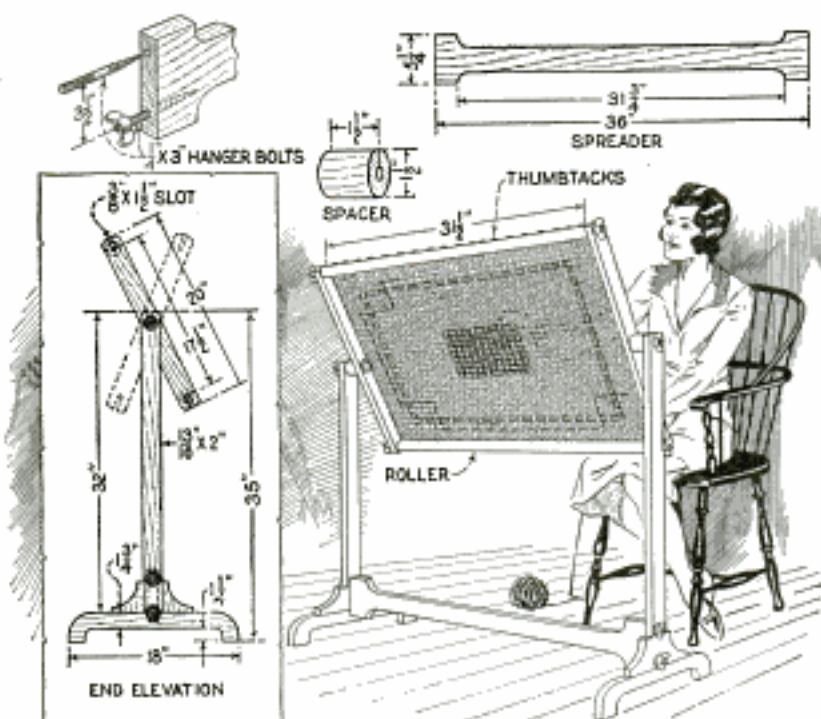

Hooked Rugs Can Be Quickly Made with This Adjustable Frame Which Holds the Burlap Foundation Taut without Lacing

An Adjustable Frame for Making Hooked Rugs

Anyone who has had experience in making hooked or punched rugs will appreciate the advantages of this type of frame for supporting the burlap foundation and keeping it taut when working with an automatic rug needle. The uprights and arms, shown in the left-hand detail, are 2 in. wide and are made from birch or maple stock. The feet are cut to shape and screwed to the bottom of the uprights and the joints strengthened with triangular braces, also screwed to the feet. A spreader bar is cut to the shape indicated in the upper right-hand detail and fastened between the uprights by means of hanger bolts, one end being driven into the bar and the other fitted with a washer and wingnut. A $\frac{1}{4}$ -in. hole is drilled in the center of each arm for carriage bolts, $3\frac{1}{2}$ in. long, also fitted with washers and wingnuts and held in slots sawed in the end of the uprights. A $1\frac{1}{2}$ -in. spacer is put over each bolt, between the arm and the upright. Center the ends of two pieces of $1\frac{3}{8}$ -in. round stock, $31\frac{1}{2}$ in. long, fit them with a hanger bolt in each end and place them in slots cut in the ends of the arms. Fasten one end of the burlap to one of the rollers with thumbtacks, and the other end to the opposite roller in the same way,

driving thumbtacks in tight and not over 1 in. apart. Give the first roller one turn and lock it securely by tightening the wingnuts at each end. Roll up the burlap on the opposite roller and draw it tight by twisting the roller at the ends, then lock the wingnuts, and you are ready for work. When the portion of the burlap foundation between the rollers has been worked, turn the frame over and clip the burlap. Roll up the finished portion on the first roller and tighten it. Turn the frame over and finish the work. By loosening the wingnuts on the rollers and the top of the uprights, and running off those on the spreader bar, the frame can be taken down in a few seconds for storing.

A Self-Measuring Container

This container will be useful for measuring coffee, sugar, and the like, where the same amount is used each time. Take a sheet-metal tube and flare one end to a funnel shape or solder part of a funnel to the tube. Then insert it through a hole drilled in the lid of any suitable container so that the tube is a snug fit. As only the contents between the bottom of the tube and the bottom of the container will come out when it is turned upside down, adjust the tube up and down until the de-

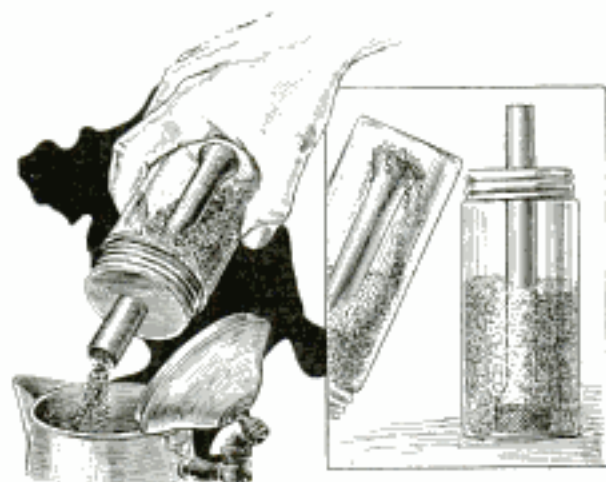

Equal Amounts of Coffee, Sugar, Etc., Are Automatically Measured with This Container

sired amount comes out. Then solder the tube to the lid. The container should be shaken each time.

Uses for Model-T Ford Parts

Old valves from a Model-T Ford motor can be made into large-head bolts by cutting threads at one end, where a small hole already is provided for a cotter key. Also, the bottom bowl of the carburetor can be removed and soldered onto a tube to make a funnel. Old cylinder-head gaskets, when split, make good shim material.

Doorstop Worked by Turning Knob

An ordinary door bolt will make a stop that automatically holds the door in any position. It is screwed to the bottom of the door, the lower end being covered with a rubber tip. A length of twine is

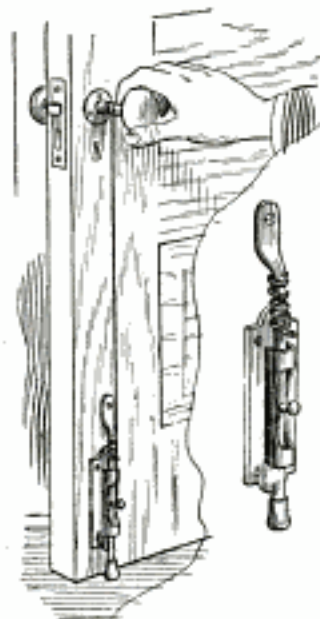

is tied to the handle of the bolt and around the shank of the knob, then securely wrapped with friction tape to prevent slipping, so that the bolt will be raised when the knob is turned. When released, the bolt is pushed firmly against the floor by a compression spring which is held in place by means of a pin in the end of the bolt

and a short rod, flattened at one end and screwed to the door as shown.

Gasoline Stove Used without Pump

The next time you go camping and forget the pump for your stove, or break it, try this trick. Pour the tank about half full of gasoline and submerge it almost to the top in cold water, leaving the filler cap open. After the tank has cooled, screw the cap tight and set it in the hot sun for a few minutes but not near flames. The cold air will expand and produce pressure enough to cook a meal.

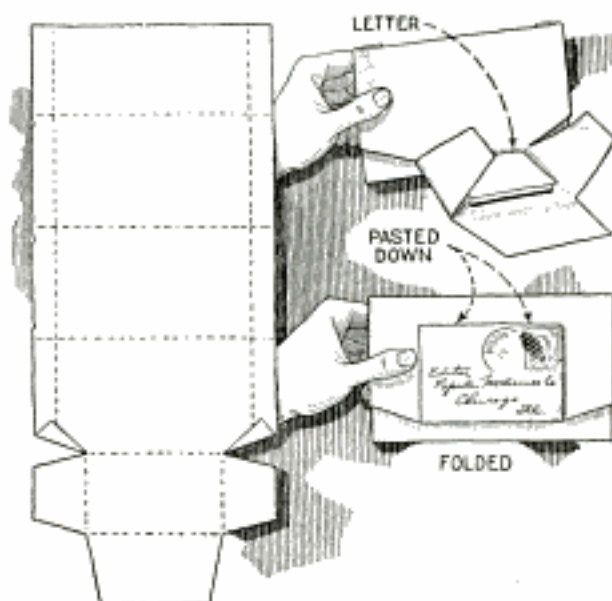

When Mailing a Letter with a Package, Try This Method of Wrapping Both under One Cover

Improvised Folder Covers Both Package and Letter

An inexpensive folder for mailing first and fourth-class matter in the same wrapper is shown in the drawing. Wrap the package in the usual way up to the last fold and then cut the flap so that it can be turned over the letter, gluing or pasting the edges down securely. This method is especially useful when no envelopes are at hand.

Cap-Visor Snap Holds Spectacles

Fishermen, sportsmen and others will find that their spectacles can be safely held behind the snap on their cap visor if the snap holds firmly and the space behind the spectacles will not allow the wider parts to slip past. Loose-fitting snaps can usually be cured by tapping the button lightly with a hammer.—Ashley Smith, Chicago, Ill.



Attractive Homes

By Robert Gregg



be trimmed down to $\frac{7}{8}$ in. in thickness and 1 in. in width across the face, as shown in the detail below Fig. 1. The spoke and assembly holes are drilled, a slot is cut on the inside of each rim for the celluloid endpieces, and a portion of the rim is cut away to form a door for the prospective cage. The easiest way to cut the door section is to drop the rim over a circular saw, as in Fig. 1, and then finish the cut

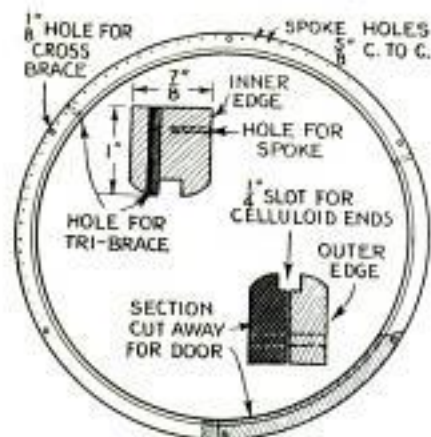

WITH blithe song and flash of color, birds are both entertaining and decorative. But no matter how gorgeous the bird or how sweet his song, the cage comes first, and it must harmonize with both the songster and the room. For small birds, a regular canary cage is usually suitable. Finches require larger cages with the bars quite close together, and nightingales need broader, lower cages, while parrots call for more spacious ones.

The circular cage shown in Fig. 6 offers a variation from the more or less stereotyped forms. The construction has a humble beginning—two wooden steering-wheel rims picked up at an auto-wrecking yard. Each rim should

Covers on Sheet Music Furnish Pleasing Designs for Decorating the Celluloid Sides of These Cages



Two Wooden Auto Steering Wheels Make a Sturdy Frame on Which the Wire Bars Can Be Quickly Assembled

for Your Birds

square with hand tools. The initial assembly is shown in Fig. 3. Ordinary bicycle spokes are used to hold the two rims together, threading the spokes through 7-in. lengths of copper tubing and fastening them with the spoke nipples. Four spokes, cut to the proper length and riveted to a metal disk or ring, furnish a three-legged brace across each ring, as in Fig. 4, to form a support for the perch and for the feed cup. The exact shape of the wires that hold the cups can be determined by purchasing two cups and fashioning the spokes to fit. The nipples should be slightly countersunk so that the holes may be filled with putty and finished flush.

With the framework made, it is a simple matter to cut No. 6 gauge piano wire to bicycle-spoke lengths, and set these in place, as shown

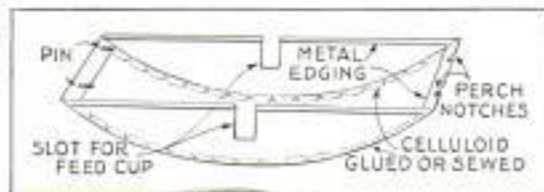
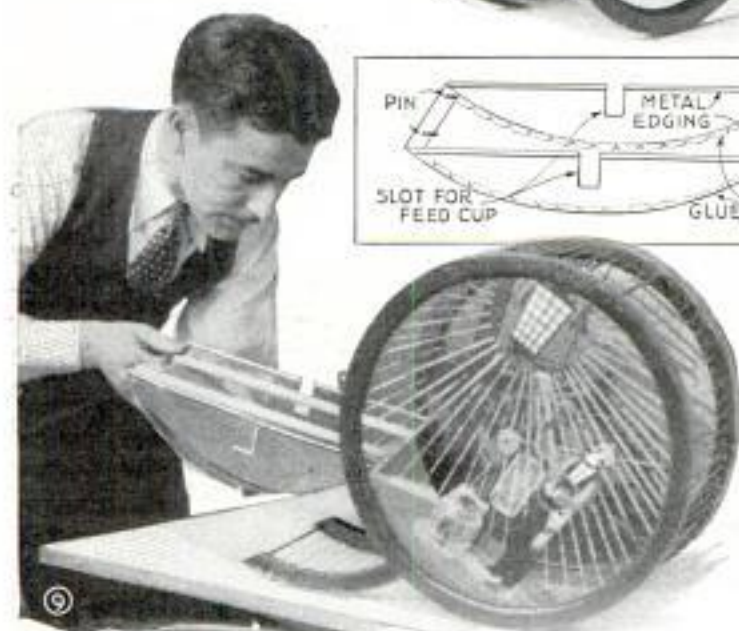
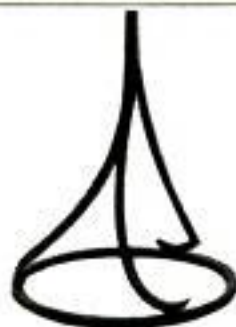
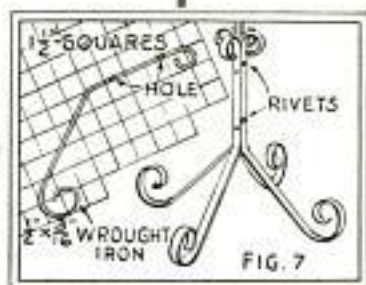
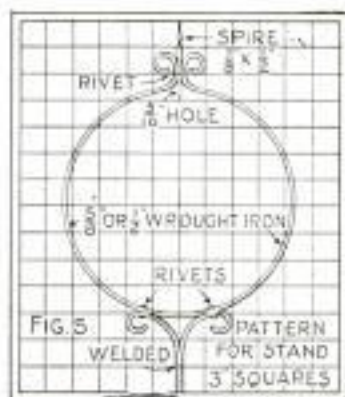

in Fig. 8. The spring of the wire will keep them firmly in position. The center part of the top-most spoke is bent to a V-shape to permit centering the supporting point. The celluloid ends come next. These are made of clear celluloid, cutting them slightly oversize so that the disk will snap into position. Each circle is properly cut so that the feed cups can be fitted in place. The exact position and size of this opening are given in Fig. 2. This detail also suggests a suitable sketch which, when done in transparent oils, adds beauty to

A Celluloid or Sheet-Metal Tray, Conforming to the Curvature of the Cage and Fitted with Perches, Is Slipped into Place

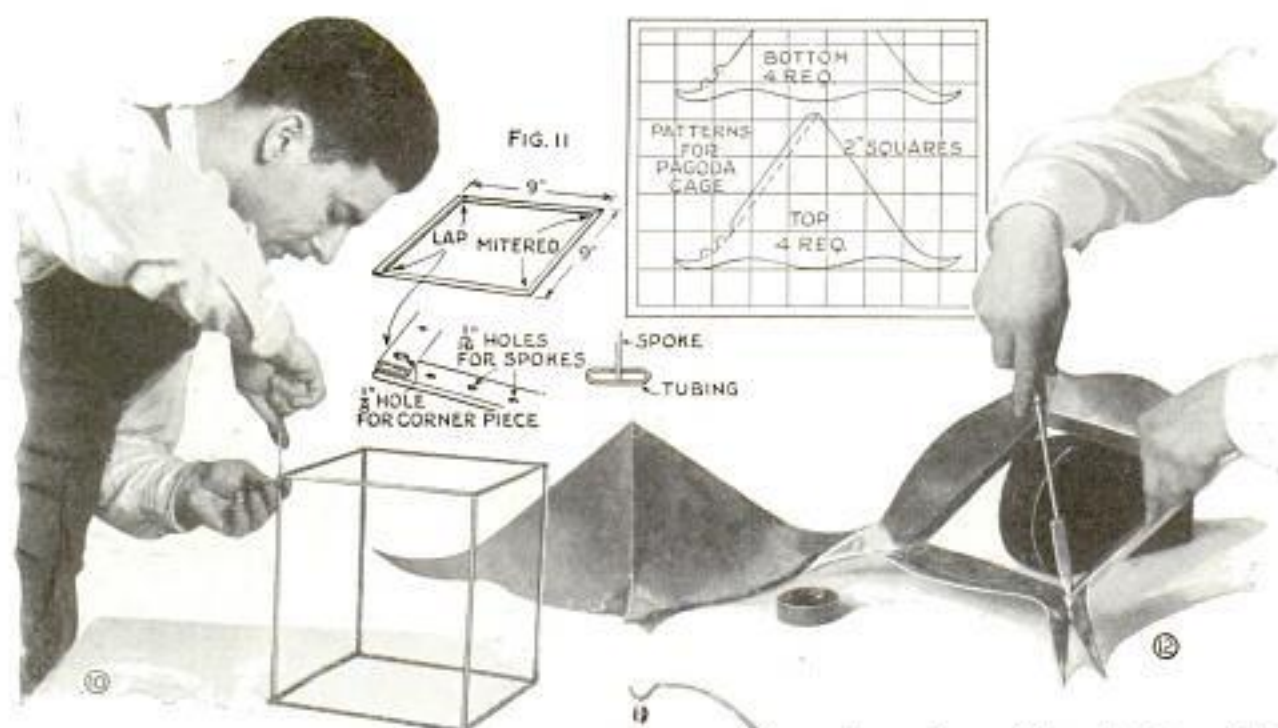

the finished cage. The cover designs on sheet music are especially adapted to this purpose. Direct tracing through the clear celluloid makes the art work very simple. The surface should be washed with household ammonia to remove finger marks over which the paint will not take. No considerable portion of clear celluloid should be left in the design, as a bird would attempt to fly through this apparent opening. After the two ends have been snapped into position, they are held in place by long strips of rattan, cut to fit. Fig. 9 shows how the pan is fitted inside the cage. Either celluloid or metal can be used. If celluloid, all edges must be bound by metal in order to reinforce the material and to furnish a base for the projecting pins and the slots that hold the feeding perches in place. Exact dimensions for the pan are best obtained direct from the work. The receptacle should be shallow enough so that it can easily be slipped through the cage door. Whether metal or celluloid, the curved bottom of the pan should be covered with a sheet of regular bird gravel paper or with coarse sandpaper. The making of a pedestal stand for this cage is a fairly simple matter, and is quite ob-

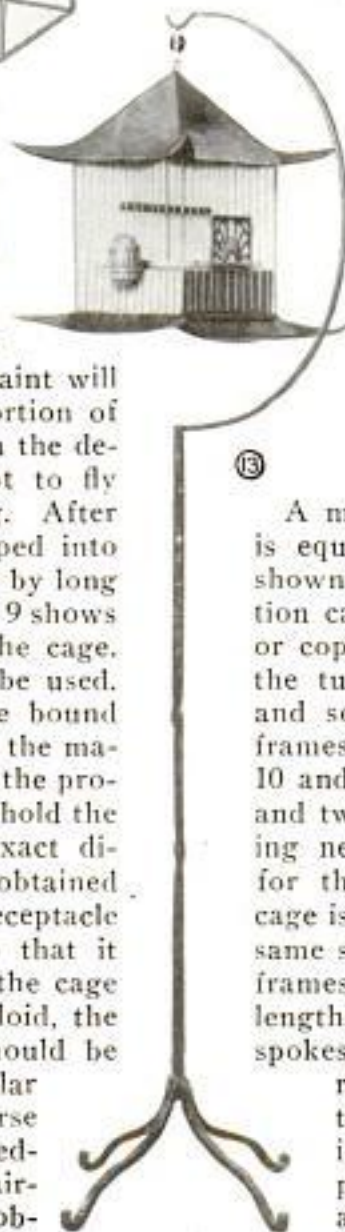

vious from Figs. 5, 6 and 7. The whole unit is built up from $\frac{1}{2}$ -in. wrought-iron stock, riveting and welding the pieces together. To eliminate the difficult weld on the tri-legs, a four-legged base of flat stock, shown in Fig. 7, can be substituted. In either case, an all-black finish is highly attractive, especially if the wooden rims of the cage are done in contrasting reds or greens.

A much simpler cage, but one that is equally novel, is the pagoda cage shown in Figs. 10 to 14. This construction calls for bicycle spokes and brass or copper tubing. Suitable lengths of the tubing are hammered almost flat and soldered together to form two frames, 9 in. square, as shown in Figs. 10 and 11. The bottom has two miter and two lap joints, the lapped end being necessary to provide an opening for the sliding tray with which the cage is fitted. The top frame, made the same size, is mitered all around. Both frames are fastened together with 9-in. lengths of copper tubing, using bicycle spokes and nipples in the manner already described. The top and bottom of the pagoda cage are fashioned from sheet copper, either plain or hammered, and soldered at the corners as shown in Fig. 12.

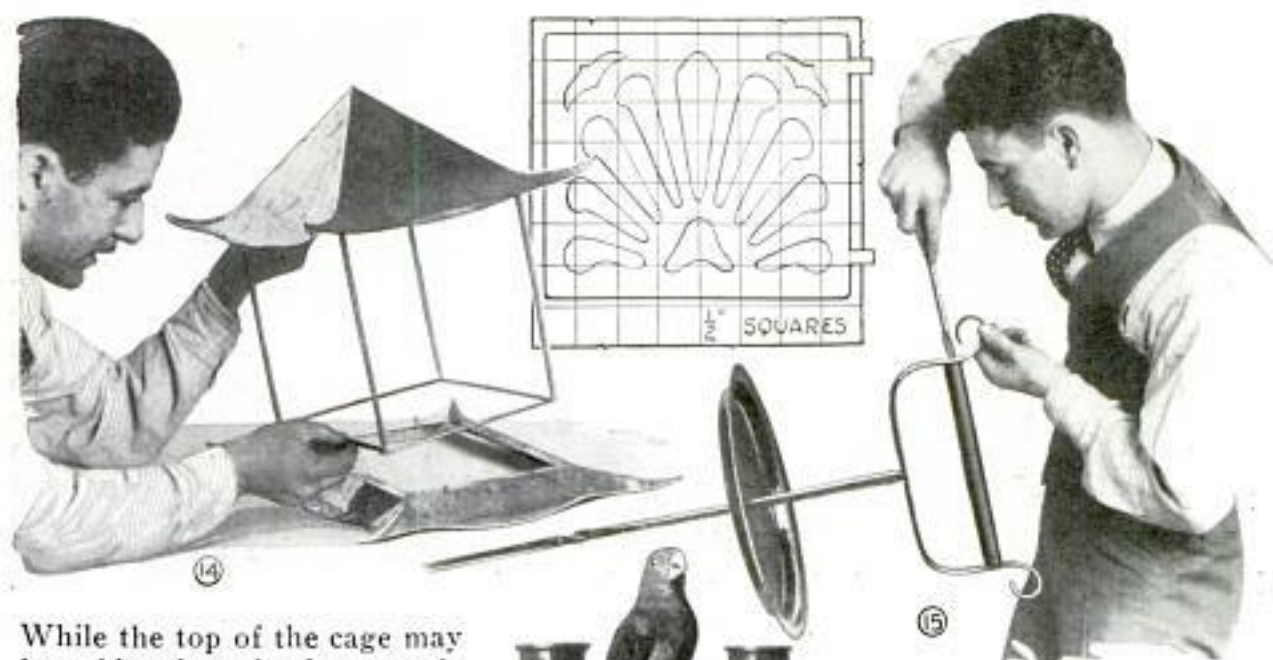

While the top of the cage may be soldered to the framework, the bottom should be made removable. This is done by soldering four small screw heads to the base piece, and fitting the tube framework with corresponding slots to lock. Lengths of No. 6 gauge piano wire are snapped into the holes cut through one side of the tube framework. Suitable openings, of course, must be provided for the feed cups so that they can be readily detached. The sliding tray is simply a flat strip of sheet copper, curled on the outer edge and slightly crimped all around to form a shallow pan. An eye is fitted to the top of the cage so that it may be hung in a simple wrought-iron stand. The door for the cage can be cut from sheet metal according to the detail above Fig. 14. The tabs are turned over to form the hinges, while a small spring makes the door self-locking. A strip of amber-colored celluloid, bent to shape and neatly fitted inside the cage, makes an excellent splash plate. Fine copper screening can be substituted for this if desired, or clear celluloid with a colorful, stenciled design.

In both cages, the perches are made from $\frac{7}{16}$ -in. dowel stock, tapered down slightly from center to ends. For the average small bird, it is unwise to make the perches smaller

than this, as ungraceful claws and rheumatism are sure to result. For larger birds, an increased diameter is necessary. Three perches are usually provided, two for feeding and one as a general resting place. A small swing may also be installed in either of these cages, but it is not necessary. From a careful examination of Figs. 15 and 16, it will

be quite apparent that either of the two pedestals pictured can be easily converted into a parrot perch by adding a simple U-shaped piece of wrought metal to which a perch, made from a section of broom handle, is fitted. The feed cups in this section are mounted on the top ends of the U-shape, the water cup being riveted over a gasket so that it will not leak. Most parrots get along nicely without a cage, but a tray must be provided. Any cheap serving tray will do for this purpose and it is a simple matter to fasten it in place.

Obviously, many other types of bird cages of artistic design to suit your fancy can readily be fashioned along the same general lines as the ones described. New features and novel treatment will do much to popularize the sunny songbirds.

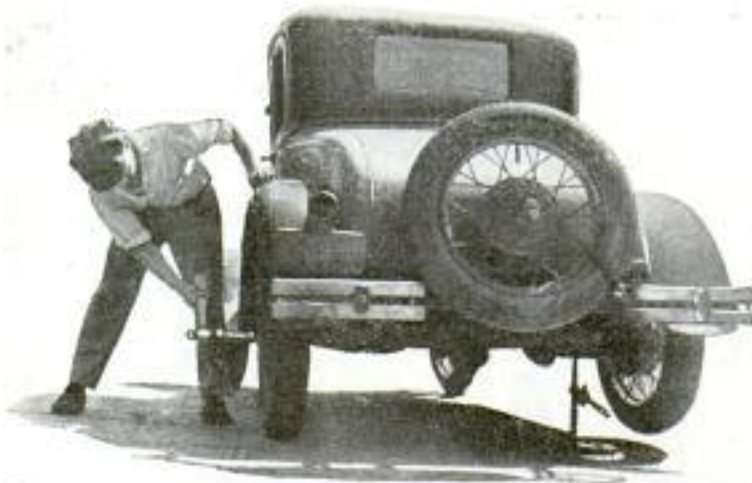

Rear Auto Wheel Removed by Jacking Up Opposite Wheel and Striking End of Axle with Small Sledge Hammer

Sledge-Hammer Blows Quickly Remove Rear Auto Wheel

In the absence of a puller, rear wheels on autos can usually be taken off in the following manner: Remove the hub cap, unscrew the axle nut until it is flush with the end of the shaft and jack up the opposite wheel. Then hold a hardwood block against the axle-shaft end of the wheel to be removed and strike it with a small sledge hammer as shown. The most stubborn wheel will usually give in to this treatment, and the axle assembly will not be harmed in any way.

Thumbtack Puller for Draftsmen Made from Film Spool

Thumbtacks can quickly be removed with a puller made from a camera-film spool, the flange at the key end being removed and a small wooden plug driven into the other end to strengthen it. Cut the plug flush with the end of the spool



and then sharpen the edge of the flange by filing it down on the outside so that it can be pushed under the thumbtacks. Bend the part of the flange that was not sharpened slightly upward.

Black lacquer top dressing makes a good refinish for old rubbers.

Nut and Ball Used to Flare Copper Tubing

Flares for the couplings on the end of a gasoline feed pipe, or other copper tubing, can be made with a nut and a center punch or steel ball. Get a nut that will just slip over the end of the tubing, and make a cut through one side toward the center with a hacksaw. Also countersink one end, if possible, to obtain a better flare. After the coupling has been slipped on the tubing, push the nut over the end, with the countersunk side up and the tubing projecting about $\frac{3}{16}$ in. Then clamp the assembly in a vise so that the nut squeezes the tubing just tight enough to hold it securely. A center punch or ball, slightly larger than the tubing, is driven into the end to flare it. To remove the nut, make another cut through the side to permit breaking it.

Notches in Screen Frame Provide Exit for Flies

Screens having notches cut in the upper rail of the frame for fly exits were specified by government inspectors for a large packing plant in Philadelphia. After extensive research, it was found that



flies on the inside of a screen will walk upward and escape through these openings, but will not come down through them from the outside.

Convex and Concave Mirrors Aid Shaving without Glasses

Men who must shave without their glasses sometimes find it rather difficult. The trouble can be overcome by using a concave mirror for far-sighted persons, or a convex one for those who are near-sighted. A concave reflector used on the old type of auto headlights has been found useful for this purpose.



This **HOMEMADE FORGE** is *Portable*

By E. G. Anderson

DRIVEN by an old but serviceable vacuum-cleaner motor, this forge is of use to the home craftsman as well as the farmer.

The fire box is an ordinary sheet-iron baking pan, about 14 by 17 in. in size. It is set in a wooden box of $\frac{3}{4}$ -in. material, which is lined inside and out with 22-gauge sheet metal, the sides being about 2 in. deep. The legs and framework are similarly built of wood according to the dimensions shown in Fig. 1, where the side view and plans are given. A back shield is cut from 20-gauge sheet metal as shown in Fig. 2, and screwed to the back of the frame, extending 9 in. along each side. A short $1\frac{1}{2}$ -in. pipe nipple and cap,

in which a number of No. 11 holes are drilled, form the tuyere which projects up $\frac{3}{4}$ in. through a hole drilled in the bottom of the pan. The nipple is fitted to a $1\frac{1}{2}$ -in. pipe tee with a plug in the bottom for cleaning, while a 5-in. nipple is screwed into the side. Approximately 2 in. from one end of the lat-

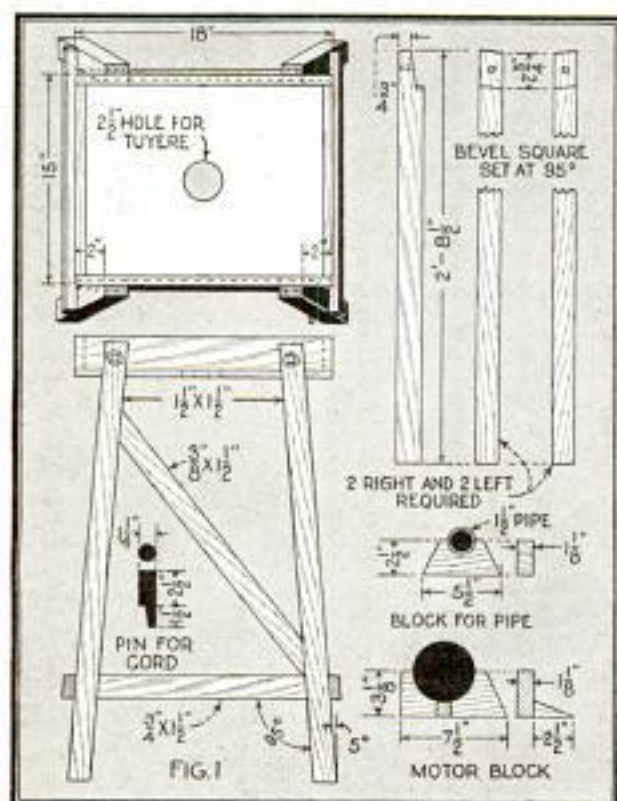

Vacuum-Cleaner Motor Provides Draft of Air, the Volume of Which Can Be Controlled

ter, a vertical slot is cut about halfway through for a draft gate, which consists of two pieces of sheet metal cut to the shape shown. These are riveted together at the top and bottom to two $\frac{3}{8}$ -in. pieces of flat iron, which serve as slides. Triangular tabs are cut as indicated and bent at right angles to the face of the gate pieces, so that the tabs will fit the outside curvature of the pipe. They are attached to the latter by means of hose clamps,



fitted over the pipe nipple, and the motor is clamped to the underside of the top with a wooden block and two metal bands. As most cleaner exhaust ports fit nicely over the end of the pipe nipple, the connection will hardly need cementing. A switch, for turning on the current, is placed in a convenient position for the operator. The draft lever, made of suitable bar iron, is pivoted to the bottom of the pan box, and its movement is limited by two slides, also screwed to the underside of the top. The pivot point on the lever should be located so that the lever will move the draft slide in and out as far as it will go, although the slide will not entirely close the draft pipe.

To complete the job, the bottom and sides of the pan are covered with fire clay, the surface of the clay being sloped at an

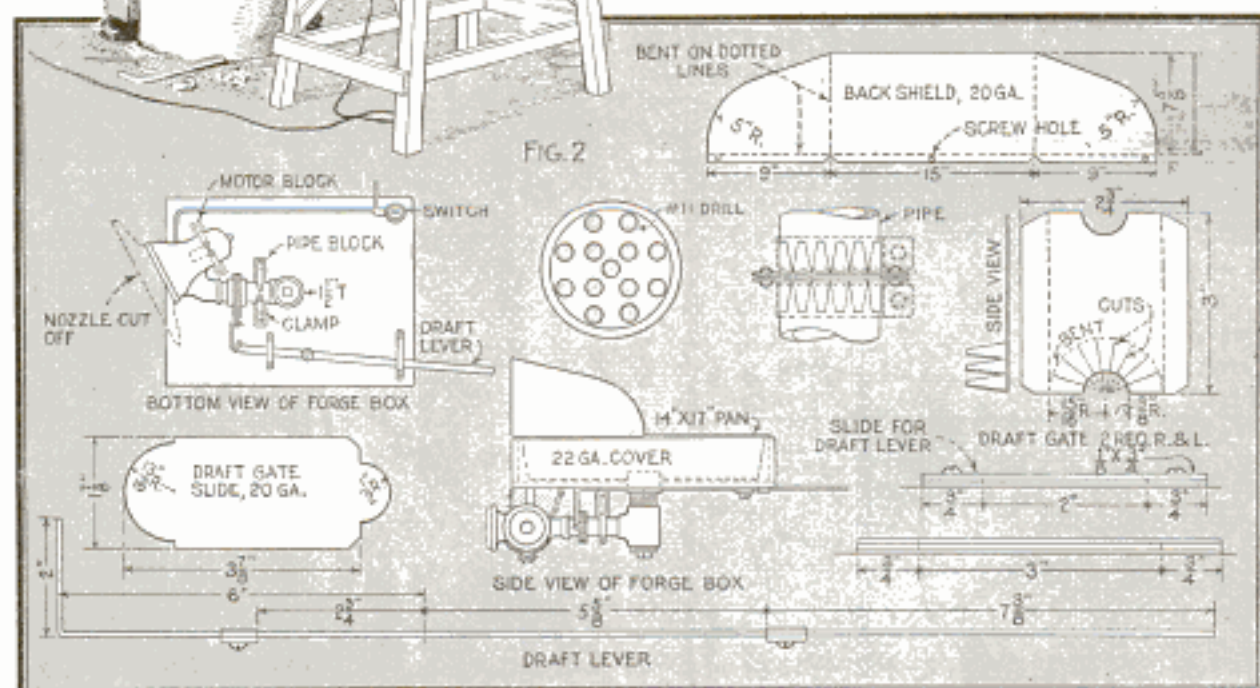

which serve to hold them in position.

Next, the draft slide is cut from 20-gauge sheet metal, and a hole is drilled in the small projection at one end for a connecting link, between it and the lever, which is used to adjust the draft slide. To hold the assembly in position, 1-in. strips of sheet metal are clamped around the pipe with stove bolts, and are screwed to supporting blocks fastened to the underside of the top. The suction nozzle of the vacuum cleaner is cut off and the resulting hole is covered with wire mesh, while the exhaust port of the cleaner is

angle from the top edge of the sides to the top edge of the tuyere.

Muriatic Acid Improves Adhesive Quality of Aluminum Paint

Pure muriatic acid mixed with aluminum paint in the proportion of one-fifth of a teaspoonful of acid to $\frac{1}{4}$ pt. of paint, will cause it to adhere without first washing the surfaces. The cover should not be put on the can until the paint has stopped foaming.—Arthur Burkman, Milwaukee, Wis.

Woven-Wire Fence Stretched with Tractor



Using Your Tractor to Hold Woven-Wire Fencing Taut While Stapling It to Posts at Regular Intervals, Makes a Neat and Sturdy Fence besides Saving Time and Work

In putting up new fencing, you can use a tractor to stretch it. The fencing is unrolled and securely fastened to a braced post at one end in the usual manner. Two heavy pieces of 2-in. stock are clamped over the other end of the wire and these are in turn fastened to the drawbar of the tractor. The latter is then slowly driven forward until the wire is sufficiently tight. If the tractor is driven close to the posts and the fencing attached by means of a chain and a swivel joint, the wire can be set vertically and stapled to the posts at regular intervals, while it is held taut by the tractor. This method can also be applied to barbed-wire fencing with good results. Care should be taken, however, not to pull the fencing too tight, as it may be broken.

Dressing Tool for Emery Wheel

The surface of an emery wheel can be dressed satisfactorily with a tool made from 10 steel washers and a 6-in. length of iron rod threaded at both ends to receive a nut. The washers are slipped over the rod and the nuts tightened to hold them fairly close together, but without

preventing them from rotating. The rod should be about $\frac{1}{8}$ in. smaller than the diameter of the holes in the washers. In use, the tool is placed parallel to the surface to be dressed and held tightly against it while the wheel turns.—A. T. Lawton, Ottawa, Can.

Removing Sickle Blades

When it is necessary to remove sickle blades, try the method indicated in the photo. A

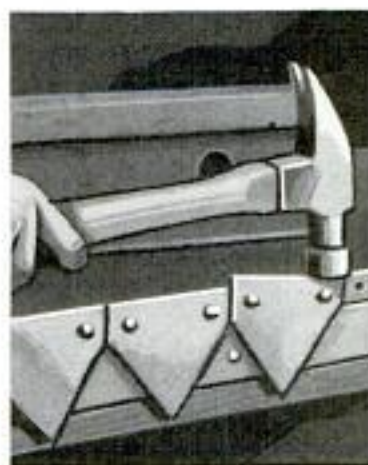

length of $1\frac{1}{2}$ by $1\frac{1}{2}$ -in. angle iron is screwed to the front edge of a workbench and the sickle is placed over it. A sharp blow on the projecting flat edge of each blade will

shear the rivets off smoothly, one at a time, after which the blade is removed.



Fluting Work Done on Drill Press by Means of This Jig and Homemade Shaper Knife

Fluting on a Drill Press

Fluting can be done on a drill press by means of this jig, which consists of two short pieces of wood lapped over the ends of another piece as shown in the detail. The work is held in the jig by means of a nail at one end and a screw at the other, the latter being tightened to hold the work rigidly. Both nail and screw are, of course, driven into the center of the work. The cutting is done with a shaper knife mounted in an adapter, which can be made from a bolt of suitable size and held in the chuck.

Self-Adjusting Bench Stop



Woodworkers will find this a quick self-adjusting stop for holding work securely. Get a 4 by 12-in. length of stock and rip it across on a bevel, so that the two smaller ends will be 1 in. wide. Nail one of the pieces to the bench top and a 2 by 12-in.

strip 1 in. from its wide end so that, when the other wedge-shaped piece is placed

between them, the assembly will be 6 in. wide and 12 in. long. A $\frac{1}{2}$ by 5-in. notch cut on the square side at the wide end of the sliding piece completes the stop. Place the work in the notch and push forward until it is gripped between the sliding wedge and the strip.

Correct Installation of Belts

There are a few things to remember when installing new belts. Be sure that the shafts are parallel and that the pulleys are in correct alignment; also that the belt is of the proper length and that the ends are cut square across where the splice is to be made. Splicing should be given considerable attention, whether the ends are laced or glued. It is not a good idea to cut the belt too short and then stretch it to make it fit, as this will weaken the material so that it will wear out faster and will also cause undue wear on the shaft bearings.

Measuring Tape Held in Position with Pencil Clip

When you are working alone and must measure work with a tape, a makeshift method of holding it in position is to use the clip

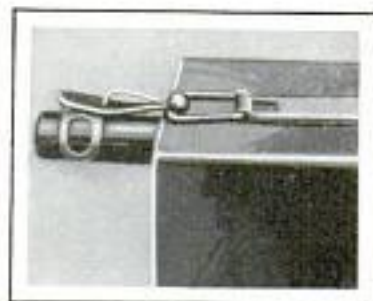

on your pencil or pen, if the work allows attachment in this way. Hook the clip over the work with the ring in the end of the tape as shown.

Sorting Auto Crankcase Screws

As crankcases on most autos are held on with bolts of different lengths, it is desirable to keep them separated in a suitable holder when the crankcase is removed. Such a holder can be made by drilling two rows of holes, to represent each side of the case, in a length of 2 by 4-in. stock. When removing the bolts, place them in corresponding holes in the holder, where the right bolt for each hole in the case is easily found.

Methods of Detecting Leaks in Cylinder-Head Gaskets

Leaky cylinder-head gaskets sometimes cause considerable damage to a motor by allowing water to get into the cylinders where it gets past the piston rings and into the oil, interfering with proper lubrication of the bearings. Slight leaks from the water jacket into the cylinder can be detected by opening the radiator cap and listening while the motor is running. If a leak is present, a bubbling sound will be heard in the radiator. A bad leak will cause the water to be thrown out of the radiator when the motor speed is increased. Leaks can sometimes be detected by an unaccountable loss of water after driving the car. On rare occasions, the gasket will blow out between the cylinders, interfering with firing.

Sunlight Reaches Entire Floor in This Poultry House

A poultry house designed and built by the owner of a farm at Medford, N. Y., has many advantages over the usual type. The overhead was reduced without sacrificing the floor space, thereby effecting a saving of 20 per cent in material. The walls were built at a 60° angle, which allows the sunlight to reach the entire floor through the windows. The owner claims that the more constant temperature possible in this type of building has decreased poultry mortality and increased profits.



Poultry House with Slanting Walls Allows Sunshine to Reach All Parts of the Floor

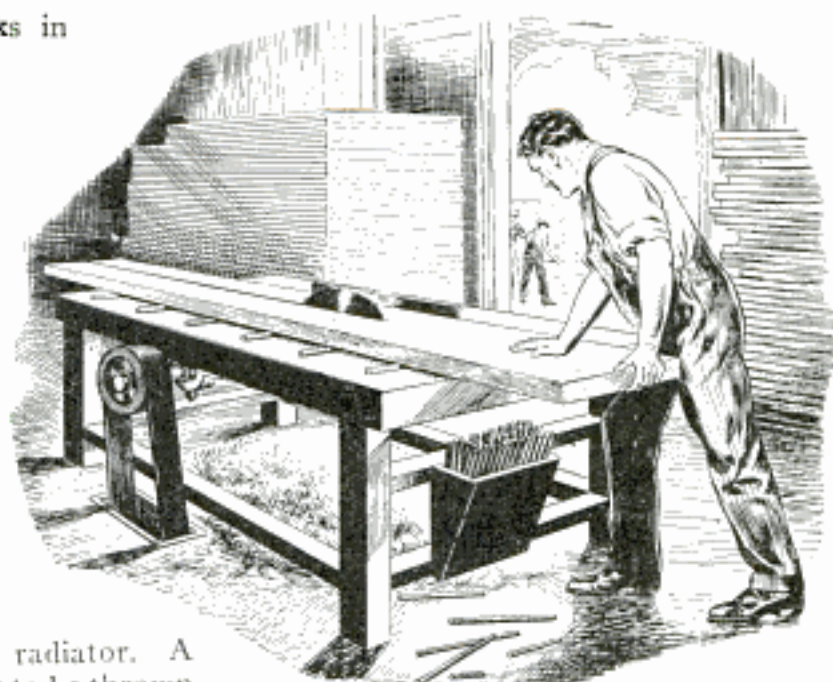

Friction of Heavy Timbers on a Saw Table Can Be Reduced by Using Dowel-Rod Rollers

Heavy Stock Rolled on Saw Table with Dowel Rods

Where considerable friction is encountered when pushing heavy stock over a saw table, the use of dowel rods as rollers will be found a great help. The rods are placed on the table at right angles to the saw blade and as the work is pushed along, additional rods are inserted under the feeding end, a supply of them being kept in a convenient position near the operator. The length of the rods depends on the width of the work, short rods being used on one or both sides of the cut. Those between the saw and the fence also must be short so that, if they happen to roll diagonally, they will not bind against the saw.—C. C. Ames, Mayville, N. D.

Celluloid Triangles Lettered with Nail Polish

Lettering can be put on celluloid articles, such as draftsmen's triangles, by using black drawing ink and liquid nail polish. First letter the objects with the ink and allow it to dry. Then brush the nail polish over the ink to provide a transparent film which cannot be rubbed or washed off. If desired, collodion may be used instead of the polish.

☛ Two 8-in. sections of an old auto casing make good false jaws for a vise.

*Synchronous motor
Messier Mfg Co
522 S Clinton
Chicago*

Novel Cases for Electric Clocks



Old Lawnmower Chassis Fitted with Wooden Body Makes Handy Cart for Milk Cans

Old Lawnmower Serves as Cart for Milk Cans

An old lawnmower chassis was utilized by a farmer near Oakford, Ind., in making a milk-can cart. A wooden body was built on the chassis as shown, which was fitted with handles so that it could be pushed along. For rubber-tired wheels, stretch a section of inner tube over them.

Carving Tool Made from Drill Rod

This carving tool, which enables one to get into out-of-the-way places more easily, is made by flattening one end of a length of drill rod with a file and drilling a $\frac{3}{8}$ -in. hole in it as shown. The rod is then tempered and ground to a knife-edge. Such a tool will also be found to be much easier on the hands than the usual type. The handle may be knurled to permit gripping it firmly.—Deane B. Caldwell, Los Angeles, Calif.

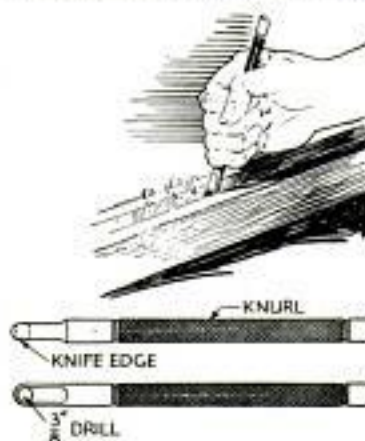

A clock in every room, and why not, when a synchronous motored clock requires little care and attention? The corner clock shown in Fig. 1 is a novel and attractive piece of furniture, which serves both as a timepiece and a shelf. Plywood panel stock for the back, shelves, skirt and crown, and white solid stock are required for the facing strips and door frame. Fig. 8 shows how the formed facing strips are made. Screws and glue are used to fasten the back to the strips, the screws being driven from the outside. Fig. 9 gives the door construction, which is a rabbeted mortise-and-tenon joint. The glass is fastened into the rabbet with strips. Fig. 4 shows a section above one of the shelves, from which the shelf size may be obtained, and also the size of the back panels. The dimensions for the turned finials are given in Fig. 3. If you have no lathe, brass or turned wood ornaments may be purchased that will serve the purpose. The patterns for the formed pieces may be obtained from Figs. 5, 6 and 7, the curves being cut with a band or coping saw. The door is hinged as shown, and a catch holds the door closed. The hanging book shelf, Fig. 2, is suitable for a den, library or living room. A box accommodates the clock movement, as shown, and is fastened to the front panel. This should be as nearly dust-tight as possible but accessible if necessary. If an outlet is arranged in the wall directly behind the clock, it will make a neat installation. Screws driven through the back at the points where the studs are located provide a suitable fastening. Hooks are not advisable because of the weight of the books. The kitchen case shown in Fig. 10 is intended for recipes and cook books but can be used as a spice cabinet with slight changes. The case is light and can be suspended from strong hooks or fastened as previously described. The material and finish for any of the clock cases will depend on the furnishings of the room in which they are to be used. The corner clock will work up best in walnut or mahogany, while the kitchen case requires soft wood for a paint or enamel finish. An electric clock having a 10-in. dial is about right for the corner clock, and smaller ones for the other pieces.

Drying Out Cribbed Corn Prevents Spoilage

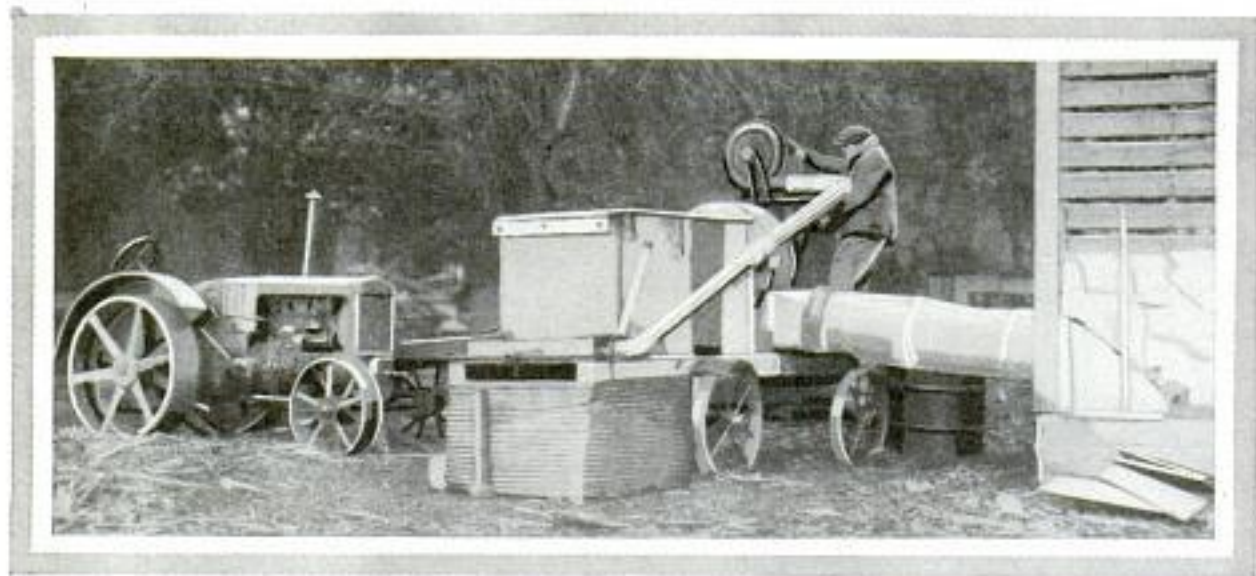

Here Is a Homemade Drier, Which Can Be Built at Small Cost and Will Save You Many Dollars by Drying Out Damp Hay, Corn and Small Grain

A corn drier has recently been developed and successfully used by the agricultural engineering staff of Purdue University, the purpose being to dry moist corn that has already been cribbed. The apparatus consists of an oil heater installed in a large box set on a wagon chassis. A small fan is used to draw outside air into the heater compartment, while a large fan forces the hot air through a sheet-metal pipe to the crib, both fans being connected so they can be run by a tractor. The exhaust pipe is provided with flexible connections of canvas so it can be placed inside the crib where needed. The burner is supplied with oil from drums set on the ground near the wagon. To make the process more efficient, building paper should be nailed around the crib to hold the heat. This apparatus can also be used for drying out green or wet stacks of hay, and for drying out oats and wheat that have been treated for smut.

Paper Prevents Colors on Paint Brushes from Mixing

In applying several colors on a paint job, the brush has to be cleaned every time a different color is used, or if a brush is provided for each color, a separate can of oil is needed for those not in use in order that the colors may not run together. By wrapping a piece of paper, or a

small paper bag, around each brush, all of them can be kept in the same can, as the paper prevents the colors from mixing.—Chas. Illingsworth, Vancouver, Can.

Press for Cleaning Oily Waste

Cotton waste can be reclaimed and used again by removing the oil with this press. It consists of a length of 5-in. pipe nipple, two caps and a plunger. One cap is drilled for the shank of the plunger, which is a 1-in. pipe threaded its entire length and provided at one end with a hardwood block fitting inside of the nipple, while the other end is fitted with a tee and two nipples to serve as a handle. The other cap is drilled and tapped for a nipple as an outlet for the oil. In use, the waste is put in by removing the top cap and taken out by removing the bottom cap. If the waste is boiled for 15 minutes in a solution of soda and water after the pressing, it will dry fluffy.

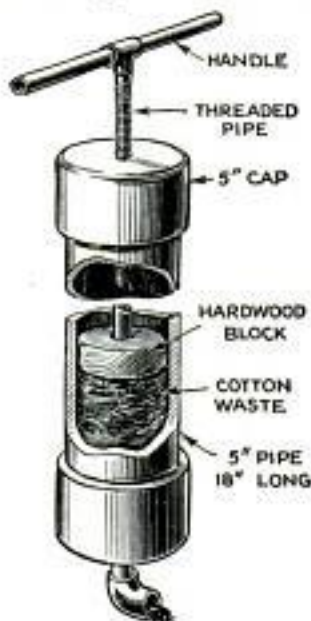

Clamp Nail Co.
4540 Palmer St.
Chicago 693

Leaky Intake-Manifold Gasket Causes Misfiring

Misfiring of an auto motor at low speeds sometimes is due to a leaky gasket on the intake manifold. A small leak causes it to misfire at low speeds, while a bad leak makes the motor miss at all speeds. To locate the trouble, squirt gasoline around the intake gaskets while the motor is running. The vacuum in the manifold will draw this gas into the motor if a leak is present, and will change the running rhythm sufficiently to be noticed, causing the motor to speed up or slow down. The sucking sound made by the motor drawing this extra gas into the manifold may also be heard.

Pipe Joints Are Easily Welded with This Holder

Welding pipe joints is facilitated by the use of this fixture which holds the work firmly, yet allows it to be turned back and forth. A piece of flat spring steel is bent to the shape shown and bolted to the bench, while a length of iron rod, formed into a ring at one end and threaded at the other, is attached as indicated. A short pipe, driven onto the upper end of the spring, forms the handle and completes the job. The work is slipped over the lower end of the holder and is kept in place securely by the ring. It is released by pressing down the handle. The size of the holder varies with the work for which it is intended.

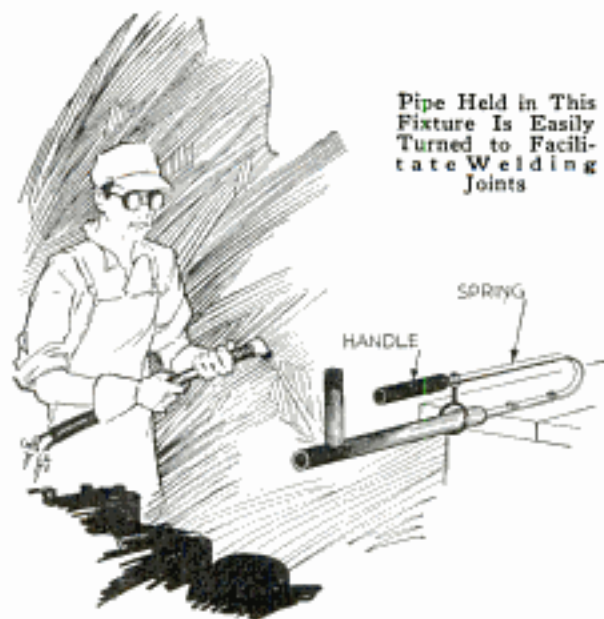

Clamp Nails Hold Wooden Pieces Together in the Lathe for Turning Half-Round Work

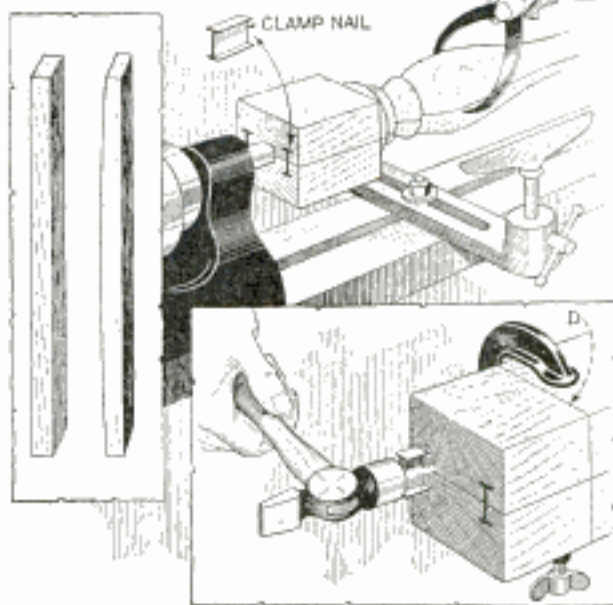

Clamp Nails Hold Work Together for Split-Wood Turnings

Halved, or split-wood, turnings, such as are used for decorative purposes on cabinetwork, can be made with less work by using clamp nails for holding the pieces together while turning them. Plane the side of one piece so that the surface is slightly curved, as shown in the upper detail, and cut kerfs for the clamp nails in the ends of both pieces, placing them so that they will not interfere with the lathe centers, or with the turning tool. The pieces are clamped together and the nails driven into them. The work should be long enough to allow 1½ in. to be sawed off at each end in order to remove the nails, as shown by the line D, after which they can be split out and used again.

A Compound for Lapping In Gears

A compound for lapping in gears can be made as follows: Mix thoroughly No. 3F Carborundum brand silicon carbide, 1 lb., mesh garnet, 14 oz., machine oil, 1 qt., and add ½ lb. of cup grease. Pour this compound into the gear housing, and set the gears in motion. When they are lapped in, wash out the housing carefully as the compound will damage the gears.

☞ To prevent the threads on an electric soldering iron from rusting, spread ordinary rosin soldering paste over them.

also garnet - White Wood Selvia Co.
197. Curtis Chicago

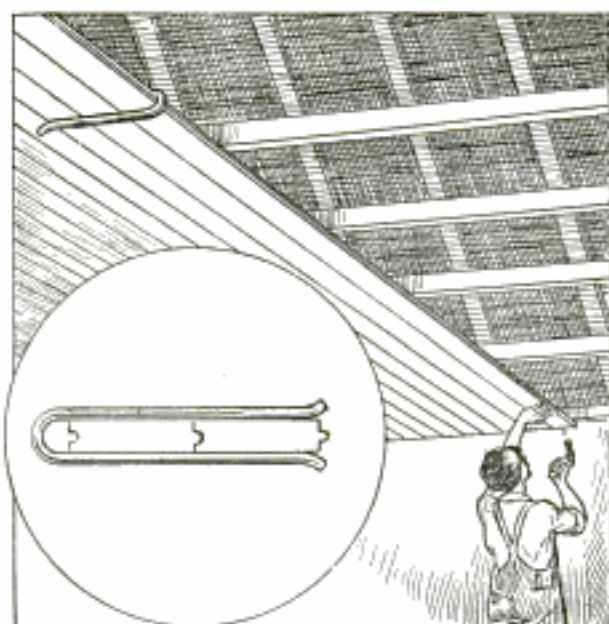

This U-Shaped Clamp to Hold Ceiling Stock Takes the Place of a Helper

A Clamp to Handle Ceiling Stock Single-Handed

When no helper is available, you can handle ceiling stock alone by means of a flat-iron clamp to hold the free ends. The clamp is made of 1 by $\frac{1}{4}$ -in. stock, 24 in. long, and is bent over the center so that it will grip the boards lightly. The ends should be bent outward slightly, so that the tool can be slipped over the work. In use, the clamp is slid over the ceiling boards already nailed in place, allowing it to project far enough to allow the insertion of another piece. With one end of the stock supported in this way the worker can start nailing at the other end.—Roger C. Dickey, Salem, N. H.

Fuel Surge in Carburetor Stops Motor

Stalling of a motor, when starting or stopping a car, is often caused by a surge of fuel in the float chamber of the carburetor. If the chamber is placed toward the front of the motor, the fuel tends to surge away from the fuel jet when the car comes to a stop, thus "starving" the motor. If the chamber is placed toward the back of the motor, the surge will flood the jet and cause a too rich mixture. The remedy depends on which of these conditions prevails. In case of an overrich mixture, set the carburetor as lean as pos-

sible when idling. If the trouble is caused by too lean a mixture, the idling-adjustment screw should be opened slightly, to overcome the tendency to stall. In some cases stalling is caused by too slow idling. The car should be driven and the adjustment set for 3 to 5 miles an hour, as may be necessary.

Durable Barrel Hoops from Old Sprocket Chain

Old sprocket chains that accumulate on the farm provide satisfactory barrel hoops that will outlast those of strap iron. Hook the ends of the chain together, after reducing or increasing the length, so that it will have to be driven onto the barrel. If the chain is not long enough, you can get a hoop of the proper size by linking the ends together with a wire, threaded back and forth several times.—Luther Stro-
snider, Onaga, Kans.

Tubular Sampler Removes Seed from Center of Sack

A seed-supply house in Phoenix, Ariz., uses a 15-in. length of seamless brass tubing, pointed at one end, for quickly taking seed from a sack for testing purposes. Several holes are drilled along one side and the tube is fitted with a sliding plunger which closes the holes. In use, the plunger is pushed in and the tubing pushed into the sack. Then the plunger is pulled back to allow the seeds to fall into the tubing. With this method, the seeds can be taken from the center and sides of the sack in one operation.

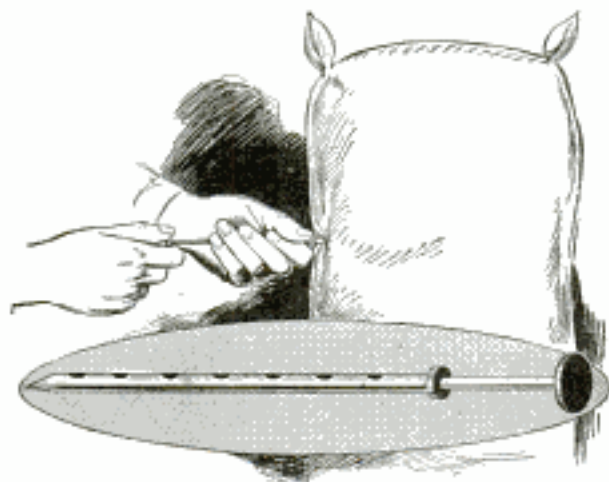

Seeds Are Taken from the Center and Side of a Sack with a Tubular Sampler

Extension Brazed to Sheared Studs Helps Remove Them

Studs that have been sheared off can be removed by using Tobin bronze to braze an extension piece to them so that they can be turned out with a pipe wrench. To do this, drill a small hole through the broken stud, if possible, to allow for expansion caused by the heat and tin the end with Tobin bronze. Then tin the end of another stud or steel rod of the same diameter and braze it to the end of the broken stud with the aid of a bronze rod. If the break is dirty or rusted it will be necessary to roughen it with a chisel or prick punch before tinning. The bronze will not adhere to the casting unless it is clean. Confine the heat as nearly as possible to the break, as this will aid by slightly expanding the surrounding metal. By working rapidly, the heat will not endanger the casting, due to the low melting point of the bronze. This method has been found successful where others have failed.

Print Roller from Typewriter Platen

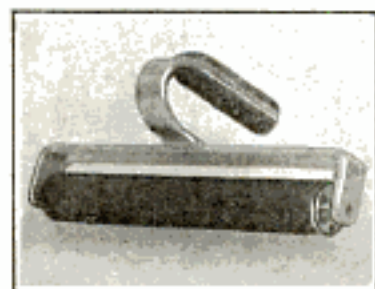

Fitted with a metal frame and a handle, a typewriter platen will form a good print roller. The frame is made of $\frac{1}{8}$ -in. steel, bent to the shape shown and drilled at each end to receive the platen shaft. The handle is made of the same material as the frame, one end being welded or brazed to the frame, and two wooden pieces riveted to the other end form a comfortable grip.

Connectors for Electricians' Testing Equipment

Connectors for electricians' and repairmen's testing equipment can be hooked into a circuit at almost any point without extra work and connected on wire without removing the insulation. To make these, cut a piece of brass to U-shape. Drill and tap holes in each leg, one for a screw, fitted with a fiber or bakelite head

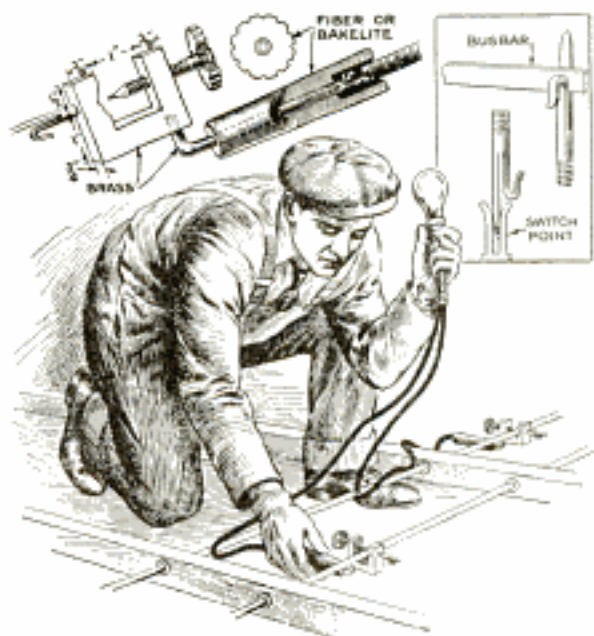

Electrical Circuits Can Be Tested at Most Points with These Connectors without Removing Insulation

and pointed at the other end to penetrate insulation on the wire, which is held in a groove filed on the inside of the opposite leg. The other hole takes a piece of brass rod, split and shaped to enable attachment to switch points or busbars. Drill a third hole in the bottom of the U-shaped piece for a handle, consisting of a length of brass rod threaded at both ends, one end being bent at right angles, while the test wire is soldered to the other. A fiber or bakelite sleeve is then turned on and test wire connected to the latter.

Coarse File Used as Plane for Edging Boards

Mounted in a suitable holder, a rasp or coarse file will often serve the purpose of a plane for edging boards. The holder consists of a wooden block and two strips of molding, which are grooved to fit over the edges of the file. The file is then placed in position and the molding, which holds the file firmly to the block, is screwed on. In use, the file is placed against the edge of the work as shown and drawn back and forth, the pieces of molding serving as guides.



Steady Rest Prevents Vibration of Long Work on Lathe

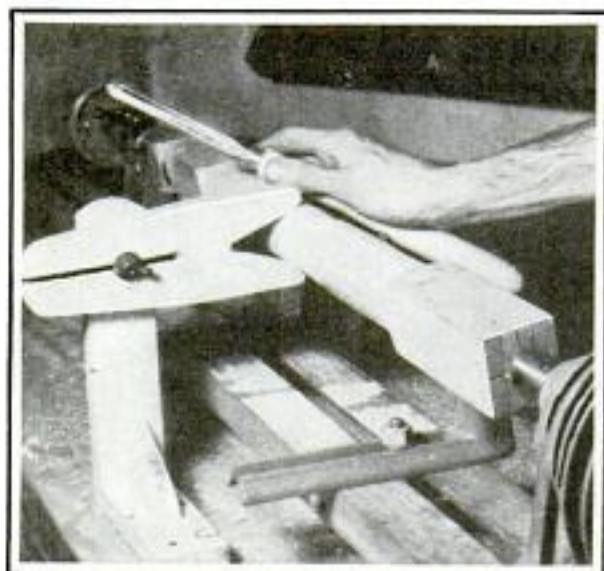

Improvised Steady Rest Prevents Vibration When Turning Long or Thin Work on a Lathe

Excessive vibration, often experienced while turning long spindles in a lathe, can be overcome by using the steady rest shown. It is made of wood and consists of an upright piece of suitable length clamped to the lathe bed at a point approximately midway between the lathe centers. A crossarm, having a V-notch cut in one end to accommodate work of various diameters, is fastened to the upright with a wingnut and bolt, which is fitted into a slot cut in the other end to allow for lateral adjustment. In use, a smooth place is turned on the work to receive the notch in the crossarm, which is then adjusted to fit firmly against it. This will steady the work.

Guide for Bit When Drilling Dowel Holes

Dowel holes are sometimes rather difficult to drill straight without a guide. One

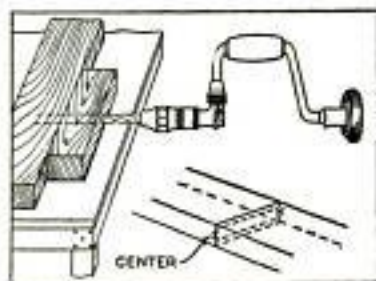

can be made by squaring a line around a wooden block, of the same thickness as the work, which should be similarly squared beforehand. Center-mark the opposite edges and drill a hole of the proper

size about halfway through, then, starting at the center on the opposite edge, drill a hole to meet the first. This will provide a true hole to guide the drill when the block is held against the work.

size about halfway through, then, starting at the center on the opposite edge, drill a hole to meet the first. This will provide a true hole to guide the drill when the block is held against the work.

Steel Wool Cleans Welding Torch Tip

Frequent rubbing with steel wool, or with fine emery cloth, will keep the outside and end of an acetylene torch tip free of incrustation. It may be necessary to have a reamer of the correct size to clean the inside of the tip. A handle can be made from a short piece of round or hexagon stock, soldered to the reamer to aid in twisting it through the tip. This method of cleaning will not distort the cone, as is sometimes done when it is rubbed against a brick to clear the tip.

Spur on Hammer Provides Grip When Shingling Roof

You may prevent an injury in slipping from a roof, if you fit your hammer with this safety spur. It is a $\frac{3}{8}$ by $\frac{5}{8}$ -in. piece of triangular steel tapered to a point and welded on the side of the hammer as shown. The spur is slightly curved, and should you slip, you can immediately check the fall by digging the spur into the roof.



Washer Stops Oil Leakage on Electric Fans

The armature shaft on electric fans in time becomes loose enough to jerk back and forth, and unless oiled by a wick, it throws oil on the blades by which it is ejected all over the room. To remedy this trouble, remove the blades and slip a metal washer over the shaft so that it fits tight enough to turn with it. Then put on a fiber washer and replace the blades, pressing them against the washers, and tighten the setscrew that holds the blades.

PORTABLE DARKROOM *Develops* Your Photos ANYWHERE

By Floyd Suiter

WHEN photos must be developed on the job, where there is no access to a darkroom, this portable outfit solves the problem of providing a light-tight place to do the work, which is especially necessary when using the extra-rapid panchromatic films and plates. Besides being useful for developing, it is also convenient for loading holders and magazines.

As the box measures 12 by 24 by 18 in., it is easy to carry around, two handles being provided on the ends for this purpose. The material used in its construction is light-gauge steel or galvanized sheet iron, all edges being bent to fit snugly and then soldered. The box is made in two parts—the body and the cover—as shown in Fig. 4. The edges of the cover are flanged as in Fig. 5 so that they project over on the inside. A layer of felt is placed all around the top edge of the box on which the cover rests and the

Angle-iron ledges are screwed to the inside of the box, near the top edge, to hold a sliding shelf as shown in Fig. 1, which is a convenient place for empty plate holders and film packs. Observation of the work from the outside is possible



Although Fitted with an Observation Window and a Safe-Light, You Can Exclude All Light from This Portable Darkroom

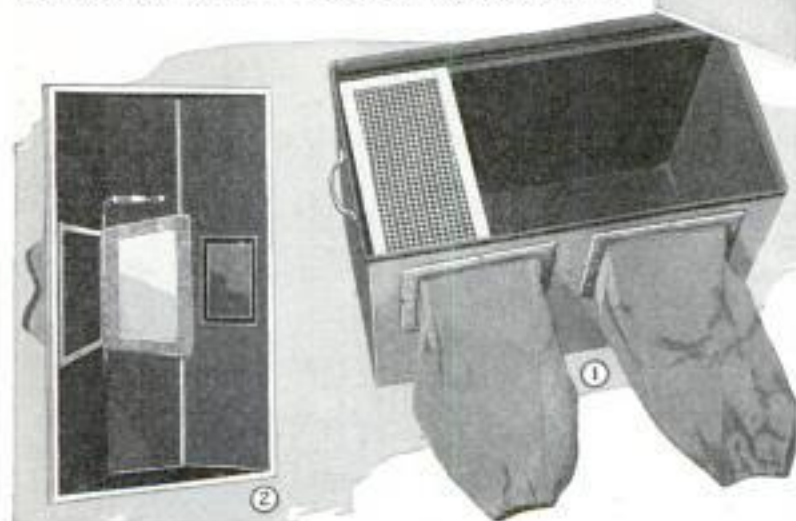

projecting edge inside fits closely, to exclude all light. The top edge of the box is bent over a length of wire, care being taken to get it perfectly straight. Two square openings are cut in the front of the box for light-tight sleeves, made of rubberized material and fitted with elastic bands to close around the arms. The sleeves are about 15 in. in length and 7 in. square. They are attached to the box by means of metal angle plates which are bolted to the box as indicated in Fig. 5.

through a small hooded window, the edge of which is cut to fit the forehead and nose and all edges are padded with felt for comfort. A piece of ruby glass is mounted permanently on the inside of the cover directly under the window, and a hinged door is fitted on one side of the glass, as shown in Fig. 3, so that it can be swung over to close the entrance, if desired. The edges of the door are padded with felt to exclude light, and a coil spring is arranged to hold it tight in a

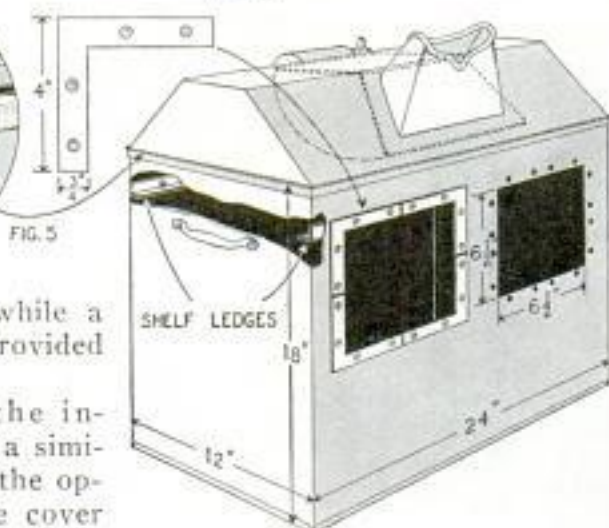
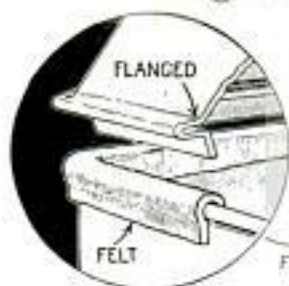
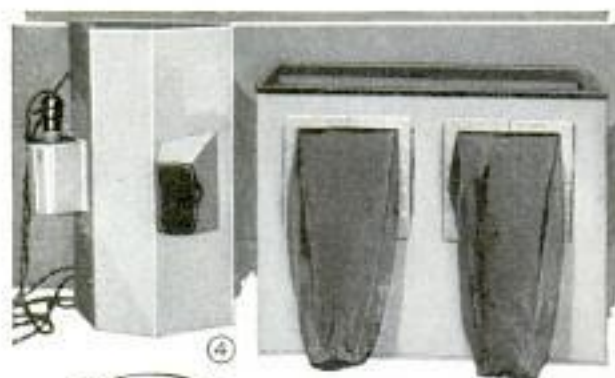

closed position, while a catch may be provided to hold it open.

To illuminate the interior of the box a similar hole is cut in the opposite side of the cover and a sheet-metal hood, for holding a suitable photographic safe-light, is soldered or riveted over the hole. An extension cord is provided to permit plugging in at any convenient outlet. Amber or ruby-colored glass can be interchanged in a slide, inside of the cover and directly under the lamp, if desired. It is also a good idea to provide an opaque cover at this point to exclude any light when developing panchromatic films and plates. Fig. 2 gives a view of the inside of the cover, showing both the window and the illuminating opening. The interior of the box should be painted dull black to minimize the possibility of light reflection, while the exterior may be painted any color to suit your fancy.

How to Extract Attar from Roses

If you have a number of rose bushes around your home, it is a simple matter to extract the attar from the petals and make a high-grade perfume. Get a gallon jar with a fairly wide mouth, such as a mustard jar, and fill it with the fresh petals, pressing them in tightly. Next put strips of a sponge in pure olive oil and

place them in a 2-oz. vial that will fit tightly over the mouth of the jar. Set the jar outdoors where the sun will shine on it and let it stand for at least a week. The heat will distill the petals, while the aroma rising into the sponge will be absorbed and held by the oil. More roses should be added as space becomes available. After the strips of sponge have been thoroughly saturated with the attar, they are placed in a bottle for future use. As the fluid is volatile, the bottle should be kept tightly corked.

Tapping Attachment for Lathe or Drillpress

Anyone can make this tapping attachment which can be attached to a bench lathe, drillpress or an emery wheel. No dimensions are given as they will depend on the facilities at hand and the kind of machine on which it is to be used. First get a suitable length of

$\frac{1}{2}$ by 2-in. flat iron and bend it to a U-shape as shown. Drill a hole in each end to receive the chuck spindle. The sheave can be turned out of aluminum, if one cannot be purchased, and is held on the spindle with a setscrew in the hub. This also holds the spindle from slipping out

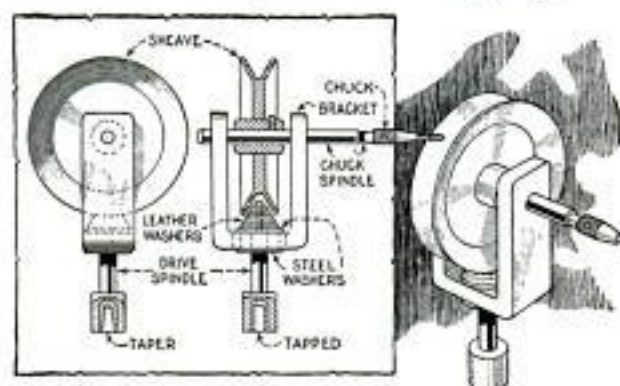

This Tapping Attachment Can Be Made to Fit Your Lathe, Drillpress or Emery Wheel

of the bracket. As the sheave is driven by friction against leather washers on the end of the drive spindle, the play between the hub and the brackets should be greater than the play between the washers and the groove in the wheel. The drive spindle is turned to a suitable size and either

tapered or tapped at the lower end for driving convenience, while the upper end is threaded and fitted with a nut which holds the washers in position. Steel washers are placed over the spindle on each side of the bracket to hold it in position. The leather washers are put on the end of the shaft and tapered to conform with the groove in the sheave, but the taper should be slightly less than that of the groove to afford a neutral position for the wheel. In use, the pressure of the work against the tap will force the wheel against the leather friction drive, and the motion can be reversed by pressure on the opposite end of the chuck spindle.—F. J. Wilhelm, Cincinnati, Ohio.

Ignition Trouble Indicated by the Ammeter

Certain kinds of ignition trouble can be detected by closely watching the dash ammeter while the motor is being cranked. If the ammeter shows a current flow when the ignition switch is first turned on, and then drops to, or near, zero, a partially open circuit is likely to be the cause of the trouble. This can be checked by cranking the engine with the starter and observing the movement of the ammeter hand. If it swings regularly to between 4 and 6 amp., this part of the system is in good condition. But if the hand does not indicate regularly the opening and closing of the timer points, the trouble may be in the low-tension side. The most common cause for this trouble is that the timer points have become burned or dirty, which can be checked by turning on the ignition switch and shorting the points with a screwdriver. This should show a normal current flow on the ammeter and a good spark when the screwdriver is moved. Other causes for ignition trouble are loose contacts, broken wires and poor contacts in the switch.

For Your Workshop

AN attractive 16 by 23-in. table giving both the decimal and metric equivalents of the fractional parts of an inch, for use in the home workshop as well as the drafting room, machine shop, garage, etc., will be sent to anyone upon receipt of 10 cents to cover mailing costs. Address Book Dept., Popular Mechanics Magazine, 200 E. Ontario St., Chicago.

Extension Light Fastens on Cap



Light on Auto Mechanic's Cap Throws Light Where Needed and Leaves Both Hands Free

Here is an extension light for the auto mechanic, which has been found a great improvement over the usual type, as it leaves both hands free and throws the light where needed. It is made from a piece of bakelite fitted with a 6-volt lamp and socket, and a suitable length of cord so that the current can be taken from an auto battery, or from the 6-volt tap of a transformer connected to the 110-volt lighting circuit. If desired, a guard can be provided to avoid breakage of the lamp. For constant use in the shop, the 6-volt lamp may be replaced by a miniature or candelabra type that works directly on 110 volts, thereby eliminating the transformer. The base is attached to the worker's cap so that the lamp can readily be removed.

Coppering Solution for Oily Steel

A coppering solution that will stick to oily steel consists of the following ingredients: $\frac{1}{2}$ oz. sulphate of copper dissolved in 4 oz. of water and a teaspoonful of sulphuric acid added drop by drop.



When Covered with the Baby's Clothing, This Sturdy Seat Cannot Be Seen in the Finished Photo

Corner in Photographer's Studio for Baby Pictures

To hold a baby securely, yet inconspicuously, is a simple matter with this seat, which has been used successfully by a photographer of Urbana, Ill. It is made of $\frac{3}{4}$ -in. wood, fitted with a wire support at the front to prevent the baby from falling forward. This, of course, is carefully covered with the clothing so that it will be almost unnoticeable in the finished photograph. A suitable background is also provided, which can be made from wallboard nailed onto a wooden frame, and, if desired, arranged to fit in a corner, a seat being formed in the frame.

Removing Stiffness from Round Leather Belting

Round leather belting, particularly of $\frac{3}{8}$ -in. size, often gives trouble when run over small pulleys at high speed. This is generally due to the stiffness and spring of the leather, and also to the method of cutting it, the result being that there is nearly always some place in the belt that is slightly kinked. This misalignment, together with the natural stiffness and spring of the leather, causes the belt to twist and ride up on the small pulley with consequent pounding and loss of power. To offset this tendency, it is necessary to run the belt very tight, and this practice

places a far too heavy load on light bearings, resulting in undue wear. To remedy the trouble, remove the belt from the pulleys, take out the wire splice and then get a piece of $\frac{1}{2}$ -in. steel shafting that is bright and free from rust. Lock this vertically in a vise, allowing it to project above the jaws about 4 or 5 in., and apply a few drops of heavy oil to the shaft so that the belt will slip over it easily. Then loop the belt one turn around the shaft, take hold of the free ends, one in each hand, draw tight and pull the belt back and forth in long strokes. Finally, crimp the ends between the fingers, bending the leather first one way and then the other. This operation does not damage the belt, but breaks the grain,

eliminating its spring and resiliency. Never soak the belt in oil, as this treatment softens the leather and causes it to stretch unduly. Oil also causes the surface of the belt to become glazed so that it will slip under a load. Replace the belt, giving just enough tension to prevent it from vibrating, and it will run smoothly and will "hug" the pulleys.

Barrier of Auto Frames Prevents Erosion of River Banks

Placed parallel to the river bank, an effective barrier which collects considerable debris, can be made from old auto frames set on end and wired together as shown. Such a flood fence has been

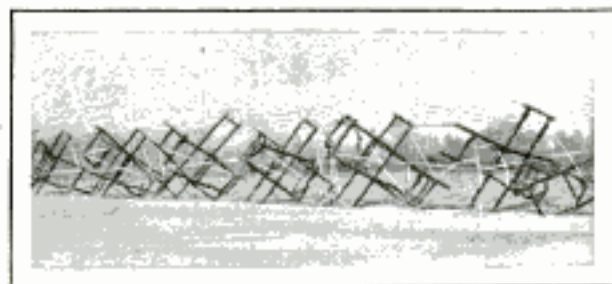

Battery of Auto Frames Wired Together Forms Effective Flood Fence on River Bank

found highly satisfactory by farmers on the Platte river near Omaha, Nebr., and costs practically nothing, as the frames usually can be obtained from dumping grounds and junk yards.

How to Set Up and Use a Home Workshop Shaper

By W. Clyde Lamme



MOTOR-driven vertical-spindle shapers are now available at a price within easy reach of the small shop owner. Four types of shaping heads for use with these are shown in Fig. 1. The first, A, a three-knife head, furnished with four sets of cutters, is practical for use in the small shop where the cost of a complete assortment of molding heads would be prohibitive.

To produce clean, smooth moldings, the cutters must be carefully ground to a keen edge. Fig. 2 indicates a method of grinding the knives fitting the heads shown in details A and B of Fig. 1. The single cutter of the three-knife head is held as in detail A, Fig. 2, the grinding being done on the fine side of an oilstone. The bevel-edged knives fitting the second head are generally furnished as blanks and must be ground to the form desired. This is easily done as at B and C of Fig. 2. By making a slotted holder for the knife, the cutter is first ground square across the end. A $\frac{1}{4}$ -in. round-faced grinding wheel must be used when the knife edge is curved. Grind both knives to the exact form desired, using the first as a template in grinding the second. Then bevel to a cutting edge as in Fig. 2, detail C, the length of the bevel being

Various Types of Cutters for Small Shapers Permit an Infinite Variety of Molding Shapes

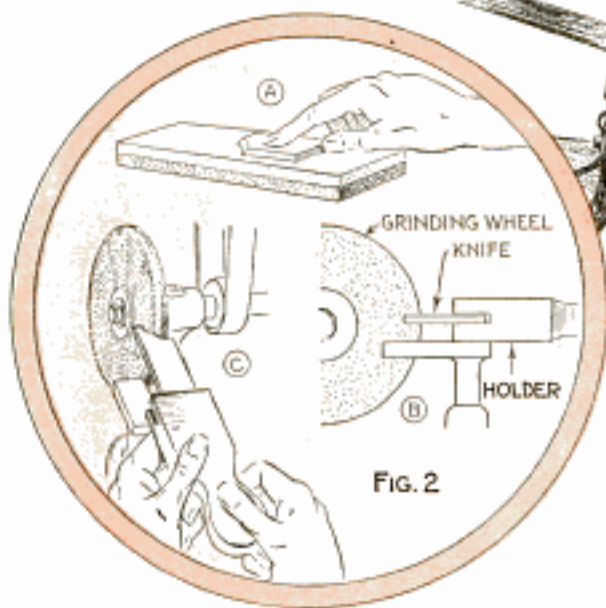
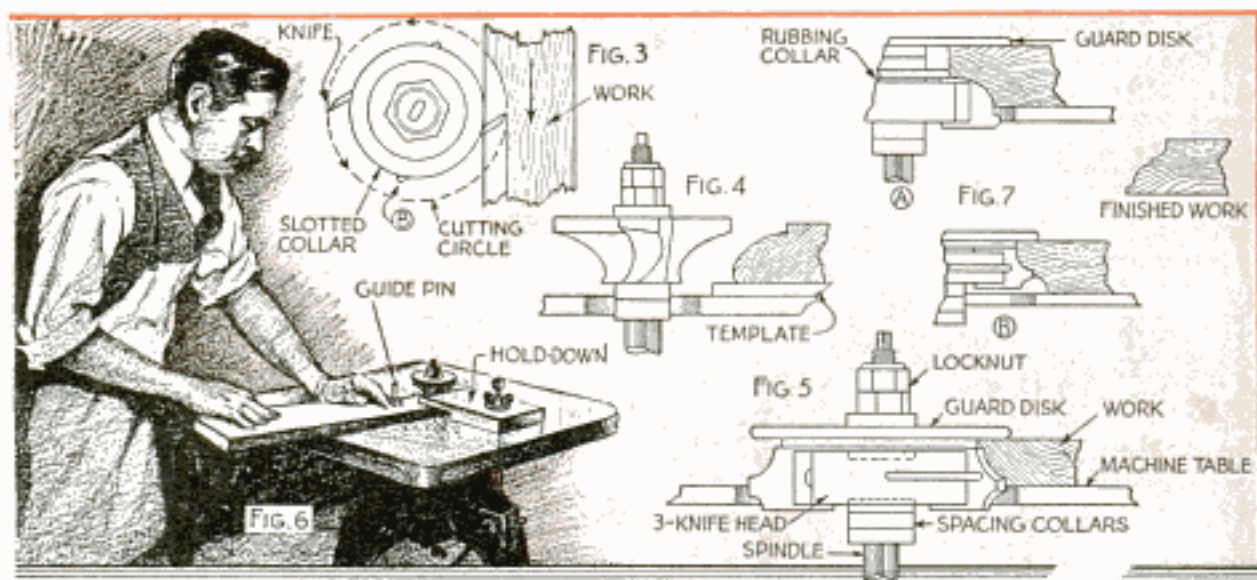

FIG. 2

about $1\frac{1}{2}$ times the thickness of the knife. Take care not to alter the form of the knives, one from the other, and when the knives have been set up between the slotted collars, make sure that the heel of the knife, indicated by B in Fig. 3, clears the edge of the stock. To insure this, it may be necessary to shorten both knives equally by grinding back the square end. Also take care that the knives are exactly the same length to assure perfect running balance of the head. The two cutters, shown in details C and D of Fig. 1, are known as the "wing" type, the cutter head C having four cutting edges, two of which cut while rotating in either direction. Both heads are easily sharpened with a file and the edges honed with a beveled slipstone.

Fig. 5 shows a set-up of a three-knife





head, and from this it will be noted that the cutting is done from underneath, and that the rotating knives are covered with a guard disk, which also acts as a hold-down. The table of the machine can be adjusted up or down to form the molding desired. When making this adjustment it is necessary to make sure that the portion of the work untouched by the knives is guided by the rubbing collar directly under the guard disk, as shown. Details A and B of Fig. 7 show a set-up of the same head to form a molding in two passes and one change of cutters, the thickness of the stock being greater than the width of the cutters. Fig. 4 shows a set-up of the molding head D of Fig. 1, the shape of the cutters being such that the stock to be molded must be tacked to a template which rides on the rubbing collar. Where the edge is curved, such as that of a tilting-table top, for example, the template is cut roughly from thin stock, tacked to the under edge of the work and band-sawed along with the work, the operation insuring uniformity between work and template.

Occasionally the shape of the work makes it necessary to provide an improvised hold-down, more particularly where the stock is thin and the edge to be molded is curved. Such work must be guided by a pin at the beginning of the cut. This accessory is provided with the machine, and a number of holes are drilled and tapped through the table so that the pin may be placed in different positions about the head. The use of the guide pin and



hold-down is shown in Fig. 6. Where the work is wider than 4 in., the hold-down is not needed, as it may then be safely held in the hands. The guide fence, which also is furnished with the machine, should always be used on straight work. If such work is thin and narrow, it is best to use the hold-down indicated in Fig. 6, as this will aid in holding the work against the cutters without danger to the hands. The hold-down may be easily sawed from a block of hardwood, one end being rabbeted as shown to allow the stock to slide under. It may be fastened to the table with a thumbscrew and locknut, turned up in one of the several threaded holes.

Shapers of the vertical-spindle type may be used for cabinet-making operations other than forming moldings, an example of which is shown in Fig. 8, where it is necessary to groove the inner edge of a curved door rail to take the panel, an operation virtually impossible with any other tool. A small saw blade is set up on the spindle as shown, a guide collar being turned from wood and placed on the spindle under the blade. The diameter of the collar should be such as to allow the blade to cut the required depth.

"Snap" Method of Adjusting Connecting-Rod Bearings

By using the "snap" method of testing connecting-rod bearings in checking their adjustment, it is unnecessary to crank the engine. The slight end play present in most such bearings is made use of in making the test. First tighten the bearing to a point which is approximately correct. Then apply pressure, first in one direction and then in the other. If the bearing is too loose, it will move without snapping, and if too tight, the pressure exerted by the hands will be insufficient to move it on the shaft. A distinct snap can be heard when the bearing is adjusted correctly. This method also can be used on bearings that require a specified clearance by placing a strip of shim stock of the required thickness in the bottom of the bearing cap, and then adjusting the bearing until it snaps, after which the shim is removed and the bearing cap tightened in the usual way.

Plumbers' Clamp Holds Many Sizes of Pipe

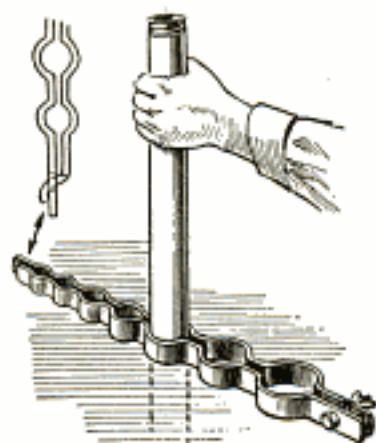

Here is a useful clamp for holding pipe when making connections between floors. Two lengths of 1½-in. bar iron are bent to the shapes shown, to accommodate pipes from 1½ to 6 in. in diameter. The bars are interlocked at one end, while holes are drilled at the other ends for a bolt and wingnut to hold the pipe securely.

A File for Different Grades of Sandpaper

Sheets of standard-size sandpaper cut in four pieces are handy to use and help eliminate waste. A small box, partitioned to hold several grades of the paper, will make it easy to select the proper kind when needed.

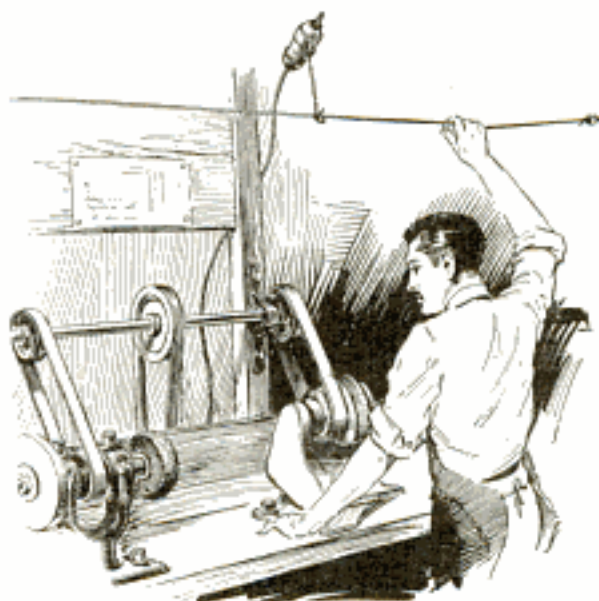

Home Workshop Machinery Can Be Controlled with Cord Fastened to a Pull-Chain Switch

Safety Switch for Home Workshop

When a pull chain is used at the source of supply for your workshop machinery, a cord running horizontally and tied to the switch will operate it at any point along the bench. The pull chain should be taut so that a slight motion will throw the switch. It is still better to have a pull-chain socket mounted on a rigid base.

Making Split Gears for Model and Experimental Machines

Split gears for model and experimental machinery can be made as follows: Get a solid gear of the proper size, drill holes through the web for capscrews and also drill and tap corresponding holes in four lengths of flat iron, which are used to clamp the gear together after it has been split, but fit the pieces on the gear before splitting it to see that all the holes line up accurately. After the gear has been cut, place it on the shaft and assemble.

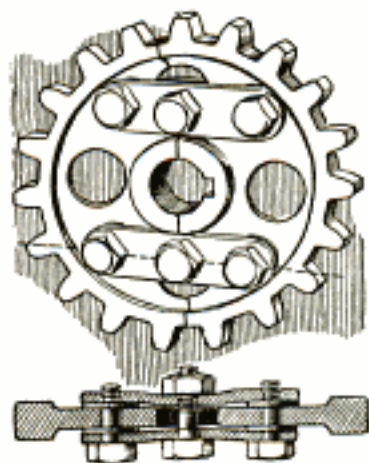

File Made from Hacksaw Blades Is Non-Clogging

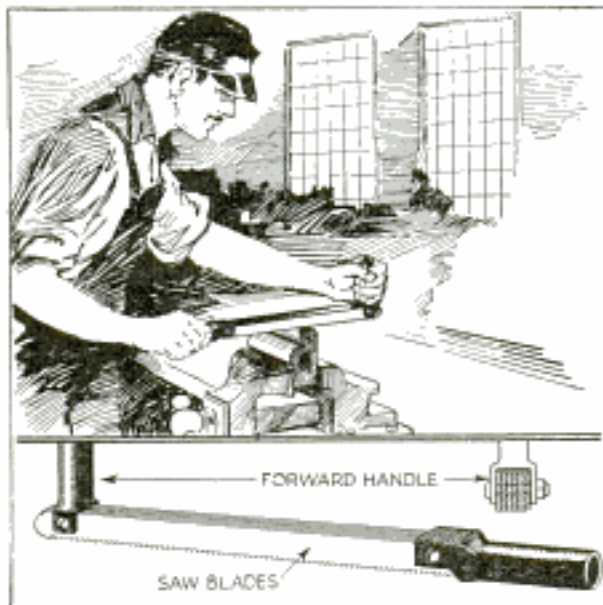

Surface Scale Can Be Quickly Removed from Molded Castings with This Hacksaw-Blade File

Rough filing on castings, etc., can be done quickly with this file made from hacksaw blades. Two tubular handles are cut and shaped as shown in the detail, and fastened to the blades with small bolts. This provides a file that will not get dull quickly and is practically non-clogging.

Improvised Center Gauge to Mark Work Accurately

A center gauge that will work accurately for either round or square stock can be made as follows: Cut a 90° V-shaped notch in a 1-in. wooden block. A piece of sheet metal is tacked to the face of the block so that one edge will bisect the 90° angle. In use, the end of the stock is placed in the notch against the metal plate, which serves both the purpose of a stop

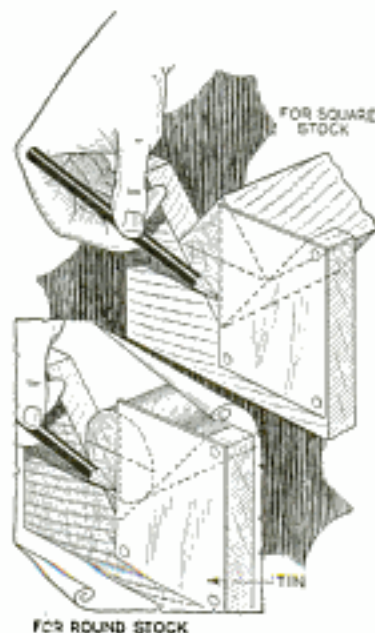

of a stop

and a straightedge. Center marking is quickly accomplished by scribing two intersecting lines across the end of the stock as indicated.

Efficiency of Drag Increased with Chains

Farmers and gardeners can utilize old chains and at the same time increase the efficiency of their drags, by fastening two or three lengths of the chain across the bottom of the drag. This will pulverize the clods that are just under the surface of the ground and otherwise would not be touched. Short lengths of chain can be used to hold self-adjusting water gaps across small streams and will be more satisfactory than hinges or wire.

Blacksmiths' Tongs Adapted to All Sizes of Work

Fitted with a number of interchangeable jaw extensions, the tongs shown herewith will cover a wide range of work. A recess is forged in one of the jaws to receive the extension pieces, which are made of 1 by 1/2-in. flat iron and should be a snug fit in the recess, while their length should vary to take stock of different sizes. If desired, holes may be drilled and tapped in the jaw and the extension pieces so that the latter can be held in place securely, if the edges of the recess wear down.

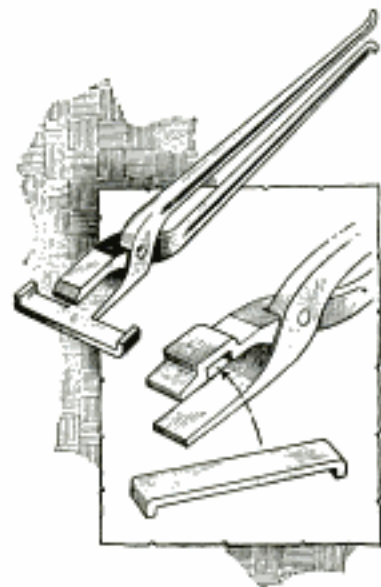

the latter can be held in place securely, if the edges of the recess wear down.

Babbitting a Bearing Box

Before pouring babbitt in a bearing box, brush zinc chloride over the surface to which the babbitt is to adhere, and dip in a molten solution of half-and-half solder. This tins the bearing shell, making the babbitt adhere more readily.

the Mailwing the Drill.... the "Yankee" Ratchet

Photograph by permission Pitcairn Aircraft, Inc.



"YANKEE" Ratchet Breast Drill No. 1555

Length, 17 in. 3-jaw; 1/2-in. Double speed. Also, 2-jaw. Price, \$11.00.

No. 1545. Hand Drill. Length, 16 in. 3-jaw; 3/8-in. Double speed. Also, 2-jaw. Price, \$10.00.

No. 1530. Hand Drill. Length only 10 1/2 in., but has same ratchet adjustments as large drills. 3-jaw; 1/4-in. Single speed. Price, \$5.25.

Eighteen styles of "Yankee" Breast and Hand Drills, at prices \$3.00 up. Ask dealer for "Yankee." Use coupon to get "Yankee" Tool Book.

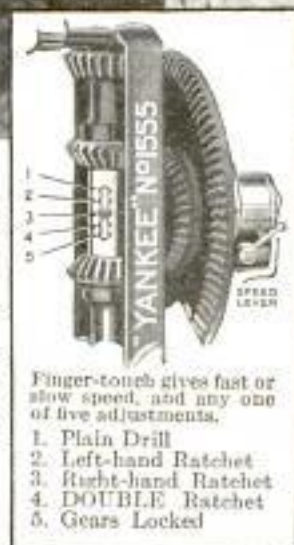

Finger-touch gives fast or slow speed, and any one of five adjustments.

1. Plain Drill
2. Left-hand Ratchet
3. Right-hand Ratchet
4. DOUBLE Ratchet
5. Gears Locked

"Yankee" Ratchet Drills are made for the kind of jobs that must be done by careful workmen, and with sensitive tools that give accurate control.

"YANKEE" TOOLS

Always Like New! All nickeled parts on "Yankee" Tools now Chromium Plated—over nickel. No extra charge.

NORTH BROS. MFG. CO., PHILADELPHIA, U. S. A.

Send your book with action pictures of "Yankee" Drills and other tools.

Name

Address(pm)

When writing to advertisers please mention Popular Mechanics

Copyrighted material

AVOID REPAIR BILLS

by using this
better OIL

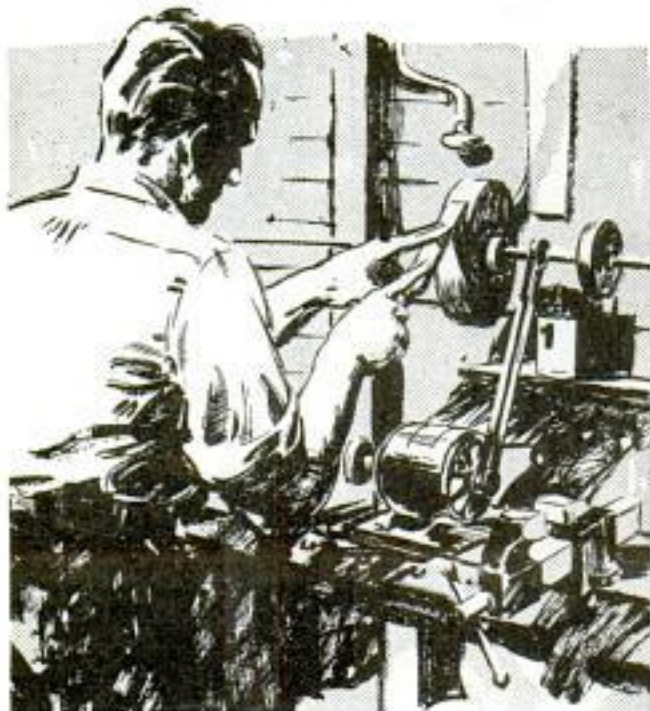

Three-in-One is blended from *animal, mineral and vegetable* oils—for a definite purpose. Not just to make it different from ordinary oils, but to make it *better*.

Because of its scientific blending, this oil *cleans and prevents rust* as it *lubricates*. This triple protection adds years to the life of your tools and workshop equipment; saves many a bill for repairs and replacements. No plain mineral oil can ever supply as much protection.

Handy cans and bottles; good stores everywhere. Write now for free sample.



THREE-IN-ONE OIL CO.
DEPARTMENT A-116
170 VARICK ST., NEW YORK
260 Second Avenue
Ville St. Pierre, Montreal

3-IN-ONE OIL

CLEANS - OILS - PREVENTS RUST

AMAZING

Saves Many Car Washes

HERE is an automobile accessory that every car owner needs. Think of it, with the Dust Puff in a few minutes time a dusty car can be made to look spick and span. No hard rubbing, no hard work. Think of the satisfaction of always having your car looking clean and shining, and of the money that can be saved in car washings alone.

A special Dust Puff is made for household use. Cleans furniture instantly and leaves a beautiful polished appearance.

Free Sample and Big Money Making Offer

Your profits as a Dust Puff agent are limited only by your own efforts. D. C. Champion of Marion, Ohio, is now selling 1000 Dust Puffs a month. There is no reason why your territory should not be equally as good. Up to \$100 a week profit is possible. Every automobile owner, every housewife is a 100% prospect. We also make it possible for you to sell to stores, garages and filling stations. Send today for our Free Sample and Big Money Making Offer.

U. S. MANUFACTURING CORP.

Dept. 113

DECATUR, ILL.

BUILD YOUR OWN AUTOMATIC ELECTRIC REFRIGERATOR



Why pay \$200.00 and upwards? Use your present ice-box. We supply parts. Can be built for only \$34.50. Easily made. No special tools necessary. Operating cost, quality and size of machine same as well known makes. Complete blue-prints and instructions—\$1.00. Circular "B" on request.



B. & L. ENGINEERING CO., 708 Bergen Ave., Jersey City, N. J.



"FLYING CLOUD"

Get clean-cut parts and clear blue-prints for 20" model. Readily made in spare hours as hull fully shaped and sanded. Set includes anchor, bell, capstan, dead eyes, wheel, rigging line, etc. Complete for \$11. Postage 5 lbs. White metal figurehead 50c. Send 15c (coins) for beautiful catalog of ships and coaches.

ROY HANCOCK

323 Douglas Ave. Portsmouth, Va.

FREE—This 1932 Pin Catalog



SHOWS HUNDREDS SCHOOL CLASS CLUB SOCIETY PINS, RINGS, MEDALS, ETC. SNAPPY 1932 DESIGNS. COMPLETE LINE PIN SHOWN SILVER PLATE 35c EA OR \$3.50 DOZ STERLING SILVER OR GOLD PLATE 50c EA OR \$5.00 DOZ 1 OR 2 COLORS ENAMEL AND NAME

BASTIAN BROS. CO., 18 South Bldg. ROCHESTER N.Y.



Individual Stationery



200 Note Sheets, 100 Envelopes, printed on Quality Bond, with name and address. Correct style. Sent postpaid for \$1.00. A Perfect Gift. Money refunded if not pleased. Send for a box. If Executive (7 1/2 x 10 1/2) is preferred, will furnish 150 Letter Sheets, 50 Envelopes to match for \$1.00.

NU-STYLE STATIONERY CO.

Room 222, Shuey Bldg. SPRINGFIELD, OHIO

This NEW BOOK

Shows You HOW to Do Things
... Easier, Quicker and Better

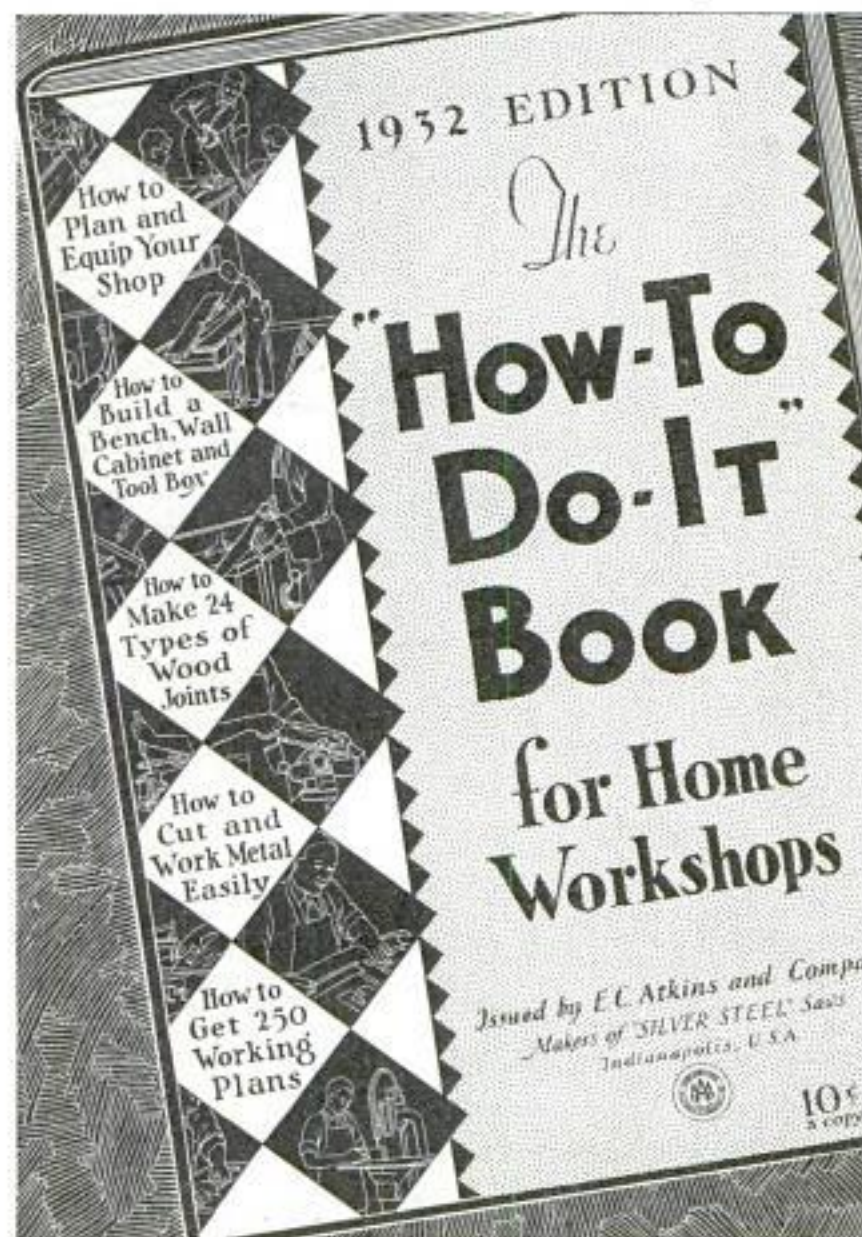

... How to Plan, Equip and Enjoy a Home Workshop

HERE is the ATKINS second book for home craftsmen! So successful was the first book that FOUR large printings were needed to satisfy the world-wide demand! Now, we announce an even larger and better handbook—brimful of latest information on workshops. If you want to start a new shop, it tells how to plan and equip one. If you want to make better joints, it shows how to cut and fit 24 types. If you wish to build a new work-bench, or other shop furniture, it gives diagrams and full directions.

If you do decorative metal work, it shows easier ways to cut and shape the pieces. If you want new project suggestions, the revised "What to Make" list is a gold mine of ideas. And, if you plan to add new tools, it shows you 50 "Silver Steel" Saws—the world's finest for home shops.

This new book costs only a dime, but you'll say it's worth a dollar when you see all the practical instruction put into its 36 pages, by veteran craftsmen. Send for your book today. It will help improve your skill, save your time, and double your pleasure or profit in home-crafting.



CUT OUT AND
MAIL COUPON

E. C. ATKINS and Company, Est. 1857
426 S. Illinois St., Indianapolis, Ind.

I enclose a dime for a copy of the
ATKINS 1932 Home Workshop Book.

Name.....
PRINT

Street.....

City..... State.....

My dealer is.....

List of Features:

Much helpful material from the first book has been revised, and several new chapters added. The 1932 edition contains:

Home-crafting—a Hobby that Pays, in Pleasure and Profit.

How to Lay Out a New Workshop. Showing three typical floor plans.

How to Select Tools. Money-saving hints on choosing tools and machines.

How to Choose Woods for Shop

Work. Data on veneers, plywood, etc.

How to Cut and Fit Wood Joints. Instructions for making 24 types, from simple butt joints to fine dovetails.

How to Equip a New Shop. Building a bench, folding work-table, saw-horse, tool box, wall cabinet, etc.

Newest methods for working metals with hand and power tools—hack saws, circular saws, band saws, etc.

How to Use Grinding Wheels, Files.

Where to Get Job Plans. List of 250 things to make of wood or metal.

50 Popular Saws for Home Shops.

When writing to advertisers please mention Popular Mechanics

Copyrighted material

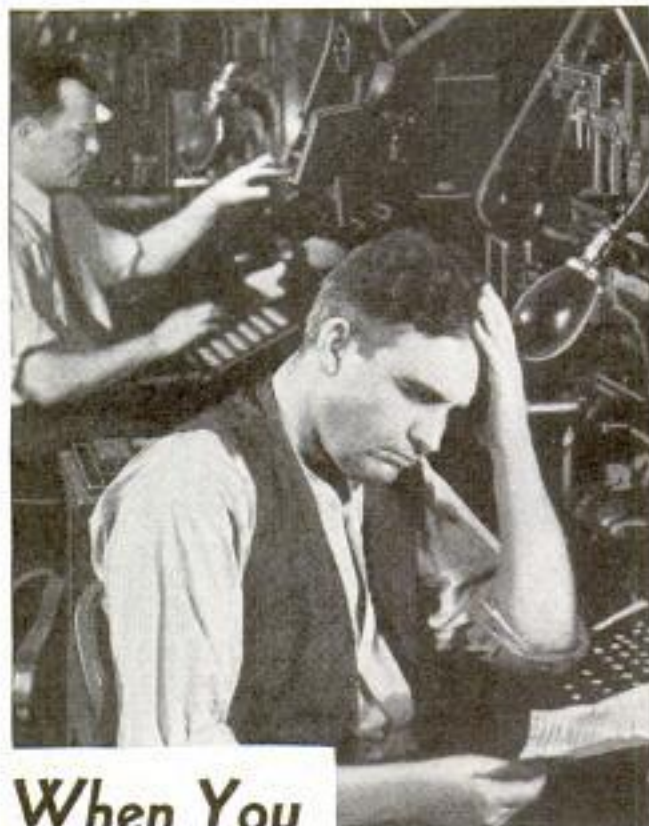

When You

CAN'T QUIT

Nerves on edge. A head that throbs. You can't stop work, but you *can* stop the pain—in a hurry. Bayer Aspirin will do it every time. Take two or three tablets, a swallow of water, and you're soon comfortable. There's nothing half-way about the action of genuine aspirin. If the box says Bayer, you'll get complete relief.

These tablets should be in every shop, office, and home. Ready to relieve any sudden ache or pain, from a grumbling tooth to lumbago. Don't suffer with neuralgia, neuritis, rheumatism, etc. Don't lose time because of colds or sore throat. Get some Bayer Aspirin and read the *proven* directions for instant relief.

Be sure to ask for Bayer Aspirin it does not affect the heart.

BAYER ASPIRIN

When writing please mention Popular Mechanics

BRING ON YOUR REPAIR JOBS!

PEERLESS WATERPROOF CEMENT 100 TIMES STRONGER THAN GLUE REPAIRS ANYTHING

Its adhesive power is amazing—holding like a vise. No matter what the material—cloth, leather, wood, china, glass, fibre, or any kind of metal—Peerless Cement will join parts or broken pieces, making a permanent and clean repair.

Has over 1,000 uses in repairing dishes, furniture, radios, airplanes, auto parts, boats, tents, etc. Waterproof, heatproof, coldproof and acid-proof—free from every fault or weakness of other cements and glues.

AGENTS WANTED

Show demonstration samples of the work Peerless Cement does, and sell to every home, store, oil or garage, factory, etc. Big profit on every sale.

SEND 25c for full size bottle to make tests yourself. Write for our liberal "Get Acquainted" sales offer. No free samples.

PEERLESS WATERPROOF CEMENT CO.
2733 Dodier St. ST. LOUIS, MO.



Good and Good for You.



Build These 3 Popular Models

Get the New IDEAL 3-in-1 Kit containing everything required to build these three popular flying models; all parts, fittings, materials and Full Size Plans and Instructions for each Model. Full fuselage Models, 15 in. Size. Biggest value ever offered; easy to build; wonderful flyers.

All Materials and Plans for 3 Models
\$1.65
Postpaid

IDEAL AEROPLANE AND SUPPLY COMPANY, Inc.,
26 West 19th Street, New York City



Forms to cast Lead Soldiers, Indians, Trappers, Hunters, Wild and Farm Animals. 239 different forms to select from. Every Form guaranteed to cast perfect figures. Send 5c stamp for illustrated catalogue.

HENRY C. SCHIERCKE SPENCER RD. GHENT, N. Y.

FREE Get BB Magic at once. A wonderful shooter's digest—tells how to hold, aim and handle rifles; helps you guide others in correct knowledge of guns. Gives facts that make crack shots. Gives safety and common sense instruction parents all like.

SEND NOW!

The principle of compressed air action that made the Benjamin Single Shot world famous has been applied to 25 shot automatic rapid firing. Learn all about both guns. Write! Benjamin Air Rifle Co., 649 N. Broadway, St. Louis, Mo.

BB MAGIC
THE SHOOTER'S DIGEST



**USE
STARRETT
TOOLS**

THE L. S. STARRETT CO.
World's Greatest Toolmakers
Manufacturers of Hacksaws Unexcelled
Steel Tapes—Standard for Accuracy
Athol, Mass., U. S. A.

Write for Starrett Catalog No. 25 "AP"



Use Starrett Hacksaws

When writing to advertisers please mention Popular Mechanics

Copyrighted material 5008



Once the coal bin —now a billiard room

FILLING cracks in the wall, ruts in the floor, etc., with Smooth-On No. 7, and painting walls and floor with Smooth-On Iron Concrete Paint, have converted this basement into an attractive room.

Similar treatment of useless cellar space, especially if you have substituted oil or gas heating for coal, would make a play room, billiard den, work or storage room, because the Smooth-On not only produces a handsome, easily cleaned finish, but also waterproofs the floor and walls.

Use Smooth-On No. 7 also in making new iron-hard, non-dusting waterproof garage and shop floors, filling depressions and cracks in old walls or floors, in waterproofing and patching foundations, ponds, troughs, etc. Worked into the finishing course during construction, Smooth-On No. 7 makes concrete surface lastingly waterproof, more durable, and gives it better appearance.

Use Smooth-On Concrete Paint for attractive waterproof finish and to stop dusting and crumbling of the old walls and floors.

The cost for the Smooth-On is small and any handy man can do a perfect job. Do this work yourself—you can then afford the improvements and will be well repaid for your efforts.

The Smooth-On Home Booklet sent free on request, gives full directions, with quantities required.

Get Smooth-On No. 7 in 5, 25 or 100-lb. metal packages and Smooth-On Concrete Paint in gallon pails. There are no substitutes. If your dealer will not supply you, write us direct.



Write for
FREE BOOK

Do it with SMOOTH-ON

SMOOTH-ON MFG. CO., Dept. 37,
574 Communipaw Ave., Jersey City, N. J.

Please send the free Smooth-On Repair Book.

Name.....

Address.....
10-31

BIGGEST SAVINGS IN YEARS

NEW—FREE! Kalamazoo Catalog of FACTORY PRICES

Write now for this new KALAMAZOO-DIRECT-TO-YOU Catalog, quoting you factory prices at sensational reductions.

Make your selections direct from factory stock. 200 styles and sizes. Kalamazoo prices are lower, far lower than ever, but Kalamazoo quality, famous for 31 years, is rigidly maintained.

Ranges as low as \$37.50

Don't miss the new Coal and Wood Ranges, new Combination Gas and Coal Ranges—new colors, new improvements. Also Gas Stoves, Oil Stoves, Household Goods.

Heaters as low as \$24.15

Pages of colored pictures and descriptions of heat circulators, New low prices on furnaces (pipe or direct heat).

Furnaces as low as \$57.85

Kalamazoo gives you 30 days Free Trial. Every Kalamazoo carries a 3 year guarantee bond on material and workmanship—\$100,000 bank bond guarantee of satisfaction. 24 hour shipments. Only \$5 down on any stove, range or furnace, regardless of size or price. A year to pay. 200,000 satisfied customers. Write today for this wonderful new book.

KALAMAZOO STOVE CO., Mfrs.
391 Rochester Ave., Kalamazoo, Mich.



"A Kalamazoo Direct to You"
Trade Mark Registered

Sell Christmas Cards!

Expensive gifts may not be in demand, but holiday greetings will be mailed by practically everyone. Make money and build a business of your own in spare time taking orders for Demaree Christmas cards. Write early for this remarkable line.

Demaree Stationery Co., 908 Walnut, Kansas City, Mo.

Only 8 Sales a Day Nets You \$116 a Week

Profits on larger size run higher. Unusual earning opportunity for ambitious men. No experience necessary; we teach. Part or full time.

FUGO World's Simplest Fire Extinguisher

Automatic and instantaneous action. Within reach of every home, shop, store, theatre, garage, car owner, etc. Even smallest place needs two or more. Exclusive territory to producers. You get your pay every day. Write for full details.

The National Formetal Co.
6535 Metta Ave. Cleveland, O.



INCREASE YOUR BUSINESS

by using the NEW \$5.85 "Two-Faced" Film Duplicator to make 100 copies, in 1 to 5 Colors each time. Or the \$37.05 "Excellograph" Rotary Stencil Duplicator to Print Copies of Anything Typed, Panned, Drawn or Traced in numbers up to 3000 each operation, as Price Lists, Hand Bills, Special Sales Announcements, Bulletins, Menus, Quotations, or "what have you?" Write—

Easy Terms
PITTSBURGH TYPEWRITER & SUPPLY CO.
Suite 552, 339 Fifth Avenue Pittsburgh, Pa.

2 cars of the same make — the same model

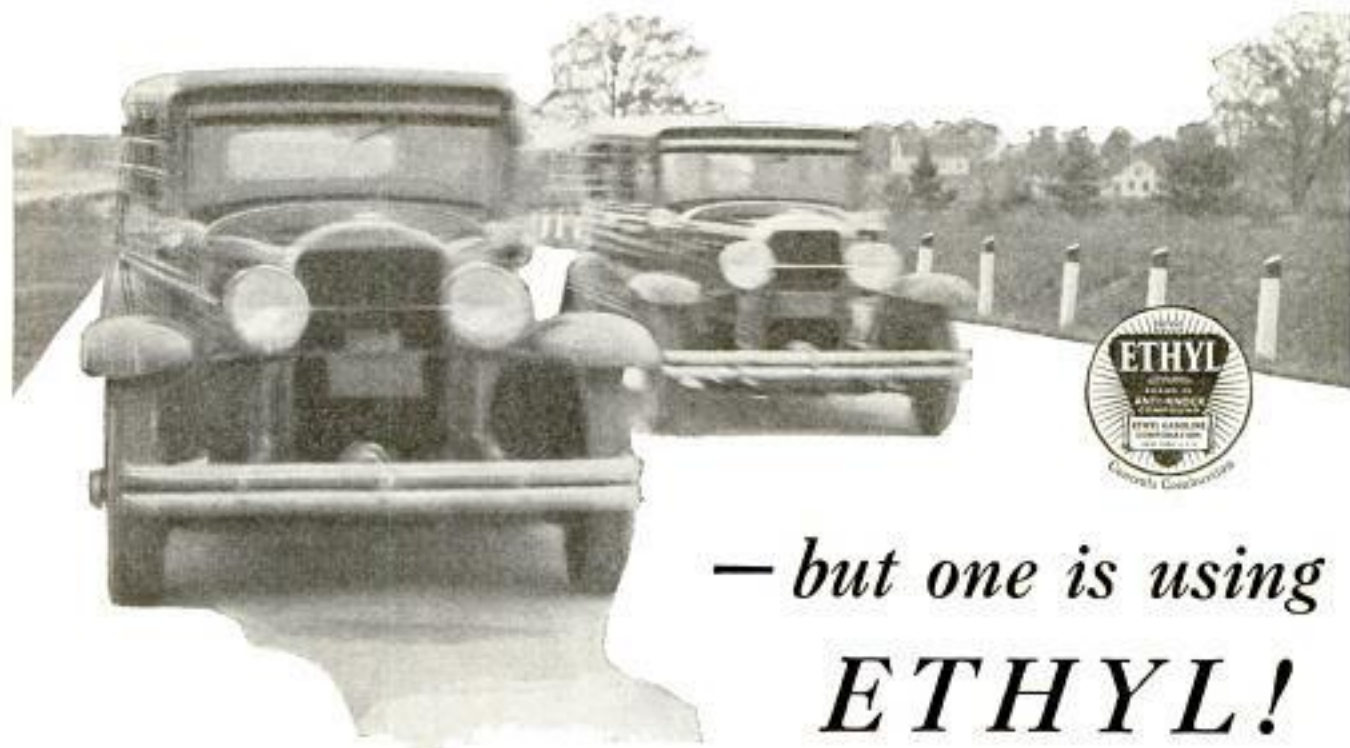

— but one is using
ETHYL!

IT'S a thrill to zoom ahead of the crowd when traffic lights turn green. But the faster pick-up Ethyl gives is more important than that.

When you are passing slow-moving trucks or other cars, the difference between quick and lazy pick-up is the difference between safety and danger.

Ethyl Gasoline gives your car all the pick-up the makers built into it because Ethyl Gasoline burns as smoothly under strain as it does when the engine is idling.

Ethyl Gasoline is *more* than gasoline. It's *good* gasoline *plus* Ethyl fluid. Inside the cylinder the Ethyl fluid *controls* combustion. Even under severe strain, Ethyl fluid

prevents gasoline from going off in uneven explosions that cause power-waste, harmful knock and overheating. It delivers the power of gasoline to the pistons with a smoothly increasing pressure that brings out the best performance and the maximum power of *any* engine.

Faster pick-up is only *one* of the benefits of controlled combustion. Your car will show you others: freedom from harmful knock, more power on hills and heavy roads, less vibration, less gear-shifting, a cooler running engine in the summer and an easier starting engine in the winter. Fill up with Ethyl Gasoline and see for yourself. Ethyl Gasoline Corporation, Chrysler Building, New York City.



THE LESS TIME you spend in the other fellow's lane—the safer you are. Ethyl Gasoline cuts down the time required for passing.



The active ingredient used in Ethyl fluid is lead.

© R. G. C. 1931

ETHYL GASOLINE

When writing to advertisers please mention Popular Mechanics

Copyrighted material

**Out of Work -
Got A Foley -
Now Making GOOD
MONEY**

I lost my job. I took my last money and bought a Foley Saw Filer. Now I am making a comfortable living filing saws. I am doing a lot of work. Saws filed on the Foley cut truer, cleaner, easier and faster than hand-filed saws.

A. STOLZ

**Read This
Letter**

**YOU,
too,**

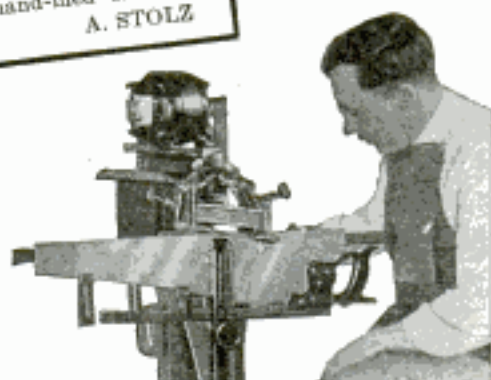

can have a steady, big-paying cash business of your own . . . be your own boss, free from worry about layoffs. Or make extra money . . . \$2 to \$3 an hour . . . in spare time. **NO CANVASSING**, no special ability required. Our Free Plan tells how to start the business coming your way. Just follow a few simple instructions and leave the rest to the

FOLEY AUTO SAW FILER

It files all saws perfectly, automatically . . . hand saws, cross cut circular saws and band saws . . . twice as fast as expert hand filing . . . makes every tooth of even size, height and spacing so that saws cut better. That's why saw users prefer Foley-filed saws, why it's so easy to start this business.

Think of the big year 'round filing business you can have from carpenters, contractors, newspapers, printers, woodworking plants, schools, factories, etc. We'll help you . . . let you have a Foley Filer on easy payments so it will pay for itself while you're getting started. Send the coupon below for **FREE PLAN**. **DO IT NOW!**

**MAIL
THIS COUPON
for
FREE
PLAN**

Foley Manufacturing Co.
218 Foley Bldg., 11 Main St., N. E.,
Minneapolis, Minnesota

Please send me **FREE PLAN** on how to start my own saw filing business with the Foley Filer.

NAME.....

ADDRESS.....

CITY..... STATE.....

If you would also like information on the Foley Automatic Key Machine check here.....

When writing please mention Popular Mechanics



A great, responsible, successful, 40-year-old company now makes this surprising offer to honest men. Invest no capital! Let us start you in this permanent business that YOU own and control for yourself. Become the authorized **McConnon Dealer** and handle the complete **McConnon line**—no red tape and no division of line. We finance you. You extend credit to your own friends and customers when you please. Only a certain number of these "no-investment" propositions are open. Each one offers a good living with a chance to put some money in the bank every week. Honest, steady men who write promptly are assured of first consideration. Write today and ask for "no-investment" offer. Address The House of Friendly Service, McConnon & Company, Desk D-6610, Winona, Minn.

**6 FUSES
in ONE PLUG**

**Agents & Distributors
Making Big Money** A necessity everywhere. A "turn to the right brings back the light." Safe, economical, dependable. **6-in-1 Fuse Plug**. Most useful invention in years. Many of our distributors in exclusive territory making \$500 to \$1000 a month. Easy to demonstrate. Easy to sell. Profits begin right away. Write at once for proposition. Send 25c for sample and working instructions.

6-in-1 Fuse Co., 801 W. Madison St., Dept. 81 Chicago

WANTED: SERVICE MEN

Large manufacturer has a number of positions open in various parts of the country for middle-aged men who are capable and willing to call on Factories, Stores, Garages, Warehouses, Schools, Hotels, etc., and inspect and service their Fire Extinguishers. Opportunity to sell new equipment while doing this service work. Earnings on inspection and service range from \$40 to \$50 a week with added earnings from sale of new equipment. Address: Fyr-Fyter Co., 90-46 Fyr-Fyter Bldg., Dayton, Ohio.

AGENTS AND SIGN MEN

**Earn up to \$100 Weekly, and over, Putting up
OUR GENUINE GOLD LEAF SIGN LETTERS**

R—on store and office windows, board signs, trucks and glass signs. We also make to order script signs and business emblems singly or by the thousands. A permanent business. No capital or experience required. Big demand in every City. Samples and Literature Free.

CONSOLIDATED SIGN LETTER CO. 71-X W. Van Buren CHICAGO, ILLINOIS

BUILD MODEL SHIPS OF THE BETTER KIND

We can supply construction sets and all sorts of parts, such as semi-attached hulls, blocks, gundecks, flag anchors, steering wheels, capstans, figure heads, guns, base prints, blocks, etc., for building real fine scale models of the U. S. Destroyer Preston, Flying Cloud, Constitution, Spanish Galleon, Viking, Baltimore, Clipper, Mississippi steamboat, Bluenose, Mayflower and many others. Also special construction sets for racing sail boats, power boats, model steam engines, boilers, propellers, etc., and fine tools for the model maker. New large 56-page photographically illustrated ship model booklet has just been released. This booklet contains valuable information and hints for building ship models, in addition to prices and full description of the above articles. Many people only slightly interested in models have become greatly enthused upon receiving this booklet. A copy will be sent postpaid upon receipt of 15 cts. (coin preferred).



MODEL SHIP SUPPLY COMPANY DEPT. L. MINEOLA, N. Y.

Here's Real Sport for Father and Son

YOU FATHERS of growing boys—here's real sport that you can both enjoy. And while your boy is having more fun than he ever had in his life before, he is learning that his dad is a regular fellow, and is receiving a training of hand and eye that will help make a real man out of him.

The best rifle team in the world is a boy and his dad with a Daisy Pump Gun, with one of the new steel Daisy Targets, which allows target practice indoors.

On rainy days, in the cellar, garage, or even in the house, what could be better sport than an hour or two of stiff competition between Dad and Junior to see which one has the old eagle eye and the lightning trigger finger.

It's a lucky boy whose father gets him one of these new improved Daisy Pump Guns, and shows him how to use it.

With the above outfit, and a tube of Bulls Eye Steel Shot, a boy has all he needs for daily practice that will train him to be a crack shot.

For over 40 years the Daisy Air Rifle has been the favorite gun of the boys of America. It is a safe



gun, and remarkably accurate in its range. The new improved Daisy Pump Gun is the finest boys' gun ever made. Has polished pistol grip walnut stock, and slide action. A 50-shot repeater for only \$5.00. Other Daisy models, for every age and purse, \$1.00 to \$5.00.

Ask your dealer to show you the latest Daisy models, and send today for a free copy of the Daisy Manual. Contains valuable hints on drill and marksmanship.

DAISY MANUFACTURING CO.
Plymouth, Michigan, U. S. A.

For Indoor Shooting

When you get your new Daisy be sure to get one of the new Daisy Targets. Made of fine sheet steel, folds to fit the pocket. Can be quickly set up anywhere. Patented device stops shots from flying wild. Great for rainy-day practice in house, cellar or garage. Extra cards, 100 for 25 cents.

DAISY AIR RIFLES



USE BULLS EYE STEEL SHOT. THE CHEAPEST, TRUEST SHOT FOR ALL AIR RIFLES.

When writing to advertisers please mention Popular Mechanics

Copyrighted material

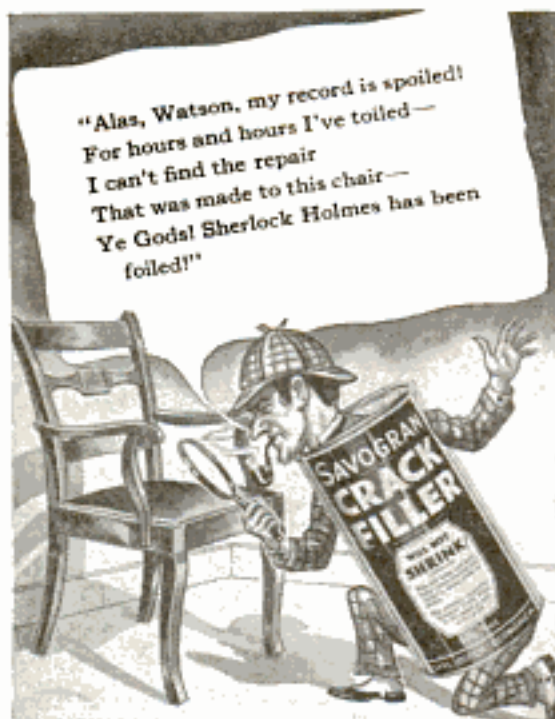

BRING on your detectives! They'll never find repairs made with Savogran Crack Filler. Why? Because this filler *will not shrink!* It stays put. When you paint over it there's no line or crack to show where the repair was made. Savogran Crack Filler does wonders for broken-down furniture—tightens pulled-out rungs and legs, loose casters, fills dents, holes, and cracks, builds up broken corners and chipped edges. Makes crippled chairs and tables strong as new. Saws, cuts, smooths—works just like wood. Great for patching plaster walls, building models and toys—hundreds of other uses.

Get a big one-pound can today at your hardware or paint store—only 30c (5-lb. can \$1.25, 35-lb. pressed-steel pail \$7.70). And get your wife a can of Painters' Savogran to make her house-cleaning easy. Saves you hard work, too, on painting and heavy cleaning jobs.

HELPFUL BOOKLET FREE!

Hundreds of helpful hints in "How to Repair and Refinish Furniture." 24 pages, plenty of illustrations. If you ever do an occasional job of painting, building, repairing, etc., you will find this booklet useful. Write for your copy—it's free!

SAVOGRAN CO., DEPT. M-10, INDIA WHARF, BOSTON

SAVOGRAN CRACK FILLER

Reg. U. S. Pat. Off.

Patent 1763022

WILL NOT SHRINK!



Pay As Low As \$2.00 per Week
Hendersons, Harley-Davidsons, Indians
Slightly used and rebuilt. Hundreds to
select from. Send 10c for list today.

MYEROW BROS. CO., 15 Berkeley St., Boston, Mass., U. S. A.



**Makes old plugs act like NEW—
starts car instantly without choke**

New motor invention "HOT SHOT" increases power—speed. SAVES UP TO 30% GAS—60% OIL. Delivers miniature streak of lightning 11,000 volts. Transparent—shows BLUE spark if ignition O. K.—RED if faulty. Pays for self immediately. \$1.50 each. Fits any car, truck, tractor or gas engine. Installed without tools. Good sales for agents. "525 a day easy," says Akman. "Rush 500 HOT SHOTS," wired Klint. "Doubled my mileage," writes Bobko. "HOT SHOT a wonder," says Albert. "Ship 100 HOT SHOTS at once," says Glassway. "Last order for 64 should arrive tomorrow and I've already sold them." Car owners assured. Will answer for prospectus. "Make Big Money Electrifying Clocks." Agents cleaning up; part time, full time.



**HOT SHOT is NEW—
STARTLING!** Nothing else like it. BIG GREAT sales everywhere. HOT SHOT on your old car will amaze by its performance. Act quick. Write for Free Sample Offer.

REARDON MFG. CO. Dept. F-10 PEORIA, ILLINOIS



**MAKE YOUR CLOCK \$219
ELECTRIC**

easily with guaranteed "SPLIT SECOND" movement on regulated 110 volt 60 cycle A. C. Great clock bearings, simple mounting instructions. No room, no winding, always accurate. Use your own dial and save.

As illustrated, with beautiful \$3.49 golden 5 1/2" dial.

Read time today for prospectus. "Make Big Money Electrifying Clocks."

Kuempel Co. Bldg. 12, Gutterberg, Iowa

Build a CLOCK for Pleasure or PROFIT!

FREE BOOK of Clock Making, Money Making ideas. Gives details, prices of movements, parts. Write NOW for copy!

Shows How YOU Can Make Fine Clocks Right at Home

—for yourself, or to sell at Big Profits. We furnish instructions, parts. Works \$1.65 up; others with shimes, all prices. Make case or assemble parts. Cash-in on demand for Mantel, Banjo, Grandfather's Clocks. Ask about new low-priced Electric Clock and Special Blue Print Offer. FREE Catalog.

AMERICAN CHIME CLOCK COMPANY
1670-R Ruffner St. Philadelphia, Pa.

**AGENTS 500%
PROFIT**
GENUINE GOLD LEAF LETTERS

S guaranteed to never tarnish. Anyone can put them on stores and office windows. Enormous demand, large profits. Paul Clark says: Smallest day \$28.70. R. L. Reel made \$920 in two months. Write today for free sample and liberal offer to general agents.

METALLIC LETTER CO., 433-B N. Clark St., CHICAGO

MOVIES In Your Home

Our marvelous, practical Movie Machines sell as low as \$5.00 postpaid. Also finest 16 mm. cameras and projectors at factory prices. A complete line of both standard and 16 mm. film available at low prices with exchange service. Write for big, FREE catalogue.

PARAMOUNT MFG. CO. Dept. G-44
Boston, Mass.

Big 3 ft. Telescope Five Sections. Brass bound. Powerful Lenses. 10-Mile range. Special Eye Piece for looking at the Sun, included FREE. Can be used as a Microscope. Guaranteed. Big value. Postpaid. \$1.75. C. O. D. 15c extra. **Benner & Company, 7-15, Trenton, N. J.**

Catch Fish!

Eels, Mink, Muskrats with our new folding galvanized **STEEL WIRE TRAP**. Write for our **FREE TRAP OFFER** and Bargain Catalog. **\$1 Box** of our famous Fish Bait FREE to introduce our traps. **WALTON SUPPLY CO., 3502 JUNIATA AVE., ST. LOUIS, MO.**

SEARS, ROEBUCK and CO.

..... a timely

Announcement

to every family in the United States

Never in all of their existence, have Sears, Roebuck and Co. bought merchandise at *such favorable price levels*. We know that the real value of our goods is greatly in excess of our selling prices and that you will make *substantial savings on every purchase*.

THIS new General Catalog for Fall and Winter is already in the hands of most of our customers. From this book they are learning a price message untold before in our time. More than this, its pages are unfolding a story of quality and value of which any store would be proud.

And now our great new catalog—The Thrift Book of a Nation—is ready for you. We think it so expresses the new day and the new standard of values and offers the new high quality merchandise at present in demand, that we would like you to have it.

From its 1100 pages, offering 48,000 articles, you may select everything you need in the quiet of your own home. Ordering by mail is most convenient. Try it if you would learn the truly modern way of shopping.

Ask for your copy of this book today. Just fill in and mail the coupon to our mail order store nearest you.

SEND TODAY

SEARS, ROEBUCK AND CO.
Chicago, Philadelphia, Boston, Minneapolis,
Kansas City, Atlanta, Memphis, Dallas,
Los Angeles, Seattle.

(Mail coupon to Store Nearest You)

Send me your Latest General Catalog. **80P63**

Name.....

Postoffice..... State.....

Rural Route..... Box No.....
(Please give both Route and Box Number if on
a Rural Route)

Street Address.....

CROSLEY

NEW

8 Tube Push-Pull Pentode Output SUPERHETERODYNE

\$49⁷⁵

Complete With Tubes

The Crosley PLAYBOY



An exquisitely designed all wood table or mantle model, 17 inches high, housing the new Crosley 8-tube push-pull Pentode output, Variable Mu, Superheterodyne chassis with latest type Crosley full floating moving coil dynamic speaker. Incorporates all the new Crosley features. Never before so much superlative radio performance at so low a price.

All of the beautiful new Crosley cabinets shown here incorporate the entirely new Crosley Superheterodyne radio receiver which embodies sensational new features, many of them exclusively Crosley. Two five-element Pentode output tubes connected in push-pull; two Variable Mu tubes; continuous (except for variable static and tone control) illuminated bakelite shadow dial with variable driver; combined volume control and on-off switch; full floating moving coil dynamic speaker. Features such as these have never before been offered in radio receivers at anything like the low prices shown here. See your Crosley dealer today—hear the wonderful performance of these outstanding sets—know the real values they represent.

The Crosley CHEERIO

A forty-inch console of fantastically attractive design housing the new Crosley 8-tube push-pull Pentode, Variable Mu, Superheterodyne chassis and latest Crosley full floating moving coil dynamic speaker. Every new Crosley feature is incorporated.



\$65⁰⁰

Complete With Tubes

The Crosley MERRYMAKER

A truly magnificent cabinet of rare beauty, forty inches high, housing the new Crosley 8-tube push-pull Pentode, Variable Mu, Superheterodyne chassis plus the new Crosley Auditorium size full floating moving coil dynamic speaker.



\$75⁰⁰

Complete With Tubes

The Crosley PLAYTIME

Here it is! A delectable come true! A grandfather type A. C. electric bell clock incorporating the new Crosley 8-tube push-pull Pentode, Variable Mu, Superheterodyne radio receiver and Crosley Auditorium size full floating moving coil dynamic speaker. One connection to the home current operates both clock and radio. Western prices slightly higher.



\$95⁰⁰

Complete With Tubes

The Crosley ANNOUNCER

One of the most beautiful of all deer console models. Stands forty-two inches high. Incorporates the new Crosley 8-tube push-pull Pentode, Variable Mu, Superheterodyne chassis plus the new type Crosley Auditorium size full floating moving coil dynamic speaker.



\$85⁰⁰

Complete With Tubes

Send postal for booklet E-10

The Crosley Radio Corporation

POWEL CROSLEY, Jr., President

Home of "The Nation's Station"—WLW

CINCINNATI

YOU'RE THERE WITH A CROSLEY
CROSLEY
RADIO

When writing please mention Popular Mechanics



The eyes of Doug Fairbanks, Jr., popular First National Pictures star

clear eyes are a social asset!

Yes, and a business one, too! There's no denying the fact that clear, bright eyes make a far better impression than do those which are dull and bloodshot. Start now to have more attractive eyes by using *Murine* each night and morning. It harmlessly clears up any bloodshot condition and imparts new lustre to the dullest eyes. 60c.

MURINE

FOR YOUR EYES

FOR FIXIT SHOPS



FREE FOTO GUIDE and Vacuum Cleaner Parts Catalog. Most complete ever published. Lists over 800 items and special tools. 28 pages. Illustrated. Standard material at lowest cost. Valuable source data on obsolete parts. Big help to all repair shops.

WASHING MACHINE PARTS

Combined washer, vac, and small motor servicing attracts trade and reduces operating expense. We can supply most replacement parts. Uniformity to highest standards guaranteed. Lowest known prices with saving on transportation and trouble. Consolidated orders earn maximum discounts. Instructive catalog free.

Uron Associated Industries

1302 Engineers Bldg.

Cleveland, Ohio



Burning Feet

Ended in 3 seconds

HOW cool and refreshed your tired, burning, aching feet feel the instant Coolene is applied. Every throbbing nerve is soothed. Every bit of fire and pain is drawn from the swollen, irritated nerves and tissues. Pains from corns, bunions, and callouses go like magic. Coolene is greaseless, vanishes instantly. Ends all agonizing foot pains in 3 seconds. Get a jar today.



Copyrighted material

FAST as a FALCON

Wing over the roads—fast as a falcon
—on a "45 Twin" Harley-Davidson.

Feel the surge of its amazing power—
the thrill of its flashing speed! "Bank"
it on sweeping curves—notice how it
balances itself like a soaring bird.
Test the velvet grip of its big brakes
—the luxury of its riding comfort—
the easy handling of its gearshift and
controls. What a motorcycle—and yet
the price is lower than ever!



\$195.00

At the Factory

Lowest price in Harley-Davidson history! This 1932 Single is sturdy, speedy, and costs almost nothing to run. Fully equipped—complete electrical system, 3-speed transmission, front and rear brakes, all conveniences. See it soon.

Look over the 1932 model
"45" at your nearest Harley-
Davidson Dealer's. Find out
how little it costs to run —
and how easy it is to buy on
his Pay-As-You-Ride Plan.

Mail Coupon

— for free literature
showing 1932 models
—Twins, Single, and
Sidecars.

Ride a
HARLEY-DAVIDSON

Harley-Davidson Motor Company
Dept. P., Milwaukee, Wis.
Interested in your motorcycles. Send Literature.

Name

Address

My age is 16-19 years, 20-30 years, 31
years and up, under 16 years.
Check your age group.

Save One-half on This New Model G-V. Rotary Compressor Type Electric Sprayer

ONLY
\$19⁷⁵

Regular Price \$39.50

for This Nationally
Advertised Outfit



While they last we save you half on the cost of these brand new Nationally advertised Electric Spray Outfits. One of the best outfits ever offered—use it for all kinds of paint, varnish and lacquer—also for spraying insecticides and other solutions. Balanced and fast for Auto fenders, bodies—for use in small shops, schools, factories. Paints anything, anywhere—gets in all the corners. Sign painters find it far superior to other outfits because of its speed. G-V. guns operate at highest efficiency on less than 1/3 pressure required for suction types.

Extra high quality—electric rotary type compressor, 110 volt Universal Motor. Can be used on AC or DC line. Encased in aluminum. The GUN is full liquid pressure type (do not confuse with ordinary cheap suction type gun) aluminum, light and easy to handle. Outfit also includes 3 interchangeable nozzles in wide basket—15 ft. high quality oil resistant hose; 10 ft. electric cord with plug-in—2 spray type, fan and round, both adjustable. Absolute satisfaction guaranteed or your money back. Our price only \$19.75. Send cash. Money Order or Draft. If you prefer, send only \$2.00 deposit, balance C. O. D. plus postage. Order at once. Send for folder of larger units at reduced prices.

NATIONAL JOBBING & EXPORT CO.,

192 N. CLARK ST.,

DEPT. 45,

CHICAGO, ILL.

SCIENCE PUTS HEAT IN TUBES

STERNO
CANNED
HEAT

... NOW
MORE
CONVENIENT
THAN EVER ...



HEAT can help you anywhere—at camp, in the shop, at home—with anything that needs heat right on the spot—soldering, hot glue, etc. How does heat help? A FREE booklet gives practical, time-saving uses. Let Sterno serve you. Full-sized tube only 10¢. Use the coupon.

STERNO CORPORATION PM-10
9 East 37th Street, New York

Send me your free booklet.
 I enclose 10¢ for full-sized tube.

Name _____

Address _____

Let us recommend the best books to study on any subject. Popular Mechanics Press, Chicago, Illinois.



Sousa

says: "Complete Equipment of Conn Instruments enhances musical value of any band at least 50%."

More than 50 years of experience, and exclusive patented processes make Conn instruments superior. FREE Trial, Easy payments if desired. Write for FREE book. Mention instrument.

C. G. CONN, LTD.
1031 Conn Bldg. Elkhart, Ind.

CONN
WORLD'S LARGEST
MANUFACTURERS OF
BAND INSTRUMENTS



Build your own outboard hydroplane motor or sail boat. Use our plans or knock-down frames and machined parts. Many models to select from. Write for new catalog. Please enclose 10¢ for catalog.

J. B. WELCH, Inc., Dept. B. 3148 No. 31st St., Milwaukee, Wis.

\$90⁰⁰ WEEKLY Easily Made

Lowest prices in years for our all wool tailored-to-measure suits. Finely made. Show our samples and make big cash profits daily plus liberal bonus. Orders come easy, quick. No experience required. Latest styles, beautiful fabrics. Big FREE sales outfit of nearly 150 swatches. Write Today
PIONEER TAILORING COMPANY
501 K-1116 Congress & Throop Sts., Chicago

\$500 to \$1150
PROFIT PER ORDER
Including Bonus

LOCAL MANAGERS WANTED

UP TO **\$60 a Week to Start!**



\$110 in 1 Week

Sol Korenblit, without previous training or experience, started making \$40 a week at the start. Now averages better than \$100 a week. Others making big money. Find out how you can, too.

WE need one man in every district to take charge of local business of big Cincinnati organization. Steady, year-round employment—full time or spare time. We furnish everything you need, give you liberal credit, and set you up in a "ready made" business that is paying others as high as \$90 a week. No capital or experience needed. We show you how—help you get established—then give you a Ford Tudor Sedan

free of charge as an extra reward or bonus so you can get around easily and supply tea, coffee, spices, extracts and other Household Products to big list of established customers and prospects. Everybody needs food. This means a steady, permanent, repeat business and big profits every day. Low prices and highest quality guaranteed by old, established million-dollar company. You don't invest a penny. Good openings now open in every territory. Full particulars sent free.

This Offer for Immediate Action. Write or Wire Today

Albert Mills, Employment Mgr., 7880 Monmouth Ave., Cincinnati, O.

Just Send in 5 Other Uses to get this Large Can

22 out of 1,000 Uses for PLASTIC WOOD

- Repairs furniture
- Repairs gouges
- Seals cracks
- Secures loose drawer pulls
- Secures loose castors
- Repairs broken toys
- Re-seals built-in tubs
- Secures loose tiles
- Repairs bathroom fixtures
- Fine for modeling
- Seals drainboard cracks
- Seals holes around pipes
- Seals cracks in shelving
- Repairs broken balusters
- Repairs concrete floor cracks
- Fills old screw holes
- Seals cracks in stucco
- Repairs wood rot
- For sealing window frames
- Strengthens rungs and joints
- Repairs loose tool handles
- Rectifies mistakes in carpentry

Many Industrial Uses Specifications

- Tensile Strength
1500 lbs. per sq. inch
- Crushing point
3000 to 4000 lbs. per sq. in.
- Weight per Cubic Foot . . . 30 lbs.
- Absorption, Fresh Water . . . 30%
- Absorption, Oil 33%
- Hold upon small screws
(White Pine at 100) . . . 143%
- Combustibility, inception
(charring) . . . 400° to 500° F.



FREE!

WITHOUT a doubt, PLASTIC WOOD is one of the greatest discoveries of the century. Imagine getting out of a can or tube a malleable substance that you can mould like putty, that hardens into weather-proof, water-proof wood . . . That's PLASTIC WOOD!

With PLASTIC WOOD you can seal cracks, hide nicks, correct mistakes, cover up signs of wear and tear around the house. After it hardens it never warps. You can paint, stain or lacquer it. You can carve it, turn it in a lathe. And it holds nails and screws better than most natural woods.

PLASTIC WOOD has an endless number of uses. 22 are mentioned here. Name just 5 more. Write them down on this coupon and mail to us. We'll send you a regular size can—any color you prefer—of PLASTIC WOOD free! No obligation at all. Also we'll send you a big 48-page book crammed full of facts concerning PLASTIC WOOD—which comes in cans and tubes and is sold by all paint, hardware and department stores in 9 colors.

FILL IN AND MAIL FOR FREE CAN

The A. S. BOYLE CO., Dept. 10-PM
Cincinnati, Ohio

Here are 5 more uses for PLASTIC WOOD. Please send me—free a regular size can of this new kind of wood,

- 1.....
- 2.....
- 3.....
- 4.....
- 5.....

Name

Street & No.

City..... State.....



LIKE MAGIC!
INSTANT HEAT
from "NOWHERE"
 (NEEDS NO FIRE - NO HOT WATER)
 NO ELECTRICITY!

\$30 DAILY FOR YOU
 WITH THIS **BAFFLING INVENTION**

**New Mystery Heat Pack Banishes Old Style
 Hot Water Bags and Electric Pads**

Heat from nowhere!—Soothing, healing heat—healthful, comfort providing, applied instantly when in urgent need, by the amazing new *Emergency Self-Heating Pack*. "What makes it work?" Prospects ask as they gasp astounded at 2-minute weird demonstration that pays you huge, spot-cash profits. "Where does the heat come from?" "How does it stay hot so long—or cool so quickly when desired?"

**Absolutely New!
 No Competition**

Thousands of prospects everywhere for this thousand-fold useful *Self-Heating Pack*. Greatest aid ever devised for aches, pains, illness of all kinds. Up to \$20-\$30 daily profits easy. \$40-\$50 net turnover.

**FREE OFFER
 Cash in at Once**

Our Spot-Cash-Profit Sales Plan gives you richest earnings in years! If you honestly want to clean up big, write quick!

Marshall Manufacturing Co.
 2032 Montrose Ave., Dept. 400, Chicago



Indispensable for the home, Sick Room, Ambulances, on Trains, Yachting, Camping, Hunting, any emergency. Recommended by physicians and nurses.

**Boys—have fun with
 chemistry—25¢**



Get CHEM-CRAFT Junior and surprise your friends with magic chemical tricks; make ink; dye cloth; test water and soil; write secret letters with invisible ink; pour blue, brown and black liquids from a pitcher of water. All these and more chemical stunts can be done with Chemcraft Junior. It's the best box of fun you ever had; shows you useful things to do. Get yours now.

**CHEMICAL SURPRISE
 Free to Boys!**

Send us the name and address of the store that sells toys where you live and we will send you a fine chemical surprise.

The Porter Chemical Company
 410 Washington St., Hagerstown, Md.



FREE 6 FAMOUS SPARK PLUGS
 worth \$4.50
 To customers for GOOD YEAR
 Goodrich - Firestone and other tires

DEALERS WANTED

Lowest Prices in History -- 75% Saving

Midland's Immense Buying Power Makes This Possible
 Thousands of motorists all over U. S. A. use and boast our Standard Brand reconstructed Tires. Hard service on roughest roads guaranteed. Our nation-wide success and reputation speaks for itself. FREE for limited time one of the best quality spark plugs with every tire shipped. Order 4 tires—get full set 6 spark plugs free. New pep for your car—no extra cost. Be sure to mention make of car, model, year built. ORDER TODAY at these Rock Bottom Prices. Satisfaction Guaranteed.

BALLOON TIRES

Size	Rim	Tires	Tubes	Reg. CORD Tires	Tubes
28x4-60-21"		\$2.30	\$1.10	\$2.20	\$1.00
28x4-60-20"		2.40	1.10	2.20	1.00
28x4-60-21"		2.45	1.20	2.20	1.00
28x4-75-19"		2.45	1.20	2.20	1.00
30x4-90-21"		2.90	1.20	2.20	1.00
32x4-90-19"		2.95	1.20	2.20	1.00
30x4-100-20"		2.95	1.20	2.20	1.00
32x4-25-18"		2.95	1.20	2.20	1.00
28x4-25-19"		2.95	1.20	2.20	1.00
28x4-25-20"		2.95	1.20	2.20	1.00
31x4-25-19"		3.10	1.20	2.20	1.00
32x4-25-19"		3.20	1.20	2.20	1.00
32x4-25-20"		3.20	1.20	2.20	1.00
32x4-25-21"		3.20	1.20	2.20	1.00
32x4-25-22"		3.20	1.20	2.20	1.00
32x4-25-23"		3.20	1.20	2.20	1.00
32x4-25-24"		3.20	1.20	2.20	1.00
32x4-25-25"		3.20	1.20	2.20	1.00
32x4-25-26"		3.20	1.20	2.20	1.00
32x4-25-27"		3.20	1.20	2.20	1.00
32x4-25-28"		3.20	1.20	2.20	1.00
32x4-25-29"		3.20	1.20	2.20	1.00
32x4-25-30"		3.20	1.20	2.20	1.00

Send \$1.00 deposit with each tire ordered. Balance C. O. D. If you send cash in full deduct 5 per cent. You are guaranteed a year's service or replacement at half price. Order Today—Save Money.

MIDLAND TIRE AND RUBBER COMPANY
 Dept. 465 1000-10 W. Sixty-Third Street Chicago

AUTO RADIO
 Long Distance Receiver

Amazing Low Price!
 Quality Performance

Six tube triple screen-grid, using 8-224, 2-227, and 1-245 power tube. Easy to install. Will fit any car. Single dial control. We guarantee that this set will pull in stations within a radius of 1000 miles and that it will deliver the volume and tone qualities of an electric set, or your money will be refunded. Order TODAY

PRICE OF SET ONLY \$20.00

Price complete including tubes, batteries, dynamic speaker and compressors, \$39.50. Send \$5.00 deposit with order. Balance C. O. D. On foreign orders remittance in full required.

CHAS. HOODWIN CO. Successors to Aero Products, Inc.
 4240 Lincoln Ave., Dept. K-20, Chicago, Ill.



BASHFUL?

"Shame on you!" Are you nervous, embarrassed in company of the other sex? Stop being shy of strangers. Conquer the terrible fear of your superiors. Be cheerful and confident of your future! Your faults easily overcome as you can enjoy life to the fullest. Send 25c for this amazing book.

RICHARD BLACKSTONE, B-4710 Flatiron Bldg. N. Y.

Now! Do Your Own Electric Nickel Plating

A REAL MONEY-MAKING OPPORTUNITY

NO EXPERIENCE REQUIRED. Do YOUR OWN Electro Plating in Your Home, Garage, Office, or Place of Business. Electrically Deposit Metal—Nickel, Brass, Copper, Silver, or Gold. You can successfully do all the plating on your Automobile, Electric Fixtures, Faucets, Spoons, Forks, Chandeliers, Tools, Coffee Urns, Surgical and Dental Instruments, Utensils, large or small, Iron Stoves, Music Instruments; recondition worn plating or plate New Work; do it instantly without interrupting the Service or without removing the parts to be plated with the

ALADDIN PORTABLE ELECTRO-PLATER

Simple and Economical to operate. Not a toy, but a practical Plating Outfit with which Perfect and Durable Work can be done. Positively Guaranteed to do as we claim. BE YOUR OWN BOSS! Build up a Profitable Aladdin Electro-Plating Business of your Own. This offers wonderful ECONOMY to users and BIG MONEY-MAKING possibilities to AGENTS. Thousands in Service since 1924. Write today for FREE PARTICULARS AND TESTIMONIALS.

P. J. F. BATENBURG CO. Dept. 256 RACINE, WISCONSIN

COMPLETE INTRODUCTORY OUTFIT ONLY \$6.50

—AGENTS— WANTED EVERYWHERE



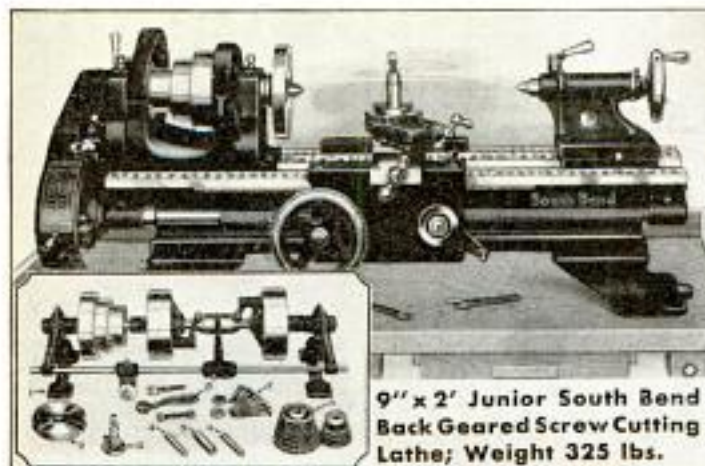

9" x 2' Junior South Bend Back Geared Screw Cutting Lathe; Weight 325 lbs.

\$150 ONLY \$30 DOWN
AND \$10.50 PER MONTH
FOR 12 MONTHS

f. o. b. South Bend with Countershaft and Equipment

9" x 2' JUNIOR

Also made in 2½' to 4½' bed lengths. Practical for precision work in manufacturing and machine shop and adapted to automobile service work on valves, bushings, commutators and pistons. Used by U. S. Government, state, municipal departments and leading industries.

\$230 ONLY \$46 DOWN
AND \$16.10 PER MONTH
FOR 12 MONTHS

f. o. b. South Bend with Countershaft and Equipment

11" x 3' JUNIOR

An ideal lathe for manufacturing and automobile repairs, handling same work as 9" Junior Lathe above; in addition does work on differential cases, connecting rods, universal joints, etc. Also available with silent chain motor drive, underneath belt motor drive, bench or floor leg type in bed lengths from 3½' to 5½'.



11" x 3' New Model Junior South Bend Back Geared Screw Cutting Lathe; Weight 430 lbs.

\$313 ONLY \$62.60 DOWN
AND \$21.91 PER MONTH
FOR 12 MONTHS

f. o. b. South Bend with Countershaft and Equipment

13" x 4' JUNIOR

Practical for manufacturing, machine shop, and automobile service work including all work handled by 9" and 11" sizes above, also brake drum truing on Fords, Chevrolets and other light cars.

EASY PAYMENTS ON ALL SIZES AND TYPES

Send for new catalog No. 92, illustrating, describing and pricing new Junior Series South Bend Lathes, also 96 other sizes and types, with details of easy payment plan. Free. Postpaid, on request.

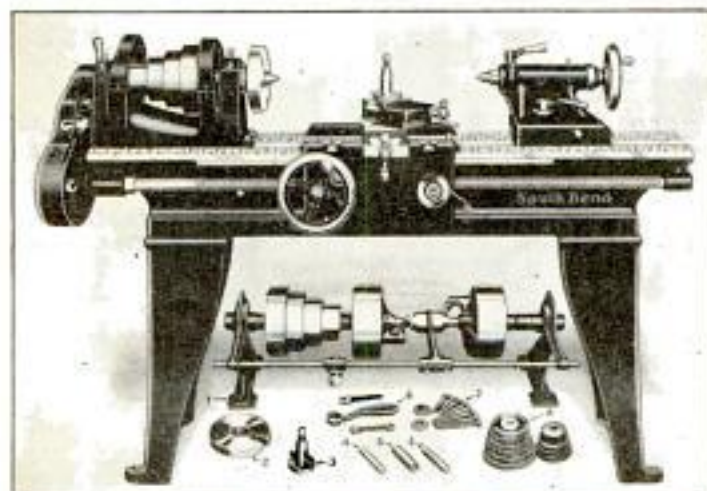

13" x 4' New Model Junior South Bend Back Geared Screw Cutting Lathe. Weight 980 lbs.

SOUTH BEND LATHE WORKS

640 E. Madison St., South Bend, Ind.

Lathe Builders for 25 Years — 55,000 South Bend Lathes in Use

SOUTH BEND LATHE WORKS

640 E. Madison St., South Bend, Indiana, U. S. A.
Please send me your catalog No. 92, on the new Junior Series Lathes; [] details of Easy Payment Plan.

Name _____
Street _____
City _____
State _____

LUMINOUS PAINT

Make Your Watches, Clocks, Etc., Visible by Night
 The very latest discovery in the scientific world, Luminous paint, practically unobtainable elsewhere at an exorbitant price, we have at last succeeded in producing this remarkable LUMINOUS PAINT, which, applied to the surfaces of any article, emits rays of white light, rendering it perfectly visible in the dark. THE DARKER THE NIGHT, THE MORE BRILLIANT IT SHINES. Quite simple to use. Anyone—you can do it. A little applied to the dial of your watch or clock will enable you to tell the time by night. You can coat the push buttons or switch plates of your electric lights, match boxes, and innumerable other articles; make your own Luminous Crucifixes, Luminous Rosaries, etc. Small bottles, price 25c. Larger sizes, 50c and \$1 postpaid. JOHNSON SMITH & CO., Dept. 819 RACINE, WIS.



CIGARETTE MAKER

Roll your own and save money. Better and quicker than any other. Use your favorite brand of tobacco. Next, useful, handy. Pocket size, weighs 1/2 lb. Made entirely of metal, nickel plated. 25c, 3 for 65c.



Exploding Cigarettes

Box contains ten genuine cigarettes of excellent quality. They appear so real, but when each cigarette is about one-third smoked, the victim gets a very great surprise as it goes off with a loud BANG! A great mirth provoker yet entirely harmless. Price 25c box.

Explosion Cigarettes
 Box contains ten genuine cigarettes of excellent quality. They appear so real, but when each cigarette is about one-third smoked, the victim gets a very great surprise as it goes off with a loud BANG! A great mirth provoker yet entirely harmless. Price 25c box.

Good Luck Ring
 Very striking, quaint and uncommon. Silver finish, skull and crossbones design, two brilliant, flashing gems sparkle out of the eyes. Said to bring good luck. Only 25c post.

NOVELTY BADGES



Kissing Permit 10c Garter Inspector 20c
 Two very novel metal badges, nickel plated, that you can wear, giving you fun out of all proportion to their trifling cost. 10c, each badge, 3 for 25c, or 75c per doz. postpaid anywhere.

SURPRISE MATCHES

More fun than fighting with your wife. Look just like ordinary matches. As the victim tries to light one he gets quite a surprise.
 Price 10c per box, 3 boxes for 25c, 12 for 75 cents.

STAR TOY MAKER

Greatest boys' book written. Tells how to make a Pinhole Camera, a Canon, model Railroad, a Telephone, Boom-rang, Telegraph Instrument, Hoax Kit, Talking Machine, Microscope, Electric Motor, Water Wheel, Paddle Boat, a pair of Skis, a Dog Sled, Bird House, Rabbit Yard, etc. 64 pages. 150 illustrations. PRICE 10c.

BOY'S OWN TOYMAKER A new book. Tells how to make chemical toys, electrical toys, gyalic toys, mechanical toys, paper toys, cardboard toys, boats, traps, etc. 200 illustrations. Price 25c per trade.

AMATEUR ELECTRICIAN, all about electricity in simple language. How to make batteries, dynamos, motors, telephones, bell electric bells, engines, lights, etc. Price 10c postpaid.

MONEY MAKING SECRETS Golden opportunity for everyone. 64 page, copyrighted book full of money-making ideas, recipes, formulas, wrinkles, trade secrets, etc. Business that can be started with little or no capital at home in spare time. 10c postpaid.

ROPE SPLICING, how to make different knots, hitches, splices, 32 pages, 100 illustrations. 20c postpaid.

125 CARD TRICKS and sleight of hand. Contains all the latest and best card tricks as performed by celebrated magicians, with secrets of card tricks used by professional gamblers. Price 25c postpaid.

MAGIC FOR AMATEUR MAGICIAN. Comparing with cards, coins, etc.; experiments in hypnosis, rheumatism, electricity, etc. 25c.

MELLER'S BOOK OF MAGIC. Magic and its mysteries. Numerous simple parlor tricks explained and illustrated, 100 pages. 25c.

TRICKS & SOCIAL ENTERTAINER. Contains hundreds of simple tricks, riddles, ditties, verses that anyone can do. Also explains secret of second sight. Price 25c postpaid.

83 OLD TIME SONGS. All old time favorites, copyrighted, secured, etc., with words and full music. Price 25c postpaid.

WONDERFUL X-RAY TUBE A wonderful little instrument producing optical illusions both surprising and startling. With it you can see what is apparently the bones of your fingers, the lead in a lead pencil, the interior opening in a pipe stem, and many other similar illusions. Price 10c, 3 for 25c.

SERPENT'S EGGS Box contains 12 eggs. When lit with a match, each one gradually hatches itself into a snake several feet long, which curls and twists about in a most life-like manner. Price per box, 10c postpaid, 3 for 25c

BLANK CARTRIDGE PISTOL

Protection against Burglars, Tramps, & Dogs. Special Offer 1 Blank Cartridge Pistol 100 Blank Cartridges 1 Lock-proof Novelty Catalog **ONLY \$1.50**
 Well made and effective, modeled on latest type of Revolver; appearance alone is enough to scare a burglar. When loaded it may be as effective as a real revolver without danger to life. It takes standard .22 Cal. Blank Cartridge—obtainable everywhere. Special case with handle offers 1 Superior quality Blank Cartridge Pistol, 100 Blank Cartridges, and our new \$50 De Luxe Catalog of latest novelties; all for ONLY \$1.50. Shipped by Express only. Cannot go by parcel post. Extra Blank Cartridges 50c per 100. Special Dealer (Monday Types) for pistol 50c. No C. O. D. shipments.

Combination Thrift Vault and Savings Bank

HAS REAL THREE NUMBER COMBINATION LOCK KEYLESS—CANNOT BE PICKED
 Your money and valuables will be perfectly safe in this new Combination Thrift Vault and Savings Bank, because it has a real combination lock just like the regular Safes and Vaults. The lock requires three numbers to open it. There are over 14,000 different combinations. The lock is pick-proof. It cannot be covered by "blowing" for the combination because it operates silently like the lock on a safe or vault. It is keyless in every sense of the word. No key is required. Once you learn the combination it can be opened in a moment or two. It takes coins of any size, currency, etc., or you can use it for storing jewelry and other valuable articles, and it keeps your private memorandums, etc., from prying eyes. Coins and currency can be placed in the bank through the slot at the top, but the larger articles will necessitate opening the bank by means of the combination. PRICE with secret instructions for opening, \$1.50 post.

LOOK 35c LOOK Wonderful Instrument.

Greatest thing yet. Nine separate articles in one. Everybody delighted with it. Odd, Curious and Interesting. Lots of pleasure as well as very useful. It is a double Microscope for examining the wonders of nature. It is also an Opera Glass, a Stereoscope, a Burning Lens, a Reading Glass, a Telescope, a Compass, a pocket Mirror, and a Laryngoscope—for examining eye, ear, nose and throat. It is worth all the cost to locate even one painful cinder in the eye. Folds flat and fits the pocket. Something great—you need one. Don't miss it. Sent by mail. Only 35c or 3 for \$1.00

PISTOL CIGARETTE CASE

It looks like a deadly weapon, but it is merely a novel Cigarette Case. This clever contrivance has proved itself better than the real thing in many an awkward encounter. Great fun "sticking up" your friends. They squirm, and protest it might be loaded. Pull the trigger and the slide files open disclosing the cigarettes. Well made, light and compact. Weight only 2 ounces.
PRICE POSTPAID 25c

GYROSCOPE TOP

Defies law of gravitation. The Gyroscope Top is a popular scientific toy that defies the law of gravitation. The illustrations above show a very few of the ways of spinning it. It can be thrown and caught, rotating rapidly all the time. It will travel about a taut string or wire. You can suspend it from a loop of string, still spinning vigorously. It will spin on the point of a pin, and will revolve in a dozen different ways on the pedestal. An effective feat can be performed by spinning the top at a high speed and noisily placing it into the square cardboard packing box. Put on the lid and then set the box on one of its corners. The box will spin around for quite a while, presenting a very curious appearance. It is a most instructive, partly always interesting for the many interesting experiments which present themselves for explanation. As a scientific instrument it is used to demonstrate the principle of attraction and repulsion of bodies in motion, the center of gravity and centrifugal force. Placed on the pedestal it illustrates the rotation of the globe better than any other mechanical device. Gyroscopes are used to steer torpedoes, steady ships, to balance monorail trains, and in aerial navigation.
PRICE 35c
 JOHNSON SMITH & CO., Dept. 819 RACINE, WIS.

MIDGET BIBLE

GREAT CURIOSITY Readable in the World. Size of a postage stamp. 200 Pages. Said to bring good luck to the owner. A genuine work of art. Must be seen to be appreciated. Make good money selling them in franks, stores, acquaintances, etc. PRICE 15c each, 3 for 40c, 12 for \$1.35, 100 for \$7.50. Also obtainable in Leather Binding, with gold edges. Price 50c each, 3 for \$1.25, \$4.50 per doz. Magnifying Glass for use with Midget Bible 15c

LEARN TO DANCE

without a teacher. Book gives instructions in old and new dances: Foxtrot, Tango, One Step, Quadrille, etc., explained and illustrated. 25c postpaid.

STAGE MONEY

With a bunch of these bills, it is easy for each person of limited means to appear prosperous by flashing a roll of these bills at the proper time and peeling off a genuine bill or two from the outside of the roll, the effect created will be found to be all that can be desired. Prices, postpaid: 40 Bills 25c, 120 for 50c, or \$1.50 thousand postpaid.

NOSE FLUTE

The Magic Nose Flute, or Harmonica, is a unique and novel musical instrument that is played with nose and mouth combined. There is just a little knack in playing it which, when once acquired after a little practice, will enable you to produce very sweet music that somewhat resembles a flute. There is no finger, and once you have mastered it you can play all kinds of music with facility and ease. When played as an accompaniment to a piano or any other musical instrument, the effect is as charming as it is surprising.
Post Paid 10c



JOHNSON SMITH & CO.

Dept. 819 RACINE, WIS.
 A De Luxe Edition of our new CATALOG mailed on receipt of 25c. Handsome binding. Bigger and better than ever. Only book of its kind in existence. Nearly 600 pages of all the latest tricks in magic, the newest novelties, puzzles, games, sporting goods, rubber stamps, unusual and interesting books, curiosities in seeds and plants, etc., unobtainable elsewhere. Remit by Cash, Money Order, Check or unencd. U. S. Cashier and Foreign Stamps for all articles listed above. See next page also.

BOYS! BOYS! BOYS!
THROW YOUR VOICE



Into a trunk, under the bed, under a table, back of the door, into a desk at school, or anywhere. You get lots of fun fooling the teacher, policemen, peddlers, and surprise and fool all your friends besides.



The Ventrilo

is a little instrument that fits in the mouth out of sight. Cannot be detected. It is used in connection with the above, and with the aid of this wonderful DOUBLE THROAT, or VENTRILLO, you can imitate many kinds of birds, animals, etc. Remember you get everything for ONLY TEN CENTS—a booklet giving you full instructions how to become a ventriloquist and throw your voice, the Double Throat, or Ventrilo, and our big catalog of novelties, tricks, puzzles, masks, books, etc.

All Sent Postpaid to Any Address for Only **10c**

INVISIBLE INK Rubber Chewing Gum

The most confidential messages can be written with this ink. For the writing makes no mark. Cannot be seen unless you know the secret. Invaluable for many reasons. Keep your secrets and other private messages safe from prying eyes. Great fun for playing practical jokes. Only 15c a Bottle; 3 for 40c.



It is just like a regular package of chewing gum and looks so real that it fools everybody. Of course no one suspects it is not genuine until they start to chew it. There's a world of fun in this rubber chewing gum—5 sticks to the package. Price, 10c Pkg.; 3 for 25c; 12 for 75c postpaid.

Rubber Tacks Box 10c
Rubber Cigarettes. Price per Box. 20c
Rubber Cigs. Price Ea. 10c
Rubber Matches. Price per Pkg. 10c

U. S. BABY TANK



This tank will keep floating along ten times longer than the ordinary run of toys. It will perform dozens of the most wonderful stunts; 25¢ inches long. Price only 25c prepaid. Stamps accepted.

\$1.50



Rolmonica is an unbreakable harmonica, that plays a music roll just like a player piano. It is a whole brass band all in one—the biggest sensation of the musical world in the last few years. Anyone can play it, for all you have to do is to insert a roll, and turn the handle while you blow. That is all there is to it. Nothing could be simpler. Any child who can do these two simple things can play the Rolmonica. It is a veritable pocket size Jazz-band, combining the principles of the harmonica and the player piano. It is an instrument of a thousand melodies. It plays the popular airs of the past, as well as the latest Broadway hits. There are hundreds of rolls to select from, such as My Blue Heaven, Home Sweet Home, America, Old Rock Joe, Annie Laurie, Sidewalks of New York, Humoresque, Wild Irish Rose, Bonnie O'Grady, Among My Souvenirs, Love's Old Sweet Song, Dixie, Macky Loh a Rose, Aloha Oe, Ramona, Juanita, Rose Marie, O-Sweet Christian Soldiers, Sally of My Dreams, Carolina Moon, I Faw Down a Go Boon, Weary River, Over There, Ma Coney, Long Way to Tipperary, Make Believe, Desert Song, La Paloma, Sweet Adeline, I've Got a Feeling, Pagan Love Song, When My Dreams Come True, Parade of Wooden Soldiers, Land of Hiogo Water, Turkey in the Straw, Hail the Gang's All Here, and hundreds of others. An unending source of amusement. You can delight your friends for hours and play tone after tone simply by changing rolls. Small in size, fitting your pocket, yet mighty in its finger-ticking, soul-tugging tone power. Not a toy, but a genuine musical instrument and the life of any party. One Roll free with each Rolmonica. Extra Rolls obtainable; complete list with each instrument. New Rolls added each month. PRICE with 1 Roll \$1.50; Extra Rolls 10c each, all postpaid.

Send remittance (Postage Stamps accepted) for all articles listed above, also in our other ad on previous page

It goes with real Yankee Pep—by its own power

Most remarkable toy ever invented. By drawing the Tank backward, either with the hand or over the floor or table and then placing it down, it will crawl along, overcoming all obstacles, in the same life-like manner as the larger Tank that proved so deadly in the great war. What makes it go is concealed in a mystery, for there is no mechanism to wind up as is usually understood with mechanical toys, yet it moves in the same life-like manner as the larger Tank that proved so deadly in the great war. What makes it go is concealed in a mystery, for there is no mechanism to wind up as is usually understood with mechanical toys, yet it moves in the same life-like manner as the larger Tank that proved so deadly in the great war.

PRICE 10c. 3 for 25c. 75c per dozen, postpaid.

ROLMONICA

A Mouth Organ that Plays with a Music Roll
Any One Can Play It Without Practice
A Wide Selection of Rolls to Choose From
A Veritable Pocket Size Jazz-Band!

THE DANDY PERISCOPE

Very Interesting and Amusing Novelty

SEE WITHOUT BEING SEEN



Look Over the Heads of the Tallest Men in a Crowd.
See Over a Fence, Around Corners, Etc.

LOTS OF FUN AND AMUSEMENT

Strongly Made. Equipped with Mirrors, Sight-Finder and Eye-Piece.

THIS is the same kind of instrument that the soldiers use in the trenches to watch the enemy without risk of being seen themselves, and every schoolboy has one to peep above the surface of the sea to keep a lookout for other vessels, etc. With it you can gaze over a high wall or see around a corner without being seen yourself, or, if you are in a crowd, you can look right over the head of the tallest men and watch all the fun. Our illustrations will give you some idea as to the numerous uses to which the Periscope can be put. Every Boy Scout should have one for spying and anyone else who wants some rare amusement. The Dandy Periscope is very strongly made, will stand the roughest handling and the hardest wear, and with ordinary use should last a lifetime. It measures 17 inches long, and a little over two inches wide. The Periscope Tube is handsomely decorated with colored designs to show many of its uses, and each Periscope comes complete in box.

Price Postpaid to any Address. **\$1.00**

MAGICIAN'S BOX OF TRICKS

Apparatus and Directions for a Number of Mysterious Tricks, Enough for an Entire Evening's Entertainment. **\$1.00**

ANYONE CAN DO THEM

It is great fun mystifying your friends. Get the Conjuror's Cabinet, and you will be the cleverest fellow in your district. It contains the apparatus for ten first-class tricks, including THE MAGIC BALL AND VASE TRICK (a wooden ball is placed inside, and upon replacing the lid has disappeared and is found in someone else's pocket); THE HINDOO TRICK CARDS (can be made to change completely no less than five times); DISAPPEARING COIN BOX (a coin, placed in the wooden box, vanishes entirely or changes into a coin of another denomination); THE GLASS GULLET TRICK (a coin is dropped into a glass of water and when the water is poured out the coin has vanished and is found somewhere else); THE RIBBON FACTORY FROM THE MOUTH TRICK (a seemingly endless supply of colored paper ribbons comes out of your mouth); THE DISAPPEARING HANDKERCHIEF (a handkerchief held in the hand mysteriously vanishes); THE WEARD'S RING COIN TRICK; THE ENCHANTED BOTTLE (no one but yourself is able to make it lay down); THE GREAT RAT AND DICE TRICK (a large die is placed on top of a hat, disappears, and is found underneath, yet no one has touched the hat), and last, but not least, the GREAT PHANTOM CARD TRICK, or two from five leaves nothing. Full instructions are sent for performing each trick. In addition to the above, a number of other feats and illusions are fully explained for which you can easily make or procure the necessary apparatus. Price complete \$1.00 postpaid. JOHNSON SMITH & CO.



RESURRECTION PLANT

Great curiosity. Place in water, plant opens up and starts to grow in few minutes. Taken out it dries up and goes to sleep until put in water again.



PRICE 10c. 3 for 25c. 75c per dozen, postpaid.



address for only 10c. 3 or six for 25c.



Comical Motto Rings
Lots of harmless fun and amusement wearing these rings. Made in platinum finish (to resemble platinum), with wording on enameloid, as illustrated. Price only 25c Postpaid.

The "Little Giant" Typewriter

A First Class Writing Machine For \$1.50



A perfect little typewriter for \$1.50. There are thousands of persons who would like to use a typewriter but whose needs and business do not warrant the expense attached to the ordinary machine. To such persons we confidently recommend our Little Giant. It is strongly made, but simple in construction, so that anyone can quickly learn to operate it, and write rapidly as they would on pen and ink. The letters of the alphabet most frequently used are so grouped as to enable one to write rapidly, the numbers 1 to 10, and the punctuation marks being together. With this machine you can send your best girl typewritten love letters, address envelopes, make out bills, and do almost any kind of work not requiring a large, expensive machine. With each typewriter we send a tube of ink and full printed instructions for using the machine. Price complete \$1.50 by mail postpaid to any address in the world. Stamps accepted.

JOHNSON SMITH & CO. Dept. 819 Racine, Wis.

PATENT

Protect Your Ideas

Take the First Step Today

If you have a useful, practical, novel idea for any new article or for an improvement on an old one, you should communicate with a competent Registered Patent Attorney AT ONCE. Every year thousands of applications for patents are filed in the U. S. Patent Office. Frequently two or more applications are made for the same or substantially the same idea (even though the inventors may live in different sections of the country and be entirely unknown to one another). In such a case, the burden of proof rests upon the last application filed. Delays of even a few days in filing the application sometimes mean the loss of a patent. So lose no time. Get in touch with me at once by mailing the coupon on the opposite page.

Prompt, Careful, Efficient Service

This large, experienced organization devotes its entire time and attention to patent and trade mark cases. Our offices are directly across the street from the U. S. Patent Office. We understand the technicalities of patent law. We know the rules and requirements of the Patent Office. We can proceed in the quickest, safest and best ways in preparing an application for a patent covering your idea. Our success has been built on the strength of careful, efficient, satisfactory service to inventors and trademark owners located in every state in the Union.

NO CHARGE for Information On How to Proceed

The booklet shown here contains valuable information relating to patent procedure that every inventor should have. And with it I will also send you my "Record of Invention" form on which you can sketch your idea and establish its date before a witness. Such evidence may later prove valuable to you. Simply mail the coupon and I will send you the booklet, and the "Record of Invention" form, together with detailed information on how to proceed and the costs involved. Do this NOW. No need to lose a minute's time. The coupon will bring you complete information entirely without charge or obligation.

My Offices
Just Across
Street From
U.S. Pat. Office



Above is a view of my drafting and specification offices where a large staff of experienced experts is in my constant employ. All drawings and specifications are prepared in my offices.

NEWS

*Inventors
Write for these*

**Free
Books**

Strict Secrecy Preserved

All communications, sketches, drawings, etc., are held in strictest confidence in strong, steel, fireproof files, which are accessible only to authorized members of my staff. Feel free to write me fully and frankly. It is probable that I can help you. Highest references. But **FIRST**—clip the coupon and get my free book. Do **THAT** right now.

Clarence A. O'Brien

Registered Patent Attorney

Member of the Bar of: The Supreme Court of the United States, U. S. Court of Customs and Patent Appeals, U. S. Court of Claims, Court of Appeals, District of Columbia and Supreme Court of the District of Columbia.

Practice confined exclusively to Patents, Trademarks and Copyrights



Clip this Coupon and Mail it Now!

CLARENCE A. O'BRIEN, Registered Patent Attorney
70-M Security Savings and Commercial Bank Bldg.
Washington, D. C.

(Or, Suite 1106, Dept. A-16, Woolworth Bldg., New York City)

Please send me your free book, "How to Obtain a Patent," and your "Record of Invention" form without any cost or obligation on my part.

Name.....

Address.....

(Important—Write or print name plainly and address office nearest you)

PATENTS TRADE MARKS COPYRIGHTS



Our New York Office
Suite 1007 Woolworth Bldg.



Our Philadelphia Office.
528 Fidelity
Phila. Trust Bldg.



Victor Building—Our New Building
Nearly Opposite U. S. Patent Office.
Specially Erected by Us for Our Own Use



Have You An Idea?

Our Offer: FOR THE PROTECTION OF YOUR INVENTION

YOUR FIRST STEP—The Inventor should write for our blank form "RECORD OF INVENTION." A sketch and description should be made on this Blank, signed, witnessed, then returned to us. We also give our opinion as to whether the invention comes within the Patent Office definition of a patentable invention. This "Record of Invention" will serve as "proof of conception." *There is no charge or obligation for this service.*

Our Five Books Mailed Free to Inventors
Our Illustrated Guide BOOK

How to Obtain a Patent
Contains full instructions regarding U. S. Patents. Our Methods, Terms, and 100 Mechanical Movements illustrated and described.

Our Trade Mark Book
Shows value and necessity of Trade Mark Protection. Information regarding *Trade Marks and unfair competition in trade.*

Our Foreign Book
We have Direct Agencies in Foreign Countries, and secure Foreign Patents in shortest time and lowest cost.

Progress of Invention
Description of World's Most Pressing Problems by Leading Scientists and Inventors.

Payment of Fees in Installments
It is not necessary that the total cost for the preparation and prosecution of a patent be paid in one payment. Our custom is to permit our clients to pay for their applications in three installments as the preparation of the application progresses in our office. This plan makes the payments easy for the inventor.

We Regard a Satisfied Client as our best advertisement, and furnish anyone, upon request, lists of clients in any state for whom we have secured patents.

**Highest References—Prompt Service
—Reasonable Terms**

VICTOR J. EVANS & CO.

Patent Attorneys, Established in 1898
Main Offices: 789 9th St., N. W., Washington, D. C.
Nearly Opposite U. S. Patent Office

DELAYS ARE DANGEROUS IN PATENT MATTERS

IMPORTANT! To Avoid Delay!

YOU SHOULD HAVE YOUR CASE MADE SPECIAL IN OUR OFFICE to save correspondence, secure protection and early filing date in the Patent Office. To secure **special preparation** of your case send \$25.00 on account with model or sketch and description of invention. If the invention is not patentable we will return fee less cost of search.

We Assist our Clients to Sell their Inventions.



MAIN OFFICE, VICTOR J. EVANS & CO.—VICTOR BUILDING, WASHINGTON, D. C.

Our Large, Comprehensive Organization has been established for 30 years and offers Prompt, Efficient and **Personal Service** by experienced Patent Lawyers and Draftsmen. Every case is in charge of a Specialist who has been selected for his knowledge and experience in certain lines of invention. Our Lawyers practice in all U. S. Courts and defend clients in suits involving Patents, Trademarks and Copyrights. All Communications, Sketches, Drawings, etc., preserved in fireproof Files, strictly **Secret and Confidential**. We shall be glad to have you consult us or to answer any questions in regard to Patents, Trademarks or Copyrights without charge or obligation.



Our Chicago Office
Suite 1640-42 Conway Bldg.



Our Pittsburgh Office
Suite 514 Empire Building



Our San Francisco Office
Suite 1010 Hobart Building

**FREE
COUPON**

VICTOR J. EVANS & CO.
PATENT ATTORNEYS *Established
in 1898*

NEW YORK OFFICES
1097 Woolworth Bldg.

CHICAGO OFFICES
Suite 1640-42 Conway Bldg.

PHILADELPHIA OFFICES 828 Fidelity Phila. Trust Bldg.

PITTSBURGH OFFICES
514 Empire Bldg.

SAN FRANCISCO OFFICES
1010 Hobart Bldg.

MAIN OFFICES: 789-9th Street, N. W., WASHINGTON, D. C.

Gentlemen: Please send me *Free of Charge* your books as described on preceding page.

Name.....

Address.....

PATENTS SECURED TRADE-MARKS REGISTERED

High-class professional service for Inventors and Trade-Mark Users is necessary for PROPER PROTECTION. We Offer you our facilities on Reasonable Terms. If you have an invention send us a model or sketch and description and we will give you our OPINION whether your invention comes within the provisions of the Patent Laws. Our book, "HOW TO GET YOUR PATENT" and Record of Invention Certificate sent on request. DELAYS are DANGEROUS in Patent Matters.

Terms Reasonable.

Best References.

WRITE TODAY

RANDOLPH & COMPANY, Patent Attorneys
301 VICTOR BUILDING, WASHINGTON, D. C.

Name.....

Address.....

PATENTS

PROTECT YOUR IDEAS

Write today for FREE BOOKLET, HOW TO OBTAIN A PATENT and RECORD OF INVENTION—or send Drawing or Model of your Invention for Examination.

Promptness Assured with Best Results

MILLER & MILLER

REGISTERED PATENT ATTORNEYS

Former Members Examining Corps U. S. Patent Office
Dept. A-1006 Woolworth Bldg. New York
255 McGill Building Washington, D. C.

PATENTS—TRADE MARKS

All cases submitted given personal attention by members of the firm. Information and booklet free. Patent Office & Federal Court Practice.

LANCASTER, ALLWINE & ROMMEL
PATENT LAW OFFICES
480 Ouray Bldg. Washington, D. C.

PATENTS

TO THE MAN WITH AN IDEA

Preliminary advice gladly furnished without charge. Booklet of information and form for disclosing idea free on request.

IRVING L. McCATHRAN, Patent Lawyer
Formerly with and successor to RICHARD B. OWEN
750 International Bldg. Washington, D. C.
41-E Park Row New York City

TRADE-MARKS

TRADE
MARKS

PATENTS

COPY-
RIGHTS

BEST RESULTS. LOWEST FEES. PARTIAL PAYMENT PLAN

Write today for free information—No obligation, sending sketches and description of invention.

HARRY W. JOHNSON

Registered Patent and Trade-Mark Attorney

FORMERLY MEMBER EXAMINING CORPS U. S. PATENT OFFICE
Member of the Bar: Supreme Court of the District of Columbia, The Court of Appeals of the District of Columbia, and the U. S. Court of Customs and Patent Appeals.

219 MCGILL BUILDING, WASHINGTON, D. C.

INVENTORS

who derive largest profits know and heed certain simple but vital facts before applying for Patents.

Our book *Patent-Sense* gives those facts; sent free. Write LACEY & LACEY, 635 F Street N. W., Dept. 5, Washington, D. C. Estab. 1869.



How to Obtain A Better Looking Nose

Improve your personal appearance

My free book tells you how I guarantee to improve the shape of your nose by remodeling the cartilage and fleshy parts, quickly, safely, and painlessly, or refund your money. The very fine, precise adjustments which only my new patented Model 25 Nose Shaper possesses, make results satisfactory and lasting. Worn night or day. Over 100,000 users. Send for free book to **M. TRILETY, Pioneer Nose Shaping Specialist** Dept. 197 BINGHAMTON, N. Y.



BOW LEGS?

THIS GARTER (Pat'd)
Makes Trousers Hang Straight
If Legs Bend In or Out
Free Booklet—Plain Sealed Envelope
THE T. GARTER CO., Dept. E
South Bend, Ind.



BUCHSTEIN'S FIBRE LIMB

Is nothing to your stump—strong, cool, neat, light, easy payments. Brace for all deformities. **BUCHSTEIN CO., 640 3rd Ave., So. MINNEAPOLIS, MINN.**

Send for Catalog Today

PATENTS

Booklet Free

Highest References

Promptness Assured

Best Results

Send drawing or model.

ALL BUSINESS GIVEN PROMPT AND PROPER ATTENTION

Listed Patent Lawyer in the latest editions of the Rand-McNally Directory of Bankers and Bank-Recommended Attorneys, published by Rand-McNally & Co., Chicago, Ill.; The Baggott & Ryall Directory of Guaranteed Attorneys, published by Legal Directory Corporation, Boston, Mass.; Flugel's Law List, published by Legal Directory Publishing Co., St. Louis, Mo.; American Lawyers Annual, published in Cleveland, Ohio; Bankers Service Legal Directory, published by Bankers Service Co., Boston, Mass.; Eyre's Law List, 9 Park Place, New York City; Walters Leg's 1 Directory, Omaha, Nebraska, and the National Directory of Attorneys, Baltimore, Maryland.

WATSON E. COLEMAN,
REGISTERED PATENT LAWYER

Victor Building, 724 Ninth Street, N. W.
WASHINGTON, D. C.

Improved WITTE Engines Enclosed--Self-Oiling--Roller Bearing

Sold On 30 Days Trial—Easy Terms

Finest Engines
In The World

Also Power Saws
and Pumps

Since 1870 WITTE has been building gasoline, kerosene and oil engines. Present models are the last word in modern engineering. Burns all American fuels. Low operating cost, soon pays for itself.

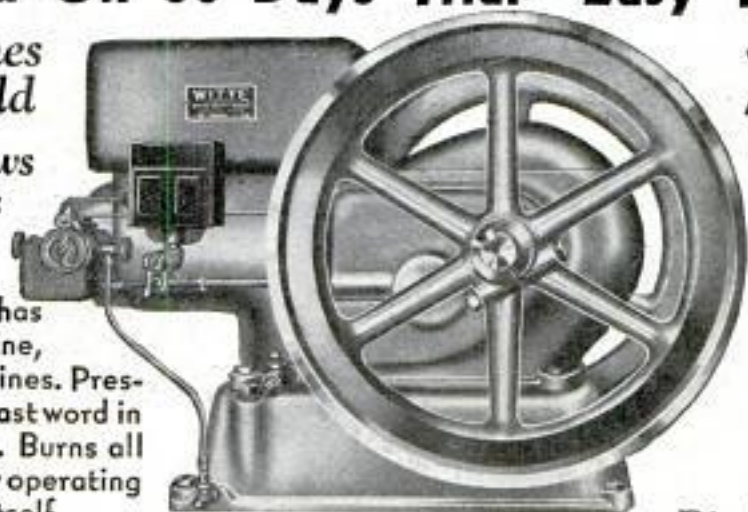

"A DIME A DAY
AND YOUR POWER
PLANT IS ON ITS
WAY."

Get the facts about these great engines. A size and style for every POWER need. Built like a fine watch. All parts absolutely interchangeable.

Big Catalog Free!

Buy Direct From Factory—Prices Lower Than Ever

210 W. Carson St.
PITTSBURGH, PA.

WITTE ENGINE WORKS

1747 Oakland Avenue
KANSAS CITY, MO.



DOUBLE YOUR INCOME

Make Colorcrete Products
NEW. EASY. FASCINATING
Many pieces sell for 10 times cost to make. Crockett (above) of Texas shows a profit of \$1231 as a side-line. Kauble of Iowa \$2000 with only three designs, etc., etc.
Permanent, charming color SELLS THEM ON SIGHT.

HOME MANUFACTURING
Start this exciting fast-growing business now. No previous experience necessary. Equipment as low as \$30.
Learn all about this great opportunity today by reading the FREE 32-page BOOK.

**COLORCRETE
INDUSTRIES**
570 Ottawa Ave. HOLLAND, MICH.



High grade, moderately priced band saw for light work; affords all the accuracy, convenience and efficiency of large band saws. Ball bearing. Self contained motor operates from light socket; or may be driven from line shaft. - Marble finished table, with graduated scale, tilts any angle to 45 degrees. Quick locking device. Saw, with spring tension, is fully guarded. We make wide line of light machines for cabinet makers, schools, and amateurs; also heavy machines for factories.

THE CRESCENT MACHINE CO.
93 Columbia St. Lectoria, Ohio

Send for FREE BULLETINS



CRESCENT
20"
Band
Saw

A.C. Electric Plants



ONAN A. C. PLANTS furnish the same current as city service—110 volt, 60 cycle. A. C. Operate Radios, Water Systems, Refrigerators, all Household Appliances.
Sizes 500 to 2000 Watts
Available from stock. No battery used except to start the engine. Ideal for farms, camps and lake homes.
Also a complete line of D. C. Models.
D. W. ONAN & SONS
90 Royalston Ave. Minneapolis, Minn.

BELLO FOR DULL BLADES

Wonder-working machine—10 days' free trial

BELLO, the Hollow Grinder, grinds a new edge for every shave, changing all blades of Probak and Gillette type to hollow ground concave.

A hundred years ahead of any stropper.

Price \$3.75. Pays for itself two to three times a year on blade cost alone.



E. S. PETERSON, Durant
dealer at Portland, Me., has
used one blade for more than
500 shaves.

TO THE NEW
A sensation in America

You have given your wife every modern device to ease her domestic burdens. If she has not alleviated your one great grief, "shaving torture," by giving you a Bello for a birthday or Christmas gift, get one for yourself.

Dr. R. J. Dice, Okla.: "One blade over a year."
A. W. Stubbs, Iowa: "350 shaves, one blade."

If you cannot secure Bello locally, send us \$3.75 (your money back if not satisfied), or we will forward on 10 days' trial if you attach this ad to your letterhead and check here

FREE — A generous size 35c tube of Bello Bubbles, the new Danish shaving cream, absolutely free, if you send cash with order.

BELLO SALES PLAN

F. A. Ward of Montpellier, N. D., a town of 176 people, has sold over 500 to date. If interested in selling Bello, check here and pin this advertisement to your letter.

THE "BELLO" CORPORATION
Desk #110, Bello Bldg., Gardner, Mass.

Name _____
Address _____

FROM THE OLD WORLD
to solid years of European success.



ACTION!

WHEN you want to go—**GO!** Go the man's way with never a care for detours, never a thought for the road. Just head your Indian toward your goal—and go!

Ever since the first Indian turned its wheels thirty years ago, men with the spirit of adventure have used Indians. Through all these years Indians have given dependable service. They have the power, the stamina and the dogged spirit that gets you there—swiftly, surely, safely.

For Men with Sporting Blood

Today, in the ranks of innumerable men with sporting blood, you'll find Indians. There's no sport that packs the thrills of motorcycling . . . and with a dependable Indian they are yours at so little cost . . . a small investment, and less than two cents for every mile of wind-blown, sun-tanned sporting transportation.

Valuable Dealer franchises are open; write for details before they are snapped up.



Indian MOTOCYCLES

INDIAN MOTOCYCLE CO., A-10, SPRINGFIELD, MASS.
Please send folder on Indian Motorcycles. My age is . . . years.

NAME.....

ADDRESS.....

When writing please mention Popular Mechanics



New Way
to
**Practice
Shooting**
at
Home!



What good is a firearm unless you can hit the mark? Here's just what you need in developing marksmanship with your pistol, revolver or rifle. Set this K-B Backstop in your basement or out in the open. You can then practice to your heart's content without danger of injuring people or damaging property. Target box of heavy gauge steel absolutely prevents ricochet and back spatter. Get one and see how it will increase your proficiency in shooting. Send for Free circular and special introductory price.

KOEHLEBROTHERS
211 Water St. Saginaw, Mich.

WRITE
for
**FREE
CIRCULAR**



Agents
WANTED

GET
YOUR
COPY OF
THIS
**FREE
BOOK**



Everybody wears
SHOES

In this whole country there's not a man who doesn't wear shoes! What a chance to make money when you sell something everybody wants! Men—Women—Children—they're all prospects for Tanners Footwear. Sales come easy because our prices are low, and our quality high.

**WRITE US
TODAY!**

Find out about this great chance to make money. Receive book "Getting Ahead" explaining everything and absolutely free. Tells how you start without experience or investment. Write us at once.

Employment Mgr.

TANNERS SHOE CO.

8710 C Street Boston, Mass.



WE ARE THE ORIGINAL COMPANY SUPPLYING PARTS TO "BUILD YOUR OWN" SHIP MODELS AND COACH MODELS

For more than 7 years we have been supplying thousands of satisfied customers.

The Beautiful Clipper Ship "FLYING CLOUD" only \$4.00, Santa Maria, Mayflower, and others \$4.50; Concord Coach or Covered Wagon, \$4.50.

The "CONSTITUTION" accurately detailed \$6.00, Spinning Wheel \$1.00; Lamps and other projects. Send 2c stamp for beautifully illustrated catalog. Models sent C. O. D. by parcel post in U. S. or Canada.

MINIATURE SHIP MODELS, INC.

PERKASIE, PA., Dept. RT

Canadian Office: No. 90 King Street, West, Toronto, Ontario

AERO WORLD-WIDE

Only
\$6.45

Short
Wave
Receiver



Span the World with this Set!

A new radio thrill for you! Listen in DIRECT to London, Paris, Berlin, Buenos Aires and other broadcasting stations throughout the world via short waves. Enjoy unique foreign programs from strange lands. Your ordinary receiver cannot tune in these low wave stations. **WORLD-WIDE RECEIVER** gets 14 to 550 meter stations with surprising clarity. **SEND NO MONEY!** Just write your name and address on a postcard and ask us to send you this wonderful guaranteed short wave set. Pay postman \$6.45 plus a small delivery charge. All orders west of Rockies must be accompanied by \$1.00 deposit. Foreign countries \$7.75 delivered. Write today for new catalog of radio bargains.

CHAS. HOODWIN CO., Successors to Aero Products, Inc.
4248 Lincoln Ave., Dept. K-2 CHICAGO

PYROIL



The Greatest Lubricating Discovery of the Age

NOW USED ON
WORLD'S LONGEST

NON-STOP FLIGHT

UNLIMITED PROFIT OPPORTUNITY FOR SALESMEN & DISTRIBUTORS
Russell Boardman and John Polando used PYROIL in both oil and gas on their record-breaking transatlantic non-stop flight from New York to Turkey with savings on both gas and oil! PYROIL is used by leading automotive industries. It is a **PROVEN** product, patent protected, **NATIONALLY ADVERTISED.**

Pyroil Heat-Proof Liquidized Graphite provides a rare, tested, proven process of lubrication that makes motors, old and new, function with amazing increased efficiency. Purely a lubricant; concentrated; no chemicals. Positively cannot burn. Designed for use in autos, airplanes, marine motors, trucks, tractors, farm machinery, road building and excavating equipment.

SOLD UNDER A POSITIVE MONEY BACK GUARANTEE

Simply added to gas and oil, Pyroil drives wear, saves noise, cuts repair bills. It reduces carbon, frees valves, seals rings. Increases mileage by reducing friction drag. Actually doubles, triples life of crankcase oil!

UP TO \$100-\$150 WEEKLY PROFITS

Write at once for the interesting and amazing best-story of Pyroil, territory opening, Sales Plans and Big Profit offer. **DON'T DELAY.**

W. V. KIDDER, PRES., THE PYROIL COMPANY
5101 Pyroil Bldg., La Crosse, Wisc.



YOU CAN MAKE
THOSE
Extra Dollars

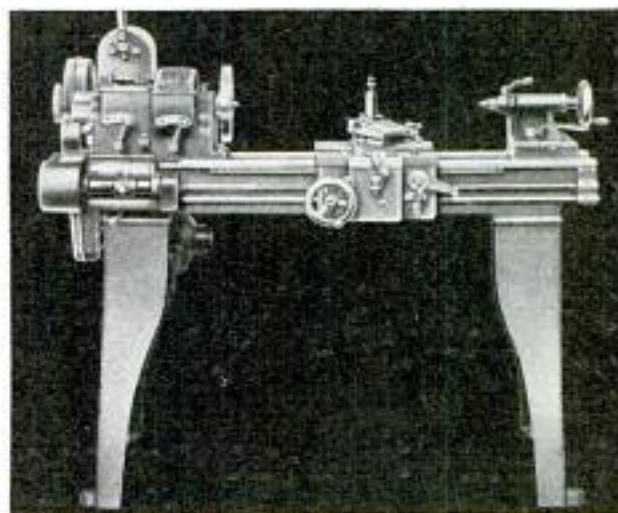

GET THIS
Regal Lathe
Built by LeBlond

A WONDERFUL opportunity to hold those dollars that are slipping through your fingers.

In your own workshop, in the garage, or the repair shop, the Regal enables even the amateur to produce profitable work.

It has an eight-speed selective geared headstock, feeds and speeds easily changed and controlled, and lathe is equipped with feed rod to maintain the accuracy of the lead screw.

The Regal is delivered complete (with motor), ready to run. It is built in five sizes, 10" to 18", and carries the LeBlond guarantee. Prices range from \$275.00 to \$947.00. Terms if you wish. Clip and mail the coupon.

The R. K. LeBlond Machine Tool Co.,
106 Regal Division, Cincinnati, Ohio.

Send details of the Regal Lathes.

Name.....
Address.....
City.....State.....

When writing please mention Popular Mechanics

... IN ONE TOOL

A tool post precision grinder for bench lathes and for off-hand grinding operations... easily changed into a high speed drill... one tool with many uses. Maximum speed, 20,000 R. P. M., grinds to finest limits.

Write for descriptive bulletin.
DUMORE CO., 52-16th St., Racine, Wis.



\$27.50
Complete

BURN YOUR NAME ON TOOLS

WITH THE
ARKOGRAF

PROTECT YOUR TOOLS FROM THEFT

Write with electricity any name or design on the hardest and finest tools and instruments, or any metal, like writing on paper with pen or pencil. Complete Outfit \$3.50—Prepaid Anywhere. Interesting illustrated circular free. Write today. Agents wanted. ARKOGRAF PEN CO., 1171 E. Stark St., Portland, Oregon



TOOL CHESTS

For Machinists—
—for Toolmakers—
—for Patternmakers—
—for particular men everywhere. Catalog Free.

H. Gerstner & Sons

494 Columbia St. Dayton, Ohio

The man who studies gets ahead. Popular Mechanics Press will advise you what books to read to advance in your trade. 200 East Ontario Street, Chicago, Illinois.

Brown & Sharpe Tools **BS**
"World's Standard of Accuracy"

Send for Catalog No. 31 describing 2300 Precision Tools.
Brown & Sharpe Mfg. Co., Providence, R. I., U. S. A.

HERE NOW AT

Diamonds

60% OF Market Prices



EXAMINE FREE

For an Investment

Diamonds Are Ideal Now

Never in 1/2 century, such amazing values here as amidst prevailing market. (Read why, in paragraph below). The rare investment advantage is obvious when you consider we can offer **Written Guarantee to Lend You an Amount Close to Our Selling Price.** Provides quick cash in an emergency—like **INSURANCE POLICY LOAN GUARANTEE.** Details in latest list.

A 1/2 Century Diamond Banking Institution has sound reasons for low prices. Write for latest list now. Bankers, Lawyers, other business men—thousands freely acknowledge they have bought diamonds here priced at tremendous savings. Even as against wholesale prices.

Why Pay Full Prices? Get Latest List Free

Examine free—without obligation to buy. Read below—how we can offer diamond values you can try to match at full 60% more. Offers backed by written, legal, binding guarantees. Any banker can tell you of our standing (highest financial rating, over \$1,000,000.00, AAA-1).

Unpaid Loans—as low as \$60 per Carat;

also various finest quality gems. Now is the time, now the opportunity to buy a diamond at a perfectly remarkable price. This world's oldest, largest diamond banking institution of its kind loans granted over \$40,000,000.00—offers the forfeited pledge diamonds from loans unpaid. Due to economic conditions, there is an unusually large number of foreclosures this year which must be sold promptly to recover our cash. Prices based on amounts borrowed—A fraction of actual market prices.

And don't forget, diamonds are indestructible—they do not change through wear and age. Unpaid loan gems here, reset in brand new mountings. Also other advantageous offers. Latest list contains all details—exact weights—grades—descriptions—guarantees. Lists limited—Write now.

Name _____

Address _____

For Free List clip this ad, fill in above and mail to—
Jos. DeRoy & Sons, Opp. P.O. 1919 Delcor Bldg., Pittsburgh, Pa.

DOES THE WORK OF A HIGH PRICED IRON



Every mechanic—whether amateur or professional—ought to own this easy-to-use electric soldering iron. Enables you to handle the hardest jobs in a jiffy.

Heats quickly; stays hot in use. Tapered copper tip gets into confined spaces. Same durable construction as Esico "Industrials" used by U. S. Navy and leading radio and electrical factories.

Grade "A" nickel chrome heating element; 85-watt. Heat insulated handle, dark mahogany. Wt. only 1 lb., length 12 3/4 in., 6 ft. cord. Plugs in any current. Price \$2.75.

Sent direct if your dealer can't supply you.

ELECTRIC SOLDERING IRON CO., 137 W. 17th St., New York, N. Y.

ESICO "Junior"

Buy a Good Saw for Your Shop!



The Parks Premier Circular Saw does a man-sized job. You need it for your home shop.

Send for complete catalog

The Parks Woodworking Machine Co.

Dept. PM-10
 1530 Knowlton St.

Cincinnati,
 Ohio

PARKS

WOODWORKING MACHINES

OTTAWA LOG SAW



Make Money! Wood is valuable. Saw 15 to 20 cords a day. Does more than 10 men. Ottawa easily operated by man or boy. Falls trees—saws limbs. Use 4-hp. engine for other work. **30 DAYS TRIAL.** Write today for **FREE** book. Shipped from factory or nearest of 4 branch houses.

OTTAWA MFG. CO., 1741-W Wood Street, Ottawa, Kansas

FREE TOOL BOOK

The entirely new Disston Saw, Tool and File Manual tells how to choose, use, and care for tools, file and set saws, etc. Sent free.

Henry Disston & Sons, Inc., Dept. M, Philadelphia. Canadian Factory, Toronto

New Tractors from Old Fords

Do All Farm Work! Easy to Build—We tell you how!

Make powerful tractor out of your Model "A" or "A" Ford, or Chevrolet with SHAW Tractor Equipment. Low cost! New HIGH ARCH Model with 30 inches clearance straddles 1 or 2 rows of corn and other crops. Cultivator, plow, seed, disk, etc. Runs left machinery. Easy to attach. **SPECIAL LOW INTRODUCTORY PRICE!** Write for **FREE** literature!

SHAW MFG. CO., 4510 Center St., Galesburg, Kans.



THREAD CUTTING LATHE



9" Swing; 18" between Centers

Lever controlled reversib's Feed permits cutting right or left threads. **\$55**

A real Lathe. Price as shown

12" BAND SAW, ROLLER GUIDES, TABLE TILTS, 530

A powerful, practical Saw. Write today for catalog on other Machines.

ROSSBACHER MACHINE CO.
 1516 Fernwood Avenue Toledo, Ohio

NOW—A REAL TELEPHONE SYSTEM

For \$5.00

Now you can have your own telephone system with Realphones—the new 3/4 size telephones that talk and ring electrically just like regular telephones. Rugged, durable construction with transmitter and receiver combined in modern French-type hand piece. Buzzer cleverly concealed in base. Guaranteed to operate satisfactorily on two standard dry cell batteries. You can use Realphones from ROOM TO ROOM—Save time and steps. Wake up the children in the morning. **WORKSHOP TO UPSTAIRS**—Work without interruption. Talk to family by telephone. **HOUSE TO GARAGE**—A protection as well as a convenience. **HOUSE TO HOUSE**—Realphones will talk and ring for hundreds of feet. Easy to install. Scores of applications. Furnished complete (EXCEPT BATTERIES) for \$5.00 including two telephones with buzzers in base and 35 feet of wire. Send cash, money order or draft. Or, if you prefer, send \$1.00 with order and pay balance to postman C. O. D. plus postage. Cash only on foreign orders. **ORDER NOW.**



AJAX ELECTRIC SPECIALTY CO.
 6106 So. La Salle St., Chicago, Illinois

\$5.00 FOR TWO TELEPHONES INCLUDING WIRING

Easy to Own Big Money Business

A delightful, dignified and fascinating business. Make and sell CRISPETTES. Delicious confection. Young and old like them. Come again and again for more. Easy to make. I supply all equipment. Raw material plentiful and cheap. Profits big. No town too small. Start now.

Quick Success Possible anywhere—cities, towns, villages; open a little retail store; or begin at home; wholesale to stores, grocers, bakers, druggists, parks, baseball games, picnics, wayside stands.

New Pop Corn Specialty Shops making lots of money now. Letters just received during past month tell of many successes.

We Start You in Business for little money. Supply machines, secret formulas, and raw material. Little capital starts you. No experience needed.



Write for
"Book of Facts"
—it's free, contains success letters from others—shows their places of business, tells how to start.

LONG-EAKINS COMPANY
1028 High St.
Springfield, Ohio

JUST OUT

**MENZIT
MARVEL
MENDER**

New Liquid Repair Material

Not a glue, solder, or cement, but does work of all three, and is vastly greater in holding strength. No heating—no acid. Repairs almost anything—wood, iron, steel, glass, dishes, leather, aluminum. Sells in every home, to stores, shops, factories, wood working mills, mechanics, farms—everywhere. Positively no competition; nothing like it. Will unite glass on metal, wood or leather on metal, or any other material. Most marvelous product offered.

Up to
**More Than
200%
Profit**

Write now, quick, for offer to agents showing up to 200% profit on easy money-making sales.

MENZIT CO. Dept. 108 Delphos, O.

Do Your PRINTING

Cards, stationery, circulars, tags, labels, advertising, etc. Save money. Print for others, big profits; easy rules sent. Will do popular Raised Printing like Engraving. Junior Press, \$5.90. Job Presses \$11 up. Power \$149. Write for free catalog. **THE KELSEY CO., Y-37, Meriden, Conn.**

NEW MODEL ALL PURPOSE BOILER

FACTORY TO YOU 20% CUT IN PRICE TO EARLY BUYERS

Extra strong, heavy, for strenuous work. 5-inch solid brass cap and spout. Simple twist of thumb screw removes cap. No threads to wear out. Ideal home cooker, boiler and pasteurizer. Steam tight. Durable, safe, practical.

Guaranteed Pure Copper

Prices quoted are net, cash with order or send 1/3 money order or your check. Pay balance C. O. D. Ask for free catalog. Shipped in plain strong box.

HOME MFG. CO., 20 E. Kinzie St., Dept. 7816, Chicago, Ill.



NEED MONEY? Then Why Not Go and GET IT?

Learn Taxidermy at home in your spare time. Mount all kinds of BIRDS, ANIMALS, GAME-HEADS, ETC. Mount trophies for Sportmen, or mount COMMON specimens, like the groups in this ad. Here is a marvelous NEW, very PROFITABLE, no-tended field. Are you interested? Then investigate! SEND THE COUPON FOR OUR HIGHLY INTERESTING FREE BOOK.

SAY TO YOURSELF "I Refuse to Be Hard-Up"

Have courage to face the facts. Times ARE hard. Jobs are scarce. Idle hands are an enemy. We all HOPE and EXPECT the depression will end soon. But how about extra money NOW? Are you out of work? Have wages been cut? Do you NEED extra money to meet bills, buy necessities—provide comforts and luxuries for yourself and your family? If so, REFUSE to lie down and wait! USE YOUR head. Determine to win, and you WILL.

Think! The "mind quitter" is the only one who deserves to lose. You CAN get out of the RUT if you want to badly enough—if you have the courage and faith in your best money-making idea. First—do something NEW—don't wait for things to turn up—MAKE THEM TURN UP. Learn a NEW TRADE—have a SURE side-line business that EARNS in SPARE TIME.

Act Men, boys, women, you must shape your own destiny; you must take your own determination and will-power. GET OUT OF THE RUT and gain your own financial independence. PERHAPS we can help you. Will you investigate? Will you give YOURSELF a chance? Will you ACT? If we cannot assist you we shall frankly tell you so. If we CAN assist in giving your problems, you WANT this service, is that not true? Then write for full particulars TODAY. It does not obligate you, and costs but a 2c stamp to SEND THE COUPON BELOW. Forget the depression! Get into a new, fresh, sparkling, popular side-line business that makes BIG PROFITS in both good and bad times. Start with NEW courage TODAY by mailing the COUPON.

A Reserve Business

That is what many folks need—a RESERVE BUSINESS—like a reserve bank account. They all the eggs are not in one basket. Our new FREE BOOK will tell you all about the wonderful TAXIDERMY BUSINESS. Easily, quickly learned at home BY MAIL. It is the greatest and most SPARE TIME money-maker in the world. FULL OF INTEREST and fascination and PROFITS. Write to our old reliable school TODAY—the ONLY school of Taxidermy in existence, with 150,000 successful graduates throughout the entire world. You will be amazed and enthralled with this ART and with FACTS we will send you FREE. Do not pass this opportunity by lightly. IT MAY be the turning point of your life.

FREE BOOK Do this PLEASE. Clip the coupon. Mail it to the school and receive ABSOLUTELY FREE—a beautiful 48-page book, fully explaining one of the most interesting home occupations businesses that exists in our country today. It tells you how thousands of THOUSANDS have brought into their lives new joys and pleasures and become financially independent. If you NEED more money—a if financial problems worry you, then you will CERTAINLY at least INVESTIGATE since it costs you nothing. Remember MEN or BOYS may love a NEW business that will delight them and one that will be a SURE PROFIT "reserve business" all their lives.

Mail the Coupon TODAY—THIS MINUTE—State Your Age

Send Coupon Today!

FREE BOOK COUPON

**NORTHWESTERN SCHOOL OF TAXIDERMY,
8377 Elwood Building, Omaha, Nebraska**

Gentlemen: Please send at once your free 48-page book on Taxidermy without any obligation on my part. Tell me how I can learn Scientific Taxidermy at home and earn real profits in spare time.

Name.....Age.....

Address.....

When writing please mention Popular Mechanics

Wave the Magic Wand of LIGHT CONTROL!

DOORS open by themselves; lights turn on and off without attention; objects are counted by mechanical brains; electric eyes inspect products; a beam of light throws the voice a thousand yards; the burglar is tripped by an invisible ray—

Indeed, there is no limit to the tricks of the magic wand of light control or simplified photo-electric art, the foundation of which is the

BURGESS RADIOVISOR* BRIDGE

A thoroughly tested English development in light-sensitive cells, combining extraordinary simplicity, ruggedness and long life. Unlimited applications. It opens up a field as thrilling, as novel and as useful as did radio broadcasting.

WRITE for data on the Burgess Radiovisor Bridge and its basic applications to the control of electrical circuits.



BURGESS BATTERY CO. RADIOVISOR DIVISION

206 E. 44th St. New York City

*Reg. U. S. Pat. Off.



For Your Home Workshop

You should have a copy of this book recently published by Popular Mechanics entitled

Make It Yourself

The home mechanic, whether young or old, amateur or professional, will take pride and delight in making many of the things described therein.

Both father and son will find fascination and an association of interest in making useful and ornamental articles for mother to admire upon their completion.

900 Articles All Different

There are attractive ship models, a great variety of toys that operate themselves by means of an ingenious application of mechanical principles, novel amusement devices for indoors and outdoors, for both water and land, unique designs in furniture for children, scores of useful appliances for the home, things of beauty and utility for lawn and garden, etc.

Special articles instruct the amateur mechanic in the care and use of tools, special tools for special purposes, how to read and use plans, how to solder, the making of a handy work bench, cuts, joints and methods in woodworking, automobile repairing, installing radio equipment, house wiring, fixture hanging, working in glass, leather, metal, celluloid, lathe work, utilizing parts of old machines to make equipment that would be expensive to buy, etc.

Some of the Articles:

- | | |
|--------------------------|------------------------|
| Tools for the Home | Monorail Coaster |
| Mechanic | Writing Cabinet |
| Ship Model Maker's Tools | Workbench |
| Build Your Own Ship | Tea Wagon |
| Model | Radio Apparatus |
| Ship Model Plans | Lawn Canopy |
| Water Sprite | Camp Car |
| Puzzles | California Cooler |
| Crazy Clown | Musical Instruments |
| Walking Wampus | Hedge Trimmer |
| Winter Toboggan Slide | Homemade Baseball Game |
| Colonial Bric-a-Brac | Small Turbine Motor |
| Merry-Go-Twist | Tools from Sewing Ma- |
| Wiggling Pup | chines |
| Black Cat Bench | Small Valves |
| Christmas Toys | Bench Lathe |
| Skating Whirligig | Auto Glare Shield |
| Venetian Swing | Sawsaw Merry-Go-Round |
| Bird Houses | Ferris Wheel |

480 Pages — 823 Illustrations. Price \$3.00
Size 7x10x1 1/2 in. Cloth Binding

Mailed Postpaid upon receipt of price anywhere in the world. If you reside in U. S., Hawaii, Porto Rico, Alaska or Mexico, we will send the book by mail C. O. D. if you prefer. Simply pay postman when he delivers the package.

POPULAR MECHANICS PRESS (ROOM P-10)
200 East Ontario St. Chicago, Ill.

\$BIG MONEY\$ You Collect Your Profits in Advance!

QUICK, EASY SELLING RADIANT HEATER

"Made \$100 in a day" says Spangler. "Clears \$53.30 in a day", says Maloney. Yes, to make Big Money selling Sunshine Radiant Heater! Gives clean, beautiful Gas Heat—wherever you live. Makes and burns own gas. No piping. No installation. No dirt, smoke, ashes. Easily carried anywhere. Beware zero is not too cold for Sunshine. It is bringing cozy comfort to thousands of homes now. Every home, store, etc., a good prospect. New low prices make easy sales. Your profit is not cut.

15-Days Trial—Try FREE—Start— Sunshine in your own home 15 days. Know why it sells easily! Write Quick!

Sunshine Products Co., 332 Factory Bld. Kansas City, Mo.

Complete Heating Unit in Field

No stock to buy

GAS HEAT Anywhere—1 1/2¢ PER HOUR

BE A MASTER CRAFTSMAN

Earn extra money at home in spare hours. Pleasant work. Make trellis, tables, chairs, kitchen nooks, and cabinets now in popular demand. With H & A portable electric woodworking equipment it's easy to learn immediately—turn out beautiful pattern and cabinet work. No. 11 Band Saw illustrated is used by thousands of commercial shops and homes everywhere. Handles heaviest jobs. No vibration, chatter or galloping. Perfectly safe and easy to use. Reasonably priced. Send today for FREE H & A Catalog of portable electric woodworking machines, and how you can make your basement into a profitable work shop. Write at once. Reliable dealers, send for SPECIAL OFFER.

HESTON & ANDERSON 610 STONE ST. FAIRFIELD, IOWA



BABY CALCULATOR
CHICAGO ILL.
MONEY SAVER

VEST POCKET ADDING MACHINE

Adds, Subtracts, Multiplies, Divides. Does work of \$200 machine. Not a toy. Million dollar capacity. Simple and accurate. Guaranteed 5 years.

FREE TRIAL \$2.50 Total Cost
—SEND NO MONEY—

Just name and address. We will ship Calculator immediately. On delivery pay postage \$2.00 (plus few cents postage). If outside U. S. send cash. 10¢ additional in Leatherette Case. If not satisfied after 10 days' trial you get your money back. THOUSANDS OF SATISFIED USERS. Write for Agents' Proposition. **BABY CALCULATOR MACHINE CO., (Mfrs.) P. O. Box 1118, Dept. 31, CHICAGO, ILLINOIS**

Electric Alarm Clock \$7.90 Value
only \$3.95

NO WINDING — NO OILING
ABSOLUTELY ACCURATE

Set it for any hour—rings until shut off. 12 Month's Factory Guarantee. Will last a lifetime. Absolutely noiseless—no ticking. Beautiful Bakelite Mahogany finish, 4 1/2 in. wide, 7 in. high. Suitable for any room. Complete with cord and plug in. Operates on any 110 volt 40 Cycle A.C. Best Power for only \$3.00 to pay address in U. S., Canada and Possessions. Satisfaction guaranteed. Order today. Send check or P. O. Money order to **NATIONAL JOBBING & EXPORT CO., Dept. 7, 192 N. Clark St., Chicago, Illinois.**

DEAFNESS IS MISERY



Many people with defective hearing and Head Noises enjoy conversation, go to Theatre and Church because they use Leonard Invisible Ear Drums which resemble Tiny Megaphones fitting in the Ear entirely out of sight. No wires, batteries or head piece. They are inexpensive. Write for booklet and sworn statement of the inventor, himself deaf.



A. O. LEONARD, Inc., Suite 699, 70 5th Ave., New York

CHROMIUM PLATING POWDER

PLATES IRON, STEEL, NICKEL, BRASS and COPPER without electricity or machinery. Guaranteed not to tarnish; dispenses with polishing. Half pint can \$1.50, prepaid. Particulars FREE. **GUNMETAL CO., Ave. S. Decatur, Illinois**

SIDE LINE OR FULL TIME

\$10-\$30 CASH DAILY

AMERICA'S MOST BEAUTIFUL LEATHER GOODS

Bill Folds, Key, Cigarette and Letter Cases, Ladies' Bags, etc.

14 KT. GOLD MONOGRAMS GIVEN

WRITE FOR FREE SAMPLE OFFER

INITIAL-IT, INC. 510 N. Dearborn CHICAGO

Genuine UNDERWOOD
Below 1/2 Mfg's. Original PRICE



New Low Price! Now Only \$39.90
Regular \$100 Model
Easiest Terms Ever Offered

Famous Model No. 5

NOW ONLY \$1 DOWN



Think of it—over 2 million buyers paid \$100 (cash) for this model No. 5 now offered direct-to-you at way below 1/2 original price—and on easiest terms besides. Positively the greatest bargain ever offered. Accept the special 10 day trial offer and be convinced. See the neat, perfect work it does—compare its bright, shiny newness without risk. Recognized as the finest, strongest typewriter built.

Easy Terms—only 10c a day

Here is positively the chance of a lifetime to own a World-famous Standard Underwood No. 5 completely refinished like new at the very lowest price and easiest terms.

Learn Touch Typewriting



Learn touch typewriting free! Complete (home study) course of famous Van Sant System given with this offer. Fully illustrated—easily learned.

10 Day Trial

You save over \$60 by quick action. These genuine guaranteed Underwoods now only \$39.90 (cash) while limited supply lasts. Only \$1 down brings the Underwood for 10 days' trial. If you keep it—only 10c a day soon pays for your Underwood on our new low price and easiest terms. Send at once before this special offer is withdrawn. Remember every machine fully guaranteed and sent on 10 day trial.

International Typewriter Exch. 231 W. Monroe St., Chicago, Dept. 1001

I enclose \$1 deposit. Send Underwood No. 5 (F.O.B. Chicago) at once for 10 days' trial. If I am not perfectly satisfied I can return it express collect and get my deposit back. If I keep it I will pay \$2 a month until I have paid \$44.90 (terms price) in full.

Name.....
Address.....
Town.....State.....

When writing please mention Popular Mechanics

Copyrighted material

New Machines—New Low Prices Again Boice-Crane Leads

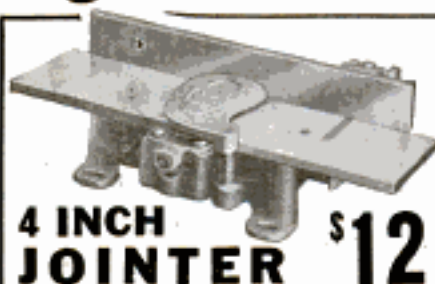

4 INCH JOINTER \$12

This is new—never before offered—a 4" solid, substantial, rigid jointer for only \$12! 16" polished tables, 2-way tilting fence. All steel safety head. Accurate.

UNIVERSAL HANDISAW

\$28



This is a new low price on our old reliable saw table.

Here comes the parade! The procession of new Boice-Crane Power Tools has started. New designs, new ideas. Just a few shown here. Don't buy until you have seen the entire line—have seen the new **LOW PRICES!** Get your name on our mailing list—get ready for the surprise of your life—never have you seen such high quality at such low prices. Anybody can now afford quality power tools.



NEW LATHE \$28

Here's another addition to the Boice-Crane line. Ball bearing—4 speed—11" x 36"—the very last word in up-to-date lathe design. A wonder at \$28.

7" X 30" LATHES

\$12⁰⁰

7" X 36" LATHES

\$17⁵⁰



10 Inch \$12 JIG SAW

Boice-Crane quality thru and thru. Solid, true-running and a bear for tough jobs. A real buy at \$12.

Send 10c for Catalog

Ten cents, coin or stamps, helps pay postage on big 52-page catalog and supplement. If you already have catalog "D" just send for supplement of new tools. Supplement is free.

W. B. & J. E. BOICE, Dept. PM-10G, TOLEDO, OHIO



RAISE CHINCHILLA AND NEW ZEALAND WHITE FUR RABBITS Make Big Money We Supply Stock AND CONTRACT FOR ALL YOU RAISE paying up to \$6.50 each. Large illustrated book, catalog and contract, also copy of Fur Farming Magazine, all for 10c. **STAHL'S OUTDOOR ENTERPRISE CO.,** Box 141A, Holmes Park, Missouri

Pick Trade You Like and Earn Big Pay

Modern equipment worth hundreds of thousands of dollars, best instructors, individual instruction and amazingly low tuition make this school the finest in the country.

MAIL COUPON FOR FREE INFORMATION

**BEDFORD
YMCA
TRADE
SCHOOL**

1115 Bedford Ave., Dept. PM-7,
Brooklyn, N. Y.

Send me without obligation complete information on (check subjects).

- Caterpillar Tractor Mechanic
 Aviation Mechanic
 Flying
 Welding
 Auto Mechanic
 Radio Mechanic
 Talking Pictures, Western Electric

Name.....
Street & No.....
Town..... State.....

Send for free catalog JEWELRY—CASH OR CREDIT

Diamonds, Watches, Jewelry .. Catalog Gives



Full Particulars of Our Easy Credit Plan

No. 972—Solid 18-K white gold wedding ring, 5 blue white Diamonds.. \$18.75

No. 884—Five blue white Diamonds; solid 18-K white gold ring, \$50. EASY TERMS

**LOFTIS BROS. & CO. : Dept. E-894
30 N. State Street Chicago, Illinois**

Build Your Own Boat!



Outboard Speeders

— Cruisers —
Fast Runabouts

It's fast, easy work with our full size paper patterns, semi-erected frames and ready-cut materials. Try it and see—or let us build one for you. Eighteen sturdy models. Special four passenger outboard runabout, mahogany finish, copper and brass fastened, only \$167 net. Germain Boats and unique systems of home construction have been popular for more than a quarter of a century. Send 10c for complete literature. Germain Boat Co., 518 S. Niagara St., Buffalo, W. S. Mich.

Send 10c for CIRCULAR

Keds

At \$1.00, \$1.25, \$1.50
\$1.75 and up to \$4.00.

United States Rubber Company

Get Into A Business of Your Own—EARN \$150 to \$300 Monthly



AUTOMATIC AIR SERVICE

Dependable, space saving compressors bring customers to your door. Only \$12 Monthly. 30 Days' Trial.



PAINT SPRAY PROFITS

Paint autos, houses, furniture. Do your own work of 3-4 hours profitably. Only \$12 Monthly. Will pay its own way.



8-HOUR BATTERY CHARGING

Recommended by leading battery makers. Halves cost, doubles profits. No special experience required.



20 MINUTE Car Washer

Big profits washing cars—averages 2 1/2 times, does better job. Savings pay for it. Only \$17 Monthly.

30 Days' Trial, to prove it. Easy Terms.

Check items of interest and mail to
HOBBART BROTHERS
Box N-101, Troy, Ohio

WRITE TODAY » Only \$16 Monthly — 30 Days Trial to Prove it « NO OBLIGATION

Crescent
Tinner's
Snips No. 547
75c.

G-26
Plier
50c.

Crescent
Hack Saw
Frame
No. 1042
75c.

**FOR LESS
THAN \$1.00**

You can slip any one of these Crescent Tools into your kit

Pick the tool you need—any hardware store can supply you with it at the price above. Look over the many other Crescent popular priced quality tools—the kind experienced mechanics choose the world over.

There's a Crescent tool to fit every pocket in your kit at a price to fit your pocket-book.

For Catalogs, write
CRESCENT TOOL COMPANY
Jamestown, N. Y.

CRESCENT and Smith & Wemenway TOOLS

AMERICAN METHOD PAYS \$25 TO \$40 A DAY

Hundreds of new floors to be finished. Thousands of old floors to be resurfaced, waxed, polished. Thomson, Michigan, earns \$30 a day. Kelley, Ontario, Canada, has 100 jobs ahead. Turner, Mississippi, took in \$447.68 in one month. Gessing, Illinois, cleared \$180 in 17 hours. We teach you the amazingly simple American Method and furnish FREE advertising cards, etc., to get you started. Write today, stating occupation.

The AMERICAN FLOOR SURFACING MACHINE CO.
524 S. St. Clair Street TOLEDO, OHIO



ALUMINUM SOLDER

You can now solder Aluminum, sheet or cast, as easy as tin. Solder brass, copper, etc., to Aluminum. Money Back Guarantee. Manufacturers and repairmen demand it. State Distrib. wanted. Pays Big Profits. Write Dept. P-6,

PERFECTION MFG. COMPANY
3534 Sunset Blvd., Los Angeles, Calif.

LOOK! NEW AND NOVEL. LOOK! MODELS OF FOREIGN CARTS AND WAGONS



COSTA RICA SUGAR CANE CART
(Including Ox and Load of Cane)
14 1/2 Inches long by 5 1/2 Inches High.

Parts fit to fit and ready to put together. Makes Model exactly as illustrated. Pay postage \$1.25 on delivery, plus postage and a few cents for C. O. D. charges. Other Models in Preparation. Send for Circulars.

INTERNATIONAL MODELS
Box 4003, Station B Philadelphia, Pa., U. S. A.

AT LAST NOISE FREE RECEPTION on SHORT WAVES and BROADCAST with STENODE



STENODE selectivity curve makes 10KC selectivity so called, look like broad tuning. STENODE'S curve covers but 1/10 the noise area of the best modern sets, less than 1/2 that of the average set.

Imagine complete absence of background noises . . . silence between stations . . . crystal clear reception . . . highest and lowest musical tones with absolute fidelity through compensated audio . . . ability to tune out heterodynes and whistles from neighboring supers without lessening volume or quality.

With the help of STENODE engineers Dr. James Robinson, former Chief of Wireless Research of the British Royal Air Force has developed a revolutionary superheterodyne with broadly tuned IF stages and no critical condensers to keep adjusted.

By the STENODE principle the highest selectivity ever attained as well as unprecedented tonal range is now made possible. All engineers agree this is impossible with ordinary super heterodynes.

STENODE amplifies signals most and static least. That's why YOU want to build an 11 tube STENODE to work from your SHORT WAVE adapter when you are not using it to log and listen with enjoyment to more broadcasters than can be heard on any other type of radio. STENODE selectivity is 5 to 1 greater than that of so called 10KC Supers. The noise does not get in along with the high audio frequencies and your STENODE reproduces perfectly higher frequencies than ever heard on any other receiver, giving

500% Better Selectivity
1000% More Freedom from Noise
Infinitely Better Quality

9 Blue Prints
Data Book
Direction Book Now **\$5**



Made in England

STENODE. Only one required in each Stenode.

This heart of the Stenode circuit consists of a quartz crystal ground to 175 KC frequency and mounted in tube form for easy handling. Standard UX socket base.

Price \$15

New prints without the inventor's signature.



James Robinson

Increased demand for Stenode Data Book, Instruction Book and Blue Prints permits our cutting former price in half. Those who have already sent in full price will receive our check for \$5. We are not interested in making profit from our engineering services. Our price comes solely from royalties paid us by our licensees.



The STENODE opens up new fields for shortwave and television work, as well as broadcasting. Full details of all sorts of applications are given in the STENODE Data Book. Nine full-sized diagrams show clearly to place every part. How to make every connection is clearly told in STENODE Book of Directions. Your finished STENODE will put you into a new world of radio. Fill in and mail the coupon with your every order for the biggest value ever offered custom set builders.

STENODE CORP. OF AMERICA, HEMPSTEAD GARDENS, L. I. N. Y.
(Formerly American Radiostat Corp.)

STENODE CORP. OF AMERICA (Formerly American Radiostat Corp.)
Hempstead Gardens, L. I., N. Y.

Enclosed find Money Order Check, for which please forward me STENODE, BLUE PRINTS, DATA BOOK and DIRECTION BOOK, for building STENODE.

Name

Street

City

State

"IF IT ISN'T A STENODE IT ISN'T A MODERN RECEIVER!"

Pure Silk Hose Given With Each \$1.00 Order

CLEARs YOU UP TO \$50 A DAY

Big opportunity for YOU offering eager, waiting women beautiful Silk Hose absolutely without cost (with each \$1.00 order). These fine hose, with sheerness and luster of \$2.50 values, given with high quality Poudre de Paris Face Powder and exquisite perfume. Poudre and Parfum alone equals loveliness and charm of \$4 retailers. Sells fast at only \$1 complete set, with Silk Hose Free. Never before such value!

100% PROFIT FOR YOU

Here's your greatest opportunity for a profit CLEAN UP of up to \$30 to \$40 daily with overwhelming, year round repeat sales.

EVERY WOMAN WANTS PARIS TOILETRIES!

Sales are waiting everywhere! Millions just jump at the chance to get these Free Silk Hose. Handsome display box sells these sets at first sight, — quality clinches sale.



GUARANTEED PURE THREAD SILK
Full length, high quality, top to toe.

Here's a deal that will pay you big, from the start. You will be amazed how fast your profits pile up.

AGENTS!

Men—Women!

Get our liberal offer

N O W.

Don't let someone else

beat you to the

earnings that can be

your! Write TODAY. Get

started NOW!

BE FIRST
Start making Big Money
ACT NOW!

PARIS LABORATORIES
3147 Locust Blvd. Dept. 9101 St. Louis, Mo.

An Amazing Business Paying 7% \$1000 Monthly



If you want a real live Business with a chance for \$1000 monthly profits, open a "hot dog" stand, and cash in on the tremendous demand for the luscious wiener. Millions of pounds sold monthly for sandwiches and everybody loves them. Will buy more readily, roasted this new way by electricity with all the delicious flavor roasted in. Profits are enormous—up to \$12.00 an hour. Machine pays for itself in a week.

Roasted By Electricity

Entirely New!—the Presto Electric Wiener Roaster. Clean, wholesome, and inviting. Attracts trade. No unsavory odors. Wieners simmer with delicious, enticing aroma. Wieners do not shrink, but actually get 20% larger. Roaster is portable. Move it anywhere. Just plug in light socket—that's all. Roasts 12 Wieners to a delicious golden brown in 3 minutes.

Start NOW Anywhere

AGENTS WANTED

Show merchants who sell foods this amazing Hot Dog device, and make up to \$150 weekly. Write for agent's offer.

Open up a "Hot Dog" Stand in front of your home, on the highway or anywhere traffic is heavy. Cash in on the big demand now for "hot dogs" and the bigger demand when roasted this amazing new way. Write for details on how to get started. We show you.

PRESTO ELECTRIC ROASTER CO.
P-45 American Bank Bldg.
Pittsburgh, Pa.

When writing please mention Popular Mechanics

DIRECT-TO-YOU AT A NEW LOW PRICE

A Genuine **BROWNING** 4975 **3** **Guns** **In One**
AUTOMATIC

the favorite with sportsmen all over the world—3 or 5-shot capacity—no equal in quality, appearance, smooth action.

12 or 16-Gauge

Send today for our new FREE Catalog No. 1023-M which tells you why the Browning "16" Automatic does the work of a "12"—yet less light and easy to carry as a "12". Ask for Catalog No. 1023-M
BROWNING ARMS CO.
Headquarters and General Offices
ST. LOUIS, MO., U. S. A.

FREE 36-Page Catalog

A BOAT for YOU



Thousands with no experience whatever have successfully assembled

BROOKS BOATS and turned their leisure time to profit as well as saving two-thirds of the usual cost of a completed boat. You too can build in your spare time this winter, a winning outboard racing speedster, runabout, cruiser, sail, row boat or any craft of 38 designs you may desire. It's simple, anyone at all handy with tools can build a **BROOKS Boat**, all parts accurately cut to shape and assembled as far as possible, with clear understandable instructions. Now's the time to choose your craft and start building for next season's use. Send 10c today for 64-page catalog of Boats and Accessories.

BROOKS BOAT CO., Inc.
Dept. 16K Saginaw West Side, Mich.

This MAGIC DISC Pays You up to \$30 and more Daily

EVERY HOME CAN AFFORD THIS AMAZING LOW COST ELECTRIC WATER HEATER. The GREATEST SELLER AND MONEY MAKER FOR AGENTS AND DISTRIBUTORS ever devised.

The LUX. New, Improved ELECTRIC WATER HEATER boils water steaming, sizzling hot in less than 2 minutes. Entirely new principle—unheard of low cost.

MEN — WOMEN — Make huge profits, fill or spare time. Vield dynamic demonstration with LUX instantly.

FREE OFFER—NO INVESTMENT
Write at once for full details.

LUX-VISEL COMPANY

107 Jackson St. Elkhart, Indiana



PANTS MATCHED



Don't Throw Away That Coat and Vest!

Save \$15 or more! Let us match your coat and vest with new trousers tailored to your measure. Save the price of a new suit. Over 100,000 patterns. Mail sample of suit, or your vest which will be returned with FREE SAMPLE for your approval. **SAMPLE Match Pants Co.** 20 W. JACKSON BLVD. Dept. A-13 CHICAGO



SPRAY GUN Formerly \$30.50 **ONLY \$7.50**

This is the famous G.-V. Full Pressure Type All Purpose Spray Gun. Nationally advertised at \$30.50. A fortunate purchase permits us to offer them for only \$7.50. G.-V. guns operate at highest efficiency on less than 1/3 pressure required for suction type. Works fast—fine for big outdoor jobs or repair shops. Can be used with container or attached to large stationary compressed. Two adjustable spray tips. Order now. Send \$7.50 with order, balance C.O.D. Guaranteed Satisfactory.

National Jobbing & Export Co. Dept. 46 192 N. Clark St., Chicago, Ill.

Copyrighted material

Delta 1932 Catalog Shows New Motor-Driven Woodworking Tools



Send for
This FREE
Catalog



EVERYTHING for the modern woodworker—professional, spare-time, or hobbyist—is illustrated and described in this big 1932 Delta Catalog. A complete line of improved motor-driven jointers, circular saws, jig saws, band saws, woodturning lathes, drill presses, moulding cutters, sanding units, borers, routers, and mortisers—all husky, accurate, efficient units—now available at astonishingly moderate 1932 price levels.

**Send for Your FREE Copy
—Ready Soon**

If you are interested in woodworking the *modern way*, the 1932 Delta catalog (soon off the press) is yours for the asking. But make certain your name is on the mailing list. Fill out the coupon below and mail it **TODAY!**

**DELTA Tools Save Time,
Money and Labor**

They take all the drudgery out of woodworking. They enable you to turn out *better work in less time*. They bring the finest professional cabinet work within the reach of all. Their compactness and practicability, their convenience and low prices, make these motor-driven tools ideal for both production work and home craftsmanship.

**10-DAY TRIAL EASY
TERMS**

Send coupon for FREE 1932 Delta Catalog. Shows complete Delta line of motor-driven tools. Many new items. New features. Also details of 10-Day Trial Offer and Easy Payment Plans. Mail the Coupon **TODAY!**

Delta Specialty Company
(Division of Delta Mfg. Co.) Dep. A1031
3775 N. Holton St. Milwaukee, Wis.

DELTA SPECIALTY COMPANY

(Division of Delta Mfg. Co.)
3775 N. Holton Street, Dept. A1031
Milwaukee, Wisconsin

Please place me, without obligation, on mailing list to receive 1932 Delta Catalog, which will be off the press soon. Also send full details of your 10-Day Trial Offer and Easy Payment Plans.

Name _____

Address _____

City _____ State _____

**DELTA
"Quality"
pays in the end**

That is what thousands of woodworkers say the country over. And the reason is, into each DELTA Tool is built *enduring quality and genuine efficiency*. Investigate for yourself **NOW!**

The man who studies gets ahead. Popular Mechanics Press will advise you what books to read to advance in your trade. 200 East Ontario Street, Chicago, Illinois.

Polox Fluid Solder

Requires no heat. Super-Strong for repairing Metal, Wood, Leather, Glass, etc. Write for FREE Circular.
POLOX MFG. CO., MERRIAM, KANS.

AGENTS MAKE UP TO \$15 A DAY

**No. 8 FOUNTAIN PEN GUARANTEED FOR LIFE
HAS ADJUSTABLE INK FEED AND RUBBER SPONGE**

which makes it write better than any other on the market. A trial order will convince you. Money Back If Not Pleased. Retail for \$1.25, can be sold for 75c and still make over 100% profit.

Sample
Only **39¢**



FREE
WHOLESALE CATALOG, showing
over 1000 fast sellers. Send for your copy now.
SPORTS IMPT. CO., 831 Main Street, LE CENTER, MINN.

When writing to advertisers please mention Popular Mechanics

Yours WITHOUT Cash

Rings of
Romance
\$9485
Bridal
Pair
the Set

Miss
America \$3750

BULOVA WATCHES

Now you can wear a nationally advertised diamond "Ring O' Romance"—a beautiful 18 kt. white gold modern ring set with a genuine diamond of generous size, and a nationally advertised Bulova watch—your faithful timekeeper for years to come.

SEND NO CASH!—Just mail coupon! Nationally Advertised Cash Price on liberal Credit—and you can wear your jewelry without delay! The name "Ring O' Romance" inside the ring and "Bulova" on the Dial are your guarantee.

Diamond Rings Priced as Low as \$15.00

Write for our New Diamond Catalogue showing marvelous new designs in both ladies' and men's diamond rings. Never have we been able to offer such beautiful diamond rings at such low prices. The catalogue is sent FREE!

Railroad Watches

Let us send you our beautiful watch catalogue showing the Famous Santa Fe Mogul Railroad watch, and the 21-jewel Santa Fe Special in both 16 and 12 sizes. Also the new 60 hour Bunn Special. Catalogue sent FREE.

Ask for our Special Spot Cash Offer. Good for 30 days only.

SANTA FE WATCH COMPANY
Dept. A-63, Thomas Building, TOPEKA, KANSAS

To SANTA FE WATCH CO.,
Dept. A-63 Thomas Bldg., Topeka, Kans.

Please send me catalog I have checked.
Railroad and dress Pocket Watches.....
Ladies' and Men's Wrist Watches.....
Ladies' and Men's Diamond Rings.....

Name.....

Address.....

When writing please mention Popular Mechanics

HOT WATER Instantly from any COLD WATER faucet

Simply attach a Hot Shot Electric Water Heater as shown in picture, plug cord in electrical appliance outlet, turn switch and get an unlimited supply of pure hot water instantly, at any desired temperature. A "Hot Shot" fits all faucets, can be moved from one faucet to another in a jiffy. A REAL necessity for homes, shops, garages, or anywhere hot water is desired. Sold at a price anyone can afford to pay.



Has Automatic Shut off—comes complete with Adapter for all faucets and water-proof, insulated cord. Fully Guaranteed. Write for low price.

Responsible
Agents
Write for Sales
Plan, Terms and
Territory

The Sensation of 1930

Write for full information, descriptive literature, and low introductory price. Not an experiment—but a Proven Success over a period of 15 months—in thousands of places, everywhere, all over the U. S. Address:

HOT SHOT, Incorporated.

Dept. 1005, 658 Richmond St. Grand Rapids, Mich.

\$50.00 SHIP MODEL for \$4.50 COACH MODEL for \$4.98



We furnish all parts out to fit, numbered and ready to assemble for the following models: Copper Ship and Flying Cloud (with electric lights), Santa Elena, Mayflower, La Bonta, \$4.50—Constellation, \$3.98—SUNSHINE GALLEON fully equipped for electrical illumination. \$3.98—COACH MODELS: Geo. Washington, Princeton to Philadelphia, TALLY-HO, Deadwood, Overland Western. Our new Illustrated Catalog FREE. All models sent C. O. D. Foreign orders accompanied by check or money order. Illustrated Catalog free upon request. C. J. BIERBOWER, Dept. PM3216 Spring St., Phila. Originator of Build Your Own Ship Model.

STEINER COMBINATION WOODWORKER \$45.00

Belt Sander, Saw, Grinder, Drill
Has 1/2 H. P. Motor, switch, cord and plug. 3x24 in. sander, 6 in. adjustable saw, 5x 1/2 in. grinder for any tool or drill. Takes up to 1/2 in. drills. Operates many other tools. Bronze bearings, endless belt, polished table. Size 20x20. Weight 60 lbs. Highest grade—lowest price. Satisfaction guaranteed. Order now or write for circular P.

STEINER-FULTON PROD. CORP.
5751 Easton Avenue St. Louis, Mo.

\$20 A DAY!



Revolutionary new invention. Increases strength of headlight 15%. No glare. Protection for and rain. Sells for \$1.20 a pair. Every motorist buys on sight. Guaranteed. Agents earn more than \$20.00 per day. Send for exclusive agents offer. Now—today. Only a few territories open.

SIKO SALES, INC.

69 Union St., Dept. A, Newton Centre, Mass.

SIKO NON-GLARE

861 PRACTICAL IDEAS for REDUCING FARM LABOR and INCREASING INCOME



One farmer writes: "I would not take \$100 for my copy if I could not secure another."

The Handbook for Farmers contains: 138 ideas for the farm shop, 35 on fencing, 98 on auto, truck and tractor, 61 on farm buildings, 36 on field machines, 48 on concrete work, 22 on orchard work, 23 on painting, 15 on live stock, 34 on poultry, 54 on garden work, 25 on electrical work, 22 on farm tools, 16 on hunting, fishing and trapping, 140 household helps. Pay postman 98 cents plus postage when delivered anywhere in U. S. Elsewhere remit with order and include 15 cents extra for postage.

POPULAR MECHANICS PRESS
Room 110, 200 E. Ontario St., CHICAGO

NEW BATTERY METER PREVENTS CAR TROUBLES



Amazing Invention Now Makes It Possible to Keep a Battery Perfectly Charged at All Times—No More Overcharging—No More Undercharging—No More Dry Batteries—Battery Life Is Doubled

Automobile owners will welcome this new instrument, called "Tel-a-Charge," that instantly tells the condition of your battery—right on the dash. It tells at a glance if the battery is overcharged, undercharged, or if water is needed. These three conditions cause practically all battery troubles. When your battery is low your car may stall anywhere at any time. It is dangerous as well as annoying to have to crank an automobile to get it started. Keep your battery in perfect condition and your car starts easier, runs smoother, has more power, and expensive troubles are eliminated.

FREE SAMPLE AND BIG MONEY MAKING OFFER TO AGENTS

We need men in every locality to aid us in the distribution of "Tel-a-Charge," and are making a proposition so unusual that workers can easily make up to \$100 a week. We are furnishing those who work for us with a free sample for demonstrating purposes. Send TODAY for this big opportunity and free sample offer.

CLUM MANUFACTURING CO.

Dept. 117 601 W. National Ave. Milwaukee, Wis.



ENJOY
**Outdoor
Sports**
The Year Round
With the Aid of This
Great Book

THE new, revised and enlarged edition of *Outdoor Sports the Year Round*, just published by Popular Mechanics Press, contains hundreds of ideas for new and popular sports and pastimes as well as the old favorites. Attractive to Young and Old Alike is the interesting variety for all seasons.

The intensive follower of a few sports will appreciate the wealth of suggestions that render the pursuit of any hobby more enjoyable. For example, for the hunter there are important details on the care and handling of guns; for the swimmer, complete instructions in fancy diving; for the camper, ideas that tend to make camping one hundred per cent comfortable and convenient; for the fisherman, many practical kinks, etc.

SPORT ENTHUSIASTS

will be amazed at the large number of devices that furnish thrills and excitement. Probably the most unique feature of the book is the fact that it contains complete instructions that enable any handy man or boy to make sport devices or equipment at very little cost.

352 Pages (large size, 7 x 10 in.) Price \$2.00
650 Illustrations, Cloth Binding

Mailed Postpaid upon receipt of price anywhere in the world. Will be sent C. O. D. anywhere in U. S. Simply pay postman price plus postage when he delivers the package.

POPULAR MECHANICS PRESS
(Room P-10) 200 East Ontario St. Chicago, Ill.

SAVE UP TO 50% on your RADIO

only
\$57.50
COMPLETELY
ASSEMBLED

Powerful
**NEW
11-TUBE
SUPER-
HETERODYNE**

AGAIN—America's famous Radio Manufacturers offer the Radio sensation of the year!

A powerful, new, 11-tube Super-Heterodyne at the amazingly low price of \$57.50, completely assembled in a beautiful new Lowboy cabinet. This is just one of the startling radio bargains from the great selection illustrated in the big FREE, 1932 Midwest catalog. Don't send a penny now. At our risk, entertain yourself for 30 full days absolutely FREE, then decide. You're not obligated to buy. Compare Midwest Radios with the costliest sets on the market. Convince yourself. We guarantee you 100% satisfaction. Midwest can make this daring offer only because of the excellent quality and proven performance of these new and longer distance radios. If you're looking for a powerful, 11-tube, Screen Grid, Super-Heterodyne, with real automatic volume control, pin-dot selectivity, and amazing new sensitivity—then mail the coupon below immediately for FREE trial offer, and beautiful new 1932 catalog.

Deal Direct with Factory Terms as low as \$5 down

The Midwest direct-to-customer policy makes the surprisingly low Midwest prices possible. Know what it means to have one of the latest and most powerful radios on the market—with all of the sensational new 1932 improvements in tone, clarity, selectivity—and at a price about half of what you would pay in retail stores.

**30
DAYS
FREE
TRIAL**

Absolute guarantee of satisfaction protects you and eliminates all risk. And don't forget—you try any set you select for 30 full days ABSOLUTELY FREE, without obligation—before you buy. You must be delighted. Mail coupon for beautiful new catalog and complete details of FREE TRIAL, easy payment plan. You'll be amazed!

MIDWEST RADIO CORP.
Dept. 11 CINCINNATI, OHIO

Mail this Coupon for Complete Details and Big FREE Catalog!

Midwest Radio Corp.,
Dept. 11,
Cincinnati, Ohio.

Without obligation on my part send me your new 1932 catalog, and complete details of your liberal 30-day free trial offer. This is NOT an order.

Name.....
Address.....
Town.....State.....

Send me SPECIAL USER AGENTS PROPOSITION.

USER AGENTS
We pay you BIG MONEY just for showing your radio to friends and neighbors. Easy EXTRA MONEY! Check coupon for details.

When writing to advertisers please mention Popular Mechanics

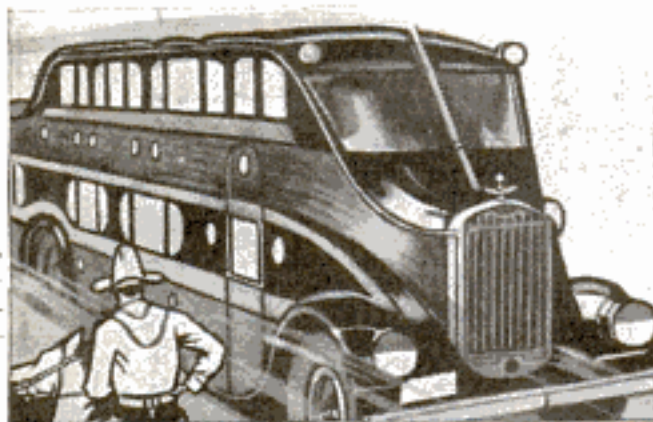

MOTOR-BUS TRANSPORTATION NEEDS trained MEN

MOTOR-BUS transportation is a modern achievement still in its infancy! To the ambitious young man, travel and adventure beckon.

The next few years will witness amazing progress. New fortunes will be made, thousands of men will hold permanent and well-paying jobs made possible by this expanding business. *And the greatest opportunities in this field will be realized by men who are familiar with the practical fundamentals of all departments of motor-bus transportation.*

Prepared by authorities, this course in motor-bus transportation is the direct result of a nation-wide demand for trained men. Owners and employees alike find in it the *essentials* of success. The subjects thoroughly covered include: the motor-bus and traffic, the bus operator, selection of bus equipment, gas-electric and other busses, problems of bus maintenance, motor-bus management problems, how to increase bus patronage, motor-bus financial problems, motor-bus law, handling bus personnel and others.

Are you interested in the opportunities of motor-bus transportation? Do you want a business of your own? Do you want to earn more money in a permanent and growing business? Then you are interested in this Motor-bus Transportation Course!

Mark and mail the coupon today.

INTERNATIONAL MOTOR-BUS SCHOOL Box 5566-G, Scranton, Penna.

Without cost or obligation, please send me a copy of your booklet, "Who Wins and Why," and full particulars about the subject before which I have marked X:

- MOTOR-BUS TRANSPORTATION
 Automobile Mechanic
 Electrical Ignition
 Machinist
 Gas Engines

Name.....Age.....

Street Address.....

City.....State.....

Occupation.....

If you reside in Canada, send this coupon to the International Correspondence Schools Canadian, Limited, Montreal, Canada

When writing please mention Popular Mechanics

ANOTHER RECORD for HEATH

New World's Altitude Mark for Light Planes

The National Aeronautic Association has just announced, subject to F. A. I. homologation, that Heath set a new light plane world's altitude record of 17,907 feet at Niles, Michigan, on July 18. This new record returns the light plane altitude title to the United States from France.



It is no new experience for Heath to win contests. For the past 23 years Heath has pioneered and led the light plane field. Heath experience has produced the new LN Model—fast, sturdy, and maneuverable—a ship splendid for the novice and amazing to experienced pilots. Buy it ready to fly for \$1074 at Niles, or build it easily at home with substantial savings. Send 15c for full information, prices, terms, etc.

HEATH AIRCRAFT CORPORATION

Dept. P-10, Niles, Michigan

Improved Up-To-Date 8" Bench Saw INVALUABLE TO HOME AND SHOP

This design embodies five exclusive features: (1) An Automatic Lifting Device, controlled by a conveniently located hand-wheel; (2) Table can be tilted to any angle up to 45°; (3) The saw blade is completely enclosed and guarded beneath the table; (4) An opening is provided at the bottom of the saw enclosure for attaching a bag to collect the sawdust; (5) A hardened and ground shaft is used for mounting the saw.

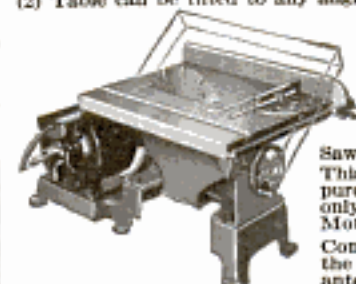

Saws lumber up to 2½ inches thick. This husky Bench Saw can now be purchased for only..... **\$16.95**
Motor and base extra.

Compare it with any saw double the price. Order at once. Guaranteed to satisfy or money refunded.

UP-TO-DATE MACHINE WORKS
2911 S. Wabash Ave. CHICAGO, ILL.

RADIO BUILDERS

We carry a complete line of radio parts for all Popular Mechanics circuits and replacement parts for all sets.

Send Us Your Order

NEWARK ELECTRIC CO.

228 W. Madison St.

CHICAGO, ILL.

BIG MONEY FOR YOUR EFFORTS

YOU COLLECT \$1.50 from every motorist who smokes. Keep this money and send the order in to us. We do the rest. Fast moving auto accessory. Write

WEBB JAY PRODUCTS, Incorporated
37 Clementina Street SAN FRANCISCO, CALIFORNIA

A New Lathe—A New Price



7" swing—25" centers. Biggest value you've ever seen. Send 10c for literature and new catalog DD10, the biggest line of small lathes, saws, etc., in America. **\$17.50**

SYIPHER-ARCON, 1524 Fernwood Ave., Toledo, Ohio

Hotter than Coal and no dirt

**A New
Invention**

Do away forever with the drudgery of wood and coal. The most simple and economical invention on the market is now giving perfect satisfaction to enthusiastic users everywhere. This new invention is a new type of oil burner that takes the place of wood or coal and automatically and silently changes cheap oil into one of the quickest and hottest fires known.

Burns 96% Air and 4% Cheap Oil

The International Oil Burner fits in the fire box of your present range, stove, or furnace. It can be installed in a few minutes by anyone. No holes to be bored, no damage to your heating plant. There is nothing complicated about the International Oil Burner. It gives you all the heat you want—when you want it. Starts instantly with a match. No soot, smoke, or odor. Costs less than coal.

Costs Only a Few Dollars

International Oil Burners heat just as well as burners costing \$400 or \$500. Simply turn 1 valve and you have all the heat you want. Cleaner and better for heating or cooking. Approved by the National Underwriters' Laboratories and engineers everywhere. Over 150,000 have been sold.

30 Days' FREE TRIAL Offer

Try this wonderful automatic oil burner right in your own home at our risk. Act quickly and get our special low introductory price. Sold under absolute money-back guarantee. Write at once for free booklet on home heating and our free burner offer.



Double Blue Flame Burner for cook stoves, ranges, and parlor circulators. Burns with beautiful clean blue flame.

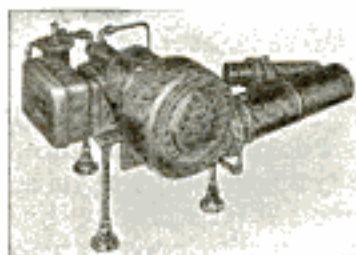

All-Electric Power Burner designed for larger houses, apartments, etc.

AGENTS—DEALERS— DISTRIBUTORS

Our free burner offer starts you in business. Big money to be made. Demand is enormous. We also want spare or full time workers immediately. If \$500 a month and more interests you, write or wire us for protected territory offer.

INTERNATIONAL OIL HEATING CO.

3800-10 Park Ave., Dept. 403-0, St. Louis, Mo.

CLIP THIS COUPON

International Oil Heating Co.,
3800-10 Park Ave., St. Louis, Mo.
Dept. 403-0

Send your free booklet and free details on home heating for stove furnace
Also free burner offer.

Date

Name

Address

City and State

Check if interested in making money as an International representative with protected territory.

450 MILES in a gallon of gas

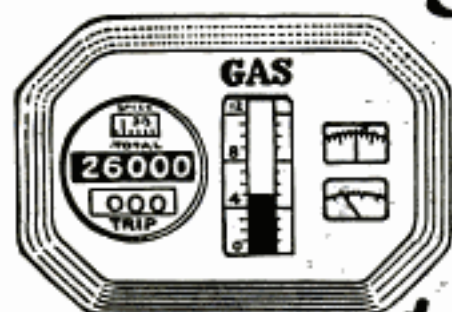

*startling
statement
of famous
Automotive Engineers*

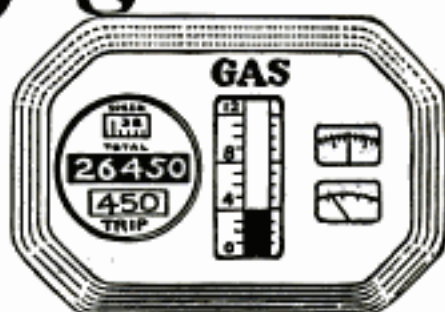

How to increase gasoline mileage has been a problem that Automotive Engineers have been trying for years to solve. Recently a world famous engineer made the statement that the energy produced by burning a gallon of gasoline would run an auto a distance of 450 miles. Other well known authorities go on record as saying that eventually it may be possible to get over four times as much out of gasoline as in the past.

Amazing Whirlwind Device Saving Millions of Gallons of Gas for Auto Owners

The Whirlwind Carbureting device embodies scientific features which conserves part of the gasoline that formerly went to waste.

Letters coming into the office tell of record mileages resulting in amazing gas savings. Low gasoline mileage is reported on practically every make of car. Greater power and smoother running motors are also noticed by users. The cost of the Whirlwind is so little that, basing its gas saving features even on the most modest reports, it would pay for itself almost immediately and then save many, many dollars for its owner by reducing gasoline consumption.

Car owners all over the world are saving money every day with the Whirlwind, besides having better operating motors. Think what this means on your own car. Figure up your savings—enough for a radio—a bank account—added pleasures. Why let the Oil Companies profit by your waste? Find out about this amazing little device that will pay for itself every few weeks in gas saving alone.

FITS ALL CARS

In just a few minutes the Whirlwind can be installed on any make of car, truck or tractor. It's actually less work than changing your oil or putting water in the battery. No drilling, tapping or changes of any kind necessary. It is guaranteed to work perfectly on any make of car, truck or tractor, large or small, new model or old model. The more you drive the more you will save.

SALESMEN and DISTRIBUTORS WANTED To Make Up To \$100.00 a Week and More

Whirlwind men are making big profits supplying this fast-selling device that car owners cannot afford to be without. Good territory is still open. Free sample offer to workers. Full particulars sent on request. Just check the coupon.

WHIRLWIND MANUFACTURING CO.
Dept. 716-A, Station C. Milwaukee, Wis.

GUARANTEE

No matter what kind of a car you have—no matter how big a gas eater it is—the Whirlwind will save you money. We absolutely guarantee that the Whirlwind will more than save its cost in gasoline alone within thirty days, or the trial will cost you nothing. We invite you to test it at our risk and expense. You are to be the sole judge.

FREE OFFER COUPON

WHIRLWIND MANUFACTURING CO.,
Dept. 716-A, Station C, Milwaukee, Wis.

Gentlemen: You may send me full particulars of your Whirlwind Carbureting device and tell me how I can get one free. This does not obligate me in any way whatever.

Name.....

Address.....

City.....State.....

() Check here if you are interested in full or part time salesman position.

Start to Play Very First Day

Give Yourself
Lifelong Fun
Profit and
Popularity



PARENTS!

What greater gift can you confer on your children this year than lifelong fun and entertainment?

Love of music means love of home, an appreciation of the finer things in life. Here is a chance to give your boy or girl that love without the tedious practice that most instruments require. The Xylorimba is easy to play. No teacher is needed. Practice is actually a joy.

Remember, the Xylorimba is the guaranteed product of a company established nearly half a century ago—a company that stands back of every promise it makes.

THINK of the best gift you have ever received. Multiply the pleasure it gave you by ten, and still you have only an idea of the joy you can give yourself right now if you act at once!

Start to Play the Very First Day!

Haven't you, like millions of others, envied the fellows who "bring down the house" with snappy xylophone or xylorimba numbers? Haven't you longed to create your own music, to be looked up to wherever you go, to be able to make real money in spare time? If you have, this ad spells O-p-p-o-r-t-u-n-i-t-y. The xylorimba—wonderful for home, in demand at dances and gatherings—is nevertheless the easiest of all instruments to play. In fact, on the very day you get yours you play simple melodies, even if you can't read a note of music right now. In a few weeks you astonish your friends and family. All your life you have the joy that comes to those who can entertain.

Plays 20 Minutes; Gets \$20!

Ralph Smith, Chicago, played twenty minutes at wedding; his "pay" was \$20. Harry Brewer, New York, has

made thousands of friends thru his xylophone selections on the radio. L. E. Hallman, Reading, Pa., writes: "Made \$300 in 5 weeks—spare time."

And now J. C. Deagan, Inc., (world's largest manufacturer of xylophonic instruments) has made it so easy to own a xylorimba that nothing stands in your way. Sizes and styles to fit every age and pocketbook. A five-day free trial that eliminates risk. Free, easy lessons that make teacher unnecessary—and, best of all, such easy payments that they are hardly noticed.

Will You Investigate?

Everyone wants to be popular. Everyone wants to make extra money. Everyone wants to be center of attraction at gatherings. But these advantages don't come by themselves. Opportunities must be seized. This is your opportunity—will you pass it up without investigation? The accompanying coupon will bring our big FREE book to your door. It tells all about the Deagan line, the free trial, the easy payments. Remember, no cost or obligation! Simply fill in and mail the coupon—but do it before it slips your mind. Today is as good a day as any. Do it NOW!

J. C. DEAGAN, Inc.
Bldg. 467, 1719 S. New Ave., Kansas City, Mo.

Please send me full details on the Free Trial offer and easy payment plan of the Deagan Xylorimba.

Name _____ Address _____
City _____ State _____

Send for
BIG FREE
Book!

YOUR
MAGIC
KEY

to Popularity

Mail
Now!



Have you tried Camels?

THE steady increase in the sales of Camel cigarettes proves one fact beyond a doubt.

If you try Camels, the odds are very much against your ever going back to your old brand.

So great is the contrast between the delights of perfectly conditioned Camels fresh from the protection of the new Humidor Pack and the harsh, hot smoke from stale dried-out cigarettes, that your decision will be immediate.

The quality is there in the first place, for Camels are a blend of choice Turkish and mild Domestic tobaccos.

In factory-prime condition, with their rare flavor and their natural moisture still intact, they are a joy to the smoker.

Now this flavor is air-sealed-in by an outer wrapping of moisture-proof Cellophane, so that no matter where you buy Camels, in any land, in any climate, you are always certain to get fresh cigarettes in factory-prime condition.

And there are other advantages as well. For the Humidor Pack also protects the cigarettes within from dust and germs and weather conditions.

Start the day on Camels. See how much milder they are, how much more flavorful they are, how cool they are to the throat.

No peppery dust to irritate delicate membrane. No harsh, hot smoke from dried-out tobacco to burn the tongue or sear the throat.

Switch to Camels for a day, then leave them—if you can.

Tune in CAMEL QUARTER HOUR featuring Morton Downey and Tony Wons
Columbia Broadcasting System — every night except Sunday

CAMELS

Mild . . . NO CIGARETTY AFTER-TASTE

• *It is the mark of a considerate hostess, by means of the Humidor Pack, to "Serve a fresh cigarette." Buy Camels by the carton — this cigarette will remain fresh in your home and office*

© 1931, R. J. Reynolds Tobacco Company, Winston-Salem, N. C.

Copyrighted material